

Water

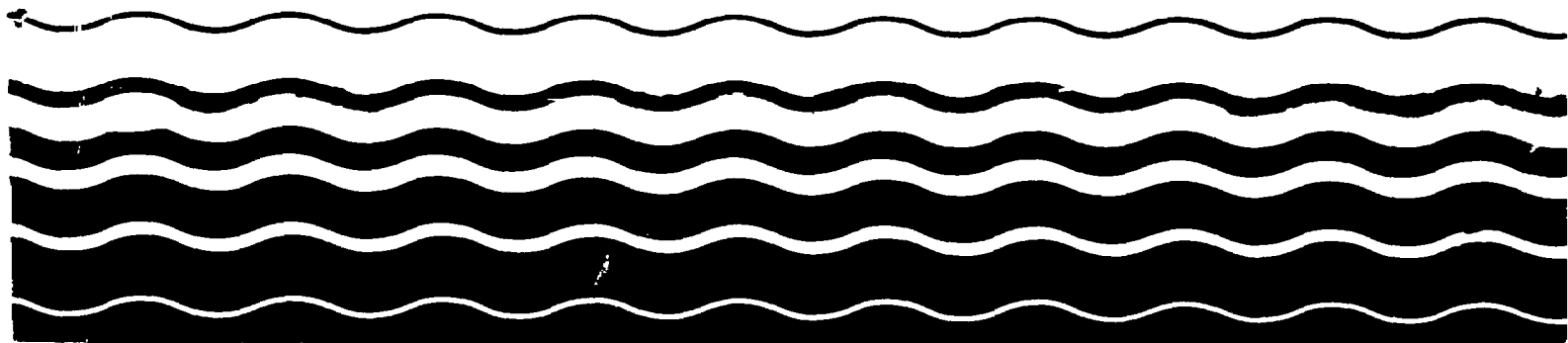

Guidance Manual for Preventing Interference at POTWs





UNITED STATES ENVIRONMENTAL PROTECTION AGENCY
WASHINGTON, D.C. 20460

OFFICE OF
WATER

MEMORANDUM

SUBJECT: Pretreatment Program Guidance

FROM: James R. Elder, Director
Office of Water Enforcement
and Permits (EN-335)

TO: Users of the Guidance Manual for
Preventing Interference at POTWs

This guidance manual was developed by EPA to aid publicly owned treatment works (POTWs) in identifying, tracking, and mitigating interference episodes caused by discharges of nondomestic wastes. Interference is defined in the General Pretreatment Regulations (40 CFR Part 403) in terms of a discharge which, alone or in combination with other discharges, inhibits or disrupts the POTW and causes it to violate its NPDES permit or applicable sludge use or disposal regulations. The legal responsibilities of POTWs and their industrial users for avoiding interference are specified in the General Pretreatment Regulations. The basic regulatory requirements are explained in this manual and technical guidance is provided to help POTW operators detect and determine the sources of interference.

This document will be useful to all POTWs that may experience interference problems, not just those that have been required to establish federally-approved pretreatment programs. Therefore, EPA is distributing it widely. Additional copies of this guidance manual or further information about the national pretreatment program can be obtained by writing to the Permits Division, (EN-336), US EPA, 401 M St., S.W., Washington, D.C. 20460.

EPA is preparing another guidance document that deals specifically with the development of local limits to prevent interference and pass through. It was distributed in draft form for comment to States and EPA Regions in May 1987 and will be mailed to all POTWs with federally-approved pretreatment programs when final. Additional information about the local limits guidance document can also be obtained from the Permits Division.

**GUIDANCE MANUAL
FOR
PREVENTING INTERFERENCE AT POTWs**

September, 1987

**U.S. Environmental Protection Agency
Office of Water
Office of Water Enforcement and Permits
401 M Street, S.W.
Washington, D.C. 20460**

ACKNOWLEDGEMENTS

This document was prepared by James M. Montgomery, Consulting Engineers, Inc. under EPA Contract No. 68-03-1821. Mr. John Grantham was the Project Manager, with Dr. Edward Wetzel and Mr. Scott Murphy acting as Project Engineer and Assistant Project Engineer, respectively. Messrs. Wetzel and Murphy are the principal authors of this manual. Treatment plant site visits conducted as part of the case study effort were made by Messrs. David Harrison, Paul Skager and Roger Stephenson and Ms. Sheila McShane, in addition to the authors. The contributions of a number of other members of the Pasadena office support staff to the production of this manual are gratefully acknowledged.

This manual was prepared under the technical direction of Ms. LeAnne Hammer and Mr. Gregory McBrien of the Permits Division, Office of Water Enforcement and Permits, and Dr. Sidney Hannah of the Water Engineering Research Laboratory (WERL). Additional guidance and assistance were provided by the other members of the Pretreatment Support Group of WERL, consisting of Messrs. James Kreissl, Dolloff Bishop, Richard Dobbs, Kenneth Dostal and Henry Tabak. Peer review and comments were also provided by Science Applications International Corporation (SAIC) under EPA Contract No. 68-01-7043. Special thanks are also offered to Mr. Guy Aydlett of the Hampton Roads Sanitation District and to Mr. Paul (Kip) Keenan of the City of Baltimore Pollution Control Section.

TABLE OF CONTENTS

	<u>Page</u>
Acknowledgements	i
Table of Contents	ii
List of Tables	iv
List of Figures	v
1. Introduction	1
1.1 Background	1
1.2 Definition of Interference	2
1.3 Guidance Manual Objectives	4
2. Detecting Interference	6
2.1 Types of Interference	6
2.1.1 Chronic Inhibition	8
2.1.2 Upset Conditions	8
2.2 Interference - Causing Substances	9
2.2.1 Conventional Pollutants	11
2.2.2 Metals and Other Inorganics	11
2.2.3 Organic Compounds	12
2.3 Sewer Collection System	12
2.4 Plant Operations	14
2.4.1 Observation	14
2.4.2 Instrumentation	15
2.4.3 Analytical Results	15
2.5 Wastewater Monitoring	16
2.5.1 POTW Influent	16
2.5.2 Other POTW Locations	17
2.5.3 Inhibitory Effects Testing	18
3. Source Identification	29
3.1 Chronic Discharges	30
3.1.1 Routine Monitoring	31
3.1.2 Tracking Program	32
3.2 Isolated Spills and Unauthorized Discharges	33
3.2.1 Hauled Wastes	35
3.3 Rapid Screening Techniques	36
3.4 Summary	37

	<u>Page</u>
4. Mitigation	43
4.1 Treatment Plant Control	43
4.1.1 Biological Process Control	43
4.1.2 Biological Augmentation	45
4.1.3 Chemical Addition	45
4.1.4 Operations Modification	46
4.1.5 Physical Modification	47
4.1.6 Summary	48
4.2 Pretreatment and Source Control	49
4.2.1 Local Limits	49
4.2.2 Accidental Spill Prevention	49
4.2.3 Pretreatment Facilities	50
4.2.4 Regulation of Waste Haulers	50
4.2.5 Planning for Future Sources	51
4.3 Legal and Enforcement Remedies	52
4.3.1 Penalties	53
4.3.2 Orders and Compliance Schedules	54
4.3.3 Litigation	54
4.3.4 Sewer Disconnection or Permit Revocation	54
References	61
Appendix A - Case Studies	
Back River (Baltimore, MD)	A-3
Patapsco (Baltimore, MD)	A-6
Bayshore Regional (Union Beach, NJ)	A-9
East Side Plant (Oswego, NY)	A-12
Hamilton Township (Trenton, NJ)	A-15
Horse Creek (North Augusta, SC)	A-18
Maiden Creek (Blandon, PA)	A-21
Metro-West Point (Seattle, WA)	A-24
Neuse River Plant (Raleigh, NC)	A-27
Newark, OH	A-30
North Shore (Gurnee, IL)	A-33
Passaic Valley (Newark, NJ)	A-36
Sioux City, IA	A-39
Tolleson, AZ	A-42
Appendix B - Interfering Substances	B-1

LIST OF TABLES

<u>No.</u>	<u>Title</u>	<u>Page</u>
2-1	Metal, Cyanide and Inorganic Compound Concentrations Inhibiting Biological Processes	20
2-2	Organic Compound Concentrations Inhibiting Biological Processes	21
2-3	Waste Characteristics Pertaining to Hazards in Collection Systems	22
2-4	Interference Identification Through Plant Observation	23
2-5	Instrumentation of Plant Processes and Wastestreams	26
2-6	Analytical Monitoring of Plant Processes	27
2-7	Methods for Evaluating Inhibitory Effects of Industrial Wastewaters	28
3-1	Industrial Spills of Hazardous Materials: Impact on Sewer Collection System	38
3-2	Industrial Spills of Hazardous Materials: Impact on Treatment Plant	39
3-3	Impacts of Waste Hauler Discharges on POTWs	40
4-1	Biological Process Control Steps	56
4-2	Chemical Additions	57
4-3	Treatment Plant Control Measures	58
A-1	Case Study Summary Table	A-1, 2
A-2	Average Metal Content of Back River Sludge	A-4

LIST OF FIGURES

<u>No.</u>	<u>Title</u>	<u>Page</u>
3-1	Treatment Plant Upset Identification Procedures	41
3-2	HRSD Source Tracking Procedure	42
4-1	Fundamental Procedures for POTW ASPP Development	59
4-2	Procedures of a Waste Hauler Permit Program	60
A-1	Monthly Acute Toxicity (Patapsco/Baltimore, MD)	A-7
A-2	Impact of Industrial Waste Discharge on POTW Loadings (Bayshore/Union Beach, NJ)	A-10
A-3	Horse Creek Pollution Control Facility Influent pH	A-19
A-4	Wastewater Discharge at Influent Metering Station (Maiden Creek/Blandon, PA)	A-21
A-5	West Point Chromium Concentrations (Seattle, WA)	A-25

NOTE TO USERS OF THE GUIDANCE MANUAL

The case studies contained in Appendix A, and referred to throughout the text were conducted over a period from December, 1985 to March, 1986. The information contained in each discussion was current at that time, but since then the status of some of the activities at the case study sites is likely to have changed.

1. INTRODUCTION

1.1 BACKGROUND

Sections 307(b)(1) and (c) of the Clean Water Act (CWA) direct the U.S. Environmental Protection Agency (EPA) to establish pretreatment standards "to prevent the discharge of any pollutant through treatment works... which are publicly owned, which pollutant interferes with, passes through, or is otherwise incompatible with such works." These sections address the problems created by discharges of pollutants from nondomestic sources to municipal sewage treatment works. Specifically addressed are discharges of pollutants which either interfere with the operation or performance of the works or pass through the works to navigable waters untreated or inadequately treated. Pretreatment standards are intended to prevent these problems from occurring by requiring nondomestic users of publicly owned treatment works (POTWs) to pretreat their wastes before discharging them to the POTW. In 1977, Congress amended Section 402(b)(8) of the CWA to require POTWs to help regulate their industrial users (IUs) by establishing local programs to ensure that industrial users comply with pretreatment standards.

In establishing the national pretreatment program to achieve these goals, the EPA adopted a broad-based regulatory approach that implements the statutory prohibitions against pass-through and interference at two basic levels. The first is through the promulgation of national categorical standards which apply to certain industrial users within selected categories of industries that commonly discharge toxic pollutants. Categorical standards establish numerical, technology-based discharge limits derived primarily to control the discharge of toxic pollutants which could interfere with or pass through POTWs. The EPA has promulgated categorical standards for many major and minor industry categories (See 40 CFR Parts 400-469). The EPA will be evaluating these industries and other industries for the control of additional toxic pollutants.

Implementation of the categorical standards will not remedy all the interference and pass-through problems that may arise at a POTW. The potential for many pass-through or interference problems depends not only on the nature of the discharge but also on local conditions (e.g., the type of treatment process used by the POTW, local water quality, the POTW's chosen method for handling sludge), and thus needs to be addressed on a case-by-case basis. Such problems can result from discharges by categorical industries of pollutants not covered by a categorical standard or from nondomestic sources not regulated by the categorical standards. In addition, since categorical standards are established industry-wide, they cannot consider site-specific conditions, and therefore, may not be adequate to prevent all pass-through and interference even for the regulated pollutants. The second level of EPA's regulatory approach, contained

in the General Pretreatment Regulations (40 CFR Part 403), addresses these areas of concern. First, Section 403.5(b) establishes specific prohibitions which apply to all nondomestic users and are designed to guard against common types of pollutant discharges that may result in interference and pass-through (e.g., no discharge of flammable, explosive, or corrosive pollutants). Second, Section 403.5(a) establishes a general prohibition against pass-through and interference which serves as a back-up standard to address localized problems that occur. In addition, POTWs with total design flow greater than 5 mgd and which receive pollutants which pass through or interfere with POTW operation or are otherwise subject to pretreatment standards must establish formal pretreatment programs which must be approved by the EPA or a designated State agency. POTWs with design flow less than 5 mgd may also be required to develop pretreatment programs if circumstances warrant in order to prevent pass-through or interference. As part of their programs, POTWs must develop and enforce specific local limits to prevent pass-through and interference. POTWs not required to develop pretreatment programs may still be required to develop local limits if they experience pass-through or interference that is likely to recur (Section 403.5(c)).

The need for guidance on preventing interference was identified by the Pretreatment Implementation Review Task Force (PIRT). PIRT was established on February 3, 1984 by the EPA Administrator. The task force was composed of 17 representatives from POTWs, States, industry, environmental groups and EPA Regions. The charge given to PIRT was to make recommendations to EPA concerning the problems faced by POTWs, States, and industry in implementing the national pretreatment program. In its Final Report to the Administrator (U.S. EPA, 1985b), one of the specific problems identified by PIRT was the difficulty experienced by POTWs in the recognition, tracking, and mitigation of interferences caused by industrial discharges. PIRT's recommendation was for EPA to provide guidance to municipalities regarding such interference problems. This report is EPA's response to that recommendation.

1.2 DEFINITION OF INTERFERENCE

The U.S. EPA recently promulgated revised definitions for the terms "pass through" and "interference" (52 Federal Register 1586, January 14, 1987). As defined in 40 CFR, Part 403.3(i):

- (i) The term "Interference" means a discharge which, alone or in conjunction with a discharge or discharges from other sources, both:
 - (1) Inhibits or disrupts the POTW, its treatment processes or operations, or its sludge processes, use or disposal; and
 - (2) Therefore is a cause of a violation of any requirement of the POTW's NPDES permit (including an increase in the magnitude or duration of a violation) or of the prevention of sewage sludge use or disposal in compliance with the following statutory provisions and regulations or permits issued thereunder (or more stringent State or local regulations): Section 405 of the Clean Water Act, the Solid Waste Disposal Act (SWDA) (including

Title II, more commonly referred to as the Resource Conservation and Recovery Act (RCRA), and including State regulations contained in any state sludge management plan prepared pursuant to Subtitle D of the SWDA), the Clean Air Act, the Toxic Substances Control Act, and the Marine Protection, Research and Sanctuaries Act.

In the same rulemaking that established the new definitions (52 Federal Register 1586, January 14, 1987), EPA amended the General Pretreatment Regulations to establish affirmative defenses to liability on the part of an industrial user for violating the general prohibitions or certain of the specific prohibitions. These defenses address situations where an industrial user did not know or have reason to know that its discharge would cause interference. The reader is referred to the Federal Register citation above for additional information and perspective, as provided in the preamble to the regulation.

The interference prohibition addresses situations where an industrial user's discharge, either alone or in conjunction with other discharges, disrupts the POTW or its sludge practices, and the disruption is a cause of a permit violation or prevents the POTW from lawfully using its chosen sludge use or disposal method. In contrast, the pass-through prohibition addresses situations where an IU's discharge exits the POTW to waters of the United States in quantities or concentrations which, alone or in conjunction with other discharges, cause a permit violation. Pass-through is not necessarily related to an inhibition or disruption of the POTW processes, but instead is related to a pollutant discharge which is not susceptible to adequate treatment by the POTW.

An industrial user whose discharge is found to cause pass-through or interference is legally liable for violating the general prohibitions, and may be subject to enforcement action. However, as discussed in the Federal Register preamble to the new definitions of pass-through and interference, an industrial user's discharge is considered to be interference or pass-through only if the discharge is a cause of the POTW's noncompliance. If a malfunction or improper operation by the POTW, rather than an industrial user's discharge, causes the POTW's noncompliance with its NPDES permit or sludge requirements, interference and/or pass-through are not occurring. The EPA intends the definitions to be interpreted and implemented in a manner consistent with the Congressional intent that pretreatment technology not be required as a substitute for adequate operation and maintenance of the POTW. Thus, if the POTW's improper operation alone prevents it from meeting the effluent limitation in its NPDES permit, the POTW must correct its operational problem.

The interference definition does not directly address situations in which a discharge causes problems other than NPDES permit violations or impairment of sludge use or disposal. For example, POTW worker health and safety problems or unacceptable air emissions could result from IU discharges. The EPA is currently considering whether and how to address these problems more specifically through guidance and future regulations, if appropriate, and by encouraging POTWs to address these concerns in their local ordinances. This

manual addresses such concerns to only a limited degree, focusing mainly on interference as defined in the above-mentioned regulation.

1.3 GUIDANCE MANUAL OBJECTIVES

The purpose of this manual is to provide POTW operators with guidance on dealing with interferences caused by pollutants from nondomestic sources. In addition, some guidance is provided on distinguishing interferences caused by nondomestic discharges from problems resulting from poor operation and maintenance of the POTW. This manual is divided into three major sections, which correspond to the order in which a POTW should address interference. These sections are:

- Detecting Interference
- Source Identification
- Mitigation

The section on detecting interference is intended to help identify the types of interferences and substances which are known to cause problems. The way in which interference occurs in both the sewer collection system and the treatment plant is also discussed, along with analytical tests and monitoring that can be conducted by POTW operators.

The second major section deals with the identification of the industrial sources of the interference-causing substances. Sources can be separated into chronic dischargers of industrial pollutants, isolated spill events, and hauled wastes. Identification techniques range from simple sensory observations to the use of sophisticated monitoring equipment for tracing problems at the POTW back to a source.

The final section on mitigation discusses ways in which municipalities can cope with interference problems. In-plant control, source control and legal and enforcement remedies are addressed in the section. Operators should be cautioned that there are few straightforward solutions to these problems, and that often a combination of techniques will need to be employed to properly mitigate an interference. The section concludes with a discussion on planning, so that future industrial discharges will not interfere with successful POTW operations.

There are two appendices included in the back of this manual. Appendix A contains case studies of 14 POTWs, visited as part of this project, that have previously experienced interferences but have mitigated the problems over the past few years. These cases are referred to throughout the manual wherever a certain case study illustrates a particular problem or solution that is discussed. While the case studies represent some of the types of interference problems experienced by POTWs, they should not necessarily be viewed as examples of pretreatment programs which are ideally implemented or fully endorsed by the EPA. It is hoped that the case studies will be useful to people who are experiencing problems similar to those described. A summary of the case studies including the names and phone numbers of individuals who can be contacted for further information is provided on Table A-1. Appendix B is a list compiled from

the published literature and actual treatment plant studies that includes many of the inorganic and organic substances now recognized as having the potential to cause interference.

2. DETECTING INTERFERENCE

2.1 TYPES OF INTERFERENCE

Interference can be broken down into two basic types: (1) interference with the POTW's ability to meet its NPDES permit; and (2) interference with its ability to utilize its chosen sludge disposal method. With either type, several sources may contribute to the interference. For example, contamination of sludge with unacceptable levels of metals may be due to the cumulative contributions from several industries. Domestic sewage background concentrations can also be a significant source of some metals. Unless the interference is caused solely by domestic sources or inadequate operation and maintenance of the POTW, each nondomestic source of the interfering pollutant should be identified and its role in causing the interference assessed. The individual sources must then be controlled as necessary to allow the POTW to meet its NPDES permit and utilize its chosen sludge disposal method.

Industrial users discharges can cause the first type of interference, involving a permit violation, by several means. These include, but are not limited to:

- physically disrupting the flow of wastewater through the POTW's system
- chemically, physically, or thermally inhibiting the treatment processes
- hydraulically overloading the plant so that proper settlement does not occur or wastes are retained for too short a time to receive adequate treatment before discharge.

The pollutants discharged by the industrial user that cause the POTW to violate its permit may be the same as, or different from, the pollutants discharged in violation of the permit. For example, an industrial user discharging excessive BOD that causes a disruption of the biological treatment process and results in the POTW exceeding its BOD discharge permit limit may be causing an interference. Likewise, the same industrial user discharging a toxic pollutant that inhibits the POTW's performance and results in effluent BOD permit violations is also causing an interference. It should be noted that in the example of an excessive BOD discharge causing a BOD permit violation, the problem could be pass-through rather than interference. For example, a heavy discharge of relatively non-degradable organic matter might pass through the plant without causing an upset. The distinction between pass-through and interference must be made depending of the individual circumstances of such cases.

The second type of interference, impairment of sludge use or disposal, results when the POTW's sludge no longer meets applicable requirements for its chosen use or disposal alternative. Thus, if the POTW has elected to apply the sludge to land but industrial discharges prevent the lawful implementation of this method, interference occurs. Detection of this type of interference is generally performed by sludge monitoring coupled with monitoring of industrial users.

As mentioned in Chapter 1, any type of interference is a violation of the general prohibition (40 CFR Part 403.5(a)). Some interferences are also violations of the specific prohibitions (40 CFR Part 403.5(b)). The specific prohibitions bar discharges which:

1. create a fire or explosion hazard;
2. are corrosive to POTW structures;
3. obstruct wastewater flow resulting in interference;
4. release pollutants (including BOD) at rates or concentrations which will cause interference; or
5. increase the influent wastewater temperature above 40°C, or inhibit biological activity due to heat, resulting in interference.

The problems referred to by the specific prohibitions do not always result in interference (ie., permit violations), yet they are detrimental to POTW operations. In fact, many local sewer use ordinances contain additional or more stringent local prohibitions, such as a prohibition against discharges which release toxic vapors endangering POTW worker health and safety. The EPA strongly supports and encourages such local prohibitions.

Another way of looking at types of interference is to classify them by the location of impact: either the collection system or the treatment plant. Collection system problems (corrosion of sewer mains, explosions in sewers, etc.) are generally easier to relate to industrial or commercial discharges, while interference at the treatment plant requires detailed analysis to ensure that it is not the result of poor operation and maintenance practices or from domestic sources. Since it is often the most difficult to detect and trace to industrial sources, this chapter emphasizes treatment process interference. The chapter looks at both chronic inhibition and upset conditions. The ability of a particular waste discharge to cause inhibition or upset is considered in terms of three factors:

- industrial discharge practices
- acclimation of POTW treatment processes to the specific pollutants
- impacts on the POTW

The next two subsections will discuss chronic inhibition and upset conditions in more detail. Collection system problems are discussed in Section 2.3.

2.1.1 Chronic Inhibition

Chronic inhibition refers to a more or less consistent pattern of impairment of the functioning of the biomass in a biological treatment process caused by influent pollutant concentrations that are above tolerable levels. Inhibition is usually defined by a decrease in oxygen uptake rate or a decrease in COD/BOD removal. If the inhibition leads to a permit violation, it then is classified as interference. This type of interference results from either a continuous or semi-continuous discharge of an industrial pollutant to the POTW. Chronic inhibition may also result from the total effect of several industries discharging a variety of inhibitory pollutants. Industrial sources of chronic problems tend to be by-products of production activities such as chemical derivatives, rinse waters and contact cooling water.

The effects of an inhibitory pollutant on plant biomass vary depending on how frequently and at what level the pollutant is discharged. The more consistently a pollutant is fed to the biological treatment process, the more chance the biomass has to develop a "resistance" to the pollutant. If a pollutant is fed at a fairly even rate and concentration, the biomass will generally eventually become accustomed to or "acclimate" to the pollutant, and BOD removal efficiency will no longer suffer. For this reason, a plant may experience operational problems unless there has been sufficient time for the biomass to become acclimated. In addition, discharges of toxics at high enough concentrations can cause inhibition even in acclimated systems.

Although it does not always result in a POTW violating its NPDES permit limits, chronic inhibition can increase the overall expense and difficulty of operating a treatment plant in compliance with NPDES permit limits. For example, a plant may have to be operated at an increased MCRT or require additional aeration capacity to counteract the negative effects of inhibition. Depending on the circumstances, this may involve significantly increased operating costs for recirculating sludge at a higher rate or providing more aeration. It may also take away any reserve capacity that the plant might otherwise have had for future growth. Therefore, POTW's experiencing chronic inhibition should take steps to mitigate it even when there is no immediate threat of an NPDES permit violation.

2.1.2 Upset Conditions

The results of 29 case studies performed in conjunction with the development of this manual showed that most interference problems are caused by intermittent discharges of high-strength conventional wastes which overload a POTW's organic capacity, causing plant upset. The term "upset" is used in this manual to refer to an exceptional incident which creates a temporary non-compliance with permit limits due to the impacts of the incoming waste characteristics on the treatment processes. Discharges causing upset commonly come from food processors such as bakeries, dairies, breweries, canneries, poultry farms and meat packaging plants. Examples of interferences due to high-strength conventional wastes are provided by the Bayshore Regional Sewerage

Authority (New Jersey), and Hamilton Township (New Jersey) case studies in Appendix A. In some cases, upsets have occurred even when the total industrial contribution was significantly less than 5 percent of the total plant flow. It is frequently the intermittent discharge of concentrated wastes which leads to the upset.

Similarly, in cases of plant upsets due to the discharge of toxic pollutants, it is usually the intermittent discharges of toxics which produce the most drastic effects. These types of discharges may result from:

- process tank contents disposal
- cleanup operations
- industrial spills
- waste hauler discharges
- midnight dumping (illegal waste hauling)

Biological populations are typically not acclimated to either the specific compounds or concentration levels observed in such discharges. The impacts on biological processes can therefore be severe and rapid, often requiring long recovery periods. Such interferences commonly affect the effluent quality rather than the stabilized and dewatered sludge characteristics, although the loss of an anaerobic digester due to slug loads of heavy metals is not unusual. A slug load is defined as any pollutant in a discharge at a flow rate and/or pollutant concentration which will cause interference at the POTW.

It is important that POTWs monitor the occurrence of upset conditions caused by industrial waste discharges. In some cases, the problems may recur in a cyclical pattern, such as once-per-week or once-per-month. Recognition of the pattern coupled with contaminant identification will go a long way toward discovering the source of the problem. Intermittent discharges of this type tend to produce similar impacts on the POTW from incident to incident. Changes in dissolved oxygen (DO) levels, mixed liquor suspended solids (MLSS), sludge volume index (SVI), reactor temperature, etc. are all indications of process changes potentially resulting from industrial wastes.

The impacts of interference-causing substances are not restricted to biological systems within a treatment facility. Interference problems can also surface in physical treatment systems (clarifiers, thickeners, filters, etc.) or in the sewer collection system. Municipalities should make every effort to mitigate discharges that threaten any treatment process as well as the integrity of the collection system, not only to avoid interference, but for the protection of worker health and safety as well.

2.2 INTERFERENCE-CAUSING SUBSTANCES

POTW interference can be caused by a wide variety of chemical, biological and physical factors. Chemical factors such as the types and concentrations of industrial wastewater constituents which cause interference are highly variable.

The studies reported in the literature discussing chemical interference/inhibition range from research done in the laboratory to studies of actual treatment plant operations. There has been a substantial body of work published and many researchers have devoted a great deal of effort to these types of studies. Previous reviews (U.S. EPA, 1979; Geating, 1981; U.S. EPA, 1981a; Russell, et al., 1983; U.S. EPA, 1986a) have presented ranges of concentrations for a variety of pollutants which inhibit biological processes. The reader should refer to these documents for a more thorough presentation of pollutant treatability and process inhibition. As an aid to POTW operators, this manual compiles available information on the types and concentrations of pollutants and compounds which inhibit some biological treatment systems.

There are various ways of measuring inhibition and the fact that different researchers use different methods results in a range of published "inhibiting concentrations", even for nearly identical study conditions. The two most typical methods of determining activated sludge inhibition are by measuring 1) decreases in COD or BOD removal or 2) decreases in oxygen utilization rates. Threshold inhibition levels as measured by these two methods are usually defined differently by individual researchers, but are most typically set at the 10-50 percent range. Anaerobic treatment inhibition is typically defined as increased volatile acid levels or decreased methane generation, but once again the threshold levels are variously defined. Nitrification inhibition is specified as a decrease in the degree of ammonia conversion.

The most important conditions that affect biological inhibition are:

- the nature and strength of the inhibiting agent
- biomass characteristics
- pH
- temperature
- synergism
- antagonism
- acclimation

For most studies, biomass characteristics are not described in the literature, except as related to whether or not the biomass was acclimated. The diverse biomass population is likely to be very different from one reported study to the next. Characteristics such as sludge age or food to microorganism (F/M) ratio will have a significant impact on the inhibitory concentration levels of pollutants. Actual test conditions, including temperature and pH, vary dramatically from study to study, with the result being that inconsistent values are reported. Wastewater pH plays a particularly important role in metal-caused inhibition. The pH affects the solubility of metal ions, and it is primarily the soluble metal that is toxic to microorganisms. Synergism, or the increase in the inhibitory effect of one substance by the presence of another, is most important when considering combinations of metals. Toxic organics do not exhibit this effect as often as metals. On the other hand, some compounds are antagonistic towards each other, decreasing the inhibitory effect of either compound alone. Examples are chelating agents, such as EDTA, which are antagonistic toward metal ions and reduce their toxic effects.

Substances which cause interference/inhibition problems can be divided into three groups:

- conventional pollutants
- metals and other inorganics
- organic compounds

Each of these categories is considered separately in the subsections to follow.

2.2.1 Conventional Pollutants

The term "conventional pollutants" as used in this manual includes BOD, suspended solids, pH, and oil and grease. Since BOD and suspended solids (SS) form the usual basis of secondary treatment plant design, interference/inhibition problems result from exceeding the peak mass loadings specified by the design. Such "shock loadings" (slug loadings) of conventional pollutants are a common cause of permit violations resulting from oxygen transfer limitations, insufficient biodegradation and solids carryover. Oil and grease are normal constituents of domestic wastewater that if present in elevated concentrations can interfere with normal waste treatment by preventing bacteriological floc from properly settling and disrupt mechanical equipment operation. The pH of a wastewater can also cause interference if it is too high or too low, or is widely fluctuating.

2.2.2 Metals and Other Inorganics

More research efforts have been directed toward the impacts of heavy metals on biological treatment than any other classification of contaminant found in wastewater. A large percentage of the insoluble metals and metal salts that enter a POTW settle out during primary clarification. Consequently, a significant impact of metals is in rendering sludges unacceptable for a variety of disposal options, notably landspreading for agricultural purposes.

The soluble fractions of the metals can upset the secondary treatment processes. Table 2-1 presents ranges of metal and other inorganic pollutant concentrations inhibiting biological processes. Important factors affecting these ranges of values are pH, solubility, and the definition of inhibition used by the researchers reporting the results. The wide range of concentrations presented results from apparently contradictory data published in the literature. The values presented in Table 2-1 represent the range of reported threshold inhibition concentrations. Acclimation is an important issue, which in many studies was either not reported or was not known. However, it would be reasonable to expect the lower end of a range to correspond to threshold levels inhibiting an unacclimated system while the upper end of the range would correspond to threshold levels inhibiting an acclimated system. The primary references, for this table are U.S. EPA (1981a), Russell, et al., (1983) and Geating (1981). U.S. EPA (1986a) provides a more complete reference list.

The inhibition levels presented in Table 2-1 are for the dissolved metal unless otherwise indicated. The dissolved form is the most toxic. However, POTWs

should control the total metal entering the plant because particulate metal or metal compounds may exert some toxicity or may later be resolubilized. The dissolved metals present in the secondary treatment process are derived both from dissolved metals in the plant influent and from desorption of metals from sludges that are recycled to secondary treatment. A large percentage of the toxic metals present in the aeration basins at some treatment plants has been found to be contributed by recycled solids handling sidestreams. Such contributions can cause a continued toxic effect long after the source has been controlled.

2.2.3 Organic Compounds

Considerable interest exists among the EPA and public health officials concerning the fate and effects of toxic organic compounds in POTWs. Organic substances which enter municipal facilities are either removed in the biological treatment processes, inhibit biological degradation, or pass through the plant. The principal removal mechanisms are:

- volatilization
- biodegradation
- adsorption to biological flocs and settling

The amount of information available on the impacts of organic contaminants is small compared with the metals, due in large part to the number of compounds of interest and also to the sophisticated analytical equipment required to measure these organics. Table 2-2 presents ranges of concentrations for toxic organic compounds which inhibit biological systems.

The classification scheme used in Table 2-2 involved grouping compounds of similar structure and characteristics which might tend to inhibit biological processes at similar concentrations. The reader is cautioned, however, that chemicals with similar structure do not always possess similar inhibition characteristics. For a more detailed summary of what is known about inhibition by individual organics, see Russell, et al. (1983), U.S. EPA (1981a), Geating (1981), and U.S. EPA, (1977b).

It is important to note that the categories in Table 2-2 are very broad and the concentration ranges presented are simply typical values for some compounds and should not be interpreted as defining an inhibition range for all compounds within the classifications. Appendix B lists the compounds that fall into these broad classifications.

2.3 SEWER COLLECTION SYSTEM

Industrial and waste hauler discharges can be very detrimental to the condition of the sewer collection system. The types of substances responsible for such problems are generally the same pollutants addressed by the specific prohibitions. Table 2-3 defines four categories of these substances with examples given for each.

Corrosivity problems can be identified by observing the deterioration of the pipe material or measuring the pH of the wastewater at several locations within the collection system. Corrosion rates generally increase significantly below pH 5 and above pH 12.5. The best approach is to maintain a program of regular sewer inspection coupled with the use of recording pH meters located at strategic interceptor locations in the sewer system. A proper inspection program should include the detection of unusual colors or odors by trained personnel.

Detecting substances which may result in ignitability or reactivity problems is a more complicated task. Instrumentation is available to detect explosive conditions, lack of oxygen and the presence of hydrogen sulfide. Such equipment is typically used for worker safety prior to entering confined, below grade areas such as manholes and sewer interceptors. To install and maintain sensitive instruments of this type, along with the recording devices needed for proper monitoring, would be very expensive if placed in numerous locations. A more practical approach is to survey the industries discharging to a POTW as a means of identifying potential dischargers of these substances (see Section 3). Once likely industrial candidates are identified, portable detection instrumentation can be used to spot check the sewer environment or permanent equipment can be installed in a few, selected locations.

Baltimore, Maryland and Passaic Valley, New Jersey are examples of locations where sewer collection system problems have been identified and addressed (see Appendix A). Discharges of volatile organics such as ethyl benzene, xylene, toluene and tetrachloroethylene (PCE) into the Baltimore collection system have resulted in pump station and other building evacuations in the past. By successfully tracing these problems to the source, the City has reduced the occurrence of such incidents dramatically. Passaic Valley experienced both sewer clogging problems from a pulp and paper mill and high concentrations of flammables from a number of industrial sources. Lower explosion limits (LEL) were established and industries identified as being dischargers of flammables were required to install LEL detection equipment in their effluent piping.

Another example of the use of LELs is by the Los Angeles County Sanitation Districts, where the wastewater ordinance requires all significant potential dischargers of flammable substances to install, operate and maintain an adequate combustible gas monitoring system. The system provides early detection so that preventive measures can be taken. Systems must be installed in a fixed location and continuously operated, incorporating an indicator, as well as an automatic continuous recorder, adjustable two-stage alarm system, calibration for methane detection, and a means for diverting flow from the sewer to a holding vessel when the combustible gas level is 20% of the LEL or greater. Industrial users, primarily petroleum refineries, storage and transfer facilities, and chemical manufacturing plants, must submit engineering drawings of their proposed systems for review and approval by the Districts prior to construction.

2.4 PLANT OPERATIONS

There are numerous tools available to the plant operator to monitor the condition and performance of the facility. Suspended growth biological treatment systems generally provide more operational control (such as sludge wasting and recycle, aeration tank D.O., process modifications), and therefore monitoring opportunities, than do fixed film systems. However, all POTWs have processes that can be easily checked on a daily basis which can signal the onset of an interference problem. Making use of the available tools may be the difference between total process failure and catching the problem before it fully develops.

The operational tools available fall into the following categories:

- observation
- instrumentation
- analytical results

2.4.1 Observation

Some of the most powerful tools in the operation of a treatment facility are the senses of sight, sound, touch and smell. Maintenance personnel are typically trained to listen for the improper operation of a blower or to feel for signs of an overheated bearing. Similarly, plant operators should be trained to observe changes in the appearance or smell of unit processes which might be indicative of a problem. A major thrust of the Hamilton Township, New Jersey, interference identification program was to require that operators spend a minimum number of hours each work shift "walking the grounds" (see Appendix A). Such a requirement can (and did) result in the identification of late night spill events that might otherwise go unnoticed until morning, when it may be too late for biological processes to recover.

Examples of what operators should notice as they work around a POTW are the:

- surface appearance of clarifiers
- amount and color of foam in aeration tanks
- presence of nuisance organisms, insects or odors near fixed film systems
- common odors at each plant location
- sludge and recycle flow appearance at each processing step

The EPA has provided troubleshooting and process control guidance to operators in previously published manuals (U.S. EPA, 1977a; U.S. EPA, 1978). These documents assist POTWs in troubleshooting process performance problems, and provide numerous tables to help the operator identify problems through visual inspection. Many problems uncovered through plant observation do not result from industrial discharges, but rather from equipment malfunction, inadequate maintenance or design deficiencies. The two manuals referenced above provide assistance in distinguishing between the potential sources of such problems. Table 2-4 identifies the operational indicators of process malfunction which may

be related to industrial waste discharges. The processes listed in Table 2-4 are for typical secondary treatment plants. Advanced wastewater treatment systems and sludge thickening and dewatering processes are not included in this manual.

2.4.2 Instrumentation

Instrumentation is designed into treatment facilities as an aid to the operations staff. Whether located at the central control panel or at the piece of equipment being monitored, digital and dial gauge readouts provide instant feedback to an experienced operator concerning the conditions in the plant. Strip chart recorders maintain permanent records of the critical parameters, such as raw wastewater feed, to identify long-term trends and isolated excursions. Despite the availability of instrumentation and level of sophistication, much of the hardware may be unused or simply ignored by operators because of a perceived complexity and/or unreliability.

When monitoring instruments are incorporated into a POTW, it is important that such equipment be maintained in accordance with manufacturer's specifications and recalibrated at regular intervals. The utility of these instruments depends upon the operator's understanding of the readout. Proper training of operations personnel is therefore a critical element in using instrumentation as possible early warning signals of a pending interference problem.

The use of simple portable instruments and equipment for routine POTW site inspection can be quite useful to the operator. The use of a device to measure the depth of sludge in clarifiers may be the best way to learn that a sludge pump did not operate as expected or that unusual wastes have entered the plant. In the Tolleson, Arizona treatment plant (see Appendix A), the operators discovered that a rapidly increasing sludge depth in the primary clarifiers was indicative of upset conditions caused by high solids discharges from a meatpacking industry.

A number of commercially available instruments can be utilized by plant operators either for permanently-mounted, continuous monitoring and control or as portable devices. Table 2-5 lists the types of instruments, where they can be utilized in the treatment facility, and the parameters of interest in interference identification. The instruments listed in the table are useful for both process evaluation as discussed in this section, and for wastewater monitoring (Section 2.5). The instrumentation selected by a POTW should be a function of the wastewater characteristics of the industrial discharges as determined by the industrial survey conducted during pretreatment program development.

2.4.3. Analytical Results

The subsection on observation (2.4.1) outlined the benefits of noting the smell and appearance of unit processes during routine plant inspections. There are a number of standard analytical techniques that can be used to confirm the presence and extent of problems identified by sensory observation. Table 2-6 lists the common test procedures that can be performed on typical treatment plant processes. The testing frequency indicated is typical of well-operated

facilities. The actual frequency used will be site-specific as a function of process problems, industrial discharges, and staff and equipment availability. The monitoring procedures listed on Table 2-6 are relevant to assessing overall plant performance, not just interference problems. As was the case in both Tolleson, Arizona (primary sludge depth) and Oswego, New York (activated sludge SVI), the relationship between operating parameters and specific industrial discharges is oftentimes correlated by trial and error.

Conductivity, D.O., flow and pH are the parameters that are measured most reliably by the instrumentation specified in Table 2-5. Some of the devices, such as the selective ion electrodes, are adversely affected by the wastewater environment, and are therefore not well-suited to on-line monitoring applications. TOC analyzers are expensive instruments that should be housed in controlled laboratory environments. In order to be effective in identifying slug discharges of organics, the instrument must be provided with representative wastewater samples on a regular basis.

2.5 WASTEWATER MONITORING

A critical aspect to any successful industrial waste management program is comprehensive monitoring of industrial discharges, POTW influent, effluent and sludge, and important process streams within the plant. The benefits derived by the municipalities in terms of understanding their influent wastewater characteristics and sources of specific contaminants are many. Monitoring is also performed to provide data from which to develop local limits and later to evaluate an industry's compliance with those limits.

Developing a large database of analytical results on a POTW's wastewater provides a baseline for future comparison. When industrial discharges cause a significant deviation from the baseline, noting such changes will help detect a potential interference problem and may prove useful in later identifying the source. In the Hamilton Township, New Jersey plant, the discharges from a pharmaceutical manufacturer were correlated to high POTW influent soluble BOD through an extensive analytical testing program. A pharmaceutical manufacturer was also implicated in the discharge of high ammonia levels to the Neuse River Plant in Raleigh, North Carolina. Year-round sampling of 70 metal finishing/electroplating industries and strict enforcement of local limits for metals has substantially reduced the concentrations of heavy metals (Cr, Cd, Cu, Pb, Ni, Zn) at the Metro-West Point Plant in Seattle, Washington over the past five years.

2.5.1 POTW Influent

Most municipalities now have some form of influent wastewater monitoring. The most common approach is to install an automatic sampler at the headworks of the plant. State-of-the-art sampling equipment provides the POTW with four options:

- timed sampling with collection in discrete sample containers
- flow-proportioned sampling with collection in discrete sample containers
- time-proportioned composite sampling
- flow-proportioned composite sampling

Samples collected in discrete containers provide a means of identifying diurnal fluctuations in wastewater characteristics. Such an approach can be costly if hourly samples are analyzed, but is particularly useful if "midnight dumping" of prohibited substances is suspected, since discrete samples do not mask the impact of short-term discharge concentrations by averaging over a 24-hour period. An alternative approach is to preserve and store the discrete samples, and then analyze only if problems occur at the POTW.

Composite sampling involves the collection of a fixed volume of wastewater at regular intervals into a single, large container. A typical approach is to collect 100 ml every 15 minutes for 24 hours into a 10-liter sample bottle. This is the most common method of obtaining average daily influent samples. A better approach is to proportion the sample volume consistent with the influent volumetric discharge at the time of collection. This technique requires a feedback signal from an influent flowmeter to the sampler, but results in a sample that is consistent with the mass loadings to the POTW.

Analyses performed on a POTW influent should routinely include BOD, SS and other pollutants (such as NH_3 and P) included in the NPDES permit. When evaluating the potential for inhibition caused by toxic pollutants, additional testing is necessary. The testing intervals for the toxic organics and metals are determined on a site-specific basis as a function of permit violations, pretreatment program requirements, process upsets, types of industrial discharges and budgetary constraints.

A suggested approach is for the POTW to survey its nondomestic users to find out what toxic metals and organics are reasonably expected to be present in its influent at detectable levels. The POTW should then analyze its plant influent for those pollutants. In addition to the pollutants expected to be present, it is recommended that the POTW sample for the metals and cyanide listed in Table 2-1. Among the toxic organic pollutants, standardized analytical methods are available primarily for EPA's list of "priority pollutants". These pollutants are covered by EPA methods in the 600 series. The reference for these methods is the Federal Register (40 CFR Part 136), October 26, 1984, and June 30, 1986. Most full-service commercial analytical laboratories, as well as some of the large municipal laboratories are capable of analyzing for the priority pollutants. A once per year scan for the priority pollutants is recommended. For pollutants which are detected in the influent at least once, additional sampling should be conducted to determine variability and evaluate trends.

2.5.2 Other POTW Locations

POTW effluent is generally composite sampled and analyzed in accordance with NPDES permit requirements. Operators may, however, select other process

streams within a facility for intermittent monitoring. For example, sampling primary effluent allows for calculations of loadings to the secondary treatment system. The response of a biological process is more easily explained if one knows the specific wastewater feed characteristics, as opposed to assuming a primary clarifier performance based on influent characteristics.

POTW sludge monitoring is necessary to determine if the POTW is meeting applicable sludge use or disposal requirements and to detect sludge contamination. If sludge contamination is found, it will trigger the need for additional sampling of both domestic wastewater and nondomestic discharges in order to identify the source(s) of contamination.

An informative yet infrequently employed sampling method is to evaluate the strength of sidestream flows, particularly from solids processing. Recycle flows can add 50 to 100 percent of the influent solids and organics to the liquid processing trains when inefficient sludge solids capture persists. POTW design often neglects the impact of recycle streams, a problem magnified when unanticipated quantities of heavy metals and priority organics are discharged from industrial sources. While monitoring such sidestreams on a daily or weekly basis may prove impractical (and costly), periodic sampling and flow measurement permits mass balancing around solids processing units, and can provide insight into the presence of substances in the POTW effluent not necessarily present in the influent.

Recycle flows can be intermittent, or at least shift dependent, and as such are poor candidates for 24-hour composite sampling. Grab sampling is done by extracting a representative sample of sufficient quantity to perform the necessary analytical tests. Some procedures, such as the extraction methods for oil and grease, require grab sampling to prevent deposition of the material on the container over the 24-hour composite period.

2.5.3. Inhibitory Effects Testing

Testing which measures the inhibitory effects of industrial discharges might prove useful in evaluating the impacts of those discharges on the POTW. One of the simplest methods of detecting inhibition due to an industrial discharge is to add incremental volumes of the waste to seeded dilution water and analyze for 5-day BOD. If the wastewater is inhibitory to the POTW bacteria, higher concentrations will result in less oxygen depletion and lower BOD. If completely biodegradable, larger volumes of the industrial waste should produce proportionately higher oxygen depletion. The advantage of this technique, termed serial addition, is that the concentration at which the waste changes from biodegradable to inhibitory can be estimated by this technique. The major disadvantages are the five day waiting period and the questionable correlation between degradation in a BOD bottle as compared with a full-scale biological reactor.

Other test procedures have been developed which overcome some of the disadvantages of the BOD procedure. One such procedure is to add varying concentrations of an industrial wastewater to a BOD bottle containing an active

biological culture (usually mixed liquor activated sludge) from the secondary treatment system. A DO meter equipped with a BOD probe can be used to measure the oxygen uptake rate after the sample is saturated with oxygen. If the industrial wastewater is inhibitory, increased doses will result in reduced oxygen utilization. A similar approach using respirometers allows for the use of larger reactors (up to 10-liters), continuous oxygen feed and strip-chart recording of the uptake rate with time. At the Patapsco Wastewater Treatment Plant in Baltimore, Maryland (see Appendix A) daily routine operation of a respirometer is used as a tool for measuring the inhibitory characteristics of the plant influent. The standard operating procedure for the respirometer involves the use of plant biomass and simulates the plant's biological system (Slattery, 1986).

Recent variations of the respirometry approach utilize special cultures of microorganisms, instead of the POTW bacteria, as more precise predictors of toxic effects. One manufacturer uses specially prepared and packaged bacterial cultures in conjunction with a DO meter to plot families of inhibition curves and to develop lethal concentration dosages analogous to those obtained by bioassay testing. A second technique uses photo-luminescent marine microorganisms, whose light output decreases proportionally to the level of toxic shock when fed varying concentrations of industrial wastewater. This approach has been used extensively in Baltimore, Maryland (see Appendix A) and Chattanooga, Tennessee to evaluate the toxicity of influent wastewaters to the POTW and to measure toxicity reduction through the biological treatment process. At the Patapsco plant in Baltimore, pure oxygen activated sludge treatment reduced the wastewater toxicity by up to 40 percent from the raw wastewater feed.

A summary of the methods available to measure biological inhibition is presented in Table 2-7. The table also includes some cost, testing and training time estimates, of concern to municipalities developing a program for determining inhibitory effects of industrial or waste hauler discharges. A potential problem with all of the techniques discussed is that the results do not accurately reflect the treatability of the wastewater if the biological treatment populations become acclimated to the industrial waste over a long period of exposure.

TABLE 2-1
METAL, CYANIDE AND INORGANIC COMPOUND CONCENTRATIONS
INHIBITING BIOLOGICAL PROCESSES
(in mg/l)

Pollutant	Biological Process			
	Activated Sludge	Nitrification	Aerobic Fixed Film	Anaerobic Digestion
Ammonia	≥480	N/A	N/A	1,500-3,000
Arsenic	0.04 - 0.4	N/A	290	0.1 - 1
Boron	0.05 - 10	N/A	N/A	2
Cadmium	0.5 - 10	5-9	5-20	0.02 - 1
Calcium	2,500	N/A	N/A	N/A
Chloride	N/A	180	N/A	20,000
Chromium (Tot.)	0.1 - 20	0.25 - 1	50	1.5 - 50
Copper	0.1 - 1	0.05 - 0.5	25 - 50	0.5 - 100
Cyanide	0.05 - 20	0.3 - 20	N/A	0.10 - 4
Iodine	10	N/A	N/A	N/A
Iron	5 - 500	N/A	N/A	5
Lead	0.1 - 10	0.5 - 1.7	N/A	50 - 250
Manganese	10	N/A	N/A	N/A
Magnesium	N/A	50	N/A	1,000
Mercury	0.1 - 5.0	2 - 12.5	N/A	1,400
Nickel	1 - 5	0.25 - 5	N/A	2 - 200
Silver	0.03 - 5	0.25	N/A	N/A
Sodium	N/A	N/A	N/A	3,500
Sulfide	>50	N/A	N/A	50 - 100
Tin	N/A	N/A	N/A	9
Vanadium	20	N/A	N/A	N/A
Zinc	0.30 - 20	0.01 - 1	N/A	1 - 10

N/A - Not Available

Sources: U.S. EPA (1981a), Russell, et al. (1983), Geating (1981) and U.S. EPA (1986a).

TABLE 2-2
**ORGANIC COMPOUND CONCENTRATIONS
 INHIBITING BIOLOGICAL PROCESSES**
 (in mg/l)

Compound Type	Biological Process		
	Activated Sludge	Nitrification	Anaerobic Digestion
Agricultural Chemical			
Common Pesticides	0.05 - 0.10	N/A	N/A
Lindane	5 - 10	N/A	N/A
Aromatics	5 - 150	N/A	100 - 870
Chlorinated Benzenes	0.1 - 5	N/A	0.1 - 1
Halogenated Aliphatics	150 - 250	< 0.1 - 18	0.1 - 100
Nitrogen Compounds	1 - 500	0.1 - 100	5 - 500
Oxygenated Compounds	120 - 500	N/A	20 - 1,000
Alcohols	1,000	N/A	N/A
Acids	N/A	N/A	10
Phenol	90 - 1,000	1 - 10	100 - 200
Chlorophenols	5 - 100	N/A	0.2 - 100
Nitrophenols	50 - 200	150	100
Methylphenols	N/A	5 - 50	N/A
Phthalates	>10	N/A	N/A
Polynuclear Aromatic Hydrocarbons	500 - 2,500	N/A	N/A

N/A - Not available

Principal Sources: Russell, et al. (1983), U.S. EPA (1977b), U.S. EPA (1981a), Geating (1981), U.S. EPA (1986a)

TABLE 2-3
WASTE CHARACTERISTICS PERTAINING TO
HAZARDS IN COLLECTION SYSTEMS
 (From Busch, 1986)

Term	Description	Examples
Ignitability	Pose a fire hazard	- Gasoline - Industrial solvents
Corrosivity	Corrode standard construction materials	- Acids - Caustics
Reactivity (Explosivity)	- Spontaneous reaction with air or water - Pose explosion hazard - Generate toxics	- Calcium carbide - Cyanides - Sulfides - Industrial solvents - Petroleum hydrocarbons
Fume Toxicity	- Build up of toxic fumes - Pose a hazard to human health	- Metals - Pesticides - Industrial solvents (benzene, toluene)

TABLE 2-4
INTERFERENCE IDENTIFICATION THROUGH PLANT OBSERVATION

Process	Observation	Possible Cause
<u>Primary Clarification</u>	Black/odorous wastewater	Inadequate pretreatment of waste
	Scum overflow	Inadequate pretreatment of waste
	Low solids content of sludge	Hydraulic overloads
<u>Activated Sludge</u>		
- Aeration Tank	Excessive air rates to maintain D.O.	Organic overloads
	Low density sludge	Acid waste, low influent pH, nutrients
	White, billowy foam	Toxics (metal, bacteriocides)
	Dark-brown sudsy-foam, black mixed liquor	Organic overloads, anaerobic conditions
- Clarifier	Pin floc in overflow	Toxic shock load
	Ash-like material floating on surface	High grease content of mixed liquor
	Straggler floc (< 1/4" dia) in supernatant	Changing organic loads
	Cloudy supernatant, poor settleability	Increased organic loads, toxic shock loads, low nutrients
	Sludge rising throughout tank	Low D.O. or low pH (<6.5) in aeration tank

Source: U.S. EPA (1977a), U.S. EPA (1978)

TABLE 2-4 (Continued)
INTEFERENCE IDENTIFICATION THROUGH PLANT OBSERVATION

Process	Observation	Possible Cause
	Localized rising sludge	Organic overloads in aeration tank
	Sludge clumps and hubbles rising to surface	Septic conditions
<u>Trickling Filters</u>		
- Filters	Surface ponding	Organic overloads, excessive biological growth
	Odors	Organic overloads, anaerobic conditions
	Slime colors	Metals, toxic shock
- Clarifier	Increased effluent suspended solids	Excessive sloughing due to pH or toxic shock loads
<u>Lagoons</u>	Poor effluent quality	Organic overloads, toxic shock
	Odors	Low D.O., sulfides
<u>Rotating Biological Contactors (RBC)</u>	Poor effluent quality	Organic overloads, poor pH conditions
	Excessive sloughing	Toxic shock, pH fluctuations
	White, stringy biomass	First stage organic overloads, sulfides
	Odors	Septic influent, sulfides

TABLE 2-4 (Continued)
INTEFERENCE IDENTIFICATION THROUGH PLANT OBSERVATION

Process	Observation	Possible Cause
<u>Anaerobic Digestion</u>	Rotten egg odor	Organic overloads, sulfides
	Rancid butter odor	Toxic shock (metals, ammonia)
	Poor supernatant quality	Organic overloads, toxic shock
	Foam in primary supernatant	Organic overloads
	Sludge temperature drop	Hydraulic overloads
	Scum blanket too thick	High grease content
<u>Aerobic Digestion</u>	Excessive foaming	Organic overloads
	Odor	Low D.O., organic overloads

TABLE 2-5
INSTRUMENTATION OF PLANT PROCESSES
AND WASTE STREAMS

Instrument	Locations	Parameters Measured
Conductivity Meter	Industrial discharge Primary effluent Final effluent	Metals, Dissolved solids
Density Meter gamma radiation ultrasonic	Aeration basins Clarifier underflow Conditioned sludge Anaerobic digesters	MLSS Solids concentration
D.O. Meter membrane electrode	Aeration basins RBC stages Final effluent	Dissolved oxygen,
Flow Meter flume, venturi, magnetic, weir	Raw wastewater Sidestream flows Return/waste sludge Chemical feed Final effluent	Flow rate
Gas Analyzers	Collection system Confined spaces Aeration basin off-gas	CO, CO ₂ , CH ₄ , H ₂ S Oxygen transfer
Oxidation-Reduction Potential (ORP) Meters	Industrial discharge Primary effluent	Metal forms
pH Meter	Industrial discharge Collection system Raw wastewater Aeration basins Anaerobic digester Final effluent	Acids, Bases
Selective Ion Electrodes	Industrial discharge Primary effluent Final effluent	Cl ⁻ , CN ⁻ , Cu ⁺ , Cu ⁺⁺ , F ⁻ , NH ₃ , NO ₃ ⁻ , Pb ⁺⁺ , S ⁼
Total Organic Carbon (TOC) Analyzer	Industrial discharge Raw wastewater Primary effluent Final effluent	Organic slugs, oil and grease

Source: James M. Montgomery, Consulting Engineers, Inc.

TABLE 2-6
ANALYTICAL MONITORING OF PLANT PROCESSES

Process	Parameters	Testing Frequency
Clarification	Dissolved oxygen	Daily
	Sludge solids content	Weekly
	Sludge blanket depth	Daily
Activated Sludge	Dissolved oxygen	Daily
	Mixed liquor suspended solids	Daily
	Oxygen uptake rates	Daily/Weekly
	Microscopic examination	Daily/Weekly
	Nutrients	Daily/Weekly
	Sludge volume index	Daily
Trickling Filters	Slime thickness	As needed
	Influent pH, temperature, H ₂ S	As needed
	Effluent solids content	As needed
RBCs	Dissolved oxygen (each stage)	Daily
	Soluble BOD (each stage)	Weekly
	Biomass thickness	As needed
	Shaft weight	Daily/Weekly
	Effluent solids content	As needed
Anaerobic Digestion	Temperature	Daily
	Solids content	Weekly
	Metals content	Weekly/Monthly
	Volatile acids/alkalinity	Daily
	Supernatant solids, NH ₃	Weekly
	Methane content of gas	Daily

Source: James M. Montgomery, Consulting Engineers, Inc.

TABLE 2-7
METHODS FOR EVALUATING INHIBITORY EFFECTS
OF INDUSTRIAL WASTEWATERS

Method	Testing Time	Approximate Equipment Costs	Operator Training
1. BOD Serial Addition	5 days	\$1,000	2-4 hrs.
2. Respirometry	30-60 min.	\$1,000 - \$5,000	4-8 hrs.
3. Packaged Bacteria	30-60 min.	\$1,000 - \$2,000	4-8 hrs.
4. Photo Luminescence	15 min.	\$5,000 - \$10,000	20-40 hrs.

Source: James M. Montgomery, Consulting Engineers, Inc.

3. SOURCE IDENTIFICATION

There are two aspects of source identification that should be considered by POTWs when investigating interference problems:

- specific causative pollutants
- industrial source(s) of the pollutants identified

The ease with which a causative agent is identified depends upon the nature of the permit violation. For example, if the interference results from the inability to dispose of sludge, the problem nearly always results from an unacceptable concentration of a particular heavy metal. However, if the plant effluent has a BOD above the permit limit, the problem can range from a shock loading of influent BOD to an inorganic or organic pollutant that is toxic to the biological population in secondary treatment. Isolated spill events are difficult to trace to a specific pollutant unless the pollutant is detected in routine influent and effluent screening or the spill is accompanied by distinct, recognizable odors, appearance, pH or solid residues. Recurring discharges may be linked to a substance with time by process of elimination and analytical testing.

Once an interference is linked to a specific pollutant, the next step is to identify the industrial source. If the POTW has sufficiently characterized its industrial users as part of its initial pretreatment program development, this task will be greatly simplified. As part of the development of a federally-approved pretreatment program, POTWs are required to conduct a survey of industrial users to characterize their wastes. The POTW should be familiar with each IU's industrial processes and the chemicals which are used, produced, stored, disposed, or otherwise handled on the site. The potential for intentional or accidental discharge of pollutants should be evaluated. The IU survey information should be updated at least annually. Another approach to identifying industrial sources is a tracking program that monitors the interfering pollutants at key interceptors and traces the substance back to its discharge point.

While industries are sometimes responsible for POTW permit violations, the fault can be with operation and maintenance practices at the POTW. Where plants experience chronic operational problems that cannot be linked to industrial waste discharges, the plant staff may wish to conduct a Composite Correction Program (U.S. EPA, 1984) to identify operational problems. If violations persist, then a more comprehensive search for industrial sources is justified. The CCP was developed by the U.S. EPA as a means to provide "information on methods to economically improve the performance of existing POTWs". It outlines an approach for POTW personnel to evaluate POTW operations and implement systematic improvement steps.

3.1 CHRONIC DISCHARGES

Industrial waste monitoring is the key to successfully identifying most chronic industrial waste sources. Industries should be monitored for conventional pollutants, with the testing of other compounds determined by the nature of the specific industrial waste. In the case of categorical industries, some substances of concern and pretreatment requirements are already specified by the regulations. For noncategorical industries, information such as permit applications and questionnaire responses or specific analytical testing of industry effluent should provide sufficient data to establish a monitoring program.

Sewer use ordinances and industrial waste management programs typically provide for some means of monitoring an industry's discharge to the municipal collection system. Such ordinances require measurements of both quantity and quality of the industrial or combined domestic/industrial flow. Industrial discharges are usually monitored both by industry, with regular self-reporting requirements, and by the municipality.

If it has been determined that a plant upset is being caused by industrial wastes and is not a result of other POTW deficiencies, then it is up to POTW personnel to identify the specific source of that upset. This may necessitate expansion of the POTW's monitoring program as discussed in the next subsection. POTWs experiencing interference problems tend to fall into one of three categories regarding interference:

1. A single major industry in town dominates the waste characteristics at a relatively small POTW.
2. One or two industries among several are primarily responsible for waste strength fluctuations in small to medium-sized POTWs.
3. Industrial wastewater from numerous sources controls the wastewater feed characteristics, with no single dominant industry.

The first category listed above is by far the easiest situation to deal with from an identification standpoint. By monitoring the industry's discharge, POTW influent and effluent and other relevant plant operations, the impact of the industrial waste on the POTW can be determined. The cities of Oswego, New York and Tolleson, Arizona are examples of small facilities significantly impacted by a single industry.

Category two is a more difficult interference to trace. A monitoring program may be sufficient if a large database exists covering a period of time. Unfortunately, when numerous industries must be tested on a frequent basis, the sampling and analysis costs can be high. Routine sampling for all industries with additional sampling for troublesome industries may provide a solution for some POTWs. For example, Paris, Texas set up a comprehensive short term (90 day) sampling program that industry supported financially. Through this effort, Paris was able to distinguish which industries were likely to be problems and then could adjust their long-term sampling accordingly.

The third category generally applies to larger facilities which are less likely to be susceptible to any particular industrial effluent. Baltimore, Maryland and Passaic Valley, New Jersey are examples of facilities which fit into this third category, but have experienced interference (see Appendix A). Large plants may be less likely to experience permit violations due to industrial waste, but they have frequently experienced inhibition and other operational and maintenance problems. Intermittent discharges are particularly difficult to pinpoint by POTW personnel because of large service areas.

3.1.1 Routine Monitoring

In order to have the ability to utilize POTW influent characterization to identify the source of interfering pollutants, adequate background and supporting information must be available to POTW personnel. A database obtained over several years of routine monitoring enables a POTW to develop action level criteria for key parameters. When monitoring shows that these criteria have been exceeded, it can be suspected that a spill or unauthorized discharge of industrial waste has occurred, which triggers a tracking program. Specific details of industrial monitoring programs have been outlined by EPA and others (EPA, 1983; WPCF, 1982).

Routine compliance monitoring, which is part of any local industrial waste control program, will sometimes serve to generate an adequate background database. However, POTWs which have interference problems may need to perform additional monitoring until the source of the problem can be identified. For compliance monitoring purposes, monitoring methods and frequency are generally specified by each municipality in its pretreatment program documents or sewer use ordinance and in discharge permits, contracts or orders issued to industrial users. Self-monitoring by industry with monthly checking by the municipality enables the POTW and the industrial users to share the expenses of monitoring. Such an approach is most successful when:

- key manholes or representative sampling points are available
- sampling procedures are clearly outlined and followed
- a qualified laboratory performs the analytical testing
- rigorous reporting requirements are established for the industries
- spot checking by the municipality is performed on a frequent yet random basis

The alternative to self-monitoring is for a municipality to perform all sampling and analytical services on a once-per-month or once-per-quarter basis, depending on the significance of the specific industry to the POTW. Under this scenario, split samples should be made available to the industry, if requested, to provide them with the opportunity to verify the test results from which their compliance status and user fees will be determined. Many municipalities prefer not to place major reliance on industrial self-monitoring for compliance determinations; they are able to recover the costs for their monitoring programs by assessing fees for industrial discharge permits or by directly billing the sampling costs to the industrial user.

Regardless of the approach taken, the objective of any industrial monitoring program is to obtain representative analytical results of the wastewater flow and characteristics. An industry with highly variable quality and quantity should be sampled more frequently than one with a consistent effluent quality. An appropriate sampling schedule or discharge schedule for batch processes should be determined for the industry.

If industrial wastes have been well characterized and adequately monitored, then the identification of an interfering or potentially interfering pollutant source will be facilitated. As an example, if a POTW suspects a change in their influent wastewater characteristics by observing a change in one or more operational parameters, this triggers influent sampling. The interfering pollutant and concentration are determined through analytical testing, which is then compared with the information from the monitoring database to identify industries that discharge (or have the potential to discharge) the problem pollutant. In some cases, especially large sewer systems, it is not easily determined which of many industrial contributors is responsible for a particular pollutant that is causing an interference. However, several large POTWs including Baltimore, Maryland and Hampton Roads, Virginia have experienced success after setting up their monitoring programs. It has even been suggested that the mere fact that they set up a program motivated some industries into cleaning up, rather than risking the consequences. Those large POTWs that have put effort into their monitoring program have been successful.

3.1.2 Tracking Program

A tracking program is a procedure developed for locating the source(s) of a pollutant or impact which has been identified at a POTW. Depending on the size of the POTW, the sewer system and the type and number of industrial users, this procedure may be very simple or rather complex. A small system with only a few industrial contributors will probably not require anything more than a procedure for comparing POTW influent sample characteristics with industrial monitoring results. On the other hand, large systems may require sophisticated programs involving computer analysis.

The City of Baltimore has a computer program that attempts to trace contaminants back to the source, knowing the necessary background data (see Appendix A). Batch printouts, called the "Daily Average Mass Discharge Reports," provide monthly listings of companies grouped by sewer service area and chemicals used, stored, and/or discharged. If a chemical compound (such as a solvent) can be identified by the tracking team, or later by means of sample analysis, a search of the Data Management System's batch printouts can identify possible industrial sources.

Rapid toxicity testing procedures may become valuable tools for identification of interference sources as they gain acceptance by municipalities. A toxic impact can be traced upstream through a collection system very rapidly when the test procedure takes less than 30 minutes. Such a system has been used at Baltimore's Patapsco Plant to identify influent toxicity problems. This approach to interference tracing is most useful if the troublesome industry discharges

toxicants. Municipalities must continue to rely on more conventional monitoring practices for upsets resulting from non-toxic contamination.

One of the most comprehensive tracking programs is maintained by the Hampton Roads Sanitation District (HRSD) in the Tidewater area of Southeastern Virginia. The HRSD operates nine treatment plants handling 130 million gallons per day generated over a service area covering 1,700 square miles. Industrial wastes from 300 sources are dominated by military installations, with other significant discharges from manufacturing and food processing. Industrial discharges are categorized according to which of the following methods of tracking is employed:

- sensory observations
- measurements with field equipment
- sampling and analysis

For the first two types of tracking methods, the HRSD has personnel on stand-by duty supplied with radio equipped vehicles and extensive field sampling and lab equipment capable of qualitative, as well as quantitative, analyses. Tracking begins by HRSD personnel checking pump stations and sewer lines in a downstream to upstream fashion until the source is isolated. Along the way samples are collected, labeled and preserved as evidence.

For the third type of tracking method, automatic sampling equipment is set up at key locations throughout a service area. The samples are collected each day and analyzed. After pollutant concentration trends are determined, the samplers are moved upstream. This general procedure is continued until the source of the problem is found.

In either case, once the source(s) is located, the industry is contacted directly and actions taken appropriate to the circumstances. All costs associated with the investigation, clean-up and any other item are billed directly to the source. The HRSD has found that just by having a highly visible industrial waste investigative team, users are deterred from unauthorized discharge to the sewer system. As a result, incidences have decreased by more than 50 percent in the last eight years.

Tracking programs such as HRSD's are most successful at tracking chronic discharges. Although not as easily accomplished, isolated spills and unauthorized slug discharges of short duration can be tracked if quick, aggressive action is taken. The next section discusses isolated spills in more detail.

3.2 ISOLATED SPILLS AND UNAUTHORIZED DISCHARGES

Interference-causing materials frequently enter POTWs as spills and unauthorized discharges. The sources generally fall into one of the following categories (Busch, 1986):

- transportation accidents or leaks
- storage tank or transfer pipe leaks
- industrial discharges

- industrial accidents
- fires in warehouses and commercial operations
- waste haulers
- midnight dumpers

The focus of this manual is on industrial discharges, industrial spills, and waste hauler discharges (both legal and illegal), because these are the problems over which the POTW usually has the most control. However, POTWs may be able to control some of the other problems listed by extending the spill prevention and control plan procedures described in this manual to any business that has toxic or hazardous materials on site. The POTW would have to assess its legal authority to set up this type of comprehensive program.

The extent of the spill and illegal discharge problem in POTWs is severe. In the spring of 1985, the Association of Metropolitan Sewerage Agencies (AMSA) surveyed 107 of their member municipalities concerning hazardous waste discharges to their facilities. The respondents to the survey represent 308 POTWs, corresponding to 39 percent of the estimated total flow and 47 percent of the estimated industrial flow nationwide. The results of the survey indicated that hazardous wastes, if improperly discharged, can have serious effects on POTWs. Specifically, the survey showed:

- nearly all POTWs receive hazardous wastes
- the most commonly discharged wastes are corrosives, solvents, electroplating baths and sludges
- the most commonly reported sources of these wastes are spills, illegal discharges from industries and routine discharges from industries
- half of the respondents indicated the discharge of explosive or flammable materials (gasoline, toluene, naphthalene, benzene, xylene, jet fuel) and nearly half reported corrosion of the sewer lines due to acids and hydrogen sulfide gas
- approximately 30 percent of the respondents have experienced one or more biological treatment system upsets since 1980 resulting from the presence of metals, cyanide, diesel fuel, toluene, paint thinner or stripper, iodine, thiocyanate and pesticides

It is clear that slug discharges resulting from spills, batch releases, dumps, and illegal discharges are a common concern for many POTWs. It is the responsibility of industry to notify a POTW of a slug discharge under federal regulations (40 CFR Part 403.12(f)). The regulations describe a slug loading as any pollutant, including oxygen-demanding pollutants (BOD, etc.), released in a discharge at a flow rate and/or pollutant concentration which will cause interference at the POTW. However, POTWs do not always receive proper notification. One POTW (HRSD) has responded to slug loads by contacting its major industries in the service area immediately upon detection. This action is taken for the following reasons:

1. an IU may not be aware that it is causing a problem;
2. it brings the problem to industry management attention;
3. it provides visibility for the POTW's control program;
4. it discourages illegal discharges;
5. if the problem is later tracked to an industry, the fact that the industry was notified of the problem immediately may strengthen enforcement proceedings against an uncooperative industry; and
6. there may still be time to correct the problem.

The mitigation efforts described in Section 4 related to industrial spills focus mainly on prevention measures and in-plant corrective measures that are best implemented if proper notification is received by the POTW. The use of permanent gas detection equipment in sewer lines or treatment plant headworks is a method of detecting certain types of pollutants that does not rely on industry notification.

Tables 3-1 and 3-2 provide some examples of industrial spill incidents as documented by Busch (1986) and Attachment 2 of the AMSA survey report.

3.2.1 Hauled Wastes

Identification of a waste hauler as the source of an interference is sometimes a difficult task. Hauled wastes can be discharged to convenient manholes and the hauler gone before the waste reaches the POTW. There are examples where hazardous waste haulers have paid industries for the seclusion their facility provides during such illegal discharge events. Approaches used to help alleviate the problem include:

- periodic sampling of suspected sewer lines
- surveillance of waste haulers and suspected discharge points
- education of industries concerning the seriousness of these violations
- increased public awareness of illegal dumping
- increased enforcement

Many states have enforcement programs to assist POTWs in detecting illegal discharges. Local law enforcement officials can also be requested to assist in surveillance activities and enforcement. Video surveillance of suspected manholes or storm drains is also a possible option. Some POTWs use locking manholes to discourage illegal dumping at suspected sites.

Table 3-3 gives examples of the impacts of hauled wastes on both the collection system and treatment plant in cities identified through the AMSA survey. A number of problems indicated by the AMSA survey showed the source as "unknown", which is indicative of the problems associated with tracking hauled waste interferences. In the Louisville, Kentucky example given in Table 3-3, the waste hauler discharged the hexachloropentadiene to a manhole located within a tobacco warehouse (Busch, 1986).

Interference can also occur when hauled wastes are discharged legally to treatment plants. POTWs that accept discharges of hauled waste should establish control procedures to ensure that the wastes are compatible with treatment processes. Procedures for regulating waste haulers are discussed in Section 4. Identification of a waste hauler as the source of interference can be facilitated by employing such measures as:

- restricting hauled waste disposal to designated, monitored sites in the collection system or at the treatment plant
- permitting waste haulers
- requiring submission of a tracking form that documents the origin, transportation, and disposal of the waste
- sampling hauler loads (samples only analyzed if there is a plant impact)
- permitting, sampling, and inspecting the waste generator

Submission of a tracking form, called a waste manifest, is already a federal requirement when haulers are discharging hazardous wastes. The Resource Conservation and Recovery Act (RCRA) places requirements on hazardous wastes received by truck, rail, or dedicated pipeline into POTWs. It is important that POTW operators become aware of these RCRA requirements and the need to coordinate their local procedures for accepting hazardous wastes with State and EPA personnel. To provide information and guidance on the RCRA hazardous waste requirements and their implications for POTWs, EPA has published a manual titled RCRA Information on Hazardous Wastes for Publicly Owned Treatment Works (EPA, 1985c).

3.3 RAPID SCREENING TECHNIQUES

Once an interference is suspected, a number of rapid chemical tests, available from chemical supply houses, can provide preliminary indication of the presence of substances thought to be producing the interference. These tests help determine in seconds the need for more thorough quantitative analysis and tracking. In addition, these screening tests are also useful when evaluating the loads of waste haulers at dumping stations (Section 4.2.4).

1. Metals -- Chemical test strips utilizing color change indicators may be used to detect the presence and concentration of specific metals.
2. Solvents -- Gas detection tubes, sensitive to gases and vapors, can indicate the presence and concentration of solvents, but may not be reliable for determining the specific solvent type due to chemical interferences among similar-type solvents. A portable hand pump draws in a calibrated amount of air through the detector tube, and the amount of color change indicates the concentration.

3.4 SUMMARY

Source identification is the key aspect of any industrial waste management program. Identifying the source(s) of interference-causing substances being discharged from a variety of industries is not an easy task and must be approached with an aggressive, well conceived program if it is to be successful.

There is no simple step-by-step procedure to follow to efficiently identify the source of every interference problem. However, a rational approach to the problem can be employed for some interferences which can minimize the effort required. Figure 3-1 is a flow chart that suggests a possible approach to dealing with permit violations or upsets. It basically outlines steps to be taken at the treatment plant to identify possible pollutants causing problems. Figure 3-2 is a flow chart developed by the HRSD that outlines the steps they take in the event that the treatment plant is upset or unusual influent is detected. It must be recognized that each POTW presents a unique management and operations structure to go along with process variations. Therefore, it is important to realize that Figures 3-1 and 3-2 are only examples, and not necessarily applicable to all POTWs. The most important aspects of any source identification or tracking program are well thought out procedures coupled with an aggressive approach to enforcement.

TABLE 3-1

**INDUSTRIAL SPILLS OF HAZARDOUS MATERIALS:
IMPACT ON SEWER COLLECTION SYSTEM**

City	Industry	Pollutants	Impact
Akron, OH	Rubber Mfg.	Naphtha, Acetone, Isopropyl Alcohol	Explosion
Bayville, NJ	Pharmaceutical	Sulfides from high BOD	Corrosion
Bergen, NJ County	Water Treatment	High and low pH	Corrosion
Bloomington, IN	Grain Processing	Hexane	Explosion
Dayton, OH	Electroplating Food Processor	Acids	Corrosion
Forth Worth, TX	Gasoline Station	Gasoline	Explosion
Hillborough, FL	Battery Salvaging	Acids	Corrosion
Jacksonville, FL	Organic Chemicals	Solvents	Corrosion, Odors
Los Angeles, CA County	Petroleum Refining	Sulfides	Corrosion
St. Paul, MN	Metal Finishing	Acids	Corrosion
Toledo, OH	Adhesives	Glue	Plugged Sewers
WSSC, MD	Photofinishing	Sodium Bisulfite, low pH	Corrosion

Sources: Busch (1986), AMSA

TABLE 3-2

INDUSTRIAL SPILLS OF HAZARDOUS MATERIALS:
IMPACT ON TREATMENT PLANT

City	Industry	Pollutants	Impact
Boise, ID	Electroplating	Cu, Ni, Zn	Reduced treatment efficiency
Camas, WA	Pulp Mill	Chlorine	Biological upset (2 days)
Camden, NJ County	Dye Mfg.	Aniline	Biological upset, sludge contamination
Dallas, TX	Organic Chemicals	Xylene, Toluene	Fouled carbon scrubbers
Depue, IL	Fertilizer Mfg.	Sulfuric Acid	Biological process wiped out

Sources: Busch (1986), AMSA

TABLE 3-3
IMPACTS OF WASTE HAULER DISCHARGES ON POTWs

City	Pollutants	Impact
Central Contra Costa, CA	Solvents	Biological process wiped out
Louisville, KY	Hexachloropentadiene	Treatment plant out of operation for 3 months
Rockford, IL	Electroplating sludge Cd, Cr, Pb, Zn, CN ⁻	Hydrogen cyanide gas production potential
San Diego, CA	Gasoline	Sewer explosion

Source: U.S. EPA (1986a)

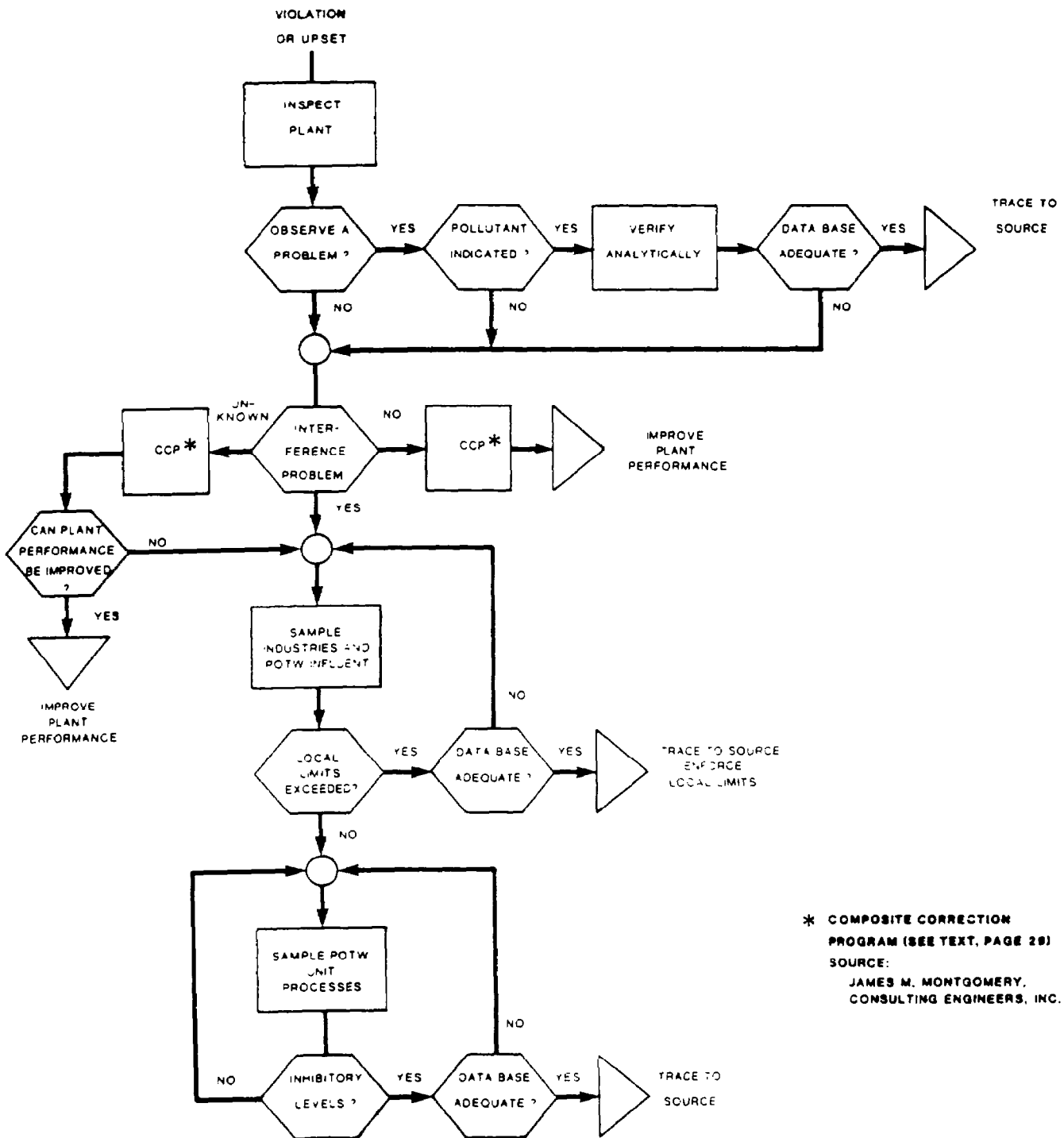

* COMPOSITE CORRECTION PROGRAM (SEE TEXT, PAGE 28)
 SOURCE:
 JAMES M. MONTGOMERY,
 CONSULTING ENGINEERS, INC.

FIGURE 3-1
TREATMENT PLANT UPSET IDENTIFICATION PROCEDURES

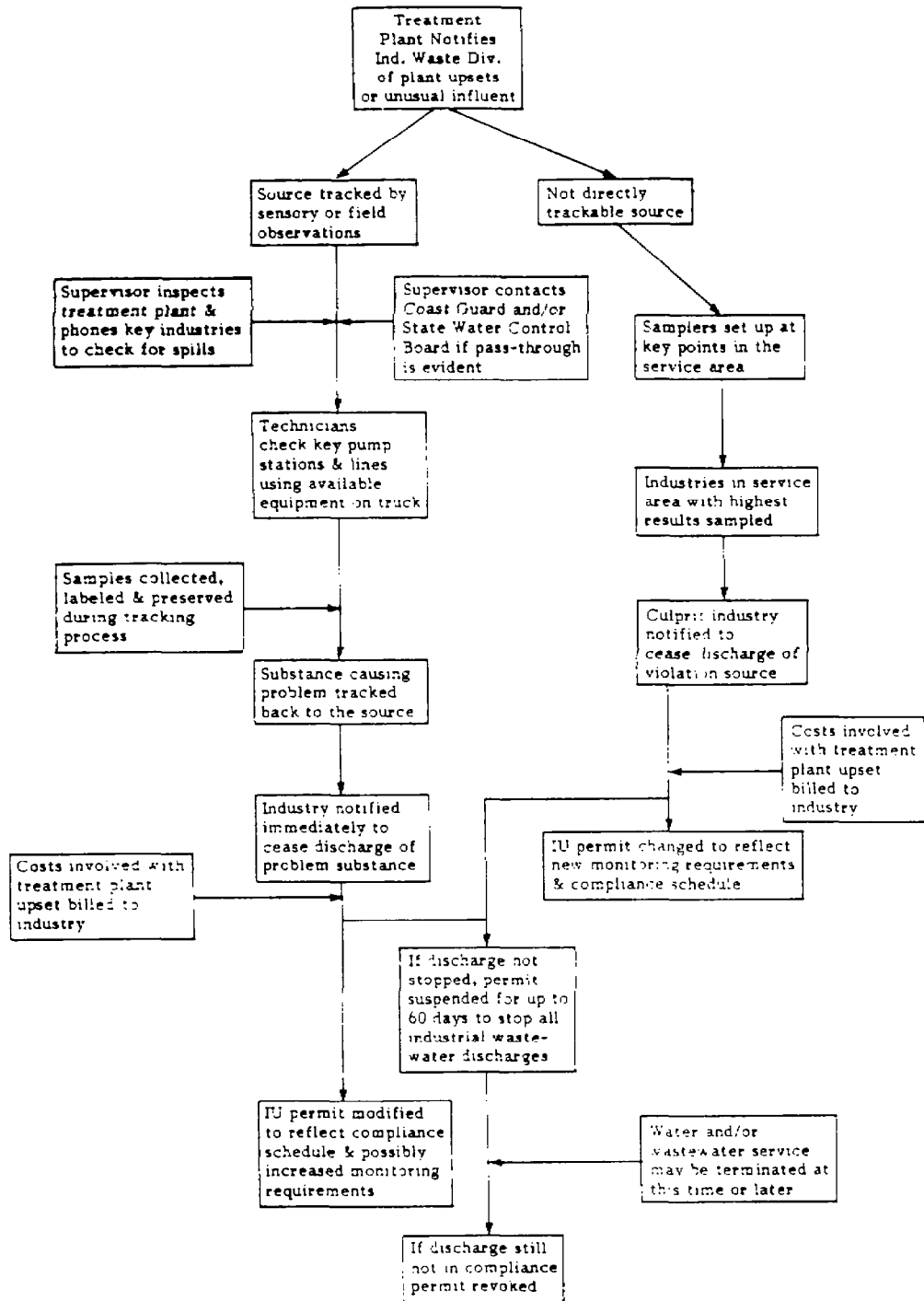

**FIGURE 3-2
HRSD SOURCE TRACKING PROCEDURE**

4. MITIGATION

Mitigating an interference is the goal following the detection of an interference problem. Whether source identification precedes mitigation depends on the success of the POTW's tracking program, its knowledge of its IUs, and the other issues discussed in Section 3. In certain cases, interim measures to address interference can be taken without initially defining the interfering pollutant substance or source, although this information can be very helpful. However, even if an isolated interference event can be handled by process modification at the treatment plant, the source of the interfering discharge should be identified and controlled. Interference mitigation by pretreatment and source control or legal and enforcement remedies obviously requires information about the discharger(s) causing the problem, but results in a more reliable solution.

The success of any effort to mitigate interference is dependent to a great extent on the characteristics of the pollutants causing the interference, the characteristics of the treatment plant (capacity, capacity utilization, biological process, etc.) and the type(s) of mitigation attempted. It is important to emphasize that mitigation of an interference problem is generally not a straightforward process. Each POTW possesses unique characteristics that exclude generalized solutions or approaches so that a combination of techniques is often necessary to realize satisfactory results.

4.1 TREATMENT PLANT CONTROL

The effects of industrial pollutants on a typical POTW can be eliminated or minimized through a number of measures initiated at the treatment plant, often in combination. They can be generally categorized as:

- biological process control
- biological augmentation
- chemical additions
- operations modifications
- physical modifications

The list above is generally in order of increasing implementation difficulty, e.g., biological process control generally requires only minor changes in plant operation while physical modifications can include costly capital improvements.

4.1.1 Biological Process Control

Biological process control is generally limited to activated sludge systems, although some modifications to fixed film processes (e.g., trickling filters, rotating biological contactors) might be considered as a form of biological

process control. An activated sludge system is generally monitored or controlled by utilizing one or more of three process parameters: mean cell residence time (MCRT), mixed liquor suspended solids (MLSS) and food to microorganism ratio (F/M). The biomass and its characteristics are controlled by varying these interrelated process parameters. The following changes to these parameters have been observed to mitigate the effects of industrial pollutants on an activated sludge system:

1. **Increase the Mean Cell Residence Time.** Increasing the MCRT (sludge age) has been shown to have the effect of reducing the inhibitory effects of all forms of toxic industrial contaminants. By increasing the MCRT at the first sign of a possible toxic upset, (by decreasing the solids wasting rate) the inhibitory effect of any toxicant will generally be less than if no action is taken.
2. **Increase the Mixed Liquor Suspended Solids.** High mixed liquor suspended solids (MLSS) concentrations have been shown to offset some of the effects of industrial pollutants. A high MLSS provides the best conditions for biosorption and acclimation to a toxic substrate. Increasing the sludge return rate to the aeration basin at the first indication of toxic upset, while at the same time diverting and storing any remaining toxic influent away from the aeration basins, will lessen the impact of a short term upset and cause quicker biomass acclimation to a long term problem.
3. **Decrease the Food-to-Microorganism Ratio.** This parameter is directly related to both the MCRT and the MLSS. It has been observed that decreasing the F/M causes improved biodegradation of toxic contaminants, and expedites biomass acclimation.

Table 4.1 summarizes these process control steps.

The process control steps described apply to both activated sludge systems treating for carbonaceous removal and nitrifying systems. Generally, the steps described are beneficial for treating any type of interfering pollutant, whether it be a metal, toxic organic or high-strength conventional pollutant.

For a fixed film process, control of the biomass characteristics is not as easily accomplished. However, varying the amount and point of recirculation in a trickling filter can modify the inhibitory effect of industrial pollutants. Recirculating secondary clarifier effluent is a means of achieving the greatest dilution effect, which may be desirable for high-strength organic waste or toxics. Should excessive biomass sloughing be a problem due to toxic pollutants, returning uncontaminated secondary clarifier underflow may help in maintaining a proper biomass population.

4.1.2 Biological Augmentation

Biological augmentation is a method by which selected microorganisms are added to an existing biological population in an attempt to improve some characteristic of the biological system. Conclusive evidence is lacking, but biological augmentation of secondary treatment systems has been reported to improve some industrial pollutant treatment by promoting the specific microorganism populations that successfully degrade particular pollutants. Other enhancements reported include reduced sludge production and increased COD removal rates (Grubbs, 1986). The addition of selected microorganisms to an aeration basin is relatively inexpensive and in the worst case will have no effect on treatment. The EPA, through ongoing experiments at the Wastewater Engineering Research Laboratory in Cincinnati, Ohio, is presently studying the subject in greater depth. Maiden Creek, Pennsylvania employed biological augmentation to improve treatment, however the results of these efforts were clouded due to other modifications made at the same time (see Appendix A). Rotating biological contactors plants have used selected bacteria under substrate-limiting conditions as a control on biomass growth, but with limited success.

After a treatment upset has occurred, biological augmentation by reseeded with viable microorganisms is a useful step in getting a plant up and running quickly. Having commercially packaged microorganisms available and in supply at a treatment facility may help in speeding such a recovery if reseeded from another treatment facility is difficult.

4.1.3 Chemical Addition

The addition of chemicals or nutrients to the wastewater stream in existing treatment steps has been shown in many instances to mitigate the effects of some industrial pollutants. The following are examples of chemicals or additives that have been shown to improve industrial wastestream treatability or biological process stability:

- chlorine
- nutrients
- lime or caustic
- organic polymers
- inorganic coagulants
- powdered activated carbon

Table 4-2 lists these chemicals and additives, the reasons for their use and the resulting effects. The reader is cautioned that the generalizations in the table do not apply to all situations. Some exceptions are pointed out in the text.

Chlorine. Chlorine has been shown to be successful in controlling bulking activated sludge caused by industrial pollutants from such industries as textiles, breweries and wood and paper products. Points of chlorine addition vary, but best results generally occur when chlorine is added to the aeration basin effluent or return activated sludge (RAS). The Horse Creek Plant in North Augusta, South Carolina and the East Side Plant in Oswego, New York are examples of facilities which have successfully employed chlorination to control bulking sludge (see Appendix A).

Nutrients. Phosphorus addition and, to a lesser extent, sulfur and nitrogen addition, occasionally improve biological treatment and sludge settleability of industrial wastewater with high carbonaceous content. In general, better treatment and settleability is attributed to correcting a nutrient deficient condition resulting from a high industrial/domestic wastewater ratio.

pH Adjustment. Lime and caustic are sometimes successful at mitigating the effects of some heavy metals on activated sludge systems. Addition of either before primary treatment has the effect of raising the pH which generally improves precipitation of heavy metals in primary clarifiers. There are exceptions to this generalization, however. For example, it makes a difference whether the pH is being raised from 2 to 6 or from 7 to 11. In this latter case, iron and chromium will go into solution rather than precipitate. Optimum pH ranges exist for metal insolubilities, but these ranges are affected by many factors and are therefore system dependent. Lime can also be used for pH adjustment of an acidic wastewater prior to aeration to provide a more conducive environment for biodegradation.

Coagulants. Polymers and inorganic coagulants such as alum and ferric chloride are introduced to POTW wastestreams in part to help mitigate the effects of industrial pollutants. Added prior to primary treatment, the coagulants improve primary sedimentation and may increase the removal of toxic pollutants before they reach the aeration basins. Added after the aeration basins, the coagulant aids can assist in controlling bulking sludge and reducing effluent suspended solids. Jar testing is an important part of any chemical addition program as the best means of determining optimum dosages. The North Shore Sanitation District in Gurnee, Illinois has utilized coagulants successfully for mitigating the effects of interference (see Appendix A). It should be noted that chemical coagulants affect the characteristics of the sludge and could alter ultimate disposal methods. If added after secondary treatment, they could increase the toxicity of the recycle sludge. Therefore, their use should be carefully evaluated and contamination potential should be investigated.

Activated Carbon. The addition of powdered activated carbon (PAC) to an activated sludge unit has been successful at reducing the inhibitory effect of toxic organic chemicals. By providing adsorption sites, the organic pollutants not biodegraded are removed by the activated carbon. The activated carbon also improves sludge settleability by providing dense floc nuclei. A patented process (PACT, licensed and sold by Zimpro, Inc) exists employing this treatment concept at full scale. However, even a slug addition of PAC to an aeration basin known to contain toxics can significantly reduce the effects of the toxics on the biomass.

4.1.4 Operations Modification

Activated Sludge Alternatives. A further means of mitigating the effects of industrial pollutants on POTWs is through modifying the operation of existing treatment steps. Activated sludge systems are often designed to operate in several different "modes" (e.g., step aeration, contact stabilization, etc.) by providing the appropriate physical layout. Some modes of operation have been shown to be more successful than others at mitigating the effects of industrial

contaminants, particularly those dosed in highly variable concentrations. It has been shown at the laboratory and plant-scale that extended aeration and step aeration (step feed) are generally more resistant to upset than complete mix and conventional activated sludge (see East Side Plant, Oswego, New York, Appendix A). It appears that complete mix generally provides more consistent treatment, particularly under shock loading conditions, than conventional plug flow treatment. The contact stabilization mode is generally less successful at treating industrial pollutants than other modes, particularly when the organic matter is predominantly soluble and waste strength fluctuations are common.

Staged Treatment. A successful means of mitigating the effects of industrial contaminants on any biological treatment process is through the use of staged treatment. Many treatment systems have realized improved conventional and industrial pollutant removal when switching from parallel treatment to series treatment. For example, two aeration basins operating in series are generally more successful at mitigating the effects of industrial contaminants than the same two basins operating in parallel. The same principles have been observed to apply equally to fixed film processes and fixed film/suspended growth combinations.

Excess Biomass. A typical response of a fixed film process to some industrial waste stressing is excess biomass growth, resulting in clogged media and reduced treatment efficiency. Should this be a problem, treatment is generally improved if the biomass population (thickness) can be reduced. By increasing or altering shearing forces, biomass sloughing increases. This can be accomplished by altering the direction of flow through RBCs and submerged fixed film basins, or by increasing or altering the aeration pattern (if any) in the basins. A second means of inducing increased biomass sloughing is through chemical addition, but this approach is potentially harmful to the biomass and should only be attempted under the guidance of professionals skilled in the use of such chemicals.

4.1.5 Physical Modification

The most permanent type of industrial pollutant mitigation effort that can be undertaken at the POTW itself comes in the form of physical addition to or modification of the treatment system. Successful modification of treatment plants for industrial waste effects mitigation have included the addition of new plant facilities such as flow equalization and physical/chemical treatment steps, the addition of facilities for adding chemicals (as previously discussed) to existing treatment processes, and the modification of existing biological systems (i.e. converting to oxygen activated sludge or replacing rock trickling filter media with plastic media).

Flow Equalization. Adding flow equalization prior to biological treatment units has the effect of dampening any slug or diurnal loads of noncompatible or high-strength industrial contaminants entering a treatment plant. Pollutants that intermittently enter a POTW in inhibitory concentrations can be diluted by flow equalization to noninhibitory levels and thus, not adversely impact the *biological* system. Maiden Creek, Pennsylvania provides a dramatic example of the effects of non-equalized industrial flows (see Figure A-4). In this particular case, hydraulic shocks were accompanied by organic shocks that resulted in

solids carryover, reduced BOD removal efficiency and sometimes total biological process failure.

Instrumentation/Control. Some POTWs use a variation of the flow equalization principle with success, especially when toxic metal pollutants are involved. pH and conductivity of the influent wastewater is measured and recorded continuously in the influent. When the pH drops or conductivity rises drastically, possibly indicating an increased heavy metal level, the influent flow is diverted to a holding basin until such time that the pH and conductivity in the influent return to normal. At that time, the diverted wastewater can be bled back to the influent wastestream in a manner such that metal concentrations are diluted and do not inhibit the biological system. This type of technique may become more useful in the future as continuously recording specific ion electrodes are developed for more pollutants.

An example of similar control steps is Chicago Heights, IL. Officials there were alerted to a pesticide spill that entered the sewer system. Operators were able to isolate the incoming spill to some parallel primary clarifiers, activated sludge and aerobic digester tanks where the toxic materials were subsequently treated chemically and biologically (Busch, 1986). Passaic Valley, New Jersey and Newark, Ohio employ similar procedures when necessary (see Appendix A).

Special Treatment Operations. Other treatment steps that might be added depend on the interfering industrial pollutants. The addition of flotation/skimming tanks is beneficial for removing pollutants like oils, greases or other water-immiscible compounds. Separate settling basins may be beneficial in some cases for chemical treatment to precipitate metals or cause coagulation of unsettlable solids.

Pure Oxygen Activated Sludge. Another type of treatment plant modification that has experienced some mitigation success is the replacement of an existing air activated sludge unit with oxygen activated sludge. Pure oxygen activated sludge has been reported by U.S. EPA (1981c) to be a more biologically stable process with improved sludge settleability over conventional air facilities when responding to toxic or high-strength organic loadings. However, a disadvantage with a covered oxygen system is that volatile organics can build up to potentially explosive levels inside the covers. Baltimore, Maryland and Passaic Valley, New Jersey have both experienced problems of this type.

Oxygen Transfer. Increasing the efficiency of oxygen transfer in aeration basins will help mitigate the effects of high-strength conventional pollutants. Retrofitting existing coarse bubble or turbine aeration units with fine bubble units may provide additional treatment capacity for a high-strength waste (see Newark, Ohio and Maiden Creek, Pennsylvania in Appendix A). However, maintaining oxygen levels above 2-3 mg/l has not been shown to consistently result in a better treatment of conventional or organic pollutants.

4.1.6 Summary

Table 4-3 summarizes the available measures that may be employed at a treatment plant to mitigate interference effects.

4.2 PRETREATMENT AND SOURCE CONTROL

Pretreatment and source control of interfering industrial pollutants is the most direct and efficient way of mitigating the effects of industrial pollutants because the cause of the interference never reaches the POTW. This reasoning was the impetus for the General Pretreatment Regulations which specify the guidelines under which municipalities must develop pretreatment programs. It is not the intent of this guidance manual to discuss pretreatment guidelines, complete program development or details of industrial treatment processes. Rather, this discussion is intended to document elements important to bringing about pollutant source control, whether as part of a municipal/industrial cooperative agreement or a fully approved pretreatment program.

4.2.1 Local Limits

Setting local industrial discharge limits is one of the best and most direct ways of mitigating any industrial interference that may exist at a POTW. Federal Categorical Pretreatment Standards must be applied by POTWs with federally-approved pretreatment programs, but this does not guarantee interference prevention because of the uniqueness of POTWs and the waste they treat. In addition, noncategorical industries are not regulated by such federal standards. Setting rational, technically-based local limits in a fair and equitable manner is a sound approach to preventing interference. The General Pretreatment Regulations (40 CFR Part 403.5(c)) require POTWs with federally-required pretreatment programs and other POTWs which experience pass-through or interference to establish local limits. Details on the development of local discharge limits are contained in the "Guidance Manual for POTW Pretreatment Program Development" (U.S. EPA, 1983). In addition, a computer program/model for helping municipalities develop local limits has been developed (U.S. EPA, 1985a) and is available from the EPA Office of Water Enforcement and Permits.

4.2.2 Accidental Spill Prevention

It is in the best interests of any municipality to consider developing an accidental spill prevention program (ASPP). The purpose of an ASPP is to provide "...a set of procedures and a regulatory structure that will minimize the chance that accidental spills of toxic materials will damage a municipality's collection system or treatment plant" (U.S. EPA, 1986b). The principal elements of an effective municipal ASPP are:

- identification of potential sources and types of spill materials
- adequate regulatory control
- POTW review of industrial user spill prevention programs
- complete emergency response procedures
- documentation of the development strategy

Spill materials would include all sources and types identified for industrial *pretreatment*, but would also include apparently insignificant users who have the potential for spillage into floor drains connected to a POTW. Facilities such as chemical warehouses, radiator shops, etc., which are supposedly "dry" or usually recycle all harmful wastes, could have an accident that would impact a POTW.

A POTW should require industrial users to develop their own in-house ASPP and the program should be reviewed for thoroughness and effectiveness by the POTW. Industrial user ASPPs, as well as the overall ASPP should include complete emergency response procedures by all involved parties. These procedures must be outlined in enough detail to be effective and all the appropriate personnel must be adequately familiar with the necessary emergency steps.

Finally, the development of the ASPP must be well documented so that as time passes and modifications become necessary, a written record of the program development will be available for consultation. This record should prevent needless rethinking of old ideas.

An active spill prevention program with a high degree of visibility can have a positive impact on reducing unauthorized discharges of industrial wastes. Figure 4-1 outlines the fundamental procedures in the development of an ASPP.

4.2.3 Pretreatment Facilities

There exists a wide variety of treatment processes applicable to industrial pretreatment, depending on the wastestream pollutants, the volume of the wastestream and the extent to which the waste must be treated. The application of specific treatment streams is not addressed by this document. However, many typical municipal treatment processes can be applied to some industrial wastestreams. There are many other types of treatment processes, usually physical/chemical, applicable to pretreatment applications.

In many cases where industries have been required to pretreat wastes, it has been found that wastewater flow equalization, pH neutralization or conservation and recycle/reuse have been all that are necessary to meet discharge limits and eliminate interferences. Process modifications or wastestream recovery processes (such as for metals) have in some cases ended up saving industries money in addition to reducing pollutant loads. These aspects of pretreatment should be emphasized in discussions with industries. The Horse Creek facility in North Augusta, South Carolina, experienced significant operational improvement from relatively small industrial operation changes (see Appendix A). Modifications such as discharging sump water from the surface rather than the drain and equalizing pumping schedules, so as to minimize hydraulic peaks were typical of successful adjustments.

4.2.4 Regulation of Waste Haulers

POTWs that accept discharges of hauled waste should establish procedures to control the wastes so as to ensure that they are compatible with the treatment process. A waste hauler permit or "manifest" system is an effective method of regulation. Use of such a system to document the origin, transportation, and disposal of the waste, along with a source control program (permitting, sampling and inspecting the generator) and pre-discharge sampling, will provide a high degree of control over incoming wastes. Figure 4-2 presents an overview of the procedures of a waste hauler permit system.

POTWs may choose to restrict the discharge of hauled waste either to a designated point in the collection system or to the plant itself. These restrictions may be implemented through a permit or license. Larger POTWs that can handle the slug load from a hauler, may grant access to the headworks.

In other cases, where storage or equalization capacity is available, hauled waste may be discharged to equalization or holding tanks, where it can be characterized prior to introduction to the system. Sioux City, Iowa has developed a successful method to regulate the impact of waste hauler discharges (see Appendix A). A large holding receptacle is utilized for all wastes and the contents are metered to the treatment plant in controlled dosages, so as to prevent any upsets from high strength waste.

If hauled waste discharges are restricted to a single site, the POTW can easily inspect and sample the waste, verify tracking records, supervise the discharge of the waste, and prohibit the discharge of wastes that would be incompatible with the POTW. Such supervision will also discourage illegal discharges. Monitoring of a collection system discharge point is more difficult than monitoring a headworks discharge point. However, dilution of the waste is achieved when discharged at a remote location in the collection system.

Waste generators may be regulated by permits specifying conditions such as self-monitoring requirements, local limitations, categorical standards, specific prohibitions, etc., which must be met before allowing discharge. Procedures to control generators of hauled wastes should be similar to those employed for generators of fixed discharges, since both are covered by the General Pretreatment Regulations (40 CFR Part 403). The POTW may inspect the generator's facility and sample the wastes for pollutants of concern to the POTW, as well as determine if any other wastes have the potential for being mixed with the wastes that are to be hauled. Based on inspection results, the POTW may sample for those pollutants which should be limited before discharge is allowed.

If the POTW monitors the waste prior to discharge, one sample of the waste may be analyzed for a single indicator parameter and a second sample preserved in case any problems occur after introduction to the POTW. While this might subject the POTW to unknown pollutants, it would save the cost of analyzing each load extensively. In the case of manifest discrepancies, or where the sample failed the indicator parameter test, or where an interference resulted, more comprehensive testing could occur.

A waste hauler permitting and monitoring program should serve as a deterrent to haulers against discharging illegal or harmful wastes. If deterrence alone is unsuccessful, such a program could trigger enforcement action such as fines, refusal of wastes, permit revocation, or assignment of liability for damages.

4.2.5 Planning for Future Sources

To prevent the likelihood of future interferences developing, POTW officials must plan for future sources of industrial pollutants. Future pollutant loadings should be considered from two sources: new industries, and new pollutant streams of existing industries. Planning for future sources is particularly

important as it relates to local limits development. Future pollutant sources and quantities must be considered in setting local limits, so that a treatment facility is able to handle increased pollutant loadings adequately.

4.3 LEGAL AND ENFORCEMENT REMEDIES

Interference is costly to POTWs in terms of worker safety, physical plant integrity, effectiveness of operation, and liability for NPDES permit violations. Interference is also a violation of a federal prohibition applicable directly to industrial users. POTWs are required to establish local limits as necessary to prevent interference and to take appropriate enforcement actions against violators.

In order to prevent and quickly remedy interference, the POTW must be ready to exercise its authority to take effective enforcement and legal actions. These actions should be clearly defined and readily understood by all parties involved. The range of enforcement mechanisms available to the POTW will depend on the legal authorities given to it by the municipality, county, and state. Wastewater treatment personnel who have not had extensive experience with enforcement and legal proceedings in the past should consult with the POTW's attorney, city solicitor, or comparable city official to determine what options are available. POTWs which have federally-approved or state-approved pretreatment programs should consult their program submission documents regarding legal authority and enforcement procedures.

EPA has recently distributed a comprehensive guidance document for POTWs titled Pretreatment Compliance Monitoring and Enforcement (PCME) Guidance (EPA, 1986c). It provides detailed discussions on compliance monitoring, establishing enforcement priorities, and conducting enforcement actions. The PCME guidance should be examined by POTW personnel for the development or review of their enforcement response procedures. POTWs are encouraged to develop an enforcement response guide containing procedures which will define, in a nonsubjective way, the type of enforcement response that can be expected for a particular kind or level of violation.

Enforcement actions for POTW interference or industrial discharge noncompliance are typically spelled out in the local sewer use ordinance, permits or contracts with industrial users, or an approved pretreatment program. In addition, the enforcement procedures can be described in the POTW's enforcement response guide or their NPDES permit. It is important that the enforcement options be strong enough to provide a real deterrent to the regulated industries. This requires that adequate manpower and documentation exist to pursue enforcement actions. Documentation will primarily consist of industrial waste monitoring as discussed elsewhere in this manual. An in-depth evaluation of all documentation concerning monitoring results, methods, and techniques, as well as quality assurance procedures should be part of the preparation for enforcement proceedings.

In interference situations in which there is imminent endangerment to human health, the environment, or the POTW, it is important that the POTW have the ability to immediately notify the discharger and bring about a halt to the

discharge. POTWs with approved pretreatment programs are required to have this authority by the General Pretreatment Regulations (40 CFR 403.8 (f)(vi)(B)). In situations in which there is no threat of immediate harm, enforcement steps usually begin with noncompliance warnings, meetings and other informal actions. Should these measures prove inadequate, other more stringent measures should be taken. These commonly include:

- penalties
- orders and compliance schedules
- litigation
- sewer disconnection and permit revocation

Bayshore Regional Sewerage Authority (Union Beach, New Jersey) and METRO-Seattle, Washington are examples of POTWs which have shown aggressive enforcement efforts (see Appendix A). These POTWs have not hesitated to levy fines and take other enforcement actions after documenting the source of interference problems.

Both formal and informal actions are important parts of an effective enforcement program. Informal actions are likely to be more successful if the POTW has developed a cooperative relationship with its industrial users. Virginia's Hampton Roads Sanitation District provides a good example of the advantages of developing and maintaining a good working and monitoring relationship between an authority and the industrial user community. Once the interfering source is located, the District technicians, along with a supervisor, directly contact the industry to notify them of the problem and see to it that the discharge ceases. The District approaches the source of any interference in a cooperative manner, with ample documentation in hand. The source is normally willing to rectify the problems and agreement on administrative and other measures is reached informally, without the need to resort to legal remedies. If a clean-up is warranted, the responsible industrial user contracts for the necessary work to be done, with District personnel overseeing the operation until completion. All costs involved with the investigation, clean-up and any other District expenditures as a result of the upset are then billed to the industrial source.

4.3.1 Penalties

After compliance warnings and efforts to encourage industrial pretreatment have failed, the enforcement option most commonly initiated is the use of penalties. The amount of a penalty is generally limited through state or municipal laws. EPA's "Guidance Manual for POTW Pretreatment Program Development" (October, 1983) recommended that POTWs have the ability to assess penalties of at least \$300 per day of violation to act as a sufficient deterrent. However, this limit may be inadequate for discharges which interfere with the POTW. Appropriate action may involve seeking the assistance of the state or EPA for obtaining penalties under state or federal law, which may be substantially greater (up to \$100,000 per day and 6 years in jail for a repeat knowing criminal violation). Penalties may be used in conjunction with billing procedures for minor violations which may be detected during inspections or compliance review of self-monitoring data. Such penalties should appear as a

separate item on a bill with the violation identified. The amount of the penalty imposed will usually depend upon the nature and severity of the interference caused or the quantity of the interfering pollutant.

Surcharges are not penalties, but rather recover the POTW's cost of treating industrial wastewaters. Payment of surcharges is not a justification for an IU to violate pretreatment standards or cause interference. POTWs should make it clear to their industrial users, as part of the IU permit or contractual agreement, that IUs may be subject to both surcharges for the additional treatment costs, as well as substantial penalties for causing interference.

4.3.2 Orders and Compliance Schedules

In order to force an industrial user to install acceptable pretreatment equipment, some POTWs may issue administrative orders to place an industrial user on an enforceable compliance schedule to meet pretreatment standards. Additionally, orders are sometimes used to require increased monitoring or installation of slug notification systems.

The Hampton Roads Sanitation District, for example, may modify an industry's discharge permit to reflect increased monitoring for a period of time to show compliance. Also, a compliance schedule from the industry is required to show what steps are taken to prevent recurrence. Depending on the severity of the problem, the District may require the industry to permanently install some type of alarm system and/or automatic shut-off.

4.3.3 Litigation

POTW-initiated litigation can be used as a further attempt to cause compliance after earlier measures have failed to bring about the desired result. In many cases, litigation is a way of obtaining an injunction against the discharger to cease the discharge or to clean it up, or to obtain a sewer disconnection or the payment of substantial penalties which go beyond routine fines. Litigation also serves to bring media attention and public pressure to bear when pressure from a sewer authority has failed. For example, the City of Canandaigua, New York obtained an out-of-court settlement dictating a compliance schedule for a user following the City's initiation of court action. The user was required to expand its pretreatment facility and the City's POTW operation was then able to meet its NPDES permit.

In some cases, litigation has been initiated to collect unpaid fines, which may amount to sizeable sums. New Jersey's Bayshore Regional Sewerage Authority found adverse publicity to have little effect on a major industrial employer, and was forced to initiate legal action in an attempt to recover \$1.25 million in back surcharge payments and costs.

4.3.4 Sewer Disconnection or Permit Revocation

Sewer disconnection or permit revocation is used by many POTWs under serious circumstances such as when there is imminent endangerment to public health, the environment or the POTW, or when other methods to obtain compliance have failed.

A local ordinance can provide this authority by allowing the POTW to issue a suspension order and by requiring the discharger to immediately halt discharging upon notification. Furthermore, the ordinance can allow the POTW to sever the sewer connection if the industry does not respond.

Frequently, unless there is an immediate threat to human health, an administrative hearing of some type is held before discontinuing service. The industrial user is invited to appear before a local hearing board, presented with the facts demonstrating noncompliance, and asked to show cause why service should not be discontinued. The board then decides whether to pursue disconnection.

Recently in New Jersey, the Hamilton Township Wastewater Treatment Plant required an industrial user to install flow equalization equipment. However, deterioration in effluent quality continued, leading to termination of sewer service. In Pennsylvania, the Maiden Creek Wastewater Treatment Plant discontinued service to a user when the discharge from the facility caused a total process failure. Any future failure to comply with municipal requirements for flow equalization and monitoring, BOD reduction, and sampling will subject the user to another shut-off. The Bayshore, New Jersey Regional Sewerage Authority's policy is to notify recalcitrant industries of a violation, with subsequent discontinuation of service if noncompliance extends beyond 15 days.

At Hampton Roads in Virginia, if a problem represents an imminent hazard to the public health, safety or welfare, or to the local environment or to any portion of the sewerage system, the District may suspend a permit for a period of up to 60 days. Failure to immediately cease discharge of all industrial wastewater into the sewerage system may also result in termination of water and/or wastewater service. If cooperation is not received from the user, then the District may revoke the industrial user's permit.

TABLE 4-1
BIOLOGICAL PROCESS CONTROL STEPS

Operating Parameter	Control Objective	Method of Implementation	Result
Mean Cell Residence Time (MCRT) also known as Sludge Age and Solids Retention Time (SRT)	Increase	Decrease solids wasting rate	Quicker acclimation to toxic pollutants Better able to accommodate fluctuating conventional pollutant loads
Mixed Liquor Suspended Solids (MLSS)	Increase	Increase solids return rate	Better biosorption and acclimation
Food-to-Microorganism Ratio (F/M)	Decrease	Increase solids return rate	Improved toxic pollutant biodegradation and acclimation

Source: U.S. EPA, 1986a

TABLE 4-2
CHEMICAL ADDITIONS

Additive	Reason for Addition	Pollutant(s) Causing Problem	Result	Point of Addition
Chlorine	Reduce bulking	Various, particularly textile and wood products wastewater	Kills filamentous organisms	Varies, but RAS & aeration basin effluent common
Phosphorus Nitrogen and Sulfur	Improve biological treatment and reduce bulking sludge	High carbonaceous strength waste	Corrects nutrient deficient condition	Before aeration basin
Lime or Caustic	Reduce biological inhibition	Heavy Metals	Raises pH causing metals to precipitate	Before primary clarifier
Polymers or Coagulants	Improve sedimentation	Various	Removes toxics and improves sedimentation	Before primary or secondary clarifier
Powdered Activated Carbon	Reduce biological inhibition	Toxic organics	Adsorbs organic pollutants	To aeration basin

Note: The generalizations in this table do not apply in all situations. The text should be consulted.
Source: James M. Montgomery, Consulting Engineers, Inc.

TABLE 4-3
TREATMENT PLANT CONTROL MEASURES

Process	Biological Process Control	Biological Augmentation	Chemical Addition	Operations Modification	Physical Modification
Primary Clarification			•		•
Activated Sludge	•	•	•	•	•
Trickling Filters	•		•	•	•
Lagoons		•	•	•	•
Rotating Biological Contactors (RBC)		•	•	•	•

Source: James M. Montgomery, Consulting Engineers, Inc.

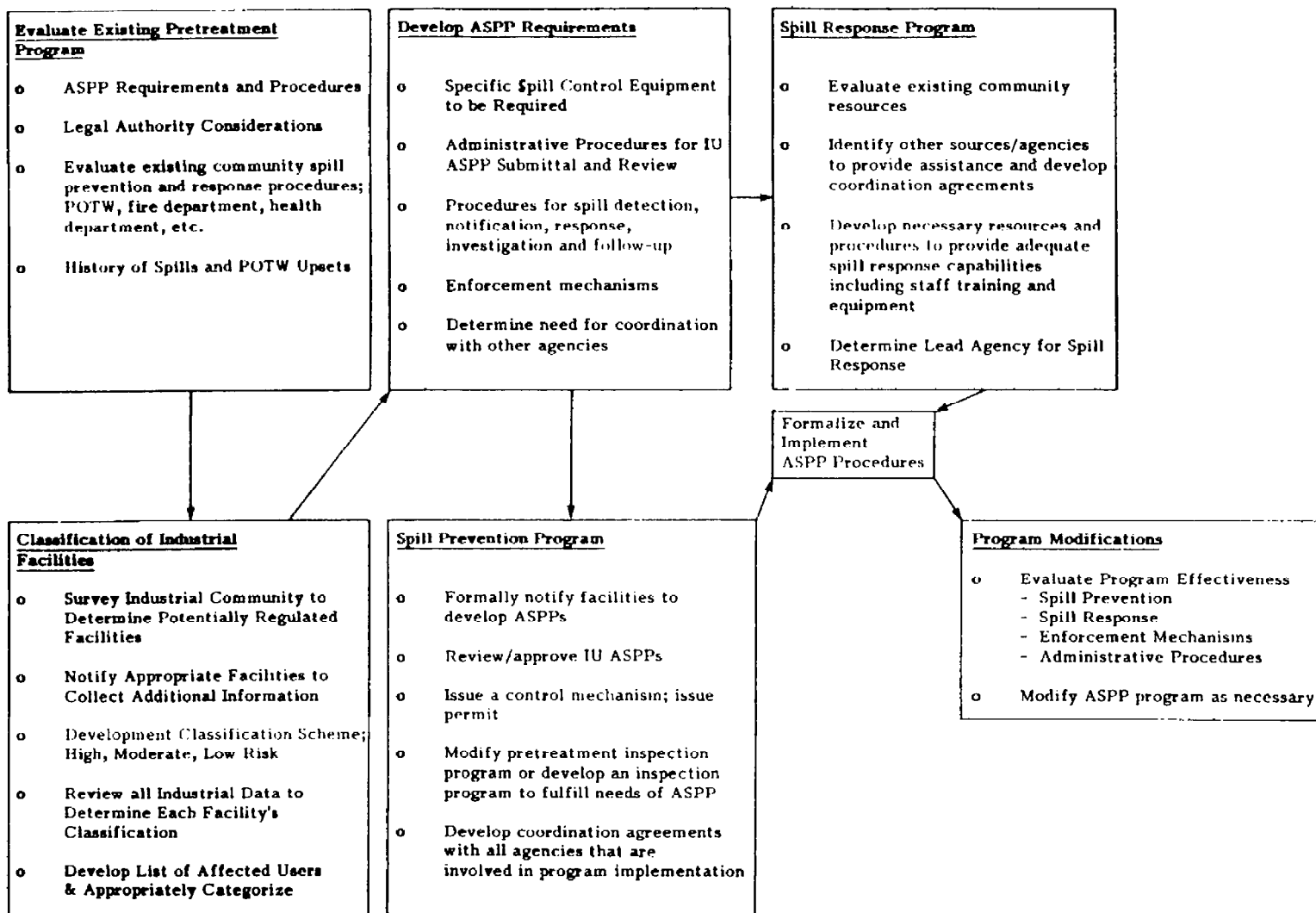

FIGURE 4-1
FUNDAMENTAL PROCEDURES FOR POTW ACCIDENTAL SPILL PREVENTION PLAN (ASPP) DEVELOPMENT
 (U.S. EPA, 1986b)

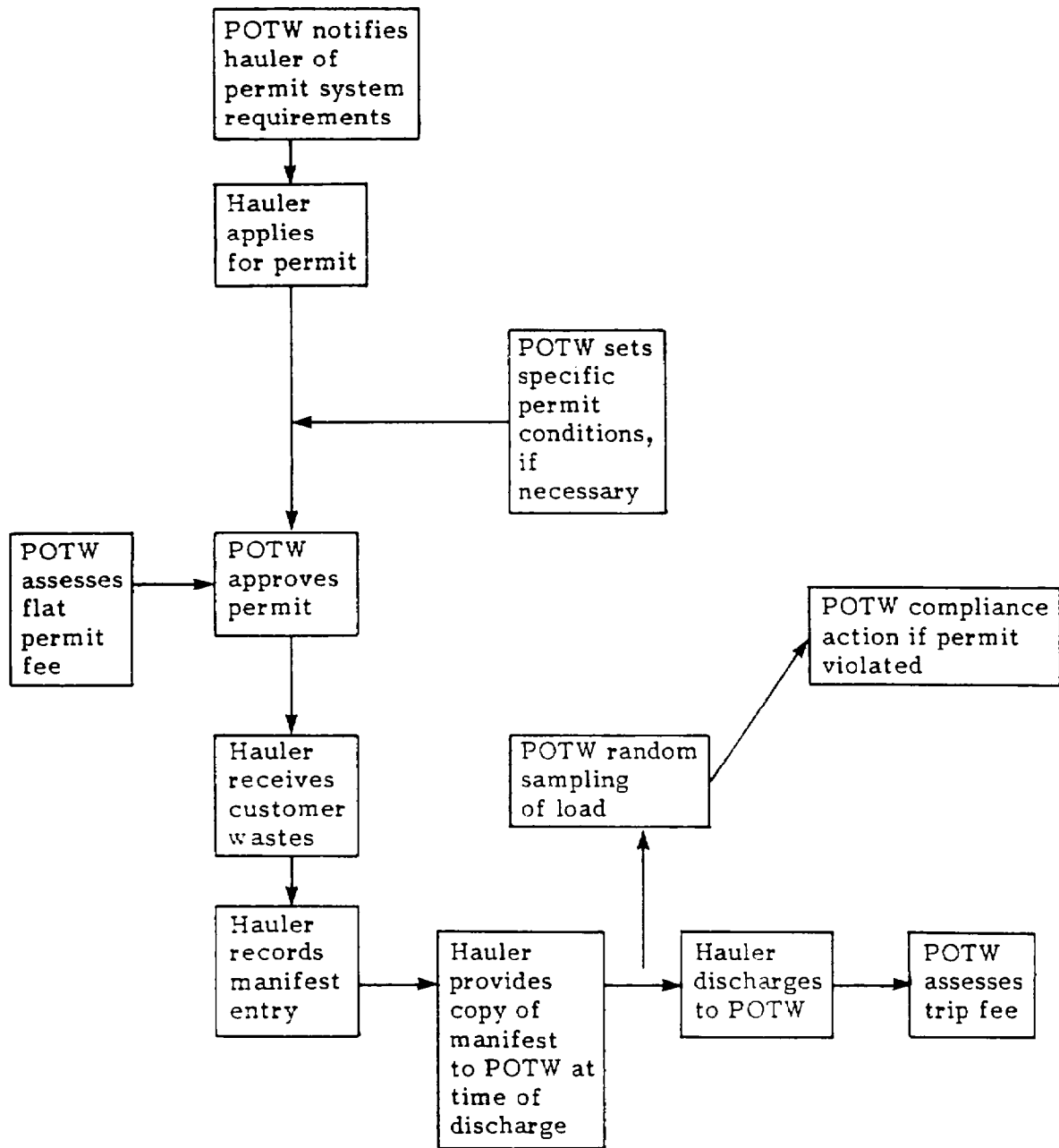

FIGURE 4-2

PROCEDURES OF A WASTE HAULER PERMIT PROGRAM
(U.S. EPA, 1985a)

REFERENCES

Busch, W.H. (1986) "Protecting Your Plant From Hazardous Waste." Operations Forum, WPCF, April Issue. 11-15.

Geating, J. (1981) "Literature Study of the Biodegradability of Chemicals in Water (Vols. 1 and 2)" U.S. EPA, Cincinnati, Ohio. 241 pp.

Grubbs, R.B. (1986) "Biotechnology Proves Good Examples." Pollution Engineering, June, 1986.

Russell, L.L., Cain, C.B. and Jenkins, D.I. (1983) "Impact of Priority Pollutants on Publicly Owned Treatment Works Processes: A Literature Review." Proc. 37th Ind. Waste Conf. Ann Arbor Publishing, Ann Arbor, Michigan. 871-883.

Silva, S.J. (1981) "EPA Moving to Control Industrial Toxic Pollutants with New NPDES Permits." Civil Engr. 51:76.

Slattery, G.H. (1986) "Patapsco Wastewater Treatment Plant Standard Operating Procedure: Routine Operation of Wastewater Respirometer", Baltimore, Maryland.

U.S. EPA (1977a) "Process Control Manual for Aerobic Biological Wastewater Treatment Facilities." Prepared by Tsugita, R.A., De Coite, D.C.W. and Russell, L.L. for U.S. EPA, Washington, DC.

U.S. EPA (1977b) "Federal Guidelines - State and Local Pretreatment Programs." U.S. EPA, Municipal Construction Division MCD-43, EPA-430/9-76-017a, Washington, D.C. 3 volumes.

U.S. EPA (1978) "Field Manual for Performance Evaluation and Troubleshooting at Municipal Wastewater Treatment Facilities." EPA-430-9-78-001. Prepared by Culp, G.L. and Heim, N.F. for U.S. EPA, Washington, DC. 387 pp.

U.S. EPA (1979) "Biodegradation and Treatability of Specific Pollutants." EPA-600/9-79-034. Prepared by Barth, E. F., and Bunch, R. L. for U.S. EPA, Cincinnati, Ohio. 60 pp.

U.S. EPA (1981a) "304(g) Guidance Document: Revised Pretreatment Guidelines (Vols. I and II)." Internal Report. Prepared by JRB Associates for U.S. EPA, Cincinnati, Ohio.

U.S. EPA (1981b) "Assessment of the Impacts of Industrial Discharges on Publicly Owned Treatment Works." Report submitted to the Office of Water Enforcement, U.S. EPA, Washington, D.C. by JRB Associates.

U.S. EPA (1981c) "Parallel Evaluation of Air and Oxygen-Activated Sludge." EPA-600/2-81-155. Prepared by Austin, S., Yunt, F. and Wuerdeman, D., for U.S. EPA, Cincinnati, Ohio, 43 pp.

U.S. EPA (1983) "Guidance Manual for POTW Pretreatment Program Development." U.S. EPA, Office of Water Enforcement and Permits, Washington, DC.

U.S. EPA (1984) "Improving POTW Performance Using the Composite Correction Program Approach." U.S. EPA, Center for Environmental Research EPA-625/6-84-008, Cincinnati, Ohio. 258 pp.

U.S. EPA (1985a) "PRELIM: The EPA Computer Program/Model for Developing Local Limits - User's Guide." Prepared by SAIC/JRB Associates for U.S. EPA, Office of Water Enforcement and Permits, Washington, DC.

U.S. EPA (1985b) "Pretreatment Implementation Review Task Force: Final Report to the Administrator." U.S. EPA, Washington, DC. 75 pp.

U.S. EPA (1985c) "RCRA Information on Hazardous Wastes for Publicly Owned Treatment Works." U.S. EPA, Office of Water Enforcement and Permits, Washington, D.C.

U.S. EPA (1986a) "Interferences at Publicly Owned Treatment Works (POTWs)." Submitted to U.S. EPA-WERL, Cincinnati, Ohio by James M. Montgomery, Consulting Engineers, Inc.

U.S. EPA, Region X (1986b) "Guidance Manual for the Development of an Accidental Spill Prevention Program." Prepared by Science Applications International Corp. for U.S. EPA, Region X, Seattle, Washington.

U.S. EPA (1986c) "Pretreatment Compliance Monitoring and Enforcement Guidance" U.S. EPA, Office of Water Enforcement and Permits, Washington, DC.

WPCF (1982) "Industrial Wastewater Control Program for Municipal Agencies." MOP OM-4, WPCF, Washington, DC. 166 pp.

**APPENDIX A
CASE STUDIES**

TABLE A-1
CASE STUDY SUMMARY TABLE

Treatment Facility	Contact Person	Nature of Interference Episode	How Detected	Causative Pollutant(s)	Method of Industrial Identification	Mitigation Step
Back River, Baltimore, MD	Bob Moore Plant Manager (301) 288-6900	Restricted Sludge disposal	Lab analysis	Various metals		Implemented pre-treatment program
		Sewer system Explosion hazard	Visual and sensory observation	Various solvents	Monitoring	Required industry to improve in-house solvent recovery
Patapsco, Baltimore, MD	Gerald Slattery Plant Manager (301) 354-2700	Inhibition permit violations	Respirometry, operating difficulties	Insecticides, solvents, petroleum compounds	Respirometry, chemical analysis	Decrease F/M ratio, develop tracking program
Bayshore, Union Beach, NJ	David Knowles Manager (201) 739-1095	Organic overload - permit violations	Lab analysis	BOD, COD, SS	Only major industry	Enforcement of discharge limits - fines
East Side, Oswego, NY	John McGrath Lab Supervisor (315) 342-3777	Suspended solids overload - permit violation	Visual examination Lab analysis	SS, BOD	Only major industry	Treatment plant operations modifications, industrial discharge permit
Hamilton Township, Trenton, NJ	Thomas Andersen Assistant Superintendent (609) 890-3540	Upset conditions - permit violations	Lab analysis	BOD, SS, Volatile Organics	Industrial community	Industrial flow metering, disconnection
Horse Creek North Augusta, SC	Stanley Wagher Manager (803) 278-1911	Biomass inhibition bulking sludge	Visual observation Lab analysis	Alkalinity, pH SS	Industrial monitoring	Implement pre-treatment program

TABLE A-1
CASE STUDY SUMMARY TABLE (CONTINUED)

Treatment Facility	Contact Person	Nature of Interference Episode	How Detected	Causative Pollutant(s)	Method of Industrial Identification	Mitigation Step
Maiden Creek, Blandon, PA	Edward Glausman Superintendent (215) 926-4140	Treatment upset due to shock loading - permit violations	Visual observation Lab analysis	BOD, SS, NH ₃	Only major industry	Treatment plant operational modifications, industrial pretreatment Implemented pre-treatment program
METRO-West Point, Seattle, WA	Douglas Hilderbrand Industrial Waste Supervisor (206) 447-6743	N/A	Lab analysis	Various metals		Implemented pre-treatment program
Neuse River, Raleigh, NC	Leon Holt Pretreatment Coordinator (919) 779-2010	Sludge contamination	Lab analysis	Various metals	Largest industry	Issue industrial discharge permit
Newark, OH	Roger Loomis Assistant Superintendent (614) 345-0549	Treatment upset due to shock loadings - permit violations	Observation Lab analysis	Phenols, ammonia Formaldehyde	Major industry, industrial monitoring	Industrial pre-treatment improvements
North Shore, Gurnee, IL	Frederic Winter Director of Laboratory Services (312) 623-6060	Nitrification inhibition, process upsets	Observation Lab analysis Bioassay	Antibiotics	Industrial monitoring	Treatment plant operations modifications. Upgrade sewer ordinance
Passaic Valley, Newark, NJ	Frank D'Ascensio Manager Industrial and Pollution Control (201) 344-1800	Treatment upset - permit violation	Lab analysis	SS, Volatile organics, metals	Industrial monitoring	Implementing pre-treatment program
Sioux City, IA	A.V. Flores Project Manager (712) 279-6169	Treatment upset due to shock loadings - sludge contamination	Lab analysis	Zinc	Industrial monitoring	Treatment plant operations modifications
Toileson, AZ	Sterling Dillow Manager (602) 936-3381	Treatment upset	Visual observation Lab analysis	BOD, SS	Only major industry	Industry-POTW contract

BACK RIVER WASTEWATER TREATMENT PLANT Baltimore, Maryland

The City of Baltimore owns and operates two wastewater treatment facilities, Back River and Patapsco, with a combined flow rate of approximately 250 million gallons per day. The plants serve a combined population of nearly 1.7 million in an area which includes approximately 4,700 sources or potential sources of nondomestic wastewater. In accordance with the requirements of the General Pretreatment Regulations (40 CFR Part 403) established by the U.S. EPA, the City developed an extensive industrial waste control program requiring a significant commitment in terms of personnel, equipment, office space, and supplies.

The Back River facility is currently undergoing a major renovation to replace the 30 acres of trickling filter rock media with complete-mix activated sludge, along with significant alteration and expansion of most process units. The renovation work is in preparation for new NPDES permit limits of 10/10 (BOD and TSS) and 2 mg/l (NH₃), which will require extensive modification of the system for nitrification and multi-media filtration. Industrial flows to Back River total approximately 27 mgd, resulting in metals and solvents in the discharge.

The primary source of metals in the system is from the 12 metal plating operations identified by the industrial waste survey. If too high, the metals content in the wastewater restricts the ultimate disposal options for the digested and dewatered sludge. When local limits were calculated based on unrestricted distribution of the sludge, the limits were occasionally one-fourth of the electroplating categorical standards. A compost facility now under construction is expected to process 150 wet tons of the 450 tons produced each day, beginning in March 1987.

The benefits of pretreatment for metals removal have been demonstrated at Back River. An incinerator had been discharging 2 tons of fly ash per hour into the collection system, which was high in metal content and was responsible for 90 percent of the cadmium in the POTW influent. Other wastewater containing metals were from steel and automobile manufacturing. In each case, industrial user pretreatment facilities have come on-line during the past year, with a measureable drop in influent and sludge concentrations. A summary of the improved metal content of the sludge from 1984 to 1986 is provided on Table A-2. Based on the current metal content, the composted sludge will be acceptable for agricultural use.

The second major area of concern at the Back River plant stems from the large, batch discharges of solvents, petroleum hydrocarbons and other toxic organics. In 1985, a 2:00 am discharge of ethyl benzene, xylene and toluene resulted in the evacuation of the largest pump station and other buildings in town. The problem was traced to a paint and chemicals manufacturer, which has since improved its in-house solvent recovery system. A similar evacuation resulted from a 4,000 gallon discharge of xylene by a waste hauler, which was traced to a

specific location in the collection system. Tetrachloroethylene has been discovered and traced to dry cleaning operations. While such discharges have not usually resulted in interference with the plant's ability to meet its NPDES permit limits, the health and safety issues and potential for explosion are of serious concern to the City.

TABLE A-2
AVERAGE METAL CONTENT OF
BACK RIVER SLUDGE
(mg/kg dry weight basis)

Metal	Allowable¹	1984	1986	% Reduction
Cr (total)	NA	1,491	273	82
Cu	1960	1,001	549	45
Pb	730	372	388	-4
Ni	575	266	67	75
Zn	5,130	2,747	1,522	45
Cd	48	26	17	35
Hg	12	5	3	40

¹ From Compost Contract Schedule 2, City of Baltimore, MD

An interesting aspect of Baltimore's program for preventing interference and sewer system hazards is the computer coding of the sewer collection system. By knowing the constituents of each industry's discharge, the flow rate and their location in the coded sewer system, a contaminant discovered at either Back River or Patapsco can theoretically be traced back to its potential source or sources. While such a backtracking program is of limited use for isolated discharges, it could prove beneficial in locating chronic dischargers of specific compounds.

In order to further protect the sewer system, a City Ordinance requires that the atmosphere in a manhole receiving an industrial discharge must not exceed 10% of the LEL (lower explosive limit) for any fuel. This regulation is in force by manual monitoring of the sewer manhole and has been successful in curbing intentional dumps or disposal of fuels and flammable solids.

**BACK RIVER WASTEWATER TREATMENT PLANT
BALTIMORE, MARYLAND**

Design Flow: 180 mgd
Secondary Treatment: Trickling Filters and Activated Sludge

INFLUENT WASTEWATER		SIGNIFICANT INDUSTRIES	
	Typical (Upset)	Industry	Problem Pollutants
Ave. Flow, mgd	180 (270)	Metal Plating (12)	Metals
% Industrial	15	Auto Mfr.	Cr, Cu, Ni, Zn
BOD ₅ , mg/l	230	Paint and Chemical	Ethyl benzene, toluene, xylene
SS, mg/l	190	Incinerator	Cd, Hg
		Waste Haulers	Solvents, petroleum hydrocarbons

PLANT LOADING

Primary Clarifiers	Typical (Upset)	Aeration Basins	Typical (Upset)
Overflow Rate, gal/sf/day	730 (1,170)	Ave. Flow, mgd	60
Detention Time, hours	3.6	F/M, lbs BOD ₅ /lbs MLSS/day	0.4
Effluent BOD ₅ , mg/l	180	MCRT, days	6.1
Effluent SS, mg/l	100	MLSS, mg/l	2,000
		Detention Time, hours	3.5
		Return Flow, %	30-40
		D.O. Level, mg/l	2-3

Secondary Clarifiers (A.S./T.F)	Typical (Upset)	Trickling Filters	Typical (Upset)
Overflow Rate, gal/sf/day	750/950	Ave. Flow, mgd	150 (200)
Detention Time, hours	2.5/2.1	Hydraulic Loadings, gal/sf/d	120 (130)
SVI, ml/gm	95	Organic Loading, lbs BOD/1000 cf/d	20
		Return Flow, %	0

PLANT PERFORMANCE

	Permit Limit	Typical (Upset)
BOD ₅ , mg/l	45	40 (50)
SS, mg/l	45	40 (50)

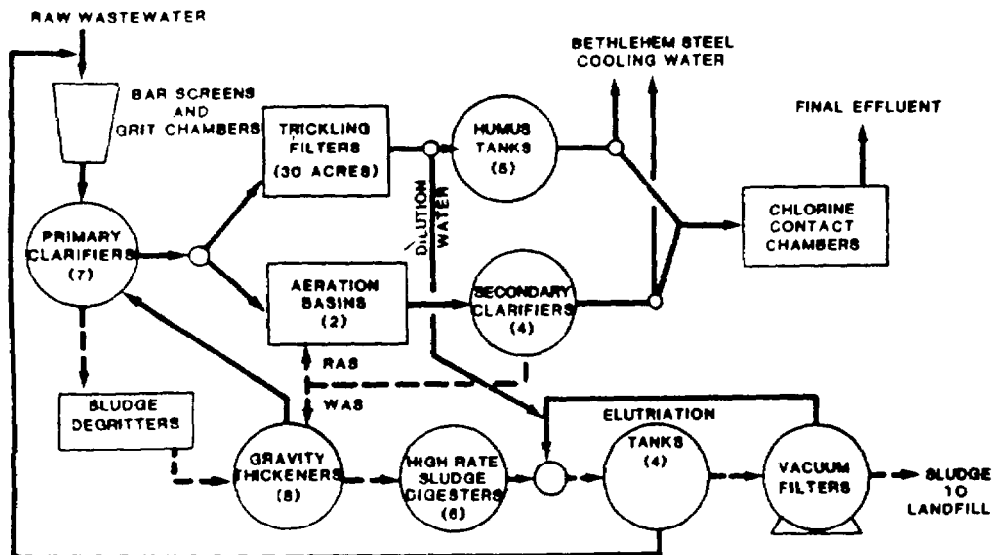

PATAPSCO WASTEWATER TREATMENT PLANT Baltimore, Maryland

A 1981 EPA-sponsored project on biomonitoring of direct discharges rated the Patapsco plant as having the most toxic effluent of those surveyed. Ironically, the second most toxic discharge came from an agricultural chemicals manufacturer who, in 1983, ceased direct discharging and now sends their pretreated wastewater to Patapsco. The high level of toxicity has prompted the collection of much bioassay, acute toxicity and respirometer data over the past four years in order to evaluate the potential for both toxicity pass-through and toxic inhibition of the plant biomass. Despite the presence of inhibitory levels of pollutants in the influent, the plant currently meets its discharge limits for BOD and SS, indicating the ability of activated sludge to acclimate to consistent levels of many inhibitory compounds. It has, however, been necessary to operate at a reduced organic loading in order to offset the effects of the inhibition. This has reduced the wastewater treatment capacity of the plant.

The City is evaluating several measures to reduce this inhibition and thus prevent any possibility of interference. They have begun daily routine operation of a respirometer for measuring the inhibitory characteristics of the plant influent. They are also evaluating the use of respirometry as a tool for assessing the impacts of several industrial effluents on the plant.

Another concern to the City is the pass-through of toxicity. Acute influent and effluent toxicity data using a Beckman Microtox unit have been collected since November 1980. Some of the results of these analyses are shown on Figure A-1. The data are on an inverse scale, with 0% indicating complete toxicity and approximately 45 percent corresponding to no toxic effect.

Figure A-1 illustrates the highly toxic nature of the plant influent and effluent until September 1982, at which time the secondary treatment system went on-line. The acclimation of the activated sludge improved the monthly average effluent toxicity from 5 percent to 40 percent by December, where it remained until secondary shutdown in February 1983. The average effluent toxicity again increased until the secondaries returned on June 15, providing clear evidence of the detoxification capability of acclimated activated sludge. Even though overall effluent toxicity has been reduced, individual daily tests continue to show substantial day-to-day variability, with significant effluent toxicity occurring in more than one-third of the tests. Therefore, the City is continuing to study ways to reduce this toxicity pass-through. In fact, the City of Baltimore is currently performing a toxicity reduction evaluation (TRE) in conjunction with the U.S. EPA.

As a means of improving both the inhibition and toxicity pass-through situations, the State of Maryland included the following in a consent order issued to the City in 1984:

- install on-line toxicity monitoring of the plant influent
- develop a toxics emergency response plan
- enlarge the scope of the City sewer ordinance to include specifics on toxicity and flammability for industrial effluents.

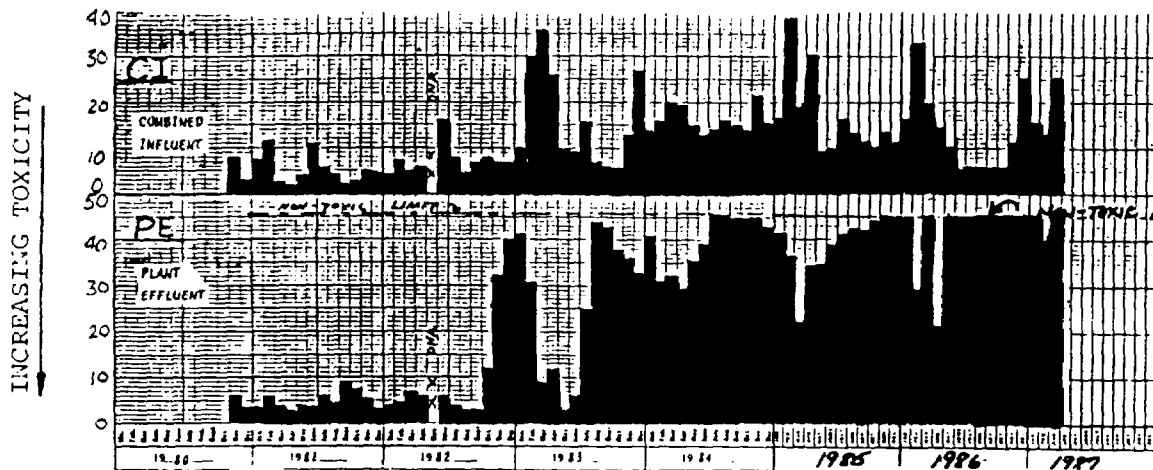

FIGURE A-1
MONTHLY ACUTE TOXICITY
 (Courtesy G.H. Slattery, City of Baltimore)

In spite of high influent toxicity, the plant is not currently experiencing interference with its ability to meet its NPDES permit limits. With a mean cell residence time varying between 10 and 15 days, the plant produces reasonably stable operation and good plant performance on removals of conventional pollutants. Although compliance with the NPDES permit has been achieved for BOD and SS at Patapsco, the plant flow is well below the 70 mgd design capacity. Toxic inhibition of the activated sludge bacteria is still present despite the improvement since 1983. Evidence of this inhibition is provided by the plant actual operating F/M of 0.3, which is significantly less than the design value of 0.5, and also was verified by respirometry tests on the plant influent.

The attached data sheet indicates that Patapsco's current noncompliance has resulted from discharging excess phosphorus and an effluent pH below 6.5. The phosphorus problem is being dealt with by installing anaerobic/oxic (A/O) technology in the oxygenation basins as a means of biological phosphorus removal. The low pH is inherent in oxygen activated sludge systems, typically producing an effluent in excess of 250 mg/l of CO₂ and a pH of 6.2. The problem can be corrected with either chemical adjustment or post-aeration of the wastewater.

**PATAPSCO WASTEWATER TREATMENT PLANT
BALTIMORE, MARYLAND**

Design Flow: 70 mgd
Secondary Treatment: Activated Sludge (Pure Oxygen)

INFLUENT WASTEWATER

	Typical (Upset)
Ave. Flow, mgd	42
% Industrial	30
BOD ₅ , mg/l	265 (320)
SS, mg/l	325 (470)
TOX, %	15

SIGNIFICANT INDUSTRIES

Industry	Flowrate (mgd)	Problem Pollutants
Chemicals	1.0	Insecticides, Volatiles, phenols, metals
Metal Finishing	0.13	pH, solvents, metals

PLANT LOADING

Primary Clarifiers	Typical (Upset)	Aeration Basins	Typical (Upset)
Overflow Rate, gal/sf/day	1,150	F/M, lbs BOD ₅ /lbs MLSS/day	0.3
Detention Time, hours	1.5	MCRT, days	10-15
Effluent BOD ₅ , mg/l	190	MLSS, mg/l	5,000
Effluent SS, mg/l	80	Detention Time, hours	2
		Return Flow, %	30
		D.O. Level, mg/l	2-4

Secondary Clarifiers	Typical (Upset)
Overflow Rate, gal/sf/day	450
Detention Time, hours	5.3
SVI, ml/gm	50-75

PLANT PERFORMANCE

	Permit Limit	Typical (Upset)
BOD ₅ , mg/l	30	13-40
SS, mg/l	30	15-40
Total-P, mg/l	2.0	3.5
pH	6.5-8.5	7-8.5
TOX, %		4)

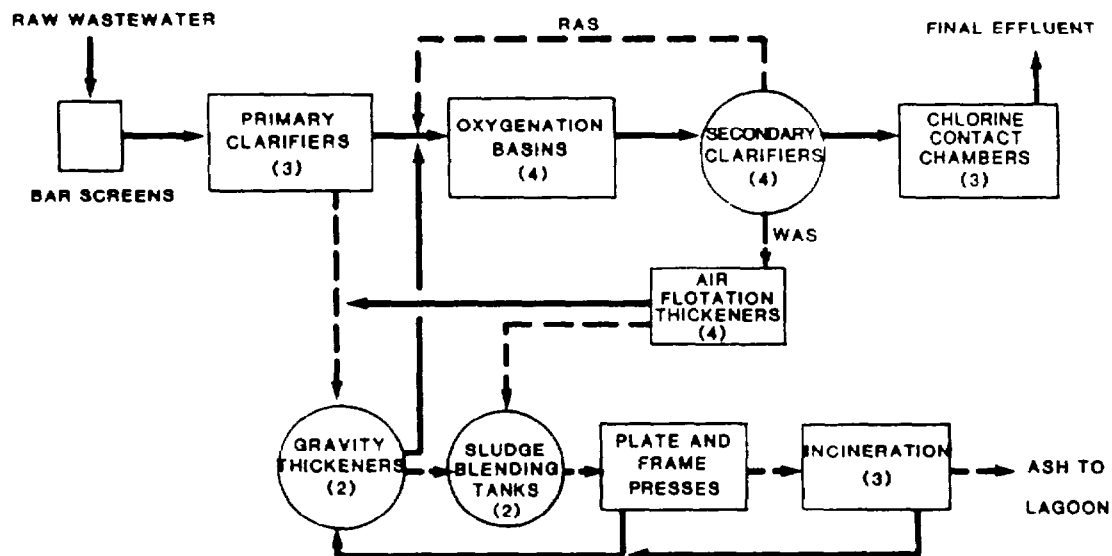

BAYSHORE REGIONAL SEWERAGE AUTHORITY
Union Beach, New Jersey

The Bayshore Regional Sewerage Authority (BRSA) operates an activated sludge treatment facility whose performance is largely dictated by a single industrial waste discharger. Three manufacturers of flavors and fragrances (one of whom is a perfume retailer) represent the total industrial wastewater flow of 325,000 gpd, or less than 5 percent of the POTW total. All three industries discharge high concentrations of conventional pollutants and routinely violate the maximum allowable monthly concentration limits for BOD (500), COD (1500) and TSS (500) as specified in their industrial waste permits. Two of the three manufacturers contribute less than 0.5 percent of the POTW flow, hence their impact is minimal. However, one building of the largest industry produces in excess of 200,000 gpd of wastewater with the following characteristics (in mg/l):

Parameter	1984			October 1985		
	Ave.	Monthly High	Monthly Low	Ave.	Daily High	Daily Low
BOD	1004	2054	245	2624	5250	522
COD	3238	4998	1440	7084	11380	2520
TSS	776	1835	94	1113	1698	672

The large variation in wastewater quality indicates that a two-stage primary pretreatment system located at the industry is not sufficient to meet the fluctuating demands of their process wastes.

The potential impact of such an industrial discharge is evident when analyzing Figure A-2. The bar graph represents the percentage of total BOD being contributed by the industry on a daily basis. The upper plot on the line graph corresponds to the mass BOD loading, with the industry's contribution plotted beneath. This graph clearly demonstrates that the effluent from this single industry has increased the BRSA plant loading above the design limit of 15,000 pounds of BOD per day. This has interfered with the plant's ability to meet its permit limit for BOD.

The BRSA has been particularly aggressive in their dealings with the industry in question. It has taken a two-pronged approach:

- notification of violation with a subsequent discontinuation of service if noncompliance persists after 15 days, and
- legal action to recover \$1.25 million in back surcharge payments and costs.

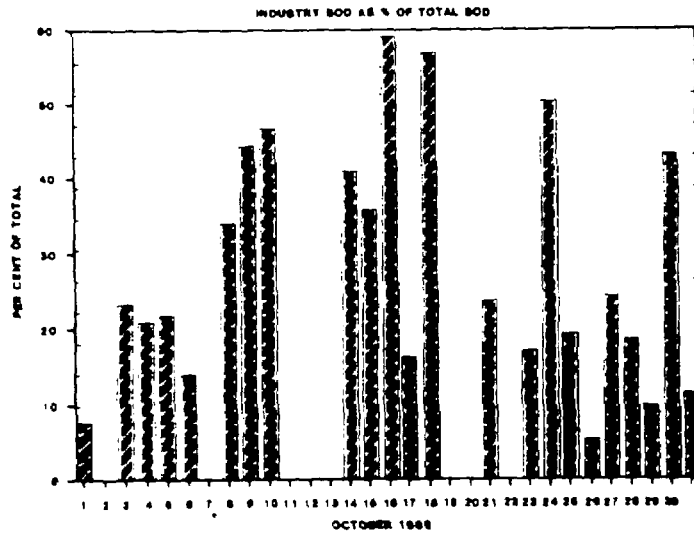
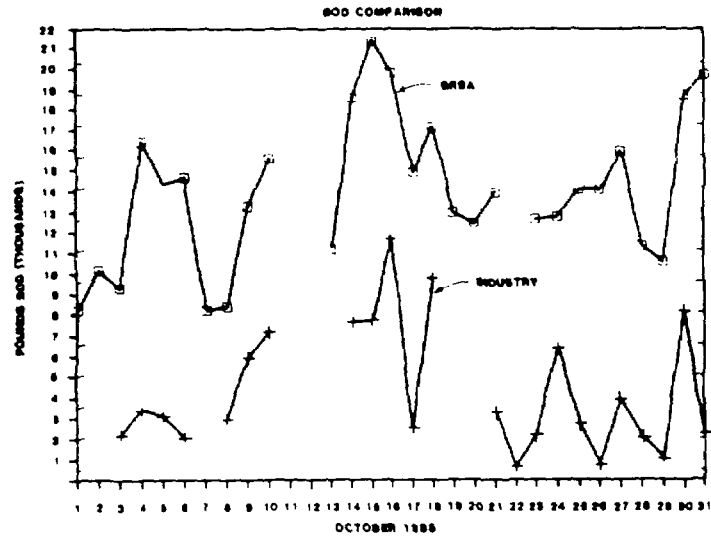

Figure A-2
 Impact of Industrial Waste Discharge on POTW Loadings
 October 1985

In addition to the BRSA actions, the County Prosecutor's office made a surprise visit to the industry in question, in which records were confiscated and samples collected for analysis. The result was a \$5 million fine levied by the State of New Jersey in June of 1986, coupled with new NJPDES permit POTW limits. As a direct consequence of the state and local actions, the industry's wastewater BOD and SS have each been consistently below 100 mg/l since July, 1986. To date, \$300,000 of the back payments have been received by the BRSA, with some litigation still pending.

BAYSHORE REGIONAL SEWERAGE AUTHORITY
Union Beach, New Jersey

Design Flow: 8.0
 Secondary Treatment: Activated Sludge (Modified Contact Stabilization)

Location: Eastern shore
 Population Served: 80,000

INFLUENT WASTEWATER

	Typical (Upset)
Ave. Flow, mgd	6.6
% Industrial	5
BOD ₅ , mg/l	220 (380)
SS, mg/l	250 (400)

SIGNIFICANT INDUSTRIES

Industry	Flowrate (1000 gpd)	Problem Pollutants
Flavors & Fragrances (3 industries)	325	BOD, TSS, COD

PLANT LOADING

Primary Clarifiers	Typical (Upset)	Aeration Basins	Typical (Upset)
Overflow Rate, gal/sf/day	825	F/M, lbs BOD ₅ /lbs MLSS/day	0.65 (1.25)
Detention Time, hours	1.75	MCRT, days	8-10
Effluent BOD ₅ , mg/l	150 (250)	MLSS, mg/l	2000-2500
Effluent SS, mg/l	100 (200)	Return Flow, %	25
		Detention Time, hours	
		Contact	3
		Reaeration	12

Secondary Clarifiers	Typical (Upset)
Overflow Rate, gal/sf/day	540
Detention Time, hours	3.35
SVI, ml/gm	125 (500)

PLANT PERFORMANCE

	Permit Limit	Typical (Upset)
BOD ₅ , mg/l	30	35 (400)
SS, mg/l	30	27 (400)
D.O., mg/l	5	2-5

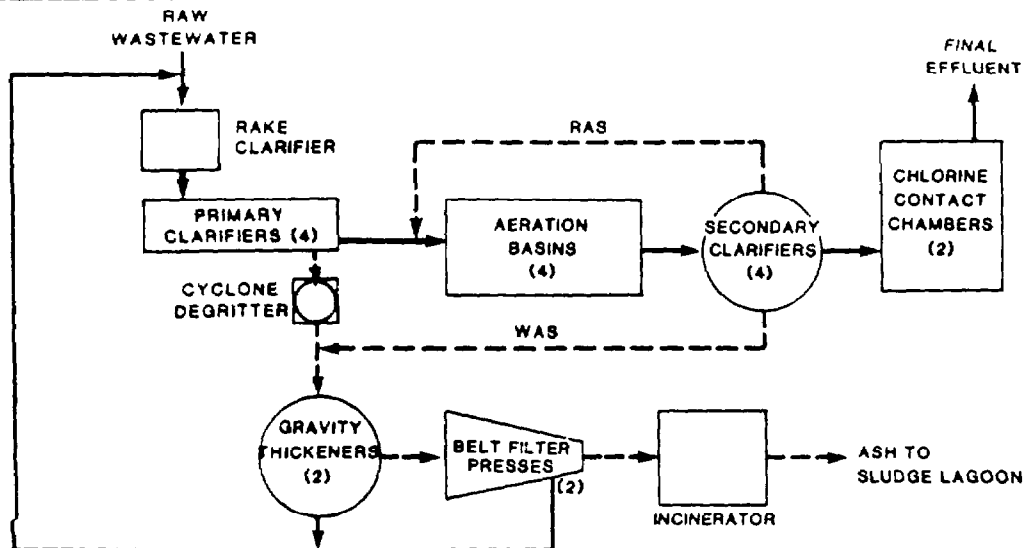

EAST SIDE SEWAGE TREATMENT PLANT Oswego, New York

The City of Oswego, East Side Treatment Plant has experienced significant non-compliance problems associated with the loss of solids from their secondary clarifiers. Half of the plant's hydraulic flow is from a paper mill which is the only major industry in the city. From 1981 to 1983, the noncompliance problems at the plant were attributed to severe hydraulic and organic load peaks from the paper mill as well as operational difficulties such as frequent breakdowns of the return sludge pump drives. It is not known whether filamentous growth in the sludge occurred at that time. In 1983 the paper mill began reducing the hydraulic and organic peaks to the plant. Solids losses from the secondary clarifier still remained a problem. During 1984, the plant frequently exceeded their NPDES discharge suspended solids by five times the limit and the BOD by three times the limit. During that period, the plant still occasionally received hydraulic peaks from the paper mill which were twice the average rate for two to three hour periods, but a substantial cause of the problem was identified as poor sludge settleability due to filamentous growth. The frequent washout of biosolids from the secondary clarifiers resulted in a low mean cell residence time and the generation of a young sludge that did not settle well. In the spring of 1985, the belt drives on the return sludge pumps which had frequently been out of service were replaced with electronic variable speed drives. This improvement allowed the plant operators to maintain better control of the solids inventory in the aeration tanks. Plant performance was still poor, however, because of sludge bulking.

Several measures have been taken at the plant in an attempt to alleviate the sludge bulking problem. The measures that were taken include:

- switching from plug flow feed to a step feed in the aeration tanks in order to achieve better dissolved oxygen distribution;
- increasing the sludge return rate and mean cell residence time to improve settleability; and
- chlorination of the return sludge for the destruction of filamentous growth in the sludge.

The step feed operation has resulted in better dissolved oxygen distribution but did not significantly improve sludge settleability. The second two mitigation efforts were ongoing at the time of writing. A chlorination dosage of 6 lb Cl₂/1000 lb solids had been applied to the return sludge. Microscopic examination of the sludge indicated that the filaments had shrunk and the SVI level had dropped to the range of 60-80. The plant operators intend to chlorinate whenever the SVI increases to 150. It has not been determined if these mitigation measures can result in plant performance that will consistently meet the permit discharge limits.

The paper mill periodically discharges slugs of waste containing high suspended solids to the treatment plant. At these times, the sludge in the primary tanks

takes on a gelatinous quality which makes sludge removal difficult. High periodic input of clay filler materials from the paper mill has resulted in poor sludge incineration with associated high fuel usage.

The City of Oswego is presently preparing an industrial discharge permit for the paper mill. The permit will restrict the monthly and daily average BOD and suspended solids levels in the influent from the paper mill as well as restrict the daily maximum hydraulic peak allowed. Under the permit provisions the paper mill will be required to submit listings of the chemicals used in their processes. The paper mill is presently investigating the possible relationship of the chemicals used in their manufacturing processes to the occurrence of filamentous growth in the activated sludge process.

**EAST SIDE SEWAGE TREATMENT PLANT
OSWEGO, NEW YORK**

Design Flow: 3 mgd
Secondary Treatment: Plug or Step Feed Activated Sludge

Location: Northern New York
Population Served: 10,000

INFLUENT WASTEWATER

	Typical (Upset)	
	Municipal	Paper Mill
Ave. Flow, mgd	2.5	
% Industrial	50	
BOD ₅ , mg/l	100	300
SS, mg/l	120	450 (1000)

SIGNIFICANT INDUSTRIES

Industry	Flowrate (1000 gpd)	Problem Pollutants
Paper Mill	1,200	SS, BOD

PLANT LOADING

Primary Clarifiers	Typical (Upset)		Aeration Basins	Typical (Upset)
Overflow Rate, gal/sf/day	600		F/M, lbs BOD ₅ /lbs MLSS/day	0.2
Detention Time, hours	2		MCRT, days	7 (3)
	Municipal	Paper Mill	MLSS, mg/l	2,000 (300)
Effluent BOD ₅ , mg/l	70	120	Detention Time, hours	1
Effluent SS, mg/l	40	100	Return Flow, %	25 - 45
			D.O. Level, mg/l	2 - 4

Secondary Clarifiers	Typical (Upset)
Overflow Rate, gal/sf/day	300
Detention Time, hours	2
SVI, ml/gm	100 (1000)

PLANT PERFORMANCE

	Permit Limit	Typical (Upset)
	Summer	Remainder of Year
BOD ₅ , mg/l	30	45
SS, mg/l	30	70
		20 (120)
		25 (300)

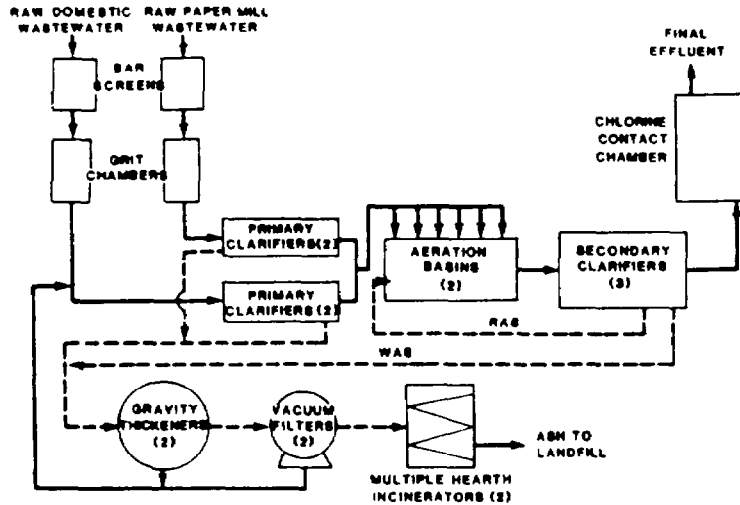

**HAMILTON TOWNSHIP WASTEWATER TREATMENT PLANT
Trenton, New Jersey**

The Hamilton Township Wastewater Treatment Plant (HTWTP) is an unusual facility in that plant upgrades over the past 30 years have been constructed as parallel flow processes rather than as replacements for older, outdated technology. Although this results in a complicated plant schematic (see below), parallel flow paths do provide operational flexibility and an opportunity to study the impact of a combined industrial/domestic wastewater on different fixed-film biological treatment processes. The HTWTP has had a difficult time meeting its permit limit for BOD over the past few years, and is currently under a Consent Order and Agreement and Compliance Schedule from the State Department of Environmental Protection.

Despite being at just over 50 percent of the plant's hydraulic capacity, Hamilton Township has experienced organic overloads, resulting in at least partial failure of 15 of the 48 RBC units. With the advent of an Industrial Waste Monitoring Program as part of a Sewers and Sewage Disposal Ordinance, the reasons for such overloading became apparent. Although the industrial waste program is still in its infancy, observations and analytical data have identified a pharmaceuticals manufacturer as a significant and potentially harmful discharger to the POTW.

Dating back to the summer of 1984, high concentrations of volatile organics were being discharged to the POTW on a once or twice-per-week basis. A monitoring program at the HTWTP uncovered an increase in influent BOD from 150 to 350-500 mg/l and high atmospheric levels of organic constituents with this discharge pattern. The specific industry was identified when a high influent pH reading led Hamilton Township personnel to the pharmaceuticals manufacturer in March, 1985. Sampling conducted at that time detected significant levels of ethyl benzene, toluene and xylene in the industry's effluent. These findings precipitated an extensive testing program by the Township, with an independent engineering study conducted by the industry. The results indicated a correlation between the pharmaceutical discharges and high influent soluble BOD at the POTW. Analyses conducted on the industry's flow streams resulted in the following calculated average effluent concentrations:

Parameter	Concentration (mg/l)
Arsenic	2.6
Phenols	25.7
Total Toxic Volatile Organics (TTVO)	1.3
BOD	21,800
TSS	557
TDS	65,800

Based on an average flow of 15,000 gpd, these wastewater characteristics should not be harmful to an 8.5 mgd facility if discharged on a steady basis. It is the intermittent discharge of this wastewater which has contributed to the overloading of the biological population of the POTW.

During a three week shutdown of the industry in July of 1985, the HTWTP recovered to the point of meeting their permit limits. Consequently, the Township only permitted the industry access to the sewer system after the installation of metering pumps to equalize flows. This requirement initially improved POTW performance during the fall of 1985, but a gradual deterioration in effluent quality (indicating possible toxicity effects) lead the Township to terminate service to the industry in late-November.

While the most recent action is being challenged, the industry is constructing an anaerobic pretreatment facility on site to reduce its loading to the POTW.

A number of operations and personnel changes have been instituted at the HTWTP to help mitigate the impact of the industrial discharges. These changes include:

- installation of aeration equipment in the influent channels to the RBCs to increase the first stage DO to 2-3 mg/l;
- extensive use of sludge depth measurement and visual monitoring to augment reliance on control room instrumentation;
- performance of bioassay testing by an independent contractor to assess toxicity effects;
- purchase of a toxicity tester to be used in calculation of local limits; and
- hiring of four more people plus the purchase of a vehicle for an extensive industrial sampling program.

HAMILTON TOWNSHIP WASTEWATER TREATMENT PLANT
Trenton, New Jersey

Design Flow: 16 mgd
Secondary Treatment: Trickling Filter and RBC

Location: Central Western Border
Population Served: 87,000

INFLUENT WASTEWATER		SIGNIFICANT INDUSTRIES	
	Typical (Upset)	Industry	Flowrate (1000 gpd) / Problem Pollutants
Ave. Flow, mgd	3.5	Pharmaceutical	15 BOD, phenol, ethyl benzene, toluene, xyiene
% Industrial	10 (est)	Electroplaters (2)	160 Cd, Cr, Zn, Ni
BOD ₅ , mg/l	240 (500)		
SS, mg/l	160 (400)		

PLANT LOADING			
Primary Clarifiers	Typical (Upset)	Trickling Filters	Typical (Upset)
Overflow Rate, gal/sf/day	930, 260, 330	Plant Flow (mgd)	2.5, 1.0
Detention Time, hours	1.8, 4.8, 5.8	Hydraulic Loading, gal/sf/day	100, 210
		Organic Loading, lbs BOD/1,000 cf/day	15, 16 (30)
		Return Flow, %	20, 100
Secondary Clarifiers	Typical (Upset)	RBCs	Typical (Upset)
Overflow Rate, gal/sf/day	520, 260, 265	Plant Flow (mgd)	5.0
Detention Time, hours	2.8, 4.3, 6.8	First Stage Organic Loading, lbs BOD/1,000 sf/day	
		- Total	5.3 (10.8)
		- Soluble	3.5 (6.7)

PLANT PERFORMANCE		
	Permit Limit	Typical (Upset)
BOD ₅ , mg/l	30	45 (120)
SS, mg/l	30	30 (50)
NH ₃ , mg/l Effective 6/86	10	22 (32)

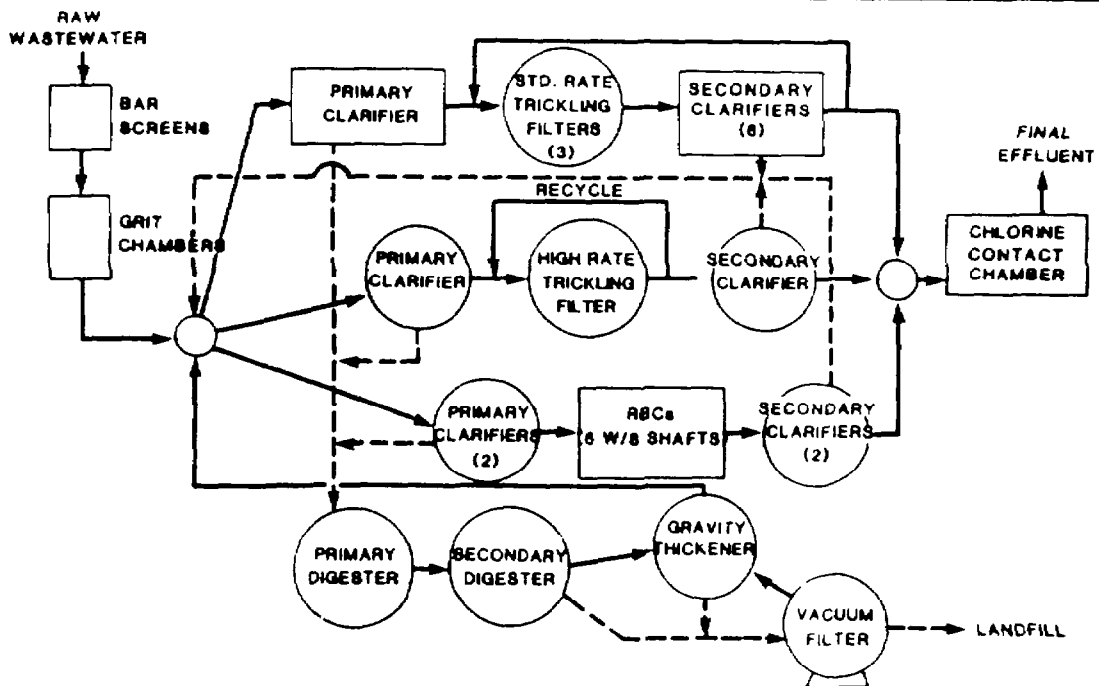

HORSE CREEK POLLUTION CONTROL FACILITY North Augusta, South Carolina

The Horse Creek Pollution Control Facility (HCPCF) is a regional plant, operated by the Aiken County Public Service Authority (ACPSA), treating a predominantly industrial wastewater. Ninety five percent of the industrial wasteload is contributed by several large textile mills and is characterized by high COD, BOD, alkalinity and pH. Combined domestic/industrial influent wastewater pH and alkalinity fluctuations caused inhibition of the biomass, poorly settling sludge and effluent suspended solids permit violations. Since implementing a pretreatment program and issuing industrial wastewater discharge permits, the treatability of the industrial waste has improved, the result being that HCPCF has been free of NPDES permit violations for over eight months.

Local textile processes include grading operations, finishing processes utilizing dyes, and specialized textile chemical manufacturing. The textile wastewater is highly caustic with alkalinity as high as 2400 mg/l, and pH exceeding 12.5. Prior to pretreatment the combined industrial/domestic influent to the HCPCF had the following characteristics:

pH	>11
BOD	360 mg/l
COD	910 mg/l
Alkalinity	1100 mg/l
TSS	210 mg/l

Other distinguishing characteristics of the influent wastewater included the light, non flocculant nature of the suspended solids and a dark blue/black color, typical of textile wastewater from washing and dyeing operations.

Prior to the summer of 1985, the textile industries employed a limited type of pretreatment and flow equalization. This limited pretreatment and flow equalization resulted in plant influent pH fluctuations of 2 to 2.5 units and alkalinity fluctuations of up to 600 mg/l in a given day. These fluctuations caused some inhibition of the biomass, but because the hydraulic detention time in the aeration basins was in excess of 3.5 days, effluent BOD was within the permit limit of 33 mg/l. These pH and alkalinity fluctuations had their most detrimental effect on biomass settling characteristics and solids carryover in the secondary clarifier often resulted, lasting for 24-36 hours. During these episodes, filamentous organisms were occasionally observed in the biomass. The solids carryover problem worsened in the winter months when wastewater temperatures were lower, but chlorination of the return activated sludge, the influent to the secondary clarifier and the contents of the aeration basin was somewhat successful at improving settleability. Despite this, the HCPCF still experienced interference with its ability to meet suspended solids limits in 15 of the 19 months prior to September, 1985.

The State of South Carolina mandated that the ACPSA implement and enforce a pretreatment program in the spring of 1984. The ACPSA responded by

developing such a program and issuing draft industrial wastewater discharge permits. Final State approval came in May, 1985. As presently written, the industrial wastewater discharge permits are not restrictive, allowing BOD, COD and alkalinity levels as high as 600 mg/l, 1300 mg/l and 1500 mg/l, respectively. However, the permits have caused the textile industries to make small, but meaningful alterations to their wastewater discharge practices, resulting in average plant influent pH levels dropping from 11-12 to 10 and alkalinity from 1100 mg/l to 700 mg/l. More importantly, maximum daily influent pH fluctuations have been reduced to 0.5 units or less. Figure A-3 shows the magnitude of pH fluctuations both before and after the implementation of pretreatment. Simple modifications at textile facilities to process operations and waste pumping schedules were typical of the changes that were necessary to realize the described results. Because of the more stable wastewater discharge, the HCPCF has realized more consistent plant operation and has not violated its NPDES permit in over eight months.

Some of the textile dischargers do not currently meet the pH and alkalinity limits of their industrial wastewater discharge permits and are under a compliance schedule to do so. The facilities are installing pretreatment works for caustic recovery that should significantly lower pH and alkalinity levels. The HCPCF is also presently studying the addition of floating mixing units to augment the turbine surface aerators in the aeration basins. To date, evidence indicates that a more consistent secondary clarifier solids feed is achieved which improves the quality of the secondary effluent.

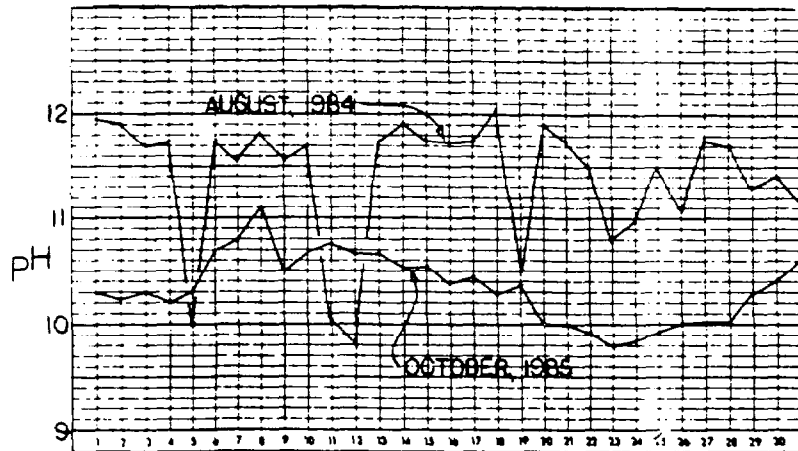

FIGURE A-3
HORSE CREEK POLLUTION CONTROL FACILITY INFLUENT pH

HORSE CREEK POLLUTION CONTROL FACILITY
Alcona County, South Carolina

Design Flow: 20 mgd
Secondary Treatment: Extended Aeration
Activated Sludge

Location: West-central South Carolina
Population Served: 70,000

INFLUENT WASTEWATER

	Typical (Upset)
Ave. Flow, mgd	10.4
% Industrial	80
BOD ₅ , mg/l	360
SS, mg/l	210
COD, mg/l	910
Alkalinity, mg/l	1100 (1600)
pH	10-11 (12.5)

SIGNIFICANT INDUSTRIES

Industry	Flowrate (1000 gpd)	Problem Pollutants
Textile	8,400	COD, Alkalinity, pH
Textile chemicals	300	COD, pH

PLANT LOADING

Primary Clarifiers	Typical (Upset)	Aeration Basins	Typical (Upset)
Overflow Rate, gal/sf/day	100	F/M, lbs-BOD ₅ /lbs MLSS/day	0.05-0.10
Detention Time, hours	4.4	MCRT, days	50-90
		MLSS, mg/l	3800-4500
		Detention Time, hours	92
		Return Flow, %	40-60
		D.O. Level, mg/l	1-3 (4)

Secondary Clarifiers	Typical (Upset)
Overflow Rate, gal/sf/day	195
Detention Time, hours	9.1

PLANT PERFORMANCE

	Permit Limit	Typical (Upset)
BOD ₅ , mg/l	33	15
SS, mg/l	57	40 (85)
COD, mg/l	-	175
pH	9	9 (10)

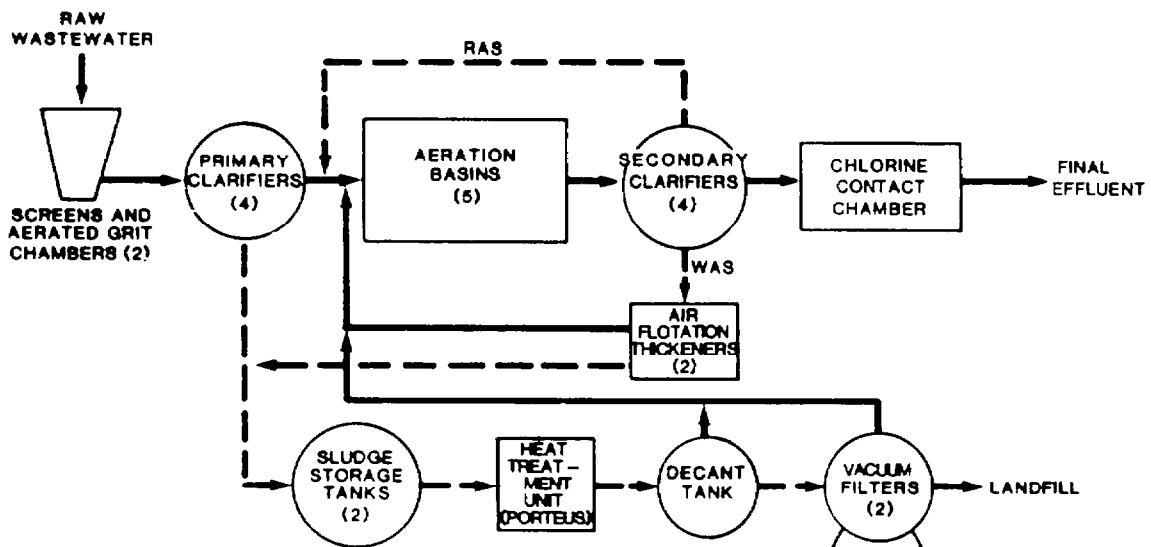

MAIDEN CREEK WASTEWATER TREATMENT PLANT
Blandon, Pennsylvania

The Maiden Creek Wastewater Treatment Plant (MCWTP) went on-line in December, 1981 as a secondary treatment facility designed to remove both carbonaceous and nitrogenous BOD. The plant uses a patented aerated submerged fixed film biological treatment system, where flat asbestos plates hanging vertically in the settled wastewater provide a growth surface for the bacteria. Each of three contact basins contains 320 plates with 200 sq. ft. of surface area. Oxygen is provided by fine bubble aeration through ceramic diffusers.

During the first six months of operation following an initial acclimation period, the MCWTP experienced gradual flow increases from 0.1 to 0.15 mgd while consistently meeting their permit limits. In August of 1981, a local mushroom processor began batch discharging high BOD wastewater to the POTW at flows sometimes exceeding 100 gpm. The hydraulic and organic shock loadings resulted in nitrifier washouts, solids carryover, reduced BOD removal efficiency and at times total biological process failure. Although the industry was not measuring their wastewater flow rates at that time, they were the only significant non-domestic contributor. After factoring out any potential infiltration/inflow from stormwater flows, the discharge pattern from the industry was obvious from an inspection of the weekly flow recordings at the POTW. Figure A-4 illustrates the dramatic effect of the industrial discharges on the MCWTP influent.

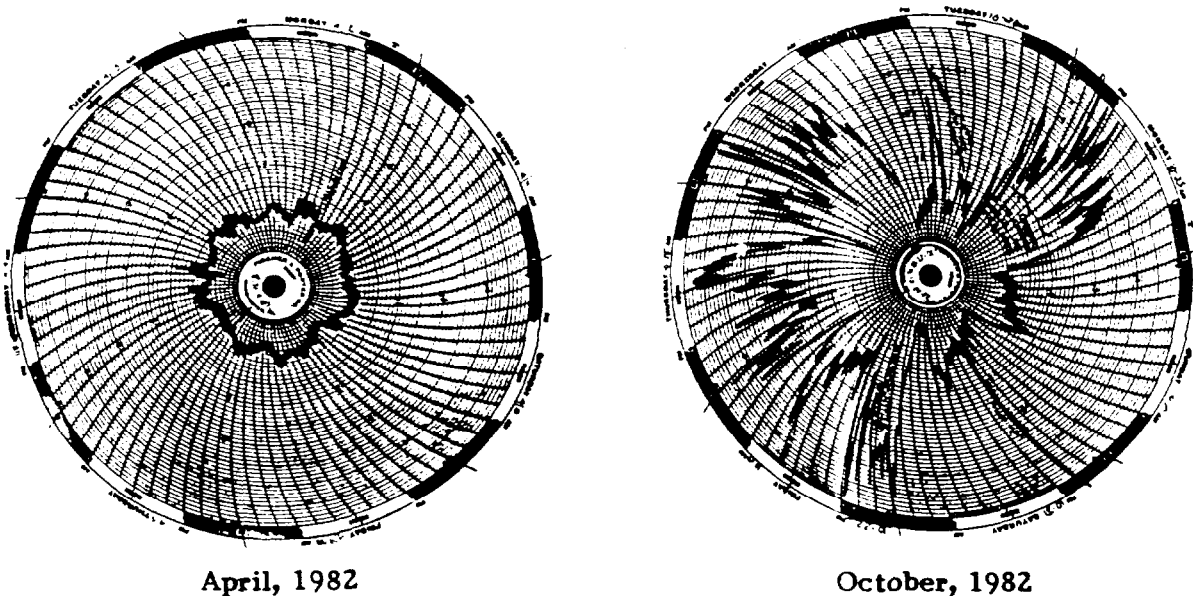

FIGURE A-4
WASTEWATER DISCHARGE AT INFLUENT METERING STATION (MGD)

As a result of significant time and effort on the part of Maiden Creek Township Municipal Authority two years ago, the food processor installed a physical-chemical treatment system which included surge control tanks and aeration. The system did reduce the solids load and partially mitigated the flow spike problem, although the surge tanks were not capable of providing complete equalization. Unfortunately, the great percentage of their organic waste is soluble, so the pretreatment facility is ineffective in reducing the BOD loading to the POTW. Additionally, wastewater production far exceeds the 50,000 gpd limit imposed by their permit, so occasional flow spikes are still evident. The industry has requested nearly ten times the current flow limit, necessitating the design of a full secondary system to reduce their waste strength to domestic levels. Such a system, including a 650,000 gallon aerated equalization basin, is scheduled to go on-line in mid-1986. In the interim, the municipality has required that the industry:

- control flow surges;
- meter and record their flows continuously;
- reduce the BOD in the effluent by in-house methods; and
- composite sample their discharge on a regular basis.

Failure to comply with the abovementioned program will result in a shut off by the POTW, a measure used previously in February, 1985 when the industry's wastewater was responsible for total process failure at the plant.

A number of operational changes were instituted in May of 1985 to help combat the high organic loads in the contact basins. These changes included:

- increasing the aeration by using all blowers at the plant, resulting in an increase in the first stage D.O. from 2 mg/l to 5 mg/l;
- addition of selective strains of bacteria to increase the rate of BOD removal;
- recycling the plant effluent to the head of the plant to dilute the incoming wastewater; and
- reducing the allowable flow from the food processor and closely monitoring their adherence to the limits.

Since these changes were implemented concurrently, it is impossible to isolate the individual impacts of each operations change. However, the collective result was a substantially improved compliance record. There have also been no flow spikes at the POTW since mid-December, 1985, indicating better flow control on the part of the food processor.

**MAIDEN CREEK WASTEWATER TREATMENT PLANT
BLANDON, PENNSYLVANIA**

Design Flow: 0.45 mgd
Secondary Treatment: Aerated Submerged Fixed Film (Contact Aeration)

Location: Southeastern Pennsylvania
Population Served: 2,000

INFLUENT WASTEWATER

	Typical (Upset)
Ave. Flow, mgd	0.25
% Industrial	20 (60)
BOD ₅ , mg/l	350 (900)
SS, mg/l	200
NH ₃ , mg/l	60

SIGNIFICANT INDUSTRIES

Industry	Flowrate (1000 gpd)	Problem Pollutants
Food Processor	50	BOD, Flow surges
Dental Office	negl.	Hg

PLANT LOADING

Primary Clarifiers	Typical (Upset)	Contact Basins	Typical (Upset)
Overflow Rate, gal/sf/day	350 (1,000)	Organic Loading (lbs BOD ₅ /1000 sf/day)	
Detention Time, hours	3.75 (1.25)	Total Plant	2.8
Effluent BOD ₅ , mg/l	260	First Stage	8.4
Effluent SS, mg/l	100	Detention Time, hours	12
		D.O. Level, mg/l	5 - 10

Secondary Clarifiers	Typical (Upset)
Overflow Rate, gal/sf/day	450 (1,300)
Detention Time, hours	2.8 (1.0)

PLANT PERFORMANCE

	Permit Limit	Typical (Upset)
BOD ₅ , mg/l	30	15 (400)
SS, mg/l	30	10 (50)
NH ₃ , mg/l	10/20	1 (60)

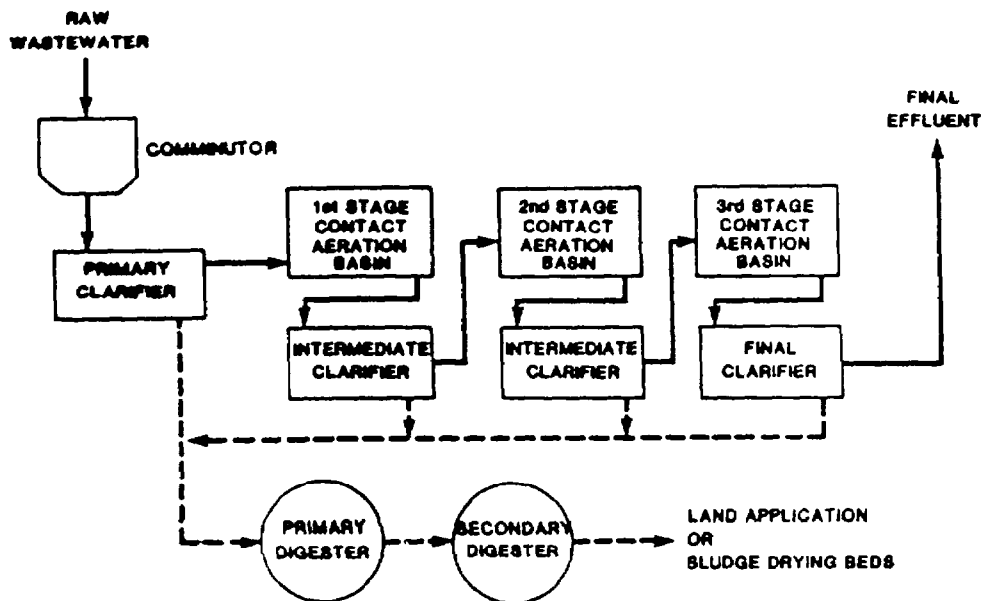

METRO-WEST POINT TREATMENT PLANT Seattle, Washington

The Municipality of Metropolitan Seattle (METRO) has had an operational industrial pretreatment program since 1969. With minor modifications, the program was EPA-approved in 1981 as one of the first in the nation. Successful reductions in influent wastewater and primary sludge heavy metal concentrations during the last five years can, to a great extent, be attributed to implementation and enforcement of pretreatment standards. As an outcome of this, self-monitoring by industrial dischargers augmented with year-round spot monitoring by Metro's Industrial Waste Section has reduced the incidences of toxic upsets in the anaerobic digesters of the West Point Treatment Plant.

The Metro-West Point Treatment Plant provides primary treatment and sludge digestion for an average daily wastewater flow of 132 mgd, 4.7 percent originating from industrial sources. Approximately 70 metal finishing/electroplating industries discharge to the sewer system in addition to a variety of other categorical and non-categorical industries. Records of periodic digester upsets go back as early as 1967, but their occurrences have become less frequent since 1980, coinciding with substantial overall reductions in heavy metal concentrations. Past upsets directly linked to toxic metals (generally chromium) caused increased volatile acid concentrations, increased carbon dioxide content of the gas produced, and reduced gas production. An October, 1980 chromium spill to the West Point facility caused a typical upset and resulted in the plant influent chromium concentration jumping 10 fold to greater than 2 mg/l. Primary sludge concentrations of chromium reached 710 mg/l, resulting in a 30 mg/l increase in digester concentrations above their normal 16-17 mg/l level. Metro practices sludge application to forest lands. Application rates had to be decreased during upsets, although no interference occurred.

Figure A-5 below typifies the reduction in metals realized during the 1981-1985 time period. Plant influent chromium levels dropped approximately 55 percent while the digested sludge concentrations were reduced by more than 40 percent. The magnitude of these decreases are typical of other heavy metals as well, averaging 41 percent for chromium, cadmium, copper, lead, nickel and zinc combined (see the accompanying data sheet). The primary reason for the reduction of cadmium and chromium concentrations is improved industrial pretreatment. In addition to pretreatment, a less corrosive city water supply has also resulted in lower background metal concentrations for the other metals, especially for copper. The city recently began chemically conditioning its water in an attempt to extend conduit life.

Success of the Metro Industrial Pretreatment Program can be attributed to a number of important factors including:

- development of stringent local limits for industrial discharges;
- year-round industrial waste sampling programs supported financially by industry; and

- follow-up procedures to industrial waste spills, taking enforcement action and levying fines when necessary.

Metro has recently implemented the following steps to improve their pretreatment program:

- information exchange with industries through the use of quarterly newsletters and personal communication, and
- increasing public awareness of industrial discharge violators by publishing the names of violating companies in local papers along with a statement of Metro's enforcement policy.

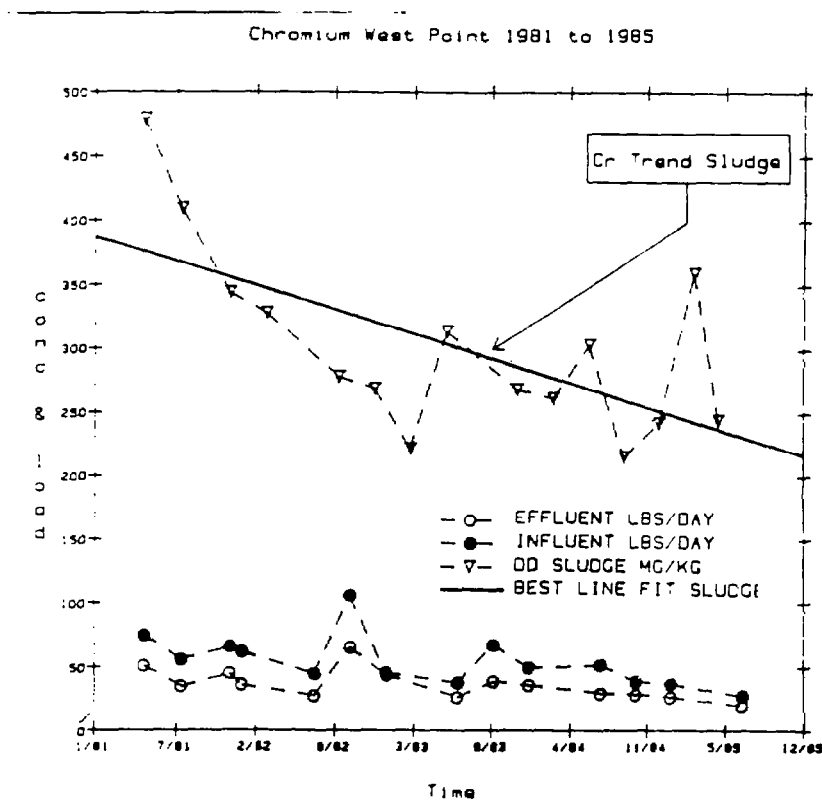

**FIGURE A-5
WEST POINT CHROMIUM CONCENTRATIONS**

**WEST POINT TREATMENT PLANT
SEATTLE, WASHINGTON**

Design Flow: 125 mgd
Primary Treatment

Location: West-Central Washington
Population Served: 500,000

INFLUENT WASTEWATER

	Typical (Upset)
Ave. Flow, mgd	132
% Industrial	5
BOD ₅ , mg/l	160
SS, mg/l	260
Cr, mg/l	0.05-2.01

SIGNIFICANT INDUSTRIES

Industry	Flowrate (mgd)	Problem Pollutants
Metal finishing and electroplating	1.1	Cd, Cr, Cu, Ni, Zn

PLANT LOADING

Primary Clarifiers	Typical (Upset)	Digested Sludge Metal Concentrations		
			1981 Level	1985 Level
Overflow Rate, gal/sf/day	1080	Cadmium, mg/kg	45	28
Detention Time, hours	1.58	Chromium, mg/kg	480	250
Effluent BOD ₅ , mg/l	75-110	Copper, mg/kg	1300	700
Effluent SS, mg/l	60-90	Nickel, mg/kg	160	120
		Lead, mg/kg	800	400

PLANT PERFORMANCE

	Permit Limit		Typical (Upset)	
	Summer	Winter	Summer	Winter
BOD ₅ , mg/l	135	85	110	75
SS, mg/l	125	65	90	60
Cr, mg/l	0.07	0.07	<0.05	0.15

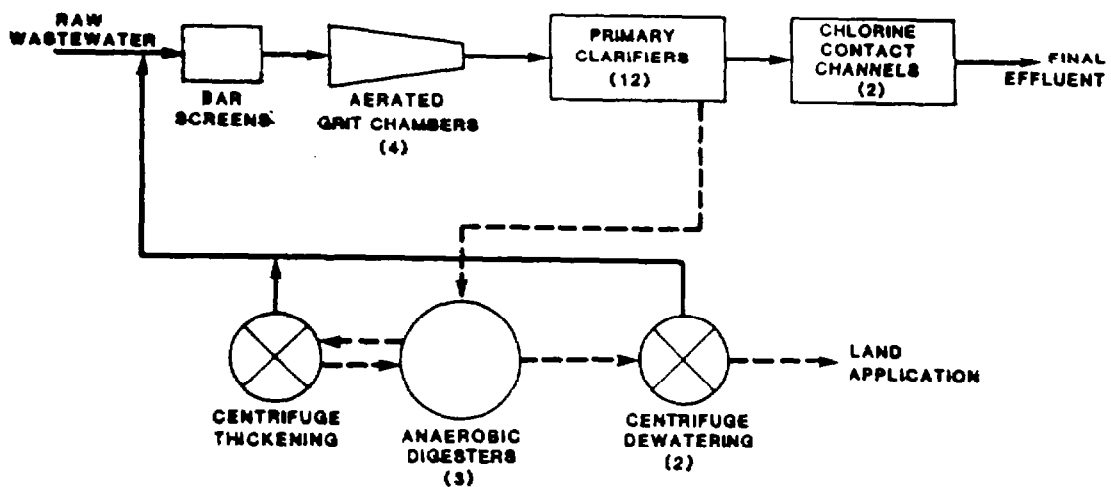

NEUSE RIVER WASTEWATER TREATMENT PLANT Raleigh, North Carolina

The Raleigh case study illustrates the need for continuous survey and monitoring even after the implementation of an industrial waste program in any dynamic population center. In 1976, the 30 mgd Neuse River Wastewater Treatment Plant (NRWTP) went on-line to replace the overloaded 16 mgd Walnut Creek plant. In the early 1960's, influent BODs exceeded 300 mg/l at Walnut Creek, with the effluent ranging from 35 to 55 mg/l. These effluent levels violated the Walnut Creek Plant permit, established by the state in order to protect the quality of the Neuse River, which was used as the raw water source for the City of Smithfield located downstream of Raleigh. Industries were encouraged to conserve and recycle wastes, resulting in a 250 mg/l influent BOD by the mid-1960's. The City's first Sewer Use Ordinance was enacted in 1972, with continual modification to comply with changes in the federal regulations. The net effect is a current influent BOD consistently below 200 mg/l, despite an industrial flow volume representing 25 percent of the plant flow.

The only significant industrial discharger of metals to the Walnut Creek plant was a large electroplater whose occasional plating bath dumps were not prohibited by a sewer use ordinance during the 1950's. Digester upsets (decreased gas production) and high sludge metals content were traced to this particular industry. Since dried sludge was being made available to the community for landscaping purposes at the time, concern for the metals levels prompted adoption of a proposed ordinance which directed the industry to construct a physical-chemical pretreatment facility.

Two other metals-related industries have been responsible for high sludge metals since the construction of the NRWTP. In the current facility, wet sludge is land applied to farmland adjacent to the POTW, hence metal content is critical. In each case (an electroplater and a printed circuit board manufacturer), the industries were discharging levels of Cr, Ni, Zn, Pb and Cu sometimes in excess of 1,000 mg/l, with highly variable effluent pH, and were uncooperative in dealing with the City of Raleigh. Fining the former industry \$1,000, and threatening the latter with the same, provided sufficient incentive to install pretreatment.

In the early 1980's, a producer of amino acids for pharmaceuticals in Raleigh discharged slug loads totaling 1,000 lbs of NH_3 to the POTW each day. Fortunately, an activated sludge system had been constructed for their facility for BOD reduction, which possessed sufficient capacity to nitrify their wastewater to an ammonia concentration of 50 mg/l. On one occasion, the NH_3 levels became toxic to the IU's activated sludge pretreatment, resulting in a gradual loss of nitrification at the POTW. Rapid identification of the NH_3 discharge by City personnel preserved the POTW nitrifier population, which was subsequently used to re-seed the industry's activated sludge with a viable nitrifier population for a speedy recovery. The rapid response prevented the monthly effluent NH_3 levels from exceeding the permit limit, despite high daily concentrations following the incident.

A dairy product manufacturer who cleans the stainless steel tanker trucks on-site had previously discharged these wastes directly to the sewer. Average BODs of 10,000 mg/l, with occasional values in the 30,000 to 40,000 mg/l range were typical, often resulting in effluent BODs in excess of the 6 mg/l (12 in winter) allowed for the POTW. Working with the North Carolina State University, a vacuum recovery system was developed and a market identified for the collected whey waste. The effluent BOD now averages 2,000 mg/l, still resulting in a high surcharge payment, but no permit violations at the POTW.

An unusual case at the NRWTP was the discovery of high zinc levels (1,000 mg/l) in the discharge from an office building with no manufacturing component. Through discussions with maintenance personnel, the City of Raleigh discovered that the contaminated discharges corresponded to floor stripping activities in the building. They learned that a Zn-based floor wax had been used, and stripping an entire office building over the course of a week discharged enough Zn to the POTW to significantly raise the level in their sludge. The elevated zinc level threatened to interfere with the POTW's ability to dispose of its sludge.

The Raleigh plant is currently under construction to increase the hydraulic capacity from 30 to 40 mgd, with an additional expansion to 60 mgd planned for the near future (the schematic shown on the next page is for the 40 mgd facility). The rapid growth of this community will continue to bring with it a variety of challenging new industrial wastewaters with, in some cases, unpredictable impacts on the POTW.

**NEUSE RIVER WASTEWATER TREATMENT PLANT
RALEIGH, NORTH CAROLINA**

Design Flow: 40 mgd
Secondary Treatment: Activated Sludge
(Extended Aeration)

Location: Central North Carolina
Population Served: 195,000

INFLUENT WASTEWATER		SIGNIFICANT INDUSTRIES	
	Typical (Upset)	Industry	Flowrate (1000 gpd) / Problem Pollutants
Ave. Flow, mgd	25	Electroplaters, Metal	
% Industrial	25	Finishers (5)	750 Cd, Cr, Cu, Ni, Pb, Zn, Cn^{+} , Fe, pH
BOD ₅ , mg/l	165 (350)	Pharmaceutical	400 NH ₃
SS, mg/l	170 (500)	Dairy	110 BOD
		Snack Foods	100 BOD

PLANT LOADING

Primary Clarifiers	Typical (Upset)	Aeration Basins	Typical (Upset)
Overflow Rate, gal/sf/day	550	F/M, lbs BOD ₅ /lbs MLSS/day	0.08-0.10
Detention Time, hours	3.0	MCRT, days	12-20
		MLSS, mg/l	2500
		Detention Time, hours	15
		Return Flow, %	50
		D.O. Level, mg/l	2
Secondary Clarifiers	Typical (Upset)	Multi-Media Filters	Typical (Upset)
Overflow Rate, gal/sf/day	580	Hydraulic loading, gpm/sf	2.5
Detention Time, Hours	3.2		
SVI, ml/gm	150-200 (250)		
Effluent BOD ₅ , mg/l	5		
Effluent SS, mg/l	15		
Effluent NH ₃ , mg/l	3		

PLANT PERFORMANCE

	Permit Limit		Typical (Upset)
	Summer	Winter	
BOD ₅ , mg/l	5	12	3 (15)
SS, mg/l	30	30	4
NH ₃ , mg/l	3	6	1.5 (5)

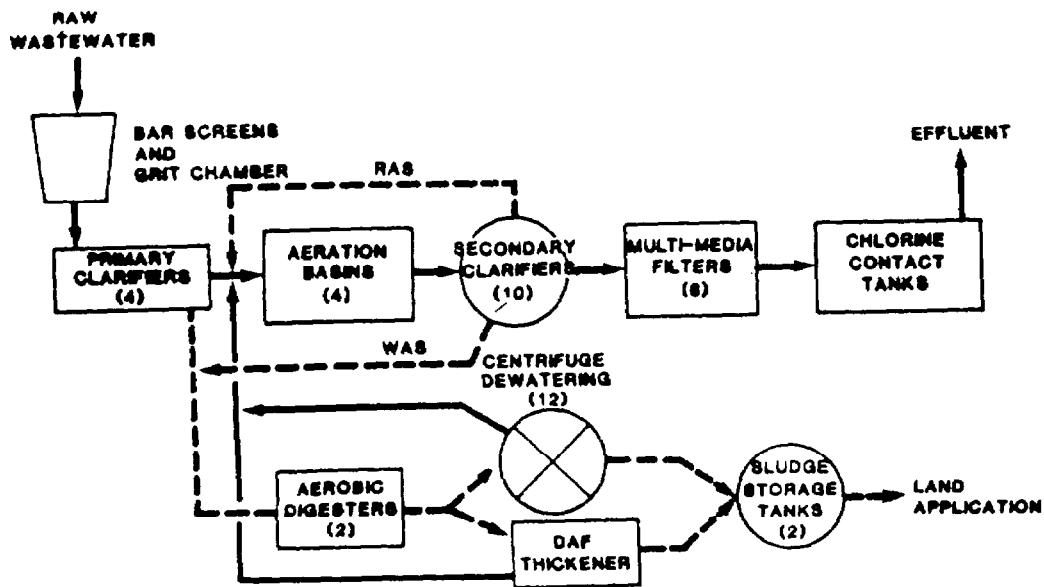

NEWARK WASTEWATER TREATMENT PLANT Newark, Ohio

The Newark Wastewater Treatment Plant (NWTP) had been in substantial non-compliance with its 1981 NPDES permit from the beginning of 1983 until the middle of 1984. This consistent violation had resulted primarily from increased waste loads on the POTW from industrial sources. Between 1979 and 1984, the percentage of industrial wastewater increased from 12 to 22 percent by volume, with influent BOD increasing from 220 to 330 mg/l, while suspended solids increased from 200 to 350 mg/l. To complicate the non-compliance problem, four separate ammonia discharge episodes occurred from August to October, 1983 which resulted in both the loss of activated sludge viability (interference) and the pass-through of the NH_3 and the subsequent killing of 80,000 fish in the Licking River. The fish kill precipitated the submission of Verified Complaints to the Ohio EPA on August 6, 1984 by the Black Hand Gorge Preservation Association, against the City of Newark and the NWTP. Following an investigation, the Ohio EPA issued Director's Final Findings and Orders, specifying a compliance schedule and interim discharge limits for the POTW until a planned facility upgrade is completed by July 1988.

There are two significant industrial contributors to the NWTP who were also issued Director's Final Findings and Orders in May, 1985. A fiberglass insulation manufacturer had been discharging high concentrations of phenol (2-5 mg/l) and NH_3 (up to 500 mg/l), with occasional spills of formaldehyde into the collection system. The activated sludge bacteria were acclimated to the phenol in the wastewater, but were susceptible to interference from shock loadings of the NH_3 and formaldehyde. Fortunately, the industry was responsive to the problems of the NWTP, and instituted a corrective program to:

- conserve and recycle plant flows, which have reduced their discharge by 60 percent (from 1.22 to 0.45 mgd) over the past two years;
- construct an aerated equalization basin to air-strip phenol and distribute diurnal fluctuations; and
- construct a pretreatment facility for their landfill leachate.

The POTW is still subject to occasionally high NH_3 loads from the industry, which is currently the only identifiable cause of isolated interference problems in the plant. The municipality and industry continue to work cooperatively to resolve this problem through the implementation of a spill prevention and control program. Additionally, the renovated POTW will use some of the existing clarifier tankage for off-line storage in the event of future spill episodes.

The replacement of coarse bubble aerators with fine bubble equipment in mid-1984 significantly improved BOD removals and the NWTP compliance record. Nitrification, which did not occur previously, now takes place in the last two aeration basins, because of the improved carbonaceous BOD (CBOD) removal in the initial basins. The only incident of non-compliance with the interim permit in 1985 resulted from an NH_3 discharge from the fiberglass manufacturer. In

this case, even though the average monthly BOD measured 29 mg/l, the carbonaceous component was less than 10 mg/l. The final permit will have a more stringent NH₃ requirement and will also designate CBOD as a permitted parameter.

A second major industry is a dairy which came on-line in 1976. Initially, the dairy stored whey waste in a silo and typically bled it into the sewer system. The discharge was high in both BOD and suspended solids (2,000 mg/l), and would occasionally be batch discharged to the POTW, resulting in a shock loading to the activated sludge and violation of the NPDES permit limits. The industry has since installed a reverse osmosis treatment system for the whey waste which has reduced the solids and organic loading to the plant.

The only categorical industry that currently discharges to NWTP is an electroplater who constructed a metals removal system in conformance with federal pretreatment regulations. In the past, dewatered sludge had been applied to corn fields adjacent to the plant property. However, when heavy metals were detected in seven of ten monitoring wells, Newark began hauling liquid sludge off-site. The planned facility upgrade will include installation of belt filter presses, so that the existing sludge (with acceptable levels of heavy metals) can once again be dewatered and more economically hauled off-site to farm land.

**NEWARK WASTEWATER TREATMENT PLANT
NEWARK, OHIO**

Design Flow: **8.0 (12.0 Hydraulic) mgd**
 Secondary Treatment: **Activated Sludge
(Conventional)**

Location: **Central Ohio**
 Population Served: **41,000**

INFLUENT WASTEWATER

	Typical (Upset)
Ave. Flow, mgd	7.5
% Industrial	15
BOD ₅ , mg/l	305 - 450
SS, mg/l	350 - 550
NH ₃ , mg/l	35 - 60

SIGNIFICANT INDUSTRIES

Industry	Flowrate (1000 gpd)	Problem Pollutants
Fiberglass	450	Phenol, NH ₃ , Formaldehyde
Dairy	223	BOD, Phosphorus, SS
Electroplater	77	Cr, Cd, Pb, Ni, Zn, Cyanide

PLANT LOADING

Primary Clarifiers

	Typical (Upset)
Overflow Rate, gal/sf/day	560
Detention Time, hours	3.2
Effluent BOD ₅ , mg/l	194 - 280
Effluent SS, mg/l	147 - 218

Aeration Basins

	Typical (Upset)
F/M, lbs BOD ₅ /lbs MLSS/day	0.25 - 0.4
MCRT, days	5-6
MLSS, mg/l	2,000
Detention Time, hours	6.3
Return Flow, %	50
D.O. Level, mg/l	2.0

Secondary Clarifiers

	Typical (Upset)
Overflow Rate, gal/sf/day	500
Detention Time, hours	3.7
SVI, ml/gm	150 - 350

PLANT PERFORMANCE

	Permit Limit	Typical (Upset)
BOD ₅ , mg/l	30	13 - 60
SS, mg/l	40	17 - 45
NH ₃ , mg/l (Summer)	25	15 - 30

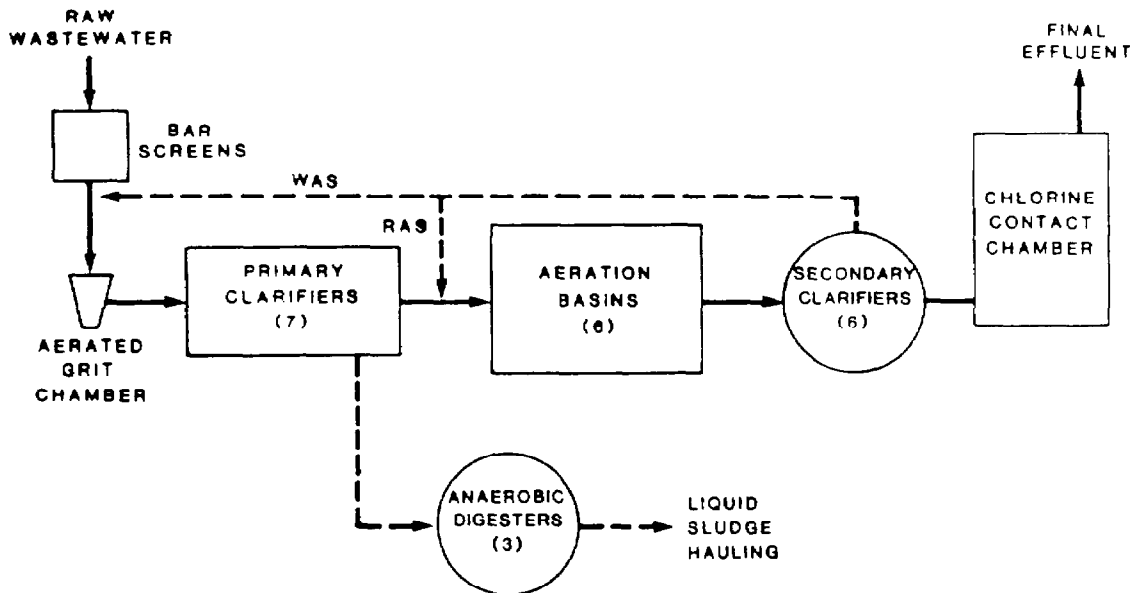

NORTH SHORE SANITARY DISTRICT GURNEE PLANT Gurnee, Illinois

The Gurnee Plant of the North Shore Sanitary District (NSSDGP) receives an average daily wastewater flow of 12.4 mgd from a variety of sources. Those sources include a major naval installation, domestic sewage discharges, secondary effluent from the District's North Chicago Sewage Treatment Plant, and other industries which contribute 17 percent of the total flow.

Since startup in 1976, the NSSDGP has experienced periodic failures at achieving nitrification in the two-stage activated sludge system. The failures to achieve nitrification to the ammonia levels of the District's NPDES effluent limits have also, at times, been accompanied by general process upsets which have resulted in effluent SS and BOD₅ violations. One of the major industrial contributors to the Gurnee Plant, a pharmaceutical manufacturer discharging an average flow of 750,000 gpd, has similarly experienced upsets of its own activated sludge pretreatment system which have resulted in violations of the District's local sewer use ordinance. It was initially believed that the observed interferences at the NSSDGP were the result of the discharge of filamentous organisms and other solids by the manufacturer. The initiation of in-plant solids control methods (which significantly lessened the quantity of solids entering the industrial wastewater pretreatment system) and pretreatment system upgrades did not, however, eliminate interferences at the NSSDGP.

In 1980, District personnel began to suspect that the presence of a nitrification inhibiting antibiotic, erythromycin, in the pharmaceutical wastewater was the main cause of the process upsets at the NSSDGP. By 1983, test and control bench-scale activated sludge reactors were placed in operation and the effects of the pharmaceutical wastewater and erythromycin on the NSSDGP were investigated. A bioassay test for the presence of erythromycin and other nitrification inhibitors was also developed, along with a Direct Insertion Probe/Mass Spectrometric technique for confirmation. The results of the bench-scale testing indicated that the presence of soluble and/or solid constituents of the pretreated pharmaceutical wastewater inhibited nitrification and, at high levels, could completely suppress nitrification. Additionally, it was found that although erythromycin inhibited nitrification, acclimation to low concentrations of erythromycin could occur in the absence of extreme concentration fluctuations.

During January of 1984, an observed average industrial pretreatment effluent erythromycin concentration of 53 mg/l with mass loading fluctuations of greater than two orders of magnitude completely inhibited nitrification in the Gurnee Plant. The resulting BOD₅ and SS concentrations were as high as 26 mg/l and 67 mg/l, respectively. Lower concentrations of erythromycin in the absence of such strong concentration fluctuations did not interfere with the performance of the Gurnee Plant during August of 1984, with average effluent BOD₅ and SS concentrations of 11 mg/l and 8 mg/l, respectively, and effluent ammonia concentrations ranging from 0.4 mg/l to 1.5 mg/l as N. Experience at the Gurnee Plant and with the bench-scale test systems has also indicated that a lag period of two to three mean cell residence times is required before the effects

of erythromycin on the activated sludge process become apparent. Erythromycin also was found to disrupt the settling of the first-stage carbonaceous organisms.

Measures undertaken by District personnel to lessen the effect of the pharmaceutical discharge on plant performance have included:

- The addition of inorganic coagulants to aid primary clarifier performance;
- the addition of polymer to the first-stage activated sludge system,
- daily bacterial (*staphylococcus aureus*) bioassays of industrial wastewaters for the presence of inhibiting substances; and
- the development of an ordinance governing the discharge of erythromycin to the NSSDGP.

Since passage of the ordinance in November, 1985, in which the discharge limits for erythromycin were established, the NSSDGP has substantially been in compliance with its NPDES permit and ammonia levels of 0.25 mg/l to 1 mg/l as N have been consistently achieved.

**NORTH SHORE SANITARY DISTRICT GURNEE PLANT
GURNEE, ILLINOIS**

Design Flow: 13.8 mgd
Secondary Treatment: Activated Sludge
(Two-Stage, Modified-Contact)

Location: Northeastern Illinois
Population Served: 65,000

INFLUENT WASTEWATER

	Typical (Upset)
Ave. Flow, mgd	12.4
% Industrial	37
BOD ₅ , mg/l	140
SS, mg/l	180
NH ₃ , mg/l	15

SIGNIFICANT INDUSTRIES

Industry	Flowrate (1000 gpd)	Problem Pollutants
Pharmaceutical	750	Antibiotics, SS
Electroplating	100	Cu, CN
Chemical	170	Organics
Nonferrous Metals	90	W
Military Installation	3,500	pH

PLANT LOADING

Primary Clarifiers	Typical (Upset)	First Stage Aeration Basins	Typical (Upset)
Overflow Rate, gal/sf/day	695	F/M, lbs BOD ₅ /lbs MLVSS/day	0.95
Detention Time, hours	2.7	MCRT, days	7
Effluent BOD ₅ , mg/l	100	MLSS, mg/l	3000
Effluent SS, mg/l	100	Detention Time, hours	4.2
		Return Flow, %	25
		D.O. Level, mg/l	2.5
First Stage Clarifiers	Typical (Upset)	Second Stage Aeration Basins	Typical (Upset)
Overflow Rate, gal/sf/day	780	F/M, lbs NH ₃ -N/lbs MLVSS/day	0.07
Detention Time, hours	2.5	MCRT, days	13
		MLSS, mg/l	3500
		Detention Time, hours	5.8
		Return Flow, %	50
		D.O. Levels, mg/l	2.5
Second Stage Clarifiers	Typical (upset)		
Overflow Rate, gal/sf/day	645		
Detention Time, hours	3.1		

PLANT PERFORMANCE

	Permit Limit	Typical (Upset)
BOD ₅ , mg/l	10	5 (17)
SS, mg/l	12	5 (23)
NH ₃ , mg/l summer	1.5	0.5 (15)

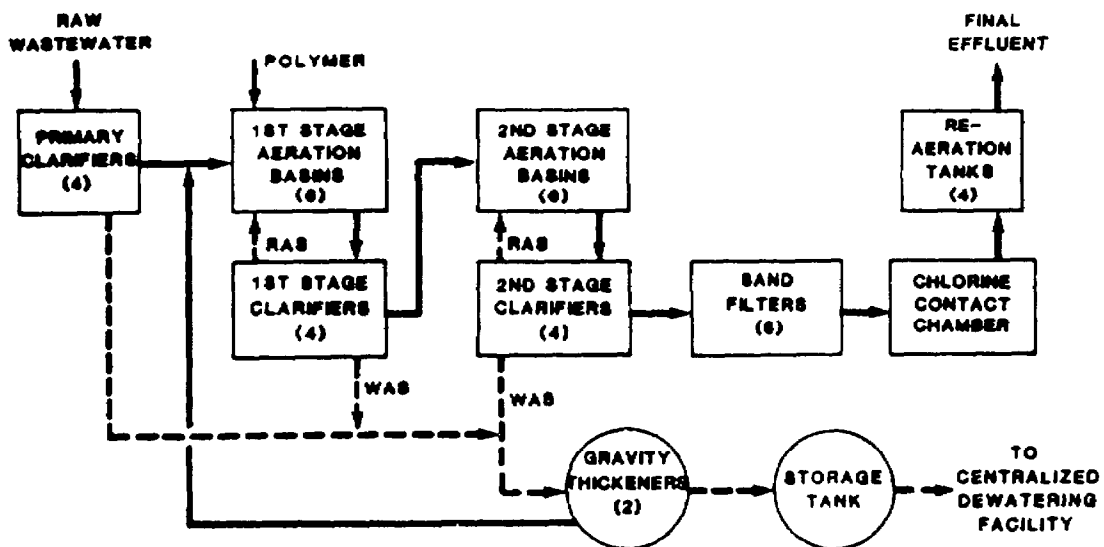

PASSAIC VALLEY WASTEWATER TREATMENT PLANT

Newark, New Jersey

Coping with industrial waste discharges to a 300 mgd POTW in a highly industrialized area is a challenging task. The Passaic Valley Sewerage Commissioners (PCSC) maintain an industrial waste control staff to monitor nearly 400 industries that contribute 20 percent of the wastewater volume and 50 percent of the waste strength. The PVSC performed their first Industrial Waste Survey for database development in 1972, and adopted a set of Rules and Regulations (including local limits) in 1976. By 1982, a comprehensive system consistent with the Federal Clean Water Act of 1977 had been adopted, which established uniform user fees for mass and volumetric loadings in the Passaic Valley plant.

The influent wastewater to the POTW is considered a high-strength waste, with typical BOD and TSS values of 290 and 450 mg/l, respectively. Despite the strength of the influent, the plant is close to meeting the 30/30 NPDES discharge limits, even though the primary clarifiers are not scheduled to go on-line until later this year (1986). The high percentage of industrial flow volume is responsible for the high influent BOD, and hence an interference exists, although the number of industries makes it impossible at this time to determine which are responsible for the interference. The PVSC believes that the addition of primary treatment coupled with the economic incentives for pretreatment created by the user charge system will reduce the effluent to consistently below the limits.

The individual constituents of concern to the PVSC fall into three general categories:

- metals
- flammables
- fibers

The sources of heavy metals are chemical manufacturers, platers and tanneries. One of the smaller (30,000 gpd) chemical companies had been identified as a significant contributor (120 lbs/day) of mercury to the POTW. Although the mercury level of 50 ug/l at the influent was not inhibitory to the activated sludge, the concentration of mercury in the sludge limited the municipality's disposal options. It is anticipated that ocean disposal of sludge will not be permitted much longer, which will require the PVSC to incinerate. The Federal Air Pollution Standards limit the mercury discharge to 3,200 g/day, which translates into a local limit of 0.4 lbs/day in the wastewater from the industry in question. The chemical company responded by isolating the relevant process streams and utilizing a batch recovery system for the mercury, reducing the discharge from 120 down to 5 lbs/day. When ocean disposal is formally eliminated as a disposal option, the company can employ carbon treatment for removal of the remaining mercury.

The oxidation of trivalent chromium to the hexavalent form in a POTW sludge incinerator is a problem caused by the chromium-laden discharge from various industrial users. An additional problem caused by the tanning industrial category

is the clogging of local sewers that results from hides being inadvertently discharged from the companies. Similar clogging problems existed at the pretreatment plant due to the balled-up fibers from the pulp and paper manufacturers which close off sludge return lines, orifices and nozzles. This condition improved substantially when the moving-bridge primary clarifiers were placed in service in December, 1985.

The Passaic Valley plant had a unique problem with high concentrations of flammable materials in the influent wastewater. The lower explosive limit (LEL) is defined as the "lowest concentration of a combustible substance in air through which a flame, once ignited, will continue to propagate". When a wastewater approaches 50 percent of the LEL, it is important that it not be discharged into the sewer collection system. The pure oxygen process has a control built into the system which vents all oxygen away from the activated sludge treatment process when high LEL is detected. Since the venting of the oxygen reduces the treatment efficiency it can result in a permit violation as well as creating a health hazard.

The PVSC instituted a three-part program in October of 1984 to mitigate the problems of flammables:

- required industries using or manufacturing solvents which come in contact with discharged wastewater to install LEL detection instruments, and to provide pretreatment to isolate the flammables if high LELs were detected;
- surveyed other industries which used solvents but had no such discharge to determine if a potential existed, requiring necessary control mechanisms; and
- monitored the collection system more closely for illegal dumping of such chemicals.

Representatives of Passaic Valley made it clear that a cooperative attitude on the part of industry was an important factor in successful mitigation of interference problems. In fact, it was the local pharmaceutical manufacturer that conducted the research resulting in the type of LEL instrument recommended by the Advisory Committee when the LEL regulation was adopted.

PASSAIC VALLEY WASTEWATER TREATMENT PLANT
Newark, New Jersey

Design Flow: 330 mgd
Secondary Treatment: Activated Sludge (Pure Oxygen)

Location: Adjacent to Newark Bay
Population Served: 1.5 Million

INFLUENT WASTEWATER		SIGNIFICANT INDUSTRIES		
	Typical (Upset)	Industry	Flowrate (mgd)	Problem Pollutants
Ave. Flow, mgd	350	Pulp and Paper (2)	10.3	Fibers
% Industrial	19	Pharmaceuticals	6	Xylene, Toluene, Hexane
BOD ₅ , mg/l	290 (500)	Tanneries (3)	1.5	Cr
SS, mg/l	450 (750)	Chemicals (3)	0.5	Cd, Cr, Hg, Pb

PLANT LOADING			
Primary Clarifiers	Typical (Upset)	Aeration Basins	Typical (Upset)
Overflow Rate, gal/sf/day	1,100	F/M, lbs BOD ₅ /lbs MLSS/day	0.6
Detention Time, hours	2.0	MCRT, days	5
Effluent BOD ₅ , mg/l	225	MLSS, mg/l	2,800
Effluent SS, mg/l	125	Detention Time, hours	1.6
		Return Flow, %	35
		D.O. Level, mg/l	4-12

PLANT PERFORMANCE			
	Typical (Upset)	Permit Limit	Typical (Upset)
BOD ₅ , mg/l	25 (40)	30	25 (40)
SS, mg/l	25 (60)	30	25 (60)

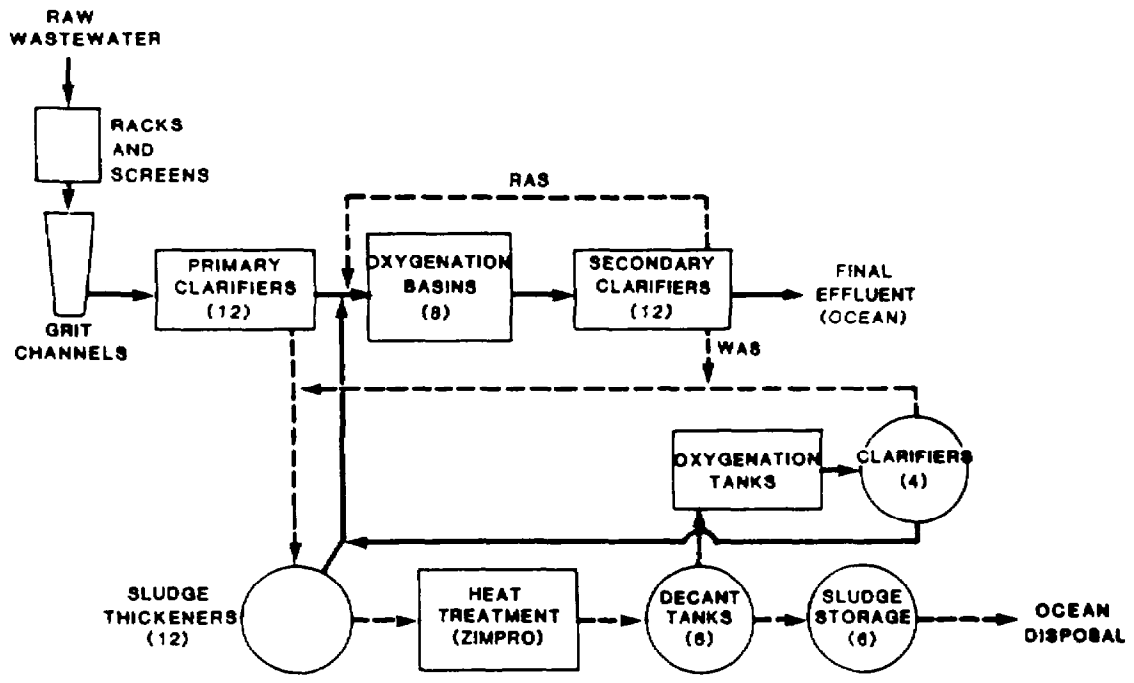

SIOUX CITY WASTE TREATMENT PLANT (SCWTP)
Sioux City, Iowa

The Sioux City Waste Treatment Plant (SCWTP) treats a combined industrial and municipal wastewater average flow of 13.5 mgd and discharges to the Missouri River. More than 140 industries were identified by an industrial survey as potential sources of wastewater. Of these, four are categorical metal finishing or electroplating industries and, as of recently, eleven industries contributed significantly to the suspended solids, BOD and oil and grease discharged to the SCWTP. Although the total volumetric load of the industrial wastewater is typically less than 10 percent of the total flow, the industrial organic loads to the plant account for greater than 50 percent of the observed loads.

The SCWTP has experienced two separate incidents in which industrial discharges have interfered with normal plant operations. Isolated slug loads of zinc were experienced by the SCWTP in March and again in April of 1984. Levels as high as 16 mg/l Zn were observed in the treatment plant influent and both slug-load incidents resulted in an upset of the activated sludge process and violations of the NPDES discharge limits. Effluent BOD₅ concentrations exceeded 60 mg/l and effluent suspended solids concentrations in excess of 200 mg/l were observed. The investigation of the first slug load of zinc was somewhat hampered by the lack of in-house capabilities for metals analysis and the first indication of a contamination problem was the process upset itself. Upon confirmation of the nature of the interference, a temporary system for the continuous addition of lime to the primary clarifiers, which would result in the precipitation of subsequent slug loads of zinc, was installed and operated until such time that frequent and periodic monitoring and analysis of the influent for metals could be performed at the SCWTP.

The source of the metal discharge was identified from the City's industrial use survey and from samples of wastewater and solids collected at specific locations in the wastewater collection system. The floor drain at the manufacturing facility through which the zinc discharges occurred was disconnected from the sanitary sewer. In addition to the process upsets, several years accumulation of sludge held in storage lagoons and slated for disposal by land application became contaminated with zinc. Upon receipt of special permitting from the State, the SCWTP was allowed to dispose of the sludge as planned.

In 1985, a pharmaceutical manufacturer came on-line discharging batches of high strength waste without pretreatment. The strength of the waste ranged from 10,000 to 100,000 mg BOD₅/l and the waste contained high levels of salt and sulfite. The average BOD₅ of the waste was 35,000 mg/l and the batch dumps represented 45 percent of the total organic load to the SCWTP. The activated sludge process was severely overloaded and intermittent depressions of the D.O. level occurred. It was possible to operate the activated sludge process to accommodate the severe organic loads, but the process would again be upset during the weekends when the pharmaceutical manufacturer was not discharging waste and the organic loads were reduced. Throughout 1985, the SCWTP experienced severe violations of their NPDES BOD₅ and suspended solids discharge limits. Frequent violations of the pharmaceutical manufacturer's

discharge permit occurred with respect to the organic strength and daily mass loading of the waste. The industrial user was placed on a compliance schedule and continued violations of the discharge permit necessitated actions that would result in flow equalization and reductions in the levels of methyl mercaptan, sulfite and sulfide. Presently, all batch waste dumps are transported by bulk to the SCWTP where they are metered, by SCWTP personnel, into the plant influent under controlled conditions.

The upset conditions presented in the following table represent conditions related to the discharge of the pharmaceutical wastewater. The reported upset conditions represent averages for several months of 1985 whereas the typical conditions were based on data for 1984 which spanned nine months and included those months in which the slug loads of zinc were experienced.

**SIOUX CITY WASTE TREATMENT PLANT
SIOUX CITY, IOWA**

Design Flow: 30 mgd
 Secondary Treatment: Activated Sludge
 (Conventional)

Location: Northwest Iowa
 Population Served: 135,000

INFLUENT WASTEWATER		SIGNIFICANT INDUSTRIES		
	Typical (Upset)	Industry	Flowrate (1000 gpd)	Problems/Pollutants
Ave. Flow, mgd	13.5	Meat Processing	1,000	BOD ₅ , oil and grease, SS
% Industrial	7	Pharmaceutical	70	BOD ₅ , methyl mercaptan, sulfite
BOD ₅ , mg/l	380 (612)	Metal Finishing	20	Zn, Cr, Ni
SS, mg/l	550 (630)			

PLANT LOADING			
Primary Clarifiers	Typical (Upset)	Aeration Basins	Typical (Upset)
Overflow Rate, gal/sf/day	577	F/M, lbs BOD ₅ /lbs MLSS/day	0.2 (0.3)
Detention Time, hours	2.9	MCRT, days	10
Effluent BOD ₅ , mg/l	220 (370)	MLSS, mg/l	2500
Effluent SS, mg/l	240 (235)	Detention Time, hours	15
		Return Flow, %	40
		D.O. Level, mg/l	2.5

Secondary Clarifiers		Typical (Upset)
Overflow Rate, gal/sf/day		722
Detention Time, hours		3
SVI, ml/gw		150

PLANT PERFORMANCE		
	Permit Limit	Typical (Upset)
BOD ₅ , mg/l	30	34 (37)
SS, mg/l	30	33 (45)

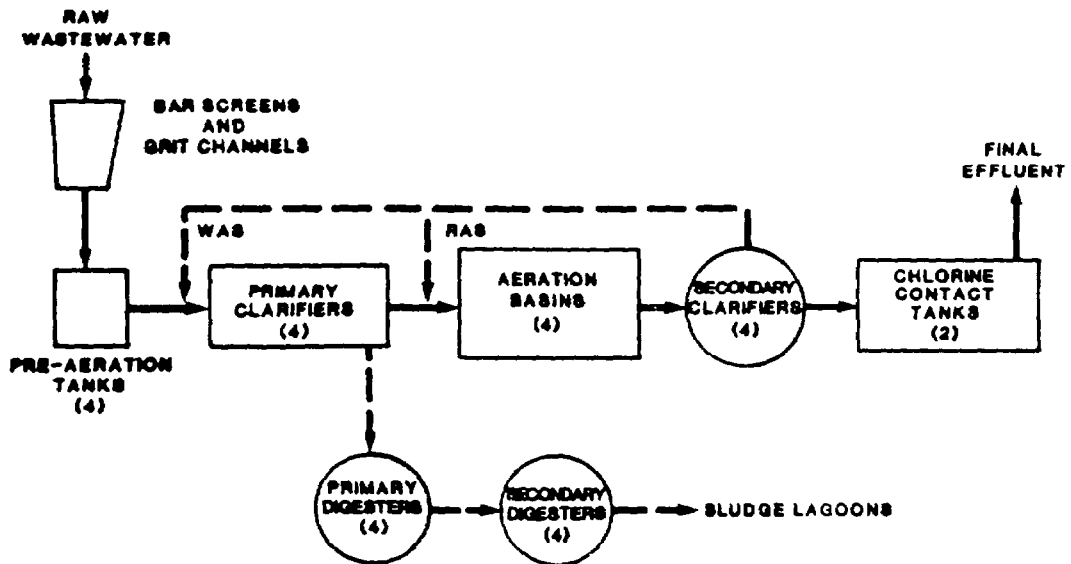

TOLLESON WASTEWATER TREATMENT PLANT

Tolleson, Arizona

The Tolleson Wastewater Treatment Plant (TWTP) is a two stage trickling filter plant that treats a predominantly domestic wastewater from Phoenix, Arizona suburbs. The successful operation of the TWTP is dependent on the one significant industrial contributor to the treatment plant, a meatpacker who processes 1,000 to 1,400 head of beef per day.

The influent to the TWTP could be typified as medium to high-strength municipal wastewater with average BOD₅ and SS levels being 275 mg/l and 225 mg/l, respectively. Approximately 25 to 30 percent of the average organic and solids loading is contributed by the meatpacker average at levels of 1,100-1,600 mg/l BOD₅ and 700-1,200 mg/l SS, for wastewater flows of 0.8-1.0 mgd. In general, the domestic/industrial waste stream BOD₅, and SS can both be treated to below 10 mg/l, well within the 30/30 discharge limits. However, in the past the meatpacker has upset the treatment process by slug discharging blood or other high strength organic slaughter by-products with BOD₅ and SS levels of up to 2,200 mg/l and 1,375 mg/l, respectively. Prior to 1982, these upset conditions would last for several days and result in weekly and monthly effluent suspended solids of 30-40 mg/l, in violation of permit limits.

Treatment upsets have diminished in frequency and intensity since 1982 for two reasons:

- A legal contract with the meatpacker limits flow to 0.8 mgd, BOD₅ to 10,675 lbs per day (1,600 mg/l) and SS to 6,670 lbs per day (1,000 mg/l), and provides for fines or disconnection if these limits are exceeded, and
- Improved treatment plant process monitoring has enabled operators to better detect, and thus act on, a potentially upsetting condition.

The contract with the meat packer attempts to prevent waste blood from being stored for more than about eight hours at a time before discharging to the sewer. Prior practice resulted in blood being held back for up to a week at a time before being discharged all at once.

Primarily through trial and error, the operators of the TWTP have established several operating parameters that help them in detecting upset conditions in the plant. The depth of sludge in the primary clarifiers is monitored closely; a high or rapidly increasing sludge depth is indicative of upset conditions and is caused by the high solids content of the meatpacking waste. The mixed liquor in the solids contact basin following the second trickling filter is monitored closely as well, with levels above 500 mg/l signaling possible problems. Mixed liquor

concentrations of 1,500 mg/l generally result in effluent suspended solids of greater than 30 mg/l. To remedy an upset condition, primary sludge pumping rates are manually increased above their normal levels to reduce the solids inventory and prevent escape in the effluent.

**TOLLESON WASTEWATER TREATMENT PLANT
TOLLESON, ARIZONA**

Design Flow: 8.3 mgd
Secondary Treatment: 2 Stage Trickling Filter with Solids Contact

Location: South Central Arizona
Population Served: 65,000

INFLUENT WASTEWATER

	Typical (Upset)
Ave. Flow, mgd	7.4
% Industrial	14
BOD ₅ , mg/l	275 (340)
SS, mg/l	225 (280)

SIGNIFICANT INDUSTRIES

Industry	Flowrate (1000 gpd)	Problem Pollutants
Meat Packer	1000	BOD, SS

PLANT LOADING

Primary Clarifiers	Typical (Upset)	First Stage Trickling Filter	Typical
Overflow Rate, gal/sf/day	860	Hydraulic Loading, gal/sf/day	1,000
Detention Time, hours	1.9	Organic Loading, lbs BOD ₅ /1000 cf/day	45
Effluent BOD ₅ , mg/l	160	Recirculation, %	100
Effluent SS, mg/l	95		
Intermediate Clarifiers	Typical (Upset)	Second Stage Trickling Filter	Typical
Overflow Rate, gal/sf/day	735	Hydraulic Loading, gal/sf/day	500
Detention Time, hours	2.4	Recirculation, %	100
Effluent BOD ₅ , mg/l	30		
Effluent SS, mg/l	30		
Secondary Clarifiers	Typical (Upset)		
Overflow Rate, gal/sf/day	480		
Detention Time, hours	7.4		

PLANT PERFORMANCE

	Permit Limit	Typical (Upset)
BOD ₅ , mg/l	30	9 (25)
SS, mg/l	30	9 (35)

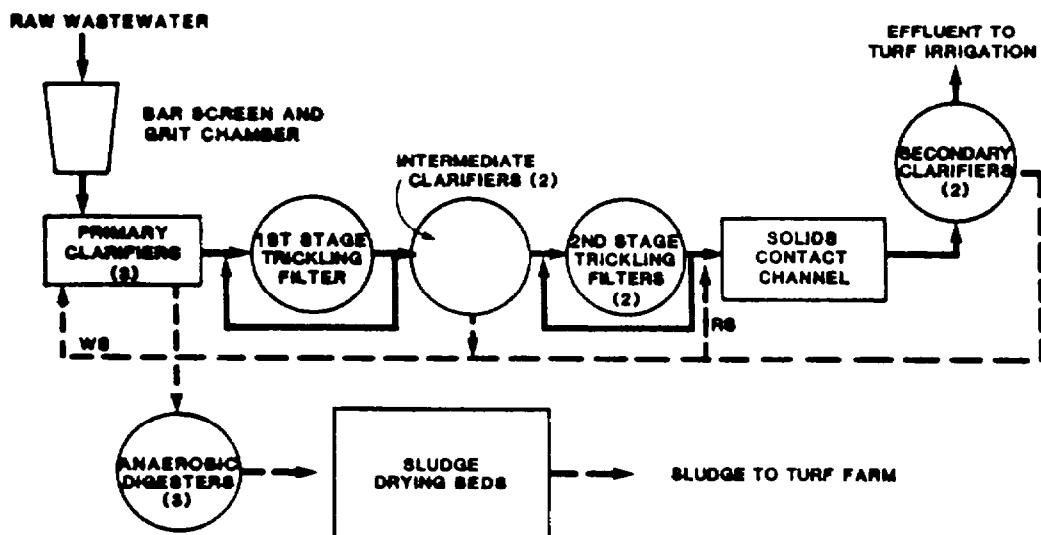

APPENDIX B
INTERFERING SUBSTANCES

CONVENTIONAL

Biochemical Oxygen Demand
Fats, Oil and Grease

pH
Suspended Solids

METALS AND INORGANICS

Alkalinity
Ammonia
Arsenic
Barium
Beryllium
Boron
Cadmium
Calcium
Chloride
Chromium
Cobalt
Copper
Cyanide
Iodine
Iron
Lead
Magnesium

Manganese
Mercury
Molybdenum
Nickel
Nitrogen
Phosphorus
Selenium
Silver
Sodium
Sulfate
Sulfide
Sulfite
Tin
Thallium
Vanadium
Zinc

AGRICULTURAL CHEMICALS

Aldrin/Dieldrin
Chlordane
Chlorophenoxy Herbicides
DDT
Endrin

Heptachlor
Lindane
Malathion
Organometallic Pesticides
Toxaphene

AROMATICS

Benzene
Chlorobenzene
Dichlorobenzene
Dinitrotoluene

Nitrobenzene
PCBs
Toluene
Zylene

HALOGENATED ALIPHATICS

Carbon Tetrachloride
Chloroform
Chloromethane
Dichloroethane
Dichloroethylene
Dichloropropane
Hexachlorobutadiene
Hexachlorocyclohexane
Hexachloroethane

Methylene Chloride
Tetrachlorodibenzodioxins
Tetrachlorodibenzofurans
Tetrachloroethane
Tetrachloroethylene
Trichloroethane
Trichloroethylene
Vinyl Chloride

NITROGEN COMPOUNDS

Acetanilide
Acetonitrile
Acrylonitrile
Aniline
Benzidine
Benzonitrile
Chloroaniline
Dichlorobenzidine
Dimethylnitrosamine
Diphenylhydrazine

Dyes
EDTA
Ethylpyridine
Fluorenamine
Hydrazine
Nitrosodiphenylamine
Pyridine
Trisodium Nitriiotriacetate
Urea

OXYGENATED COMPOUNDS (Acids, Alcohols, Aldehydes, Esters, Ethers, Ketones)

Acetone
Acrolein
Adipic Acid Esters
Allyl Alcohol
Benzoic Acid
Boric Acid
Butanol
Butyl Benzoate
Chlorobenzoate
Chloroethyl Ether
Cinnamic Acid
Crotonol
Cyclohexanecarboxylic Acid
Diethylene Glycol
Ethoxy Ethanol
Ethyl Acetate

Ethylene Glycol
Formaldehyde
Formic Acid
Heptanol
Hexanol
Isophorone
Linoleic Acid
Malonic Acid
Methanol
Methylethyl Ketone
Methylisobutyl Ketone
Octanol
Polyethylene Glycols
Polyvinyl Alcohols
Protocatechuic Acid
Syringic Acid

PHENOLS

Catechol
Chlorophenol
Cresol
Dichlorophenol
Dinitrophenol
Nitrophenol

Pentachlorophenol
Phenol
Trichlorophenol
Trinitrophenol
Vanillin

PHTHALATES

Dimethylphthalate
Diisobutylphthalate
Ethylhexylphthalate

POLYNUCLEAR AROMATIC HYDROCARBONS

Anthracene
Benzo (a) Anthracene
Chloronaphthalenes
di-Isopropylnaphthalene

Naphthalene
Phenanthrene
Pyrene