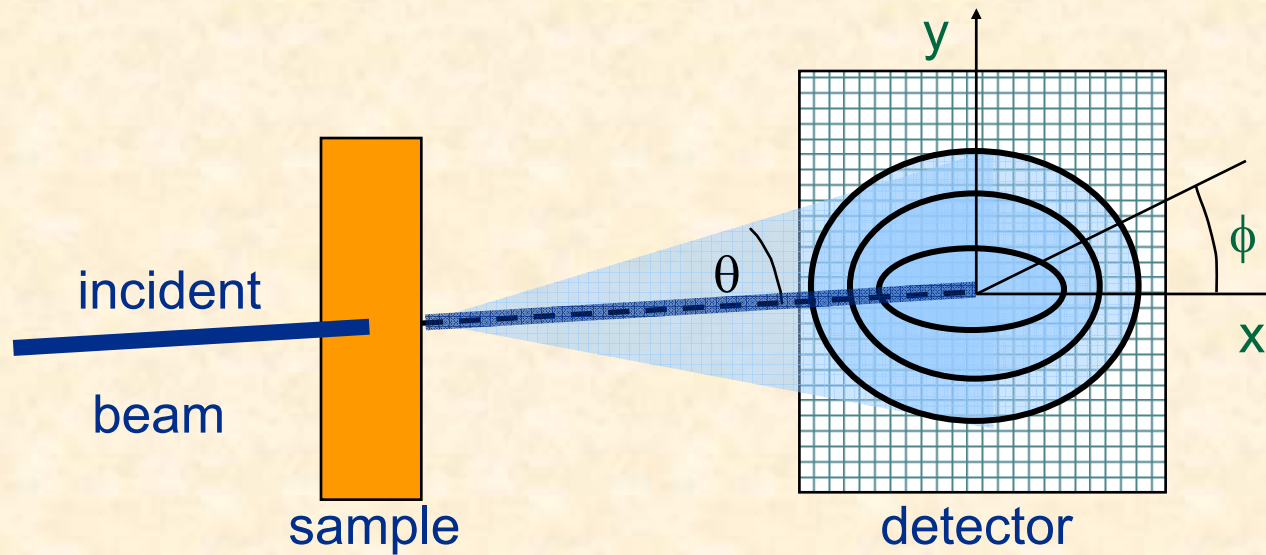


SMALL ANGLE NEUTRON SCATTERING FOR BEGINNERS

Volker Urban



Outline

- Applications – is SANS for you?
- Comparison with microscopy and diffraction
- Basic concepts of the technique
- At the beamline – SANS jargon
- Some words on data analysis/interpretation


SAS of x-rays, neutrons, laser light

- **SAXS & SANS: structural information 1nm-1 μ m**
- **X-rays**
 - Rotating anode / sealed tube: ~ 400 k\$
 - Synchrotron: high flux, very small beams
- **Neutrons**
 - Isotope contrast, high penetration, magnetic contrast
- **Laser Light scattering**
 - Bench top technique, static and dynamic
- **Applications in ...**
 - Important for polymers, soft materials, (biology)
 - Particulate and non-particulate
 - Pretty much anything 1nm-1 μ m



...really anything?

SAS applications A to Z



But what
about SEM,
TEM, AFM
...?

Alzheimer's disease, aerogel, alloys

Bio-macromolecular assemblies,
bone

Colloids, **complex fluids**, catalysts

Detergents, dairy (casein micelles)

Earth science, emulsions

Fluid adsorption in nanopores, fuel
cells, food science (chocolate)
FRIENDLY users!

Gelation, green solvents

High pressure, high temperature...,
hydrogen storage, helium bubble
growth in fusion reactors

Implants (UHDPE)

Jelly

Kinetics (e.g. of polymerization or
protein folding), keratin

Liquid crystals

Magnetic flux lines, materials
science

Nano-anything

Orientalional order

Polymers, phase behavior, porosity

Quantum dots (GISAXS)

Rubber, ribosome

Soft matter, surfactants

Time-resolved, thermodynamics

Uranium separation

Vesicles, virus

Wine science

Xylose isomerase

Yttrium-stabilized zirconia (YSZ)

Zeolites

Neutron Scattering and Microscopy

- **Common features**

- Size range 1nm-1 μ m
- Contrast labeling options (stains / isotope labels)

- **SANS practical aspects**

- No special sample preparation such as cryo-microtome
- Sample environments control (p, T, H)
- Non-destructive
- In-situ, time-resolved

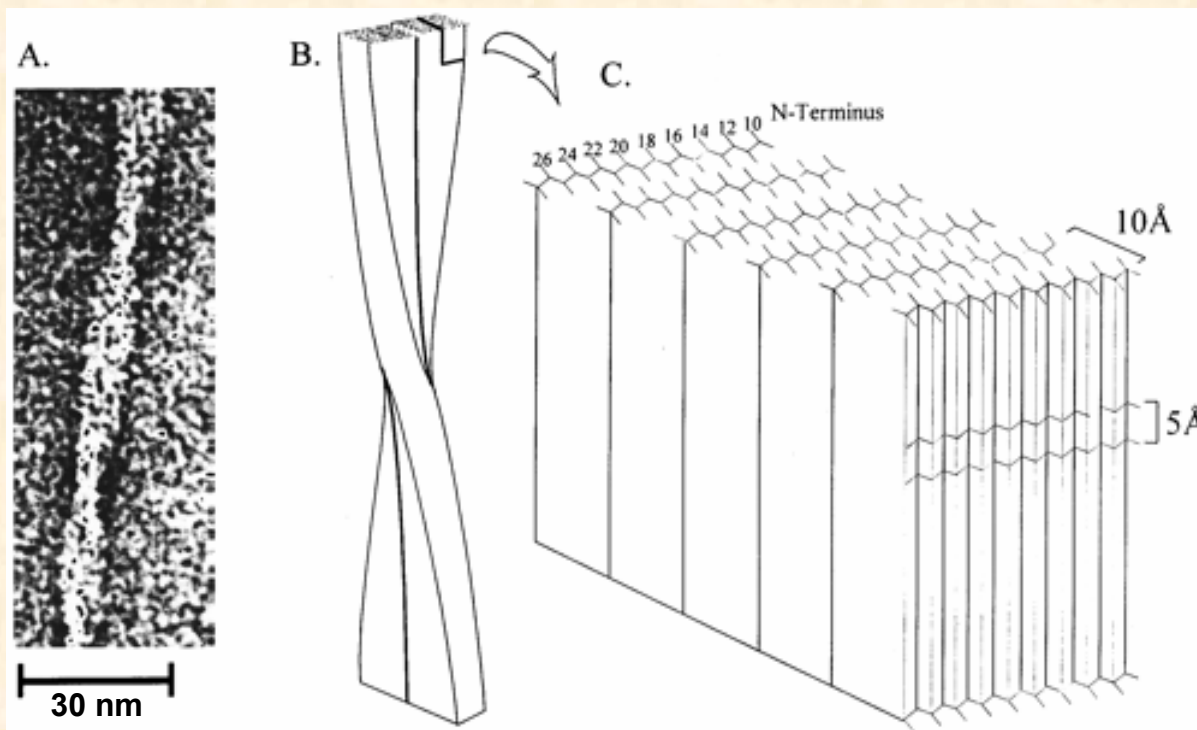
- **Fundamental difference**

- “Real space” image with certain resolution
- Scattering pattern, averaged over volume

- **Complimentarity**

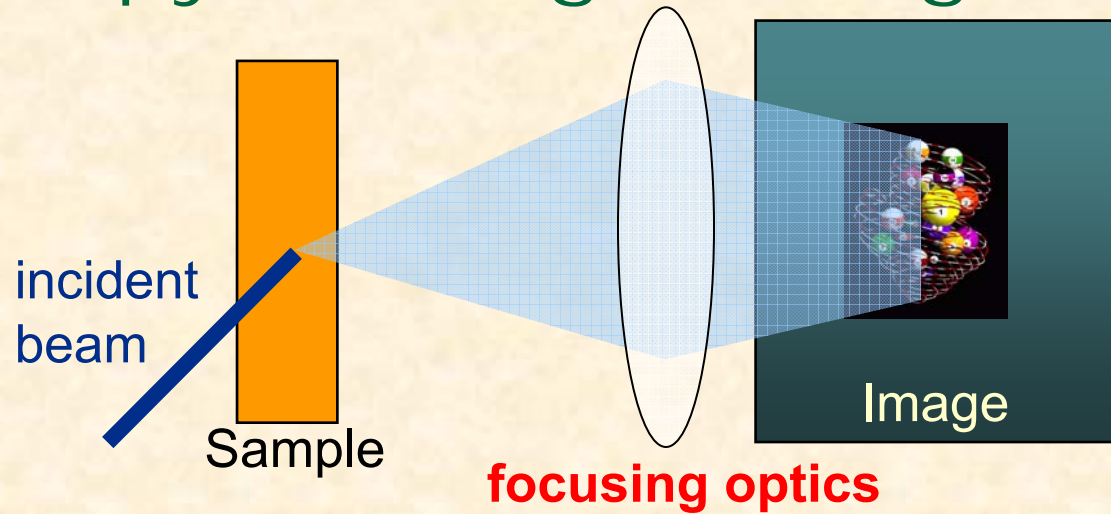
Alzheimer's Disease – β -Amyloid

- Among leading causes of death
- Miss-folded peptides form hierarchical ordered fibril structures & plaques
- Structure established using synthetic model peptides and **complimentary** methods NMR, SANS, EM

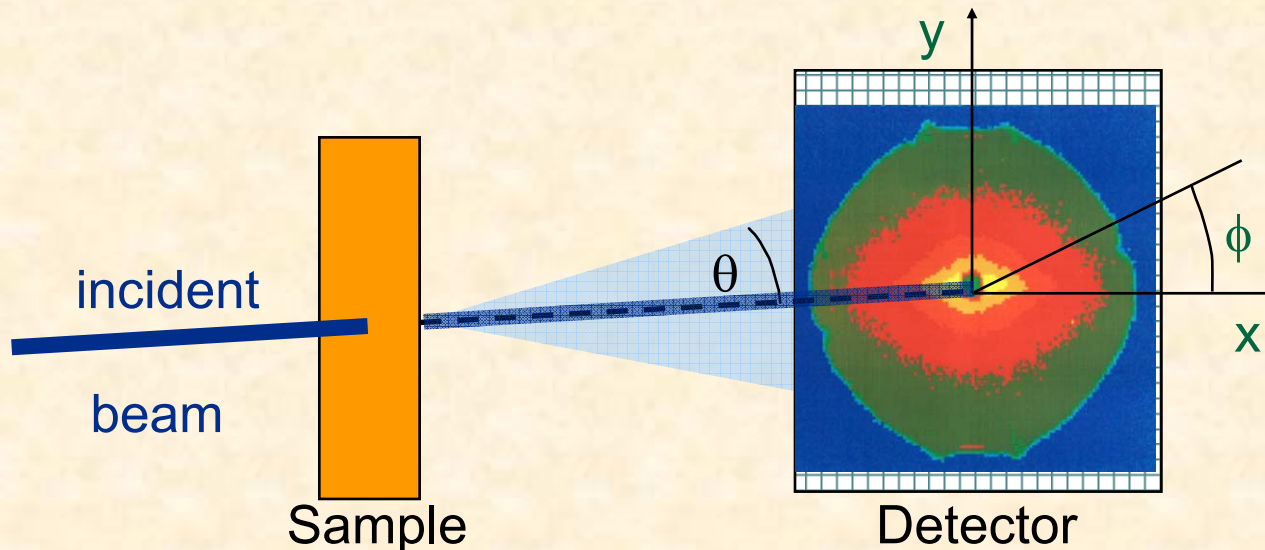


- **NMR**
 - β -fold
- **SANS**
 - Fiber shape
 - Diameter
 - 6 sheet stack
- **EM**
 - Overall morphology
 - Twist

Microscopy : enlarged image



SAS : interference pattern



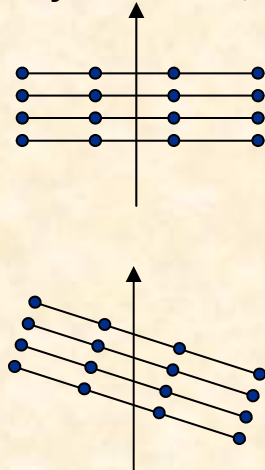
Scattering and Diffraction (Crystallography)

- **Strictly/historical: Scattering from individual electrons/nuclei, Diffraction through interference of primary waves**
- **Today's common language: **Diffraction** from crystals, **Scattering** from anything else (less ordered) > the difference is in the SAMPLE!**
- **Same basic physics: interactions of radiation with matter**
 - **SAXS/WAXS, SAND/WAND**
 - **Instruments: resolution (D) / flux (S)**
 - **Diffraction needs crystals, scattering does not.**
 - **Analysis?!**

Diffraction (Crystallography) *here at Small Angles*

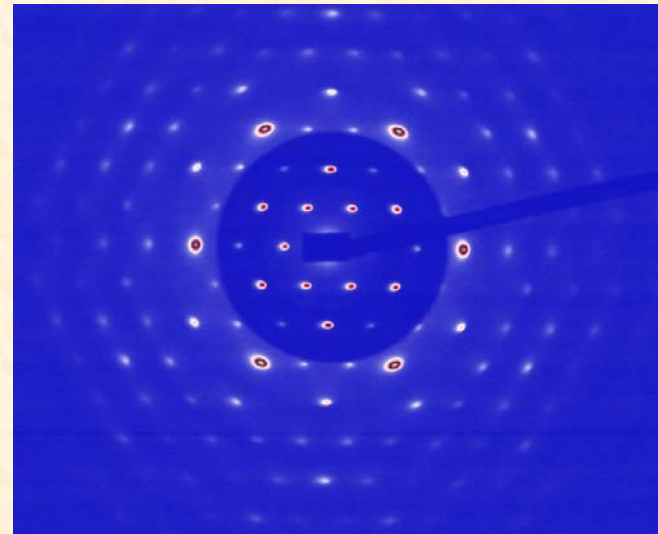


Plate Geometry - Versmold, Uni Aachen



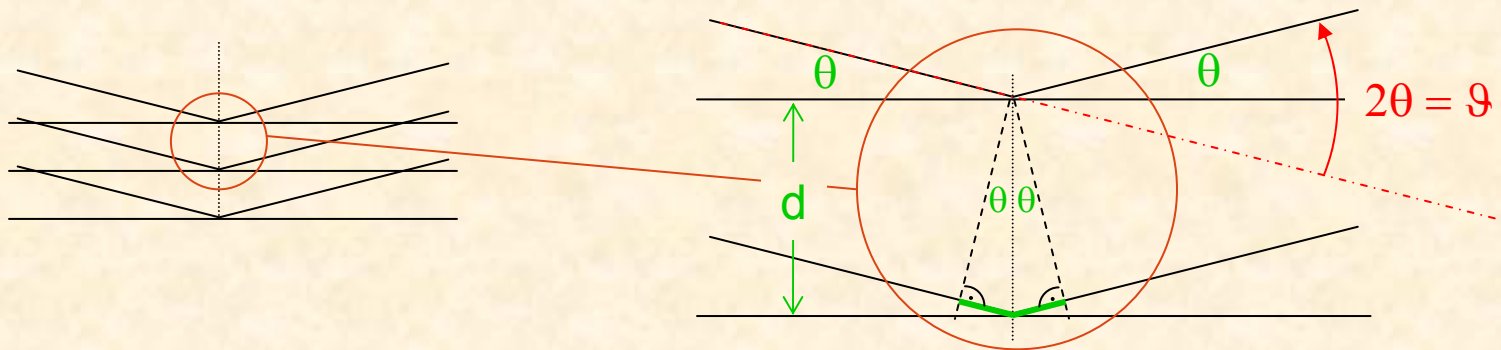
**Shear ordered charge
stabilized colloidal dispersion**

**Scattering along Bragg-rods
of layered system
> stacking sequence**



Diffraction - Bragg's Law

Waves with wavelength λ are reflected by sets of lattice planes



Phase shift = $2\pi \Delta/\lambda$

if $\Delta = n \lambda$ then reflection
otherwise extinction



$$n\lambda = 2d \sin(\theta)$$

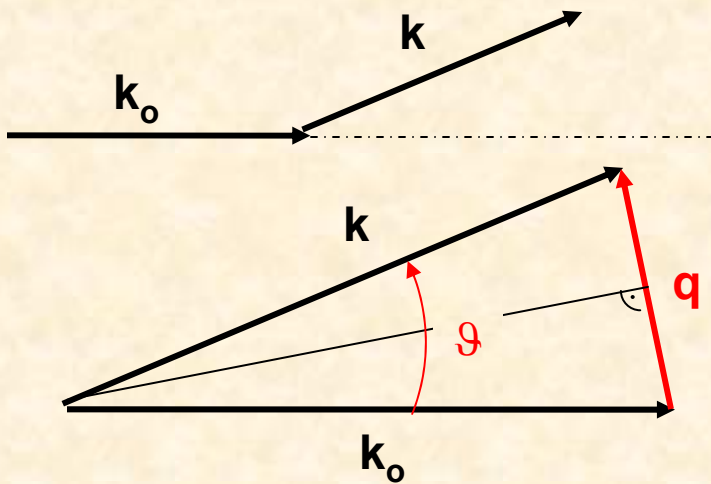
$$\Delta = 2d \sin(\theta)$$

$$1/d = 2/\lambda \sin(\phi/2)$$

Scattering Vector – q

aka momentum transfer, Q , h , k , s

Wave vector \mathbf{k} : $|\mathbf{k}| = k = 2\pi/\lambda$



$$\frac{1}{d} = \frac{2}{\lambda} \sin\left(\frac{\vartheta}{2}\right)$$



$$d = \frac{2\pi}{q}$$

$$q = 2k \sin\left(\frac{\vartheta}{2}\right) = \frac{4\pi}{\lambda} \sin\left(\frac{\vartheta}{2}\right)$$

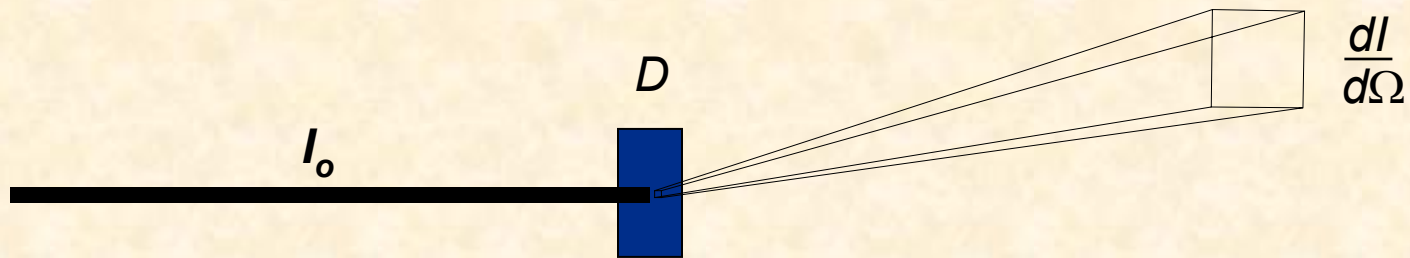
q in nm^{-1} or \AA^{-1}

Neutron Scattering Intensity

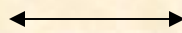
- Incoming waves scatter off individual nuclei according to scattering length **b** (can be + or -).
- Interference of wavelets from distribution of nuclei (= structure) adds up to “net scattering” amplitude (Fourier transform of structure).
- Measured intensity is the magnitude square of amplitude.
- Measured intensity is also the Fourier transform of pair correlation function $P(r)$.

$$I(q) = \left| \int_V (\rho(\vec{r}) - \rho_s) e^{-i\vec{q} \cdot \vec{r}} d^3 r \right|^2$$

Absolute Intensity / Scattering Cross Section – cm^{-1} ?



$$\frac{dI}{d\Omega} = TI_0 D \frac{d\Sigma}{d\Omega}$$



$$\frac{d\Sigma}{d\Omega} = \frac{1}{TI_0 D} \frac{dI}{d\Omega} \quad [\text{cm}^{-1}\text{sterad}^{-1}]$$

$dI/d\Omega$ = Scattered intensity per solid angle







I_0 = Primary beam intensity

T = Transmission (x-ray absorption, incoherent neutron scattering)

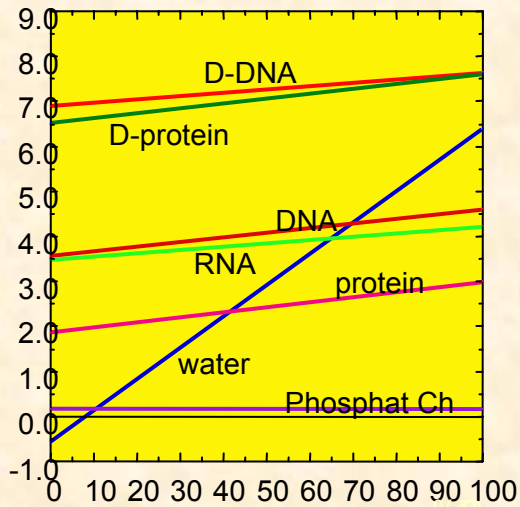
D = Thickness

$d\Sigma/d\Omega$ = Scattering **cross section per unit volume** [$\text{cm}^{-1}\text{sterad}^{-1}$]

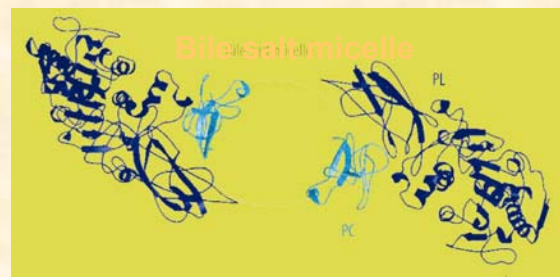
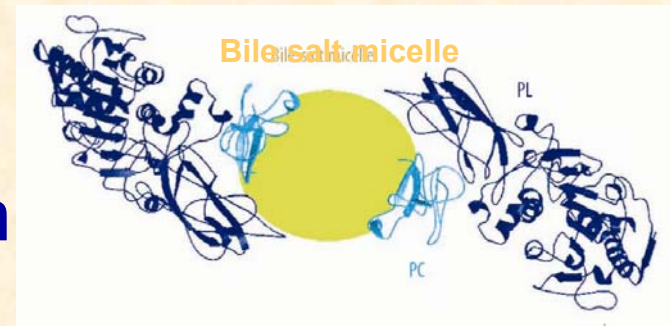
Contrast – Atomic Scattering Lengths

Element	Neutrons (10^{-12} cm)	X-rays (10^{-12} cm)	Electrons
^1H	-0.374	0.28	1 
^2H (D)	0.667	0.28	1 
C	0.665	1.67	6 
N	0.940	1.97	7 
O	0.580	2.25	8 
P	0.520	4.23	15 

SANS – Contrast Variation

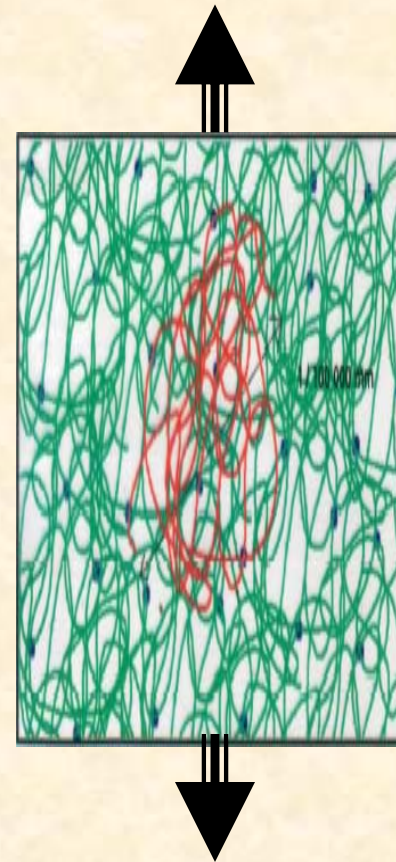
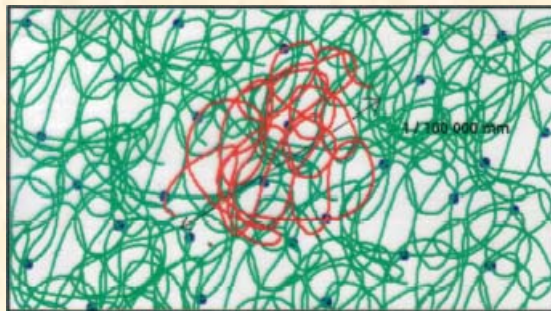


**D₂O/H₂O
contrast variation**



Rubber (Polymer Network)

- Unique mechanical properties – “liquid” on local scale but long range structure memory
- Economic importance – Tires



- Blend “normal” H- and some % D-polyisoprene
- Cross-link to form rubber network
- Stretch rubber sample in the SANS beam and collect data

SANS at increasing deformation

- Stronger anisotropy at smaller q (larger distances)
- Ellipse > diamond transition at large deformation
- Warner-Edwards tube approach:

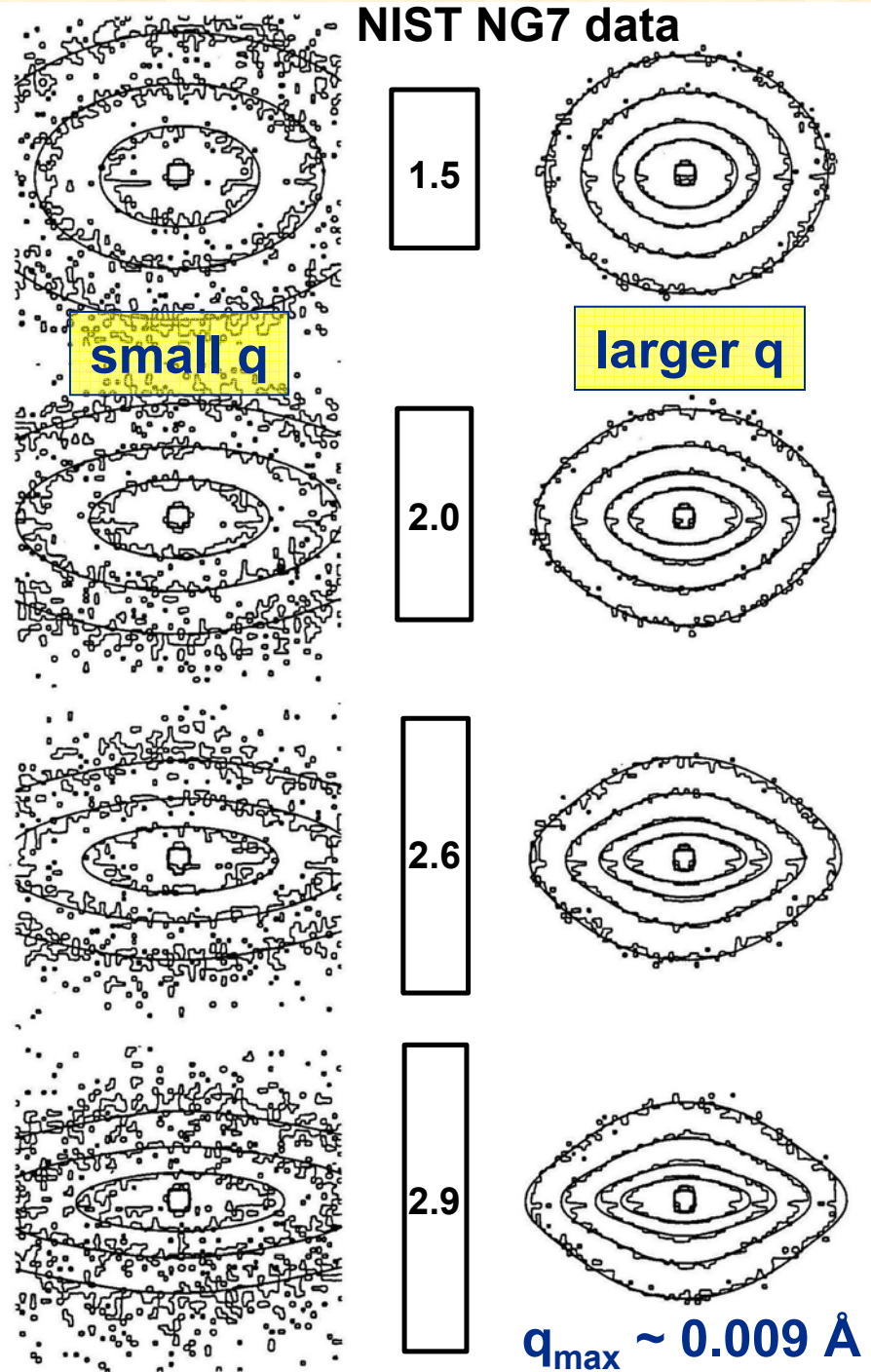
affinely deformed Gauss chain

$$S(\bar{q}, \lambda) = 2N \int_0^1 dx \int_0^x dx' \prod_{\mu} \exp \left\{ - (Q_{\mu} \lambda_{\mu})^2 (x - x') - \right.$$

$$\left. \frac{Q_{\mu}^2 (1 - \lambda_{\mu}^2)}{2\sqrt{6}R_g^2} \left[1 - \exp \left[- \frac{(x - x')}{\frac{d_{\mu}^2}{2\sqrt{6}R_g^2}} \right] \right] \right\}$$

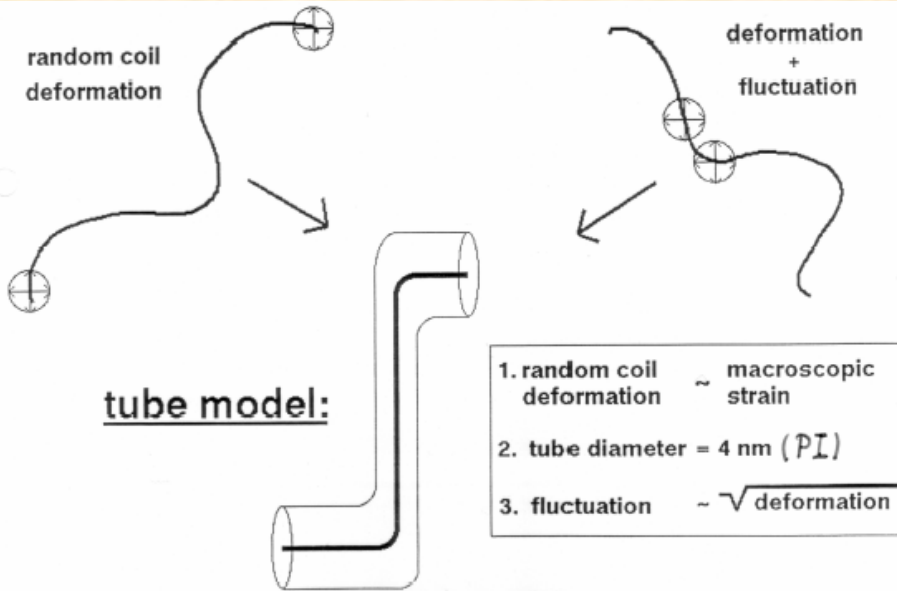
non-affine fluctuation contribution

NIST NG7 data



SANS at increasing deformation

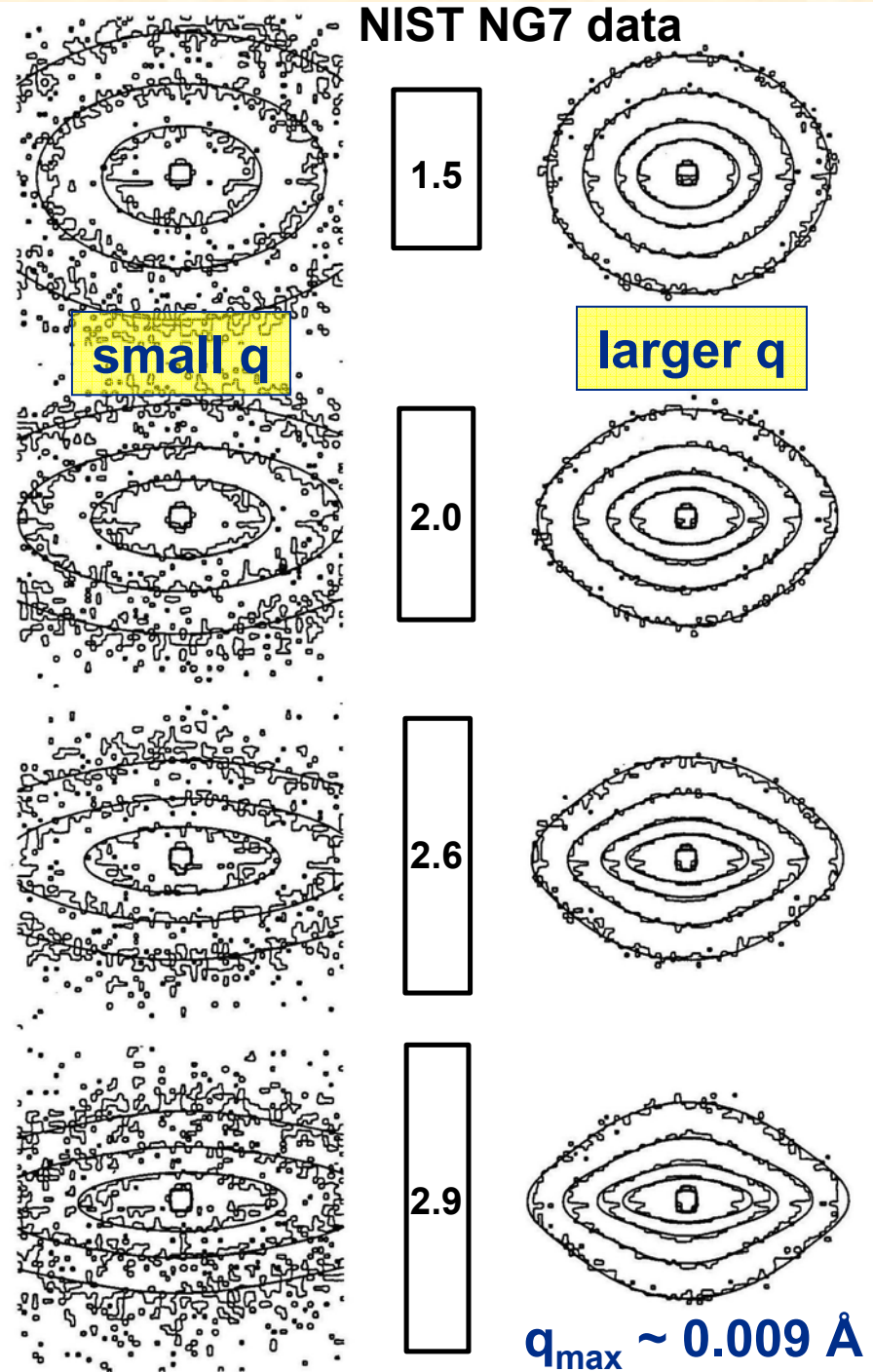
- Self-consistent tube model with deformation dependent tube width:



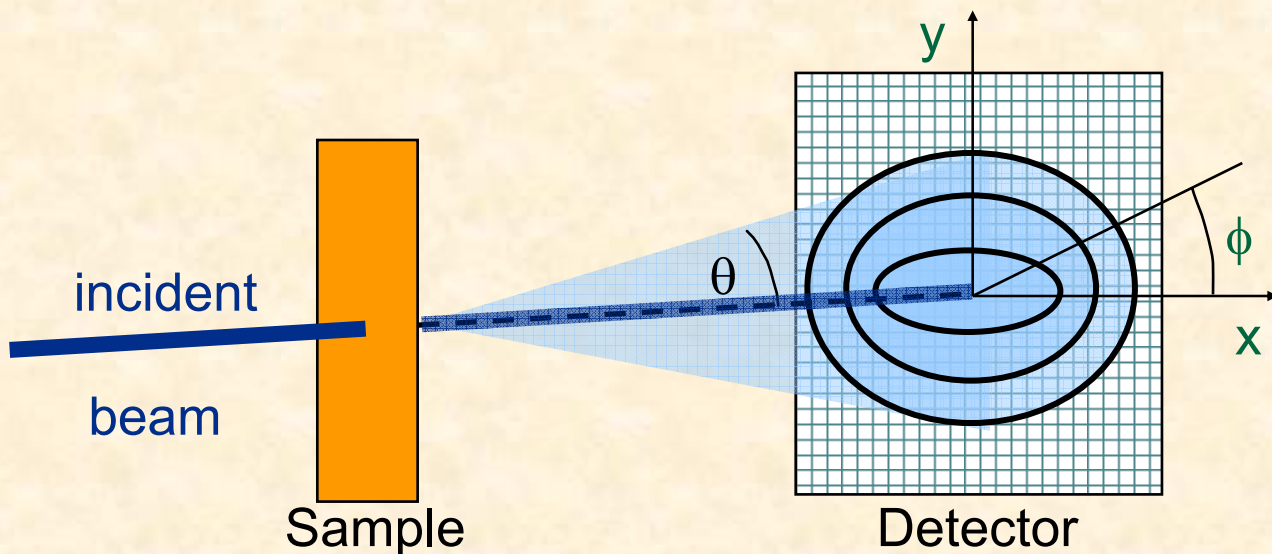
E. Straube et al., *Macromolecules* **27**, 7681 (1994)
 E. Straube et al., *Physical Review Letters* **74**, 4464 (1995)

U. S. DEPARTMENT OF ENERGY

NIST NG7 data

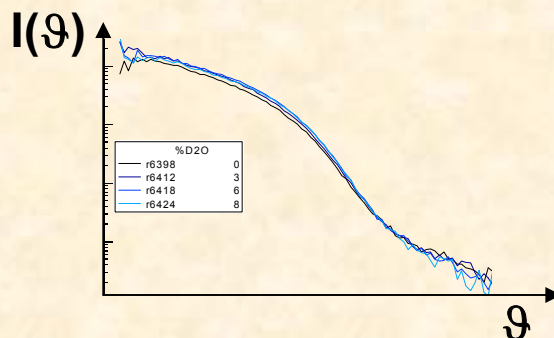


At the beamline (SANS jargon demystified)

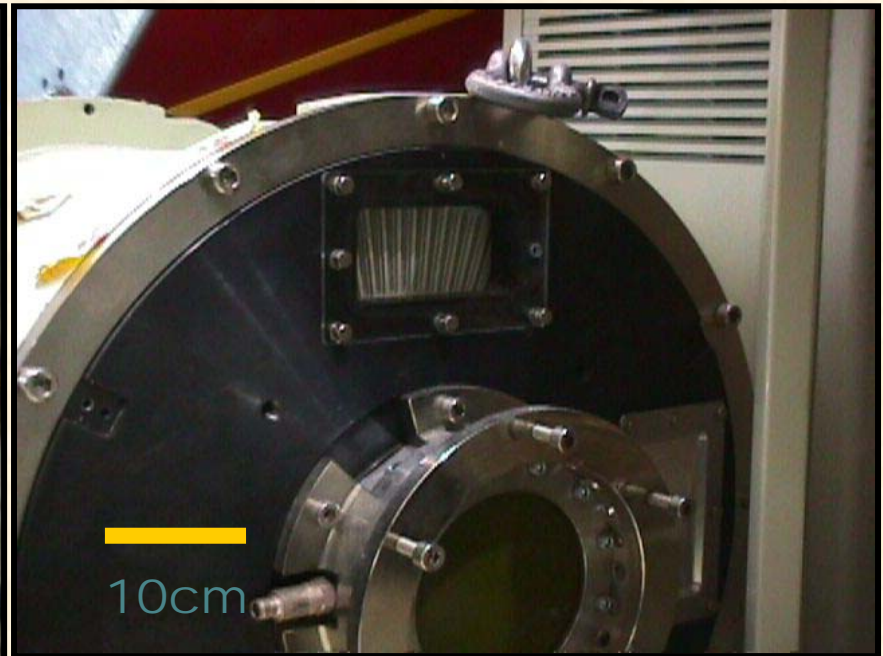


Monochromatic beam ($\Delta\lambda/\lambda$)
Pinhole camera ($\Delta\theta/\theta$)
Area detector

**If data isotropic:
azimuthal average $I(\vartheta)$
(aka “radial average”)**



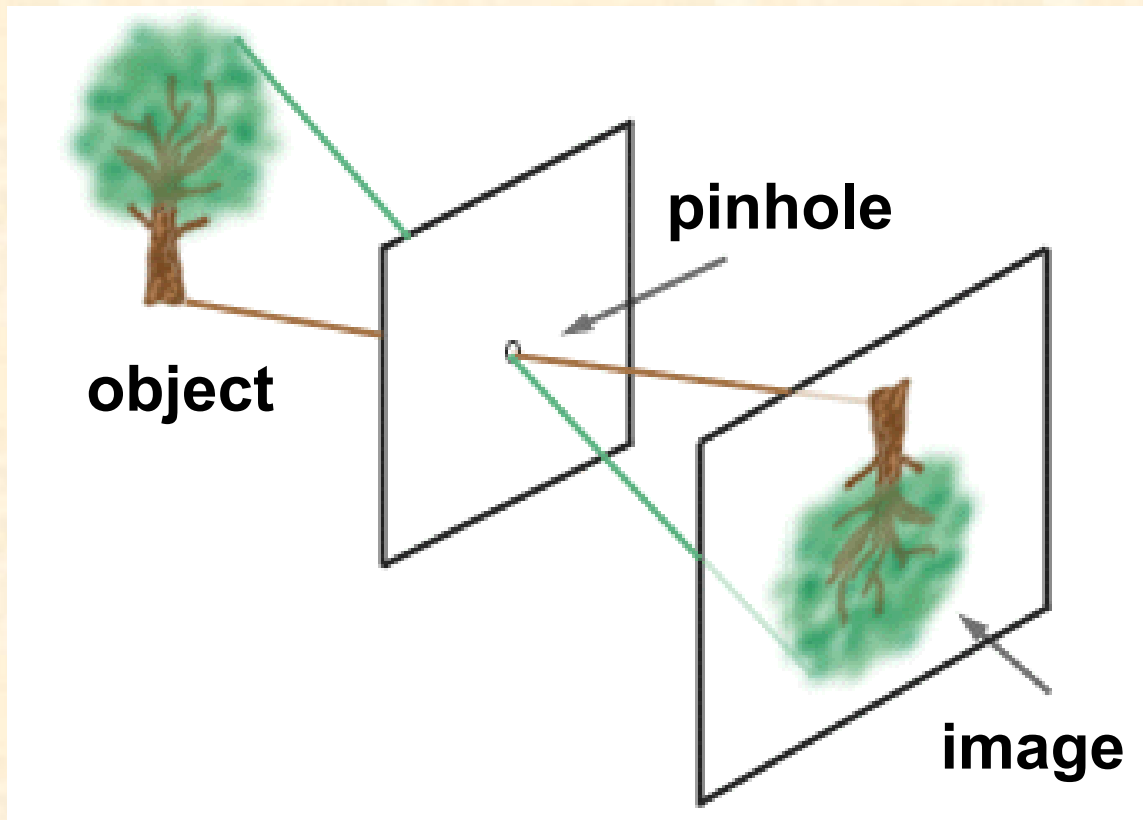
Monochromator – Velocity Selector



De Broglie: $\lambda = \frac{h}{p} = \frac{h}{mv}$

	Cold	Thermal
T (K)	20	300
v (m/s)	574	2224
E (meV)	1.7	25.9
λ (Å)	6.89	1.78

SANS Instrument – a pinhole camera?

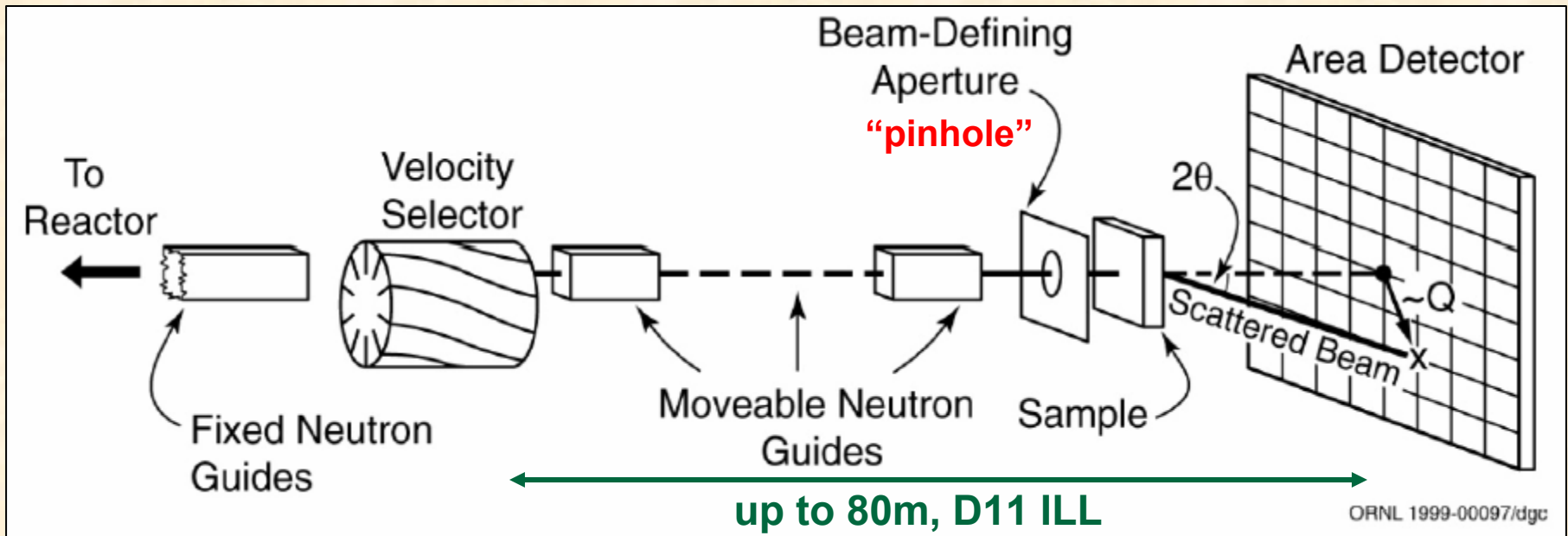


So it does take pictures?

Yes, but of what?

Of the source aperture, not of the sample!

Layout of a SANS instrument



Typical layout at a continuous (reactor) source

SANS guide hall (HFIR)



SANS guide hall (HFIR)



Analysis of SAS data

(here typical particulate solution scattering)

$$\frac{d\Sigma}{d\Omega}(q) = \Delta\rho^2 n V^2 P(q) S(q)$$

lim $q, n \rightarrow 0$:

$$\frac{d\Sigma}{d\Omega}(q = 0) = \Delta\rho^2 n V^2$$

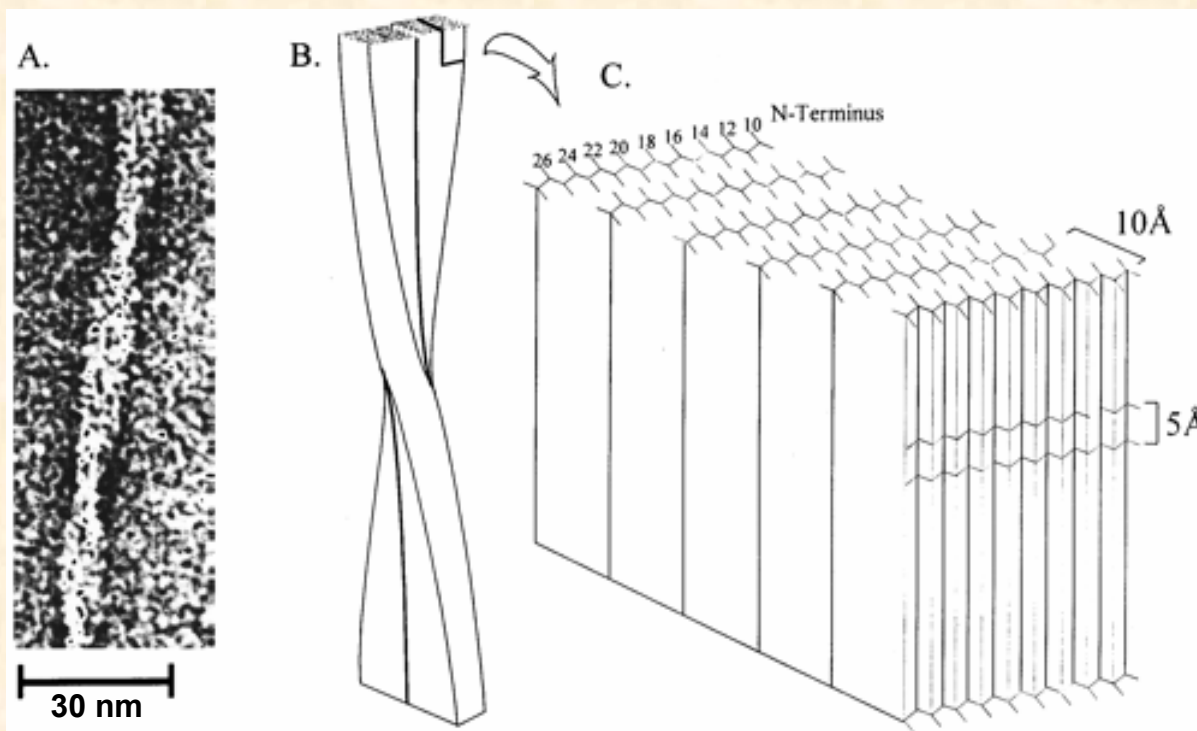
- n - Number density (concentration)
- V - Particle volume (molecular mass)

- $\Delta\rho^2$ - Contrast = square of scattering length density difference between particle and medium
 - x-rays: electron density
 - neutrons: isotope labeling, particularly H > D
- $P(q)$ - Size & shape
- $S(q)$ - Interaction

Measure and subtract background very carefully!
Do the absolute calibration – it's worth the effort!

Alzheimer's Disease – β -Amyloid

- Among leading causes of death
- Miss-folded peptides form hierarchical ordered fibril structures & plaques
- Structure established using synthetic model peptides and complimentary methods NMR, SANS, EM



- NMR
 - β -fold
- SANS
 - Fiber
 - Diameter
 - 6 sheet stack
- EM
 - Overall morphology
 - Twist

Analysis of SAS data

$S(q) * P(q)$ is not always a useful approach!

- $P(q)$

- Guinier approximation → radius of gyration

- $\ln[I(q)] \propto q^2 R_g^2 / 3 \quad qR_g < 1; \quad \text{sphere} : R = \sqrt{\frac{5}{3}} R_g$

- (modified Guinier for rods and sheets)

- Form factor fit / modeling

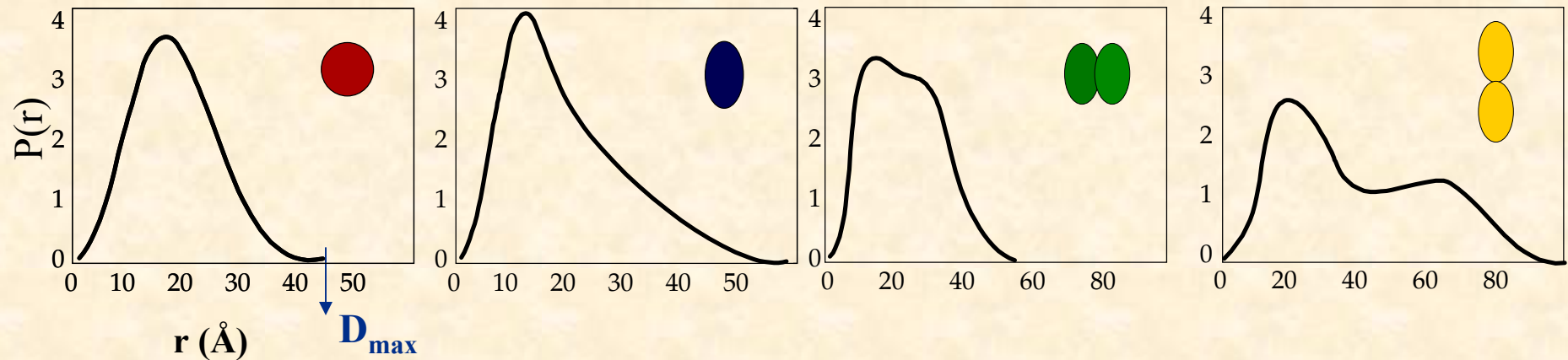
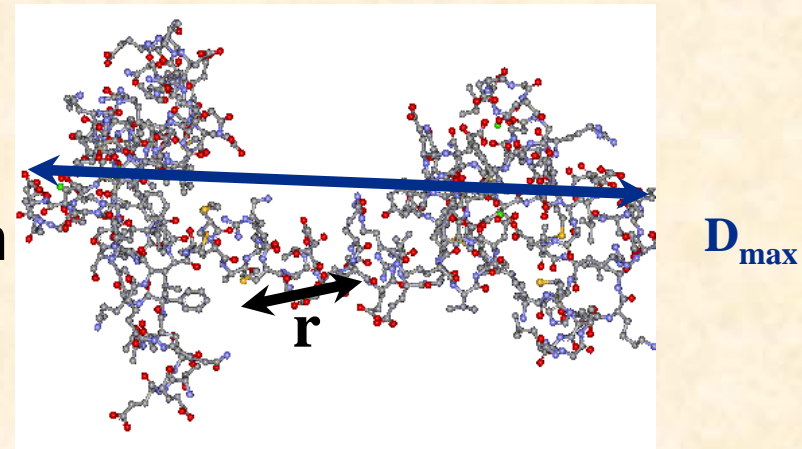
- sphere, ellipsoid, rod, protein structure, fractal etc.

- $S(q)$

- hard sphere potential, sticky sphere etc.

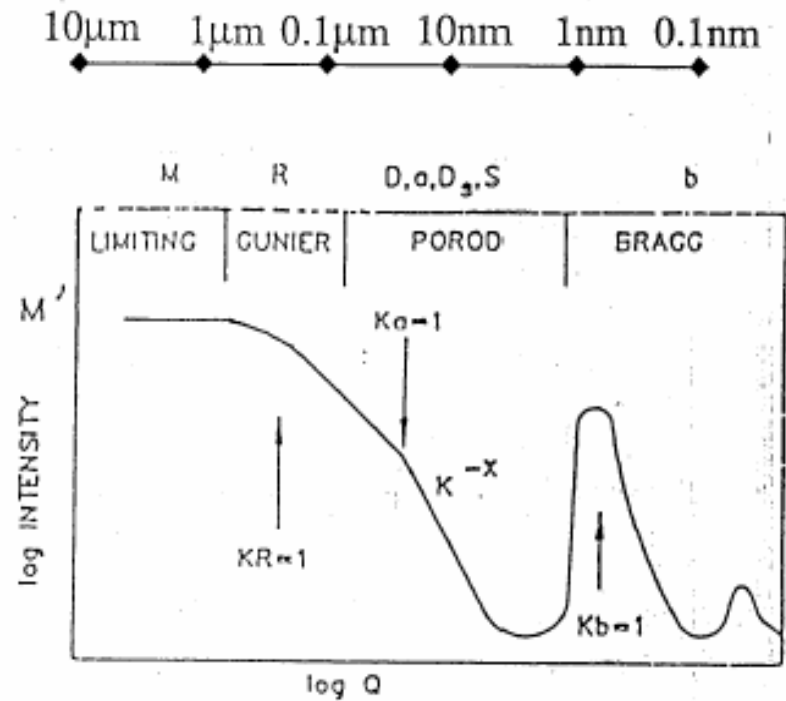
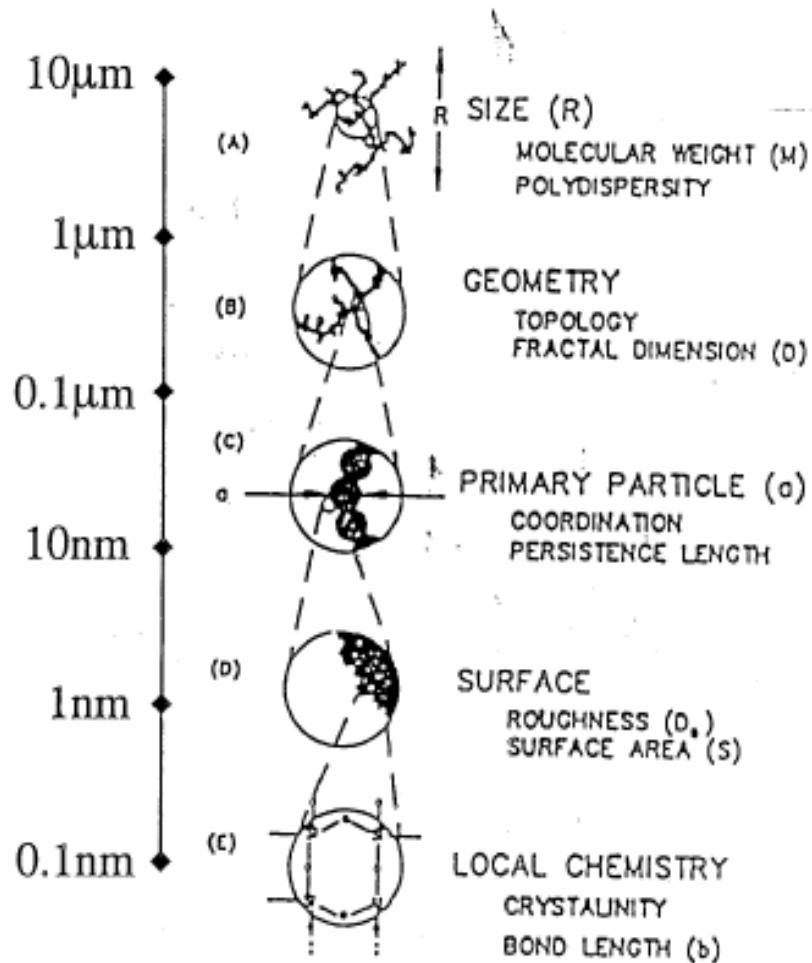
Pair correlation function and shape

$P(r)$: inverse Fourier transform of scattering function : Probability of finding a vector of length r between scattering centers within the scattering particle.

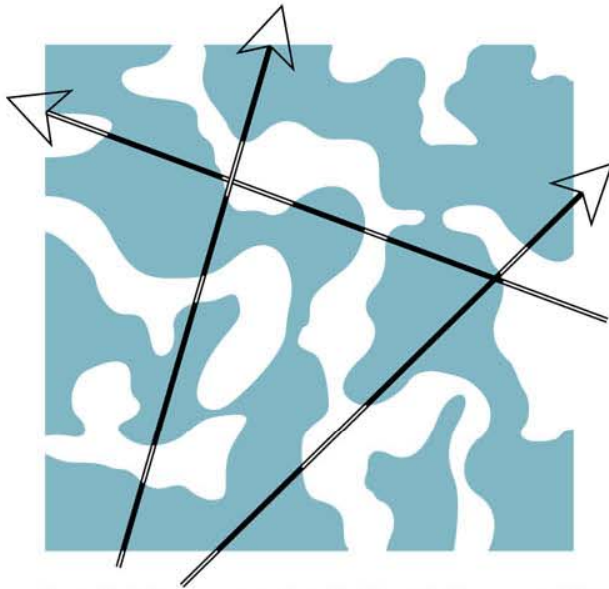


Shape : Modeled as a uniform density distribution that best fits the scattering data.

Structural Hierarchy (particulate)



Debye Bueche Model for Two-Phase System, Each with Random Shape, Uniform Electron or Scattering Length Density and Sharp Boundaries



Physical Concept of the Mean Chord or Inhomogeneity Length

Mean Chord Intercepts:

$$L_1 = \frac{a}{\phi}$$

$$L_2 = \frac{a}{(1 - \phi)}$$

The fluctuations in scattering power at two points A and B, distance r apart, can be characterized by $\gamma(r) \langle \eta^2 \rangle_{AV} = \langle \eta_A \eta_B \rangle_{AV}$. For random two phase system: $\gamma(r) = e^{-r/a}$

$$\frac{d\Sigma}{d\Omega}(\mathbf{Q}) = \frac{A}{[1 + Q^2 a^2]^2}$$

J. Appl.Cryst., 28, 679 (1957)

ORNL-DWG 92M-9485

Summary

- **SANS applications are in the nm to μm range and otherwise only limited by imagination.**
- **SANS is used alone, but often complementary to other methods, e.g. microscopy.**
- **SANS is similar to diffraction (but different).**
- **SANS data analysis can be tough math, or make use of readily available approximations, models and software.**

OAK RIDGE NATIONAL LABORATORY
U. S. DEPARTMENT OF ENERGY



SANS vs. Synchrotron SAXS

- **SAXS & SANS**
 - nm scale structural analysis ($\sim 1\text{nm}-1\mu\text{m}$)
 - Non-destructive
 - In-situ
- **Synchrotron X-rays**
 - High throughput
 - Time-resolution (ms – ps)
 - Tiny beams – microfocus: e.g. scanning of cells
- **Neutrons**
 - ‘see’ light atoms: polymers, biology, soft condensed matter, hydrogen in metals
 - **Isotope labeling**
 - High penetration
 - bulky specimens, e.g. residual stress in motor block
 - complicated environments (P,T), e.g. ^4He cryostat
 - Magnetic contrast