

# United States of America

United States Patent and Trademark Office

# PS one

**Reg. No. 4,273,704**

**Registered Jan. 15, 2013**

**Int. Cls.: 14, 16, 18, 21,  
25, 26, 28, 35, 37, 38, 40,  
41 and 42**

**TRADEMARK**

**SERVICE MARK**

**PRINCIPAL REGISTER**

KABUSHIKI KAISHA SONY COMPUTER ENTERTAINMENT (JAPAN CORPORATION),  
TA SONY COMPUTER ENTERTAINMENT INC.  
1-1, AKASAKA 7-CHOME  
MINATO-KU  
TOKYO, JAPAN 1070052

FOR: ALARM CLOCKS; ASHTRAYS, OF PRECIOUS METAL, FOR SMOKERS; BADGES OF PRECIOUS METAL; BASKETS OF PRECIOUS METAL, FOR HOUSEHOLD PURPOSES; BOXES OF PRECIOUS METAL FOR SWEETMEATS; BRACELETS FOR JEWELRY; BROOCHES FOR JEWELRY; BUCKLES OF PRECIOUS METAL; BUSTS OF PRECIOUS METAL; CABARETS OF PRECIOUS METAL; CASES FOR WATCHES; CHAIN MESH PURSES OF PRECIOUS METAL; CHAINS FOR JEWELRY; CHRONOMETERS; CIGAR CASES OF PRECIOUS METAL; CIGARETTE CASES OF PRECIOUS METAL; CLOCK CASES; CLOCKS; CLOCKS AND WATCHES, ELECTRIC; CLOISONNE JEWELRY; COFFEE SERVICES OF PRECIOUS METAL; COFFEEPOTS, NON-ELECTRIC, OF PRECIOUS METAL; COINS, NAMELY, NON MONETARY COINS; CUFF LINKS; CUPS OF PRECIOUS METAL; DIAMONDS; DISHES OF PRECIOUS METAL; EARRINGS; FLASKS OF PRECIOUS METAL; GOLD THREAD FOR JEWELRY; HARNESS FITTINGS OF PRECIOUS METAL; HAT ORNAMENTS OF PRECIOUS METAL; HOUSEHOLD CONTAINERS OF PRECIOUS METAL; HOUSEHOLD UTENSILS OF PRECIOUS METAL, NAMELY, STRAINERS, SUGAR BOWLS AND SALT SHAKERS, EGG CUPS, NAPKIN HOLDERS AND NAPKIN RINGS, SERVING TRAYS FOR DOMESTIC PURPOSES, TOOTHPICK HOLDERS, SHAKERS, PEPPER SHAKERS, COCKTAIL SHAKERS, RICE SCOOPS, HAND-OPERATED PEPPER MILLS, FUNNELS, DINING TRAYS/STANDS, BOTTLE OPENERS, HOUSEHOLD UTENSILS, NAMELY, GRATERS, TART SCOOPS, TRIVETS, KITCHEN LADLES/DIPPERS, SIEVES, FLOUR SIFTERS, JEWEL CASES OF PRECIOUS METAL; JEWELRY OF YELLOW AMBER; JUGS OF PRECIOUS METAL; KEY RINGS OF PRECIOUS METAL; KITCHEN CONTAINERS OF PRECIOUS METAL; KITCHEN UTENSILS OF PRECIOUS METAL, NAMELY, PANS, NON-ELECTRIC COFFEE POTS, KETTLES, ICE PAILS, NON-ELECTRIC WHISKS FOR HOUSEHOLD PURPOSES, MEDALLIONS FOR JEWELRY; MEDALS; NAPKIN HOLDERS OF PRECIOUS METAL; NAPKIN RINGS OF PRECIOUS METAL; NECKLACES FOR JEWELRY; NUTCRACKERS OF PRECIOUS METAL; ORNAMENTAL PINS; ORNAMENTS FOR JEWELRY; PASTE JEWELRY; PEARLS FOR JEWELRY; PEARLS MADE OF AMBROID; PEPPER POTS OF PRECIOUS METAL; PINS FOR JEWELRY; PLATED ARTICLES, NAMELY, JUGS, CENTERPIECES, SERVING TRAYS, BOWLS, ASHTRAYS, VASES, CANDLESTICKS; PRECIOUS METAL PLATING; POWDER COMPACTS OF PRECIOUS METAL SOLD EMPTY; PURSES OF PRECIOUS METAL; RINGS FOR JEWELRY; SALAD BOWLS OF PRECIOUS



*David J. Kyros*

Director of the United States Patent and Trademark Office

**Reg. No. 4,273,704** METAL; SALT SHAKERS OF PRECIOUS METAL; SAUCERS OF PRECIOUS METAL; SEMI-PRECIOUS STONES; SHOE ORNAMENTS OF PRECIOUS METAL; SILVER ORNAMENTS; SILVER PLATE; SOUP BOWLS OF PRECIOUS METAL; STATUES OF PRECIOUS METAL; STRAPS FOR WRISTWATCHES; SUGAR BOWLS OF PRECIOUS METAL; TABLE PLATES OF PRECIOUS METAL; TABLEWARE SERVICES OF PRECIOUS METAL, NAMELY, DISHES, TABLE PLATES, GOBLET, SUGAR BOWLS, PEPPER POTS, SALT SHAKERS, CRUET STANDS FOR OIL AND VINEGAR, SAUCERS, SOUP BOWLS, EGG CUPS AND NAPKIN RINGS; TEA CADDIES OF PRECIOUS METAL; TEA INFUSERS OF PRECIOUS METAL; TEA SERVICES OF PRECIOUS METAL; TEA STRAINERS OF PRECIOUS METAL; TEAPOTS OF PRECIOUS METAL; TIE CLIPS; TIE PINS; TRAYS OF PRECIOUS METAL, FOR HOUSEHOLD PURPOSES; TRINKETS FOR JEWELRY; VASES OF PRECIOUS METAL; WATCH CHAINS; WATCHES; WRISTWATCHES , IN CLASS 14 (U.S. CLS. 2, 27, 28 AND 50).

FOR: PAPER AND CARDBOARD OTHER THAN PAPER ARTICLES, NAMELY, CARDBOARD, ART PAPER, BOND PAPER, CARBON PAPER COPY PAPER, CRAFT PAPER, CREPE PAPER, COMPUTER PAPER, FLUORESCENT PAPER, MASKING PAPER, MANIFOLD PAPER, NOTE PAPER, ONION SKIN PAPER, OPAQUE PAPER, PACKING PAPER, PADDING PAPER, ART PAPER; PRINTING PAPER; INDIA PAPER; GLASSINE PAPER; NEWSPRINT PAPER; BLOTTER; TYPEWRITING PAPER; TOILET PAPER; WRITING PAPER; WRAPPING PAPER; RICE PAPER; PARCHMENT PAPER; FILTER PAPER; PAPERBOARD, MANILA PAPER COLOR BOARD, NAMELY, COLORED PAPERBOARD; STRAWBOARD; WHITE PAPERBOARD; CORRUGATED MEDIUM FLUTING PAPER; CORRUGATED CARDBOARD; LINER BOARD FOR CORRUGATED CARDBOARD; MILLBOARD; POSTCARD PAPER; JAPANESE PAPER; MULCH PAPER; KASA-GAMI, NAMELY, OILED PAPER FOR PAPER UMBRELLAS; GUNPOWDER WRAPPING PAPER; GANPISHI, NAMELY, TISSUE PAPER FOR USE AS A MATERIAL OF STENCIL PAPER; JAPANESE HANDICRAFT PAPER; CALLIGRAPHY PAPER; COARSE TISSUE FOR TOILETRY USE; STENCIL PAPER; MIMEOGRAPH PAPER; NAPKIN PAPER; DUPLICATING PAPER; PAPER LACE; IMITATION LEATHER PAPER; PERFORATED CARDS FOR JACQUARD LOOMS; ACID-RESISTANT PAPER; PARAFFINED PAPER, NAMELY, WAXED PAPER; FUSUMA-GAMI, NAMELY, PAPER FOR JAPANESE INDOOR SLIDING PARTITIONS; FIREPROOF PAPER, NAMELY, FIREPROOF PAPER FOR PACKAGING; MILDEW PROOF PAPER, NAMELY, MILDEW PROOF PAPER FOR PACKAGING; WATERPROOF PAPER, NAMELY, WATER PROOF PAPER FOR PACKAGING; ANTI-RUST PAPER, NAMELY, ANTI-RUST PAPER FOR PACKAGING; OIL PROOF PAPER, NAMELY, OIL PROOF PAPER FOR PACKAGING; LUMINOUS PAPER; CELLOPHANE PAPER; ORDINARY CELLOPHANE PAPER; MOISTURE PROOF PAPER, NAMELY, MOISTURE PROOF PAPER FOR WRAPPING; SYNTHETIC PAPER; INDUSTRIAL PACKAGING CONTAINERS OF PAPER; PAPERBOARD BOXES FOR INDUSTRIAL PACKAGING; PAPER BAGS AND SACKS; CORRUGATED CARDBOARD BOXES; FIBERBOARD BOXES; FOOD WRAPPING PLASTIC FILM FOR HOUSEHOLD PURPOSES; GARBAGE BAGS OF PAPER FOR HOUSEHOLD USE; GARBAGE BAGS OF PLASTICS FOR HOUSEHOLD USE; HYGIENIC PAPER; TOWELS OF PAPER; TABLE NAPKINS OF PAPER; HAND TOWELS OF PAPER; HANDKERCHIEFS OF PAPER; PAPER PATTERNS; TAILORS' CHALK; TABLE CLOTHS OF PAPER; BLINDS OF PAPER; BANNERS OF PAPER; FLAGS OF PAPER; BABIES' DIAPERS OF PAPER; PRINTED MATTER, NAMELY, ACCOUNT BOOKS; ACCOUNTING FORMS; AGENDAS; ALMANACS; ANIMATION CELLS; ANNIVERSARY BOOKS; ANNOUNCEMENT CARDS; CARDS BEARING UNIVERSAL GREETINGS; CARICATURES; CHART POINTERS; CARTOON PRINTS; CARTOON STRIPS; CASH RECEIPT BOOKS; CHILDREN'S ACTIVITY BOOKS; CHILDREN'S BOOKS; CHRISTMAS CARD; COLORING BOOKS; COMIC BOOKS; COMIC STRIPS' COMIC FEATURES; COMMEMORATIVE STAMP SHEETS; COMPOSITION BOOKS; COMPUTER GAME INSTRUCTION MANUALS; DAILY PLANNERS; DATA BOOKS; DATE BOOKS; GIFT CARDS; GIFT WRAPPING PAPER; GRAPHIC ART REPRODUCTIONS; GRAPHIC NOVELS; GREETING CARDS; HOUSE ORGANS; HYMN BOOKS; LAW DIGESTS; LAW REPORTS; LEDGER BOOKS; MEMORANDUM BOOKS; NEWS BULLETINS; NEWSPAPER CARTOONS; NEWSPAPER COMIC STRIPS; NEWSPAPERS FOR GENERAL CIRCULATION; NOVELS; ORDER FORMS; PAPER PARTY DECORATIONS; PAPER PARTY HATS; PAPER PENNANTS;

**Reg. No. 4,273,704** PAPER PILLOWCASES; PAPER PLACE MATS; PICTURE BOOKS; PICTURE POSTCARDS; PLAYING CARD CASES; PLAYING CARDS; POCKET CALENDARS; POSTCARDS; POSTERS; PRAYER BOOKS; PRESCRIPTION REMINDER PADS; PRESENTATION BOARDS; PRICE TAGS; PRICE TICKETS; PRINTED AWARDS; PRINTED EMBLEMS; PRINTED FORMS; PRINTED INVITATIONS; PRINTED MUSIC BOOKS; PRINTED PATTERNS; PRINTED PLANS; PRINTED RECIPES SOLD AS A COMPONENT OF FOOD PACKAGING; PRINTED SEMINAR NOTES IN THE FIELD OF ELECTRONIC GAMES; PRINTED SURVEY ANSWER SHEETS; RELIGIOUS CIRCULAR LETTERS; ROMANCE NOVELS; SHEET MUSIC; SPORTS TRADING CARDS; WALL CALENDARS; WALL COVERING SAMPLE BOOKS; WALLPAPER SAMPLE BOOK; MAGAZINES FEATURING COMPUTER AND VIDEO GAMES AND ACCESSORIES; PUBLICATIONS, NAMELY, PAMPHLETS IN THE FIELD OF COMPUTER AND VIDEO GAMES AND ACCESSORIES; GEOGRAPHICAL MAPS; DIARIES; NEWSLETTERS FEATURING COMPUTER AND VIDEO GAMES AND ACCESSORIES, IN CLASS 16 (U.S. CLS. 2, 5, 22, 23, 29, 37, 38 AND 50).

FOR: ATTACHES CASES; BACKPACKS; BAGS FOR CLIMBERS IN THE NATURE OF ALL-PURPOSE CARRYING BAGS; CREDIT CARD CASES, BUSINESS CARD CASES, NAME CARD CASES, CALLING CARD CASES; BEACH BAGS; BOXES OF LEATHER OR LEATHER BOARD; BRIEFCASES; CASES OF LEATHER OR LEATHER BOARD; CASINGS OF LEATHER FOR SPRINGS; CHAIN MESH PURSES, NOT OF PRECIOUS METAL; CHAMOIS LEATHER, OTHER THAN FOR CLEANING PURPOSES; CLOTHING FOR PETS; ENVELOPES OF LEATHER FOR PACKAGING; FRAMES FOR UMBRELLAS OR PARASOLS; FUR-SKINS; FURNITURE UPHOLSTERY OF LEATHER; GARMENT BAGS FOR TRAVEL; HANDBAGS; HAT BOXES OF LEATHER; IMITATION LEATHER SOLD IN BULK; KEY CASES OF LEATHER; LEATHER SHOULDER BELTS; LEATHER STRAPS; LININGS OF LEATHER FOR BOOTS AND SHOES; MOUNTAINEERING STICKS; NET BAGS FOR SHOPPING; PARASOLS; POCKET WALLETS; PURSES; PURSES, NOT OF PRECIOUS METAL; SCHOOLS BAGS; SCHOOL SACHELS; SHOPPING BAGS; SLING BAGS FOR CARRYING INFANTS; SUITCASE HANDLES; SUITCASES; TRAVELING BAGS; TRAVELING SETS OF LEATHER; TRAVELING TRUNKS; TRUNKS; UMBRELLA COVERS; UMBRELLA HANDLES; UMBRELLA OR PARASOL RIBS; UMBRELLA RINGS; UMBRELLA STICKS; UMBRELLAS; VALISES; VANITY CASES, NOT FITTED; WALKING STICK HANDLES; WALKING STICKS; WHEELED SHOPPING BAGS; BAGGAGE TAGS, IN CLASS 18 (U.S. CLS. 1, 2, 3, 22 AND 41).

FOR: AEROSOL DISPENSERS, NOT FOR MEDICAL PURPOSES; BASINS FOR RECEPTACLE; FLOWER BASKETS, PLANT BASKETS, STEAMER BASKETS, WASTEPAPER BASKETS MADE OF WICKER, STRAW, WOOD OR CLOTH FOR DOMESTIC USE; BASTING SPOONS FOR KITCHEN USE; BEATERS, NON-ELECTRIC; BEER MUGS; BLENDERS, NON-ELECTRIC FOR HOUSEHOLD PURPOSES; BOTTLE OPENERS; SPORTS BOTTLES SOLD EMPTY; VACUUM BOTTLES; BOXES OF GLASS; BOXES OF METAL FOR DISPENSING PAPER TOWELS; BREAD BASKETS FOR DOMESTIC USE; BATH BRUSHES; BRUSHES FOR BASTING MEAT; BRUSHES FOR PETS; CLOTHES BRUSHES; COSMETIC BRUSHES; HAIR BRUSHES; BRUSHES FOR FOOTWEAR; BUCKETS; BUCKETS MADE OF WOVEN FABRICS; BUSTS OF CHINA, TERRA-COTTA OR GLASS; BUTTER DISHES; BUTTONHOOKS; CANDY BOXES, NOT OF PRECIOUS METAL; NON-ELECTRIC CARPET SWEEPERS; CERAMICS FOR HOUSEHOLD PURPOSES, NAMELY, BOWLS, FIGURINES; CHINA ORNAMENTS; CLOTH FOR WASHING FLOORS; CLOTHES RACKS FOR DRYING; CLOTHES PINS; CLOTHS FOR CLEANING; COASTERS, NOT OF PAPER AND OTHER THAN TABLE LINEN; COFFEE FILTERS, NON-ELECTRIC; COFFEE GRINDERS, HAND-OPERATED; COFFEE PERCOLATORS, NON-ELECTRIC; COFFEE SERVICES, NOT OF PRECIOUS METAL; COFFEEPOTS NOT OF PREVIOUS METAL, COMBS, NAMELY, HAIR COMBS AND CLEANING COMBS; CONFECTIONERS' DECORATING BAGS; CONTAINERS FOR HOUSEHOLD OR KITCHEN USE, EXCEPT IN PRECIOUS METAL; COOKIE CUTTERS; COOKIE JARS; COOKING POTS; NON-ELECTRIC COOKING UTENSILS, NAMELY, GRILLS, TOOTHPICKS, LEMON SQUEEZERS, NON-ELECTRIC WAFFLE IRONS, ROLLING PINS, SPATULAS, TURNERS, WHISKS, STRAINERS, CORKSCREWS; CRUETS, NOT OF PRECIOUS METAL; CRYSTAL GLASSWARE; CUPS OF PAPER OR PLASTIC; CUPS, NOT OF PRECIOUS

**Reg. No. 4,273,704** METAL; CUTTING BOARDS FOR THE KITCHEN; DECANTERS; DISH COVERS; DISHES, NOT OF PRECIOUS METAL; DRINKING FLASKS FOR TRAVELERS; DRINKING GLASSES; DRINKING VESSELS; DRYING RACKS FOR WASHING; DUSTING CLOTHS; EARTHENWARE SAUCEPANS; COMBS, NAMELY, HAIR COMBS, CLEANING COMBS, CURRY COMBS; EPERGNES, NOT OF PRECIOUS METAL; EYEBROW BRUSHES; FITTED PICNIC BASKETS INCLUDING DISHES; FLASKS, NOT OF PRECIOUS METAL; FLOSS FOR DENTAL PURPOSES; FLOWER POTS; FOOD COOLING DEVICES CONTAINING HEAT EXCHANGE FLUIDS FOR HOUSEHOLD PURPOSES; FRUIT CUPS; FRUIT PRESSES, NON-ELECTRIC FOR HOUSEHOLD PURPOSES; FRYING PANS; GARBAGE CANS; GLASS BOWLS; GLASS CAPS; GLASS FLASKS FOR CONTAINERS; GLASS FOR RECEPTACLES, NAMELY, OPAL GLASS FOR RECEPTACLES, PRESSED GLASS FOR RECEPTACLES, SPECKLED GLASS FOR RECEPTACLES; GLASS FOR VEHICLE WINDOWS FOR SEMI-FINISHED PRODUCT; GLASS INCORPORATING FINE ELECTRICAL CONDUCTORS; GLOVE STRETCHERS; GLOVES FOR HOUSEHOLD PURPOSES; GRATERS FOR HOUSEHOLD UTENSILS; GRILLS FOR COOKING UTENSILS; HAND-OPERATED CLEANING INSTRUMENTS, NAMELY, BROOMS, MOPS DUST BINS, DUST PANS, AND DUSTING BRUSHES, HEAT INSULATED CONTAINERS FOR BEVERAGES; HEATERS FOR FEEDING BOTTLES, NON-ELECTRIC; HOLDERS FOR FLOWERS AND PLANTS; HOT POTS, NOT ELECTRICALLY HEATED; ICE BUCKETS; ICE CUBE MOLDS; IRONING BOARD COVERS; IRONING BOARDS; ISOTHERMIC BAGS FOR FOOD; KETTLES, NON-ELECTRIC; KITCHEN CONTAINERS, NOT OF PRECIOUS METAL; KITCHEN UTENSILS, NOT OF PRECIOUS METAL, NAMELY, CAKE PANS, FRYING PANS, GLASS PANS, METAL PANS; NON-ELECTRIC COFFEE POTS, KETTLES, ICE PAILS, NON-ELECTRIC WHISKS FOR HOUSEHOLD PURPOSES, STRAINERS NOT OF PRECIOUS METAL, PEPPER POTS NOT OF PRECIOUS METAL, SUGAR BOWLS AND SALT SHAKERS NOT OF PRECIOUS METAL, EGG CUPS NOT OF PRECIOUS METAL, NAPKIN HOLDERS AND NAPKIN RINGS NOT OF PRECIOUS METAL, SERVING TRAYS NOT OF PRECIOUS METAL, TOOTHPICK HOLDERS NOT OF PRECIOUS METAL, BAMBOO BOWLS, SHAKERS, NAMELY, COCKTAIL SHAKERS, RICE SCOOPS, HAND OPERATED COFFEE GRINDERS AND HAND OPERATED PEPPER MILLS, FUNNELS, DINING TRAYS, DINING STANDS, BOTTLE OPENERS, GRATERS, TART SCOOPS, PAN MATS/TRIVETS, LADLES/DIPPERS, SIEVES/SIFTERS, CHOPPING BOARDS, CUTTING BOARDS, ROLLING PINS, GRILLS, TOOTHPICKS, LEMON SQUEEZERS, NON-ELECTRIC WAFFLE IRONS; EARTHENWARE SAUCEPANS; KNIFE RESTS FOR THE TABLE; LARGE-TOOTHED COMBS FOR THE HAIR; LIQUEUR SETS COMPRISING, NAMELY, SERVING TRAY, LIQUEUR GLASSES AND FLASKS FOR LIQUEUR; LITTER BOXES FOR PETS; LUNCH BOXES; MENU CARD HOLDERS; MESS-TINS; MILLS FOR DOMESTIC PURPOSES, IN CLASS 21 (U.S. CLS. 2, 13, 23, 29, 30, 33, 40 AND 50).

FOR: APRONS FOR CLOTHING; BABIES' DIAPERS OF TEXTILE; BANDANAS; BATH ROBES; BATH SANDALS; BATHING CAPS; BATHING DRAWERS; BATHING SUITS; BEACH SHOES; BELTS FOR CLOTHING; BERETS; BODICES FOR LINGERIE; BOOTS; BOOTS FOR SPORTS; BRASSIERES; BREECHES FOR WEAR; CAMISOLES; CAP PEAKS; CAPS FOR HEADWEAR; CHEMISETTES FOR SHIRT FRONTS; CLOTHING FOR GYMNASTICS, NAMELY, SWEATSHIRTS, SWEAT PANTS, SWEAT BANDS, HEAD BANDS, BODY SUITS, LEOTARDS, LEGGINGS, LEG WARMERS; CLOTHING OF IMITATIONS OF LEATHER, NAMELY, TROUSERS, SHIRTS, JACKETS, GLOVES, SCARVES, HATS, COATS, VESTS, BELTS, SUITS, SKIRTS AND DRESSES; CLOTHING OF LEATHER, NAMELY, TROUSERS, SHIRTS, JACKETS, GLOVES, SCARVES, HATS, COATS, VESTS, BELTS, SUITS, SKIRTS AND DRESSES; COATS; COLLAR PROTECTORS; CORSETS FOR UNDER-CLOTHING; CUFFS; CYCLISTS' CLOTHING, NAMELY, RACING SUITS, BALACLAVAS, SOCKS, JACKETS, JACKETS WITH RIB AND ELBOW PROTECTIONS, OVERALLS, SHIRTS, SWEATSHIRTS, VESTS, PANTS, PANTS WITH KNEE PROTECTION, GLOVES, RACING SHOES; DRESSING GOWNS; EAR MUFFS FOR CLOTHING; FISHING VESTS; FITTINGS OF METAL FOR SHOES AND BOOTS; FOOTBALL SHOES; FOOT MUFFS, NOT ELECTRICALLY HEATED; FOOTWEAR; FOOTWEAR UPPERS; FUR STOLEES; FUR CLOTHING, NAMELY, FUR CLOAKS, FUR COATS, FUR HATS, FUR JACKETS, FUR MUFFS AND FUR STOLEES; GIRDLES; GLOVES FOR CLOTHING; GYMNASTIC SHOES; HALF-BOOTS; HATS;

**Reg. No. 4,273,704** HEADBANDS FOR CLOTHING; HEELS; HOODS FOR CLOTHING; INNER SOLES; JACKETS FOR CLOTHING; LACE BOOTS; LAYETTES FOR CLOTHING; LIVERIES; MASQUERADE COSTUMES; MITTENS; MONEY BELTS; MUFFS FOR CLOTHING; NECKTIES; OUTER CLOTHING, NAMELY, OUTER JACKETS, OUTER COATS AND OUTER PANTS; OVERCOATS; PANTS; PARKAS; PETTICOATS; POCKET SQUARES; POCKETS FOR CLOTHING; PULLOVERS; PAJAMAS; SANDALS; SARIS; SCARVES; SHAWLS; SHIRTS; SHOES; SHOULDER WRAPS; SHOWER CAPS; SKI BOOTS; SKIRTS; SKULL CAPS; SLIPPERS; SLIPS FOR UNDERGARMENTS; SMOCKS; SOCK SUSPENDERS; SOCKS; SOLES FOR FOOTWEAR; SPATS; SPORTS JERSEYS; SPORTS SHOES; STOCKINGS; STUFFED JACKETS FOR CLOTHING; SUITS; SUN VISORS; SUSPENDERS; SWEAT-ABSORBENT STOCKINGS; SWEAT-ABSORBENT UNDERCLOTHING; SWEATERS; SWIMSUITS; TEE-SHIRTS; TIGHTS; TOP HATS; TROUSER STRAPS; TROUSERS; UNDERWEAR; UNIFORMS; VEILS FOR CLOTHING; VESTS; WATERPROOF CLOTHING, NAMELY, RAINCOATS, JACKETS, COATS, PANTS, SHORTS, TOPS, SWEATERS, SHIRTS, GOLF SHIRTS, SUITS CONSISTING OF JACKETS, PANTS, AND CAPS; WET SUITS FOR WATER-SKIING, IN CLASS 25 (U.S. CLS. 22 AND 39).

FOR: ARTIFICIAL FLOWERS; ARTIFICIAL FRUIT; ARTIFICIAL GARLANDS; BADGES FOR WEAR, NOT OF PRECIOUS METAL; BARRETTES FOR HAIR-SLIDES; BELT CLASPS; BIRDS' FEATHERS FOR CLOTHING ACCESSORIES; BLOUSE FASTENERS; BOWS FOR THE HAIR; BRASSARDS; BROOCHES FOR CLOTHING ACCESSORIES; BUCKLES FOR CLOTHING ACCESSORIES; BUTTONS FOR CLOTHING; CHENILLE FOR PASSEMENTERIE; COMPETITORS' NUMBERS NOT OF TEXTILE; EDGINGS FOR CLOTHING; ELASTIC RIBBONS; EMBROIDERING CROCHET HOOKS; EMBROIDERY; EXPANDING BANDS FOR HOLDING SLEEVES; FALSE HAIR; FASTENINGS FOR CLOTHING; FASTENINGS FOR SUSPENDERS; FEATHERS FOR CLOTHING ACCESSORIES; FESTOONS FOR EMBROIDERY; FRILLS FOR CLOTHING; FRILLS FOR LACEWORK; FRINGES; HAIR BANDS; HAIR COLORING CAPS; HAIR CURLERS OTHER THAN HAND IMPLEMENTS, NON-ELECTRIC; HAIR CURLING PINS; HAIR GRIPS; HAIR NETS; HAIR ORNAMENTS; HAIR PINS; HAT ORNAMENTS, NOT OF PRECIOUS METAL; HOOK AND PILE FASTENING TAPES; HOOKS FOR CORSETS; LACE FOR EDGINGS; LACE TRIMMINGS; LETTERS FOR MARKING LINEN; NUMERALS FOR MARKING LINEN; ORNAMENTAL NOVELTY BADGES; OSTRICH FEATHERS FOR CLOTHING ACCESSORIES; PICOT OF LACE TRIMMING; PLAITED HAIR; PRIZE RIBBONS; RIBBONS FOR HABERDASHERY; ROSETTES FOR HABERDASHERY; SEWING BOXES; SHOE BUCKLES; SHOE EYELETS; SHOE FASTENERS; SHOE HOOKS; SHOE LACES; SHOE ORNAMENTS, NOT OF PRECIOUS METAL; SLIDE LOCKS FOR BAGS; SNAP FASTENERS; SPANGLES FOR CLOTHING; TAPE FOR CURTAIN HEADING; TASSELS FOR HABERDASHERY; TEA COSIES; TOP-KNOTS; TRIMMINGS FOR CLOTHING; WREATHS OF ARTIFICIAL FLOWERS; ZIPPERS; SEWING BASKETS FOR DOMESTIC USE, IN CLASS 26 (U.S. CLS. 37, 39, 40, 42 AND 50).

FOR: HAND-HELD UNITS FOR PLAYING ELECTRONIC GAMES; HANDHELD UNIT FOR PLAYING AN ELECTRONIC LIQUID CRYSTAL DISPLAY GAME WITH ROM CARTRIDGE RECORDED WITH PROGRAMS FOR GAMES WITH LIQUID CRYSTAL DISPLAY, EXCLUSIVE USE EARPHONES FOR GAMES WITH LIQUID CRYSTAL PICTURES AND OTHER PARTS AND ACCESSORIES FOR GAMES WITH LIQUID CRYSTAL DISPLAY SOLD AS A UNIT; GAME MACHINES, NAMELY, STAND ALONE VIDEO GAME, LCD GAME MACHINES, ELECTRONIC EDUCATIONAL GAME MACHINES, ARCADE GAME MACHINES AND AMUSEMENT GAME MACHINES; KORINTO-GAME MACHINES, NAMELY, HORIZONTAL PINBALL MACHINES; SMART BALL MACHINES, NAMELY, JAPANESE HORIZONTAL PINBALL MACHINES; PACHINKO MACHINES, NAMELY, JAPANESE VERTICAL PINBALL MACHINES; BILLIARD CUES; CHALK FOR BILLIARD CUES; BILLIARD BALLS; BILLIARD MARKERS; BILLIARD TABLES; GO GAMES, NAMELY, JAPANESE BOARD GAMES, EQUIPMENT FOR PLAYING A JAPANESE BOARD GAME, NAMELY, GO STONES; GOKE POTS IN THE NATURE OF STONE-PIECES AND GO BOARDS; EQUIPMENT FOR JAPANESE CHESS GAME, IN THE NATURE OF KOMA-DAI, NAMELY, STANDS FOR SHOGI PIECES AND SHOGI BOARDS; DICE; SUGOROKU GAMES, NAMELY, JAPANESE PARCHEESI; DICE CUPS; DIAMOND GAMES; CHESS GAMES; CHECKERS; CHECKER

**Reg. No. 4,273,704** SETS; CONJURING APPARATUS FOR PLAYING MAGIC TRICK; DOMINOES; EQUIPMENT FOR PLAYING A PARLOR TYPE GAME, NAMELY, MAH-JONG; TOYS, NAMELY, ACTION FIGURES AND ACCESSORIES THEREFOR; ACTION FIGURES; ACTION SKILL GAMES; ACTION-TYPE TARGET GAMES; ADULTS' AND CHILDREN'S PARTY GAMES; AERODYNAMIC DISK FOR USE IN PLAYING CATCHING GAMES; ARCADE GAMES; BABY MULTIPLE ACTIVITY TOYS; BABY RATTLES; BACKGAMMON GAME SETS; BOARD GAMES; CHILDREN'S ACTIVITY TABLES CONTAINING MANIPULATIVE TOYS WHICH CONVERT TO EASELS; COLLECTABLE TOY FIGURES; CONSTRUCTION TOYS; CRIB TOYS; DART BOARD CASES; DART BOARDS; ELECTRONIC DART GAMES; MECHANICAL ACTION TOYS; PLAY SETS FOR DOLLS; PLUSH TOYS; POP UP TOYS; PORCELAIN DOLLS; RAG DOLLS; RIDE-ON TOYS; SAND TOYS; SANDBOX TOYS; SKETCHING TOYS; SOFT SCULPTURE DOLLS; SOFT SCULPTURE PLUSH TOYS; SOFTBALL BATS; STAND ALONE VIDEO GAME; STUFFED TOY ANIMALS; STUFFED TOYS; SURF FINS; SURFBOARD FINS; SURFBOARD LEASHES; SURFBOARD; TOSSING DISC TOYS; TOY ACTION FIGURES AND ACCESSORIES THEREFOR; TOY ACTION FIGURES; TOY ARMOR; TOY ARTIFICIAL FINGERNAILS; TOY BOWS AND ARROWS; TOY BOXES; TOY FIGURES; TOY GLIDERS; TOY GUNS; TOY HOLSTERS; TOY HOOP SETS; TOY MOBILES; TOY MODEL HOBBY CRAFT KITS; TOY MODELING DOUGH; TOY PISTOLS; TOY PUTTY; TOY ROCKETS; TOY SNOW GLOBES; TOY STAMPS; TOY SWORDS; TOY VEHICLES; TOY VEHICLES WITH TRANSFORMING PARTS, TOY WATCHES; TOY WEAPONS; TOYS, NAMELY, TRAIN SET ACCESSORIES, NAMELY, ARTIFICIAL TREES, TURF, FOLIAGE, BALLAST, LICHEN AND GRASS; TRANSFORMING ROBOTIC TOY VEHICLES; TRANSFORMING ROBOTIC TOYS; UMPIRE PROTECTION EQUIPMENT; VENTRILOQUIST'S DUMMIES; STANDALONE VIDEO OUTPUT GAME MACHINES; VOLLEYBALL FLOOR PLATES; WIND-UP TOYS; WIND-UP WALKING TOYS; YO-YOS; METAL TOYS, NAMELY, BASKETBALL GOAL SETS, GOAL POSTS FOR SOCCER, FIELD HOCKEY, LACROSSE, FOOTBALL, AND ICE HOCKEY, SOCCER GOALS, TOY SOLDIERS, TOY PEOPLE, TOY CARS, TOY TRUCKS, TOY TRAINS, TOY MODEL VEHICLES, AND TOY MODEL TRAIN SETS; TOY CLOCKS AND WATCHES; ROLLER TOYS, NAMELY, MANUALLY-DRIVEN TOY CARS, TOY TRAINS; SPRING-DRIVEN TOYS, NAMELY, WINDUP CRAWLING DOLLS, WINDUP TOY CARS; TOY CLOCKS MADE OF METAL; ELECTRICALLY-DRIVEN TOYS, NAMELY, BATTERY-OPERATED TOY TELEPHONE SETS, TOYS FOR DOMESTIC PETS, FISHING TACKLE SETS, ELECTRICALLY-DRIVEN TOY LOCOMOTIVES; FLY-WHEEL-DRIVEN TOYS, NAMELY, TOY FIRE ENGINES WITH A FLY-WHEEL; TOY BROOCHES; TOY WHISTLES; LEVER ACTION TOYS; WOODEN OR BAMBOO TOYS, NAMELY, RIDE ON TOYS, TOY VEHICLES, ACTION WOODEN TOYS, TRAINS, CARS, WOOD PIECE TOYS, NAMELY, TOY BRICKS, BATTLEDORE PADDLES; WOOD TOYS MADE OF BOARD OR PLANK, NAMELY, DOLLHOUSES AND DOLLHOUSE FURNITURE, WOOD CONSTRUCTION BLOCKS, WOOD PLAY FOOD, WOOD TOY VEHICLES, WOOD TOY MUSICAL INSTRUMENTS, WOOD RIDE-ON TOYS, WOOD PULL TOYS, WOOD WIND UP TOY ANIMALS AND WIND UP TOY VEHICLES, WOOD TOY COMPASSES, WOOD GARAGE, WOOD GAS STATION, WOOD CAR WASH, WOOD BOAT, WOOD HELICOPTER, IN CLASS 28 (U.S. CLS. 22, 23, 38 AND 50).

FOR: ADVERTISING, NAMELY, DIRECT MAIL ADVERTISING, ELECTRONIC BILL BOARD ADVERTISING, PROVIDING TELEVISION ADVERTISING FOR OTHERS; ADVERTISING AGENCIES; ADVERTISING BY MAIL ORDER; AUCTIONEERING; BUSINESS INFORMATION IN THE FIELDS OF DEVELOPMENT OF GAME SOFTWARE, COMPUTER GAMES, GAME STRATEGIES AND PLAY STRATEGIES FOR VIDEO GAME SOFTWARE, NETWORK COMMUNICATIONS, COMPUTER SYSTEMS; BUSINESS INVESTIGATIONS; BUSINESS MANAGEMENT AND ORGANIZATION CONSULTANCY; BUSINESS MANAGEMENT ASSISTANCE; BUSINESS MANAGEMENT CONSULTANCY; BUSINESS MANAGEMENT OF PERFORMING ARTISTS; BUSINESS ORGANIZATION CONSULTANCY; BUSINESS RESEARCH; COMMERCIAL INFORMATION AGENCIES; COMMERCIAL AND INDUSTRIAL MANAGEMENT ASSISTANCE; COMPILATION OF INFORMATION INTO COMPUTER DATABASES; COMPUTERIZED FILE MANAGEMENT; COST PRICE ANALYSIS; DEMONSTRATION OF GOODS; DIRECT MAIL ADVERTISING; DISSEMINATION OF ADVERTISING MATTER; DISTRIBUTION OF SAMPLES; DOCUMENT REPRODUCTION;

**Reg. No. 4,273,704** ECONOMIC FORECASTING; EMPLOYMENT AGENCIES; IMPORT-EXPORT AGENCIES; LOCATION OF FREIGHT CARS BY COMPUTER; MAIL ORDER SERVICES FEATURING MAGAZINES, MUSIC, CINEMA AND GAME SOFT WARES; MARKETING RESEARCH; CONDUCTING MARKETING STUDIES; MODELING FOR ADVERTISING OR SALES PROMOTION; OFFICE MACHINES AND EQUIPMENT RENTAL; DISSEMINATION OF ADVERTISING FOR OTHERS VIA AN ONLINE DATA COMMUNICATIONS NETWORK; OPINION POLLING FOR BUSINESS OR ADVERTISING PURPOSES; ORGANIZATION OF TRADE FAIRS FOR COMMERCIAL OR ADVERTISING PURPOSES; PERSONNEL MANAGEMENT CONSULTANCY; PERSONNEL RECRUITMENT; PHOTOCOPYING; PROFESSIONAL BUSINESS CONSULTANCY; PUBLIC RELATIONS; PUBLICATION OF PUBLICITY TEXTS; PUBLICITY COLUMNS PREPARATION; PUBLICITY MATERIAL RENTAL, NAMELY, RENTAL OF ADVERTISING SIGNS, RENTAL OF ADVERTISING POSTERS, RENTAL OF ADVERTISING SLIDES; PROVIDING RADIO ADVERTISING FOR OTHERS; RELOCATION SERVICES FOR BUSINESSES; RENTAL ADVERTISING TIME ON COMMUNICATION MEDIA; RENTAL OF ADVERTISING SPACE; RENTAL OF PHOTOCOPYING MACHINES; SALES PROMOTION FOR OTHERS PROMOTING THE GOODS AND SERVICES OF OTHERS THROUGH DISTRIBUTION OF PRINTED MATERIAL; SECRETARIAL SERVICES; PROVIDING STATISTICAL INFORMATION; SYSTEMIZATION OF INFORMATION INTO COMPUTER DATABASES; TELEPHONE ANSWERING FOR UNAVAILABLE SUBSCRIBERS; PROVIDING TELEVISION ADVERTISING FOR OTHERS; UPDATING OF ADVERTISING MATERIAL; WORD PROCESSING; RENTAL OF VENDING MACHINES; PRODUCTION OF TELEVISION COMMERCIALS, IN CLASS 35 (U.S. CLS. 100, 101 AND 102).

FOR: CABINET REPAIR; CLEANING OF CLOTHING; CLOCK AND WATCH REPAIR; CLOTHING REPAIR; CONSTRUCTION INFORMATION; DISINFECTING; ELECTRIC APPLIANCE INSTALLATION AND REPAIR; FILM PROJECTOR REPAIR AND MAINTENANCE; FUR CARE, CLEANING AND REPAIR; FURNACE INSTALLATION AND REPAIR; FURNITURE RESTORATION; GAME APPARATUS REPAIR; INSTALLATION, MAINTENANCE AND REPAIR OF COMPUTER HARDWARE; INTERFERENCE SUPPRESSION IN ELECTRICAL APPARATUS; LAUNDERING OF CLOTH, CLOTHING, FABRIC, LINEN, TEXTILES; LEATHER CARE, CLEANING AND REPAIR; MACHINERY INSTALLATION, MAINTENANCE AND REPAIR; MENDING CLOTHING; OFFICE MACHINES AND EQUIPMENT INSTALLATION, MAINTENANCE AND REPAIR; PHOTOGRAPHIC APPARATUS REPAIR; PRESSING OF CLOTHING; RENOVATION OF CLOTHING; RENTAL OF CLEANING MACHINES; BUILDING REPAIR INFORMATION; COMPUTER REPAIR INFORMATION SAFE MAINTENANCE AND REPAIR; SHOE REPAIR; TELEPHONE INSTALLATION AND REPAIR; VEHICLE CLEANING; VEHICLE MAINTENANCE; VEHICLE POLISHING; VEHICLE REPAIR; VEHICLE SERVICE STATIONS; WASHING OF VEHICLES; WASHING OF LINEN; WINDOW CLEANING, IN CLASS 37 (U.S. CLS. 100, 103 AND 106).

FOR: CABLE TELEVISION BROADCASTING; CELLULAR TELEPHONE COMMUNICATION; COMMUNICATIONS BY COMPUTER TERMINALS; COMMUNICATIONS BY FIBER OPTIC NETWORKS; COMMUNICATIONS BY TELEGRAMS; COMMUNICATIONS BY TELEPHONE; COMPUTER AIDED TRANSMISSION OF MESSAGES AND IMAGES; ELECTRONIC MAIL; FACSIMILE TRANSMISSION; INFORMATION ABOUT TELECOMMUNICATION; MESSAGE SENDING BY DELIVERY OF MESSAGES BY ELECTRONIC TRANSMISSION, ELECTRONIC TRANSMISSION OF MESSAGES; PAGING SERVICES; PROVIDING TELECOMMUNICATION CONNECTIONS TO A GLOBAL COMPUTER NETWORK; RADIO BROADCASTING; RENTAL OF FACSIMILE APPARATUS; RENTAL OF MESSAGE SENDING APPARATUS; RENTAL OF MODEMS; RENTAL OF TELECOMMUNICATION EQUIPMENT; RENTAL OF TELEPHONES; SATELLITE TRANSMISSION; SENDING OF TELEGRAMS, NAMELY, TELEGRAM TRANSMISSION; TELECOMMUNICATION GATEWAY SERVICES; TELECONFERENCING SERVICES, NAMELY, AUDIO TELECONFERENCING SERVICES, VIDEO TELECONFERENCING SERVICE; TELEGRAPH SERVICES; TELEPHONE SERVICES, NAMELY, TELEPHONE COMMUNICATION SERVICES, CELLULAR TELEPHONE SERVICES; TELEVISION BROADCASTING; TRANSMISSION OF TELEGRAMS, IN CLASS 38 (U.S. CLS. 100, 101 AND 104).

**Reg. No. 4,273,704** FOR: APPLYING FINISHES TO TEXTILES; BOOKBINDING; BURNISHING BY ABRASION; CLOTH CUTTING; CLOTH DYEING; COLOR SEPARATION SERVICES; CUSTOM ASSEMBLING OF MATERIALS FOR THE FABRICATION AND PRODUCTION OF FURNITURE, CONTAINERS, DRAPERY, COUNTER TOPS; DIGITAL IMAGING SERVICES; LAMINATING OF METAL PLATES AND PLASTIC SHEETS; MATERIAL TREATMENT INFORMATION; PATTERN PRINTING; PHOTOGRAPHIC FILM DEVELOPMENT; PHOTOGRAPHIC PRINTING; PHOTOGRAVURE; PROCESSING OF CINEMATOGRAPHIC FILMS; SERVICES OF A DENTAL TECHNICIAN; TAILORING, IN CLASS 40 (U.S. CLS. 100, 103 AND 106).

FOR: ACADEMIES FOR EDUCATION IN THE FIELD OF COMPUTERS AND PHYSICAL EDUCATION, ACADEMIES FOR EDUCATION ON THE SECONDARY LEVEL AND COLLEGE LEVEL; AMUSEMENT PARKS; ARRANGING AND CONDUCTING OF COLLOQUIUMS IN THE FIELDS OF COMPUTER GRAPHICS AND VIDEO GAME PROGRAMS; ARRANGING AND CONDUCTING OF CONFERENCES IN THE FIELD OF COMPUTER GRAPHICS AND VIDEO GAME PROGRAMS; ARRANGING AND CONDUCTING OF CONGRESSES IN THE FIELDS OF COMPUTER GRAPHICS AND VIDEO GAME PROGRAMS; ARRANGING AND CONDUCTING OF SEMINARS IN THE FIELDS OF COMPUTER GRAPHICS AND VIDEO GAME PROGRAMS; ARRANGING AND CONDUCTING OF WORKSHOPS IN THE FIELDS OF COMPUTER GRAPHICS AND VIDEO GAME PROGRAMS; ARRANGING AND CONDUCTING OF SYMPOSIUMS IN THE FIELDS OF COMPUTER GRAPHICS AND VIDEO GAME PROGRAMS; BOOKING OF SEATS FOR SHOWS; CINEMA SERVICES PROVIDED ON-LINE FROM A COMPUTER NETWORK, NAMELY, REVIEWS AND INFORMATION ON MOVIES, CINEMA AND ARRANGING FOR TICKET RESERVATIONS FOR CINEMA; CLUB SERVICES ABOUT ENTERTAINMENT OR EDUCATION, NAMELY, COUNTRY CLUBS, SOCIAL CLUBS, HEALTH CLUBS, COMEDY CLUBS, YACHT CLUBS; CORRESPONDENCE COURSES IN THE FIELD OF COMPUTER GRAPHICS AND VIDEO GAME PROGRAMS; ENTERTAINMENT IN THE NATURE OF AN AMUSEMENT PARK RIDE; DISCOTHEQUE SERVICES; DUBBING; EDUCATION INFORMATION IN THE FIELD OF COMPUTER GRAPHICS AND VIDEO GAME PROGRAMS; ENTERTAINER IN THE NATURE OF LIVE MUSICAL GROUP, TELEVISION COMEDY SERIES, ETHNIC FESTIVALS; ENTERTAINMENT INFORMATION REGARDING COMPUTER GAMES AND COMPUTER GAME SOFTWARE, AMUSEMENTS, NAMELY, MUSIC, MOVIES, ONGOING TELEVISION PROGRAMS IN THE FIELD OF NEWS, COMEDY, VARIETY, COMMENTARY, FILM, VIDEO GAMES, HOME ENTERTAINMENT, VIDEOS AND GAMES; MOTION PICTURE FILM PRODUCTION; GAME SERVICES, NAMELY, PROVIDING AN ON-LINE COMPUTER GAME; FAN CLUBS; PROVIDING AN ON-LINE COMPUTER GAME; PROVIDING A COMPUTER GAME THAT MAY BE ACCESSED NETWORK-WIDE BY NETWORK USERS; INTERNET PUBLICATION OF ELECTRONIC BOOKS AND JOURNALS ON-LINE; LENDING LIBRARIES; MOVIE STUDIOS; MUSIC-HALLS; ADMINISTRATION OF LOTTERIES FOR OTHERS, CONDUCTING LOTTERIES FOR OTHERS; ORGANIZATION OF COMPETITIONS IN THE FIELD OF ATHLETIC AND SPORTS COMPETITIONS FOR EDUCATION OR ENTERTAINMENT PURPOSE; PARTY PLANNING FOR ENTERTAINMENT PURPOSE; PRODUCTION OF RADIO AND TELEVISION PROGRAMS; PRODUCTION OF CABLE TELEVISION PROGRAMS; PRODUCTION OF CLOSED CAPTION TELEVISION PROGRAMS; PRODUCTION OF RADIO AND TELEVISION PROGRAMS; PROVIDING KARAOKE FACILITIES; PROVIDING AMUSEMENT ARCADE SERVICES; PROVIDING CINEMA FACILITIES; PUBLICATION OF BOOKS; PUBLICATION OF TEXTS OTHER THAN PUBLICITY TEXTS; RADIO ENTERTAINMENT SERVICES, NAMELY, RADIO PROGRAMS FEATURING PERFORMANCES BY FICTIONAL CHARACTER, RADIO PERSONALITY; RADIO ENTERTAINMENT PRODUCTION; RECORDING STUDIO SERVICES; RECREATION INFORMATION; RENTAL OF AUDIO EQUIPMENT; RENTAL OF CINE-FILMS; RENTAL OF LIGHTING APPARATUS FOR THEATRICAL SETS OR TELEVISION STUDIOS; RENTAL OF MOVIE PROJECTORS AND ACCESSORIES; RENTAL OF RADIO AND TELEVISION SETS; RENTAL OF SHOW SCENERY; RENTAL OF SKIN DIVING EQUIPMENT; RENTAL OF SOUND RECORDINGS; RENTAL OF SPORTS EQUIPMENT, EXCEPT VEHICLES; RENTAL OF STADIUM FACILITIES; RENTAL OF STAGE SCENERY; RENTAL OF VIDEO CAMERAS; RENTAL OF VIDEO CASSETTE RECORDERS; RENTAL OF VIDEOTAPES; RENTAL OF VIDEO GAME SOFTWARE; RENTAL OF VIDEO GAME APPARATUS WITH TELEVISION; TELE-



**Reg. No. 4,273,704** VISION ENTERTAINMENT, NAMELY, TELEVISION NEWS SHOWS, TELEVISION PROGRAMS IN THE FIELD OF COMEDY; TELEVISION SHOW PRODUCTION; TELEVISION PROGRAM SYNDICATION ENTERTAINMENT IN THE FIELD OF THEATER PRODUCTIONS; VIDEOTAPE EDITING; VIDEOTAPE FILM PRODUCTION, IN CLASS 41 (U.S. CLS. 100, 101 AND 107).

FOR: ARBITRATION SERVICES; BEAUTY SALONS; CAFES; CAFETERIAS; CANTEENS; CATERING; COCKTAIL LOUNGE SERVICES; COMPUTER PROGRAMMING FOR OTHERS; COMPUTER RENTAL; COMPUTER SOFTWARE DESIGN; COMPUTER SYSTEMS ANALYSIS; CONSULTANCY IN THE FIELD OF COMPUTER HARDWARE; DATING SERVICES; DRESS RENTAL; EDITING OF WRITTEN TEXTS; EVENING DRESS RENTAL; FASHION INFORMATION; FLOWER ARRANGING; FUNERAL SERVICES, NAMELY, ARRANGING AND CONDUCTING FUNERALS; GRAPHIC ARTS DESIGNING; HEALTH CARE; HOROSCOPE CASTING; MAKING HOTEL RESERVATIONS FOR OTHERS; INTELLECTUAL PROPERTY CONSULTANCY; LEASING ACCESS TO A COMPUTER DATABASE IN THE FIELDS OF GENERAL AND LOCAL NEWS, INFORMATION OF INTEREST TO SPECIFIC GEOGRAPHIC AREAS, COMPUTER GAMES, COMPUTER GAME SOFTWARE; LEASING TIME TO A COMPUTER DATA BASE FOR THE MANIPULATION OF DATA; LEGAL RESEARCH; LEGAL SERVICES; LICENSING OF INTELLECTUAL PROPERTY; LITHOGRAPHIC PRINTING; MAINTENANCE OF COMPUTER SOFTWARE; MARRIAGE BUREAU; MEDICAL ASSISTANCE; MICROFILMING FOR OTHERS; OFFSET PRINTING; PACKAGING DESIGN FOR OTHERS; PATENT EXPLOITATION, NAMELY, THE LICENSING OF INTELLECTUAL PROPERTY; PERSONAL LETTER WRITING; PHARMACY ADVICE; PHOTOGRAPHIC REPORTING; PHOTOGRAPHY; PRINTING; NON-BUSINESS PROFESSIONAL CONSULTANCY IN THE FIELD OF SOFTWARE DESIGN, COMPUTER SOFTWARE, COMPUTER SECURITY, COMPUTER PROGRAMMING; PROVIDING FACILITIES FOR EXHIBITIONS; RECOVERY OF COMPUTER DATA; RENTAL OF CHAIRS, TABLES, TABLE LINEN AND GLASSWARE; RENTAL OF COMPUTER SOFTWARE; RENTAL OF MEETING ROOMS; RESEARCH AND DEVELOPMENT FOR OTHERS IN THE FIELD OF NEW PRODUCTS; SECURITY CONSULTANCY; SILKSCREEN PRINTING; UPDATING OF COMPUTER SOFTWARE; TEMPORARY ACCOMMODATION RESERVATIONS FOR OTHERS; BRAILLE TRANSLATION; LANGUAGE TRANSLATION; UNIFORM RENTAL; VETERINARY ASSISTANCE; VIDEOTAPING; VOCATIONAL GUIDANCE; WEATHER FORECASTING, IN CLASS 42 (U.S. CLS. 100 AND 101).

PRIORITY CLAIMED UNDER SEC. 44(D) ON JAPAN APPLICATION NO. 2000-38416, FILED 4-11-2000, REG. NO. 844543, DATED 7-31-2000, EXPIRES 7-31-2010.

OWNER OF ERPN CMNTY TM OFC REG. NO. 001824606, DATED 1-28-2002, EXPIRES 8-2-2020.

OWNER OF ERPN CMNTY TM OFC REG. NO. 001704592, DATED 11-19-2003, EXPIRES 6-2-2020.

SER. NO. 76-118,174, FILED 8-25-2000.

PRISCILLA MILTON, EXAMINING ATTORNEY

# United States of America

United States Patent and Trademark Office

## BEA WEBLOGIC INTEGRATION

**Reg. No. 4,273,705**

**Registered Jan. 15, 2013**

**Int. Cl.: 9**

**TRADEMARK**

**PRINCIPAL REGISTER**

BEA SYSTEMS, INC. (DELAWARE CORPORATION)  
500 ORACLE PARKWAY  
REDWOOD SHORES, CA 94065

FOR: COMPUTER SOFTWARE FOR PROGRAMMING, DEVELOPMENT AND DEPLOYMENT OF COMPUTER SOFTWARE; COMPUTER SOFTWARE THAT ALLOWS DISPARATE SOFTWARE TO COMMUNICATE OVER A NETWORK AND TO ACCESS AND UPDATE DATA DISTRIBUTED OVER A NETWORK; COMPUTER SOFTWARE FOR ACCESSING, CONNECTING, DEVELOPING AND MANAGING DISTRIBUTED APPLICATION SOFTWARE; COMPUTER SOFTWARE USED IN DISTRIBUTED TRANSACTION PROCESSING SYSTEMS TO PROVIDE INTER-OPERATION BETWEEN TELEPROCESSING MONITORS; COMPUTER SOFTWARE THAT OPERATES AT A SYSTEM LEVEL TO INTEGRATE MULTIPLE SOFTWARE APPLICATIONS ACROSS PLATFORMS AND NETWORK TRANSPORTS; COMPUTER SOFTWARE FOR ONLINE MESSAGING; COMPUTER SOFTWARE FOR INTEGRATION AND SHARED USE OF INFORMATION FROM DIFFERENT APPLICATIONS, PLATFORMS, OPERATING SYSTEMS OR DATABASES; COMPUTER SOFTWARE FOR MANAGEMENT OF BUSINESSES PROCESSES, IN CLASS 9 (U.S. CLS. 21, 23, 26, 36 AND 38).

FIRST USE 6-0-2001; IN COMMERCE 9-0-2001.

OWNER OF U.S. REG. NO. 2,474,341.

NO CLAIM IS MADE TO THE EXCLUSIVE RIGHT TO USE "INTEGRATION", APART FROM THE MARK AS SHOWN.

SER. NO. 76-323,717, FILED 10-10-2001.

BRENDAN MCCAULEY, EXAMINING ATTORNEY



*David J. Kyros*

Director of the United States Patent and Trademark Office

# United States of America

United States Patent and Trademark Office



**Reg. No. 4,273,706**

JAY-Y ENTERPRISE CO., INC. (CALIFORNIA CORPORATION)  
632 NEW YORK DRIVE  
POMONA, CA 91768

**Registered Jan. 15, 2013**

**Int. Cl.: 9**

FOR: SUNGLASSES OPTICAL FRAMES AND READING GLASSES, IN CLASS 9 (U.S. CLS. 21, 23, 26, 36 AND 38).

**TRADEMARK**

FIRST USE 2-1-2002; IN COMMERCE 2-1-2002.

**PRINCIPAL REGISTER**

OWNER OF U.S. REG. NOS. 2,999,916 AND 3,221,256.

SER. NO. 76-619,226, FILED 11-2-2004.

PAUL MORENO, EXAMINING ATTORNEY



*David J. Kyffers*

Director of the United States Patent and Trademark Office

# United States of America

United States Patent and Trademark Office



**Reg. No. 4,273,707**

SQUARE-H BRANDS, INC. (DELAWARE CORPORATION), DBA "SQUARE-H BRANDS"  
2731 SOUTH SOTO STREET  
LOS ANGELES, CA 90058

**Registered Jan. 15, 2013**

**Int. Cl.: 29**

FOR: FRESH, FROZEN AND PROCESSED MEATS AND MEAT PRODUCTS, NAMELY, HOT DOGS. BACON AND SAUSAGE, IN CLASS 29 (U.S. CL. 46).

**TRADEMARK**

FIRST USE 7-1-1985; IN COMMERCE 7-1-1985.

**PRINCIPAL REGISTER**

THE MARK CONSISTS OF THE WORDING "BLARNEY STONE" IN A GOTHIC STYLE OF LETTERING.

SER. NO. 76-670,314, FILED 12-14-2006.

DORITT L. CARROLL, EXAMINING ATTORNEY



*David J. Kybas*

Director of the United States Patent and Trademark Office

# United States of America

United States Patent and Trademark Office

# Post Institute

**Reg. No. 4,273,708**

POST, BRYAN (UNITED STATES INDIVIDUAL)  
2819 HADEN MARTIN ROAD  
PALMYRA, VA 22963

**Registered Jan. 15, 2013**

**Int. Cl.: 16**

FOR: PAPER GOODS AND PRINTED MATTER, NAMELY, SERIES OF BOOKS IN THE FIELD OF PARENTING, IN CLASS 16 (U.S. CLS. 2, 5, 22, 23, 29, 37, 38 AND 50).

**TRADEMARK**

FIRST USE 0-0-1995; IN COMMERCE 0-0-1995.

**PRINCIPAL REGISTER**

THE MARK CONSISTS OF STANDARD CHARACTERS WITHOUT CLAIM TO ANY PARTICULAR FONT, STYLE, SIZE, OR COLOR.

NO CLAIM IS MADE TO THE EXCLUSIVE RIGHT TO USE "INSTITUTE", APART FROM THE MARK AS SHOWN.

SER. NO. 76-705,171, FILED 11-1-2010.

DAVID C. REIHNER, EXAMINING ATTORNEY



*David J. Kyffers*

Director of the United States Patent and Trademark Office

# United States of America

United States Patent and Trademark Office

**PANCRESEA**

**Reg. No. 4,273,709**

BIOENERGIMED, LLC (NEVADA LIMITED LIABILITY COMPANY)  
1629 LONG RUN ROAD  
SCHUYLKILL HAVEN, PA 17972

**Registered Jan. 15, 2013**

**Int. Cl.: 5**

FOR: DIETARY SUPPLEMENTS FOR HUMAN CONSUMPTION, IN CLASS 5 (U.S. CLS. 6, 18, 44, 46, 51 AND 52).

**TRADEMARK**

FIRST USE 12-1-1998; IN COMMERCE 12-10-2000.

**PRINCIPAL REGISTER**

SER. NO. 76-706,267, FILED 2-3-2011.

ANGELA M. MICHELI, EXAMINING ATTORNEY



*David J. Kyjars*

Director of the United States Patent and Trademark Office

# United States of America

United States Patent and Trademark Office



**Reg. No. 4,273,710**

**Registered Jan. 15, 2013**

**Int. Cls.: 1, 4, 7, 9, 11  
and 12**

**TRADEMARK**

**PRINCIPAL REGISTER**

TUCKER-ROCKY CORPORATION, INC. (DELAWARE CORPORATION)  
103 FOULK ROAD  
SUITE 202  
WILMINGTON, DE 19803

FOR: TRANSMISSION FLUID, IN CLASS 1 (U.S. CLS. 1, 5, 6, 10, 26 AND 46).

FIRST USE 12-0-1998; IN COMMERCE 0-0-2010.

FOR: TRANSMISSION GEAR LUBRICANTS; ENGINE OIL; QUICK CHANGE OIL KITS COMPRISING ENGINE OIL AND OIL FILTER; CHAIN CASE LUBRICANT, IN CLASS 4 (U.S. CLS. 1, 6 AND 15).

FIRST USE 12-0-1998; IN COMMERCE 0-0-2010.

FOR: AIR FILTERS FOR MOTORCYCLE MOTORS AND ENGINES; ENGINE MUFFLERS, IN CLASS 7 (U.S. CLS. 13, 19, 21, 23, 31, 34 AND 35).

FIRST USE 12-0-1998; IN COMMERCE 0-0-2010.

FOR: BATTERIES FOR VEHICLES; OIL PRESSURE GAUGES; SPEEDOMETER CABLES, TACHOMETER CABLES, IN CLASS 9 (U.S. CLS. 21, 23, 26, 36 AND 38).

FIRST USE 12-0-1998; IN COMMERCE 0-0-2010.

FOR: REAR LIGHTS FOR VEHICLES; TAIL LIGHTS FOR VEHICLES, IN CLASS 11 (U.S. CLS. 13, 21, 23, 31 AND 34).

FIRST USE 12-0-1998; IN COMMERCE 0-0-2010.

FOR: MOTORCYCLE PARTS AND WHEEL ACCESSORIES, NAMELY, AXLE SPACER, WHEEL SPACER, PULLEY SPACER, CLUTCH PUSHROD, FORK TUBE, TURN SIGNALS, TURN SIGNAL SWITCH, THROTTLE AND CLUTCH CABLES, HAND GRIPS, HAND CONTROLS, NAMELY, HANDLE BAR CONTROL LEVERS, REARVIEW MIRRORS, HANDLE BAR CLAMPS, TRANSMISSION END WIRES, HANDLE BAR WIRE HARNESS, SHOCK ABSORBERS, TIRES, ENGINE GUARDS, NAMELY, A METAL BUMPER THAT AFFIXES TO THE FRAME OF THE MOTORCYCLE USED TO PROTECT THE ENGINE PARTS IN THE



*David J. Kyjars*

Director of the United States Patent and Trademark Office

**Reg. No. 4,273,710** EVENT OF A LOW SPEED TIP OVER, KICKSTANDS, BRAKE PADS, THROTTLE CABLES, CLUTCH CABLES, CHOKE CABLES, IDLE CABLES, BRAKE CABLES, REPLACEMENT HANDLE BAR CONTROL LEVERS, THROTTLE CLAMPS, BRAKE LEVERS, GAS CAPS, FENDERS, SHIFT LEVERS, MOTORCYCLE HANDLEBARS, GAS TANKS, AND DROP SEAT CONVERSION KIT COMPRISED OF THE FRAME, THE SEAT AND THE SIDE PANELS, REAR FRAME SECTION INCLUDING THE BATTERY MOUNTING BOX, FUSE BOX, MOUNT FOR THE TURN SIGNAL MODULE, MOUNTING HARDWARE, BATTERY CABLES, PLASTIC TIE STRAPS AND ZIP TIES TO MAKE STRUCTURAL CHANGES TO AN AUTOMOBILE, IN CLASS 12 (U.S. CLS. 19, 21, 23, 31, 35 AND 44).

FIRST USE 12-0-1998; IN COMMERCE 12-0-1998.

OWNER OF U.S. REG. NOS. 2,496,626, 2,513,032 AND OTHERS.

NO CLAIM IS MADE TO THE EXCLUSIVE RIGHT TO USE "BIKER'S", APART FROM THE MARK AS SHOWN.

THE MARK CONSISTS OF WORDS "BIKER'S CHOICE" IN A STYLIZED FONT WITH AN EAGLE AND WINGS DESIGN SITUATED CENTRALLY AND BEHIND THE WORDS.

SER. NO. 76-706,978, FILED 3-28-2011.

SCOTT BIBB, EXAMINING ATTORNEY



# United States of America

United States Patent and Trademark Office



**Reg. No. 4,273,711**

**Registered Jan. 15, 2013**

**Int. Cl.: 29**

**TRADEMARK**

**PRINCIPAL REGISTER**

THE INTERNATIONAL UNION FOR INTEGRATED FOOD INDUSTRIES S.A.E. (EGYPT STOCK CORPORATION)  
34, 26TH JULY STREET, LEBANON SQUARE  
MOHANDESEEN, GIZA, EGYPT

FOR: CANNED FRUITS AND VEGETABLES; CHEESE; CHICKEN; CHICKEN NUGGETS; DRIED FRUIT AND VEGETABLES; FALAFEL; FROZEN EGGS; FROZEN FRUITS; FROZEN SEAFOOD; FROZEN VEGETABLES; MEAT; MEAT, FISH, FRUIT AND VEGETABLE PRESERVES; MEAT, FROZEN; PEANUT BUTTER; PEELED TOMATOES; POULTRY AND GAME; PRESERVED FRUIT AND VEGETABLES; PROCESSED MEAT; PROCESSED MUSHROOMS; PROCESSED NUTS; PROCESSED VEGETABLES AND FRUITS, IN CLASS 29 (U.S. CL. 46).

FIRST USE 1-0-2010; IN COMMERCE 1-0-2010.

THE NON-LATIN CHARACTERS IN THE MARK TRANSLITERATE TO "LAZAH", AND THIS HAS NO MEANING IN A FOREIGN LANGUAGE.

SER. NO. 76-708,215, FILED 7-1-2011.

MARK RADEMACHER, EXAMINING ATTORNEY



*David J. Kyffers*

Director of the United States Patent and Trademark Office

# United States of America

United States Patent and Trademark Office

## X-PLAIN

**Reg. No. 4,273,712**

**Registered Jan. 15, 2013**

**Int. Cl.: 41**

**SERVICE MARK**

**PRINCIPAL REGISTER**

PATIENT EDUCATION INSTITUTE, INC. (IOWA CORPORATION), DBA THE PATIENT  
EDUCATION INSTITUTE  
2000 JAMES STREET, SUITE 219  
CORALVILLE, IA 52241

FOR: MEDICAL PATIENT EDUCATIONAL SERVICES, NAMELY, PROVIDING EDUCATION  
COURSES IN THE FIELD OF MEDICAL CARE OFFERED THROUGH ON-LINE, NON-  
DOWNLOADABLE VIDEOS, IN CLASS 41 (U.S. CLS. 100, 101 AND 107).

FIRST USE 5-1-1995; IN COMMERCE 5-1-1995.

THE MARK CONSISTS OF STANDARD CHARACTERS WITHOUT CLAIM TO ANY PAR-  
TICULAR FONT, STYLE, SIZE, OR COLOR.

SER. NO. 76-708,272, FILED 7-8-2011.

ANDREW LEASER, EXAMINING ATTORNEY



*David J. Kyffers*

Director of the United States Patent and Trademark Office

# United States of America

United States Patent and Trademark Office

# DR. PINK

**Reg. No. 4,273,713**

DR. PINK, LLC (TEXAS LIMITED LIABILITY COMPANY)  
100 N. WOODSTOCK CIRCLE DR.  
THE WOODLANDS, TX 77381

**Registered Jan. 15, 2013**

**Int. Cl.: 25**

FOR: BRASSIERES FOR USE BY FEMALES AFTER MASTECTOMY OR LUMPECTOMY; BRASSIERES; WOMEN'S UNDERGARMENTS; NIGHT GOWNS; PANTS; T-SHIRTS; HATS; SUN VISORS; SLIPPERS; SANDALS; FLIP FLOPS, ALL SOLD TO CANCER SURVIVORS AND THEIR SUPPORTERS, IN CLASS 25 (U.S. CLS. 22 AND 39).

**TRADEMARK**

**PRINCIPAL REGISTER**

FIRST USE 8-9-2011; IN COMMERCE 8-26-2011.

THE MARK CONSISTS OF STANDARD CHARACTERS WITHOUT CLAIM TO ANY PARTICULAR FONT, STYLE, SIZE, OR COLOR.

THE NAME "DR. PINK" IN THE MARK IDENTIFIES DR. MASSY WILLIAMS WHOSE CONSENT TO REGISTER IS OF RECORD.

SER. NO. 76-709,051, FILED 9-13-2011.

LINDA ESTRADA, EXAMINING ATTORNEY



*David J. Kyffers*

Director of the United States Patent and Trademark Office

# United States of America

United States Patent and Trademark Office

## KEEPING LIFE FRESH

**Reg. No. 4,273,714**

**Registered Jan. 15, 2013**

**Int. Cl.: 35**

**SERVICE MARK**

**PRINCIPAL REGISTER**

AMERIFRESH, INC. (DELAWARE CORPORATION)  
16100 N. 71ST STREET  
STE 500  
SCOTTSDALE, AZ 852542125

FOR: DISTRIBUTORSHIP SERVICES IN THE FOOD INDUSTRY FEATURING FRESH PRODUCE, FRUITS, VEGETABLES AND BERRIES, IN CLASS 35 (U.S. CLS. 100, 101 AND 102).

FIRST USE 0-0-2000; IN COMMERCE 0-0-2000.

THE MARK CONSISTS OF STANDARD CHARACTERS WITHOUT CLAIM TO ANY PARTICULAR FONT, STYLE, SIZE, OR COLOR.

SER. NO. 76-709,591, FILED 10-31-2011.

MARK SPARACINO, EXAMINING ATTORNEY



*David J. Kyffers*

Director of the United States Patent and Trademark Office

United States of America  
United States Patent and Trademark Office

**SNOBOY**

**Reg. No. 4,273,715**

AMERIFRESH, INC. (DELAWARE CORPORATION)  
16100 N. 71ST STREET, STE 500  
SCOTTSDALE, AZ 852542125

**Registered Jan. 15, 2013**

**Int. Cl.: 31**

FOR: FRESH PRODUCE, NAMELY, FRESH FRUIT, FRESH VEGETABLES AND FRESH BERRIES, IN CLASS 31 (U.S. CLS. 1 AND 46).

**TRADEMARK**

FIRST USE 4-9-1925; IN COMMERCE 4-9-1925.

**PRINCIPAL REGISTER**

THE MARK CONSISTS OF STANDARD CHARACTERS WITHOUT CLAIM TO ANY PARTICULAR FONT, STYLE, SIZE, OR COLOR.

OWNER OF U.S. REG. NOS. 546,047, 1,630,200 AND OTHERS.

SER. NO. 76-709,654, FILED 11-7-2011.

MARK SPARACINO, EXAMINING ATTORNEY



*David J. Kyffers*

Director of the United States Patent and Trademark Office

# United States of America

United States Patent and Trademark Office



**Reg. No. 4,273,716**

AMERIFRESH, INC. (DELAWARE CORPORATION)  
16100 N. 71ST STREET, STE 500  
SCOTTSDALE, AZ 852542125

**Registered Jan. 15, 2013**

**Int. Cl.: 31**

FOR: FRESH PRODUCE, NAMELY, FRESH FRUITS, FRESH VEGETABLES AND FRESH BERRIES, IN CLASS 31 (U.S. CLS. 1 AND 46).

**TRADEMARK**

FIRST USE 9-1-1990; IN COMMERCE 9-1-1990.

**PRINCIPAL REGISTER**

OWNER OF U.S. REG. NOS. 546,047, 2,936,396 AND OTHERS.

THE MARK CONSIST OF STYLIZED ILLUSTRATION OF A BUST OF A SMILING SNOW-MAN, SHOWING HEAD, SHOULDERS AND ARMS, WITH EARMUFFS WORN ON HEAD, AND ARMS OUTSTRETCHED PROVIDING BACKGROUND FOR DISPLAY OF TEXT "SNOBOY".

SER. NO. 76-709,655, FILED 11-7-2011.

MARK SPARACINO, EXAMINING ATTORNEY



*David J. Kybas*

Director of the United States Patent and Trademark Office

# United States of America

United States Patent and Trademark Office



**Reg. No. 4,273,717**

AMERIFRESH, INC. (DELAWARE CORPORATION)  
16100 N. 71ST STREET, STE 500  
SCOTTSDALE, AZ 852542125

**Registered Jan. 15, 2013**

**Int. Cl.: 31**

FOR: FRESH PRODUCE, NAMELY, FRESH FRUITS, FRESH VEGETABLES AND FRESH BERRIES, IN CLASS 31 (U.S. CLS. 1 AND 46).

**TRADEMARK**

FIRST USE 7-1-1992; IN COMMERCE 7-1-1992.

**PRINCIPAL REGISTER**

OWNER OF U.S. REG. NOS. 546,047, 2,936,393 AND OTHERS.

THE MARK CONSIST OF STYLIZED ILLUSTRATION OF A BUST OF A SMILING SNOW-MAN, SHOWING HEAD, SHOULDERS AND ARMS, WITH ARMS STRETCHED FORWARD, AND EARMUFFS WORN ON HEAD.

SER. NO. 76-709,656, FILED 11-7-2011.

MARK SPARACINO, EXAMINING ATTORNEY



*David J. Kyffers*

Director of the United States Patent and Trademark Office

# United States of America

United States Patent and Trademark Office

*B*  
*Porsamo Bleu*

**Reg. No. 4,273,718**

MA DIAMOND DESIGN CO., INC. (CALIFORNIA CORPORATION)  
637 S. HILL STREET, SUITE FL  
LOS ANGELES, CA 90014

**Registered Jan. 15, 2013**

**Int. Cl.: 14**

FOR: WATCHES; JEWELRY, IN CLASS 14 (U.S. CLS. 2, 27, 28 AND 50).

**TRADEMARK**

FIRST USE 11-0-2011; IN COMMERCE 11-0-2011.

**PRINCIPAL REGISTER**

THE MARK CONSISTS OF THE WORDING B PORSAMO BLEU IN STYLIZED FONT.

THE ENGLISH TRANSLATION OF THE WORD BLEU IS BLUE. PORSAMO HAS NO ENGLISH TRANSLATION, MEANING OR SIGNIFICANCE IN CONNECTION WITH THE IDENTIFIED GOODS.

SER. NO. 76-710,296, FILED 1-18-2012.

KEVON CHISOLM, EXAMINING ATTORNEY



*David J. Kyffers*

Director of the United States Patent and Trademark Office



# United States of America

United States Patent and Trademark Office

## TOSS N' SCORE

**Reg. No. 4,273,719**

WESTMINSTER, INC. (GEORGIA CORPORATION)  
159 ARMOUR AVENUE NE  
ATLANTA, GA 30324

**Registered Jan. 15, 2013**

**Int. Cl.: 28**

FOR: ACTION SKILL GAMES, IN CLASS 28 (U.S. CLS. 22, 23, 38 AND 50).

**TRADEMARK**

FIRST USE 1-25-2011; IN COMMERCE 3-9-2011.

**PRINCIPAL REGISTER**

THE MARK CONSISTS OF STANDARD CHARACTERS WITHOUT CLAIM TO ANY PARTICULAR FONT, STYLE, SIZE, OR COLOR.

NO CLAIM IS MADE TO THE EXCLUSIVE RIGHT TO USE "TOSS", APART FROM THE MARK AS SHOWN.

SER. NO. 76-710,798, FILED 3-2-2012.

NELSON SNYDER, EXAMINING ATTORNEY



*David J. Kybas*

Director of the United States Patent and Trademark Office

# United States of America

United States Patent and Trademark Office

# RELUCU

**Reg. No. 4,273,720**

**Registered Jan. 15, 2013**

**Int. Cl.: 9**

**TRADEMARK**

**PRINCIPAL REGISTER**

HERAEUS MATERIALS TECHNOLOGY GMBH & CO. KG (FED REP GERMANY LIMITED LIABILITY COMPANY)  
HERAEUSSTRASSE 12-14  
D-63450 HANAU, FED REP GERMANY

FOR: BONDING WIRE FOR CIRCUIT CONNECTIONS, IN CLASS 9 (U.S. CLS. 21, 23, 26, 36 AND 38).

THE MARK CONSISTS OF STANDARD CHARACTERS WITHOUT CLAIM TO ANY PARTICULAR FONT, STYLE, SIZE, OR COLOR.

PRIORITY CLAIMED UNDER SEC. 44(D) ON ERPN CMNTY TM OFC APPLICATION NO. 010495851, FILED 12-15-2011, REG. NO. 010495851, DATED 5-16-2012, EXPIRES 12-15-2021.

SER. NO. 76-711,073, FILED 3-30-2012.

DAVID HOFFMAN, EXAMINING ATTORNEY



*David J. Kyffers*

Director of the United States Patent and Trademark Office

# United States of America

United States Patent and Trademark Office

## SUN PRO by World Pac

**Reg. No. 4,273,721**

WORLD PAC INTERNATIONAL USA, INC. (WISCONSIN CORPORATION)  
7900 DURAND AVENUE  
STURTEVANT, WI 53177

**Registered Jan. 15, 2013**

**Int. Cl.: 18**

FOR: FLAT FILM CASINGS OR WRAPPINGS FOR FOOD PRODUCTS, ALL BEING USED AS CASINGS AND FLAVORED WRAPPINGS FOR FORMED MEATS, POULTRY, FISH, CHEESE PRODUCTS AND RELATED FOOD PRODUCTS, IN CLASS 18 (U.S. CLS. 1, 2, 3, 22 AND 41).

**TRADEMARK**

**PRINCIPAL REGISTER**

FIRST USE 10-1-1991; IN COMMERCE 10-13-1991.

THE MARK CONSISTS OF STANDARD CHARACTERS WITHOUT CLAIM TO ANY PARTICULAR FONT, STYLE, SIZE, OR COLOR.

OWNER OF U.S. REG. NOS. 2,832,724, 2,861,065 AND OTHERS.

NO CLAIM IS MADE TO THE EXCLUSIVE RIGHT TO USE "PRO", APART FROM THE MARK AS SHOWN.

SER. NO. 76-711,086, FILED 4-2-2012.

WILLIAM JACKSON, EXAMINING ATTORNEY



*David J. Kyros*

Director of the United States Patent and Trademark Office

# United States of America

United States Patent and Trademark Office

## WHERE YOUR JOB IS YOUR CREDIT

**Reg. No. 4,273,722**

SABMD, LLC (MARYLAND LIMITED LIABILITY COMPANY)  
9075 EUCLID AVENUE  
MANASSAS, VA 20110

**Registered Jan. 15, 2013**

**Int. Cl.: 35**

FOR: RETAIL STORE SERVICES FEATURING AUTOMOBILES, IN CLASS 35 (U.S. CLS. 100, 101 AND 102).

**SERVICE MARK**

FIRST USE 1-19-1997; IN COMMERCE 1-19-1997.

**PRINCIPAL REGISTER**

THE MARK CONSISTS OF STANDARD CHARACTERS WITHOUT CLAIM TO ANY PARTICULAR FONT, STYLE, SIZE, OR COLOR.

SER. NO. 76-711,102, FILED 4-2-2012.

SAMUEL E. SHARPER JR., EXAMINING ATTORNEY



*David J. Kyffers*

Director of the United States Patent and Trademark Office

# United States of America

United States Patent and Trademark Office

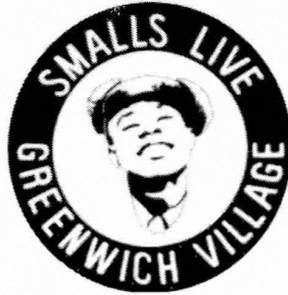

**Reg. No. 4,273,723**

SMALLSLIVE LLC (NEW YORK LIMITED LIABILITY COMPANY)  
183 WEST 10TH STREET  
NEW YORK, NY 10014

**Registered Jan. 15, 2013**

**Int. Cl.: 38**

FOR: STREAMING OF AUDIOVISUAL MATERIAL OF JAZZ CLUB PERFORMANCES, IN CLASS 38 (U.S. CLS. 100, 101 AND 104).

**SERVICE MARK**

FIRST USE 12-14-2011; IN COMMERCE 12-14-2011.

**PRINCIPAL REGISTER**

OWNER OF U.S. REG. NO. 3,361,757.

NO CLAIM IS MADE TO THE EXCLUSIVE RIGHT TO USE "LIVE" AND "GREENWICH VILLAGE", APART FROM THE MARK AS SHOWN.

THE PORTRAIT IN THE MARK DOES NOT IDENTIFY A LIVING INDIVIDUAL.

THE MARK CONSISTS OF THE IMAGE OF A MAN'S HEAD WEARING A HAT WITH THE WORDS "SMALLS LIVE" ABOVE THE IMAGE AND "GREENWICH VILLAGE" BELOW THE IMAGE WITHIN A CIRCLE SURROUNDING THE IMAGE.

SER. NO. 76-711,182, FILED 4-10-2012.

CARYN GLASSER, EXAMINING ATTORNEY



*David J. Kybas*

Director of the United States Patent and Trademark Office

# United States of America

United States Patent and Trademark Office

## TITAN CCA

**Reg. No. 4,273,724**

**Registered Jan. 15, 2013**

**Int. Cl.: 9**

**TRADEMARK**

**PRINCIPAL REGISTER**

PROGRESSION, INC. (DELAWARE CORPORATION)  
22 PARKRIDGE ROAD  
HAVERHILL, MA 01835

FOR: SCIENTIFIC INSTRUMENTS, NAMELY, COAL ANALYZERS FOR MEASURING ENERGY CONTENT, ANY SPECIFIC ELEMENTS OR COMPOUNDS AND TOTAL, BOUND AND FREE MOISTURE CONTENT, IN CLASS 9 (U.S. CLS. 21, 23, 26, 36 AND 38).

FIRST USE 12-0-2010; IN COMMERCE 12-0-2010.

THE MARK CONSISTS OF STANDARD CHARACTERS WITHOUT CLAIM TO ANY PARTICULAR FONT, STYLE, SIZE, OR COLOR.

NO CLAIM IS MADE TO THE EXCLUSIVE RIGHT TO USE "CCA", APART FROM THE MARK AS SHOWN.

SER. NO. 76-711,210, FILED 4-13-2012.

SHANNON TWOHIG, EXAMINING ATTORNEY



*David J. Kyffers*

Director of the United States Patent and Trademark Office

**United States of America**  
United States Patent and Trademark Office

# AEROVORTEX

**Reg. No. 4,273,725**

AMERICAN CUSTOM GOLFCARS, INC. (CALIFORNIA CORPORATION), AKA ACG, INC.  
15740 EL PRADO ROAD  
CHINO, CA 91710

**Registered Jan. 15, 2013**

**Int. Cl.: 12**

FOR: AERODYNAMIC DEVICES FOR MOTOR VEHICLES, NAMELY, VORTEX GENERATORS FOR USE ON LAND VEHICLES SUCH AS: AUTOMOBILES, TRUCKS AND BOX TRAILERS , IN CLASS 12 (U.S. CLS. 19, 21, 23, 31, 35 AND 44).

**TRADEMARK**

FIRST USE 4-1-2012; IN COMMERCE 4-1-2012.

**PRINCIPAL REGISTER**

THE MARK CONSISTS OF STANDARD CHARACTERS WITHOUT CLAIM TO ANY PARTICULAR FONT, STYLE, SIZE, OR COLOR.

SER. NO. 76-711,260, FILED 4-18-2012.

FRANK LATTUCA, EXAMINING ATTORNEY



*David J. Kyffers*

Director of the United States Patent and Trademark Office

# United States of America

United States Patent and Trademark Office

# READYPOINT

**Reg. No. 4,273,726**

**Registered Jan. 15, 2013**

**Int. Cl.: 41**

**SERVICE MARK**

**PRINCIPAL REGISTER**

DISASTERSNET, INC. (TENNESSEE CORPORATION)  
40 BURTON HILLS BOULEVARD, SUITE 150  
NASHVILLE, TN 37215

FOR: PROVIDING TRAINING OF NURSES, DOCTORS, HEALTHCARE FACILITY EXECUTIVES, OFFICERS AND ADMINISTRATORS, ALL CLINICAL AND NON-CLINICAL HEALTHCARE FACILITY PERSONNEL AND OTHER MEDICAL PROFESSIONALS IN THE FIELDS OF DISASTER PREPAREDNESS, HOSPITAL INCIDENT COMMAND, AND DISASTER RESPONSE RECOVERY, IN CLASS 41 (U.S. CLS. 100, 101 AND 107).

FIRST USE 7-6-2011; IN COMMERCE 7-6-2011.

THE MARK CONSISTS OF STANDARD CHARACTERS WITHOUT CLAIM TO ANY PARTICULAR FONT, STYLE, SIZE, OR COLOR.

SER. NO. 76-711,289, FILED 4-19-2012.

HEATHER SAPP, EXAMINING ATTORNEY



*David J. Kyffers*

Director of the United States Patent and Trademark Office



# United States of America

United States Patent and Trademark Office



**Reg. No. 4,273,727**

**Registered Jan. 15, 2013**

**Int. Cl.: 35**

**SERVICE MARK**

**PRINCIPAL REGISTER**

ALLIANTGROUP, L.P. (TEXAS PARTNERSHIP)  
5400 WESTHEIMER COURT, SUITE 700  
HOUSTON, TX 77056

FOR: TAX CONSULTING SERVICES, IN CLASS 35 (U.S. CLS. 100, 101 AND 102).

FIRST USE 3-19-2012; IN COMMERCE 3-19-2012.

THE MARK CONSIST OF THE WORDING "THE OFFICIAL SPONSOR OF AMERICAN INNOVATION AND JOB CREATION" AND THE LETTER "A" IN STYLIZED BLUE LETTERING WRITTEN ON SEVEN LINES AGAINST A WHITE BACKGROUND INSIDE THREE CONCENTRIC CIRCLES. THE OUTER AND INNER CIRCLE APPEARS BLUE. THE MIDDLE CIRCLE APPEARS WHITE. FIVE BLUE STARS APPEAR ABOVE AND THREE BLUE STARS APPEAR UNDERNEATH THE WORDING "AND JOB CREATION". TWO BLUE EARS OF WHEAT APPEAR INSIDE THE CENTER CIRCLE. THE LETTER "A" APPEARS IN LOWERCASE LETTERING OVERLAPPING BOTTOM OF THE TWO EARS OF WHEAT. THE COLOR WHITE IN THE MARK REPRESENTS BACKGROUND, OUTLINING, SHADING OR TRANSPARENT AREAS AND ARE NOT PART OF THE MARK.

THE COLOR(S) BLUE IS/ARE CLAIMED AS A FEATURE OF THE MARK.

SER. NO. 76-711,356, FILED 4-27-2012.

JEFFREY LOOK, EXAMINING ATTORNEY



*David J. Kyffers*

Director of the United States Patent and Trademark Office

# United States of America

United States Patent and Trademark Office

## DOUGLAS LIGHTING CONTROLS

**Reg. No. 4,273,728**

**Registered Jan. 15, 2013**

**Int. Cl.: 9**

**TRADEMARK**

**PRINCIPAL REGISTER**

UNIVERSAL LIGHTING TECHNOLOGIES, INC. (DELAWARE CORPORATION)  
26 CENTURY BOULEVARD, SUITE 500  
NASHVILLE, TN 372143683

FOR: ACCESS CONTROL AND ALARM MONITORING SYSTEMS; ALARM CENTRAL UNITS; DISTRIBUTION BOXES FOR ELECTRICAL POWER; ELECTRICAL DISTRIBUTION BOXES; ELECTRICAL DISTRIBUTION SYSTEMS, NAMELY, POWER DISTRIBUTION PANELS; CIRCUIT BOARDS; COMPUTER NETWORK ADAPTERS; COMPUTER NETWORKING HARDWARE; COMPUTER PROGRAMS FOR THE ENABLING OF ACCESS OR ENTRANCE CONTROL; CUT-OUT SWITCHES; ELECTRIC CIRCUIT CLOSERS; ELECTRIC CONTROL PANELS; ELECTRICITY DISTRIBUTION CONSOLES; ELECTRIC LIGHT DIMMERS; ELECTRIC LIGHT SWITCHES; ELECTRIC OR ELECTRONIC SENSORS FOR LIGHT; ELECTRIC RELAYS; ELECTRIC SWITCH PLATES; ELECTRIC SWITCHES; ELECTRIC TRANSFORMERS; ELECTRICAL CONNECTION BOXES; ELECTRICAL CONTROLLERS; ELECTRICAL CONTROLLING DEVICES; ELECTRICAL DISTRIBUTION BOXES; ELECTRONIC INDICATOR BOARDS; ELECTRONIC MOTION SENSITIVE SWITCHES; ELECTRONIC TIMERS; ELECTRONIC TOUCH SENSITIVE SWITCHES; FACILITIES MANAGEMENT SOFTWARE, NAMELY, SOFTWARE TO CONTROL BUILDING ENVIRONMENTAL, ACCESS AND SECURITY SYSTEMS; INTERFACES FOR DETECTORS; LIGHTING CONTROL PANELS; MOTION SENSITIVE SECURITY LIGHTS; PHOTOMETERS; POWER DISTRIBUTING BOXES; PROXIMITY SENSORS; SCANNERS; SENSORS FOR THE DETERMINATION OF TEMPERATURES, POSITIONS AND DISTANCES; TEMPERATURE INDICATORS; TEMPERATURE SENSORS; TIME CLOCKS; ULTRASONIC SENSORS, IN CLASS 9 (U.S. CLS. 21, 23, 26, 36 AND 38).

FIRST USE 6-1-1998; IN COMMERCE 6-1-1998.

THE MARK CONSISTS OF STANDARD CHARACTERS WITHOUT CLAIM TO ANY PARTICULAR FONT, STYLE, SIZE, OR COLOR.

OWNER OF U.S. REG. NO. 3,249,177.

NO CLAIM IS MADE TO THE EXCLUSIVE RIGHT TO USE "LIGHTING CONTROLS", APART FROM THE MARK AS SHOWN.

SER. NO. 76-711,433, FILED 5-7-2012.



*David J. Kybas*

Director of the United States Patent and Trademark Office

**Reg. No. 4,273,728** HOWARD SMIGA, EXAMINING ATTORNEY

# United States of America

United States Patent and Trademark Office

## COMFORTSCAN

**Reg. No. 4,273,729**

**Registered Jan. 15, 2013**

**Int. Cl.: 10**

**TRADEMARK**

**PRINCIPAL REGISTER**

DOBI GLOBAL, LLC (MASSACHUSETTS LIMITED LIABILITY COMPANY)  
30 FAIRVIEW DRIVE  
SOUTHBOROUGH, MA 017721717

FOR: MEDICAL EQUIPMENT, NAMELY, OPTICAL AND DIGITAL OPTICAL SCANNERS  
AND PARTS THEREOF FOR BREAST IMAGING, IN CLASS 10 (U.S. CLS. 26, 39 AND 44).

FIRST USE 11-24-2004; IN COMMERCE 11-24-2004.

THE MARK CONSISTS OF STANDARD CHARACTERS WITHOUT CLAIM TO ANY PAR-  
TICULAR FONT, STYLE, SIZE, OR COLOR.

OWNER OF U.S. REG. NO. 2,981,303.

SER. NO. 76-711,582, FILED 5-24-2012.

AHSEN KHAN, EXAMINING ATTORNEY



*David J. Kyffers*

Director of the United States Patent and Trademark Office

# United States of America

United States Patent and Trademark Office



BRAND BROKERS

**Reg. No. 4,273,730**

PENROW, TONY (UNITED STATES INDIVIDUAL)  
6725 LANDINGS DRIVE #205  
LAUDERHILL, FL 33319

**Registered Jan. 15, 2013**

**Int. Cl.: 35**

FOR: ADVERTISING AND MARKETING SERVICES, NAMELY, DISSEMINATION OF ADVERTISING FOR OTHERS; BUSINESS MARKETING CONSULTING SERVICES; DIRECT MARKETING ADVERTISING SERVICES; PROMOTING THE GOODS AND SERVICES OF OTHERS VIA DISTRIBUTING ADVERTISING ON THE INTERNET, IN CLASS 35 (U.S. CLS. 100, 101 AND 102).

**SERVICE MARK**

**PRINCIPAL REGISTER**

FIRST USE 6-30-2009; IN COMMERCE 6-30-2009.

THE MARK CONSISTS OF THE LETTERS "BB" WITHIN A CIRCLE WITH A CROWN ON TOP AND WINGS ON EACH SIDE. BELOW THIS IS THE TERM "BRAND BROKERS".

SER. NO. 76-711,586, FILED 5-24-2012.

AHSEN KHAN, EXAMINING ATTORNEY



*David J. Kybas*

Director of the United States Patent and Trademark Office

# United States of America

United States Patent and Trademark Office

## NURTURED HEART

**Reg. No. 4,273,731**

**Registered Jan. 15, 2013**

**Int. Cl.: 41**

**SERVICE MARK**

**PRINCIPAL REGISTER**

GLASSER, HOWARD (UNITED STATES INDIVIDUAL)  
4165 W. IRONWOOD HILLS DRIVE  
TUCSON, AZ 85745

FOR: EDUCATIONAL SERVICES, NAMELY, CONDUCTING CLASSES, SEMINARS, WORKSHOPS, PRESENTATIONS AND TRAINING IN THE FIELD OF FAMILY RELATIONSHIPS, CLASSROOM MANAGEMENT AND EDUCATIONAL POLICY, FOR CHILDREN AND ADULTS, AND CONSULTATION SERVICES RELATED THERETO, IN CLASS 41 (U.S. CLS. 100, 101 AND 107).

FIRST USE 1-0-1995; IN COMMERCE 1-0-1995.

THE MARK CONSISTS OF STANDARD CHARACTERS WITHOUT CLAIM TO ANY PARTICULAR FONT, STYLE, SIZE, OR COLOR.

OWNER OF U.S. REG. NO. 3,563,537.

SER. NO. 76-711,600, FILED 5-29-2012.

IRA J. GOODSaid, EXAMINING ATTORNEY



*David J. Kyffers*

Director of the United States Patent and Trademark Office

# United States of America

United States Patent and Trademark Office

# BIG BOY

**Reg. No. 4,273,732**

**Registered Jan. 15, 2013**

**Int. Cl.: 11**

**TRADEMARK**

**PRINCIPAL REGISTER**

RANKAM (CHINA) MANUFACTURING CO., LTD. (HONG KONG CORPORATION)  
18F NEW LEE WAH CENTRE  
88 TOKWAWAN ROAD  
KOWLOON, HONG KONG

FOR: OUTDOOR GAS AND CHARCOAL GRILLS AND GAS DEEP FAT FISH AND TURKEY  
FRYERS, IN CLASS 11 (U.S. CLS. 13, 21, 23, 31 AND 34).

FIRST USE 10-12-2009; IN COMMERCE 10-12-2009.

SER. NO. 76-711,647, FILED 6-4-2012.

ANGELA DUONG, EXAMINING ATTORNEY

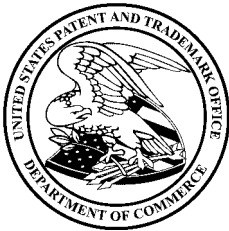

*David J. Kyjars*

Director of the United States Patent and Trademark Office

# United States of America

## United States Patent and Trademark Office



**Reg. No. 4,273,733**

DISNEY ENTERPRISES, INC. (DELAWARE CORPORATION)  
500 SOUTH BUENA VISTA STREET  
BURBANK, CA 91521

**Registered Jan. 15, 2013**

**Int. Cls.: 3, 9, 14, 16, 18,  
20, 21, 24, 25, 28 and 30**

FOR: COSMETICS; NON-MEDICATED TOILETRIES; FRAGRANCES FOR PERSONAL USE;  
ROOM FRAGRANCES, IN CLASS 3 (U.S. CLS. 1, 4, 6, 50, 51 AND 52).

FIRST USE 2-2-2010; IN COMMERCE 2-2-2010.

### TRADEMARK

### PRINCIPAL REGISTER

FOR: AUDIO AND VISUAL RECORDINGS FEATURING LIVE-ACTION, ANIMATION,  
MUSIC, STORIES; PRE-RECORDED AUDIO DISCS, COMPACT DISCS FEATURING MUSIC;  
AUDIO RECORDINGS FEATURING MUSIC; DECORATIVE REFRIGERATOR MAGNETS;  
PRE-RECORDED DVDS, DIGITAL VERSATILE DISCS AND DIGITAL VIDEO DISCS FEATURING  
LIVE ACTION AND ANIMATED ENTERTAINMENT, MOTION PICTURE FILMS,  
AND TELEVISION SHOWS; HEADPHONES; MUSICAL SOUND RECORDINGS;  
SUNGLASSES; VIDEO GAME CARTRIDGES; VIDEO GAME DISCS; AND MOUSE PADS,  
IN CLASS 9 (U.S. CLS. 21, 23, 26, 36 AND 38).

FIRST USE 3-16-2010; IN COMMERCE 3-16-2010.

FOR: CLOCKS; JEWELRY; JEWELRY BOXES; WATCHES; JEWELRY CASES, IN CLASS  
14 (U.S. CLS. 2, 27, 28 AND 50).

FIRST USE 11-2-2009; IN COMMERCE 11-2-2009.



FOR: ART PRINTS; SCHOOL SUPPLIES IN THE NATURE OF ARTS AND CRAFT PAINT  
KITS; AUTOGRAPH BOOKS; BALL POINT PENS; A SERIES OF FICTION BOOKS; CALEN-  
DARS; CHRISTMAS CARDS; COLOR PENCILS; DECALS; DIARIES; ENVELOPES; ERASERS;  
FELT PENS; GREETING CARDS; PENCILS; PENCIL SHARPENERS; PEN AND PENCIL  
CASES AND BOXES; PENS; PHOTOGRAPH ALBUMS; POSTERS; WRITING PAPER;  
WRITING IMPLEMENTS; NOTEBOOKS; RUBBER STAMPS; TRADING CARDS, IN CLASS  
16 (U.S. CLS. 2, 5, 22, 23, 29, 37, 38 AND 50).

FIRST USE 12-22-2009; IN COMMERCE 12-22-2009.

*David J. Kyros*

Director of the United States Patent and Trademark Office

FOR: ARTICLES MADE FROM IMITATIONS OF LEATHER, NAMELY, BACKPACKS AND  
LUGGAGE; DUFFEL BAGS; SHOPPING BAGS MADE OF TEXTILE; TOTE BAGS; WALLETS;



**Reg. No. 4,273,733** UMBRELLAS; COIN PURSES; BOOK BAGS; PURSES AND HANDBAGS, IN CLASS 18 (U.S. CLS. 1, 2, 3, 22 AND 41).

FIRST USE 11-2-2009; IN COMMERCE 11-2-2009.

FOR: PICTURE FRAMES; PILLOWS, IN CLASS 20 (U.S. CLS. 2, 13, 22, 25, 32 AND 50).

FIRST USE 11-2-2009; IN COMMERCE 11-2-2009.

FOR: BEVERAGEWARE; BEVERAGE GLASSWARE; BOWLS; COOKIE JARS; COOKIE CUTTERS; CUPS; DINNERWARE; DISHES; FIGURINES MADE OF PORCELAIN; LUNCH BOXES; MUGS; PIE SERVERS; PLASTIC CUPS; PLATES; TEA KETTLES; THERMAL INSULATED CONTAINERS FOR FOOD OR BEVERAGE; COASTERS NOT OF PAPER AND NOT BEING TABLE LINEN; SPORTS BOTTLES SOLD EMPTY, IN CLASS 21 (U.S. CLS. 2, 13, 23, 29, 30, 33, 40 AND 50).

FIRST USE 4-28-2010; IN COMMERCE 4-28-2010.

FOR: TEXTILE ARTICLES NOT INCLUDED IN OTHER CLASSES, NAMELY, BARBECUE MITTS AND OVEN MITTS; BED BLANKETS; BED LINEN; BED SHEETS; BLANKET THROWS; GOLF TOWELS; HOUSEHOLD LINEN; KITCHEN TOWELS; PILLOW CASES; PILLOW COVERS; THROWS; TOWELS; COMFORTERS, IN CLASS 24 (U.S. CLS. 42 AND 50).

FIRST USE 12-23-2009; IN COMMERCE 12-23-2009.

FOR: APRONS; BEACHWEAR; BOTTOMS; COSTUMES FOR USE IN ROLE-PLAYING GAMES; COVER-UPS; DRESSES; FOOTWEAR; HALLOWEEN COSTUMES; HEADWEAR; HOSIERY; INFANTWEAR; JACKETS; LEGGINGS; LOUNGEWEAR; PANTS; SCARVES; SHIRTS; SHORTS; SLEEPWEAR; SOCKS; SWEATSHIRTS; SWIMWEAR; TOPS; UNDERWEAR; TIES; LEOTARDS, IN CLASS 25 (U.S. CLS. 22 AND 39).

FIRST USE 11-2-2009; IN COMMERCE 11-2-2009.

FOR: ACTION FIGURES AND ACCESSORIES THEREFOR; BOARD GAMES; CARD GAMES; BATH TOYS; BEAN BAG DOLLS; CHILDREN'S PLAY COSMETICS; CHRISTMAS TREE ORNAMENTS AND DECORATIONS; COLLECTABLE TOY FIGURES; DOLLS; DOLL CLOTHING; DOLL ACCESSORIES; DOLL PLAYSETS; ELECTRIC ACTION TOYS; JIGSAW PUZZLES; MUSICAL TOYS; PLUSH TOYS; SNOW GLOBES; SQUEEZE TOYS; STUFFED TOYS; TALKING TOYS; TEDDY BEARS; TOY ACTION FIGURES AND ACCESSORIES THEREFOR; TOY VEHICLES; TOY CARS; TOY FIGURES; TOY BANKS; TOY TRUCKS; BASKETBALLS; WIND-UP TOYS; BASEBALLS; PLAYING CARDS, IN CLASS 28 (U.S. CLS. 22, 23, 38 AND 50).

FIRST USE 11-2-2009; IN COMMERCE 11-2-2009.

FOR: COFFEE, IN CLASS 30 (U.S. CL. 46).

FIRST USE 11-2-2009; IN COMMERCE 11-2-2009.

THE MARK CONSISTS OF A FANCIFUL DOG.

SER. NO. 76-711,693, FILED 6-11-2012.

REGINA DRUMMOND, EXAMINING ATTORNEY

# United States of America

United States Patent and Trademark Office



**Reg. No. 4,273,734**

**Registered Jan. 15, 2013**

**Int. Cl.: 29**

**TRADEMARK**

**PRINCIPAL REGISTER**

STANDARD FOODS CORPORATION (TAIWAN CORPORATION)  
8F.-5, NO. 136, SEC. 3, REN-AI RD.  
TAIPEI, TAIWAN

FOR: SUNFLOWER OIL; RAPE FLOWER OIL, GRAPE SEED OIL, PLANT OIL, NAMELY, OLIVE OIL, SALAD OIL, CORN OIL, SOYBEAN OIL, MEAT, MEAT EXTRACTS, NAMELY, CHICKEN EXTRACTS, PEANUT SOUP, RED BEANS SOUP, MUNG BEANS SOUP, SWALLOW-NESTS SOUP, IN CLASS 29 (U.S. CL. 46).

OWNER OF TAIWAN REG. NO. 01302441, DATED 3-1-2008, EXPIRES 2-28-2018.

THE NON-LATIN CHARACTER(S) IN THE MARK TRANSLITERATE INTO "DUO LI", AND THIS MEANS "MORE POWER" IN ENGLISH.

THE MARK CONSISTS OF A HUMAN MALE CHARACTER DRESSED IN A CAPE WITHIN A CIRCLE WITH RECTANGULAR PROJECTIONS TO THE LEFT AND RIGHT OF THE CIRCLE EACH CONTAINING ONE CHINESE CHARACTER AND THE WORD "MIGHTY" IN THE LOWER PORTION OF THE CIRCLE.

THE FOREIGN WORDING IN THE MARK TRANSLATES INTO ENGLISH AS "MORE POWER".

SER. NO. 77-035,530, FILED 11-2-2006.

JOHN SCHUYLER YARD, EXAMINING ATTORNEY



*David J. Kyros*

Director of the United States Patent and Trademark Office

# United States of America

United States Patent and Trademark Office



**Reg. No. 4,273,735**

**Registered Jan. 15, 2013**

**Int. Cl.: 44**

**SERVICE MARK**

**PRINCIPAL REGISTER**

SENSATIONAL SKIN CENTERS, PLLC (ARIZONA PROFESSIONAL L.L.C.)  
SONORAN OFFICE PLAZA  
11111 N. SCOTTSDALE ROAD, SUITE 115  
SCOTTSDALE, AZ 85254

FOR: COSMETIC SKIN AND LASER MEDICAL SERVICES FEATURING TREATMENTS FOR ACNE, ACNE SCARS, PIGMENTATION, ROSACEA, WRINKLES, AGE SPOTS, SKIN DISCOLORATION, SUN DAMAGE, SPIDER VEINS, FACIAL VEINS, FACIAL AND BODY HAIR, SAGGING SKIN, LASER TREATMENTS FOR SKIN RESURFACING, SKIN TIGHTENING AND SKIN LEVELING; SKIN CARE SALON SERVICES FEATURING MICRODERM-ABRASION, GLYCOLIC PEELS, DEEP PORE CLEANSING AND EXTRACTATIONS, FACIALS AND PARAFFIN DIPS, IN CLASS 44 (U.S. CLS. 100 AND 101).

FIRST USE 10-1-1998; IN COMMERCE 10-1-1999.

NO CLAIM IS MADE TO THE EXCLUSIVE RIGHT TO USE "SKIN", APART FROM THE MARK AS SHOWN.

THE MARK CONSISTS OF THE STYLIZED WORDING "SENSATIONAL" OVER THE STYLIZED WORDING "SKIN" AND THE DESIGN OF A HORIZONTAL LINE BENEATH THE WORDING "SENSATIONAL", ALL WITHIN A SHADED RECTANGLE.

SER. NO. 77-161,116, FILED 4-19-2007.

JAY BESCH, EXAMINING ATTORNEY



*David J. Kyjars*

Director of the United States Patent and Trademark Office

# United States of America

United States Patent and Trademark Office

# MAPP

**Reg. No. 4,273,736**

**Registered Jan. 15, 2013**

**Int. Cl.: 35**

**SERVICE MARK**

**PRINCIPAL REGISTER**

P.S. KOEPEL & ASSOCIATES, INC. (TEXAS CORPORATION)  
SUITE 270  
16200 DALLAS PARKWAY  
DALLAS, TX 75248

FOR: ADVERTISING AND ADVERTISEMENT SERVICES, IN CLASS 35 (U.S. CLS. 100, 101 AND 102).

FIRST USE 4-30-2007; IN COMMERCE 4-30-2007.

THE MARK CONSISTS OF STANDARD CHARACTERS WITHOUT CLAIM TO ANY PARTICULAR FONT, STYLE, SIZE, OR COLOR.

SER. NO. 77-309,812, FILED 10-22-2007.

ANTHONY RINKER, EXAMINING ATTORNEY



*David J. Kybas*

Director of the United States Patent and Trademark Office

# United States of America

United States Patent and Trademark Office

## GLOBAL ALLIES L.L.C.

**Reg. No. 4,273,737**

GLOBAL ALLIES, LLC (CALIFORNIA LIMITED LIABILITY COMPANY)  
P.O. BOX 1418  
LOCKEFORD, CA 95237

**Registered Jan. 15, 2013**

**Int. Cl.: 20**

FOR: CHAIRS FOR THE HOSPITALITY INDUSTRY, IN CLASS 20 (U.S. CLS. 2, 13, 22, 25, 32 AND 50).

**TRADEMARK**

FIRST USE 5-1-2001; IN COMMERCE 5-1-2001.

**PRINCIPAL REGISTER**

THE MARK CONSISTS OF STANDARD CHARACTERS WITHOUT CLAIM TO ANY PARTICULAR FONT, STYLE, SIZE, OR COLOR.

NO CLAIM IS MADE TO THE EXCLUSIVE RIGHT TO USE "L.L.C.", APART FROM THE MARK AS SHOWN.

SER. NO. 77-340,432, FILED 11-29-2007.

TRACY WHITTAKER-BROWN, EXAMINING ATTORNEY



*David J. Kyros*

Director of the United States Patent and Trademark Office

# United States of America

United States Patent and Trademark Office

# VALE

**Reg. No. 4,273,738**

**Registered Jan. 15, 2013**

**Int. Cls.: 1, 6, 14, 35, 37,  
40 and 42**

**TRADEMARK**

**SERVICE MARK**

**PRINCIPAL REGISTER**

COMPANHIA VALE DO RIO DOCE (BRAZIL CORPORATION)  
AVENIDA GRAÇA ARANHA, 26 - BAIRRO CASTEL  
RIO DE JANEIRO - RJ, BRAZIL

FOR: ALKALINE METALS, NAMELY, POTASSIUM, CESIUM, SODIUM AND LITHIUM; EARTHY ALKALINE METALS, NAMELY, BERYLLIUM, MAGNESIUM, CALCIUM, BARIUM, STRONTIUM AND RADIUM; BAUXITE, IN CLASS 1 (U.S. CLS. 1, 5, 6, 10, 26 AND 46).

FOR: ALUMINUM; ORES, NAMELY, TIN ORE, TITANIUM ORE, NIOBIUM ORE, NICKEL ORE, MOLYBDENUM ORE, COBALT ORE, ZINC ORE, COPPER ORE, MAGNESIUM ORE, MANGANESE ORE, ALUMINUM ORE; COMMON METALS AND THEIR ALLOYS UNWROUGHT FOR FURTHER MANUFACTURE, NAMELY, FERROTITANIUM, NIOBIUM, NICKEL-SILVER, MOLYBDENUM, MAGNESIUM, MANGANESE; SEMI-WORKED ARTICLES OF UNREFINED NICKEL, MOLYBDENUM, COBALT, ZINC, ZINC ALLOYS, COPPER ALLOYS, MAGNESIUM, MANGANESE, ALUMINUM, AND ALUMINUM ALLOYS; ALUMINUM ALLOYS, NAMELY, ALUMINUM OXIDE; IRON ORES; UNWROUGHT IRONS AND STEELS, COPPER ALLOYS AND INGOTS, NICKEL INGOTS, ALUMINUM INGOTS, ZINC INGOTS, TITANIUM ALLOY INGOTS, NIOBIUM INGOTS; INGOTS OF WHITE METALS, NAMELY, TIN, LEAD, COPPER, ZINC, ALUMINUM AND NICKEL, IN CLASS 6 (U.S. CLS. 2, 12, 13, 14, 23, 25 AND 50).

FOR: GOLD; PRECIOUS METAL ALLOYS; DIAMONDS; PRECIOUS STONES, NAMELY, SPINEL; IRIIDIUM; INGOTS OF PRECIOUS METAL; OLIVINE; OSMIUM; PALLADIUM; PLATINUM; RHODIUM; RUTHENIUM, IN CLASS 14 (U.S. CLS. 2, 27, 28 AND 50).

FOR: IMPORT AND EXPORT OF RAW MATERIALS AND PRODUCTS, NAMELY, ALKALINE METALS, NAMELY, POTASSIUM, CESIUM, SODIUM AND LITHIUM AND ITS OXIDES, EARTHY ALKALINE METALS, NAMELY, BERYLLIUM, MAGNESIUM, CALCIUM, BARIUM, STRONTIUM AND RADIUM, ROUGH OR SEMIWORKED METALS AND THEIR ALLOYS, NAMELY, RARE EARTH, URANIUM, ANTIMONY, BARIUM, GALLIUM, LITHIUM, RADIUM, SELENIUM, YTTRIUM, RARE EARTH METALS, OXIDIZED ALUM, BAUXITE, ALUMINUM ALLOYS AND INGOTS, ORES, NAMELY, TIN ORE, FERROTITANIUM ORE, TITANIUM ORE, NIOBIUM ORE, NICKEL ORE, NICKEL-SILVER ORE, MOLYBDENUM ORE, COBALT ORE, ZINC ORE, COPPER ORE, MAGNESIUM ORE, MANGANESE ORE, ALUMINUM ORE, NONFERROUS METAL INGOTS OF ALUMINUM, COPPER, TITANIUM, ZINC, NICKEL, COBALT, AND TUNGSTEN, COMMON METALS AND THEIR



*David J. Kyffers*

Director of the United States Patent and Trademark Office

**Reg. No. 4,273,738** ALLOYS UNWROUGHT FOR FURTHER MANUFACTURE, NAMELY, FERROTITANIUM, NIOBIUM, NICKEL-SILVER, MOLYBDENUM, MAGNESIUM, MANGANESE, SEMI-WORKED ARTICLES OF UNREFINED NICKEL, MOLYBDENUM, COBALT, ZINC, ZINC ALLOYS, COPPER ALLOYS, MAGNESIUM, MANGANESE, ALUMINUM, AND ALUMINUM ALLOYS, ALUMINUM ALLOYS, NAMELY, ALUMINUM OXIDE, IRON ORES, UNWROUGHT IRONS AND STEELS, COPPER ALLOYS AND INGOTS, NICKEL INGOTS, ALUMINUM INGOTS, LEAD INGOTS, ZINC INGOTS, TIN INGOTS, TITANIUM ALLOY INGOTS, NIOBIUM INGOTS, INGOTS OF WHITE METALS, NAMELY, TIN, LEAD, COPPER, ZINC, ALUMINUM AND NICKEL, GOLD, PRECIOUS METAL ALLOYS, DIAMONDS, PRECIOUS STONES, NAMELY, SPINEL, IRIIDIUM AND ITS ALLOYS, INGOTS OF PRECIOUS METAL, OLIVINE, OSMIUM AND ITS ALLOYS, PALLADIUM AND ITS ALLOYS, PLATINUM, RHODIUM AND ITS ALLOYS, RUTHENIUM AND ITS ALLOYS, IN CLASS 35 (U.S. CLS. 100, 101 AND 102).

FOR: MINING EXTRACTION, IN CLASS 37 (U.S. CLS. 100, 103 AND 106).

FOR: TREATMENT OF COMMON AND WHITE METALS, IN CLASS 40 (U.S. CLS. 100, 103 AND 106).

FOR: CHEMICAL RESEARCH AND LABORATORY BASED CHEMICAL ANALYSIS; GEOLOGICAL RESEARCH, NAMELY, GEOLOGICAL PROSPECTION AND GEOLOGICAL SURVEYING, IN CLASS 42 (U.S. CLS. 100 AND 101).

THE MARK CONSISTS OF STANDARD CHARACTERS WITHOUT CLAIM TO ANY PARTICULAR FONT, STYLE, SIZE, OR COLOR.

PRIORITY CLAIMED UNDER SEC. 44(D) ON BRAZIL APPLICATION NO. 829354956, FILED 8-3-2007, REG. NO. 829354956, DATED 1-19-2010, EXPIRES 1-19-2020.

PRIORITY CLAIMED UNDER SEC. 44(D) ON BRAZIL APPLICATION NO. 829354930, FILED 8-3-2007, REG. NO. 829354930, DATED 1-19-2010, EXPIRES 1-19-2020.

PRIORITY CLAIMED UNDER SEC. 44(D) ON BRAZIL APPLICATION NO. 829354905, FILED 8-3-2007, REG. NO. 829354905, DATED 10-26-2010, EXPIRES 10-26-2020.

PRIORITY CLAIMED UNDER SEC. 44(D) ON BRAZIL APPLICATION NO. 829355022, FILED 8-3-2007, REG. NO. 829355022, DATED 1-19-2010, EXPIRES 1-19-2020.

PRIORITY CLAIMED UNDER SEC. 44(D) ON BRAZIL APPLICATION NO. 829355006, FILED 8-3-2007, REG. NO. 829355006, DATED 1-19-2010, EXPIRES 1-19-2020.

PRIORITY CLAIMED UNDER SEC. 44(D) ON BRAZIL APPLICATION NO. 829354980, FILED 8-3-2007, REG. NO. 829354980, DATED 4-19-2011, EXPIRES 4-19-2021.

PRIORITY CLAIMED UNDER SEC. 44(D) ON BRAZIL APPLICATION NO. 829354964, FILED 8-3-2007, REG. NO. 829354964, DATED 1-19-2010, EXPIRES 1-19-2020.

THE ENGLISH TRANSLATION OF "VALE" IS "VALLEY".

SER. NO. 77-342,057, FILED 12-2-2007.

EDWARD FENNESSY, EXAMINING ATTORNEY

# United States of America

United States Patent and Trademark Office

## RE-ANIMATOR

**Reg. No. 4,273,739**

RE-ANIMATOR PRODUCTIONS, INC. (CALIFORNIA CORPORATION)  
1626 NORTH WILCOX AVENUE, #244  
LOS ANGELES, CA 90028

**Registered Jan. 15, 2013**

**Int. Cl.: 9**

FOR: LASERDISCS, VIDEO DISCS AND DVDS FEATURING FULL LENGTH THEATRICAL FILMS, IN CLASS 9 (U.S. CLS. 21, 23, 26, 36 AND 38).

**TRADEMARK**

FIRST USE 0-0-1995; IN COMMERCE 0-0-1995.

**PRINCIPAL REGISTER**

THE MARK CONSISTS OF STANDARD CHARACTERS WITHOUT CLAIM TO ANY PARTICULAR FONT, STYLE, SIZE, OR COLOR.

SER. NO. 77-354,691, FILED 12-18-2007.

BRIAN NEVILLE, EXAMINING ATTORNEY



*David J. Kybas*

Director of the United States Patent and Trademark Office



# United States of America

United States Patent and Trademark Office

Dream. Believe. Achieve.

**Reg. No. 4,273,740**

FARINA, RANDI (UNITED STATES INDIVIDUAL)  
10651 BEXLEY BLVD.

**Registered Jan. 15, 2013**

BOCA RATON, FL 33428

**Int. Cl.: 14**

FOR: BRACELETS; BROOCHES; JEWELRY; NECKLACES; PENDANTS; PINS; RUBBER OR SILICON WRISTBANDS IN THE NATURE OF A BRACELET, IN CLASS 14 (U.S. CLS. 2, 27, 28 AND 50).

**TRADEMARK**

FIRST USE 3-0-2007; IN COMMERCE 5-0-2007.

**PRINCIPAL REGISTER**

THE MARK CONSISTS OF STANDARD CHARACTERS WITHOUT CLAIM TO ANY PARTICULAR FONT, STYLE, SIZE, OR COLOR.

SER. NO. 77-368,892, FILED 1-10-2008.

PATRICIA EVANKO, EXAMINING ATTORNEY



*David J. Kyjars*

Director of the United States Patent and Trademark Office

# United States of America

United States Patent and Trademark Office

# EQUILIBRIUM

**Reg. No. 4,273,741**

**Registered Jan. 15, 2013**

**Int. Cl.: 33**

**TRADEMARK**

**PRINCIPAL REGISTER**

CONSTELLATION BRANDS U.S. OPERATIONS, INC. (NEW YORK CORPORATION)  
235 NORTH BLOOMFIELD ROAD  
CANANDAIGUA, NY 14424

FOR: WINES, IN CLASS 33 (U.S. CLS. 47 AND 49).

FIRST USE 0-0-2001; IN COMMERCE 0-0-2001.

THE MARK CONSISTS OF STANDARD CHARACTERS WITHOUT CLAIM TO ANY PARTICULAR FONT, STYLE, SIZE, OR COLOR.

SER. NO. 77-409,969, FILED 2-29-2008.

CHRISIE B. KING, EXAMINING ATTORNEY



*David J. Kybas*

Director of the United States Patent and Trademark Office

# United States of America

United States Patent and Trademark Office

## HOCKEY IS LIFE

**Reg. No. 4,273,742**

BIG BALL SPORTS, LLC (NEW YORK LIMITED LIABILITY COMPANY)  
347 5TH AVE  
NEW YORK, NY 10016

**Registered Jan. 15, 2013**

**Int. Cl.: 25**

FOR: T-SHIRTS; SWEAT PANTS; SWEAT SHIRTS; SWEAT SUITS; SHORTS, IN CLASS 25  
(U.S. CLS. 22 AND 39).

**TRADEMARK**

FIRST USE 1-30-1993; IN COMMERCE 1-30-1993.

**PRINCIPAL REGISTER**

THE MARK CONSISTS OF STANDARD CHARACTERS WITHOUT CLAIM TO ANY PARTICULAR FONT, STYLE, SIZE, OR COLOR.

OWNER OF U.S. REG. NOS. 2,405,108 AND 2,407,709.

SEC. 2(F).

SER. NO. 77-414,199, FILED 3-5-2008.

ELISSA GARBER KON, EXAMINING ATTORNEY



*David J. Kyffers*

Director of the United States Patent and Trademark Office

# United States of America

United States Patent and Trademark Office



**Reg. No. 4,273,743**

**Registered Jan. 15, 2013**

**Int. Cl.: 39**

LINEA AEREA DE SERVICIO EJECUTIVO REGIONAL (LASER), C.A. (VENEZUELA CORPORATION)  
TORRE BAZAR BOLIVAR, PISO 08, EL MARQUES  
AVE. FRANCISCO DE MIRANDA  
CARACAS, VENEZUELA

**SERVICE MARK**

FOR: TRANSPORTATION OF PASSENGERS AND FREIGHT BY AIR AND STORAGE OF GOODS, IN CLASS 39 (U.S. CLS. 100 AND 105).

**PRINCIPAL REGISTER**

OWNER OF VENEZUELA REG. NO. S042495, DATED 6-18-2009, EXPIRES 6-18-2024.

THE COLOR(S) GREEN AND YELLOW IS/ARE CLAIMED AS A FEATURE OF THE MARK.

NO CLAIM IS MADE TO THE EXCLUSIVE RIGHT TO USE "CARGO", APART FROM THE MARK AS SHOWN.

THE MARK CONSISTS OF A YELLOW DIAMOND SUPERIMPOSED OVER A PORTION OF THE TIPS OF FOUR GREEN ARROWS. TO THE RIGHT OF THE DESIGN APPEARS THE WORDING "LASER CARGO" IN GREEN .

SER. NO. 77-455,494, FILED 4-23-2008.

JENNIFER MARTIN, EXAMINING ATTORNEY



*David J. Kyjars*

Director of the United States Patent and Trademark Office

# United States of America

United States Patent and Trademark Office



**Reg. No. 4,273,744**

**Registered Jan. 15, 2013**

**Int. Cl.: 39**

LINEA AEREA DE SERVICIO EJECUTIVO REGIONAL (LASER), C.A. (VENEZUELA CORPORATION)

TORRE BAZAR BOLIVAR, PISO 08, EL MARQUES  
AVE. FRANCISCO DE MIRANDA  
CARACAS, VENEZUELA

**SERVICE MARK**

FOR: TRANSPORTATION OF PASSENGERS AND FREIGHT BY AIR AND STORAGE OF GOODS, IN CLASS 39 (U.S. CLS. 100 AND 105).

**PRINCIPAL REGISTER**

OWNER OF VENEZUELA REG. NO. S038358, DATED 8-13-2008, EXPIRES 8-13-2018.

THE COLOR(S) GREEN AND YELLOW IS/ARE CLAIMED AS A FEATURE OF THE MARK.

NO CLAIM IS MADE TO THE EXCLUSIVE RIGHT TO USE "AIRLINES", APART FROM THE MARK AS SHOWN.

THE MARK CONSISTS OF A YELLOW DIAMOND SUPERIMPOSED OVER A PORTION OF THE TIPS OF FOUR GREEN ARROWS. TO THE RIGHT OF THE DESIGN APPEARS THE WORDING "LASER AIRLINES" IN GREEN.

SER. NO. 77-455,590, FILED 4-23-2008.

JENNIFER MARTIN, EXAMINING ATTORNEY



*David J. Kybas*

Director of the United States Patent and Trademark Office

# United States of America

United States Patent and Trademark Office

# UGLY ALE

**Reg. No. 4,273,745**

**Registered Jan. 15, 2013**

**Int. Cl.: 32**

**TRADEMARK**

**PRINCIPAL REGISTER**

CACTUS RESTAURANTS LTD. (CANADA CORPORATION)  
200-604 WEST BROADWAY  
VANCOUVER, BRITISH COLOMBIA, CANADA V51K3

FOR: BREWED ALCOHOLIC BEVERAGES, NAMELY, BEERS, IN CLASS 32 (U.S. CLS. 45, 46 AND 48).

THE MARK CONSISTS OF STANDARD CHARACTERS WITHOUT CLAIM TO ANY PARTICULAR FONT, STYLE, SIZE, OR COLOR.

OWNER OF CANADA REG. NO. TMA522434, DATED 1-27-2000, EXPIRES 1-27-2015.

NO CLAIM IS MADE TO THE EXCLUSIVE RIGHT TO USE "ALE", APART FROM THE MARK AS SHOWN.

SER. NO. 77-483,825, FILED 5-27-2008.

DANNEAN HETZEL, EXAMINING ATTORNEY



*David J. Kyffers*

Director of the United States Patent and Trademark Office

# United States of America

United States Patent and Trademark Office

## WELCOME TO KINDERGARTEN

**Reg. No. 4,273,746**

**Registered Jan. 15, 2013**

**Int. Cls.: 9, 16, 18 and 41**

**TRADEMARK**

**SERVICE MARK**

**PRINCIPAL REGISTER**

THE LEARNING PARTNERSHIP CANADA (CANADA CORPORATION)  
4211 YONGE STREET  
SUITE 301  
TORONTO, ONTARIO, CANADA M2P2A9

FOR: PRE-RECORDED COMPACT DISCS CONTAINING SPOKEN INFORMATION AND MUSIC FOR FAMILIES AND CAREGIVERS OF PRE-SCHOOL CHILDREN TO HELP THEM PREPARE CHILDREN FOR SCHOOL AND FOR PRE-SCHOOL CHILDREN TO HELP THEM PREPARE THEMSELVES FOR SCHOOL; PRE-RECORDED DIGITAL VIDEO DISCS CONTAINING SHOWS AND MOVIES FOR FAMILIES AND CAREGIVERS OF PRE-SCHOOL CHILDREN TO HELP THEM PREPARE CHILDREN FOR SCHOOL AND FOR PRE-SCHOOL CHILDREN TO HELP THEM PREPARE THEMSELVES FOR SCHOOL; NOVELTY ITEMS, NAMELY, MAGNETS, IN CLASS 9 (U.S. CLS. 21, 23, 26, 36 AND 38).

FOR: PRINTED MATERIALS, NAMELY, LEAFLETS, BROCHURES, FLYERS, CALENDARS, BOOKMARKS, BOOKS, PICTURE BOOKS, COLOURING BOOKS, ALL OF WHICH CONTAIN INFORMATION AND MATERIALS FOR FAMILIES AND CAREGIVERS OF PRE-SCHOOL CHILDREN TO HELP THEM PREPARE CHILDREN FOR SCHOOL AND PRE-SCHOOL CHILDREN TO PREPARE THEMSELVES FOR SCHOOL; SCHOOL SUPPLIES, NAMELY, PENS, PENCILS, CRAYONS, COPYBOOKS, BINDERS, AND PENCIL CASES, IN CLASS 16 (U.S. CLS. 2, 5, 22, 23, 29, 37, 38 AND 50).

FOR: ALL PURPOSE CLOTH AND VINYL BAGS, IN CLASS 18 (U.S. CLS. 1, 2, 3, 22 AND 41).

FOR: EDUCATIONAL SERVICES, NAMELY, EDUCATIONAL ASSESSMENT, EDUCATIONAL RESEARCH, AND EDUCATIONAL TESTING AND THE ORGANIZING, IMPLEMENTING AND OPERATING OF AN EDUCATIONAL PROGRAM TO PREPARE CHILDREN FOR SCHOOL; TRAINING SERVICES, NAMELY, ORGANIZING AND HOSTING WORKSHOPS AND TRAINING SESSIONS OFFERED TO FAMILIES AND CAREGIVERS OF PRE-SCHOOL CHILDREN TO HELP THEM PREPARE CHILDREN FOR SCHOOL, IN CLASS 41 (U.S. CLS. 100, 101 AND 107).

THE MARK CONSISTS OF STANDARD CHARACTERS WITHOUT CLAIM TO ANY PARTICULAR FONT, STYLE, SIZE, OR COLOR.



*David J. Kyjars*

Director of the United States Patent and Trademark Office

**Reg. No. 4,273,746** PRIORITY CLAIMED UNDER SEC. 44(D) ON CANADA APPLICATION NO. 1373976, FILED 11-28-2007, REG. NO. TMA785,077, DATED 12-15-2010, EXPIRES 12-15-2025.

SER. NO. 77-485,342, FILED 5-28-2008.

LEIGH CAROLINE CASE, EXAMINING ATTORNEY



# United States of America

United States Patent and Trademark Office

# MEDISAVE

**Reg. No. 4,273,747**

**Registered Jan. 15, 2013**

**Int. Cls.: 10, 35 and 40**

**TRADEMARK**

**SERVICE MARK**

**PRINCIPAL REGISTER**

MEDISAVE UK LIMITED (UNITED KINGDOM CORPORATION)  
UNIT A, LITTLESEA INDUSTRIAL ESTATE  
LYNCH LANE  
WEYMOUTH, DORSET, UNITED KINGDOM DT49DN

FOR: MEDICAL APPARATUS AND INSTRUMENTS, NAMELY, STETHOSCOPES, BLOOD TESTING APPARATUS, BLOOD PRESSURE MONITORS AND SPHYGMOMANOMETERS, ECG MONITORING APPARATUS, PULSE OXIMETERS, OTOSCOPES, OPHTHALMOSCOPES, DERMATOSCOPES; DIAGNOSTIC SETS COMPRISING OTOSCOPES, AND OPHTHALMOSCOPES FOR DIAGNOSING EAR NOSE AND THROAT DISEASES; THERMOMETERS FOR MEDICAL PURPOSES; MEDICAL SCISSORS; SURGICAL FORCEPS; NEEDLES FOR MEDICAL PURPOSES; SYRINGES FOR MEDICAL PURPOSES; SAMPLE COLLECTION DEVICES, NAMELY, URINE COLLECTION VIALS, AND BLOOD COLLECTION VIALS; MEDICAL DISPOSABLES, NAMELY, FACE SHIELDS IN THE NATURE OF CPR (CARDIOPULMONARY RESUSCITATION) MASKS; DISPOSABLE PROTECTIVE GLOVES FOR MEDICAL PURPOSES; DOCTOR AND HEALTH PROFESSIONAL MEDICAL BAGS AND MEDICAL CASES FOR TRANSPORTATION OF EQUIPMENT, SOLD EMPTY; SURGICAL SCRUB SUITS, IN CLASS 10 (U.S. CLS. 26, 39 AND 44).

FOR: THE BRINGING TOGETHER, FOR THE BENEFIT OF OTHERS, OF A VARIETY OF MEDICAL APPARATUS AND INSTRUMENTS, ENABLING CUSTOMERS TO CONVENIENTLY VIEW AND PURCHASE THOSE GOODS BY MEANS OF TELECOMMUNICATIONS VIA THE INTERNET, IN CLASS 35 (U.S. CLS. 100, 101 AND 102).

FOR: ENGRAVING SERVICES; ENGRAVING SERVICES IN CONNECTION WITH DIAGNOSTIC PRODUCTS AND STETHOSCOPES, IN CLASS 40 (U.S. CLS. 100, 103 AND 106).

THE MARK CONSISTS OF STANDARD CHARACTERS WITHOUT CLAIM TO ANY PARTICULAR FONT, STYLE, SIZE, OR COLOR.

PRIORITY CLAIMED UNDER SEC. 44(D) ON ERPN CMNTY TM OFC APPLICATION NO. 006991061, FILED 6-16-2008, REG. NO. 006991061, DATED 5-27-2009, EXPIRES 6-16-2018.

SER. NO. 77-506,788, FILED 6-24-2008.

JAMES MACFARLANE, EXAMINING ATTORNEY



*David J. Kyfos*

Director of the United States Patent and Trademark Office

# United States of America

United States Patent and Trademark Office



## HISTORY & HERALDRY

**Reg. No. 4,273,748**

HISTORY & HERALDRY LIMITED (UNITED KINGDOM LIMITED COMPANY (LTD.))  
2 DENBY WAY

**Registered Jan. 15, 2013**

HELLABY INDUSTRIAL EST, UNITED KINGDOM S668HR

**Int. Cl.: 9**

FOR: DECORATIVE MAGNETS, IN CLASS 9 (U.S. CLS. 21, 23, 26, 36 AND 38).

**TRADEMARK**

OWNER OF ERPN CMNTY TM OFC REG. NO. 003688371, DATED 9-26-2006, EXPIRES 9-26-2016.

**PRINCIPAL REGISTER**

THE MARK CONSISTS OF THE LETTERS AND SYMBOLS "H & & H" APPEARING IN A BOX WITH THE WORDING "HISTORY & HERALDRY" UNDERNEATH.

SER. NO. 77-542,983, FILED 8-8-2008.

SHAUNIA CARLYLE, EXAMINING ATTORNEY



*David J. Kybas*

Director of the United States Patent and Trademark Office

# United States of America

United States Patent and Trademark Office

## TALENT ARCHITECTS

**Reg. No. 4,273,749**

ACME WIDGET, L.P. (TEXAS LIMITED PARTNERSHIP)  
301 COMMERCE STREET, SUITE 3200  
FT. WORTH, TX 76102

**Registered Jan. 15, 2013**

**Int. Cl.: 35**

FOR: EMPLOYMENT HIRING, RECRUITING, PLACEMENT AND STAFFING SERVICES,  
IN CLASS 35 (U.S. CLS. 100, 101 AND 102).

**SERVICE MARK**

FIRST USE 10-31-2001; IN COMMERCE 10-31-2001.

**PRINCIPAL REGISTER**

THE MARK CONSISTS OF STANDARD CHARACTERS WITHOUT CLAIM TO ANY PAR-  
TICULAR FONT, STYLE, SIZE, OR COLOR.

SER. NO. 77-545,210, FILED 8-12-2008.

BARBARA RUTLAND, EXAMINING ATTORNEY



*David J. Kybas*

Director of the United States Patent and Trademark Office

# United States of America

United States Patent and Trademark Office



**Reg. No. 4,273,750**

LESTER, MARK (UNITED STATES INDIVIDUAL)  
P.O. BOX 492  
NEWPORT, RI 02840

**Registered Jan. 15, 2013**

**Int. Cl.: 33**

FOR: WHITE CACHACA, IN CLASS 33 (U.S. CLS. 47 AND 49).

**TRADEMARK**

FIRST USE 5-1-2008; IN COMMERCE 5-19-2008.

**PRINCIPAL REGISTER**

THE MARK CONSISTS OF THE STYLIZED WORD "SOUL".

SER. NO. 77-588,799, FILED 10-8-2008.

MARK SPARACINO, EXAMINING ATTORNEY



*David J. Kyffers*

Director of the United States Patent and Trademark Office

# United States of America

United States Patent and Trademark Office

# ViPR

**Reg. No. 4,273,751**

**Registered Jan. 15, 2013**

**Int. Cls.: 9, 16, 25, 28  
and 41**

**TRADEMARK**

**SERVICE MARK**

**PRINCIPAL REGISTER**

FITNESS PROFESSIONALS LIMITED (UNITED KINGDOM LIMITED COMPANY (LTD.))  
113 LONDON ROAD  
LONDON, UNITED KINGDOM E130DA

FOR: AUDIO AND VIDEO RECORDINGS, AUDIO TAPES, DVDS, VIDEO TAPES, AND COMPACT DISCS ALL FEATURING PHYSICAL FITNESS AND EXERCISE ACTIVITIES AND INSTRUCTION; ELECTRONIC PUBLICATIONS, NAMELY, BOOKS, MAGAZINES AND NEWSLETTERS IN THE FIELD OF PHYSICAL FITNESS AND EXERCISE ACTIVITIES AND INSTRUCTION RECORDED ON COMPUTER MEDIA, IN CLASS 9 (U.S. CLS. 21, 23, 26, 36 AND 38).

FOR: PRINTED MATTER, NAMELY, BOOKS, MAGAZINES, NEWSLETTERS, STATIONERY AND INSTRUCTIONAL AND TEACHING MATERIAL IN THE FIELD OF PHYSICAL FITNESS AND EXERCISE ACTIVITIES AND INSTRUCTION, IN CLASS 16 (U.S. CLS. 2, 5, 22, 23, 29, 37, 38 AND 50).

FOR: CLOTHING, NAMELY, HEADGEAR IN THE NATURE OF HATS AND CAPS, AND TRACKSUITS, SHORTS, SKIRTS, T-SHIRTS AND PERFORMANCE TRAINING APPAREL, NAMELY, RUNNING TIGHTS, RUNNING SHORTS, TANK TOPS, SHIRTS AND BRA TOPS ALL FOR USE IN PHYSICAL FITNESS AND EXERCISE ACTIVITIES, IN CLASS 25 (U.S. CLS. 22 AND 39).

FOR: GYMNASTIC AND SPORTING ARTICLES, EQUIPMENT AND APPARATUS, NAMELY, BODY TRAINING APPARATUS IN THE NATURE OF FUNCTIONAL LOAD, RESISTANCE TRAINING AND MOVEMENT DEVICES, ALL FOR USE IN CHOREOGRAPHED EXERCISE CLASSES WITH OR WITHOUT MUSIC, IN CLASS 28 (U.S. CLS. 22, 23, 38 AND 50).

FOR: PROVIDING FITNESS AND EXERCISE FACILITIES; PHYSICAL FITNESS INSTRUCTION; PHYSICAL EDUCATION; AND GYMNASIUMS, IN CLASS 41 (U.S. CLS. 100, 101 AND 107).

THE MARK CONSISTS OF STANDARD CHARACTERS WITHOUT CLAIM TO ANY PARTICULAR FONT, STYLE, SIZE, OR COLOR.

PRIORITY CLAIMED UNDER SEC. 44(D) ON ERPN CMNTY TM OFC APPLICATION NO. 6933196, FILED 5-23-2008, REG. NO. 006933196, DATED 2-10-2009, EXPIRES 5-23-2018.



*David J. Kyffers*

Director of the United States Patent and Trademark Office

**Reg. No. 4,273,751** SER. NO. 77-615,763, FILED 11-17-2008.

MARC LEIPZIG, EXAMINING ATTORNEY

# United States of America

United States Patent and Trademark Office

## CARETRACKER

**Reg. No. 4,273,752**

**Registered Jan. 15, 2013**

**Int. Cls.: 35 and 42**

**SERVICE MARK**

**PRINCIPAL REGISTER**

INGENIX, INC. (DELAWARE CORPORATION)  
12125 TECHNOLOGY DRIVE  
EDEN PRAIRIE, MN 55344

FOR: PHYSICIAN PRACTICE AND MEDICAL PRACTICE MANAGEMENT FOR OTHERS; COMPUTERIZED DATABASE MANAGEMENT IN THE FIELDS OF MEDICAL RECORDS AND MEDICAL BILLING; ONLINE BUSINESS AND FINANCIAL RECORDS MANAGEMENT IN THE FIELDS OF MEDICAL RECORDS AND MEDICAL BILLING; FINANCIAL RECORDS MANAGEMENT, NAMELY, REVENUE MANAGEMENT SERVICES FOR PHYSICIAN PRACTICES AND MEDICAL PRACTICES, IN CLASS 35 (U.S. CLS. 100, 101 AND 102).

FIRST USE 1-1-1999; IN COMMERCE 1-1-1999.

FOR: APPLICATION SERVICE PROVIDER (ASP) FEATURING SOFTWARE FOR USE IN PHYSICIAN PRACTICE MANAGEMENT; APPLICATION SERVICE PROVIDER (ASP) FEATURING SOFTWARE FOR USE IN ELECTRONIC RECORDS MANAGEMENT IN THE FIELDS OF MEDICAL RECORDS AND MEDICAL BILLING; APPLICATION SERVICE PROVIDER (ASP) FEATURING SOFTWARE FOR USE IN REVENUE MANAGEMENT AND CLAIMS REIMBURSEMENT MANAGEMENT FOR MEDICAL PRACTICES; PROVIDING TEMPORARY USE OF NON-DOWNLOADABLE COMPUTER SOFTWARE FOR USE IN PHYSICIAN PRACTICE MANAGEMENT; PROVIDING TEMPORARY USE OF NON-DOWNLOADABLE COMPUTER SOFTWARE FOR USE IN ELECTRONIC RECORDS MANAGEMENT IN THE FIELDS OF MEDICAL RECORDS AND MEDICAL BILLING; PROVIDING TEMPORARY USE OF NON-DOWNLOADABLE COMPUTER SOFTWARE FOR USE IN REVENUE MANAGEMENT AND CLAIMS REIMBURSEMENT MANAGEMENT FOR MEDICAL PRACTICES, IN CLASS 42 (U.S. CLS. 100 AND 101).

FIRST USE 1-1-1999; IN COMMERCE 1-1-1999.

THE MARK CONSISTS OF STANDARD CHARACTERS WITHOUT CLAIM TO ANY PARTICULAR FONT, STYLE, SIZE, OR COLOR.

SER. NO. 77-618,050, FILED 11-19-2008.

REBECCA GILBERT, EXAMINING ATTORNEY



*David J. Kypos*

Director of the United States Patent and Trademark Office

# United States of America

United States Patent and Trademark Office

# LGBR

**Reg. No. 4,273,753**

**Registered Jan. 15, 2013**

**Int. Cls.: 6 and 9**

**TRADEMARK**

**PRINCIPAL REGISTER**

LA GARD DO BRASIL LTDA (BRAZIL SOCIEDADE POR QUOTAS DE RESPONSABILIDADE LIMITADA (LTDA))  
AVENIDA CAPITAO CASA, 1485/1487  
SAO BERNARDO DO CAMPO, BRAZIL 09812-000

FOR: GATE HARDWARE, NAMELY, METAL GATE LATCHES; METAL LOCKS; METAL LOCKS AND KEYS THEREFOR; METAL LOCKS FOR SAFES; METAL LOCKSETS; METAL PADLOCKS, IN CLASS 6 (U.S. CLS. 2, 12, 13, 14, 23, 25 AND 50).

FOR: ACCESS CONTROL AND ALARM MONITORING SYSTEMS; ALARM INSTALLATIONS AND ALARMS; AUTOMATED SECURITY GATES; AUTOMATED SELF CONTAINED ELECTRONIC SURVEILLANCE DEVICES THAT CAN BE DEPLOYED TO GATHER EVIDENCE OR INTELLIGENCE IN REMOTE LOCATIONS; ELECTRIC CIRCUIT CLOSERS; ELECTRIC DOOR CLOSING SYSTEM; ELECTRIC DOOR OPENERS AND CLOSERS; ELECTRIC DOOR OPENING AND CLOSING SYSTEM; ELECTRIC DOOR OPENING SYSTEM; ELECTRIC GATE OPERATORS; ELECTRONIC DOOR OPENING AND CLOSING SYSTEM; ELECTRONIC LOCKS; ELECTRONIC SAFES; ELECTRONIC TIMERS; ELECTRONICALLY-OPERATED DOOR LATCHES, IN CLASS 9 (U.S. CLS. 21, 23, 26, 36 AND 38).

THE MARK CONSISTS OF STANDARD CHARACTERS WITHOUT CLAIM TO ANY PARTICULAR FONT, STYLE, SIZE, OR COLOR.

PRIORITY CLAIMED UNDER SEC. 44(D) ON BRAZIL APPLICATION NO. 901317950, FILED 11-19-2008, REG. NO. 901317950, DATED 5-8-2012, EXPIRES 5-8-2022.

PRIORITY CLAIMED UNDER SEC. 44(D) ON BRAZIL APPLICATION NO. 901318019, FILED 11-19-2008, REG. NO. 901318019, DATED 2-1-2011, EXPIRES 2-1-2021.

SER. NO. 77-645,087, FILED 1-7-2009.

AMY HELLA, EXAMINING ATTORNEY



*David J. Kyffers*

Director of the United States Patent and Trademark Office



# United States of America

United States Patent and Trademark Office

# VIDTEL

**Reg. No. 4,273,754**

**Registered Jan. 15, 2013**

**Int. Cls.: 9 and 38**

**TRADEMARK**

**SERVICE MARK**

**PRINCIPAL REGISTER**

VIDTEL, INC. (DELAWARE CORPORATION)  
825 E. MIDDLEFIELD ROAD  
MOUNTAIN VIEW, CA 94043

FOR: VIDEO TELEPHONES, IN CLASS 9 (U.S. CLS. 21, 23, 26, 36 AND 38).

FIRST USE 12-2-2008; IN COMMERCE 12-2-2008.

FOR: TELECOMMUNICATION SERVICES, NAMELY, LOCAL AND LONG DISTANCE TELEPHONE SERVICES; LOCAL AND LONG DISTANCE VIDEO TELEPHONE SERVICES; VOICEMAIL, VIDEO MAIL AND VIDEO MESSAGING SERVICES; ELECTRONIC TRANSMISSION OF VOICE AND VIDEO BY MEANS OF VIDEO TELEPHONE, IN CLASS 38 (U.S. CLS. 100, 101 AND 104).

FIRST USE 12-2-2008; IN COMMERCE 12-2-2008.

THE MARK CONSISTS OF STANDARD CHARACTERS WITHOUT CLAIM TO ANY PARTICULAR FONT, STYLE, SIZE, OR COLOR.

SER. NO. 77-660,077, FILED 1-30-2009.

BRENDAN REGAN, EXAMINING ATTORNEY



*David J. Kybas*

Director of the United States Patent and Trademark Office

# United States of America

United States Patent and Trademark Office

# TRITONS

**Reg. No. 4,273,755**

**Registered Jan. 15, 2013**

**Int. Cls.: 6, 16, 21, 25  
and 41**

THE REGENTS OF THE UNIVERSITY OF CALIFORNIA (CALIFORNIA CORPORATION)  
1111 FRANKLIN ST., 8TH FLOOR  
OAKLAND, CA 94607

FOR: METAL KEY RINGS AND CHAINS, IN CLASS 6 (U.S. CLS. 2, 12, 13, 14, 23, 25 AND 50).

FIRST USE 12-31-1976; IN COMMERCE 12-31-1976.

**TRADEMARK**

**SERVICE MARK**

**PRINCIPAL REGISTER**

FOR: FOLDERS; BINDERS; NOTE BOOKS; NOTE PADS; NOTE PAPER AND HOLDERS THEREFOR; WRITING PAPER; ENVELOPES; LETTER OPENERS AND PAPER KNIVES; MESSAGE BOARDS IN THE NATURE OF SLATE BOARDS FOR WRITING; PAPER WEIGHTS; PAPER CLIP TRAYS; BOOK ENDS; DECALS; STICKERS; BUMPER STICKERS; POSTERS; DAY PLANNERS; DESK TOP PLANNERS; PERSONAL PLANNERS; ADDRESS BOOKS; ADDRESS ORGANIZERS IN THE NATURE OF ADDRESS BOOKS AND DIARIES AND CASES THEREFOR; POSTCARDS; GREETING CARDS; PHOTO ALBUMS; BOOK-MARKS; CALENDARS; MONEY CLIPS; PENCILS; PENS; PEN HOLDERS; COLORING BOOKS; NEWSLETTERS IN THE FIELD OF COLLEGE LIFE, UNIVERSITY ACTIVITIES, ACADEMIC, EDUCATIONAL AND ATHLETIC PROGRAMS, VISUAL, LITERARY AND PERFORMING ARTS PRESENTATIONS; PAMPHLETS IN THE FIELD OF COLLEGE LIFE, UNIVERSITY ACTIVITIES, ACADEMIC, EDUCATIONAL AND ATHLETIC PROGRAMS, VISUAL, LITERARY AND PERFORMING ARTS PRESENTATIONS; PERIODIC BROCHURES IN THE FIELD OF COLLEGE LIFE, UNIVERSITY ACTIVITIES, ACADEMIC, EDUCATIONAL AND ATHLETIC PROGRAMS, VISUAL, LITERARY AND PERFORMING ARTS PRESENTATIONS, IN CLASS 16 (U.S. CLS. 2, 5, 22, 23, 29, 37, 38 AND 50).

FIRST USE 12-31-1976; IN COMMERCE 12-31-1976.

FOR: BEVERAGE GLASSWARE; CUPS; COFFEE CUPS; PLASTIC CUPS; MUGS; STEINS; PLASTIC WATER BOTTLES SOLD EMPTY; SHOT GLASSES; PORTABLE BEVERAGE COOLERS; WATER BOTTLE INSULATOR, NAMELY, INSULATED CONTAINERS AND SLEEVES FOR WATER BOTTLES; CORK SCREWS; SNACK BOWLS , IN CLASS 21 (U.S. CLS. 2, 13, 23, 29, 30, 33, 40 AND 50).

FIRST USE 12-31-1976; IN COMMERCE 12-31-1976.



*David J. Kyjars*

Director of the United States Patent and Trademark Office

**Reg. No. 4,273,755** FOR: CLOTHING, NAMELY, TOPS, BOTTOMS, BOXER SHORTS, SHIRTS, T-SHIRTS, POLO SHIRTS, SPORTS SHIRTS, TANK TOPS, SHORTS, SWEAT PANTS, SWEAT SHIRTS, WARM UP SUITS, SOCKS, COATS, NECK TIES, HEADWEAR, VISORS, CAPS, IN CLASS 25 (U.S. CLS. 22 AND 39).

FIRST USE 12-31-1976; IN COMMERCE 12-31-1976.

FOR: EDUCATIONAL SERVICES, NAMELY, PROVIDING COURSES OF INSTRUCTION AT THE UNDERGRADUATE, GRADUATE UNIVERSITY AND DOCTORATE LEVELS; CONTINUING EDUCATION SERVICES, NAMELY, PROVIDING CONTINUING PROFESSIONAL EDUCATION COURSES AND SEMINARS IN THE FIELDS OF ART, SCIENCES, HUMANITIES, PHOTOGRAPHY, MUSIC, BUSINESS, ECONOMICS, EDUCATION, ENGINEERING, DEFENSE TECHNOLOGY, ENGLISH LANGUAGE STUDIES, FOREIGN LANGUAGES, HEALTHCARE AND BEHAVIORAL SCIENCES, HUMANITIES AND WRITING, INFORMATION TECHNOLOGY AND SOFTWARE ENGINEERING, LAW, LEADERSHIP AND MANAGEMENT DEVELOPMENT, LIFE SCIENCES, OCCUPATIONAL AND ENVIRONMENTAL SAFETY AND HEALTH, MEDICINE, NURSING, PUBLIC SERVICE AND SOCIAL RESPONSIBILITY, GOVERNMENT; EDUCATIONAL SEMINARS IN THE FIELDS OF ART, SCIENCES, HUMANITIES, PHOTOGRAPHY, MUSIC, BUSINESS, ECONOMICS, EDUCATION, ENGINEERING, DEFENSE TECHNOLOGY, ENGLISH LANGUAGE STUDIES, FOREIGN LANGUAGES, HEALTHCARE AND BEHAVIORAL SCIENCES, HUMANITIES AND WRITING, INFORMATION TECHNOLOGY AND SOFTWARE ENGINEERING, LAW, LEADERSHIP AND MANAGEMENT DEVELOPMENT, LIFE SCIENCES, OCCUPATIONAL AND ENVIRONMENTAL SAFETY AND HEALTH, MEDICINE, NURSING, PUBLIC SERVICE AND SOCIAL RESPONSIBILITY, GOVERNMENT; ARRANGING AND CONDUCTING ATHLETIC AND SPORTING EVENTS AND COMPETITIONS; ARRANGING AND CONDUCTING VISUAL, LITERARY AND PERFORMING ARTS PRESENTATIONS, NAMELY, PRESENTATIONS OF LIVE SHOW PERFORMANCES, MUSICAL PERFORMANCES, DANCE AND BALLET PERFORMANCES, THEATER PRODUCTIONS AND LIVE LITERARY READINGS AND LECTURES, IN CLASS 41 (U.S. CLS. 100, 101 AND 107).

FIRST USE 12-31-1976; IN COMMERCE 12-31-1976.

THE MARK CONSISTS OF STANDARD CHARACTERS WITHOUT CLAIM TO ANY PARTICULAR FONT, STYLE, SIZE, OR COLOR.

SER. NO. 77-687,855, FILED 3-10-2009.

MATTHEW MCDOWELL, EXAMINING ATTORNEY

# United States of America

United States Patent and Trademark Office

# GUILTY

**Reg. No. 4,273,756**

**Registered Jan. 15, 2013**

**Int. Cl.: 25**

**TRADEMARK**

**PRINCIPAL REGISTER**

9149-5077 QUEBEC INC. (CANADA CORPORATION)  
SUITE 1009  
433 CHABANEL STREET WEST, NORTH TOWER  
MONTREAL, QUEBEC, CANADA H2N2J9

FOR: MEN'S, LADIES', WOMEN'S, TEENS' AND CHILDREN'S WEARING APPAREL, NAMELY, SHIRTS AND TIES, BLOUSES, T-SHIRTS, SWEATERS, JACKETS, JOGGING SUITS, SWEAT SUITS AND SWEAT TOPS, UNDERWEAR, SKIRTS, DRESSES, GLOVES, HATS AND BELTS; LADIES', WOMEN'S, TEENS' AND GIRLS' WEARING APPAREL, NAMELY, KNITTED T-SHIRTS, TANK TOPS, PANTS, SLACKS AND TROUSERS, VESTS, DRESSES, SEAMLESS LACE TOPS, BUSTIERS, KNITTED TOPS, LEGGINGS; MEN'S, TEENS' AND BOYS' WEARING APPAREL, NAMELY, WOVEN SHIRTS AND KNITTED T-SHIRTS, IN CLASS 25 (U.S. CLS. 22 AND 39).

THE MARK CONSISTS OF STANDARD CHARACTERS WITHOUT CLAIM TO ANY PARTICULAR FONT, STYLE, SIZE, OR COLOR.

PRIORITY CLAIMED UNDER SEC. 44(D) ON CANADA APPLICATION NO. 1420436, FILED 12-3-2008, REG. NO. TMA803,479, DATED 8-3-2011, EXPIRES 8-3-2026.

SER. NO. 77-700,875, FILED 3-27-2009.

JESSICA A. POWERS, EXAMINING ATTORNEY



*David J. Kybas*

Director of the United States Patent and Trademark Office

# United States of America

United States Patent and Trademark Office

# PROTEAN

**Reg. No. 4,273,757**

**Registered Jan. 15, 2013**

**Int. Cls.: 7, 9 and 12**

**TRADEMARK**

**PRINCIPAL REGISTER**

PROTEAN ELECTRIC LIMITED (UNITED KINGDOM CORPORATION)  
COXBRIDGE BUSINESS PARK, ALTON ROAD  
SILVERTREE, UNIT LOB  
FARNHAM, SURREY, UNITED KINGDOM GUIO 5EH

FOR: CONTROL GEAR FOR ELECTRIC MOTORS, NAMELY, GEARS AND ENCLOSED DRIVES FOR INDUSTRIAL MACHINERY; ENCLOSED DRIVE UNITS INCORPORATING ELECTRIC MOTORS FOR INDUSTRIAL MACHINERY; ELECTRIC DRIVING MOTORS FOR MACHINES; AND COMPONENT PARTS FOR ALL THE AFORESAID GOODS, IN CLASS 7 (U.S. CLS. 13, 19, 21, 23, 31, 34 AND 35).

FOR: ELECTRONIC CONTROLLERS FOR ELECTRIC MOTORS; TORQUE CONTROL SOFTWARE FOR CONTROLLING THE AMOUNT AND DURATION OF TORQUE APPLIED BY ELECTRIC MOTORS, IN CLASS 9 (U.S. CLS. 21, 23, 26, 36 AND 38).

FOR: ELECTRIC MOTORS FOR LAND VEHICLES; ELECTRIC DRIVES FOR VEHICLE MOTORS; LAND VEHICLES; ELECTRIC LAND VEHICLES; HYBRID ELECTRIC LAND VEHICLES; FOUR WHEEL DRIVE ELECTRICALLY POWERED MOTOR VEHICLES; AND COMPONENT PARTS FOR ALL THE AFORESAID GOODS, IN CLASS 12 (U.S. CLS. 19, 21, 23, 31, 35 AND 44).

THE MARK CONSISTS OF STANDARD CHARACTERS WITHOUT CLAIM TO ANY PARTICULAR FONT, STYLE, SIZE, OR COLOR.

PRIORITY CLAIMED UNDER SEC. 44(D) ON UNITED KINGDOM APPLICATION NO. 2513376, FILED 4-8-2009, REG. NO. 2513376, DATED 4-8-2009, EXPIRES 4-8-2019.

OWNER OF U.S. REG. NO. 3,885,549.

SER. NO. 77-719,302, FILED 4-22-2009.

MICHAEL LITZAU, EXAMINING ATTORNEY



*David J. Kypos*

Director of the United States Patent and Trademark Office

# United States of America

United States Patent and Trademark Office

## PROTEAN DRIVE

**Reg. No. 4,273,758**

**Registered Jan. 15, 2013**

**Int. Cls.: 7, 9 and 12**

**TRADEMARK**

**PRINCIPAL REGISTER**

PROTEAN ELECTRIC LIMITED (UNITED KINGDOM CORPORATION)  
COXBRIDGE BUSINESS PARK, ALTON ROAD  
SILVERTREE, UNIT LOB  
FARNHAM, SURREY, UNITED KINGDOM GUIO 5EH

FOR: CONTROL GEAR FOR ELECTRIC MOTORS, NAMELY, GEARS AND ENCLOSED DRIVES FOR INDUSTRIAL MACHINERY; ENCLOSED DRIVE UNITS INCORPORATING ELECTRIC MOTORS FOR INDUSTRIAL MACHINERY; ELECTRIC DRIVING MOTORS FOR MACHINES; AND COMPONENT PARTS FOR ALL THE AFORESAID GOODS, IN CLASS 7 (U.S. CLS. 13, 19, 21, 23, 31, 34 AND 35).

FOR: ELECTRONIC CONTROLLERS FOR ELECTRIC MOTORS; TORQUE CONTROL SOFTWARE FOR CONTROLLING THE AMOUNT AND DURATION OF TORQUE APPLIED BY ELECTRIC MOTORS, IN CLASS 9 (U.S. CLS. 21, 23, 26, 36 AND 38).

FOR: ELECTRIC MOTORS FOR LAND VEHICLES; ELECTRIC DRIVES FOR VEHICLE MOTORS; LAND VEHICLES; ELECTRIC LAND VEHICLES; HYBRID ELECTRIC LAND VEHICLES; FOUR WHEEL DRIVE ELECTRICALLY POWERED MOTOR VEHICLES; AND COMPONENT PARTS FOR ALL THE AFORESAID GOODS, IN CLASS 12 (U.S. CLS. 19, 21, 23, 31, 35 AND 44).

THE MARK CONSISTS OF STANDARD CHARACTERS WITHOUT CLAIM TO ANY PARTICULAR FONT, STYLE, SIZE, OR COLOR.

PRIORITY CLAIMED UNDER SEC. 44(D) ON UNITED KINGDOM APPLICATION NO. 2513375, FILED 4-8-2009, REG. NO. 2513375, DATED 4-8-2009, EXPIRES 4-8-2019.

OWNER OF U.S. REG. NO. 3,885,549.

NO CLAIM IS MADE TO THE EXCLUSIVE RIGHT TO USE "DRIVE", APART FROM THE MARK AS SHOWN.

SER. NO. 77-719,329, FILED 4-22-2009.

MICHAEL LITZAU, EXAMINING ATTORNEY



*David J. Kypos*

Director of the United States Patent and Trademark Office

# United States of America

United States Patent and Trademark Office

# MAGENTA

**Reg. No. 4,273,759**

**Registered Jan. 15, 2013**

**Int. Cl.: 9**

**TRADEMARK**

**PRINCIPAL REGISTER**

MAGENTA RESEARCH LTD. (CONNECTICUT CORPORATION)  
128 LITCHFIELD ROAD  
NEW MILFORD, CT 06776

FOR: ELECTRONIC AUDIO AND VIDEO EQUIPMENT, NAMELY, AUDIO RECEIVERS, VIDEO RECEIVERS, ELECTRIC AND COAXIAL CABLES; ELECTRICAL AND ELECTRONIC APPARATUS AND INSTRUMENTS FOR CONDUCTING, SWITCHING AND FLEXIBLE DISTRIBUTION OF AUDIO, VIDEO AND SERIAL SIGNALS OVER STRUCTURED CABLING; STRUCTURED WIRING SYSTEMS, NAMELY, ELECTRIC WIRES AND CABLES; AUDIO AND VIDEO CABLE CONNECTORS, IN CLASS 9 (U.S. CLS. 21, 23, 26, 36 AND 38).

FIRST USE 0-0-1998; IN COMMERCE 0-0-1998.

THE MARK CONSISTS OF STANDARD CHARACTERS WITHOUT CLAIM TO ANY PARTICULAR FONT, STYLE, SIZE, OR COLOR.

SER. NO. 77-732,938, FILED 5-8-2009.

PAULA MAHONEY, EXAMINING ATTORNEY



*David J. Kyffers*

Director of the United States Patent and Trademark Office

# United States of America

United States Patent and Trademark Office

# Windfuels

**Reg. No. 4,273,760**

**Registered Jan. 15, 2013**

**Int. Cls.: 39 and 42**

**SERVICE MARK**

**PRINCIPAL REGISTER**

DOTY SCIENTIFIC, INC. (SOUTH CAROLINA CORPORATION)  
700 CLEMSON ROAD  
COLUMBIA, SC 292294339

FOR: PROVIDING A WEB SITE FEATURING INFORMATION ON CHEMICAL STORAGE OF ENERGY; PROVIDING A WEB SITE FEATURING INFORMATION ON CHEMICAL STORAGE OF ENERGY DERIVED FROM WIND POWER, IN CLASS 39 (U.S. CLS. 100 AND 105).

FIRST USE 5-1-2008; IN COMMERCE 5-1-2008.

FOR: PROVIDING A WEB SITE FEATURING INFORMATION ON CHEMICAL ENGINEERING; PROVIDING A WEB SITE FEATURING INFORMATION ON CHEMICAL ENGINEERING METHODS FOR RECYCLING OF CO2 INTO TRANSPORTATION FUELS, IN CLASS 42 (U.S. CLS. 100 AND 101).

FIRST USE 5-1-2008; IN COMMERCE 5-1-2008.

THE MARK CONSISTS OF STANDARD CHARACTERS WITHOUT CLAIM TO ANY PARTICULAR FONT, STYLE, SIZE, OR COLOR.

SER. NO. 77-759,277, FILED 6-14-2009.

DAVID TAYLOR, EXAMINING ATTORNEY



*David J. Kyffers*

Director of the United States Patent and Trademark Office



# United States of America

United States Patent and Trademark Office

# blingwear

**Reg. No. 4,273,761**

**Registered Jan. 15, 2013**

**Int. Cls.: 14 and 25**

**TRADEMARK**

**PRINCIPAL REGISTER**

BODY GLAM INC. (CALIFORNIA CORPORATION)  
717 E CALIFORNIA AVE  
GLENDALE, CA 91206

FOR: BODY JEWELRY, IN CLASS 14 (U.S. CLS. 2, 27, 28 AND 50).

FIRST USE 1-1-2009; IN COMMERCE 1-1-2009.

FOR: ATHLETIC APPAREL, NAMELY, SHIRTS, PANTS, JACKETS, FOOTWEAR, HATS  
AND CAPS, ATHLETIC UNIFORMS, IN CLASS 25 (U.S. CLS. 22 AND 39).

FIRST USE 1-1-2009; IN COMMERCE 1-1-2009.

THE MARK CONSISTS OF THE WORD "BLINGWEAR" IN LOWERCASE LETTERS, IN A  
STYLIZED FONT.

SER. NO. 77-778,925, FILED 7-10-2009.

KATINA MISTER, EXAMINING ATTORNEY



*David J. Kyffers*

Director of the United States Patent and Trademark Office

# United States of America

United States Patent and Trademark Office

# M'ME

**Reg. No. 4,273,762**

WILLIAMS, LASHONDRA (UNITED STATES INDIVIDUAL), DBA M'ME  
2302 RUTH STREET  
HOUSTON, TX 77004

**Registered Jan. 15, 2013**

**Int. Cl.: 25**

FOR: WEARABLE GARMENTS AND CLOTHING, NAMELY, SHIRTS, IN CLASS 25 (U.S. CLS. 22 AND 39).

**TRADEMARK**

FIRST USE 2-1-2008; IN COMMERCE 2-1-2008.

**PRINCIPAL REGISTER**

THE MARK CONSISTS OF STANDARD CHARACTERS WITHOUT CLAIM TO ANY PARTICULAR FONT, STYLE, SIZE, OR COLOR.

SER. NO. 77-783,528, FILED 7-17-2009.

DORITT L. CARROLL, EXAMINING ATTORNEY



*David J. Kyffers*

Director of the United States Patent and Trademark Office

# United States of America

United States Patent and Trademark Office



## SHARE YOUR AMERICAN DREAM

**Reg. No. 4,273,763**

**Registered Jan. 15, 2013**

**Int. Cl.: 41**

**SERVICE MARK**

**PRINCIPAL REGISTER**

BRINGING BACK THE AMERICAN DREAM, LLC (UTAH LIMITED LIABILITY COMPANY)  
770 ALAN POINT CIRCLE  
DRAPER, UT 84020

FOR: CONDUCTING WORKSHOPS AND SEMINARS IN WEALTH BUILDING; TRAINING SERVICES IN THE FIELD OF WEALTH BUILDING, IN CLASS 41 (U.S. CLS. 100, 101 AND 107).

FIRST USE 1-1-2009; IN COMMERCE 1-1-2009.

THE MARK CONSISTS OF THE CAPITALIZED WORDS "SHARE YOUR" IN BLUE SANS-SERIF TYPEFACE CENTERED ABOVE THE CAPITALIZED WORDS "AMERICAN DREAM" IN RED SERIF TYPEFACE, TO THE RIGHT OF A BLUE STAR WITH THE CAPITALIZED WORDS "BRINGING BACK" IN BLUE SERIF TYPEFACE SLOPING DIAGONALLY DOWNWARD IN THE WHITE CENTER OF AN OPEN ENDED RED RIBBON AND THE CAPITALIZED WORD "THE" IN BLUE SERIF TYPEFACE BELOW THE BLUE STAR, ALL ON A WHITE BACKGROUND.

THE COLOR(S) RED, WHITE AND BLUE IS/ARE CLAIMED AS A FEATURE OF THE MARK.

SER. NO. 77-813,698, FILED 8-27-2009.

DORITT L. CARROLL, EXAMINING ATTORNEY



*David J. Kybas*

Director of the United States Patent and Trademark Office

# United States of America

United States Patent and Trademark Office



**Reg. No. 4,273,764**

**Registered Jan. 15, 2013**

**Int. Cl.: 9**

**TRADEMARK**

**PRINCIPAL REGISTER**

RAYTEC VISION S.P.A. (ITALY JOINT STOCK COMPANY)  
1/3 FRAZ. LEMIGNANO;  
VIA MAESTRI DEL LAVORO,  
COLLECCHIO (PARMA), ITALY I-43044

FOR: ELECTRONIC SENSOR SORTING APPARATUS, WITH AN ELECTRO-PNEUMATIC EJECTION COMPONENT, EQUIPPED WITH NEAR INFRARED TECHNOLOGY TO DETERMINE THE DEGREE OF RIPENESS AND/OR THE PRESENCE OF ORGANIC OR INORGANIC FOREIGN BODIES IN FRUIT AND VEGETABLES; CAMERA SORTING APPARATUS, WITH A SUCTION EJECTION COMPONENT, FOR USE IN FRUIT AND VEGETABLE PRODUCTION PROCESSES; X-RAY INSPECTION SYSTEMS FOR CHECKING CANS, GLASS JARS, BOTTLES AND CARDBOARD PACKAGING THEREFOR; X-RAY INSPECTION SYSTEMS FOR CHECKING PACKED AND BULK PRODUCTS IN ORDER TO REMOVE FROM THE PRODUCTION PROCESS ANY NON-CONFORMING PRODUCTS AND/OR THOSE SUSPECTED TO CONTAIN FOREIGN BODIES, SUCH AS GLASS, STONES, METAL AND BONES; CAMERA SORTING APPARATUS, WITH AN AIR JET EJECTION COMPONENT; X-RAY INSPECTION SYSTEMS FOR CHECKING LIQUID AND PUMPING PRODUCTS; MACHINES FOR DETECTING THE PRESENCE OF FOREIGN BODIES IN PACKED AND BULK FOOD PRODUCTS, IN CLASS 9 (U.S. CLS. 21, 23, 26, 36 AND 38).

OWNER OF ITALY REG. NO. 1111509, DATED 5-9-2008, EXPIRES 5-9-2018.

THE MARK CONSISTS OF THE WORDING "RAY TEC VISION" WITH A DIAGONAL LINE PLACED OVER THE WORDING.

SER. NO. 77-820,493, FILED 9-4-2009.

LESLIE RICHARDS, EXAMINING ATTORNEY



*David J. Kyros*

Director of the United States Patent and Trademark Office

# United States of America

United States Patent and Trademark Office



**Reg. No. 4,273,765**

**Registered Jan. 15, 2013**

**Int. Cl.: 37**

**SERVICE MARK**

**PRINCIPAL REGISTER**

AAA SERVICE NETWORK, INC. (MICHIGAN CORPORATION)  
4675 E. GRAND RIVER AVE.  
HOWELL, MI 48843

FOR: ELECTRICAL REPAIRS, MAINTENANCE, AND INSTALLATION OF ELECTRICAL WIRING, OUTLETS, LIGHT FIXTURES, AND ELECTRICAL PANELS; FURNACE INSTALLATION AND REPAIR; INSTALLATION OF KITCHEN APPLIANCES; INSTALLATION, REPAIR AND MAINTENANCE OF HEATING EQUIPMENT; MAINTENANCE AND REPAIR OF COMPUTER HARDWARE; PLUMBING; REPAIR OR MAINTENANCE OF GAS WATER HEATERS, IN CLASS 37 (U.S. CLS. 100, 103 AND 106).

FIRST USE 7-1-1989; IN COMMERCE 7-1-1989.

NO CLAIM IS MADE TO THE EXCLUSIVE RIGHT TO USE "SERVICE NETWORK" AND "HEATING & AIR CONDITIONING APPLIANCE REPAIR PLUMBING/ELECTRICAL WHOLE HOUSE GENERATORS COMPUTER REPAIR...& MORE WE FIX JUST ABOUT ANYTHING IN YOUR HOME..OR BUSINESS", APART FROM THE MARK AS SHOWN.

THE COLOR(S) RED, WHITE AND BLACK IS/ARE CLAIMED AS A FEATURE OF THE MARK.

THE MARK CONSISTS OF A PICTURE OF A VAN IN RED AND WHITE WITH BLACK TIRES. "A" RED FLAG WITH THE WORDS "AAA SERVICE NETWORK" IN WHITE ON THE WHITE PORTION OF THE VAN. "1-800-FIX-IT-NOW" BELOW THE FLAG IN RED ON THE WHITE PORTION OF THE VAN. "HEATING & AIR, APPLIANCE REPAIR, PLUMBING/ELECTRICAL, WHOLE HOUSE GENERATORS COMPUTER REPAIR...&MORE" TO THE RIGHT OF THE FLAG LISTED BELOW ONE ANOTHER IN WHITE ON THE RED PORTION OF THE VAN. ACROSS THE BOTTOM "WE FIX JUST ABOUT ANYTHING IN YOUR HOME...OR BUSINESS" IN WHITE ON THE RED PORTION OF THE VAN.



SER. NO. 77-823,769, FILED 9-10-2009.

STEPHANIE ALI, EXAMINING ATTORNEY

*David J. Kyffers*

Director of the United States Patent and Trademark Office

# United States of America

United States Patent and Trademark Office

## SCRATCH GOLF COMPANY

**Reg. No. 4,273,766**

**Registered Jan. 15, 2013**

**Int. Cl.: 35**

**SERVICE MARK**

**PRINCIPAL REGISTER**

SCRATCH GOLF, LLC (SOUTH CAROLINA LIMITED LIABILITY COMPANY), FORMERLY  
SCRATCH GOLF COMPANY  
60 HILTON HEAD NATIONAL DRIVE  
BLUFFTON, SC 29910

FOR: RETAIL SHOPS FEATURING GOLF-RELATED GOODS OF OTHERS, IN CLASS 35  
(U.S. CLS. 100, 101 AND 102).

FIRST USE 11-1-1989; IN COMMERCE 11-1-1989.

THE MARK CONSISTS OF STANDARD CHARACTERS WITHOUT CLAIM TO ANY PAR-  
TICULAR FONT, STYLE, SIZE, OR COLOR.

NO CLAIM IS MADE TO THE EXCLUSIVE RIGHT TO USE "GOLF COMPANY", APART  
FROM THE MARK AS SHOWN.

SER. NO. 77-843,530, FILED 10-7-2009.

LINDSEY RUBIN, EXAMINING ATTORNEY



*David J. Kyros*

Director of the United States Patent and Trademark Office

# United States of America

United States Patent and Trademark Office

# CONSERVE

**Reg. No. 4,273,767**

**Registered Jan. 15, 2013**

**Int. Cl.: 9**

**TRADEMARK**

**PRINCIPAL REGISTER**

BELKIN INTERNATIONAL, INC. (DELAWARE CORPORATION)  
12045 EAST WATERFRONT DRIVE  
PLAYA VISTA, CA 90094

FOR: ELECTRICAL AND ELECTRONIC DEVICES, NAMELY, VOLTAGE SURGE PROTECTORS, VOLTAGE SURGE SUPPRESSORS, ELECTRIC SWITCHES, THERMOMETERS, THERMOSTATS, CHARGING STATIONS FOR CHARGING BATTERIES FOR CONSUMER ELECTRONICS, MONITORS AND MONITOR MODULES FOR MONITORING ELECTRIC CURRENT AND ELECTRICAL SIGNALS, ELECTRICAL SOCKETS, ELECTRICAL CONNECTORS, TIMERS, ELECTRONIC DISPLAY INTERFACES FOR THE AFORESAID GOODS, AND REMOTE CONTROLS FOR THE AFORESAID GOODS, IN CLASS 9 (U.S. CLS. 21, 23, 26, 36 AND 38).

FIRST USE 0-0-2008; IN COMMERCE 0-0-2008.

THE MARK CONSISTS OF STANDARD CHARACTERS WITHOUT CLAIM TO ANY PARTICULAR FONT, STYLE, SIZE, OR COLOR.

SEC. 2(F).

SER. NO. 77-844,438, FILED 10-8-2009.

STEVEN R. FINE, EXAMINING ATTORNEY



*David J. Kyffers*

Director of the United States Patent and Trademark Office

# United States of America

United States Patent and Trademark Office



**Reg. No. 4,273,768**

**Registered Jan. 15, 2013**

**Int. Cl.: 35**

**SERVICE MARK**

**PRINCIPAL REGISTER**

SCRATCH GOLF, LLC (SOUTH CAROLINA LIMITED LIABILITY COMPANY), FORMERLY  
SCRATCH GOLF COMPANY  
60 HILTON HEAD NATIONAL DRIVE  
BLUFFTON, SC 29910

FOR: RETAIL SHOPS FEATURING GOLF-RELATED GOODS OF OTHERS, IN CLASS 35  
(U.S. CLS. 100, 101 AND 102).

FIRST USE 9-16-1992; IN COMMERCE 12-31-1992.

NO CLAIM IS MADE TO THE EXCLUSIVE RIGHT TO USE "GOLF COMPANY", APART  
FROM THE MARK AS SHOWN.

THE MARK CONSISTS OF AN OVAL WITH A THICK DARK BAND AND THE WORDS  
"SCRATCH GOLF COMPANY" AROUND THE OVAL. INSIDE THE OVAL IS A PINEAPPLE  
ON WHICH THE INTERTWINED LETTERS "SGC" APPEAR. A WREATH APPEARS AROUND  
THE PINEAPPLE.

SER. NO. 77-846,312, FILED 10-12-2009.

LINDSEY RUBIN, EXAMINING ATTORNEY



*David J. Kyffers*

Director of the United States Patent and Trademark Office



# United States of America

United States Patent and Trademark Office

## LIQUID KITCHEN

**Reg. No. 4,273,769**

KATHY CASEY, INC. (WASHINGTON CORPORATION)  
5130 BALLARD AVENUE NW  
SEATTLE, WA 98107

**Registered Jan. 15, 2013**

**Int. Cl.: 35**

FOR: BUSINESS CONSULTING AND INFORMATION SERVICES, IN CLASS 35 (U.S. CLS. 100, 101 AND 102).

**SERVICE MARK**

FIRST USE 9-22-2004; IN COMMERCE 9-22-2004.

**PRINCIPAL REGISTER**

THE MARK CONSISTS OF STANDARD CHARACTERS WITHOUT CLAIM TO ANY PARTICULAR FONT, STYLE, SIZE, OR COLOR.

SER. NO. 77-868,707, FILED 11-9-2009.

REGINA DRUMMOND, EXAMINING ATTORNEY



*David J. Kybas*

Director of the United States Patent and Trademark Office

# United States of America

United States Patent and Trademark Office

## LIQUID KITCHEN

**Reg. No. 4,273,770**

KATHY CASEY, INC. (WASHINGTON CORPORATION)  
5130 BALLARD AVENUE NW  
SEATTLE, WA 98107

**Registered Jan. 15, 2013**

**Int. Cl.: 41**

FOR: TRAINING IN THE FIELD OF BEVERAGES; TRAINING IN THE FIELD OF BEVERAGE PREPARATION, DESIGN, AND PRESENTATION, IN CLASS 41 (U.S. CLS. 100, 101 AND 107).

**SERVICE MARK**

FIRST USE 9-22-2004; IN COMMERCE 9-22-2004.

**PRINCIPAL REGISTER**

THE MARK CONSISTS OF STANDARD CHARACTERS WITHOUT CLAIM TO ANY PARTICULAR FONT, STYLE, SIZE, OR COLOR.

SER. NO. 77-868,710, FILED 11-9-2009.

REGINA DRUMMOND, EXAMINING ATTORNEY



*David J. Kyffers*

Director of the United States Patent and Trademark Office

# United States of America

United States Patent and Trademark Office



**Reg. No. 4,273,771**

**Registered Jan. 15, 2013**

**Int. Cl.: 14**

**TRADEMARK**

**PRINCIPAL REGISTER**

KLOSS, KIM E (UNITED STATES INDIVIDUAL), DBA ME TOO CHARMS  
9 TRUE LANE  
GEORGETOWN, MA 01833

FOR: CHARMS, IN CLASS 14 (U.S. CLS. 2, 27, 28 AND 50).

FIRST USE 10-1-2009; IN COMMERCE 10-1-2009.

NO CLAIM IS MADE TO THE EXCLUSIVE RIGHT TO USE "CHARMS" , APART FROM THE MARK AS SHOWN.

THE COLOR(S) GREEN AND BROWN IS/ARE CLAIMED AS A FEATURE OF THE MARK.

THE MARK CONSISTS OF THE STYLIZED WORDING "ME TOO CHARMS" ON BROWN SQUARE WITH TWO DOTS AT THE TOP LEFT OF THE SQUARE, WITH ONE OF THE DOTS PARTIALLY OBSCURED BY THE LETTER "M" IN THE WORD "ME". THE DOTS AND THE WORD "CHARMS" ARE GREEN. THE SQUARE IS BROWN. THE WHITE IN THE WORDING "ME TOO" IS NOT PART OF THE MARK AND REPRESENTS BACKGROUND AREA.

SER. NO. 77-881,521, FILED 11-27-2009.

ELLEN B. AWRICH, EXAMINING ATTORNEY



*David J. Kyffers*

Director of the United States Patent and Trademark Office

# United States of America

United States Patent and Trademark Office

## Spotlight Express

**Reg. No. 4,273,772**

DAVIS, BARRY G. (VIRGINIA CORPORATION)  
406 PLUM ST.

**Registered Jan. 15, 2013**

DANVILLE, VA 24540

**Int. Cl.: 35**

FOR: PRODUCTION OF FILM AND TELEVISION ADVERTISING; PRODUCTION OF TELEVISION COMMERCIALS, IN CLASS 35 (U.S. CLS. 100, 101 AND 102).

**SERVICE MARK**

FIRST USE 1-3-1989; IN COMMERCE 1-3-1989.

**PRINCIPAL REGISTER**

THE MARK CONSISTS OF STANDARD CHARACTERS WITHOUT CLAIM TO ANY PARTICULAR FONT, STYLE, SIZE, OR COLOR.

SER. NO. 77-904,035, FILED 1-3-2010.

CORY BOONE, EXAMINING ATTORNEY



*David J. Kybas*

Director of the United States Patent and Trademark Office

# United States of America

United States Patent and Trademark Office

# CERTON

**Reg. No. 4,273,773**

CERTON SOFTWARE (FLORIDA CORPORATION)  
400 N. MIRAMAR AVENUE  
INDIALANTIC, FL 32903

**Registered Jan. 15, 2013**

**Int. Cl.: 42**

FOR: TECHNOLOGICAL CONSULTATION SERVICES IN THE TECHNOLOGY FIELD OF AVIONICS, IN CLASS 42 (U.S. CLS. 100 AND 101).

**SERVICE MARK**

FIRST USE 7-31-2007; IN COMMERCE 7-31-2007.

**PRINCIPAL REGISTER**

THE MARK CONSISTS OF STANDARD CHARACTERS WITHOUT CLAIM TO ANY PARTICULAR FONT, STYLE, SIZE, OR COLOR.

THE TERM "CERTON" HAS NO MEANING IN A FOREIGN LANGUAGE.

SER. NO. 77-923,782, FILED 1-29-2010.

ANDREW RHIM, EXAMINING ATTORNEY



*David J. Kyffers*

Director of the United States Patent and Trademark Office

# United States of America

United States Patent and Trademark Office

## THE BOXING TRUTH

**Reg. No. 4,273,774**

DENISON, BEAU (UNITED STATES INDIVIDUAL)  
14067 59TH STREET N.  
CLEARWATER, FL 33760

**Registered Jan. 15, 2013**

**Int. Cl.: 41**

FOR: PROVIDING INFORMATION AND WRITING ARTICLES FOR PERIODICALS OTHER THAN FOR ADVERTISING OR PUBLICITY IN THE FIELD OF BOXING; PROVIDING A WEBSITE FEATURING INFORMATION AND ARTICLES IN THE FIELD OF BOXING, IN CLASS 41 (U.S. CLS. 100, 101 AND 107).

**SERVICE MARK**

**PRINCIPAL REGISTER**

FIRST USE 6-0-2004; IN COMMERCE 6-0-2004.

THE MARK CONSISTS OF STANDARD CHARACTERS WITHOUT CLAIM TO ANY PARTICULAR FONT, STYLE, SIZE, OR COLOR.

NO CLAIM IS MADE TO THE EXCLUSIVE RIGHT TO USE "BOXING", APART FROM THE MARK AS SHOWN.

SER. NO. 77-942,511, FILED 2-23-2010.

TARA PATE, EXAMINING ATTORNEY



*David J. Kyffers*

Director of the United States Patent and Trademark Office

# United States of America

United States Patent and Trademark Office

## HONEST EARTH

**Reg. No. 4,273,775**

IDAHOAN FOODS, LLC (DELAWARE LIMITED LIABILITY COMPANY)  
529 NORTH 3500 EAST  
LEWISVILLE, ID 83431

**Registered Jan. 15, 2013**

**Int. Cl.: 29**

FOR: INSTANT POTATOES; PROCESSED POTATOES; DEHYDRATED POTATOES, IN CLASS 29 (U.S. CL. 46).

**TRADEMARK**

FIRST USE 5-31-2008; IN COMMERCE 5-31-2008.

**PRINCIPAL REGISTER**

THE MARK CONSISTS OF STANDARD CHARACTERS WITHOUT CLAIM TO ANY PARTICULAR FONT, STYLE, SIZE, OR COLOR.

SER. NO. 77-977,365, FILED 12-10-2007.

BARNEY CHARLON, EXAMINING ATTORNEY



*David J. Kyfos*

Director of the United States Patent and Trademark Office

# United States of America

United States Patent and Trademark Office



**Reg. No. 4,273,776**

**Registered Jan. 15, 2013**

**Int. Cl.: 41**

**SERVICE MARK**

**PRINCIPAL REGISTER**

SCRATCH GOLF, LLC (SOUTH CAROLINA LIMITED LIABILITY COMPANY), FORMERLY  
SCRATCH GOLF COMPANY  
60 HILTON HEAD NATIONAL DRIVE  
BLUFFTON, SC 29910

FOR: GOLF COURSES, IN CLASS 41 (U.S. CLS. 100, 101 AND 107).

FIRST USE 9-16-1992; IN COMMERCE 12-31-1992.

NO CLAIM IS MADE TO THE EXCLUSIVE RIGHT TO USE "GOLF COMPANY", APART  
FROM THE MARK AS SHOWN.

THE MARK CONSISTS OF AN OVAL WITH A THICK DARK BAND AND THE WORDS  
"SCRATCH GOLF COMPANY" AROUND THE OVAL. INSIDE THE OVAL IS A PINEAPPLE  
ON WHICH THE INTERTWINED LETTERS "SGC" APPEAR. A WREATH APPEARS AROUND  
THE PINEAPPLE.

SER. NO. 77-980,697, FILED 10-12-2009.

LINDSEY RUBIN, EXAMINING ATTORNEY



*David J. Kybas*

Director of the United States Patent and Trademark Office



# United States of America

United States Patent and Trademark Office

## SCRATCH GOLF COMPANY

**Reg. No. 4,273,777**

**Registered Jan. 15, 2013**

**Int. Cl.: 41**

**SERVICE MARK**

**PRINCIPAL REGISTER**

SCRATCH GOLF, LLC (SOUTH CAROLINA LIMITED LIABILITY COMPANY), FORMERLY  
SCRATCH GOLF COMPANY  
60 HILTON HEAD NATIONAL DRIVE  
BLUFFTON, SC 29910

FOR: GOLF COURSES, IN CLASS 41 (U.S. CLS. 100, 101 AND 107).

FIRST USE 5-17-1988; IN COMMERCE 10-30-1988.

THE MARK CONSISTS OF STANDARD CHARACTERS WITHOUT CLAIM TO ANY PARTICULAR FONT, STYLE, SIZE, OR COLOR.

NO CLAIM IS MADE TO THE EXCLUSIVE RIGHT TO USE "GOLF COMPANY", APART FROM THE MARK AS SHOWN.

SER. NO. 77-980,698, FILED 10-7-2009.

LINDSEY RUBIN, EXAMINING ATTORNEY



*David J. Kybas*

Director of the United States Patent and Trademark Office

# United States of America

United States Patent and Trademark Office

# CAR-ILLON

**Reg. No. 4,273,778**

GROSSMAN, RICHARD (UNITED STATES INDIVIDUAL)  
2000 DEMILLE DRIVE  
LOS ANGELES, CA 90027

**Registered Jan. 15, 2013**

**Int. Cl.: 41**

FOR: ENTERTAINMENT SERVICES IN THE NATURE OF LIVE MUSICAL PERFORMANCES BY A PERFORMANCE ARTIST THAT FEATURES MUSICAL SOUNDS CREATED BY PLAYING A CONFIGURATION OF AUTOMOBILES THAT FORM A MUSICAL INSTRUMENT BY CONNECTING AUTOMOBILES OUTFITTED WITH SPEAKERS TO A CENTRAL AUTOMOBILE THAT IS OUTFITTED WITH A KEYBOARD, IN CLASS 41 (U.S. CLS. 100, 101 AND 107).

**SERVICE MARK**

**PRINCIPAL REGISTER**

FIRST USE 10-0-2011; IN COMMERCE 10-0-2011.

THE MARK CONSISTS OF STANDARD CHARACTERS WITHOUT CLAIM TO ANY PARTICULAR FONT, STYLE, SIZE, OR COLOR.

SER. NO. 77-983,144, FILED 3-10-2010.

ANTHONY RINKER, EXAMINING ATTORNEY



*David J. Kyffers*

Director of the United States Patent and Trademark Office

# United States of America

United States Patent and Trademark Office

## URANIUM ONE

**Reg. No. 4,273,779**

**Registered Jan. 15, 2013**

**Int. Cls.: 14 and 36**

**TRADEMARK**

**SERVICE MARK**

**PRINCIPAL REGISTER**

URANIUM ONE INC. (CANADA CORPORATION)  
BAY ADELAIDE CENTRE  
SUITE 1710, 333 BAY STREET  
TORONTO, ONTARIO, CANADA M5H2R2

FOR: REFINED METALS AND METALLIFEROUS PRODUCTS, NAMELY, GOLD, GOLD DORE AND SILVER; PRECIOUS METAL ORES, NAMELY, GOLD AND SILVER, IN CLASS 14 (U.S. CLS. 2, 27, 28 AND 50).

FOR: FINANCIAL SERVICES, NAMELY, MONEY LENDING TO OWNERS OF MINERAL AND MINERAL EXPLORATION PROPERTIES, IN CLASS 36 (U.S. CLS. 100, 101 AND 102).

THE MARK CONSISTS OF STANDARD CHARACTERS WITHOUT CLAIM TO ANY PARTICULAR FONT, STYLE, SIZE, OR COLOR.

PRIORITY CLAIMED UNDER SEC. 44(D) ON CANADA APPLICATION NO. 1304351, FILED 5-19-2006, REG. NO. TMA700358, DATED 11-6-2007, EXPIRES 11-6-2022.

OWNER OF CANADA REG. NO. TMA700358, DATED 11-6-2007, EXPIRES 11-6-2022.

NO CLAIM IS MADE TO THE EXCLUSIVE RIGHT TO USE "URANIUM", APART FROM THE MARK AS SHOWN.

SER. NO. 77-983,429, FILED 11-17-2006.

TRICIA SONNEBORN, EXAMINING ATTORNEY



*David J. Kyffers*

Director of the United States Patent and Trademark Office

# United States of America

United States Patent and Trademark Office

# cha cha

**Reg. No. 4,273,780**

**Registered Jan. 15, 2013**

**Int. Cl.: 43**

LFS BRAND COMPANY AG IN LIQUIDATION (FED REP GERMANY JOINT STOCK COMPANY)  
OBERDORFSTRASSE 34  
CH-9100 HERISAU  
SWITZERLAND

**SERVICE MARK**

FOR: SERVICES FOR PROVIDING FOOD AND DRINKS IN COFFEE BARS, CAFETERIAS, CANTEENS, RESTAURANTS, SELF SERVICE RESTAURANTS AND SNACK BARS , IN CLASS 43 (U.S. CLS. 100 AND 101).

**PRINCIPAL REGISTER**

THE MARK CONSISTS OF STANDARD CHARACTERS WITHOUT CLAIM TO ANY PARTICULAR FONT, STYLE, SIZE, OR COLOR.

OWNER OF INTERNATIONAL REGISTRATION 0939166 DATED 9-5-2007, EXPIRES 9-5-2017.

SER. NO. 79-070,031, FILED 4-23-2009.

JAMES GRIFFIN, EXAMINING ATTORNEY



*David J. Kyfos*

Director of the United States Patent and Trademark Office

# United States of America

United States Patent and Trademark Office

# OPENWAYS

**Reg. No. 4,273,781**

**Registered Jan. 15, 2013**

**Int. Cls.: 6, 9 and 38**

**TRADEMARK**

**SERVICE MARK**

**PRINCIPAL REGISTER**

OPENWAYS SAS (FRANCE SOCIÉTÉ PAR ACTIONS SIMPLIFIÉE)  
5 RUE D'ANKARA  
F-75016 PARIS  
FRANCE

FOR: NON-ELECTRIC CABLES AND WIRES OF COMMON METALS; LOCKSMITHING MATERIALS, NAMELY, LOCK CYLINDERS OF METAL; METAL SAFES; BOXES OF COMMON METAL; METAL CHESTS; METAL LOCKS OTHER THAN ELECTRIC; METAL KEYS; DOORS OF METAL; ANTI-PANIC DOOR OPENING SYSTEMS CONSISTING OF METAL DOOR FRAMES, METAL DOOR BOLTS, METAL HANDLES AND METAL LOCKS FOR DOORS; LOCK CYLINDERS OF METAL OTHER THAN ELECTRIC; COMPONENTS OF METAL LOCKS OTHER THAN ELECTRIC, NAMELY, BARRELS; MASTER KEYS OF METAL; ORGANIZATIONAL CHARTS KEYS OF METAL; METAL PADLOCKS; KEY BOXES OF METAL, IN CLASS 6 (U.S. CLS. 2, 12, 13, 14, 23, 25 AND 50).

FOR: SOFTWARE FOR CHECKING ACCESS FOR ELECTRONIC LOCKS AND LOCK CYLINDERS; ELECTRONIC KEY CARDS; ELECTRONIC ENCODED SWIPE CARDS AND BADGES FOR USE IN MONITORING ACCESS; SOFTWARE FOR MANAGING ACCESS TO BUILDINGS, VEHICLES, HOTEL ROOMS AND SAFE ROOMS; ELECTRONICALLY ENCODED SWIPE CARD READING DEVICES FOR USE IN MONITORING BUILDING ACCESS; COMPUTER SOFTWARE FOR ENCRYPTION; ELECTRONIC ENCRYPTION UNITS; ELECTRONIC MASTER KEY CARDS; ELECTRONIC SYSTEMS, NAMELY, FOR ORGANIZING ACCESS WITH MASTER KEYS OR PARTIAL PRIVILEGES, NAMELY, COMPUTER SOFTWARE; ELECTRONIC LOCKS, ELECTRONIC LOCK ASSEMBLIES; ELECTRONIC SAFES, ALL OF THE ABOVE FOR PROVIDING ACCESS TO HOTEL ROOMS AND OTHER LODGING ACCOMMODATIONS, OFFICE BUILDINGS, APARTMENTS BUILDINGS, RESIDENTIAL FACILITIES, UNIVERSITIES, CARS, CRUISE SHIPS AND SECURITY SYSTEMS, NONE OF THE ABOVE FOR USE IN METERING AND UTILITY SOFTWARE OR HARDWARE, IN CLASS 9 (U.S. CLS. 21, 23, 26, 36 AND 38).

FOR: TELECOMMUNICATIONS SERVICES BY MOBILE PHONES, NAMELY, WIRELESS ELECTRONIC TRANSMISSION OF DATA AND AUDIO WIRELESS TRANSMISSION OF COMMUNICATIONS AND DATA FEATURING ENCRYPTION, DECRYPTION AND CREDENTIAL AUTHENTICATION AND DELIVERY; ENCRYPTED ELECTRONIC TRANSMISSION AND DELIVERY OF CREDENTIAL AND SECURITY INFORMATION, ALL TRANSMITTED BY MOBILE PHONES, ALL OF THE ABOVE FOR PROVIDING ACCESS TO HOTEL ROOMS AND OTHER LODGING ACCOMMODATIONS, OFFICE BUILDINGS, APARTMENTS



*David J. Kyjars*

Director of the United States Patent and Trademark Office

**Reg. No. 4,273,781** BUILDINGS, RESIDENTIAL FACILITIES, UNIVERSITIES, CARS, CRUISE SHIPS AND SECURITY SYSTEMS, NONE OF THE ABOVE FOR USE IN METERING AND UTILITY SOFTWARE OR HARDWARE, IN CLASS 38 (U.S. CLS. 100, 101 AND 104).

THE MARK CONSISTS OF STANDARD CHARACTERS WITHOUT CLAIM TO ANY PARTICULAR FONT, STYLE, SIZE, OR COLOR.

PRIORITY DATE OF 6-11-2009 IS CLAIMED.

OWNER OF INTERNATIONAL REGISTRATION 1036632 DATED 12-11-2009, EXPIRES 12-11-2019.

SER. NO. 79-081,826, FILED 12-11-2009.

ANDREA HACK, EXAMINING ATTORNEY

# United States of America

United States Patent and Trademark Office



**Reg. No. 4,273,782**

**Registered Jan. 15, 2013**

**Int. Cls.: 25, 28 and 41**

**TRADEMARK**

**SERVICE MARK**

**PRINCIPAL REGISTER**

LAWRENCE GRIMM (SWITZERLAND INDIVIDUAL)  
BURGSTRASSE 15  
CH-8037 ZÜRICH  
SWITZERLAND

FOR: CLOTHING, NAMELY, SHIRTS, PANTS, DRESSES; FOOTWEAR; HEADGEAR, NAMELY, HATS, CAPS, IN CLASS 25 (U.S. CLS. 22 AND 39).

FOR: GAMES, NAMELY, BOARD GAMES; TOYS, NAMELY, BATH TOYS; GYMNAS TIC AND SPORTING ARTICLES NOT INCLUDED IN OTHER CLASSES, NAMELY, GYMNAS TIC APPARATUS, BALLS FOR SPORTS; DECORATIONS FOR CHRISTMAS TREES; PLAYING CARDS, IN CLASS 28 (U.S. CLS. 22, 23, 38 AND 50).

FOR: EDUCATION SERVICES, NAMELY, CONDUCTING CLASSES, SEMINARS, WORKSHOPS IN THE FIELD OF ART; PROVIDING OF TRAINING IN THE FIELD OF ART; CONDUCTING ENTERTAINMENT EXHIBITIONS IN THE NATURE OF ART FESTIVALS; ORGANIZING AND ARRANGING EXHIBITIONS FOR ENTERTAINMENT PURPOSES, IN CLASS 41 (U.S. CLS. 100, 101 AND 107).

NO CLAIM IS MADE TO THE EXCLUSIVE RIGHT TO USE "TEA TIME FOR A UNIVERSE", APART FROM THE MARK AS SHOWN.

PRIORITY DATE OF 12-3-2009 IS CLAIMED.

OWNER OF INTERNATIONAL REGISTRATION 1036677 DATED 3-24-2010, EXPIRES 3-24-2020.

THE MARK CONSISTS OF THE BLACK WORDING "TEA TIME FOR A UNIVERSE" AROUND A DESIGN OF A BLACK MOON WITH CRATERS. THE COLOR WHITE REPRESENTS BACKGROUND, OUTLINING, SHADING, AND/OR TRANSPARENT AREAS AND IS NOT A PART OF THE MARK.

SER. NO. 79-081,843, FILED 3-24-2010.

SEAN CROWLEY, EXAMINING ATTORNEY



*David J. Kybas*

Director of the United States Patent and Trademark Office

# United States of America

United States Patent and Trademark Office

# AVIS

**Reg. No. 4,273,783**

**Registered Jan. 15, 2013**

**Int. Cls.: 35 and 36**

**SERVICE MARK**

**PRINCIPAL REGISTER**

TECHNIKUS AG (LIECHTENSTEIN STOCK COMPANY)  
AEULESTRASSE 5  
FL-9490 VADUZ  
LIECHTENSTEIN

FOR: ADVICE ON THE ORGANIZATION AND MANAGEMENT OF BUSINESSES; ACCOUNTING; ORGANIZATIONAL CONSULTING IN BUSINESS MATTERS; PREPARATION OF TAX RETURNS; BUSINESS ADVICE; HUMAN RESOURCES CONSULTANCY; ADVERTISING; BUSINESS ADMINISTRATION AND OFFICE WORK, IN CLASS 35 (U.S. CLS. 100, 101 AND 102).

FOR: RAISING CAPITAL FOR CHARITABLE FOUNDATIONS; BILL PAYMENT, IN CLASS 36 (U.S. CLS. 100, 101 AND 102).

THE MARK CONSISTS OF STANDARD CHARACTERS WITHOUT CLAIM TO ANY PARTICULAR FONT, STYLE, SIZE, OR COLOR.

PRIORITY DATE OF 2-4-2010 IS CLAIMED.

OWNER OF INTERNATIONAL REGISTRATION 1042972 DATED 4-26-2010, EXPIRES 4-26-2020.

THE ENGLISH TRANSLATION OF THE FOREIGN WORD(S) IN THE MARK IS: "NOTIFICATION".

SER. NO. 79-084,137, FILED 4-26-2010.

STEVEN R. FINE, EXAMINING ATTORNEY



*David J. Kybas*

Director of the United States Patent and Trademark Office



United States of America  
United States Patent and Trademark Office

**BIZZARRINI**

**Reg. No. 4,273,784**

**Registered Jan. 15, 2013**

**Int. Cls.: 12 and 25**

**TRADEMARK**

**PRINCIPAL REGISTER**

MOMBERGER'S BRANDNET GMBH (FED REP GERMANY LIMITED LIABILITY COMPANY)  
HAINER TRIFT 15  
63303 DREIEICH, FED REP GERMANY

FOR: LAND VEHICLES AND STRUCTURAL PARTS THEREOF, IN CLASS 12 (U.S. CLS. 19, 21, 23, 31, 35 AND 44).

FOR: CLOTHING, NAMELY, PANTS, SHIRTS AND JACKETS; FOOTWEAR; HEADGEAR, NAMELY, HATS AND CAPS, IN CLASS 25 (U.S. CLS. 22 AND 39).

THE MARK CONSISTS OF STANDARD CHARACTERS WITHOUT CLAIM TO ANY PARTICULAR FONT, STYLE, SIZE, OR COLOR.

PRIORITY DATE OF 1-22-2010 IS CLAIMED.

OWNER OF INTERNATIONAL REGISTRATION 1043639 DATED 5-21-2010, EXPIRES 5-21-2020.

THE WORDING "BIZZARRINI" HAS NO MEANING IN A FOREIGN LANGUAGE.

SER. NO. 79-084,441, FILED 5-21-2010.

ALLISON SCHRODY, EXAMINING ATTORNEY



*David J. Kyffers*

Director of the United States Patent and Trademark Office

# United States of America

United States Patent and Trademark Office

# DEXTERITE

**Reg. No. 4,273,785**

**Registered Jan. 15, 2013**

**Int. Cls.: 9 and 10**

**TRADEMARK**

**PRINCIPAL REGISTER**

DEXTERITE SURGICAL (FRANCE SOCIÉTÉ PAR ACTIONS SIMPLIFIÉE)  
53 RUE CARNOT  
F-74000 ANNECY, FRANCE

FOR: EQUIPMENT FOR CAMERA IMAGE PROCESSING FOR SURGICAL MANIPULATION, NAMELY, COMPUTERS; COMPUTER SOFTWARE FOR SURGICAL MANIPULATION SYSTEMS, NAMELY, OPERATING SOFTWARE FOR SURGICAL DEVICES, IN CLASS 9 (U.S. CLS. 21, 23, 26, 36 AND 38).

FOR: ARTICULATED AND MOTOR DRIVEN INSTRUMENTS FOR USE IN UROLOGY, GYNECOLOGY, VASCULAR, CARDIAC AND GASTROINTESTINAL LAPAROSCOPIC SURGERY; ARTIFICIAL LIMBS, EYES AND TEETH; ORTHOPAEDIC ARTICLES, NAMELY, ORTHOPEDIC BRACES; ROBOTIC SURGICAL APPARATUS AND INSTRUMENTS, NAMELY, SURGICAL ARTICULATED AND MOTOR DRIVEN INSTRUMENTS; COMPUTERIZED APPARATUS AND INSTRUMENTS FOR SURGICAL MANIPULATION, NAMELY, SURGICAL ARTICULATED AND MOTOR DRIVEN INSTRUMENTS; ARTICULATED AND MOTOR DRIVEN ARMS FOR SURGICAL MANIPULATION; ELECTRICAL SURGICAL APPARATUS AND INSTRUMENTS, NAMELY, SURGICAL ARTICULATED AND MOTOR DRIVEN INSTRUMENTS; JOINTED AND MOTORISED SURGICAL APPARATUS AND INSTRUMENTS FOR ENDOSCOPIC AND LAPROSCOPIC SURGERY, IN CLASS 10 (U.S. CLS. 26, 39 AND 44).

THE MARK CONSISTS OF STANDARD CHARACTERS WITHOUT CLAIM TO ANY PARTICULAR FONT, STYLE, SIZE, OR COLOR.

PRIORITY DATE OF 2-16-2010 IS CLAIMED.

OWNER OF INTERNATIONAL REGISTRATION 1049384 DATED 8-13-2010, EXPIRES 8-13-2020.

THE ENGLISH TRANSLATION OF THE FOREIGN WORD(S) IN THE MARK IS: "DEXTERITY".

SER. NO. 79-086,708, FILED 8-13-2010.

SEAN CROWLEY, EXAMINING ATTORNEY



*David J. Kyffers*

Director of the United States Patent and Trademark Office

# United States of America

United States Patent and Trademark Office

# Blue4Green

**Reg. No. 4,273,786**

**Registered Jan. 15, 2013**

**Int. Cls.: 9, 10 and 42**

**TRADEMARK**

**SERVICE MARK**

**PRINCIPAL REGISTER**

BLUE4GREEN B.V. (NETHERLANDS LIMITED LIABILITY COMPANY)  
DRIENERLOLAAN 5 HOGEKAMP 9234  
NL-7522 NB ENSCHEDE  
NETHERLANDS

FOR: SCIENTIFIC, NAUTICAL, SURVEYING, PHOTOGRAPHIC, CINEMATOGRAPHIC, OPTICAL, WEIGHING, MEASURING, SIGNALING, CHECKING/SUPERVISION, LIFE-SAVING AND TEACHING APPARATUS AND INSTRUMENTS, NAMELY, PERSONAL DATA ASSISTANTS (PDA) AND LAB-ON-A-CHIP (LOC), NAMELY, ANALYZERS FOR LABORATORY ANALYSIS AND PLATES FOR CONTAINING OR HOLDING DEVICES THAT INTEGRATE MULTIPLE LABORATORY FUNCTIONS IN CHIP FORMAT; APPARATUS FOR RECORDING, TRANSMISSION OR REPRODUCTION OF SOUND OR IMAGES; BLANK MAGNETIC DATA CARRIERS, BLANK RECORDING DISCS; AUTOMATIC VENDING MACHINES AND MECHANISMS FOR COIN-OPERATED APPARATUS; CASH REGISTERS, CALCULATING MACHINES, DATA PROCESSING EQUIPMENT AND COMPUTERS; FIRE-EXTINGUISHING APPARATUS, IN CLASS 9 (U.S. CLS. 21, 23, 26, 36 AND 38).

FOR: ARTIFICIAL LIMBS, EYES AND TEETH; SUTURE MATERIALS, IN CLASS 10 (U.S. CLS. 26, 39 AND 44).

FOR: SCIENTIFIC AND TECHNOLOGICAL SERVICES, NAMELY, SCIENTIFIC RESEARCH, ANALYSIS, DESIGN AND AT POINT OF CARE TESTING IN THE FIELD OF HUMAN AND ANIMAL HEALTHCARE AND RESEARCH AND DESIGN RELATING THERETO; DESIGN AND DEVELOPMENT OF COMPUTER HARDWARE AND SOFTWARE, IN CLASS 42 (U.S. CLS. 100 AND 101).

THE MARK CONSISTS OF STANDARD CHARACTERS WITHOUT CLAIM TO ANY PARTICULAR FONT, STYLE, SIZE, OR COLOR.

PRIORITY DATE OF 9-20-2010 IS CLAIMED.

OWNER OF INTERNATIONAL REGISTRATION 1061283 DATED 10-22-2010, EXPIRES 10-22-2020.

SER. NO. 79-091,127, FILED 10-22-2010.



*David J. Kyffers*

Director of the United States Patent and Trademark Office

**Reg. No. 4,273,786** ALICIA COLLINS, EXAMINING ATTORNEY

# United States of America

United States Patent and Trademark Office

# SOBATERIA

**Reg. No. 4,273,787**

**Registered Jan. 15, 2013**

**Int. Cls.: 30, 35 and 43**

**TRADEMARK**

**SERVICE MARK**

**PRINCIPAL REGISTER**

SOBATERIA, INC. (JAPAN CORPORATION)  
16-2, DAIKANYAMACHO  
SHIBUYA-KU  
TOKYO, JAPAN 1500034

FOR: CEREAL PREPARATIONS, NAMELY, PROCESSED CEREALS, READY-TO-EAT CEREALS; SEASONING SOY SAUCE, WORCESTERSHIRE SAUCE, MEAT GRAVIES, KETCHUP, SOY SAUCE, VINEGAR, VINEGAR MIXES, SALAD DRESSINGS, WHITE SAUCE, MAYONNAISE, SAUCES FOR BARBECUED MEAT, IN CLASS 30 (U.S. CL. 46).

FOR: BUSINESS MANAGEMENT ANALYSIS, BUSINESS MANAGEMENT GUIDANCE, BUSINESS MANAGEMENT ADMINISTRATION AND BUSINESS MANAGEMENT CONSULTANCY BASED ON FRANCHISE SYSTEM, AND PROVIDING INFORMATION THEREON; MARKETING RESEARCH; PROVIDING INFORMATION ON COMMERCIAL SALES; ADVERTISING AND PUBLICITY SERVICES; RETAIL STORE SERVICES AND WHOLESALE STORE SERVICES FEATURING FOODS AND BEVERAGES; RETAIL STORE SERVICES AND WHOLESALE STORE SERVICES FEATURING LIQUOR; RETAIL STORE SERVICES AND WHOLESALE STORE SERVICES FEATURING MEAT; RETAIL STORE SERVICES AND WHOLESALE STORE SERVICES FEATURING SEA FOOD; RETAIL STORE SERVICES AND WHOLESALE STORE SERVICES FEATURING VEGETABLES AND FRUITS; RETAIL STORE SERVICES AND WHOLESALE STORE SERVICES FEATURING CONFECTIONERY, BREAD AND BUNS; RETAIL STORE SERVICES AND WHOLESALE STORE SERVICES FEATURING RICE AND CEREALS; RETAIL STORE SERVICES AND WHOLESALE STORE SERVICES FEATURING MILK; RETAIL STORE SERVICES AND WHOLESALE STORE SERVICES FEATURING CARBONATED DRINKS AND NON-ALCOHOLIC FRUIT JUICE BEVERAGES; RETAIL STORE SERVICES AND WHOLESALE STORE SERVICES FEATURING TEA, COFFEE AND COCOA; RETAIL STORE SERVICES AND WHOLESALE STORE SERVICES FEATURING PROCESSED FOOD, IN CLASS 35 (U.S. CLS. 100, 101 AND 102).

FOR: PROVIDING FOOD AND BEVERAGES, IN CLASS 43 (U.S. CLS. 100 AND 101).

THE MARK CONSISTS OF THE WORDING "SOBATERIA" WITH THE LETTER "O" FEATURING A STYLIZED FLOWER IN THE CENTER OF THE LETTER "O".

PRIORITY DATE OF 6-18-2010 IS CLAIMED.



*David J. Kyros*

Director of the United States Patent and Trademark Office

**Reg. No. 4,273,787** OWNER OF INTERNATIONAL REGISTRATION 1068662 DATED 12-15-2010, EXPIRES 12-15-2020.

THE WORDING "SOBATERIA" HAS NO MEANING IN A FOREIGN LANGUAGE.

SER. NO. 79-094,151, FILED 12-15-2010.

KELLY TRUSILO, EXAMINING ATTORNEY

United States of America  
United States Patent and Trademark Office

**MAGNANNI**

**Reg. No. 4,273,788**

**Registered Jan. 15, 2013**

**Int. Cls.: 18 and 35**

**TRADEMARK**

**SERVICE MARK**

**PRINCIPAL REGISTER**

BLANCO MARTINEZ,PASCUAL (SPAIN INDIVIDUAL)  
PIO BAROJA, 1-7°  
E-02640 ALMANSA (ALBACETE), SPAIN

FOR: LEATHER AND IMITATION LEATHER; HANDBAGS, CLUTCH PURSES, BRIEFCASES, WALLETS, MONEY PURSES; TRUNKS AND TRAVELLING SUITCASES; BAGS, NAMELY, BACKPACKS, BOOK BAGS, SPORTS BAGS, TRAVELING BAGS AND BUM BAGS; LEATHER LINING FOR FOOTWEAR; LEATHER LACES; LEATHER STRAPS; LEATHER FITTED COVERS FOR HANDBAGS, IN CLASS 18 (U.S. CLS. 1, 2, 3, 22 AND 41).

FOR: ON-LINE RETAIL AND WHOLESALE STORE SERVICES FEATURING FOOTWEAR, LEATHERWARE, AND CLOTHING; AUCTION SERVICES; ADVICE IN THE RUNNING OF ESTABLISHMENTS AS FRANCHISES; ADVERTISING SERVICES RELATING TO ALL TYPES OF FOOTWEAR, AND THE ACCESSORIES AND FITTINGS THEREOF, LEATHERWARE, CLOTHING, IN CLASS 35 (U.S. CLS. 100, 101 AND 102).

THE MARK CONSISTS OF STANDARD CHARACTERS WITHOUT CLAIM TO ANY PARTICULAR FONT, STYLE, SIZE, OR COLOR.

OWNER OF INTERNATIONAL REGISTRATION 1028352 DATED 10-19-2009, EXPIRES 10-19-2019.

THE WORD(S) "MAGNANNI" HAS NO MEANING IN A FOREIGN LANGUAGE.

SER. NO. 79-095,634, FILED 2-15-2011.

PAM WILLIS, EXAMINING ATTORNEY



*David J. Kyffers*

Director of the United States Patent and Trademark Office

# United States of America

United States Patent and Trademark Office

# Ravenwood

**Reg. No. 4,273,789**

**Registered Jan. 15, 2013**

**Int. Cls.: 7 and 16**

**TRADEMARK**

**PRINCIPAL REGISTER**

RAVENWOOD PACKAGING LTD (UNITED KINGDOM PRIVATE LIMITED COMPANY)  
UNIT 1, BRUNEL BUSINESS COURT  
EASTERN WAY  
BURY ST EDMUNDS, UNITED KINGDOM IP32 7AB

FOR: MACHINES FOR THE MANUFACTURE OF PACKAGING MATERIAL; MACHINES FOR PRINTING LABELS FOR COMMERCIAL OR INDUSTRIAL USE; MACHINES FOR THE MANUFACTURE OF LINER-LESS, ADHESIVE BACKED LABELS; LABEL APPLICATORS, NAMELY, AUTOMATIC INDUSTRIAL LABELING MACHINES FOR APPLYING ADHESIVE LABELS TO PACKAGING, CONTAINERS AND BOTTLES, IN CLASS 7 (U.S. CLS. 13, 19, 21, 23, 31, 34 AND 35).

FOR: NON-TEXTILE ADHESIVE LABELS, IN CLASS 16 (U.S. CLS. 2, 5, 22, 23, 29, 37, 38 AND 50).

THE MARK CONSISTS OF STANDARD CHARACTERS WITHOUT CLAIM TO ANY PARTICULAR FONT, STYLE, SIZE, OR COLOR.

PRIORITY DATE OF 5-24-2010 IS CLAIMED.

OWNER OF INTERNATIONAL REGISTRATION 1073277 DATED 11-23-2010, EXPIRES 11-23-2020.

SER. NO. 79-095,855, FILED 11-23-2010.

ANDREW LEASER, EXAMINING ATTORNEY



*David J. Kyffers*

Director of the United States Patent and Trademark Office



# United States of America

United States Patent and Trademark Office



**Reg. No. 4,273,790**

**Registered Jan. 15, 2013**

**Int. Cls.: 7, 9, 12 and 28**

**TRADEMARK**

**PRINCIPAL REGISTER**

MARATHON ROBOTICS PTY LTD (AUSTRALIA CORPORATION)  
NATIONAL INNOVATION CENTRE  
4 CORNWALLIS STREET; EVELEIGH NSW 2015  
AUSTRALIA

FOR: MOBILE INDUSTRIAL ROBOTS; MACHINE COUPLINGS AND TRANSMISSION COMPONENTS EXCEPT FOR LAND VEHICLES, AND PARTS THEREFOR; TRANSMISSIONS FOR MACHINES; MACHINE WHEELS; WHEELS BEING PARTS OF MACHINES; REPLACEMENT PARTS FOR THE AFOREMENTIONED GOODS EXCLUDING CONVEYOR BELTS AND WATER HEATERS; AND ACCESSORIES FOR THE AFOREMENTIONED GOODS, NAMELY, TORSO PLATES FOR INDUSTRIAL MOBILE ROBOTS, BUT EXCLUDING CONVEYOR BELTS AND WATER HEATERS, IN CLASS 7 (U.S. CLS. 13, 19, 21, 23, 31, 34 AND 35).

FOR: COMPUTER HARDWARE AND SOFTWARE FOR USE IN CONNECTION WITH THE CONTROL AND OPERATION OF ROBOTS AND AUTOMATIC MACHINES; ELECTRONIC CONTROLS FOR MOTORS; REMOTE CONTROL APPARATUS AND EQUIPMENT, NAMELY, ELECTRICAL CONTROLS FOR ROBOTS; TIMERS; ELECTRONIC SENSORS FOR SENSING LIGHT, SOUND, PRESSURE, CHEMICALS, RADIATION, MOVEMENT, VIBRATION, WATER AND CURRENT; PHOTOGRAPHIC EQUIPMENT, NAMELY, CAMERAS; ULTRASONIC SENSORS; ULTRASONIC EQUIPMENT, NAMELY, ULTRASONIC OBJECT DETECTORS FOR USE ON VEHICLES; GLOBAL POSITIONING SYSTEMS; SPEECH PROCESSORS AND SYNTHESIZERS BEING COMPUTER SOFTWARE; MODEMS; AND REPLACEMENT PARTS FOR THE AFORESAID GOODS, IN CLASS 9 (U.S. CLS. 21, 23, 26, 36 AND 38).

FOR: VEHICLES, NAMELY, ROBOTS CAPABLE OF LOCOMOTION IN THE NATURE OF ROBOTIC TRANSPORT VEHICLES, ALL-TERRAIN VEHICLES (ATVS) AND ARMORED VEHICLES; ROBOTIC TRANSPORT VEHICLES, NAMELY, ALL-TERRAIN, SELF-PROPELLED TRACKED CARRIERS; AMPHIBIOUS VEHICLES; AUTOMATIC GUIDED VEHICLES; ROBOTIC TRANSPORT VEHICLES; APPARATUS FOR LOCOMOTION, NAMELY, WHEELED AND TRACKED LAND VEHICLES; REMOTE CONTROLLED TRANSPORT VEHICLES, NAMELY, REMOTE CONTROLLED ROBOTIC TRANSPORT VEHICLES; REMOTE CONTROLLED TRANSPORT VEHICLES, NAMELY, REMOTE CONTROLLED ALL-TERRAIN VEHICLES, SELF-PROPELLED TRACKED CARRIERS; AMPHIBIOUS VEHICLES AND ROBOTIC TRANSPORT VEHICLES; ARMOR PLATES AND ARMOR STRUCTURES FOR VEHICLES; WHEEL HUBS FOR VEHICLES AND REPLACEMENT PARTS FOR THE AFORESAID GOODS, IN CLASS 12 (U.S. CLS. 13, 19, 21, 23, 31, 34 AND 35).



*David J. Kybas*

Director of the United States Patent and Trademark Office

**Reg. No. 4,273,790** MENT PARTS FOR THE AFORESAID GOODS, IN CLASS 12 (U.S. CLS. 19, 21, 23, 31, 35 AND 44).

FOR: TARGETS FOR MILITARY USE INCLUDING ELECTRONIC TARGETS, ROBOTIC TARGETS AND SMART TARGETS; TARGET MANNEQUINS, IN CLASS 28 (U.S. CLS. 22, 23, 38 AND 50).

THE MARK CONSISTS OF A HIGHLY STYLIZED LETTER "M" APPEARING ABOVE THE WORD "MARATHON" IN STYLIZED LETTERING.

PRIORITY DATE OF 7-29-2010 IS CLAIMED.

OWNER OF INTERNATIONAL REGISTRATION 1074153 DATED 1-21-2011, EXPIRES 1-21-2021.

SER. NO. 79-096,267, FILED 1-21-2011.

ELLEN BURNS, EXAMINING ATTORNEY

# United States of America

United States Patent and Trademark Office

nk

**Reg. No. 4,273,791**

**Registered Jan. 15, 2013**

**Int. Cl.: 6**

**TRADEMARK**

**PRINCIPAL REGISTER**

NOKEN DESIGN, S.A. (SPAIN SOCIEDAD ANÓNIMA)  
CTRA. VILLARREAL-PUEBLA DE ARENOSO (CV-20  
KM-2  
E-12540 VILLARREAL (CASTELLÓN), SPAIN

FOR: BUILDING MATERIALS OF METAL, NAMELY, TUBES OF METAL FOR WATER-PIPES, MANUALLY OPERATED WATER-PIPE VALVES OF METAL, FLOOR TILES AND PAVING BLOCKS OF METAL, BATH CUBICLES OF METAL, IN CLASS 6 (U.S. CLS. 2, 12, 13, 14, 23, 25 AND 50).

OWNER OF INTERNATIONAL REGISTRATION 1074398 DATED 3-29-2011, EXPIRES 3-29-2021.

SER. NO. 79-096,382, FILED 3-29-2011.

GILBERT SWIFT, EXAMINING ATTORNEY



*David J. Kyffers*

Director of the United States Patent and Trademark Office

# United States of America

United States Patent and Trademark Office

# REHA VIBRA

**Reg. No. 4,273,792**

**Registered Jan. 15, 2013**

**Int. Cls.: 10 and 28**

**TRADEMARK**

**PRINCIPAL REGISTER**

LANNY, MICHAEL (FED REP GERMANY INDIVIDUAL)  
HÖFNER STRASSE 20  
SCHÖMBERG, FED REP GERMANY 75328

FOR: BANDAGES, PADDINGS, COMPRESSES FOR ORTHOPAEDIC PURPOSES; INSTRUMENTS AND APPARATUS FOR MASSAGE, ACUPUNCTURE, ACUPRESSURE; PHYSICAL TRAINING APPARATUS FOR MEDICAL, DIAGNOSTIC OR THERAPEUTIC PURPOSES, NAMELY, TREADMILL APPARATUS, OSCILLATING MACHINES FOR PHYSICAL TRAINING FOR MEDICAL PURPOSES, MEDICAL DIAGNOSTIC APPARATUS, NAMELY, DIAGNOSTIC APPARATUS FOR DETECTING DISORDERS OF THE LOCOMOTOR SYSTEM, MEDICAL THERAPEUTIC APPARATUS, NAMELY, APPARATUS FOR TREATING THE LOCOMOTOR SYSTEM; MEDICAL TESTING APPARATUS, NAMELY, APPARATUS FOR TESTING THE LOCOMOTOR SYSTEM; ANALYZERS, NAMELY, MEDICAL APPARATUS FOR ANALYZING THE LOCOMOTOR SYSTEM; MEDICAL EVALUATION APPARATUS, NAMELY, APPARATUS FOR EVALUATING THE LOCOMOTOR SYSTEM, MEDICAL MEASURING APPARATUS, NAMELY, APPARATUS FOR MEASURING PARAMETERS OF THE LOCOMOTOR SYSTEM AND FOR THE RECORDING AND ANALYSIS OF MOVEMENT SEQUENCES, MEDICAL APPARATUS FOR THE RECORDING AND ANALYSIS OF STATIC OR DYNAMIC LOAD PROFILES OF THE LOCOMOTOR SYSTEM; DEVICES AND APPARATUS, NAMELY, TREADMILL FOR TREATING DISORDERS OF THE LOCOMOTOR SYSTEM, IN PARTICULAR DAMAGE TO THE COFFIN JOINT AND TENDON DAMAGE, AND FOR STIMULATING THE LOCOMOTOR SYSTEM; DEVICES AND APPARATUS FOR CONDUCTING REHABILITATION TREATMENTS, NAMELY, REHABILITATION APPARATUS FOR MEDICAL PURPOSES; THE AFORESAID GOODS IN PARTICULAR FOR HORSES; MECHANICAL TRAINING APPARATUS, NAMELY, TREADMILL APPARATUS AND MEDICAL TREATMENT APPARATUS FOR STIMULATING AND PRODUCING EXCITATIONS FOR THE LOCOMOTOR SYSTEM FOR HUMAN BEINGS AND ANIMALS, IN PARTICULAR, HORSES, ALL THE AFOREMENTIONED APPARATUS FOR MEDICAL PURPOSES, IN CLASS 10 (U.S. CLS. 26, 39 AND 44).



*David J. Kyjars*

Director of the United States Patent and Trademark Office

FOR: SPORTING APPARATUS, NAMELY, APPARATUS FOR TRAINING THE LOCOMOTOR SYSTEM, NAMELY, FOR STIMULATING AND PRODUCING EXCITATIONS; APPARATUS FOR GYMNASTIC AND SPORTING PURPOSES, NAMELY, EXERCISE TREADMILL; DEVICES AND APPARATUS FOR STIMULATING AND TRAINING THE LOCOMOTOR SYSTEM OF LIVING CREATURES, NAMELY, TREADMILL AND MECHANICAL OSCILLATING EXERCISE MACHINES; MECHANICAL TRAINING APPARATUS, NAMELY, TREADMILL APPARATUS AND TREATMENT APPARATUS FOR HUMAN BEINGS AND

**Reg. No. 4,273,792** ANIMALS, IN PARTICULAR, HORSES, NAMELY, TREADMILL AND MECHANICAL OSCILLATING EXERCISE MACHINES; ALL THE AFOREMENTIONED APPARATUS FOR USE IN HUMAN AND ANIMAL EXERCISE, IN PARTICULAR FOR HORSES; MECHANICAL PHYSICAL TRAINING APPARATUS, NAMELY, TREADMILL APPARATUS AND TREADMILL AND MECHANICAL OSCILLATING EXERCISE MACHINES FOR NON-MEDICAL PURPOSES, IN CLASS 28 (U.S. CLS. 22, 23, 38 AND 50).

THE MARK CONSISTS OF STANDARD CHARACTERS WITHOUT CLAIM TO ANY PARTICULAR FONT, STYLE, SIZE, OR COLOR.

OWNER OF INTERNATIONAL REGISTRATION 1075851 DATED 11-12-2010, EXPIRES 11-12-2020.

NO CLAIM IS MADE TO THE EXCLUSIVE RIGHT TO USE "REHA", APART FROM THE MARK AS SHOWN.

SER. NO. 79-096,920, FILED 11-12-2010.

ALICE BENMAMAN, EXAMINING ATTORNEY

# United States of America

United States Patent and Trademark Office



**Reg. No. 4,273,793**

**Registered Jan. 15, 2013**

**Int. Cl.: 41**

**SERVICE MARK**

**PRINCIPAL REGISTER**

FLAMES & FORTUNE LIMITED (UNITED KINGDOM CORPORATION)  
5 BURGH STREET  
LONDON N1 8HF  
UNITED KINGDOM

FOR: ADVISORY SERVICES RELATING TO LIVE ENTERTAINMENT, ARRANGING AND CONDUCTING OF CONCERTS, ARRANGING AND ORGANIZING MUSIC AND DANCE FESTIVALS, ARRANGING AND PRODUCING LIVE AND RECORDED MUSICAL PERFORMANCES, ARRANGING OF VISUAL ENTERTAINMENT, IN THE NATURE OF CABARET SERVICES AND CIRCUS PRODUCTIONS, PROVIDING CLUB CABARET SERVICES AND DISCOTHEQUE SERVICES, PROVIDING MUSIC AND DISCO ENTERTAINMENT SERVICES, ENTERTAINMENT BOOKING AGENCY SERVICES, ENTERTAINMENT IN THE NATURE OF LIVE MUSICAL CONCERTS, ENTERTAINMENT SERVICES IN THE NATURE OF PROVIDING TELEVISION PROGRAMS IN THE FIELD OF MUSIC AND BINGO, ENTERTAINMENT SERVICES IN THE NATURE OF PRODUCING LIVE THEATRE PRODUCTIONS AND LIVE MUSICAL PERFORMANCES; ENTERTAINMENT SERVICES IN THE FORM OF RECORDED MUSIC PRESENTED TO MOBILE COMMUNICATIONS DEVICES VIA A GLOBAL COMPUTER NETWORK AND WIRELESS NETWORKS; ENTERTAINMENT SERVICES IN THE NATURE OF PRODUCTION AND DISTRIBUTION OF MOTION PICTURES FOR THEATRICAL OR TELEVISION EXHIBITION; ENTERTAINMENT SERVICES FEATURING LIVE MUSIC AND VOCAL PERFORMANCES; ENTERTAINMENT SERVICES FEATURING MUSIC AND DANCE AT DISCOTHEQUES AND HOTELS; ENTERTAINMENT SERVICES IN THE NATURE OF MUSIC FOR RADIO PROGRAMS; MUSICAL ENTERTAINMENT SERVICES FEATURING LIVE PERFORMANCES BY A MUSICAL GROUP, ORGANIZATION OF ENTERTAINMENT FOR NIGHT CLUBS AND SOCIAL EVENTS IN THE NATURE OF WEDDINGS AND BIRTHDAY PARTIES, ENTERTAINMENT IN THE NATURE OF PARTY PLANNING SERVICES; ENTERTAINMENT SERVICES IN THE NATURE OF PRODUCTION OF RADIO AND TELEVISION PROGRAMS, IN CLASS 41 (U.S. CLS. 100, 101 AND 107).



NO CLAIM IS MADE TO THE EXCLUSIVE RIGHT TO USE "BINGO CLUB", APART FROM THE MARK AS SHOWN.

*David J. Kyffers*

OWNER OF INTERNATIONAL REGISTRATION 1077123 DATED 10-28-2010, EXPIRES 10-28-2020.

**Reg. No. 4,273,793** THE MARK CONSISTS OF THE WORDS "THE UNDERGROUND REBEL BINGO CLUB" ON A SHIELD DESIGN WITH A BANNER ACROSS IT, WITH STARS ABOVE THE SHIELD, CIRCLE DESIGNS ON THE SIDE OF THE SHIELD AND DRIPS FALLING FROM THE BOTTOM OF THE SHIELD.

SER. NO. 79-097,380, FILED 10-28-2010.

JANICE L. MCMORROW, EXAMINING ATTORNEY

# United States of America

United States Patent and Trademark Office

# CALEXOR

**Reg. No. 4,273,794**

**Registered Jan. 15, 2013**

**Int. Cls.: 1 and 19**

**TRADEMARK**

**PRINCIPAL REGISTER**

"S.A. LHOIST RECHERCHE ET DEVELOPPEMENT" EN ABRÉGÉ "L.R.D.", SOCIÉTÉ ANONYME (BELGIUM JOINT STOCK COMPANY)  
RUE CHARLES DUBOIS 28  
B-1342 OTTIGNIES-LOUVAIN-LA-NEUVE  
BELGIUM

FOR: CHEMICALS FOR USE IN INDUSTRY; INDUSTRIAL CHEMICALS BASED ON CALCIUM CARBONATE, MAGNESIUM CARBONATE, DOLOMITE, CALCIUM OXIDE, MAGNESIUM OXIDE, DOLOMITIC LIME, CALCIUM HYDROXIDE, MAGNESIUM HYDROXIDE, HYDRATED DOLIME, MILK OF LIME AND/OR DOLIME, CALCIUM AND/OR MAGNESIUM SALTS AND MIXTURES OUT OF THE ABOVE MENTIONED MATERIALS; INDUSTRIAL CHEMICALS FOR METALLURGICAL PROCESSES WITH MINERAL AND/OR ARTIFICIAL AND/OR METALLIC ADDITIVES BASED ON THE ABOVE MENTIONED SUBSTANCES FOR SLAG FORMATION, CLEANING AND REFINING STEPS IN FERROUS AND NON-FERROUS METAL-PRODUCTION, IN CLASS 1 (U.S. CLS. 1, 5, 6, 10, 26 AND 46).

FOR: NON-METAL BUILDING MATERIALS IN FORM OF AGGREGATES-FRACTIONS, GRAIN-FRACTIONS, SAND-FRACTIONS, POWDERS AND SUSPENSIONS COMPOSED OF NON-AGRICULTURAL LIME FOR USE IN CONSTRUCTION OR BUILDING, HYDRATED LIME, LIMESTONE, NON-AGRICULTURAL DOLIME FOR USE IN CONSTRUCTION OR BUILDING, HYDRATED DOLIME AND MIXTURES OUT OF THE ABOVE MENTIONED MATERIALS; NON-AGRICULTURAL LIME FOR USE IN CONSTRUCTION OR BUILDING; LIMESTONE; NONAGRICULTURAL DOLIME FOR USE IN CONSTRUCTION OR BUILDING, IN CLASS 19 (U.S. CLS. 1, 12, 33 AND 50).

THE MARK CONSISTS OF STANDARD CHARACTERS WITHOUT CLAIM TO ANY PARTICULAR FONT, STYLE, SIZE, OR COLOR.

OWNER OF INTERNATIONAL REGISTRATION 1077424 DATED 4-1-2011, EXPIRES 4-1-2021.

THE WORDING "CALEXOR" HAS NO MEANING IN A FOREIGN LANGUAGE.

SER. NO. 79-097,487, FILED 4-1-2011.

TINA BROWN, EXAMINING ATTORNEY



*David J. Kyffers*

Director of the United States Patent and Trademark Office



# United States of America

United States Patent and Trademark Office

★ musée du quai Branly  
LÀ OÙ DIALOGUENT LES CULTURES

**Reg. No. 4,273,795**

**Registered Jan. 15, 2013**

**Int. Cls.: 9, 14, 16, 18, 20,  
21, 24, 25, 28, 35, 38, 40,  
41, 42 and 43**

**TRADEMARK**

**SERVICE MARK**

**PRINCIPAL REGISTER**

ETABLISSEMENT PUBLIC DU MUSEE DU QUAI BRANLY (FRANCE ETABLISSEMENT PUBLIC NATIONAL À CARACTÈRE ADMINISTRATIF)  
222 RUE DE L'UNIVERSITÉ  
F-75007 PARIS, FRANCE

FOR: APPARATUS FOR RECORDING, TRANSMITTING, REPRODUCING OR PROCESSING SOUND OR IMAGES RELATING TO ART; PRE-RECORDED MAGNETIC DATA CARRIERS FEATURING IMAGES OF ARTWORK; SOUND RECORDINGS FEATURING MUSEUM TOURS, MUSIC SHOWS, MUSICAL CONCERTS, BALLETS, ARCHIVAL INFORMATION, INTERVIEWS, DOCUMENTARIES, AND PERFORMING ARTS IN THE NATURE OF MUSIC; OPTICAL DISKS FEATURING IMAGES OF ARTWORK; BLANK FLOPPY DISKS FOR TEXT PROCESSING; AUTOMATIC VENDING MACHINES AND ELECTRONIC PAYMENT TERMINALS; CALCULATING MACHINES; DATA PROCESSING AND COMPUTER EQUIPMENT, NAMELY, COMPUTER SOFTWARE FOR CHECKING AND IMPROVING THE SOUND QUALITY OF COMPUTER HARDWARE; FIRE-EXTINGUISHING APPARATUS; GAMING SOFTWARE; COMPUTER SOFTWARE FOR TEXT PROCESSING; SPECTACLES; OPTICAL GOODS, NAMELY, CORRECTING LENSES FOR SPECTACLES, OPTICAL LENSES AND OPTICAL MIRRORS; SPECTACLE CASES; SAFETY TARPAULINS; CALCULATORS, IN CLASS 9 (U.S. CLS. 21, 23, 26, 36 AND 38).

FOR: JEWELRY; JEWELRY, NAMELY, TIEPINS, CUFF LINKS, EARRINGS, NECKLACES, WATCH BANDS, PENDANTS, BROOCHES, RINGS, MEDALLIONS; PRECIOUS STONES; HOROLOGICAL AND CHRONOMETRIC INSTRUMENTS; NON-MONETARY COINS; COMMEMORATIVE PLATES OF PRECIOUS METAL; WORKS OF ART OF PRECIOUS METAL, NAMELY, STATUETTES OF PRECIOUS METAL, SCULPTURES MADE OF PRECIOUS METAL, ORNAMENTS MADE OF PRECIOUS METAL AND STATUES OF PRECIOUS METAL; JEWELRY CASES; BOXES OF PRECIOUS METAL, NAMELY, JEWELRY BOXES MADE OF PRECIOUS METAL, DECORATIVE BOXES OF PRECIOUS METAL AND WATCH CASES MADE OF PRECIOUS METAL; CLOCK HOUSINGS, RUBBER OR SILICON WRISTBANDS IN THE NATURE OF A BRACELET, JEWELRY CHAINS, NAMELY, NECK CHAINS AND WATCH CHAINS, WATCH SPRINGS; WATCH GLASSES; NOVELTY KEY RINGS OF PRECIOUS METAL; STATUES OR FIGURINES OF PRECIOUS METALS; CASES OR PRESENTATION CASES FOR TIMEPIECES; MEDALS, IN CLASS 14 (U.S. CLS. 2, 27, 28 AND 50).



*David J. Kappas*

Director of the United States Patent and Trademark Office

FOR: BOOKBINDING ARTICLES, NAMELY, BOOKBINDING STRIPS AND STRING; PHOTOGRAPHS; STATIONERY ARTICLES, NAMELY, ADHESIVE SHEETS FOR STATIONERY

**Reg. No. 4,273,795** USE, ENVELOPES FOR STATIONERY USE, OFFICE STATIONERY, STATIONERY, STATIONERY BOXES, STATIONERY SETS COMPRISED OF STATIONERY, WRITING PADS, NOTEBOOKS, BOOKLETS IN THE FIELD OF ART, ART SPECTACLES, ENTERTAINMENT, EDUCATION, AND ART RESEARCH; DECALCOMANIAS; WRITING PAPER AND ENVELOPES, SLEEVE FOLDERS FOR DOCUMENTS, BINDERS AND DOCUMENT FILES FOR STATIONERY USE; ADHESIVES FOR STATIONERY OR HOUSEHOLD PURPOSES; ARTISTS' MATERIALS, NAMELY, PAINTBRUSHES, PASTELS, PENCILS, PEN NIBS, CANVASES, DRAWING CARDBOARD AND PAINTING SETS FOR CHILDREN; PAINTBRUSHES; OFFICE REQUISITES, EXCEPT FURNITURE, NAMELY, ADHESIVE TAPE DISPENSERS, CORRECTING FLUIDS FOR TYPEWRITERS, ENVELOPE SEALING MACHINES FOR OFFICE USE, MACHINES FOR FOLDING PAPER, ELASTIC BANDS FOR OFFICE USE AND STAPLERS; PAPER AND PRINTED TEACHING MATERIAL IN THE FIELD OF ART; PRINTING BLOCKS; PAPER; CARDBOARD; CARDBOARD OR PAPER BOXES; POSTERS; ALBUMS, NAMELY, SCRAPBOOK ALBUMS AND PHOTO ALBUMS; CARDS, NAMELY, CHRISTMAS CARDS, GREETING CARDS, POSTCARDS AND INVITATION CARDS; BOOKS RELATING TO ART; NEWSPAPERS; PROSPECTUSES RELATING TO ART; PAMPHLETS RELATING TO ART; CALENDARS; WRITING INSTRUMENTS; ENGRAVINGS OR LITHOGRAPHIC PRINTS; FRAMED OR UNFRAMED PAINTINGS; WATERCOLORS; SEWING PATTERNS; GRAPHIC PRINTS; DRAWING INSTRUMENTS; PAPER HANDKERCHIEFS; PAPER FACE TOWELS; PAPER TABLE LINEN; TOILET PAPER; DIAPERS OF PAPER OR CELLULOSE; BAGS AND SMALL BAGS OF PAPER OR PLASTIC FOR PACKAGING PURPOSES; GARBAGE BAGS OF PAPER OR PLASTIC, IN CLASS 16 (U.S. CLS. 2, 5, 22, 23, 29, 37, 38 AND 50).

FOR: LEATHER AND IMITATION LEATHER; ANIMAL SKINS, PELTS AND HIDES; TRUNKS AND SUITCASES; UMBRELLAS, PARASOLS AND WALKING STICKS; WHIPS, HARNESS AND SADDLERY; WALLETS; COIN WALLETS; HANDBAGS, BACKPACKS, WHEELED BAGS; ALL PURPOSE BAGS AND BACKPACKS FOR CLIMBERS AND CAMPERS, TRAVEL BAGS, BEACH BAGS, SCHOOL BAGS; UNFITTED VANITY CASES; COLLARS OR COVERS FOR ANIMALS; REUSABLE SHOPPING NETS OR BAGS; LEATHER BAGS FOR PACKAGING; SMALL LEATHER BAGS FOR PACKAGING, IN CLASS 18 (U.S. CLS. 1, 2, 3, 22 AND 41).

FOR: FURNITURE MIRRORS, FRAMES, NAMELY, MIRROR FRAMES, PAINTING FRAMES, BED FRAMES, EMBROIDERY FRAMES AND FURNITURE FRAMES; WORKS OF ART, NAMELY, FIGURINES, SCULPTURES, STATUES AND DECORATIVE CENTERPIECES MADE OF WOOD, WAX, PLASTER, CORK, REED, RUSH, WICKER, HORN, BONE, IVORY, WHALEBONE, SHELL, AMBER, MOTHER-OF-PEARL, PLASTIC AND MEERSCHAUM, AND SUBSTITUTES OF THESE MATERIALS; COAT HANGERS; CHESTS OF DRAWERS; CUSHIONS; SHELVING UNITS; PACKAGING CONTAINERS OF PLASTIC; ARMCHAIRS; SEATS; MATTRESSES; FUNERARY URNS; PLATE RACKS; WICKERWORK, NAMELY, FIGURINES OF WICKER; BOXES OF WOOD OR PLASTIC, IN CLASS 20 (U.S. CLS. 2, 13, 22, 25, 32 AND 50).

FOR: NON-ELECTRIC UTENSILS AND CONTAINERS FOR HOUSEHOLD OR KITCHEN USE, NAMELY, SPATULAS, GRATERS, SIEVES, PADDLES, GRILL COVERS, SERVING TRAYS OF WIRE AND WIRE MESH; COMBS AND SPONGES, NAMELY, SCRUBBING BRUSHES, BATH SPONGES AND CLEANING SPONGES; BRUSHES, EXCEPT PAINTBRUSHES, NAMELY, CAKE BRUSHES, CRUMB BRUSHES, DISHWASHING BRUSHES AND DUSTING BRUSHES; PORCELAIN WARE, NAMELY, PORCELAIN KNOBS, PORCELAIN GOBLETs, PORCELAIN BUSTS, PORCELAIN FIGURINES, PORCELAIN DECORATIONS, PORCELAIN STATUETTES; EARTHENWARE, NAMELY, PLATES, DISHES, FIGURINES, SCULPTURES, STATUES AND ORNAMENTS; BOTTLES SOLD EMPTY; ART OBJECTS MADE OF PORCELAIN OR GLASS, NAMELY, FIGURINES, SCULPTURES, STATUES AND ORNAMENTS; STATUES OR FIGURINES OF PORCELAIN OR GLASS; TOILETRY UTENSILS OR KITS, NAMELY, TOILET BRUSHES, TOILET BRUSH HOLDERS, SPONGES AND TOILET PAPER ROLL HOLDERS; GARBAGE CANS; DRINKING GLASSES; DISHWARE; INDOOR AQUARIA, IN CLASS 21 (U.S. CLS. 2, 13, 23, 29, 30, 33, 40 AND 50).

**Reg. No. 4,273,795** FOR: FABRICS, NAMELY, COTTON FABRIC, DENIM FABRIC, LINEN FABRIC, WOOL FABRIC, ORGANIC COTTON FABRIC; BED COVERS; TABLE COVERS OF TEXTILE OR PLASTIC; FABRICS FOR TEXTILE USE; ELASTIC FABRICS FOR CLOTHING; VELVET; BED LINEN; HOUSEHOLD LINEN; TABLE LINEN NOT OF PAPER; BATH LINEN, IN CLASS 24 (U.S. CLS. 42 AND 50).

FOR: CLOTHING, NAMELY, PULLOVERS, SHIRTS, T-SHIRTS, SUITS, JACKETS, UNDER-SHORTS, JEANS, COATS, HATS, SLING PUMPS, SKIRTS, DRESSES, SHORT-SLEEVED SHIRTS, SOCKS, SHOULDER WRAPS, BANDANAS, BONNETS, CAPS, SHAWLS, SASHES FOR WEAR, BATHING SUITS, WRAPS AND MUFFS; FOOTWEAR, HEADWEAR; LEATHER OR IMITATION LEATHER CLOTHING, NAMELY, COATS OF LEATHER OR IMITATION LEATHER, JACKETS OF LEATHER OR IMITATION LEATHER, STOLES OF LEATHER OR IMITATION LEATHER, UNDERSHORTS OF LEATHER OR IMITATION LEATHER AND CAPES OF LEATHER OR IMITATION LEATHER; BELTS; FURS, NAMELY, FUR COATS, FUR JACKETS, FUR STOLES, FUR CAPES, FUR HATS AND FUR MUFFS; GLOVES; SCARVES; NECKTIES; HOSIERY; SLIPPERS; BEACH, SKI OR SPORTS FOOTWEAR; DIAPERS OF TEXTILE; UNDERCLOTHING, IN CLASS 25 (U.S. CLS. 22 AND 39).

FOR: GAMES AND TOYS, NAMELY, SPORTS BALLS, CHECKERBOARDS, DOMINO SETS, DICE FOR GAMES, KALEIDOSCOPES, PUZZLES, BUILDING GAMES, CHECKERS, CHESS SETS, ARCADE-TYPE ELECTRONIC VIDEO GAMES, DICE GAMES, GO GAMES, KITES; DECORATIONS FOR CHRISTMAS TREES, EXCEPT LIGHTING ARTICLES; CHRISTMAS TREES OF SYNTHETIC MATERIAL; FISHING TACKLE; BALLS FOR GAMES OR PLAY; BILLIARD TABLES, CUES AND BALLS; CARD AND BOARD GAMES; ICE AND ROLLER SKATES; SCOOTERS; SURF BOARDS OR WINDSURFING BOARDS; RACKETS; SNOW-SHOES; SKIS, IN CLASS 28 (U.S. CLS. 22, 23, 38 AND 50).

FOR: ADVERTISING; BUSINESS MANAGEMENT; BUSINESS ADMINISTRATION; DISSEMINATION OF ADVERTISING MATERIALS, NAMELY, LEAFLETS, PROSPECTUSES, PRINTED MATTER, SAMPLES; ARRANGING OF NEWSPAPER SUBSCRIPTIONS FOR THIRD PARTIES; DOCUMENT REPRODUCTION; COMPUTER FILE MANAGEMENT; ARRANGING OF EXHIBITIONS FOR COMMERCIAL OR ADVERTISING PURPOSES; ON-LINE ADVERTISING VIA A COMPUTER NETWORK; RENTAL OF ADVERTISING TIME VIA ANY COMMUNICATIONS MEDIA; PUBLICATION OF ADVERTISING TEXTS; RENTAL OF ADVERTISING SPACE; DISSEMINATION OF ADVERTISING MATTER; PUBLIC RELATIONS, IN CLASS 35 (U.S. CLS. 100, 101 AND 102).

FOR: TELECOMMUNICATIONS SERVICES, NAMELY, TRANSMISSION OF WEBCASTS, WIRELESS TELEPHONE SERVICES; INFORMATION ABOUT TELECOMMUNICATIONS; COMMUNICATIONS VIA COMPUTER TERMINALS OR VIA FIBER-OPTIC NETWORKS; RADIO OR TELEPHONE COMMUNICATIONS; MOBILE RADIO-TELEPHONY SERVICES; PROVIDING USER ACCESS TO A GLOBAL COMPUTER NETWORK; ELECTRONIC BULLETIN BOARD SERVICES; PROVIDING TELECOMMUNICATIONS CONNECTIONS TO A GLOBAL COMPUTER NETWORK; RENTAL OF TELECOMMUNICATIONS EQUIPMENT; RADIO OR TELEVISION BROADCASTING; TELECONFERENCING SERVICES; ELECTRONIC MESSAGING SERVICES; RENTAL OF ACCESS TIME TO GLOBAL COMPUTER NETWORKS, IN CLASS 38 (U.S. CLS. 100, 101 AND 104).

FOR: SEWING; PRINTING; EMBROIDERING SERVICES; ENGRAVING SERVICES; GALVANIZING; GILDING SERVICES; TREATMENT OF TEXTILES, NAMELY, CREASE-RESISTANT TREATMENT FOR FABRICS, PERMANENT-PRESS TREATMENT FOR FABRICS, ANTI-MOLD TREATMENT FOR FABRICS; BOOKBINDING SERVICES; ART WORK FRAMING SERVICES; PHOTOGRAPHIC PRINTING; PHOTOGRAPHIC FILM DEVELOPMENT; SCREEN PRINTING; PHOTOENGRAVING SERVICES; GLASS BLOWING; TAXIDERMY, IN CLASS 40 (U.S. CLS. 100, 103 AND 106).

FOR: TEACHING, NAMELY, ARRANGING OF PROGRAMS, CLASSES, SEMINARS, CONFERENCES, WORKSHOPS IN THE FIELD OF ART AND DISSEMINATION OF COURSE

**Reg. No. 4,273,795** MATERIAL IN CONNECTION THEREWITH; ART TRAINING; ENTERTAINMENT RELATING TO THE FIELD OF ART, NAMELY, ART EXHIBITIONS; CULTURAL ACTIVITIES, NAMELY, ARRANGING OF LOCAL CULTURAL EVENTS; PROVIDING A WEB SITE FEATURING EDUCATIONAL AND ENTERTAINMENT INFORMATION IN THE FIELD OF ART; LEISURE SERVICES, NAMELY, MUSEUMS, EDUCATIONAL ACTIVITIES IN THE NATURE OF MUSEUM TOURS, AND SPECTACLES IN THE NATURE OF ART EXHIBITIONS; BOOK PUBLISHING; LENDING LIBRARIES; VIDEOTAPE FILM PRODUCTION; RENTAL OF MOTION PICTURE FILMS; RENTAL OF SOUND RECORDINGS; RENTAL OF SHOW SCENERY; VIDEOTAPE EDITING; PHOTOGRAPHY SERVICES; ARRANGING OF COMPETITIONS, NAMELY, ARRANGING OF WOODWORKING COMPETITIONS, ARRANGING OF ARTISTIC SKATING COMPETITIONS; ARRANGING AND CONDUCTING OF COLLOQUIUMS, CONFERENCES OR CONVENTIONS RELATING TO ART; ARRANGING OF EXHIBITIONS FOR CULTURAL OR EDUCATIONAL PURPOSES; BOOKING OF SEATS FOR SHOWS; PUBLICATION OF ELECTRONIC BOOKS AND JOURNALS ON-LINE, NAMELY, PUBLISHING OF BOOKS AND PERIODICALS FOR THIRD PARTIES RELATING TO ART; ELECTRONIC DESKTOP PUBLISHING, IN CLASS 41 (U.S. CLS. 100, 101 AND 107).

FOR: SCIENTIFIC AND TECHNICAL EVALUATIONS, ASSESSMENTS AND RESEARCH IN THE FIELD OF ENGINEERING, THE AFOREMENTIONED SERVICES CARRIED OUT BY ENGINEERS; DESIGN AND DEVELOPMENT OF COMPUTER HARDWARE AND SOFTWARE; RESEARCH AND DEVELOPMENT OF NEW PRODUCTS FOR THIRD PARTIES; ENGINEERING SERVICES, NAMELY, CONDUCTING TECHNICAL PROJECT STUDIES RELATING TO MULTIMEDIA AND INTERIOR DESIGN; ARCHITECTURE; INTERIOR DESIGN; DESIGN, DEVELOPMENT, INSTALLATION, MAINTENANCE, UPDATING OR RENTAL OF SOFTWARE; COMPUTER PROGRAMMING; COMPUTER CONSULTING; DATA CONVERSION OF COMPUTER PROGRAMS AND DATA, NOT PHYSICAL CONVERSION; CONVERSION OF DATA OR DOCUMENTS FROM PHYSICAL TO ELECTRONIC MEDIA; GRAPHIC ARTS DESIGN SERVICES; INTERIOR STYLING SERVICES; AUTHENTICATION OF WORKS OF ART, IN CLASS 42 (U.S. CLS. 100 AND 101).

FOR: PROVIDING OF FOOD AND DRINK, NAMELY, FAST-FOOD RESTAURANTS, SELF-SERVICE RESTAURANTS, CONTINUOUS OPERATION RESTAURANTS AND SNACK-BARS; PROVIDING TEMPORARY ACCOMMODATION; BAR SERVICES; CATERING SERVICES; HOTEL SERVICES; AGENCY SERVICES FOR THE RESERVATION OF TEMPORARY ACCOMMODATION, IN CLASS 43 (U.S. CLS. 100 AND 101).

OWNER OF U.S. REG. NOS. 3,286,510 AND 3,286,511.

OWNER OF INTERNATIONAL REGISTRATION 1079754 DATED 12-22-2010, EXPIRES 12-22-2020.

THE COLOR(S) RED AND BLACK IS/ARE CLAIMED AS A FEATURE OF THE MARK.

NO CLAIM IS MADE TO THE EXCLUSIVE RIGHT TO USE "MUSEE", APART FROM THE MARK AS SHOWN.

THE COLOR BLACK APPEARS IN THE TEXT OF THE WORDING "MUSÉE DU QUAI BRANLY", AND IN THE FIVE POINTED STAR DESIGN TO THE LEFT OF THE WORDING "MUSÉE DU QUAI BRANLY". THE COLOR RED APPEARS IN THE TEXT OF THE WORDING "LÀ OÙ DIALOGUENT LES CULTURES".

THE ENGLISH TRANSLATION OF "MUSÉE DU QUAI BRANLY LÀ OÙ DIALOGUENT LES CULTURES" IN THE MARK IS "QUAI BRANLY MUSEUM", "WHERE CULTURES MEET IN DIALOGUE" OR "QUAI BRANLY MUSEUM", "WHERE CULTURES CONVERSE".

SER. NO. 79-098,296, FILED 12-22-2010.

**Reg. No. 4,273,795** ELI HELLMAN, EXAMINING ATTORNEY

# United States of America

United States Patent and Trademark Office

# MODLIFE

**Reg. No. 4,273,796**

**Registered Jan. 15, 2013**

**Int. Cls.: 16, 20, 21 and  
22**

**TRADEMARK**

**PRINCIPAL REGISTER**

ROTHO KUNSTSTOFF AG (SWITZERLAND SOCIÉTÉ ANONYME)  
INDUSTRIESTRASSE ALTHAU 11,  
CH-5303 WÜRENLINGEN  
SWITZERLAND

FOR: PAPER, CARDBOARD AND GOODS MADE FROM THESE MATERIALS, FOR USE AS FINISHED PRODUCTS FOR HOUSEHOLD PURPOSES, KITCHEN PURPOSES AND HOME OFFICE PURPOSES, NOT INCLUDED IN OTHER CLASSES, NAMELY, PAPER AND CARDBOARD BOXES, PAPER BAGS, CARDBOARD CONTAINERS; PLASTIC MATERIALS FOR PACKAGING, NOT INCLUDED IN OTHER CLASSES, NAMELY, PLASTIC BAGS FOR PACKAGING, PLASTIC BUBBLE PACKS FOR PACKAGING, HUMIDITY CONTROL SHEETS OF PLASTIC FOR FOODSTUFF PACKAGING; PLASTIC PARTS FOR OFFICE REQUISITES INCLUDED IN THIS CLASS, NAMELY, PLASTIC TRANSPARENCIES, PLASTIC SHEETS FOR WRITING, PRINTING, AND MARKING; OFFICE REQUISITES, NAMELY, DESKTOP AND DESK MOUNTED CABINETS FOR STATIONERY; FOLDERS FOR PAPERS; STATIONERY DOCUMENT FILES; PAINT BOXES; ARTISTS' WATERCOLOR SAUCERS, NAMELY, PALETTES FOR PAINTING; PEN CLIPS; STENCIL CASES; DISPENSERS OF ADHESIVE TAPE AND NON-FABRIC LABELS; STENCILS; STANDS FOR PENS AND PENCILS; PLASTIC GARBAGE BAGS; DRAWING MATERIALS, IN PARTICULAR, OF PLASTIC, NAMELY, PLASTIC DRAWING TRIANGLES, PLASTIC DRAWING TRAYS, PLASTIC DRAWING TEMPLATES; STORAGE BOXES, NAMELY, CORRUGATED RECORD STORAGE BOXES, PHOTO STORAGE BOXES, FILE BOXES FOR STORAGE OF BUSINESS AND PERSONAL RECORD; DOCUMENT COVERS OF PLASTIC, IN CLASS 16 (U.S. CLS. 2, 5, 22, 23, 29, 37, 38 AND 50).



FOR: PLASTIC PACKAGING RECEPTACLES, NAMELY, COMMERCIAL PACKAGING MATERIALS IN THE NATURE OF CORRUGATED PLASTIC BOXES, BINS AND TRAYS; BROOM HANDLES NOT OF METAL, BARRELS AND CASKS, ALL THE AFORESAID GOODS OF NON-METALLIC MATERIALS; PLASTIC BOXES; PLASTIC BINS; PACKAGING CONTAINERS OF PLASTIC; NEWSPAPER HOLDERS, NAMELY, RACKS FOR HOLDING NEWSPAPERS, PLASTIC BOXES FOR HOLDING NEWSPAPERS, PLASTIC BINS FOR HOLDING NEWSPAPERS; SHOWCASES, IN CLASS 20 (U.S. CLS. 2, 13, 22, 25, 32 AND 50).

*David J. Kyjars*

Director of the United States Patent and Trademark Office

FOR: HOUSEHOLD OR KITCHEN UTENSILS AND CONTAINERS, NEITHER OF PRECIOUS METAL, NOR PLATED THEREWITH, NAMELY, SPATULAS, STRAINERS, GRATERS, CONTAINERS FOR HOUSEHOLD OR KITCHEN USE, BREAD BINS; PLASTIC LADLES FOR FOODSTUFFS, NAMELY, SERVING LADLES, KITCHEN LADLES; SPOONS FOR ED-

**Reg. No. 4,273,796** IBLE ICES, NAMELY, SERVING SPOONS, MIXING SPOONS, SLOTTED SPOONS; PLASTIC PASTA SERVING TONGS; KITCHEN SPOONS AND LADLES, NAMELY, SERVING SPOONS, BASTING SPOONS, MIXING SPOONS, KITCHEN LADLES, SERVING LADLES; PLASTIC CHOPPING BOARDS FOR KITCHEN USE; PLASTIC KNIFE HOLDERS, NAMELY, PLASTIC KNIFE BLOCKS, PLASTIC KNIFE RESTS; KITCHEN AND HOUSEHOLD CONTAINERS AND THEIR LIDS AND CLOSURES IN THE NATURE OF TENSION CLOSING DEVICES FOR CONTAINER LIDS, ALL THE AFORESAID GOODS NOT OF PRECIOUS METALS, OR PLATED THEREWITH; TABLEWARE, NAMELY, TABLE PLACE CARD HOLDERS NOT OF PRECIOUS METAL, DISHES, SERVING DISHES; COOKING POT SETS AND COOKING DISHES; PLASTIC PASTA BOARDS, NAMELY, PLASTIC CUTTING BOARDS FOR PASTA; PASTRY TRAYS, NAMELY, NON-METALLIC TRAYS FOR PASTRY, SERVING TRAYS FOR PASTRY, PASTRY TRAYS FOR DOMESTIC PURPOSES; PASTRY BOARDS; TRAYS FOR SERVING; NON-ELECTRIC PORTABLE COOLERS; INSULATING BAGS FOR BOTTLES; GLASSWARE, PORCELAIN AND EARTHENWARE, NOT INCLUDED IN OTHER CLASSES, NAMELY, DRINKING GLASSES, PORCELAIN FIGURINES, EARTHENWARE MUGS NOT INCLUDED IN OTHER CLASSES; GLASS JAR CARBOYS; VACUUM BOTTLES AND CONTAINERS, NAMELY, VACUUM FLASKS, IN CLASS 21 (U.S. CLS. 2, 13, 23, 29, 30, 33, 40 AND 50).

FOR: SMALL BAGS, ENVELOPES AND POUCHES FOR PACKAGING OF TEXTILE MATERIAL; TEXTILE FIBERS; NETS, NAMELY, FISHING NETS, NETS FOR HAY, COMMERCIAL NETS; TENTS; TARPAULINS; SAILS; SACKS AND BAGS, NOT INCLUDED IN OTHER CLASSES, NAMELY, SACKS AND BAGS FOR THE TRANSPORTATION OR STORAGE OF MATERIALS IN BULK, GARMENT BAGS FOR STORAGE, BANK DEPOSIT BAGS, IN CLASS 22 (U.S. CLS. 1, 2, 7, 19, 22, 42 AND 50).

THE MARK CONSISTS OF STANDARD CHARACTERS WITHOUT CLAIM TO ANY PARTICULAR FONT, STYLE, SIZE, OR COLOR.

PRIORITY DATE OF 9-20-2010 IS CLAIMED.

OWNER OF INTERNATIONAL REGISTRATION 1080533 DATED 3-18-2011, EXPIRES 3-18-2021.

SER. NO. 79-098,608, FILED 3-18-2011.

TINA BROWN, EXAMINING ATTORNEY

# United States of America

United States Patent and Trademark Office



# LUBIC

**Reg. No. 4,273,797**

**Registered Jan. 15, 2013**

**Int. Cl.: 9**

JIA LE HUA (SHENZHEN) INDUSTRY DEV. CO., LTD. (CHINA CORPORATION)  
07H, TOWER A, XIANDAI ZHI CHUANG DASHA  
THE CROSS OF HUAQIANG NORTH ROAD; AND ZHENHUA ROAD.; FUTIAN DISTRICT,  
SHENZHEN; GUANGDONG PROVINCE  
CHINA

**TRADEMARK**

**PRINCIPAL REGISTER**

FOR: COMPUTER PERIPHERAL DEVICES; TIME RECORDING APPARATUS; NAVIGATION APPARATUS FOR VEHICLES IN THE NATURE OF ON-BOARD COMPUTERS; CABINETS FOR LOUDSPEAKERS; MATERIAL FOR ELECTRICITY MAINS, NAMELY, WIRES AND CABLES; ELECTRIC CELL SWITCHES; ELECTRIC INVERTERS; ACOUSTIC SOUND ALARMS; BATTERY CHARGERS; CIGAR LIGHTERS FOR AUTOMOBILES, IN CLASS 9 (U.S. CLS. 21, 23, 26, 36 AND 38).

THE MARK CONSISTS OF THE STYLIZED WORDING "LUBIC" AND A CURVED, INCOMPLETE TRIANGULAR SHAPED PATTERN.

OWNER OF INTERNATIONAL REGISTRATION 1081169 DATED 5-27-2011, EXPIRES 5-27-2021.

SER. NO. 79-098,828, FILED 5-27-2011.

TRICIA SONNEBORN, EXAMINING ATTORNEY



*David J. Kyffers*

Director of the United States Patent and Trademark Office



# United States of America

United States Patent and Trademark Office

# METAPOR

**Reg. No. 4,273,798**

**Registered Jan. 15, 2013**

**Int. Cls.: 1 and 19**

**TRADEMARK**

**PRINCIPAL REGISTER**

DENNERT PORAVER GMBH (FED REP GERMANY LIMITED LIABILITY COMPANY)  
GEWERBEGEBIET OST 17  
92353 POSTBAUER-HENG, FED REP GERMANY

FOR: MINERAL ADHESIVES FOR FLOOR, CEILING AND WALL TILES; CALCINED KAOLIN FOR USE AS AGGREGATES FOR BUILDING MATERIALS; CALCINED KAOLIN, IN CLASS 1 (U.S. CLS. 1, 5, 6, 10, 26 AND 46).

FOR: NON-METALLIC BUILDING MATERIALS, NAMELY, PARTICLE MIXTURES OF CALCINED KAOLIN AND EXPANDED GLASS GRANULATE AS ADDITIVES AS LIME-BINDING MATERIALS AND AS CEMENT-BINDING MATERIALS, AND AS ADDITIVES TO MORTARS, PLASTERS, AND CONCRETES; ACTIVE POZZOLANIC HARDENING ADDITIVES IN THE NATURE OF CEMENT FILLER AND LIME FILLER FOR CEMENT AND LIME BOUND MATERIALS, EXPANDED GLASS IN LOOSE AND BOUND FORM, MINERAL FILLER PARTICLE MATERIALS FOR MORTARS AND PLASTERS, NAMELY, MORTAR MIX, NON-METALLIC MINERALS FOR BUILDING AND CONSTRUCTION, MINERAL PELLETS FOR USE IN THE BUILDING INDUSTRY IN MORTARS AND PLASTERS; MASONRY MORTAR AND PLASTER; FLOOR SCREED, NAMELY, FLOOR PAVEMENTS IN THE NATURE OF CEMENT-BASED COATINGS AND SEALANTS FOR USE AS FLOOR COVERINGS; FLOORING UNDERLAYMENTS; MINERAL BUILDING MATERIALS FOR DECORATIVE COATING FOR FLOOR, WALL AND CEILING SURFACES, NAMELY, MINERAL PELLETS FOR USE IN THE BUILDING INDUSTRY, NON-METALLIC MINERALS FOR BUILDING AND CONSTRUCTION; CONCRETE; CONCRETE BUILDING ELEMENTS, NAMELY, BLOCKS, BRICKS, POSTS, SLABS AND PANELS, IN CLASS 19 (U.S. CLS. 1, 12, 33 AND 50).



THE MARK CONSISTS OF STANDARD CHARACTERS WITHOUT CLAIM TO ANY PARTICULAR FONT, STYLE, SIZE, OR COLOR.

OWNER OF INTERNATIONAL REGISTRATION 1081738 DATED 4-19-2011, EXPIRES 4-19-2021.

THE WORDING "METAPOR" HAS NO MEANING IN A FOREIGN LANGUAGE.

SER. NO. 79-099,035, FILED 4-19-2011.

TINA BROWN, EXAMINING ATTORNEY

*David J. Kyffers*

Director of the United States Patent and Trademark Office

# United States of America

United States Patent and Trademark Office

# KÖFTEXPRESS

**Reg. No. 4,273,799**

**Registered Jan. 15, 2013**

**Int. Cls.: 29, 30 and 32**

**TRADEMARK**

**PRINCIPAL REGISTER**

METRO IKRAM PAZARLAMA ANONIM SIRKETI (TURKEY JOINT STOCK COMPANY)  
BÜYÜK İSTANBUL OTOGARI 45.15 KOD A-182  
BAYRAMPASA - İSTANBUL  
TURKEY

FOR: FROZEN AND PREPARED MEAT, FISH AND POULTRY, AND COOKED MEAT, FISH AND POULTRY, IN CLASS 29 (U.S. CL. 46).

FOR: BREAD, SANDWICHES, ICE CREAM, DAIRY-BASED PUDDINGS, PASTRIES AND BAKERY DESSERTS, IN CLASS 30 (U.S. CL. 46).

FOR: MINERAL WATER, SPRING WATER, TABLE WATER, VEGETABLE AND FRUIT JUICES, FRUIT NECTARS AND NON-ALCOHOLIC BEVERAGES, NAMELY CARBONATED BEVERAGES; NON-ALCOHOLIC BEVERAGES CONTAINING FRUIT JUICES; SOFT-DRINKS, IN CLASS 32 (U.S. CLS. 45, 46 AND 48).

THE MARK CONSISTS OF STANDARD CHARACTERS WITHOUT CLAIM TO ANY PARTICULAR FONT, STYLE, SIZE, OR COLOR.

OWNER OF INTERNATIONAL REGISTRATION 1082868 DATED 3-18-2011, EXPIRES 3-18-2021.

SER. NO. 79-099,467, FILED 3-18-2011.

VIVIAN MICZNIK FIRST, EXAMINING ATTORNEY



*David J. Kybas*

Director of the United States Patent and Trademark Office

# United States of America

United States Patent and Trademark Office

# FXD

**Reg. No. 4,273,800**

**Registered Jan. 15, 2013**

**Int. Cls.: 9, 18 and 25**

**TRADEMARK**

**PRINCIPAL REGISTER**

GLOBE INTERNATIONAL NOMINEES PTY LTD ACN: 095410281 (AUSTRALIA COMPANY)  
1 FENNEL STREET  
PORT MELBOURNE VIC 3207  
AUSTRALIA

FOR: ARTICLES OF PROTECTIVE CLOTHING FOR WEAR FOR PROTECTION AGAINST ACCIDENT OR INJURY FOR USE IN SKATEBOARDING, SURFING, SKIING, SNOWBOARDING, CAR RACING, MOTOCROSS, MOTORCYCLING, BICYCLING, MOTORSPORTS, WATER SPORTS, PHYSICAL ACTIVITIES, EXTREME SPORTS AND WORKERS, AND WATER SKI SAFETY VESTS; CLOTHING FOR PROTECTION AGAINST ACCIDENTS; BLAST RESISTANT CLOTHING AND GARMENTS; INSULATED CLOTHING FOR PROTECTION AGAINST ACCIDENT OR INJURY; PROTECTIVE CLOTHING ESPECIALLY MADE FOR USE IN LABORATORIES, FOOTWEAR AND SHOES FOR PROTECTION AGAINST ACCIDENTS; ARTICLES OF PROTECTIVE FOOTWEAR FOR WEAR FOR PROTECTION AGAINST ACCIDENT OR INJURY FOR USE IN SKATEBOARDING, SURFING, SKIING, SNOWBOARDING, CAR RACING, MOTOCROSS, MOTORCYCLING, BICYCLING, MOTORSPORTS, WATER SPORTS, PHYSICAL ACTIVITIES, EXTREME SPORTS AND WORKERS; ARTICLES OF PROTECTIVE HEADWEAR FOR WEAR FOR PROTECTION AGAINST ACCIDENT OR INJURY FOR USE IN SKATEBOARDING, SURFING, SKIING, SNOWBOARDING, CAR RACING, MOTOCROSS, MOTORCYCLING, BICYCLING, MOTORSPORTS, WATER SPORTS, PHYSICAL ACTIVITIES, EXTREME SPORTS AND WORKERS, CLOTHING FOR PROTECTION AGAINST ACCIDENTS; PROTECTIVE CLOTHING FOR WORKERS, HELMETS, AND EYEWEAR; EYEWEAR, NAMELY, EYE COVERS FOR PROTECTIVE PURPOSES, NOSE GUARDS WHICH CAN BE WORN BY ATTACHMENT TO EYEWEAR SUCH AS SUNGLASSES AND SKI GOGGLES, GOGGLES, SAFETY EYEWEAR, SPORTS EYEWEAR, PROTECTIVE EYEWEAR AND COMPONENT PARTS THEREOF, SUNGLASSES, EYEGLASSES AND OPHTHALMIC FRAMES AND CASES THEREFOR; PROTECTIVE AND SAFETY HELMETS, PROTECTIVE HELMETS FOR SPORTS; PROTECTIVE SPORTS HELMET ACCESSORIES THAT ATTACH TO THE HELMETS, NAMELY, MOUTH GUARDS, EAR PADS, THROAT PROTECTORS, CHIN STRAPS, FACE MASKS, JAW PADS AND EYE SHIELDS; PROTECTIVE FACE-SHIELDS FOR PROTECTIVE HELMETS; SPORTS HELMETS; SAFETY HELMETS; GLOVES FOR PROTECTION AGAINST ACCIDENTS; SUPPORT BELTS FOR WORKERS. ELBOW PADS, KNEE PADS AND SHIN GUARDS FOR WORKERS, REFLECTIVE AND ILLUMINATED CLOTHING FOR SAFETY PURPOSES, CLOTHING FOR PROTECTION AGAINST ACCIDENTS, IRRADIATION AND FIRE, PROTECTIVE GLOVES FOR INDUSTRIAL USE, PROTECTIVE HEAD GUARDS FOR INDUSTRIAL PURPOSES, PROTECTIVE INDUSTRIAL BOOTS, PROTECTIVE INDUSTRIAL SHOES, PROTECTIVE



*David J. Kyros*

Director of the United States Patent and Trademark Office

**Reg. No. 4,273,800** WORK GLOVES, REFLECTIVE AND ILLUMINATED CLOTHING FOR SAFETY PURPOSES, CLOTHING FOR PROTECTION AGAINST CHEMICALS, IN CLASS 9 (U.S. CLS. 21, 23, 26, 36 AND 38).

FOR: BAGS, NAMELY, ALL PURPOSE SPORTS BAGS, ALL-PURPOSE ATHLETIC BAGS, ALL-PURPOSE CARRYING BAGS, ATHLETIC BAGS, BOOK BAGS, BAGS FOR SPORTS CLOTHING, BAGS FOR SPORTS, BEACH BAGS, BOOK BAGS, CARRY-ON BAGS, GYM BAGS, OVERNIGHT BAGS, SCHOOL BAGS, TRAVEL BAGS; BACKPACKS; SUITCASES; TRUNKS AND TRAVELLING BAGS; PURSES; WALLETS; SATCHELS, BRIEF CASES; ATTACHÉ CASES; KEY CASES; UMBRELLAS; LEATHER AND IMITATION LEATHER; LEATHER AND IMITATION LEATHER BACKPACKS, PURSES, ATTACHÉ CASES, KEY CASES, KEY CHAINS, WALLETS, SATCHELS, BRIEF CASES, LEATHER CASES, CREDIT CARD CASES, DOCUMENT CASES, OVERNIGHT CASES, SPORTS BAGS, TOOL BAGS SOLD EMPTY, IN CLASS 18 (U.S. CLS. 1, 2, 3, 22 AND 41).

FOR: CLOTHING, NAMELY, TOPS, BOTTOMS, T-SHIRTS, SHIRTS, SWEATSHIRTS, PANTS, BEACHWEAR, LOUNGEWEAR, JACKETS, PULLOVERS, SKI WEAR, SURF WEAR, SWIM WEAR; PAINTER'S PANTS, CARPENTER'S PANTS, OVERALLS, COVERALLS, RAIN WEAR, SUN PROTECTIVE CLOTHING, NAMELY, TOPS AND BOTTOMS, LIGHT-REFLECTING JACKETS, FOOTWEAR; HEADGEAR, NAMELY, HEADWEAR; ACCESSORIES IN THIS CLASS, NAMELY, BELTS, SCARVES, GLOVES, NECKTIES, SOCKS, HEADBANDS, FITTED SHOE OR BOOT COVERING TO PROTECT THE SHOES OR BOOTS FROM WATER OR OTHER DAMAGE, IN CLASS 25 (U.S. CLS. 22 AND 39).

THE MARK CONSISTS OF STANDARD CHARACTERS WITHOUT CLAIM TO ANY PARTICULAR FONT, STYLE, SIZE, OR COLOR.

PRIORITY DATE OF 12-2-2010 IS CLAIMED.

OWNER OF INTERNATIONAL REGISTRATION 1083140 DATED 5-27-2011, EXPIRES 5-27-2021.

SER. NO. 79-099,593, FILED 5-27-2011.

MARLENE BELL, EXAMINING ATTORNEY

# United States of America

United States Patent and Trademark Office

## CHEF CHARLIE

**Reg. No. 4,273,801**

**Registered Jan. 15, 2013**

**Int. Cls.: 9, 16, 25, 28, 29,  
30, 32 and 41**

**TRADEMARK**

**SERVICE MARK**

**PRINCIPAL REGISTER**

ROBERT MATTHEW BREDEN (AUSTRALIA INDIVIDUAL)  
LA GAYANE  
F-84220 JOUCAS  
FRANCE

FOR: PRE-RECORDED AUDIO AND VIDEO FILMS, CASSETTES, TAPES, CDS, AND DVDS, ALL IN THE NATURE OF CHILDREN'S ENTERTAINMENT AND EDUCATION; ELECTRONIC BOOKS RECORDED ON COMPUTER MEDIA, IN THE NATURE OF CHILDREN'S ENTERTAINMENT AND EDUCATION; CHILDREN'S EDUCATIONAL INTERACTIVE AND MULTI-MEDIA SOFTWARE, PRE-RECORDED FLOPPY DISKETTES, PRE-RECORDED DVDS, AND PRE-RECORDED CD-ROMS, ALL IN THE NATURE OF CHILDREN'S ENTERTAINMENT AND EDUCATION; COMPUTER, ELECTRONIC AND VIDEO GAMES PROGRAMMES; DOWNLOADABLE ELECTRONIC GAMES PROVIDED ONLINE FROM A COMPUTER DATABASE; ANIMATED FILMS IN THE NATURE OF CHILDREN'S ENTERTAINMENT AND EDUCATION; DOWNLOADABLE CONTENT IN THE NATURE OF ANIMATED CARTOONS, IN CLASS 9 (U.S. CLS. 21, 23, 26, 36 AND 38).

FOR: MAGAZINES FEATURING CARTOONS AIMED AT CHILDREN; BOOKS FEATURING CARTOONS AIMED AT CHILDREN; BLANK CARDS; POSTCARDS; GREETINGS CARDS; COASTERS OF PAPER; STATIONERY; ADHESIVES FOR STATIONERY OR HOUSEHOLD USE; ARTISTS' MATERIALS, NAMELY, EASELS, PAINT TRAYS, AND PAINT BRUSHES, IN CLASS 16 (U.S. CLS. 2, 5, 22, 23, 29, 37, 38 AND 50).

FOR: CLOTHING, NAMELY, SHIRTS, SKIRTS, SOCKS, PANTS, UNDERWEAR, COATS, AND JACKETS; FOOTWEAR; HEADGEAR, NAMELY, HATS AND CAPS; SLEEPWEAR; SHOES; SLIPPERS, IN CLASS 25 (U.S. CLS. 22 AND 39).

FOR: EDUCATIONAL TOYS USED TO TEACH ABOUT COOKING AND NUTRITION; ACTION FIGURE TOYS, AND BOARD GAMES, ALL AFOREMENTIONED GOODS NOT INCLUDING TEDDY BEARS AND OTHER STUFFED ANIMALS; CHRISTMAS TREE DECORATIONS; HAND-HELD UNITS FOR PLAYING VIDEO GAMES, OTHER THAN THOSE ADAPTED FOR USE WITH AN EXTERNAL DISPLAY SCREEN OR MONITOR; HAND PUPPETS; DOLLS, IN CLASS 28 (U.S. CLS. 22, 23, 38 AND 50).

FOR: PRESERVED, FROZEN, DRIED AND COOKED FRUITS AND VEGETABLES; JELLIES, JAMS, COMPOTES; EGGS, MILK AND MILK PRODUCTS, EXCLUDING ICE CREAM, ICE MILK, AND FROZEN YOGURT; EDIBLE OILS AND FAT, IN CLASS 29 (U.S. CL. 46).



*David J. Kyros*

Director of the United States Patent and Trademark Office

**Reg. No. 4,273,801** FOR: COFFEE; TEA; COCOA; SUGAR; RICE; TAPIOCA; SAGO; ARTIFICIAL COFFEE; FLOUR; PREPARATIONS MADE FROM CEREALS, NAMELY, BREAKFAST CEREALS; BREAD; PASTRY; CONFECTIONERY, NAMELY, CANDY; EDIBLE ICES; HONEY; TREACLE; YEAST; BAKING-POWDER; SALT; MUSTARD; VINEGAR; SAUCES; SPICES; ICE, IN CLASS 30 (U.S. CL. 46).

FOR: MINERAL AND AERATED WATERS; FRUIT DRINKS AND FRUIT JUICES; SYRUPS FOR MAKING BEVERAGES; CONCENTRATES AND POWDERS USED IN THE PREPARATION OF SOFT DRINKS, IN CLASS 32 (U.S. CLS. 45, 46 AND 48).

FOR: ENTERTAINMENT SERVICES IN THE NATURE OF ORGANIZING AND CONDUCTING COOKING DEMONSTRATIONS; EDUCATIONAL SERVICES, NAMELY, CONDUCTING CLASSES AND DEMONSTRATIONS IN THE SUBJECT OF COOKING; PRODUCTION OF CABLE TELEVISION PROGRAMMES, FILM PRODUCTION, CARTOON ANIMATION PRODUCTION SERVICES; PRODUCTION OF RADIO PROGRAMMES; DISTRIBUTION OF TELEVISION PROGRAMMES; DISTRIBUTION OF MOTION PICTURE FILMS; DISTRIBUTION OF RADIO PROGRAMMES; PROVISION OF ELECTRONIC GAMES PROVIDED ON-LINE FROM A COMPUTER DATABASE; PUBLICATION OF ON-LINE CHILDREN'S BOOKS AND CHILDREN'S MAGAZINES, IN CLASS 41 (U.S. CLS. 100, 101 AND 107).

THE MARK CONSISTS OF STANDARD CHARACTERS WITHOUT CLAIM TO ANY PARTICULAR FONT, STYLE, SIZE, OR COLOR.

OWNER OF INTERNATIONAL REGISTRATION 1084665 DATED 3-21-2011, EXPIRES 3-21-2021.

THE NAME(S), PORTRAIT(S), AND/OR SIGNATURE(S) SHOWN IN THE MARK DOES NOT IDENTIFY A PARTICULAR LIVING INDIVIDUAL.

SER. NO. 79-100,211, FILED 3-21-2011.

SAMUEL E. SHARPER JR., EXAMINING ATTORNEY

United States of America  
United States Patent and Trademark Office

**BIOFAR**

**Reg. No. 4,273,802**

**Registered Jan. 15, 2013**

**Int. Cl.: 5**

**TRADEMARK**

**PRINCIPAL REGISTER**

BIOFAR (FRANCE SOCIÉTÉ À RESPONSABILITÉ LIMITÉE)  
6, RUE DES MARGUERITES  
F-92000 NANTERRE  
FRANCE

FOR: FOOD SUPPLEMENTS CONTAINING PROTEINS, CARBOHYDRATES, LIPIDS, FIBERS, MICRONUTRIENTS, VITAMINS, MINERALS, AMINO ACIDS AND/OR FATTY ACIDS IN INDIVIDUAL DOSES, IN THE FORM OF CAPSULES, EFFERVESCENT AND NON-EFFERVESCENT TABLETS, SUGAR-COATED PILLS, HARD GELATIN CAPSULES, SACHETS, CHEWING GUMS, DRY EXTRACTS AND POWDERS FOR PHARMACEUTICAL USE, GRANULES, CELLULOSE MICROSPHERES IMPREGNATED WITH ACTIVE PRINCIPLES, AND DEPURATIVES, IN CLASS 5 (U.S. CLS. 6, 18, 44, 46, 51 AND 52).

THE MARK CONSISTS OF STANDARD CHARACTERS WITHOUT CLAIM TO ANY PARTICULAR FONT, STYLE, SIZE, OR COLOR.

OWNER OF INTERNATIONAL REGISTRATION 0805668 DATED 6-19-2003, EXPIRES 6-19-2013.

SER. NO. 79-100,314, FILED 5-27-2010.

STEVEN R. FINE, EXAMINING ATTORNEY



*David J. Kybas*

Director of the United States Patent and Trademark Office

# United States of America

United States Patent and Trademark Office

HISSTERIA



**Reg. No. 4,273,803**

**Registered Jan. 15, 2013**

**Int. Cls.: 9, 28, 38 and 41**

**TRADEMARK**

**SERVICE MARK**

**PRINCIPAL REGISTER**

YAZINO GROUP AG (SWITZERLAND CORPORATION)  
C/O RISK-CONSULT AG  
POSTSTRASSE 22  
CH-6300 ZUG, SWITZERLAND

FOR: COMPUTERS; RECORDED COMPUTER PROGRAMS, NAMELY, COMPUTER GAME PROGRAMS; DOWNLOADABLE COMPUTER PROGRAMS AND COMPUTER SOFTWARE FOR COMPUTER GAME PROGRAMS; COMPUTER PROGRAMS, NAMELY, COMPUTER AND VIDEO GAME PROGRAMS, DOWNLOADABLE ONLINE AND BROWSER GAME PROGRAMS, COMPUTER GAME SOFTWARE FOR MOBILE TELEPHONES, IN CLASS 9 (U.S. CLS. 21, 23, 26, 36 AND 38).

FOR: TOYS AND PLAYTHINGS, NAMELY, PARLOR GAMES, CARD GAMES, BOARD GAMES, PARLOR GAMES OF CHANCE, CARD GAMES OF CHANCE, BOARD GAMES OF CHANCE, PARLOR CASINO GAMES, CARD CASINO GAMES, BOARD CASINO GAMES, IN CLASS 28 (U.S. CLS. 22, 23, 38 AND 50).

FOR: PROVIDING ACCESS TO COMPUTER NETWORKS, INTERNET PLATFORMS, AND DATA BASES AND CONTAINING ELECTRONIC PUBLICATIONS; PROVIDING INTERNET CHAT ROOMS; PROVIDING MULTIPLE-USER ACCESS TO DATA ON THE INTERNET IN THE FIELD OF COMPUTER GAME PROGRAMS AND ELECTRONIC PUBLICATIONS; PROVIDING ONLINE INFORMATION SERVICES, NAMELY, ACCESS TO COMPUTER NETWORKS, INTERNET PLATFORMS, AND DATA BASES AND CONTAINING ELECTRONIC PUBLICATIONS; PROVIDING ACCESS TO CLIENT-SPECIFIC WEB-SITES WITH USER-DEFINED INFORMATION, PERSONAL PROFILES AND INFORMATION; WEB MESSAGING, NAMELY, DATA TRANSFER AND RELAY OF MESSAGES OF ALL KINDS VIA TELECOMMUNICATIONS; TRANSMISSION OF INFORMATION BY ELECTRONIC MEANS, NAMELY, ELECTRONIC MESSAGING; TRANSMISSION VIA COMPUTER AND COMPUTER NETWORKS OF MESSAGES AND IMAGES, IN CLASS 38 (U.S. CLS. 100, 101 AND 104).

FOR: ENTERTAINMENT HOSTING SERVICES IN THE NATURE OF A WEB-BASED SYSTEM AND ON-LINE PORTAL FOR CUSTOMERS TO PARTICIPATE IN ONLINE GAMING; OPERATION OF A CASINO; ENTERTAINMENT SERVICES, NAMELY, PROVIDING ONLINE GAMING SERVICES VIA THE INTERNET, INTERNET PORTALS, INTERNET PLATFORMS AND GLOBAL COMPUTER NETWORKS, IN PARTICULAR NON-DOWNLOADABLE SOFTWARE FOR VIDEO, MOBILE TELEPHONE AND BROWSER GAMES, AND PROVIDING RELATED GAMING INFORMATION; PROVIDING ONLINE GAMING SERVICES VIA



*David J. Kybas*

Director of the United States Patent and Trademark Office



**Reg. No. 4,273,803** COMPUTER NETWORKS, NAMELY, MULTI-PLAYER ONLINE ELECTRONIC GAMING SERVICES, IN CLASS 41 (U.S. CLS. 100, 101 AND 107).

THE MARK CONSISTS OF THE TERM "HISSTERIA" IN STYLIZED FONT AT THE TOP OF THE MARK. CENTERED BELOW THE TERM IS A DESIGN OF A STYLIZED SNAKE FORMING A CIRCLE WITH THE HEAD AND TAIL OF THE SNAKE AT THE TOP OF THE CIRCLE. WITHIN THE CIRCLE IS A SMALLER DARK CIRCLE WITH A STYLIZED "H" CUT FROM THE MIDDLE OF THE SMALLER CIRCLE. THERE IS A REFLECTION OF THE LOWER HALF OF THE DESIGN IN THE FOREGROUND OF THE MARK.

PRIORITY DATE OF 3-28-2011 IS CLAIMED.

OWNER OF INTERNATIONAL REGISTRATION 1086820 DATED 5-25-2011, EXPIRES 5-25-2021.

SER. NO. 79-101,072, FILED 5-25-2011.

PAULA MAHONEY, EXAMINING ATTORNEY

# United States of America

United States Patent and Trademark Office



**Reg. No. 4,273,804**

**Registered Jan. 15, 2013**

**Int. Cl.: 14**

**TRADEMARK**

**PRINCIPAL REGISTER**

JTR APS (DENMARK PRIVATE LIMITED COMPANY)  
STORE KONGENSGADE 25, 5  
DK-1264 KØBENHAVN K  
DK-1264 KØBENHAVN K, DENMARK

FOR: JEWELLERY, NAMELY, EARRINGS, BRACELETS, NECKLACES, RINGS AND ANKLETS MADE EITHER BY MACRAMÉ-BRAID OR MADE BY A COMBINATION OF MACRAMÉ-BRAID AND PRECIOUS METALS OR PRECIOUS STONES OR MADE BY MACRAMÉ-BRAID OF LEATHER OR SKIN, IN CLASS 14 (U.S. CLS. 2, 27, 28 AND 50).

NO CLAIM IS MADE TO THE EXCLUSIVE RIGHT TO USE "THE ORIGINAL MACRAME", APART FROM THE MARK AS SHOWN.

PRIORITY DATE OF 12-29-2010 IS CLAIMED.

OWNER OF INTERNATIONAL REGISTRATION 1086887 DATED 6-29-2011, EXPIRES 6-29-2021.

SER. NO. 79-101,093, FILED 6-29-2011.

LINDA MICKLEBURGH, EXAMINING ATTORNEY



*David J. Kyffers*

Director of the United States Patent and Trademark Office

# United States of America

United States Patent and Trademark Office

# ECO-FLEX

**Reg. No. 4,273,805**

**Registered Jan. 15, 2013**

**Int. Cls.: 7 and 8**

**TRADEMARK**

**PRINCIPAL REGISTER**

AMANDA PATENT & LICENSING SIA (LATVIA CORPORATION)  
ENKURA IELA 2-18, KIPSALA  
LV-1048 RIGA  
LATVIA

FOR: SANDING MACHINES; AUTOMATIC SANDING TOOLS, NAMELY, BELT SANDING MACHINES, SANDING PADS FOR POWER-OPERATED SANDERS, ABRASIVE BELTS FOR POWER-OPERATED SANDERS, ABRASIVE DISKS FOR POWER-OPERATED SANDERS, SANDING HEADS FOR POWER-OPERATED SANDERS; SPRAYING MACHINES, BRUSHES BEING PARTS OF MACHINES; INDUSTRIAL ROBOTS; HYDRO-PNEUMATIC LIFTING WORK PLATFORMS; STRUCTURAL PARTS FOR ALL THE AFORE-MENTIONED GOODS; NONE OF THE FOREGOING GOODS FOR USE FOR GROUND COVER APPLICATION FOR CONTROLLING SOIL EROSION, CONDITIONING SOIL OR PROVIDING SEED PROTECTION, IN CLASS 7 (U.S. CLS. 13, 19, 21, 23, 31, 34 AND 35).

FOR: HAND OPERATED SANDING TOOLS, NAMELY, BRUSH BACKED SANDING HEADS, SANDING PADS FOR NON-ELECTRIC, HAND-OPERATED SANDERS, SANDING BLOCKS; HAND OPERATED ABRADING TOOLS, NAMELY, BRUSHES FOR ABRADING; STRUCTURAL PARTS FOR ALL THE AFORE-MENTIONED GOODS, IN CLASS 8 (U.S. CLS. 23, 28 AND 44).

THE MARK CONSISTS OF STANDARD CHARACTERS WITHOUT CLAIM TO ANY PARTICULAR FONT, STYLE, SIZE, OR COLOR.

PRIORITY DATE OF 2-1-2011 IS CLAIMED.

OWNER OF INTERNATIONAL REGISTRATION 1087544 DATED 7-6-2011, EXPIRES 7-6-2021.

SER. NO. 79-101,360, FILED 7-6-2011.

KAPIL BHANOT, EXAMINING ATTORNEY



*David J. Kyros*

Director of the United States Patent and Trademark Office

# United States of America

United States Patent and Trademark Office

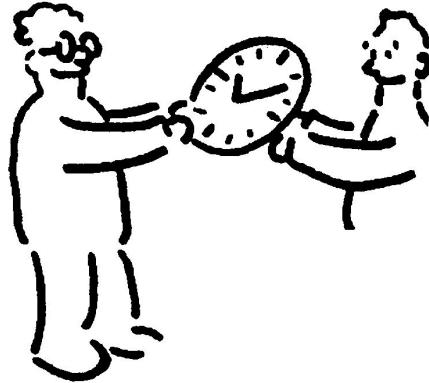

**Reg. No. 4,273,806**

**Registered Jan. 15, 2013**

**Int. Cl.: 36**

**SERVICE MARK**

**PRINCIPAL REGISTER**

A & A TIME TRADERS LIMITED (UNITED KINGDOM LIMITED COMPANY)  
126 GREENCROFT GARDENS  
LONDON NW6 3PJ, UNITED KINGDOM

FOR: CHARITABLE FUND-RAISING SERVICES, IN CLASS 36 (U.S. CLS. 100, 101 AND 102).

THE MARK CONSISTS OF A DESIGN OF 2 STYLIZED MEN HOLDING A CLOCK BETWEEN THEM. THE WHOLE FIGURE OF ONE MAN CAN BE SEEN AND A PARTIAL FIGURE OF A SECOND MAN CAN BE SEEN WHICH CONSISTS OF A HEAD, TORSO AND ARMS.

PRIORITY DATE OF 5-20-2011 IS CLAIMED.

OWNER OF INTERNATIONAL REGISTRATION 1087905 DATED 6-17-2011, EXPIRES 6-17-2021.

SER. NO. 79-101,499, FILED 6-17-2011.

SUE LAWRENCE, EXAMINING ATTORNEY



*David J. Kybas*

Director of the United States Patent and Trademark Office

# United States of America

United States Patent and Trademark Office

# INTUPLAN

**Reg. No. 4,273,807**

**Registered Jan. 15, 2013**

**Int. Cls.: 9, 41 and 42**

**TRADEMARK**

**SERVICE MARK**

**PRINCIPAL REGISTER**

SIEMENS AKTIENGESELLSCHAFT (FED REP GERMANY JOINT STOCK COMPANY)  
WITTELSBACHERPLATZ 2  
80333 MÜNCHEN  
FED REP GERMANY

FOR: DATA-PROCESSING EQUIPMENT AND COMPUTERS; COMPUTER SOFTWARE FOR CREATING MODELS OF INDUSTRIAL MACHINES AND ENTIRE INDUSTRIAL INSTALLATIONS; COMPUTER SOFTWARE FOR DESIGNING MACHINES AND FOR SIMULATING THE OPERATIONAL LAYOUT OF MACHINES; COMPUTER SOFTWARE FOR SIMULATING CONTROL AND OPERATING PROCESSES ON INDIVIDUAL MACHINES AND ENTIRE INSTALLATIONS; COMPUTER SOFTWARE FOR DESIGNING AND SIMULATING WORK PROCESSES AND PRODUCTION PROCESSES IN COMPLETE FACTORY INSTALLATIONS, IN CLASS 9 (U.S. CLS. 21, 23, 26, 36 AND 38).

FOR: PROVISION OF TRAINING AND FURTHER TRAINING IN THE FIELD OF COMPUTER HARDWARE AND SOFTWARE; ARRANGING SEMINARS, LECTURES, TRAINING COURSES AND WORKSHOPS FOR TRAINING, INSTRUCTIONAL, AND FURTHER TRAINING PURPOSES IN THE FIELD OF FACTORY LAYOUT PLANNING AND THE USE OF COMPUTER HARDWARE, COMPUTER SOFTWARE AND COMPUTER PERIPHERALS FOR COMPUTER AIDED DESIGN, SIMULATION OF THE OPERATIONS OF INDUSTRIAL MACHINES AND FACTORIES, CREATION OF TWO DIMENSIONAL AND THREE DIMENSIONAL MODELS OF PROPOSED FACTORY LAYOUTS, AND THE ANALYSIS AND OPTIMIZATION OF MATERIAL FLOW, RESOURCE CONSUMPTION AND THROUGHPUT TIME IN VARIOUS FACTORY MODELS; PROVIDING ELECTRONIC PUBLICATIONS, NAMELY, PROVIDING ON-LINE, NON-DOWNLOADABLE ELECTRONIC PUBLICATIONS, NAMELY, BOOKS AND NEWSLETTERS IN THE FIELD OF COMPUTER HARDWARE, COMPUTER SOFTWARE, COMPUTER AIDED DESIGN, CREATION OF COMPUTER SIMULATIONS OF INDUSTRIAL MACHINERY AND INDUSTRIAL INSTALLATIONS AND FACTORY LAYOUT PLANNING; DIGITAL IMAGING SERVICES, IN CLASS 41 (U.S. CLS. 100, 101 AND 107).

FOR: SCIENTIFIC AND TECHNOLOGICAL SERVICES, NAMELY, RESEARCH AND DESIGN IN THE FIELDS OF COMPUTER AIDED DESIGN, AND COMPUTER SOFTWARE TO SIMULATE FACTORY OPERATIONS AND TO PLAN OPTIMAL FACTORY LAYOUTS; INDUSTRIAL ANALYSIS AND RESEARCH SERVICES IN THE FIELD OF PLANNING AND OPTIMIZATION OF INDUSTRIAL OPERATIONS AND PROCESSES; DESIGN AND DEVELOPMENT OF COMPUTER HARDWARE AND SOFTWARE; TECHNICAL CONSULTANCY IN



*David J. Kyjars*

Director of the United States Patent and Trademark Office

**Reg. No. 4,273,807** THE FIELD OF COMPUTER HARDWARE AND SOFTWARE FOR MODELING, SIMULATING, ANALYZING, VISUALIZING AND OPTIMIZING INDUSTRIAL OPERATIONS AND PROCESSES AND MACHINERY AND FACTORY LAYOUT; TECHNICAL PROJECT STUDIES AND TECHNICAL PROJECT MANAGEMENT, NAMELY, ENGINEERING SERVICES IN THE FIELD OF ELECTRONIC DATA PROCESSING; COMPUTER PROGRAMMING FOR OTHERS; MAINTENANCE AND INSTALLATION OF SOFTWARE, IN CLASS 42 (U.S. CLS. 100 AND 101).

THE MARK CONSISTS OF STANDARD CHARACTERS WITHOUT CLAIM TO ANY PARTICULAR FONT, STYLE, SIZE, OR COLOR.

PRIORITY DATE OF 7-30-2010 IS CLAIMED.

OWNER OF INTERNATIONAL REGISTRATION 1088501 DATED 1-26-2011, EXPIRES 1-26-2021.

SER. NO. 79-101,732, FILED 1-26-2011.

APRIL ROACH, EXAMINING ATTORNEY

# United States of America

United States Patent and Trademark Office

# SAFEHOUSE

**Reg. No. 4,273,808**

**Registered Jan. 15, 2013**

**Int. Cls.: 6, 7, 8, 9, 17, 19,  
22, 37, 42 and 45**

SAFEHOUSE HABITATS (SCOTLAND) LIMITED (UNITED KINGDOM UNITED KINGDOM LIMITED COMPANY)

UNITS 2 AND 3, BOWBRIDGE WORKS

DUNDEE DD3 7RF

UNITED KINGDOM

**TRADEMARK**

FOR: METAL DOORS AND METAL DOOR FRAMES; SCAFFOLDING MADE OF METAL; AIR LOCKS MADE OF METAL; ALL BEING FOR USE ON OFFSHORE OIL AND GAS EXPLORATION AND EXTRACTION ENVIRONMENTS, IN CLASS 6 (U.S. CLS. 2, 12, 13, 14, 23, 25 AND 50).

**SERVICE MARK**

**PRINCIPAL REGISTER**

FOR: POWER TOOLS, NAMELY, ELECTRICAL, PNEUMATIC AND HYDRAULIC POWER TOOLS FOR HOLE CUTTING, DRILLING, TAPPING, REAMING, COUNTERSINKING, SAWING, GRINDING, POLISHING, AND ABRADING, NAMELY, HOLE CUTTERS, DRILLS, TAPS, REAMERS, COUNTERSINKING DRILLS, SAWS, GRINDERS AND GRINDING DISCS, POLISHERS, AND ABRADERS AND PARTS AND FITTINGS FOR USE THEREWITH; CUTTING AND GRINDING MACHINES; REMOTELY-OPERABLE ROBOTIC CUTTING AND GRINDING MACHINES; GRINDING TOOLS FOR GRINDERS AND GRINDING MACHINES; SPARK-FREE GRINDERS, GRINDING MACHINES, AND GRINDING TOOLS FOR GRINDERS AND GRINDING MACHINES; HEAT-FREE GRINDERS, GRINDING MACHINES, AND GRINDING TOOLS FOR GRINDERS AND GRINDING MACHINES, IN CLASS 7 (U.S. CLS. 13, 19, 21, 23, 31, 34 AND 35).



FOR: HAND-OPERATED TOOLS FOR HOLE CUTTING, DRILLING, TAPPING, REAMING, COUNTERSINKING, SAWING, GRINDING, POLISHING, AND ABRADING, AND PARTS AND FITTINGS FOR USE THEREWITH; HAND-OPERATED CUTTING AND GRINDING MACHINES; HAND-OPERATED GRINDING TOOLS FOR GRINDERS AND GRINDING MACHINES; HAND-OPERATED SPARK-FREE GRINDERS, GRINDING MACHINES, AND GRINDING TOOLS FOR GRINDERS AND GRINDING MACHINES; HAND-OPERATED HEAT-FREE GRINDERS, GRINDING MACHINES, AND GRINDING TOOLS FOR GRINDERS AND GRINDING MACHINES, IN CLASS 8 (U.S. CLS. 23, 28 AND 44).

*David J. Kyros*

Director of the United States Patent and Trademark Office

FOR: SAFETY APPARATUS FOR USE ON OFF-SHORE OIL AND GAS EXPLORATION AND EXTRACTION ENVIRONMENTS, NAMELY HABITATS, SHELTERS AND INFLATABLE MODULAR ENCLOSURES FOR USE DURING WELDING, GRINDING, AND HOT WORK OPERATIONS; INDUSTRIAL SAFETY APPARATUS FOR THE PROTECTION OF WORKERS AGAINST INJURY OR ACCIDENTS, NAMELY, HABITATS, SHELTERS AND INFLATABLE

**Reg. No. 4,273,808** MODULAR ENCLOSURES FOR USE DURING WELDING, GRINDING, AND HOT WORK OPERATIONS, ALL FOR USE ON OFF-SHORE OIL AND GAS EXPLORATION AND EXTRACTION ENVIRONMENTS; HABITATS, SHELTERS AND INFLATABLE MODULAR ENCLOSURES FOR USE DURING WELDING, GRINDING, AND HOT WORK OPERATIONS FOR USE IN UNDERTAKING HOT WORK ON OFF-SHORE OIL AND GAS EXPLORATION AND EXTRACTION ENVIRONMENTS; ALL BEING INDUSTRIAL SAFETY APPARATUS FOR THE PROTECTION OF WORKERS AGAINST INJURY OR ACCIDENTS, IN CLASS 9 (U.S. CLS. 21, 23, 26, 36 AND 38).

FOR: FLAME-RETARDANT INSULATING FABRICS FOR USE IN OFFSHORE OIL AND GAS EXPLORATION AND EXTRACTION ENVIRONMENTS, IN CLASS 17 (U.S. CLS. 1, 5, 12, 13, 35 AND 50).

FOR: NON-METAL PORTABLE SHELTERS FOR USE IN OFF-SHORE OIL AND GAS EXPLORATION AND EXTRACTION ENVIRONMENTS, IN CLASS 19 (U.S. CLS. 1, 12, 33 AND 50).

FOR: TEMPORARY STRUCTURES MADE OF FABRICS, NAMELY, HABITATS, INFLATABLE MODULAR ENCLOSURES FOR USE DURING WELDING, GRINDING, AND HOT WORK OPERATIONS, AND SHELTERS MADE OF FLAME RETARDANT FABRIC MATERIAL; TARPAULINS, TENTS; GROUND SHEETS, NAMELY, GROUND SHEETS MADE OF FLAME RETARDANT FABRIC FOR USE WITH HABITATS, SHELTERS AND FOR USE IN INFLATABLE MODULAR ENCLOSURES FOR USE DURING WELDING, GRINDING, AND HOT WORK OPERATIONS FOR UNDERTAKING HOT WORK ON OFF-SHORE OIL AND GAS EXPLORATION AND EXTRACTION ENVIRONMENTS, IN CLASS 22 (U.S. CLS. 1, 2, 7, 19, 22, 42 AND 50).

FOR: INSPECTION OF OIL AND GAS EXPLORATION AND EXTRACTION INSTALLATIONS PRIOR TO REPAIR; RENTAL OF APPARATUS FOR USE IN THE REPAIR OF OIL AND GAS EXPLORATION AND EXTRACTION INSTALLATIONS, NAMELY, RENTAL OF HABITATS, INFLATABLE MODULAR ENCLOSURES FOR USE DURING WELDING, GRINDING, AND HOT WORK OPERATIONS, AND SHELTERS AND FOR USE IN UNDERTAKING HOT WORK ON OFF-SHORE OIL AND GAS EXPLORATION AND EXTRACTION ENVIRONMENTS, IN CLASS 37 (U.S. CLS. 100, 103 AND 106).

FOR: DESIGN AND CONSULTANCY SERVICES IN RELATION TO SAFETY APPARATUS FOR USE ON OIL AND GAS EXPLORATION AND EXTRACTION INSTALLATIONS; PROVIDING PROJECT MANAGEMENT TECHNICAL SUPPORT, NAMELY, DRAWING UP EXPERT TECHNICAL OPINIONS IN CONNECTION WITH THE INSTALLATION OF HABITATS, INFLATABLE MODULAR ENCLOSURES FOR USE DURING WELDING, GRINDING, AND HOT WORK OPERATIONS, AND SHELTERS AND FOR USE IN UNDERTAKING HOT WORK ON OFF-SHORE OIL AND GAS EXPLORATION AND EXTRACTION ENVIRONMENTS, IN CLASS 42 (U.S. CLS. 100 AND 101).

FOR: RENTAL OF SAFETY APPARATUS FOR INDUSTRIAL USE NAMELY, RENTAL OF HABITATS, SHELTERS AND INFLATABLE MODULAR ENCLOSURES FOR USE DURING WELDING, GRINDING, AND HOT WORK OPERATIONS, FOR USE IN UNDERTAKING HOT WORK ON OFF-SHORE OIL AND GAS EXPLORATION AND EXTRACTION ENVIRONMENTS; RENTAL OF PORTABLE SHELTERS FOR USE AS SAFETY APPARATUS IN OFF-SHORE OIL AND GAS EXPLORATION AND EXTRACTION ENVIRONMENTS, IN CLASS 45 (U.S. CLS. 100 AND 101).

THE MARK CONSISTS OF STANDARD CHARACTERS WITHOUT CLAIM TO ANY PARTICULAR FONT, STYLE, SIZE, OR COLOR.

PRIORITY DATE OF 6-7-2010 IS CLAIMED.



**Reg. No. 4,273,808** OWNER OF INTERNATIONAL REGISTRATION 1088641 DATED 12-2-2010, EXPIRES 12-2-2020.

SER. NO. 79-101,799, FILED 12-2-2010.

DAVID TAYLOR, EXAMINING ATTORNEY

# United States of America

United States Patent and Trademark Office



**Reg. No. 4,273,809**

**Registered Jan. 15, 2013**

**Int. Cls.: 16, 28 and 41**

**TRADEMARK**

**SERVICE MARK**

**PRINCIPAL REGISTER**

ARBOS DI PAOLIN ORAZIO SERGIO & C. S.N.C. (ITALY PARTNERSHIP)  
VIA TORRE, 40  
SOLAGNA (VI), ITALY I36020

FOR: PAPER, CARDBOARD AND GOODS MADE FROM THESE MATERIALS, NAMELY, NOTEBOOKS, PHOTO ALBUMS, NOTE PADS, FOLDERS, COPY BOOKS, RECYCLED PAPER, CALENDARS, NOTE CARDS, ENVELOPES, STATIONERY; PRINTED MATTER, NAMELY, DECORATIVE PAPER; BOOKBINDING MATERIAL; PHOTOGRAPHS; STATIONERY; ADHESIVES FOR STATIONERY OR HOUSEHOLD PURPOSES; PAINT BRUSHES; PLASTIC BAGS FOR PACKAGING, IN CLASS 16 (U.S. CLS. 2, 5, 22, 23, 29, 37, 38 AND 50).

FOR: PLAYING CARDS, IN CLASS 28 (U.S. CLS. 22, 23, 38 AND 50).

FOR: PUBLISHING SERVICES, NAMELY, PUBLISHING OF BOOKS, IN CLASS 41 (U.S. CLS. 100, 101 AND 107).

THE MARK CONSISTS OF THE WORD "ARBOS" WRITTEN WITH LOWER-CASE BLOCK LETTERS PLACED INSIDE A SQUARE FRAME, THE STYLIZED DESIGN OF A LEAF CAN BE SEEN ABOVE SAID WORD "ARBOS".

OWNER OF INTERNATIONAL REGISTRATION 1091109 DATED 9-6-2011, EXPIRES 9-6-2021.

THE ENGLISH TRANSLATION OF "ARBOS" IN THE MARK IS TREE.

SER. NO. 79-102,708, FILED 9-6-2011.

KATHERINE E. HALMEN, EXAMINING ATTORNEY



*David J. Kybas*

Director of the United States Patent and Trademark Office

# United States of America

United States Patent and Trademark Office

# CHROMACON

**Reg. No. 4,273,810**

**Registered Jan. 15, 2013**

**Int. Cls.: 9, 11 and 42**

**TRADEMARK**

**SERVICE MARK**

**PRINCIPAL REGISTER**

CHROMACON AG (SWITZERLAND AKTIENGESELLSCHAFT)  
TECHNOPARKSTRASSE 1  
CH-8005 ZÜRICH  
SWITZERLAND

FOR: SCIENTIFIC APPARATUS AND INSTRUMENTS AND CONTROLS THEREOF IN THE NATURE OF APPARATUS AND INSTRUMENTS FOR SEPARATION AND PURIFICATION OF CHEMICAL PREPARATIONS, NAMELY, CHROMATOGRAPHY COLUMNS FOR USE IN PURIFICATION IN THE LABORATORY AND PARTS AND FITTINGS THEREFOR, CHROMATOGRAPHY COLUMNS FOR USE IN PURIFICATION IN THE LABORATORY, PRE-PACKED COLUMNS FOR USE IN SEPARATION AND PURIFICATION; SCIENTIFIC APPARATUS AND INSTRUMENTS FOR INDUSTRIAL AND LABORATORY USE, NAMELY, LIQUID CHROMATOGRAPHY APPARATUS IN THE NATURE OF PREPARATIVE CHROMATOGRAPHY UNITS FOR LIQUID CHROMATOGRAPHY IN BATCH MODE AND CONTINUOUS MODE; SCIENTIFIC APPARATUS AND INSTRUMENTS FOR INDUSTRIAL AND LABORATORY USE IN THE NATURE OF PREPARATIVE CHROMATOGRAPHY APPARATUS AND INSTRUMENTS, NAMELY, CHROMATOGRAPHY APPARATUS FOR LABORATORY USE IN THE NATURE OF PREPARATIVE CHROMATOGRAPHY UNITS FOR CARBON-DIOXIDE RECYCLING IN BATCH AND CONTINUOUS MODES AND PREPARATIVE CHROMATOGRAPHY UNITS FOR MULTICOLUMN CONTINUOUS CHROMATOGRAPHY, IN CLASS 9 (U.S. CLS. 21, 23, 26, 36 AND 38).

FOR: CHROMATOGRAPHY APPARATUS FOR INDUSTRIAL USE, NAMELY, MEMBRANE FILTER CARTRIDGES FOR THE SEPARATION OF BIOMOLECULES IN BIOPHARMACEUTICAL PRODUCTION, IN CLASS 11 (U.S. CLS. 13, 21, 23, 31 AND 34).

FOR: SCIENTIFIC LABORATORY SERVICES AND RESEARCH SERVICES IN THE FIELDS OF CHEMISTRY, PHARMACEUTICALS, PHARMACOLOGY, CLINICAL BIOLOGY AND CHROMATOGRAPHY; SCIENTIFIC RESEARCH, NAMELY, SCIENTIFIC STUDIES FOR SEPARATION AND FRACTIONATION USING CHROMATOGRAPHY AND PHARMACEUTICAL ENGINEERING FOR OUTSIDE CLIENTS; SCIENTIFIC RESEARCH RELATING TO NEW PRODUCTS IN THE FOOD AND PHARMACEUTICAL INDUSTRIES; RESEARCH AND DEVELOPMENT IN THE FIELDS OF FOOD AND PHARMACEUTICALS, IN CLASS 42 (U.S. CLS. 100 AND 101).



*David J. Kyjars*

Director of the United States Patent and Trademark Office

THE MARK CONSISTS OF STANDARD CHARACTERS WITHOUT CLAIM TO ANY PARTICULAR FONT, STYLE, SIZE, OR COLOR.

**Reg. No. 4,273,810** OWNER OF INTERNATIONAL REGISTRATION 0955931 DATED 2-19-2008, EXPIRES 2-19-2018.

SER. NO. 79-102,855, FILED 12-3-2010.

JAY BESCH, EXAMINING ATTORNEY

# United States of America

United States Patent and Trademark Office

# SHAMBALLA

**Reg. No. 4,273,811**

SHAMBALLA JEWELS APS (DENMARK A PRIVATE LIMITED LIABILITY COMPANY)  
GRØNNEGADE 36 ST TV  
DK-1107 COPENHAGEN K, DENMARK

**Registered Jan. 15, 2013**

**Int. Cls.: 9, 14, 18 and 20**

FOR: SPECTACLES AND SUNGLASSES, PARTS FOR THESE GOODS IN THE FORM OF SPECTACLE FRAMES, SPECTACLE CASES, IN CLASS 9 (U.S. CLS. 21, 23, 26, 36 AND 38).

**TRADEMARK**

FOR: JEWELLERY, PERSONAL ORNAMENTS IN THE NATURE OF JEWELRY, COSTUME JEWELLERY, CUFFLINKS, KEY RINGS OF PRECIOUS METALS, TIE PINS, JEWELLERY CASES, WATCHES AND THEIR PARTS IN THE FORM OF WATCH BANDS, CASES FOR WATCHES, IN CLASS 14 (U.S. CLS. 2, 27, 28 AND 50).

**PRINCIPAL REGISTER**

FOR: LEATHER BAGS FOR PACKAGING; BOXES OF LEATHER OR OF LEATHER BOARD, IN CLASS 18 (U.S. CLS. 1, 2, 3, 22 AND 41).

FOR: DISPLAY STANDS, INCLUDING DISPLAY STANDS FOR JEWELLERY, CASES AND BOXES OF WOOD, IN CLASS 20 (U.S. CLS. 2, 13, 22, 25, 32 AND 50).

THE MARK CONSISTS OF STANDARD CHARACTERS WITHOUT CLAIM TO ANY PARTICULAR FONT, STYLE, SIZE, OR COLOR.

PRIORITY DATE OF 4-5-2011 IS CLAIMED.

OWNER OF INTERNATIONAL REGISTRATION 1091870 DATED 8-2-2011, EXPIRES 8-2-2021.

THE WORDING "SHAMBALLA" HAS NO MEANING IN A FOREIGN LANGUAGE.

SER. NO. 79-102,992, FILED 8-2-2011.

STEVEN PEREZ, EXAMINING ATTORNEY



*David J. Kyfos*

Director of the United States Patent and Trademark Office

# United States of America

United States Patent and Trademark Office



## APPersonality

**Reg. No. 4,273,812**

**Registered Jan. 15, 2013**

**Int. Cls.: 9, 16, 28, 35, 38,  
41 and 42**

**TRADEMARK**

**SERVICE MARK**

**PRINCIPAL REGISTER**

NERD COMMUNICATIONS GMBH, BERLIN (FED REP GERMANY GESELLSCHAFT MIT  
BESCHRÄNKTER HAFTUNG (GMBH))

ROCHSTRASSE 17

10178 BERLIN

FED REP GERMANY

FOR: MAGNETIC DATA CARRIERS, CDS, CD-ROMS, DVDS, VIDEOTAPES, OPTICAL DATA CARRIERS, AS WELL AS SOUND AND VISUAL MAGNETIC AND OPTICAL DATA CARRIERS, ALL BEING PRE-RECORDED AND FEATURING SOUND, MUSIC, MUSIC VIDEO AND ENTERTAINMENT VIDEO; SOFTWARE, NAMELY, SOFTWARE FOR VIDEO GAMES AND MOBILE GAMES, ENTERTAINMENT PURPOSES, AND COMMUNICATION PURPOSES VIA THE INTERNET, IN CLASS 9 (U.S. CLS. 21, 23, 26, 36 AND 38).

FOR: PAPER, CARDBOARD AND GOODS MADE THEREOF INCLUDED IN THIS CLASS, NAMELY, PRINTED POSTERS, STAND-UP CARDBOARD CUT-OUTS, PAPER SHOPPING BAGS, PAPER TOWELS AND CARDBOARD GIFT BOXES; PRINTED MATTER, NAMELY, PRINTED CALENDARS AND PAMPHLETS, BROCHURES, NEWSLETTERS, JOURNALS, MAGAZINES IN THE FIELD OF MUSIC, FILM, MOBILE GAMES, COMPUTER GAMES, AND ENTERTAINMENT; PHOTOGRAPHS; STATIONERY, IN CLASS 16 (U.S. CLS. 2, 5, 22, 23, 29, 37, 38 AND 50).

FOR: GAMES, NAMELY, BOARD GAMES, ELECTRONIC BOARD GAMES, CARD GAMES AND HAND-HELD UNITS FOR PLAYING ELECTRONIC GAMES OTHER THAN THOSE ADAPTED FOR USE WITH AN EXTERNAL DISPLAY SCREEN OR MONITOR, IN CLASS 28 (U.S. CLS. 22, 23, 38 AND 50).

FOR: ON-LINE RETAIL AND MAIL ORDER SERVICES FEATURING SOFTWARE, COMPUTER, VIDEO GAMES AND ADVERTISING SOFTWARE APPLICATIONS, IN CLASS 35 (U.S. CLS. 100, 101 AND 102).

FOR: TELECOMMUNICATION, TELECOMMUNICATION AND COMMUNICATION SERVICES, NAMELY, INTERNET SERVICE PROVIDER SERVICES, VOICE OVER IP SERVICES, VIDEO CONFERENCING OVER IP SERVICES, TEXT MESSAGE SERVICES, WIRELESS BROADBAND COMMUNICATION SERVICES; SERVICES OF A NEWS AGENCY, NAMELY, RECEIVING AND TRANSMITTING OF NEWS BY ELECTRONIC TRANSFER, ESPECIALLY VIA THE INTERNET; PROVIDING ACCESS TO DIGITAL MUSIC, VIDEOS AND OTHER MULTIMEDIA WEBSITES BY WAY OF TELECOMMUNICATION; WIRELESS TELECOM-



*David J. Kybas*

Director of the United States Patent and Trademark Office

**Reg. No. 4,273,812** MUNICATION SERVICES VIA ELECTRONIC COMMUNICATION NETWORKS, NAMELY, WIRELESS BROADBAND COMMUNICATION SERVICES, IN CLASS 38 (U.S. CLS. 100, 101 AND 104).

FOR: EDUCATION, NAMELY, CLASSES, SEMINARS, WORKSHOPS, AND ON-LINE SEMINARS IN THE FIELD OF MUSIC, LITERATURE, PUBLISHING, COMPUTER GAMES, AND ENTERTAINMENT; ENTERTAINMENT, SPORTING AND CULTURAL ACTIVITIES, NAMELY, LIVE CONCERTS, FILM, MUSIC AND COMPUTER FESTIVALS, THEATRICAL PRODUCTION OF PLAYS, LIVE ART PERFORMANCES, ART EXHIBITIONS AND FAIRS; FILM PRODUCTION; PROVISION OF NON-DOWNLOADABLE ELECTRONIC PUBLICATIONS AND ON-LINE ELECTRONIC PUBLICATIONS, NOT FOR ADVERTISING PURPOSES, NAMELY, PAMPHLETS, BROCHURES, NEWSLETTERS, JOURNALS, MAGAZINES IN THE FIELD OF MUSIC, FILM, MOBILE GAMES, COMPUTER GAMES, AND ENTERTAINMENT; PROVISION OF NON-DOWNLOADABLE PUBLICATIONS FROM A GLOBAL COMPUTER NETWORK OR THE INTERNET ACCESSED ONLINE, NAMELY, PAMPHLETS, BROCHURES, NEWSLETTERS, JOURNALS, MAGAZINES IN THE FIELD OF MUSIC, FILM, MOBILE GAMES, COMPUTER GAMES AND ENTERTAINMENT, IN CLASS 41 (U.S. CLS. 100, 101 AND 107).

FOR: DESIGN, DEVELOPMENT AND PROGRAMMING OF COMPUTER SOFTWARE; DESIGN OF ELECTRONIC DATA PROTECTION HARDWARE AND SOFTWARE, IN CLASS 42 (U.S. CLS. 100 AND 101).

PRIORITY DATE OF 12-7-2010 IS CLAIMED.

OWNER OF INTERNATIONAL REGISTRATION 1092141 DATED 6-1-2011, EXPIRES 6-1-2021.

SER. NO. 79-103,081, FILED 6-1-2011.

APRIL ROACH, EXAMINING ATTORNEY

# United States of America

United States Patent and Trademark Office



**Reg. No. 4,273,813**

**Registered Jan. 15, 2013**

**Int. Cl.: 21**

**TRADEMARK**

**PRINCIPAL REGISTER**

FLORIAN ENGHARD (FED REP GERMANY INDIVIDUAL)  
WIESENSTRASSE 17  
65843 SULZBACH  
FED REP GERMANY

FOR: HOUSEHOLD OR KITCHEN UTENSILS AND CONTAINERS, NAMELY, BOTTLES SOLD EMPTY AND BOWLS, NOT OF PRECIOUS METAL OR COATED THEREWITH, IN CLASS 21 (U.S. CLS. 2, 13, 23, 29, 30, 33, 40 AND 50).

OWNER OF U.S. REG. NO. 4,120,105.

PRIORITY DATE OF 11-24-2010 IS CLAIMED.

OWNER OF INTERNATIONAL REGISTRATION 1093225 DATED 4-6-2011, EXPIRES 4-6-2021.

NO CLAIM IS MADE TO THE EXCLUSIVE RIGHT TO USE "BOTTLE", APART FROM THE MARK AS SHOWN.

THE MARK CONSISTS OF THE STYLIZED WORD "SPIDER" OVER THE STYLIZED WORD "BOTTLE", WITH A HORIZONTAL LINE SEPARATING THE WORDS. TO THE LEFT OF THE WORDING ARE FIVE CIRCLES, WITH SUCCESSIVELY SMALLER CIRCLES PLACED INSIDE ONE ANOTHER AND ALL SHARING THE SAME RIGHT EDGE.

SER. NO. 79-103,538, FILED 4-6-2011.

ROBIN MITTLER, EXAMINING ATTORNEY



*David J. Kyffers*

Director of the United States Patent and Trademark Office



# United States of America

United States Patent and Trademark Office

# DÜRKOPP ADLER

**Reg. No. 4,273,814**

**Registered Jan. 15, 2013**

**Int. Cls.: 7 and 9**

**TRADEMARK**

**PRINCIPAL REGISTER**

DÜRKOPP ADLER AKTIENGESELLSCHAFT (FED REP GERMANY CORPORATION)  
POSTDAMER STRASSE 190  
33729 BIELEFELD, FED REP GERMANY

FOR: SEWING MACHINES, SEWING ROBOTS, SEWING UNITS COMPRISING SEWING MACHINES, FABRIC SUPPLY DEVICES, NAMELY, MECHANIZED FABRIC FEEDERS AND FABRIC STACKERS AS PARTS OF SEWING ROBOTS; FEATURE OF A SEWING MACHINE, NAMELY, FABRIC GUIDING APPARATUS; ADDITIONAL EQUIPMENT IN THE NATURE OF PARTS OF SEWING MACHINE, NAMELY, FABRIC GUIDING AND FOLDING APPARATUS; FABRIC SUPPLY AND REMOVAL DEVICES, IN THE NATURE OF MECHANIZED FABRIC FEEDERS AS PART OF SEWING ROBOTS; FABRIC WINDING DEVICES AS PART OF SEWING ROBOTS; MACHINE TOOLS USED FOR MACHINING PARTS OF SEWING ROBOTS; MACHINE PRESSES FOR FABRICS AND FABRIC PIECES; CONVEYERS, NAMELY, ACTUATED OR NON-ACTUATED CONVEYERS, ROLLER CONVEYERS, AND MOBILE SHELVES; PARTS OF THE AFOREMENTIONED GOODS, IN CLASS 7 (U.S. CLS. 13, 19, 21, 23, 31, 34 AND 35).

FOR: ELECTRONIC CONTROLS FOR SEWING ROBOTS AND FOR UNITS COMPRISING SEWING MACHINES, SUPPLY DEVICES AND STACKERS; COMPUTER SOFTWARE PROGRAMS AND DATA PROCESSORS FOR THE ELECTRONIC CONTROL OF THE AFOREMENTIONED SEWING ROBOTS AND UNITS; COMPUTER SOFTWARE PROGRAMS AND DATA PROCESSORS USED FOR THE CONTROL AN OPERATION OF MACHINING MACHINE-TOOLS FOR PARTS OF SEWING MACHINES OR UNITS; COMPUTER SOFTWARE PROGRAMS AND DATA PROCESSING PROGRAMS STORED ON ELECTRONIC MEDIA FOR ELECTRONIC CONTROL OF THE AFOREMENTIONED SEWING ROBOTS AND UNITS; CONTROL AND MONITORING UNITS IN THE NATURE OF COMPUTER SOFTWARE AND DATA PROCESSORS USED TO CONTROL AND OPERATE CONVEYING INSTALLATIONS MENTIONED BEFORE; PARTS OF THE AFOREMENTIONED GOODS, IN CLASS 9 (U.S. CLS. 21, 23, 26, 36 AND 38).

OWNER OF U.S. REG. NOS. 1,019,237, 1,745,516, AND 3,367,615.

OWNER OF INTERNATIONAL REGISTRATION 0562496 DATED 10-17-1990, EXPIRES 10-17-2020.

THE MARK "DURKOPP ADLER" DOES NOT IDENTIFY A LIVING INDIVIDUAL.



*David J. Kybas*

Director of the United States Patent and Trademark Office

**Reg. No. 4,273,814** SER. NO. 79-103,785, FILED 11-8-2010.

SUE LAWRENCE, EXAMINING ATTORNEY

# United States of America

United States Patent and Trademark Office

# ALLTION

**Reg. No. 4,273,815**

**Registered Jan. 15, 2013**

**Int. Cls.: 9 and 10**

**TRADEMARK**

**PRINCIPAL REGISTER**

ALLTION (WUZHOU) CO., LTD (CHINA LIMITED COMPANY)  
ROOM 1102-1, UNIT 1, SUITE B,  
11/F, LIJING TOWER, CATHAY PLAZA., ZHONGSHAN ROAD; WUZHOU; GUANGXI  
CHINA

FOR: MICROSCOPES; TIME RECORDING APPARATUS; WEIGHING MACHINES; HOLDERS  
FOR ELECTRIC COILS; PRINTED CIRCUITS; BATTERIES FOR LIGHTING, IN CLASS 9  
(U.S. CLS. 21, 23, 26, 36 AND 38).

FOR: MIRRORS FOR SURGEONS; ROENTGEN APPARATUS FOR MEDICAL PURPOSES;  
ULTRASONIC MEDICAL TREATMENT INSTRUMENT AND PARTS THEREOF; SURGICAL  
APPARATUS AND INSTRUMENTS; MASKS FOR USE BY MEDICAL PERSONNEL, IN  
CLASS 10 (U.S. CLS. 26, 39 AND 44).

THE WORDING "ALLTION" HAS NO MEANING IN A FOREIGN LANGUAGE.

OWNER OF INTERNATIONAL REGISTRATION 1094144 DATED 9-27-2011, EXPIRES 9-27-  
2021.

SER. NO. 79-103,892, FILED 9-27-2011.

MARILYN IZZI, EXAMINING ATTORNEY



*David J. Kypos*

Director of the United States Patent and Trademark Office

# United States of America

United States Patent and Trademark Office

# EASY Bolt

**Reg. No. 4,273,816**

**Registered Jan. 15, 2013**

**Int. Cls.: 7, 9 and 12**

KIEKERT AKTIENGESELLSCHAFT (FED REP GERMANY INCORPORATED COMPANY  
(AG))  
HÖSELER PLATZ 2  
42579 HEILIGENHAUS  
FED REP GERMANY

**TRADEMARK**

**PRINCIPAL REGISTER**

FOR: ELECTRICALLY CONTROLLED ADJUSTING EQUIPMENT AND APPARATUS HAVING AN ELECTRICAL DRIVE, NAMELY, REMOTE RACKING MOTORS FOR ENGAGING AND DISENGAGING ELECTRICAL POWER CIRCUIT BREAKER; EQUIPMENT HAVING AN ELECTRICAL OR MECHANICAL DRIVE, NAMELY, ELECTRIC MOTORS FOR MACHINES WITH A DIGITAL SERVO DRIVE CONTROLLER; ELECTRICAL OR ELECTRONIC CONTROL EQUIPMENT FOR THE DRIVE FOR LOCKS OF FLAPS OR ELECTRICAL PLUG CONNECTIONS, NAMELY, LINEAR ACTUATORS AND HYDRAULIC CONTROLS FOR MACHINES, MOTORS AND ENGINES, IN CLASS 7 (U.S. CLS. 13, 19, 21, 23, 31, 34 AND 35).

FOR: ELECTRICAL AND ELECTRONIC COMPONENTS, NAMELY, ELECTRICAL OR ELECTRONIC PLUG CONNECTORS, STRUCTURAL PARTS OF AN ELECTRICAL OR ELECTRONIC PLUG CONNECTOR, AND ELECTRIC CABLES FOR AN ELECTRICAL OR ELECTRONIC PLUG CONNECTOR; ELECTRICAL PLUGS AND SOCKETS FOR ELECTRIC VEHICLES; ELECTRIC LOCKS IN PARTICULAR FOR FLAPS OR ELECTRICAL PLUG CONNECTIONS; ELECTRICAL APPARATUS OR INSTRUMENTS FOR CLOSING OR OPENING FLAPS OR ELECTRICAL PLUG CONNECTIONS, NAMELY, MINI ELECTRIC ACTUATORS AND ELECTRICAL CONTROLLERS, IN CLASS 9 (U.S. CLS. 21, 23, 26, 36 AND 38).

FOR: ELECTRIC LOW-POWER MOTORS FOR MOTOR CARS; ELECTRIC SMALL DRIVES FOR DRIVING MOTOR CARS, ADJUSTING AND ACTUATING MOTOR VEHICLE LOCKS; VEHICLE MUD FLAPS; ELECTRICAL PLUG CONNECTORS OF VEHICLES, IN CLASS 12 (U.S. CLS. 19, 21, 23, 31, 35 AND 44).

THE MARK CONSISTS OF THE WORDING "EASY BOLT" WITH THE LETTER "E" IN THE WORD "EASY" IN THE COLOR BLUE, AND THE LETTERS "ASY" IN THE WORD "EASY" IN THE COLOR GRAY. THE WORD "BOLT" IS IN THE COLOR GRAY. THE LETTER "E" AND THE LETTER "Y" IN THE WORD "EASY" ARE FORMED BY PLUGS. THE COLOR WHITE ON THE PLUG FORMING THE LETTER "Y" REPRESENTS BACKGROUND ONLY AND IS NOT CLAIMED AS A FEATURE OF THE MARK.



*David J. Kyffers*

Director of the United States Patent and Trademark Office

**Reg. No. 4,273,816** PRIORITY DATE OF 5-30-2011 IS CLAIMED.

OWNER OF INTERNATIONAL REGISTRATION 1094175 DATED 7-13-2011, EXPIRES 7-13-2021.

THE COLOR(S) BLUE AND GREY IS/ARE CLAIMED AS A FEATURE OF THE MARK.

SER. NO. 79-103,905, FILED 7-13-2011.

TASNEEM HUSSAIN, EXAMINING ATTORNEY

# United States of America

United States Patent and Trademark Office

## LUMI - COMPLEX

**Reg. No. 4,273,817**

CASTER (FRANCE SOCIETE PAR ACTIONS SIMPLIFIEE)  
99 RUE DU FAUBOURG SAINT HONORÉ  
F-75008 PARIS, FRANCE

**Registered Jan. 15, 2013**

**Int. Cl.: 1**

FOR: CHEMICALS FOR USE IN INDUSTRY, NAMELY, ACTIVE ELEMENTS OBTAINED FROM EXTRACTS OF NATURAL, PLANT OR SYNTHETIC ORIGIN AND INTENDED FOR USE AS INGREDIENTS IN THE MANUFACTURE OF COSMETICS, IN CLASS 1 (U.S. CLS. 1, 5, 6, 10, 26 AND 46).

**TRADEMARK**

**PRINCIPAL REGISTER**

THE MARK CONSISTS OF STANDARD CHARACTERS WITHOUT CLAIM TO ANY PARTICULAR FONT, STYLE, SIZE, OR COLOR.

PRIORITY DATE OF 4-15-2011 IS CLAIMED.

OWNER OF INTERNATIONAL REGISTRATION 1094192 DATED 9-8-2011, EXPIRES 9-8-2021.

NO CLAIM IS MADE TO THE EXCLUSIVE RIGHT TO USE "COMPLEX", APART FROM THE MARK AS SHOWN.

SER. NO. 79-103,914, FILED 9-8-2011.

EVELYN BRADLEY, EXAMINING ATTORNEY



*David J. Kyjars*

Director of the United States Patent and Trademark Office

# United States of America

United States Patent and Trademark Office

# EASYMIX

**Reg. No. 4,273,818**

**Registered Jan. 15, 2013**

**Int. Cls.: 7, 9 and 12**

LIEBHERR-INTERNATIONAL AUSTRIA GMBH (AUSTRIA GESELLSCHAFT MIT  
BESCHRÄNKTER HAFTUNG (GMBH))  
DR. HANS-LIEBHERR-STRASSE 4  
A-5500 BISCHOFSHOFEN  
AUSTRIA

**TRADEMARK**

**PRINCIPAL REGISTER**

FOR: STATIONARY CONCRETE MIXERS; DIESEL ENGINES FOR MACHINES AND NOT FOR LAND VEHICLES, ELECTRIC MOTORS FOR MACHINES AND NOT FOR LAND VEHICLES; HYDRAULIC ENGINES, MOTORS AND MIXING DRUMS FOR STATIONARY CONCRETE MIXERS; COMPONENTS, SPARE PARTS AND ACCESSORIES FOR ALL THE AFOREMENTIONED GOODS AS FAR AS INCLUDED IN THIS CLASS, NAMELY, HYDRAULIC LINEAR ACTUATORS, HYDRAULIC VALVE ACTUATORS, PNEUMATIC LINEAR ACTUATORS, PNEUMATIC VALVE ACTUATORS, SERVO AND POSITIONING DRIVES FOR MOTORS, VALVES BEING PARTS OF DIESEL ENGINES, SERVOS IN THE NATURE OF SERVO-MOTORS, AND SERVO-VALVES, PNEUMATIC SYSTEMS COMPRISED OF PRESSURE SWITCHES AND SENSORS FOR MONITORING, CONTROLLING, AND SWITCHING PNEUMATIC SYSTEMS, PNEUMATIC PUMPS, COMPRESSORS, PIPING, AND FITTINGS, HYDRAULIC SYSTEMS COMPRISED OF HYDRAULIC CONTROLS FOR MACHINES, MOTORS, AND ENGINES, HYDRAULIC CONVEYORS, HYDRAULIC PUMPS, HYDRAULIC COMPRESSORS, CYLINDERS, PIPING, AND FITTINGS, POSITIONING DRIVES, FILTERS, CONCRETE MIXER SILOS, CONVEYOR BELTS, BOWL FEEDERS, AGITATORS, AGGREGATE BINS, ALL FOR MACHINES, IN CLASS 7 (U.S. CLS. 13, 19, 21, 23, 31, 34 AND 35).



FOR: OPTICAL, MEASURING, SIGNALING, CHECKING AND SUPERVISION APPARATUS AND INSTRUMENTS, NAMELY, SCALES FOR WEIGHING CEMENT AND AGGREGATE, TEMPERATURE SENSORS FOR CONCRETE MIXERS, MOISTURE SENSORS FOR CONCRETE MIXERS, CONTROL SYSTEMS FOR MIXING INSTALLATIONS COMPRISING COMPUTER HARDWARE, COMPUTER SOFTWARE, AND COMPUTER DISPLAYS ALL FOR USE IN CONTROLLING MIXING INSTALLATIONS, IN CLASS 9 (U.S. CLS. 21, 23, 26, 36 AND 38).

*David J. Kyffers*

Director of the United States Patent and Trademark Office

FOR: TRUCK CONCRETE MIXERS; DIESEL ENGINES FOR LAND VEHICLES, ELECTRIC MOTORS FOR LAND VEHICLES, HYDRAULIC CIRCUITS FOR VEHICLES; COMPONENTS, SPARE PARTS AND ACCESSORIES FOR ALL THE AFOREMENTIONED GOODS AS FAR AS INCLUDED IN THIS CLASS, NAMELY, TRAVEL GEARS, DRIVE GEARS, TRANSMISSION GEARS, TIMING GEARS, ACTUATORS FOR BRAKES AND DRIVING MECHANISMS,

**Reg. No. 4,273,818** PISTONS, HYDRAULIC AND PNEUMATIC SYSTEMS COMPRISED OF BRAKES, COMPRESSORS, SWITCHES, SENSORS, CYLINDERS, REGULATORS, AND PUMPS, VALVES BEING PARTS OF DIESEL ENGINES, SERVO AND POSITIONING DRIVES FOR LAND VEHICLE MOTORS, HYDRAULIC AND PNEUMATIC PARTS, NAMELY, COMPRESSORS, SWITCHES, SENSORS, CYLINDERS, REGULATORS, AND PUMPS, ALL FOR LAND VEHICLES, IN CLASS 12 (U.S. CLS. 19, 21, 23, 31, 35 AND 44).

THE MARK CONSISTS OF STANDARD CHARACTERS WITHOUT CLAIM TO ANY PARTICULAR FONT, STYLE, SIZE, OR COLOR.

OWNER OF INTERNATIONAL REGISTRATION 1094723 DATED 7-14-2011, EXPIRES 7-14-2021.

SER. NO. 79-104,133, FILED 7-14-2011.

MARILYN IZZI, EXAMINING ATTORNEY



# United States of America

United States Patent and Trademark Office

# VOLEX

**Reg. No. 4,273,819**

**Registered Jan. 15, 2013**

**Int. Cl.: 9**

**TRADEMARK**

**PRINCIPAL REGISTER**

VOLEX PLC (ENGLAND PUBLIC LIMITED COMPANY (PLC))  
10 EASTBOURNE TERRACE  
PADDINGTON, LONDON, UNITED KINGDOM W2 6LG

FOR: ELECTRICAL, ELECTRONIC, FIBRE OPTIC AND POWER CABLES, AND COMBINATIONS THEREOF; ELECTRICAL, ELECTRONIC, FIBRE OPTIC AND POWER CABLE ASSEMBLIES, AND COMBINATIONS THEREOF, COMPOSED OF WIRES OR CABLES, OR A COMBINATION THEREOF, A CONNECTOR AND SUBASSEMBLIES THEREOF; ELECTRICAL, ELECTRONIC, FIBRE OPTIC AND POWER HARNESSSES, AND COMBINATIONS THEREOF, COMPOSED OF WIRES OR CABLES, OR A COMBINATION THEREOF, MULTIPLE CONNECTORS AND SUBASSEMBLIES THEREOF; ELECTRICAL POWER CORDS; ELECTRICAL PLUGS; ELECTRICAL TERMINATORS; ELECTRIC, ELECTRONIC AND DIGITAL ADAPTORS; ELECTRICAL POWER DISTRIBUTION UNITS; AND CONNECTORS, NAMELY, RADIO FREQUENCY, ELECTRICAL, DIGITAL AND OPTICAL CONNECTORS, IN CLASS 9 (U.S. CLS. 21, 23, 26, 36 AND 38).

THE MARK CONSISTS OF STANDARD CHARACTERS WITHOUT CLAIM TO ANY PARTICULAR FONT, STYLE, SIZE, OR COLOR.

OWNER OF INTERNATIONAL REGISTRATION 1095478 DATED 9-3-2011, EXPIRES 9-3-2021.

OWNER OF U.S. REG. NO. 2,500,568.

SER. NO. 79-104,435, FILED 9-3-2011.

TASHIA BUNCH, EXAMINING ATTORNEY



*David J. Kyros*

Director of the United States Patent and Trademark Office

# United States of America

United States Patent and Trademark Office



**Reg. No. 4,273,820**

**Registered Jan. 15, 2013**

**Int. Cl.: 16**

**TRADEMARK**

**PRINCIPAL REGISTER**

COMMONWEALTH EDUCATION TRUST (UNITED KINGDOM CHARITY)  
6TH FLOOR, NEW ZEALAND HOUSE,  
80 HAYMARKET; LONDON SW1Y 4TE  
UNITED KINGDOM

FOR: PRINTED PUBLICATIONS AND PRINTED MATTER, NAMELY, BOOKS, HANDOUTS, WORKBOOKS, MAGAZINES AND BOOKLETS IN THE FIELDS OF EDUCATION AND TRAINING AND NOT IN THE FIELDS OF POLITICS AND PUBLIC AFFAIRS; STATIONERY; INSTRUCTIONAL AND TEACHING MATERIAL EXCLUDING APPARATUS, NAMELY, WORKBOOKS, HANDOUTS, AND BOOKS IN THE FIELDS OF EDUCATION AND TRAINING, IN CLASS 16 (U.S. CLS. 2, 5, 22, 23, 29, 37, 38 AND 50).

NO CLAIM IS MADE TO THE EXCLUSIVE RIGHT TO USE "COMMONWEALTH EDUCATION TRUST", APART FROM THE MARK AS SHOWN.

OWNER OF INTERNATIONAL REGISTRATION 1096196 DATED 7-27-2011, EXPIRES 7-27-2021.

THE MARK CONSISTS OF A STYLIZED DESIGN OF TWO FANNED OPEN BOOKS ABOVE THE WORDING "COMMONWEALTH EDUCATION TRUST".

SER. NO. 79-104,807, FILED 7-27-2011.

ELIZABETH KAJUBI, EXAMINING ATTORNEY



*David J. Kybas*

Director of the United States Patent and Trademark Office

# United States of America

United States Patent and Trademark Office

# KÄNGABOX

**Reg. No. 4,273,821**

**Registered Jan. 15, 2013**

**Int. Cls.: 20 and 21**

FEBRA-KUNSTSTOFFE GMBH (FED REP GERMANY GESELLSCHAFT MIT  
BESCHRÄNKTER HAFTUNG)  
KLINGENBERGER STR. 2  
74336 BRACKENHEIM  
FED REP GERMANY

**TRADEMARK**

FOR: CONTAINERS, TRESTLES, NOT OF METAL, FOR TRANSPORT PURPOSES, IN CLASS  
20 (U.S. CLS. 2, 13, 22, 25, 32 AND 50).

**PRINCIPAL REGISTER**

FOR: THERMAL INSULATING CONTAINERS, AT LEAST PARTLY OF METAL, IN PAR-  
TICULAR FOR THE TRANSPORT AND/OR STORAGE OF FOODSTUFFS AND/OR MEDI-  
CINES; THERMAL INSULATING CONTAINERS, NOT OF METAL, IN PARTICULAR FOR  
THE TRANSPORT AND/OR STORAGE OF FOODSTUFFS AND/OR MEDICINES, IN CLASS  
21 (U.S. CLS. 2, 13, 23, 29, 30, 33, 40 AND 50).

THE MARK CONSISTS OF STANDARD CHARACTERS WITHOUT CLAIM TO ANY PAR-  
TICULAR FONT, STYLE, SIZE, OR COLOR.

PRIORITY DATE OF 4-12-2011 IS CLAIMED.

OWNER OF INTERNATIONAL REGISTRATION 1096378 DATED 10-6-2011, EXPIRES 10-  
6-2021.

SER. NO. 79-104,881, FILED 10-6-2011.

SANI KHOURI, EXAMINING ATTORNEY



*David J. Kyros*

Director of the United States Patent and Trademark Office

# United States of America

United States Patent and Trademark Office



**Reg. No. 4,273,822**

**Registered Jan. 15, 2013**

**Int. Cls.: 6, 8, 9, 11, 14,  
18, 20, 22 and 25**

**TRADEMARK**

**PRINCIPAL REGISTER**

DIETER RIX (FED REP GERMANY INDIVIDUAL)  
IM KLINKENHAGEN 50  
48653 COESFELD  
FED REP GERMANY

FOR: GOODS OF COMMON METAL, NAMELY, BOTTLE CLOSURES OF METAL; AND CUPS, NAMELY, COMMEMORATIVE STATUARY CUPS MADE OF NON-PRECIOUS METAL, IN CLASS 6 (U.S. CLS. 2, 12, 13, 14, 23, 25 AND 50).

FOR: KNIVES; HAND-OPERATED MULTI-FUNCTIONAL TOOLS, NAMELY, COMPRISED OF SCREWDRIVERS, KNIVES, CAN OPENERS, FILES, PLIERS, SAFETY CUTTERS, SAWS, BOTTLE OPENERS, TWEEZERS, CLIPPERS, CLIPS IN THE NATURE OF MANUAL CLIPPERS, AND SCISSORS, IN CLASS 8 (U.S. CLS. 23, 28 AND 44).

FOR: APPARATUS AND INSTRUMENTS FOR CONVEYING, DISTRIBUTING, TRANSFORMING, STORING, REGULATING AND CONTROLLING ELECTRIC CURRENT; ELECTRIC RELAYS; BATTERIES; OPTICAL APPARATUS AND INSTRUMENTS, NAMELY, BINOCULARS; HELMETS, NAMELY, SPORTS HELMETS, PROTECTIVE HELMETS, HELMETS FOR BICYCLES AND MOTORCYCLE HELMETS, IN CLASS 9 (U.S. CLS. 21, 23, 26, 36 AND 38).

FOR: ELECTRIC LAMPS; ULTRAVIOLET RAY LAMPS, NOT FOR MEDICAL PURPOSES; LAMPS; ARC LAMPS; LAMPS, NAMELY, FOR SAFETY; HEADLAMPS, NAMELY, HEADLAMPS FOR OUTDOOR USE AND OUTDOOR PORTABLE LIGHTING PRODUCTS IN THE NATURE OF HEADLAMPS; LAMPS FOR OUTDOOR USE; ELECTRIC POCKET TORCHES, NAMELY, FLASHLIGHTS AND POCKET SEARCH LIGHTS; SOCKETS FOR ELECTRIC LIGHTS; LAMP GLASSES; FLUORESCENT LAMP TUBES; LED LAMPS, IN CLASS 11 (U.S. CLS. 13, 21, 23, 31 AND 34).

FOR: VASES OF PRECIOUS METAL; WATCHES FOR OUTDOOR USE; WATCHES; BRACELETS, CASES FOR CLOCKS AND WATCHES; ACCESSORIES OF CLOCKS, NAMELY, DIALS FOR CLOCK AND WATCH MAKING, CLOCK CABINETS AND CLOCK HOUSINGS, IN CLASS 14 (U.S. CLS. 2, 27, 28 AND 50).

FOR: BACKPACKS FOR OUTDOOR USE; ACCESSORIES, NAMELY, BAGS FOR SPORTS, BOOK BAGS, BOSTON BAGS, BELT BAGS, AND BEACH BAGS; PURSES; FANNY PACKS; AND BAGS FOR TRAVEL CONTAINING INSULATION AND ALL-PURPOSE CARRYING



*David J. Kappas*

Director of the United States Patent and Trademark Office

**Reg. No. 4,273,822** BAGS CONTAINING INSULATION FOR OUTDOOR USES, IN CLASS 18 (U.S. CLS. 1, 2, 3, 22 AND 41).

FOR: SLEEPING BAGS FOR CAMPING, IN CLASS 20 (U.S. CLS. 2, 13, 22, 25, 32 AND 50).

FOR: TENTS, IN CLASS 22 (U.S. CLS. 1, 2, 7, 19, 22, 42 AND 50).

FOR: OUTER CLOTHING, NAMELY, COATS, JACKETS, HATS, SCARVES, MITTENS, GLOVES, JUMP SUITS, COVERALLS, OVERALLS, HOODED PULLOVERS, PULLOVERS AND BOOTS; JERSEYS; PERSPIRATION-ABSORBENT UNDERWEAR; RAINWEAR; SHOES; HEADGEAR, NAMELY, HATS AND CAPS, IN CLASS 25 (U.S. CLS. 22 AND 39).

THE MARK CONSISTS OF THE STYLIZED WORDING "LITEXPRESS" BENEATH THE DESIGN OF AN OVAL HAVING A TITLED TRIANGULAR DESIGN THEREON WHICH NEARLY SEPARATES THE OVAL INTO TWO SECTIONS

OWNER OF INTERNATIONAL REGISTRATION 0799205 DATED 2-7-2003, EXPIRES 2-7-2013.

SER. NO. 79-105,055, FILED 5-17-2011.

ANDREA K. NADELMAN, EXAMINING ATTORNEY

United States of America  
United States Patent and Trademark Office

**KITORQ**

**Reg. No. 4,273,823**

**Registered Jan. 15, 2013**

**Int. Cl.: 9**

**TRADEMARK**

**PRINCIPAL REGISTER**

KISTLER HOLDING AG (SWITZERLAND AKTIENGESELLSCHAFT)  
EULACHSTRASSE 22  
CH-8408 WINTERTHUR  
SWITZERLAND

FOR: APPARATUS FOR RECORDING, TRANSFORMING, ANALYZING AND TRANSMITTING OF MEASURED DATA; MEASURING APPARATUS, NAMELY, APPARATUS FOR SENSING PRESSURE, FORCES, SHEAR, TORQUE, MOMENTS; MEASURING INSTRUMENTS, NAMELY, PRESSURESENSORS, FORCESENSORS, SHEARSSENSORS, TORQUESENSORS, MOMENTSSENSORS; MEASURING APPARATUS IN THE FORM OF FLANGES, NAMELY, FOR SENSING PRESSURE, FORCES, SHEAR, TORQUE, MOMENTS, IN CLASS 9 (U.S. CLS. 21, 23, 26, 36 AND 38).

THE MARK CONSISTS OF STANDARD CHARACTERS WITHOUT CLAIM TO ANY PARTICULAR FONT, STYLE, SIZE, OR COLOR.

PRIORITY DATE OF 5-16-2011 IS CLAIMED.

OWNER OF INTERNATIONAL REGISTRATION 1096837 DATED 10-12-2011, EXPIRES 10-12-2021.

THE WORDING "KITORQ" HAS NO MEANING IN A FOREIGN LANGUAGE.

SER. NO. 79-105,086, FILED 10-12-2011.

SHANNON TWOHIG, EXAMINING ATTORNEY



*David J. Kybas*

Director of the United States Patent and Trademark Office

# United States of America

United States Patent and Trademark Office

## SIX SWISS EXCHANGE LIQUIDNET SERVICE (SLS)

**Reg. No. 4,273,824**

**Registered Jan. 15, 2013**

**Int. Cls.: 35 and 36**

**SERVICE MARK**

**PRINCIPAL REGISTER**

SIX SWISS EXCHANGE AG (SWITZERLAND AKTIENGESELLSCHAFT (AG) / SOCIÉTÉ ANONYME (SA))  
SELNAUSTRASSE 30  
CH-8001 ZÜRICH  
SWITZERLAND

FOR: BUSINESS MEDIATION FOR OTHERS, IN CLASS 35 (U.S. CLS. 100, 101 AND 102).

FOR: STOCK EXCHANGE SERVICES, ELECTRONIC STOCK EXCHANGE SERVICES, IN CLASS 36 (U.S. CLS. 100, 101 AND 102).

THE MARK CONSISTS OF STANDARD CHARACTERS WITHOUT CLAIM TO ANY PARTICULAR FONT, STYLE, SIZE, OR COLOR.

PRIORITY DATE OF 4-1-2011 IS CLAIMED.

OWNER OF INTERNATIONAL REGISTRATION 1097149 DATED 8-19-2011, EXPIRES 8-19-2021.

NO CLAIM IS MADE TO THE EXCLUSIVE RIGHT TO USE "SWISS EXCHANGE" AND "SERVICE", APART FROM THE MARK AS SHOWN.

SER. NO. 79-105,198, FILED 8-19-2011.

KHANH LE, EXAMINING ATTORNEY



*David J. Kybas*

Director of the United States Patent and Trademark Office

# United States of America

United States Patent and Trademark Office

# M<sub>2</sub>G

**Reg. No. 4,273,825**

**Registered Jan. 15, 2013**

**Int. Cls.: 9, 11 and 37**

SABIEN TECHNOLOGY IP LIMITED (UNITED KINGDOM A UNITED KINGDOM LIMITED COMPANY)

C/O CARSON MCDOWELL,  
MURRAY HOUSE, MURRAY STREET BELFAST (NORTHERN IRELAND) BT1 6DN  
UNITED KINGDOM

**TRADEMARK**

**SERVICE MARK**

**PRINCIPAL REGISTER**

FOR: APPARATUS FOR CONTROLLING HEATING SYSTEMS AND INSTALLATIONS, CENTRAL HEATING SYSTEMS AND INSTALLATIONS, BOILERS, INCLUDING OIL-FIRED BOILERS AND GAS BOILERS, AND BURNERS, INCLUDING OIL-FIRED BURNERS AND GAS-FIRED BURNERS, NAMELY, BOILER CONTROL INSTRUMENTS AND ELECTRONIC CONTROLLERS FOR OPTIMIZING BOILER PERFORMANCE; COMPUTER SOFTWARE FOR CONTROLLING BOILER CONTROL INSTRUMENTS AND FOR CONTROLLING ELECTRONIC APPARATUS FOR OPTIMIZING BOILER PERFORMANCE, IN THE FIELD OF ENERGY CONSUMPTION, IN CLASS 9 (U.S. CLS. 21, 23, 26, 36 AND 38).

FOR: HEATING INSTALLATIONS; HEATING APPARATUS AND SYSTEMS, NAMELY, HOT WATER SPACE HEATING APPARATUS, HOT AIR SPACE HEATING APPARATUS, HEATING BOILERS; CENTRAL HEATING SYSTEMS AND INSTALLATIONS, NAMELY, HEATING SYSTEMS COMPOSED PRIMARILY OF TUBES, PIPES AND PRE-ASSEMBLED MANIFOLDS THROUGH WHICH COLD OR HOT WATER CIRCULATES; BOILERS, NAMELY, OIL-FIRED ELECTRICAL BOILERS AND GAS-FIRED ELECTRICAL BOILERS; FURNACE BOILERS AND INDUSTRIAL BOILERS; BOILER PIPES, NAMELY, PIPES FOR HEATING BOILERS; BURNERS, NAMELY, OIL-FIRED BURNERS FOR COMMERCIAL AND DOMESTIC USE, AND GAS-FIRED BURNERS FOR COMMERCIAL AND DOMESTIC USE; RADIATORS, IN CLASS 11 (U.S. CLS. 13, 21, 23, 31 AND 34).

FOR: MAINTENANCE, INSTALLATION AND REPAIR OF HEATING SYSTEMS AND INSTALLATIONS INCLUDING CENTRAL HEATING SYSTEMS AND INSTALLATIONS, BOILERS AND BURNERS; MAINTENANCE, INSTALLATION AND REPAIR OF APPARATUS FOR CONTROLLING HEATING SYSTEMS AND INSTALLATIONS INCLUDING CENTRAL HEATING SYSTEMS AND INSTALLATIONS, BOILERS AND BURNERS, IN CLASS 37 (U.S. CLS. 100, 103 AND 106).



*David J. Kyros*

Director of the United States Patent and Trademark Office

OWNER OF INTERNATIONAL REGISTRATION 1097250 DATED 10-20-2011, EXPIRES 10-20-2021.

SER. NO. 79-105,236, FILED 10-20-2011.



**Reg. No. 4,273,825** JAMES MACFARLANE, EXAMINING ATTORNEY

# United States of America

United States Patent and Trademark Office



SAUNA  
YOGA

**Reg. No. 4,273,826**

**Registered Jan. 15, 2013**

**Int. Cls.: 19, 28 and 41**

**TRADEMARK**

**SERVICE MARK**

**PRINCIPAL REGISTER**

WINSPIRATIONAL OY (FINLAND OSAKEYHTIÖ/LIMITED LIABILITY COMPANY)  
RUOHOLAHDENRANTA 1 D 60  
FI-00180 HELSINKI  
FINLAND

FOR: NON-METALLIC BUILDING MATERIALS, NAMELY, PLASTIC SUPPORTS, GYPSUM, BOARDS OF WOOD, SEMI-WORKED WOODS, CEILING BOARDS OF WOOD, FIRE RESISTING WOOD, FLOOR BOARDS OF WOOD, HARD WOOD FLOORING, MULTI-LAYERED WOOD, NOISE BARRIERS MADE OF WOOD, STRUCTURAL AND ARCHITECTURAL MEMBERS FORMED OF PRESSED WOOD FIBERS, WOOD BEAMS, WOOD BLOCKS, WOOD BOARDS, WOOD DOOR FRAMES, WOOD JOINTS, WOOD JOISTS, WOOD MOLDINGS, WOOD PANELING, WOOD POSTS, WOOD RAFTERS, WOOD SIDING, WOOD SPORTS FLOORS, WOOD TILE FLOORING, WOOD TRIM, WOOD VENEERS; NON-METAL BUILDING MATERIALS, NAMELY, LEATHER, ROPE, AND FOAM USED IN DECORATIVE SURFACE APPLICATION AND CONSTRUCTION; NON-METALLIC RIGID PIPES FOR BUILDING; ASPHALT, PITCH AND BITUMEN; NON-METALLIC TRANSPORTABLE BUILDINGS; MONUMENTS, NOT OF METAL, IN CLASS 19 (U.S. CLS. 1, 12, 33 AND 50).

FOR: GAMES AND PLAYTHINGS, NAMELY, BOARD GAMES, APPARATUS FOR ELECTRONIC GAMES OTHER THAN THOSE ADAPTED FOR USE WITH AN EXTERNAL DISPLAY SCREEN OR MONITOR, HAND-HELD ELECTRONIC GAMES ADAPTED FOR USE WITH TELEVISION RECEIVERS ONLY, AMUSEMENT GAME MACHINES; GYMNAS TIC APPARATUS; SPORTING ARTICLES, NAMELY, YOGA MATS, YOGA BLOCKS, YOGA STRAPS, YOGA BOLSTERS, YOGA STRETCH BANDS, YOGA CUSHIONS AND YOGA BELTS; DECORATIONS FOR CHRISTMAS TREES, IN CLASS 28 (U.S. CLS. 22, 23, 38 AND 50).

FOR: PROVIDING OF TRAINING, NAMELY, YOGA INSTRUCTION, TRAINING IN THE FIELD OF YOGA, TRAINING IN THE FIELDS OF YOGA AND WELLBEING; TRAINING TRAINERS IN THE FIELD OF YOGA AND WELLBEING; YOGA AND STRESS MANAGEMENT INSTRUCTION, IN CLASS 41 (U.S. CLS. 100, 101 AND 107).

NO CLAIM IS MADE TO THE EXCLUSIVE RIGHT TO USE "SAUNA YOGA", APART FROM THE MARK AS SHOWN.

PRIORITY DATE OF 5-16-2011 IS CLAIMED.



*David J. Kyjars*

Director of the United States Patent and Trademark Office

**Reg. No. 4,273,826** OWNER OF INTERNATIONAL REGISTRATION 1097268 DATED 10-24-2011, EXPIRES 10-24-2021.

THE COLOR(S) BLACK AND WHITE IS/ARE CLAIMED AS A FEATURE OF THE MARK.

THE MARK CONSISTS OF THE WORDING "SY" WITH THREE WAVY VERTICAL LINES BETWEEN THE LETTERS IN BLACK. THE "SY" AND LINE DESIGN IS WITHIN A BLACK OVAL WITH WHITE INTERIOR. THE WORDING "SAUNA YOGA" APPEARS IN BLACK BELOW THE OVAL DESIGN.

SER. NO. 79-105,239, FILED 10-24-2011.

DANIEL CAPSHAW, EXAMINING ATTORNEY

# United States of America

United States Patent and Trademark Office



**Reg. No. 4,273,827**

**Registered Jan. 15, 2013**

**Int. Cls.: 5, 29 and 30**

**TRADEMARK**

**PRINCIPAL REGISTER**

CURTI S.R.L. (ITALY SOCIÉTÉ À RESPONSABILITÉ LIMITÉE)  
VIA STAZIONE, 113  
I-27020 VALLE LOMELLINA (PV)  
ITALY

FOR: DIETETIC FOODS ADAPTED FOR MEDICAL PURPOSES MADE WITH RICE; NUTRITIONAL AND DIETARY SUPPLEMENTS MADE WITH RICE, BEVERAGES FOR USE AS A NUTRITIONAL SUPPLEMENT, NOT MADE WITH MILK PRODUCTS, BUT WITH SOYA AND RICE, ALL THE AFORESAID GOODS BEING FOR MEDICAL PURPOSES; READY-PREPARED FOOD FOR BABIES, MAINLY CONSISTING OF MEAT, FISH, HAM, POULTRY, VEGETABLES, RICE AND PASTA; DIETETIC FOODS ADAPTED FOR MEDICAL PURPOSES FOR CHILDREN AND THE SICK; MEDICAL PLASTERS; MATERIALS FOR DRESSINGS, NAMELY, MEDICAL DRESSINGS AND WOUND DRESSINGS; BALMS FOR MEDICAL PURPOSES; MATERIAL FOR DENTAL FILLINGS AND DENTAL IMPRESSIONS, IN CLASS 5 (U.S. CLS. 6, 18, 44, 46, 51 AND 52).

FOR: RICE MILK FOR USE AS A MILK SUBSTITUTE, READY-MADE SOUPS WITH RICE; CRÈME FRAÎCHE MADE WITH RICE; READY-TO-EAT PACKAGED DINNERS CONSISTING OF PRIMARILY MEAT, PASTA, RICE, POTATOES AND POULTRY; MEAT, FISH, SHELL-FISH AND CRUSTACEANS, NOT LIVE; POULTRY AND GAME; MEAT EXTRACTS; CANNED MEAT; PRESERVED, DRIED AND COOKED FRUITS AND VEGETABLES; JELLIES; JAMS; EGGS; MILK; MILK PRODUCTS EXCLUDING ICE CREAM, ICE MILK AND FROZEN YOGURT; CHEESE; BUTTER; YOGURTS; BEVERAGES MADE WITH MILK; EDIBLE OILS AND FATS; VEGETABLES IN VINEGAR; FRUITS, CANNED; VEGETABLES, CANNED; MEAT, CANNED; FISH, CANNED, IN CLASS 29 (U.S. CL. 46).

FOR: RICE AND PRODUCTS MADE WITH RICE, NAMELY, RICE CAKES; GLUTEN-FREE RICE, CREAMED RICE, RICE CUSTARDS, RICE PUDDING; RICE FLOUR, RICE CAKES, RICE GALETTES, RICE BISCUITS, RICE CRACKERS, FLOURS AND PREPARATIONS MADE WITH RICE, PASTRIES MADE WITH RICE, FARINACEOUS FOOD PASTES FOR HUMAN CONSUMPTION MADE WITH RICE, PACKAGED MEAL KITS CONSISTING PRIMARILY OF RICE, SAUCES AND CONDIMENTS FOR RICE; CAKE PASTE MADE OF CHOCOLATE; PASTA; SWEETMEATS; COFFEE; TEA; COCOA; SUGAR; RICE VINEGARS; TAPIOCA; ARTIFICIAL COFFEE; FLOURS; BREAD; BISCUITS; CAKES; PASTRIES; COMFITS; ICES; HONEY; GOLDEN SYRUPS; PEPPER; VINEGAR; SAUCES; SPICES; ICE FOR REFRESHMENT; BEVERAGES MADE WITH COFFEE, COCOA OR CHOCOLATE, IN CLASS 30 (U.S. CL. 46).



*David J. Kyjars*

Director of the United States Patent and Trademark Office

**Reg. No. 4,273,827** THE MARK CONSISTS OF THE WORDING "CURTIRISO" IN SPECIAL CHARACTERS WITHIN A ROUNDED STAMP. ABOVE THIS WORD IS A STYLIZED IMAGE OF AN EAR OF WHEAT. TO THE LEFT OF THE STAMP IS A STYLIZED IMAGE OF A WOMAN ENGAGED IN HARVESTING.

PRIORITY DATE OF 7-12-2011 IS CLAIMED.

OWNER OF INTERNATIONAL REGISTRATION 1097979 DATED 8-30-2011, EXPIRES 8-30-2021.

THE WORDING "CURTIRISO" HAS NO MEANING IN A FOREIGN LANGUAGE.

SER. NO. 79-105,628, FILED 8-30-2011.

TRACY CROSS, EXAMINING ATTORNEY

# United States of America

United States Patent and Trademark Office



## San Lorenzo

**Reg. No. 4,273,828**

**Registered Jan. 15, 2013**

**Int. Cls.: 29 and 30**

**TRADEMARK**

**PRINCIPAL REGISTER**

TECO S.R.L. (ITALY LIMITED LIABILITY COMPANY)  
CORSO MATTEOTTI 32/A  
I-10121 TORINO (TO)  
ITALY

FOR: MEAT, FISH, POULTRY AND GAME; MEAT EXTRACTS; PRESERVED, DRIED AND COOKED FRUIT AND VEGETABLES; JELLIES, JAMS, COMPOTES; EGGS, MILK AND DAIRY PRODUCTS, EXCLUDING ICE CREAM, ICE MILK AND FROZEN YOGURT; EDIBLE OILS AND FATS, IN CLASS 29 (U.S. CL. 46).

FOR: COCOA, SUGAR, RICE, TAPIOCA, SAGO; FLOUR, EDIBLE ICE; TREACLE; SALT, MUSTARD; VINEGAR, SAUCES BEING CONDIMENTS; SPICES; ICE FOR REFRESHMENT, IN CLASS 30 (U.S. CL. 46).

THE MARK CONSISTS OF A SERIES OF CONCENTRIC CIRCLES WITH THE CENTER CIRCLE HAVING A MAN SITTING AT A THRONE WITH AN AIR OF ROYALTY, HOLDING A SCEPTER IN ONE HAND AND AN URN WITH A CROSS OVER IT IN THE OTHER HAND AND ON EACH SIDE OF THE MAN THERE ARE TWO WILD ANIMALS AND WITH THE PHRASE "SAN LORENZO" APPEARING TWICE AROUND ONE OF THE CONCENTRIC CIRCLES WITH A DOT IN BETWEEN "SAN" AND "LORENZO" ON THE LEFT SIDE, A DOT IN BETWEEN "LORENZO" AND "SAN" ON THE TOP AND A DOT BETWEEN "SAN" AND "LORENZO" ON THE RIGHT SIDE AND A GREEK CROSS IN BETWEEN "SAN" AND "LORENZO" AT THE BOTTOM ALL ABOVE THE STYLIZED PHRASE "SAN LORENZO" BENEATH THE CIRCLES.

OWNER OF INTERNATIONAL REGISTRATION 0755038 DATED 3-19-2001, EXPIRES 3-19-2021.

THE ENGLISH TRANSLATION OF "SAN LORENZO" IN THE MARK IS SAINT LAWRENCE.

SER. NO. 79-105,828, FILED 7-1-2011.

TIMOTHY O. SCHIMPF, EXAMINING ATTORNEY



*David J. Kybas*

Director of the United States Patent and Trademark Office

United States of America  
United States Patent and Trademark Office

# Rosenprinz

**Reg. No. 4,273,829**

**Registered Jan. 15, 2013**

**Int. Cl.: 28**

**TRADEMARK**

**PRINCIPAL REGISTER**

AJE GMBH (SWITZERLAND SOCIÉTÉ À RESPONSABILITÉ LIMITÉE)  
SCHWERZISTRASSE 6  
CH-8807 FREIENBACH  
SWITZERLAND

FOR: DECORATIONS FOR CHRISTMAS TREES, IN CLASS 28 (U.S. CLS. 22, 23, 38 AND 50).

THE MARK CONSISTS OF STANDARD CHARACTERS WITHOUT CLAIM TO ANY PARTICULAR FONT, STYLE, SIZE, OR COLOR.

OWNER OF INTERNATIONAL REGISTRATION 1028967 DATED 11-17-2009, EXPIRES 11-17-2019.

THE ENGLISH TRANSLATION OF THE FOREIGN WORD(S) IN THE MARK IS: "ROSE PRINCE".

SER. NO. 79-105,884, FILED 4-28-2011.

ELLEN PERKINS, EXAMINING ATTORNEY



*David J. Kybas*

Director of the United States Patent and Trademark Office

# United States of America

United States Patent and Trademark Office

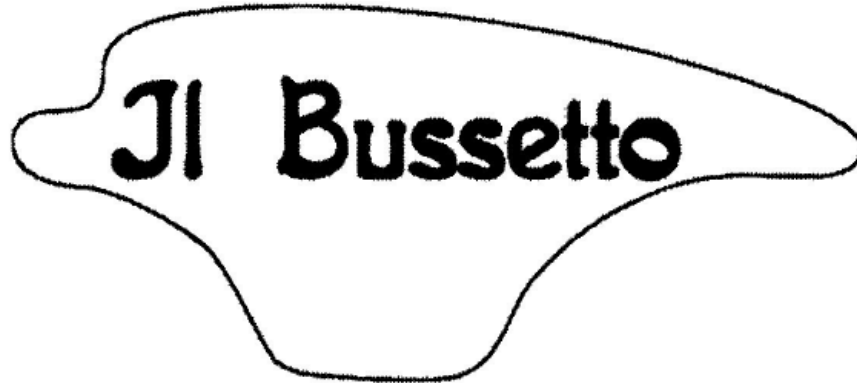

**Reg. No. 4,273,830**

**Registered Jan. 15, 2013**

**Int. Cls.: 18 and 25**

**TRADEMARK**

**PRINCIPAL REGISTER**

MAUGAN DI MAURO GOBBI E C. SAS (ITALY LIMITED PARTNERSHIP)  
VIA EDOLO, 40  
MILANO, ITALY I20125

FOR: PURSES, BUSINESS CARD CASES, WALLETS, CREDIT CARD WALLETS, AND BRIEFCASES, ALL MADE FROM LEATHER OR IMITATION LEATHER, IN CLASS 18 (U.S. CLS. 1, 2, 3, 22 AND 41).

FOR: FOOTWEAR MADE OF LEATHER AND BELTS MADE OF LEATHER AND IMITATION LEATHER, IN CLASS 25 (U.S. CLS. 22 AND 39).

THE MARK CONSISTS OF THE WORDING "IL BUSSETTO" IN STYLIZED FORM IN THE CENTER OF A STYLIZED MONOLINE DRAWING OF A LEATHER POLISHING TOOL CALLED A "BUSSETTO".

OWNER OF INTERNATIONAL REGISTRATION 1099195 DATED 9-29-2011, EXPIRES 9-29-2021.

THE ENGLISH TRANSLATION OF "IL BUSSETTO" IN THE MARK IS A TOOL MADE OF STEEL, IRON OR WOOD USED FOR THE HANDCRAFT OF LEATHER.

SER. NO. 79-106,133, FILED 9-29-2011.

ALLISON HOLTZ, EXAMINING ATTORNEY



*David J. Kybas*

Director of the United States Patent and Trademark Office



# United States of America

United States Patent and Trademark Office

# MITEC

**Reg. No. 4,273,831**

**Registered Jan. 15, 2013**

**Int. Cls.: 7, 9, 12, 40 and 42**

**TRADEMARK**

**SERVICE MARK**

**PRINCIPAL REGISTER**

MITEC AUTOMOTIVE AG (FED REP GERMANY JOINT STOCK COMPANY)  
RENNBAHN 25  
99817 EISENACH  
FED REP GERMANY

FOR: DRIVING MOTOR EXCEPT FOR LAND VEHICLES; PROPULSION MECHANISMS, NAMELY, TURBO COMPOUND MECHANISM, MASSES BALANCING MECHANISM, BEVEL DRIVES, RACK-WHEELS, FOUR WHEEL DRIVES, HIGH-SPEED-GEARING MECHANISM FOR ENGINES, CROWN WHEEL MECHANISMS, ALL OF THESE GOODS EXCEPT FOR LAND VEHICLES; SUPERCHARGER, NAMELY, TURBOCHARGER FOR MACHINES AND ENGINES AS A SEPARATE COMPONENT; MECHANICAL COMPONENTS FOR AERONAUTICAL ENGINES, NAMELY, GEARS FOR TRANSMISSION BEING A COMPONENT PART OF JET ENGINES; TRANSMISSION SHAFTS OTHER THAN FOR LAND VEHICLES; GEARS FOR VEHICLES, OTHER THAN FOR LAND VEHICLES; TRANSMISSIONS FOR MACHINES; GENERATORS OF ELECTRICITY; INSERTED TOOLS, NAMELY, FOR GEAR CUTTING, LATHING AND GRINDING OF METAL AND THE HOLDER FOR INSERTED TOOLS, HYDRAULIC PUMPS FOR HEATING INSTALLATIONS; PUMPS FOR MACHINES AND ENGINES; VACUUM PUMPS; OTHER THAN FOR THE AFTER TREATMENT OF EXHAUST EMISSIONS AND OTHER THAN FOR CONTROL AND REGULATING SYSTEMS OF AFTER TREATMENT OF EXHAUST EMISSIONS, NAMELY, NOT FOR ELECTRIC HEATABLE CONVERTER FOR HOT GASES, IN CLASS 7 (U.S. CLS. 13, 19, 21, 23, 31, 34 AND 35).

FOR: SELF-REGULATING FUEL PUMPS OTHER THAN FOR THE AFTER TREATMENT OF EXHAUST EMISSIONS AND OTHER THAN CONTROL AND REGULATING SYSTEMS OF AFTER TREATMENT OF EXHAUST EMISSIONS, NAMELY, NOT FOR ELECTRIC HEATABLE CONVERTER FOR HOT GASES, IN CLASS 9 (U.S. CLS. 21, 23, 26, 36 AND 38).

FOR: DRIVE GEARS FOR LAND VEHICLES; DRIVING MOTORS FOR LAND VEHICLES; TRANSMISSION SHAFTS FOR LAND VEHICLES; THE GOODS AFOREMENTIONED OTHER THAN FOR THE AFTER TREATMENT OF EXHAUST EMISSIONS AND OTHER THAN FOR CONTROL AND REGULATING SYSTEMS OF AFTER TREATMENT OF EXHAUST EMISSIONS, NAMELY, NOT FOR ELECTRIC HEATABLE CONVERTER FOR HOT GASES, IN CLASS 12 (U.S. CLS. 19, 21, 23, 31, 35 AND 44).

FOR: METAL TREATING, IN CLASS 40 (U.S. CLS. 100, 103 AND 106).



*David J. Kyjars*

Director of the United States Patent and Trademark Office

**Reg. No. 4,273,831** FOR: RESEARCH AND DEVELOPMENT OF NEW PRODUCTS FOR OTHERS IN THE FIELD OF AUTOMOTIVE SUPPLY INDUSTRY, IN CLASS 42 (U.S. CLS. 100 AND 101).

THE MARK CONSISTS OF THE HIGHLY STYLIZED WORD "MITEC" IN BLUE LETTERING.

PRIORITY DATE OF 7-19-2011 IS CLAIMED.

OWNER OF INTERNATIONAL REGISTRATION 1099286 DATED 10-5-2011, EXPIRES 10-5-2021.

THE COLOR(S) BLUE IS/ARE CLAIMED AS A FEATURE OF THE MARK.

SER. NO. 79-106,170, FILED 10-5-2011.

MATTHEW MCDOWELL, EXAMINING ATTORNEY

# United States of America

United States Patent and Trademark Office



**Reg. No. 4,273,832**

**Registered Jan. 15, 2013**

**Int. Cl.: 21**

**TRADEMARK**

**PRINCIPAL REGISTER**

TAIZHOU SHUANGMA PLASTIC; MANUFACTURING INC. (CHINA CORPORATION)  
SHANGJIN VILLAGE  
YANJIANG TOWN,; LINHAI CITY; ZHEJIANG  
CHINA

FOR: WATERING CANS; CUTTING BOARDS FOR THE KITCHEN; BASINS; KNIFE RESTS FOR THE TABLE; FITTED PICNIC BASKETS; PIE SERVERS; CUPS OF PAPER AND OF PLASTIC; MIXING SPOONS; LUNCH BOXES, IN CLASS 21 (U.S. CLS. 2, 13, 23, 29, 30, 33, 40 AND 50).

THE MARK CONSISTS OF TWO STYLIZED SEAHORSES FACING EACH OTHER.

OWNER OF INTERNATIONAL REGISTRATION 1099379 DATED 11-2-2011, EXPIRES 11-2-2021.

SER. NO. 79-106,198, FILED 11-2-2011.

LEIGH LOWRY, EXAMINING ATTORNEY



*David J. Kyffers*

Director of the United States Patent and Trademark Office

# United States of America

United States Patent and Trademark Office

# GINSENG

**Reg. No. 4,273,833**

**Registered Jan. 15, 2013**

**Int. Cls.: 9 and 42**

SCIENTIA LIMITED (UNITED KINGDOM LIMITED COMPANY ORGANIZED UNDER THE LAWS OF ENGLAND AND WALES)  
CPC, 1 CAPITAL PARK  
FULBOURN, CAMBRIDGE CB21 5XE  
UNITED KINGDOM

**TRADEMARK**

**SERVICE MARK**

**PRINCIPAL REGISTER**

FOR: DATA PROCESSING EQUIPMENT AND COMPUTERS; COMPUTER SOFTWARE FOR LOGISTIC MANAGEMENT OF RESOURCES, LOGISTIC MANAGEMENT OF FACILITIES, THE PLANNING, ARRANGING AND MANAGEMENT OF RESOURCE ALLOCATION, WORKLOAD TRACKING, PROJECT MANAGEMENT, THE PLANNING, ARRANGING AND MANAGEMENT OF SCHEDULING, THE PLANNING, ARRANGING AND MANAGEMENT OF DUTY ROSTERS, THE PLANNING, ARRANGING AND MANAGEMENT OF TIME-TABLING, THE PLANNING, ARRANGING AND MANAGEMENT OF ENROLLMENT, EDUCATIONAL COURSE AND EXAMINATION PLANNING, SCHEDULING AND MANAGEMENT, PLANNING, SCHEDULING AND MANAGEMENT OF ROOM AVAILABILITY, PLANNING, SCHEDULING AND MANAGEMENT OF EQUIPMENT AND IDENTIFYING PROBLEMS WITH BUSINESS CAPITAL INVESTMENT, COMPILING SCHEDULES AND ALLOCATING HUMAN RESOURCES TO ACTIVITIES IN THE SCHEDULE TO MEET THE NEEDS OF INDIVIDUAL HUMAN RESOURCES, INCLUDING FACULTY STAFF AND STUDENTS, BY TAKING INTO ACCOUNT THE MULTI-YEAR GOALS OF INDIVIDUAL HUMAN RESOURCES, BY USING INFORMATION HELD IN SCHEDULES TO CONTROL INDIVIDUAL BUILDING RESOURCES INCLUDING CONTROL OF HEATING, LIGHTING, SECURITY AND ACCESS, BY CREATING SCHEDULES FOR INDIVIDUAL HUMAN RESOURCES INCLUDING FACULTY STAFF AND STUDENTS SO THAT THE WORKLOAD AND QUALITY OF THE SCHEDULE FOR INDIVIDUAL HUMAN RESOURCES IS FAIR AND REASONABLE AND BY ALLOWING OTHER COMPUTER PROGRAMS INCLUDING MOBILE DEVICES TO ACCESS THIS INFORMATION AND BE NOTIFIED; COMPUTER SOFTWARE FOR RESOURCE SCHEDULING AND MANAGEMENT; PROGRAM-DEVELOPMENT ENVIRONMENT SOFTWARE FOR THE PLANNING, SCHEDULING AND MANAGEMENT OF MANUFACTURING OPERATIONS, RESOURCES, PROJECTS, EDUCATIONAL ACTIVITIES AND TRAINING ACTIVITIES AND STRUCTURAL EQUIPMENT RELATING THERETO AND FOR THE PREPARATION AND MAINTENANCE OF PLANS, SCHEDULES, TIMETABLES AND DUTY ROSTERS; DATABASE CONSTRUCTION AND OPERATION SOFTWARE; COMPUTER PROGRAMS FOR USE IN THE PLANNING, SCHEDULING AND MANAGEMENT OF RESOURCES AND PROJECTS; COMPUTER PROGRAMS FOR THE PLANNING AND SCHEDULING OF MAINTENANCE ACTIVITIES; COMPUTER PROGRAMS FOR THE PLANNING, SCHEDULING AND MANAGEMENT OF MANUFACTURING OPER-



*David J. Kyffers*

Director of the United States Patent and Trademark Office

**Reg. No. 4,273,833** ATIONS; COMPUTER PROGRAMS FOR THE PLANNING, SCHEDULING AND MANAGEMENT OF EDUCATIONAL AND TRAINING ACTIVITIES AND STRUCTURAL EQUIPMENT RELATING THERETO; COMPUTER PROGRAMS FOR THE PREPARATION AND MAINTENANCE OF PLANS, SCHEDULES, TIMETABLES AND DUTY ROSTERS; COMPUTER PROGRAMS FOR PERSONNEL DEVELOPMENT AND TRAINING; BLANK COMPUTER MEMORY CHIPS AND BLANK MAGNETIC AND OPTICAL STORAGE MEDIA; COMPUTER SOFTWARE AND PROGRAMS FOR PROVIDING DOWNLOADABLE ON-LINE HELP AND DOWNLOADABLE TRAINING PROGRAMS FOR ALL THE AFORESAID; STRUCTURAL PARTS AND STRUCTURAL FITTINGS FOR ALL THE AFORESAID GOODS, IN CLASS 9 (U.S. CLS. 21, 23, 26, 36 AND 38).

FOR: COMPUTER SOFTWARE, HARDWARE AND FIRMWARE DESIGN SERVICES; RESEARCH AND DEVELOPMENT OF COMPUTER SOFTWARE, HARDWARE AND FIRMWARE FOR OTHERS; PROVISION OF INFORMATION RELATING TO RESEARCH AND DEVELOPMENT OF COMPUTER SOFTWARE, HARDWARE, AND FIRMWARE FOR OTHERS; TECHNICAL RESEARCH SERVICES IN THE FIELD OF COMPUTER SOFTWARE, HARDWARE AND FIRMWARE; CONSULTANCY AND TECHNICAL RESEARCH SERVICES IN THE FIELDS OF INFORMATION TECHNOLOGY, COMPUTERS, COMPUTER PROGRAMS, COMPUTER SOFTWARE, COMPUTER HARDWARE, COMPUTER FIRMWARE, DESIGN OF WEB PAGES AND WEBSITES, CREATION OF WEB PAGES AND WEBSITES, HOSTING OF WEB PAGES AND WEBSITES AND MAINTENANCE OF WEB PAGES AND WEBSITES; COMPUTER PROGRAMMING SERVICES; PROGRAMMING OF COMPUTER SOFTWARE, HARDWARE AND FIRMWARE; DESIGN AND DEVELOPMENT OF COMPUTER SOFTWARE, COMPUTER HARDWARE AND COMPUTER FIRMWARE; DESIGN, CREATION, HOSTING AND MAINTENANCE OF WEB PAGES AND WEBSITES FOR OTHERS; INFORMATION, ADVISORY AND CONSULTANCY RELATING TO ALL OF THE AFORESAID SERVICES, IN CLASS 42 (U.S. CLS. 100 AND 101).

THE MARK CONSISTS OF STANDARD CHARACTERS WITHOUT CLAIM TO ANY PARTICULAR FONT, STYLE, SIZE, OR COLOR.

PRIORITY DATE OF 7-6-2011 IS CLAIMED.

OWNER OF INTERNATIONAL REGISTRATION 1099428 DATED 9-1-2011, EXPIRES 9-1-2021.

SER. NO. 79-106,218, FILED 9-1-2011.

LINDSEY RUBIN, EXAMINING ATTORNEY

# United States of America

## United States Patent and Trademark Office

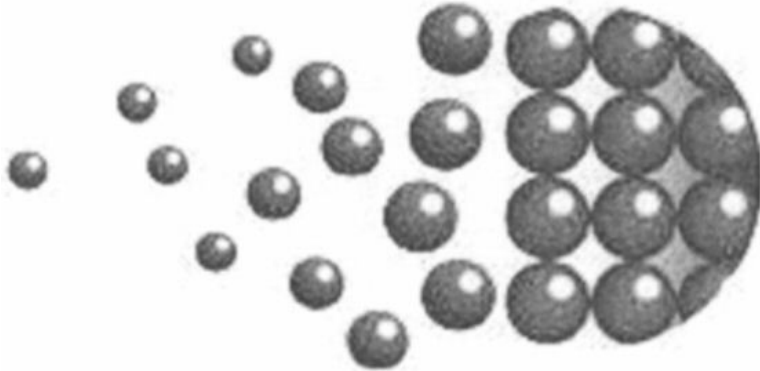

**Reg. No. 4,273,834**

**Registered Jan. 15, 2013**

**Int. Cls.: 9 and 42**

SCIENTIA LIMITED (UNITED KINGDOM LIMITED COMPANY UNDER THE LAWS OF ENGLAND AND WALES)  
CPC, 1 CAPITAL PARK  
FULBOURN, CAMBRIDGE CB21 5XE  
UNITED KINGDOM

**TRADEMARK**

**SERVICE MARK**

**PRINCIPAL REGISTER**

FOR: DATA PROCESSING EQUIPMENT AND COMPUTERS; COMPUTER SOFTWARE FOR RESOURCE SCHEDULING AND MANAGEMENT; EDUCATIONAL PROGRAM-DEVELOPMENT ENVIRONMENT SOFTWARE FOR THE PLANNING, SCHEDULING AND MANAGEMENT OF MANUFACTURING OPERATIONS, RESOURCES, PROJECTS, EDUCATIONAL ACTIVITIES AND TRAINING ACTIVITIES AND STRUCTURAL EQUIPMENT RELATING THERETO AND FOR THE PREPARATION AND MAINTENANCE OF PLANS, SCHEDULES, TIMETABLES AND DUTY ROSTERS; DATABASE CONSTRUCTION AND OPERATION SOFTWARE; DECISION SUPPORT TOOL SOFTWARE FOR RESOURCE SCHEDULING AND MANAGEMENT AND FOR THE PREPARATION AND MAINTENANCE OF PLANS, SCHEDULES, TIMETABLES AND DUTY ROSTERS; RULE AND OBJECT MANAGEMENT SOFTWARE FOR THE PLANNING, SCHEDULING AND MANAGEMENT OF EDUCATIONAL AND TRAINING ACTIVITIES AND STRUCTURAL EQUIPMENT RELATING THERETO; COMPUTER SOFTWARE AND COMPUTER PROGRAMS FOR USE IN THE EDUCATIONAL FIELD FOR USE IN THE PLANNING OF PERSONNEL DEVELOPMENT AND TRAINING, NAMELY, BY COMPILING SCHEDULES AND ALLOCATING HUMAN RESOURCES TO ACTIVITIES IN THE SCHEDULE TO MEET THE NEEDS OF INDIVIDUAL HUMAN RESOURCES, INCLUDING FACULTY STAFF AND STUDENTS, BY TAKING INTO ACCOUNT THE MULTI-YEAR GOALS OF INDIVIDUAL HUMAN RESOURCES, BY USING INFORMATION HELD IN SCHEDULES TO CONTROL INDIVIDUAL BUILDING RESOURCES INCLUDING CONTROL OF HEATING, LIGHTING, SECURITY AND ACCESS, BY CREATING SCHEDULES FOR INDIVIDUAL HUMAN RESOURCES INCLUDING FACULTY STAFF AND STUDENTS SO THAT THE WORKLOAD AND QUALITY OF THE SCHEDULE FOR INDIVIDUAL HUMAN RESOURCES IS FAIR AND REASONABLE AND BY ALLOWING OTHER COMPUTER PROGRAMS INCLUDING MOBILE DEVICES TO ACCESS THIS INFORMATION AND BE NOTIFIED; COMPUTER PROGRAMS FOR USE IN THE PLANNING, SCHEDULING AND MANAGEMENT OF RESOURCES AND PROJECTS; COMPUTER PROGRAMS FOR THE PLANNING AND SCHEDULING OF MAINTENANCE ACTIVITIES; COMPUTER PROGRAMS FOR THE PLANNING, SCHEDULING AND MANAGEMENT OF MANUFACTURING OPERATIONS; COMPUTER PROGRAMS FOR THE PLANNING, SCHEDULING AND MANAGEMENT OF EDUCATIONAL AND TRAINING ACTIVITIES AND STRUCTURAL EQUIPMENT RELATING THERETO; COMPUTER PROGRAMS FOR



*David J. Kyros*

Director of the United States Patent and Trademark Office

**Reg. No. 4,273,834** THE PREPARATION AND MAINTENANCE OF PLANS, SCHEDULES, TIMETABLES AND DUTY ROSTERS; COMPUTER PROGRAMS FOR PERSONNEL DEVELOPMENT AND TRAINING; COMPUTER MEMORY CHIPS AND BLANK MAGNETIC AND OPTICAL STORAGE MEDIA; STRUCTURAL PARTS AND STRUCTURAL FITTINGS FOR ALL THE AFORESAID GOODS, IN CLASS 9 (U.S. CLS. 21, 23, 26, 36 AND 38).

FOR: COMPUTER SOFTWARE, HARDWARE AND FIRMWARE DESIGN SERVICES; RESEARCH AND DEVELOPMENT OF COMPUTER SOFTWARE, HARDWARE AND FIRMWARE FOR OTHERS; PROVISION OF INFORMATION RELATING TO RESEARCH AND DEVELOPMENT OF COMPUTER SOFTWARE, HARDWARE, AND FIRMWARE FOR OTHERS; TECHNICAL RESEARCH SERVICES IN THE FIELD OF COMPUTER SOFTWARE, HARDWARE AND FIRMWARE; DIAGNOSTIC AND DEVELOPMENTAL CONSULTANCY AND TECHNICAL RESEARCH SERVICES IN THE FIELDS OF INFORMATION TECHNOLOGY, COMPUTERS, COMPUTER PROGRAMS, COMPUTER SOFTWARE, COMPUTER HARDWARE, COMPUTER FIRMWARE, DESIGN OF WEB PAGES AND WEBSITES, CREATION OF WEB PAGES AND WEBSITES, HOSTING OF WEB PAGES AND WEBSITES AND MAINTENANCE OF WEB PAGES AND WEBSITES; COMPUTER PROGRAMMING SERVICES; PROGRAMMING OF SOFTWARE, COMPUTER HARDWARE AND COMPUTER FIRMWARE; DESIGN AND DEVELOPMENT OF COMPUTER SOFTWARE, HARDWARE AND FIRMWARE; DESIGN, CREATION, HOSTING AND MAINTENANCE OF WEB PAGES AND WEBSITES FOR OTHERS; INFORMATION, ADVISORY AND CONSULTANCY RELATING TO THE AFORESAID SERVICES, IN CLASS 42 (U.S. CLS. 100 AND 101).

THE MARK CONSISTS OF SEVERAL CIRCULAR SHAPES BECOMING GRADUALLY LARGER IN SIZE FROM LEFT TO RIGHT WITH THE BIGGER CIRCULAR SHAPES ON THE RIGHT DISAPPEARING INTO A SEMI CIRCULAR DESIGN ELEMENT.

PRIORITY DATE OF 3-4-2011 IS CLAIMED.

OWNER OF INTERNATIONAL REGISTRATION 1099430 DATED 9-1-2011, EXPIRES 9-1-2021.

SER. NO. 79-106,219, FILED 9-1-2011.

LINDSEY RUBIN, EXAMINING ATTORNEY

# United States of America

United States Patent and Trademark Office

## CRAZY DOMAINS

**Reg. No. 4,273,835**

**Registered Jan. 15, 2013**

**Int. Cls.: 35, 38, 42 and  
45**

**SERVICE MARK**

**PRINCIPAL REGISTER**

AUST. DOMAINS; INTERNATIONAL PTY LTD (AUSTRALIA COMPANY INCORPORATED UNDER THE LAWS OF THE COMMONWEALTH OF AUSTRALIA)

PO BOX 3333  
ADELAIDE TERRACE WA 6832  
AUSTRALIA

FOR: ADVERTISING, MARKETING AND PROMOTIONAL SERVICES INCLUDING SUCH SERVICES RELATING TO WEBSITES; DIRECT MARKETING SERVICES VIA EMAIL; BUSINESS SERVICES, NAMELY, MANAGEMENT OF DATA, VOICE AND VIDEO COMMUNICATIONS NETWORKS, PROVIDING VIRTUAL ON-LINE OFFICE SUPPORT STAFF SERVICES FOR BUSINESSES, AND PROMOTING THE GOODS AND SERVICES OF OTHERS BY PROVIDING AUTOMATED HYPERTEXT LINKS TO THE WEBSITES OF OTHERS USING OPTIMAL SEARCH TERMS AND SEARCH ENGINES; GATHERING, PROVISION AND ANALYSIS OF MARKET RESEARCH STATISTICS AND DATA; DATABASE SERVICES, NAMELY, THE COMPILATION AND SYSTEMIZATION OF INFORMATION INTO DATABASES AND DATABASE MANAGEMENT; PROVIDING INFORMATION, CONSULTANCY AND ADVICE IN RELATION TO ADVERTISING, MARKETING, PROMOTIONAL ACTIVITIES, BUSINESS MATTERS, COMPUTER NETWORK-RELATED BUSINESS ACTIVITIES, STATISTICAL INFORMATION AND DATABASE MANAGEMENT, IN CLASS 35 (U.S. CLS. 100, 101 AND 102).

FOR: COMPUTER AIDED TRANSMISSION OF MESSAGES AND IMAGES VIA THE WEB, COMPUTER NETWORKS AND EMAIL INTERFACES; ELECTRONIC MAIL SERVICES; ELECTRONIC BULLETIN BOARD SERVICES; MESSAGE SENDING AND SMS MESSAGE SERVICES PROVIDED VIA THE WEB, COMPUTER NETWORKS AND EMAIL INTERFACES; PROVIDING ACCESS TO COMPUTER NETWORKS IN THE NATURE OF INTERNET ACCESS PROVIDER SERVICES; PROVIDING ACCESS TO DATABASES; PROVIDING ACCESS TO TELECOMMUNICATIONS NETWORKS IN THE NATURE OF ELECTRONIC MESSAGING SYSTEMS; ELECTRONIC TRANSMISSION OF DATA AND DOCUMENTS VIA COMPUTER NETWORKS, WEBSITES AND DATABASES; PROVIDING ACCESS TO COMPUTER NETWORKS, WEBSITES AND DATABASES, IN CLASS 38 (U.S. CLS. 100, 101 AND 104).

FOR: TECHNOLOGICAL SERVICES, NAMELY, TECHNOLOGICAL PLANNING IN THE FIELD OF COMPUTER HARDWARE SYSTEMS; COMPUTER AND COMPUTER NETWORK-RELATED SERVICES, NAMELY, COMPUTER NETWORK CONFIGURATION SERVICES AND DATA ENCRYPTION SERVICES FOR DIGITAL COMMUNICATIONS FEATURING DIGITAL ENCRYPTION CERTIFICATES; DESIGN AND DEVELOPMENT OF COMPUTER



*David J. Kyffers*

Director of the United States Patent and Trademark Office



**Reg. No. 4,273,835** HARDWARE AND SOFTWARE; INSTALLATION, MAINTENANCE AND UPGRADING OF SOFTWARE; TECHNICAL SUPPORT SERVICES, NAMELY, TROUBLESHOOTING OF COMPUTER SOFTWARE PROBLEMS FOR SOFTWARE USED IN ASSISTING WITH USER DIGITAL SIGNATURE CERTIFICATION AND WITH DATA ENCRYPTION; WEBSITE DEVELOPMENT AND HOSTING SERVICES; PROVISION OF HOSTING EQUIPMENT, NAMELY, RENTAL OF WEB SERVERS AND DATA STORAGE EQUIPMENT; MAINTENANCE OF SOFTWARE FOR HOSTING EQUIPMENT; COMPUTER SERVICES IN THE NATURE OF MONITORING, MANAGEMENT AND ANALYSIS OF COMPUTER NETWORK AND WEB TRAFFIC; DEVELOPMENT OF COMPUTER NETWORK AND WEB TRAFFIC, NAMELY, PROVIDING SEARCH ENGINE OPTIMIZATION (SEO) SERVICES; ANTI-VIRUS AND ANTI-SPAM SERVICES, NAMELY, PROVIDING SPAM FILTERING SERVICES TO PROTECT WEBSITES AND ONLINE APPLICATIONS FROM RECEIVING UNSOLICITED MESSAGES, COMPUTER VIRUS PROTECTION SERVICES; COMPUTER PROGRAMMING SERVICES; DESIGN AND DEVELOPMENT OF COMPUTER DATABASES; PROVIDING INFORMATION, CONSULTANCY AND ADVICE IN THE AREAS OF INFORMATION TECHNOLOGY, COMPUTER TECHNOLOGY, COMPUTER NETWORKS, INSTALLATION, MAINTENANCE AND UPGRADING SOFTWARE, HOSTING WEBSITES, MONITORING COMPUTER NETWORK AND WEB TRAFFIC, PROVIDING ANTI-VIRUS AND ANTI-SPAM COMPUTER SERVICES, AND DESIGN AND DEVELOPMENT OF COMPUTER DATABASES; RENTAL OF COMPUTERS, COMPUTER HARDWARE, COMPUTER PERIPHERAL DEVICES, COMPUTER ACCESSORIES IN THE NATURE OF COMPUTER HARDWARE AND SOFTWARE FOR FACILITATING NETWORKING AND WIRELESS NETWORKING, AND TECHNOLOGICAL APPARATUS IN THE NATURE OF WEB SERVERS, IN CLASS 42 (U.S. CLS. 100 AND 101).

FOR: DOMAIN NAME SERVICES, NAMELY, DOMAIN NAME RESERVATION, RENEWAL, AND TRANSFER SERVICES; DOMAIN NAME REGISTRATION AND LEGAL MANAGEMENT SERVICES INCLUDING LICENSING, REVIEWING, MONITORING, CANCELLING AND TRANSFERRING DOMAIN NAMES; DOMAIN NAME DISPUTE RESOLUTION SERVICES; LEGAL SERVICES IN THE NATURE OF TRACKING, INVESTIGATING AND REPORTING RELATING TO POTENTIAL OR ACTUAL INFRINGEMENT OF INTELLECTUAL PROPERTY RIGHTS; AUTHENTICATION, IDENTIFICATION VERIFICATION AND ISSUANCE OF DIGITAL CERTIFICATES OF USERS OF ELECTRONIC, DIGITAL AND COMMUNICATION SYSTEMS; LICENSING SERVICES RELATING TO TECHNOLOGICAL PRODUCTS, SOFTWARE AND INTELLECTUAL PROPERTY; PROVIDING INFORMATION, CONSULTANCY AND ADVICE IN THE AREAS OF DOMAIN NAME REGISTRATION, LEGAL ISSUES, INTELLECTUAL PROPERTY, DIGITAL CERTIFICATE ISSUANCE, AND AUTHENTICATION, IDENTIFICATION VERIFICATION AND ISSUANCE OF DIGITAL CERTIFICATES OF USERS OF ELECTRONIC, DIGITAL AND COMMUNICATION SYSTEMS, IN CLASS 45 (U.S. CLS. 100 AND 101).

THE MARK CONSISTS OF STANDARD CHARACTERS WITHOUT CLAIM TO ANY PARTICULAR FONT, STYLE, SIZE, OR COLOR.

OWNER OF INTERNATIONAL REGISTRATION 1092206 DATED 8-31-2011, EXPIRES 8-31-2021.

NO CLAIM IS MADE TO THE EXCLUSIVE RIGHT TO USE "DOMAINS", APART FROM THE MARK AS SHOWN.

SER. NO. 79-106,379, FILED 11-2-2011.

LEIGH LOWRY, EXAMINING ATTORNEY

# United States of America

United States Patent and Trademark Office



**Reg. No. 4,273,836**

**Registered Jan. 15, 2013**

**Int. Cls.: 1, 2, 3, 4, 5 and 42**

**TRADEMARK**

**SERVICE MARK**

**PRINCIPAL REGISTER**

CARAMBA HOLDING GMBH (DELAWARE GMBH)  
BERNERSTR. 6  
74653 KÜNZELSAU  
FED REP GERMANY

FOR: CHEMICALS USED IN INDUSTRY, SCIENCE AND PHOTOGRAPHY EXCEPT CHEMICALS USED IN AGRICULTURE, HORTICULTURE AND FORESTRY; TEMPERING PREPARATIONS AND SOLDERING CHEMICALS; CHEMICAL SUBSTANCES FOR PRESERVING FOODSTUFFS, NAMELY, CHEMICAL PRODUCTS FOR THE FRESH-KEEPING AND PRESERVING OF FOOD; TANNING SUBSTANCES, NAMELY, TANNING AGENTS FOR USE IN THE MANUFACTURE OF LEATHER; ADHESIVES USED IN INDUSTRY, IN CLASS 1 (U.S. CLS. 1, 5, 6, 10, 26 AND 46).

FOR: PAINTS, VARNISHES, LACQUERS; PRESERVATIVES AGAINST RUST IN THE NATURE OF A COATING AND AGAINST DETERIORATION OF WOOD; COLORANTS; MORDANT DYES, IN CLASS 2 (U.S. CLS. 6, 11 AND 16).

FOR: BLEACHING PREPARATIONS AND OTHER SUBSTANCES FOR LAUNDRY USE, NAMELY, LAUNDRY BLEACH, LAUNDRY DETERGENTS, FABRIC SOFTENERS, STAIN REMOVERS; CLEANING, POLISHING, SCOURING AND ABRASIVE PREPARATIONS; SOAPS, NAMELY, BAR SOAP, BATH SOAP, ANTIBACTERIAL SOAP, LAUNDRY SOAP, HAND SOAP, GRANULATED SOAP, INDUSTRIAL SOAP, LIQUID SOAP, AND TOILET SOAP; PERFUMERY, ESSENTIAL OILS, COSMETICS, HAIR LOTIONS, IN CLASS 3 (U.S. CLS. 1, 4, 6, 50, 51 AND 52).

FOR: INDUSTRIAL OILS AND GREASES; INDUSTRIAL LUBRICANTS; DUST ABSORBING AND BINDING COMPOSITIONS FOR USE IN MANUFACTURING PLANTS, FACTORIES, AND WORKSHOPS; FUELS; ILLUMINANTS, NAMELY, CANDLE TORCHES; CANDLES AND WICKS FOR CANDLES FOR LIGHTING, IN CLASS 4 (U.S. CLS. 1, 6 AND 15).

FOR: SANITARY PREPARATIONS FOR MEDICAL PURPOSES; ALL-PURPOSE DISINFECTANTS; ALL THE AFORESAID GOODS NOT INTENDED FOR THE FIELD OF DENTISTRY, IN CLASS 5 (U.S. CLS. 6, 18, 44, 46, 51 AND 52).

FOR: SCIENTIFIC AND TECHNOLOGICAL SERVICES, NAMELY, RESEARCH AND DESIGN IN THE FIELD OF CAR CARE PRODUCTS; INDUSTRIAL ANALYSIS AND RESEARCH SERVICES RELATING TO THE TECHNOLOGICAL COMPONENTS OF CAR WASH



*David J. Kyffers*

Director of the United States Patent and Trademark Office

**Reg. No. 4,273,836** EQUIPMENT AND ACCESSORIES AND AUTOMOBILE MAINTENANCE FACILITIES;  
RESEARCH AND DEVELOPMENT FOR OTHERS WITH REGARD TO NEW PRODUCTS,  
IN CLASS 42 (U.S. CLS. 100 AND 101).

OWNER OF U.S. REG. NOS. 2,966,172, 4,113,516 AND OTHERS.

PRIORITY DATE OF 7-6-2011 IS CLAIMED.

OWNER OF INTERNATIONAL REGISTRATION 1100032 DATED 10-27-2011, EXPIRES 10-27-2021.

THE MARK CONSISTS OF THE WORD "CARAMBA" CENTERED ON AN OVAL WITH POINTED LEFT AND RIGHT EDGES, WITH A THREE-DIMENSIONAL BUBBLE CONTAINED WITHIN THE OVAL.

THE ENGLISH TRANSLATION OF "CARAMBA" IN THE MARK IS "MY WORD" OR OTHER EXPRESSION OF ASTONISHMENT.

SER. NO. 79-106,515, FILED 10-27-2011.

SHAILA SETTLES, EXAMINING ATTORNEY

# United States of America

United States Patent and Trademark Office

# AINDOOR GPS

**Reg. No. 4,273,837**

**Registered Jan. 15, 2013**

**Int. Cl.: 9**

**TRADEMARK**

**PRINCIPAL REGISTER**

AIN SYSTEMES INNOVANTS (FRANCE SOCIÉTÉ PAR ACTIONS SIMPLIFIÉE)  
466 RUE ALBERT FERIER  
F-01350 CULOZ  
FRANCE

FOR: ELECTRONIC AND COMPUTER APPARATUS AND INSTRUMENTS FOR GEOPOSITIONING, NAVIGATING AND TRACKING BY MEANS OF GPS; ELECTRONIC AND COMPUTER APPARATUS AND INSTRUMENTS FOR REMOTE COMMUNICATION, PROCESSING AND RECORDING OF DATA, IN CLASS 9 (U.S. CLS. 21, 23, 26, 36 AND 38).

THE MARK CONSISTS OF STANDARD CHARACTERS WITHOUT CLAIM TO ANY PARTICULAR FONT, STYLE, SIZE, OR COLOR.

PRIORITY DATE OF 4-21-2011 IS CLAIMED.

OWNER OF INTERNATIONAL REGISTRATION 1100074 DATED 10-18-2011, EXPIRES 10-18-2021.

NO CLAIM IS MADE TO THE EXCLUSIVE RIGHT TO USE "GPS", APART FROM THE MARK AS SHOWN.

SER. NO. 79-106,533, FILED 10-18-2011.

KRISTINA MORRIS, EXAMINING ATTORNEY



*David J. Kybas*

Director of the United States Patent and Trademark Office

# United States of America

United States Patent and Trademark Office

# MOBS

**Reg. No. 4,273,838**

**Registered Jan. 15, 2013**

**Int. Cls.: 18, 25 and 28**

**TRADEMARK**

**PRINCIPAL REGISTER**

ALEXANDRE BENAÏM (FRANCE INDIVIDUAL)  
C/O INTERCAFCO S.A.  
SUCCURSALE DE GENÈVE, RUE DU MONT-BLANC7  
GENÈVE, SWITZERLAND CH1201

FOR: LEATHER AND IMITATIONS OF LEATHER; LEATHER AND IMITATION LEATHER GOODS, NAMELY, PURSES, WALLETS, CREDIT CARD CASES, GARMENT BAGS FOR TRAVEL, LEATHER AND IMITATION LEATHER BAGS, HANDBAGS; TRUNKS AND TRAVELING BAGS; RUCKSACKS, HANDBAGS, BEACH BAGS, TRAVELING BAGS, LEATHER BAGS, SHOULDER BAGS; MULTI-PURPOSE BAGS, NAMELY, ALL PURPOSE SPORT BAGS, ALL-PURPOSE CARRYING BAGS, IN CLASS 18 (U.S. CLS. 1, 2, 3, 22 AND 41).

FOR: CLOTHING, NAMELY, SHIRTS, T-SHIRTS, SHORTS, PANTS, SKIRTS, DRESSES, BRIEFS, UNDERWEAR, WARM UP SUITS, YOGA PANTS, SPORTS SHIRTS, SPORTS PANTS, JACKETS, COATS, VESTS, FLEECE PULLOVERS, SWEATERS, GLOVES, BELTS, SKIWEAR, SNOWBOARDING SUITS, SWIMWEAR, BATHING SUITS, BEACH COVER-UPS, BEACHWEAR, FOOTWEAR, HEADWEAR; BOOTS FOR SPORTS, BEACH SHOES, STREET SHOES, SNOW BOOTS, WALKING BOOTS, IN CLASS 25 (U.S. CLS. 22 AND 39).

FOR: SPORTS BAGS SPECIALLY ADAPTED FOR SPORTS EQUIPMENT, IN CLASS 28 (U.S. CLS. 22, 23, 38 AND 50).

PRIORITY DATE OF 7-4-2011 IS CLAIMED.

OWNER OF INTERNATIONAL REGISTRATION 1100100 DATED 11-2-2011, EXPIRES 11-2-2021.

SER. NO. 79-106,542, FILED 11-2-2011.

LEIGH LOWRY, EXAMINING ATTORNEY



*David J. Kyffers*

Director of the United States Patent and Trademark Office

United States of America  
United States Patent and Trademark Office

DEKTITE

**Reg. No. 4,273,839**

**Registered Jan. 15, 2013**

**Int. Cl.: 17**

**TRADEMARK**

**PRINCIPAL REGISTER**

DEKS INDUSTRIES PTY LTD (AUSTRALIA COMPANY)  
5/841 MOUNTAIN HIGHWAY  
BAYSWATER VIC 3153, AUSTRALIA

FOR: SEAL DEVICES IN THIS CLASS INCORPORATING A RESILIENT COMPONENT OR COMPONENTS INCLUDING SEAL DEVICES FOR USE IN SEALING ABOUT A MEMBER EXTENDING THROUGH AN APERTURE IN ANOTHER MEMBER, NAMELY, SEALING PLUGS MADE PRIMARILY OF RUBBER AND RUBBER WASHERS FOR SEALING AROUND FIXING ELEMENTS, IN CLASS 17 (U.S. CLS. 1, 5, 12, 13, 35 AND 50).

THE MARK CONSISTS OF STANDARD CHARACTERS WITHOUT CLAIM TO ANY PARTICULAR FONT, STYLE, SIZE, OR COLOR.

OWNER OF INTERNATIONAL REGISTRATION 1100247 DATED 4-18-2011, EXPIRES 4-18-2021.

OWNER OF U.S. REG. NOS. 1,217,573, 2,965,375, AND 3,130,072.

SER. NO. 79-106,590, FILED 4-18-2011.

MAUREEN DALL, EXAMINING ATTORNEY



*David J. Kyffers*

Director of the United States Patent and Trademark Office

United States of America  
United States Patent and Trademark Office

# KIOSKED

**Reg. No. 4,273,840**

**Registered Jan. 15, 2013**

**Int. Cls.: 9 and 35**

**TRADEMARK**

**SERVICE MARK**

**PRINCIPAL REGISTER**

KIOSKED OY AB (FINLAND CORPORATION)  
RUNEBERGINKATU 43 B 9  
FI-00100 HELSINKI  
FINLAND

FOR: COMPUTER PROGRAMS FOR CUSTOMER RELATIONS MANAGEMENT; COMPUTER PROGRAMS FOR CREATING, IMPLEMENTING, ORGANIZING, VIEWING, DISSEMINATING AND ANALYZING MARKETING TARGETED AT SPECIFIC CUSTOMERS; SELF-DIAGNOSTIC COMPUTER PROGRAMS FOR DIRECT MARKETING; SELF-DIAGNOSTIC COMPUTER PROGRAMS FOR MARKETING COMMUNICATIONS; COMPUTER PROGRAMS FOR CREATING, IMPLEMENTING, ORGANIZING, VIEWING, DISSEMINATING AND ANALYZING FACE-TO-FACE MARKETING; COMPUTER PROGRAMS FOR FACILITATING, MANAGING, ORGANIZING AND ANALYZING HOME SALES/PURCHASES, IN CLASS 9 (U.S. CLS. 21, 23, 26, 36 AND 38).

FOR: ADVERTISING SERVICES; ONLINE ADVERTISING ON COMPUTER NETWORKS; PUBLICITY SERVICES; ADVERTISING AND MARKETING SERVICES; ADVERTISING AND MARKETING; ADVERTISING AND PUBLICITY SERVICES, IN CLASS 35 (U.S. CLS. 100, 101 AND 102).

THE MARK CONSISTS OF STANDARD CHARACTERS WITHOUT CLAIM TO ANY PARTICULAR FONT, STYLE, SIZE, OR COLOR.

OWNER OF INTERNATIONAL REGISTRATION 1100345 DATED 11-8-2011, EXPIRES 11-8-2021.

SER. NO. 79-106,627, FILED 11-8-2011.

ELISSA GARBER KON, EXAMINING ATTORNEY



*David J. Kyffers*

Director of the United States Patent and Trademark Office

# United States of America

United States Patent and Trademark Office



molon labe

**Reg. No. 4,273,841**

**Registered Jan. 15, 2013**

**Int. Cl.: 25**

**TRADEMARK**

**PRINCIPAL REGISTER**

CHRISTOF WERSCHKULL (FED REP GERMANY INDIVIDUAL)  
WILHELMSHÖHE 3-5  
42655 SOLINGEN  
FED REP GERMANY

FOR: CLOTHING, NAMELY, SHIRTS, POLO SHIRTS, T-SHIRTS, SWEAT SHIRTS, HOODED SWEAT SHIRTS, PANTS, JEANS, TROUSERS, JOGGING PANTS, ANORAKS, WINDCHEATERS, SWEATERS AND FLEECE JACKETS; FOOTWEAR; HEADGEAR, NAMELY, HATS AND CAPS; TRIATHLON CLOTHING, NAMELY, SKIN SUITS, SHORTS, BIB SHORTS, JERSEYS, TANK TOPS, ARM AND LEG SLEEVES, JACKETS AND VESTS; KNITWEAR CLOTHING, NAMELY, SHIRTS, POLO SHIRTS, T-SHIRTS, SWEAT SHIRTS, HOODED SWEAT SHIRTS, PANTS, SWEATERS AND FLEECE JACKETS; BATHING TRUNKS, BATHING SUITS, BATHING CAPS; CLOTHING ACCESSORIES, INCLUDED IN THIS CLASS, NAMELY, ARM COOLERS, LEG COOLERS, ARM WARMERS, LEG WARMERS, SOCKS, TIGHTS, SPORT BRAS, HEADBANDS, BANDEAUX, SCARVES, GLOVES AND SWEATBANDS, IN CLASS 25 (U.S. CLS. 22 AND 39).

THE MARK CONSISTS OF A STYLIZED ARMOR HELMET IN A CIRCLE WITH THE WORDING "MOLON LABE" UNDERNEATH THE CIRCLE AND DESIGN.

OWNER OF INTERNATIONAL REGISTRATION 1100369 DATED 10-20-2011, EXPIRES 10-20-2021.

SER. NO. 79-106,636, FILED 10-20-2011.

ANNE FARRELL, EXAMINING ATTORNEY



*David J. Kybas*

Director of the United States Patent and Trademark Office



# United States of America

United States Patent and Trademark Office

## CERAMISPHERE

**Reg. No. 4,273,842**

**Registered Jan. 15, 2013**

**Int. Cls.: 1 and 42**

**TRADEMARK**

**SERVICE MARK**

**PRINCIPAL REGISTER**

CERAMISPHERE PTY LTD (AUSTRALIA COMPANY)  
UNIT 10  
41-53 COLLEGE STREET; GLADESVILLE NSW 2111  
AUSTRALIA

FOR: CHEMICAL ADDITIVES FOR USE IN MANUFACTURE OF A WIDE VARIETY OF GOODS FOR USE IN INDUSTRY; CHEMICAL PREPARATIONS, NAMELY, CERAMIC OR SILICA MICRO-PARTICLES OR NANO-PARTICLES CONTAINING CHEMICAL OR BIOLOGICAL MOLECULES OR MATERIALS THAT ARE USED AS ADDITIVES IN THE MANUFACTURE OF ANTI-CORROSION COATINGS, ANTI-MICROBIAL COATINGS, ANTI-FOULING COATINGS, PAINTS, PIGMENTS, PRINTING INKS, PHARMACEUTICALS, FOODS, FEED, NUTRACEUTICALS, COSMETICS, COSMECEUTICALS AND PRODUCTS FOR USE IN INDUSTRY TO PROVIDE CONTROLLED OR SUSTAINED RELEASE OF THE CHEMICAL OR BIOLOGICAL MOLECULES OR MATERIALS; CHEMICAL PREPARATIONS, NAMELY, CERAMIC OR SILICA MICRO-PARTICLES OR NANO-PARTICLES CONTAINING CHEMICAL CORROSION INHIBITORS THAT ARE USED AS ADDITIVES IN THE MANUFACTURE OF ANTI-CORROSION PAINTS AND COATINGS FOR METAL; CHEMICAL PREPARATIONS, NAMELY, CERAMIC OR SILICA MICRO-PARTICLES OR NANO-PARTICLES CONTAINING BIOCIDES THAT ARE USED AS ADDITIVES IN THE MANUFACTURE OF BIOCIDAL AND ANTI-MICROBIAL PAINTS AND COATINGS; CHEMICAL PREPARATIONS, NAMELY, CERAMIC OR SILICA MICRO-PARTICLES OR NANO-PARTICLES CONTAINING BIOCIDES THAT ARE USED AS ADDITIVES IN THE MANUFACTURE OF ANTI-MICROBIAL, ANTI-FUNGAL AND ANTI-MOULD PAINTS AND COATINGS FOR THE PROTECTION OF WOOD; CHEMICAL PREPARATIONS, NAMELY, CERAMIC OR SILICA MICRO-PARTICLES OR NANO-PARTICLES CONTAINING BIOCIDES THAT ARE USED AS ADDITIVES IN THE MANUFACTURE OF ANTI-MICROBIAL, ANTI-FUNGAL AND ANTI-MOULD PAINTS, COATINGS AND RENDER; CHEMICAL PREPARATIONS, NAMELY, CERAMIC OR SILICA MICRO-PARTICLES OR NANO-PARTICLES CONTAINING CHEMICAL OR BIOLOGICAL MOLECULES OR MATERIALS THAT ARE USED AS ADDITIVES IN THE MANUFACTURE OF CONCRETE AND OTHER BUILDING MATERIALS; CHEMICAL PREPARATIONS, NAMELY, CERAMIC OR SILICA MICRO-PARTICLES OR NANO-PARTICLES CONTAINING ENZYMES THAT ARE USED AS ADDITIVES IN THE MANUFACTURE OF SELF-CLEANING COATINGS AND PAINTS, DETERGENTS AND SIMILAR CLEANING PRODUCTS; CHEMICAL PREPARATIONS, NAMELY, CERAMIC OR SILICA MICRO-PARTICLES OR NANO-PARTICLES CONTAINING CHEMICAL OR BIOLOGICAL MOLECULES OR MATERIALS THAT ARE USED IN THE MANUFACTURE OF PIGMENTS, INKS AND PRINTING MATERIALS; CHEMICAL PREPARATIONS,



*David J. Kyffers*

Director of the United States Patent and Trademark Office

**Reg. No. 4,273,842** NAMELY, CERAMIC OR SILICA MICRO-PARTICLES OR NANO-PARTICLES CONTAINING FRAGRANCES, FLAVORS OR SWEETENERS THAT CAN BE USED TO PROVIDE CONTROLLED RELEASE OF SUCH FRAGRANCES, FLAVORS OR SWEETENERS; CHEMICAL PREPARATIONS, NAMELY, CERAMIC OR SILICA MICRO-PARTICLES OR NANO-PARTICLES CONTAINING VITAMINS, ANTI-OXIDANTS OR OTHER ACTIVE MOLECULES, FOR USE AS ADDITIVES IN THE MANUFACTURE OF COSMETICS AND COSMECEUTICAL PRODUCTS; CHEMICAL PREPARATIONS, NAMELY, CERAMIC OR SILICA MICRO-PARTICLES OR NANO-PARTICLES CONTAINING NUTRIENTS, ANTIBIOTICS, ANTI-MICROBIAL, ANTI-PARASITIC CHEMICALS AND OTHER MEDICAMENTS FOR USE AS ADDITIVES IN FEED FOR ANIMALS AND FISH; CHEMICAL PREPARATIONS, NAMELY, CERAMIC OR SILICA MICRO-PARTICLES OR NANO-PARTICLES CONTAINING FERTILIZERS, FUNGICIDES, HERBICIDES, PARASITICIDES OR INSECTICIDES THAT ARE USED AS ADDITIVES IN THE MANUFACTURE OF AGRICULTURAL OR HORTICULTURAL PRODUCTS TO PROVIDE CONTROLLED RELEASE OF THE FERTILIZERS, FUNGICIDES, HERBICIDES, PARASITICIDES OR INSECTICIDES IN SUCH PRODUCTS; CHEMICAL PREPARATIONS, NAMELY, CERAMIC OR SILICA MICRO-PARTICLES OR NANO-PARTICLES CONTAINING CHEMICAL OR BIOLOGICAL MOLECULES OR MATERIALS THAT ARE USED IN THE PREPARATION OF PHARMACEUTICALS AND VACCINES FOR HUMAN OR VETERINARY USE; CHEMICAL PREPARATIONS, NAMELY, CERAMIC OR SILICA MICRO-PARTICLES OR NANO-PARTICLES CONTAINING CHEMICAL OR BIOLOGICAL MOLECULES THAT ARE USED AS NUTRIENTS, TREATMENTS OR THERAPIES IN INDUSTRY; CHEMICAL PRODUCTS FOR USE IN MANUFACTURING, BUILDING MATERIALS, DETERGENTS, DRUGS, FOODS, FRAGRANCES, MEDICAL PREPARATIONS, PAINTS, PHARMACEUTICAL PREPARATIONS AND WASHING AGENTS; CERAMIC MATERIALS, NAMELY, CERAMIC OR SILICA MICRO-PARTICLES OR NANO-PARTICLES CONTAINING OR NOT CONTAINING CHEMICAL OR BIOLOGICAL MOLECULES OR MATERIALS, IN POWDER FORM, GRANULE FORM AND SLURRY FORM, FOR USE IN INDUSTRY; PRODUCTS FOR USE IN AQUACULTURE, NAMELY, CERAMIC PARTICLES CONTAINING NATURAL OR ARTIFICIAL COLORING AGENTS OR DYES, NUTRIENTS, VITAMINS, MINERALS, ANTIBIOTICS ANTI-PARASITICIDES AND OTHER PHARMACEUTICALS USED TO IMPROVE OR ENHANCE THE GROWTH OF FISH OR FISH LARVAE, IN CLASS 1 (U.S. CLS. 1, 5, 6, 10, 26 AND 46).

FOR: CHEMICAL LABORATORY SERVICES; CHEMICAL RESEARCH; SCIENTIFIC RESEARCH RELATING TO CHEMICAL PRODUCTS, IN CLASS 42 (U.S. CLS. 100 AND 101).

THE MARK CONSISTS OF STANDARD CHARACTERS WITHOUT CLAIM TO ANY PARTICULAR FONT, STYLE, SIZE, OR COLOR.

OWNER OF INTERNATIONAL REGISTRATION 1100584 DATED 11-2-2011, EXPIRES 11-2-2021.

SER. NO. 79-106,724, FILED 11-2-2011.

KATHRYN COWARD, EXAMINING ATTORNEY

# United States of America

United States Patent and Trademark Office

高  
炉  
家

**Reg. No. 4,273,843**

ANHUI SHUANGLUN LIQUOR CO., LTD. (CHINA LIMITED LIABILITY COMPANY)  
GAOLU TOWN  
GUOYANG COUNTY, ANHUI PROVINCE, CHINA

**Registered Jan. 15, 2013**

**Int. Cl.: 33**

FOR: LIQUEURS; EDIBLE ALCOHOL, NAMELY, ABSINTHE, BOURBON, COGNAC,  
BRANDY, WHISKEY, IN CLASS 33 (U.S. CLS. 47 AND 49).

**TRADEMARK**

THE MARK CONSISTS OF A COLUMN OF THREE CHINESE CHARACTERS.

**PRINCIPAL REGISTER**

OWNER OF INTERNATIONAL REGISTRATION 1100595 DATED 11-24-2011, EXPIRES 11-24-2021.

THE NON-LATIN CHARACTERS IN THE MARK TRANSLITERATE TO "GAO LU JIA" AND THIS HAS NO MEANING IN A FOREIGN LANGUAGE.

THE WORDING "GAO LU JIA" HAS NO MEANING IN A FOREIGN LANGUAGE.

SER. NO. 79-106,731, FILED 11-24-2011.

SUZANNE BLANE, EXAMINING ATTORNEY



*David J. Kyros*

Director of the United States Patent and Trademark Office

# United States of America

United States Patent and Trademark Office



**Reg. No. 4,273,844**

**Registered Jan. 15, 2013**

**Int. Cl.: 32**

**TRADEMARK**

**PRINCIPAL REGISTER**

BROUWERIJ DE KONINCK,; NAAMLOZE VENNOOTSCHAP (BELGIUM JOINT STOCK COMPANY)  
291, MECHELSESTEENWEG  
B-2018 ANTWERPEN, BELGIUM

FOR: BEERS, NAMELY, ALE, LAGER, PORTER AND STOUT, IN CLASS 32 (U.S. CLS. 45, 46 AND 48).

OWNER OF U.S. REG. NO. 2,622,638.

PRIORITY DATE OF 8-31-2011 IS CLAIMED.

OWNER OF INTERNATIONAL REGISTRATION 1100640 DATED 11-3-2011, EXPIRES 11-3-2021.

THE COLOR(S) RED, WHITE, GREEN AND BLACK IS/ARE CLAIMED AS A FEATURE OF THE MARK.

THE MARK CONSISTS OF THE STYLIZED WORDING "DE KONINCK" IN WHITE AND OUTLINED IN RED AND BLACK BELOW A DESIGN OF TWO SHIELDS OUTLINED IN WHITE, RED AND BLACK. THE SHIELD ON THE LEFT IS GREEN WITH A DESIGN OF A WHITE AND GREEN CASTLE AND TWO WHITE AND GREEN HANDS. THE SHIELD ON THE RIGHT IS RED WITH A DESIGN OF A WHITE AND RED HAND. THE BACKGROUND IS RED.

SER. NO. 79-106,751, FILED 11-3-2011.

ROBERT STRUCK, EXAMINING ATTORNEY



*David J. Kybas*

Director of the United States Patent and Trademark Office

# United States of America

United States Patent and Trademark Office

# NONIQUE

**Reg. No. 4,273,845**

**Registered Jan. 15, 2013**

**Int. Cl.: 3**

**TRADEMARK**

**PRINCIPAL REGISTER**

REINHARD KRINKE (FED REP GERMANY INDIVIDUAL)  
STEUBENSTR. 104  
68199 MANNHEIM  
FED REP GERMANY

FOR: PREPARATIONS FOR BODY AND BEAUTY, NAMELY LIPSTICKS AND BALSAM FOR LIPS, PERFUMS, ESSENTIAL OILS, COSMETIC PREPARATIONS FOR THE FACE AND BODY, SPECIALLY FOR THE FACE, FACE PACKS, COSMETIC BODY LOTION, CREAMS, EMULSIONS, SHOWER GELS, SHOWER CREAMS, BODY OILS, HAIR SHAMPOOS, HAIR CARE PREPARATIONS AND HAIR LOTION, PREPARATIONS FOR CARING AND CLEANING THE HAIR, SOAPS, DENTIFRICES, IN CLASS 3 (U.S. CLS. 1, 4, 6, 50, 51 AND 52).

THE MARK CONSISTS OF STANDARD CHARACTERS WITHOUT CLAIM TO ANY PARTICULAR FONT, STYLE, SIZE, OR COLOR.

PRIORITY DATE OF 8-25-2011 IS CLAIMED.

OWNER OF INTERNATIONAL REGISTRATION 1100647 DATED 11-17-2011, EXPIRES 11-17-2021.

SER. NO. 79-106,754, FILED 11-17-2011.

MICHAEL WIENER, EXAMINING ATTORNEY



*David J. Kyffers*

Director of the United States Patent and Trademark Office

# United States of America

United States Patent and Trademark Office

# DoveTail

**Reg. No. 4,273,846**

**Registered Jan. 15, 2013**

**Int. Cls.: 9 and 42**

**TRADEMARK**

**SERVICE MARK**

**PRINCIPAL REGISTER**

CGGVERITAS SERVICES SA (FRANCE SOCIÉTÉ ANONYME)  
27 AVENUE CARNOT  
MASSY, FRANCE F91300

FOR: COMPUTER SOFTWARE IN VIEW OF ACQUIRING, PROCESSING, IMAGING AND INTERPRETING GEOPHYSICAL AND SEISMIC DATA FOR THE EXPLORATION, EXPLOITATION AND MONITORING OF SUBSURFACE RESOURCES, INCLUDING OIL AND GAS RESERVOIRS; SCIENTIFIC APPARATUS AND INSTRUMENTS FOR ACQUIRING, PROCESSING, IMAGING AND INTERPRETING GEOPHYSICAL AND/OR SEISMIC DATA WITH A VIEW TO EXPLORING, EXPLOITING AND/OR MONITORING UNDERGROUND RESOURCES, INCLUDING HYDROCARBON AND GAS DEPOSITS, IN CLASS 9 (U.S. CLS. 21, 23, 26, 36 AND 38).

FOR: SCIENTIFIC RESEARCH SERVICES FOR ACQUIRING, PROCESSING, IMAGING AND INTERPRETING GEOPHYSICAL AND/OR SEISMIC DATA WITH A VIEW TO EXPLORING, EXPLOITING AND/OR MONITORING UNDERGROUND RESOURCES, INCLUDING HYDROCARBON AND GAS DEPOSITS, IN CLASS 42 (U.S. CLS. 100 AND 101).

THE MARK CONSISTS OF STANDARD CHARACTERS WITHOUT CLAIM TO ANY PARTICULAR FONT, STYLE, SIZE, OR COLOR.

OWNER OF INTERNATIONAL REGISTRATION 1100818 DATED 11-7-2011, EXPIRES 11-7-2021.

SER. NO. 79-106,866, FILED 11-7-2011.

DAVID HOFFMAN, EXAMINING ATTORNEY



*David J. Kypos*

Director of the United States Patent and Trademark Office

United States of America  
United States Patent and Trademark Office

**BUCCELLATI**

**Reg. No. 4,273,847**

**Registered Jan. 15, 2013**

**Int. Cl.: 43**

**SERVICE MARK**

**PRINCIPAL REGISTER**

DEL VALLINO S.P.A. (ITALY JOINT STOCK COMPANY)  
VIA DELLA SPIGA, 2  
I-20121 MILANO  
ITALY

FOR: HOTELS, MOTELS; RESERVATION SERVICES FOR HOTELS AND MOTELS FOR OTHERS; RENTAL OF TEMPORARY ACCOMMODATION; TOURIST HOMES; RESTAURANT AND BAR SERVICES; FOOD AND DRINK CATERING, IN CLASS 43 (U.S. CLS. 100 AND 101).

THE MARK CONSISTS OF STANDARD CHARACTERS WITHOUT CLAIM TO ANY PARTICULAR FONT, STYLE, SIZE, OR COLOR.

PRIORITY DATE OF 8-4-2011 IS CLAIMED.

OWNER OF INTERNATIONAL REGISTRATION 1101115 DATED 10-26-2011, EXPIRES 10-26-2021.

SER. NO. 79-106,978, FILED 10-26-2011.

MATTHEW EINSTEIN, EXAMINING ATTORNEY



*David J. Kyfos*

Director of the United States Patent and Trademark Office

# United States of America

United States Patent and Trademark Office

# WEBSITE X5

**Reg. No. 4,273,848**

**Registered Jan. 15, 2013**

**Int. Cl.: 9**

INCOMEDIA S.R.L. (ITALY SOCIETÀ A RESPONSABILITÀ LIMITATA (LIMITED LIABILITY COMPANY))

VIA BUROLO NO. 22 A

I-10015 IVREA (TORINO)

ITALY

**TRADEMARK**

FOR: COMPUTER SOFTWARE FOR USE IN THE CREATION OF WEBSITES, BLOGS AND ON-LINE STORES, IN CLASS 9 (U.S. CLS. 21, 23, 26, 36 AND 38).

**PRINCIPAL REGISTER**

THE MARK CONSISTS OF STANDARD CHARACTERS WITHOUT CLAIM TO ANY PARTICULAR FONT, STYLE, SIZE, OR COLOR.

OWNER OF INTERNATIONAL REGISTRATION 1101555 DATED 11-22-2011, EXPIRES 11-22-2021.

NO CLAIM IS MADE TO THE EXCLUSIVE RIGHT TO USE "WEBSITE", APART FROM THE MARK AS SHOWN.

SER. NO. 79-107,128, FILED 11-22-2011.

TASHIA BUNCH, EXAMINING ATTORNEY



*David J. Kyffers*

Director of the United States Patent and Trademark Office



# United States of America

United States Patent and Trademark Office

## INHIBISPHERES

**Reg. No. 4,273,849**

**Registered Jan. 15, 2013**

**Int. Cl.: 1**

**TRADEMARK**

**PRINCIPAL REGISTER**

CERAMISPHERE PTY LTD (AUSTRALIA COMPANY)  
UNIT 10  
41-53 COLLEGE STREET; GLADESVILLE NSW 2111  
AUSTRALIA

FOR: CHEMICAL ADDITIVES FOR USE IN MANUFACTURE OF A WIDE VARIETY OF GOODS, FOR USE IN INDUSTRY; CHEMICAL PREPARATIONS, NAMELY, CERAMIC OR SILICA MICRO-PARTICLES OR NANO-PARTICLES CONTAINING CHEMICAL OR BIOLOGICAL MOLECULES OR MATERIALS THAT ARE USED AS ADDITIVES IN THE MANUFACTURE OF ANTI-CORROSION COATINGS, ANTI-MICROBIAL COATINGS, ANTI-FOULING COATINGS, PAINTS, PIGMENTS, PRINTING INKS AND PRODUCTS FOR USE IN INDUSTRY TO PROVIDE CONTROLLED OR SUSTAINED RELEASE OF THE CHEMICAL OR BIOLOGICAL MOLECULES OR MATERIALS; CHEMICAL PREPARATIONS, NAMELY, CERAMIC OR SILICA MICRO-PARTICLES OR NANO-PARTICLES CONTAINING CHEMICAL CORROSION INHIBITORS THAT ARE USED AS ADDITIVES IN THE MANUFACTURE OF ANTI-CORROSION PAINTS AND COATINGS FOR METAL; CHEMICAL PREPARATIONS, NAMELY, CERAMIC OR SILICA MICRO-PARTICLES OR NANO-PARTICLES CONTAINING ENZYMES OR BIOCIDES OR OTHER AGENTS TO PREVENT BIOFILM FORMATION, THAT MAY BE USED AS ADDITIVES IN THE MANUFACTURE OF ANTI-FOULING PAINTS AND COATINGS FOR USE IN INDUSTRY; CHEMICAL PREPARATIONS, NAMELY, CERAMIC OR SILICA MICRO-PARTICLES OR NANO-PARTICLES CONTAINING BIOCIDES THAT ARE USED AS ADDITIVES IN THE MANUFACTURE OF BIOCIDAL AND ANTI-MICROBIAL PAINTS AND COATINGS; CHEMICAL PREPARATIONS, NAMELY, CERAMIC OR SILICA MICRO-PARTICLES OR NANO-PARTICLES CONTAINING BIOCIDES THAT ARE USED AS ADDITIVES IN THE MANUFACTURE OF ANTI-MICROBIAL, ANTI-FUNGAL AND ANTI-MOULD PAINTS AND COATINGS FOR THE PROTECTION OF WOOD; CHEMICAL PREPARATIONS, NAMELY, CERAMIC OR SILICA MICRO-PARTICLES OR NANO-PARTICLES CONTAINING BIOCIDES THAT ARE USED AS ADDITIVES IN THE MANUFACTURE OF ANTI-MICROBIAL, ANTI-FUNGAL AND ANTI-MOULD PAINTS, COATINGS AND RENDER; CHEMICAL PREPARATIONS, NAMELY, CERAMIC OR SILICA MICRO-PARTICLES OR NANO-PARTICLES CONTAINING CHEMICAL OR BIOLOGICAL MOLECULES OR MATERIALS THAT ARE USED AS ADDITIVES IN THE MANUFACTURE OF CONCRETE AND OTHER BUILDING MATERIALS; CERAMIC MATERIALS, NAMELY, CERAMIC OR SILICA MICRO-PARTICLES OR NANO-PARTICLES CONTAINING OR NOT CONTAINING CHEMICAL OR BIOLOGICAL MOLECULES OR MATERIALS, IN POWDER FORM, GRANULE FORM AND SLURRY FORM, FOR USE IN INDUSTRY, IN CLASS 1 (U.S. CLS. 1, 5, 6, 10, 26 AND 46).



*David J. Kyjars*

Director of the United States Patent and Trademark Office

**Reg. No. 4,273,849** THE MARK CONSISTS OF STANDARD CHARACTERS WITHOUT CLAIM TO ANY PARTICULAR FONT, STYLE, SIZE, OR COLOR.

OWNER OF INTERNATIONAL REGISTRATION 1101589 DATED 11-2-2011, EXPIRES 11-2-2021.

SER. NO. 79-107,147, FILED 11-2-2011.

KATHRYN COWARD, EXAMINING ATTORNEY

# United States of America

United States Patent and Trademark Office

# Magic Leaves

**Reg. No. 4,273,850**

**Registered Jan. 15, 2013**

**Int. Cl.: 3**

**TRADEMARK**

**PRINCIPAL REGISTER**

REINHARD KRINKE (FED REP GERMANY INDIVIDUAL)  
STEUBENSTR. 104  
68199 MANNHEIM  
FED REP GERMANY

FOR: PREPARATIONS FOR BODY AND BEAUTY, NAMELY, LIPSTICKS AND BALSAM FOR LIPS, PERFUMS, ESSENTIAL OILS, COSMETIC PREPARATIONS FOR THE FACE AND BODY, SPECIALLY FOR THE FACE, FACE PACKS, COSMETIC BODY LOTION, CREAMS, EMULSIONS, SHOWER GELS, SHOWER CREAMS, BODY OILS, HAIR SHAMPOOS, HAIR CARE PREPARATIONS AND HAIR LOTION PREPARATIONS FOR CARING AND CLEANING THE HAIR, SOAPS, DENTIFRICES, IN CLASS 3 (U.S. CLS. 1, 4, 6, 50, 51 AND 52).

THE MARK CONSISTS OF STANDARD CHARACTERS WITHOUT CLAIM TO ANY PARTICULAR FONT, STYLE, SIZE, OR COLOR.

PRIORITY DATE OF 10-5-2011 IS CLAIMED.

OWNER OF INTERNATIONAL REGISTRATION 1101630 DATED 11-17-2011, EXPIRES 11-17-2021.

SER. NO. 79-107,152, FILED 11-17-2011.

MICHAEL WIENER, EXAMINING ATTORNEY



*David J. Kyffers*

Director of the United States Patent and Trademark Office

# United States of America

United States Patent and Trademark Office

## PAM HYDROCLASS

**Reg. No. 4,273,851**

**Registered Jan. 15, 2013**

**Int. Cls.: 6, 11, 17 and 19**

**TRADEMARK**

**PRINCIPAL REGISTER**

SAINT-GOBAIN PAM (FRANCE SOCIÉTÉ ANONYME)  
91, AVENUE DE LA LIBÉRATION  
F-54000 NANCY  
FRANCE

FOR: METAL BUILDING MATERIALS, NAMELY, PIPES, TUBES AND PIPE FITTINGS OF METAL OR CONTAINING METAL; ROAD SYSTEM COMPONENTS, NAMELY, METAL MANHOLE COVERS AND GRILLES OF DUCTILE CAST IRON FOR PAVEMENTS AND CURBS; COMPONENTS OF METAL OR CONTAINING METAL FOR CONDUITS FOR UNDERGROUND PUBLIC WORKS OR FOR SEWAGE OR RAINWATER DRAINAGE SYSTEMS FOR BUILDINGS, NAMELY, COVERS FOR CABLE CHAMBERS, RAIN-WATER PIPES, GROUND EQUIPMENT, SIPHONS, RAINWATER GULLIES, FLUID SEPARATORS, PIPE CONNECTORS, JOINERY FITTINGS AND CAST PARTS IN THE NATURE OF COUPLINGS AND JOINTS FOR THE FITTING, ASSEMBLY, INSTALLATION AND REPAIR OF CONDUITS; IRONMONGERY AND METAL PARTS FOR BUILDING DOORS, WINDOWS OR ASSEMBLIES OF TEMPERED GLASS, NAMELY, METAL LOCKS, KNOBS AND PULLS; PROFILED SECTIONS FOR BUILDINGS, NAMELY, METAL PROFILES MADE OF STEEL, IRON, METAL TITANIUM AND OTHER METALS AND THEIR ALLOYS; METAL WATER-PIPE VALVES, IN CLASS 6 (U.S. CLS. 2, 12, 13, 14, 23, 25 AND 50).

FOR: WATER PURIFICATION INSTALLATIONS; WATER SUPPLY AND DISTRIBUTION INSTALLATIONS, NAMELY, WATER TANKS AND WATER PIPES; AGRICULTURAL IRRIGATION UNITS; FIRE PROTECTION NETWORKS IN THE NATURE OF FIRE HYDRANTS LINKED TOGETHER AS A UNIT; IRRIGATION HYDRANTS; FLUSH HYDRANTS; POST HYDRANTS; GRIT SEPARATORS FOR SEWAGE COLLECTORS FOR CLEANING AND PURIFYING WATER; DEVICES FOR ACCESS TO SEWAGE DISPOSAL SYSTEMS, NAMELY, REGULATING VALVES FOR SEWAGE DISPOSAL SYSTEMS; PLUMBING FIXTURES FOR WATER SUPPLY NETWORKS IN THE NATURE OF PLUMBING VALVES; SHUT-OFF VALVES FOR WATER SUPPLY NETWORKS IN THE NATURE OF SHOWER AND TUB CONTROL VALVES; BUTTERFLY VALVES, NAMELY, MANUALLY OPERATED PLUMBING VALVES; APPARATUS FOR WATER PUMP AND WATER TANK EQUIPMENT, NAMELY, PLUMBING BIBS AND PUMP PROTECTION VALVES; REGULATING APPARATUS FOR WATER SUPPLY, NAMELY, REGULATING VALVES AND FLOW LIMITERS IN THE NATURE OF HYDRAULIC COMPENSATORS AND WATER TANK TAPS; SAFETY VALVES, ADJUSTABLE OPENING VALVES FOR WATER SUPPLY NETWORKS; SHUTOFF VALVES IN THE NATURE OF SHOWER AND TUB CONTROL VALVES; PLUMBING FITTINGS, NAMELY, CURB COCKS; APPARATUS FOR PROTECTING WATER PIPE NET-



*David J. Kybas*

Director of the United States Patent and Trademark Office

**Reg. No. 4,273,851** WORKS, NAMELY, AIR BLEED VALVES BEING PLUMBING FITTINGS FOR WATER DISTRIBUTION INSTALLATIONS; AIR VENTS FOR WATER DISTRIBUTION INSTALLATIONS FOR RELEASING AIR AND REGULATING PRESSURE IN WATER INSTALLATIONS, IN CLASS 11 (U.S. CLS. 13, 21, 23, 31 AND 34).

FOR: RUBBER, GUTTA-PERCHA, GUM, ASBESTOS, AND MICA; GOODS MADE FROM RUBBER, GUTTA-PERCHA, GUM, ASBESTOS, AND MICA NOT INCLUDED IN OTHER CLASSES, NAMELY, CLUTCH LININGS, SHOCK ABSORBERS FOR PIPES, SEALING RINGS FOR USE AS CONNECTION SEALS, AND INSULATING STRIPS; WEATHER STRIPPING; JOINTS FOR USE IN AUTOMOBILES AND HOMES; EXPANSION JOINT FILLERS, NON-METALLIC PIPE JACKETS FOR USE WITH WATER, SEWER AND INDUSTRIAL PIPES; INSULATING PAINTS; SEMI-PROCESSED PLASTICS; PACKING AND INSULATING MATERIALS; STOPPING MATERIALS, NAMELY, PIPE GASKETS; NON-METALLIC FLEXIBLE PIPES; NON-METALLIC FLEXIBLE TUBES OF PLASTIC; NON-METALLIC PIPE FITTINGS FOR FLEXIBLE PIPES FOR WATER, SEWER, DRAINAGE AND INDUSTRIAL USE; JOINTS, NAMELY, PIPE JOINT COMPOUND AND JOINT PACKING FOR WATER PIPES, IN CLASS 17 (U.S. CLS. 1, 5, 12, 13, 35 AND 50).

FOR: NON-METALLIC BUILDING MATERIALS, NAMELY, NON-METALLIC RIGID PIPES; NON-METAL FILTERING TUBES USED TO PREVENT STORM WATER RUNOFF POLLUTANTS FROM ENTERING SEWER SYSTEMS; CONNECTORS IN THE NATURE OF NON-METAL PIPE FITTINGS, COUPLINGS AND JOINTS; GROUND EQUIPMENT IN THE NATURE OF NON METAL IN-GROUND SEWAGE AND WATER RUN-OFF BASINS, NON-METAL MANHOLE COVERS, NON-METAL CURB AND ROADWAY GRATING; SIPHONS FOR USE IN THE DRAINAGE OF WATER; RAINWATER GULLIES IN THE NATURE OF CONDUITS FOR DRAINAGE AND IRRIGATION; AND COMPONENT PARTS FOR THE FITTING AND INSTALLATION OF CONDUITS FOR DRAINAGE AND IRRIGATION IN THE NATURE OF FLUID SEPARATORS, PIPE CONNECTORS, AND TUBING AND TUBING COUPLINGS FOR JOINING AND TERMINATING PIPES; ALL THESE GOODS BEING RIGID AND NOT OF METAL, IN CLASS 19 (U.S. CLS. 1, 12, 33 AND 50).

OWNER OF U.S. REG. NOS. 3,152,722 AND 3,212,209.

PRIORITY DATE OF 3-17-2011 IS CLAIMED.

OWNER OF INTERNATIONAL REGISTRATION 1101785 DATED 9-16-2011, EXPIRES 9-16-2021.

THE COLOR(S) GRAY AND BLUE IS/ARE CLAIMED AS A FEATURE OF THE MARK.

THE MARK CONSISTS OF THE WORD "PAM" IN GRAY WITH BLUE WAVES EXTENDING FROM THE LOWER PORTION OF THE LETTER "A" IN THE WORD TO THE END OF THE LOWER PORTION OF THE LETTER "M" IN THE WORD, AND THE WORD "HYDROCLASS" IN DARK GRAY TO THE RIGHT OF THE WORD "PAM" AND WAVE DESIGN.

SER. NO. 79-107,226, FILED 9-16-2011.

JENNIFER WILLISTON, EXAMINING ATTORNEY

# United States of America

United States Patent and Trademark Office

# JUMPLEAD

**Reg. No. 4,273,852**

**Registered Jan. 15, 2013**

**Int. Cls.: 35 and 42**

**SERVICE MARK**

**PRINCIPAL REGISTER**

MOOLOOP LTD (UNITED KINGDOM COMPANY)  
85 HOLT DRIVE  
LOUGHBOROUGH; LEICESTERSHIRE LE11 3HZ  
UNITED KINGDOM

FOR: CUSTOMER RELATIONSHIP MANAGEMENT, PROVIDING A BUSINESS SERVICE VIA THE INTERNET, NAMELY, PROVIDING A WEBSITE UPON WHICH USERS CAN CARRY OUT CUSTOMER RELATIONSHIP MANAGEMENT; BUSINESS RESEARCH; BUSINESS MONITORING AND CONSULTING SERVICES, NAMELY, TRACKING USAGE OF WEB SITES TO PROVIDE MARKETING AND SALES LEADS, IN CLASS 35 (U.S. CLS. 100, 101 AND 102).

FOR: COMPUTER SERVICES, NAMELY, MONITORING, ANALYZING, AND REPORTING ON THE INTERNET TRAFFIC OF THE WEB SITES OF OTHERS, IN CLASS 42 (U.S. CLS. 100 AND 101).

THE MARK CONSISTS OF STANDARD CHARACTERS WITHOUT CLAIM TO ANY PARTICULAR FONT, STYLE, SIZE, OR COLOR.

PRIORITY DATE OF 5-11-2011 IS CLAIMED.

OWNER OF INTERNATIONAL REGISTRATION 1101878 DATED 11-9-2011, EXPIRES 11-9-2021.

SER. NO. 79-107,256, FILED 11-9-2011.

GEOFFREY FOSDICK, EXAMINING ATTORNEY



*David J. Kyros*

Director of the United States Patent and Trademark Office

# United States of America

United States Patent and Trademark Office

# JHK

**Reg. No. 4,273,853**

**Registered Jan. 15, 2013**

**Int. Cls.: 25 and 28**

**TRADEMARK**

**PRINCIPAL REGISTER**

JACINTO CERVERA BERNALDO DE QUIRÓS (SPAIN INDIVIDUAL)  
C/ CADMIO, 7  
POL. IND. SONSOLES  
E-28946 FUENLABRADA (MADRID), SPAIN

FOR: CLOTHING, NAMELY, T-SHIRTS, POLO SHIRTS, SWEATSHIRT, SHIRTS, COATS, SHORTS, BLOUSES; FOOTWEAR; HEADGEAR, NAMELY, CAPS AND HATS; CLOTHING FOR GYMNASTICS, NAMELY, GYMNASTICS SHIRTS; SHORT SLEEVED T-SHIRTS; SPORTS JERSEYS; CLOTHING FOR CYCLISTS AND MOTORISTS, NAMELY, CYCLIST JERSEYS; SPORTS AND BEACH FOOTWEAR; SOCKS; SHIRTS; JACKETS; STUFF JACKETS; BELTS BEING CLOTHING; NECKTIES; GABARDINES, NAMELY, JACKETS; CAPS; GLOVES; WATERPROOF CLOTHING, NAMELY, RAINCOATS; JERSEYS; UNDERWEAR; POCKET SQUARES; ASCOTS; SWIMWEAR, NAMELY, BATHING SUITS; FROCKS, IN CLASS 25 (U.S. CLS. 22 AND 39).

FOR: GAMES AND TOYS, NAMELY, BOARD GAMES, TOY CARS; GYMNASTIC AND SPORTING ARTICLES, NAMELY, SPORTS BALLS, IN CLASS 28 (U.S. CLS. 22, 23, 38 AND 50).

THE COLOR BLUE APPEARS IN THE LETTERS "JHK".

PRIORITY DATE OF 10-28-2011 IS CLAIMED.

OWNER OF INTERNATIONAL REGISTRATION 1102039 DATED 10-31-2011, EXPIRES 10-31-2021.

THE COLOR(S) BLUE IS/ARE CLAIMED AS A FEATURE OF THE MARK.

SER. NO. 79-107,322, FILED 10-31-2011.

EVELYN BRADLEY, EXAMINING ATTORNEY



*David J. Kypos*

Director of the United States Patent and Trademark Office

# United States of America

United States Patent and Trademark Office

# kangsbey

**Reg. No. 4,273,854**

**Registered Jan. 15, 2013**

**Int. Cls.: 5, 42 and 44**

GUANGZHOU BAIYUNSHAN PHARMACEUTICAL; CO., LTD. GUANGZHOU  
BAIYUNSHAN; PHARMACEUTICAL FACTORY (CHINA LIMITED COMPANY)  
NO. 88 YUNXIANG ROAD  
TONGHE STREET.; BAIYUN DISTRICT.; GUANGZHOU; GUANGDONG  
CHINA

**TRADEMARK**

**SERVICE MARK**

**PRINCIPAL REGISTER**

FOR: MEDICINES FOR HUMAN PURPOSES FOR THE TREATMENT OF INFECTIOUS DISEASES, NAMELY, RESPIRATORY INFECTIONS, CENTRAL NERVOUS SYSTEM INFECTIONS, GASTROINTESTINAL INFECTIONS, GENITOURINARY INFECTIONS, OCULAR INFECTIONS, DERMATOLOGICAL INFECTIONS, IMMUNE SYSTEM INFECTIONS; MEDICINES FOR HUMAN PURPOSES FOR THE TREATMENT OF RESPIRATORY INFLAMMATION; MEDICINES FOR HUMAN PURPOSES FOR THE TREATMENT OF IMMUNOLOGIC DISEASES, NAMELY, AUTOIMMUNE DISEASES, IMMUNOLOGIC DEFICIENCY SYNDROMES; PHARMACEUTICAL PREPARATIONS FOR THE TREATMENT OF INFECTIOUS DISEASES, NAMELY, RESPIRATORY INFECTIONS, CENTRAL NERVOUS SYSTEM INFECTIONS, GASTROINTESTINAL INFECTIONS, GENITOURINARY INFECTIONS, OCULAR INFECTIONS, DERMATOLOGICAL INFECTIONS, IMMUNE SYSTEM INFECTIONS; PHARMACEUTICAL PREPARATIONS FOR THE TREATMENT OF RESPIRATORY INFLAMMATION; PHARMACEUTICAL PREPARATIONS FOR THE TREATMENT OF IMMUNOLOGIC DISEASES, NAMELY, AUTOIMMUNE DISEASES, IMMUNOLOGIC DEFICIENCY SYNDROMES; DIAGNOSTIC PREPARATIONS FOR MEDICAL PURPOSES; ANTIBIOTICS; DIETETIC SUBSTANCES ADAPTED FOR MEDICAL USE, NAMELY, SUGAR SUBSTITUTES; MEDICAL DRESSINGS; ANTI-INFECTIVE MEDICINES FOR VETERINARY USE; NUTRITIONALLY FORTIFIED BEVERAGES FOR MEDICAL USE; EYE-WASHES; PREPARATIONS FOR DESTROYING VERMIN, IN CLASS 5 (U.S. CLS. 6, 18, 44, 46, 51 AND 52).



FOR: PHARMACEUTICAL RESEARCH AND DEVELOPMENT; SCIENTIFIC RESEARCH; QUALITY CONTROL FOR OTHERS; QUALITY MEASUREMENT AND ANALYSIS FOR MEDICAL PRACTICE; CHEMICAL RESEARCH; CHEMICAL ANALYSIS; BIOLOGICAL RESEARCH; MATERIAL TESTING; PACKAGING DESIGN; HOSTING THE WEB SITES OF OTHERS ON A COMPUTER SERVER FOR A GLOBAL COMPUTER NETWORK, IN CLASS 42 (U.S. CLS. 100 AND 101).

*David J. Kyffers*

FOR: MEDICAL CLINICS; HOSPITALS; HEALTH CARE; PHARMACEUTICAL ADVICE; SERVICES OF A PSYCHOLOGIST, NAMELY, PSYCHOLOGICAL COUNSELING; CONVALESCENT HOMES; DIETARY AND NUTRITIONAL GUIDANCE; BEAUTY SALONS;



**Reg. No. 4,273,854** VERMIN EXTERMINATING FOR AGRICULTURE, HORTICULTURE AND FORESTRY, IN CLASS 44 (U.S. CLS. 100 AND 101).

OWNER OF INTERNATIONAL REGISTRATION 1102139 DATED 11-24-2011, EXPIRES 11-24-2021.

SER. NO. 79-107,350, FILED 11-24-2011.

DAVID ELTON, EXAMINING ATTORNEY

# United States of America

United States Patent and Trademark Office

# ARIDION

**Reg. No. 4,273,855**

**Registered Jan. 15, 2013**

**Int. Cls.: 1, 7, 9 and 40**

**TRADEMARK**

**SERVICE MARK**

**PRINCIPAL REGISTER**

P21 LIMITED (UNITED KINGDOM LIMITED COMPANY (LTD.))  
127 NORTH  
MILTON PARK; ABINGDON, OXFORDSHIRE OX144SA  
UNITED KINGDOM

FOR: CHEMICALS USED IN INDUSTRY; CHEMICALS USED IN INDUSTRY, NAMELY, LIQUID REPELLENT, WATER RESISTANT, ANTI STAINING AND CORROSION PREVENTIVE COATING AND CHEMICALS OTHER THAN PAINTS, NAMELY, CHEMICAL COMPOSITIONS FOR PROVIDING WATERPROOF, WATER RESISTANT AND WATER REPELLANT COATINGS AND FOR PREVENTING STAINING OR CORROSION; LIQUID REPELLENT NANO-COATING, NAMELY, CHEMICAL COMPOSITION PROVIDING WATERPROOF, WATER RESISTANT, AND WATER REPELLANT COATINGS AND FOR PREVENTING STAINING OR CORROSION; TEXTILE FINISHING CHEMICALS HAVING LIQUID-REPELLENT PROPERTIES, NAMELY, WATER-REPELLENT COMPOSITIONS OTHER THAN PAINTS; LIQUID REPELLENT COATING AND CHEMICALS FOR USE ON PLASTICS, GLASS, CERAMICS, OPTICAL LENSES, METALS, FIBRES, MASONRY, NAMELY, CHEMICAL COMPOSITIONS FOR PROVIDING WATERPROOF, WATER RESISTANT AND WATER REPELLANT COATINGS AND FOR PREVENTING STAINING OR CORROSION; LIQUID-REPELLENT COMPOSITIONS GENERALLY, NAMELY, CHEMICAL PREPARATIONS TO BE APPLIED TO TEXTILES, PLASTICS, METALS, AND COATINGS TO PREVENT WATER DAMAGE; LIQUID-REPELLENT COMPOSITIONS GENERALLY, NAMELY, CHEMICAL COMPOSITION FOR PROVIDING COATINGS WHICH SUBSTANTIALLY PREVENT PERMEATION BY WATER, IN CLASS 1 (U.S. CLS. 1, 5, 6, 10, 26 AND 46).



*David J. Kyffers*

Director of the United States Patent and Trademark Office

FOR: MACHINES AND MACHINE TOOLS FOR THE TREATMENT OF GOODS WITH LIQUID REPELLENT AND LIQUID ABSORBENT COATINGS AND CHEMICALS; INDUSTRIAL AND COMMERCIAL SURFACE TREATMENT EQUIPMENT, NAMELY, APPARATUS AND INSTRUMENTS FOR TREATING GOODS WITH LIQUID REPELLENT, WATER RESISTANT, ANTI STAINING AND CORROSION PREVENTIVE COATING AND CHEMICALS COMPRISING INDUSTRIAL AND BENCHTOP MACHINES AND EQUIPMENT FOR LIQUID REPELLENT, WATER RESISTANT, ANTI STAINING AND CORROSION PREVENTIVE COATING AND CHEMICALS IN A COMMERCIAL OR INDUSTRIAL MANUFACTURING ENVIRONMENT AND TREATMENT CHAMBER FOR HOLDING THE GOODS AND STRUCTURAL PARTS THEREFOR, IN CLASS 7 (U.S. CLS. 13, 19, 21, 23, 31, 34 AND 35).

FOR: BLANK MAGNETIC DATA CARRIERS AND DISCS; MOBILE PHONES; CARRIERS ADAPTED FOR MOBILE PHONES; CASES ADAPTED FOR MOBILE PHONES; HOLDERS

**Reg. No. 4,273,855** ADAPTED FOR MOBILE PHONES; MP3 PLAYERS; CASES FOR MP3 PLAYERS; PIPETTES, LABORATORY CONSUMABLES AND EQUIPMENT, NAMELY, PIPETTE TIPS, PETRI DISHES, AND MICROTITRE PLATES; SKI GOGGLES; SUNGLASSES; LIGHT EMITTING DIODES (LEDS); BUT NOT INCLUDING COMPUTER APPLICATION SOFTWARE FOR OPTIMIZATION OF OPERATIONS, SCIENTIFIC COMPUTING, NUMERICAL COMPUTATION, ALGORITHM DESIGN, ALGORITHM COLLABORATION, COMPUTER LANGUAGE IMPLEMENTATION AND DOMAIN SPECIFIC LANGUAGE CREATION, ALL IN THE FIELDS OF OPERATIONS RESEARCH, MANAGEMENT SCIENCE, TRANSPORTATION, FINANCE, MANUFACTURING, ENERGY AND ENGINEERING APPLICATIONS, IN CLASS 9 (U.S. CLS. 21, 23, 26, 36 AND 38).

FOR: TREATMENT OF MATERIALS, NAMELY, APPLICATION OF PROTECTIVE COATINGS IN THE NATURE OF WATERPROOF, WATER REPELLANT AND WATER RESISTANT COATINGS AND FINISHING CHEMICALS TO MANUFACTURED GOODS AND ELECTRONICS AND COMPONENTS OF SUCH GOODS; APPLICATION OF LIQUID COATINGS AND CHEMICALS TO GOODS, NAMELY, APPLICATION OF PROTECTIVE COATINGS IN THE NATURE OF WATERPROOF, WATER REPELLANT AND RESISTANT COATINGS AND FINISHING CHEMICALS TO MANUFACTURED GOODS AND ELECTRONICS AND COMPONENTS OF SUCH GOODS; APPLICATION OF LIQUID COATINGS AND CHEMICALS TO PLASTICS, GLASS, CERAMICS, OPTICAL LENSES, METALS, FIBRES, MASONRY, NAMELY, APPLICATION OF PROTECTIVE COATINGS IN THE NATURE OF WATERPROOF, WATER REPELLANT AND WATER RESISTANT COATINGS AND FINISHING CHEMICALS; APPLICATION OF LIQUID REPELLENT AND LIQUID ANTI-ABSORBENT COATINGS AND CHEMICALS TO GOODS, NAMELY, APPLICATION OF PROTECTIVE COATINGS IN THE NATURE OF WATERPROOF, WATER REPELLANT AND WATER RESISTANT COATINGS AND FINISHING CHEMICALS; APPLICATION OF TEXTILE FINISHING CHEMICALS TO MANUFACTURED GOODS AND COMPONENTS OF GOODS, NAMELY, APPLICATION OF PROTECTIVE COATINGS IN THE NATURE OF WATERPROOF, WATER REPELLANT AND WATER RESISTANT COATINGS AND FINISHING CHEMICALS TO MANUFACTURED GOODS AND COMPONENTS OF SUCH GOODS; LEASING AND HIRE OF APPARATUS AND INSTRUMENTS FOR TREATING GOODS WITH LIQUID REPELLENT AND LIQUID ABSORBENT COATINGS AND CHEMICALS, NAMELY, LEASING EQUIPMENT FOR THE APPLICATION OF PROTECTIVE COATINGS IN THE NATURE OF WATERPROOF, WATER REPELLANT AND WATER RESISTANT COATINGS AND FINISHING CHEMICALS TO MANUFACTURED GOODS AND ELECTRONICS AND COMPONENTS OF SUCH GOODS, IN CLASS 40 (U.S. CLS. 100, 103 AND 106).

THE MARK CONSISTS OF STANDARD CHARACTERS WITHOUT CLAIM TO ANY PARTICULAR FONT, STYLE, SIZE, OR COLOR.

OWNER OF INTERNATIONAL REGISTRATION 1102250 DATED 8-11-2011, EXPIRES 8-11-2021.

SER. NO. 79-107,395, FILED 8-11-2011.

ROBERT STRUCK, EXAMINING ATTORNEY

United States of America  
United States Patent and Trademark Office

# ROCKS

**Reg. No. 4,273,856**

**Registered Jan. 15, 2013**

**Int. Cl.: 34**

**TRADEMARK**

**PRINCIPAL REGISTER**

TEKA PURO ÜRETİM VE TIC. A.S. (TURKEY CORPORATION)  
CEVIZLI TEKEL KAMPÜSÜ  
KARTAL-ISTANBUL  
TURKEY

FOR: TOBACCO; SMOKERS' ARTICLES, NAMELY, ABSORBENT PAPER FOR TOBACCO PIPES, ASHTRAYS FOR SMOKERS, CIGAR CASES, CIGARETTE CASES, CHEWING TOBACCO, CIGAR CASES, CIGAR CUTTERS, CIGAR HOLDERS, GAS CONTAINERS FOR CIGAR LIGHTERS, CIGARETTE CASES, CIGARETTE FILTERS, CIGARETTE HOLDERS, CIGARETTE PAPER, CIGARETTE TIPS, CIGARETTES, CIGARETTES CONTAINING TOBACCO SUBSTITUTES, NOT FOR MEDICAL PURPOSES, POCKET MACHINES FOR ROLLING CIGARETTES, CIGARILLOS, CIGARS, CIGAR CUTTERS, CIGARETTE FILTERS, FIRESTONES, GAS CONTAINERS FOR CIGAR LIGHTERS, HUMIDORS, LIGHTERS FOR SMOKERS, MATCH BOXES, MATCH HOLDERS, MATCHES, MOUTHPIECES FOR CIGARETTE HOLDERS, PIPE CLEANERS FOR TOBACCO PIPES, PIPE RACKS FOR TOBACCO PIPES, PIPES, SPITTOONS FOR TOBACCO USERS, CIGARETTE TIPS, TOBACCO, TOBACCO JARS, TOBACCO PIPES, TOBACCO POUCHES, IN CLASS 34 (U.S. CLS. 2, 8, 9 AND 17).

THE MARK CONSISTS OF THE WORD "ROCKS" APPEARING IN STYLIZED FONT.

OWNER OF INTERNATIONAL REGISTRATION 1102322 DATED 10-7-2011, EXPIRES 10-7-2021.

SER. NO. 79-107,428, FILED 10-7-2011.

ROBERT STRUCK, EXAMINING ATTORNEY



*David J. Kybas*

Director of the United States Patent and Trademark Office

# United States of America

United States Patent and Trademark Office

## VALUE RETAIL

**Reg. No. 4,273,857**

**Registered Jan. 15, 2013**

**Int. Cls.: 36 and 37**

VALUE RETAIL PLC (UNITED KINGDOM SOCIÉTÉ OUVERTE À RESPONSABILITÉ  
LIMITÉE)  
19 BERKELEY STREET  
LONDON W1J 8ED  
UNITED KINGDOM

**SERVICE MARK**

**PRINCIPAL REGISTER**

FOR: RENTAL OF COMMERCIAL PREMISES, IN CLASS 36 (U.S. CLS. 100, 101 AND 102).

FOR: CONSTRUCTION OF SHOPPING CENTERS AND OTHER COMMERCIAL BUILDINGS;  
REPAIR OF COMMERCIAL BUILDINGS; INSTALLATION OF BUILDING INSULATION,  
HEATING, VENTILATION AND AIR CONDITIONING AND REFRIGERATION SYSTEMS;  
INSTALLATION OF MASONRY WALLS AND STRUCTURES, POP-UP BOUTIQUES AND  
OTHER OCCASIONAL STRUCTURES SUCH AS SUMMER CAFÉS; INSTALLATION OF  
ARTWORK AND STATUARY, IN CLASS 37 (U.S. CLS. 100, 103 AND 106).

THE MARK CONSISTS OF STANDARD CHARACTERS WITHOUT CLAIM TO ANY PAR-  
TICULAR FONT, STYLE, SIZE, OR COLOR.

OWNER OF INTERNATIONAL REGISTRATION 1091421 DATED 8-26-2011, EXPIRES 8-26-  
2021.

NO CLAIM IS MADE TO THE EXCLUSIVE RIGHT TO USE "RETAIL", APART FROM THE  
MARK AS SHOWN.

SER. NO. 79-107,447, FILED 11-8-2011.

PRISCILLA MILTON, EXAMINING ATTORNEY



*David J. Kybas*

Director of the United States Patent and Trademark Office

# United States of America

United States Patent and Trademark Office

# pppyple

**Reg. No. 4,273,858**

**Registered Jan. 15, 2013**

**Int. Cl.: 9**

**TRADEMARK**

**PRINCIPAL REGISTER**

PPYPLE INCORPORATION (REPUBLIC OF KOREA CORPORATION)  
#1101, INCHEON IT TOWER  
592-5, DOHWA-DONG,; NAM-GU; INCHEON METROPOLITAN CITY  
REPUBLIC OF KOREA AND

KIM, SANGSHIN (REPUBLIC OF KOREA INDIVIDUAL)  
3-804, LOTTE APTS.  
617-11, SIMGOKBON-DONG,; SOSA-GU,; BUCHEON-SIO; GYEONGGI-DO  
REPUBLIC OF KOREA AND

HWANG, YEOSIL (REPUBLIC OF KOREA INDIVIDUAL)  
3-804, LOTTE APTS.  
617-11, SIMGOKBON-DONG,; SOSA-GU,; BUCHEON-SI; GYEONGGI-DO  
REPUBLIC OF KOREA

FOR: MOBILE PHONES; TABLET COMPUTERS; PROTECTIVE FILMS FOR MOBILE PHONES; PROTECTIVE FILMS FOR TABLET COMPUTERS; PROTECTIVE CASES FOR MOBILE PHONES; PROTECTIVE CASES FOR TABLET COMPUTERS; GLOVES IN THE NATURE OF PROTECTIVE CASES FOR TOUCH SCREENS; PENS IN THE NATURE OF STYLI FOR TOUCH SCREENS; LOUDSPEAKERS; MOBILE PHONE RESTS FOR HOUSEHOLD PURPOSES; MOBILE PHONE RESTS FOR VEHICLES; MOBILE PHONE RESTS FOR BICYCLES; PROJECTION SCREENS; PICTURE PROJECTORS; BEAM PROJECTORS, NAMELY, VIDEO PROJECTORS; DIGITAL CAMERAS; CAMERA CASES; 3-DIMENSIONAL EYEGLASSES; SOLAR BATTERY CHARGERS; MPEG AUDIO LAYER-3 MP3 PLAYERS; DEVICES FOR WIRELESS RADIO COMMUNICATION, NAMELY, TRANSCEIVERS; APPARATUS FOR THE RECORDING, TRANSMISSION OR REPRODUCTION OF SOUND AND IMAGES; TELECOMMUNICATION MACHINES AND IMPLEMENTS, NAMELY, TELEPHONES; TRANSMITTING SETS FOR TELECOMMUNICATION, NAMELY, WIRELESS TELEPHONE TRANSMITTERS; KEYBOARDS FOR MOBILE PHONES; DEVICES FOR HANDS-FREE USE OF MOBILE PHONES; EARPHONES; TELEPHONE TERMINALS; APPARATUS FOR WIRELESS TRANSMISSION OF ACOUSTIC INFORMATION; COMPUTER PROGRAMS FOR EDITING IMAGES, SOUND AND VIDEO; COMPUTER APPLICATION SOFTWARE FOR MOBILE PHONES, NAMELY, SOFTWARE FOR USE IN ELECTRONIC STORAGE OF DATA; COMPUTER PERIPHERAL DEVICES; COMPUTER SOFTWARE TO ENABLE THE TRANSMISSION OF PHOTOGRAPHS TO MOBILE PHONES; DOWNLOADABLE APPLICATION SOFTWARE FOR MOBILE PHONES, NAMELY, SOFTWARE FOR USE IN ELECTRONIC STORAGE OF DATA; DOWNLOADABLE APPLICATION SOFTWARE



*David J. Kyros*

Director of the United States Patent and Trademark Office

**Reg. No. 4,273,858** FOR TABLET COMPUTERS, NAMELY, SOFTWARE FOR USE IN ELECTRONIC STORAGE OF DATA; ELECTRIC CURRENT ADAPTERS FOR HOUSEHOLD PURPOSES; ELECTRIC CURRENT ADAPTERS FOR VEHICLES; PORTABLE BATTERY PACKS, IN CLASS 9 (U.S. CLS. 21, 23, 26, 36 AND 38).

THE WORDING "PPYPLE" HAS NO MEANING IN A FOREIGN LANGUAGE.

PRIORITY DATE OF 10-27-2011 IS CLAIMED.

OWNER OF INTERNATIONAL REGISTRATION 1102483 DATED 10-28-2011, EXPIRES 10-28-2021.

SER. NO. 79-107,516, FILED 10-28-2011.

LIEF MARTIN, EXAMINING ATTORNEY

# United States of America

United States Patent and Trademark Office



**Reg. No. 4,273,859**

**Registered Jan. 15, 2013**

**Int. Cls.: 3, 16, 32 and 35**

CHRISTINE SALOPEK (GERMAN DEM REP INDIVIDUAL)  
BGM. EBNER STRASSE 70  
86316 FRIEDBERG  
FED REP GERMANY

FOR: SOAPS FOR PERSONAL USE, PERFUMERY, ESSENTIAL OILS, COSMETICS, COSMETIC SKIN CREAMS, LOTIONS FOR FACE AND BODY CARE, MAKE-UP, COSMETIC PENCILS, HAIR LOTIONS, DENTIFRICES, IN CLASS 3 (U.S. CLS. 1, 4, 6, 50, 51 AND 52).

**TRADEMARK**

**SERVICE MARK**

FOR: PRINTED MATTER, NAMELY, NEWSPAPERS, PERIODICALS IN THE FIELD OF COSMETICS FOR FACE AND BODYCARE, MAGAZINES IN THE FIELD OF COSMETICS FOR FACE AND BODY CARE, PROSPECTUSES IN THE FIELD OF COSMETICS FOR FACE AND BODY CARE; POSTERS, IN CLASS 16 (U.S. CLS. 2, 5, 22, 23, 29, 37, 38 AND 50).

**PRINCIPAL REGISTER**

FOR: BEERS; MINERAL WATER AND AERATED WATERS AND OTHER NON-ALCOHOLIC DRINKS, NAMELY, SODA, LEMONADE AND TEA DRINKS; FRUIT DRINKS AND FRUIT JUICES; SYRUPS FOR MAKING BEVERAGES, AND PREPARATIONS FOR MAKING BEVERAGES, NAMELY, SODA, LEMONADE AND TEA DRINKS, IN CLASS 32 (U.S. CLS. 45, 46 AND 48).

FOR: WHOLESALE AND RETAIL STORE SERVICES, INCLUDING OVER THE INTERNET AND MAIL ORDER RETAIL STORE SERVICES IN THE FOLLOWING FIELDS: SOAPS, PERFUMERY, ESSENTIAL OILS, COSMETICS, COSMETIC SKIN CREAMS, LOTIONS, MAKE-UP, COSMETIC PENCILS, HAIR LOTIONS, DENTIFRICES, PRINTED MATTER, NEWSPAPERS, PERIODICALS, MAGAZINES, PROSPECTUSES, POSTERS, IN CLASS 35 (U.S. CLS. 100, 101 AND 102).



THE MARK CONSISTS OF A REPRESENTATION OF A FLAMING ROC ASIDE A VERTICAL LINE, OVER THE TERM "SILENOS".

PRIORITY DATE OF 10-12-2011 IS CLAIMED.

OWNER OF INTERNATIONAL REGISTRATION 1102573 DATED 11-14-2011, EXPIRES 11-14-2021.

SER. NO. 79-107,539, FILED 11-14-2011.

*David J. Kyros*

Director of the United States Patent and Trademark Office



**Reg. No. 4,273,859** BRIAN NEVILLE, EXAMINING ATTORNEY

# United States of America

United States Patent and Trademark Office

# DOSI-FUSER

**Reg. No. 4,273,860**

**Registered Jan. 15, 2013**

**Int. Cl.: 10**

**TRADEMARK**

**PRINCIPAL REGISTER**

LEVENTON S.A. (SPAIN SOCIEDAD ANÓNIMA)  
TORRE WERFEN, PLAÇA D'EUROPA 21-23  
L'HOSPITALET DE LLOBREGAT; E-08908 BARCELONA  
SPAIN

FOR: MEDICAL APPARATUS AND INSTRUMENTS, SPECIFICALLY PORTABLE ELASTOMERIC INFUSION DEVICES FOR ADMINISTERING DRUGS, IN CLASS 10 (U.S. CLS. 26, 39 AND 44).

THE MARK CONSISTS OF STANDARD CHARACTERS WITHOUT CLAIM TO ANY PARTICULAR FONT, STYLE, SIZE, OR COLOR.

OWNER OF INTERNATIONAL REGISTRATION 1102588 DATED 12-2-2011, EXPIRES 12-2-2021.

SER. NO. 79-107,543, FILED 12-2-2011.

CARYN GLASSER, EXAMINING ATTORNEY



*David J. Kyffers*

Director of the United States Patent and Trademark Office

# United States of America

United States Patent and Trademark Office

# XERFI

**Reg. No. 4,273,861**

**Registered Jan. 15, 2013**

**Int. Cls.: 35, 38, 41 and  
42**

**SERVICE MARK**

**PRINCIPAL REGISTER**

XERFI.COM (FRANCE SOCIÉTÉ PAR ACTIONS SIMPLIFIÉE)  
13-15 RUE DE CALAIS  
F-75009 PARIS  
FRANCE

FOR: NEWSPAPER AND MAGAZINE SUBSCRIPTION SERVICES; BUSINESS ADVICE, INFORMATION OR INQUIRIES; COMPUTER FILE MANAGEMENT; ARRANGING OF EXHIBITIONS FOR COMMERCIAL AND ADVERTISING PURPOSES; COLLECTION OF DATA IN A CENTRAL FILE, SYSTEMIZATION OF DATA IN A CENTRAL FILE; MARKET STUDIES, IN CLASS 35 (U.S. CLS. 100, 101 AND 102).

FOR: COMMUNICATION VIA COMPUTER TERMINALS, IN CLASS 38 (U.S. CLS. 100, 101 AND 104).

FOR: PUBLICATION OF BOOKS, MAGAZINES AND STUDIES; ARRANGING AND CONDUCTING OF COLLOQUIUMS, CONFERENCES, CONVENTIONS, AND EXHIBITIONS FOR CULTURAL OR EDUCATIONAL PURPOSES; VIDEO TAPE PRODUCTION AND EDITING, IN CLASS 41 (U.S. CLS. 100, 101 AND 107).

FOR: COMPUTER PROGRAMMING; CREATION OF INTERNET SITES; RECOVERY OF COMPUTER DATA; CREATION AND MANAGEMENT OF DATABASES, IN CLASS 42 (U.S. CLS. 100 AND 101).

THE MARK CONSISTS OF STANDARD CHARACTERS WITHOUT CLAIM TO ANY PARTICULAR FONT, STYLE, SIZE, OR COLOR.

PRIORITY DATE OF 7-28-2011 IS CLAIMED.

OWNER OF INTERNATIONAL REGISTRATION 1102600 DATED 11-18-2011, EXPIRES 11-18-2021.

SER. NO. 79-107,548, FILED 11-18-2011.

TOBY BULLOFF, EXAMINING ATTORNEY



*David J. Kyffers*

Director of the United States Patent and Trademark Office

# United States of America

United States Patent and Trademark Office

*the way  
we like,  
to live*

**Reg. No. 4,273,862**

**Registered Jan. 15, 2013**

**Int. Cls.: 12, 25 and 35**

STIL NOVO SVILUPPO S.P.A. (ITALY CORPORATION)  
VIALE DELL'ASTRONOMIA, 30  
I-00144 ROMA  
ITALY

FOR: ALL TERRAIN VEHICLES AND AUTOMOBILES; APPARATUS FOR LOCOMOTION BY LAND, AIR OR WATER, NAMELY, AIRPLANES AND YACHTS, IN CLASS 12 (U.S. CLS. 19, 21, 23, 31, 35 AND 44).

**TRADEMARK**

**SERVICE MARK**

**PRINCIPAL REGISTER**

FOR: CLOTHING, NAMELY, COATS, OVERCOATS, TRENCH COATS, RAINCOATS, ANORAKS, PARKAS, BLAZERS, JACKETS, CARDIGANS, BOLEROS, SPORT COATS, SUITS, TUXEDOS, VESTS, DRESSES, CAFTANS, JUMPERS, SKIRTS, PANTS, SLACKS, TROUSERS, JEANS, DUNGAREES, JUMPSUITS, OVERALLS, COVERALLS, SWEAT PANTS, SHORTS, UNDERWEAR, SWEATERS, PULLOVERS, JERSEYS, SHIRTS, FORMAL SHIRTS, BLOUSES, TUNICS, SWEATSHIRTS, T-SHIRTS, BODYSUITS, CAMISOLES, CHEMISES, TIGHTS, SOCKS, NECKTIES, BOW TIES, ASCOTS, POCKET SQUARES, SCARVES, SHAWLS, NECKERCHIEFS, GLOVES, MITTENS, BELTS, SNOW SUITS, PLAYSUITS; FOOTWEAR; HEADGEAR, NAMELY, HATS AND CAPS, IN CLASS 25 (U.S. CLS. 22 AND 39).

FOR: RETAIL STORE SERVICES FEATURING APPAREL, CLOTHING, FOOTWEAR, LEATHER PRODUCTS, FOODSTUFFS, GIFTS, FURNITURE AND INTERIOR DESIGN ITEMS, COSMETICS AND FRAGRANCES WITH A SPECIAL EMPHASIS ON PRODUCTS MANUFACTURED IN ITALY; BUSINESS MANAGEMENT ADVISORY SERVICES RELATING TO FRANCHISING; ORGANIZATION OF EXHIBITIONS AND TRADE FAIRS FOR BUSINESS AND PROMOTIONAL PURPOSES WITH SPECIAL EMPHASIS ON THE PROMOTION OF PRODUCTS MANUFACTURED IN ITALY, IN CLASS 35 (U.S. CLS. 100, 101 AND 102).



THE MARK CONSISTS OF THE WORDING "THE WAY WE LIKE TO LIVE" IN STYLIZED FONT.

PRIORITY DATE OF 11-7-2011 IS CLAIMED.

OWNER OF INTERNATIONAL REGISTRATION 1102657 DATED 11-10-2011, EXPIRES 11-10-2021.

SER. NO. 79-107,573, FILED 11-10-2011.

*David J. Kyffers*

Director of the United States Patent and Trademark Office

**Reg. No. 4,273,862** JULIE VEPPUMTHARA, EXAMINING ATTORNEY

United States of America  
United States Patent and Trademark Office

**CATALANO**

**Reg. No. 4,273,863**

**Registered Jan. 15, 2013**

**Int. Cl.: 11**

**TRADEMARK**

**PRINCIPAL REGISTER**

CERAMICA CATALANO S.R.L. (ITALY LIMITED LIABILITY COMPANY)  
VIA FALERINA KM 7,200  
FABRICA DI ROMA (VT)  
ITALY

FOR: SANITARY INSTALLATIONS AND PART THEREOF, NAMELY, BATHS, BATHTUBS, WHIRLPOOL BATHS AND BATH INSTALLATIONS, TOILETS, SHOWER BASES, SHOWER DOORS, BIDETS, HOT TUBS, SINKS, TOILET BOWLS, TOILET SEATS; DISINFECTANT DISPENSERS FOR TOILETS; TAP WATER FAUCETS; TAPS FOR WASHSTANDS, SHOWER TRAYS, WATER CLOSETS, IN CLASS 11 (U.S. CLS. 13, 21, 23, 31 AND 34).

THE TRADEMARK CONSISTS IN THE WORDING "CATALANO" IN PARTICULAR TYPE.

OWNER OF INTERNATIONAL REGISTRATION 1102658 DATED 11-11-2011, EXPIRES 11-11-2021.

SEC. 2(F).

SER. NO. 79-107,574, FILED 11-11-2011.

TASNEEM HUSSAIN, EXAMINING ATTORNEY



*David J. Kyffers*

Director of the United States Patent and Trademark Office

# United States of America

United States Patent and Trademark Office



**Reg. No. 4,273,864**

**Registered Jan. 15, 2013**

**Int. Cl.: 29**

**TRADEMARK**

**PRINCIPAL REGISTER**

WALFOOD SA (BELGIUM SOCIÉTÉ ANONYME (SA))  
127, RUE DE MÜHLENBACH  
L-2168 LUXEMBOURG, GRAND-DUCHÉ DE LUXEMBOURG  
LUXEMBOURG

FOR: FRESH, FROZEN AND PRESERVED FISH AND CRUSTACEANS, INCLUDING FRESH NON-LIVE CRAB; PREPARED ENTREES, FOOD KITS AND MEALS CONSISTING PRIMARILY OF FISH AND/OR CRUSTACEANS, NAMELY, PREPARED AND PACKAGED FROZEN DISHES CONSISTING MAINLY OF FISH AND CRUSTACEANS; STURGEON AND SALMON CAVIAR, IN CLASS 29 (U.S. CL. 46).

OWNER OF U.S. REG. NO. 3,619,470.

PRIORITY DATE OF 7-7-2011 IS CLAIMED.

OWNER OF INTERNATIONAL REGISTRATION 1102674 DATED 11-15-2011, EXPIRES 11-15-2021.

THE COLOR(S) BLUE, RED, PINK, GOLD, BLACK AND YELLOW IS/ARE CLAIMED AS A FEATURE OF THE MARK.

THE MARK CONSISTS OF THE WORD "CHATKA" IN BLUE WITH A PINK OUTLINE; BELOW THE WORD IS A DESIGN OF A RED CRAB HAVING BLACK AND YELLOW HIGHLIGHTS OUTLINED IN GOLD; TO THE LEFT AND RIGHT OF THE DESIGN ARE GOLD STARS WITH RED OUTLINES HAVING THE WORD "CHATKA" IN RED IN A CIRCLE IN THE CENTER OF THE STARS.

SER. NO. 79-107,583, FILED 11-15-2011.

MAYUR VAGHANI, EXAMINING ATTORNEY



*David J. Kybas*

Director of the United States Patent and Trademark Office

# United States of America

United States Patent and Trademark Office



**Reg. No. 4,273,865**

**Registered Jan. 15, 2013**

**Int. Cls.: 14, 18, 25 and 35**

**TRADEMARK**

**SERVICE MARK**

**PRINCIPAL REGISTER**

VOROLA FINANCIAL LTD (RUSSIAN FED. LIMITED LIABILITY COMPANY)  
33 PORTER ROAD, P.O. BOX 3169  
PMB 103, ROAD TOWN  
TORTOLA, BR. VIRGIN ISLANDS

FOR: PRECIOUS METALS AND THEIR ALLOYS AND GOODS IN PRECIOUS METALS OR COATED THEREWITH, NOT INCLUDED IN OTHER CLASSES, NAMELY, RINGS, NECKLACES, BRACELETS; JEWELRY. PRECIOUS STONES; HOROLOGICAL AND CHRONOMETRIC INSTRUMENTS, IN CLASS 14 (U.S. CLS. 2, 27, 28 AND 50).

FOR: LEATHER AND IMITATIONS OF LEATHER, AND GOODS MADE OF THESE MATERIALS AND NOT INCLUDED IN OTHER CLASSES, NAMELY, PURSES, HANDBAGS; ANIMAL SKINS, ANIMAL HIDES; TRUNKS AND TRAVELLING BAGS; UMBRELLAS, PARASOLS AND WALKING STICKS; WHIPS, HARNESS AND SADDLERY, IN CLASS 18 (U.S. CLS. 1, 2, 3, 22 AND 41).

FOR: CLOTHING, NAMELY, SHIRTS, PANTS, DRESSES, COATS, JACKETS; FOOTWEAR, HEADGEAR, NAMELY, HEADWEAR, IN CLASS 25 (U.S. CLS. 22 AND 39).

FOR: PRESENTATION OF GOODS ON COMMUNICATION MEDIA, FOR RETAIL PURPOSES, NAMELY, PROVIDING TELEVISION, INTERNET HOME SHOPPING SERVICES IN THE FIELD OF GENERAL CONSUMER MERCHANDISE; SALES PROMOTION SERVICES FOR OTHERS; PROCUREMENT SERVICES FOR OTHERS, NAMELY, PURCHASING GOODS AND SERVICES FOR OTHER BUSINESSES IN THE NATURE OF JEWELRY, IN CLASS 35 (U.S. CLS. 100, 101 AND 102).

THE MARK CONSISTS OF A SHADED RECTANGLE WITH THE TERM "KARI" INSIDE IT.

PRIORITY DATE OF 11-14-2011 IS CLAIMED.

OWNER OF INTERNATIONAL REGISTRATION 1102679 DATED 11-17-2011, EXPIRES 11-17-2021.

SER. NO. 79-107,585, FILED 11-17-2011.

MICHAEL WIENER, EXAMINING ATTORNEY



*David J. Kyros*

Director of the United States Patent and Trademark Office



United States of America  
United States Patent and Trademark Office

# BACCUPS

**Reg. No. 4,273,866**

**Registered Jan. 15, 2013**

**Int. Cl.: 12**

**TRADEMARK**

**PRINCIPAL REGISTER**

CMBC DIRECT PTY LTD (AUSTRALIA PROPRIETARY LIMITED COMPANY)  
GROUND FLOOR 12 GIPPS STREET  
COLLINGWOOD VIC 3066  
AUSTRALIA

FOR: GUIDE POSTS MOUNTABLE TO A VEHICLE OR TRAILER TO PROVIDE A VISUAL AID IN MANEUVERING OR REVERSING A VEHICLE OR TRAILER; INDICATOR DEVICES MOUNTABLE TO A VEHICLE OR TRAILER TO PROVIDE A VISUAL AID IN MANEUVERING OR REVERSING A VEHICLE OR TRAILER; DIRECTIONAL SIGNALS FOR VEHICLES AND TRAILERS; BACK UP WARNING ALARMS FOR VEHICLES; PARTS AND ACCESSORIES FOR THE AFOREMENTIONED IN THIS CLASS, IN CLASS 12 (U.S. CLS. 19, 21, 23, 31, 35 AND 44).

THE MARK CONSISTS OF STANDARD CHARACTERS WITHOUT CLAIM TO ANY PARTICULAR FONT, STYLE, SIZE, OR COLOR.

PRIORITY DATE OF 6-14-2011 IS CLAIMED.

OWNER OF INTERNATIONAL REGISTRATION 1102945 DATED 11-21-2011, EXPIRES 11-21-2021.

SER. NO. 79-107,674, FILED 11-21-2011.

JAMES A. RAUEN, EXAMINING ATTORNEY



*David J. Kyffers*

Director of the United States Patent and Trademark Office

# United States of America

United States Patent and Trademark Office



**Reg. No. 4,273,867**

**Registered Jan. 15, 2013**

**Int. Cls.: 9, 38 and 42**

CROSSCAN GMBH (FED REP GERMANY GMBH, GESELLSCHAFT MIT BESCHRÄNKTER HAFTUNG)  
RUHRSTRASSE 46  
58452 WITTEN  
FED REP GERMANY

**TRADEMARK**

**SERVICE MARK**

**PRINCIPAL REGISTER**

FOR: PRERECORDED MAGNETIC DATA CARRIERS FEATURING SOFTWARE PROGRAMS FOR THE CAPTURE OF OBJECTS AND OBJECT PARAMETERS, IN PARTICULAR NUMBER, POSITION, MOVEMENT, MOVEMENT PARAMETERS AND/OR MOVEMENT SEQUENCES AND FOR EVALUATING CAPTURED OBJECTS AND OBJECT PARAMETERS, IN PARTICULAR NUMBER, POSITION, MOVEMENT, MOVEMENT PARAMETERS AND MOVEMENT SEQUENCES; PRERECORDED MAGNETIC DATA CARRIERS FEATURING INFORMATION IN THE FORM OF TEXT, SOUNDS, DRAWINGS AND IMAGES ON THE CAPTURE OF OBJECTS AND OBJECT PARAMETERS, IN PARTICULAR NUMBER, POSITION, MOVEMENT, MOVEMENT PARAMETERS AND MOVEMENT SEQUENCES AND THE EVALUATING OF CAPTURED OBJECTS AND OBJECT PARAMETERS, IN PARTICULAR NUMBER, POSITION, MOVEMENT, MOVEMENT PARAMETERS AND/OR MOVEMENT SEQUENCES; OPTICAL APPARATUS AND INSTRUMENTS, NAMELY, OPTICAL INSPECTION APPARATUS FOR THE CAPTURE OF OBJECTS AND OBJECT PARAMETERS, IN PARTICULAR NUMBER, POSITION, MOVEMENT, MOVEMENT PARAMETERS AND MOVEMENT SEQUENCES; VIDEO CAMERAS; ALARM APPARATUS AND SYSTEMS, OTHER THAN FOR USE IN VEHICLES, IN CLASS 9 (U.S. CLS. 21, 23, 26, 36 AND 38).



FOR: PROVIDING ACCESS TO THE INTERNET FOR AND ELECTRONIC TRANSMISSION OF INFORMATION IN THE FORM OF TEXT, SOUND, DRAWINGS AND IMAGES ON THE INTERNET FOR THE CAPTURE OF OBJECTS AND OBJECT PARAMETERS, IN PARTICULAR NUMBER, POSITION, MOVEMENT, MOVEMENT PARAMETERS AND MOVEMENT SEQUENCES AND FOR EVALUATING CAPTURED OBJECTS AND OBJECT PARAMETERS, IN PARTICULAR NUMBER, POSITION, MOVEMENT, MOVEMENT PARAMETERS AND/OR MOVEMENT SEQUENCES, IN CLASS 38 (U.S. CLS. 100, 101 AND 104).

*David J. Kyffers*

Director of the United States Patent and Trademark Office

FOR: TECHNICAL CONSULTANCY IN FIELD OF DESIGN, DEVELOPMENT AND CREATION OF COMPUTER PROGRAMS FOR THE COMPILATION, ORGANISATION, OPTIMISATION, EDITING, PROCESSING, PRESENTATION, DOCUMENTATION OR ARCHIVING OF INFORMATION IN THE FORM OF TEXTS, SOUNDS, DRAWINGS AND IMAGES, IN PARTICULAR FOR THE NUMBER, POSITION, MOVEMENT, MOVEMENT PARAMETERS AND MOVEMENT SEQUENCES AND/OR FOR EVALUATING CAPTURED OBJECTS AND

**Reg. No. 4,273,867** OBJECT PARAMETERS, IN PARTICULAR NUMBER, POSITION, MOVEMENT, MOVEMENT PARAMETERS AND MOVEMENT SEQUENCES, FOR THE INTERNET, USE VIA THE INTERNET, FOR INTRANETS AND FOR USE ON INTRANETS; CONFIGURATION OF COMPUTER NETWORKS BY MEANS OF SOFTWARE, NAMELY NETWORKS FOR THE COMPILATION, ORGANIZATION, OPTIMIZATION, EDITING, PROCESSING, PRESENTATION, DOCUMENTATION OR ARCHIVING OF INFORMATION IN THE FORM OF TEXTS, SOUNDS, DRAWINGS AND IMAGES FOR THE CAPTURE OF OBJECTS AND OBJECT PARAMETERS, IN PARTICULAR NUMBER, POSITION, MOVEMENT, MOVEMENT PARAMETERS AND MOVEMENT SEQUENCES AND FOR THE EVALUATING OF CAPTURED OBJECTS AND OBJECT PARAMETERS, IN PARTICULAR NUMBER, POSITION, MOVEMENT, MOVEMENT PARAMETERS AND MOVEMENT SEQUENCES, IN PARTICULAR COMPUTER SYSTEMS BY MEANS OF SOFTWARE, IN CLASS 42 (U.S. CLS. 100 AND 101).

THE MARK CONSISTS OF THE STYLIZED WORD "CROSSCAN" TO THE RIGHT AND ABOVE A CIRCULAR DESIGN WITH AN ARROW.

OWNER OF INTERNATIONAL REGISTRATION 1102979 DATED 3-16-2011, EXPIRES 3-16-2021.

SER. NO. 79-107,686, FILED 3-16-2011.

JASON TURNER, EXAMINING ATTORNEY

# United States of America

United States Patent and Trademark Office



**Reg. No. 4,273,868**

**Registered Jan. 15, 2013**

**Int. Cls.: 24 and 25**

**TRADEMARK**

**PRINCIPAL REGISTER**

BRAGARD SA (FRANCE SOCIÉTÉ ANONYME)  
2, RUE CHRISTOPHE DENIS  
EPINAL, FRANCE F88000 AND

TENTHOREY (FRANCE SOCIÉTÉ PAR ACTIONS SIMPLIFIÉE)  
ZI DE LA PLAINE  
ELOYES, FRANCE F88510

FOR: COTTON FABRICS, BED SHEETS, PILLOWCASES, BOLSTER COVERS, BEDSPREADS, BED BLANKETS, COVERLETS, EIDERDOWNS, TABLE COVERS OF TEXTILE, TEXTILE TABLECLOTHS, TABLE NAPKINS OF TEXTILE, TABLEMATS OF TEXTILE, HAND TOWELS OF TEXTILE, BATHROOM SETS OF TEXTILE, NAMELY, BATHROOM TOWELS AND BATH MATS, WASHCLOTHS, BATH TOWELS, BEACH TOWELS, ALL MADE IN WHOLE OR IN SUBSTANTIAL PART OF PIMA COTTON, IN CLASS 24 (U.S. CLS. 42 AND 50).

FOR: BLOUSES, APRONS, HOUSE FROCKS, WORK WEAR, NAMELY, UNIFORMS, CHEF'S JACKETS, PANTS, SHIRTS, COVERALLS, RAIN WEAR, OVERCOATS AND COATS, JACKETS, TROUSERS, VESTS, SUITS, DRESSES, SKIRTS, LINGERIE, HOSIERY, ALL MADE IN WHOLE OR IN SUBSTANTIAL PART OF PIMA COTTON, IN CLASS 25 (U.S. CLS. 22 AND 39).

NO CLAIM IS MADE TO THE EXCLUSIVE RIGHT TO USE "PIMA" AND "PREMIUM", APART FROM THE MARK AS SHOWN.

PRIORITY DATE OF 10-25-2011 IS CLAIMED.

OWNER OF INTERNATIONAL REGISTRATION 1103068 DATED 11-14-2011, EXPIRES 11-14-2021.

THE MARK CONSISTS OF THE WORDS "PIMA" ALONG THE TOP OF A SQUARE, AND "PREMIUM", ALONG THE BOTTOM, WITH THE NUMERALS "00" ALONG THE LEFT SIDE OF THE SQUARE, AND "76" ALONG THE RIGHT SIDE. BENEATH "PIMA", BETWEEN THE "00" AND "76", IS A DESIGN OF A CHEF'S HAT. BELOW THE HAT IS A FANCIFUL DEPICTION OF A COTTON BLOSSOM THAT IS CENTERED WITHIN AN OPEN SEMI-CIRCLE.



*David J. Kybas*

Director of the United States Patent and Trademark Office

**Reg. No. 4,273,868** SER. NO. 79-107,724, FILED 11-14-2011.

JASON TURNER, EXAMINING ATTORNEY

# United States of America

United States Patent and Trademark Office

# M—T I T E

**Reg. No. 4,273,869**

**Registered Jan. 15, 2013**

**Int. Cl.: 6**

**TRADEMARK**

**PRINCIPAL REGISTER**

NITTO SEIKO CO., LTD. (JAPAN CORPORATION)  
20 UMEGAHATA, INOKURA-CHO  
AYABE-SHI; KYOTO 623-0054  
JAPAN

FOR: WASHERS OF METAL; NUTS OF METAL; SCREWS OF METAL; BOLTS OF METAL;  
RIVETS OF METAL, IN CLASS 6 (U.S. CLS. 2, 12, 13, 14, 23, 25 AND 50).

THE MARK CONSISTS OF STANDARD CHARACTERS WITHOUT CLAIM TO ANY PAR-  
TICULAR FONT, STYLE, SIZE, OR COLOR.

OWNER OF INTERNATIONAL REGISTRATION 1103192 DATED 12-5-2011, EXPIRES 12-  
5-2021.

OWNER OF U.S. REG. NOS. 3,598,765 AND 3,606,267.

SER. NO. 79-107,773, FILED 12-5-2011.

ANNE FARRELL, EXAMINING ATTORNEY



*David J. Kyffers*

Director of the United States Patent and Trademark Office

# United States of America

United States Patent and Trademark Office

# BCMS

**Reg. No. 4,273,870**

**Registered Jan. 15, 2013**

**Int. Cls.: 35 and 41**

**SERVICE MARK**

**PRINCIPAL REGISTER**

BCMS CORPORATE LIMITED (UNITED KINGDOM LIMITED COMPANY)  
KINGSCLERE PARK, KINGSCLERE  
NEWBURY, BERKSHIRE, UNITED KINGDOM RG20 4SW

FOR: BUSINESS ADVICE RELATING TO THE SALE OF BUSINESSES; BUSINESS CONSULTATION RELATING TO THE SALE OF BUSINESSES; BUSINESS NEGOTIATIONS, NAMELY, NEGOTIATION OF COMMERCIAL TRANSACTIONS FOR THIRD PARTIES; NEGOTIATION OF COMMERCIAL CONTRACTS FOR OTHERS; ACQUISITION OF BUSINESS INFORMATION RELATING TO COMPANY ACTIVITIES; BUSINESS ADVISORY SERVICES RELATING TO COMPANY PERFORMANCE; PROVISION OF BUSINESS MANAGEMENT INFORMATION AND MANAGEMENT ASSISTANCE; PROVIDING BUSINESS INFORMATION, SPECIFICALLY COMPANY DATA INFORMATION; COMPANY MONITORING, NAMELY, MONITORING COMMERCIAL TRANSACTIONS FOR OTHERS; BUSINESS SERVICES, NAMELY, CONDUCTING SEARCHES RELATING TO BUSINESS INFORMATION ABOUT COMPANIES; COMPILATION OF COMPANY INFORMATION FOR BUSINESS PURPOSES; BUSINESS RESEARCH; BUSINESS MANAGEMENT CONSULTING; CORPORATE PLANNING AND CORPORATE POSITIONING SERVICES, NAMELY, BUSINESS STRATEGIC PLANNING; BUSINESS PROCESS MANAGEMENT AND CONSULTING; BUSINESS PROJECT MANAGEMENT; BUSINESS ACQUISITIONS CONSULTING; BUSINESS ANALYSIS AND RESEARCH SERVICES; MARKET ANALYSIS; ANALYSIS OF BUSINESS INFORMATION AND STATISTICS; MANAGEMENT AND ANALYSIS OF MARKET RESEARCH DATA; BUSINESS APPRAISALS AND RISK ASSESSMENT; CONDUCTING BUSINESS AND MARKET RESEARCH SURVEYS; BUSINESS PLANNING CONSULTANCY; BUSINESS STRATEGIC MANAGEMENT AND PLANNING SERVICES; BUSINESS MERGER CONSULTATION; CORPORATE REPORTING, NAMELY, PREPARING BUSINESS REPORTS; PROVIDING INFORMATION IN THE FIELD OF BUSINESS MANAGEMENT CONSULTANCY; BUSINESS INFORMATION SERVICES PROVIDED BY ACCESS TO A COMPUTER DATABASE; ON-LINE BUSINESS DATA RETRIEVAL AND PROCESSING SERVICES; INFORMATION AND ADVISORY SERVICES, ALL RELATING TO THE AFORESAID SERVICES, IN CLASS 35 (U.S. CLS. 100, 101 AND 102).



*David J. Kappas*

Director of the United States Patent and Trademark Office

FOR: EDUCATIONAL SERVICES, NAMELY, COURSES IN THE FIELD OF BUSINESS; TRAINING AND INSTRUCTIONAL SERVICES IN THE FIELD OF BUSINESS; PROVISION OF TRAINING COURSES AND SEMINARS IN THE FIELD OF BUSINESS; BUSINESS TRAINING CONSULTANCY SERVICES; PROVIDING EDUCATION COURSES IN THE FIELD OF BUSINESS OFFERED THROUGH SOUND AND VIDEO RECORDINGS; PUBLICATION OF TRAINING MANUALS, GUIDES AND PRINTED AND ELECTRONIC EDUCA-

**Reg. No. 4,273,870** TIONAL PUBLICATIONS; CONSULTANCY SERVICES RELATING TO TRAINING; INFORMATION, ADVISORY AND CONSULTANCY SERVICES AND PUBLISHING OF RESEARCH REPORTS, ALL RELATING TO THE AFORESAID SERVICES, IN CLASS 41 (U.S. CLS. 100, 101 AND 107).

THE MARK CONSISTS OF STANDARD CHARACTERS WITHOUT CLAIM TO ANY PARTICULAR FONT, STYLE, SIZE, OR COLOR.

PRIORITY DATE OF 1-27-2011 IS CLAIMED.

OWNER OF INTERNATIONAL REGISTRATION 1103312 DATED 6-14-2011, EXPIRES 6-14-2021.

SER. NO. 79-107,802, FILED 6-14-2011.

EVELYN BRADLEY, EXAMINING ATTORNEY



# United States of America

United States Patent and Trademark Office

# TROIS RIVIERES

**Reg. No. 4,273,871**

**Registered Jan. 15, 2013**

**Int. Cl.: 33**

**TRADEMARK**

**PRINCIPAL REGISTER**

DISTILLERIES AGRICOLES; DE SAINTE LUCE S.A. (FRANCE SOCIÉTÉ PAR ACTIONS SIMPLIFIÉE)  
ZONE INDUSTRIELLE DE GENIPA  
F-97224 DUCOS, FRANCE

FOR: ALCOHOLIC BEVERAGES EXCEPT BEERS AND WINE, NAMELY, RUM, AND ALCOHOLIC PUNCHES AND PREPARED ALCOHOLIC COCKTAILS CONTAINING RUM , IN CLASS 33 (U.S. CLS. 47 AND 49).

THE ENGLISH TRANSLATION OF "TROIS RIVIERES" IS "THREE RIVERS".

OWNER OF INTERNATIONAL REGISTRATION 0588829 DATED 8-3-1992, EXPIRES 8-3-2022.

SER. NO. 79-107,832, FILED 11-19-2011.

ELI HELLMAN, EXAMINING ATTORNEY



*David J. Kyros*

Director of the United States Patent and Trademark Office

# United States of America

United States Patent and Trademark Office

# BayWa

**Reg. No. 4,273,872**

**Registered Jan. 15, 2013**

**Int. Cls.: 1, 4, 5, 6, 7, 8,  
11, 19, 31, 35, 37, 39, 42,  
44 and 45**

**TRADEMARK**

**SERVICE MARK**

**PRINCIPAL REGISTER**

BAYWA AG (FED REP GERMANY JOINT STOCK COMPANY)  
ARABELLSTRASSE 4  
81925 MÜNCHEN  
FED REP GERMANY

FOR: CHEMICALS USED IN INDUSTRY, SCIENCE AND PHOTOGRAPHY, AS WELL AS IN AGRICULTURE, HORTICULTURE AND FORESTRY, EXCEPT FUNGICIDES, HERBICIDES, INSECTICIDES AND PARACITICIDES; UNPROCESSED ARTIFICIAL RESINS; UNPROCESSED PLASTICS; MANURES; CHEMICAL SUBSTANCES FOR PRESERVING FOODSTUFFS; TANNING SUBSTANCES; AND ADHESIVES USED IN INDUSTRY, IN CLASS 1 (U.S. CLS. 1, 5, 6, 10, 26 AND 46).

FOR: INDUSTRIAL OILS AND GREASES; INDUSTRIAL LUBRICANTS; INDUSTRIAL LUBRICANTS FROM VEGETABLE OIL; FUELS, MOTOR SPIRIT AND ILLUMINANTS, NAMELY, GASOLINE AND DIESEL; AND CANDLES AND WICKS FOR LIGHTING PURPOSES, IN CLASS 4 (U.S. CLS. 1, 6 AND 15).

FOR: PLANT PROTECTION AND PEST CONTROL PRODUCTS, NAMELY, HERBICIDES FOR DOMESTIC AND AGRICULTURAL USE, IN CLASS 5 (U.S. CLS. 6, 18, 44, 46, 51 AND 52).

FOR: METAL BUILDING MATERIALS, NAMELY, SOFFITS, CEILING BOARDS, FLOOR BOARDS, AND COMPOSITE PANELS COMPOSED PRIMARILY OF METAL; TRANSPORTABLE BUILDINGS OF METAL; NON-ELECTRIC CABLES AND WIRES OF COMMON METAL; IRONMONGERY AND SMALL ITEMS OF METAL HARDWARE, NAMELY, BOLTS, NAILS, SCREWS AND METAL FASTENING ANCHORS; AND METAL PIPES, IN CLASS 6 (U.S. CLS. 2, 12, 13, 14, 23, 25 AND 50).

FOR: AGRICULTURAL, GARDEN AND FORESTRY MACHINES, MACHINERY AND IMPLEMENTS, NAMELY, COMBINES, HARVESTERS, THRESHERS, TILLERS, WINDROWERS, MOWERS, LAWN MOWERS, CULTIVATORS, DISK HARROWS, PLANTERS, FIELD CULTIVATORS, HAY BALERS, HAY RAKES, HAY TEDDERS, HAY MOWERS, HAY CONDITIONERS, SEEDERS, TRIMMERS, SCARIFIERS, MOTOR-DRIVEN SAWS AND CUTTING EQUIPMENT, AND SHREDDER HAY MOWERS, AND REPLACEMENT PARTS FOR THE AFORESAID GOODS; POST-EMERGE AGRICULTURAL CHEMICAL APPLICATION MACHINES; POWER-OPERATED AGRICULTURAL SPRAYERS; MECHANICAL AGRICULTURAL SPREADERS; VEHICLE MOUNTED FERTILIZER SPREADERS AND FERTILIZER



*David J. Kypos*

Director of the United States Patent and Trademark Office

**Reg. No. 4,273,872** HAULING UNITS THEREFOR; TRACTOR-TOWED POWER-OPERATED SPRAYERS; AGRICULTURAL EQUIPMENT, NAMELY, SEED PLANTERS AND REPLACEMENT PARTS THEREFOR; AND MOTORS AND ENGINES, OTHER THAN FOR LAND VEHICLES , IN CLASS 7 (U.S. CLS. 13, 19, 21, 23, 31, 34 AND 35).

FOR: HAND-OPERATED TOOLS FOR AGRICULTURAL, GARDEN HORTICULTURAL AND FORESTRY PURPOSES, NAMELY, SCARIFIERS, PENDULUM SCARIFIERS, EDGERS, SPREADERS, BLADES, CUTTERS, SAWS, SCISSORS, KNIVES, FRUIT PICKERS, RAKES, CULTIVATORS, CRUMBLERS, SCRAPERS, TILLERS, ENGRAVERS, FORKS, WEEDERS, BULB PLANTERS, RAKES, TONGS, SPADES, SHOVELS, AND HOES, IN CLASS 8 (U.S. CLS. 23, 28 AND 44).

FOR: APPARATUS FOR LIGHTING, NAMELY, LIGHTING INSTALLATIONS, APPARATUS FOR HEATING, STEAM GENERATING, COOKING, REFRIGERATING, DRYING, VENTILATING, WATER SUPPLY AND SANITARY PURPOSES, NAMELY, HEAT ACCUMULATORS, FURNACES, HEAT AND STEAM GENERATORS, REFRIGERATORS, WATER COOLERS, AIR CONDITIONERS, AND VENTILATING FANS FOR COMMERCIAL AND INDUSTRIAL USE; INDUSTRIAL BOILERS; RADIATORS; HEATING CONTROL PANELS USED FOR INDOOR HEATING PURPOSES; PIPES BEING PART OF SANITARY FACILITIES AND COOLING TANKS, IN CLASS 11 (U.S. CLS. 13, 21, 23, 31 AND 34).

FOR: NON-METALLIC BUILDING MATERIALS, NAMELY, BRICKS, CEMENT, NON-METALLIC TILES, LUMBER, NON-METAL ROOFING, AND NON-METALLIC WATERPIPES FOR BUILDING PURPOSES; NON-METALLIC PIPE COUPLINGS AND JOINTS FOR BUILDING PURPOSES, ASPHALT, PITCH AND BITUMEN ROOFING TILES; AND NON-METALLIC TRANSPORTABLE BUILDINGS, IN CLASS 19 (U.S. CLS. 1, 12, 33 AND 50).

FOR: AGRICULTURAL, HORTICULTURAL AND FORESTRY PRODUCTS, NAMELY, FRESH, RAW AND UNPROCESSED POTATOES, FRESH FRUIT, FRESH, RAW AND UNPROCESSED VEGETABLES, AGRICULTURAL SOWING GRAIN FOR PLANTING, AGRICULTURAL AND HORTICULTURAL SEEDS, FLOWER AND VEGETABLE SEEDS, LIVING PLANTS, ANIMAL AND LIVESTOCK FEED STUFFS AND UNPROCESSED GRAINS; MALT FOR BREWING AND DISTILLING; AND FRESH, RAW AND UNPROCESSED HOPS FOR BREWING, IN CLASS 31 (U.S. CLS. 1 AND 46).

FOR: MARKETING SALES RESEARCH; ADVERTISING, BUSINESS MANAGEMENT AND BUSINESS CONSULTING FOR FRANCHISE CONCEPTS; BUSINESS CONSULTING; CONSULTING SERVICES RELATING TO ADVERTISING AND PUBLICITY WORK FOR FRANCHISE ENTERPRISES; BUSINESS ADMINISTRATION CONSULTANCY FOR THIRD PARTY BUSINESS INTERESTS IN CONNECTION WITH COMPANIES; BUSINESS ORGANIZATIONAL CONSULTING IN THE MANAGEMENT, CONTROL AND SUPERVISION OF COMPANIES; MEDIATION OF CONTRACTS FOR THE PURCHASE AND SALE OF GOODS AND THE PROVISION OF RELEVANT SERVICES, NAMELY, MEDIATION OF AGREEMENTS REGARDING THE SALE AND PURCHASE OF GOODS FOR THIRD PARTIES; AND PROVIDING OFFICE FUNCTIONS, IN CLASS 35 (U.S. CLS. 100, 101 AND 102).

FOR: BUILDING CONSTRUCTION IN THE NATURE OF THE ASSEMBLY OF SILO AND LIQUID MANURE CONTAINERS, BIOGAS PLANTS, BARN AND STALL BUILDINGS, PARTICULARLY FOR AGRICULTURE AND FORESTRY; INSTALLATION OF HEATING AND VENTILATION FOR RESIDENTIAL HOMES AND APARTMENT BUILDINGS AND THE INSTALLATION OF SANITARY FACILITIES, REPAIR OF AGRICULTURAL, HORTICULTURAL AND FORESTRY EQUIPMENT; INSTALLATION OF HAIL PROTECTION NETTING FOR FRUIT PLANTATIONS; AND RENOVATION OF OLD BUILDINGS THROUGH BUILDING REPAIR WORK, IN CLASS 37 (U.S. CLS. 100, 103 AND 106).

FOR: TRANSPORT BY TRUCK; WAREHOUSING SERVICES OF A TRANSPORT COMPANY; AND PACKAGING AND STORAGE OF GOODS, IN CLASS 39 (U.S. CLS. 100 AND 105).

**Reg. No. 4,273,872** FOR: TECHNOLOGY CONSULTING IN THE FIELD OF FRANCHISE CONCEPTS; AND TECHNOLOGICAL CONSULTING IN THE FIELD OF THE MANAGEMENT OF COMPANIES, IN CLASS 42 (U.S. CLS. 100 AND 101).

FOR: SERVICES IN THE AGRICULTURAL, HORTICULTURAL OR FORESTRY SECTORS, PARTICULARLY TECHNICAL PLANNING AND MONITORING OF SILO AND SWILL CONTAINERS, BARNS AND STALLS, AND BIOGAS PLANTS, AGRICULTURAL CONSULTING IN THE NATURE OF AGRICULTURAL ADVICE ON THE USE OF SEED, FERTILIZER AND PLANT PROTECTION PRODUCTS AND MACHINE USE AND SELECTION; HIRING OF MACHINERY FOR AGRICULTURE, HORTICULTURE AND FORESTRY, NAMELY, RENTAL OF FARMING, AGRICULTURAL, HORTICULTURAL AND FORESTRY EQUIPMENT, IN CLASS 44 (U.S. CLS. 100 AND 101).

FOR: AWARD OF LICENSES, NAMELY, LICENSING OF FRANCHISE CONCEPTS, IN CLASS 45 (U.S. CLS. 100 AND 101).

THE MARK CONSISTS OF STANDARD CHARACTERS WITHOUT CLAIM TO ANY PARTICULAR FONT, STYLE, SIZE, OR COLOR.

OWNER OF INTERNATIONAL REGISTRATION 1009196 DATED 1-15-2009, EXPIRES 1-15-2019.

THE WORDING "BAYWA" HAS NO MEANING IN A FOREIGN LANGUAGE.

SER. NO. 79-107,834, FILED 10-17-2011.

TAMARA FRAZIER, EXAMINING ATTORNEY

# United States of America

United States Patent and Trademark Office



**Reg. No. 4,273,873**

**Registered Jan. 15, 2013**

**Int. Cls.: 8, 16 and 21**

**TRADEMARK**

**PRINCIPAL REGISTER**

N.V. KONINKLIJKE DELFTSCH AARDEWERKFABRIEK "DE PORCELEYNE FLES ANNO 1653", VOORHEEN JOOST THOOFT EN LABOUCHÈRE, ALSO TRADING UNDER THE NAME(S) N.V. FAÏENCERIE ROYALE DE DELFT "DE PORCELEYNE FLES ANNO 1653", CI-DEVANT THOOFT ET LABOUCHÈRE, N.V. ROYAL DELFT WARE MANUFACTORY "DE PORCELEYNE FLES ANNO 1653", LATE JOOST THOOFT AND LABOUCHÈRE, N.V. KÖNIGLICHE DELFTER FAÏENCE MANUFAKTUR "DE PORCELEYNE FLES ANNO 1653" VORMALS JOOST THOOFT UND LABOUCHÈRE (NETHERLANDS PUBLIC LIMITED COMPANY)

ROTTERDAMSEWEG 196  
AR DELFT, NETHERLANDS NL2628

FOR: CUTLERY, NAMELY, FORKS, SPOONS, AND KNIVES, IN CLASS 8 (U.S. CLS. 23, 28 AND 44).

FOR: PAPER, CARDBOARD AND GOODS MADE OF THESE MATERIALS, NOT INCLUDED IN OTHER CLASSES, NAMELY, CARDBOARD PACKAGING, BOXES OF PAPER; PRINTED MATTER, NAMELY, PRINTED CALENDARS, PRINTED FORMS, PRINTED INVITATIONS; BOOKBINDING MATERIAL; PHOTOGRAPHS; STATIONERY; ADHESIVES FOR STATIONERY AND HOUSEHOLD PURPOSES; ARTISTS' MATERIALS, NAMELY, ART PADS, ART PAPER; PAINT BRUSHES; TYPEWRITERS AND OFFICE REQUISITES EXCEPT FURNITURE, NAMELY, DESKTOP STATIONERY CABINETS; PLASTIC MATERIALS FOR PACKAGING, NOT INCLUDED IN OTHER CLASSES, NAMELY, PLASTIC BAGS FOR PACKAGING; PRINTERS' TYPE; PRINTING BLOCKS, IN CLASS 16 (U.S. CLS. 2, 5, 22, 23, 29, 37, 38 AND 50).

FOR: HOUSEHOLD OR KITCHEN UTENSILS AND CONTAINERS NOT OF PRECIOUS METAL OR COATED THEREWITH, NAMELY, CONTAINERS FOR HOUSEHOLD USE, GRATERS, SIEVES, SPATULAS, STRAINERS, TURNERS AND KITCHEN TONGS; COMBS AND SPONGES FOR HOUSEHOLD PURPOSES; BRUSHES, NAMELY, HAIR BRUSHES AND SCRUBBING BRUSHES; BRUSH-MAKING MATERIALS; ARTICLES FOR CLEANING PURPOSES, NAMELY, CLEANING BRUSHES FOR HOUSEHOLD USE, CLEANING CLOTHS, CLEANING PADS, CLEANING RAGS AND CLEANING SPONGES; STEEL WOOL; UN-WORKED OR SEMI-WORKED GLASS EXCEPT GLASS USED IN BUILDING; BEVERAGE GLASSWARE, PORCELAIN AND EARTHENWARE, NOT INCLUDED IN OTHER CLASSES, NAMELY, MUGS, BOWLS, FLOWERPOTS AND STATUES MADE OF PORCELAIN AND EARTHENWARE; CANDLESTICKS; MUGS, VASES, TEA SETS AND COFFEE SERVICES, TABLE PLATES, POTS, TEAPOTS, FLOWERPOTS, SALT MILLS AND SHAKERS AND



*David J. Kybas*

Director of the United States Patent and Trademark Office

**Reg. No. 4,273,873** PEPPER MILLS AND POTS, NOT OF PRECIOUS METAL, IN CLASS 21 (U.S. CLS. 2, 13, 23, 29, 30, 33, 40 AND 50).

OWNER OF U.S. REG. NOS. 27,287 AND 2,380,193.

PRIORITY DATE OF 5-17-2011 IS CLAIMED.

OWNER OF INTERNATIONAL REGISTRATION 1103453 DATED 11-3-2011, EXPIRES 11-3-2021.

NO CLAIM IS MADE TO THE EXCLUSIVE RIGHT TO USE "DELFT 1653", APART FROM THE MARK AS SHOWN.

THE MARK CONSISTS OF A DESIGN OF A CROWN AND THE WORDING "ROYAL DELFT 1653" WITH THE NUMERALS BETWEEN TWO HORIZONTAL BARS.

SER. NO. 79-107,856, FILED 11-3-2011.

ROBERT STRUCK, EXAMINING ATTORNEY

# United States of America

United States Patent and Trademark Office

# SIL@a+

**Reg. No. 4,273,874**

**Registered Jan. 15, 2013**

**Int. Cl.: 17**

**TRADEMARK**

**PRINCIPAL REGISTER**

HUTCHINSON (FRANCE SOCIETE ANONYME)  
2, RUE BALZAC  
F-75008 PARIS  
FRANCE

FOR: MATERIAL MADE WITH REINFORCED SILICON FOR USE IN MANUFACTURE OF ANTI-VIBRATION AND SEALING PARTS; MATERIAL MADE WITH REINFORCED SILICON USED FOR TRANSFERRING FLUIDS FOR APPLICATION IN SITUATIONS OF HIGH HEAT CONTENT OR IMPROVED MECHANICAL PROPERTIES, NAMELY FOR APPLICATION IN AIR HOSES AND TURBO AIR CHARGERS AT HIGH TEMPERATURE AND IN IMPROVED MECHANICAL PROPERTIES WHICH CAN ENDURE FATIGUE RESISTANCE AND BURST PRESSURE, IN CLASS 17 (U.S. CLS. 1, 5, 12, 13, 35 AND 50).

THE MARK CONSISTS OF STANDARD CHARACTERS WITHOUT CLAIM TO ANY PARTICULAR FONT, STYLE, SIZE, OR COLOR.

PRIORITY DATE OF 7-11-2011 IS CLAIMED.

OWNER OF INTERNATIONAL REGISTRATION 1103632 DATED 11-10-2011, EXPIRES 11-10-2021.

SER. NO. 79-107,914, FILED 11-10-2011.

JULIE VEPPUMTHARA, EXAMINING ATTORNEY



*David J. Kyffers*

Director of the United States Patent and Trademark Office

United States of America  
United States Patent and Trademark Office

holodb

**Reg. No. 4,273,875**

**Registered Jan. 15, 2013**

**Int. Cls.: 35 and 42**

**SERVICE MARK**

**PRINCIPAL REGISTER**

RICHTER,STEFAN (FED REP GERMANY INDIVIDUAL)  
LOUIS-SEGELKEN-STRASSE 25  
27721 RITTERHUDE  
FED REP GERMANY

FOR: DATABASE MANAGEMENT; SYSTEMIZATION OF INFORMATION INTO COMPUTER DATABASES; MANAGEMENT AND COMPILATION OF COMPUTERISED DATABASES; COMPUTERIZED DATA MANAGEMENT SERVICES, NAMELY, THE COLLECTION, RETRIEVAL, ANALYSIS AND REPORTING OF INFORMATION AND DATA FOR OTHERS; ADVERTISING; BUSINESS MANAGEMENT; BUSINESS ADMINISTRATION; OFFICE FUNCTIONS, IN CLASS 35 (U.S. CLS. 100, 101 AND 102).

FOR: DESIGN AND DEVELOPMENT OF COMPUTER HARDWARE AND SOFTWARE, COMPUTER SOFTWARE CONSULTING; RENTAL OF SOFTWARE, IN PARTICULAR DATABASE SOFTWARE, IN CLASS 42 (U.S. CLS. 100 AND 101).

THE MARK CONSISTS OF STANDARD CHARACTERS WITHOUT CLAIM TO ANY PARTICULAR FONT, STYLE, SIZE, OR COLOR.

PRIORITY DATE OF 6-15-2011 IS CLAIMED.

OWNER OF INTERNATIONAL REGISTRATION 1103647 DATED 12-14-2011, EXPIRES 12-14-2021.

THE WORDING "HOLODB" HAS NO MEANING IN A FOREIGN LANGUAGE.

SER. NO. 79-107,918, FILED 12-14-2011.

AMY ALFIERI, EXAMINING ATTORNEY



*David J. Kybas*

Director of the United States Patent and Trademark Office



United States of America  
United States Patent and Trademark Office

swisstom

**Reg. No. 4,273,876**

**Registered Jan. 15, 2013**

**Int. Cl.: 10**

**TRADEMARK**

**PRINCIPAL REGISTER**

SWISSTOM AG (SWITZERLAND AKTIENGESELLSCHAFT)  
SCHULSTRASSE 1  
CH-7302 LANDQUART  
SWITZERLAND

FOR: SURGICAL AND MEDICAL APPARATUS AND INSTRUMENTS, NAMELY, ANESTHETIC APPARATUS, NAMELY, ANESTHETIC INHALERS, ANESTHESIA SYSTEM COMPRISING ANESTHESIA DELIVERY APPARATUS AND VENTILATOR APPARATUS; AND ARTIFICIAL RESPIRATION APPARATUS, PATIENT MONITORS FOR CRITICAL CARE AND ANESTHESIA; APPARATUS AND INSTRUMENTS FOR MEASURING ELECTRICAL IMPEDANCE, NAMELY, EXTERNAL ORTHOPEDIC DEVICES USING ELECTRICAL SIGNALS TO STIMULATE BONE GROWTH; ELECTRODES FOR MEDICAL USE, INCUBATORS FOR BABIES, APPARATUS FOR HEAT THERAPY, NAMELY, ELECTRIC HEATING DEVICES FOR CURATIVE TREATMENT, IN CLASS 10 (U.S. CLS. 26, 39 AND 44).

THE MARK CONSISTS OF STANDARD CHARACTERS WITHOUT CLAIM TO ANY PARTICULAR FONT, STYLE, SIZE, OR COLOR.

OWNER OF INTERNATIONAL REGISTRATION 1103846 DATED 11-30-2011, EXPIRES 11-30-2021.

SER. NO. 79-107,987, FILED 11-30-2011.

SAMUEL E. SHARPER JR., EXAMINING ATTORNEY



*David J. Kybas*

Director of the United States Patent and Trademark Office

# United States of America

United States Patent and Trademark Office

# TEDEMIS

**Reg. No. 4,273,877**

**Registered Jan. 15, 2013**

**Int. Cls.: 9, 35, 38, 41  
and 42**

**TRADEMARK**

**SERVICE MARK**

**PRINCIPAL REGISTER**

TEDEMIS (FRANCE SOCIÉTÉ ANONYME À DIRECTOIRE ET CONSEIL DE  
SURVEILLANCE)  
24 RUE DE LIÈGE  
F-75008 PARIS  
FRANCE

FOR: COMPUTER SOFTWARE FOR THE COLLECTION, EDITING, ORGANIZING, MODIFYING, BOOK MARKING, TRANSMISSION, STORAGE AND SHARING OF DATA AND INFORMATION; COMPUTER GAME PROGRAMS; ELECTRONIC AND VIDEO GAMES SOFTWARE DESIGNED FOR USE ONLY WITH AN EXTERNAL DISPLAY SCREEN OR MONITOR, IN CLASS 9 (U.S. CLS. 21, 23, 26, 36 AND 38).

FOR: ADVERTISING; BUSINESS INQUIRIES; ADVERTISING AGENCIES; COPYWRITING AND PUBLISHING ADVERTISING TEXTS; DISTRIBUTION OF ADVERTISING MATERIAL IN THE NATURE OF LEAFLETS, PROSPECTUSES, PRINTED MATTER, SAMPLES, EMAILS; DIRECT MAIL ADVERTISING SERVICES; COMPILATION OF STATISTICS; MARKETING STUDIES; ANALYSIS AND COLLECTION OF DATA FOR BUSINESS PURPOSES; COMPILATION AND SYSTEMIZATION OF DATA INTO COMPUTER DATABASES; OPINION POLLING; SALES PROMOTION FOR OTHERS; RENTAL OF ADVERTISING SPACE; PRESENTATION OF GOODS ON COMMUNICATION MEDIA, FOR RETAIL PURPOSES; ON-LINE ADVERTISING ON A COMPUTER NETWORK; ADVERTISING BY MAIL ORDER; ORGANIZATION OF EXHIBITIONS FOR COMMERCIAL OR ADVERTISING PURPOSES; MARKETING CONSULTING, IN CLASS 35 (U.S. CLS. 100, 101 AND 102).



FOR: CONSULTING AND INFORMATION ON TELECOMMUNICATIONS; PROVIDING ACCESS TO DATABASES; PROVIDING USER ACCESS TO GLOBAL COMPUTER NETWORKS; PROVIDING CHAT FORUMS FOR TRANSMISSION OF MESSAGES AMONG COMPUTER USERS; ELECTRONIC BULLETIN BOARD SERVICES; COMMUNICATIONS VIA COMPUTER TERMINALS OR FIBER-OPTIC NETWORKS; RADIO OR TELEPHONE COMMUNICATIONS; MOBILE TELEPHONE SERVICES; ELECTRONIC MAIL; PROVIDING MULTIPLE USE ACCESS TO GLOBAL COMPUTER INFORMATION NETWORKS FOR THE TRANSFER AND DISSEMINATION OF A WIDE RANGE OF INFORMATION INCLUDING DISSEMINATION OF IMAGES, SOUNDS, INFORMATION, MESSAGES AND DATA BY TELEPHONE, VIA FIBER-OPTIC NETWORKS, DATA COMMUNICATION, SATELLITE AND COMPUTER NETWORKS, IN CLASS 38 (U.S. CLS. 100, 101 AND 104).

*David J. Kyjars*

Director of the United States Patent and Trademark Office

**Reg. No. 4,273,877** FOR: PROVIDING OF TRAINING IN THE FIELD OF SEARCH ENGINE OPTIMIZATION, E-MAIL TARGETING AND MEDIA COMMUNICATIONS OUTREACH; ORGANIZATION OF COMPETITIONS IN THE FIELD OF VIDEO GAMES; PROVIDING ON-LINE COMPUTER GAMES FROM A COMPUTER NETWORK; OPERATING LOTTERIES; ARRANGING AND CONDUCTING OF EDUCATIONAL COLLOQUIUMS, CONFERENCES OR CONGRESSES; PUBLISHING OF BOOKS, REVIEWS, MAGAZINES, MAGNETIC AND DIGITAL DATA, SOUND AND IMAGE MEDIA; PUBLICATION OF ELECTRONIC BOOKS AND JOURNALS ON-LINE; PUBLICATION OF INTERACTIVE GAMES FOR COMPUTERS AND GLOBAL COMPUTER NETWORKS, IN CLASS 41 (U.S. CLS. 100, 101 AND 107).

FOR: RENTAL OF COMPUTER SOFTWARE; DESIGN AND DEVELOPMENT OF COMPUTERS AND SOFTWARE; INSTALLATION, MAINTENANCE AND UPDATING OF COMPUTER SOFTWARE; COMPUTER PROGRAMMING; RESEARCH AND DEVELOPMENT OF NEW PRODUCTS FOR OTHERS; COMPUTER SERVICES, NAMELY, RESTORATION AND UPDATING OF DATABASES; DATA CONVERSION FOR COMPUTER PROGRAMS AND DATA NOT PHYSICAL CONVERSION; CONVERSION OF DATA OR DOCUMENTS FROM PHYSICAL TO ELECTRONIC MEDIA; CREATING AND UPDATING OF INTERNET SITES AND OF COMPUTER SOFTWARE DEVELOPMENT FOR MOBILE APPLICATIONS FOR OTHERS; CONSULTANCY SERVICES RELATING TO SOFTWARE, DATABASE DESIGN AND DEVELOPMENT, AND TELECOMMUNICATIONS NETWORKS TECHNOLOGY; TECHNICAL PROJECT STUDIES, NAMELY, COMPUTER PROJECT MANAGEMENT SERVICES; COMPUTER AND SOFTWARE CONSULTANCY, IN CLASS 42 (U.S. CLS. 100 AND 101).

THE MARK CONSISTS OF STANDARD CHARACTERS WITHOUT CLAIM TO ANY PARTICULAR FONT, STYLE, SIZE, OR COLOR.

PRIORITY DATE OF 5-3-2011 IS CLAIMED.

OWNER OF INTERNATIONAL REGISTRATION 1103926 DATED 10-24-2011, EXPIRES 10-24-2021.

THE WORDING "TEDEMIS" HAS NO MEANING IN A FOREIGN LANGUAGE.

SER. NO. 79-108,040, FILED 10-24-2011.

GINA FINK, EXAMINING ATTORNEY

# United States of America

United States Patent and Trademark Office



**Reg. No. 4,273,878**

**Registered Jan. 15, 2013**

**Int. Cls.: 35 and 42**

**SERVICE MARK**

**PRINCIPAL REGISTER**

STEFAN RICHTER (FED REP GERMANY INDIVIDUAL)  
LOUIS-SEGELKEN-STRASSE 25  
27721 RITTERHUDE  
FED REP GERMANY

FOR: DATABASE MANAGEMENT; SYSTEMIZATION OF INFORMATION INTO COMPUTER DATABASES; MANAGEMENT AND COMPILATION OF COMPUTERISED DATABASES; COLLATING OF DATA IN COMPUTER DATABASES; ADVERTISING; BUSINESS MANAGEMENT; BUSINESS ADMINISTRATION; OFFICE FUNCTIONS, IN CLASS 35 (U.S. CLS. 100, 101 AND 102).

FOR: DESIGN AND DEVELOPMENT OF COMPUTER HARDWARE AND SOFTWARE, COMPUTER SOFTWARE CONSULTING; RENTAL OF SOFTWARE, IN PARTICULAR DATABASE SOFTWARE, IN CLASS 42 (U.S. CLS. 100 AND 101).

THE MARK CONSISTS OF A GREEN SHIELD CONTAINING THE OUTLINE OF A POLYGON WITH INTERNAL LINES, SHOWN IN YELLOW, WITH A FOUR-POINTED STAR AT THE UPPER RIGHT CORNER OF THE POLYGON, WITH THE COLORING OF THE SHIELD SHOWING AS GREEN ON THE LEFT AND GRADUALLY GETTING LIGHTER TO THE RIGHT UNTIL IT IS YELLOW IN THE UPPER RIGHT CORNER OF THE SHIELD.

PRIORITY DATE OF 6-15-2011 IS CLAIMED.

OWNER OF INTERNATIONAL REGISTRATION 1104056 DATED 12-14-2011, EXPIRES 12-14-2021.

THE COLOR(S) GREEN AND YELLOW IS/ARE CLAIMED AS A FEATURE OF THE MARK.

SER. NO. 79-108,083, FILED 12-14-2011.

ESTHER BELENKER, EXAMINING ATTORNEY



*David J. Kybas*

Director of the United States Patent and Trademark Office

United States of America  
United States Patent and Trademark Office

SUBA

**Reg. No. 4,273,879**

**Registered Jan. 15, 2013**

**Int. Cl.: 9**

**TRADEMARK**

**PRINCIPAL REGISTER**

PANDORA UNDERWATER EQUIPMENT SA (SWITZERLAND SOCIÉTÉ ANONYME (SA))  
CHEMIN DU BOIS DE RUZ 1  
CH-1801 LE MONT-PÈLERIN, SWITZERLAND

FOR: LIFE-SAVING AND TEACHING APPARATUS AND INSTRUMENTS, NAMELY, RAFTS, BUOYANCY COMPENSATOR DEVICES FOR DIVERS; BUOYANCY COMPENSATOR JACKET FOR USE IN SCUBA DIVING; DECOMPRESSION CHAMBERS; MEASURING INSTRUMENTS, NAMELY, TEMPERATURE SENSORS; PRESSURE MEASURING APPARATUS, NAMELY, PRESSURE SENSORS; PRESSURE GAUGES; PRESSURE INDICATOR PLUGS FOR VALVES; BREATHING APPARATUS FOR UNDERWATER SWIMMING; BREATHING APPARATUS FOR DIVERS, NAMELY, REBREATHERS, BUOYANCY BLADDERS; DIVING SUITS; DIVING GLOVES; DIVERS' MASKS; EAR PLUGS FOR DIVERS; SWIMMING BELTS; SWIMMING JACKETS; LIFE JACKETS; LIFE BELTS; LIFE-SAVING RAFTS; LIFE BUOYS; SIGNALLING BUOYS; DIRECTIONAL COMPASSES; SPECTACLES; GOGGLES FOR SPORTS; SWIMMING GOGGLES; ELECTRO VALVE INJECTION AND EXPULSION PRESSURE SENSOR MICROCOMPUTER; DATA PROCESSING EQUIPMENT AND COMPUTERS FOR USE IN SCUBA DIVING; COMPUTER SOFTWARE FOR USE IN SCUBA DIVING FOR COMPUTERIZED LOGBOOKS, COMPUTERIZED DECOMPRESSION TABLES, DIVE PROFILES USED IN LOGGING AND TRACKING INFORMATION RELATED TO UNDERWATER DIVING SAFETY AND UNDERWATER INSTRUCTION AND CERTIFICATION; COMPUTER SOFTWARE USED TO MONITOR AND CONTROL A BUOYANCY COMPENSATION JACKET AND APPARATUS FOR BUOYANCY COMPENSATION, IN CLASS 9 (U.S. CLS. 21, 23, 26, 36 AND 38).

THE MARK CONSISTS OF STANDARD CHARACTERS WITHOUT CLAIM TO ANY PARTICULAR FONT, STYLE, SIZE, OR COLOR.

PRIORITY DATE OF 6-17-2011 IS CLAIMED.

OWNER OF INTERNATIONAL REGISTRATION 1104267 DATED 12-14-2011, EXPIRES 12-14-2021.

SER. NO. 79-108,152, FILED 12-14-2011.

INGA ERVIN, EXAMINING ATTORNEY



*David J. Kypas*

Director of the United States Patent and Trademark Office

# United States of America

United States Patent and Trademark Office



**Reg. No. 4,273,880**

**Registered Jan. 15, 2013**

**Int. Cl.: 11**

**TRADEMARK**

**PRINCIPAL REGISTER**

LIMITED LIABILITY COMPANY; "DIS PLUS" (RUSSIAN FED. LIMITED LIABILITY COMPANY)

16 PARK STREET, 26  
RU-105484 MOSCOW  
RUSSIAN FED.

FOR: ELECTRIC LAMPS; LUMINOUS HOUSE NUMBERS; LIGHTING APPARATUS, NAMELY, LIGHTING INSTALLATIONS; LIGHTING APPARATUS FOR VEHICLES; LAMPS; STANDARD LAMPS; STREET LAMPS; CEILING LIGHTS, IN CLASS 11 (U.S. CLS. 13, 21, 23, 31 AND 34).

THE MARK CONSISTS OF THE WORDING "INLIGHTON", WITH A STYLIZED INITIAL LETTER "I".

OWNER OF INTERNATIONAL REGISTRATION 1104300 DATED 9-20-2011, EXPIRES 9-20-2021.

SER. NO. 79-108,165, FILED 9-20-2011.

PAUL MORENO, EXAMINING ATTORNEY



*David J. Kybas*

Director of the United States Patent and Trademark Office

United States of America  
United States Patent and Trademark Office

# Lumiotec

**Reg. No. 4,273,881**

**Registered Jan. 15, 2013**

**Int. Cl.: 11**

**TRADEMARK**

**PRINCIPAL REGISTER**

LUMIOTEC INC. (JAPAN CORPORATION)  
4149-8, HACHIMANPARA 5-CHOME  
YONEZAWA-SHI; YAMAGATA 992-1128  
JAPAN

FOR: LIGHTING APPARATUS, NAMELY, FLAT PANEL LIGHTING APPARATUS; ELECTRIC LAMPS, IN CLASS 11 (U.S. CLS. 13, 21, 23, 31 AND 34).

THE MARK CONSISTS OF THE WORDING "LUMIOTEC" IN STYLIZED FORMAT.

PRIORITY DATE OF 8-15-2011 IS CLAIMED.

OWNER OF INTERNATIONAL REGISTRATION 1104406 DATED 12-9-2011, EXPIRES 12-9-2021.

SER. NO. 79-108,213, FILED 12-9-2011.

ELLEN PERKINS, EXAMINING ATTORNEY



*David J. Kybas*

Director of the United States Patent and Trademark Office

# United States of America

United States Patent and Trademark Office

# QUITE4ME

**Reg. No. 4,273,882**

**Registered Jan. 15, 2013**

**Int. Cl.: 42**

**SERVICE MARK**

**PRINCIPAL REGISTER**

QUITERIAN, S.L. (SPAIN SOCIEDAD LIMITADA)  
FREDERIC MOMPOU, 5, 3<sup>o</sup>  
E-08960 SANT JUST DESVERN (BARCELONA)  
SPAIN

FOR: CLOUD COMPUTING FEATURING SOFTWARE FOR USE IN MARKETING AND DATA ANALYSIS, ALL FOR BUSINESS INTELLIGENCE AND INTEGRATION OF DATA OBTAINED FROM SOCIAL MEDIA, WEB ANALYTICS, CUSTOMER RELATIONSHIP MANAGEMENT (CRM), ENTERPRISE RESOURCE PLANNING (ERP) AND E-MAIL MARKETING PLATFORMS; CLOUD COMPUTING FEATURING SOFTWARE FOR THE COLLECTION, EDITING, ORGANIZING, MODIFYING, BOOK MARKING, TRANSMISSION, STORAGE, ANALYSIS AND SHARING OF DATA AND INFORMATION; DESIGN AND DEVELOPMENT OF COMPUTERS AND SOFTWARE, IN CLASS 42 (U.S. CLS. 100 AND 101).

THE MARK CONSISTS OF STANDARD CHARACTERS WITHOUT CLAIM TO ANY PARTICULAR FONT, STYLE, SIZE, OR COLOR.

PRIORITY DATE OF 11-10-2011 IS CLAIMED.

OWNER OF INTERNATIONAL REGISTRATION 1104523 DATED 11-15-2011, EXPIRES 11-15-2021.

SER. NO. 79-108,279, FILED 11-15-2011.

MAYUR VAGHANI, EXAMINING ATTORNEY



*David J. Kybas*

Director of the United States Patent and Trademark Office



# United States of America

United States Patent and Trademark Office

# NAROO

**Reg. No. 4,273,883**

**Registered Jan. 15, 2013**

**Int. Cl.: 25**

**TRADEMARK**

**PRINCIPAL REGISTER**

NAROO CEM CO., LTD (REPUBLIC OF KOREA CORPORATION)  
RM.617 SSANGYONG PLATINUM, 1445-13  
SEOCHO-DONG, SEOCHO-GU  
SEOUL, REPUBLIC OF KOREA

FOR: SPORTS SHOES; SOLES FOR FOOTWEAR; VINYL SHOES; BOOTS; CYCLING SHOES; SANDALS; SLIPPERS; SLIPPER SOLES; FOOTWEAR; ATHLETIC FOOTWEAR; CLOTHING OF LEATHER, NAMELY, LEATHER PANTS; GOLF TROUSERS; GOLF WEAR, NAMELY, GOLF SKIRTS AND GOLF JUMPERS; CLOTHES FOR FISHING, NAMELY, FISHING TROUSERS AND FISHING JACKETS; CLIMBING TROUSERS; CLIMBING CLOTHES, NAMELY, CLIMBING BOOTS; RAIN COATS; WIND JACKETS; WIND VESTS; TROUSERS FOR SWEATING; RAINPROOF JACKETS; WINTER CLOTHES, NAMELY, JACKETS FOR THE PROTECTION AGAINST THE COLD; SNOWBOARD SUITS; SNOWBOARD PANTS; SNOWBOARD JACKETS; SNOW BOARDING SUITS; SKATEBOARD PANTS; SKATEBOARD SUITS; SKATING OUTFITS; SKI JACKETS; SKI WEAR; SKI PANTS; SPORTS OVERCOATS; SPORTS JACKETS; CHILDREN'S CLOTHING, NAMELY, JUMPERS; JACKETS; PARKAS; GOLF SHIRTS; GOLF VESTS; LONG SLEEVED SHIRTS; FISHING VESTS; BATHING SUITS FOR MEN; SINGLET; BASKETBALL PANTS; KNITWEAR, NAMELY, KNITTED UNDERWEAR; CLIMBING VESTS; SWEAT SUITS; SWEAT-ABSORBENT UNDERWEAR; CLOTHING FOR RUNNING, NAMELY, RUNNING SHIRTS; HOSIERY; SHORT-SLEEVED OR LONG-SLEEVED T-SHIRTS; SHORT-SLEEVED SHIRTS; BEACHWEAR; SHIRTS; SLEEVELESS JERSEYS; UNDERWEAR; DRAWERS; UNDERSHIRTS; BATHING CAPS; BATHING SUITS; BATHING DRAWERS; SHIRTS FOR SUITS; SPORT SHIRTS; SPORTS JERSEYS; ATHLETIC UNIFORMS; WARM-UP SUITS; JOGGING PANTS; JOGGING SUITS; VESTS; SPORTS SHIRTS WITH SHORT SLEEVES; JERKINS; TANK TOPS; TRACK SUITS; TRAINING WEAR, NAMELY, TRAINING SUITS; TEE-SHIRTS; BEACHWEAR; MEN'S SOCKS; LEG WARMERS; SWEAT-ABSORBENT STOCKINGS; LEGGINGS; MUFFS; FUR MUFFS; MUFFLERS; BANDANAS; ANKLE SOCKS; FOOTMUFFS; ANTI-PERSPIRANT SOCKS; EAR MUFFS; WINTER GLOVES; MITTENS; FOOTMUFFS, NOT ELECTRICALLY HEATED; WRISTBANDS; SHAWLS; SLEEP MASKS; SOCKS; SOCKS COVER; WOOLLEN SOCKS; DRESS SHIELDS; SPORTS SOCKS; POCKET SQUARES; GLOVES; GOLF CAPS; LEATHER HEADWEAR; KOREAN HEADBANDS MADE OF HORSEHAIR CALLED MANGGON; CAPS; SUN VISORS; HAT FRAMES; FUR HATS; BASEBALL CAPS; CHILDREN'S HEADWEAR; HOODS; CAPS WITH VISORS; TURBANS; SKULL CAPS; TOP HATS; SKI MASKS, IN CLASS 25 (U.S. CLS. 22 AND 39).



*David J. Kyjars*

Director of the United States Patent and Trademark Office

THE MARK CONSISTS OF THE STYLIZED WORD "NAROO".

**Reg. No. 4,273,883** OWNER OF INTERNATIONAL REGISTRATION 1104808 DATED 10-21-2011, EXPIRES 10-21-2021.

THE WORD(S) "NAROO" HAS NO MEANING IN A FOREIGN LANGUAGE.

SER. NO. 79-108,374, FILED 10-21-2011.

ANDREW RHIM, EXAMINING ATTORNEY

# United States of America

United States Patent and Trademark Office

# WindCarrier

**Reg. No. 4,273,884**

**Registered Jan. 15, 2013**

**Int. Cls.: 6, 7 and 9**

**TRADEMARK**

**PRINCIPAL REGISTER**

FRANZ KESSLER GMBH (FED REP GERMANY LIMITED COMPANY (GMBH))  
FRANZ-KESSLER-STRASSE 2  
88422 BAD BUCHAU  
FED REP GERMANY

FOR: METAL MASTS FOR USE IN WIND TURBINES, IN CLASS 6 (U.S. CLS. 2, 12, 13, 14, 23, 25 AND 50).

FOR: WIND GENERATORS; ELECTRIC POWER GENERATORS; WIND TURBINE MACHINES AND INSTALLATIONS CONSISTING OF WIND TURBINE MACHINES FOR ELECTRIC POWER GENERATION; MACHINES FOR USE IN AND COMBINED TO WIND TURBINES FOR ELECTRIC POWER GENERATION, IN CLASS 7 (U.S. CLS. 13, 19, 21, 23, 31, 34 AND 35).

FOR: CONTROL DEVICES FOR WIND TURBINES; CONTROL DEVICES FOR ELECTRIC POWER GENERATORS, IN CLASS 9 (U.S. CLS. 21, 23, 26, 36 AND 38).

THE MARK CONSISTS OF STANDARD CHARACTERS WITHOUT CLAIM TO ANY PARTICULAR FONT, STYLE, SIZE, OR COLOR.

PRIORITY DATE OF 5-25-2011 IS CLAIMED.

OWNER OF INTERNATIONAL REGISTRATION 1104826 DATED 11-23-2011, EXPIRES 11-23-2021.

SER. NO. 79-108,381, FILED 11-23-2011.

PAM WILLIS, EXAMINING ATTORNEY



*David J. Kyffers*

Director of the United States Patent and Trademark Office

# United States of America

United States Patent and Trademark Office



**Reg. No. 4,273,885**

**Registered Jan. 15, 2013**

**Int. Cl.: 9**

**TRADEMARK**

**PRINCIPAL REGISTER**

TECNISCO LTD. (JAPAN CORPORATION)  
2-15, MINAMI-SHINAGAWA 2-CHOME  
SHINAGAWA-KU; TOKYO 140-0004  
JAPAN

FOR: CHEMISTRY APPARATUS AND INSTRUMENTS FOR LABORATORY USE, NAMELY, LABORATORY CHEMICAL REACTORS; ELECTRONIC MACHINES AND APPARATUS, NAMELY, THERMOELECTRIC MODULES FOR COOLING SEMI-CONDUCTOR CIRCUITS, AND THEIR STRUCTURAL PARTS, IN CLASS 9 (U.S. CLS. 21, 23, 26, 36 AND 38).

THE MARK CONSISTS OF FOUR WAVY BANDS, THE FIRST IN SHADES OF LIGHT BLUE, BLUE AND DARK BLUE, THE SECOND IN ORANGE AND YELLOW, THE THIRD IN LIGHT BLUE AND BLUE AND THE FOURTH IN DARK BLUE AND BLACK.

PRIORITY DATE OF 10-20-2011 IS CLAIMED.

OWNER OF INTERNATIONAL REGISTRATION 1104852 DATED 12-7-2011, EXPIRES 12-7-2021.

THE COLOR(S) LIGHT BLUE, BLUE, DARK BLUE, BLACK, ORANGE AND YELLOW IS/ARE CLAIMED AS A FEATURE OF THE MARK.

SER. NO. 79-108,384, FILED 12-7-2011.

CARYN GLASSER, EXAMINING ATTORNEY



*David J. Kyffers*

Director of the United States Patent and Trademark Office

# United States of America

United States Patent and Trademark Office

# whitenergy

**Reg. No. 4,273,886**

**Registered Jan. 15, 2013**

**Int. Cls.: 9 and 11**

**TRADEMARK**

**PRINCIPAL REGISTER**

ENAN S.A. (POLAND SPÓLKA AKCYJNA)  
UL. GRANICZNA 73  
PL-62-081 BARANOWO  
POLAND

FOR: BATTERIES; CONVERTERS, ELECTRIC; ELECTROCHEMICAL CELLS IN THE NATURE OF BATTERIES; ELECTRIC BATTERIES; BATTERY CHARGING APPARATUS; APPARATUS FOR THE SUPPLY, REGULATION, TRANSMISSION, CONTROL, STORAGE AND DISTRIBUTION OF ELECTRICITY, NAMELY, ELECTRICAL POWER SUPPLIES, VOLTAGE REGULATORS FOR ELECTRIC POWER, ELECTRIC CABLES, ELECTRICAL CONTROLLERS, ELECTRICAL STORAGE BATTERIES, AND ELECTRICAL POWER DISTRIBUTION UNITS; CURRENT COLLECTORS, NAMELY, ELECTRICAL TRANSDUCERS; EXTENSION CABLES; RECHARGEABLE BATTERIES; ELECTRIC CONNECTIONS IN THE NATURE OF ELECTRICAL SOCKETS, PLUGS AND OTHER CONTACTS, NAMELY, ELECTRIC CONTACTS AND SAFETY CONTACT PLUGS; ELECTRIC PLUGS, SOCKETS, CONTACTS AND CONNECTORS; APPARATUS AND DEVICES FOR SUPPLYING, DISTRIBUTING, TRANSFORMING, ACCUMULATING, REGULATING OR CONTROLLING ELECTRICITY, NAMELY, ELECTRICAL POWER SUPPLIES, ELECTRICAL POWER DISTRIBUTION UNITS, ELECTRICAL TRANSFORMERS, ACCUMULATORS, VOLTAGE REGULATORS FOR ELECTRIC POWER, AND ELECTRICAL CONTROLLERS; COMPUTER PERIPHERAL DEVICES, IN CLASS 9 (U.S. CLS. 21, 23, 26, 36 AND 38).

FOR: ELECTRIC LIGHT BULBS AND TUBES; LIGHT BULBS, IN CLASS 11 (U.S. CLS. 13, 21, 23, 31 AND 34).

THE MARK CONSISTS OF THE STYLIZED WORDING "WHITENERGY", WITH THE FIRST "E" IN THE WORDING APPEARING IN YELLOW AND THE REMAINDER OF THE LETTERING APPEARING IN GREY.

OWNER OF INTERNATIONAL REGISTRATION 1104910 DATED 12-8-2011, EXPIRES 12-8-2021.

THE COLOR(S) GREY AND YELLOW (COOL GREY 10 C, PANTONE 116 C) IS/ARE CLAIMED AS A FEATURE OF THE MARK.

SER. NO. 79-108,406, FILED 12-8-2011.



*David J. Kyffers*

Director of the United States Patent and Trademark Office

**Reg. No. 4,273,886** KEVIN CORWIN, EXAMINING ATTORNEY

# United States of America

United States Patent and Trademark Office



**Reg. No. 4,273,887**

**Registered Jan. 15, 2013**

**Int. Cls.: 5 and 31**

**TRADEMARK**

**PRINCIPAL REGISTER**

NANTONG SUNSHINE; INTERNATIONAL TRADE CO., LTD (CHINA CORPORATION)  
ROOM 2701, HUACHEN BUILDING  
NO. 111, GONGNONG ROAD,; NANTONG; JIANGSU PROVINCE  
CHINA

FOR: LYSINE MONOHYDROCHLORIDE; NUTRITIONAL ADDITIVES FOR MEDICAL USE, NAMELY, NUTRITIONAL ADDITIVES FOR LIVESTOCK FEED, NUTRITIONAL ADDITIVES FOR MEDICAL PURPOSES USED IN FOODS AND SUPPLEMENTS FOR HUMAN CONSUMPTION; MINERAL FOOD ADDITIVES, NAMELY, MINERAL FOOD ADDITIVES BEING MINERAL SALTS FOR MEDICAL PURPOSES; VETERINARY AMINOACIDS; VITAMIN PREPARATIONS; ANTHELMINTICS FOR HUMAN OR VETERINARY USE; ACARICIDE FOR AGRICULTURAL USE, IN CLASS 5 (U.S. CLS. 6, 18, 44, 46, 51 AND 52).

FOR: FEED ADDITIVES NOT FOR MEDICAL USE, NAMELY, NON-MEDICATED ADDITIVES FOR ANIMAL FEED; DISTILLERY WASTE FOR ANIMAL CONSUMPTION, NAMELY, YEAST FOR ANIMAL FEED, IN CLASS 31 (U.S. CLS. 1 AND 46).

THE MARK CONSISTS OF A CIRCLE WITH A DOVE IN THE TOP HALF AND A TRIANGLE IN THE BOTTOM PORTION.

PRIORITY DATE OF 6-16-2011 IS CLAIMED.

OWNER OF INTERNATIONAL REGISTRATION 1104985 DATED 12-13-2011, EXPIRES 12-13-2021.

SER. NO. 79-108,443, FILED 12-13-2011.

APRIL ROACH, EXAMINING ATTORNEY



*David J. Kybas*

Director of the United States Patent and Trademark Office

# United States of America

United States Patent and Trademark Office

# AZEV

**Reg. No. 4,273,888**

**Registered Jan. 15, 2013**

**Int. Cl.: 12**

**TRADEMARK**

**PRINCIPAL REGISTER**

AZEV ALURAD GMBH (FED REP GERMANY LIMITED LIABILITY COMPANY)  
VON-SIEMENS-STR. 60  
64646 HEPPENHEIM  
FED REP GERMANY

FOR: AUTOMOBILE ACCESSORIES, AS FAR AS CONTAINED IN THIS CLASS, IN PARTICULAR WHEELS, TYRES, INNER TUBES FOR PNEUMATIC TYRES, RIMS, HUB CAPS, VALVES FOR VEHICLE TYRES, BEARINGS FOR WHEELS, ANTI-SKID CHAINS, SHOCK ABSORBERS FOR VEHICLES, SPRING STRUTS, STEERING WHEELS, BRAKE HAND LEVERS AND SWITCH BRAKE KNOBS, VEHICLE SEATS, IN PARTICULAR SPORTING SEATS, HEAD RESTS, SAFETY BELTS, LUGGAGE CARRIERS, SKI CARRIERS FOR CARS, MUDGUARDS, WIND DEFLECTORS, SPOILERS, SLIDING ROOFS, LIFTING ROOFS, CHILDREN SEATS, IN PARTICULAR SAFETY SEATS, UPHOLSTERY OF LEATHER, PLASTICS, NATURAL FIBERS OR FUR FOR VEHICLES, IN CLASS 12 (U.S. CLS. 19, 21, 23, 31, 35 AND 44).

THE MARK CONSISTS OF STANDARD CHARACTERS WITHOUT CLAIM TO ANY PARTICULAR FONT, STYLE, SIZE, OR COLOR.

OWNER OF INTERNATIONAL REGISTRATION 1105029 DATED 11-17-2011, EXPIRES 11-17-2021.

OWNER OF U.S. REG. NO. 1,798,624.

SER. NO. 79-108,461, FILED 11-17-2011.

LINDA E. BLOHM, EXAMINING ATTORNEY



*David J. Kypos*

Director of the United States Patent and Trademark Office



# United States of America

United States Patent and Trademark Office

# Toggla

**Reg. No. 4,273,889**

TREMEO GMBH (FED REP GERMANY GMBH (COMPANY WITH LIMITED LIABILITY))  
ISPELSTR. 35

**Registered Jan. 15, 2013**

47805 KREFELD, FED REP GERMANY

**Int. Cls.: 9, 28, 35, 38, 41  
and 42**

FOR: CALCULATING MACHINES, DATA PROCESSING EQUIPMENT AND COMPUTERS; COMPUTER HARDWARE; COMPUTER SOFTWARE, NAMELY, COMPUTER SOFTWARE TO CONTROL TELEVISIONS, MONITORS, DISPLAYS AND COMPUTER SOFTWARE TO CONTROL AUDIO-VISUAL MEDIA CONTENT VIA COMPUTER, NAMELY, SOFTWARE TO CONTROL AUDIO EQUIPMENT, SOUND QUALITY, AND STREAMING MEDIA ON AUDIO EQUIPMENT, SOFTWARE TO CONTROL THE REMOTE CONTROL FUNCTIONALITY OF TELEVISIONS AND MONITORS, AND OF STREAMING MEDIA ON TELEVISIONS AND MONITORS, AND SOFTWARE FOR CALIBRATING TELEVISIONS AND VIDEO INPUT DEVICES; DOWNLOADABLE AUDIO-VISUAL MEDIA CONTENT, NAMELY, DOWNLOADABLE AUDIO FILES, DOWNLOADABLE VIDEOS, IN THE FIELDS OF NEWS, ENTERTAINMENT, SPORTS, COMEDY, DRAMA, MUSIC AND MUSIC VIDEOS; COMPUTER SOFTWARE FOR STREAMING AUDIO-VISUAL MEDIA CONTENT VIA THE INTERNET, TELEVISION AND MOBILE DIGITAL ELECTRONIC DEVICES; COMPUTER SOFTWARE TO CONTROL AUDIO-VISUAL MEDIA CONTENT ON TELEVISIONS, MONITORS AND DISPLAYS VIA MOBILE ELECTRONIC DEVICES AND SMART PHONES; SOFTWARE FOR MOBILE PHONES TO CONTROL AUDIO-VISUAL MEDIA CONTENT; DOWNLOADABLE AUDIO-VISUAL CONTENT IN THE NATURE OF TELEVISION SHOWS, RADIO SHOWS, MOTION PICTURES, FILMS, VIDEOS, PHOTOGRAPHS, MUSIC VIDEOS, MUSIC, NOVELS, NEWSPAPERS, GENERAL FEATURE MAGAZINES, IN THE FIELDS OF CURRENT EVENT REPORTING, ENTERTAINMENT, SPORTS, COMEDY, DRAMA, MUSIC AND MUSIC VIDEOS; VIDEO GAME SOFTWARE, IN CLASS 9 (U.S. CLS. 21, 23, 26, 36 AND 38).

**TRADEMARK**

**SERVICE MARK**

**PRINCIPAL REGISTER**

FOR: GAMES AND PLAYTHINGS, NAMELY, BOARD GAMES, DICE GAMES, CARD GAMES, IN CLASS 28 (U.S. CLS. 22, 23, 38 AND 50).

FOR: ADVERTISING SERVICES; BUSINESS MANAGEMENT; BUSINESS ADMINISTRATION; PROVIDING OFFICE FUNCTIONS, IN CLASS 35 (U.S. CLS. 100, 101 AND 102).

FOR: TELECOMMUNICATION SERVICES, NAMELY, TRANSMITTING OF DIGITAL MEDIA CONTENT, NAMELY, VOICE, DATA, IMAGES, SIGNALS, MESSAGES AND DIGITAL FILES FOR OTHERS VIA GLOBAL AND LOCAL COMPUTER NETWORKS; ELECTRONIC TRANSMISSION AND STREAMING OF DIGITAL MEDIA CONTENT, NAMELY, VOICE, DATA, IMAGES, SIGNALS, MESSAGES AND DIGITAL FILES FOR OTHERS VIA GLOBAL



*David J. Kyros*

Director of the United States Patent and Trademark Office

**Reg. No. 4,273,889** AND LOCAL COMPUTER NETWORKS; RADIO AND VIDEO BROADCASTING AND TRANSMISSION SERVICES; TELECOMMUNICATION SERVICES, NAMELY, TRANSMISSION OF DATA, GRAPHICS, IMAGES, AUDIO AND VIDEO BY MEANS OF TELECOMMUNICATIONS NETWORKS, WIRELESS COMMUNICATION NETWORKS AND THE INTERNET; BROADCASTING AND STREAMING OF AUDIO-VISUAL MEDIA CONTENT IN THE FIELDS OF NEWS, ENTERTAINMENT, SPORTS, COMEDY, DRAMA, MUSIC AND MUSIC VIDEOS VIA A GLOBAL COMPUTER NETWORK; TRANSMISSION OF DOWNLOADABLE AUDIO-VISUAL MEDIA CONTENT IN THE NATURE OF FULL-LENGTH, PARTIAL-LENGTH, AND CLIPS FROM MOTION PICTURES, TELEVISION PROGRAMMING, VIDEOS, MUSIC VIDEOS AND MUSIC; VIDEO-ON-DEMAND TRANSMISSION SERVICES, IN CLASS 38 (U.S. CLS. 100, 101 AND 104).

FOR: DISTRIBUTION OF TELEVISION PROGRAMS FOR OTHERS; EDUCATION AND ENTERTAINMENT SERVICES, NAMELY, PROVIDING ONLINE, NON-DOWNLOADABLE AUDIO-VISUAL CONTENT, NAMELY, TELEVISION SHOWS, FILMS, PHOTOGRAPHS, MUSIC VIDEOS, NOVELS, NEWSPAPERS, GENERAL FEATURE MAGAZINES, IN THE FIELDS OF CURRENT EVENT REPORTING, ENTERTAINMENT, SPORTS, COMEDY, DRAMA, MUSIC AND MUSIC VIDEOS; PROVIDING ONLINE ENTERTAINMENT INFORMATION VIA A GLOBAL COMPUTER NETWORK ON THE SUBJECTS OF RADIO, MOTION PICTURES, TELEVISION PROGRAMMING, VIDEOS, MUSIC VIDEOS AND MUSIC; PROVIDING ONLINE NON-DOWNLOADABLE INTERACTIVE RESOURCE IN THE FIELD OF ENTERTAINMENT, INCLUDING PROGRAMMING GUIDES ON THE SUBJECTS OF RADIO, MOTION PICTURES, TELEVISION PROGRAMMING, VIDEOS, MUSIC VIDEOS AND MUSIC TAILORED TO VIEWER'S PROGRAMMING PREFERENCES; PROVIDING A WEBSITE FEATURING ONLINE, NON-DOWNLOADABLE AUDIO-VISUAL CONTENT, SPECIFICALLY, RADIO SHOWS, MOTION PICTURES, TELEVISION PROGRAMMING, VIDEOS, MUSIC VIDEOS, AND MUSIC, AND VIDEO CLIPS, AUDIO CLIPS, MUSIC CLIPS, FILM CLIPS AND PHOTOGRAPHS, IN THE FIELDS OF CURRENT EVENT REPORTING, ENTERTAINMENT, SPORTS, COMEDY, DRAMA, MUSIC AND MUSIC VIDEOS, IN CLASS 41 (U.S. CLS. 100, 101 AND 107).

FOR: DESIGN AND DEVELOPMENT OF COMPUTER HARDWARE AND SOFTWARE; HOSTING OF DIGITAL CONTENT ON THE INTERNET; INTERNET AND WEBSITE SERVICES, NAMELY, THE DESIGN AND DEVELOPMENT OF WEBSITES FOR OTHERS; PRODUCING AND DISTRIBUTING HARDWARE, NAMELY, COMPUTER HARDWARE DEVELOPMENT AND DESIGN OF COMPUTER HARDWARE, IN CLASS 42 (U.S. CLS. 100 AND 101).

THE MARK CONSISTS OF STANDARD CHARACTERS WITHOUT CLAIM TO ANY PARTICULAR FONT, STYLE, SIZE, OR COLOR.

PRIORITY DATE OF 6-27-2011 IS CLAIMED.

OWNER OF INTERNATIONAL REGISTRATION 1105080 DATED 8-10-2011, EXPIRES 8-10-2021.

SER. NO. 79-108,484, FILED 8-10-2011.

ALAIN LAPTEK, EXAMINING ATTORNEY

# United States of America

United States Patent and Trademark Office

# SAF

**Reg. No. 4,273,890**

**Registered Jan. 15, 2013**

**Int. Cls.: 9, 12, 35 and 37**

**TRADEMARK**

**SERVICE MARK**

**PRINCIPAL REGISTER**

SAF-HOLLAND GMBH (FED REP GERMANY LIMITED LIABILITY COMPANY)  
HAUPTSTRASSE 26  
63856 BESSENBACH  
FED REP GERMANY

FOR: MEASURING AND CHECKING APPARATUS AND INSTRUMENTS, NAMELY, SENSORS, ABS SENSORS, WEAR INDICATING DEVICE FOR BRAKE PADS, DEVICES FOR MEASURING CASTER; ELECTRONIC CHECKING INSTRUMENTS FOR INDICATING THE STATUS OF VEHICLE TRAILER COUPLINGS AND ELECTRONIC COMPONENTS SOLD TOGETHER THEREWITH, IN PARTICULAR, ELECTRONIC SENSORS FOR DETECTING THE POSITION OF COMPONENTS OF VEHICLE TRAILER COUPLINGS AND ELECTRONIC DISPLAY MONITOR MODULES FOR INDICATING THE STATUS OF TRAILER COUPLINGS AND FOR DISPLAYING ERROR CODE DIAGNOSIS, IN CLASS 9 (U.S. CLS. 21, 23, 26, 36 AND 38).

FOR: LAND VEHICLES; APPARATUS FOR LOCOMOTION BY LAND, NAMELY, TRUCKS AND TRAILERS; VEHICLE PARTS, IN PARTICULAR, AXLES WITH AIR SUSPENSIONS, AXLES WITH MECHANICAL SUSPENSIONS, SWIVEL AXLES AND BOGIES, AXLES WITH DISC BRAKE, AXLES WITH DRUM BRAKE FOR LORRIES AND TRAILER VEHICLES; AXLE SUSPENSIONS FOR LORRIES AND TRAILER VEHICLES; MECHANICALLY AND MANUALLY OPERATED DEVICES FOR LIFTING AND LOWERING SEMI-TRAILERS AND TRAILERS, BEING PARTS FOR THESE VEHICLES; LEAF SPRING AXLES FOR LAND CRAFTS; AIR SUSPENSIONS FOR CONTROLLING SUSPENSION HEIGHT FOR VEHICLES, LEAF SPRING CHASSIS AND LEAF SPRINGS FOR LAND CRAFTS BOTH IN THE NATURE OF LAND VEHICLE SUSPENSION PARTS; SHOCK ABSORBER AND THEIR STRUCTURAL PARTS, NAMELY, SPRING SHOCK ABSORBER, SUSPENSION STRUT BEARINGS, SHOCK ABSORBER SPRINGS FOR LORRIES AND TRAILER VEHICLES; BRAKE SYSTEMS FOR LAND CRAFTS; VEHICLE COUPLINGS, IN PARTICULAR, FIFTH WHEELS, TRAILER COUPLINGS, TOWING HOOKS FOR LAND VEHICLES, PINTLE HOOKS IN THE NATURE OF TRAILER HITCHES AND STEERING SWIVEL PINS, TRAILER SUPPORTS, NAMELY, LANDING GEARS AND SLIDING TRAILER SUPPORTS, NAMELY, SLIDERS, ALL BEING PARTS FOR LAND CRAFTS; LIFT GATES IN THE NATURE OF TAIL GATES FOR TRAILERS; SPARE TIRE CARRIERS AND SHOCK ABSORBER TUBES FOR LAND CRAFTS, IN CLASS 12 (U.S. CLS. 19, 21, 23, 31, 35 AND 44).



*David J. Kyros*

Director of the United States Patent and Trademark Office

FOR: ADVERTISING; PRESENTATION OF GOODS, IN PARTICULAR, VEHICLES AND VEHICLE PARTS, ON COMMUNICATIONS MEDIA FOR RETAIL PURPOSES, AND ONLINE

**Reg. No. 4,273,890** RETAIL STORE SERVICES IN THE FIELD OF VEHICLES AND VEHICLE PARTS, IN CLASS 35 (U.S. CLS. 100, 101 AND 102).

FOR: REPAIR OF VEHICLES AND VEHICLE PARTS, IN PARTICULAR, AXLES WITH AIR SUSPENSIONS, AXLES WITH MECHANICAL SUSPENSIONS, SWIVEL AXLES AND BOGIES, AXLES WITH DISC BRAKE, AXLES WITH DRUM BRAKE; FOR LORRIES AND TRAILER VEHICLES; AXLE SUSPENSIONS FOR LORRIES AND TRAILER VEHICLES; MECHANICALLY AND MANUALLY OPERATED DEVICES FOR LIFTING AND LOWERING SEMI-TRAILERS AND TRAILERS; LEAF SPRING AXLES FOR LAND CRAFTS; AIR SUSPENSIONS; BRAKE SYSTEMS FOR LAND CRAFTS; VEHICLE COUPLINGS, IN PARTICULAR, FIFTH WHEELS, TRAILER COUPLINGS, TOWING HOOKS FOR LAND VEHICLES, PINTLE HOOKS IN THE NATURE OF TRAILER HITCHES AND STEERING SWIVEL PINS, TRAILER SUPPORTS, NAMELY, LANDING GEARS AND SLIDING TRAILER SUPPORTS, NAMELY, SLIDERS; LIFT GATES IN THE NATURE OF TAIL GATES FOR TRAILERS, IN CLASS 37 (U.S. CLS. 100, 103 AND 106).

THE MARK CONSISTS OF STANDARD CHARACTERS WITHOUT CLAIM TO ANY PARTICULAR FONT, STYLE, SIZE, OR COLOR.

OWNER OF INTERNATIONAL REGISTRATION 1105090 DATED 7-29-2011, EXPIRES 7-29-2021.

OWNER OF U.S. REG. NOS. 1,623,538, 3,991,886 AND OTHERS.

SER. NO. 79-108,490, FILED 7-29-2011.

JENNIFER WILLISTON, EXAMINING ATTORNEY

# United States of America

United States Patent and Trademark Office

## PIMA PREMIUM 0076

**Reg. No. 4,273,891**

**Registered Jan. 15, 2013**

**Int. Cls.: 24 and 25**

**TRADEMARK**

**PRINCIPAL REGISTER**

BRAGARD SA (FRANCE SOCIÉTÉ ANONYME)  
2, RUE CHRISTOPHE DENIS  
EPINAL, FRANCE F88000 AND

TENTHOREY (FRANCE SOCIÉTÉ PAR ACTIONS SIMPLIFIÉE)  
ZI DE LA PLAINE  
ELOYES, FRANCE F88510

FOR: COTTON FABRICS, BED SHEETS, PILLOWCASES, BOLSTER COVERS, BEDSPREADS, BED BLANKETS, COVERLETS, EIDERDOWNS, TABLE COVERS OF TEXTILE, TEXTILE TABLECLOTHS, TABLE NAPKINS OF TEXTILE, TABLEMATS OF TEXTILE, HAND TOWELS OF TEXTILE, BATHROOM SETS OF TEXTILE, NAMELY, BATHROOM TOWELS AND BATH MATS, WASHCLOTHS, BATH TOWELS, BEACH TOWELS, ALL MADE IN WHOLE OR IN SUBSTANTIAL PART OF PIMA COTTON, IN CLASS 24 (U.S. CLS. 42 AND 50).

FOR: BLOUSES, APRONS, HOUSE FROCKS, WORK WEAR, NAMELY, UNIFORMS, CHEF'S JACKETS, PANTS, SHIRTS, COVERALLS, RAIN WEAR, OVERCOATS AND COATS, JACKETS, TROUSERS, VESTS, SUITS, DRESSES, SKIRTS, LINGERIE, HOSIERY, ALL MADE IN WHOLE OR IN SUBSTANTIAL PART OF PIMA COTTON, IN CLASS 25 (U.S. CLS. 22 AND 39).

THE MARK CONSISTS OF STANDARD CHARACTERS WITHOUT CLAIM TO ANY PARTICULAR FONT, STYLE, SIZE, OR COLOR.

PRIORITY DATE OF 10-25-2011 IS CLAIMED.

OWNER OF INTERNATIONAL REGISTRATION 1105110 DATED 11-17-2011, EXPIRES 11-17-2021.

NO CLAIM IS MADE TO THE EXCLUSIVE RIGHT TO USE "PIMA PREMIUM", APART FROM THE MARK AS SHOWN.

SER. NO. 79-108,503, FILED 11-17-2011.

JASON TURNER, EXAMINING ATTORNEY



*David J. Kyffers*

Director of the United States Patent and Trademark Office

# United States of America

United States Patent and Trademark Office



**Reg. No. 4,273,892**

**Registered Jan. 15, 2013**

**Int. Cl.: 43**

**SERVICE MARK**

**PRINCIPAL REGISTER**

GUIDO BALLERINI (ITALY INDIVIDUAL)  
VIA TOSCA FIESOLI, 7  
I-50013 CAMPI BISENZIO (FI), ITALY

FOR: SERVICES FOR PROVIDING FOOD AND DRINK; ICE CREAM PARLORS, IN CLASS 43 (U.S. CLS. 100 AND 101).

NO CLAIM IS MADE TO THE EXCLUSIVE RIGHT TO USE "GELATERIA", APART FROM THE MARK AS SHOWN.

OWNER OF INTERNATIONAL REGISTRATION 1105156 DATED 11-15-2011, EXPIRES 11-15-2021.

THE COLOR(S) RED AND BLUE IS/ARE CLAIMED AS A FEATURE OF THE MARK.

THE MARK INCLUDES THE WORD "GELATERIA" IN BLUE LATIN UPPERCASE CHARACTERS, NEXT TO WHICH THERE IS THE BLUE STYLIZED REPRESENTATION OF A HORSE RIDDEN BY A JOCKEY IN ACTION OF JUMPING AN OBSTACLE FROM RIGHT TO LEFT; UNDERNEATH SUCH REPRESENTATION THERE ARE THE WORDS: (I) "IL", IN BLUE ITALIC LATIN CHARACTERS; (II) "FANTINO", IN RED FANTASIZED LATIN CHARACTERS WITH THE CENTRAL CHARACTERS OF A BIGGER SIZE COMPARED TO THOSE ON THE SIDES, ALL TOGETHER STYLIZED TO RESEMBLE AN OBSTACLE THAT A JOCKEY ON TOP OF A HORSE IS JUMPING FROM RIGHT TO LEFT; UNDERNEATH THE LAST TWO CHARACTERS OF THE WORD "FANTINO" THERE IS THE CAPTION "DI GUIDO", IN BLUE LOWER CASES EXCEPT THE LETTER "G" WHICH IS IN CAPITAL CASE. THE COLOR WHITE REPRESENTS BACKGROUND AREAS AND IS NOT PART OF THE MARK.

THE ENGLISH TRANSLATION OF "GELATERIA IL FANTINO DI GUIDO" IS "ICE CREAM SHOP THE JOCKEY BY GUIDO".

SER. NO. 79-108,539, FILED 11-15-2011.

MAYUR VAGHANI, EXAMINING ATTORNEY



*David J. Kyffers*

Director of the United States Patent and Trademark Office

# United States of America

United States Patent and Trademark Office

## SWATYCOMET

**Reg. No. 4,273,893**

SWATYCOMET D.O.O. (SLOVENIA LIMITED LIABILITY COMPANY)

**Registered Jan. 15, 2013**

TITOVA CESTA 60  
SI-2000 MARIBOR, SLOVENIA

**Int. Cls.: 7 and 8**

FOR: GRINDING WHEELS BEING PARTS OF MACHINES, SHARPENING WHEELS BEING PARTS OF MACHINES; GLAZIERS' DIAMONDS BEING PARTS OF MACHINES; TOOLS BEING PARTS OF MACHINES, NAMELY, SUPERABRASIVE DIAMOND WHEELS AND SUPERABRASIVE GRINDING WHEEL DRESSERS; BLADES BEING PARTS OF MACHINES; MACHINES AND POWER OPERATED TOOLS FOR THE MANUFACTURE OF ARTIFICIAL ABRASIVES AND GRINDING TOOLS; ARTIFICIAL GRINDING TOOLS FOR GRINDING MACHINES; POLISHING TOOLS BEING PARTS OF MACHINES; GRINDING TOOLS BEING PARTS OF MACHINES; GRINDING MACHINE TOOLS AND GRINDING TOOLS AS CONSTITUENT PARTS OF MACHINES; CUT-OFF, ABRASIVE AND GRINDING DISCS AND WHEELS FOR POWER OPERATED GRINDERS; DIAMOND POWER DRILLS; DIAMOND POWER SAW BLADES; MACHINE PARTS, NAMELY, DIAMOND BLADES; DIAMOND GRINDING CUPS FOR POWER OPERATED GRINDERS; DIAMOND CORE DRILLS BEING PARTS OF MACHINES; DIAMOND CUT-OFF WHEELS BEING PARTS OF MACHINES; POLISHING DISCS AND WHEELS BEING PARTS OF MACHINES; MACHINE PARTS, NAMELY, MOUNTED GRINDING POINTS WITH SHAFT AND GRINDING CUPS, IN CLASS 7 (U.S. CLS. 13, 19, 21, 23, 31, 34 AND 35).

**TRADEMARK**

**PRINCIPAL REGISTER**

FOR: HAND TOOLS AND HAND OPERATED IMPLEMENTS, NAMELY, GRINDING HAND TOOLS; WHETSTONES; MANUALLY-OPERATED EMERY GRINDING WHEELS; MANUALLY-OPERATED HAMMER SHARPENERS; MANUALLY-OPERATED GRINDSTONES BEING HAND TOOLS, MANUALLY-OPERATED SHARPENING WHEELS BEING HAND TOOLS, MANUALLY-OPERATED GRINDING WHEELS BEING HAND TOOLS; SHARPENING STONES; GLAZIERS' DIAMONDS BEING PARTS OF HAND TOOLS; MANUALLY-OPERATED SHARPENING INSTRUMENTS; MANUALLY-OPERATED BLADE SHARPENING INSTRUMENTS; DRAWING KNIVES; SAWS BEING HAND TOOLS; MANUALLY-OPERATED POLISHING DISCS AND WHEELS; MOUNTED GRINDING POINTS WITH SHAFT FOR MANUALLY-OPERATED GRINDING WHEELS; GRINDING CUPS FOR MANUALLY-OPERATED GRINDING WHEELS; MANUALLY-OPERATED GRINDING WHEELS AND DISCS, IN CLASS 8 (U.S. CLS. 23, 28 AND 44).



*David J. Kyffers*

THE MARK CONSISTS OF STANDARD CHARACTERS WITHOUT CLAIM TO ANY PARTICULAR FONT, STYLE, SIZE, OR COLOR.

**Reg. No. 4,273,893** PRIORITY DATE OF 3-28-2011 IS CLAIMED.

OWNER OF INTERNATIONAL REGISTRATION 1105311 DATED 9-19-2011, EXPIRES 9-19-2021.

SER. NO. 79-108,601, FILED 9-19-2011.

KRISTINA MORRIS, EXAMINING ATTORNEY



United States of America  
United States Patent and Trademark Office

**micro A**

**Reg. No. 4,273,894**

MICROA AS (NORWAY AKSJESELSKAP)  
POSTBOKS 197

**Registered Jan. 15, 2013**

N-4098 TANANGER, NORWAY

**Int. Cls.: 9, 31 and 42**

FOR: BIOREACTORS FOR CELL CULTURES, IN CLASS 9 (U.S. CLS. 21, 23, 26, 36 AND 38).

**TRADEMARK**

FOR: ALGAE FOR HUMAN OR ANIMAL CONSUMPTION; NATURAL PLANTS; ANIMAL FOODSTUFFS, IN CLASS 31 (U.S. CLS. 1 AND 46).

**SERVICE MARK**

**PRINCIPAL REGISTER**

FOR: SCIENTIFIC AND TECHNOLOGICAL SERVICES, NAMELY, RESEARCH AND DESIGN IN THE FIELD OF MICROALGAE PRODUCTS; INDUSTRIAL ANALYSIS AND RESEARCH SERVICES, NAMELY, SCIENTIFIC RESEARCH AND ANALYSIS IN THE FIELD OF MICROALGAE PRODUCTS; BIOLOGICAL RESEARCH; CHEMICAL ANALYSIS; CHEMISTRY SERVICES, NAMELY, CHEMISTRY CONSULTATION; CHEMICAL RESEARCH; AND UNDERWATER EXPLORATION, IN CLASS 42 (U.S. CLS. 100 AND 101).

THE MARK CONSISTS OF THE STYLIZED WORDING "MICROA".

PRIORITY DATE OF 5-16-2011 IS CLAIMED.

OWNER OF INTERNATIONAL REGISTRATION 1105327 DATED 11-14-2011, EXPIRES 11-14-2021.

SER. NO. 79-108,608, FILED 11-14-2011.

PATRICIA EVANKO, EXAMINING ATTORNEY



*David J. Kybas*

Director of the United States Patent and Trademark Office

# United States of America

United States Patent and Trademark Office

## Legend of Yulong

**Reg. No. 4,273,895**

**Registered Jan. 15, 2013**

**Int. Cls.: 9 and 41**

**TRADEMARK**

**SERVICE MARK**

**PRINCIPAL REGISTER**

TENCENT TECHNOLOGY (SHENZHEN),; COMPANY LIMITED (CHINA CORPORATION)  
NO. 403, EAST, BUILDING 2  
SAIGE TECHNOLOGY PARK, FUTIAN DISTRICT  
SHENZHEN CITY, GUANGDONG, CHINA

FOR: COMPUTER GAME SOFTWARE; COMPUTER GAME SOFTWARE FOR USE ONLINE;  
COMPUTER GAME PROGRAMS; COMPUTER GAME PROGRAMS DOWNLOADABLE VIA  
THE INTERNET; COMPUTER PROGRAMS FOR PRE-RECORDED GAMES; COMPUTER  
PROGRAMS FOR VIDEO AND COMPUTER GAMES; DOWNLOADABLE COMPUTER  
GAME PROGRAMS; DOWNLOADABLE ELECTRONIC PUBLICATIONS IN THE FIELD OF  
COMPUTER GAMES, GAMING AND MULTIMEDIA ONLINE GAMING, IN CLASS 9 (U.S.  
CLS. 21, 23, 26, 36 AND 38).

FOR: PROVIDING RECREATION FACILITIES; PROVIDING AMUSEMENT ARCADE SER-  
VICES; ELECTRONIC GAME SERVICES PROVIDED ONLINE FROM A COMPUTER NET-  
WORK ENTERTAINMENT, NAMELY, PROVIDING ONLINE GAMES; ORGANISATION OF  
ENTERTAINMENT COMPETITIONS IN THE FIELD OF ONLINE GAMES, IN CLASS 41  
(U.S. CLS. 100, 101 AND 107).

THE MARK CONSISTS OF THE STYLIZED WORDS "LEGEND OF YULONG".

PRIORITY DATE OF 8-2-2011 IS CLAIMED.

OWNER OF INTERNATIONAL REGISTRATION 1105412 DATED 10-26-2011, EXPIRES 10-  
26-2021.

SER. NO. 79-108,641, FILED 10-26-2011.

KRISTINA MORRIS, EXAMINING ATTORNEY



*David J. Kyros*

Director of the United States Patent and Trademark Office

# United States of America

United States Patent and Trademark Office

# KONECRANES

**Reg. No. 4,273,896**

**Registered Jan. 15, 2013**

**Int. Cls.: 7, 9, 12, 35, 37  
and 41**

**TRADEMARK**

**SERVICE MARK**

**PRINCIPAL REGISTER**

KONECRANES PLC (FINLAND PUBLIC LIMITED COMPANY)  
KONEENKATU 8  
HYVINKÄÄ, FINLAND FI05830

FOR: MACHINES AND POWERED MACHINE TOOLS FOR LIFTING INDUSTRIAL EQUIPMENT, MANUFACTURING EQUIPMENT, CONSTRUCTION EQUIPMENT, MINING EQUIPMENT, FREIGHT, SHIPPING CONTAINERS, BULK MATERIALS, AGGREGATES, AND THE LIKE; MOTORS AND ENGINES EXCEPT FOR LAND VEHICLES; MACHINE COUPLING AND TRANSMISSION COMPONENTS EXCEPT FOR LAND VEHICLES; HOISTS AND CRANES; MACHINES THAT ALLOW THE OPERATOR TO PICK, LIFT, MOVE AND PLACE ITEMS BY HAND, NAMELY, LOAD MANIPULATORS; UNLOADING CRANES, NAMELY, GRAB UNLOADERS; RUBBER TIRED GANTRY CRANES, RAIL MOUNTED GANTRY CRANES, STRADDLE CARRIERS, AUTOMATED STACKING CRANES, SHIP-TO-SHORE GANTRY CRANES, GOLIATH GANTRY CRANES, JIB CRANES, SHIPBOARD GANTRY CRANES; STACKING MACHINES, NAMELY, EMPTY CONTAINER HANDLERS FOR STACKING AND MOVING EMPTY SHIPPING CONTAINERS AND FREIGHT CONTAINERS; MOTORS, DRIVES, TRANSMISSION COMPONENTS, GEARS AND END CARRIAGES FOR CRANES, HOISTS AND LIFTING EQUIPMENT; HOOKS AND FORKS FOR CRANES AND HOISTS; METAL FRAMES BEING PARTS OF HOISTS AND CRANES; BRAKE COMPONENTS FOR CRANES AND HOISTS, IN CLASS 7 (U.S. CLS. 13, 19, 21, 23, 31, 34 AND 35).



*David J. Kyffers*

Director of the United States Patent and Trademark Office

FOR: APPARATUS AND INSTRUMENTS FOR CONDUCTING, SWITCHING, TRANSFORMING, ACCUMULATING, REGULATING OR CONTROLLING ELECTRICITY; APPARATUS FOR RECORDING, TRANSMISSION OR REPRODUCTION OF SOUND OR IMAGES; AUTOMATIC VENDING MACHINES AND MECHANISMS FOR COIN-OPERATED APPARATUS; CASH REGISTERS, CALCULATING MACHINES, DATA PROCESSING EQUIPMENT AND COMPUTERS; FIRE-EXTINGUISHING APPARATUS; ELECTRONIC REMOTE AND SPEED CONTROLS FOR CRANES, HOISTS AND LIFTING EQUIPMENT; ELECTRONIC INSTRUMENTS FOR MEASURING LOAD CAPACITY OF CRANES, HOISTS AND LIFTING EQUIPMENT; ELECTRONIC INSTRUMENTS FOR MEASURING THE OPERATING LIFE-CYCLE OF CRANES, HOISTS AND LIFTING EQUIPMENT; ELECTRICAL SWITCHES FOR CRANES, HOISTS AND LIFTING EQUIPMENT; ENCODED MAGNETIC CARDS FOR USE AS DATA CARRIERS, NAMELY, MEMORY CARDS; ELECTRONIC CIRCUIT CARDS; COMPUTER SOFTWARE FOR CONTROLLING AND MONITORING CRANES, HOISTS AND LIFTING EQUIPMENT; COMPUTER SOFTWARE FOR THE OPERATIONAL MANAGEMENT OF ELECTRONIC CARDS; COMPUTER SOFTWARE AND DATA PROCESSING EQUIPMENT

**Reg. No. 4,273,896** FOR CONTAINER HANDLING; POWER SUPPLIES AND BATTERIES FOR CRANES, HOISTS AND LIFTING EQUIPMENT; DOWNLOADABLE ELECTRONIC INSTRUCTION MANUALS IN THE FIELD OF USING AND OPERATING CRANES, HOISTS AND LIFTING EQUIPMENT; COMPUTER SOFTWARE FOR CONTAINER POSITIONING AND GANTRY CRANE STEERING; ELECTRONIC DISTANCE MEASURING APPARATUS; COMPUTER SOFTWARE FOR DISTANCE MEASURING, IN CLASS 9 (U.S. CLS. 21, 23, 26, 36 AND 38).

FOR: LAND VEHICLES; TRUCKS, NAMELY, LIFT TRUCKS, FORKLIFT TRUCKS, REACH STACKERS, GANTRY TRUCKS, LOADING TRUCKS, AND MOTORIZED VEHICLES, NAMELY, WHEELED CARRIERS FOR TRANSPORTING CARGO, IN CLASS 12 (U.S. CLS. 19, 21, 23, 31, 35 AND 44).

FOR: ADVERTISING; BUSINESS MANAGEMENT; BUSINESS ADMINISTRATION; OFFICE FUNCTIONS; PROCESSING OF DATA RELATING TO CRANES, HOISTS, MACHINE TOOLS AND LIFTING EQUIPMENT; COMPILATION, COLLATING AND SYSTEMATIZATION OF DATA RELATING TO CRANES, HOISTS, MACHINE TOOLS AND LIFTING EQUIPMENT IN COMPUTER DATABASES; COMPUTERIZED DATA PROCESSING AND MANAGEMENT RELATING TO CRANES, HOISTS, MACHINE TOOLS AND LIFTING EQUIPMENT; PROVISION OF COMPUTERIZED BUSINESS STATISTICS RELATING TO CRANES, HOISTS, MACHINE TOOLS AND LIFTING EQUIPMENT, IN CLASS 35 (U.S. CLS. 100, 101 AND 102).

FOR: BUILDING CONSTRUCTION; INSTALLATION, MAINTENANCE AND REPAIR OF CRANES, HOISTS, MACHINE TOOLS AND LIFTING EQUIPMENT; CONSULTATION RELATING TO INSTALLATION, MAINTENANCE AND REPAIR OF CRANES, HOISTS, MACHINE TOOLS AND LIFTING EQUIPMENT; INSPECTION OF CRANES, HOISTS, MACHINE TOOLS AND LIFTING EQUIPMENT PRIOR TO MAINTENANCE; REMOTE DIAGNOSIS SERVICES FOR ASCERTAINING THE CAUSE OF MALFUNCTIONS IN CRANES, HOISTS, MACHINE TOOLS AND LIFTING EQUIPMENT PRIOR TO MAINTENANCE AND REPAIR; REMOTE DIAGNOSIS SERVICES FOR MONITORING THE CONDITION AND FUNCTION OF CRANES, HOISTS, MACHINE TOOLS AND LIFTING EQUIPMENT PRIOR TO MAINTENANCE AND REPAIR, IN CLASS 37 (U.S. CLS. 100, 103 AND 106).

FOR: EDUCATIONAL SERVICES, NAMELY, PROVIDING CLASSES AND WORKSHOPS IN THE USE OF CRANES, HOISTS, MACHINE TOOLS AND LIFTING EQUIPMENT; TRAINING IN THE USE OF CRANES, HOISTS, MACHINE TOOLS AND LIFTING EQUIPMENT; TRAINING FOR HARBOR OPERATORS AND OPERATORS OF CRANES, HOISTS, MACHINE TOOLS AND LIFTING EQUIPMENT, IN CLASS 41 (U.S. CLS. 100, 101 AND 107).

OWNER OF U.S. REG. NOS. 2,041,645, 3,689,455, AND 3,689,458.

OWNER OF INTERNATIONAL REGISTRATION 1105506 DATED 9-2-2011, EXPIRES 9-2-2021.

SER. NO. 79-108,671, FILED 9-2-2011.

KRISTINA MORRIS, EXAMINING ATTORNEY

# United States of America

United States Patent and Trademark Office

# AKITA

**Reg. No. 4,273,897**

**Registered Jan. 15, 2013**

**Int. Cl.: 10**

**TRADEMARK**

**PRINCIPAL REGISTER**

ACTIVAERO GMBH (FED REP GERMANY GMBH)  
WOHRAER STR. 37  
35285 GEMÜNDEN  
FED REP GERMANY

FOR: MEDICAL INHALERS, IN CLASS 10 (U.S. CLS. 26, 39 AND 44).

THE MARK CONSISTS OF STANDARD CHARACTERS WITHOUT CLAIM TO ANY PARTICULAR FONT, STYLE, SIZE, OR COLOR.

OWNER OF INTERNATIONAL REGISTRATION 1105614 DATED 1-9-2012, EXPIRES 1-9-2022.

SER. NO. 79-108,725, FILED 1-9-2012.

SARA BENJAMIN, EXAMINING ATTORNEY



*David J. Kybas*

Director of the United States Patent and Trademark Office

# United States of America

United States Patent and Trademark Office

# PROTECHT

**Reg. No. 4,273,898**

**Registered Jan. 15, 2013**

**Int. Cls.: 5 and 10**

PROTECHT SOLUTIONS PTY LTD (AUSTRALIA PROPRIETARY LIMITED COMPANY  
(PTY LTD))  
5 MILLENIUM COURT  
SILVERWATER NSW 2128  
AUSTRALIA

**TRADEMARK**

**PRINCIPAL REGISTER**

FOR: SANITARY PREPARATIONS FOR MEDICAL PURPOSES; MEDICAL PLASTERS; SANITARY UNDERCLOTHING IN THE NATURE OF INCONTINENCE GARMENTS, NAMELY, SANITARY BRIEFS, SANITARY KNICKERS, SANITARY PANTIES, SANITARY PANTS; MASKING MATERIALS FOR MEDICAL USE, NAMELY, MEDICAL ADHESIVE TAPES, IN CLASS 5 (U.S. CLS. 6, 18, 44, 46, 51 AND 52).

FOR: ARTICLES OF CLOTHING IN THIS CLASS INCLUDING DISPOSABLE CLOTHING AND CLOTHING COVERS OR PROTECTORS, NAMELY, MEDICAL GOWNS, PATIENT EXAMINATION GOWNS, SURGICAL GOWNS; GLOVES IN THIS CLASS, NAMELY, DENTAL GLOVES, GLOVES FOR MASSAGE, GLOVES FOR MEDICAL PURPOSES, GLOVES FOR MEDICAL USE, GLOVES FOR USE IN HOSPITALS, LATEX MEDICAL GLOVES, MEDICAL EXAMINATION GLOVES, MEDICAL GLOVES, NITRITE GLOVES FOR MEDICAL USE, PROTECTIVE GLOVES FOR MEDICAL USE, SURGICAL GLOVES; MASKS, NAMELY, FACE MASKS FOR USE BY HEALTH CARE PROVIDERS, FACE MASKS FOR USE BY DENTAL CARE PROVIDERS, MASKS FOR USE BY MEDICAL PERSONNEL, SANITARY MASKS FOR DUST PREVENTION FOR MEDICAL PURPOSES, SANITARY MASKS FOR DUST ISOLATION FOR MEDICAL PURPOSES, SANITARY MASKS FOR DUST ISOLATION FOR MEDICAL PURPOSES, SANITARY MASKS FOR FUNGUS ISOLATION PURPOSES, SANITARY MASKS FOR GERM ISOLATION PURPOSES, SANITARY MASKS FOR MEDICAL WELLNESS PURPOSES, SANITARY MASKS FOR MEDICAL PURPOSES, SANITARY MASKS FOR POLLEN ISOLATION PURPOSES, SANITARY MASKS FOR VIRUS ISOLATION PURPOSES, SURGICAL MASKS, IN CLASS 10 (U.S. CLS. 26, 39 AND 44).



THE MARK CONSISTS OF STANDARD CHARACTERS WITHOUT CLAIM TO ANY PARTICULAR FONT, STYLE, SIZE, OR COLOR.

OWNER OF INTERNATIONAL REGISTRATION 1105621 DATED 9-15-2011, EXPIRES 9-15-2021.

THE WORDING "PROTECHT" HAS NO MEANING IN A FOREIGN LANGUAGE.

*David J. Kyffers*

Director of the United States Patent and Trademark Office

**Reg. No. 4,273,898** SER. NO. 79-108,728, FILED 9-15-2011.

CARYN GLASSER, EXAMINING ATTORNEY

# United States of America

United States Patent and Trademark Office

# FILAVAC

**Reg. No. 4,273,899**

**Registered Jan. 15, 2013**

**Int. Cls.: 5 and 42**

**TRADEMARK**

**SERVICE MARK**

**PRINCIPAL REGISTER**

FILAVIE (FRANCE SOCIÉTÉ PAR ACTIONS SIMPLIFIÉE)  
LA CORBIÈRE  
F-49450 ROUSSAY  
FRANCE

FOR: SANITARY PRODUCTS FOR MEDICAL PURPOSES, AUTOVACCINES, VACCINES, BACTERIAL AND BACTERIOLOGICAL PREPARATIONS FOR MEDICAL OR VETERINARY USE, IN CLASS 5 (U.S. CLS. 6, 18, 44, 46, 51 AND 52).

FOR: BIOLOGICAL RESEARCH, RESEARCH IN THE FIELDS OF BACTERIOLOGY AND CHEMISTRY, CHEMICAL ANALYSES, IN CLASS 42 (U.S. CLS. 100 AND 101).

THE MARK CONSISTS OF STANDARD CHARACTERS WITHOUT CLAIM TO ANY PARTICULAR FONT, STYLE, SIZE, OR COLOR.

PRIORITY DATE OF 6-1-2011 IS CLAIMED.

OWNER OF INTERNATIONAL REGISTRATION 1105684 DATED 11-30-2011, EXPIRES 11-30-2021.

THE WORDING "FILAVAC" OR "FILA" HAS NO MEANING IN A FOREIGN LANGUAGE.

SER. NO. 79-108,754, FILED 11-30-2011.

KELLEY WELLS, EXAMINING ATTORNEY



*David J. Kyffers*

Director of the United States Patent and Trademark Office



# United States of America

United States Patent and Trademark Office

## GUSTAVE LORENTZ

**Reg. No. 4,273,900**

**Registered Jan. 15, 2013**

**Int. Cl.: 33**

GUSTAVE LORENTZ; (SOCIÉTÉ PAR ACTIONS SIMPLIFIÉE) (FRANCE SOCIÉTÉ PAR ACTIONS SIMPLIFIÉE)  
91 RUE DES VIGNERONS  
F-68750 BERGHEIM  
FRANCE

**TRADEMARK**

**PRINCIPAL REGISTER**

FOR: ALCOHOLIC BEVERAGES, EXCEPT BEER, IN CLASS 33 (U.S. CLS. 47 AND 49).

THE MARK CONSISTS OF STANDARD CHARACTERS WITHOUT CLAIM TO ANY PARTICULAR FONT, STYLE, SIZE, OR COLOR.

PRIORITY DATE OF 6-20-2011 IS CLAIMED.

OWNER OF INTERNATIONAL REGISTRATION 1106006 DATED 12-19-2011, EXPIRES 12-19-2021.

THE NAME(S), PORTRAIT(S), AND/OR SIGNATURE(S) SHOWN IN THE MARK DOES NOT IDENTIFY A PARTICULAR LIVING INDIVIDUAL.

SER. NO. 79-108,875, FILED 12-19-2011.

JACQUELINE A. LAVINE, EXAMINING ATTORNEY



*David J. Kyffers*

Director of the United States Patent and Trademark Office

# United States of America

United States Patent and Trademark Office



**Reg. No. 4,273,901**

**Registered Jan. 15, 2013**

**Int. Cl.: 30**

**TRADEMARK**

**PRINCIPAL REGISTER**

SHANDONG BAILONG CHUANGYUAN; BIOTECHNOLOGY CO., LTD. (CHINA CORPORATION)

DEXIN STREET

HIGH TECHNOLOGY DEVELOPMENT ZONE,; YUCHENG CITY; SHANDONG PROVINCE CHINA

FOR: FARINACEOUS FOOD PASTES FOR HUMAN CONSUMPTION, IN CLASS 30 (U.S. CL. 46).

THE MARK CONSISTS OF TWO CHINESE CHARACTERS FOLLOWED BY THE DESIGN OF A DRAGON'S HEAD FORMING A LETTER "B", ALL APPEARING ABOVE THE WORDING "QIANSHOU".

OWNER OF INTERNATIONAL REGISTRATION 1106126 DATED 1-15-2012, EXPIRES 1-15-2022.

THE NON-LATIN CHARACTERS IN THE MARK TRANSLITERATE TO "QIANSHOU" AND THIS HAS NO MEANING IN A FOREIGN LANGUAGE.

SER. NO. 79-108,904, FILED 1-15-2012.

JENNIFER MARTIN, EXAMINING ATTORNEY



*David J. Kyffers*

Director of the United States Patent and Trademark Office

# United States of America

United States Patent and Trademark Office

# VOLFONI

**Reg. No. 4,273,902**

**Registered Jan. 15, 2013**

**Int. Cls.: 9 and 42**

**TRADEMARK**

**SERVICE MARK**

**PRINCIPAL REGISTER**

VOLFONI (FRANCE SOCIÉTÉ PAR ACTIONS SIMPLIFIÉE)  
49 AVENUE PIERRE GRENIER  
F-92100 BOULOGNE BILLANCOURT  
FRANCE

FOR: SPECTACLES; ANTI-GLARE GLASSES; GOGGLES FOR SPORTS; SUNGLASSES; OPTICAL GOODS, NAMELY, SPECTACLES GLASSES, BINOCULARS, OPTICAL LENSES, TELESCOPES, OPTICAL MAGNIFYING GLASSES; OPTICAL APPARATUS AND INSTRUMENTS, NAMELY, SPECTACLE GLASSES; CONTACT LENSES; CORRECTING OPTICAL LENSES; GLASS COVERED WITH AN ELECTRICAL CONDUCTOR; SPECTACLE FRAMES; CASES FOR CONTACT LENSES; SPECTACLE CASES; OPTICAL LENSES; TELESCOPES; MAGNIFYING GLASSES; ALIDADES; INSTRUMENTS CONTAINING EYEPIECES, NAMELY, SPECTACLES GLASSES, BINOCULARS, OPTICAL LENSES, TELESCOPES, OPTICAL MAGNIFYING GLASSES; SURVEYORS' LEVELS; DIVERS' MASKS; PROTECTIVE MASKS; MICROSCOPES; OBSERVATION INSTRUMENTS, NAMELY, BINOCULARS, OPTICAL LENSES, TELESCOPES; CAMERAS; VIEWFINDERS; PROJECTION APPARATUS, NAMELY, PROJECTION SCREENS; MEASURING GLASSWARE; PROJECTION SCREENS; FLUORESCENT PHOTOGRAPHY SCREENS; WORKMEN'S PROTECTIVE FACE-SHIELDS; VIDEO SCREENS; FIBER OPTIC CABLES; APPARATUS FOR RECORDING, TRANSMITTING, REPRODUCING OR PROCESSING SOUND OR IMAGES; DATA PROCESSING EQUIPMENT AND COMPUTERS; COMPUTER SOFTWARE FOR THREE-DIMENSIONAL IMAGE MODELING; COMPUTER GAME PROGRAMS; AUDIO AND VIDEO RECORDINGS FEATURING INFORMATION WITH RESPECT TO COMPUTING; COMPUTER MEMORIES; COMPUTER PERIPHERAL DEVICES; COMPUTERS; AUDIOVISUAL GAMES DESIGNED FOR USE WITH A TELEVISION ONLY; FILM PROJECTION APPARATUS, NAMELY, PROJECTION SCREENS; SOUND RECORDING DISCS; BLANK VIDEO CASSETTES, BLANK LASER DISKS, BLANK OPTICAL DISKS; HOLOGRAMS; TRANSPARENCIES; VIDEO CAMERAS; MOVIE CAMERAS; PORTABLE TELEPHONES; TELEVISIONS; VIDEO TELEPHONES; MICROMETER SCREWS FOR OPTICAL INSTRUMENTS; EXPOSED FILMS; AMPLIFIERS; AUDIOVISUAL TEACHING APPARATUS, NAMELY, OVERHEAD PROJECTORS; HEADPHONES; SLIDE PROJECTORS; VIDEO SCREENS; OPTICAL CHARACTER READERS, IN CLASS 9 (U.S. CLS. 21, 23, 26, 36 AND 38).



*David J. Kyffers*

Director of the United States Patent and Trademark Office

FOR: DESIGN AND DEVELOPMENT OF COMPUTERS AND SOFTWARE; RESEARCH IN THE FIELD OF THREE-DIMENSIONAL TECHNOLOGY AND THREE-DIMENSIONAL IMAGERY; DESIGN AND DEVELOPMENT IN THE FIELD OF THREE-DIMENSIONAL ENGINEERING; RESEARCH IN THE FIELD OF DIGITAL TECHNOLOGY; RESEARCH AND DE-

**Reg. No. 4,273,902** DEVELOPMENT FOR OTHERS; DEVELOPMENT (DESIGN), INSTALLATION, MAINTENANCE, UPDATING OR RENTAL OF SOFTWARE; CONSULTANCY IN THE FIELD OF COMPUTER HARDWARE AND SOFTWARE; SURVEYING; INSTALLATION OF COMPUTER SOFTWARE; RENTAL OF COMPUTER SOFTWARE; COMPUTER SOFTWARE CONSULTANCY; DEVELOPMENT (DESIGN) OF SOFTWARE AND PARTICULARLY OF THREE-DIMENSIONAL IMAGE MODELING SOFTWARE, IN CLASS 42 (U.S. CLS. 100 AND 101).

THE MARK CONSISTS OF STANDARD CHARACTERS WITHOUT CLAIM TO ANY PARTICULAR FONT, STYLE, SIZE, OR COLOR.

PRIORITY DATE OF 7-8-2011 IS CLAIMED.

OWNER OF INTERNATIONAL REGISTRATION 1106313 DATED 12-14-2011, EXPIRES 12-14-2021.

OWNER OF U.S. REG. NO. 3,983,714.

THE WORDING "VOLFONI" HAS NO MEANING IN A FOREIGN LANGUAGE.

SER. NO. 79-108,971, FILED 12-14-2011.

JACQUELINE A. LAVINE, EXAMINING ATTORNEY

# United States of America

United States Patent and Trademark Office

## REAL LIFE THINKING

**Reg. No. 4,273,903**

**Registered Jan. 15, 2013**

**Int. Cl.: 35**

**SERVICE MARK**

**PRINCIPAL REGISTER**

BVA (FRANCE SOCIÉTÉ PAR ACTIONS SIMPLIFIÉE)  
75 RUE SAINT-JEAN  
F-31130 BALMA  
FRANCE

FOR: ADVERTISING, DISSEMINATION OF ADVERTISING MATTER, DEMONSTRATION OF GOODS, DIRECT MAIL ADVERTISING, NAMELY, THE DIRECT MAILING OF TRACTS, PROSPECTUSES, PRINTED MATTER AND SAMPLES; UPDATING OF ADVERTISING MATERIAL, PUBLICATION OF PUBLICITY TEXTS, ON-LINE ADVERTISING ON A COMPUTER NETWORK, RENTAL OF ADVERTISING TIME ON COMMUNICATION MEDIA; BUSINESS MANAGEMENT AND ORGANIZATION CONSULTANCY; BUSINESS APPRAISALS AND EVALUATIONS IN BUSINESS MATTERS; BUSINESS MANAGEMENT; BUSINESS ADMINISTRATION; COST-PRICE ANALYSIS, MARKETING STUDIES, MARKETING OPINION POLLING, BEHAVIOURAL STUDIES OF CONSUMERS FOR MARKETING PURPOSES, NAMELY, CONDUCTING CONSUMER TRACKING BEHAVIOR RESEARCH AND CONSUMER TREND ANALYSIS, ECONOMIC FORECASTING; ARRANGING EXHIBITIONS FOR COMMERCIAL OR ADVERTISING PURPOSES, COMPILATION AND SYSTEMIZATION OF DATA INTO COMPUTER DATABASES, COMPUTER FILE MANAGEMENT, STATISTICAL INFORMATION FOR BUSINESS PURPOSES, ACCOUNTING, OFFICE FUNCTIONS; ARRANGING NEWSPAPER SUBSCRIPTIONS FOR OTHERS, IN CLASS 35 (U.S. CLS. 100, 101 AND 102).

THE MARK CONSISTS OF STANDARD CHARACTERS WITHOUT CLAIM TO ANY PARTICULAR FONT, STYLE, SIZE, OR COLOR.

PRIORITY DATE OF 5-26-2011 IS CLAIMED.

OWNER OF INTERNATIONAL REGISTRATION 1106342 DATED 11-25-2011, EXPIRES 11-25-2021.

SER. NO. 79-108,980, FILED 11-25-2011.

EUGENIA MARTIN, EXAMINING ATTORNEY



*David J. Kyffers*

Director of the United States Patent and Trademark Office

# United States of America

United States Patent and Trademark Office

# STORZ

## KARL STORZ—SOLUTIONS

**Reg. No. 4,273,904**

**Registered Jan. 15, 2013**

**Int. Cls.: 35, 36, 37, 38,  
39, 41 and 44**

**SERVICE MARK**

**PRINCIPAL REGISTER**

KARL STORZ GMBH & CO. KG (FED REP GERMANY GMBH & CO. KG)  
MITTELSTRASSE 8  
78532 TUTTLINGEN  
FED REP GERMANY

FOR: ADVERTISING SERVICES; ADVERTISING CONSULTANCY, NONE OF THE FOREGOING DIRECTED TO GOODS AND SERVICES IN THE OPHTHALMIC FIELD, IN CLASS 35 (U.S. CLS. 100, 101 AND 102).

FOR: INSURANCE UNDERWRITING FOR ALL TYPES OF INSURANCE; INSURANCE CONSULTATION; FINANCIAL AND MONETARY AFFAIRS, NAMELY, PROVIDING FINANCIAL INFORMATION, MANAGEMENT, AND ANALYSIS SERVICES; REAL ESTATE AFFAIRS, NAMELY, PROVIDING CONSULTING IN THE FIELD OF REAL ESTATE, NONE OF THE FOREGOING DIRECTED TO GOODS AND SERVICES IN THE OPHTHALMIC FIELD, IN CLASS 36 (U.S. CLS. 100, 101 AND 102).

FOR: REPAIR AND MAINTENANCE OF MEDICAL INSTRUMENTS AND APPARATUS IN THE FIELD OF MEDICAL TECHNOLOGY; INSTALLATION, REPAIR AND MAINTENANCE OF COMPUTER HARDWARE, NONE OF THE FOREGOING DIRECTED TO GOODS AND SERVICES IN THE OPHTHALMIC FIELD, IN CLASS 37 (U.S. CLS. 100, 103 AND 106).

FOR: TRANSMISSION OF INFORMATION OF ALL KINDS IN ELECTRONIC MEDIA, NAMELY, TRANSMISSION OF INFORMATION VIA THE INTERNET; PROVIDING ACCESS TO INFORMATION VIA PROVISION OF INTERNET ACCESS; COMMUNICATION AND TRANSMISSION OF INFORMATION BY MEANS OF COMPUTER, NONE OF THE FOREGOING DIRECTED TO GOODS AND SERVICES IN THE OPHTHALMIC FIELD, IN CLASS 38 (U.S. CLS. 100, 101 AND 104).

FOR: STORAGE AND TRANSPORT OF SURGICAL AND MEDICAL INSTRUMENTS AND APPARATUS, NONE OF THE FOREGOING DIRECTED TO GOODS AND SERVICES IN THE OPHTHALMIC FIELD, IN CLASS 39 (U.S. CLS. 100 AND 105).

FOR: PUBLICATION OF PRINTED MATTER OTHER THAN PUBLICITY TEXTS; PUBLICATION OF ELECTRONIC MEDIA, NAMELY, ELECTRONIC PUBLICATIONS OTHER THAN PUBLICITY TEXTS, NONE OF THE FOREGOING DIRECTED TO GOODS AND SERVICES IN THE OPHTHALMIC FIELD, IN CLASS 41 (U.S. CLS. 100, 101 AND 107).



*David J. Kybas*

Director of the United States Patent and Trademark Office

**Reg. No. 4,273,904** FOR: MEDICAL AND VETERINARY SERVICES, NAMELY, LOAN SERVICE AND RENTAL OF MEDICAL AND VETERINARY INSTRUMENTS AND APPARATUS; MEDICAL CONSULTANCY IN THE OPERATION OF MEDICAL AND VETERINARY INSTRUMENTS AND APPARATUS; MEDICAL AND VETERINARY PRACTICE CONSULTING, NONE OF THE FOREGOING DIRECTED TO GOODS AND SERVICES IN THE OPHTHALMIC FIELD, IN CLASS 44 (U.S. CLS. 100 AND 101).

OWNER OF U.S. REG. NOS. 1,181,498, 3,705,458 AND OTHERS.

PRIORITY DATE OF 6-1-2011 IS CLAIMED.

OWNER OF INTERNATIONAL REGISTRATION 1106411 DATED 12-1-2011, EXPIRES 12-1-2021.

NO CLAIM IS MADE TO THE EXCLUSIVE RIGHT TO USE "SOLUTIONS", APART FROM THE MARK AS SHOWN.

THE NAME(S), PORTRAIT(S), AND/OR SIGNATURE(S) SHOWN IN THE MARK DOES NOT IDENTIFY A PARTICULAR LIVING INDIVIDUAL.

THE MARK CONSISTS OF THE STYLIZED WORDING "STORZ KARL STORZ - SOLUTIONS" WITH THE FIRST WORDING "STORZ" LARGE IN RELATION TO THE OTHER WORDING WITH A TARGET LIKE DESIGN MAKING UP THE LETTER "O" AND THE "OR" PORTION SHADED. THE "O" IN "SOLUTIONS" ALSO CONTAINS AN INNER CIRCLE WHICH MAKES THE LETTER RESEMBLE A TARGET DESIGN.

SER. NO. 79-108,998, FILED 12-1-2011.

DANIEL CAPSHAW, EXAMINING ATTORNEY

# United States of America

United States Patent and Trademark Office

# sailfish

**Reg. No. 4,273,905**

**Registered Jan. 15, 2013**

**Int. Cl.: 25**

**TRADEMARK**

**PRINCIPAL REGISTER**

SAILFISH GMBH (FED REP GERMANY GMBH (LIMITED LIABILITY COMPANY))  
GOETHESTR. 5  
PFUNGSTADT 64319, FED REP GERMANY

FOR: CLOTHING, NAMELY, SWIMWEAR AND NEOPRENE WETSUITS, HEADWEAR, FOOTWEAR, SWIMMING CAPS, AND NEOPRENE TOE PROTECTORS IN THE NATURE OF TOE CAPS, IN CLASS 25 (U.S. CLS. 22 AND 39).

THE MARK CONSISTS OF STANDARD CHARACTERS WITHOUT CLAIM TO ANY PARTICULAR FONT, STYLE, SIZE, OR COLOR.

PRIORITY DATE OF 3-29-2011 IS CLAIMED.

OWNER OF INTERNATIONAL REGISTRATION 1106619 DATED 9-20-2011, EXPIRES 9-20-2021.

OWNER OF U.S. REG. NO. 4,064,225.

SER. NO. 79-109,085, FILED 9-20-2011.

STEVEN PEREZ, EXAMINING ATTORNEY



*David J. Kyfos*

Director of the United States Patent and Trademark Office



# United States of America

United States Patent and Trademark Office



**Reg. No. 4,273,906**

**Registered Jan. 15, 2013**

**Int. Cls.: 9 and 42**

**TRADEMARK**

**SERVICE MARK**

**PRINCIPAL REGISTER**

SIMPOE (FRANCE SOCIÉTÉ PAR ACTIONS SIMPLIFIÉE)  
1 ALLÉE EMILE COHL  
F-77200 TORCY  
FRANCE

FOR: COMPUTER SOFTWARE FOR DATABASE MANAGEMENT, FOR SIMULATION OF MANUFACTURING PROCESSES, FOR MANAGEMENT OF BUSINESS PROJECTS AND BUSINESS PROCESSES, AND FOR MANAGEMENT OF MANUFACTURING DATA, IN CLASS 9 (U.S. CLS. 21, 23, 26, 36 AND 38).

FOR: COMPUTER SOFTWARE DEVELOPMENT, COMPUTER SOFTWARE DESIGN, CONSULTING ON COMPUTER SOFTWARE, RENTAL OF COMPUTER SOFTWARE, UPDATING OF COMPUTER SOFTWARE, MAINTENANCE OF COMPUTER SOFTWARE, IN CLASS 42 (U.S. CLS. 100 AND 101).

THE MARK CONSISTS OF THE WORD "SIMPOE" IN BLUE LETTERING TO THE RIGHT OF A DESIGN OF A BLACK CIRCLE WITH A TRIANGLE WITHIN IT. THE TRIANGLE IS COMPOSED OF THREE SMALLER FIGURES WITH AN OVERALL TRIANGULAR SHAPE WITH THE TOP ONE IN YELLOW, THE LEFT ONE IN BLUE AND THE RIGHT ONE IN RED.

PRIORITY DATE OF 6-6-2011 IS CLAIMED.

OWNER OF INTERNATIONAL REGISTRATION 1106768 DATED 12-6-2011, EXPIRES 12-6-2021.

THE COLOR(S) BLUE, RED, YELLOW AND BLACK IS/ARE CLAIMED AS A FEATURE OF THE MARK.

THE WORDING "SIMPOE" HAS NO MEANING IN A FOREIGN LANGUAGE.

SER. NO. 79-109,132, FILED 12-6-2011.

MATTHEW MCDOWELL, EXAMINING ATTORNEY



*David J. Kyros*

Director of the United States Patent and Trademark Office

# United States of America

United States Patent and Trademark Office



**Reg. No. 4,273,907**

INFRONT MOTOR SPORTS LICENCE S.R.L. (ITALY LIMITED LIABILITY COMPANY)  
VIA VITO GIUSEPPE GALATI, 100/E  
I-00155 ROMA, ITALY

**Registered Jan. 15, 2013**

**Int. Cl.: 41**

FOR: EDUCATIONAL SERVICES, NAMELY, PROVIDING CLASSES, SEMINARS, WORKSHOPS IN THE FIELD OF MOTOR SPORTS RACING; PROVIDING TRAINING IN THE FIELD OF MOTOR SPORTS RACING; ENTERTAINMENT IN THE NATURE OF MOTOR SPORTS RACING; ARRANGING, ORGANIZING AND STAGING OF MOTOR SPORTS RACING EVENTS, IN CLASS 41 (U.S. CLS. 100, 101 AND 107).

**SERVICE MARK**

**PRINCIPAL REGISTER**

OWNER OF U.S. REG. NOS. 3,476,636, 4,111,243 AND OTHERS.

PRIORITY DATE OF 11-4-2011 IS CLAIMED.

OWNER OF INTERNATIONAL REGISTRATION 1106839 DATED 12-6-2011, EXPIRES 12-6-2021.

THE COLOR(S) LIGHT GREY, DARK GREY, RED, BLACK, AND DARK RED IS/ARE CLAIMED AS A FEATURE OF THE MARK.

NO CLAIM IS MADE TO THE EXCLUSIVE RIGHT TO USE "SUPERPOLE", APART FROM THE MARK AS SHOWN.



THE MARK CONSISTS OF THE WORDING "SBK" WRITTEN IN LIGHT GREY CAPITAL LETTERS ON THE TOP AND DARK GREY AT THE BOTTOM, THE TWO PARTS BEING SEPARATED BY A CURVE; A STYLIZED CHEVRONS TO THE RIGHT OF THE LETTER "K" IS IN RED, DARK RED, AND BLACK; THE WORD "SUPERPOLE" IS WRITTEN IN CAPITAL LETTERS, THE WORD "SUPER" IS WRITTEN IN DARK GREY AND THE WORD "POLE" IS WRITTEN IN RED.

SEC. 2(F) AS TO "SBK" .

SER. NO. 79-109,162, FILED 12-6-2011.

MATTHEW EINSTEIN, EXAMINING ATTORNEY

*David J. Kyffers*

Director of the United States Patent and Trademark Office

# United States of America

United States Patent and Trademark Office



**Reg. No. 4,273,908**

**Registered Jan. 15, 2013**

**Int. Cls.: 9, 25, 35 and 42**

**TRADEMARK**

**SERVICE MARK**

**PRINCIPAL REGISTER**

ZAPPAR LTD (UNITED KINGDOM LIMITED COMPANY)  
20 FORTH STREET  
EDINBURGH EH1 3LH  
UNITED KINGDOM

FOR: COMPUTER SOFTWARE USING IMAGE RECOGNITION AND/OR AUGMENTED REALITY TECHNOLOGY FOR USE WITH MOBILE PHONES, TABLETS AND HANDHELD GAMING DEVICES FOR BROWSING, SEARCHING AND CONTENT DELIVERY, IN CLASS 9 (U.S. CLS. 21, 23, 26, 36 AND 38).

FOR: CLOTHING, NAMELY, COATS, OVERCOATS, SPORTS COATS, RAINCOATS, SUITS, JACKETS, TROUSERS, PANTS, JEANS, SHORTS, SHIRTS, T-SHIRTS, POLO SHIRTS, TOPS, TANK TOPS, PULLOVERS, SWEATERS, JERSEYS, CARDIGANS, SWEATSHIRTS, JUMPERS, FLEECE, FLEECE PULLOVERS, DRESSES, BLOUSES, SKIRTS, OVERALLS, BELTS, SUSPENDERS, UNDERWEAR, VESTS, DINNER JACKETS, TIES, CRAVATS, ROBES, AND PAJAMAS, FOOTWEAR, AND HEADGEAR, NAMELY, HATS AND CAPS, IN CLASS 25 (U.S. CLS. 22 AND 39).

FOR: PROVISION OF DATA ANALYTICS AND EVALUATION REPORTS IN THE FIELD OF BUSINESS BASED ON THE USE OF IMAGE RECOGNITION TECHNOLOGY, IN CLASS 35 (U.S. CLS. 100, 101 AND 102).

FOR: APPLICATION SERVICE PROVIDER (ASP) SERVICES FEATURING SOFTWARE FOR USE IN CONNECTION WITH VISION BASED AND/OR AUGMENTED REALITY TECHNOLOGY THAT ENABLES USERS TO ACCESS AUDIO, VIDEO, TEXT AND MULTIMEDIA CONTENT FROM HANDHELD DEVICES, IN CLASS 42 (U.S. CLS. 100 AND 101).



THE MARK CONSISTS OF A VERTICAL ZIGZAG LINE RESEMBLING A LIGHTNING BOLT SUPERIMPOSED OVER A SHADED CIRCLE, ALL SHOWN CENTERED OVER A SHADED SQUARE HAVING ROUNDED CORNERS, WITH THE LOWER HALF OF THE SQUARE, THE CIRCLE AND THE LIGHTNING BOLT ALL HAVING MORE SHADING THAN THE UPPER HALVES OF THOSE ELEMENTS, WITH THE HEAVIER SHADING HAVING A CURVED EDGE CROSSING OVER THE SQUARE, THE CIRCLE AND THE LIGHTNING BOLT.

*David J. Kybas*

PRIORITY DATE OF 3-28-2011 IS CLAIMED.

**Reg. No. 4,273,908** OWNER OF INTERNATIONAL REGISTRATION 1106876 DATED 9-14-2011, EXPIRES 9-14-2021.

THE ENGLISH TRANSLATION OF "ZAPPAR" IN THE MARK IS "TO ZAP".

SER. NO. 79-109,180, FILED 9-14-2011.

ESTHER BELENKER, EXAMINING ATTORNEY

United States of America  
United States Patent and Trademark Office

**tecnisco**

**Reg. No. 4,273,909**

**Registered Jan. 15, 2013**

**Int. Cl.: 9**

**TRADEMARK**

**PRINCIPAL REGISTER**

TECNISCO LTD. (JAPAN CORPORATION)  
2-15, MINAMI-SHINAGAWA 2-CHOME  
SHINAGAWA-KU; TOKYO 140-0004  
JAPAN

FOR: CHEMISTRY APPARATUS AND INSTRUMENTS FOR LABORATORY USE, NAMELY, LABORATORY CHEMICAL REACTORS; ELECTRONIC MACHINES AND APPARATUS, NAMELY, THERMOELECTRIC MODULES FOR COOLING SEMI-CONDUCTOR CIRCUITS, AND THEIR STRUCTURAL PARTS, IN CLASS 9 (U.S. CLS. 21, 23, 26, 36 AND 38).

OWNER OF U.S. REG. NO. 2,669,915.

PRIORITY DATE OF 10-20-2011 IS CLAIMED.

OWNER OF INTERNATIONAL REGISTRATION 1106917 DATED 12-7-2011, EXPIRES 12-7-2021.

SER. NO. 79-109,196, FILED 12-7-2011.

CARYN GLASSER, EXAMINING ATTORNEY



*David J. Kyjars*

Director of the United States Patent and Trademark Office

United States of America  
United States Patent and Trademark Office

seeoo

**Reg. No. 4,273,910**

**Registered Jan. 15, 2013**

**Int. Cls.: 9, 25 and 44**

**TRADEMARK**

**SERVICE MARK**

**PRINCIPAL REGISTER**

MAGLIONE MASSIMO (ITALY INDIVIDUAL)  
VIA ROBERTO BRACCO, 59  
I-00137 ROMA, ITALY AND

GERALD LASNIK (AUSTRIA INDIVIDUAL)  
KEILGASSE 13  
KOFLACH, AUSTRIA AND

MARTIN LASNIK (AUSTRIA INDIVIDUAL)  
STEIRERGRASSE 9  
BARNBACH, AUSTRIA

FOR: SPECTACLES, TELESCOPES, BINOCULARS, OPTICAL GLASSES, SPECTACLE LENSES, AND CONTACT LENSES, IN CLASS 9 (U.S. CLS. 21, 23, 26, 36 AND 38).

FOR: CLOTHING, NAMELY, SHIRTS, PANTS, HATS, AND SHOES, IN CLASS 25 (U.S. CLS. 22 AND 39).

FOR: OPTICIAN SERVICE, IN CLASS 44 (U.S. CLS. 100 AND 101).

THE MARK CONSISTS OF THE STYLIZED WORD "SEEEO" IN BLACK.

PRIORITY DATE OF 5-19-2011 IS CLAIMED.

OWNER OF INTERNATIONAL REGISTRATION 1106924 DATED 11-16-2011, EXPIRES 11-16-2021.

THE COLOR(S) BLACK IS/ARE CLAIMED AS A FEATURE OF THE MARK.

THE WORDING "SEEEO" HAS NO MEANING IN A FOREIGN LANGUAGE.

SER. NO. 79-109,200, FILED 11-16-2011.

ELISSA GARBER KON, EXAMINING ATTORNEY



*David J. Kyros*

Director of the United States Patent and Trademark Office

# United States of America

United States Patent and Trademark Office



**Reg. No. 4,273,911**

**Registered Jan. 15, 2013**

**Int. Cls.: 35, 37, 41 and  
42**

**SERVICE MARK**

**PRINCIPAL REGISTER**

NOMURA CO., LTD. (JAPAN AN INCORPORATED COMPANY)  
3-4, 2-CHOME DAIBA,  
MINATO-KU; TOKYO 135-8622  
JAPAN

FOR: PRODUCTION OF OUTDOOR ADVERTISING MATERIALS, NAMELY, WELCOMING BANNERS, SIGNBOARDS OR ADVERTISING TOWERS OR PILLARS; SHOP WINDOW DRESSING; PLANNING, ORGANIZATION OR HOLDING OF GOODS EXHIBITIONS FOR SALES PROMOTION; PREPARING ADVERTISEMENTS OF OTHERS, NAMELY, SIGN-BOARD ADVERTISEMENTS, MAP-BOARD OR INFORMATION BOARD ADVERTISEMENTS OR NEON-SIGN ADVERTISEMENTS; PLANNING OR CONSULTANCY FOR COMPLETE REFORM OF CORPORATE IMAGE, NAMELY, CREATING CORPORATE AND BRAND IDENTITY FOR OTHERS; MARKETING RESEARCH; PUBLICITY MATERIAL RENTAL, IN CLASS 35 (U.S. CLS. 100, 101 AND 102).

FOR: GENERAL BUILDING CONSTRUCTION; UPHOLSTERING; STEEL STRUCTURE CONSTRUCTION WORKS; INSTALLATION OF ADVERTISING MATERIALS, NAMELY, SIGNBOARDS, MAP-BOARDS, INFORMATION BOARDS, ADVERTISING TOWERS OR PILLARS OR NEON SIGNS, IN CLASS 37 (U.S. CLS. 100, 103 AND 106).

FOR: ARRANGING, CONDUCTING OR ORGANIZATION OF SEMINARS IN THE FIELD OF SELF-AWARENESS; ART EXHIBITIONS; ORGANIZATION, MANAGEMENT OR ARRANGEMENT OF PARTIES, EVENTS OR ENTERTAINMENT, NAMELY, PARTY PLANNING AND SPECIAL EVENT PLANNING FOR SOCIAL ENTERTAINMENT PURPOSES, EXCLUDING MOVIES, SHOWS, PLAYS, MUSICAL PERFORMANCES, SPORTS, HORSE RACES, BICYCLE RACES, BOAT RACES AND AUTORACES; PLANNING OR ARRANGEMENT OF SHOWING MOVIES, SHOWS, PLAYS OR MUSICAL PERFORMANCES; ORGANIZATION OF SPORTS COMPETITIONS, IN CLASS 41 (U.S. CLS. 100, 101 AND 107).

FOR: ARCHITECTURAL DESIGNING; DESIGNING, NAMELY, INTERIOR DESIGN SERVICES, IN CLASS 42 (U.S. CLS. 100 AND 101).

THE MARK CONSISTS OF A HIGHLY STYLIZED JAPANESE CHARACTER.

PRIORITY DATE OF 12-9-2011 IS CLAIMED.



*David J. Kyjars*

Director of the United States Patent and Trademark Office

**Reg. No. 4,273,911** OWNER OF INTERNATIONAL REGISTRATION 1107135 DATED 12-19-2011, EXPIRES 12-19-2021.

THE NON-LATIN CHARACTERS IN THE MARK TRANSLITERATE TO "NO" AND THIS HAS NO MEANING IN A FOREIGN LANGUAGE.

SER. NO. 79-109,266, FILED 12-19-2011.

JANICE KIM, EXAMINING ATTORNEY



# United States of America

United States Patent and Trademark Office

# COTTONBOX

**Reg. No. 4,273,912**

**Registered Jan. 15, 2013**

**Int. Cls.: 24 and 25**

**TRADEMARK**

**PRINCIPAL REGISTER**

SUMAS TEKSTIL; SANAYI VE TICARET ANONIM SIRKETI (TURKEY CORPORATION)  
IZMIR ASFALTI UZERI AKCESME  
MAHALLESİ 2013 SOKAK NO:1  
DENIZLI, TURKEY

FOR: TEXTILES AND TEXTILE GOODS, NAMELY, CURTAINS OF TEXTILE, FELT AND NON-WOVEN TEXTILE FABRICS, TOWELS MADE OF TEXTILE MATERIALS; FABRICS FOR TEXTILE USE, FABRICS FOR CURTAINS, FIBERGLASS FABRICS FOR TEXTILE USE, VELVET, FABRIC OF IMITATION ANIMAL SKINS, WOOLLEN FABRIC, COTTON FABRICS, CALICO, CURTAINS OF TEXTILE, SHOWER CURTAINS OF TEXTILE, BED AND PLASTIC TABLE COVERS, BED CLOTHES, NAMELY, BED BLANKETS, BED SPREADS, BED THROWS; BED LINEN; UNFITTED FABRIC FURNITURE COVERS; COVERLETS, COVERS FOR CUSHIONS, TABLE NAPKINS OF TEXTILE; QUILTS, BED BLANKETS; FACE TOWELS OF TEXTILE, TOWELS OF TEXTILE; WALL HANGINGS OF TEXTILE; HANDKERCHIEFS OF TEXTILE, LABELS OF CLOTH, FLAGS NOT OF PAPER, NAMELY, CLOTH FLAGS, FABRICS FLAGS; SHEETS, NAMELY, BATH SHEETS, BED SHEETS, CRIB SHEETS; FITTED TOILET LID COVERS OF FABRIC, PILLOW COVERS, PILLOWCASES, NAPKINS OF TEXTILE, NAMELY, TEXTILE NAPKINS FOR REMOVING MAKE-UP, TABLE NAPKINS OF TEXTILE; ALL THE FOREGOING MADE IN WHOLE OR IN SUBSTANTIAL PART OF COTTON, IN CLASS 24 (U.S. CLS. 42 AND 50).

FOR: CLOTHING, NAMELY, PANTS, TROUSERS, SWEATERS, SWEAT SHIRTS, TOPS, T-SHIRTS, BLOUSES, JACKETS, COATS, JERSEYS, BELTS, SOCKS; FOOTWEAR; HEADGEAR, NAMELY, HATS, CAPS; BATH ROBES, BATHING CAPS, BATHING SUITS, BATHING TRUNKS, BRASSIERES, CLOTHING FOR GYMNASTICS, NAMELY, GYMNASTIC SHOES, TIGHTS; CLOTHING OF IMITATIONS OF LEATHER, NAMELY, PANTS, JACKETS, COATS, BELTS; CLOTHING OF LEATHER, NAMELY, PANTS, JACKETS, COATS, BELTS; COATS, CORSELETS, DRESSING GOWNS, FISHING VESTS, FROCKS, FUR STOLEES, FURS, NAMELY, FUR MUFFS, FUR CLOAKS; GLOVES, JACKETS, MANTILLAS, MASQUERADE COSTUMES, MITTENS, PANTS; PARKAS, PETTICOATS, PULLOVERS, PYJAMAS, PAPER CLOTHING, NAMELY, PAPER APRONS; SPORTS JERSEYS, SHIRTS, SKIRTS, SMOCKS, SUITS, SWEATERS, SWIMSUITS, T-SHIRTS, TIGHTS, TOPCOATS, TROUSERS, TRUNKS, UNDERPANTS, UNDERWEAR, UNIFORMS, VEILS, VESTS, WAISTCOATS; SOCKS; BABIES' DIAPERS OF TEXTILE, BABIES' PANTS; BERETS, CAP PEAKS, CAPS, HATS, SHOWER CAPS, TOP HATS, CUFFS, NECKTIES, SCARVES, SHAWLS, SHIRT YOKES, TURBANS, GIRDLES, SUSPENDERS, BELTS, GARTERS, SLIPPERS, SHOES, SANDALS, BATH SLIPPERS, BATH SANDALS, BANDANAS, NECKERCHIEFS, APRONS, HEADBANDS, LACE



*David J. Kyffers*

Director of the United States Patent and Trademark Office

**Reg. No. 4,273,912** BOOTS; ALL THE FOREGOING MADE IN WHOLE OR IN SUBSTANTIAL PART OF COTTON, IN CLASS 25 (U.S. CLS. 22 AND 39).

OWNER OF INTERNATIONAL REGISTRATION 1093518 DATED 7-14-2011, EXPIRES 7-14-2021.

SER. NO. 79-109,384, FILED 12-12-2011.

DAVID TOOLEY, EXAMINING ATTORNEY

# United States of America

United States Patent and Trademark Office

# MASTER-SOFT

**Reg. No. 4,273,913**

**Registered Jan. 15, 2013**

**Int. Cls.: 19 and 21**

**TRADEMARK**

**PRINCIPAL REGISTER**

SAINT-GOBAIN GLASS FRANCE (FRANCE SOCIÉTÉ ANONYME)  
"LES MIROIRS"  
18, AVENUE D'ALSACE; F-92400 COURBEVOIE  
FRANCE

FOR: BUILDING MATERIALS NOT OF METAL, NAMELY, BUILDING GLASS; PRINTED GLASS FOR BUILDING AND CONSTRUCTION; GLAZINGS, NAMELY, GLASS FOR DOORS, WINDOWS AND GLASS PARTITIONS; WINDOWS AND DOORS NOT OF METAL; SHEETS, PLATES, PANELS, WALLS AND GLASS FOR BUILDINGS, FURNISHING, EXTERIOR AND INTERIOR DECORATION; GLASS WALLS AND PARTITIONS FOR BUILDING AND CONSTRUCTION, IN CLASS 19 (U.S. CLS. 1, 12, 33 AND 50).

FOR: UNWORKED OR SEMI-WORKED GLASS NOT FOR BUILDING; PRINTED GLASS NOT FOR BUILDING; OPAQUE OR TRANSLUCENT ENAMELED GLASS NOT FOR BUILDING; LACQUERED GLASS NOT FOR BUILDING; SERIGRAPHED GLASS NOT FOR BUILDING; PAINTED GLASSWARE, NAMELY, DRINKING AND BEVERAGE GLASSWARE; RAW AND SEMI-PROCESSED GLASS IN THE FORM OF SHEETS AND PLATES USED IN THE MANUFACTURE OF SANITARY INSTALLATIONS, SHOWER CUBICLES, SHOWER DOORS, SHOWER PARTITIONS AND WALLS, REFRIGERATOR SHELVES, GLAZINGS, WALLS, PARTITIONS, DOORS, CUPBOARD AND FURNITURE DOORS; HOUSEHOLD OR KITCHEN UTENSILS, NAMELY, SPATULAS, ROLLING PINS, SIEVES, WHISKS, SLOTTED SPOONS, MIXING SPOONS, GRILLS, GRATERS, AND STRAINERS; HOUSEHOLD OR KITCHEN CONTAINERS NOT OF PRECIOUS METAL OR COATED THEREWITH, IN CLASS 21 (U.S. CLS. 2, 13, 23, 29, 30, 33, 40 AND 50).



OWNER OF U.S. REG. NOS. 2,539,090 AND 3,427,088.

PRIORITY DATE OF 12-2-2011 IS CLAIMED.

OWNER OF INTERNATIONAL REGISTRATION 1107424 DATED 12-20-2011, EXPIRES 12-20-2021.

SER. NO. 79-109,398, FILED 12-20-2011.

ESTHER BELENKER, EXAMINING ATTORNEY

*David J. Kyffers*

Director of the United States Patent and Trademark Office

# United States of America

United States Patent and Trademark Office

# NUMTUMS

**Reg. No. 4,273,914**

**Registered Jan. 15, 2013**

**Int. Cls.: 9, 16, 25, 28  
and 41**

**TRADEMARK**

**SERVICE MARK**

**PRINCIPAL REGISTER**

THE BRITISH BROADCASTING CORPORATION (UNITED KINGDOM CORPORATION)  
BROADCASTING HOUSE  
PORTLAND PLACE; LONDON W1A 1AA  
UNITED KINGDOM

FOR: DATA RECORDINGS, NAMELY, VISUAL AND AUDIO RECORDING FEATURING AUDIO, STILL AND MOVING IMAGES AND TEXT FEATURING A WIDE RANGE OF ENTERTAINMENT AND INFORMATION ON TOPICS OF INTEREST TO CHILDREN AND THEIR PARENTS AND CAREGIVERS; COMPUTER SOFTWARE, NAMELY, SOFTWARE FOR USE IN DOWNLOADING, STORING, REPRODUCING AND ORGANISING AUDIO, VIDEO, STILL AND MOVING IMAGES AND DATA; EDUCATIONAL SOFTWARE FEATURING INSTRUCTIONS IN CHILDREN'S EDUCATIONAL SOFTWARE; DOWNLOADABLE ELECTRONIC PUBLICATIONS FEATURING INFORMATION ON TOPICS OF INTEREST TO CHILDREN AND THEIR PARENTS AND CAREGIVERS; DOWNLOADABLE RING TONES AND GRAPHICS FOR MOBILE PHONES; DOWNLOADABLE GRAPHICS FOR COMPUTERS; COMPUTER, ELECTRONIC AND VIDEO GAMES PROGRAMMES AND EQUIPMENT, NAMELY, COMPUTER GAME PROGRAMS, SOFTWARE, CASSETTES, DISCS AND TAPES; ELECTRONIC INSTRUCTIONAL AND TEACHING APPARATUS AND INSTRUMENTS, NAMELY, COMPACT DISCS, AUDIO AND VIDEO CASSETTES, VIDEO-TAPES, CD-ROMS AND DOWNLOADS IN THE NATURE OF DOWNLOADABLE AUDIO AND VIDEO FILES, ALL FEATURING ANIMATION, CHILDREN'S STORIES, MUSIC AND DANCE; PROTECTIVE HELMETS; FLOATS FOR BATHING AND SWIMMING, IN CLASS 9 (U.S. CLS. 21, 23, 26, 36 AND 38).



*David J. Kyros*

Director of the United States Patent and Trademark Office

FOR: PRINTED PUBLICATIONS, NAMELY, PAMPHLETS AND PRINTED GUIDES PROVIDING INSTRUCTION, ENTERTAINMENT, AND EDUCATION, ALL FEATURING TOPICS OF INTEREST TO CHILDREN AND THEIR PARENTS AND CAREGIVERS; MAGAZINES FEATURING INSTRUCTION, ENTERTAINMENT, AND EDUCATION FEATURING TOPICS OF INTEREST TO CHILDREN AND THEIR PARENTS AND CAREGIVERS; BOOKS FEATURING INSTRUCTION, ENTERTAINMENT, AND EDUCATION FEATURING TOPICS OF INTEREST TO CHILDREN AND THEIR PARENTS AND CAREGIVERS; CATALOGUES FEATURING INSTRUCTION, ENTERTAINMENT, AND EDUCATION FEATURING TOPICS OF INTEREST TO CHILDREN AND THEIR PARENTS AND CAREGIVERS; EVENTS PROGRAMMES; PHOTOGRAPHS; STATIONERY; ARTISTS' MATERIALS, NAMELY, PAINTING SETS FOR CHILDREN, PAINT BRUSHES; PRINTED INSTRUCTIONAL AND TEACHING MATERIAL; PRINTING BLOCKS; POSTERS; HOLIDAY CARDS; POSTCARDS; GREETING CARDS; TRADING CARDS; PRINTED INVITATIONS; DIARIES;

**Reg. No. 4,273,914** CALENDARS; PHOTOGRAPH ALBUMS; PRINTS; PAPER GIFT BAGS, GIFT BOXES, GIFT TAGS AND GIFT WRAP; NOTEPADS; WRITING INSTRUMENTS AND CRAYONS; STICKERS; TRANSFERS; RUBBER STAMPS; PERSONAL ORGANISERS; ADDRESS BOOKS; NOTE BOOKS; PEN AND PENCIL HOLDERS; DESK MATS; EMBROIDERY, SEWING AND KNITTING PATTERNS; POSTAGE STAMPS, IN CLASS 16 (U.S. CLS. 2, 5, 22, 23, 29, 37, 38 AND 50).

FOR: CLOTHING, NAMELY, SHIRTS, T-SHIRTS, BLOUSES, VESTS, PANTS, JEANS, SWEAT PANTS, OVERALLS, SHORTS, SKIRTS, DRESSES, SWIMSUITS, JACKETS, COATS, SWEATERS, SWEATSHIRTS, ROBES, TIES, BELTS, GLOVES, MITTENS, PAJAMAS, UNDERWEAR; FOOTWEAR; HEADGEAR, NAMELY, HATS AND CAPS; COSTUMES FOR USE IN ROLE-PLAYING GAMES, COSTUMES FOR USE IN CHILDREN'S DRESS UP PLAY, DANCE COSTUMES, HALLOWEEN COSTUMES, MASQUERADE COSTUMES, IN CLASS 25 (U.S. CLS. 22 AND 39).

FOR: TOYS, NAMELY, DOLLS, SOFT SCULPTURE TOYS, PLUSH TOYS, TOY AND NOVELTY FACE MASKS, TOY MUSICAL BOXES, TOY MUSICAL INSTRUMENTS; GAMES, NAMELY, PUZZLES, BOARD GAMES, CARD GAMES FOR PLAY PURPOSES; PLAYTHINGS, NAMELY, ACTION FIGURES, MODELED TOY FIGURINES, TOY KEY CHAINS, VEHICLES AND PLAY SETS FOR DOLLS, ACTION FIGURES AND MODELED PLASTIC TOY FIGURES; SPORTING ARTICLES, NAMELY, SKATEBOARDS, ROLLER SKATES, INLINE SKATES, BASES BATS AND BALLS FOR PLAYING INDOOR AND OUTDOOR GAMES; KNEE PADS AND ELBOW PADS FOR ATHLETIC USE; CHRISTMAS CRACKERS, TREE DECORATIONS AND ORNAMENTS; TOY MODELS; PUZZLES; KITES; PLAY BALLS AND PLAY BALLOONS; SWIMMING FLIPPERS; INFLATABLE TOYS FOR PLAY PURPOSES; PLAYING CARDS; COMPUTER, ELECTRONIC AND VIDEO GAMES EQUIPMENT OTHER THAN THOSE ADAPTED FOR USE WITH AN EXTERNAL DISPLAY SCREEN OR MONITOR; PUPPETS; PLASTIC TOYS, NAMELY, PLASTIC SCALE MODELS IN KIT FORM, PLASTIC CHARACTER TOYS; BATH TOYS; PLAYSETS FOR CHILDREN, NAMELY, PLAYSET BUILDINGS, PLAYSETS FOR DOLLS AND PLAY SETS FOR ACTION FIGURES; DEVELOPMENTAL TOYS, NAMELY, INFANT DEVELOPMENTAL TOYS; WHEELED TOYS, NAMELY, TOY CARS, TOY BICYCLES, AND TOY TRICYCLES AND RIDE-ON TOYS, TOY SCOOTERS, CHILDREN'S TOY BICYCLES OTHER THAN FOR TRANSPORT, RIDE-ON TOYS; COSTUMES BEING CHILDREN'S PLAYTHINGS, NAMELY, DOLL COSTUMES; TOY BICYCLES AND TOY TRICYCLES OTHER THAN FOR TRANSPORT, IN CLASS 28 (U.S. CLS. 22, 23, 38 AND 50).

FOR: ENTERTAINMENT SERVICES, NAMELY, PRODUCTION OF RADIO AND TELEVISION ENTERTAINMENT AND AUDIO AND VIDEO RECORDINGS, NAMELY, ONGOING RADIO AND TELEVISION PROGRAMS, ONLINE TELEVISION PROGRAMS, ONLINE NON-DOWNLOADABLE FILMS VIA VIDEO ON DEMAND SERVICES, AND ONLINE COMPUTER GAMES, TELEVISION SHOWS, PLAYS; EDUCATIONAL SERVICES, NAMELY, LIVE AND ON-LINE EDUCATIONAL AND ENTERTAINMENT DEMONSTRATIONS IN THE NATURE OF LIVE MUSIC CONCERTS AND SHOWS ON TOPICS OF INTEREST TO CHILDREN AND THEIR PARENTS AND CAREGIVERS; PUBLISHING SERVICES, NAMELY, ELECTRONIC PUBLISHING SERVICES, NAMELY, PUBLICATION OF TEXT, GRAPHIC WORKS AND DATA ONLINE AND IN DOWNLOADABLE FORMATS FEATURING ENTERTAINMENT, EDUCATION, RECREATION, INSTRUCTION AND TRAINING, NAMELY, IN THE FIELDS OF RECREATIONAL ACTIVITIES, MUSIC, DRAMA, FILM, NEWS, TRAVEL, GARDENING, TELEVISION PROGRAMS, NAMELY, CHILDREN'S TELEVISION PROGRAMS AND EDUCATIONAL/INSTRUCTIONAL TELEVISION PROGRAMS, GAMES, LIVE CONCERTS AND EVENTS, DOCUMENTARIES, HISTORY, NATURAL HISTORY, FICTION, NON-FICTION, SCIENCE AND TECHNOLOGY IN FOREIGN AND ENGLISH LANGUAGES; PUBLISHING OF NON-DOWNLOADABLE ELECTRONIC PUBLICATIONS; ENTERTAINMENT SERVICES, NAMELY, ORGANISATION, PRODUCTION AND PRESENTATION OF LIVE SHOW PERFORMANCES, SPORTS COMPETITIONS, LIVE SPORTS GAMES, CONCERTS, EXHIBITIONS FOR CULTURAL AND EDUCATIONAL PURPOSES AND EVENTS IN THE NATURE OF THEATRICAL PERFORMANCES, CONCERTS, LIVE PERFORMANCES, AND AUDIENCE

**Reg. No. 4,273,914** PARTICIPATION EVENTS ALL RELATED TO CHILDREN'S TELEVISION AND RADIO PROGRAMMING; LANGUAGE TEACHING; PROVISION OF INFORMATION AND ADVISORY SERVICES RELATING TO ANY OF THE AFORESAID SERVICES, IN CLASS 41 (U.S. CLS. 100, 101 AND 107).

THE MARK CONSISTS OF STANDARD CHARACTERS WITHOUT CLAIM TO ANY PARTICULAR FONT, STYLE, SIZE, OR COLOR.

PRIORITY DATE OF 9-30-2011 IS CLAIMED.

OWNER OF INTERNATIONAL REGISTRATION 1107478 DATED 10-14-2011, EXPIRES 10-14-2021.

SER. NO. 79-109,416, FILED 10-14-2011.

ALLISON HOLTZ, EXAMINING ATTORNEY

# United States of America

United States Patent and Trademark Office

# FORGIVE ME

**Reg. No. 4,273,915**

CARINE ROITFELD (FRANCE INDIVIDUAL)

**Registered Jan. 15, 2013**

38 BIS RUE FABERT  
PARIS, FRANCE F75007

**Int. Cl.: 3**

**TRADEMARK**

**PRINCIPAL REGISTER**

FOR: SOAP, CAKES OF TOILET SOAP, TOILET SOAP; PERFUMERY, PERFUMES, TOILET WATER, EAUX-DE-COLOGNE; SCENTED WATER, NAMELY, SCENTED WATER IN THE NATURE OF PERFUMES; ESSENTIAL OILS, OILS FOR TOILET PURPOSES, ALMOND OILS FOR PERSONAL USE; COSMETICS, COSMETIC OILS AND LOTIONS; COSMETIC CREAMS, SKIN CARE COSMETICS; COSMETIC PREPARATIONS AND BATH SALTS NOT FOR MEDICAL PURPOSES; CREAMS, MILKS, LOTIONS, GELS AND POWDERS NOT FOR MEDICAL PURPOSES FOR THE FACE, BODY AND HANDS; TISSUES IMPREGNATED WITH COSMETIC LOTIONS; SKIN MOISTURIZING LOTIONS; BEAUTY MASKS; TANNING AND AFTER-SUN CREAMS, MILKS, GELS AND OILS FOR COSMETIC PURPOSES; SUN-TANNING PREPARATIONS; SUNBURN OINTMENTS FOR COSMETIC PURPOSES; SHAMPOOS; HAIR LOTIONS; MOUSSES AND BALMS FOR HAIR CARE; HAIR GELS AND WAXES; SHAVING PREPARATIONS, AFTER-SHAVE LOTIONS; BODY DEODORANTS; DEODORANTS FOR HUMAN BEINGS OR FOR ANIMALS; POTPOURRIS; NAIL VARNISH AND POLISH; HAIR SPRAY; FALSE NAILS; MAKE-UP AND MAKE-UP REMOVING PREPARATIONS; COSMETIC PENCILS; LIP LINERS, EYE LINERS; CORRECTOR PENS FOR COSMETIC PURPOSES; EYE-LINER; LIPSTICKS; LIP GLOSSES; MASCARA; COSMETIC PREPARATIONS FOR EYELASHES; FALSE EYELASHES; CONCEALERS; MAKE-UP; BLUSHES, EYE SHADOWS, EYE MAKE-UP; MAKE-UP POWDER; FOUNDATION; ADHESIVES FOR COSMETIC PURPOSES; COSMETIC PREPARATIONS FOR SLIMMING PURPOSES; SHAMPOOS FOR PETS; COTTON WOOL FOR COSMETIC PURPOSES; ALL PURPOSE COTTON SWABS FOR PERSONAL USE; SWABS FOR COSMETIC PURPOSES; SKIN WHITENING PREPARATIONS; HAIR DYES; HAIR WAVING PREPARATIONS; DEPILATORY PREPARATIONS; DEPILATORY WAX; DECORATIVE TRANSFERS FOR COSMETIC PURPOSES; BLEACHING PREPARATIONS FOR COSMETIC PURPOSES; INCENSE; PREPARATIONS FOR REMOVING NAIL POLISH AND NAIL VARNISH; SACHETS FOR PERFUMING LINEN; DENTIFRICES; DENTAL BLEACHING GELS; BLEACHING PREPARATIONS AND OTHER SUBSTANCES FOR LAUNDRY USE, NAMELY, LAUNDRY BLEACH, DETERGENT AND SOAP; CLEANING, POLISHING, DEGREASING AND ABRASIVE PREPARATIONS; HARD SKIN STONES IN THE NATURE OF POLISHING STONES; PUMICE STONE FOR PERSONAL USE; SMOOTHING STONES, NAMELY, FOOT SMOOTHING STONES, IN CLASS 3 (U.S. CLS. 1, 4, 6, 50, 51 AND 52).



*David J. Kyros*

Director of the United States Patent and Trademark Office

**Reg. No. 4,273,915** THE MARK CONSISTS OF STANDARD CHARACTERS WITHOUT CLAIM TO ANY PARTICULAR FONT, STYLE, SIZE, OR COLOR.

PRIORITY DATE OF 1-17-2012 IS CLAIMED.

OWNER OF INTERNATIONAL REGISTRATION 1107671 DATED 1-19-2012, EXPIRES 1-19-2022.

SER. NO. 79-109,488, FILED 1-19-2012.

PATRICIA EVANKO, EXAMINING ATTORNEY



# United States of America

United States Patent and Trademark Office

## Simetal RCB Temp

**Reg. No. 4,273,916**

**Registered Jan. 15, 2013**

**Int. Cl.: 9**

**TRADEMARK**

**PRINCIPAL REGISTER**

SIEMENS AKTIENGESELLSCHAFT  
WITTELSBACHERPLATZ 2  
80333 MÜNCHEN  
FED REP GERMANY

FOR: DEVICES FOR CONTACTLESS TEMPERATURE MEASUREMENT IN ARC FURNACES, NAMELY, TEMPERATURE INDICATORS AND METERS FOR DETERMINING TEMPERATURE OF LIQUID METALS WITH INCORPORATED OXYGEN LANCES FOR INJECTING AN OXYGEN STREAM INTO LIQUID METAL TO ENABLE TEMPERATURE INDICATOR TO OBTAIN A TEMPERATURE READING, COMPUTER HARDWARE AND SOFTWARE FOR RECORDING, PROCESSING, ANALYSING AND DISPLAYING TEMPERATURE DATA, IN CLASS 9 (U.S. CLS. 21, 23, 26, 36 AND 38).

THE MARK CONSISTS OF STANDARD CHARACTERS WITHOUT CLAIM TO ANY PARTICULAR FONT, STYLE, SIZE, OR COLOR.

PRIORITY DATE OF 9-5-2011 IS CLAIMED.

OWNER OF INTERNATIONAL REGISTRATION 1108007 DATED 2-3-2012, EXPIRES 2-3-2022.

NO CLAIM IS MADE TO THE EXCLUSIVE RIGHT TO USE "TEMP", APART FROM THE MARK AS SHOWN.

SER. NO. 79-109,624, FILED 2-3-2012.

GINA HAYES, EXAMINING ATTORNEY



*David J. Kyffers*

Director of the United States Patent and Trademark Office

# United States of America

United States Patent and Trademark Office

# PRO-MATRIX

**Reg. No. 4,273,917**

**Registered Jan. 15, 2013**

**Int. Cl.: 10**

**TRADEMARK**

**PRINCIPAL REGISTER**

ASTEK INNOVATIONS LIMITED (UNITED KINGDOM LIMITED COMPANY)  
ASTEK HOUSE, ATLANTIC STREET  
ALTRINCHAM, CHESHIRE, UNITED KINGDOM WA14 5DH

FOR: DENTAL APPARATUS AND INSTRUMENTS, NAMELY, MATRIX BANDS, IN CLASS  
10 (U.S. CLS. 26, 39 AND 44).

THE MARK CONSISTS OF STANDARD CHARACTERS WITHOUT CLAIM TO ANY PAR-  
TICULAR FONT, STYLE, SIZE, OR COLOR.

OWNER OF INTERNATIONAL REGISTRATION 1098957 DATED 10-28-2011, EXPIRES 10-  
28-2021.

SER. NO. 79-109,673, FILED 1-23-2012.

DAVID TOOLEY, EXAMINING ATTORNEY



*David J. Kyffers*

Director of the United States Patent and Trademark Office

# United States of America

United States Patent and Trademark Office

# INHYDRATE

**Reg. No. 4,273,918**

**Registered Jan. 15, 2013**

**Int. Cls.: 1, 3, 5, 29 and 30**

**TRADEMARK**

**PRINCIPAL REGISTER**

LIPOTEC, S.A. (SPAIN SOCIEDAD ANÓNIMA)  
ISAAC PERAL, 17 -  
POL. IND. CAMÍ RAL; E-08850 GAVÁ (BARCELONA)  
SPAIN

FOR: CHEMICAL PRODUCTS FOR USE IN SCIENCE, AND FOR IN THE COSMETIC, TEXTILE AND FOOD INDUSTRIES, NAMELY, CHEMICAL PREPARATIONS FOR USE IN THE MANUFACTURE OF COSMETICS, TEXTILES AND FOOD, IN CLASS 1 (U.S. CLS. 1, 5, 6, 10, 26 AND 46).

FOR: SOAP, SKIN SOAP, BATH SOAP, TOILET SOAP, DISINFECTANT SOAP; COSMETICS, PERFUMERY, ESSENTIAL OILS, HAIR CARE LOTIONS, DENTIFRICES, IN CLASS 3 (U.S. CLS. 1, 4, 6, 50, 51 AND 52).

FOR: CHEMICO-PHARMACEUTICAL PREPARATIONS FOR DERMATOLOGICAL USE; PHARMACEUTICAL PREPARATIONS FOR DERMATOLOGICAL USE; CICATRIZANT PHARMACEUTICAL PREPARATIONS; SANITARY PREPARATIONS FOR MEDICAL USE; NUTRITIONAL SUPPLEMENTS AND DIETETIC FOODS ADAPTED FOR MEDICAL PURPOSES; MEDICAL PLASTERS; MATERIALS FOR MEDICAL DRESSING; MEDICAL ADHESIVE TAPE AND GAUZE; SURGICAL TISSUES; MEDICATED COMPRESSES; BANDAGES FOR DRESSINGS FOR DERMATOLOGICAL USE AND FOR THE SKIN; NET BANDAGES AND SOCKS IMPREGNATED WITH PHARMACEUTICAL CICATRIZANT AND MOISTURIZING PREPARATIONS, IN CLASS 5 (U.S. CLS. 6, 18, 44, 46, 51 AND 52).

FOR: JELLIES; JAMS, COMPOTES; MILK AND MILK PRODUCTS EXCLUDING ICE CREAM, ICE MILK AND FROZEN YOGURT, IN CLASS 29 (U.S. CL. 46).

FOR: COCOA; FLOUR AND PREPARATIONS MADE FROM CEREALS, NAMELY, PROCESSED CEREAL-BASED SNACK FOOD TO BE USED AS A BREAKFAST FOOD, SNACK FOOD OR ENERGY BAR; BREAD, PASTRY AND CONFECTIONERY, NAMELY, SNACK FOODS, NAMELY, CHOCOLATE, CANDY, SWEETS, IN CLASS 30 (U.S. CL. 46).

THE MARK CONSISTS OF STANDARD CHARACTERS WITHOUT CLAIM TO ANY PARTICULAR FONT, STYLE, SIZE, OR COLOR.

PRIORITY DATE OF 7-13-2011 IS CLAIMED.



*David J. Kyjars*

Director of the United States Patent and Trademark Office

**Reg. No. 4,273,918** OWNER OF INTERNATIONAL REGISTRATION 1108087 DATED 12-27-2011, EXPIRES 12-27-2021.

SER. NO. 79-109,677, FILED 12-27-2011.

KRISTINA MORRIS, EXAMINING ATTORNEY

# United States of America

United States Patent and Trademark Office

# Hydronit

**Reg. No. 4,273,919**

**Registered Jan. 15, 2013**

**Int. Cl.: 7**

**TRADEMARK**

**PRINCIPAL REGISTER**

GAMBUSERA ANDREA ARTURO (ITALY INDIVIDUAL)  
VIA GORIZIA, 34  
BOVISIO MASCIAGO (MB), ITALY I20813

FOR: MACHINES AND MACHINE TOOLS, NAMELY, HYDRAULIC POWER PACKS, HYDRAULIC CONTROLS FOR MACHINES, MOTORS AND ENGINES, HYDRAULIC LIFTS, HYDRAULIC PRESSES, HYDRAULIC PUMPS AND MOTORS FOR HYDROSTATIC SYSTEMS, COMPRISED OF PUMPS, MOTORS, VALVES, SWITCHES, SENSORS AND ELECTRONIC CONTROLS, FOR HYDRAULIC DRIVES AND FORCE TRANSMISSION IN MACHINES, MACHINE TOOLS, GRINDING AND FOOD PROCESSING MACHINES AND IN OFF-ROAD-VEHICLES, MECHANICAL AND HYDRAULIC LIFTS, HYDRAULIC DOOR CLOSERS AND OPENERS, HYDRAULIC LIFT TABLES; MOTORS EXCEPT FOR LAND VEHICLES; MACHINE COUPLING AND TRANSMISSION COMPONENTS EXCEPT FOR LAND VEHICLES; AGRICULTURAL IMPLEMENTS OTHER THAN HAND-OPERATED, NAMELY, INCORPORATORS, SEED DRILLS, HAY BALERS, IN CLASS 7 (U.S. CLS. 13, 19, 21, 23, 31, 34 AND 35).

THE MARK CONSISTS OF THE WORDING "HYDRONIT" WHERE THE LETTERS "HY" APPEAR IN THE COLOR RED AND THE LETTERS "DRONIT" APPEAR IN THE COLOR BLUE.

PRIORITY DATE OF 6-13-2011 IS CLAIMED.

OWNER OF INTERNATIONAL REGISTRATION 1108306 DATED 12-12-2011, EXPIRES 12-12-2021.

THE COLOR(S) RED AND BLUE IS/ARE CLAIMED AS A FEATURE OF THE MARK.

THE WORDING "HYDRONIT" HAS NO MEANING IN A FOREIGN LANGUAGE.

SER. NO. 79-109,750, FILED 12-12-2011.

KEVIN CORWIN, EXAMINING ATTORNEY



*David J. Kyffers*

Director of the United States Patent and Trademark Office

# United States of America

United States Patent and Trademark Office

# ePLACE

**Reg. No. 4,273,920**

**Registered Jan. 15, 2013**

**Int. Cls.: 9 and 42**

**TRADEMARK**

**SERVICE MARK**

**PRINCIPAL REGISTER**

EQUICON SOFTWARE GMBH JENA (FED REP GERMANY LIMITED LIABILITY COMPANY)  
KONRAD-ZUSE-STRASSE 2  
07745 JENA  
FED REP GERMANY

FOR: SOFTWARE, RECORDED PROGRAMS AND CONTROL PROGRAMS FOR THE CONTROL OF ELECTRON BEAM LITHOGRAPHY AND PHOTO LITHOGRAPHY INSTALLATIONS FOR THE MANUFACTURE OF SEMICONDUCTORS, INTEGRATED CIRCUITS AND FOR NANOTECHNOLOGY, IN CLASS 9 (U.S. CLS. 21, 23, 26, 36 AND 38).

FOR: DEVELOPMENT OF SOFTWARE AND CONTROL PROGRAMS FOR THE CONTROL OF ELECTRON BEAM LITHOGRAPHY AND PHOTO LITHOGRAPHY INSTALLATIONS FOR THE MANUFACTURE OF SEMICONDUCTORS, INTEGRATED CIRCUITS AND FOR NANOTECHNOLOGY, IN CLASS 42 (U.S. CLS. 100 AND 101).

OWNER OF INTERNATIONAL REGISTRATION 1108712 DATED 10-8-2011, EXPIRES 10-8-2021.

SER. NO. 79-109,901, FILED 10-8-2011.

CAROLINE WOOD, EXAMINING ATTORNEY



*David J. Kyffers*

Director of the United States Patent and Trademark Office

United States of America  
United States Patent and Trademark Office

**BOLLO**

**Reg. No. 4,273,921**

**Registered Jan. 15, 2013**

**Int. Cl.: 31**

**TRADEMARK**

**PRINCIPAL REGISTER**

VERCOM, S.A.T. (SPAIN SOCIEDAD DE TRANSFORMACIÓN AGRARIA (SAT))  
C/ COLON Nº 19  
E-46791 BENIFAIRO DE LA VALLDIGNA (VALENCIA)  
SPAIN

FOR: FRESH ORANGES, FRESH MANDARINS, FRESH LEMONS, FRESH CITRUS FRUITS,  
FRESH FRUIT, FRESH ONIONS, FRESH GREEN VEGETABLES AND FRESH VEGETABLES,  
IN CLASS 31 (U.S. CLS. 1 AND 46).

THE ENGLISH TRANSLATION OF "BOLLO" IN THE MARK IS "BUN, BREAD ROLL".

OWNER OF INTERNATIONAL REGISTRATION 0537548 DATED 4-13-1989, EXPIRES 4-13-  
2019.

SER. NO. 79-109,915, FILED 9-14-2011.

CAROLINE WOOD, EXAMINING ATTORNEY



*David J. Kyffers*

Director of the United States Patent and Trademark Office

# United States of America

United States Patent and Trademark Office



**Reg. No. 4,273,922**

**Registered Jan. 15, 2013**

**Int. Cls.: 6, 7, 9, 11, 19,  
37 and 42**

**TRADEMARK**

**SERVICE MARK**

**PRINCIPAL REGISTER**

MT-ENERGIE GMBH (FED REP GERMANY LIMITED LIABILITY COMPANY)  
LUDWIG-ELSBETT-STR. 1  
27404 ZEVEN  
FED REP GERMANY

FOR: CONTAINERS OF METAL FOR STORAGE OF SILAGE AND AGRICULTURAL PRODUCTS, NAMELY, BUNKERS WITH SLIDING FLOORS AND SILOS FOR USE IN BIOGAS INSTALLATIONS AND BLOCK-TYPE COGENERATION INSTALLATIONS; INDUSTRIAL PACKAGING CONTAINERS OF METAL, NAMELY, BUNKERS WITH SLIDING FLOORS AND SILOS FOR USE IN BIOGAS INSTALLATIONS AND BLOCK-TYPE COGENERATION INSTALLATIONS; INDUSTRIAL PACKAGING CONTAINERS OF METAL FOR SILAGE AND AGRICULTURAL PRODUCTS, NAMELY, BUNKERS WITH SLIDING FLOORS AND SILOS FOR BIOGAS INSTALLATIONS AND BLOCK-TYPE COGENERATION INSTALLATIONS; METAL SILOS FOR BIOGAS INSTALLATIONS AND BLOCK-TYPE COGENERATION INSTALLATIONS, IN CLASS 6 (U.S. CLS. 2, 12, 13, 14, 23, 25 AND 50).

FOR: MECHANICAL TRANSPORT AND CONVEYOR DEVICES FOR FEEDING SOLIDS IN BIOGAS FERMENTERS, NAMELY, PNEUMATIC AND HYDRAULIC TRANSPORTERS, CONVEYORS AND MACHINES FOR CONVEYING SOLIDS, ALL UNRELATED TO ELECTRONIC EQUIPMENT; MECHANICAL TRANSPORT AND CONVEYOR DEVICES FOR USE IN SLIDING FLOOR BUNKERS AND SILOS, NAMELY, PNEUMATIC AND HYDRAULIC TRANSPORTERS, CONVEYORS AND MACHINES FOR CONVEYING SOLIDS, ALL UNRELATED TO ELECTRONIC EQUIPMENT; MECHANICAL TRANSPORT AND CONVEYOR DEVICES FOR BIOGAS INSTALLATIONS AND BLOCK-TYPE COGENERATION INSTALLATIONS, NAMELY, PNEUMATIC AND HYDRAULIC TRANSPORTERS, CONVEYORS AND MACHINES FOR CONVEYING SOLIDS, ALL UNRELATED TO ELECTRONIC EQUIPMENT; AGITATORS FOR CIRCULATING LIQUID AND SEMI-LIQUID MEDIA FOR BIOGAS INSTALLATIONS AND BLOCK-TYPE COGENERATION INSTALLATIONS, AND CRUSHING AND PRESSING MACHINES, NAMELY, WASTE CRUSHING MACHINES, INDUSTRIAL MACHINE PRESSES FOR BIOGAS INSTALLATIONS AND BLOCK-TYPE COGENERATION INSTALLATIONS; INSTALLATIONS FOR SEPARATING SOLID AND LIQUID SUBSTANCES, NAMELY, CENTRIFUGES; VALVES FOR CONTROLLING EXCESS PRESSURE AND NEGATIVE PRESSURE IN GAS STORAGE UNITS AND FERMENTATION VESSELS, NAMELY, PUMP CONTROL VALVES, VALVES FOR PUMPS, SERVO-VALVES; INSTALLATIONS FOR PROCESS HEAT RECOVERY IN BIOGAS INSTALLATIONS, NAMELY, HEAT EXCHANGERS BEING PARTS OF MACHINES FOR RECOVERING PROCESS HEAT; INSTALLATIONS FOR EXTRACTING NUTRIENTS AND FERTILIZERS, NAMELY, CENTRI-



*David J. Kybas*

Director of the United States Patent and Trademark Office



**Reg. No. 4,273,922** FUGES AND EXTRACTING MACHINES; VALVES FOR CONTROLLING EXCESS PRESSURE AND NEGATIVE PRESSURE IN GAS STORAGE UNITS AND FERMENTATION VESSELS, NAMELY, VALVES BEING PARTS OF MACHINES; VALVES FOR CONTROLLING EXCESS PRESSURE AND NEGATIVE PRESSURE IN GAS STORAGE UNITS AND FERMENTATION VESSELS, NAMELY, AUTOMATIC VALVES, CONTROL VALVES FOR REGULATING THE FLOW OF GASES AND LIQUIDS; VALVES FOR CONTROLLING EXCESS PRESSURE AND NEGATIVE PRESSURE IN GAS STORAGE UNITS AND FERMENTATION VESSELS, NAMELY, AUTOMATIC VALVES, THERMOSTATIC CONTROL VALVES FOR MACHINES, FOR REGULATING THE FLOW OF LIQUIDS AND GASES; INSTALLATIONS FOR CARRYING OUT BIOGAS PROCESSES, NAMELY, POWER PLANTS, IN CLASS 7 (U.S. CLS. 13, 19, 21, 23, 31, 34 AND 35).

FOR: MEASURING GLASSES AND MEASURING INSTRUMENTS FOR PROCESS MEASURING AND PROCESSING CONTROL SYSTEMS IN BIOGAS INSTALLATIONS AND BLOCK-TYPE COGENERATION INSTALLATIONS, NAMELY, GAS SENSORS FOR MEASURING GAS CONCENTRATION, MEASURING APPARATUS FOR MEASURING TEMPERATURE AND HUMIDITY LEVELS IN GASES AND SOLID SUBSTANCES; INSTALLATIONS AND APPARATUS FOR REMOTE DATA TRANSMISSION AND REMOTE CONTROL OF BIOGAS INSTALLATIONS AND BLOCK-TYPE COGENERATION INSTALLATIONS, NAMELY, REMOTE CONTROL TELEMETERING MACHINES AND APPARATUS, WIRELESS REMOTE TEMPERATURE AND HUMIDITY MONITORS FOR BUILDING MAINTENANCE, DEVICES FOR WIRELESS RADIO TRANSMISSION, WIRELESS CONTROLLER TO MONITOR AND CONTROL THE FUNCTIONING OF OTHER ELECTRIC DEVICES; APPARATUS AND INSTRUMENTS FOR MEASURING EXCESS PRESSURE OR NEGATIVE PRESSURE IN BIOGAS INSTALLATIONS AND BLOCK-TYPE COGENERATION INSTALLATIONS, NAMELY, AUTOMATIC PRESSURE CONTROL MACHINES AND INSTRUMENTS, PRESSURE GAUGES, PRESSURE INDICATING PLUGS FOR VALVES, PRESSURE SENSORS; INDUSTRIAL PROCESS CONTROL SOFTWARE FOR BIOGAS INSTALLATIONS AND BLOCK-TYPE COGENERATION INSTALLATIONS; ELECTRONIC VALVES FOR CONTROLLING GAS OR FLUIDS, IN CLASS 9 (U.S. CLS. 21, 23, 26, 36 AND 38).

FOR: BIOGAS REACTORS, NAMELY, BIOGAS FERMENTERS USED IN INSTALLATIONS FOR PRODUCING BIOGAS AND IN BLOCK-TYPE COGENERATION INSTALLATIONS, AND FITTED PLASTIC FOIL COVERS AND FITTED AIR-SUPPORTED FOIL COVERS THEREFOR; INSTALLATIONS FOR TREATING FERMENTED PRODUCTS, RESIDUES AND SUBSTANCES AND FOR SEPARATING SOLID AND LIQUID SUBSTANCES, NAMELY FILTERS FOR SOLID AND LIQUID SEPARATION, FILTERING UNITS FOR WATER FILTERING, AND DISTILLING UNITS; INSTALLATIONS FOR PROCESS HEAT RECOVERY IN BIOGAS INSTALLATIONS, NAMELY, HEAT EXCHANGERS NOT BEING PARTS OF MACHINES FOR RECOVERING PROCESS HEAT, IN CLASS 11 (U.S. CLS. 13, 21, 23, 31 AND 34).

FOR: CONTAINERS NOT OF METAL, IN PARTICULAR MODULAR, PRE-FABRICATED SILOS, IN CLASS 19 (U.S. CLS. 1, 12, 33 AND 50).

FOR: TECHNICAL SUPPORT SERVICES, NAMELY, TROUBLESHOOTING IN THE NATURE OF THE REPAIR OF COMPUTER HARDWARE USED IN INSTALLATIONS FOR THE PRODUCTION OF BIOGAS, NAMELY, COMPUTER HARDWARE USED TO MONITOR BIOLOGICAL PROCESSES; BUILDING CONSTRUCTION SERVICES, NAMELY, CONSTRUCTION OF INSTALLATIONS FOR THE PRODUCTION OF BIOGAS AND BLOCK-TYPE COGENERATION INSTALLATIONS; REPAIR AND MAINTENANCE OF INSTALLATIONS FOR THE PRODUCTION OF BIOGAS AND COMPONENTS THEREOF, AND BLOCK-TYPE COGENERATION INSTALLATIONS; INSTALLATION OF PROCESSING CONTROL SYSTEMS FOR BLOCK-TYPE COGENERATION INSTALLATIONS AND BIOGAS INSTALLATIONS, IN CLASS 37 (U.S. CLS. 100, 103 AND 106).

FOR: TECHNICAL SUPPORT SERVICES, NAMELY, TROUBLESHOOTING IN THE NATURE OF DIAGNOSING COMPUTER HARDWARE AND SOFTWARE PROBLEMS FOR COMPUTER

**Reg. No. 4,273,922** HARDWARE AND SOFTWARE USED IN INSTALLATIONS FOR THE PRODUCTION OF BIOGAS, NAMELY, COMPUTER HARDWARE AND SOFTWARE USED TO MONITOR BIOLOGICAL PROCESSES; TECHNICAL SUPPORT SERVICES, NAMELY, TROUBLESHOOTING OF COMPUTER SOFTWARE PROBLEMS FOR SOFTWARE USED IN INSTALLATIONS FOR THE PRODUCTION OF BIOGAS, NAMELY, SOFTWARE USED TO MONITOR BIOLOGICAL PROCESSES; TECHNOLOGY CONSULTATION IN THE FIELD OF SCIENTIFIC TECHNOLOGY USED IN INSTALLATIONS FOR THE PRODUCTION OF BIOGAS, NAMELY, WITH REGARD TO TECHNOLOGY USED TO MONITOR AND PRODUCE BIOLOGICAL PROCESSES; CONSULTATION SERVICES IN THE FIELD OF BIOLOGICAL RESEARCH AND ANALYSIS OF BIOLOGICAL PROCESSES USED IN INSTALLATIONS FOR THE PRODUCTION OF BIOGAS; ENGINEERING, IN PARTICULAR FOR THE PLANNING, DEVELOPMENT AND CONTROL OF BIOGAS INSTALLATIONS AND BLOCK TYPE COGENERATION INSTALLATIONS; DESIGN PLANNING OF BUILDING INSTALLATIONS FOR THE PRODUCTION OF BIOGAS AND BLOCK-TYPE COGENERATING INSTALLATIONS, IN CLASS 42 (U.S. CLS. 100 AND 101).

THE MARK CONSISTS OF A GREY HORIZONTAL LINE CONNECTING AND SURROUNDING A CIRCLE WITH A GREEN AND WHITE BACKGROUND, A CIRCLE WITH AN ORANGE BACKGROUND AND A CIRCLE WITH A RED BACKGROUND. THE CIRCLE WITH THE GREEN AND WHITE BACKGROUND CONTAINS A GREEN AND WHITE CORN STALK AND THREE CURVED LINES IN THE COLOR WHITE. THE CIRCLE WITH THE ORANGE BACKGROUND CONTAINS SEVEN BUBBLES OUTLINED IN THE COLOR WHITE. THE CIRCLE WITH THE RED BACKGROUND CONTAINS TWO FLAMES OUTLINED IN THE COLOR WHITE.

PRIORITY DATE OF 1-19-2011 IS CLAIMED.

OWNER OF INTERNATIONAL REGISTRATION 1108796 DATED 5-26-2011, EXPIRES 5-26-2021.

THE COLOR(S) GREY, RED, GREEN, ORANGE AND WHITE IS/ARE CLAIMED AS A FEATURE OF THE MARK.

SER. NO. 79-109,953, FILED 5-26-2011.

EVELYN BRADLEY, EXAMINING ATTORNEY

# United States of America

United States Patent and Trademark Office

# RXT

**Reg. No. 4,273,923**

**Registered Jan. 15, 2013**

**Int. Cl.: 42**

RESERVOIR EXPLORATION TECHNOLOGY ASA (NORWAY PUBLIC STOCK CORPORATION)  
P.O. BOX 104  
N-1325 LYSAKER  
NORWAY

**SERVICE MARK**

**PRINCIPAL REGISTER**

FOR: SCIENTIFIC AND TECHNOLOGICAL SERVICES, NAMELY, RESEARCH AND DESIGN IN THE FIELD OF OIL AND GAS EXPLORATION; INDUSTRIAL RESEARCH AND ANALYSIS SERVICES IN THE OIL AND GAS INDUSTRY, NAMELY, OIL EXPLORATION OPERATIONS, SUBSURFACE SURVEYING, ACQUISITION OF MARINE SEISMIC DATA, AND PROVISION OF MARINE SEISMIC DATA; SCIENTIFIC AND TECHNOLOGICAL SERVICES IN THE FIELD OF OCEAN AND LAND SEISMIC DATA, NAMELY, ACQUISITION OF SEISMIC DATA, PROVISION OF SEISMIC DATA, AND ANALYTICAL PROCESSING OF SEISMIC DATA; SCIENTIFIC AND TECHNOLOGICAL SERVICES IN THE OIL AND GAS INDUSTRY, NAMELY, EXPLORATION AND SURVEYS OF OIL AND GAS ACCUMULATIONS, IN CLASS 42 (U.S. CLS. 100 AND 101).

THE MARK CONSISTS OF THE STYLIZED LETTERS "RXT".

OWNER OF INTERNATIONAL REGISTRATION 1109130 DATED 10-3-2011, EXPIRES 10-3-2021.

SER. NO. 79-110,016, FILED 10-3-2011.

JASON TURNER, EXAMINING ATTORNEY



*David J. Kybas*

Director of the United States Patent and Trademark Office

United States of America  
United States Patent and Trademark Office

**kiskin**

**Reg. No. 4,273,924**

**Registered Jan. 15, 2013**

**Int. Cl.: 25**

**TRADEMARK**

**PRINCIPAL REGISTER**

CARRADORI, CHIARA (ITALY INDIVIDUAL)  
VIA ORPIANO, 16  
I-62025 FIUMINATA (MC)  
ITALY

FOR: CLOTHING ITEMS NAMELY, SWEATERS, CARDIGANS, WAISTCOATS, SUITS, TROUSERS, SHORTS, JUMPERS, RAINCOATS, CLOTHING MADE OF LEATHER, NAMELY, LEATHER COATS, LEATHER JACKETS, LEATHER VESTS, PANT SUITS OF LEATHER, TROUSERS OF LEATHER; STOCKINGS AND SOCKS, STOCKING SUSPENDERS, SOCK SUSPENDERS, WIND RESISTANT JACKETS, SKI TROUSERS, FUR COATS, OVERCOATS, SKIRTS, DRESSES, JACKETS, UNDERSHIRTS, T-SHIRTS, SPORT CLOTHING NAMELY, SPORT JERSEYS AND BREECHES FOR SPORTS, SPORTS OVER UNIFORMS, BLOUSES, SHIRT COLLARS, SHIRTS, FOULARDS, TRACKSUITS; BATHING SUITS AND SWIMMING COSTUMES, NAMELY, SWIM SUITS, BIKINI, BATHING COSTUMES; BATH ROBES; WEDDING DRESSES; UNDERWEAR, BRAS, BRASSIERE, CORSETS, UNDERPANTS, BRIEFS, VESTS, NIGHTGOWNS, NEGLIGEEES, PYJAMAS, GLOVES, SHAWLS, SCARVES, NECKTIES, BOW TIES, BELTS, SUSPENDERS, HATS, CAPS; SHOES, BOOTS, HALF BOOTS, LEATHER SHOES, GALOSHES, RAIN BOOTS, SPORT FOOTWEAR, SLIPPERS, SHOE SOLES, SHOE HEELS, SHOE UPPERS, MOULDED SOLES FOR SHOES, BEACH SANDALS AND FLIP FLOPS, IN CLASS 25 (U.S. CLS. 22 AND 39).

THE MARK CONSISTS OF THE STYLIZED WORDING "KISKIN" WITH A HEART DESIGN BELOW THE LETTER S.

OWNER OF INTERNATIONAL REGISTRATION 1109798 DATED 12-7-2011, EXPIRES 12-7-2021.

THE WORD(S) "KISKIN" HAS NO MEANING IN A FOREIGN LANGUAGE.

SER. NO. 79-110,179, FILED 12-7-2011.

EVELYN BRADLEY, EXAMINING ATTORNEY



*David J. Kyffers*

Director of the United States Patent and Trademark Office

United States of America  
United States Patent and Trademark Office

# Kosogorov

**Reg. No. 4,273,925**

**Registered Jan. 15, 2013**

**Int. Cl.: 33**

**TRADEMARK**

**PRINCIPAL REGISTER**

OBSHCHESTVO S OGRANICHENNOJ; OTVETSTVENNOST'YU; "SAMOGON" (RUSSIAN FED. LIMITED LIABILITY COMPANY)  
VARSHAVSKOE SHOSSE, DOM 33  
RU-117105 MOSCOW  
RUSSIAN FED.

FOR: ALCOHOLIC BEVERAGES EXCEPT BEERS, IN CLASS 33 (U.S. CLS. 47 AND 49).

THE MARK CONSISTS OF STANDARD CHARACTERS WITHOUT CLAIM TO ANY PARTICULAR FONT, STYLE, SIZE, OR COLOR.

PRIORITY DATE OF 12-6-2011 IS CLAIMED.

OWNER OF INTERNATIONAL REGISTRATION 1109527 DATED 2-8-2012, EXPIRES 2-8-2022.

THE ENGLISH TRANSLATION OF "KOSOGOROV" IN THE MARK IS "MOUNTAIN'S SLOPE".

SER. NO. 79-110,239, FILED 2-8-2012.

APRIL HESIK, EXAMINING ATTORNEY



*David J. Kyros*

Director of the United States Patent and Trademark Office

# United States of America

United States Patent and Trademark Office

# GEMBALLA

**Reg. No. 4,273,926**

**Registered Jan. 15, 2013**

**Int. Cls.: 9, 12, 14, 18, 25,  
27, 28, 35 and 37**

**TRADEMARK**

**SERVICE MARK**

**PRINCIPAL REGISTER**

GEMBALLA GMBH (FED REP GERMANY LIMITED LIABILITY COMPANY)  
MOLLENBACHSTRASSE 17  
71229 LEONBERG  
FED REP GERMANY

FOR: APPARATUS AND INSTRUMENTS, NAMELY, INTEGRATED NAVIGATION COMPUTER SYSTEMS FOR AUTOMOBILES CONSISTING OF ELECTRONIC DISPLAY INTERFACE, COMPUTER TERMINAL, NAVIGATION COMPUTER SYSTEM OPERATING SOFTWARE, CD-ROM DRIVE, TELEPHONE, CASSETTE PLAYER, RADIO AND SATELLITE CONTROLLED GLOBAL POSITIONING SYSTEM WITH INTEGRATED ANTENNA AND SATELLITE RECEIVER; DEVICES FOR RECORDING, TRANSMISSION AND REPRODUCTION OF SOUND AND IMAGES, NAMELY, CAMERAS, RADIOS, TELEVISION, AUDIO TAPE CASSETTE RECORDERS, VIDEO TAPE CASSETTE RECORDERS; SPECTACLES, NAMELY, SUNGLASSES, ANTI-GLARE GLASSES, BINOCULARS, TELESCOPES AND COMPASSES; SPEED CHECKING APPARATUS FOR AUTOMOBILES, NAMELY, ODOMETERS, THERMOSTATS FOR AUTOMOBILES; FIRE EXTINGUISHERS, IN CLASS 9 (U.S. CLS. 21, 23, 26, 36 AND 38).

FOR: VEHICLES, NAMELY, AUTOMOBILES AND STRUCTURAL PARTS THEREOF; SPORTS CARS AND STRUCTURAL PARTS THEREOF; AUTOMOBILE BODIES AND AUTOMOBILE ENGINES; SPOILERS FOR VEHICLES; REAR VIEW MIRRORS; ACCESSORIES FOR AUTOMOBILES AND SPORTS CARS, NAMELY, ANTI-THEFT ALARMS FOR VEHICLES, LUGGAGE CARRIERS FOR AUTOMOBILES, CHILDREN'S CAR SEATS, CAR WINDOW SHADES, HUB CAPS, CAR ROOF RACKS, SEAT CUSHIONS AND CANOPIES FOR VEHICLES, IN CLASS 12 (U.S. CLS. 19, 21, 23, 31, 35 AND 44).

FOR: PRECIOUS METALS AND THEIR ALLOYS AND GOODS MADE OF PRECIOUS METALS OR COATED THEREWITH, NAMELY, KEY CHAINS; JEWELRY, NAMELY, BRACELETS, CUFF LINKS, TIE PINS; HOROLOGICAL AND CHRONOMETRIC INSTRUMENTS, IN CLASS 14 (U.S. CLS. 2, 27, 28 AND 50).

FOR: LEATHER AND IMITATION LEATHER; GOODS MADE OF LEATHER AND IMITATION LEATHER, NAMELY, WALLETS, ATTACHÉ CASES, SUIT CASES, TRAVELING BAGS AND GARMENT BAGS FOR TRAVEL; CASES FOR TRAVEL DOCUMENTS, CREDIT CARDS AND CALLING CARDS, ALL MADE OF LEATHER, IN CLASS 18 (U.S. CLS. 1, 2, 3, 22 AND 41).



*David J. Kappas*

Director of the United States Patent and Trademark Office

**Reg. No. 4,273,926** FOR: CLOTHING, NAMELY, T-SHIRTS, POLO SHIRTS, GOLF SHIRTS, JACKETS, RAIN COATS, ANORAKS, PULLOVERS, SWEATERS, SHORTS AND TROUSERS; BELTS, NECKTIES, CAPS AND HATS; FOOTWEAR, IN CLASS 25 (U.S. CLS. 22 AND 39).

FOR: CARPETS, RUGS AND FLOOR MATS FOR AUTOMOBILES AND SPORTS CARS, IN CLASS 27 (U.S. CLS. 19, 20, 37, 42 AND 50).

FOR: GAMES AND TOYS, NAMELY, TOY MODEL CARS, PLAYING CARDS; SPORTING ARTICLES, NAMELY, GOLF BAGS, GOLF GLOVES AND GOLF CLUBS, IN CLASS 28 (U.S. CLS. 22, 23, 38 AND 50).

FOR: RETAIL AND WHOLESALE STORE SERVICES IN THE FIELD OF AUTOMOBILES, AUTOMOBILE PARTS, AUTOMOBILE ACCESSORIES; IMPORT-EXPORT AGENCY SERVICES IN THE FIELD OF AUTOMOBILES AND SPORTS CARS, AND AUTOMOBILE PARTS AND ACCESSORIES, IN CLASS 35 (U.S. CLS. 100, 101 AND 102).

FOR: MAINTENANCE AND REPAIR OF AUTOMOBILES AND SPORTS CARS; INSTALLATION OF AUTOMOBILE PARTS AND AUTOMOBILE ACCESSORIES; TUNING OF AUTOMOBILES AND SPORTS CARS, NAMELY, MAINTENANCE OF AUTOMOBILES AND SPORTS CARS; INSTALLATION AND FITTING OF SPECIAL EQUIPMENT IN AND TO AUTOMOBILES AND SPORTS CARS; TECHNICAL SUPPORT OF AUTOMOBILES, NAMELY, PROVIDING TECHNICAL ADVICE CONCERNING THE REPAIR AND MAINTENANCE OF SPORTS CARS; MAINTENANCE OF SPORTS CARS, IN CLASS 37 (U.S. CLS. 100, 103 AND 106).

THE MARK CONSISTS OF STANDARD CHARACTERS WITHOUT CLAIM TO ANY PARTICULAR FONT, STYLE, SIZE, OR COLOR.

PRIORITY DATE OF 6-14-2011 IS CLAIMED.

OWNER OF INTERNATIONAL REGISTRATION 1109681 DATED 11-30-2011, EXPIRES 11-30-2021.

SER. NO. 79-110,295, FILED 11-30-2011.

LINDA LAVACHE, EXAMINING ATTORNEY

# United States of America

United States Patent and Trademark Office

**YOUR PERFECT MOMENT**



**Reg. No. 4,273,927**

**Registered Jan. 15, 2013**

**Int. Cl.: 10**

**TRADEMARK**

**PRINCIPAL REGISTER**

FUN FACTORY GMBH (FED REP GERMANY GESELLSCHAFT MIT BESCHRÄNKTER HAFTUNG)  
AM HOHENTORSHAFEN 17-19  
28197 BREMEN, FED REP GERMANY

FOR: MASSAGE APPARATUS, IN PARTICULAR MASSAGE RODS WITH AND WITHOUT MOTORS, AND MASSAGE BALLS; ADULT SEXUAL AIDS OF SILICONE AND OTHER PLASTICS, NAMELY, ERECTION AND ORGASM-ENHANCING ARTICLES IN THE NATURE OF ARTIFICIAL PENISES, CONSTRICTION RINGS FOR USE IN MAINTAINING PENILE RIGIDITY IN MEN WITH ERECTILE DYSFUNCTION, AND VIBRATORS, IN CLASS 10 (U.S. CLS. 26, 39 AND 44).

OWNER OF U.S. REG. NOS. 3,196,106, 4,024,736 AND OTHERS.

PRIORITY DATE OF 1-26-2012 IS CLAIMED.

OWNER OF INTERNATIONAL REGISTRATION 1110224 DATED 2-20-2012, EXPIRES 2-20-2022.

THE COLOR(S) RED AND WHITE IS/ARE CLAIMED AS A FEATURE OF THE MARK.

THE MARK CONSISTS OF THE STYLIZED WORDING "YOUR PERFECT MOMENT" TO THE LEFT OF A CIRCLE WITH THE WORDING "FUN FACTORY" THEREIN. THE COLOR RED APPEARS IN THE BACKGROUND OF THE CIRCLE AND IN THE WORDING "YOUR PERFECT MOMENT". THE COLOR WHITE APPEARS IN THE WORDING "FUN FACTORY". THE REMAINDER OF THE WHITE IN THE DRAWING REPRESENTS BACKGROUND AREAS ONLY AND IS NOT PART OF THE MARK.

SER. NO. 79-110,468, FILED 2-20-2012.

MAUREEN DALL, EXAMINING ATTORNEY



*David J. Kyjars*

Director of the United States Patent and Trademark Office



United States of America  
United States Patent and Trademark Office

鹏翔

**PENGXIANG**

**Reg. No. 4,273,928**

**Registered Jan. 15, 2013**

**Int. Cl.: 19**

**TRADEMARK**

**PRINCIPAL REGISTER**

FUJIAN PENGXIANG INDUSTRIAL CO.,LTD. (CHINA CORPORATION)  
BINHAI INDUSTRIAL AREA  
SHUITOU TOWN, NAN'AN CITY  
FUJIAN, CHINA 362300

FOR: ARTIFICIAL STONE; MARBLE; GRANITE; CEMENT; FIREPROOF CEMENT COATINGS; BITUMEN; CERAMIC TILE, IN CLASS 19 (U.S. CLS. 1, 12, 33 AND 50).

THE MARK CONSISTS OF TWO LARGE CHINESE CHARACTERS ABOVE THE TERM "PENGXIAN".

OWNER OF INTERNATIONAL REGISTRATION 1110292 DATED 11-23-2011, EXPIRES 11-23-2021.

THE NON-LATIN CHARACTERS IN THE MARK TRANSLITERATE TO "PENGXIANG" AND THIS MEANS "A MYTHICAL GIANT BIRD CIRCLING OR FLYING IN THE SKY" IN ENGLISH.

THE ENGLISH TRANSLATION OF "PENGXIANG" IN THE MARK IS A MYTHICAL GIANT BIRD CIRCLING OR FLYING IN THE SKY.

SER. NO. 79-110,493, FILED 11-23-2011.

ANTHONY RINKER, EXAMINING ATTORNEY



*David J. Kybas*

Director of the United States Patent and Trademark Office

United States of America  
United States Patent and Trademark Office

# MOBOOM

**Reg. No. 4,273,929**

**Registered Jan. 15, 2013**

**Int. Cls.: 9 and 38**

**TRADEMARK**

**SERVICE MARK**

**PRINCIPAL REGISTER**

MOBOOM LIMITED (AUSTRALIA PROPRIETARY LIMITED COMPANY)  
LEVEL 4,  
1 HOWARD STREET PERTH. WA 6000  
AUSTRALIA

FOR: APPLICATIONS FOR CELLULAR TELEPHONES AND MOBILE TELEPHONES, NAMELY, COMMUNICATION SOFTWARE FOR PROVIDING ACCESS TO THE INTERNET AND THE WORLD WIDE WEB; APPLICATIONS FOR CELLULAR TELEPHONES AND MOBILE TELEPHONES, NAMELY, COMMUNICATION SOFTWARE FOR PROVIDING AND OPTIMIZING INTERNET AND WEBSITE ACCESS; DOWNLOADABLE SOFTWARE IN THE NATURE OF A MOBILE APPLICATION FOR CELLULAR TELEPHONES AND MOBILE TELEPHONES FOR PROVIDING AND OPTIMIZING ACCESS TO THE INTERNET AND THE WORLD WIDE WEB, IN CLASS 9 (U.S. CLS. 21, 23, 26, 36 AND 38).

FOR: CELLULAR TELEPHONE COMMUNICATION; MOBILE TELEPHONE COMMUNICATION SERVICES; PROVISION OF USER ACCESS TO THE INTERNET, INCLUDING PROVISION OF USER ACCESS TO THE INTERNET FOR USERS OF CELLULAR TELEPHONES AND MOBILE TELEPHONES, IN CLASS 38 (U.S. CLS. 100, 101 AND 104).

THE MARK CONSISTS OF STANDARD CHARACTERS WITHOUT CLAIM TO ANY PARTICULAR FONT, STYLE, SIZE, OR COLOR.

PRIORITY DATE OF 12-20-2011 IS CLAIMED.

OWNER OF INTERNATIONAL REGISTRATION 1110329 DATED 1-18-2012, EXPIRES 1-18-2022.

SER. NO. 79-110,509, FILED 1-18-2012.

KATHERINE CHANG, EXAMINING ATTORNEY



*David J. Kybas*

Director of the United States Patent and Trademark Office

# United States of America

## United States Patent and Trademark Office



**Reg. No. 4,273,930**

**Registered Jan. 15, 2013**

**Int. Cls.: 35 and 39**

**SERVICE MARK**

**PRINCIPAL REGISTER**

MALTACOURT LIMITED (UNITED KINGDOM LIMITED COMPANY)  
MALTACOURT HOUSE  
DARESBUURY COURT;; EVENWOOD CLOSE; RUNCORN, CHESHIRE WA7 1LZ  
UNITED KINGDOM

FOR: BUSINESS MANAGEMENT; BUSINESS ADMINISTRATION; BUSINESS ADVISORY SERVICES; BUSINESS ADVISORY SERVICES RELATING TO IMPORT AND EXPORT OF GOODS; IMPORT-EXPORT AGENCY SERVICES; BUSINESS ADVISORY SERVICES RELATING TO LOGISTICS AND TRANSPORT; SUPPLY CHAIN MANAGEMENT SERVICES; CUSTOMS CLEARANCE SERVICES; UPDATING, MAINTENANCE, SYSTEMATIC ORDERING AND COLLATING OF DATA IN COMPUTER DATABASES; ADDRESSING, ENVELOPING AND FRANKING OF GOODS, IN PARTICULAR LETTERS, PARCELS AND PACKAGES; DISTRIBUTION OF SAMPLES, IN CLASS 35 (U.S. CLS. 100, 101 AND 102).

FOR: TRANSPORT SERVICES, IN PARTICULAR TRANSPORT OF GOODS BY MOTOR VEHICLE, LORRY, RAIL, SHIP AND AEROPLANE; PACKAGING AND STORAGE OF GOODS; TRANSPORTATION INFORMATION; FREIGHT BROKERAGE; STORAGE INFORMATION; COURIER SERVICES; SUPPLY CHAIN LOGISTICS IN THE TRANSPORT SECTOR IN THE NATURE OF STORAGE, TRANSPORTATION AND DELIVERY OF GOODS FOR OTHERS BY AIR, RAIL, SHIP OR TRUCK; COLLECTION, TRANSPORT AND DELIVERY OF GOODS, IN PARTICULAR DOCUMENTS, PACKAGES, PARCELS, LETTERS AND PALLETS; FREIGHTING BY SHIP, AEROPLANE, RAIL, MOTOR VEHICLE AND LORRY; TRACKING BY MEANS OF THE ELECTRONIC TRACKING OF GOODS, IN PARTICULAR DOCUMENTS, PACKAGES, PARCELS, LETTERS AND PALLETS, INCLUDED IN THIS CLASS; WAREHOUSE MANAGEMENT SERVICES; WAREHOUSE STORAGE SERVICES; RENTAL OF STORAGE CONTAINERS; CONSULTANCY RELATING TO LOGISTICS SERVICES CONSISTING OF TRANSPORT, PACKAGING AND STORAGE OF GOODS; LOGISTICS CONSULTANCY, NAMELY, CONSULTANCY RELATING TO SUPPLY CHAIN, LOGISTICS AND REVERSE LOGISTICS, NAMELY, STORAGE, TRANSPORTATION AND DELIVERY OF DOCUMENTS, PACKAGES, RAW MATERIALS AND OTHER FREIGHT FOR OTHERS BY AIR, RAIL, SHIP OR TRUCK; PACKAGING ARTICLES FOR TRANSPORTATION; RENTAL OF DOCUMENT BOXES FOR TRANSPORT, PACKAGING AND STORAGE; ADVISORY AND CONSULTANCY SERVICES IN RELATION TO ALL OF THE AFOREMENTIONED; PROVIDING COMPUTERIZED TRACKING OF PACKAGES IN TRANSIT, IN CLASS 39 (U.S. CLS. 100 AND 105).



*David J. Kyjars*

Director of the United States Patent and Trademark Office

**Reg. No. 4,273,930** THE MARK CONSISTS OF AN INCOMPLETE OVAL DESIGN COMPRISING RED, ORANGE, AND YELLOW CURVED DIAGONAL BANDS.

PRIORITY DATE OF 10-10-2011 IS CLAIMED.

OWNER OF INTERNATIONAL REGISTRATION 1110657 DATED 10-27-2011, EXPIRES 10-27-2021.

THE COLOR(S) RED, ORANGE, AND YELLOW IS/ARE CLAIMED AS A FEATURE OF THE MARK.

SER. NO. 79-110,655, FILED 10-27-2011.

MELISSA VALLILLO, EXAMINING ATTORNEY

# United States of America

United States Patent and Trademark Office

# FABI

**Reg. No. 4,273,931**

**Registered Jan. 15, 2013**

**Int. Cls.: 3, 9, 14, 18 and  
25**

**TRADEMARK**

**PRINCIPAL REGISTER**

FABI SPA (ITALY JOINT STOCK COMPANY)  
VIA BORE CHIENZI SCN  
I-62015 MONTE SAN GIUSTO (MC)  
ITALY

FOR: SOAPS; HAIR CARE PREPARATIONS, NAMELY, HAIR LOTIONS, SHAMPOO; COSMETIC SOAPS; OILS FOR TOILETRY PURPOSES; EYE SHADOWS; NON-MEDICATED SKIN CARE PREPARATIONS; EYEBROW COSMETICS; BEAUTY MASK; NAIL CARE PREPARATIONS; NAIL VARNISH FOR COSMETIC PURPOSES; SHAVING SOAP; AFTER SHAVE LOTIONS; MAKE-UP PREPARATIONS; COSMETIC SUN-PROTECTING PREPARATIONS; COSMETICS; LIPSTICKS; EYE MAKE-UP; EYE PENCILS; NON-MEDICATED TOILETRIES; PERFUMES FOR PERSONAL USE; DEODORANTS FOR PERSONAL USE; EAU DE PARFUM; MASCARA; COSMETIC CREAMS, IN CLASS 3 (U.S. CLS. 1, 4, 6, 50, 51 AND 52).

FOR: EYE GLASSES, SUNGLASSES AND SPECTACLES, IN CLASS 9 (U.S. CLS. 21, 23, 26, 36 AND 38).

FOR: PRECIOUS METALS AND THEIR ALLOYS, JEWELLERY, SILVER, IVORY ORNAMENTS, STUDS MADE OF PRECIOUS METALS, BRACELETS, WRISTWATCHES, BRACELETS FOR WATCHES; ORNAMENTS FOR SHOES MADE OF PRECIOUS METALS; CHAINS FOR WATCHES, PENDANTS, NECKLACES; TIE CLIPS; ORNAMENTAL PINS, LAPEL BADGE MADE OF PRECIOUS METAL AND JEWELLERY; DIAMONDS, STRINGS MADE OF PRECIOUS METALS AND JEWELLERY, EARRINGS MADE OF PRECIOUS METAL AND JEWELLERY, ORNAMENTS, PEARL, STONES, NAMELY, SEMI-PRECIOUS STONES; PRECIOUS STONES; PRECIOUS METALS; CLOCKS, WATCHES AND CHRONOMETRIC INSTRUMENTS, IN CLASS 14 (U.S. CLS. 2, 27, 28 AND 50).

FOR: LEATHER AND IMITATIONS OF LEATHER; UNWORKED OR SEMI-WORKED LEATHER; ANIMAL SKINS; ANIMAL HIDES; TRUNKS; SUITCASES; BAGS, NAMELY, TRAVELING BAGS, GARMENT BAGS FOR TRAVEL, HANDBAGS, BEACH BAGS, WHEELED BAGS, BRIEFCASES; LEATHER SHOULDER STRAPS; VALISES; SCHOOL SATCHELS; KEY CASES OF LEATHER OR IMITATION LEATHER; WALLETS; PURSES; COSMETIC BAGS SOLD EMPTY; PARASOLS; UMBRELLAS; WALKING STICKS, IN CLASS 18 (U.S. CLS. 1, 2, 3, 22 AND 41).



*David J. Kappas*

Director of the United States Patent and Trademark Office

**Reg. No. 4,273,931** FOR: CLOTHING, NAMELY, COATS, JACKETS, OVERALLS, SMOCKS, SWEATERS, PANTS, SKIRTS, BLOUSES, SHORTS, VEST, SWEATER, PAJAMAS, SUITS, BELTS, NECKWEAR, TIGHTS, VESTS, TRACKSUITS, T-SHIRTS, SLIPS, PAJAMAS, GLOVES, BATH ROBE; BABY LAYETTES FOR CLOTHING AND CLOTHING FOR BABIES, NAMELY, JUMPERS, OVERALLS, SLEEPWEAR, PAJAMAS, FOOTWEAR, NAMELY, SHOES, HEELS, INSOLES; HEADGEAR, NAMELY, CAPS AND HATS, IN CLASS 25 (U.S. CLS. 22 AND 39).

THE MARK CONSISTS OF STANDARD CHARACTERS WITHOUT CLAIM TO ANY PARTICULAR FONT, STYLE, SIZE, OR COLOR.

PRIORITY DATE OF 3-29-2011 IS CLAIMED.

OWNER OF INTERNATIONAL REGISTRATION 1111107 DATED 8-16-2011, EXPIRES 8-16-2021.

SEC. 2(F).

SER. NO. 79-110,808, FILED 8-16-2011.

KATHLEEN M. VANSTON, EXAMINING ATTORNEY

# United States of America

United States Patent and Trademark Office

## MAISON SCOTCH

**Reg. No. 4,273,932**

**Registered Jan. 15, 2013**

**Int. Cls.: 14 and 18**

**TRADEMARK**

**PRINCIPAL REGISTER**

SCOTCH & SODA B.V. (NETHERLANDS PRIVATE LIMITED LIABILITY COMPANY)  
JACOBUS SPIJKERDREEF 20-24  
NL-2132 PZ HOOFDORP  
NETHERLANDS

FOR: PRECIOUS METALS AND THEIR ALLOYS AND GOODS IN PRECIOUS METALS OR COATED THEREWITH, NAMELY, BRACELETS, JEWELRY, CLOCKS, FIGURINES, KEY CHAINS, ORNAMENTAL PINS, WATCHES; JEWELLERY, PRECIOUS STONES; HOROLOGICAL AND CHRONOMETRIC INSTRUMENTS, IN CLASS 14 (U.S. CLS. 2, 27, 28 AND 50).

FOR: LEATHER AND IMITATIONS OF LEATHER, AND GOODS MADE OF THESE MATERIALS AND NOT INCLUDED IN OTHER CLASSES, NAMELY, LEATHER AND IMITATION LEATHER BAGS, LEATHER AND IMITATION LEATHER KEY CHAINS; BAGS NOT INCLUDED IN OTHER CLASSES, NAMELY, ALL PURPOSE SPORT BAGS, SCHOOL BAGS, BOOK BAGS, CARRY-ALL BAGS; SADDLE BELTS OF LEATHER, TRUNKS AND TRAVELLING BAGS; UMBRELLAS, PARASOLS, IN CLASS 18 (U.S. CLS. 1, 2, 3, 22 AND 41).

THE MARK CONSISTS OF STANDARD CHARACTERS WITHOUT CLAIM TO ANY PARTICULAR FONT, STYLE, SIZE, OR COLOR.

OWNER OF INTERNATIONAL REGISTRATION 1007003 DATED 5-20-2009, EXPIRES 5-20-2019.

OWNER OF U.S. REG. NOS. 3,767,705, 3,799,773, AND 4,134,407.

THE ENGLISH TRANSLATION OF "MAISON" IN THE MARK IS HOUSE.

SER. NO. 79-110,865, FILED 10-7-2011.

STEVEN JACKSON, EXAMINING ATTORNEY



*David J. Kyros*

Director of the United States Patent and Trademark Office

# United States of America

United States Patent and Trademark Office

## SCOTCH & SODA

**Reg. No. 4,273,933**

**Registered Jan. 15, 2013**

**Int. Cls.: 14 and 18**

**TRADEMARK**

**PRINCIPAL REGISTER**

SCOTCH & SODA B.V. (NETHERLANDS PRIVATE LIMITED LIABILITY COMPANY)  
JACOBUS SPIJKERDREEF 20-24  
NL-2132 PZ HOOFFDORP  
NETHERLANDS

FOR: PRECIOUS METALS AND THEIR ALLOYS AND GOODS IN PRECIOUS METALS OR COATED THEREWITH, NAMELY, BRACELETS, JEWELLERY, CLOCKS, FIGURINES, KEY CHAINS, ORNAMENTAL PINS, WATCHES; JEWELLERY, PRECIOUS STONES; HOROLOGICAL AND CHRONOMETRIC INSTRUMENTS, IN CLASS 14 (U.S. CLS. 2, 27, 28 AND 50).

FOR: LEATHER AND IMITATIONS OF LEATHER, AND GOODS MADE OF THESE MATERIALS AND NOT INCLUDED IN OTHER CLASSES, NAMELY, LEATHER AND IMITATION LEATHER BAGS, LEATHER AND IMITATION LEATHER KEY CHAINS; BAGS NOT INCLUDED IN OTHER CLASSES, NAMELY, ALL PURPOSE SPORT BAGS, SCHOOL BAGS, BOOK BAGS, CARRY-ALL BAGS; SADDLE BELTS OF LEATHER, TRUNKS AND TRAVELLING BAGS; UMBRELLAS, PARASOLS, IN CLASS 18 (U.S. CLS. 1, 2, 3, 22 AND 41).

THE MARK CONSISTS OF STANDARD CHARACTERS WITHOUT CLAIM TO ANY PARTICULAR FONT, STYLE, SIZE, OR COLOR.

OWNER OF INTERNATIONAL REGISTRATION 1028904 DATED 1-13-2010, EXPIRES 1-13-2020.

OWNER OF U.S. REG. NOS. 3,135,965 AND 3,870,373.

SER. NO. 79-110,877, FILED 10-7-2011.

LEIGH CAROLINE CASE, EXAMINING ATTORNEY



*David J. Kypos*

Director of the United States Patent and Trademark Office



# United States of America

United States Patent and Trademark Office

## MALTACOURT

**Reg. No. 4,273,934**

**Registered Jan. 15, 2013**

**Int. Cls.: 35 and 39**

**SERVICE MARK**

**PRINCIPAL REGISTER**

MALTACOURT LIMITED (UNITED KINGDOM LIMITED COMPANY)  
MALTACOURT HOUSE  
DARESURY COURT,; EVENWOOD CLOSE; RUNCORN, CHESHIRE WA7 1LZ  
UNITED KINGDOM

FOR: BUSINESS MANAGEMENT; BUSINESS ADMINISTRATION; BUSINESS ADVISORY SERVICES; BUSINESS ADVISORY SERVICES RELATING TO IMPORT AND EXPORT OF GOODS; IMPORT-EXPORT AGENCY SERVICES; BUSINESS ADVISORY SERVICES RELATING TO LOGISTICS AND TRANSPORT; SUPPLY CHAIN MANAGEMENT SERVICES; ADMINISTRATIVE SERVICES RELATING TO CUSTOMS CLEARANCE; UPDATING, MAINTENANCE, SYSTEMATIC ORDERING AND COLLATING OF DATA IN COMPUTER DATABASES; AUTOMATED ADDRESSING OF LETTERS, PARCELS AND PACKAGES; DISTRIBUTION OF SAMPLES, IN CLASS 35 (U.S. CLS. 100, 101 AND 102).

FOR: TRANSPORT SERVICES, IN PARTICULAR TRANSPORT OF GOODS BY MOTOR VEHICLE, LORRY, RAIL, SHIP AND AEROPLANE; PACKAGING AND STORAGE OF GOODS; TRANSPORTATION INFORMATION; FREIGHT BROKERAGE; STORAGE INFORMATION; COURIER SERVICES; SUPPLY CHAIN LOGISTICS IN THE TRANSPORT SECTOR IN THE NATURE OF STORAGE, TRANSPORTATION AND DELIVERY OF GOODS FOR OTHERS BY AIR, RAIL, SHIP OR TRUCK; COLLECTION, TRANSPORT AND DELIVERY OF GOODS, IN PARTICULAR DOCUMENTS, PACKAGES, PARCELS, LETTERS AND PALLETS; FREIGHTING BY SHIP, AEROPLANE, RAIL, MOTOR VEHICLE AND LORRY; TRACKING BY MEANS OF THE ELECTRONIC TRACKING OF GOODS, IN PARTICULAR DOCUMENTS, PACKAGES, PARCELS, LETTERS AND PALLETS, INCLUDED IN THIS CLASS; WAREHOUSE MANAGEMENT SERVICES; WAREHOUSE STORAGE SERVICES; RENTAL OF STORAGE CONTAINERS; CONSULTANCY RELATING TO LOGISTICS SERVICES CONSISTING OF TRANSPORT, PACKAGING AND STORAGE OF GOODS; LOGISTICS CONSULTANCY, NAMELY, CONSULTANCY RELATING TO SUPPLY CHAIN, LOGISTICS AND REVERSE LOGISTICS, NAMELY, STORAGE, TRANSPORTATION AND DELIVERY OF DOCUMENTS, PACKAGES, RAW MATERIALS AND OTHER FREIGHT FOR OTHERS BY AIR, RAIL, SHIP OR TRUCK; PACKAGING ARTICLES FOR TRANSPORTATION; RENTAL OF DOCUMENT BOXES FOR TRANSPORT, PACKAGING AND STORAGE; ADVISORY AND CONSULTANCY SERVICES IN RELATION TO ALL OF THE AFOREMENTIONED; PROVIDING COMPUTERIZED TRACKING OF PACKAGES IN TRANSIT, IN CLASS 39 (U.S. CLS. 100 AND 105).



*David J. Kyjars*

Director of the United States Patent and Trademark Office

**Reg. No. 4,273,934** THE MARK CONSISTS OF STANDARD CHARACTERS WITHOUT CLAIM TO ANY PARTICULAR FONT, STYLE, SIZE, OR COLOR.

PRIORITY DATE OF 10-10-2011 IS CLAIMED.

OWNER OF INTERNATIONAL REGISTRATION 1111231 DATED 10-27-2011, EXPIRES 10-27-2021.

SER. NO. 79-110,930, FILED 10-27-2011.

JUSTINE D. PARKER, EXAMINING ATTORNEY

# United States of America

United States Patent and Trademark Office

# Showcase

**Reg. No. 4,273,935**

**Registered Jan. 15, 2013**

**Int. Cls.: 35 and 38**

**SERVICE MARK**

**PRINCIPAL REGISTER**

SHOWCASE VENTURES LIMITED (UNITED KINGDOM LIMITED LIABILITY COMPANY)  
GROUND FLOOR  
76-80 CITY RD  
LONDON EC1Y 2BJ, UNITED KINGDOM

FOR: ONLINE BUSINESS NETWORKING SERVICES; MARKET OPINION POLLING;  
DATABASE MANAGEMENT, NAMELY, UPDATING OF DATABASES FOR THE USE OF  
SUBSCRIBERS, IN CLASS 35 (U.S. CLS. 100, 101 AND 102).

FOR: COMMUNICATION SERVICES, NAMELY, PROVIDING ACCESS TO AN INTERACTIVE  
COMPUTER DATABASE FOR ELECTRONIC SUBMISSION OF DATA AND DOCUMENTS  
TO FACILITATE USERS WITH COMMON INTERESTS TO COMMUNICATE, MEET AND  
GATHER, IN CLASS 38 (U.S. CLS. 100, 101 AND 104).

THE MARK CONSISTS OF STANDARD CHARACTERS WITHOUT CLAIM TO ANY PAR-  
TICULAR FONT, STYLE, SIZE, OR COLOR.

OWNER OF INTERNATIONAL REGISTRATION 1111482 DATED 12-22-2011, EXPIRES 12-  
22-2021.

SER. NO. 79-111,055, FILED 12-22-2011.

MATTHEW EINSTEIN, EXAMINING ATTORNEY



*David J. Kyffers*

Director of the United States Patent and Trademark Office

# United States of America

United States Patent and Trademark Office

# glyXera

**Reg. No. 4,273,936**

**Registered Jan. 15, 2013**

**Int. Cls.: 9, 41 and 42**

**TRADEMARK**

**SERVICE MARK**

**PRINCIPAL REGISTER**

GLYXERA GMBH (FED REP GERMANY LIMITED LIABILITY COMPANY)  
LEIPZIGER STRAÙE 44  
(ZENIT-GEBÄUDE HAUS 65)39120 MAGDEBURG  
FED REP GERMANY

FOR: MEASURING, SIGNALING, AND CHECKING APPARATUS AND INSTRUMENTS, NAMELY, CLINICAL LABORATORY ANALYZERS FOR MEASURING, TESTING, AND ANALYZING BLOOD AND OTHER BODILY FLUIDS, LASERS FOR MEASURING PURPOSES, ELECTRIC SENSORS; DATA PROCESSING EQUIPMENT, NAMELY, DATA PROCESSORS; COMPUTERS; COMPUTER SOFTWARE, NAMELY, FOR USE IN DATABASE MANAGEMENT; COMPUTER PROGRAMS, NAMELY, FOR USE IN DATABASE MANAGEMENT; DATA PROCESSING PROGRAMS AND APPARATUS AND INSTRUMENTS WITH SAID DATA PROCESSING PROGRAMS, NAMELY, DATA PROCESSORS SOLD TOGETHER WITH COMPUTER SOFTWARE FOR PROCESSING DATA AND PROVIDING A STATISTICAL ANALYSIS OF DATA; ALL GOODS IN PARTICULAR IN THE FIELD OF THE ANALYTICS OF CARBOHYDRATES, IN CLASS 9 (U.S. CLS. 21, 23, 26, 36 AND 38).

FOR: EDUCATION AND TRAINING, IN PARTICULAR EDUCATION IN THE NATURE OF CLASSES, SEMINARS, AND WORKSHOPS ON TECHNICAL AND SCIENTIFIC SERVICES IN THE FIELD OF ANALYTICS OF CARBOHYDRATES; ARRANGING AND CONDUCTING CONFERENCES, CONGRESSES AND SYMPOSIUMS IN THE FIELD OF THE ANALYTICS OF CARBOHYDRATES; ARRANGING AND CONDUCTION OF TRAINING WORKSHOPS IN THE FIELD OF THE ANALYTICS OF CARBOHYDRATES, IN CLASS 41 (U.S. CLS. 100, 101 AND 107).

FOR: SCIENTIFIC AND TECHNOLOGICAL SERVICES AND RESEARCH AND DESIGN RELATING THERETO, NAMELY, SCIENTIFIC RESEARCH, ANALYSIS, AND TESTING IN THE FIELD OF THE ANALYTICS OF CARBOHYDRATES; INDUSTRIAL SCIENTIFIC ANALYSIS AND RESEARCH SERVICES IN THE FIELD OF THE ANALYTICS OF CARBOHYDRATES, DESIGN AND DEVELOPMENT OF COMPUTER HARDWARE AND SOFTWARE IN THE FIELD OF THE ANALYTICS OF CARBOHYDRATES, IN CLASS 42 (U.S. CLS. 100 AND 101).

THE MARK CONSISTS OF STANDARD CHARACTERS WITHOUT CLAIM TO ANY PARTICULAR FONT, STYLE, SIZE, OR COLOR.

PRIORITY DATE OF 7-18-2011 IS CLAIMED.



*David J. Kyffers*

Director of the United States Patent and Trademark Office

**Reg. No. 4,273,936** OWNER OF INTERNATIONAL REGISTRATION 1111540 DATED 1-17-2012, EXPIRES 1-17-2022.

SER. NO. 79-111,081, FILED 1-17-2012.

JENNIFER WILLISTON, EXAMINING ATTORNEY

# United States of America

United States Patent and Trademark Office



**Reg. No. 4,273,937**

**Registered Jan. 15, 2013**

**Int. Cl.: 20**

**TRADEMARK**

**PRINCIPAL REGISTER**

OPERA NATIONAL DE PARIS (FRANCE ÉTABLISSEMENT PUBLIC NATIONAL)  
120, RUE DE LYON  
F-75012 PARIS, FRANCE

FOR: MIRRORS, NAMELY, LOOKING GLASSES NOT FOR CARRYING WITH; CUSHIONS;  
FURNITURE; FANS FOR PERSONAL USE, NON-ELECTRIC, IN CLASS 20 (U.S. CLS. 2, 13,  
22, 25, 32 AND 50).

NO CLAIM IS MADE TO THE EXCLUSIVE RIGHT TO USE "PARIS", APART FROM THE  
MARK AS SHOWN.

OWNER OF INTERNATIONAL REGISTRATION 1112088 DATED 2-22-2012, EXPIRES 2-22-  
2022.

THE MARK CONSISTS OF THE WORDS "OPERA NATIONAL DE PARIS", IN STYLIZED  
LETTERS.

THE ENGLISH TRANSLATION OF THE FOREIGN WORD(S) IN THE MARK IS: "NATIONAL  
OPERA OF PARIS".

SER. NO. 79-111,345, FILED 2-22-2012.

MICHAEL WIENER, EXAMINING ATTORNEY



*David J. Kybas*

Director of the United States Patent and Trademark Office

# United States of America

United States Patent and Trademark Office

# vjoon K4

**Reg. No. 4,273,938**

**Registered Jan. 15, 2013**

**Int. Cls.: 9, 38 and 42**

**TRADEMARK**

**SERVICE MARK**

**PRINCIPAL REGISTER**

VJOON GMBH (FED REP GERMANY LIMITED LIABILITY COMPANY)  
KIELER STR. 103-107  
25474 BÖNNINGSTEDT, FED REP GERMANY

FOR: COMPUTER SOFTWARE, BOTH RECORDED ON DATA MEDIA AND DOWNLOADABLE, FOR CONTROLLING PROCESSES IN THE PUBLISHING INDUSTRY IN EDITORIAL DEPARTMENTS OR ORGANIZATIONS SIMILAR TO EDITORIAL DEPARTMENTS, NAMELY, SOFTWARE FOR MANAGING WORKFLOW AND MULTI-USER ACCESS TO DOCUMENTS, FOR RESEARCH OF FACTS FOR CITE CHECKING AND EDITING PURPOSES, AND FOR INTERMEDIATE STORAGE AND FOR THE DISTRIBUTION OF RESEARCH RESULTS TO OTHER MEMBERS OF THE COMPANY AND INDUSTRY, IN CLASS 9 (U.S. CLS. 21, 23, 26, 36 AND 38).

FOR: PROVISION OF USER ACCESS TO COMPUTER PROGRAMS IN DATA NETWORKS; PROVISION OF ACCESS TO DATA IN DATA NETWORKS FOR FURTHER PROCESSING IN SYSTEMS OF THIRD PARTIES TO ENABLE PROCESS CONTROLLED UPDATES AND THE SUPPLEMENTATION OF ADDITIONAL INFORMATION AND/OR DATA, IN CLASS 38 (U.S. CLS. 100, 101 AND 104).

FOR: INSTALLATION AND MAINTENANCE OF COMPUTER SOFTWARE; THE DEVELOPMENT OF DATA PROCESSING PROGRAMS FOR OTHERS; PROFESSIONAL COMPUTER PROGRAMMING SERVICES, AND PROFESSIONAL CONSULTANCY SERVICES RELATING TO COMPUTER PROGRAMMING; IMPLEMENTATION OF COMPUTER SOFTWARE IN NETWORK STRUCTURES, IN CLASS 42 (U.S. CLS. 100 AND 101).

THE MARK CONSISTS OF STANDARD CHARACTERS WITHOUT CLAIM TO ANY PARTICULAR FONT, STYLE, SIZE, OR COLOR.

OWNER OF INTERNATIONAL REGISTRATION 1112431 DATED 9-27-2011, EXPIRES 9-27-2021.

OWNER OF U.S. REG. NO. 3,763,355.

THE WORDING "VJOON K4" HAS NO MEANING IN A FOREIGN LANGUAGE.

SER. NO. 79-111,470, FILED 9-27-2011.



*David J. Kyjars*

Director of the United States Patent and Trademark Office

**Reg. No. 4,273,938** GINA FINK, EXAMINING ATTORNEY



# United States of America

United States Patent and Trademark Office

# EMPALINA

**Reg. No. 4,273,939**

**Registered Jan. 15, 2013**

**Int. Cl.: 5**

**TRADEMARK**

**PRINCIPAL REGISTER**

BOEHRINGER INGELHEIM INTERNATIONAL GMBH (FED REP GERMANY CORPORATION)  
55218 INGELHEIM  
FED REP GERMANY

FOR: PHARMACEUTICAL PREPARATIONS, FOR THE TREATMENT OF DIABETES; PHARMACEUTICAL PREPARATIONS FOR THE TREATMENT OF DISEASES AND DISORDERS OF THE ALIMENTARY TRACT, METABOLISM, BLOOD AND BLOOD FORMING ORGANS, IN CLASS 5 (U.S. CLS. 6, 18, 44, 46, 51 AND 52).

THE MARK CONSISTS OF STANDARD CHARACTERS WITHOUT CLAIM TO ANY PARTICULAR FONT, STYLE, SIZE, OR COLOR.

PRIORITY DATE OF 10-27-2011 IS CLAIMED.

OWNER OF INTERNATIONAL REGISTRATION 1112909 DATED 2-28-2012, EXPIRES 2-28-2022.

SER. NO. 79-111,696, FILED 2-28-2012.

CHRISIE B. KING, EXAMINING ATTORNEY



*David J. Kybas*

Director of the United States Patent and Trademark Office

United States of America  
United States Patent and Trademark Office

valucor

**Reg. No. 4,273,940**

**Registered Jan. 15, 2013**

**Int. Cls.: 35, 36 and 42**

**SERVICE MARK**

**PRINCIPAL REGISTER**

DR. THOMAS GISLER (SWITZERLAND INDIVIDUAL)  
HAFENSTRASSE 1  
CH-6440 BRUNNEN  
SWITZERLAND

FOR: ADVERTISING; BUSINESS MANAGEMENT AND BUSINESS MANAGEMENT CONSULTING; BUSINESS ADMINISTRATION FOR PRIVATE INDIVIDUALS, COMPANIES AND PENSION FUNDS; OFFICE FUNCTIONS, IN CLASS 35 (U.S. CLS. 100, 101 AND 102).

FOR: INSURANCE UNDERWRITING CONSULTATION IN THE FIELDS OF LIFE, PENSION, HEALTH, ACCIDENT AND FIRE; BANKING; REAL ESTATE AFFAIRS, NAMELY, REAL ESTATE BROKERAGE, REAL ESTATE CONSULTATION AND REAL ESTATE INVESTMENT, IN CLASS 36 (U.S. CLS. 100, 101 AND 102).

FOR: SCIENTIFIC AND TECHNOLOGICAL SERVICES, NAMELY, SCIENTIFIC RESEARCH, ANALYSIS AND TESTING IN THE FIELD OF INFORMATION TECHNOLOGY AND SOFTWARE, AND DESIGN RELATING THERETO , IN CLASS 42 (U.S. CLS. 100 AND 101).

THE MARK CONSISTS OF STANDARD CHARACTERS WITHOUT CLAIM TO ANY PARTICULAR FONT, STYLE, SIZE, OR COLOR.

PRIORITY DATE OF 1-8-2012 IS CLAIMED.

OWNER OF INTERNATIONAL REGISTRATION 1113301 DATED 3-21-2012, EXPIRES 3-21-2022.

THE WORDING "VALUCOR" HAS NO MEANING IN A FOREIGN LANGUAGE.

SER. NO. 79-111,844, FILED 3-21-2012.

NATALIE POLZER, EXAMINING ATTORNEY



*David J. Kybas*

Director of the United States Patent and Trademark Office

# United States of America

United States Patent and Trademark Office



**Reg. No. 4,273,941**

**Registered Jan. 15, 2013**

**Int. Cl.: 12**

**TRADEMARK**

**PRINCIPAL REGISTER**

ENUMA CHAIN MFG. CO., LTD. (JAPAN CORPORATION)  
300, KAMIKAWASAKIMACHI  
KAGA-SHI; ISHIKAWA 922-0013  
JAPAN

FOR: ROLLER CHAINS FOR TWO-WHEELED MOTOR VEHICLES OR BICYCLES; CHAINS FOR TWO-WHEELED MOTOR VEHICLES OR BICYCLES; DRIVING CHAINS FOR TWO-WHEELED MOTOR VEHICLES OR BICYCLES; TRANSMISSION CHAINS TWO-WHEELED MOTOR VEHICLES OR BICYCLES, IN CLASS 12 (U.S. CLS. 19, 21, 23, 31, 35 AND 44).

OWNER OF U.S. REG. NO. 1,083,833.

OWNER OF INTERNATIONAL REGISTRATION 1028389 DATED 12-24-2009, EXPIRES 12-24-2019.

THE MARK CONSISTS OF THE LETTERS "EK" TO THE LEFT OF A DESIGN OF A STYLIZED MAN HOLDING A CHAIN LINK ABOVE HIS HEAD. IN THE MIDDLE OF THE CHAIN LINK ARE THE LETTERS "EK."

SER. NO. 79-112,194, FILED 4-9-2012.

PAULA MAHONEY, EXAMINING ATTORNEY



*David J. Kyros*

Director of the United States Patent and Trademark Office

# United States of America

United States Patent and Trademark Office

# Jeckerson

**Reg. No. 4,273,942**

**Registered Jan. 15, 2013**

**Int. Cl.: 25**

**TRADEMARK**

**PRINCIPAL REGISTER**

JECKERSON S.P.A. (ITALY JOINT STOCK COMPANY)  
VIA DELLO SCALO, 5  
I-40131 BOLOGNA  
ITALY

FOR: CLOTHING, NAMELY, PANTS, SHIRTS, SKIRTS, GLOVES, TROUSERS, JEANS, SWEATERS, BELTS, PULLOVERS, SCARVES, TOPS, BOTTOMS, SHORTS, JACKETS; FOOTWEAR; HEADWEAR, IN CLASS 25 (U.S. CLS. 22 AND 39).

OWNER OF U.S. REG. NO. 3,046,307.

PRIORITY DATE OF 3-7-2012 IS CLAIMED.

OWNER OF INTERNATIONAL REGISTRATION 1114692 DATED 3-13-2012, EXPIRES 3-13-2022.

THE MARK CONSISTS IN THE STYLIZED WORDING "JECKERSON".

SER. NO. 79-112,398, FILED 3-13-2012.

LEIGH LOWRY, EXAMINING ATTORNEY



*David J. Kyffers*

Director of the United States Patent and Trademark Office

# United States of America

United States Patent and Trademark Office



**Reg. No. 4,273,943**

**Registered Jan. 15, 2013**

**Int. Cl.: 29**

**TRADEMARK**

**PRINCIPAL REGISTER**

BRUS HOLDING EUROPE B.V. (NETHERLANDS LIMITED LIABILITY COMPANY)  
MEERPAAL 14 D  
NL-4904 SK OOSTERHOUT  
NETHERLANDS

FOR: FISH, ESPECIALLY TUNA, IN CLASS 29 (U.S. CL. 46).

THE MARK CONSISTS OF A CIRCULAR BORDER CONTAINING AN IMAGE OF A WOMAN WITH FLOWERS IN HER HAIR AND WEARING A FLOWER LEI.

PRIORITY DATE OF 12-9-2011 IS CLAIMED.

OWNER OF INTERNATIONAL REGISTRATION 1114715 DATED 4-12-2012, EXPIRES 4-12-2022.

SER. NO. 79-112,411, FILED 4-12-2012.

STEVEN PEREZ, EXAMINING ATTORNEY



*David J. Kyffers*

Director of the United States Patent and Trademark Office

# United States of America

United States Patent and Trademark Office



**Reg. No. 4,273,944**

**Registered Jan. 15, 2013**

**Int. Cl.: 23**

**TRADEMARK**

**PRINCIPAL REGISTER**

TEKO LLC (COLORADO LIMITED LIABILITY COMPANY)  
1712 PEARL STREET  
BOULDER, CO 80302

FOR: YARNS AND THREADS, FOR TEXTILE USE; THREAD; YARN; TEXTILE YARNS MADE OF NATURAL OR MAN-MADE FIBRES; SEWING THREAD AND YARNS; DARNING THREAD AND YARNS; EMBROIDERY THREAD AND YARNS; WEAVING THREAD AND YARNS; KNITTING YARNS; KNITTING WOOL; FLOCKED YARNS; CARDED YARNS IN NATURAL FIBRES FOR TEXTILE USE; ELASTIC, FIBREGLASS, RUBBER AND PLASTIC THREADS AND YARNS FOR TEXTILE USE; SPUN THREAD AND YARNS; SPUN COTTON, SILK AND WOOL; WORSTED THREAD AND YARN, IN CLASS 23 (U.S. CL. 43).

THE MARK CONSISTS OF THE WORDING "S3" IN THE COLOUR BLUE. BELOW THIS WORDING IS THE WORDING "SIN3RGI" IN THE COLOUR BLACK.

PRIORITY DATE OF 9-20-2011 IS CLAIMED.

OWNER OF INTERNATIONAL REGISTRATION 1114814 DATED 3-14-2012, EXPIRES 3-14-2022.

THE COLOR(S) BLACK AND BLUE IS/ARE CLAIMED AS A FEATURE OF THE MARK.

SER. NO. 79-112,470, FILED 3-14-2012.

WENDY JUN, EXAMINING ATTORNEY



*David J. Kyffers*

Director of the United States Patent and Trademark Office

# United States of America

United States Patent and Trademark Office

# COLOSSEUM

**Reg. No. 4,273,945**

**Registered Jan. 15, 2013**

**Int. Cl.: 9**

**TRADEMARK**

**PRINCIPAL REGISTER**

COCOSOFT CO., LTD. (REPUBLIC OF KOREA CORPORATION)  
3F, DONGGWANG BUILDING  
923-14, BANGBAE-DONG, SEOCHO-GU., SEOUL, 137-843  
REPUBLIC OF KOREA

FOR: AMUSEMENT APPARATUS ADAPTED FOR USE WITH TELEVISION RECEIVERS ONLY; VIRTUAL REALITY GAME SOFTWARE; PERSONAL COMPUTERS; COMPUTER PROGRAMS FOR PRE-RECORDED GAMES; RECORDED COMPUTER-GAMING SOFTWARE; RECORDED COMPUTER OPERATING PROGRAMS; RECORDED COMPUTER GAME PROGRAMS; COMPUTER GAME PROGRAMS DOWNLOADABLE VIA THE INTERNET; NOTEBOOK COMPUTERS; COMPUTER SOFTWARE FOR WIRELESS CONTENT DELIVERY; COMPUTER SOFTWARE FOR ENCRYPTION; SOFTWARE FOR PROCESSING IMAGES, GRAPHICS AND TEXT; COMPUTER PROGRAMS FOR EDITING IMAGES, SOUND AND VIDEO; SOFTWARE TO CONTROL AND IMPROVE SOUND QUALITY OF AUDIO EQUIPMENT; AMUSEMENT APPARATUS ADAPTED FOR USE WITH AN EXTERNAL DISPLAY SCREEN OR MONITOR; OPERATING SYSTEM PROGRAMS; COMPUTER WORKSTATIONS COMPRISING COMPUTER AND COMPUTER HARDWARE; COMPUTER SOFTWARE TO ENABLE THE TRANSMISSION OF PHOTOGRAPHS TO MOBILE TELEPHONES; COMPUTER APPLICATION SOFTWARE FOR MOBILE PHONES, NAMELY, SOFTWARE FOR GAME; COMPUTER SOFTWARE FOR CONTROLLING SELF-SERVICE TERMINALS; ELECTRIC MONITORING APPARATUS, NAMELY, LIQUID CRYSTAL DISPLAY (LCD) MONITORS; CASES FOR ELECTRONIC DIARIES; SOFTWARE FOR ENSURING THE SECURITY OF ELECTRONIC MAIL; ELECTRONIC AGENDAS; ELECTRONIC PENS; COMPUTERS; COMPUTER GAME PROGRAMS; COMPUTER GAME SOFTWARE; COMPUTER MEMORIES; COMPUTER MONITORS; DISK DRIVES FOR COMPUTERS; WRIST RESTS FOR USE WITH COMPUTERS; PRINTERS FOR USE WITH COMPUTERS; COMPUTER PERIPHERAL DEVICES; HANDHELD COMPUTERS; POCKET COMPUTERS FOR NOTE-TAKING; POCKET CALCULATORS; ELECTRONIC POCKET TRANSLATORS; DOWNLOADABLE DIGITAL MUSIC; PRE-RECORDED MUSIC ELECTRONIC MEDIA, NAMELY, DVDS FEATURING MUSIC AND CDS FEATURING MUSIC; ELECTRONIC PUBLICATIONS, NAMELY, BOOK AND MAGAZINE FEATURING COMPUTER GAMES RECORDED ON COMPUTER MEDIA; VIDEO DISKS AND VIDEO TAPES WITH RECORDED ANIMATED CARTOONS; DOWNLOADABLE ELECTRONIC PUBLICATIONS IN THE NATURE OF MAGAZINES IN THE FIELD OF ON-LINE COMPUTER GAMES; DOWNLOADABLE ELECTRONIC BOOKS IN THE FIELD OF ON-LINE COMPUTER GAMES; DOWNLOADABLE ELECTRONIC NEWSPAPERS IN THE FIELD OF ON-LINE COMPUTER GAMES, IN CLASS 9 (U.S. CLS. 21, 23, 26, 36 AND 38).



*David J. Kyjars*

Director of the United States Patent and Trademark Office

**Reg. No. 4,273,945** THE MARK CONSISTS OF THE WORDING "COLOSSEUM".

PRIORITY DATE OF 12-13-2011 IS CLAIMED.

OWNER OF INTERNATIONAL REGISTRATION 1115008 DATED 12-20-2011, EXPIRES 12-20-2021.

SER. NO. 79-112,542, FILED 12-20-2011.

RAMONA ORTIGA, EXAMINING ATTORNEY



# United States of America

United States Patent and Trademark Office

# PATAACU

**Reg. No. 4,273,946**

**Registered Jan. 15, 2013**

**Int. Cls.: 35 and 38**

**SERVICE MARK**

**PRINCIPAL REGISTER**

FABIANA DANIELA RUGGIERI (ITALY INDIVIDUAL)  
VIA GIOVANNI BATTISTA TIEPOLO, 20  
I-00196 ROMA  
ITALY AND

SIMONE ORLANDINI (ITALY INDIVIDUAL)  
VIA GIOVANNI BATTISTA TIEPOLO, 20  
I-00196 ROMA  
ITALY

FOR: ADVERTISING FOR OTHERS ON THE INTERNET; ON-LINE ADVERTISING, IN CLASS 35 (U.S. CLS. 100, 101 AND 102).

FOR: PROVIDING INTERNET ACCESS TO A WEB SITE WHERE USERS CAN POST ITEMS FOR SALE THROUGH ONLINE CLASSIFIED ADVERTISEMENTS; PROVIDING INTERNET ACCESS TO DATABASES ON THE INTERNET FEATURING CLASSIFIED ADVERTISEMENTS AND EMPLOYMENT OPPORTUNITIES, IN CLASS 38 (U.S. CLS. 100, 101 AND 104).

THE MARK CONSISTS OF STANDARD CHARACTERS WITHOUT CLAIM TO ANY PARTICULAR FONT, STYLE, SIZE, OR COLOR.

OWNER OF INTERNATIONAL REGISTRATION 1115009 DATED 11-17-2011, EXPIRES 11-17-2021.

SER. NO. 79-112,543, FILED 11-17-2011.

RAMONA ORTIGA, EXAMINING ATTORNEY



*David J. Kyffers*

Director of the United States Patent and Trademark Office

# United States of America

United States Patent and Trademark Office

# SCOTT-NICHOL

**Reg. No. 4,273,947**

**Registered Jan. 15, 2013**

**Int. Cl.: 25**

**TRADEMARK**

**PRINCIPAL REGISTER**

HJ SOCK GROUP LTD. (UNITED KINGDOM LIMITED COMPANY)  
COVENTRY ROAD  
HINCKLEY; LEICESTERSHIRE LE10 0JX  
UNITED KINGDOM

FOR: CLOTHING. NAMELY, SHIRTS, SWEATSHIRTS, T-SHIRTS, POLO SHIRTS, BLOUSES, JERSEYS, PULLOVERS, VESTS, JACKETS, COATS, SUITS, PANTS, TROUSERS, SHORTS, SKIRTS, DRESSES. SOCKS, STOCKINGS, TIGHTS, LEGGINGS, UNDERWEAR, UNDER-SHIRTS. LONG JOHNS, BATH ROBES, DRESSING GOWNS, NIGHTWEAR, GLOVES, SCARVES; FOOTWEAR, HEADWEAR; UNDERWEAR, LEGWEAR, NAMELY, TIGHTS, LEGGINGS, LEGWARMERS, STOCKINGS AND SOCKS, IN CLASS 25 (U.S. CLS. 22 AND 39).

THE MARK CONSISTS OF STANDARD CHARACTERS WITHOUT CLAIM TO ANY PARTICULAR FONT, STYLE, SIZE, OR COLOR.

OWNER OF INTERNATIONAL REGISTRATION 1115363 DATED 1-11-2012, EXPIRES 1-11-2022.

SER. NO. 79-112,710, FILED 1-11-2012.

SEAN CROWLEY, EXAMINING ATTORNEY



*David J. Kybas*

Director of the United States Patent and Trademark Office

# United States of America

United States Patent and Trademark Office

# COLORWAY

**Reg. No. 4,273,948**

**Registered Jan. 15, 2013**

**Int. Cls.: 1, 2, 9, 16, 37  
and 42**

**TRADEMARK**

**SERVICE MARK**

**PRINCIPAL REGISTER**

GASAENKO IGOR MARATOVYCH (UKRAINE INDIVIDUAL)  
VUL. SVIATOSHYNSKA, 6, KV. 126  
M. KYIV 03115  
UKRAINE AND

KRYSTIUK OLEG ANATOLIYOVYCH (UKRAINE INDIVIDUAL)  
VUL. V. GETMANA, 22-B, KV. 19  
M. KYIV 03058  
UKRAINE

FOR: CHEMICALS USED IN INDUSTRY, SCIENCE AND PHOTOGRAPHY, IN CLASS 1 (U.S. CLS. 1, 5, 6, 10, 26 AND 46).

FOR: PAINTS, COLORANTS, IN CLASS 2 (U.S. CLS. 6, 11 AND 16).

FOR: APPARATUS FOR RECORDING, TRANSMISSION OR REPRODUCTION OF IMAGES, NAMELY, CONTINUOUS INK SUPPLY SYSTEM TO REFILL PRINTER CARTRIDGES; COMPUTER PERIPHERAL DEVICES, IN CLASS 9 (U.S. CLS. 21, 23, 26, 36 AND 38).

FOR: PAPER, CARDBOARD AND GOODS MADE FROM THESE MATERIALS, NAMELY, BANNERS OF PAPER, PAPER LABELS, POSTERS, FOLDERS, NOTEBOOKS, BOXES, CARTONS, STORAGE CONTAINERS, AND PACKAGING CONTAINERS, IN CLASS 16 (U.S. CLS. 2, 5, 22, 23, 29, 37, 38 AND 50).

FOR: INSTALLATION, MAINTENANCE AND REPAIR OF COMPUTERS, IN CLASS 37 (U.S. CLS. 100, 103 AND 106).

FOR: COMPUTER PROGRAMMING; COMPUTER RENTAL; COMPUTER SOFTWARE DESIGN; COMPUTER SYSTEM DESIGN; COMPUTER SYSTEMS ANALYSIS; CONSULTANCY IN THE FIELD OF COMPUTER HARDWARE; CONVERSION OF DATA OR DOCUMENTS FROM PHYSICAL TO ELECTRONIC MEDIA; CREATING AND MAINTAINING WEB SITES FOR OTHERS; DUPLICATION OF COMPUTER PROGRAMS; INSTALLATION OF COMPUTER SOFTWARE; MAINTENANCE OF COMPUTER SOFTWARE; RECOVERY OF COMPUTER DATA; UPDATING OF COMPUTER SOFTWARE; DESIGN AND DEVELOPMENT OF COMPUTER HARDWARE AND SOFTWARE, IN CLASS 42 (U.S. CLS. 100 AND 101).



*David J. Kyffers*

Director of the United States Patent and Trademark Office

**Reg. No. 4,273,948** OWNER OF INTERNATIONAL REGISTRATION 1047223 DATED 6-10-2010, EXPIRES 6-10-2020.

SER. NO. 79-112,839, FILED 3-22-2012.

ANNE MADDEN, EXAMINING ATTORNEY

# United States of America

United States Patent and Trademark Office

# CWMA

**Reg. No. 4,273,949**

**Registered Jan. 15, 2013**

**Int. Cls.: 36 and 41**

**SERVICE MARK**

**PRINCIPAL REGISTER**

UBS AG (SWITZERLAND SOCIÉTÉ ANONYME)  
BAHNHOFSTRASSE 45  
CH-8001 ZÜRICH  
SWITZERLAND

FOR: BANKING AND FINANCIAL SERVICES, NAMELY, BANKING, FINANCIAL ANALYSIS AND CONSULTATION, FINANCIAL PLANNING, FINANCIAL PORTFOLIO MANAGEMENT, AND ASSET MANAGEMENT; SERVICES IN THE FIELD OF WEALTH MANAGEMENT AND ASSET MANAGEMENT FOR PRIVATE CLIENTS AND ENTERPRISES AS WELL AS FOR INSTITUTIONS; INVESTMENT BANK SERVICES; ALL THE AFORESAID SERVICES ALSO BEING ACCESSIBLE ELECTRONICALLY OVER THE INTERNET OR VIA A SIMILAR ELECTRONIC NETWORK, IN CLASS 36 (U.S. CLS. 100, 101 AND 102).

FOR: PROVIDING OF TRAINING, NAMELY, TRAINING IN THE FIELDS OF BANKING, FINANCIAL ANALYSIS AND CONSULTATION, FINANCIAL PLANNING, FINANCIAL PORTFOLIO MANAGEMENT, AND ASSET MANAGEMENT; ARRANGING AND CONDUCTING OF SEMINARS AND TRAINING WORKSHOPS, IN CLASS 41 (U.S. CLS. 100, 101 AND 107).

THE MARK CONSISTS OF STANDARD CHARACTERS WITHOUT CLAIM TO ANY PARTICULAR FONT, STYLE, SIZE, OR COLOR.

PRIORITY DATE OF 10-3-2011 IS CLAIMED.

OWNER OF INTERNATIONAL REGISTRATION 1116000 DATED 3-28-2012, EXPIRES 3-28-2022.

SER. NO. 79-112,946, FILED 3-28-2012.

TASHIA BUNCH, EXAMINING ATTORNEY



*David J. Kyffers*

Director of the United States Patent and Trademark Office

# United States of America

United States Patent and Trademark Office

# SKY EYES

**Reg. No. 4,273,950**

**Registered Jan. 15, 2013**

**Int. Cl.: 9**

**TRADEMARK**

**PRINCIPAL REGISTER**

REY JEAN-FRANÇOIS (FRANCE INDIVIDUAL)  
15 BOULEVARD DES TILLEULS  
F-13013 MARSEILLE  
FRANCE

FOR: OPTICAL APPARATUS AND INSTRUMENTS, NAMELY, SPECTACLES; OPTICAL GOODS, NAMELY, SPECTACLE CASES, IN CLASS 9 (U.S. CLS. 21, 23, 26, 36 AND 38).

NO CLAIM IS MADE TO THE EXCLUSIVE RIGHT TO USE "EYES", APART FROM THE MARK AS SHOWN.

OWNER OF INTERNATIONAL REGISTRATION 1116106 DATED 4-4-2012, EXPIRES 4-4-2022.

SER. NO. 79-112,976, FILED 4-4-2012.

CATHERINE ROEHL, EXAMINING ATTORNEY



*David J. Kyffers*

Director of the United States Patent and Trademark Office

United States of America  
United States Patent and Trademark Office

# Skyrama

**Reg. No. 4,273,951**

**Registered Jan. 15, 2013**

**Int. Cls.: 9, 28, 38 and 41**

**TRADEMARK**

**SERVICE MARK**

**PRINCIPAL REGISTER**

BIGPOINT GMBH (FED REP GERMANY LIMITED LIABILITY COMPANY)  
DREHBAHN 47-48  
20354 HAMBURG  
FED REP GERMANY

FOR: COMPUTERS, RECORDED COMPUTER GAME PROGRAMS; DOWNLOADABLE COMPUTER GAME PROGRAMS AND GAME SOFTWARE, IN PARTICULAR FOR COMPUTER, VIDEO, ONLINE AND BROWSER GAMES AS WELL AS GAME PROGRAMS FOR MOBILE TELEPHONES, IN CLASS 9 (U.S. CLS. 21, 23, 26, 36 AND 38).

FOR: APPARATUS FOR ELECTRONIC GAMES OTHER THAN THOSE ADAPTED FOR USE WITH AN EXTERNAL DISPLAY SCREEN OR MONITOR; GAMES, NAMELY ELECTRONIC GAME CONSOLES AS HAND-HELD UNITS NOT FOR USE WITH EXTERNAL DISPLAY SCREENS OR MONITORS, IN CLASS 28 (U.S. CLS. 22, 23, 38 AND 50).

FOR: PROVIDING ACCESS TO INFORMATION VIA THE INTERNET, NAMELY, PROVIDING ACCESS TO DATABASES ON THE INTERNET; TRANSMISSION OF INFORMATION AND IMAGES BY ELECTRONIC MEANS; TRANSMISSION OF MESSAGES AND IMAGES VIA COMPUTER NETWORKS, IN CLASS 38 (U.S. CLS. 100, 101 AND 104).

FOR: PROVIDING ONLINE COMPUTER GAMES; ENTERTAINMENT, NAMELY IN THE FORM OF PROVIDING ONLINE COMPUTER GAMES, ONLINE VIDEO COMPUTER GAMES, ONLINE COMPUTER GAMES AND ONLINE BROWSER COMPUTER GAMES AND COMPUTER GAMES FOR MOBILE TELEPHONES, IN PARTICULAR VIA PORTALS AND PLATFORMS ON THE INTERNET, IN CLASS 41 (U.S. CLS. 100, 101 AND 107).

THE MARK CONSISTS OF STANDARD CHARACTERS WITHOUT CLAIM TO ANY PARTICULAR FONT, STYLE, SIZE, OR COLOR.

OWNER OF INTERNATIONAL REGISTRATION 1116712 DATED 11-15-2011, EXPIRES 11-15-2021.

SER. NO. 79-113,185, FILED 11-15-2011.

RAMONA ORTIGA, EXAMINING ATTORNEY



*David J. Kyffers*

Director of the United States Patent and Trademark Office

# United States of America

United States Patent and Trademark Office



**Reg. No. 4,273,952**

**Registered Jan. 15, 2013**

**Int. Cls.: 6, 9 and 17**

**TRADEMARK**

**PRINCIPAL REGISTER**

ESCHENBACH OPTIK GMBH (FED REP GERMANY LIMITED LIABILITY COMPANY)  
SCHOPENHAUERSTRASSE 10  
90409 NÜRNBERG  
FED REP GERMANY

FOR: NON-PRECIOUS METALS AND METAL ALLOYS FOR MANUFACTURING SPECTACLES AND/OR SPECTACLE FRAMES, IN CLASS 6 (U.S. CLS. 2, 12, 13, 14, 23, 25 AND 50).

FOR: OPTICAL APPARATUS AND INSTRUMENTS, NAMELY, SPECTACLES, SUNGLASSES; FRAMES FOR SPECTACLES AND/OR SUNGLASSES, IN CLASS 9 (U.S. CLS. 21, 23, 26, 36 AND 38).

FOR: SEMI-PROCESSED PLASTICS FOR MAKING SPECTACLES AND/OR SPECTACLE FRAMES, IN CLASS 17 (U.S. CLS. 1, 5, 12, 13, 35 AND 50).

THE MARK CONSISTS OF THE LETTERS "EPX" IN STYLIZED FORM WITH THE LETTERS "EP" IN RED AND THE LETTER "X" IN BLACK. A SMALL BLACK TRIANGLE IS PLACED BETWEEN THE LETTERS "P" AND "X".

OWNER OF INTERNATIONAL REGISTRATION 1116837 DATED 2-10-2012, EXPIRES 2-10-2022.

THE COLOR(S) RED AND BLACK IS/ARE CLAIMED AS A FEATURE OF THE MARK.

SER. NO. 79-113,224, FILED 2-10-2012.

STEVEN PEREZ, EXAMINING ATTORNEY



*David J. Kyros*

Director of the United States Patent and Trademark Office



# United States of America

United States Patent and Trademark Office



**Reg. No. 4,273,953**

**Registered Jan. 15, 2013**

**Int. Cl.: 9**

**TRADEMARK**

**PRINCIPAL REGISTER**

FT. TECHNOLOGIES LIMITED (ENGLAND LIMITED COMPANY (LTD.))  
CHURCH LANE  
TEDDINGTON, MIDDLESEX, UNITED KINGDOM TW11 8PA

FOR: APPARATUS AND INSTRUMENTS FOR MEASURING AIR FLOW SPEED AND DIRECTION, NAMELY, ULTRASONIC ANEMOMETERS; APPARATUS AND INSTRUMENTS FOR MEASURING AIR TEMPERATURE, NAMELY, TEMPERATURE SENSORS UTILIZING ACOUSTIC RESONANCE; APPARATUS AND INSTRUMENTS FOR MEASURING AIR PRESSURE, NAMELY, ULTRASONIC PRESSURE SENSORS FOR MEASURING ATMOSPHERIC AIR PRESSURE; APPARATUS FOR TRANSMISSION OF SOUND; DATA PROCESSING EQUIPMENT AND COMPUTER SOFTWARE FOR USE IN MEASURING THE SPEED, DIRECTION, TEMPERATURE AND PRESSURE OF AIRFLOW, IN CLASS 9 (U.S. CLS. 21, 23, 26, 36 AND 38).

NO CLAIM IS MADE TO THE EXCLUSIVE RIGHT TO USE "TECHNOLOGY", APART FROM THE MARK AS SHOWN.

OWNER OF INTERNATIONAL REGISTRATION 1117004 DATED 2-21-2012, EXPIRES 2-21-2022.

THE COLOR(S) BLACK, WHITE AND BLUE IS/ARE CLAIMED AS A FEATURE OF THE MARK.

THE MARK CONSISTS OF THE STYLIZED WHITE WORDING "POWERED BY" APPEARING ABOVE THE STYLIZED WORDING "ACU RES" IN THE COLOR BLACK, WHICH APPEARS ABOVE THE STYLIZED WORDING "TECHNOLOGY" IN THE COLOR WHITE. THE ENTIRE MARK APPEARS ON A BLUE BACKGROUND.

SER. NO. 79-113,285, FILED 2-21-2012.

MARCIE MILONE, EXAMINING ATTORNEY



*David J. Kyjars*

Director of the United States Patent and Trademark Office

# United States of America

United States Patent and Trademark Office

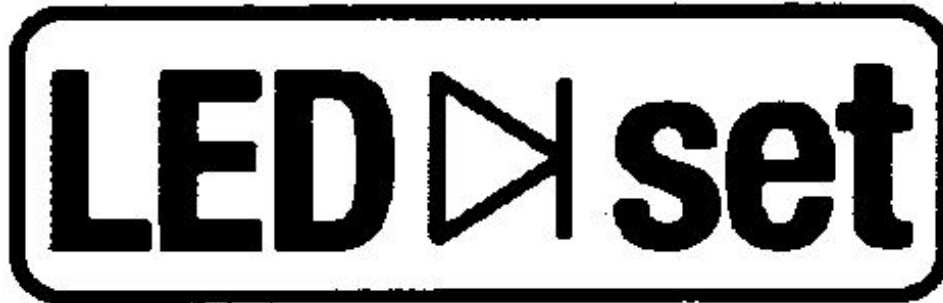

**Reg. No. 4,273,954**

**Registered Jan. 15, 2013**

**Int. Cls.: 9, 11 and 42**

**TRADEMARK**

**SERVICE MARK**

**PRINCIPAL REGISTER**

OSRAMAG (FED REP GERMANY CORPORATION), AKA OSRAMAKTIENGESELLSCHAFT  
DEPT OSR GC IP TM; 2011W18906WOUS  
HELLABRUNNER STR. 1  
MÜNCHEN, FED REP GERMANY D81543

FOR: LIGHT EMITTING DIODES; LED MODULES FOR SIGNALLING APPLICATIONS NOT IN THE NATURE OF LIGHT BULBS; LIGHTING CONTROL SYSTEMS, NAMELY, ELECTRONIC CONTROL GEAR (ECG) FOR REGULATING CURRENT AND VOLTAGE APPLIED TO LED MODULES; DISPLAY DEVICES, INCORPORATING LED LIGHT SOURCES; AND REPLACEMENT COMPONENT PARTS FOR ALL THE AFORESAID GOODS, IN CLASS 9 (U.S. CLS. 21, 23, 26, 36 AND 38).

FOR: APPARATUS FOR LIGHTING, NAMELY, ELECTRIC LAMPS AND LUMINAIRES; LED LAMPS AND LED LUMINAIRES FOR COMMERCIAL, RESIDENTIAL AND PUBLIC FACILITY ILLUMINATION; SOLID-STATE ELECTRONIC INTERFACES BETWEEN KNOBS/SWITCHES AND LED MODULES; AND COMPONENT REPLACEMENT PARTS FOR ALL THE AFORESAID GOODS, IN CLASS 11 (U.S. CLS. 13, 21, 23, 31 AND 34).

FOR: SCIENTIFIC AND TECHNOLOGY SERVICES, NAMELY, DESIGN SERVICES IN THE FIELD OF ELECTRIC ILLUMINATION AND CONSULTING SERVICES RELATING TO THE SELECTION OF ELECTRIC ILLUMINATION FOR INTERIOR AND EXTERIOR BUILDING DECOR, IN CLASS 42 (U.S. CLS. 100 AND 101).

NO CLAIM IS MADE TO THE EXCLUSIVE RIGHT TO USE "LED" OR "SET", APART FROM THE MARK AS SHOWN.

OWNER OF INTERNATIONAL REGISTRATION 1118241 DATED 4-20-2012, EXPIRES 4-20-2022.

THE MARK CONSISTS OF THE ACRONYM "LED" IN UPPER CASE, THE ELECTRICAL SCHEMATIC SYMBOL FOR A DIODE, AND "SET" IN LOWER CASE, ALL WITHIN A CURVED RECTANGULAR BORDER.

SER. NO. 79-113,677, FILED 4-20-2012.

TOBY BULLOFF, EXAMINING ATTORNEY



*David J. Kyros*

Director of the United States Patent and Trademark Office

# United States of America

United States Patent and Trademark Office

## MARQUIS DE LA FAYETTE

**Reg. No. 4,273,955**

**Registered Jan. 15, 2013**

**Int. Cl.: 33**

**TRADEMARK**

**PRINCIPAL REGISTER**

SAS PIERREL & ASSOCIES (FRANCE SOCIÉTÉ PAR ACTIONS SIMPLIFIÉE (SAS))  
26 RUE HENRY DUNANT  
F-51200 EPERNAY  
FRANCE

FOR: ALCOHOLIC BEVERAGES, NAMELY, WINES, SPARKLING WINES, WINES OF FRENCH ORIGIN, AOC WINES PROTECTED BY AN APPELLATION OF ORIGIN, NAMELY, CHAMPAGNE, DIGESTIVES, LIQUEURS, EAUX-DE-VIE, BRANDY, SPIRITS, IN CLASS 33 (U.S. CLS. 47 AND 49).

THE MARK CONSISTS OF STANDARD CHARACTERS WITHOUT CLAIM TO ANY PARTICULAR FONT, STYLE, SIZE, OR COLOR.

OWNER OF INTERNATIONAL REGISTRATION 1118656 DATED 12-30-2011, EXPIRES 12-30-2021.

THE NAME(S), PORTRAIT(S), AND/OR SIGNATURE(S) SHOWN IN THE MARK DOES NOT IDENTIFY A PARTICULAR LIVING INDIVIDUAL.

SER. NO. 79-113,819, FILED 12-30-2011.

MICHAEL WIENER, EXAMINING ATTORNEY



*David J. Kybas*

Director of the United States Patent and Trademark Office

# United States of America

United States Patent and Trademark Office



**WRUNG**

**Reg. No. 4,273,956**

**Registered Jan. 15, 2013**

**Int. Cl.: 25**

**TRADEMARK**

**PRINCIPAL REGISTER**

WRUNG DIVISION (FRANCE SARL)  
106 RUE DE LA JARRY  
F-94300 VINCENNES  
FRANCE

FOR: CLOTHES, NAMELY, TEE-SHIRTS, SWEATSHIRTS, SHIRTS, JACKETS, COATS, TROUSERS, JEANS, BELTS, FUR COATS, GLOVES, SCARVES, SASHES FOR WEAR, TIES, HOSIERY, SOCKS AND UNDERWEAR; CLOTHING MADE FROM LEATHER OR IMITATION LEATHER, NAMELY, JACKETS, COATS, TROUSERS AND BELTS; SHOES, HEADWEAR, HATS AND CAPS, IN CLASS 25 (U.S. CLS. 22 AND 39).

THE MARK CONSISTS OF THE STYLIZED WORDING "WRÜNG" ON AN OVAL BACKGROUND ABOVE THE WORDING "WRUNG".

OWNER OF INTERNATIONAL REGISTRATION 0696303 DATED 7-24-1998, EXPIRES 7-24-2018.

SER. NO. 79-113,841, FILED 3-21-2012.

WILLIAM VERHOSEK, EXAMINING ATTORNEY



*David J. Kyffers*

Director of the United States Patent and Trademark Office

United States of America  
United States Patent and Trademark Office

IDEVA

**Reg. No. 4,273,957**

**Registered Jan. 15, 2013**

**Int. Cl.: 12**

**TRADEMARK**

**PRINCIPAL REGISTER**

MAZDA MOTOR CORPORATION (JAPAN CORPORATION)  
3-1, SHINCHI, FUCHU-CHO  
AKI-GUN; HIROSHIMA 730-8670  
JAPAN

FOR: AUTOMOBILES AND STRUCTURAL PARTS AND FITTINGS THEREOF; ENGINES FOR AUTOMOBILES; MOTORS AND ENGINES FOR OTHER LAND VEHICLES, EXCLUDING THEIR PARTS; TRANSMISSIONS AND GEARINGS FOR LAND VEHICLES; BRAKES FOR LAND VEHICLES; ALTERNATING CURRENT MOTORS AND DIRECT CURRENT MOTORS FOR LAND VEHICLES, EXCLUDING THEIR PARTS, IN CLASS 12 (U.S. CLS. 19, 21, 23, 31, 35 AND 44).

THE MARK CONSISTS OF STANDARD CHARACTERS WITHOUT CLAIM TO ANY PARTICULAR FONT, STYLE, SIZE, OR COLOR.

OWNER OF INTERNATIONAL REGISTRATION 1118855 DATED 3-15-2012, EXPIRES 3-15-2022.

THE WORDING "IDEVA" HAS NO MEANING IN A FOREIGN LANGUAGE.

SER. NO. 79-113,916, FILED 3-15-2012.

KEVIN CORWIN, EXAMINING ATTORNEY



*David J. Kypos*

Director of the United States Patent and Trademark Office

**United States of America**  
United States Patent and Trademark Office

**RIDELOC**

**Reg. No. 4,273,958**

**Registered Jan. 15, 2013**

**Int. Cl.: 12**

**TRADEMARK**

**PRINCIPAL REGISTER**

SCOTT USA LIMITED (GUERNSEY GMBH / LIMITED)  
7 NEW STREET  
ST. PETER PORT, GUERNSEY GY1 4BZ  
GUERNSEY

FOR: COMPONENTS AND PARTS OF BICYCLES AND ACCESSORIES, IN PARTICULAR SHOCK ABSORBERS, HANDLEBAR GRIPS, SADDLES AND HANDLEBARS, IN CLASS 12 (U.S. CLS. 19, 21, 23, 31, 35 AND 44).

THE MARK CONSISTS OF STANDARD CHARACTERS WITHOUT CLAIM TO ANY PARTICULAR FONT, STYLE, SIZE, OR COLOR.

PRIORITY DATE OF 1-12-2012 IS CLAIMED.

OWNER OF INTERNATIONAL REGISTRATION 1118949 DATED 5-29-2012, EXPIRES 5-29-2022.

SER. NO. 79-113,948, FILED 5-29-2012.

KELLY TRUSILO, EXAMINING ATTORNEY



*David J. Kyffers*

Director of the United States Patent and Trademark Office

# United States of America

United States Patent and Trademark Office



S M A R T T E X T I L E S

**Reg. No. 4,273,959**

**Registered Jan. 15, 2013**

**Int. Cls.: 3, 21 and 24**

**TRADEMARK**

**PRINCIPAL REGISTER**

DECITEX (FRANCE SOCIÉTÉ PAR ACTIONS SIMPLIFIÉE)  
51 RUE DE LA SOURCE  
F-62149 GIVENCHY LES LA BASSEE  
FRANCE

FOR: BLEACHING PREPARATIONS, DETERGENT AND SOAP FOR LAUNDRY USE; CLEANING, POLISHING, ABRASIVE AND DEGREASING PREPARATIONS FOR HOUSEHOLD USE; SOAP; PRESERVATIVES FOR LEATHER IN THE NATURE OF POLISHES; CREAMS FOR LEATHER, IN CLASS 3 (U.S. CLS. 1, 4, 6, 50, 51 AND 52).

FOR: NON-ELECTRIC UTENSILS AND CONTAINERS FOR HOUSEHOLD OR KITCHEN USE, NAMELY, SPATULAS, BUCKETS, BASINS; COMBS AND SPONGES FOR HOUSEHOLD USE; BRUSHES, NAMELY, BATH BRUSHES, BRUSHES FOR CLEANING THE FLOOR; BRUSH-MAKING MATERIALS IN THE NATURE OF ANIMAL BRISTLES; HAND-OPERATED CLEANING INSTRUMENTS, NAMELY, BROOMS, BROOM BRUSHES; STEEL WOOL; TOILET UTENSILS, NAMELY, BRUSHES, SPONGES, IN CLASS 21 (U.S. CLS. 2, 13, 23, 29, 30, 33, 40 AND 50).

FOR: KNITTED FABRICS; BED AND PLASTIC TABLE COVERS; FABRICS FOR TEXTILE USE; ELASTIC WOVEN FABRICS; VELVET; BED LINEN; HOUSEHOLD LINEN; TABLE LINEN, NOT OF PAPER; BATH LINEN EXCEPT CLOTHING, IN CLASS 24 (U.S. CLS. 42 AND 50).

NO CLAIM IS MADE TO THE EXCLUSIVE RIGHT TO USE "TEXTILES", APART FROM THE MARK AS SHOWN.

PRIORITY DATE OF 11-22-2011 IS CLAIMED.

OWNER OF INTERNATIONAL REGISTRATION 1119173 DATED 4-5-2012, EXPIRES 4-5-2022.

THE MARK CONSISTS OF THE TERM "DECITEX" INSIDE OF A SHADED GEOMETRIC DESIGN WITH AN OVERALL OVAL SHAPE AND THE LANGUAGE "SMART TEXTILES" APPEARING UNDER THE OVAL SHAPE.

SER. NO. 79-114,046, FILED 4-5-2012.



*David J. Kyros*

Director of the United States Patent and Trademark Office

**Reg. No. 4,273,959** LAURIE MAYES, EXAMINING ATTORNEY



United States of America  
United States Patent and Trademark Office

# SkyAngle

**Reg. No. 4,273,960**

**Registered Jan. 15, 2013**

**Int. Cls.: 7, 9 and 12**

**TRADEMARK**

**PRINCIPAL REGISTER**

HITACHI CONSTRUCTION; MACHINERY CO., LTD. (JAPAN CORPORATION)  
5-1, KOURAKU 2-CHOME,  
BUNKYOU-KU; TOKYO 112-0004  
JAPAN

FOR: CRAWLER-TRACKED LOADERS; POWER SHOVELS, IN CLASS 7 (U.S. CLS. 13, 19, 21, 23, 31, 34 AND 35).

FOR: VEHICLE-MOUNTED ELECTRIC MONITORING APPARATUS, NAMELY, VEHICLE SAFETY EQUIPMENT, NAMELY, BACK-UP SENSORS AND CAMERAS; VEHICLE SAFETY EQUIPMENT, NAMELY, AN ON-BOARD VEHICULAR SURVEILLANCE SYSTEM COMPRISED OF CAMERAS AND MONITORS FOR EXPOSING AND ELIMINATING BLIND SPOTS NEAR THE VEHICLE, IN CLASS 9 (U.S. CLS. 21, 23, 26, 36 AND 38).

FOR: LUGGAGE TRUCKS; DUMP TRUCKS, IN CLASS 12 (U.S. CLS. 19, 21, 23, 31, 35 AND 44).

PRIORITY DATE OF 2-14-2012 IS CLAIMED.

OWNER OF INTERNATIONAL REGISTRATION 1119537 DATED 3-8-2012, EXPIRES 3-8-2022.

SER. NO. 79-114,167, FILED 3-8-2012.

BARBARA GAYNOR, EXAMINING ATTORNEY



*David J. Kybas*

Director of the United States Patent and Trademark Office

# United States of America

United States Patent and Trademark Office

## LACOSTE BORIE

**Reg. No. 4,273,961**

**Registered Jan. 15, 2013**

**Int. Cl.: 33**

GROUPEMENT FONCIER AGRICOLE; DU CHATEAU GRAND PUY LACOSTE (FRANCE  
SOCIÉTÉ CIVILE)  
CHATEAU GRAND PUY LACOSTE  
F-33250 PAUILLAC  
FRANCE

**TRADEMARK**

FOR: PAUILLAC AOC WINES (WINES WITH PROTECTED APPELLATION OF ORIGIN),  
IN CLASS 33 (U.S. CLS. 47 AND 49).

**PRINCIPAL REGISTER**

THE MARK CONSISTS OF STANDARD CHARACTERS WITHOUT CLAIM TO ANY PAR-  
TICULAR FONT, STYLE, SIZE, OR COLOR.

PRIORITY DATE OF 12-1-2011 IS CLAIMED.

OWNER OF INTERNATIONAL REGISTRATION 1119745 DATED 5-30-2012, EXPIRES 5-30-  
2022.

SER. NO. 79-114,251, FILED 5-30-2012.

BRIAN NEVILLE, EXAMINING ATTORNEY



*David J. Kyffers*

Director of the United States Patent and Trademark Office

United States of America  
United States Patent and Trademark Office

# AeroScan

**Reg. No. 4,273,962**

**Registered Jan. 15, 2013**

**Int. Cls.: 7, 9 and 12**

**TRADEMARK**

**PRINCIPAL REGISTER**

HITACHI CONSTRUCTION; MACHINERY CO., LTD. (JAPAN CORPORATION)  
5-1, KOURAKU 2-CHOME  
BUNKYOU-KU; TOKYO 112-0004  
JAPAN

FOR: CRAWLER-TRACKED LOADERS; POWER SHOVELS, IN CLASS 7 (U.S. CLS. 13, 19, 21, 23, 31, 34 AND 35).

FOR: VEHICLE-MOUNTED ELECTRIC MONITORING APPARATUS, NAMELY, VEHICLE SAFETY EQUIPMENT, NAMELY, BACK-UP SENSORS AND CAMERAS; VEHICLE SAFETY EQUIPMENT, NAMELY, AN ON-BOARD VEHICULAR SURVEILLANCE SYSTEM COMPRISED OF CAMERAS AND MONITORS FOR EXPOSING AND ELIMINATING BLIND SPOTS NEAR THE VEHICLE, IN CLASS 9 (U.S. CLS. 21, 23, 26, 36 AND 38).

FOR: LUGGAGE TRUCKS; DUMP TRUCKS, IN CLASS 12 (U.S. CLS. 19, 21, 23, 31, 35 AND 44).

PRIORITY DATE OF 2-14-2012 IS CLAIMED.

OWNER OF INTERNATIONAL REGISTRATION 1119816 DATED 3-8-2012, EXPIRES 3-8-2022.

SER. NO. 79-114,289, FILED 3-8-2012.

MICHAEL LITZAU, EXAMINING ATTORNEY



*David J. Kybas*

Director of the United States Patent and Trademark Office

# United States of America

United States Patent and Trademark Office



**Reg. No. 4,273,963**

**Registered Jan. 15, 2013**

**Int. Cl.: 7**

**TRADEMARK**

**PRINCIPAL REGISTER**

TECNOLINE S.R.L. (ITALY LIMITED LIABILITY COMPANY)  
CORSO VITTORIO VENETO, 159  
SAN CESARIO SUL PANARO (MO), ITALY I41018

FOR: MOTORS, OTHER THAN FOR LAND VEHICLES, NAMELY, HYDRAULIC OR PNEUMATIC ROTARY MOTORS; OLEO HYDRAULIC COMPONENTS OF MOTORS, NAMELY, DISTRIBUTOR VALVES, OVERPRESSURE VALVES, CONTROL VALVES, IN CLASS 7 (U.S. CLS. 13, 19, 21, 23, 31, 34 AND 35).

NO CLAIM IS MADE TO THE EXCLUSIVE RIGHT TO USE "LINE", APART FROM THE MARK AS SHOWN.

PRIORITY DATE OF 9-19-2011 IS CLAIMED.

OWNER OF INTERNATIONAL REGISTRATION 1119890 DATED 3-14-2012, EXPIRES 3-14-2022.

THE MARK CONSISTS OF THE WORDS "TECNO LINE" IN STYLIZED THREE-DIMENSIONAL FONT WITH THE INITIAL LETTERS "T" AND "L" PRESENTED IN UPPERCASE AND LARGER THAN THE OTHER LETTERS.

SER. NO. 79-114,317, FILED 3-14-2012.

STEVEN PEREZ, EXAMINING ATTORNEY



*David J. Kyros*

Director of the United States Patent and Trademark Office

# United States of America

United States Patent and Trademark Office

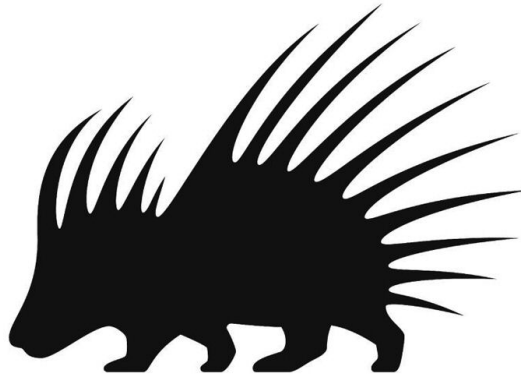

**Reg. No. 4,273,964**

**Registered Jan. 15, 2013**

**Int. Cls.: 3, 25 and 44**

**TRADEMARK**

**SERVICE MARK**

**PRINCIPAL REGISTER**

RUFFIANS GROUP LIMITED (UNITED KINGDOM LIMITED COMPANY)  
57 NOEL ROAD  
LONDON N1 8HE, UNITED KINGDOM

FOR: NON-MEDICATED TOILET PREPARATIONS, NAMELY, SHAMPOO, HAIR CONDITIONER, STYLING GEL, STYLING PUTTY, STYLING GUM, MATT CLAY, STYLING WAX, STYLING POWDER, HAIR TONIC; HAIRCARE AND SHAVING PREPARATIONS; SKINCARE PREPARATIONS, NAMELY, MOISTURIZERS, FACIAL CLEANSERS, FACIAL WASHES, HAND WASH AND BODY WASH; PERFUMES AND FRAGRANCES, IN CLASS 3 (U.S. CLS. 1, 4, 6, 50, 51 AND 52).

FOR: CLOTHING FOR MEN AND BOYS, NAMELY, JACKETS, COATS, SWEATERS, T SHIRTS, VESTS, TROUSERS, PANTS, SHORTS, SOCKS, UNDERPANTS, GLOVES, TIES, SCARVES, BELTS; FOOTWEAR; HEADGEAR, NAMELY, HATS AND CAPS; ALL FOR MEN AND BOYS, IN CLASS 25 (U.S. CLS. 22 AND 39).

FOR: BARBER SHOP SERVICES, MALE GROOMING SERVICES, NAMELY, HAIR CUTTING SERVICES, HAIR WASHING SERVICES, HAIR DYEING SERVICES, SHAVING SERVICES, MANICURE AND PEDICURE SERVICES; MASSAGE SERVICES, IN CLASS 44 (U.S. CLS. 100 AND 101).

THE MARK CONSISTS OF THE DESIGN OF A PORCUPINE.

PRIORITY DATE OF 9-15-2011 IS CLAIMED.

OWNER OF INTERNATIONAL REGISTRATION 1120169 DATED 1-3-2012, EXPIRES 1-3-2022.

SER. NO. 79-114,482, FILED 1-3-2012.

MICHAEL LITZAU, EXAMINING ATTORNEY



*David J. Kybas*

Director of the United States Patent and Trademark Office

# United States of America

United States Patent and Trademark Office

# ASAHI Gaia

**Reg. No. 4,273,965**

**Registered Jan. 15, 2013**

**Int. Cl.: 10**

**TRADEMARK**

**PRINCIPAL REGISTER**

ASAHI INTECC CO., LTD. (JAPAN CORPORATION)  
1703 WAKITA-CHO  
MORIYAMA-KU, NAGOYA-SHI  
AICHI 463-0024, JAPAN

FOR: MEDICAL GUIDEWIRES, AND STRUCTURAL PARTS THEREFOR; IVR (INTERVENTIONAL RADIOLOGY) GUIDEWIRES; PTCA (PERCUTANEOUS TRANSLUMINAL CORONARY ANGIOPLASTY) GUIDEWIRES; MEDICAL SPRING GUIDEWIRES; MEDICAL PLASTIC CLAD GUIDEWIRES, IN CLASS 10 (U.S. CLS. 26, 39 AND 44).

THE MARK CONSISTS OF STANDARD CHARACTERS WITHOUT CLAIM TO ANY PARTICULAR FONT, STYLE, SIZE, OR COLOR.

PRIORITY DATE OF 2-21-2012 IS CLAIMED.

OWNER OF INTERNATIONAL REGISTRATION 1120331 DATED 3-6-2012, EXPIRES 3-6-2022.

OWNER OF U.S. REG. NOS. 2,844,884, 3,330,384 AND OTHERS.

THE ENGLISH TRANSLATION OF "ASAHI" IN THE MARK IS "RISING SUN".

SER. NO. 79-114,540, FILED 3-6-2012.

TINA BROWN, EXAMINING ATTORNEY



*David J. Kyffers*

Director of the United States Patent and Trademark Office

# United States of America

United States Patent and Trademark Office



**Reg. No. 4,273,966**

**Registered Jan. 15, 2013**

**Int. Cl.: 25**

**TRADEMARK**

**PRINCIPAL REGISTER**

LUKE STEDMAN (AUSTRALIA INDIVIDUAL)  
61 HILLCREST AVENUE  
MONA VALE NSW 2103  
AUSTRALIA

FOR: CLOTHING, NAMELY, SHIRTS, T-SHIRTS, TANK TOPS, UNDERSHIRTS, SWEATERS, SWEATSHIRTS, VESTS, SHORTS, BOARD SHORTS, BOXERS, JEANS, PANTS, TROUSERS, SOCKS, BELTS, TIES, NECKERCHIEFS, SCARVES, JACKETS, COATS, RAIN COATS, WIND-RESISTANT JACKETS, GLOVES, AND MITTENS; FOOTWEAR; AND HEADWEAR, NAMELY, HATS, CAPS, VISORS, BEANIES AND HEADBANDS, IN CLASS 25 (U.S. CLS. 22 AND 39).

THE MARK CONSISTS OF A STYLIZED SMILEY FACE IN A CIRCULAR BACKGROUND. THE SMILEY FACE IS FORMED BY AN ANCHOR DESIGN AND THE CIRCULAR BACKGROUND IS SHADED.

OWNER OF INTERNATIONAL REGISTRATION 1120700 DATED 3-23-2012, EXPIRES 3-23-2022.

SER. NO. 79-114,639, FILED 3-23-2012.

MATTHEW KLINE, EXAMINING ATTORNEY



*David J. Kyffers*

Director of the United States Patent and Trademark Office

# United States of America

United States Patent and Trademark Office

# VP41

**Reg. No. 4,273,967**

**Registered Jan. 15, 2013**

**Int. Cl.: 1**

**TRADEMARK**

**PRINCIPAL REGISTER**

DANSTAR FERMENT AG (SWITZERLAND JOINT STOCK COMPANY)  
BAHNHOFSTRASSE 7  
CH-6301 ZUG  
SWITZERLAND

FOR: BACTERIAL PREPARATIONS FOR USE IN OENOLOGY, IN CLASS 1 (U.S. CLS. 1, 5, 6, 10, 26 AND 46).

THE MARK CONSISTS OF STANDARD CHARACTERS WITHOUT CLAIM TO ANY PARTICULAR FONT, STYLE, SIZE, OR COLOR.

PRIORITY DATE OF 1-12-2012 IS CLAIMED.

OWNER OF INTERNATIONAL REGISTRATION 1120759 DATED 6-6-2012, EXPIRES 6-6-2022.

SER. NO. 79-114,651, FILED 6-6-2012.

TRACY FLETCHER, EXAMINING ATTORNEY



*David J. Kyffers*

Director of the United States Patent and Trademark Office



# United States of America

United States Patent and Trademark Office

DENKA L a B 6 C a t h o d e

**Reg. No. 4,273,968**

**Registered Jan. 15, 2013**

**Int. Cl.: 9**

**TRADEMARK**

**PRINCIPAL REGISTER**

DENKI KAGAKU KOGYO KABUSHIKI KAISHA (JAPAN CORPORATION)  
1-1, NIHONBASHI MUROMACHI 2-CHOME  
CHUO-KU;  
TOKYO 103-8338, JAPAN

FOR: LANTHANUM HEXABORIDE MADE ELECTRON EMISSION SOURCE, NAMELY, PARTS OF ELECTRON MICROSCOPE AND ELECTRON BEAM EXPOSURE EQUIPMENT; LANTHANUM HEXABORIDE MADE ELECTRON EMISSION SOURCE, NAMELY, MICROSCOPE PARTS; PARTS OF ELECTRON MICROSCOPE; PARTS OF ELECTRONIC MACHINES AND APPARATUS, NAMELY, MICROSCOPES, IN CLASS 9 (U.S. CLS. 21, 23, 26, 36 AND 38).

THE MARK CONSISTS OF STANDARD CHARACTERS WITHOUT CLAIM TO ANY PARTICULAR FONT, STYLE, SIZE, OR COLOR.

OWNER OF INTERNATIONAL REGISTRATION 1121021 DATED 3-9-2012, EXPIRES 3-9-2022.

OWNER OF U.S. REG. NOS. 2,985,608, 3,754,853 AND OTHERS.

NO CLAIM IS MADE TO THE EXCLUSIVE RIGHT TO USE "LAB6 CATHODE", APART FROM THE MARK AS SHOWN.

THE WORDING "DENKA" HAS NO MEANING IN A FOREIGN LANGUAGE.

SER. NO. 79-114,763, FILED 3-9-2012.

TASNEEM HUSSAIN, EXAMINING ATTORNEY



*David J. Kyros*

Director of the United States Patent and Trademark Office

# United States of America

United States Patent and Trademark Office



**Reg. No. 4,273,969**

**Registered Jan. 15, 2013**

**Int. Cls.: 6, 9, 19, 20, 37,  
42 and 45**

SÄLZER SICHERHEITSTECHNIK GMBH (FED REP GERMANY LIMITED LIABILITY COMPANY)

DIETRICH-BONHOEFFER-STRABE 1-3  
35037 MARBURG

FED REP GERMANY

**TRADEMARK**

**SERVICE MARK**

**PRINCIPAL REGISTER**

FOR: COMPONENTS AND SEMI-FINISHED PRODUCTS THAT ARE PRESSED, ROILED OR CAST OF METAL, HARD METAL, LIGHT METAL, OR ALLOYS THEREOF, NAMELY, WINDOWS, DOORS, GATES, FACADE PANELS FOR CONSTRUCTION PURPOSES; COMPONENTS AND SEMI-FINISHED PRODUCTS THAT ARE PRESSED, ROLLED OR CAST OF METAL, HARD METAL, LIGHT METAL, OR ALLOYS THEREOF AND COMBINED WITH WOOD, PLASTICS, OR OTHER COMPOSITE MATERIALS, NAMELY, CURTAIN WALLS, MULLION TRANSOM FACADES, WINDOW FRAMES, DOOR FRAMES, WINDOW SHUTTERS, AND DOOR SHUTTERS; GRIDS OF METAL FOR WINDOWS; RAILINGS OF METAL FOR BALCONIES; WINDOWS, DOORS, GATES, FACADES, WINDOW/DOOR FRAMES AND SHUTTERS FOR WINDOWS AND DOORS WITHOUT/WITH SAFETY REQUIREMENTS AGAINST FIRE, FUME, EXPLOSION, EARTHQUAKE, FLOODWATER, BURGLARY, OUTBREAK, PENETRATION, THROUGH THROWING, PASSAGE OF SOUND, LIGHT AND HEAT; MADE OF METAL OR METAL ALLOYS; DOOR AND WINDOW HARDWARE, NAMELY, KEYS, GUARDS AND CLASPS, HINGES, WINDOW TRIMS, WINDOW FITTINGS, DOOR FITTINGS, GATE HARDWARE, NAMELY, GATE LATCHES, DOOR HANDLES, DOOR TRIM, DOOR BOLTS, DOOR LATCHES, LOCKS FOR WINDOWS, DOORS, GATES AND SHUTTERS, MADE OF PRESSED, ROLLED OR CAST OF METAL, HARD METAL, LIGHT METAL, AND THEIR RESPECTIVE ALLOYS; METAL FENCE SYSTEMS COMPRISING METAL FENCE PANELS, PETAL FENCE POSTS, METAL GATES, METAL RAILINGS, METAL HARDWARE AND METAL FENCE STAYS; METAL GRILL DOORS AND GATES; METAL WALLS FOR BUILDING; METAL BLOCKADES AND BARRIERS SECURITY; METAL TRANSPORTABLE WATCH HOUSES FOR SECURING AND CONTROLLING ENTRANCES, IN CLASS 6 (U.S. CLS. 2, 12, 13, 14, 23, 25 AND 50).



*David J. Kybas*

FOR: ELECTRONIC CONTROL, SIGNAL, INSPECTION, MONITORING AND REPORTING DEVICES FOR SECURITY AND/OR BLOCKING INSTALLATIONS, NAMELY, ELECTRONIC CONTROLLERS FOR CONTROLLING ACCESS TO A PREMISES, SECURITY PRODUCTS IN THE NATURE OF ENTRY DOOR SYSTEMS COMPRISING TOUCH PADS AND SECURITY DOORS, CAMERAS, OPTICAL SCANNERS; MAGNETIC CONTACTS; AND PROTECTIVE SHIELDS FOR PERSONAL SECURITY, IN CLASS 9 (U.S. CLS. 21, 23, 26, 36 AND 38).

**Reg. No. 4,273,969** FOR: COMPONENTS AND SEMI-FINISHED PRODUCTS MADE OF PRESSED, ROLLED, CAST OR FLOATED OF WOOD, PLASTICS AND GLASS, AND NON-METAL COMPOSITES, NAMELY, WINDOWS, DOORS, GATES, FACADE PANELS FOR CONSTRUCTION PURPOSES, WINDOW SHUTTERS, DOOR FRAMES, WINDOW FRAMES; NON-METAL GRIDS BEING NON-METAL BARS IN DOORS AND WINDOWS FOR SECURITY PURPOSES; NON-METAL GUARD RAILINGS FOR BALCONIES, GLASS PLATES, INSULATION GLASS, LAMINATED GLASS AND SECURITY GLASS, IN EACH CASE FOR PURPOSES OF BUILDING; WINDOWS, DOORS, GATES, FACADES, WINDOW AND DOOR FRAMES AND SHUTTERS FOR WINDOWS AND DOORS WITHOUT AND WITH SAFETY REQUIREMENTS AGAINST FIRE, FUME, EXPLOSION, EARTHQUAKE, FLOODWATER, BURGLARY, OUTBREAK, PENETRATION, RIDDLE, PASSAGE OF SOUND, LIGHT AND HEAT, MADE OF NON-METAL; NON-METAL HATCHES AND MOVING TROUGHS FOR BUILDING; NON-METAL FENCE SYSTEMS COMPRISING NON-METAL FENCE POSTS, NON-METAL FENCE PANELS, NON-METAL FENCE STAYS; NON-METAL GRILL DOORS AND GATES AND OTHER DIVIDING WALLS AT OR IN BUILDINGS, RAILINGS, THROUGH BLOCKADES, BARRIERS, CHAINS AND FENDER DEVICES; NON-METAL TRANSPORTABLE WATCH HOUSES, IN CLASS 19 (U.S. CLS. 1, 12, 33 AND 50).

FOR: NON-METAL FITTINGS, HARDWARE AND COMPONENT PARTS FOR WINDOWS, DOORS, GATES, FACADES, WINDOW FRAMES, DOOR FRAMES, AND SHUTTERS FOR WINDOWS AND DOORS, NAMELY, LOCKS, STRIPES, ANCHORAGES, LOCKING DEVICES, T AND CORNER CONNECTIONS, TURN, SWING, TILT, CLICK AND TURN/TILT FITTINGS, IN CLASS 20 (U.S. CLS. 2, 13, 22, 25, 32 AND 50).

FOR: ASSEMBLY AND INSTALLATION OF WINDOWS, DOORS, GATES, GRILL DOORS, GRILL GATES AND OTHER CUTTING UNITS, OF RAILINGS, THROUGH BLOCKADES, BARRIERS, CHAINS, FENDER DEVICES, FACADES, FRAMES, VITRIFICATIONS, ROLLER AND FOLDING SHUTTERS, FENCE SYSTEMS, WATCH HOUSES, OF HARDWARE FOR ELECTRONIC CONTROL, SIGNAL, INSPECTION, MONITORING AND REPORTING DEVICES FOR SECURITY AND/OR BLOCKING INSTALLATIONS AND OF MAGNETIC CONTACTS, IN CLASS 37 (U.S. CLS. 100, 103 AND 106).

FOR: TECHNICAL PRODUCT DEVELOPMENT FOR OTHERS AND TECHNICAL DESIGN PLANNING FOR OTHERS OF WINDOWS, DOORS, GATES, GRIDS, GRILL DOORS, GRILL GATES AND OTHER CUTTING UNITS, OF RAILINGS, THROUGH BLOCKADES, BARRIERS, CHAINS, FENDER DEVICES, FACADES, FRAMES, VITRIFICATIONS, ROLLER AND FOLDING SHUTTERS, FENCE SYSTEMS, WATCH HOUSES, OF ELECTRONIC CONTROL, SIGNAL, INSPECTION, MONITORING AND REPORTING DEVICES FOR SECURITY AND/OR BLOCKING INSTALLATIONS AND OF MAGNETIC CONTACTS AS WELL AS OF ACCESSORIES AND FITTINGS FOR WINDOWS, DOORS, GATES AND FACADES FOR VALUE FOR THIRD PARTIES; SERVICES OF AN ENGINEER IN THE FIELD OF SAFETY ENGINEERING, ESPECIALLY PLANNING AND ACCOMPANYING CONSULTANCY CONCERNING TENDERS, WORKS CONTRACTS, EXECUTION, FINAL INSPECTION, CERTIFICATION OF SAFETY CONCEPTS AND SAFETY-RELATED COMPONENTS AND EQUIPMENT; INSTALLATION OF SOFTWARE FOR ELECTRONIC CONTROL, SIGNAL, INSPECTION, MONITORING AND REPORTING DEVICES FOR SECURITY AND/OR BLOCKING INSTALLATIONS, IN CLASS 42 (U.S. CLS. 100 AND 101).

FOR: CONSULTANCY IN THE FIELD OF SAFETY, ESPECIALLY PREPARATION OF SAFETY CONCEPTS AND EXAMINATION OF EXISTING SAFETY CONCEPTS, IN CLASS 45 (U.S. CLS. 100 AND 101).

PRIORITY DATE OF 1-3-2012 IS CLAIMED.

OWNER OF INTERNATIONAL REGISTRATION 1122088 DATED 4-23-2012, EXPIRES 4-23-2022.

**Reg. No. 4,273,969** THE COLOR(S) ANTHRACITE AND GREEN IS/ARE CLAIMED AS A FEATURE OF THE MARK.

CIRCLE/BALL: ANTHRACITE; STRIPES: GREEN.

SER. NO. 79-115,163, FILED 4-23-2012.

PATRICIA EVANKO, EXAMINING ATTORNEY

# United States of America

United States Patent and Trademark Office



**Reg. No. 4,273,970**

**Registered Jan. 15, 2013**

**Int. Cls.: 7 and 40**

**TRADEMARK**

**SERVICE MARK**

**PRINCIPAL REGISTER**

NINGBO YONG'AN MACHINE MANUFACTURING CO., LTD. (CHINA CORPORATION)  
XIA'AO VILLAGE  
DAXU TOWN, XIANGSHAN  
ZHEJIANG, CHINA

FOR: COMPRESSION AND INJECTION MOULDING MACHINES; MOULDS AS PARTS OF MACHINES; DIE-CASTING MOULDS AS PARTS FOR EXTRUSION MACHINES; COLD PUNCHING MOULDS AS PARTS OF EXTRUSION MACHINES; EXHAUST-MANIFOLD FOR ENGINES; CYLINDER HEADS FOR ENGINES; CYLINDERS FOR MOTORS AND ENGINES; WATER PUMPS FOR LAND VEHICLES; OIL FILTERS; DIESEL FILTERS, IN CLASS 7 (U.S. CLS. 13, 19, 21, 23, 31, 34 AND 35).

FOR: METAL CASTING; METAL SMELTING; TREATMENT OF METALS; METAL TEMPERING; APPLYING FINISHES TO TEXTILES; WOODWORKING; DRESSMAKING; PRINTING; WATER TREATING; SORTING OF WASTE AND RECYCLABLE MATERIAL , IN CLASS 40 (U.S. CLS. 100, 103 AND 106).

THE MARK IS A LOGO COMPOSED OF A BOLD LETTER "V" AND A SOLID TRIANGLE.

OWNER OF INTERNATIONAL REGISTRATION 1122303 DATED 5-2-2012, EXPIRES 5-2-2022.

SER. NO. 79-115,245, FILED 5-2-2012.

VIVIAN MICZNIK FIRST, EXAMINING ATTORNEY



*David J. Kybas*

Director of the United States Patent and Trademark Office

# United States of America

United States Patent and Trademark Office

# EUROFOLD

**Reg. No. 4,273,971**

**Registered Jan. 15, 2013**

**Int. Cl.: 7**

**TRADEMARK**

**PRINCIPAL REGISTER**

MULTIGRAF AG (SWITZERLAND CORPORATION)  
GRINDELSTRASSE 26  
CH-5630 MURI  
SWITZERLAND

FOR: MACHINES FOR PROCESSING PAPER, IN PARTICULAR MACHINES AND COMPONENTS THEREOF FOR TRANSPORTING, SORTING, SCORING, FOLDING, ASSEMBLING, STAPLING, GLUING, CUTTING, BUNDLING, STACKING, PACKING AND PALLETIZING PAPER, ALL THE AFORESAID GOODS FROM EUROPE, IN CLASS 7 (U.S. CLS. 13, 19, 21, 23, 31, 34 AND 35).

PRIORITY DATE OF 11-15-2011 IS CLAIMED.

OWNER OF INTERNATIONAL REGISTRATION 1122544 DATED 5-4-2012, EXPIRES 5-4-2022.

SER. NO. 79-115,348, FILED 5-4-2012.

SEAN CROWLEY, EXAMINING ATTORNEY



*David J. Kybas*

Director of the United States Patent and Trademark Office

# United States of America

United States Patent and Trademark Office



**Reg. No. 4,273,972**

**Registered Jan. 15, 2013**

**Int. Cl.: 7**

**TRADEMARK**

**PRINCIPAL REGISTER**

MYLAN GROUP (VIETNAM CORPORATION)  
LONG DUC INDUSTRIAL PARK  
TRA VINH CITY; TRA VINH PROVINCE  
VIETNAM

FOR: PRINTING MACHINES FOR INDUSTRIAL USE, IN CLASS 7 (U.S. CLS. 13, 19, 21, 23, 31, 34 AND 35).

THE MARK CONSISTS OF THE STYLIZED TEXT "VJET" IN DARK BLUE AND THREE STYLIZED LEAVES IN DARK BLUE, GREY AND RED LOCATED ABOVE THE LOWERCASE LETTER "E" WITHIN THE TEXT. THE LOWERCASE LETTER "V" APPEARS AS A CHECK MARK WITH THE LEFT DIAGONAL LINE HAVING A SERIF AT THE TOP AND THE RIGHT DIAGONAL LINE RISING ABOVE THE LEFT SIDE OF THE LETTER. THE DESCENDER OF THE LOWERCASE LETTER "J" CONTAINS A BREAK THAT RUNS THROUGH THE LETTER AND IS EVEN TO THE BASELINE OF THE WORDING "VJET".

PRIORITY DATE OF 12-15-2011 IS CLAIMED.

OWNER OF INTERNATIONAL REGISTRATION 1122859 DATED 3-26-2012, EXPIRES 3-26-2022.

THE COLOR(S) DARK BLUE, RED, AND GRAY IS/ARE CLAIMED AS A FEATURE OF THE MARK.

THE COLORS DARK BLUE: THE STYLIZED "VJET" AND THE FIRST STYLIZED LEAF; GREY: THE SECOND STYLIZED LEAF; RED: THE THIRD STYLIZED LEAF ARE CLAIMED AS A FEATURE OF THE MARK.

SER. NO. 79-115,467, FILED 3-26-2012.

MATTHEW GALAN, EXAMINING ATTORNEY



*David J. Kybas*

Director of the United States Patent and Trademark Office

# United States of America

United States Patent and Trademark Office

# Twinduro

**Reg. No. 4,273,973**

**Registered Jan. 15, 2013**

**Int. Cl.: 12**

**TRADEMARK**

**PRINCIPAL REGISTER**

CONTINENTAL REIFEN DEUTSCHLAND GMBH (FED REP GERMANY LIMITED LIABILITY COMPANY)  
VAHRENWALDER STR. 9  
30165 HANNOVER  
FED REP GERMANY

FOR: PNEUMATIC VEHICLE TIRES, IN CLASS 12 (U.S. CLS. 19, 21, 23, 31, 35 AND 44).

THE MARK CONSISTS OF STANDARD CHARACTERS WITHOUT CLAIM TO ANY PARTICULAR FONT, STYLE, SIZE, OR COLOR.

OWNER OF INTERNATIONAL REGISTRATION 1122910 DATED 6-11-2012, EXPIRES 6-11-2022.

SER. NO. 79-115,487, FILED 6-11-2012.

SCOTT BIBB, EXAMINING ATTORNEY



*David J. Kyffers*

Director of the United States Patent and Trademark Office



**United States of America**  
United States Patent and Trademark Office

**TURNING**

**Reg. No. 4,273,974**

**Registered Jan. 15, 2013**

**Int. Cl.: 9**

**TRADEMARK**

**PRINCIPAL REGISTER**

TANIGUCHI OPTICAL., INC. (JAPAN CORPORATION)  
27-5, NISHIBUKURO-CHO  
SABAE-SHI; FUKUI 916-1221  
JAPAN

FOR: EYEGLASSES; EYEGLASS FRAMES; EYEGLASS CASES; SUNGLASSES, IN CLASS  
9 (U.S. CLS. 21, 23, 26, 36 AND 38).

OWNER OF INTERNATIONAL REGISTRATION 1123095 DATED 6-5-2012, EXPIRES 6-5-  
2022.

SER. NO. 79-115,550, FILED 6-5-2012.

SHARON MEIER, EXAMINING ATTORNEY



*David J. Kybas*

Director of the United States Patent and Trademark Office

# United States of America

United States Patent and Trademark Office

# BALINDUR

**Reg. No. 4,273,975**

**Registered Jan. 15, 2013**

**Int. Cls.: 1 and 17**

**TRADEMARK**

**PRINCIPAL REGISTER**

BASF SE (FED REP GERMANY SOCIETAS EUROPAEA (SE))  
CARL-BOSCH-STRASSE 38  
67063 LUDWIGSHAFEN AM RHEIN  
FED REP GERMANY

FOR: CHEMICALS USED IN INDUSTRY AND SCIENCE, UNPROCESSED ARTIFICIAL RESINS, UNPROCESSED PLASTICS, ADHESIVES USED IN INDUSTRY, IN CLASS 1 (U.S. CLS. 1, 5, 6, 10, 26 AND 46).

FOR: PLASTICS IN EXTRUDED FORM FOR USE IN MANUFACTURE, PACKING, STOPPING AND INSULATING MATERIALS; FLEXIBLE PIPES, NOT OF METAL, IN CLASS 17 (U.S. CLS. 1, 5, 12, 13, 35 AND 50).

THE MARK CONSISTS OF STANDARD CHARACTERS WITHOUT CLAIM TO ANY PARTICULAR FONT, STYLE, SIZE, OR COLOR.

PRIORITY DATE OF 3-19-2012 IS CLAIMED.

OWNER OF INTERNATIONAL REGISTRATION 1123259 DATED 6-6-2012, EXPIRES 6-6-2022.

SER. NO. 79-115,614, FILED 6-6-2012.

KATHRYN COWARD, EXAMINING ATTORNEY



*David J. Kyffers*

Director of the United States Patent and Trademark Office

# United States of America

United States Patent and Trademark Office

# SAFETIHEEL

**Reg. No. 4,273,976**

**Registered Jan. 15, 2013**

**Int. Cl.: 10**

**TRADEMARK**

**PRINCIPAL REGISTER**

NSP TECH PTE LTD (SINGAPORE PRIVATE LIMITED COMPANY)  
10 ADMIRALTY STREET  
#02-07 NORTH LINK BUILDING; SINGAPORE 757695  
SINGAPORE

FOR: APPARATUS FOR THE WITHDRAWAL OF BLOOD FOR MEDICAL EXAMINATION,  
IN CLASS 10 (U.S. CLS. 26, 39 AND 44).

PRIORITY DATE OF 11-25-2011 IS CLAIMED.

OWNER OF INTERNATIONAL REGISTRATION 1124925 DATED 5-23-2012, EXPIRES 5-23-2022.

SER. NO. 79-116,238, FILED 5-23-2012.

MEREDITH MARESCA, EXAMINING ATTORNEY



*David J. Kyffers*

Director of the United States Patent and Trademark Office

**United States of America**  
United States Patent and Trademark Office

**DELAWIN**

**Reg. No. 4,273,977**

**Registered Jan. 15, 2013**

**Int. Cl.: 5**

**TRADEMARK**

**PRINCIPAL REGISTER**

OTSUKA PHARMACEUTICAL CO., LTD. (JAPAN CORPORATION)  
2-9, KANDA-TSUKASAMACHI  
CHIYODA-KU, TOKYO 101-8535  
JAPAN

FOR: PHARMACEUTICAL PREPARATIONS FOR THE PREVENTION AND TREATMENT OF TUBERCULOSIS; ANTITUBERCULOUS AGENTS, IN CLASS 5 (U.S. CLS. 6, 18, 44, 46, 51 AND 52).

THE MARK CONSISTS OF STANDARD CHARACTERS WITHOUT CLAIM TO ANY PARTICULAR FONT, STYLE, SIZE, OR COLOR.

PRIORITY DATE OF 12-12-2011 IS CLAIMED.

OWNER OF INTERNATIONAL REGISTRATION 1125079 DATED 6-4-2012, EXPIRES 6-4-2022.

SER. NO. 79-116,292, FILED 6-4-2012.

JENNY PARK, EXAMINING ATTORNEY



*David J. Kyffers*

Director of the United States Patent and Trademark Office

**United States of America**  
United States Patent and Trademark Office

# DELASERA

**Reg. No. 4,273,978**

**Registered Jan. 15, 2013**

**Int. Cl.: 5**

**TRADEMARK**

**PRINCIPAL REGISTER**

OTSUKA PHARMACEUTICAL CO., LTD. (JAPAN CORPORATION)  
2-9, KANDA-TSUKASAMACHI  
CHIYODA-KU, TOKYO 101-8535  
JAPAN

FOR: PHARMACEUTICAL PREPARATIONS FOR THE PREVENTION AND TREATMENT OF TUBERCULOSIS; ANTITUBERCULOUS AGENTS, IN CLASS 5 (U.S. CLS. 6, 18, 44, 46, 51 AND 52).

THE MARK CONSISTS OF STANDARD CHARACTERS WITHOUT CLAIM TO ANY PARTICULAR FONT, STYLE, SIZE, OR COLOR.

PRIORITY DATE OF 12-12-2011 IS CLAIMED.

OWNER OF INTERNATIONAL REGISTRATION 1125080 DATED 6-4-2012, EXPIRES 6-4-2022.

SER. NO. 79-116,293, FILED 6-4-2012.

JENNY PARK, EXAMINING ATTORNEY



*David J. Kyffers*

Director of the United States Patent and Trademark Office

**United States of America**  
United States Patent and Trademark Office

**DELTYBA**

**Reg. No. 4,273,979**

**Registered Jan. 15, 2013**

**Int. Cl.: 5**

**TRADEMARK**

**PRINCIPAL REGISTER**

OTSUKA PHARMACEUTICAL CO., LTD. (JAPAN CORPORATION)  
2-9, KANDA-TSUKASAMACHI  
CHIYODA-KU, TOKYO 101-8535  
JAPAN

FOR: PHARMACEUTICAL PREPARATIONS FOR THE PREVENTION AND TREATMENT OF TUBERCULOSIS; ANTITUBERCULOUS AGENTS, IN CLASS 5 (U.S. CLS. 6, 18, 44, 46, 51 AND 52).

THE MARK CONSISTS OF STANDARD CHARACTERS WITHOUT CLAIM TO ANY PARTICULAR FONT, STYLE, SIZE, OR COLOR.

PRIORITY DATE OF 12-12-2011 IS CLAIMED.

OWNER OF INTERNATIONAL REGISTRATION 1125081 DATED 6-4-2012, EXPIRES 6-4-2022.

SER. NO. 79-116,294, FILED 6-4-2012.

JENNY PARK, EXAMINING ATTORNEY



*David J. Kyffers*

Director of the United States Patent and Trademark Office

# United States of America

United States Patent and Trademark Office

## YOU KNOW BETTER

**Reg. No. 4,273,980**

**Registered Jan. 15, 2013**

**Int. Cl.: 33**

**TRADEMARK**

**PRINCIPAL REGISTER**

SPIRITS INTERNATIONAL B.V. (NETHERLANDS B.V. (CORPORATION))  
7, RUE NICOLAS BOVÉ  
L-1253 LUXEMBOURG  
LUXEMBOURG

FOR: ALCOHOLIC BEVERAGES (EXCEPT BEERS), INCLUDING VODKAS, IN CLASS 33  
(U.S. CLS. 47 AND 49).

THE MARK CONSISTS OF STANDARD CHARACTERS WITHOUT CLAIM TO ANY PARTICULAR FONT, STYLE, SIZE, OR COLOR.

PRIORITY DATE OF 12-8-2011 IS CLAIMED.

OWNER OF INTERNATIONAL REGISTRATION 1125221 DATED 6-4-2012, EXPIRES 6-4-2022.

THE ENGLISH TRANSLATION OF THE FOREIGN WORD(S) IN THE MARK IS: "VOUS SAVEZ MIEUX".

SER. NO. 79-116,355, FILED 6-4-2012.

ANNE MADDEN, EXAMINING ATTORNEY



*David J. Kybas*

Director of the United States Patent and Trademark Office

# United States of America

United States Patent and Trademark Office

## DREAM RAIDERS

**Reg. No. 4,273,981**

**Registered Jan. 15, 2013**

**Int. Cl.: 28**

**TRADEMARK**

**PRINCIPAL REGISTER**

KABUSHIKI KAISHA SEGA; D/B/A SEGA CORPORATION (JAPAN CORPORATION)  
1-2-12, HANEDA  
OHTA-KU; TOKYO 144-8531  
JAPAN

FOR: COIN-OPERATED VIDEO GAMES; ARCADE GAME MACHINES WITH BUILT-IN SCREENS; ARCADE GAME MACHINES OTHER THAN THOSE ADAPTED FOR USE WITH TELEVISION RECEIVERS; TOY VEHICLES; DOLLS; STUFFED TOYS; TOY ACTION FIGURES, IN CLASS 28 (U.S. CLS. 22, 23, 38 AND 50).

THE MARK CONSISTS OF STANDARD CHARACTERS WITHOUT CLAIM TO ANY PARTICULAR FONT, STYLE, SIZE, OR COLOR.

PRIORITY DATE OF 3-13-2012 IS CLAIMED.

OWNER OF INTERNATIONAL REGISTRATION 1125272 DATED 6-4-2012, EXPIRES 6-4-2022.

SER. NO. 79-116,372, FILED 6-4-2012.

ANNE MADDEN, EXAMINING ATTORNEY



*David J. Kyffers*

Director of the United States Patent and Trademark Office



**United States of America**  
United States Patent and Trademark Office

# MEDI-GRIP

**Reg. No. 4,273,982**

**Registered Jan. 15, 2013**

**Int. Cl.: 10**

**TRADEMARK**

**PRINCIPAL REGISTER**

ANSELL LIMITED (AUSTRALIA LIMITED COMPANY)  
VICTORIA GARDENS,  
LEVEL 3/678 VICTORIA STREET; RICHMOND VIC 3121  
AUSTRALIA

FOR: MEDICAL AND SURGICAL GLOVES, IN CLASS 10 (U.S. CLS. 26, 39 AND 44).

OWNER OF INTERNATIONAL REGISTRATION 0535042 DATED 2-16-1989, EXPIRES 2-16-2019.

SER. NO. 79-116,497, FILED 7-16-2012.

EUGENIA MARTIN, EXAMINING ATTORNEY



*David J. Kybas*

Director of the United States Patent and Trademark Office

United States of America  
United States Patent and Trademark Office

FARAN

**Reg. No. 4,273,983**

**Registered Jan. 15, 2013**

**Int. Cl.: 3**

**TRADEMARK**

**PRINCIPAL REGISTER**

NATURE SCENT Y.S. LTD. (ISRAEL LIMITED LIABILITY COMPANY)  
22 HAR ARDON ST.  
80600 MITZPE RAMON  
ISRAEL

FOR: COSMETIC SOAPS; CREAM SOAPS; LIQUID SOAPS; PERFUMED SOAPS; SOAPS FOR BODY CARE; SOAPS FOR PERSONAL USE; ESSENTIAL OILS; COSMETIC CREAMS FOR SKIN CARE; HAIR CARE CREAMS; HAIR CARE PREPARATIONS; HAIR CARE LOTIONS; LOTIONS FOR FACE AND BODY CARE; NAIL CARE PREPARATIONS; BODY AND BEAUTY CARE COSMETICS; COSMETIC CREAMS; COSMETIC PREPARATIONS; COSMETICS; BODY OILS; HAIR COLORING PREPARATIONS; HAIR STYLING PREPARATIONS; HAIR SHAMPOOS AND CONDITIONERS; BABY OILS; SHAMPOOS FOR BABIES; BATH AND SHOWER GELS AND SALTS NOT FOR MEDICAL PURPOSES; BATH OILS; BATH SOAPS; BATH FOAM; MASSAGE OILS; COSMETIC MASSAGE CREAMS; SUN SCREEN PREPARATIONS; SUNSCREEN CREAMS; SUN-TANNING OILS AND LOTIONS; SUN BLOCK PREPARATIONS; TANNING AND AFTER-SUN MILKS, GELS AND OILS; BEAUTY GELS; BEAUTY CREAMS, BODY CREAMS, FACE CREAMS FOR COSMETIC USE, BEAUTY LOTIONS; BODY LOTIONS; SKIN LOTIONS; MAKE-UP; COSMETICS AND MAKE-UP; MAKE-UP FOR THE FACE AND BODY; MAKE-UP REMOVING PREPARATIONS, IN CLASS 3 (U.S. CLS. 1, 4, 6, 50, 51 AND 52).

THE MARK CONSISTS OF STANDARD CHARACTERS WITHOUT CLAIM TO ANY PARTICULAR FONT, STYLE, SIZE, OR COLOR.

PRIORITY DATE OF 5-24-2012 IS CLAIMED.

OWNER OF INTERNATIONAL REGISTRATION 1125795 DATED 5-28-2012, EXPIRES 5-28-2022.

SER. NO. 79-116,587, FILED 5-28-2012.

JEANIE LEE, EXAMINING ATTORNEY



*David J. Kypos*

Director of the United States Patent and Trademark Office

# United States of America

United States Patent and Trademark Office

# TP-LINK

**Reg. No. 4,273,984**

**Registered Jan. 15, 2013**

**Int. Cl.: 41**

TP-LINK TECHNOLOGIES CO., LTD. (CHINA CORPORATION)  
1ST FL., 3RD TO 5TH FL., SOUTH BUILDING  
INDUSTRY WORKSHOP NO.24, & 1ST TO 4TH FLOOR.; NORTH BUILDING, INDUSTRY  
WORKSHOP NO. 28.; SCIENCE AND TECHNOLOGY PARK, SHENNAN ROAD; NANSHAN,  
SHENZHEN  
CHINA

**SERVICE MARK**

**PRINCIPAL REGISTER**

FOR: COMPUTER EDUCATION TRAINING SERVICES; PROVIDING EDUCATIONAL  
DEMONSTRATIONS; ARRANGING AND CONDUCTING BUSINESS SEMINARS IN THE  
FIELD OF COMMUNICATION APPARATUS; ARRANGING PROFESSIONAL WORKSHOP  
AND TRAINING COURSES; PRODUCTION OF RADIO AND TELEVISION PROGRAMMES;  
PRODUCTION OF MUSICAL VIDEOS; AMUSEMENT ARCADE SERVICES, IN CLASS 41  
(U.S. CLS. 100, 101 AND 107).

THIS TRADEMARK CONSISTS OF TWO ENGLISH CAPITAL LETTERS "TP" AND ENGLISH  
WORD "LINK", BOTH IN STYLIZED FORM

PRIORITY DATE OF 12-2-2011 IS CLAIMED.

OWNER OF INTERNATIONAL REGISTRATION 1126871 DATED 3-6-2012, EXPIRES 3-6-  
2022.

SER. NO. 79-117,007, FILED 3-6-2012.

ANNE MADDEN, EXAMINING ATTORNEY



*David J. Kyffers*

Director of the United States Patent and Trademark Office

# United States of America

United States Patent and Trademark Office

# PANVIRAGEN

**Reg. No. 4,273,985**

NOVARTIS AG (SWITZERLAND AKTIENGESELLSCHAFT (CORPORATION))  
CH-4002 BASEL  
SWITZERLAND

**Registered Jan. 15, 2013**

**Int. Cl.: 5**

FOR: PHARMACEUTICAL PREPARATIONS FOR THE PREVENTION OR TREATMENT OF DISEASES AND DISORDERS OF THE NERVOUS SYSTEM, THE IMMUNE SYSTEM, THE CARDIOVASCULAR SYSTEM, THE METABOLIC SYSTEM, THE RESPIRATORY SYSTEM, THE MUSCULO-SKELETAL SYSTEM AND THE GENITOURINARY SYSTEM; PHARMACEUTICAL PREPARATIONS FOR THE TREATMENT OF INFLAMMATORY DISORDERS; PHARMACEUTICAL PREPARATIONS FOR USE IN DERMATOLOGY, ONCOLOGY, HEMATOLOGY AND IN TISSUE AND ORGAN TRANSPLANTATION, IN OPHTHALMOLOGY AND FOR GASTROENTEROLOGICAL DISORDERS; PHARMACEUTICAL PREPARATIONS FOR THE PREVENTION AND TREATMENT OF OCULAR DISORDERS AND DISEASES; PHARMACEUTICAL PREPARATIONS FOR THE TREATMENT OF DISEASES AND DISORDERS CAUSED BY BACTERIA, AUTOIMMUNE DISEASES AND DISORDERS, KIDNEY DISEASES AND DISORDERS, DIABETES; ANTIFUNGAL, ANTI-INFECTIVE, ANTIVIRAL PREPARATIONS AND ANTIBIOTICS, IN CLASS 5 (U.S. CLS. 6, 18, 44, 46, 51 AND 52).

**TRADEMARK**

**PRINCIPAL REGISTER**

THE MARK CONSISTS OF STANDARD CHARACTERS WITHOUT CLAIM TO ANY PARTICULAR FONT, STYLE, SIZE, OR COLOR.

PRIORITY DATE OF 3-29-2012 IS CLAIMED.

OWNER OF INTERNATIONAL REGISTRATION 1127503 DATED 4-10-2012, EXPIRES 4-10-2022.

SER. NO. 79-117,239, FILED 4-10-2012.

ALLISON HOLTZ, EXAMINING ATTORNEY



*David J. Kyffers*

Director of the United States Patent and Trademark Office

# United States of America

United States Patent and Trademark Office

# SPOVIRET

**Reg. No. 4,273,986**

NOVARTIS AG (SWITZERLAND CORPORATION)  
CH-4002 BASEL  
SWITZERLAND

**Registered Jan. 15, 2013**

**Int. Cl.: 5**

FOR: PHARMACEUTICAL PREPARATIONS FOR THE PREVENTION OR TREATMENT OF DISEASES AND DISORDERS OF THE NERVOUS SYSTEM, THE IMMUNE SYSTEM, THE CARDIOVASCULAR SYSTEM, THE METABOLIC SYSTEM, THE RESPIRATORY SYSTEM, THE MUSCULO-SKELETAL SYSTEM AND THE GENITOURINARY SYSTEM; PHARMACEUTICAL PREPARATIONS FOR THE TREATMENT OF INFLAMMATORY DISORDERS; PHARMACEUTICAL PREPARATIONS FOR USE IN DERMATOLOGY, ONCOLOGY, HEMATOLOGY AND IN TISSUE AND ORGAN TRANSPLANTATION, IN OPHTHALMOLOGY AND FOR GASTROENTEROLOGICAL DISORDERS; PHARMACEUTICAL PREPARATIONS FOR THE PREVENTION AND TREATMENT OF OCULAR DISORDERS AND DISEASES; PHARMACEUTICAL PREPARATIONS FOR THE TREATMENT OF DISEASES AND DISORDERS CAUSED BY BACTERIA, AUTOIMMUNE DISEASES AND DISORDERS, KIDNEY DISEASES AND DISORDERS, DIABETES; ANTIFUNGAL, ANTI-INFECTIVE, ANTIVIRAL PREPARATIONS AND ANTIBIOTICS, IN CLASS 5 (U.S. CLS. 6, 18, 44, 46, 51 AND 52).

**TRADEMARK**

**PRINCIPAL REGISTER**

THE MARK CONSISTS OF STANDARD CHARACTERS WITHOUT CLAIM TO ANY PARTICULAR FONT, STYLE, SIZE, OR COLOR.

PRIORITY DATE OF 3-29-2012 IS CLAIMED.

OWNER OF INTERNATIONAL REGISTRATION 1127504 DATED 4-10-2012, EXPIRES 4-10-2022.

SER. NO. 79-117,240, FILED 4-10-2012.

ALLISON HOLTZ, EXAMINING ATTORNEY



*David J. Kyjars*

Director of the United States Patent and Trademark Office

# United States of America

United States Patent and Trademark Office

# HYTALIF

**Reg. No. 4,273,987**

NOVARTIS AG (SWITZERLAND CORPORATION)  
CH-4002 BASEL  
SWITZERLAND

**Registered Jan. 15, 2013**

**Int. Cl.: 5**

FOR: PHARMACEUTICAL PREPARATIONS FOR THE PREVENTION OR TREATMENT OF DISEASES AND DISORDERS OF THE NERVOUS SYSTEM, THE IMMUNE SYSTEM, THE CARDIOVASCULAR SYSTEM, THE METABOLIC SYSTEM, THE RESPIRATORY SYSTEM, THE MUSCULO-SKELETAL SYSTEM AND THE GENITOURINARY SYSTEM; PHARMACEUTICAL PREPARATIONS FOR THE TREATMENT OF INFLAMMATORY DISORDERS; PHARMACEUTICAL PREPARATIONS FOR USE IN DERMATOLOGY, ONCOLOGY, HEMATOLOGY AND IN TISSUE AND ORGAN TRANSPLANTATION, IN OPHTHALMOLOGY AND FOR GASTROENTEROLOGICAL DISORDERS; PHARMACEUTICAL PREPARATIONS FOR THE PREVENTION AND TREATMENT OF OCULAR DISORDERS AND DISEASES; PHARMACEUTICAL PREPARATIONS FOR THE TREATMENT OF DISEASES AND DISORDERS CAUSED BY BACTERIA, AUTOIMMUNE DISEASES AND DISORDERS, KIDNEY DISEASES AND DISORDERS, DIABETES; ANTIFUNGAL, ANTI-INFECTIVE, ANTIVIRAL PREPARATIONS AND ANTIBIOTICS, IN CLASS 5 (U.S. CLS. 6, 18, 44, 46, 51 AND 52).

**TRADEMARK**

**PRINCIPAL REGISTER**

THE MARK CONSISTS OF STANDARD CHARACTERS WITHOUT CLAIM TO ANY PARTICULAR FONT, STYLE, SIZE, OR COLOR.

PRIORITY DATE OF 3-29-2012 IS CLAIMED.

OWNER OF INTERNATIONAL REGISTRATION 1127507 DATED 4-10-2012, EXPIRES 4-10-2022.

SER. NO. 79-117,242, FILED 4-10-2012.

ALLISON HOLTZ, EXAMINING ATTORNEY



*David J. Kyffers*

Director of the United States Patent and Trademark Office

# United States of America

United States Patent and Trademark Office

# PADVIRAM

**Reg. No. 4,273,988**

NOVARTIS AG (SWITZERLAND CORPORATION)  
CH-4002 BASEL  
SWITZERLAND

**Registered Jan. 15, 2013**

**Int. Cl.: 5**

FOR: PHARMACEUTICAL PREPARATIONS FOR THE PREVENTION OR TREATMENT OF DISEASES AND DISORDERS OF THE NERVOUS SYSTEM, THE IMMUNE SYSTEM, THE CARDIOVASCULAR SYSTEM, THE METABOLIC SYSTEM, THE RESPIRATORY SYSTEM, THE MUSCULO-SKELETAL SYSTEM AND THE GENITOURINARY SYSTEM; PHARMACEUTICAL PREPARATIONS FOR THE TREATMENT OF INFLAMMATORY DISORDERS; PHARMACEUTICAL PREPARATIONS FOR USE IN DERMATOLOGY, ONCOLOGY, HEMATOLOGY AND IN TISSUE AND ORGAN TRANSPLANTATION, IN OPHTHALMOLOGY AND FOR GASTROENTEROLOGICAL DISORDERS; PHARMACEUTICAL PREPARATIONS FOR THE PREVENTION AND TREATMENT OF OCULAR DISORDERS AND DISEASES; PHARMACEUTICAL PREPARATIONS FOR THE TREATMENT OF DISEASES AND DISORDERS CAUSED BY BACTERIA, AUTOIMMUNE DISEASES AND DISORDERS, KIDNEY DISEASES AND DISORDERS, DIABETES; ANTIFUNGAL, ANTI-INFECTIVE, ANTIVIRAL PREPARATIONS AND ANTIBIOTICS, IN CLASS 5 (U.S. CLS. 6, 18, 44, 46, 51 AND 52).

**TRADEMARK**

**PRINCIPAL REGISTER**

THE MARK CONSISTS OF STANDARD CHARACTERS WITHOUT CLAIM TO ANY PARTICULAR FONT, STYLE, SIZE, OR COLOR.

PRIORITY DATE OF 3-29-2012 IS CLAIMED.

OWNER OF INTERNATIONAL REGISTRATION 1127508 DATED 4-10-2012, EXPIRES 4-10-2022.

SER. NO. 79-117,243, FILED 4-10-2012.

ALLISON HOLTZ, EXAMINING ATTORNEY



*David J. Kyjars*

Director of the United States Patent and Trademark Office

United States of America  
United States Patent and Trademark Office

# SUVIRAY

**Reg. No. 4,273,989**

NOVARTIS AG (SWITZERLAND CORPORATION)  
CH-4002 BASEL  
SWITZERLAND

**Registered Jan. 15, 2013**

**Int. Cl.: 5**

FOR: PHARMACEUTICAL PREPARATIONS FOR THE PREVENTION OR TREATMENT OF DISEASES AND DISORDERS OF THE NERVOUS SYSTEM, THE IMMUNE SYSTEM, THE CARDIO-VASCULAR SYSTEM, THE METABOLIC SYSTEM, THE RESPIRATORY SYSTEM, THE MUSCULO-SKELETAL SYSTEM AND THE GENITOURINARY SYSTEM; PHARMACEUTICAL PREPARATIONS FOR THE TREATMENT OF INFLAMMATORY DISORDERS; PHARMACEUTICAL PREPARATIONS FOR USE IN DERMATOLOGY, ONCOLOGY, HEMATOLOGY AND IN TISSUE AND ORGAN TRANSPLANTATION, IN OPHTHALMOLOGY AND FOR GASTROENTEROLOGICAL DISORDERS; PHARMACEUTICAL PREPARATIONS FOR THE PREVENTION AND TREATMENT OF OCULAR DISORDERS AND DISEASES; PHARMACEUTICAL PREPARATIONS FOR THE TREATMENT OF DISEASES AND DISORDERS CAUSED BY BACTERIA, AUTOIMMUNE DISEASES AND DISORDERS, KIDNEY DISEASES AND DISORDERS, DIABETES; ANTIFUNGAL, ANTI-INFECTIVE, ANTIVIRAL PREPARATIONS AND ANTIBIOTICS, IN CLASS 5 (U.S. CLS. 6, 18, 44, 46, 51 AND 52).

**TRADEMARK**

**PRINCIPAL REGISTER**

THE MARK CONSISTS OF STANDARD CHARACTERS WITHOUT CLAIM TO ANY PARTICULAR FONT, STYLE, SIZE, OR COLOR.

PRIORITY DATE OF 3-29-2012 IS CLAIMED.

OWNER OF INTERNATIONAL REGISTRATION 1127509 DATED 4-10-2012, EXPIRES 4-10-2022.

SER. NO. 79-117,244, FILED 4-10-2012.

ALLISON HOLTZ, EXAMINING ATTORNEY



*David J. Kyjars*

Director of the United States Patent and Trademark Office



United States of America  
United States Patent and Trademark Office

VVAULT

**Reg. No. 4,273,990**

**Registered Jan. 15, 2013**

**Int. Cl.: 9**

**TRADEMARK**

**PRINCIPAL REGISTER**

OREGA INC. (JAPAN CORPORATION)  
TOWA-EDOGAWABASHI BLDG. 6F  
347 YAMABUKI-CHO.; SHINJUKU-KU; TOKYO 162-0801  
JAPAN

FOR: COMPUTER PROGRAMS FOR STORAGE MANAGEMENT, IN CLASS 9 (U.S. CLS. 21, 23, 26, 36 AND 38).

THE MARK CONSISTS OF STANDARD CHARACTERS WITHOUT CLAIM TO ANY PARTICULAR FONT, STYLE, SIZE, OR COLOR.

PRIORITY DATE OF 5-14-2012 IS CLAIMED.

OWNER OF INTERNATIONAL REGISTRATION 1127517 DATED 5-16-2012, EXPIRES 5-16-2022.

SER. NO. 79-117,247, FILED 5-16-2012.

SANDRA BUJA, EXAMINING ATTORNEY



*David J. Kyfos*

Director of the United States Patent and Trademark Office

**United States of America**  
**United States Patent and Trademark Office**

# Jetts

**Reg. No. 4,273,991**

**Registered Jan. 15, 2013**

**Int. Cl.: 44**

**SERVICE MARK**

**PRINCIPAL REGISTER**

24/7 BRANDS PTY LTD (AUSTRALIA PROPRIETARY COMPANY)  
PO BOX 519  
BUDDINA QLD 4575  
AUSTRALIA

FOR: AQUATIC AND PHYSICAL REHABILITATION AND NUTRITIONAL ADVICE, IN CLASS 44 (U.S. CLS. 100 AND 101).

THE MARK CONSISTS OF STANDARD CHARACTERS WITHOUT CLAIM TO ANY PARTICULAR FONT, STYLE, SIZE, OR COLOR.

OWNER OF INTERNATIONAL REGISTRATION 1127707 DATED 4-19-2012, EXPIRES 4-19-2022.

SER. NO. 79-117,308, FILED 4-19-2012.

LEIGH LOWRY, EXAMINING ATTORNEY



*David J. Kyros*

Director of the United States Patent and Trademark Office

# United States of America

United States Patent and Trademark Office



**Reg. No. 4,273,992**

**Registered Jan. 15, 2013**

**Int. Cls.: 37, 40 and 42**

**SERVICE MARK**

**PRINCIPAL REGISTER**

ACS ACTIVIDADES DE CONSTRUCCION Y SERVICIOS, S.A. (SPAIN SOCIEDAD ANONIMA)  
AVDA. PIO XII, 102, PLANTA 9  
E-28036 MADRID, SPAIN

FOR: CONSTRUCTION AND REPAIR SERVICES, NAMELY, CONSTRUCTION AND REPAIR OF BUILDINGS, CONSTRUCTION OF TUNNELS, HIGHWAYS, BRIDGES, ELECTRICAL SYSTEMS, AND OF TELEPHONY SYSTEMS, REPAIR OF TUNNELS, HIGHWAYS, BRIDGES, AND OF TELEPHONY SYSTEMS; ASPHALTING, PLUMBING, MINING EXTRACTION, QUARRY SERVICES, DRILLING OF WELLS, IN CLASS 37 (U.S. CLS. 100, 103 AND 106).

FOR: TREATMENT OF MATERIALS, NAMELY, TREATMENT OF URBAN WASTE INCLUDING BIOMETHANIZATION OF ORGANIC WASTE, ENERGY RECOVERY FROM WASTE TO GENERATE ELECTRICITY, AND DEGASIFICATION OF WASTE, IN CLASS 40 (U.S. CLS. 100, 103 AND 106).

FOR: PROJECTS IN THE NATURE OF ENGINEERING SERVICES FOR BUILDING INSTRUMENTATION AND MONITORING; PROJECTS IN THE NATURE OF DESIGN OF MASONRY WALLS; PROJECTS IN THE NATURE OF CUSTOM DESIGN OF TELEPHONY SYSTEMS; ESTIMATES, NAMELY, GEOLOGICAL ESTIMATIONS; EVALUATIONS, NAMELY, EVALUATIONS OF THE STRUCTURAL PROPERTIES OF MASONRY WALLS IN THE FIELD OF CONSTRUCTION AND REPAIR OF BUILDINGS, TUNNELS, HIGHWAYS, AND BRIDGES, IN CLASS 42 (U.S. CLS. 100 AND 101).

NO CLAIM IS MADE TO THE EXCLUSIVE RIGHT TO USE "ACTIVIDADES DE CONSTRUCCION Y SERVICIOS", APART FROM THE MARK AS SHOWN.

OWNER OF INTERNATIONAL REGISTRATION 0948047 DATED 7-6-2007, EXPIRES 7-6-2017.

THE COLOR(S) YELLOW, BLUE, WHITE AND BLACK IS/ARE CLAIMED AS A FEATURE OF THE MARK.

THE MARK CONSISTS OF THE LETTERS "ACS" IN YELLOW OVER THE WORDING "ACTIVIDADES DE CONSTRUCCION Y SERVICIOS" IN WHITE. IN THE BOTTOM RIGHT IS A WHITE DIAMOND DESIGN WITH BLUE AND YELLOW POLYGONS. THE BACKGROUND IS BLUE WITH BLACK NOISE.



*David J. Kappas*

Director of the United States Patent and Trademark Office

**Reg. No. 4,273,992** THE ENGLISH TRANSLATION OF "ACTIVIDADES DE CONSTRUCCION Y SERVICIOS"  
IN THE MARK IS "CONSTRUCTION ACTIVITIES AND SERVICES".

SER. NO. 79-975,147, FILED 12-16-2008.

JAMES STEIN, EXAMINING ATTORNEY

# United States of America

United States Patent and Trademark Office

# GP JOULE

**Reg. No. 4,273,993**

**Registered Jan. 15, 2013**

**Int. Cls.: 36 and 37**

**SERVICE MARK**

**PRINCIPAL REGISTER**

PETERSEN, OVE (FED REP GERMANY INDIVIDUAL)  
CECILIENKOOG 16  
25821 REUßENKÖGE  
FED REP GERMANY

FOR: FINANCIAL ADVICE AND ASSISTANCE WITH ECONOMIC PREPARATION OF BUILDING PROJECTS, NAMELY, ASSISTING OTHERS WITH DEVELOPMENT OF FINANCING PLANS, ADVISING OTHERS ON FINANCING SERVICES FOR SUBSIDIES AND FEED-IN REMUNERATION AND ASSISTING OTHERS WITH FINANCING OF PURCHASES OF FIXED-RATE ELECTRICITY; FINANCIAL CONSULTING ON BUILDING PROJECTS, IN CLASS 36 (U.S. CLS. 100, 101 AND 102).

FOR: BUILDING CONSTRUCTION; CONSTRUCTION OF ENERGY-PRODUCING, ENERGY DISTRIBUTION AND HEATING AND AIR CONDITIONING INSTALLATIONS; MAINTENANCE AND REPAIR OF ENERGY-PRODUCING, ENERGY DISTRIBUTION AND HEATING AND AIR CONDITIONING INSTALLATIONS; CONSULTANCY WITH REGARD TO THE CONSTRUCTION OF ENERGY-PRODUCING, ENERGY DISTRIBUTION AND HEATING AND AIR CONDITIONING INSTALLATIONS; AND CONSULTANCY WITH REGARD TO THE MAINTENANCE AND REPAIR OF ENERGY-PRODUCING, ENERGY DISTRIBUTION AND HEATING AND AIR CONDITIONING INSTALLATIONS; CONSTRUCTION PLANNING, IN CLASS 37 (U.S. CLS. 100, 103 AND 106).

THE MARK CONSISTS OF STANDARD CHARACTERS WITHOUT CLAIM TO ANY PARTICULAR FONT, STYLE, SIZE, OR COLOR.

OWNER OF INTERNATIONAL REGISTRATION 1039671 DATED 1-21-2010, EXPIRES 1-21-2020.

SER. NO. 79-975,222, FILED 1-21-2010.

TASNEEM HUSSAIN, EXAMINING ATTORNEY



*David J. Kypos*

Director of the United States Patent and Trademark Office

# United States of America

United States Patent and Trademark Office



**Reg. No. 4,273,994**

**Registered Jan. 15, 2013**

**Int. Cl.: 1**

**TRADEMARK**

**PRINCIPAL REGISTER**

N9 WORLD TECHNOLOGIES PRIVATE LTD. (INDIA CORPORATION)  
BCIE LTD.  
UNIT NO. 30 OLD MADRAS ROAD  
BANGALORE, INDIA 560016

FOR: CHEMICALS USED IN INDUSTRY AND SCIENCE, AS WELL AS IN AGRICULTURE, HORTICULTURE AND FORESTRY EXCEPT FUNGICIDES, HERBICIDES, INSECTICIDES AND PARASITICIDES; UNPROCESSED ARTIFICIAL RESINS; UNPROCESSED PLASTICS; MANURES; FIRE EXTINGUISHING COMPOSITIONS; TEMPERING PREPARATIONS AND SOLDERING CHEMICALS; CHEMICAL SUBSTANCES FOR PRESERVING FOODSTUFFS; TANNING ENZYMES FOR USE IN TANNING LEATHER; ADHESIVES USED IN INDUSTRY; UNPROCESSED PLASTICS IN THE FORM OF LIQUIDS, CHIPS OR GRANULES; BACTERIOSTATS AND FUNGISTATS FOR INDUSTRIAL USE AND MANUFACTURING; CHEMICAL PRESERVATIVES FOR THE PROTECTION AGAINST THE GROWTH AND DEVELOPMENT OF MICRO-ORGANISMS, BACTERIA AND FUNGI IN FOOD, IN CLASS 1 (U.S. CLS. 1, 5, 6, 10, 26 AND 46).

OWNER OF ERPN CMNTY TM OFC REG. NO. 009072191, DATED 10-19-2010, EXPIRES 4-30-2020.

THE MARK CONSISTS OF THE CHARACTERS "N9" AND A DESIGN OF THREE OVERLAPPING ELLIPSES.

SER. NO. 85-031,460, FILED 5-6-2010.

VIVIAN MICZNIK FIRST, EXAMINING ATTORNEY



*David J. Kybas*

Director of the United States Patent and Trademark Office

# United States of America

United States Patent and Trademark Office



**Reg. No. 4,273,995**

**Registered Jan. 15, 2013**

**Int. Cl.: 1**

**TRADEMARK**

**PRINCIPAL REGISTER**

N9 WORLD TECHNOLOGIES PRIVATE LTD. (INDIA CORPORATION)  
BCIE LTD.  
UNIT NO. 30 OLD MADRAS ROAD  
BANGALORE, INDIA 560016

FOR: CHEMICALS USED IN INDUSTRY AND SCIENCE, AS WELL AS IN AGRICULTURE, HORTICULTURE AND FORESTRY EXCEPT FUNGICIDES, HERBICIDES, INSECTICIDES AND PARASITICIDES; UNPROCESSED ARTIFICIAL RESINS; UNPROCESSED PLASTICS; MANURES; FIRE EXTINGUISHING COMPOSITIONS; TEMPERING PREPARATIONS AND SOLDERING CHEMICALS; CHEMICAL SUBSTANCES FOR PRESERVING FOODSTUFFS; TANNING ENZYMES FOR USE IN TANNING LEATHER; ADHESIVES USED IN INDUSTRY; UNPROCESSED PLASTICS IN THE FORM OF LIQUIDS, CHIPS OR GRANULES; BACTERIOSTATS AND FUNGISTATS FOR INDUSTRIAL USE AND MANUFACTURING; CHEMICAL PRESERVATIVES FOR THE PROTECTION AGAINST THE GROWTH AND DEVELOPMENT OF MICRO-ORGANISMS, BACTERIA AND FUNGI IN FOOD, CONTAINING PURE SILVER, IN CLASS 1 (U.S. CLS. 1, 5, 6, 10, 26 AND 46).

OWNER OF ERPN CMNTY TM OFC REG. NO. 9072191, DATED 10-19-2010, EXPIRES 10-19-2020.

THE COLOR(S) WHITE, GREEN, BLUE, PURPLE, PINK, BROWN, ORANGE AND GREY IS/ARE CLAIMED AS A FEATURE OF THE MARK.

OWNER OF ERPN CMNTY TM OFC REG. NO. 9072174, DATED 10-19-2010, EXPIRES 10-19-2020.

NO CLAIM IS MADE TO THE EXCLUSIVE RIGHT TO USE "PURE SILVER", APART FROM THE MARK AS SHOWN.

THE MARK CONSISTS OF THE CHARACTERS "N9" IN WHITE, THE WORDS "PURE SILVER" IN GREY AND A FANCIFUL DESIGN HAVING AN ORANGE HEXAGON AT CENTER WITH DESIGN PORTIONS ADJACENT THERETO WITH THE COLORS GREEN, PURPLE, BROWN, GREEN, PURPLE AND BROWN CLOCKWISE FROM THE TOP, AND OUTER DESIGN PORTIONS WITH THE COLORS BLUE, PINK, GREEN, BLUE, PINK AND GREEN CLOCKWISE FROM TOP RIGHT PORTION.



*David J. Kybas*

Director of the United States Patent and Trademark Office

SER. NO. 85-031,484, FILED 5-6-2010.

**Reg. No. 4,273,995** VIVIAN MICZNIK FIRST, EXAMINING ATTORNEY



# United States of America

United States Patent and Trademark Office

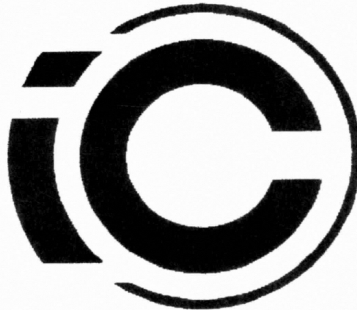

Standard No.

**Reg. No. 4,273,996**

**Registered Jan. 15, 2013**

INSPEC INTERNATIONAL LIMITED (UNITED KINGDOM CORPORATION)  
56 LESLIE HOUGH WAY  
SALFORD, UNITED KINGDOM M66AJ

**CERTIFICATION MARK**

**PRINCIPAL REGISTER**

FOR: ARTICLES OF PROTECTIVE HEADGEAR INCLUDING HELMETS; EAR PROTECTORS INCLUDING PROTECTIVE SPECTACLES, GOGGLES, FACE SHIELDS AND VISORS, BUT EXCLUDING FASHION EYEWEAR, PRESCRIPTION GLASSES, SUNGLASSES, SPORTS GLASSES, MAGNIFYING SPECTACLES, LOUPES AND BINOCULAR LOUPES; RESPIRATORY PROTECTION APPARATUS INCLUDING MASKS, FILTERS, HOODS AND BREATHING APPARATUS; APPARATUS FOR PROTECTION AGAINST FALLING INCLUDING SAFETY HARNESSSES, BELTS, LIFELINES AND SAFETY ROPE SYSTEMS FOR PERSONS WORKING AT HEIGHTS; ARTICLES OF PROTECTIVE LEG AND FOOTWEAR INCLUDING BOOTS AND SHOES; ARTICLES OF PROTECTIVE HAND WEAR INCLUDING GLOVES, MITTENS AND GAUNTLETS; ARTICLES OF PROTECTIVE CLOTHING, BUT EXCLUDING FASHION CLOTHING, FASHION FOOTWEAR AND FASHION HEADGEAR, IN CLASS A (U.S. CL. A).

OWNER OF UNITED KINGDOM REG. NO. 2522151, DATED 7-16-2009, EXPIRES 7-16-2019.

NO CLAIM IS MADE TO THE EXCLUSIVE RIGHT TO USE STANDARD NO., APART FROM THE MARK AS SHOWN.

THE MARK CONSISTS OF STYLIZED LETTERS "I" AND "C".

THE CERTIFICATION MARK, AS INTENDED TO BE USED BY AUTHORIZED PERSONS, IS INTENDED TO CERTIFY THAT THE GOODS PROVIDED HERE HAVE COMPLIED WITH ESTABLISHED GUIDELINES AND STANDARDS FOR SAFETY AND PROTECTION.

SER. NO. 85-046,084, FILED 5-24-2010.

SHAUNIA CARLYLE, EXAMINING ATTORNEY



*David J. Kybas*

Director of the United States Patent and Trademark Office

# United States of America

United States Patent and Trademark Office



**Reg. No. 4,273,997**

CEDAR WORKS, LLC (OHIO LIMITED LIABILITY COMPANY)  
19 CEDAR DRIVE  
PEEBLES, OH 45660

**Registered Jan. 15, 2013**

**Int. Cl.: 21**

FOR: BIRD FEEDERS, BIRD HOUSES, SQUIRREL FEEDERS, SQUIRREL HOUSES, IN CLASS 21 (U.S. CLS. 2, 13, 23, 29, 30, 33, 40 AND 50).

**TRADEMARK**

FIRST USE 6-0-2008; IN COMMERCE 6-0-2008.

**PRINCIPAL REGISTER**

THE MARK CONSISTS OF THE WORDS "BIRD'S EYE VIEW" CURVED OVER AN INTER-TWINING THREE LEAF DESIGN, WITH THE WORDS "NATURE INSPIRED" CURVED BELOW LEAF DESIGN.

SER. NO. 85-048,564, FILED 5-26-2010.

MARK SHINER, EXAMINING ATTORNEY



*David J. Kybas*

Director of the United States Patent and Trademark Office

# United States of America

United States Patent and Trademark Office



**Reg. No. 4,273,998**

**Registered Jan. 15, 2013**

**Int. Cl.: 36**

**SERVICE MARK**

**PRINCIPAL REGISTER**

ASL ENERGY CORP. (TEXAS CORPORATION)  
100 HIGHLAND PARK VILLAGE, SUITE 200  
DALLAS, TX 75205

FOR: INVESTMENT SERVICES IN OIL AND GAS ASSETS, NAMELY, ASSET ACQUISITION, CONSULTATION, DEVELOPMENT AND MANAGEMENT SERVICES FOR OIL AND GAS EXPLORATION AND PRODUCTION, IN CLASS 36 (U.S. CLS. 100, 101 AND 102).

FIRST USE 2-0-2009; IN COMMERCE 2-0-2009.

NO CLAIM IS MADE TO THE EXCLUSIVE RIGHT TO USE "ENERGY", APART FROM THE MARK AS SHOWN.

THE MARK CONSISTS OF A CIRCULAR SHAPE MADE OF CRESCENTS APPEARING TO THE LEFT OF THE WORDING "ONE ENERGY".

SER. NO. 85-054,588, FILED 6-4-2010.

KELLY BOULTON, EXAMINING ATTORNEY



*David J. Kybas*

Director of the United States Patent and Trademark Office

# United States of America

United States Patent and Trademark Office

## THE 24 HOUR PLAYS

**Reg. No. 4,273,999**

THE 24 HOUR COMPANY (NEW YORK CORPORATION)  
82 VISITATION PLACE  
BROOKLYN, NY 11231

**Registered Jan. 15, 2013**

**Int. Cl.: 41**

FOR: ENTERTAINMENT IN THE NATURE OF LIVE PERFORMANCES BY A THEATER GROUP, IN CLASS 41 (U.S. CLS. 100, 101 AND 107).

**SERVICE MARK**

FIRST USE 10-28-1995; IN COMMERCE 10-28-1995.

**PRINCIPAL REGISTER**

THE MARK CONSISTS OF STANDARD CHARACTERS WITHOUT CLAIM TO ANY PARTICULAR FONT, STYLE, SIZE, OR COLOR.

NO CLAIM IS MADE TO THE EXCLUSIVE RIGHT TO USE "PLAYS", APART FROM THE MARK AS SHOWN.

SEC. 2(F).

SER. NO. 85-056,344, FILED 6-7-2010.

TARA PATE, EXAMINING ATTORNEY



*David J. Kybas*

Director of the United States Patent and Trademark Office

# United States of America

United States Patent and Trademark Office

# FOAM DEPOT

**Reg. No. 4,274,000**

**Registered Jan. 15, 2013**

**Int. Cl.: 35**

**SERVICE MARK**

**PRINCIPAL REGISTER**

COATING & FOAM SOLUTIONS, LLC (WISCONSIN LIMITED LIABILITY COMPANY)  
SUITE D  
1860 EXECUTIVE DRIVE  
OCONOMOWOC, WI 53066

FOR: RETAIL STORE SERVICES FEATURING POLYURETHANE FOAM, POLYUREA,  
ELASTOMERIC COATINGS AND SPRAY EQUIPMENT, IN CLASS 35 (U.S. CLS. 100, 101  
AND 102).

FIRST USE 6-1-2010; IN COMMERCE 6-1-2010.

THE MARK CONSISTS OF STANDARD CHARACTERS WITHOUT CLAIM TO ANY PAR-  
TICULAR FONT, STYLE, SIZE, OR COLOR.

NO CLAIM IS MADE TO THE EXCLUSIVE RIGHT TO USE "FOAM", APART FROM THE  
MARK AS SHOWN.

SER. NO. 85-059,339, FILED 6-10-2010.

DARRYL SPRUILL, EXAMINING ATTORNEY



*David J. Kyfos*

Director of the United States Patent and Trademark Office

# United States of America

United States Patent and Trademark Office

# ECOSHAPE

**Reg. No. 4,274,001**

**Registered Jan. 15, 2013**

**Int. Cl.: 6**

**TRADEMARK**

**PRINCIPAL REGISTER**

BOSCH REXROTH AG (FED REP GERMANY CORPORATION)  
HEIDEHOFSTRASSE 31  
STUTTGART, FED REP GERMANY 70184

FOR: PRE-FABRICATED METAL BUILDING ASSEMBLY KITS COMPRISED OF TWO PROFILES WITH CAPS, THREADED SLEEVE FASTENERS AND RELATED ADAPTORS; PIPES AND TUBES OF METAL IN PARTICULAR EXTRUDED PIPES AND TUBES OF ALUMINUM; PIPE CONNECTORS OF METAL; METAL BUILDING MATERIALS, NAMELY, METAL ATTACHMENT COMPONENTS FOR LOAD BEARING, FRAME AND PROTECTIVE CONSTRUCTIONS, IN PARTICULAR PLATES, EXPANSION JOINT BASES FOR FLOORS AND WALLS, DEFLECTING AND PEDESTAL ROLLERS AND END PIECES FOR BUILDING FLOORS AND WALLS; METAL HARDWARE, NAMELY, METAL SCREWS, NUTS, BOLTS, BRACKETS FOR GENERAL USE, PROFILES FOR PREFABRICATED METAL BUILDING ASSEMBLY KITS, TUBES AND PIPES , IN CLASS 6 (U.S. CLS. 2, 12, 13, 14, 23, 25 AND 50).

THE MARK CONSISTS OF STANDARD CHARACTERS WITHOUT CLAIM TO ANY PARTICULAR FONT, STYLE, SIZE, OR COLOR.

PRIORITY CLAIMED UNDER SEC. 44(D) ON ERPN CMNTY TM OFC APPLICATION NO. 008970428, FILED 3-8-2010, REG. NO. 008970428, DATED 5-7-2010, EXPIRES 3-8-2020.

SER. NO. 85-059,392, FILED 6-10-2010.

PAULA MAHONEY, EXAMINING ATTORNEY



*David J. Kyffers*

Director of the United States Patent and Trademark Office

# United States of America

United States Patent and Trademark Office

## NED GOODMAN INVESTMENT COUNSEL LIMITED

**Reg. No. 4,274,002**

**Registered Jan. 15, 2013**

**Int. Cl.: 36**

**SERVICE MARK**

**PRINCIPAL REGISTER**

DUNDEE CORPORATION (CANADA CORPORATION)  
1 ADELAIDE STREET EAST, 28TH FLOOR  
TORONTO, ONTARIO, CANADA M5C2V9

FOR: INVESTMENT MANAGEMENT SERVICES, NAMELY, CREATING, MANAGING AND ADMINISTERING INVESTMENTS COMPRISING MUTUAL FUNDS, CLOSED END FUNDS, THIRD PARTY ASSET MANAGEMENT AND TAX ASSISTED INVESTMENTS AND PRIVATE CLIENT ADVISORY SERVICES, IN CLASS 36 (U.S. CLS. 100, 101 AND 102).

THE MARK CONSISTS OF STANDARD CHARACTERS WITHOUT CLAIM TO ANY PARTICULAR FONT, STYLE, SIZE, OR COLOR.

PRIORITY CLAIMED UNDER SEC. 44(D) ON CANADA APPLICATION NO. 1469214, FILED 2-11-2010, REG. NO. 804909, DATED 8-22-2011, EXPIRES 8-22-2026.

OWNER OF U.S. REG. NOS. 2,322,980 AND 3,671,285.

NO CLAIM IS MADE TO THE EXCLUSIVE RIGHT TO USE "INVESTMENT COUNSEL LIMITED", APART FROM THE MARK AS SHOWN.

THE NAME(S), PORTRAIT(S), AND/OR SIGNATURE(S) SHOWN IN THE MARK IDENTIFIES "NED GOODMAN", WHOSE CONSENT(S) TO REGISTER IS MADE OF RECORD.

SER. NO. 85-061,925, FILED 6-14-2010.

JULIE GUTTADAURO, EXAMINING ATTORNEY



*David J. Kybas*

Director of the United States Patent and Trademark Office

# United States of America

United States Patent and Trademark Office



**Reg. No. 4,274,003**

**Registered Jan. 15, 2013**

**Int. Cl.: 5**

**TRADEMARK**

**PRINCIPAL REGISTER**

TROPICAL FRUITS WORLD & RESEARCH PARK SDN BHD (MALAYSIA PRIVATE LIMITED COMPANY)  
NO. 28, JALAN 1  
TAMAN TUN ABDUL RAZAK  
AMPANG, SELANGOR, MALAYSIA 68100

FOR: DIETARY AND NUTRITIONAL SUPPLEMENTS, IN CLASS 5 (U.S. CLS. 6, 18, 44, 46, 51 AND 52).

PRIORITY CLAIMED UNDER SEC. 44(D) ON MALAYSIA APPLICATION NO. 2010008439, FILED 5-13-2010, REG. NO. 2010008439, DATED 5-13-2010, EXPIRES 5-13-2020.

THE MARK CONSISTS OF THE STYLIZED WORDING "MIREIKE" IN CAPITAL LETTERS WITH THE LETTERS "M" AND "E" BEING UNDERLINED, AND A DEPICTION OF TWO OVERLAPPING BERRIES BEHIND THE STYLIZED WORDING "MIREIKE".

SER. NO. 85-104,697, FILED 8-11-2010.

MARIA-VICTORIA SUAREZ, EXAMINING ATTORNEY



*David J. Kybas*

Director of the United States Patent and Trademark Office



# United States of America

United States Patent and Trademark Office

## PURE TAILGATE

**Reg. No. 4,274,004**

GLOBAL IP, INC. (FLORIDA CORPORATION)  
8040 BELVEDERE ROAD  
WEST PALM BEACH, FL 33411

**Registered Jan. 15, 2013**

**Int. Cl.: 20**

FOR: STADIUM CUSHION, STADIUM CHAIR SEAT, IN CLASS 20 (U.S. CLS. 2, 13, 22, 25, 32 AND 50).

**TRADEMARK**

FIRST USE 7-1-2010; IN COMMERCE 7-1-2010.

**PRINCIPAL REGISTER**

THE MARK CONSISTS OF STANDARD CHARACTERS WITHOUT CLAIM TO ANY PARTICULAR FONT, STYLE, SIZE, OR COLOR.

NO CLAIM IS MADE TO THE EXCLUSIVE RIGHT TO USE "TAILGATE", APART FROM THE MARK AS SHOWN.

SER. NO. 85-105,935, FILED 8-12-2010.

LESLIE RICHARDS, EXAMINING ATTORNEY



*David J. Kybas*

Director of the United States Patent and Trademark Office

# United States of America

United States Patent and Trademark Office



**Reg. No. 4,274,005**

**Registered Jan. 15, 2013**

**Int. Cl.: 41**

**SERVICE MARK**

**PRINCIPAL REGISTER**

LARSSON SMITH, INGELA, MIRJAM (GREAT BRITAIN INDIVIDUAL)  
GRASMERE COTTAGE, LOWER BENTLEY  
BROMSGROVE, WORCS, GREAT BRITAIN B604JB

FOR: EDUCATION SERVICES, NAMELY, MENTORING IN THE FIELDS OF HORSE SKILLS IN THE NATURE OF HORSE CARE, HORSE HANDLING AND HORSE RIDING USING NATURAL HORSEMANSHIP PRINCIPLES TO TEACH TRADITIONAL HORSEMANSHIP TASKS, LIFE SKILLS USING THE HORSE AS A METAPHOR TO TEACH LEADERSHIP SKILLS, COMMUNICATION SKILLS, RELATIONSHIP SKILLS AND TEAM SKILLS AS WELL AS CONFIDENCE, ENGLISH SKILLS, AND CHRISTIAN FAITH USING THE HORSE AS A METAPHOR, IN CLASS 41 (U.S. CLS. 100, 101 AND 107).

FIRST USE 4-1-2010; IN COMMERCE 4-1-2010.

THE MARK CONSISTS OF A LARGE BROWN "H" WITH BLACK OUTLINE AND DARKER BROWN BEVEL AND EMBOSS AND A CREAM STAR IN THE MIDDLE OF THE "H". THE WORD "FACTOR" APPEARS THROUGH THE MIDDLE OF THE "H", STICKING OUT ON THE LEFT AND RIGHT SIDES BY A LETTER AND A HALF. "FACTOR" APPEARS WITH BLACK OUTLINING AND WITH THE COLOR BLACK AT THE BOTTOM, FADING INTO BROWN TO DARK YELLOW TO GOLD AND TO CREAM AT THE TOP.

THE COLOR(S) BLACK, BROWN, GOLD, CREAM, YELLOW IS/ARE CLAIMED AS A FEATURE OF THE MARK.

SEC. 2(F).

SER. NO. 85-107,630, FILED 8-14-2010.

MATTHEW MCDOWELL, EXAMINING ATTORNEY



*David J. Kyjars*

Director of the United States Patent and Trademark Office

# United States of America

United States Patent and Trademark Office



**Reg. No. 4,274,006**

CREEP STREET, LLC (NEW YORK LIMITED LIABILITY COMPANY)  
250 WEST 39 STREET, UNIT 308  
NEW YORK, NY 10018

**Registered Jan. 15, 2013**

**Int. Cl.: 25**

FOR: CLOTHING, NAMELY, SHIRTS, T-SHIRTS, SWEATSHIRTS, PANTS, SHORTS, SWEATPANTS, UNDERWEAR AND HEADWEAR, IN CLASS 25 (U.S. CLS. 22 AND 39).

**TRADEMARK**

FIRST USE 10-1-2006; IN COMMERCE 10-1-2006.

**PRINCIPAL REGISTER**

NO CLAIM IS MADE TO THE EXCLUSIVE RIGHT TO USE "CREEP STREET", APART FROM THE MARK AS SHOWN.

THE MARK CONSISTS OF THE WORDS "CREEP STREET" WITH HORROR INSPIRED LETTERING WITH THE WORD "CREEP" STACKED ON TOP OF THE WORD "STREET".

SER. NO. 85-107,930, FILED 8-16-2010.

SUE LAWRENCE, EXAMINING ATTORNEY



*David J. Kybas*

Director of the United States Patent and Trademark Office

# United States of America

United States Patent and Trademark Office

# CHEFEL

**Reg. No. 4,274,007**

**Registered Jan. 15, 2013**

**Int. Cl.: 11**

**TRADEMARK**

**PRINCIPAL REGISTER**

HAPPYCALL CO., LTD. (REPUBLIC OF KOREA CORPORATION)  
1229-1 SAMGYE-DONG, GIMHAE-SI  
GYEONGSANGNAM-DO, REPUBLIC OF KOREA 621-070

FOR: GAS GRILLS; NON-ELECTRIC WATER PURIFIERS FOR HOUSEHOLD PURPOSES; DISH DISINFECTANT APPARATUS FOR HOUSEHOLD PURPOSES; WATER PURIFIERS FOR HOUSEHOLD PURPOSES; ROASTING SPITS, NAMELY, ROTISSERIES; BARBECUES; COOKING RINGS; ELECTRIC GRIDDLES; ELECTRIC GRILLS; BARBECUE GRILLS; FILTERS FOR DRINKING WATER; ELECTRIC BREAD TOASTER ; ROTISSERIES; GAS FIRES; GAS STOVES; OIL STOVES; COAL STOVES; DOMESTIC FIREPLACES; AIR REHEATERS, NAMELY, ELECTRIC SPACE HEATERS; HEARTHES; HEARTHES EXCEPT ELECTRIC HEARTHES; CHIMNEY DAMPERS; RADIATORS; ELECTRIC COOKING STOVES; WARMING PANS FOR BEDS; RADIATOR CAPS; OIL COOKING STOVES; COAL STOVES; AIR HEATING FURNACES; WATER HEATERS; FILAMENTS FOR ELECTRIC LAMPS; ELECTRIC HEATING APPARATUS, NAMELY, ELECTRIC HEATING FANS; ELECTRIC RADIATORS; CENTRAL HEATING RADIATORS; FIRE POTS IN THE NATURE OF A FONDUE POT WITH A HEAT SOURCE; HUMIDIFIERS; ELECTRIC HUMIDIFIERS FOR HOUSEHOLD USE; ELECTRIC FREEZERS FOR HOUSEHOLD PURPOSES; ELECTRIC SPACE COOLING APPARATUS FOR HOUSEHOLD PURPOSES; ELECTRIC REFRIGERATORS FOR HOUSEHOLD PURPOSES; ELECTRIC BLANKETS FOR HOUSEHOLD PURPOSES; ELECTRIC COOKING POTS FOR HOUSEHOLD PURPOSES; ELECTRIC DISH DISINFECTANT APPARATUS FOR HOUSEHOLD PURPOSES; ELECTRIC CLOTHES DRYING MACHINES FOR HOUSEHOLD PURPOSES; ELECTRIC WATER PURIFIERS FOR HOUSEHOLD PURPOSES; ELECTRIC KETTLES FOR HOUSEHOLD PURPOSES; ELECTRIC COFFEE MAKERS FOR HOUSEHOLD PURPOSES; ELECTRIC TOASTERS FOR HOUSEHOLD PURPOSES; ELECTRIC COOKING STOVES FOR HOUSEHOLD PURPOSES; ELECTRIC FURNACES FOR HOUSEHOLD PURPOSES; ELECTROMAGNETIC INDUCTION COOKERS FOR HOUSEHOLD PURPOSES; DEHUMIDIFIERS FOR HOUSEHOLD PURPOSES; ELECTRIC FANS FOR PERSONAL USE; ELECTRIC FOOT WARMERS FOR PERSONAL USE; REFRIGERATORS; HAIR DRYERS; ELECTRIC BLANKETS, NOT FOR MEDICAL PURPOSES; ELECTRIC HEATING CUSHIONS, NOT FOR MEDICAL PURPOSES; ELECTRIC FANS; ELECTRIC HAND DRYING APPARATUS FOR WASHROOMS; STEAM FACIAL APPARATUS IN THE NATURE OF ELECTRONIC FACIAL STEAMERS; MICROWAVE OVENS; ELECTRIC REFRIGERATORS; ELECTRIC REFRIGERATING SHOWCASES; ELECTRIC RANGES; ELECTRIC STOVES; ELECTRICALLY HEATED FOOT WARMERS; ELECTRIC LAUNDRY DRYERS; ELECTRIC PRESSURE COOKING SAUCEPANS; ELECTRIC AUTOCLAVES; ELECTRIC WAFFLE IRONS; ELECTRIC APPLIANCES FOR MAKING YOGURT; ELECTRIC HEATERS FOR BABIES' BOTTLES;



*David J. Kyjars*

Director of the United States Patent and Trademark Office

**Reg. No. 4,274,007** ELECTRIC KETTLES; ELECTRIC COFFEE MACHINES; COFFEE FILTERS NOT OF PAPER BEING PART OF ELECTRIC COFFEE MAKERS; ELECTRIC COFFEE PERCOLATORS; ELECTRIC DEEP FRYERS; ELECTRIC BEDCLOTHES IN THE NATURE OF ELECTRIC BLANKETS FOR THE BED FOR HOUSEHOLD PURPOSES; ELECTRIC FOOT WARMERS; ELECTRIC COFFEEPOTS; ELECTRIC COOKERS, NAMELY, ELECTRIC RICE COOKERS; ELECTRIC DEHYDRATORS; ELECTRIC TOASTERS; ELECTRIC COOKING STOVES; ELECTRICALLY HEATED CARPETS; BED WARMERS; ELECTRIC BED WARMERS, NOT FOR MEDICAL PURPOSES, IN CLASS 11 (U.S. CLS. 13, 21, 23, 31 AND 34).

THE MARK CONSISTS OF STANDARD CHARACTERS WITHOUT CLAIM TO ANY PARTICULAR FONT, STYLE, SIZE, OR COLOR.

PRIORITY CLAIMED UNDER SEC. 44(D) ON REPUBLIC OF KOREA APPLICATION NO. 402010040698, FILED 8-5-2010, REG. NO. 40-0903149, DATED 2-8-2012, EXPIRES 2-8-2022.

OWNER OF U.S. REG. NO. 3,862,179.

SER. NO. 85-108,381, FILED 8-16-2010.

B. PARADEWELAI, EXAMINING ATTORNEY

# United States of America

United States Patent and Trademark Office

# RAYNE

**Reg. No. 4,274,008**

**Registered Jan. 15, 2013**

**Int. Cl.: 28**

**TRADEMARK**

**PRINCIPAL REGISTER**

RAYNE LONGBOARDS INC. (CANADA CORPORATION)  
167 B EAST 1ST STREET  
NORTH VANCOUVER, B.C., CANADA V7L1B2

FOR: SKATEBOARDS; SKATEBOARD DECKS; SKATEBOARD HARDWARE AND ACCESSORIES, NAMELY, TRUCKS, WHEELS, GRIP TAPES, BEARINGS AND RISER PADS, IN CLASS 28 (U.S. CLS. 22, 23, 38 AND 50).

FIRST USE 4-27-2004; IN COMMERCE 1-13-2007.

THE MARK CONSISTS OF STANDARD CHARACTERS WITHOUT CLAIM TO ANY PARTICULAR FONT, STYLE, SIZE, OR COLOR.

OWNER OF CANADA REG. NO. TMA779403, DATED 10-7-2010, EXPIRES 10-7-2025.

SEC. 2(F).

SER. NO. 85-122,392, FILED 9-2-2010.

MARCIE MILONE, EXAMINING ATTORNEY



*David J. Kyffers*

Director of the United States Patent and Trademark Office

# United States of America

United States Patent and Trademark Office



**Reg. No. 4,274,009**

PAYROLLING.COM CORPORATION (CALIFORNIA CORPORATION)  
4626 ALBUQUERQUE STREET  
SAN DIEGO, CA 92109

**Registered Jan. 15, 2013**

**Int. Cl.: 35**

FOR: ADMINISTRATION OF BUSINESS PAYROLL FOR OTHERS; PAYROLL PROCESSING SERVICES, IN CLASS 35 (U.S. CLS. 100, 101 AND 102).

**SERVICE MARK**

FIRST USE 12-17-1994; IN COMMERCE 12-31-1998.

**PRINCIPAL REGISTER**

THE MARK CONSISTS OF A DARK GREEN AND LIGHT GREEN OPEN CIRCLE OR OVAL RESEMBLING THE LETTER "O" WITH "PAYROLLING.COM" WRITTEN IN BLACK LETTERS WITH GREY SHADOWS AT AN ANGLE THROUGH THE CIRCLE OR OVAL.

THE COLOR(S) LIGHT GREEN, DARK GREEN, GREY, AND BLACK IS/ARE CLAIMED AS A FEATURE OF THE MARK.

SEC. 2(F) AS TO "PAYROLLING.COM".

SER. NO. 85-131,313, FILED 9-16-2010.

APRIL HESIK, EXAMINING ATTORNEY



*David J. Kyfos*

Director of the United States Patent and Trademark Office

# United States of America

United States Patent and Trademark Office

## JOB DICTIONARY

**Reg. No. 4,274,010**

BRABANT, JEAN DE (CANADA INDIVIDUAL)  
425 WOOD AVENUE

**Registered Jan. 15, 2013**

WESTMOUNT, QUEBEC, CANADA H3Y3J3

**Int. Cl.: 35**

FOR: BUSINESS SERVICES, NAMELY, ADMINISTRATION OF A PROGRAM FOR ENABLING PARTICIPANTS TO RECEIVE EXPEDITED SERVICES IN THE FIELD OF JOB SEARCHING, IN CLASS 35 (U.S. CLS. 100, 101 AND 102).

**SERVICE MARK**

THE MARK CONSISTS OF STANDARD CHARACTERS WITHOUT CLAIM TO ANY PARTICULAR FONT, STYLE, SIZE, OR COLOR.

**PRINCIPAL REGISTER**

PRIORITY CLAIMED UNDER SEC. 44(D) ON CANADA APPLICATION NO. 1496415, FILED 9-20-2010, REG. NO. TMA819,914, DATED 3-15-2012, EXPIRES 3-15-2027.

SER. NO. 85-136,679, FILED 9-23-2010.

INGRID C. EULIN, EXAMINING ATTORNEY



*David J. Kybas*

Director of the United States Patent and Trademark Office



# United States of America

United States Patent and Trademark Office

MYDENTAL  
HUB 

**Reg. No. 4,274,011**

HANDS ON TRAINING INSTITUTE INC. (CANADA CORPORATION)  
1750 - 255 QUEENS AVENUE

**Registered Jan. 15, 2013**

LONDON, ONTARIO, CANADA N6A5R8

**Int. Cls.: 9, 35 and 44**

FOR: DVDS FEATURING INFORMATION FOR DENTISTS ON THE SUBJECT OF TREATMENTS AND PROCEDURES RELATED TO DENTISTRY, IN CLASS 9 (U.S. CLS. 21, 23, 26, 36 AND 38).

**TRADEMARK**

FOR: PROVIDING A WEBSITE FOR DENTAL PRACTICE MANAGEMENT AND ADMINISTRATIVE SUPPORT SERVICES TO INDIVIDUAL DENTISTS OR GROUP PRACTICES, IN CLASS 35 (U.S. CLS. 100, 101 AND 102).

**SERVICE MARK**

**PRINCIPAL REGISTER**

FOR: PROVIDING A WEBSITE FEATURING INFORMATION FOR DENTISTS ON THE SUBJECT OF TREATMENTS AND PROCEDURES RELATED TO DENTISTRY; PROVIDING A WEBSITE FEATURING INFORMATION FOR PATIENTS IN THE FIELD OF DENTAL HEALTH, IN CLASS 44 (U.S. CLS. 100 AND 101).

PRIORITY CLAIMED UNDER SEC. 44(D) ON CANADA APPLICATION NO. 1480207, FILED 5-7-2010, REG. NO. TMA829,825, DATED 8-13-2012, EXPIRES 8-13-2027.

NO CLAIM IS MADE TO THE EXCLUSIVE RIGHT TO USE "DENTAL", APART FROM THE MARK AS SHOWN.



THE MARK CONSISTS OF THE WORDS "MY DENTAL" ABOVE THE WORD "HUB" AND A GRAPHIC DEPICTION OF A HUB CONNECTED TO THE LETTER "T" IN THE WORD "DENTAL".

SER. NO. 85-136,938, FILED 9-23-2010.

ANGELA DUONG, EXAMINING ATTORNEY

*David J. Kybas*

Director of the United States Patent and Trademark Office

# United States of America

United States Patent and Trademark Office



**Reg. No. 4,274,012**

**Registered Jan. 15, 2013**

**Int. Cls.: 35, 36 and 39**

HEAVYWEIGHT AIR EXPRESS LIMITED (UNITED KINGDOM PRIVATE LIMITED COMPANY)

UNIT 3, CYGNUS COURT  
PEGASUS BUSINESS PARK, CASTLE DONINGTON  
DERBYSHIRE, UNITED KINGDOM DE742SA

**SERVICE MARK**

**PRINCIPAL REGISTER**

FOR: ADVICE IN THE FIELD OF MARKETING AND BUSINESS MANAGEMENT; BUSINESS ADVICE RELATING TO LOGISTICS; BUSINESS ADVICE RELATING TO MARKETING; BUSINESS ADVICE RELATING TO STRATEGIC MARKETING; PROMOTION OF BUSINESS OPPORTUNITIES; DIRECT MARKETING; FOREIGN TRADE CONSULTANCY SERVICES; PROVIDING BUSINESS ADVICE RELATING TO MARKETING; DIRECT MARKETING CONSULTING SERVICES; MARKETING CONSULTING; ADVERTISING AND MARKETING BY MAIL; PROVIDING BUSINESS MARKETING INFORMATION; CONSUMER MARKETING RESEARCH; BUSINESS MARKETING; DEVELOPMENT OF MARKETING STRATEGIES AND CONCEPTS; PROVISION OF REPORTS FOR MARKETING; PROMOTIONAL ADVERTISING SERVICES; SALES PROMOTION SERVICES FOR THIRD PARTIES; PROVISION OF MARKETING REPORTS; RESEARCH SERVICES RELATING TO MARKETING, NAMELY, CONSUMER MARKETING RESEARCH; SALES PROMOTION FOR OTHERS; SALES PROMOTION SERVICES; TRADE MARKETING, NAMELY, BUSINESS MARKETING SERVICES; TRADE PROMOTIONAL SERVICES, NAMELY, PROMOTION OF BUSINESS OPPORTUNITIES, IN CLASS 35 (U.S. CLS. 100, 101 AND 102).

FOR: ARRANGING THE PAYMENT OF CUSTOMS DUTIES, NAMELY, TAX PAYMENT PROCESSING SERVICES; ARRANGING THE RETURN OF CUSTOMS DUTIES, NAMELY, DUTY DRAWBACK SERVICES; CUSTOMS BONDING SERVICES; AND CUSTOMS BROKERAGE, IN CLASS 36 (U.S. CLS. 100, 101 AND 102).

FOR: ADVISORY SERVICES RELATING TO ROAD TRANSPORTATION; ADVISORY SERVICES RELATING TO THE TRANSPORTATION OF GOODS; AGENCY SERVICES FOR ARRANGING THE TRANSPORTATION OF GOODS, NAMELY, TRANSPORT BROKERAGE; AIR CARGO TRANSPORT; AIR FREIGHT TRANSPORTATION; AIR TRANSPORTATION SERVICES FOR CARGO; AIR TRANSPORTATION SERVICES FOR FREIGHT; AIRCRAFT CHARTERING; AIRLINE SERVICES FOR THE TRANSPORTATION OF CARGO; AIRLINE SERVICES FOR THE TRANSPORTATION OF GOODS; AIRLINE TRANSPORTATION SERVICES; ARRANGING TRANSPORT SERVICES BY LAND, SEA AND AIR, NAMELY, TRANSPORT BROKERAGE; BOAT TRANSPORTATION SERVICES; TRANSPORT BROKERAGE SERVICES; CARGO AGENCY SERVICES, NAMELY, CARGO SHIP TRANS-



*David J. Kyppas*

Director of the United States Patent and Trademark Office

**Reg. No. 4,274,012** PORT; CARGO STORAGE CONTAINER RENTAL SERVICES; CARGO DELIVERY SERVICES; FREIGHT FORWARDING SERVICES; CARGO HANDLING; CARGO LOADING SERVICES; CARGO TRANSPORTATION; CARGO UNLOADING SERVICES; CHARTERING OF AIRCRAFT; CHARTERING OF MARINE VESSELS; CHARTERING OF BOATS; CHARTERING OF SHIPS; CHARTERING OF LAND VEHICLES FOR TRANSPORTATION; CHARTERING OF TRUCKS; FREIGHT TRANSPORTATION BROKERAGE; CONTAINER TRANSPORT SERVICES, NAMELY, GLOBAL TRANSPORTATION OF FREIGHT FOR OTHERS BY ALL AVAILABLE MEANS; COURIER SERVICES FOR THE TRANSPORTATION OF CARGO; DELIVERY OF CARGO BY AIR; DELIVERY OF CARGO BY LAND; FILLING OF VEHICLES WITH FREIGHT, NAMELY, PACKING ARTICLES FOR TRANSPORTATION; FILLING OF VESSELS WITH FREIGHT, NAMELY, PACKING ARTICLES FOR TRANSPORTATION; FORWARDING OF FREIGHT; SHIPPING OF GOODS; FREIGHT BROKERAGE; FREIGHT FORWARDING BETWEEN SEA PORTS; FREIGHT FORWARDING BY AIR; FREIGHT FORWARDING BY LAND; FREIGHT FORWARDING BY SEA; FREIGHT FORWARDING; AIR FREIGHT SHIPPING; FREIGHT TRANSPORTATION BROKERAGE; FREIGHT WAREHOUSING; GROUND SUPPORT FREIGHT HANDLING SERVICES PROVIDED AT AIRPORTS, NAMELY, CARGO HANDLING; IMPORT AND EXPORT CARGO HANDLING SERVICES; TRANSPORTATION INFORMATION; PROVIDING INFORMATION CONCERNING COLLECTION AND DELIVERY OF ASSETS IN TRANSIT, NAMELY, VEHICLES, TRAILERS, CARGO AND DELIVERY CONTAINERS; INFORMATION IN THE FIELD OF CARGO SHIP TRANSPORT; INFORMATION SERVICES IN THE FIELD OF TRANSPORTATION OF GOODS; INFORMATION IN THE FIELD OF AIR TRANSPORTATION; LAND FREIGHT SERVICES, NAMELY, RAILWAY TRANSPORT; LOADING OF AIR FREIGHT, NAMELY, PACKING ARTICLES FOR TRANSPORTATION; LOADING OF CARGO, NAMELY, PACKING ARTICLES FOR TRANSPORTATION; LOADING OF FREIGHT, NAMELY, PACKING ARTICLES FOR TRANSPORTATION; MARINE FREIGHT FORWARDING; MARINE TRANSPORT SERVICES; PACKING OF FREIGHT FOR TRANSPORTATION; PRE-TRANSIT STORAGE OF CARGO; INFORMATION IN THE FIELD OF AIR TRANSPORT OF FREIGHT; RAIL WAREHOUSING SERVICES, NAMELY, STORAGE, DISTRIBUTION, PICK-UP, AND PACKING FOR SHIPMENT OF, PACKAGES AND OTHER FREIGHT FOR OTHERS; TRANSPORTATION OF FREIGHT BY RAIL; RAIL TRANSPORT SERVICES; RENTAL OF STORAGE CONTAINERS FOR FREIGHT; TRANSPORTATION RESERVATION SERVICES FOR THE TRANSPORTATION OF GOODS BY SHIP; TRANSPORTATION RESERVATION SERVICES FOR THE TRANSPORTATION OF GOODS; ROAD FREIGHT SERVICES, NAMELY, TRANSPORTATION AND DELIVERY SERVICES BY ROAD; TRANSPORT BY TRUCK; SEA FREIGHT SERVICES, NAMELY, TRANSPORT BY BOAT; SEA FREIGHT-FORWARDING SERVICES; SEA TRANSPORT SERVICES; SEA TRANSPORTATION SERVICES; SECURITY STORAGE SERVICES, NAMELY, STORAGE OF GOODS; SERVICES FOR ARRANGING THE TRANSPORTATION OF GOODS BY AIR, NAMELY, AIR FREIGHT SHIPPING SERVICES; SERVICES FOR ARRANGING THE TRANSPORTATION OF GOODS BY RAIL, NAMELY, RAILWAY TRANSPORT; SERVICES FOR ARRANGING THE TRANSPORTATION OF GOODS BY ROAD, NAMELY, TRANSPORTATION AND DELIVERY SERVICES BY ROAD; SERVICES FOR ARRANGING THE TRANSPORTATION OF GOODS BY SEA, NAMELY, TRANSPORTATION AND DELIVERY SERVICES BY SEA; TRANSPORTATION OF GOODS; FREIGHT-FORWARDING BY AIR; FREIGHT-FORWARDING BY LAND; FREIGHT-FORWARDING BY SEA; STORAGE OF FREIGHT; STORAGE OF AIR TRANSPORTATION GOODS; TRANSPORTATION OF FREIGHT BY TRUCK; CARGO SHIP TRANSPORT SERVICES; TRANSPORT BROKERAGE; STORAGE OF CARGO AFTER TRANSPORTATION; STORAGE OF CARGO BEFORE TRANSPORTATION; STORAGE OF CARGO; STORAGE OF FREIGHT; STORAGE SERVICES FOR FREIGHT; TRANSPORT OF CARGO BY AIR; TRANSPORT OF FREIGHT BY AIR; TRANSPORTATION OF CARGO BY LAND VEHICLE; AIR TRANSPORTATION OF CARGO; TRANSPORTATION OF FREIGHT BY LAND; TRANSPORTATION OF FREIGHT BY ROAD; TRANSPORTATION OF FREIGHT BY WATER; AIR TRANSPORTATION OF FREIGHT; AND WAREHOUSING OF FREIGHT, IN CLASS 39 (U.S. CLS. 100 AND 105).

PRIORITY CLAIMED UNDER SEC. 44(D) ON UNITED KINGDOM APPLICATION NO. 2551753, FILED 6-30-2010, REG. NO. 2551753, DATED 10-15-2010, EXPIRES 6-30-2020.

**Reg. No. 4,274,012** THE COLOR(S) RED, BLACK, GREY AND WHITE IS/ARE CLAIMED AS A FEATURE OF THE MARK.

OWNER OF U.S. REG. NO. 3,896,541.

NO CLAIM IS MADE TO THE EXCLUSIVE RIGHT TO USE "HEAVYWEIGHT AIR CARGO EXCHANGE", APART FROM THE MARK AS SHOWN.

THE MARK CONSISTS OF CAPITAL BLOCK LETTERS "HX" IN RED, WITH SHADING BEHIND THE LETTERS IN GREY; A BLACK AIRPLANE POSITIONED IN FRONT OF A WHITE SPHERE OUTLINED IN GREY AND MARKED BY INTERSECTING CURVED VERTICAL AND HORIZONTAL LINES THAT ARE GREY; AND THE WORDS "HEAVY-WEIGHT AIR CARGO EXCHANGE" IN BLACK.

SER. NO. 85-139,018, FILED 9-27-2010.

JORDAN BAKER, EXAMINING ATTORNEY

# United States of America

United States Patent and Trademark Office

# PROPHECIDE

**Reg. No. 4,274,013**

VARS, STEVEN J (UNITED STATES INDIVIDUAL)  
35 RUSSELL AVE  
PAWCATUCK, CT 06379

**Registered Jan. 15, 2013**

**Int. Cl.: 9**

FOR: AUDIO RECORDINGS OF MUSIC UNDER THE NAME PROPHECIDE, IN CLASS 9  
(U.S. CLS. 21, 23, 26, 36 AND 38).

**TRADEMARK**

FIRST USE 6-5-2010; IN COMMERCE 10-19-2010.

**PRINCIPAL REGISTER**

THE MARK CONSISTS OF STANDARD CHARACTERS WITHOUT CLAIM TO ANY PARTICULAR FONT, STYLE, SIZE, OR COLOR.

SER. NO. 85-140,817, FILED 9-29-2010.

MATTHEW EINSTEIN, EXAMINING ATTORNEY



*David J. Kyros*

Director of the United States Patent and Trademark Office

# United States of America

United States Patent and Trademark Office

## FLATRON SUPER GREEN

**Reg. No. 4,274,014**

LG ELECTRONICS INC. (REPUBLIC OF KOREA CORPORATION)  
20 YEOUIDO-DONG YEONGDEUNGPO-GU  
SEOUL 150-721, REPUBLIC OF KOREA

**Registered Jan. 15, 2013**

**Int. Cl.: 9**

FOR: COMPUTER MONITORS, IN CLASS 9 (U.S. CLS. 21, 23, 26, 36 AND 38).

**TRADEMARK**

THE MARK CONSISTS OF STANDARD CHARACTERS WITHOUT CLAIM TO ANY PARTICULAR FONT, STYLE, SIZE, OR COLOR.

**PRINCIPAL REGISTER**

PRIORITY CLAIMED UNDER SEC. 44(D) ON REPUBLIC OF KOREA APPLICATION NO. 2010-0041525, FILED 8-11-2010, REG. NO. 0908239, DATED 3-5-2012, EXPIRES 3-5-2022.

OWNER OF U.S. REG. NOS. 2,309,738, 3,515,118 AND OTHERS.

NO CLAIM IS MADE TO THE EXCLUSIVE RIGHT TO USE "SUPER GREEN", APART FROM THE MARK AS SHOWN.

SER. NO. 85-143,244, FILED 10-1-2010.

BARBARA BROWN, EXAMINING ATTORNEY



*David J. Kyffers*

Director of the United States Patent and Trademark Office

# United States of America

United States Patent and Trademark Office

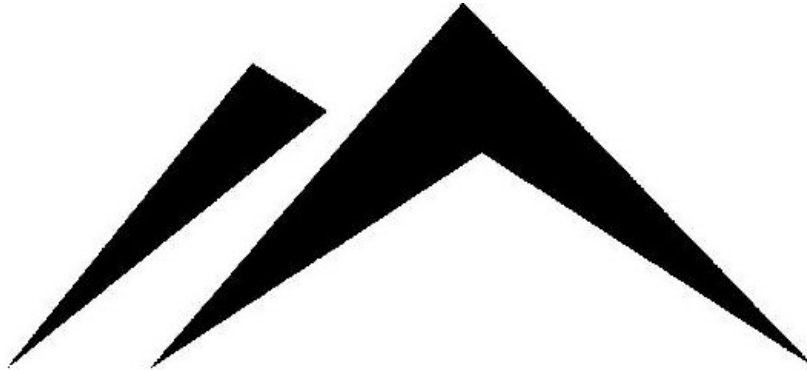

**Reg. No. 4,274,015**

**Registered Jan. 15, 2013**

**Int. Cl.: 37**

**SERVICE MARK**

**PRINCIPAL REGISTER**

PEAK ENERGY SERVICES LTD. (CANADA CORPORATION)  
SUITE 900  
222-3RD AVENUE SW  
CALGARY, ALBERTA., CANADA T2P0B4

FOR: RENTAL AND MAINTENANCE OF OIL FIELD EQUIPMENT, NAMELY, SURFACE EQUIPMENT AND SOLIDS CONTROL EQUIPMENT; RENTAL AND MAINTENANCE OF OIL FIELD SURFACE EQUIPMENT, NAMELY, WELL SITE ACCOMMODATION TRAILERS, WASTEWATER TREATMENT SYSTEMS, HOLDING TANKS, UPRIGHT TANKS, BERMS, FIRE EXTINGUISHERS, GENERATORS, AND VACUUMS; RENTAL AND MAINTENANCE OF SOLIDS CONTROL EQUIPMENT, NAMELY, CENTRIFUGES, FLUID MANAGEMENT SYSTEMS, AUGER TANKS, UPRIGHT TANKS, DEWATERING SYSTEMS, BARITE RECOVERY SYSTEMS, DRILLED CUTTINGS DRYING SYSTEMS, FEED PUMPS, AND TRANSFER PUMPS, IN CLASS 37 (U.S. CLS. 100, 103 AND 106).

FIRST USE 0-0-2004; IN COMMERCE 0-0-2004.

PRIORITY CLAIMED UNDER SEC. 44(D) ON CANADA APPLICATION NO. 1,497,904, FILED 9-30-2010, REG. NO. TMA809,072, DATED 10-14-2011, EXPIRES 10-14-2026.

THE MARK CONSISTS OF TWO STYLIZED PEAKS.

SER. NO. 85-145,784, FILED 10-5-2010.

TINA L. SNAPP, EXAMINING ATTORNEY



*David J. Kybas*

Director of the United States Patent and Trademark Office

# United States of America

United States Patent and Trademark Office



**Reg. No. 4,274,016**

**Registered Jan. 15, 2013**

**Int. Cl.: 37**

**SERVICE MARK**

**PRINCIPAL REGISTER**

PEAK ENERGY SERVICES LTD. (CANADA CORPORATION)  
SUITE 900  
222-3RD AVENUE SW  
CALGARY, ALBERTA., CANADA T2P0B4

FOR: RENTAL AND MAINTENANCE OF OIL FIELD EQUIPMENT, NAMELY, SURFACE EQUIPMENT AND SOLIDS CONTROL EQUIPMENT; RENTAL AND MAINTENANCE OF OIL FIELD SURFACE EQUIPMENT, NAMELY, WELL SITE ACCOMMODATION TRAILERS, WASTEWATER TREATMENT SYSTEMS, HOLDING TANKS, UPRIGHT TANKS, BERMS, FIRE EXTINGUISHERS, GENERATORS, AND VACUUMS; RENTAL AND MAINTENANCE OF SOLIDS CONTROL EQUIPMENT, NAMELY, CENTRIFUGES, FLUID MANAGEMENT SYSTEMS, AUGER TANKS, UPRIGHT TANKS, DEWATERING SYSTEMS, BARITE RECOVERY SYSTEMS, DRILLED CUTTINGS DRYING SYSTEMS, FEED PUMPS, AND TRANSFER PUMPS, IN CLASS 37 (U.S. CLS. 100, 103 AND 106).

FIRST USE 7-0-2010; IN COMMERCE 7-0-2010.

PRIORITY CLAIMED UNDER SEC. 44(D) ON CANADA APPLICATION NO. 1,497,905, FILED 9-30-2010, REG. NO. TMA809,073, DATED 10-14-2011, EXPIRES 10-14-2026.

THE MARK CONSISTS OF TWO STYLIZED PEAKS IN A CIRCLE.

SER. NO. 85-145,788, FILED 10-5-2010.

TINA L. SNAPP, EXAMINING ATTORNEY



*David J. Kyjars*

Director of the United States Patent and Trademark Office



# United States of America

United States Patent and Trademark Office



**Reg. No. 4,274,017**

**Registered Jan. 15, 2013**

**Int. Cls.: 31 and 41**

**TRADEMARK**

**SERVICE MARK**

**PRINCIPAL REGISTER**

VISION EARTH SOCIETY (FLORIDA NON-PROFIT CORPORATION), DBA RAWGANICS  
1825 NE 149 STREET  
MIAMI, FL 33181

FOR: NATURAL AGRICULTURAL PRODUCTS, NAMELY, RAW APPLES, RAW APRICOTS, RAW ARTICHOKES, RAW ASPARAGUS, RAW AVOCADOS, RAW BEAN SPROUTS, RAW BEANS, RAW BEETS, RAW BLUEBERRIES, RAW CABBAGE, RAW COCOA BEANS, RAW COCONUTS, RAW CORN, RAW DATES, RAW FRUITS, RAW GARLIC, RAW GINGER, RAW HERBS, RAW HORSERADISH ROOT, RAW LEMONS, RAW MUSHROOMS, RAW NUTS, RAW OATS, RAW OLIVES, RAW ONIONS, RAW ORANGES, RAW PEACHES, RAW PEPPERS, RAW PULSES, RAW QUINCE, RAW SUGAR CANE BAGASSES, RAW SWEET POTATOES, RAW TOMATOES, RAW VEGETABLES, RAW WHEAT, RAW YAMS, RAW ZUCCHINI, SEEDS FOR FRUIT AND VEGETABLES, VEGETABLE SEEDS FOR PLANTING, ORGANIC GARDENING KIT FOR INDOOR AND OUTDOOR PLANTING COMPOSED PRIMARILY OF ORGANIC SEEDS FOR FRUIT, VEGETABLES AND SEEDS FOR FLOWERS AND ALSO INCLUDING CONTAINER TO HOUSE THE SEEDS WHILE THEY GROW, E.G. ORGANIC AND RAW FRUITS AND VEGETABLES, IN CLASS 31 (U.S. CLS. 1 AND 46).

FIRST USE 4-21-1993; IN COMMERCE 4-21-1993.

FOR: EDUCATION AND ENTERTAINMENT SERVICES, NAMELY, PROVIDING ONLINE INSTRUCTION IN THE FIELD OF THE RAW ORGANIC LIFESTYLE, VIA AN ONLINE WEBSITE AND CONDUCTING PRESENTATIONS, NAMELY, THE SHOWING OF EDUCATIONAL DVDS, ABOUT NUTRITION AND THE RAW ORGANIC LIFESTYLE AND DISTRIBUTION OF MATERIALS IN CONNECTION THEREWITH AND EDUCATIONAL CONSULTING RELATED THERETO, IN CLASS 41 (U.S. CLS. 100, 101 AND 107).

FIRST USE 4-21-1993; IN COMMERCE 4-21-1993.

NO CLAIM IS MADE TO THE EXCLUSIVE RIGHT TO USE "RAWGANICS", APART FROM THE MARK AS SHOWN.

THE COLOR(S) RED, YELLOW, GREEN, BLUE, VIOLET, TAN AND WHITE IS/ARE CLAIMED AS A FEATURE OF THE MARK.

THE MARK CONSISTS OF THE WORD "RAWGANICS" IN VIOLET, OUTLINED BY WHITE AND GREEN ABOVE TWO CONCENTRIC CIRCLES WITH THE MAIN BLUE CIRCLE



*David J. Kyffers*

Director of the United States Patent and Trademark Office

**Reg. No. 4,274,017** OUTLINED BY YELLOW AND GREEN, ENCLOSING A RED AND GREEN TOMATO IN THE UPPER LEFT, A YELLOW LEMON IN THE UPPER RIGHT, A TAN MUSHROOM, GREEN PEA PODS, AND YELLOW BANANA LOCATED IN THE LOWER HEMISPHERE OF THE LARGE BLUE CIRCLE; ALL FRUITS AND VEGETABLES ARE OUTLINED IN WHITE.

SER. NO. 85-167,486, FILED 11-2-2010.

PAUL MORENO, EXAMINING ATTORNEY

# United States of America

United States Patent and Trademark Office



**Reg. No. 4,274,018**

**Registered Jan. 15, 2013**

**Int. Cl.: 41**

**SERVICE MARK**

**PRINCIPAL REGISTER**

SOURCE INTERLINK MAGAZINES, LLC (DELAWARE LIMITED LIABILITY COMPANY)  
831 SOUTH DOUGLAS STREET  
EL SEGUNDO, CA 90245

FOR: ENTERTAINMENT SERVICES, NAMELY PROVIDING AN ON-GOING LIVE RADIO SHOW CONCERNING AUTOMOBILES, NAMELY, HOT RODS THAT IS BROADCAST TO CONSUMERS VIA SATELLITE RADIO, RADIO, THE INTERNET, MOBILE DEVICES, AND ANY OTHER BROADCASTING PLATFORMS USED TO DISTRIBUTE RADIO CONTENT TO CONSUMERS, IN CLASS 41 (U.S. CLS. 100, 101 AND 107).

FIRST USE 10-7-2010; IN COMMERCE 10-7-2010.

OWNER OF U.S. REG. NOS. 2,372,437 AND 3,316,211.

THE COLOR(S) WHITE, BLACK, AND RED IS/ARE CLAIMED AS A FEATURE OF THE MARK.

NO CLAIM IS MADE TO THE EXCLUSIVE RIGHT TO USE "MAGAZINE" AND "LIVE", APART FROM THE MARK AS SHOWN.

THE MARK CONSISTS OF THE WORDS "HOT ROD" IN WHITE STYLIZED FORM WITH A BLACK SHADOW OUTLINE ABOVE THE WORD "MAGAZINE" IN BLACK CAPITAL LETTERS. TO THE RIGHT IS THE WORD "LIVE" IN BLACK STYLIZED FORM. A BLACK CORD AND PLUG DESIGN WRAPS AROUND THE WORDS "HOT ROD MAGAZINE LIVE". THE BLACK CORD IS COMING FROM A BLACK MICROPHONE THAT IS TO THE RIGHT OF THE LITERAL ELEMENTS. SOUND BARS IN WHITE APPEAR AT TOP OF MICROPHONE. ALL OF THE FOREGOING ELEMENTS ARE SUPERIMPOSED OVER A RED RECTANGULAR BACKGROUND.

SEC. 2(F) AS TO "HOT ROD".

SER. NO. 85-169,684, FILED 11-4-2010.

MICHELLE DUBOIS, EXAMINING ATTORNEY



*David J. Kappas*

Director of the United States Patent and Trademark Office

# United States of America

United States Patent and Trademark Office

# ACOLYTE

**Reg. No. 4,274,019**

**Registered Jan. 15, 2013**

**Int. Cls.: 11 and 35**

**TRADEMARK**

**SERVICE MARK**

**PRINCIPAL REGISTER**

ACOLYTE TECHNOLOGIES CORPORATION (NEW YORK CORPORATION)  
44 EAST 32ND STREET  
NEW YORK, NY 10016

FOR: LIGHTING DEVICES FOR EVENT DESIGN, NAMELY, DISPOSABLE LED ACCENT LIGHTS, WATERPROOF LED DECORATIVE ACCENT LIGHTS, LED LIGHTS FOR USE IN ILLUMINATING SIGNS, DISPLAYS AND DISPLAY ARRANGEMENTS, SPOT LIGHTS, LIGHTING FIXTURES IN THE NATURE OF LIGHTED BASES AND LIGHTED STANDS FOR ILLUMINATING VASES AND OTHER DECORATIVE OBJECTS, IN CLASS 11 (U.S. CLS. 13, 21, 23, 31 AND 34).

FIRST USE 10-0-1998; IN COMMERCE 10-0-1998.

FOR: WHOLESALE STORE AND DISTRIBUTOR SERVICES FEATURING LIGHTING DEVICES FOR EVENT DESIGN, IN CLASS 35 (U.S. CLS. 100, 101 AND 102).

FIRST USE 10-0-1998; IN COMMERCE 10-0-1998.

THE MARK CONSISTS OF STANDARD CHARACTERS WITHOUT CLAIM TO ANY PARTICULAR FONT, STYLE, SIZE, OR COLOR.

SER. NO. 85-171,291, FILED 11-8-2010.

ANDREA K. NADELMAN, EXAMINING ATTORNEY



*David J. Kybas*

Director of the United States Patent and Trademark Office

# United States of America

United States Patent and Trademark Office



**Reg. No. 4,274,020**

**Registered Jan. 15, 2013**

**Int. Cl.: 1**

**TRADEMARK**

**PRINCIPAL REGISTER**

THOMSON RESEARCH ASSOCIATES INC. (CANADA CORPORATION)  
49 GERVAIS DRIVE  
TORONTO, ONTARIO, CANADA M3C1Y9

FOR: BACTERIOSTATS AND FUNGISTATS FOR USE IN MANUFACTURING AND FINISHING OF ADHESIVES, CARPETING, FOAM, LEATHER, PAINTS, RUBBER, SEALANTS, SILICONE, TEXTILES, FABRICS, VINYL AND WOOL, IN CLASS 1 (U.S. CLS. 1, 5, 6, 10, 26 AND 46).

OWNER OF CANADA REG. NO. TMA829051, DATED 8-2-2012, EXPIRES 8-2-2027.

OWNER OF U.S. REG. NOS. 1,330,317 AND 1,918,654.

THE MARK CONSISTS OF THE WORDS "ULTRA FRESH FRESHNESS PROTECTION" WITHIN A BROKEN OVAL BORDER.

SER. NO. 85-172,271, FILED 11-9-2010.

JEAN IM, EXAMINING ATTORNEY



*David J. Kyffers*

Director of the United States Patent and Trademark Office

# United States of America

United States Patent and Trademark Office



**Reg. No. 4,274,021**

**Registered Jan. 15, 2013**

**Int. Cl.: 1**

**TRADEMARK**

**PRINCIPAL REGISTER**

THOMSON RESEARCH ASSOCIATES INC. (CANADA CORPORATION)  
49 GERVAIS DRIVE  
TORONTO, ONTARIO, CANADA M3C1Y9

FOR: BACTERIOSTATS AND FUNGISTATS FOR USE IN MANUFACTURING AND FINISHING OF ADHESIVES, CARPETING, FOAM, LEATHER, PAINTS, RUBBER, SEALANTS, SILICONE, TEXTILES, FABRICS, VINYL AND WOOL, IN CLASS 1 (U.S. CLS. 1, 5, 6, 10, 26 AND 46).

OWNER OF CANADA REG. NO. TMA823226, DATED 5-2-2012, EXPIRES 5-2-2027.

OWNER OF U.S. REG. NOS. 1,330,317 AND 1,918,654.

NO CLAIM IS MADE TO THE EXCLUSIVE RIGHT TO USE "ANTIMICROBIAL TECHNOLOGY", APART FROM THE MARK AS SHOWN.

THE MARK CONSISTS OF THE WORDS "ULTRA FRESH ANTIMICROBIAL TECHNOLOGY" WITHIN A BROKEN OVAL BORDER.

SER. NO. 85-172,282, FILED 11-9-2010.

JEAN IM, EXAMINING ATTORNEY



*David J. Kybas*

Director of the United States Patent and Trademark Office

# United States of America

United States Patent and Trademark Office

## ECO-SAFETY

**Reg. No. 4,274,022**

RUBBER-CAL, INC. (CALIFORNIA CORPORATION)  
3012 SOUTH CRODDY WAY  
SANTA ANA, CA 92704

**Registered Jan. 15, 2013**

**Int. Cl.: 19**

FOR: RUBBER AND SYNTHETIC NON-METAL TILES FOR USE ON INDOOR AND OUTDOOR FLOORS, RUBBER FLOORING, RUBBER FLOOR TILES, IN CLASS 19 (U.S. CLS. 1, 12, 33 AND 50).

**TRADEMARK**

FIRST USE 3-1-2010; IN COMMERCE 3-1-2010.

**PRINCIPAL REGISTER**

THE MARK CONSISTS OF STANDARD CHARACTERS WITHOUT CLAIM TO ANY PARTICULAR FONT, STYLE, SIZE, OR COLOR.

SER. NO. 85-174,618, FILED 11-11-2010.

ELLEN BURNS, EXAMINING ATTORNEY



*David J. Kyffers*

Director of the United States Patent and Trademark Office

# United States of America

United States Patent and Trademark Office

## MODERN-TWIST STUDIO

**Reg. No. 4,274,023**

**Registered Jan. 15, 2013**

**Int. Cls.: 21, 24 and 35**

**TRADEMARK**

**SERVICE MARK**

**PRINCIPAL REGISTER**

MODERN TWIST INC. (CALIFORNIA CORPORATION)  
6020 CASTLE DRIVE  
OAKLAND, CA 94611

FOR: SILICONE COASTERS; WINE GLASS TAGS, NAMELY, CHARMS FOR ATTACHMENT TO WINE GLASSES FOR IDENTIFICATION PURPOSES, IN CLASS 21 (U.S. CLS. 2, 13, 23, 29, 30, 33, 40 AND 50).

FIRST USE 12-31-2009; IN COMMERCE 12-31-2009.

FOR: SILICONE PLACEMATS; SILICONE DOILIES, IN CLASS 24 (U.S. CLS. 42 AND 50).

FIRST USE 12-31-2009; IN COMMERCE 12-31-2009.

FOR: ON-LINE RETAIL STORE SERVICES FEATURING HOUSEHOLD AND KITCHEN UTENSILS, IN CLASS 35 (U.S. CLS. 100, 101 AND 102).

FIRST USE 12-31-2009; IN COMMERCE 12-31-2009.

THE MARK CONSISTS OF STANDARD CHARACTERS WITHOUT CLAIM TO ANY PARTICULAR FONT, STYLE, SIZE, OR COLOR.

NO CLAIM IS MADE TO THE EXCLUSIVE RIGHT TO USE "STUDIO", APART FROM THE MARK AS SHOWN.

SER. NO. 85-187,728, FILED 11-30-2010.

REBECCA EISINGER, EXAMINING ATTORNEY



*David J. Kyffers*

Director of the United States Patent and Trademark Office



# United States of America

United States Patent and Trademark Office

# FRONTIERVILLE

**Reg. No. 4,274,024**

ZYNGA INC. (DELAWARE CORPORATION)

**Registered Jan. 15, 2013**

699 EIGHTH STREET  
SAN FRANCISCO, CA 94103

**Int. Cl.: 41**

FOR: ENTERTAINMENT SERVICES, NAMELY, PROVIDING ONLINE COMPUTER GAMES, ONLINE VIDEO GAMES, AND ONLINE INTERACTIVE GAMES, IN CLASS 41 (U.S. CLS. 100, 101 AND 107).

**SERVICE MARK**

FIRST USE 6-9-2010; IN COMMERCE 6-9-2010.

**PRINCIPAL REGISTER**

THE MARK CONSISTS OF THE WORD "FRONTIERVILLE" WRITTEN IN A WESTERN STYLE FONT.

SER. NO. 85-187,815, FILED 11-30-2010.

KATHERINE CHANG, EXAMINING ATTORNEY



*David J. Kyffers*

Director of the United States Patent and Trademark Office

# United States of America

United States Patent and Trademark Office

Infosys  
iEngage  
Digital Consumer Platform

**Reg. No. 4,274,025**

**Registered Jan. 15, 2013**

**Int. Cls.: 9, 35, 38 and 42**

**TRADEMARK**

**SERVICE MARK**

**PRINCIPAL REGISTER**

INFOSYS LIMITED (INDIA CORPORATION)  
HOSUR ROAD  
PLOT NO. 44  
ELECTRONICS CITY, INDIA 560 100

FOR: COMPUTER SOFTWARE FOR USE IN DATABASE MANAGEMENT, COMPUTER SOFTWARE FOR USE AS AN APPLICATION PROGRAMMING INTERFACE (API); COMPUTER SOFTWARE WHICH FACILITATES ONLINE SERVICES FOR SOCIAL NETWORKING AND BUSINESS TRANSACTIONS, BUILDING BUSINESS TRANSACTION AND COMMUNICATION APPLICATIONS AND FOR ALLOWING DATA RETRIEVAL, UPLOAD, DOWNLOAD, ACCESS AND MANAGEMENT; COMPUTER SOFTWARE TO ENABLE UP-LOADING, DOWNLOADING, ACCESSING, POSTING, DISPLAYING, TAGGING, BLOGGING, STREAMING, LINKING, SHARING OR OTHERWISE PROVIDING ELECTRONIC MEDIA OR INFORMATION VIA COMPUTER AND COMMUNICATION NETWORKS AND ONLINE PLATFORMS; COMPUTER SOFTWARE FOR SUPPORTING ECOMMERCE TRANSACTIONS; COMPUTER SOFTWARE FOR HUMAN RESOURCES AND EMPLOYEE MANAGEMENT; COMPUTER SOFTWARE FOR SUPPORTING CUSTOMER RELATIONS FUNCTIONS; COMPUTER SOFTWARE FOR SALES SUPPORT; COMPUTER SOFTWARE FOR DISTRIBUTING CONTENT VIA THE INTERNET; COMPUTER SOFTWARE FOR SUPPORTING MOBILE DEVICE APPLICATIONS; COMPUTER SOFTWARE FOR SOCIAL NETWORKING; COMPUTER SOFTWARE FOR MANAGING CUSTOMER REWARD PROGRAMS, IN CLASS 9 (U.S. CLS. 21, 23, 26, 36 AND 38).

FOR: ADVERTISING SERVICES; BUSINESS MANAGEMENT; BUSINESS ADMINISTRATION; PROVIDING OFFICE FUNCTIONS, IN CLASS 35 (U.S. CLS. 100, 101 AND 102).

FOR: TELECOMMUNICATIONS, NAMELY, COMMUNICATION BY COMPUTER TERMINALS; COMPUTER AIDED TRANSMISSION OF DATA, MESSAGES AND IMAGES; TELECOMMUNICATION ACCESS SERVICES; TELECOMMUNICATIONS BY E-MAIL AND FACSIMILE COMMUNICATION; TELECOMMUNICATIONS GATEWAY SERVICES; TELECOMMUNICATIONS, NAMELY, PROVIDING ACCESS TO COMPUTER, ELECTRONIC AND ONLINE DATABASES; PROVIDING INTERNET ACCESS SO THAT USERS CAN ACCESS WEB SITES OF OTHERS HOSTED ON COMPUTER SERVERS ACCESSIBLE VIA A GLOBAL COMPUTER NETWORK; AUDIO AND VIDEO BROADCASTING SERVICES OVER THE INTERNET; INTERNET BROADCASTING SERVICES, IN CLASS 38 (U.S. CLS. 100, 101 AND 104).



*David J. Kyros*

Director of the United States Patent and Trademark Office

**Reg. No. 4,274,025** FOR: SCIENTIFIC AND TECHNOLOGICAL SERVICES AND RESEARCH AND DESIGN RELATING THERETO, NAMELY, APPLICATION SERVICE PROVIDER (ASP) SERVICES, NAMELY, DESIGNING AND HOSTING COMPUTER SOFTWARE APPLICATIONS OF OTHERS; APPLICATION SERVICE PROVIDER (ASP) SERVICES FEATURING SOFTWARE TO ENABLE OR FACILITATE THE UPLOADING, DOWNLOADING, STREAMING, POSTING, DISPLAYING, BLOGGING, LINKING, SHARING OR OTHERWISE PROVIDING ELECTRONIC MEDIA OR INFORMATION OVER COMMUNICATION NETWORKS; PROVIDING A WEB SITE FEATURING TECHNOLOGY THAT ENABLES ONLINE USERS TO PERFORM BUSINESS TRANSACTIONS; INDUSTRIAL ANALYSIS AND RESEARCH SERVICES, NAMELY, COMPUTER SYSTEMS ANALYSIS; TECHNICAL RESEARCH, NAMELY, MECHANICAL AND PRODUCT RESEARCH; DESIGN AND DEVELOPMENT OF COMPUTER HARDWARE AND SOFTWARE; SOFTWARE AS A SERVICE (SAAS), NAMELY, CONSULTING SERVICES IN THE FIELD OF SOFTWARE AS A SERVICE (SAAS); SOFTWARE AS A SERVICE (SAAS) SERVICES FEATURING SOFTWARE FOR DATABASE MANAGEMENT, SUPPORTING ECOMMERCE TRANSACTIONS, HUMAN RESOURCES AND EMPLOYEE MANAGEMENT, SUPPORTING CUSTOMER RELATIONS FUNCTIONS, SALES SUPPORT, DISTRIBUTING CONTENT VIA THE INTERNET, SUPPORTING MOBILE DEVICE APPLICATIONS, SOCIAL NETWORKING, AND MANAGING CUSTOMER REWARD PROGRAMS; COMPUTER SERVICES, NAMELY, CREATING INDEXES OF INFORMATION, SITES AND OTHER RESOURCES AVAILABLE ON COMPUTER NETWORKS, DESIGN AND DEVELOPMENT OF COMPUTER HARDWARE AND COMPUTER SOFTWARE, COMPUTER NETWORK DESIGN FOR OTHERS, COMPUTER PROJECT MANAGEMENT SERVICES; TECHNICAL SUPPORT SERVICES, NAMELY, TROUBLESHOOTING COMPUTER SOFTWARE PROBLEMS; MAINTENANCE OF COMPUTER SOFTWARE; COMPUTER SOFTWARE CONSULTING, IN CLASS 42 (U.S. CLS. 100 AND 101).

PRIORITY CLAIMED UNDER SEC. 44(D) ON ERPN CMNTY TM OFC APPLICATION NO. 009171182, FILED 6-11-2010, REG. NO. 009171182, DATED 10-26-2010, EXPIRES 6-11-2020.

THE COLOR(S) BLUE, ORANGE, AND BLACK IS/ARE CLAIMED AS A FEATURE OF THE MARK.

OWNER OF U.S. REG. NOS. 1,809,733, 3,170,377, AND 3,326,887.

NO CLAIM IS MADE TO THE EXCLUSIVE RIGHT TO USE "DIGITAL CONSUMER PLATFORM", APART FROM THE MARK AS SHOWN.

THE MARK CONSISTS OF THE WORD "INFOSYS" IN THE COLOR BLUE, THE WORD "IENGAGE" IN THE COLOR ORANGE BELOW THE WORD "INFOSYS", AND THE WORDING "DIGITAL CONSUMER PLATFORM" IN BLACK LOCATED AT THE BOTTOM OF THE MARK UNDER A BLACK HORIZONTAL LINE.

SER. NO. 85-188,166, FILED 12-1-2010.

KATHERINE E. HALMEN, EXAMINING ATTORNEY

# United States of America

United States Patent and Trademark Office

# Touch V

**Reg. No. 4,274,026**

LG ELECTRONICS INC. (REPUBLIC OF KOREA CORPORATION)  
20 YEOUIDO-DONG YEONGDEUNGPO-GU  
SEOUL 150-721, REPUBLIC OF KOREA

**Registered Jan. 15, 2013**

**Int. Cl.: 9**

FOR: TELEVISION RECEIVERS, IN CLASS 9 (U.S. CLS. 21, 23, 26, 36 AND 38).

**TRADEMARK**

THE MARK CONSISTS OF STANDARD CHARACTERS WITHOUT CLAIM TO ANY PARTICULAR FONT, STYLE, SIZE, OR COLOR.

**PRINCIPAL REGISTER**

PRIORITY CLAIMED UNDER SEC. 44(D) ON REPUBLIC OF KOREA APPLICATION NO. 402010005992, FILED 11-19-2010, REG. NO. 0923315, DATED 6-13-2012, EXPIRES 11-19-2020.

NO CLAIM IS MADE TO THE EXCLUSIVE RIGHT TO USE "TOUCH", APART FROM THE MARK AS SHOWN.

SER. NO. 85-192,589, FILED 12-7-2010.

TOBY BULLOFF, EXAMINING ATTORNEY



*David J. Kyffers*

Director of the United States Patent and Trademark Office

# United States of America

United States Patent and Trademark Office

# Pentouch

**Reg. No. 4,274,027**

LG ELECTRONICS INC. (REPUBLIC OF KOREA CORPORATION)  
20 YEUIDO-DONG YEONGDEUNGPO-GU  
SEOUL 150-721, REPUBLIC OF KOREA

**Registered Jan. 15, 2013**

**Int. Cl.: 9**

FOR: TELEVISION RECEIVERS, IN CLASS 9 (U.S. CLS. 21, 23, 26, 36 AND 38).

**TRADEMARK**

THE MARK CONSISTS OF STANDARD CHARACTERS WITHOUT CLAIM TO ANY PARTICULAR FONT, STYLE, SIZE, OR COLOR.

**PRINCIPAL REGISTER**

PRIORITY CLAIMED UNDER SEC. 44(D) ON REPUBLIC OF KOREA APPLICATION NO. 402010005992, FILED 11-19-2010.

OWNER OF AUSTRALIA REG. NO. 1398518, DATED 12-8-2010, EXPIRES 12-28-2020.

SER. NO. 85-192,607, FILED 12-7-2010.

TOBY BULLOFF, EXAMINING ATTORNEY



*David J. Kyffers*

Director of the United States Patent and Trademark Office

# United States of America

United States Patent and Trademark Office

# Aurèle

**Reg. No. 4,274,028**

**Registered Jan. 15, 2013**

**Int. Cl.: 14**

**TRADEMARK**

**PRINCIPAL REGISTER**

SAMIR RACHED (UNITED STATES INDIVIDUAL)  
1 N.E 1ST STREET SUITE 18  
MIAMI, FL 33132

FOR: JEWELRY, IN CLASS 14 (U.S. CLS. 2, 27, 28 AND 50).

FIRST USE 3-25-2000; IN COMMERCE 3-25-2000.

THE MARK CONSISTS OF STANDARD CHARACTERS WITHOUT CLAIM TO ANY PARTICULAR FONT, STYLE, SIZE, OR COLOR.

SER. NO. 85-194,239, FILED 12-9-2010.

JOHN E. MICHOS, EXAMINING ATTORNEY



*David J. Kybas*

Director of the United States Patent and Trademark Office

# United States of America

United States Patent and Trademark Office

HEAD  TRIP

**Reg. No. 4,274,029**

**Registered Jan. 15, 2013**

**Int. Cl.: 9**

**TRADEMARK**

**PRINCIPAL REGISTER**

INGRAM MICRO INC. (DELAWARE CORPORATION)  
P.O. BOX 25125  
1600 EAST ST. ANDREW PLACE  
SANTA ANA, CA 92705

FOR: EAR BUDS; EARPHONES AND HEADPHONES, IN CLASS 9 (U.S. CLS. 21, 23, 26, 36 AND 38).

FIRST USE 5-1-2009; IN COMMERCE 5-1-2009.

THE MARK CONSISTS OF A GRAPHIC REPRESENTATION OF A PERSON'S HEAD WEARING HEADPHONES BETWEEN THE WORDS "HEAD" AND "TRIP".

SER. NO. 85-194,657, FILED 12-9-2010.

ALEX KEAM, EXAMINING ATTORNEY



*David J. Kybas*

Director of the United States Patent and Trademark Office

# United States of America

United States Patent and Trademark Office

FISICHINO

**Reg. No. 4,274,030**

CRISFER S.R.L. (ITALY LIMITED LIABILITY COMPANY)  
VIA CASTEGGIO7  
10131 TORINO, ITALY

**Registered Jan. 15, 2013**

**Int. Cl.: 25**

FOR: MEN'S AND WOMEN'S CLOTHING, NAMELY, DRESSES, SUITS, TROUSERS, JEANS, SHORTS, SKIRTS, VESTS, SHIRTS, BLOUSES, T-SHIRTS, JUMPERS, BLAZERS, JERKINS, JACKETS AND COATS, RAINCOATS, WAISTCOATS, BELTS, SOCKS, TIGHTS, NECKWEAR, TIES, SCARVES, FOULARDS, SHAWLS, GLOVES, BATH ROBES, SWIMMING SUITS, JOGGING SUITS, SPORT COATS, UNDERWEAR, LOUNGE WEAR, PAJAMAS, SHOES, BOOTS, SLIPPERS, HATS AND CAPS, IN CLASS 25 (U.S. CLS. 22 AND 39).

**TRADEMARK**

**PRINCIPAL REGISTER**

OWNER OF ITALY REG. NO. 1465880, DATED 11-22-2001, RENEWED AS REG. NO. 1465880, DATED 10-19-2011, EXPIRES 10-19-2021.

THE MARK CONSISTS OF THE TERM "FISICHINO" IN STYLIZED STIPPLING LETTERS.

SER. NO. 85-202,442, FILED 12-21-2010.

SKYE YOUNG, EXAMINING ATTORNEY



*David J. Kybas*

Director of the United States Patent and Trademark Office



# United States of America

United States Patent and Trademark Office

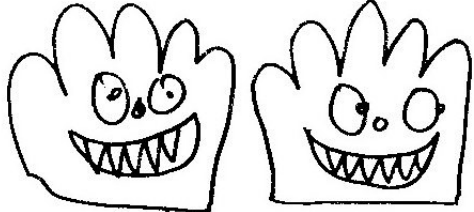
WASH YOUR  
  
MONSTER HANDS

**Reg. No. 4,274,031**

**Registered Jan. 15, 2013**

**Int. Cl.: 16**

**TRADEMARK**

**PRINCIPAL REGISTER**

THOMPSON, CHARLES T (UNITED STATES INDIVIDUAL)  
8251 KINGSMERE CT.  
CINCINNATI, OH 45231

FOR: PRINTED PAMPHLETS, BROCHURES, MANUALS, BOOKS, BOOKLETS, LEAFLETS, FLYERS, INFORMATIONAL SHEETS AND NEWSLETTERS, ADHESIVE BACKED STICKERS, AND KITS COMPRISING ONE OR MORE OF THE FOREGOING MATERIALS IN THE FIELD OF HYGIENE, IN CLASS 16 (U.S. CLS. 2, 5, 22, 23, 29, 37, 38 AND 50).

FIRST USE 6-1-2010; IN COMMERCE 6-30-2010.

THE MARK CONSISTS OF "WASH YOUR MONSTER HANDS" WITH A DRAWING OF TWO HANDS, EACH HAND HAS EYES, NOSE AND MOUTH. THE MOUTH HAS TEETH.

SER. NO. 85-203,462, FILED 12-21-2010.

CHRIS WELLS, EXAMINING ATTORNEY



*David J. Kybas*

Director of the United States Patent and Trademark Office

# United States of America

United States Patent and Trademark Office



international  
antiaging-systems.com

**Reg. No. 4,274,032**

**Registered Jan. 15, 2013**

**Int. Cls.: 5, 9 and 16**

**TRADEMARK**

**PRINCIPAL REGISTER**

PHARM-ASSAY INTERNATIONAL LIMITED (UNITED KINGDOM LIMITED COMPANY (LTD.))  
5 BROOKFIELDS, PAVENHAM  
BEDFORD BEDFORDSHIRE, UNITED KINGDOM MK437QA

FOR: PHARMACEUTICAL PREPARATIONS FOR THE TREATMENT, OR PREVENTION, OF AGING DISORDERS OR DISEASES, BACTERIAL INFECTION, STRESS, DEPRESSION, OBESITY, DEMENTIA, PARKINSON'S DISEASE, NICOTINE ADDICTION, IMPOTENCE, ERECTILE DYSFUNCTION, CATARACTS, HORMONAL DISORDERS, CANCER AND ALLERGIES, IN CLASS 5 (U.S. CLS. 6, 18, 44, 46, 51 AND 52).

FOR: COMPUTER SOFTWARE FOR CAPTURING, ANALYSING AND STORING MEDICAL AND BIOLOGICAL DATA; ELECTRONIC PUBLICATIONS RECORDED ON COMPUTER MEDIA IN THE NATURE OF JOURNALS, CATALOGUES, ARTICLES, BOOKS AND NEWSLETTERS IN THE FIELD OF PHARMACEUTICAL PRODUCTS, VITAMINS AND HEALTHCARE, IN CLASS 9 (U.S. CLS. 21, 23, 26, 36 AND 38).

FOR: PRINTED PUBLICATIONS IN THE NATURE OF JOURNALS, CATALOGUES, BOOKS AND NEWSLETTERS IN THE FIELD OF PHARMACEUTICAL PRODUCTS, VITAMINS AND HEALTHCARE, IN CLASS 16 (U.S. CLS. 2, 5, 22, 23, 29, 37, 38 AND 50).

OWNER OF ERPN CMNTY TM OFC REG. NO. 009573742, DATED 4-19-2011, EXPIRES 12-3-2020.

THE COLOR(S) BLUE IS/ARE CLAIMED AS A FEATURE OF THE MARK.

NO CLAIM IS MADE TO THE EXCLUSIVE RIGHT TO USE "INTERNATIONAL ANTIAGING-SYSTEMS.COM", APART FROM THE MARK AS SHOWN.

THE MARK CONSISTS OF AN INFINITY SYMBOL WITH THE LETTERS "IAS" ON IT OVER THE WORDS "INTERNATIONAL ANTIAGING-SYSTEMS.COM"; ALL ASPECTS OF THE MARK ARE IN SHADES OF BLUE.

SER. NO. 85-207,175, FILED 12-29-2010.

JAMES GRIFFIN, EXAMINING ATTORNEY



*David J. Kyffers*

Director of the United States Patent and Trademark Office

# United States of America

United States Patent and Trademark Office



**Reg. No. 4,274,033**

**Registered Jan. 15, 2013**

**Int. Cls.: 1 and 5**

**TRADEMARK**

**PRINCIPAL REGISTER**

PHARM-ASSAY INTERNATIONAL LIMITED (UNITED KINGDOM LIMITED COMPANY (LTD.))  
5 BROOKFIELDS, PAVENHAM  
BEDFORD BEDFORDSHIRE, UNITED KINGDOM MK437QA

FOR: CHEMICAL ADDITIVES FOR USE IN THE MANUFACTURE OF PHARMACEUTICALS; THIOCYANATES FOR USE IN THE PRODUCTION OR MANUFACTURE OF PHARMACEUTICAL AND SANITARY PREPARATIONS, IN CLASS 1 (U.S. CLS. 1, 5, 6, 10, 26 AND 46).

FOR: PHARMACEUTICAL AND SANITARY PREPARATIONS FOR FIGHTING BACTERIAL AND VIRAL INFECTIONS; CHEMICAL PREPARATIONS, NAMELY, THIOCYANATE SOLUTIONS FOR PHARMACEUTICAL AND SANITARY PURPOSES, NAMELY, FOR FIGHTING BACTERIAL AND VIRAL INFECTIONS, IN CLASS 5 (U.S. CLS. 6, 18, 44, 46, 51 AND 52).

OWNER OF ERPN CMNTY TM OFC REG. NO. 009573858, DATED 6-10-2011, EXPIRES 12-3-2020.

THE COLOR(S) GREEN, GREY AND WHITE IS/ARE CLAIMED AS A FEATURE OF THE MARK.

THE MARK CONSISTS OF A GREY SHIELD OUTLINED IN WHITE AND HAS A GREEN BACKGROUND; THE SHIELD DESIGN IS OVER THE WORDS "1ST LINE", WHICH ARE ALSO IN GREY.

SER. NO. 85-207,183, FILED 12-29-2010.

JAMES GRIFFIN, EXAMINING ATTORNEY



*David J. Kybas*

Director of the United States Patent and Trademark Office

# United States of America

United States Patent and Trademark Office

# Can-C

**Reg. No. 4,274,034**

**Registered Jan. 15, 2013**

**Int. Cl.: 5**

**TRADEMARK**

**PRINCIPAL REGISTER**

PHARM-ASSAY INTERNATIONAL LIMITED (UNITED KINGDOM LIMITED COMPANY  
(LTD.))  
5 BROOKFIELDS, PAVENHAM  
BEDFORD BEDFORDSHIRE, UNITED KINGDOM MK437QA

FOR: NON-MEDICATED EYE DROPS AND NON-MEDICATED LUBRICATING SOLUTIONS  
FOR THE EYES; PHARMACEUTICAL PREPARATIONS FOR THE TREATMENT OF  
CATARACTS; MEDICATED EYE DROPS, IN CLASS 5 (U.S. CLS. 6, 18, 44, 46, 51 AND 52).

THE MARK CONSISTS OF STANDARD CHARACTERS WITHOUT CLAIM TO ANY PAR-  
TICULAR FONT, STYLE, SIZE, OR COLOR.

OWNER OF ERPN CMNTY TM OFC REG. NO. 009573775, DATED 5-13-2011, EXPIRES 12-  
3-2020.

SER. NO. 85-207,187, FILED 12-29-2010.

JAMES GRIFFIN, EXAMINING ATTORNEY



*David J. Kyffers*

Director of the United States Patent and Trademark Office

# United States of America

United States Patent and Trademark Office

## AGING MATTERS

**Reg. No. 4,274,035**

**Registered Jan. 15, 2013**

**Int. Cls.: 9 and 16**

**TRADEMARK**

**PRINCIPAL REGISTER**

PHARM-ASSAY INTERNATIONAL LIMITED (UNITED KINGDOM LIMITED COMPANY (LTD.))  
5 BROOKFIELDS, PAVENHAM  
BEDFORD BEDFORDSHIRE, UNITED KINGDOM MK437QA

FOR: COMPUTER SOFTWARE FOR CAPTURING, ANALYZING AND STORING MEDICAL AND BIOLOGICAL DATA; ELECTRONIC PUBLICATIONS RECORDED ON COMPUTER MEDIA IN THE NATURE OF JOURNALS, CATALOGUES, ARTICLES, BOOKS AND NEWSLETTERS IN THE FIELD OF PHARMACEUTICAL PRODUCTS, VITAMINS AND HEALTHCARE, IN CLASS 9 (U.S. CLS. 21, 23, 26, 36 AND 38).

FOR: PRINTED PUBLICATIONS IN THE NATURE OF JOURNALS, CATALOGUES, BOOKS AND NEWSLETTERS IN THE FIELD OF PHARMACEUTICAL PRODUCTS, VITAMINS AND HEALTHCARE, IN CLASS 16 (U.S. CLS. 2, 5, 22, 23, 29, 37, 38 AND 50).

THE MARK CONSISTS OF STANDARD CHARACTERS WITHOUT CLAIM TO ANY PARTICULAR FONT, STYLE, SIZE, OR COLOR.

OWNER OF UNITED KINGDOM REG. NO. 2566128, DATED 12-3-2010, EXPIRES 12-3-2020.

NO CLAIM IS MADE TO THE EXCLUSIVE RIGHT TO USE "AGING", APART FROM THE MARK AS SHOWN.

SER. NO. 85-207,188, FILED 12-29-2010.

JAMES GRIFFIN, EXAMINING ATTORNEY



*David J. Kyffers*

Director of the United States Patent and Trademark Office

# United States of America

United States Patent and Trademark Office

# MIKROTEC

**Reg. No. 4,274,036**

PDNS, LLC (KENTUCKY LIMITED LIABILITY COMPANY)  
20 LAYNESVILLE ROAD  
HAROLD, KY 41635

**Registered Jan. 15, 2013**

**Int. Cls.: 35 and 37**

FOR: RETAIL STORE SERVICES FEATURING SECURITY EQUIPMENT AND SYSTEMS,  
IN CLASS 35 (U.S. CLS. 100, 101 AND 102).

**SERVICE MARK**

FIRST USE 1-1-2008; IN COMMERCE 1-1-2008.

**PRINCIPAL REGISTER**

FOR: INSTALLATION, MAINTENANCE AND REPAIR OF SECURITY SYSTEMS, IN CLASS  
37 (U.S. CLS. 100, 103 AND 106).

FIRST USE 1-1-2008; IN COMMERCE 1-1-2008.

THE MARK CONSISTS OF STANDARD CHARACTERS WITHOUT CLAIM TO ANY PAR-  
TICULAR FONT, STYLE, SIZE, OR COLOR.

OWNER OF U.S. REG. NOS. 2,393,431, 2,393,432, AND 3,027,029.

SER. NO. 85-207,356, FILED 12-29-2010.

GRETТА YAO, EXAMINING ATTORNEY



*David J. Kyffers*

Director of the United States Patent and Trademark Office

# United States of America

United States Patent and Trademark Office

# BouX

— AVENUE —

**Reg. No. 4,274,037**

TWOFATHERS LIMITED (JERSEY LIMITED COMPANY (LTD.))  
12 CASTLE STREET

**Registered Jan. 15, 2013**

ST HELIER, JERSEY JE23RT

**Int. Cls.: 3, 4, 9, 14, 16,  
18, 20, 21, 24, 25, 28 and  
35**

FOR: COSMETICS, NON-MEDICATED TOILETRIES; NON-MEDICATED HAIR CARE PREPARATIONS; PERFUMES, EAU DE TOILETTE AND EAU DE COLOGNE, OTHER PERFUMED CREAMS; BUBBLE BATH, SHOWER GEL, SOAPS FOR PERSONAL USE, BODY CREAMS, BODY OILS; PERSONAL CARE PRODUCTS, NAMELY, AFTERSHAVE GELS AND LOTIONS, ANTIPERSPIRANT, ARTIFICIAL NAILS, ASTRINGENT FOR THE FACE FOR COSMETIC PURPOSES, ASTRINGENT FOR THE SKIN FOR COSMETIC PURPOSES, BATH OIL, BODY OIL, BODY PAINT, BATH BEADS, BATH SALTS, BLUSH, BODY GLITTER, NON-MEDICATED SKIN CARE PREPARATIONS IN THE NATURE OF BODY MIST, BODY CLEANSER, BODY WASH, BODY SCRUB, BODY GEL IN THE NATURE OF SHOWER GELS, BODY MOUSSE IN THE NATURE OF SKIN FACIAL MOUSSE, BODY POLISH, BODY EXFOLIANT FOR HAIR AND SKIN, BODY BRONZERS, BUBBLE BATH, CLEANSER FOR THE FACE, COLOGNE, COTTON SWABS FOR COSMETIC PURPOSES, CREAMS FOR THE BODY, CREAM FOR CUTICLES, CREAM FOR THE EYES, CREAM FOR THE FACE, CREAM FOR THE HANDS, NON-MEDICATED CREAM FOR THE FEET, DEODORANT FOR PERSONAL USE, EXFOLIATORS FOR SKIN, EYE GELS, EYE MAKEUP PENCILS, EYE SHADOW, EYELINER, NON-MEDICATED FACE MIST, FACE SCRUB, FACE TONER, FOUNDATION, FRAGRANT BODY SPLASH, NON-MEDICATED FRAGRANT BODY MIST, HAIR CONDITIONER, HAIR DYES, HAIR GLITTER, HAIR RINSES, HAIR SHAMPOO, HAIR REMOVING CREAMS, HAIR SPRAY, HAIR STYLING GEL, HAIR STYLING MOUSSE, LOTION FOR THE BODY, LOTION FOR THE HANDS, LOTION FOR THE FACE, NON-MEDICATED LOTION FOR THE FEET, LIP BALM, LIP GLOSS, LIP MAKEUP PENCILS, LIPSTICK, LIQUID EYE SHADOW, LIP LINER, LIP PENCIL, MAKEUP FOR THE BODY, MAKEUP FOR THE FACE, MAKEUP REMOVER, MASCARA, MASSAGE CREAM, MASSAGE OILS, NAIL CORRECTOR PENS PRE-FILLED WITH NAIL POLISH, NAIL POLISH, NAIL POLISH REMOVER, NON-MEDICATED BLEMISH STICK FOR COSMETIC PURPOSES, NON-MEDICATED CLEANSER FOR THE FACE, NON-MEDICATED BODY SPRAY, NON-MEDICATED MASSAGE OINTMENT, OIL BLOTTING SHEETS FOR THE SKIN FOR COSMETIC USE, PERFUME, SHAMPOO, POWDER FOR THE BODY, POWDER FOR THE FACE, NON-MEDICATED POWDER FOR THE FEET, PUMICE STONES FOR PERSONAL USE, ROUGE, SHAVING CREAM, SALT SCRUBS FOR THE SKIN, SHOWER GEL AND CREAM, SKIN BRONZING CREAM, SOAP FOR THE BODY, SOAP FOR THE FACE, SOAP FOR THE HANDS, SUN BLOCK FOR THE BODY AND FACE, SUNTAN LOTION FOR THE BODY, SUNTAN LOTION FOR THE FACE, SUNLESS TANNING LOTION FOR

**TRADEMARK**

**SERVICE MARK**

**PRINCIPAL REGISTER**



*David J. Kypas*

Director of the United States Patent and Trademark Office

**Reg. No. 4,274,037** THE BODY, SUNLESS TANNING LOTION FOR THE FACE, PRE SUN TANNING LOTION FOR THE BODY, PRE-SUN TANNING LOTION FOR THE FACE, POST-SUN TANNING LOTION FOR THE FACE, POST-SUN TANNING LOTION FOR THE BODY, TALCUM POWDER; NAIL ORANGE STICKS, NAMELY, NAIL STICKS FOR USE IN MANICURE OR PEDICURE, IN CLASS 3 (U.S. CLS. 1, 4, 6, 50, 51 AND 52).

FOR: CANDLES, FRAGRANCED AND SCENTED CANDLES; ILLUMINANTS IN THE NATURE OF CANDLES, TAPERS, NIGHTLIGHTS BEING CANDLES, WICKS FOR CANDLES AND LAMPS AND LAMP OIL, IN CLASS 4 (U.S. CLS. 1, 6 AND 15).

FOR: SUNGLASSES AND SPECTACLES; FRAMES AND CASES FOR SUNGLASSES AND SPECTACLES, IN CLASS 9 (U.S. CLS. 21, 23, 26, 36 AND 38).

FOR: JEWELLERY AND IMITATION JEWELLERY; BROOCHES; BRACELETS; DECORATIVE BOXES MADE OF PRECIOUS METALS OR COATED THEREWITH; JEWEL CASES OF PRECIOUS METAL; CLOCKS AND WATCHES; STOP-WATCHES; WATCH STRAPS AND WATCH BRACELETS; HAT PINS IN THE NATURE OF JEWELRY PINS FOR USE ON HATS, BADGES OF PRECIOUS METALS, LAPEL PINS, CUFFLINKS, TIE CLIPS, TIE PINS, TIE SLIDES FOR BOLO TIES AND TIE BARS; COLLAR AND SHIRT STUDS; SCARF RINGS MADE OF PRECIOUS METAL; KEY RINGS OF PRECIOUS METAL; STRUCTURAL PARTS AND FITTINGS FOR ALL THE AFORESAID GOODS , IN CLASS 14 (U.S. CLS. 2, 27, 28 AND 50).

FOR: PAPER, CARDBOARD AND GOODS MADE FROM THESE MATERIALS, NOT INCLUDED IN OTHER CLASSES, NAMELY, TISSUE PAPER, WRAPPING PAPER, STORAGE BOXES, HAT BOXES; PRINTED MATTER, NAMELY, PHOTOGRAPHS, INFORMATION CARDS IN THE FIELD OF CLOTHING, FASHION, HAIRSTYLE, SCENTS, CANDLES, JEWELLERY, DESIGN, INTERIOR DESIGN, FURNITURE, TOILETRIES AND COSMETICS, LIFESTYLE, RECIPES, AND GARDENING; STATIONERY; ADHESIVES FOR STATIONERY; PLASTIC MATERIALS FOR PACKAGING NOT INCLUDED IN OTHER CLASSES, NAMELY, PLASTIC BAGS AND PLASTIC BUBBLE PACKS, PLASTIC COVERS FOR BOOKS; ENVELOPES; PRINTED PUBLICATIONS, NAMELY, JOURNALS, PERIODICALS, INFORMATIONAL BROCHURES IN THE FIELD OF CLOTHING, FASHION, HAIRSTYLE, SCENTS, CANDLES, JEWELLERY, DESIGN, INTERIOR DESIGN, FURNITURE, TOILETRIES AND COSMETICS, LIFESTYLE, CELEBRITY GOSSIP, RECIPES, GARDENING; CALENDARS; CATALOGUES IN THE FIELD OF CLOTHING, FASHION, HAIRSTYLE, SCENTS, CANDLES, JEWELLERY, DESIGN, INTERIOR DESIGN, FURNITURE, TOILETRIES AND COSMETICS, LIFESTYLE, CELEBRITY GOSSIP, RECIPES, GARDENING; DIARIES; PAPER TAGS AND LABELS; PHOTOGRAPH ALBUMS; POSTCARDS; GREETING CARDS; WRAPPING AND PACKAGING PAPER; NOTEBOOKS, BOOKS IN THE FIELD OF CLOTHING, FASHION, HAIRSTYLE, SCENTS, CANDLES, JEWELLERY, DESIGN, INTERIOR DESIGN, FURNITURE, TOILETRIES AND COSMETICS, LIFESTYLE, CELEBRITY GOSSIP, RECIPES, GARDENING; PAPER BOOK COVERS; BOOK MARKS; ART PRINTS; PENS, PENCILS; CASES FOR PENS OR PENCILS; CHECK BOOK HOLDERS , IN CLASS 16 (U.S. CLS. 2, 5, 22, 23, 29, 37, 38 AND 50).

FOR: TRUNKS AND TRAVELLING BAGS; LUGGAGE, TRAVEL BAGS, LEISURE CARRY-ALL BAGS, SPORTS BAGS, HOLDALLS, TRAVEL CASES, RUCKSACKS, HANDBAGS; TOILETRY AND COSMETIC BAGS SOLD EMPTY; TIE CASES; BRIEFCASES; BELTS, NAMELY, LEATHER SHOULDER BELTS; WALLETS, CREDIT CARD HOLDERS, PURSES; WALKING STICKS, UMBRELLAS AND PARASOLS, IN CLASS 18 (U.S. CLS. 1, 2, 3, 22 AND 41).

FOR: FURNITURE; HOUSEHOLD FURNITURE; MIRRORS AND PICTURE FRAMES; PLASTIC SHIPPING AND STORAGE BOXES; SEAT CUSHIONS; DECORATIVE SCATTER CUSHIONS AND REMOVABLE TRIMS SOLD TOGETHER WITH CUSHIONS; CUSHIONS; ARTICLES MADE FROM LEATHER OR IMITATION LEATHER, NAMELY, LEATHER OR



**Reg. No. 4,274,037** IMITATION LEATHER PICTURE FRAMES; PICTURE FRAMES; MIRRORS, IN CLASS 20 (U.S. CLS. 2, 13, 22, 25, 32 AND 50).

FOR: GLASSWARE; CROCKERY, NAMELY, PLATES, DISHES, SAUCERS, DRINKING CUPS, MUGS; PLATES; TABLEWARE, NAMELY, SERVING FORKS, SERVING SPOONS; CERAMIC FIGURINES, PORCELAIN MUGS, EARTHENWARE MUGS AND ENAMELWARE MUGS AND PLATES; DECORATIVE ARTICLES, NAMELY, GLASS ORNAMENTS, FIGURINES, MIRROR BALLS, CHINA ORNAMENTS, FIGURINES OF PORCELAIN, TERRA-COTTA AND GLASS, FLOWER-POT COVERS, NOT OF PAPER, HOLDERS FOR FLOWERS AND PLANTS, TOILET PAPER HOLDERS, STATUETTES OF PORCELAIN, TERRA-COTTA, AND GLASS, WORKS OF ART OF PORCELAIN, TERRA-COTTA, AND GLASS, CRYSTAL GLASSWARE; COOKWARE, NAMELY, POTS AND PANS; HOUSEHOLD UTENSILS, NAMELY, CANDLE EXTINGUISHERS, SALT AND PEPPER HOLDERS, MUSTARD JARS, CRUET SETS, GRATERS, SIEVES, SPATULAS, STRAINERS, TURNERS, POT AND PAN SCRAPERS, ROLLING PINS, WHISKS, SKIMMERS AND CONTAINERS FOR HOUSEHOLD UTENSILS; SOAP DISHES AND SOAP DISPENSERS; TOILET TISSUE HOLDERS; HAIR BRUSHES, COMBS AND SCRUB SPONGES; BOWLS, VASES AND PLANT POTS; CANDLESTICKS AND CANDLEHOLDERS; LAUNDRY BASKETS, IN CLASS 21 (U.S. CLS. 2, 13, 23, 29, 30, 33, 40 AND 50).

FOR: TEXTILES AND TEXTILE GOODS, NAMELY, THROWS FOR THE BED, THROWS FOR SOFAS, CURTAINS, AFGHANS, BARBECUE MITTS, BATH GLOVES, BATH LINEN, BATH SHEETS, BATH TOWELS, BEACH TOWELS, WALL HANGINGS OF TEXTILE, CASHMERE BLANKETS, BLANKET THROWS, CURTAIN TIE-BACKS IN THE NATURE OF TEXTILE CURTAIN HOLDERS, DISH CLOTHS, DRAPERY, FABRIC VALANCES, HANDKERCHIEFS, KITCHEN TOWELS; BED AND TEXTILE AND PLASTIC TABLE COVERS; HOUSEHOLD LINEN; LINEN CLOTH; BED LINEN; TABLE LINEN; CURTAINS; PILLOW SHAMS; PILLOW CASES; BED SHEETS; TOWELS; EIDERDOWNS; DUVETS; COVERS FOR DUVETS AND EIDERDOWNS; QUILTS; TEXTILE NAPKINS; TEXTILE SERVIETTES; FACE TOWELS OF TEXTILE; FLANNELS; TISSUES OF TEXTILE FOR REMOVING MAKE-UP; CUSHION COVERS, IN CLASS 24 (U.S. CLS. 42 AND 50).

FOR: FOOTWEAR; HEADGEAR IN THE NATURE OF HATS AND CAPS, SHOWER CAPS; UNDERWEAR, LINGERIE, NIGHTWEAR, LEISUREWEAR IN THE NATURE OF LEISURE SHOES AND SUITS; SLEEP SHIRTS, SLEEP PANTS, SLEEP TOPS, PYJAMAS, PAJAMAS SETS, BABY DOLL NIGHTDRESSES, NIGHTDRESSES; KIMONOS, ROBES, GOWNS AND WRAPS; T-SHIRTS; SWEATSHIRTS, CARDIGANS AND JACKETS, ALL WITH ATTACHED HOODS; JACKETS, TOPS, PANTS, CAPRI PANTS, SARONGS; CAMISOLES, CHEMISES, SLIPS, BOXER SHORTS; FOOTWEAR, SLIPPERS, BOOTIES, SOCKS; HEADGEAR, NAMELY, HATS; EYE MASKS IN THE NATURE OF SLEEP MASKS; CLOTHING, NAMELY, BRAS, SPORT BRAS, BRALETS, BUSTIERS, BODY SUITS, BRA ACCESSORIES, NAMELY, BRA STRAPS, BRA EXTENDERS IN THE NATURE OF REMOVABLE BREAST ENHANCER PADS USED IN A BRA; REMOVABLE BREAST ENHANCER BRA PADS, SELF-ADHESIVE SUPPORT TAPES FOR WEAR, NIPPLE COVERS IN THE NATURE OF PASTIES; SLIPS, PANTIES, G-STRINGS, THONGS, BOYLEGS IN THE NATURE OF BOY SHORTS, BIKINIS, BRIEFS, BOXER SHORTS, GARTER BELTS, GIRDLES, SARONGS, STOCKINGS, HOSIERY, PANTYHOSE, SOCKS, TIGHTS, LEOTARDS, LEGGINGS, CAMISOLES, LINGERIE, NEGLIGES, PYJAMAS, NIGHTGOWNS, BATHROBES, CHEMISES, TEDDIES, SLEEP SHIRTS, SLEEP PANTS, BABY DOLL PYJAMAS, CAPRI SETS, BOXER SETS, KIMONOS, T SHIRTS, HALTER TOPS, TANK TOPS, CROP TOPS, SHIRTS, PANTS, SHORTS, SWEATERS, CAPRIS, SKIRTS, DRESSES, BLAZERS, BLOUSES, JACKETS, COATS, SLACKS, SUITS, JEANS, VESTS, SWEATPANTS, SWEATSHIRTS, SWEAT SHORTS, SWEAT SUITS, JOGGING SUITS, UNDERPANTS, UNDERSHIRTS, UNDERWEAR, SWIMWEAR, BEACH COVER-UPS, HEADBANDS, GLOVES, SCARVES, HATS, CAPS, TIES AND BELTS; LADIES FOOTWEAR, NAMELY, SHOES, SLIPPERS, SANDALS, BOOTIES, WORKOUT SHOES AND RUNNING SHOES; EYESHADES; BELTS, IN CLASS 25 (U.S. CLS. 22 AND 39).

**Reg. No. 4,274,037** FOR: TOYS, GAMES AND PLAYTHINGS, NAMELY, PLUSH TOYS, TEDDY BEARS, BOARD GAMES; NOVELTIES IN THE FORM OF SOUVENIRS, NAMELY, PARTY FAVORS, NAMELY, SMALL TOYS, CRACKERS AND NOISEMAKERS, CHRISTMAS TREE ORNAMENTS, PIÑATAS, SNOW GLOBES, THEATRICAL MASKS, TOY MASKS; PLAYING CARDS, IN CLASS 28 (U.S. CLS. 22, 23, 38 AND 50).

FOR: ADVERTISING; BUSINESS MANAGEMENT; BUSINESS ADMINISTRATION; OFFICE FUNCTIONS; ADVERTISING AND MARKETING; ADVERTISING AND MARKETING SERVICES; RETAIL STORE SERVICES AND ONLINE RETAIL STORE SERVICES FEATURING SOAPS, PERFUMES, ESSENTIAL OILS, COSMETICS, HAIR LOTIONS, PERSONAL CARE PRODUCTS, CANDLES, SUNGLASSES AND SPECTACLES, FRAMES AND CASES FOR SUNGLASSES AND SPECTACLES, EYESHADES, JEWELLERY, BROOCHES, BRACELETS, WATCHES, HAT PINS, BADGES, LAPEL PINS, CUFFLINKS, TIE CLIPS, TIE PINS, TIE SLIDES AND TIE BARS, COLLAR AND SHIRT STUDS, SCARF RINGS, KEY RINGS, PRINTED MATTER, PHOTOGRAPHS, STATIONERY, ADHESIVES FOR STATIONERY, PRINTED PUBLICATIONS, JOURNALS, BROCHURES, CALENDARS, CATALOGUES, DIARIES, TAGS AND LABELS, NOTEBOOKS, BOOKS, BOOK COVERS, BOOK MARKS, PRINTS, PENS, PENCILS, CASES FOR PENS OR PENCILS, BAGS, LUGGAGE, TRAVEL BAGS, LEISURE BAGS, SPORTS BAGS, HOLDALLS, CASES, RUCKSACKS, HANDBAGS, TOILETRY AND COSMETIC BAGS, TIE CASES, BRIEFCASES, BELTS, WALLETS, CARD HOLDERS, CHEQUE BOOK HOLDERS, PURSES, WALKING STICKS, UMBRELLAS AND PARASOLS, FURNITURE, HOUSEHOLD FURNITURE, MIRRORS AND PICTURE FRAMES, LAUNDRY BASKETS, STORAGE BOXES, CUSHIONS, GLASSWARE, CROCKERY, MUGS, PLATES, TABLEWARE, CERAMICS, PORCELAIN, EARTHENWARE AND ENAMELWARE, COOKWARE, HOUSEHOLD UTENSILS AND CONTAINERS, SOAP DISHES AND SOAP DISPENSERS, TISSUE HOLDERS, BRUSHES, COMBS AND SPONGES, BOWLS, VASES AND PLANT POTS, CANDLESTICKS AND CANDLEHOLDERS, BED AND TABLE COVERS, HOUSEHOLD LINEN, LINEN CLOTH, BED LINEN, TABLE LINEN, CUSHIONS, PILLOW SHAMS, PILLOW CASES, SHEETS, EIDERDOWNS, DUVETS, COVERS FOR DUVETS AND EIDERDOWNS, QUILTS, TISSUES OF TEXTILE FOR REMOVING MAKE-UP, CLOTHING, FOOTWEAR, HEADGEAR, UNDERWEAR, LINGERIE, NIGHTWEAR, LEISUREWEAR, SLEEP SHIRTS, SLEEP PANTS, SLEEP TOPS, PYJAMAS, PAJAMAS SETS, BABY DOLL NIGHTDRESSES, NIGHTDRESSES, KIMONOS, ROBES, GOWNS AND WRAPS, T-SHIRTS; SWEATSHIRTS, CARDIGANS AND JACKETS, ALL WITH ATTACHED HOODS, JACKETS, TOPS, PANTS, CAPRI PANTS, SARONGS, CAMISOLES, CHEMISES, SLIPS, BOXER SHORTS, FOOTWEAR, SLIPPERS, BOOTIES, SOCKS, HEADGEAR, HAT, EYE MASKS, BRAS, SPORT BRAS, BRALETS, BUSTIERS, BODY SUITS, BRA STRAPS, BRA EXTENDERS, BRA PADS, SELF-ADHESIVE SUPPORT TAPES FOR WEAR, NIPPLE COVERS, SLIPS, PANTIES, G-STRINGS, THONGS, BOYLEGS, BIKINIS, BRIEFS, BOXER SHORTS, GARTER BELTS, GIRDLES, SARONGS, STOCKINGS, HOSIERY, PANTYHOSE, SOCKS, TIGHTS, LEOTARDS, LEGGINGS, CAMISOLES, LINGERIE, NEGLIGEEES, PYJAMAS, NIGHTGOWNS, BATH-ROBES, CHEMISES, TEDDIES, SLEEP SHIRTS, SLEEP PANTS, BABY DOLLS, CAPRI SETS, BOXER SETS, KIMONOS, T SHIRTS, HALTER TOPS, TANK TOPS, CROP TOPS, SHIRTS, PANTS, SHORTS, SWEATERS, CAPRIS, SKIRTS, DRESSES, BLAZERS, BLOUSES, JACKETS, COATS, SLACKS, SUITS, JEANS, VESTS, SWEATPANTS, SWEATSHIRTS, SWEAT SHORTS, SWEAT SUITS, JOGGING SUITS, UNDERPANTS, UNDERSHIRTS, UNDERWEAR, SWIMWEAR, BEACH COVER-UPS, HEADBANDS, GLOVES, SCARVES, HATS, CAPS, TIES AND BELTS, SHOES, SLIPPERS, SANDALS, BOOTIES, WORKOUT SHOES AND RUNNING SHOES, TOYS, GAMES AND PLAYTHINGS, PLAYING CARDS; THE BRINGING TOGETHER FOR THE BENEFIT OF OTHERS, OF A VARIETY OF GOODS ENABLING CUSTOMERS TO CONVENIENTLY VIEW AND PURCHASE THOSE GOODS IN A RETAIL STORE, FROM AN INTERNET WEBSITE, FROM A MAIL ORDER CATALOGUE OR BY MEANS OF TELECOMMUNICATIONS, WHERE THE VARIETY OF GOODS FEATURES SOAPS, PERFUMES, ESSENTIAL OILS, COSMETICS, HAIR LOTIONS, PERSONAL CARE PRODUCTS, CANDLES, SUNGLASSES AND SPECTACLES, FRAMES AND CASES FOR SUNGLASSES AND SPECTACLES, EYESHADES, JEWELLERY, BROOCHES, BRACELETS, WATCHES, HAT PINS, BADGES, LAPEL PINS, CUFFLINKS, TIE CLIPS, TIE PINS, TIE SLIDES AND TIE BARS, COLLAR AND SHIRT STUDS, SCARF RINGS, KEY RINGS, PRINTED MATTER,

**Reg. No. 4,274,037** PHOTOGRAPHS, STATIONERY, ADHESIVES FOR STATIONERY, PRINTED PUBLICATIONS, JOURNALS, BROCHURES, CALENDARS, CATALOGUES, DIARIES, TAGS AND LABELS, NOTEBOOKS, BOOKS, BOOK COVERS, BOOK MARKS, PRINTS, PENS, PENCILS, CASES FOR PENS OR PENCILS, BAGS, LUGGAGE, TRAVEL BAGS, LEISURE BAGS, SPORTS BAGS, HOLDALLS, CASES, RUCKSACKS, HANDBAGS, TOILETRY AND COSMETIC BAGS, TIE CASES, BRIEFCASES, BELTS, WALLETS, CARD HOLDERS, CHEQUE BOOK HOLDERS, PURSES, WALKING STICKS, UMBRELLAS AND PARASOLS, FURNITURE, HOUSEHOLD FURNITURE, MIRRORS AND PICTURE FRAMES, LAUNDRY BASKETS, STORAGE BOXES, CUSHIONS, GLASSWARE, CROCKERY, MUGS, PLATES, TABLEWARE, CERAMICS, PORCELAIN, EARTHENWARE AND ENAMELWARE, COOKWARE, HOUSEHOLD UTENSILS AND CONTAINERS, SOAP DISHES AND SOAP DISPENSERS, TISSUE HOLDERS, BRUSHES, COMBS AND SPONGES, BOWLS, VASES AND PLANT POTS, CANDLESTICKS AND CANDLEHOLDERS, BED AND TABLE COVERS, HOUSEHOLD LINEN, LINEN CLOTH, BED LINEN, TABLE LINEN, CUSHIONS, CURTAINS AND RUGS, CARPETS, TRAVELLING RUGS, BATH MATS, NON-TEXTILE WALL HANGINGS, WALLPAPER, PILLOW SHAMS, PILLOW CASES, SHEETS, EIDERDOWNS, DUVETS, COVERS FOR DUVETS AND EIDERDOWNS, QUILTS, TISSUES OF TEXTILE FOR REMOVING MAKE-UP, CLOTHING, FOOTWEAR, HEADGEAR, UNDERWEAR, LINGERIE, NIGHTWEAR, LEISUREWEAR, SLEEP SHIRTS, SLEEP PANTS, SLEEP TOPS, PYJAMAS, PAJAMAS SETS, BABY DOLL NIGHTDRESSES, NIGHTDRESSES, KIMONOS, ROBES, GOWNS AND WRAPS, T-SHIRTS; SWEATSHIRTS, CARDIGANS AND JACKETS, ALL WITH ATTACHED HOODS, JACKETS, TOPS, PANTS, CAPRI PANTS, SARONGS, CAMISOLES, CHEMISES, SLIPS, BOXER SHORTS, FOOTWEAR, SLIPPERS, BOOTIES, SOCKS, HEADGEAR, HAT, EYE MASKS, BRAS, SPORT BRAS, BRALETS, BUSTIERS, BODY SUITS, BRA STRAPS, BRA EXTENDERS, BRA PADS, SELF-ADHESIVE SUPPORT TAPES FOR WEAR, NIPPLE COVERS, SLIPS, PANTIES, G-STRINGS, THONGS, BOYLEGS, BIKINIS, BRIEFS, BOXER SHORTS, GARTER BELTS, GIRDLES, SARONGS, STOCKINGS, HOSIERY, PANTYHOSE, SOCKS, TIGHTS, LEOTARDS, LEGGINGS, CAMISOLES, LINGERIE, NEGLIGEEES, PYJAMAS, NIGHTGOWNS, BATHROBES, CHEMISES, TEDDIES, SLEEP SHIRTS, SLEEP PANTS, BABY DOLLS, CAPRI SETS, BOXER SETS, KIMONOS, T SHIRTS, HALTER TOPS, TANK TOPS, CROP TOPS, SHIRTS, PANTS, SHORTS, SWEATERS, CAPRIS, SKIRTS, DRESSES, BLAZERS, BLOUSES, JACKETS, COATS, SLACKS, SUITS, JEANS, VESTS, SWEATPANTS, SWEATSHIRTS, SWEAT SHORTS, SWEAT SUITS, JOGGING SUITS, UNDERPANTS, UNDERSHIRTS, UNDERWEAR, SWIMWEAR, BEACH COVER-UPS, HEADBANDS, GLOVES, SCARVES, HATS, CAPS, TIES AND BELTS, SHOES, SLIPPERS, SANDALS, BOOTIES, WORKOUT SHOES AND RUNNING SHOES, TOYS, GAMES AND PLAYTHINGS, PLAYING CARDS; ADVERTISING AND MARKETING; ADVERTISING AND MARKETING SERVICES, IN CLASS 35 (U.S. CLS. 100, 101 AND 102).

PRIORITY CLAIMED UNDER SEC. 44(D) ON UNITED KINGDOM APPLICATION NO. 2559575, FILED 9-24-2010, REG. NO. 2559575, DATED 12-31-2010, EXPIRES 9-24-2020.

THE COLOR(S) BLACK AND PINK IS/ARE CLAIMED AS A FEATURE OF THE MARK.

OWNER OF ERPN CMNTY TM OFC REG. NO. 010034056, DATED 5-27-2011, EXPIRES 9-24-2020.

THE MARK CONSISTS OF THE WORDS "BOUX AVENUE" IN A STYLIZED FORMAT. THE WORD "BOUX" APPEARS IN A LARGER SIZE FONT DIRECTLY ABOVE THE WORD "AVENUE". THERE ARE HORIZONTAL LINES BOTH PRECEDING AND FOLLOWING THE WORD AVENUE. THE LETTERS "BOU" IN THE WORD ":BOUX", THE WORD "AVENUE", AND THE HORIZONTAL LINES ARE THE COLOR BLACK. THE LETTER "X" IN THE WORD "BOUX" IS THE COLOR PINK.

SER. NO. 85-207,905, FILED 12-30-2010.

LAURIE MAYES, EXAMINING ATTORNEY

# United States of America

United States Patent and Trademark Office



**Reg. No. 4,274,038**

**Registered Jan. 15, 2013**

**Int. Cl.: 32**

**TRADEMARK**

**PRINCIPAL REGISTER**

SPB LLC (WISCONSIN LIMITED LIABILITY COMPANY)  
2617 WATER STREET  
STEVENS POINT, WI 54481

FOR: ALE, IN CLASS 32 (U.S. CLS. 45, 46 AND 48).

FIRST USE 2-24-2010; IN COMMERCE 2-24-2010.

OWNER OF U.S. REG. NOS. 2,805,011, 2,829,521, AND 2,912,594.

THE COLOR(S) BLACK, WHITE, GOLD AND RED IS/ARE CLAIMED AS A FEATURE OF THE MARK.

NO CLAIM IS MADE TO THE EXCLUSIVE RIGHT TO USE "BLACK ALE", APART FROM THE MARK AS SHOWN.

THE MARK CONSISTS OF A BLACK RECTANGLE WITH GOLD WHEAT SHAFTS IN THE CORNERS; IN THE MIDDLE OF THE UPPER PORTION OF THE RECTANGLE IS A CIRCULAR ELEMENT INCORPORATING BLACK TREES BESIDE A WHITE RIVER, ALL INSIDE A RED CIRCLE; IMMEDIATELY BELOW THIS IS THE WORD "POINT" IN WHITE LETTERS; UNDERNEATH THIS IS A RED COLORED BANNER. IMMEDIATELY BELOW THIS ARE THE WORDS "2012 BLACK ALE" IN WHITE LETTERS; A REPRESENTATION OF A MAYAN CALENDAR IN BLACK WITH GOLD HIGHLIGHTS IS POSITIONED BEHIND THE WORDS.

SER. NO. 85-212,679, FILED 1-7-2011.

HENRY S. ZAK, EXAMINING ATTORNEY



*David J. Kyffers*

Director of the United States Patent and Trademark Office

# United States of America

United States Patent and Trademark Office



FancyRose  
فانسي روز

**Reg. No. 4,274,039**

**Registered Jan. 15, 2013**

**Int. Cl.: 14**

**TRADEMARK**

**PRINCIPAL REGISTER**

ABDUL HAFIZ SALAHI FACTORY FOR GOLD & JEWELLERY (SAUDI ARABIA CORPORATION)  
P. O. BOX 7101  
JEDDAH, SAUDI ARABIA 22235

FOR: PRECIOUS METALS AND ALLOYS THEREOF; ITEMS MADE OF PRECIOUS METALS AND THEIR ALLOYS, NAMELY, CHARMS, WATCHES, BADGES, BASKETS, BOLO TIES WITH PRECIOUS METAL TIPS, BOTTLE CAPS, BOXES, BUSTS, BRACELETS, CUPS, CUFF LINKS, DECORATIVE BOXES, DRAWER PULLS, FANCY KEYRINGS, FIGURES, FIGURINES, GRAVE MARKERS, HAT ORNAMENTS, HOLIDAY ORNAMENTS, IDENTITY PLATES, INGOTS, INSIGNIAS, JEWEL CASES, JEWELRY CASES, JEWELRY CHAIN, JEWELRY CASKETS, KEY CHAINS, KEY HOLDERS, KEY RINGS, MODEL FIGURES, ORNAMENT PINS, ORNAMENTS, METAL KNOBS, METAL PULLS, METAL TROPHIES, METAL TROPHY COLUMNS, SCULPTURES, SHEET METAL, SHEETS, STATUETTES, THREADS, TIE CLIPS, TIE PINS, TOMBSTONES, TROPHIES, WALL PLAQUES, WORKS OF ART; JEWELRY, PRECIOUS STONES; HOROLOGICAL AND CHRONOMETRIC INSTRUMENTS, IN CLASS 14 (U.S. CLS. 2, 27, 28 AND 50).

OWNER OF SAUDI ARABIA REG. NO. 1343/89, DATED 2-13-2011, EXPIRES 10-26-2020.

THE COLOR(S) PURPLE AND WHITE IS/ARE CLAIMED AS A FEATURE OF THE MARK.

THE NON-LATIN CHARACTERS IN THE MARK TRANSLITERATE TO "FANCY ROSE" AND THIS MEANS "FANCY ROSE" IN ENGLISH.

NO CLAIM IS MADE TO THE EXCLUSIVE RIGHT TO USE "FANCY ROSE", APART FROM THE MARK AS SHOWN.

THE MARK CONSISTS OF PURPLE, STYLIZED LETTERS "FANCYROSE" ABOVE ARABIC CHARACTERS, ALSO APPEARING IN PURPLE. WHITE, STYLIZED LETTERS "F" AND "R" ARE IN A PURPLE RECTANGLE TO THE LEFT OF THE WORDS "FANCYROSE" AND THE ARABIC CHARACTERS.

SER. NO. 85-215,076, FILED 1-11-2011.

MARK SPARACINO, EXAMINING ATTORNEY



*David J. Kappas*

Director of the United States Patent and Trademark Office

# United States of America

United States Patent and Trademark Office

## ALLIANCE CORPORATION

**Reg. No. 4,274,040**

**Registered Jan. 15, 2013**

**Int. Cls.: 35, 37 and 42**

**SERVICE MARK**

**PRINCIPAL REGISTER**

ALLIANCE CORPORATION (CANADA CORPORATION)  
2395 MEADOWPINE BLVD  
MISSISSAUGA ONTARIO, CANADA L5N7W6

FOR: (BASED ON USE IN COMMERCE) (BASED ON 44(E)) DISTRIBUTORSHIP SERVICES FEATURING PRODUCTS FOR AC SURGE SUPPRESSION, DIRECT CURRENT SURGE PROTECTION, INTEGRATED LOAD CENTERS, RADIO FREQUENCY CONDITIONING, COMBINERS/DIVIDERS BASE STATIONS, PRESSURIZATION FOR TRANSMISSION LINES, WAVEGUIDE, GROUNDING AND ENTRY PORTS; DISTRIBUTORSHIP SERVICES FEATURING PRODUCTS, NAMELY, DATA, TOWER MOUNT ANTENNAS, FILTERS, POWER AMPLIFIERS, REPEATERS, EARTH STATION ANTENNAS, IN BUILDING ANTENNAS, RADAR ANTENNAS, MICROWAVE ANTENNAS, SPLITTERS, COUPLERS, TERMINATIONS, STEEL PRODUCTS, TEST EQUIPMENT FOR ANTENNAS, CABLES, SITE ANALYZERS, CABLE MONITORING EQUIPMENT, CALIBRATION KITS, BATTERIES, BLOWER KITS, RADIO FREQUENCY CABLES, CASES, CONNECTORS AND ADAPTERS, COUPLING KITS, DUCTING, RACK MOUNTING KITS, TEST CABLES, LOADS, SURGE ARRESTORS, POWER SYSTEMS FOR STANDBY, MODULAR GOODS, BI-FUEL, TRANSFER SWITCHES, GENERATOR CONTROLS AND GENERATORS; BUSINESS CONSULTING SERVICES FOR NETWORK IMPLEMENTATIONS; PROVIDING SALES SUPPORT SERVICES FOR THE BUSINESSES OF OTHERS; CUSTOM LABELING AND PACKAGING SERVICES FOR OTHERS ALL FOR USE IN WIRELESS TELECOMMUNICATION SERVICES, IN CLASS 35 (U.S. CLS. 100, 101 AND 102).

FIRST USE 6-11-2002; IN COMMERCE 6-11-2002.



*David J. Kyjars*

Director of the United States Patent and Trademark Office

FOR: (BASED ON USE IN COMMERCE) INSTALLATION, MAINTENANCE AND REPAIR SERVICES RELATING TO AC SURGE SUPPRESSION, DIRECT CURRENT SURGE PROTECTION, INTEGRATED LOAD CENTERS, RADIO FREQUENCY CONDITIONING, COMBINERS/DIVIDERS BASE STATIONS, PRESSURIZATION FOR TRANSMISSION LINES, WAVEGUIDE, GROUNDING AND ENTRY PORTS, DATA, TOWER MOUNT ANTENNAS, FILTERS, POWER AMPLIFIERS, REPEATERS, EARTH STATION ANTENNAS, IN BUILDING ANTENNAS, RADAR ANTENNAS, MICROWAVE ANTENNAS, SPLITTERS, COUPLERS, TERMINATIONS, STEEL PRODUCTS, TEST EQUIPMENT FOR ANTENNAS, CABLES, SITE ANALYZERS, CABLE MONITORING EQUIPMENT, CALIBRATION KITS, BATTERIES, BLOWER KITS, RADIO FREQUENCY CABLES, CASES, CONNECTORS AND ADAPTERS, COUPLING KITS, DUCTING, RACK MOUNTING KITS, TEST CABLES, LOADS, SURGE ARRESTORS, POWER SYSTEMS FOR STANDBY, MODULAR GOODS, BI-FUEL, TRANSFER

**Reg. No. 4,274,040** SWITCHES, GENERATOR CONTROLS AND GENERATORS, CABLE CUTTING, KIT ASSEMBLIES AND JUMPER ASSEMBLIES ALL FOR USE IN WIRELESS TELECOMMUNICATION SERVICES, IN CLASS 37 (U.S. CLS. 100, 103 AND 106).

FIRST USE 6-11-2002; IN COMMERCE 6-11-2002.

FOR: (BASED ON USE IN COMMERCE) (BASED ON 44(E)) COMPUTER NETWORK DESIGN CONSULTING SERVICES; TECHNICAL SUPPORT SERVICES RELATING TO AC SURGE SUPPRESSION, DIRECT CURRENT SURGE PROTECTION, INTEGRATED LOAD CENTERS, RADIO FREQUENCY CONDITIONING, COMBINERS/DIVIDERS BASE STATIONS, PRESURIZATION FOR TRANSMISSION LINES, WAVEGUIDE, GROUNDING AND ENTRY PORTS DATA, TOWER MOUNT ANTENNAS, FILTERS, POWER AMPLIFIERS, REPEATERS, EARTH STATION ANTENNAS, IN BUILDING ANTENNAS, RADAR ANTENNAS, MICROWAVE ANTENNAS, SPLITTERS, COUPLERS, TERMINATIONS, STEEL PRODUCTS, TEST EQUIPMENT FOR ANTENNAS, CABLES, SITE ANALYZERS, CABLE MONITORING EQUIPMENT, CALIBRATION KITS, BATTERIES, BLOWER KITS, RADIO FREQUENCY CABLES, CASES, CONNECTORS AND ADAPTERS, COUPLING KITS, DUCTING, RACK MOUNTING KITS, TEST CABLES, LOADS, SURGE ARRESTORS, POWER SYSTEMS FOR STANDBY, MODULAR GOODS, BI-FUEL, TRANSFER SWITCHES, GENERATOR CONTROLS AND GENERATORS; PRODUCT TESTING; PROVIDING TECHNICAL PRODUCT SUPPORT SERVICES IN THE FIELD OF WIRELESS TELECOMMUNICATIONS ALL FOR USE IN WIRELESS TELECOMMUNICATION SERVICES, IN CLASS 42 (U.S. CLS. 100 AND 101).

FIRST USE 6-11-2002; IN COMMERCE 6-11-2002.

THE MARK CONSISTS OF STANDARD CHARACTERS WITHOUT CLAIM TO ANY PARTICULAR FONT, STYLE, SIZE, OR COLOR.

OWNER OF CANADA REG. NO. TMA785,116, DATED 12-15-2010, EXPIRES 12-15-2025.

NO CLAIM IS MADE TO THE EXCLUSIVE RIGHT TO USE "CORPORATION", APART FROM THE MARK AS SHOWN.

SER. NO. 85-216,143, FILED 1-12-2011.

REGINA DRUMMOND, EXAMINING ATTORNEY

# United States of America

United States Patent and Trademark Office

# primera

**Reg. No. 4,274,041**

AMOREPACIFIC CORPORATION (REPUBLIC OF KOREA CORPORATION)  
181, 2-KA, HANGANG-RO, YONGSAN-KU  
SEOUL, REPUBLIC OF KOREA

**Registered Jan. 15, 2013**

**Int. Cl.: 3**

FOR: SKIN LOTIONS; CREAMY FOUNDATION; EYE CREAMS; COSMETIC NOURISHING CREAMS; COSMETIC SKIN FRESHENERS; MAKE-UP POWDER; COSMETICS; COSMETIC CREAMS FOR SKIN CARE; HAIR SHAMPOO; DENTIFRICES, IN CLASS 3 (U.S. CLS. 1, 4, 6, 50, 51 AND 52).

**TRADEMARK**

**PRINCIPAL REGISTER**

OWNER OF REPUBLIC OF KOREA REG. NO. 0874543, DATED 7-29-2011, EXPIRES 7-29-2021.

THE MARK CONSISTS OF THE WORD "PRIMERA" IN A STYLIZED FONT.

THE ENGLISH TRANSLATION OF "PRIMERA" IN THE MARK IS "FIRST".

SER. NO. 85-216,621, FILED 1-13-2011.

SAMUEL E. SHARPER JR., EXAMINING ATTORNEY



*David J. Kyros*

Director of the United States Patent and Trademark Office



# United States of America

United States Patent and Trademark Office

# burger 101

**Reg. No. 4,274,042**

GS&D CAPITAL PARTNERS (TEXAS LIMITED LIABILITY COMPANY)  
1826 COUNTRY PLACE PKWY, #102  
PEARLAND, TX 77584

**Registered Jan. 15, 2013**

**Int. Cl.: 43**

FOR: RESTAURANT SERVICES, INCLUDING SIT-DOWN SERVICE OF FOOD AND TAKE-OUT RESTAURANT SERVICES, IN CLASS 43 (U.S. CLS. 100 AND 101).

**SERVICE MARK**

FIRST USE 3-1-2011; IN COMMERCE 3-1-2011.

**PRINCIPAL REGISTER**

NO CLAIM IS MADE TO THE EXCLUSIVE RIGHT TO USE "BURGER", APART FROM THE MARK AS SHOWN.

THE MARK CONSISTS OF "BURGER 101" ON AMERICAN TYPE-WRITER FONT.

SER. NO. 85-218,652, FILED 1-15-2011.

MARK SHINER, EXAMINING ATTORNEY



*David J. Kyffers*

Director of the United States Patent and Trademark Office

# United States of America

United States Patent and Trademark Office

## Skin + Science Design

**Reg. No. 4,274,043**

**Registered Jan. 15, 2013**

**Int. Cl.: 3**

**TRADEMARK**

**PRINCIPAL REGISTER**

BESSINGER, G. TODD (UNITED STATES INDIVIDUAL)  
420 N. CARRINGTON AVENUE  
BUFFALO, WY 82834

FOR: AROMATIC BODY CARE PRODUCTS, NAMELY, BODY LOTION, SHOWER GEL, CUTICLE CREAM, SHAMPOO, CONDITIONER, NON-MEDICATED LIP BALM, SOAP, BODY POLISH, BODY AND FOOT SCRUB AND NON-MEDICATED FOOT CREAM; BEAUTY CREAMS; BEAUTY CREAMS FOR BODY CARE; BEAUTY GELS; BEAUTY LOTIONS; BEAUTY MASKS; BEAUTY SERUMS; BEAUTY SOAP; BODY AND BEAUTY CARE COSMETICS, IN CLASS 3 (U.S. CLS. 1, 4, 6, 50, 51 AND 52).

FIRST USE 5-2-2008; IN COMMERCE 6-30-2008.

THE MARK CONSISTS OF STANDARD CHARACTERS WITHOUT CLAIM TO ANY PARTICULAR FONT, STYLE, SIZE, OR COLOR.

NO CLAIM IS MADE TO THE EXCLUSIVE RIGHT TO USE "SKIN", APART FROM THE MARK AS SHOWN.

SER. NO. 85-218,744, FILED 1-15-2011.

HEATHER BIDDULPH, EXAMINING ATTORNEY



*David J. Kyros*

Director of the United States Patent and Trademark Office

# United States of America

United States Patent and Trademark Office



**Reg. No. 4,274,044**

**Registered Jan. 15, 2013**

**Int. Cl.: 35**

**SERVICE MARK**

**PRINCIPAL REGISTER**

VIRGINIA EARLY CHILDHOOD FOUNDATION (VIRGINIA CORPORATION)  
8001 FRANKLIN FARMS DRIVE, SUITE 116  
RICHMOND, VA 23229

FOR: PLANNING AND MANAGING EDUCATIONAL INITIATIVES, NAMELY, PROMOTING THE PUBLIC INTEREST AND AWARENESS IN THE IMPORTANCE OF EARLY CHILDHOOD SCHOOL READINESS WITH A FOCUS ON BASIC SKILLS TO PREPARE CHILDREN FOR KINDERGARTEN, IN CLASS 35 (U.S. CLS. 100, 101 AND 102).

FIRST USE 5-31-2010; IN COMMERCE 5-31-2010.

OWNER OF U.S. REG. NO. 4,167,580.

THE COLOR(S) GREEN AND BLUE IS/ARE CLAIMED AS A FEATURE OF THE MARK.

NO CLAIM IS MADE TO THE EXCLUSIVE RIGHT TO USE "EARLY CHILDHOOD FOUNDATION", APART FROM THE MARK AS SHOWN.

THE MARK CONSISTS OF AN OUTLINE IN GREEN OF AN APPLE WITH A STEM AND SINGLE LEAF, ACCOMPANIED BY THE WORDS IN BLUE LETTERS "VIRGINIA EARLY CHILDHOOD FOUNDATION".

SEC. 2(F) AS TO "VIRGINIA EARLY CHILDHOOD FOUNDATION".

SER. NO. 85-219,176, FILED 1-17-2011.

NAAKWAMA ANKRAH, EXAMINING ATTORNEY



*David J. Kyjars*

Director of the United States Patent and Trademark Office

United States of America  
United States Patent and Trademark Office

**PACE**  
**AIR FREIGHT**

**Reg. No. 4,274,045**

PACE AIR FREIGHT (INDIANA CORPORATION)  
3345 EAST MAIN STREET  
PLAINFIELD, IN 46168

**Registered Jan. 15, 2013**

**Int. Cl.: 39**

FOR: COMMERCIAL FREIGHT TRANSPORTATION SERVICES FOR TEMPERATURE-SENSITIVE PRODUCTS PROVIDED TO EXPORTERS, IMPORTERS, FREIGHT FORWARDERS AND AIRLINES, NAMELY, PICK-UP, TRANSPORTATION AND DELIVERY OF PACKAGES CONTAINING TEMPERATURE-SENSITIVE PRODUCTS REQUIRING CLIMATE CONTROL AND ON-GOING MONITORING TO MAINTAIN PRODUCT INTEGRITY DURING THE ENTIRE TRANSPORTATION PROCESS, IN CLASS 39 (U.S. CLS. 100 AND 105).

**SERVICE MARK**

**PRINCIPAL REGISTER**

FIRST USE 1-1-1980; IN COMMERCE 1-1-1990.

NO CLAIM IS MADE TO THE EXCLUSIVE RIGHT TO USE "AIR FREIGHT", APART FROM THE MARK AS SHOWN.

THE MARK CONSISTS OF UPPERCASE BOLD STYLIZED LETTERING HAND DRAWN FOR "PACE" AND ALL UPPERCASE FOR "AIR FREIGHT" IN THE TYPE STYLE HELVETICA NEUE (BOLD ITALIC) FONT FAMILY.

SER. NO. 85-221,210, FILED 1-19-2011.

KRISTIN CARLSON, EXAMINING ATTORNEY



*David J. Kyjars*

Director of the United States Patent and Trademark Office

# United States of America

United States Patent and Trademark Office

## FACE & it

**Reg. No. 4,274,046**

**Registered Jan. 15, 2013**

**Int. Cl.: 3**

**TRADEMARK**

**PRINCIPAL REGISTER**

THEFACESHOP CO., LTD. (REPUBLIC OF KOREA CORPORATION)  
(SINMUNNO 2-GA)  
58, SAEMUNAN-RO, JONGNO-GU  
SEOUL, REPUBLIC OF KOREA

FOR: SKIN MILK LOTIONS; PERFUMES; SKIN CLEANSING CREAMS; BATH SOAP; LIP-STICKS; ETHEREAL ESSENCES FOR THE FACE; SHAMPOOS; EYE SHADOWS; TOOTH-PASTE; COMMON TOILET WATER; HAIR COLORANTS; SOAP POWDER; FALSE EYE-LASHES; FALSE NAILS; TISSUES IMPREGNATED WITH COSMETIC LOTIONS; LIQUID SOAP; HERB EXTRACTS OF ELECAMPANE SOLD AS COMPONENTS OF COSMETICS; HAIR RINSES; HAIR SPRAY; HAIR MOUSSE; ETHEREAL ESSENCES FOR THE HAIR; SUNSCREEN LOTIONS; DEPILATORIES; COLOR-REMOVING PREPARATIONS FOR HAIR; FABRIC SOFTENERS FOR LAUNDRY USE; MOUTH WASHES, NOT FOR MEDICAL PURPOSES; DENTAL RINSES, NON-MEDICATED; FOUNDATION CREAMS; CHEEK COLORS IN THE NATURE OF BLUSH; BLUSHERS; EYELINER; NAIL POLISH; NUTRITIONAL CREAMS FOR COSMETIC PURPOSES; ANTISTATIC PREPARATIONS FOR HOUSEHOLD PURPOSES; NAIL DECOLORING PREPARATIONS FOR COSMETIC PURPOSES; BEAUTY MASKS; MASK PACK FOR COSMETIC PURPOSES; COSMETIC SOAPS; DETERGENTS PREPARED FROM PETROLEUM FOR HOUSEHOLD CLEANING USE; LAUNDRY FABRIC CONDITIONER; TOILET BOWL DETERGENTS; CLEANING PREPARATIONS FOR KITCHEN; BABY OIL; LIP GLOSS; LIP BALM; MASSAGE CREAM; BODY LOTIONS; HAIR GEL; NON-MEDICATED PROTECTIVE PREPARATIONS FOR LIPS; AFTER-SHAVE LOTIONS; SHAVING FOAM; SHAVING CREAMS; DEODORANTS FOR PERSONAL USE; FUMIGATING INCENSES; LAVENDER OIL; ROSE OIL FOR COSMETIC PURPOSES; MINT OIL FOR PERFUMERY; VANILLA PERFUMERY; DEPILATORY; BATH GELS; SHOWER GELS; BODY SCRUBS; MASSAGE OIL; BLEACHING PREPARATIONS FOR LAUNDRY USE; DETERGENT FOR LAUNDRY; PREPARATIONS FOR DENTAL BLEACHING; NOURISHING CREAMS FOR COSMETIC PURPOSES; LIQUID ROUGE; MASCARAS; MASSAGE GEL; NAIL ENAMEL FOR MANICURE; VARNISH-REMOVING PREPARATIONS; HAIR STYLING PREPARATIONS FOR USE IN HAIR DRYING; HAIR CARE PREPARATIONS FOR USE IN HAIR PRESERVATION TREATMENTS; HAIR WAVING PREPARATIONS; ESSENCE OILS OF BADIAN; VANISHING CREAMS; BATH OIL; COSMETIC BATH POWDER; BABY POWDER; PERFUMED POWDER; NON-MEDICATED HAIR CARE LOTIONS FOR TREATING DANDRUFF; NON-MEDICATED HAIR CARE CREAMS FOR TREATING DANDRUFF; BATH SALTS, NON-MEDICATED; COSMETIC SUN MILK LOTIONS; SUNSCREEN CREAMS; COSMETIC SUN OILS; SUNTANNING PREPARATIONS; NAIL COLORING PREPARATIONS FOR COSMETIC PURPOSES; COSMETIC SKIN FRESHENERS; EYE MAKE-UP REMOVERS;

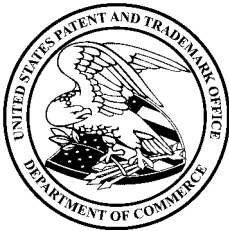

*David J. Kyros*

Director of the United States Patent and Trademark Office

**Reg. No. 4,274,046** EAU DE COLOGNE; COSMETIC PREPARATIONS FOR BRIGHTENING LIPS; COSMETIC PREPARATIONS FOR NEUTRALIZING LIP COLORS; COSMETIC PREPARATIONS FOR CONDITIONING LIPS; COLD CREAMS; SOLID POWDER FOR COMPACTS; DEPILATORY WAX; PERMANENT WAVE PREPARATIONS; NON-MEDICATED HAIR CARE PREPARATIONS FOR NEUTRALIZING HAIR CONDITION FROM PERMANENT HAIR WAVES; FACE POWDER; POTPOURRI PERFUME; SKIN WHITENING CREAMS; HAND CREAMS; HAIR GLAZE; HAIR DRESSINGS; HAIR LACQUERS; HAIR LOTIONS; HAIR MOISTURIZERS; HAIR CONDITIONERS; HAIR CREAMS; HAIR TONIC; MAKE-UP POWDER; ASTRINGENTS FOR COSMETIC PURPOSES; BODY CREAMS; FOAM CLEANSERS FOR PERSONAL USE; SKIN CLEANSING LOTION; LIP PENCILS; SHOWER COLOGNE; EAU DE TOILET; TOILET WATER FOR SKIN EXFOLIATION; EXFOLIANT CREAMS FOR SKIN; ETHEREAL ESSENCES FOR COSMETICS; COSMETIC PREPARATIONS FOR SLIMMING PURPOSES; INCENSE STICKS; ADHESIVES FOR AFFIXING FALSE HAIR; COTTON STICKS FOR COSMETIC PURPOSES; ADHESIVES FOR COSMETIC PURPOSES; COTTON WOOL FOR COSMETIC PURPOSES; BEAUTY SOAPS; PAPER SOAPS, NAMELY, DISPOSABLE WIPES IMPREGNATED WITH CLEANSING CHEMICALS OR COMPOUNDS FOR PERSONAL HYGIENE; CREAM SOAPS; SKIN CLEANSERS FOR THE BODY; SHAVING SOAP; SOAP FOR FOOT PERSPIRATION; DEODORANT SOAP; ALMOND SOAP; MEDICATED SOAP, NOT FOR MEDICAL TREATMENT; BREATH FRESHENING SPRAYS; TOOTH POWDERS; TISSUES IMPREGNATED WITH COSMETIC LOTIONS; TISSUES IMPREGNATED WITH COSMETIC LOTIONS FOR REMOVING OIL; ALL-PURPOSE DEGREASING PREPARATIONS FOR HOUSEHOLD PURPOSES; RUST REMOVING PREPARATIONS; FLOOR WAX REMOVERS; CLEANING PREPARATIONS FOR CLEANING WASTE PIPES; GLASS CLEANERS; WINDSCREEN CLEANING LIQUIDS; BOOT CREAM; POLISHING WAX; EMERY BOARDS; ABRASIVE CLOTH; CLOTH PATCHES IMPREGNATED WITH DENTAL BLEACHING PREPARATIONS; CLEANING PREPARATIONS FOR CLEANING DENTURES; COSMETICS; CLEANING PREPARATIONS; SOAPS, NOT FOR PERSONAL USE; COMMON TOILET SOAPS; FABRIC SOFTENERS; PENCIL-SHAPE TUBES FILLED WITH TOOTH BLEACHING GELS; TOOTH BLEACHING CREAMS; TOOTH BLEACHING PREPARATIONS IN THE FORM OF PENCILS; AROMATIC OILS FOR HOUSEHOLD PURPOSES; FRAGRANCES FOR PERSONAL USE; HAND CLEANERS; HAND CLEANING PREPARATIONS, IN CLASS 3 (U.S. CLS. 1, 4, 6, 50, 51 AND 52).

PRIORITY CLAIMED UNDER SEC. 44(D) ON REPUBLIC OF KOREA APPLICATION NO. 2011-0002860, FILED 1-18-2011, REG. NO. 0898763, DATED 1-10-2012, EXPIRES 1-10-2022.

NO CLAIM IS MADE TO THE EXCLUSIVE RIGHT TO USE "FACE", APART FROM THE MARK AS SHOWN.

THE MARK CONSISTS OF THE STYLIZED WORDING "FACE & IT".

SER. NO. 85-222,295, FILED 1-20-2011.

DAWN HAN, EXAMINING ATTORNEY

# United States of America

United States Patent and Trademark Office

## ROMA LIVING

**Reg. No. 4,274,047**

**Registered Jan. 15, 2013**

**Int. Cls.: 16 and 20**

**TRADEMARK**

**PRINCIPAL REGISTER**

ROMA MOULDING INC. (CANADA CORPORATION)  
360 HANLAN ROAD  
WOODBIDGE, ONTARIO, CANADA L4L3P6

FOR: FRAMED ART, NAMELY, FRAMED ART PICTURES, FRAMED ART PRINTS, FRAMED ART PHOTOGRAPHY, FRAMED ART REPRODUCTIONS, FRAMED GRAPHIC ART, FRAMED ETCHINGS AND FRAMED PAINTINGS, IN CLASS 16 (U.S. CLS. 2, 5, 22, 23, 29, 37, 38 AND 50).

FIRST USE 10-1-2010; IN COMMERCE 10-1-2010.

FOR: MOULDINGS, NAMELY, PHOTO FRAME MOULDINGS, PICTURE FRAME MOULDINGS; MIRRORS, DECORATIVE ART, NAMELY, DECORATIVE FRAME MOULDINGS; PHOTO FRAMES; SOFAS, CHAIRS, IN CLASS 20 (U.S. CLS. 2, 13, 22, 25, 32 AND 50).

FIRST USE 10-1-2010; IN COMMERCE 10-1-2010.

THE MARK CONSISTS OF STANDARD CHARACTERS WITHOUT CLAIM TO ANY PARTICULAR FONT, STYLE, SIZE, OR COLOR.

PRIORITY CLAIMED UNDER SEC. 44(D) ON CANADA APPLICATION NO. 1489878, FILED 7-23-2010, REG. NO. TMA831,022, DATED 9-4-2012, EXPIRES 9-4-2027.

OWNER OF U.S. REG. NOS. 2,656,015 AND 3,457,572.

SER. NO. 85-223,118, FILED 1-21-2011.

FRANK LATTUCA, EXAMINING ATTORNEY



*David J. Kybas*

Director of the United States Patent and Trademark Office

# United States of America

United States Patent and Trademark Office

# TRITON

**Reg. No. 4,274,048**

**Registered Jan. 15, 2013**

**Int. Cls.: 9 and 42**

**TRADEMARK**

**SERVICE MARK**

**PRINCIPAL REGISTER**

WEBSense, INC. (DELAWARE CORPORATION)  
10240 SORRENTO VALLEY  
SAN DIEGO, CA 92121

FOR: PROVIDING DOWNLOADABLE SOFTWARE FOR PROVIDING WEB SECURITY AND PROTECTION, PROVIDING E-MAIL MESSAGING SECURITY AND PROTECTION, AND FOR DATA LOSS PREVENTION, IN CLASS 9 (U.S. CLS. 21, 23, 26, 36 AND 38).

FIRST USE 2-9-2010; IN COMMERCE 2-9-2010.

FOR: PROVIDING NON-DOWNLOADABLE SOFTWARE FOR USE IN MAINTAINING AND MONITORING WEB SECURITY, DATA SECURITY AND E-MAIL SECURITY, IN CLASS 42 (U.S. CLS. 100 AND 101).

FIRST USE 2-9-2010; IN COMMERCE 2-9-2010.

THE MARK CONSISTS OF STANDARD CHARACTERS WITHOUT CLAIM TO ANY PARTICULAR FONT, STYLE, SIZE, OR COLOR.

SER. NO. 85-223,145, FILED 1-21-2011.

NAPOLEON SHARMA, EXAMINING ATTORNEY



*David J. Kybas*

Director of the United States Patent and Trademark Office



# United States of America

United States Patent and Trademark Office

## YARRUNGA FIELD

**Reg. No. 4,274,049**

**Registered Jan. 15, 2013**

**Int. Cl.: 33**

**TRADEMARK**

**PRINCIPAL REGISTER**

DIRECT WINES LIMITED (UNITED KINGDOM LIMITED LIABILITY COMPANY)  
NEW AQUITAINE HOUSE EXETER WAY, THEALE  
READING, BERKSHIRE, UNITED KINGDOM RG74PL

FOR: ALCOHOLIC BEVERAGES EXCEPT BEERS; SHERRY; WINES, IN CLASS 33 (U.S. CLS. 47 AND 49).

THE MARK CONSISTS OF STANDARD CHARACTERS WITHOUT CLAIM TO ANY PARTICULAR FONT, STYLE, SIZE, OR COLOR.

OWNER OF ERPN CMNTY TM OFC REG. NO. 009585498, DATED 4-19-2011, EXPIRES 12-9-2020.

SER. NO. 85-225,593, FILED 1-25-2011.

MICHAEL ENGEL, EXAMINING ATTORNEY



*David J. Kybas*

Director of the United States Patent and Trademark Office

# United States of America

United States Patent and Trademark Office

## ECO TRACKER

**Reg. No. 4,274,050**

**Registered Jan. 15, 2013**

**Int. Cls.: 35 and 42**

**SERVICE MARK**

**PRINCIPAL REGISTER**

ENERGY PROFILES LIMITED (CANADA CORPORATION)  
295 THE WEST MALL, SUITE 503  
ETOBICOKE, ONTARIO, CANADA M9C4Z4

FOR: UTILITY BILL MANAGEMENT SERVICES, NAMELY, TRACKING, REPORTING AND ANALYZING ENERGY DATA IN THE FORM OF UTILITY BILLS, UTILITY METER DATA AND INTERVAL METER DATA; UTILITY BILL MANAGEMENT SERVICES, NAMELY, TRACKING AND ANALYZING UTILITY INFORMATION IN THE FORM OF UTILITY METER DATA RATE SCHEDULES; UTILITY ACCOUNT AUDITING FOR OTHERS, NAMELY, VERIFICATION OF UTILITY BILLS AND IDENTIFICATION OF UTILITY USAGE ANOMALIES, PREPARATION OF BUSINESS REPORTS IN THE FIELD OF MONTHLY/QUARTERLY UTILITY COST ACCRUALS; BUSINESS CONSULTING IN THE FIELDS OF ANNUAL UTILITY BUDGETS, UTILITY BUDGET TRACKING, UTILITY VARIANCE, UTILITY BENCHMARKING, UTILITY CONSUMPTION AND COST SAVINGS CALCULATION, ENERGY PROFILING, WASTE DATA, PROJECTIONS OF FUTURE ENERGY USAGE FOLLOWING IMPLEMENTATION OF MEASURES, BUILDING ENERGY USAGE RECORDING/TRACKING, AND SUBMETERING COST ALLOCATION; ALL NOT USED IN RELATION TO MONITORING OF WATER TREATMENT AND CHEMICAL RECOVER EQUIPMENT, IN CLASS 35 (U.S. CLS. 100, 101 AND 102).

FIRST USE 6-0-2009; IN COMMERCE 11-0-2009.



*David J. Kyffers*

Director of the United States Patent and Trademark Office

FOR: COMPUTER SERVICES, NAMELY, PROVIDING TEMPORARY USE OF AN ON-LINE, NON-DOWNLOADABLE SOFTWARE TOOL FOR MONITORING AND ANALYZING UTILITY CONSUMPTION, COST AND WASTE DATA, NAMELY, UTILITY INTERVAL DATA, UTILITY BUDGET DATA, BENCHMARKING DATA AND MODELING OF ENERGY SAVINGS BASED ON RETROFIT MEASURES; GREENHOUSE GAS EMISSION MEASURING AND ANALYSIS, NAMELY, CALCULATION AND PREPARATION OF RELATED REPORTS OF GREENHOUSE GAS (GHG) EMISSIONS AT COMMERCIAL, INSTITUTIONAL, RETAIL AND INDUSTRIAL BUILDINGS, INCLUDING REPORTS USING CALCULATIONS THAT CONVERT UTILITY CONSUMPTION TO EKWH AND USE GHG EMISSIONS FACTORS TO PRODUCE A GHG EMISSIONS REPORT; ALL NOT USED IN RELATION TO MONITORING OF WATER TREATMENT AND CHEMICAL RECOVER EQUIPMENT, IN CLASS 42 (U.S. CLS. 100 AND 101).

FIRST USE 6-0-2009; IN COMMERCE 11-0-2009.

**Reg. No. 4,274,050** THE MARK CONSISTS OF STANDARD CHARACTERS WITHOUT CLAIM TO ANY PARTICULAR FONT, STYLE, SIZE, OR COLOR.

OWNER OF CANADA REG. NO. TMA786713, DATED 1-10-2011, EXPIRES 1-20-2026.

NO CLAIM IS MADE TO THE EXCLUSIVE RIGHT TO USE "TRACKER", APART FROM THE MARK AS SHOWN.

SER. NO. 85-230,968, FILED 2-1-2011.

TARA PATE, EXAMINING ATTORNEY

# United States of America

United States Patent and Trademark Office

## PI SPEAKERS

**Reg. No. 4,274,051**

PARHAM, WAYNE (OKLAHOMA SOLE PROPRIETORSHIP), DBA PI SPEAKERS  
P. O. BOX 702006  
TULSA, OK 74170

**Registered Jan. 15, 2013**

**Int. Cl.: 40**

FOR: CUSTOM MANUFACTURE OF LOUDSPEAKER SYSTEMS, IN CLASS 40 (U.S. CLS. 100, 103 AND 106).

**SERVICE MARK**

FIRST USE 2-4-1980; IN COMMERCE 2-4-1980.

**PRINCIPAL REGISTER**

THE MARK CONSISTS OF STANDARD CHARACTERS WITHOUT CLAIM TO ANY PARTICULAR FONT, STYLE, SIZE, OR COLOR.

NO CLAIM IS MADE TO THE EXCLUSIVE RIGHT TO USE "SPEAKERS", APART FROM THE MARK AS SHOWN.

SER. NO. 85-232,559, FILED 2-2-2011.

DANNEAN HETZEL, EXAMINING ATTORNEY



*David J. Kyffers*

Director of the United States Patent and Trademark Office

# United States of America

United States Patent and Trademark Office

## SOLAR DREAM LOAN

**Reg. No. 4,274,052**

IMAGINE ENERGY, LLC (OREGON LIMITED LIABILITY COMPANY)  
439 N. BROADWAY STREET  
PORTLAND, OR 97227

**Registered Jan. 15, 2013**

**Int. Cl.: 36**

FOR: ARRANGING AND PROVISION OF CREDIT AND LOANS TO FACILITATE THE INSTALLATION OF SOLAR ENERGY SYSTEMS, IN CLASS 36 (U.S. CLS. 100, 101 AND 102).

**SERVICE MARK**

FIRST USE 1-5-2011; IN COMMERCE 1-5-2011.

**PRINCIPAL REGISTER**

THE MARK CONSISTS OF STANDARD CHARACTERS WITHOUT CLAIM TO ANY PARTICULAR FONT, STYLE, SIZE, OR COLOR.

NO CLAIM IS MADE TO THE EXCLUSIVE RIGHT TO USE "SOLAR" AND "LOAN", APART FROM THE MARK AS SHOWN.

SER. NO. 85-232,609, FILED S.R. 2-2-2011 AM. P.R. 3-22-2011.

CURTIS FRENCH, EXAMINING ATTORNEY



*David J. Kybas*

Director of the United States Patent and Trademark Office

# United States of America

United States Patent and Trademark Office

# MILKAMUNE

**Reg. No. 4,274,053**

**Registered Jan. 15, 2013**

**Int. Cl.: 5**

**TRADEMARK**

**PRINCIPAL REGISTER**

QUANTEC LIMITED (NEW ZEALAND CORPORATION)  
WAIKATO INNOVATION PARK, RUAKURA ROAD  
HAMILTON, NEW ZEALAND

FOR: PHARMACEUTICAL PREPARATIONS FOR TREATMENT OR PREVENTION OF IMMUNE DYSFUNCTION; DIETETIC FOODS CONTAINING MILK-DERIVED POWDERS ADAPTED FOR MEDICAL USE; DIETARY SUPPLEMENTS CONTAINING MILK-DERIVED OR COLOSTRUM-DERIVED SUBSTANCES; NUTRITIONAL SUPPLEMENTS CONTAINING MILK-DERIVED OR COLOSTRUM-DERIVED SUBSTANCES; SPECIALIZED TABLETS AND POWDERS FOR THE DELIVERY OF PHARMACEUTICALS SOLD WITHOUT THE PHARMACEUTICAL INGREDIENT; SPECIALIZED TABLETS AND POWDERS FOR THE DELIVERY OF NUTRITIONAL SUPPLEMENTS SOLD WITHOUT THE NUTRITIONAL SUPPLEMENT INGREDIENT; MILK POWDERS, NAMELY, POWDERED MILK FOR BABIES, IN CLASS 5 (U.S. CLS. 6, 18, 44, 46, 51 AND 52).

THE MARK CONSISTS OF STANDARD CHARACTERS WITHOUT CLAIM TO ANY PARTICULAR FONT, STYLE, SIZE, OR COLOR.

PRIORITY CLAIMED UNDER SEC. 44(D) ON NEW ZEALAND APPLICATION NO. 831239, FILED 9-30-2010, REG. NO. 831239, DATED 9-30-2010, EXPIRES 9-30-2020.

THE WORDING "MILKAMUNE" HAS NO MEANING IN A FOREIGN LANGUAGE.

SER. NO. 85-233,613, FILED 2-3-2011.

ANDREW RHIM, EXAMINING ATTORNEY



*David J. Kyros*

Director of the United States Patent and Trademark Office

# United States of America

United States Patent and Trademark Office

## RX SUZUKA

**Reg. No. 4,274,054**

**Registered Jan. 15, 2013**

**Int. Cls.: 1, 5, 9 and 10**

**TRADEMARK**

**PRINCIPAL REGISTER**

RANDOX LABORATORIES LTD (UNITED KINGDOM LIMITED COMPANY (LTD.))  
DIAMOND ROAD, CRUMLIN  
ARDMORE  
ANTRIM, UNITED KINGDOM BT294QY

FOR: CHEMICALS IN THE FIELD OF BIOMARKER DIAGNOSTICS USED IN INDUSTRY, SCIENCE, PHOTOGRAPHY, AGRICULTURE, HORTICULTURE AND FORESTRY EXCEPT FUNGICIDES, HERBICIDES, INSECTICIDES AND PARASITICIDES; CHEMICAL REAGENTS FOR NON-MEDICAL PURPOSES, NAMELY, BIOMARKERS; ENZYMES AND RAW PROTEINS FOR SCIENTIFIC AND RESEARCH PURPOSES, NAMELY, BIOMARKERS; DIAGNOSTIC PREPARATIONS FOR SCIENTIFIC PURPOSES; DIAGNOSTIC PREPARATIONS, NAMELY, BIOMARKERS FOR ANALYSIS OF FOOD PRODUCTS AND WATER AND ALL THE AFORESAID FOR SALE IN KIT FORM; CLINICAL DIAGNOSTICS PREPARATIONS FOR CLINICAL OR MEDICAL LABORATORY USE IN THE FIELD OF BIOMARKER DIAGNOSTICS; DIAGNOSTIC SCANNING AGENTS FOR SCIENTIFIC AND RESEARCH USE, NAMELY, BIOMARKERS; DIAGNOSTIC TESTING MATERIAL, NAMELY, TESTING OF BIOCHEMICAL MARKERS FOR SCIENTIFIC AND RESEARCH USE, ALL OF THE FOREGOING NOT HAVING TO DO WITH THE DESIGN OR DEVELOPMENT OF DRUGS, IN CLASS 1 (U.S. CLS. 1, 5, 6, 10, 26 AND 46).

FOR: ANTITOXIC SERA AND ANTISERA FOR DIAGNOSTIC PURPOSES; DIAGNOSTIC PREPARATIONS FOR MEDICAL AND VETERINARY USE, NAMELY, BIOMARKERS; DIAGNOSTIC PREPARATIONS FOR SALE IN KIT FORM FOR MEDICAL AND VETERINARY USE RELATED TO BIOMARKERS; DIAGNOSTIC SCANNING AGENTS, NAMELY, BIOMARKERS FOR MEDICAL AND VETERINARY USE; CLINICAL DIAGNOSTIC PREPARATIONS FOR MEDICAL AND VETERINARY USE IN THE FIELD OF BIOMARKERS; DIAGNOSTIC TESTING PREPARATIONS FOR MEDICAL AND VETERINARY USE IN THE FIELD OF BIOMARKERS; REAGENTS FOR USE IN DIAGNOSTIC TESTS FOR MEDICAL AND VETERINARY PURPOSES IN THE FIELD OF BIOMARKERS; DIAGNOSTIC REAGENTS FOR USE WITH ANALYZERS FOR MEDICAL AND VETERINARY PURPOSES IN THE FIELD OF BIOMARKERS, ALL OF THE FOREGOING NOT HAVING TO DO WITH THE DESIGN OR DEVELOPMENT OF DRUGS, IN CLASS 5 (U.S. CLS. 6, 18, 44, 46, 51 AND 52).



*David J. Kyjars*

Director of the United States Patent and Trademark Office

FOR: COMPUTER SOFTWARE FOR SCHEDULING, PROGRAMMING, ANALYSING AND REPORTING ON DIAGNOSTIC TESTS IN THE FIELD OF BIOMARKERS; COMPUTER SOFTWARE FOR AUTOMATIC CALIBRATION, BARCODE SCANNING, REAGENT INFORMATION MANAGEMENT, REACTION PROCESS MONITORING AND CROSS-CON-

**Reg. No. 4,274,054** TAMINATION PREVENTION IN THE FIELD OF BIOMARKERS; COMPUTER SOFTWARE FOR PATIENT INFORMATION MEMORY AND ASSOCIATION INPUT, REPORT AUDITING, PRINTING AND PUBLISHING DIAGNOSTIC TEST RESULTS AND STATISTICS IN THE FIELD OF BIOMARKERS; DETECTORS FOR CHEMICAL COMPOUNDS AND REAGENTS IN THE FIELD OF BIOMARKERS; DIAGNOSTIC APPARATUS AND INSTRUMENTS FOR THE TESTING OF CLINICAL CHEMISTRY, TOXICOLOGY, FOOD AND WINE, NOT FOR MEDICAL PURPOSES; DIAGNOSTIC TESTING APPARATUS AND INSTRUMENTS FOR USE IN IMMUNOASSAY PROCEDURES, NOT FOR MEDICAL PURPOSES; DIAGNOSTIC IMAGING APPARATUS FOR THE STUDY OF CHEMICAL COMPOUNDS AND STRUCTURES OTHER THAN FOR MEDICAL USE; CLINICAL LABORATORY ANALYTICAL INSTRUMENTS, NAMELY, CLINICAL CHEMISTRY OR IMMUNOASSAY ANALYSERS, OTHER THAN FOR MEDICAL USE, ALL OF THE FOREGOING NOT HAVING TO DO WITH THE DESIGN OR DEVELOPMENT OF DRUGS, IN CLASS 9 (U.S. CLS. 21, 23, 26, 36 AND 38).

FOR: MEDICAL APPARATUS AND INSTRUMENTS FOR USE IN BIOMARKER DIAGNOSTICS; DIAGNOSTIC APPARATUS AND INSTRUMENTS FOR MEDICAL USE, NAMELY, BIOMARKERS FOR DETECTING AND ANALYSING INFECTIOUS AND NON-INFECTIOUS DISEASES, ORGAN FUNCTION IN HUMANS AND ANIMALS, THERAPEUTIC DRUGS AND DRUGS OF ABUSE, PROTEINS, ACIDS AND ANTIOXIDANTS; CLINICAL CHEMISTRY ANALYZERS FOR DISEASE, TOXICOLOGY AND BODILY FUNCTION ANALYSIS FOR MEDICAL AND VETERINARY USE IN THE FIELD OF BIOMARKER DIAGNOSTICS; DIAGNOSTIC TESTING APPARATUS AND INSTRUMENTS FOR USE IN IMMUNOASSAY PROCEDURES; CLINICAL LABORATORY ANALYTICAL INSTRUMENTS FOR MEDICAL AND VETERINARY USE, NAMELY, APPARATUS FOR CLINICAL DIAGNOSIS IN THE FIELD OF BIOMARKERS, ALL OF THE FOREGOING NOT HAVING TO DO WITH THE DESIGN OR DEVELOPMENT OF DRUGS, IN CLASS 10 (U.S. CLS. 26, 39 AND 44).

THE MARK CONSISTS OF STANDARD CHARACTERS WITHOUT CLAIM TO ANY PARTICULAR FONT, STYLE, SIZE, OR COLOR.

PRIORITY CLAIMED UNDER SEC. 44(D) ON ERPN CMNTY TM OFC APPLICATION NO. 009677865, FILED 1-21-2011, REG. NO. 009677865, DATED 6-28-2011, EXPIRES 1-21-2021.

THE WORD(S) "SUZUKA" HAS NO MEANING IN A FOREIGN LANGUAGE.

SER. NO. 85-235,852, FILED 2-7-2011.

DAVID TOOLEY, EXAMINING ATTORNEY



# United States of America

United States Patent and Trademark Office



**Reg. No. 4,274,055**

**Registered Jan. 15, 2013**

**Int. Cl.: 45**

**SERVICE MARK**

**PRINCIPAL REGISTER**

ALLSTATE CORPORATE SERVICES CORP. (NEW YORK CORPORATION)  
SUITE 301  
1222 AVENUE M  
BROOKLYN, NY 11230

FOR: LEGAL RESEARCH SERVICES FOR ATTORNEYS AND BUSINESSES, NAMELY, NAME SEARCHES, DOCUMENT RESEARCH AND RETRIEVAL; PREPARATION AND FILING OF LEGAL DOCUMENTS RELATING TO DOMESTIC AND FOREIGN INCORPORATION; LEGAL SERVICES, NAMELY, STATUTORY REPRESENTATION OF CORPORATIONS; LEGAL SERVICES, NAMELY, INTELLECTUAL PROPERTY RESEARCH AND INTELLECTUAL PROPERTY APPLICATION FILING SERVICES, IN CLASS 45 (U.S. CLS. 100 AND 101).

FIRST USE 6-27-2003; IN COMMERCE 6-27-2003.

NO CLAIM IS MADE TO THE EXCLUSIVE RIGHT TO USE "CORPORATE SERVICES" OR "NATIONWIDE", APART FROM THE MARK AS SHOWN.

THE COLOR(S) BLUE, GREY, BROWN, RED, BLACK AND WHITE IS/ARE CLAIMED AS A FEATURE OF THE MARK.

THE MARK CONSISTS OF TWO CONCENTRIC CIRCLES COMPRISED OF NUMEROUS SMALL GRAY BARS. THE BARS COMPRISING THE OUTER CIRCLE APPEAR ON A WHITE BACKGROUND, WHILE THE BARS COMPRISING THE INNER CIRCLES APPEAR ON A GRAY BACKGROUND. THE SPACE BETWEEN THE CIRCLES FORMS A RING AROUND A CENTER CIRCLE, AND CONTAINS THE WORDING "ALLSTATE CORPORATE SERVICES" ALONG THE TOP AND "NATIONWIDE" ALONG THE BOTTOM, ALL OF WHICH IS PRESENTED IN DARK BLUE STYLIZED FONT ON A WHITE BACKGROUND. THE INNERMOST CIRCLE HAS A LIGHT GRAY BACKGROUND AND CONTAINS A PHOTOGRAPHIC DEPICTION OF A HAND-HELD STAMP IN THE CENTER. THE STAMP IS PRESENTED IN VARYING SHADES OF RED, BROWN AND BLACK, AND IS OUTLINED IN GRAY. THE WORDING "MAKING BUSINESS HAPPEN" APPEARS IN BLUE STYLIZED FONT BELOW THE STAMP. THE MARK IN ITS ENTIRETY APPEARS ON A TRANSPARENT BACKGROUND.



*David J. Kyjars*

SER. NO. 85-241,769, FILED 2-14-2011.

**Reg. No. 4,274,055** GRETCHEN ULRICH, EXAMINING ATTORNEY

# United States of America

United States Patent and Trademark Office



**Reg. No. 4,274,056**

VEN PROPERTIES, LLC (MINNESOTA LIMITED LIABILITY COMPANY)  
10320 28TH AVENUE NORTH  
PLYMOUTH, MN 55441

**Registered Jan. 15, 2013**

**Int. Cl.: 28**

FOR: GOLF TRAINING APPARATUS, NAMELY, DEVICES USED TO HELP IMPROVE A GOLF STROKE, IN CLASS 28 (U.S. CLS. 22, 23, 38 AND 50).

**TRADEMARK**

FIRST USE 11-15-2008; IN COMMERCE 11-15-2008.

**PRINCIPAL REGISTER**

THE MARK CONSISTS OF A STYLIZED LETTER "G" FOLLOWED BY A DASH FOLLOWED BY A STYLIZED NUMBER "4" WITH A MAN SWINGING A GOLF CLUB BEHIND THE LETTER "G" AND A GRAPHICAL REPRESENTATION OF A FAIRWAY EXTENDING BETWEEN THE "G" AND THE "4".

SER. NO. 85-242,437, FILED 2-15-2011.

B. PARADEWELAI, EXAMINING ATTORNEY



*David J. Kyffers*

Director of the United States Patent and Trademark Office

# United States of America

United States Patent and Trademark Office

## GOOD PROSPECTS

**Reg. No. 4,274,057**

**Registered Jan. 15, 2013**

**Int. Cls.: 41 and 45**

**SERVICE MARK**

**PRINCIPAL REGISTER**

GOODWILL INDUSTRIES INTERNATIONAL INC. (MASSACHUSETTS CORPORATION)  
15810 INDIANOLA DRIVE  
ROCKVILLE, MD 20855

FOR: EDUCATIONAL SERVICES, NAMELY, PROVIDING CLASSES, SEMINARS AND WORKSHOPS IN THE FIELD OF CAREER EXPLORATION AND DEVELOPMENT LEADING TO PERSONAL FINANCIAL STABILITY, IN CLASS 41 (U.S. CLS. 100, 101 AND 107).

FIRST USE 2-14-2011; IN COMMERCE 2-14-2011.

FOR: INTERNET-BASED SOCIAL NETWORKING, IN CLASS 45 (U.S. CLS. 100 AND 101).

FIRST USE 2-14-2011; IN COMMERCE 2-14-2011.

THE MARK CONSISTS OF STANDARD CHARACTERS WITHOUT CLAIM TO ANY PARTICULAR FONT, STYLE, SIZE, OR COLOR.

SER. NO. 85-254,521, FILED 3-1-2011.

DAVID COLLIER, EXAMINING ATTORNEY



*David J. Kyffers*

Director of the United States Patent and Trademark Office

# United States of America

United States Patent and Trademark Office

## FURRY COUTURE

**Reg. No. 4,274,058**

**Registered Jan. 15, 2013**

**Int. Cl.: 18**

**TRADEMARK**

**PRINCIPAL REGISTER**

ARGENTOSC (NEW YORK CORPORATION)  
SUITE 2201  
1407 BROADWAY  
NEW YORK, NY 10018

FOR: PET CLOTHING, IN CLASS 18 (U.S. CLS. 1, 2, 3, 22 AND 41).

FIRST USE 9-1-2008; IN COMMERCE 9-1-2008.

THE MARK CONSISTS OF STANDARD CHARACTERS WITHOUT CLAIM TO ANY PARTICULAR FONT, STYLE, SIZE, OR COLOR.

OWNER OF U.S. REG. NOS. 4,046,826 AND 4,099,982.

NO CLAIM IS MADE TO THE EXCLUSIVE RIGHT TO USE "COUTURE", APART FROM THE MARK AS SHOWN.

SER. NO. 85-257,669, FILED 3-4-2011.

KIM MONINGHOFF, EXAMINING ATTORNEY



*David J. Kyffers*

Director of the United States Patent and Trademark Office

# United States of America

United States Patent and Trademark Office

## Eva by Eva Franco

**Reg. No. 4,274,059**

FRANJO APPAREL, LLC (NEW YORK LIMITED LIABILITY COMPANY)  
260 WEST 39 ST., 6TH FLOOR  
NEW YORK, NY 10018

**Registered Jan. 15, 2013**

**Int. Cl.: 25**

FOR: BELTS; CLOTHING, NAMELY, WRAP-AROUNDS; COATS; DRESSES; DUSTERS;  
JACKETS; PANTS; SCARFS; SHIFTS; SHORTS; SKIRTS; SLIPS; SWEATERS; T-SHIRTS;  
TANK TOPS; TOPS, IN CLASS 25 (U.S. CLS. 22 AND 39).

**TRADEMARK**

FIRST USE 2-15-2010; IN COMMERCE 2-15-2010.

**PRINCIPAL REGISTER**

THE MARK CONSISTS OF STANDARD CHARACTERS WITHOUT CLAIM TO ANY PARTICULAR FONT, STYLE, SIZE, OR COLOR.

OWNER OF U.S. REG. NO. 3,430,444.

THE NAME(S), PORTRAIT(S), AND/OR SIGNATURE(S) SHOWN IN THE MARK DOES NOT IDENTIFY A PARTICULAR LIVING INDIVIDUAL.

SER. NO. 85-262,854, FILED 3-9-2011.

SARA BENJAMIN, EXAMINING ATTORNEY



*David J. Kybas*

Director of the United States Patent and Trademark Office

# United States of America

United States Patent and Trademark Office

# MOBITEST

**Reg. No. 4,274,060**

AKAMAI TECHNOLOGIES CANADA INC (CANADA CORPORATION)  
207 QUEEN STREET  
OTTAWA, CANADA K1P6E5

**Registered Jan. 15, 2013**

**Int. Cl.: 42**

FOR: WEBSITE PERFORMANCE TESTING SERVICE PROVIDED OVER A GLOBAL NETWORK FOR TESTING THE DOWNLOAD SPEED OF WEBSITE PAGES AND/OR CONTENT WHEN ACCESSED BY WEB BROWSERS OF MOBILE DEVICES, IN CLASS 42 (U.S. CLS. 100 AND 101).

**SERVICE MARK**

**PRINCIPAL REGISTER**

FIRST USE 2-24-2011; IN COMMERCE 2-24-2011.

THE MARK CONSISTS OF STANDARD CHARACTERS WITHOUT CLAIM TO ANY PARTICULAR FONT, STYLE, SIZE, OR COLOR.

PRIORITY CLAIMED UNDER SEC. 44(D) ON CANADA APPLICATION NO. 1,517,333, FILED 3-2-2011, REG. NO. TMA828768, DATED 7-30-2012, EXPIRES 7-30-2027.

SER. NO. 85-263,803, FILED 3-10-2011.

FLORENTINA BLANDU, EXAMINING ATTORNEY



*David J. Kyjars*

Director of the United States Patent and Trademark Office

# United States of America

United States Patent and Trademark Office

# Learnengineer

**Reg. No. 4,274,061**

**Registered Jan. 15, 2013**

**Int. Cl.: 41**

**SERVICE MARK**

**PRINCIPAL REGISTER**

LEARNENGIN (TEXAS LIMITED LIABILITY COMPANY)  
3910 EDWARDS MOUNTAIN DR  
AUSTIN, TX 78731

FOR: EDUCATION SERVICES, NAMELY, PROVIDING ON-LINE CLASSES, SEMINARS, AND WORKSHOPS IN THE FIELD OF SCIENCE, TECHNOLOGY, ENGINEERING, HEALTH, MEDICAL AND MATHEMATICS; EDUCATION SERVICES, NAMELY, PROVIDING CLASSES, SEMINARS, AND WORKSHOPS IN THE FIELD OF SCIENCE, TECHNOLOGY, ENGINEERING, HEALTH, MEDICAL AND MATHEMATICS, IN CLASS 41 (U.S. CLS. 100, 101 AND 107).

FIRST USE 12-10-2009; IN COMMERCE 2-3-2011.

THE MARK CONSISTS OF STANDARD CHARACTERS WITHOUT CLAIM TO ANY PARTICULAR FONT, STYLE, SIZE, OR COLOR.

SER. NO. 85-264,983, FILED 3-11-2011.

NORA BUCHANAN WILL, EXAMINING ATTORNEY



*David J. Kyffers*

Director of the United States Patent and Trademark Office



# United States of America

United States Patent and Trademark Office

# TOM JONES

**Reg. No. 4,274,062**

**Registered Jan. 15, 2013**

**Int. Cls.: 9, 16, 25 and 41**

**TRADEMARK**

**SERVICE MARK**

**PRINCIPAL REGISTER**

SECONDS OUT PRODUCTIONS LLC (DELAWARE LIMITED LIABILITY COMPANY)  
C/O PHILLIPS GOLD & COMPANY LLP  
1430 BROADWAY  
NEW YORK, NY 10018

FOR: APPARATUS FOR RECORDING, TRANSMITTING OR REPRODUCTION OF SOUND, MUSIC, IMAGES, DATA AND VIDEOS, NAMELY, CDS, DVDS, DIGITAL AUDIO TAPES AND DIGITAL AUDIO CASSETTES, HIGH DEFINITION VIDEO DISCS, MINI AUDIO DISCS, AUDIO RECORDS, AUDIO TAPES, AUDIO CASSETTES AND AUDIO DISCS FEATURING MUSICAL RECORDINGS, MUSICAL PERFORMANCES, CELEBRITY INTERVIEWS, SPOKEN WORD, ARTISTIC PERFORMANCES, GAMESHOWS, DRAMA, COMEDY, ACTION, ADVENTURE, ANIMATION AND DOCUMENTARIES; AUDIO AND VIDEO RECORDINGS FEATURING MUSICAL RECORDINGS, MUSICAL PERFORMANCES, CELEBRITY INTERVIEWS, SPOKEN WORD, ARTISTIC PERFORMANCES, GAMESHOWS, DRAMA, COMEDY, ACTION, ADVENTURE, ANIMATION AND DOCUMENTARIES; MOTION PICTURE FILMS FEATURING MUSICAL RECORDINGS, MUSICAL PERFORMANCES, CELEBRITY INTERVIEWS, SPOKEN WORD, ARTISTIC PERFORMANCES, GAMESHOWS, DRAMA, COMEDY, ACTION, ADVENTURE, ANIMATION AND DOCUMENTARIES; TELEVISION FILMS AND PROGRAMS RECORDED ON CD, DVD, DIGITAL AUDIO TAPES AND DIGITAL AUDIO CASSETTES, HIGH DEFINITION VIDEO DISCS, MINI AUDIO DISCS, AUDIO RECORDS, AUDIO TAPES, AUDIO CASSETTES AND AUDIO DISCS FEATURING MUSICAL RECORDINGS, MUSICAL PERFORMANCES, CELEBRITY INTERVIEWS, SPOKEN WORD, ARTISTIC PERFORMANCES, GAMESHOWS, DRAMA, COMEDY, ACTION, ADVENTURE, ANIMATION AND DOCUMENTARIES; RADIO PROGRAMMES RECORDED ON CD, DVD, DIGITAL AUDIO TAPES AND DIGITAL AUDIO CASSETTES, HIGH DEFINITION VIDEO DISCS, MINI AUDIO DISCS, AUDIO RECORDS, AUDIO TAPES, AUDIO CASSETTES AND AUDIO DISCS FEATURING MUSICAL RECORDINGS, MUSICAL PERFORMANCES, CELEBRITY INTERVIEWS, SPOKEN WORD, ARTISTIC PERFORMANCES, GAMESHOWS, DRAMA, COMEDY, ACTION, ADVENTURE, ANIMATION AND DOCUMENTARIES; PRE-RECORDED CDS, CDRS, DVDS, DIGITAL AUDIO TAPES AND DIGITAL AUDIO CASSETTES, HIGH DEFINITION VIDEO DISCS, MINI AUDIO DISCS, AUDIO RECORDS, AUDIO TAPES, AUDIO CASSETTES AND AUDIO DISCS FEATURING MUSICAL RECORDINGS, MUSICAL PERFORMANCES, CELEBRITY INTERVIEWS, SPOKEN WORD, ARTISTIC PERFORMANCES, GAMESHOWS, DRAMA, COMEDY, ACTION, ADVENTURE, ANIMATION AND DOCUMENTARIES; LASER DISCS FOR RECORDING, REPRODUCING AND PLAYING SOUND, IMAGES, MUSIC, DATA OR VIDEO FEATURING MUSICAL RECORDINGS, MUSICAL PERFORMANCES, CELEBRITY INTERVIEWS, SPOKEN WORD, ARTISTIC PER-



*David J. Kybas*

Director of the United States Patent and Trademark Office

**Reg. No. 4,274,062** FORMANCES, GAMESHOWS, DRAMA, COMEDY, ACTION, ADVENTURE, ANIMATION AND DOCUMENTARIES; OPTICAL-READ DISCS FOR RECORDING, REPRODUCING AND PLAYING SOUND, IMAGES, MUSIC, DATA OR VIDEO FEATURING MUSICAL RECORDINGS, MUSICAL PERFORMANCES, CELEBRITY INTERVIEWS, SPOKEN WORD, ARTISTIC PERFORMANCES, GAMESHOWS, DRAMA, COMEDY, ACTION, ADVENTURE, ANIMATION AND DOCUMENTARIES; DOWNLOADABLE MEDIA, NAMELY, AUDIO FILES, VIDEO FILES, MP3S, MP4S AND MP3 RECORDINGS FEATURING MUSICAL RECORDINGS, MUSICAL PERFORMANCES, CELEBRITY INTERVIEWS, SPOKEN WORD, ARTISTIC PERFORMANCES, GAMESHOWS, DRAMA, COMEDY, ACTION, ADVENTURE, ANIMATION AND DOCUMENTARIES; MOUSE PADS; DOWNLOADABLE DIGITAL VIDEOS, IMAGES, FILMS AND TV PROGRAMS PROVIDED FROM THE INTERNET AND MP4 WEBSITES FEATURING MUSICAL RECORDINGS, MUSICAL PERFORMANCES, CELEBRITY INTERVIEWS, SPOKEN WORD, ARTISTIC PERFORMANCES, GAMESHOWS, DRAMA, COMEDY, ACTION, ADVENTURE, ANIMATION AND DOCUMENTARIES; REFRIGERATOR MAGNETS; SUNGLASSES; EYEWEAR; AUDIO BOOKS ON CD, MINI AUDIO DISC, RECORDS, CASSETTE OR DISC IN THE FIELD OF MUSICAL RECORDINGS, MUSICAL PERFORMANCES, CELEBRITY INTERVIEWS, SPOKEN WORD, ARTISTIC PERFORMANCES, GAMESHOWS, DRAMA, COMEDY, ACTION, ADVENTURE, ANIMATION AND DOCUMENTARIES; DOWNLOADABLE ELECTRONIC PUBLICATIONS, NAMELY, MAGAZINES, PERIODICALS AND NEWSPAPERS IN THE FIELD OF MUSIC, MUSICAL RECORDINGS, MUSICAL PERFORMANCES, TELEVISION AND RADIO PROGRAMS, MOTION PICTURE FILMS, ARTISTIC PERFORMANCES, CONCERTS, APPEARANCES BY A CELEBRITY, APPEARANCES BY AN ACTOR AND APPEARANCES BY A PROFESSIONAL ENTERTAINER; DOWNLOADABLE PHOTOGRAPHS IN THE ELECTRONIC FORM IN THE FIELD OF MUSIC, MUSICAL RECORDINGS, MUSICAL PERFORMANCES, TELEVISION AND RADIO PROGRAMS, MOTION PICTURE FILMS, ARTISTIC PERFORMANCES, CONCERTS, APPEARANCES BY A CELEBRITY, APPEARANCES BY AN ACTOR AND APPEARANCES BY A PROFESSIONAL ENTERTAINER, IN CLASS 9 (U.S. CLS. 21, 23, 26, 36 AND 38).

FOR: PRINTED PUBLICATIONS, NAMELY, MAGAZINES FEATURING INFORMATION ABOUT MUSIC, MUSICAL RECORDINGS, MUSICAL PERFORMANCES, TELEVISION AND RADIO PROGRAMS, MOTION PICTURE FILMS, ARTISTIC PERFORMANCES, CONCERTS, APPEARANCES BY A CELEBRITY, APPEARANCES BY AN ACTOR AND APPEARANCES BY A PROFESSIONAL ENTERTAINER; STATIONERY; ADVERTISING MATERIALS, NAMELY, POSTERS, BROCHURES FEATURING INFORMATION ABOUT MUSIC, MUSICAL RECORDINGS, MUSICAL PERFORMANCES, TELEVISION AND RADIO PROGRAMS, MOTION PICTURE FILMS, ARTISTIC PERFORMANCES, CONCERTS, APPEARANCES BY A CELEBRITY, APPEARANCES BY AN ACTOR AND APPEARANCES BY A PROFESSIONAL ENTERTAINER; BOOKS IN THE FIELD OF MUSIC, MUSICAL RECORDINGS, MUSICAL PERFORMANCES, TELEVISION AND RADIO PROGRAMS, MOTION PICTURE FILMS, ARTISTIC PERFORMANCES, CONCERTS, APPEARANCES BY A CELEBRITY, APPEARANCES BY AN ACTOR AND APPEARANCES BY A PROFESSIONAL ENTERTAINER; PRINTED PERIODICALS FEATURING INFORMATION ABOUT MUSIC, MUSICAL RECORDINGS, MUSICAL PERFORMANCES, TELEVISION AND RADIO PROGRAMS, MOTION PICTURE FILMS, ARTISTIC PERFORMANCES, CONCERTS, APPEARANCES BY A CELEBRITY, APPEARANCES BY AN ACTOR AND APPEARANCES BY A PROFESSIONAL ENTERTAINER; PAMPHLETS FEATURING INFORMATION ABOUT MUSIC, MUSICAL RECORDINGS, MUSICAL PERFORMANCES, TELEVISION AND RADIO PROGRAMS, MOTION PICTURE FILMS, ARTISTIC PERFORMANCES, CONCERTS, APPEARANCES BY A CELEBRITY, APPEARANCES BY AN ACTOR AND APPEARANCES BY A PROFESSIONAL ENTERTAINER; MAGAZINES FEATURING INFORMATION ABOUT MUSIC, MUSICAL RECORDINGS, MUSICAL PERFORMANCES, TELEVISION AND RADIO PROGRAMS, MOTION PICTURE FILMS, ARTISTIC PERFORMANCES, CONCERTS, APPEARANCES BY A CELEBRITY, APPEARANCES BY AN ACTOR AND APPEARANCES BY A PROFESSIONAL ENTERTAINER; POSTCARDS; PICTURES; POSTERS; DIARIES; DRAWING INSTRUMENTS, NAMELY, PENS AND PENCILS; GREETING CARDS; ADDRESS BOOKS; CATALOGUES FEATURING INFORMATION ABOUT MUSIC, MUSICAL RECORDINGS, MUSICAL PER-

**Reg. No. 4,274,062** FORMANCES, TELEVISION AND RADIO PROGRAMS, MOTION PICTURE FILMS, ARTISTIC PERFORMANCES, CONCERTS, APPEARANCES BY A CELEBRITY, APPEARANCES BY AN ACTOR AND APPEARANCES BY A PROFESSIONAL ENTERTAINER; BROCHURES FEATURING INFORMATION ABOUT MUSIC, MUSICAL RECORDINGS, MUSICAL PERFORMANCES, TELEVISION AND RADIO PROGRAMS, MOTION PICTURE FILMS, ARTISTIC PERFORMANCES, CONCERTS, APPEARANCES BY A CELEBRITY, APPEARANCES BY AN ACTOR AND APPEARANCES BY A PROFESSIONAL ENTERTAINER; EVENT SOUVENIR PROGRAMS FEATURING INFORMATION ABOUT MUSIC, MUSICAL RECORDINGS, MUSICAL PERFORMANCES, TELEVISION AND RADIO PROGRAMS, MOTION PICTURE FILMS, ARTISTIC PERFORMANCES, CONCERTS, APPEARANCES BY A CELEBRITY, APPEARANCES BY AN ACTOR AND APPEARANCES BY A PROFESSIONAL ENTERTAINER; EVENT AND CONCERT TICKETS; CALENDARS; PHOTOGRAPHS; SIGNED PHOTOGRAPHS; AUTOGRAPHS OF FAMOUS INDIVIDUALS ON PRINTED ITEMS, NAMELY, BOOKS, POSTERS AND CALENDARS; PHOTOGRAPHIC ALBUMS; AUTOGRAPH ALBUMS; NEWSPAPERS FEATURING INFORMATION ABOUT MUSIC, MUSICAL RECORDINGS, MUSICAL PERFORMANCES, TELEVISION AND RADIO PROGRAMS, MOTION PICTURE FILMS, ARTISTIC PERFORMANCES, CONCERTS, APPEARANCES BY A CELEBRITY, APPEARANCES BY AN ACTOR AND APPEARANCES BY A PROFESSIONAL ENTERTAINER; NEWSLETTERS FEATURING INFORMATION ABOUT MUSIC, MUSICAL RECORDINGS, MUSICAL PERFORMANCES, TELEVISION AND RADIO PROGRAMS, MOTION PICTURE FILMS, ARTISTIC PERFORMANCES, CONCERTS, APPEARANCES BY A CELEBRITY, APPEARANCES BY AN ACTOR AND APPEARANCES BY A PROFESSIONAL ENTERTAINER; NOTELETS; NOTE PADS; NOTE BOOKS; STICKERS; DECALCOMANIAS; SOUVENIR EVENT PROGRAMMES; BOOKS AND COMMEMORATIVE BOOKS RELATING TO MUSIC, MUSICAL RECORDINGS, MUSICAL PERFORMANCES, TELEVISION AND RADIO PROGRAMS, MOTION PICTURE FILMS, ARTISTIC PERFORMANCES, CONCERTS, APPEARANCES BY A CELEBRITY, APPEARANCES BY AN ACTOR AND APPEARANCES BY A PROFESSIONAL ENTERTAINER; RECORD TOKEN CARDS, NAMELY, FOLDED PIECES OF PAPER, PAPER CARDS, OR ENVELOPES IN WHICH CAN BE PLACED, A RECORD TOKEN; GIFT TOKEN CARDS, NAMELY, FOLDED PIECES OF PAPER, PAPER CARDS, OR ENVELOPES IN WHICH CAN BE PLACED, A GIFT TOKEN; WRAPPING PAPER; PENS; BALLPOINT PENS; FOUNTAIN PENS; PENCILS; RULERS; ERASERS; PENCIL SHARPENERS; PEN AND PENCIL CASES; PICTURE CARDS, NAMELY, CARDS FEATURING PHOTOGRAPHS OR STILLS FROM MUSICAL RECORDINGS, MUSICAL PERFORMANCES, TELEVISION AND RADIO PROGRAMS, MOTION PICTURE FILMS, ARTISTIC PERFORMANCES, CONCERTS, APPEARANCES BY A CELEBRITY, APPEARANCES BY AN ACTOR AND APPEARANCES BY A PROFESSIONAL ENTERTAINER; PICTURE BOOKS; SONG BOOKS; SHEET MUSIC; CARDBOARD AND PAPER BADGES; PAPER FLAGS, BANNERS AND PENNANTS; COLOURING BOOKS; PAINTING SETS FOR CHILDREN; COMIC BOOKS; MUSIC BOOKS; SCRAP BOOKS; BOOKMARKS; PAPER TISSUES; ADHESIVE LABELS AND PAPER INSERTS FOR CDS, DVDS, DIGITAL AUDIO TAPES AND DIGITAL AUDIO CASSETTES, HIGH DEFINITION VIDEO DISCS, MINI AUDIO DISCS, AUDIO RECORDS, AUDIO TAPES, AUDIO CASSETTES AND AUDIO DISCS, IN CLASS 16 (U.S. CLS. 2, 5, 22, 23, 29, 37, 38 AND 50).

FOR: CLOTHING, NAMELY, T-SHIRTS, SHIRTS, JACKETS, SWEATSHIRTS, HOODED TOPS, PULLOVERS, JUMPERS, SHORTS, BOXER SHORTS, UNDERWEAR, SOCKS, SCARVES, DRESSING GOWNS, PYJAMAS, DUNGAREES, BRACES, TIES, LINGERIE, HOSIERY, BATHING COSTUMES, BATHING SUITS, BATHING TRUNKS, BATHROBES, GLOVES, JEANS, KILTS, NIGHTWEAR, PAJAMAS, TROUSER SUITS, SLACKS, SLEEPING GARMENTS, SLEEPWEAR, SUITS, SWIM WEAR, SWIMSUITS, TROUSERS, TUXEDOS AND WAISTCOATS; HEADGEAR, NAMELY, HATS, CAPS, BANDANAS AND BERETS; FOOTWEAR, NAMELY, SHOES, SNEAKERS, BOOTS, SLIPPERS AND FLIP-FLOPS , IN CLASS 25 (U.S. CLS. 22 AND 39).

FOR: ENTERTAINMENT IN THE NATURE OF LIVE MUSICAL PERFORMANCES; ENTERTAINER SERVICES, NAMELY, LIVE APPEARANCES BY A PROFESSIONAL ENTERTAINER; ENTERTAINMENT SERVICES, NAMELY, TELEVISED AND MOVIE APPEARANCES BY

**Reg. No. 4,274,062** A PROFESSIONAL ENTERTAINER; ENTERTAINMENT SERVICES, NAMELY, TELEVISED AND MOVIE APPEARANCES BY AN ACTOR; ENTERTAINMENT SERVICES, NAMELY, TELEVISED AND MOVIE APPEARANCES BY A CELEBRITY; ENTERTAINMENT IN THE NATURE OF VISUAL AND AUDIO PERFORMANCES BY AN ACTOR; ENTERTAINMENT IN THE NATURE OF VISUAL AND AUDIO PERFORMANCES BY A CELEBRITY; ENTERTAINMENT IN THE NATURE OF VISUAL AND AUDIO PERFORMANCES BY A PROFESSIONAL ENTERTAINER; LIVE ENTERTAINMENT IN THE NATURE OF LIVE MUSIC CONCERTS; ARRANGING AND CONDUCTING OF MUSICAL PERFORMANCE EVENTS AND MUSICAL PERFORMANCES; PRODUCTION OF TELEVISION PROGRAMS AND MOTION PICTURE FILMS, ENTERTAINMENT IN THE NATURE OF LIVE TELEVISION AND RADIO INTERVIEWS; PROVISION OF ON-LINE ENTERTAINMENT INFORMATION SERVICES RELATING TO MUSIC, MUSICAL RECORDINGS, MUSICAL PERFORMANCES, TELEVISION AND RADIO PROGRAMS, MOTION PICTURE FILMS, ARTISTIC PERFORMANCES, CONCERTS, APPEARANCES BY A CELEBRITY, APPEARANCES BY AN ACTOR AND APPEARANCES BY A PROFESSIONAL ENTERTAINER; PROVISION OF CONTINUING NEWS PROGRAMS FEATURING MUSIC, MUSICAL RECORDINGS, MUSICAL PERFORMANCES, TELEVISION AND RADIO PROGRAMS, MOTION PICTURE FILMS, ARTISTIC PERFORMANCES, CONCERTS, APPEARANCES BY A CELEBRITY, APPEARANCES BY AN ACTOR AND APPEARANCES BY A PROFESSIONAL ENTERTAINER; PRODUCTION AND PRESENTATION OF MUSICAL SHOWS; LIVE MUSICAL CONCERT SERVICES; ENTERTAINMENT IN THE NATURE OF LIVE PERFORMANCE OF DANCE, MUSIC AND DRAMA; CONSULTATION AND ADVICE REGARDING MUSICAL SELECTIONS AND ARRANGEMENTS FOR SOUNDS RECORDINGS AND LIVE PERFORMANCES; ENTERTAINMENT IN THE NATURE OF LIVE THEATRICAL, STAGE AND VARIETY ENTERTAINMENT; CONDUCTING ENTERTAINMENT EXHIBITION FESTIVALS FOR ENTERTAINMENT PURPOSES; ENTERTAINMENT IN THE NATURE OF COMPETITIONS IN THE FIELD OF MUSIC WHERE ENTRY IS BY PERSONAL ATTENDANCE, MAIL, EMAIL, TELEPHONE, TEXT MESSAGE OR VIA THE INTERNET; ARRANGING OF FESTIVALS FOR ENTERTAINMENT PURPOSES; ARRANGING OF MUSIC PERFORMANCES, MUSIC SHOWS, MUSIC EVENTS AND MUSICAL ENTERTAINMENT; SERVICES PROVIDING ENTERTAINMENT IN THE FORM OF MUSICAL PERFORMANCES OR IN THE FORM OF RECORDED MUSIC; PERFORMANCE OF MUSIC; PERFORMANCE OF DRAMA; PUBLICATION OF BOOKS; MUSIC PUBLISHING SERVICES; PUBLISHING OF MUSICAL WORKS; SONG PUBLISHING; PUBLICATION OF LYRICS OF SONGS IN BOOK AND SHEET FORM; PUBLICATION OF MUSIC AND MUSIC BOOKS; ON-LINE LIBRARY SERVICES, NAMELY, PROVIDING ELECTRONIC LIBRARY SERVICES WHICH FEATURE NEWSPAPERS, MAGAZINES, PHOTOGRAPHS AND PICTURES VIA AN ON-LINE COMPUTER NETWORK; PROVIDING NON-DOWNLOADABLE PLAYBACK OF MUSIC AND TELEVISION RECORDINGS VIA GLOBAL COMMUNICATIONS NETWORKS; PROVISION OF NON-DOWNLOADABLE FILMS AND TELEVISION PROGRAMS VIA A VIDEO-ON-DEMAND SERVICE; PROVISION OF NON-DOWNLOADABLE FILMS AND MOVIES VIA A VIDEO-ON-DEMAND SERVICE, IN CLASS 41 (U.S. CLS. 100, 101 AND 107).

THE MARK CONSISTS OF STANDARD CHARACTERS WITHOUT CLAIM TO ANY PARTICULAR FONT, STYLE, SIZE, OR COLOR.

OWNER OF ERPN CMNTY TM OFC REG. NO. 003526712, DATED 8-10-2005, EXPIRES 8-10-2015.

OWNER OF U.S. REG. NO. 3,648,061.

THE NAME "TOM JONES" IDENTIFIES THE STAGE NAME OF THOMAS J. WOODWARD, A LIVING INDIVIDUAL WHOSE CONSENT IS OF RECORD.

SER. NO. 85-265,769, FILED 3-14-2011.

KAPIL BHANOT, EXAMINING ATTORNEY

# United States of America

United States Patent and Trademark Office

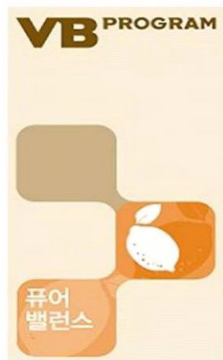

**Reg. No. 4,274,063**

**Registered Jan. 15, 2013**

**Int. Cl.: 29**

**TRADEMARK**

**PRINCIPAL REGISTER**

AMOREPACIFIC CORPORATION (REPUBLIC OF KOREA CORPORATION)  
181, 2-KA, HANGANG-RO, YONGSAN-KU  
SEOUL, REPUBLIC OF KOREA

FOR: PROCESSED FRUITS; PROCESSED VEGETABLES; PROCESSED MEAT; HEALTH FUNCTIONAL FOODS, NAMELY, PROCESSED FRUIT JELLIES, NOT BEING CONFECTIONERY, BASED ON LEMON EXTRACT; HEALTH FUNCTIONAL FOODS, NAMELY, PROCESSED FRUIT JELLIES, NOT BEING CONFECTIONERY, BASED ON FLAVONOID IN FRUIT EXTRACTS; HEALTH FUNCTIONAL FOODS, NAMELY, PROCESSED FRUIT JELLIES, NOT BEING CONFECTIONERY, BASED ON LEMON EXTRACT AND CONTAINING VITAMINS, PROTEINS AND COLLAGEN FROM FISH EXTRACTS; HEALTH FUNCTIONAL FOODS, NAMELY, PROCESSED FRUIT JELLIES, NOT BEING CONFECTIONERY, BASED ON LEMON EXTRACT AND CONTAINING LACTOSE; HEALTH FUNCTIONAL FOODS, NAMELY, PROCESSED FRUIT JELLIES, NOT BEING CONFECTIONERY, BASED ON LEMON EXTRACT, AND CONTAINING VITAMINS AND GLUCOSE; HEALTH FUNCTIONAL FOOD; NAMELY, PROCESSED FRUIT JELLIES, NOT BEING CONFECTIONERY, BASED ON LEMON EXTRACTS, AND CONTAINING VITAMIN AND LACTOSE; HEALTH FUNCTIONAL FOOD; NAMELY, PROCESSED FRUIT JELLIES, NOT BEING CONFECTIONERY, BASED ON LEMON EXTRACTS, AND CONTAINING VITAMINS, PROTEIN AND COLLAGEN FROM FISH EXTRACTS, GLUCOSE AND LACTOSE, IN CLASS 29 (U.S. CL. 46).

OWNER OF REPUBLIC OF KOREA REG. NO. 0890219, DATED 11-16-2011, EXPIRES 11-16-2021.

THE COLOR(S) BEIGE, BROWN, TAN, ORANGE, LIGHT ORANGE, AND WHITE IS/ARE CLAIMED AS A FEATURE OF THE MARK.

THE NON-LATIN CHARACTERS IN THE MARK TRANSLITERATE TO PURE BALANCE AND THIS MEANS PURE BALANCE IN ENGLISH.

OWNER OF U.S. REG. NO. 3,633,601.

NO CLAIM IS MADE TO THE EXCLUSIVE RIGHT TO USE "PROGRAM", APART FROM THE MARK AS SHOWN.

THE MARK CONSISTS OF THE BROWN WORDING "VB PROGRAM" IN THE BEIGE-COLORED RECTANGLE WHICH CONTAINS THREE ROUND-EDGED SQUARES IN TAN,



*David J. Kyjars*

Director of the United States Patent and Trademark Office

**Reg. No. 4,274,063** ORANGE AND LIGHT ORANGE CONNECTED TO ONE ANOTHER. THE TOP SQUARE IS TAN, THE MIDDLE SQUARE IS ORANGE WITH A STYLIZED WHITE LEMON AND LEAF DESIGN WITH A DARK ORANGE LEMON DESIGNS BEHIND IT AND THE BOTTOM SQUARE IN LIGHT ORANGE CONTAINS EIGHT WHITE STYLIZED KOREAN CHARACTERS WITH A LIGHT ORANGE LEMON DESIGN BEHIND IT.

SER. NO. 85-274,148, FILED 3-23-2011.

JASON TURNER, EXAMINING ATTORNEY

# United States of America

United States Patent and Trademark Office



**DIAMANT ROUGE**  
PARIS

**Reg. No. 4,274,064**

PACIFIC-CONCEPTS, INC (NEW YORK CORPORATION)  
271 NORTH AVENUE, SUITE 500  
NEW ROCHELLE, NY 10801

**Registered Jan. 15, 2013**

**Int. Cl.: 14**

FOR: WATCHES CONTAINING RED DIAMONDS MANUFACTURED, PACKAGED, AND SHIPPED FROM PARIS, FRANCE, IN CLASS 14 (U.S. CLS. 2, 27, 28 AND 50).

**TRADEMARK**

FIRST USE 12-1-2011; IN COMMERCE 12-1-2011.

**PRINCIPAL REGISTER**

NO CLAIM IS MADE TO THE EXCLUSIVE RIGHT TO USE "DIAMANT ROUGE PARIS", APART FROM THE MARK AS SHOWN.

THE MARK CONSISTS OF THE STYLIZED WORDS "DIAMANT ROUGE PARIS" WITH THE WORD "PARIS" CENTERED BENEATH THE WORDS IN STYLIZED FONT. ABOVE THE WORDING IS A DESIGN OF A FOUR-POINT STAR.

THE ENGLISH TRANSLATION OF "DIAMANT ROUGE" IN THE MARK IS "RED DIAMOND".

SER. NO. 85-278,374, FILED S.R. 3-28-2011 AM. P.R. 8-10-2012.

JEFFREY LOOK, EXAMINING ATTORNEY



*David J. Kybas*

Director of the United States Patent and Trademark Office

United States of America  
United States Patent and Trademark Office

# FUELBOX

**Reg. No. 4,274,065**

FUELBELT, INC. (RHODE ISLAND CORPORATION)  
267 WATER ST. 2ND FLOOR  
WARREN, RI 02885

**Registered Jan. 15, 2013**

**Int. Cl.: 12**

FOR: BICYCLE ACCESSORIES, NAMELY, BICYCLE BAGS FOR CONTAINING PERSONAL ITEMS OR FOOD, IN CLASS 12 (U.S. CLS. 19, 21, 23, 31, 35 AND 44).

**TRADEMARK**

FIRST USE 1-1-2006; IN COMMERCE 3-1-2006.

**PRINCIPAL REGISTER**

THE MARK CONSISTS OF STANDARD CHARACTERS WITHOUT CLAIM TO ANY PARTICULAR FONT, STYLE, SIZE, OR COLOR.

OWNER OF U.S. REG. NO. 2,537,992.

SER. NO. 85-279,488, FILED 3-29-2011.

BERYL GARDNER, EXAMINING ATTORNEY



*David J. Kyffers*

Director of the United States Patent and Trademark Office



# United States of America

United States Patent and Trademark Office

## MADE BY ME! JUNIOR

**Reg. No. 4,274,066**

HORIZON GROUP USA, INC (NEW JERSEY CORPORATION)

**Registered Jan. 15, 2013**

76 STIRLING ROAD, SUITE 101  
WARREN, NJ 07059

**Int. Cls.: 14, 16, 26 and  
28**

FOR: CRAFT AND ACTIVITY KITS FOR CHILDREN TO CREATE PLAY JEWELRY INCLUDING BEADS, PENDANTS, RINGS AND ACRYLIC STONES, IN CLASS 14 (U.S. CLS. 2, 27, 28 AND 50).

**TRADEMARK**

FIRST USE 3-0-2010; IN COMMERCE 3-0-2010.

**PRINCIPAL REGISTER**

FOR: CRAFT AND ACTIVITY KITS FOR CHILDREN, NAMELY, PAINT AND CLAY KITS; CRAFT AND ACTIVITY KITS FOR CHILDREN FOR DECORATING A BACKPACK, NAMELY, MARKERS AND A BACKPACK; CRAFT AND ACTIVITY KITS FOR CHILDREN FOR PAINTING AND DECORATING FRIENDSHIP STONES, NAMELY, PAINT, PAINT BRUSHES, PLASTER AND MOLDS; CRAFT AND ACTIVITY KITS FOR CHILDREN FOR PAINTING AND DECORATING A CLOCK, NAMELY, PAINT, PAINT BRUSHES AND A CLOCK; CRAFT AND ACTIVITY KITS FOR CHILDREN FOR PAINTING AND DECORATING TOY CARS, NAMELY, PAINT, PAINT BRUSHES AND TOY CARS; CRAFT AND ACTIVITY KITS FOR CHILDREN FOR PAINTING AND DECORATING MAGNETS, NAMELY, PAINT, PAINT BRUSHES, AND MAGNETS; CRAFT AND ACTIVITY KITS FOR CHILDREN FOR PAINTING DECORATING AND BURNING WOOD OBJECTS, NAMELY, PAINT, PAINT BRUSHES, WOODEN OBJECTS AND WOOD BURNING IRON; CRAFT AND ACTIVITY KITS FOR CHILDREN FOR PAINTING AND DECORATING A TIME CAPSULE, NAMELY, PAINT, PAINT BRUSHES AND A TIME CAPSULE; CRAFT AND ACTIVITY KITS FOR CHILDREN FOR PAINTING AND DECORATING TOY PETS, NAMELY, PAINT, PAINT BRUSHES AND TOY PETS; CRAFT AND ACTIVITY KITS FOR CHILDREN FOR PAINTING AND DECORATING BOBBLE HEAD OBJECTS, NAMELY, PAINT, PAINT BRUSHES AND BOBBLE HEAD OBJECTS; CRAFT AND ACTIVITY KITS FOR CHILDREN FOR PAINTING AND DECORATING FIGURINES, NAMELY, PAINT, PAINT BRUSHES AND FIGURINES; CRAFT AND ACTIVITY KITS FOR CHILDREN FOR CREATING SAND ART, NAMELY, SAND AND A CONTAINER; CRAFT AND ACTIVITY KITS FOR CHILDREN FOR DECORATING FRAMES, NAMELY, PAINT, BRUSHES AND FRAMES; ARTS AND CRAFT KITS CONTAINING VARIOUS COMBINATIONS OF SELECTED ART AND CRAFT SUPPLIES, NAMELY, PAINT, PAINT BRUSHES AND CLAY, IN CLASS 16 (U.S. CLS. 2, 5, 22, 23, 29, 37, 38 AND 50).



*David J. Kyffers*

Director of the United States Patent and Trademark Office

FIRST USE 3-0-2010; IN COMMERCE 3-0-2010.

**Reg. No. 4,274,066** FOR: CRAFT AND ACTIVITY KITS FOR CHILDREN FOR WEAVING OBJECTS INCLUDING A WEAVING LOOM, WEAVING HOCK AND WEAVING LOOPS, IN CLASS 26 (U.S. CLS. 37, 39, 40, 42 AND 50).

FIRST USE 3-0-2010; IN COMMERCE 3-0-2010.

FOR: CRAFT AND ACTIVITY KITS FOR CHILDREN, NAMELY, TOY BUILDING BLOCKS; CRAFT AND ACTIVITY KITS FOR CHILDREN TO CREATE HAND PUPPETS, NAMELY, HAND PUPPETS, IN CLASS 28 (U.S. CLS. 22, 23, 38 AND 50).

FIRST USE 3-0-2010; IN COMMERCE 3-0-2010.

THE MARK CONSISTS OF STANDARD CHARACTERS WITHOUT CLAIM TO ANY PARTICULAR FONT, STYLE, SIZE, OR COLOR.

SER. NO. 85-282,540, FILED 3-31-2011.

DAVID TOOLEY, EXAMINING ATTORNEY

# United States of America

United States Patent and Trademark Office

## DESERTLAND

**Reg. No. 4,274,067**

**Registered Jan. 15, 2013**

**Int. Cl.: 35**

**SERVICE MARK**

**PRINCIPAL REGISTER**

DESERTLAND.COM LLC (CALIFORNIA LIMITED LIABILITY COMPANY), DBA  
DESERTLAND.COM  
4460 REDWOOD HIGHWAY #16356  
SAN RAFAEL, CA 94903

FOR: REAL ESTATE ADVERTISING SERVICES, IN CLASS 35 (U.S. CLS. 100, 101 AND 102).

FIRST USE 12-12-2006; IN COMMERCE 12-12-2006.

THE MARK CONSISTS OF STANDARD CHARACTERS WITHOUT CLAIM TO ANY PARTICULAR FONT, STYLE, SIZE, OR COLOR.

SEC. 2(F).

SER. NO. 85-284,202, FILED 4-1-2011.

APRIL HESIK, EXAMINING ATTORNEY



*David J. Kyffers*

Director of the United States Patent and Trademark Office

# United States of America

United States Patent and Trademark Office



**Reg. No. 4,274,068**

**Registered Jan. 15, 2013**

**Int. Cl.: 30**

**TRADEMARK**

**PRINCIPAL REGISTER**

RICHARD E. COLGIN I LTD. (TEXAS LIMITED PARTNERSHIP), DBA THE COLGIN COMPANIES  
2230 VALDINA STREET  
DALLAS, TX 752076101

FOR: FOOD FLAVORINGS, IN CLASS 30 (U.S. CL. 46).

FIRST USE 4-1-1944; IN COMMERCE 4-1-1944.

NO CLAIM IS MADE TO THE EXCLUSIVE RIGHT TO USE "LIQUID SMOKE", APART FROM THE MARK AS SHOWN.

THE MARK CONSISTS OF THE WORD "COLGIN" IN A BORDERED OVAL ENCASING ABOVE THE WORDS "LIQUID SMOKE" IN A LOG-LIKE FONT THAT HOVERS OVER A LOG-LIT FIRE.

SER. NO. 85-286,933, FILED 4-5-2011.

STEVEN R. FINE, EXAMINING ATTORNEY



*David J. Kyros*

Director of the United States Patent and Trademark Office

# United States of America

United States Patent and Trademark Office

# HIGH 5

**Reg. No. 4,274,069**

**Registered Jan. 15, 2013**

**Int. Cl.: 36**

**SERVICE MARK**

**PRINCIPAL REGISTER**

BERTRAM CAPITAL MANAGEMENT LLC (CALIFORNIA LIMITED LIABILITY COMPANY)  
SUITE 100  
800 CONCAR DRIVE  
SAN MATEO, CA 94402

FOR: FINANCIAL INVESTMENT SERVICES, NAMELY, PROVIDING VENTURE CAPITAL FUNDING SERVICES TO EMERGING COMPANIES, FINANCIAL PLANNING AND CONSULTATION IN THE FIELD OF VENTURE CAPITAL FUNDING SERVICES TO EMERGING COMPANIES, INVESTMENT MANAGEMENT OF EQUITY SHARES IN THE FIELD OF VENTURE CAPITAL FUNDING SERVICES TO EMERGING COMPANIES, FINANCING SERVICES IN THE FIELD OF VENTURE CAPITAL FUNDING SERVICES TO EMERGING COMPANIES, FINANCIAL ANALYSIS IN THE FIELD OF VENTURE CAPITAL FUNDING SERVICES TO EMERGING COMPANIES, FINANCIAL MANAGEMENT IN THE FIELD OF VENTURE CAPITAL FUNDING SERVICES TO EMERGING COMPANIES, FUNDS INVESTMENTS IN THE FIELD OF VENTURE CAPITAL FUNDING SERVICES TO EMERGING COMPANIES, MANAGEMENT OF CAPITAL INVESTMENTS IN THE FIELD OF VENTURE CAPITAL FUNDING SERVICES TO EMERGING COMPANIES, ASSET MANAGEMENT IN THE FIELD OF VENTURE CAPITAL FUNDING SERVICES TO EMERGING COMPANIES, INVESTMENT ANALYSIS IN THE FIELD OF VENTURE CAPITAL FUNDING SERVICES TO EMERGING COMPANIES, IN CLASS 36 (U.S. CLS. 100, 101 AND 102).

FIRST USE 2-25-2007; IN COMMERCE 2-25-2007.

THE MARK CONSISTS OF STANDARD CHARACTERS WITHOUT CLAIM TO ANY PARTICULAR FONT, STYLE, SIZE, OR COLOR.

SER. NO. 85-287,429, FILED 4-6-2011.

TARA PATE, EXAMINING ATTORNEY



*David J. Kyjars*

Director of the United States Patent and Trademark Office

# United States of America

United States Patent and Trademark Office

# GO4

**Reg. No. 4,274,070**

GEOTAB INC. (CANADA CORPORATION)  
1081 SOUTH SERVICE ROAD WEST  
OAKVILLE, ONTARIO, CANADA L6L6K3

**Registered Jan. 15, 2013**

**Int. Cl.: 9**

FOR: GLOBAL POSITIONING SYSTEM (GPS) FOR TRACKING AND MONITORING VEHICLES, IN CLASS 9 (U.S. CLS. 21, 23, 26, 36 AND 38).

**TRADEMARK**

FIRST USE 6-0-2008; IN COMMERCE 6-0-2008.

**PRINCIPAL REGISTER**

THE MARK CONSISTS OF STANDARD CHARACTERS WITHOUT CLAIM TO ANY PARTICULAR FONT, STYLE, SIZE, OR COLOR.

SER. NO. 85-287,763, FILED 4-6-2011.

TEJBIR SINGH, EXAMINING ATTORNEY



*David J. Kybas*

Director of the United States Patent and Trademark Office

# United States of America

United States Patent and Trademark Office



**Reg. No. 4,274,071**

THE MELANOMA RESEARCH FOUNDATION (TEXAS NON-PROFIT CORPORATION)  
1411 K STREET, NW, SUITE 500  
WASHINGTON, DC 20005

**Registered Jan. 15, 2013**

**Int. Cl.: 41**

FOR: ARRANGING AND CONDUCTING EDUCATIONAL CONFERENCES AND SYMPOSIA  
IN THE FIELD OF MELANOMA RESEARCH, IN CLASS 41 (U.S. CLS. 100, 101 AND 107).

**SERVICE MARK**

FIRST USE 10-3-2010; IN COMMERCE 10-3-2010.

**PRINCIPAL REGISTER**

NO CLAIM IS MADE TO THE EXCLUSIVE RIGHT TO USE "CONSORTIUM", APART FROM  
THE MARK AS SHOWN.

THE MARK CONSISTS OF THE WORDS "MELANOMA RESEARCH FOUNDATION  
BREAKTHROUGH CONSORTIUM" STACKED VERTICALLY ABOVE "ACCELERATING  
RESEARCH FOR A CURE" ALL TO THE RIGHT OF A HALF-CIRCLE WITH SEVEN RADI-  
ATING LINES OF DOTS THAT PROGRESSIVELY DIMINISH IN SIZE.

SEC. 2(F) AS TO "MELANOMA RESEARCH FOUNDATION".

SER. NO. 85-293,945, FILED 4-13-2011.

SHANNON TWOHIG, EXAMINING ATTORNEY



*David J. Kybas*

Director of the United States Patent and Trademark Office

# United States of America

United States Patent and Trademark Office



**Reg. No. 4,274,072**

**Registered Jan. 15, 2013**

**Int. Cl.: 35**

**SERVICE MARK**

**PRINCIPAL REGISTER**

THE MELANOMA RESEARCH FOUNDATION (TEXAS NON-PROFIT CORPORATION)  
1411 K STREET, NW, SUITE 500  
WASHINGTON, DC 20005

FOR: PROMOTING THE EXCHANGE OF INFORMATION AND RESOURCES WITHIN THE SCIENTIFIC RESEARCH AND MEDICAL COMMUNITIES TO ACHIEVE ADVANCES IN THE FIELD OF MELANOMA RESEARCH; PROMOTING COLLABORATION WITHIN THE SCIENTIFIC, RESEARCH AND MEDICAL COMMUNITIES TO ACHIEVE ADVANCES IN THE FIELD OF MELANOMA RESEARCH; PROMOTING COLLABORATION WITHIN THE SCIENTIFIC, RESEARCH AND MEDICAL COMMUNITIES TO DEVELOP AND IMPLEMENT CLINICAL TRIALS FOR TREATMENT IN THE FIELD OF MELANOMA, IN CLASS 35 (U.S. CLS. 100, 101 AND 102).

FIRST USE 10-3-2010; IN COMMERCE 10-3-2010.

NO CLAIM IS MADE TO THE EXCLUSIVE RIGHT TO USE "CONSORTIUM", APART FROM THE MARK AS SHOWN.

THE MARK CONSISTS OF THE WORDS "MELANOMA RESEARCH FOUNDATION BREAKTHROUGH CONSORTIUM" STACKED VERTICALLY ABOVE "ACCELERATING RESEARCH FOR A CURE" ALL TO THE RIGHT OF A HALF-CIRCLE WITH SEVEN RADIATING LINES OF DOTS THAT PROGRESSIVELY DIMINISH IN SIZE.

SEC. 2(F) AS TO "MELANOMA RESEARCH FOUNDATION".

SER. NO. 85-294,072, FILED 4-13-2011.

SHANNON TWOHIG, EXAMINING ATTORNEY



*David J. Kyjars*

Director of the United States Patent and Trademark Office



# United States of America

United States Patent and Trademark Office

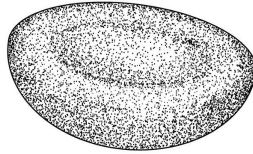

**Reg. No. 4,274,073**

**Registered Jan. 15, 2013**

**Int. Cl.: 30**

**TRADEMARK**

**PRINCIPAL REGISTER**

TOOTSIE ROLL INDUSTRIES LLC (DELAWARE LIMITED LIABILITY COMPANY)  
7401 SOUTH CICERO AVENUE  
CHICAGO, IL 60629

FOR: CANDY, IN CLASS 30 (U.S. CL. 46).

FIRST USE 0-0-1949; IN COMMERCE 0-0-1949.

THE MARK CONSISTS OF A PIECE OF CANDY WITH THE BOTTOM OF THE CANDY HAVING A CONCAVE CENTER, WHICH IS CURRENTLY PICTURED AS THE TOP OF THE MARK. THE TOP OF THE CANDY IS ROUNDED AND CONVEX AND IS CURRENTLY PICTURED AT THE BOTTOM OF THE MARK..

SEC. 2(F).

SER. NO. 85-296,411, FILED 4-15-2011.

DAWN FELDMAN, EXAMINING ATTORNEY



*David J. Kybas*

Director of the United States Patent and Trademark Office

# United States of America

United States Patent and Trademark Office

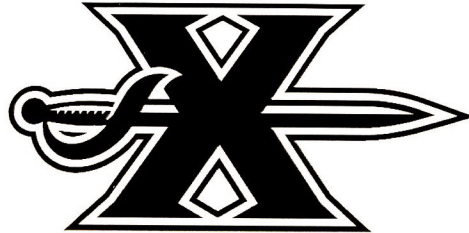

**Reg. No. 4,274,074**

**Registered Jan. 15, 2013**

**Int. Cl.: 16**

**TRADEMARK**

**PRINCIPAL REGISTER**

XAVIER UNIVERSITY (OHIO CORPORATION), DBA XAVIER UNIVERSITY  
3800 VICTORY PARKWAY  
CINCINNATI, OH 45207

FOR: DRY ERASE WRITING BOARDS AND WRITING SURFACES; STICK-ON WHITE-BOARDS AND DRY-ERASE BOARDS, IN CLASS 16 (U.S. CLS. 2, 5, 22, 23, 29, 37, 38 AND 50).

FIRST USE 6-1-2010; IN COMMERCE 6-1-2010.

OWNER OF U.S. REG. NOS. 2,122,467 AND 2,329,147.

THE MARK CONSISTS OF A STYLIZED LETTER "X" WITH A STYLIZED DEPICTION OF A SWORD RUNNING HORIZONTALLY THROUGH THE MIDDLE OF THE "X". THE SWORD DESIGN AND THE "X" ARE OUTLINED IN THEIR ENTIRETY.

SER. NO. 85-296,566, FILED 4-15-2011.

GRETCHEN ULRICH, EXAMINING ATTORNEY



*David J. Kybas*

Director of the United States Patent and Trademark Office

# United States of America

United States Patent and Trademark Office

## RENEWALSMANAGER

**Reg. No. 4,274,075**

SYNNEX CORPORATION (DELAWARE CORPORATION)

**Registered Jan. 15, 2013**

44201 NOBEL DRIVE  
FREMONT, CA 94538

**Int. Cl.: 42**

**SERVICE MARK**

**PRINCIPAL REGISTER**

FOR: PROVIDING ONLINE NON-DOWNLOADABLE SOFTWARE FOR USE IN TRACKING, RENEWING AND MANAGING SUBSCRIPTION CONTRACTS AND LICENSES FOR COMPUTER HARDWARE AND SOFTWARE; PROVIDING ONLINE NON-DOWNLOADABLE SOFTWARE FOR USE IN REPORTING ON, AND SENDING NOTIFICATIONS REGARDING SUBSCRIPTION CONTRACTS AND LICENSES FOR COMPUTER HARDWARE AND SOFTWARE; SOFTWARE AS A SERVICE (SAAS) SERVICES FEATURING SOFTWARE FOR USE IN TRACKING, RENEWING AND MANAGING SUBSCRIPTION CONTRACTS AND LICENSES FOR COMPUTER HARDWARE AND SOFTWARE; SOFTWARE AS A SERVICE (SAAS) SERVICES FEATURING SOFTWARE FOR USE IN REPORTING ON, AND SENDING NOTIFICATIONS REGARDING SUBSCRIPTION CONTRACTS AND LICENSES FOR COMPUTER HARDWARE AND SOFTWARE; PROVIDING ONLINE NON-DOWNLOADABLE SOFTWARE FOR OBTAINING QUOTES FOR EXISTING AND NEW CONTRACTS AND LICENSES FOR COMPUTER HARDWARE AND SOFTWARE; SOFTWARE AS A SERVICE (SAAS) SERVICES FEATURING SOFTWARE FOR OBTAINING QUOTES FOR EXISTING AND NEW CONTRACTS AND LICENSES FOR COMPUTER HARDWARE AND SOFTWARE; CONSULTING SERVICES, NAMELY PROVIDING ADVICE REGARDING MANAGEMENT OF INFORMATION TECHNOLOGY SUPPORT SYSTEMS FOR TECHNOLOGY COMPANIES; TECHNICAL SUPPORT SERVICES, NAMELY, TROUBLESHOOTING OF COMPUTER SOFTWARE PROBLEMS; COMPUTER TECHNOLOGY SUPPORT SERVICES, NAMELY, HELP DESK SERVICES, IN CLASS 42 (U.S. CLS. 100 AND 101).



FIRST USE 7-0-2006; IN COMMERCE 7-0-2006.

THE MARK CONSISTS OF STANDARD CHARACTERS WITHOUT CLAIM TO ANY PARTICULAR FONT, STYLE, SIZE, OR COLOR.

SEC. 2(F).

SER. NO. 85-298,998, FILED 4-19-2011.

ANNE E. GUSTASON, EXAMINING ATTORNEY

*David J. Kyros*

Director of the United States Patent and Trademark Office

# United States of America

United States Patent and Trademark Office

# TILLXTREME

**Reg. No. 4,274,076**

PEER BEARING COMPANY (ILLINOIS CORPORATION)  
2200 NORMAN DRIVE SOUTH  
WAUKEGAN, IL 60085

**Registered Jan. 15, 2013**

**Int. Cl.: 7**

FOR: MACHINE PARTS, NAMELY, BALL BEARINGS FOR AGRICULTURAL AND INDUSTRIAL EQUIPMENT, IN CLASS 7 (U.S. CLS. 13, 19, 21, 23, 31, 34 AND 35).

**TRADEMARK**

FIRST USE 4-20-2011; IN COMMERCE 4-20-2011.

**PRINCIPAL REGISTER**

THE MARK CONSISTS OF STANDARD CHARACTERS WITHOUT CLAIM TO ANY PARTICULAR FONT, STYLE, SIZE, OR COLOR.

SER. NO. 85-301,595, FILED 4-21-2011.

EMILY CARLSEN, EXAMINING ATTORNEY



*David J. Kyffers*

Director of the United States Patent and Trademark Office

# United States of America

United States Patent and Trademark Office



**Reg. No. 4,274,077**

**Registered Jan. 15, 2013**

**Int. Cl.: 18**

**TRADEMARK**

**PRINCIPAL REGISTER**

B.L.K. INTERNATIONAL, INC. (CALIFORNIA CORPORATION)  
814 SAN FERNANDO ROAD  
LOS ANGELES, CA 90065

FOR: HANDBAGS, IN CLASS 18 (U.S. CLS. 1, 2, 3, 22 AND 41).

FIRST USE 10-1-2004; IN COMMERCE 10-1-2004.

NO CLAIM IS MADE TO THE EXCLUSIVE RIGHT TO USE "AMERICAN", APART FROM THE MARK AS SHOWN.

THE COLOR(S) RED, WHITE, BLUE, BLACK, BROWN AND TAN IS/ARE CLAIMED AS A FEATURE OF THE MARK.

THE NAME(S), PORTRAIT(S), AND/OR SIGNATURE(S) SHOWN IN THE MARK DOES NOT IDENTIFY A PARTICULAR LIVING INDIVIDUAL.

THE MARK CONSISTS OF THE CAPTION IN BOLD CAPITALIZED LETTERS "AMERICAN COWGIRL". THE "AMERICAN" IS DIRECTLY ABOVE THE "COWGIRL". THE LETTERS OF THE WORD "AMERICAN" ARE TWO-TONE WITH RED ON THE TOP-HALF AND WHITE ON THE BOTTOM-HALF. THE LETTERS OF THE WORD "COWGIRL" ARE ALSO IN TWO-TONE, WITH WHITE ON THE TOP-HALF AND BLUE ON THE BOTTOM-HALF. IMMEDIATELY FOLLOWING THE CAPTION IS THE PORTRAIT OF THE HEAD, FACE AND BUST OF A WOMAN. ON HER HEAD IS A WHITE COWGIRL HAT AND HER BUST IS PARTIALLY COVERED IN A STRAPLESS WHITE BLOUSE. SHE HAS A WHITE GLOVE ON HER RIGHT HAND. SHE ALSO HAS BLACK HAIR. DIRECTLY ABOVE THE WORD "AMERICAN" IS A COMET FIGURE FROM RIGHT TO LEFT WITH A 5-POINT STAR ON ITS TAIL. THE COMET FIGURE IS IN THE COLOR BLUE WITH A WHITE STREAK TOWARDS ITS TAIL. THE CENTER OF THE STAR IS IN THE COLOR RED AND ALL 5 POINTS ARE IN THE COLOR BLUE. DIRECTLY BENEATH AND STRETCHING ACROSS THE CAPTION "AMERICAN COWGIRL" AND THE PORTRAIT IN BOLD WHITE CAPITALIZED LETTERS IS THE SENTENCE, "YOU KNOW YOU ARE A COWGIRL WHEN YOU". THE MARK IS ON A BROWN WOODEN BACKGROUND AND THE WOMAN HAS A TAN COMPLEXION.



*David J. Kybas*

SER. NO. 85-304,142, FILED 4-25-2011.

Director of the United States Patent and Trademark Office

**Reg. No. 4,274,077** INGA ERVIN, EXAMINING ATTORNEY

# United States of America

United States Patent and Trademark Office

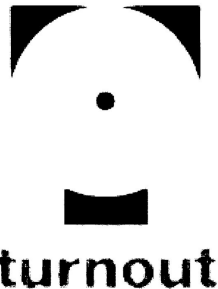

**Reg. No. 4,274,078**

**Registered Jan. 15, 2013**

**Int. Cls.: 9, 35 and 41**

**TRADEMARK**

**SERVICE MARK**

**PRINCIPAL REGISTER**

SKYSCRAPER VENTURES, INC. (WASHINGTON CORPORATION), DBA TURNOUT  
24 ROY STREET #424  
SEATTLE, WA 98109

FOR: PRE-RECORDED AUDIO TAPES, DISCS AND CASSETTES, VIDEO TAPES, DIGITAL AUDIO AND AUDIO VIDEO TAPES AND DISCS, CDS, DVDS, LASER DISCS, AND PHONOGRAPH RECORDS FEATURING MUSIC, SOUNDS AND ENTERTAINMENT, NAMELY, AUDIO RECORDINGS FEATURING MUSIC; MUSICAL SOUND AND VIDEO RECORDINGS; DOWNLOADABLE RING TONES, MUSIC, SOUND FILES, MP3 FILES, GRAPHICS, ELECTRONIC GAMES, IMAGE FILES CONTAINING MUSICIAN IMAGES AND MUSIC VIDEOS FOR WIRELESS COMMUNICATION DEVICES; DOWNLOADABLE MUSIC, SOUND FILES, MP3 FILES, GRAPHICS, COMPUTER GAMES, IMAGE FILES CONTAINING MUSICIAN IMAGES AND MUSIC VIDEOS, IN CLASS 9 (U.S. CLS. 21, 23, 26, 36 AND 38).

FIRST USE 4-1-2011; IN COMMERCE 4-1-2011.

FOR: RECORD LABEL SERVICES, NAMELY, DISTRIBUTION OF MUSICAL AND NON-MUSICAL SOUND RECORDINGS AND VIDEO RECORDINGS FOR PROMOTIONAL, ADVERTISING AND PUBLICITY PURPOSES, MARKETING, PROMOTION AND ADVERTISING FOR RECORDING ARTISTS AND MANAGEMENT OF RECORDING ARTISTS; ADVERTISING AND PROMOTION SERVICES AND RELATED CONSULTING SERVICES, NAMELY, PROMOTION OF MUSIC, MARKETING AND CONSULTING; ADVERTISING AND PUBLICITY SERVICES; ASSOCIATION SERVICES, NAMELY, PROMOTING THE INTERESTS OF MUSICIANS, SINGERS, SONGWRITERS, MUSICAL PERFORMERS AND ARTISTS; ORGANIZATION OF PROMOTIONS USING AUDIO-VISUAL MEDIA; PROMOTING THE CONCERTS OF OTHERS; MANAGEMENT SERVICES FOR RECORDING AND PERFORMING ARTISTS; ADVERTISING, NAMELY, PROMOTION OF PRODUCTS AND SERVICES OF THIRD PARTIES THROUGH SPONSORING ARRANGEMENTS; COMMERCIAL ADMINISTRATION OF LICENSE AGREEMENTS RELATING TO MUSIC EVENTS OF OTHERS; COMMERCIAL ADMINISTRATION OF THE LICENSING OF MUSICAL AND NON-MUSICAL SOUND RECORDINGS OF OTHERS, IN CLASS 35 (U.S. CLS. 100, 101 AND 102).

FIRST USE 4-1-2011; IN COMMERCE 4-1-2011.

FOR: RECORD LABEL SERVICES, NAMELY, PRODUCTION AND PUBLISHING OF MUSIC; PROVIDING ONLINE ENTERTAINMENT, NAMELY, PROVIDING NON-DOWNLOADABLE



*David J. Kyffers*

Director of the United States Patent and Trademark Office

**Reg. No. 4,274,078** SOUND AND VIDEO RECORDINGS IN THE FIELD OF MUSIC AND MUSIC BASED ENTERTAINMENT IN INTERNATIONAL CLASS 041, IN CLASS 41 (U.S. CLS. 100, 101 AND 107).

FIRST USE 4-1-2011; IN COMMERCE 4-1-2011.

THE MARK CONSISTS OF THE WORDING "TURNOUT" AND DESIGN. THE DESIGN CONSISTS OF A "T" SHAPE WITH A CENTRAL ANNULAR CUTAWAY LEAVING A CENTRAL CIRCULAR PORTION OR DOT. THE CIRCULAR PORTION OF THE MARK RESEMBLES A HIGHLY STYLIZED RECORD. THE TERM "TURNOUT" APPEARS BELOW THE DESIGN.

SER. NO. 85-306,057, FILED 4-27-2011.

MARLENE BELL, EXAMINING ATTORNEY



# United States of America

United States Patent and Trademark Office

# IST

**Reg. No. 4,274,079**

**Registered Jan. 15, 2013**

**Int. Cl.: 7**

**TRADEMARK**

**PRINCIPAL REGISTER**

I.S.T. ITALIA SISTEMI TECNOLOGICI S.R.L. (ITALY LIMITED LIABILITY COMPANY)  
VIA S. ANNA  
590 MODENA, ITALY

FOR: MACHINES FOR THE RECLAIMING OF SOLVENTS FOR USE IN PAINT MANUFACTURING, PAINT CLEANUP, CLEANING OF MECHANICAL PARTS, PRINTING, MANUFACTURING AND FABRICATION; CONTINUOUS CYCLE MACHINES FOR SOLVENT RECLAIMING FOR USE IN PAINT MANUFACTURING, PAINT CLEANUP, CLEANING OF MECHANICAL PARTS, PRINTING, MANUFACTURING AND FABRICATION; WASHING UNITS FOR MECHANICAL PIECES FOR USE IN PAINT MANUFACTURING, PAINT CLEANUP, CLEANING OF MECHANICAL PARTS, PRINTING, MANUFACTURING AND FABRICATION; SOLVENT AND WATER BASED WASHING UNITS FOR MECHANICAL PIECES FOR USE IN PAINT MANUFACTURING, PAINT CLEANUP, CLEANING OF MECHANICAL PARTS, PRINTING, MANUFACTURING AND FABRICATION; PNEUMATIC AND ELECTRIC VACUUM UNITS FOR USE IN PAINT MANUFACTURING, PAINT CLEANUP, CLEANING OF MECHANICAL PARTS, PRINTING, MANUFACTURING AND FABRICATION; ALL OF THE ABOVE-MENTIONED GOODS BEING MACHINES OR PARTS OF MACHINES BUT NONE OF THE ABOVE-MENTIONED GOODS BEING UNITS FOR THE POLYMERIZATION OF COATINGS OF FILMS, ESPECIALLY PAINTS, VARNISHES AND LACQUERS, IN CLASS 7 (U.S. CLS. 13, 19, 21, 23, 31, 34 AND 35).

FIRST USE 12-2-2002; IN COMMERCE 12-2-2002.

THE MARK CONSISTS OF STANDARD CHARACTERS WITHOUT CLAIM TO ANY PARTICULAR FONT, STYLE, SIZE, OR COLOR.

SER. NO. 85-307,457, FILED 4-28-2011.

YAT SYE, LEE, EXAMINING ATTORNEY



*David J. Kypos*

Director of the United States Patent and Trademark Office

# United States of America

United States Patent and Trademark Office

## SMARTREDEPLOY

**Reg. No. 4,274,080**

RISESMART, INC. (DELAWARE CORPORATION)  
2055 GATEWAY PLACE, SUITE 150  
SAN JOSE, CA 95110

**Registered Jan. 15, 2013**

**Int. Cl.: 42**

FOR: SOFTWARE AS A SERVICE (SAAS) SERVICES FEATURING SOFTWARE IN THE FIELD OF PERSONNEL PLACEMENT AND RECRUITMENT TO ENABLE EMPLOYERS TO REASSIGN, RATHER THAN LOSE, VALUABLE EMPLOYEES DURING A REDUCTION IN FORCE BY MATCHING EMPLOYEE TALENT TO INTERNAL POSITIONS, IN CLASS 42 (U.S. CLS. 100 AND 101).

**SERVICE MARK**

**PRINCIPAL REGISTER**

FIRST USE 5-1-2010; IN COMMERCE 5-1-2010.

THE MARK CONSISTS OF STANDARD CHARACTERS WITHOUT CLAIM TO ANY PARTICULAR FONT, STYLE, SIZE, OR COLOR.

SER. NO. 85-307,657, FILED 4-28-2011.

TRICIA SONNEBORN, EXAMINING ATTORNEY



*David J. Kyros*

Director of the United States Patent and Trademark Office

# United States of America

United States Patent and Trademark Office

## WHY ISRAEL?

**Reg. No. 4,274,081**

CHRISTIANS FOR ISRAEL INTERNATIONAL (NETHERLANDS NONPROFIT FOUNDATION)  
P.O. BOX 1100, 3860 BC  
NIJKERK, NETHERLANDS

**Registered Jan. 15, 2013**

**Int. Cl.: 41**

FOR: ON-LINE JOURNALS, NAMELY, BLOGS FEATURING INFORMATION IN THE FIELDS OF INTER-RELIGIOUS DIALOGUE, CHRISTIANITY, JUDAISM, BIBLICAL PROPHECY AND HISTORY, AND A BIBLICAL UNDERSTANDING OF THE JEWISH PEOPLE, IN CLASS 41 (U.S. CLS. 100, 101 AND 107).

**SERVICE MARK**

**PRINCIPAL REGISTER**

FIRST USE 0-0-2009; IN COMMERCE 0-0-2009.

THE MARK CONSISTS OF STANDARD CHARACTERS WITHOUT CLAIM TO ANY PARTICULAR FONT, STYLE, SIZE, OR COLOR.

NO CLAIM IS MADE TO THE EXCLUSIVE RIGHT TO USE "ISRAEL", APART FROM THE MARK AS SHOWN.

SER. NO. 85-308,344, FILED 4-29-2011.

ADA HAN, EXAMINING ATTORNEY



*David J. Kyjars*

Director of the United States Patent and Trademark Office

# United States of America

United States Patent and Trademark Office

# Mojo Ball

**Reg. No. 4,274,082**

SANDOVAL, SHAWN (UNITED STATES INDIVIDUAL)  
6 IRONWOOD  
IRVINE, CA 92604

**Registered Jan. 15, 2013**

**Int. Cl.: 28**

FOR: ACTION SKILL GAMES, IN CLASS 28 (U.S. CLS. 22, 23, 38 AND 50).

**TRADEMARK**

FIRST USE 5-1-2011; IN COMMERCE 5-1-2011.

**PRINCIPAL REGISTER**

THE MARK CONSISTS OF STANDARD CHARACTERS WITHOUT CLAIM TO ANY PARTICULAR FONT, STYLE, SIZE, OR COLOR.

OWNER OF U.S. REG. NO. 3,110,636.

NO CLAIM IS MADE TO THE EXCLUSIVE RIGHT TO USE "BALL", APART FROM THE MARK AS SHOWN.

SER. NO. 85-309,400, FILED 5-2-2011.

TINA MAI, EXAMINING ATTORNEY



*David J. Kyffers*

Director of the United States Patent and Trademark Office

# United States of America

United States Patent and Trademark Office

## CITI FLU CARE

**Reg. No. 4,274,083**

CITIGROUP INC. (DELAWARE CORPORATION)  
399 PARK AVENUE  
NEW YORK, NY 10043

**Registered Jan. 15, 2013**

**Int. Cl.: 36**

FOR: ISSUING PROPRIETARY PREPAID CARDS TO EMPLOYERS FOR USE BY EMPLOYEES IN OBTAINING AND PAYING FOR FLU VACCINATIONS AND MEDICAL CARE, IN CLASS 36 (U.S. CLS. 100, 101 AND 102).

**SERVICE MARK**

FIRST USE 11-0-2010; IN COMMERCE 11-0-2010.

**PRINCIPAL REGISTER**

THE MARK CONSISTS OF STANDARD CHARACTERS WITHOUT CLAIM TO ANY PARTICULAR FONT, STYLE, SIZE, OR COLOR.

OWNER OF U.S. REG. NOS. 1,181,467, 2,801,076 AND OTHERS.

NO CLAIM IS MADE TO THE EXCLUSIVE RIGHT TO USE "FLU CARE", APART FROM THE MARK AS SHOWN.

SER. NO. 85-309,753, FILED 5-2-2011.

ANNE E. GUSTASON, EXAMINING ATTORNEY



*David J. Kyffers*

Director of the United States Patent and Trademark Office

# United States of America

United States Patent and Trademark Office



**Reg. No. 4,274,084**

**Registered Jan. 15, 2013**

**Int. Cl.: 16**

**TRADEMARK**

**PRINCIPAL REGISTER**

PRIMELINK SOLUTIONS, LLC (CALIFORNIA LIMITED LIABILITY COMPANY)  
1350 BAYSHORE HIGHWAY, SUITE 700  
BURLINGAME, CA 94010

FOR: BIODEGRADABLE PAPER PULP-BASED TO-GO CONTAINERS FOR FOOD; CARD-BOARD CARRIERS FOR FOOD AND BEVERAGES; PAPER PACKAGING AND CONTAINERS FOR FOOD AND BEVERAGES COMPRISED OF MATERIALS DESIGNED TO LESSEN ADVERSE EFFECTS ON THE ENVIRONMENT; PAPER TAKE-OUT CARTONS FOR FOOD; PLASTIC FOOD STORAGE BAGS FOR HOUSEHOLD USE; BIODEGRADABLE PAPER PULP-BASED HINGED-LID CONTAINERS FOR FOOD, IN CLASS 16 (U.S. CLS. 2, 5, 22, 23, 29, 37, 38 AND 50).

FIRST USE 1-1-2008; IN COMMERCE 1-1-2008.

NO CLAIM IS MADE TO THE EXCLUSIVE RIGHT TO USE "LLC", APART FROM THE MARK AS SHOWN.

THE COLOR(S) GREEN IS/ARE CLAIMED AS A FEATURE OF THE MARK.

THE MARK CONSISTS OF GREEN ELONGATED SLANTED OVAL SHAPE WITH FIVE HORIZONTAL LINES VARYING IN SIZE LOCATED ON THE RIGHT HAND PERIMETER OF THE OVAL, THE WORD "PRIMEWARE" IN BOLD GREEN LETTERS LOCATED TO THE RIGHT OF THE OVAL SHAPE AND THE WORDS "BY PRIMELINK SOLUTIONS, LLC" IN GREEN LETTERS LOCATED DIRECTLY BELOW THE WORD "PRIMEWARE". THE WHITE COLOR APPEARING IN THE MARK IS BACKGROUND ONLY.

SER. NO. 85-313,063, FILED 5-5-2011.

HELENE LIWINSKI, EXAMINING ATTORNEY



*David J. Kyros*

Director of the United States Patent and Trademark Office

# United States of America

United States Patent and Trademark Office

# panacea health

**Reg. No. 4,274,085**

**Registered Jan. 15, 2013**

**Int. Cls.: 42 and 45**

**SERVICE MARK**

**PRINCIPAL REGISTER**

PANACEA HEALTH, LLC (MARYLAND LIMITED LIABILITY COMPANY), DBA PANACEA HEALTH  
6910 DEER VALLEY RD.  
HIGHLAND, MD 20777

FOR: CREATING AN ONLINE COMMUNITY FOR REGISTERED USERS TO BLOG ON TOPICS SUCH AS HEALTH, NUTRITION, EXERCISE, MEDICATIONS, TREATMENTS, AND GENERAL WELLBEING, IN CLASS 42 (U.S. CLS. 100 AND 101).

FIRST USE 6-4-2010; IN COMMERCE 6-4-2010.

FOR: ONLINE SOCIAL NETWORKING SERVICES, IN CLASS 45 (U.S. CLS. 100 AND 101).

FIRST USE 6-4-2010; IN COMMERCE 6-4-2010.

THE MARK CONSISTS OF STANDARD CHARACTERS WITHOUT CLAIM TO ANY PARTICULAR FONT, STYLE, SIZE, OR COLOR.

NO CLAIM IS MADE TO THE EXCLUSIVE RIGHT TO USE "HEALTH", APART FROM THE MARK AS SHOWN.

SER. NO. 85-313,307, FILED 5-5-2011.

DANNEAN HETZEL, EXAMINING ATTORNEY



*David J. Kyjars*

Director of the United States Patent and Trademark Office

# United States of America

United States Patent and Trademark Office



**Reg. No. 4,274,086**

**Registered Jan. 15, 2013**

**Int. Cl.: 14**

EAST INDIA COMPANY HOLDINGS PTE. LTD, THE (SINGAPORE LIMITED COMPANY (LTD.))  
150 ORCHARD ROAD  
ORCHARD PLAZA  
SINGAPORE, SINGAPORE 238841

**TRADEMARK**

**PRINCIPAL REGISTER**

FOR: PRECIOUS METALS AND THEIR ALLOYS; PRECIOUS METALS AND THEIR ALLOYS AND GOODS IN PRECIOUS METALS OR COATED THEREWITH, NAMELY, JEWELRY AND PRECIOUS STONES, TIE PINS, TIARAS, CUFFLINKS, SHIRT PINS AND STUDS; HOROLOGICAL AND CHRONOMETRIC INSTRUMENTS; CLOCKS AND WATCHES; COSTUME JEWELRY; GOLD, SILVER, PLATINUM AND PRECIOUS METALS; COLLECTIBLE AND NON-MONETARY COINS; BULLION MADE OF GOLD, SILVER, AND PLATINUM, IN CLASS 14 (U.S. CLS. 2, 27, 28 AND 50).

OWNER OF ERPN CMNTY TM OFC REG. NO. 9244501, DATED 12-24-2010, EXPIRES 7-13-2020.

THE MARK CONSISTS OF A STYLIZED LION IN FRONT OF A STYLIZED PALM TREE.

SER. NO. 85-314,207, FILED 5-6-2011.

REBECCA EISINGER, EXAMINING ATTORNEY



*David J. Kybas*

Director of the United States Patent and Trademark Office



# United States of America

United States Patent and Trademark Office

# R-SKIN

**Reg. No. 4,274,087**

**Registered Jan. 15, 2013**

**Int. Cls.: 3 and 44**

**TRADEMARK**

**SERVICE MARK**

**PRINCIPAL REGISTER**

RODIAL LIMITED (UNITED KINGDOM LIMITED COMPANY (LTD.))  
535 KINGS ROAD  
THE PLAZA, SUITE 3.25  
LONDON, UNITED KINGDOM SW100SZ

FOR: PERFUMES; NON-MEDICATED BATH PREPARATIONS; NON-MEDICATED TOILET PREPARATIONS, NAMELY, TOILET WATERS AND SOAPS; COSMETIC PREPARATIONS; NON-MEDICATED LOTIONS AND CREAMS FOR USE ON THE SKIN, POWDERS FOR USE ON THE SKIN, NAMELY, BODY POWDERS, DUSTING POWDERS, BABY POWDERS AND FOOT POWDERS; SCRUBBING PREPARATIONS FOR USE ON THE SKIN, NAMELY, BODY SCRUBS, FACIAL SCRUBS; FACE MOISTURIZERS AND TONERS; DEPILATORY PREPARATIONS; DEODORANTS FOR PERSONAL USE; TOILET ARTICLES, NAMELY, SOAPS AND TOILET WATER; LIP BALM; SKIN AND HAIR MASKS; PREPARATIONS FOR CARE OF THE HAIR; SHAMPOOS AND HAIR CONDITIONERS; SOAPS; ESSENTIAL OILS; MASSAGE PREPARATIONS, NAMELY, OILS AND CREAMS; PREPARATIONS FOR CARE OF THE NAILS; COSMETICS FOR SUN SCREENING; COTTON WOOL AND COTTON WOOL BUDS FOR COSMETICS AND TOILET USE; EMERY BOARDS, IN CLASS 3 (U.S. CLS. 1, 4, 6, 50, 51 AND 52).

FOR: BEAUTY SALON SERVICES; BEAUTY TREATMENT SERVICES, NAMELY, COSMETIC BODY CARE SERVICES; AROMATHERAPY; COSMETIC SKIN CARE SERVICES; MASSAGE SERVICES; BEAUTY SPA SERVICES, NAMELY, COSMETIC BODY CARE; COSMETIC TREATMENTS, NAMELY, FACIAL TREATMENT SERVICES IN THE NATURE OF COSMETIC PEELS, HEALTH SPA SERVICES FOR HEALTH AND WELLNESS OF THE BODY AND SPIRIT, NAMELY, PROVIDING FACIAL AND BODY TREATMENT SERVICES, COSMETIC BODY CARE SERVICES; COUNSELING, ADVISORY AND INFORMATION SERVICES, ALL RELATING TO THE AFORESAID, NAMELY, PROVIDING BEAUTY CONSULTATION AND ADVISE AND PROVIDING INFORMATION ABOUT BEAUTY, IN CLASS 44 (U.S. CLS. 100 AND 101).



THE MARK CONSISTS OF STANDARD CHARACTERS WITHOUT CLAIM TO ANY PARTICULAR FONT, STYLE, SIZE, OR COLOR.

*David J. Kyffers*

PRIORITY CLAIMED UNDER SEC. 44(D) ON UNITED KINGDOM APPLICATION NO. 2579579, FILED 4-28-2011, REG. NO. 2579579, DATED 4-28-2011, EXPIRES 4-28-2021.

SER. NO. 85-314,546, FILED 5-6-2011.

**Reg. No. 4,274,087** JAMES LOVELACE, EXAMINING ATTORNEY

United States of America  
United States Patent and Trademark Office

# SmokinGel

**Reg. No. 4,274,088**

MESCAVAGE, BRADLEY (UNITED STATES INDIVIDUAL)  
1622 WEST WALNUT ST  
ALLENTOWN, PA 18102

**Registered Jan. 15, 2013**

**Int. Cl.: 34**

FOR: TOBACCO ALTERNATIVE IN THE NATURE OF A HAND OR SKIN GEL, IN CLASS 34 (U.S. CLS. 2, 8, 9 AND 17).

**TRADEMARK**

FIRST USE 11-25-2011; IN COMMERCE 11-25-2011.

**PRINCIPAL REGISTER**

THE MARK CONSISTS OF STANDARD CHARACTERS WITHOUT CLAIM TO ANY PARTICULAR FONT, STYLE, SIZE, OR COLOR.

SER. NO. 85-314,706, FILED 5-6-2011.

LINDSEY RUBIN, EXAMINING ATTORNEY



*David J. Kyffers*

Director of the United States Patent and Trademark Office

# United States of America

United States Patent and Trademark Office

# Snow Beige

**Reg. No. 4,274,089**

LG ELECTRONICS INC. (REPUBLIC OF KOREA CORPORATION)  
20 YEOUIDO-DONG YOUNGDEUNGPO-GU  
SEOUL 150-721, REPUBLIC OF KOREA

**Registered Jan. 15, 2013**

**Int. Cl.: 11**

FOR: ELECTRIC REFRIGERATORS, IN CLASS 11 (U.S. CLS. 13, 21, 23, 31 AND 34).

**TRADEMARK**

THE MARK CONSISTS OF STANDARD CHARACTERS WITHOUT CLAIM TO ANY PARTICULAR FONT, STYLE, SIZE, OR COLOR.

**PRINCIPAL REGISTER**

PRIORITY CLAIMED UNDER SEC. 44(D) ON REPUBLIC OF KOREA APPLICATION NO. 40-2011-0011, FILED 3-4-2011, REG. NO. 0931327, DATED 8-20-2012, EXPIRES 8-20-2022.

NO CLAIM IS MADE TO THE EXCLUSIVE RIGHT TO USE "BEIGE", APART FROM THE MARK AS SHOWN.

SER. NO. 85-314,862, FILED 5-6-2011.

FRANK LATTUCA, EXAMINING ATTORNEY



*David J. Kyffers*

Director of the United States Patent and Trademark Office

# United States of America

United States Patent and Trademark Office

## DR. LAURA BERMAN

**Reg. No. 4,274,090**

**Registered Jan. 15, 2013**

**Int. Cl.: 9**

**TRADEMARK**

**PRINCIPAL REGISTER**

DR. LAURA BERMAN (UNITED STATES INDIVIDUAL)  
625 N. MICHIGAN AVE., SUITE 2500  
CHICAGO, IL 60611

FOR: PRE-RECORDED DVDS AND CDS FEATURING EDUCATION AND ENTERTAINMENT IN THE FIELDS OF RELATIONSHIPS AND SEX; DOWNLOADABLE ELECTRONIC BOOKS, ARTICLES, AND EDUCATIONAL MATERIALS FEATURING HUMAN ANATOMY DIAGRAMS, IN THE FIELDS OF RELATIONSHIPS AND SEX, IN CLASS 9 (U.S. CLS. 21, 23, 26, 36 AND 38).

FIRST USE 1-7-2007; IN COMMERCE 1-7-2007.

THE MARK CONSISTS OF STANDARD CHARACTERS WITHOUT CLAIM TO ANY PARTICULAR FONT, STYLE, SIZE, OR COLOR.

OWNER OF U.S. REG. NO. 3,430,662.

NO CLAIM IS MADE TO THE EXCLUSIVE RIGHT TO USE "DR", APART FROM THE MARK AS SHOWN.

THE NAME "DR. LAURA BERMAN" IDENTIFIES A LIVING INDIVIDUAL WHOSE CONSENT IS OF RECORD.

SER. NO. 85-315,252, FILED 5-8-2011.

GISELLE AGOSTO, EXAMINING ATTORNEY



*David J. Kybas*

Director of the United States Patent and Trademark Office

# United States of America

United States Patent and Trademark Office



**Reg. No. 4,274,091**

**Registered Jan. 15, 2013**

**Int. Cl.: 41**

**SERVICE MARK**

**PRINCIPAL REGISTER**

SANTANA, RICHARD (UNITED STATES INDIVIDUAL)  
C/O GRAY JOHNSON LAW  
108 NORTH ELM STREET  
GREENSBORO, NC 27401

FOR: ENTERTAINMENT SERVICES IN THE NATURE OF LIVE MUSIC PERFORMANCES AND LIVE CONCERTS; ENTERTAINMENT SERVICES, NAMELY, RECORDING, PRODUCTION, AND POST PRODUCTION OF MUSIC AND VIDEO SERVICES; MUSIC PUBLISHING, IN CLASS 41 (U.S. CLS. 100, 101 AND 107).

FIRST USE 1-1-2006; IN COMMERCE 1-1-2006.

NO CLAIM IS MADE TO THE EXCLUSIVE RIGHT TO USE "MUSIC GROUP", APART FROM THE MARK AS SHOWN.

THE MARK CONSISTS OF THE UPPER CASE STYLIZED CAPITAL LETTERS "LMG" OUTLINED WITH THICK BORDERS FOR EACH LETTER. THE LETTERS ARE CONNECTED TO EACH OTHER WITH THE INTERIOR OF EACH LETTER CONSISTING OF CLEAR SPACE. THERE IS TEXT IN THE INTERIOR ARM OF THE LETTER "L" THAT IS CONNECTED TO THE LETTER "G". THE TEXT READS "LEGA MUZIK GROUP".

SER. NO. 85-316,696, FILED 5-10-2011.

VIVIAN MICZNIK FIRST, EXAMINING ATTORNEY



*David J. Kyffers*

Director of the United States Patent and Trademark Office

# United States of America

United States Patent and Trademark Office

# XPEM

**Reg. No. 4,274,092**

**Registered Jan. 15, 2013**

**Int. Cls.: 35 and 42**

**SERVICE MARK**

**PRINCIPAL REGISTER**

XPEM, INC. (CALIFORNIA CORPORATION)  
2351 SUNSET BOULEVARD #170  
ROCKLIN, CA 95765

FOR: BUSINESS ANALYSIS AND BUSINESS STRATEGIC PLANNING SERVICES IN THE TECHNOLOGY INDUSTRY; BUSINESS CONSULTING SERVICES RELATING TO THE INTEGRATION OF THE AREAS OF BUSINESS PROCESS TECHNOLOGY, ORGANIZATIONAL LEARNING, CHANGE MANAGEMENT, AND OPERATIONAL SUSTAINABILITY; CONSULTING SERVICES IN THE FIELD OF HUMAN RESOURCES DEVELOPMENT, NAMELY, UTILIZING TECHNOLOGY FOR THE PROMOTION OF EMPLOYEE RETENTION, CAREER GROWTH AND INCREASED PRODUCTIVITY FOR EMPLOYEES AND EMPLOYERS; CUSTOM WRITING SERVICES COMPRISING PUBLIC RELATIONS AND MARKETING MATERIALS FOR THE AUDIO, VIDEO AND TECHNOLOGY INDUSTRIES; VALUE-ADDED RESELLER SERVICES, NAMELY, DISTRIBUTORSHIP SERVICES FEATURING COMPUTER SECURITY AND INFORMATION TECHNOLOGY PRODUCTS, IN CLASS 35 (U.S. CLS. 100, 101 AND 102).

FIRST USE 5-1-2006; IN COMMERCE 5-1-2006.

FOR: BUSINESS TECHNOLOGY SOFTWARE CONSULTATION SERVICES; COMPUTER SERVICES, NAMELY, PROVIDING AN INTERACTIVE WEB SITE FEATURING TECHNOLOGY THAT ALLOWS USERS TO COLLECT, STORE, MANAGE, DELIVER AND SHOW-CASE ELECTRONIC AND PAPER-BASED CONTENT; DEVELOPMENT OF NEW TECHNOLOGY FOR OTHERS IN THE FIELD OF RETAIL STORE SERVICES; PROVIDING A SECURE ELECTRONIC ONLINE SYSTEM FEATURING TECHNOLOGY WHICH ALLOWS CONSUMERS TO PURCHASE PRODUCTS ONLINE; PROVIDING A WEB SITE FEATURING TECHNOLOGY THAT ENABLES USERS TO CREATE, BOOKMARK, ANNOTATE AND PUBLICLY SHARE DATA; PROVIDING A WEB SITE THAT FEATURES INFORMATION ON COMPUTER TECHNOLOGY AND PROGRAMMING; PROVIDING A WEBSITE FEATURING TECHNOLOGY THAT ENABLES USERS TO PRESENT PRODUCTS, SERVICES, AND PROPOSALS TO OTHERS FOR COMMENT, AND GATHER FEEDBACK FROM THOSE OTHERS ABOUT THOSE PRODUCTS, SERVICES, AND PROPOSALS; PROVIDING AN INTERNET WEBSITE PORTAL IN THE FIELDS OF TECHNOLOGY AND SOFTWARE DEVELOPMENT; PROVIDING AN ON-LINE NETWORK ENVIRONMENT THAT FEATURES TECHNOLOGY THAT ENABLES USERS TO SHARE DATA; PROVIDING INFORMATION IN THE FIELDS OF TECHNOLOGY AND SOFTWARE DEVELOPMENT VIA AN ON-LINE WEBSITE, IN CLASS 42 (U.S. CLS. 100 AND 101).



*David J. Kyffers*

Director of the United States Patent and Trademark Office

**Reg. No. 4,274,092** FIRST USE 5-1-2006; IN COMMERCE 5-1-2006.

THE MARK CONSISTS OF CAPITAL LETTER "X", CAPITAL LETTER "P", LOWERCASE LETTER "E", CAPITAL LETTER "M".

SER. NO. 85-318,260, FILED 5-11-2011.

ALICIA COLLINS, EXAMINING ATTORNEY



# United States of America

United States Patent and Trademark Office

# pvLocker

**Reg. No. 4,274,093**

BUFFALO HOLDINGS, LTD. (ST.KITTS-NEVIS CORPORATION)  
P.O. BOX 642

**Registered Jan. 15, 2013**

CHARLESTOWN, NEVIS, ST.KITTS-NEVIS

**Int. Cl.: 39**

FOR: ELECTRONIC STORAGE OF DATA AND DIGITAL CONTENT IN THE NATURE OF TEXT, DOCUMENTS, IMAGES AND VIDEOS; ELECTRONIC STORAGE OF COMPUTERIZED DATA; STORAGE OF ELECTRONIC MEDIA, NAMELY, COMPUTERIZED DIGITAL TEXT, IMAGE, AUDIO, AND VIDEO DATA, IN CLASS 39 (U.S. CLS. 100 AND 105).

**SERVICE MARK**

**PRINCIPAL REGISTER**

FIRST USE 4-14-2011; IN COMMERCE 4-14-2011.

THE MARK CONSISTS OF STANDARD CHARACTERS WITHOUT CLAIM TO ANY PARTICULAR FONT, STYLE, SIZE, OR COLOR.

SER. NO. 85-318,508, FILED 5-11-2011.

EVELYN BRADLEY, EXAMINING ATTORNEY



*David J. Kyros*

Director of the United States Patent and Trademark Office

# United States of America

United States Patent and Trademark Office

# O-NITS

**Reg. No. 4,274,094**

**Registered Jan. 15, 2013**

**Int. Cl.: 14**

**TRADEMARK**

**PRINCIPAL REGISTER**

O-NITS, INC (ILLINOIS CORPORATION)  
7216 BONNIE DRIVE  
LAKEWOOD, IL 60014

FOR: CHARMS; NECKLACES, IN CLASS 14 (U.S. CLS. 2, 27, 28 AND 50).

FIRST USE 6-1-2010; IN COMMERCE 9-9-2010.

THE MARK CONSISTS OF STANDARD CHARACTERS WITHOUT CLAIM TO ANY PARTICULAR FONT, STYLE, SIZE, OR COLOR.

SER. NO. 85-318,881, FILED 5-12-2011.

DAVID YONTEF, EXAMINING ATTORNEY



*David J. Kyfos*

Director of the United States Patent and Trademark Office

# United States of America

United States Patent and Trademark Office

## VOCES Action

**Reg. No. 4,274,095**

**Registered Jan. 15, 2013**

**Int. Cl.: 35**

**SERVICE MARK**

**PRINCIPAL REGISTER**

VOCES ACTION (TEXAS NON-PROFIT ORGANIZATION)  
13617 ROLLING HILLS LANE  
DALLAS, TX 75240

FOR: PUBLIC ADVOCACY TO PROMOTE AWARENESS OF CONSERVATIVE ISSUES, ECONOMIC DEVELOPMENT, 10TH AMENDMENT: FIGHTING INTRUSIVE WASHINGTON POLICIES, BORDER SECURITY, PUBLIC AND HIGHER EDUCATION, HEALTH CARE, TORT REFORM, ENVIRONMENT AND NATURAL RESOURCES, ABORTION, BANNING EMBRYONIC STEM CELL RESEARCH, PROTECTING TRADITIONAL MARRIAGE, PROMOTING ADOPTION, TRANSPORTATION, CRIMINAL JUSTICE AND PROPERTY RIGHTS, IN CLASS 35 (U.S. CLS. 100, 101 AND 102).

FIRST USE 5-26-2009; IN COMMERCE 5-26-2009.

THE MARK CONSISTS OF STANDARD CHARACTERS WITHOUT CLAIM TO ANY PARTICULAR FONT, STYLE, SIZE, OR COLOR.

THE ENGLISH TRANSLATION OF "VOCES" IN THE MARK IS "VOICES".

SER. NO. 85-325,865, FILED 5-20-2011.

HENRY S. ZAK, EXAMINING ATTORNEY



*David J. Kyffers*

Director of the United States Patent and Trademark Office

# United States of America

United States Patent and Trademark Office

## AIRCRAFT REGISTRY OF CHOICE

**Reg. No. 4,274,096**

AVIATION REGISTRY GROUP, LLC (FLORIDA LIMITED LIABILITY COMPANY)  
8750 NW 36 STREET, SUITE 210  
DORAL, FL 33178

**Registered Jan. 15, 2013**

**Int. Cls.: 35, 42 and 45**

FOR: AIRCRAFT REGISTRY SERVICES, NAMELY, MAINTAINING A REGISTRY OF COMMERCIAL AND PRIVATE AIRCRAFT WITH GOVERNMENT AND PRIVATE BODIES, IN CLASS 35 (U.S. CLS. 100, 101 AND 102).

**SERVICE MARK**

FIRST USE 7-1-2010; IN COMMERCE 7-1-2010.

**PRINCIPAL REGISTER**

FOR: AIRCRAFT INSPECTION SERVICES, NAMELY, INSPECTIONS OF COMMERCIAL AND PRIVATE AIRCRAFT FOR CERTIFICATION PURPOSES, IN CLASS 42 (U.S. CLS. 100 AND 101).

FIRST USE 7-1-2010; IN COMMERCE 7-1-2010.

FOR: AIRCRAFT CONSULTING, NAMELY, REVIEWING STANDARDS AND PRACTICES TO ASSURE COMPLIANCE WITH REGARDS TO AIRCRAFT REGULATION AND COMPLIANCE REQUIREMENTS WORLDWIDE TO OWNERS, OPERATORS AND OTHER INTERESTED PARTIES OF COMMERCIAL AND PRIVATE AIRCRAFT, IN CLASS 45 (U.S. CLS. 100 AND 101).

FIRST USE 7-1-2010; IN COMMERCE 7-1-2010.

THE MARK CONSISTS OF STANDARD CHARACTERS WITHOUT CLAIM TO ANY PARTICULAR FONT, STYLE, SIZE, OR COLOR.

SER. NO. 85-326,285, FILED 5-20-2011.

MARK SPARACINO, EXAMINING ATTORNEY



*David J. Kyffers*

Director of the United States Patent and Trademark Office

# United States of America

United States Patent and Trademark Office

# SOLARLIBERTY

**Reg. No. 4,274,097**

SOLAR LIBERTY ENERGY SYSTEMS, INC. (NEW YORK CORPORATION)  
6500 SHERIDAN DRIVE SUITE 120  
BUFFALO, NY 14221

**Registered Jan. 15, 2013**

**Int. Cls.: 9, 37 and 42**

FOR: APPARATUS FOR CONVERTING ELECTROMAGNETIC RADIATION TO ELECTRICAL ENERGY, NAMELY, PHOTOVOLTAIC SOLAR MODULES OR SOLAR-THERMAL HYBRID MODULES, IN CLASS 9 (U.S. CLS. 21, 23, 26, 36 AND 38).

**TRADEMARK**

FIRST USE 6-13-2006; IN COMMERCE 6-13-2006.

**SERVICE MARK**

FOR: INSTALLATION OF SOLAR ENERGY EQUIPMENT, NAMELY, SOLAR PANELS, PHOTOVOLTAIC CELLS, AND SOLAR-THERMAL HYBRID MODULES, IN CLASS 37 (U.S. CLS. 100, 103 AND 106).

**PRINCIPAL REGISTER**

FIRST USE 6-13-2006; IN COMMERCE 6-13-2006.

FOR: DESIGNING OF SOLAR ENERGY EQUIPMENT, NAMELY, SOLAR PANELS, PHOTOVOLTAIC CELLS, AND SOLAR-THERMAL HYBRID MODULES, IN CLASS 42 (U.S. CLS. 100 AND 101).

FIRST USE 6-13-2006; IN COMMERCE 6-13-2006.

NO CLAIM IS MADE TO THE EXCLUSIVE RIGHT TO USE "SOLAR", APART FROM THE MARK AS SHOWN.

THE MARK CONSISTS OF THE WORD, "SOLAR LIBERTY" IN STYLIZED SCRIPT. THE "O" FORMING A RADIANT SUN IN THE CENTER OF THE "O".

SER. NO. 85-327,988, FILED 5-23-2011.

KEVON CHISOLM, EXAMINING ATTORNEY



*David J. Kyros*

Director of the United States Patent and Trademark Office

# United States of America

United States Patent and Trademark Office

## MIDNIGHT WARRIOR

**Reg. No. 4,274,098**

**Registered Jan. 15, 2013**

**Int. Cl.: 33**

**TRADEMARK**

**PRINCIPAL REGISTER**

VAMPT BEVERAGE USA, CORP. (NEVADA CORPORATION)  
C/O 187 TERRACE HILL COURT  
KELOWNA, BC, BRITISH COLUMBIA V1V 2T2

FOR: ALCOHOLIC BEVERAGES, NAMELY, PREMIXED COCKTAILS AND TEQUILA BASED COOLERS; FLAVORED ALCOHOLIC MALT COOLERS PRODUCED FROM BREWED MALT BASE WITH NATURAL FLAVORS, IN CLASS 33 (U.S. CLS. 47 AND 49).

FIRST USE 2-0-2011; IN COMMERCE 2-0-2011.

THE MARK CONSISTS OF STANDARD CHARACTERS WITHOUT CLAIM TO ANY PARTICULAR FONT, STYLE, SIZE, OR COLOR.

PRIORITY CLAIMED UNDER SEC. 44(D) ON CANADA APPLICATION NO. 1528366, FILED 5-18-2011.

SER. NO. 85-329,748, FILED 5-25-2011.

DOMINIC FATHY, EXAMINING ATTORNEY



*David J. Kyffers*

Director of the United States Patent and Trademark Office

# United States of America

United States Patent and Trademark Office

## SMOOTH TALKER

**Reg. No. 4,274,099**

**Registered Jan. 15, 2013**

**Int. Cl.: 33**

**TRADEMARK**

**PRINCIPAL REGISTER**

VAMPT BEVERAGE USA, CORP. (NEVADA CORPORATION)  
C/O 187 TERRACE HILL COURT  
KELOWNA, BC, BRITISH COLUMBIA V1V 2T2

FOR: ALCOHOLIC BEVERAGES, NAMELY, PREMIXED COCKTAILS AND TEQUILA BASED COOLERS; FLAVORED ALCOHOLIC MALT COOLERS PRODUCED FROM BREWED MALT BASE WITH NATURAL FLAVORS, IN CLASS 33 (U.S. CLS. 47 AND 49).

FIRST USE 2-0-2011; IN COMMERCE 2-0-2011.

THE MARK CONSISTS OF STANDARD CHARACTERS WITHOUT CLAIM TO ANY PARTICULAR FONT, STYLE, SIZE, OR COLOR.

PRIORITY CLAIMED UNDER SEC. 44(D) ON CANADA APPLICATION NO. 1528367, FILED 5-18-2011.

SER. NO. 85-329,786, FILED 5-25-2011.

DOMINIC FATHY, EXAMINING ATTORNEY



*David J. Kybas*

Director of the United States Patent and Trademark Office

# United States of America

United States Patent and Trademark Office

# napoleon

PERDIS

**Reg. No. 4,274,100**

NAPOLEON PERDIS LLC (DELAWARE LIMITED LIABILITY COMPANY)  
6621 HOLLYWOOD BLVD.  
HOLLYWOOD, CA 90028

**Registered Jan. 15, 2013**

**Int. Cls.: 3, 8, 16, 18, 20,  
21, 35, 41 and 44**

FOR: COSMETICS; MAKE-UP; HAIR CARE LOTIONS; PERFUMES; ESSENTIAL OILS; BODY OILS; BODY SCRUBS; BODY LOTIONS; BODY POLISHES; BODY SPRAYS; BODY WASHES; BODY MISTS; SKIN CARE LOTIONS; SKIN CARE PRODUCTS, NAMELY, FACE PRIMER, EYE PRIMER, PORE MINIMIZER AND MATTIFIERS, SMOOTHING CREAM, NON-MEDICATED FACE SERUM, BODY WASH, BODY LOTION, SHOWER GEL, AND BODY SCRUB; COSMETIC TANNING PREPARATIONS; BLUSH; BLUSHING POWDER; CONCEALERS; CONTOURERS, NAMELY, MOSAIC POWDER, BLUSH DUO AND ULTIMATE CONTOUR MAKEUP PALETTE; MAKE-UP POWDERS; FOUNDATIONS; MAKE-UP REMOVING PREPARATIONS; NAIL POLISH; COSMETICS ACCESSORIES, NAMELY, MAKE-UP BLOTTING PAPER AND COSMETIC BRUSH CLEANER; MASCARA; COSMETIC EYELASH PRODUCTS, NAMELY, EYELASH ADHESIVE AND EYELINER SEALER; COSMETIC EYE PENCILS; EYE COLOURS; EYE LINERS; EYE SHADOW; COSMETIC EYE DUST; LIPSTICKS; LIP LACQUERS; LIP GLOSS; LIP PENCILS; LIP LINERS; LIP VEIL; CONCEALER PENS; CLOTHS IMPREGNATED WITH COSMETIC PREPARATIONS; CLOTHS IMPREGNATED WITH COSMETIC REMOVAL PREPARATIONS; ARTIFICIAL NAILS; ARTIFICIAL EYELASHES; COSMETIC KITS COMPRISED OF MAKEUP PALETTES, COSMETICS BRUSHES, EYE/LIP LINERS, LIPSTICK, LIP VEILS, LIP GLOSS, FACE PRIMER, CONCEALER PENS, CONCEALER POTS, PORE MINIMIZER AND MATTIFIER; COSMETIC GLUE, NAMELY, EYELASH GLUE AND EYELASH ADHESIVE; COSMETIC EYELASH GLUE; COSMETIC PALETTES, NAMELY, COMPACTS CONTAINING MAKE-UP; COSMETIC DISCS, NAMELY, COMPACTS CONTAINING MAKE UP; SOAPS; BATH SALTS; BATH GELS; SHOWER GELS; EYE CARE PRODUCTS, NAMELY, EYE MASKS, EYE CREAM; FACE CARE PRODUCTS, NAMELY, NON-MEDICATED FACE SERUM, FACE SPRITZ; LIP CARE PRODUCTS, NAMELY, NON-MEDICATED LIP TREATMENT, LIP PRIMER, AND LIP BALM; NON-MEDICATED SERUMS TO REPLENISH THE SKIN; DAY FACIAL CREAMS; NIGHT CREAMS; FACIAL TONERS; SKIN BRONZERS; PORE MINIMISERS; SKIN MATTIFIER CREAMS AND LOTIONS; COTTON PUFFS FOR COSMETIC PURPOSES, IN CLASS 3 (U.S. CLS. 1, 4, 6, 50, 51 AND 52).

**TRADEMARK**

**SERVICE MARK**

**PRINCIPAL REGISTER**



*David J. Kappas*

FOR: COSMETIC TWEEZERS; EYELASH CURLERS, IN CLASS 8 (U.S. CLS. 23, 28 AND 44).



**Reg. No. 4,274,100** FOR: PRINTED MATTER, NAMELY, BOOKS, PHOTOGRAPHS, MAGAZINES, AND BROCHURES FEATURING COSMETICS AND MAKEUP ARTISTRY; PRINTED PERIODICALS IN THE FIELD OF BEAUTY, FASHION, AND COSMETICS; MAGAZINES IN THE FIELD OF BEAUTY AND FASHION; BOOKS IN THE FIELD OF BEAUTY; STATIONERY; PRINTED INSTRUCTIONAL AND TEACHING MATERIALS IN THE FIELD OF BEAUTY, COSMETICS, AND MAKEUP ARTISTRY; COSMETIC PENCIL SHARPENERS; EYE/LIP PENCIL SHARPENERS; NON IMPREGNATED TISSUES OF PAPER FOR REMOVAL OF COSMETICS, IN CLASS 16 (U.S. CLS. 2, 5, 22, 23, 29, 37, 38 AND 50).

FOR: COSMETIC BAGS AND CASES, NOT FITTED AND NOT OF PRECIOUS METAL, SOLD EMPTY; MAKE-UP BAGS, NOT FITTED AND NOT OF PRECIOUS METAL, SOLD EMPTY; MAKE-UP CASES, NOT FITTED AND NOT MADE OF PRECIOUS METAL, SOLD EMPTY; FITTED COSMETIC BAGS, CASES AND CONTAINERS, SOLD EMPTY, IN CLASS 18 (U.S. CLS. 1, 2, 3, 22 AND 41).

FOR: MIRROR COMPACTS FOR COSMETICS, NOT FITTED AND NOT OF PRECIOUS METAL; PERSONAL COMPACT MIRRORS, IN CLASS 20 (U.S. CLS. 2, 13, 22, 25, 32 AND 50).

FOR: BRUSHES FOR THE APPLICATION OR REMOVAL OF COSMETICS; NAIL BRUSHES; EYE BRUSHES; FACE BRUSHES; LIP BRUSHES; KITS COMPRISED OF COSMETIC BRUSHES; FOAM APPLICATOR STICKS FOR APPLYING COSMETICS; COSMETIC BRUSHES AND HAIR COMBS; COSMETIC SPONGES, NAMELY, FACIAL SPONGES FOR APPLYING MAKE-UP; BODY SCRUBBING PUFFS; POWDER PUFFS FOR COSMETICS; SPONGES FOR THE APPLICATION AND REMOVAL OF COSMETICS; POWDER COSMETIC COMPACTS SOLD EMPTY, IN CLASS 21 (U.S. CLS. 2, 13, 23, 29, 30, 33, 40 AND 50).

FOR: RETAIL STORE SERVICES FEATURING COSMETICS AND MAKEUP ARTISTRY; COSMETICS RETAIL STORE SERVICES FEATURING COSMETICS AND MAKEUP ARTISTRY; WHOLESALE STORE SERVICES FEATURING COSMETICS AND MAKEUP ARTISTRY; DISTRIBUTORSHIP SERVICES IN THE FIELD OF COSMETICS, IN CLASS 35 (U.S. CLS. 100, 101 AND 102).

FOR: EDUCATION SERVICES, NAMELY, PROVIDING CLASSES, WORKSHOPS, SEMINARS, IN THE FIELDS OF COSMETICS, MAKE UP APPLICATION, AND SKIN CARE; TEACHING THE APPLICATION OF COSMETICS AND MAKE-UP; ENTERTAINMENT SERVICES, NAMELY, THE PROVISION OF CONTINUING PROGRAMS, SEGMENTS, AND SHOWS FEATURING COSMETICS AND MAKEUP ARTISTRY DELIVERED BY TELEVISION OR BY THE INTERNET; PRODUCTION AND DISTRIBUTION TO THE PUBLIC OF FILMS AND TELEVISION PROGRAMS; PRODUCTION AND DISTRIBUTION TO THE PUBLIC OF SOUND, IMAGES OR BOTH, NAMELY, NON-DOWNLOADABLE AUDIO AND VIDEO RECORDINGS ONLINE OR VIA THE INTERNET; PUBLISHING OF BOOKS, MAGAZINES; ENTERTAINMENT SERVICES, NAMELY, PUBLISHING OF ELECTRONIC PUBLICATIONS FEATURING COSMETICS AND MAKEUP ARTISTRY; ORGANIZATION AND PRESENTATION OF FASHION, COSMETICS, AND BEAUTY SHOWS FOR ENTERTAINMENT PURPOSES, IN CLASS 41 (U.S. CLS. 100, 101 AND 107).

FOR: BEAUTY SALON SERVICES; BEAUTY SPA SERVICES, NAMELY, COSMETIC BODY CARE SERVICES; COSMETIC SKIN CARE SERVICES; COSMETIC LIP CARE SERVICES, IN CLASS 44 (U.S. CLS. 100 AND 101).

PRIORITY CLAIMED UNDER SEC. 44(D) ON AUSTRALIA APPLICATION NO. 1398338, FILED 12-7-2010, REG. NO. 1398338, DATED 12-7-2010, EXPIRES 12-7-2020.

THE NAME(S), PORTRAIT(S), AND/OR SIGNATURE(S) SHOWN IN THE MARK IDENTIFIES A LIVING INDIVIDUAL, WHOSE CONSENT(S) TO REGISTER IS MADE OF RECORD.

THE MARK CONSISTS OF THE WORDING "NAPOLEON PERDIS" IN A STYLIZED FONT.

**Reg. No. 4,274,100** SER. NO. 85-330,536, FILED 5-26-2011.

TRACY CROSS, EXAMINING ATTORNEY

# United States of America

United States Patent and Trademark Office

# 特效眼明素

**Reg. No. 4,274,101**

EDWARD WYNN LLC (NEVADA LIMITED LIABILITY COMPANY)  
308 S. FIRST AVENUE #D  
ARCADIA, CA 91006

**Registered Jan. 15, 2013**

**Int. Cl.: 5**

FOR: DIETARY AND NUTRITIONAL SUPPLEMENTS; DIETARY SUPPLEMENTS, IN CLASS 5 (U.S. CLS. 6, 18, 44, 46, 51 AND 52).

**TRADEMARK**

FIRST USE 8-1-2010; IN COMMERCE 8-1-2010.

**PRINCIPAL REGISTER**

THE MARK CONSISTS OF FIVE NON-LATIN CHARACTERS.

THE NON-LATIN CHARACTERS IN THE MARK TRANSLITERATE TO "TE XIAO YAN MING SU" AND THIS MEANS "ESPECIALLY EFFICIENT SOUL VISION ELEMENT" IN ENGLISH.

SER. NO. 85-335,778, FILED 6-1-2011.

PAM WILLIS, EXAMINING ATTORNEY



*David J. Kybas*

Director of the United States Patent and Trademark Office

# United States of America

United States Patent and Trademark Office

# VOA

**Reg. No. 4,274,102**

**Registered Jan. 15, 2013**

**Int. Cls.: 38 and 41**

BROADCASTING BOARD OF GOVERNORS (UNITED STATES AGENCY OF THE UNITED STATES GOVERNMENT)  
SUITE 3349, COHEN BUILDING  
330 INDEPENDENCE AVE., SW  
WASHINGTON, DC 20237

**SERVICE MARK**

**PRINCIPAL REGISTER**

FOR: STREAMING OF AUDIO AND VIDEO INTERNATIONAL NEWS MATERIAL ON THE INTERNET; AUDIO BROADCASTING OF INTERNATIONAL NEWS; PROVIDING AN ON-LINE FORUM FOR INTERNATIONAL NEWS PROGRAMMING FEATURING NEWS AND COMMENTARY SEGMENTS; PROVIDING ACCESS TO DIGITAL MUSIC WEBSITES ON THE INTERNET; INTERNET RADIO BROADCASTING OF INTERNATIONAL NEWS SERVICES, IN CLASS 38 (U.S. CLS. 100, 101 AND 104).

FIRST USE 3-31-1996; IN COMMERCE 3-31-1996.

FOR: INTERNATIONAL NEWS SERVICES, NAMELY, PROVIDING ON-GOING TELEVISION PROGRAMS IN THE FIELD OF NEWS COMMENTARY VIA A GLOBAL COMPUTER NETWORK; ON-LINE SOCIAL MEDIA JOURNALS, NAMELY, INTERNATIONAL NEWS BLOGS FEATURING NEWS AND COMMENTARY SEGMENTS; ENGLISH LANGUAGE INSTRUCTION, IN CLASS 41 (U.S. CLS. 100, 101 AND 107).

FIRST USE 12-31-1996; IN COMMERCE 12-31-1996.

THE MARK CONSISTS OF STANDARD CHARACTERS WITHOUT CLAIM TO ANY PARTICULAR FONT, STYLE, SIZE, OR COLOR.

SER. NO. 85-336,342, FILED 6-2-2011.

SUSAN LESLIE DUBOIS, EXAMINING ATTORNEY



*David J. Kybas*

Director of the United States Patent and Trademark Office

# United States of America

United States Patent and Trademark Office

## UTIL CANADA

**Reg. No. 4,274,103**

UTIL INDUSTRIES S.P.A. (ITALY CORPORATION)  
VIA GIOVANNI XXIII, 10, 14019-  
VILLANOVA D'ASTI, ITALY

**Registered Jan. 15, 2013**

**Int. Cls.: 7, 12, 35 and 40**

FOR: DIES FOR USE WITH MACHINE TOOLS USED IN METAL STAMPING OPERATIONS, IN CLASS 7 (U.S. CLS. 13, 19, 21, 23, 31, 34 AND 35).

**TRADEMARK**

FOR: AUTOMOTIVE DISC BRAKE BACKING PLATES AND BRAKE SHOES, BRAKE SYSTEM HARDWARE AND BRAKE SHIMS FOR LAND VEHICLES, IN CLASS 12 (U.S. CLS. 19, 21, 23, 31, 35 AND 44).

**SERVICE MARK**

**PRINCIPAL REGISTER**

FOR: DISTRIBUTORSHIPS IN THE FIELD OF CONVENTIONAL AND FINE BLANKED METAL AUTOMOTIVE BRAKE COMPONENTS, IN CLASS 35 (U.S. CLS. 100, 101 AND 102).

FOR: CONTRACT MANUFACTURING OF CONVENTIONAL AND FINE BLANKED METAL AUTOMOTIVE BRAKE COMPONENTS FOR ORIGINAL EQUIPMENT AND AFTERMARKET CUSTOMERS, IN CLASS 40 (U.S. CLS. 100, 103 AND 106).

THE MARK CONSISTS OF STANDARD CHARACTERS WITHOUT CLAIM TO ANY PARTICULAR FONT, STYLE, SIZE, OR COLOR.

PRIORITY CLAIMED UNDER SEC. 44(D) ON CANADA APPLICATION NO. 1530329, FILED 6-3-2011, REG. NO. TMA830,569, DATED 8-23-2012, EXPIRES 8-23-2027.

OWNER OF U.S. REG. NO. 2,592,384.

NO CLAIM IS MADE TO THE EXCLUSIVE RIGHT TO USE "CANADA", APART FROM THE MARK AS SHOWN.

THE ENGLISH TRANSLATION OF "UTIL" IN THE MARK IS "USEFUL".

SER. NO. 85-337,426, FILED 6-3-2011.

BARBARA GAYNOR, EXAMINING ATTORNEY



*David J. Kyros*

Director of the United States Patent and Trademark Office

United States of America  
United States Patent and Trademark Office

ADKT

**Reg. No. 4,274,104**

JERMAINE C. ROLISON (UNITED STATES INDIVIDUAL), AKA ADKT CLOTHING  
8124 AUTUMN STAR AVE  
LAS VEGAS, NV 89145

**Registered Jan. 15, 2013**

**Int. Cl.: 25**

FOR: SHIRTS, POLO SHIRTS, DENIM PANTS, JACKETS, SWEAT SHIRTS, HATS, AND SHORTS, IN CLASS 25 (U.S. CLS. 22 AND 39).

**TRADEMARK**

FIRST USE 2-11-2011; IN COMMERCE 2-11-2011.

**PRINCIPAL REGISTER**

THE MARK CONSISTS OF THE STYLIZED WORDING "ADKT".

SER. NO. 85-339,430, FILED S.R. 6-7-2011 AM. P.R. 2-22-2012.

CIMMERIAN COLEMAN, EXAMINING ATTORNEY



*David J. Kyffers*

Director of the United States Patent and Trademark Office

# United States of America

United States Patent and Trademark Office



**Reg. No. 4,274,105**

**Registered Jan. 15, 2013**

**Int. Cl.: 30**

**TRADEMARK**

**PRINCIPAL REGISTER**

B. TOFFEE (CALIFORNIA LIMITED LIABILITY COMPANY)  
SUITE K  
410 W. COAST HWY  
NEWPORT BEACH, CA 92663

FOR: TOFFEE CANDY CONFECTIONS, IN CLASS 30 (U.S. CL. 46).

FIRST USE 1-1-2009; IN COMMERCE 1-1-2009.

NO CLAIM IS MADE TO THE EXCLUSIVE RIGHT TO USE "TOFFEE" , APART FROM THE MARK AS SHOWN.

THE MARK CONSISTS OF THE STYLIZED TEXT "B." ABOVE THE STYLIZED TEXT "TOFFEE". THE TEXT IS ENCLOSED IN A DOUBLE-LINED SQUARE.

SER. NO. 85-340,046, FILED 6-7-2011.

ERNEST SHOSHO, EXAMINING ATTORNEY



*David J. Kybas*

Director of the United States Patent and Trademark Office

# United States of America

United States Patent and Trademark Office

# FORESTAR

**Reg. No. 4,274,106**

**Registered Jan. 15, 2013**

**Int. Cls.: 4, 35, 40 and 45**

FORESTAR GROUP INC. (DELAWARE CORPORATION)  
BUILDING TWO, SUITE 500  
6300 BEE CAVE ROAD  
AUSTIN, TX 78746

FOR: CRUDE OIL; NATURAL GAS, IN CLASS 4 (U.S. CLS. 1, 6 AND 15).

**TRADEMARK**

FIRST USE 12-28-2007; IN COMMERCE 12-28-2007.

**SERVICE MARK**

FOR: EVALUATION OF STANDING TIMBER; FOREST MANAGEMENT, IN CLASS 35 (U.S. CLS. 100, 101 AND 102).

**PRINCIPAL REGISTER**

FIRST USE 12-28-2007; IN COMMERCE 12-28-2007.

FOR: PROVIDING TECHNICAL INFORMATION IN THE FIELD OF MINERAL PROCESSING, IN CLASS 40 (U.S. CLS. 100, 103 AND 106).

FIRST USE 12-28-2007; IN COMMERCE 12-28-2007.

FOR: OBTAINING ENTITLEMENTS, NAMELY, GOVERNMENT AND REGULATORY PERMITS, LICENSES AND APPROVALS, TO BUILD SUBDIVISIONS, RESIDENTIAL AND/OR COMMERCIAL STRUCTURES FOR OTHERS, IN CLASS 45 (U.S. CLS. 100 AND 101).

FIRST USE 12-28-2007; IN COMMERCE 12-28-2007.

THE MARK CONSISTS OF STANDARD CHARACTERS WITHOUT CLAIM TO ANY PARTICULAR FONT, STYLE, SIZE, OR COLOR.

OWNER OF U.S. REG. NO. 3,561,464.

SER. NO. 85-343,334, FILED 6-10-2011.

SANJEEV VOHRA, EXAMINING ATTORNEY



*David J. Kyffers*

Director of the United States Patent and Trademark Office



# United States of America

United States Patent and Trademark Office

## ISTARTSTRONG

**Reg. No. 4,274,107**

**Registered Jan. 15, 2013**

**Int. Cl.: 41**

**SERVICE MARK**

**PRINCIPAL REGISTER**

CPP, INC. (CALIFORNIA CORPORATION)  
1055 JOAQUIN ROAD, SUITE 200  
MOUNTAIN VIEW, CA 94043

FOR: CAREER ASSESSMENT AND CAREER COUNSELING SERVICES; PREPARING, ADMINISTERING, SCORING AND REPORTING TESTS IN THE FIELD OF CAREER ASSESSMENT AND CAREER COUNSELING; ALL THE FOREGOING EXCLUDING CHARITABLE FUNDRAISING, JEWELRY, WRISTBANDS, AND THE FIELDS OF CANCER AND CANCER-RELATED GOODS, SERVICES OR ACTIVITIES, IN CLASS 41 (U.S. CLS. 100, 101 AND 107).

FIRST USE 1-14-2011; IN COMMERCE 1-14-2011.

THE MARK CONSISTS OF STANDARD CHARACTERS WITHOUT CLAIM TO ANY PARTICULAR FONT, STYLE, SIZE, OR COLOR.

SER. NO. 85-345,028, FILED 6-13-2011.

ERNEST SHOSHO, EXAMINING ATTORNEY



*David J. Kyffers*

Director of the United States Patent and Trademark Office

# United States of America

United States Patent and Trademark Office



**Reg. No. 4,274,108**

**Registered Jan. 15, 2013**

**Int. Cl.: 11**

**TRADEMARK**

**PRINCIPAL REGISTER**

PYTEL, DON (UNITED STATES INDIVIDUAL)  
2885 SANFORD AVE SW #14758  
GRANDVILLE, MI 49418

FOR: LIGHT EMITTING DIODE (LED) PLANT GROW LIGHT, IN CLASS 11 (U.S. CLS. 13, 21, 23, 31 AND 34).

FIRST USE 3-18-2011; IN COMMERCE 3-18-2011.

THE MARK CONSISTS OF DOTS SIMULATING LED DIODES FORMING THE LETTERS "GS", IN PURPLE, BLUE, GREEN, YELLOW, ORANGE AND RED. THE BLACK SEEN IS FOR BACKGROUND PURPOSES AND IS NOT CLAIMED AS PART OF THE MARK.

THE COLOR(S) PURPLE, BLUE, GREEN, YELLOW, ORANGE AND RED IS/ARE CLAIMED AS A FEATURE OF THE MARK.

SER. NO. 85-345,221, FILED 6-14-2011.

DEZMONA MIZELLE, EXAMINING ATTORNEY



*David J. Kyffers*

Director of the United States Patent and Trademark Office

# United States of America

United States Patent and Trademark Office

## LEADINAPPS

**Reg. No. 4,274,109**

LEADINAPPS, INC. (DELAWARE CORPORATION)

**Registered Jan. 15, 2013**

1891 LANDINGS DRIVE  
MOUNTAIN VIEW, CA 94043

**Int. Cls.: 9, 35, 38, 39, 41,  
42 and 45**

FOR: COMPUTER SOFTWARE PROGRAMS AND SOFTWARE APPLICATIONS FOR MOBILE TELEPHONES AND ELECTRONIC TABLETS WHICH ALLOWS TO LOAD, SEND, SHOW, DISPLAY, MARK, PUBLISH OR SHARE INFORMATION OR CONTENT THROUGH THE INTERNET OR OTHER COMMUNICATION NETWORKS; DOWNLOADABLE SOFTWARE FOR MOBILE APPLICATIONS KNOWN AS APPS AND ANY OTHER APP COMPATIBLE DEVICE, EITHER PORTABLE, SEMI-PORTABLE OR FIXED WHICH ALLOWS TO LOAD, SEND, SHOW, DISPLAY, MARK, PUBLISH OR SHARE INFORMATION OR CONTENT THROUGH THE INTERNET OR OTHER COMMUNICATION NETWORKS, IN CLASS 9 (U.S. CLS. 21, 23, 26, 36 AND 38).

**TRADEMARK**

**SERVICE MARK**

**PRINCIPAL REGISTER**

FOR: ADVERTISING SERVICES, BUSINESS MANAGEMENT; BUSINESS ADMINISTRATION; OFFICE WORK, NAMELY, SERVICES TO PROVIDE COMMERCIAL INFORMATION IN AN ONLINE DIRECTORY THAT PRESENTS ADVERTISING AND COMMERCIAL INFORMATION CONCERNING COMPUTER SOFTWARE PROGRAMS OR APPLICATIONS FOR MOBILE TELEPHONES OR TABLETS; ELECTRONIC ADVERTISEMENT SERVICES, IN CLASS 35 (U.S. CLS. 100, 101 AND 102).



FOR: TELECOMMUNICATIONS SERVICES, NAMELY, SERVICES TO PROVIDE ONLINE CHAT; COMPUTER ASSISTED TRANSMISSION OF MESSAGES AND IMAGES; TELECONFERENCE SERVICES; E-MAIL, COMMUNICATIONS THROUGH COMPUTER TERMINALS; COMPUTER SERVICES, NAMELY, CREATING AN ON-LINE COMMUNITY FOR REGISTERED USERS TO FORM VIRTUAL COMMUNITIES; ELECTRONIC TRANSMISSION OF DATA IN THE FORM OF APPLICATIONS AND TRACING OF ONLINE COURSES; PROVIDING INFORMATION IN THE FIELD OF VIRTUAL CHAT ROOMS ESTABLISHED VIA TEXT MESSAGING; PROVIDING INFORMATION IN THE FIELD OF ELECTRONIC TRANSMISSION OF DATA IN THE FORM OF APPLICATIONS AND TRACING OF ONLINE COURSES, IN CLASS 38 (U.S. CLS. 100, 101 AND 104).

*David J. Kyros*

Director of the United States Patent and Trademark Office

FOR: ELECTRONIC STORAGE OF MESSAGES AND DATA; PROVIDING INFORMATION IN THE FIELD OF ELECTRONIC STORAGE OF MESSAGES AND DATA, INCLUDING SOFTWARE OR PIECES OF SOFTWARE CODING, APPLICATIONS, MESSAGES, USER INFORMATION, APPLICATION INFORMATION AND ADVERTISEMENTS, IN CLASS 39 (U.S. CLS. 100 AND 105).

**Reg. No. 4,274,109** FOR: EDUCATION SERVICES, NAMELY, PROVIDING WEBINARS IN THE FIELD OF COMPUTER SCIENCES AND APPLICATION DEVELOPMENT; TRAINING SERVICES IN THE FIELD OF COMPUTER SCIENCES AND APPLICATION DEVELOPMENT; PROVIDING INFORMATION IN THE FIELDS OF EDUCATION AND ENTERTAINMENT, IN CLASS 41 (U.S. CLS. 100, 101 AND 107).

FOR: PROVIDING ONLINE, NON-DOWNLOADABLE COMPUTER SOFTWARE FOR MOBILE APPLICATIONS KNOWN AS APPS AND ANY OTHER APP COMPATIBLE DEVICE, EITHER PORTABLE, SEMI-PORTABLE OR FIXED WHICH ALLOWS TO LOAD, SEND, SHOW, DISPLAY, MARK, PUBLISH OR SHARE INFORMATION OR CONTENT THROUGH THE INTERNET OR OTHER COMMUNICATION NETWORKS; PROVIDING INFORMATION IN THE FIELDS OF COMPUTER APPLICATIONS FOR MOBILE TELEPHONES AND ELECTRONIC TABLETS; CONSULTING, UPDATING, LEASING, DESIGNING, INSTALLATION AND MAINTENANCE OF COMPUTER PROGRAMS AND SOFTWARE; PROVIDING ONLINE, NON-DOWNLOADABLE COMPUTER SOFTWARE FOR USERS TO UTILIZE IN THE CREATION AND UTILIZATION OF APPLICATIONS, WEB PAGES AND ONLINE PLATFORMS THROUGH MOBILE DEVICES; PROVIDING INFORMATION IN THE FIELDS OF COMPUTER PROGRAM SOFTWARE; PROVIDING INFORMATION RELATED TO DEVELOPING AND USING COMPUTER APPLICATIONS FOR MOBILE TELEPHONE OR ELECTRONIC TABLETS, VIRTUAL COMMUNITIES, SOCIAL NETWORKS, ELECTRONIC STORAGE, DISTRIBUTION OF CONTENTS AND COURSE TRACKING, IN CLASS 42 (U.S. CLS. 100 AND 101).

FOR: SOCIAL NETWORKING SERVICES ON THE INTERNET; PROVIDING INFORMATION IN THE FIELD OF SOCIAL NETWORKING, IN CLASS 45 (U.S. CLS. 100 AND 101).

THE MARK CONSISTS OF STANDARD CHARACTERS WITHOUT CLAIM TO ANY PARTICULAR FONT, STYLE, SIZE, OR COLOR.

PRIORITY CLAIMED UNDER SEC. 44(D) ON MEXICO APPLICATION NO. 1183518, FILED 6-3-2011, REG. NO. 1251469, DATED 11-14-2011, EXPIRES 6-3-2021.

PRIORITY CLAIMED UNDER SEC. 44(D) ON MEXICO APPLICATION NO. 1183519, FILED 6-3-2011, REG. NO. 1269446, DATED 2-21-2012, EXPIRES 6-3-2021.

PRIORITY CLAIMED UNDER SEC. 44(D) ON MEXICO APPLICATION NO. 1183521, FILED 6-3-2011, REG. NO. 1271679, DATED 3-5-2012, EXPIRES 6-3-2021.

PRIORITY CLAIMED UNDER SEC. 44(D) ON MEXICO APPLICATION NO. 1183522, FILED 6-3-2011, REG. NO. 1270241, DATED 2-23-2012, EXPIRES 6-3-2021.

PRIORITY CLAIMED UNDER SEC. 44(D) ON MEXICO APPLICATION NO. 1183510, FILED 6-3-2011, REG. NO. 1246829, DATED 10-21-2011, EXPIRES 6-3-2021.

SER. NO. 85-345,458, FILED 6-14-2011.

MATTHEW EINSTEIN, EXAMINING ATTORNEY

# United States of America

United States Patent and Trademark Office



**Reg. No. 4,274,110**

UTIL INDUSTRIES S.P.A. (ITALY CORPORATION)  
VIA GIOVANNI XXIII, 10  
14019-VILLA D'ASTI, ITALY

**Registered Jan. 15, 2013**

**Int. Cls.: 7, 12, 35 and 40**

FOR: DIES FOR USE WITH MACHINE TOOLS USED IN METAL STAMPING OPERATIONS, IN CLASS 7 (U.S. CLS. 13, 19, 21, 23, 31, 34 AND 35).

**TRADEMARK**

FOR: AUTOMOTIVE DISC BRAKE BACKING PLATES AND BRAKE SHOES, BRAKE SYSTEM HARDWARE AND BRAKE SHIMS FOR LAND VEHICLES, IN CLASS 12 (U.S. CLS. 19, 21, 23, 31, 35 AND 44).

**SERVICE MARK**

**PRINCIPAL REGISTER**

FOR: DISTRIBUTORSHIPS IN THE FIELD OF CONVENTIONAL AND FINE BLANKED METAL AUTOMOTIVE BRAKE COMPONENTS, IN CLASS 35 (U.S. CLS. 100, 101 AND 102).

FOR: CONTRACT MANUFACTURING OF CONVENTIONAL AND FINE BLANKED METAL AUTOMOTIVE BRAKE COMPONENTS FOR ORIGINAL EQUIPMENT AND AFTERMARKET CUSTOMERS, IN CLASS 40 (U.S. CLS. 100, 103 AND 106).

PRIORITY CLAIMED UNDER SEC. 44(D) ON CANADA APPLICATION NO. 1532160, FILED 6-17-2011, REG. NO. TMA830,568, DATED 8-23-2012, EXPIRES 8-23-2027.

OWNER OF U.S. REG. NO. 2,592,384.

NO CLAIM IS MADE TO THE EXCLUSIVE RIGHT TO USE "CANADA", APART FROM THE MARK AS SHOWN.

THE MARK CONSISTS OF THE WORD "CANADA" UNDER THE WORD "UTIL" FLANKED BY HORIZONTAL LINES.

THE ENGLISH TRANSLATION OF "UTIL" IN THE MARK IS "USEFUL".

SER. NO. 85-349,275, FILED 6-17-2011.

BARBARA GAYNOR, EXAMINING ATTORNEY

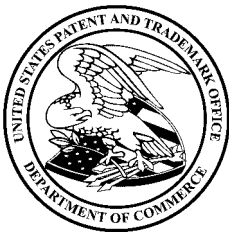

*David J. Kyros*

Director of the United States Patent and Trademark Office

# United States of America

United States Patent and Trademark Office



**Reg. No. 4,274,111**

UTIL INDUSTRIES S.P.A. (ITALY CORPORATION)  
VIA GIOVANNI XXIII, 10  
14019-VILLA D'ASTI, ITALY

**Registered Jan. 15, 2013**

**Int. Cls.: 7, 12, 35 and 40**

FOR: DIES FOR USE WITH MACHINE TOOLS USED IN METAL STAMPING OPERATIONS, IN CLASS 7 (U.S. CLS. 13, 19, 21, 23, 31, 34 AND 35).

**TRADEMARK**

FOR: AUTOMOTIVE DISC BRAKE BACKING PLATES; AND BRAKE SHOES, BRAKE SYSTEM HARDWARE AND BRAKE SHIMS FOR LAND VEHICLES, IN CLASS 12 (U.S. CLS. 19, 21, 23, 31, 35 AND 44).

**SERVICE MARK**

**PRINCIPAL REGISTER**

FOR: DISTRIBUTORSHIPS IN THE FIELD OF CONVENTIONAL AND FINE BLANKED METAL AUTOMOTIVE BRAKE COMPONENTS, IN CLASS 35 (U.S. CLS. 100, 101 AND 102).

FOR: CONTRACT MANUFACTURING OF CONVENTIONAL AND FINE BLANKED METAL AUTOMOTIVE BRAKE COMPONENTS FOR ORIGINAL EQUIPMENT AND AFTERMARKET CUSTOMERS, IN CLASS 40 (U.S. CLS. 100, 103 AND 106).

PRIORITY CLAIMED UNDER SEC. 44(D) ON CANADA APPLICATION NO. 1532160, FILED 6-17-2011, REG. NO. TMA830,567, DATED 8-23-2012, EXPIRES 8-23-2027.

OWNER OF U.S. REG. NO. 2,592,384.

NO CLAIM IS MADE TO THE EXCLUSIVE RIGHT TO USE "MEXICO", APART FROM THE MARK AS SHOWN.

THE MARK CONSISTS OF THE WORD "MEXICO" UNDER THE WORD "UTIL" FLANKED BY HORIZONTAL LINES.

THE ENGLISH TRANSLATION OF "UTIL" IN THE MARK IS "USEFUL".

SER. NO. 85-349,289, FILED 6-17-2011.

BARBARA GAYNOR, EXAMINING ATTORNEY



*David J. Kyros*

Director of the United States Patent and Trademark Office

# United States of America

United States Patent and Trademark Office



**Reg. No. 4,274,112**

**Registered Jan. 15, 2013**

**Int. Cls.: 9 and 16**

**TRADEMARK**

**PRINCIPAL REGISTER**

SOUNDSENTIMENTS, INC. (NEW YORK CORPORATION)  
SUITE 2, 138 NASSAU AVE  
BROOKLYN, NY 11222

FOR: DIGITAL MUSIC DOWNLOADABLE FROM THE INTERNET; DOWNLOADABLE MUSICAL SOUND RECORDINGS; DOWNLOADABLE MUSIC, SONGS, SONG SAMPLES, RING TONES VIA THE INTERNET AND WIRELESS DEVICES, IN CLASS 9 (U.S. CLS. 21, 23, 26, 36 AND 38).

FIRST USE 11-12-2011; IN COMMERCE 11-12-2011.

FOR: GREETING CARDS, IN CLASS 16 (U.S. CLS. 2, 5, 22, 23, 29, 37, 38 AND 50).

FIRST USE 11-12-2011; IN COMMERCE 11-12-2011.

NO CLAIM IS MADE TO THE EXCLUSIVE RIGHT TO USE "SOUND", "EST. 2011" AND "NYC", APART FROM THE MARK AS SHOWN.

THE MARK CONSISTS OF TWO CONCENTRIC CIRCLES WITH "EST. 2011" BETWEEN THE UPPER PART OF THE CIRCLES AND "NYC" BETWEEN THE LOWER PARTS OF THE CIRCLES, AND "SOUND SENTIMENTS" ACROSS AND OVER THE CENTRAL REGION OF THE CIRCLES, AND A SET OF FIVE PARALLEL WAVY LINES EXTENDING FROM THE UPPER RIGHT PORTION OF THE OUTER CIRCLE WITH SEVERAL MUSICAL NOTES ON THE LINES.

SER. NO. 85-350,044, FILED 6-20-2011.

RONALD AIKENS, EXAMINING ATTORNEY



*David J. Kyffers*

Director of the United States Patent and Trademark Office

# United States of America

United States Patent and Trademark Office

# LIZARD

**Reg. No. 4,274,113**

**Registered Jan. 15, 2013**

**Int. Cl.: 13**

**TRADEMARK**

**PRINCIPAL REGISTER**

ELBIT SYSTEMS LTD. (ISRAEL CORPORATION)  
ADVANCED TECHNOLOGY CENTER  
P.O.B 539  
HAIFA, ISRAEL 31053

FOR: GUIDED ROCKET AND BOMB PARTS KIT COMPRISED OF ATTACHABLE ADJUSTABLE AERIAL FINS WITH MECHANICAL ADAPTORS AND CANARD ACTUATORS, AND ATTACHABLE NOSECONE HOUSING WITH MECHANICAL ADAPTORS AND CONTAINING RADAR, ANTENNA, GPS NAVIGATION DEVICE, LASER TARGET DESIGNATORS, INFRARED SENSORS AND DETECTORS, AND COMPUTER HARDWARE, ALL FOR USE IN NAVIGATION AND HOMING OF GUIDED ROCKETS AND BOMBS, AND DETECTION AND TRACKING OF GUIDED ROCKET AND BOMB TARGETS, IN CLASS 13 (U.S. CLS. 2 AND 9).

THE MARK CONSISTS OF STANDARD CHARACTERS WITHOUT CLAIM TO ANY PARTICULAR FONT, STYLE, SIZE, OR COLOR.

PRIORITY CLAIMED UNDER SEC. 44(D) ON ISRAEL APPLICATION NO. 234985, FILED 1-17-2011, REG. NO. 234985, DATED 5-2-2012, EXPIRES 1-17-2021.

SER. NO. 85-350,690, FILED 6-20-2011.

NELSON SNYDER, EXAMINING ATTORNEY



*David J. Kyros*

Director of the United States Patent and Trademark Office



# United States of America

United States Patent and Trademark Office

## CHATTERBAY

**Reg. No. 4,274,114**

CHATTERBAY APS (DENMARK ANPARTSSELSKAB (APS))  
C.F.MØLLERS ALLÉ 40, 4. TV.

**Registered Jan. 15, 2013**

KØBENHAVN S, DENMARK DK2300

**Int. Cl.: 36**

FOR: FINANCIAL AFFAIRS AND MONETARY AFFAIRS, NAMELY, FINANCIAL INFORMATION, MANAGEMENT AND ANALYSIS SERVICES; MONEY TRANSFER SERVICES OFFERED VIA WEBSITES AND OTHER ELECTRONIC MEDIA, IN CLASS 36 (U.S. CLS. 100, 101 AND 102).

**SERVICE MARK**

**PRINCIPAL REGISTER**

THE MARK CONSISTS OF STANDARD CHARACTERS WITHOUT CLAIM TO ANY PARTICULAR FONT, STYLE, SIZE, OR COLOR.

PRIORITY CLAIMED UNDER SEC. 44(D) ON DENMARK APPLICATION NO. VA201003811, FILED 12-22-2010, REG. NO. VR201101446, DATED 6-16-2011, EXPIRES 6-16-2021.

SER. NO. 85-350,788, FILED 6-20-2011.

KIM SAITO, EXAMINING ATTORNEY



*David J. Kyffers*

Director of the United States Patent and Trademark Office

# United States of America

United States Patent and Trademark Office

## GREEN MOTION

**Reg. No. 4,274,115**

**Registered Jan. 15, 2013**

**Int. Cl.: 39**

**SERVICE MARK**

**PRINCIPAL REGISTER**

GREEN MOTION VEHICLE RENTAL LIMITED (UNITED KINGDOM LIMITED COMPANY  
(LTD.))  
MID-DAY COURT  
20-24 BRIGHTON ROAD  
SUTTON, SURREY, UNITED KINGDOM SM25BN

FOR: RENTAL OF MOTOR VEHICLES AND LAND VEHICLES; CONTRACT HIRE AND  
LEASING OF MOTOR VEHICLES AND LAND VEHICLES , IN CLASS 39 (U.S. CLS. 100  
AND 105).

THE MARK CONSISTS OF STANDARD CHARACTERS WITHOUT CLAIM TO ANY PAR-  
TICULAR FONT, STYLE, SIZE, OR COLOR.

OWNER OF ERPN CMNTY TM OFC REG. NO. 005311709, DATED 8-8-2007, EXPIRES 9-13-  
2016.

NO CLAIM IS MADE TO THE EXCLUSIVE RIGHT TO USE "GREEN", APART FROM THE  
MARK AS SHOWN.

SER. NO. 85-355,932, FILED 6-24-2011.

TRICIA SONNEBORN, EXAMINING ATTORNEY



*David J. Kyffers*

Director of the United States Patent and Trademark Office

# United States of America

United States Patent and Trademark Office

## UTIL MEXICO

**Reg. No. 4,274,116**

UTIL INDUSTRIES S.P.A (ITALY CORPORATION)  
VIA GIOVANNI XXIII, 10  
14019-VILLA D'ASTI, ITALY

**Registered Jan. 15, 2013**

**Int. Cls.: 7, 12, 35 and 40**

FOR: DIES FOR USE WITH MACHINE TOOLS USED IN METAL STAMPING OPERATIONS, IN CLASS 7 (U.S. CLS. 13, 19, 21, 23, 31, 34 AND 35).

**TRADEMARK**

FOR: AUTOMOTIVE DISC BRAKE BACKING PLATES AND BRAKE SHOES, BRAKE SYSTEM HARDWARE AND BRAKE SHIMS FOR LAND VEHICLES, IN CLASS 12 (U.S. CLS. 19, 21, 23, 31, 35 AND 44).

**SERVICE MARK**

**PRINCIPAL REGISTER**

FOR: DISTRIBUTORSHIPS IN THE FIELD OF CONVENTIONAL AND FINE BLANKED METAL AUTOMOTIVE BRAKE COMPONENTS, IN CLASS 35 (U.S. CLS. 100, 101 AND 102).

FOR: CONTRACT MANUFACTURING OF CONVENTIONAL AND FINE BLANKED METAL AUTOMOTIVE BRAKE COMPONENTS FOR ORIGINAL EQUIPMENT AND AFTERMARKET CUSTOMERS, IN CLASS 40 (U.S. CLS. 100, 103 AND 106).

THE MARK CONSISTS OF STANDARD CHARACTERS WITHOUT CLAIM TO ANY PARTICULAR FONT, STYLE, SIZE, OR COLOR.

PRIORITY CLAIMED UNDER SEC. 44(D) ON CANADA APPLICATION NO. 1533343, FILED 6-27-2011, REG. NO. TMA830,566, DATED 8-23-2012, EXPIRES 8-23-2027.

OWNER OF U.S. REG. NO. 2,592,384.

NO CLAIM IS MADE TO THE EXCLUSIVE RIGHT TO USE "MEXICO", APART FROM THE MARK AS SHOWN.

THE ENGLISH TRANSLATION OF "UTIL" IN THE MARK IS "USEFUL".

SER. NO. 85-356,839, FILED 6-27-2011.

BARBARA GAYNOR, EXAMINING ATTORNEY

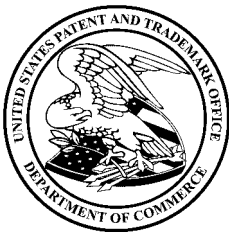

*David J. Kyros*

Director of the United States Patent and Trademark Office

# United States of America

United States Patent and Trademark Office

## LIFEBALANCE

**Reg. No. 4,274,117**

**Registered Jan. 15, 2013**

**Int. Cl.: 9**

**TRADEMARK**

**PRINCIPAL REGISTER**

CERIDIAN CORPORATION (DELAWARE CORPORATION)  
3311 EAST OLD SHAKOPEE ROAD  
MINNEAPOLIS, MN 55425

FOR: DOWNLOADABLE PERIODIC ELECTRONIC NEWSLETTERS IN THE FIELD OF GENERAL INTEREST, NAMELY, ACHIEVING FINANCIAL GOALS, GOOD HEALTH, EXCELLENT FAMILY CARE AND SUCCESS AT WORK; AUDIO RECORDINGS FEATURING TOPICS OF GENERAL INTEREST, NAMELY, ACHIEVING FINANCIAL GOALS, GOOD HEALTH, EXCELLENT FAMILY CARE AND SUCCESS AT WORK; AND DOWNLOADABLE PODCASTS IN THE FIELD OF GENERAL INTEREST, NAMELY, ACHIEVING FINANCIAL GOALS, GOOD HEALTH, EXCELLENT FAMILY CARE AND SUCCESS AT WORK, IN CLASS 9 (U.S. CLS. 21, 23, 26, 36 AND 38).

FIRST USE 12-31-2000; IN COMMERCE 12-31-2000.

THE MARK CONSISTS OF STANDARD CHARACTERS WITHOUT CLAIM TO ANY PARTICULAR FONT, STYLE, SIZE, OR COLOR.

OWNER OF U.S. REG. NO. 3,156,278.

SER. NO. 85-357,140, FILED 6-27-2011.

ERIN FALK, EXAMINING ATTORNEY



*David J. Kyros*

Director of the United States Patent and Trademark Office

# United States of America

United States Patent and Trademark Office

The logo consists of the letters "CVC" in a bold, sans-serif font. The letters are positioned over a light gray, slanted oval background that is slightly offset to the left and bottom, creating a shadow effect.

**Reg. No. 4,274,118**

**Registered Jan. 15, 2013**

**Int. Cl.: 39**

**SERVICE MARK**

**PRINCIPAL REGISTER**

CVC BRASIL OPERADORA E AGENCIA DE VIAGENS S.A. (BRAZIL PRIVATELY-HELD COMPANY)  
RUA GERTRUDES DE LIMA, NO 53 CONJUNTO 52  
CENTRO SANTO ANDRE, SP, BRAZIL

FOR: ARRANGING FOR PACKAGE TOURS; TRAVEL BOOKING AGENCIES; TRAVEL AGENCY SERVICES, NAMELY, RESERVATIONS AND BOOKINGS FOR TEMPORARY TRANSPORTATION, IN CLASS 39 (U.S. CLS. 100 AND 105).

OWNER OF BRAZIL REG. NO. 825894069, DATED 7-3-2007, EXPIRES 7-3-2017.

THE MARK CONSISTS OF THE LETTERS "CVC" ACROSS A SLANTED OVAL DESIGN.

SER. NO. 85-359,921, FILED 6-29-2011.

KIM MONINGHOFF, EXAMINING ATTORNEY



*David J. Kyffers*

Director of the United States Patent and Trademark Office

# United States of America

United States Patent and Trademark Office

# iPower6

**Reg. No. 4,274,119**

**Registered Jan. 15, 2013**

**Int. Cl.: 36**

**SERVICE MARK**

**PRINCIPAL REGISTER**

IPOWER6, LLC (WYOMING LIMITED LIABILITY COMPANY), DBA IPOWER6  
23150 FASHION DRIVE, SUITE T237  
ESTERO, FL 33928

FOR: ENERGY BROKERAGE SERVICES, IN CLASS 36 (U.S. CLS. 100, 101 AND 102).

FIRST USE 9-15-2010; IN COMMERCE 9-15-2010.

THE MARK CONSISTS OF STANDARD CHARACTERS WITHOUT CLAIM TO ANY PARTICULAR FONT, STYLE, SIZE, OR COLOR.

THE WORDING "IPOWER6" HAS NO MEANING IN A FOREIGN LANGUAGE.

SER. NO. 85-362,155, FILED S.R. 7-1-2011 AM. P.R. 9-25-2012.

NAKIA HENRY, EXAMINING ATTORNEY



*David J. Kyffers*

Director of the United States Patent and Trademark Office

# United States of America

United States Patent and Trademark Office

## MICRO ROBOTIC CREATURES

**Reg. No. 4,274,120**

INNOVATION FIRST, INC. (TEXAS CORPORATION)  
1519 INTERSTATE 30 WEST  
GREENVILLE, TX 75402

**Registered Jan. 15, 2013**

**Int. Cl.: 28**

FOR: TOYS, NAMELY, TOY ANIMALS AND ACCESSORIES THEREFOR, IN CLASS 28  
(U.S. CLS. 22, 23, 38 AND 50).

**TRADEMARK**

FIRST USE 4-1-2007; IN COMMERCE 4-1-2007.

**PRINCIPAL REGISTER**

THE MARK CONSISTS OF STANDARD CHARACTERS WITHOUT CLAIM TO ANY PARTICULAR FONT, STYLE, SIZE, OR COLOR.

NO CLAIM IS MADE TO THE EXCLUSIVE RIGHT TO USE "ROBOTIC", APART FROM THE MARK AS SHOWN.

SER. NO. 85-366,853, FILED 7-8-2011.

REBECCA EISINGER, EXAMINING ATTORNEY



*David J. Kyffers*

Director of the United States Patent and Trademark Office

# United States of America

United States Patent and Trademark Office

# ZENITH

**Reg. No. 4,274,121**

ZENITH INDUSTRIAL CHEMICALS PTE LTD (SINGAPORE PRIVATE LIMITED COMPANY)  
9/9A LOK YANG WAY

**Registered Jan. 15, 2013**

SINGAPORE, SINGAPORE 628628

**Int. Cl.: 1**

FOR: CHEMICAL PREPARATIONS AND CHEMICAL SUBSTANCES USED IN PAPER MAKING, PULP MAKING, LEATHER MAKING AND THE TREATMENT OF WATER, ALL OF THE AFORESAID GOODS BEING FOR INDUSTRIAL USE; CHEMICAL ADDITIVES AND PRESERVATIVES FOR USE IN MAKING PAPER PULP; CHEMICAL ADDITIVES AND PRESERVATIVES FOR USE IN MAKING PAPER; CHEMICAL ADDITIVES AND PRESERVATIVES FOR USE IN MAKING LEATHER; ENZYME PREPARATIONS FOR USE IN THE PAPER MAKING INDUSTRY; TANNING AGENTS FOR USE IN THE MANUFACTURE OF LEATHER; CHEMICALS FOR USE IN RE-PULPING AND DE-INKING IN THE FIELD OF WASTE PAPER RECYCLING, IN CLASS 1 (U.S. CLS. 1, 5, 6, 10, 26 AND 46).

**TRADEMARK**

**PRINCIPAL REGISTER**

THE MARK CONSISTS OF STANDARD CHARACTERS WITHOUT CLAIM TO ANY PARTICULAR FONT, STYLE, SIZE, OR COLOR.

OWNER OF SINGAPORE REG. NO. T1102370B, DATED 2-25-2011, EXPIRES 2-25-2021.

SER. NO. 85-367,825, FILED 7-11-2011.

JAMES LOVELACE, EXAMINING ATTORNEY



*David J. Kypos*

Director of the United States Patent and Trademark Office



# United States of America

United States Patent and Trademark Office

# PICADITAS

**Reg. No. 4,274,122**

**Registered Jan. 15, 2013**

**Int. Cl.: 30**

**TRADEMARK**

**PRINCIPAL REGISTER**

GRUPO BIMBO, S.A. B. DE C.V. (MEXICO CORPORATION)  
PROLONGACION PASEO DE LA REFORMA  
NO. 1000, COL. PENA BLANCA SANTA FE  
MEXICO CITY, MEXICO 01210

FOR: TORTILLA CHIPS AND TOSTADAS, IN CLASS 30 (U.S. CL. 46).

FIRST USE 9-30-2008; IN COMMERCE 9-30-2008.

THE MARK CONSISTS OF STANDARD CHARACTERS WITHOUT CLAIM TO ANY PARTICULAR FONT, STYLE, SIZE, OR COLOR.

THE WORDING "PICADITAS" HAS NO MEANING IN A FOREIGN LANGUAGE.

SER. NO. 85-371,573, FILED 7-14-2011.

TIMOTHY FINNEGAN, EXAMINING ATTORNEY



*David J. Kybas*

Director of the United States Patent and Trademark Office

# United States of America

United States Patent and Trademark Office

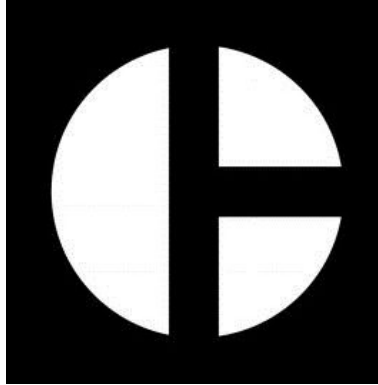

**Reg. No. 4,274,123**

**Registered Jan. 15, 2013**

**Int. Cls.: 7 and 12**

**TRADEMARK**

**PRINCIPAL REGISTER**

CATERPILLAR INC. (DELAWARE CORPORATION)  
100 N.E. ADAMS STREET  
PEORIA, IL 61629

FOR: MACHINES FOR USE IN AGRICULTURE, COMPACTION, CONSTRUCTION, DEMOLITION, EARTH CONDITIONING, EARTH CONTOURING, EARTH MOVING, FORESTRY, LANDSCAPING, LAWN CARE, LIFTING, MARINE PROPULSION, MATERIAL HANDLING, MINING, OIL AND GAS PRODUCTION, PAVING, PIPELAYING, POWER GENERATION, AND ROAD BUILDING AND REPAIR, IN CLASS 7 (U.S. CLS. 13, 19, 21, 23, 31, 34 AND 35).

FIRST USE 0-0-1967; IN COMMERCE 0-0-1967.

FOR: LAND VEHICLES FOR USE IN AGRICULTURE, COMPACTION, CONSTRUCTION, DEMOLITION, EARTH CONDITIONING, EARTH CONTOURING, EARTH MOVING, FORESTRY, LANDSCAPING, LAWN CARE, LIFTING, MARINE PROPULSION, MATERIAL HANDLING, MINING, OIL AND GAS PRODUCTION, PAVING, PIPELAYING, POWER GENERATION, AND ROAD BUILDING AND REPAIR, IN CLASS 12 (U.S. CLS. 19, 21, 23, 31, 35 AND 44).

FIRST USE 0-0-1967; IN COMMERCE 0-0-1967.

THE MARK CONSISTS OF A STYLIZED LETTER "C" ON A SOLID SQUARE BACKGROUND, THE STYLIZED "C" IS FORMED FROM A CIRCLE THAT IS DIVIDED BY A SINGLE VERTICAL LINE AND A SINGLE HORIZONTAL LINE WHICH EXTENDS FROM THE MIDDLE OF THE VERTICAL LINE.

SER. NO. 85-373,511, FILED 7-18-2011.

RONALD MCMORROW, EXAMINING ATTORNEY



*David J. Kybas*

Director of the United States Patent and Trademark Office

# United States of America

United States Patent and Trademark Office

# STAMPZZ

**Reg. No. 4,274,124**

**Registered Jan. 15, 2013**

**Int. Cl.: 9**

**TRADEMARK**

**PRINCIPAL REGISTER**

STAMPZZ MEDIA S.A. (LUXEMBOURG CORPORATION)  
4, RUE DICKS  
LUXEMBOURG, LUXEMBOURG L1417

FOR: DOWNLOADABLE COMPUTER COMMUNICATIONS SOFTWARE ENABLING USERS TO CAPTURE, UPLOAD, POST, AND DISPLAY DIGITAL VISUAL IMAGES, VIEW, EXCHANGE, FORWARD, AND SHARE TITLED OR NON-TITLED DIGITAL VISUAL IMAGES AND ENABLING USERS TO SEARCH, MODIFY, ENHANCE, COMMENT ON, TAG AND GEOLOCALIZE DIGITAL VISUAL IMAGES; DOWNLOADABLE COMPUTER COMMUNICATIONS MANAGEMENT SOFTWARE ENABLING USERS TO FOLLOW OTHER USERS, ENGAGE IN SOCIAL NETWORKING AND EXCHANGE MESSAGES AND DATA ONLINE IN REAL-TIME, IN CLASS 9 (U.S. CLS. 21, 23, 26, 36 AND 38).

FIRST USE 9-9-2011; IN COMMERCE 9-9-2011.

THE MARK CONSISTS OF STANDARD CHARACTERS WITHOUT CLAIM TO ANY PARTICULAR FONT, STYLE, SIZE, OR COLOR.

SER. NO. 85-374,897, FILED 7-19-2011.

STEVEN PEREZ, EXAMINING ATTORNEY



*David J. Kyros*

Director of the United States Patent and Trademark Office

# United States of America

United States Patent and Trademark Office

## MOM ON A MISSION

**Reg. No. 4,274,125**

**Registered Jan. 15, 2013**

**Int. Cl.: 41**

**SERVICE MARK**

**PRINCIPAL REGISTER**

HEALTHY CHILD HEALTHY WORLD (NEW JERSEY CORPORATION)  
SUITE 320  
12300 WILSHIRE BOULEVARD  
LOS ANGELES, CA 90025

FOR: PROVIDING RECOGNITION AND INCENTIVES BY WAY OF AWARDS TO SPECIAL AND INSPIRING AMERICAN WOMEN DEDICATED TO CREATING HEALTHIER AND HAPPIER ENVIRONMENTS FOR CHILDREN, IN CLASS 41 (U.S. CLS. 100, 101 AND 107).

FIRST USE 1-1-2009; IN COMMERCE 1-1-2009.

THE MARK CONSISTS OF STANDARD CHARACTERS WITHOUT CLAIM TO ANY PARTICULAR FONT, STYLE, SIZE, OR COLOR.

SER. NO. 85-376,467, FILED 7-20-2011.

CIMMERIAN COLEMAN, EXAMINING ATTORNEY



*David J. Kyffers*

Director of the United States Patent and Trademark Office

# United States of America

United States Patent and Trademark Office

# MetaField

**Reg. No. 4,274,126**

**Registered Jan. 15, 2013**

**Int. Cl.: 42**

**SERVICE MARK**

**PRINCIPAL REGISTER**

BRAUN INTERTEC CORPORATION (MINNESOTA CORPORATION)  
11001 HAMPSHIRE AVENUE SOUTH  
MINNEAPOLIS, MN 55438

FOR: SOFTWARE AS A SERVICE (SAAS) SERVICES, NAMELY, HOSTING SOFTWARE FOR USE BY THE ARCHITECTURAL, ENGINEERING, CONSTRUCTION INDUSTRY (AEC) TO COLLECT, MANAGE, AND SHARE DATA FROM ACTIVITIES CONDUCTED IN REAL TIME IN THE FIELD AND THE PRODUCTION AND GENERATION OF REPORTS THEREFOR, IN CLASS 42 (U.S. CLS. 100 AND 101).

FIRST USE 10-19-2010; IN COMMERCE 10-19-2010.

THE MARK CONSISTS OF STANDARD CHARACTERS WITHOUT CLAIM TO ANY PARTICULAR FONT, STYLE, SIZE, OR COLOR.

SER. NO. 85-376,686, FILED 7-20-2011.

REBECCA EISINGER, EXAMINING ATTORNEY



*David J. Kyffers*

Director of the United States Patent and Trademark Office

# United States of America

United States Patent and Trademark Office

## DAILYDOLLAR

**Reg. No. 4,274,127**

**Registered Jan. 15, 2013**

**Int. Cl.: 41**

**SERVICE MARK**

**PRINCIPAL REGISTER**

NATIONAL WEB LEADS, LLC (FLORIDA LIMITED LIABILITY COMPANY)  
21741 HELMSDALE RUN  
ESTERO, FL 33928

FOR: PROVIDING ONLINE NEWSLETTER FOR THE PURPOSE OF HELPING INDIVIDUALS AND BUSINESSES MANAGE, SAVE AND EARN MONEY; PROVIDING ONLINE NEWSLETTER FOR THE PURPOSE OF COUPON OFFERINGS; PROVIDING ONLINE ELECTRONIC NEWSLETTER DELIVERED VIA EMAIL FOR THE PURPOSE OF HELPING INDIVIDUALS AND BUSINESSES MANAGE, SAVE AND EARN MONEY, IN CLASS 41 (U.S. CLS. 100, 101 AND 107).

FIRST USE 3-27-2009; IN COMMERCE 3-27-2009.

THE MARK CONSISTS OF STANDARD CHARACTERS WITHOUT CLAIM TO ANY PARTICULAR FONT, STYLE, SIZE, OR COLOR.

SER. NO. 85-379,992, FILED 7-25-2011.

SANI KHOURI, EXAMINING ATTORNEY



*David J. Kybas*

Director of the United States Patent and Trademark Office

# United States of America

United States Patent and Trademark Office

## THE GROSS GANG IN YOUR GARBAGE!

**Reg. No. 4,274,128**

**Registered Jan. 15, 2013**

**Int. Cls.: 16, 25 and 28**

**TRADEMARK**

**PRINCIPAL REGISTER**

MOOSE CREATIVE PTY LTD (AUSTRALIA LIMITED LIABILITY COMPANY)  
7-13 ARDENA COURT  
EAST BENTLEIGH, AUSTRALIA

FOR: PAPER AND PAPER PRODUCTS IN THE NATURE OF CRAFT ITEMS, NAMELY, ARTS AND CRAFTS PAINT KITS AND CHILDREN'S ARTS AND CRAFTS PAPER KITS, CARDBOARD AND CARD PRODUCTS IN THE NATURE OF CRAFT ITEMS, NAMELY, ARTS AND CRAFTS PAINT KITS AND CHILDREN'S ARTS AND CRAFTS PAPER KITS; ARTS AND CRAFTS KITS, NAMELY, ARTS AND CRAFTS PAINT KITS AND CHILDREN'S ARTS AND CRAFTS PAPER KITS ; STICKERS; CRAFT ACTIVITY KITS FOR MAKING AND DECORATING COMPRISING PAINTS, STICKERS, PATTERNED TEMPLATES AND PLASTIC EMBELLISHMENTS FOR STICKERS, NAMELY, PLASTIC GEM STONES AND PLASTIC DECORATIONS; MODELING CLAY FOR CHILDREN; PRINTED PATTERNS; PRINTED INSTRUCTIONS AND BOOKLETS FOR HOBBY CRAFTS; PRINTED INSTRUCTION CARDS IN THE FIELD OF HOBBIES AND CRAFTS; PUNCHES FOR PAPER FOR CRAFT USE; PAPER DRAWING TEMPLATES; GREETING CARDS AND GIFT BAGS OF PAPER; STATIONERY; ARTISTS MATERIALS IN THE NATURE OF MOULDS FOR MODELING CLAYS; WRITING MATERIAL, NAMELY, WRITING PENS AND WRITING INSTRUMENTS; ERASERS; STICKERS; ADHESIVES FOR STATIONERY AND HOUSEHOLD PURPOSES, IN CLASS 16 (U.S. CLS. 2, 5, 22, 23, 29, 37, 38 AND 50).

FOR: CLOTHING, NAMELY, SHIRTS, PANTS, SHORTS, SKIRTS, DRESSES AND JACKETS; FOOTWEAR; HEADGEAR, NAMELY, HATS, CAPS AND VISORS, IN CLASS 25 (U.S. CLS. 22 AND 39).



FOR: TOYS, GAMES AND PLAYTHINGS, NAMELY, COLLECTIBLE FIGURINES, COLLECTIBLE ANIMAL FIGURINES, COLLECTIBLE TOYS, NAMELY, TOY FIGURES AND COLLECTIBLE TOY CHARACTERS AND COLLECTABLE BENDABLE TOY CHARACTERS, OUTFITS FOR TOYS, POUCHES FOR TOYS AND COLLECTOR CASES FOR TOYS; PUPPETS; PUZZLES; PACKAGED AMUSEMENT AND EDUCATIONAL GAMES, NAMELY, ELECTRONIC EDUCATIONAL GAME MACHINES FOR CHILDREN; TOY ENVIRONMENTS FOR USE WITH TOY CHARACTERS, NAMELY, PLAY PIECES IN THE NATURE OF TOY BUILDINGS, TOY VEHICLES, TOY BUILDING STRUCTURES, TOY CONSTRUCTION SETS; PLAY SETS FOR TOY CHARACTERS, PLAY TOY COSTUMES, FANTASY CHARACTER TOYS, TOY ACTION FIGURES AND ACCESSORIES THEREFOR, IN CLASS 28 (U.S. CLS. 22, 23, 38 AND 50).

*David J. Kybas*

Director of the United States Patent and Trademark Office

**Reg. No. 4,274,128** THE MARK CONSISTS OF STANDARD CHARACTERS WITHOUT CLAIM TO ANY PARTICULAR FONT, STYLE, SIZE, OR COLOR.

PRIORITY CLAIMED UNDER SEC. 44(D) ON AUSTRALIA APPLICATION NO. 1418940, FILED 4-20-2011, REG. NO. 1418940, DATED 4-20-2011, EXPIRES 4-20-2021.

PRIORITY CLAIMED UNDER SEC. 44(D) ON AUSTRALIA APPLICATION NO. 1425435, FILED 5-25-2011, REG. NO. 1425435, DATED 5-25-2011, EXPIRES 5-25-2021.

SER. NO. 85-380,574, FILED 7-26-2011.

COLLEEN KEARNEY, EXAMINING ATTORNEY



# United States of America

United States Patent and Trademark Office

## FLUTTER PETALS

**Reg. No. 4,274,129**

SHERI EVANS (UNITED STATES INDIVIDUAL)  
1144 ALGONQUIN DRIVE  
PITTSBURGH, PA 15205

**Registered Jan. 15, 2013**

**Int. Cl.: 26**

FOR: HAIR BANDS; HAIR BARRETTES; HAIR BOWS; HAIR BUCKLES; HAIR CLIPS, IN CLASS 26 (U.S. CLS. 37, 39, 40, 42 AND 50).

**TRADEMARK**

FIRST USE 6-16-2011; IN COMMERCE 7-20-2011.

**PRINCIPAL REGISTER**

THE MARK CONSISTS OF STANDARD CHARACTERS WITHOUT CLAIM TO ANY PARTICULAR FONT, STYLE, SIZE, OR COLOR.

NO CLAIM IS MADE TO THE EXCLUSIVE RIGHT TO USE "PETALS", APART FROM THE MARK AS SHOWN.

SER. NO. 85-382,150, FILED 7-27-2011.

GISELLE AGOSTO, EXAMINING ATTORNEY



*David J. Kybas*

Director of the United States Patent and Trademark Office

# United States of America

United States Patent and Trademark Office

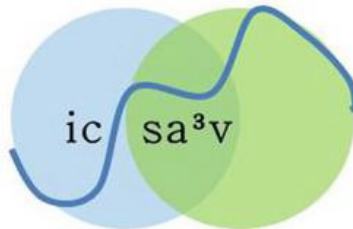

**Reg. No. 4,274,130**

**Registered Jan. 15, 2013**

**Int. Cl.: 35**

**SERVICE MARK**

**PRINCIPAL REGISTER**

DYNAMIC ENERGY GROUP (OHIO LIMITED LIABILITY COMPANY)  
23210 CHAGRIN BLVD. #200  
BEACHWOOD, OH 44122

FOR: BUSINESS MANAGEMENT CONSULTING WITH RELATION TO STRATEGY, MARKETING, SALES, OPERATION, PRODUCT DESIGN PARTICULARLY SPECIALIZING IN THE USE OF ANALYTIC AND STATISTIC MODELS FOR THE UNDERSTANDING AND PREDICTING OF CONSUMERS, BUSINESSES, AND MARKET TRENDS AND ACTIONS, IN CLASS 35 (U.S. CLS. 100, 101 AND 102).

FIRST USE 6-1-2011; IN COMMERCE 6-1-2011.

THE MARK CONSISTS TWO OVERLAPPING CIRCLES, WITH THE LEFT CIRCLE DEPICTED IN BLUE AND THE RIGHT CIRCLE DEPICTED IN GREEN. A CURVED BLUE LINE CUTS THROUGH BOTH CIRCLES. THE BLACK WORDING "IC" APPEARS ABOVE THE PORTION OF THE CURVED LINE CUTTING ACROSS THE BLUE CIRCLE, AND THE BLACK WORDING "SA<sup>3</sup>V" APPEARS BELOW THE PORTION OF THE CURVED LINE CUTTING ACROSS THE GREEN CIRCLE WITH THE "3" APPEARING IN SUPERSCRIPIT.

THE COLOR(S) GREEN, BLUE AND BLACK IS/ARE CLAIMED AS A FEATURE OF THE MARK.

SER. NO. 85-384,277, FILED 7-29-2011.

EMILY CARLSEN, EXAMINING ATTORNEY



*David J. Kyjars*

Director of the United States Patent and Trademark Office

# United States of America

## United States Patent and Trademark Office

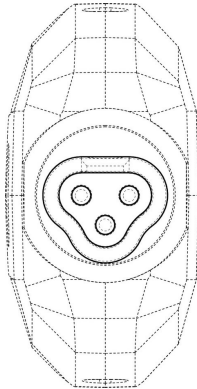

**Reg. No. 4,274,131**

**Registered Jan. 15, 2013**

**Int. Cl.: 9**

**TRADEMARK**

**PRINCIPAL REGISTER**

VIDEX, INC. (OREGON CORPORATION)  
1105 NE CIRCLE BLVD.  
CORVALLIS, OR 97330

FOR: ELECTRONIC KEYS FOR USE WITH ELECTRONIC LOCKS, IN CLASS 9 (U.S. CLS. 21, 23, 26, 36 AND 38).

FIRST USE 5-7-2000; IN COMMERCE 5-7-2000.

OWNER OF U.S. REG. NOS. 2,897,495, 3,079,745, AND 3,351,670.

THE MARK CONSISTS OF THE DESIGN OF AN ELECTRONIC KEY HAVING A TRIANGULAR-SHAPED TIP END WITH ELECTRICAL PINS ARRANGED NEAR THE ROUNDED CORNERS THEREOF. THE BROKEN LINES SHOW THE POSITION OF THE MARK AND ARE NOT CLAIMED AS PART OF THE MARK.

SEC. 2(F).

SER. NO. 85-384,951, FILED 7-29-2011.

TASNEEM HUSSAIN, EXAMINING ATTORNEY



*David J. Kybas*

Director of the United States Patent and Trademark Office

United States of America  
United States Patent and Trademark Office

**ONiell's**

**Reg. No. 4,274,132**

**Registered Jan. 15, 2013**

**Int. Cl.: 43**

**SERVICE MARK**

**PRINCIPAL REGISTER**

O'NIELL'S INTELLECTUAL PROPERTY, LLC. (NEW MEXICO LIMITED LIABILITY COMPANY)  
4310 CENTRAL AVENUE, S.E., SUITE B  
ALBUQUERQUE, NM 87108

FOR: RESTAURANT SERVICES, IN CLASS 43 (U.S. CLS. 100 AND 101).

FIRST USE 5-5-1994; IN COMMERCE 5-5-1994.

THE MARK CONSISTS OF THE STYLIZED LETTERS "ONIELL'S".

SEC. 2(F).

SER. NO. 85-386,887, FILED 8-2-2011.

JASON TURNER, EXAMINING ATTORNEY



*David J. Kyffers*

Director of the United States Patent and Trademark Office

# United States of America

United States Patent and Trademark Office

# GynEc

**Reg. No. 4,274,133**

**Registered Jan. 15, 2013**

**Int. Cl.: 10**

**TRADEMARK**

**PRINCIPAL REGISTER**

GEADIC BIOTECH, AIE (SPAIN CORPORATION)  
GRAN CAPITÀ, 10  
SANT JOAN DESPI (BARC), SPAIN 08970

FOR: MEDICAL AND VETERINARY DIAGNOSTIC KITS COMPRISING A TUBE FOR DRAWING UTERINE ASPIRATE, A TEST TUBE FOR HOLDING TISSUE, AN INSTRUCTION LEAFLET, A SHIPPING POUCH USED TO SEND MATERIALS TO A LABORATORY FOR ANALYSIS, IN CLASS 10 (U.S. CLS. 26, 39 AND 44).

THE MARK CONSISTS OF STANDARD CHARACTERS WITHOUT CLAIM TO ANY PARTICULAR FONT, STYLE, SIZE, OR COLOR.

PRIORITY CLAIMED UNDER SEC. 44(D) ON ERPN CMNTY TM OFC APPLICATION NO. 010009363, FILED 5-31-2011, REG. NO. 010009363, DATED 10-7-2011, EXPIRES 10-7-2021.

SER. NO. 85-387,864, FILED 8-3-2011.

CHRISTOPHER BUONGIORNO, EXAMINING ATTORNEY



*David J. Kybas*

Director of the United States Patent and Trademark Office

# United States of America

United States Patent and Trademark Office

## TECHCLARITY

**Reg. No. 4,274,134**

**Registered Jan. 15, 2013**

**Int. Cl.: 42**

**SERVICE MARK**

**PRINCIPAL REGISTER**

TECHCLARITY LLC (VIRGINIA LIMITED LIABILITY COMPANY)  
SUITE 1580  
1650 TYSONS BOULEVARD  
MCLEAN, VA 22102

FOR: TECHNICAL SUPPORT SERVICES, NAMELY, SERVICE/HELP DESK SERVICES IN THE NATURE OF DIAGNOSING COMPUTER HARDWARE AND SOFTWARE PROBLEMS; COMPUTER SERVICES, NAMELY, REMOTE AND ON-SITE MANAGEMENT OF THE INFORMATION TECHNOLOGY (IT) SYSTEMS OF OTHERS; COMPUTER SERVICES, NAMELY, REMOTE AND ON-SITE ADMINISTRATION OF THE INFORMATION TECHNOLOGY (IT) SYSTEMS OF OTHERS; INSTALLATION AND REPAIR OF COMPUTER SOFTWARE, INCLUDING REMOTE AND ON-SITE PERFORMANCE OF SUCH SERVICES FOR OTHERS; UPDATING OF COMPUTER SOFTWARE FOR OTHERS; CONSULTING SERVICES IN THE FIELD OF DESIGN, SELECTION, IMPLEMENTATION AND USE OF COMPUTER HARDWARE AND SOFTWARE SYSTEMS FOR OTHERS; CONSULTING SERVICES IN THE FIELD OF COMPUTER-BASED INFORMATION SYSTEMS FOR BUSINESSES; PROFESSIONAL COMPUTER SERVICES, NAMELY, NETWORK ANALYSIS, LAN/WAN DESIGN, WIRELESS ENGINEERING, VIRTUALIZATION, CLOUD HOSTING AND COMPUTER PROJECT MANAGEMENT; REMOTE COMPUTER NETWORK TECHNICAL MONITORING AND SOFTWARE MAINTENANCE SERVICES; COMPUTER VIRUS PROTECTION AND REMOVAL SERVICES. PROVIDING VIRTUAL COMPUTER SYSTEMS AND VIRTUAL COMPUTER ENVIRONMENTS THROUGH CLOUD COMPUTING; REMOTE ONLINE BACKUP OF COMPUTER DATA; COMPUTER SERVICES, NAMELY, FILTERING OF UNWANTED E-MAILS; COMPUTER AND NETWORK MONITORING SERVICE WHICH TRACKS THE PERFORMANCE AND AVAILABILITY OF COMPUTER AND NETWORK SYSTEMS OF OTHERS, PROVIDES REPORTING AND ALERTING REGARDING SUCH PERFORMANCE AND AVAILABILITY, AND PROVIDES ALERTS CONCERNING SUCH PERFORMANCE AND AVAILABILITY, IN CLASS 42 (U.S. CLS. 100 AND 101).



FIRST USE 4-1-2011; IN COMMERCE 5-3-2011.

THE MARK CONSISTS OF STANDARD CHARACTERS WITHOUT CLAIM TO ANY PARTICULAR FONT, STYLE, SIZE, OR COLOR.

SER. NO. 85-390,352, FILED 8-5-2011.

EMILY CARLSEN, EXAMINING ATTORNEY

*David J. Kyros*

Director of the United States Patent and Trademark Office

# United States of America

United States Patent and Trademark Office

# JOBY

**Reg. No. 4,274,135**

**Registered Jan. 15, 2013**

**Int. Cls.: 3 and 35**

**TRADEMARK**

**SERVICE MARK**

**PRINCIPAL REGISTER**

JOBY TRADING CORPORATION (CALIFORNIA CORPORATION)  
1762 TYLER AVE.  
SOUTH EL MONTE, CA 91733

FOR: NAIL FASHION PRODUCTS FOR COSMETIC PURPOSES, NAMELY, NAIL ART STICKERS, NAIL ART DECALS, NAIL ART STENCILS, NAIL ART STONES, NAIL ART PENS, NAIL ART TEMPLATES, NAIL ART STAMPS; NAIL ART APPLICATION KITS COMPRISED OF NAIL ART DECALS AND APPLICATION RODS; NAIL ART APPLICATION TOOLS COMPRISED OF BRUSHES AND NAIL ART APPLICATION RODS, IN CLASS 3 (U.S. CLS. 1, 4, 6, 50, 51 AND 52).

FIRST USE 7-10-2000; IN COMMERCE 1-1-2003.

FOR: RETAIL AND WHOLESALE STORE SERVICES AND ONLINE RETAIL AND WHOLESALE STORE SERVICES FEATURING NAIL FASHION PRODUCTS AND NAIL ART FOR COSMETIC PURPOSES FEATURING NAIL ART STICKERS, NAIL ART DECALS, NAIL ART STENCILS, NAIL ART JEWELRY, NAIL ART STONES, NAIL ART PENS, NAIL ART TEMPLATES, NAIL ART STAMPS, NAIL ART APPLICATION KITS, NAIL ART APPLICATION TOOLS, IN CLASS 35 (U.S. CLS. 100, 101 AND 102).

FIRST USE 7-10-2000; IN COMMERCE 1-1-2003.

THE MARK CONSISTS OF STANDARD CHARACTERS WITHOUT CLAIM TO ANY PARTICULAR FONT, STYLE, SIZE, OR COLOR.

SER. NO. 85-393,371, FILED 8-9-2011.

BRIAN NEVILLE, EXAMINING ATTORNEY



*David J. Kybas*

Director of the United States Patent and Trademark Office

# United States of America

United States Patent and Trademark Office

# Panatrack

**Reg. No. 4,274,136**

**Registered Jan. 15, 2013**

**Int. Cl.: 42**

**SERVICE MARK**

**PRINCIPAL REGISTER**

PANATRACK, INC. (WISCONSIN CORPORATION), FORMERLY THE BURNHAM GROUP, INC.  
SUITE 201  
394 WILLIAMSTOWNE  
DELAFIELD, WI 53018

FOR: COMPUTER SOFTWARE CONSULTING; DESIGN AND DEVELOPMENT OF COMPUTER SOFTWARE; DESIGN AND DEVELOPMENT OF COMPUTER SOFTWARE FOR THE COLLECTION AND MANAGEMENT OF INVENTORY, ASSET AND ACTIVITY TRANSACTIONS, IN CLASS 42 (U.S. CLS. 100 AND 101).

FIRST USE 5-1-2001; IN COMMERCE 11-13-2001.

THE MARK CONSISTS OF STANDARD CHARACTERS WITHOUT CLAIM TO ANY PARTICULAR FONT, STYLE, SIZE, OR COLOR.

SER. NO. 85-394,075, FILED 8-10-2011.

TRACY CROSS, EXAMINING ATTORNEY



*David J. Kyffers*

Director of the United States Patent and Trademark Office



# United States of America

United States Patent and Trademark Office

# CENTRASEP

**Reg. No. 4,274,137**

**Registered Jan. 15, 2013**

**Int. Cl.: 7**

**TRADEMARK**

**PRINCIPAL REGISTER**

ADVANCED SEPARATION TECHNOLOGIES, LLC (INDIANA LIMITED LIABILITY COMPANY)  
11805 NORTH PENNSYLVANIA STREET  
CARMEL, IN 46032

FOR: CENTRIFUGES FOR SEPARATING SOLIDS FROM LIQUIDS, IN CLASS 7 (U.S. CLS. 13, 19, 21, 23, 31, 34 AND 35).

FIRST USE 1-19-1998; IN COMMERCE 1-19-1998.

THE MARK CONSISTS OF STANDARD CHARACTERS WITHOUT CLAIM TO ANY PARTICULAR FONT, STYLE, SIZE, OR COLOR.

SER. NO. 85-394,203, FILED 8-10-2011.

HENRY S. ZAK, EXAMINING ATTORNEY



*David J. Kyffers*

Director of the United States Patent and Trademark Office

United States of America  
United States Patent and Trademark Office

# THiN-Wall

**Reg. No. 4,274,138**

**Registered Jan. 15, 2013**

**Int. Cl.: 19**

COMPOSITE INSULATED CONCRETE SYSTEMS LLC (US VIRGIN ISLANDS LIMITED LIABILITY COMPANY)

210 N 13TH STREET  
210 N. 13TH STREET  
SEWARD, NE 68434

**TRADEMARK**

**PRINCIPAL REGISTER**

FOR: PRECAST CONCRETE FLOORS; STANDARD LOAD BEARING CONCRETE PANELS; STANDARD LOAD BEARING CONCRETE WALLS , IN CLASS 19 (U.S. CLS. 1, 12, 33 AND 50).

FIRST USE 8-11-2010; IN COMMERCE 9-9-2010.

NO CLAIM IS MADE TO THE EXCLUSIVE RIGHT TO USE "THIN WALL", APART FROM THE MARK AS SHOWN.

THE COLOR(S) RED, GRAY AND WHITE IS/ARE CLAIMED AS A FEATURE OF THE MARK.

THE MARK CONSISTS OF THE WORD "THIN" HYPHENATED WITH THE WORD "WALL" IN THE COLOR RED. THE WORD "THIN" IS STYLIZED SUCH THAT THE LETTERS "T", "H" AND "N" ARE CAPITALIZED AND THE LETTER "I" IS LOWER CASE. IN THE WORD "WALL", THERE IS A GRAPHIC FEATURE SUCH THAT THE PARALLEL LETTERS "L" AND "L" CONSIST OF A "SANDWICH" WITH A GRAY LINE, A THINNER RED LINE, AND ANOTHER GRAY LINE IN IT. A WAVY, VERTICAL WHITE LINE PASSES THROUGH THIS RED AND GRAY FEATURE.

SER. NO. 85-396,235, FILED 8-12-2011.

AISHA CLARKE, EXAMINING ATTORNEY



*David J. Kybas*

Director of the United States Patent and Trademark Office

# United States of America

United States Patent and Trademark Office

# KYMIA

**Reg. No. 4,274,139**

**Registered Jan. 15, 2013**

**Int. Cls.: 1, 2 and 17**

**TRADEMARK**

**PRINCIPAL REGISTER**

CONSORCIO COMEX, S.A. DE C.V. (MEXICO CORPORATION)  
PENTHOUSE 1/2, COL. LOMAS DE CHAPULTEPEC  
BLVD. MANUEL AVILA CAMACHO # 138  
MEXICO, D.F., MEXICO 11560

FOR: CHEMICALS FOR USE IN INDUSTRY, SCIENCE, PHOTOGRAPHY, AGRICULTURE, HORTICULTURE AND FORESTRY; UNPROCESSED ARTIFICIAL RESINS AND PRIMERS, UNPROCESSED PLASTICS; FIRE EXTINGUISHING COMPOSITIONS, TEMPERING AND SOLDERING PREPARATIONS FOR METALS, FOOD PRESERVING CHEMICALS; ADHESIVES IN THE NATURE OF GLUES USED IN INDUSTRY; UNPROCESSED ACRYLIC RESINS, IN CLASS 1 (U.S. CLS. 1, 5, 6, 10, 26 AND 46).

FOR: COATINGS IN THE NATURE OF PAINTS, VARNISHES AND LACQUERS; PRESERVATIVES IN THE NATURE OF COATINGS USED FOR RUST PREVENTATIVES AND AGAINST DETERIORATION OF BLACKSMITHING AND WOOD MATERIALS; MORDANT DYES; RAW NATURAL RESINS, METALS IN FOIL AND POWDER FOR PAINTERS, DECORATORS, PRINTERS AND ARTISTS, IN CLASS 2 (U.S. CLS. 6, 11 AND 16).

FOR: RUBBER, GUTTA-PERCHA, GUM ASBESTOS, MICA AND MICA FOR USE AS A FILLER IN PLASTICS; SEMI-FINISHED PLASTIC IN THE FORM OF FILMS, SHEETS, AND TUBES; CAULKING COMPOUNDS FOR CAULKING, TOWING AND INSULATING, NON METALLIC FLEXIBLE PIPES, IN CLASS 17 (U.S. CLS. 1, 5, 12, 13, 35 AND 50).

THE MARK CONSISTS OF STANDARD CHARACTERS WITHOUT CLAIM TO ANY PARTICULAR FONT, STYLE, SIZE, OR COLOR.

OWNER OF MEXICO REG. NO. 1179854, DATED 9-21-2010, EXPIRES 9-21-2020.

OWNER OF MEXICO REG. NO. 1179855, DATED 9-21-2010, EXPIRES 9-21-2020.

OWNER OF MEXICO REG. NO. 1179856, DATED 9-21-2010, EXPIRES 9-21-2020.

THE WORD(S) "KYMIA" HAS NO MEANING IN A FOREIGN LANGUAGE.

SER. NO. 85-396,629, FILED 8-12-2011.

DANNEAN HETZEL, EXAMINING ATTORNEY



*David J. Kyffers*

Director of the United States Patent and Trademark Office

# United States of America

United States Patent and Trademark Office



**NITROSET**

**Reg. No. 4,274,140**

NITROSET, LLC (TEXAS LIMITED LIABILITY COMPANY)  
5600 BONHOMME ROAD, # D  
HOUSTON, TX 77036

**Registered Jan. 15, 2013**

**Int. Cl.: 8**

FOR: MANUALLY OPERATED HAND TOOLS, NAMELY, DRIVERS FOR SETTING FASTENERS ATTACHED TO PROPELLANT CHARGES AND EXTENSION POLES AS COMPONENT PARTS OF THE TOOLS, IN CLASS 8 (U.S. CLS. 23, 28 AND 44).

**TRADEMARK**

FIRST USE 3-31-2010; IN COMMERCE 3-31-2010.

**PRINCIPAL REGISTER**

THE MARK CONSISTS OF A CHECK-MARK WITH THE LONGER LEG POSITIONED NEAR-HORIZONTAL OVER THE WORD "NITROSET" AND THE SHORTER LEG EXTENDING TOWARD THE 10 O'CLOCK POSITION FROM THE RIGHT-HAND END OF THE LONGER LEG.

SER. NO. 85-397,399, FILED 8-13-2011.

ASMAT KHAN, EXAMINING ATTORNEY



*David J. Kyffers*

Director of the United States Patent and Trademark Office

# United States of America

United States Patent and Trademark Office

## GROUP POWER

**Reg. No. 4,274,141**

**Registered Jan. 15, 2013**

**Int. Cl.: 41**

**SERVICE MARK**

**PRINCIPAL REGISTER**

THE STEP COMPANY (GEORGIA CORPORATION)  
2130 NEWMARKET PARKWAY  
MARIETTA, GA 30067

FOR: PHYSICAL FITNESS INSTRUCTION, IN CLASS 41 (U.S. CLS. 100, 101 AND 107).

FIRST USE 5-1-2005; IN COMMERCE 5-1-2005.

THE MARK CONSISTS OF STANDARD CHARACTERS WITHOUT CLAIM TO ANY PARTICULAR FONT, STYLE, SIZE, OR COLOR.

OWNER OF U.S. REG. NO. 3,138,099.

SEC. 2(F).

SER. NO. 85-397,665, FILED 8-15-2011.

AMY HELLA, EXAMINING ATTORNEY



*David J. Kyffers*

Director of the United States Patent and Trademark Office

# United States of America

United States Patent and Trademark Office

## HIGHEREDGE

**Reg. No. 4,274,142**

TEXAS GUARANTEED STUDENT LOAN CORPORATION (TEXAS CORPORATION)  
P.O. BOX 83100  
ROUND ROCK, TX 78683

**Registered Jan. 15, 2013**

**Int. Cls.: 36, 41 and 45**

FOR: FINANCIAL CONSULTING SERVICES, NAMELY, LOAN DEFAULT PLANNING, MANAGEMENT AND DELINQUENCY PREVENTION, IN CLASS 36 (U.S. CLS. 100, 101 AND 102).

**SERVICE MARK**

FIRST USE 3-7-2011; IN COMMERCE 3-7-2011.

**PRINCIPAL REGISTER**

FOR: EDUCATION, NAMELY, CLASSES, SEMINARS, WEBINARS, WORKSHOPS AND TRAINING SERVICES IN THE FIELD OF LOAN DEFAULT PLANNING, MANAGEMENT, DELINQUENCY PREVENTION AND REGULATORY COMPLIANCE, IN CLASS 41 (U.S. CLS. 100, 101 AND 107).

FIRST USE 5-24-2011; IN COMMERCE 5-24-2011.

FOR: CONSULTING REGARDING FEDERAL STUDENT LOAN REGULATORY COMPLIANCE, IN CLASS 45 (U.S. CLS. 100 AND 101).

FIRST USE 3-7-2011; IN COMMERCE 3-7-2011.

THE MARK CONSISTS OF STANDARD CHARACTERS WITHOUT CLAIM TO ANY PARTICULAR FONT, STYLE, SIZE, OR COLOR.

SER. NO. 85-398,887, FILED 8-16-2011.

JEFFREY LOOK, EXAMINING ATTORNEY



*David J. Kypos*

Director of the United States Patent and Trademark Office

# United States of America

United States Patent and Trademark Office

## PRECISIONFLOW TECHNOLOGIES

**Reg. No. 4,274,143**

**Registered Jan. 15, 2013**

**Int. Cl.: 7**

**TRADEMARK**

**PRINCIPAL REGISTER**

PRECISION FLOW TECHNOLOGIES, INC. (NEW YORK CORPORATION)  
P.O. BOX 149  
3 TOWER DRIVE  
SAUGERTIES, NY 12477

FOR: INDUSTRIAL MACHINES FOR MANUFACTURING SEMICONDUCTORS, LIGHT EMITTING DIODES AND PHOTOVOLTAIC CELLS, NAMELY, UNITS FOR THE PURPOSE OF CHEMICAL DELIVERY, VAPOR DELIVERY, GAS ISOLATION, GAS MIXING, GAS MONITORING, GAS PURGING AND GAS DELIVERY DURING MANUFACTURING; INDUSTRIAL MACHINES FOR MANUFACTURING SEMICONDUCTORS, LIGHT EMITTING DIODES AND PHOTOVOLTAIC CELLS, NAMELY, GAS CABINETS, GAS CYLINDER UNITS, GAS PANELS, AND GAS DEWAR DELIVERY UNITS, IN CLASS 7 (U.S. CLS. 13, 19, 21, 23, 31, 34 AND 35).

FIRST USE 7-30-1997; IN COMMERCE 7-30-1997.

THE MARK CONSISTS OF STANDARD CHARACTERS WITHOUT CLAIM TO ANY PARTICULAR FONT, STYLE, SIZE, OR COLOR.

NO CLAIM IS MADE TO THE EXCLUSIVE RIGHT TO USE "TECHNOLOGIES", APART FROM THE MARK AS SHOWN.

SER. NO. 85-400,581, FILED 8-17-2011.

HANNO RITTNER, EXAMINING ATTORNEY



*David J. Kyffers*

Director of the United States Patent and Trademark Office

# United States of America

United States Patent and Trademark Office

## ABILIFY SOCIELL

**Reg. No. 4,274,144**

**Registered Jan. 15, 2013**

**Int. Cl.: 5**

**TRADEMARK**

**PRINCIPAL REGISTER**

OTSUKA PHARMACEUTICAL CO., LTD. (JAPAN CORPORATION)  
2-9 KANDA-TSUKASAMACHI  
CHIYODA-KU, TOKYO, JAPAN

FOR: PHARMACEUTICAL PREPARATIONS FOR THE TREATMENT OF CENTRAL NERVOUS SYSTEM DISEASES AND DISORDERS, IN CLASS 5 (U.S. CLS. 6, 18, 44, 46, 51 AND 52).

THE MARK CONSISTS OF STANDARD CHARACTERS WITHOUT CLAIM TO ANY PARTICULAR FONT, STYLE, SIZE, OR COLOR.

OWNER OF JAPAN REG. NO. 5467756, DATED 2-3-2012, EXPIRES 2-3-2022.

OWNER OF U.S. REG. NOS. 2,772,697 AND 3,349,278.

SER. NO. 85-400,609, FILED 8-17-2011.

DAVID H. STINE, EXAMINING ATTORNEY



*David J. Kyros*

Director of the United States Patent and Trademark Office



# United States of America

United States Patent and Trademark Office

W A D E

**Reg. No. 4,274,145**

POST APARTMENT HOMES, L.P. (GEORGIA LIMITED PARTNERSHIP)  
4401 NORTHSIDE PARKWAY, SUITE 800  
ATLANTA, GA 30327

**Registered Jan. 15, 2013**

**Int. Cl.: 37**

FOR: LAND DEVELOPMENT SERVICES, NAMELY, PLANNING AND LAYING OUT OF  
RESIDENTIAL AND/OR COMMERCIAL COMMUNITIES; REAL ESTATE DEVELOPMENT  
, IN CLASS 37 (U.S. CLS. 100, 103 AND 106).

**SERVICE MARK**

FIRST USE 8-17-2011; IN COMMERCE 8-17-2011.

**PRINCIPAL REGISTER**

THE MARK CONSISTS OF A STYLIZED "W" SUPERIMPOSED OVER THE WORD "WADE".

SER. NO. 85-401,349, FILED 8-18-2011.

WARREN L. OLANDRIA, EXAMINING ATTORNEY



*David J. Kyffers*

Director of the United States Patent and Trademark Office

# United States of America

United States Patent and Trademark Office



**Reg. No. 4,274,146**

**Registered Jan. 15, 2013**

**Int. Cl.: 37**

**SERVICE MARK**

**PRINCIPAL REGISTER**

ROGER D. JONES (UNITED STATES INDIVIDUAL)  
22923 HWY 72 E. STE. D  
ATHENS, AL 35613

FOR: ROOFING INSTALLATION, IN CLASS 37 (U.S. CLS. 100, 103 AND 106).

FIRST USE 0-0-2008; IN COMMERCE 0-0-2008.

NO CLAIM IS MADE TO THE EXCLUSIVE RIGHT TO USE "ROOFING, INC.", APART FROM THE MARK AS SHOWN.

THE COLOR(S) YELLOW & BLACK IS/ARE CLAIMED AS A FEATURE OF THE MARK.

THE MARK CONSISTS OF THE DESIGN OF A YELLOW HAMMER WITH A YELLOW BIRD PERCHED ON THE HANDLE OF THE HAMMER. INSIDE THE BLACK OVAL WITH A YELLOW BORDER SUPERIMPOSED ON A BLACK RECTANGLE WITH THE WORDING "YELLOWHAMMER ROOFING, INC" IN YELLOW BELOW THE DESIGN AND A YELLOW LINE UNDERNEATH THE WORDING "YELLOW HAMMER".

SER. NO. 85-401,596, FILED 8-18-2011.

LESLEY LAMOTHE, EXAMINING ATTORNEY



*David J. Kyffers*

Director of the United States Patent and Trademark Office

# United States of America

United States Patent and Trademark Office

## FAKO ELEMENTS CULTURAL ASSOCIATION

**Reg. No. 4,274,147**

**Registered Jan. 15, 2013**

**Int. Cl.: 35**

**SERVICE MARK**

**PRINCIPAL REGISTER**

FAKO ELEMENTS CULTURAL ASSOCIATION (MARYLAND CORPORATION), AKA FECA  
MD, FECA WASHINGTON, FECA WASHINGTON METROPOLITAN AREA.  
9618 WASHINGTON AVENUE  
LAUREL, MD 20723

FOR: CHARITABLE SERVICES, NAMELY, ORGANIZING AND DEVELOPING PROJECTS  
THAT AIM TO IMPROVE THE LIVES OF UNDERPRIVILEGED AND IMPOVERISHED  
CHILDREN, IN CLASS 35 (U.S. CLS. 100, 101 AND 102).

FIRST USE 2-25-2010; IN COMMERCE 2-25-2010.

THE MARK CONSISTS OF STANDARD CHARACTERS WITHOUT CLAIM TO ANY PAR-  
TICULAR FONT, STYLE, SIZE, OR COLOR.

NO CLAIM IS MADE TO THE EXCLUSIVE RIGHT TO USE "CULTURAL ASSOCIATION",  
APART FROM THE MARK AS SHOWN.

THE ENGLISH TRANSLATION OF "FAKO" IN THE MARK IS "MOUNTAIN".

SER. NO. 85-401,853, FILED 8-18-2011.

STEPHANIE ALI, EXAMINING ATTORNEY



*David J. Kyffers*

Director of the United States Patent and Trademark Office

# United States of America

United States Patent and Trademark Office

## FULL METAL JACKET

**Reg. No. 4,274,148**

**Registered Jan. 15, 2013**

**Int. Cl.: 7**

**TRADEMARK**

**PRINCIPAL REGISTER**

TERRA COMPACTOR WHEEL CORP. (ALABAMA CORPORATION)  
1394 CLEMONS ROAD  
SCOTTSBORO, AL 35769

FOR: COMPACTION EQUIPMENT, NAMELY, COMPACTION WHEELS AND COMPACTION CLEATS AND TEETH FOR USE WITH WASTE CRUSHING MACHINERY, IN CLASS 7 (U.S. CLS. 13, 19, 21, 23, 31, 34 AND 35).

FIRST USE 3-1-2011; IN COMMERCE 3-1-2011.

THE MARK CONSISTS OF STANDARD CHARACTERS WITHOUT CLAIM TO ANY PARTICULAR FONT, STYLE, SIZE, OR COLOR.

SER. NO. 85-402,003, FILED 8-19-2011.

JOSETTE BEVERLY, EXAMINING ATTORNEY



*David J. Kybas*

Director of the United States Patent and Trademark Office

# United States of America

United States Patent and Trademark Office



**Reg. No. 4,274,149**

ARIZONA YOGURT COMPANY, LLC (ARIZONA LIMITED LIABILITY COMPANY)  
7008 W. MORROW DRIVE  
GLENDALE, AZ 85308

**Registered Jan. 15, 2013**

**Int. Cl.: 43**

FOR: FROZEN YOGURT SHOP SERVICES IN THE NATURE OF A RESTAURANT, IN CLASS 43 (U.S. CLS. 100 AND 101).

**SERVICE MARK**

FIRST USE 10-29-2010; IN COMMERCE 10-29-2010.

**PRINCIPAL REGISTER**

NO CLAIM IS MADE TO THE EXCLUSIVE RIGHT TO USE "AZ" AND "CO", APART FROM THE MARK AS SHOWN.

THE MARK CONSISTS OF THE WORDING "AZ YO CO" IN STYLIZED CAPITAL LETTERS.

SER. NO. 85-409,434, FILED 8-29-2011.

REGINA DRUMMOND, EXAMINING ATTORNEY



*David J. Kybas*

Director of the United States Patent and Trademark Office

# United States of America

United States Patent and Trademark Office

## MINIMIZE YOUR COSTS ASSOCIATED WITH THE OWNERSHIP OF HVAC MECHANICAL SYSTEMS

**Reg. No. 4,274,150**

**Registered Jan. 15, 2013**

**Int. Cls.: 37 and 42**

**SERVICE MARK**

**PRINCIPAL REGISTER**

MURPHY & MILLER, INC. (DELAWARE CORPORATION)  
600 WEST TAYLOR STREET  
CHICAGO, IL 60607

FOR: HEATING, VENTILATION, AND AIR CONDITIONING CONTRACTOR SERVICES, NAMELY, THE INSTALLATION, MAINTENANCE AND REPAIR OF HEATING, VENTILATION, AND AIR CONDITIONING SYSTEMS; CONSULTING IN THE FIELD OF HEATING, VENTILATION, AND AIR CONDITIONING CONTRACTOR SERVICES, IN CLASS 37 (U.S. CLS. 100, 103 AND 106).

FIRST USE 12-31-1984; IN COMMERCE 12-31-1984.

FOR: DESIGN OF HEATING, VENTILATION, AND AIR CONDITIONING SYSTEMS, IN CLASS 42 (U.S. CLS. 100 AND 101).

FIRST USE 12-31-1984; IN COMMERCE 12-31-1984.

THE MARK CONSISTS OF STANDARD CHARACTERS WITHOUT CLAIM TO ANY PARTICULAR FONT, STYLE, SIZE, OR COLOR.

SER. NO. 85-410,215, FILED 8-30-2011.

MAUREEN DALL, EXAMINING ATTORNEY



*David J. Kyros*

Director of the United States Patent and Trademark Office

United States of America  
United States Patent and Trademark Office

# FIELDPLUS

**Reg. No. 4,274,151**

**Registered Jan. 15, 2013**

**Int. Cl.: 11**

**TRADEMARK**

**PRINCIPAL REGISTER**

LINDSAY CORPORATION (DELAWARE CORPORATION)  
2222 NORTH 111TH STREET  
OMAHA, NE 68164

FOR: PIVOTING JOINT USED EXCLUSIVELY AS AN INTEGRAL PART OF AN AGRICULTURAL IRRIGATION UNIT CONNECTING PORTIONS OF PIPELINE TO ALLOW FOR INCREASED IRRIGATION COVERAGE, IN CLASS 11 (U.S. CLS. 13, 21, 23, 31 AND 34).

FIRST USE 12-0-2003; IN COMMERCE 12-0-2003.

THE MARK CONSISTS OF STANDARD CHARACTERS WITHOUT CLAIM TO ANY PARTICULAR FONT, STYLE, SIZE, OR COLOR.

OWNER OF U.S. REG. NOS. 3,040,976 AND 3,596,715.

SER. NO. 85-410,253, FILED 8-30-2011.

DAWN HAN, EXAMINING ATTORNEY



*David J. Kyffers*

Director of the United States Patent and Trademark Office

# United States of America

United States Patent and Trademark Office

## Hotel Surplus Outlet

**Reg. No. 4,274,152**

**Registered Jan. 15, 2013**

**Int. Cl.: 35**

**SERVICE MARK**

**PRINCIPAL REGISTER**

THE FENNING GROUP, LLC (CALIFORNIA LIMITED LIABILITY COMPANY), DBA HOTEL SURPLUS OUTLET  
4434 DENSMORE AVE  
ENCINO, CA 91436

FOR: RETAIL AND WHOLESALE STORE SERVICES FEATURING LIQUIDATED HOTEL ASSETS, FURNITURE AND FURNISHINGS, IN CLASS 35 (U.S. CLS. 100, 101 AND 102).

FIRST USE 10-1-1997; IN COMMERCE 3-1-1998.

THE MARK CONSISTS OF STANDARD CHARACTERS WITHOUT CLAIM TO ANY PARTICULAR FONT, STYLE, SIZE, OR COLOR.

NO CLAIM IS MADE TO THE EXCLUSIVE RIGHT TO USE "OUTLET", APART FROM THE MARK AS SHOWN.

SEC. 2(F).

SER. NO. 85-415,711, FILED 9-6-2011.

MARY ROSSMAN, EXAMINING ATTORNEY



*David J. Kyffers*

Director of the United States Patent and Trademark Office



# United States of America

United States Patent and Trademark Office

## DRAWINGSEARCHER GOLD

**Reg. No. 4,274,153**

**Registered Jan. 15, 2013**

**Int. Cl.: 9**

**TRADEMARK**

**PRINCIPAL REGISTER**

DOCUPOINT, LLC (DELAWARE LIMITED LIABILITY COMPANY)  
515 HICHBORN STREET, SUITE 100  
VALLEJO, CA 94590

FOR: COMPUTER SOFTWARE FOR FINDING TARGETED INFORMATION IN ELECTRONIC FILES, FOR INDEXING ELECTRONIC FILES, AND FOR PROVIDING BROWSING, VIEWING AND EDITING ACCESS TO INDEXED ELECTRONIC FILES THROUGH A WEB-BASED INTERFACE, IN CLASS 9 (U.S. CLS. 21, 23, 26, 36 AND 38).

FIRST USE 4-30-2010; IN COMMERCE 4-30-2010.

THE MARK CONSISTS OF STANDARD CHARACTERS WITHOUT CLAIM TO ANY PARTICULAR FONT, STYLE, SIZE, OR COLOR.

NO CLAIM IS MADE TO THE EXCLUSIVE RIGHT TO USE "DRAWING SEARCHER", APART FROM THE MARK AS SHOWN.

SER. NO. 85-416,900, FILED S.R. 9-7-2011 AM. P.R. 6-22-2012.

TRACY FLETCHER, EXAMINING ATTORNEY



*David J. Kyffers*

Director of the United States Patent and Trademark Office

# United States of America

United States Patent and Trademark Office

## DRAWINGSEARCHER SILVER

**Reg. No. 4,274,154**

**Registered Jan. 15, 2013**

**Int. Cl.: 9**

**TRADEMARK**

**PRINCIPAL REGISTER**

DOCUPOINT, LLC (DELAWARE LIMITED LIABILITY COMPANY)  
515 HICHBORN STREET, SUITE 100  
VALLEJO, CA 94590

FOR: COMPUTER SOFTWARE FOR FINDING TARGETED INFORMATION IN ELECTRONIC FILES, FOR INDEXING ELECTRONIC FILES, AND FOR PROVIDING BROWSING, VIEWING AND EDITING ACCESS TO INDEXED ELECTRONIC FILES THROUGH A WEB-BASED INTERFACE, IN CLASS 9 (U.S. CLS. 21, 23, 26, 36 AND 38).

FIRST USE 3-31-2011; IN COMMERCE 3-31-2011.

THE MARK CONSISTS OF STANDARD CHARACTERS WITHOUT CLAIM TO ANY PARTICULAR FONT, STYLE, SIZE, OR COLOR.

NO CLAIM IS MADE TO THE EXCLUSIVE RIGHT TO USE "DRAWING SEARCHER", APART FROM THE MARK AS SHOWN.

SER. NO. 85-416,948, FILED 9-7-2011.

TRACY FLETCHER, EXAMINING ATTORNEY



*David J. Kyffers*

Director of the United States Patent and Trademark Office

# United States of America

United States Patent and Trademark Office

## From Our Hands to Yours

**Reg. No. 4,274,155**

**Registered Jan. 15, 2013**

**Int. Cls.: 41 and 44**

**SERVICE MARK**

**PRINCIPAL REGISTER**

JAMCO INVESTMENTS, INC. (FLORIDA CORPORATION)  
8380 WOODSMUIR DRIVE  
WEST PALM BEACH, FL 33412

FOR: EDUCATIONAL SERVICES, NAMELY, PROVIDING CONTINUING PROFESSIONAL EDUCATION COURSES OF INSTRUCTION IN THE FIELDS OF MEDICINE AND PATIENT SELF MEDICAL CARE AND MEDICAL SERVICES AND DISTRIBUTION OF COURSE MATERIAL IN CONNECTION THEREWITH, IN CLASS 41 (U.S. CLS. 100, 101 AND 107).

FIRST USE 1-0-2005; IN COMMERCE 1-0-2005.

FOR: MEDICAL INFORMATION, IN CLASS 44 (U.S. CLS. 100 AND 101).

FIRST USE 1-0-2005; IN COMMERCE 1-0-2005.

THE MARK CONSISTS OF STANDARD CHARACTERS WITHOUT CLAIM TO ANY PARTICULAR FONT, STYLE, SIZE, OR COLOR.

SER. NO. 85-419,877, FILED 9-12-2011.

JESSICA FATHY, EXAMINING ATTORNEY



*David J. Kybas*

Director of the United States Patent and Trademark Office

# United States of America

United States Patent and Trademark Office

## BETTY'S ATTIC

**Reg. No. 4,274,156**

**Registered Jan. 15, 2013**

**Int. Cls.: 16 and 35**

**TRADEMARK**

**SERVICE MARK**

**PRINCIPAL REGISTER**

JOHNSON SMITH COMPANY (FLORIDA CORPORATION)  
4514 19TH STREET COURT EAST  
BRADENTON, FL 34203

FOR: MAIL ORDER CATALOGS FEATURING HISTORICAL BOOKS, AUDIO AND VIDEO TAPES, MEMORABILIA, DIE CAST GOODS AND TOYS, TRENDY HOUSEWARES, SHIRTS, JEWELRY, AND COLLECTIBLES, IN CLASS 16 (U.S. CLS. 2, 5, 22, 23, 29, 37, 38 AND 50).

FIRST USE 0-0-1997; IN COMMERCE 0-0-1997.

FOR: ONLINE RETAIL STORE SERVICES FEATURING HISTORICAL BOOKS, AUDIO AND VIDEO TAPES, MEMORABILIA, DIE CAST GOODS AND TOYS, TRENDY HOUSEWARES, SHIRTS, JEWELRY, AND COLLECTIBLES, IN CLASS 35 (U.S. CLS. 100, 101 AND 102).

FIRST USE 0-0-2002; IN COMMERCE 0-0-2002.

THE MARK CONSISTS OF STANDARD CHARACTERS WITHOUT CLAIM TO ANY PARTICULAR FONT, STYLE, SIZE, OR COLOR.

SER. NO. 85-419,994, FILED 9-12-2011.

MARY ROSSMAN, EXAMINING ATTORNEY



*David J. Kyros*

Director of the United States Patent and Trademark Office

# United States of America

United States Patent and Trademark Office

## LUCKY DUCKY

**Reg. No. 4,274,157**

**Registered Jan. 15, 2013**

**Int. Cl.: 9**

**TRADEMARK**

**PRINCIPAL REGISTER**

VIDEO GAMING TECHNOLOGIES, INC. (TENNESSEE CORPORATION)  
308 MALLORY STATION ROAD  
FRANKLIN, TN 37067

FOR: COMPUTER SOFTWARE AND FIRMWARE FOR GAMES OF CHANCE ON ANY COMPUTERIZED PLATFORM, NAMELY, DEDICATED GAMING CONSOLES, VIDEO BASED SLOT MACHINES, REEL BASED SLOT MACHINES, AND VIDEO LOTTERY TERMINALS; GAMING DEVICES, NAMELY, GAMING MACHINES, SLOT MACHINES, BINGO MACHINES, WITH OR WITHOUT VIDEO OUTPUT, IN CLASS 9 (U.S. CLS. 21, 23, 26, 36 AND 38).

FIRST USE 12-0-2002; IN COMMERCE 12-0-2002.

THE MARK CONSISTS OF STANDARD CHARACTERS WITHOUT CLAIM TO ANY PARTICULAR FONT, STYLE, SIZE, OR COLOR.

SER. NO. 85-421,218, FILED 9-13-2011.

BRIAN NEVILLE, EXAMINING ATTORNEY



*David J. Kyffers*

Director of the United States Patent and Trademark Office

# United States of America

United States Patent and Trademark Office

## COSMIC WIND

**Reg. No. 4,274,158**

**Registered Jan. 15, 2013**

**Int. Cl.: 37**

**SERVICE MARK**

**PRINCIPAL REGISTER**

COSMIC WIND TURBINE SERVICE INC. (CANADA CORPORATION)  
SUITE 801  
2300 YONGE STREET  
TORONTO, ONTARIO, CANADA M4P1E4

FOR: CONSTRUCTION PLANNING AND CONSTRUCTION SERVICES REGARDING WIND ENERGY INSTALLATIONS; MAINTENANCE OF WIND ENERGY INSTALLATIONS AND EQUIPMENT , IN CLASS 37 (U.S. CLS. 100, 103 AND 106).

THE MARK CONSISTS OF STANDARD CHARACTERS WITHOUT CLAIM TO ANY PARTICULAR FONT, STYLE, SIZE, OR COLOR.

PRIORITY CLAIMED UNDER SEC. 44(D) ON CANADA APPLICATION NO. 1,523,745, FILED 4-14-2011, REG. NO. TMA823137, DATED 5-1-2012, EXPIRES 5-1-2027.

NO CLAIM IS MADE TO THE EXCLUSIVE RIGHT TO USE "WIND", APART FROM THE MARK AS SHOWN.

SER. NO. 85-421,326, FILED 9-13-2011.

RUDY R. SINGLETON, EXAMINING ATTORNEY



*David J. Kyfos*

Director of the United States Patent and Trademark Office

# United States of America

United States Patent and Trademark Office



# **CLEANUP FIRE & WATER**

**Reg. No. 4,274,159**

**Registered Jan. 15, 2013**

**Int. Cl.: 37**

**SERVICE MARK**

**PRINCIPAL REGISTER**

CLARK, ERIC (UNITED STATES INDIVIDUAL)  
268  
1525 PARK MANOR BLVD  
PITTSBURGH, PA 15205

FOR: PROVIDING RESTORATION SERVICES IN THE FIELD OF WATER AND FIRE DAMAGE; PROVIDING ASBESTOS REMOVAL AND SEWAGE CLEAN-UP SERVICES, IN CLASS 37 (U.S. CLS. 100, 103 AND 106).

FIRST USE 3-5-2010; IN COMMERCE 3-5-2010.

NO CLAIM IS MADE TO THE EXCLUSIVE RIGHT TO USE "CLEANUP FIRE & WATER", APART FROM THE MARK AS SHOWN.

THE MARK CONSISTS OF A SWOOSH INSIDE A TRIANGLE. TO THE RIGHT THERE IS THE STYLIZED TEXT "CLEANUP FIRE & WATER".

SER. NO. 85-422,590, FILED 9-14-2011.

KELLY TRUSILO, EXAMINING ATTORNEY



*David J. Kyffers*

Director of the United States Patent and Trademark Office

# United States of America

United States Patent and Trademark Office



**Reg. No. 4,274,160**

**Registered Jan. 15, 2013**

**Int. Cl.: 39**

**SERVICE MARK**

**PRINCIPAL REGISTER**

HUNT EUROPE LTD. (MACEDONIA LIMITED LIABILITY COMPANY)  
KACANICKI PAT B. B.  
INDUSTRISKA ZONA VIZBEGOVO  
SKOPJE, MACEDONIA 1000

FOR: ARRANGING, ORGANIZING, AND CONDUCTING HUNTING AND FISHING TRIPS,  
IN CLASS 39 (U.S. CLS. 100 AND 105).

FIRST USE 9-1-2011; IN COMMERCE 9-1-2011.

NO CLAIM IS MADE TO THE EXCLUSIVE RIGHT TO USE "HUNT EUROPE LTD.", APART  
FROM THE MARK AS SHOWN.

THE MARK CONSISTS OF THE PHRASES "HUNT EUROPE LTD.", WHICH IS PLACED  
ALONG THE UPPER CURB OF THE CIRCLE AND "VENERATIO, SCIENTIA, GNARUS",  
WHICH IS INSIDE THE BANNER BELOW THE BRANCH, AND THE DESIGN MADE UP  
OF A BEAR ON THE LEFT SIDE AND A DEER ON THE RIGHT SIDE, BOTH OF WHICH  
HOLDING THE COAT OF ARMS WHICH IS COMPOSED OF A PHEASANT AT THE TOP  
AND FOUR DIFFERENT ANTLERS IN EACH OF FOUR SECTIONS INSIDE THE COAT OF  
ARMS, AND THE BEAR AND THE DEER PERCHING ON THE BRANCH AND THE TWO  
STYLIZED CHARACTERS "H" AND "E" AT THE CENTER OF THE BRANCH, ALL OF  
WHICH INSIDE TWO CONCENTRIC CIRCLES.

THE ENGLISH TRANSLATION OF "VENERATIO, SCIENTIA, GNARUS" IN THE MARK IS  
HONOR OR VENERATION, SCIENCE OR KNOWLEDGE, SKILLED.

SER. NO. 85-423,001, FILED 9-14-2011.

MARY ROSSMAN, EXAMINING ATTORNEY



*David J. Kyros*

Director of the United States Patent and Trademark Office



# United States of America

United States Patent and Trademark Office

# LAUREN

**Reg. No. 4,274,161**

PRL USA HOLDINGS, INC. (DELAWARE CORPORATION)  
550 SEVENTH AVENUE  
NEW YORK, NY 10018

**Registered Jan. 15, 2013**

**Int. Cl.: 25**

FOR: A FULL LINE OF WOMEN'S APPAREL; FOOTWEAR, IN CLASS 25 (U.S. CLS. 22 AND 39).

**TRADEMARK**

FIRST USE 7-0-1996; IN COMMERCE 7-0-1996.

**PRINCIPAL REGISTER**

THE MARK CONSISTS OF STANDARD CHARACTERS WITHOUT CLAIM TO ANY PARTICULAR FONT, STYLE, SIZE, OR COLOR.

OWNER OF U.S. REG. NOS. 2,246,900, 2,419,959, AND 2,643,114.

SER. NO. 85-423,503, FILED 9-15-2011.

NANCY CLARKE, EXAMINING ATTORNEY



*David J. Kybas*

Director of the United States Patent and Trademark Office

# United States of America

United States Patent and Trademark Office



**Reg. No. 4,274,162**

**Registered Jan. 15, 2013**

**Int. Cl.: 44**

**SERVICE MARK**

**PRINCIPAL REGISTER**

MOBILE C-ARM SERVICES LLC (TEXAS LIMITED LIABILITY COMPANY)  
327 DERRICK DRIVE  
HUMBLE, TX 77338

FOR: MEDICAL IMAGING SERVICES, IN CLASS 44 (U.S. CLS. 100 AND 101).

FIRST USE 1-18-2010; IN COMMERCE 1-18-2010.

NO CLAIM IS MADE TO THE EXCLUSIVE RIGHT TO USE "MOBILE C-ARM SERVICES",  
APART FROM THE MARK AS SHOWN.

THE MARK CONSISTS OF THE STYLIZED TEXT "MOBILE C-ARM" WITH AN IMAGE OF  
A C-ARM BETWEEN THE TWO WORDS. UNDER THIS TEXT IS THE STYLIZED TEXT  
"SERVICES".

SER. NO. 85-425,714, FILED 9-19-2011.

MARGARET POWER, EXAMINING ATTORNEY



*David J. Kyffers*

Director of the United States Patent and Trademark Office

# United States of America

United States Patent and Trademark Office

VOA

**Reg. No. 4,274,163**

**Registered Jan. 15, 2013**

**Int. Cls.: 38 and 41**

**SERVICE MARK**

**PRINCIPAL REGISTER**

BROADCASTING BOARD OF GOVERNORS (UNITED STATES FEDERAL AGENCY)  
SUITE 3349, COHEN BUILDING  
330 INDEPENDENCE AVENUE, SW  
WASHINGTON, DC 20237

FOR: STREAMING OF AUDIO AND VIDEO INTERNATIONAL NEWS MATERIAL ON THE INTERNET; AUDIO BROADCASTING OF INTERNATIONAL NEWS; PROVIDING AN ON-LINE FORUM FOR INTERNATIONAL NEWS PROGRAMMING FEATURING NEWS AND COMMENTARY SEGMENTS; PROVIDING ACCESS TO DIGITAL MUSIC WEBSITES ON THE INTERNET; INTERNET RADIO BROADCASTING OF INTERNATIONAL NEWS SERVICES, IN CLASS 38 (U.S. CLS. 100, 101 AND 104).

FIRST USE 12-31-2004; IN COMMERCE 12-31-2004.

FOR: INTERNATIONAL NEWS SERVICES, NAMELY, PROVIDING ON-GOING TELEVISION PROGRAMS IN THE FIELD OF NEWS COMMENTARY VIA A GLOBAL COMPUTER NETWORK; ON-LINE SOCIAL MEDIA JOURNALS, NAMELY, INTERNATIONAL NEWS BLOGS FEATURING NEWS AND COMMENTARY SEGMENTS; ENGLISH LANGUAGE INSTRUCTION, IN CLASS 41 (U.S. CLS. 100, 101 AND 107).

FIRST USE 12-31-2004; IN COMMERCE 12-31-2004.

OWNER OF U.S. REG. NO. 3,205,170.

THE MARK CONSISTS OF A STYLIZED DEPICTION OF THE LETTERS VOA SO THAT THE "O" IS DEPICTED AS A CUT-OUT FROM THE "V" AND "A" LETTERS AND ITS SHAPE IS DEFINED BY EMPTY SPACE FROM THE "V" AND THE "A" AND A SOLID CIRCLE AND SO THAT THE "A" IS DEPICTED AS AN UPSIDE-DOWN "V".

SER. NO. 85-427,950, FILED 9-21-2011.

SUSAN LESLIE DUBOIS, EXAMINING ATTORNEY



*David J. Kyffers*

Director of the United States Patent and Trademark Office

# United States of America

United States Patent and Trademark Office



ChristianWorks for Children

**Reg. No. 4,274,164**

**Registered Jan. 15, 2013**

**Int. Cl.: 45**

**SERVICE MARK**

**PRINCIPAL REGISTER**

CHRISTIANWORKS FOR CHILDREN, INC. (TEXAS CORPORATION)  
6320 LBJ FREEWAY, SUITE 126  
DALLAS, TX 75240

FOR: PROVIDING EMOTIONAL COUNSELING AND EMOTIONAL SUPPORT SERVICES FOR YOUTH AND THEIR FAMILIES IN THE FIELDS OF DIVORCE COUNSELING, GRIEF COUNSELING, ADOPTION COUNSELING, AND MARRIAGE COUNSELING; COUNSELING IN THE FIELD OF DEVELOPING, STRENGTHENING AND SUSTAINING WELL-BALANCED FAMILIES AND FAMILY RELATIONSHIPS, IN CLASS 45 (U.S. CLS. 100 AND 101).

FIRST USE 10-1-2004; IN COMMERCE 10-1-2004.

NO CLAIM IS MADE TO THE EXCLUSIVE RIGHT TO USE "CHILDREN", APART FROM THE MARK AS SHOWN.

THE MARK CONSISTS OF THE WORDS "CHRISTIANWORKS FOR CHILDREN" TO THE RIGHT OF A FOUR-PART SHIELD CONTAINING THE STYLIZED DEPICTIONS OF AN ADULT CRADLING AN INFANT IN HIS/HER ARMS, A PERSON WITH HEAD IN HANDS, TWO PEOPLE SEATED AND FACING EACH OTHER, AND TWO PEOPLE JOINED TO FORM A HEART.

SER. NO. 85-428,421, FILED 9-21-2011.

TASHIA BUNCH, EXAMINING ATTORNEY



*David J. Kyjars*

Director of the United States Patent and Trademark Office

# United States of America

United States Patent and Trademark Office

## ATLAS PEAK CAPITAL

**Reg. No. 4,274,165**

**Registered Jan. 15, 2013**

**Int. Cl.: 36**

**SERVICE MARK**

**PRINCIPAL REGISTER**

ATLAS PEAK CAPITAL MANAGEMENT, LLC (DELAWARE LIMITED LIABILITY COMPANY)

400 MONTGOMERY STREET, SUITE 900  
ATLAS PEAK CAPITAL MANAGEMENT, LLC  
SAN FRANCISCO, CA 94104

FOR: INVESTMENT MANAGEMENT AND INVESTMENT FUND SERVICES, EXCLUDING VENTURE CAPITAL SERVICES PROVIDED TO COMPANIES IN THE FIELDS OF TECHNOLOGY, E-COMMERCE, INTERNET, WEB, WEB SERVICES, DATA, TELECOMMUNICATIONS, AND LIFE SCIENCES, IN CLASS 36 (U.S. CLS. 100, 101 AND 102).

FIRST USE 9-19-2011; IN COMMERCE 9-19-2011.

THE MARK CONSISTS OF STANDARD CHARACTERS WITHOUT CLAIM TO ANY PARTICULAR FONT, STYLE, SIZE, OR COLOR.

NO CLAIM IS MADE TO THE EXCLUSIVE RIGHT TO USE "CAPITAL", APART FROM THE MARK AS SHOWN.

SER. NO. 85-429,471, FILED 9-22-2011.

JUDITH HELFMAN, EXAMINING ATTORNEY



*David J. Kyffers*

Director of the United States Patent and Trademark Office

# United States of America

United States Patent and Trademark Office



ATLAS PEAK  
CAPITAL

**Reg. No. 4,274,166**

**Registered Jan. 15, 2013**

**Int. Cl.: 36**

ATLAS PEAK CAPITAL MANAGEMENT, LLC (DELAWARE LIMITED LIABILITY COMPANY)  
400 MONTGOMERY STREET, SUITE 900  
ATLAS PEAK CAPITAL MANAGEMENT, LLC  
SAN FRANCISCO, CA 94104

**SERVICE MARK**

**PRINCIPAL REGISTER**

FOR: INVESTMENT MANAGEMENT AND INVESTMENT FUND SERVICES, EXCLUDING VENTURE CAPITAL SERVICES PROVIDED TO COMPANIES IN THE FIELDS OF TECHNOLOGY, E-COMMERCE, INTERNET, WEB, WEB SERVICES, DATA, TELECOMMUNICATIONS, AND LIFE SCIENCES, IN CLASS 36 (U.S. CLS. 100, 101 AND 102).

FIRST USE 9-19-2011; IN COMMERCE 9-19-2011.

NO CLAIM IS MADE TO THE EXCLUSIVE RIGHT TO USE "CAPITAL", APART FROM THE MARK AS SHOWN.

THE MARK CONSISTS OF AN INCOMPLETE SQUARE-SHAPED DESIGN CONSISTING OF A LINE THAT BEGINS AS A CHEVRON, EXTENDS ALONG THE BORDER OF A SQUARE, AND FORMS A SECOND INTERIOR CHEVRON AND TWO TRIANGLES RESEMBLING THE OUTLINE OF A LETTER "A" AND A MOUNTAIN PEAK, WITH THE WORDS "ATLAS PEAK" CENTERED DIRECTLY BELOW THE DESIGN, AND THE WORD "CAPITAL" IN SMALLER TYPE, FLANKED ON BOTH SIDES BY HORIZONTAL LINES, CENTERED DIRECTLY BELOW THE WORDS "ATLAS PEAK".

SER. NO. 85-429,501, FILED 9-22-2011.

JUDITH HELFMAN, EXAMINING ATTORNEY



*David J. Kyros*

Director of the United States Patent and Trademark Office

# United States of America

United States Patent and Trademark Office

# Firefly Video

**Reg. No. 4,274,167**

**Registered Jan. 15, 2013**

**Int. Cl.: 35**

**SERVICE MARK**

**PRINCIPAL REGISTER**

EXPONENTIAL INTERACTIVE, INC. (DELAWARE CORPORATION)  
2200 POWELL STREET, SUITE 600  
EMERYVILLE, CA 94608

FOR: PROMOTING THE GOODS AND SERVICES OF OTHERS BY DELIVERING TARGETED VIDEO, GRAPHIC AND TEXTUAL ADVERTISING FOR SELECTION AND VIEWING BY ONLINE CONSUMERS; DISSEMINATION OF ADVERTISING FOR OTHERS VIA THE INTERNET AND OTHER COMMUNICATION NETWORKS, IN CLASS 35 (U.S. CLS. 100, 101 AND 102).

FIRST USE 5-9-2010; IN COMMERCE 5-9-2010.

THE MARK CONSISTS OF STANDARD CHARACTERS WITHOUT CLAIM TO ANY PARTICULAR FONT, STYLE, SIZE, OR COLOR.

NO CLAIM IS MADE TO THE EXCLUSIVE RIGHT TO USE "VIDEO", APART FROM THE MARK AS SHOWN.

SER. NO. 85-429,533, FILED 9-22-2011.

TASNEEM HUSSAIN, EXAMINING ATTORNEY



*David J. Kyffers*

Director of the United States Patent and Trademark Office

# United States of America

United States Patent and Trademark Office

## CATCH-A-Raindrop

**Reg. No. 4,274,168**

AMERIMAX HOME PRODUCTS, INC. (DELAWARE CORPORATION)  
4455 RIVER GREEN PARKWAY  
DULUTH, GA 30096

**Registered Jan. 15, 2013**

**Int. Cl.: 11**

FOR: WATER INSTALLATIONS INCLUDING RAINWATER COLLECTION DEVICES, NAMELY, A COLLECTOR INSTALLED IN A DOWNSPOUT FOR COLLECTING, FILTERING AND DIVERTING RAINWATER FROM THE DOWNSPOUT INTO A REMOTE RAINWATER STORAGE FACILITY, IN CLASS 11 (U.S. CLS. 13, 21, 23, 31 AND 34).

**TRADEMARK**

**PRINCIPAL REGISTER**

FIRST USE 8-2-2011; IN COMMERCE 8-2-2011.

THE MARK CONSISTS OF STANDARD CHARACTERS WITHOUT CLAIM TO ANY PARTICULAR FONT, STYLE, SIZE, OR COLOR.

SER. NO. 85-429,868, FILED 9-22-2011.

ZACHARY BELLO, EXAMINING ATTORNEY



*David J. Kyffers*

Director of the United States Patent and Trademark Office



# United States of America

United States Patent and Trademark Office

## THE DAILY CRAZE

**Reg. No. 4,274,169**

**Registered Jan. 15, 2013**

**Int. Cl.: 35**

**SERVICE MARK**

**PRINCIPAL REGISTER**

THE DAILY CRAZE INC. (OREGON CORPORATION)  
909 S. RIVERSIDE  
MEDFORD, OR 97501

FOR: PROMOTING THE GOODS AND SERVICES OF OTHERS BY PROVIDING A WEBSITE FEATURING COUPONS, REBATES, PRICE-COMPARISON INFORMATION, PRODUCT REVIEWS, LINKS TO THE RETAIL WEBSITES OF OTHERS, AND DISCOUNT INFORMATION; PROMOTING THE GOODS AND SERVICES OF OTHERS BY PROVIDING A WEBSITE FEATURING DISCOUNT VOUCHERS, COUPONS, REBATES, SPECIAL OFFERS, AND PRODUCT REVIEWS, IN CLASS 35 (U.S. CLS. 100, 101 AND 102).

FIRST USE 4-14-2011; IN COMMERCE 4-14-2011.

THE MARK CONSISTS OF STANDARD CHARACTERS WITHOUT CLAIM TO ANY PARTICULAR FONT, STYLE, SIZE, OR COLOR.

NO CLAIM IS MADE TO THE EXCLUSIVE RIGHT TO USE "DAILY", APART FROM THE MARK AS SHOWN.

SER. NO. 85-430,406, FILED 9-23-2011.

CAROLINE WOOD, EXAMINING ATTORNEY



*David J. Kyros*

Director of the United States Patent and Trademark Office

# United States of America

United States Patent and Trademark Office



**Reg. No. 4,274,170**

**Registered Jan. 15, 2013**

**Int. Cl.: 9**

**TRADEMARK**

**PRINCIPAL REGISTER**

STAMPZZ MEDIA S.A. (LUXEMBOURG CORPORATION)  
4, RUE DICKS  
LUXEMBOURG, LUXEMBOURG L-1417

FOR: DOWNLOADABLE COMPUTER COMMUNICATIONS SOFTWARE ENABLING USERS TO CAPTURE, UPLOAD, POST, AND DISPLAY DIGITAL VISUAL IMAGES, VIEW, EXCHANGE, FORWARD, AND SHARE TITLED OR NON-TITLED DIGITAL VISUAL IMAGES AND ENABLING USERS TO SEARCH, MODIFY, ENHANCE, COMMENT ON, TAG AND GEOLOCALIZE DIGITAL VISUAL IMAGES; DOWNLOADABLE COMPUTER COMMUNICATIONS MANAGEMENT SOFTWARE ENABLING USERS TO FOLLOW OTHER USERS, ENGAGE IN SOCIAL NETWORKING AND EXCHANGE MESSAGES AND DATA ONLINE IN REAL-TIME, IN CLASS 9 (U.S. CLS. 21, 23, 26, 36 AND 38).

FIRST USE 9-9-2011; IN COMMERCE 9-9-2011.

THE MARK CONSISTS OF A BLUE RECTANGLE CONTAINING A DESIGN OF A BLUE AND WHITE OWL WITH ONE EYE CLOSED AND ONE EYE OPENED AND WITH AN OVERALL SHAPE INTENDED TO SUGGEST A SNAPSHOT FROM AN INSTANT CAMERA. BENEATH THE OWL DESIGN IS THE WORD "STAMPZZ" IN STYLISED WHITE FONT.

THE COLOR(S) WHITE AND BLUE IS/ARE CLAIMED AS A FEATURE OF THE MARK.

SER. NO. 85-431,488, FILED 9-26-2011.

MICHAEL SOUDERS, EXAMINING ATTORNEY



*David J. Kyjars*

Director of the United States Patent and Trademark Office

United States of America  
United States Patent and Trademark Office

**ActSocial**

**Reg. No. 4,274,171**

NICKEL RIVER, LLC (WISCONSIN LIMITED LIABILITY COMPANY)  
3680 NASSAU DRIVE  
BROOKFIELD, WI 53045

**Registered Jan. 15, 2013**

**Int. Cl.: 42**

FOR: SOCIAL MEDIA SOFTWARE SERVICES AND SOLUTIONS, NAMELY, DESIGN AND DEVELOPMENT OF SOCIAL MEDIA SOFTWARE APPLICATIONS AND RELATED CONSULTING, IN CLASS 42 (U.S. CLS. 100 AND 101).

**SERVICE MARK**

FIRST USE 3-1-2011; IN COMMERCE 3-1-2011.

**PRINCIPAL REGISTER**

THE MARK CONSISTS OF THE WORDING "ACTSOCIAL" IN WHICH "ACT" IS IN RED AND "SOCIAL" IS IN BLACK.

THE COLOR(S) BLACK AND RED IS/ARE CLAIMED AS A FEATURE OF THE MARK.

SER. NO. 85-432,038, FILED 9-26-2011.

ANDREW LEASER, EXAMINING ATTORNEY



*David J. Kyffers*

Director of the United States Patent and Trademark Office

# United States of America

United States Patent and Trademark Office



**RARE BIRD**  
TRADING COMPANY  
瑞比邻

**Reg. No. 4,274,172**

**Registered Jan. 15, 2013**

**Int. Cl.: 35**

**SERVICE MARK**

**PRINCIPAL REGISTER**

RARE BIRD TRADING COMPANY, LLC (NORTH CAROLINA LIMITED LIABILITY COMPANY)  
10900 WORLD TRADE BLVD  
RESEARCH TRIANGLE PARK, NC 27709

FOR: GLOBAL SOURCING, NAMELY, COMBINED STRATEGIC GOODS AND SERVICES SOURCING FOR OTHERS; CONSULTING IN THE FIELD OF IMPORTING AND EXPORTING GOODS; IMPORT AND EXPORT AGENCY SERVICES FOR BULK GOODS IN THE FIELD OF COMMERCIAL AND CONSUMER GOODS, CUSTOMS CLEARANCE SERVICES AND LOGISTICS MANAGEMENT ASSISTANCE IN THE FIELD OF COMMERCIAL AND CONSUMER SHIPMENTS OF BULK GOODS; TRANSPORTATION LOGISTIC SERVICES, NAMELY, ARRANGING THE TRANSPORTATION OF BULK SHIPMENTS OF GOODS FOR OTHERS, PLANNING AND SCHEDULING SHIPMENT FOR USERS OF TRANSPORTATION SERVICES, IN CLASS 35 (U.S. CLS. 100, 101 AND 102).

FIRST USE 2-15-2011; IN COMMERCE 2-15-2011.

NO CLAIM IS MADE TO THE EXCLUSIVE RIGHT TO USE "TRADING COMPANY", APART FROM THE MARK AS SHOWN.

THE COLOR(S) BLACK AND RED IS/ARE CLAIMED AS A FEATURE OF THE MARK.

THE NON-LATIN CHARACTERS IN THE MARK TRANSLITERATE TO "RU BI LIN" AND THIS MEANS "AUSPICIOUS AS A NEIGHBOR OR NEXT TO" IN ENGLISH.

THE MARK CONSISTS OF THE BLACK WORDING "RARE BIRD", BELOW WHICH IS THE RED WORDING "TRADING COMPANY", BELOW WHICH ARE THREE BLACK CHINESE CHARACTERS FOLLOWED BY A RED LINE TO THE LEFT OF THE WORDING IS A STYLIZED GLOBE MADE UP OF RED CURVED LINES, AT THE TOP OF THE STYLIZED GLOBE, THE LINES TURN INTO A STYLIZED DEPICTION OF A RED BIRD.

SER. NO. 85-433,602, FILED 9-28-2011.

CHRISTINA SOBRAL, EXAMINING ATTORNEY



*David J. Kyjars*

Director of the United States Patent and Trademark Office

# United States of America

United States Patent and Trademark Office

## HOLLYWOOD FUNK

**Reg. No. 4,274,173**

FLANAGAN, CONOR (UNITED STATES INDIVIDUAL)  
1715 CABRILLO STREET  
SAN FRANCISCO, CA 94121

**Registered Jan. 15, 2013**

**Int. Cl.: 25**

FOR: APPAREL, NAMELY, SHIRTS, SWEAT SHIRTS AND HATS, IN CLASS 25 (U.S. CLS. 22 AND 39).

**TRADEMARK**

FIRST USE 9-0-2011; IN COMMERCE 9-0-2011.

**PRINCIPAL REGISTER**

THE MARK CONSISTS OF STANDARD CHARACTERS WITHOUT CLAIM TO ANY PARTICULAR FONT, STYLE, SIZE, OR COLOR.

SER. NO. 85-439,085, FILED 10-4-2011.

JEFFREY LOOK, EXAMINING ATTORNEY



*David J. Kybas*

Director of the United States Patent and Trademark Office

# United States of America

United States Patent and Trademark Office



**Reg. No. 4,274,174**

KORUS CO., INC. (CALIFORNIA CORPORATION)  
1353 OAKLAND ROAD  
SAN JOSE, CA 95112

**Registered Jan. 15, 2013**

**Int. Cls.: 9 and 18**

FOR: LAPTOP CARRYING CASES, IN CLASS 9 (U.S. CLS. 21, 23, 26, 36 AND 38).

FIRST USE 8-18-2010; IN COMMERCE 9-3-2010.

**TRADEMARK**

FOR: LUGGAGE; TOTE BAGS; BACKPACKS; DUFFEL BAGS; TEXTILE SHOPPING BAGS;  
FANNY PACKS; HIP PACKS; MESSENGER BAGS; SATCHELS; GYM BAGS; CARRY-ON  
BAGS, IN CLASS 18 (U.S. CLS. 1, 2, 3, 22 AND 41).

**PRINCIPAL REGISTER**

FIRST USE 8-18-2010; IN COMMERCE 9-3-2010.

THE MARK CONSISTS OF THE STYLIZED TEXT "WP".

SER. NO. 85-443,634, FILED 10-10-2011.

KATHLEEN LORENZO, EXAMINING ATTORNEY



*David J. Kybas*

Director of the United States Patent and Trademark Office

# United States of America

United States Patent and Trademark Office

## BADASS DIGEST

**Reg. No. 4,274,175**

**Registered Jan. 15, 2013**

**Int. Cls.: 41 and 43**

**SERVICE MARK**

**PRINCIPAL REGISTER**

ALAMO DRAFTHOUSE CINEMAS, LLC (TEXAS LIMITED LIABILITY COMPANY)  
1717 WEST SIXTH STREET, SUITE 351  
AUSTIN, TX 78703

FOR: ENTERTAINMENT SERVICES, NAMELY, PROVIDING A WEB SITE FEATURING PHOTOGRAPHIC, AUDIO, AND VIDEO PRESENTATIONS IN THE FIELDS OF ENTERTAINMENT, CULTURE, CURRENT EVENT NEWS, ART, FILM, MUSIC, AND LOCAL ENTERTAINMENT EVENTS; ON-LINE JOURNALS, NAMELY, BLOGS FEATURING INFORMATION IN THE FIELDS OF CULTURE, ENTERTAINMENT, MOVIES, TELEVISION, VIDEO GAMES, ART, LOCAL ENTERTAINMENT EVENTS, CURRENT EVENT NEWS, AND FASHION; ENTERTAINMENT SERVICES, NAMELY, PROVIDING ON-LINE REVIEWS OF MOVIES, VIDEO GAMES, TELEVISION, AND LOCAL ENTERTAINMENT EVENTS; PROVIDING A WEBSITE FEATURING ENTERTAINMENT INFORMATION, IN CLASS 41 (U.S. CLS. 100, 101 AND 107).

FIRST USE 9-17-2010; IN COMMERCE 9-17-2010.

FOR: PROVIDING ON-LINE REVIEWS OF RESTAURANTS; PROVIDING ONLINE REVIEWS OF FOOD PRODUCTS FOR FOOD APPRECIATION PURPOSES; PROVIDING ONLINE REVIEWS OF BEER AND WINE FOR BEER AND WINE APPRECIATION PURPOSES, IN CLASS 43 (U.S. CLS. 100 AND 101).

FIRST USE 9-17-2010; IN COMMERCE 9-17-2010.

THE MARK CONSISTS OF STANDARD CHARACTERS WITHOUT CLAIM TO ANY PARTICULAR FONT, STYLE, SIZE, OR COLOR.

NO CLAIM IS MADE TO THE EXCLUSIVE RIGHT TO USE "DIGEST", APART FROM THE MARK AS SHOWN.

SER. NO. 85-443,847, FILED 10-10-2011.

DAVID TAYLOR, EXAMINING ATTORNEY



*David J. Kyffers*

Director of the United States Patent and Trademark Office

# United States of America

United States Patent and Trademark Office



**Reg. No. 4,274,176**

WACOAL AMERICA, INC. (DELAWARE CORPORATION)  
136 MADISON AVENUE  
NEW YORK, NY 10016

**Registered Jan. 15, 2013**

**Int. Cl.: 35**

FOR: ON-LINE RETAIL STORE SERVICES IN THE FIELD OF BRASSIERES, FEMININE SHAPE WEAR AND UNDERGARMENTS, IN CLASS 35 (U.S. CLS. 100, 101 AND 102).

**SERVICE MARK**

FIRST USE 8-4-2010; IN COMMERCE 8-4-2010.

**PRINCIPAL REGISTER**

OWNER OF U.S. REG. NOS. 4,026,420, 4,029,104, AND 4,031,931.

THE MARK CONSISTS OF "B.TEMPT'D" IN STYLIZED LETTERS AND A STYLIZED LETTER "B" APPEARING ON A SHIELD WITH A CREST DESIGN.

SER. NO. 85-445,645, FILED 10-12-2011.

JOHN GARTNER, EXAMINING ATTORNEY



*David J. Kybas*

Director of the United States Patent and Trademark Office



**United States of America**  
United States Patent and Trademark Office

# AGRIPAC

**Reg. No. 4,274,177**

**Registered Jan. 15, 2013**

**Int. Cl.: 22**

**TRADEMARK**

**PRINCIPAL REGISTER**

AT FILMS INC. (CANADA CORPORATION)  
2507, 10088 - 102 AVENUE  
EDMONTON, ALBERTA, CANADA T5J2K1

FOR: SILAGE BAGS, IN CLASS 22 (U.S. CLS. 1, 2, 7, 19, 22, 42 AND 50).

FIRST USE 6-1-1990; IN COMMERCE 6-1-1990.

THE MARK CONSISTS OF STANDARD CHARACTERS WITHOUT CLAIM TO ANY PARTICULAR FONT, STYLE, SIZE, OR COLOR.

OWNER OF U.S. REG. NO. 2,667,638.

SER. NO. 85-446,393, FILED 10-13-2011.

GIANCARLO CASTRO, EXAMINING ATTORNEY



*David J. Kybas*

Director of the United States Patent and Trademark Office

# United States of America

United States Patent and Trademark Office

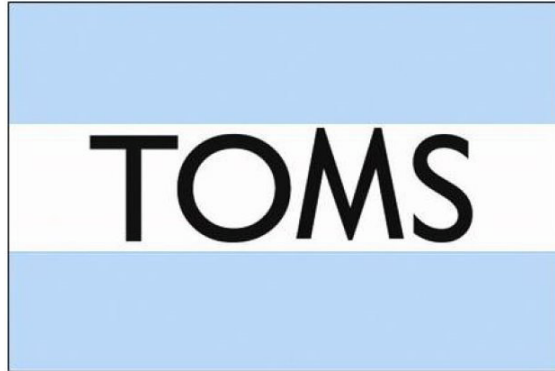

**Reg. No. 4,274,178**

**Registered Jan. 15, 2013**

**Int. Cl.: 35**

**SERVICE MARK**

**PRINCIPAL REGISTER**

MYCOSKIE, LLC (CALIFORNIA LIMITED LIABILITY COMPANY)  
STAGE C 3025  
OLYMPIC BOULEVARD  
SANTA MONICA, CA 90404

FOR: RETAIL STORE SERVICES AND ON-LINE RETAIL STORE SERVICES IN THE FIELD OF FOOTWEAR, APPAREL, EYEWEAR, JEWELRY, BOOKS, JOURNALS, AND GIFT PACKS CONSISTING OF DVDS AND POSTERS, IN CLASS 35 (U.S. CLS. 100, 101 AND 102).

FIRST USE 5-15-2000; IN COMMERCE 5-15-2000.

OWNER OF U.S. REG. NOS. 3,353,902, 3,662,112 AND OTHERS.

THE COLOR(S) BLUE, WHITE AND BLACK IS/ARE CLAIMED AS A FEATURE OF THE MARK.

THE MARK CONSISTS OF A FLAG-LIKE LOGO WITH THREE EQUAL SIZED STRIPES, THE STRIPES ARE BLUE ON THE TOP AND BOTTOM AND WHITE IN THE MIDDLE WITH THE TERM "TOMS" PRINTED IN BLACK LETTERING IN THE MIDDLE WHITE STRIPE, AND A THIN BLACK LINE OUTLINING THE ENTIRE MARK

SER. NO. 85-446,592, FILED 10-13-2011.

BILL DAWE, EXAMINING ATTORNEY



*David J. Kyffers*

Director of the United States Patent and Trademark Office

# United States of America

United States Patent and Trademark Office

## The House on Christmas Street

**Reg. No. 4,274,179**

JUDITH E. PANCOAST (UNITED STATES INDIVIDUAL)  
43 PINEHILL AVE.

**Registered Jan. 15, 2013**

MANCHESTER, NH 03102

**Int. Cl.: 9**

FOR: AUDIO AND VIDEO RECORDINGS FEATURING MUSIC AND ARTISTIC PERFORMANCES; COMPACT DISCS FEATURING MUSIC; COMPUTER SOFTWARE FEATURING MUSICAL SOUND RECORDINGS AND MUSICAL VIDEO RECORDINGS; DIGITAL MEDIA, NAMELY, PRE-RECORDED DVDS, DOWNLOADABLE AUDIO AND VIDEO RECORDINGS, AND CDS FEATURING AND PROMOTING MUSIC; DIGITAL MEDIA, NAMELY, PRE-RECORDED VIDEO CASSETTES, DIGITAL VIDEO DISCS, DIGITAL VERSATILE DISCS, DOWNLOADABLE AUDIO AND VIDEO RECORDINGS, DVDS, AND HIGH DEFINITION DIGITAL DISCS FEATURING MUSIC; DIGITAL MUSIC DOWNLOADABLE FROM THE INTERNET; DOWNLOADABLE MP3 FILES AND MP3 RECORDINGS FEATURING MUSIC; DOWNLOADABLE MUSICAL SOUND RECORDINGS; DOWNLOADABLE RING TONES, GRAPHICS AND MUSIC VIA A GLOBAL COMPUTER NETWORK AND WIRELESS DEVICES; PRERECORDED AUDIO TAPES FEATURING MUSIC; PRERECORDED VIDEO TAPES FEATURING MUSIC, IN CLASS 9 (U.S. CLS. 21, 23, 26, 36 AND 38).

**TRADEMARK**

**PRINCIPAL REGISTER**

FIRST USE 12-1-1998; IN COMMERCE 12-15-1998.

THE MARK CONSISTS OF STANDARD CHARACTERS WITHOUT CLAIM TO ANY PARTICULAR FONT, STYLE, SIZE, OR COLOR.

SER. NO. 85-446,599, FILED 10-13-2011.

EMILY CARLSEN, EXAMINING ATTORNEY



*David J. Kyros*

Director of the United States Patent and Trademark Office

# United States of America

United States Patent and Trademark Office

## LIVEHELPNOW

**Reg. No. 4,274,180**

ZAZA NETWORK INC. (PENNSYLVANIA CORPORATION), DBA LIVEHELPNOW  
149 SHOEMAKER ROAD  
HUNTINGDON VALLEY, PA 19006

**Registered Jan. 15, 2013**

**Int. Cl.: 42**

FOR: SOFTWARE AS A SERVICE FOR USE IN PROVIDING REAL-TIME, ON-DEMAND, PROACTIVE MARKETING AND CUSTOMER ACQUISITION IN CONNECTION WITH SALES INFORMATION, PRODUCT INFORMATION, SERVICES INFORMATION AND MARKETING INFORMATION, IN CLASS 42 (U.S. CLS. 100 AND 101).

**SERVICE MARK**

**PRINCIPAL REGISTER**

FIRST USE 5-2-2003; IN COMMERCE 5-2-2003.

THE MARK CONSISTS OF STANDARD CHARACTERS WITHOUT CLAIM TO ANY PARTICULAR FONT, STYLE, SIZE, OR COLOR.

SEC. 2(F).

SER. NO. 85-446,660, FILED 10-13-2011.

JESSICA A. POWERS, EXAMINING ATTORNEY



*David J. Kyffers*

Director of the United States Patent and Trademark Office

# United States of America

United States Patent and Trademark Office

## SMOKIN' COUNTRY CONCERT

**Reg. No. 4,274,181**

SMOKIN' COUNTRY CONCERT (OHIO LIMITED LIABILITY COMPANY)  
4591 S SR 19

**Registered Jan. 15, 2013**

BLOOMVILLE, OH 44818

**Int. Cl.: 25**

FOR: MEN'S, WOMEN'S AND CHILDREN'S CLOTHING, NAMELY, SHIRTS, PANTS, SHORTS, JACKETS, SWEATERS, HOODED SWEATERS, ZIPPERED SWEATERS, SWEAT-PANTS, SWIMWEAR, VISORS, IN CLASS 25 (U.S. CLS. 22 AND 39).

**TRADEMARK**

FIRST USE 6-11-2011; IN COMMERCE 6-11-2011.

**PRINCIPAL REGISTER**

THE MARK CONSISTS OF STANDARD CHARACTERS WITHOUT CLAIM TO ANY PARTICULAR FONT, STYLE, SIZE, OR COLOR.

SER. NO. 85-447,305, FILED 10-14-2011.

TASHIA BUNCH, EXAMINING ATTORNEY



*David J. Kyffers*

Director of the United States Patent and Trademark Office

# United States of America

United States Patent and Trademark Office

**SPREAD IT** & **FORGET IT**  
for greener turf all season long

**Reg. No. 4,274,182**

**Registered Jan. 15, 2013**

**Int. Cl.: 1**

**TRADEMARK**

**PRINCIPAL REGISTER**

AGRIUM ADVANCED TECHNOLOGIES (U.S.) INC. (DELAWARE CORPORATION)  
2915 ROCKY MOUNTAIN AVENUE, SUITE 400  
LOVELAND, CO 80538

FOR: FERTILIZER, IN CLASS 1 (U.S. CLS. 1, 5, 6, 10, 26 AND 46).

FIRST USE 2-0-2010; IN COMMERCE 2-0-2010.

OWNER OF U.S. REG. NO. 3,561,534.

THE MARK CONSISTS OF THE WORDING "SPREAD IT & FORGET IT FOR GREENER TURF ALL SEASON LONG" WITH THE AMPERSAND SHOWN IN NEGATIVE IMAGE ON A DARK CIRCLE.

SER. NO. 85-447,426, FILED 10-14-2011.

FRED CARL, EXAMINING ATTORNEY



*David J. Kyffers*

Director of the United States Patent and Trademark Office

# United States of America

United States Patent and Trademark Office



**Reg. No. 4,274,183**

**Registered Jan. 15, 2013**

**Int. Cls.: 14 and 25**

**TRADEMARK**

**PRINCIPAL REGISTER**

DUKE UNIVERSITY (NORTH CAROLINA CORPORATION)  
OFFICE OF COUNSEL  
310 BLACKWELL STREET, 4TH FLOOR  
DURHAM, NC 27701

FOR: RINGS, IN CLASS 14 (U.S. CLS. 2, 27, 28 AND 50).

FIRST USE 1-1-1987; IN COMMERCE 1-1-1987.

FOR: HEADWEAR; TOPS , IN CLASS 25 (U.S. CLS. 22 AND 39).

FIRST USE 3-1-2011; IN COMMERCE 3-1-2011.

OWNER OF U.S. REG. NOS. 1,701,827, 1,707,766 AND OTHERS.

THE MARK CONSISTS OF A STYLIZED CAPITAL LETTER "D" SHOWN IN GOTHIC SCRIPT.

SER. NO. 85-447,767, FILED 10-14-2011.

MARC LEIPZIG, EXAMINING ATTORNEY



*David J. Kybas*

Director of the United States Patent and Trademark Office

# United States of America

United States Patent and Trademark Office

# SPEEDLOK

**Reg. No. 4,274,184**

**Registered Jan. 15, 2013**

**Int. Cl.: 7**

**TRADEMARK**

**PRINCIPAL REGISTER**

THERMAL DYNAMICS CORPORATION (DELAWARE CORPORATION)  
16052 SWINGLEY RIDGE ROAD, SUITE 300  
CHESTERFIELD, MO 63017

FOR: RETAINER FOR RETAINING CONSUMABLE PARTS USED AS A COMPONENT OF WELDERS, TORCHES AND CUTTERS, IN CLASS 7 (U.S. CLS. 13, 19, 21, 23, 31, 34 AND 35).

FIRST USE 12-0-2006; IN COMMERCE 12-0-2006.

THE MARK CONSISTS OF STANDARD CHARACTERS WITHOUT CLAIM TO ANY PARTICULAR FONT, STYLE, SIZE, OR COLOR.

SER. NO. 85-447,931, FILED 10-14-2011.

RAUL CORDOVA, EXAMINING ATTORNEY



*David J. Kyffers*

Director of the United States Patent and Trademark Office



# United States of America

United States Patent and Trademark Office

Invest in your life.  
Invest for life.

**Reg. No. 4,274,185**

**Registered Jan. 15, 2013**

**Int. Cl.: 36**

**SERVICE MARK**

**PRINCIPAL REGISTER**

T. ROWE PRICE GROUP, INC. (MARYLAND CORPORATION)  
100 EAST PRATT STREET  
BALTIMORE, MD 21202

FOR: HOUSE MARK FOR PROVIDING A FULL RANGE OF SERVICES IN THE INVESTMENT AND FINANCIAL FIELD, NAMELY, BANKING, INVESTMENT BROKERAGE, INVESTMENT MANAGEMENT, ASSET MANAGEMENT, INVESTMENT ADVICE, INVESTMENT CONSULTATION, FINANCIAL RESEARCH, COLLEGE SAVINGS PLANS, CHARITABLE GIVING, RETIREMENT PLANNING, AND VARIABLE ANNUITIES INVESTMENT, IN CLASS 36 (U.S. CLS. 100, 101 AND 102).

FIRST USE 5-0-2007; IN COMMERCE 5-0-2007.

THE MARK CONSISTS OF THE WORDING "INVEST IN YOUR LIFE. INVEST FOR LIFE." IN STYLIZED FORMAT.

SER. NO. 85-449,077, FILED 10-17-2011.

DEBORAH LOBO, EXAMINING ATTORNEY



*David J. Kyjars*

Director of the United States Patent and Trademark Office

# United States of America

United States Patent and Trademark Office

## WAFFLE MONSTER

**Reg. No. 4,274,186**

CHOCOLATE MOOSE ON THE LOOSE (UTAH LIMITED LIABILITY COMPANY)  
336 WEST BROADWAY, SUITE 101  
SALT LAKE CITY, UT 84101

**Registered Jan. 15, 2013**

**Int. Cl.: 30**

FOR: WAFFLE AND ICE CREAM DESSERT FOR ON PREMISES DISTRIBUTION ONLY,  
IN CLASS 30 (U.S. CL. 46).

**TRADEMARK**

FIRST USE 4-1-2011; IN COMMERCE 4-1-2011.

**PRINCIPAL REGISTER**

THE MARK CONSISTS OF STANDARD CHARACTERS WITHOUT CLAIM TO ANY PARTICULAR FONT, STYLE, SIZE, OR COLOR.

NO CLAIM IS MADE TO THE EXCLUSIVE RIGHT TO USE "WAFFLE", APART FROM THE MARK AS SHOWN.

SER. NO. 85-449,785, FILED 10-18-2011.

CHRISTINE MARTIN, EXAMINING ATTORNEY



*David J. Kybas*

Director of the United States Patent and Trademark Office

# United States of America

United States Patent and Trademark Office

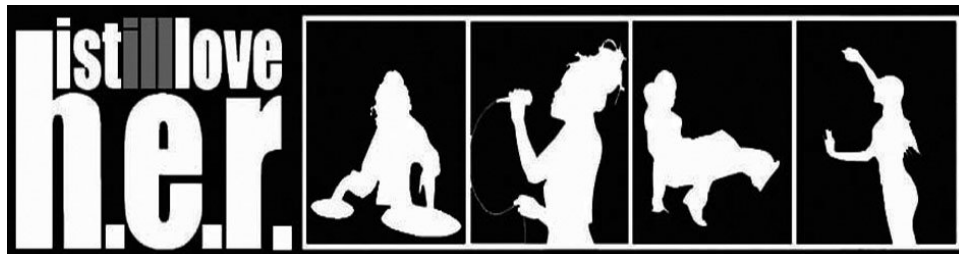

**Reg. No. 4,274,187**

**Registered Jan. 15, 2013**

**Int. Cl.: 35**

**SERVICE MARK**

**PRINCIPAL REGISTER**

I STILL LOVE HER, INC. (ILLINOIS CORPORATION)  
2113 N. CAMPBELL AVE  
CHICAGO, IL 60647

FOR: ENTERTAINMENT SERVICES IN THE NATURE OF PROMOTING CONCERTS AND SPECIAL EVENTS INCLUDING MUSIC, DANCE, AND ART, IN CLASS 35 (U.S. CLS. 100, 101 AND 102).

FIRST USE 1-8-2011; IN COMMERCE 2-16-2011.

THE MARK CONSISTS OF THE WORDS "I STILL LOVE H.E.R." IN STYLIZED LETTERS TO THE LEFT OF 4 PHOTO FRAMES WHICH INCLUDE SILHOUETTES OF FEMALES ENGAGING IN THE ELEMENTS OF HIP HOP, FRAME #1 DJ WITH TURNTABLES, FRAME #2 MC WITH MICROPHONE, FRAME #3 BREAKDANCER, FRAME #4 GRAFFITI ARTIST.

SER. NO. 85-450,359, FILED 10-18-2011.

LAURIE MAYES, EXAMINING ATTORNEY



*David J. Kyffers*

Director of the United States Patent and Trademark Office

# United States of America

United States Patent and Trademark Office

# TWISTERS

**Reg. No. 4,274,188**

GATEWAY SAFETY, INC. (OHIO CORPORATION)  
11111 MEMPHIS AVENUE  
CLEVELAND, OH 44144

**Registered Jan. 15, 2013**

**Int. Cl.: 9**

FOR: EAR PLUGS FOR SOUNDPROOFING; EAR PLUGS NOT FOR MEDICAL PURPOSES,  
IN CLASS 9 (U.S. CLS. 21, 23, 26, 36 AND 38).

**TRADEMARK**

FIRST USE 10-0-2002; IN COMMERCE 10-0-2002.

**PRINCIPAL REGISTER**

THE MARK CONSISTS OF STANDARD CHARACTERS WITHOUT CLAIM TO ANY PARTICULAR FONT, STYLE, SIZE, OR COLOR.

SER. NO. 85-451,209, FILED 10-19-2011.

TINA BROWN, EXAMINING ATTORNEY



*David J. Kybas*

Director of the United States Patent and Trademark Office

# United States of America

United States Patent and Trademark Office

## FLOWER SPROUT

**Reg. No. 4,274,189**

**Registered Jan. 15, 2013**

**Int. Cl.: 31**

**TRADEMARK**

**PRINCIPAL REGISTER**

TOZER SEEDS AMERICA, LLC (CALIFORNIA LIMITED LIABILITY COMPANY)  
06236.001  
3070 SKYWAY DRIVE SUITE 502  
SANTA MARIA, CA 93455

FOR: SEEDS FOR AGRICULTURAL PURPOSES, IN CLASS 31 (U.S. CLS. 1 AND 46).

FIRST USE 10-6-2011; IN COMMERCE 10-6-2011.

THE MARK CONSISTS OF STANDARD CHARACTERS WITHOUT CLAIM TO ANY PARTICULAR FONT, STYLE, SIZE, OR COLOR.

NO CLAIM IS MADE TO THE EXCLUSIVE RIGHT TO USE "SPROUT", APART FROM THE MARK AS SHOWN.

SER. NO. 85-451,408, FILED 10-19-2011.

RONALD AIKENS, EXAMINING ATTORNEY



*David J. Kyffers*

Director of the United States Patent and Trademark Office

# United States of America

United States Patent and Trademark Office



**Reg. No. 4,274,190**

**Registered Jan. 15, 2013**

**Int. Cl.: 7**

**TRADEMARK**

**PRINCIPAL REGISTER**

PRECISION FLOW TECHNOLOGIES, INC. (NEW YORK CORPORATION)  
P.O. BOX 149  
3 TOWER DRIVE  
SAUGERTIES, NY 12477

FOR: INDUSTRIAL MACHINES FOR MANUFACTURING SEMICONDUCTORS, LIGHT EMITTING DIODES AND PHOTOVOLTAIC CELLS, NAMELY, UNITS FOR THE PURPOSE OF CHEMICAL DELIVERY, VAPOR DELIVERY, GAS ISOLATION, GAS MIXING, GAS MONITORING, GAS PURGING AND GAS DELIVERY DURING MANUFACTURING; INDUSTRIAL MACHINES FOR MANUFACTURING SEMICONDUCTORS, LIGHT EMITTING DIODES AND PHOTOVOLTAIC CELLS, NAMELY, GAS CABINETS, GAS CYLINDER UNITS, GAS PANELS, AND GAS DEWAR DELIVERY UNITS, IN CLASS 7 (U.S. CLS. 13, 19, 21, 23, 31, 34 AND 35).

FIRST USE 11-30-2009; IN COMMERCE 11-30-2009.

NO CLAIM IS MADE TO THE EXCLUSIVE RIGHT TO USE "TECHNOLOGIES" , APART FROM THE MARK AS SHOWN.

THE MARK CONSISTS OF "PRECISIONFLOW TECHNOLOGIES" WITH A SWOOSH BEFORE THE LETTER "P" AND PARTIALLY GOING UNDER THE WORD "PRECISION".

SER. NO. 85-451,796, FILED 10-20-2011.

HANNO RITTNER, EXAMINING ATTORNEY



*David J. Kybas*

Director of the United States Patent and Trademark Office

# United States of America

United States Patent and Trademark Office



**Reg. No. 4,274,191**

**Registered Jan. 15, 2013**

**Int. Cls.: 9 and 41**

**TRADEMARK**

**SERVICE MARK**

**PRINCIPAL REGISTER**

LEFORT, DOMINIQUE (FRANCE INDIVIDUAL)  
P.O. BOX 4133  
KEY WEST, FL 33040

FOR: PRERECORDED DVDS FEATURING ACROBATIC AND DANCE PERFORMANCES BY AN INDIVIDUAL AND HIS TRAINED HOUSE CATS, IN CLASS 9 (U.S. CLS. 21, 23, 26, 36 AND 38).

FIRST USE 5-16-2011; IN COMMERCE 5-16-2011.

FOR: ENTERTAINMENT, NAMELY LIVE ACROBATIC AND DANCE PERFORMANCES BY AN INDIVIDUAL AND HIS TRAINED HOUSE CATS, IN CLASS 41 (U.S. CLS. 100, 101 AND 107).

FIRST USE 5-16-2011; IN COMMERCE 5-16-2011.

OWNER OF U.S. REG. NO. 3,105,465.

NO CLAIM IS MADE TO THE EXCLUSIVE RIGHT TO USE "KEY WEST, FLORIDA", APART FROM THE MARK AS SHOWN.

THE NAME(S), PORTRAIT(S), AND/OR SIGNATURE(S) SHOWN IN THE MARK IDENTIFIES THE STAGE NAME OF DOMINIQUE LEFORT, A LIVING INDIVIDUAL, WHOSE CONSENT(S) TO REGISTER IS MADE OF RECORD.

THE MARK CONSISTS OF THE LARGE STYLIZED TERM "CATMAN" SUPERIMPOSED ON A LARGE HEART WITH A STYLISTIC DRAWING OF LARGE CAT JUMPING OFF THE LIGHTER SHADED "T", THIS IS UNDERNEATH THE WORDS "KEY WEST, FLORIDA" "KEY WEST, FLORIDA" SEPARATED BY A SMALL SHADED CIRCLE, IN AN ARC PATTERN, WHICH IS ABOVE THE TERMS "WWW.CATMANKEYWEST.COM" WRITTEN IN AN ARC PATTERN.

SER. NO. 85-452,421, FILED 10-20-2011.

ANTHONY RINKER, EXAMINING ATTORNEY



*David J. Kyffers*

Director of the United States Patent and Trademark Office

# United States of America

United States Patent and Trademark Office

# GBM

**Reg. No. 4,274,192**

**Registered Jan. 15, 2013**

**Int. Cl.: 36**

**SERVICE MARK**

**PRINCIPAL REGISTER**

CORPORATIVO GBM, S.A.B. DE C.V. (MEXICO CORPORATION)  
SAN JOSE INSURGENTES  
AV. INSURGENTES SUR 1605 PISO 31  
MEXICO, MEXICO 03900

FOR: CAPITAL INVESTMENT SERVICES; CREDIT AND LOAN SERVICES; FINANCIAL ANALYSIS AND CONSULTATION; FINANCIAL SECURITIES EXCHANGE SERVICES; FINANCIAL SERVICES, NAMELY, BROKER/DEALER SERVICES ON SECURITIES EXCHANGES AND OVER-THE-COUNTER MARKETS; FUNDS INVESTMENT; HEDGE FUND INVESTMENT SERVICES; MUTUAL FUND BROKERAGE; SECURITIES UNDERWRITING; TRUST MANAGEMENT ACCOUNTS, IN CLASS 36 (U.S. CLS. 100, 101 AND 102).

FIRST USE 0-0-1992; IN COMMERCE 0-0-1992.

THE MARK CONSISTS OF STANDARD CHARACTERS WITHOUT CLAIM TO ANY PARTICULAR FONT, STYLE, SIZE, OR COLOR.

SER. NO. 85-452,522, FILED 10-20-2011.

BARBARA GAYNOR, EXAMINING ATTORNEY



*David J. Kyros*

Director of the United States Patent and Trademark Office



# United States of America

United States Patent and Trademark Office

# CRA FUND

**Reg. No. 4,274,193**

**Registered Jan. 15, 2013**

**Int. Cl.: 36**

THE COMMUNITY REINVESTMENT ACT QUALIFIED INVESTMENT FUND (DELAWARE BUSINESS TRUST)  
DRINKER BIDDLE & REATH LLP  
1500 K STREET, N.W.  
WASHINGTON, DC 200051209

**SERVICE MARK**

FOR: MUTUAL FUND INVESTMENT, IN CLASS 36 (U.S. CLS. 100, 101 AND 102).

**PRINCIPAL REGISTER**

FIRST USE 8-0-1999; IN COMMERCE 8-0-1999.

THE MARK CONSISTS OF STANDARD CHARACTERS WITHOUT CLAIM TO ANY PARTICULAR FONT, STYLE, SIZE, OR COLOR.

NO CLAIM IS MADE TO THE EXCLUSIVE RIGHT TO USE "FUND", APART FROM THE MARK AS SHOWN.

SER. NO. 85-452,889, FILED 10-21-2011.

PRISCILLA MILTON, EXAMINING ATTORNEY



*David J. Kybas*

Director of the United States Patent and Trademark Office

# United States of America

United States Patent and Trademark Office

## Aqua-Green-Clean

**Reg. No. 4,274,194**

**Registered Jan. 15, 2013**

**Int. Cls.: 1 and 3**

TURNER CAPITAL, INC. (GEORGIA CORPORATION), DBA DECONTAMINATION RESTORATION SERVICE, LLC  
SUITE 102  
318 CHEROKEE AVENUE  
ATLANTA, GA 30312

**TRADEMARK**

**PRINCIPAL REGISTER**

FOR: CHEMICAL PREPARATIONS FOR CLEANING PURPOSES IN THE FOOD AND FOOD PROCESSING INDUSTRIES; CHEMICAL PREPARATIONS, NAMELY, DEGREASING AND CLEANING SOLVENTS; CHEMICAL PREPARATIONS, NAMELY, PRODUCTS FOR USE IN PREVENTING ODORS, MOLD AND MILDEW FROM BUILDING UP ON OUTDOOR FURNITURE, CARPETS AND CUSHIONS; CHEMICAL PRESERVATIVES FOR USE IN THE PRODUCTION OF A WIDE VARIETY OF CHEMICALS; CHEMICAL PRODUCT FOR NEUTRALIZING STAINLESS ALLOYS OF STEEL, IRON AND METALS OF VARIOUS COLORS; CHEMICAL PRODUCTS FOR BRIGHTENING DYESTUFFS; CHEMICAL PRODUCTS FOR GLAZING LEATHER; CHEMICAL PRODUCTS FOR PREVENTING SCALE; CHEMICAL PRODUCTS FOR THE FRESH-KEEPING AND PRESERVING OF FOOD; CHEMICAL PRODUCTS FOR THE PREPARATION OF ENAMELS; CHEMICALS FOR USE IN BIOTECHNOLOGICAL PRODUCT DEVELOPMENT, IN CLASS 1 (U.S. CLS. 1, 5, 6, 10, 26 AND 46).

FIRST USE 3-15-2009; IN COMMERCE 5-1-2009.



FOR: ALL PURPOSE CLEANING PREPARATION WITH DEODORIZING PROPERTIES; ALL PURPOSE CLEANING PREPARATIONS; BIOTECHNOLOGICAL CLEANING SOLUTION FOR ELIMINATING ODORS, BREAKING DOWN ORGANICS, AND REMOVING STAINS; CARPET CLEANING PREPARATIONS; CLEANING AGENTS AND PREPARATIONS; CLEANING AGENTS FOR CLEANING SURFACES; CLEANING AND POLISHING PREPARATIONS; CLEANING PREPARATIONS; CLEANING PREPARATIONS FOR CLEANING SURFACES; FLOOR STRIPPING/CLEANING PREPARATION, IN CLASS 3 (U.S. CLS. 1, 4, 6, 50, 51 AND 52).

FIRST USE 3-15-2009; IN COMMERCE 5-1-2009.

*David J. Kappas*

THE MARK CONSISTS OF STANDARD CHARACTERS WITHOUT CLAIM TO ANY PARTICULAR FONT, STYLE, SIZE, OR COLOR.

SER. NO. 85-453,438, FILED 10-21-2011.

**Reg. No. 4,274,194** ANGELA M. MICHELI, EXAMINING ATTORNEY

# United States of America

United States Patent and Trademark Office



**Reg. No. 4,274,195**

**Registered Jan. 15, 2013**

**Int. Cls.: 30 and 32**

**TRADEMARK**

**PRINCIPAL REGISTER**

NUTRICALFÉS - CAFÉ E RESTAURAÇÃO, S.A. (PORTUGAL SOCIEDADE ANÓNIMA)  
RUA DAS FONTAÍNHAS, Nº 70  
VENDA NOVA, 2700-191  
AMADORA, PORTUGAL

FOR: COFFEE, TEA, COCOA, SUGAR, RICE, TAPIOCA, ARTIFICIAL COFFEE; FLOUR, BREAD, PASTRY AND CANDY, EDIBLE ICES; HONEY; YEAST, BAKING-POWDER; SALT, MUSTARD; VINEGAR, SAUCES; SPICES; ICE, IN CLASS 30 (U.S. CL. 46).

FOR: BEERS; MINERAL AND AERATED WATERS; FRUIT DRINKS AND FRUIT JUICES; SYRUPS FOR MAKING BEVERAGES, IN CLASS 32 (U.S. CLS. 45, 46 AND 48).

PRIORITY CLAIMED UNDER SEC. 44(D) ON ERPN CMNTY TM OFC APPLICATION NO. 010343366, FILED 10-14-2011, REG. NO. 010343366, DATED 3-27-2012, EXPIRES 10-14-2021.

THE COLOR(S) YELLOW, BROWN AND WHITE IS/ARE CLAIMED AS A FEATURE OF THE MARK.

NO CLAIM IS MADE TO THE EXCLUSIVE RIGHT TO USE "CAFES", APART FROM THE MARK AS SHOWN.

THE MARK CONSISTS OF THE STYLIZED WORDING "CHAVE D'OURO CAFES" IN A BROWN RECTANGLE ABOVE A YELLOW DESIGN ON A WHITE BACKGROUND; THE WORDS "CHAVE" AND "CAFES" APPEAR IN WHITE LETTERING, WHILE "D'OURO" IS IN YELLOW LETTERING.

THE ENGLISH TRANSLATION OF "CHAVE D'OURO CAFES" IN THE MARK IS "GOLDEN KEY COFFEE".

SER. NO. 85-453,520, FILED 10-21-2011.

INGRID C. EULIN, EXAMINING ATTORNEY



*David J. Kybas*

Director of the United States Patent and Trademark Office

# United States of America

United States Patent and Trademark Office



**Reg. No. 4,274,196**

**Registered Jan. 15, 2013**

**Int. Cl.: 42**

**SERVICE MARK**

**PRINCIPAL REGISTER**

NEW AGE SOFTWARE AND SOLUTIONS (INDIA CORPORATION)  
PLOT A-38, PHASE 1,  
MEPZ, TAMBARAM  
CHENNAI, INDIA 600045

FOR: COMPUTER PROGRAMMING AND COMPUTER SYSTEM ANALYSIS; COMPUTER SOFTWARE DEVELOPMENT; COMPUTER SOFTWARE DEVELOPMENT AND COMPUTER PROGRAMMING DEVELOPMENT FOR OTHERS; COMPUTER SOFTWARE DEVELOPMENT IN THE FIELD OF FREIGHT TRANSPORTATION BY TRUCK, RAIL, AIR AND OCEAN; MAINTENANCE AND UPDATING OF COMPUTER SOFTWARE; RESEARCH, DEVELOPMENT, DESIGN AND UPGRADING OF COMPUTER SOFTWARE, IN CLASS 42 (U.S. CLS. 100 AND 101).

FIRST USE 8-31-2011; IN COMMERCE 8-31-2011.

NO CLAIM IS MADE TO THE EXCLUSIVE RIGHT TO USE "EFREIGHT SUITE", APART FROM THE MARK AS SHOWN.

THE COLOR(S) RED, BLUE AND WHITE IS/ARE CLAIMED AS A FEATURE OF THE MARK.

THE MARK CONSISTS OF THE WORD "EFREIGHT SUITE", WITH THE LETTER "E" WRITTEN IN RED IN A STYLIZED MANNER AND THE WORDS "FREIGHT" AND "SUITE" WRITTEN IN BLUE IN A STYLIZED MANNER, ALL ON A WHITE BACKGROUND.

SER. NO. 85-453,808, FILED S.R. 10-22-2011 AM. P.R. 9-5-2012.

ELISSA GARBER KON, EXAMINING ATTORNEY



*David J. Kybas*

Director of the United States Patent and Trademark Office

# United States of America

United States Patent and Trademark Office

**PASQUALES**

**Reg. No. 4,274,197**

**Registered Jan. 15, 2013**

**Int. Cls.: 39 and 43**

**SERVICE MARK**

**PRINCIPAL REGISTER**

PASQUALE FOOD SYSTEMS, INC. (ALABAMA CORPORATION)  
SUITE 100N  
1 PERIMETER PARK SOUTH  
BIRMINGHAM, AL 35243

FOR: PIZZA DELIVERY, IN CLASS 39 (U.S. CLS. 100 AND 105).

FIRST USE 8-0-1978; IN COMMERCE 8-0-1978.

FOR: PIZZA PARLORS , IN CLASS 43 (U.S. CLS. 100 AND 101).

FIRST USE 8-0-1978; IN COMMERCE 8-0-1978.

OWNER OF U.S. REG. NO. 3,335,201.

THE MARK CONSISTS OF THE WORD "PASQUALE'S" IN ALL CAPITAL LETTERS IN A CONVEX ARCHED FORMAT.

SER. NO. 85-454,242, FILED 10-24-2011.

AMY KELLY, EXAMINING ATTORNEY



*David J. Kyros*

Director of the United States Patent and Trademark Office

# United States of America

United States Patent and Trademark Office

# ADGISTICS

**Reg. No. 4,274,198**

7941749 CANADA INC. (CANADA CORPORATION), TA ADGISTICS NORTH AMERICA  
1200-439 UNIVERSITY AVENUE  
TORONTO, ONTARIO, CANADA M5G1Y8

**Registered Jan. 15, 2013**

**Int. Cls.: 9, 35, 41, 42  
and 45**

FOR: COMPUTER SOFTWARE RELATING TO THE MANAGEMENT OF ADVERTISEMENTS AND ADVERTISING CAMPAIGNS, PROVIDED ON-LINE OR OTHERWISE; CUSTOMIZED COMPUTER SOFTWARE RELATING TO THE MANAGEMENT OF ADVERTISEMENTS AND ADVERTISING CAMPAIGNS, IN CLASS 9 (U.S. CLS. 21, 23, 26, 36 AND 38).

**TRADEMARK**

FIRST USE 7-31-2011; IN COMMERCE 7-31-2011.

**SERVICE MARK**

**PRINCIPAL REGISTER**

FOR: ADVERTISING SERVICES; BUSINESS MANAGEMENT SERVICES; BUSINESS ADMINISTRATION CONSULTANCY SERVICES; ASSISTANCE TO MANAGEMENT IN COMMERCIAL ENTERPRISES IN RESPECT OF ADVERTISING; ADVERTISING SERVICES, NAMELY, MANAGEMENT AND PRODUCTION OF ADVERTISEMENTS AND ADVERTISING CAMPAIGNS AND ADVICE AND ASSISTANCE IN RELATION THERETO; PROVIDING INFORMATION AND IMAGES RELATING TO ADVERTISING AND BUSINESS MANAGEMENT SERVICES PROVIDED FROM A COMPUTER DATABASE OR THE INTERNET, IN CLASS 35 (U.S. CLS. 100, 101 AND 102).

FIRST USE 7-31-2011; IN COMMERCE 7-31-2011.

FOR: LIBRARY SERVICES; ARCHIVE LIBRARY SERVICES; LIBRARY SERVICES AND ARCHIVE LIBRARY SERVICES RELATING TO ADVERTISING MATERIALS AND ADVERTISING CAMPAIGNS, IN CLASS 41 (U.S. CLS. 100, 101 AND 107).

FIRST USE 7-31-2011; IN COMMERCE 7-31-2011.

FOR: COMPUTER PROGRAMMING; COMPUTER PROGRAMMING RELATING TO THE MANAGEMENT OF ADVERTISEMENTS AND ADVERTISING CAMPAIGNS PROVIDED ON-LINE OR OTHERWISE, IN CLASS 42 (U.S. CLS. 100 AND 101).

FIRST USE 7-31-2011; IN COMMERCE 7-31-2011.

FOR: COMPUTER SOFTWARE LICENSING, IN CLASS 45 (U.S. CLS. 100 AND 101).

FIRST USE 7-31-2011; IN COMMERCE 7-31-2011.



*David J. Kyffers*

Director of the United States Patent and Trademark Office

**Reg. No. 4,274,198** THE MARK CONSISTS OF STANDARD CHARACTERS WITHOUT CLAIM TO ANY PARTICULAR FONT, STYLE, SIZE, OR COLOR.

SER. NO. 85-454,362, FILED 10-24-2011.

VIVIAN MICZNIK FIRST, EXAMINING ATTORNEY



# United States of America

United States Patent and Trademark Office

# LiteN

**Reg. No. 4,274,199**

**Registered Jan. 15, 2013**

**Int. Cl.: 2**

**TRADEMARK**

**PRINCIPAL REGISTER**

NPLEX LABORATORY INC (DELAWARE CORPORATION)  
NPLEX LABORATORY INC  
3495 EDISON WAY  
MENLO PARK, CA 94025

FOR: STAINING AGENTS, NAMELY, SYNTHETIC DYES FOR USE WITH DETECTION OR IMAGING OF BIOLOGICAL SAMPLES AND SIGNAL AMPLIFICATION IN BIOASSAYS , IN CLASS 2 (U.S. CLS. 6, 11 AND 16).

FIRST USE 10-1-2011; IN COMMERCE 10-12-2011.

THE MARK CONSISTS OF STANDARD CHARACTERS WITHOUT CLAIM TO ANY PARTICULAR FONT, STYLE, SIZE, OR COLOR.

SER. NO. 85-455,056, FILED 10-25-2011.

CHRISTOPHER BUONGIORNO, EXAMINING ATTORNEY



*David J. Kybas*

Director of the United States Patent and Trademark Office

# United States of America

United States Patent and Trademark Office

## SMOKE ON THE WATER

**Reg. No. 4,274,200**

**Registered Jan. 15, 2013**

**Int. Cl.: 32**

**TRADEMARK**

**PRINCIPAL REGISTER**

CLIPPER CITY BREWING CO., LP (MARYLAND LIMITED PARTNERSHIP)  
4615 HOLLINS FERRY ROAD  
SUITE B  
BALTIMORE, MD 21227

FOR: BEVERAGES, NAMELY, BEER, ALES, AND MALT LIQUORS, IN CLASS 32 (U.S. CLS. 45, 46 AND 48).

FIRST USE 4-26-2010; IN COMMERCE 6-3-2010.

THE MARK CONSISTS OF STANDARD CHARACTERS WITHOUT CLAIM TO ANY PARTICULAR FONT, STYLE, SIZE, OR COLOR.

SER. NO. 85-455,183, FILED 10-25-2011.

SUSAN RICHARDS, EXAMINING ATTORNEY



*David J. Kyffers*

Director of the United States Patent and Trademark Office

# United States of America

United States Patent and Trademark Office

# SCF

**Reg. No. 4,274,201**

**Registered Jan. 15, 2013**

**Int. Cls.: 35 and 39**

**SERVICE MARK**

**PRINCIPAL REGISTER**

SEACOR HOLDINGS, INC. (DELAWARE CORPORATION)  
2200 ELLER DRIVE, P.O. BOX 13038  
FORT LAUDERDALE, FL 33316

FOR: BUSINESS AND LOGISTICS MANAGEMENT AND CONSULTING SERVICES IN THE FIELD OF SHIP AND VESSEL OPERATIONS, MANAGEMENT, SHIPPING AND TRANSPORTATION AND RELATED WAREHOUSE STORAGE, ALL SUCH SERVICES TO BE CONDUCTED IN CONNECTION WITH INLAND AND INTERNAL WATERWAYS OR FOR DOMESTIC SERVICE, IN CLASS 35 (U.S. CLS. 100, 101 AND 102).

FIRST USE 0-0-1980; IN COMMERCE 0-0-1980.

FOR: INLAND AND INTERNAL WATERWAYS SHIPPING AND TRANSPORTATION; FREIGHT SERVICES BY SHIPS, BARGES AND OTHER VESSELS, NAMELY, THE TRANSPORT AND DELIVERY OF GOODS FOR OTHERS; SHIP, BARGE AND OTHER VESSEL MANAGEMENT, OPERATION AND LEASING; LOGISTICS SERVICES RELATING TO INLAND AND INTERNAL WATERWAYS TRANSPORTATION, STORAGE OF GOODS, AND TOWING; INFORMATIONAL AND CONSULTING SERVICES RELATED TO INLAND AND INTERNAL WATERWAYS TRANSPORTATION, STORAGE AND TOWING; SUPPLY CHAIN LOGISTICS, NAMELY, STORAGE, TRANSPORTATION AND DELIVERY OF GOODS FOR OTHERS BY SHIP, BARGE AND OTHER VESSELS; INLAND AND INTERNAL WATERWAYS SHIP, BARGE AND VESSEL BROKERAGE; SHIP, BARGE AND VESSEL SALVAGE; PORT AND TERMINAL SUPPORT SERVICES; INLAND AND INTERNAL WATERWAYS SHIP, BARGE AND VESSEL TOWAGE AND FLEETING SERVICES ALL SUCH SERVICES TO BE CONDUCTED IN CONNECTION WITH INLAND AND INTERNAL WATERWAYS OR FOR DOMESTIC SERVICE, IN CLASS 39 (U.S. CLS. 100 AND 105).

FIRST USE 0-0-1980; IN COMMERCE 0-0-1980.

THE MARK CONSISTS OF STANDARD CHARACTERS WITHOUT CLAIM TO ANY PARTICULAR FONT, STYLE, SIZE, OR COLOR.

SER. NO. 85-456,481, FILED 10-26-2011.

JEFF DEFORD, EXAMINING ATTORNEY



*David J. Kyffers*

Director of the United States Patent and Trademark Office

# United States of America

United States Patent and Trademark Office



**Reg. No. 4,274,202**

**Registered Jan. 15, 2013**

**Int. Cl.: 32**

**TRADEMARK**

**PRINCIPAL REGISTER**

PYEONGCHANG COUNTY (REPUBLIC OF KOREA LOCAL GOVERNMENT)  
77 GUNCHEONG-GIL  
PYEONGCHANG-EUP, PYEONGCHANG-GUN  
GANGWON-DO, REPUBLIC OF KOREA 232-700

FOR: MINERAL WATER; SPRING WATER, IN CLASS 32 (U.S. CLS. 45, 46 AND 48).

PRIORITY CLAIMED UNDER SEC. 44(D) ON REPUBLIC OF KOREA APPLICATION NO. 2011-0041608, FILED 8-1-2011, REG. NO. 40-0924669, DATED 6-26-2012, EXPIRES 6-26-2022.

THE COLOR(S) RED, PURPLE, BLUE, YELLOW, GREEN, AND GRAY IS/ARE CLAIMED AS A FEATURE OF THE MARK.

NO CLAIM IS MADE TO THE EXCLUSIVE RIGHT TO USE "PYEONGCHANG MINERAL WATER", APART FROM THE MARK AS SHOWN.

THE MARK CONSISTS OF THE WORDING "HAPPY 700 PYEONGCHANG WATER", WITH EACH LETTER OF THE WORD "HAPPY" APPEARING IN A DIFFERENT COLOR, NAMELY, THE "H" IN RED, THE "A" IN PURPLE, THE FIRST "P" IN BLUE, THE SECOND "P" IN YELLOW, AND A GREEN GEOMETRIC FIGURE FORMING THE "Y". THE TERM "700" APPEARS IN GRAY AND THE WORDING "PYEONGCHANG MINERAL WATER" IS IN THE COLOR BLUE.

SER. NO. 85-456,724, FILED 10-26-2011.

MARTHA FROMM, EXAMINING ATTORNEY



*David J. Kyjars*

Director of the United States Patent and Trademark Office

# United States of America

United States Patent and Trademark Office

# STRINGS

**Reg. No. 4,274,203**

**Registered Jan. 15, 2013**

**Int. Cl.: 41**

**SERVICE MARK**

**PRINCIPAL REGISTER**

STRING LETTER PUBLISHING, INC. (CALIFORNIA CORPORATION)  
P.O. BOX 767  
SAN ANSELMO, CA 949790767

FOR: MULTIMEDIA PUBLISHING OF BOOKS, MAGAZINES, JOURNALS, SOFTWARE, GAMES, MUSIC, AND ELECTRONIC PUBLICATIONS; PROVIDING A WEBSITE FEATURING NON-DOWNLOADABLE PUBLICATIONS IN THE NATURE OF ELECTRONIC MAGAZINES, BOOKS, NEWSLETTERS, VIDEOS IN THE FIELD OF MUSIC, ART AND ENTERTAINMENT; PROVIDING ON-LINE MAGAZINES IN THE FIELD OF MUSIC, ART AND ENTERTAINMENT, IN CLASS 41 (U.S. CLS. 100, 101 AND 107).

FIRST USE 9-0-1985; IN COMMERCE 4-14-2003.

THE MARK CONSISTS OF STANDARD CHARACTERS WITHOUT CLAIM TO ANY PARTICULAR FONT, STYLE, SIZE, OR COLOR.

OWNER OF U.S. REG. NOS. 2,774,783, 2,873,237 AND OTHERS.

SEC. 2(F).

SER. NO. 85-457,111, FILED 10-26-2011.

SHAILA SETTLES, EXAMINING ATTORNEY



*David J. Kyros*

Director of the United States Patent and Trademark Office

# United States of America

United States Patent and Trademark Office

# GILD

**Reg. No. 4,274,204**

**Registered Jan. 15, 2013**

**Int. Cls.: 35 and 45**

**SERVICE MARK**

**PRINCIPAL REGISTER**

GILD, INC. (DELAWARE CORPORATION)  
SUITE 205  
660 THIRD STREET  
SAN FRANCISCO, CA 94107

FOR: PROVIDING A WEBSITE FEATURING SERVICE RATINGS RELATING TO THE CONSUMER SERVICES OF OTHERS IN THE FIELD OF SOFTWARE, TECHNOLOGY PERSONNEL AND PROFESSIONAL SERVICES PERSONNEL; EMPLOYMENT HIRING, RECRUITING, PLACEMENT, STAFFING AND CAREER NETWORKING SERVICES IN THE FIELD OF SOFTWARE AND TECHNOLOGY PERSONNEL, EXCLUDING CONSULTING SERVICES; TESTING TO DETERMINE EMPLOYMENT SKILLS IN THE FIELD OF SOFTWARE AND TECHNOLOGY PERSONNEL; EMPLOYMENT AGENCIES IN THE FIELD OF SOFTWARE AND TECHNOLOGY PERSONNEL; EMPLOYMENT VERIFICATION IN THE FIELD OF SOFTWARE AND TECHNOLOGY PERSONNEL; PROVIDING AN ONLINE SEARCHABLE DATABASE FEATURING CLASSIFIED AD LISTINGS AND EMPLOYMENT OPPORTUNITIES IN THE FIELD OF SOFTWARE AND TECHNOLOGY PERSONNEL; TALENT AGENCIES FOR SOFTWARE AND TECHNOLOGY PERSONNEL; TEMPORARY EMPLOYMENT AGENCIES FOR SOFTWARE AND TECHNOLOGY PERSONNEL; PROVIDING AN ONLINE SEARCHABLE DATABASE FEATURING EMPLOYMENT AND CAREER OPPORTUNITIES, EMPLOYMENT AND PROFESSIONAL QUERIES AND ANSWERS IN THE FIELD OF SOFTWARE AND TECHNOLOGY PERSONNEL; JOB PLACEMENT SERVICES IN THE FIELD OF SOFTWARE AND TECHNOLOGY PERSONNEL; PROVIDING ONLINE CAREER NETWORKING SERVICES AND INFORMATION IN THE FIELDS OF EMPLOYMENT, RECRUITMENT, JOB RESOURCES, AND JOB LISTINGS FOR SOFTWARE AND TECHNOLOGY PERSONNEL; PERSONNEL RECRUITMENT AND PLACEMENT SERVICES FOR SOFTWARE AND TECHNOLOGY PERSONNEL; PROVIDING NETWORKING OPPORTUNITIES FOR INDIVIDUALS SEEKING EMPLOYMENT IN THE FIELD OF SOFTWARE AND TECHNOLOGY; PROVIDING ONLINE PROFESSIONAL NETWORKING OPPORTUNITIES FOR INDIVIDUAL SEEKING EMPLOYMENT IN THE FIELD OF TECHNOLOGY AND SOFTWARE, IN CLASS 35 (U.S. CLS. 100, 101 AND 102).



FIRST USE 9-0-2010; IN COMMERCE 9-0-2010.

*David J. Kyjars*

FOR: ONLINE SOCIAL NETWORKING SERVICES; SOCIAL NETWORKING SERVICES IN THE FIELD OF SOFTWARE DEVELOPMENT, TECHNOLOGY AND PROFESSIONAL SERVICES, IN CLASS 45 (U.S. CLS. 100 AND 101).

**Reg. No. 4,274,204** FIRST USE 9-0-2010; IN COMMERCE 9-0-2010.

THE MARK CONSISTS OF STANDARD CHARACTERS WITHOUT CLAIM TO ANY PARTICULAR FONT, STYLE, SIZE, OR COLOR.

SER. NO. 85-457,175, FILED 10-26-2011.

SANI KHOURI, EXAMINING ATTORNEY

# United States of America

United States Patent and Trademark Office



CLEAN  
ENERGY  
CAPITAL

**Reg. No. 4,274,205**

**Registered Jan. 15, 2013**

**Int. Cl.: 36**

**SERVICE MARK**

**PRINCIPAL REGISTER**

CLEAN ENERGY CAPITAL, LLC (DELAWARE LIMITED LIABILITY COMPANY)  
5151 E. BROADWAY, SUITE 510  
TUCSON, AZ 85711

FOR: EQUITY CAPITAL AND FINANCIAL INVESTMENT IN THE FIELD OF RENEWABLE ENERGY, NAMELY, BIOFUEL PRODUCTION, DISTRIBUTION AND TECHNOLOGY, BIOMASS ELECTRICITY, WASTE-TO-ENERGY, ENERGY EFFICIENCY, ENERGY STORAGE, CARBON AND TRADITIONAL FUEL INNOVATIONS; FUNDS INVESTMENT; HEDGE FUND INVESTMENT SERVICES; INVESTMENT BANKING; INVESTMENT MANAGEMENT; MANAGEMENT OF A CAPITAL INVESTMENT FUND, IN CLASS 36 (U.S. CLS. 100, 101 AND 102).

FIRST USE 8-26-2011, THE MARK WAS FIRST USED ANYWHERE IN A DIFFERENT FORM OTHER THAN THAT SOUGHT TO BE REGISTERED AT LEAST AS EARLY AS 07/22/2009; IN COMMERCE 8-26-2011, THE MARK WAS FIRST USED IN COMMERCE IN A DIFFERENT FORM OTHER THAN THAT SOUGHT TO BE REGISTERED AT LEAST AS EARLY AS 07/22/2009.

NO CLAIM IS MADE TO THE EXCLUSIVE RIGHT TO USE "CLEAN ENERGY CAPITAL", APART FROM THE MARK AS SHOWN.

THE MARK CONSISTS OF THE STYLIZED WORDING "CLEAN ENERGY CAPITAL" TO THE RIGHT OF A SOLID BOX CONTAINING THE STYLIZED LETTERS "CEC".

SER. NO. 85-457,779, FILED 10-27-2011.

LEIGH LOWRY, EXAMINING ATTORNEY



*David J. Kyros*

Director of the United States Patent and Trademark Office



# United States of America

United States Patent and Trademark Office

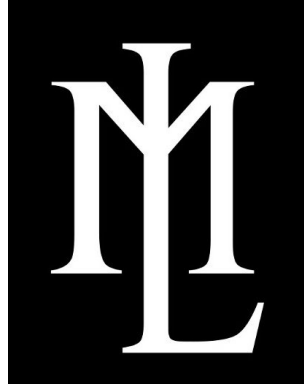

**Reg. No. 4,274,206**

LEXANI HOLDINGS, INC. (CALIFORNIA CORPORATION)  
2380 RAILROAD ST. BLDG 101  
CORONA, CA 92880

**Registered Jan. 15, 2013**

**Int. Cl.: 12**

FOR: CUSTOM VEHICLES, NAMELY, CARS, BUSES, LIMOUSINES, AND STRETCHED LAND VEHICLES, IN CLASS 12 (U.S. CLS. 19, 21, 23, 31, 35 AND 44).

**TRADEMARK**

FIRST USE 3-1-2010; IN COMMERCE 3-1-2010.

**PRINCIPAL REGISTER**

THE MARK CONSISTS OF THE LETTER "L" CENTERED OVER THE LETTER "M" ALL INSIDE A RECTANGLE DESIGN.

SER. NO. 85-457,831, FILED 10-27-2011.

CHRISIE B. KING, EXAMINING ATTORNEY



*David J. Kyffers*

Director of the United States Patent and Trademark Office

# United States of America

## United States Patent and Trademark Office



**Reg. No. 4,274,207**

**Registered Jan. 15, 2013**

**Int. Cl.: 45**

**SERVICE MARK**

**PRINCIPAL REGISTER**

BETHEL WORLD OUTREACH CAPITOL CHURCH- WASHINGTON (D.C. NON-PROFIT ORGANIZATION)  
SUITE #405  
8811 COLESVILLE ROAD  
SILVER SPRING, MD 20910 AND

WORLD CHANGERS MINISTRIES INTERNATIONAL (MARYLAND NON-PROFIT ORGANIZATION)  
SUITE #405  
8811 COLESVILLE ROAD  
SILVER SPRING, MD 20910

FOR: MINISTERIAL SERVICES, NAMELY, SOCIAL SERVICES, IN THE NATURE OF RELIGIOUS MARITAL COUNSELING AND PROVIDING CLOTHING TO NEEDY PEOPLE, AND SPIRITUAL SERVICES PROVIDED TO MEMBERS, THE COMMUNITY, AND FOREIGN NATIONS, IN CLASS 45 (U.S. CLS. 100 AND 101).

FIRST USE 1-3-2011; IN COMMERCE 1-3-2011.

NO CLAIM IS MADE TO THE EXCLUSIVE RIGHT TO USE "WORLD OUTREACH CAPITOL CHURCH" OR "MINISTRIES INTERNATIONAL", APART FROM THE MARK AS SHOWN.



THE MARK CONSISTS OF TWO CONCENTRIC CIRCLES. IN THE BORDER BETWEEN THE TWO CIRCLES ARE THE PHRASES "BETHEL WORLD OUTREACH CAPITOL CHURCH" IN ALL CAPITAL LETTERS AT THE TOP, AND "WORLD CHANGERS MINISTRIES INTERNATIONAL" IN ALL CAPITAL LETTERS AT THE BOTTOM. THE PHRASES ARE SEPARATED BY A STAR ON EITHER SIDE, ON THE HORIZONTAL DIAMETER OF THE CIRCLE. INSIDE THE SMALLER CIRCLE IS AN IMAGE OF A DOVE, WITH A WORLD MAP SUPERIMPOSED ON ITS SPREAD WINGS. THE DOVE IS IN FLIGHT ABOVE AN OPEN BOOK. NEBULOUS STARS APPEAR BEHIND THE BIRD AND BOOK. CENTERED DIRECTLY BELOW THE BOOK ARE THE WORDS "ENGAGING WITH HEAVEN AND" CENTERED DIRECTLY BELOW THAT PHRASE ARE THE WORDS "IMPACTING EARTH".

*David J. Kyros*

SER. NO. 85-457,979, FILED 10-27-2011.

ALLISON SCHRODY, EXAMINING ATTORNEY

# United States of America

United States Patent and Trademark Office



**Reg. No. 4,274,208**

**Registered Jan. 15, 2013**

**Int. Cl.: 33**

**TRADEMARK**

**PRINCIPAL REGISTER**

KYOYA SHUZO YUGEN KAISHA (JAPAN LIMITED LIABILITY COMPANY)  
3-2, ABURATSU 2-CHOME  
NICHINAN-SHI, MIYAZAKI, JAPAN 887-0001

FOR: LIQUEURS, IN CLASS 33 (U.S. CLS. 47 AND 49).

FIRST USE 4-0-2004; IN COMMERCE 11-19-2010.

THE MARK CONSISTS OF THE MARK "HEBESS COOL" INSIDE A RECTANGLE COMPOSED OF TWO TRIANGLES.

THE WORD(S) "HEBESS" HAS NO MEANING IN A FOREIGN LANGUAGE.

SER. NO. 85-458,275, FILED 10-27-2011.

LESLIE RICHARDS, EXAMINING ATTORNEY



*David J. Kybas*

Director of the United States Patent and Trademark Office

# United States of America

United States Patent and Trademark Office

## NUTRICIN + GOJI

**Reg. No. 4,274,209**

NATURAL WELLNESS, LLC (FLORIDA LIMITED LIABILITY COMPANY)  
440 S FEDERAL HWY, SUITE 107  
DEERFIELD BEACH, FL 33441

**Registered Jan. 15, 2013**

**Int. Cl.: 5**

FOR: DIETARY SUPPLEMENTS CONTAINING GOJI BERRY IN WHOLE OR IN PART, IN CLASS 5 (U.S. CLS. 6, 18, 44, 46, 51 AND 52).

**TRADEMARK**

FIRST USE 4-28-2011; IN COMMERCE 4-28-2011.

**PRINCIPAL REGISTER**

THE MARK CONSISTS OF STANDARD CHARACTERS WITHOUT CLAIM TO ANY PARTICULAR FONT, STYLE, SIZE, OR COLOR.

NO CLAIM IS MADE TO THE EXCLUSIVE RIGHT TO USE "GOJI", APART FROM THE MARK AS SHOWN.

SER. NO. 85-458,436, FILED 10-27-2011.

DAVID HOFFMAN, EXAMINING ATTORNEY



*David J. Kyfos*

Director of the United States Patent and Trademark Office

# United States of America

United States Patent and Trademark Office

## COREOGRAPHY

**Reg. No. 4,274,210**

**Registered Jan. 15, 2013**

**Int. Cl.: 41**

**SERVICE MARK**

**PRINCIPAL REGISTER**

SUDITO, SUDITO (UNITED STATES INDIVIDUAL)  
1201 N.E. 86TH STREET  
MIAMI, FL 33138

FOR: CONDUCTING FITNESS CLASSES; DANCE INSTRUCTION; LIVE AERIAL ACROBATIC PERFORMANCES ON FABRIC, HOOP, TRAPEZE, AERIAL AND YOGA HAMMOCK, CORDE LISSE, NET, AND BUNGEE; PHYSICAL FITNESS CONDITIONING CLASSES; PHYSICAL FITNESS INSTRUCTION; PHYSICAL FITNESS STUDIO SERVICES, NAMELY, PROVIDING EXERCISE CLASSES, BODY SCULPTING CLASSES, AND GROUP FITNESS CLASSES; PHYSICAL FITNESS STUDIO SERVICES, NAMELY, PROVIDING GROUP EXERCISE INSTRUCTION, EQUIPMENT, AND FACILITIES; PHYSICAL FITNESS TRAINING OF INDIVIDUALS AND GROUPS; PROVIDING FITNESS AND EXERCISE STUDIO SERVICES, NAMELY, PILATES INSTRUCTION AND TRAINING; YOGA INSTRUCTION, IN CLASS 41 (U.S. CLS. 100, 101 AND 107).

FIRST USE 10-16-2011; IN COMMERCE 10-16-2011.

THE MARK CONSISTS OF STANDARD CHARACTERS WITHOUT CLAIM TO ANY PARTICULAR FONT, STYLE, SIZE, OR COLOR.

SER. NO. 85-458,500, FILED 10-27-2011.

JAY BESCH, EXAMINING ATTORNEY



*David J. Kybas*

Director of the United States Patent and Trademark Office

# United States of America

United States Patent and Trademark Office

# iAccounts

**Reg. No. 4,274,211**

**Registered Jan. 15, 2013**

**Int. Cl.: 9**

**TRADEMARK**

**PRINCIPAL REGISTER**

FRANCESCO GARBIN (ITALY SOLE PROPRIETORSHIP), DBA VENTICENTO STUDIO DI  
FRANCESCO GARBIN  
VIA PIAVE 54  
TREVISO, ITALY

FOR: COMPUTER APPLICATION SOFTWARE FOR MOBILE PHONES, NAMELY, SOFTWARE FOR STORING PERSONAL IDENTITY INFORMATION, IN CLASS 9 (U.S. CLS. 21, 23, 26, 36 AND 38).

FIRST USE 11-23-2010; IN COMMERCE 11-23-2010.

THE MARK CONSISTS OF STANDARD CHARACTERS WITHOUT CLAIM TO ANY PARTICULAR FONT, STYLE, SIZE, OR COLOR.

SER. NO. 85-458,533, FILED 10-28-2011.

CAROLINE WOOD, EXAMINING ATTORNEY



*David J. Kybas*

Director of the United States Patent and Trademark Office

# United States of America

United States Patent and Trademark Office

# rarefaction

**Reg. No. 4,274,212**

JEROLD P. HUEBNER (UNITED STATES INDIVIDUAL)  
244 FIFTH AVE #G270  
NEW YORK, NY 10001

**Registered Jan. 15, 2013**

**Int. Cl.: 25**

FOR: BASEBALL CAPS AND HATS; BELTS; GARTER BELTS; HATS; HOODED SWEATSHIRTS; JACKETS; PANTS; SHIRTS; SHOES; SWEATSHIRTS; T-SHIRTS; WEARABLE GARMENTS AND CLOTHING, NAMELY, SHIRTS; WOOLLY HATS, IN CLASS 25 (U.S. CLS. 22 AND 39).

**TRADEMARK**

**PRINCIPAL REGISTER**

FIRST USE 5-22-2002; IN COMMERCE 2-22-2005.

THE MARK CONSISTS OF STANDARD CHARACTERS WITHOUT CLAIM TO ANY PARTICULAR FONT, STYLE, SIZE, OR COLOR.

OWNER OF U.S. REG. NO. 3,210,860.

SER. NO. 85-458,868, FILED 10-28-2011.

COLLEEN MULCRONE, EXAMINING ATTORNEY



*David J. Kybas*

Director of the United States Patent and Trademark Office

# United States of America

United States Patent and Trademark Office

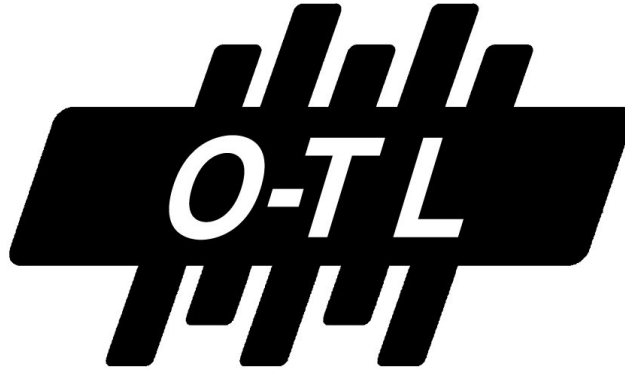

**Reg. No. 4,274,213**

OMNI-TEST LABORATORIES, INC. (OREGON CORPORATION)  
P.O. BOX 301367  
PORTLAND, OR 97294

**Registered Jan. 15, 2013**

**CERTIFICATION MARK**

FOR: RESIDENTIAL ROOM HEATERS, IN CLASS A (U.S. CL. A).

**PRINCIPAL REGISTER**

FIRST USE 8-29-1997; IN COMMERCE 8-29-1997.

OWNER OF U.S. REG. NO. 2,351,151.

THE MARK CONSISTS OF THE LETTERS "O-TL" ON A SHADED QUADRILATERAL WITH FIVE SHADED CROSS BARS.

THE CERTIFICATION MARK, AS USED OR INTENDED TO BE USED BY PERSONS AUTHORIZED BY THE CERTIFIER, CERTIFIES OR IS INTENDED TO CERTIFY THAT THE RESIDENTIAL ROOM HEATERS MEET NATIONAL AND INTERNATIONAL SAFETY TEST STANDARDS.

SER. NO. 85-459,171, FILED 10-28-2011.

PATRICIA EVANKO, EXAMINING ATTORNEY



*David J. Kybas*

Director of the United States Patent and Trademark Office



# United States of America

United States Patent and Trademark Office



**Reg. No. 4,274,214**

WOODY'S OCEAN GRILLE LLC (NEW JERSEY LIMITED LIABILITY COMPANY)  
1 EAST CHURCH STREET  
SEA BRIGHT, NJ 07760

**Registered Jan. 15, 2013**

**Int. Cl.: 43**

FOR: RESTAURANT SERVICES, NAMELY, CALIFORNIA COASTAL FOOD AND BAR SERVICES, IN CLASS 43 (U.S. CLS. 100 AND 101).

**SERVICE MARK**

FIRST USE 8-29-2011; IN COMMERCE 8-29-2011.

**PRINCIPAL REGISTER**

THE MARK CONSISTS OF THE STYLIZED WORDING "WOODY'S" ON A SURFBOARD WITHIN A GEOMETRIC DIAMOND DESIGN.

SER. NO. 85-460,281, FILED 10-31-2011.

ALLISON SCHRODY, EXAMINING ATTORNEY



*David J. Kyffers*

Director of the United States Patent and Trademark Office

# United States of America

United States Patent and Trademark Office



**Reg. No. 4,274,215**

KATERBERG-VERHAGE, INC. (MICHIGAN CORPORATION)  
3717 MICHIGAN, N.E.  
GRAND RAPIDS, MI 49525

**Registered Jan. 15, 2013**

**Int. Cl.: 35**

FOR: WHOLESALE AND RETAIL STORE SERVICES FEATURING HARDSCAPE MATERIALS INCLUDING SOILS, BARK, STONE, RETAINING WALL BLOCKS, AND PAVERS, IN CLASS 35 (U.S. CLS. 100, 101 AND 102).

**SERVICE MARK**

FIRST USE 0-0-1985; IN COMMERCE 0-0-1985.

**PRINCIPAL REGISTER**

NO CLAIM IS MADE TO THE EXCLUSIVE RIGHT TO USE "DISTRIBUTING" AND "LANDSCAPE SUPPLIES", APART FROM THE MARK AS SHOWN.

THE MARK CONSISTS OF THE WORDING "GREENLEAF DISTRIBUTING" UNDERLINED ABOVE THE WORDING "LANDSCAPE SUPPLIES", ALL TO THE RIGHT OF A LEAF.

SER. NO. 85-460,349, FILED 10-31-2011.

HEATHER THOMPSON, EXAMINING ATTORNEY



*David J. Kyros*

Director of the United States Patent and Trademark Office

United States of America  
United States Patent and Trademark Office



allegiance

**Reg. No. 4,274,216**

ALLEGIANCE SOFTWARE, INC. (NORTH DAKOTA CORPORATION)  
3064 49TH STREET SOUTH  
FARGO, ND 58104

**Registered Jan. 15, 2013**

**Int. Cl.: 9**

FOR: COMPUTER SOFTWARE FOR USE IN MANAGING MEMBERSHIP INFORMATION AND FOR USE IN FUNDRAISING FOR NON-PROFIT ORGANIZATIONS, NAMELY, FOR ACCEPTING, RECORDING AND MANAGING DONATIONS, IN CLASS 9 (U.S. CLS. 21, 23, 26, 36 AND 38).

**TRADEMARK**

**PRINCIPAL REGISTER**

FIRST USE 4-0-2009; IN COMMERCE 4-0-2009.

OWNER OF U.S. REG. NO. 1,738,091.

THE MARK CONSISTS OF THE WORD "ALLEGIANCE" WITH THREE PARTIAL OVALS OVER IT.

SER. NO. 85-460,664, FILED 10-31-2011.

ELLEN PERKINS, EXAMINING ATTORNEY



*David J. Kybas*

Director of the United States Patent and Trademark Office

# United States of America

United States Patent and Trademark Office

## Blended Model

**Reg. No. 4,274,217**

**Registered Jan. 15, 2013**

**Int. Cls.: 41 and 43**

**SERVICE MARK**

**PRINCIPAL REGISTER**

U-GRO LEARNING CENTRES, INC. (PENNSYLVANIA CORPORATION)  
3880 TECPORT DRIVE  
HARRISBURG, PA 17111

FOR: EARLY CHILDHOOD EDUCATION AND PRE-SCHOOL SERVICES, IN CLASS 41  
(U.S. CLS. 100, 101 AND 107).

FIRST USE 6-30-2010; IN COMMERCE 6-30-2010.

FOR: DAYCARE SERVICES, IN CLASS 43 (U.S. CLS. 100 AND 101).

FIRST USE 6-30-2010; IN COMMERCE 6-30-2010.

THE MARK CONSISTS OF STANDARD CHARACTERS WITHOUT CLAIM TO ANY PARTICULAR FONT, STYLE, SIZE, OR COLOR.

SER. NO. 85-460,673, FILED 10-31-2011.

AISHA SALEM, EXAMINING ATTORNEY



*David J. Kybas*

Director of the United States Patent and Trademark Office

# United States of America

United States Patent and Trademark Office

# Storyboard

**Reg. No. 4,274,218**

SHUTTERFLY, INC. (DELAWARE CORPORATION)  
2800 BRIDGE PARKWAY  
REDWOOD CITY, CA 94065

**Registered Jan. 15, 2013**

**Int. Cls.: 39 and 42**

FOR: DIGITAL IMAGING SERVICES, NAMELY, ARCHIVAL SERVICES IN THE NATURE OF COLLECTION AND STORAGE OF DIGITAL IMAGES FOR USE IN PHOTO BOOKS, IN CLASS 39 (U.S. CLS. 100 AND 105).

**SERVICE MARK**

FIRST USE 8-28-2008; IN COMMERCE 8-28-2008.

**PRINCIPAL REGISTER**

FOR: PROVIDING TEMPORARY USE OF NON-DOWNLOADABLE SOFTWARE FOR CREATING CUSTOM PHOTO BOOKS WITH AUTOMATIC COMPUTER ARRANGEMENT AND RE-ARRANGEMENT OF PHOTOS, IN CLASS 42 (U.S. CLS. 100 AND 101).

FIRST USE 8-28-2008; IN COMMERCE 8-28-2008.

THE MARK CONSISTS OF STANDARD CHARACTERS WITHOUT CLAIM TO ANY PARTICULAR FONT, STYLE, SIZE, OR COLOR.

SER. NO. 85-460,947, FILED 10-31-2011.

HANNO RITTNER, EXAMINING ATTORNEY



*David J. Kybas*

Director of the United States Patent and Trademark Office

# United States of America

United States Patent and Trademark Office

## JAB Broadband

**Reg. No. 4,274,219**

**Registered Jan. 15, 2013**

**Int. Cl.: 38**

**SERVICE MARK**

**PRINCIPAL REGISTER**

JAB WIRELESS, INC. (COLORADO CORPORATION)  
400 INVERNESS PARKWAY, SUITE 330  
ENGLEWOOD, CO 80112

FOR: TELECOMMUNICATION SERVICES, NAMELY, TRANSMISSION OF VOICE, DATA, GRAPHICS, IMAGES, AUDIO AND VIDEO BY MEANS OF TELECOMMUNICATIONS NETWORKS, WIRELESS COMMUNICATION NETWORKS AND THE INTERNET BUT NOT OPTICAL NETWORKING SERVICES TO THE MOTION PICTURE AND TELEVISION INDUSTRY; NETWORKING SERVICES, NAMELY, PROVIDING INTERNET ACCESS TO CLIENTS AND PRIVATE WIDE AREA NETWORKING SERVICES TO CLIENTS WHO HAVE MULTIPLE LOCATIONS; INTERNET SERVICE PROVIDER; VOICE OVER INTERNET PROTOCOL (VOIP) PROVIDER, IN CLASS 38 (U.S. CLS. 100, 101 AND 104).

FIRST USE 6-1-2006; IN COMMERCE 6-1-2006.

THE MARK CONSISTS OF STANDARD CHARACTERS WITHOUT CLAIM TO ANY PARTICULAR FONT, STYLE, SIZE, OR COLOR.

NO CLAIM IS MADE TO THE EXCLUSIVE RIGHT TO USE "BROADBAND", APART FROM THE MARK AS SHOWN.

SER. NO. 85-461,340, FILED 11-1-2011.

RON FAIRBANKS, EXAMINING ATTORNEY



*David J. Kyffers*

Director of the United States Patent and Trademark Office

# United States of America

United States Patent and Trademark Office

## THE CAPITAL AGENDA

**Reg. No. 4,274,220**

**Registered Jan. 15, 2013**

**Int. Cls.: 35 and 36**

**SERVICE MARK**

**PRINCIPAL REGISTER**

EYGN LIMITED (BAHAMAS COMPANY)  
ONE MONTAGUE PLACE  
EAST BAY STREET  
NASSAU, BAHAMAS

FOR: BUSINESS MERGER AND ACQUISITION CONSULTATION, IN CLASS 35 (U.S. CLS. 100, 101 AND 102).

FIRST USE 11-0-2009; IN COMMERCE 11-0-2009.

FOR: STRATEGIC FINANCIAL ADVISORY SERVICES, IN CLASS 36 (U.S. CLS. 100, 101 AND 102).

FIRST USE 11-0-2009; IN COMMERCE 11-0-2009.

THE MARK CONSISTS OF STANDARD CHARACTERS WITHOUT CLAIM TO ANY PARTICULAR FONT, STYLE, SIZE, OR COLOR.

PRIORITY CLAIMED UNDER SEC. 44(D) ON ERPN CMNTY TM OFC APPLICATION NO. 10050706, FILED 6-15-2011.

NO CLAIM IS MADE TO THE EXCLUSIVE RIGHT TO USE "CAPITAL", APART FROM THE MARK AS SHOWN.

SER. NO. 85-461,384, FILED 11-1-2011.

NORA BUCHANAN WILL, EXAMINING ATTORNEY



*David J. Kyffers*

Director of the United States Patent and Trademark Office

# United States of America

United States Patent and Trademark Office



**Reg. No. 4,274,221**

**Registered Jan. 15, 2013**

**Int. Cl.: 43**

**SERVICE MARK**

**PRINCIPAL REGISTER**

GINZA PROJECT, LLC (NEW YORK LIMITED LIABILITY COMPANY)  
41 EAST 20TH STREET  
NEW YORK, NY 10003

FOR: RESTAURANT AND CAFE SERVICES; RESTAURANT SERVICES; RESTAURANT SERVICES FEATURING DUMPLINGS; RESTAURANT SERVICES, INCLUDING SIT-DOWN SERVICE OF FOOD AND TAKE-OUT RESTAURANT SERVICES; RESTAURANT SERVICES, NAMELY, PROVIDING OF FOOD AND BEVERAGES FOR CONSUMPTION ON AND OFF THE PREMISES; TAKE-OUT RESTAURANT SERVICES, IN CLASS 43 (U.S. CLS. 100 AND 101).

FIRST USE 0-0-2008; IN COMMERCE 0-0-2011.

NO CLAIM IS MADE TO THE EXCLUSIVE RIGHT TO USE "PELMEN' HAND MADE CAFE", APART FROM THE MARK AS SHOWN.

THE MARK CONSISTS OF A MAN'S FACE WITH EYES AND A MUSTACHE ABOVE THE STYLED WORDING "PELMEN'" ABOVE THE WORDING "HAND MADE CAFE".

SER. NO. 85-461,468, FILED 11-1-2011.

TRACY CROSS, EXAMINING ATTORNEY



*David J. Kyros*

Director of the United States Patent and Trademark Office



# United States of America

United States Patent and Trademark Office

**NOVAWEAR**  
THERMAL MEDICAL COMFORT

**Reg. No. 4,274,222**

NOVEQ MEDICAL (CALIFORNIA LIMITED LIABILITY COMPANY)  
PO BOX 1627  
PALO ALTO, CA 94302

**Registered Jan. 15, 2013**

**Int. Cl.: 25**

FOR: THERMAL UNDERWEAR, IN CLASS 25 (U.S. CLS. 22 AND 39).

**TRADEMARK**

FIRST USE 11-1-2011; IN COMMERCE 8-6-2012.

**PRINCIPAL REGISTER**

NO CLAIM IS MADE TO THE EXCLUSIVE RIGHT TO USE "THERMAL MEDICAL", APART FROM THE MARK AS SHOWN.

THE COLOR(S) PURPLE, GREY AND BLACK IS/ARE CLAIMED AS A FEATURE OF THE MARK.

THE MARK CONSISTS OF THE BRAND NAME IS "NOVAWEAR" WRITTEN IN PURPLE ("NOVA") AND GREY ("WEAR") WITH TWO LINES UNDERNEATH IT, ONE IN PURPLE ON THE LEFT AND ONE IN GREY ON THE RIGHT. UNDERNEATH THE TWO LINE IS THE WORDING "THERMAL MEDICAL COMFORT" WRITTEN IN BLACK.

SER. NO. 85-461,567, FILED 11-1-2011.

AMY C. KEAN, EXAMINING ATTORNEY



*David J. Kyros*

Director of the United States Patent and Trademark Office

# United States of America

United States Patent and Trademark Office

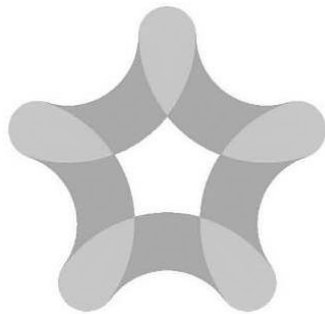

extended  
**STAY  
AMERICA**

**Reg. No. 4,274,223**

**Registered Jan. 15, 2013**

**Int. Cl.: 43**

**SERVICE MARK**

**PRINCIPAL REGISTER**

ESH STRATEGIES BRANDING LLC (DELAWARE LIMITED LIABILITY COMPANY)  
11525 N. COMMUNITY HOUSE ROAD  
SUITE 100  
CHARLOTTE, NC 28277

FOR: HOTEL SERVICES; PROVIDING TEMPORARY HOUSING ACCOMMODATIONS, IN CLASS 43 (U.S. CLS. 100 AND 101).

FIRST USE 10-26-2011; IN COMMERCE 10-26-2011.

OWNER OF U.S. REG. NOS. 2,021,504, 3,496,984 AND OTHERS.

THE MARK CONSISTS OF A FIVE-POINTED STAR OR ASTERISK; THE STYLIZED WORDING "EXTENDED STAY AMERICA" APPEARS ON THE RIGHT.

SEC. 2(F) AS TO "EXTENDED STAY AMERICA".

SER. NO. 85-462,158, FILED 11-2-2011.

ALLISON HOLTZ, EXAMINING ATTORNEY



*David J. Kyros*

Director of the United States Patent and Trademark Office

United States of America  
United States Patent and Trademark Office

extended  
**STAY  
AMERICA**

**Reg. No. 4,274,224**

**Registered Jan. 15, 2013**

**Int. Cl.: 43**

**SERVICE MARK**

**PRINCIPAL REGISTER**

ESH STRATEGIES BRANDING LLC (DELAWARE LIMITED LIABILITY COMPANY)  
11525 N. COMMUNITY HOUSE ROAD  
SUITE 100  
CHARLOTTE, NC 28277

FOR: HOTEL SERVICES; PROVIDING TEMPORARY HOUSING ACCOMMODATIONS, IN  
CLASS 43 (U.S. CLS. 100 AND 101).

FIRST USE 10-26-2011; IN COMMERCE 10-26-2011.

OWNER OF U.S. REG. NOS. 2,021,504, 3,496,984 AND OTHERS.

THE MARK CONSISTS OF THE STYLIZED WORDING "EXTENDED STAY AMERICA".

SEC. 2(F).

SER. NO. 85-462,167, FILED 11-2-2011.

ALLISON HOLTZ, EXAMINING ATTORNEY



*David J. Kybas*

Director of the United States Patent and Trademark Office

# United States of America

United States Patent and Trademark Office

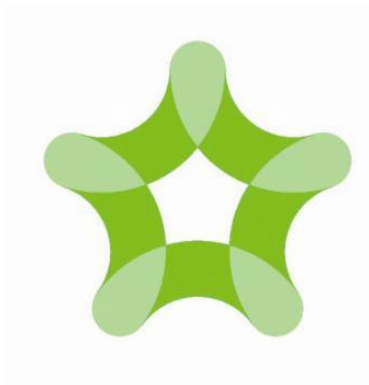

**Reg. No. 4,274,225**

**Registered Jan. 15, 2013**

**Int. Cl.: 43**

**SERVICE MARK**

**PRINCIPAL REGISTER**

ESH STRATEGIES BRANDING LLC (DELAWARE LIMITED LIABILITY COMPANY)  
11525 N. COMMUNITY HOUSE ROAD, SUITE 100  
CHARLOTTE, NC 28277

FOR: HOTEL SERVICES; PROVIDING TEMPORARY HOUSING ACCOMMODATIONS, IN CLASS 43 (U.S. CLS. 100 AND 101).

FIRST USE 10-26-2011; IN COMMERCE 10-26-2011.

THE MARK CONSISTS OF A FIVE-POINTED STAR OR ASTERISK. THE COLOR LIGHT GREEN APPEARS IN THE ROUNDED POINTS AND THE COLOR GREEN APPEARS IN THE CONNECTED CURVED BANDS.

THE COLOR(S) GREEN AND LIGHT GREEN IS/ARE CLAIMED AS A FEATURE OF THE MARK.

SER. NO. 85-462,171, FILED 11-2-2011.

ALLISON HOLTZ, EXAMINING ATTORNEY



*David J. Kybas*

Director of the United States Patent and Trademark Office

# United States of America

United States Patent and Trademark Office



**Reg. No. 4,274,226**

**Registered Jan. 15, 2013**

**Int. Cl.: 43**

**SERVICE MARK**

**PRINCIPAL REGISTER**

ESH STRATEGIES BRANDING LLC (DELAWARE LIMITED LIABILITY COMPANY)  
11525 N. COMMUNITY HOUSE ROAD  
SUITE 100  
CHARLOTTE, NC 28277

FOR: HOTEL SERVICES; PROVIDING TEMPORARY HOUSING ACCOMMODATIONS, IN CLASS 43 (U.S. CLS. 100 AND 101).

FIRST USE 10-26-2011; IN COMMERCE 10-26-2011.

OWNER OF U.S. REG. NOS. 2,021,504, 3,496,984 AND OTHERS.

THE COLOR(S) GREEN, LIGHT GREEN, AND BROWN IS/ARE CLAIMED AS A FEATURE OF THE MARK.

THE MARK CONSISTS OF A FIVE-POINTED STAR OR ASTERISK WITH THE ROUNDED POINTS IN LIGHT GREEN AND THE CONNECTING CURVED BANDS IN GREEN; THE STYLIZED WORDING "EXTENDED STAY AMERICA" APPEARS ON THE RIGHT WITH "EXTENDED" IN GREEN AND "STAY AMERICA" IN BROWN.

SEC. 2(F) AS TO "EXTENDED STAY AMERICA".

SER. NO. 85-462,178, FILED 11-2-2011.

ALLISON HOLTZ, EXAMINING ATTORNEY



*David J. Kyjars*

Director of the United States Patent and Trademark Office

# United States of America

United States Patent and Trademark Office

extended  
**STAY  
AMERICA**

**Reg. No. 4,274,227**

**Registered Jan. 15, 2013**

**Int. Cl.: 43**

**SERVICE MARK**

**PRINCIPAL REGISTER**

ESH STRATEGIES BRANDING LLC (DELAWARE LIMITED LIABILITY COMPANY)  
11525 N. COMMUNITY HOUSE ROAD  
SUITE 100  
CHARLOTTE, NC 28277

FOR: HOTEL SERVICES; PROVIDING TEMPORARY HOUSING ACCOMMODATIONS, IN CLASS 43 (U.S. CLS. 100 AND 101).

FIRST USE 10-26-2011; IN COMMERCE 10-26-2011.

OWNER OF U.S. REG. NOS. 2,021,504, 3,496,984 AND OTHERS.

THE COLOR(S) GREEN AND BROWN IS/ARE CLAIMED AS A FEATURE OF THE MARK.

THE MARK CONSISTS OF THE STYLIZED WORDING "EXTENDED STAY AMERICA" WITH "EXTENDED" IN GREEN AND "STAY AMERICA" IN BROWN.

SEC. 2(F).

SER. NO. 85-462,184, FILED 11-2-2011.

ALLISON HOLTZ, EXAMINING ATTORNEY



*David J. Kybas*

Director of the United States Patent and Trademark Office

# United States of America

United States Patent and Trademark Office

## THE CHRISTMAS BOX INTERNATIONAL

**Reg. No. 4,274,228**

THE CHRISTMAS BOX INTERNATIONAL (UTAH CORPORATION)  
1775 WEST 1500 SOUTH  
SALT LAKE CITY, UT 84105

**Registered Jan. 15, 2013**

**Int. Cl.: 43**

FOR: CHILD WELFARE SERVICES, NAMELY, PROVIDING RESIDENTIAL COMPREHENSIVE CHILD ASSESSMENT HOME FOR UNDERPRIVILEGED CHILDREN, IN CLASS 43 (U.S. CLS. 100 AND 101).

**SERVICE MARK**

FIRST USE 1-0-2004; IN COMMERCE 1-0-2004.

**PRINCIPAL REGISTER**

THE MARK CONSISTS OF STANDARD CHARACTERS WITHOUT CLAIM TO ANY PARTICULAR FONT, STYLE, SIZE, OR COLOR.

OWNER OF U.S. REG. NOS. 2,464,097 AND 2,522,923.

NO CLAIM IS MADE TO THE EXCLUSIVE RIGHT TO USE "INTERNATIONAL", APART FROM THE MARK AS SHOWN.

SER. NO. 85-462,194, FILED 11-2-2011.

MARILYN IZZI, EXAMINING ATTORNEY



*David J. Kyros*

Director of the United States Patent and Trademark Office

# United States of America

United States Patent and Trademark Office

## Nutrition Authority

**Reg. No. 4,274,229**

DOUGLAS, BROOKE (UNITED STATES INDIVIDUAL)  
15308 136TH AVENUE EAST  
PUYALLUP, WA 98374

**Registered Jan. 15, 2013**

**Int. Cl.: 44**

FOR: CONSULTING SERVICES IN THE FIELDS OF HEALTH AND NUTRITION; SERVICES RENDERED BY A DIETICIAN, IN CLASS 44 (U.S. CLS. 100 AND 101).

**SERVICE MARK**

FIRST USE 1-1-2004; IN COMMERCE 1-1-2005.

**PRINCIPAL REGISTER**

THE MARK CONSISTS OF STANDARD CHARACTERS WITHOUT CLAIM TO ANY PARTICULAR FONT, STYLE, SIZE, OR COLOR.

NO CLAIM IS MADE TO THE EXCLUSIVE RIGHT TO USE "NUTRITION", APART FROM THE MARK AS SHOWN.

SER. NO. 85-462,289, FILED 11-2-2011.

MATTHEW KLINE, EXAMINING ATTORNEY



*David J. Kybas*

Director of the United States Patent and Trademark Office



# United States of America

United States Patent and Trademark Office

## ph prescription

**Reg. No. 4,274,230**

**Registered Jan. 15, 2013**

**Int. Cl.: 11**

**TRADEMARK**

**PRINCIPAL REGISTER**

NO BRAINER, LLC (FLORIDA LIMITED LIABILITY COMPANY)  
1476 S E VILLAGE GREEN DRIVE  
PORT ST LUCIE, FL 34952

FOR: FILTERING UNITS FOR WATER FILTERING; WATER FILTERING APPARATUS;  
WATER FILTERING UNITS FOR DOMESTIC AND COMMERCIAL USE; WATER FILTERS;  
WATER FILTRATION AND PURIFICATION UNITS AND REPLACEMENT CARTRIDGES  
AND FILTERS THEREFOR; WATER FILTRATION APPARATUS FOR THE DEIONIZATION  
OF WATER; WATER TREATMENT EQUIPMENT, NAMELY, WATER FILTRATION UNITS,  
IN CLASS 11 (U.S. CLS. 13, 21, 23, 31 AND 34).

FIRST USE 10-1-2011; IN COMMERCE 10-1-2011.

THE MARK CONSISTS OF STANDARD CHARACTERS WITHOUT CLAIM TO ANY PARTICULAR FONT, STYLE, SIZE, OR COLOR.

NO CLAIM IS MADE TO THE EXCLUSIVE RIGHT TO USE "PH", APART FROM THE MARK AS SHOWN.

SER. NO. 85-462,338, FILED 11-2-2011.

LESLEY LAMOTHE, EXAMINING ATTORNEY



*David J. Kyjars*

Director of the United States Patent and Trademark Office

# United States of America

United States Patent and Trademark Office

# NANOLED

**Reg. No. 4,274,231**

HORIBA JOBIN YVON INC. (DELAWARE CORPORATION)  
3880 PARK AVENUE  
EDISON, NJ 08820

**Registered Jan. 15, 2013**

**Int. Cl.: 9**

FOR: SCIENTIFIC APPARATUS AND INSTRUMENTS FOR OPTICAL ANALYSIS, NAMELY, RAMAN, PHOTOLUMINESCENCE AND FLUORESCENCE SPECTROMETERS AND SPECTROGRAPHS AND RELATED COMPONENTS THEREOF, NAMELY, LIGHT SOURCE CONTROLLER MODULES, LASER DIODES, AND LIGHT EMITTING DIODES USED AS LIGHT SOURCES AND PULSED LIGHT SOURCES, IN CLASS 9 (U.S. CLS. 21, 23, 26, 36 AND 38).

**TRADEMARK**

**PRINCIPAL REGISTER**

FIRST USE 10-7-1998; IN COMMERCE 4-1-1999.

THE MARK CONSISTS OF STANDARD CHARACTERS WITHOUT CLAIM TO ANY PARTICULAR FONT, STYLE, SIZE, OR COLOR.

SEC. 2(F).

SER. NO. 85-462,433, FILED 11-2-2011.

SIMON TENG, EXAMINING ATTORNEY



*David J. Kybas*

Director of the United States Patent and Trademark Office

# United States of America

United States Patent and Trademark Office

## GLOBAL BRIDGE

**Reg. No. 4,274,232**

**Registered Jan. 15, 2013**

**Int. Cl.: 35**

**SERVICE MARK**

**PRINCIPAL REGISTER**

LARTA INSTITUTE (CALIFORNIA CORPORATION)  
606 SOUTH OLIVE STREET, SUITE 650  
LOS ANGELES, CA 90014

FOR: BUSINESS MANAGEMENT CONSULTANCY AND ADVISORY, NAMELY, ASSISTING COMPANIES IN DEVELOPING BUSINESS STRATEGIES, FINDING PARTNERS, ASSESSING RESOURCES AND EXPANDING INTO NEW REGIONAL AND INTERNATIONAL MARKETS; POLICY ADVISORY SERVICES RELATING TO BUSINESS MANAGEMENT AND BUSINESS OPERATIONS, NAMELY, ASSISTING U.S. AND INTERNATIONAL GOVERNMENT ENTITIES, UNIVERSITIES, AND MULTILATERAL ORGANIZATIONS IN DESIGNING AND DEPLOYING INNOVATION AND ENTREPRENEURSHIP POLICIES, STRATEGIES, AND PROGRAMS, IN CLASS 35 (U.S. CLS. 100, 101 AND 102).

FIRST USE 0-0-2004; IN COMMERCE 0-0-2004.

THE MARK CONSISTS OF STANDARD CHARACTERS WITHOUT CLAIM TO ANY PARTICULAR FONT, STYLE, SIZE, OR COLOR.

NO CLAIM IS MADE TO THE EXCLUSIVE RIGHT TO USE "GLOBAL", APART FROM THE MARK AS SHOWN.

SER. NO. 85-462,702, FILED 11-2-2011.

TAMARA FRAZIER, EXAMINING ATTORNEY



*David J. Kyros*

Director of the United States Patent and Trademark Office

# United States of America

United States Patent and Trademark Office



**Reg. No. 4,274,233**

**Registered Jan. 15, 2013**

**Int. Cl.: 30**

**TRADEMARK**

**PRINCIPAL REGISTER**

FARRELL, KRISTIN N (UNITED STATES INDIVIDUAL), DBA IN A JAR FOODS  
9 RENSHAW ROAD  
DARIEN, CT 06820

FOR: MIXES FOR MAKING BAKING BATTERS, IN CLASS 30 (U.S. CL. 46).

FIRST USE 11-1-2011; IN COMMERCE 11-1-2011.

NO CLAIM IS MADE TO THE EXCLUSIVE RIGHT TO USE "IN A JAR" AND "FOODS.COM",  
APART FROM THE MARK AS SHOWN.

THE COLOR(S) BLACK, WHITE, GRAY AND LIGHT GREEN IS/ARE CLAIMED AS A  
FEATURE OF THE MARK.

THE COLOR BLACK APPEARS IN THE WORDING "IN A JAR", IN THE WORDING  
"FOODS.COM" AND IN THE DESIGN OF A JAR TOP AND A CIRCLE BORDER; THE  
COLOR WHITE APPEARS IN THE DESIGN OF A JAR AND A STRING AT THE TOP OF  
THE JAR; THE COLOR GRAY APPEARS AS THE OUTLINE OF A JAR; THE COLOR LIGHT  
GREEN APPEARS AS BACKGROUND.

SER. NO. 85-463,079, FILED 11-2-2011.

AISHA SALEM, EXAMINING ATTORNEY



*David J. Kybas*

Director of the United States Patent and Trademark Office

# United States of America

United States Patent and Trademark Office



**Reg. No. 4,274,234**

**Registered Jan. 15, 2013**

**Int. Cl.: 3**

**TRADEMARK**

**PRINCIPAL REGISTER**

STRENGTH OF NATURE, LLC (GEORGIA LIMITED LIABILITY COMPANY)  
64 ROSS ROAD  
SAVANNAH, GA 31405

FOR: HAIR CARE PREPARATIONS, IN CLASS 3 (U.S. CLS. 1, 4, 6, 50, 51 AND 52).

FIRST USE 1-1-2010; IN COMMERCE 1-1-2010.

OWNER OF U.S. REG. NOS. 1,784,713, 1,838,533, AND 2,866,588.

THE COLOR(S) RED, WHITE, GREEN AND GRAY IS/ARE CLAIMED AS A FEATURE OF THE MARK.

NO CLAIM IS MADE TO THE EXCLUSIVE RIGHT TO USE "AFRICAN", APART FROM THE MARK AS SHOWN.

THE MARK CONSISTS OF THE WORD "AFRICAN" INSIDE A RECTANGLE WITH A CURVED TOP. THE RECTANGLE IS ABOVE THE STYLIZED WORD "PRIDE", WHICH IS ABOVE A CURVED LINE. THE COLOR GRAY APPEARS IN THE SHADING OVER THE RECTANGLE. THE COLOR RED APPEARS IN THE RECTANGLE AND IS INTERMIXED WITH GRAY AT THE TOP AND EDGES. THE COLOR RED ALSO APPEARS IN THE WORD "PRIDE" AND IN THE CURVED LINE. THE COLOR GREEN APPEARS IN THE DOT OVER THE "I" IN "AFRICAN" IN THE MARK. THE COLOR WHITE APPEARS IN THE WORD "AFRICAN" IN THE MARK, EXCEPT FOR THE DOT OVER THE LETTER "I." THE REMAINDER OF THE WHITE IN THE DRAWING REPRESENTS BACKGROUND AREAS ONLY AND IS NOT PART OF THE MARK.

SER. NO. 85-463,387, FILED 11-3-2011.

MAUREEN DALL, EXAMINING ATTORNEY



*David J. Kyros*

Director of the United States Patent and Trademark Office

# United States of America

United States Patent and Trademark Office

# MEXIAUTO

**Reg. No. 4,274,235**

**Registered Jan. 15, 2013**

**Int. Cl.: 36**

**SERVICE MARK**

**PRINCIPAL REGISTER**

MEXIPASS INTERNATIONAL INSURANCE SERVICES, LLC (CALIFORNIA LIMITED LIABILITY COMPANY)  
77 N. MENTOR AVE., SUITE 200  
PASADENA, CA 91106

FOR: INSURANCE AGENCY AND BROKERAGE, INSURANCE ADMINISTRATION, INSURANCE CONSULTANCY, INSURANCE UNDERWRITING SERVICES IN AUTOMOBILE INSURANCE IN COUNTRIES WHERE THE INSURED IS NOT DOMICILED, AND INSURANCE UNDERWRITING CONSULTATION, IN CLASS 36 (U.S. CLS. 100, 101 AND 102).

FIRST USE 11-3-2011; IN COMMERCE 11-3-2011.

THE MARK CONSISTS OF STANDARD CHARACTERS WITHOUT CLAIM TO ANY PARTICULAR FONT, STYLE, SIZE, OR COLOR.

SER. NO. 85-464,183, FILED 11-3-2011.

ELIZABETH KAJUBI, EXAMINING ATTORNEY



*David J. Kybas*

Director of the United States Patent and Trademark Office

# United States of America

United States Patent and Trademark Office

## RUSSELL CROSSROADS

**Reg. No. 4,274,236**

RUSSELL LANDS, INCORPORATED (ALABAMA CORPORATION)  
2544 WILLOW POINT ROAD  
ALEXANDER CITY, AL 350106219

**Registered Jan. 15, 2013**

**Int. Cl.: 36**

FOR: LEASING OF REAL ESTATE FOR COMMERCIAL AND RESIDENTIAL USES, IN CLASS 36 (U.S. CLS. 100, 101 AND 102).

**SERVICE MARK**

FIRST USE 1-1-2008; IN COMMERCE 1-1-2008.

**PRINCIPAL REGISTER**

THE MARK CONSISTS OF STANDARD CHARACTERS WITHOUT CLAIM TO ANY PARTICULAR FONT, STYLE, SIZE, OR COLOR.

SER. NO. 85-464,476, FILED 11-4-2011.

INGRID C. EULIN, EXAMINING ATTORNEY



*David J. Kybas*

Director of the United States Patent and Trademark Office

# United States of America

United States Patent and Trademark Office



**Reg. No. 4,274,237**

**Registered Jan. 15, 2013**

**Int. Cl.: 29**

**TRADEMARK**

**PRINCIPAL REGISTER**

MI HOPE INC (CALIFORNIA CORPORATION), AKA GREEN HOPE USA  
1634 SPRUCE STREET  
SOUTH PASADENA, CA 91030

FOR: DRIED VEGETABLES IN POWDER FORM, IN CLASS 29 (U.S. CL. 46).

FIRST USE 5-25-2009; IN COMMERCE 11-4-2011.

NO CLAIM IS MADE TO THE EXCLUSIVE RIGHT TO USE "GREEN" AND "USA", APART FROM THE MARK AS SHOWN.

THE MARK CONSISTS OF A FLYING BIRD CARRYING A BRANCH OF THE MORINGA TREE WITH ITS LEAVES APPEARING WITHIN A CENTER CIRCULAR DESIGN WITH THE WORDING "GREEN HOPE" APPEARING WITHIN THE BORDER OF THE OUTER CIRCLE DESIGN AT THE TOP LEFT AND THE WORDS "USA" APPEARING WITHIN THE BORDER AT THE BOTTOM CENTER.

SER. NO. 85-464,704, FILED 11-4-2011.

C. DIONNE CLYBURN, EXAMINING ATTORNEY



*David J. Kybas*

Director of the United States Patent and Trademark Office



# United States of America

United States Patent and Trademark Office

## HID MOBILE ACCESS

**Reg. No. 4,274,238**

**Registered Jan. 15, 2013**

**Int. Cls.: 9, 42 and 45**

**TRADEMARK**

**SERVICE MARK**

**PRINCIPAL REGISTER**

ASSA ABLOY AB (SWEDEN CORPORATION)  
P.O. BOX 70340  
STOCKHOLM, SWEDEN SE-10723

FOR: COMPUTER SOFTWARE FOR ISSUING AND MANAGING ENCRYPTED AND DIGITALLY SIGNED AND AUTHENTICATED IDENTITY REPRESENTATION DATA FOR USE IN THE FIELD OF PHYSICAL AND LOGICAL ACCESS CONTROL, STORED VALUE TRANSACTIONS, TRANSACTIONS INVOLVING SECURE IDENTITY, AND TRANSACTIONS INVOLVING BIOMETRIC DATA; COMPUTER SOFTWARE FOR GENERATING AND MANAGING SECURE IDENTITY REPRESENTATION DATA; MOBILE DEVICE SOFTWARE FOR DOWNLOADING AND IMPLEMENTING ACCESS CONTROL FUNCTIONALITY FOR IDENTITY VERIFICATION AND ACCESS OR DENIAL OF ACCESS TO DIGITAL DATA, PHYSICAL PREMISES OR COMPUTER NETWORKS; PHYSICAL ACCESS CONTROL SYSTEMS AND DEVICES, NAMELY, SMART CARDS, RFID CARDS, NFC ENABLED DEVICES, SMART CARD READERS, RFID READERS, NFC READERS, SYSTEM CONTROL PANELS AND DOOR HARDWARE; LOGICAL ACCESS CONTROL SYSTEMS AND DEVICES, NAMELY, SMART CARDS, RFID CARDS, NFC ENABLED DEVICES, SMART CARD READERS, RFID READERS, NFC READERS, SYSTEM CONTROL PANELS; PHYSICAL AND LOGICAL ACCESS CONTROL SYSTEMS AND DEVICES, NAMELY, SMART CARDS, RFID CARDS, NFC ENABLED DEVICES, SMART CARD READERS, RFID READERS, NFC READERS, SYSTEM CONTROL PANELS AND DOOR HARDWARE; INTEGRATED CIRCUIT CARDS AND COMPONENTS CONTAINING PROGRAMMING USED FOR ACCESS CONTROL SYSTEMS; ENCODED SMART CARDS CONTAINING PROGRAMMING USED FOR ACCESS CONTROL SYSTEMS; ELECTRONIC CARD READERS; ELECTRONIC CARD READER/ENROLLER, ELECTRONIC RFID CARD AND NFC ENABLED DEVICE READERS AND CONTROLLERS FOR CONTROLLING ACCESS TO A PREMISES; NEAR FIELD COMMUNICATION (NFC) TECHNOLOGY-ENABLED READERS; ELECTRIC LOCKS; ELECTRONIC LOCK ASSEMBLIES; ELECTRONICALLY OPERATED HIGH SECURITY LOCK CYLINDERS; RADIO-FREQUENCY CONTROLLED LOCKS; ELECTRONIC RELAYS; ELECTRONIC SWITCHES; ELECTRONIC DOOR OPENERS AND CLOSERS; ELECTRONIC DOOR OPENING AND CLOSING SYSTEM; ELECTRONIC STRIKES FOR REMOTE CONTROL OF DOOR INGRESS AND EGRESS; AUTOMATIC TURNSTILES; AUTOMATED SECURITY GATES; ELECTRIC GATE OPERATORS, IN CLASS 9 (U.S. CLS. 21, 23, 26, 36 AND 38).



*David J. Kyffers*

FOR: DATA ENCRYPTION SERVICES FOR IDENTITY REPRESENTATION DATA FOR OTHERS, IN CLASS 42 (U.S. CLS. 100 AND 101).

**Reg. No. 4,274,238** FOR: DATA LIFECYCLE MANAGEMENT SERVICES FOR OTHERS, NAMELY, ISSUANCE, AUTHENTICATION AND REVOCATION OF DIGITAL RIGHTS FOR PHYSICAL AND LOGICAL ACCESS CONTROL SYSTEMS; DIGITAL SIGNATURE AUTHENTICATION SERVICES FOR IDENTITY REPRESENTATION DATA FOR OTHERS, NAMELY, DATA ENCRYPTION AND DATA INTEGRITY; PROVIDING FOR OTHERS ENCRYPTED AND DIGITALLY SIGNED AND AUTHENTICATED IDENTITY REPRESENTATION DATA FOR USE IN ELECTRONIC PHYSICAL ACCESS CONTROL AND LOGICAL ACCESS CONTROL STORED VALUE TRANSACTIONS, TRANSACTIONS INVOLVING SECURE IDENTITY, AND TRANSACTIONS INVOLVING BIOMETRIC DATA, NAMELY, ISSUANCE, AND VALIDATION OF DIGITAL CERTIFICATES AND ACCESS RIGHTS, IN CLASS 45 (U.S. CLS. 100 AND 101).

THE MARK CONSISTS OF STANDARD CHARACTERS WITHOUT CLAIM TO ANY PARTICULAR FONT, STYLE, SIZE, OR COLOR.

PRIORITY CLAIMED UNDER SEC. 44(D) ON ERPN CMNTY TM OFC APPLICATION NO. 010387546, FILED 11-3-2011, REG. NO. 010387546, DATED 4-10-2012, EXPIRES 11-3-2021.

NO CLAIM IS MADE TO THE EXCLUSIVE RIGHT TO USE "MOBILE ACCESS", APART FROM THE MARK AS SHOWN.

SER. NO. 85-464,792, FILED 11-4-2011.

JAMES STEIN, EXAMINING ATTORNEY

# United States of America

United States Patent and Trademark Office



**Reg. No. 4,274,239**

**Registered Jan. 15, 2013**

**Int. Cl.: 10**

**TRADEMARK**

**PRINCIPAL REGISTER**

HYMAN FAMILY CORP. (CALIFORNIA CORPORATION), DBA JADYN ROSE  
831 LAWSON STREET  
CITY OF INDUSTRY, CA 91748

FOR: MEDICAL WEARING APPAREL, NAMELY, SCRUB PANTS; MEDICAL WEARING APPAREL, NAMELY, SCRUB TOPS, IN CLASS 10 (U.S. CLS. 26, 39 AND 44).

FIRST USE 2-1-2011; IN COMMERCE 9-12-2011.

THE NAME "JADYN ROSE" IDENTIFIES A LIVING INDIVIDUAL WHOSE CONSENT IS OF RECORD.

THE MARK CONSISTS OF A BLOOMING ROSE ABOVE THE WORDING "JADYN ROSE".

SER. NO. 85-464,873, FILED 11-4-2011.

KEVIN DINALLO, EXAMINING ATTORNEY



*David J. Kybas*

Director of the United States Patent and Trademark Office

United States of America  
United States Patent and Trademark Office

**PASQUALE'S**

**Reg. No. 4,274,240**

**Registered Jan. 15, 2013**

**Int. Cl.: 43**

**SERVICE MARK**

**PRINCIPAL REGISTER**

PASQUALE FOOD SYSTEMS, INC. (ALABAMA CORPORATION)  
WWW.MSNATTORNEYS.COM  
1 PERIMETER PARK SOUTH  
BIRMINGHAM, AL 35243

FOR: PIZZA PARLORS, IN CLASS 43 (U.S. CLS. 100 AND 101).

FIRST USE 5-1-1957; IN COMMERCE 5-1-1957.

OWNER OF U.S. REG. NO. 3,335,201.

THE MARK CONSISTS OF THE WORD "PASQUALE'S" IN A STRAIGHT LINE, IN ALL CAPITAL LETTERS AND IN A POSSESSIVE FORM. ALL OF THE LETTERS ARE TILTED AND OUT OF SQUARE WITH EACH OTHER. EACH LETTER IS SOMEWHAT BLOCKED INSTEAD OF PERFECTLY ROUNDED.

SER. NO. 85-465,129, FILED 11-4-2011.

AMY KELLY, EXAMINING ATTORNEY



*David J. Kyros*

Director of the United States Patent and Trademark Office

# United States of America

United States Patent and Trademark Office

## WORKSITE OPTIMIZATION

**Reg. No. 4,274,241**

REIER, MIKE (UNITED STATES INDIVIDUAL)  
404 3RD AVE N  
MINNEAPOLIS, MN 55401

**Registered Jan. 15, 2013**

**Int. Cl.: 36**

FOR: FINANCIAL RISK MANAGEMENT CONSULTATION; PROVIDING INFORMATION IN THE FIELD OF EMPLOYEE FINANCIAL BENEFIT PLANS; PROVIDING COUNSELING AND CONSULTING IN THE FIELD OF EMPLOYEE FINANCIAL AND HEALTHCARE BENEFITS; CONSULTING SERVICES IN THE FIELD OF EMPLOYEE BENEFIT PLANS CONCERNING INSURANCE AND FINANCE, IN CLASS 36 (U.S. CLS. 100, 101 AND 102).

**SERVICE MARK**

**PRINCIPAL REGISTER**

FIRST USE 9-1-2008; IN COMMERCE 2-1-2010.

THE MARK CONSISTS OF STANDARD CHARACTERS WITHOUT CLAIM TO ANY PARTICULAR FONT, STYLE, SIZE, OR COLOR.

SER. NO. 85-465,147, FILED 11-4-2011.

DAVID C. REIHNER, EXAMINING ATTORNEY



*David J. Kyffers*

Director of the United States Patent and Trademark Office

# United States of America

United States Patent and Trademark Office

## BANDAI ENTERTAINMENT

**Reg. No. 4,274,242**

KABUSHIKI KAISHA BANDAI (JAPAN CORPORATION), AKA BANDAI CO., LTD.  
1-4-8 KOMAGATA, TAITO-KU  
TOKYO 111-8081, JAPAN

**Registered Jan. 15, 2013**

**Int. Cls.: 9, 16 and 38**

FOR: DVDS AND OPTICAL DISCS CONTAINING MOTION PICTURES AND TELEVISION SERIES FEATURING ANIMATION MOVIES, ANIMATED STORIES AND/OR LIVE ACTION, IN CLASS 9 (U.S. CLS. 21, 23, 26, 36 AND 38).

**TRADEMARK**

FIRST USE 1-1-2001; IN COMMERCE 1-1-2001.

**SERVICE MARK**

FOR: COMIC BOOKS; NOVELS, IN CLASS 16 (U.S. CLS. 2, 5, 22, 23, 29, 37, 38 AND 50).

**PRINCIPAL REGISTER**

FIRST USE 5-1-2006; IN COMMERCE 5-1-2006.

FOR: STREAMING OF AUDIO, VISUAL AND AUDIOVISUAL MATERIAL VIA A GLOBAL COMPUTER NETWORK, IN CLASS 38 (U.S. CLS. 100, 101 AND 104).

FIRST USE 5-1-2006; IN COMMERCE 5-1-2006.

THE MARK CONSISTS OF STANDARD CHARACTERS WITHOUT CLAIM TO ANY PARTICULAR FONT, STYLE, SIZE, OR COLOR.

OWNER OF U.S. REG. NO. 3,015,322.

NO CLAIM IS MADE TO THE EXCLUSIVE RIGHT TO USE "ENTERTAINMENT", APART FROM THE MARK AS SHOWN.

THE ENGLISH TRANSLATION OF "BANDAI" IN THE MARK IS "ETERNITY" OR "PERPETUITY".

SER. NO. 85-465,241, FILED 11-4-2011.

LESLEY LAMOTHE, EXAMINING ATTORNEY



*David J. Kyffers*

Director of the United States Patent and Trademark Office

# United States of America

United States Patent and Trademark Office

## Dynamic Solutions at Work

**Reg. No. 4,274,243**

CONSENTIENT, LLC (COLORADO LIMITED LIABILITY COMPANY)  
9457 S UNIVERSITY BLVD, #162  
HIGHLANDS RANCH, CO 80126

**Registered Jan. 15, 2013**

**Int. Cl.: 35**

FOR: BUSINESS CONSULTATION IN THE FIELD OF ACCOUNTING AND SYSTEM IMPLEMENTATION, IN CLASS 35 (U.S. CLS. 100, 101 AND 102).

**SERVICE MARK**

FIRST USE 8-28-2011; IN COMMERCE 10-17-2011.

**PRINCIPAL REGISTER**

THE MARK CONSISTS OF STANDARD CHARACTERS WITHOUT CLAIM TO ANY PARTICULAR FONT, STYLE, SIZE, OR COLOR.

SER. NO. 85-465,388, FILED 11-5-2011.

JEFFREY LOOK, EXAMINING ATTORNEY



*David J. Kybas*

Director of the United States Patent and Trademark Office

# United States of America

United States Patent and Trademark Office

## The Secret Cookie Service

**Reg. No. 4,274,244**

**Registered Jan. 15, 2013**

**Int. Cls.: 30 and 39**

**TRADEMARK**

**SERVICE MARK**

**PRINCIPAL REGISTER**

THE SECRET COOKIE SERVICE (CALIFORNIA SOLE PROPRIETORSHIP), DBA THE  
SECRET COOKIE SERVICE  
8946 CAMINITO VERANO  
LA JOLLA, CA 92037

FOR: COOKIES, IN CLASS 30 (U.S. CL. 46).

FIRST USE 9-25-2011; IN COMMERCE 9-25-2011.

FOR: DELIVERY OF GOODS; MESSAGE DELIVERY, IN CLASS 39 (U.S. CLS. 100 AND  
105).

FIRST USE 9-25-2011; IN COMMERCE 9-25-2011.

THE MARK CONSISTS OF STANDARD CHARACTERS WITHOUT CLAIM TO ANY PAR-  
TICULAR FONT, STYLE, SIZE, OR COLOR.

NO CLAIM IS MADE TO THE EXCLUSIVE RIGHT TO USE "COOKIE SERVICE", APART  
FROM THE MARK AS SHOWN.

SER. NO. 85-465,405, FILED 11-5-2011.

WILLIAM BRECKENFELD, EXAMINING ATTORNEY



*David J. Kyffers*

Director of the United States Patent and Trademark Office



# United States of America

United States Patent and Trademark Office

Animal   
Intelligence

**Reg. No. 4,274,245**

**Registered Jan. 15, 2013**

**Int. Cl.: 9**

ANIMAL INTELLIGENCE SOFTWARE, INC. (WASHINGTON CORPORATION), DBA  
ANIMAL INTELLIGENCE SOFTWARE, INC.  
SUITE 100  
1616 SE ELLIS CT  
PORT ORCHARD, WA 98367

**TRADEMARK**

**PRINCIPAL REGISTER**

FOR: COMPUTER SOFTWARE AND HARDWARE FOR MANAGING PATIENT MEDICAL RECORDS IN THE FIELD OF VETERINARY PRACTICES; COMPUTER SOFTWARE FOR APPLICATION AND DATABASE INTEGRATION; COMPUTER SOFTWARE FOR CONTROLLING AND MANAGING PATIENT MEDICAL INFORMATION; COMPUTER SOFTWARE FOR CREATING SEARCHABLE DATABASES OF INFORMATION AND DATA; COMPUTER SOFTWARE FOR PROCESSING DIGITAL IMAGES; COMPUTER SOFTWARE FOR THE COLLECTION, EDITING, ORGANIZING, MODIFYING, BOOK MARKING, TRANSMISSION, STORAGE AND SHARING OF DATA AND INFORMATION; COMPUTER SOFTWARE FOR USE IN THE SAFEGUARDING OF DIGITAL FILES, INCLUDING AUDIO, VIDEO, TEXT, BINARY, STILL IMAGES, GRAPHICS AND MULTIMEDIA FILES; COMPUTER SOFTWARE FOR VETERINARY MEDICAL RECORDS; COMPUTER SOFTWARE THAT PROVIDES REAL-TIME, INTEGRATED BUSINESS MANAGEMENT INTELLIGENCE BY COMBINING INFORMATION FROM VARIOUS DATABASES AND PRESENTING IT IN AN EASY-TO-UNDERSTAND USER INTERFACE; COMPUTER SOFTWARE THAT PROVIDES WEB-BASED ACCESS TO APPLICATIONS AND SERVICES THROUGH A WEB OPERATING SYSTEM OR PORTAL INTERFACE; ELECTRONIC SOFTWARE UPDATES, NAMELY, DOWNLOADABLE COMPUTER SOFTWARE AND ASSOCIATED DATA FILES FOR UPDATING COMPUTER SOFTWARE IN THE FIELDS OF VETERINARY MEDICINE, PROVIDED VIA COMPUTER AND COMMUNICATION NETWORKS, IN CLASS 9 (U.S. CLS. 21, 23, 26, 36 AND 38).



FIRST USE 11-1-1998; IN COMMERCE 11-1-1998.

NO CLAIM IS MADE TO THE EXCLUSIVE RIGHT TO USE "ANIMAL INTELLIGENCE", APART FROM THE MARK AS SHOWN.

THE COLOR(S) TEAL, BLACK, WHITE IS/ARE CLAIMED AS A FEATURE OF THE MARK.

THE MARK CONSISTS OF THE WORD "ANIMAL" IS IN TEAL COLOR USING AN UPPER CASE "A", AND LOWER CASE REMAINING LETTERS. ON THE LEFT HAND SIDE OF THE SAME LINE AS THE TEAL COLORED WORD, "ANIMAL", IS A BLACK PAW PRINT WITH

*David J. Kyjars*

Director of the United States Patent and Trademark Office

**Reg. No. 4,274,245** 4 ROUNDED TOE PRINTS, WITH THE LAST TOE PRINT ON THE RIGHT BEING HALF BLACK AND HALF WHITE. TO THE RIGHT OF THE BLACK PAW PRINT, THE WHITE HALF OF THE LAST TOE PRINT ON THE RIGHT IS PART OF A TEAL COLORED SQUARE IMAGE CONTAINING A WHITE PAW PRINT WHICH IS LOCATED AT THE RIGHT OF THE BLACK PAW PRINT. THE WHITE PAW PRINT IS CENTERED IN THE TEAL SQUARE AND CONSISTS OF A ROUND CENTER PAD, AND 4 RECTANGULAR TOE PRINTS, PLUS THE HALF OF THE WHITE TOE PRINT FROM THE BLACK PAW PRINT AT THE LEFT. UNDER THE WORD "ANIMAL" AND THE BLACK, WHITE, AND TEAL PAW PRINTS, THE WORD, "INTELLIGENCE" APPEARS IN BLACK LETTERS. THE "I" IN INTELLIGENCE IS CAPITALIZED, AND THE REMAINING LETTERS ARE IN LOWER CASE. THE "I" IN "INTELLIGENCE" LINES UP DIRECTLY UNDER THE TEAL COLORED "A" OF THE WORD "ANIMAL" WHICH IS ABOVE. THE WORD "INTELLIGENCE" SPANS THE FULL WIDTH UNDERNEATH THE WORD "ANIMAL" AND PAW PRINT IMAGES.

SER. NO. 85-465,436, FILED 11-5-2011.

SALLY SHIH, EXAMINING ATTORNEY

# United States of America

United States Patent and Trademark Office



**Reg. No. 4,274,246**

**Registered Jan. 15, 2013**

**Int. Cls.: 19, 20 and 27**

**TRADEMARK**

**PRINCIPAL REGISTER**

FRITZ EGGER GMBH & CO. OG (AUSTRIA PARTNERSHIP)  
WEIBERNDORF 20  
ST. JOHANN IN TIROL, AUSTRIA 6380

FOR: CORK BUILDING MATERIALS, NAMELY, FLOOR PANELS, NOT OF METAL; WALL PANELS, NOT OF METAL; CEILING PANELS, NOT OF METAL; CORK TILES AND TILES OF CORK-BASED CONGLOMERATES FOR FLOOR, WALL AND CEILING COVERINGS, SEMI-WORKED WOODS; WALL BOARDS; HARDWOOD BOARDS; DECKING BOARDS; WOOD PARTICLE BOARDS; NON-METAL COUNTERTOPS FOR FURTHER INSTALLATION; COMPOSITE PANELS COMPOSED PRIMARILY OF NON-METAL MATERIALS; CHIPBOARD AND WOOD FIBER BOARD AND CHEMICALLY TREATED CHIP BOARD AND WOOD FIBER BOARD, NAMELY, RAW AND CHEMICALLY TREATED CHIP BOARD FOR THE BUILDING INDUSTRY, FURNITURE, AND INTERIOR DECORATING; PANELS, NAMELY, LAMINATED, NON-METAL PRESSED WOOD FLOOR, ROOF, CEILING, DOOR, FENCE, FENCING AND GATE PANELS FORMED OF PRESSED WOOD FIBERS; WOOD VENEERS FOR FURNITURE; LAMINATE FLOORING; WOOD COMPONENTS, NAMELY, WOODEN CONSTRUCTION ELEMENTS, NAMELY, SUPPORTS, SHORES, BRACES; JOISTS, SLABS AND MOLDINGS; NON-METAL WINDOW SILLS, CORK UNDERLAY FOR LAMINATE FLOORING; ALL OF THE ABOVE-IDENTIFIED GOODS MADE IN SIGNIFICANT PART OF CORK, IN CLASS 19 (U.S. CLS. 1, 12, 33 AND 50).

FOR: CORK FURNITURE AND CORK FURNITURE PARTS MADE OF CHIPBOARD AND PRESSED WOOD FIBERS, NAMELY, WORK TOPS, FURNITURE FRAMES AND FURNITURE TRIM IN THE NATURE OF EDGINGS AND EDGE ELEMENTS OF WOOD FIBRE BOARD OR CHIPBOARD, ALL OF THE ABOVE-IDENTIFIED GOODS MADE IN SIGNIFICANT PART OF CORK, IN CLASS 20 (U.S. CLS. 2, 13, 22, 25, 32 AND 50).

FOR: CORK FLOOR COVERINGS AND CORK WALL COVERINGS, CORK FOR USE AS A FLOOR OR WALL COVERING;, ALL OF THE ABOVE-IDENTIFIED GOODS MADE IN SIGNIFICANT PART OF CORK, IN CLASS 27 (U.S. CLS. 19, 20, 37, 42 AND 50).

OWNER OF ERPN CMNTY TM OFC REG. NO. 009697616, DATED 10-7-2011, EXPIRES 1-31-2021.

THE COLOR(S) GREEN AND WHITE IS/ARE CLAIMED AS A FEATURE OF THE MARK.



*David J. Kyffers*

Director of the United States Patent and Trademark Office

**Reg. No. 4,274,246** NO CLAIM IS MADE TO THE EXCLUSIVE RIGHT TO USE "CORK", APART FROM THE MARK AS SHOWN.

THE MARK CONSISTS OF THE TERM "CORK" FOLLOWED BY THE PLUS SYMBOL AS A SUPERSCRIP<sup>T</sup>, BOTH IN WHITE. TO THE LEFT OF THE TERM "CORK" ARE TWO JAGGED OVERLAPPING BRACKETS, IN WHITE. ALL THE AFOREMENTIONED ELEMENTS ARE CONTAINED WITHIN A GREEN CIRCLE BACKGROUND.

SER. NO. 85-465,897, FILED 11-7-2011.

SUSAN RICHARDS, EXAMINING ATTORNEY

# United States of America

United States Patent and Trademark Office



**Reg. No. 4,274,247**

**Registered Jan. 15, 2013**

**Int. Cl.: 35**

**SERVICE MARK**

**PRINCIPAL REGISTER**

THE ROPER CENTER, INC. (DELAWARE CORPORATION)  
369 FAIRFIELD WAY, UNIT 2164  
STORRS, CT 062692164

FOR: PROVIDING A WEBSITE FEATURING INFORMATION ABOUT RESULTS OF PUBLIC OPINION POLLS; PROVIDING AN ONLINE SEARCHABLE DATA BASE IN THE FIELD OF PUBLIC OPINION POLLS, IN CLASS 35 (U.S. CLS. 100, 101 AND 102).

FIRST USE 0-0-2010; IN COMMERCE 0-0-2010.

NO CLAIM IS MADE TO THE EXCLUSIVE RIGHT TO USE "IPOLL", APART FROM THE MARK AS SHOWN.

THE COLOR(S) BLUE, GOLD, BLACK AND WHITE IS/ARE CLAIMED AS A FEATURE OF THE MARK.

THE MARK CONSISTS OF STYLIZED STICK FIGURE IN THE FORM OF A LOWER CASE "I", WITH THE BODY IN BLUE AND THE HEAD IN GOLD, NEXT TO THE LETTERING "IPOLL", ALL IN A BLACK BORDERED BOX WITH ROUNDED CORNERS ON A WHITE BACKGROUND.

SER. NO. 85-465,917, FILED 11-7-2011.

SUSAN RICHARDS, EXAMINING ATTORNEY



*David J. Kybas*

Director of the United States Patent and Trademark Office

# United States of America

United States Patent and Trademark Office

## SUPPORTED INTELLIGENCE

**Reg. No. 4,274,248**

**Registered Jan. 15, 2013**

**Int. Cl.: 9**

**TRADEMARK**

**PRINCIPAL REGISTER**

ANDERSON, PATRICK L. (UNITED STATES INDIVIDUAL)  
SUITE 100  
1555 WATERTOWER PLACE  
LANSING, MI 48823

FOR: COMPUTER SOFTWARE FOR A COMPUTER-AIDED DECISION MAKING SYSTEM  
USED FOR DECISION MAKING, MODELING AND ANALYSIS, IN CLASS 9 (U.S. CLS. 21,  
23, 26, 36 AND 38).

FIRST USE 7-13-2012; IN COMMERCE 7-13-2012.

THE MARK CONSISTS OF STANDARD CHARACTERS WITHOUT CLAIM TO ANY PAR-  
TICULAR FONT, STYLE, SIZE, OR COLOR.

SER. NO. 85-466,106, FILED 11-7-2011.

KATINA MISTER, EXAMINING ATTORNEY



*David J. Kybas*

Director of the United States Patent and Trademark Office

# United States of America

United States Patent and Trademark Office



**S M I T H**

**Reg. No. 4,274,249**

SMITH ELECTRIC VEHICLES US CORP. (DELAWARE CORPORATION)  
12200 N.W. AMBASSADOR DRIVE, SUITE 326  
KANSAS CITY, MO 64163

**Registered Jan. 15, 2013**

**Int. Cl.: 12**

FOR: ELECTRIC VEHICLES, NAMELY, AUTOMOBILES, TRUCKS, BUSES AND VANS, IN CLASS 12 (U.S. CLS. 19, 21, 23, 31, 35 AND 44).

**TRADEMARK**

FIRST USE 9-8-2011; IN COMMERCE 9-8-2011.

**PRINCIPAL REGISTER**

THE MARK CONSISTS OF THE OUTLINE OF A GRIFFIN LIKE FIGURE WITH THE WORD "SMITH" POSITIONED BELOW THE GRIFFIN LIKE FIGURE.

SER. NO. 85-466,214, FILED 11-7-2011.

JUSTINE D. PARKER, EXAMINING ATTORNEY



*David J. Kybas*

Director of the United States Patent and Trademark Office

# United States of America

United States Patent and Trademark Office



**Reg. No. 4,274,250**

**Registered Jan. 15, 2013**

**Int. Cl.: 35**

**SERVICE MARK**

**PRINCIPAL REGISTER**

SCHOOL MEDIA INC. (MINNESOTA CORPORATION)  
200  
8560 COTTONWOOD ST. NW  
COON RAPIDS, MN 55433

FOR: ADVERTISING AND MARKETING SERVICES, NAMELY, PROMOTING THE GOODS AND SERVICES OF OTHERS, IN CLASS 35 (U.S. CLS. 100, 101 AND 102).

FIRST USE 6-24-2010; IN COMMERCE 6-24-2010.

NO CLAIM IS MADE TO THE EXCLUSIVE RIGHT TO USE "SCHOOL MEDIA", APART FROM THE MARK AS SHOWN.

THE STIPPLING IS FOR SHADING PURPOSES ONLY.

THE MARK CONSISTS OF THE WORDS "SCHOOL MEDIA"; TO THE LEFT OF THE WORDING IS A STYLIZED APPLE DESIGN

SER. NO. 85-466,308, FILED 11-7-2011.

HENRY S. ZAK, EXAMINING ATTORNEY



*David J. Kyjars*

Director of the United States Patent and Trademark Office



# United States of America

United States Patent and Trademark Office

sugardaddyforme.com

**Reg. No. 4,274,251**

WEBSITE DEVELOPMENT SERVICES, LLC (FLORIDA LIMITED LIABILITY COMPANY)  
382 NE 191ST STREET  
MIAMI, FL 33179

**Registered Jan. 15, 2013**

**Int. Cl.: 41**

FOR: ENTERTAINMENT SERVICES, NAMELY, CONDUCTING PARTIES FOR THE PURPOSE OF DATING AND SOCIAL INTRODUCTION FOR ADULTS, IN CLASS 41 (U.S. CLS. 100, 101 AND 107).

**SERVICE MARK**

FIRST USE 7-15-2011; IN COMMERCE 7-15-2011.

**PRINCIPAL REGISTER**

THE MARK CONSISTS OF STANDARD CHARACTERS WITHOUT CLAIM TO ANY PARTICULAR FONT, STYLE, SIZE, OR COLOR.

SER. NO. 85-466,985, FILED 11-8-2011.

AISHA CLARKE, EXAMINING ATTORNEY



*David J. Kybas*

Director of the United States Patent and Trademark Office

# United States of America

United States Patent and Trademark Office



**Reg. No. 4,274,252**

**Registered Jan. 15, 2013**

**Int. Cl.: 35**

**SERVICE MARK**

**PRINCIPAL REGISTER**

HEADLANDS VENTURES, LLC (CALIFORNIA LIMITED LIABILITY COMPANY), AKA  
MIKE'S BIKES  
819 5TH AVENUE  
SAN RAFAEL, CA 94901

FOR: RETAIL STORE AND ONLINE RETAIL STORE SERVICES FEATURING BICYCLES,  
BICYCLE PARTS, BICYCLE ACCESSORIES, AND BICYCLE CLOTHING , IN CLASS 35  
(U.S. CLS. 100, 101 AND 102).

FIRST USE 4-0-2006; IN COMMERCE 6-0-2006.

OWNER OF U.S. REG. NO. 3,247,083.

THE COLOR(S) BLUE AND YELLOW IS/ARE CLAIMED AS A FEATURE OF THE MARK.

THE MARK CONSISTS OF THE COLOR BLUE APPEARING IN THE CIRCULAR GEAR  
THAT FORMS THE OUTER RING OF THE MARK AND AS AN OUTLINE FOR THE "M"  
AND "B" IN THE MARK. THE COLOR YELLOW APPEARS AS THE COLOR FOR LETTERS  
"M" AND "B" IN THE MARK. THE MARK CONSISTS OF THE LETTERS "M", "B" INSIDE  
A BICYCLE GEAR CIRCLE.

SER. NO. 85-467,214, FILED 11-8-2011.

NAKIA HENRY, EXAMINING ATTORNEY



*David J. Kyjars*

Director of the United States Patent and Trademark Office

# United States of America

United States Patent and Trademark Office



**Reg. No. 4,274,253**

AWGI, LLC (DELAWARE LIMITED LIABILITY COMPANY)  
1212 ST. GEORGE ROAD  
EVANSVILLE, IN 47711

**Registered Jan. 15, 2013**

**Int. Cls.: 35, 37 and 40**

FOR: LOGISTICS MANAGEMENT IN THE FIELD OF INSTALLATION OF RESTAURANT EQUIPMENT, NAMELY, TABLES, CHAIRS, BOOTHS AND SHELVING, HEALTHCARE FACILITY FURNITURE AND EQUIPMENT, NAMELY, HOSPITAL BEDS, OVERHEAD TABLES, LOCKERS, OFFICE FURNITURE AND SHELVING, IN CLASS 35 (U.S. CLS. 100, 101 AND 102).

**SERVICE MARK**

**PRINCIPAL REGISTER**

FIRST USE 12-1-2006; IN COMMERCE 12-1-2006.

FOR: INSTALLATION AND MAINTENANCE OF RESTAURANT EQUIPMENT, NAMELY, TABLES, CHAIRS, BOOTHS AND SHELVING, HEALTHCARE FACILITY FURNITURE AND EQUIPMENT, NAMELY, HOSPITAL BEDS, OVERHEAD TABLES, LOCKERS, OFFICE FURNITURE AND SHELVING, IN CLASS 37 (U.S. CLS. 100, 103 AND 106).

FIRST USE 12-1-2006; IN COMMERCE 12-1-2006.

FOR: ASSEMBLY OF OFFICE AND INDUSTRIAL FURNITURE, SHELVING AND EQUIPMENT FOR OTHERS; ASSEMBLY OF PRODUCTS FOR OTHERS, IN CLASS 40 (U.S. CLS. 100, 103 AND 106).

FIRST USE 12-1-2006; IN COMMERCE 12-1-2006.

NO CLAIM IS MADE TO THE EXCLUSIVE RIGHT TO USE "GLOBAL DISTRIBUTION", APART FROM THE MARK AS SHOWN.

THE COLOR(S) DARK BLUE, LIGHT BLUE, WHITE, RED AND GREY IS/ARE CLAIMED AS A FEATURE OF THE MARK.

THE MARK CONSISTS OF A CIRCLE, DISSECTED BY A WHITE LINE WITH AN ARROW, WHICH CREATES A LEFT CRESCENT PORTION OF THE CIRCLE IN DARK BLUE AND THE RIGHT PORTION IN LIGHT BLUE. THE WORD "TITAN", IN RED, APPEARS TO THE RIGHT OF THE CIRCLE WITH A TOP LEFT PORTION OF THE "T" OVERLAPPING THE CIRCLE. BELOW THE WORD "TITAN" IS "GLOBAL DISTRIBUTION" IN GREY.



*David J. Kyjars*

Director of the United States Patent and Trademark Office

**Reg. No. 4,274,253** SER. NO. 85-467,259, FILED 11-8-2011.

JAMES LOVELACE, EXAMINING ATTORNEY

# United States of America

United States Patent and Trademark Office

# 28MT

**Reg. No. 4,274,254**

**Registered Jan. 15, 2013**

**Int. Cl.: 7**

**TRADEMARK**

**PRINCIPAL REGISTER**

REMY TECHNOLOGIES, LLC (DELAWARE LIMITED LIABILITY COMPANY)  
600 CORPORATION DRIVE  
LEGAL DEPARTMENT  
PENDLETON, IN 46064

FOR: STARTERS FOR MOTORS AND ENGINES, IN CLASS 7 (U.S. CLS. 13, 19, 21, 23, 31, 34 AND 35).

FIRST USE 1-1-1988; IN COMMERCE 1-1-1988.

THE MARK CONSISTS OF STANDARD CHARACTERS WITHOUT CLAIM TO ANY PARTICULAR FONT, STYLE, SIZE, OR COLOR.

SER. NO. 85-467,310, FILED 11-8-2011.

MARY CRAWFORD, EXAMINING ATTORNEY



*David J. Kyffers*

Director of the United States Patent and Trademark Office

# United States of America

United States Patent and Trademark Office

## The Untraining: Untraining White Liberal Racism

**Reg. No. 4,274,255**

**Registered Jan. 15, 2013**

**Int. Cl.: 41**

**SERVICE MARK**

**PRINCIPAL REGISTER**

HORTON, ROBERT A. (UNITED STATES INDIVIDUAL), DBA THE UNTRAINING  
6128 JORDAN AVENUE  
EL CERRITO, CA 94530 AND

SHIMMIN, RITA (UNITED STATES INDIVIDUAL)  
484 LAKE PARK AVENUE #340  
OAKLAND, CA 94610

FOR: EDUCATION SERVICES, NAMELY, PROVIDING CLASSES, SEMINARS AND  
WORKSHOPS IN THE FIELD OF ANTI-RACISM TRAINING, IN CLASS 41 (U.S. CLS. 100,  
101 AND 107).

FIRST USE 7-1-1996; IN COMMERCE 1-1-1997.

THE MARK CONSISTS OF STANDARD CHARACTERS WITHOUT CLAIM TO ANY PAR-  
TICULAR FONT, STYLE, SIZE, OR COLOR.

SER. NO. 85-467,436, FILED 11-8-2011.

DARRYL SPRUILL, EXAMINING ATTORNEY



*David J. Kyffers*

Director of the United States Patent and Trademark Office

# United States of America

United States Patent and Trademark Office

## AUDIOMERCIAL

**Reg. No. 4,274,256**

**Registered Jan. 15, 2013**

**Int. Cl.: 35**

**SERVICE MARK**

**PRINCIPAL REGISTER**

AR ENTERPRISES COMPANY, INC. (MASSACHUSETTS CORPORATION), DBA JOHN  
MELLEY VOICE OVERS & PRODUCTIONS  
77 DYSART STREET  
QUINCY, MA 02169

FOR: PRODUCTION OF AUDIO ADVERTISING COMMERCIALS IN THE FORM OF PRO-  
MOTIONS, TESTIMONIALS AND ANNOUNCEMENTS; COPY WRITING FOR ADVERTISING  
PURPOSES, POST-PRODUCTION EDITING FOR AUDIO COMMERCIALS; PROVIDING  
VOICEOVERS FOR COMMERCIALS, IN CLASS 35 (U.S. CLS. 100, 101 AND 102).

FIRST USE 12-30-2010; IN COMMERCE 1-9-2011.

THE MARK CONSISTS OF STANDARD CHARACTERS WITHOUT CLAIM TO ANY PAR-  
TICULAR FONT, STYLE, SIZE, OR COLOR.

SER. NO. 85-468,101, FILED 11-9-2011.

FRED CARL, EXAMINING ATTORNEY



*David J. Kybas*

Director of the United States Patent and Trademark Office

# United States of America

United States Patent and Trademark Office



**Reg. No. 4,274,257**

**Registered Jan. 15, 2013**

**Int. Cl.: 41**

**SERVICE MARK**

**PRINCIPAL REGISTER**

KIDS NEED TO READ (CALIFORNIA NON-PROFIT CORPORATION)  
33 S. MESA DRIVE  
MESA, AZ 85210

FOR: CHARITABLE SERVICES, NAMELY, PROVIDING BOOKS TO CHILDREN THROUGH THE DONATION OF BOOKS TO SCHOOLS, LIBRARIES AND LITERACY PROGRAMS; CONDUCTING ENTERTAINMENT EXHIBITIONS IN THE NATURE OF LITERACY FESTIVALS FOR SCHOOLS; PROVIDING LITERACY-BASED ACTIVITIES TO SCHOOLS, LIBRARIES AND LITERACY PROGRAMS, NAMELY, EDUCATION SERVICES IN THE NATURE OF PROVIDING CLASSES, SEMINARS, WORKSHOPS, LECTURES, AND MOTIVATIONAL AND EDUCATIONAL SPEAKERS IN THE FIELD OF LITERACY, IN CLASS 41 (U.S. CLS. 100, 101 AND 107).

FIRST USE 7-17-2010; IN COMMERCE 7-17-2010.

THE MARK CONSISTS OF THE WORDING "KIDS NEED TO READ", WITH "KIDS" IN RED, "NEED" IN GREEN, "TO" IN YELLOW, AND "READ" IN BLUE, ALL APPEARING OVER A YELLOW BOOK DESIGN FLANKED BY YELLOW HORIZONTAL LINE SEGMENTS, WITH THE ABOVE WORDING AND DESIGNS APPEARING OVER THE GREEN WORDING "INSPIRING IMAGINATION", AND ALL OF THE AFOREMENTIONED WORDING AND DESIGN ELEMENTS APPEARING ON A BLACK BACKGROUND.

THE COLOR(S) RED, GREEN, YELLOW, BLUE AND BLACK IS/ARE CLAIMED AS A FEATURE OF THE MARK.

SER. NO. 85-468,461, FILED 11-9-2011.

KEVIN CORWIN, EXAMINING ATTORNEY



*David J. Kyros*

Director of the United States Patent and Trademark Office



# United States of America

United States Patent and Trademark Office

## philosophy of me

**Reg. No. 4,274,258**

**Registered Jan. 15, 2013**

**Int. Cl.: 25**

**TRADEMARK**

**PRINCIPAL REGISTER**

FERRANTI CLIFT, CHRISTINA M. (RHODE ISLAND LIMITED LIABILITY COMPANY),  
DBA SPIT-FIRE LLC  
35 DRUID ROAD  
WARWICK, RI 02888

FOR: T-SHIRTS, IN CLASS 25 (U.S. CLS. 22 AND 39).

FIRST USE 6-25-2011; IN COMMERCE 10-23-2011.

THE MARK CONSISTS OF STANDARD CHARACTERS WITHOUT CLAIM TO ANY PARTICULAR FONT, STYLE, SIZE, OR COLOR.

SER. NO. 85-469,014, FILED 11-10-2011.

INGA ERVIN, EXAMINING ATTORNEY



*David J. Kyffers*

Director of the United States Patent and Trademark Office

# United States of America

United States Patent and Trademark Office

## THE LITTLE MEDICAL SCHOOL

**Reg. No. 4,274,259**

**Registered Jan. 15, 2013**

**Int. Cl.: 41**

**SERVICE MARK**

**PRINCIPAL REGISTER**

MASON MEDSTAT MEDIA, LLC (MISSOURI LIMITED LIABILITY COMPANY)  
8 SUFFIELD PLACE  
CREVE COEUR, MO 63141

FOR: ENTERTAINMENT AND EDUCATIONAL SERVICES, NAMELY, PROVIDING SEMINARS, CLASSES, CAMPS, WORKSHOPS, CONFERENCES, PARTIES, SPECIAL EVENTS, PROGRAMS, AFTER SCHOOL EDUCATIONAL PROGRAMS, AND HANDS-ON EDUCATIONAL PROGRAMS FOR CHILDREN IN THE FIELDS OF MEDICINE, SCIENCE AND HEALTHCARE, IN CLASS 41 (U.S. CLS. 100, 101 AND 107).

FIRST USE 11-12-2011; IN COMMERCE 1-20-2012.

THE MARK CONSISTS OF STANDARD CHARACTERS WITHOUT CLAIM TO ANY PARTICULAR FONT, STYLE, SIZE, OR COLOR.

NO CLAIM IS MADE TO THE EXCLUSIVE RIGHT TO USE "MEDICAL SCHOOL", APART FROM THE MARK AS SHOWN.

SER. NO. 85-469,373, FILED 11-10-2011.

LAURA KOVALSKY, EXAMINING ATTORNEY



*David J. Kybas*

Director of the United States Patent and Trademark Office

# United States of America

United States Patent and Trademark Office

# AUTOQUANT

**Reg. No. 4,274,260**

MEDIA CYBERNETICS (DELAWARE CORPORATION)  
4340 EAST WEST HWY., SUITE 400  
BETHESDA, MD 20814

**Registered Jan. 15, 2013**

**Int. Cl.: 9**

FOR: IMAGE DECONVOLUTION AND 3D VISUALIZATION SOFTWARE FOR USE IN MICROSCOPY IN THE LIFE SCIENCE INDUSTRY, IN CLASS 9 (U.S. CLS. 21, 23, 26, 36 AND 38).

**TRADEMARK**

FIRST USE 7-7-2004; IN COMMERCE 7-7-2004.

**PRINCIPAL REGISTER**

THE MARK CONSISTS OF STANDARD CHARACTERS WITHOUT CLAIM TO ANY PARTICULAR FONT, STYLE, SIZE, OR COLOR.

SER. NO. 85-469,438, FILED 11-10-2011.

COURTNEY ALVAREZ, EXAMINING ATTORNEY



*David J. Kyffers*

Director of the United States Patent and Trademark Office

# United States of America

United States Patent and Trademark Office



**Reg. No. 4,274,261**

**Registered Jan. 15, 2013**

**Int. Cls.: 9 and 42**

**TRADEMARK**

**SERVICE MARK**

**PRINCIPAL REGISTER**

NEWS360 LTD. (RUSSIAN FED. LIMITED LIABILITY COMPANY)  
9B DMITROVSKOE SH.  
MOSCOW, RUSSIAN FED.

FOR: COMPUTER APPLICATION SOFTWARE FOR MOBILE PHONES, HANDHELD COMPUTERS, AND MOBILE ELECTRONIC DEVICES, NAMELY, DOWNLOADABLE SOFTWARE FOR PROVIDING NON-DOWNLOADABLE MAGAZINES, PERIODICALS, NEWSLETTERS, REPORTS, BLOGS, AND ARTICLES IN THE FIELD OF GLOBAL CURRENT EVENTS REPORTING, IN CLASS 9 (U.S. CLS. 21, 23, 26, 36 AND 38).

FIRST USE 10-21-2010; IN COMMERCE 10-21-2010.

FOR: COMPUTER SERVICES, NAMELY, PROVIDING A NEWS AGGREGATION SITE WHICH ALLOWS THE USER TO VIEW EXISTING FEEDS FROM NEWSPAPERS AND ONLINE PUBLICATIONS AND THEN ASSEMBLE THE INFORMATION TO CREATE USER SPECIFIC NEWSPAPERS OR REPORTS, IN CLASS 42 (U.S. CLS. 100 AND 101).

FIRST USE 10-21-2010; IN COMMERCE 10-21-2010.

THE MARK CONSISTS OF THREE CONCENTRIC CIRCLES FORMING THE APPEARANCE OF AN EYE, FOLLOWED BY WORDING, "NEWS360", AND A DEGREE SYMBOL.

SER. NO. 85-470,287, FILED 11-11-2011.

JEFF DEFORD, EXAMINING ATTORNEY



*David J. Kybas*

Director of the United States Patent and Trademark Office

# United States of America

United States Patent and Trademark Office

# AI EASY

**Reg. No. 4,274,262**

ADVISORS ASSET MANAGEMENT, INC. (DELAWARE CORPORATION)  
18925 BASE CAMP ROAD  
MONUMENT, CO 80132

**Registered Jan. 15, 2013**

**Int. Cl.: 36**

FOR: FINANCIAL AND INVESTMENT CONSULTANCY AND MANAGEMENT SERVICES  
IN THE FIELD OF ALTERNATIVE INVESTMENTS, IN CLASS 36 (U.S. CLS. 100, 101 AND  
102).

**SERVICE MARK**

FIRST USE 2-29-2012; IN COMMERCE 2-29-2012.

**PRINCIPAL REGISTER**

THE MARK CONSISTS OF STANDARD CHARACTERS WITHOUT CLAIM TO ANY PAR-  
TICULAR FONT, STYLE, SIZE, OR COLOR.

NO CLAIM IS MADE TO THE EXCLUSIVE RIGHT TO USE "AI", APART FROM THE MARK  
AS SHOWN.

SER. NO. 85-470,351, FILED 11-11-2011.

DAVID COLLIER, EXAMINING ATTORNEY



*David J. Kyffers*

Director of the United States Patent and Trademark Office

# United States of America

United States Patent and Trademark Office

# OXTEX

**Reg. No. 4,274,263**

**Registered Jan. 15, 2013**

**Int. Cl.: 24**

**TRADEMARK**

**PRINCIPAL REGISTER**

PAK-LITE, INC. (GEORGIA CORPORATION)  
550 OLD PEACHTREE RD. NW  
SUWANEE, GA 30024

FOR: LAID SCRIM, KNIT, WOVEN AND NON-WOVEN REINFORCEMENT FABRICS MADE OF POLYESTER OR FIBERGLASS FOR INDUSTRIAL APPLICATIONS; NON-WOVEN TEXTILE FABRICS; SYNTHETIC FIBER FABRICS, IN CLASS 24 (U.S. CLS. 42 AND 50).

FIRST USE 3-25-2011; IN COMMERCE 3-25-2011.

THE MARK CONSISTS OF STANDARD CHARACTERS WITHOUT CLAIM TO ANY PARTICULAR FONT, STYLE, SIZE, OR COLOR.

SER. NO. 85-470,399, FILED 11-11-2011.

DOMINIC J. FERRAIUOLO, EXAMINING ATTORNEY



*David J. Kyffers*

Director of the United States Patent and Trademark Office

# United States of America

United States Patent and Trademark Office

# METREX

**Reg. No. 4,274,264**

**Registered Jan. 15, 2013**

**Int. Cls.: 3 and 5**

**TRADEMARK**

**PRINCIPAL REGISTER**

METREX RESEARCH, LLC (WISCONSIN LIMITED LIABILITY COMPANY)  
1717 WEST COLLINS AVENUE  
ORANGE, CA 92867

FOR: CLEANING SOLUTIONS FOR MEDICAL AND DENTAL INSTRUMENTS, EQUIPMENT AND SURFACES AND ANTIMICROBIAL SKIN CARE PRODUCTS, NAMELY, LIQUID SOAP, HAND CLEANSING GEL, PRE-MOISTENED SKIN CLEANSING AND SKIN MOISTURIZING TOWELETTES, AND SKIN LOTION, IN CLASS 3 (U.S. CLS. 1, 4, 6, 50, 51 AND 52).

FIRST USE 7-0-1996; IN COMMERCE 7-0-1996.

FOR: STERILIZING AND DISINFECTING SOLUTIONS FOR MEDICAL AND DENTAL INSTRUMENTS, EQUIPMENT AND SURFACES; ANTIMICROBIAL SKIN CARE PRODUCTS, ANTIMICROBIAL SKIN CARE PRODUCTS, NAMELY, NO-RINSE HAND SANITIZING PREPARATIONS IN THE FORM OF GELS AND SPRAYS, IN CLASS 5 (U.S. CLS. 6, 18, 44, 46, 51 AND 52).

FIRST USE 7-0-1996; IN COMMERCE 7-0-1996.

THE MARK CONSISTS OF STANDARD CHARACTERS WITHOUT CLAIM TO ANY PARTICULAR FONT, STYLE, SIZE, OR COLOR.

OWNER OF U.S. REG. NO. 1,851,868.

SER. NO. 85-470,560, FILED 11-11-2011.

GIANCARLO CASTRO, EXAMINING ATTORNEY



*David J. Kypos*

Director of the United States Patent and Trademark Office

# United States of America

United States Patent and Trademark Office

# ZDOCK

**Reg. No. 4,274,265**

**Registered Jan. 15, 2013**

**Int. Cl.: 9**

**TRADEMARK**

**PRINCIPAL REGISTER**

SA, SHUANG (CANADA INDIVIDUAL)  
100-13551 VERDUN PLACE  
RICHMOND, BC, CANADA V6V1W5

FOR: DIGITAL DATA TRANSFORMERS, FOR USE IN DIGITAL AND HANDHELD ELECTRONIC APPARATUS; ELECTRONIC ACCESSORIES, NAMELY, HOLDERS AND STANDS FOR PERSONAL DIGITAL ELECTRONIC DEVICES, NAMELY, CONVERTERS, ELECTRONIC RECEIVERS AND TRANSMITTERS FOR HANDHELD COMPUTERS, BARCODE READERS, SCANNERS AND PERSONAL DIGITAL ASSISTANTS, LAPTOP COMPUTERS, NOTEBOOKS, TOUCH PADS; DIGITAL DATA STORAGE DEVICES, NAMELY, BLANK USB FLASH DRIVES AND MEMORY CARDS, ALL USED IN THE FOLLOWING DEVICES, NAMELY, MEDIA PLAYERS, ARCADE GAME MACHINES, WIRELESS TELEPHONES, CAMCORDERS, CAMERAS, REMOTE CONTROLS AND COMPUTER PERIPHERALS, SIGNAL SPLITTERS FOR ELECTRONIC APPARATUS AND AMPLIFIERS, IN CLASS 9 (U.S. CLS. 21, 23, 26, 36 AND 38).

FIRST USE 12-23-2005; IN COMMERCE 12-23-2005.

THE MARK CONSISTS OF STANDARD CHARACTERS WITHOUT CLAIM TO ANY PARTICULAR FONT, STYLE, SIZE, OR COLOR.

SER. NO. 85-470,610, FILED 11-11-2011.

JOHN SCHUYLER YARD, EXAMINING ATTORNEY



*David J. Kypos*

Director of the United States Patent and Trademark Office



# United States of America

## United States Patent and Trademark Office

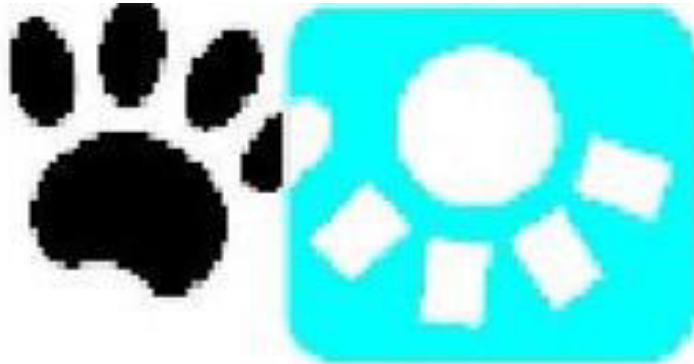

**Reg. No. 4,274,266**

**Registered Jan. 15, 2013**

**Int. Cl.: 9**

**TRADEMARK**

**PRINCIPAL REGISTER**

ANIMAL INTELLIGENCE SOFTWARE, INC. (WASHINGTON CORPORATION)  
SUITE 100  
1616 SE ELLIS CT  
PORT ORCHARD, WA 98367

FOR: COMPUTER HARDWARE AND SOFTWARE SYSTEMS FOR MANAGING PATIENT MEDICAL RECORDS IN THE FIELD OF VETERINARY MEDICAL PRACTICES; COMPUTER HARDWARE AND SOFTWARE, FOR USE WITH MEDICAL PATIENT MONITORING EQUIPMENT, FOR RECEIVING, PROCESSING, TRANSMITTING AND DISPLAYING DATA; COMPUTER SOFTWARE FOR APPLICATION AND DATABASE INTEGRATION; COMPUTER SOFTWARE FOR CONTROLLING AND MANAGING PATIENT MEDICAL INFORMATION; COMPUTER SOFTWARE FOR CREATING SEARCHABLE DATABASES OF INFORMATION AND DATA; COMPUTER SOFTWARE FOR ORGANIZING AND VIEWING DIGITAL IMAGES AND PHOTOGRAPHS; COMPUTER SOFTWARE FOR PROCESSING DIGITAL IMAGES; COMPUTER SOFTWARE FOR THE COLLECTION, EDITING, ORGANIZING, MODIFYING, BOOK MARKING, TRANSMISSION, STORAGE AND SHARING OF DATA AND INFORMATION; COMPUTER SOFTWARE FOR USE IN CUSTOMER RELATIONSHIP MANAGEMENT (CRM); COMPUTER SOFTWARE FOR USE IN THE SAFEGUARDING OF DIGITAL FILES, INCLUDING AUDIO, VIDEO, TEXT, BINARY, STILL IMAGES, GRAPHICS AND MULTIMEDIA FILES; COMPUTER SOFTWARE FOR VETERINARY PRACTICE MANAGEMENT; COMPUTER SOFTWARE FOR MANAGING PATIENT MEDICAL RECORDS FOR THE FIELD OF VETERINARY PRACTICES THAT MAY BE DOWNLOADED FROM A GLOBAL COMPUTER NETWORK; COMPUTER SOFTWARE PLATFORMS FOR ELECTRONIC VETERINARY MEDICAL RECORDS AND PRACTICE MANAGEMENT; COMPUTER SOFTWARE THAT PROVIDES REAL-TIME, INTEGRATED BUSINESS MANAGEMENT INTELLIGENCE BY COMBINING INFORMATION FROM VARIOUS DATABASES AND PRESENTING IT IN AN EASY-TO-UNDERSTAND USER INTERFACE; COMPUTER SOFTWARE THAT PROVIDES WEB-BASED ACCESS TO APPLICATIONS AND SERVICES THROUGH A WEB OPERATING SYSTEM OR PORTAL INTERFACE; COMPUTER SOFTWARE TO AUTOMATE DATA WAREHOUSING; DATABASE MANAGEMENT SOFTWARE FOR VETERINARY PRACTICES; DOWNLOADABLE SOFTWARE FOR VETERINARY ELECTRONIC MEDICAL RECORDS; ELECTRONIC SOFTWARE UPDATES, NAMELY, DOWNLOADABLE COMPUTER SOFTWARE AND ASSOCIATED DATA FILES FOR UPDATING COMPUTER SOFTWARE IN THE FIELDS OF VETERINARY MEDICINE, PROVIDED VIA COMPUTER AND COMMUNICATION NETWORKS; MEDICAL SOFTWARE FOR MANAGING PATIENT MEDICAL RECORD IN THE FIELD OF VETERINARY MEDICINE, IN CLASS 9 (U.S. CLS. 21, 23, 26, 36 AND 38).



*David J. Kappas*

Director of the United States Patent and Trademark Office

**Reg. No. 4,274,266** FIRST USE 11-1-1998; IN COMMERCE 12-1-1998.

THE MARK CONSISTS OF BLACK PAW PRINT ON A WHITE BACKGROUND WITH ROUNDED BLACK CENTER PAW PRINT IMAGE AND 4 ROUNDED BLACK TOES PRINTS FACING UP, THE LAST TOE PRINT ON THE RIGHT IS HALF BLACK AND HALF WHITE. THE WHITE HALF OF THE BLACK TOE PRINT BREAKS INTO THE TEAL A ROUNDED CORNER TEAL SQUARE ON THE RIGHT. IN THE CENTER OF THE TEAL ROUNDED CORNER SQUARE IS AN UPSIDE DOWN WHITE PAW PRINT WITH A ROUND WHITE CENTER PAW PRINT AND 5 RECTANGULAR WHITE TOE PRINTS. THE LAST RECTANGULAR TOE PRINT ON THE LEFT OF THE WHITE PAW PRINT IS THE OTHER HALF OF THE BLACK ROUNDED TOE PRINT OF THE BLACK PAW PRINT TO THE LEFT OF THE TEAL ROUNDED CORNER SQUARE. THE WHITE PAW PRINT IS UPSIDE DOWN COMPARED TO THE ADJOINING BLACK PAW PRINT TO THE LEFT OF THE TEAL SQUARE.

THE COLOR(S) BLACK, WHITE, AND TEAL IS/ARE CLAIMED AS A FEATURE OF THE MARK.

SEC. 2(F).

SER. NO. 85-470,923, FILED 11-11-2011.

SALLY SHIH, EXAMINING ATTORNEY

# United States of America

United States Patent and Trademark Office

# 4Site

**Reg. No. 4,274,267**

**Registered Jan. 15, 2013**

**Int. Cl.: 42**

**SERVICE MARK**

**PRINCIPAL REGISTER**

4SITE INTERACTIVE STUDIOS, INC. (MARYLAND CORPORATION)  
SUITE 1  
3431 14TH ST., NW  
WASHINGTON, DC 20010

FOR: DESIGN, CREATION, HOSTING, MAINTENANCE OF WEBSITES FOR OTHERS, IN CLASS 42 (U.S. CLS. 100 AND 101).

FIRST USE 8-1-2001; IN COMMERCE 8-1-2001.

THE MARK CONSISTS OF STANDARD CHARACTERS WITHOUT CLAIM TO ANY PARTICULAR FONT, STYLE, SIZE, OR COLOR.

SER. NO. 85-471,447, FILED 11-14-2011.

MARK SHINER, EXAMINING ATTORNEY



*David J. Kybas*

Director of the United States Patent and Trademark Office

# United States of America

United States Patent and Trademark Office

YOUR INSPIRATION. OUR  
KNOW-HOW.

**Reg. No. 4,274,268**

ACE HARDWARE CORPORATION (DELAWARE CORPORATION)  
2200 KENSINGTON COURT  
OAK BROOK, IL 60523

**Registered Jan. 15, 2013**

**Int. Cl.: 2**

FOR: INTERIOR AND EXTERIOR LATEX AND OIL-BASED PAINTS, PRIMERS, STAINS FOR WOOD, METAL AND CONCRETE, PAINT THINNERS, VARNISHES AND LACQUERS, IN CLASS 2 (U.S. CLS. 6, 11 AND 16).

**TRADEMARK**

FIRST USE 9-1-2011; IN COMMERCE 9-1-2011.

**PRINCIPAL REGISTER**

THE MARK CONSISTS OF STANDARD CHARACTERS WITHOUT CLAIM TO ANY PARTICULAR FONT, STYLE, SIZE, OR COLOR.

SER. NO. 85-471,578, FILED 11-14-2011.

KATHLEEN LORENZO, EXAMINING ATTORNEY



*David J. Kyffers*

Director of the United States Patent and Trademark Office

# United States of America

United States Patent and Trademark Office



**Reg. No. 4,274,269**

**Registered Jan. 15, 2013**

**Int. Cl.: 45**

**SERVICE MARK**

**PRINCIPAL REGISTER**

MORGAN, LEWIS & BOCKIUS LLP (PENNSYLVANIA LIMITED LIABILITY PARTNERSHIP)  
1701 MARKET STREET  
PHILADELPHIA, PA 19103

FOR: PROVIDING AN ON-LINE INTERACTIVE DATABASE FEATURING LEGAL INFORMATION, IN CLASS 45 (U.S. CLS. 100 AND 101).

FIRST USE 8-4-2011; IN COMMERCE 8-4-2011.

THE MARK CONSISTS OF A LOWERCASE LETTER "E" APPEARING BELOW A DESIGN MADE UP OF TWO LEAVES.

SER. NO. 85-471,776, FILED 11-14-2011.

KIMBERLY FRYE, EXAMINING ATTORNEY



*David J. Kybas*

Director of the United States Patent and Trademark Office

# United States of America

United States Patent and Trademark Office

# WHITNEY

**Reg. No. 4,274,270**

**Registered Jan. 15, 2013**

**Int. Cl.: 41**

**SERVICE MARK**

**PRINCIPAL REGISTER**

GOOFBALL, INC. (CALIFORNIA CORPORATION)  
C/O KARL AUSTEN JACKOWAY TYERMAN ET. AL.  
1925 CENTURY PARK EAST, 22ND FLOOR  
LOS ANGELES, CA 90067

FOR: ENTERTAINMENT SERVICES IN THE NATURE OF A TELEVISION SERIES FEATURING SITUATION COMEDY; ENTERTAINMENT SERVICES IN THE NATURE OF LIVE COMEDY PERFORMANCES, PROVISION VIA A VIDEO-ON-DEMAND SERVICE OF NON-DOWNLOADABLE TELEVISED AND FILMED COMEDY PERFORMANCES; ACTING SERVICES, IN CLASS 41 (U.S. CLS. 100, 101 AND 107).

FIRST USE 9-22-2011; IN COMMERCE 9-22-2011.

THE MARK CONSISTS OF STANDARD CHARACTERS WITHOUT CLAIM TO ANY PARTICULAR FONT, STYLE, SIZE, OR COLOR.

SER. NO. 85-471,836, FILED 11-14-2011.

BRENDAN REGAN, EXAMINING ATTORNEY



*David J. Kybas*

Director of the United States Patent and Trademark Office

# United States of America

United States Patent and Trademark Office

## WHITNEY CUMMINGS

**Reg. No. 4,274,271**

**Registered Jan. 15, 2013**

**Int. Cl.: 41**

**SERVICE MARK**

**PRINCIPAL REGISTER**

GOOFBALL, INC. (CALIFORNIA CORPORATION)  
1925 CENTURY PARK EAST, 22ND FLOOR  
C/O KARL AUSTEN JACKOWAY TYERMAN ET. AL.  
LOS ANGELES, CA 90067

FOR: ENTERTAINMENT SERVICES IN THE NATURE OF LIVE COMEDY PERFORMANCES, PROVISION VIA A VIDEO-ON-DEMAND SERVICE OF NON-DOWNLOADABLE TELEVISED AND FILMED COMEDY PERFORMANCES; ACTING SERVICES; ENTERTAINMENT SERVICES IN THE NATURE OF COMEDY WRITINGS DISTRIBUTED ONLINE, IN CLASS 41 (U.S. CLS. 100, 101 AND 107).

FIRST USE 6-0-2005; IN COMMERCE 6-0-2005.

THE MARK CONSISTS OF STANDARD CHARACTERS WITHOUT CLAIM TO ANY PARTICULAR FONT, STYLE, SIZE, OR COLOR.

THE NAME(S), PORTRAIT(S), AND/OR SIGNATURE(S) SHOWN IN THE MARK IDENTIFIES A LIVING INDIVIDUAL, WHOSE CONSENT(S) TO REGISTER IS MADE OF RECORD.

SER. NO. 85-471,838, FILED 11-14-2011.

BRENDAN REGAN, EXAMINING ATTORNEY



*David J. Kyffers*

Director of the United States Patent and Trademark Office

# United States of America

United States Patent and Trademark Office

## THE PROFESSIONAL TEAMWORK SYSTEM

**Reg. No. 4,274,272**

**Registered Jan. 15, 2013**

**Int. Cl.: 36**

**SERVICE MARK**

**PRINCIPAL REGISTER**

R. W. ROGE & COMPANY, INC. (NEW YORK CORPORATION)  
630 JOHNSON AVENUE, SUITE 103  
BOHEMIA, NY 11716

FOR: FINANCIAL INVESTMENT AND MANAGEMENT SERVICES, NAMELY, MULTI-DISCIPLINE FINANCIAL COORDINATION SERVICES IN THE NATURE OF FINANCIAL ADVICE, FINANCIAL INVESTMENT, FINANCIAL RETIREMENT PLANNING, AND FINANCIAL RISK MANAGEMENT, IN CLASS 36 (U.S. CLS. 100, 101 AND 102).

FIRST USE 8-14-2003; IN COMMERCE 8-14-2003.

THE MARK CONSISTS OF STANDARD CHARACTERS WITHOUT CLAIM TO ANY PARTICULAR FONT, STYLE, SIZE, OR COLOR.

OWNER OF U.S. REG. NO. 3,091,696.

SEC. 2(F).

SER. NO. 85-471,955, FILED 11-14-2011.

DAVID TAYLOR, EXAMINING ATTORNEY



*David J. Kyfos*

Director of the United States Patent and Trademark Office



# United States of America

United States Patent and Trademark Office

# COVERMATE

**Reg. No. 4,274,273**

LEISURE CONCEPTS, INC. (WASHINGTON CORPORATION)  
5342 N. FLORIDA ST.  
SPOKANE, WA 99217

**Registered Jan. 15, 2013**

**Int. Cl.: 11**

FOR: FITTED INSULATED SPA COVERS AND LIFTING FRAMES FOR FITTED SPA COVERS, IN CLASS 11 (U.S. CLS. 13, 21, 23, 31 AND 34).

**TRADEMARK**

FIRST USE 11-1-1997; IN COMMERCE 11-1-1997.

**PRINCIPAL REGISTER**

THE MARK CONSISTS OF STANDARD CHARACTERS WITHOUT CLAIM TO ANY PARTICULAR FONT, STYLE, SIZE, OR COLOR.

SER. NO. 85-472,244, FILED 11-14-2011.

AHSEN KHAN, EXAMINING ATTORNEY



*David J. Kyffers*

Director of the United States Patent and Trademark Office

# United States of America

United States Patent and Trademark Office



**Reg. No. 4,274,274**

BRONSON HEALTHCARE GROUP, INC. (MICHIGAN CORPORATION)  
301 JOHN STREET  
KALAMAZOO, MI 49007

**Registered Jan. 15, 2013**

**Int. Cl.: 44**

FOR: MEDICAL AND HEALTH CARE SERVICES FOR CHILDREN, IN CLASS 44 (U.S. CLS. 100 AND 101).

**SERVICE MARK**

FIRST USE 10-2-2011; IN COMMERCE 10-2-2011.

**PRINCIPAL REGISTER**

OWNER OF U.S. REG. NOS. 2,959,776 AND 3,461,344.

NO CLAIM IS MADE TO THE EXCLUSIVE RIGHT TO USE "CHILDREN'S HOSPITAL", APART FROM THE MARK AS SHOWN.

THE MARK CONSISTS OF THE WORD "BRONSON" ABOVE THE WORD "CHILDREN'S" ABOVE THE WORD "HOSPITAL". THE LETTER "I" IN THE WORD "CHILDREN'S" IS A STYLIZED FLOWER.

SER. NO. 85-473,033, FILED 11-15-2011.

MAYUR VAGHANI, EXAMINING ATTORNEY



*David J. Kyjars*

Director of the United States Patent and Trademark Office

# United States of America

United States Patent and Trademark Office



**Reg. No. 4,274,275**

**Registered Jan. 15, 2013**

**Int. Cl.: 33**

**TRADEMARK**

**PRINCIPAL REGISTER**

WORLD ELITE SPIRITS (GEORGIA LIMITED LIABILITY COMPANY)  
200 BUCKNELL CT. SW, SUITE B  
ATLANTA, GA 30336

FOR: VODKA, IN CLASS 33 (U.S. CLS. 47 AND 49).

FIRST USE 11-1-2011; IN COMMERCE 11-1-2011.

NO CLAIM IS MADE TO THE EXCLUSIVE RIGHT TO USE "THE ORIGINAL PLATINUM FILTERED VODKA", APART FROM THE MARK AS SHOWN.

THE STIPLING IS A FEATURE OF THE MARK AND DOES NOT INDICATE COLOR.

THE MARK CONSISTS OF WORDING "PLATINKA THE ORIGINAL PLATINUM FILTERED VODKA" AND THE ADDITIONAL WORDING "PLATINUM", "PT", AND NUMBERS "78" AND "195.06". APPEARING ON THE FRONT OF THE BOTTLE, THE WORD "PLATINKA" IS DISPLAYED ABOVE THE PHRASE "THE ORIGINAL", ABOVE THE WORDING "PLATINUM FILTERED", ABOVE THE WORD "VODKA". THROUGH A CLEAR RECTANGULAR PORTION OF THE BOTTLE, FIVE PERIODIC TABLE ELEMENTS APPEAR ON THE INTERIOR BACK OF THE BOTTLE. THE CLEAR PORTION OF THE BOTTLE IS BOUNDED ON THE TOP AND BOTTOM BY TWO HORIZONTAL BANDS WHICH TRAVEL THE CIRCUMFERENCE OF THE BOTTLE. EACH PERIODIC TABLE CONTAINS THE TEXT "PT", "PLATINUM", "78" AND "195.06". A SIXTH PERIODIC TABLE APPEARS IN THE CENTER, FRONT OF THE BOTTLE, AND ALSO CONTAINS THE TEXT "PT", "PLATINUM", "78" AND "195.06".

THE WORDING "PLATINKA" HAS NO MEANING IN A FOREIGN LANGUAGE.

SER. NO. 85-473,605, FILED 11-15-2011.

LAURA KOVALSKY, EXAMINING ATTORNEY



*David J. Kyros*

Director of the United States Patent and Trademark Office

# United States of America

United States Patent and Trademark Office

# HOLYCOM

**Reg. No. 4,274,276**

**Registered Jan. 15, 2013**

**Int. Cl.: 9**

**TRADEMARK**

**PRINCIPAL REGISTER**

LI YAO (CHINA INDIVIDUAL)  
RM305?BLD2,2ND WEST DISTRICT OF HUAGONG  
NO.381, WUSHAN ROAD, TIANHE DISTRICT  
GUANGZHOU GUANGDONG, CHINA

FOR: ACOUSTIC COUPLERS; COAXIAL CABLES; COMMUNICATION HUBS; COMPUTER PERIPHERAL DEVICES; ELECTRIC CABLES; ELECTRIC CONNECTIONS AND CONNECTORS; ELECTRIC CONNECTORS; ELECTRIC JUNCTION BOXES; ELECTRICAL PLUGS AND SOCKETS; FIBER OPTIC CABLES; INSULATED COPPER ELECTRICAL WIRE; JUNCTION SLEEVES FOR ELECTRIC CABLES; TELEPHONE WIRES, IN CLASS 9 (U.S. CLS. 21, 23, 26, 36 AND 38).

FIRST USE 10-12-2009; IN COMMERCE 11-12-2010.

THE MARK CONSISTS OF THE TERM "HOLYCOM" WITH THE FIRST "O" SLIGHTLY THINNER THAN A REGULAR "O" AND THE SECOND "O" WITH INWARD CONCENTRIC SHADED CIRCLES AND FLAT SIDES ALL AROUND.

THE WORDING "HOLYCOM" HAS NO MEANING IN A FOREIGN LANGUAGE.

SER. NO. 85-473,670, FILED 11-16-2011.

CAROLINE WOOD, EXAMINING ATTORNEY



*David J. Kypos*

Director of the United States Patent and Trademark Office

# United States of America

United States Patent and Trademark Office

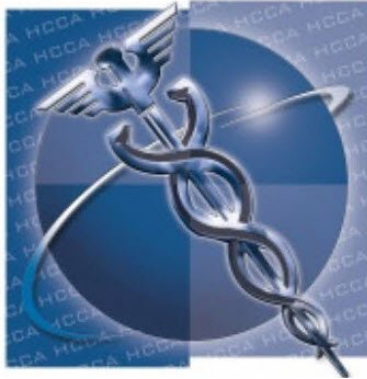

**Reg. No. 4,274,277**

**Registered Jan. 15, 2013**

**Int. Cl.: 35**

**SERVICE MARK**

**PRINCIPAL REGISTER**

THE HEALTH CARE COMPLIANCE ASSOCIATION (PENNSYLVANIA NON-PROFIT CORPORATION), DBA SOCIETY OF CORPORATE COMPLIANCE AND ETHICS  
6500 BARRIE ROAD, SUITE 250  
MINNEAPOLIS, MN 55435

FOR: ASSOCIATION SERVICES, NAMELY, PROMOTING THE INTERESTS OF HEALTH CARE COMPLIANCE PROFESSIONALS, IN CLASS 35 (U.S. CLS. 100, 101 AND 102).

FIRST USE 6-0-2003; IN COMMERCE 6-0-2003.

OWNER OF U.S. REG. NO. 3,635,336.

THE COLOR(S) DARK BLUE AND LIGHT BLUE IS/ARE CLAIMED AS A FEATURE OF THE MARK.

NO CLAIM IS MADE TO THE EXCLUSIVE RIGHT TO USE DESIGN, SYMBOL OR CONFIGURATION OF CADUCEUS, APART FROM THE MARK AS SHOWN.

THE MARK CONSISTS OF A DIVIDED BOX WITH DARK BLUE ON THE LEFT AND LIGHT BLUE ON THE RIGHT WITH A WATERMARKED BACKGROUND CONTAINING THE REPEATED LETTERS "HCCA". THE BOX CONTAINS A RINGED SPHERE DIVIDED INTO FOUR EQUAL PARTS, WITH TWO DARK BLUE SECTIONS AND TWO LIGHT BLUE SECTIONS. A BLUE MEDICAL SYMBOL SLANTING TO THE LEFT IS IN THE CENTER OF THE SPHERE.

SER. NO. 85-473,829, FILED 11-16-2011.

ZACHARY BELLO, EXAMINING ATTORNEY



*David J. Kyffers*

Director of the United States Patent and Trademark Office

# United States of America

United States Patent and Trademark Office



**Reg. No. 4,274,278**

**Registered Jan. 15, 2013**

**Int. Cl.: 35**

**SERVICE MARK**

**PRINCIPAL REGISTER**

THE HEALTH CARE COMPLIANCE ASSOCIATION (PENNSYLVANIA NON-PROFIT CORPORATION), DBA SOCIETY OF CORPORATE COMPLIANCE AND ETHICS  
6500 BARRIE ROAD, SUITE 250  
MINNEAPOLIS, MN 55435

FOR: ASSOCIATION SERVICES, NAMELY, PROMOTING THE INTERESTS OF HEALTH CARE COMPLIANCE PROFESSIONALS, IN CLASS 35 (U.S. CLS. 100, 101 AND 102).

FIRST USE 6-0-2003; IN COMMERCE 6-0-2003.

OWNER OF U.S. REG. NO. 3,635,336.

NO CLAIM IS MADE TO THE EXCLUSIVE RIGHT TO USE DESIGN, SYMBOL OR CONFIGURATION OF CADUCEUS, APART FROM THE MARK AS SHOWN.

THE MARK CONSISTS OF A DIVIDED BOX WITH A WATERMARKED BACKGROUND CONTAINING THE REPEATED LETTERS "HCCA". THE BOX CONTAINS A RINGED SPHERE DIVIDED INTO FOUR EQUAL PARTS. A MEDICAL SYMBOL SLANTING TO THE LEFT IS IN THE CENTER OF THE SPHERE.

SER. NO. 85-473,839, FILED 11-16-2011.

ZACHARY BELLO, EXAMINING ATTORNEY



*David J. Kybas*

Director of the United States Patent and Trademark Office

# United States of America

United States Patent and Trademark Office



## Educando a América

Escuela de Español

**Reg. No. 4,274,279**

**Registered Jan. 15, 2013**

**Int. Cl.: 41**

**SERVICE MARK**

**PRINCIPAL REGISTER**

EDUCANDO A AMERICA, LLC (FLORIDA LIMITED LIABILITY COMPANY), DBA  
EDUCANDO A AMÉRICA  
1562 NW 168 AVE  
PEMBROKE PINES, FL 33028

FOR: SPANISH LANGUAGE LEARNING AFTER SCHOOL PROGRAM FOR CHILDREN  
BETWEEN 3 AND 17 YEARS OLD, IN CLASS 41 (U.S. CLS. 100, 101 AND 107).

FIRST USE 9-17-2004; IN COMMERCE 9-17-2004.

NO CLAIM IS MADE TO THE EXCLUSIVE RIGHT TO USE "EDUCANDO A AMÉRICA"  
AND "ESCUELA DE ESPAÑOL", APART FROM THE MARK AS SHOWN.

THE COLOR(S) YELLOW, RED, BLACK AND WHITE IS/ARE CLAIMED AS A FEATURE  
OF THE MARK.

THE MARK CONSISTS OF AN IMAGE OF A YELLOW BRIDGE. ON THE TOP OF THE  
BRIDGE ON A RED BACKGROUND APPEARS THE LATIN WORDS "PER ARDUA AD  
ASTRA" IN WHITE. AT THE BOTTOM OF THE BRIDGE THERE ARE TWO LETTERS "EA"  
IN WHITE OVER A RED SURFACE. AT THE RIGHT OF THIS IMAGE DISPLAYS THE NAME  
"EDUCANDO A AMÉRICA" IN BLACK AND BELOW "ESCUELA DE ESPAÑOL" IN BLACK.  
THE WHITE AREA IN THE ARCH AND SIDES OF THE BRIDGE IS TRANSPARENT AREA.

THE ENGLISH TRANSLATION OF "EDUCANDO A AMÉRICA", "ESCUELA DE ESPAÑOL"  
AND "PER ARDUA AD ASTRA" IN THE MARK IS "EDUCATING AMERICA", "SPANISH  
SCHOOL", AND "IT IS THROUGH HARDSHIP THAT WE REACH THE STARS".

SER. NO. 85-473,922, FILED 11-16-2011.

KATHLEEN M. VANSTON, EXAMINING ATTORNEY



*David J. Kybas*

Director of the United States Patent and Trademark Office

# United States of America

United States Patent and Trademark Office



**Reg. No. 4,274,280**

**Registered Jan. 15, 2013**

**Int. Cl.: 28**

**TRADEMARK**

**PRINCIPAL REGISTER**

HUTCHISON, MICHAEL C. (UNITED STATES INDIVIDUAL)  
3927 VILLAGE CIRCLE DR  
TRAVERSE CITY, MI 496863985

FOR: A MANDIBULAR ATHLETIC MOUTH GUARD, IN CLASS 28 (U.S. CLS. 22, 23, 38 AND 50).

FIRST USE 6-1-2011; IN COMMERCE 6-1-2011.

OWNER OF U.S. REG. NO. 4,045,815.

THE MARK CONSISTS OF A CAPITAL "P" AND A PLUS SIGN INSIDE A CIRCLE BROKEN IN TO FOUR QUARTERS.

SER. NO. 85-474,058, FILED 11-16-2011.

RUSS HERMAN, EXAMINING ATTORNEY



*David J. Kyffers*

Director of the United States Patent and Trademark Office



# United States of America

United States Patent and Trademark Office



**Reg. No. 4,274,281**

**Registered Jan. 15, 2013**

**Int. Cls.: 29 and 30**

**TRADEMARK**

**PRINCIPAL REGISTER**

CHAN, YEE HUNG DEBBY (UNITED STATES INDIVIDUAL)  
APT 18J  
280 PARK AVENUE SOUTH  
NEW YORK, NY 10010

FOR: PROCESSED MEAT, SEAFOOD, POULTRY OR VEGETABLES; SAUSAGES; FROZEN MEALS CONTAINING PROCESSED MEAT, SEAFOOD, POULTRY OR VEGETABLES; SOUP, IN CLASS 29 (U.S. CL. 46).

FIRST USE 6-29-2012; IN COMMERCE 6-29-2012.

FOR: FROZEN DIM SUMS CONTAINING PROCESSED MEATS, SEAFOOD, POULTRY OR VEGETABLES ENROBED IN WHEAT OR RICE FLOUR WRAPPINGS; DUMPLINGS; FROZEN BUNS, BREAD, ROLLS ALL CONTAINING PROCESSED MEAT, SEAFOOD, POULTRY OR VEGETABLES, IN CLASS 30 (U.S. CL. 46).

FIRST USE 6-29-2012; IN COMMERCE 6-29-2012.

THE MARK CONSISTS OF A ROUND BLUE TRIANGLE OUTLINED IN WHITE IN WHICH THERE IS A YELLOW SUN MOTIF SURROUNDED BY THE THREE STARS IN YELLOW. UNDERNEATH THE TRIANGLE, THE LITERAL ELEMENT "BINONDO" APPEARS IN RED. THE LITERAL ELEMENT IS CAPITALIZED AND ITALICIZED. IT IS ALSO OUTLINED IN BLUE AND WHITE.

THE COLOR(S) BLUE, YELLOW, WHITE AND RED IS/ARE CLAIMED AS A FEATURE OF THE MARK.

THE WORDING "BINONDO" HAS NO MEANING IN A FOREIGN LANGUAGE.

SER. NO. 85-474,544, FILED 11-16-2011.

LINDA ESTRADA, EXAMINING ATTORNEY



*David J. Kyffers*

Director of the United States Patent and Trademark Office

# United States of America

United States Patent and Trademark Office

## IF NOT, Y NOT?

**Reg. No. 4,274,282**

**Registered Jan. 15, 2013**

**Int. Cls.: 31 and 35**

**TRADEMARK**

**SERVICE MARK**

**PRINCIPAL REGISTER**

TAGAWA GREENHOUSE ENTERPRISES, LLC (COLORADO LIMITED LIABILITY COMPANY)  
17999 WELD COUNTY ROAD 4  
BRIGHTON, CO 80601

FOR: LIVING PLANTS; LIVE FLOWERING PLANTS; LIVE FLOWER OR PLANT ARRANGEMENTS; TOPSOIL; FRESH FRUITS AND VEGETABLES; UNPROCESSED NUTS, IN CLASS 31 (U.S. CLS. 1 AND 46).

FIRST USE 3-14-2012; IN COMMERCE 3-14-2012.

FOR: RETAIL STORE SERVICES FEATURING SOILS, MULCHES, GARDENING TOOLS, CLOTHING FOR GARDENING, STATUARY FOR YARDS AND GARDENS, FOUNTAINS FOR YARDS AND GARDENS, WIND CHIMES, BIRD HOUSES AND BIRD FEEDERS, PLANT AND FLOWER CONTAINERS, YARD AND GARDEN CHEMICALS, FERTILIZERS, POWER EQUIPMENT, IRRIGATION EQUIPMENT, AND GARDENING EQUIPMENT, WATER FEATURES, PONDS, POOLS, PAVING STONES, FURNITURE FOR YARDS, GARDENS AND PATIOS, PUBLICATIONS AND PRINTED MATERIALS, FOODS AND FOOD PRODUCTS, IN CLASS 35 (U.S. CLS. 100, 101 AND 102).

FIRST USE 3-14-2012; IN COMMERCE 3-14-2012.

THE MARK CONSISTS OF STANDARD CHARACTERS WITHOUT CLAIM TO ANY PARTICULAR FONT, STYLE, SIZE, OR COLOR.

SER. NO. 85-474,658, FILED 11-16-2011.

ELI HELLMAN, EXAMINING ATTORNEY



*David J. Kypos*

Director of the United States Patent and Trademark Office

# United States of America

United States Patent and Trademark Office



**Reg. No. 4,274,283**

BRISCOE, BRAD (UNITED STATES INDIVIDUAL)  
137 COPPERSMITH CT.  
ST. CHARLES, MO 63301

**Registered Jan. 15, 2013**

**Int. Cl.: 35**

FOR: ADVERTISING AND PUBLICITY SERVICES, NAMELY, PROMOTING THE GOODS, SERVICES, BRAND IDENTITY AND COMMERCIAL INFORMATION AND NEWS OF THIRD PARTIES THROUGH PRINT, AUDIO, VIDEO, DIGITAL AND ON-LINE MEDIUM, IN CLASS 35 (U.S. CLS. 100, 101 AND 102).

**SERVICE MARK**

**PRINCIPAL REGISTER**

FIRST USE 2-28-2010; IN COMMERCE 2-28-2010.

NO CLAIM IS MADE TO THE EXCLUSIVE RIGHT TO USE "MEDIA", APART FROM THE MARK AS SHOWN.

THE COLOR(S) BLACK, WHITE, BLUE, GREEN, AND GRAY IS/ARE CLAIMED AS A FEATURE OF THE MARK.

THE NAME "BRAD" IDENTIFIES "BRAD BRISCOE", A LIVING INDIVIDUAL WHOSE CONSENT TO REGISTER IS OF RECORD.

THE MARK CONSISTS OF THE WORDING "BRADMADMEDIA" WHERE THE WORDS "BRAD" AND "MEDIA" ARE WHITE WITH GRAY OUTLINING AND RECESSED GRAY SHADING AND THE WORDING "MAD" IS WHITE WITH GREEN OUTLINING AND GRAY RECESSED SHADING. BELOW IS THE WORDING "MAD MEDIA FUN" IN GREEN. TO THE LEFT OF THE RECTANGLE IS A STYLIZED GRAY LETTER "B" APPEARING INSIDE A BLUE CIRCLE OUTLINED IN BLACK, WHITE AND BLUE.



SER. NO. 85-474,899, FILED 11-17-2011.

LINDA LAVACHE, EXAMINING ATTORNEY

*David J. Kyjars*

Director of the United States Patent and Trademark Office

# United States of America

United States Patent and Trademark Office

潭 興

**Reg. No. 4,274,284**

**Registered Jan. 15, 2013**

**Int. Cl.: 7**

**TRADEMARK**

**PRINCIPAL REGISTER**

WEI, WU-HSIUNG (TAIWAN INDIVIDUAL)  
NO. 26, LANE 131  
SANHE ROAD, SHENGANG DISTRICT  
TAICHUNG CITY, TAIWAN

FOR: METAL WORKING MACHINES; MACHINE TOOL HOLDERS; CHUCKS FOR POWER DRILLS; SERVO DRIVE TURRETS FOR MOTORS; ROTARY GRINDING MACHINES; CNC TILTING ROTARY TABLES FOR THE PURPOSE OF METAL CUTTING; CNC MANUAL TILTING ROTARY GRINDING MACHINES, ROTARY BRUSHES, AND ROTARY PUMPS; GEARS FOR MACHINES; GEAR LEVER KNOBS FOR MACHINES; MACHINE PARTS, NAMELY, GEAR DRIVES; TRANSMISSION GEARS FOR MACHINES; METAL WORKING MACHINES, NAMELY, MACHINING CENTERS; BORING MACHINES; MILLING MACHINES; LATHES, IN CLASS 7 (U.S. CLS. 13, 19, 21, 23, 31, 34 AND 35).

FIRST USE 7-24-1996; IN COMMERCE 5-19-2011.

THE MARK CONSISTS OF THE CHINESE CHARACTERS "TAN" AND "XING".

THE NON-LATIN CHARACTERS IN THE MARK TRANSLITERATE TO "TAN" AND "XING" AND THIS HAS NO MEANING IN A FOREIGN LANGUAGE.

SER. NO. 85-475,040, FILED 11-17-2011.

JENNIFER DIXON, EXAMINING ATTORNEY



*David J. Kybas*

Director of the United States Patent and Trademark Office

# United States of America

United States Patent and Trademark Office

# TANSHING

**Reg. No. 4,274,285**

**Registered Jan. 15, 2013**

**Int. Cl.: 7**

**TRADEMARK**

**PRINCIPAL REGISTER**

WEI, WU-HSIUNG (TAIWAN INDIVIDUAL)  
NO. 26, LANE 131  
SANHE ROAD, SHENGANG DISTRICT  
TAICHUNG CITY, TAIWAN

FOR: METAL WORKING MACHINES; MACHINE TOOL HOLDERS; CHUCKS FOR POWER DRILLS; SERVO DRIVE TURRETS FOR MOTORS; ROTARY GRINDING MACHINES; CNC TILTING ROTARY TABLES FOR THE PURPOSE OF METAL CUTTING; CNC MANUAL TILTING ROTARY GRINDING MACHINES, ROTARY BRUSHES, AND ROTARY PUMPS; GEARS FOR MACHINES; GEAR LEVER KNOBS FOR MACHINES; MACHINE PARTS, NAMELY, GEAR DRIVES; TRANSMISSION GEARS FOR MACHINES; METAL WORKING MACHINES, NAMELY, MACHINING CENTERS; BORING MACHINES; MILLING MACHINES; LATHES, IN CLASS 7 (U.S. CLS. 13, 19, 21, 23, 31, 34 AND 35).

FIRST USE 7-24-1996; IN COMMERCE 5-19-2011.

THE MARK CONSISTS OF STANDARD CHARACTERS WITHOUT CLAIM TO ANY PARTICULAR FONT, STYLE, SIZE, OR COLOR.

THE WORDING "TANSHING" HAS NO MEANING IN A FOREIGN LANGUAGE.

SER. NO. 85-475,041, FILED 11-17-2011.

JENNIFER DIXON, EXAMINING ATTORNEY



*David J. Kybas*

Director of the United States Patent and Trademark Office

# United States of America

United States Patent and Trademark Office

## "TANKS" FOR YOUR FRIENDSHIP!

**Reg. No. 4,274,286**

**Registered Jan. 15, 2013**

**Int. Cls.: 28 and 35**

**TRADEMARK**

**SERVICE MARK**

**PRINCIPAL REGISTER**

TEDDY TANK TECHNOLOGY, LLC (FLORIDA LIMITED LIABILITY COMPANY)  
21110 BISCAYNE BOULEVARD, SUITE 312  
AVENTURA, FL 33180

FOR: STUFFED TOY ANIMAL FIGURES CONTAINING VIEWABLE ENCLOSURES, IN CLASS 28 (U.S. CLS. 22, 23, 38 AND 50).

FIRST USE 8-27-2011; IN COMMERCE 8-27-2011.

FOR: ONLINE RETAIL STORE SERVICES FEATURING STUFFED ANIMAL FIGURES CONTAINING VIEWABLE ENCLOSURES, IN CLASS 35 (U.S. CLS. 100, 101 AND 102).

FIRST USE 8-27-2011; IN COMMERCE 8-27-2011.

THE MARK CONSISTS OF STANDARD CHARACTERS WITHOUT CLAIM TO ANY PARTICULAR FONT, STYLE, SIZE, OR COLOR.

SER. NO. 85-475,281, FILED 11-17-2011.

JANICE KIM, EXAMINING ATTORNEY



*David J. Kyros*

Director of the United States Patent and Trademark Office

# United States of America

United States Patent and Trademark Office

## WOMEN'S HEALTH ANNUAL VISIT

**Reg. No. 4,274,287**

**Registered Jan. 15, 2013**

**Int. Cl.: 41**

**SERVICE MARK**

**PRINCIPAL REGISTER**

US HEALTHCONNECT, INC. (PENNSYLVANIA CORPORATION)  
SUITE 300  
500 OFFICE CENTER DRIVE  
FORT WASHINGTON, PA 19034

FOR: PROVIDING CONTINUING MEDICAL EDUCATION COURSES, IN CLASS 41 (U.S. CLS. 100, 101 AND 107).

FIRST USE 10-1-2004; IN COMMERCE 10-1-2004.

THE MARK CONSISTS OF STANDARD CHARACTERS WITHOUT CLAIM TO ANY PARTICULAR FONT, STYLE, SIZE, OR COLOR.

OWNER OF U.S. REG. NO. 3,150,805.

NO CLAIM IS MADE TO THE EXCLUSIVE RIGHT TO USE "WOMEN'S HEALTH", APART FROM THE MARK AS SHOWN.

SEC. 2(F).

SER. NO. 85-475,536, FILED 11-17-2011.

EDWARD FENNESSY, EXAMINING ATTORNEY



*David J. Kybas*

Director of the United States Patent and Trademark Office

# United States of America

United States Patent and Trademark Office



**Reg. No. 4,274,288**

**Registered Jan. 15, 2013**

**Int. Cls.: 6, 22 and 35**

**TRADEMARK**

**SERVICE MARK**

**PRINCIPAL REGISTER**

KOCH INDUSTRIES, INC. (MINNESOTA CORPORATION)  
4200 DAHLBERG DRIVE, SUITE 200  
MINNEAPOLIS, MN 55422

FOR: METAL AND STEEL CHAINS; METAL AND STEEL CHAIN ATTACHMENTS, NAMELY, FASTENERS; WIRE ROPE; WIRE ROPE HARDWARE, NAMELY, METAL CLIPS, METAL THIMBLES, METAL BUTTON STOPS AND SLEEVES, METAL SHACKLES, METAL CABLE BLOCKS, METAL SNATCH BLOCKS; METAL RIGGING HARDWARE, NAMELY, FASTENERS IN THE NATURE OF BOLTS, SNAPS, HOOKS, SWIVELS; METAL BOLT SNAPS; THREE-POINT HITCH HARDWARE FOR TRACTORS, LOAD BINDERS, CABLE PULLERS, IN THE NATURE OF METAL PULLEYS; METAL CABINET HARDWARE, NAMELY, HINGES, DOOR CATCHES, STOPS; MISCELLANEOUS FARM HARDWARE ACCESSORIES, NAMELY, METAL CLEAVISES, METAL HOOKS, METAL BALL LOCK PINS, IN CLASS 6 (U.S. CLS. 2, 12, 13, 14, 23, 25 AND 50).

FIRST USE 0-0-1976; IN COMMERCE 0-0-1976.

FOR: CORDAGE; ROPE; TWINE; TENTS; UNFITTED TARPS FOR POWER MACHINERY, IN CLASS 22 (U.S. CLS. 1, 2, 7, 19, 22, 42 AND 50).

FIRST USE 0-0-1976; IN COMMERCE 0-0-1976.

FOR: WHOLESALE STORE SERVICES FEATURING HARDWARE, NAMELY, HOME IMPROVEMENT HARDWARE AND FARM HARDWARE AND ACCESSORIES, IN CLASS 35 (U.S. CLS. 100, 101 AND 102).

FIRST USE 0-0-1976; IN COMMERCE 0-0-1976.

THE MARK CONSISTS OF THE STYLIZED WORDING "KOCH" IN RED WITH THE UPPER RIGHT HAND SIDE OF THE LETTER "K" EXTENDING AND LEADING TO A RED CIRCLE ABOVE THE LETTER "O" IN "KOCH". WITHIN THE RED CIRCLE APPEAR SIX WHITE CIRCLES AND INSIDE OF THE SIX WHITE CIRCLES APPEAR NUMEROUS CIRCLES OUTLINED IN THE COLOR RED.

THE COLOR(S) RED AND WHITE IS/ARE CLAIMED AS A FEATURE OF THE MARK.

SER. NO. 85-475,556, FILED 11-17-2011.



*David J. Kyffers*

Director of the United States Patent and Trademark Office



**Reg. No. 4,274,288** COURTNEY ALVAREZ, EXAMINING ATTORNEY

# United States of America

United States Patent and Trademark Office

## EZSET

**Reg. No. 4,274,289**

**Registered Jan. 15, 2013**

**Int. Cl.: 6**

**TRADEMARK**

**PRINCIPAL REGISTER**

TONG LUNG METAL INDUSTRY CO., LTD. (TAIWAN CORPORATION)  
NO. 62, CHUNG-HSIAO 1ST ST., HOU-HU LI  
CHIA-YI CITY, TAIWAN

FOR: LOCKS OF METAL OTHER THAN ELECTRIC, METAL LOCKS, DOOR LOCKS MADE OF METAL, DOOR LOCK KEYS MADE OF METAL, METAL SECURITY LOCK CYLINDERS, BLANK KEYS OF METAL, FIRE-INSULATING DOOR LOCKS OF METAL, LOCK CYLINDERS OF METAL, IN CLASS 6 (U.S. CLS. 2, 12, 13, 14, 23, 25 AND 50).

FIRST USE 2-1-1993; IN COMMERCE 2-1-1993.

OWNER OF U.S. REG. NOS. 1,440,423, 3,044,057, AND 3,044,061.

THE MARK CONSISTS OF THE TERMS "EZ SET" IN A STYLIZED FONT.

SEC. 2(F).

SER. NO. 85-476,301, FILED 11-18-2011.

ANTHONY RINKER, EXAMINING ATTORNEY



*David J. Kybas*

Director of the United States Patent and Trademark Office

# United States of America

United States Patent and Trademark Office



**M4SYS**  
C O R P O R A T I O N

**Reg. No. 4,274,290**

**Registered Jan. 15, 2013**

**Int. Cl.: 42**

**SERVICE MARK**

**PRINCIPAL REGISTER**

M4SYS CORPORATION (FLORIDA CORPORATION)  
200 SOUTH ANDREWS AVENUE STE 101  
C/O DUVEKOT CORPORATION  
FORT LAUDERDALE, FL 33301

FOR: SOFTWARE DESIGN AND DEVELOPMENT, IN CLASS 42 (U.S. CLS. 100 AND 101).

FIRST USE 4-25-2011; IN COMMERCE 4-25-2011.

NO CLAIM IS MADE TO THE EXCLUSIVE RIGHT TO USE "CORPORATION", APART FROM THE MARK AS SHOWN.

THE MARK CONSISTS OF "M4SYS CORPORATION" AND DESIGN OF A FULLY SHADED CIRCLE WITH THREE OVERLAPPING OVALS.

SER. NO. 85-476,870, FILED 11-18-2011.

REBECCA SMITH, EXAMINING ATTORNEY



*David J. Kyffers*

Director of the United States Patent and Trademark Office

# United States of America

United States Patent and Trademark Office

## MASSAGING GEL

**Reg. No. 4,274,291**

MSD CONSUMER CARE, INC. (DELAWARE CORPORATION)  
3030 JACKSON AVENUE  
MEMPHIS, TN 38151

**Registered Jan. 15, 2013**

**Int. Cl.: 25**

FOR: INSOLES, BALL OF FOOT CUSHIONS, HEEL CUSHIONS AND HEEL CUPS, IN CLASS 25 (U.S. CLS. 22 AND 39).

**TRADEMARK**

FIRST USE 12-31-2002; IN COMMERCE 12-31-2002.

**PRINCIPAL REGISTER**

THE MARK CONSISTS OF STANDARD CHARACTERS WITHOUT CLAIM TO ANY PARTICULAR FONT, STYLE, SIZE, OR COLOR.

OWNER OF U.S. REG. NOS. 3,366,977 AND 3,917,615.

NO CLAIM IS MADE TO THE EXCLUSIVE RIGHT TO USE "GEL", APART FROM THE MARK AS SHOWN.

SEC. 2(F).

SER. NO. 85-476,882, FILED 11-18-2011.

KHANH LE, EXAMINING ATTORNEY



*David J. Kybas*

Director of the United States Patent and Trademark Office

# United States of America

United States Patent and Trademark Office

## IDEA TO EXIT

**Reg. No. 4,274,292**

**Registered Jan. 15, 2013**

**Int. Cl.: 35**

**SERVICE MARK**

**PRINCIPAL REGISTER**

EGL INTERNATIONAL, LLC (TEXAS LIMITED LIABILITY COMPANY), DBA ENTERPRISE GROUP, LTD.

#2336  
14781 MEMORIAL DRIVE  
HOUSTON, TX 77079

FOR: BUSINESS MANAGEMENT CONSULTING; BUSINESS INFORMATION, IN CLASS 35 (U.S. CLS. 100, 101 AND 102).

FIRST USE 11-1-2011; IN COMMERCE 11-1-2011.

THE MARK CONSISTS OF STANDARD CHARACTERS WITHOUT CLAIM TO ANY PARTICULAR FONT, STYLE, SIZE, OR COLOR.

SER. NO. 85-477,070, FILED 11-19-2011.

ANN E. SAPPENFIELD, EXAMINING ATTORNEY



*David J. Kybas*

Director of the United States Patent and Trademark Office

# United States of America

United States Patent and Trademark Office

## THE BUSINESS JOURNEY

**Reg. No. 4,274,293**

**Registered Jan. 15, 2013**

**Int. Cl.: 35**

**SERVICE MARK**

**PRINCIPAL REGISTER**

EGL INTERNATIONAL, LLC (TEXAS LIMITED LIABILITY COMPANY), DBA ENTERPRISE GROUP, LTD.

#2336  
14781 MEMORIAL DRIVE  
HOUSTON, TX 77079

FOR: BUSINESS MANAGEMENT CONSULTING; BUSINESS INFORMATION, IN CLASS 35 (U.S. CLS. 100, 101 AND 102).

FIRST USE 11-1-2011; IN COMMERCE 11-1-2011.

THE MARK CONSISTS OF STANDARD CHARACTERS WITHOUT CLAIM TO ANY PARTICULAR FONT, STYLE, SIZE, OR COLOR.

NO CLAIM IS MADE TO THE EXCLUSIVE RIGHT TO USE "BUSINESS", APART FROM THE MARK AS SHOWN.

SER. NO. 85-477,071, FILED 11-19-2011.

ANN E. SAPPENFIELD, EXAMINING ATTORNEY



*David J. Kyffers*

Director of the United States Patent and Trademark Office

# United States of America

United States Patent and Trademark Office

## THEEARTHSTORE

**Reg. No. 4,274,294**

**Registered Jan. 15, 2013**

**Int. Cl.: 35**

**SERVICE MARK**

**PRINCIPAL REGISTER**

THE EARTH STORE (VIRGINIA LIMITED LIABILITY COMPANY)  
P.O. BOX 880 544 N. MAIN STREET  
KILMARNOCK, VA 22482

FOR: ON-LINE RETAIL STORE SERVICES AND RETAIL STORE SERVICES FEATURING GRASS SEEDS, FERTILIZERS, LANDSCAPE FABRICS, WEED BARRIER FABRICS, MULCH, COMPOST AND OTHER LANDSCAPE ITEMS, IN CLASS 35 (U.S. CLS. 100, 101 AND 102).

FIRST USE 1-1-2005; IN COMMERCE 1-2-2005.

THE MARK CONSISTS OF STANDARD CHARACTERS WITHOUT CLAIM TO ANY PARTICULAR FONT, STYLE, SIZE, OR COLOR.

SEC. 2(F).

SER. NO. 85-477,105, FILED 11-19-2011.

MATTHEW KLINE, EXAMINING ATTORNEY



*David J. Kyffers*

Director of the United States Patent and Trademark Office

# United States of America

United States Patent and Trademark Office

## MYFREESHOTS.COM

**Reg. No. 4,274,295**

**Registered Jan. 15, 2013**

**Int. Cl.: 38**

**SERVICE MARK**

**PRINCIPAL REGISTER**

SOUTH COAST PHOTOGRAPHIC (CALIFORNIA CORPORATION)  
3071 E. CEENA COURT  
ANAHEIM, CA 92806

FOR: A HIGH SCHOOL MEDIA WEBSITE SERVICE, NAMELY, PROVIDING ONLINE COMPUTER DATABASES AND ONLINE SEARCHABLE DATABASES IN THE FIELD OF TRANSMISSION OF PHOTOGRAPHIC IMAGES CONCERNING HIGH SCHOOL EVENTS AND ACTIVITIES; PEER-TO-PEER PHOTO SHARING SERVICES, NAMELY, ELECTRONIC TRANSMISSION OF DIGITAL PHOTO FILES AMONG REGISTERED INTERNET USERS; PROVIDING ACCESS TO COMPUTER, ELECTRONIC AND ONLINE PHOTOGRAPHIC DATABASES; TELECOMMUNICATIONS SERVICES, NAMELY, ELECTRONIC TRANSMISSION OF PHOTOGRAPHIC DATA; PROVIDING ONLINE COMMUNICATIONS LINKS WHICH TRANSFER WEB SITE USERS TO OTHER LOCAL AND GLOBAL WEB PAGES; PROVISION OF ONLINE FORUMS FOR THE TRANSMISSION OF PHOTOGRAPHIC IMAGES; STREAMING OF VIDEO MATERIALS IN THE NATURE OF ELECTRONIC PHOTOGRAPHS OF HIGH SCHOOL EVENTS, IN CLASS 38 (U.S. CLS. 100, 101 AND 104).

FIRST USE 6-1-2011; IN COMMERCE 6-1-2011.

THE MARK CONSISTS OF STANDARD CHARACTERS WITHOUT CLAIM TO ANY PARTICULAR FONT, STYLE, SIZE, OR COLOR.

SER. NO. 85-477,311, FILED 11-20-2011.

SAMUEL E. SHARPER JR., EXAMINING ATTORNEY



*David J. Kybas*

Director of the United States Patent and Trademark Office



# United States of America

United States Patent and Trademark Office

## Clean Aesthetic

**Reg. No. 4,274,296**

CLEAN AESTHETIC (CALIFORNIA PARTNERSHIP)  
7075 1/2 W. MANCHESTER AVE.  
LOS ANGELES, CA 90045

**Registered Jan. 15, 2013**

**Int. Cl.: 25**

FOR: BELTS FOR CLOTHING; FABRIC BELTS; HATS; HOODED SWEATSHIRTS;  
SWEATERS; SWEATSHIRTS; T-SHIRTS; TANK TOPS; WEARABLE GARMENTS AND  
CLOTHING, NAMELY, SHIRTS, IN CLASS 25 (U.S. CLS. 22 AND 39).

**TRADEMARK**

FIRST USE 3-15-2010; IN COMMERCE 12-10-2010.

**PRINCIPAL REGISTER**

THE MARK CONSISTS OF STANDARD CHARACTERS WITHOUT CLAIM TO ANY PAR-  
TICULAR FONT, STYLE, SIZE, OR COLOR.

SER. NO. 85-477,355, FILED 11-20-2011.

KARANENDRA S. CHHINA, EXAMINING ATTORNEY



*David J. Kyffers*

Director of the United States Patent and Trademark Office

# United States of America

United States Patent and Trademark Office

# Steuben's

**Reg. No. 4,274,297**

STEUBENS INC. (COLORADO CORPORATION), DBA STEUBEN'S, INC.  
523 EAST 17TH AVENUE  
DENVER, CO 80203

**Registered Jan. 15, 2013**

**Int. Cl.: 43**

FOR: RESTAURANT SERVICES, NAMELY, PROVIDING OF FOOD AND BEVERAGES FOR CONSUMPTION ON AND OFF THE PREMISES, IN CLASS 43 (U.S. CLS. 100 AND 101).

**SERVICE MARK**

FIRST USE 6-19-2006; IN COMMERCE 6-19-2006.

**PRINCIPAL REGISTER**

THE MARK CONSISTS OF STANDARD CHARACTERS WITHOUT CLAIM TO ANY PARTICULAR FONT, STYLE, SIZE, OR COLOR.

SEC. 2(F).

SER. NO. 85-478,204, FILED 11-21-2011.

GISELLE AGOSTO, EXAMINING ATTORNEY



*David J. Kyffers*

Director of the United States Patent and Trademark Office

# United States of America

United States Patent and Trademark Office

# DEBO STEP

**Reg. No. 4,274,298**

DEBO, GREGORY F. (UNITED STATES INDIVIDUAL)  
141 SILVER SPRING RD.  
NEW BRIGHTON, PA 15066

**Registered Jan. 15, 2013**

**Int. Cl.: 12**

FOR: STEPS FOR ATTACHMENT TO LAND VEHICLES, IN CLASS 12 (U.S. CLS. 19, 21, 23, 31, 35 AND 44).

**TRADEMARK**

FIRST USE 12-1-2005; IN COMMERCE 12-1-2005.

**PRINCIPAL REGISTER**

THE MARK CONSISTS OF STANDARD CHARACTERS WITHOUT CLAIM TO ANY PARTICULAR FONT, STYLE, SIZE, OR COLOR.

OWNER OF U.S. REG. NO. 3,113,290.

NO CLAIM IS MADE TO THE EXCLUSIVE RIGHT TO USE "STEP", APART FROM THE MARK AS SHOWN.

SEC. 2(F).

SER. NO. 85-478,512, FILED 11-22-2011.

MARILYN IZZI, EXAMINING ATTORNEY



*David J. Kyffers*

Director of the United States Patent and Trademark Office

# United States of America

United States Patent and Trademark Office

## WEST OF OLE ENGLAND

**Reg. No. 4,274,299**

**Registered Jan. 15, 2013**

**Int. Cl.: 25**

**TRADEMARK**

**PRINCIPAL REGISTER**

WEST OF OLE ENGLAND, INC. (FLORIDA CORPORATION)  
650 S. E. MONTEREY ROAD  
STUART, FL 37994

FOR: CLOTHING, NAMELY, SHIRTS, SKIRTS, DRESSES, SWEATERS, SWEATSHIRTS, PANTS, SHORTS, SOCKS, AND UNDERGARMENTS, FOOTWEAR AND HEADWEAR; WESTERN WEAR, NAMELY, JEANS, SHIRTS, SKIRTS, DRESSES, SWEATERS, SWEATSHIRTS, PANTS, SHORTS, SOCKS, AND UNDERGARMENTS, IN CLASS 25 (U.S. CLS. 22 AND 39).

FIRST USE 12-1-1974; IN COMMERCE 12-1-1974.

THE MARK CONSISTS OF STANDARD CHARACTERS WITHOUT CLAIM TO ANY PARTICULAR FONT, STYLE, SIZE, OR COLOR.

SER. NO. 85-478,799, FILED 11-22-2011.

KEVON CHISOLM, EXAMINING ATTORNEY



*David J. Kybas*

Director of the United States Patent and Trademark Office

# United States of America

United States Patent and Trademark Office



**Reg. No. 4,274,300**

**Registered Jan. 15, 2013**

**Int. Cl.: 39**

**SERVICE MARK**

**PRINCIPAL REGISTER**

OMNI AIR INTERNATIONAL (NEVADA CORPORATION)  
3303 NORTH SHERIDAN ROAD, HANGAR 19  
TULSA, OK 74115

FOR: AIR CHARTER TRANSPORTATION SERVICES; AIR TRANSPORT SERVICES, IN CLASS 39 (U.S. CLS. 100 AND 105).

FIRST USE 4-14-2011; IN COMMERCE 4-14-2011.

THE MARK CONSISTS OF A GOLDEN EAGLE IMAGE. THE STYLIZED WORDING "PATRIOT TEAM" IS IN GOLD AND IS TO THE RIGHT OF THE EAGLE IMAGE. THE COLORS BLACK AND WHITE REPRESENT BACKGROUND, OUTLINING, SHADING AND/OR TRANSPARENT AREAS AND ARE NOT PART OF THE MARK.

THE COLOR(S) GOLD IS/ARE CLAIMED AS A FEATURE OF THE MARK.

SER. NO. 85-479,101, FILED 11-22-2011.

TASNEEM HUSSAIN, EXAMINING ATTORNEY



*David J. Kybas*

Director of the United States Patent and Trademark Office

# United States of America

United States Patent and Trademark Office

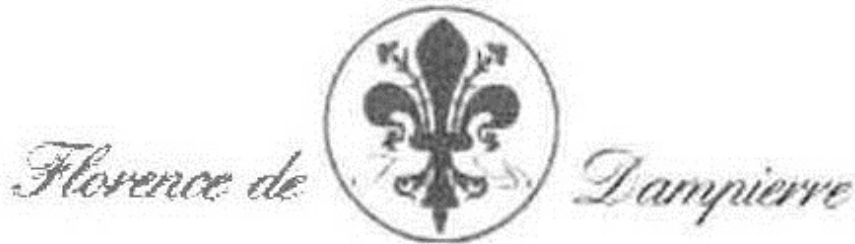

**Reg. No. 4,274,301**

**Registered Jan. 15, 2013**

**Int. Cl.: 20**

**TRADEMARK**

**PRINCIPAL REGISTER**

FLORENCE DE DAMPIERRE DESIGN LLC (CONNECTICUT LIMITED LIABILITY COMPANY)  
158 NORTH STREET  
LITCHFIELD, CT 06759

FOR: BED FRAMES; BEDROOM STORAGE, NAMELY, BUREAUS, CHESTS, STORAGE BENCHES, TABLES, WARDROBES, DRESSING TABLES AND CABINETS; DINING FURNITURE, NAMELY, TABLES, CHAIRS, CABINETS, SERVING STANDS IN THE NATURE OF ROLLING TEA CARTS, ROLLING SIDE BOARDS AND LIQUOR CABINETS FEATURING WHEELS, WORK ISLANDS IN THE NATURE OF CENTER TABLES; CONSOLE TABLES; OCCASIONAL FURNITURE, NAMELY, MEDIA CONSOLE TABLES AND MEDIA CABINETS; COFFEE TABLES; SIDE TABLES; BOOKCASES; DESKS; UPHOLSTERED FURNITURE, NAMELY, SOFAS, LOUNGE CHAIRS, CHAISE LOUNGES, OTTOMANS, CHAIRS, SETTEES AND LOVESEATS; PILLOWS AND MIRRORS, IN CLASS 20 (U.S. CLS. 2, 13, 22, 25, 32 AND 50).

FIRST USE 4-19-2012; IN COMMERCE 4-19-2012.

THE NAME "FLORENCE DE DAMPIERRE" IDENTIFIES A LIVING INDIVIDUAL WHOSE CONSENT IS OF RECORD.

THE MARK CONSISTS OF THE NAME "FLORENCE DE DAMPIERRE" WITH A FLEUR DE LYS IN A CIRCLE BETWEEN THE WORDS "DE" AND "DAMPIERRE".

SER. NO. 85-479,212, FILED 11-22-2011.

DORITT L. CARROLL, EXAMINING ATTORNEY



*David J. Kybas*

Director of the United States Patent and Trademark Office

# United States of America

United States Patent and Trademark Office

## BE AN ACTUARY.

**Reg. No. 4,274,302**

**Registered Jan. 15, 2013**

**Int. Cls.: 16 and 36**

**TRADEMARK**

**SERVICE MARK**

**PRINCIPAL REGISTER**

SOCIETY OF ACTUARIES (ILLINOIS CORPORATION)  
475 NORTH MARTINGALE RD., SUITE 600  
SCHAUMBURG, IL 60173 AND

CASUALTY ACTUARIAL SOCIETY (ILLINOIS CORPORATION)  
4350 N. FAIRFAX DRIVE, SUITE 250  
ARLINGTON, VA 22203

FOR: PRINTED MATERIALS, NAMELY, INFORMATIONAL BROCHURES, PRINTED INFORMATIONAL MATERIALS AND POSTER BOARDS, ALL IN THE FIELD OF ACTUARIAL SCIENCE, IN CLASS 16 (U.S. CLS. 2, 5, 22, 23, 29, 37, 38 AND 50).

FIRST USE 10-31-1999; IN COMMERCE 10-31-1999.

FOR: PROVIDING A WEBSITE FEATURING INFORMATION IN THE FIELD OF ACTUARIAL SCIENCE, IN CLASS 36 (U.S. CLS. 100, 101 AND 102).

FIRST USE 10-31-1999; IN COMMERCE 10-31-1999.

THE MARK CONSISTS OF STANDARD CHARACTERS WITHOUT CLAIM TO ANY PARTICULAR FONT, STYLE, SIZE, OR COLOR.

SER. NO. 85-479,264, FILED 11-22-2011.

JOHN GARTNER, EXAMINING ATTORNEY



*David J. Kyffers*

Director of the United States Patent and Trademark Office

# United States of America

United States Patent and Trademark Office

## GEMINI TWINSEAM

**Reg. No. 4,274,303**

**Registered Jan. 15, 2013**

**Int. Cl.: 25**

**TRADEMARK**

**PRINCIPAL REGISTER**

P.O.S. ENTERPRISES (TENNESSEE PARTNERSHIP)  
13 CAMELBACK COURT  
BRENTWOOD, TN 37027

FOR: CLOTHING, NAMELY, JEANS, JACKETS AND SHIRTS, IN CLASS 25 (U.S. CLS. 22 AND 39).

FIRST USE 9-22-2011; IN COMMERCE 9-22-2011.

THE MARK CONSISTS OF STANDARD CHARACTERS WITHOUT CLAIM TO ANY PARTICULAR FONT, STYLE, SIZE, OR COLOR.

SER. NO. 85-479,370, FILED 11-22-2011.

AMY KELLY, EXAMINING ATTORNEY



*David J. Kyffers*

Director of the United States Patent and Trademark Office



# United States of America

United States Patent and Trademark Office

## LifeScience Logistics

**Reg. No. 4,274,304**

**Registered Jan. 15, 2013**

**Int. Cls.: 35 and 39**

**SERVICE MARK**

**PRINCIPAL REGISTER**

LIFE SCIENCE LOGISTICS, LLC (FLORIDA LIMITED LIABILITY COMPANY)  
2600 REGENT BOULEVARD  
DWF AIRPORT, TX 75261

FOR: SUPPLY CHAIN LOGISTICS MANAGEMENT FOR OTHERS IN THE FIELD OF HEALTHCARE PRODUCTS; ORDER FULFILLMENT SERVICES; OPERATING A DISTRIBUTION CENTER AND WAREHOUSE FACILITY FOR STORING AND DISTRIBUTING HEALTHCARE PRODUCTS; BUSINESS SERVICES, NAMELY, FREIGHT INFORMATION MANAGEMENT SERVICES, SHIPMENT PROCESSING, PREPARING SHIPPING DOCUMENTS AND INVOICES, TRACKING DOCUMENTS, PACKAGES AND FREIGHT OVER COMPUTER NETWORKS, INTRANETS, INTERNETS, BY TELEPHONE AND BY FACSIMILE; INFORMATION MANAGEMENT SERVICES, NAMELY, SHIPMENT PROCESSING, PREPARING SHIPPING DOCUMENTS AND INVOICES, TRACKING DOCUMENTS, PACKAGES AND FREIGHT OVER COMPUTER NETWORKS, INTRANETS, INTERNETS, BY TELEPHONE AND BY FACSIMILE; ORDER TO CASH SERVICES, NAMELY, SHIPMENT PROCESSING, PREPARING SHIPPING DOCUMENTS AND INVOICES, TRACKING DOCUMENTS, PACKAGES AND FREIGHT OVER COMPUTER NETWORKS, INTRANETS, INTERNETS, BY TELEPHONE AND BY FACSIMILE, IN CLASS 35 (U.S. CLS. 100, 101 AND 102).

FIRST USE 9-15-2006; IN COMMERCE 9-15-2006.

FOR: SUPPLY CHAIN LOGISTICS AND REVERSE LOGISTICS SERVICES, NAMELY, STORAGE, TRANSPORTATION AND DELIVERY OF GOODS FOR OTHERS BY AIR, RAIL, SHIP, OR TRUCK, IN CLASS 39 (U.S. CLS. 100 AND 105).

FIRST USE 1-22-2007; IN COMMERCE 1-22-2007.

THE MARK CONSISTS OF STANDARD CHARACTERS WITHOUT CLAIM TO ANY PARTICULAR FONT, STYLE, SIZE, OR COLOR.

OWNER OF U.S. REG. NO. 3,322,034.

NO CLAIM IS MADE TO THE EXCLUSIVE RIGHT TO USE "LOGISTICS", APART FROM THE MARK AS SHOWN.

SEC. 2(F).



*David J. Kyjars*

Director of the United States Patent and Trademark Office

**Reg. No. 4,274,304** SER. NO. 85-480,081, FILED 11-23-2011.

DAVID TAYLOR, EXAMINING ATTORNEY

# United States of America

United States Patent and Trademark Office



**LifeScience  
Logistics**

**Reg. No. 4,274,305**

**Registered Jan. 15, 2013**

**Int. Cls.: 35 and 39**

**SERVICE MARK**

**PRINCIPAL REGISTER**

LIFE SCIENCE LOGISTICS, LLC (FLORIDA LIMITED LIABILITY COMPANY)  
2600 REGENT BOULEVARD  
DWF AIRPORT, TX 75261

FOR: SUPPLY CHAIN LOGISTICS MANAGEMENT FOR OTHERS IN THE FIELD OF HEALTHCARE PRODUCTS; ORDER FULFILLMENT SERVICES; OPERATING A DISTRIBUTION CENTER AND WAREHOUSE FACILITY FOR STORING AND DISTRIBUTING HEALTHCARE PRODUCTS; BUSINESS SERVICES, NAMELY, FREIGHT INFORMATION MANAGEMENT SERVICES, SHIPMENT PROCESSING, PREPARING SHIPPING DOCUMENTS AND INVOICES, TRACKING DOCUMENTS, PACKAGES AND FREIGHT OVER COMPUTER NETWORKS, INTRANETS, INTERNETS, BY TELEPHONE AND BY FACSIMILE; INFORMATION MANAGEMENT SERVICES, NAMELY, SHIPMENT PROCESSING, PREPARING SHIPPING DOCUMENTS AND INVOICES, TRACKING DOCUMENTS, PACKAGES AND FREIGHT OVER COMPUTER NETWORKS, INTRANETS, INTERNETS, BY TELEPHONE AND BY FACSIMILE; ORDER TO CASH SERVICES, NAMELY, SHIPMENT PROCESSING, PREPARING SHIPPING DOCUMENTS AND INVOICES, TRACKING DOCUMENTS, PACKAGES AND FREIGHT OVER COMPUTER NETWORKS, INTRANETS, INTERNETS, BY TELEPHONE AND BY FACSIMILE, IN CLASS 35 (U.S. CLS. 100, 101 AND 102).

FIRST USE 9-15-2006; IN COMMERCE 9-15-2006.

FOR: SUPPLY CHAIN LOGISTICS AND REVERSE LOGISTICS SERVICES, NAMELY, STORAGE, TRANSPORTATION AND DELIVERY OF GOODS FOR OTHERS BY AIR, RAIL, SHIP, OR TRUCK, IN CLASS 39 (U.S. CLS. 100 AND 105).

FIRST USE 1-22-2007; IN COMMERCE 1-22-2007.

OWNER OF U.S. REG. NO. 3,322,034.

NO CLAIM IS MADE TO THE EXCLUSIVE RIGHT TO USE "LOGISTICS", APART FROM THE MARK AS SHOWN.

THE MARK CONSISTS OF THE WORDING "LIFESCIENCE LOGISTICS" ADJACENT TO A DESIGN COMPONENT COMPRISING A GEOMETRIC DESIGN.

SEC. 2(F) AS TO "LIFESCIENCE".



*David J. Kappas*

Director of the United States Patent and Trademark Office

**Reg. No. 4,274,305** SER. NO. 85-480,113, FILED 11-23-2011.

DAVID TAYLOR, EXAMINING ATTORNEY

# United States of America

United States Patent and Trademark Office

## BABES AT THE MUSEUM

**Reg. No. 4,274,306**

AARONSON, XAVIER (UNITED STATES INDIVIDUAL)  
325 RIVERSIDE DRIVE, APT. 101  
NEW YORK, NY 10025

**Registered Jan. 15, 2013**

**Int. Cl.: 25**

FOR: SHORT-SLEEVED AND LONG-SLEEVED T-SHIRTS; T-SHIRTS, IN CLASS 25 (U.S. CLS. 22 AND 39).

**TRADEMARK**

FIRST USE 4-23-2011; IN COMMERCE 10-1-2011.

**PRINCIPAL REGISTER**

THE MARK CONSISTS OF STANDARD CHARACTERS WITHOUT CLAIM TO ANY PARTICULAR FONT, STYLE, SIZE, OR COLOR.

SER. NO. 85-480,445, FILED 11-23-2011.

FONG HSU, EXAMINING ATTORNEY



*David J. Kybas*

Director of the United States Patent and Trademark Office

# United States of America

United States Patent and Trademark Office

# Martorano's

**Reg. No. 4,274,307**

CM TRADEMARK HOLDINGS II, INC. (FLORIDA CORPORATION)  
3031 NE 42ND STREET

**Registered Jan. 15, 2013**

FORT LAUDERDALE, FL 33308

**Int. Cl.: 41**

FOR: ENTERTAINMENT SERVICES, NAMELY, PROVIDING A WEB SITE FEATURING PHOTOGRAPHIC, VIDEO AND PROSE PRESENTATIONS FEATURING ENTERTAINMENT AND INFORMATION ABOUT FOOD AND COOKING, IN CLASS 41 (U.S. CLS. 100, 101 AND 107).

**SERVICE MARK**

**PRINCIPAL REGISTER**

FIRST USE 10-1-2011; IN COMMERCE 10-1-2011.

THE MARK CONSISTS OF STANDARD CHARACTERS WITHOUT CLAIM TO ANY PARTICULAR FONT, STYLE, SIZE, OR COLOR.

OWNER OF U.S. REG. NOS. 3,279,213 AND 3,289,724.

SEC. 2(F).

SER. NO. 85-480,595, FILED 11-23-2011.

THEODORE MCBRIDE, EXAMINING ATTORNEY



*David J. Kyffers*

Director of the United States Patent and Trademark Office

# United States of America

United States Patent and Trademark Office

## OPTION ALPHA

**Reg. No. 4,274,308**

DU PLESSIS, KIRK (UNITED STATES INDIVIDUAL)  
631 CONSTELLATION SQUARE SE UNIT L  
LEESBURG, VA 20175

**Registered Jan. 15, 2013**

**Int. Cl.: 36**

FOR: PROVIDING A WEB SITE FEATURING EDUCATIONAL INFORMATION IN THE FIELD OF EQUITY TRADING AND THE STOCK MARKET, IN CLASS 36 (U.S. CLS. 100, 101 AND 102).

**SERVICE MARK**

FIRST USE 11-2-2010; IN COMMERCE 11-8-2010.

**PRINCIPAL REGISTER**

THE MARK CONSISTS OF STANDARD CHARACTERS WITHOUT CLAIM TO ANY PARTICULAR FONT, STYLE, SIZE, OR COLOR.

NO CLAIM IS MADE TO THE EXCLUSIVE RIGHT TO USE "OPTION", APART FROM THE MARK AS SHOWN.

SER. NO. 85-480,638, FILED 11-24-2011.

JOHN WILKE, EXAMINING ATTORNEY



*David J. Kyffers*

Director of the United States Patent and Trademark Office

# United States of America

United States Patent and Trademark Office



**Reg. No. 4,274,309**

**Registered Jan. 15, 2013**

**Int. Cl.: 41**

**SERVICE MARK**

**PRINCIPAL REGISTER**

PRAXIS HISPANIA, S.L. (SPAIN SOCIEDAD DE RESPONSABILIDAD LIMITADA (SL))  
AVENIDA DE FELIPE II, 1  
EL ESCORIAL (MADRID), SPAIN 28280

FOR: ENTERTAINMENT AND EDUCATIONAL SERVICES IN THE NATURE OF COMPETITIONS IN THE FIELD OF ENTERTAINMENT, EDUCATION, CULTURE, SPORTS, AND OTHER NON-BUSINESS AND NON-COMMERCIAL FIELDS; ARRANGING AND CONDUCTING EDUCATIONAL CONFERENCES, SEMINARS, WORKSHOPS AND CONGRESSES IN THE FIELD OF BUSINESS ADMINISTRATION; ORGANIZING AND ARRANGING EXHIBITIONS FOR CULTURAL, EDUCATIONAL OR ENTERTAINMENT PURPOSES, IN CLASS 41 (U.S. CLS. 100, 101 AND 107).

OWNER OF SPAIN REG. NO. 2985688, DATED 10-4-2011, EXPIRES 5-31-2021.

THE COLOR(S) BLUE AND RED IS/ARE CLAIMED AS A FEATURE OF THE MARK.

NO CLAIM IS MADE TO THE EXCLUSIVE RIGHT TO USE "YOUNG BUSINESS TALENTS", APART FROM THE MARK AS SHOWN.

THE MARK CONSISTS OF THE WORDING "YOUNG BUSINESS TALENTS" DISPLAYED IN BLUE WITH THE WORDS STACKED VERTICALLY AND STAGGERED AND THE WORD "BUSINESS" IN BOLD TYPE FONT, A LINE EXTENDING HORIZONTALLY FROM THE WORD "YOUNG" AND ENDING WITH A RED RECTANGLE, AND A RED 5-SIDED RIBBON ADJACENT THE TERMS "BUSINESS" AND "TALENTS" AND BELOW THE LINE AND RED RECTANGLE.

SER. NO. 85-481,493, FILED 11-28-2011.

ROBERT C. CLARK JR., EXAMINING ATTORNEY



*David J. Kyros*

Director of the United States Patent and Trademark Office



# United States of America

United States Patent and Trademark Office

# IACET

The Standard for Lifelong Learning

**Reg. No. 4,274,310**

**Registered Jan. 15, 2013**

**Int. Cl.: 35**

**SERVICE MARK**

**PRINCIPAL REGISTER**

INTERNATIONAL ASSOCIATION FOR CONTINUING EDUCATION AND TRAINING  
(NORTH CAROLINA NON-PROFIT ASSOCIATION)

SUITE 500  
1760 OLD MEADOW ROAD  
MCLEAN, VA 22102

FOR: ASSOCIATION SERVICES, NAMELY, PROMOTION OF CONTINUING EDUCATION STANDARDS IN THE FIELDS OF INDUSTRIAL AND PROFESSIONAL SERVICES, IN CLASS 35 (U.S. CLS. 100, 101 AND 102).

FIRST USE 1-31-2008; IN COMMERCE 1-31-2008.

OWNER OF U.S. REG. NOS. 2,643,244 AND 3,577,650.

THE MARK CONSISTS OF THE LETTERS "IACET" WITH A GLOBE INSIDE THE "C", AND THE WORDS "THE STANDARD FOR LIFELONG LEARNING" UNDERNEATH THE LETTERS "IACET".

SER. NO. 85-481,527, FILED 11-28-2011.

BARBARA BROWN, EXAMINING ATTORNEY



*David J. Kyffers*

Director of the United States Patent and Trademark Office

# United States of America

United States Patent and Trademark Office

# WIREWAX

**Reg. No. 4,274,311**

**Registered Jan. 15, 2013**

**Int. Cls.: 9, 38, 41 and 42**

**TRADEMARK**

**SERVICE MARK**

**PRINCIPAL REGISTER**

WIREWAX LIMITED (ENGLAND COMPANY)  
STUDIO 54  
CLINK STREET STUDIOS, ONE CLINK STREET  
LONDON, ENGLAND SE19DG

FOR: APPARATUS FOR RECORDING, TRANSMISSION OR REPRODUCTION OF SOUND OR IMAGES; AUTOMATIC VENDING MACHINES AND MECHANISMS FOR COIN-OPERATED APPARATUS; CASH REGISTERS, CALCULATING MACHINES, DATA PROCESSING EQUIPMENT AND COMPUTERS; FIRE-EXTINGUISHING APPARATUS; COMPUTER SOFTWARE FOR EDITING VIDEO AND OTHER ELECTRONIC MEDIA; SOFTWARE FOR ENABLING UPLOADING, TAGGING, SHARING, EDITING AND BROADCASTING OF VIDEO AND OTHER ELECTRONIC MEDIA; FACE RECOGNITION SOFTWARE; SOFTWARE, NAMELY, OBJECT RECOGNITION SOFTWARE; COMPUTER SOFTWARE THAT ALLOWS THE USER TO ELECTRONICALLY TAG PERSONS OR OBJECTS IN A VIDEO AND OTHER ELECTRONIC MEDIA AND ALLOWS THE USER TO TRACK THE TAGGED PERSONS OR OBJECTS ACTIONS OR MOVEMENTS THROUGH THE VIDEO AND OTHER ELECTRONIC MEDIA; COMPUTER SOFTWARE THAT ALLOWS THE USER TO ELECTRONICALLY TAG PERSONS OR OBJECTS IN A VIDEO OR OTHER ELECTRONIC MEDIA AND INTERACT WITH THE PERSONS OR OBJECTS THAT ARE TAGGED; COMPUTER SOFTWARE THAT ALLOWS THE USER TO ELECTRONICALLY TAG PERSONS OR OBJECTS IN A VIDEO OR OTHER ELECTRONIC MEDIA AND TO ADD, EDIT, AND DELETE TAGS; SOFTWARE THAT ALLOWS THE USERS TO ADD OR DELETE INFORMATION, IMAGES, EXTERNAL LINKS AND APPLICATIONS; SOFTWARE THAT ALLOWS USERS TO SHARE AND EMBED VIDEOS AND OTHER ELECTRONIC MEDIA ACROSS SOCIAL MEDIA, WEBSITES AND BLOGS, IN CLASS 9 (U.S. CLS. 21, 23, 26, 36 AND 38).



*David J. Kyjars*

Director of the United States Patent and Trademark Office

FOR: TELECOMMUNICATIONS, NAMELY, TRANSMISSION OF VOICE, DATA, GRAPHICS, IMAGES, AUDIO AND VIDEO BY MEANS OF TELECOMMUNICATIONS NETWORKS, WIRELESS COMMUNICATION NETWORKS, AND THE INTERNET; TRANSMISSION OF ELECTRONIC MEDIA, NAMELY, ELECTRONIC TRANSMISSION OF MESSAGES AND DATA; BROADCASTING SERVICES, NAMELY, BROADCASTING OF VIDEOS, STREAMING VIDEOS, AND OTHER ELECTRONIC MEDIA BY MEANS OF TELECOMMUNICATIONS NETWORKS, WIRELESS COMMUNICATION NETWORKS, AND THE INTERNET; PROVISION OF ACCESS TO ELECTRONIC MEDIA, NAMELY, PROVIDING MULTIPLE-USER ACCESS TO A GLOBAL COMPUTER INFORMATION NETWORK; INFORMATION, ADVISORY AND CONSULTANCY SERVICES RELATING TO THE AFORESAID, NAMELY, TELECOMMUNICATIONS CONSULTATION, IN CLASS 38 (U.S. CLS. 100, 101 AND 104).

**Reg. No. 4,274,311** FOR: EDUCATION, NAMELY, PROVIDING CLASSES, SEMINARS, WORKSHOPS IN THE FIELD OF COMPUTER SOFTWARE FOR EDITING VIDEO AND OTHER ELECTRONIC MEDIA AND SOFTWARE FOR ENABLING UPLOADING, TAGGING, SHARING, EDITING AND BROADCASTING OF VIDEOS AND OTHER ELECTRONIC MEDIA; PROVIDING OF TRAINING SERVICES IN THE FIELD OF COMPUTER SOFTWARE FOR EDITING VIDEO AND OTHER ELECTRONIC MEDIA AND SOFTWARE FOR ENABLING, UPLOADING, TAGGING, SHARING, EDITING AND BROADCASTING OF VIDEO AND OTHER ELECTRONIC MEDIA; SPORTING AND CULTURAL ACTIVITIES, NAMELY, ORGANIZING COMMUNITY SPORTING AND CULTURAL EVENTS; VIDEO EDITING AND ONLINE VIDEO EDITING; ELECTRONIC MULTI-MEDIA EDITING SERVICES IN THE NATURE OF VIDEO EDITING AND ONLINE VIDEO EDITING; ENTERTAINMENT AND EDUCATIONAL SERVICES PROVIDED ON-LINE AND FEATURING MULTI-MEDIA CONTENT, NAMELY, PROVIDING NON-DOWNLOADABLE VIDEOS TO TEACH A USER HOW TO ELECTRONICALLY TAG PERSONS OR OBJECTS IN THE VIDEO AND OTHER ELECTRONIC MEDIA AND ALLOW THE USER TO TRACK THE TAGGED PERSONS OR OBJECTS ACTIONS OR MOVEMENTS; PROVIDING EDUCATION COURSES IN THE FIELD OF COMPUTERS OFFERED THROUGH ONLINE, NON-DOWNLOADABLE VIDEOS THAT ALLOW THE USER TO LEARN HOW TO ELECTRONICALLY TAG PERSONS OR OBJECTS IN VIDEOS AND OTHER ELECTRONIC MEDIA AND INTERACT WITH THE PERSONS OR OBJECTS THAT ARE TAGGED, IN CLASS 41 (U.S. CLS. 100, 101 AND 107).

FOR: WEB SITE HOSTING SERVICES; PROVIDING INFORMATION IN THE FIELDS OF TECHNOLOGY AND SOFTWARE DEVELOPMENT VIA AN ON-LINE WEBSITE, NAMELY, PROVIDING INFORMATION ON-LINE ABOUT VIDEOS AND OTHER ELECTRONIC MEDIA THAT CAN BE UPLOADED, TAGGED, SHARED, EDITED AND BROADCAST ACROSS SOCIAL MEDIA, WEBSITES AND BLOGS; PROVIDING A WEBSITE FEATURING NON-DOWNLOADABLE SOFTWARE THAT ENABLES USERS TO UPLOAD, TAG, SHARE AND EDIT VIDEOS AND OTHER ELECTRONIC MEDIA AND TO BROADCAST THE VIDEOS AND OTHER ELECTRONIC MEDIA ACROSS SOCIAL MEDIA, WEBSITES AND BLOGS; PROVIDING TEMPORARY USE OF ONLINE NON-DOWNLOADABLE COMPUTER SOFTWARE FOR EDITING VIDEO; PROVIDING TEMPORARY USE OF ONLINE NON-DOWNLOADABLE COMPUTER SOFTWARE FOR ENABLING UPLOADING, TAGGING, SHARING, EDITING AND BROADCASTING OF VIDEO AND OTHER ELECTRONIC MEDIA; TECHNICAL INFORMATION, ADVISORY AND CONSULTANCY SERVICES IN THE FIELD OF INFORMATION TECHNOLOGY AND SPECIFICALLY RELATING TO ENABLING, UPLOADING, TAGGING, SHARING, EDITING AND BROADCASTING OF VIDEOS AND OTHER ELECTRONIC MEDIA; PROVIDING COMPUTER SOFTWARE INFORMATION, ADVISORY AND CONSULTANCY SERVICES RELATING TO FACE RECOGNITION AND OBJECT RECOGNITION SOFTWARE, IN CLASS 42 (U.S. CLS. 100 AND 101).

THE MARK CONSISTS OF STANDARD CHARACTERS WITHOUT CLAIM TO ANY PARTICULAR FONT, STYLE, SIZE, OR COLOR.

OWNER OF ERPN CMNTY TM OFC REG. NO. 009316738, DATED 3-11-2011, EXPIRES 8-16-2020.

SER. NO. 85-481,544, FILED 11-28-2011.

MARCIE MILONE, EXAMINING ATTORNEY

# United States of America

United States Patent and Trademark Office

## LIGHT & MOTION

**Reg. No. 4,274,312**

LIGHT & MOTION INDUSTRIES (CALIFORNIA CORPORATION)  
300 CANNERY ROW  
MONTEREY, CA 93940

**Registered Jan. 15, 2013**

**Int. Cls.: 9 and 11**

FOR: LIGHTS FOR USE WITH UNDERWATER STILL AND VIDEO CAMERAS; UNDERWATER CAMERA HOUSINGS, IN CLASS 9 (U.S. CLS. 21, 23, 26, 36 AND 38).

**TRADEMARK**

FIRST USE 1-1-1990; IN COMMERCE 1-1-1990.

**PRINCIPAL REGISTER**

FOR: BICYCLE LIGHTS; DIVING LIGHTS, IN CLASS 11 (U.S. CLS. 13, 21, 23, 31 AND 34).

FIRST USE 1-1-1990; IN COMMERCE 1-1-1990.

THE MARK CONSISTS OF STANDARD CHARACTERS WITHOUT CLAIM TO ANY PARTICULAR FONT, STYLE, SIZE, OR COLOR.

NO CLAIM IS MADE TO THE EXCLUSIVE RIGHT TO USE "LIGHT", APART FROM THE MARK AS SHOWN.

SER. NO. 85-481,751, FILED 11-28-2011.

IRA J. GOODSaid, EXAMINING ATTORNEY



*David J. Kyffers*

Director of the United States Patent and Trademark Office

# United States of America

United States Patent and Trademark Office

## The Meeting Department

**Reg. No. 4,274,313**

**Registered Jan. 15, 2013**

**Int. Cl.: 35**

**SERVICE MARK**

**PRINCIPAL REGISTER**

THE MEETING DEPARTMENT LLC (TEXAS LIMITED LIABILITY COMPANY), DBA THE MEETING DEPARTMENT  
10151 FAIRCREST DR  
DALLAS, TX 752381609

FOR: ARRANGING AND CONDUCTING BUSINESS CONFERENCES; ARRANGING AND CONDUCTING OF FAIRS AND EXHIBITIONS FOR BUSINESS AND ADVERTISING PURPOSES; ARRANGING AND CONDUCTING SPECIAL EVENTS FOR BUSINESS PURPOSES; BUSINESS ADVICE AND ANALYSIS OF MARKETS; BUSINESS ADVISORY SERVICES, NAMELY, SEARCH FOR AND SELECTION OF THE BEST POTENTIAL SUPPLIERS FOR OTHERS; BUSINESS CONSULTING SERVICES IN THE FIELD OF BUSINESS CONFERENCES AND SPECIAL EVENTS; BUSINESS MEETING PLANNING; EVENT PLANNING AND MANAGEMENT FOR MARKETING, BRANDING, PROMOTING OR ADVERTISING THE GOODS AND SERVICES OF OTHERS; ORGANISATION OF EXHIBITIONS AND TRADE FAIRS FOR BUSINESS AND PROMOTIONAL PURPOSES; ORGANIZATION OF BUSINESS CONVENTIONS; ORGANIZING, PROMOTING AND CONDUCTING EXHIBITIONS, TRADESHOWS AND EVENTS FOR BUSINESS PURPOSES; SPECIAL EVENT PLANNING FOR BUSINESS PURPOSES; SPECIAL EVENT PLANNING FOR COMMERCIAL, PROMOTIONAL OR ADVERTISING PURPOSES, IN CLASS 35 (U.S. CLS. 100, 101 AND 102).

FIRST USE 8-31-2007; IN COMMERCE 8-31-2007.

THE MARK CONSISTS OF STANDARD CHARACTERS WITHOUT CLAIM TO ANY PARTICULAR FONT, STYLE, SIZE, OR COLOR.

NO CLAIM IS MADE TO THE EXCLUSIVE RIGHT TO USE "MEETING", APART FROM THE MARK AS SHOWN.

SER. NO. 85-482,043, FILED 11-28-2011.

TARAH HARDY, EXAMINING ATTORNEY



*David J. Kyffers*

Director of the United States Patent and Trademark Office

# United States of America

United States Patent and Trademark Office

# SignaFresh

**Reg. No. 4,274,314**

DOOSAN CORPORATION (REPUBLIC OF KOREA CORPORATION)  
18-12, 6TH ST. ULCHI-RO, CHUNG-GU  
SEOUL, REPUBLIC OF KOREA

**Registered Jan. 15, 2013**

**Int. Cl.: 1**

FOR: FERTILIZERS; PLANT HORMONES FOR HASTING THE RIPENING OF FRUIT; AGRICULTURAL CHEMICALS, EXCEPT FUNGICIDES, WEED KILLERS, HERBICIDES, INSECTICIDES AND PARASITICIDES; PREPARATIONS FOR FORTIFYING PLANTS; PLANT GROWTH REGULATING PREPARATIONS; PLANT GROWTH REGULATORS FOR AGRICULTURAL USE; PREPARATIONS OF TRACE ELEMENTS FOR USE IN REGULATING PLANTS GROWTH; PLANT NUTRITION PREPARATIONS FOR REARING PLANTS; PLANT HORMONES, NAMELY, PHYTOHORMONES; BIOLOGICAL PREPARATIONS FOR USE IN CELL CULTURES OTHER THAN FOR MEDICAL OR VETERINARY PURPOSES, IN CLASS 1 (U.S. CLS. 1, 5, 6, 10, 26 AND 46).

**TRADEMARK**

**PRINCIPAL REGISTER**

THE MARK CONSISTS OF STANDARD CHARACTERS WITHOUT CLAIM TO ANY PARTICULAR FONT, STYLE, SIZE, OR COLOR.

PRIORITY CLAIMED UNDER SEC. 44(D) ON REPUBLIC OF KOREA APPLICATION NO. 2011-0028699, FILED 5-26-2011, REG. NO. 0919016, DATED 5-8-2012, EXPIRES 5-8-2022.

SER. NO. 85-482,136, FILED 11-28-2011.

KELLEY WELLS, EXAMINING ATTORNEY



*David J. Kypos*

Director of the United States Patent and Trademark Office

# United States of America

United States Patent and Trademark Office

## DIGITAL FARM

**Reg. No. 4,274,315**

KUPER COMMUNICATIONS, INC. (WASHINGTON CORPORATION)  
1914 N. 42ND ST.  
SEATTLE, WA 98103

**Registered Jan. 15, 2013**

**Int. Cl.: 41**

FOR: DIGITAL VIDEO PRODUCTION AND CONSULTING; DIGITAL PHOTOGRAPHY SERVICE, IN CLASS 41 (U.S. CLS. 100, 101 AND 107).

**SERVICE MARK**

FIRST USE 9-26-1997; IN COMMERCE 10-1-1997.

**PRINCIPAL REGISTER**

THE MARK CONSISTS OF STANDARD CHARACTERS WITHOUT CLAIM TO ANY PARTICULAR FONT, STYLE, SIZE, OR COLOR.

NO CLAIM IS MADE TO THE EXCLUSIVE RIGHT TO USE "DIGITAL", APART FROM THE MARK AS SHOWN.

SER. NO. 85-482,484, FILED 11-29-2011.

KEVON CHISOLM, EXAMINING ATTORNEY



*David J. Kyffers*

Director of the United States Patent and Trademark Office

# United States of America

United States Patent and Trademark Office

## BUBBLE SAGA

**Reg. No. 4,274,316**

**Registered Jan. 15, 2013**

**Int. Cls.: 9 and 41**

**TRADEMARK**

**SERVICE MARK**

**PRINCIPAL REGISTER**

KING.COM LIMITED (MALTA CORPORATION)  
125/14 THE STRAND  
GZIRA GZR 1027, MALTA

FOR: SCIENTIFIC, NAUTICAL, SURVEYING, PHOTOGRAPHIC, CINEMATOGRAPHIC, OPTICAL, WEIGHING, MEASURING, SIGNALLING, CHECKING (SUPERVISION), LIFE-SAVING AND TEACHING APPARATUS AND INSTRUMENTS, NAMELY, COMPUTER HARDWARE AND PERIPHERALS; APPARATUS AND INSTRUMENTS FOR CONDUCTING, SWITCHING, TRANSFORMING, ACCUMULATING, REGULATING OR CONTROLLING ELECTRICITY, NAMELY, WIRELESS COMPUTER PERIPHERALS; APPARATUS FOR RECORDING, TRANSMISSION OR REPRODUCTION OF SOUND OR IMAGES; BLANK MAGNETIC DATA CARRIERS, BLANK MAGNETIC DATA RECORDING DISCS; COMPACT DISCS, DVDS AND OTHER DIGITAL RECORDING MEDIA FEATURING GAMES; MECHANISMS FOR COIN-OPERATED APPARATUS; CASH REGISTERS, CALCULATING MACHINES, DATA PROCESSING EQUIPMENT, COMPUTERS; COMPUTER SOFTWARE FOR VIDEO AND COMPUTER GAMES; COMPUTER PROGRAMS FOR PRE-RECORDED GAMES; COMPUTER GAMES; COMPUTER GAME SOFTWARE FOR USE ON MOBILE AND CELLULAR PHONES; COMPUTER GAME DISCS; COMPUTER GAME SOFTWARE FOR USE IN CONNECTION WITH COMPUTERS, PERSONAL ELECTRONIC DEVICES, TABLETS AND PHONES; DOWNLOADABLE GAME SOFTWARE; DOWNLOADABLE GAME SOFTWARE VIA A GLOBAL COMPUTER NETWORK AND WIRELESS DEVICES; FIRE EXTINGUISHERS, IN CLASS 9 (U.S. CLS. 21, 23, 26, 36 AND 38).



*David J. Kyffers*

Director of the United States Patent and Trademark Office

FOR: EDUCATIONAL SERVICES, NAMELY, CONDUCTING CLASSES, SEMINARS, WORKSHOPS IN THE FIELD OF COMPUTERS, COMPUTER GAMES; TRAINING IN THE FIELD OF COMPUTERS, COMPUTER GAMES; ENTERTAINMENT, NAMELY, PROVIDING ON-LINE COMPUTER GAMES; ENTERTAINMENT SERVICES, NAMELY, PROVIDING TEMPORARY USE OF NON-DOWNLOADABLE INTERACTIVE GAMES; ENTERTAINMENT SERVICES, NAMELY, PROVIDING TEMPORARY USE OF NON-DOWNLOADABLE ELECTRONIC GAMES; ENTERTAINMENT SERVICES, NAMELY, PROVIDING A WEBSITE FEATURING GAMES AND PUZZLES; ENTERTAINMENT SERVICES, NAMELY, PROVIDING ONLINE VIDEO GAMES; ELECTRONIC GAME SERVICES PROVIDED BY MEANS OF THE INTERNET; ENTERTAINMENT SERVICES, NAMELY, PROVIDING ONLINE GAMES; PROVISION OF INFORMATION RELATING TO ELECTRONIC COMPUTER GAMES PROVIDED VIA THE INTERNET; ORGANIZING COMPUTER GAME COMPETITIONS; ORGANIZING CULTURAL ACTIVITIES, NAMELY, GAME FESTIVALS; PROVISION OF COMPUTER GAMES ON LINE OR BY MEANS OF A GLOBAL COMPUTER NETWORK;



**Reg. No. 4,274,316** PROVIDING INTERACTIVE MULTI-PLAYER COMPUTER GAMES VIA THE INTERNET AND ELECTRONIC COMMUNICATION NETWORKS; MULTIMEDIA PUBLISHING OF COMPUTER GAME SOFTWARE AND VIDEO GAMES SOFTWARE; PROVIDING ON-LINE COMPUTER GAMES; ENTERTAINMENT, NAMELY, PROVIDING ON-LINE COMPUTER GAMES, IN CLASS 41 (U.S. CLS. 100, 101 AND 107).

THE MARK CONSISTS OF STANDARD CHARACTERS WITHOUT CLAIM TO ANY PARTICULAR FONT, STYLE, SIZE, OR COLOR.

PRIORITY CLAIMED UNDER SEC. 44(D) ON ERPN CMNTY TM OFC APPLICATION NO. 010452985, FILED 11-29-2011, REG. NO. 010452985, DATED 5-2-2012, EXPIRES 11-29-2021.

SER. NO. 85-482,741, FILED 11-29-2011.

HOWARD B. LEVINE, EXAMINING ATTORNEY

# United States of America

United States Patent and Trademark Office

## BUBBLE WITCH SAGA

**Reg. No. 4,274,317**

**Registered Jan. 15, 2013**

**Int. Cls.: 9 and 41**

**TRADEMARK**

**SERVICE MARK**

**PRINCIPAL REGISTER**

KING.COM LIMITED (MALTA CORPORATION)  
125/14 THE STRAND  
GZIRA GZR 1027, MALTA

FOR: SCIENTIFIC, NAUTICAL, SURVEYING, PHOTOGRAPHIC, CINEMATOGRAPHIC, OPTICAL, WEIGHING, MEASURING, SIGNALLING, CHECKING (SUPERVISION), LIFE-SAVING AND TEACHING APPARATUS AND INSTRUMENTS, NAMELY, COMPUTER HARDWARE AND PERIPHERALS; APPARATUS AND INSTRUMENTS FOR CONDUCTING, SWITCHING, TRANSFORMING, ACCUMULATING, REGULATING OR CONTROLLING ELECTRICITY, NAMELY, WIRELESS COMPUTER PERIPHERALS; APPARATUS FOR RECORDING, TRANSMISSION OR REPRODUCTION OF SOUND OR IMAGES; BLANK MAGNETIC DATA CARRIERS, BLANK MAGNETIC DATA RECORDING DISCS; COMPACT DISCS, DVDS AND OTHER DIGITAL RECORDING MEDIA FEATURING GAMES; MECHANISMS FOR COIN-OPERATED APPARATUS; CASH REGISTERS, CALCULATING MACHINES, DATA PROCESSING EQUIPMENT, COMPUTERS; COMPUTER SOFTWARE FOR VIDEO AND COMPUTER GAMES; COMPUTER PROGRAMS FOR PRE-RECORDED GAMES; COMPUTER GAMES; COMPUTER GAME SOFTWARE FOR USE ON MOBILE AND CELLULAR PHONES; COMPUTER GAME DISCS; COMPUTER GAME SOFTWARE FOR USE IN CONNECTION WITH COMPUTERS, PERSONAL ELECTRONIC DEVICES, TABLETS AND PHONES; DOWNLOADABLE GAME SOFTWARE; DOWNLOADABLE GAME SOFTWARE VIA A GLOBAL COMPUTER NETWORK AND WIRELESS DEVICES; FIRE EXTINGUISHERS, IN CLASS 9 (U.S. CLS. 21, 23, 26, 36 AND 38).



*David J. Kyffers*

Director of the United States Patent and Trademark Office

FOR: EDUCATIONAL SERVICES, NAMELY, CONDUCTING CLASSES, SEMINARS, WORKSHOPS IN THE FIELD OF COMPUTERS, COMPUTER GAMES; TRAINING IN THE FIELD OF COMPUTERS, COMPUTER GAMES; ENTERTAINMENT, NAMELY, PROVIDING ON-LINE COMPUTER GAMES; ENTERTAINMENT SERVICES, NAMELY, PROVIDING TEMPORARY USE OF NON-DOWNLOADABLE INTERACTIVE GAMES; ENTERTAINMENT SERVICES, NAMELY, PROVIDING TEMPORARY USE OF NON-DOWNLOADABLE ELECTRONIC GAMES; ENTERTAINMENT SERVICES, NAMELY, PROVIDING A WEBSITE FEATURING GAMES AND PUZZLES; ENTERTAINMENT SERVICES, NAMELY, PROVIDING ONLINE VIDEO GAMES; ELECTRONIC GAME SERVICES PROVIDED BY MEANS OF THE INTERNET; ENTERTAINMENT SERVICES, NAMELY, PROVIDING ONLINE GAMES; PROVISION OF INFORMATION RELATING TO ELECTRONIC COMPUTER GAMES PROVIDED VIA THE INTERNET; ORGANIZING COMPUTER GAME COMPETITIONS; ORGANIZING CULTURAL ACTIVITIES, NAMELY, GAME FESTIVALS; PROVISION OF COMPUTER GAMES ON LINE OR BY MEANS OF A GLOBAL COMPUTER NETWORK;

**Reg. No. 4,274,317** PROVIDING INTERACTIVE MULTI-PLAYER COMPUTER GAMES VIA THE INTERNET AND ELECTRONIC COMMUNICATION NETWORKS; MULTIMEDIA PUBLISHING OF COMPUTER GAME SOFTWARE AND VIDEO GAMES SOFTWARE; PROVIDING ON-LINE COMPUTER GAMES; ENTERTAINMENT, NAMELY, PROVIDING ON-LINE COMPUTER GAMES, IN CLASS 41 (U.S. CLS. 100, 101 AND 107).

THE MARK CONSISTS OF STANDARD CHARACTERS WITHOUT CLAIM TO ANY PARTICULAR FONT, STYLE, SIZE, OR COLOR.

PRIORITY CLAIMED UNDER SEC. 44(D) ON ERPN CMNTY TM OFC APPLICATION NO. 010453009, FILED 11-29-2011, REG. NO. 0104530009, DATED 5-2-2012, EXPIRES 11-29-2021.

SER. NO. 85-482,745, FILED 11-29-2011.

HOWARD B. LEVINE, EXAMINING ATTORNEY

# United States of America

United States Patent and Trademark Office

## WINEMASTERS

**Reg. No. 4,274,318**

GENESIS MARKETING CONCEPTS LLC (FLORIDA LIMITED LIABILITY COMPANY)  
PO BOX 2473

**Registered Jan. 15, 2013**

WAYNE, NJ 074742473

**Int. Cl.: 35**

FOR: ON-LINE RETAIL STORE SERVICES FEATURING A WIDE VARIETY OF CONSUMER GOODS OF OTHERS; ON-LINE RETAIL STORE SERVICES FEATURING WINE; RETAIL STORE SERVICES FEATURING FOODS AND BEVERAGES, NAMELY, WINES, SPARKLING WINES AND SPIRITS, IN CLASS 35 (U.S. CLS. 100, 101 AND 102).

**SERVICE MARK**

**PRINCIPAL REGISTER**

FIRST USE 5-15-1996; IN COMMERCE 5-15-1996.

THE MARK CONSISTS OF STANDARD CHARACTERS WITHOUT CLAIM TO ANY PARTICULAR FONT, STYLE, SIZE, OR COLOR.

SER. NO. 85-483,072, FILED 11-29-2011.

ALYSSA STEEL, EXAMINING ATTORNEY



*David J. Kyffers*

Director of the United States Patent and Trademark Office

# United States of America

United States Patent and Trademark Office



**Reg. No. 4,274,319**

**Registered Jan. 15, 2013**

**Int. Cl.: 41**

**SERVICE MARK**

**PRINCIPAL REGISTER**

MARIA FERNANDEZ (UNITED STATES INDIVIDUAL), DBA FOODIEBRAT  
UNIT 7J  
50 BAYARD STREET  
NEW YORK, NY 10013

FOR: PROVIDING A WEBSITE FEATURING BLOGS AND NON-DOWNLOADABLE PUBLICATIONS IN THE NATURE OF ARTICLES, WRITE UPS AND INTERVIEWS WITHIN THE RESTAURANT, BAR AND MIXOLOGY INDUSTRY FOR THE PURPOSES OF EVENT PLANNING IN THE FIELD(S) OF HOSPITALITY, MIXOLOGY, FOOD, DATING AND FASHION, IN CLASS 41 (U.S. CLS. 100, 101 AND 107).

FIRST USE 1-1-2011; IN COMMERCE 1-1-2011.

THE MARK CONSISTS OF FOUR SLEEK LOOKING HIGH BALL GLASSES WITH DECORATIVE COCKTAILS INSIDE OF THEM; THE FIRST ONE, LEFT, IS A CLEAR COCKTAIL WITH ICE CUBES, ONE LIME WEDGE TO THE LEFT WHICH IS YELLOW INSIDE AND HAS A GREEN PEEL AND THERE IS A SPRIG OF GREEN MINT IN THE COCKTAIL AS WELL. IT IS GARNISHED WITH A LIME WEDGE THAT IS YELLOW INSIDE WITH A GREEN PEEL AND THERE IS A LITTLE GREEN MINT LEAF COMING OUT OF THE LIME TO THE RIGHT OF THE COCKTAIL. THE SECOND COCKTAIL IS YELLOW, HAS ICE CUBES IN IT AND THERE IS A GREEN LIME WEDGE RESTING ON TOP OF IT THAT IS YELLOW ON THE INSIDE AND HAS A GREEN PEEL. THE THIRD COCKTAIL CAN BARELY BE SEEN BECAUSE THE LOGO IS COVERING WHAT IS INSIDE OF IT BUT YOU CAN SEE CLEAR LIQUID ON TOP WITH ICE CUBES AND IT IS GARNISHED WITH A BABY RED RADISH WITH THREE SMALL GREEN LEAVES COMING OUT OF THE TOP OF THE RADISH. THE FOURTH COCKTAIL HAS A COUPLE OF GREEN SLICES OF CUCUMBER INSIDE OF IT WITH ICE CUBES AND WHAT LOOKS LIKE RED JUICE, WITH A GREEN LIME WEDGE AND A SMALL GREEN SPRIG OF MINT. IT IS ALSO GARNISHED WITH A RED STRAWBERRY TO THE RIGHT OF IT WITH A GREEN SLICE OF CUCUMBER RIND CIRCLING AROUND THE STRAWBERRY WITH THE THREE SMALL LEAVES COMING OUT OF THE STRAWBERRY. THERE IS A PINK BAR THAT GOES ACROSS THE COCKTAILS WITH THE WORDS "FOODIE BRAT" IN WHITE WRITTEN ACROSS THE PINK BAR. THERE IS A BLACK BAR UNDER THE PINK BAR BUT MORE TO THE RIGHT OF IT WITH THE WORDS: "BOOZE, FOOD, SHOES & DUDES" WRITTEN IN WHITE IN CURSIVE IN THE BLACK BAR IN SMALLER LETTERS.



*David J. Kappas*

Director of the United States Patent and Trademark Office

**Reg. No. 4,274,319** THE COLOR(S) PINK, WHITE, RED, YELLOW, BLACK AND GREEN IS/ARE CLAIMED  
AS A FEATURE OF THE MARK.

SER. NO. 85-483,143, FILED 11-29-2011.

JAY FLOWERS, EXAMINING ATTORNEY

# United States of America

United States Patent and Trademark Office

## TURNSCORPRO

**Reg. No. 4,274,320**

JACKSON, CHRISTOPHER (UNITED STATES INDIVIDUAL)  
16926 DYNAMIC DRIVE  
LAKEVILLE, MN 55122

**Registered Jan. 15, 2013**

**Int. Cl.: 42**

FOR: PROVIDING TEMPORARY USE OF NON-DOWNLOADABLE COMPUTER SOFTWARE, NAMELY, CREDIT MANAGEMENT SOFTWARE FOR GENERATING BUSINESS REFERRALS FROM CLIENTS WHO WISH TO PURCHASE GOODS AND SERVICES FROM BUSINESSES BUT ARE DENIED BECAUSE OF A CREDIT SCORE, IN CLASS 42 (U.S. CLS. 100 AND 101).

**SERVICE MARK**

**PRINCIPAL REGISTER**

FIRST USE 10-31-2011; IN COMMERCE 10-31-2011.

THE MARK CONSISTS OF STANDARD CHARACTERS WITHOUT CLAIM TO ANY PARTICULAR FONT, STYLE, SIZE, OR COLOR.

SER. NO. 85-483,241, FILED 11-30-2011.

SAIMA MAKHDOOM, EXAMINING ATTORNEY



*David J. Kybas*

Director of the United States Patent and Trademark Office

# United States of America

United States Patent and Trademark Office

## CLYDE FRAZIER'S WINE AND DINE

**Reg. No. 4,274,321**

**Registered Jan. 15, 2013**

**Int. Cl.: 43**

**SERVICE MARK**

**PRINCIPAL REGISTER**

CLYDE ARK LLC (DELAWARE LIMITED LIABILITY COMPANY)  
85 FIFTH AVENUE  
NEW YORK, NY 10003

FOR: RESTAURANT SERVICES, IN CLASS 43 (U.S. CLS. 100 AND 101).

FIRST USE 11-15-2011; IN COMMERCE 3-16-2012.

NO CLAIM IS MADE TO THE EXCLUSIVE RIGHT TO USE "WINE AND DINE", APART FROM THE MARK AS SHOWN.

"CLYDE FRAZIER" IDENTIFIES THE NICKNAME/STAGE NAME OF WALTER "FRAZIER", WHOSE CONSENT TO REGISTER IS MADE OF RECORD.

THE MARK CONSISTS OF THE WORDS "CLYDE FRAZIER'S WINE AND DINE".

SER. NO. 85-483,358, FILED 11-30-2011.

MATTHEW PAPPAS, EXAMINING ATTORNEY



*David J. Kyffers*

Director of the United States Patent and Trademark Office



# United States of America

United States Patent and Trademark Office

# 40something

**Reg. No. 4,274,322**

**Registered Jan. 15, 2013**

**Int. Cl.: 16**

**TRADEMARK**

**PRINCIPAL REGISTER**

QUAD INT'L INCORPORATED (FLORIDA CORPORATION)  
1629 NW 84TH AVENUE  
MIAMI, FL 33126

FOR: MAGAZINES FEATURING ADULT CONTENT IN THE NATURE OF ADULT NUDE MODELS FOR ADULT ENTERTAINMENT PURPOSES, IN CLASS 16 (U.S. CLS. 2, 5, 22, 23, 29, 37, 38 AND 50).

FIRST USE 4-1-2003; IN COMMERCE 4-1-2003.

THE MARK CONSISTS OF STANDARD CHARACTERS WITHOUT CLAIM TO ANY PARTICULAR FONT, STYLE, SIZE, OR COLOR.

OWNER OF U.S. REG. NO. 3,063,613.

SEC. 2(F).

SER. NO. 85-483,965, FILED 11-30-2011.

AHSEN KHAN, EXAMINING ATTORNEY



*David J. Kyros*

Director of the United States Patent and Trademark Office

# United States of America

United States Patent and Trademark Office

# WADSON

**Reg. No. 4,274,323**

**Registered Jan. 15, 2013**

**Int. Cl.: 7**

**TRADEMARK**

**PRINCIPAL REGISTER**

WADSON CO., LTD. (TAIWAN LIMITED COMPANY (LTD.))  
1F., NO.32, YINGCAI LANE  
KAIYUAN RD., DAJIA DIST.  
TAICHUNG CITY, TAIWAN

FOR: HAND-HELD TOOLS, OTHER THAN HAND-OPERATED, NAMELY, PNEUMATIC PUMPS; CHUCKS SOLD AS PARTS OF POWER OPERATED MACHINES; CHUCKS FOR MACHINE POWER DRILLS; HAND-HELD TOOLS, OTHER THAN HAND-OPERATED, NAMELY, KITCHEN MIXERS, IN CLASS 7 (U.S. CLS. 13, 19, 21, 23, 31, 34 AND 35).

FIRST USE 7-1-2011; IN COMMERCE 7-1-2011.

THE MARK CONSISTS OF STANDARD CHARACTERS WITHOUT CLAIM TO ANY PARTICULAR FONT, STYLE, SIZE, OR COLOR.

SER. NO. 85-484,042, FILED 11-30-2011.

HANNO RITTNER, EXAMINING ATTORNEY



*David J. Kyfos*

Director of the United States Patent and Trademark Office

# United States of America

United States Patent and Trademark Office

## Bench-to-Barnyard

**Reg. No. 4,274,324**

**Registered Jan. 15, 2013**

**Int. Cl.: 42**

**SERVICE MARK**

**PRINCIPAL REGISTER**

COFACTOR GENOMICS, LLC (MISSOURI LIMITED LIABILITY COMPANY)  
3141 OLIVE STREET  
SAINT LOUIS, MO 63103

FOR: SCIENTIFIC RESEARCH AND TECHNOLOGICAL PLANNING AND CONSULTING SERVICES IN THE FIELDS OF AGRICULTURAL GENETICS, EPIGENETICS AND GENE EXPRESSION ANALYSIS AS RELATED TO AGRICULTURAL SCIENCE AND DIAGNOSTIC RESEARCH; PRODUCT DEVELOPMENT SERVICES, NAMELY, DEVELOPING REAGENTS AND REAGENT KITS FOR USE IN PREPARING, DETECTING, ANALYZING AND SEQUENCING NUCLEIC ACIDS AND OTHER BIOLOGICAL MOLECULES IN THE FIELDS OF AGRICULTURAL SCIENCE AND DIAGNOSTIC RESEARCH; DEVELOPMENT OF COMPUTER HARDWARE AND SOFTWARE SYSTEMS FOR COLLECTING, STORING, ANALYZING AND REPORTING BIOLOGICAL INFORMATION, AND FOR SAMPLE TRACKING AND MANAGING PROJECTS, LABORATORY WORKFLOW AND DATA TO THE ORDER AND SPECIFICATION OF OTHERS, IN THE FIELDS OF AGRICULTURAL SCIENCE AND DIAGNOSTIC RESEARCH; SCIENTIFIC LABORATORY SERVICES, NAMELY, PREPARATION, DETECTION, QUANTIFICATION, AND ANALYSIS OF BIOLOGICAL MATERIAL, FOR GENOTYPING, FOR DIAGNOSTIC ASSAYS, AND FOR CARRYING OUT NUCLEIC ACID SEQUENCING REACTIONS IN THE FIELDS OF AGRICULTURAL SCIENCE AND DIAGNOSTIC RESEARCH; CONSULTANCY, INFORMATION AND ADVISORY SERVICES RELATING TO SCIENTIFIC LABORATORY SERVICES, NAMELY, PREPARATION, DETECTION, QUANTIFICATION, AND ANALYSIS OF BIOLOGICAL MATERIAL, FOR GENOTYPING, FOR DIAGNOSTIC ASSAYS, AND FOR CARRYING OUT NUCLEIC ACID SEQUENCING REACTIONS IN THE FIELDS OF AGRICULTURAL SCIENCE AND DIAGNOSTIC RESEARCH, IN CLASS 42 (U.S. CLS. 100 AND 101).



FIRST USE 11-30-2011; IN COMMERCE 11-30-2011.

THE MARK CONSISTS OF STANDARD CHARACTERS WITHOUT CLAIM TO ANY PARTICULAR FONT, STYLE, SIZE, OR COLOR.

SER. NO. 85-484,176, FILED 11-30-2011.

JOHN SCHUYLER YARD, EXAMINING ATTORNEY

*David J. Kyffers*

Director of the United States Patent and Trademark Office

# United States of America

United States Patent and Trademark Office

# WADSON

**Reg. No. 4,274,325**

**Registered Jan. 15, 2013**

**Int. Cl.: 8**

**TRADEMARK**

**PRINCIPAL REGISTER**

WADSON CO., LTD. (TAIWAN LIMITED COMPANY (LTD.))  
1F., NO.32, YINGCAI LANE,  
KAIYUAN RD., DAJIA DIST.  
TAICHUNG CITY, TAIWAN

FOR: HAND-HELD HAND-OPERATED TOOLS, NAMELY, SCISSORS AND HAND-OPERATED PUMPS, IN CLASS 8 (U.S. CLS. 23, 28 AND 44).

FIRST USE 7-1-2011; IN COMMERCE 7-1-2011.

THE MARK CONSISTS OF STANDARD CHARACTERS WITHOUT CLAIM TO ANY PARTICULAR FONT, STYLE, SIZE, OR COLOR.

SER. NO. 85-484,226, FILED 11-30-2011.

HANNO RITTNER, EXAMINING ATTORNEY



*David J. Kyfos*

Director of the United States Patent and Trademark Office

# United States of America

United States Patent and Trademark Office



**Reg. No. 4,274,326**

**Registered Jan. 15, 2013**

**Int. Cl.: 41**

**SERVICE MARK**

**PRINCIPAL REGISTER**

YELE, MARINA DIMITRA (GREECE INDIVIDUAL)  
1567 BLUE JAY WAY  
WEST HOLLYWOOD, CA 90069 AND

MOUSOULIS, KONSTANTINOS (GREECE INDIVIDUAL)  
1746 NORTH ORANGE DRIVE, #616  
LOS ANGELES, CA 90028

FOR: FILM PRODUCTION, IN CLASS 41 (U.S. CLS. 100, 101 AND 107).

FIRST USE 6-0-2011; IN COMMERCE 6-0-2011.

NO CLAIM IS MADE TO THE EXCLUSIVE RIGHT TO USE "PICTURES", APART FROM THE MARK AS SHOWN.

THE MARK CONSISTS OF THE WORDS "HOMERIC PICTURES" AROUND A CIRCULAR DESIGN CONTAINING AN IMAGE OF HOMER, THE ANCIENT GREEK AUTHOR.

SER. NO. 85-484,231, FILED 11-30-2011.

BRIAN CALLAGHAN, EXAMINING ATTORNEY



*David J. Kyfos*

Director of the United States Patent and Trademark Office

# United States of America

United States Patent and Trademark Office

## MATTRESS RENEWER

**Reg. No. 4,274,327**

JEFFCO FIBRES, INC. (MASSACHUSETTS CORPORATION)  
12 PARK STREET  
WEBSTER, MA 01570

**Registered Jan. 15, 2013**

**Int. Cl.: 20**

FOR: MATTRESS TOPPERS, IN CLASS 20 (U.S. CLS. 2, 13, 22, 25, 32 AND 50).

**TRADEMARK**

FIRST USE 6-30-2011; IN COMMERCE 6-30-2011.

**PRINCIPAL REGISTER**

THE MARK CONSISTS OF STANDARD CHARACTERS WITHOUT CLAIM TO ANY PARTICULAR FONT, STYLE, SIZE, OR COLOR.

NO CLAIM IS MADE TO THE EXCLUSIVE RIGHT TO USE "MATTRESS", APART FROM THE MARK AS SHOWN.

SER. NO. 85-484,534, FILED 12-1-2011.

ANTHONY RINKER, EXAMINING ATTORNEY



*David J. Kybas*

Director of the United States Patent and Trademark Office

# United States of America

United States Patent and Trademark Office

# VGIRLS

**Reg. No. 4,274,328**

MELISSA J. SCHWARTZ (UNITED STATES INDIVIDUAL)  
1809 OVERLAND AVE. UNIT 1  
LOS ANGELES, CA 90025

**Registered Jan. 15, 2013**

**Int. Cls.: 14 and 25**

FOR: NECKLACES; PENDANTS, IN CLASS 14 (U.S. CLS. 2, 27, 28 AND 50).

**TRADEMARK**

FIRST USE 11-30-2011; IN COMMERCE 11-30-2011.

**PRINCIPAL REGISTER**

FOR: SHIRTS , IN CLASS 25 (U.S. CLS. 22 AND 39).

FIRST USE 11-30-2011; IN COMMERCE 11-30-2011.

THE MARK CONSISTS OF STANDARD CHARACTERS WITHOUT CLAIM TO ANY PARTICULAR FONT, STYLE, SIZE, OR COLOR.

SER. NO. 85-484,895, FILED 12-1-2011.

KATINA MISTER, EXAMINING ATTORNEY



*David J. Kybas*

Director of the United States Patent and Trademark Office

# United States of America

United States Patent and Trademark Office



**Reg. No. 4,274,329**

**Registered Jan. 15, 2013**

**Int. Cls.: 41 and 42**

**SERVICE MARK**

**PRINCIPAL REGISTER**

LEARN2PERFORM, INC. (DELAWARE CORPORATION)  
1122 KENILWORTH DRIVE, SUITE 416  
BALTIMORE, MD 21204

FOR: PROVIDING EDUCATIONAL TRAINING, COURSES, SEMINARS, AND WORKSHOPS  
IN THE FIELD OF BUSINESS-RELATED SOFTWARE PROGRAMS, IN CLASS 41 (U.S. CLS.  
100, 101 AND 107).

FIRST USE 11-30-2009; IN COMMERCE 11-30-2009.

FOR: CONSULTING SERVICES IN THE FIELD OF COMPUTER-BASED INFORMATION  
SYSTEMS FOR BUSINESSES, IN CLASS 42 (U.S. CLS. 100 AND 101).

FIRST USE 11-30-2009; IN COMMERCE 11-30-2009.

NO CLAIM IS MADE TO THE EXCLUSIVE RIGHT TO USE "ACADEMY", APART FROM  
THE MARK AS SHOWN.

THE MARK CONSISTS OF A DESIGN CONSISTING OF AN OVERLAY OF A STYLIZED  
NUMBER 2 SET ATOP THE STYLIZED CAPITAL LETTERS "L" AND "M", ALL ABOVE  
THE WORD "ACADEMY" IN STYLIZED CAPITAL LETTERS.

SER. NO. 85-485,150, FILED 12-1-2011.

WILLIAM VERHOSEK, EXAMINING ATTORNEY



*David J. Kyros*

Director of the United States Patent and Trademark Office



# United States of America

United States Patent and Trademark Office

## READING IN CONTEXT

**Reg. No. 4,274,330**

**Registered Jan. 15, 2013**

**Int. Cls.: 9 and 16**

**TRADEMARK**

**PRINCIPAL REGISTER**

SADDLEBACK EDUCATIONAL, INC. (CALIFORNIA CORPORATION)  
3120-A PULLMAN STREET  
COSTA MESA, CA 926264564

FOR: DOWNLOADABLE ELECTRONIC PUBLICATIONS IN THE NATURE OF ELECTRONIC BOOKS, AUDIO BOOKS AND TEACHER'S GUIDES IN THE FIELD OF REMEDIAL EDUCATION FOR SECONDARY AND ADULT EDUCATION, IN CLASS 9 (U.S. CLS. 21, 23, 26, 36 AND 38).

FIRST USE 0-0-2004; IN COMMERCE 0-0-2004.

FOR: PUBLICATIONS, NAMELY, BOOKS AND TEACHER'S GUIDES IN THE FIELD OF REMEDIAL EDUCATION FOR SECONDARY AND ADULT EDUCATION, IN CLASS 16 (U.S. CLS. 2, 5, 22, 23, 29, 37, 38 AND 50).

FIRST USE 0-0-2004; IN COMMERCE 0-0-2004.

THE MARK CONSISTS OF STANDARD CHARACTERS WITHOUT CLAIM TO ANY PARTICULAR FONT, STYLE, SIZE, OR COLOR.

NO CLAIM IS MADE TO THE EXCLUSIVE RIGHT TO USE "READING", APART FROM THE MARK AS SHOWN.

SER. NO. 85-485,205, FILED 12-1-2011.

ANNE E. GUSTASON, EXAMINING ATTORNEY



*David J. Kyffers*

Director of the United States Patent and Trademark Office

# United States of America

United States Patent and Trademark Office

# BIG SYPHE

**Reg. No. 4,274,331**

TREJO, ADRIAN (UNITED STATES INDIVIDUAL)  
2049 CENTURY PARK EAST, SUITE 3850  
LOS ANGELES, CA 90067

**Registered Jan. 15, 2013**

**Int. Cl.: 41**

FOR: ENTERTAINMENT SERVICES, NAMELY, PRODUCTION AND REMIXING OF MUSICAL AUDIO RECORDINGS, ORGANIZING CONCERTS FEATURING LIVE MUSICAL PERFORMANCES; PERFORMANCES AS A DISC JOCKEY (DJ) FOR PARTIES, NIGHTCLUBS, CONCERTS AND SPECIAL EVENTS; RADIO ENTERTAINMENT SERVICES, NAMELY, RADIO PROGRAMS FEATURING PERFORMANCES BY A RADIO PERSONALITY; ENTERTAINMENT SERVICES BY A MUSICAL ARTIST AND PRODUCER, NAMELY, MUSICAL COMPOSITION FOR OTHERS AND PRODUCTION OF MUSICAL SOUND RECORDINGS; ENTERTAINMENT SERVICES IN THE NATURE OF PRESENTING LIVE MUSICAL PERFORMANCES; ENTERTAINMENT SERVICES IN THE NATURE OF RECORDING, PRODUCTION AND POST-PRODUCTION SERVICES IN THE FIELD OF MUSIC; MUSIC COMPOSITION SERVICES; MUSIC PRODUCTION SERVICES; PROVIDING A WEBSITE FEATURING INFORMATION IN THE FIELD OF MUSIC AND ENTERTAINMENT, IN CLASS 41 (U.S. CLS. 100, 101 AND 107).

**SERVICE MARK**

**PRINCIPAL REGISTER**

FIRST USE 8-1-1995; IN COMMERCE 5-5-2001.

THE MARK CONSISTS OF STANDARD CHARACTERS WITHOUT CLAIM TO ANY PARTICULAR FONT, STYLE, SIZE, OR COLOR.

SER. NO. 85-485,222, FILED 12-1-2011.

MARY CRAWFORD, EXAMINING ATTORNEY



*David J. Kyros*

Director of the United States Patent and Trademark Office

# United States of America

United States Patent and Trademark Office

# D2F

**Reg. No. 4,274,332**

**Registered Jan. 15, 2013**

**Int. Cls.: 9 and 15**

**TRADEMARK**

**PRINCIPAL REGISTER**

D2F COVERS, INC. (WASHINGTON CORPORATION)  
8104 N.E. 121ST STREET  
KIRKLAND, WA 98034

FOR: PROTECTIVE COVERS SPECIALLY ADAPTED FOR MUSICAL INSTRUMENT AMPLIFIERS, AUDIO AMPLIFIERS, PUBLIC ADDRESS SPEAKERS, AND AUDIO SPEAKERS, IN CLASS 9 (U.S. CLS. 21, 23, 26, 36 AND 38).

FIRST USE 1-14-2005; IN COMMERCE 1-14-2005.

FOR: PROTECTIVE COVERS SPECIALLY ADAPTED FOR MUSICAL INSTRUMENTS, IN CLASS 15 (U.S. CLS. 2, 21 AND 36).

FIRST USE 1-14-2005; IN COMMERCE 1-14-2005.

THE MARK CONSISTS OF STANDARD CHARACTERS WITHOUT CLAIM TO ANY PARTICULAR FONT, STYLE, SIZE, OR COLOR.

SER. NO. 85-485,363, FILED 12-1-2011.

LINDA LAVACHE, EXAMINING ATTORNEY



*David J. Kypos*

Director of the United States Patent and Trademark Office

# United States of America

United States Patent and Trademark Office

## FORESIGHT AS ACCURATE AS HINDSIGHT.

**Reg. No. 4,274,333**

**Registered Jan. 15, 2013**

**Int. Cl.: 42**

**SERVICE MARK**

**PRINCIPAL REGISTER**

POWER ANALYTICS CORPORATION (DELAWARE CORPORATION)  
16870 WEST BERNARDO DRIVE, SUITE 330  
SAN DIEGO, CA 92127

FOR: ENGINEERING CONSULTING SERVICES IN THE FIELDS OF ELECTRICAL POWER DISTRIBUTION SYSTEM INFRASTRUCTURES FOR MICRO GRIDS, SMART GRIDS, AND MISSION CRITICAL FACILITIES; TECHNICAL CONSULTING, ANALYSIS, DESIGN, AND ENGINEERING IN THE FIELD OF ELECTRICAL POWER DISTRIBUTION SYSTEM INFRASTRUCTURES FOR MICRO GRIDS, SMART GRIDS, AND MISSION CRITICAL FACILITIES; COMPUTER SOFTWARE DESIGN; TECHNICAL SUPPORT SERVICES, NAMELY, TROUBLESHOOTING IN THE NATURE OF DIAGNOSING COMPUTER HARDWARE AND SOFTWARE PROBLEMS; TECHNOLOGICAL CONSULTING SERVICES IN FILE CONVERSION, IN CLASS 42 (U.S. CLS. 100 AND 101).

FIRST USE 10-31-2010; IN COMMERCE 10-31-2010.

THE MARK CONSISTS OF STANDARD CHARACTERS WITHOUT CLAIM TO ANY PARTICULAR FONT, STYLE, SIZE, OR COLOR.

SER. NO. 85-485,377, FILED 12-1-2011.

KIMBERLY PERRY, EXAMINING ATTORNEY



*David J. Kyros*

Director of the United States Patent and Trademark Office

# United States of America

United States Patent and Trademark Office



**Reg. No. 4,274,334**

**Registered Jan. 15, 2013**

**Int. Cl.: 4**

**TRADEMARK**

**PRINCIPAL REGISTER**

GAINES GROUP LLC (TEXAS LIMITED LIABILITY COMPANY)  
2901 W. SAM HOUSTON PARKWAY  
SUITE A100  
HOUSTON, TX 77043

FOR: CANDLES, WAX FRAGRANCE BEADS FOR USE IN FRAGRANCE BURNERS, IN CLASS 4 (U.S. CLS. 1, 6 AND 15).

FIRST USE 9-1-2011; IN COMMERCE 9-1-2011.

THE MARK CONSISTS OF THE STYLIZED WORD "SPRINKLES" IN BLACK WITH THE EXCEPTION OF THE LETTER "S" WHICH IS IN PINK AND FEATURES A WHITE ZEBRA TAIL HAVING PINK STRIPES AND THE FURRY END IS PINK AND BLACK.

THE COLOR(S) PINK, WHITE, AND BLACK IS/ARE CLAIMED AS A FEATURE OF THE MARK.

SER. NO. 85-485,870, FILED 12-2-2011.

SIMON TENG, EXAMINING ATTORNEY



*David J. Kybas*

Director of the United States Patent and Trademark Office

# United States of America

United States Patent and Trademark Office



## Brain PathWays

**Reg. No. 4,274,335**

**Registered Jan. 15, 2013**

**Int. Cl.: 45**

**SERVICE MARK**

**PRINCIPAL REGISTER**

THE HADRON GROUP, INC. (MISSOURI CORPORATION)  
#3  
401 TIMBER RIDGE DRIVE  
GRAFTON, IL 62037

FOR: CONDUCTING PERSONAL LIFESTYLE PERFORMANCE ASSESSMENTS TO ENHANCE A PERSON'S UNDERSTANDING OF ONE'S BRAIN ACTIVITIES AND HOW BRAIN ACTIVITY PROCESSES SENSORY INFORMATION AND THUS IMPROVES MEMORY AND THE SPEED OF PROCESSING, AND HOW BRAIN ACTIVITY PROVIDES A VARIETY OF COGNITIVE BENEFITS THAT POSITIVELY IMPACT QUALITY OF LIFE, IN CLASS 45 (U.S. CLS. 100 AND 101).

FIRST USE 12-4-2009; IN COMMERCE 12-4-2009.

NO CLAIM IS MADE TO THE EXCLUSIVE RIGHT TO USE "BRAIN PATHWAYS", APART FROM THE MARK AS SHOWN.

THE COLOR(S) GOLD, YELLOW, AND TAN IS/ARE CLAIMED AS A FEATURE OF THE MARK.

THE MARK CONSISTS OF A STYLIZED PATHWAY SUPERIMPOSED ON A STYLIZED DESIGN OF A HUMAN BRAIN COLORED GOLD, WITH THE PATHWAY LEADING TO A SUNRISE DESIGN COLORED YELLOW; A TAN-COLORED OVAL SHAPE IN THE NATURE OF A SHADOW APPEARS BELOW THE BRAIN DESIGN; THE WORDS "BRAIN PATHWAYS" APPEAR BELOW THE DESIGN IN THE COLOR GOLD.

SER. NO. 85-486,079, FILED 12-2-2011.

JOHN GARTNER, EXAMINING ATTORNEY



*David J. Kybas*

Director of the United States Patent and Trademark Office

# United States of America

United States Patent and Trademark Office

## BRAIN MODE POWER

**Reg. No. 4,274,336**

**Registered Jan. 15, 2013**

**Int. Cl.: 45**

**SERVICE MARK**

**PRINCIPAL REGISTER**

THE HADRON GROUP, INC. (MISSOURI CORPORATION)  
#3  
401 TIMBER RIDGE DRIVE  
GRAFTON, IL 62037

FOR: CONDUCTING PERSONAL LIFESTYLE PERFORMANCE ASSESSMENTS IN THE FIELD OF INDIVIDUAL SENSORY AND THINKING STYLES, IN CLASS 45 (U.S. CLS. 100 AND 101).

FIRST USE 2-27-2004; IN COMMERCE 2-27-2004.

THE MARK CONSISTS OF STANDARD CHARACTERS WITHOUT CLAIM TO ANY PARTICULAR FONT, STYLE, SIZE, OR COLOR.

OWNER OF U.S. REG. NO. 3,026,105.

SER. NO. 85-486,083, FILED 12-2-2011.

JOHN GARTNER, EXAMINING ATTORNEY



*David J. Kyffers*

Director of the United States Patent and Trademark Office

# United States of America

United States Patent and Trademark Office



**SUNRISE**  
**CONFECTIONS**

A Division of Mount Franklin Foods, LLC

**Reg. No. 4,274,337**

**Registered Jan. 15, 2013**

**Int. Cl.: 30**

**TRADEMARK**

**PRINCIPAL REGISTER**

MOUNT FRANKLIN FOODS, LLC (TEXAS LIMITED LIABILITY COMPANY)  
1800 NORTHWESTERN  
EL PASO, TX 79912

FOR: CANDY, IN CLASS 30 (U.S. CL. 46).

FIRST USE 7-1-2007; IN COMMERCE 7-1-2007.

OWNER OF U.S. REG. NOS. 3,149,045, 3,162,959, AND 3,162,960.

NO CLAIM IS MADE TO THE EXCLUSIVE RIGHT TO USE "CONFECTIONS, A DIVISION OF MOUNT FRANKLIN FOODS, LLC", APART FROM THE MARK AS SHOWN.

THE MARK CONSISTS OF SMALL SUN SYMBOL ABOVE THE WORDS "SUNRISE CONFECTIONS", ABOVE THE WORDS "A DIVISION OF MOUNT FRANKLIN FOODS, LLC".

SER. NO. 85-486,102, FILED 12-2-2011.

WENDY JUN, EXAMINING ATTORNEY



*David J. Kybas*

Director of the United States Patent and Trademark Office



# United States of America

United States Patent and Trademark Office

## Freedom Filter

**Reg. No. 4,274,338**

KFS MARKETING INC (TEXAS CORPORATION)  
2716 PETIT LANE  
SCHULENBURG, TX 78956

**Registered Jan. 15, 2013**

**Int. Cl.: 11**

FOR: FILTERS FOR DRINKING WATER, IN CLASS 11 (U.S. CLS. 13, 21, 23, 31 AND 34).

**TRADEMARK**

FIRST USE 6-10-2011; IN COMMERCE 6-10-2011.

**PRINCIPAL REGISTER**

THE MARK CONSISTS OF STANDARD CHARACTERS WITHOUT CLAIM TO ANY PARTICULAR FONT, STYLE, SIZE, OR COLOR.

NO CLAIM IS MADE TO THE EXCLUSIVE RIGHT TO USE "FILTER", APART FROM THE MARK AS SHOWN.

SER. NO. 85-486,107, FILED 12-2-2011.

GIANCARLO CASTRO, EXAMINING ATTORNEY



*David J. Kyffers*

Director of the United States Patent and Trademark Office

# United States of America

United States Patent and Trademark Office



**Reg. No. 4,274,339**

TWIN TIGER ASSETS CORP. (NEVADA CORPORATION)  
520 ESPLANADE # B  
REDONDO BEACH, CA 90277

**Registered Jan. 15, 2013**

**Int. Cl.: 14**

FOR: BRACELETS FOR RAISING MONEY FOR CANCER RESEARCH; NYLON BRACELETS FOR RAISING MONEY FOR CANCER RESEARCH; RUBBER OR SILICON WRISTBANDS IN THE NATURE OF A BRACELET FOR RAISING MONEY FOR CANCER RESEARCH, IN CLASS 14 (U.S. CLS. 2, 27, 28 AND 50).

**TRADEMARK**

**PRINCIPAL REGISTER**

FIRST USE 11-16-2011; IN COMMERCE 11-16-2011.

THE MARK CONSISTS OF I (HEART OR LOVE SYMBOL) HEAD.

SER. NO. 85-486,172, FILED 12-2-2011.

STEPHANIE ALI, EXAMINING ATTORNEY



*David J. Kyffers*

Director of the United States Patent and Trademark Office

# United States of America

United States Patent and Trademark Office

# LELLI'S

**Reg. No. 4,274,340**

**Registered Jan. 15, 2013**

**Int. Cls.: 30 and 43**

**TRADEMARK**

**SERVICE MARK**

**PRINCIPAL REGISTER**

LELLI'S INN OF AUBURN HILLS, INC. (MICHIGAN CORPORATION)  
885 N. OPDYKE ROAD  
AUBURN HILLS, MI 48326

FOR: SOUPS AND SAUCES FOR CONSUMPTION ON OR OFF THE PREMISES, IN CLASS 30 (U.S. CL. 46).

FIRST USE 0-0-1939; IN COMMERCE 0-0-1939.

FOR: RESTAURANT SERVICES, IN CLASS 43 (U.S. CLS. 100 AND 101).

FIRST USE 0-0-1939; IN COMMERCE 0-0-1939.

THE MARK CONSISTS OF STANDARD CHARACTERS WITHOUT CLAIM TO ANY PARTICULAR FONT, STYLE, SIZE, OR COLOR.

SEC. 2(F).

SER. NO. 85-487,202, FILED 12-5-2011.

MATTHEW KLINE, EXAMINING ATTORNEY



*David J. Kyfos*

Director of the United States Patent and Trademark Office

# United States of America

United States Patent and Trademark Office

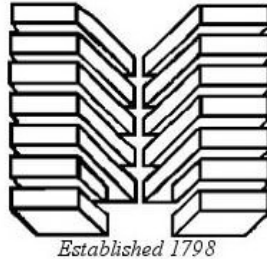

**Reg. No. 4,274,341**

J. GIBSON MCILVAIN COMPANY (MARYLAND CORPORATION)  
10701 PHILADELPHIA ROAD  
WHITE MARSH, MD 21162

**Registered Jan. 15, 2013**

**Int. Cls.: 35, 40 and 42**

FOR: WHOLESALE DISTRIBUTORSHIP FEATURING LUMBER, IN CLASS 35 (U.S. CLS. 100, 101 AND 102).

**SERVICE MARK**

FIRST USE 1-0-1982; IN COMMERCE 1-0-1982.

**PRINCIPAL REGISTER**

FOR: CUSTOM MILLWORKING AND WOOD MOULDING SERVICES FOR OTHERS, IN CLASS 40 (U.S. CLS. 100, 103 AND 106).

FIRST USE 1-0-1982; IN COMMERCE 1-0-1982.

FOR: GRADING OF LUMBER, IN CLASS 42 (U.S. CLS. 100 AND 101).

FIRST USE 1-0-1982; IN COMMERCE 1-0-1982.

NO CLAIM IS MADE TO THE EXCLUSIVE RIGHT TO USE "ESTABLISHED 1798", APART FROM THE MARK AS SHOWN.

THE MARK CONSISTS OF DRAWINGS OF STACKED LUMBER IN THE SHAPE OF THE LETTER "M" AND THE WORDS "ESTABLISHED 1798" UNDERNEATH THE DESIGN.

SER. NO. 85-487,404, FILED 12-5-2011.

ODESSA BIBBINS, EXAMINING ATTORNEY



*David J. Kybas*

Director of the United States Patent and Trademark Office

# United States of America

United States Patent and Trademark Office

# MEXICHEM

**Reg. No. 4,274,342**

**Registered Jan. 15, 2013**

**Int. Cl.: 6**

**TRADEMARK**

**PRINCIPAL REGISTER**

MEXICHEM, S.A.B. DE C.V. (MEXICO PUBLIC STOCK CORPORATION)  
RIO SAN JAVIER NO. 10  
COLONIA VIVEROS DEL RIO  
TLALNEPANTLA, MEXICO 54060

FOR: PIPES AND TUBES OF METAL, IN CLASS 6 (U.S. CLS. 2, 12, 13, 14, 23, 25 AND 50).

THE MARK CONSISTS OF STANDARD CHARACTERS WITHOUT CLAIM TO ANY PARTICULAR FONT, STYLE, SIZE, OR COLOR.

OWNER OF MEXICO REG. NO. 1208213, DATED 3-23-2011, EXPIRES 11-29-2020.

THE WORDING "MEXICHEM" HAS NO MEANING IN A FOREIGN LANGUAGE.

SER. NO. 85-488,165, FILED 12-6-2011.

MEGHAN REINHART, EXAMINING ATTORNEY



*David J. Kybas*

Director of the United States Patent and Trademark Office

# United States of America

United States Patent and Trademark Office

# Mexichem

**Reg. No. 4,274,343**

**Registered Jan. 15, 2013**

**Int. Cl.: 10**

**TRADEMARK**

**PRINCIPAL REGISTER**

MEXICHEM, S.A.B. DE C.V. (MEXICO PUBLIC STOCK CORPORATION)  
RIO SAN JAVIER NO. 10  
COLONIA VIVEROS DEL RIO  
TLALNEPANTLA, MEXICO 54060

FOR: MEDICAL APPARATUS AND INSTRUMENTS, NAMELY, NEBULIZERS FOR RESPIRATION THERAPY, INHALERS SOLD EMPTY FOR MEDICAL PURPOSES, INHALERS SOLD EMPTY FOR THERAPEUTIC PURPOSES, IN CLASS 10 (U.S. CLS. 26, 39 AND 44).

OWNER OF MEXICO REG. NO. 1208199, DATED 3-23-2011, EXPIRES 11-29-2020.

THE COLOR(S) BLUE AND GREEN IS/ARE CLAIMED AS A FEATURE OF THE MARK.

THE MARK CONSISTS OF THE LETTER "M" IN BLUE, THE LETTERS "EX" IN A COMBINATION OF BLUE AND GREEN, THE LETTERS "IC" IN GREEN, THE LETTERS "HE" IN A COMBINATION OF GREEN AND LIGHT BLUE AND THE LETTER "M" IN LIGHT BLUE.

THE WORDING "MEXICHEM" HAS NO MEANING IN A FOREIGN LANGUAGE.

SER. NO. 85-488,481, FILED 12-6-2011.

CHRISIE B. KING, EXAMINING ATTORNEY



*David J. Kyros*

Director of the United States Patent and Trademark Office

# United States of America

United States Patent and Trademark Office

# Mexichem

**Reg. No. 4,274,344**

**Registered Jan. 15, 2013**

**Int. Cl.: 11**

**TRADEMARK**

**PRINCIPAL REGISTER**

MEXICHEM, S.A.B. DE C.V. (MEXICO PUBLIC STOCK CORPORATION)  
RIO SAN JAVIER NO. 10  
COLONIA VIVEROS DEL RIO  
TLALNEPANTLA, MEXICO 54060

FOR: APPARATUS FOR LIGHTING, NAMELY, ELECTRIC LIGHT BULBS, ELECTRIC LIGHTING FIXTURES, FLUORESCENT LIGHTING TUBES; HEATING APPARATUS, NAMELY, CENTRAL HEATING BOILERS AND RADIATORS, STEAM HEATING APPARATUS, HEATING APPARATUS FOR DEFROSTING WINDOWS OF VEHICLES; STEAM GENERATING INSTALLATIONS, REFRIGERATING MACHINES; DRYING APPARATUS, NAMELY, INDUSTRIAL DRYING MACHINES FOR HEATING AND DEHUMIDIFYING FOR USE IN THE CHEMICALS, OIL, GAS AND POWER GENERATION INDUSTRIES; VENTILATING APPARATUS, NAMELY, VENTILATORS FOR USE IN THE CHEMICALS, OIL, GAS AND POWER GENERATION INDUSTRIES; WATER SUPPLY APPARATUS, NAMELY, METERED VALVES AND WATER FILTERS FOR USE IN THE CHEMICALS, OIL, GAS AND POWER GENERATION INDUSTRIES; APPARATUS FOR SANITARY PURPOSES, NAMELY, PIPES BEING PARTS OF SANITARY FACILITIES, OZONE SANITIZERS FOR AIR AND WATER, IN CLASS 11 (U.S. CLS. 13, 21, 23, 31 AND 34).

OWNER OF MEXICO REG. NO. 1208204, DATED 3-23-2011, EXPIRES 11-29-2020.

THE COLOR(S) BLUE AND GREEN IS/ARE CLAIMED AS A FEATURE OF THE MARK.

THE MARK CONSISTS OF THE LETTER "M" IN BLUE, THE LETTERS "EX" IN A COMBINATION OF BLUE AND GREEN, THE LETTERS "IC" IN GREEN, THE LETTERS "HE" IN A COMBINATION OF GREEN AND LIGHT BLUE AND THE LETTER "M" IN LIGHT BLUE.

THE WORDING "MEXICHEM" HAS NO MEANING IN A FOREIGN LANGUAGE.

SER. NO. 85-488,496, FILED 12-6-2011.

CHRISIE B. KING, EXAMINING ATTORNEY



*David J. Kybas*

Director of the United States Patent and Trademark Office

# United States of America

United States Patent and Trademark Office

# Mexichem

**Reg. No. 4,274,345**

**Registered Jan. 15, 2013**

**Int. Cl.: 19**

**TRADEMARK**

**PRINCIPAL REGISTER**

MEXICHEM, S.A.B. DE C.V. (MEXICO PUBLIC STOCK CORPORATION)  
RIO SAN JAVIER NO. 10  
COLONIA VIVEROS DEL RIO  
TLALNEPANTLA, MEXICO 54060

FOR: BUILDING MATERIALS, NAMELY, SEMI-WORKED WOODS, PARTICLE BOARDS, MARBLE, REINFORCING MATERIALS NOT OF METAL FOR BUILDING PURPOSES, CONCRETE BLOCKS, BRICKS, NON-METAL CEILING PANELS, PLANKS, SLABS OF POLYVINYL CHLORIDE FOR KITCHEN WORK TOPS AND WORK SURFACES FOR FURTHER INSTALLATION; BUILDING MATERIALS, NAMELY, PLASTIC PIPE SUPPORTS, NON-METAL PIPE FITTINGS COMPRISED PRIMARILY OF PLASTIC; NON-METAL GUTTER, WATER, DRAINAGE AND PIPES AND NON-METAL FITTINGS THEREFOR; KITCHEN AND BATHROOM TILES, NAMELY, NON-METALLIC FLOOR TILES, NON-METAL TILES, PLASTIC TILES, IN CLASS 19 (U.S. CLS. 1, 12, 33 AND 50).

OWNER OF MEXICO REG. NO. 1208203, DATED 3-23-2011, EXPIRES 11-29-2020.

THE COLOR(S) BLUE AND GREEN IS/ARE CLAIMED AS A FEATURE OF THE MARK.

THE MARK CONSISTS OF THE LETTER "M" IN BLUE, THE LETTERS "EX" IN A COMBINATION OF BLUE AND GREEN, THE LETTERS "IC" IN GREEN, THE LETTERS "HE" IN A COMBINATION OF GREEN AND LIGHT BLUE AND THE LETTER "M" IN LIGHT BLUE.

THE WORDING "MEXICHEM" HAS NO MEANING IN A FOREIGN LANGUAGE.

SER. NO. 85-488,510, FILED 12-6-2011.

CHRISIE B. KING, EXAMINING ATTORNEY



*David J. Kypos*

Director of the United States Patent and Trademark Office



# United States of America

United States Patent and Trademark Office

## California Girl

**Reg. No. 4,274,346**

**Registered Jan. 15, 2013**

**Int. Cl.: 3**

**TRADEMARK**

**PRINCIPAL REGISTER**

LEFFINGWELL, APRIL A (UNITED STATES INDIVIDUAL), DBA SHEA CHIC  
12662 SABRE VIEW COVE  
SAN DIEGO, CA 92128

FOR: PERSONAL CARE PREPARATIONS, NAMELY, SOAP, SKIN MOISTURIZERS, LIP BALMS, CUTICLE CREAM, BATH SALTS, BATH BOMBS, AND FRAGRANCE SPRAYS; PERSONAL CARE PREPARATION, NAMELY, SKIN LOTIONS, SKIN CREAMS, NON-MEDICATED SKIN BALMS, BODY BUTTER, BODY OIL FOR COSMETIC USE, BODY SCRUBS, EXFOLIANT CREAMS, SKIN MOISTURIZING GELS, IN CLASS 3 (U.S. CLS. 1, 4, 6, 50, 51 AND 52).

FIRST USE 6-27-2011; IN COMMERCE 6-27-2011.

THE MARK CONSISTS OF STANDARD CHARACTERS WITHOUT CLAIM TO ANY PARTICULAR FONT, STYLE, SIZE, OR COLOR.

SER. NO. 85-488,955, FILED 12-7-2011.

MARK SPARACINO, EXAMINING ATTORNEY



*David J. Kyffers*

Director of the United States Patent and Trademark Office

# United States of America

United States Patent and Trademark Office



**Reg. No. 4,274,347**

**Registered Jan. 15, 2013**

**Int. Cl.: 10**

**TRADEMARK**

**PRINCIPAL REGISTER**

PITTMAN DENTAL LABORATORY (GEORGIA CORPORATION)  
2355 CENTENNIAL CIRCLE  
GAINESVILLE, GA 30504

FOR: CERAMIC ALLOY USED IN DENTAL CROWNS; DENTAL BRIDGES; DENTAL CAPS;  
DENTAL CROWNS; DENTAL INLAYS; DENTAL ONLAYS, IN CLASS 10 (U.S. CLS. 26, 39  
AND 44).

FIRST USE 11-2-2011; IN COMMERCE 11-7-2011.

NO CLAIM IS MADE TO THE EXCLUSIVE RIGHT TO USE "PREMIUM ZIRCONIA", APART  
FROM THE MARK AS SHOWN.

THE COLOR(S) BLACK, WHITE, AND BLUE IS/ARE CLAIMED AS A FEATURE OF THE  
MARK.

THE MARK CONSISTS OF THE STYLIZED WORDING "DIAMANTE" ABOVE THE  
WORDING "PREMIUM ZIRCONIA" ALL IN WHITE, WITH A BLUE LIGHT RAY DESIGN  
BEHIND THE WORDING, ALL TO THE RIGHT OF A WHITE DIAMOND STONE WITHIN  
A WHITE DIAMOND SHAPE, ALL WITHIN A BLACK RECTANGLE .

SER. NO. 85-489,394, FILED 12-7-2011.

ANNE MADDEN, EXAMINING ATTORNEY



*David J. Kyjars*

Director of the United States Patent and Trademark Office

# United States of America

United States Patent and Trademark Office



**Reg. No. 4,274,348**

**Registered Jan. 15, 2013**

**Int. Cl.: 28**

PERFECT STRIKE LLC (MISSOURI LIMITED LIABILITY COMPANY)  
4600 W. KEARNEY ST.  
SUITE 750  
SPRINGFIELD, MO 65803

FOR: FISHING TACKLE, IN CLASS 28 (U.S. CLS. 22, 23, 38 AND 50).

**TRADEMARK**

**PRINCIPAL REGISTER**

FIRST USE 12-1-2010, THE MARK WAS FIRST USED ANYWHERE IN A DIFFERENT FORM OTHER THAN THAT SOUGHT TO BE REGISTERED AT LEAST AS EARLY AS 08/01/2010; IN COMMERCE 3-23-2011, THE MARK WAS FIRST USED IN COMMERCE IN A DIFFERENT FORM OTHER THAN THAT SOUGHT TO BE REGISTERED AT LEAST AS EARLY AS 12/01/2010.

THE MARK CONSISTS OF THE WORDING "PERFECT STRIKE" APPEARING IN FRONT OF AN IMAGE OF A FISH WITH A TARGET IN THE FISH'S MOUTH AND A LINE EXTENDING FROM THE TARGET TO THE "P" IN "PERFECT."

SER. NO. 85-489,444, FILED 12-7-2011.

MAUREEN DALL, EXAMINING ATTORNEY



*David J. Kybas*

Director of the United States Patent and Trademark Office

# United States of America

United States Patent and Trademark Office

# MALL RAT

**Reg. No. 4,274,349**

**Registered Jan. 15, 2013**

**Int. Cls.: 9, 35 and 42**

**TRADEMARK**

**SERVICE MARK**

**PRINCIPAL REGISTER**

SYNERGY MEDIA CORP. (CANADA CORPORATION)  
6208 CRESCENT PLACE  
DELTA, CANADA V4K4V1

FOR: COMPUTER APPLICATION SOFTWARE FOR MOBILE PHONES, NAMELY, SOFTWARE FOR PROVIDING INDOOR MAPS OF SHOPPING MALLS; COMPUTER APPLICATION SOFTWARE FOR MOBILE PHONES, NAMELY, SOFTWARE FOR ALLOWING USERS TO PURCHASE GOODS AND SERVICES FROM SHOPPING MALLS, IN CLASS 9 (U.S. CLS. 21, 23, 26, 36 AND 38).

FIRST USE 12-1-2011; IN COMMERCE 12-5-2011.

FOR: ADVERTISING, MARKETING, AND PROMOTING THE GOODS AND SERVICES OF OTHERS VIA MOBILE DEVICES, IN CLASS 35 (U.S. CLS. 100, 101 AND 102).

FIRST USE 12-1-2011; IN COMMERCE 12-5-2011.

FOR: APPLICATION SERVICE PROVIDER FEATURING APPLICATION PROGRAMMING INTERFACE (API) SOFTWARE FOR THE LICENSING OF MAPPING DATA, IN CLASS 42 (U.S. CLS. 100 AND 101).

FIRST USE 12-1-2011; IN COMMERCE 12-5-2011.

THE MARK CONSISTS OF STANDARD CHARACTERS WITHOUT CLAIM TO ANY PARTICULAR FONT, STYLE, SIZE, OR COLOR.

SER. NO. 85-490,088, FILED 12-8-2011.

GINA FINK, EXAMINING ATTORNEY



*David J. Kyros*

Director of the United States Patent and Trademark Office

# United States of America

United States Patent and Trademark Office

# STARDUST

**Reg. No. 4,274,350**

**Registered Jan. 15, 2013**

**Int. Cl.: 31**

**TRADEMARK**

**PRINCIPAL REGISTER**

DÜMMEN GMBH (FED REP GERMANY GESELLSCHAFT MIT BESCHRÄNKTER HAFTUNG  
(GMBH))  
DAMMWEG 18-20  
RHEINBERG, FED REP GERMANY D 47495

FOR: LIVING ORNAMENTAL EUPHORBIA CHAMAESYCE PLANTS AND NATURAL  
FLOWERS THEREOF, EXCLUDING TREES AND BLUEGRASS, IN CLASS 31 (U.S. CLS. 1  
AND 46).

THE MARK CONSISTS OF STANDARD CHARACTERS WITHOUT CLAIM TO ANY PAR-  
TICULAR FONT, STYLE, SIZE, OR COLOR.

OWNER OF FED REP GERMANY REG. NO. 302010014899, DATED 6-7-2010, EXPIRES 3-  
11-2020.

SER. NO. 85-490,381, FILED 12-8-2011.

HOWARD B. LEVINE, EXAMINING ATTORNEY



*David J. Kyffers*

Director of the United States Patent and Trademark Office

# United States of America

United States Patent and Trademark Office

# Hydro Kem

**Reg. No. 4,274,351**

MTM HYDRO, INCORPORATED (MINNESOTA CORPORATION)  
7430 WASHINGTON AVENUE SOUTH  
EDEN PRAIRIE, MN 55344

**Registered Jan. 15, 2013**

**Int. Cl.: 3**

FOR: CLEANING AGENTS AND PREPARATIONS FOR USE WITH PRESSURE WASHERS,  
IN CLASS 3 (U.S. CLS. 1, 4, 6, 50, 51 AND 52).

**TRADEMARK**

FIRST USE 10-11-2011; IN COMMERCE 10-11-2011.

**PRINCIPAL REGISTER**

THE MARK CONSISTS OF STANDARD CHARACTERS WITHOUT CLAIM TO ANY PARTICULAR FONT, STYLE, SIZE, OR COLOR.

SER. NO. 85-490,581, FILED 12-8-2011.

FLORENTINA BLANDU, EXAMINING ATTORNEY



*David J. Kybas*

Director of the United States Patent and Trademark Office

# United States of America

United States Patent and Trademark Office

# BACO

**Reg. No. 4,274,352**

BACHMEIER & CO., INC. (NEW YORK CORPORATION)  
P.O. BOX 400  
KEARNY, NJ 07032

**Registered Jan. 15, 2013**

**Int. Cl.: 2**

FOR: ANILINE DYE; DYESTUFFS, IN CLASS 2 (U.S. CLS. 6, 11 AND 16).

**TRADEMARK**

FIRST USE 4-1-1916; IN COMMERCE 4-1-1916.

**PRINCIPAL REGISTER**

THE MARK CONSISTS OF STANDARD CHARACTERS WITHOUT CLAIM TO ANY PARTICULAR FONT, STYLE, SIZE, OR COLOR.

SER. NO. 85-490,660, FILED 12-8-2011.

HEATHER THOMPSON, EXAMINING ATTORNEY



*David J. Kyffers*

Director of the United States Patent and Trademark Office

# United States of America

United States Patent and Trademark Office

## TEJON RANCH COMMERCE CENTER

**Reg. No. 4,274,353**

TEJON INDUSTRIAL CORP. (CALIFORNIA CORPORATION)  
P.O. BOX 1000  
LEBEC, CA 93243

**Registered Jan. 15, 2013**

**Int. Cls.: 36 and 37**

FOR: LEASING OF REAL ESTATE; LEASING OR RENTING OF BUILDINGS; REAL ESTATE MANAGEMENT SERVICES; RENTAL OF SPACE IN MARKETPLACES FOR SELLERS OF GOODS AND/OR SERVICES, IN CLASS 36 (U.S. CLS. 100, 101 AND 102).

**SERVICE MARK**

FIRST USE 11-0-2010; IN COMMERCE 11-0-2010.

**PRINCIPAL REGISTER**

FOR: LAND DEVELOPMENT SERVICES, NAMELY, PLANNING AND LAYING OUT OF COMMERCIAL BUILDINGS; REAL ESTATE DEVELOPMENT, IN CLASS 37 (U.S. CLS. 100, 103 AND 106).

FIRST USE 11-0-2010; IN COMMERCE 11-0-2010.

THE MARK CONSISTS OF STANDARD CHARACTERS WITHOUT CLAIM TO ANY PARTICULAR FONT, STYLE, SIZE, OR COLOR.

OWNER OF U.S. REG. NOS. 1,827,718, 3,063,522 AND OTHERS.

NO CLAIM IS MADE TO THE EXCLUSIVE RIGHT TO USE "RANCH COMMERCE CENTER", APART FROM THE MARK AS SHOWN.

THE ENGLISH TRANSLATION OF "TEJON" IN THE MARK IS BADGER.

SER. NO. 85-490,883, FILED 12-8-2011.

LAURA KOVALSKY, EXAMINING ATTORNEY



*David J. Kybas*

Director of the United States Patent and Trademark Office



# United States of America

United States Patent and Trademark Office



**Reg. No. 4,274,354**

**Registered Jan. 15, 2013**

**Int. Cl.: 42**

**SERVICE MARK**

**PRINCIPAL REGISTER**

APPSTACK (DELAWARE CORPORATION)  
21250 HAWTHORNE BLVD  
SUITE 770  
TORRANCE, CA 90503

FOR: COMPUTER SOFTWARE DEVELOPMENT IN THE FIELD OF MOBILE APPLICATIONS,  
IN CLASS 42 (U.S. CLS. 100 AND 101).

FIRST USE 10-18-2011; IN COMMERCE 10-27-2011.

THE MARK CONSISTS OF THREE HOLLOW SQUARES STACKED ON TOP OF EACHOTHER,  
APPEARING TO THE LEFT OF THE LOWERCASE WORD "APPSTACK", WHERE "APP"  
APPEARS IN BOLD LETTERS AND "STACK" DOES NOT CONTAIN BOLD LETTERS.

SER. NO. 85-490,889, FILED 12-8-2011.

LEIGH LOWRY, EXAMINING ATTORNEY



*David J. Kyros*

Director of the United States Patent and Trademark Office

# United States of America

## United States Patent and Trademark Office

*AITreatment*

**Reg. No. 4,274,355**

ANIMAL INTELLIGENCE SOFTWARE, INC. (WASHINGTON CORPORATION)  
PO BOX 554

**Registered Jan. 15, 2013**

PORT ORCHARD, WA 98366

**Int. Cl.: 9**

FOR: COMPUTER APPLICATION SOFTWARE FOR VETERINARY ELECTRONIC MEDICAL RECORDS, NAMELY, SOFTWARE FOR WHITEBOARD MANAGEMENT AND TREATMENT INPUT; COMPUTER PROGRAMS FOR DOCUMENT MANAGEMENT; COMPUTER SOFTWARE AND HARDWARE FOR MANAGING MEDICAL, TREATMENT, ORDERS, AND CARE RECORDS IN THE FIELD OF VETERINARY PRACTICES; COMPUTER SOFTWARE FOR APPLICATION AND DATABASE INTEGRATION; COMPUTER SOFTWARE FOR CREATING SEARCHABLE DATABASES OF INFORMATION AND DATA; COMPUTER SOFTWARE FOR THE COLLECTION, EDITING, ORGANIZING, MODIFYING, BOOK MARKING, TRANSMISSION, STORAGE AND SHARING OF DATA AND INFORMATION; COMPUTER SOFTWARE FOR MANAGING TREATMENT, ORDERS, AND MEDICAL RECORDS IN THE FIELD OF VETERINARY PRACTICES; COMPUTER WHITEBOARDS; DATABASE MANAGEMENT SOFTWARE FOR TREATMENT SHEETS AND WHITEBOARDS; INTERFACES FOR COMPUTERS; MEDICAL SOFTWARE DISPLAYING AND PROCESSING TREATMENT PLANS AND ORDERS, AND TREATMENT RECORDS FOR PATIENTS IN VETERINARY PRACTICES, IN CLASS 9 (U.S. CLS. 21, 23, 26, 36 AND 38).

**TRADEMARK**

**PRINCIPAL REGISTER**

FIRST USE 10-1-2007; IN COMMERCE 10-10-2007.

THE MARK CONSISTS OF "AITREATMENT" AS ONE WORD WITH THE LETTERS "AI" CAPITALIZED AND NON-ITALICIZED. THE WORD "TREATMENT" IS ITALICIZED AND THE LETTER "T" IS CAPITALIZED AND ITALICIZED.

SER. NO. 85-491,163, FILED 12-9-2011.

SALLY SHIH, EXAMINING ATTORNEY



*David J. Kyros*

Director of the United States Patent and Trademark Office

# United States of America

United States Patent and Trademark Office

## Penguin Diner

**Reg. No. 4,274,356**

**Registered Jan. 15, 2013**

**Int. Cl.: 9**

**TRADEMARK**

**PRINCIPAL REGISTER**

BIGWIG MEDIA LTD (UNITED KINGDOM CORPORATION)  
37 COLLINGWOOD CRESCENT  
GUILDFORD, SURREY, UNITED KINGDOM GU12NU

FOR: COMPUTER PROGRAMS FOR VIDEO AND COMPUTER GAMES FEATURING ANIMATED PENGUIN CHARACTERS; ELECTRONIC GAME SOFTWARE, FEATURING ANIMATED PENGUIN CHARACTERS, FOR HANDHELD ELECTRONIC DEVICES, IN CLASS 9 (U.S. CLS. 21, 23, 26, 36 AND 38).

FIRST USE 4-1-2008; IN COMMERCE 4-1-2008.

THE MARK CONSISTS OF STANDARD CHARACTERS WITHOUT CLAIM TO ANY PARTICULAR FONT, STYLE, SIZE, OR COLOR.

SER. NO. 85-491,194, FILED 12-9-2011.

BARBARA RUTLAND, EXAMINING ATTORNEY



*David J. Kyffers*

Director of the United States Patent and Trademark Office

# United States of America

United States Patent and Trademark Office

## BRAIN INJURY ASSOCIATION OF AMERICA

**Reg. No. 4,274,357**

**Registered Jan. 15, 2013**

**Int. Cls.: 9, 16, 35, 41  
and 44**

BRAIN INJURY ASSOCIATION OF AMERICA, INC. (MASSACHUSETTS NON-PROFIT CORPORATION)

SUITE 110  
1608 SPRING HILL ROAD  
VIENNA, VA 22182

FOR: DVDS FEATURING INFORMATION ON BRAIN INJURY; VIDEO RECORDINGS FEATURING INFORMATION ON BRAIN INJURY, IN CLASS 9 (U.S. CLS. 21, 23, 26, 36 AND 38).

**TRADEMARK**

FIRST USE 2-25-2002; IN COMMERCE 2-25-2002.

**SERVICE MARK**

**PRINCIPAL REGISTER**

FOR: PUBLICATIONS, NAMELY, BOOKS, PAMPHLETS, POSTERS, BROCHURES, WALLET CARDS AND MAGAZINES IN THE FIELDS OF BRAIN INJURY, IN CLASS 16 (U.S. CLS. 2, 5, 22, 23, 29, 37, 38 AND 50).

FIRST USE 2-25-2002; IN COMMERCE 2-25-2002.

FOR: ASSOCIATION SERVICES, NAMELY, PROMOTING THE INTERESTS OF INDIVIDUALS WITH BRAIN INJURIES; ON-LINE RETAIL STORE SERVICES FEATURING BOOKS, PAMPHLETS, POSTERS, BROCHURES, MAGAZINES, DVDS, CDS, AND VIDEOS, ALL IN THE FIELD OF BRAIN INJURY, AND JEWELRY; PROVIDING CONSUMER INFORMATION IN THE FIELD OF BRAIN INJURY, IN CLASS 35 (U.S. CLS. 100, 101 AND 102).

FIRST USE 2-25-2002; IN COMMERCE 2-25-2002.

FOR: ARRANGING PROFESSIONAL WORKSHOP AND TRAINING COURSES; EDUCATIONAL SERVICES, NAMELY, CONDUCTING CONFERENCES, SYMPOSIA, WORKSHOPS, LECTURES AND WEBINARS IN THE FIELD OF OF BRAIN INJURY AND DISTRIBUTION OF EDUCATIONAL MATERIALS IN CONNECTION THEREWITH, IN CLASS 41 (U.S. CLS. 100, 101 AND 107).

FIRST USE 2-25-2002; IN COMMERCE 2-25-2002.

FOR: PROVIDING A WEBSITE FEATURING INFORMATION IN THE FIELD OF THE DIAGNOSIS AND TREATMENT OF BRAIN INJURIES, IN CLASS 44 (U.S. CLS. 100 AND 101).



*David J. Kyjars*

Director of the United States Patent and Trademark Office

**Reg. No. 4,274,357** FIRST USE 2-25-2002; IN COMMERCE 2-25-2002.

THE MARK CONSISTS OF STANDARD CHARACTERS WITHOUT CLAIM TO ANY PARTICULAR FONT, STYLE, SIZE, OR COLOR.

NO CLAIM IS MADE TO THE EXCLUSIVE RIGHT TO USE "ASSOCIATION", APART FROM THE MARK AS SHOWN.

SEC. 2(F).

SER. NO. 85-491,266, FILED 12-9-2011.

BARBARA RUTLAND, EXAMINING ATTORNEY

# United States of America

United States Patent and Trademark Office



**Reg. No. 4,274,358**

**Registered Jan. 15, 2013**

**Int. Cl.: 5**

**TRADEMARK**

**PRINCIPAL REGISTER**

GENSCO LABORATORIES, LLC (FLORIDA LIMITED LIABILITY COMPANY)  
WAR ROOM  
12741 MIRAMAR PARKWAY, SUITE 301  
MIRAMAR, FL 33027

FOR: PHARMACEUTICAL PREPARATIONS FOR TOPICAL GELS AND OINTMENTS FOR TRANSDERMAL DELIVERY OF ANALGESICS, ANTI-INFLAMMATORY AGENTS, ANTI-NEOPLASTIC AGENTS, MUSCLE RELAXANTS, ANAESTHETIC AGENTS, PEPTIDES, PROTEINS, GROWTH FACTORS, HORMONES, SUBSTANCE P ANTAGONISTS, ANTI-FUNGAL COMPOUNDS, ANTIVIRAL COMPOUNDS, ANTIBACTERIAL COMPOUNDS, ANTI-OBESITY DRUGS, HOMEOPATHIC AGENTS, ANTIANGINAL COMPOUNDS, HAIR GROWTH STIMULATORS OR RETARDANTS, NUTRIENTS, AND ANTIMETABOLITES, IN CLASS 5 (U.S. CLS. 6, 18, 44, 46, 51 AND 52).

FIRST USE 1-1-2007; IN COMMERCE 3-19-2007.

NO CLAIM IS MADE TO THE EXCLUSIVE RIGHT TO USE "LABORATORIES" , APART FROM THE MARK AS SHOWN.

THE COLOR(S) BLUE, GRAY AND WHITE IS/ARE CLAIMED AS A FEATURE OF THE MARK.

THE MARK CONSISTS OF THE WORD "GENSCO" IN BLUE ON THE TOP OF THE WORD "LABORATORIES" IN GREY WRAPPED BY TWO SEMI-CIRCLES AGAINST A WHITE BACKGROUND.

SER. NO. 85-491,472, FILED 12-9-2011.

NAKIA HENRY, EXAMINING ATTORNEY



*David J. Kybas*

Director of the United States Patent and Trademark Office

# United States of America

United States Patent and Trademark Office

## A.T. Still Research Institute

**Reg. No. 4,274,359**

A.T. STILL UNIVERSITY OF HEALTH SCIENCES (MISSOURI CORPORATION)  
800 WEST JEFFERSON STREET  
KIRKSVILLE, MO 65101

**Registered Jan. 15, 2013**

**Int. Cl.: 41**

FOR: EDUCATIONAL SERVICES IN THE NATURE OF MEDICAL SCHOOLS, IN CLASS 41  
(U.S. CLS. 100, 101 AND 107).

**SERVICE MARK**

FIRST USE 1-16-2003; IN COMMERCE 1-16-2003.

**PRINCIPAL REGISTER**

THE MARK CONSISTS OF STANDARD CHARACTERS WITHOUT CLAIM TO ANY PARTICULAR FONT, STYLE, SIZE, OR COLOR.

OWNER OF U.S. REG. NOS. 4,104,091 AND 4,104,092.

NO CLAIM IS MADE TO THE EXCLUSIVE RIGHT TO USE "RESEARCH INSTITUTE", APART FROM THE MARK AS SHOWN.

SER. NO. 85-491,598, FILED 12-9-2011.

KAREN BRACEY, EXAMINING ATTORNEY



*David J. Kyffers*

Director of the United States Patent and Trademark Office

# United States of America

United States Patent and Trademark Office

# ATSU

**Reg. No. 4,274,360**

**Registered Jan. 15, 2013**

**Int. Cl.: 41**

**SERVICE MARK**

**PRINCIPAL REGISTER**

A.T. STILL UNIVERSITY OF HEALTH SCIENCES (MISSOURI CORPORATION)  
800 WEST JEFFERSON STREET  
KIRKSVILLE, MO 63501

FOR: EDUCATION SERVICES IN THE NATURE OF COURSES AT THE UNIVERSITY LEVEL, IN CLASS 41 (U.S. CLS. 100, 101 AND 107).

FIRST USE 1-16-2003; IN COMMERCE 1-16-2003.

THE MARK CONSISTS OF STANDARD CHARACTERS WITHOUT CLAIM TO ANY PARTICULAR FONT, STYLE, SIZE, OR COLOR.

OWNER OF U.S. REG. NOS. 4,104,091 AND 4,104,092.

SER. NO. 85-491,600, FILED 12-9-2011.

KAREN BRACEY, EXAMINING ATTORNEY



*David J. Kyffers*

Director of the United States Patent and Trademark Office



# United States of America

United States Patent and Trademark Office

## A.T. Still University

**Reg. No. 4,274,361**

**Registered Jan. 15, 2013**

**Int. Cl.: 41**

**SERVICE MARK**

**PRINCIPAL REGISTER**

A. T. STILL UNIVERSITY OF HEALTH SCIENCES (MISSOURI CORPORATION)  
800 WEST JEFFERSON STREET  
KIRKSVILLE, MO 63501

FOR: EDUCATIONAL SERVICES IN THE NATURE OF MEDICAL SCHOOLS, IN CLASS 41  
(U.S. CLS. 100, 101 AND 107).

FIRST USE 1-16-2003; IN COMMERCE 1-16-2003.

THE MARK CONSISTS OF STANDARD CHARACTERS WITHOUT CLAIM TO ANY PARTICULAR FONT, STYLE, SIZE, OR COLOR.

OWNER OF U.S. REG. NOS. 4,104,091 AND 4,104,092.

NO CLAIM IS MADE TO THE EXCLUSIVE RIGHT TO USE "UNIVERSITY", APART FROM THE MARK AS SHOWN.

SER. NO. 85-491,616, FILED 12-9-2011.

KAREN BRACEY, EXAMINING ATTORNEY



*David J. Kybas*

Director of the United States Patent and Trademark Office

# United States of America

United States Patent and Trademark Office

# SOLA DIVE

**Reg. No. 4,274,362**

**Registered Jan. 15, 2013**

**Int. Cl.: 11**

**TRADEMARK**

**PRINCIPAL REGISTER**

LIGHT & MOTION INDUSTRIES (CALIFORNIA CORPORATION)  
300 CANNERY ROW  
MONTEREY, CA 93940

FOR: DIVING LIGHTS, IN CLASS 11 (U.S. CLS. 13, 21, 23, 31 AND 34).

FIRST USE 11-1-2010; IN COMMERCE 11-1-2010.

THE MARK CONSISTS OF STANDARD CHARACTERS WITHOUT CLAIM TO ANY PARTICULAR FONT, STYLE, SIZE, OR COLOR.

NO CLAIM IS MADE TO THE EXCLUSIVE RIGHT TO USE "DIVE", APART FROM THE MARK AS SHOWN.

THE ENGLISH TRANSLATION OF "SOLA" IN THE MARK IS "SINGLE".

SER. NO. 85-491,754, FILED 12-9-2011.

IRA J. GOODSAY, EXAMINING ATTORNEY



*David J. Kyffers*

Director of the United States Patent and Trademark Office

# United States of America

United States Patent and Trademark Office

# batchgeo

**Reg. No. 4,274,363**

BATCHGEO, LLC (OREGON LIMITED LIABILITY COMPANY)  
1030 SE CLINTON STREET  
PORTLAND, OR 97202

**Registered Jan. 15, 2013**

**Int. Cl.: 42**

FOR: APPLICATION SERVICE PROVIDER FEATURING GEOGRAPHIC CODING LOCATION SOFTWARE FOR USE IN CREATING MAPS CONTAINING GEOGRAPHICALLY CODED INFORMATION FROM A USER'S UPLOADED DATA, IN CLASS 42 (U.S. CLS. 100 AND 101).

**SERVICE MARK**

**PRINCIPAL REGISTER**

FIRST USE 1-27-2010; IN COMMERCE 1-27-2010.

THE MARK CONSISTS OF STANDARD CHARACTERS WITHOUT CLAIM TO ANY PARTICULAR FONT, STYLE, SIZE, OR COLOR.

SER. NO. 85-492,915, FILED 12-12-2011.

DEZMONA MIZELLE, EXAMINING ATTORNEY



*David J. Kyffers*

Director of the United States Patent and Trademark Office

# United States of America

United States Patent and Trademark Office

## KOENDERS WINDMILLS

**Reg. No. 4,274,364**

**Registered Jan. 15, 2013**

**Int. Cls.: 7 and 11**

**TRADEMARK**

**PRINCIPAL REGISTER**

KOENDERS WATER SOLUTIONS INC. (CANADA CORPORATION)  
#700-1914 HAMILTON STREET  
REGINA, SASKATCHEWAN, CANADA S4P3N6

FOR: WINDMILLS; WIND-DRIVEN WATER PUMPS FOR IRRIGATION AND LIVESTOCK WATERING; WATER AERATION SYSTEMS COMPRISING WATER PUMPS AND AIR COMPRESSORS; AIR COMPRESSORS; REPLACEMENT PARTS FOR ALL OF THE FOREGOING, IN CLASS 7 (U.S. CLS. 13, 19, 21, 23, 31, 34 AND 35).

FIRST USE 0-0-1988; IN COMMERCE 0-0-1988.

FOR: WATER FOUNTAINS AND REPLACEMENT PARTS THEREFOR, IN CLASS 11 (U.S. CLS. 13, 21, 23, 31 AND 34).

FIRST USE 0-0-1988; IN COMMERCE 0-0-1988.

THE MARK CONSISTS OF STANDARD CHARACTERS WITHOUT CLAIM TO ANY PARTICULAR FONT, STYLE, SIZE, OR COLOR.

NO CLAIM IS MADE TO THE EXCLUSIVE RIGHT TO USE "WINDMILLS" , APART FROM THE MARK AS SHOWN.

SEC. 2(F).

SER. NO. 85-492,967, FILED 12-12-2011.

ALEXANDER L. POWERS, EXAMINING ATTORNEY



*David J. Kypos*

Director of the United States Patent and Trademark Office

# United States of America

United States Patent and Trademark Office

## NATURE'S POND CONDITIONER

**Reg. No. 4,274,365**

**Registered Jan. 15, 2013**

**Int. Cl.: 1**

**TRADEMARK**

**PRINCIPAL REGISTER**

KOENDERS WATER SOLUTIONS INC. (CANADA CORPORATION)  
#700-1914 HAMILTON STREET  
REGINA, SASKATCHEWAN, CANADA S4P3N6

FOR: BIOLOGICALLY ACTIVE ENZYMES AND MICROORGANISMS USED IN POND MAINTENANCE, IN CLASS 1 (U.S. CLS. 1, 5, 6, 10, 26 AND 46).

FIRST USE 0-0-2007; IN COMMERCE 0-0-2007.

THE MARK CONSISTS OF STANDARD CHARACTERS WITHOUT CLAIM TO ANY PARTICULAR FONT, STYLE, SIZE, OR COLOR.

NO CLAIM IS MADE TO THE EXCLUSIVE RIGHT TO USE "POND CONDITIONER", APART FROM THE MARK AS SHOWN.

SER. NO. 85-492,981, FILED 12-12-2011.

ALEXANDER L. POWERS, EXAMINING ATTORNEY



*David J. Kyffers*

Director of the United States Patent and Trademark Office

# United States of America

United States Patent and Trademark Office

## SUPERIOR WINDMILL

**Reg. No. 4,274,366**

**Registered Jan. 15, 2013**

**Int. Cl.: 7**

**TRADEMARK**

**PRINCIPAL REGISTER**

KOENDERS WATER SOLUTIONS INC. (CANADA CORPORATION)  
#700-1914 HAMILTON STREET  
REGINA, SASKATCHEWAN, CANADA S4P3N6

FOR: WINDMILLS; WIND-DRIVEN WATER PUMPS FOR IRRIGATION AND LIVESTOCK WATERING; WATER AERATION SYSTEMS COMPRISING WATER PUMPS AND AIR COMPRESSORS; AIR COMPRESSORS; REPLACEMENT PARTS FOR ALL OF THE FOREGOING, IN CLASS 7 (U.S. CLS. 13, 19, 21, 23, 31, 34 AND 35).

FIRST USE 0-0-2005; IN COMMERCE 0-0-2005.

THE MARK CONSISTS OF STANDARD CHARACTERS WITHOUT CLAIM TO ANY PARTICULAR FONT, STYLE, SIZE, OR COLOR.

OWNER OF U.S. REG. NO. 2,896,483.

NO CLAIM IS MADE TO THE EXCLUSIVE RIGHT TO USE "WINDMILL", APART FROM THE MARK AS SHOWN.

SEC. 2(F).

SER. NO. 85-492,997, FILED 12-12-2011.

ALEXANDER L. POWERS, EXAMINING ATTORNEY



*David J. Kyffers*

Director of the United States Patent and Trademark Office

**United States of America**  
United States Patent and Trademark Office

# HOSTPAPA

**Reg. No. 4,274,367**

**Registered Jan. 15, 2013**

**Int. Cl.: 42**

**SERVICE MARK**

**PRINCIPAL REGISTER**

HOSTPAPA INC. (CANADA CORPORATION)  
115 GEORGE STREET  
SUITE 511  
OAKVILLE, ONTARIO, CANADA L6J0A2

FOR: WEB SITE HOSTING SERVICES, IN CLASS 42 (U.S. CLS. 100 AND 101).

FIRST USE 1-12-2006; IN COMMERCE 5-26-2006.

THE MARK CONSISTS OF STANDARD CHARACTERS WITHOUT CLAIM TO ANY PARTICULAR FONT, STYLE, SIZE, OR COLOR.

SER. NO. 85-493,127, FILED 12-12-2011.

JENNIFER MARTIN, EXAMINING ATTORNEY



*David J. Kybas*

Director of the United States Patent and Trademark Office

# United States of America

United States Patent and Trademark Office

THE PRESERVE



GOLF CLUB

**Reg. No. 4,274,368**

**Registered Jan. 15, 2013**

**Int. Cl.: 41**

**SERVICE MARK**

**PRINCIPAL REGISTER**

THE PRESERVE GOLF CLUB (CALIFORNIA CORPORATION), AKA THE SANTA LUCIA PRESERVE  
1 RANCHO SAN CARLOS ROAD  
CARMEL, CA 93923

FOR: ENTERTAINMENT IN THE NATURE OF GOLF TOURNAMENTS; GOLF CADDIE SERVICES; GOLF CLUB SERVICES; GOLF COURSES; SOCIAL CLUB SERVICES, NAMELY, ARRANGING, ORGANIZING, AND HOSTING SOCIAL EVENTS, GET-TOGETHERS, AND PARTIES FOR CLUB MEMBERS, IN CLASS 41 (U.S. CLS. 100, 101 AND 107).

FIRST USE 0-0-1998; IN COMMERCE 0-0-1998.

NO CLAIM IS MADE TO THE EXCLUSIVE RIGHT TO USE "GOLF CLUB", APART FROM THE MARK AS SHOWN.

THE COLOR(S) BLACK, WHITE, RED, GREEN, CREAM AND TAN IS/ARE CLAIMED AS A FEATURE OF THE MARK.

THE MARK CONSISTS OF A DIAMOND, WITH RED AS THE PRIMARY COLOR, A BORDER AND LINES RUNNING THROUGH IN RED, GREEN, CREAM AND TAN. THE LETTERS "THE PRESERVE GOLF CLUB" ARE IN BLACK UPPER-CASE LETTERS ON A WHITE BACKGROUND WHICH REPRESENTS A TRANSPARENT AREA.

SER. NO. 85-493,309, FILED 12-12-2011.

ANN E. SAPPENFIELD, EXAMINING ATTORNEY



*David J. Kyffers*

Director of the United States Patent and Trademark Office



# United States of America

United States Patent and Trademark Office

## A. T. Still University of Health Sciences

**Reg. No. 4,274,369**

**Registered Jan. 15, 2013**

**Int. Cl.: 41**

**SERVICE MARK**

**PRINCIPAL REGISTER**

A. T. STILL UNIVERSITY OF HEALTH SCIENCES (MISSOURI CORPORATION)  
800 WEST JEFFERSON STREET  
KIRKSVILLE, MO 63501

FOR: EDUCATIONAL SERVICES IN THE NATURE OF MEDICAL SCHOOLS, IN CLASS 41  
(U.S. CLS. 100, 101 AND 107).

FIRST USE 1-16-2003; IN COMMERCE 1-16-2003.

THE MARK CONSISTS OF STANDARD CHARACTERS WITHOUT CLAIM TO ANY PARTICULAR FONT, STYLE, SIZE, OR COLOR.

OWNER OF U.S. REG. NOS. 4,104,091 AND 4,104,092.

NO CLAIM IS MADE TO THE EXCLUSIVE RIGHT TO USE "UNIVERSITY OF HEALTH SCIENCES", APART FROM THE MARK AS SHOWN.

SER. NO. 85-493,422, FILED 12-12-2011.

KAREN BRACEY, EXAMINING ATTORNEY



*David J. Kybas*

Director of the United States Patent and Trademark Office

# United States of America

United States Patent and Trademark Office

# COPT

**Reg. No. 4,274,370**

**Registered Jan. 15, 2013**

**Int. Cls.: 36 and 37**

CORPORATE OFFICE PROPERTIES TRUST (MARYLAND REAL ESTATE INVESTMENT TRUST)  
6711 COLUMBIA GATEWAY DRIVE  
SUITE 300  
COLUMBIA, MD 21046

**SERVICE MARK**

**PRINCIPAL REGISTER**

FOR: REAL ESTATE SERVICES, NAMELY, REAL ESTATE ACQUISITION; REAL ESTATE LEASING; MANAGEMENT OF COMMERCIAL PROPERTY; FINANCIAL ASSET MANAGEMENT OF COMMERCIAL REAL ESTATE; FINANCIAL INVESTMENT SERVICES IN THE FIELD OF COMMERCIAL REAL ESTATE, IN THE NATURE OF A REAL ESTATE INVESTMENT TRUST, IN CLASS 36 (U.S. CLS. 100, 101 AND 102).

FIRST USE 0-0-1998; IN COMMERCE 0-0-1998.

FOR: REAL ESTATE SERVICES, NAMELY, DEVELOPMENT OF LAND AND PLANNING AND LAYING OUT OF BUILDINGS FOR USES INCLUDING RETAIL, COMMERCIAL, OFFICE AND/OR INDUSTRIAL; CONSTRUCTION OF COMMERCIAL REAL ESTATE; REAL ESTATE PROPERTY REHABILITATION, REPAIR AND MAINTENANCE, IN CLASS 37 (U.S. CLS. 100, 103 AND 106).

FIRST USE 0-0-1998; IN COMMERCE 0-0-1998.

THE MARK CONSISTS OF STANDARD CHARACTERS WITHOUT CLAIM TO ANY PARTICULAR FONT, STYLE, SIZE, OR COLOR.

SER. NO. 85-493,980, FILED 12-13-2011.

GINA HAYES, EXAMINING ATTORNEY



*David J. Kyffers*

Director of the United States Patent and Trademark Office

# United States of America

United States Patent and Trademark Office

## CREATING ENVIRONMENTS THAT INSPIRE SUCCESS

**Reg. No. 4,274,371**

**Registered Jan. 15, 2013**

**Int. Cls.: 36 and 37**

CORPORATE OFFICE PROPERTIES TRUST (MARYLAND REAL ESTATE INVESTMENT TRUST)  
TRUST)  
SUITE 300  
6711 COLUMBIA GATEWAY DRIVE  
COLUMBIA, MD 21046

**SERVICE MARK**

**PRINCIPAL REGISTER**

FOR: REAL ESTATE SERVICES, NAMELY, REAL ESTATE ACQUISITION; REAL ESTATE LEASING; MANAGEMENT OF COMMERCIAL PROPERTY; FINANCIAL ASSET MANAGEMENT OF COMMERCIAL REAL ESTATE; FINANCIAL INVESTMENT SERVICES IN THE FIELD OF COMMERCIAL REAL ESTATE, IN THE NATURE OF A REAL ESTATE INVESTMENT TRUST, IN CLASS 36 (U.S. CLS. 100, 101 AND 102).

FIRST USE 0-0-2006; IN COMMERCE 0-0-2006.

FOR: REAL ESTATE SERVICES, NAMELY, DEVELOPMENT OF LAND AND PLANNING AND LAYING OUT OF BUILDINGS FOR USES INCLUDING RETAIL, COMMERCIAL, OFFICE AND/OR INDUSTRIAL; CONSTRUCTION OF COMMERCIAL REAL ESTATE; REAL ESTATE PROPERTY REHABILITATION, REPAIR AND MAINTENANCE, IN CLASS 37 (U.S. CLS. 100, 103 AND 106).

FIRST USE 0-0-2006; IN COMMERCE 0-0-2006.

THE MARK CONSISTS OF STANDARD CHARACTERS WITHOUT CLAIM TO ANY PARTICULAR FONT, STYLE, SIZE, OR COLOR.

SER. NO. 85-494,065, FILED 12-13-2011.

GINA HAYES, EXAMINING ATTORNEY



*David J. Kyffers*

Director of the United States Patent and Trademark Office

# United States of America

United States Patent and Trademark Office

**HIREWIRE**  
workplace news

**Reg. No. 4,274,372**

CAREERSUSA, INC. (FLORIDA CORPORATION), DBA CAREERSUSA  
6501 CONGRESS AVENUE SUITE 200  
BOCA RATON, FL 33487

**Registered Jan. 15, 2013**

**Int. Cl.: 16**

FOR: PRINTED PUBLICATIONS, NAMELY, NEWSLETTER AND MAGAZINES IN THE FIELD OF RECRUITING, STAFFING, AND OTHER RELATED PERSONNEL SERVICES, IN CLASS 16 (U.S. CLS. 2, 5, 22, 23, 29, 37, 38 AND 50).

**TRADEMARK**

FIRST USE 9-0-1988; IN COMMERCE 9-0-1988.

**PRINCIPAL REGISTER**

OWNER OF U.S. REG. NO. 2,582,910.

THE COLOR(S) BROWN, GRAY AND BLACK IS/ARE CLAIMED AS A FEATURE OF THE MARK.

NO CLAIM IS MADE TO THE EXCLUSIVE RIGHT TO USE "WORKPLACE NEWS", APART FROM THE MARK AS SHOWN.

THE MARK CONSISTS OF THE WORDING "HIREWIRE WORKPLACE NEWS" IN A STYLIZED FONT, WITH THE WORDING "HIRE" IN BROWN AND "WIRE" IN GRAY AND THE LETTER "I" IN "WIRE" APPEARING AS A STYLIZED STICK FIGURE PERSON, AND WITH THE WORDING "WORKPLACE NEWS" IN BLACK.



SER. NO. 85-494,914, FILED 12-14-2011.

JAMES MACFARLANE, EXAMINING ATTORNEY

*David J. Kybas*

Director of the United States Patent and Trademark Office

# United States of America

United States Patent and Trademark Office



**Reg. No. 4,274,373**

**Registered Jan. 15, 2013**

**Int. Cl.: 21**

**TRADEMARK**

**PRINCIPAL REGISTER**

LIM, SANG MAN (REPUBLIC OF KOREA INDIVIDUAL)  
802-1, SUKMO-RI, YANGCHON-MYUN  
KIMPO-SI, GYEONGGI-DO, REPUBLIC OF KOREA

FOR: NON-METAL CONTAINERS FOR USE WITH FOOD; NON-METAL CRUETS; COOKING STEAMERS FOR RICE; SPICE RACK; PORTABLE COLDBOXES NON-ELECTRIC; RICE CHESTS; BUCKETS FOR USE WITH DISHWASHING, IN CLASS 21 (U.S. CLS. 2, 13, 23, 29, 30, 33, 40 AND 50).

OWNER OF REPUBLIC OF KOREA REG. NO. 0835093, DATED 9-3-2010, EXPIRES 9-3-2020.

THE MARK CONSISTS OF THE STYLIZED TEXT "ROCK" ABOVE THE STYLIZED TEXT "STAR", AND FOUR STARS ARRANGED IN AN IMAGINARY CURVE THAT LINKS THE LETTER "R" AND THE LETTER "S", WHEREIN THE ORIFICE IN THE LETTER "R" IS IN THE SHAPE OF A FIVE POINT STAR.

SER. NO. 85-497,026, FILED 12-16-2011.

JACQUELINE A. LAVINE, EXAMINING ATTORNEY



*David J. Kybas*

Director of the United States Patent and Trademark Office

# United States of America

United States Patent and Trademark Office

## WHITE CASTLE SLIDER BOWL

**Reg. No. 4,274,374**

WHITE CASTLE MANAGEMENT CO. (DELAWARE CORPORATION)  
555 WEST GOODALE STREET  
COLUMBUS, OH 43215

**Registered Jan. 15, 2013**

**Int. Cl.: 41**

FOR: ENTERTAINMENT SERVICES, NAMELY, CONDUCTING CONTESTS, IN CLASS 41  
(U.S. CLS. 100, 101 AND 107).

**SERVICE MARK**

FIRST USE 10-25-2011; IN COMMERCE 10-25-2011.

**PRINCIPAL REGISTER**

THE MARK CONSISTS OF STANDARD CHARACTERS WITHOUT CLAIM TO ANY PARTICULAR FONT, STYLE, SIZE, OR COLOR.

OWNER OF U.S. REG. NOS. 501,821, 962,253 AND OTHERS.

NO CLAIM IS MADE TO THE EXCLUSIVE RIGHT TO USE "SLIDER BOWL", APART FROM THE MARK AS SHOWN.

SER. NO. 85-497,061, FILED S.R. 12-16-2011 AM. P.R. 9-4-2012.

DARRYL SPRUILL, EXAMINING ATTORNEY



*David J. Kyfos*

Director of the United States Patent and Trademark Office

# United States of America

United States Patent and Trademark Office

# A.D.D EMPOWER

**Reg. No. 4,274,375**

**Registered Jan. 15, 2013**

**Int. Cls.: 41 and 44**

**SERVICE MARK**

**PRINCIPAL REGISTER**

SCREAMING NONSEQUITUR PRODUCTIONS, INC. (CONNECTICUT CORPORATION)  
GREENS FARMS POST OFFICE  
P.O. BOX 128  
GREENS FARMS, CT 06838

FOR: PROVIDING A WEBSITE FEATURING A SERIES OF NON-DOWNLOADABLE ELECTRONIC PUBLICATIONS IN THE NATURE OF ARTICLES IN THE FIELD OF MENTAL HEALTH, MENTAL HEALTH THERAPY, DIAGNOSIS AND TREATMENT OF ATTENTION DEFICIT DISORDER AND ATTENTION DEFICIT HYPERACTIVITY DISORDER, IN CLASS 41 (U.S. CLS. 100, 101 AND 107).

FIRST USE 10-7-2011; IN COMMERCE 10-7-2011.

FOR: PROVIDING A WEBSITE FEATURING INFORMATION AND NON-DOWNLOADABLE VIDEO PRESENTATIONS, ALL IN THE FIELD OF MENTAL HEALTH, MENTAL HEALTH THERAPY, DIAGNOSIS AND TREATMENT OF ATTENTION DEFICIT DISORDER AND ATTENTION DEFICIT HYPERACTIVITY DISORDER, IN CLASS 44 (U.S. CLS. 100 AND 101).

FIRST USE 10-7-2011; IN COMMERCE 10-7-2011.

NO CLAIM IS MADE TO THE EXCLUSIVE RIGHT TO USE "A.D.D.", APART FROM THE MARK AS SHOWN.

THE MARK CONSISTS OF THE WORD "EMPOWER", WITH THE LETTERS "A.D.D" APPEARING ABOVE THE LETTERS "EMP", WITH THE "O" IN "EMPOWER" APPEARING LARGER THAN THE REMAINING LETTERS OF THE WORD, AND APPEARING IN A SOMEWHAT STYLIZED FORMAT RESEMBLING A CABLE IN A CIRCLE.

SER. NO. 85-497,101, FILED 12-16-2011.

NANCY CLARKE, EXAMINING ATTORNEY



*David J. Kyffers*

Director of the United States Patent and Trademark Office

# United States of America

United States Patent and Trademark Office

## JEREMY STAAT FOUNDATION

**Reg. No. 4,274,376**

JEREMY P. STAAT (UNITED STATES INDIVIDUAL)

**Registered Jan. 15, 2013**

PO BOX 81702  
BAKERSFIELD, CA 933801702

**Int. Cl.: 41**

FOR: EDUCATIONAL SERVICES, NAMELY, PROVIDING EDUCATIONAL SPEAKERS IN THE FIELD OF VETERANS, VETERANS ORGANIZATIONS, VETERANS SERVICES, AND VETERANS RIGHTS, IN CLASS 41 (U.S. CLS. 100, 101 AND 107).

**SERVICE MARK**

FIRST USE 6-30-2011; IN COMMERCE 8-30-2011.

**PRINCIPAL REGISTER**

THE MARK CONSISTS OF STANDARD CHARACTERS WITHOUT CLAIM TO ANY PARTICULAR FONT, STYLE, SIZE, OR COLOR.

NO CLAIM IS MADE TO THE EXCLUSIVE RIGHT TO USE "FOUNDATION", APART FROM THE MARK AS SHOWN.

THE NAME "JEREMY STAAT" IDENTIFIES A LIVING INDIVIDUAL WHOSE CONSENT IS OF RECORD.

SER. NO. 85-497,925, FILED 12-16-2011.

JORDAN BAKER, EXAMINING ATTORNEY



*David J. Kybas*

Director of the United States Patent and Trademark Office



# United States of America

United States Patent and Trademark Office

## Persevere Believe Win

**Reg. No. 4,274,377**

**Registered Jan. 15, 2013**

**Int. Cl.: 25**

**TRADEMARK**

**PRINCIPAL REGISTER**

PRIMO ACTIVEWEAR, LLC (GEORGIA LIMITED LIABILITY COMPANY)  
355 WELWYN WALK  
ALPHARETTA, GA 30022

FOR: A-SHIRTS; APPAREL FOR DANCERS, NAMELY, TEE SHIRTS, SWEATSHIRTS, PANTS, LEGGINGS, SHORTS AND JACKETS; ATHLETIC APPAREL, NAMELY, SHIRTS, PANTS, JACKETS, FOOTWEAR, HATS AND CAPS, ATHLETIC UNIFORMS; BODY SHIRTS; BUTTON DOWN SHIRTS; BUTTON-FRONT ALOHA SHIRTS; CAMOUFLAGE SHIRTS; CAMP SHIRTS; CLOTHING FOR ATHLETIC USE, NAMELY, PADDED SHIRTS; CLOTHING FOR BABIES, TODDLERS AND CHILDREN, TREATED WITH FIRE AND HEAT RETARDANTS, NAMELY, PAJAMAS, JACKETS, SHIRTS, PANTS, JUMPERS; CLOTHING SHIELDS, NAMELY, PADS APPLIED TO THE UNDERARMS OF SHIRTS, BLOUSES AND SWEATERS; COLLARED SHIRTS; DRESS SHIRTS; FISHING SHIRTS; GOLF PANTS, SHIRTS AND SKIRTS; GOLF SHIRTS; HOODED SWEAT SHIRTS; KNIT SHIRTS; LEATHER SHIRTS; LONG-SLEEVED SHIRTS; MOISTURE-WICKING SPORTS SHIRTS; NIGHT SHIRTS; OPEN-NECKED SHIRTS; OVER SHIRTS; POLO SHIRTS; RUGBY SHIRTS; SCIENTIFIC AND TECHNOLOGICAL APPAREL, NAMELY, SHIRTS, PANTS, JACKETS, FOOTWEAR, HATS AND CAPS, UNIFORMS; SHIRT FRONTS; SHIRT INSERTS, NAMELY, DICKIES; SHIRT YOKES; SHIRTS; SHIRTS AND SHORT-SLEEVED SHIRTS; SHIRTS AND SLIPS; SHIRTS FOR INFANTS, BABIES, TODDLERS AND CHILDREN; SHIRTS FOR SUITS; SHORT-SLEEVED OR LONG-SLEEVED T-SHIRTS; SLEEP SHIRTS; SLEEVES WORN SEPARATE AND APART FROM BLOUSES, SHIRTS AND OTHER TOPS; SNAP CROTCH SHIRTS FOR INFANTS AND TODDLERS; SPORTS SHIRTS; SPORTS SHIRTS WITH SHORT SLEEVES; SWEAT SHIRTS; T-SHIRTS; TEE SHIRTS; TRIATHLON CLOTHING, NAMELY, TRIATHLON TIGHTS, TRIATHLON SHORTS, TRIATHLON SINGLETS, TRIATHLON SHIRTS, TRIATHLON SUITS; TURTLE NECK SHIRTS; WEARABLE GARMENTS AND CLOTHING, NAMELY, SHIRTS; WIND SHIRTS; WOMEN'S CLOTHING, NAMELY, SHIRTS, DRESSES, SKIRTS, BLOUSES; YOGA SHIRTS, IN CLASS 25 (U.S. CLS. 22 AND 39).



FIRST USE 1-2-2009; IN COMMERCE 1-2-2009.

THE MARK CONSISTS OF STANDARD CHARACTERS WITHOUT CLAIM TO ANY PARTICULAR FONT, STYLE, SIZE, OR COLOR.

SER. NO. 85-498,271, FILED 12-18-2011.

RAMONA ORTIGA, EXAMINING ATTORNEY

*David J. Kyros*

Director of the United States Patent and Trademark Office

# United States of America

United States Patent and Trademark Office

# PARADIGM

**Reg. No. 4,274,378**

**Registered Jan. 15, 2013**

**Int. Cl.: 44**

**SERVICE MARK**

**PRINCIPAL REGISTER**

PARADIGM MANAGEMENT SERVICES, LLC (DELAWARE LIMITED LIABILITY COMPANY)  
SUITE 800  
1277 TREAT BOULEVARD  
WALNUT CREEK, CA 94597

FOR: MANAGED HEALTH CARE SERVICES, IN CLASS 44 (U.S. CLS. 100 AND 101).

FIRST USE 7-1-1991; IN COMMERCE 7-1-1991.

THE MARK CONSISTS OF STANDARD CHARACTERS WITHOUT CLAIM TO ANY PARTICULAR FONT, STYLE, SIZE, OR COLOR.

OWNER OF U.S. REG. NO. 4,004,355.

SER. NO. 85-499,602, FILED 12-20-2011.

JAMES LOVELACE, EXAMINING ATTORNEY



*David J. Kyffers*

Director of the United States Patent and Trademark Office

# United States of America

United States Patent and Trademark Office

## LIVE FOR THE RIDE

**Reg. No. 4,274,379**

**Registered Jan. 15, 2013**

**Int. Cl.: 25**

**TRADEMARK**

**PRINCIPAL REGISTER**

SAYER, RICHARD (UNITED STATES INDIVIDUAL)  
508 BELLEVUE AVENUE  
HAMMONTON, NJ 08037

FOR: CLOTHING, NAMELY, POLO SHIRTS, T-SHIRTS, HOODED T-SHIRTS, SWEATSHIRTS, SWEATPANTS, SHORTS, PANTS, JACKETS, SKIRTS, HATS, HEADWEAR, SOCKS, SWIMSUITS, AND BELTS; ALL OF THE FOREGOING EXCLUDING CLOTHING DESIGNED OR PROMOTED SPECIFICALLY FOR WINTER SPORTS SUCH AS SKIING OR SNOWBOARDING, IN CLASS 25 (U.S. CLS. 22 AND 39).

FIRST USE 7-16-2010; IN COMMERCE 7-1-2011.

THE MARK CONSISTS OF STANDARD CHARACTERS WITHOUT CLAIM TO ANY PARTICULAR FONT, STYLE, SIZE, OR COLOR.

SER. NO. 85-499,750, FILED 12-20-2011.

PAM WILLIS, EXAMINING ATTORNEY



*David J. Kyffers*

Director of the United States Patent and Trademark Office

# United States of America

United States Patent and Trademark Office

# mylooks

**Reg. No. 4,274,380**

**Registered Jan. 15, 2013**

**Int. Cl.: 44**

**SERVICE MARK**

**PRINCIPAL REGISTER**

CEDARS WORLDWIDE LIMITED (LIECHTENSTEIN CORPORATION)  
LANDSTRASSE 14  
BALZERS, LIECHTENSTEIN

FOR: COSMETIC AND PLASTIC SURGERY; COSMETIC SURGERY SERVICES; ORAL SURGERY AND DENTAL IMPLANT SERVICES; PLASTIC SURGERY SERVICES, IN CLASS 44 (U.S. CLS. 100 AND 101).

FIRST USE 9-1-2011; IN COMMERCE 9-1-2011.

THE MARK CONSISTS OF STANDARD CHARACTERS WITHOUT CLAIM TO ANY PARTICULAR FONT, STYLE, SIZE, OR COLOR.

SER. NO. 85-500,162, FILED 12-20-2011.

STEPHANIE ALI, EXAMINING ATTORNEY



*David J. Kyffers*

Director of the United States Patent and Trademark Office

# United States of America

United States Patent and Trademark Office

## CONGRESS ON HEALTHCARE LEADERSHIP

**Reg. No. 4,274,381**

**Registered Jan. 15, 2013**

**Int. Cl.: 41**

**SERVICE MARK**

**PRINCIPAL REGISTER**

AMERICAN COLLEGE OF HEALTHCARE EXECUTIVES (ILLINOIS NON-PROFIT CORPORATION)  
SUITE 1700, ONE NORTH FRANKLIN STREET  
CHICAGO, IL 606063491

FOR: ARRANGING AND CONDUCTING EDUCATIONAL CONFERENCES IN THE FIELD OF HEALTHCARE MANAGEMENT, IN CLASS 41 (U.S. CLS. 100, 101 AND 107).

FIRST USE 0-0-2006; IN COMMERCE 0-0-2006.

THE MARK CONSISTS OF STANDARD CHARACTERS WITHOUT CLAIM TO ANY PARTICULAR FONT, STYLE, SIZE, OR COLOR.

SEC. 2(F).

SER. NO. 85-500,345, FILED 12-20-2011.

WENDY JUN, EXAMINING ATTORNEY



*David J. Kybas*

Director of the United States Patent and Trademark Office

# United States of America

United States Patent and Trademark Office



# ESUCHEN

**Reg. No. 4,274,382**

**Registered Jan. 15, 2013**

**Int. Cl.: 3**

**TRADEMARK**

**PRINCIPAL REGISTER**

SHAAN HONQ INTERNATIONAL COSMETICS CORPORATION (TAIWAN CORPORATION)  
29 FLOOR, NO.55, CHUNG CHENG 3RD ROAD  
KAOHSIUNG CITY 800, TAIWAN

FOR: COSMETICS, NAMELY, HAIR SHAMPOO, HAIR GEL, AND HAIR CONDITIONER;  
HAIR TREATMENT, NAMELY, HAIR LOTION, HAIR TONICS, HAIR CREAM, AND HAIR  
OILS; HAIR STYLING, NAMELY, HAIR SPRAY, HAIR STYLING GEL, HAIR MOUSSE,  
AND HAIR SCULPTING LOTION; HAIR PREPARATIONS, NAMELY, HAIR COLOR AND  
DYES, AND HAIR COLOR REMOVERS, IN CLASS 3 (U.S. CLS. 1, 4, 6, 50, 51 AND 52).

FIRST USE 10-16-1987; IN COMMERCE 10-16-1987.

THE MARK CONSISTS OF THE STYLIZED WORDING OF "ESUCHEN" NEAR A RELAT-  
IVELY ROUND-SHAPED DESIGN MARK WITH A DARK BACKGROUND, WITHIN WHICH  
IS A LIGHT COLOR FACIAL PROFILE OF A LADY FACING TOWARD THE LEFT SIDE OF  
THE MARK, AND THIS LADY HAS A SET OF CURLY HAIR (EXPRESSED BY WAVY  
DARK AND LIGHT LINES) COVERING HER HEAD AND THE BACK SIDE OF HER NECK.

SER. NO. 85-500,514, FILED 12-21-2011.

ESTHER BELENKER, EXAMINING ATTORNEY



*David J. Kyros*

Director of the United States Patent and Trademark Office

# United States of America

United States Patent and Trademark Office

# ABAM

**Reg. No. 4,274,383**

**Registered Jan. 15, 2013**

**CERTIFICATION MARK**

**PRINCIPAL REGISTER**

THE AMERICAN BOARD OF ADDICTION MEDICINE, INC. (DELAWARE NON-PROFIT CORPORATION)

UPPER ARCADE, SUITE 101  
4601 NORTH PARK AVENUE  
CHEVY CHASE, MD 20815

FOR: MEDICAL SERVICES IN THE FIELD OF ADDICTION MEDICINE AND TREATMENT, IN CLASS B (U.S. CL. B).

FIRST USE 5-2-2009; IN COMMERCE 5-2-2009.

THE MARK CONSISTS OF STANDARD CHARACTERS WITHOUT CLAIM TO ANY PARTICULAR FONT, STYLE, SIZE, OR COLOR.

THE CERTIFICATION MARK, AS USED BY AUTHORIZED PERSONS, CERTIFIES THAT SUCH PERSONS MEET THE CERTIFIER'S STANDARDS AS TO PROFESSIONAL EDUCATION, EXPERIENCE AND COMPETENCE AS REFLECTED BY THE SUCCESSFUL COMPLETION OF A WRITTEN EXAMINATION.

SER. NO. 85-500,856, FILED 12-21-2011.

MATTHEW MCDOWELL, EXAMINING ATTORNEY



*David J. Kyffers*

Director of the United States Patent and Trademark Office

# United States of America

United States Patent and Trademark Office

## CHARLOTTE'S

**Reg. No. 4,274,384**

**Registered Jan. 15, 2013**

**Int. Cl.: 35**

**SERVICE MARK**

**PRINCIPAL REGISTER**

CHARLOTTE'S, INC. (NORTH CAROLINA CORPORATION)  
707 RUNNYMEAD ROAD  
RALEIGH, NC 27607

FOR: RETAIL STORE SERVICES FEATURING FINE JEWELRY, NAMELY, GOLD AND STERLING SILVER WITH PRECIOUS STONES; RETAIL STORE SERVICES FEATURING COSTUME JEWELRY, NAMELY, RINGS, EARRINGS, BRACELETS AND NECKLACES; RETAIL STORE SERVICES FEATURING WOMEN'S ACCESSORIES, NAMELY, CLOTHES, SHOES, HANDBAGS, GLOVES, SCARVES, PURSES, WATCHES; RETAIL STORE SERVICES FEATURING BATH PRODUCTS, NAMELY, BATH SALTS, LOTION, BODY BUFFERS, BATH GELS, PERFUME; RETAIL STORE SERVICES FEATURING HOME DÉCOR, NAMELY, COOK BOOKS, NAPKINS, GLASSWARE, PICTURE FRAMES, CANDLES, PICTURE ALBUMS, SILVER POLISH, TELEPHONE DIRECTORIES, CALENDARS, BOWLS, PLACEMATS, TRASH CANS, TISSUE HOLDERS, TOOTH BRUSH HOLDERS, SOAP, SOAP DISHES, PICTURES, LAMPS, PILLOWS; RETAIL STORE SERVICES FEATURING MEN'S ACCESSORIES, NAMELY, BELTS, TIES, SHIRTS, HATS, WALLETS, MONEY CLIPS, KEY RINGS, BUCKLES, PENS; RETAIL STORE SERVICES FEATURING BABY PRODUCTS, NAMELY, FRAMES, RATTLES, CUPS, SPOONS, JEWELRY, TEETHING RINGS, PILLOWS, BIBS, BLANKETS, CLOTHES, DIAPER BAGS, BOOKS, SHOES, BANKS, PLATES, SOCKS; RETAIL STORE SERVICES FEATURING WEDDING PRODUCTS, NAMELY, BOOKS, FRAMES, GIFTS, PHOTO ALBUMS, WINE GLASSES, INVITATIONS AND SAVE THE DATE CARDS; RETAIL STORE SERVICES FEATURING PAPER PRODUCTS, NAMELY, CARDS, BLANK CARDS, CHRISTMAS CARDS, JOURNALS, NOTE CARDS, NOTE PADS, APPOINTMENT BOOKS, PLANNERS, STATIONARY; RETAIL STORE SERVICES FEATURING MONOGRAMMED GIFTS, NAMELY, LUNCH BAGS, BEACH BAGS, LUGGAGE TAGS, CLOTH BAGS, JEWELRY ROLLS, HOUSE SHOES, MAKEUP BAGS, TOWEL WRAPS, ROBES, LEATHER PASSPORT HOLDERS, CREDIT CARD HOLDERS AND CALLING CARD HOLDERS; RETAIL STORE SERVICES FEATURING ENGRAVED GIFTS, NAMELY, NOTE PADS, JEWELRY, CUPS, SILVER PLATE AND STERLING SILVER BOXES, FRAMES, MONEY CLIPS, BRUSHES, COMBS AND ACRYLIC TRAYS, BOOKS, PLATES, PLATTERS, RECIPE BOXES, PAPER WEIGHTS AND GLASSWARE; RETAIL STORE SERVICES FEATURING COLLEGE ITEMS, NAMELY, GLASSWARE, BELTS, HAND PAINTED WINE GLASSES, PLATES, BOWLS, COFFEE CUPS, PICTURE FRAMES, BUCKETS, BABY SOCKS AND HATS, IN CLASS 35 (U.S. CLS. 100, 101 AND 102).



*David J. Kyjars*

FIRST USE 1-1-1993; IN COMMERCE 1-8-1993.



**Reg. No. 4,274,384** THE MARK CONSISTS OF STANDARD CHARACTERS WITHOUT CLAIM TO ANY PARTICULAR FONT, STYLE, SIZE, OR COLOR.

THE NAME(S), PORTRAIT(S), AND/OR SIGNATURE(S) SHOWN IN THE MARK IDENTIFIES "CHARLOTTE HARRIS", WHOSE CONSENT(S) TO REGISTER IS MADE OF RECORD.

SER. NO. 85-501,078, FILED 12-21-2011.

BERYL GARDNER, EXAMINING ATTORNEY

United States of America  
United States Patent and Trademark Office

**WOTER**

**Reg. No. 4,274,385**

DJTOL GROUP (USA) CO., LIMITED (CALIFORNIA CORPORATION)  
9460 TELSTAR AVE SUITE 5  
EL MONTE, CA 91731

**Registered Jan. 15, 2013**

**Int. Cl.: 7**

FOR: MACHINE TOOLS, NAMELY, BITS FOR POWER DRILLS, CUTTING MACHINES, ELECTRIC KNIFE SHARPENERS, GRINDING MACHINES, LATHES, METAL WORKING MACHINES, ROBOTIC ARMS FOR INDUSTRIAL PURPOSES, IN CLASS 7 (U.S. CLS. 13, 19, 21, 23, 31, 34 AND 35).

**TRADEMARK**

**PRINCIPAL REGISTER**

FIRST USE 7-19-2010; IN COMMERCE 7-19-2010.

THE MARK CONSISTS OF THE ITALICIZED CHARACTERS "WOTER" WITH "O" IN AN INCOMPLETE POLYGON.

SER. NO. 85-501,648, FILED 12-21-2011.

ANDREA HACK, EXAMINING ATTORNEY



*David J. Kyffers*

Director of the United States Patent and Trademark Office

# United States of America

United States Patent and Trademark Office

## STATEMENT OF CERTAINTY

**Reg. No. 4,274,386**

NATIONAL MEDICAL SERVICES, INC. (DELAWARE CORPORATION)  
3701 WELSH ROAD  
WILLOW GROVE, PA 19090

**Registered Jan. 15, 2013**

**Int. Cl.: 42**

FOR: BLOOD ANALYSIS SERVICES; DRUG, ALCOHOL AND DNA SCREENING FOR FORENSIC RESEARCH PURPOSES, IN CLASS 42 (U.S. CLS. 100 AND 101).

**SERVICE MARK**

FIRST USE 12-20-2011; IN COMMERCE 12-20-2011.

**PRINCIPAL REGISTER**

THE MARK CONSISTS OF STANDARD CHARACTERS WITHOUT CLAIM TO ANY PARTICULAR FONT, STYLE, SIZE, OR COLOR.

SER. NO. 85-502,030, FILED 12-22-2011.

MARK SHINER, EXAMINING ATTORNEY



*David J. Kyffers*

Director of the United States Patent and Trademark Office

# United States of America

United States Patent and Trademark Office



**Reg. No. 4,274,387**

**Registered Jan. 15, 2013**

**Int. Cls.: 9 and 11**

**TRADEMARK**

**PRINCIPAL REGISTER**

PIX20 CORPORATION (CALIFORNIA CORPORATION)  
SUITE 100  
1300 VALLEY HOUSE DR.  
ROHNERT PARK, CA 94928

FOR: ELECTRONIC DISPLAYS, NAMELY, LARGE SCALE LED DISPLAYS AND RELATED COMPONENTS, NAMELY, LED LIGHT CONTROLS, LED CIRCUIT BOARDS, DISPLAY MODULES, ELECTRONIC CONTROL AND CONFIGURATION SOFTWARE AND COMPUTER HARDWARE, VIDEO PROCESSING UNITS, PIXEL ROUTERS AND PIXEL SWITCHES, POWER SUPPLIES AND ELECTRICAL POWER EXTENSION CORDS; ELECTRONIC DISPLAYS, NAMELY, LARGE SCALE LED DISPLAYS AND RELATED COMPONENTS, NAMELY, LED LIGHT CONTROLS, LED CIRCUIT BOARDS, DISPLAY MODULES, MOUNTING HARDWARE AND STRUCTURAL SUPPORT SYSTEMS COMPRISING TRUSSES, SUPPORT TOWERS AND TRAILERS, CONTROL AND CONFIGURATION SOFTWARE AND COMPUTER HARDWARE COMPRISING VIDEO PROCESSING UNITS, PIXEL ROUTERS AND PIXEL SWITCHES, AND POWER SUPPLIES AND ELECTRICAL POWER EXTENSION CORDS, ALL SOLD AS A UNIT, IN CLASS 9 (U.S. CLS. 21, 23, 26, 36 AND 38).

FIRST USE 2-16-2011; IN COMMERCE 2-16-2011.

FOR: LIGHTING FIXTURES FOR USE WITH LED DISPLAYS, IN CLASS 11 (U.S. CLS. 13, 21, 23, 31 AND 34).

FIRST USE 2-16-2011; IN COMMERCE 2-16-2011.

THE MARK CONSISTS OF A TEXT PORTION, HAVING THE LETTERS "PIX", FOLLOWED BY THE SUBSCRIPT "2", FOLLOWED BY THE LETTER "O", ALL OF WHICH ARE IN A CIRCLE HAVING A WIDTH THAT SUBSTANTIALLY ENCLOSES THIS TEXT PORTION.

SER. NO. 85-502,262, FILED 12-22-2011.

JOHN SCHUYLER YARD, EXAMINING ATTORNEY



*David J. Kyffers*

Director of the United States Patent and Trademark Office

# United States of America

United States Patent and Trademark Office

## VISIONARY VIDEO SOLUTIONS

**Reg. No. 4,274,388**

**Registered Jan. 15, 2013**

**Int. Cl.: 9**

**TRADEMARK**

**PRINCIPAL REGISTER**

PIX20 CORPORATION (CALIFORNIA CORPORATION)  
SUITE 100  
1300 VALLEY HOUSE DR.  
ROHNERT PARK, CA 94928

FOR: ELECTRONIC DISPLAYS, NAMELY, LARGE SCALE LED DISPLAYS AND RELATED COMPONENTS, NAMELY, LED LIGHT CONTROLS, LED CIRCUIT BOARDS, DISPLAY MODULES, ELECTRONIC CONTROL AND CONFIGURATION SOFTWARE AND COMPUTER HARDWARE, VIDEO PROCESSING UNITS, PIXEL ROUTERS AND PIXEL SWITCHES, POWER SUPPLIES AND ELECTRICAL POWER EXTENSION CORDS; ELECTRONIC DISPLAYS, NAMELY, LARGE SCALE LED DISPLAYS AND RELATED COMPONENTS, NAMELY, LED LIGHT CONTROLS, LED CIRCUIT BOARDS, DISPLAY MODULES, MOUNTING HARDWARE AND STRUCTURAL SUPPORT SYSTEMS COMPRISING TRUSSES, SUPPORT TOWERS AND TRAILERS, CONTROL AND CONFIGURATION SOFTWARE AND COMPUTER HARDWARE COMPRISING VIDEO PROCESSING UNITS, PIXEL ROUTERS AND PIXEL SWITCHES, AND POWER SUPPLIES AND ELECTRICAL POWER EXTENSION CORDS, ALL SOLD AS A UNIT, IN CLASS 9 (U.S. CLS. 21, 23, 26, 36 AND 38).

FIRST USE 2-16-2011; IN COMMERCE 2-16-2011.

THE MARK CONSISTS OF STANDARD CHARACTERS WITHOUT CLAIM TO ANY PARTICULAR FONT, STYLE, SIZE, OR COLOR.

NO CLAIM IS MADE TO THE EXCLUSIVE RIGHT TO USE "VIDEO", APART FROM THE MARK AS SHOWN.

SER. NO. 85-502,334, FILED 12-22-2011.

JOHN SCHUYLER YARD, EXAMINING ATTORNEY



*David J. Kyros*

Director of the United States Patent and Trademark Office

# United States of America

United States Patent and Trademark Office



**Reg. No. 4,274,389**

**Registered Jan. 15, 2013**

**Int. Cl.: 30**

**TRADEMARK**

**PRINCIPAL REGISTER**

KONG YEN FOODS CO., LTD. (TAIWAN CORPORATION)  
1FL., NO. 1, LANE 10, SEC. 3  
CHUNG-SHIAU E. RD.  
TAIPEI CITY, TAIWAN

FOR: RICE VINEGAR, IN CLASS 30 (U.S. CL. 46).

FIRST USE 1-16-1952; IN COMMERCE 3-5-1985.

NO CLAIM IS MADE TO THE EXCLUSIVE RIGHT TO USE "RICEVINEGAR" AND THE NON-LATIN CHARACTER THAT TRANSLITERATES TO "TSU", APART FROM THE MARK AS SHOWN.

THE COLOR(S) GREEN, YELLOW, WHITE AND BLACK IS/ARE CLAIMED AS A FEATURE OF THE MARK.

THE NON-LATIN CHARACTERS IN THE MARK TRANSLITERATE TO "TSU" AND THIS MEANS "VINEGAR" IN ENGLISH.

THE MARK CONSISTS OF A GREEN RECTANGLE WITH A BLACK OUTLINE. INSIDE THE GREEN RECTANGLE APPEAR MULTIPLE YELLOW LEAF LIKE DESIGNS AND TWO LARGE CONCENTRIC YELLOW CIRCLES DIVIDED BY A WHITE CIRCLE. IN THE MIDDLE OF THE CIRCLES IS THE BLACK WORDING "RICEVINEGAR" AND A CHINESE CHARACTER APPEARING IN BLACK.

SER. NO. 85-503,745, FILED S.R. 12-26-2011 AM. P.R. 1-16-2012.

KATHERINE E. HALMEN, EXAMINING ATTORNEY



*David J. Kybas*

Director of the United States Patent and Trademark Office

# United States of America

United States Patent and Trademark Office

# SOCARE

**Reg. No. 4,274,390**

**Registered Jan. 15, 2013**

**Int. Cl.: 7**

**TRADEMARK**

**PRINCIPAL REGISTER**

SOCARE INTERNATIONAL USA, LLC (OHIO LIMITED LIABILITY COMPANY)  
11435 CENTURY CIRCLE WEST  
CINCINNATI, OH 45246

FOR: BEARINGS, AS PARTS OF MACHINES, NOT USED IN AIRCRAFT OR SPACECRAFT;  
GEARS FOR MACHINES, NOT USED IN AIRCRAFT OR SPACECRAFT; MACHINE PARTS  
NOT USED IN AIRCRAFT OR SPACECRAFT, NAMELY, RING GEARS, BALL SLEWING  
RINGS, CROSS ROLLER SLEWING RINGS, ROLLER SLEWING RINGS, BEARING PRECI-  
SION SLEW RINGS, IN CLASS 7 (U.S. CLS. 13, 19, 21, 23, 31, 34 AND 35).

FIRST USE 12-8-2010; IN COMMERCE 12-8-2010.

THE MARK CONSISTS OF STANDARD CHARACTERS WITHOUT CLAIM TO ANY PAR-  
TICULAR FONT, STYLE, SIZE, OR COLOR.

THE ENGLISH TRANSLATION OF "SOCARE" IN THE MARK IS "COME TO SUCCESS  
SMOOTHLY".

SER. NO. 85-504,493, FILED 12-27-2011.

DAVID TAYLOR, EXAMINING ATTORNEY



*David J. Kypos*

Director of the United States Patent and Trademark Office

# United States of America

United States Patent and Trademark Office

## NW Kids Magazine

**Reg. No. 4,274,391**

**Registered Jan. 15, 2013**

**Int. Cl.: 16**

**TRADEMARK**

**PRINCIPAL REGISTER**

MICHE MEDIA LLC (OREGON LIMITED LIABILITY COMPANY), DBA NW KIDS PUBLICATIONS  
P O BOX 91563  
PORTLAND, OR 97291

FOR: GENERAL FEATURE MAGAZINE IN THE FIELD OF EDUCATION AND ENTERTAINMENT FOR CHILDREN, PARENTS AND FAMILIES, IN CLASS 16 (U.S. CLS. 2, 5, 22, 23, 29, 37, 38 AND 50).

FIRST USE 2-1-2003; IN COMMERCE 2-1-2003.

THE MARK CONSISTS OF STANDARD CHARACTERS WITHOUT CLAIM TO ANY PARTICULAR FONT, STYLE, SIZE, OR COLOR.

NO CLAIM IS MADE TO THE EXCLUSIVE RIGHT TO USE "MAGAZINE", APART FROM THE MARK AS SHOWN.

SEC. 2(F).

SER. NO. 85-504,521, FILED 12-27-2011.

PAM WILLIS, EXAMINING ATTORNEY



*David J. Kyffers*

Director of the United States Patent and Trademark Office



# United States of America

United States Patent and Trademark Office

## Adaptive Learning Pathway

**Reg. No. 4,274,392**

**Registered Jan. 15, 2013**

**Int. Cl.: 42**

MCCANN ASSOCIATES HOLDINGS, LLC (DELAWARE LIMITED LIABILITY COMPANY),  
TA VANTAGE LEARNING (USA), LICENSOR TO MCCANN ASSOCIATES  
KENNETH J. LAFIANDRA, ESQUIRE  
6805 ROUTE 202  
NEW HOPE, PA 18938

**SERVICE MARK**

**PRINCIPAL REGISTER**

FOR: CLOUD COMPUTING FEATURING SOFTWARE FOR USE AS AN ADAPTIVE TECHNOLOGY ALGORITHMIC BASED PROCESS DELIVERED AS SOFTWARE-AS-A SERVICE (SAAS) FOR COMPILING AND PRESENTING AN ONLINE WEB-BASED SERIES OF LEARNING PLANS USED TO DIRECT AND GUIDE LEARNERS ON RECOMMENDED PATH TO MASTERY OF A SUBJECT MATTER AND TO PROVIDE INSTRUCTORS WITH INFORMATION TO FINE TUNE INTERPERSONAL FEEDBACK TO LEARNERS, IN CLASS 42 (U.S. CLS. 100 AND 101).

FIRST USE 10-1-2011; IN COMMERCE 10-1-2011.

THE MARK CONSISTS OF STANDARD CHARACTERS WITHOUT CLAIM TO ANY PARTICULAR FONT, STYLE, SIZE, OR COLOR.

NO CLAIM IS MADE TO THE EXCLUSIVE RIGHT TO USE "ADAPTIVE LEARNING", APART FROM THE MARK AS SHOWN.

SER. NO. 85-504,884, FILED 12-28-2011.

ANN E. SAPPENFIELD, EXAMINING ATTORNEY



*David J. Kybas*

Director of the United States Patent and Trademark Office

# United States of America

United States Patent and Trademark Office

# Helles Belles

**Reg. No. 4,274,393**

NINKASI BREWERY, LLC (OREGON LIMITED LIABILITY COMPANY)  
272 VAN BUREN STREET  
EUGENE, OR 97402

**Registered Jan. 15, 2013**

**Int. Cl.: 32**

FOR: BEER, IN CLASS 32 (U.S. CLS. 45, 46 AND 48).

**TRADEMARK**

FIRST USE 7-28-2011; IN COMMERCE 7-28-2011.

**PRINCIPAL REGISTER**

THE MARK CONSISTS OF STANDARD CHARACTERS WITHOUT CLAIM TO ANY PARTICULAR FONT, STYLE, SIZE, OR COLOR.

SER. NO. 85-505,135, FILED 12-28-2011.

JENNIFER WILLISTON, EXAMINING ATTORNEY



*David J. Kybas*

Director of the United States Patent and Trademark Office

# United States of America

United States Patent and Trademark Office

## ECLIPSE MEMBRANES

**Reg. No. 4,274,394**

**Registered Jan. 15, 2013**

**Int. Cl.: 11**

**TRADEMARK**

**PRINCIPAL REGISTER**

MARKEL CORPORATION (PENNSYLVANIA CORPORATION)  
435 SCHOOL LANE  
PLYMOUTH MEETING, PA 19462

FOR: POLYTETRAFLUOROETHYLENE (PTFE) MEMBRANES BEING FILTER CARTRIDGES FOR THE SEPARATION OF BIOMOLECULES IN BIOPHARMACEUTICAL PRODUCTION; MEMBRANES BEING LIQUID OR GAS-AND-LIQUID FILTERING UNITS FOR INDUSTRIAL AND DOMESTIC USE IN FOOD AND BEVERAGE, WINE, BEER, VINEGAR, DAIRY, FRUIT JUICE AND EDIBLE OIL PRODUCTION, AND FOR PRODUCING POTABLE WATER FOR DOMESTIC USE; MEMBRANES BEING LIQUID OR GAS-AND-LIQUID FILTERING UNITS FOR INDUSTRIAL USE IN WAFER, PRINTED CIRCUIT, AND PHOTOETCH PRODUCTION; MEMBRANES BEING LIQUID OR GAS-AND-LIQUID FILTERING UNITS FOR INDUSTRIAL USE IN THE FIELDS OF ORGANIC SYNTHESIS, THE PRODUCTION OF ACIDS AND ALKALI, AND WASTE TREATMENT; MEMBRANE CONTACTORS AND SEPARATORS FOR THE CLEANING AND PURIFICATION OF GASES AND LIQUIDS, NAMELY, MEMBRANE DISTILLATION, DESALINATION, DEGASSING AND DEBUBBLING; MEMBRANE CONTACTORS FOR LIQUID OR GAS AND LIQUID SEPARATION, NAMELY, OSMOTIC DISTILLATION AND OZONE DISPERSION IN WATER; MEMBRANE SEPARATORS FOR ISOLATING GASES FROM LIQUIDS, NAMELY, MOTIONLESS OZONE CHECK VALVES BEING PARTS OF OZONE SANITIZERS FOR AIR AND WATER; OZONE SANITIZERS FOR AIR AND WATER; COMPONENT PARTS SOLD AS INTEGRAL COMPONENTS OF MEMBRANE LIQUID OR GAS-AND-LIQUID FILTERS AND MEMBRANE CONTRACTORS, NAMELY, ELASTOMERIC, THERMOPLASTIC, AND THERMOSET POTTING COMPOUNDS, HOUSINGS AND BONDING COMPOUNDS THAT HOLDS THE BUNDLED ENDS OF HOLLOW FIBERS TOGETHER, ESTABLISHING A LEAK PROOF SEAL BETWEEN THE OPEN ENDS OF THE HOLLOW FIBERS AND THEIR OUTSIDE SURFACES; ALL OF THE FOREGOING NOT FOR MEDICAL PRODUCTS DIRECTED TO PATIENT USE, IN CLASS 11 (U.S. CLS. 13, 21, 23, 31 AND 34).



FIRST USE 11-0-2011; IN COMMERCE 12-0-2011.

THE MARK CONSISTS OF STANDARD CHARACTERS WITHOUT CLAIM TO ANY PARTICULAR FONT, STYLE, SIZE, OR COLOR.

NO CLAIM IS MADE TO THE EXCLUSIVE RIGHT TO USE "MEMBRANES", APART FROM THE MARK AS SHOWN.

*David J. Kyjars*

Director of the United States Patent and Trademark Office

**Reg. No. 4,274,394** SER. NO. 85-505,617, FILED 12-29-2011.

JOHN GARTNER, EXAMINING ATTORNEY

# United States of America

United States Patent and Trademark Office

# ECLIPSE

MEMBRANES

**Reg. No. 4,274,395**

**Registered Jan. 15, 2013**

**Int. Cl.: 11**

**TRADEMARK**

**PRINCIPAL REGISTER**

MARKEL CORPORATION (PENNSYLVANIA CORPORATION)  
435 SCHOOL LANE  
PLYMOUTH MEETING, PA 19462

FOR: POLYTETRAFLUOROETHYLENE (PTFE) MEMBRANES BEING FILTER CARTRIDGES FOR THE SEPARATION OF BIOMOLECULES IN BIOPHARMACEUTICAL PRODUCTION; MEMBRANES BEING LIQUID OR GAS-AND-LIQUID FILTERING UNITS FOR INDUSTRIAL AND DOMESTIC USE IN FOOD AND BEVERAGE, WINE, BEER, VINEGAR, DAIRY, FRUIT JUICE AND EDIBLE OIL PRODUCTION, AND FOR PRODUCING POTABLE WATER FOR DOMESTIC USE; MEMBRANES BEING LIQUID OR GAS-AND-LIQUID FILTERING UNITS FOR INDUSTRIAL USE IN WAFER, PRINTED CIRCUIT, AND PHOTOETCH PRODUCTION; MEMBRANES BEING LIQUID OR GAS-AND-LIQUID FILTERING UNITS FOR INDUSTRIAL USE IN THE FIELDS OF ORGANIC SYNTHESIS, THE PRODUCTION OF ACIDS AND ALKALI, AND WASTE TREATMENT; MEMBRANE CONTACTORS AND SEPARATORS FOR THE CLEANING AND PURIFICATION OF GASES AND LIQUIDS, NAMELY, MEMBRANE DISTILLATION, DESALINATION, DEGASSING AND DEBUBBLING; MEMBRANE CONTACTORS FOR LIQUID OR GAS AND LIQUID SEPARATION, NAMELY OSMOTIC DISTILLATION AND OZONE DISPERSION IN WATER; MEMBRANE SEPARATORS FOR ISOLATING GASES FROM LIQUIDS NAMELY MOTIONLESS OZONE CHECK VALVES BEING PARTS OF OZONE SANITIZERS FOR AIR AND WATER; OZONE SANITIZERS FOR AIR AND WATER; COMPONENT PARTS SOLD AS INTEGRAL COMPONENTS OF MEMBRANE LIQUID OR GAS-AND-LIQUID FILTERS AND MEMBRANE CONTRACTORS, NAMELY, ELASTOMERIC, THERMOPLASTIC, AND THERMOSET POTTING COMPOUNDS, HOUSINGS AND BONDING COMPOUNDS THAT HOLDS THE BUNDLED ENDS OF HOLLOW FIBERS TOGETHER, ESTABLISHING A LEAK PROOF SEAL BETWEEN THE OPEN ENDS OF THE HOLLOW FIBERS AND THEIR OUTSIDE SURFACES; ALL OF THE FOREGOING NOT FOR MEDICAL PRODUCTS DIRECTED TO PATIENT USE, IN CLASS 11 (U.S. CLS. 13, 21, 23, 31 AND 34).



FIRST USE 11-0-2011; IN COMMERCE 12-0-2011.

NO CLAIM IS MADE TO THE EXCLUSIVE RIGHT TO USE "MEMBRANES", APART FROM THE MARK AS SHOWN.

*David J. Kyffers*

THE COLOR(S) BLACK, BLUE AND WHITE IS/ARE CLAIMED AS A FEATURE OF THE MARK.

**Reg. No. 4,274,395** THE MARK CONSISTS OF THE WORD "ECLIPSE" IN BLACK ABOVE FOUR BLUE DOTS EACH LIGHTER IN SHADE THAN THE ONE PRECEDING WITH THE WORD "MEMBRANES" IN BLACK TO THE RIGHT OF THE DOTS FOLLOWED BY TWO MORE DOTS OUTLINED IN BLUE WITH AN INTERIOR WHITE COLOR.

SER. NO. 85-505,724, FILED 12-29-2011.

JOHN GARTNER, EXAMINING ATTORNEY

# United States of America

United States Patent and Trademark Office

# MCGUIRE

**Reg. No. 4,274,396**

SYSTEMS, INC. (WISCONSIN CORPORATION)  
W194 N11481 MCCORMICK DRIVE  
GERMANTOWN, WI 53022

**Registered Jan. 15, 2013**

**Int. Cls.: 6, 7, 17 and 19**

FOR: METAL LOADING DOCK SHELTERS; VEHICLE RESTRAINTS, NAMELY, MANUALLY ACTUATED METAL RESTRAINTS FOR VEHICLES IN THE NATURE OF A SYSTEM COMPRISING A WALL OR DRIVEWAY METAL MOUNTED LATCH, TO HOLD A VEHICLE TRAILER IN PLACE WHILE LOADING AND UNLOADING, IN CLASS 6 (U.S. CLS. 2, 12, 13, 14, 23, 25 AND 50).

**TRADEMARK**

**PRINCIPAL REGISTER**

FIRST USE 2-0-1959; IN COMMERCE 2-0-1959.

FOR: LOADING DOCK EQUIPMENT, NAMELY, DOCK LEVELERS, VERTICAL DOCK LEVELERS, HYDRAULICALLY ACTUATED DOCK LEVELERS, MECHANICALLY ACTUATED DOCK LEVELERS, SPRING ACTUATED DOCK LEVELERS, AND AIR BAG ACTUATED DOCK LEVELERS, NAMELY, MACHINE OPERATED PLATFORMS CAPABLE OF ELEVATION ABOVE GROUND LEVEL TO FACILITATE LOADING AND UNLOADING BETWEEN VEHICLES AND TRAILERS, AND LOADING DOCKS OR PLATFORMS OF VARYING HEIGHTS; VEHICLE RESTRAINTS, NAMELY, ELECTRICALLY AND HYDRAULICALLY ACTUATED METAL RESTRAINTS FOR VEHICLES IN THE NATURE OF A SYSTEM COMPRISING A WALL OR DRIVEWAY MOUNTED LATCH, MOTORIZED PUMP, PUSH BUTTON ACTIVATION CONTROLS AND AUTOMATIC LIGHT SEQUENCE NOTIFICATION, TO HOLD A VEHICLE TRAILER IN PLACE WHILE LOADING AND UNLOADING, IN CLASS 7 (U.S. CLS. 13, 19, 21, 23, 31, 34 AND 35).

FIRST USE 2-0-1959; IN COMMERCE 2-0-1959.

FOR: NON-METAL DOCK SHELTER SEALS FOR SEALING A VEHICLE TRAILER TO A LOADING DOCK ENTRANCE, IN CLASS 17 (U.S. CLS. 1, 5, 12, 13, 35 AND 50).

FIRST USE 0-0-1964; IN COMMERCE 0-0-1964.

FOR: NON-METAL LOADING DOCK SHELTERS, IN CLASS 19 (U.S. CLS. 1, 12, 33 AND 50).

FIRST USE 0-0-1964; IN COMMERCE 0-0-1964.



*David J. Kyffers*

Director of the United States Patent and Trademark Office

**Reg. No. 4,274,396** THE MARK CONSISTS OF STANDARD CHARACTERS WITHOUT CLAIM TO ANY PARTICULAR FONT, STYLE, SIZE, OR COLOR.

SEC. 2(F).

SER. NO. 85-505,941, FILED 12-29-2011.

SANI KHOURI, EXAMINING ATTORNEY



# United States of America

United States Patent and Trademark Office



**Reg. No. 4,274,397**

SYSTEMS, INC. (WISCONSIN CORPORATION)  
W194 N11481 MCCORMICK DRIVE  
GERMANTOWN, WI 53022

**Registered Jan. 15, 2013**

**Int. Cls.: 6, 7, 17 and 19**

FOR: METAL LOADING DOCK SHELTERS; VEHICLE RESTRAINTS, NAMELY, MANUALLY ACTUATED METAL RESTRAINTS FOR VEHICLES IN THE NATURE OF A SYSTEM COMPRISING A WALL OR DRIVEWAY METAL MOUNTED LATCH, TO HOLD A VEHICLE TRAILER IN PLACE WHILE LOADING AND UNLOADING, IN CLASS 6 (U.S. CLS. 2, 12, 13, 14, 23, 25 AND 50).

**TRADEMARK**

**PRINCIPAL REGISTER**

FIRST USE 2-0-1959; IN COMMERCE 2-0-1959.

FOR: LOADING DOCK EQUIPMENT, NAMELY, DOCK LEVELERS, VERTICAL DOCK LEVELERS, HYDRAULICALLY ACTUATED DOCK LEVELERS, MECHANICALLY ACTUATED DOCK LEVELERS, SPRING ACTUATED DOCK LEVELERS, AND AIR BAG ACTUATED DOCK LEVELERS, NAMELY, MACHINE OPERATED PLATFORMS CAPABLE OF ELEVATION ABOVE GROUND LEVEL TO FACILITATE LOADING AND UNLOADING BETWEEN VEHICLES AND TRAILERS, AND LOADING DOCKS OR PLATFORMS OF VARYING HEIGHTS; VEHICLE RESTRAINTS, NAMELY, ELECTRICALLY AND HYDRAULICALLY ACTUATED METAL RESTRAINTS FOR VEHICLES IN THE NATURE OF A SYSTEM COMPRISING A WALL OR DRIVEWAY MOUNTED LATCH, MOTORIZED PUMP, PUSH BUTTON ACTIVATION CONTROLS AND AUTOMATIC LIGHT SEQUENCE NOTIFICATION, TO HOLD A VEHICLE TRAILER IN PLACE WHILE LOADING AND UNLOADING, IN CLASS 7 (U.S. CLS. 13, 19, 21, 23, 31, 34 AND 35).

FIRST USE 2-0-1959; IN COMMERCE 2-0-1959.

FOR: NON-METAL DOCK SHELTER SEALS FOR SEALING A VEHICLE TRAILER TO A LOADING DOCK ENTRANCE, IN CLASS 17 (U.S. CLS. 1, 5, 12, 13, 35 AND 50).

FIRST USE 0-0-1964; IN COMMERCE 0-0-1964.

FOR: NON-METAL LOADING DOCK SHELTERS, IN CLASS 19 (U.S. CLS. 1, 12, 33 AND 50).

FIRST USE 0-0-1964; IN COMMERCE 0-0-1964.



*David J. Kyffers*

Director of the United States Patent and Trademark Office

**Reg. No. 4,274,397** THE MARK CONSISTS OF THE WORD "MCGUIRE" CONTAINED WITHIN AN UNDERLINED RECTANGLE WITH AN UPSIDE-DOWN TRIANGLE ABOVE THE WORD.

SER. NO. 85-505,946, FILED 12-29-2011.

SANI KHOURI, EXAMINING ATTORNEY

# United States of America

United States Patent and Trademark Office

# CEREX

**Reg. No. 4,274,398**

**Registered Jan. 15, 2013**

**Int. Cl.: 6**

**TRADEMARK**

**PRINCIPAL REGISTER**

VAG- ARMATUREN GMBH (FED REP GERMANY GESELLSCHAFT MIT BESCHRÄNKTER HAFTUNG (GMBH))  
CARL-REUTHER-STRASSE 1  
MANNHEIM, FED REP GERMANY 68305

FOR: VALVES OF METAL OTHER THAN PARTS OF MACHINES INCLUDING THOSE FROM ALLOY STEEL AND TITANIUM; METAL BUTTERFLY VALVES NOT BEING PARTS OF MACHINES USED TO CONNECT PIPELINES AND AS AN END-OF-LINE VALVE, AND REPLACEMENT PARTS THEREFOR, IN CLASS 6 (U.S. CLS. 2, 12, 13, 14, 23, 25 AND 50).

THE MARK CONSISTS OF STANDARD CHARACTERS WITHOUT CLAIM TO ANY PARTICULAR FONT, STYLE, SIZE, OR COLOR.

OWNER OF ERPN CMNTY TM OFC REG. NO. 010437846, DATED 7-5-2012, EXPIRES 11-23-2021.

THE WORDING "CEREX" HAS NO MEANING IN A FOREIGN LANGUAGE.

SER. NO. 85-506,443, FILED 12-30-2011.

AISHA SALEM, EXAMINING ATTORNEY



*David J. Kyffers*

Director of the United States Patent and Trademark Office

# United States of America

United States Patent and Trademark Office

# RIKO

**Reg. No. 4,274,399**

**Registered Jan. 15, 2013**

**Int. Cl.: 6**

**TRADEMARK**

**PRINCIPAL REGISTER**

VAG- ARMATUREN GMBH (FED REP GERMANY GESELLSCHAFT MIT BESCHRÄNKTER HAFTUNG (GMBH))  
CARL-REUTHER-STRASSE 1  
MANNHEIM, FED REP GERMANY 68305

FOR: VALVES OF METAL OTHER THAN PARTS OF MACHINES INCLUDING THOSE FROM ALLOY STEEL AND TITANIUM , IN CLASS 6 (U.S. CLS. 2, 12, 13, 14, 23, 25 AND 50).

THE MARK CONSISTS OF STANDARD CHARACTERS WITHOUT CLAIM TO ANY PARTICULAR FONT, STYLE, SIZE, OR COLOR.

OWNER OF ERPN CMNTY TM OFC REG. NO. 006060222, DATED 6-25-2008, EXPIRES 7-2-2017.

THE WORDING "RIKO" HAS NO MEANING IN A FOREIGN LANGUAGE.

SER. NO. 85-506,455, FILED 12-30-2011.

AISHA SALEM, EXAMINING ATTORNEY



*David J. Kyjars*

Director of the United States Patent and Trademark Office

# United States of America

United States Patent and Trademark Office

## The Box Office

*Modular Office Concept*

**Reg. No. 4,274,400**

**Registered Jan. 15, 2013**

**Int. Cl.: 20**

**TRADEMARK**

**PRINCIPAL REGISTER**

ALLIANCE STATE LIMITED (HONG KONG LIMITED LIABILITY COMPANY)  
2/F JONSIM PLACE  
NO.228 QUEEN'S ROAD EAST  
WANCHAI, HONG KONG

FOR: BAMBOO CURTAINS; BOLSTERS; BOOK RESTS; CONTAINERS, NOT OF METAL FOR COMMERCIAL USE; DESKS; FILING CABINETS; FURNITURE; FURNITURE FITTINGS, NOT OF METAL; FURNITURE OF METAL; FURNITURE PARTITIONS; FURNITURE, NAMELY, SHOWCASES; HAND-OPERATED NON-METAL GARDEN HOSE REELS; MAGAZINE RACKS; METAL DISPLAY STANDS; MIRRORS; NON-METAL BED FITTINGS; NON-METAL BINS; NON-METAL DOOR FITTINGS; NON-METAL ENGINE STANDS; NON-METAL HAND-OPERATED ELECTRICAL HOLIDAY LIGHT STORAGE REELS; OFFICE FURNITURE; PLACARDS OF WOOD OR PLASTIC; SEATS; TELEVISION STANDS; TOOL AND TOOL ACCESSORY BOXES NOT MADE OF METAL SOLD EMPTY AND PARTS AND FITTINGS THEREFOR; TOOL AND TOOL ACCESSORY TRAYS NOT MADE OF METAL SOLD EMPTY AND PARTS AND FITTINGS THEREFOR; WORKS OF ART OF WOOD, WAX, PLASTER OR PLASTIC; WRITING DESKS, IN CLASS 20 (U.S. CLS. 2, 13, 22, 25, 32 AND 50).

FIRST USE 8-2-2009; IN COMMERCE 10-17-2011.

NO CLAIM IS MADE TO THE EXCLUSIVE RIGHT TO USE "MODULAR OFFICE", APART FROM THE MARK AS SHOWN.

THE MARK CONSISTS OF THE WORDING "THE BOX OFFICE MODULAR OFFICE CONCEPT", WITH AN ELLIPSE BEHIND THE WORDING "THE BOX OFFICE".

SER. NO. 85-506,773, FILED 12-31-2011.

MICHAEL ENGEL, EXAMINING ATTORNEY



*David J. Kyffers*

Director of the United States Patent and Trademark Office

# United States of America

United States Patent and Trademark Office

## Baby BATTLE RATTLE

**Reg. No. 4,274,401**

MOORE, LEIGH (UNITED STATES INDIVIDUAL)  
2815 WAKEWATER WAY  
WOODBIDGE, VA 22191

**Registered Jan. 15, 2013**

**Int. Cl.: 24**

FOR: BABY BEDDING, NAMELY, BUNDLE BAGS, SWADDLING BLANKETS, CRIB BUMPERS, FITTED CRIB SHEETS, CRIB SKIRTS, CRIB BLANKETS, AND DIAPER CHANGING PAD COVERS NOT OF PAPER, IN CLASS 24 (U.S. CLS. 42 AND 50).

**TRADEMARK**

FIRST USE 12-1-2009; IN COMMERCE 12-1-2009.

**PRINCIPAL REGISTER**

THE MARK CONSISTS OF STANDARD CHARACTERS WITHOUT CLAIM TO ANY PARTICULAR FONT, STYLE, SIZE, OR COLOR.

NO CLAIM IS MADE TO THE EXCLUSIVE RIGHT TO USE "BABY", APART FROM THE MARK AS SHOWN.

SER. NO. 85-506,932, FILED 12-31-2011.

JIM RINGLE, EXAMINING ATTORNEY



*David J. Kybas*

Director of the United States Patent and Trademark Office

# United States of America

United States Patent and Trademark Office

## Redneck Starter Kit

**Reg. No. 4,274,402**

LULU AND LINDAS LLC (VIRGINIA LIMITED LIABILITY COMPANY)  
12337 MORNINGCREEK RD  
GLEN ALLEN, VA 23059

**Registered Jan. 15, 2013**

**Int. Cl.: 21**

FOR: SET OF WINE GLASSES MADE FROM STEMS AND GLASSES, IN CLASS 21 (U.S. CLS. 2, 13, 23, 29, 30, 33, 40 AND 50).

**TRADEMARK**

FIRST USE 12-20-2011; IN COMMERCE 12-20-2011.

**PRINCIPAL REGISTER**

THE MARK CONSISTS OF STANDARD CHARACTERS WITHOUT CLAIM TO ANY PARTICULAR FONT, STYLE, SIZE, OR COLOR.

NO CLAIM IS MADE TO THE EXCLUSIVE RIGHT TO USE "STARTER KIT", APART FROM THE MARK AS SHOWN.

SER. NO. 85-507,098, FILED 1-2-2012.

KELLY TRUSILO, EXAMINING ATTORNEY



*David J. Kyffers*

Director of the United States Patent and Trademark Office

# United States of America

United States Patent and Trademark Office

## INOFIELD CHARTMD

**Reg. No. 4,274,403**

**Registered Jan. 15, 2013**

**Int. Cl.: 9**

**TRADEMARK**

**PRINCIPAL REGISTER**

INOFIELD LLC (DELAWARE LIMITED LIABILITY COMPANY)  
10400 OVERLAND ROAD, #393  
BOISE, ID 83709

FOR: COMPUTER SOFTWARE FOR SCANNING, CONTROLLING AND MANAGING PATIENT MEDICAL DOCUMENTATION, IMAGES, AND INFORMATION, IN CLASS 9 (U.S. CLS. 21, 23, 26, 36 AND 38).

FIRST USE 9-0-2009; IN COMMERCE 9-0-2009.

THE MARK CONSISTS OF STANDARD CHARACTERS WITHOUT CLAIM TO ANY PARTICULAR FONT, STYLE, SIZE, OR COLOR.

OWNER OF U.S. REG. NO. 3,774,198.

NO CLAIM IS MADE TO THE EXCLUSIVE RIGHT TO USE "CHART MD", APART FROM THE MARK AS SHOWN.

SER. NO. 85-507,438, FILED 1-3-2012.

TARA PATE, EXAMINING ATTORNEY



*David J. Kyffers*

Director of the United States Patent and Trademark Office



# United States of America

United States Patent and Trademark Office

## INOFIL MESSSENGER

**Reg. No. 4,274,404**

**Registered Jan. 15, 2013**

**Int. Cl.: 9**

**TRADEMARK**

**PRINCIPAL REGISTER**

INOFIL LLC (DELAWARE LIMITED LIABILITY COMPANY)  
10400 OVERLAND ROAD, #393  
BOISE, ID 83709

FOR: COMPUTER SOFTWARE FOR INTEGRATION OF MEDICAL DOCUMENTATION, IMAGES, AND INFORMATION FOR USE IN CLINICAL ENVIRONMENTS, NAMELY, MEDICAL CLINICS, PHYSICIANS OFFICES, HOSPITALS, AND OTHER LOCATIONS OFFERING MEDICAL CARE, IN CLASS 9 (U.S. CLS. 21, 23, 26, 36 AND 38).

FIRST USE 11-0-2010; IN COMMERCE 11-0-2010.

THE MARK CONSISTS OF STANDARD CHARACTERS WITHOUT CLAIM TO ANY PARTICULAR FONT, STYLE, SIZE, OR COLOR.

OWNER OF U.S. REG. NO. 3,774,198.

SER. NO. 85-507,451, FILED 1-3-2012.

TARA PATE, EXAMINING ATTORNEY



*David J. Kyffers*

Director of the United States Patent and Trademark Office

# United States of America

United States Patent and Trademark Office

# BrandFuse

**Reg. No. 4,274,405**

**Registered Jan. 15, 2013**

**Int. Cl.: 35**

**SERVICE MARK**

**PRINCIPAL REGISTER**

BRANDFUSE, INC. (CALIFORNIA CORPORATION)  
#202  
802 COLLEGE AVE.  
KENTFIELD, CA 94904

FOR: ON-LINE RETAIL STORE SERVICES FEATURING PROMOTIONAL PRODUCTS, IN CLASS 35 (U.S. CLS. 100, 101 AND 102).

FIRST USE 6-1-2011; IN COMMERCE 6-1-2011.

THE MARK CONSISTS OF STANDARD CHARACTERS WITHOUT CLAIM TO ANY PARTICULAR FONT, STYLE, SIZE, OR COLOR.

SER. NO. 85-507,513, FILED 1-3-2012.

LINDA POWELL, EXAMINING ATTORNEY



*David J. Kybas*

Director of the United States Patent and Trademark Office

# United States of America

United States Patent and Trademark Office



**Reg. No. 4,274,406**

SHP GROUP LEARNING TOURS, LLC (PENNSYLVANIA LIMITED LIABILITY COMPANY)  
305 HULMERVILLE AVE.  
LANGHORNE, PA 19047

**Registered Jan. 15, 2013**

**Int. Cl.: 39**

FOR: ARRANGING, ORGANIZING, AND CONDUCTING CYCLING TOURS AND TRIPS,  
IN CLASS 39 (U.S. CLS. 100 AND 105).

**SERVICE MARK**

FIRST USE 1-1-2011; IN COMMERCE 1-1-2011.

**PRINCIPAL REGISTER**

NO CLAIM IS MADE TO THE EXCLUSIVE RIGHT TO USE "BICYCLE ADVENTURES",  
APART FROM THE MARK AS SHOWN.

THE COLOR(S) ORANGE AND BLACK IS/ARE CLAIMED AS A FEATURE OF THE MARK.

THE MARK CONSISTS OF THE HANDLE BARS AND FRONT WHEEL OF A BICYCLE IN  
ORANGE, WITH THE LETTERS "SHP" AND THE WORDS, "BICYCLE ADVENTURES",  
PROTRUDING FROM THE WHEEL OF THE BICYCLE, IN BLACK.

SER. NO. 85-507,573, FILED 1-3-2012.

STEVEN R. FINE, EXAMINING ATTORNEY



*David J. Kybas*

Director of the United States Patent and Trademark Office

# United States of America

United States Patent and Trademark Office

## GOT DIRT? GET SOIL.

**Reg. No. 4,274,407**

HOWARD G. BUFFETT FOUNDATION (ILLINOIS CORPORATION)  
145 N. MERCHANT ST.  
DECATUR, IL 62523

**Registered Jan. 15, 2013**

**Int. Cls.: 9, 16, 25, 36  
and 44**

FOR: DOWNLOADABLE ELECTRONIC PUBLICATIONS, NAMELY, NEWSLETTERS, ADVERTORIALS, EDITORIALS AND PROGRAM INFORMATION GUIDES IN THE FIELD OF U.S. AGRICULTURE PRACTICES AND SATISFYING WORLD HUNGER; ELECTRONIC PUBLICATIONS, NAMELY, NEWSLETTERS, ADVERTORIALS, EDITORIALS AND PROGRAM INFORMATION GUIDES IN THE FIELD OF U.S. AGRICULTURE PRACTICES AND SATISFYING WORLD HUNGER RECORDED ON COMPUTER MEDIA, IN CLASS 9 (U.S. CLS. 21, 23, 26, 36 AND 38).

**TRADEMARK**

**SERVICE MARK**

**PRINCIPAL REGISTER**

FIRST USE 12-6-2011; IN COMMERCE 12-6-2011.

FOR: PRINTED PUBLICATIONS, NAMELY, NEWSLETTERS, ADVERTORIALS, PROGRAM INFORMATION GUIDES, EDITORIALS, ANNUAL REPORTS, PROGRAM REPORTS, BOOKS, AND HANDOUTS IN THE FIELD OF U.S. AGRICULTURE PRACTICES AND SATISFYING WORLD HUNGER, IN CLASS 16 (U.S. CLS. 2, 5, 22, 23, 29, 37, 38 AND 50).

FIRST USE 12-6-2011; IN COMMERCE 12-6-2011.

FOR: CLOTHING, NAMELY, HATS AND SHIRTS, IN CLASS 25 (U.S. CLS. 22 AND 39).

FIRST USE 12-6-2011; IN COMMERCE 12-6-2011.

FOR: PROVIDING INFORMATION IN THE FIELD OF CHARITABLE FUNDRAISING TO END WORLD HUNGER AND PROMOTE SUSTAINABLE AGRICULTURE PRACTICES, IN CLASS 36 (U.S. CLS. 100, 101 AND 102).

FIRST USE 12-6-2011; IN COMMERCE 12-6-2011.

FOR: PROVIDING INFORMATION IN THE FIELD OF U.S. AGRICULTURAL FARMING PRACTICES, IN CLASS 44 (U.S. CLS. 100 AND 101).

FIRST USE 12-6-2011; IN COMMERCE 12-6-2011.



*David J. Kyjars*

Director of the United States Patent and Trademark Office

**Reg. No. 4,274,407** THE MARK CONSISTS OF STANDARD CHARACTERS WITHOUT CLAIM TO ANY PARTICULAR FONT, STYLE, SIZE, OR COLOR.

SER. NO. 85-507,772, FILED 1-3-2012.

HANNO RITTNER, EXAMINING ATTORNEY

# United States of America

United States Patent and Trademark Office

## HOOP DE LOOP SAGA

**Reg. No. 4,274,408**

**Registered Jan. 15, 2013**

**Int. Cls.: 9, 25 and 41**

**TRADEMARK**

**SERVICE MARK**

**PRINCIPAL REGISTER**

KING.COM LIMITED (MALTA CORPORATION)  
125/14 THE STRAND  
GZIRA GZR 1027, MALTA

FOR: SCIENTIFIC, NAUTICAL, SURVEYING, PHOTOGRAPHIC, CINEMATOGRAPHIC, OPTICAL, WEIGHING, MEASURING, SIGNALING, CHECKING (SUPERVISION), LIFE-SAVING AND TEACHING APPARATUS AND INSTRUMENTS, NAMELY, COMPUTER HARDWARE AND PERIPHERALS; APPARATUS AND INSTRUMENTS FOR CONDUCTING, SWITCHING, TRANSFORMING, ACCUMULATING, REGULATING OR CONTROLLING ELECTRICITY, NAMELY, WIRELESS COMPUTER PERIPHERALS; APPARATUS FOR RECORDING, TRANSMISSION OR REPRODUCTION OF SOUND OR IMAGES; BLANK MAGNETIC DATA CARRIERS, BLANK MAGNETIC DATA RECORDING DISCS; COMPACT DISCS, DVDS AND OTHER DIGITAL RECORDING MEDIA FEATURING GAMES; MECHANISMS FOR COIN-OPERATED APPARATUS; CASH REGISTERS, CALCULATING MACHINES, DATA PROCESSING EQUIPMENT, COMPUTERS; COMPUTER SOFTWARE FOR VIDEO AND COMPUTER GAMES; COMPUTER PROGRAMS FOR PRE-RECORDED GAMES; COMPUTER GAMES; COMPUTER GAME SOFTWARE FOR USE ON MOBILE AND CELLULAR PHONES; COMPUTER GAME DISCS; COMPUTER GAME SOFTWARE FOR USE IN CONNECTION WITH COMPUTERS, PERSONAL ELECTRONIC DEVICES, TABLETS AND PHONES; DOWNLOADABLE GAME SOFTWARE; DOWNLOADABLE GAME SOFTWARE VIA A GLOBAL COMPUTER NETWORK AND WIRELESS DEVICES, IN CLASS 9 (U.S. CLS. 21, 23, 26, 36 AND 38).



*David J. Kyjars*

Director of the United States Patent and Trademark Office

FOR: CLOTHING, NAMELY, APRONS, BANDANAS, BATH ROBES, BATHING CAPS, BATHING SUITS, BATHING TRUNKS, BEACHWEAR, BEACH SHOES, BELTS, BIBS NOT OF PAPER, BOOTS, CAPS HEADWEAR, COATS, DRESSES, DRESSING GOWNS, EAR MUFFS, FOOTBALL BOOTS, GLOVES, HATS, HEADBANDS, JACKETS CLOTHING, JUMPERS, PULLOVERS, MASQUERADE COSTUMES, MONEY BELTS, NECKTIES, OVERALLS, OVERCOATS, PAJAMAS, PANTS, PAPER HATS FOR USE AS CLOTHING, SANDALS, SARONGS, SHIRTS, SHOES, SHORT-SLEEVE SHIRTS, SHOWER CAPS, SKI BOOTS, SKI GLOVES, SKIRTS, SLEEP MASKS, SLIPPERS, SLIPS, SOCKS, SOLES FOR FOOTWEAR, SPORTS JERSEYS, SPORTS SHOES, STOCKINGS, SUITS, SUN VISORS, SWEATERS, SWEATSHIRTS, SWIMSUITS, TEE-SHIRTS, TIGHTS, TROUSERS, UNDER GARMENTS, UNDERPANTS, UNDERWEAR, UNIFORMS, VESTS, WAISTCOATS, WRISTBANDS CLOTHING; FOOTWEAR; HEADWEAR, IN CLASS 25 (U.S. CLS. 22 AND 39).

**Reg. No. 4,274,408** FOR: EDUCATIONAL SERVICES, NAMELY, CONDUCTING CLASSES, SEMINARS, WORKSHOPS IN THE FIELD OF COMPUTERS, COMPUTER GAMES; TRAINING IN THE FIELD OF COMPUTERS, COMPUTER GAMES; ENTERTAINMENT NAMELY, PROVIDING ON-LINE COMPUTER GAMES; ENTERTAINMENT SERVICES, NAMELY, PROVIDING TEMPORARY USE OF NON-DOWNLOADABLE INTERACTIVE GAMES; ENTERTAINMENT SERVICES, NAMELY, PROVIDING TEMPORARY USE OF NON-DOWNLOADABLE ELECTRONIC GAMES; ENTERTAINMENT SERVICES, NAMELY, PROVIDING A WEBSITE FEATURING GAMES AND PUZZLES; ENTERTAINMENT SERVICES, NAMELY, PROVIDING ONLINE VIDEO GAMES; ELECTRONIC GAME SERVICES PROVIDED BY MEANS OF THE INTERNET; ENTERTAINMENT SERVICES, NAMELY, PROVIDING ONLINE GAMES; PROVISION OF INFORMATION RELATING TO ELECTRONIC COMPUTER GAMES PROVIDED VIA THE INTERNET; ORGANIZING COMPUTER GAME COMPETITIONS; ORGANIZING CULTURAL ACTIVITIES, NAMELY, GAME FESTIVALS; PROVISION OF COMPUTER GAMES ON LINE OR BY MEANS OF A GLOBAL COMPUTER NETWORK; PROVIDING INTERACTIVE MULTI-PLAYER COMPUTER GAMES VIA THE INTERNET AND ELECTRONIC COMMUNICATION NETWORKS; MULTIMEDIA PUBLISHING OF COMPUTER GAME SOFTWARE AND VIDEO GAMES SOFTWARE; PROVIDING ON-LINE COMPUTER GAMES; ENTERTAINMENT, NAMELY, PROVIDING ON-LINE COMPUTER GAMES, IN CLASS 41 (U.S. CLS. 100, 101 AND 107).

THE MARK CONSISTS OF STANDARD CHARACTERS WITHOUT CLAIM TO ANY PARTICULAR FONT, STYLE, SIZE, OR COLOR.

PRIORITY CLAIMED UNDER SEC. 44(D) ON ERPN CMNTY TM OFC APPLICATION NO. 010540532, FILED 1-4-2012, REG. NO. 010540532, DATED 5-31-2012, EXPIRES 1-4-2022.

SER. NO. 85-508,384, FILED 1-4-2012.

HOWARD B. LEVINE, EXAMINING ATTORNEY

# United States of America

United States Patent and Trademark Office

# ActiveFloor

**Reg. No. 4,274,409**

GLOCKL, JOSEF (FED REP GERMANY INDIVIDUAL)  
AMMERSEESTR. 6

**Registered Jan. 15, 2013**

KIRCHHEIM B. MUNCHEN, FED REP GERMANY 85551

**Int. Cls.: 10, 20 and 27**

FOR: ORTHOPEDIC ARTICLES, IN PARTICULAR ORTHOPEDIC SEATS, IN CLASS 10 (U.S. CLS. 26, 39 AND 44).

**TRADEMARK**

FOR: FURNITURE, IN PARTICULAR SEATING FURNITURE, SEATING UNITS, STANDING AIDS IN THE NATURE OF A STOOL-LIKE DEVICE HAVING A BASE CONNECTED TO AT LEAST ONE LEG THAT IS TALL ENOUGH TO PERMIT A PERSON TO STAND WHILE LEANING ON A TOP PORTION OF THE DEVICE'S LEG, STOOLS, DESKS, WORKING TABLES, LECTERNS, AND COMBINATIONS THEREOF, IN CLASS 20 (U.S. CLS. 2, 13, 22, 25, 32 AND 50).

**PRINCIPAL REGISTER**

FOR: CARPETS, RUGS, MATS AND MATTING, LINOLEUM FOR COVERING EXISTING FLOORS; OTHER MATERIAL FOR COVERING EXISTING FLOORS, NAMELY, VINYL, RUBBER, AND HARD SURFACE COVERINGS; NON-TEXTILE WALL HANGINGS, IN CLASS 27 (U.S. CLS. 19, 20, 37, 42 AND 50).

THE MARK CONSISTS OF STANDARD CHARACTERS WITHOUT CLAIM TO ANY PARTICULAR FONT, STYLE, SIZE, OR COLOR.

OWNER OF ERPN CMNTY TM OFC REG. NO. 010094704, DATED 10-20-2011, EXPIRES 7-4-2021.

SER. NO. 85-508,457, FILED 1-4-2012.

MICHAEL LITZAU, EXAMINING ATTORNEY



*David J. Kyffers*

Director of the United States Patent and Trademark Office



# United States of America

United States Patent and Trademark Office

## Nation Accessories

**Reg. No. 4,274,410**

MID-WEST METAL PRODUCTS CO., INC. (INDIANA CORPORATION)  
P.O. BOX 1031  
MUNCIE, IN 47308

**Registered Jan. 15, 2013**

**Int. Cl.: 24**

FOR: PET BLANKETS, IN CLASS 24 (U.S. CLS. 42 AND 50).

**TRADEMARK**

FIRST USE 3-1-2010; IN COMMERCE 3-1-2010.

**PRINCIPAL REGISTER**

THE MARK CONSISTS OF STANDARD CHARACTERS WITHOUT CLAIM TO ANY PARTICULAR FONT, STYLE, SIZE, OR COLOR.

NO CLAIM IS MADE TO THE EXCLUSIVE RIGHT TO USE "ACCESSORIES", APART FROM THE MARK AS SHOWN.

SER. NO. 85-509,411, FILED 1-5-2012.

JENNIFER DIXON, EXAMINING ATTORNEY



*David J. Kyffers*

Director of the United States Patent and Trademark Office

# United States of America

United States Patent and Trademark Office



**Reg. No. 4,274,411**

**Registered Jan. 15, 2013**

**Int. Cl.: 42**

**SERVICE MARK**

**PRINCIPAL REGISTER**

GS1 US, INC. (DELAWARE CORPORATION)  
PRINCETON PIKE CORPORATE CENTER  
1009 LENOX DRIVE, SUITE 202  
LAWRENCEVILLE, NJ 08648

FOR: PROVIDING ONLINE INFORMATION IN THE FIELD OF ELECTRONIC COMMERCE AND THE SUPPLY CHAIN IN INDUSTRY WITH RESPECT TO STANDARDS DEVELOPMENT; COMPUTER SERVICES, NAMELY, CREATING AN ON-LINE COMMUNITY FOR USERS TO PARTICIPATE IN DISCUSSIONS RELATIVE TO ELECTRONIC COMMERCE AND THE SUPPLY CHAIN IN INDUSTRY WITH RESPECT TO STANDARDS DEVELOPMENT, IN CLASS 42 (U.S. CLS. 100 AND 101).

FIRST USE 12-1-2011; IN COMMERCE 12-1-2011.

THE MARK CONSISTS OF A LIGHT BLUE PIXELATED BRIEFCASE WITH A WHITE CROSS AND A WHITE HANDLE ALL CONTAINED IN A DARK BLUE CIRCLE.

THE COLOR(S) LIGHT BLUE, DARK BLUE AND WHITE IS/ARE CLAIMED AS A FEATURE OF THE MARK.

SER. NO. 85-509,606, FILED 1-5-2012.

HENRY S. ZAK, EXAMINING ATTORNEY



*David J. Kybas*

Director of the United States Patent and Trademark Office

# United States of America

United States Patent and Trademark Office



**Reg. No. 4,274,412**

**Registered Jan. 15, 2013**

**Int. Cl.: 42**

**SERVICE MARK**

**PRINCIPAL REGISTER**

GS1 US, INC. (DELAWARE CORPORATION)  
PRINCETON PIKE CORPORATE CENTER  
1009 LENOX DRIVE, SUITE 202  
LAWRENCEVILLE, NJ 08648

FOR: PROVIDING ONLINE INFORMATION IN THE FIELD OF ELECTRONIC COMMERCE AND THE SUPPLY CHAIN IN INDUSTRY WITH RESPECT TO STANDARDS DEVELOPMENT; COMPUTER SERVICES, NAMELY, CREATING AN ON-LINE COMMUNITY FOR USERS TO PARTICIPATE IN DISCUSSIONS RELATIVE TO ELECTRONIC COMMERCE AND THE SUPPLY CHAIN IN INDUSTRY, WITH RESPECT TO STANDARDS DEVELOPMENT, IN CLASS 42 (U.S. CLS. 100 AND 101).

FIRST USE 12-1-2011; IN COMMERCE 12-1-2011.

THE MARK CONSISTS OF A YELLOW GEAR WITH A WHITE RULING AROUND THE INSIDE OF THE GEAR CONTAINING A WHITE BARCODE WITH THE NUMBERS "414101" ALL CONTAINED IN AN ORANGE CIRCLE.

THE COLOR(S) YELLOW, ORANGE AND WHITE IS/ARE CLAIMED AS A FEATURE OF THE MARK.

SER. NO. 85-509,631, FILED 1-5-2012.

HENRY S. ZAK, EXAMINING ATTORNEY



*David J. Kyffers*

Director of the United States Patent and Trademark Office

# United States of America

United States Patent and Trademark Office



**Reg. No. 4,274,413**

MID-WEST METAL PRODUCTS CO., INC. (INDIANA CORPORATION)  
P.O. BOX 1031  
MUNCIE, IN 47308

**Registered Jan. 15, 2013**

**Int. Cl.: 20**

FOR: DOG KENNELS, IN CLASS 20 (U.S. CLS. 2, 13, 22, 25, 32 AND 50).

**TRADEMARK**

FIRST USE 2-1-2005; IN COMMERCE 2-1-2005.

**PRINCIPAL REGISTER**

NO CLAIM IS MADE TO THE EXCLUSIVE RIGHT TO USE "K 9 KENNEL", APART FROM THE MARK AS SHOWN.

THE MARK CONSISTS OF A STYLIZED LETTER "K" WITH THE WORDS "QUICK & EASY" IN THE MIDDLE OF THE LETTER, A STYLIZED NUMBER "9" AND THE STYLIZED WORD "KENNEL" UNDERNEATH THE STYLIZED NUMBER "9".

SER. NO. 85-509,881, FILED 1-5-2012.

JENNIFER DIXON, EXAMINING ATTORNEY



*David J. Kybas*

Director of the United States Patent and Trademark Office

# United States of America

United States Patent and Trademark Office

# Suero Oralit

**Reg. No. 4,274,414**

PLAZA IZALCO INC. (VIRGINIA CORPORATION)  
3007 CALVIN STREET  
ALEXANDRIA, VA 22312

**Registered Jan. 15, 2013**

**Int. Cl.: 5**

FOR: ELECTROLYTE REPLACEMENT SOLUTIONS, IN CLASS 5 (U.S. CLS. 6, 18, 44, 46, 51 AND 52).

**TRADEMARK**

FIRST USE 11-1-2011; IN COMMERCE 11-1-2011.

**PRINCIPAL REGISTER**

THE MARK CONSISTS OF STANDARD CHARACTERS WITHOUT CLAIM TO ANY PARTICULAR FONT, STYLE, SIZE, OR COLOR.

NO CLAIM IS MADE TO THE EXCLUSIVE RIGHT TO USE "SUERO", APART FROM THE MARK AS SHOWN.

THE ENGLISH TRANSLATION OF "SUERO" IN THE MARK IS "SERUM".

SER. NO. 85-511,136, FILED 1-7-2012.

SUNG IN, EXAMINING ATTORNEY



*David J. Kyfos*

Director of the United States Patent and Trademark Office

# United States of America

United States Patent and Trademark Office



**Reg. No. 4,274,415**

**Registered Jan. 15, 2013**

**Int. Cls.: 9 and 41**

**TRADEMARK**

**SERVICE MARK**

**PRINCIPAL REGISTER**

FREEDOM CHILD ENTERTAINMENT LLC (CALIFORNIA LIMITED LIABILITY COMPANY)  
3029 PROSPECT AVENUE  
CLEVELAND, OH 44115

FOR: MUSICAL SOUND RECORDINGS AND AUDIO-VISUAL RECORDINGS FEATURING MUSIC AND MUSICAL BASED ENTERTAINMENT; DOWNLOADABLE SOUND RECORDINGS AND DOWNLOADABLE AUDIO-VISUAL RECORDINGS FEATURING MUSIC AND MUSICAL BASED ENTERTAINMENT; DVD'S FEATURING MUSIC AND MUSICAL BASED ENTERTAINMENT, IN CLASS 9 (U.S. CLS. 21, 23, 26, 36 AND 38).

FIRST USE 11-23-2010; IN COMMERCE 11-23-2010.

FOR: ENTERTAINMENT SERVICES, NAMELY, LIVE MUSICAL PERFORMANCES AND MUSICAL TOURS; PROVIDING A WEBSITE ON A GLOBAL COMPUTER NETWORK FEATURING INFORMATION ON MUSIC, MUSICAL SOUND RECORDINGS, MUSICAL VIDEO RECORDINGS, MUSICAL PERFORMANCES, TOURS, AND MUSICAL PERFORMERS; MUSIC PUBLISHING SERVICES; FAN CLUB SERVICES, IN CLASS 41 (U.S. CLS. 100, 101 AND 107).

FIRST USE 11-23-2010; IN COMMERCE 11-23-2010.

NO CLAIM IS MADE TO THE EXCLUSIVE RIGHT TO USE "ENTERTAINMENT", APART FROM THE MARK AS SHOWN.

THE MARK CONSISTS OF SILHOUETTE OF AN EAGLE TO THE LEFT OF THE STYLIZED TEXT "FREEDOM CHILD ENTERTAINMENT" WITH A FIVE POINT STAR ABOVE THE "D" IN THE WORD "CHILD".

SER. NO. 85-511,538, FILED 1-9-2012.

JENNY PARK, EXAMINING ATTORNEY



*David J. Kyjars*

Director of the United States Patent and Trademark Office

# United States of America

United States Patent and Trademark Office



**Reg. No. 4,274,416**

FREEDOM CHILD ENTERTAINMENT LLC (CALIFORNIA LIMITED LIABILITY COMPANY)  
3029 PROSPECT AVENUE  
CLEVELAND, OH 44115

**Registered Jan. 15, 2013**

**Int. Cls.: 9, 16, 25 and 41**

FOR: MUSICAL SOUND RECORDINGS AND AUDIO-VISUAL RECORDINGS FEATURING MUSIC AND MUSICAL BASED ENTERTAINMENT; DOWNLOADABLE SOUND RECORDINGS AND DOWNLOADABLE AUDIO-VISUAL RECORDINGS FEATURING MUSIC AND MUSICAL BASED ENTERTAINMENT; DVD'S FEATURING MUSIC AND MUSICAL BASED ENTERTAINMENT, IN CLASS 9 (U.S. CLS. 21, 23, 26, 36 AND 38).

**TRADEMARK**

**SERVICE MARK**

**PRINCIPAL REGISTER**

FIRST USE 11-23-2010; IN COMMERCE 11-23-2010.

FOR: POSTERS, FRAMED AND UNFRAMED PHOTOGRAPHS, SOUVENIR BOOKS AND SOUVENIR PROGRAMS FEATURING INFORMATION ON A MUSIC GROUP AND ITS PERFORMANCES, IN CLASS 16 (U.S. CLS. 2, 5, 22, 23, 29, 37, 38 AND 50).

FIRST USE 11-23-2010; IN COMMERCE 11-23-2010.

FOR: CLOTHING, NAMELY, SHIRTS, IN CLASS 25 (U.S. CLS. 22 AND 39).

FIRST USE 11-23-2010; IN COMMERCE 11-23-2010.

FOR: ENTERTAINMENT SERVICES, NAMELY, LIVE MUSICAL PERFORMANCES AND MUSICAL TOURS; PROVIDING A WEBSITE ON A GLOBAL COMPUTER NETWORK FEATURING INFORMATION ON MUSIC, MUSICAL SOUND RECORDINGS, MUSICAL VIDEO RECORDINGS, MUSICAL PERFORMANCES, TOURS, AND MUSICAL PERFORMERS; MUSIC PUBLISHING SERVICES; FAN CLUB SERVICES, IN CLASS 41 (U.S. CLS. 100, 101 AND 107).

FIRST USE 11-23-2010; IN COMMERCE 11-23-2010.

NO CLAIM IS MADE TO THE EXCLUSIVE RIGHT TO USE "ROCK & ROLL" AND "SHOW", APART FROM THE MARK AS SHOWN.

THE MARK CONSISTS OF A CAMOUFLAGE HELMET WITH A GRENADE SILHOUETTE AND A BAND SITS ON TOP OF A DECORATIVE ELONGATED SHIELD SHAPED BANNER OUTLINED WITH DECORATIVE UPPER LEFT AND RIGHT CORNERS; THE TEST "ROCK



*David J. Kyjars*

Director of the United States Patent and Trademark Office

**Reg. No. 4,274,416** & ROLL FREEDOM SHOW" ARE IN THE MIDDLE WITH A STYLIZED FIVE POINT STAR BEFORE THE "R" IN "ROCK" AND AFTER THE "L" IN "ROLL"; A STYLIZED DESIGN IS BELOW THE TEXT "FREEDOM SHOW".

SER. NO. 85-511,539, FILED 1-9-2012.

JENNY PARK, EXAMINING ATTORNEY



# United States of America

United States Patent and Trademark Office



*stay tuned*  
P R O J E C T

**Reg. No. 4,274,417**

**Registered Jan. 15, 2013**

**Int. Cl.: 41**

**SERVICE MARK**

**PRINCIPAL REGISTER**

SERGEY KORBAKOV (UKRAINE INDIVIDUAL), AKA SERGE CURRANSHEE  
4309 RIDGEMONT CIRCLE  
BIRMINGHAM, AL 35244

FOR: ENTERTAINMENT IN THE NATURE OF VISUAL AND AUDIO PERFORMANCES BY MUSICAL BAND; ENTERTAINMENT IN THE NATURE OF VISUAL AND AUDIO PERFORMANCES, NAMELY, MUSICAL BAND, ROCK GROUP, GYMNASIIC, DANCE, AND BALLET PERFORMANCES; ENTERTAINMENT SERVICES BY A MUSICAL ARTIST AND PRODUCER, NAMELY, MUSICAL COMPOSITION FOR OTHERS AND PRODUCTION OF MUSICAL SOUND RECORDINGS; ENTERTAINMENT, NAMELY, LIVE PERFORMANCES BY A MUSICAL BAND; ENTERTAINMENT, NAMELY, LIVE PERFORMANCES BY MUSICAL BANDS; LIVE PERFORMANCES BY A MUSICAL GROUP; PRODUCTION OF MUSICAL SOUND RECORDING, IN CLASS 41 (U.S. CLS. 100, 101 AND 107).

FIRST USE 6-12-2011; IN COMMERCE 6-12-2011.

THE MARK CONSISTS OF THE WORDS "STAY TUNED PROJECT" BENEATH A DESIGN OF A CIRCULAR GAUGE WITH TICK MARKS INSIDE THE GAUGE AND AN ARROW POINTING TO THE MARKING IN THE UPPER RIGHT HAND CORNER OF THE GAUGE. THE CAPITAL LETTERS "RPM" APPEAR AT THE BOTTOM CENTER INSIDE THE GAUGE.

SER. NO. 85-511,598, FILED 1-9-2012.

AMY KELLY, EXAMINING ATTORNEY



*David J. Kyjars*

Director of the United States Patent and Trademark Office

# United States of America

United States Patent and Trademark Office

## First in Whole Person Healthcare Education

**Reg. No. 4,274,418**

A.T. STILL UNIVERSITY OF HEALTH SCIENCES (MISSOURI CORPORATION)  
800 WEST JEFFERSON STREET  
KIRKSVILLE, MO 65101

**Registered Jan. 15, 2013**

**Int. Cl.: 41**

FOR: EDUCATIONAL SERVICES IN THE NATURE OF MEDICAL SCHOOLS, IN CLASS 41  
(U.S. CLS. 100, 101 AND 107).

**SERVICE MARK**

FIRST USE 9-1-2011; IN COMMERCE 9-1-2011.

**PRINCIPAL REGISTER**

THE MARK CONSISTS OF STANDARD CHARACTERS WITHOUT CLAIM TO ANY PARTICULAR FONT, STYLE, SIZE, OR COLOR.

NO CLAIM IS MADE TO THE EXCLUSIVE RIGHT TO USE "WHOLE PERSON HEALTHCARE EDUCATION", APART FROM THE MARK AS SHOWN.

SER. NO. 85-512,151, FILED 1-9-2012.

KAREN BRACEY, EXAMINING ATTORNEY



*David J. Kybas*

Director of the United States Patent and Trademark Office

# United States of America

United States Patent and Trademark Office

## First in Whole Person Healthcare

**Reg. No. 4,274,419**

**Registered Jan. 15, 2013**

**Int. Cl.: 41**

**SERVICE MARK**

**PRINCIPAL REGISTER**

A.T. STILL UNIVERSITY OF HEALTH SCIENCES (MISSOURI CORPORATION)  
800 WEST JEFFERSON STREET  
KIRKSVILLE, MO 65101

FOR: EDUCATIONAL SERVICES IN THE NATURE OF MEDICAL SCHOOLS, IN CLASS 41  
(U.S. CLS. 100, 101 AND 107).

FIRST USE 9-1-2011; IN COMMERCE 9-1-2011.

THE MARK CONSISTS OF STANDARD CHARACTERS WITHOUT CLAIM TO ANY PARTICULAR FONT, STYLE, SIZE, OR COLOR.

NO CLAIM IS MADE TO THE EXCLUSIVE RIGHT TO USE "WHOLE PERSON HEALTHCARE", APART FROM THE MARK AS SHOWN.

SER. NO. 85-512,154, FILED 1-9-2012.

KAREN BRACEY, EXAMINING ATTORNEY



*David J. Kybas*

Director of the United States Patent and Trademark Office

# United States of America

United States Patent and Trademark Office

# Brackish

**Reg. No. 4,274,420**

BRACKISH (WASHINGTON LIMITED LIABILITY COMPANY)  
1823 18TH AVE  
SEATTLE, WA 98122

**Registered Jan. 15, 2013**

**Int. Cl.: 20**

FOR: BATHROOM FURNITURE; BEAUTY SALON FURNITURE, NAMELY, STYLING STATIONS; BEDROOM FURNITURE; BUFFETS; CAMPING FURNITURE; COMPUTER FURNITURE; CUSHIONS; CUSTOM FURNITURE; DINNER WAGONS; DOORS FOR FURNITURE; ENTERTAINMENT CENTERS; FITTED FABRIC FURNITURE COVERS; FITTED FABRIC SLIPCOVERS FOR FURNITURE; FURNITURE; FURNITURE FOR CAMPING; FURNITURE FOR DISPLAYING GOODS; FURNITURE FOR HOUSE, OFFICE AND GARDEN; FURNITURE MADE FROM WOOD OR SUBSTITUTES FOR WOOD; FURNITURE PRIMARILY OF METAL, NAMELY, MIRRORS, BED FRAMES, DINING TABLES, COFFEE TABLES, END TABLES, DESKS, DISPLAY CASES, SHELVING, DOG GATES, AND BABY GATES; FURNITURE, MIRRORS, PICTURE FRAMES; FURNITURE, NAMELY, SHOWCASES; METAL FURNITURE; MIRRORS; OFFICE FURNITURE; OUTDOOR FURNITURE; PATIO FURNITURE; UPHOLSTERED FURNITURE, IN CLASS 20 (U.S. CLS. 2, 13, 22, 25, 32 AND 50).

**TRADEMARK**

**PRINCIPAL REGISTER**

FIRST USE 7-20-2011; IN COMMERCE 7-20-2011.

THE MARK CONSISTS OF STANDARD CHARACTERS WITHOUT CLAIM TO ANY PARTICULAR FONT, STYLE, SIZE, OR COLOR.

SER. NO. 85-512,278, FILED 1-9-2012.

RONALD MCMORROW, EXAMINING ATTORNEY



*David J. Kyffers*

Director of the United States Patent and Trademark Office

# United States of America

United States Patent and Trademark Office

## CHARLES FAZZINO

**Reg. No. 4,274,421**

CHARLES FAZZINO (UNITED STATES INDIVIDUAL)  
32 RELYEA PLACE

**Registered Jan. 15, 2013**

NEW ROCHELLE, NY 10801

**Int. Cl.: 28**

FOR: PUZZLES, ORDINARY PLAYING CARDS, IN CLASS 28 (U.S. CLS. 22, 23, 38 AND 50).

**TRADEMARK**

FIRST USE 9-0-2008; IN COMMERCE 9-0-2008.

**PRINCIPAL REGISTER**

THE MARK CONSISTS OF STANDARD CHARACTERS WITHOUT CLAIM TO ANY PARTICULAR FONT, STYLE, SIZE, OR COLOR.

THE NAME IN THE MARK IDENTIFIES A LIVING INDIVIDUAL WHOSE CONSENT IS OF RECORD.

SER. NO. 85-513,058, FILED 1-10-2012.

KELLY TRUSILO, EXAMINING ATTORNEY



*David J. Kybas*

Director of the United States Patent and Trademark Office

United States of America  
United States Patent and Trademark Office



**Reg. No. 4,274,422**

**Registered Jan. 15, 2013**

**Int. Cl.: 25**

**TRADEMARK**

**PRINCIPAL REGISTER**

CHEF DUDS INC (GEORGIA CORPORATION)  
300 SHAWNEE NORTH DR SUITE 300  
SUWANEE, GA 30024

FOR: KITCHEN AND RESTAURANT APPAREL, NAMELY, COATS, PANTS, HATS, APRONS, GOLF SHIRTS, GOLF CAPS, TOPS, BOTTOMS, AND UNIFORMS, IN CLASS 25 (U.S. CLS. 22 AND 39).

FIRST USE 1-1-1999; IN COMMERCE 1-1-1999.

NO CLAIM IS MADE TO THE EXCLUSIVE RIGHT TO USE "CHEF DUDS", APART FROM THE MARK AS SHOWN.

THE STIPPLING IS A FEATURE OF THE MARK AND DOES NOT INDICATE COLOR.

THE MARK CONSISTS OF THE WORDS "CHEF DUDS" WRITTEN WITH A KNIFE GOING THROUGH THE TOP OF THE "H" AND A FORK BELOW THE WORD "DUDS".

SER. NO. 85-513,377, FILED 1-10-2012.

SARA BENJAMIN, EXAMINING ATTORNEY



*David J. Kyros*

Director of the United States Patent and Trademark Office

# United States of America

United States Patent and Trademark Office

## CAPITAL BANKCARD

**Reg. No. 4,274,423**

**Registered Jan. 15, 2013**

**Int. Cls.: 9 and 42**

**TRADEMARK**

**SERVICE MARK**

**PRINCIPAL REGISTER**

MERCHANTWAREHOUSE.COM, LLC (DELAWARE LIMITED LIABILITY COMPANY)  
ONE FEDERAL STREET  
2ND FLOOR  
BOSTON, MA 02110

FOR: DOWNLOADABLE SOFTWARE FOR FACILITATING CREDIT CARD TRANSACTIONS, NAMELY, SOFTWARE TO ALLOW USERS TO PERFORM ELECTRONIC BUSINESS TRANSACTIONS VIA A GLOBAL COMPUTER NETWORK OR CELLULAR TELEPHONE DATA NETWORK, IN CLASS 9 (U.S. CLS. 21, 23, 26, 36 AND 38).

FIRST USE 5-19-2011; IN COMMERCE 5-19-2011.

FOR: PROVIDING ON-LINE NON-DOWNLOADABLE SOFTWARE AND APPLICATIONS FOR PROCESSING, REVIEWING AND ADMINISTERING CREDIT CARD TRANSACTIONS OVER NETWORKS, INTRANETS AND THE INTERNET, IN CLASS 42 (U.S. CLS. 100 AND 101).

FIRST USE 4-1-2007; IN COMMERCE 4-1-2007.

THE MARK CONSISTS OF STANDARD CHARACTERS WITHOUT CLAIM TO ANY PARTICULAR FONT, STYLE, SIZE, OR COLOR.

OWNER OF U.S. REG. NO. 3,411,436.

NO CLAIM IS MADE TO THE EXCLUSIVE RIGHT TO USE "BANKCARD", APART FROM THE MARK AS SHOWN.

SER. NO. 85-514,107, FILED 1-11-2012.

ESTHER BELENKER, EXAMINING ATTORNEY



*David J. Kybas*

Director of the United States Patent and Trademark Office

# United States of America

United States Patent and Trademark Office

## Everything Works

**Reg. No. 4,274,424**

**Registered Jan. 15, 2013**

**Int. Cl.: 41**

**SERVICE MARK**

**PRINCIPAL REGISTER**

DUWYN, TREVOR ALBERT (CANADA SOLE PROPRIETORSHIP), DBA EVERYTHING WORKS  
1662 VALLEY CLOSE  
BURLINGTON, ONTARIO, CANADA L7P4W4

FOR: DISTRIBUTION OF MOTION PICTURE FILMS; ENTERTAINMENT MEDIA PRODUCTION SERVICES FOR MOTION PICTURES, TELEVISION AND INTERNET; ENTERTAINMENT SERVICES, NAMELY, MULTIMEDIA PRODUCTION SERVICES; MOTION PICTURE FILM PRODUCTION; PRODUCTION AND DISTRIBUTION OF INDEPENDENT MOTION PICTURES; PRODUCTION AND DISTRIBUTION OF MOTION PICTURES, IN CLASS 41 (U.S. CLS. 100, 101 AND 107).

FIRST USE 6-1-2011; IN COMMERCE 12-20-2011.

THE MARK CONSISTS OF STANDARD CHARACTERS WITHOUT CLAIM TO ANY PARTICULAR FONT, STYLE, SIZE, OR COLOR.

SER. NO. 85-514,246, FILED 1-11-2012.

WILLIAM JACKSON, EXAMINING ATTORNEY



*David J. Kyros*

Director of the United States Patent and Trademark Office



# United States of America

United States Patent and Trademark Office



**Reg. No. 4,274,425**

**Registered Jan. 15, 2013**

**Int. Cls.: 35 and 39**

**SERVICE MARK**

**PRINCIPAL REGISTER**

AIRLINE DISPATCHERS FEDERATION (D.C. NON-PROFIT CORPORATION)  
2020 PENNSYLVANIA AVENUE, NW  
WASHINGTON, DC 20006

FOR: ASSOCIATION SERVICES, NAMELY, PROMOTING THE INTERESTS OF AIRLINE DISPATCHERS, IN CLASS 35 (U.S. CLS. 100, 101 AND 102).

FIRST USE 7-0-2011; IN COMMERCE 7-0-2011.

FOR: PROVIDING INFORMATION IN THE FIELD OF AIR TRANSPORTATION, IN CLASS 39 (U.S. CLS. 100 AND 105).

FIRST USE 7-0-2011; IN COMMERCE 7-0-2011.

OWNER OF U.S. REG. NOS. 2,964,570 AND 2,965,561.

NO CLAIM IS MADE TO THE EXCLUSIVE RIGHT TO USE "FEDERATION", APART FROM THE MARK AS SHOWN.

THE MARK CONSISTS OF THE LETTERS "ADF" WITH AN AIRPLANE ABOVE A RIBBON DESIGN WITH THE WORDS "AIRLINE DISPATCHERS FEDERATION".

SEC. 2(F).

SER. NO. 85-514,642, FILED 1-12-2012.

BARBARA BROWN, EXAMINING ATTORNEY



*David J. Kybas*

Director of the United States Patent and Trademark Office

# United States of America

United States Patent and Trademark Office



**Reg. No. 4,274,426**

**Registered Jan. 15, 2013**

**Int. Cl.: 36**

**SERVICE MARK**

**PRINCIPAL REGISTER**

IRONSHORE INC. (CAYMAN ISLANDS CORPORATION)  
CENTURY YARD, CRICKET SQUARE  
HUTCHINS DRIVE, P.O. BOX 2681 GT  
GEORGE TOWN, CAYMAN ISLANDS

FOR: INSURANCE UNDERWRITING SERVICES IN THE FIELDS OF FIDELITY AND CRIME, COMPUTER CRIME, PROFESSIONAL INDEMNITY, DIRECTORS' AND OFFICERS' LIABILITY, FIDUCIARY LIABILITY, UNAUTHORIZED TRADING, PRODUCT AND AGREEMENT WARRANTY, CARGO, TERRORISM, MEDICAL MALPRACTICE, ACCIDENT AND HEALTH, AVIATION WAR, MARINE WAR, MARINE LIABILITY, CASUALTY, PROPERTY, FINE ART, SPECIE, JEWELRY, CASH IN TRANSIT, EXCESS INVESTORS' INSURANCE, MARINE HULL, AVIATION HULL, CREDIT, CONTRACT FRUSTRATION, CONFISCATION AND EXPROPRIATION, ENVIRONMENTAL LIABILITY, KIDNAP AND RANSOM, TRUSTEE LIABILITY, CLASSIC CAR, MOTOR SPORTS, EVENT CONTINGENCY, CANCELLATION AND ABANDONMENT, AND TAX LIABILITY, PROTECTION AND INDEMNITY, IN CLASS 36 (U.S. CLS. 100, 101 AND 102).

FIRST USE 10-1-2011; IN COMMERCE 10-1-2011.

OWNER OF U.S. REG. NOS. 3,328,886, 3,454,753 AND OTHERS.

THE COLOR(S) BLUE, ORANGE, WHITE AND BLACK IS/ARE CLAIMED AS A FEATURE OF THE MARK.

NO CLAIM IS MADE TO THE EXCLUSIVE RIGHT TO USE "INTERNATIONAL", APART FROM THE MARK AS SHOWN.

THE MARK CONSISTS OF THE STYLIZED DESIGN OF A SCALLOPED SHELL IN THE COLOR BLUE WITH A CROWN OR A CRENNELLATED MOLDING ON TOP IN THE COLOR ORANGE TO THE RIGHT OF WHICH IS THE WORD "IRONSHORE" IN ALL CAPITAL LETTERS WITH THE WORD "IRON" IN THE COLOR ORANGE AND THE WORD "SHORE" IN THE COLOR BLUE. TO THE RIGHT OF "IRONSHORE" IS A RECTANGLE WITH ROUNDED CORNERS IN THE COLOR ORANGE WITH THE WORD "INTERNATIONAL" IN ALL CAPITAL LETTERS IN WHITE WITHIN THE RECTANGLE. ON THE SECOND LINE TO THE RIGHT OF THE SCALLOP DESIGN AND DIRECTLY BELOW THE WORDS "IRONSHORE" AND "INTERNATIONAL" ARE THE WORDS "DEPTH IN LEADERSHIP."



*David J. Kappas*

Director of the United States Patent and Trademark Office

**Reg. No. 4,274,426** TRUSTED PARTNERSHIP. YOUR SAFE HARBOR." IN BOTH CAPITAL AND LOWERCASE  
ITALIC LETTERS IN BLACK.

SER. NO. 85-514,754, FILED 1-12-2012.

MARCIE MILONE, EXAMINING ATTORNEY

United States of America  
United States Patent and Trademark Office

**FOCUS**  
INTERNATIONAL

**Reg. No. 4,274,427**

**Registered Jan. 15, 2013**

**Int. Cl.: 41**

**SERVICE MARK**

**PRINCIPAL REGISTER**

FOCUS INTERNATIONAL, INC. (KANSAS CORPORATION)  
7830 WESTLAWN COURT  
WICHITA, KS 67212

FOR: EDUCATIONAL RELIGIOUS PROGRAM FOR TRAINING CHRISTIAN UNIVERSITY STUDENTS AND LEADERS TO BECOME INVOLVED IN MINISTRY TO STUDENTS AROUND THE WORLD, IN CLASS 41 (U.S. CLS. 100, 101 AND 107).

FIRST USE 1-17-2012; IN COMMERCE 2-9-2012.

OWNER OF U.S. REG. NO. 2,169,222.

NO CLAIM IS MADE TO THE EXCLUSIVE RIGHT TO USE "INTERNATIONAL", APART FROM THE MARK AS SHOWN.

THE MARK CONSISTS OF THE STYLIZED WORDING "FOCUS INTERNATIONAL", WITH THE LETTERS "OC" THEREOF IN A INTERLOCKING DESIGN.

SER. NO. 85-514,850, FILED 1-12-2012.

DAWN HAN, EXAMINING ATTORNEY



*David J. Kybas*

Director of the United States Patent and Trademark Office

# United States of America

United States Patent and Trademark Office

 **PRO**  
*ultima*  
S E R I E S

**Reg. No. 4,274,428**

MID-WEST METAL PRODUCTS CO., INC. (INDIANA CORPORATION)  
P.O. BOX 1031  
MUNCIE, IN 47308

**Registered Jan. 15, 2013**

**Int. Cl.: 21**

FOR: CAGES FOR PETS, IN CLASS 21 (U.S. CLS. 2, 13, 23, 29, 30, 33, 40 AND 50).

**TRADEMARK**

FIRST USE 3-1-2009; IN COMMERCE 3-1-2009.

**PRINCIPAL REGISTER**

OWNER OF U.S. REG. NO. 3,074,587.

NO CLAIM IS MADE TO THE EXCLUSIVE RIGHT TO USE "SERIES", APART FROM THE MARK AS SHOWN.

THE MARK CONSISTS OF THE STYLIZED WORDS "PRO ULTIMA SERIES" WITH A SUN DESIGN IN THE DOT OF THE LETTER "I" IN THE STYLIZED WORD "ULTIMA".

SER. NO. 85-515,169, FILED 1-12-2012.

JENNIFER DIXON, EXAMINING ATTORNEY



*David J. Kyffers*

Director of the United States Patent and Trademark Office

# United States of America

United States Patent and Trademark Office

★ Critterville ★

**Reg. No. 4,274,429**

**Registered Jan. 15, 2013**

**Int. Cl.: 20**

**TRADEMARK**

**PRINCIPAL REGISTER**

MID-WEST METAL PRODUCTS CO., INC. (INDIANA CORPORATION)  
P.O. BOX 1031  
MUNCIE, IN 47308

FOR: PLAYPENS, IN CLASS 20 (U.S. CLS. 2, 13, 22, 25, 32 AND 50).

FIRST USE 1-1-2011; IN COMMERCE 1-1-2011.

THE STIPPLING IS A FEATURE OF THE MARK.

THE MARK CONSISTS OF THE STYLIZED WORD "CRITTERVILLE" WITH A STAR DESIGN AT THE TOP LEFT AND TOP RIGHT CORNERS OF THE MARK AND A STAR DESIGN BETWEEN THE LETTER "R" AND LETTER "V" IN THE WORD "CRITTERVILLE".

SER. NO. 85-515,499, FILED 1-12-2012.

JENNIFER DIXON, EXAMINING ATTORNEY



*David J. Kybas*

Director of the United States Patent and Trademark Office

# United States of America

United States Patent and Trademark Office

# THE TREND

**Reg. No. 4,274,430**

CANAAN RUBIN PRODUCTIONS, INC. (CALIFORNIA CORPORATION)  
8715 SUNSET PLAZA PLACE  
LOS ANGELES, CA 90069

**Registered Jan. 15, 2013**

**Int. Cl.: 41**

FOR: ENTERTAINMENT SERVICES, NAMELY, PRODUCTION AND DISTRIBUTION OF ONGOING TELEVISION PROGRAMS IN THE FIELD OF FASHION AND COUTURE, IN CLASS 41 (U.S. CLS. 100, 101 AND 107).

**SERVICE MARK**

FIRST USE 6-15-2011; IN COMMERCE 6-15-2011.

**PRINCIPAL REGISTER**

THE MARK CONSISTS OF STANDARD CHARACTERS WITHOUT CLAIM TO ANY PARTICULAR FONT, STYLE, SIZE, OR COLOR.

SER. NO. 85-516,142, FILED 1-13-2012.

SUZANNE BLANE, EXAMINING ATTORNEY



*David J. Kyffers*

Director of the United States Patent and Trademark Office

# United States of America

United States Patent and Trademark Office

## CMI Case Load Capacity Calculator

**Reg. No. 4,274,431**

CONSULTING MANAGEMENT INNOVATORS, INC. (ARKANSAS CORPORATION)  
6301 RANCH DRIVE  
LITTLE ROCK, AR 72223

**Registered Jan. 15, 2013**

**Int. Cl.: 42**

FOR: PROVIDING A WEBSITE FEATURING NON-DOWNLOADABLE SOFTWARE FOR HEALTH CARE CASE MANAGEMENT, IN CLASS 42 (U.S. CLS. 100 AND 101).

**SERVICE MARK**

FIRST USE 10-4-2011; IN COMMERCE 10-4-2011.

**PRINCIPAL REGISTER**

THE MARK CONSISTS OF STANDARD CHARACTERS WITHOUT CLAIM TO ANY PARTICULAR FONT, STYLE, SIZE, OR COLOR.

NO CLAIM IS MADE TO THE EXCLUSIVE RIGHT TO USE "CASE LOAD CAPACITY CALCULATOR", APART FROM THE MARK AS SHOWN.

SER. NO. 85-516,467, FILED 1-13-2012.

PRISCILLA MILTON, EXAMINING ATTORNEY



*David J. Kyffers*

Director of the United States Patent and Trademark Office



# United States of America

United States Patent and Trademark Office

## WEBWALKERS

**Reg. No. 4,274,432**

WEBWALKERS, LLC (MAINE LIMITED LIABILITY COMPANY)  
PO BOX 2436

**Registered Jan. 15, 2013**

SOUTH PORTLAND, ME 04106

**Int. Cl.: 35**

FOR: DEVELOPING AND FACILITATING ONLINE FUNDRAISING CAMPAIGNS FOR OTHERS, IN CLASS 35 (U.S. CLS. 100, 101 AND 102).

**SERVICE MARK**

FIRST USE 12-31-2011; IN COMMERCE 12-31-2011.

**PRINCIPAL REGISTER**

THE MARK CONSISTS OF STANDARD CHARACTERS WITHOUT CLAIM TO ANY PARTICULAR FONT, STYLE, SIZE, OR COLOR.

SER. NO. 85-516,508, FILED 1-13-2012.

LAURA KOVALSKY, EXAMINING ATTORNEY



*David J. Kybas*

Director of the United States Patent and Trademark Office

# United States of America

United States Patent and Trademark Office

## WEB WALKERS

**Reg. No. 4,274,433**

WEBWALKERS, LLC (MAINE LIMITED LIABILITY COMPANY)  
PO BOX 2436

**Registered Jan. 15, 2013**

SOUTH PORTLAND, ME 04106

**Int. Cl.: 35**

FOR: DEVELOPING AND FACILITATING ONLINE FUNDRAISING CAMPAIGNS FOR OTHERS, IN CLASS 35 (U.S. CLS. 100, 101 AND 102).

**SERVICE MARK**

FIRST USE 12-31-2011; IN COMMERCE 12-31-2011.

**PRINCIPAL REGISTER**

THE MARK CONSISTS OF STANDARD CHARACTERS WITHOUT CLAIM TO ANY PARTICULAR FONT, STYLE, SIZE, OR COLOR.

SER. NO. 85-516,514, FILED 1-13-2012.

LAURA KOVALSKY, EXAMINING ATTORNEY



*David J. Kybas*

Director of the United States Patent and Trademark Office

# United States of America

United States Patent and Trademark Office

## SCENTSABILITY

**Reg. No. 4,274,434**

SCENTSABILITY, INC. (FLORIDA CORPORATION)  
503 N.W. 118TH WAY  
CORAL SPRINGS, FL 33071

**Registered Jan. 15, 2013**

**Int. Cl.: 35**

FOR: RETAIL STORE AND ON-LINE RETAIL STORE SERVICES FEATURING CANDLES,  
IN CLASS 35 (U.S. CLS. 100, 101 AND 102).

**SERVICE MARK**

FIRST USE 5-2-2010; IN COMMERCE 5-2-2010.

**PRINCIPAL REGISTER**

THE MARK CONSISTS OF STANDARD CHARACTERS WITHOUT CLAIM TO ANY PAR-  
TICULAR FONT, STYLE, SIZE, OR COLOR.

SER. NO. 85-517,875, FILED 1-17-2012.

CHRISTINA SOBRAL, EXAMINING ATTORNEY



*David J. Kybas*

Director of the United States Patent and Trademark Office

# United States of America

United States Patent and Trademark Office

# HI-NUTRA

**Reg. No. 4,274,435**

**Registered Jan. 15, 2013**

**Int. Cl.: 5**

**TRADEMARK**

**PRINCIPAL REGISTER**

MILK PRODUCTS LLC (MINNESOTA LIMITED LIABILITY COMPANY)  
435 EAST MAIN STREET  
CHILTON, WI 53014

FOR: ANIMAL MILK REPLACER, NAMELY, NUTRITIONAL DRINKS FOR ANIMALS;  
MEDICATED ANIMAL FEED, NAMELY, ANIMAL MILK REPLACER, IN CLASS 5 (U.S.  
CLS. 6, 18, 44, 46, 51 AND 52).

FIRST USE 12-29-2000; IN COMMERCE 12-29-2000.

THE MARK CONSISTS OF STANDARD CHARACTERS WITHOUT CLAIM TO ANY PAR-  
TICULAR FONT, STYLE, SIZE, OR COLOR.

SER. NO. 85-517,934, FILED 1-17-2012.

MEGHAN REINHART, EXAMINING ATTORNEY



*David J. Kyffers*

Director of the United States Patent and Trademark Office

# United States of America

United States Patent and Trademark Office



TOWELS FOR MEN

**Reg. No. 4,274,436**

GILLIS, JOE, S. (UNITED STATES INDIVIDUAL)  
2251 ASHFORD PL  
EL DORADO HILLS, CA 95762

**Registered Jan. 15, 2013**

**Int. Cl.: 5**

FOR: SANITARY TOWELS, IN CLASS 5 (U.S. CLS. 6, 18, 44, 46, 51 AND 52).

**TRADEMARK**

FIRST USE 11-1-2011; IN COMMERCE 11-1-2011.

**PRINCIPAL REGISTER**

NO CLAIM IS MADE TO THE EXCLUSIVE RIGHT TO USE "TOWELS FOR MEN", APART FROM THE MARK AS SHOWN.

THE MARK CONSISTS OF THE WORDS "ON THE GO" IN RECTANGLE BOX ABOVE THE WORDS "TOWELS FOR MEN".

SER. NO. 85-518,656, FILED 1-17-2012.

LINDA POWELL, EXAMINING ATTORNEY



*David J. Kyffers*

Director of the United States Patent and Trademark Office

# United States of America

United States Patent and Trademark Office

# radventures

**Reg. No. 4,274,437**

**Registered Jan. 15, 2013**

**Int. Cl.: 9**

**TRADEMARK**

**PRINCIPAL REGISTER**

SNOWBALL LLC (COLORADO LIMITED LIABILITY COMPANY)  
405 WOOD STREET  
FORT COLLINS, CO 80521

FOR: CHILDREN'S EDUCATIONAL SOFTWARE; COMPUTER APPLICATION SOFTWARE FOR MOBILE PHONES, PORTABLE MEDIA PLAYERS, HANDHELD COMPUTERS, AND COMPUTERS, NAMELY, CHILDREN'S ENTERTAINMENT AND EDUCATIONAL SOFTWARE; COMPUTER APPLICATION SOFTWARE FOR MOBILE PHONES, PORTABLE MEDIA PLAYERS, HANDHELD COMPUTERS, AND COMPUTERS, NAMELY, EDUCATION AND ENTERTAINMENT SOFTWARE FOR INSTRUCTION IN ECOLOGICAL AND ENVIRONMENTAL AWARENESS FOR USE BY PARENTS AND FAMILIES; DOWNLOADABLE ELECTRONIC PUBLICATIONS IN THE NATURE OF INTERACTIVE BOOKS FOR CHILDREN, PARENTS, AND FAMILIES IN THE FIELD OF ENVIRONMENTAL EDUCATION; DOWNLOADABLE SOFTWARE IN THE NATURE OF A MOBILE APPLICATION FOR CHILDREN'S EDUCATION AND ENTERTAINMENT; DOWNLOADABLE SOFTWARE IN THE NATURE OF A MOBILE APPLICATION FOR INSTRUCTION IN ECOLOGICAL AND ENVIRONMENTAL AWARENESS FOR USE BY PARENTS AND FAMILIES, IN CLASS 9 (U.S. CLS. 21, 23, 26, 36 AND 38).

FIRST USE 8-1-2008; IN COMMERCE 12-9-2011.

THE MARK CONSISTS OF STANDARD CHARACTERS WITHOUT CLAIM TO ANY PARTICULAR FONT, STYLE, SIZE, OR COLOR.

SER. NO. 85-520,050, FILED 1-19-2012.

TRACY FLETCHER, EXAMINING ATTORNEY



*David J. Kyjars*

Director of the United States Patent and Trademark Office

# United States of America

United States Patent and Trademark Office

## Sunset Beach Jiu-Jitsu SBJJ

**Reg. No. 4,274,438**

SITT, EZRA (UNITED STATES INDIVIDUAL)  
59-136 KAMEHAMEHA HIGHWAY  
HALEIWA, HI 96712

**Registered Jan. 15, 2013**

**Int. Cl.: 41**

FOR: ENTERTAINMENT SERVICES, NAMELY, PARTICIPATION IN MARTIAL ARTS TOURNAMENTS AND COMPETITIONS; MARTIAL ARTS INSTRUCTION; OPERATING OF MARTIAL ARTS' SCHOOLS, IN CLASS 41 (U.S. CLS. 100, 101 AND 107).

**SERVICE MARK**

FIRST USE 11-0-2009; IN COMMERCE 11-0-2009.

**PRINCIPAL REGISTER**

THE MARK CONSISTS OF STANDARD CHARACTERS WITHOUT CLAIM TO ANY PARTICULAR FONT, STYLE, SIZE, OR COLOR.

NO CLAIM IS MADE TO THE EXCLUSIVE RIGHT TO USE "SUNSET BEACH JIU-JITSU", APART FROM THE MARK AS SHOWN.

SER. NO. 85-520,069, FILED 1-19-2012.

JOHN KELLY, EXAMINING ATTORNEY



*David J. Kyffers*

Director of the United States Patent and Trademark Office

# United States of America

United States Patent and Trademark Office

## For Pizza Out, Its Pizza Inn

**Reg. No. 4,274,439**

PIZZA INN, INC. (MISSOURI CORPORATION)  
3551 PLANO PARKWAY  
THE COLONY, TX 75056

**Registered Jan. 15, 2013**

**Int. Cl.: 43**

FOR: RESTAURANT SERVICES; CARRY-OUT RESTAURANT SERVICES, IN CLASS 43  
(U.S. CLS. 100 AND 101).

**SERVICE MARK**

FIRST USE 5-0-2012; IN COMMERCE 5-0-2012.

**PRINCIPAL REGISTER**

THE MARK CONSISTS OF STANDARD CHARACTERS WITHOUT CLAIM TO ANY PARTICULAR FONT, STYLE, SIZE, OR COLOR.

OWNER OF U.S. REG. NOS. 923,553, 3,822,543 AND OTHERS.

SER. NO. 85-520,419, FILED 1-19-2012.

FRANK LATTUCA, EXAMINING ATTORNEY



*David J. Kyffers*

Director of the United States Patent and Trademark Office



# United States of America

United States Patent and Trademark Office

## UNIQUE DUAL-ACTION FORMULA

**Reg. No. 4,274,440**

**Registered Jan. 15, 2013**

**Int. Cl.: 3**

**TRADEMARK**

**PRINCIPAL REGISTER**

WILLIAM M. YARBROUGH FOUNDATION (ILLINOIS CORPORATION)  
C/O MICHAEL J. LEGAMARO  
77 W. WACKER DR.  
CHICAGO, IL 606015094

FOR: NON-MEDICATED TOPICAL WASH FOR USE IN POISON IVY, OAK AND LIKE REACTIONS, IN CLASS 3 (U.S. CLS. 1, 4, 6, 50, 51 AND 52).

FIRST USE 4-1-2005; IN COMMERCE 4-1-2005.

THE MARK CONSISTS OF STANDARD CHARACTERS WITHOUT CLAIM TO ANY PARTICULAR FONT, STYLE, SIZE, OR COLOR.

NO CLAIM IS MADE TO THE EXCLUSIVE RIGHT TO USE "DUAL-ACTION FORMULA", APART FROM THE MARK AS SHOWN.

SER. NO. 85-520,568, FILED 1-19-2012.

MICHAEL WIENER, EXAMINING ATTORNEY



*David J. Kyjars*

Director of the United States Patent and Trademark Office

# United States of America

United States Patent and Trademark Office

# Finerplanet

**Reg. No. 4,274,441**

FINERPLANET (MARYLAND LIMITED LIABILITY COMPANY)  
14621 PEBBLE HILL LANE  
NORTH POTOMAC, MD 20878

**Registered Jan. 15, 2013**

**Int. Cl.: 41**

FOR: PUBLISHING OF BOOKS, E-BOOKS, AUDIO BOOKS, MUSIC AND ILLUSTRATIONS,  
IN CLASS 41 (U.S. CLS. 100, 101 AND 107).

**SERVICE MARK**

FIRST USE 11-20-2011; IN COMMERCE 1-2-2012.

**PRINCIPAL REGISTER**

THE MARK CONSISTS OF STANDARD CHARACTERS WITHOUT CLAIM TO ANY PAR-  
TICULAR FONT, STYLE, SIZE, OR COLOR.

SER. NO. 85-521,724, FILED 1-20-2012.

DAVID I, EXAMINING ATTORNEY



*David J. Kyfos*

Director of the United States Patent and Trademark Office

# United States of America

United States Patent and Trademark Office

# UltraLabel

**Reg. No. 4,274,442**

DELPHON INDUSTRIES, LLC (DELAWARE LIMITED LIABILITY COMPANY)  
31398 HUNTWOOD AVENUE  
HAYWARD, CA 94544

**Registered Jan. 15, 2013**

**Int. Cls.: 9 and 16**

FOR: LABEL PRINTERS FOR USE IN CLEAN ROOM ENVIRONMENTS; THERMAL LABEL PRINTERS, IN CLASS 9 (U.S. CLS. 21, 23, 26, 36 AND 38).

**TRADEMARK**

FIRST USE 9-15-2010; IN COMMERCE 9-15-2010.

**PRINCIPAL REGISTER**

FOR: ADHESIVE LABELS AND INK RIBBONS FOR USE WITH CLEAN ROOM AND THERMAL LABEL PRINTERS; DIRECT THERMAL ADHESIVE LABELS; THERMAL TRANSFER ADHESIVE LABELS, IN CLASS 16 (U.S. CLS. 2, 5, 22, 23, 29, 37, 38 AND 50).

FIRST USE 9-15-2010; IN COMMERCE 9-15-2010.

THE MARK CONSISTS OF STANDARD CHARACTERS WITHOUT CLAIM TO ANY PARTICULAR FONT, STYLE, SIZE, OR COLOR.

SER. NO. 85-521,904, FILED 1-20-2012.

CHRIS WELLS, EXAMINING ATTORNEY



*David J. Kyfos*

Director of the United States Patent and Trademark Office

# United States of America

United States Patent and Trademark Office

# SuperHD

**Reg. No. 4,274,443**

**Registered Jan. 15, 2013**

**Int. Cl.: 5**

**TRADEMARK**

**PRINCIPAL REGISTER**

WOODBOLT DISTRIBUTION LTD (TEXAS LIMITED LIABILITY COMPANY)  
715 NORTH MAIN ST.  
BRYAN, TX 77803

FOR: DIETARY AND NUTRITIONAL SUPPLEMENTS; DIETARY AND NUTRITIONAL SUPPLEMENTS FOR ENDURANCE SPORTS; DIETARY AND NUTRITIONAL SUPPLEMENTS USED FOR WEIGHT LOSS; DIETARY FOOD SUPPLEMENTS; DIETARY SUPPLEMENTS; DIETARY SUPPLEMENTS FOR HUMAN CONSUMPTION; DIETARY SUPPLEMENTS FOR HUMANS; FOOD SUPPLEMENTS; FOOD SUPPLEMENTS FOR HUMANS; HEALTH FOOD SUPPLEMENTS; NUTRACEUTICALS FOR USE AS A DIETARY SUPPLEMENT; NUTRACEUTICALS FOR USE AS A DIETARY SUPPLEMENT FOR WEIGHT LOSS; NUTRITIONAL SUPPLEMENTS; NUTRITIONAL SUPPLEMENTS FOR WEIGHT LOSS; NUTRITIONAL SUPPLEMENTS IN THE FORM OF CAPSULES; WEIGHT MANAGEMENT SUPPLEMENTS, IN CLASS 5 (U.S. CLS. 6, 18, 44, 46, 51 AND 52).

FIRST USE 10-17-2011; IN COMMERCE 1-4-2012.

THE MARK CONSISTS OF STANDARD CHARACTERS WITHOUT CLAIM TO ANY PARTICULAR FONT, STYLE, SIZE, OR COLOR.

OWNER OF U.S. REG. NOS. 4,075,985 AND 4,076,246.

SER. NO. 85-522,499, FILED 1-23-2012.

CORY BOONE, EXAMINING ATTORNEY



*David J. Kyros*

Director of the United States Patent and Trademark Office

# United States of America

United States Patent and Trademark Office

# SAUCE BOSS

**Reg. No. 4,274,444**

THE VOLLRATH COMPANY, L.L.C. (WISCONSIN LIMITED LIABILITY COMPANY)  
1236 N. 18TH STREET  
SHEBOYGAN, WI 53081

**Registered Jan. 15, 2013**

**Int. Cl.: 20**

FOR: PORTABLE PLASTIC DISPENSERS FOR DISPENSING A SET AMOUNT OF FLUID FOOD ITEMS, NAMELY, CONDIMENTS, SAUCES, OR DRESSINGS, IN CLASS 20 (U.S. CLS. 2, 13, 22, 25, 32 AND 50).

**TRADEMARK**

FIRST USE 3-0-1990; IN COMMERCE 3-0-1990.

**PRINCIPAL REGISTER**

THE MARK CONSISTS OF STANDARD CHARACTERS WITHOUT CLAIM TO ANY PARTICULAR FONT, STYLE, SIZE, OR COLOR.

OWNER OF U.S. REG. NOS. 1,642,449, 1,651,525, AND 1,657,443.

NO CLAIM IS MADE TO THE EXCLUSIVE RIGHT TO USE "SAUCE", APART FROM THE MARK AS SHOWN.

SER. NO. 85-523,196, FILED 1-23-2012.

JEFF DEFORD, EXAMINING ATTORNEY



*David J. Kyffers*

Director of the United States Patent and Trademark Office

# United States of America

United States Patent and Trademark Office



**Reg. No. 4,274,445**

SAMFORD UNIVERSITY (ALABAMA CORPORATION)  
800 LAKESHORE DRIVE  
BIRMINGHAM, AL 35229

**Registered Jan. 15, 2013**

**Int. Cl.: 41**

FOR: FOOTBALL EVENTS PROVIDED IN THE FINANCIAL AND MORAL SUPPORT OF HIGHER EDUCATION, IN CLASS 41 (U.S. CLS. 100, 101 AND 107).

**SERVICE MARK**

FIRST USE 8-1-2011; IN COMMERCE 8-1-2011.

**PRINCIPAL REGISTER**

NO CLAIM IS MADE TO THE EXCLUSIVE RIGHT TO USE "FAST BREAK FOOTBALL" AND "UNIVERSITY", APART FROM THE MARK AS SHOWN.

THE COLOR(S) GRAY, BLUE, RED, WHITE IS/ARE CLAIMED AS A FEATURE OF THE MARK.

THE MARK CONSISTS OF GRAY BULLDOG HEAD WITH A RED COLLAR CONTAINING THREE SPIKES ON THE LEFT WITH THE WORDS "FAST BREAK" IN WHITE LARGE PRINT OUTLINED IN RED IMMEDIATELY TO THE RIGHT OF THE BULLDOG AND ON TOP, WITH THE WORD "FOOTBALL" IN EQUALLY LARGE WHITE PRINT OUTLINED IN RED TO THE IMMEDIATE RIGHT OF THE BULLDOG AND DIRECTLY UNDER THE WORDS "FAST BREAK", WITH THE WORDS "SAMFORD UNIVERSITY" IN SMALL RED PRINT ON THE BOTTOM TO THE IMMEDIATE RIGHT OF THE BULLDOG AND DIRECTLY UNDER THE WORD "FOOTBALL", WITH A BLUE BACKGROUND OUTLINED IN RED IN A NON-UNIFORM SHAPE SURROUNDING THE BULLDOG AND THE WORDS "FAST BREAK FOOTBALL SAMFORD UNIVERSITY".



SER. NO. 85-523,617, FILED 1-24-2012.

HEATHER SAPP, EXAMINING ATTORNEY

*David J. Kyjars*

Director of the United States Patent and Trademark Office

# United States of America

United States Patent and Trademark Office

## FLAUGE

**Reg. No. 4,274,446**

FLAUGE, L.L.C. (D.C. LIMITED LIABILITY COMPANY)  
810 E. GRAND AVENUE, UNIT E  
EL SEGUNDO, CA 90245

**Registered Jan. 15, 2013**

**Int. Cl.: 26**

FOR: PLASTIC GUARDS FOR PROTECTING SHOE LACES WHEN SKATEBOARDING, IN CLASS 26 (U.S. CLS. 37, 39, 40, 42 AND 50).

**TRADEMARK**

FIRST USE 12-20-2011; IN COMMERCE 12-20-2011.

**PRINCIPAL REGISTER**

THE MARK CONSISTS OF A DESIGN OF AN "F" RIGHT SIDE UP AND INVERTED IN FRONT OF THE WORDS "FLAUGE".

SER. NO. 85-524,217, FILED 1-24-2012.

BRIAN CALLAGHAN, EXAMINING ATTORNEY



*David J. Kybas*

Director of the United States Patent and Trademark Office

# United States of America

United States Patent and Trademark Office

# CRP

**Reg. No. 4,274,447**

CENTRAL RECOVERY HOLDINGS, LLC (NEVADA LIMITED LIABILITY COMPANY)  
3321 NORTH BUFFALO DRIVE, SUITE 200  
LAS VEGAS, NV 89129

**Registered Jan. 15, 2013**

**Int. Cl.: 16**

FOR: PUBLICATIONS, NAMELY, TEXTS, BOOKS, BOOKLETS AND JOURNALS IN THE FIELDS OF CHEMICAL DEPENDENCY, ADDICTION TREATMENT, PAIN MANAGEMENT, COUNSELING AND OTHER MEDICAL REHABILITATION SERVICES, IN CLASS 16 (U.S. CLS. 2, 5, 22, 23, 29, 37, 38 AND 50).

**TRADEMARK**

**PRINCIPAL REGISTER**

FIRST USE 6-27-2011; IN COMMERCE 6-27-2011.

THE MARK CONSISTS OF THE TEXT "CRP" WITH AN EIGHT POINT STAR CENTERED INSIDE THE "C".

SER. NO. 85-524,221, FILED 1-24-2012.

ROBERT C. CLARK JR., EXAMINING ATTORNEY



*David J. Kyffers*

Director of the United States Patent and Trademark Office



# United States of America

United States Patent and Trademark Office

# JUVEEL

**Reg. No. 4,274,448**

**Registered Jan. 15, 2013**

**Int. Cls.: 1 and 3**

**TRADEMARK**

**PRINCIPAL REGISTER**

DR. SUWELACK SKIN & HEALTH CARE AG (FED REP GERMANY CORPORATION)  
JOSEF-SUWELACK-STR.  
48727 BILLERBECK, FED REP GERMANY

FOR: CHEMICALS USED IN INDUSTRY, SCIENCE AND PHOTOGRAPHY; UNPROCESSED ARTIFICIAL RESINS; UNPROCESSED PLASTICS; FIRE EXTINGUISHING COMPOSITIONS; TEMPERING AND SOLDERING PREPARATIONS; CHEMICAL SUBSTANCES FOR PRESERVING FOODSTUFFS; ADHESIVES USED IN INDUSTRY, IN CLASS 1 (U.S. CLS. 1, 5, 6, 10, 26 AND 46).

FOR: COSMETICS, NAMELY, FREEZE DRIED SOLUBLE BIOMATRICES AS MOULDING FORMS, IN CLASS 3 (U.S. CLS. 1, 4, 6, 50, 51 AND 52).

THE MARK CONSISTS OF STANDARD CHARACTERS WITHOUT CLAIM TO ANY PARTICULAR FONT, STYLE, SIZE, OR COLOR.

OWNER OF FED REP GERMANY REG. NO. 30352959, DATED 12-1-2003, EXPIRES 10-31-2013.

OWNER OF U.S. REG. NO. 2,998,433.

THE WORDING "JUVEEL" HAS NO MEANING IN A FOREIGN LANGUAGE.

SER. NO. 85-525,052, FILED 1-25-2012.

NATALIE POLZER, EXAMINING ATTORNEY



*David J. Kypos*

Director of the United States Patent and Trademark Office

# United States of America

United States Patent and Trademark Office

# TWIST-O

**Reg. No. 4,274,449**

**Registered Jan. 15, 2013**

**Int. Cl.: 28**

**TRADEMARK**

**PRINCIPAL REGISTER**

CHARLES HOBERMAN (UNITED STATES INDIVIDUAL)  
C/O HOBERMAN DESIGNS, INC.  
472 GREENWICH STREET, NO. 7  
NEW YORK, NY 10013

FOR: TOYS, NAMELY, EXPANDING AND UNFOLDING TOYS THAT CHANGE THEIR SHAPE AND SIZE, IN CLASS 28 (U.S. CLS. 22, 23, 38 AND 50).

FIRST USE 12-31-2004; IN COMMERCE 12-31-2004.

THE MARK CONSISTS OF STANDARD CHARACTERS WITHOUT CLAIM TO ANY PARTICULAR FONT, STYLE, SIZE, OR COLOR.

SER. NO. 85-525,085, FILED 1-25-2012.

NAKIA HENRY, EXAMINING ATTORNEY



*David J. Kybas*

Director of the United States Patent and Trademark Office

# United States of America

United States Patent and Trademark Office



**Reg. No. 4,274,450**

**Registered Jan. 15, 2013**

**Int. Cl.: 35**

**SERVICE MARK**

**PRINCIPAL REGISTER**

ATLANTIC COAST ORTHOPAEDIC MEDICAL SUPPLY, INC. (NORTH CAROLINA CORPORATION), DBA ACO MED SUPPLY  
6510 NORTH PARK BLVD.  
CHARLOTTE, NC 28216

FOR: DISTRIBUTORSHIP SERVICES IN THE FIELD OF ORTHOPEDIC PRODUCTS, NAMELY, ORTHOPEDIC HARDWARE, ORTHOPEDIC BRACING, KNEE IMMOBILIZERS, POST-OP BRACES, SOFT ANKLE BRACES, RIGID ANKLE BRACES, ACL CUSTOM BRACES, PCL CUSTOM BRACES, LUMBAR BRACES, ORTHOPEDIC FOOT WEAR, CERVICAL TRACTION, COLD THERAPY, SLINGS, AIR CASTS, CASTING SAWS, CASTING PADDING, AND CASTING PLASTER, IN CLASS 35 (U.S. CLS. 100, 101 AND 102).

FIRST USE 9-21-2011; IN COMMERCE 9-21-2011.

NO CLAIM IS MADE TO THE EXCLUSIVE RIGHT TO USE "MED SUPPLY", APART FROM THE MARK AS SHOWN.

THE COLOR(S) BLUE AND GREY IS/ARE CLAIMED AS A FEATURE OF THE MARK.

THE MARK CONSISTS OF A CIRCULAR DESIGN APPEARING IN GREY WITH A BLUE ARC INTERSECTING THE CIRCLE AND THE LITERAL ELEMENT WHERE "ACO" APPEARS ABOVE "MED SUPPLY", WITH "ACO" APPEARING IN BLUE AND "MED SUPPLY" APPEARING IN GREY.

SER. NO. 85-525,223, FILED 1-25-2012.

KIMBERLY PARKS, EXAMINING ATTORNEY



*David J. Kyros*

Director of the United States Patent and Trademark Office

# United States of America

United States Patent and Trademark Office

# APPEAL PROPERTY TAX.COM

**Reg. No. 4,274,451**

APPEALPROPERTYTAX.COM, INC. (TEXAS CORPORATION)

**Registered Jan. 15, 2013**

3801 KIRBY #176  
HOUSTON, TX 77098

**Int. Cl.: 35**

**SERVICE MARK**

**PRINCIPAL REGISTER**

FOR: REAL ESTATE TAX APPEAL SERVICES, NAMELY, RESIDENTIAL AND COMMERCIAL PROPERTY TAX ASSESSMENT REDUCTION SERVICES; BUSINESS SERVICES, NAMELY, PREPARATION AND FILING OF PROPERTY TAX PROTESTS AND APPEAL PETITION FORMS WITH COUNTY AUTHORITIES; BUSINESS SERVICES, NAMELY, THE GATHERING AND ONLINE SUBMISSION OF PROPERTY TAX APPEAL EVIDENCE IN THE NATURE OF COMPARABLE PROPERTY SALES DATA, PROPERTY INCOME DATA, PROPERTY IMPROVEMENTS AND REPAIRS AND PROPERTY APPRAISALS, SAID EVIDENCE PREPARED IN CONSULTATION WITH THE CLIENT; BUSINESS SERVICES, NAMELY, PROPOSAL OF PROPERTY TAX ASSESSMENT REDUCTIONS TO COUNTY AUTHORITIES ON BEHALF OF THE CLIENT AND/OR CLIENT PROPERTY, IN CLASS 35 (U.S. CLS. 100, 101 AND 102).

FIRST USE 10-1-2011, THE MARK WAS FIRST USED ANYWHERE IN A DIFFERENT FORM OTHER THAN THAT SOUGHT TO BE REGISTERED AT LEAST AS EARLY AS 04/01/2007; IN COMMERCE 10-1-2011, THE MARK WAS FIRST USED IN COMMERCE IN A DIFFERENT FORM OTHER THAN THAT SOUGHT TO BE REGISTERED AT LEAST AS EARLY AS 04/01/2007.

THE MARK CONSISTS OF THE WORDING "APPEALPROPERTYTAX.COM" AND A DESIGN OF A RECTANGLE.

SEC. 2(F) AS TO "APPEALPROPERTYTAX.COM".

SER. NO. 85-526,923, FILED 1-27-2012.

FRED CARL, EXAMINING ATTORNEY



*David J. Kypos*

Director of the United States Patent and Trademark Office

# United States of America

United States Patent and Trademark Office



INSPIRING CREATIVITY

[www.studiodesigns.com](http://www.studiodesigns.com)

**Reg. No. 4,274,452**

**Registered Jan. 15, 2013**

**Int. Cl.: 20**

**TRADEMARK**

**PRINCIPAL REGISTER**

STUDIO DESIGNS, INC. (CALIFORNIA CORPORATION)  
5701  
UNION PACIFIC AVENUE  
COMMERCE, CA 90022

FOR: COMPUTER FURNITURE; DRAFTING TABLES; ENTERTAINMENT CENTERS; FURNITURE FOR HOUSE, OFFICE AND GARDEN; FURNITURE MADE FROM STEEL TUBING; FURNITURE MADE FROM WOOD OR SUBSTITUTES FOR WOOD; FURNITURE OF METAL; FURNITURE PRIMARILY OF METAL, NAMELY, MIRRORS, BED FRAMES, DINING TABLES, COFFEE TABLES, END TABLES, DESKS, DISPLAY CASES, SHELVING, DOG GATES, AND BABY GATES; FURNITURE, NAMELY, WALL UNITS; OFFICE FURNITURE; RESIDENTIAL AND COMMERCIAL FURNITURE; SEATING FURNITURE; TABLES; TELEVISION STANDS, IN CLASS 20 (U.S. CLS. 2, 13, 22, 25, 32 AND 50).

FIRST USE 4-22-2007; IN COMMERCE 5-23-2007.

NO CLAIM IS MADE TO THE EXCLUSIVE RIGHT TO USE "STUDIO DESIGNS" OR "WWW.STUDIODESIGNS.COM", APART FROM THE MARK AS SHOWN.

THE COLOR(S) BLUE: C - 100, M - 30, Y - 0, K - 20 YELLOW: C - 3, M - 20, Y - 94, K - 0 IS/ARE CLAIMED AS A FEATURE OF THE MARK.

THE MARK CONSISTS OF THE WORDING "STUDIO DESIGNS" IN THE COLOR BLUE. BETWEEN THESE TWO WORDS IS A GLOBE DESIGN, WITH THE WATER APPEARING IN THE COLOR BLUE AND THE LAND ELEMENTS APPEARING IN THE COLOR YELLOW. BELOW IS THE WORDING "INSPIRING CREATIVITY" AND "WWW.STUDIODESIGNS.COM" APPEARING IN THE COLOR BLUE.

SER. NO. 85-527,726, FILED 1-27-2012.

ALLISON SCHRODY, EXAMINING ATTORNEY



*David J. Kybas*

Director of the United States Patent and Trademark Office

# United States of America

United States Patent and Trademark Office

## Arsenal Attorneys

**Reg. No. 4,274,453**

**Registered Jan. 15, 2013**

**Int. Cl.: 45**

**SERVICE MARK**

**PRINCIPAL REGISTER**

BERGSTROM, MATTHEW J. (UNITED STATES INDIVIDUAL)  
#128  
344 MAPLE AVE. W.  
VIENNA, VA 22180

FOR: LEGAL SERVICES, NAMELY, PROVIDING CUSTOMIZED DOCUMENTATION, INFORMATION, COUNSELING, ADVICE AND CONSULTATION SERVICES IN ALL AREAS OF LAW, IN CLASS 45 (U.S. CLS. 100 AND 101).

FIRST USE 8-1-2011; IN COMMERCE 8-1-2011.

THE MARK CONSISTS OF STANDARD CHARACTERS WITHOUT CLAIM TO ANY PARTICULAR FONT, STYLE, SIZE, OR COLOR.

NO CLAIM IS MADE TO THE EXCLUSIVE RIGHT TO USE "ATTORNEYS", APART FROM THE MARK AS SHOWN.

SER. NO. 85-528,054, FILED 1-29-2012.

BILL DAWE, EXAMINING ATTORNEY



*David J. Kyffers*

Director of the United States Patent and Trademark Office

# United States of America

United States Patent and Trademark Office

## CONSCIOUS LEADER NETWORK

**Reg. No. 4,274,454**

**Registered Jan. 15, 2013**

**Int. Cl.: 41**

**SERVICE MARK**

**PRINCIPAL REGISTER**

CONSCIOUS LEADER NETWORK, LLC (CALIFORNIA LIMITED LIABILITY COMPANY)  
5699 KANAN ROAD, SUITE 368  
AGOURA HILLS, CA 91362

FOR: PROVIDING GROUP COACHING AND LEARNING FORUMS IN THE FIELD OF LEADERSHIP DEVELOPMENT; BUSINESS TRAINING IN THE FIELD OF LEADERSHIP DEVELOPMENT AND EXECUTIVE COACHING; PROVIDING AN IN-PERSON EDUCATIONAL FORUM IN THE FIELD OF LEADERSHIP DEVELOPMENT AND EXECUTIVE COACHING, IN CLASS 41 (U.S. CLS. 100, 101 AND 107).

FIRST USE 6-1-2011; IN COMMERCE 6-1-2011.

THE MARK CONSISTS OF STANDARD CHARACTERS WITHOUT CLAIM TO ANY PARTICULAR FONT, STYLE, SIZE, OR COLOR.

OWNER OF U.S. REG. NO. 4,114,472.

NO CLAIM IS MADE TO THE EXCLUSIVE RIGHT TO USE "LEADER NETWORK", APART FROM THE MARK AS SHOWN.

SER. NO. 85-528,144, FILED 1-30-2012.

SOPHIA S. KIM, EXAMINING ATTORNEY



*David J. Kybas*

Director of the United States Patent and Trademark Office

# United States of America

United States Patent and Trademark Office



**Reg. No. 4,274,455**

FUTURE PET PRODUCTS, INC. (NEW YORK CORPORATION)  
600 MAIN STREET, SUITE 222  
TONAWANDA, NY 14150

**Registered Jan. 15, 2013**

**Int. Cl.: 31**

FOR: BEEF OR PORK CHEWS FOR DOGS, IN CLASS 31 (U.S. CLS. 1 AND 46).

**TRADEMARK**

FIRST USE 1-0-2010; IN COMMERCE 1-0-2012.

**PRINCIPAL REGISTER**

NO CLAIM IS MADE TO THE EXCLUSIVE RIGHT TO USE "DOG CHEWS", APART FROM THE MARK AS SHOWN.

THE COLOR(S) DARK GREEN, GREEN, BLACK AND WHITE IS/ARE CLAIMED AS A FEATURE OF THE MARK.

THE MARK CONSISTS OF STYLIZED WORDING "NATURE'S OWN" IN DARK GREEN ABOVE STYLIZED WORDING "DOG CHEWS" IN GREEN WITH DARK GREEN OUTLINE AND WHITE DOG WITH BLACK OUTLINE IN BETWEEN THE WORDS "DOG" AND "CHEWS".

SER. NO. 85-528,812, FILED 1-30-2012.

KRISTIN DAHLING, EXAMINING ATTORNEY



*David J. Kyros*

Director of the United States Patent and Trademark Office



# United States of America

United States Patent and Trademark Office



**Reg. No. 4,274,456**

**Registered Jan. 15, 2013**

**Int. Cl.: 42**

**SERVICE MARK**

**PRINCIPAL REGISTER**

INTERNATIONAL COUNCIL OF E-COMMERCE CONSULTANTS (NEVADA CORPORATION), AKA EC-COUNCIL  
6330  
RIVERSIDE PLAZA LANE NW  
ALBUQUERQUE, NM 87120

FOR: TESTING, ANALYSIS, AND EVALUATION OF THE KNOWLEDGE, SKILLS AND ABILITIES OF OTHERS FOR THE PURPOSE OF CERTIFICATION AND RE-CERTIFICATION IN THE FIELD OF INFORMATION TECHNOLOGY SECURITY EDUCATION, IN CLASS 42 (U.S. CLS. 100 AND 101).

FIRST USE 1-1-2010; IN COMMERCE 1-1-2010.

NO CLAIM IS MADE TO THE EXCLUSIVE RIGHT TO USE "CERTIFIED INCIDENT HANDLER", APART FROM THE MARK AS SHOWN.

THE MARK CONSISTS OF THE WORDING "E" AND "CIH" ALL APPEARING IN LARGE BOLD LETTERING. THE "E" IS SEPARATED FROM THE "CIH" BY A VERTICAL LINE. THE WORDING, "EC-COUNCIL", APPEARS BELOW THE "E" AND ON THE OTHER SIDE OF THE LINE "CERTIFIED INCIDENT HANDLER" APPEARS BELOW THE "CIH".

SEC. 2(F).

SER. NO. 85-529,225, FILED 1-31-2012.

C. DIONNE CLYBURN, EXAMINING ATTORNEY



*David J. Kybas*

Director of the United States Patent and Trademark Office

# United States of America

United States Patent and Trademark Office

## OVERVIEW

**Reg. No. 4,274,457**

**Registered Jan. 15, 2013**

**Int. Cl.: 41**

**SERVICE MARK**

**PRINCIPAL REGISTER**

HOMEAWAY.COM, INC. (DELAWARE CORPORATION)  
SUITE 300  
1011 W. FIFTH STREET  
AUSTIN, TX 78703

FOR: PROVIDING ONLINE NEWSLETTERS FEATURING LODGING, TRAVEL INFORMATION, FEATURED DESTINATIONS, REVIEWS, AND OTHER INFORMATION RELATED TO LODGING AND TRAVEL PROVIDERS, NAMELY, INFORMATION ABOUT PROPERTIES, PROMOTIONS, OFFERS, LOCAL ATTRACTIONS, EVENTS AND DESTINATION INFORMATION IN THE FIELD OF VACATION RENTAL PROPERTY OWNERSHIP AND MANAGEMENT; PROVIDING AN ONLINE BLOG FEATURING LODGING, TRAVEL INFORMATION, FEATURED DESTINATIONS, REVIEWS, AND OTHER INFORMATION RELATED TO LODGING AND TRAVEL PROVIDERS, NAMELY, INFORMATION ABOUT PROPERTIES, PROMOTIONS, OFFERS, LOCAL ATTRACTIONS, EVENTS AND DESTINATION INFORMATION IN THE FIELD OF VACATION RENTAL PROPERTY OWNERSHIP AND MANAGEMENT; CONDUCTING WORKSHOPS AND SEMINARS IN THE FIELD OF VACATION PROPERTY RENTAL, IN CLASS 41 (U.S. CLS. 100, 101 AND 107).

FIRST USE 8-24-2011; IN COMMERCE 9-8-2011.

THE MARK CONSISTS OF STANDARD CHARACTERS WITHOUT CLAIM TO ANY PARTICULAR FONT, STYLE, SIZE, OR COLOR.

SER. NO. 85-529,559, FILED 1-31-2012.

ALEX KEAM, EXAMINING ATTORNEY



*David J. Kyros*

Director of the United States Patent and Trademark Office

# United States of America

United States Patent and Trademark Office

## LUXURY PORTFOLIO

**Reg. No. 4,274,458**

**Registered Jan. 15, 2013**

**Int. Cls.: 35 and 36**

**SERVICE MARK**

**PRINCIPAL REGISTER**

RELIANCE RELOCATION SERVICES, INC. (DELAWARE CORPORATION)  
SUITE 1250  
161 NORTH CLARK STREET  
CHICAGO, IL 60601

FOR: REAL ESTATE ADVERTISING AND REAL ESTATE MARKETING SERVICES, NAMELY, SHOWCASING, WORLD-WIDE, HIGH-END RESIDENTIAL PROPERTIES TO BUYERS THROUGH ON-LINE AND PRINT MATERIALS, IN CLASS 35 (U.S. CLS. 100, 101 AND 102).

FIRST USE 8-29-2005; IN COMMERCE 8-29-2005.

FOR: PROVIDING INFORMATION IN THE FIELD OF REAL ESTATE AGENCIES, FINANCING, SALES AND LEASING VIA THE INTERNET, IN CLASS 36 (U.S. CLS. 100, 101 AND 102).

FIRST USE 11-23-2005; IN COMMERCE 11-23-2005.

THE MARK CONSISTS OF STANDARD CHARACTERS WITHOUT CLAIM TO ANY PARTICULAR FONT, STYLE, SIZE, OR COLOR.

SEC. 2(F).

SER. NO. 85-529,813, FILED 1-31-2012.

DAVID C. REIHNER, EXAMINING ATTORNEY



*David J. Kyffers*

Director of the United States Patent and Trademark Office

# United States of America

United States Patent and Trademark Office

## OVERVIEW

**Reg. No. 4,274,459**

**Registered Jan. 15, 2013**

**Int. Cl.: 43**

**SERVICE MARK**

**PRINCIPAL REGISTER**

HOMEAWAY.COM, INC. (DELAWARE CORPORATION)  
SUITE 300  
1011 W. FIFTH STREET  
AUSTIN, CA 78703

FOR: AGENCY SERVICES FOR THE RESERVATION OF TEMPORARY ACCOMMODATION; PROVIDING A WEBSITE FOR MAKING RESERVATIONS AND BOOKING OF ECO-LODGING; PROVIDING TRAVEL LODGING INFORMATION SERVICES AND TRAVEL LODGING BOOKING AGENCY SERVICES FOR TRAVELERS; PROVIDING AN INTERACTIVE WEBSITE FOR MAKING RESERVATIONS FOR TEMPORARY LODGING AND ARRANGING TEMPORARY HOUSING ACCOMMODATIONS, IN CLASS 43 (U.S. CLS. 100 AND 101).

FIRST USE 8-24-2011; IN COMMERCE 9-8-2011.

THE MARK CONSISTS OF STANDARD CHARACTERS WITHOUT CLAIM TO ANY PARTICULAR FONT, STYLE, SIZE, OR COLOR.

SER. NO. 85-529,900, FILED 1-31-2012.

ALEX KEAM, EXAMINING ATTORNEY



*David J. Kybas*

Director of the United States Patent and Trademark Office

# United States of America

United States Patent and Trademark Office



**Reg. No. 4,274,460**

YOUNG PHILANTHROPISTS FOUNDATION (COLORADO NON-PROFIT CORPORATION)  
1407 LARIMER ST., SUITE 200  
DENVER, CO 80202

**Registered Jan. 15, 2013**

**Int. Cl.: 35**

FOR: CHARITABLE SERVICES, NAMELY, ORGANIZING AND CONDUCTING PHILANTHROPIC VOLUNTEER PROGRAMS AND COMMUNITY SERVICE PROJECTS ENGAGING YOUNG PEOPLE, STUDENTS, CHILDREN AND THEIR FAMILIES, IN CLASS 35 (U.S. CLS. 100, 101 AND 102).

**SERVICE MARK**

**PRINCIPAL REGISTER**

FIRST USE 10-31-2010; IN COMMERCE 3-29-2011.

NO CLAIM IS MADE TO THE EXCLUSIVE RIGHT TO USE "YOUNG PHILANTHROPISTS FOUNDATION", APART FROM THE MARK AS SHOWN.

THE COLOR(S) BROWN, GREEN AND GRAY IS/ARE CLAIMED AS A FEATURE OF THE MARK.

THE MARK CONSISTS OF A STYLIZED GREEN DANDELION FLOWER ON A GREEN STEM, GONE TO SEED AND THE SEEDS HAVE BEEN DISPERSED AND ALL OF THE SEEDS ARE IN GRAY. THE WORDS "YOUNG PHILANTHROPISTS FOUNDATION" APPEARS BELOW THE DESIGN AND IS IN THE COLOR BROWN.

SER. NO. 85-530,247, FILED 1-31-2012.

EDWARD NELSON, EXAMINING ATTORNEY



*David J. Kybas*

Director of the United States Patent and Trademark Office

# United States of America

United States Patent and Trademark Office



**Reg. No. 4,274,461**

**Registered Jan. 15, 2013**

**Int. Cl.: 42**

**SERVICE MARK**

**PRINCIPAL REGISTER**

INTERNATIONAL COUNCIL OF E-COMMERCE CONSULTANTS (NEVADA CORPORATION), AKA EC-COUNCIL  
6330  
RIVERSIDE PLAZA LANE NW  
ALBUQUERQUE, NM 87120

FOR: TESTING, ANALYSIS, AND EVALUATION OF THE KNOWLEDGE, SKILLS AND ABILITIES OF OTHERS FOR THE PURPOSE OF CERTIFICATION AND RE-CERTIFICATION IN THE FIELD OF INFORMATION TECHNOLOGY SECURITY EDUCATION, IN CLASS 42 (U.S. CLS. 100 AND 101).

FIRST USE 5-1-2008; IN COMMERCE 5-1-2008.

NO CLAIM IS MADE TO THE EXCLUSIVE RIGHT TO USE "CERTIFIED SECURE PROGRAMMER", APART FROM THE MARK AS SHOWN.

THE MARK CONSISTS OF THE WORDING "E" AND "CSP" ALL APPEARING IN LARGE BOLD LETTERING. THE "E" IS SEPARATED FROM THE "CSP" BY A VERTICAL LINE. THE WORDING, "E-COUNCIL", APPEARS BELOW THE "E" AND ON THE OTHER SIDE OF THE LINE "CERTIFIED SECURE PROGRAMMER" APPEARS BELOW THE "CSP".

SEC. 2(F).

SER. NO. 85-530,377, FILED 1-31-2012.

C. DIONNE CLYBURN, EXAMINING ATTORNEY



*David J. Kybas*

Director of the United States Patent and Trademark Office

# United States of America

United States Patent and Trademark Office



**Reg. No. 4,274,462**

**Registered Jan. 15, 2013**

**Int. Cl.: 42**

**SERVICE MARK**

**PRINCIPAL REGISTER**

INTERNATIONAL COUNCIL OF E-COMMERCE CONSULTANTS (NEVADA CORPORATION), AKA EC-COUNCIL  
6330  
RIVERSIDE PLAZA LANE NW  
ALBUQUERQUE, NM 87120

FOR: TESTING, ANALYSIS, AND EVALUATION OF THE KNOWLEDGE, SKILLS AND ABILITIES OF OTHERS FOR THE PURPOSE OF CERTIFICATION AND RE-CERTIFICATION IN THE FIELD OF INFORMATION TECHNOLOGY SECURITY EDUCATION, IN CLASS 42 (U.S. CLS. 100 AND 101).

FIRST USE 6-1-2011; IN COMMERCE 6-1-2011.

NO CLAIM IS MADE TO THE EXCLUSIVE RIGHT TO USE "SECURE COMPUTER USER SPECIALIST", APART FROM THE MARK AS SHOWN.

THE MARK CONSISTS OF THE WORDING "S" AND "CUS" ALL APPEARING IN LARGE BOLD LETTERING. THE "S" IS SEPARATED FROM THE "CUS" BY A VERTICAL LINE. THE WORDING, "SECURE", APPEARS BELOW THE "S" AND ON THE OTHER SIDE OF THE LINE "COMPUTER USER SPECIALIST" APPEARS BELOW THE "CUS".

SEC. 2(F).

SER. NO. 85-530,385, FILED 1-31-2012.

C. DIONNE CLYBURN, EXAMINING ATTORNEY



*David J. Kyffers*

Director of the United States Patent and Trademark Office

# United States of America

United States Patent and Trademark Office



**Reg. No. 4,274,463**

MARANA AEROSPACE SOLUTIONS, INC. (OREGON CORPORATION)  
24641 E. PINAL AIR PARK ROAD  
MARANA, AZ 856538914

**Registered Jan. 15, 2013**

**Int. Cl.: 37**

FOR: AIRCRAFT MAINTENANCE, REPAIR, AND REFUELING, IN CLASS 37 (U.S. CLS. 100, 103 AND 106).

**SERVICE MARK**

FIRST USE 4-1-2012; IN COMMERCE 4-1-2012.

**PRINCIPAL REGISTER**

NO CLAIM IS MADE TO THE EXCLUSIVE RIGHT TO USE "MARANA AEROSPACE SOLUTIONS", APART FROM THE MARK AS SHOWN.

THE MARK CONSISTS OF THE WORDS "MARANA AEROSPACE SOLUTIONS" BELOW A TRIANGULAR DESIGN PARTIALLY ENCLOSED BY A CIRCLE.

SER. NO. 85-530,860, FILED 2-1-2012.

ALAIN LAPTER, EXAMINING ATTORNEY



*David J. Kyffers*

Director of the United States Patent and Trademark Office



# United States of America

United States Patent and Trademark Office

## DR. GRIMME'S TATER TOWER

**Reg. No. 4,274,464**

GRIMME, JOHN D. (UNITED STATES INDIVIDUAL)  
2315 W. 28TH AVENUE  
EUGENE, OR 97405

**Registered Jan. 15, 2013**

**Int. Cl.: 21**

FOR: RAISED GARDEN PLANTERS, IN CLASS 21 (U.S. CLS. 2, 13, 23, 29, 30, 33, 40 AND 50).

**TRADEMARK**

FIRST USE 1-31-2012; IN COMMERCE 1-31-2012.

**PRINCIPAL REGISTER**

THE MARK CONSISTS OF STANDARD CHARACTERS WITHOUT CLAIM TO ANY PARTICULAR FONT, STYLE, SIZE, OR COLOR.

NO CLAIM IS MADE TO THE EXCLUSIVE RIGHT TO USE "TATER TOWER", APART FROM THE MARK AS SHOWN.

THE NAME(S), PORTRAIT(S), AND/OR SIGNATURE(S) SHOWN IN THE MARK IDENTIFIES "DR. GRIMME", WHOSE CONSENT(S) TO REGISTER IS MADE OF RECORD.

SER. NO. 85-531,410, FILED 2-1-2012.

AMEEN IMAM, EXAMINING ATTORNEY



*David J. Kyfos*

Director of the United States Patent and Trademark Office

United States of America  
United States Patent and Trademark Office

# DEGREZIA

**Reg. No. 4,274,465**

VINCENT DEGREZIA (UNITED STATES INDIVIDUAL)  
350 EAST 52ND STREET, APT 3A  
NEW YORK, NY 10022

**Registered Jan. 15, 2013**

**Int. Cl.: 43**

FOR: BAR SERVICES; RESTAURANT SERVICES, IN CLASS 43 (U.S. CLS. 100 AND 101).

**SERVICE MARK**

FIRST USE 11-30-1987; IN COMMERCE 11-30-1987.

**PRINCIPAL REGISTER**

THE MARK CONSISTS OF STANDARD CHARACTERS WITHOUT CLAIM TO ANY PARTICULAR FONT, STYLE, SIZE, OR COLOR.

SEC. 2(F).

SER. NO. 85-531,535, FILED 2-1-2012.

LESLIE RICHARDS, EXAMINING ATTORNEY



*David J. Kyffers*

Director of the United States Patent and Trademark Office

# United States of America

United States Patent and Trademark Office

## RAISE A LITTLE CANE

**Reg. No. 4,274,466**

RAISING CANE'S U.S.A., LLC (LOUISIANA LIMITED LIABILITY COMPANY)  
5800 TENNYSON PARKWAY, SUITE 200  
PLANO, TX 750243549

**Registered Jan. 15, 2013**

**Int. Cls.: 36 and 43**

FOR: CHARITABLE FUNDRAISING SERVICES IN SUPPORT OF ANIMAL WELFARE AND RELATED ORGANIZATIONS, IN CLASS 36 (U.S. CLS. 100, 101 AND 102).

**SERVICE MARK**

FIRST USE 11-25-2011; IN COMMERCE 11-25-2011.

**PRINCIPAL REGISTER**

FOR: RESTAURANT SERVICES, IN CLASS 43 (U.S. CLS. 100 AND 101).

FIRST USE 11-25-2011; IN COMMERCE 11-25-2011.

THE MARK CONSISTS OF STANDARD CHARACTERS WITHOUT CLAIM TO ANY PARTICULAR FONT, STYLE, SIZE, OR COLOR.

OWNER OF U.S. REG. NOS. 2,739,919, 3,272,782, AND 3,583,353.

SER. NO. 85-531,777, FILED 2-2-2012.

JEFFREY LOOK, EXAMINING ATTORNEY



*David J. Kyffers*

Director of the United States Patent and Trademark Office

# United States of America

United States Patent and Trademark Office

# A&E

**Reg. No. 4,274,467**

**Registered Jan. 15, 2013**

**Int. Cls.: 11 and 35**

**TRADEMARK**

**SERVICE MARK**

**PRINCIPAL REGISTER**

A&E BATH & SHOWER INC. (CANADA CORPORATION)  
9181 BOIVIN ST.  
MONTREAL, QUEBEC, CANADA H8R2E8

FOR: BATH TUBS; FAUCETS; SHOWER ENCLOSURES; SHOWERS, IN CLASS 11 (U.S. CLS. 13, 21, 23, 31 AND 34).

FIRST USE 6-1-2009; IN COMMERCE 6-1-2009.

FOR: WHOLESALE STORE SERVICES FEATURING SHOWER STALLS, BATH TUBS, FAUCETS, IN CLASS 35 (U.S. CLS. 100, 101 AND 102).

FIRST USE 6-1-2009; IN COMMERCE 6-1-2009.

THE MARK CONSISTS OF STANDARD CHARACTERS WITHOUT CLAIM TO ANY PARTICULAR FONT, STYLE, SIZE, OR COLOR.

SER. NO. 85-531,890, FILED 2-2-2012.

AISHA CLARKE, EXAMINING ATTORNEY



*David J. Kyffers*

Director of the United States Patent and Trademark Office

# United States of America

United States Patent and Trademark Office



**Reg. No. 4,274,468**

CEDILLO, MAYTE RODRIGUEZ (UNITED STATES INDIVIDUAL)  
P.O. BOX 210485  
CHULA VISTA, CA 91921

**Registered Jan. 15, 2013**

**Int. Cl.: 16**

FOR: MAGAZINES FEATURING TRAVEL IN BAJA, IN CLASS 16 (U.S. CLS. 2, 5, 22, 23, 29, 37, 38 AND 50).

**TRADEMARK**

FIRST USE 11-25-1998; IN COMMERCE 11-25-1998.

**PRINCIPAL REGISTER**

OWNER OF U.S. REG. NO. 2,439,635.

THE MARK CONSISTS OF "TRAVELER" IN LARGE ALL CAPS FONT AND "BAJA" IN SMALL ALL CAPS FONT POSITIONED NEXT TO THE "T" IN TRAVELER.

THE ENGLISH TRANSLATION OF "BAJA" IN THE MARK IS "LOWER".

SEC. 2(F).

SER. NO. 85-531,897, FILED 2-2-2012.

IRA J. GOODSaid, EXAMINING ATTORNEY



*David J. Kybas*

Director of the United States Patent and Trademark Office

# United States of America

United States Patent and Trademark Office

# EMY MACK

**Reg. No. 4,274,469**

EMY MACK, LLC (PENNSYLVANIA LIMITED LIABILITY COMPANY)  
1151 FREEPORT RD. SUITE 343  
PITTSBURGH, PA 15238

**Registered Jan. 15, 2013**

**Int. Cl.: 25**

FOR: FOOTWEAR, NAMELY CUSTOM FITTED FASHION SHOES FOR WOMEN, IN CLASS 25 (U.S. CLS. 22 AND 39).

**TRADEMARK**

FIRST USE 11-27-2011; IN COMMERCE 11-27-2011.

**PRINCIPAL REGISTER**

THE MARK CONSISTS OF STANDARD CHARACTERS WITHOUT CLAIM TO ANY PARTICULAR FONT, STYLE, SIZE, OR COLOR.

THE NAME(S), PORTRAIT(S), AND/OR SIGNATURE(S) SHOWN IN THE MARK IDENTIFIES EMILY MACK JAMISON, A LIVING INDIVIDUAL, WHOSE CONSENT(S) TO REGISTER IS MADE OF RECORD.

SER. NO. 85-532,616, FILED 2-2-2012.

FLORENTINA BLANDU, EXAMINING ATTORNEY



*David J. Kybas*

Director of the United States Patent and Trademark Office

# United States of America

United States Patent and Trademark Office

# BLACKBETTY

**Reg. No. 4,274,470**

DQC INTERNATIONAL CORP. (SOUTH CAROLINA CORPORATION)  
3 HERON POND CT  
COLUMBIA, SC 29223

**Registered Jan. 15, 2013**

**Int. Cl.: 28**

FOR: FISHING REELS; FISHING RODS; REELS FOR FISHING; RODS FOR FISHING, IN CLASS 28 (U.S. CLS. 22, 23, 38 AND 50).

**TRADEMARK**

FIRST USE 10-1-2011; IN COMMERCE 12-1-2011.

**PRINCIPAL REGISTER**

THE MARK CONSISTS OF STANDARD CHARACTERS WITHOUT CLAIM TO ANY PARTICULAR FONT, STYLE, SIZE, OR COLOR.

SER. NO. 85-532,867, FILED 2-3-2012.

KIMBERLY PARKS, EXAMINING ATTORNEY



*David J. Kyffers*

Director of the United States Patent and Trademark Office

# United States of America

United States Patent and Trademark Office



**Reg. No. 4,274,471**

**Registered Jan. 15, 2013**

**Int. Cl.: 2**

**TRADEMARK**

**PRINCIPAL REGISTER**

SYNTA, INC. (GEORGIA CORPORATION)  
675 PARK NORTH BLVD SUITE 120  
CLARKSTON, GA 30021

FOR: EXTERIOR SURFACE PROTECTIVE COATINGS, IN CLASS 2 (U.S. CLS. 6, 11 AND 16).

FIRST USE 3-1-2009; IN COMMERCE 3-1-2009.

NO CLAIM IS MADE TO THE EXCLUSIVE RIGHT TO USE "DECK RESTORE", "LIQUID", AND "RESURFACER", APART FROM THE MARK AS SHOWN.

THE COLOR(S) BLACK, TAN, WHITE AND GRAY IS/ARE CLAIMED AS A FEATURE OF THE MARK.

THE MARK CONSISTS OF A RECTANGLE FEATURING THE WORDING "DECK" IN THE COLOR TAN AND SEPARATED BY A VERTICAL WHITE LINE FROM THE WORDING "RESTORE", WHICH IS IN THE COLOR WHITE WITH GRAY SHADOW LETTERS, BELOW WHICH IS THE WORDING "LIQUID ARMOR RESURFACER" IN THE COLOR WHITE AND SITUATED BETWEEN WHITE HORIZONTAL LINES, ALL AGAINST A BLACK BACKGROUND INSIDE THE RECTANGLE.

SER. NO. 85-532,886, FILED 2-3-2012.

STEVEN R. FINE, EXAMINING ATTORNEY



*David J. Kybas*

Director of the United States Patent and Trademark Office



# United States of America

United States Patent and Trademark Office

# ICAP

**Reg. No. 4,274,472**

IOXUS, INC. (DELAWARE CORPORATION)  
18 STADIUM CIRCLE  
ONEONTA, NY 13820

**Registered Jan. 15, 2013**

**Int. Cl.: 9**

FOR: ENERGY STORAGE DEVICES, NAMELY, CAPACITORS; RECHARGEABLE ELECTRIC STORAGE BATTERIES, IN CLASS 9 (U.S. CLS. 21, 23, 26, 36 AND 38).

**TRADEMARK**

FIRST USE 1-0-2012; IN COMMERCE 1-0-2012.

**PRINCIPAL REGISTER**

THE MARK CONSISTS OF STANDARD CHARACTERS WITHOUT CLAIM TO ANY PARTICULAR FONT, STYLE, SIZE, OR COLOR.

SER. NO. 85-532,962, FILED 2-3-2012.

BARBARA BROWN, EXAMINING ATTORNEY



*David J. Kyffers*

Director of the United States Patent and Trademark Office

# United States of America

United States Patent and Trademark Office



**Reg. No. 4,274,473**

**Registered Jan. 15, 2013**

**Int. Cl.: 25**

**TRADEMARK**

**PRINCIPAL REGISTER**

LOGGERHEAD APPAREL, LLC (SOUTH CAROLINA LIMITED LIABILITY COMPANY),  
DBA LOGGERHEAD APPAREL  
109 HADDINGTON LANE  
GREENVILLE, SC 29609

FOR: BUTTON DOWN SHIRTS; COLLARED SHIRTS; DRESS SHIRTS; FISHING SHIRTS;  
POLO SHIRTS; SHIRTS AND SHORT-SLEEVED SHIRTS; SHORT-SLEEVED SHIRTS , IN  
CLASS 25 (U.S. CLS. 22 AND 39).

FIRST USE 11-15-2011; IN COMMERCE 12-17-2011.

THE MARK CONSISTS OF A STYLIZED IMAGE OF LOGGERHEAD TURTLE ANGLED UPWARDS TO THE RIGHT AT APPROXIMATELY 60 DEGREES WITH NAVY BLUE BASE ON SHELL, MAIN BODY OF FLIPPERS, AND MAIN BODY OF HEAD, WHICH IS ACCENTED BY GREEN DIAMOND-SHAPED PATTERN ACROSS THE BACK AND TOP OF SHELL, ALL OF WHICH IS INSIDE A CIRCLE WITH NAVY BLUE OUTLINE AND GREEN FILL.

THE COLOR(S) NAVY BLUE AND GREEN IS/ARE CLAIMED AS A FEATURE OF THE MARK.

SER. NO. 85-533,094, FILED 2-3-2012.

AMY C. KEAN, EXAMINING ATTORNEY



*David J. Kybas*

Director of the United States Patent and Trademark Office

# United States of America

United States Patent and Trademark Office

MYKELTI  
WILLIAMSON'S



**Reg. No. 4,274,474**

**Registered Jan. 15, 2013**

**Int. Cl.: 30**

**TRADEMARK**

**PRINCIPAL REGISTER**

WILLIAMSON, MYKELTI (UNITED STATES INDIVIDUAL)  
28364 S. WESTERN AVENUE, NO. 508  
RANCHO PALOS VERDES, CA 90275

FOR: FOOD SEASONINGS, NAMELY, BARBEQUE DRY RUB, SPICY BARBEQUE DRY RUB, DRY SPICE RUB FOR MEATS AND FISH, SPICY DRY SPICE RUB FOR MEATS AND FISH; DRY SPICE RUBS, SPICY DRY SPICE RUBS, BARBEQUE SAUCE, KETCHUP, HOT SAUCE AND CORN CHIPS, IN CLASS 30 (U.S. CL. 46).

FIRST USE 2-28-2011; IN COMMERCE 2-28-2011.

THE NAME "MYKELTI WILLIAMSON" SHOWN IN THE MARK IDENTIFIES A LIVING INDIVIDUAL WHOSE CONSENT IS OF RECORD.

THE MARK CONSISTS OF THE WORDS "MYKELTI WILLIAMSON'S BUBBA STYLE" AS SHOWN IN THE DRAWING. THE WORDS "MYKELTI WILLIAMSON'S" APPEAR ABOVE THE WORD "BUBBA". IN THE "B" IN "BUBBA" THERE IS A SIDE PROFILE SILHOUETTE OF A MAN. BELOW THE WORD "BUBBA" IS THE WORD "STYLE". UNDERNEATH THE "L" AND "E" IN "STYLE" IS A SMALL LINE.

SER. NO. 85-533,615, FILED 2-3-2012.

BRENDAN MCCAULEY, EXAMINING ATTORNEY



*David J. Kappas*

Director of the United States Patent and Trademark Office

# United States of America

United States Patent and Trademark Office

# GlyAcid

**Reg. No. 4,274,475**

CROSSCHEM LIMITED (TEXAS LIMITED PARTNERSHIP)  
5816 DRYDEN PLACE STE 200  
CARLSBAD, CA 92008

**Registered Jan. 15, 2013**

**Int. Cl.: 1**

FOR: GLYCOLIC ACID, IN CLASS 1 (U.S. CLS. 1, 5, 6, 10, 26 AND 46).

**TRADEMARK**

FIRST USE 7-1-2005; IN COMMERCE 2-1-2006.

**PRINCIPAL REGISTER**

THE MARK CONSISTS OF STANDARD CHARACTERS WITHOUT CLAIM TO ANY PARTICULAR FONT, STYLE, SIZE, OR COLOR.

SER. NO. 85-534,302, FILED 2-5-2012.

JIM RINGLE, EXAMINING ATTORNEY



*David J. Kyffers*

Director of the United States Patent and Trademark Office

# United States of America

United States Patent and Trademark Office



**Reg. No. 4,274,476**

**Registered Jan. 15, 2013**

**Int. Cl.: 29**

**TRADEMARK**

**PRINCIPAL REGISTER**

MONSIEUR SINGH, LLC (NEW YORK LIMITED LIABILITY COMPANY)  
APT 9M  
784 COLUMBUS AVENUE  
NEW YORK, NY 10025

FOR: BEVERAGES HAVING A MILK BASE; BEVERAGES MADE FROM YOGHURT; BEVERAGES MADE WITH YOGHURT; DAIRY-BASED BEVERAGES; MILK BEVERAGES CONTAINING FRUITS; YOGURT-BASED BEVERAGES, IN CLASS 29 (U.S. CL. 46).

FIRST USE 7-9-2011; IN COMMERCE 2-2-2012.

NO CLAIM IS MADE TO THE EXCLUSIVE RIGHT TO USE "LASSI BAR", APART FROM THE MARK AS SHOWN.

THE MARK CONSISTS OF A STYLIZED DESIGN OF A MAN'S HEAD WEARING A TURBAN AND HAVING A MUSTACHE AND BEARD, DESIGNED TO LOOK LIKE A MEMBER OF THE SIKH RELIGION. HIS MOUSTACHE IS BASED ON A FRENCH CHEF'S MOUSTACHE AND HE IS MEDITATING. BELOW THIS DESIGN IS A QUADRILATERAL-SHAPED BANNER WITH THE STYLIZED WORDING "MONSIEUR SINGH" ABOVE THE WORDING "LASSI", AND A HORIZONTAL LINE ON THE EITHER SIDE OF "LASSI". ALL THE FOREGOING IS SET AGAINST A CIRCULAR BACKGROUND MADE UP OF AN ORNAMENTAL DESIGN.

SER. NO. 85-534,344, FILED 2-6-2012.

ANDREW LEASER, EXAMINING ATTORNEY



*David J. Kybas*

Director of the United States Patent and Trademark Office

United States of America  
United States Patent and Trademark Office

**IPEXtreme** ▶

**Reg. No. 4,274,477**

**Registered Jan. 15, 2013**

**Int. Cl.: 9**

**TRADEMARK**

**PRINCIPAL REGISTER**

IPEXTREME, INC. (DELAWARE CORPORATION)  
808 E. MCGLINCY LANE  
CAMPBELL, CA 95008

FOR: COMPUTER SOFTWARE REPRESENTING INTEGRATED CIRCUIT FUNCTIONS WHICH CAN BE INSERTED INTO INTEGRATED CIRCUIT DESIGNS BY END USERS; AND COMPUTER SOFTWARE FOR THE IMPLEMENTATION, SIMULATION AND TESTING OF OTHER COMPUTER SOFTWARE AND INTEGRATED CIRCUIT DESIGNS, IN CLASS 9 (U.S. CLS. 21, 23, 26, 36 AND 38).

FIRST USE 4-30-2006; IN COMMERCE 4-30-2006.

OWNER OF U.S. REG. NOS. 3,055,039 AND 3,144,397.

THE COLOR(S) RED AND BLACK IS/ARE CLAIMED AS A FEATURE OF THE MARK.

THE MARK CONSISTS OF THE PHRASE "IPEXTREME" REPRESENTED IN STYLIZED LETTERS WITH THE LEFT HALF OF THE "X" APPEARING IN RED AND THE REMAINDER OF THE PHRASE APPEARING IN BLACK, WITH A SMALL TRIANGLE APPEARING IN RED LOCATED TO THE RIGHT OF THE PHRASE "IPEXTREME".

SER. NO. 85-534,577, FILED 2-6-2012.

RONALD DELGIZZI, EXAMINING ATTORNEY



*David J. Kyros*

Director of the United States Patent and Trademark Office

# United States of America

United States Patent and Trademark Office



**Reg. No. 4,274,478**

**Registered Jan. 15, 2013**

**Int. Cl.: 1**

**TRADEMARK**

**PRINCIPAL REGISTER**

101ST EARTH BORN ENVIRONMENTAL TECHNOLOGIES, LP (KANSAS LIMITED PARTNERSHIP)  
1235 COUNTRY CLUB DRIVE  
COLBY, KS 67701

FOR: CHEMICAL ADDITIVES FOR DRILLING MUDS; CHEMICAL ADDITIVES FOR OIL WELL DRILLING FLUID; CHEMICAL PREPARATIONS FOR USE IN INDUSTRY; CHEMICAL PREPARATIONS, NAMELY, DEGREASING AND CLEANING SOLVENTS; CHEMICAL PRODUCTS FOR PREVENTING SCALE; CHEMICAL SOLUTIONS IN THE NATURE OF MULTIMETAL CORROSION AND SCALE INHIBITOR TREATMENTS FOR HYDRONIC HEATING AND COOLING SYSTEMS; CHEMICALS FOR THE TREATMENT OF COOLING WATER SYSTEMS; CHEMICALS FOR USE IN INDUSTRY; CHEMICALS USED IN OIL DRILLING; DEGREASING AGENTS; DESCALING PREPARATIONS FOR INDUSTRIAL PURPOSES; ENGINE DECARBONIZING CHEMICALS; FLUSHING AGENTS FOR AUTOMOBILE RADIATORS; RADIATOR ADDITIVES TO PREVENT RUST, IN CLASS 1 (U.S. CLS. 1, 5, 6, 10, 26 AND 46).

FIRST USE 2-6-2012; IN COMMERCE 2-6-2012.

NO CLAIM IS MADE TO THE EXCLUSIVE RIGHT TO USE "CLEAN", APART FROM THE MARK AS SHOWN.

THE COLOR(S) BLACK, WHITE, BROWN, ORANGE, BLUE, DARK BLUE AND GREEN IS/ARE CLAIMED AS A FEATURE OF THE MARK.

THE MARK CONSISTS OF THE STYLIZED TERMS "EARTH BORN" IN BLACK LETTERING OUTLINED IN WHITE. BENEATH THOSE TERMS IS THE STYLIZED TERM "CLEAN" IN THE SAME BLACK LETTERING AND WHITE OUTLINE. UNDERNEATH ALL TERMS IS A STYLIZED DESIGN OF AN EAGLE IN BROWN, WHITE AND BLACK. THE EAGLE FEATURES AN ORANGE BEAK. THE EAGLE IS SURROUNDING A STYLIZED GLOBE WITH BLUE WATER ON THE OUTSIDE EDGE, AND FADES TO DARKER BLUE IN THE CENTER. THE CONTINENTS ARE DISPLAYED IN GREEN.



*David J. Kypos*

SER. NO. 85-535,124, FILED 2-6-2012.

JOHN DWYER, EXAMINING ATTORNEY

# United States of America

United States Patent and Trademark Office

## EARTHBORN CLEAN

**Reg. No. 4,274,479**

**Registered Jan. 15, 2013**

**Int. Cl.: 1**

**TRADEMARK**

**PRINCIPAL REGISTER**

101ST EARTHBORN ENVIRONMENTAL TECHNOLOGIES, LP (KANSAS LIMITED PARTNERSHIP)  
1235 COUNTRY CLUB DRIVE  
COLBY, KS 67701

FOR: CHEMICAL ADDITIVES FOR DRILLING MUDS; CHEMICAL ADDITIVES FOR OIL WELL DRILLING FLUID; CHEMICAL PREPARATIONS FOR USE IN INDUSTRY; CHEMICAL PREPARATIONS, NAMELY, DEGREASING AND CLEANING SOLVENTS; CHEMICAL PRODUCTS FOR PREVENTING SCALE; CHEMICAL SOLUTIONS IN THE NATURE OF MULTIMETAL CORROSION AND SCALE INHIBITOR TREATMENTS FOR HYDRONIC HEATING AND COOLING SYSTEMS; CHEMICALS FOR THE TREATMENT OF COOLING WATER SYSTEMS; CHEMICALS FOR USE IN INDUSTRY; CHEMICALS FOR USE IN THE FIELD OF OIL EXPLORATION AND PRODUCTION; CHEMICALS USED IN INDUSTRY; CHEMICALS USED IN OIL DRILLING; DEGREASING AGENTS; DESCALING PREPARATIONS FOR INDUSTRIAL PURPOSES; ENGINE DECARBONIZING CHEMICALS; FLUSHING AGENTS FOR AUTOMOBILE RADIATORS; RADIATOR ADDITIVES TO PREVENT RUST, IN CLASS 1 (U.S. CLS. 1, 5, 6, 10, 26 AND 46).

FIRST USE 2-6-2012; IN COMMERCE 2-6-2012.

THE MARK CONSISTS OF STANDARD CHARACTERS WITHOUT CLAIM TO ANY PARTICULAR FONT, STYLE, SIZE, OR COLOR.

NO CLAIM IS MADE TO THE EXCLUSIVE RIGHT TO USE "CLEAN", APART FROM THE MARK AS SHOWN.

SER. NO. 85-535,148, FILED 2-6-2012.

JOHN DWYER, EXAMINING ATTORNEY



*David J. Kyffers*

Director of the United States Patent and Trademark Office



# United States of America

United States Patent and Trademark Office

## MONDO BALDO

**Reg. No. 4,274,480**

BALDYLOCKS, LLC (GEORGIA LIMITED LIABILITY COMPANY)  
640 GLEN IRIS DR. NE #411  
ATLANTA, GA 30308

**Registered Jan. 15, 2013**

**Int. Cl.: 25**

FOR: CLOTHING, NAMELY, HATS, TOPS, AND BOTTOMS, IN CLASS 25 (U.S. CLS. 22 AND 39).

**TRADEMARK**

FIRST USE 10-25-2011; IN COMMERCE 1-7-2012.

**PRINCIPAL REGISTER**

THE MARK CONSISTS OF STANDARD CHARACTERS WITHOUT CLAIM TO ANY PARTICULAR FONT, STYLE, SIZE, OR COLOR.

SER. NO. 85-535,743, FILED 2-7-2012.

SHAVELL MCPHERSON, EXAMINING ATTORNEY



*David J. Kyffers*

Director of the United States Patent and Trademark Office

# United States of America

United States Patent and Trademark Office

## Satchel & Page

**Reg. No. 4,274,481**

**Registered Jan. 15, 2013**

**Int. Cl.: 9**

**TRADEMARK**

**PRINCIPAL REGISTER**

SACHEL & PAGE LLC (TEXAS LIMITED LIABILITY COMPANY)  
777 DUNLAVY ST. UNIT 9303  
HOUSTON, TX 77019

FOR: BACKPACKS ESPECIALLY ADAPTED FOR HOLDING LAPTOPS; BACKPACKS ESPECIALLY ADAPTED FOR HOLDING LAPTOPS AND NOTEBOOK COMPUTERS; BRIEFCASES ESPECIALLY ADAPTED FOR HOLDING LAPTOP COMPUTERS; MESSENGER BAGS ESPECIALLY ADAPTED FOR HOLDING LAPTOPS; NOTEBOOK AND LAPTOP COMPUTERS, IN CLASS 9 (U.S. CLS. 21, 23, 26, 36 AND 38).

FIRST USE 7-1-2011; IN COMMERCE 9-1-2011.

THE MARK CONSISTS OF STANDARD CHARACTERS WITHOUT CLAIM TO ANY PARTICULAR FONT, STYLE, SIZE, OR COLOR.

NO CLAIM IS MADE TO THE EXCLUSIVE RIGHT TO USE "SACHEL", APART FROM THE MARK AS SHOWN.

SER. NO. 85-536,514, FILED 2-7-2012.

AISHA SALEM, EXAMINING ATTORNEY



*David J. Kyffers*

Director of the United States Patent and Trademark Office

# United States of America

United States Patent and Trademark Office

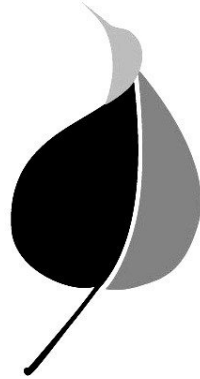

**Reg. No. 4,274,482**

**Registered Jan. 15, 2013**

**Int. Cls.: 18, 22, 23, 24,  
25, 26 and 27**

**TRADEMARK**

**PRINCIPAL REGISTER**

BUDDHIST COMPASSION RELIEF TZU CHI FOUNDATION (TAIWAN FOUNDATION)  
SINCHENG HSIANG  
NO. 1 LANE 88 JINGSHE ST. KANGLE VILLAGE  
HUALIEN COUNTY, TAIWAN

FOR: SCHOOL BAGS, TRUNKS, HANDBAGS, CANVAS, MESH AND TEXTILE SHOPPING BAGS, PURSES, BACKPACKS; UMBRELLAS; WALKING STICKS; IMITATION LEATHER; BAGS FOR PETS, NAMELY, ANIMAL CARRIERS; SLING BAGS FOR CARRYING INFANTS, IN CLASS 18 (U.S. CLS. 1, 2, 3, 22 AND 41).

FIRST USE 10-22-2008; IN COMMERCE 4-15-2010.

FOR: TEXTILE FIBERS MADE OF NATURAL AND ARTIFICIAL MATERIALS, NAMELY, PLASTIC, SILK, POLYESTER, AND RUBBER; PLASTIC BANDS FOR WRAPPING OR BINDING; PLASTIC ROPES; TENTS; AWNINGS; FISHING NETS; MOTH PREVENTION NETS FOR AGRICULTURAL PURPOSES; TEXTILE MAIL BAGS; LAUNDRY NETS, IN CLASS 22 (U.S. CLS. 1, 2, 7, 19, 22, 42 AND 50).

FIRST USE 10-22-2008; IN COMMERCE 4-15-2010.

FOR: YARNS AND THREADS FOR TEXTILE PURPOSES, NAMELY, PLASTIC THREAD SYNTHETIC FIBER THREAD, ARTIFICIAL FIBER THREADS, RUBBER THREADS, ARTIFICIAL FIBER YARNS, SYNTHETIC FIBER YARNS, AND ELASTIC FIBER YARNS, IN CLASS 23 (U.S. CL. 43).

FIRST USE 10-22-2008; IN COMMERCE 4-15-2010.

FOR: FABRICS FOR TEXTILE USE; QUILTS, QUILT COVERS, BEDSPREADS, COVERLETS, PILLOW SHAMS, MOSQUITO NETS, CHILDREN'S BLANKETS, LAP BLANKETS, BLANKET THROWS, WALL BLANKETS, PLASTIC CURTAINS, UNFITTED COVERS FOR CUSHIONS, TOWELS, TABLE RUNNERS, HANDKERCHIEFS, WASHING MITTS, UNFITTED PLASTIC COVERINGS FOR FURNITURE, PLASTIC SHOWER CURTAINS; WATERPROOF SAIL-CLOTH, IN CLASS 24 (U.S. CLS. 42 AND 50).

FIRST USE 10-22-2008; IN COMMERCE 4-15-2010.



*David J. Kyjars*

Director of the United States Patent and Trademark Office

**Reg. No. 4,274,482** FOR: ANORAKS, BATHING COSTUMES; BLAZERS; BLOUSES; BLOUSONS; CHILDREN'S AND INFANT'S APPAREL, NAMELY, JUMPERS, OVERALL, SLEEPWEAR, PAJAMAS, ROMPERS AND ONE-PIECE GARMENTS; DRESSES; JEANS; LEISURE SUITS; MEN'S AND WOMEN'S JACKETS, TROUSERS, VESTS; MEN'S SUITS; WOMEN'S SUITS; OVERCOATS; PANTIES, SHORTS AND BRIEFS; PANTS; POLO SHIRTS; SHIRTS; SKIRTS; T-SHIRTS; WIND COATS; RAIN COATS; SWIMSUITS; SHOES; SCARVES; HOODS; TIES, BOW TIES; HATS, CAPS; SOCKS; GLOVES FOR CLOTHING; BELTS FOR CLOTHING; APRONS, IN CLASS 25 (U.S. CLS. 22 AND 39).

FIRST USE 10-22-2008; IN COMMERCE 4-15-2010.

FOR: DECORATIVE AND ORNAMENTAL GOODS, NAMELY, WOVEN BRAIDS, COLORED RIBBONS, ELASTIC RIBBONS, ADHESIVE PATCHES FOR DECORATION OF CLOTHES, DECORATIVE CHINESE MACRAME AND KNOTS AND WOVEN HANDICRAFT OF CORDS AND THREADS; HAIR PINS; HAIR BANDS; BUTTONS; ZIPPERS; WIGS, HAIRPIECES, AND ADD-IN AND ADD-ON HAIR ACCESSORIES CONSTRUCTED PRIMARILY OF SYNTHETIC HAIR; ARTIFICIAL FLOWERS; ARTIFICIAL TREES; SHOE LACES, IN CLASS 26 (U.S. CLS. 37, 39, 40, 42 AND 50).

FIRST USE 10-22-2008; IN COMMERCE 4-15-2010.

FOR: WOVEN STRAW MATS, PLASTIC CARPETS, CARPETS, AUTOMOBILE CARPETS, PLASTIC BATH MATS, AUTOMOBILE FLOOR MATS, NON-SLIP MATS FOR FLOORS, BATH MATS, WALLPAPERS, PLASTIC WALLPAPERS, ARTIFICIAL TURF, SPORTS MATS, NAMELY, WRESTLING MATS AND GYMNAS TIC MATS, IN CLASS 27 (U.S. CLS. 19, 20, 37, 42 AND 50).

FIRST USE 10-22-2008; IN COMMERCE 4-15-2010.

THE MARK CONSISTS OF A BO TREE LEAF DESIGN.

SER. NO. 85-536,968, FILED 2-8-2012.

ROBIN CHOSID, EXAMINING ATTORNEY

# United States of America

United States Patent and Trademark Office

## THE STONY BROOK SCHOOL

**Reg. No. 4,274,483**

**Registered Jan. 15, 2013**

**Int. Cl.: 41**

**SERVICE MARK**

**PRINCIPAL REGISTER**

THE STONY BROOK SCHOOL (NEW YORK NON-PROFIT CORPORATION)  
1 CHAPMAN PARKWAY  
STONYBROOK, NY 11790

FOR: EDUCATION SERVICES, NAMELY, PROVIDING 7TH THROUGH 12TH GRADE CLASSROOM INSTRUCTION AND PRIVATE COLLEGE PREPARATORY EDUCATIONAL SERVICES, IN CLASS 41 (U.S. CLS. 100, 101 AND 107).

FIRST USE 1-1-1922; IN COMMERCE 1-1-1922.

THE MARK CONSISTS OF STANDARD CHARACTERS WITHOUT CLAIM TO ANY PARTICULAR FONT, STYLE, SIZE, OR COLOR.

NO CLAIM IS MADE TO THE EXCLUSIVE RIGHT TO USE "SCHOOL", APART FROM THE MARK AS SHOWN.

SEC. 2(F) AS TO "STONY BROOK".

SER. NO. 85-537,024, FILED 2-8-2012.

FONG HSU, EXAMINING ATTORNEY



*David J. Kyffers*

Director of the United States Patent and Trademark Office

# United States of America

United States Patent and Trademark Office

## CHARACTER BEFORE CAREER

**Reg. No. 4,274,484**

**Registered Jan. 15, 2013**

**Int. Cl.: 41**

**SERVICE MARK**

**PRINCIPAL REGISTER**

THE STONY BROOK SCHOOL (NEW YORK NON-PROFIT CORPORATION)  
1 CHAPMAN PARKWAY  
STONYBROOK, NY 11790

FOR: EDUCATION SERVICES, NAMELY, PROVIDING 7TH THROUGH 12TH GRADE CLASSROOM INSTRUCTION AND PRIVATE COLLEGE PREPARATORY EDUCATIONAL SERVICES, IN CLASS 41 (U.S. CLS. 100, 101 AND 107).

FIRST USE 1-1-1922; IN COMMERCE 1-1-1922.

THE MARK CONSISTS OF STANDARD CHARACTERS WITHOUT CLAIM TO ANY PARTICULAR FONT, STYLE, SIZE, OR COLOR.

SER. NO. 85-537,028, FILED 2-8-2012.

FONG HSU, EXAMINING ATTORNEY



*David J. Kyffers*

Director of the United States Patent and Trademark Office

# United States of America

United States Patent and Trademark Office



**Reg. No. 4,274,485**

**Registered Jan. 15, 2013**

**Int. Cls.: 18, 22, 23, 24,  
25, 26 and 27**

**TRADEMARK**

**PRINCIPAL REGISTER**

BUDDHIST COMPASSION RELIEF TZU CHI FOUNDATION (TAIWAN FOUNDATION)  
SINCHENG HSIANG  
NO. 1 LANE 88 JINGSHE ST. KANGLE VILLAGE  
HUALIEN COUNTY, TAIWAN

FOR: SCHOOL BAGS, TRUNKS, HANDBAGS, CANVAS, MESH AND TEXTILE SHOPPING BAGS, PURSES, BACKPACKS; UMBRELLAS; WALKING STICKS; IMITATION LEATHER; BAGS FOR PETS, NAMELY, ANIMAL CARRIERS; SLING BAGS FOR CARRYING INFANTS, IN CLASS 18 (U.S. CLS. 1, 2, 3, 22 AND 41).

FIRST USE 10-22-2008; IN COMMERCE 4-15-2010.

FOR: TEXTILE FIBERS MADE OF NATURAL AND ARTIFICIAL MATERIALS, NAMELY, PLASTIC, SILK, POLYESTER, AND RUBBER; PLASTIC BANDS FOR WRAPPING OR BINDING; PLASTIC ROPES; TENTS; AWNINGS; FISHING NETS; MOTH PREVENTION NETS FOR AGRICULTURAL PURPOSES; TEXTILE MAIL BAGS; LAUNDRY NETS, IN CLASS 22 (U.S. CLS. 1, 2, 7, 19, 22, 42 AND 50).

FIRST USE 10-22-2008; IN COMMERCE 4-15-2010.

FOR: YARNS AND THREADS FOR TEXTILE PURPOSES, NAMELY, PLASTIC THREAD SYNTHETIC FIBER THREAD, ARTIFICIAL FIBER THREADS, RUBBER THREADS, ARTIFICIAL FIBER YARNS, SYNTHETIC FIBER YARNS, AND ELASTIC FIBER YARNS, IN CLASS 23 (U.S. CL. 43).

FIRST USE 10-22-2008; IN COMMERCE 4-15-2010.

FOR: FABRICS FOR TEXTILE USE; QUILTS, QUILT COVERS, BEDSPREADS, COVERLETS, PILLOW SHAMS, MOSQUITO NETS, CHILDREN'S BLANKETS, LAP BLANKETS, BLANKET THROWS, WALL BLANKETS, PLASTIC CURTAINS, UNFITTED COVERS FOR CUSHIONS, TOWELS, TABLE RUNNERS, HANDKERCHIEFS, WASHING MITTS, UNFITTED PLASTIC COVERINGS FOR FURNITURE, PLASTIC SHOWER CURTAINS; WATERPROOF SAIL-CLOTH, IN CLASS 24 (U.S. CLS. 42 AND 50).

FIRST USE 10-22-2008; IN COMMERCE 4-15-2010.



*David J. Kyffers*

Director of the United States Patent and Trademark Office

**Reg. No. 4,274,485** FOR: ANORAKS; BATHING COSTUMES; BLAZERS; BLOUSES; BLOUSONS; CHILDREN'S AND INFANT'S APPAREL, NAMELY, JUMPERS, OVERALL, SLEEPWEAR, PAJAMAS, ROMPERS AND ONE-PIECE GARMENTS; DRESSES; JEANS; LEISURE SUITS; MEN'S AND WOMEN'S JACKETS, TROUSERS, VESTS; MEN'S SUITS; WOMEN'S SUITS; OVERCOATS; PANTIES, SHORTS AND BRIEFS; PANTS; POLO SHIRTS; SHIRTS; SKIRTS; T-SHIRTS; WIND COATS; RAIN COATS; SWIMSUITS; SHOES; SCARVES; HOODS; TIES, BOW TIES; HATS, CAPS; SOCKS; GLOVES FOR CLOTHING; BELTS FOR CLOTHING; APRONS, IN CLASS 25 (U.S. CLS. 22 AND 39).

FIRST USE 10-22-2008; IN COMMERCE 4-15-2010.

FOR: DECORATIVE AND ORNAMENTAL GOODS, NAMELY, WOVEN BRAIDS, COLORED RIBBONS, ELASTIC RIBBONS, ADHESIVE PATCHES FOR DECORATION OF CLOTHES, DECORATIVE CHINESE MACRAME AND KNOTS AND WOVEN HANDICRAFT OF CORDS AND THREADS; HAIR PINS; HAIR BANDS; BUTTONS; ZIPPERS; WIGS, HAIRPIECES, AND ADD-IN AND ADD-ON HAIR ACCESSORIES CONSTRUCTED PRIMARILY OF SYNTHETIC HAIR; ARTIFICIAL FLOWERS; ARTIFICIAL TREES; SHOE LACES, IN CLASS 26 (U.S. CLS. 37, 39, 40, 42 AND 50).

FIRST USE 10-22-2008; IN COMMERCE 4-15-2010.

FOR: WOVEN STRAW MATS, PLASTIC CARPETS, CARPETS, AUTOMOBILE CARPETS, PLASTIC BATH MATS, AUTOMOBILE FLOOR MATS, NON-SLIP MATS FOR FLOORS, BATH MATS, WALLPAPERS, PLASTIC WALLPAPERS, ARTIFICIAL TURF, SPORTS MATS, NAMELY, WRESTLING MATS AND GYMNASTIC MATS, IN CLASS 27 (U.S. CLS. 19, 20, 37, 42 AND 50).

FIRST USE 10-22-2008; IN COMMERCE 4-15-2010.

THE MARK CONSISTS OF A STYLIZED GLOBE DESIGN WITH A LEAF WRAPPING AROUND THE GLOBE.

SER. NO. 85-537,038, FILED 2-8-2012.

ROBIN CHOSID, EXAMINING ATTORNEY



# United States of America

United States Patent and Trademark Office

# BOTICCA

**Reg. No. 4,274,486**

**Registered Jan. 15, 2013**

**Int. Cls.: 14, 18, 25 and 35**

**TRADEMARK**

**SERVICE MARK**

**PRINCIPAL REGISTER**

BOTICCA.COM LIMITED (UNITED KINGDOM LIMITED COMPANY (LTD.))  
SECOND FLOOR, CARDIFF HOUSE, TILLING RD.  
LONDON, UNITED KINGDOM NW21LJ

FOR: PRECIOUS METALS AND THEIR ALLOYS AND GOODS, NAMELY, CUFF BRACELETS, ANKLETS IN THE NATURE OF JEWELRY, NECKLACES, AND PENDANTS IN PRECIOUS METALS OR COATED THEREWITH, NOT INCLUDED IN OTHER CLASSES; JEWELLERY, COSTUME JEWELLERY, RINGS, NECKLACES, EARRINGS, CUFFLINKS, PRECIOUS STONES; HOROLOGICAL AND CHRONOMETRIC INSTRUMENTS, CLOCKS AND WATCHES; PARTS AND FITTINGS FOR ALL THE AFOREMENTIONED GOODS, IN CLASS 14 (U.S. CLS. 2, 27, 28 AND 50).

FOR: LEATHER AND IMITATIONS OF LEATHER, AND GOODS MADE OF THESE MATERIALS AND NOT INCLUDED IN OTHER CLASSES, NAMELY, BRIEF CASES, DOCUMENT CASES, KEY CASES AND SUITCASES; ANIMAL SKINS, ANIMAL HIDES; TRUNKS AND TRAVELLING BAGS; HANDBAGS, RUCKSACKS, PURSES, WALLETS; UMBRELLAS, PARASOLS AND WALKING STICKS; WHIPS, HARNESSES AND SADDLERY; CLOTHING FOR ANIMALS; PARTS AND FITTINGS FOR ALL THE AFOREMENTIONED GOODS, IN CLASS 18 (U.S. CLS. 1, 2, 3, 22 AND 41).

FOR: CUFFS, IN CLASS 25 (U.S. CLS. 22 AND 39).

FOR: ADVERTISING, MARKETING AND PROMOTIONAL SERVICES; ADVERTISING, MARKETING AND PROMOTIONAL SERVICES PROVIDED VIA THE INTERNET; BUSINESS MANAGEMENT; BUSINESS ADMINISTRATION; PROVIDING ONLINE MARKETPLACES FOR SELLERS AND BUYERS OF DESIGNER AND FASHION GOODS; RETAIL STORE SERVICES, ONLINE RETAIL STORE SERVICES AND MAIL ORDER SERVICES, ALL FEATURING PRECIOUS METALS AND THEIR ALLOYS AND GOODS IN PRECIOUS METALS OR COATED THEREWITH, NOT INCLUDED IN OTHER CLASSES, JEWELLERY, COSTUME JEWELLERY, RINGS, NECKLACES, CUFFS, EARRINGS, CUFFLINKS, PRECIOUS STONES, HOROLOGICAL AND CHRONOMETRIC INSTRUMENTS, CLOCKS AND WATCHES, PARTS AND FITTINGS FOR ALL THE AFOREMENTIONED GOODS, LEATHER AND IMITATIONS OF LEATHER, AND GOODS MADE OF THESE MATERIALS AND NOT INCLUDED IN OTHER CLASSES, ANIMAL SKINS, HIDES, TRUNKS AND TRAVELLING BAGS, HANDBAGS, RUCKSACKS, PURSES, WALLETS, UMBRELLAS, PARASOLS AND WALKING STICKS, WHIPS, HARNESS AND SADDLERY, CLOTHING FOR ANIMALS, PARTS AND FITTINGS FOR ALL THE AFOREMENTIONED GOODS, CLOTHING, FOOT-



*David J. Kyros*

Director of the United States Patent and Trademark Office

**Reg. No. 4,274,486** WEAR, HEADGEAR, SCARVES, HATS, BELTS, HAIR ORNAMENTS, HAIR PIECES, HAIR BANDS, HAIR CLIPS, HAIR GRIPS, HAIR BOWS, HAIR RIBBONS, HAIR PINS, HAIR NETS, STICKS FOR USE IN DECORATING THE HAIR AND HAIR SLIDES, INCLUDING ANY SUCH RETAIL SERVICES PROVIDED VIA SHOPS, BOUTIQUES, DEPARTMENT STORE CONCESSIONS, MAIL ORDER OR VIA THE INTERNET, IN CLASS 35 (U.S. CLS. 100, 101 AND 102).

THE MARK CONSISTS OF STANDARD CHARACTERS WITHOUT CLAIM TO ANY PARTICULAR FONT, STYLE, SIZE, OR COLOR.

PRIORITY CLAIMED UNDER SEC. 44(D) ON UNITED KINGDOM APPLICATION NO. 2590858, FILED 8-10-2011, REG. NO. 2590858, DATED 11-11-2011, EXPIRES 8-10-2021.

SER. NO. 85-537,191, FILED 2-8-2012.

FRANK LATTUCA, EXAMINING ATTORNEY

# United States of America

United States Patent and Trademark Office



**Reg. No. 4,274,487**

**Registered Jan. 15, 2013**

**Int. Cls.: 9, 35 and 42**

**TRADEMARK**

**SERVICE MARK**

**PRINCIPAL REGISTER**

KENTON COUNTY AIRPORT BOARD (UNITED STATES MUNICIPAL CORPORATION),  
DBA CINCINNATI/NORTHERN KENTUCKY INTERNATIONAL AIRPORT  
P.O. BOX 752000  
CINCINNATI, OH 45275

FOR: COMPUTER APPLICATION SOFTWARE FOR MOBILE PHONES, PORTABLE MEDIA PLAYERS, HANDHELD COMPUTERS, NAMELY, SOFTWARE FOR PROVIDING AIRLINE AND FLIGHT STATUS AND TRAFFIC INFORMATION, PROVIDING WEATHER INFORMATION, PROVIDING PARKING AVAILABILITY INFORMATION, PROVIDING GROUND TRANSPORTATION INFORMATION, ALLOWING USERS TO MAKE RESERVATIONS FOR AIR TRAVEL, AND HOTEL AND CAR RENTALS, ALLOWING USERS TO MAKE PRICE COMPARISONS BETWEEN AND AMONG AIRLINES FOR AIR TRAVEL, HOTELS FOR LODGING, AND CAR RENTALS BUSINESSES FOR MOTOR VEHICLE RENTALS EXCLUDING SOFTWARE GAMES AND GAMING, IN CLASS 9 (U.S. CLS. 21, 23, 26, 36 AND 38).

FIRST USE 2-28-2012; IN COMMERCE 2-28-2012.

FOR: PRICE COMPARISON SERVICES IN THE FIELD OF AIRLINE, HOTEL, CAR RENTAL, PARKING AND OTHER TRAVEL SERVICES, IN CLASS 35 (U.S. CLS. 100, 101 AND 102).

FIRST USE 10-31-2011; IN COMMERCE 10-31-2011.

FOR: PROVIDING A WEB-BASED SYSTEM AND ON-LINE PORTAL THAT GIVES COMPUTER USERS THE ABILITY TO OBTAIN AIRLINE AND FLIGHT STATUS AND TRAFFIC INFORMATION, WEATHER INFORMATION, PARKING AVAILABILITY INFORMATION, GROUND TRANSPORTATION INFORMATION, TO MAKE RESERVATIONS FOR AIR TRAVEL, AND HOTEL AND CAR RENTALS, AND TO MAKE PRICE COMPARISONS BETWEEN AND AMONG AIRLINES FOR AIR TRAVEL, HOTELS FOR LODGING, AND CAR RENTALS BUSINESSES FOR MOTOR VEHICLE RENTALS, IN CLASS 42 (U.S. CLS. 100 AND 101).

FIRST USE 10-31-2011; IN COMMERCE 10-31-2011.

OWNER OF U.S. REG. NOS. 4,014,175, 4,069,952 AND OTHERS.

THE COLOR(S) BLUE AND GREEN IS/ARE CLAIMED AS A FEATURE OF THE MARK.



*David J. Kyjars*

Director of the United States Patent and Trademark Office

**Reg. No. 4,274,487** THE MARK CONSISTS OF THE LETTERS "CVG" HORIZONTALLY SHOWN IN BLUE WITH A STYLIZED ROAD IN GREEN EMANATING FROM THE LOWER TRUNCATED PORTION OF THE LETTER "V" AND BISECTING THE LETTER "G".

SEC. 2(F) AS TO "CVG".

SER. NO. 85-537,263, FILED 2-8-2012.

WILLIAM VERHOSEK, EXAMINING ATTORNEY

# United States of America

United States Patent and Trademark Office

# MOTO

**Reg. No. 4,274,488**

**Registered Jan. 15, 2013**

**Int. Cl.: 28**

**TRADEMARK**

**PRINCIPAL REGISTER**

RIEDEL SHOES, INC. (MINNESOTA CORPORATION)  
PO BOX 21  
122 CANNON RIVER AVENUE  
RED WING, MN 55066

FOR: ROLLER SKATE BALL BEARINGS, IN CLASS 28 (U.S. CLS. 22, 23, 38 AND 50).

FIRST USE 9-14-2011; IN COMMERCE 9-14-2011.

THE MARK CONSISTS OF STANDARD CHARACTERS WITHOUT CLAIM TO ANY PARTICULAR FONT, STYLE, SIZE, OR COLOR.

SER. NO. 85-537,434, FILED 2-8-2012.

CHRISTINE MARTIN, EXAMINING ATTORNEY



*David J. Kybas*

Director of the United States Patent and Trademark Office

# United States of America

United States Patent and Trademark Office

# DA.AI

**Reg. No. 4,274,489**

**Registered Jan. 15, 2013**

**Int. Cls.: 18, 22, 23, 24,  
25, 26 and 27**

**TRADEMARK**

**PRINCIPAL REGISTER**

BUDDHIST COMPASSION RELIEF TZU CHI FOUNDATION (TAIWAN FOUNDATION)  
SINCHENG HSIANG  
NO. 1 LANE 88 JINGSHE ST. KANGLE VILLAGE  
HUALIEN COUNTY, TAIWAN

FOR: SCHOOL BAGS; TRUNKS; HANDBAGS; CANVAS, MESH AND TEXTILE SHOPPING BAGS; PURSES; BACKPACKS; UMBRELLAS; WALKING STICKS; IMITATION LEATHER; BAGS FOR PETS, NAMELY, ANIMAL CARRIERS; SLING BAGS FOR CARRYING INFANTS, IN CLASS 18 (U.S. CLS. 1, 2, 3, 22 AND 41).

FIRST USE 10-22-2008; IN COMMERCE 4-15-2010.

FOR: TEXTILE FIBERS MADE OF NATURAL AND ARTIFICIAL MATERIALS, NAMELY, PLASTIC, SILK, POLYESTER, AND RUBBER; PLASTIC BANDS FOR WRAPPING OR BINDING; PLASTIC ROPES; TENTS; AWNINGS; FISHING NETS; MOTH PREVENTION NETS FOR AGRICULTURAL PURPOSES; TEXTILE MAIL BAGS; LAUNDRY NETS, IN CLASS 22 (U.S. CLS. 1, 2, 7, 19, 22, 42 AND 50).

FIRST USE 10-22-2008; IN COMMERCE 4-15-2010.

FOR: YARNS AND THREADS FOR TEXTILE PURPOSES, NAMELY, PLASTIC THREAD SYNTHETIC FIBER THREAD, ARTIFICIAL FIBER THREADS, RUBBER THREADS, ARTIFICIAL FIBER YARNS, SYNTHETIC FIBER YARNS, AND ELASTIC FIBER YARNS, IN CLASS 23 (U.S. CL. 43).

FIRST USE 10-22-2008; IN COMMERCE 4-15-2010.

FOR: FABRICS FOR TEXTILE USE; QUILTS, QUILT COVERS, BEDSPREADS, COVERLETS, PILLOW SHAMS, MOSQUITO NETS, CHILDREN'S BLANKETS, LAP BLANKETS, BLANKET THROWS, WALL BLANKETS, PLASTIC CURTAINS, UNFITTED COVERS FOR CUSHIONS, TOWELS, TABLE RUNNERS, HANDKERCHIEFS, WASHING MITTS, UNFITTED PLASTIC COVERINGS FOR FURNITURE, PLASTIC SHOWER CURTAINS; WATERPROOF SAIL-CLOTH, IN CLASS 24 (U.S. CLS. 42 AND 50).

FIRST USE 10-22-2008; IN COMMERCE 4-15-2010.



*David J. Kyffers*

Director of the United States Patent and Trademark Office

**Reg. No. 4,274,489** FOR: ANORAKS, BATHING COSTUMES; BLAZERS; BLOUSES; BLOUSONS; CHILDREN'S AND INFANT'S APPAREL, NAMELY, JUMPERS, OVERALL, SLEEPWEAR, PAJAMAS, ROMPERS AND ONE-PIECE GARMENTS; DRESSES; JEANS; LEISURE SUITS; MEN'S AND WOMEN'S JACKETS, TROUSERS, VESTS; MEN'S SUITS; WOMEN'S SUITS; OVERCOATS; PANTIES, SHORTS AND BRIEFS; PANTS; POLO SHIRTS; SHIRTS; SKIRTS; T-SHIRTS; WIND COATS; RAIN COATS; SWIMSUITS; SHOES; SCARVES; HOODS; TIES, BOW TIES; HATS, CAPS; SOCKS; GLOVES FOR CLOTHING; BELTS FOR CLOTHING; APRONS, IN CLASS 25 (U.S. CLS. 22 AND 39).

FIRST USE 10-22-2008; IN COMMERCE 4-15-2010.

FOR: DECORATIVE AND ORNAMENTAL GOODS, NAMELY, WOVEN BRAIDS, COLORED RIBBONS, ELASTIC RIBBONS, ADHESIVE PATCHES FOR DECORATION OF CLOTHES, DECORATIVE CHINESE MACRAME AND KNOTS AND WOVEN HANDICRAFT OF CORDS AND THREADS; HAIR PINS; HAIR BANDS; BUTTONS; ZIPPERS; WIGS, HAIRPIECES, AND ADD-IN AND ADD-ON HAIR ACCESSORIES CONSTRUCTED PRIMARILY OF SYNTHETIC HAIR; ARTIFICIAL FLOWERS; ARTIFICIAL TREES; SHOE LACES, IN CLASS 26 (U.S. CLS. 37, 39, 40, 42 AND 50).

FIRST USE 10-22-2008; IN COMMERCE 4-15-2010.

FOR: WOVEN STRAW MATS, PLASTIC CARPETS, CARPETS, AUTOMOBILE CARPETS, PLASTIC BATH MATS, AUTOMOBILE FLOOR MATS, NON-SLIP MATS FOR FLOORS, BATH MATS, WALLPAPERS, PLASTIC WALLPAPERS, ARTIFICIAL TURF, SPORTS MATS, NAMELY, WRESTLING MATS AND GYMNASTIC MATS, IN CLASS 27 (U.S. CLS. 19, 20, 37, 42 AND 50).

FIRST USE 10-22-2008; IN COMMERCE 4-15-2010.

THE MARK CONSISTS OF STANDARD CHARACTERS WITHOUT CLAIM TO ANY PARTICULAR FONT, STYLE, SIZE, OR COLOR.

THE ENGLISH TRANSLATION OF "DA.AI" IN THE MARK IS "GREAT LOVE".

SER. NO. 85-537,493, FILED 2-8-2012.

ROBIN CHOSID, EXAMINING ATTORNEY

# United States of America

United States Patent and Trademark Office

## Natural Handcrafted Accessories Pearl Couture PC

**Reg. No. 4,274,490**

**Registered Jan. 15, 2013**

**Int. Cl.: 14**

**TRADEMARK**

**PRINCIPAL REGISTER**

PEARL COUTURE, LLC (GEORGIA LIMITED LIABILITY COMPANY)  
#501  
8949 CARROLL MANOR DR.  
SANDY SPRINGS, GA 30350

FOR: JEWELRY MADE IN SIGNIFICANT PART OF PEARLS, IN CLASS 14 (U.S. CLS. 2, 27, 28 AND 50).

FIRST USE 3-10-2011; IN COMMERCE 3-10-2011.

THE MARK CONSISTS OF STANDARD CHARACTERS WITHOUT CLAIM TO ANY PARTICULAR FONT, STYLE, SIZE, OR COLOR.

NO CLAIM IS MADE TO THE EXCLUSIVE RIGHT TO USE "NATURAL HANDCRAFTED ACCESSORIES PEARL COUTURE", APART FROM THE MARK AS SHOWN.

SER. NO. 85-537,957, FILED 2-9-2012.

ESTHER BELENKER, EXAMINING ATTORNEY



*David J. Kybas*

Director of the United States Patent and Trademark Office



# United States of America

United States Patent and Trademark Office

# LISTEC

**Reg. No. 4,274,491**

**Registered Jan. 15, 2013**

**Int. Cl.: 9**

**TRADEMARK**

**PRINCIPAL REGISTER**

THE TIFFEN COMPANY,LLC (DELAWARE LIMITED LIABILITY COMPANY)  
90 OSER AVENUE  
HAUPPAUGE, NY 11788

FOR: TELEPROMPTERS; TELEPROMPTING HARDWARE, NAMELY, FLAT PANEL DISPLAY SCREENS; COMPUTER SOFTWARE FOR CONTROLLING THE OPERATION OF TELEPROMPTERS; HOOD ASSEMBLIES FOR TELEPROMPTERS; DC CONVERTER FOR FLAT PANEL MONITORS; ELECTRIC CABLES; DISTRIBUTION AMPLIFIERS; TELEPROMPTER PARTS, NAMELY, MIRRORS FOR USE WITH TELEPROMPTERS; CAMERA RISERS; CAMERA PARTS, NAMELY, COUNTERBALANCE WEIGHTS, CASES FOR TELEPROMPTERS AND PARTS THEREFOR; WIRELESS REMOTES AND CONTROLLERS FOR USE WITH TELEPROMPTERS, IN CLASS 9 (U.S. CLS. 21, 23, 26, 36 AND 38).

FIRST USE 0-0-1967; IN COMMERCE 0-0-1967.

THE MARK CONSISTS OF STANDARD CHARACTERS WITHOUT CLAIM TO ANY PARTICULAR FONT, STYLE, SIZE, OR COLOR.

SER. NO. 85-538,439, FILED 2-9-2012.

PAUL MORENO, EXAMINING ATTORNEY



*David J. Kypos*

Director of the United States Patent and Trademark Office

# United States of America

United States Patent and Trademark Office

## Cheese. Cows. Wows!

**Reg. No. 4,274,492**

SWEETWATER VALLEY FARM, INC. (TENNESSEE CORPORATION)  
17988 W. LEE HWY

**Registered Jan. 15, 2013**

PHILADELPHIA, TN 378462475

**Int. Cl.: 29**

FOR: CHEESE; DAIRY PRODUCTS EXCLUDING ICE CREAM, ICE MILK AND FROZEN YOGURT, IN CLASS 29 (U.S. CL. 46).

**TRADEMARK**

FIRST USE 3-25-2009; IN COMMERCE 4-30-2009.

**PRINCIPAL REGISTER**

THE MARK CONSISTS OF STANDARD CHARACTERS WITHOUT CLAIM TO ANY PARTICULAR FONT, STYLE, SIZE, OR COLOR.

NO CLAIM IS MADE TO THE EXCLUSIVE RIGHT TO USE "CHEESE", APART FROM THE MARK AS SHOWN.

SER. NO. 85-538,627, FILED 2-9-2012.

CHRISTINE MARTIN, EXAMINING ATTORNEY



*David J. Kybas*

Director of the United States Patent and Trademark Office

# United States of America

United States Patent and Trademark Office



**Reg. No. 4,274,493**

**Registered Jan. 15, 2013**

**Int. Cl.: 43**

**SERVICE MARK**

**PRINCIPAL REGISTER**

MICHEL'S CORNER, LLC (COLORADO LIMITED LIABILITY COMPANY)  
18 PERINS VISTA DRIVE  
DURANGO, CO 81301

FOR: RESTAURANT SERVICES; RESTAURANT SERVICES FEATURING CREPES, SOUPS, WAFFLES; RESTAURANT SERVICES, INCLUDING SIT-DOWN SERVICE OF FOOD AND TAKE-OUT RESTAURANT SERVICES; RESTAURANT SERVICES, NAMELY, PROVIDING OF FOOD AND BEVERAGES FOR CONSUMPTION ON AND OFF THE PREMISES, IN CLASS 43 (U.S. CLS. 100 AND 101).

FIRST USE 11-27-2009; IN COMMERCE 11-27-2009.

NO CLAIM IS MADE TO THE EXCLUSIVE RIGHT TO USE "AUTHENTIC CREPES, ETC" AND PICTORIAL REPRESENTATION OF A CREPE, APART FROM THE MARK AS SHOWN.

THE COLOR(S) YELLOW, BLUE, LIGHT BLUE, RED, WHITE, BLACK, BROWN, GRAY AND GOLD IS/ARE CLAIMED AS A FEATURE OF THE MARK.

THE NAME "MICHEL" POU MAY IDENTIFIES A LIVING INDIVIDUAL WHOSE CONSENT IS OF RECORD.

THE MARK CONSISTS OF THE WORDS "MICHEL'S CORNER" IN YELLOW IN A HORIZONTAL BANNER IN BLUE, LIGHT BLUE AND OUTLINED IN RED, ON EITHER SIDE OF A DEPICTION OF A SMILING CHEF WEARING A WHITE CHEF HAT, WHITE CHEF JACKET WITH BLACK PANTS, BROWN SHOES AND A MEDALLION IN GOLD AND RED AND HOLDING A GRAY PAN AND A CREPE BEING FLIPPED IN THE AIR AND THE WORDS "AUTHENTIC CREPES, ETC" APPEARING HORIZONTALLY BELOW THE CHEF IN YELLOW ON A BANNER IN BLUE AND GRAY WITH SCALLOPED DESIGN IN GOLD AND RED, ON TOP A OVAL DESIGN IN BLUE, GRAY, GOLD AND RED.

SER. NO. 85-538,666, FILED 2-9-2012.

STEPHANIE ALI, EXAMINING ATTORNEY



*David J. Kappas*

Director of the United States Patent and Trademark Office

United States of America  
United States Patent and Trademark Office

MESKITA

**Reg. No. 4,274,494**

MESQUITA, ALESSANDRA (UNITED STATES INDIVIDUAL)  
116 CENTRAL PARK SOUTH APT. 9  
NEW YORK, NY 10019

**Registered Jan. 15, 2013**

**Int. Cl.: 25**

FOR: SHIRTS, TOPS, BLOUSES, SWIMWEAR, SWIMWEAR COVERS, BIKINIS, BATHINGSUITS, JUMPSUITS, JUMPERS, ROMPERS, SKIRTS, PANTS, SHORTS, FOOTWEAR, HEADWEAR, SHAWLS, PONCHOS, IN CLASS 25 (U.S. CLS. 22 AND 39).

**TRADEMARK**

FIRST USE 2-1-2012; IN COMMERCE 2-1-2012.

**PRINCIPAL REGISTER**

THE MARK CONSISTS OF STANDARD CHARACTERS WITHOUT CLAIM TO ANY PARTICULAR FONT, STYLE, SIZE, OR COLOR.

SER. NO. 85-538,818, FILED 2-9-2012.

JAMES A. RAUEN, EXAMINING ATTORNEY



*David J. Kyffers*

Director of the United States Patent and Trademark Office

# United States of America

United States Patent and Trademark Office

## Keep on singing, my friends!

**Reg. No. 4,274,495**

MCKAIG, NICHOLAS C (UNITED STATES INDIVIDUAL)  
3220 W. BAY VISTA AVENUE  
TAMPA, FL 33611

**Registered Jan. 15, 2013**

**Int. Cl.: 41**

FOR: ENTERTAINMENT SERVICES, NAMELY, PROVIDING A WEB SITE FEATURING NON-DOWNLOADABLE MUSICAL PERFORMANCES, MUSICAL VIDEOS, RELATED FILM CLIPS, PHOTOGRAPHS, AND OTHER MULTIMEDIA MATERIALS FEATURING MUSICAL ARTISTS, IN CLASS 41 (U.S. CLS. 100, 101 AND 107).

**SERVICE MARK**

**PRINCIPAL REGISTER**

FIRST USE 10-14-2011; IN COMMERCE 10-14-2011.

THE MARK CONSISTS OF STANDARD CHARACTERS WITHOUT CLAIM TO ANY PARTICULAR FONT, STYLE, SIZE, OR COLOR.

SER. NO. 85-538,949, FILED 2-9-2012.

ALICE BENMAMAN, EXAMINING ATTORNEY



*David J. Kyffers*

Director of the United States Patent and Trademark Office

# United States of America

United States Patent and Trademark Office

## At Home In Tampa Bay

**Reg. No. 4,274,496**

PARK, JULIE ANNE (UNITED STATES INDIVIDUAL)  
6204 KINGBIRD MANOR DRIVE  
LITHIA, FL 33547

**Registered Jan. 15, 2013**

**Int. Cl.: 35**

FOR: ADVERTISING OF COMMERCIAL OR RESIDENTIAL REAL ESTATE, IN CLASS 35  
(U.S. CLS. 100, 101 AND 102).

**SERVICE MARK**

FIRST USE 7-8-2004; IN COMMERCE 7-8-2004.

**PRINCIPAL REGISTER**

THE MARK CONSISTS OF STANDARD CHARACTERS WITHOUT CLAIM TO ANY PARTICULAR FONT, STYLE, SIZE, OR COLOR.

NO CLAIM IS MADE TO THE EXCLUSIVE RIGHT TO USE "TAMPA BAY", APART FROM THE MARK AS SHOWN.

SER. NO. 85-540,119, FILED 2-10-2012.

WANDA KAY PRICE, EXAMINING ATTORNEY



*David J. Kybas*

Director of the United States Patent and Trademark Office

# United States of America

United States Patent and Trademark Office

# HELPMERAD

**Reg. No. 4,274,497**

**Registered Jan. 15, 2013**

**Int. Cl.: 44**

**SERVICE MARK**

**PRINCIPAL REGISTER**

SMITH, DOUGLAS (UNITED STATES INDIVIDUAL)  
101 BRETTFORD COURT  
SAN ANTONIO, TX 78230

FOR: PROVIDING AN INTERNET WEBSITE FOR MEDICAL PROFESSIONALS IN THE NATURE OF TELERADIOLOGY PROFESSIONALS FEATURING MEDICAL INFORMATION FROM REMOTE LOCATIONS VIA DEVICES THAT FEED INFORMATION TO THE WEBSITE THAT IS PROCESSED, EXCHANGED AND ACCESSED IN REAL-TIME BY USERS, IN CLASS 44 (U.S. CLS. 100 AND 101).

FIRST USE 6-15-2010; IN COMMERCE 6-15-2010.

THE MARK CONSISTS OF STANDARD CHARACTERS WITHOUT CLAIM TO ANY PARTICULAR FONT, STYLE, SIZE, OR COLOR.

SER. NO. 85-540,212, FILED 2-11-2012.

CAROLINE WOOD, EXAMINING ATTORNEY



*David J. Kyffers*

Director of the United States Patent and Trademark Office

# United States of America

United States Patent and Trademark Office

# GOLD SPOT

**Reg. No. 4,274,498**

**Registered Jan. 15, 2013**

**Int. Cl.: 32**

**TRADEMARK**

**PRINCIPAL REGISTER**

MEENAXI ENTERPRISE, INC. (NEW JERSEY CORPORATION), DBA MEENAXI  
ENTERPRISE, INC.  
2500B HAMILTON BOULEVARD  
SOUTH PLAINFIELD, NJ 07080

FOR: CONCENTRATES, SYRUPS OR POWDERS USED IN THE PREPARATION OF SOFT  
DRINKS; SOFT DRINKS, NAMELY, SODAS, IN CLASS 32 (U.S. CLS. 45, 46 AND 48).

FIRST USE 1-1-2008; IN COMMERCE 1-1-2008.

THE MARK CONSISTS OF STANDARD CHARACTERS WITHOUT CLAIM TO ANY PAR-  
TICULAR FONT, STYLE, SIZE, OR COLOR.

NO CLAIM IS MADE TO THE EXCLUSIVE RIGHT TO USE "GOLD", APART FROM THE  
MARK AS SHOWN.

SER. NO. 85-540,291, FILED 2-11-2012.

GINA HAYES, EXAMINING ATTORNEY



*David J. Kyffers*

Director of the United States Patent and Trademark Office



# United States of America

United States Patent and Trademark Office

## The Pond People

**Reg. No. 4,274,499**

SCHARA LIVING TRUST (WISCONSIN TRUST)  
N4833 MISTY MEADOW ROAD  
SEYMOUR, WI 54165

**Registered Jan. 15, 2013**

**Int. Cls.: 1, 2, 7 and 37**

FOR: BACTERIA AND MICROORGANISMS FOR THE USE IN THE WATER TREATMENT OF PONDS AND WATER GARDENS , IN CLASS 1 (U.S. CLS. 1, 5, 6, 10, 26 AND 46).

**TRADEMARK**

FIRST USE 3-1-2002; IN COMMERCE 3-1-2002.

**SERVICE MARK**

FOR: BIOLOGICAL PRODUCTS, NAMELY, DYES FOR ENHANCING THE PERFORMANCE OF BIOLOGICAL PRODUCTS, IN CLASS 2 (U.S. CLS. 6, 11 AND 16).

**PRINCIPAL REGISTER**

FIRST USE 3-1-2002; IN COMMERCE 3-1-2002.

FOR: POND AND WATER GARDEN AERATION SYSTEMS COMPRISING WATER PUMPS, AIR COMPRESSORS, AIR BLOWER AND FINNED WHEEL FOR PRESSURIZING AND AERATING PONDS AND AQUAIUMS, IN CLASS 7 (U.S. CLS. 13, 19, 21, 23, 31, 34 AND 35).

FIRST USE 3-1-2002; IN COMMERCE 3-1-2002.

FOR: POND TREATMENT SERVICES, NAMELY, USING NATURAL PRODUCTS, MICROORGANISMS AND BIOLOGICAL PRODUCTS WITH AERATION SYSTEMS IN THE TREATMENT AND MAINTENANCE OF PONDS AND WATER GARDENS; POND TREATMENT SERVICES, NAMELY, USING HERBICIDES AND ALGAECIDES TO KILL WEEDS AND ALGAE IN PONDS AND WATER GARDENS, IN CLASS 37 (U.S. CLS. 100, 103 AND 106).

FIRST USE 3-1-2002; IN COMMERCE 3-1-2002.

THE MARK CONSISTS OF STANDARD CHARACTERS WITHOUT CLAIM TO ANY PARTICULAR FONT, STYLE, SIZE, OR COLOR.

NO CLAIM IS MADE TO THE EXCLUSIVE RIGHT TO USE "POND", APART FROM THE MARK AS SHOWN.

SER. NO. 85-540,749, FILED 2-13-2012.

REGINA DRUMMOND, EXAMINING ATTORNEY



*David J. Kyros*

Director of the United States Patent and Trademark Office

# United States of America

United States Patent and Trademark Office

## PHOTON-MACHINES

**Reg. No. 4,274,500**

PHOTON MACHINES INC. (DELAWARE CORPORATION)  
366B GALLATIN PARK DR.  
BOZEMAN, MT 59715

**Registered Jan. 15, 2013**

**Int. Cl.: 9**

FOR: APPARATUS AND INSTRUMENTS FOR ELECTROPHORESIS AND MASS SPECTROMETRY, IN CLASS 9 (U.S. CLS. 21, 23, 26, 36 AND 38).

**TRADEMARK**

FIRST USE 6-30-2006; IN COMMERCE 6-30-2006.

**PRINCIPAL REGISTER**

THE MARK CONSISTS OF STANDARD CHARACTERS WITHOUT CLAIM TO ANY PARTICULAR FONT, STYLE, SIZE, OR COLOR.

SEC. 2(F).

SER. NO. 85-540,917, FILED 2-13-2012.

COLLEEN KEARNEY, EXAMINING ATTORNEY



*David J. Kybas*

Director of the United States Patent and Trademark Office

# United States of America

United States Patent and Trademark Office



**Reg. No. 4,274,501**

**Registered Jan. 15, 2013**

**Int. Cl.: 41**

**SERVICE MARK**

**PRINCIPAL REGISTER**

REZERRECK RECORDS (NEW JERSEY SOLE PROPRIETORSHIP)  
9 KINGSWOOD CT  
WESTAMPTON, NJ 08060

FOR: AUDIO RECORDING AND PRODUCTION; MUSIC PRODUCTION SERVICES; MUSIC VIDEO PRODUCTION; VIDEO PRODUCTION SERVICES, IN CLASS 41 (U.S. CLS. 100, 101 AND 107).

FIRST USE 1-30-2012; IN COMMERCE 1-30-2012.

NO CLAIM IS MADE TO THE EXCLUSIVE RIGHT TO USE "RECORDS", APART FROM THE MARK AS SHOWN.

THE COLOR(S) BLACK, WHITE, GREEN, BLUE, AND PURPLE IS/ARE CLAIMED AS A FEATURE OF THE MARK.

THE MARK CONSISTS OF A DESIGN THAT DEPICTS A HEART RATE MONITOR READING WITH THE END PART OF THE READING ENDING WITH A STRAIGHT LINE THAT HAS A BOTTOM GLOW IN THE COLORS OF BLUE AND PURPLE. THE WORDING "REZERRECK", IN STYLIZED FONT AND IN THE COLOR OF GREEN, IS PLACED ON TOP OF THE STRAIGHT LINE. DIRECTLY BELOW, IS THE WORDING "RECORDS", IN STYLIZED AN IN THE COLOR OF GREEN, IS PLACED DIRECTLY BELOW THE STRAIGHT LINE. THE BACKGROUND OF THE MARK CONSISTS OF A CHECKERED PATTERN DESIGN IN BLACK AND WHITE.

SER. NO. 85-541,072, FILED 2-13-2012.

WILLIAM BRECKENFELD, EXAMINING ATTORNEY



*David J. Kypos*

Director of the United States Patent and Trademark Office

# United States of America

United States Patent and Trademark Office

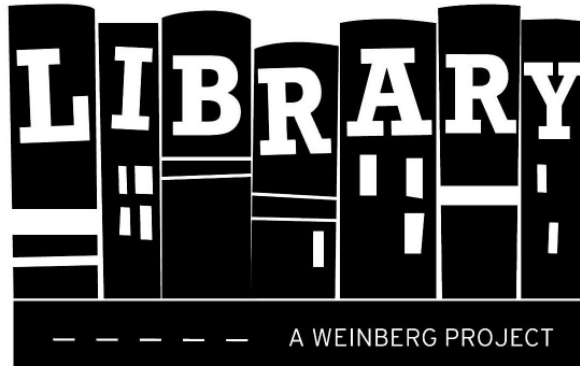

**Reg. No. 4,274,502**

**Registered Jan. 15, 2013**

**Int. Cl.: 36**

**SERVICE MARK**

**PRINCIPAL REGISTER**

THE HARRY AND JEANETTE WEINBERG FOUNDATION, INC. (MARYLAND CORPORATION)  
7 PARK CENTER COURT  
OWINGS MILLS, MD 21117

FOR: CHARITABLE FOUNDATION SERVICES, NAMELY, PROVIDING GRANTS FOR USE IN CONSTRUCTION AND RENOVATION OF LIBRARIES, IN CLASS 36 (U.S. CLS. 100, 101 AND 102).

FIRST USE 12-0-2011; IN COMMERCE 12-0-2011.

NO CLAIM IS MADE TO THE EXCLUSIVE RIGHT TO USE "LIBRARY" OR "PROJECT", APART FROM THE MARK AS SHOWN.

THE NAME "WEINBERG" DOES NOT IDENTIFY A LIVING INDIVIDUAL.

THE MARK CONSISTS OF THE WORD "LIBRARY" SPELLED OUT ON THE SPINES OF BOOKS WHICH ALSO APPEAR AS BUILDINGS OVER A ROAD WITH THE WORDS "A WEINBERG PROJECT".

SER. NO. 85-541,873, FILED 2-14-2012.

SAIMA MAKHDOOM, EXAMINING ATTORNEY



*David J. Kyjars*

Director of the United States Patent and Trademark Office

# United States of America

United States Patent and Trademark Office

## DEEDS FOR NEEDS

**Reg. No. 4,274,503**

**Registered Jan. 15, 2013**

**Int. Cl.: 35**

**SERVICE MARK**

**PRINCIPAL REGISTER**

DEEDS FOR NEEDS, INC. (CONNECTICUT CORPORATION)  
2324 GRIMMERSBOROUGH LANE  
DEEDS FOR NEEDS, INC.  
CHARLOTTE, NC 28270

FOR: CHARITABLE SERVICES, NAMELY, ORGANIZING AND DEVELOPING PROJECTS THAT AIM TO IMPROVE THE LIVES OF INDIVIDUALS IN NEED, NAMELY, OBTAINING GOODS FOR OTHERS IN NEED, DISTRIBUTION OF GOODS TO OTHERS IN NEED, AND PERFORMING SERVICES FOR OTHERS IN NEED, IN CLASS 35 (U.S. CLS. 100, 101 AND 102).

FIRST USE 5-0-2011; IN COMMERCE 5-0-2011.

THE MARK CONSISTS OF STANDARD CHARACTERS WITHOUT CLAIM TO ANY PARTICULAR FONT, STYLE, SIZE, OR COLOR.

SER. NO. 85-543,424, FILED 2-15-2012.

FLORENTINA BLANDU, EXAMINING ATTORNEY



*David J. Kyjars*

Director of the United States Patent and Trademark Office

# United States of America

United States Patent and Trademark Office



**Reg. No. 4,274,504**

**Registered Jan. 15, 2013**

**COLLECTIVE  
MEMBERSHIP**

**PRINCIPAL REGISTER**

IRON JUSTICE MOTORCYCLE CLUB UNINCORPORATED (NEW YORK JOINT VENTURE)  
197 O'HARA ROAD  
LITTLE FALLS, NY 13365

FOR: INDICATING MEMBERSHIP IN A MOTORCYCLE CLUB CONSISTING OF CURRENT AND RETIRED LAW ENFORCEMENT PROFESSIONALS, IN CLASS 200 (U.S. CL. 200).

FIRST USE 6-1-2009; IN COMMERCE 11-20-2011.

NO CLAIM IS MADE TO THE EXCLUSIVE RIGHT TO USE "911" AND "NEW YORK", APART FROM THE MARK AS SHOWN.

THE COLOR(S) RED, WHITE, BLUE, SILVER, GOLD AND BLACK IS/ARE CLAIMED AS A FEATURE OF THE MARK.

THE MARK CONSISTS OF A WHITE HUMAN SKULL FACING FORWARD WEARING A BANDANA WITH RED AND WHITE STRIPES AND A BLUE AREA WITH WHITE STARS. THIS IS SUPERIMPOSED OVER A SILVER "V" TWIN MOTORCYCLE ENGINE. COVERING THE MOUTH AREA OF THE SKULL IS A GOLD DETECTIVE STYLE BADGE WITH A BLACK MOARNING DRAPE AND THE WORDS "NEW YORK" AND THE NUMBERS "911" ON THE BADGE.

SER. NO. 85-543,823, FILED 2-15-2012.

WILLIAM BRECKENFELD, EXAMINING ATTORNEY



*David J. Kyros*

Director of the United States Patent and Trademark Office

# United States of America

United States Patent and Trademark Office



**Reg. No. 4,274,505**

**Registered Jan. 15, 2013**

**Int. Cls.: 18 and 25**

**TRADEMARK**

**PRINCIPAL REGISTER**

LONGHAO TIANDI CORPORATION LIMITED (CHINA CORPORATION)  
NO.05-11 27F SHENHUA BUSINESS BUILDING  
NO. 2018, JIABIN ROAD, LUOHU DISTRICT  
SHENZHEN CITY, CHINA

FOR: IMITATION LEATHER; CATTLE SKINS; PURSES; CALLING CARD CASES; CREDIT CARD CASES; POCKET WALLETS; ATTACHÉ CASES; LEATHER TRAVELING BAGS; BRIEFCASES; LEATHER CASES; IMITATION LEATHER CASES; LEATHER STRAPS; ANIMAL SKINS; UMBRELLAS; MOUNTAINEERING STICKS; SADDLERY; BACKPACKS; BAGS FOR CLIMBERS IN THE NATURE OF ALL-PURPOSE CARRYING BAGS; BAGS FOR CAMPERS IN THE NATURE OF ALL-PURPOSE CARRYING BAG, IN CLASS 18 (U.S. CLS. 1, 2, 3, 22 AND 41).

FIRST USE 1-1-2001; IN COMMERCE 2-27-2007.

FOR: CLOTHING, NAMELY, SWEATERS, TROUSERS, COATS, T-SHIRTS, SKIRTS, SHIRTS, SHIFTS, JERSEYS; LAYETTES; SWIMSUITS; WATERPROOF JACKETS AND PANTS; RAINCOATS; FOOTBALL SHOES; SHOES; TENNIS SHOES; LEATHER SHOES; INFANTS' SHOES AND BOOTS; BEACH SHOES; SPORT SHOES; INSOLES FOR SHOES AND BOOTS; CAPS; HOSIERY; GLOVES; NECKTIES; GIRDLES; LEATHER BELTS; WEDDING DRESSES; SWEAT-ABSORBENT UNDERCLOTHES; ANTI-SWEAT UNDERCLOTHES; DOWN JACKETS; MOUNTAINEERING CLIMBING BOOTS; TURBANS, IN CLASS 25 (U.S. CLS. 22 AND 39).

FIRST USE 1-1-2001; IN COMMERCE 2-27-2007.

THE MARK CONSISTS OF THE WORD "MORRESI" AND ABOVE, A BOOMERANG WITH SHARP EDGES.

SER. NO. 85-544,072, FILED 2-15-2012.

EVELYN BRADLEY, EXAMINING ATTORNEY



*David J. Kyffers*

Director of the United States Patent and Trademark Office

# United States of America

United States Patent and Trademark Office

# Skier Trash

**Reg. No. 4,274,506**

**Registered Jan. 15, 2013**

**Int. Cl.: 25**

**TRADEMARK**

**PRINCIPAL REGISTER**

SKIER TRASH LLC (WEST VIRGINIA LIMITED LIABILITY COMPANY), DBA SKIER TRASH  
ONE PAVILION DRIVE  
DANIELS, WV 25832

FOR: BANDANAS; BEANIES; HATS; HOODED SWEATSHIRTS; SKI MASKS; SWEATSHIRTS; T-SHIRTS; TEE SHIRTS, IN CLASS 25 (U.S. CLS. 22 AND 39).

FIRST USE 12-1-2007; IN COMMERCE 1-31-2011.

THE MARK CONSISTS OF STANDARD CHARACTERS WITHOUT CLAIM TO ANY PARTICULAR FONT, STYLE, SIZE, OR COLOR.

NO CLAIM IS MADE TO THE EXCLUSIVE RIGHT TO USE "SKIER", APART FROM THE MARK AS SHOWN.

SER. NO. 85-544,725, FILED 2-16-2012.

MICHAEL WIENER, EXAMINING ATTORNEY



*David J. Kyffers*

Director of the United States Patent and Trademark Office



# United States of America

United States Patent and Trademark Office

CONTINENTAL  
CONTROLS  
CORPORATION

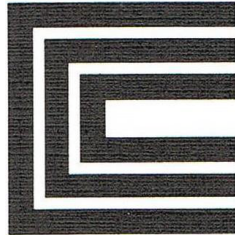

**Reg. No. 4,274,507**

**Registered Jan. 15, 2013**

**Int. Cls.: 7 and 9**

**TRADEMARK**

**PRINCIPAL REGISTER**

CONTINENTAL CONTROLS CORPORATION (CALIFORNIA CORPORATION)  
8845 REHCO ROAD  
SAN DIEGO, CA 92121

FOR: PILOT VALVES FOR LOW NOX TURBINE ENGINES, HIGH POWER IGNITION DEVICES FOR GAS TURBINE ENGINES, ELECTRONIC GAS CARBURETOR FOR GAS ENGINES FOR VEHICLES, STANDALONE AIR/FUEL MIXING VENTURI TUBES FOR GAS ENGINES, MIXING VENTURI TUBE INSERTS, ELECTRONIC GAS FUEL VALVES FOR GAS ENGINES, IN CLASS 7 (U.S. CLS. 13, 19, 21, 23, 31, 34 AND 35).

FIRST USE 1-1-2010; IN COMMERCE 1-1-2010.

FOR: GAS FUEL METERING VALVES FOR SMALL, MIDSIZE AND LARGE TURBINE ENGINES, LIQUID FUEL METERING VALVES FOR TURBINE ENGINES, AUTOMATIC EMISSION CONTROL VALVES FOR GAS ENGINES, CATALYST MONITOR AND DATA LOGGER FOR GAS ENGINES, ENGINE SPEED MONITORS FOR TURBINE ENGINES, IN CLASS 9 (U.S. CLS. 21, 23, 26, 36 AND 38).

FIRST USE 4-7-1989; IN COMMERCE 4-7-1989.

NO CLAIM IS MADE TO THE EXCLUSIVE RIGHT TO USE "CONTROLS CORPORATION", APART FROM THE MARK AS SHOWN.

THE MARK CONSISTS OF THE WORDING "CONTINENTAL CONTROLS CORPORATION" OVER STYLIZED INITIALS "CCC" FORMING INCOMPLETE RECTANGLES WITHIN RECTANGLES, ALL OPEN ON THEIR RIGHT SIDES.

SER. NO. 85-545,812, FILED 2-17-2012.

FRED CARL, EXAMINING ATTORNEY



*David J. Kyffers*

Director of the United States Patent and Trademark Office

**United States of America**  
United States Patent and Trademark Office

# Cherrypick

**Reg. No. 4,274,508**

RENDEZ VOUS LABS (CALIFORNIA CORPORATION)  
57 RODGERS AVENUE, SUITE C  
SAN FRANCISCO, CA 94103

**Registered Jan. 15, 2013**

**Int. Cl.: 45**

FOR: INTERNET-BASED DATING, SOCIAL INTRODUCTION AND SOCIAL NETWORKING,  
IN CLASS 45 (U.S. CLS. 100 AND 101).

**SERVICE MARK**

FIRST USE 2-17-2012; IN COMMERCE 2-17-2012.

**PRINCIPAL REGISTER**

THE MARK CONSISTS OF STANDARD CHARACTERS WITHOUT CLAIM TO ANY PAR-  
TICULAR FONT, STYLE, SIZE, OR COLOR.

SER. NO. 85-546,123, FILED 2-17-2012.

RAUL CORDOVA, EXAMINING ATTORNEY



*David J. Kybas*

Director of the United States Patent and Trademark Office

# United States of America

United States Patent and Trademark Office

## THE SCIENCE OF HAIR GROWTH.

**Reg. No. 4,274,509**

LEXINGTON INTERNATIONAL, LLC (FLORIDA LIMITED LIABILITY COMPANY)  
777 YAMATO RD., SUITE 105  
BOCA RATON, FL 33431

**Registered Jan. 15, 2013**

**Int. Cls.: 3 and 10**

FOR: HAIR PRODUCTS, NAMELY, SHAMPOOS, CONDITIONERS, HAIR CARE PREPARATIONS, AND HAIR CARE KITS COMPRISED OF NON-MEDICATED HAIR CARE PREPARATIONS, NAMELY, SHAMPOOS, CONDITIONERS AND LOTIONS, IN CLASS 3 (U.S. CLS. 1, 4, 6, 50, 51 AND 52).

**TRADEMARK**

**PRINCIPAL REGISTER**

FIRST USE 2-6-2012; IN COMMERCE 2-6-2012.

FOR: LIGHT EMITTING DEVICES, NAMELY, LASER LIGHT EMITTING DEVICES AND LIGHT EMITTING DIODE (LED) DEVICES FOR MEDICAL USE IN THE COSMETIC TREATMENT OF THE SCALP AND HAIR, IN CLASS 10 (U.S. CLS. 26, 39 AND 44).

FIRST USE 2-6-2012; IN COMMERCE 2-6-2012.

THE MARK CONSISTS OF STANDARD CHARACTERS WITHOUT CLAIM TO ANY PARTICULAR FONT, STYLE, SIZE, OR COLOR.

NO CLAIM IS MADE TO THE EXCLUSIVE RIGHT TO USE "HAIR GROWTH", APART FROM THE MARK AS SHOWN.

SER. NO. 85-546,300, FILED 2-17-2012.

LAURA KOVALSKY, EXAMINING ATTORNEY



*David J. Kyros*

Director of the United States Patent and Trademark Office

# United States of America

United States Patent and Trademark Office

## betLweIeNntEheS

**Reg. No. 4,274,510**

JOHNSON, BURLEY R. (UNITED STATES INDIVIDUAL)  
6412 JULIE ANN DR  
HANOVER, MD 21076

**Registered Jan. 15, 2013**

**Int. Cl.: 41**

FOR: DANCE INSTRUCTION, IN CLASS 41 (U.S. CLS. 100, 101 AND 107).

**SERVICE MARK**

FIRST USE 2-14-2012; IN COMMERCE 2-18-2012.

**PRINCIPAL REGISTER**

THE MARK CONSISTS OF STANDARD CHARACTERS WITHOUT CLAIM TO ANY PARTICULAR FONT, STYLE, SIZE, OR COLOR.

SER. NO. 85-547,056, FILED 2-20-2012.

ROBIN CHOSID, EXAMINING ATTORNEY



*David J. Kyffers*

Director of the United States Patent and Trademark Office

# United States of America

United States Patent and Trademark Office



**Reg. No. 4,274,511**

**Registered Jan. 15, 2013**

**Int. Cl.: 35**

**SERVICE MARK**

**PRINCIPAL REGISTER**

GRAFFITI FROZEN YOGURT LLC (NORTH CAROLINA LIMITED LIABILITY COMPANY)  
2715 CREEK RUN COURT  
CHAPEL HILL, NC 27514

FOR: SELF-SERVE YOGURT SHOP SERVICES, IN CLASS 35 (U.S. CLS. 100, 101 AND 102).

FIRST USE 6-1-2012; IN COMMERCE 6-1-2012.

THE MARK CONSISTS OF THE WORD "GRAFFITI" FOLLOWED BY A STYLIZED IMAGE OF A CUP OF FROZEN YOGURT.

SER. NO. 85-547,375, FILED 2-20-2012.

SUSAN RICHARDS, EXAMINING ATTORNEY



*David J. Kybas*

Director of the United States Patent and Trademark Office

# United States of America

United States Patent and Trademark Office

Bid**Abode**

**Reg. No. 4,274,512**

**Registered Jan. 15, 2013**

**Int. Cl.: 35**

**SERVICE MARK**

**PRINCIPAL REGISTER**

ABODE INC (DELAWARE CORPORATION)  
SUITE 1200  
1000 N WEST STREET  
WILMINGTON, DE 19801

FOR: AUCTION MANAGEMENT SERVICES PROVIDED TO OTHERS OVER AN ON-LINE WEB SITE ACCESSED THROUGH A GLOBAL COMPUTER NETWORK, IN CLASS 35 (U.S. CLS. 100, 101 AND 102).

FIRST USE 9-30-2011; IN COMMERCE 11-1-2011.

THE MARK CONSISTS OF THE WORDING "BID" IN GREY AND THE WORDING "ABODE" IN LIME GREEN. THE DESIGN OF A LIME GREEN AND WHITE HOUSE IS ABOVE THE WORD "ABODE".

THE COLOR(S) GRAY, LIME GREEN AND WHITE IS/ARE CLAIMED AS A FEATURE OF THE MARK.

SER. NO. 85-547,764, FILED 2-20-2012.

WILLIAM BRECKENFELD, EXAMINING ATTORNEY



*David J. Kyros*

Director of the United States Patent and Trademark Office

# United States of America

United States Patent and Trademark Office



HUMAN CAPITAL 360

**Reg. No. 4,274,513**

**Registered Jan. 15, 2013**

**Int. Cl.: 35**

ARMANDO MELGAREJO RAMOS (FLORIDA LIMITED LIABILITY COMPANY), DBA  
VA-US SOLUTIONS LLC  
SUITE 800  
1395 BRICKELL AVE  
MIAMI, FL 33131

**SERVICE MARK**

**PRINCIPAL REGISTER**

FOR: BUSINESS SERVICES, ACROSS MULTIPLE INDUSTRY SECTORS NAMELY, PROVIDING ONLINE INFORMATION IN RELATION TO RESOURCE PLANNING FOR THE HUMAN RESOURCES MANAGEMENT AND PROJECT MANAGEMENT; CONSULTING SERVICES IN THE FIELD OF HUMAN RESOURCES DEVELOPMENT, NAMELY, FOR THE PROMOTION OF EMPLOYEE RETENTION, CAREER GROWTH, AND INCREASED PRODUCTIVITY FOR EMPLOYEES AND EMPLOYERS; CONSULTING SERVICES IN THE FIELD OF HUMAN RESOURCES DEVELOPMENT, NAMELY, UTILIZING TECHNOLOGY FOR THE PROMOTION OF EMPLOYEE RETENTION, CAREER GROWTH AND INCREASED PRODUCTIVITY FOR EMPLOYEES AND EMPLOYERS; CONSULTING SERVICES IN THE FIELDS HUMAN RESOURCES, AND BUSINESS ORGANIZATIONAL DESIGN; HUMAN CAPITAL MANAGEMENT OUTSOURCING SERVICES; HUMAN RESOURCE ANALYSIS AND CONSULTING SERVICES; HUMAN RESOURCE SERVICES, NAMELY, COLLECTING, ANALYZING, REPORTING, AND PROVIDING FEEDBACK FROM INDIVIDUALS WHO SEPARATE FROM AN ORGANIZATION; HUMAN RESOURCE SERVICES, NAMELY, FACILITATING THE EMPLOYEE TERMINATION AND SEPARATION PROCESS BY EXECUTING THE REQUIRED ACTIVITY AND COMMUNICATION RELATED TO EMPLOYEE TERMINATION AND SEPARATION; HUMAN RESOURCES CONSULTANCY; HUMAN RESOURCES CONSULTATION; HUMAN RESOURCES MANAGEMENT; HUMAN RESOURCES SERVICES IN THE FIELD OF EDUCATION, NAMELY, RECRUITING AND PLACING TEACHERS AT INTERNATIONAL SCHOOLS; HUMAN RESOURCES SERVICES, NAMELY, PERSONNEL SELECTION FOR OTHERS; PROMOTING PUBLIC AWARENESS OF THE UNIQUENESS AND DIVERSITY OF HUMANITY THROUGH A NATIONAL ANNUAL DAY EVENT; SERVING AS A HUMAN RESOURCES DEPARTMENT FOR OTHERS, IN CLASS 35 (U.S. CLS. 100, 101 AND 102).



FIRST USE 2-26-2011; IN COMMERCE 2-26-2011.

*David J. Kyros*

NO CLAIM IS MADE TO THE EXCLUSIVE RIGHT TO USE "HUMAN CAPITAL", APART FROM THE MARK AS SHOWN.

**Reg. No. 4,274,513** THE COLOR(S) DARK BLUE AND LIGHT BLUE IS/ARE CLAIMED AS A FEATURE OF THE MARK.

THE MARK CONSISTS OF EIGHT STYLIZED HUMAN FIGURES FORMING A GLOBE DESIGN. BELOW THE DESIGN ARE THE STACKED TERMS "HUMAN" AND "CAPITAL" TO THE LEFT OF THE NUMBER "360". THE FIGURES, WORDING AND NUMBER ALL APPEAR IN GRADIENT DARK BLUE TO LIGHT BLUE.

SER. NO. 85-547,896, FILED 2-21-2012.

PAULA MAHONEY, EXAMINING ATTORNEY



# United States of America

United States Patent and Trademark Office



**Reg. No. 4,274,514**

PHILIPPE GILARDI (FRANCE INDIVIDUAL)  
EN BLANC

**Registered Jan. 15, 2013**

MAUREMONT, FRANCE 31290

**Int. Cls.: 6, 20, 37 and 39**

FOR: METAL STORAGE TANK; METAL STORAGE TANK FOR LIQUID WITH METALLIC CARRIER STRUCTURE PARTICULARLY SUITED FOR AGRICULTURE, CIVIL SECURITY, HOME AUTOMATION, INDUSTRY, IN CLASS 6 (U.S. CLS. 2, 12, 13, 14, 23, 25 AND 50).

**TRADEMARK**

FOR: STORAGE TANK MADE OF PLASTIC OR RUBBER; STORAGE TANK FOR LIQUID THE CONTAINER OF WHICH IS A FLEXIBLE ENVELOPE MADE OF PLASTIC OR RUBBER, PARTICULARLY DESIGNED FOR AGRICULTURE, CIVIL SECURITY, HOME AUTOMATION, INDUSTRY, IN CLASS 20 (U.S. CLS. 2, 13, 22, 25, 32 AND 50).

**SERVICE MARK**

**PRINCIPAL REGISTER**

FOR: INSTALLATION, MAINTENANCE AND REPAIR OF TANKS FOR LIQUID PARTICULARLY SUITED FOR AGRICULTURE, CIVIL SECURITY, HOME AUTOMATION, INDUSTRY, IN CLASS 37 (U.S. CLS. 100, 103 AND 106).

FOR: RENTAL OF STORAGE TANKS FOR LIQUID PARTICULARLY SUITED FOR AGRICULTURE, CIVIL SECURITY, HOME AUTOMATION, INDUSTRY, IN CLASS 39 (U.S. CLS. 100 AND 105).

OWNER OF FRANCE REG. NO. 093687670, DATED 10-30-2009, EXPIRES 10-30-2019.



THE COLOR(S) BLUE, BROWN, AND YELLOW IS/ARE CLAIMED AS A FEATURE OF THE MARK.

NO CLAIM IS MADE TO THE EXCLUSIVE RIGHT TO USE "WATER" AND "ORIGINAL ADAPTATION", APART FROM THE MARK AS SHOWN.

THE MARK CONSISTS OF THE WORDS "MAXI WATER" IN A MISCELLANEOUS PATTERN OF THE COLORS BROWN, BLUE AND YELLOW, WITH THE HEAD OF A CAMEL APPEARING IN THE "W" AND ALSO FEATURING THE COLOR PATTERN OF BROWN, BLUE, AND YELLOW, AND TWO SPIKES APPEARING ON THE LETTER A IN WATER. THE WORDS "ORIGINAL ADAPTATION" IN THE COLOR BLUE APPEAR UNDER THE WORD "WATER". BELOW THE WORDS, THERE IS A BLUE ARC LABELLED "50" WITH THE SYMBOL FOR DEGREES, EACH IN BLUE. ABOVE THE WORDS THERE IS A BLUE ARC LABELLED IN

*David J. Kybas*

Director of the United States Patent and Trademark Office

**Reg. No. 4,274,514** TWO PLACES WITH "65" WITH THE SYMBOL FOR DEGREES, EACH IN BLUE. AN IRREGULAR BLUE POLYGON SITS ATOP THE UPPER ARC.

SER. NO. 85-548,007, FILED 2-21-2012.

DAVID TAYLOR, EXAMINING ATTORNEY

# United States of America

United States Patent and Trademark Office

## Sorta Naughty

**Reg. No. 4,274,515**

GARLAND, CARRIE (UNITED STATES INDIVIDUAL)  
G303

**Registered Jan. 15, 2013**

4900 BOARDWALK DR  
FORT COLLIN, CO 80525

**Int. Cl.: 25**

FOR: HATS; SHIRTS; SWEATSHIRTS, IN CLASS 25 (U.S. CLS. 22 AND 39).

**TRADEMARK**

FIRST USE 11-15-2011; IN COMMERCE 11-15-2011.

**PRINCIPAL REGISTER**

THE MARK CONSISTS OF STANDARD CHARACTERS WITHOUT CLAIM TO ANY PARTICULAR FONT, STYLE, SIZE, OR COLOR.

SER. NO. 85-548,037, FILED 2-21-2012.

RON FAIRBANKS, EXAMINING ATTORNEY



*David J. Kyffers*

Director of the United States Patent and Trademark Office

# United States of America

United States Patent and Trademark Office

# pagely

**Reg. No. 4,274,516**

**Registered Jan. 15, 2013**

**Int. Cl.: 42**

**SERVICE MARK**

**PRINCIPAL REGISTER**

OBU WEB TECHNOLOGIES INC. (ARIZONA CORPORATION), DBA PAGELY  
18205 W LA MIRADA DR  
GOODYEAR, AZ 85338

FOR: HOSTING INTERNET SITES FOR OTHERS; HOSTING OF WEB SITES; HOSTING THE SOFTWARE, WEBSITES AND OTHER COMPUTER APPLICATIONS OF OTHERS ON A VIRTUAL PRIVATE SERVER; HOSTING WEBSITES ON THE INTERNET; SOFTWARE AS A SERVICE (SAAS) SERVICES, NAMELY, HOSTING SOFTWARE FOR USE BY OTHERS FOR USE IN ONLINE PUBLISHING, BLOGGING, AND THE CREATION OF WEBSITES.; WEB SITE HOSTING SERVICES, IN CLASS 42 (U.S. CLS. 100 AND 101).

FIRST USE 5-20-2009; IN COMMERCE 9-29-2009.

THE MARK CONSISTS OF STANDARD CHARACTERS WITHOUT CLAIM TO ANY PARTICULAR FONT, STYLE, SIZE, OR COLOR.

SEC. 2(F).

SER. NO. 85-549,023, FILED 2-21-2012.

MATTHEW KLINE, EXAMINING ATTORNEY



*David J. Kypas*

Director of the United States Patent and Trademark Office

# United States of America

United States Patent and Trademark Office

## ROCKSTAR NORTH

**Reg. No. 4,274,517**

**Registered Jan. 15, 2013**

**Int. Cls.: 9 and 41**

**TRADEMARK**

**SERVICE MARK**

**PRINCIPAL REGISTER**

TAKE-TWO INTERACTIVE SOFTWARE, INC. (DELAWARE CORPORATION)  
622 BROADWAY  
NEW YORK, NY 10012

FOR: COMPUTER AND VIDEO GAME PROGRAMS AND SOFTWARE; DOWNLOADABLE COMPUTER AND VIDEO GAME PROGRAMS AND SOFTWARE; DOWNLOADABLE DIGITAL MATERIALS NAMELY, VIDEOS, FILMS, MULTIMEDIA FILES, ANIMATED FILMS IN THE FIELD OF VIDEO GAMES AND COMPUTER GAMES, ALL DELIVERED VIA GLOBAL COMPUTER NETWORKS AND WIRELESS NETWORKS; PRE-RECORDED DIGITAL MEDIA FEATURING COMPUTER GAMES AND VIDEO GAMES, GRAPHICS, VIDEOS, FILMS, MULTIMEDIA FILES, ANIMATED FILMS IN THE FIELD OF VIDEO GAMES AND COMPUTER GAMES; AND PRE-RECORDED VIDEO DISCS AND OTHER PRE-RECORDED DIGITAL AND ELECTRONIC MEDIA IN THE FIELD OF LIVE ACTION PROGRAMS, MOTION PICTURES, OR ANIMATION FEATURING ENTERTAINMENT, NAMELY, ACTION, ADVENTURE, DRAMATIC, COMEDIC, CHILDREN'S AND DOCUMENTARY THEMES, IN CLASS 9 (U.S. CLS. 21, 23, 26, 36 AND 38).

FIRST USE 10-31-2002; IN COMMERCE 10-31-2002.

FOR: ENTERTAINMENT SERVICES, NAMELY, PROVIDING ONLINE GAMES, PROVIDING A WEBSITE FEATURING NEWS AND INFORMATION IN THE FIELD OF COMPUTER GAMES AND VIDEO GAMES; PROVIDING INFORMATION, NEWS AND COMMENTARY IN THE FIELD OF COMPUTER GAMES AND VIDEO GAMES; AND ANIMATED MOTION PICTURE FILMS FEATURING ENTERTAINMENT, NAMELY, ACTION, ADVENTURE, DRAMATIC, COMEDIC, CHILDREN'S AND DOCUMENTARY THEMES, IN CLASS 41 (U.S. CLS. 100, 101 AND 107).

FIRST USE 10-31-2002; IN COMMERCE 10-31-2002.

THE MARK CONSISTS OF STANDARD CHARACTERS WITHOUT CLAIM TO ANY PARTICULAR FONT, STYLE, SIZE, OR COLOR.

OWNER OF U.S. REG. NOS. 2,456,387, 4,037,654 AND OTHERS.

SER. NO. 85-549,240, FILED 2-22-2012.

KARANENDRA S. CHHINA, EXAMINING ATTORNEY



*David J. Kyffers*

Director of the United States Patent and Trademark Office

# United States of America

United States Patent and Trademark Office



**Reg. No. 4,274,518**

**Registered Jan. 15, 2013**

**Int. Cl.: 35**

**SERVICE MARK**

**PRINCIPAL REGISTER**

SMALL BEGINNINGS INC (WYOMING CORPORATION)  
17229 LEMON ST #E7, HESPERIA, CA 92345  
APPLE VALLEY, CA 92307 AND

ROGONE, M. SHARON (UNITED STATES INDIVIDUAL)  
14043 CHOCO RD  
APPLE VALLEY, CA 92307

FOR: RETAIL SERVICES BY DIRECT SOLICITATION BY SALES AGENTS OR MAIL ORDER SOLICITATIONS IN THE FIELD OF MEDICAL PRODUCTS AND SUPPLIES; RETAIL SHOPS FEATURING MEDICAL PRODUCTS AND SUPPLIES; DISTRIBUTORSHIPS FEATURING MEDICAL PRODUCTS AND SUPPLIES; WHOLESALE DISTRIBUTORSHIPS FEATURING MEDICAL PRODUCTS AND SUPPLIES; AND WHOLESALE STORES FEATURING MEDICAL PRODUCTS AND SUPPLIES, IN CLASS 35 (U.S. CLS. 100, 101 AND 102).

FIRST USE 4-15-1996; IN COMMERCE 4-15-1996.

NO CLAIM IS MADE TO THE EXCLUSIVE RIGHT TO USE "BABY COMPANY" , APART FROM THE MARK AS SHOWN.

SEC. 2(F) AS TO "TINY BABY COMPANY".

SER. NO. 85-549,600, FILED 2-22-2012.

SARA BENJAMIN, EXAMINING ATTORNEY



*David J. Kybas*

Director of the United States Patent and Trademark Office

# United States of America

United States Patent and Trademark Office

## LONDA'S BODY CARE

**Reg. No. 4,274,519**

**Registered Jan. 15, 2013**

**Int. Cl.: 3**

**TRADEMARK**

**PRINCIPAL REGISTER**

LONDAS BODY CARE, LLC (NEW YORK LIMITED LIABILITY COMPANY)  
44 W CLINTON AVE  
ROOSEVELT, NY 11575

FOR: COLD PROCESSED BAR SOAP, SUGAR SCRUBS FOR THE SKIN, BODY AND FACIAL SCRUBS, BODY BUTTERS, BEAUTY LOTIONS, BATH SALTS, NON-MEDICATED FACIAL SERUMS CONTAINING ANTIOXIDANTS, FACIAL CREAMS, BATH MILKS, FACE AND BODY CREAMS, NON-MEDICATED SKIN CARE PREPARATIONS, IN CLASS 3 (U.S. CLS. 1, 4, 6, 50, 51 AND 52).

FIRST USE 4-24-2009; IN COMMERCE 1-26-2010.

THE MARK CONSISTS OF STANDARD CHARACTERS WITHOUT CLAIM TO ANY PARTICULAR FONT, STYLE, SIZE, OR COLOR.

NO CLAIM IS MADE TO THE EXCLUSIVE RIGHT TO USE "BODY CARE", APART FROM THE MARK AS SHOWN.

SER. NO. 85-550,056, FILED 2-22-2012.

HOWARD SMIGA, EXAMINING ATTORNEY



*David J. Kyffers*

Director of the United States Patent and Trademark Office

# United States of America

United States Patent and Trademark Office

Londa's  
Body Care, LLC

**Reg. No. 4,274,520**

**Registered Jan. 15, 2013**

**Int. Cl.: 3**

**TRADEMARK**

**PRINCIPAL REGISTER**

LONDAS BODY CARE, LLC (NEW YORK LIMITED LIABILITY COMPANY)  
44 W CLINTON AVE  
ROOSEVELT, NY 11575

FOR: COLD PROCESSED BAR SOAP, SUGAR SCRUBS FOR THE SKIN, BODY AND FACIAL SCRUBS, BODY BUTTERS, BEAUTY LOTIONS, BATH SALTS, NON-MEDICATED FACIAL SERUMS CONTAINING ANTIOXIDANTS, FACIAL CREAMS, BATH MILKS, FACE AND BODY CREAMS, NON-MEDICATED SKIN CARE PREPARATIONS, IN CLASS 3 (U.S. CLS. 1, 4, 6, 50, 51 AND 52).

FIRST USE 4-24-2009; IN COMMERCE 1-26-2010.

NO CLAIM IS MADE TO THE EXCLUSIVE RIGHT TO USE "BODY CARE, LLC", APART FROM THE MARK AS SHOWN.

THE MARK CONSISTS OF WORDS "LONDA'S BODY CARE, LLC" IN WHICH THERE IS AN IMAGE OF TWO SMALL LEAVES PLACED IN BETWEEN ALPHABET "A" AND "S" OF THE WORDS "LONDA'S" AS SHOWN IN THE MARK.

SER. NO. 85-550,170, FILED 2-22-2012.

HOWARD SMIGA, EXAMINING ATTORNEY



*David J. Kyffers*

Director of the United States Patent and Trademark Office



# United States of America

United States Patent and Trademark Office

# VITHANE

**Reg. No. 4,274,521**

**Registered Jan. 15, 2013**

**Int. Cl.: 2**

**TRADEMARK**

**PRINCIPAL REGISTER**

MEGGITT (ROCKMART), INC. (DELAWARE CORPORATION)  
1955 N. SURVEYOR AVENUE  
SIMI VALLEY, CA 93063

FOR: POLYURETHANE COATING USED AS CONSTRUCTION MATERIAL IN THE MANUFACTURE AND REPAIR OF FUEL CELLS WHICH ACTS AS A SEALANT, BARRIER PROTECTANT, AND WHICH IS RESISTANT TO WEAR, FOR USE IN THE MILITARY AND COMMERCIAL FIELDS, IN CLASS 2 (U.S. CLS. 6, 11 AND 16).

FIRST USE 4-3-1963; IN COMMERCE 4-3-1963.

THE MARK CONSISTS OF STANDARD CHARACTERS WITHOUT CLAIM TO ANY PARTICULAR FONT, STYLE, SIZE, OR COLOR.

SER. NO. 85-550,498, FILED 2-23-2012.

WENDY GOODMAN, EXAMINING ATTORNEY



*David J. Kybas*

Director of the United States Patent and Trademark Office

**United States of America**  
United States Patent and Trademark Office

**HACKNY**

**Reg. No. 4,274,522**

HACK NY, INC. (NEW YORK CORPORATION)  
141 SECOND AVENUE, APT. 4  
NEW YORK, NY 10003

**Registered Jan. 15, 2013**

**Int. Cls.: 35 and 41**

FOR: INTERNSHIP PLACEMENT SERVICES; ORGANIZING OF BUSINESS COMPETITIONS IN THE NATURE OF SOFTWARE DEVELOPMENT COMPETITIONS AND BUSINESS PLAN COMPETITIONS, IN CLASS 35 (U.S. CLS. 100, 101 AND 102).

**SERVICE MARK**

FIRST USE 3-0-2010; IN COMMERCE 3-0-2010.

**PRINCIPAL REGISTER**

FOR: ARRANGING AND CONDUCTING CONTESTS; PROVIDING RECOGNITION AND INCENTIVES BY THE WAY OF AWARDS AND CONTESTS TO DEMONSTRATE EXCELLENCE IN THE FIELDS OF SOFTWARE DEVELOPMENT, TECHNOLOGY AND BUSINESS; EDUCATIONAL SERVICES, NAMELY, PROVIDING INTERNSHIPS AND APPRENTICESHIPS IN THE FIELDS OF SOFTWARE DEVELOPMENT, TECHNOLOGY AND BUSINESS, IN CLASS 41 (U.S. CLS. 100, 101 AND 107).

FIRST USE 3-0-2010; IN COMMERCE 3-0-2010.

THE MARK CONSISTS OF STANDARD CHARACTERS WITHOUT CLAIM TO ANY PARTICULAR FONT, STYLE, SIZE, OR COLOR.

SER. NO. 85-550,624, FILED 2-23-2012.

WENDY GOODMAN, EXAMINING ATTORNEY



*David J. Kybas*

Director of the United States Patent and Trademark Office

# United States of America

United States Patent and Trademark Office

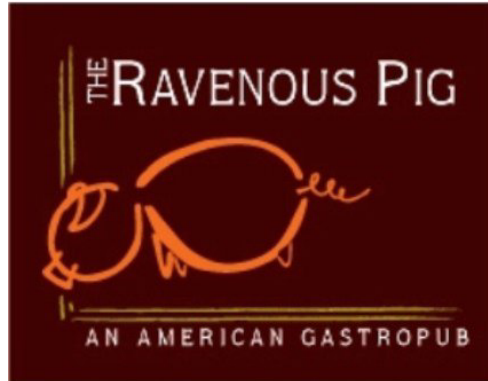

**Reg. No. 4,274,523**

**Registered Jan. 15, 2013**

**Int. Cl.: 43**

**SERVICE MARK**

**PRINCIPAL REGISTER**

J P RESTAURANTS, LLC (FLORIDA LIMITED LIABILITY COMPANY), DBA THE RAVENOUS PIG  
1234 ORANGE AVE.  
WINTER PARK,, FL 32789

FOR: RESTAURANT IN THE NATURE OF AN AMERICAN GASTROPUB, IN CLASS 43 (U.S. CLS. 100 AND 101).

FIRST USE 9-10-2007; IN COMMERCE 9-10-2007.

NO CLAIM IS MADE TO THE EXCLUSIVE RIGHT TO USE "AN AMERICAN GASTROPUB", APART FROM THE MARK AS SHOWN.

THE COLOR(S) WHITE, BROWN, ORANGE AND YELLOW IS/ARE CLAIMED AS A FEATURE OF THE MARK.

THE MARK CONSISTS OF THE WORDING "THE RAVENOUS PIG" IN WHITE LETTERING ACROSS THE TOP AND THE WORDING "AN AMERICAN GASTROPUB" IN WHITE LETTERING ACROSS THE BOTTOM. BETWEEN THE WORDING IS A STYLIZED DESIGN OF A PIG OUTLINED IN ORANGE. THERE ARE TWO YELLOW VERTICAL STRIPES TO THE LEFT OF THE PIG DESIGN AND TWO YELLOW HORIZONTAL STRIPES BENEATH THE PIG. THE ENTIRE MARK IS AGAINST A BROWN BACKGROUND.

SER. NO. 85-550,631, FILED 2-23-2012.

WENDY GOODMAN, EXAMINING ATTORNEY



*David J. Kyjars*

Director of the United States Patent and Trademark Office

# United States of America

United States Patent and Trademark Office

## MEMOTHERM

**Reg. No. 4,274,524**

GEM INNOV (FRANCE CORPORATION)  
12 LOTISSEMENT LES CYPRES  
13420 GEMENOS, FRANCE

**Registered Jan. 15, 2013**

**Int. Cls.: 2 and 9**

FOR: COLORANTS, COLOR PIGMENTS, PAINTS, VARNISHES, PRINTING INKS, THERMOSENSITIVE PAINTS, IN CLASS 2 (U.S. CLS. 6, 11 AND 16).

**TRADEMARK**

FOR: TEMPERATURE INDICATORS, THERMOMETERS NOT FOR MEDICAL PURPOSES; THERMOCHROMIC PRODUCTS IN THE FORM OF MICROCAPSULES TO BE USED AS TEMPERATURE INDICATORS, IN CLASS 9 (U.S. CLS. 21, 23, 26, 36 AND 38).

**PRINCIPAL REGISTER**

THE MARK CONSISTS OF STANDARD CHARACTERS WITHOUT CLAIM TO ANY PARTICULAR FONT, STYLE, SIZE, OR COLOR.

PRIORITY CLAIMED UNDER SEC. 44(D) ON FRANCE APPLICATION NO. 113854383, FILED 8-24-2011, REG. NO. 113854383, DATED 8-24-2011, EXPIRES 8-24-2021.

SER. NO. 85-551,189, FILED 2-23-2012.

DOMINIC J. FERRAIUOLO, EXAMINING ATTORNEY



*David J. Kyfos*

Director of the United States Patent and Trademark Office

# United States of America

United States Patent and Trademark Office

**Orunmila**  
**EGDO**

**Reg. No. 4,274,525**

ORUNMILA EDITION PUBLISHING & DISTRIBUTION, INC. (FLORIDA CORPORATION)  
7014 GLENVIEW DR.  
TAMPA, FL 33619

**Registered Jan. 15, 2013**

**Int. Cls.: 16 and 41**

FOR: BROCHURES ABOUT EDUCATIONAL, SCIENTIFIC, AND CULTURAL MATTERS; CHILDREN'S BOOKS; COMMEMORATIVE BOOKS FEATURING EDUCATIONAL, SCIENTIFIC, AND CULTURAL MATTERS; MAGAZINES IN THE FIELD OF EDUCATIONAL, SCIENTIFIC, AND CULTURAL MATTERS; NON-FICTION BOOKS ON A VARIETY OF TOPICS; PAPER BANNERS; POSTERS, IN CLASS 16 (U.S. CLS. 2, 5, 22, 23, 29, 37, 38 AND 50).

**TRADEMARK**

**SERVICE MARK**

**PRINCIPAL REGISTER**

FIRST USE 12-1-2005; IN COMMERCE 12-1-2005.

FOR: EDITING OR RECORDING OF SOUNDS AND IMAGES; FILM EDITING; PHOTO EDITING; VIDEO EDITING; WRITTEN TEXT EDITING, IN CLASS 41 (U.S. CLS. 100, 101 AND 107).

FIRST USE 12-1-2005; IN COMMERCE 12-1-2005.

THE MARK CONSISTS OF A SHORT THICK HORIZONTAL LINE BECOMING A LONGER THICK VERTICAL SLANTED LINE ENDING IN A SHORT THICK HORIZONTAL LINE, ALL WITH WITH A DROP SHADOW; ALL TO THE LEFT OF THE WORD, "ORUNMILA", IN A STYLISTIC SHADOWED FONT, WITH THE "O" LARGER THAN THE REST OF THE WORD; ALL ABOVE AND LEFT JUSTIFIED WITH A SHORT THICK HORIZONTAL LINE WITH A DROP SHADOW IN PARALLEL WITH THE LINE ABOVE AND ENDING JUST AFTER THE "O"; ALL ABOVE AND LEFT JUSTIFIED WITH THE LETTERS, "EGDO", IN A SMALLER STYLISTIC SHADOWED FONT.



SER. NO. 85-551,240, FILED 2-23-2012.

KELLY BOULTON, EXAMINING ATTORNEY

*David J. Kybas*

Director of the United States Patent and Trademark Office

# United States of America

United States Patent and Trademark Office

# AMPHION

**Reg. No. 4,274,526**

MOCANA CORPORATION (DELAWARE CORPORATION)  
350 SANSOME STREET, STE. 1010  
SAN FRANCISCO, CA 94104

**Registered Jan. 15, 2013**

**Int. Cl.: 35**

FOR: ORGANIZING, PROMOTING AND CONDUCTING TRADE SHOW EXHIBITIONS, TRADE SHOWS AND BUSINESS CONFERENCES PERTAINING TO THE SECURITY OF DEVICES NETWORKED OR CONNECTED TO THE INTERNET, IN CLASS 35 (U.S. CLS. 100, 101 AND 102).

**SERVICE MARK**

**PRINCIPAL REGISTER**

FIRST USE 11-1-2010; IN COMMERCE 11-1-2010.

THE MARK CONSISTS OF STANDARD CHARACTERS WITHOUT CLAIM TO ANY PARTICULAR FONT, STYLE, SIZE, OR COLOR.

SER. NO. 85-551,397, FILED 2-23-2012.

ELLEN PERKINS, EXAMINING ATTORNEY



*David J. Kyffers*

Director of the United States Patent and Trademark Office

# United States of America

United States Patent and Trademark Office

## AMPHION FORUM

**Reg. No. 4,274,527**

MOCANA CORPORATION (DELAWARE CORPORATION)  
350 SANSOME STREET, STE. 1010  
SAN FRANCISCO, CA 94104

**Registered Jan. 15, 2013**

**Int. Cl.: 35**

FOR: ORGANIZING, PROMOTING AND CONDUCTING TRADE SHOW EXHIBITIONS, TRADE SHOWS AND BUSINESS CONFERENCES PERTAINING TO THE SECURITY OF DEVICES NETWORKED OR CONNECTED TO THE INTERNET, IN CLASS 35 (U.S. CLS. 100, 101 AND 102).

**SERVICE MARK**

**PRINCIPAL REGISTER**

FIRST USE 11-1-2010; IN COMMERCE 11-1-2010.

THE MARK CONSISTS OF STANDARD CHARACTERS WITHOUT CLAIM TO ANY PARTICULAR FONT, STYLE, SIZE, OR COLOR.

NO CLAIM IS MADE TO THE EXCLUSIVE RIGHT TO USE "FORUM", APART FROM THE MARK AS SHOWN.

SER. NO. 85-551,404, FILED 2-23-2012.

ELLEN PERKINS, EXAMINING ATTORNEY



*David J. Kyffers*

Director of the United States Patent and Trademark Office

# United States of America

United States Patent and Trademark Office

## AMPHION FORUM

**Reg. No. 4,274,528**

**Registered Jan. 15, 2013**

**Int. Cl.: 41**

**SERVICE MARK**

**PRINCIPAL REGISTER**

MOCANA CORPORATION (DELAWARE CORPORATION)  
350 SANSOME STREET, STE. 1010  
SAN FRANCISCO, CA 94104

FOR: EDUCATIONAL SERVICES, NAMELY, CONDUCTING SEMINARS, CONFERENCES AND WORKSHOPS PERTAINING TO THE SECURITY OF DEVICES NETWORKED OR CONNECTED TO THE INTERNET, IN CLASS 41 (U.S. CLS. 100, 101 AND 107).

FIRST USE 11-10-2010; IN COMMERCE 11-10-2010.

THE MARK CONSISTS OF STANDARD CHARACTERS WITHOUT CLAIM TO ANY PARTICULAR FONT, STYLE, SIZE, OR COLOR.

NO CLAIM IS MADE TO THE EXCLUSIVE RIGHT TO USE "FORUM", APART FROM THE MARK AS SHOWN.

SER. NO. 85-551,426, FILED 2-23-2012.

ELLEN PERKINS, EXAMINING ATTORNEY



*David J. Kyffers*

Director of the United States Patent and Trademark Office



# United States of America

United States Patent and Trademark Office

# Higher Wharf ^ ^ ^ ^ ^ Productions

**Reg. No. 4,274,529**

HOOGERWERF JAMES J (UNITED STATES INDIVIDUAL), AKA HOOGERWERF4106  
1050 RIDGE TARN

**Registered Jan. 15, 2013**

SANDY SPRINGS, GA 30350

**Int. Cl.: 41**

FOR: PROVISION OF NON-DOWNLOADABLE FILMS AND MOVIES VIA A VIDEO-ON-DEMAND SERVICE, IN THE FIELDS OF TRAVEL, GEOGRAPHY, HISTORY, PEOPLE, ANIMALS, TECHNOLOGY AND VEHICLES, IN CLASS 41 (U.S. CLS. 100, 101 AND 107).

**SERVICE MARK**

FIRST USE 1-1-2009; IN COMMERCE 1-1-2011.

**PRINCIPAL REGISTER**

THE MARK CONSISTS OF STANDARD CHARACTERS WITHOUT CLAIM TO ANY PARTICULAR FONT, STYLE, SIZE, OR COLOR.

NO CLAIM IS MADE TO THE EXCLUSIVE RIGHT TO USE "PRODUCTIONS", APART FROM THE MARK AS SHOWN.

SER. NO. 85-551,710, FILED 2-24-2012.

FRED CARL, EXAMINING ATTORNEY



*David J. Kyros*

Director of the United States Patent and Trademark Office

# United States of America

United States Patent and Trademark Office

## TAQUEROS DEL SUR

**Reg. No. 4,274,530**

COCINA AUTENTICA, LLC (DELAWARE LIMITED LIABILITY COMPANY)  
7701 LEGACY DRIVE  
PLANO, TX 75024

**Registered Jan. 15, 2013**

**Int. Cl.: 30**

FOR: CORN-BASED SNACK FOODS; TORTILLA CHIPS, IN CLASS 30 (U.S. CL. 46).

FIRST USE 7-0-2012; IN COMMERCE 7-0-2012.

**TRADEMARK**

THE MARK CONSISTS OF STANDARD CHARACTERS WITHOUT CLAIM TO ANY PARTICULAR FONT, STYLE, SIZE, OR COLOR.

**PRINCIPAL REGISTER**

THE ENGLISH TRANSLATION OF "TAQUEROS DEL SUR" IN THE MARK IS "TACO SELLERS OF THE SOUTH".

SER. NO. 85-551,872, FILED 2-24-2012.

LINDA ESTRADA, EXAMINING ATTORNEY



*David J. Kybas*

Director of the United States Patent and Trademark Office

# United States of America

United States Patent and Trademark Office

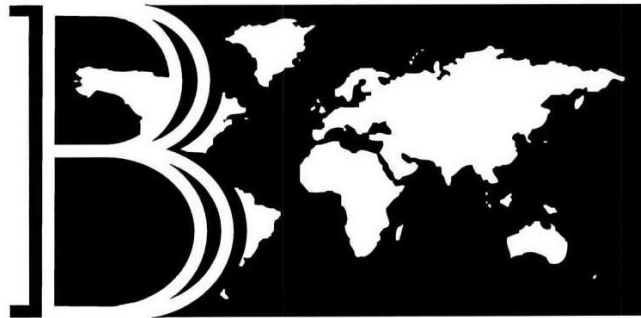

**BENNETT GROUP OF FUNDS**

**Reg. No. 4,274,531**

**Registered Jan. 15, 2013**

**Int. Cl.: 36**

**SERVICE MARK**

**PRINCIPAL REGISTER**

BENNETT GROUP FINANCIAL SERVICES LLC (DELAWARE LIMITED LIABILITY COMPANY)

5335 WISCONSIN AVENUE NW, SUITE 500  
WASHINGTON, DC 20015

FOR: FINANCIAL SERVICES, NAMELY, MUTUAL FUND INVESTMENT, INVESTING IN STOCKS, BONDS, ETFS AND OTHER TRADE VEHICLES, FINANCIAL PLANNING, WEALTH MANAGEMENT AND INSURANCE INFORMATION AND CONSULTING; FINANCIAL ADVICE AND CONSULTATION, IN CLASS 36 (U.S. CLS. 100, 101 AND 102).

FIRST USE 6-1-2011; IN COMMERCE 6-1-2011.

NO CLAIM IS MADE TO THE EXCLUSIVE RIGHT TO USE "GROUP OF FUNDS", APART FROM THE MARK AS SHOWN.

THE MARK CONSISTS OF THE LETTER "B" AND A MAP OF THE WORLD WITH CONTINENTS APPEARING ON A RECTANGULAR BACKGROUND AND THE WORDING "BENNETT GROUP OF FUNDS".

SER. NO. 85-552,342, FILED 2-24-2012.

KATHLEEN LORENZO, EXAMINING ATTORNEY



*David J. Kyjars*

Director of the United States Patent and Trademark Office

# United States of America

United States Patent and Trademark Office



Care  
for  
Life

**Reg. No. 4,274,532**

**Registered Jan. 15, 2013**

**Int. Cl.: 25**

**TRADEMARK**

**PRINCIPAL REGISTER**

CARE FOR LIFE, INC. (ARIZONA CORPORATION)  
3850 E. BASELINE ROAD, SUITE 114  
MESA, AZ 852064638

FOR: SHIRTS; T-SHIRTS, IN CLASS 25 (U.S. CLS. 22 AND 39).

FIRST USE 1-1-2010; IN COMMERCE 1-1-2010.

OWNER OF U.S. REG. NOS. 3,268,395 AND 3,268,396.

THE MARK CONSISTS OF PORTRAIT VIEW OF A WOMAN AND CHILD IN SILHOUETTE WITHIN AN OVAL BORDER NEXT TO THE PHRASE "CARE FOR LIFE" IN STYLIZED FONT.

SER. NO. 85-552,476, FILED 2-24-2012.

STEVEN PEREZ, EXAMINING ATTORNEY



*David J. Kybas*

Director of the United States Patent and Trademark Office

# United States of America

United States Patent and Trademark Office

## CDN Shaping

**Reg. No. 4,274,533**

**Registered Jan. 15, 2013**

**Int. Cl.: 9**

**TRADEMARK**

**PRINCIPAL REGISTER**

DIGITAL KEYSTONE, INC. (DELAWARE CORPORATION)  
1975 W. EL CAMINO REAL #306  
MOUNTAIN VIEW, CA 94040

FOR: COMPUTER SOFTWARE AND HARDWARE FOR CONTENT DISTRIBUTION MANAGEMENT, IN CLASS 9 (U.S. CLS. 21, 23, 26, 36 AND 38).

FIRST USE 1-10-2012; IN COMMERCE 1-10-2012.

THE MARK CONSISTS OF STANDARD CHARACTERS WITHOUT CLAIM TO ANY PARTICULAR FONT, STYLE, SIZE, OR COLOR.

NO CLAIM IS MADE TO THE EXCLUSIVE RIGHT TO USE "CDN", APART FROM THE MARK AS SHOWN.

SER. NO. 85-552,603, FILED 2-24-2012.

ESTHER BELENKER, EXAMINING ATTORNEY



*David J. Kyros*

Director of the United States Patent and Trademark Office

# United States of America

United States Patent and Trademark Office

# PANOPTIS

**Reg. No. 4,274,534**

**Registered Jan. 15, 2013**

**Int. Cl.: 36**

**SERVICE MARK**

**PRINCIPAL REGISTER**

PANOPTIS IP, LLC (TEXAS LIMITED LIABILITY COMPANY)  
2101 CEDAR SPRINGS RD., STE. 1900  
DALLAS, TX 75201

FOR: FINANCIAL ADVISORY AND CONSULTANCY SERVICES, NAMELY, ADVISING OTHERS CONCERNING INVESTMENTS IN INTELLECTUAL PROPERTY ASSETS AND INTANGIBLE BUSINESS ASSETS, BOTH DIRECTLY AND INDIRECTLY THROUGH OTHER ENTITIES; FINANCIAL SERVICES, NAMELY, INTELLECTUAL PROPERTY ASSET ACQUISITION AND FUNDING SERVICES RENDERED IN CONNECTION WITH INTELLECTUAL PROPERTY LITIGATION, INTELLECTUAL PROPERTY LICENSING, AND INTELLECTUAL PROPERTY ASSET ACQUISITION AND MANAGEMENT; FINANCIAL SERVICES, NAMELY, CONTINGENCY FEE LITIGATION VALUATION AND FUNDING SERVICES RENDERED IN CONNECTION WITH LINES OF CREDIT FOR LITIGATION FINANCE; INTELLECTUAL PROPERTY FUND MANAGEMENT SERVICES, IN CLASS 36 (U.S. CLS. 100, 101 AND 102).

FIRST USE 3-25-2010; IN COMMERCE 3-25-2010.

THE MARK CONSISTS OF STANDARD CHARACTERS WITHOUT CLAIM TO ANY PARTICULAR FONT, STYLE, SIZE, OR COLOR.

OWNER OF U.S. REG. NO. 3,940,909.

SER. NO. 85-553,567, FILED 2-27-2012.

STEVEN JACKSON, EXAMINING ATTORNEY



*David J. Kyros*

Director of the United States Patent and Trademark Office

# United States of America

United States Patent and Trademark Office



**Reg. No. 4,274,535**

**Registered Jan. 15, 2013**

**Int. Cl.: 11**

**TRADEMARK**

**PRINCIPAL REGISTER**

YU, DAVID (UNITED STATES INDIVIDUAL), DBA SQUAREWALNUT LLC.  
1165 WARNER AVE  
TUSTIN, CA 92780

FOR: ELECTRIC ILLUMINATION DEVICES, NAMELY, RECESSED LIGHT FIXTURES, MINIATURE CABINET RECESSED LIGHTS, TRACK LIGHTS, CEILING LIGHTS, CHANDELIERS, FLUORESCENT LAMPS, HALOGEN FLOOR LAMPS, WALL LIGHTS, SPOT LIGHTS, LAMPS, OSCILLATING LAMPS AND ACCESSORIES FOR THE AFOREMENTIONED GOODS, NAMELY, COLOR FILTERS, REFLECTORS, LAMP SCREENS, COLOR SCREENS; SOCKETS FOR ELECTRIC LIGHTS, LIGHT-BEAMING DEVICES, NAMELY, REFLECTIVE LAMPS, LAMP REFLECTORS, LAMP HANGERS, LAMP POSITIONERS, LAMP STANDS, LAMP MOUNTS AND LAMPS, CABLE MOUNTED LAMPS, IN CLASS 11 (U.S. CLS. 13, 21, 23, 31 AND 34).

FIRST USE 2-1-2010; IN COMMERCE 4-1-2010.

THE MARK CONSISTS OF THE WORDING "SQUARE WALNUT" INSIDE A RECTANGULAR SHAPE WITH ROUNDED CORNERS AND TWO PROTRUDING ANGLED ENDS REPRESENTING THE SHAPE OF A WALNUT.

SER. NO. 85-554,016, FILED 2-27-2012.

MARIA-VICTORIA SUAREZ, EXAMINING ATTORNEY



*David J. Kybas*

Director of the United States Patent and Trademark Office

# United States of America

United States Patent and Trademark Office



**Reg. No. 4,274,536**

**Registered Jan. 15, 2013**

**Int. Cl.: 35**

**SERVICE MARK**

**PRINCIPAL REGISTER**

APRENDE NEGOCIOS, LLC (CALIFORNIA LIMITED LIABILITY COMPANY)  
1499 RIDGECREST STREET, NO. 26  
MONTEREY PARK, CA 91754

FOR: BUSINESS CONSULTATION SERVICES; BUSINESS CONSULTING AND BUSINESS INFORMATION FOR ENTERPRISES; BUSINESS CONSULTING AND INFORMATION SERVICES; BUSINESS CONSULTING, INQUIRIES OR INFORMATION; BUSINESS SUPPORT SERVICES, NAMELY, BUSINESS CONSULTING TO FREELANCERS, START-UPS, EXISTING BUSINESSES AND NON-PROFIT ORGANIZATIONS; PROFESSIONAL BUSINESS CONSULTING, IN CLASS 35 (U.S. CLS. 100, 101 AND 102).

FIRST USE 1-1-2001; IN COMMERCE 1-1-2001.

NO CLAIM IS MADE TO THE EXCLUSIVE RIGHT TO USE "APRENDENEGOCIOS.COM", APART FROM THE MARK AS SHOWN.

THE COLOR(S) DARK GREY, LIGHT GREY, DARK BLUE AND TURQUOISE IS/ARE CLAIMED AS A FEATURE OF THE MARK.

THE MARK CONSISTS OF THE WORDS "APRENDENEGOCIOS" WITH THE WORD "APRENDE" IN DARK GREY AND THE WORD "NEGOCIOS" IN LIGHT GREY WITH ".COM" AT THE RIGHT END IN DARK BLUE CURSIVE LETTERS AND THE SLOGAN BELOW IN SPANISH "YO SOY MI PROPIO JEFE" IN LIGHT GREY LETTERS; STYLIZED V-SHAPE(S) IN SHADES OF DARK BLUE AND TURQUOISE TO THE LEFT WITH HEAD(S) AND DOT(S) ON TOP, CURVED; BARS, CURVED; CURVED LINE(S), BAND(S), BAR(S); LINES, CURVED.

THE ENGLISH TRANSLATION OF THE WORDS "APRENDENEGOCIOS.COM", "YO SOY MI PROPIO JEFE" IN THE MARK IS "LEARNBUSINESS.COM", "I AM MY OWN BOSS".

SER. NO. 85-554,147, FILED 2-27-2012.

MARGERY A. TIERNEY, EXAMINING ATTORNEY



*David J. Kybas*

Director of the United States Patent and Trademark Office



# United States of America

United States Patent and Trademark Office

## POWERTRAXX

**Reg. No. 4,274,537**

**Registered Jan. 15, 2013**

**Int. Cl.: 10**

**TRADEMARK**

**PRINCIPAL REGISTER**

FERNO-WASHINGTON, INC. (OHIO CORPORATION)  
70 WEIL WAY  
WILMINGTON, OH 451779371

FOR: POWERED CONTINUOUS BELTS SOLD AS A FEATURE OF EVACUATION STAIR CHAIRS TO FACILITATE MOVEMENT OF THE CHAIRS UP AND DOWN STAIRS, FOR TRANSPORT OF PATIENTS; POWERED CONTINUOUS BELTS SPECIALLY ADAPTED FOR USE IN RETROFITTING EVACUATION STAIR CHAIRS TO FACILITATE MOVEMENT OF THE CHAIRS UP AND DOWN STAIRS, FOR TRANSPORT OF PATIENTS, IN CLASS 10 (U.S. CLS. 26, 39 AND 44).

FIRST USE 2-21-2012; IN COMMERCE 2-21-2012.

THE MARK CONSISTS OF STANDARD CHARACTERS WITHOUT CLAIM TO ANY PARTICULAR FONT, STYLE, SIZE, OR COLOR.

SER. NO. 85-554,343, FILED 2-28-2012.

JAMES LOVELACE, EXAMINING ATTORNEY



*David J. Kyfos*

Director of the United States Patent and Trademark Office

# United States of America

United States Patent and Trademark Office

## 123 PHONE CALLS

**Reg. No. 4,274,538**

C2B INTERACTIVE, LLC (NEW JERSEY LIMITED LIABILITY COMPANY)

**Registered Jan. 15, 2013**

P.O. BOX 292  
COLTS NECK, NJ 07722

**Int. Cl.: 35**

FOR: ADVERTISING, MARKETING AND PROMOTIONAL SERVICES; CONSULTING SERVICES FOR COMMERCIAL, PROMOTIONAL AND/OR ADVERTISING PURPOSES, NAMELY, ONLINE AND OFFLINE ADVERTISING, MARKETING AND PROMOTIONS; MARKET RESEARCH; PROVIDING SALES LEADS; CUSTOMER SERVICE MANAGEMENT FOR OTHERS AND CONSULTING SERVICES RELATED THERETO, IN CLASS 35 (U.S. CLS. 100, 101 AND 102).

**SERVICE MARK**

**PRINCIPAL REGISTER**

FIRST USE 11-1-2011; IN COMMERCE 11-1-2011.

THE MARK CONSISTS OF STANDARD CHARACTERS WITHOUT CLAIM TO ANY PARTICULAR FONT, STYLE, SIZE, OR COLOR.

NO CLAIM IS MADE TO THE EXCLUSIVE RIGHT TO USE "PHONE CALLS", APART FROM THE MARK AS SHOWN.

SER. NO. 85-555,604, FILED 2-28-2012.

WILLIAM JACKSON, EXAMINING ATTORNEY



*David J. Kyros*

Director of the United States Patent and Trademark Office

# United States of America

United States Patent and Trademark Office

## CLOUD 9 CINEMATOGRAPHY

**Reg. No. 4,274,539**

KIM, HYUN WOOK (UNITED STATES INDIVIDUAL)  
326 DISTRICT CT  
FULLERTON, CA 92832

**Registered Jan. 15, 2013**

**Int. Cl.: 41**

FOR: VIDEO TAPE EDITING; FILM AND VIDEO TAPE FILM PRODUCTION; VIDEOTAPING SERVICES, IN CLASS 41 (U.S. CLS. 100, 101 AND 107).

**SERVICE MARK**

FIRST USE 10-1-2009; IN COMMERCE 10-1-2009.

**PRINCIPAL REGISTER**

THE MARK CONSISTS OF STANDARD CHARACTERS WITHOUT CLAIM TO ANY PARTICULAR FONT, STYLE, SIZE, OR COLOR.

NO CLAIM IS MADE TO THE EXCLUSIVE RIGHT TO USE "CINEMATOGRAPHY", APART FROM THE MARK AS SHOWN.

SER. NO. 85-555,739, FILED 2-29-2012.

ZACHARY BELLO, EXAMINING ATTORNEY



*David J. Kyffers*

Director of the United States Patent and Trademark Office

# United States of America

United States Patent and Trademark Office

## THE FAX GUYS

**Reg. No. 4,274,540**

DYNAMIC SOLUTIONS GROUP, INC. (MINNESOTA CORPORATION)  
11975 PORTLAND AVENUE S, SUITE 110  
BURNSVILLE, MN 55337

**Registered Jan. 15, 2013**

**Int. Cls.: 35, 37, 38, 39  
and 42**

FOR: ELECTRONIC DOCUMENT INPUT SERVICES, NAMELY, DATA PROCESSING SERVICES, IN CLASS 35 (U.S. CLS. 100, 101 AND 102).

FIRST USE 12-0-2011; IN COMMERCE 12-0-2011.

**SERVICE MARK**

FOR: INSTALLATION OF FAX AUTOMATION EQUIPMENT, IN CLASS 37 (U.S. CLS. 100, 103 AND 106).

**PRINCIPAL REGISTER**

FIRST USE 12-0-2011; IN COMMERCE 12-0-2011.

FOR: FAX AUTOMATION SERVICES, NAMELY, PROVIDING E-MAIL FAX SERVICES; CONSULTING IN THE FIELD OF FAX AUTOMATION, NAMELY, FACSIMILE TRANSMISSION AND RETRIEVAL SERVICES; PROVIDING TECHNICAL SUPPORT SERVICES REGARDING THE USAGE OF FAX COMMUNICATIONS EQUIPMENT, IN CLASS 38 (U.S. CLS. 100, 101 AND 104).

FIRST USE 12-0-2011; IN COMMERCE 12-0-2011.

FOR: ELECTRONIC DOCUMENT STORAGE, IN CLASS 39 (U.S. CLS. 100 AND 105).

FIRST USE 12-0-2011; IN COMMERCE 12-0-2011.

FOR: ELECTRONIC PUBLIC DOCUMENT RETRIEVAL SERVICES; CONSULTING IN THE FIELD OF CONFIGURATION MANAGEMENT FOR COMPUTER-BASED FACSIMILE HARDWARE AND SOFTWARE AND INSTALLATION OF COMPUTER SOFTWARE FOR THE SENDING AND RECEIPT OF FACSIMILE TRANSMISSIONS, IN CLASS 42 (U.S. CLS. 100 AND 101).

FIRST USE 12-0-2011; IN COMMERCE 12-0-2011.

THE MARK CONSISTS OF STANDARD CHARACTERS WITHOUT CLAIM TO ANY PARTICULAR FONT, STYLE, SIZE, OR COLOR.



*David J. Kybas*

Director of the United States Patent and Trademark Office

**Reg. No. 4,274,540** NO CLAIM IS MADE TO THE EXCLUSIVE RIGHT TO USE "FAX", APART FROM THE MARK AS SHOWN.

SER. NO. 85-555,975, FILED 2-29-2012.

ALICE BENMAMAN, EXAMINING ATTORNEY

# United States of America

United States Patent and Trademark Office

## PARTS DOLL

**Reg. No. 4,274,541**

ROB'S CYCLE SUPPLY INC. (NEW YORK CORPORATION)  
3812 BREWERTON ROAD  
NORTH SYRACUSE, NY 13212

**Registered Jan. 15, 2013**

**Int. Cl.: 35**

FOR: WHOLESALE AND RETAIL STORE SERVICES AND ONLINE WHOLESALE AND RETAIL STORE SERVICES FEATURING MOTORCYCLE PARTS, NAMELY, MOTORCYCLE ENGINE PARTS, MOTORCYCLE STRUCTURAL PARTS, MOTORCYCLE DECORATIVE PARTS, MOTORCYCLE PERFORMANCE PARTS, MOTORCYCLE RACING PARTS, IN CLASS 35 (U.S. CLS. 100, 101 AND 102).

**SERVICE MARK**

**PRINCIPAL REGISTER**

FIRST USE 9-0-2011; IN COMMERCE 1-20-2012.

THE MARK CONSISTS OF STANDARD CHARACTERS WITHOUT CLAIM TO ANY PARTICULAR FONT, STYLE, SIZE, OR COLOR.

NO CLAIM IS MADE TO THE EXCLUSIVE RIGHT TO USE "PARTS", APART FROM THE MARK AS SHOWN.

SER. NO. 85-556,045, FILED 2-29-2012.

LINDA ORNDORFF, EXAMINING ATTORNEY



*David J. Kyffers*

Director of the United States Patent and Trademark Office

# United States of America

United States Patent and Trademark Office

## STEELWORKER FOR THE FUTURE

**Reg. No. 4,274,542**

**Registered Jan. 15, 2013**

**Int. Cl.: 41**

**SERVICE MARK**

**PRINCIPAL REGISTER**

ARCELORMITTAL USA LLC (DELAWARE LIMITED LIABILITY COMPANY)  
1 SOUTH DEARBORN STREET, 19TH FLOOR  
CHICAGO, IL 606039888

FOR: EDUCATION SERVICES, NAMELY, PROVIDING CAREER TRAINING CLASSES AND ON-SITE TRAINING IN THE FIELD OF THE STEEL INDUSTRY, IN CLASS 41 (U.S. CLS. 100, 101 AND 107).

FIRST USE 8-1-2008; IN COMMERCE 8-1-2008.

THE MARK CONSISTS OF STANDARD CHARACTERS WITHOUT CLAIM TO ANY PARTICULAR FONT, STYLE, SIZE, OR COLOR.

NO CLAIM IS MADE TO THE EXCLUSIVE RIGHT TO USE "STEELWORKER", APART FROM THE MARK AS SHOWN.

SER. NO. 85-556,571, FILED 2-29-2012.

MARIA-VICTORIA SUAREZ, EXAMINING ATTORNEY



*David J. Kybas*

Director of the United States Patent and Trademark Office

# United States of America

United States Patent and Trademark Office

## The House Of Vapor

**Reg. No. 4,274,543**

**Registered Jan. 15, 2013**

**Int. Cls.: 1 and 34**

**TRADEMARK**

**PRINCIPAL REGISTER**

THE HOUSE OF VAPOR LLC (NEW YORK LIMITED LIABILITY COMPANY)  
PO BOX 242  
AMHERST, NY 14226

FOR: AMPOULES CONTAINING PROPYLENE GLYCOL LIQUID FOR ELECTRIC CIGARETTES, ELECTRIC CIGARS, ELECTRIC CIGARILLOS AND ELECTRIC PIPES; CARTRIDGES CONTAINING PROPYLENE GLYCOL LIQUID FOR ELECTRIC CIGARETTES, ELECTRIC CIGARS, ELECTRIC CIGARILLOS AND ELECTRIC PIPES, IN CLASS 1 (U.S. CLS. 1, 5, 6, 10, 26 AND 46).

FIRST USE 4-27-2009; IN COMMERCE 4-27-2009.

FOR: TOBACCO; CIGARETTES; CIGARILLOS; CIGARS; ELECTRONIC CIGARETTES; SMOKING PIPES; ELECTRONIC SMOKING PIPES; AMPOULES FOR STORING TOBACCO; CARTRIDGES SOLD EMPTY AND FILTERS FOR ELECTRIC TOBACCO, CIGARETTES, CIGARILLOS, CIGARS, AND PIPES; TOBACCO BOXES; CIGAR AND CIGARETTE BOXES; CIGARILLO BOXES; ELECTRIC CIGARS; ELECTRIC CIGARILLOS; STORAGE CONTAINERS FOR AFOREMENTIONED PRODUCTS, NAMELY, BOXES, JARS, POUCHES FOR ELECTRIC CIGARETTES, ELECTRIC CIGARS, ELECTRIC CIGARILLOS, ELECTRIC PIPES, AND TOBACCO, IN CLASS 34 (U.S. CLS. 2, 8, 9 AND 17).

FIRST USE 4-27-2009; IN COMMERCE 4-27-2009.

THE MARK CONSISTS OF STANDARD CHARACTERS WITHOUT CLAIM TO ANY PARTICULAR FONT, STYLE, SIZE, OR COLOR.

NO CLAIM IS MADE TO THE EXCLUSIVE RIGHT TO USE "VAPOR", APART FROM THE MARK AS SHOWN.

SER. NO. 85-556,893, FILED 2-29-2012.

Laurie Kaufman, Examining Attorney



*David J. Kyffers*

Director of the United States Patent and Trademark Office



# United States of America

United States Patent and Trademark Office

# CANDOBABY!

**Reg. No. 4,274,544**

VALINS, SCOTT (UNITED STATES INDIVIDUAL)  
131 VARICK STREET, SUITE 1027  
NEW YORK, NY 10013

**Registered Jan. 15, 2013**

**Int. Cl.: 9**

FOR: COMPUTER APPLICATION SOFTWARE FOR TABLET COMPUTERS, MOBILE PHONES AND OTHER MOBILE COMPUTING DEVICES, NAMELY, SOFTWARE FOR ENTERING, ARRANGING, STORING, AND SHARING WITH OTHERS CHILDHOOD DEVELOPMENT PROGRESS MILESTONES AND CHILDHOOD MEMORIES, IN CLASS 9 (U.S. CLS. 21, 23, 26, 36 AND 38).

**TRADEMARK**

**PRINCIPAL REGISTER**

FIRST USE 2-28-2012; IN COMMERCE 2-28-2012.

THE MARK CONSISTS OF STANDARD CHARACTERS WITHOUT CLAIM TO ANY PARTICULAR FONT, STYLE, SIZE, OR COLOR.

SER. NO. 85-557,204, FILED 3-1-2012.

JESSICA A. POWERS, EXAMINING ATTORNEY



*David J. Kyjars*

Director of the United States Patent and Trademark Office

# United States of America

United States Patent and Trademark Office

# LEGALMAX

**Reg. No. 4,274,545**

**Registered Jan. 15, 2013**

**Int. Cl.: 35**

**SERVICE MARK**

**PRINCIPAL REGISTER**

RAINMAKER IP HOLDING, LLC (FLORIDA LIMITED LIABILITY COMPANY)  
SUITE 904  
12550 BISCAYNE BLVD  
NORTH MIAMI, FL 33181

FOR: BUSINESS AND MANAGEMENT CONSULTING FOR ATTORNEYS, LAW FIRMS  
AND RELATED BUSINESSES IN THE FIELD OF LAW; PROFESSIONAL BUSINESS CON-  
SULTING , IN CLASS 35 (U.S. CLS. 100, 101 AND 102).

FIRST USE 2-6-2012; IN COMMERCE 2-6-2012.

THE MARK CONSISTS OF STANDARD CHARACTERS WITHOUT CLAIM TO ANY PAR-  
TICULAR FONT, STYLE, SIZE, OR COLOR.

SER. NO. 85-557,381, FILED 3-1-2012.

ASMAT KHAN, EXAMINING ATTORNEY



*David J. Kybas*

Director of the United States Patent and Trademark Office

# United States of America

United States Patent and Trademark Office



**CHASIN**BACON

**Reg. No. 4,274,546**

**Registered Jan. 15, 2013**

**Int. Cl.: 35**

**SERVICE MARK**

**PRINCIPAL REGISTER**

CHASIN BACON LLC (FLORIDA LIMITED LIABILITY COMPANY)  
6790 SOUTHWEST 16 STREET  
PLANTATION, FL 33317

FOR: BUSINESS INTERMEDIARY SERVICES IN THE FIELD OF RENDERING PROFESSIONAL HUNTING SERVICES FOR SPECIFIC GAME, IN CLASS 35 (U.S. CLS. 100, 101 AND 102).

FIRST USE 1-0-2012; IN COMMERCE 1-0-2012.

THE MARK CONSISTS OF A HOG WITH THE WORD "CHASIN" IN RED AND "BACON" IN BLACK UNDERNEATH.

THE COLOR(S) RED AND BLACK IS/ARE CLAIMED AS A FEATURE OF THE MARK.

SER. NO. 85-557,475, FILED 3-1-2012.

JASON TURNER, EXAMINING ATTORNEY



*David J. Kybas*

Director of the United States Patent and Trademark Office

# United States of America

United States Patent and Trademark Office

## THE MCCAMMON GROUP

**Reg. No. 4,274,547**

**Registered Jan. 15, 2013**

**Int. Cl.: 45**

**SERVICE MARK**

**PRINCIPAL REGISTER**

MCCAMMON GROUP, LTD., THE (VIRGINIA CORPORATION)  
6641 WEST BROAD STREET  
SUITE 400  
RICHMOND, VA 23230

FOR: ALTERNATIVE DISPUTE RESOLUTION SERVICES, NAMELY, MEDIATION, ARBITRATION, MEDIATION WITH AND AGREEMENT TO FOLLOW WITH ARBITRATION IF MEDIATION FAILS, PRIVATE JUDGING, JUDGE PRO TEMPORE, SPECIAL MASTER; PROVIDING THE SERVICES OF A HEARING OFFICER FOR PUBLIC AND PRIVATE HEARINGS; PROVIDING THE SERVICE OF NEUTRAL EVALUATION OF LEGAL CASE VALUE, IN CLASS 45 (U.S. CLS. 100 AND 101).

FIRST USE 9-15-1999; IN COMMERCE 10-26-1999.

THE MARK CONSISTS OF STANDARD CHARACTERS WITHOUT CLAIM TO ANY PARTICULAR FONT, STYLE, SIZE, OR COLOR.

NO CLAIM IS MADE TO THE EXCLUSIVE RIGHT TO USE "GROUP", APART FROM THE MARK AS SHOWN.

SEC. 2(F).

SER. NO. 85-558,481, FILED 3-2-2012.

ODESSA BIBBINS, EXAMINING ATTORNEY



*David J. Kyffers*

Director of the United States Patent and Trademark Office

# United States of America

United States Patent and Trademark Office

## Online Allergies

**Reg. No. 4,274,548**

ONLINE ALLERGIES, INC. (CALIFORNIA CORPORATION)  
225 N. ROSE ST #214  
BURBANK, CA 91505

**Registered Jan. 15, 2013**

**Int. Cl.: 45**

FOR: ONLINE SOCIAL NETWORKING SERVICES IN THE FIELD OF ALLERGIES PROVIDED VIA A WEBSITE, IN CLASS 45 (U.S. CLS. 100 AND 101).

**SERVICE MARK**

FIRST USE 10-28-2010; IN COMMERCE 8-16-2012.

**PRINCIPAL REGISTER**

THE MARK CONSISTS OF STANDARD CHARACTERS WITHOUT CLAIM TO ANY PARTICULAR FONT, STYLE, SIZE, OR COLOR.

SER. NO. 85-559,441, FILED 3-3-2012.

ELIZABETH KAJUBI, EXAMINING ATTORNEY



*David J. Kybas*

Director of the United States Patent and Trademark Office

# United States of America

United States Patent and Trademark Office



**Reg. No. 4,274,549**

**Registered Jan. 15, 2013**

**Int. Cls.: 37 and 40**

**SERVICE MARK**

**PRINCIPAL REGISTER**

SURFACE SPECIALIST SYSTEMS, INC. (NORTH CAROLINA CORPORATION)  
621B STALLINGS ROAD  
MATTHEWS, NC 28104

FOR: REPAIR, REFINISHING AND RESURFACING OF KITCHEN AND BATHROOM SURFACES, NAMELY, BATHTUBS, SHOWERS, SINKS, VANITIES, CERAMIC TILE, COUNTERTOPS, FIBERGLASS, GRANITE, MARBLE, ACRYLIC, PVC/ABS AND PORCELAIN FIXTURES, WOOD, VINYL, GLASS, APPLIANCES, METAL SURFACES, POOLS AND SPAS; PLUMBING AND MECHANICAL REPAIR SERVICES FOR WHIRLPOOLS; BATHROOM FIXTURE CONVERSIONS; INSTALLATION OF ACRYLIC TUBLINER AND WALL SYSTEMS; APPLICATION OF PROTECTIVE COATINGS TO BATHROOM FIXTURES, IN CLASS 37 (U.S. CLS. 100, 103 AND 106).

FIRST USE 2-29-2012; IN COMMERCE 2-29-2012.

FOR: GLASS POLISHING SERVICES, IN CLASS 40 (U.S. CLS. 100, 103 AND 106).

FIRST USE 2-29-2012; IN COMMERCE 2-29-2012.

OWNER OF U.S. REG. NOS. 1,455,742 AND 3,049,936.

THE COLOR(S) BLUE, BLACK AND WHITE IS/ARE CLAIMED AS A FEATURE OF THE MARK.

THE MARK CONSISTS OF A WHITE STYLIZED LETTER "S" WITHIN A CIRCLE, WITH THE LEFT SIDE OF THE CIRCLE BEING BLUE AND THE RIGHT SIDE IN BLACK; THE AFOREMENTIONED WHITE "S" IS SHARED AS THE INITIAL LETTER TO FORM THE WORDS "SURFACE SPECIALISTS", WITH THE LETTERS "URFACE" APPEARING IN BLUE OVER THE LETTERS "PECIALISTS" IN BLUE, ALL TO THE RIGHT OF THE WHITE LETTER "S" DESIGN.

SEC. 2(F) AS TO "SURFACE SPECIALISTS".

SER. NO. 85-560,031, FILED 3-5-2012.

KEVIN CORWIN, EXAMINING ATTORNEY



*David J. Kyros*

Director of the United States Patent and Trademark Office

# United States of America

United States Patent and Trademark Office



**Reg. No. 4,274,550**

**Registered Jan. 15, 2013**

**Int. Cls.: 37 and 40**

**SERVICE MARK**

**PRINCIPAL REGISTER**

SURFACE SPECIALIST SYSTEMS, INC. (NORTH CAROLINA CORPORATION)  
621B STALLINGS ROAD  
MATTHEWS, NC 28104

FOR: REPAIR, REFINISHING AND RESURFACING OF KITCHEN AND BATHROOM SURFACES, NAMELY, BATHTUBS, SHOWERS, SINKS, VANITIES, CERAMIC TILE, COUNTERTOPS, FIBERGLASS, GRANITE, MARBLE, ACRYLIC, PVC/ABS AND PORCELAIN FIXTURES, WOOD, VINYL, GLASS, APPLIANCES, METAL SURFACES, POOLS AND SPAS; PLUMBING AND MECHANICAL REPAIR SERVICES FOR WHIRLPOOLS; BATHROOM FIXTURE CONVERSIONS; INSTALLATION OF ACRYLIC TUBLINER AND WALL SYSTEMS; APPLICATION OF PROTECTIVE COATINGS TO BATHROOM FIXTURES, IN CLASS 37 (U.S. CLS. 100, 103 AND 106).

FIRST USE 2-29-2012; IN COMMERCE 2-29-2012.

FOR: GLASS POLISHING SERVICES, IN CLASS 40 (U.S. CLS. 100, 103 AND 106).

FIRST USE 2-29-2012; IN COMMERCE 2-29-2012.

OWNER OF U.S. REG. NOS. 1,455,742 AND 3,049,936.

THE MARK CONSISTS OF A STYLIZED LETTER "S" WITHIN A CIRCLE, WITH SAID "S" BEING SHARED AS THE INITIAL LETTER TO FORM THE WORDS "SURFACE SPECIALISTS", WITH THE LETTERS "URFACE" APPEARING OVER THE LETTERS "PECIALISTS" TO THE RIGHT OF THE LETTER "S" DESIGN.

SEC. 2(F) AS TO "SURFACE SPECIALISTS".

SER. NO. 85-560,034, FILED 3-5-2012.

KEVIN CORWIN, EXAMINING ATTORNEY



*David J. Kybas*

Director of the United States Patent and Trademark Office

# United States of America

United States Patent and Trademark Office



**Reg. No. 4,274,551**

**Registered Jan. 15, 2013**

**Int. Cl.: 16**

**TRADEMARK**

**PRINCIPAL REGISTER**

MAYO FOUNDATION FOR MEDICAL EDUCATION AND RESEARCH (MINNESOTA  
NON-PROFIT CORPORATION)  
200 FIRST STREET S.W.  
ROCHESTER, MN 55905

FOR: PRINTED PUBLICATIONS, NAMELY, NEWSLETTERS, BROCHURES, AND INFORMATION PACKETS REGARDING MEDICAL RESEARCH AND CLINICAL TRIALS FOR CANCER TREATMENT, IN CLASS 16 (U.S. CLS. 2, 5, 22, 23, 29, 37, 38 AND 50).

FIRST USE 11-1-2011; IN COMMERCE 11-1-2011.

NO CLAIM IS MADE TO THE EXCLUSIVE RIGHT TO USE "ACADEMIC AND COMMUNITY CANCER RESEARCH", APART FROM THE MARK AS SHOWN.

THE MARK CONSISTS OF THE LETTERS "ACCRU" WITH THREE STYLIZED STARS APPEARING VERTICALLY ON THE LEFT SIDE OF THE LETTER "A" AND THE STYLIZED WORDS "ACADEMIC AND COMMUNITY CANCER RESEARCH UNITED" APPEARING BELOW THE LETTERS "ACCRU".

SER. NO. 85-560,506, FILED 3-5-2012.

LINDA MICKLEBURGH, EXAMINING ATTORNEY



*David J. Kyffers*

Director of the United States Patent and Trademark Office



# United States of America

United States Patent and Trademark Office



**Reg. No. 4,274,552**

**Registered Jan. 15, 2013**

**Int. Cl.: 35**

**SERVICE MARK**

**PRINCIPAL REGISTER**

MAYO FOUNDATION FOR MEDICAL EDUCATION AND RESEARCH (MINNESOTA  
NON-PROFIT CORPORATION)  
200 FIRST STREET S.W.  
ROCHESTER, MN 55905

FOR: ASSOCIATION SERVICES, NAMELY, PROMOTING COLLABORATION WITHIN THE  
SCIENTIFIC, RESEARCH, PHARMACEUTICAL, AND MEDICAL COMMUNITIES IN THE  
FIELDS OF CANCER RESEARCH AND CLINICAL TRIALS, PROVIDING CANCER  
TREATMENT, AND IMPROVING CANCER PATIENT CARE, IN CLASS 35 (U.S. CLS. 100,  
101 AND 102).

FIRST USE 11-1-2011; IN COMMERCE 11-1-2011.

NO CLAIM IS MADE TO THE EXCLUSIVE RIGHT TO USE "ACADEMIC AND COMMUNITY  
CANCER RESEARCH", APART FROM THE MARK AS SHOWN.

THE MARK CONSISTS OF THE LETTERS "ACCRU" WITH THREE STYLIZED STARS AP-  
PEARING VERTICALLY ON THE LEFT SIDE OF THE LETTER "A" AND THE STYLIZED  
WORDS "ACADEMIC AND COMMUNITY CANCER RESEARCH UNITED" APPEARING  
BELOW THE LETTERS "ACCRU".

SER. NO. 85-560,513, FILED 3-5-2012.

LINDA MICKLEBURGH, EXAMINING ATTORNEY



*David J. Kyjars*

Director of the United States Patent and Trademark Office

# United States of America

United States Patent and Trademark Office

## ACCRU ACADEMIC AND COMMUNITY CANCER RESEARCH UNITED

**Reg. No. 4,274,553**

**Registered Jan. 15, 2013**

**Int. Cl.: 16**

**TRADEMARK**

**PRINCIPAL REGISTER**

MAYO FOUNDATION FOR MEDICAL EDUCATION AND RESEARCH (MINNESOTA  
NON-PROFIT CORPORATION)  
200 FIRST STREET S.W.  
ROCHESTER, MN 55905

FOR: PRINTED PUBLICATIONS, NAMELY, NEWSLETTERS, BROCHURES, AND INFORMATION PACKETS REGARDING MEDICAL RESEARCH AND CLINICAL TRIALS FOR CANCER TREATMENT, IN CLASS 16 (U.S. CLS. 2, 5, 22, 23, 29, 37, 38 AND 50).

FIRST USE 11-1-2011; IN COMMERCE 11-1-2011.

THE MARK CONSISTS OF STANDARD CHARACTERS WITHOUT CLAIM TO ANY PARTICULAR FONT, STYLE, SIZE, OR COLOR.

NO CLAIM IS MADE TO THE EXCLUSIVE RIGHT TO USE "ACADEMIC AND COMMUNITY CANCER RESEARCH", APART FROM THE MARK AS SHOWN.

SER. NO. 85-560,537, FILED 3-5-2012.

LINDA MICKLEBURGH, EXAMINING ATTORNEY



*David J. Kyffers*

Director of the United States Patent and Trademark Office

# United States of America

United States Patent and Trademark Office



**Reg. No. 4,274,554**

**Registered Jan. 15, 2013**

**Int. Cl.: 44**

**SERVICE MARK**

**PRINCIPAL REGISTER**

MAYO FOUNDATION FOR MEDICAL EDUCATION AND RESEARCH (MINNESOTA  
NON-PROFIT CORPORATION)  
200 FIRST STREET S.W.  
ROCHESTER, MN 55905

FOR: MEDICAL AND HEALTHCARE SERVICES, NAMELY, HOSPITAL SERVICES, CLINICAL SERVICES, PHYSICIAN SERVICES, NURSING SERVICES, AND MEDICAL TESTING SERVICES IN THE FIELDS OF CANCER TREATMENT AND PATIENT CARE, IN CLASS 44 (U.S. CLS. 100 AND 101).

FIRST USE 11-1-2011; IN COMMERCE 11-1-2011.

NO CLAIM IS MADE TO THE EXCLUSIVE RIGHT TO USE "ACADEMIC AND COMMUNITY CANCER RESEARCH", APART FROM THE MARK AS SHOWN.

THE MARK CONSISTS OF THE LETTERS "ACCRU" WITH THREE STYLIZED STARS APPEARING VERTICALLY ON THE LEFT SIDE OF THE LETTER "A" AND THE STYLIZED WORDS "ACADEMIC AND COMMUNITY CANCER RESEARCH UNITED" APPEARING BELOW THE LETTERS "ACCRU".

SER. NO. 85-560,546, FILED 3-5-2012.

LINDA MICKLEBURGH, EXAMINING ATTORNEY



*David J. Kyjars*

Director of the United States Patent and Trademark Office

# United States of America

United States Patent and Trademark Office

## ACCRU ACADEMIC AND COMMUNITY CANCER RESEARCH UNITED

**Reg. No. 4,274,555**

**Registered Jan. 15, 2013**

**Int. Cl.: 35**

**SERVICE MARK**

**PRINCIPAL REGISTER**

MAYO FOUNDATION FOR MEDICAL EDUCATION AND RESEARCH (MINNESOTA  
NON-PROFIT CORPORATION)  
200 FIRST STREET S.W.  
ROCHESTER, MN 55905

FOR: ASSOCIATION SERVICES, NAMELY, PROMOTING COLLABORATION WITHIN THE  
SCIENTIFIC, RESEARCH, PHARMACEUTICAL, AND MEDICAL COMMUNITIES IN THE  
FIELDS OF CANCER RESEARCH AND CLINICAL TRIALS, PROVIDING CANCER  
TREATMENT, AND IMPROVING CANCER PATIENT CARE, IN CLASS 35 (U.S. CLS. 100,  
101 AND 102).

FIRST USE 11-1-2011; IN COMMERCE 11-1-2011.

THE MARK CONSISTS OF STANDARD CHARACTERS WITHOUT CLAIM TO ANY PAR-  
TICULAR FONT, STYLE, SIZE, OR COLOR.

NO CLAIM IS MADE TO THE EXCLUSIVE RIGHT TO USE "ACADEMIC AND COMMUNITY  
CANCER RESEARCH", APART FROM THE MARK AS SHOWN.

SER. NO. 85-560,560, FILED 3-5-2012.

LINDA MICKLEBURGH, EXAMINING ATTORNEY



*David J. Kybas*

Director of the United States Patent and Trademark Office

# United States of America

United States Patent and Trademark Office

## ACCRU ACADEMIC AND COMMUNITY CANCER RESEARCH UNITED

**Reg. No. 4,274,556**

**Registered Jan. 15, 2013**

**Int. Cl.: 44**

**SERVICE MARK**

**PRINCIPAL REGISTER**

MAYO FOUNDATION FOR MEDICAL EDUCATION AND RESEARCH (MINNESOTA  
NON-PROFIT CORPORATION)  
200 FIRST STREET S.W.  
ROCHESTER, MN 55905

FOR: MEDICAL AND HEALTHCARE SERVICES, NAMELY, HOSPITAL SERVICES, CLINICAL SERVICES, PHYSICIAN SERVICES, NURSING SERVICES, AND MEDICAL TESTING SERVICES IN THE FIELDS OF CANCER TREATMENT AND PATIENT CARE, IN CLASS 44 (U.S. CLS. 100 AND 101).

FIRST USE 11-1-2011; IN COMMERCE 11-1-2011.

THE MARK CONSISTS OF STANDARD CHARACTERS WITHOUT CLAIM TO ANY PARTICULAR FONT, STYLE, SIZE, OR COLOR.

NO CLAIM IS MADE TO THE EXCLUSIVE RIGHT TO USE "ACADEMIC AND COMMUNITY CANCER RESEARCH", APART FROM THE MARK AS SHOWN.

SER. NO. 85-560,577, FILED 3-5-2012.

LINDA MICKLEBURGH, EXAMINING ATTORNEY



*David J. Kyfos*

Director of the United States Patent and Trademark Office

# United States of America

United States Patent and Trademark Office

## MAX POSSIBLE

**Reg. No. 4,274,557**

SCHEIBNER, FRANK (FED REP GERMANY INDIVIDUAL)  
KRONENSTRASSE 75

**Registered Jan. 15, 2013**

BERLIN, FED REP GERMANY D-10117

**Int. Cl.: 35**

FOR: PUBLIC RELATIONS SERVICES FOR MEDIA AGENCIES AND ADVERTISING AGENCIES, IN CLASS 35 (U.S. CLS. 100, 101 AND 102).

**SERVICE MARK**

FIRST USE 3-12-2003; IN COMMERCE 3-12-2003.

**PRINCIPAL REGISTER**

THE MARK CONSISTS OF STANDARD CHARACTERS WITHOUT CLAIM TO ANY PARTICULAR FONT, STYLE, SIZE, OR COLOR.

SER. NO. 85-561,072, FILED 3-6-2012.

ARETHA SOMERVILLE, EXAMINING ATTORNEY



*David J. Kybas*

Director of the United States Patent and Trademark Office

# United States of America

United States Patent and Trademark Office

## Support Systems Associates, Inc.

**Reg. No. 4,274,558**

**Registered Jan. 15, 2013**

**Int. Cl.: 42**

**SERVICE MARK**

**PRINCIPAL REGISTER**

SUPPORT SYSTEMS ASSOCIATES, INC. (FLORIDA CORPORATION)  
SUITE 350  
709 S. HARBOR CITY BLVD.  
MELBOURNE, FL 32901

FOR: ENGINEERING, IN CLASS 42 (U.S. CLS. 100 AND 101).

FIRST USE 3-17-1969; IN COMMERCE 3-17-1969.

THE MARK CONSISTS OF STANDARD CHARACTERS WITHOUT CLAIM TO ANY PARTICULAR FONT, STYLE, SIZE, OR COLOR.

NO CLAIM IS MADE TO THE EXCLUSIVE RIGHT TO USE "ASSOCIATES, INC.", APART FROM THE MARK AS SHOWN.

SEC. 2(F).

SER. NO. 85-561,322, FILED 3-6-2012.

STEVEN R. FINE, EXAMINING ATTORNEY



*David J. Kyffers*

Director of the United States Patent and Trademark Office

# United States of America

United States Patent and Trademark Office



**Reg. No. 4,274,559**

**Registered Jan. 15, 2013**

**Int. Cl.: 16**

**TRADEMARK**

**PRINCIPAL REGISTER**

BURR, RODNEY L. (UNITED STATES INDIVIDUAL), DBA BGBINARY.NET  
7 LOVELL CT.  
ELKTON, MD 21921

FOR: ART PRINTS FEATURING GRAPHIC REPRESENTATIONS AND/OR POEMS; PRINTED POSTERS FEATURING PRINTED GRAPHIC REPRESENTATIONS AND/OR PRINTED POEMS THEREON, IN CLASS 16 (U.S. CLS. 2, 5, 22, 23, 29, 37, 38 AND 50).

FIRST USE 1-1-2011; IN COMMERCE 12-29-2011.

THE MARK CONSISTS OF THE STYLIZED LETTERS "BG" NEXT TO THE STYLIZED WORDING "BINARY NET". ABOVE THE WORDING IS THE GRAPHIC REPRESENTATION OF A MUTUALLY ORBITING BINARY (TWO) STAR SYSTEM. THE COLOR BLUE APPEARS IN THE "B" IN "BG", IN THE LOWER PORTION OF THE ORBIT DESIGN, AND IN THE LEFT STAR EXCEPT FOR THE CENTER DOT, WHICH IS WHITE. THE COLOR GREEN APPEARS IN THE "G" IN "BG", IN THE UPPER PORTION OF THE ORBIT DESIGN, AND IN THE RIGHT STAR EXCEPT FOR THE CENTER DOT, WHICH IS WHITE. THE COLOR WHITE ALSO APPEARS IN THE WORDING "BINARY NET" IN THE MARK. THE BLACK IN THE DRAWING REPRESENTS BACKGROUND AREAS ONLY AND IS NOT PART OF THE MARK.

THE COLOR(S) BLUE, GREEN AND WHITE IS/ARE CLAIMED AS A FEATURE OF THE MARK.

SER. NO. 85-561,330, FILED 3-6-2012.

MAUREEN DALL, EXAMINING ATTORNEY



*David J. Kybas*

Director of the United States Patent and Trademark Office



# United States of America

United States Patent and Trademark Office

# ZIP Scripts

**Reg. No. 4,274,560**

**Registered Jan. 15, 2013**

**Int. Cl.: 35**

**SERVICE MARK**

**PRINCIPAL REGISTER**

WRIGHT, JR. DOUGLAS M. (UNITED STATES INDIVIDUAL)  
2844 TRACELAND DR  
PO BOX 3667  
TUPELO, MS 38803

FOR: RETAIL PHARMACY SERVICES, IN CLASS 35 (U.S. CLS. 100, 101 AND 102).

FIRST USE 12-1-2011; IN COMMERCE 1-24-2012.

THE MARK CONSISTS OF STANDARD CHARACTERS WITHOUT CLAIM TO ANY PARTICULAR FONT, STYLE, SIZE, OR COLOR.

NO CLAIM IS MADE TO THE EXCLUSIVE RIGHT TO USE "SCRIPTS", APART FROM THE MARK AS SHOWN.

SER. NO. 85-561,941, FILED 3-6-2012.

KEVON CHISOLM, EXAMINING ATTORNEY



*David J. Kybas*

Director of the United States Patent and Trademark Office

# United States of America

United States Patent and Trademark Office

# OEXO

**Reg. No. 4,274,561**

**Registered Jan. 15, 2013**

**Int. Cl.: 9**

**TRADEMARK**

**PRINCIPAL REGISTER**

PLETRONICS, INCORPORATED (WASHINGTON CORPORATION)  
19013 36TH AVE. W, SUITE H  
LYNNWOOD, WA 98036

FOR: OSCILLATORS, IN CLASS 9 (U.S. CLS. 21, 23, 26, 36 AND 38).

FIRST USE 3-6-2012; IN COMMERCE 3-6-2012.

THE MARK CONSISTS OF STANDARD CHARACTERS WITHOUT CLAIM TO ANY PARTICULAR FONT, STYLE, SIZE, OR COLOR.

SER. NO. 85-562,196, FILED 3-6-2012.

JENNIFER DIXON, EXAMINING ATTORNEY



*David J. Kybas*

Director of the United States Patent and Trademark Office

# United States of America

United States Patent and Trademark Office

## THE ORIGINAL BUG SHIRT

**Reg. No. 4,274,562**

**Registered Jan. 15, 2013**

**Int. Cl.: 25**

**TRADEMARK**

**PRINCIPAL REGISTER**

1078410 ONTARIO INC. (CANADA CORPORATION), TA THE ORIGINAL BUG SHIRT  
COMPANY  
PO BOX 127  
TROUT CREEK, CANADA P0H2L0

FOR: CAMOUFLAGE PANTS; CAMOUFLAGE SHIRTS; CAMP SHIRTS; CARGO PANTS;  
FISHING SHIRTS; HOODS; HUNTING PANTS; HUNTING SHIRTS; LONG-SLEEVED SHIRTS;  
PANTS; SHIRTS; SPORT SHIRTS; SPORTS PANTS, IN CLASS 25 (U.S. CLS. 22 AND 39).

FIRST USE 4-9-1991; IN COMMERCE 6-1-1991.

THE MARK CONSISTS OF STANDARD CHARACTERS WITHOUT CLAIM TO ANY PAR-  
TICULAR FONT, STYLE, SIZE, OR COLOR.

NO CLAIM IS MADE TO THE EXCLUSIVE RIGHT TO USE "SHIRT", APART FROM THE  
MARK AS SHOWN.

SEC. 2(F).

SER. NO. 85-563,835, FILED 3-8-2012.

AMY HELLA, EXAMINING ATTORNEY



*David J. Kyffers*

Director of the United States Patent and Trademark Office

# United States of America

United States Patent and Trademark Office

## INTELLIGENT MIX

**Reg. No. 4,274,563**

**Registered Jan. 15, 2013**

**Int. Cl.: 35**

**SERVICE MARK**

**PRINCIPAL REGISTER**

FASTAFF, LLC (COLORADO LIMITED LIABILITY COMPANY)  
6501 S. FIDDLER'S GREEN CIRCLE  
#200  
GREENWOOD VILLAGE, CO 80111

FOR: EMPLOYMENT AGENCY SERVICES, NAMELY, TEMPORARY PLACEMENT OF NURSES IN AN EFFICIENT AND COST EFFECTIVE MANNER, IN CLASS 35 (U.S. CLS. 100, 101 AND 102).

FIRST USE 10-3-2011; IN COMMERCE 10-3-2011.

THE MARK CONSISTS OF STANDARD CHARACTERS WITHOUT CLAIM TO ANY PARTICULAR FONT, STYLE, SIZE, OR COLOR.

SER. NO. 85-564,392, FILED 3-8-2012.

SOPHIA S. KIM, EXAMINING ATTORNEY



*David J. Kyffers*

Director of the United States Patent and Trademark Office

# United States of America

United States Patent and Trademark Office



**Reg. No. 4,274,564**

**Registered Jan. 15, 2013**

**Int. Cl.: 10**

**TRADEMARK**

**PRINCIPAL REGISTER**

EAST FLYER INDUSTRIAL CO., LTD. (HONG KONG LIMITED LIABILITY COMPANY)  
BLOCK A, 1/F., MEI SIK INDUSTRIAL BLDG.  
NO. 1-11 KWAI TING ROAD  
LOWER KWAI CHUNG, N.T., HONG KONG

FOR: ADULT SEXUAL STIMULATION KIT COMPRISED PRIMARILY OF ADULT SEXUAL STIMULATION AIDS; MASSAGE APPARATUS AND INSTRUMENTS; ARTIFICIAL PENIS, ARTIFICIAL VAGINAS; MALE PENIS ERECTION PUMPS AND DEVICES; CONDOMS; BREAST PUMPS; SEXUAL AIDS, NAMELY, VIBRATORS, PLASTIC COVERS FOR VIBRATORS, IN CLASS 10 (U.S. CLS. 26, 39 AND 44).

OWNER OF HONG KONG REG. NO. 301839529, DATED 2-22-2011, EXPIRES 2-21-2021.

THE COLOR(S) BLUE, RED, BLACK IS/ARE CLAIMED AS A FEATURE OF THE MARK.

THE MARK CONSISTS OF THE STYLIZED WORDING "GZONE". THE "G" IS IN BLUE WITH THE HORIZONTAL LINE IN THE LETTER FORMED BY PART OF THE BLACK LETTER "Z". THE LETTER "G" HAS A RED TRIANGLE INSIDE OF IT TO FORM A STYLIZED GAUGE DESIGN. THE WORD "ZONE" IS IN BLACK WITH THE BOTTOM LINE OF THE "Z" UNDERLINING THE LETTERS "ONE".

SER. NO. 85-565,415, FILED 3-9-2012.

ELIZABETH HUGHITT, EXAMINING ATTORNEY



*David J. Kyjars*

Director of the United States Patent and Trademark Office

# United States of America

United States Patent and Trademark Office

# Daiquiri Deck

**Reg. No. 4,274,565**

DAIQUIRI DECK, INC. (FLORIDA CORPORATION)  
5254 OCEAN BLVD.  
SARASOTA, FL 34242

**Registered Jan. 15, 2013**

**Int. Cl.: 43**

FOR: FULL RESTAURANT SERVICES, INCLUDING SIT-DOWN SERVICE OF FOOD AND BEVERAGE AND TAKE-OUT RESTAURANT SERVICES, BAR SERVICES AND CATERING SERVICES, IN CLASS 43 (U.S. CLS. 100 AND 101).

**SERVICE MARK**

FIRST USE 1-21-1993; IN COMMERCE 1-21-1993.

**PRINCIPAL REGISTER**

THE MARK CONSISTS OF STANDARD CHARACTERS WITHOUT CLAIM TO ANY PARTICULAR FONT, STYLE, SIZE, OR COLOR.

SEC. 2(F).

SER. NO. 85-565,452, FILED 3-9-2012.

JENNIFER RICHARDSON, EXAMINING ATTORNEY



*David J. Kyffers*

Director of the United States Patent and Trademark Office

# United States of America

United States Patent and Trademark Office

# EASY RIDER

**Reg. No. 4,274,566**

**Registered Jan. 15, 2013**

**Int. Cl.: 32**

**TRADEMARK**

**PRINCIPAL REGISTER**

LUCETTE BREWING COMPANY, L.L.C. (MINNESOTA LIMITED LIABILITY COMPANY)  
910 HUDSON ROAD  
MENOMONIE, WI 54751

FOR: ALE, IN CLASS 32 (U.S. CLS. 45, 46 AND 48).

FIRST USE 10-22-2010; IN COMMERCE 10-22-2010.

THE MARK CONSISTS OF STANDARD CHARACTERS WITHOUT CLAIM TO ANY PARTICULAR FONT, STYLE, SIZE, OR COLOR.

SER. NO. 85-565,626, FILED 3-9-2012.

JESSICA FATHY, EXAMINING ATTORNEY



*David J. Kybas*

Director of the United States Patent and Trademark Office

# United States of America

United States Patent and Trademark Office

# L'Nature

**Reg. No. 4,274,567**

**Registered Jan. 15, 2013**

**Int. Cl.: 5**

**TRADEMARK**

**PRINCIPAL REGISTER**

FIRST AIRBORNE SERVICE TRADING CORP (FLORIDA CORPORATION)  
1800 S OCEAN DR. APT 3404  
HALLANDALE, FL 33009

FOR: CALCIUM SUPPLEMENTS; DIETARY AND NUTRITIONAL SUPPLEMENTS; DIETARY AND NUTRITIONAL SUPPLEMENTS FOR ENDURANCE SPORTS; DIETARY AND NUTRITIONAL SUPPLEMENTS USED FOR WEIGHT LOSS; DIETARY FIBER TO AID DIGESTION; DIETARY SUPPLEMENT FOR ELIMINATING TOXINS FROM THE INTESTINAL TRACT; DIETARY SUPPLEMENTAL DRINKS IN THE NATURE OF VITAMIN AND MINERAL BEVERAGES; DIETARY SUPPLEMENTS; DIETARY SUPPLEMENTS IN THE NATURE OF WEIGHT LOSS POWDERS; ENZYME DIETARY SUPPLEMENTS; LECITHIN FOR USE AS A DIETARY SUPPLEMENT; LIQUID NUTRITIONAL SUPPLEMENT; LIQUID VITAMIN SUPPLEMENTS; NUTRACEUTICALS FOR USE AS A DIETARY SUPPLEMENT FOR PROMOTING DIGESTION; NUTRITIONAL SUPPLEMENT FOR ELIMINATING TOXINS FROM THE BODY; NUTRITIONAL SUPPLEMENT FOR ELIMINATING TOXINS FROM THE INTESTINAL TRACT; NUTRITIONAL SUPPLEMENT SHAKES; NUTRITIONAL SUPPLEMENTS IN THE FORM OF CAPSULES, GELS; VITAMIN AND MINERAL SUPPLEMENTS; VITAMIN SUPPLEMENTS; WHEY PROTEIN SUPPLEMENTS, IN CLASS 5 (U.S. CLS. 6, 18, 44, 46, 51 AND 52).

FIRST USE 8-10-2011; IN COMMERCE 8-10-2011.

THE MARK CONSISTS OF STANDARD CHARACTERS WITHOUT CLAIM TO ANY PARTICULAR FONT, STYLE, SIZE, OR COLOR.

OWNER OF U.S. REG. NO. 4,151,412.

THE ENGLISH TRANSLATION OF "L'NATURE" IN THE MARK IS "THE NATURE".

SER. NO. 85-565,885, FILED 3-9-2012.

MARK RADEMACHER, EXAMINING ATTORNEY



*David J. Kyros*

Director of the United States Patent and Trademark Office



# United States of America

United States Patent and Trademark Office



**Reg. No. 4,274,568**

CIGNEX DATAMATICS, INC. (CALIFORNIA CORPORATION)  
2350 MISSION COLLEGE BOULEVARD, SUITE 49  
SANTA CLARA, CA 95054

**Registered Jan. 15, 2013**

**Int. Cls.: 9, 35, 38, 41  
and 42**

FOR: COMPUTER SOFTWARE FOR USE IN WEB CONTENT MANAGEMENT AND DATABASE MANAGEMENT; COMPUTER E-COMMERCE SOFTWARE TO ALLOW USERS TO PERFORM ELECTRONIC BUSINESS TRANSACTIONS VIA A GLOBAL COMPUTER NETWORK; COMPUTER SOFTWARE FOR USE IN ENTERPRISE RESOURCE PLANNING, IN CLASS 9 (U.S. CLS. 21, 23, 26, 36 AND 38).

**TRADEMARK**

**SERVICE MARK**

FIRST USE 10-27-2011; IN COMMERCE 10-27-2011.

**PRINCIPAL REGISTER**

FOR: EMPLOYMENT STAFFING IN THE FIELD OF INFORMATION TECHNOLOGY, IN CLASS 35 (U.S. CLS. 100, 101 AND 102).

FIRST USE 10-27-2011; IN COMMERCE 10-27-2011.

FOR: COMPUTER AIDED TRANSMISSION OF MESSAGES AND IMAGES; PROVIDING E-MAIL SERVICES; MESSAGE SENDING AND RECEIVING SERVICES; PROVIDING ACCESS TO DATABASES, IN CLASS 38 (U.S. CLS. 100, 101 AND 104).

FIRST USE 10-27-2011; IN COMMERCE 10-27-2011.

FOR: TRAINING THE FIELDS OF DESIGN, DEVELOPMENT, SELECTION, IMPLEMENTATION, MIGRATION, INTEGRATION, USE AND MAINTENANCE OF OPEN SOURCE AND ENTERPRISE RESOURCE PLANNING SOFTWARE SYSTEMS, IN CLASS 41 (U.S. CLS. 100, 101 AND 107).

FIRST USE 10-27-2011; IN COMMERCE 10-27-2011.

FOR: COMPUTER SOFTWARE CONSULTANCY; COMPUTER SOFTWARE DESIGN, DEVELOPMENT AND UPDATING FOR OTHERS; COMPUTER SOFTWARE INSTALLATION AND MAINTENANCE; COMPUTER SYSTEMS ANALYSIS; COMPUTER SYSTEM DESIGN SERVICES; CONVERSION OF DATA OR DOCUMENTS FROM PHYSICAL TO ELECTRONIC MEDIA; DATA CONVERSION OF COMPUTER PROGRAMS AND DATA, NOT PHYSICAL CONVERSION; WEBSITE DESIGN, DEVELOPMENT AND MAINTENANCE FOR OTHERS; CREATION OF COMPUTER PROGRAMS, IN CLASS 42 (U.S. CLS. 100 AND 101).



*David J. Kyffers*

Director of the United States Patent and Trademark Office

**Reg. No. 4,274,568** FIRST USE 10-27-2011; IN COMMERCE 10-27-2011.

THE MARK CONSISTS OF 2 SIDES, BISECTED BY A VERTICAL GREEN LINE, TO THE RIGHT OF WHICH APPEAR THE WORDS "MAKING OPEN SOURCE WORK" IN BLACK; TO THE LEFT OF THE LINE APPEAR THE WORDS "CIGNEX" IN GREEN (WITH ONE LEG OF THE "X" IN YELLOW) AND THE WORD "DATAMATICS" IN BLACK; THREE QUADRILATERALS WITH ROUNDED CORNERS, ONE EACH IN LIGHT BLUE, YELLOW AND DARKER BLUE SURROUND THE TOP END OF THE "X" IN YELLOW.

THE COLOR(S) GREEN, BLACK, BLUE AND YELLOW IS/ARE CLAIMED AS A FEATURE OF THE MARK.

SER. NO. 85-566,509, FILED 3-12-2012.

TIMOTHY FINNEGAN, EXAMINING ATTORNEY

# United States of America

United States Patent and Trademark Office

**Silk**utane  
by Mauro Paravisinni

**Reg. No. 4,274,569**

ARZUAGA-PARAVISINNI CORP. (PUERTO RICO CORPORATION)  
PO BOX 10389

**Registered Jan. 15, 2013**

SAN JUAN, PUERTO RICO 00922

**Int. Cl.: 5**

FOR: ANTI-CELLULITE NUTRITIONAL SUPPLEMENTS, IN CLASS 5 (U.S. CLS. 6, 18, 44, 46, 51 AND 52).

**TRADEMARK**

FIRST USE 3-0-2010; IN COMMERCE 3-0-2010.

**PRINCIPAL REGISTER**

THE NAME(S), PORTRAIT(S), AND/OR SIGNATURE(S) SHOWN IN THE MARK IDENTIFIES "MAURO PARAVISINNI", WHOSE CONSENT(S) TO REGISTER IS MADE OF RECORD.

THE COLOR(S) GRAY, PINK IS/ARE CLAIMED AS A FEATURE OF THE MARK.

THE MARK CONSISTS OF THE WORD "SILK" APPEARING IN PINK, THE LETTERS "UTANE" AND THE WORDING "BY MAURO PARAVISINNI" APPEARING GRAY, ALL APPEARING IN STYLIZED FONT WITH THE WORD "SILKUTANE" APPEARING ABOVE THE WORDING "BY MAURO PARAVISINNI".

SER. NO. 85-566,749, FILED 3-12-2012.

PAM WILLIS, EXAMINING ATTORNEY



*David J. Kyros*

Director of the United States Patent and Trademark Office

# United States of America

United States Patent and Trademark Office

## COME CLEAN

**Reg. No. 4,274,570**

**Registered Jan. 15, 2013**

**Int. Cl.: 3**

**TRADEMARK**

**PRINCIPAL REGISTER**

KINKY-CURLY HAIR CARE, LLC (DELAWARE LIMITED LIABILITY COMPANY)  
289 S. ROBERTSON BLVD; SUITE 374  
BEVERLY HILLS, CA 90211

FOR: SHAMPOOS, IN CLASS 3 (U.S. CLS. 1, 4, 6, 50, 51 AND 52).

FIRST USE 0-0-2004; IN COMMERCE 0-0-2004.

THE MARK CONSISTS OF STANDARD CHARACTERS WITHOUT CLAIM TO ANY PARTICULAR FONT, STYLE, SIZE, OR COLOR.

NO CLAIM IS MADE TO THE EXCLUSIVE RIGHT TO USE "CLEAN", APART FROM THE MARK AS SHOWN.

SER. NO. 85-568,155, FILED 3-13-2012.

ANNE MADDEN, EXAMINING ATTORNEY



*David J. Kyffers*

Director of the United States Patent and Trademark Office

# United States of America

United States Patent and Trademark Office



**Reg. No. 4,274,571**

VIZ GLASS, INC. (CALIFORNIA CORPORATION)  
1200 BUSINESS CENTER DRIVE  
SAN LEANDRO, CA 94577

**Registered Jan. 15, 2013**

**Int. Cl.: 11**

FOR: PENDANT AND CHANDELIER CEILING LIGHTING; TABLE LAMPS, IN CLASS 11  
(U.S. CLS. 13, 21, 23, 31 AND 34).

**TRADEMARK**

FIRST USE 1-0-2012; IN COMMERCE 1-0-2012.

**PRINCIPAL REGISTER**

NO CLAIM IS MADE TO THE EXCLUSIVE RIGHT TO USE "LIGHTING", APART FROM  
THE MARK AS SHOWN.

THE MARK CONSISTS OF THE LETTER, PUNCTUATION AND WORDS "L D'FINE LIGHTING" AS SHOWN IN THE DRAWING. THERE IS A STYLIZED "L" WHICH HAS A SHADOW EFFECT. ON EITHER SIDE OF THE "L" ARE TWO THICK LINES. THERE IS AN ARCH WHICH EXTENDS FROM THE OUTER SIDE OF ONE THICK LINE TO THE OUTER SIDE OF THE OTHER THICK LINE. THERE ARE 5 SMALL LINES WHICH RADIATE AROUND THE ARCH. BENEATH THE "L" ARE THE WORDS AND PUNCTUATION "D'FINE" IN CURSIVE LETTERING. UNDERNEATH THE WORDS "D'FINE" IS THE WORD "LIGHTING" WHICH IS IN BLOCK LETTERING.

SER. NO. 85-568,345, FILED 3-13-2012.

JANICE L. MCMORROW, EXAMINING ATTORNEY



*David J. Kybas*

Director of the United States Patent and Trademark Office

# United States of America

United States Patent and Trademark Office



**Reg. No. 4,274,572**

**Registered Jan. 15, 2013**

**Int. Cl.: 38**

**SERVICE MARK**

**PRINCIPAL REGISTER**

PITTSBURGH COMMUNITY BROADCASTING CORPORATION (PENNSYLVANIA CORPORATION)  
67 BEDFORD SQUARE  
PITTSBURGH, PA 15203

FOR: RADIO BROADCASTING, IN CLASS 38 (U.S. CLS. 100, 101 AND 104).

FIRST USE 1-1-1998; IN COMMERCE 1-1-1998.

NO CLAIM IS MADE TO THE EXCLUSIVE RIGHT TO USE "91.3FM", APART FROM THE MARK AS SHOWN.

THE MARK CONSISTS OF AN OUTLINE OF A MAN WITH A NOTE FOR A HEAD AND THE WORDS "91.3 FM WYEP".

SER. NO. 85-568,871, FILED 3-14-2012.

IRA J. GOODSaid, EXAMINING ATTORNEY



*David J. Kyros*

Director of the United States Patent and Trademark Office

# United States of America

United States Patent and Trademark Office

# GEOPATH

**Reg. No. 4,274,573**

**Registered Jan. 15, 2013**

**Int. Cl.: 9**

**TRADEMARK**

**PRINCIPAL REGISTER**

BASIC NC INC. (CALIFORNIA CORPORATION)  
467 SARATOGA AVENUE  
SUITE 474  
SAN JOSE, CA 95129

FOR: COMPUTER SOFTWARE FOR COMPUTER-AIDED DESIGN (CAD) AND COMPUTER-AIDED MANUFACTURING (CAM) FOR USE BY ARCHITECTS, CIVIL ENGINEERS, CONSTRUCTION MANAGERS, COMPUTER AIDED DESIGNERS, GRAPHICS PROFESSIONALS, MANUFACTURING ENGINEERS, MANUFACTURING SPECIALISTS AND STUDENTS OF CAD/CAM SOFTWARE, IN CLASS 9 (U.S. CLS. 21, 23, 26, 36 AND 38).

FIRST USE 9-29-1979; IN COMMERCE 9-29-1979.

THE MARK CONSISTS OF STANDARD CHARACTERS WITHOUT CLAIM TO ANY PARTICULAR FONT, STYLE, SIZE, OR COLOR.

SER. NO. 85-569,391, FILED 3-14-2012.

JENNY PARK, EXAMINING ATTORNEY



*David J. Kyffers*

Director of the United States Patent and Trademark Office

# United States of America

United States Patent and Trademark Office

# POWERCAM

**Reg. No. 4,274,574**

**Registered Jan. 15, 2013**

**Int. Cl.: 9**

**TRADEMARK**

**PRINCIPAL REGISTER**

BASIC NC INC. (CALIFORNIA CORPORATION)  
467 SARATOGA AVENUE  
SUITE 474  
SAN JOSE, CA 95129

FOR: COMPUTER SOFTWARE FOR COMPUTER-AIDED DESIGN (CAD) AND COMPUTER-AIDED MANUFACTURING (CAM) FOR USE BY ARCHITECTS, CIVIL ENGINEERS, CONSTRUCTION MANAGERS, COMPUTER AIDED DESIGNERS, GRAPHICS PROFESSIONALS, MANUFACTURING ENGINEERS, MANUFACTURING SPECIALISTS AND STUDENTS OF CAD/CAM SOFTWARE, IN CLASS 9 (U.S. CLS. 21, 23, 26, 36 AND 38).

FIRST USE 10-21-1990; IN COMMERCE 10-21-1990.

THE MARK CONSISTS OF STANDARD CHARACTERS WITHOUT CLAIM TO ANY PARTICULAR FONT, STYLE, SIZE, OR COLOR.

SER. NO. 85-569,423, FILED 3-14-2012.

JENNY PARK, EXAMINING ATTORNEY



*David J. Kyffers*

Director of the United States Patent and Trademark Office



**United States of America**  
United States Patent and Trademark Office

**MAZACAM**

**Reg. No. 4,274,575**

**Registered Jan. 15, 2013**

**Int. Cl.: 9**

**TRADEMARK**

**PRINCIPAL REGISTER**

BASIC NC INC. (CALIFORNIA CORPORATION)  
467 SARATOGA AVENUE  
SUITE 474  
SAN JOSE, CA 95129

FOR: COMPUTER SOFTWARE FOR COMPUTER-AIDED DESIGN (CAD) AND COMPUTER-AIDED MANUFACTURING (CAM) FOR USE BY ARCHITECTS, CIVIL ENGINEERS, CONSTRUCTION MANAGERS, COMPUTER AIDED DESIGNERS, GRAPHICS PROFESSIONALS, MANUFACTURING ENGINEERS, MANUFACTURING SPECIALISTS AND STUDENTS OF CAD/CAM SOFTWARE, IN CLASS 9 (U.S. CLS. 21, 23, 26, 36 AND 38).

FIRST USE 10-30-1997; IN COMMERCE 10-30-1997.

THE MARK CONSISTS OF STANDARD CHARACTERS WITHOUT CLAIM TO ANY PARTICULAR FONT, STYLE, SIZE, OR COLOR.

SER. NO. 85-569,501, FILED 3-14-2012.

JENNY PARK, EXAMINING ATTORNEY



*David J. Kyffers*

Director of the United States Patent and Trademark Office

# United States of America

United States Patent and Trademark Office

# Punderdome

**Reg. No. 4,274,576**

PUNDERDOME, LLC (MISSOURI LIMITED LIABILITY COMPANY)  
8157 KINGSBURY BOULEVARD

**Registered Jan. 15, 2013**

SAINT LOUIS, MO 63105

**Int. Cl.: 41**

**SERVICE MARK**

**PRINCIPAL REGISTER**

FOR: ARRANGING AND CONDUCTING NIGHTCLUB ENTERTAINMENT EVENTS; ARRANGING, ORGANIZING, CONDUCTING, AND HOSTING SOCIAL ENTERTAINMENT EVENTS; ENTERTAINMENT IN THE NATURE OF AN ON-GOING SPECIAL VARIETY, NEWS, MUSIC OR COMEDY SHOW FEATURING PUN CONTESTS BROADCAST OVER TELEVISION, SATELLITE, AUDIO, AND VIDEO MEDIA; ENTERTAINMENT IN THE NATURE OF COMPETITIONS IN THE FIELD OF PUN MAKING; ENTERTAINMENT IN THE NATURE OF LIVE PERFORMANCES BY COMEDIANS PARTICIPATING IN PUN CONTESTS; ENTERTAINMENT IN THE NATURE OF LIVE RADIO PERSONALITY PERFORMANCES; ENTERTAINMENT IN THE NATURE OF LIVE STAGE PERFORMANCES IN THE NATURE OF PUN CONTESTS IN THE FIELD OF PUN MAKING BY AN INDIVIDUAL; ENTERTAINMENT IN THE NATURE OF VISUAL AND AUDIO PERFORMANCES BY COMEDIANS PARTICIPATING IN PUN CONTESTS; ENTERTAINMENT IN THE NATURE OF VISUAL AND AUDIO PERFORMANCES, AND MUSICAL, VARIETY, NEWS AND COMEDY SHOWS; ENTERTAINMENT SERVICES IN THE NATURE OF COMEDY SHOWS; ENTERTAINMENT SERVICES, NAMELY, ARRANGING AND CONDUCTING OF COMPETITIONS FOR PUN MAKING; ENTERTAINMENT SERVICES, NAMELY, CONDUCTING CONTESTS; ENTERTAINMENT SERVICES, NAMELY, CONTEST AND INCENTIVE AWARD PROGRAMS DESIGNED TO REWARD PROGRAM PARTICIPANTS WHO WIN PUN CONTESTS; ENTERTAINMENT SERVICES, NAMELY, PRODUCTION AND DISTRIBUTION OF A GAME SHOW; ENTERTAINMENT SERVICES, NAMELY, PRODUCTION AND DISTRIBUTION OF A QUIZ SHOW, IN CLASS 41 (U.S. CLS. 100, 101 AND 107).



FIRST USE 5-9-2011; IN COMMERCE 5-9-2011.

THE MARK CONSISTS OF STANDARD CHARACTERS WITHOUT CLAIM TO ANY PARTICULAR FONT, STYLE, SIZE, OR COLOR.

SER. NO. 85-569,877, FILED 3-14-2012.

DAVID TAYLOR, EXAMINING ATTORNEY

*David J. Kyffers*

Director of the United States Patent and Trademark Office

# United States of America

United States Patent and Trademark Office

## Big Yellow Cup Club

**Reg. No. 4,274,577**

**Registered Jan. 15, 2013**

**Int. Cl.: 35**

**SERVICE MARK**

**PRINCIPAL REGISTER**

DICKEY'S BARBECUE PIT, INC. (TEXAS CORPORATION)  
STE. 1015  
4514 COLE AVE.  
DALLAS, TX 75205

FOR: ADMINISTRATION OF A CONSUMER LOYALTY PROGRAM TO PROMOTE RESTAURANT SERVICES AND RETAIL SERVICES OF OTHERS; CONSUMER LOYALTY SERVICES FOR COMMERCIAL, PROMOTIONAL, AND/OR ADVERTISING PURPOSES, NAMELY, ADMINISTRATION OF FREQUENT FLYER PROGRAM THAT ALLOWS MEMBERS TO REDEEM MILES FOR POINTS OR AWARDS OFFERED BY OTHER LOYALTY PROGRAMS; CONTESTS AND INCENTIVE AWARD PROGRAMS TO PROMOTE THE SALE OF PRODUCTS AND SERVICES OF OTHERS; CUSTOMER LOYALTY SERVICES AND CUSTOMER CLUB SERVICES, FOR COMMERCIAL, PROMOTIONAL AND/OR ADVERTISING PURPOSES; INCENTIVE AWARD PROGRAMS TO PROMOTE THE SALE OF PRODUCTS AND SERVICES OF OTHERS; ONLINE ADVERTISING AND PROMOTIONAL SERVICES; ORGANISATION OF PROMOTIONS USING AUDIOVISUAL MEDIA, IN CLASS 35 (U.S. CLS. 100, 101 AND 102).

FIRST USE 1-1-2006; IN COMMERCE 1-1-2006.

THE MARK CONSISTS OF STANDARD CHARACTERS WITHOUT CLAIM TO ANY PARTICULAR FONT, STYLE, SIZE, OR COLOR.

NO CLAIM IS MADE TO THE EXCLUSIVE RIGHT TO USE "CLUB", APART FROM THE MARK AS SHOWN.

SER. NO. 85-570,583, FILED 3-15-2012.

CIMMERIAN COLEMAN, EXAMINING ATTORNEY



*David J. Kypos*

Director of the United States Patent and Trademark Office

# United States of America

United States Patent and Trademark Office

## The Behavior Minder

**Reg. No. 4,274,578**

TEMENOS, INC. (HAWAII CORPORATION)  
37 KAWANANAKOA PLACE  
HONOLULU, HI 96817

**Registered Jan. 15, 2013**

**Int. Cl.: 41**

FOR: BUSINESS TRAINING IN THE FIELD OF LEADERSHIP; PROFESSIONAL COACHING SERVICES IN THE FIELD OF LEADERSHIP; PROVIDING GROUP COACHING IN THE FIELD OF LEADERSHIP, IN CLASS 41 (U.S. CLS. 100, 101 AND 107).

**SERVICE MARK**

FIRST USE 1-27-1995; IN COMMERCE 1-27-1995.

**PRINCIPAL REGISTER**

THE MARK CONSISTS OF STANDARD CHARACTERS WITHOUT CLAIM TO ANY PARTICULAR FONT, STYLE, SIZE, OR COLOR.

OWNER OF U.S. REG. NO. 2,132,343.

NO CLAIM IS MADE TO THE EXCLUSIVE RIGHT TO USE "BEHAVIOR", APART FROM THE MARK AS SHOWN.

SER. NO. 85-571,685, FILED 3-16-2012.

RICHARD WHITE, EXAMINING ATTORNEY



*David J. Kyffers*

Director of the United States Patent and Trademark Office

# United States of America

United States Patent and Trademark Office

# ideas42

**Reg. No. 4,274,579**

**Registered Jan. 15, 2013**

**Int. Cl.: 42**

**SERVICE MARK**

**PRINCIPAL REGISTER**

BEHAVIORAL IDEAS LAB, INC. (MASSACHUSETTS CORPORATION)  
SUITE 1000  
242 WEST 30TH STREET  
NEW YORK, NY 10001

FOR: SCIENTIFIC RESEARCH CONSULTING IN THE FIELD OF BEHAVIOR THAT IMPACTS SOCIAL AND ECONOMIC ISSUES, IN CLASS 42 (U.S. CLS. 100 AND 101).

FIRST USE 6-30-2008; IN COMMERCE 6-30-2008.

THE MARK CONSISTS OF STANDARD CHARACTERS WITHOUT CLAIM TO ANY PARTICULAR FONT, STYLE, SIZE, OR COLOR.

SER. NO. 85-571,849, FILED 3-16-2012.

BERYL GARDNER, EXAMINING ATTORNEY



*David J. Kyjars*

Director of the United States Patent and Trademark Office

# United States of America

United States Patent and Trademark Office

THINK LIKE A LEADER NOT A  
FOLLOWER!

**Reg. No. 4,274,580**

**Registered Jan. 15, 2013**

**Int. Cl.: 25**

**TRADEMARK**

**PRINCIPAL REGISTER**

CURTIS CHARLES WILLIAMS (UNITED STATES INDIVIDUAL)  
#151  
815 N LA BREA  
INGLEWOOD, CA 90302

FOR: COATS; HATS; PANTS; SOCKS; SWEAT SHIRTS; T-SHIRTS, IN CLASS 25 (U.S. CLS. 22 AND 39).

FIRST USE 11-1-2007; IN COMMERCE 4-1-2008.

THE MARK CONSISTS OF STANDARD CHARACTERS WITHOUT CLAIM TO ANY PARTICULAR FONT, STYLE, SIZE, OR COLOR.

SER. NO. 85-572,256, FILED 3-16-2012.

DEZMONA MIZELLE, EXAMINING ATTORNEY



*David J. Kyros*

Director of the United States Patent and Trademark Office

# United States of America

United States Patent and Trademark Office

## Embrace the Chaos

**Reg. No. 4,274,581**

MIGLANI, ROBERT (UNITED STATES INDIVIDUAL)  
42 EQUESTRIAN WAY

**Registered Jan. 15, 2013**

MONROE TOWNSHIP, NJ 08831

**Int. Cl.: 16**

FOR: PRINTED MATTER, NAMELY, PAPER SIGNS, BOOKS, MANUALS, CURRICULUM, NEWSLETTERS, INFORMATIONAL CARDS AND BROCHURES IN THE FIELD OF SELF HELP, MOTIVATION, BUSINESS; PRINTED PAMPHLETS, BROCHURES, MANUALS, BOOKS, BOOKLETS, LEAFLETS, FLYERS, INFORMATIONAL SHEETS AND NEWSLETTERS, ADHESIVE BACKED STICKERS, AND KITS COMPRISING ONE OR MORE OF THE FOREGOING MATERIALS IN THE FIELD OF SELF HELP, MOTIVATION, BUSINESS, IN CLASS 16 (U.S. CLS. 2, 5, 22, 23, 29, 37, 38 AND 50).

**TRADEMARK**

**PRINCIPAL REGISTER**

FIRST USE 6-3-2011; IN COMMERCE 6-16-2011.

THE MARK CONSISTS OF STANDARD CHARACTERS WITHOUT CLAIM TO ANY PARTICULAR FONT, STYLE, SIZE, OR COLOR.

SER. NO. 85-572,680, FILED 3-18-2012.

HEATHER THOMPSON, EXAMINING ATTORNEY



*David J. Kyffers*

Director of the United States Patent and Trademark Office

# United States of America

United States Patent and Trademark Office

# WISHWORKS

**Reg. No. 4,274,582**

**Registered Jan. 15, 2013**

**Int. Cls.: 16, 21 and 28**

**TRADEMARK**

**PRINCIPAL REGISTER**

RHO ACQUISITION LLC (DELAWARE CORPORATION)  
1 HSN DRIVE  
ST. PETERSBURG, FL 33729

FOR: PARTY SUPPLIES, NAMELY, PRINTED INVITATIONS, THANK YOU NOTE CARDS AND NOTE PAPER; PAPER BANNERS, PAPER PARTY DECORATIONS, PAPER PARTY FAVORS; PAPER NAPKINS; TREAT BAGS, NAMELY, GIFT BAGS; DECORATIVE PAPER CENTERPIECES, PAPER TABLECLOTHS, AND STICKERS, IN CLASS 16 (U.S. CLS. 2, 5, 22, 23, 29, 37, 38 AND 50).

FIRST USE 3-15-2012; IN COMMERCE 3-15-2012.

FOR: PAPER BAKING CUPS; CAKE DECORATING SETS SOLD AS A UNIT COMPRISED PRIMARILY OF DECORATING TUBES, COUPLERS AND TIPS; PAPER PLATES, CUPS; TREAT BUCKETS; CUPCAKE KITS COMPRISED OF PAPER BAKING CUPS, IN CLASS 21 (U.S. CLS. 2, 13, 23, 29, 30, 33, 40 AND 50).

FIRST USE 3-15-2012; IN COMMERCE 3-15-2012.

FOR: PAPER CUTOUTS, NAMELY, PAPER FACE MASKS; PARTY GAMES, PIÑATAS; PAPER PARTY HATS, PLASTIC PARTY HATS AND TIARAS, IN CLASS 28 (U.S. CLS. 22, 23, 38 AND 50).

FIRST USE 3-15-2012; IN COMMERCE 3-15-2012.

THE MARK CONSISTS OF STANDARD CHARACTERS WITHOUT CLAIM TO ANY PARTICULAR FONT, STYLE, SIZE, OR COLOR.

SER. NO. 85-573,794, FILED 3-19-2012.

GINA FINK, EXAMINING ATTORNEY



*David J. Kyffers*

Director of the United States Patent and Trademark Office



# United States of America

United States Patent and Trademark Office

## WORCESTER ACADEMY

**Reg. No. 4,274,583**

**Registered Jan. 15, 2013**

**Int. Cl.: 41**

**SERVICE MARK**

**PRINCIPAL REGISTER**

WORCESTER ACADEMY (MASSACHUSETTS CORPORATION)  
81 PROVIDENCE STREET  
WORCESTER, MA 01604

FOR: EDUCATIONAL SERVICES, NAMELY, A RESIDENTIAL AND NON-RESIDENTIAL COEDUCATIONAL SCHOOL FOR GRADES 6 THROUGH 12 AND A POST-GRADUATE YEAR, AND DISTRIBUTION OF COURSE MATERIAL IN CONNECTION THEREWITH, IN THE FIELDS OF SCIENCES, LANGUAGE, LITERATURE, MATHEMATICS, VISUAL ARTS; PHYSICAL EDUCATION SERVICES; ENTERTAINMENT SERVICES, NAMELY, CONDUCTING ATHLETIC EXHIBITIONS AND GAMES CONDUCTED AT THE INTRAMURAL LEVEL BETWEEN GRADES 9-12; LIBRARIES; COMPUTER SERVICES, NAMELY, PROVIDING A WEB SITE FEATURING INFORMATION AND LINKS TO OTHER WEB SITES REGARDING SCHOOL ADMISSIONS, SCHOOL ACADEMICS, SCHOOL ATHLETICS, SCHOOL EMPLOYMENT OPPORTUNITIES, SCHOOL ADMINISTRATIVE SERVICES, ALUMNI ACTIVITIES AND ORGANIZATIONS, EDUCATIONAL COUNSELING SERVICES TO ASSIST STUDENTS IN PLANNING AND PREPARING FOR FURTHER EDUCATION, STUDENT ACTIVITIES AND ORGANIZATIONS OFFERED AT THE SCHOOL AND INFORMATION RELATING TO EDUCATIONAL SERVICES IN THE NATURE OF SCHOOL TECHNOLOGY SERVICES, IN CLASS 41 (U.S. CLS. 100, 101 AND 107).

FIRST USE 2-28-1834; IN COMMERCE 2-28-1834.

THE MARK CONSISTS OF STANDARD CHARACTERS WITHOUT CLAIM TO ANY PARTICULAR FONT, STYLE, SIZE, OR COLOR.

NO CLAIM IS MADE TO THE EXCLUSIVE RIGHT TO USE "ACADEMY", APART FROM THE MARK AS SHOWN.

SEC. 2(F).

SER. NO. 85-574,040, FILED 3-20-2012.

AMEEN IMAM, EXAMINING ATTORNEY



*David J. Kyffers*

Director of the United States Patent and Trademark Office

# United States of America

United States Patent and Trademark Office

## MAGIC MINERALS BY JEROME ALEXANDER

**Reg. No. 4,274,584**

**Registered Jan. 15, 2013**

**Int. Cl.: 3**

**TRADEMARK**

**PRINCIPAL REGISTER**

JEROME ALEXANDER CONSULTING CORP. (FLORIDA CORPORATION)  
SUITE 206  
9553 HARDING AVENUE  
SURFSIDE, FL 33154

FOR: FACE POWDER FEATURING MINERAL ENHANCEMENTS, IN CLASS 3 (U.S. CLS. 1, 4, 6, 50, 51 AND 52).

FIRST USE 9-1-2009; IN COMMERCE 9-1-2009.

THE MARK CONSISTS OF STANDARD CHARACTERS WITHOUT CLAIM TO ANY PARTICULAR FONT, STYLE, SIZE, OR COLOR.

OWNER OF U.S. REG. NO. 3,020,192.

NO CLAIM IS MADE TO THE EXCLUSIVE RIGHT TO USE "MINERALS", APART FROM THE MARK AS SHOWN.

THE NAME(S), PORTRAIT(S), AND/OR SIGNATURE(S) SHOWN IN THE MARK IDENTIFIES "JEROME ALEXANDER", A PSEUDONYM FOR JEROME AXELROD, A LIVING INDIVIDUAL, WHOSE CONSENT(S) TO REGISTER IS MADE OF RECORD.

SER. NO. 85-574,383, FILED 3-20-2012.

GILBERT SWIFT, EXAMINING ATTORNEY



*David J. Kyffers*

Director of the United States Patent and Trademark Office

# United States of America

United States Patent and Trademark Office

## AUTONOMY PICTURES

**Reg. No. 4,274,585**

TLA RELEASING LLC (DELAWARE LIMITED LIABILITY COMPANY)  
234 MARKET STREET  
PHILADELPHIA, PA 19106

**Registered Jan. 15, 2013**

**Int. Cl.: 41**

FOR: MOTION PICTURE AND VIDEO RENTAL SERVICES, IN CLASS 41 (U.S. CLS. 100, 101 AND 107).

**SERVICE MARK**

FIRST USE 10-20-2011; IN COMMERCE 10-20-2011.

**PRINCIPAL REGISTER**

THE MARK CONSISTS OF STANDARD CHARACTERS WITHOUT CLAIM TO ANY PARTICULAR FONT, STYLE, SIZE, OR COLOR.

NO CLAIM IS MADE TO THE EXCLUSIVE RIGHT TO USE "PICTURES", APART FROM THE MARK AS SHOWN.

SER. NO. 85-574,486, FILED 3-20-2012.

FRED CARL, EXAMINING ATTORNEY



*David J. Kybas*

Director of the United States Patent and Trademark Office

# United States of America

United States Patent and Trademark Office



**Reg. No. 4,274,586**

**Registered Jan. 15, 2013**

**Int. Cl.: 35**

**SERVICE MARK**

**PRINCIPAL REGISTER**

PHILABUNDANCE (PENNSYLVANIA NON-PROFIT CORPORATION)  
P.O. BOX 37555  
3616 GALLOWAY STREET  
PHILADELPHIA, PA 19148

FOR: CHARITABLE SERVICES, NAMELY, COORDINATION OF THE PROCUREMENT OF DONATED FOOD; CHARITABLE SERVICES, NAMELY, COORDINATION OF NON-MONETARY CONTRIBUTIONS TO CHARITIES AND NON-PROFITS, IN CLASS 35 (U.S. CLS. 100, 101 AND 102).

FIRST USE 3-20-2012; IN COMMERCE 3-20-2012.

OWNER OF U.S. REG. NO. 4,116,281.

THE COLOR(S) PURPLE AND GREEN IS/ARE CLAIMED AS A FEATURE OF THE MARK.

THE MARK CONSISTS OF THE STYLIZED WORDS "FARE & SQUARE GOOD FOOD RIGHT AROUND THE CORNER" AND DESIGN, CONSISTING OF GREEN ROUNDED CORNER SQUARES, ONE INSIDE ANOTHER, WITH THE WORDS "GOOD FOOD RIGHT AROUND THE CORNER" WRAPPING AROUND THE UPPER RIGHT CORNER OF THE INTERIOR SQUARE. THE WORDS "FARE & SQUARE" APPEAR IN PURPLE IN TWO LINES DIAGONALLY ON THE INSIDE OF THE INTERIOR SQUARE, WITH A PURPLE CARROT WITH A GREEN TOP OVERLAPPING THE INTERIOR OF BOTH SQUARE BELOW.

SER. NO. 85-575,328, FILED 3-21-2012.

JERI J. FICKES, EXAMINING ATTORNEY



*David J. Kybas*

Director of the United States Patent and Trademark Office

# United States of America

United States Patent and Trademark Office



**Reg. No. 4,274,587**

**Registered Jan. 15, 2013**

**Int. Cl.: 7**

**TRADEMARK**

**PRINCIPAL REGISTER**

ONEIDA AIR SYSTEMS, INCORPORATED (NEW YORK CORPORATION)  
1001 WEST FAYETTE STREET  
SYRACUSE, NY 13204

FOR: DUST SEPARATION AND CONTAINMENT MACHINES AND DUST SEPARATORS THAT ATTACH TO WOODWORKING MACHINES, SANDERS AND FLOOR EDGERS , IN CLASS 7 (U.S. CLS. 13, 19, 21, 23, 31, 34 AND 35).

FIRST USE 4-8-2011; IN COMMERCE 4-8-2011.

OWNER OF U.S. REG. NO. 3,932,263.

NO CLAIM IS MADE TO THE EXCLUSIVE RIGHT TO USE "PRO DUST COLLECTOR", APART FROM THE MARK AS SHOWN.

THE MARK CONSISTS OF THE WORDS "THE SMART PRO DUST COLLECTOR" WITH ALTERNATING HORIZONTAL BARS OF DARK AND LIGHT, THE UPPER BAR HAVING VERTICAL LINES.

SER. NO. 85-575,820, FILED 3-21-2012.

BERYL GARDNER, EXAMINING ATTORNEY



*David J. Kyffers*

Director of the United States Patent and Trademark Office

# United States of America

United States Patent and Trademark Office

# IMAGENE

**Reg. No. 4,274,588**

**Registered Jan. 15, 2013**

**Int. Cl.: 9**

**TRADEMARK**

**PRINCIPAL REGISTER**

BIODISCOVERY INC. (CALIFORNIA CORPORATION)  
2221 ROSECRANS AVE., SUITE 227  
EL SEGUNDO, CA 90245

FOR: SOFTWARE AND COMPUTER SYSTEMS FOR BIOTECHNOLOGY RESEARCH APPLICATIONS, NAMELY, SOFTWARE AND COMPUTER SYSTEMS COMPRISING A CPU, DISPLAY DEVICE, AND KEYBOARD FOR USE IN BIOINFORMATICS AND GENE EXPRESSION MICROARRAY IMAGE ANALYSIS, IN CLASS 9 (U.S. CLS. 21, 23, 26, 36 AND 38).

FIRST USE 11-0-1997; IN COMMERCE 11-0-1997.

THE MARK CONSISTS OF STANDARD CHARACTERS WITHOUT CLAIM TO ANY PARTICULAR FONT, STYLE, SIZE, OR COLOR.

SER. NO. 85-576,366, FILED 3-21-2012.

BRIAN NEVILLE, EXAMINING ATTORNEY



*David J. Kyffers*

Director of the United States Patent and Trademark Office

# United States of America

United States Patent and Trademark Office

## E Pluribus DATUM

**Reg. No. 4,274,589**

DATUM ANALYSIS LLC (MICHIGAN LIMITED LIABILITY COMPANY)  
3381 NIAGARA AVENUE  
CANTON, MI 48188

**Registered Jan. 15, 2013**

**Int. Cls.: 9, 35 and 42**

FOR: COMPUTER SOFTWARE FOR DATA COLLECTION, ORGANIZING DATA, AND STATISTICAL ANALYSIS, IN CLASS 9 (U.S. CLS. 21, 23, 26, 36 AND 38).

**TRADEMARK**

FIRST USE 3-21-2012; IN COMMERCE 3-21-2012.

**SERVICE MARK**

FOR: BUSINESS CONSULTING AND INFORMATION SERVICES; BUSINESS DATA ANALYSIS; INFORMATION SERVICES RELATING TO BUSINESS MATTERS; PROVIDING BUSINESS INFORMATION, NAMELY, COMMERCIAL CORPORATE AND STATISTICAL INFORMATION PROVIDED ON-LINE FROM A COMPUTER DATABASE OR THE INTERNET; STATISTICAL ANALYSIS AND REPORTING SERVICES FOR BUSINESS PURPOSES, IN CLASS 35 (U.S. CLS. 100, 101 AND 102).

**PRINCIPAL REGISTER**

FIRST USE 3-21-2012; IN COMMERCE 3-21-2012.

FOR: COMPUTER SERVICES, NAMELY, PROVIDING AN INTERACTIVE WEB SITE FEATURING TECHNOLOGY THAT ALLOWS USERS TO COLLECT, STORE, MANAGE, DELIVER AND SHOWCASE ELECTRONIC AND PAPER-BASED CONTENT; DATA AUTOMATION AND COLLECTION SERVICE USING PROPRIETARY SOFTWARE TO EVALUATE, ANALYZE AND COLLECT SERVICE DATA; DATA MINING, IN CLASS 42 (U.S. CLS. 100 AND 101).

FIRST USE 3-21-2012; IN COMMERCE 3-21-2012.

NO CLAIM IS MADE TO THE EXCLUSIVE RIGHT TO USE "DATUM", APART FROM THE MARK AS SHOWN.

THE MARK CONSISTS OF THE STYLIZED WORDING "E PLURIBUS DATUM" WITH "DATUM" IN ALL CAPITALIZED LETTERS THAT ARE BOLDER THAN "E PLURIBUS".

THE ENGLISH TRANSLATION OF THE LATIN WORDING "E PLURIBUS" IN THE MARK IS "FROM SEVERAL".



*David J. Kyffers*

Director of the United States Patent and Trademark Office

SER. NO. 85-576,800, FILED 3-22-2012.

**Reg. No. 4,274,589** RUDY R. SINGLETON, EXAMINING ATTORNEY



# United States of America

United States Patent and Trademark Office



**Reg. No. 4,274,590**

**Registered Jan. 15, 2013**

**Int. Cl.: 9**

**TRADEMARK**

**PRINCIPAL REGISTER**

PIONEER KABUSHIKI KAISHA D/B/A PIONEER CORPORATION (JAPAN CORPORATION)  
1-1, SHIN-OGURA, SAIWAI-KU, KAWASAKI-SHI  
KANAGAWA, 212-0031, JAPAN

FOR: COMPUTER SOFTWARE FOR CONTROLLING THE OPERATION OF AUDIO AND VIDEO DEVICES; COMPUTER SOFTWARE FOR CONFIGURING AND MANAGING THE OPERATION OF AUDIO AND VIDEO DEVICES; COMPUTER SOFTWARE FOR THE COLLECTION, EDITING, ORGANIZING, MODIFYING, BOOK MARKING, TRANSMISSION, STORAGE AND SHARING OF DATA AND INFORMATION; COMPUTER SOFTWARE FOR PLAYING VIRTUAL DISC JOCKEYS; AUDIO MIXERS; ELECTRONIC SOUND EFFECTS MACHINES; AMPLIFIERS, IN CLASS 9 (U.S. CLS. 21, 23, 26, 36 AND 38).

PRIORITY CLAIMED UNDER SEC. 44(D) ON JAPAN APPLICATION NO. 2012-14787, FILED 2-29-2012, REG. NO. 5515551, DATED 8-17-2012, EXPIRES 8-17-2022.

THE MARK CONSISTS OF THE WORDING "REMIXBOX" IN STYLIZED FONT TO THE RIGHT OF A BROKEN CIRCLE AND ARROW DESIGN.

SER. NO. 85-576,897, FILED 3-22-2012.

HOWARD SMIGA, EXAMINING ATTORNEY



*David J. Kybas*

Director of the United States Patent and Trademark Office

# United States of America

United States Patent and Trademark Office



**Reg. No. 4,274,591**

CAMP RX, LLC (MICHIGAN LIMITED LIABILITY COMPANY)  
1179 MAPLELAWN DR.  
TROY, MI 48084

**Registered Jan. 15, 2013**

**Int. Cl.: 39**

FOR: PACKAGING PHARMACEUTICALS FOR TRANSPORTATION AND SHIPPING OF PHARMACEUTICALS, IN CLASS 39 (U.S. CLS. 100 AND 105).

**SERVICE MARK**

FIRST USE 2-28-2006; IN COMMERCE 2-28-2006.

**PRINCIPAL REGISTER**

THE MARK CONSISTS OF A PATCH-LIKE IMAGE WITH "CAMP" IN WHITE FONT MADE TO APPEAR LIKE STITCHING FOLLOWED BY "RX" IN ORANGE FONT MADE TO APPEAR LIKE STITCHING, BOTH ON A GREEN BACKGROUND WITH AN ORANGE BORDER.

THE COLOR(S) ORANGE, GREEN AND WHITE IS/ARE CLAIMED AS A FEATURE OF THE MARK.

SER. NO. 85-576,908, FILED 3-22-2012.

JULIE VEPPUMTHARA, EXAMINING ATTORNEY



*David J. Kyros*

Director of the United States Patent and Trademark Office

# United States of America

United States Patent and Trademark Office

## E Pluribus DATUM

**Reg. No. 4,274,592**

DATUM ANALYSIS LLC (MICHIGAN LIMITED LIABILITY COMPANY)  
3381 NIAGARA AVENUE  
CANTON, MI 48188

**Registered Jan. 15, 2013**

**Int. Cls.: 9, 35 and 42**

FOR: COMPUTER SOFTWARE FOR DATA COLLECTION, ORGANIZING DATA, AND STATISTICAL ANALYSIS, IN CLASS 9 (U.S. CLS. 21, 23, 26, 36 AND 38).

**TRADEMARK**

FIRST USE 3-21-2012; IN COMMERCE 3-21-2012.

**SERVICE MARK**

FOR: BUSINESS CONSULTING AND INFORMATION SERVICES; BUSINESS DATA ANALYSIS; INFORMATION SERVICES RELATING TO BUSINESS MATTERS; PROVIDING BUSINESS INFORMATION, NAMELY, COMMERCIAL CORPORATE AND STATISTICAL INFORMATION PROVIDED ON-LINE FROM A COMPUTER DATABASE OR THE INTERNET; STATISTICAL ANALYSIS AND REPORTING SERVICES FOR BUSINESS PURPOSES, IN CLASS 35 (U.S. CLS. 100, 101 AND 102).

**PRINCIPAL REGISTER**

FIRST USE 3-21-2012; IN COMMERCE 3-21-2012.

FOR: COMPUTER SERVICES, NAMELY, PROVIDING AN INTERACTIVE WEB SITE FEATURING TECHNOLOGY THAT ALLOWS USERS TO COLLECT, STORE, MANAGE, DELIVER AND SHOWCASE ELECTRONIC AND PAPER-BASED CONTENT; DATA AUTOMATION AND COLLECTION SERVICE USING PROPRIETARY SOFTWARE TO EVALUATE, ANALYZE AND COLLECT SERVICE DATA; DATA MINING, IN CLASS 42 (U.S. CLS. 100 AND 101).



FIRST USE 3-21-2012; IN COMMERCE 3-21-2012.

THE MARK CONSISTS OF STANDARD CHARACTERS WITHOUT CLAIM TO ANY PARTICULAR FONT, STYLE, SIZE, OR COLOR.

NO CLAIM IS MADE TO THE EXCLUSIVE RIGHT TO USE "DATUM", APART FROM THE MARK AS SHOWN.

*David J. Kyffers*

THE ENGLISH TRANSLATION OF THE LATIN WORDING "E PLURIBUS" IN THE MARK IS "FROM SEVERAL".

Director of the United States Patent and Trademark Office

SER. NO. 85-576,918, FILED 3-22-2012.

**Reg. No. 4,274,592** RUDY R. SINGLETON, EXAMINING ATTORNEY

# United States of America

United States Patent and Trademark Office

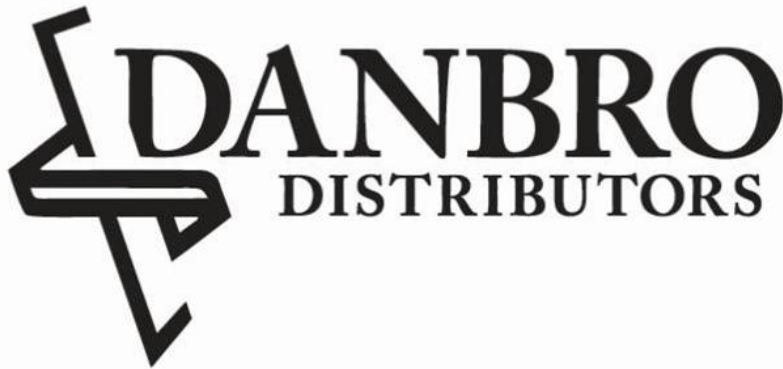

**Reg. No. 4,274,593**

DANBRO DISTRIBUTORS, LLC (PENNSYLVANIA LIMITED LIABILITY COMPANY)  
3700 SOUTH 26TH STREET  
PHILADELPHIA, PA 19145

**Registered Jan. 15, 2013**

**Int. Cl.: 6**

FOR: CONSTRUCTION ELEMENTS MADE OF METAL, NAMELY, FABRICATED METAL COMPONENTS FOR BUILDING FOUNDATIONS; CONSTRUCTION ELEMENTS MADE OF METAL, NAMELY, SUPPORTS; CONSTRUCTION MATERIALS, NAMELY, METAL PILES, IN CLASS 6 (U.S. CLS. 2, 12, 13, 14, 23, 25 AND 50).

**TRADEMARK**

**PRINCIPAL REGISTER**

FIRST USE 12-9-2011; IN COMMERCE 1-3-2012.

NO CLAIM IS MADE TO THE EXCLUSIVE RIGHT TO USE "DISTRIBUTORS", APART FROM THE MARK AS SHOWN.

THE MARK CONSISTS OF "DANBRO DISTRIBUTORS" NAME, WITH A DEPICTION OF A HELICAL PILE.

SER. NO. 85-576,948, FILED 3-22-2012.

PRISCILLA MILTON, EXAMINING ATTORNEY



*David J. Kybas*

Director of the United States Patent and Trademark Office

# United States of America

United States Patent and Trademark Office



**Reg. No. 4,274,594**

JANE E. SUTTER (UNITED STATES INDIVIDUAL)  
7376 PERSHING BOULEVARD  
ST. LOUIS, MO 63130

**Registered Jan. 15, 2013**

**Int. Cl.: 41**

FOR: PROVIDING A WEBSITE OFFERING INFORMATION ON THE SUBJECT OF THE PROTECTION AND PRESERVATION OF MIGRATORY BIRDS AND THEIR HABITATS, IN CLASS 41 (U.S. CLS. 100, 101 AND 107).

**SERVICE MARK**

FIRST USE 10-11-2002; IN COMMERCE 10-11-2002.

**PRINCIPAL REGISTER**

THE MARK CONSISTS OF A HUMMINGBIRD IN FLIGHT SUPERIMPOSED OVER A HANDPRINT.

SER. NO. 85-576,959, FILED 3-22-2012.

SAIMA MAKHDOOM, EXAMINING ATTORNEY



*David J. Kybas*

Director of the United States Patent and Trademark Office

# United States of America

United States Patent and Trademark Office

# BAIN

**Reg. No. 4,274,595**

**Registered Jan. 15, 2013**

**Int. Cls.: 35 and 36**

**SERVICE MARK**

**PRINCIPAL REGISTER**

BAIN & COMPANY INC. (MASSACHUSETTS CORPORATION)  
131 DARTMOUTH STREET  
BOSTON, MA 02116

FOR: BUSINESS MANAGEMENT AND CONSULTATION, IN CLASS 35 (U.S. CLS. 100, 101 AND 102).

FIRST USE 4-0-1973; IN COMMERCE 4-0-1973.

FOR: FINANCIAL ANALYSIS AND CONSULTATION, IN CLASS 36 (U.S. CLS. 100, 101 AND 102).

FIRST USE 4-0-1973; IN COMMERCE 4-0-1973.

THE MARK CONSISTS OF STANDARD CHARACTERS WITHOUT CLAIM TO ANY PARTICULAR FONT, STYLE, SIZE, OR COLOR.

OWNER OF U.S. REG. NOS. 2,725,433, 2,782,558, AND 3,805,364.

SER. NO. 85-577,226, FILED 3-22-2012.

SUNG IN, EXAMINING ATTORNEY



*David J. Kyfos*

Director of the United States Patent and Trademark Office

# United States of America

United States Patent and Trademark Office



**Reg. No. 4,274,596**

**Registered Jan. 15, 2013**

**Int. Cl.: 25**

**TRADEMARK**

**PRINCIPAL REGISTER**

JIMMY ROLLINS ENTERTAINMENT GROUP, LLC (NEW JERSEY LIMITED LIABILITY COMPANY)

C/O CHRISTOPHER J. CABOTT, ESQ.  
1650 MARKET STREET, 56TH FLOOR  
PHILADELPHIA, PA 19103

FOR: BASEBALL CAPS AND HATS; HATS; HEADGEAR, NAMELY, HATS; SHORT-SLEEVED OR LONG-SLEEVED T-SHIRTS; SPORTS CAPS AND HATS; T-SHIRTS, IN CLASS 25 (U.S. CLS. 22 AND 39).

FIRST USE 8-12-2011; IN COMMERCE 8-12-2011.

THE MARK CONSISTS OF THE NUMBER 11 EMBODIED INSIDE THE LETTERS "J" AND "R," AS VIEWED SIDE BY SIDE FROM LEFT TO RIGHT.

SER. NO. 85-577,569, FILED 3-22-2012.

ARETHA SOMERVILLE, EXAMINING ATTORNEY



*David J. Kybas*

Director of the United States Patent and Trademark Office



United States of America  
United States Patent and Trademark Office

**BYXAS**

**Reg. No. 4,274,597**

**Registered Jan. 15, 2013**

**Int. Cl.: 8**

VISION INVESTMENT INTERNATIONAL (HONGKONG) LIMITED (CHINA LIMITED COMPANY)  
UNIT 04 7/F BRIGHT WAY TOWER 33 MONG  
KOK, ROAD KL  
HONG KONG, CHINA

**TRADEMARK**

**PRINCIPAL REGISTER**

FOR: TOOLS AND HAND TOOLS, NAMELY, SHOVELS, SAWS, WRENCHES, HAMMERS, PLIERS, SCREWDRIVERS, RATCHETS, NAMELY, RATCHET WRENCHES, TWEEZERS, SCISSORS, BLADES FOR HAND SAWS, RIVETERS, DRILLS, FILES, GOUGES, HATCHETS, HAND-OPERATED GARDEN TOOLS, NAMELY, CULTIVATORS, ABRADING TOOLS, SQUARES, SAW BLADES, NAMELY, BLADES FOR HAND SAWS, MALLET, PLANES, RASPS, NAMELY, CALLUS RASPS, HAND-OPERATED SCRAPING TOOL FOR CLEANING CLEFTS FOR ATTACHMENT TO SPORTS SHOES, NIPPERS, PINNERS, HAND-OPERATED LIFTING JACKS, PUNCHES; NON-ELECTRIC HAND TOOLS, NAMELY, PARING IRONS, IN CLASS 8 (U.S. CLS. 23, 28 AND 44).

FIRST USE 5-5-2011; IN COMMERCE 5-5-2011.

THE MARK CONSISTS OF THE WORDING "BYXAS" WITH THE "BY" AND "AS" IN STYLIZED FONT AND SOLID, AND THE LETTER "X" APPEARING IN STRIPES WITH A SOLID CIRCLE IN THE MIDDLE OF IT.

SER. NO. 85-577,858, FILED 3-23-2012.

WANDA KAY PRICE, EXAMINING ATTORNEY



*David J. Kybas*

Director of the United States Patent and Trademark Office

# United States of America

United States Patent and Trademark Office



**Reg. No. 4,274,598**

**Registered Jan. 15, 2013**

**Int. Cl.: 35**

**SERVICE MARK**

**PRINCIPAL REGISTER**

OLDCASTLE SOUTHERN GROUP, INC. (GEORGIA CORPORATION), DBA CONRAD YELVINGTON DISTRIBUTORS, INC.  
C/O OLDCASTLE LAW GROUP  
900 ASHWOOD PARKWAY  
ATLANTA, GA 30338

FOR: DISTRIBUTORSHIP OF CONSTRUCTION MATERIALS AND CONSTRUCTION AGGREGATES IN THE NATURE OF HARDROCK, GRAVEL, SILICIA SAND, GRANITE, LIGHTWEIGHT AGGREGATES, DECORATIVE LANDSCAPING AGGREGATES, TRAP ROCK, RIP RAP, GABION STONE, CLAY, LIMESTONE AGGREGATES, SOD LAVA ROCK AND VARIOUS FORMS OF ASH PRODUCTS TO WHOLESALE AND RETAIL CUSTOMERS, IN CLASS 35 (U.S. CLS. 100, 101 AND 102).

FIRST USE 4-4-1988; IN COMMERCE 6-2-1988.

OWNER OF U.S. REG. NO. 2,478,806.

NO CLAIM IS MADE TO THE EXCLUSIVE RIGHT TO USE "DISTRIBUTORS, INC.", APART FROM THE MARK AS SHOWN.

THE NAME(S), PORTRAIT(S), AND/OR SIGNATURE(S) SHOWN IN THE MARK IDENTIFIES "CONRAD YELVINGTON", WHOSE CONSENT(S) TO REGISTER IS MADE OF RECORD.

THE MARK CONSISTS OF PLAIN SINGLE LINE TRIANGLES IN THE FORM OF THREE TRIANGLES TOUCHING OR INTERSECTING TRIANGLES THAT ARE COMPLETELY OR PARTIALLY SHADED, ABOVE THE UNDERLINED WORDS "CONRAD YELVINGTON," WITH THE WORDS "DISTRIBUTORS, INC." BENEATH.

SER. NO. 85-578,687, FILED 3-23-2012.

VIVIAN MICZNIK FIRST, EXAMINING ATTORNEY



*David J. Kybas*

Director of the United States Patent and Trademark Office

# United States of America

United States Patent and Trademark Office



**Reg. No. 4,274,599**

**Registered Jan. 15, 2013**

**Int. Cl.: 25**

**TRADEMARK**

**PRINCIPAL REGISTER**

XPRO INC. (MARYLAND CORPORATION)  
11821 CENTURION WAY  
POTOMAC, MD 20854

FOR: ATHLETIC APPAREL, NAMELY, SHIRTS, PANTS, JACKETS, FOOTWEAR, HATS AND CAPS, ATHLETIC UNIFORMS, IN CLASS 25 (U.S. CLS. 22 AND 39).

FIRST USE 1-1-2012; IN COMMERCE 1-1-2012.

THE MARK CONSISTS OF THE STYLIZED LETTERS "XP" WHERE THE "X" IS FORMED BY A SWOOPING ARC AND THE "P" IS THE SWOOPING ARC THAT CROSSES THROUGH THE LEG OF THE FORMED "X".

SER. NO. 85-579,264, FILED 3-25-2012.

PRISCILLA MILTON, EXAMINING ATTORNEY



*David J. Kyffers*

Director of the United States Patent and Trademark Office

# United States of America

United States Patent and Trademark Office



**Reg. No. 4,274,600**

**Registered Jan. 15, 2013**

**Int. Cl.: 35**

**SERVICE MARK**

**PRINCIPAL REGISTER**

CONSUMER SOURCE HOLDINGS INC. (DELAWARE CORPORATION)  
3585 ENGINEERING DRIVE  
NORCROSS, GA 30092

FOR: ADVERTISING REAL PROPERTY FOR SALE BY OTHERS VIA THE INTERNET;  
PROVIDING CONSUMER INFORMATION AND CONSUMER BUSINESS ADVICE IN THE  
FIELD OF HOME BUYING VIA THE INTERNET, IN CLASS 35 (U.S. CLS. 100, 101 AND  
102).

FIRST USE 10-0-2009; IN COMMERCE 10-0-2009.

OWNER OF U.S. REG. NO. 3,105,952.

NO CLAIM IS MADE TO THE EXCLUSIVE RIGHT TO USE "AMERICAN" AND  
"HOMEGUIDES.COM", APART FROM THE MARK AS SHOWN.

THE MARK CONSISTS OF THE WORD "AMERICAN" IN UPPER CASE WITH A TALL  
INITIAL LETTER "A", AND BELOW THE WORD ARE A DRAWING OF A HOUSE WITH A  
SHADED BACKGROUND ON THE LEFT SIDE AND THE WORDING "HOMEGUIDES.COM"  
IN SMALLER FONT.

SER. NO. 85-579,511, FILED 3-26-2012.

ELISSA GARBER KON, EXAMINING ATTORNEY



*David J. Kybas*

Director of the United States Patent and Trademark Office

# United States of America

United States Patent and Trademark Office

# MASK LAB

**Reg. No. 4,274,601**

**Registered Jan. 15, 2013**

**Int. Cl.: 42**

**SERVICE MARK**

**PRINCIPAL REGISTER**

COMPOSITE EFFECTS, LLC (LOUISIANA LIMITED LIABILITY COMPANY)  
6786 PECUE LANE, SUITE I  
BATON ROUGE, LA 70817

FOR: COMPUTER SERVICES, NAMELY, PROVIDING AN INTERACTIVE WEBSITE WHICH  
ALLOWS USERS TO CREATE MASKS, GLOVES OR OTHER THEATRICAL PROPS , IN  
CLASS 42 (U.S. CLS. 100 AND 101).

FIRST USE 2-29-2012; IN COMMERCE 2-29-2012.

THE MARK CONSISTS OF STANDARD CHARACTERS WITHOUT CLAIM TO ANY PAR-  
TICULAR FONT, STYLE, SIZE, OR COLOR.

NO CLAIM IS MADE TO THE EXCLUSIVE RIGHT TO USE "MASK", APART FROM THE  
MARK AS SHOWN.

SER. NO. 85-579,922, FILED 3-26-2012.

MAYUR VAGHANI, EXAMINING ATTORNEY



*David J. Kyros*

Director of the United States Patent and Trademark Office

# United States of America

United States Patent and Trademark Office



# Outlaw

**Reg. No. 4,274,602**

**Registered Jan. 15, 2013**

**Int. Cl.: 9**

**TRADEMARK**

**PRINCIPAL REGISTER**

OUTLAW AUDIO, LLC (MASSACHUSETTS LIMITED LIABILITY COMPANY)  
P.O. BOX 975  
EASTON, MA 02334

FOR: AUDIO AND VIDEO EQUIPMENT, NAMELY, AMPLIFIERS, RECEIVERS, SURROUND PROCESSORS, PRE-AMPLIFIERS, CABLES AND INTERCONNECTS FOR TRANSMISSION OF SOUND AND IMAGES, BASS MANAGEMENT DEVICES FOR USE WITH ANALOG AND DIGITAL AUDIO THAT PERMIT THE REDIRECTION AND INDIVIDUAL CONTROL OF THE BASS FROM ALL CHANNELS TO ONE OR MORE INDIVIDUAL SPEAKERS OR SUBWOOFERS, SPEAKERS, SUB-WOOFERS, TRANSDUCERS, WIRELESS AUDIO TRANSMITTERS, WIRELESS AUDIO RECEIVERS, SURROUND SOUND SPEAKER BAR, RADIOS AND DVD-CASES, IN CLASS 9 (U.S. CLS. 21, 23, 26, 36 AND 38).

FIRST USE 12-31-2003; IN COMMERCE 12-31-2003.

OWNER OF U.S. REG. NOS. 1,901,533, 2,680,765, AND 3,067,301.

THE MARK CONSISTS OF A HORSE AND RIDER DESIGN ENCIRCLED BY AN OVAL LINE DRAWING WHICH IS TO THE LEFT OF THE WORD "OUTLAW" IN STYLIZED LETTERING.

SER. NO. 85-580,209, FILED 3-26-2012.

HEATHER BIDDULPH, EXAMINING ATTORNEY



*David J. Kybas*

Director of the United States Patent and Trademark Office

# United States of America

United States Patent and Trademark Office

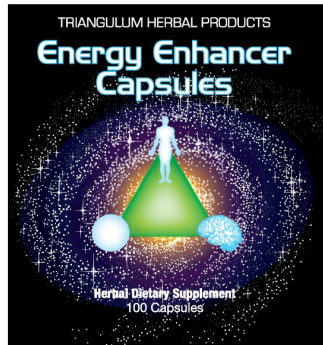

**Reg. No. 4,274,603**

TRIANGULUM HERBAL PRODUCTS LLC (TEXAS LIMITED LIABILITY COMPANY)  
3100 STONE EDGE RD.  
EL PASO, TX 79904

**Registered Jan. 15, 2013**

**Int. Cl.: 5**

FOR: DIETARY FOOD SUPPLEMENTS FOR ENERGY ENHANCEMENT, IN CLASS 5 (U.S. CLS. 6, 18, 44, 46, 51 AND 52).

**TRADEMARK**

FIRST USE 7-19-2011; IN COMMERCE 1-10-2012.

**PRINCIPAL REGISTER**

NO CLAIM IS MADE TO THE EXCLUSIVE RIGHT TO USE "HERBAL PRODUCTS", "ENERGY ENHANCER CAPSULES", "HERBAL DIETARY SUPPLEMENT" OR "100 CAPSULES", APART FROM THE MARK AS SHOWN.

THE COLOR(S) GREEN, BLUE, BLACK, WHITE, YELLOW, ORANGE, AND PURPLE IS/ARE CLAIMED AS A FEATURE OF THE MARK.

THE MARK CONSISTS OF A GREEN TRIANGLE THAT IS LIGHTER GREEN IN THE CENTER. THERE IS A WHITE AND LIGHT BLUE SILHOUETTE OF A HUMAN BODY AT THE TOP POINT OF THE TRIANGLE, A WHITE AND LIGHT BLUE BRAIN ON THE BOTTOM RIGHT POINT OF THE TRIANGLE, AND A WHITE AND LIGHT BLUE CIRCLE REPRESENTING THE HUMAN SOUL ON THE BOTTOM LEFT OF THE TRIANGLE. ALL OF THIS IS SUPERIMPOSED ON A BLACK RECTANGULAR BACKGROUND THAT DISPLAYS WHITE STARS IN AN ELLIPTICAL, SPIRALING, GALAXY. AROUND THE GREEN TRIANGLE IS A HALO OF YELLOW AND ORANGE SIMILAR TO THE COLOR OF A SUN. THE AREA BETWEEN THE RINGS OF STARS AROUND THE YELLOW AND ORANGE HALO IS PURPLE. AT THE TOP OF THE RECTANGLE IS THE WHITE STYLIZED TEXT "TRIANGULUM HERBAL PRODUCTS". BELOW THIS TEXT IS THE STYLIZED TEXT "ENERGY ENHANCER" WHICH IS WHITE WITH A LIGHT BLUE BORDER. BELOW THIS TEXT IS THE STYLIZED TEXT "CAPSULES" THAT IS WHITE WITH A LIGHT BLUE BORDER. BELOW THE GREEN TRIANGLE IS THE WHITE STYLIZED TEXT "HERBAL DIETARY SUPPLEMENT" ABOVE THE WHITE STYLIZED TEXT "100 CAPSULES".



SER. NO. 85-580,239, FILED 3-26-2012.

*David J. Kappas*

BARBARA GAYNOR, EXAMINING ATTORNEY

# United States of America

United States Patent and Trademark Office

## FREEZERWORKS

**Reg. No. 4,274,604**

DATAWORKS DEVELOPMENT, INC. (WASHINGTON CORPORATION)  
6608 216TH ST SW STE 100  
MOUNTLAKE TERRACE, WA 98043

**Registered Jan. 15, 2013**

**Int. Cl.: 9**

FOR: COMPUTER SOFTWARE FOR CREATING SEARCHABLE DATABASES OF INFORMATION AND DATA; COMPUTER SOFTWARE FOR LABORATORY INVENTORY; DATABASE MANAGEMENT SOFTWARE FOR LABORATORY FREEZER INVENTORY, IN CLASS 9 (U.S. CLS. 21, 23, 26, 36 AND 38).

**TRADEMARK**

**PRINCIPAL REGISTER**

FIRST USE 4-1-1992; IN COMMERCE 4-1-1992.

THE MARK CONSISTS OF STANDARD CHARACTERS WITHOUT CLAIM TO ANY PARTICULAR FONT, STYLE, SIZE, OR COLOR.

SER. NO. 85-580,952, FILED 3-27-2012.

KIMBERLY PARKS, EXAMINING ATTORNEY



*David J. Kyros*

Director of the United States Patent and Trademark Office



# United States of America

United States Patent and Trademark Office

# HENNA HUT

**Reg. No. 4,274,605**

MOONDYIE INC. (TEXAS CORPORATION), DBA HENNA HUT  
25319 RAYFORD CREST DR.  
SPRING, TX 77386

**Registered Jan. 15, 2013**

**Int. Cl.: 3**

FOR: ANTI-WRINKLE CREAMS; BATH OILS AND BATH SALTS; BATH SALTS; BEARD DYES; BODY LOTION; BODY OILS; COSMETIC BATH SALTS; FACE AND BODY LOTIONS; FACIAL BEAUTY MASKS; HAIR COLOR; HAIR COLORANTS; HAIR COLORING PREPARATIONS; HENNA FOR COSMETIC PURPOSES; LIP BALM; MASSAGE OILS; NATURAL COCOA BUTTER BASED PERSONAL CARE PRODUCTS, NAMELY, BODY LOTION, SHOWER GEL, SOAP, BODY POLISH, BODY AND FOOT SCRUB AND NON-MEDICATED SKIN CREAMS; NON-MEDICATED FOOT CREAM; SHAMPOOS; SHOWER AND BATH GEL; SHOWER CREAMS; SHOWER GEL, IN CLASS 3 (U.S. CLS. 1, 4, 6, 50, 51 AND 52).

**TRADEMARK**

**PRINCIPAL REGISTER**

FIRST USE 4-0-2007; IN COMMERCE 4-0-2007.

THE MARK CONSISTS OF STANDARD CHARACTERS WITHOUT CLAIM TO ANY PARTICULAR FONT, STYLE, SIZE, OR COLOR.

NO CLAIM IS MADE TO THE EXCLUSIVE RIGHT TO USE "HENNA", APART FROM THE MARK AS SHOWN.

SER. NO. 85-581,298, FILED 3-27-2012.

JENNIFER MARTIN, EXAMINING ATTORNEY



*David J. Kypos*

Director of the United States Patent and Trademark Office

# United States of America

United States Patent and Trademark Office



**Reg. No. 4,274,606**

**Registered Jan. 15, 2013**

**Int. Cls.: 9, 16 and 41**

**TRADEMARK**

**SERVICE MARK**

**PRINCIPAL REGISTER**

SPLENDOR IN THE RAW, LLC (OREGON LIMITED LIABILITY COMPANY), DBA  
CHEFTINAJO.COM  
757 EMORY ST. #563  
IMPERIAL BEACH, CA 91932

FOR: DIGITAL MEDIA, NAMELY, PRE-RECORDED DVDS, DOWNLOADABLE AUDIO AND VIDEO RECORDINGS, AND CDS IN THE FIELD OF VEGAN AND RAW VEGAN CULINARY PREPARATION, IN CLASS 9 (U.S. CLS. 21, 23, 26, 36 AND 38).

FIRST USE 2-24-2012; IN COMMERCE 2-24-2012.

FOR: A SERIES OF BOOKS, WRITTEN ARTICLES, HANDOUTS AND WORKSHEETS IN THE FIELD OF VEGAN AND RAW VEGAN CULINARY PREPARATION, IN CLASS 16 (U.S. CLS. 2, 5, 22, 23, 29, 37, 38 AND 50).

FIRST USE 7-27-2010; IN COMMERCE 7-27-2010.

FOR: EDUCATION SERVICES, NAMELY, MENTORING IN THE FIELD OF VEGAN AND RAW VEGAN CULINARY PREPARATION; EDUCATION SERVICES, NAMELY, PROVIDING LIVE AND ON-LINE CLASSES, SEMINARS AND WORKSHOPS IN THE FIELD OF VEGAN AND RAW VEGAN CULINARY PREPARATION; EDUCATION SERVICES, NAMELY, PROVIDING TUTORING IN THE FIELD OF VEGAN AND RAW VEGAN CULINARY PREPARATION; EDUCATIONAL SERVICES, NAMELY, CONDUCTING PROGRAMS IN THE FIELD OF VEGAN AND RAW VEGAN CULINARY PREPARATION; EDUCATIONAL SERVICES, NAMELY, CONDUCTING CLASSES, SEMINARS, CONFERENCES, WORKSHOPS AND RETREATS IN THE FIELDS OF VEGAN AND RAW VEGAN CULINARY PREPARATION AND DISTRIBUTION OF TRAINING MATERIALS IN CONNECTION THEREWITH, IN CLASS 41 (U.S. CLS. 100, 101 AND 107).

FIRST USE 7-27-2010; IN COMMERCE 7-27-2010.

OWNER OF U.S. REG. NO. 4,008,613.

THE COLOR(S) OF BROWN, DIFFERENT SHADES OF GREEN, AND RED IS/ARE CLAIMED AS A FEATURE OF THE MARK.



*David J. Kybas*

Director of the United States Patent and Trademark Office

**Reg. No. 4,274,606** NO CLAIM IS MADE TO THE EXCLUSIVE RIGHT TO USE "CHEF" AND "RAW", APART FROM THE MARK AS SHOWN.

THE NAME(S), PORTRAIT(S), AND/OR SIGNATURE(S) SHOWN IN THE MARK IDENTIFIES "TINA JO" STEPHENS, WHOSE CONSENT(S) TO REGISTER IS MADE OF RECORD.

THE MARK CONSISTS OF A TREE GROWING OUT OF BROWN FORK WITH DIFFERENT COLORED GREEN LEAVES AND RED LEAVES WITH THE WORDS "CHEF" (IN GREEN) "TINA JO" (IN RED) UNDER A TREE AND OVER A GREEN LINE WITH THE WORDS "REAL LIFE RAW" IN BROWN UNDER THE LINE.

SEC. 2(F).

SER. NO. 85-581,493, FILED 3-27-2012.

STEVEN R. FINE, EXAMINING ATTORNEY

# United States of America

United States Patent and Trademark Office

# TALENTFiRST

**Reg. No. 4,274,607**

**Registered Jan. 15, 2013**

**Int. Cl.: 42**

**SERVICE MARK**

**PRINCIPAL REGISTER**

GUPTA, RISHAV (UNITED STATES INDIVIDUAL)  
60 ANDERSON AVENUE  
ENGLEWOOD CLIFFS, NJ 07632

FOR: ADVISORY SERVICES IN THE FIELD OF PRODUCT DEVELOPMENT AND QUALITY IMPROVEMENT OF SOFTWARE; APPLICATION SERVICE PROVIDER (ASP) FEATURING SOFTWARE FOR USE IN DATA PROCESSING IN THE FIELD OF RECRUITMENT; APPLICATION SERVICE PROVIDER (ASP), NAMELY, HOSTING COMPUTER SOFTWARE APPLICATIONS OF OTHERS; APPLICATION SERVICE PROVIDER FEATURING APPLICATION PROGRAMMING INTERFACE (API) SOFTWARE FOR DATABASE MANAGEMENT; APPLICATION SERVICE PROVIDER, NAMELY, HOSTING, MANAGING, DEVELOPING, ANALYZING, AND MAINTAINING APPLICATIONS, SOFTWARE, AND WEB SITES, OF OTHERS IN THE FIELDS OF HEALTHCARE, BENEFITS PROGRAMS, EMPLOYEE PRODUCTIVITY, RISK MANAGEMENT; APPLICATION SERVICE PROVIDER, NAMELY, HOSTING, MANAGING, DEVELOPING, AND MAINTAINING APPLICATIONS, SOFTWARE, AND WEB SITES, IN THE FIELDS OF PERSONAL PRODUCTIVITY, WIRELESS COMMUNICATION, MOBILE INFORMATION ACCESS, AND REMOTE DATA MANAGEMENT FOR WIRELESS DELIVERY OF CONTENT TO HANDHELD COMPUTERS, LAPTOPS AND MOBILE ELECTRONIC DEVICES; BUSINESS TECHNOLOGY SOFTWARE CONSULTATION SERVICES; COMPUTER CO-LOCATION SERVICES, NAMELY, PROVIDING FACILITIES FOR THE LOCATION OF COMPUTER SERVERS WITH THE EQUIPMENT OF OTHERS; COMPUTER CONSULTATION; COMPUTER CONSULTATION IN THE FIELD OF COMPUTER SECURITY; COMPUTER MONITORING SERVICE WHICH TRACKS APPLICATION SOFTWARE PERFORMANCE, PERFORMS PERIODIC MAINTENANCE AND PROVIDES REPORTS AND ALERTS CONCERNING SUCH PERFORMANCE; COMPUTER NETWORK CONFIGURATION SERVICES; COMPUTER NETWORK DESIGN AND COMPUTER SOFTWARE DESIGN FOR THE STAFFING INDUSTRY; COMPUTER NETWORK DESIGN FOR OTHERS; COMPUTER PROGRAMMING AND COMPUTER SYSTEM ANALYSIS; COMPUTER PROGRAMMING AND MAINTENANCE OF COMPUTER PROGRAMS; COMPUTER PROGRAMMING AND RENTAL OF COMPUTER PROGRAMS; COMPUTER PROGRAMMING AND SOFTWARE DESIGN; COMPUTER PROGRAMMING CONSULTANCY; COMPUTER PROGRAMMING SERVICES FOR OTHERS IN THE FIELD OF SOFTWARE CONFIGURATION MANAGEMENT; COMPUTER PROGRAMMING SERVICES FOR STAFFING INDUSTRY; COMPUTER SECURITY CONSULTANCY; COMPUTER SERVICES, NAMELY, CLOUD HOSTING PROVIDER SERVICES; COMPUTER SERVICES, NAMELY, COMPUTER SYSTEM ADMINISTRATION FOR OTHERS; COMPUTER SERVICES, NAMELY, INTEGRATION OF COMPUTER SOFTWARE INTO MULTIPLE SYSTEMS AND NETWORKS; COMPUTER



*David J. Kyros*

Director of the United States Patent and Trademark Office

**Reg. No. 4,274,607** SERVICES, NAMELY, REMOTE MANAGEMENT OF DATABASES FOR OTHERS; COMPUTER SOFTWARE CONSULTING; COMPUTER SOFTWARE DESIGN AND UPDATING; COMPUTER SOFTWARE DESIGN FOR OTHERS; COMPUTER SOFTWARE DEVELOPMENT AND COMPUTER PROGRAMMING DEVELOPMENT FOR OTHERS; COMPUTER SOFTWARE DEVELOPMENT IN THE FIELD OF MOBILE APPLICATIONS; COMPUTER SOFTWARE DEVELOPMENT IN THE FIELD OF RECRUITMENT; COMPUTER SOFTWARE DEVELOPMENT, COMPUTER PROGRAMMING AND MAINTENANCE OF COMPUTER SOFTWARE FOR RECRUITING INDUSTRY; COMPUTER SOFTWARE INSTALLATION AND MAINTENANCE; COMPUTER SOFTWARE RENTAL; CONSULTANCY IN THE FIELD OF SOFTWARE DESIGN; CONSULTING SERVICES IN THE FIELD OF COMPUTER-BASED INFORMATION SYSTEMS FOR BUSINESSES; CONSULTING SERVICES IN THE FIELD OF HOSTING COMPUTER SOFTWARE APPLICATIONS; CONSULTING SERVICES IN THE FIELD OF OFFICE AND WORKPLACE AUTOMATION; CONSULTING SERVICES IN THE FIELD OF PROVIDING ONLINE, NON-DOWNLOADABLE SOFTWARE AND APPLICATIONS; CONSULTING SERVICES IN THE FIELD OF SEARCH ENGINE OPTIMIZATION; CREATING, MAINTAINING, AND MODERNIZING COMPUTER SOFTWARE; CUSTOMIZING COMPUTER SOFTWARE; DATABASE DESIGN AND DEVELOPMENT; DATABASE DEVELOPMENT SERVICES; DESIGN AND DEVELOPMENT OF COMPUTER SOFTWARE; DESIGN AND DEVELOPMENT OF COMPUTER SOFTWARE FOR THE IMPROVEMENTS OF PURCHASING FUNCTIONS OF BUSINESS; DESIGN AND DEVELOPMENT OF COMPUTER SOFTWARE FOR HOSTING CUSTOMER DATABASES; DESIGN AND DEVELOPMENT OF ELECTRONIC DATA SECURITY SYSTEMS; DESIGN AND DEVELOPMENT OF ON-LINE COMPUTER SOFTWARE SYSTEMS; DESIGN AND DEVELOPMENT OF WIRELESS COMMUNICATION SYSTEMS FOR TRANSMISSION AND RECEPTION OF VOICE, DATA AND VIDEO; DESIGN AND DEVELOPMENT OF WIRELESS COMPUTER NETWORKS; DESIGN AND WRITING OF COMPUTER SOFTWARE; DESIGN OF COMPUTER DATABASE; DESIGN OF COMPUTER NETWORKS AND SOFTWARE FOR OTHERS FOR THE STAFFING INDUSTRY; DESIGN, DEPLOYMENT AND MANAGEMENT OF WIRELESS NETWORKS FOR OTHERS; DESIGN, DEVELOPMENT AND IMPLEMENTATION OF SOFTWARE; DESIGN, DEVELOPMENT, AND IMPLEMENTATION OF SOFTWARE FOR SYSTEM SECURITY AND DATABASE SECURITY; DESIGN, DEVELOPMENT, INSTALLATION AND MAINTENANCE OF COMPUTER SOFTWARE; DESIGN, INSTALLATION, UPDATING AND MAINTENANCE OF COMPUTER SOFTWARE; DESIGN, MAINTENANCE, DEVELOPMENT AND UPDATING OF COMPUTER SOFTWARE; DESIGN, UPDATING AND RENTAL OF COMPUTER SOFTWARE; DESIGN, UPGRADING AND RENTAL OF COMPUTER SOFTWARE; DEVELOPING AND UPDATING COMPUTER SOFTWARE; DEVELOPING COMPUTER SOFTWARE; DEVELOPING CUSTOMIZED SOFTWARE FOR OTHERS; DEVELOPING CUSTOMIZED SOFTWARE IN THE FIELD OF STAFFING FOR OTHERS; DEVELOPING CUSTOMIZED WEB PAGES AND OTHER DATA FEED FORMATS FEATURING USER-DEFINED INFORMATION; DEVELOPMENT OF SOFTWARE FOR SECURE NETWORK OPERATIONS; DEVELOPMENT, UPDATING AND MAINTENANCE OF SOFTWARE AND DATA BASES; FILE SHARING SERVICES, NAMELY, PROVIDING A WEBSITE FEATURING TECHNOLOGY ENABLING USERS TO UPLOAD AND DOWNLOAD ELECTRONIC FILES; HOSTING OF DIGITAL CONTENT ON THE INTERNET; INSTALLATION AND MAINTENANCE OF COMPUTER SOFTWARE; INSTALLATION, MAINTENANCE AND REPAIR OF SOFTWARE FOR COMPUTER SYSTEMS; MAINTENANCE AND UPDATING OF COMPUTER SOFTWARE; MAINTENANCE AND UPGRADING OF COMPUTER SOFTWARE; MAINTENANCE OF ON-LINE DATABASES FOR OTHERS; MAINTENANCE OF SOFTWARE FOR INTERNET ACCESS; MAPPING; PREPARATION, UPDATE, INSTALLATION AND MAINTENANCE OF COMPUTER SOFTWARE; PROGRAMMING OF COMPUTER SOFTWARE FOR OTHERS; PROVIDING A WEBSITE FEATURING TECHNOLOGY THAT ENABLES SUBSCRIBERS TO TRANSFER FILES TO AND FROM A FILE TRANSFER PROTOCOL SERVER; PROVIDING AN ON-LINE NETWORK ENVIRONMENT THAT FEATURES TECHNOLOGY THAT ENABLES USERS TO SHARE DATA; PROVIDING AN ONLINE NETWORK SERVICE THAT ENABLES USERS TO SHARE DATA IN THE FIELD OF STAFFING; RECOVERY OF COMPUTER DATA; REMOTE COMPUTER BACKUP SERVICES; REMOTE ONLINE BACKUP OF COMPUTER DATA; RENTAL AND MAINTENANCE OF COMPUTER SOFTWARE; RENTAL OF A DATABASE SERVER (TO THIRD PARTIES);

**Reg. No. 4,274,607** RENTAL OF APPLICATION SOFTWARE; RENTAL OF COMPUTER SOFTWARE AND PROGRAMS; RENTING COMPUTER SOFTWARE; REPAIR OF COMPUTER SOFTWARE; REPAIR OF SOFTWARE; RESEARCH, DEVELOPMENT, DESIGN AND UPGRADING OF COMPUTER SOFTWARE; SOFTWARE DESIGN AND DEVELOPMENT; TECHNICAL SUPPORT SERVICES, NAMELY, 24X7 MONITORING OF NETWORK SYSTEMS, SERVERS AND WEB AND DATABASE APPLICATIONS AND NOTIFICATION OF RELATED EVENTS AND ALERTS; TECHNICAL SUPPORT SERVICES, NAMELY, INSTALLATION, ADMINISTRATION, AND TROUBLESHOOTING OF WEB AND DATABASE APPLICATIONS; TECHNICAL SUPPORT SERVICES, NAMELY, MIGRATION OF DATACENTER, SERVER AND DATABASE APPLICATIONS; TECHNICAL SUPPORT SERVICES, NAMELY, REMOTE ADMINISTRATION AND MANAGEMENT OF IN-HOUSE AND HOSTED DATACENTER DEVICES, DATABASES AND SOFTWARE APPLICATIONS; TECHNICAL SUPPORT SERVICES, NAMELY, REMOTE AND ON-SITE INFRASTRUCTURE MANAGEMENT SERVICES FOR MONITORING, ADMINISTRATION AND MANAGEMENT OF PUBLIC AND PRIVATE CLOUD COMPUTING IT AND APPLICATION SYSTEMS; TECHNICAL SUPPORT SERVICES, NAMELY, TECHNICAL ADMINISTRATION OF SERVERS FOR OTHERS AND TROUBLESHOOTING IN THE NATURE OF DIAGNOSING SERVER PROBLEMS; TECHNICAL SUPPORT SERVICES, NAMELY, TROUBLESHOOTING OF COMPUTER SOFTWARE PROBLEMS; TECHNICAL SUPPORT, NAMELY, MONITORING OF NETWORK SYSTEMS; TESTING OF SECURITY SYSTEMS; UPDATING AND DESIGN OF COMPUTER SOFTWARE; UPDATING AND MAINTENANCE OF COMPUTER SOFTWARE; UPDATING AND RENTAL OF SOFTWARE FOR DATA PROCESSING; UPDATING OF COMPUTER PROGRAMS FOR THIRD PARTIES; UPDATING OF COMPUTER SOFTWARE FOR OTHERS, IN CLASS 42 (U.S. CLS. 100 AND 101).

FIRST USE 3-1-2005; IN COMMERCE 3-1-2005.

THE MARK CONSISTS OF STANDARD CHARACTERS WITHOUT CLAIM TO ANY PARTICULAR FONT, STYLE, SIZE, OR COLOR.

SER. NO. 85-582,837, FILED 3-28-2012.

DEIRDRE ROBERTSON, EXAMINING ATTORNEY

# United States of America

United States Patent and Trademark Office



**Reg. No. 4,274,608**

LAYTON, ROBIN (UNITED STATES INDIVIDUAL)  
1501 LAKE WASHINGTON BLVD.  
SEATTLE, WA 98122

**Registered Jan. 15, 2013**

**Int. Cl.: 9**

FOR: COMPUTER APPLICATION SOFTWARE FOR MOBILE PHONES, NAMELY, ENTERTAINMENT AND STRESS MANAGEMENT SOFTWARE FOR VIEWING DIGITAL IMAGES AND PHOTOGRAPHS WITH ACCOMPANYING MUSIC, IN CLASS 9 (U.S. CLS. 21, 23, 26, 36 AND 38).

**TRADEMARK**

**PRINCIPAL REGISTER**

FIRST USE 3-22-2012; IN COMMERCE 3-22-2012.

NO CLAIM IS MADE TO THE EXCLUSIVE RIGHT TO USE "RELIEF", APART FROM THE MARK AS SHOWN.

THE MARK CONSISTS OF A SQUARE WITH ROUNDED EDGES. INSIDE THE SQUARE IS THE CAPITAL LETTER "R" ABOVE THE WORD "RELIEF." THE TOP OF THE SQUARE IS A LIGHTER COLOR GRADUALLY GETTING DARKER AS IT MOVES TO THE BOTTOM OF THE SQUARE.

SER. NO. 85-582,896, FILED 3-28-2012.

NATALIE POLZER, EXAMINING ATTORNEY



*David J. Kyjars*

Director of the United States Patent and Trademark Office

# United States of America

United States Patent and Trademark Office

## TriMerge BPO

**Reg. No. 4,274,609**

**Registered Jan. 15, 2013**

**Int. Cl.: 36**

**SERVICE MARK**

**PRINCIPAL REGISTER**

LANDMARK NETWORK, INC (NEVADA CORPORATION)  
SUITE 202  
4312 WOODMAN AVENUE  
SHERMAN OAKS, CA 91423

FOR: REAL ESTATE VALUATIONS, IN CLASS 36 (U.S. CLS. 100, 101 AND 102).

FIRST USE 10-15-2011; IN COMMERCE 10-15-2011.

THE MARK CONSISTS OF STANDARD CHARACTERS WITHOUT CLAIM TO ANY PARTICULAR FONT, STYLE, SIZE, OR COLOR.

NO CLAIM IS MADE TO THE EXCLUSIVE RIGHT TO USE "BPO", APART FROM THE MARK AS SHOWN.

SER. NO. 85-582,920, FILED 3-28-2012.

DEIRDRE ROBERTSON, EXAMINING ATTORNEY



*David J. Kybas*

Director of the United States Patent and Trademark Office



# United States of America

United States Patent and Trademark Office

# iCoachFirst

**Reg. No. 4,274,610**

**Registered Jan. 15, 2013**

**Int. Cl.: 42**

**SERVICE MARK**

**PRINCIPAL REGISTER**

GUPTA, RISHAV (UNITED STATES INDIVIDUAL)  
60 ANDERSON AVENUE  
ENGLEWOOD CLIFFS, NJ 07632

FOR: ADVISORY SERVICES IN THE FIELD OF PRODUCT DEVELOPMENT AND QUALITY IMPROVEMENT OF SOFTWARE; APPLICATION SERVICE PROVIDER (ASP) FEATURING SOFTWARE FOR USE IN DATA PROCESSING IN THE FIELD OF RECRUITMENT; APPLICATION SERVICE PROVIDER (ASP), NAMELY, HOSTING COMPUTER SOFTWARE APPLICATIONS OF OTHERS; APPLICATION SERVICE PROVIDER FEATURING APPLICATION PROGRAMMING INTERFACE (API) SOFTWARE FOR DATABASE MANAGEMENT; APPLICATION SERVICE PROVIDER, NAMELY, HOSTING, MANAGING, DEVELOPING, ANALYZING, AND MAINTAINING APPLICATIONS, SOFTWARE, AND WEB SITES, OF OTHERS IN THE FIELDS OF HEALTHCARE, BENEFITS PROGRAMS, EMPLOYEE PRODUCTIVITY, RISK MANAGEMENT; APPLICATION SERVICE PROVIDER, NAMELY, HOSTING, MANAGING, DEVELOPING, AND MAINTAINING APPLICATIONS, SOFTWARE, AND WEB SITES, IN THE FIELDS OF PERSONAL PRODUCTIVITY, WIRELESS COMMUNICATION, MOBILE INFORMATION ACCESS, AND REMOTE DATA MANAGEMENT FOR WIRELESS DELIVERY OF CONTENT TO HANDHELD COMPUTERS, LAPTOPS AND MOBILE ELECTRONIC DEVICES; BUSINESS TECHNOLOGY SOFTWARE CONSULTATION SERVICES; COMPUTER CO-LOCATION SERVICES, NAMELY, PROVIDING FACILITIES FOR THE LOCATION OF COMPUTER SERVERS WITH THE EQUIPMENT OF OTHERS; COMPUTER CONSULTATION; COMPUTER CONSULTATION IN THE FIELD OF COMPUTER SECURITY; COMPUTER MONITORING SERVICE WHICH TRACKS APPLICATION SOFTWARE PERFORMANCE, PERFORMS PERIODIC MAINTENANCE AND PROVIDES REPORTS AND ALERTS CONCERNING SUCH PERFORMANCE; COMPUTER NETWORK CONFIGURATION SERVICES; COMPUTER NETWORK DESIGN AND COMPUTER SOFTWARE DESIGN FOR THE STAFFING INDUSTRY; COMPUTER NETWORK DESIGN FOR OTHERS; COMPUTER PROGRAMMING AND COMPUTER SYSTEM ANALYSIS; COMPUTER PROGRAMMING AND MAINTENANCE OF COMPUTER PROGRAMS; COMPUTER PROGRAMMING AND RENTAL OF COMPUTER PROGRAMS; COMPUTER PROGRAMMING AND SOFTWARE DESIGN; COMPUTER PROGRAMMING CONSULTANCY; COMPUTER PROGRAMMING SERVICES FOR OTHERS IN THE FIELD OF SOFTWARE CONFIGURATION MANAGEMENT; COMPUTER PROGRAMMING SERVICES FOR STAFFING INDUSTRY; COMPUTER SECURITY CONSULTANCY; COMPUTER SERVICES, NAMELY, CLOUD HOSTING PROVIDER SERVICES; COMPUTER SERVICES, NAMELY, COMPUTER SYSTEM ADMINISTRATION FOR OTHERS; COMPUTER SERVICES, NAMELY, INTEGRATION OF COMPUTER SOFTWARE INTO MULTIPLE SYSTEMS AND NETWORKS; COMPUTER



*David J. Kyjars*

Director of the United States Patent and Trademark Office

**Reg. No. 4,274,610** SERVICES, NAMELY, REMOTE MANAGEMENT OF DATABASES FOR OTHERS; COMPUTER SOFTWARE CONSULTING; COMPUTER SOFTWARE DESIGN AND UPDATING; COMPUTER SOFTWARE DESIGN FOR OTHERS; COMPUTER SOFTWARE DEVELOPMENT AND COMPUTER PROGRAMMING DEVELOPMENT FOR OTHERS; COMPUTER SOFTWARE DEVELOPMENT IN THE FIELD OF MOBILE APPLICATIONS; COMPUTER SOFTWARE DEVELOPMENT IN THE FIELD OF RECRUITMENT; COMPUTER SOFTWARE DEVELOPMENT, COMPUTER PROGRAMMING AND MAINTENANCE OF COMPUTER SOFTWARE FOR RECRUITING INDUSTRY; COMPUTER SOFTWARE INSTALLATION AND MAINTENANCE; COMPUTER SOFTWARE RENTAL; CONSULTANCY IN THE FIELD OF SOFTWARE DESIGN; CONSULTING SERVICES IN THE FIELD OF COMPUTER-BASED INFORMATION SYSTEMS FOR BUSINESSES; CONSULTING SERVICES IN THE FIELD OF HOSTING COMPUTER SOFTWARE APPLICATIONS; CONSULTING SERVICES IN THE FIELD OF OFFICE AND WORKPLACE AUTOMATION; CONSULTING SERVICES IN THE FIELD OF PROVIDING ONLINE, NON-DOWNLOADABLE SOFTWARE AND APPLICATIONS; CONSULTING SERVICES IN THE FIELD OF SEARCH ENGINE OPTIMIZATION; CREATING, MAINTAINING, AND MODERNIZING COMPUTER SOFTWARE; CUSTOMIZING COMPUTER SOFTWARE; DATABASE DESIGN AND DEVELOPMENT; DATABASE DEVELOPMENT SERVICES; DESIGN AND DEVELOPMENT OF COMPUTER SOFTWARE; DESIGN AND DEVELOPMENT OF COMPUTER SOFTWARE FOR THE IMPROVEMENTS OF PURCHASING FUNCTIONS OF BUSINESS; DESIGN AND DEVELOPMENT OF COMPUTER SOFTWARE FOR HOSTING CUSTOMER DATABASES; DESIGN AND DEVELOPMENT OF ELECTRONIC DATA SECURITY SYSTEMS; DESIGN AND DEVELOPMENT OF ON-LINE COMPUTER SOFTWARE SYSTEMS; DESIGN AND DEVELOPMENT OF WIRELESS COMMUNICATION SYSTEMS FOR TRANSMISSION AND RECEPTION OF VOICE, DATA AND VIDEO; DESIGN AND DEVELOPMENT OF WIRELESS COMPUTER NETWORKS; DESIGN AND WRITING OF COMPUTER SOFTWARE; DESIGN OF COMPUTER DATABASE; DESIGN OF COMPUTER NETWORKS AND SOFTWARE FOR OTHERS FOR THE STAFFING INDUSTRY; DESIGN, DEPLOYMENT AND MANAGEMENT OF WIRELESS NETWORKS FOR OTHERS; DESIGN, DEVELOPMENT AND IMPLEMENTATION OF SOFTWARE; DESIGN, DEVELOPMENT, AND IMPLEMENTATION OF SOFTWARE FOR SYSTEM SECURITY AND DATABASE SECURITY; DESIGN, DEVELOPMENT, INSTALLATION AND MAINTENANCE OF COMPUTER SOFTWARE; DESIGN, INSTALLATION, UPDATING AND MAINTENANCE OF COMPUTER SOFTWARE; DESIGN, MAINTENANCE, DEVELOPMENT AND UPDATING OF COMPUTER SOFTWARE; DESIGN, UPDATING AND RENTAL OF COMPUTER SOFTWARE; DESIGN, UPGRADING AND RENTAL OF COMPUTER SOFTWARE; DEVELOPING AND UPDATING COMPUTER SOFTWARE; DEVELOPING COMPUTER SOFTWARE; DEVELOPING CUSTOMIZED SOFTWARE FOR OTHERS; DEVELOPING CUSTOMIZED SOFTWARE IN THE FIELD OF STAFFING FOR OTHERS; DEVELOPING CUSTOMIZED WEB PAGES AND OTHER DATA FEED FORMATS FEATURING USER-DEFINED INFORMATION; DEVELOPMENT OF SOFTWARE FOR SECURE NETWORK OPERATIONS; DEVELOPMENT, UPDATING AND MAINTENANCE OF SOFTWARE AND DATA BASES; FILE SHARING SERVICES, NAMELY, PROVIDING A WEBSITE FEATURING TECHNOLOGY ENABLING USERS TO UPLOAD AND DOWNLOAD ELECTRONIC FILES; HOSTING OF DIGITAL CONTENT ON THE INTERNET; INSTALLATION AND MAINTENANCE OF COMPUTER SOFTWARE; INSTALLATION, MAINTENANCE AND REPAIR OF SOFTWARE FOR COMPUTER SYSTEMS; MAINTENANCE AND UPDATING OF COMPUTER SOFTWARE; MAINTENANCE AND UPGRADING OF COMPUTER SOFTWARE; MAINTENANCE OF ON-LINE DATABASES FOR OTHERS; MAINTENANCE OF SOFTWARE FOR INTERNET ACCESS; MAPPING; PREPARATION, UPDATE, INSTALLATION AND MAINTENANCE OF COMPUTER SOFTWARE; PROGRAMMING OF COMPUTER SOFTWARE FOR OTHERS; PROVIDING A WEBSITE FEATURING TECHNOLOGY THAT ENABLES SUBSCRIBERS TO TRANSFER FILES TO AND FROM A FILE TRANSFER PROTOCOL SERVER; PROVIDING AN ON-LINE NETWORK ENVIRONMENT THAT FEATURES TECHNOLOGY THAT ENABLES USERS TO SHARE DATA; PROVIDING AN ONLINE NETWORK SERVICE THAT ENABLES USERS TO SHARE DATA IN THE FIELD OF STAFFING; RECOVERY OF COMPUTER DATA; REMOTE COMPUTER BACKUP SERVICES; REMOTE ONLINE BACKUP OF COMPUTER DATA; RENTAL AND MAINTENANCE OF COMPUTER SOFTWARE; RENTAL OF A DATABASE SERVER (TO THIRD PARTIES);

**Reg. No. 4,274,610** RENTAL OF APPLICATION SOFTWARE; RENTAL OF COMPUTER SOFTWARE AND PROGRAMS; RENTING COMPUTER SOFTWARE; REPAIR OF COMPUTER SOFTWARE; REPAIR OF SOFTWARE; RESEARCH, DEVELOPMENT, DESIGN AND UPGRADING OF COMPUTER SOFTWARE; SOFTWARE DESIGN AND DEVELOPMENT; TECHNICAL SUPPORT SERVICES, NAMELY, 24X7 MONITORING OF NETWORK SYSTEMS, SERVERS AND WEB AND DATABASE APPLICATIONS AND NOTIFICATION OF RELATED EVENTS AND ALERTS; TECHNICAL SUPPORT SERVICES, NAMELY, INSTALLATION, ADMINISTRATION, AND TROUBLESHOOTING OF WEB AND DATABASE APPLICATIONS; TECHNICAL SUPPORT SERVICES, NAMELY, MIGRATION OF DATACENTER, SERVER AND DATABASE APPLICATIONS; TECHNICAL SUPPORT SERVICES, NAMELY, REMOTE ADMINISTRATION AND MANAGEMENT OF IN-HOUSE AND HOSTED DATACENTER DEVICES, DATABASES AND SOFTWARE APPLICATIONS; TECHNICAL SUPPORT SERVICES, NAMELY, REMOTE AND ON-SITE INFRASTRUCTURE MANAGEMENT SERVICES FOR MONITORING, ADMINISTRATION AND MANAGEMENT OF PUBLIC AND PRIVATE CLOUD COMPUTING IT AND APPLICATION SYSTEMS; TECHNICAL SUPPORT SERVICES, NAMELY, TECHNICAL ADMINISTRATION OF SERVERS FOR OTHERS AND TROUBLESHOOTING IN THE NATURE OF DIAGNOSING SERVER PROBLEMS; TECHNICAL SUPPORT SERVICES, NAMELY, TROUBLESHOOTING OF COMPUTER SOFTWARE PROBLEMS; TECHNICAL SUPPORT, NAMELY, MONITORING OF NETWORK SYSTEMS; TESTING OF SECURITY SYSTEMS; UPDATING AND DESIGN OF COMPUTER SOFTWARE; UPDATING AND MAINTENANCE OF COMPUTER SOFTWARE; UPDATING AND RENTAL OF SOFTWARE FOR DATA PROCESSING; UPDATING OF COMPUTER PROGRAMS FOR THIRD PARTIES; UPDATING OF COMPUTER SOFTWARE FOR OTHERS, IN CLASS 42 (U.S. CLS. 100 AND 101).

FIRST USE 6-1-2011; IN COMMERCE 6-1-2011.

THE MARK CONSISTS OF STANDARD CHARACTERS WITHOUT CLAIM TO ANY PARTICULAR FONT, STYLE, SIZE, OR COLOR.

SER. NO. 85-582,984, FILED 3-28-2012.

DEIRDRE ROBERTSON, EXAMINING ATTORNEY

# United States of America

United States Patent and Trademark Office

## DYNAMIC CATALOG

**Reg. No. 4,274,611**

**Registered Jan. 15, 2013**

**Int. Cl.: 35**

**SERVICE MARK**

**PRINCIPAL REGISTER**

DIGI-KEY CORPORATION (MINNESOTA CORPORATION)  
701 BROOKS AVENUE SOUTH  
THIEF RIVER FALLS, MN 56701

FOR: CATALOG ORDERING SERVICE FEATURING ELECTRONIC COMPONENTS AND HARDWARE; DISTRIBUTORSHIP SERVICES IN THE FIELD OF ELECTRONIC COMPONENTS AND HARDWARE; ELECTRONIC CATALOG SERVICES FEATURING ELECTRONIC COMPONENTS AND HARDWARE; OPERATING AN ON-LINE SHOPPING SITE IN THE FIELD OF ELECTRONIC COMPONENTS AND HARDWARE; WEB-BASED CATALOG SERVICES FEATURING ELECTRONIC COMPONENTS AND HARDWARE, IN CLASS 35 (U.S. CLS. 100, 101 AND 102).

FIRST USE 4-12-2012; IN COMMERCE 4-12-2012.

THE MARK CONSISTS OF STANDARD CHARACTERS WITHOUT CLAIM TO ANY PARTICULAR FONT, STYLE, SIZE, OR COLOR.

NO CLAIM IS MADE TO THE EXCLUSIVE RIGHT TO USE "CATALOG" , APART FROM THE MARK AS SHOWN.

SER. NO. 85-583,979, FILED 3-29-2012.

JASON TURNER, EXAMINING ATTORNEY



*David J. Kyffers*

Director of the United States Patent and Trademark Office

# United States of America

United States Patent and Trademark Office



**Reg. No. 4,274,612**

**Registered Jan. 15, 2013**

**Int. Cl.: 42**

**SERVICE MARK**

**PRINCIPAL REGISTER**

RESTAURANT SOLUTIONS, LLC (MISSOURI LIMITED LIABILITY COMPANY)  
1424 CROSS CREEK DRIVE  
RAYMORE, MO 64083

FOR: SOFTWARE AS A SERVICE (SAAS) SERVICES FEATURING SOFTWARE FOR USE  
IN WORK FORCE, OPERATIONS, AND SALES MANAGEMENT, IN CLASS 42 (U.S. CLS.  
100 AND 101).

FIRST USE 3-1-2008; IN COMMERCE 3-1-2008.

THE MARK CONSISTS OF AN "S" CONTAINED WITHIN A DARK SQUARE WITH ROUN-  
DED CORNERS IN WHICH THE UPPER AND LOWER PART OF THE DARK SQUARE ARE  
LIGHTER, WHICH IS ITSELF CONTAINED WITHIN TWO SQUARE BORDERS, ONE LIGHT  
THE OTHER DARK.

SER. NO. 85-584,472, FILED 3-30-2012.

FRED CARL, EXAMINING ATTORNEY



*David J. Kyffers*

Director of the United States Patent and Trademark Office

# United States of America

United States Patent and Trademark Office

# Satis

**Reg. No. 4,274,613**

**Registered Jan. 15, 2013**

**Int. Cl.: 33**

**TRADEMARK**

**PRINCIPAL REGISTER**

MONTECASTELLI SELECTIONS LTD (NEW YORK LIMITED LIABILITY COMPANY)  
387 CLINTON STREET, SUITE 4R  
BROOKLYN, NY 11231

FOR: WINES DERIVED FROM GRAPES GROWN IN ITALY, LABELED AND ADVERTISED  
IN COMPLIANCE WITH UNITED STATES OF AMERICA LAWS FOR ALCOHOL AND TO-  
BACCO TAX AND TRADE BUREAU, IN CLASS 33 (U.S. CLS. 47 AND 49).

FIRST USE 4-15-2001; IN COMMERCE 11-2-2001.

THE MARK CONSISTS OF STANDARD CHARACTERS WITHOUT CLAIM TO ANY PAR-  
TICULAR FONT, STYLE, SIZE, OR COLOR.

THE WORDING "SATIS" HAS NO MEANING IN A FOREIGN LANGUAGE.

SER. NO. 85-584,749, FILED 3-30-2012.

NATALIE POLZER, EXAMINING ATTORNEY



*David J. Kyffers*

Director of the United States Patent and Trademark Office

# United States of America

United States Patent and Trademark Office

## LIVING YOUR VOICE

**Reg. No. 4,274,614**

LIVING YOUR VOICE, LLC (TEXAS LIMITED LIABILITY COMPANY)  
917 WAVERLY STREET, SUITE 301  
HOUSTON, TX 77008

**Registered Jan. 15, 2013**

**Int. Cl.: 41**

FOR: EDUCATIONAL SERVICES, NAMELY, PROVIDING VOCAL TRAINING IN THE FIELD OF MUSIC; PERSONAL COACHING SERVICES IN THE FIELDS OF PUBLIC SPEAKING AND PERSONAL DEVELOPMENT THROUGH SINGING, IN CLASS 41 (U.S. CLS. 100, 101 AND 107).

**SERVICE MARK**

**PRINCIPAL REGISTER**

FIRST USE 6-4-2008; IN COMMERCE 6-4-2008.

THE MARK CONSISTS OF STANDARD CHARACTERS WITHOUT CLAIM TO ANY PARTICULAR FONT, STYLE, SIZE, OR COLOR.

NO CLAIM IS MADE TO THE EXCLUSIVE RIGHT TO USE "VOICE", APART FROM THE MARK AS SHOWN.

SER. NO. 85-584,777, FILED 3-30-2012.

KEVEN MITTLER, EXAMINING ATTORNEY



*David J. Kyffers*

Director of the United States Patent and Trademark Office

# United States of America

United States Patent and Trademark Office

## Parks in Focus

**Reg. No. 4,274,615**

**Registered Jan. 15, 2013**

**Int. Cls.: 16 and 41**

**TRADEMARK**

**SERVICE MARK**

**PRINCIPAL REGISTER**

MORRIS K. UDALL AND STEWART L. UDALL FOUNDATION (UNITED STATES AGENCY OF THE UNITED STATES GOVERNMENT)  
130 S. SCOTT AVE.  
TUCSON, AZ 85701

FOR: EDUCATIONAL PUBLICATIONS, NAMELY, TRAINING MANUALS IN THE FIELD OF ENVIRONMENTAL AND OUTDOOR EDUCATION AND NATURE PHOTOGRAPHY; PACKAGED KITS COMPRISING PRINTED INSTRUCTIONAL, EDUCATIONAL, AND TEACHING MATERIALS FOR EDUCATIONAL ACTIVITIES IN THE FIELD OF ENVIRONMENTAL AND OUTDOOR EDUCATION AND NATURE PHOTOGRAPHY, IN CLASS 16 (U.S. CLS. 2, 5, 22, 23, 29, 37, 38 AND 50).

FIRST USE 3-1-1999; IN COMMERCE 3-1-1999.

FOR: EDUCATION SERVICES, NAMELY, PROVIDING CLASSES AND INSTRUCTION FOR MIDDLE SCHOOL STUDENTS IN THE FIELD OF THE ENVIRONMENT, NATURE PHOTOGRAPHY AND OUTDOOR EDUCATION; EDUCATIONAL SERVICES, NAMELY, CONDUCTING TRAINING, WORKSHOPS, AND SEMINARS IN THE FIELDS OF ENVIRONMENTAL AND OUTDOOR EDUCATION AND NATURE PHOTOGRAPHY FOR MIDDLE SCHOOL STUDENTS AND DISTRIBUTION OF TRAINING MATERIALS IN CONNECTION THEREWITH; EDUCATIONAL SERVICES, NAMELY, PROVIDING DISPLAYS AND EXHIBITS IN THE FIELD OF ENVIRONMENTAL AND OUTDOOR EDUCATION AND NATURE PHOTOGRAPHY, IN CLASS 41 (U.S. CLS. 100, 101 AND 107).

FIRST USE 1-1-2001; IN COMMERCE 1-1-2001.

THE MARK CONSISTS OF STANDARD CHARACTERS WITHOUT CLAIM TO ANY PARTICULAR FONT, STYLE, SIZE, OR COLOR.

SER. NO. 85-584,907, FILED 3-30-2012.

RICHARD WHITE, EXAMINING ATTORNEY



*David J. Kyffers*

Director of the United States Patent and Trademark Office



# United States of America

United States Patent and Trademark Office

# TECHMARX

**Reg. No. 4,274,616**

COX, MIKE (UNITED STATES INDIVIDUAL)  
21 INVERLEITH TERRACE  
MORAGA, CA 94556

**Registered Jan. 15, 2013**

**Int. Cl.: 35**

FOR: MANUFACTURER REPRESENTATIVES IN THE FIELD OF CONSTRUCTION PRODUCTS, IN CLASS 35 (U.S. CLS. 100, 101 AND 102).

**SERVICE MARK**

FIRST USE 5-12-1988; IN COMMERCE 6-30-1988.

**PRINCIPAL REGISTER**

THE MARK CONSISTS OF STANDARD CHARACTERS WITHOUT CLAIM TO ANY PARTICULAR FONT, STYLE, SIZE, OR COLOR.

SER. NO. 85-585,544, FILED 3-30-2012.

JASON LOTT, EXAMINING ATTORNEY



*David J. Kybas*

Director of the United States Patent and Trademark Office

# United States of America

United States Patent and Trademark Office

# ForestMaster

**Reg. No. 4,274,617**

**Registered Jan. 15, 2013**

**Int. Cl.: 35**

**SERVICE MARK**

**PRINCIPAL REGISTER**

NICK GROMICKO LAND AND MINERAL COMPANY, LLC (COLORADO LIMITED LIABILITY COMPANY)  
1750 30TH STREET  
BOULDER, CO 80301

FOR: FORESTRY MANAGEMENT SERVICES, IN CLASS 35 (U.S. CLS. 100, 101 AND 102).

FIRST USE 3-30-2012; IN COMMERCE 3-30-2012.

THE MARK CONSISTS OF STANDARD CHARACTERS WITHOUT CLAIM TO ANY PARTICULAR FONT, STYLE, SIZE, OR COLOR.

SER. NO. 85-585,821, FILED 3-31-2012.

LAURIE MAYES, EXAMINING ATTORNEY



*David J. Kybas*

Director of the United States Patent and Trademark Office

# United States of America

United States Patent and Trademark Office



**Reg. No. 4,274,618**

**Registered Jan. 15, 2013**

**Int. Cl.: 18**

**TRADEMARK**

**PRINCIPAL REGISTER**

THE REACTORPANEL SADDLE COMPANY, LLC (COLORADO LIMITED LIABILITY COMPANY)  
414 LESSER STREET  
OAKLAND, CA 94601

FOR: HORSE SADDLES AND HORSE TACK, NAMELY, BRIDLES, REINS, STIRRUP LEATHERS, HALTERS AND GIRTH STRAPS, IN CLASS 18 (U.S. CLS. 1, 2, 3, 22 AND 41).

FIRST USE 10-1-1999; IN COMMERCE 10-1-1999.

NO CLAIM IS MADE TO THE EXCLUSIVE RIGHT TO USE "SADDLE COMPANY", APART FROM THE MARK AS SHOWN.

THE COLOR(S) GOLD AND BLACK IS/ARE CLAIMED AS A FEATURE OF THE MARK.

THE MARK CONSISTS OF A GOLD CIRCLE WITH A BACKWARD FACING BLACK-BROWN "R" AND A NORMAL FACING BLACK-BROWN "P" IN THE CENTER; ENCIRCLED BY A BLACK-BROWN RING WITH THE WORDS "THE REACTORPANEL" ON THE TOP AND "SADDLE COMPANY" ON THE BOTTOM, AND ALL ENCIRCLED WITH A GOLD RIM.

SER. NO. 85-585,827, FILED 3-31-2012.

MATTHEW KLINE, EXAMINING ATTORNEY



*David J. Kyros*

Director of the United States Patent and Trademark Office

# United States of America

United States Patent and Trademark Office

# bun stuffer

**Reg. No. 4,274,619**

MANNING, ALICIA M (UNITED STATES INDIVIDUAL)  
226 15TH ST APT 4D  
BROOKLYN, NY 11215

**Registered Jan. 15, 2013**

**Int. Cl.: 26**

FOR: HAIR ACCESSORIES, NAMELY, HAIR DONUTS, MESH HAIR BUN INSERTS, IN CLASS 26 (U.S. CLS. 37, 39, 40, 42 AND 50).

**TRADEMARK**

FIRST USE 3-16-2012; IN COMMERCE 3-16-2012.

**PRINCIPAL REGISTER**

THE MARK CONSISTS OF STANDARD CHARACTERS WITHOUT CLAIM TO ANY PARTICULAR FONT, STYLE, SIZE, OR COLOR.

NO CLAIM IS MADE TO THE EXCLUSIVE RIGHT TO USE "BUN", APART FROM THE MARK AS SHOWN.

SER. NO. 85-585,880, FILED 4-1-2012.

JUHI KAVEESHVAR, EXAMINING ATTORNEY



*David J. Kyffers*

Director of the United States Patent and Trademark Office

# United States of America

United States Patent and Trademark Office



**Reg. No. 4,274,620**

50 EGGS HOLDINGS, LLC (FLORIDA LIMITED LIABILITY COMPANY)  
4770 BISCAYNE BLVD., SUITE 1280  
MIAMI, FL 33137

**Registered Jan. 15, 2013**

**Int. Cl.: 43**

FOR: RESTAURANT SERVICES, IN CLASS 43 (U.S. CLS. 100 AND 101).

**SERVICE MARK**

FIRST USE 10-3-2011; IN COMMERCE 10-3-2011.

**PRINCIPAL REGISTER**

NO CLAIM IS MADE TO THE EXCLUSIVE RIGHT TO USE "TABLE AND BAR", APART FROM THE MARK AS SHOWN.

THE MARK CONSISTS OF THE WORD "YARBIRD" IN A STYLIZED FONT WITH THE DESIGN OF A ROOSTER CENTERED ABOVE AND THE WORDS "SOUTHERN TABLE & BAR" UNDERNEATH THE WORD "YARBIRD".

SER. NO. 85-586,430, FILED 4-2-2012.

STEPHANIE ALI, EXAMINING ATTORNEY



*David J. Kybas*

Director of the United States Patent and Trademark Office

# United States of America

United States Patent and Trademark Office



**Reg. No. 4,274,621**

**Registered Jan. 15, 2013**

**Int. Cls.: 9, 16 and 41**

**TRADEMARK**

**SERVICE MARK**

**PRINCIPAL REGISTER**

THE BRITISH EDITORIAL SOCIETY OF BONE AND JOINT SURGERY (UNITED KINGDOM COMPANY)  
22 BUCKINGHAM STREET  
LONDON, UNITED KINGDOM WC2N6ET

FOR: PRE-RECORDED CD-ROMS, DVDS, VIDEO TAPES, AUDIO CASSETTES AND OTHER RECORDABLE MEDIA RELATING TO MEDICINE AND SCIENCE; DOWNLOADABLE PUBLICATIONS, NAMELY, JOURNALS, MAGAZINES, NEWSLETTERS AND BOOKS IN ELECTRONIC FORM PROVIDED OVER THE INTERNET OR BY E-MAIL RELATING TO MEDICINE AND SCIENCE, IN CLASS 9 (U.S. CLS. 21, 23, 26, 36 AND 38).

FOR: PRINTED PUBLICATIONS, NAMELY, JOURNALS, MAGAZINES, NEWSLETTERS AND BOOKS RELATING TO MEDICINE AND SCIENCE, IN CLASS 16 (U.S. CLS. 2, 5, 22, 23, 29, 37, 38 AND 50).

FOR: EDUCATIONAL SERVICES, NAMELY, CLASSES, SEMINARS, AND EDUCATIONAL WORKSHOPS ALL RELATING TO MEDICINE AND SCIENCE; ORGANIZATION OF LECTURES AND SEMINARS RELATING TO MEDICINE AND SCIENCE; EDUCATIONAL CONFERENCES RELATING TO MEDICINE AND SCIENCE; PROVISION OF PUBLICATIONS FOR VIEWING OVER THE INTERNET, NAMELY, JOURNALS, MAGAZINES, NEWSLETTERS AND BOOKS RELATING TO MEDICINE AND SCIENCE; PUBLICATION OF ELECTRONIC BOOKS AND JOURNALS ON-LINE, IN CLASS 41 (U.S. CLS. 100, 101 AND 107).



OWNER OF ERPN CMNTY TM OFC REG. NO. 010328524, DATED 2-20-2012, EXPIRES 10-10-2021.

OWNER OF ERPN CMNTY TM OFC REG. NO. 010328565, DATED 2-20-2012, EXPIRES 10-10-2021.

THE MARK CONSISTS OF THE DESIGN OF A TREE TO THE LEFT OF WHICH APPEARS A SUPPORT.

SER. NO. 85-586,459, FILED 4-2-2012.

EDWARD FENNESSY, EXAMINING ATTORNEY

*David J. Kypos*

Director of the United States Patent and Trademark Office

# United States of America

United States Patent and Trademark Office

## SCATTERED SEATS

**Reg. No. 4,274,622**

MLB ADVANCED MEDIA, L.P. (DELAWARE LIMITED PARTNERSHIP)  
75 NINTH AVENUE  
NEW YORK, NY 10011

**Registered Jan. 15, 2013**

**Int. Cls.: 41 and 42**

FOR: ARRANGING FOR TICKETS FOR SPORTING EVENTS, MUSICAL CONCERTS AND OTHER ENTERTAINMENT EVENTS; BOOKING OF SEATS FOR SPORTING EVENTS, MUSICAL CONCERTS AND OTHER LIVE ENTERTAINMENT EVENTS; ONLINE PROVISION OF INFORMATION RELATING TO SPORTING EVENTS, MUSICAL CONCERTS AND OTHER LIVE ENTERTAINMENT EVENTS, IN CLASS 41 (U.S. CLS. 100, 101 AND 107).

**SERVICE MARK**

**PRINCIPAL REGISTER**

FIRST USE 3-27-2012; IN COMMERCE 3-27-2012.

FOR: PROVIDING AN ONLINE SEARCH ENGINE SERVICE FOR OBTAINING DATA IN THE FIELD OF SPORTING EVENTS, MUSICAL CONCERTS AND OTHER LIVE ENTERTAINMENT EVENTS, IN CLASS 42 (U.S. CLS. 100 AND 101).

FIRST USE 3-27-2012; IN COMMERCE 3-27-2012.

THE MARK CONSISTS OF STANDARD CHARACTERS WITHOUT CLAIM TO ANY PARTICULAR FONT, STYLE, SIZE, OR COLOR.

NO CLAIM IS MADE TO THE EXCLUSIVE RIGHT TO USE "SEATS", APART FROM THE MARK AS SHOWN.

SER. NO. 85-586,786, FILED 4-2-2012.

MARK SPARACINO, EXAMINING ATTORNEY



*David J. Kybas*

Director of the United States Patent and Trademark Office

# United States of America

United States Patent and Trademark Office

# Iridium Live

**Reg. No. 4,274,623**

**Registered Jan. 15, 2013**

**Int. Cl.: 41**

**SERVICE MARK**

**PRINCIPAL REGISTER**

1650 BROADWAY ASSOCIATES INC (NEW YORK CORPORATION), DBA IRIDIUM JAZZ CLUB  
1650 BROADWAY SUITE 406  
NEW YORK, NY 10019

FOR: ENTERTAINMENT SERVICES IN THE NATURE OF PRESENTING LIVE MUSICAL PERFORMANCES, IN CLASS 41 (U.S. CLS. 100, 101 AND 107).

FIRST USE 8-15-2011; IN COMMERCE 8-15-2011.

THE MARK CONSISTS OF STANDARD CHARACTERS WITHOUT CLAIM TO ANY PARTICULAR FONT, STYLE, SIZE, OR COLOR.

NO CLAIM IS MADE TO THE EXCLUSIVE RIGHT TO USE "LIVE", APART FROM THE MARK AS SHOWN.

SER. NO. 85-586,907, FILED 4-2-2012.

DEIRDRE ROBERTSON, EXAMINING ATTORNEY



*David J. Kybas*

Director of the United States Patent and Trademark Office



# United States of America

United States Patent and Trademark Office



ISOACOUSTICS

Sound quality by design

**Reg. No. 4,274,624**

ISOACOUSTICS (CANADA CORPORATION)  
4981 HWY 7, EAST, UNIT 12A, SUITE 160  
MARKHAM, ONTARIO, CANADA

**Registered Jan. 15, 2013**

**Int. Cl.: 9**

FOR: STANDS SPECIALLY ADAPTED FOR AUDIO SPEAKERS AND AUDIO MONITORS,  
IN CLASS 9 (U.S. CLS. 21, 23, 26, 36 AND 38).

**TRADEMARK**

FIRST USE 4-15-2011; IN COMMERCE 4-15-2011.

**PRINCIPAL REGISTER**

THE MARK CONSISTS OF THE WORD "ISOACOUSTICS" IN A STYLIZED FONT, WITH "ISO" IN BLACK AND "ACOUSTICS" IN SLIGHTLY LARGER FONT IN GREY, AND THE PHRASE "SOUND QUALITY BY DESIGN" BELOW IN BLACK, SMALLER STYLIZED FONT, AND FOUR GREEN CURVED LINES AT THE LEFT PART OF THE LETTERING THAT RESEMBLES A SOUND SIGNAL ICON.

THE COLOR(S) GREEN, BLACK AND GREY IS/ARE CLAIMED AS A FEATURE OF THE MARK.

SER. NO. 85-587,176, FILED 4-2-2012.

B. PARADEWELAI, EXAMINING ATTORNEY



*David J. Kyffers*

Director of the United States Patent and Trademark Office

# United States of America

United States Patent and Trademark Office

# SELmedia

**Reg. No. 4,274,625**

**Registered Jan. 15, 2013**

**Int. Cls.: 9, 16 and 41**

**TRADEMARK**

**SERVICE MARK**

**PRINCIPAL REGISTER**

SELMEDIA, INC. (NORTH CAROLINA CORPORATION)  
SUITE 200  
1901 N. HARRISON AVENUE  
CARY, NC 27513

FOR: DVDS IN THE FIELD OF SOCIAL EMOTIONAL LEARNING AND CHARACTER EDUCATION, IN CLASS 9 (U.S. CLS. 21, 23, 26, 36 AND 38).

FIRST USE 1-1-2007; IN COMMERCE 1-1-2007.

FOR: PRINTED BOOKS AND PRINTED CURRICULA IN THE FIELD OF SOCIAL EMOTIONAL LEARNING AND CHARACTER EDUCATION, IN CLASS 16 (U.S. CLS. 2, 5, 22, 23, 29, 37, 38 AND 50).

FIRST USE 1-1-2007; IN COMMERCE 1-1-2007.

FOR: PROVIDING NON-DOWNLOADABLE CURRICULA IN THE FIELD OF SOCIAL AND EMOTIONAL CONDUCT LEARNING AND CHARACTER EDUCATION; PROVIDING A WEBSITE FEATURING EDUCATIONAL INFORMATION IN THE FIELD OF SOCIAL AND EMOTIONAL CONDUCT LEARNING AND CHARACTER EDUCATION, IN CLASS 41 (U.S. CLS. 100, 101 AND 107).

FIRST USE 1-1-2007; IN COMMERCE 1-1-2007.

THE MARK CONSISTS OF STANDARD CHARACTERS WITHOUT CLAIM TO ANY PARTICULAR FONT, STYLE, SIZE, OR COLOR.

SER. NO. 85-587,421, FILED 4-3-2012.

GISELLE AGOSTO, EXAMINING ATTORNEY



*David J. Kybas*

Director of the United States Patent and Trademark Office

# United States of America

United States Patent and Trademark Office

## EASY GRAIN

**Reg. No. 4,274,626**

BAY STATE MILLING COMPANY (MINNESOTA CORPORATION)  
100 CONGRESS STREET  
QUINCY, MA 02169

**Registered Jan. 15, 2013**

**Int. Cl.: 30**

FOR: PIZZA DOUGH MIX SOLD IN BULK TO THE COMMERCIAL MARKET, NAMELY, WHOLESALE BAKERY TRADE, MANUFACTURERS AND BAKERY DISTRIBUTORS, IN CLASS 30 (U.S. CL. 46).

**TRADEMARK**

FIRST USE 8-6-2012; IN COMMERCE 8-6-2012.

**PRINCIPAL REGISTER**

THE MARK CONSISTS OF STANDARD CHARACTERS WITHOUT CLAIM TO ANY PARTICULAR FONT, STYLE, SIZE, OR COLOR.

NO CLAIM IS MADE TO THE EXCLUSIVE RIGHT TO USE "GRAIN", APART FROM THE MARK AS SHOWN.

SER. NO. 85-587,762, FILED 4-3-2012.

AMEEN IMAM, EXAMINING ATTORNEY



*David J. Kyffers*

Director of the United States Patent and Trademark Office

# United States of America

United States Patent and Trademark Office

**Dent Magic**  
**Auto Appearance Specialists**

**Reg. No. 4,274,627**

MILLER, DAVID (UNITED STATES INDIVIDUAL)  
4651 POTH RD.

**Registered Jan. 15, 2013**

COLUMBUS, OH 43213

**Int. Cl.: 37**

FOR: VEHICLE REPAIR SERVICES, IN CLASS 37 (U.S. CLS. 100, 103 AND 106).

**SERVICE MARK**

FIRST USE 11-1-2001; IN COMMERCE 1-2-2002.

**PRINCIPAL REGISTER**

NO CLAIM IS MADE TO THE EXCLUSIVE RIGHT TO USE "DENT" AND "AUTO APPEARANCE SPECIALISTS", APART FROM THE MARK AS SHOWN.

THE MARK CONSISTS OF THE STYLIZED TEXT "DENT MAGIC AUTO APPEARANCE SPECIALISTS". THE WORDS "DENT" AND "MAGIC" ARE LARGER THAN THE "AUTO APPEARANCE SPECIALISTS". THE WORD "DENT" APPEARS FURTHEST TO THE LEFT WITH A SPACE AND THEN THE WORD "MAGIC" TO THE RIGHT OF THE WORD "DENT". THE WORD "MAGIC" IS A TINY BIT TALLER THAN THE WORD "DENT" AND IS POSITIONED A LITTLE BIT LOWER THAN THE WORD "DENT". ABOVE THE LOWER CASE "I" IN THE WORD "MAGIC" IS A STAR THAT DOTS THE "I". BELOW THE WORD "DENT" IS A SOLID LINE WITH TWO SPACES, ONE AT THE FAR LEFT AND ONE AT THE FAR RIGHT THAT SECTION OFF TWO SQUARE DOTS AT EACH END OF THE LINE. BELOW THAT LINE BEGINNING JUST A LITTLE BIT TO THE LEFT OF WHERE THE TOP LINE BEGINS IS A SECOND LINE THAT GOES ALL THE WAY TO THE TAIL OF THE LETTER "G" IN THE WORD "MAGIC" AND STOPS RIGHT BEFORE IT. THIS LINE ALSO IS A SOLID LINE WITH TWO SPACES, ONE AT THE FAR LEFT AND ONE AT THE FAR RIGHT THAT SECTION OFF TWO SQUARE DOTS AT EACH END OF THE LINE. IT IS LONGER THAN THE LINE ABOVE IT. BELOW BOTH LINES ARE THE WORDS, "AUTO APPEARANCE SPECIALISTS". THESE WORDS ARE AS LONG AS THE TWO LARGER WORDS ABOVE "DENT MAGIC". THE LEFT EDGE OF THE "A" IN "AUTO" LINES UP WITH THE LEFT EDGE IN THE WORD "DENT" AND THE RIGHT EDGE OF THE "S" AT THE END OF THE WORD "SPECIALISTS" LINES UP WITH THE RIGHT EDGE OF THE LETTER "C" IN "MAGIC".



*David J. Kypos*

SER. NO. 85-588,119, FILED 4-3-2012.

ALICE BENMAMAN, EXAMINING ATTORNEY

# United States of America

United States Patent and Trademark Office



**Reg. No. 4,274,628**

WICKED Z FITNESS LLC (CONNECTICUT LIMITED LIABILITY COMPANY)  
509 OLD MAIN STREET  
ROCKY HILL, CT 06067

**Registered Jan. 15, 2013**

**Int. Cl.: 41**

FOR: EDUCATIONAL AND ENTERTAINMENT SERVICES, NAMELY, PROVIDING CLASSES AND INSTRUCTION IN THE FIELD OF DANCE FITNESS; YOGA CLASSES AND INSTRUCTION, IN CLASS 41 (U.S. CLS. 100, 101 AND 107).

**SERVICE MARK**

FIRST USE 4-1-2011; IN COMMERCE 4-1-2011.

**PRINCIPAL REGISTER**

NO CLAIM IS MADE TO THE EXCLUSIVE RIGHT TO USE "DANCE & FITNESS", APART FROM THE MARK AS SHOWN.

THE COLOR(S) BLACK, GREEN AND PURPLE IS/ARE CLAIMED AS A FEATURE OF THE MARK.

THE MARK CONSISTS OF THE STYLIZED WORDING "WICKED Z DANCE & FITNESS" WITH THE WORDS "WICKED" AND "DANCE & FITNESS" APPEARING IN BLACK AND WITH THE LETTER "Z" IN GREEN FLANKED TO EACH SIDE BY A PURPLE BACKGROUND ELEMENT FORMING A ROUND BACKGROUND FIELD.

SER. NO. 85-588,488, FILED 4-4-2012.

HANNO RITTNER, EXAMINING ATTORNEY



*David J. Kypos*

Director of the United States Patent and Trademark Office

# United States of America

United States Patent and Trademark Office



**Reg. No. 4,274,629**

**Registered Jan. 15, 2013**

**Int. Cl.: 35**

**SERVICE MARK**

**PRINCIPAL REGISTER**

BOOT, WILLEM (UNITED STATES INDIVIDUAL), DBA BOOT COFFEE CONSULTING AND TRAINING  
28 REED STREET  
MILL VALLEY, CA 94941

FOR: BUSINESS CONSULTING SERVICES IN THE FIELD OF COFFEE QUALITY IMPROVEMENT AND PRODUCT DEVELOPMENT FOR GROWERS, ROASTERS, GOVERNMENTS AND NON-GOVERNMENTAL ORGANIZATIONS, IN CLASS 35 (U.S. CLS. 100, 101 AND 102).

FIRST USE 3-21-2012; IN COMMERCE 3-21-2012.

NO CLAIM IS MADE TO THE EXCLUSIVE RIGHT TO USE "COFFEE", APART FROM THE MARK AS SHOWN.

THE MARK CONSISTS OF ON THE LEFT SIDE THE WORDS "BOOT COFFEE" RUNNING UPWARD AND ON THE RIGHT SIDE STYLIZED IMAGES DESCENDING VERTICALLY IN THE FOLLOWING ORDER: A LEAF, A COFFEE BEAN, A DROP AND A CUP.

SER. NO. 85-588,641, FILED 4-4-2012.

DARRYL SPRUILL, EXAMINING ATTORNEY



*David J. Kyros*

Director of the United States Patent and Trademark Office

# United States of America

United States Patent and Trademark Office

## scil vIP

**Reg. No. 4,274,630**

**Registered Jan. 15, 2013**

**Int. Cls.: 9, 41 and 42**

**TRADEMARK**

**SERVICE MARK**

**PRINCIPAL REGISTER**

BIONET HOLDING GMBH (FED REP GERMANY GESELLSCHAFT MIT BESCHRÄNKTER HAFTUNG (GMBH))  
FRAUNHOFERSTRASSE 15  
MARTINSRIED, FED REP GERMANY 82152

FOR: VETERINARY MEDICINE COMPUTER SOFTWARE FOR THE DATA TRANSFER OF VETERINARY LABORATORY ANALYSIS MEASUREMENT RESULTS AND PATIENT DATA; DATA CARRIERS CONTAINING SOFTWARE PROGRAMS FOR THE DATA TRANSFER OF VETERINARY LABORATORY ANALYSIS MEASUREMENT RESULTS AND PATIENT DATA AND/OR DATA ABOUT VETERINARY MEDICINE; DOWNLOADABLE PUBLICATIONS FOR VETERINARY MEDICINE, NAMELY, SOFTWARE MANUALS AND SOFTWARE APPLICATION MANUALS FOR THE DATA TRANSFER OF VETERINARY LABORATORY ANALYSIS MEASUREMENT RESULTS AND PATIENT DATA IN THE FIELD OF VETERINARY MEDICINE, IN CLASS 9 (U.S. CLS. 21, 23, 26, 36 AND 38).

FOR: ARRANGING AND CONDUCTING OF TRAINING COURSES, SEMINARS AND TRAINING WORKSHOPS IN THE FIELD OF USING COMPUTER SOFTWARE AND SOFTWARE APPLICATIONS RELATED TO THE DATA TRANSFER OF VETERINARY LABORATORY ANALYSIS MEASUREMENT RESULTS AND PATIENT DATA IN THE FIELD OF VETERINARY MEDICINE; PROVIDING EDUCATION IN THE FIELD OF USING COMPUTER SOFTWARE AND SOFTWARE APPLICATIONS RELATED TO THE DATA TRANSFER OF VETERINARY LABORATORY ANALYSIS MEASUREMENT RESULTS AND PATIENT DATA IN THE FIELD OF VETERINARY MEDICINE RENDERED THROUGH CORRESPONDENCE COURSES AND ON-LINE TRAINING COURSES, IN CLASS 41 (U.S. CLS. 100, 101 AND 107).

FOR: TECHNICAL SUPPORT SERVICES VIA A HOTLINE, NAMELY, TROUBLESHOOTING OF VETERINARY MEDICINE AND VETERINARY LABORATORY ANALYSIS COMPUTER SOFTWARE PROBLEMS; CONSULTING SERVICES IN THE FIELD OF DESIGN, SELECTION, IMPLEMENTATION AND USE OF COMPUTER HARDWARE RELATED TO VETERINARY MEDICINE AND VETERINARY LABORATORY ANALYSIS FOR OTHERS; COMPUTER SOFTWARE CONSULTING IN THE FIELD OF VETERINARY MEDICINE AND VETERINARY LABORATORY ANALYSIS; COMPUTER PROGRAMMING; SOFTWARE DEVELOPMENT SERVICES; UPDATING OF COMPUTER SOFTWARE; ALL SERVICES RELATED TO VETERINARY MEDICINE AND VETERINARY LABORATORY ANALYSIS, IN CLASS 42 (U.S. CLS. 100 AND 101).



*David J. Kyjars*

Director of the United States Patent and Trademark Office

**Reg. No. 4,274,630** THE MARK CONSISTS OF STANDARD CHARACTERS WITHOUT CLAIM TO ANY PARTICULAR FONT, STYLE, SIZE, OR COLOR.

PRIORITY CLAIMED UNDER SEC. 44(D) ON FED REP GERMANY APPLICATION NO. 302011062443, FILED 12-13-2011, REG. NO. 302011062443, DATED 1-23-2012, EXPIRES 12-31-2021.

OWNER OF U.S. REG. NO. 2,712,364.

SER. NO. 85-588,820, FILED 4-4-2012.

SIMON TENG, EXAMINING ATTORNEY



# United States of America

United States Patent and Trademark Office

# PEOPLES

**Reg. No. 4,274,631**

PEOPLES FLOWER SHOPS, INC. (NEW MEXICO CORPORATION)  
3520 CANDELARIA RD. NE  
ALBUQUERQUE, NM 87107

**Registered Jan. 15, 2013**

**Int. Cl.: 35**

FOR: RETAIL FLORIST SHOPS FEATURING FLOWERS, PLANTS, FRUIT AND GOURMET FOOD GIFT BASKETS AND FLOWER ACCESSORIES, IN CLASS 35 (U.S. CLS. 100, 101 AND 102).

**SERVICE MARK**

FIRST USE 12-31-1944; IN COMMERCE 12-31-1946.

**PRINCIPAL REGISTER**

THE MARK CONSISTS OF STANDARD CHARACTERS WITHOUT CLAIM TO ANY PARTICULAR FONT, STYLE, SIZE, OR COLOR.

SER. NO. 85-589,388, FILED 4-4-2012.

EVELYN BRADLEY, EXAMINING ATTORNEY



*David J. Kybas*

Director of the United States Patent and Trademark Office

# United States of America

United States Patent and Trademark Office

## REV YOUR CAUSE

**Reg. No. 4,274,632**

REV YOUR CAUSE, LLC (CALIFORNIA LIMITED LIABILITY COMPANY)  
1440 JASON WAY STE 100  
SANTA MARIA, CA 93455

**Registered Jan. 15, 2013**

**Int. Cl.: 35**

FOR: DEVELOPING AND MANAGING THE CHARITABLE GIVING PROGRAMS OF OTHERS, IN CLASS 35 (U.S. CLS. 100, 101 AND 102).

**SERVICE MARK**

FIRST USE 3-1-2012; IN COMMERCE 3-1-2012.

**PRINCIPAL REGISTER**

THE MARK CONSISTS OF STANDARD CHARACTERS WITHOUT CLAIM TO ANY PARTICULAR FONT, STYLE, SIZE, OR COLOR.

SER. NO. 85-589,523, FILED 4-4-2012.

CHARLES L. JENKINS, EXAMINING ATTORNEY



*David J. Kybas*

Director of the United States Patent and Trademark Office

# United States of America

United States Patent and Trademark Office

## AUTUMN CASHMERE KIDS

**Reg. No. 4,274,633**

**Registered Jan. 15, 2013**

**Int. Cl.: 25**

**TRADEMARK**

**PRINCIPAL REGISTER**

AUTUMN CASHMERE, INC. (MICHIGAN CORPORATION)  
SUITE 1111  
231 WEST 39TH STREET  
NEW YORK, NY 10018

FOR: CLOTHING MADE IN WHOLE OR SUBSTANTIAL PART OF CASHMERE, NAMELY, SWEATERS, HOODED SWEAT SHIRTS AND SHIRTS, DRESSES, HATS, GLOVES, PANTS, SCARVES, HEADBANDS AND BABY CLOTHING, NAMELY, SWEATERS, JACKETS, PANTS, HATS, SCARVES, GLOVES, MITTENS AND HEADBANDS, IN CLASS 25 (U.S. CLS. 22 AND 39).

FIRST USE 3-28-2012; IN COMMERCE 3-28-2012.

THE MARK CONSISTS OF STANDARD CHARACTERS WITHOUT CLAIM TO ANY PARTICULAR FONT, STYLE, SIZE, OR COLOR.

OWNER OF U.S. REG. NOS. 2,150,535 AND 3,755,190.

NO CLAIM IS MADE TO THE EXCLUSIVE RIGHT TO USE "CASHMERE KIDS", APART FROM THE MARK AS SHOWN.

SER. NO. 85-589,784, FILED 4-5-2012.

SUSAN RICHARDS, EXAMINING ATTORNEY



*David J. Kyjars*

Director of the United States Patent and Trademark Office

# United States of America

United States Patent and Trademark Office



**Reg. No. 4,274,634**

**Registered Jan. 15, 2013**

**Int. Cl.: 38**

**SERVICE MARK**

**PRINCIPAL REGISTER**

CITY OF RANCHO MIRAGE (CALIFORNIA MUNICIPAL CORPORATION)  
69-825 HIGHWAY 111  
RANCHO MIRAGE, CA 92270

FOR: CABLE TELEVISION BROADCASTING, IN CLASS 38 (U.S. CLS. 100, 101 AND 104).

FIRST USE 3-9-2012; IN COMMERCE 3-9-2012.

NO CLAIM IS MADE TO THE EXCLUSIVE RIGHT TO USE "TELEVISION" AND "RANCHO MIRAGE TELEVISION", APART FROM THE MARK AS SHOWN.

THE COLOR(S) RED, BLUE, WHITE, AND BLACK IS/ARE CLAIMED AS A FEATURE OF THE MARK.

THE MARK CONSISTS OF AN ARTISTIC DEPICTION OF A RED AND BLUE CUBE WITH THE LETTERS "RMTV", IN THE COLOR WHITE, IMPOSED OVER THE CUBE; ON TOP OF THE CUBE ARE THE WORDS "IT'S NOT JUST TELEVISION" IN THE COLOR WHITE; BELOW THE CUBE ARE THE WORDS "IT'S RANCHO MIRAGE TELEVISION" IN THE COLOR WHITE. THERE IS A BLACK RECTANGULAR BACKGROUND.

THE WORDING "RANCHO" AND "RANCHO MIRAGE" HAS NO MEANING IN A FOREIGN LANGUAGE.

SER. NO. 85-590,006, FILED 4-5-2012.

WANDA KAY PRICE, EXAMINING ATTORNEY



*David J. Kyffers*

Director of the United States Patent and Trademark Office

# United States of America

United States Patent and Trademark Office

## ACE LEADERSHIP



**Reg. No. 4,274,635**

AMERICAN COUNCIL ON EDUCATION (D.C. CORPORATION)  
ONE DUPONT CIRCLE, N.W.  
WASHINGTON, DC 20036

**Registered Jan. 15, 2013**

**Int. Cl.: 35**

FOR: HIGHER EDUCATION LEADERSHIP DEVELOPMENT, IN CLASS 35 (U.S. CLS. 100, 101 AND 102).

**SERVICE MARK**

FIRST USE 1-0-2012; IN COMMERCE 1-0-2012.

**PRINCIPAL REGISTER**

OWNER OF U.S. REG. NOS. 2,484,476, 3,495,340 AND OTHERS.

NO CLAIM IS MADE TO THE EXCLUSIVE RIGHT TO USE "LEADERSHIP", APART FROM THE MARK AS SHOWN.

THE MARK CONSISTS OF "ACE LEADERSHIP" WITH A CURVING LINE UNDERNEATH "LEADERSHIP".

SER. NO. 85-590,124, FILED 4-5-2012.

PRISCILLA MILTON, EXAMINING ATTORNEY



*David J. Kybas*

Director of the United States Patent and Trademark Office

# United States of America

United States Patent and Trademark Office

# FORMAGEL

**Reg. No. 4,274,636**

**Registered Jan. 15, 2013**

**Int. Cl.: 3**

**TRADEMARK**

**PRINCIPAL REGISTER**

DE ROBLIN, INC. (CALIFORNIA CORPORATION)  
17070 GREEN DRIVE,  
CITY OF INDUSTRY, CA 91745

FOR: CLEAR BUILDER GEL FOR NAILS, IN CLASS 3 (U.S. CLS. 1, 4, 6, 50, 51 AND 52).

FIRST USE 1-0-2011; IN COMMERCE 1-0-2011.

THE MARK CONSISTS OF STANDARD CHARACTERS WITHOUT CLAIM TO ANY PARTICULAR FONT, STYLE, SIZE, OR COLOR.

SER. NO. 85-591,510, FILED 4-6-2012.

LINDA ORNDORFF, EXAMINING ATTORNEY



*David J. Kyffers*

Director of the United States Patent and Trademark Office

# United States of America

United States Patent and Trademark Office

## "Alaina Inspired"

**Reg. No. 4,274,637**

SELLERS, PENNY Y. (GEORGIA SOLE PROPRIETORSHIP), DBA ALAINA INSPIRED  
6121 PETERS RD  
RAY CITY, GA 31645

**Registered Jan. 15, 2013**

**Int. Cl.: 25**

FOR: BABIES' PANTS; BABY BIBS NOT OF PAPER; BABY BODYSUITS; BABY BOTTOMS; BABY LAYETTES FOR CLOTHING; BABY TOPS; BOTTOMS; CLOTH BIBS; HATS FOR INFANTS, BABIES, TODDLERS AND CHILDREN; INFANT AND TODDLER ONE PIECE CLOTHING; JACKETS; ONE PIECE GARMENT FOR INFANTS AND TODDLERS; SHIRTS FOR INFANTS, BABIES, TODDLERS AND CHILDREN; SHORT SETS; SNAP CROTCH SHIRTS FOR INFANTS AND TODDLERS; SWADDLING CLOTHES; T-SHIRTS FOR CHILDREN AND BABIES; TOPS; WRISTBANDS, IN CLASS 25 (U.S. CLS. 22 AND 39).

**TRADEMARK**

**PRINCIPAL REGISTER**

FIRST USE 3-1-2012; IN COMMERCE 3-1-2012.

THE MARK CONSISTS OF STANDARD CHARACTERS WITHOUT CLAIM TO ANY PARTICULAR FONT, STYLE, SIZE, OR COLOR.

SER. NO. 85-591,981, FILED 4-8-2012.

BRENDAN REGAN, EXAMINING ATTORNEY



*David J. Kybas*

Director of the United States Patent and Trademark Office

# United States of America

United States Patent and Trademark Office

The logo for HOTZONE360 features the text "HOTZONE360" in a bold, red, sans-serif font. The letters are set against a background of stylized, bright yellow and orange flames, giving the impression of fire.

**Reg. No. 4,274,638**

DING, QING (UNITED STATES INDIVIDUAL), DBA HOTZONE360  
5352 MONTSERRAT DR  
LAKELAND, FL 33812

**Registered Jan. 15, 2013**

**Int. Cl.: 2**

FOR: COPYING INKS; FILLED INK CARTRIDGES; INK CARTRIDGES FOR PRINTERS;  
INK JET CARTRIDGES; INK JET PRINTER INK; PRINTERS' INK; PRINTING INKS, IN  
CLASS 2 (U.S. CLS. 6, 11 AND 16).

**TRADEMARK**

FIRST USE 6-20-2009; IN COMMERCE 7-20-2009.

**PRINCIPAL REGISTER**

THE MARK CONSISTS OF THE IMAGE IS IN YELLOW AND RED COLOR, THE WORD  
"HOTZONE360" LOOKS LIKE IT IS IN FIRE.

THE COLOR(S) RED AND YELLOW IS/ARE CLAIMED AS A FEATURE OF THE MARK.

SER. NO. 85-592,059, FILED 4-8-2012.

ELIZABETH KAJUBI, EXAMINING ATTORNEY



*David J. Kybas*

Director of the United States Patent and Trademark Office



# United States of America

United States Patent and Trademark Office



**Reg. No. 4,274,639**

**Registered Jan. 15, 2013**

**Int. Cls.: 35 and 43**

**SERVICE MARK**

**PRINCIPAL REGISTER**

REMOTE INTERNATIONAL LOGISTICS, LLC (TEXAS LIMITED LIABILITY COMPANY),  
AKA REMOTE LOGISTICS INTERNATIONAL, LLC  
SUITE 320  
6430 RICHMOND AVENUE  
HOUSTON, TX 77057

FOR: BUSINESS MANAGEMENT SERVICES, NAMELY, SUPPLY CHAIN LOGISTICS, REVERSE LOGISTICS AND LIQUIDATION OF GOODS OF OTHERS; LOGISTICS MANAGEMENT IN THE FIELD OF LODGING, CATERING AND HOUSEKEEPING SERVICES TO REMOTE SITES AND MARINE LOCATIONS, IN CLASS 35 (U.S. CLS. 100, 101 AND 102).

FIRST USE 5-1-2011; IN COMMERCE 5-1-2011.

FOR: HOTEL ACCOMMODATION SERVICES; HOTEL SERVICES; PROVIDING EXTENDED-STAY HOTELS; RESIDENTIAL HOTEL SERVICES; RESTAURANT AND HOTEL SERVICES, IN CLASS 43 (U.S. CLS. 100 AND 101).

FIRST USE 5-1-2011; IN COMMERCE 5-1-2011.

NO CLAIM IS MADE TO THE EXCLUSIVE RIGHT TO USE "REMOTE LOGISTICS INTERNATIONAL, LLC", APART FROM THE MARK AS SHOWN.

THE COLOR(S) YELLOW, GREEN, AND BLACK IS/ARE CLAIMED AS A FEATURE OF THE MARK.

THE MARK CONSISTS OF THE STYLIZED WORDING "REMOTE LOGISTICS INTERNATIONAL, LLC" IN THE COLOR BLACK NEXT TO A GREEN AND YELLOW SPHERE WITH A CIRCLE AROUND IT.

SER. NO. 85-592,418, FILED 4-9-2012.

TRICIA SONNEBORN, EXAMINING ATTORNEY



*David J. Kyffers*

Director of the United States Patent and Trademark Office

# United States of America

United States Patent and Trademark Office



**Reg. No. 4,274,640**

MD PROPERTYCO, LLC (TEXAS LIMITED LIABILITY COMPANY)  
4714 SHAVANO OAK  
SAN ANTONIO, TX 78249

**Registered Jan. 15, 2013**

**Int. Cl.: 43**

FOR: BAR SERVICES; RESTAURANT SERVICES, IN CLASS 43 (U.S. CLS. 100 AND 101).

**SERVICE MARK**

FIRST USE 10-1-2010; IN COMMERCE 10-1-2010.

**PRINCIPAL REGISTER**

THE MARK CONSISTS OF THE DESIGN OF A DOG PLACED WITHIN A LARGE CIRCLE.

SER. NO. 85-592,827, FILED 4-9-2012.

AHSEN KHAN, EXAMINING ATTORNEY



*David J. Kyffers*

Director of the United States Patent and Trademark Office

United States of America  
United States Patent and Trademark Office

Boxset

**Reg. No. 4,274,641**

**Registered Jan. 15, 2013**

**Int. Cl.: 28**

**TRADEMARK**

**PRINCIPAL REGISTER**

NINGBO ZENIT INDUSTRIAL COMPANY LIMITED (CHINA LIMITED COMPANY)  
RM1613, BLOCK B, CHANGJIANG INT'L CENTER  
CHANGJIANG ROAD 461, BEILUN  
NINGBO, CHINA

FOR: BALLS FOR GAMES; BODY-BUILDING APPARATUS; BODY-TRAINING APPARATUS AND DEVICES FOR PHYSICAL EXERCISES, NAMELY, BASEBALL BATS AND BASEBALL SWING TRAINING DEVICES; CHRISTMAS TREE DECORATIONS; ELECTRONIC ACTION TOYS; JIGSAW PUZZLES; MAGIC TRICKS; MARIONETTES; ROCKING HORSES; TOYS, NAMELY, PUPPETS AND ACCESSORIES THEREFOR, IN CLASS 28 (U.S. CLS. 22, 23, 38 AND 50).

FIRST USE 0-0-2010; IN COMMERCE 8-0-2010.

THE MARK CONSISTS OF STYLIZED LATIN WORDING OF "BOXSET".

SER. NO. 85-593,075, FILED 4-10-2012.

MAYUR VAGHANI, EXAMINING ATTORNEY



*David J. Kyffers*

Director of the United States Patent and Trademark Office

# United States of America

United States Patent and Trademark Office

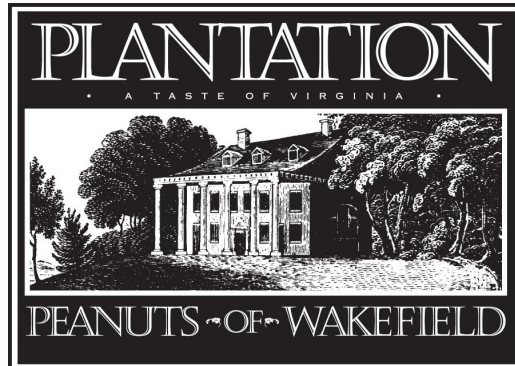

**Reg. No. 4,274,642**

PLANTATION PEANUTS OF WAKEFIELD VA, INC. (VIRGINIA CORPORATION)  
P.O. BOX 128  
WAKEFIELD, VA 23888

**Registered Jan. 15, 2013**

**Int. Cl.: 29**

FOR: CANDIED NUTS; CANNED PEANUTS; PREPARED NUTS; ROASTED NUTS;  
SEASONED NUTS; SHELLED NUTS, IN CLASS 29 (U.S. CL. 46).

**TRADEMARK**

FIRST USE 12-30-1993; IN COMMERCE 12-30-1993.

**PRINCIPAL REGISTER**

NO CLAIM IS MADE TO THE EXCLUSIVE RIGHT TO USE "PEANUTS OF WAKEFIELD"  
AND "VIRGINIA", APART FROM THE MARK AS SHOWN.

THE MARK CONSISTS OF THE WORDING "PLANTATION A TASTE OF VIRGINIA" AT  
THE TOP OF THE MARK WITHIN A RECTANGULAR BORDER. THE MIDDLE OF THE  
DESIGN CONTAINS A PLANTATION HOUSE SURROUNDED BY TREES ON BOTH SIDES.  
THE WORDING "PEANUTS OF WAKEFIELD" APPEARS BELOW WITHIN A RECTANGULAR  
BORDER AT THE BOTTOM.

SER. NO. 85-593,209, FILED 4-10-2012.

ANDREA K. NADELMAN, EXAMINING ATTORNEY



*David J. Kybas*

Director of the United States Patent and Trademark Office

# United States of America

United States Patent and Trademark Office



scientivity  
CREATIVE MEDICAL MARKETING

**Reg. No. 4,274,643**

**Registered Jan. 15, 2013**

**Int. Cls.: 35 and 41**

**SERVICE MARK**

**PRINCIPAL REGISTER**

SCIENTIVITY LLC (DELAWARE LIMITED LIABILITY COMPANY)  
SUITE 101  
828 SOUTH BROADWAY  
TARRYTOWN, NY 10591

FOR: ADVERTISING, MARKETING AND PROMOTIONAL SERVICES FOR THE MEDICAL AND HEALTHCARE INDUSTRY, IN CLASS 35 (U.S. CLS. 100, 101 AND 102).

FIRST USE 1-31-2012; IN COMMERCE 1-31-2012.

FOR: EDUCATIONAL SERVICES, NAMELY, PROVIDING INSTRUCTION AND TRAINING TO HEALTHCARE PROFESSIONALS ON THE UTILIZATION AND BENEFITS OF PHARMACEUTICALS AND MEDICAL DEVICES FOR DIAGNOSES AND TREATMENT, IN CLASS 41 (U.S. CLS. 100, 101 AND 107).

FIRST USE 1-31-2012; IN COMMERCE 1-31-2012.

NO CLAIM IS MADE TO THE EXCLUSIVE RIGHT TO USE "CREATIVE MEDICAL MARKETING", APART FROM THE MARK AS SHOWN.

THE MARK CONSISTS OF THE LETTERS "SCIENTIV", "I" IN THE SHAPE OF A TEST TUBE, AND THE LETTERS "TY". ABOVE THE TEST TUBE ARE FOUR BUBBLES; BENEATH THESE LETTERS APPEAR THE WORDS "CREATIVE MEDICAL MARKETING".

SER. NO. 85-593,358, FILED 4-10-2012.

BRIAN CALLAGHAN, EXAMINING ATTORNEY



*David J. Kyros*

Director of the United States Patent and Trademark Office

# United States of America

United States Patent and Trademark Office

## CREATING THE JEWISH TEAM

**Reg. No. 4,274,644**

**Registered Jan. 15, 2013**

**Int. Cls.: 39 and 41**

**SERVICE MARK**

**PRINCIPAL REGISTER**

MACCABI WORLD UNION, INC. (DELAWARE NON-PROFIT CORPORATION)  
4TH FLOOR  
520 EIGHTH AVENUE  
NEW YORK, NY 10018

FOR: TOURISM AS SERVICE, NAMELY, ARRANGING, ORGANIZING, AND CONDUCTING TRAVEL TOURS, IN CLASS 39 (U.S. CLS. 100 AND 105).

FIRST USE 0-0-2011; IN COMMERCE 0-0-2011.

FOR: ORGANIZING AND CONDUCTING SPORTS COMPETITIONS; EDUCATIONAL PROGRAMS, NAMELY, PROVIDING CLASSES AND SEMINARS IN THE FIELD OF SPORTS AND JEWISH EDUCATION; TOURISM AS SERVICE, NAMELY, GUIDED TOURS OF A MUSEUM; EDUCATIONAL AND ENTERTAINMENT SERVICES, NAMELY, ORGANIZING EXHIBITIONS, CONFERENCES AND COMPETITIONS FEATURING SPORTS, IN CLASS 41 (U.S. CLS. 100, 101 AND 107).

FIRST USE 0-0-2011; IN COMMERCE 0-0-2011.

THE MARK CONSISTS OF STANDARD CHARACTERS WITHOUT CLAIM TO ANY PARTICULAR FONT, STYLE, SIZE, OR COLOR.

SER. NO. 85-594,306, FILED 4-11-2012.

MATTHEW EINSTEIN, EXAMINING ATTORNEY



*David J. Kybas*

Director of the United States Patent and Trademark Office

# United States of America

United States Patent and Trademark Office

# INKIRU

**Reg. No. 4,274,645**

**Registered Jan. 15, 2013**

**Int. Cls.: 9 and 42**

**TRADEMARK**

**SERVICE MARK**

**PRINCIPAL REGISTER**

INKIRU, INC. (CALIFORNIA CORPORATION)  
101 UNIVERSITY AVENUE, SUITE 240  
PALO ALTO, CA 94301

FOR: ONSITE SOFTWARE THAT USES PREDICTIVE ANALYTICS TO IMPROVE BUSINESS INTELLIGENCE AND PROVIDE ACTIONABLE RECOMMENDATIONS ON EVENTS AFFECTING CUSTOMER BEHAVIOR AND EXPERIENCE; ONSITE SOFTWARE FOR REAL-TIME SEGMENTATION OF BUSINESSES' EXISTING CUSTOMERS TO ALLOW THEM TO TARGET FREQUENT BUYERS WITH LOYALTY PROGRAM; ONSITE SOFTWARE FOR A REAL-TIME FRAUD DETECTION SYSTEM FOR EVALUATION OF COMMERCE TRANSACTIONS; ONSITE SOFTWARE THAT COMBINES DATA FROM DIFFERENT STRUCTURED AND UNSTRUCTURED DATA SOURCES TO GENERATE AN INTERCONNECTED GROUP OF DATA; ONSITE SOFTWARE FOR DELIVERING REAL-TIME SCORING AND DECISIONING FOR THE PURPOSE OF PREDICTING USER BEHAVIOR; ONSITE SOFTWARE FOR ENABLING USERS TO DEFINE RULES AND RULE CONFIGURATIONS FOR THE PURPOSE OF REAL-TIME ANALYSIS, IN CLASS 9 (U.S. CLS. 21, 23, 26, 36 AND 38).

FIRST USE 11-28-2011; IN COMMERCE 11-28-2011.

FOR: PROVIDING SOFTWARE-AS-A-SERVICE FEATURING SOFTWARE THAT USES PREDICTIVE ANALYTICS TO IMPROVE BUSINESS INTELLIGENCE AND PROVIDE ACTIONABLE RECOMMENDATIONS ON EVENTS AFFECTING CUSTOMER BEHAVIOR AND EXPERIENCE; PROVIDING SOFTWARE-AS-A-SERVICE FEATURING SOFTWARE FOR REAL-TIME SEGMENTATION OF BUSINESSES' EXISTING CUSTOMERS TO ALLOW THEM TO TARGET FREQUENT BUYERS WITH LOYALTY PROGRAM; PROVIDING SOFTWARE-AS-A-SERVICE FEATURING SOFTWARE FOR A REAL-TIME FRAUD DETECTION SYSTEM FOR EVALUATION OF COMMERCE TRANSACTIONS; PROVIDING SOFTWARE-AS-A-SERVICE FEATURING SOFTWARE THAT COMBINES DATA FROM DIFFERENT STRUCTURED AND UNSTRUCTURED DATA SOURCES TO GENERATE AN INTERCONNECTED GROUP OF DATA; PROVIDING SOFTWARE-AS-A-SERVICE FEATURING SOFTWARE THAT DELIVERS REAL-TIME SCORING AND DECISIONING FOR THE PURPOSE OF PREDICTING USER BEHAVIOR; PROVIDING SOFTWARE-AS-A-SERVICE FEATURING A SOFTWARE LANGUAGE THAT ENABLES USERS TO DEFINE RULES AND RULE CONFIGURATIONS FOR THE PURPOSE OF REAL-TIME ANALYSIS, IN CLASS 42 (U.S. CLS. 100 AND 101).



*David J. Kyffers*

Director of the United States Patent and Trademark Office

FIRST USE 11-28-2011; IN COMMERCE 11-28-2011.

**Reg. No. 4,274,645** THE MARK CONSISTS OF STANDARD CHARACTERS WITHOUT CLAIM TO ANY PARTICULAR FONT, STYLE, SIZE, OR COLOR.

THE ENGLISH TRANSLATION OF "INKIRU" IN THE MARK IS "THE BEST IS STILL TO COME".

SER. NO. 85-594,603, FILED 4-11-2012.

ALLISON SCHRODY, EXAMINING ATTORNEY



# United States of America

United States Patent and Trademark Office

# CommCare

**Reg. No. 4,274,646**

**Registered Jan. 15, 2013**

**Int. Cl.: 9**

**TRADEMARK**

**PRINCIPAL REGISTER**

DIMAGI, INC. (MASSACHUSETTS CORPORATION)  
SUITE 3  
585 MASSACHUSETTS AVE  
CAMBRIDGE, MA 02139

FOR: COMPUTER APPLICATION SOFTWARE FOR SERVERS AND WEB APPLICATIONS, NAMELY, SOFTWARE FOR DATA COLLECTION, CASE MANAGEMENT, AND DECISION SUPPORT FOR DATA COLLECTION, SMS COMMUNICATION, PATIENT MANAGEMENT, DISEASE DIAGNOSTICS, TESTING, TRAINING, OR SELF-EDUCATION IN HEALTHCARE, AGRICULTURE, FINANCE, AND EDUCATION INDUSTRIES THROUGH THE USE OF MOBILE AND CLOUD-BASED TECHNOLOGIES, IN CLASS 9 (U.S. CLS. 21, 23, 26, 36 AND 38).

FIRST USE 6-1-2007; IN COMMERCE 4-2-2008.

THE MARK CONSISTS OF STANDARD CHARACTERS WITHOUT CLAIM TO ANY PARTICULAR FONT, STYLE, SIZE, OR COLOR.

SER. NO. 85-594,714, FILED 4-11-2012.

DAWN FELDMAN, EXAMINING ATTORNEY



*David J. Kyros*

Director of the United States Patent and Trademark Office

# United States of America

United States Patent and Trademark Office

# CommCareHQ

**Reg. No. 4,274,647**

**Registered Jan. 15, 2013**

**Int. Cl.: 9**

**TRADEMARK**

**PRINCIPAL REGISTER**

DIMAGI, INC. (MASSACHUSETTS CORPORATION)  
SUITE 3  
585 MASSACHUSETTS AVE  
CAMBRIDGE, MA 02139

FOR: COMPUTER APPLICATION SOFTWARE FOR SERVERS AND WEB APPLICATIONS, NAMELY, SOFTWARE FOR DATA COLLECTION, CASE MANAGEMENT, AND DECISION SUPPORT FOR DATA COLLECTION, SMS COMMUNICATION, PATIENT MANAGEMENT, DISEASE DIAGNOSTICS, TESTING, TRAINING, OR SELF-EDUCATION IN HEALTHCARE, AGRICULTURE, FINANCE, AND EDUCATION INDUSTRIES THROUGH THE USE OF MOBILE AND CLOUD-BASED TECHNOLOGIES, IN CLASS 9 (U.S. CLS. 21, 23, 26, 36 AND 38).

FIRST USE 9-1-2009; IN COMMERCE 9-1-2009.

THE MARK CONSISTS OF STANDARD CHARACTERS WITHOUT CLAIM TO ANY PARTICULAR FONT, STYLE, SIZE, OR COLOR.

SER. NO. 85-594,821, FILED 4-11-2012.

DAWN FELDMAN, EXAMINING ATTORNEY



*David J. Kyros*

Director of the United States Patent and Trademark Office

# United States of America

United States Patent and Trademark Office

## MAKE KIDS SMILE BUBBLE FUN

**Reg. No. 4,274,648**

**Registered Jan. 15, 2013**

**Int. Cl.: 28**

**TRADEMARK**

**PRINCIPAL REGISTER**

P&C INTERNATIONAL DEVELOPMENT LIMITED (HONG KONG CORPORATION)  
ROOM C, 17/F., LUCKY PLAZA  
315 LOCKHART ROAD  
WANCHAI, HONG KONG

FOR: BUBBLE MAKING WAND AND SOLUTION SETS; PLASTIC CHARACTER TOYS, IN  
CLASS 28 (U.S. CLS. 22, 23, 38 AND 50).

FIRST USE 7-8-2011; IN COMMERCE 7-8-2011.

THE MARK CONSISTS OF STANDARD CHARACTERS WITHOUT CLAIM TO ANY PAR-  
TICULAR FONT, STYLE, SIZE, OR COLOR.

NO CLAIM IS MADE TO THE EXCLUSIVE RIGHT TO USE "BUBBLE", APART FROM THE  
MARK AS SHOWN.

SER. NO. 85-595,824, FILED 4-12-2012.

JULIE WATSON, EXAMINING ATTORNEY



*David J. Kybas*

Director of the United States Patent and Trademark Office

# United States of America

United States Patent and Trademark Office



**Reg. No. 4,274,649**

**Registered Jan. 15, 2013**

**Int. Cl.: 9**

**TRADEMARK**

**PRINCIPAL REGISTER**

SOUND AROUND INC. (NEW YORK CORPORATION)  
1600 63RD STREET  
BROOKLYN, NY 11204

FOR: AUTOMOTIVE AUDIO AND VISUAL PRODUCTS, NAMELY, SPEAKERS, CUSTOM SPEAKER ENCLOSURES AND WOOFERS, AUDIO AMPLIFIERS, LOUD SPEAKERS, AUDIO CASSETTE PLAYERS, EQUALIZERS, CROSSOVERS, SUBWOOFERS AND AUTOMOTIVE LCD TELEVISIONS, IN CLASS 9 (U.S. CLS. 21, 23, 26, 36 AND 38).

FIRST USE 3-0-1989; IN COMMERCE 3-0-1989.

THE MARK CONSISTS OF WAVING FLAG WITH STARS AND STRIPES.

SER. NO. 85-595,834, FILED 4-12-2012.

KATHY DE JONGE, EXAMINING ATTORNEY



*David J. Kyffers*

Director of the United States Patent and Trademark Office

# United States of America

United States Patent and Trademark Office

## TATALOU SCIENCE

**Reg. No. 4,274,650**

TATALOU SCIENCE, LLC (UTAH LIMITED LIABILITY COMPANY)  
2151 E LOGAN AVE

**Registered Jan. 15, 2013**

SALT LAKE CITY, UT 84108

**Int. Cl.: 5**

FOR: DIETARY AND NUTRITIONAL SUPPLEMENTS; DIETARY AND NUTRITIONAL SUPPLEMENTS DESIGNED FOR WOMEN; DIETARY AND NUTRITIONAL SUPPLEMENTS USED FOR WEIGHT LOSS; AND DIETARY AND NUTRITIONAL SUPPLEMENTS FOR SUPPORTING, RESTORING AND IMPROVING COGNITIVE FUNCTION, IN CLASS 5 (U.S. CLS. 6, 18, 44, 46, 51 AND 52).

**TRADEMARK**

**PRINCIPAL REGISTER**

FIRST USE 2-17-2012; IN COMMERCE 2-17-2012.

THE MARK CONSISTS OF STANDARD CHARACTERS WITHOUT CLAIM TO ANY PARTICULAR FONT, STYLE, SIZE, OR COLOR.

NO CLAIM IS MADE TO THE EXCLUSIVE RIGHT TO USE "SCIENCE", APART FROM THE MARK AS SHOWN.

THE WORDING "TATALOU" HAS NO MEANING IN A FOREIGN LANGUAGE.

SER. NO. 85-596,306, FILED 4-12-2012.

GILBERT SWIFT, EXAMINING ATTORNEY



*David J. Kypos*

Director of the United States Patent and Trademark Office

# United States of America

United States Patent and Trademark Office

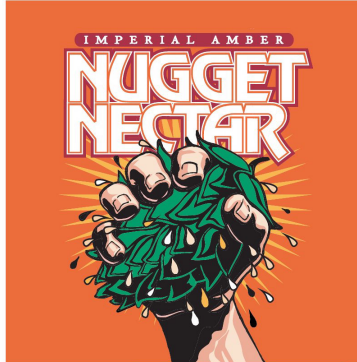

**Reg. No. 4,274,651**

**Registered Jan. 15, 2013**

**Int. Cl.: 32**

**TRADEMARK**

**PRINCIPAL REGISTER**

TROEGS BREWING COMPANY (PENNSYLVANIA CORPORATION)  
200 EAST HERSHEY PARK DRIVE  
HERSHEY, PA 17033

FOR: ALE; BEER, IN CLASS 32 (U.S. CLS. 45, 46 AND 48).

FIRST USE 1-16-2007; IN COMMERCE 1-16-2007.

OWNER OF U.S. REG. NOS. 3,082,070, 3,372,807, AND 4,048,975.

THE COLOR(S) BLACK, WHITE, TAN, GREEN, RED AND ORANGE IS/ARE CLAIMED AS A FEATURE OF THE MARK.

NO CLAIM IS MADE TO THE EXCLUSIVE RIGHT TO USE "IMPERIAL AMBER", APART FROM THE MARK AS SHOWN.

THE MARK CONSISTS OF THE STYLIZED WORDING "IMPERIAL AMBER" SURROUNDED BY AN OBLONG APPEARING ABOVE THE STYLIZED WORDING "NUGGET NECTAR" ALL OF WHICH APPEARS ABOVE THE DEPICTION OF A FIST SQUEEZING DROPS OF FLUID FROM A HOP PLANT WITH RAYS APPEARING BEHIND THE FIST. THE COLOR WHITE APPEARS IN THE WORDING "IMPERIAL AMBER" AND "NUGGET NECTAR" AS WELL AS IN THE DEPICTION OF SOME OF THE DROPS OF FLUID. THE COLOR GREEN APPEARS IN THE DEPICTION OF THE HOP PLANT. THE COLOR TAN APPEARS IN THE DEPICTION OF THE FIST AS WELL AS IN SOME OF THE DROPS OF FLUID. THE COLOR BLACK APPEARS AS SHADING ON THE FIST AND HOP PLANT AS WELL AS IN SOME OF THE DROPS OF FLUID. THE COLOR ORANGE APPEARS AS AN OUTLINE IN THE WORDING "NUGGET NECTAR" AS WELL AS IN THE RAYS SURROUNDING THE FIST AND THE BACKGROUND SURROUNDING THE WORDING AND DESIGN. THE COLOR RED APPEARS IN THE DEPICTION OF THE OBLONG SURROUNDING THE WORDING "IMPERIAL AMBER" AS WELL AS THE OUTER BORDER OF THE WORDING "NUGGET NECTAR".

SER. NO. 85-596,334, FILED 4-12-2012.

MICHAEL TANNER, EXAMINING ATTORNEY



*David J. Kyros*

Director of the United States Patent and Trademark Office

# United States of America

United States Patent and Trademark Office

# CONCORD

**Reg. No. 4,274,652**

T-MOBILE USA, INC. (DELAWARE CORPORATION)  
12920 S.E. 38TH STREET  
BELLEVUE, WA 98006

**Registered Jan. 15, 2013**

**Int. Cl.: 9**

FOR: WIRELESS TELECOMMUNICATIONS DEVICES, NAMELY, WIRELESS TELEPHONES AND SMARTPHONES, IN CLASS 9 (U.S. CLS. 21, 23, 26, 36 AND 38).

**TRADEMARK**

FIRST USE 8-23-2012; IN COMMERCE 8-23-2012.

**PRINCIPAL REGISTER**

THE MARK CONSISTS OF STANDARD CHARACTERS WITHOUT CLAIM TO ANY PARTICULAR FONT, STYLE, SIZE, OR COLOR.

SER. NO. 85-596,460, FILED 4-12-2012.

CATHERINE ROEHL, EXAMINING ATTORNEY



*David J. Kybas*

Director of the United States Patent and Trademark Office

# United States of America

United States Patent and Trademark Office

# myEasyMatch

**Reg. No. 4,274,653**

**Registered Jan. 15, 2013**

**Int. Cl.: 36**

**SERVICE MARK**

**PRINCIPAL REGISTER**

APEX PRINT TECHNOLOGIES, LLC (MINNESOTA LIMITED LIABILITY COMPANY)  
100 S OWASSO BLVD. W  
ST. PAUL, MN 55117

FOR: ELECTRONIC PAYMENT, NAMELY, ELECTRONIC PROCESSING AND TRANSMISSION OF BILL PAYMENT DATA; FINANCIAL TRANSACTION SERVICES, NAMELY, PROVIDING SECURE COMMERCIAL TRANSACTIONS AND PAYMENT OPTIONS; MERCHANT SERVICES, NAMELY, PAYMENT TRANSACTION PROCESSING SERVICES, IN CLASS 36 (U.S. CLS. 100, 101 AND 102).

FIRST USE 6-0-2011; IN COMMERCE 6-0-2011.

THE MARK CONSISTS OF STANDARD CHARACTERS WITHOUT CLAIM TO ANY PARTICULAR FONT, STYLE, SIZE, OR COLOR.

SER. NO. 85-596,648, FILED 4-12-2012.

WILLIAM ROSSMAN, EXAMINING ATTORNEY



*David J. Kyros*

Director of the United States Patent and Trademark Office



# United States of America

United States Patent and Trademark Office

## The Brooklyn Cottage

**Reg. No. 4,274,654**

DOUGLAS, JENNIFER L. (UNITED STATES INDIVIDUAL)  
301 STERLING PLACE  
BROOKLYN, NY 11238

**Registered Jan. 15, 2013**

**Int. Cl.: 41**

FOR: EDUCATIONAL SERVICES, NAMELY, CONDUCTING CONFERENCES, WORKSHOPS, PROFESSIONAL TRAININGS IN THE FIELDS OF HOLISTIC HEALTH, PSYCHOLOGICAL DEVELOPMENT, SPIRITUAL PRACTICE AND RELATED PRACTICES, IN CLASS 41 (U.S. CLS. 100, 101 AND 107).

**SERVICE MARK**

**PRINCIPAL REGISTER**

FIRST USE 2-9-2012; IN COMMERCE 2-9-2012.

THE MARK CONSISTS OF STANDARD CHARACTERS WITHOUT CLAIM TO ANY PARTICULAR FONT, STYLE, SIZE, OR COLOR.

NO CLAIM IS MADE TO THE EXCLUSIVE RIGHT TO USE "BROOKLYN", APART FROM THE MARK AS SHOWN.

SER. NO. 85-596,970, FILED 4-13-2012.

ANNE MADDEN, EXAMINING ATTORNEY



*David J. Kyffers*

Director of the United States Patent and Trademark Office

# United States of America

United States Patent and Trademark Office



**Reg. No. 4,274,655**

**Registered Jan. 15, 2013**

**Int. Cl.: 41**

**SERVICE MARK**

**PRINCIPAL REGISTER**

INTERNATIONAL SOCIETY OF ARBORICULTURE (ILLINOIS CORPORATION)  
2101 W. PARK COURT  
CHAMPAIGN, IL 61821

FOR: PROVIDING EDUCATIONAL INFORMATION IN THE ACADEMIC FIELD OF ARBORICULTURE FOR THE PURPOSE OF ACADEMIC STUDY, IN CLASS 41 (U.S. CLS. 100, 101 AND 107).

FIRST USE 7-1-2011; IN COMMERCE 7-1-2011.

OWNER OF U.S. REG. NOS. 1,786,035 AND 3,813,600.

THE MARK CONSISTS OF A CARRIER DESIGN OF ROUNDED RECTANGLES. INSIDE THE TOP PORTION RECTANGLE IS AN ACORN DESIGN CONTAINING THE LETTERS "CEU". INSIDE THE BOTTOM PORTION ARE THE LETTERS "ISA" WITH AN OAK LEAF DESIGN STANDING IN FOR FOR THE SPACE IN THE TOP OF THE LETTER "A".

SER. NO. 85-597,049, FILED 4-13-2012.

JANICE L. MCMORROW, EXAMINING ATTORNEY



*David J. Kyffers*

Director of the United States Patent and Trademark Office

# United States of America

United States Patent and Trademark Office

## STATE OF CREATIVITY

**Reg. No. 4,274,656**

CREATIVE OKLAHOMA, INC. (OKLAHOMA CORPORATION)  
133 WEST MAIN STREET, SUITE 100  
OKLAHOMA CITY, OK 73102

**Registered Jan. 15, 2013**

**Int. Cl.: 41**

FOR: ORGANIZATION OF EXHIBITIONS FOR CULTURAL OR EDUCATION PURPOSES;  
ARRANGING OF SEMINARS; PROVIDING RECOGNITION AND INCENTIVES BY THE  
WAY OF AWARDS AND CONTESTS TO PROMOTE CREATIVITY IN THE FIELDS OF  
EDUCATION, COMMERCE, AND CULTURE, IN CLASS 41 (U.S. CLS. 100, 101 AND 107).

**SERVICE MARK**

**PRINCIPAL REGISTER**

FIRST USE 2-8-2008; IN COMMERCE 2-8-2008.

THE MARK CONSISTS OF STANDARD CHARACTERS WITHOUT CLAIM TO ANY PAR-  
TICULAR FONT, STYLE, SIZE, OR COLOR.

NO CLAIM IS MADE TO THE EXCLUSIVE RIGHT TO USE "CREATIVITY", APART FROM  
THE MARK AS SHOWN.

SER. NO. 85-597,177, FILED 4-13-2012.

TIMOTHY FINNEGAN, EXAMINING ATTORNEY



*David J. Kyffers*

Director of the United States Patent and Trademark Office

# United States of America

United States Patent and Trademark Office

## Automotive Workwear

**Reg. No. 4,274,657**

**Registered Jan. 15, 2013**

**Int. Cl.: 35**

**SERVICE MARK**

**PRINCIPAL REGISTER**

AUTOMOTIVE WORKWEAR, INC. (CALIFORNIA CORPORATION)  
#113  
881 SNEATH LANE  
SAN BRUNO, CA 94066

FOR: DISTRIBUTORSHIP SERVICES IN THE FIELD OF WORK CLOTHING AND UNIFORMS,  
IN CLASS 35 (U.S. CLS. 100, 101 AND 102).

FIRST USE 1-5-2002; IN COMMERCE 3-2-2002.

THE MARK CONSISTS OF STANDARD CHARACTERS WITHOUT CLAIM TO ANY PAR-  
TICULAR FONT, STYLE, SIZE, OR COLOR.

NO CLAIM IS MADE TO THE EXCLUSIVE RIGHT TO USE "WORKWEAR", APART FROM  
THE MARK AS SHOWN.

SEC. 2(F).

SER. NO. 85-597,701, FILED 4-13-2012.

KATHERINE M. DUBRAY, EXAMINING ATTORNEY



*David J. Kyffers*

Director of the United States Patent and Trademark Office

# United States of America

United States Patent and Trademark Office

RDV

**Reg. No. 4,274,658**

**Registered Jan. 15, 2013**

**Int. Cl.: 33**

**TRADEMARK**

**PRINCIPAL REGISTER**

RDV VINEYARDS, LLC (VIRGINIA LIMITED LIABILITY COMPANY)  
2550 DELAPLANE GRADE ROAD  
DELAPLANE, VA 20144

FOR: ALCOHOLIC BEVERAGES, NAMELY, WINE, IN CLASS 33 (U.S. CLS. 47 AND 49).

FIRST USE 4-1-2011; IN COMMERCE 4-1-2011.

OWNER OF U.S. REG. NO. 4,026,412.

THE MARK CONSISTS OF THE LETTERS "RDV" IN A STYLIZED MANNER WITH THE LOWER CASE LETTER "D" INSIDE THE LETTER "V".

SER. NO. 85-597,719, FILED 4-13-2012.

MAUREEN DALL, EXAMINING ATTORNEY



*David J. Kyffers*

Director of the United States Patent and Trademark Office

# United States of America

United States Patent and Trademark Office



**Reg. No. 4,274,659**

**Registered Jan. 15, 2013**

**Int. Cl.: 41**

**SERVICE MARK**

**PRINCIPAL REGISTER**

ORBIS EDUCATION SERVICES, INC. (INDIANA CORPORATION)  
SUITE 300  
9002 PURDUE ROAD  
INDIANAPOLIS, IN 46268

FOR: EDUCATIONAL SERVICES, NAMELY, DEVELOPING CURRICULA FOR OTHERS IN THE FIELD OF NURSING, NAMELY, DEVELOPING ONLINE NURSING COURSES DESIGNED TO TRAIN NURSES IN SPECIFIC AREAS OF MEDICINE AND THUS TO ALLEVIATE NURSING SHORTAGES, IN CLASS 41 (U.S. CLS. 100, 101 AND 107).

FIRST USE 1-11-2004; IN COMMERCE 1-11-2004.

NO CLAIM IS MADE TO THE EXCLUSIVE RIGHT TO USE "EDUCATION", APART FROM THE MARK AS SHOWN.

THE MARK CONSISTS OF A GLOBE WITH THREE WHITE STRIPES AND THE VERTICAL WORDS "ORBIS EDUCATION" IN A PARTICULAR FONT SEPARATED BY A LINE.

SER. NO. 85-598,374, FILED 4-16-2012.

DORITT L. CARROLL, EXAMINING ATTORNEY



*David J. Kyjars*

Director of the United States Patent and Trademark Office

# United States of America

United States Patent and Trademark Office

## *Dream-Dentistry*

**Reg. No. 4,274,660**

ROEDER JR. GORDON S. (UNITED STATES INDIVIDUAL)  
1326 W. BROAD ST.  
QUAKERTOWN, PA 18951

**Registered Jan. 15, 2013**

**Int. Cl.: 44**

FOR: COSMETIC DENTISTRY; DENTISTRY; DENTISTRY SERVICES, NAMELY, ADMINISTERING PORTABLE INTRAVENOUS SEDATION; PROVIDING NEWS AND INFORMATION IN THE FIELD OF DENTISTRY, IN CLASS 44 (U.S. CLS. 100 AND 101).

**SERVICE MARK**

FIRST USE 1-22-1999; IN COMMERCE 1-22-1999.

**PRINCIPAL REGISTER**

SER. NO. 85-598,578, FILED 4-16-2012.

SIMON TENG, EXAMINING ATTORNEY



*David J. Kyffers*

Director of the United States Patent and Trademark Office

# United States of America

United States Patent and Trademark Office

## IT'S A DINNER BELL FOR FISH

**Reg. No. 4,274,661**

CHICKY INVESTMENTS, LLC (TEXAS LIMITED LIABILITY COMPANY)  
PO BOX 1701  
HELOTES, TX 78023

**Registered Jan. 15, 2013**

**Int. Cl.: 28**

FOR: FISHING LURES, IN CLASS 28 (U.S. CLS. 22, 23, 38 AND 50).

**TRADEMARK**

FIRST USE 6-30-2009; IN COMMERCE 6-30-2009.

**PRINCIPAL REGISTER**

THE MARK CONSISTS OF STANDARD CHARACTERS WITHOUT CLAIM TO ANY PARTICULAR FONT, STYLE, SIZE, OR COLOR.

SER. NO. 85-598,756, FILED 4-16-2012.

TRACY FLETCHER, EXAMINING ATTORNEY



*David J. Kybas*

Director of the United States Patent and Trademark Office



# United States of America

United States Patent and Trademark Office



**Reg. No. 4,274,662**

**Registered Jan. 15, 2013**

**Int. Cl.: 9**

**TRADEMARK**

**PRINCIPAL REGISTER**

SNI/ SI NETWORKS L.L.C. (DELAWARE LIMITED LIABILITY COMPANY)  
1633 BROADWAY, 16TH FLOOR  
NEW YORK, NY 10019

FOR: DOWNLOADABLE COMPUTER SOFTWARE IN THE NATURE OF A MOBILE APPLICATION FOR MOBILE PHONES, SMARTPHONES, PORTABLE MEDIA PLAYERS, AND HANDHELD COMPUTERS FOR GAMING AND FOR USE IN PROVIDING INFORMATION ON A VARIETY OF TOPICS, IN CLASS 9 (U.S. CLS. 21, 23, 26, 36 AND 38).

FIRST USE 5-31-2010; IN COMMERCE 5-31-2011.

THE MARK CONSISTS OF THE STYLIZED LETTERS "AF" WHERE THE LETTER "A" IS INCORPORATED INTO THE BOTTOM LEFT SIDE OF THE LETTER "F".

SER. NO. 85-599,079, FILED 4-16-2012.

TINA BROWN, EXAMINING ATTORNEY



*David J. Kybas*

Director of the United States Patent and Trademark Office

# United States of America

United States Patent and Trademark Office

## TINKERtools

**Reg. No. 4,274,663**

**Registered Jan. 15, 2013**

**Int. Cl.: 6**

**TRADEMARK**

**PRINCIPAL REGISTER**

MATTHEWS STUDIO EQUIPMENT, INC. (CALIFORNIA CORPORATION)  
2405 EMPIRE AVENUE  
BURBANK, CA 91504

FOR: METAL MECHANICAL CLAMPS, RODS OF VARIOUS LENGTHS, ADAPTERS, MOUNTS, AND ARMS FOR COUPLING STILL, MOTION PICTURE, AND VIDEO CAMERAS, LIGHTS, AND MICROPHONES TO STANDS, TRIPODS, AND OTHER SURFACES, FOR MOTION PICTURE, VIDEO, AND STILL PHOTOGRAPHY APPLICATIONS, IN CLASS 6 (U.S. CLS. 2, 12, 13, 14, 23, 25 AND 50).

FIRST USE 2-1-2012; IN COMMERCE 2-1-2012.

THE MARK CONSISTS OF STANDARD CHARACTERS WITHOUT CLAIM TO ANY PARTICULAR FONT, STYLE, SIZE, OR COLOR.

NO CLAIM IS MADE TO THE EXCLUSIVE RIGHT TO USE "TOOLS", APART FROM THE MARK AS SHOWN.

SER. NO. 85-599,230, FILED 4-16-2012.

HENRY S. ZAK, EXAMINING ATTORNEY



*David J. Kybas*

Director of the United States Patent and Trademark Office

# United States of America

United States Patent and Trademark Office



**Reg. No. 4,274,664**

**Registered Jan. 15, 2013**

**Int. Cl.: 16**

JEFFREY S. POMERLEAU (MINNESOTA SOLE PROPRIETORSHIP), DBA TOO PLUS TOO STUDIO  
2077 154TH LANE NW  
ANDOVER, MN 55304

FOR: GREETING CARDS, IN CLASS 16 (U.S. CLS. 2, 5, 22, 23, 29, 37, 38 AND 50).

**TRADEMARK**

FIRST USE 4-15-2012; IN COMMERCE 4-16-2012.

**PRINCIPAL REGISTER**

THE MARK CONSISTS OF THE TERM "TOO PLUS TOO STUDIO" IN BLACK. WITHIN THE TWO "O"S IN THE FIRST "TOO" APPEAR TWO MAGENTA COLORED LIPS. WITHIN THE TWO "O"S IN THE SECOND "TOO" APPEAR TWO BROWN MUSTACHES.

THE COLOR(S) MAGENTA, BROWN AND BLACK IS/ARE CLAIMED AS A FEATURE OF THE MARK.

SER. NO. 85-599,304, FILED S.R. 4-16-2012 AM. P.R. 8-16-2012.

GIANCARLO CASTRO, EXAMINING ATTORNEY



*David J. Kybas*

Director of the United States Patent and Trademark Office

# United States of America

United States Patent and Trademark Office

# BEEcube

**Reg. No. 4,274,665**

**Registered Jan. 15, 2013**

**Int. Cl.: 9**

**TRADEMARK**

**PRINCIPAL REGISTER**

BEECUBE INC. (DELAWARE CORPORATION)  
39465 PASEO PADRE PKWY, SUITE 3700  
FREMONT, CA 94538

FOR: COMPUTERS, IN CLASS 9 (U.S. CLS. 21, 23, 26, 36 AND 38).

FIRST USE 5-8-2006; IN COMMERCE 5-8-2006.

THE MARK CONSISTS OF STANDARD CHARACTERS WITHOUT CLAIM TO ANY PARTICULAR FONT, STYLE, SIZE, OR COLOR.

SER. NO. 85-599,329, FILED 4-16-2012.

ELI HELLMAN, EXAMINING ATTORNEY



*David J. Kyfos*

Director of the United States Patent and Trademark Office

# United States of America

United States Patent and Trademark Office

 **adrenaline365**

**Reg. No. 4,274,666**

ADRENALINE, INC. (NEVADA CORPORATION)  
1040 W. ADAMS ST. #256  
CHICAGO, IL 60607

**Registered Jan. 15, 2013**

**Int. Cl.: 35**

FOR: INTERNET MARKETING SERVICES FOR OTHERS IN THE FIELD OF ADVENTURES AND EXPERIENCES, IN CLASS 35 (U.S. CLS. 100, 101 AND 102).

**SERVICE MARK**

FIRST USE 2-13-2011; IN COMMERCE 2-13-2011.

**PRINCIPAL REGISTER**

THE MARK CONSISTS OF A STYLIZED LOWERCASE "A" IN RED NEXT TO THE WORD "ADRENALINE" IN BLACK AND THE NUMBER "365" IN RED.

THE COLOR(S) RED AND BLACK IS/ARE CLAIMED AS A FEATURE OF THE MARK.

SER. NO. 85-599,373, FILED 4-16-2012.

JENNIFER MARTIN, EXAMINING ATTORNEY



*David J. Kybas*

Director of the United States Patent and Trademark Office

# United States of America

United States Patent and Trademark Office

# GIT-R-DONE

**Reg. No. 4,274,667**

GIT-R-DONE PRODUCTIONS, INC. (FLORIDA CORPORATION)  
1050 CROWN POINTE PKWY SUITE 1000  
ATLANTA, GA 30338

**Registered Jan. 15, 2013**

**Int. Cl.: 41**

FOR: ENTERTAINMENT IN THE NATURE OF LIVE PERFORMANCES BY PROFESSIONAL BULL RIDING IN A RODEO, IN CLASS 41 (U.S. CLS. 100, 101 AND 107).

**SERVICE MARK**

FIRST USE 4-15-2007; IN COMMERCE 4-15-2007.

**PRINCIPAL REGISTER**

THE MARK CONSISTS OF STANDARD CHARACTERS WITHOUT CLAIM TO ANY PARTICULAR FONT, STYLE, SIZE, OR COLOR.

OWNER OF U.S. REG. NO. 3,000,528.

SER. NO. 85-599,704, FILED 4-17-2012.

GIANCARLO CASTRO, EXAMINING ATTORNEY



*David J. Kyffers*

Director of the United States Patent and Trademark Office

# United States of America

United States Patent and Trademark Office

## CHANGE MASTERS

**Reg. No. 4,274,668**

**Registered Jan. 15, 2013**

**Int. Cl.: 41**

**SERVICE MARK**

**PRINCIPAL REGISTER**

CHANGE MASTERS INCORPORATED (MINNESOTA CORPORATION)  
SUITE 1050  
601 CARLSON PARKWAY  
MINNETONKA, MN 55305

FOR: EDUCATIONAL SERVICES, NAMELY, PROFESSIONAL COACHING, CLASSES, WORKSHOPS, AND TRAINING TO BUSINESS EXECUTIVES AND PROFESSIONALS IN THE FIELDS OF INDIVIDUAL DEVELOPMENT, TEAM AND LEADERSHIP DEVELOPMENT, GLOBAL KNOWLEDGE TRANSFER, SKILL DEVELOPMENT, AND EFFECTIVENESS TRAINING, IN CLASS 41 (U.S. CLS. 100, 101 AND 107).

FIRST USE 9-17-1987; IN COMMERCE 5-10-1988.

THE MARK CONSISTS OF STANDARD CHARACTERS WITHOUT CLAIM TO ANY PARTICULAR FONT, STYLE, SIZE, OR COLOR.

OWNER OF U.S. REG. NO. 1,524,780.

SER. NO. 85-600,011, FILED 4-17-2012.

MICHELLE DUBOIS, EXAMINING ATTORNEY



*David J. Kyjars*

Director of the United States Patent and Trademark Office

# United States of America

United States Patent and Trademark Office

## MODUS COOPERANDI

**Reg. No. 4,274,669**

MODUS COOPERANDI, INC. (WASHINGTON CORPORATION)  
1900 WEST NICKERSON STREET, SUITE 116-88  
SEATTLE, WA 98119

**Registered Jan. 15, 2013**

**Int. Cls.: 35 and 41**

FOR: BUSINESS MANAGEMENT CONSULTING AND ADVISORY SERVICES IN THE FIELDS OF PROJECT MANAGEMENT, PERSONAL, GROUP AND ENTERPRISE-LEVEL PRODUCTIVITY, AND ORGANIZATIONAL AND OPERATIONAL EFFICIENCY FOR KNOWLEDGE WORKERS, IN CLASS 35 (U.S. CLS. 100, 101 AND 102).

**SERVICE MARK**

**PRINCIPAL REGISTER**

FIRST USE 3-18-2008; IN COMMERCE 3-18-2008.

FOR: EDUCATIONAL SERVICES, NAMELY, SEMINARS IN THE FIELD OF PROJECT MANAGEMENT, PERSONAL, GROUP AND ENTERPRISE-LEVEL PRODUCTIVITY, ORGANIZATIONAL AND OPERATIONAL EFFICIENCY AND DISTRIBUTION OF EDUCATIONAL MATERIALS IN CONNECTION THEREWITH; BUSINESS TRAINING IN THE FIELD OF PROJECT MANAGEMENT, PERSONAL, GROUP AND ENTERPRISE-LEVEL PRODUCTIVITY, ORGANIZATIONAL AND OPERATIONAL EFFICIENCY, AND DISTRIBUTION OF TRAINING MATERIALS IN CONNECTION THEREWITH, IN CLASS 41 (U.S. CLS. 100, 101 AND 107).

FIRST USE 3-18-2008; IN COMMERCE 3-18-2008.

THE MARK CONSISTS OF STANDARD CHARACTERS WITHOUT CLAIM TO ANY PARTICULAR FONT, STYLE, SIZE, OR COLOR.

SER. NO. 85-600,700, FILED 4-18-2012.

MICHAEL SOUDERS, EXAMINING ATTORNEY



*David J. Kyffers*

Director of the United States Patent and Trademark Office



# United States of America

United States Patent and Trademark Office

## PERSONAL KANBAN

**Reg. No. 4,274,670**

MODUS COOPERANDI, INC. (WASHINGTON CORPORATION)  
1900 WEST NICKERSON STREET, SUITE 116-88  
SEATTLE, WA 98119

**Registered Jan. 15, 2013**

**Int. Cl.: 41**

**SERVICE MARK**

**PRINCIPAL REGISTER**

FOR: EDUCATIONAL SERVICES, NAMELY, CONDUCTING COURSES IN THE FIELD OF IMPROVEMENT OF PERSONAL AND SMALL TEAM PRODUCTIVITY AND EFFECTIVENESS BY RECORDING UPCOMING WORK INTO A VISUAL BACKLOG, LIMITING WORK-IN-PROGRESS, TRACKING OF WORK AS IT FLOWS FROM BACKLOG THROUGH AN ACTIVE STATES OR STATES AND INTO COMPLETION ALONG A VISIBLE VALUE STREAM THAT DEPICTS THE STAGES OF WORK NECESSARY FOR COMPLETION; TRAINING SERVICES IN THE FIELD OF IMPROVEMENT OF PERSONAL AND SMALL TEAM PRODUCTIVITY AND EFFECTIVENESS BY RECORDING UPCOMING WORK INTO A VISUAL BACKLOG, LIMITING WORK-IN-PROGRESS, TRACKING OF WORK AS IT FLOWS FROM BACKLOG THROUGH AN ACTIVE STATES OR STATES AND INTO COMPLETION ALONG A VISIBLE VALUE STREAM THAT DEPICTS THE STAGES OF WORK NECESSARY FOR COMPLETION; PROVIDING ON-LINE TRAINING, NAMELY, COURSES, SEMINARS AND WORKSHOPS IN THE FIELD OF IMPROVEMENT OF PERSONAL AND SMALL TEAM PRODUCTIVITY AND EFFECTIVENESS BY RECORDING UPCOMING WORK INTO A VISUAL BACKLOG, LIMITING WORK-IN-PROGRESS, TRACKING OF WORK AS IT FLOWS FROM BACKLOG THROUGH AN ACTIVE STATES OR STATES AND INTO COMPLETION ALONG A VISIBLE VALUE STREAM THAT DEPICTS THE STAGES OF WORK NECESSARY FOR COMPLETION; PROVIDING A WEBSITE FEATURING BLOGS AND ONLINE PUBLICATIONS IN THE NATURE OF ARTICLES, PRACTICE GUIDES, TEMPLATES, BOOKS AND EBOOKS IN THE FIELD OF IMPROVEMENT OF PERSONAL AND SMALL TEAM PRODUCTIVITY AND EFFECTIVENESS BY RECORDING UPCOMING WORK INTO A VISUAL BACKLOG, LIMITING WORK-IN-PROGRESS, TRACKING OF WORK AS IT FLOWS FROM BACKLOG THROUGH AN ACTIVE STATES OR STATES AND INTO COMPLETION ALONG A VISIBLE VALUE STREAM THAT DEPICTS THE STAGES OF WORK NECESSARY FOR COMPLETION; EDUCATIONAL SERVICES, NAMELY, PROVIDING A CONTINUING PRERECORDED AUDIO PROGRAM IN THE FIELD OF IMPROVEMENT OF PERSONAL AND SMALL TEAM PRODUCTIVITY AND EFFECTIVENESS BY RECORDING UPCOMING WORK INTO A VISUAL BACKLOG, LIMITING WORK-IN-PROGRESS, TRACKING OF WORK AS IT FLOWS FROM BACKLOG THROUGH AN ACTIVE STATES OR STATES AND INTO COMPLETION ALONG A VISIBLE VALUE STREAM THAT DEPICTS THE STAGES OF WORK NECESSARY FOR COMPLETION ACCESSIBLE ON THE INTERNET; PROVIDING EDUCATION COURSES IN THE FIELD OF IMPROVEMENT OF PERSONAL AND SMALL TEAM PRODUCTIVITY AND EFFECTIVENESS BY



*David J. Kybas*

Director of the United States Patent and Trademark Office

**Reg. No. 4,274,670** RECORDING UPCOMING WORK INTO A VISUAL BACKLOG, LIMITING WORK-IN-PROGRESS, TRACKING OF WORK AS IT FLOWS FROM BACKLOG THROUGH AN ACTIVE STATES OR STATES AND INTO COMPLETION ALONG A VISIBLE VALUE STREAM THAT DEPICTS THE STAGES OF WORK NECESSARY FOR COMPLETION OFFERED THROUGH ON-LINE, NON-DOWNLOADABLE VIDEOS AND INSTRUCTOR ASSISTANCE, IN CLASS 41 (U.S. CLS. 100, 101 AND 107).

FIRST USE 3-18-2008; IN COMMERCE 3-18-2008.

THE MARK CONSISTS OF STANDARD CHARACTERS WITHOUT CLAIM TO ANY PARTICULAR FONT, STYLE, SIZE, OR COLOR.

SER. NO. 85-600,704, FILED 4-18-2012.

MICHAEL SOUDERS, EXAMINING ATTORNEY

# United States of America

United States Patent and Trademark Office

# LWT

**Reg. No. 4,274,671**

**Registered Jan. 15, 2013**

**Int. Cl.: 7**

**TRADEMARK**

**PRINCIPAL REGISTER**

LIQUID WASTE TECHNOLOGY, LLC (MARYLAND LIMITED LIABILITY COMPANY)  
1425 WICOMICO STREET  
BALTIMORE, MD 21230

FOR: DREDGES UTILIZING A PUMP AND AN AUGER FOR EXCAVATING AND REMOVING SEDIMENTATION AS A SLURRY FROM THE BOTTOM OF WATERWAYS, PONDS, AND SETTLING LAGOONS, AND STRUCTURAL COMPONENT PARTS THEREOF; AND SUBMERSIBLE CRAWLER DREDGES UTILIZING A PUMP AND AN AUGER FOR REMOVING SLUDGE AND BUILDUP IN SEWERS, TANKS, COVERED LAGOONS AND OTHER CLOSED BODIES OF WATER, IN CLASS 7 (U.S. CLS. 13, 19, 21, 23, 31, 34 AND 35).

FIRST USE 0-0-1997; IN COMMERCE 0-0-1997.

THE MARK CONSISTS OF STANDARD CHARACTERS WITHOUT CLAIM TO ANY PARTICULAR FONT, STYLE, SIZE, OR COLOR.

SER. NO. 85-600,774, FILED 4-18-2012.

TASNEEM HUSSAIN, EXAMINING ATTORNEY



*David J. Kyffers*

Director of the United States Patent and Trademark Office

# United States of America

United States Patent and Trademark Office



**Reg. No. 4,274,672**

TORRES, M.D., JOSEPH L. (UNITED STATES INDIVIDUAL)  
8159 LAKE SERENE DRIVE  
ORLANDO, FL 32836

**Registered Jan. 15, 2013**

**Int. Cl.: 44**

FOR: HEALTH CARE AND MEDICAL SERVICES, NAMELY, WELL WOMEN EXAMS, ECHOCARDIOGRAMS, SCHOOL AND SPORTS PHYSICALS, EXERCISE STRESS TESTS, SPORTS MEDICINE, MEDICAL ORTHOPEDICS, WOMEN'S HEALTH, FAA CLASS 2 AND 3, IMMIGRATION PHYSICALS, WEIGHT LOSS, DIABETES CARE, HYPERTENSION CARE, WELLNESS EXAMS AND IN OFFICE PROCEDURES SUCH AS MINOR SURGERY, ECHOCARDIOGRAMS, STRESS TESTS, IN CLASS 44 (U.S. CLS. 100 AND 101).

**SERVICE MARK**

**PRINCIPAL REGISTER**

FIRST USE 1-1-2002; IN COMMERCE 1-1-2002.

NO CLAIM IS MADE TO THE EXCLUSIVE RIGHT TO USE "HEALTH CENTER", APART FROM THE MARK AS SHOWN.

THE MARK CONSISTS OF THE WORDS "FLORIDA SPORTS & FAMILY HEALTH CENTER" CENTERED IN THE DESIGN WITH A WAVE LIKE CURVY LINE ON TOP AND ON THE BOTTOM OF THE WORDS AND A FIGURE LIKE IMAGE OF A MAN TO THE LEFT AND A FIGURE LIKE IMAGE OF A WOMAN TO THE RIGHT.

SEC. 2(F) AS TO "FLORIDA SPORTS & FAMILY HEALTH CENTER".

SER. NO. 85-601,140, FILED 4-18-2012.

CHRISTOPHER LAW, EXAMINING ATTORNEY



*David J. Kybas*

Director of the United States Patent and Trademark Office

# United States of America

United States Patent and Trademark Office

cloudnine   
MEDIA

**Reg. No. 4,274,673**

**Registered Jan. 15, 2013**

**Int. Cl.: 35**

**SERVICE MARK**

**PRINCIPAL REGISTER**

CLOUD 9 WIRELESS, INC. (CALIFORNIA CORPORATION)  
FL. 3  
1261 HOWARD ST.  
SAN FRANCISCO, CA 94103

FOR: BUSINESS MONITORING AND CONSULTING SERVICES, NAMELY, TRACKING WEB SITES AND APPLICATIONS OF OTHERS TO PROVIDE STRATEGY, INSIGHT, MARKETING, SALES, OPERATION, PRODUCT DESIGN, PARTICULARLY SPECIALIZING IN THE USE OF ANALYTIC AND STATISTIC MODELS FOR THE UNDERSTANDING AND PREDICTING OF CONSUMERS, BUSINESSES, AND MARKET TRENDS AND ACTIONS; BUSINESS MANAGEMENT CONSULTING WITH RELATION TO STRATEGY, MARKETING, SALES, OPERATION, PRODUCT DESIGN PARTICULARLY SPECIALIZING IN THE USE OF ANALYTIC AND STATISTIC MODELS FOR THE UNDERSTANDING AND PREDICTING OF CONSUMERS, BUSINESSES, AND MARKET TRENDS AND ACTIONS; DISSEMINATION OF ADVERTISING FOR OTHERS VIA PUBLIC AND PRIVATE WIRELESS NETWORKS FOR DISPLAY ON MOBILE DEVICES, LAPTOPS AND TABLETS; MARKETING, ADVERTISING, AND PROMOTING THE RETAIL GOODS AND SERVICES OF OTHERS TO WIRELESS ELECTRONIC DEVICES, IN CLASS 35 (U.S. CLS. 100, 101 AND 102).

FIRST USE 2-1-2012; IN COMMERCE 2-1-2012.

NO CLAIM IS MADE TO THE EXCLUSIVE RIGHT TO USE "MEDIA", APART FROM THE MARK AS SHOWN.

THE MARK CONSISTS OF THE WORD "CLOUDNINE" FOLLOWED BY THE NUMBER "9" ENCASED IN A CLOUD-LIKE SHAPE, ALL DIRECTLY ABOVE THE WORD "MEDIA".

SER. NO. 85-601,260, FILED 4-18-2012.

CHARLES L. JENKINS, EXAMINING ATTORNEY



*David J. Kyjars*

Director of the United States Patent and Trademark Office

# United States of America

United States Patent and Trademark Office

# SBE

**Reg. No. 4,274,674**

SYNTEC LLC (MARYLAND LIMITED LIABILITY COMPANY)  
4800 PULASKI HIGHWAY  
BALTIMORE, MD 21224

**Registered Jan. 15, 2013**

**Int. Cl.: 19**

FOR: NON-METAL CONSTRUCTION MATERIALS, NAMELY, POLYPROPYLENE MESH IN THE NATURE OF GEOTEXTILES FOR USE IN STABILIZING AND REINFORCING THE SOIL FOR CIVIL ENGINEERING, ENVIRONMENTAL ENGINEERING, AND CONSTRUCTION APPLICATIONS, IN CLASS 19 (U.S. CLS. 1, 12, 33 AND 50).

**TRADEMARK**

**PRINCIPAL REGISTER**

FIRST USE 4-16-2012; IN COMMERCE 4-16-2012.

THE MARK CONSISTS OF STANDARD CHARACTERS WITHOUT CLAIM TO ANY PARTICULAR FONT, STYLE, SIZE, OR COLOR.

SER. NO. 85-601,419, FILED 4-18-2012.

JOHN DWYER, EXAMINING ATTORNEY



*David J. Kyffers*

Director of the United States Patent and Trademark Office

# United States of America

United States Patent and Trademark Office

## PHILLIPS RBM APPROACH

**Reg. No. 4,274,675**

**Registered Jan. 15, 2013**

**Int. Cl.: 41**

**SERVICE MARK**

**PRINCIPAL REGISTER**

VILLAGE EAST GIFTED, INC. (NEW YORK CORPORATION)  
12 DOTI COURT  
HUNTINGTON, NY 11743

FOR: EDUCATIONAL SERVICES, NAMELY, PROVIDING PROGRAMS OF INSTRUCTION USING A METHOD PRIMARILY FOR TEACHING GIFTED STUDENTS AT THE PRE-SCHOOL, PRIMARY, SECONDARY SCHOOL AND COLLEGE LEVELS IN ALL SUBJECT MATTERS; RELATED EDUCATIONAL SERVICES, NAMELY, PROVIDING PROGRAMS OF INSTRUCTION USING A METHOD FOR TEACHING CHILDREN WITH SPECIAL NEEDS AND ALL OTHER STUDENTS AT THE PRE-SCHOOL, PRIMARY, SECONDARY SCHOOL, AND COLLEGE LEVELS IN ALL SUBJECT MATTERS, IN CLASS 41 (U.S. CLS. 100, 101 AND 107).

FIRST USE 4-18-2012; IN COMMERCE 4-18-2012.

THE MARK CONSISTS OF STANDARD CHARACTERS WITHOUT CLAIM TO ANY PARTICULAR FONT, STYLE, SIZE, OR COLOR.

NO CLAIM IS MADE TO THE EXCLUSIVE RIGHT TO USE "APPROACH", APART FROM THE MARK AS SHOWN.

SER. NO. 85-602,244, FILED 4-19-2012.

MAYUR VAGHANI, EXAMINING ATTORNEY



*David J. Kypos*

Director of the United States Patent and Trademark Office

# United States of America

United States Patent and Trademark Office

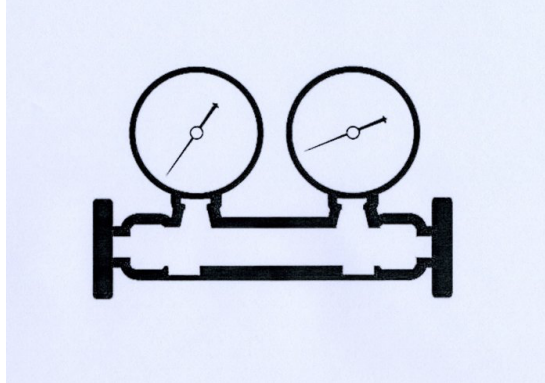

**Reg. No. 4,274,676**

**Registered Jan. 15, 2013**

**Int. Cl.: 37**

**SERVICE MARK**

**PRINCIPAL REGISTER**

M.J. MAC INC. (PENNSYLVANIA CORPORATION)  
3510 DAVISVILLE ROAD  
HATBORO, PA 19040

FOR: INSTALLATION, MAINTENANCE, AND REPAIR OF REFRIGERATION, AIR CONDITIONING, AND HEATING EQUIPMENT, IN CLASS 37 (U.S. CLS. 100, 103 AND 106).

FIRST USE 9-30-2007; IN COMMERCE 1-31-2008.

THE MARK CONSISTS OF A GAUGE DESIGN.

SER. NO. 85-602,770, FILED 4-19-2012.

LEIGH CAROLINE CASE, EXAMINING ATTORNEY



*David J. Kyffers*

Director of the United States Patent and Trademark Office



# United States of America

United States Patent and Trademark Office



**Reg. No. 4,274,677**

**Registered Jan. 15, 2013**

**Int. Cl.: 43**

**SERVICE MARK**

**PRINCIPAL REGISTER**

TOM AND CHEE LLC (OHIO LIMITED LIABILITY COMPANY)  
133 E COURT ST.  
CINCINNATI, OH 45202

FOR: RESTAURANT SERVICES, IN CLASS 43 (U.S. CLS. 100 AND 101).

FIRST USE 6-0-2009; IN COMMERCE 12-3-2009.

NO CLAIM IS MADE TO THE EXCLUSIVE RIGHT TO USE "GRILLED CHEESE" AND "TOMATO SOUP", APART FROM THE MARK AS SHOWN.

THE COLOR(S) BLACK, WHITE, RED AND YELLOW IS/ARE CLAIMED AS A FEATURE OF THE MARK.

THE MARK CONSISTS OF A SOLID RED CIRCLE SURROUNDED BY WHITE AND YELLOW RINGS. IN THE CENTER OF THE RED CIRCLE IS THE WHITE STYLIZED TEXT "TOM+CHEE". ARCHING AROUND THE TOP LEFT OF THE YELLOW RING IS THE BLACK STYLIZED TEXT "GRILLED CHEESE" AND ARCHING AROUND THE LOWER RIGHT OF THE YELLOW RING IS THE BLACK STYLIZED TEXT "TOMATO SOUP".

SER. NO. 85-603,032, FILED 4-19-2012.

STEVEN PEREZ, EXAMINING ATTORNEY



*David J. Kybas*

Director of the United States Patent and Trademark Office

# United States of America

United States Patent and Trademark Office



## LITTLE CREEK PRESS

A DIVISION OF KRISTIN MITCHELL DESIGN, LLC

**Reg. No. 4,274,678**

KRISTIN MITCHELL DESIGN, LLC (WISCONSIN LIMITED LIABILITY COMPANY)  
5341 SUNNY RIDGE RD.

**Registered Jan. 15, 2013**

MINERAL POINT, WI 53565

**Int. Cl.: 41**

FOR: PUBLICATION OF BOOKS, E-BOOKS AND MAGAZINES, IN CLASS 41 (U.S. CLS. 100, 101 AND 107).

**SERVICE MARK**

FIRST USE 8-1-2011; IN COMMERCE 8-1-2011.

**PRINCIPAL REGISTER**

NO CLAIM IS MADE TO THE EXCLUSIVE RIGHT TO USE "PRESS", "A DIVISION OF" AND "DESIGN, LLC", APART FROM THE MARK AS SHOWN.

THE NAME(S), PORTRAIT(S), AND/OR SIGNATURE(S) SHOWN IN THE MARK IDENTIFIES "KRISTIN MITCHELL", WHOSE CONSENT(S) TO REGISTER IS MADE OF RECORD.

THE MARK CONSISTS OF FIVE VERTICAL BLADES OF GRASS STANDING IN HALF-CIRCLES REPRESENTING A POOL OF WATER, NEXT TO A FLYING DRAGONFLY, WITH THE WORDS "LITTLE CREEK PRESS" IN STYLIZED FONT BELOW, AND THE WORDS "A DIVISION OF KRISTIN MITCHELL DESIGN, LLC" IN SMALLER STYLIZED FONT AT THE BOTTOM.

SER. NO. 85-603,056, FILED 4-19-2012.

RON FAIRBANKS, EXAMINING ATTORNEY



*David J. Kybas*

Director of the United States Patent and Trademark Office

# United States of America

United States Patent and Trademark Office



Jamerican

**Reg. No. 4,274,679**

**Registered Jan. 15, 2013**

**Int. Cl.: 3**

**TRADEMARK**

**PRINCIPAL REGISTER**

THE STEAMSTRESS LLC (NORTH CAROLINA LIMITED LIABILITY COMPANY), DBA  
THE STEAMSTRESS LLC  
4811 WATERFORD CLUB CROSSING #228  
RALEIGH, NC 27612

FOR: HAIR SHAMPOO; HANDMADE SOAP BARS, IN CLASS 3 (U.S. CLS. 1, 4, 6, 50, 51  
AND 52).

FIRST USE 1-1-2011; IN COMMERCE 1-1-2011.

THE MARK CONSISTS OF THE WORD "JAMERICAN" IN BLACK STANDARD CHARACTERS, A BLACK BUTTERFLY BODY, THE FIRST WING HAS RED AND WHITE STRIPES AND WHITE STARS ON A BLUE BACKGROUND, THE SECOND WING HAS A YELLOW "X" IN THE MIDDLE WITH THE COLOR GREEN ON EITHER SIDE AND THE COLOR BLACK ON THE TOP AND BOTTOM.

THE COLOR(S) BLACK, RED, WHITE, BLUE, YELLOW, AND GREEN IS/ARE CLAIMED AS A FEATURE OF THE MARK.

SER. NO. 85-603,465, FILED 4-20-2012.

TINA L. SNAPP, EXAMINING ATTORNEY



*David J. Kybas*

Director of the United States Patent and Trademark Office

# United States of America

United States Patent and Trademark Office

# InstaGamer

**Reg. No. 4,274,680**

**Registered Jan. 15, 2013**

**Int. Cl.: 9**

**TRADEMARK**

**PRINCIPAL REGISTER**

HIDDEN ELEPHANT INC. (CALIFORNIA CORPORATION)  
3192 WOODS CIRCLE  
DAVIS, CA 95616

FOR: VIDEO GAME PROGRAMS FOR MOBILE DEVICES, PERSONAL COMPUTERS, VIDEO GAME CONSOLES AND TABLET COMPUTERS, AND FOR USE ON GAMING MACHINES INCLUDING SLOT MACHINES OR VIDEO LOTTERY TERMINALS; ELECTRONIC GAME PROGRAMS; DOWNLOADABLE ELECTRONIC GAME PROGRAMS; ELECTRONIC GAME SOFTWARE; COMPUTER GAME PROGRAMS; DOWNLOADABLE COMPUTER GAME PROGRAMS; INTERACTIVE GAME PROGRAMS; INTERACTIVE GAME SOFTWARE, IN CLASS 9 (U.S. CLS. 21, 23, 26, 36 AND 38).

FIRST USE 3-12-2012; IN COMMERCE 3-12-2012.

THE MARK CONSISTS OF STANDARD CHARACTERS WITHOUT CLAIM TO ANY PARTICULAR FONT, STYLE, SIZE, OR COLOR.

SER. NO. 85-603,497, FILED 4-20-2012.

STEVEN R. FINE, EXAMINING ATTORNEY



*David J. Kyros*

Director of the United States Patent and Trademark Office

# United States of America

United States Patent and Trademark Office

# SuccessLine

**Reg. No. 4,274,681**

**Registered Jan. 15, 2013**

**Int. Cl.: 42**

**SERVICE MARK**

**PRINCIPAL REGISTER**

APOGEE DESIGN, INC. (IDAHO CORPORATION), DBA APOGEEINVENT  
105 W PARK ST  
105 W PARK ST  
AMERICAN FALLS, ID 83211

FOR: PROVIDING ON-LINE NON-DOWNLOADABLE SOFTWARE FOR THE PURPOSE OF MARKETING USING TOOLS SUCH AS AUTOMATED E-MAIL REMINDERS FOR MULTI-LEVEL MARKETING COMPANIES, IN CLASS 42 (U.S. CLS. 100 AND 101).

FIRST USE 12-15-2011; IN COMMERCE 12-15-2011.

THE MARK CONSISTS OF STANDARD CHARACTERS WITHOUT CLAIM TO ANY PARTICULAR FONT, STYLE, SIZE, OR COLOR.

SER. NO. 85-603,634, FILED 4-20-2012.

AMY C. KEAN, EXAMINING ATTORNEY



*David J. Kybas*

Director of the United States Patent and Trademark Office

# United States of America

United States Patent and Trademark Office

# GAVILON 31

**Reg. No. 4,274,682**

**Registered Jan. 15, 2013**

**Int. Cl.: 1**

**TRADEMARK**

**PRINCIPAL REGISTER**

THE GAVILON GROUP, LLC (DELAWARE LIMITED LIABILITY COMPANY)  
ELEVEN CONAGRA DRIVE  
OMAHA, NE 68102

FOR: FERTILIZERS FOR AGRICULTURAL USE, IN CLASS 1 (U.S. CLS. 1, 5, 6, 10, 26 AND 46).

FIRST USE 3-31-2012; IN COMMERCE 3-31-2012.

THE MARK CONSISTS OF STANDARD CHARACTERS WITHOUT CLAIM TO ANY PARTICULAR FONT, STYLE, SIZE, OR COLOR.

OWNER OF U.S. REG. NOS. 3,664,536 AND 3,664,537.

NO CLAIM IS MADE TO THE EXCLUSIVE RIGHT TO USE "31", APART FROM THE MARK AS SHOWN.

SER. NO. 85-603,774, FILED 4-20-2012.

DAWN HAN, EXAMINING ATTORNEY



*David J. Kyffers*

Director of the United States Patent and Trademark Office

# United States of America

United States Patent and Trademark Office

# GAVILON 30

**Reg. No. 4,274,683**

**Registered Jan. 15, 2013**

**Int. Cl.: 1**

**TRADEMARK**

**PRINCIPAL REGISTER**

THE GAVILON GROUP, LLC (DELAWARE LIMITED LIABILITY COMPANY)  
ELEVEN CONAGRA DRIVE  
OMAHA, NE 68102

FOR: FERTILIZERS FOR AGRICULTURAL USE, IN CLASS 1 (U.S. CLS. 1, 5, 6, 10, 26 AND 46).

FIRST USE 3-15-2010; IN COMMERCE 3-15-2010.

THE MARK CONSISTS OF STANDARD CHARACTERS WITHOUT CLAIM TO ANY PARTICULAR FONT, STYLE, SIZE, OR COLOR.

OWNER OF U.S. REG. NOS. 3,664,536 AND 3,664,537.

NO CLAIM IS MADE TO THE EXCLUSIVE RIGHT TO USE "30", APART FROM THE MARK AS SHOWN.

SER. NO. 85-603,780, FILED 4-20-2012.

DAWN HAN, EXAMINING ATTORNEY



*David J. Kyffers*

Director of the United States Patent and Trademark Office

# United States of America

United States Patent and Trademark Office

## MARTIAL WELLNESS

**Reg. No. 4,274,684**

**Registered Jan. 15, 2013**

**Int. Cl.: 41**

**SERVICE MARK**

**PRINCIPAL REGISTER**

MARCHTALER, KENNETH (CANADA INDIVIDUAL)  
1 - 3946 QUADRA ST  
VICTORIA, CANADA

FOR: OPERATING OF MARTIAL ARTS' SCHOOLS; MARTIAL ARTS INSTRUCTION; ORGANIZING LIVE MARTIAL ARTS EVENTS, COMPETITIONS, SPORTING AND CULTURAL ACTIVITIES, IN CLASS 41 (U.S. CLS. 100, 101 AND 107).

FIRST USE 1-13-2006; IN COMMERCE 1-13-2006.

THE MARK CONSISTS OF STANDARD CHARACTERS WITHOUT CLAIM TO ANY PARTICULAR FONT, STYLE, SIZE, OR COLOR.

NO CLAIM IS MADE TO THE EXCLUSIVE RIGHT TO USE "MARTIAL", APART FROM THE MARK AS SHOWN.

SER. NO. 85-603,904, FILED 4-20-2012.

MICHAEL SOUDERS, EXAMINING ATTORNEY



*David J. Kybas*

Director of the United States Patent and Trademark Office



# United States of America

United States Patent and Trademark Office

# Lacuna

**Reg. No. 4,274,685**

**Registered Jan. 15, 2013**

**Int. Cl.: 9**

**TRADEMARK**

**PRINCIPAL REGISTER**

LACUNA SYSTEMS INC. (WASHINGTON CORPORATION)  
218 MAIN ST.  
#733  
KIRKLAND, WA 98033

FOR: COMPUTER SOFTWARE AND HARDWARE FOR APPLICATION PERFORMANCE  
MANAGEMENT, IN CLASS 9 (U.S. CLS. 21, 23, 26, 36 AND 38).

FIRST USE 12-6-2010; IN COMMERCE 2-2-2011.

THE MARK CONSISTS OF STANDARD CHARACTERS WITHOUT CLAIM TO ANY PAR-  
TICULAR FONT, STYLE, SIZE, OR COLOR.

SER. NO. 85-604,578, FILED 4-21-2012.

JORDAN BAKER, EXAMINING ATTORNEY



*David J. Kyffers*

Director of the United States Patent and Trademark Office

# United States of America

United States Patent and Trademark Office

# Indico

**Reg. No. 4,274,686**

**Registered Jan. 15, 2013**

**Int. Cl.: 9**

**TRADEMARK**

**PRINCIPAL REGISTER**

LACUNA SYSTEMS INC. (WASHINGTON CORPORATION)  
218 MAIN ST.  
#733  
KIRKLAND, WA 98033

FOR: COMPUTER SOFTWARE AND HARDWARE FOR APPLICATION PERFORMANCE MANAGEMENT, IN CLASS 9 (U.S. CLS. 21, 23, 26, 36 AND 38).

FIRST USE 1-5-2011; IN COMMERCE 3-24-2011.

THE MARK CONSISTS OF STANDARD CHARACTERS WITHOUT CLAIM TO ANY PARTICULAR FONT, STYLE, SIZE, OR COLOR.

THE ENGLISH TRANSLATION OF "INDICO" IN THE MARK IS "INDICATE", "PROCLAIM" OR "REVEAL".

SER. NO. 85-604,583, FILED 4-21-2012.

JORDAN BAKER, EXAMINING ATTORNEY



*David J. Kyfos*

Director of the United States Patent and Trademark Office

# United States of America

United States Patent and Trademark Office

## Yoga Girl's Club Do Yoga. Make Art. Be You

**Reg. No. 4,274,687**

YOGA GIRL'S CLUB (VIRGINIA SOLE PROPRIETORSHIP)  
314 FAIRFAX AVENUE  
NORFOLK, VA 23507

**Registered Jan. 15, 2013**

**Int. Cl.: 41**

FOR: YOGA INSTRUCTION, IN CLASS 41 (U.S. CLS. 100, 101 AND 107).

**SERVICE MARK**

FIRST USE 1-1-2012; IN COMMERCE 1-27-2012.

**PRINCIPAL REGISTER**

THE MARK CONSISTS OF STANDARD CHARACTERS WITHOUT CLAIM TO ANY PARTICULAR FONT, STYLE, SIZE, OR COLOR.

NO CLAIM IS MADE TO THE EXCLUSIVE RIGHT TO USE "YOGA GIRL'S CLUB" AND "YOGA", APART FROM THE MARK AS SHOWN.

SER. NO. 85-604,741, FILED 4-22-2012.

KELLY TRUSILO, EXAMINING ATTORNEY



*David J. Kyffers*

Director of the United States Patent and Trademark Office

# United States of America

United States Patent and Trademark Office

# KaPlur

**Reg. No. 4,274,688**

**Registered Jan. 15, 2013**

**Int. Cl.: 9**

**TRADEMARK**

**PRINCIPAL REGISTER**

ARROWPOINT CORP. (NEVADA CORPORATION)  
459 SIERRA PLACE  
GURNEE, IL 60031

FOR: ANTI-SCRATCH AND ANTI-GLARE PROTECTORS FOR MOBILE PHONE SCREENS;  
LAPTOP KEYBOARD SKIN PROTECTORS; KEYBOARD COVERS AND PROTECTORS, IN  
CLASS 9 (U.S. CLS. 21, 23, 26, 36 AND 38).

FIRST USE 4-1-2010; IN COMMERCE 6-1-2010.

THE MARK CONSISTS OF STANDARD CHARACTERS WITHOUT CLAIM TO ANY PAR-  
TICULAR FONT, STYLE, SIZE, OR COLOR.

SER. NO. 85-605,062, FILED 4-23-2012.

THEODORE MCBRIDE, EXAMINING ATTORNEY



*David J. Kybas*

Director of the United States Patent and Trademark Office

# United States of America

United States Patent and Trademark Office

## HACIENDA TRES AGUILAS-THE EQUINE EXPERIENCE

**Reg. No. 4,274,689**

**Registered Jan. 15, 2013**

**Int. Cl.: 41**

**SERVICE MARK**

**PRINCIPAL REGISTER**

TRES AGUILAS, LTD. (TEXAS LIMITED PARTNERSHIP)  
PMB 429  
20475 HIGHWAY 46 WEST SUITE 180  
SPRING BRANCH, TX 78070

FOR: EDUCATION SERVICES, NAMELY, PROVIDING CLASSES, SEMINARS, CONFERENCES, WORKSHOPS AND ONE-ON-ONE TRAINING IN THE FIELD OF EQUINE THERAPY; EDUCATION SERVICES, NAMELY, PROVIDING CLASSES, SEMINARS, CONFERENCES, WORKSHOPS AND ONE-ON-ONE TRAINING IN THE FIELD OF HUMAN DEVELOPMENT, ADVANCEMENT AND LEADERSHIP; INSTRUCTIONAL SERVICES, NAMELY, TEACHING OTHERS ABOUT EQUINE THERAPY AND THE USE OF HORSES TO FACILITATE LEARNING ABOUT HUMAN DEVELOPMENT, ADVANCEMENT AND LEADERSHIP, IN CLASS 41 (U.S. CLS. 100, 101 AND 107).

FIRST USE 12-31-1994; IN COMMERCE 12-31-1994.

THE MARK CONSISTS OF STANDARD CHARACTERS WITHOUT CLAIM TO ANY PARTICULAR FONT, STYLE, SIZE, OR COLOR.

NO CLAIM IS MADE TO THE EXCLUSIVE RIGHT TO USE "EQUINE", APART FROM THE MARK AS SHOWN.

THE ENGLISH TRANSLATION OF "HACIENDA TRES AGUILAS" IN THE MARK IS "THREE EAGLES RANCH".

SER. NO. 85-605,149, FILED 4-23-2012.

LUCY ARANT, EXAMINING ATTORNEY



*David J. Kybas*

Director of the United States Patent and Trademark Office

# United States of America

United States Patent and Trademark Office

## V Series

**Reg. No. 4,274,690**

ALLMAND BROS., INC. (NEBRASKA CORPORATION)  
1502 WEST 4TH AVENUE  
LINCOLN, NE 68949

**Registered Jan. 15, 2013**

**Int. Cl.: 11**

FOR: TRAILER MOUNTED DIESEL GENERATOR-POWERED FLOODLIGHTING SYSTEM WITH VERTICALLY ORIENTED MAST ASSEMBLY COMPRISED OF FLOODLIGHTS ATTACHED TO A VERTICLE MAST THAT IS ALWAYS IN THE VERTICLE POSITION, IN CLASS 11 (U.S. CLS. 13, 21, 23, 31 AND 34).

**TRADEMARK**

**PRINCIPAL REGISTER**

FIRST USE 2-27-2008; IN COMMERCE 2-27-2008.

THE MARK CONSISTS OF STANDARD CHARACTERS WITHOUT CLAIM TO ANY PARTICULAR FONT, STYLE, SIZE, OR COLOR.

NO CLAIM IS MADE TO THE EXCLUSIVE RIGHT TO USE "SERIES", APART FROM THE MARK AS SHOWN.

SER. NO. 85-605,443, FILED 4-23-2012.

ELIZABETH KAJUBI, EXAMINING ATTORNEY



*David J. Kyffers*

Director of the United States Patent and Trademark Office

# United States of America

United States Patent and Trademark Office



**Reg. No. 4,274,691**

GREER, MICHAEL (UNITED STATES INDIVIDUAL)  
470 OVERLOOK MOUNTAIN DR.  
SUWANEE, GA 30024

**Registered Jan. 15, 2013**

**Int. Cl.: 37**

FOR: CAR WASHING, IN CLASS 37 (U.S. CLS. 100, 103 AND 106).

**SERVICE MARK**

FIRST USE 8-0-2009; IN COMMERCE 4-27-2012.

**PRINCIPAL REGISTER**

NO CLAIM IS MADE TO THE EXCLUSIVE RIGHT TO USE "FOAM BATH", APART FROM THE MARK AS SHOWN.

THE COLOR(S) RED, ORANGE, GOLD, YELLOW, WHITE, BLACK, AND TAN IS/ARE CLAIMED AS A FEATURE OF THE MARK.

THE MARK CONSISTS OF THE WORDS "DRAGON FOAM BATH" IN WHITE, ITALIC LETTERING, OUTLINED IN RED, OUTLINED IN BLACK, IN FRONT OF A CARTOON REPRESENTATION OF FLAMES IN YELLOW, GOLD, RED, ORANGE, AND BLACK, EMANATING FROM THE JAWS OF A RED CARTOON DRAGON'S HEAD, WITH TAN-COLORED SCALES ON ITS NECK, WHICH FACES BACK TOWARDS THE AFORESAID WORDS.

SER. NO. 85-605,563, FILED 4-23-2012.

DORITT L. CARROLL, EXAMINING ATTORNEY



*David J. Kyros*

Director of the United States Patent and Trademark Office

# United States of America

United States Patent and Trademark Office

# +75K

**Reg. No. 4,274,692**

**Registered Jan. 15, 2013**

**Int. Cl.: 1**

**TRADEMARK**

**PRINCIPAL REGISTER**

REV YOUR CAUSE, LLC (CALIFORNIA LIMITED LIABILITY COMPANY)  
1440 JASON WAY  
STE 100  
SANTA MARIA, CA 93455

FOR: CHEMICAL ENGINE TREATMENTS AND ADDITIVES FOR ENGINE OILS, GASOLINE AND DIESEL FUELS, TRANSMISSION FLUIDS AND COOLING SYSTEMS , IN CLASS 1 (U.S. CLS. 1, 5, 6, 10, 26 AND 46).

FIRST USE 2-28-2012; IN COMMERCE 2-28-2012.

THE MARK CONSISTS OF STANDARD CHARACTERS WITHOUT CLAIM TO ANY PARTICULAR FONT, STYLE, SIZE, OR COLOR.

SER. NO. 85-605,600, FILED 4-23-2012.

CHARLES L. JENKINS, EXAMINING ATTORNEY



*David J. Kyros*

Director of the United States Patent and Trademark Office



# United States of America

United States Patent and Trademark Office

# miniBEE

**Reg. No. 4,274,693**

BEECUBE INC. (CALIFORNIA CORPORATION)  
39465 PASEO PADRE PKWY, SUITE 3700  
FREMONT, CA 94538

**Registered Jan. 15, 2013**

**Int. Cl.: 9**

FOR: COMPUTER HARDWARE, IN CLASS 9 (U.S. CLS. 21, 23, 26, 36 AND 38).

**TRADEMARK**

FIRST USE 7-27-2010; IN COMMERCE 7-27-2010.

**PRINCIPAL REGISTER**

THE MARK CONSISTS OF STANDARD CHARACTERS WITHOUT CLAIM TO ANY PARTICULAR FONT, STYLE, SIZE, OR COLOR.

SER. NO. 85-605,888, FILED 4-23-2012.

ELI HELLMAN, EXAMINING ATTORNEY



*David J. Kybas*

Director of the United States Patent and Trademark Office

**United States of America**  
United States Patent and Trademark Office

# CHASCONA

**Reg. No. 4,274,694**

**Registered Jan. 15, 2013**

**Int. Cl.: 18**

**TRADEMARK**

**PRINCIPAL REGISTER**

CHASCONA ENTERPRISES LLC (NEW YORK LIMITED LIABILITY COMPANY)  
4 LEXINGTON AVENUE, 6K  
NEW YORK, NY 10010

FOR: HANDBAGS, IN CLASS 18 (U.S. CLS. 1, 2, 3, 22 AND 41).

FIRST USE 7-19-2011; IN COMMERCE 7-19-2011.

THE MARK CONSISTS OF STANDARD CHARACTERS WITHOUT CLAIM TO ANY PARTICULAR FONT, STYLE, SIZE, OR COLOR.

THE ENGLISH TRANSLATION OF "CHASCONA" IN THE MARK IS "MATTED, TANGLED".

SER. NO. 85-606,068, FILED 4-24-2012.

LINDA MICKLEBURGH, EXAMINING ATTORNEY



*David J. Kyffers*

Director of the United States Patent and Trademark Office

# United States of America

United States Patent and Trademark Office

## Comerica Convenience Card

**Reg. No. 4,274,695**

**Registered Jan. 15, 2013**

**Int. Cl.: 36**

**SERVICE MARK**

**PRINCIPAL REGISTER**

COMERICA INCORPORATED (DELAWARE CORPORATION)  
MC 3391  
411 LAFAYETTE  
DETROIT, MI 48226

FOR: BANKING AND FINANCIAL SERVICES, SPECIFICALLY A RELOADABLE DEBIT CARD THAT PROVIDES EASY ACCESS TO FUNDS WHEN PURCHASES ARE MADE AT MERCHANTS WORLDWIDE AND WITHDRAWALS AT ATMS, IN CLASS 36 (U.S. CLS. 100, 101 AND 102).

FIRST USE 9-1-2011; IN COMMERCE 9-1-2011.

THE MARK CONSISTS OF STANDARD CHARACTERS WITHOUT CLAIM TO ANY PARTICULAR FONT, STYLE, SIZE, OR COLOR.

OWNER OF U.S. REG. NOS. 4,134,449, 4,169,231, AND 4,174,188.

NO CLAIM IS MADE TO THE EXCLUSIVE RIGHT TO USE "CONVENIENCE CARD", APART FROM THE MARK AS SHOWN.

SER. NO. 85-606,175, FILED 4-24-2012.

FLORENTINA BLANDU, EXAMINING ATTORNEY



*David J. Kyffers*

Director of the United States Patent and Trademark Office

# United States of America

United States Patent and Trademark Office

## Hanging jewelry where it goes...with your clothes

**Reg. No. 4,274,696**

MCMAHON, SHERRE S. (UNITED STATES INDIVIDUAL)  
4419 NE PARK SPRINGS COURT  
LEES SUMMIT, MO 64064

**Registered Jan. 15, 2013**

**Int. Cl.: 21**

FOR: CONTAINERS OF PLASTIC FOR JEWELRY STORAGE FOR DOMESTIC USE, IN CLASS 21 (U.S. CLS. 2, 13, 23, 29, 30, 33, 40 AND 50).

**TRADEMARK**

FIRST USE 9-1-2011; IN COMMERCE 1-1-2012.

**PRINCIPAL REGISTER**

THE MARK CONSISTS OF STANDARD CHARACTERS WITHOUT CLAIM TO ANY PARTICULAR FONT, STYLE, SIZE, OR COLOR.

NO CLAIM IS MADE TO THE EXCLUSIVE RIGHT TO USE "JEWELRY", APART FROM THE MARK AS SHOWN.

SER. NO. 85-606,692, FILED S.R. 4-24-2012 AM. P.R. 8-22-2012.

GRETCHEN ULRICH, EXAMINING ATTORNEY



*David J. Kybas*

Director of the United States Patent and Trademark Office

# United States of America

United States Patent and Trademark Office

# elem3nts

BY TAYLOR MORRISON

**Reg. No. 4,274,697**

**Registered Jan. 15, 2013**

**Int. Cl.: 37**

**SERVICE MARK**

**PRINCIPAL REGISTER**

TAYLOR MORRISON, INC. (DELAWARE CORPORATION)  
SUITE 2000  
4900 N. SCOTTSDALE RD.  
SCOTTSDALE, AZ 85251

FOR: REAL ESTATE DEVELOPMENT, CONSTRUCTION, LAND PLANNING, AND LAND DEVELOPMENT SERVICES, NAMELY, CUSTOM CONSTRUCTION OF HOMES, BUILDINGS, AND RESIDENTIAL AND COMMERCIAL COMMUNITIES ALL IN A MANNER TO PROMOTE GREEN, ENVIRONMENTALLY-FRIENDLY, EFFICIENT, AND SUSTAINABLE HOMES, BUILDINGS, AND COMMUNITIES, IN CLASS 37 (U.S. CLS. 100, 103 AND 106).

FIRST USE 4-21-2012; IN COMMERCE 4-21-2012.

OWNER OF U.S. REG. NO. 3,861,267.

THE NAME IN THE MARK DOES NOT IDENTIFY A PARTICULAR LIVING INDIVIDUAL.

THE MARK CONSISTS OF THE WORD "ELEM3NTS" WRITTEN IN LARGE FONT, LOWER CASE LETTERS, WITH THE THIRD "E" OF THE WORD "ELEM3NTS" APPEARING AS THE NUMBER "3" CONTAINED WITHIN A BOX, AND WITH THE TAGLINE "BY TAYLOR MORRISON" APPEARING BELOW THE WORD "ELEM3NTS".

SER. NO. 85-606,907, FILED 4-24-2012.

KAREN K. BUSH, EXAMINING ATTORNEY



*David J. Kyros*

Director of the United States Patent and Trademark Office

# United States of America

United States Patent and Trademark Office

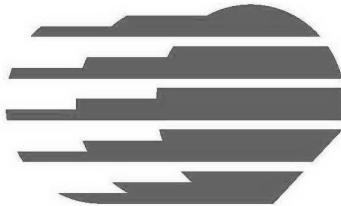

**Reg. No. 4,274,698**

**Registered Jan. 15, 2013**

**Int. Cl.: 9**

**TRADEMARK**

**PRINCIPAL REGISTER**

CIRRUS LOGIC, INC. (DELAWARE CORPORATION)  
800 W. 6TH STREET  
AUSTIN, TX 78701

FOR: CIRCUIT BOARDS; ELECTRONIC CIRCUIT BOARD; INTEGRATED CIRCUIT MODULE; INTEGRATED CIRCUIT MODULES; INTEGRATED CIRCUITS, IN CLASS 9 (U.S. CLS. 21, 23, 26, 36 AND 38).

FIRST USE 3-4-2012; IN COMMERCE 3-4-2012.

THE MARK CONSISTS OF THREE OVERLAPPING PARTIALLY-SHADED STYLIZED SILICON WAFERS, WITH THE FIRST CONTAINING THE LEAST HORIZONTAL SHADING, THE SECOND GREATER HORIZONTAL SHADING, AND THE THIRD THE MOST HORIZONTAL SHADING.

SER. NO. 85-606,987, FILED 4-24-2012.

ODESSA BIBBINS, EXAMINING ATTORNEY



*David J. Kybas*

Director of the United States Patent and Trademark Office

# United States of America

United States Patent and Trademark Office

## ECHELON FRONT

**Reg. No. 4,274,699**

ECHELON FRONT LLC (DELAWARE LIMITED LIABILITY COMPANY)  
4335 LONG BRANCH AVE  
SAN DIEGO, CA 92107

**Registered Jan. 15, 2013**

**Int. Cl.: 35**

**SERVICE MARK**

**PRINCIPAL REGISTER**

FOR: BUSINESS MANAGEMENT CONSULTING; BUSINESS MANAGEMENT CONSULTING WITH RESPECT TO LEADERSHIP, STRATEGY, INNOVATION, MANAGEMENT, TEAM BUILDING, CONTINGENCY PLANNING, AND CRISIS MANAGEMENT; CONDUCTING ROUND TABLE BUSINESS MEETINGS WITH EXECUTIVE LEADERS AND DEPARTMENT HEADS; BUSINESS MANAGEMENT CONSULTING SERVICES WITH RESPECT TO LEADERSHIP, STRATEGY, INNOVATION, MANAGEMENT, TEAM BUILDING, CONTINGENCY PLANNING, AND CRISIS MANAGEMENT, NAMELY, OBSERVING AND ASSESSING BUSINESS PRACTICES AND OPERATIONS, CONDUCTING IN-DEPTH STRATEGIC LEADERSHIP ASSESSMENT, BRIEFING SPECIFIC LEADERS WITHIN AN ORGANIZATION, AND CONDUCTING PERIODIC STRATEGIC ASSESSMENTS; BUSINESS MANAGEMENT CONSULTING SERVICES WITH RESPECT TO LEADERSHIP, STRATEGY, INNOVATION, MANAGEMENT, TEAM BUILDING, CONTINGENCY PLANNING, AND CRISIS MANAGEMENT, NAMELY, CONDUCTING ROUND TABLE BUSINESS MEETINGS WITH EXECUTIVE LEADERSHIP AND SENIOR MANAGEMENT OF ORGANIZATIONS; BUSINESS MANAGEMENT CONSULTING SERVICES WITH RESPECT TO LEADERSHIP, STRATEGY, INNOVATION, MANAGEMENT, TEAM BUILDING, CONTINGENCY PLANNING, AND CRISIS MANAGEMENT, NAMELY, DEVELOPING LONG TERM PROGRAMS FOR EVALUATING ORGANIZATIONS, IN CLASS 35 (U.S. CLS. 100, 101 AND 102).

FIRST USE 1-1-2010; IN COMMERCE 1-1-2010.

THE MARK CONSISTS OF STANDARD CHARACTERS WITHOUT CLAIM TO ANY PARTICULAR FONT, STYLE, SIZE, OR COLOR.

SER. NO. 85-607,059, FILED 4-24-2012.

KATINA MISTER, EXAMINING ATTORNEY



*David J. Kyjars*

Director of the United States Patent and Trademark Office

# United States of America

United States Patent and Trademark Office

# iBrusher

**Reg. No. 4,274,700**

ELZAYYAT, BAYAN AREF (NEW ZEALAND INDIVIDUAL)  
2/57 ROSE ROAD, GREY LYNN  
AUCKLAND, NEW ZEALAND 1021

**Registered Jan. 15, 2013**

**Int. Cl.: 21**

FOR: SHAVING BRUSHES, IN CLASS 21 (U.S. CLS. 2, 13, 23, 29, 30, 33, 40 AND 50).

**TRADEMARK**

FIRST USE 4-4-2012; IN COMMERCE 4-24-2012.

**PRINCIPAL REGISTER**

THE MARK CONSISTS OF STANDARD CHARACTERS WITHOUT CLAIM TO ANY PARTICULAR FONT, STYLE, SIZE, OR COLOR.

SER. NO. 85-607,280, FILED 4-25-2012.

NATALIE POLZER, EXAMINING ATTORNEY



*David J. Kyffers*

Director of the United States Patent and Trademark Office



# United States of America

United States Patent and Trademark Office

## ALLIED FARMS

**Reg. No. 4,274,701**

**Registered Jan. 15, 2013**

**Int. Cl.: 29**

**TRADEMARK**

**PRINCIPAL REGISTER**

GROCERY EXPORTS INC. (FLORIDA CORPORATION)  
10992 NW 92ND TERRACE  
MIAMI, FL 33178

FOR: CANNED COOKED MEAT; CANNED FRUITS AND VEGETABLES; CHEESE, NAMELY, GOUDA, EDAM, CHEDDAR AND PROCESSED; COOKING OIL; CORN OIL; COTTAGE CHEESE; CREAM CHEESE; DAIRY PRODUCTS EXCLUDING ICE CREAM, ICE MILK AND FROZEN YOGURT; DAIRY-BASED DIPS; DAIRY-BASED FOOD BEVERAGES; NON-DAIRY CREAMER; OLIVE OIL; SOYBEAN OIL, IN CLASS 29 (U.S. CL. 46).

FIRST USE 10-1-2009; IN COMMERCE 10-1-2009.

THE MARK CONSISTS OF STANDARD CHARACTERS WITHOUT CLAIM TO ANY PARTICULAR FONT, STYLE, SIZE, OR COLOR.

NO CLAIM IS MADE TO THE EXCLUSIVE RIGHT TO USE "FARMS", APART FROM THE MARK AS SHOWN.

SER. NO. 85-607,457, FILED 4-25-2012.

KAREN BRACEY, EXAMINING ATTORNEY



*David J. Kyffers*

Director of the United States Patent and Trademark Office

**United States of America**  
United States Patent and Trademark Office

**INDIGENA**

**Reg. No. 4,274,702**

ANA MARIA PUELLO (COLOMBIA INDIVIDUAL)  
951 BRICKELL AVENUE, SUITE 4110  
MIAMI, FL 33131

**Registered Jan. 15, 2013**

**Int. Cl.: 18**

FOR: CLUTCH PURSES; CLUTCHES; FASHION HANDBAGS; HANDBAGS; HANDBAGS FOR LADIES; PURSES, IN CLASS 18 (U.S. CLS. 1, 2, 3, 22 AND 41).

**TRADEMARK**

FIRST USE 8-23-2011; IN COMMERCE 8-23-2011.

**PRINCIPAL REGISTER**

THE MARK CONSISTS OF STANDARD CHARACTERS WITHOUT CLAIM TO ANY PARTICULAR FONT, STYLE, SIZE, OR COLOR.

THE ENGLISH TRANSLATION OF "INDIGENA" IN THE MARK IS "INDIGENOUS".

SER. NO. 85-607,494, FILED 4-25-2012.

COLLEEN DOMBROW, EXAMINING ATTORNEY



*David J. Kyffers*

Director of the United States Patent and Trademark Office

# United States of America

United States Patent and Trademark Office

## Theatre Of Illusion

**Reg. No. 4,274,703**

SPENCER, KEVIN (UNITED STATES INDIVIDUAL)  
PO BOX 10396

**Registered Jan. 15, 2013**

LYLNCHBURG, VA 24506

**Int. Cl.: 41**

FOR: ENTERTAINMENT IN THE NATURE OF MAGIC SHOWS, IN CLASS 41 (U.S. CLS. 100, 101 AND 107).

**SERVICE MARK**

FIRST USE 1-1-1988; IN COMMERCE 1-1-1988.

**PRINCIPAL REGISTER**

THE MARK CONSISTS OF STANDARD CHARACTERS WITHOUT CLAIM TO ANY PARTICULAR FONT, STYLE, SIZE, OR COLOR.

NO CLAIM IS MADE TO THE EXCLUSIVE RIGHT TO USE "THEATRE", APART FROM THE MARK AS SHOWN.

SEC. 2(F).

SER. NO. 85-607,662, FILED 4-25-2012.

CAROLYN CATALDO, EXAMINING ATTORNEY



*David J. Kyffers*

Director of the United States Patent and Trademark Office

# United States of America

United States Patent and Trademark Office



**Reg. No. 4,274,704**

FRIENDS FIRST, INC. (COLORADO NON-PROFIT CORPORATION)  
P.O. BOX 270302  
LITTLETON, CO 80127

**Registered Jan. 15, 2013**

**Int. Cl.: 41**

FOR: EDUCATIONAL SERVICES, NAMELY, CONDUCTING CLASSES IN THE FIELD OF SEXUAL ABSTINENCE AND DISTRIBUTION OF EDUCATIONAL MATERIALS IN CONNECTION THEREWITH, IN CLASS 41 (U.S. CLS. 100, 101 AND 107).

**SERVICE MARK**

FIRST USE 9-0-2009; IN COMMERCE 9-0-2009.

**PRINCIPAL REGISTER**

OWNER OF U.S. REG. NO. 2,184,058.

THE MARK CONSISTS OF A HEART INSIDE A CIRCLE, WITH THE WORDS "FRIENDS FIRST A HEALTHY CHOICE" TO THE RIGHT.

SER. NO. 85-607,735, FILED 4-25-2012.

STEVEN R. FINE, EXAMINING ATTORNEY



*David J. Kybas*

Director of the United States Patent and Trademark Office

United States of America  
United States Patent and Trademark Office

UniverS<sup>al</sup>

**Reg. No. 4,274,705**

UNIVERSAL APPLIANCES, KITCHENS AND BATHS, INC. (CALIFORNIA CORPORATION)  
12050 VENTURA BLVD., B-105  
STUDIO CITY, CA 91604

**Registered Jan. 15, 2013**

**Int. Cl.: 35**

FOR: RETAIL STORE SERVICES AND ON-LINE RETAIL STORE SERVICES FEATURING KITCHEN, BATH, AND HOUSEHOLD APPLIANCES AND FIXTURES; RETAIL STORE SERVICES AND ON-LINE RETAIL STORE SERVICES FEATURING PLUMBING SYSTEMS, FIXTURES, AND SUPPLIES, IN CLASS 35 (U.S. CLS. 100, 101 AND 102).

**SERVICE MARK**

**PRINCIPAL REGISTER**

FIRST USE 12-12-2000; IN COMMERCE 12-12-2000.

THE MARK CONSISTS OF THE WORD "UNIVERSAL" IN BLACK LETTERS, WITH A CAPITAL "U" AND ALL OTHER LETTERS IN LOWER-CASE, WITH THE EXCEPTION OF THE LETTER "S" APPEARING IN UPPER-CASE, IN A SIZE LARGER THAN THE OTHER LETTERS, AND IN THE COLOR RED; THE TOP OF THE LETTER "S" EXTENDS HORIZONTALLY TO THE RIGHT, TO THE TOP OF THE LETTER "L"; THE BOTTOM OF THE LETTER "S" EXTENDS HORIZONTALLY TO THE LEFT, TO THE BOTTOM OF THE LETTER "U".

THE COLOR(S) BLACK AND RED IS/ARE CLAIMED AS A FEATURE OF THE MARK.

SER. NO. 85-607,885, FILED 4-25-2012.

APRIL ROACH, EXAMINING ATTORNEY



*David J. Kypos*

Director of the United States Patent and Trademark Office

# United States of America

United States Patent and Trademark Office

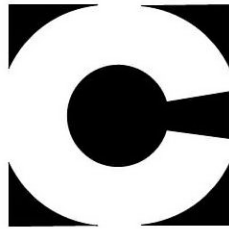

THE CONCILIO

**Reg. No. 4,274,706**

**Registered Jan. 15, 2013**

**Int. Cl.: 41**

**SERVICE MARK**

**PRINCIPAL REGISTER**

THE CONCILIO (TEXAS NON-PROFIT ORGANIZATION)  
400 SOUTH ZANG BOULEVARD, SUITE 300  
DALLAS, TX 75208

FOR: EDUCATIONAL SERVICES, NAMELY, PROVIDING COURSES OF INSTRUCTION  
IN THE FIELD OF PARENT EDUCATION, IN CLASS 41 (U.S. CLS. 100, 101 AND 107).

FIRST USE 1-4-2010; IN COMMERCE 1-4-2010.

NO CLAIM IS MADE TO THE EXCLUSIVE RIGHT TO USE "CONCILIO", APART FROM  
THE MARK AS SHOWN.

THE MARK CONSISTS OF THE SQUARE DESIGN WITH THE LETTER "C" INSIDE AND  
THE WORDS "THE CONCILIO" BENEATH THE DESIGN.

THE ENGLISH TRANSLATION OF THE WORD "CONCILIO" IN THE MARK IS COUNCIL.

SER. NO. 85-608,693, FILED 4-26-2012.

DANNEAN HETZEL, EXAMINING ATTORNEY



*David J. Kyffers*

Director of the United States Patent and Trademark Office

# United States of America

United States Patent and Trademark Office

## Music With A Purpose

**Reg. No. 4,274,707**

MUSIC WITH A PURPOSE, LLC (TENNESSEE LIMITED LIABILITY COMPANY)  
NINE MUSIC SQUARE SOUTH SUITE 318  
NASHVILLE, TN 37203

**Registered Jan. 15, 2013**

**Int. Cl.: 41**

FOR: ARRANGING AND CONDUCTING OF CONCERTS; CONCERT BOOKING; ENTERTAINMENT, NAMELY, LIVE MUSIC CONCERTS, IN CLASS 41 (U.S. CLS. 100, 101 AND 107).

**SERVICE MARK**

FIRST USE 9-1-2011; IN COMMERCE 9-1-2011.

**PRINCIPAL REGISTER**

THE MARK CONSISTS OF STANDARD CHARACTERS WITHOUT CLAIM TO ANY PARTICULAR FONT, STYLE, SIZE, OR COLOR.

NO CLAIM IS MADE TO THE EXCLUSIVE RIGHT TO USE "MUSIC", APART FROM THE MARK AS SHOWN.

SER. NO. 85-609,034, FILED 4-26-2012.

PAULA MAHONEY, EXAMINING ATTORNEY



*David J. Kyffers*

Director of the United States Patent and Trademark Office

# United States of America

United States Patent and Trademark Office

# STRUCTURE

**Reg. No. 4,274,708**

**Registered Jan. 15, 2013**

**Int. Cl.: 41**

**SERVICE MARK**

**PRINCIPAL REGISTER**

GIGA OMNI MEDIA, INC. (DELAWARE CORPORATION)  
4TH FLOOR  
218 SECOND STREET  
SAN FRANCISCO, CA 94105

FOR: EDUCATIONAL SERVICES, NAMELY, CONDUCTING CONFERENCES IN THE FIELD OF SCIENCE AND TECHNOLOGY AND DISTRIBUTION OF EDUCATIONAL MATERIALS IN CONNECTION THEREWITH, IN CLASS 41 (U.S. CLS. 100, 101 AND 107).

FIRST USE 3-1-2008; IN COMMERCE 3-1-2008.

THE MARK CONSISTS OF STANDARD CHARACTERS WITHOUT CLAIM TO ANY PARTICULAR FONT, STYLE, SIZE, OR COLOR.

SER. NO. 85-609,139, FILED 4-26-2012.

JAMES LOVELACE, EXAMINING ATTORNEY



*David J. Kyffers*

Director of the United States Patent and Trademark Office



# United States of America

United States Patent and Trademark Office

## WOLPERTINGER

**Reg. No. 4,274,709**

URBAN CHESTNUT BREWING COMPANY, INC. (MISSOURI CORPORATION)  
3229 WASHINGTON AVENUE  
ST. LOUIS, MO 63103

**Registered Jan. 15, 2013**

**Int. Cls.: 32 and 41**

FOR: BEER, IN CLASS 32 (U.S. CLS. 45, 46 AND 48).

**TRADEMARK**

FIRST USE 2-13-2012; IN COMMERCE 2-13-2012.

**SERVICE MARK**

FOR: ENTERTAINMENT SERVICES IN THE NATURE OF BEER AND FOOD FESTIVALS,  
IN CLASS 41 (U.S. CLS. 100, 101 AND 107).

**PRINCIPAL REGISTER**

FIRST USE 2-4-2012; IN COMMERCE 2-4-2012.

THE MARK CONSISTS OF STANDARD CHARACTERS WITHOUT CLAIM TO ANY PARTICULAR FONT, STYLE, SIZE, OR COLOR.

SER. NO. 85-609,191, FILED 4-26-2012.

BRENDAN MCCAULEY, EXAMINING ATTORNEY



*David J. Kybas*

Director of the United States Patent and Trademark Office

# United States of America

United States Patent and Trademark Office

# ALFALINA

**Reg. No. 4,274,710**

PHARMADEL LLC (DELAWARE LIMITED LIABILITY COMPANY)  
178 VENTURE DR.  
SEAFORD, DE 19973

**Registered Jan. 15, 2013**

**Int. Cl.: 5**

FOR: GROUND FLAXSEED FIBER FOR USE AS A DIETARY SUPPLEMENT; NUTRITIONAL SUPPLEMENTS IN THE FORM OF CAPSULES, IN CLASS 5 (U.S. CLS. 6, 18, 44, 46, 51 AND 52).

**TRADEMARK**

FIRST USE 7-28-2009; IN COMMERCE 7-28-2009.

**PRINCIPAL REGISTER**

THE MARK CONSISTS OF STANDARD CHARACTERS WITHOUT CLAIM TO ANY PARTICULAR FONT, STYLE, SIZE, OR COLOR.

SER. NO. 85-609,458, FILED 4-26-2012.

NAAKWAMA ANKRAH, EXAMINING ATTORNEY



*David J. Kyffers*

Director of the United States Patent and Trademark Office

# United States of America

United States Patent and Trademark Office



# ConnectMD

**Reg. No. 4,274,711**

**Registered Jan. 15, 2013**

**Int. Cls.: 37, 38 and 42**

**SERVICE MARK**

**PRINCIPAL REGISTER**

GENERAL COMMUNICATION, INC. (ALASKA CORPORATION)  
SUITE 1000  
2550 DENALI STREET  
ANCHORAGE, AK 99503

FOR: PROVIDING REAL-TIME MAINTENANCE OF VIDEOCONFERENCING SYSTEMS USED IN THE FIELD OF HEALTHCARE, IN CLASS 37 (U.S. CLS. 100, 103 AND 106).

FIRST USE 4-1-2012; IN COMMERCE 4-1-2012.

FOR: COMMUNICATION SERVICES, NAMELY, PROVIDING SECURE ELECTRONIC TRANSMISSION OF A PATIENT'S PRIVATE MEDICAL RECORDS AND INFORMATION BETWEEN TREATING HEALTH CARE PROFESSIONALS FOR THE MEDICAL CARE AND TREATMENT OF THAT PATIENT, IN COMPLIANCE WITH THE CONFIDENTIALITY REQUIREMENTS OF LAW; PROVIDING EMAIL SERVICES FOR PHYSICIANS, NURSES, HEALTHCARE ADMINISTRATORS AND SUPPORT STAFF; PROVIDING VIDEOCONFERENCING SERVICES FOR USE IN PRESENTING AND VIEWING CONTINUING MEDICAL EDUCATION DEMONSTRATIONS AND PRESENTATIONS; PROVIDING VIDEOCONFERENCING SERVICES TO THE HEALTHCARE INDUSTRY FOR USE IN DELIVERING TELEMEDICINE SERVICES; PROVIDING TECHNICAL SUPPORT SERVICES TO CUSTOMERS REGARDING THE USAGE OF VIDEOCONFERENCING EQUIPMENT IN THE FIELD OF HEALTHCARE, IN CLASS 38 (U.S. CLS. 100, 101 AND 104).

FIRST USE 4-1-2012; IN COMMERCE 4-1-2012.

FOR: PROVIDING REAL-TIME MONITORING OF VIDEOCONFERENCING SYSTEMS USED IN THE FIELD OF HEALTHCARE FOR THE PURPOSE OF ASSURING UNINTERRUPTED SERVICE; DESIGN AND DEPLOYMENT OF CUSTOMIZED VIDEOCONFERENCING NETWORKS, IN CLASS 42 (U.S. CLS. 100 AND 101).

FIRST USE 4-1-2012; IN COMMERCE 4-1-2012.

OWNER OF U.S. REG. NOS. 2,287,632, 3,190,861 AND OTHERS.

NO CLAIM IS MADE TO THE EXCLUSIVE RIGHT TO USE THE CADUCEUS SYMBOL, APART FROM THE MARK AS SHOWN.



*David J. Kyjars*

Director of the United States Patent and Trademark Office

**Reg. No. 4,274,711** THE MARK CONSISTS OF THE LETTERS "GCI" WITH A LINE DESIGN BEGINNING NEXT TO AND EXTENDING ABOVE THE LETTER "G" CONNECTING TO AN OUTLINE OF AN INCOMPLETE 4 POINTED STAR WITH THE TERM "CONNECTMD" APPEARING BELOW THE LETTERS "GCI" AND TO THE RIGHT APPEARS A MEDICAL SYMBOL WITH A CABLE OR CORD WRAPPED AROUND FROM THE BOTTOM AND EXTENDING ABOVE THE TOP OF THE SYMBOL WITH THREE CURVED LINES APPEARING ON EACH SIDE OF THE CORD OR CABLE DEPICTING SOUND WAVES.

SER. NO. 85-609,588, FILED 4-26-2012.

LEE-ANNE BERNS, EXAMINING ATTORNEY

# United States of America

United States Patent and Trademark Office

## EASY CLEANSE

**Reg. No. 4,274,712**

**Registered Jan. 15, 2013**

**Int. Cl.: 5**

**TRADEMARK**

**PRINCIPAL REGISTER**

NOW HEALTH GROUP, INC. (ILLINOIS CORPORATION)  
395 S. GLEN ELLYN ROAD  
BLOOMINGDALE, IL 60108

FOR: DIETARY SUPPLEMENTS, IN CLASS 5 (U.S. CLS. 6, 18, 44, 46, 51 AND 52).

FIRST USE 9-0-2008; IN COMMERCE 9-0-2008.

THE MARK CONSISTS OF STANDARD CHARACTERS WITHOUT CLAIM TO ANY PARTICULAR FONT, STYLE, SIZE, OR COLOR.

NO CLAIM IS MADE TO THE EXCLUSIVE RIGHT TO USE "CLEANSE", APART FROM THE MARK AS SHOWN.

SER. NO. 85-609,706, FILED 4-26-2012.

SALLY SHIH, EXAMINING ATTORNEY



*David J. Kyffers*

Director of the United States Patent and Trademark Office

# United States of America

United States Patent and Trademark Office



**Reg. No. 4,274,713**

CYPRESS GARDENS SKI FACTORY, LLC (FLORIDA LIMITED LIABILITY COMPANY)  
4618 REYNOSA DRIVE, SW  
WINTER HAVEN, FL 33880

**Registered Jan. 15, 2013**

**Int. Cl.: 25**

FOR: ATHLETIC APPAREL, NAMELY, SHIRTS, PANTS, JACKETS, FOOTWEAR, HATS AND CAPS, ATHLETIC UNIFORMS; COLLARED SHIRTS; DRESS SHIRTS; JACKETS; JERSEYS, IN CLASS 25 (U.S. CLS. 22 AND 39).

**TRADEMARK**

FIRST USE 5-4-2011; IN COMMERCE 5-4-2011.

**PRINCIPAL REGISTER**

NO CLAIM IS MADE TO THE EXCLUSIVE RIGHT TO USE "SKI FACTORY", APART FROM THE MARK AS SHOWN.

THE MARK CONSISTS OF A STYLIZED WORDING "CYPRESS GARDEN SKI FACTORY" TO THE RIGHT OF A GEOMETRIC DESIGN RESEMBLING THE LETTER C INCORPORATING THE LETTER G IN THE FORM OF FILLED AND CURVED LINES AND A CIRCLE IN ITS MIDDLE.

SER. NO. 85-610,048, FILED 4-27-2012.

DAWN HAN, EXAMINING ATTORNEY



*David J. Kyros*

Director of the United States Patent and Trademark Office

# United States of America

United States Patent and Trademark Office



**Reg. No. 4,274,714**

CYPRESS GARDENS SKI FACTORY, LLC (FLORIDA LIMITED LIABILITY COMPANY)  
4618 REYNOSA DRIVE, SW  
WINTER HAVEN, FL 33880

**Registered Jan. 15, 2013**

**Int. Cl.: 25**

FOR: ATHLETIC APPAREL, NAMELY, SHIRTS, PANTS, JACKETS, FOOTWEAR, HATS AND CAPS, ATHLETIC UNIFORMS; COLLARED SHIRTS; DRESS SHIRTS; JACKETS, IN CLASS 25 (U.S. CLS. 22 AND 39).

**TRADEMARK**

FIRST USE 5-4-2011; IN COMMERCE 5-4-2011.

**PRINCIPAL REGISTER**

NO CLAIM IS MADE TO THE EXCLUSIVE RIGHT TO USE "SKIS", APART FROM THE MARK AS SHOWN.

THE MARK CONSISTS OF A STYLIZED WORDING "CYPRESS GARDEN SKIS" TO THE RIGHT OF A GEOMETRIC DESIGN RESEMBLING THE LETTER C INCORPORATING THE LETTER G IN THE FORM OF FILLED AND CURVED LINES AND A CIRCLE IN ITS MIDDLE.

SER. NO. 85-610,055, FILED 4-27-2012.

DAWN HAN, EXAMINING ATTORNEY



*David J. Kyros*

Director of the United States Patent and Trademark Office

# United States of America

United States Patent and Trademark Office



**Reg. No. 4,274,715**

**Registered Jan. 15, 2013**

**Int. Cl.: 25**

**TRADEMARK**

**PRINCIPAL REGISTER**

CYPRESS GARDENS SKI FACTORY, LLC (FLORIDA LIMITED LIABILITY COMPANY)  
4618 REYNOSA DRIVE, SW  
WINTER HAVEN, FL 33880

FOR: ATHLETIC APPAREL, NAMELY, SHIRTS, PANTS, JACKETS, FOOTWEAR, HATS  
AND CAPS, ATHLETIC UNIFORMS; COLLARED SHIRTS; DRESS SHIRTS; JACKETS , IN  
CLASS 25 (U.S. CLS. 22 AND 39).

FIRST USE 5-4-2011; IN COMMERCE 5-4-2011.

THE MARK CONSISTS OF A BIRD DESIGN SUPERIMPOSED ON A GEOMETRIC DESIGN  
RESEMBLING THE LETTER C INCORPORATING THE LETTER G IN THE FORM OF FILLED  
AND CURVED LINES AND A CIRCLE IN ITS MIDDLE.

SER. NO. 85-610,057, FILED 4-27-2012.

DAWN HAN, EXAMINING ATTORNEY



*David J. Kybas*

Director of the United States Patent and Trademark Office



# United States of America

United States Patent and Trademark Office

## PROFESSIONAL DOCUMENT MANAGEMENT

**Reg. No. 4,274,716**

**Registered Jan. 15, 2013**

**Int. Cls.: 39, 40 and 42**

**SERVICE MARK**

**PRINCIPAL REGISTER**

PROFESSIONAL DOCK MANAGEMENT, INC. (COLORADO CORPORATION), DBA  
PROFESSIONAL DOCUMENT MANAGEMENT, INC.  
5001 S. COLLEGE AVENUE, UNIT B  
FORT COLLINS, CO 80525

FOR: DOCUMENT STORAGE SERVICES, IN CLASS 39 (U.S. CLS. 100 AND 105).

FIRST USE 12-31-2001; IN COMMERCE 12-31-2001.

FOR: DOCUMENT DESTRUCTION SERVICES, IN CLASS 40 (U.S. CLS. 100, 103 AND 106).

FIRST USE 12-31-2001; IN COMMERCE 12-31-2001.

FOR: ELECTRONIC SCANNING AND DIGITIZATION OF DOCUMENTS, IN CLASS 42 (U.S.  
CLS. 100 AND 101).

FIRST USE 12-31-2001; IN COMMERCE 12-31-2001.

THE MARK CONSISTS OF STANDARD CHARACTERS WITHOUT CLAIM TO ANY PAR-  
TICULAR FONT, STYLE, SIZE, OR COLOR.

NO CLAIM IS MADE TO THE EXCLUSIVE RIGHT TO USE "DOCUMENT MANAGEMENT"  
, APART FROM THE MARK AS SHOWN.

SEC. 2(F).

SER. NO. 85-610,277, FILED 4-27-2012.

HEATHER THOMPSON, EXAMINING ATTORNEY



*David J. Kybas*

Director of the United States Patent and Trademark Office

# United States of America

United States Patent and Trademark Office

## Rapid Recursive

**Reg. No. 4,274,717**

**Registered Jan. 15, 2013**

**Int. Cl.: 9**

**TRADEMARK**

**PRINCIPAL REGISTER**

SUPPORTED INTELLIGENCE, LLC (MICHIGAN LIMITED LIABILITY COMPANY)  
SUITE 100  
EAST LANSING, MI 48823

FOR: COMPUTER SOFTWARE FOR USE IN DECISION MAKING WHICH EVALUATES SEQUENTIAL DECISION PROBLEMS WHERE THERE IS AN ORGANIZATION OR INDIVIDUAL WITH OPPORTUNITIES TO TAKE DIFFERENT ACTIONS OVER TIME AND/OR VARYING REWARDS OR COSTS ACCOMPANYING EACH FUTURE DECISION AND UNCERTAINTY ABOUT THE FUTURE STATE OF AFFAIRS, IN CLASS 9 (U.S. CLS. 21, 23, 26, 36 AND 38).

FIRST USE 7-13-2012; IN COMMERCE 7-13-2012.

THE MARK CONSISTS OF STANDARD CHARACTERS WITHOUT CLAIM TO ANY PARTICULAR FONT, STYLE, SIZE, OR COLOR.

SER. NO. 85-610,509, FILED 4-27-2012.

TARAH HARDY, EXAMINING ATTORNEY



*David J. Kyffers*

Director of the United States Patent and Trademark Office

# United States of America

United States Patent and Trademark Office

# EcoRenew

**Reg. No. 4,274,718**

WATER RESCUE SERVICES HOLDINGS, LLC (TEXAS LIMITED LIABILITY COMPANY)  
505 MAIN STREET, SUITE 220  
FORT WORTH, TX 76102

**Registered Jan. 15, 2013**

**Int. Cl.: 12**

FOR: WATER TREATMENT EQUIPMENT, NAMELY, ADVANCED ELECTROCOAGULATION UNITS, COMBINED AS INTEGRAL COMPONENT PARTS OF TRAILERS AND USED FOR THE PURPOSES OF RECYCLING THE OIL AND GAS INDUSTRY'S FLOW BACK AND PRODUCED WATER FOR REUSE, IN CLASS 12 (U.S. CLS. 19, 21, 23, 31, 35 AND 44).

**TRADEMARK**

**PRINCIPAL REGISTER**

FIRST USE 4-25-2012; IN COMMERCE 4-25-2012.

THE MARK CONSISTS OF THE TERM "ECO" IN THE COLOR GREEN FOLLOWED BY THE TERM "RENEW" IN THE COLOR BLUE.

THE COLOR(S) GREEN AND BLUE IS/ARE CLAIMED AS A FEATURE OF THE MARK.

SER. NO. 85-610,556, FILED 4-27-2012.

MAUREEN DALL, EXAMINING ATTORNEY



*David J. Kyffers*

Director of the United States Patent and Trademark Office

# United States of America

United States Patent and Trademark Office

# YME

**Reg. No. 4,274,719**

**Registered Jan. 15, 2013**

**Int. Cl.: 35**

**SERVICE MARK**

**PRINCIPAL REGISTER**

SALESGENOMIX LLC (ARIZONA LIMITED LIABILITY COMPANY)  
10801 EAST HAPPY VALLEY ROAD #64  
SCOTTSDALE, AZ 85255

FOR: EMPLOYMENT COUNSELING AND RECRUITING; EMPLOYMENT OUTPLACEMENT SERVICES; EMPLOYMENT RECRUITING CONSULTATION; EMPLOYMENT STAFFING CONSULTATION SERVICES; EXECUTIVE RECRUITING SERVICES; PROVIDING AN ON-LINE SEARCHABLE DATABASE FEATURING EMPLOYMENT OPPORTUNITIES; PROVIDING CAREER INFORMATION; PROVIDING EMPLOYMENT INFORMATION; PROVIDING NETWORKING OPPORTUNITIES FOR INDIVIDUALS SEEKING EMPLOYMENT; PROVIDING ON-LINE EMPLOYMENT INFORMATION IN THE FIELD OF RECRUITMENT, CAREERS, JOB RESOURCES AND LISTINGS, AND RESUMES; EMPLOYMENT AND EMPLOYEE COST ASSESSMENT SERVICES FOR OTHERS, IN CLASS 35 (U.S. CLS. 100, 101 AND 102).

FIRST USE 4-25-2012; IN COMMERCE 4-25-2012.

THE MARK CONSISTS OF STANDARD CHARACTERS WITHOUT CLAIM TO ANY PARTICULAR FONT, STYLE, SIZE, OR COLOR.

THE WORDING "YME" HAS NO MEANING IN A FOREIGN LANGUAGE.

SER. NO. 85-610,568, FILED 4-27-2012.

NAKIA HENRY, EXAMINING ATTORNEY



*David J. Kybas*

Director of the United States Patent and Trademark Office

# United States of America

United States Patent and Trademark Office

## MYGLASSES.COM

**Reg. No. 4,274,720**

**Registered Jan. 15, 2013**

**Int. Cl.: 35**

**SERVICE MARK**

**PRINCIPAL REGISTER**

TIGRIS ENTERPRISES, INC. (NEW YORK CORPORATION)  
217 Highbrook Avenue North  
Pelham, NY 10803

FOR: RETAIL STORE SERVICES, ONLINE OR ON THE INTERNET, FEATURING PRESCRIPTION AND NON-PRESCRIPTION EYEGLASSES INCLUDING RIMLESS, SEMI RIMLESS, FULL RIM, METAL AND PLASTIC MEMORY, METAL, TITANIUM, STAINLESS STEEL, PLASTIC, MONEL, ALUMINUM, GOLD, PLATINUM, SILVER, A METAL AND PLASTIC COMBINATION AND OTHER METAL AND PLASTIC ALLOYS, RETAIL STORE SERVICES, ONLINE AND/OR ON THE INTERNET, FEATURING PRESCRIPTION AND NONPRESCRIPTION SUNGLASSES SUCH AS RIMLESS, SEMI RIMLESS, FULL RIM, METAL AND PLASTIC MEMORY, METAL, TITANIUM, STAINLESS STEEL, PLASTIC, MONEL, ALUMINUM, GOLD, PLATINUM, SILVER, METAL/PLASTIC COMBINATION AND OTHER METAL AND PLASTIC ALLOYS, RETAIL STORE SERVICES, ONLINE AND/OR ON THE INTERNET FEATURING SPORTS EYEWEAR, SAFETY EYEWEAR, RX AND NON RX SWIM GOGGLES, CONTACT LENSES SOFT AND HARD, AND OPTICAL ACCESSORIES; RETAIL STORE SERVICES, ONLINE AND/OR ON THE INTERNET FEATURING READERS AND OTHER RELATED ITEMS, IN CLASS 35 (U.S. CLS. 100, 101 AND 102).

FIRST USE 12-31-2002; IN COMMERCE 12-31-2002.

THE MARK CONSISTS OF STANDARD CHARACTERS WITHOUT CLAIM TO ANY PARTICULAR FONT, STYLE, SIZE, OR COLOR.

SER. NO. 85-610,617, FILED 4-27-2012.

ANNE MADDEN, EXAMINING ATTORNEY



*David J. Kyros*

Director of the United States Patent and Trademark Office

# United States of America

United States Patent and Trademark Office

# LINDEX

**Reg. No. 4,274,721**

**Registered Jan. 15, 2013**

**Int. Cl.: 36**

**SERVICE MARK**

**PRINCIPAL REGISTER**

DAVID P. LIND & ASSOCIATES, L.L.C. (IOWA LIMITED LIABILITY COMPANY), DBA  
DAVID P. LIND BENCHMARK  
SUITE 202  
13375 UNIVERSITY  
CLIVE, IA 50325

FOR: ADVISORY SERVICES IN THE FIELD OF EMPLOYEE BENEFIT PLANS, NAMELY,  
A DATABASE OF EMPLOYER BENEFIT INFORMATION AND RATING SYSTEM, IN CLASS  
36 (U.S. CLS. 100, 101 AND 102).

FIRST USE 4-26-2012; IN COMMERCE 4-26-2012.

THE MARK CONSISTS OF STANDARD CHARACTERS WITHOUT CLAIM TO ANY PAR-  
TICULAR FONT, STYLE, SIZE, OR COLOR.

SER. NO. 85-610,631, FILED 4-27-2012.

GINA HAYES, EXAMINING ATTORNEY



*David J. Kyffers*

Director of the United States Patent and Trademark Office

# United States of America

United States Patent and Trademark Office

# Slickynotes

**Reg. No. 4,274,722**

ECOSTATIC INC. (CALIFORNIA CORPORATION), DBA ECOSTATIC INC.  
100 STERLING OAKS DRIVE #249  
CHICO, CA 95928

**Registered Jan. 15, 2013**

**Int. Cl.: 16**

FOR: ADHESIVE NOTE PADS, IN CLASS 16 (U.S. CLS. 2, 5, 22, 23, 29, 37, 38 AND 50).

**TRADEMARK**

FIRST USE 4-16-2012; IN COMMERCE 4-25-2012.

**PRINCIPAL REGISTER**

THE MARK CONSISTS OF STANDARD CHARACTERS WITHOUT CLAIM TO ANY PARTICULAR FONT, STYLE, SIZE, OR COLOR.

SER. NO. 85-610,815, FILED 4-27-2012.

MARK SHINER, EXAMINING ATTORNEY



*David J. Kyffers*

Director of the United States Patent and Trademark Office

# United States of America

United States Patent and Trademark Office

## Mommy's Sippy Cup

**Reg. No. 4,274,723**

MOM AT LAST LLC (DELAWARE LIMITED LIABILITY COMPANY)  
9 TIDEWATER DRIVE  
SEAFORD, DE 19973

**Registered Jan. 15, 2013**

**Int. Cl.: 21**

FOR: CUPS; WINE GLASSES, IN CLASS 21 (U.S. CLS. 2, 13, 23, 29, 30, 33, 40 AND 50).

**TRADEMARK**

FIRST USE 3-28-2012; IN COMMERCE 3-28-2012.

**PRINCIPAL REGISTER**

THE MARK CONSISTS OF STANDARD CHARACTERS WITHOUT CLAIM TO ANY PARTICULAR FONT, STYLE, SIZE, OR COLOR.

NO CLAIM IS MADE TO THE EXCLUSIVE RIGHT TO USE "CUP", APART FROM THE MARK AS SHOWN.

SER. NO. 85-611,153, FILED 4-28-2012.

JULIE GUTTADAURO, EXAMINING ATTORNEY



*David J. Kybas*

Director of the United States Patent and Trademark Office



# United States of America

United States Patent and Trademark Office

## Corner Performer

**Reg. No. 4,274,724**

DJH MARRKETING, LLC (VIRGINIA LIMITED LIABILITY COMPANY)  
500 BOTETOURT ST., #201  
NORFOLK, VA 23510

**Registered Jan. 15, 2013**

**Int. Cl.: 35**

FOR: ADVERTISING, MARKETING, AND PROMOTING THE GOODS AND SERVICES OF OTHERS VIA HUMAN COSTUMED CHARACTERS, IN CLASS 35 (U.S. CLS. 100, 101 AND 102).

**SERVICE MARK**

FIRST USE 6-15-2012; IN COMMERCE 6-20-2012.

**PRINCIPAL REGISTER**

THE MARK CONSISTS OF STANDARD CHARACTERS WITHOUT CLAIM TO ANY PARTICULAR FONT, STYLE, SIZE, OR COLOR.

NO CLAIM IS MADE TO THE EXCLUSIVE RIGHT TO USE "PERFORMER", APART FROM THE MARK AS SHOWN.

SER. NO. 85-611,289, FILED 4-29-2012.

ELIZABETH KAJUBI, EXAMINING ATTORNEY



*David J. Kyffers*

Director of the United States Patent and Trademark Office

# United States of America

United States Patent and Trademark Office

# Forever King

**Reg. No. 4,274,725**

SMITH, RHAUMON LETWAN (FLORIDA SOLE PROPRIETORSHIP), DBA FOREVER KING  
1197 BOLLE CIR.

**Registered Jan. 15, 2013**

ROCKLEDGE, FL 32955

**Int. Cl.: 25**

FOR: WEARABLE GARMENTS AND CLOTHING, NAMELY, SHIRTS, IN CLASS 25 (U.S. CLS. 22 AND 39).

**TRADEMARK**

FIRST USE 1-7-2011; IN COMMERCE 3-5-2012.

**PRINCIPAL REGISTER**

THE MARK CONSISTS OF STANDARD CHARACTERS WITHOUT CLAIM TO ANY PARTICULAR FONT, STYLE, SIZE, OR COLOR.

SER. NO. 85-611,721, FILED 4-30-2012.

NANCY CLARKE, EXAMINING ATTORNEY



*David J. Kyffers*

Director of the United States Patent and Trademark Office

# United States of America

United States Patent and Trademark Office

## English Premium Formula

**Reg. No. 4,274,726**

PALM 1 LLC (FLORIDA LIMITED LIABILITY COMPANY)  
1680 MICHIGAN AVE., SUITE 920  
MIAMI BEACH, FL 33139

**Registered Jan. 15, 2013**

**Int. Cls.: 1 and 3**

FOR: CHEMICAL PREPARATIONS, NAMELY, DEGREASING AND CLEANING SOLVENTS,  
IN CLASS 1 (U.S. CLS. 1, 5, 6, 10, 26 AND 46).

**TRADEMARK**

FIRST USE 10-15-2011; IN COMMERCE 10-15-2011.

**PRINCIPAL REGISTER**

FOR: ALL PURPOSE CLEANING PREPARATIONS; CLEANING AND POLISHING PREPARATIONS,  
IN CLASS 3 (U.S. CLS. 1, 4, 6, 50, 51 AND 52).

FIRST USE 10-15-2011; IN COMMERCE 10-15-2011.

THE MARK CONSISTS OF STANDARD CHARACTERS WITHOUT CLAIM TO ANY PARTICULAR FONT, STYLE, SIZE, OR COLOR.

NO CLAIM IS MADE TO THE EXCLUSIVE RIGHT TO USE "PREMIUM FORMULA", APART FROM THE MARK AS SHOWN.

SER. NO. 85-611,860, FILED 4-30-2012.

C. DIONNE CLYBURN, EXAMINING ATTORNEY



*David J. Kybas*

Director of the United States Patent and Trademark Office

# United States of America

United States Patent and Trademark Office

# NUCCA

**Reg. No. 4,274,727**

**Registered Jan. 15, 2013**

**Int. Cls.: 35, 41, 42 and  
44**

**SERVICE MARK**

**PRINCIPAL REGISTER**

THE NATIONAL UPPER CERVICAL CHIROPRACTIC ASSOCIATION, INC. (MICHIGAN CORPORATION)  
217 W. 2ND STREET  
MONROE, MI 48161

FOR: ONLINE PROFESSIONAL NETWORKING SERVICES FOR CHIROPRACTIC CARE PROVIDERS; ASSOCIATION SERVICES, NAMELY, PROMOTING THE INTERESTS OF CHIROPRACTIC PROFESSIONALS, IN CLASS 35 (U.S. CLS. 100, 101 AND 102).

FIRST USE 12-31-1995; IN COMMERCE 12-31-1995.

FOR: PROVIDING WEB-BASED AND CLASSROOM TRAINING AND CONDUCTING SEMINARS IN THE FIELD OF CHIROPRACTIC HEALTH CARE SERVICES, IN CLASS 41 (U.S. CLS. 100, 101 AND 107).

FIRST USE 12-31-1995; IN COMMERCE 12-31-1995.

FOR: TESTING, EVALUATION AND ANALYSIS OF THE KNOWLEDGE, SKILLS AND ABILITIES OF OTHERS FOR THE PURPOSE OF CERTIFICATION AND RECERTIFICATION OF OTHERS IN THE FIELD OF CHIROPRACTIC HEALTH CARE SERVICES; COMPILING DATA FOR RESEARCH PURPOSES IN THE FIELD OF CHIROPRACTIC CARE, IN CLASS 42 (U.S. CLS. 100 AND 101).

FIRST USE 12-31-1995; IN COMMERCE 12-31-1995.

FOR: PROVIDING AN ONLINE SEARCHABLE DATABASE IN THE FIELD OF CHIROPRACTIC HEALTH CARE SERVICE PROVIDERS, IN CLASS 44 (U.S. CLS. 100 AND 101).

FIRST USE 4-16-1966; IN COMMERCE 4-16-1966.

THE MARK CONSISTS OF STANDARD CHARACTERS WITHOUT CLAIM TO ANY PARTICULAR FONT, STYLE, SIZE, OR COLOR.

OWNER OF U.S. REG. NOS. 2,515,354, 2,552,478 AND OTHERS.

SER. NO. 85-612,266, FILED 4-30-2012.

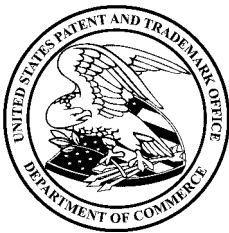

*David J. Kyffers*

Director of the United States Patent and Trademark Office

**Reg. No. 4,274,727** JENNIFER WILLISTON, EXAMINING ATTORNEY

# United States of America

United States Patent and Trademark Office



**Reg. No. 4,274,728**

PERI, ODED (ISRAEL INDIVIDUAL)  
137 MAIN ST, UNIT A  
HAYDENVILLE, MA 01039

**Registered Jan. 15, 2013**

**Int. Cl.: 9**

FOR: MEASURING TAPES, IN CLASS 9 (U.S. CLS. 21, 23, 26, 36 AND 38).

**TRADEMARK**

FIRST USE 4-0-2011; IN COMMERCE 4-0-2011.

**PRINCIPAL REGISTER**

THE MARK CONSISTS OF A STYLIZED WORDING "M1", WITH THE NUMERAL "1" APPEARING AS THE RIGHT STEM OF THE LETTER "M".

SER. NO. 85-612,286, FILED 4-30-2012.

DAWN HAN, EXAMINING ATTORNEY



*David J. Kyffers*

Director of the United States Patent and Trademark Office

# United States of America

United States Patent and Trademark Office

# drawMD

**Reg. No. 4,274,729**

**Registered Jan. 15, 2013**

**Int. Cl.: 9**

**TRADEMARK**

**PRINCIPAL REGISTER**

VISIBLE HEALTH, INC. (TEXAS CORPORATION)  
2110 SOUTH LAMAR BOULEVARD  
AUSTIN, TX 78704

FOR: SOFTWARE FOR MOBILE DEVICES, NAMELY, SOFTWARE THAT ENABLES CARE PROVIDERS TO USE DETAILED ANATOMIC IMAGES IN CONJUNCTION WITH SKETCHING, TYPING OR STAMPING DIRECTLY ON THE ANATOMIC IMAGE AND SHARE THE IMAGES AND INFORMATION DIRECTLY WITH PATIENTS IN ORDER TO COUNSEL AND EDUCATE PATIENTS ON PLANNED OR PROPOSED SURGICAL PROCEDURES, MEDICAL CONDITIONS, AND TREATMENT PLANS, AND TO DOCUMENT THE DISCUSSIONS, PLANNED OR PROPOSED SURGICAL PROCEDURES, MEDICAL CONDITIONS, AND TREATMENT PLANS FOR THE PATIENT AND FOR INCLUSION IN THE PATIENT'S RECORDS, IN CLASS 9 (U.S. CLS. 21, 23, 26, 36 AND 38).

FIRST USE 12-1-2010; IN COMMERCE 12-1-2010.

THE MARK CONSISTS OF STANDARD CHARACTERS WITHOUT CLAIM TO ANY PARTICULAR FONT, STYLE, SIZE, OR COLOR.

SER. NO. 85-612,307, FILED 4-30-2012.

ANDREW RHIM, EXAMINING ATTORNEY



*David J. Kybas*

Director of the United States Patent and Trademark Office

# United States of America

United States Patent and Trademark Office



**Reg. No. 4,274,730**

**Registered Jan. 15, 2013**

**Int. Cl.: 25**

**TRADEMARK**

**PRINCIPAL REGISTER**

VERTICAL EDGE, LLC (GEORGIA LIMITED LIABILITY COMPANY)  
760 JOSEPH E. LOWERY BLVD., SW  
ATLANTA, GA 30310

FOR: APPAREL FOR DANCERS, NAMELY, TEE SHIRTS, SWEATSHIRTS, PANTS, LEGGINGS, SHORTS AND JACKETS, IN CLASS 25 (U.S. CLS. 22 AND 39).

FIRST USE 1-15-2011; IN COMMERCE 7-23-2011.

THE MARK CONSISTS OF STYLIZED LETTER "V" AND LETTER "E" BOTH IN GREY. "VERTICAL EDGE" IN DARK BLUE BENEATH THE STYLIZED "V" AND "E". A FUSCHIA COLORED UPSIDE DOWN PYRAMID ON TOP OF THE STYLIZED "V" AND AN OUTLINE OF AN UPSIDE DOWN DANCER IN BETWEEN THE "V" AND THE "E" IN WHITE AND OUTLINED IN GREY.

THE COLOR(S) FUSCHIA, GREY, DARK BLUE, WHITE IS/ARE CLAIMED AS A FEATURE OF THE MARK.

SER. NO. 85-612,775, FILED 5-1-2012.

EDWARD FENNESSY, EXAMINING ATTORNEY



*David J. Kyffers*

Director of the United States Patent and Trademark Office



# United States of America

United States Patent and Trademark Office

# NuSleep

**Reg. No. 4,274,731**

RH ASSOCIATES LLC (DELAWARE LIMITED LIABILITY COMPANY)  
257 MIDDLE COUNTRY RD.  
SMITHTOWN, NY 11787

**Registered Jan. 15, 2013**

**Int. Cl.: 10**

FOR: MEDICAL APPARATUS FOR DIAGNOSING OR TREATING RESPIRATORY CONDITIONS, NAMELY, A DEVICE TO TREAT SLEEP APNEA, IN CLASS 10 (U.S. CLS. 26, 39 AND 44).

**TRADEMARK**

FIRST USE 3-15-2012; IN COMMERCE 3-15-2012.

**PRINCIPAL REGISTER**

THE MARK CONSISTS OF THE STYLIZED WORDS "NUSLEEP". THERE IS A STYLIZED IMAGE OF A CRESCENT MOON ABOVE THE "U" IN "NU".

SER. NO. 85-612,844, FILED 5-1-2012.

NICHOLAS ALTREE, EXAMINING ATTORNEY



*David J. Kyffers*

Director of the United States Patent and Trademark Office

# United States of America

United States Patent and Trademark Office

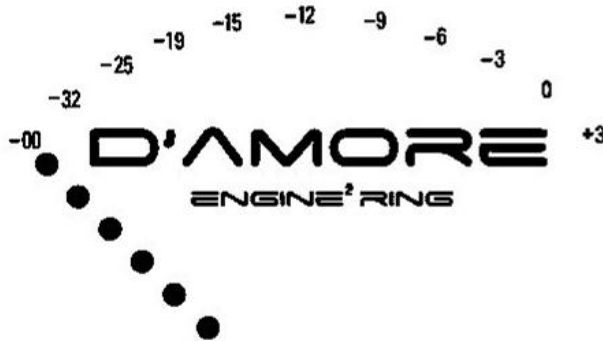

**Reg. No. 4,274,732**

**Registered Jan. 15, 2013**

**Int. Cl.: 9**

**TRADEMARK**

**PRINCIPAL REGISTER**

D'AMORE ENGINEERING LLC (CALIFORNIA LIMITED LIABILITY COMPANY)  
340 PASEO CAMARILLO, #202  
CAMARILLO, CA 93010

FOR: AUDIO SIGNAL TESTING EQUIPMENT AND AUDIO SIGNAL DETECTION EQUIPMENT, NAMELY, VOLTAGE AND AMPERAGE TESTERS FOR TESTING AUDIO SIGNALS, CIRCUIT TESTERS, ELECTRONIC TESTING EQUIPMENT IN THE NATURE OF SOUND LEVEL METERS, DISTRIBUTION AMPLIFIERS FOR AUDIO SIGNALS, ELECTRONIC PRODUCTS FOR GENERATION AND ANALYSIS OF AUDIO SIGNALS IN THE NATURE OF AUDIO ANALYZERS, ELECTRONIC SCALERS AND SWITCHES FOR AUDIO SIGNALS, OPTICAL SIGNALING CABLES, PANEL METERS IN THE NATURE OF ELECTRONIC INSTRUMENTS THAT DISPLAY INPUT SIGNALS IN EITHER DIGITAL OR ANALOG FORMS AND SIGNAL PROCESSORS; ELECTRIC AUDIO SIGNAL OUTPUT METERS; AUDIO SIGNAL OUTPUT METERS, NAMELY, PANEL METERS IN THE NATURE OF ELECTRONIC INSTRUMENTS THAT DISPLAY INPUT SIGNALS IN EITHER DIGITAL OR ANALOG FORMS; AUDIO SIGNAL CALIBRATION EQUIPMENT, NAMELY, CALIBRATION DEVICES FOR SOUND LEVEL METERS FOR TESTING AUDIO SIGNALS, ELECTRONIC AUDIO ANALYZERS FOR GENERATION AND ANALYSIS OF AUDIO SIGNALS, ELECTRONIC PANEL METERS THAT DISPLAY INPUT SIGNALS IN EITHER DIGITAL OR ANALOG FORMS AND ELECTRIC AUDIO SIGNAL OUTPUT METERS, IN CLASS 9 (U.S. CLS. 21, 23, 26, 36 AND 38).

FIRST USE 6-1-2011; IN COMMERCE 6-1-2011.

NO CLAIM IS MADE TO THE EXCLUSIVE RIGHT TO USE "ENGINEERING" AND "-00 -32 -25 -19 -15 -12 -9 -6 -3 0 +3", APART FROM THE MARK AS SHOWN.

THE MARK CONSISTS OF THE WORDS "D'AMORE ENGINE2RING" IN STYLIZED FONT, A DOTTED LINE COMPRISED OF SIX CIRCLES REPRESENTING A METER NEEDLE AND THE NUMBERS "-00 -32 -25 -19 -15 -12 -9 -6 -3 0 +3" POSITIONED IN A CURVED ARC FORMATION.

THE ENGLISH TRANSLATION OF "D'AMORE" IN THE MARK IS OF LOVE.

SER. NO. 85-613,027, FILED 5-1-2012.

DAVID YONTEF, EXAMINING ATTORNEY



*David J. Kyfos*

Director of the United States Patent and Trademark Office

# United States of America

United States Patent and Trademark Office

## We Were Prepared

**Reg. No. 4,274,733**

WE WERE PREPARED, L.L.C. (TEXAS LIMITED LIABILITY COMPANY)  
16227 BARCELONA  
FRIENDSWOOD, TX 77546

**Registered Jan. 15, 2013**

**Int. Cl.: 35**

FOR: PUBLICITY AND SALES PROMOTION SERVICES, IN CLASS 35 (U.S. CLS. 100, 101 AND 102).

**SERVICE MARK**

FIRST USE 2-20-2012; IN COMMERCE 4-16-2012.

**PRINCIPAL REGISTER**

THE MARK CONSISTS OF STANDARD CHARACTERS WITHOUT CLAIM TO ANY PARTICULAR FONT, STYLE, SIZE, OR COLOR.

SER. NO. 85-613,141, FILED 5-1-2012.

TIMOTHY FINNEGAN, EXAMINING ATTORNEY



*David J. Kybas*

Director of the United States Patent and Trademark Office

# United States of America

United States Patent and Trademark Office



**Reg. No. 4,274,734**

**Registered Jan. 15, 2013**

**Int. Cl.: 9**

**TRADEMARK**

**PRINCIPAL REGISTER**

BRAVE RIVER SOLUTIONS, INC. (DELAWARE CORPORATION)  
BUILDING 3  
875 CENTERVILLE ROAD  
WARWICK, RI 02886

FOR: COMPUTER APPLICATION SOFTWARE FOR MOBILE PHONES, NAMELY, SOFTWARE FOR CREATING LOCATIONS AND LIST FOR BUSINESS TO DISPLAY THEIR LOCATIONS AND PROVIDE OTHER BUSINESS RELATED INFORMATION, IN CLASS 9 (U.S. CLS. 21, 23, 26, 36 AND 38).

FIRST USE 2-15-2012; IN COMMERCE 3-15-2012.

THE MARK CONSISTS OF THE WORD "MOBEO" IN BLUE LETTERING WITH A WHITE BACKGROUND. THE WORD "MOBEO" IS ON TOP OF A MAP THAT IS ALSO IN BLUE AND WHITE. ABOVE THE "O" IN "MOBEO" THERE ARE THREE ARCS IN BLUE THAT ARE SIMILAR TO WHAT WOULD APPEAR ON A CELL PHONE INDICATING THE STRENGTH OF SIGNAL ON A CELL PHONE. BEHIND THE ARCS ARE A WHITE BACKGROUND.

THE COLOR(S) BLUE AND WHITE IS/ARE CLAIMED AS A FEATURE OF THE MARK.

SER. NO. 85-613,235, FILED 5-1-2012.

GIANCARLO CASTRO, EXAMINING ATTORNEY



*David J. Kyjars*

Director of the United States Patent and Trademark Office

# United States of America

United States Patent and Trademark Office

## Walkabout Solution

**Reg. No. 4,274,735**

**Registered Jan. 15, 2013**

**Int. Cl.: 9**

**TRADEMARK**

**PRINCIPAL REGISTER**

WALKABOUT TRAVEL GEAR (CALIFORNIA LIMITED LIABILITY COMPANY)  
SUITE G  
33 HEALDSBURG AVENUE  
HEALDSBURG, CA 95448

FOR: ELECTRIC CONVERTERS, IN CLASS 9 (U.S. CLS. 21, 23, 26, 36 AND 38).

FIRST USE 4-16-2012; IN COMMERCE 4-16-2012.

THE MARK CONSISTS OF STANDARD CHARACTERS WITHOUT CLAIM TO ANY PARTICULAR FONT, STYLE, SIZE, OR COLOR.

OWNER OF U.S. REG. NO. 2,246,228.

NO CLAIM IS MADE TO THE EXCLUSIVE RIGHT TO USE "SOLUTION", APART FROM THE MARK AS SHOWN.

SER. NO. 85-613,386, FILED 5-1-2012.

ODESSA BIBBINS, EXAMINING ATTORNEY



*David J. Kyffers*

Director of the United States Patent and Trademark Office

# United States of America

United States Patent and Trademark Office



**Reg. No. 4,274,736**

**Registered Jan. 15, 2013**

**Int. Cl.: 35**

**SERVICE MARK**

**PRINCIPAL REGISTER**

DOWNEY ASSOCIATION OF REALTORS (CALIFORNIA CORPORATION)  
12073 PARAMOUNT BOULEVARD  
DOWNEY, CA 90242

FOR: ASSOCIATION SERVICES, NAMELY, PROMOTING THE INTERESTS OF REAL ESTATE PROFESSIONALS; TRADE ASSOCIATION SERVICES, NAMELY, PROMOTING THE INTERESTS OF REAL ESTATE PROFESSIONALS, IN CLASS 35 (U.S. CLS. 100, 101 AND 102).

FIRST USE 3-1-2011; IN COMMERCE 3-1-2011.

NO CLAIM IS MADE TO THE EXCLUSIVE RIGHT TO USE "DOWNEY ASSOCIATION", APART FROM THE MARK AS SHOWN.

THE COLOR(S) BLACK, BLUE, YELLOW IS/ARE CLAIMED AS A FEATURE OF THE MARK.

THE MARK CONSISTS OF THE ACRONYM "DAOR" IN LARGE BLUE CAPITAL LETTERS OVER THE WORDS "DOWNEY ASSOCIATION OF REALTORS" IN SMALL BLACK CAPITAL LETTERS WITH AN OFFSET BLACK OUTLINE OF A HOUSE COMPRISED OF TWO WALLS AND A ROOF ARCHING OVER THE LETTERING STARTING OVER THE SMALL "D" ON THE LEFT AND ENDING OVER THE LARGE "O" ON THE RIGHT, WITH AN OUTLINE OF A CHIMNEY ON THE LEFT SIDE OF THE ROOF AND A SUN COMPRISED OF A SOLID YELLOW CIRCLE WITH FIVE TRIANGULAR YELLOW RAYS SURROUNDING IT; THE COLOR WHITE IN THE DRAWING OF THE MARK REPRESENTS TRANSPARENT AREAS AND IS NOT A PART OF THE MARK.

SER. NO. 85-613,431, FILED 5-1-2012.

KEVEN MITTLER, EXAMINING ATTORNEY



*David J. Kybas*

Director of the United States Patent and Trademark Office

# United States of America

United States Patent and Trademark Office

# Biml

**Reg. No. 4,274,737**

**Registered Jan. 15, 2013**

**Int. Cls.: 9 and 42**

**TRADEMARK**

**SERVICE MARK**

**PRINCIPAL REGISTER**

VARIGENCE, INC. (SOUTH CAROLINA CORPORATION)  
30 COLLIER LANE  
GREER, SC 29650

FOR: COMPUTER PROGRAMS FOR DEVELOPING, ANALYZING, CODING, CHECKING AND CONTROLLING OTHER COMPUTER SOFTWARE; COMPUTER PROGRAMS FOR IMPLEMENTING A PROGRAMMING LANGUAGE FOR ASSISTING DEVELOPERS IN CREATING PROGRAM CODE FOR USE IN MULTIPLE APPLICATION PROGRAMS; AND COMPUTER PROGRAMS FOR MARKING AND TRACKING METADATA OF COMPUTER PROGRAMS OF OTHERS, IN CLASS 9 (U.S. CLS. 21, 23, 26, 36 AND 38).

FIRST USE 5-0-2009; IN COMMERCE 5-0-2009.

FOR: PROVIDING INFORMATION IN THE FIELD OF COMPUTER PROGRAMMING FEATURING METADATA MARKING AND TRACKING OF COMPUTER PROGRAMS OF OTHERS, IN CLASS 42 (U.S. CLS. 100 AND 101).

FIRST USE 5-0-2009; IN COMMERCE 5-0-2009.

THE MARK CONSISTS OF STANDARD CHARACTERS WITHOUT CLAIM TO ANY PARTICULAR FONT, STYLE, SIZE, OR COLOR.

SER. NO. 85-613,557, FILED 5-1-2012.

DAWN HAN, EXAMINING ATTORNEY



*David J. Kyffers*

Director of the United States Patent and Trademark Office

# United States of America

United States Patent and Trademark Office

# ENVIROLOCK

**Reg. No. 4,274,738**

EUROFRESH INC. (DELAWARE CORPORATION)  
26050 S. EUROFRESH AVE.  
WILLCOX, AZ 85643

**Registered Jan. 15, 2013**

**Int. Cl.: 31**

FOR: FRESH PRODUCE, NAMELY, FRESH FRUITS AND VEGETABLES GROWN IN A CONTAMINANT CONTROLLED ENVIRONMENT, IN CLASS 31 (U.S. CLS. 1 AND 46).

**TRADEMARK**

FIRST USE 4-23-2012; IN COMMERCE 4-23-2012.

**PRINCIPAL REGISTER**

THE MARK CONSISTS OF STANDARD CHARACTERS WITHOUT CLAIM TO ANY PARTICULAR FONT, STYLE, SIZE, OR COLOR.

OWNER OF U.S. REG. NOS. 4,165,275 AND 4,168,637.

SER. NO. 85-613,558, FILED 5-1-2012.

DAWN HAN, EXAMINING ATTORNEY



*David J. Kyffers*

Director of the United States Patent and Trademark Office



# United States of America

United States Patent and Trademark Office

# ROTOTOUGH

**Reg. No. 4,274,739**

IOWA ROTOCAST PLASTICS, INC. (IOWA CORPORATION)  
1712 MOELLERS DRIVE  
DECORAH, IA 52101

**Registered Jan. 15, 2013**

**Int. Cl.: 21**

FOR: PORTABLE COOLERS, NAMELY, PORTABLE BEVERAGE OR ICE COOLERS MOUNTED ON TELESCOPING WHEELED CADDIES; ICE PAILS; PORTABLE COOLERS, IN CLASS 21 (U.S. CLS. 2, 13, 23, 29, 30, 33, 40 AND 50).

**TRADEMARK**

FIRST USE 9-1-1986; IN COMMERCE 9-1-1986.

**PRINCIPAL REGISTER**

THE MARK CONSISTS OF STANDARD CHARACTERS WITHOUT CLAIM TO ANY PARTICULAR FONT, STYLE, SIZE, OR COLOR.

SER. NO. 85-613,836, FILED 5-1-2012.

BRENDAN REGAN, EXAMINING ATTORNEY



*David J. Kyffers*

Director of the United States Patent and Trademark Office

# United States of America

United States Patent and Trademark Office

# IRP

**Reg. No. 4,274,740**

**Registered Jan. 15, 2013**

**Int. Cls.: 20 and 21**

**TRADEMARK**

**PRINCIPAL REGISTER**

IOWA ROTOCAST PLASTICS, INC. (IOWA CORPORATION)  
1712 MOELLERS DRIVE  
DECORAH, IA 52101

FOR: DISPLAY RACKS; BOTTLE RACKS; RACKS USED TO DISPLAY BEVERAGES OR SNACK ITEMS IN CONVENIENCE STORES, GROCERY STORES, AND DISTRIBUTOR RETAIL LOCATIONS, IN CLASS 20 (U.S. CLS. 2, 13, 22, 25, 32 AND 50).

FIRST USE 1-1-1985; IN COMMERCE 1-1-1985.

FOR: PORTABLE COOLERS, PORTABLE BEVERAGE COOLERS, NAMELY, PORTABLE BEVERAGE OR ICE COOLERS MOUNTED ON TELESCOPING WHEELED CADDIES; ICE PAILS, IN CLASS 21 (U.S. CLS. 2, 13, 23, 29, 30, 33, 40 AND 50).

FIRST USE 1-1-1985; IN COMMERCE 1-1-1985.

THE MARK CONSISTS OF STANDARD CHARACTERS WITHOUT CLAIM TO ANY PARTICULAR FONT, STYLE, SIZE, OR COLOR.

SER. NO. 85-613,851, FILED 5-1-2012.

BRENDAN REGAN, EXAMINING ATTORNEY



*David J. Kybas*

Director of the United States Patent and Trademark Office

# United States of America

United States Patent and Trademark Office



**Reg. No. 4,274,741**

**Registered Jan. 15, 2013**

**Int. Cl.: 36**

**SERVICE MARK**

**PRINCIPAL REGISTER**

SUN EAST FEDERAL CREDIT UNION (UNITED STATES FEDERALLY CHARTERED  
NONPROFIT ORGANIZATION)  
4500 PENNELL ROAD  
ASTON, PA 19014

FOR: CREDIT UNION SERVICES, IN CLASS 36 (U.S. CLS. 100, 101 AND 102).

FIRST USE 2-27-2012; IN COMMERCE 2-27-2012.

OWNER OF U.S. REG. NOS. 2,688,044 AND 3,112,883.

NO CLAIM IS MADE TO THE EXCLUSIVE RIGHT TO USE "FEDERAL CREDIT UNION",  
APART FROM THE MARK AS SHOWN.

THE MARK CONSISTS OF THE DESIGN OF A SEMI-CIRCLE, RESEMBLING THE SUN,  
ATOP A CURVED WAVY LINE WITH THE STYLIZED WORDING "SUN EAST FEDERAL  
CREDIT UNION" BENEATH THE WAVY LINE.

SER. NO. 85-614,033, FILED 5-2-2012.

DAWN HAN, EXAMINING ATTORNEY



*David J. Kyros*

Director of the United States Patent and Trademark Office

# United States of America

United States Patent and Trademark Office



**Reg. No. 4,274,742**

**Registered Jan. 15, 2013**

**Int. Cl.: 36**

**SERVICE MARK**

**PRINCIPAL REGISTER**

SUN EAST FEDERAL CREDIT UNION (UNITED STATES FEDERALLY CHARTERED  
NONPROFIT ORGANIZATION)  
4500 PENNELL ROAD  
ASTON, PA 19014

FOR: CREDIT UNION SERVICES, IN CLASS 36 (U.S. CLS. 100, 101 AND 102).

FIRST USE 2-27-2012; IN COMMERCE 2-27-2012.

OWNER OF U.S. REG. NOS. 2,688,044 AND 3,112,883.

NO CLAIM IS MADE TO THE EXCLUSIVE RIGHT TO USE "FEDERAL CREDIT UNION",  
APART FROM THE MARK AS SHOWN.

THE MARK CONSISTS OF THE DESIGN OF A SEMI-CIRCLE, RESEMBLING THE SUN,  
ATOP A CURVED WAVY LINE AND TO THE LEFT OF THE STYLIZED WORDING "SUN  
EAST FEDERAL CREDIT UNION".

SER. NO. 85-614,042, FILED 5-2-2012.

DAWN HAN, EXAMINING ATTORNEY



*David J. Kyros*

Director of the United States Patent and Trademark Office

# United States of America

United States Patent and Trademark Office

## MBG MARKETING

**Reg. No. 4,274,743**

**Registered Jan. 15, 2013**

**Int. Cls.: 29 and 31**

**TRADEMARK**

**PRINCIPAL REGISTER**

MICHIGAN BLUEBERRY GROWERS (MICHIGAN CORPORATION)  
04726 COUNTRY ROAD 215  
GRAND JUNCTION, MI 49056

FOR: FROZEN FRUITS, IN CLASS 29 (U.S. CL. 46).

FIRST USE 4-1-1989; IN COMMERCE 4-1-1989.

FOR: FRESH FRUITS, IN CLASS 31 (U.S. CLS. 1 AND 46).

FIRST USE 4-1-1989; IN COMMERCE 4-1-1989.

THE MARK CONSISTS OF STANDARD CHARACTERS WITHOUT CLAIM TO ANY PARTICULAR FONT, STYLE, SIZE, OR COLOR.

OWNER OF U.S. REG. NO. 1,658,330.

NO CLAIM IS MADE TO THE EXCLUSIVE RIGHT TO USE "MARKETING", APART FROM THE MARK AS SHOWN.

SER. NO. 85-614,117, FILED 5-2-2012.

SHANNON TWOHIG, EXAMINING ATTORNEY



*David J. Kybas*

Director of the United States Patent and Trademark Office

# United States of America

United States Patent and Trademark Office

## ULTIMATE ATHLETE

**Reg. No. 4,274,744**

FITNESS & LIFESTYLES, INC. (FLORIDA CORPORATION)

**Registered Jan. 15, 2013**

619 NORTH 21ST AVENUE  
HOLLYWOOD, FL 33020

**Int. Cl.: 25**

FOR: ATHLETIC APPAREL, NAMELY, SHIRTS, PANTS, JACKETS, FOOTWEAR, HATS AND CAPS, ATHLETIC UNIFORMS; BATHING SUITS; BERMUDA SHORTS; BOXER BRIEFS; BRIEFS; CAPS; CAPS WITH VISORS; FLEECE PULLOVERS; GLOVES; GYM PANTS; GYM SHORTS; GYM SUITS; HATS; JACKETS; LADIES' UNDERWEAR; MEN'S UNDERWEAR; PANTIES; PANTS; SANDALS; SHIRTS; SHOES; SHORTS; SOCKS; SWEATERS; SWEATSHIRTS; SWIM TRUNKS; T-SHIRTS FOR MEN, WOMEN, CHILDREN, TODDLERS AND INFANTS; UNDERWEAR; VISORS; WET SUITS; WIND PANTS; WIND RESISTANT JACKETS; WOMEN'S UNDERWEAR, IN CLASS 25 (U.S. CLS. 22 AND 39).

**TRADEMARK**

**PRINCIPAL REGISTER**

FIRST USE 1-10-2012; IN COMMERCE 1-10-2012.

THE MARK CONSISTS OF STANDARD CHARACTERS WITHOUT CLAIM TO ANY PARTICULAR FONT, STYLE, SIZE, OR COLOR.

NO CLAIM IS MADE TO THE EXCLUSIVE RIGHT TO USE "ATHLETE", APART FROM THE MARK AS SHOWN.

SER. NO. 85-614,186, FILED 5-2-2012.

PRISCILLA MILTON, EXAMINING ATTORNEY



*David J. Kyros*

Director of the United States Patent and Trademark Office

# United States of America

United States Patent and Trademark Office



**Reg. No. 4,274,745**

**Registered Jan. 15, 2013**

**Int. Cl.: 9**

**TRADEMARK**

**PRINCIPAL REGISTER**

FRIED PRODUCTS CORPORATION (PENNSYLVANIA CORPORATION)  
PO BOX 680  
GLADWYNE, PA 19035

FOR: AUDIO LOUDSPEAKERS; AUDIO LOUDSPEAKER ENCLOSURES; APPARATUS FOR BROADCASTING, RECORDING, TRANSMISSION OR REPRODUCTION OF SOUND OR IMAGES; APPARATUS FOR RECORDING, TRANSMISSION OR REPRODUCTION OF SOUND; APPARATUS FOR RECORDING, TRANSMISSION AND REPRODUCTION OF IMAGES; AUDIO AMPLIFIERS; AUDIO CABLES; AUDIO EQUIPMENT FOR VEHICLES, NAMELY, STEREOS, SPEAKERS, AMPLIFIERS, EQUALIZERS, CROSSOVERS AND SPEAKER HOUSINGS; AUDIO EQUIPMENT FOR VEHICLES, NAMELY, SUBWOOFERS; AUDIO SPEAKER ENCLOSURES; AUDIO SPEAKERS; AUDIO-RECEIVERS AND VIDEO-RECEIVERS; AUDIOVISUAL RECEIVERS; VIDEO MONITORS; STANDS SPECIALLY ADAPTED FOR STEREOS AND AUDIO SPEAKERS; RADIOS; ELECTRICAL PHONOGRAPH RECORD TURNTABLE CARTRIDGES; ELECTRICAL PHONOGRAPH RECORD TURNTABLE; AUDIO CD PLAYERS, IN CLASS 9 (U.S. CLS. 21, 23, 26, 36 AND 38).

FIRST USE 2-12-2004; IN COMMERCE 2-12-2004.

NO CLAIM IS MADE TO THE EXCLUSIVE RIGHT TO USE "PRODUCTS", APART FROM THE MARK AS SHOWN.

THE MARK CONSISTS OF A STYLIZED TRANSMISSION LINE ENCLOSURE IN A CROSS SECTION. TO THE RIGHT THERE IS THE STYLIZED TEXT "FRIED PRODUCTS".

SER. NO. 85-614,241, FILED 5-2-2012.

LEIGH LOWRY, EXAMINING ATTORNEY



*David J. Kyffers*

Director of the United States Patent and Trademark Office

# United States of America

United States Patent and Trademark Office



**Reg. No. 4,274,746**

**Registered Jan. 15, 2013**

**Int. Cls.: 9 and 36**

**TRADEMARK**

**SERVICE MARK**

**PRINCIPAL REGISTER**

VBUSINESS PROCESSING, INC. (NEVADA CORPORATION)  
2533 N. CARSON ST., SUITE 1782  
CARSON CITY, NV 89706

FOR: COMPUTER SOFTWARE, NAMELY, ELECTRONIC FINANCIAL PLATFORM THAT ACCOMMODATES MULTIPLE TYPES OF PAYMENT AND DEBT TRANSACTIONS IN AN INTEGRATED MOBILE PHONE, PDA, AND WEB BASED ENVIRONMENT, IN CLASS 9 (U.S. CLS. 21, 23, 26, 36 AND 38).

FIRST USE 2-1-2008; IN COMMERCE 2-1-2008.

FOR: MERCHANT SERVICES, NAMELY, PAYMENT TRANSACTION PROCESSING SERVICES, IN CLASS 36 (U.S. CLS. 100, 101 AND 102).

FIRST USE 2-1-2008; IN COMMERCE 2-1-2008.

THE MARK CONSISTS OF THE STYLIZED LETTERS "VSG" IN BLACK OVERLAYING THE GREEN IMAGE OF A COMBINATION LOCK FACE.

THE COLOR(S) BLACK AND GREEN IS/ARE CLAIMED AS A FEATURE OF THE MARK.

SER. NO. 85-614,338, FILED 5-2-2012.

KEVEN MITTLER, EXAMINING ATTORNEY



*David J. Kyffers*

Director of the United States Patent and Trademark Office



# United States of America

United States Patent and Trademark Office

## WORLD ELITE

**Reg. No. 4,274,747**

**Registered Jan. 15, 2013**

**Int. Cls.: 39, 41, 43, 44  
and 45**

**SERVICE MARK**

**PRINCIPAL REGISTER**

MASTERCARD INTERNATIONAL INCORPORATED (DELAWARE CORPORATION)  
2000 PURCHASE STREET  
PURCHASE, NY 105772405

FOR: PERSONAL SERVICES RENDERED BY OTHERS TO MEET THE NEEDS OF INDIVIDUALS, NAMELY, TRAVEL AND TOUR TICKET RESERVATION SERVICES AND MAKING RESERVATIONS AND BOOKINGS FOR TRANSPORTATION; CONCIERGE SERVICES TO MEET THE INDIVIDUAL NEEDS OF PREMIER CUSTOMER CARD HOLDERS AND TRAVELERS, NAMELY, TRAVEL AND TOUR TICKET RESERVATION SERVICES, MAKING RESERVATIONS AND BOOKINGS FOR TRANSPORTATION, AND PROVIDING CUSTOMER-SPECIFIC INFORMATION RELATED THERETO, IN CLASS 39 (U.S. CLS. 100 AND 105).

FIRST USE 10-11-2011; IN COMMERCE 10-11-2011.

FOR: PERSONAL SERVICES RENDERED BY OTHERS TO MEET THE NEEDS OF INDIVIDUALS, NAMELY, PARTY AND SPECIAL EVENT PLANNING, ARRANGING FOR TICKET RESERVATIONS FOR SHOWS AND OTHER ENTERTAINMENT, SPORTING, OR CULTURAL EVENTS; CONCIERGE SERVICES TO MEET THE INDIVIDUAL NEEDS OF PREMIER CUSTOMER CARD HOLDERS AND TRAVELERS, NAMELY, PARTY AND SPECIAL EVENT PLANNING, ARRANGING FOR TICKET RESERVATIONS FOR SHOWS AND OTHER ENTERTAINMENT, SPORTING, OR CULTURAL EVENTS, AND PROVIDING CUSTOMER-SPECIFIC INFORMATION RELATED THERETO, IN CLASS 41 (U.S. CLS. 100, 101 AND 107).

FIRST USE 10-11-2011; IN COMMERCE 10-11-2011.

FOR: PERSONAL SERVICES RENDERED BY OTHERS TO MEET THE NEEDS OF INDIVIDUALS, NAMELY, MAKING RESTAURANT AND HOTEL RESERVATIONS; CONCIERGE SERVICES TO MEET THE INDIVIDUAL NEEDS OF PREMIER CUSTOMER CARD HOLDERS AND TRAVELERS, NAMELY, MAKING RESTAURANT AND HOTEL RESERVATIONS AND PROVIDING CUSTOMER-SPECIFIC INFORMATION RELATED THERETO, IN CLASS 43 (U.S. CLS. 100 AND 101).

FIRST USE 10-11-2011; IN COMMERCE 10-11-2011.



*David J. Kyjars*

Director of the United States Patent and Trademark Office

**Reg. No. 4,274,747** FOR: PERSONAL SERVICES RENDERED BY OTHERS TO MEET THE NEEDS OF INDIVIDUALS, NAMELY, MAKING RESERVATIONS AND BOOKINGS FOR PHYSICAL AND BEAUTY TREATMENTS AT SALONS AND HEALTH SPAS; CONCIERGE SERVICES TO MEET THE INDIVIDUAL NEEDS OF PREMIER CUSTOMER CARD HOLDERS AND TRAVELERS, NAMELY, MAKING RESERVATIONS AND BOOKINGS FOR PHYSICAL AND BEAUTY TREATMENTS AT SALONS AND HEALTH SPAS, AND PROVIDING CUSTOMER-SPECIFIC INFORMATION RELATED THERETO, IN CLASS 44 (U.S. CLS. 100 AND 101).

FIRST USE 10-11-2011; IN COMMERCE 10-11-2011.

FOR: PERSONAL AND SOCIAL SERVICES RENDERED BY OTHERS TO MEET THE NEEDS OF INDIVIDUALS, NAMELY, PERSONAL SHOPPING SERVICES; HOTEL CONCIERGE SERVICES; CONCIERGE SERVICES TO MEET THE INDIVIDUAL NEEDS OF PREMIER CUSTOMER CARD HOLDERS AND TRAVELERS, NAMELY, PERSONAL SHOPPING SERVICES AND PROVIDING CUSTOMER-SPECIFIC INFORMATION RELATED THERETO; SECURITY PRINTING, NAMELY, ENCODING IDENTIFICATION INFORMATION ON PRODUCTS; MONITORING OF COMPUTER SYSTEMS FOR SECURITY PURPOSES; FRAUD DETECTION SERVICES IN THE FIELD OF PAYMENT CARDS FOR ON-LINE PURCHASING; INVESTIGATION AND SURVEILLANCE SERVICES RELATING TO IDENTITY THEFT AS IT RELATES TO THE SAFETY OF PERSONS AND ENTITIES, IN CLASS 45 (U.S. CLS. 100 AND 101).

FIRST USE 10-11-2011; IN COMMERCE 10-11-2011.

THE MARK CONSISTS OF STANDARD CHARACTERS WITHOUT CLAIM TO ANY PARTICULAR FONT, STYLE, SIZE, OR COLOR.

OWNER OF U.S. REG. NO. 3,353,757.

SER. NO. 85-614,759, FILED 5-2-2012.

KIMBERLY FRYE, EXAMINING ATTORNEY

# United States of America

United States Patent and Trademark Office

## WORLD ELITE MASTERCARD

**Reg. No. 4,274,748**

**Registered Jan. 15, 2013**

**Int. Cls.: 39, 41, 43, 44  
and 45**

**SERVICE MARK**

**PRINCIPAL REGISTER**

MASTERCARD INTERNATIONAL INCORPORATED (DELAWARE CORPORATION)  
2000 PURCHASE STREET  
PURCHASE, NY 105772405

FOR: PERSONAL SERVICES RENDERED BY OTHERS TO MEET THE NEEDS OF INDIVIDUALS, NAMELY, TRAVEL AND TOUR TICKET RESERVATION SERVICES AND MAKING RESERVATIONS AND BOOKINGS FOR TRANSPORTATION; CONCIERGE SERVICES TO MEET THE INDIVIDUAL NEEDS OF PREMIER CUSTOMER CARD HOLDERS AND TRAVELERS, NAMELY, TRAVEL AND TOUR TICKET RESERVATION SERVICES, MAKING RESERVATIONS AND BOOKINGS FOR TRANSPORTATION, AND PROVIDING CUSTOMER-SPECIFIC INFORMATION RELATED THERETO, IN CLASS 39 (U.S. CLS. 100 AND 105).

FIRST USE 10-11-2011; IN COMMERCE 10-11-2011.

FOR: PERSONAL SERVICES RENDERED BY OTHERS TO MEET THE NEEDS OF INDIVIDUALS, NAMELY, PARTY AND SPECIAL EVENT PLANNING, ARRANGING FOR TICKET RESERVATIONS FOR SHOWS AND OTHER ENTERTAINMENT, SPORTING, OR CULTURAL EVENTS; CONCIERGE SERVICES TO MEET THE INDIVIDUAL NEEDS OF PREMIER CUSTOMER CARD HOLDERS AND TRAVELERS, NAMELY, PARTY AND SPECIAL EVENT PLANNING, ARRANGING FOR TICKET RESERVATIONS FOR SHOWS AND OTHER ENTERTAINMENT, SPORTING, OR CULTURAL EVENTS, AND PROVIDING CUSTOMER-SPECIFIC INFORMATION RELATED THERETO, IN CLASS 41 (U.S. CLS. 100, 101 AND 107).

FIRST USE 10-11-2011; IN COMMERCE 10-11-2011.

FOR: PERSONAL SERVICES RENDERED BY OTHERS TO MEET THE NEEDS OF INDIVIDUALS, NAMELY, MAKING RESTAURANT AND HOTEL RESERVATIONS; CONCIERGE SERVICES TO MEET THE INDIVIDUAL NEEDS OF PREMIER CUSTOMER CARD HOLDERS AND TRAVELERS, NAMELY, MAKING RESTAURANT AND HOTEL RESERVATIONS AND PROVIDING CUSTOMER-SPECIFIC INFORMATION RELATED THERETO, IN CLASS 43 (U.S. CLS. 100 AND 101).

FIRST USE 10-11-2011; IN COMMERCE 10-11-2011.



*David J. Kybas*

Director of the United States Patent and Trademark Office

**Reg. No. 4,274,748** FOR: PERSONAL SERVICES RENDERED BY OTHERS TO MEET THE NEEDS OF INDIVIDUALS, NAMELY, MAKING RESERVATIONS AND BOOKINGS FOR PHYSICAL AND BEAUTY TREATMENTS AT SALONS AND HEALTH SPAS; CONCIERGE SERVICES TO MEET THE INDIVIDUAL NEEDS OF PREMIER CUSTOMER CARD HOLDERS AND TRAVELERS, NAMELY, MAKING RESERVATIONS AND BOOKINGS FOR PHYSICAL AND BEAUTY TREATMENTS AT SALONS AND HEALTH SPAS, AND PROVIDING CUSTOMER-SPECIFIC INFORMATION RELATED THERETO, IN CLASS 44 (U.S. CLS. 100 AND 101).

FIRST USE 10-11-2011; IN COMMERCE 10-11-2011.

FOR: PERSONAL AND SOCIAL SERVICES RENDERED BY OTHERS TO MEET THE NEEDS OF INDIVIDUALS, NAMELY, PERSONAL SHOPPING SERVICES; HOTEL CONCIERGE SERVICES; CONCIERGE SERVICES TO MEET THE INDIVIDUAL NEEDS OF PREMIER CUSTOMER CARD HOLDERS AND TRAVELERS, NAMELY, PERSONAL SHOPPING SERVICES AND PROVIDING CUSTOMER-SPECIFIC INFORMATION RELATED THERETO; SECURITY PRINTING, NAMELY, ENCODING IDENTIFICATION INFORMATION ON PRODUCTS; MONITORING OF COMPUTER SYSTEMS FOR SECURITY PURPOSES; FRAUD DETECTION SERVICES IN THE FIELD OF PAYMENT CARDS FOR ON-LINE PURCHASING; INVESTIGATION AND SURVEILLANCE SERVICES RELATING TO IDENTITY THEFT AS IT RELATES TO THE SAFETY OF PERSONS AND ENTITIES, IN CLASS 45 (U.S. CLS. 100 AND 101).

FIRST USE 10-11-2011; IN COMMERCE 10-11-2011.

THE MARK CONSISTS OF STANDARD CHARACTERS WITHOUT CLAIM TO ANY PARTICULAR FONT, STYLE, SIZE, OR COLOR.

OWNER OF U.S. REG. NOS. 1,186,117, 3,357,874 AND OTHERS.

SER. NO. 85-614,772, FILED 5-2-2012.

KIMBERLY FRYE, EXAMINING ATTORNEY

# United States of America

United States Patent and Trademark Office



**Reg. No. 4,274,749**

**Registered Jan. 15, 2013**

**Int. Cls.: 39, 41, 43, 44  
and 45**

**SERVICE MARK**

**PRINCIPAL REGISTER**

MASTERCARD INTERNATIONAL INCORPORATED (DELAWARE CORPORATION)  
2000 PURCHASE STREET  
PURCHASE, NY 105772405

FOR: PERSONAL SERVICES RENDERED BY OTHERS TO MEET THE NEEDS OF INDIVIDUALS, NAMELY, TRAVEL AND TOUR TICKET RESERVATION SERVICES AND MAKING RESERVATIONS AND BOOKINGS FOR TRANSPORTATION; CONCIERGE SERVICES TO MEET THE INDIVIDUAL NEEDS OF PREMIER CUSTOMER CARD HOLDERS AND TRAVELERS, NAMELY, TRAVEL AND TOUR TICKET RESERVATION SERVICES, MAKING RESERVATIONS AND BOOKINGS FOR TRANSPORTATION, AND PROVIDING CUSTOMER-SPECIFIC INFORMATION RELATED THERETO, IN CLASS 39 (U.S. CLS. 100 AND 105).

FIRST USE 10-11-2011; IN COMMERCE 10-11-2011.

FOR: PERSONAL SERVICES RENDERED BY OTHERS TO MEET THE NEEDS OF INDIVIDUALS, NAMELY, PARTY AND SPECIAL EVENT PLANNING, ARRANGING FOR TICKET RESERVATIONS FOR SHOWS AND OTHER ENTERTAINMENT, SPORTING, OR CULTURAL EVENTS; CONCIERGE SERVICES TO MEET THE INDIVIDUAL NEEDS OF PREMIER CUSTOMER CARD HOLDERS AND TRAVELERS, NAMELY, PARTY AND SPECIAL EVENT PLANNING, ARRANGING FOR TICKET RESERVATIONS FOR SHOWS AND OTHER ENTERTAINMENT, SPORTING, OR CULTURAL EVENTS, AND PROVIDING CUSTOMER-SPECIFIC INFORMATION RELATED THERETO, IN CLASS 41 (U.S. CLS. 100, 101 AND 107).

FIRST USE 10-11-2011; IN COMMERCE 10-11-2011.

FOR: PERSONAL SERVICES RENDERED BY OTHERS TO MEET THE NEEDS OF INDIVIDUALS, NAMELY, MAKING RESTAURANT AND HOTEL RESERVATIONS; CONCIERGE SERVICES TO MEET THE INDIVIDUAL NEEDS OF PREMIER CUSTOMER CARD HOLDERS AND TRAVELERS, NAMELY, MAKING RESTAURANT AND HOTEL RESERVATIONS AND PROVIDING CUSTOMER-SPECIFIC INFORMATION RELATED THERETO, IN CLASS 43 (U.S. CLS. 100 AND 101).

FIRST USE 10-11-2011; IN COMMERCE 10-11-2011.



*David J. Kybas*

Director of the United States Patent and Trademark Office

**Reg. No. 4,274,749** FOR: PERSONAL SERVICES RENDERED BY OTHERS TO MEET THE NEEDS OF INDIVIDUALS, NAMELY, MAKING RESERVATIONS AND BOOKINGS FOR PHYSICAL AND BEAUTY TREATMENTS AT SALONS AND HEALTH SPAS; CONCIERGE SERVICES TO MEET THE INDIVIDUAL NEEDS OF PREMIER CUSTOMER CARD HOLDERS AND TRAVELERS, NAMELY, MAKING RESERVATIONS AND BOOKINGS FOR PHYSICAL AND BEAUTY TREATMENTS AT SALONS AND HEALTH SPAS, AND PROVIDING CUSTOMER-SPECIFIC INFORMATION RELATED THERETO, IN CLASS 44 (U.S. CLS. 100 AND 101).

FIRST USE 10-11-2011; IN COMMERCE 10-11-2011.

FOR: PERSONAL AND SOCIAL SERVICES RENDERED BY OTHERS TO MEET THE NEEDS OF INDIVIDUALS, NAMELY, PERSONAL SHOPPING SERVICES; HOTEL CONCIERGE SERVICES; CONCIERGE SERVICES TO MEET THE INDIVIDUAL NEEDS OF PREMIER CUSTOMER CARD HOLDERS AND TRAVELERS, NAMELY, PERSONAL SHOPPING SERVICES AND PROVIDING CUSTOMER-SPECIFIC INFORMATION RELATED THERETO; SECURITY PRINTING, NAMELY, ENCODING IDENTIFICATION INFORMATION ON PRODUCTS; MONITORING OF COMPUTER SYSTEMS FOR SECURITY PURPOSES; FRAUD DETECTION SERVICES IN THE FIELD OF PAYMENT CARDS FOR ON-LINE PURCHASING; INVESTIGATION AND SURVEILLANCE SERVICES RELATING TO IDENTITY THEFT AS IT RELATES TO THE SAFETY OF PERSONS AND ENTITIES, IN CLASS 45 (U.S. CLS. 100 AND 101).

FIRST USE 10-11-2011; IN COMMERCE 10-11-2011.

OWNER OF U.S. REG. NOS. 1,186,117, 3,597,490 AND OTHERS.

THE COLOR(S) SILVER, BLACK AND WHITE IS/ARE CLAIMED AS A FEATURE OF THE MARK.

THE MARK CONSISTS OF THE WORD MARK "MASTERCARD" IN WHITE LETTERS HIGHLIGHTED IN BLACK SUPERIMPOSED ACROSS TWO INTERLOCKING CIRCLES. BOTH CIRCLES ARE SILVER IN COLOR WITH HORIZONTAL LINES IN THE PORTION OF THE CIRCLES THAT INTERLOCK.

SER. NO. 85-614,852, FILED 5-2-2012.

KIMBERLY FRYE, EXAMINING ATTORNEY

United States of America  
United States Patent and Trademark Office

MITICAÑA

**Reg. No. 4,274,750**

**Registered Jan. 15, 2013**

**Int. Cl.: 29**

**TRADEMARK**

**PRINCIPAL REGISTER**

FOREVER CHEESE INC (NEW YORK CORPORATION)  
SUITE 307  
36-36 33RD ST.  
ASTORIA, NY 11106

FOR: CHEESE, IN CLASS 29 (U.S. CL. 46).

FIRST USE 10-5-2002; IN COMMERCE 10-5-2002.

THE MARK CONSISTS OF STANDARD CHARACTERS WITHOUT CLAIM TO ANY PARTICULAR FONT, STYLE, SIZE, OR COLOR.

THE WORDING "MITICAÑA" HAS NO MEANING IN A FOREIGN LANGUAGE.

SER. NO. 85-614,910, FILED 5-2-2012.

BRIAN NEVILLE, EXAMINING ATTORNEY



*David J. Kyffers*

Director of the United States Patent and Trademark Office

# United States of America

United States Patent and Trademark Office

# outrider

**Reg. No. 4,274,751**

NAYANO (CALIFORNIA LIMITED LIABILITY COMPANY)  
P.O. BOX 351355

**Registered Jan. 15, 2013**

LOS ANGELES, CA 90035

**Int. Cl.: 9**

FOR: BLANK DIGITAL STORAGE MEDIA; BLANK ELECTRONIC STORAGE MEDIA; BLANK USB FLASH DRIVES; COMPUTER HARDWARE FOR UPLOAD, STORAGE, RETRIEVAL, DOWNLOAD, TRANSMISSION AND DELIVERY OF DIGITAL CONTENT; COMPUTER MEMORIES; COMPUTER MEMORY HARDWARE; COMPUTER PERIPHERAL DEVICES; COMPUTER STORAGE DEVICES, NAMELY, BLANK FLASH DRIVES; ELECTRONIC MEMORIES; FLASH CARD ADAPTERS; FLASH CARD READERS; FLASH MEMORY CARD; MEMORY CARDS; SOLID STATE DRIVES; SOLID STATE STORAGE, NAMELY, A NONVOLATILE STORAGE MEDIUM THAT EMPLOYS INTEGRATED CIRCUITS, IN CLASS 9 (U.S. CLS. 21, 23, 26, 36 AND 38).

**TRADEMARK**

**PRINCIPAL REGISTER**

FIRST USE 3-18-2011; IN COMMERCE 2-27-2012.

THE MARK CONSISTS OF STANDARD CHARACTERS WITHOUT CLAIM TO ANY PARTICULAR FONT, STYLE, SIZE, OR COLOR.

SER. NO. 85-615,259, FILED 5-3-2012.

INGRID C. EULIN, EXAMINING ATTORNEY



*David J. Kyfos*

Director of the United States Patent and Trademark Office



# United States of America

United States Patent and Trademark Office

## DOOKIE BUTLER

**Reg. No. 4,274,752**

MADILL, WILLIAM J. JR. (UNITED STATES INDIVIDUAL)  
9601 GLENOX LANE  
RIVERVIEW, FL 33569

**Registered Jan. 15, 2013**

**Int. Cl.: 8**

FOR: DOG WASTE COLLECTION DEVICE COMPRISING A HANDLE FORMED WITH A COLLECTION HEAD HAVING A OPENING AND MEANS TO ATTACH A DISPOSABLE BAG POSITIONED BENEATH THE OPENING TO COLLECT DOG FECES, IN CLASS 8 (U.S. CLS. 23, 28 AND 44).

**TRADEMARK**

**PRINCIPAL REGISTER**

FIRST USE 3-1-2012; IN COMMERCE 3-1-2012.

THE MARK CONSISTS OF STANDARD CHARACTERS WITHOUT CLAIM TO ANY PARTICULAR FONT, STYLE, SIZE, OR COLOR.

NO CLAIM IS MADE TO THE EXCLUSIVE RIGHT TO USE "DOOKIE", APART FROM THE MARK AS SHOWN.

SER. NO. 85-615,531, FILED 5-3-2012.

ANN E. SAPPENFIELD, EXAMINING ATTORNEY



*David J. Kyffers*

Director of the United States Patent and Trademark Office

# United States of America

United States Patent and Trademark Office



**Reg. No. 4,274,753**

DENNIS HUDGENS (UNITED STATES INDIVIDUAL)  
320 SADDLE TRAIL  
SAGINAW, TX 76179

**Registered Jan. 15, 2013**

**Int. Cl.: 40**

FOR: OIL PRODUCTION SERVICES, IN CLASS 40 (U.S. CLS. 100, 103 AND 106).

**SERVICE MARK**

FIRST USE 4-15-2012; IN COMMERCE 4-15-2012.

**PRINCIPAL REGISTER**

NO CLAIM IS MADE TO THE EXCLUSIVE RIGHT TO USE "SALTWATER SYSTEMS, INC.", APART FROM THE MARK AS SHOWN.

THE MARK CONSISTS OF A THREE-TIERED STYLIZED IMAGE. THE TOP TIER CONTAINS THE PICTURE OF A GREEK GOD'S FACE ON THE LEFT-MOST PORTION WITH THE WORD "POSEIDON" IN ALL CAPITALIZED LETTERS BUTTING AGAINST THE PICTURE OF THE GREEK GOD'S FACE. THE MIDDLE TIER CONSISTS OF THE WORDS "SALT-WATER SYSTEMS, INC." IN ALL CAPITAL LETTERS. THE LETTERS OF THE SECOND TIER ARE LOCATED BELOW THE TOP TIER AND ARE COMPRISED OF A SMALLER FONT THAN THE LETTERS THAT COMPRISE THE TOP TIER. THE BOTTOM TIER IS COMPRISED OF A TRIDENT WITH THE STAFF OF THE TRIDENT EXTENDING FROM THE LEFT SIDE OF THE IMAGE AND THE TRIDENT'S TREBLE PRONG RESIDING ON THE RIGHT SIDE OF THE IMAGE'S BOTTOM TIER.

SER. NO. 85-615,554, FILED 5-3-2012.

TRACY FLETCHER, EXAMINING ATTORNEY



*David J. Kybas*

Director of the United States Patent and Trademark Office

# United States of America

United States Patent and Trademark Office

# T4D LAB

**Reg. No. 4,274,754**

T4D LAB LLC (NEW YORK LIMITED LIABILITY COMPANY)  
2253 24TH STREET  
ASTORIA, NY 11105

**Registered Jan. 15, 2013**

**Int. Cl.: 42**

FOR: DEVELOPMENT OF NEW TECHNOLOGY FOR OTHERS IN THE FIELD OF CONSERVATION, SOCIAL CHALLENGES, RENEWABLE ENERGY, HUMANITARIAN TECHNOLOGIES, EMERGENCY RELIEF, TRACKING AND LOGISTICS AND INTERACTION DESIGN.; PRODUCT DEVELOPMENT; PRODUCT DEVELOPMENT AND ENGINEERING SERVICES FOR OTHERS; PRODUCT DEVELOPMENT CONSULTATION; RESEARCH AND DEVELOPMENT AND CONSULTATION RELATED THERETO IN THE FIELD OF CONSERVATION, SOCIAL CHALLENGES, RENEWABLE ENERGY, HUMANITARIAN TECHNOLOGIES, EMERGENCY RELIEF, TRACKING AND LOGISTICS AND INTERACTION DESIGN, IN CLASS 42 (U.S. CLS. 100 AND 101).

**SERVICE MARK**

**PRINCIPAL REGISTER**

FIRST USE 1-11-2012; IN COMMERCE 3-6-2012.

THE MARK CONSISTS OF STANDARD CHARACTERS WITHOUT CLAIM TO ANY PARTICULAR FONT, STYLE, SIZE, OR COLOR.

NO CLAIM IS MADE TO THE EXCLUSIVE RIGHT TO USE "LAB", APART FROM THE MARK AS SHOWN.

SER. NO. 85-615,625, FILED 5-3-2012.

FONG HSU, EXAMINING ATTORNEY



*David J. Kyros*

Director of the United States Patent and Trademark Office

# United States of America

United States Patent and Trademark Office

## WEALTH WITH NO REGRETS

**Reg. No. 4,274,755**

**Registered Jan. 15, 2013**

**Int. Cl.: 36**

**SERVICE MARK**

**PRINCIPAL REGISTER**

BOOMFISH WEALTH GROUP, LLC (GEORGIA LIMITED LIABILITY COMPANY)  
SUITE 100  
12600 DEERFIELD PARKWAY  
ALPHARETTA, GA 30004

FOR: FINANCIAL PLANNING, INVESTMENT ADVISORY AND WEALTH PLANNING SERVICES, IN CLASS 36 (U.S. CLS. 100, 101 AND 102).

FIRST USE 1-0-2012; IN COMMERCE 1-0-2012.

THE MARK CONSISTS OF STANDARD CHARACTERS WITHOUT CLAIM TO ANY PARTICULAR FONT, STYLE, SIZE, OR COLOR.

NO CLAIM IS MADE TO THE EXCLUSIVE RIGHT TO USE "WEALTH", APART FROM THE MARK AS SHOWN.

SER. NO. 85-615,797, FILED 5-3-2012.

DEZMONA MIZELLE, EXAMINING ATTORNEY



*David J. Kyffers*

Director of the United States Patent and Trademark Office

# United States of America

United States Patent and Trademark Office



**Reg. No. 4,274,756**

GREAT AMERICAN OPPORTUNITIES, INC. (TENNESSEE CORPORATION)  
2451 ATRIUM WAY  
NASHVILLE, TN 37230

**Registered Jan. 15, 2013**

**Int. Cl.: 36**

FOR: FUNDRAISING SERVICES, NAMELY, ORGANIZING, ARRANGING AND CONDUCTING FUNDRAISING PROGRAMS FOR THE BENEFIT OF SCHOOLS AND NON-PROFIT ORGANIZATIONS, IN CLASS 36 (U.S. CLS. 100, 101 AND 102).

**SERVICE MARK**

FIRST USE 2-0-2012; IN COMMERCE 2-0-2012.

**PRINCIPAL REGISTER**

OWNER OF U.S. REG. NOS. 960,085, 3,496,324 AND OTHERS.

THE MARK CONSISTS OF THE LETTER "Q" INTERCONNECTED WITH A STAR, ADJACENT TO THE WORDS "GREAT AMERICAN OPPORTUNITIES STRENGTHENED BY THE RICH HERITAGE OF QSP".

SER. NO. 85-615,894, FILED 5-3-2012.

JAY BESCH, EXAMINING ATTORNEY



*David J. Kypos*

Director of the United States Patent and Trademark Office

# United States of America

United States Patent and Trademark Office



**Reg. No. 4,274,757**

**Registered Jan. 15, 2013**

**Int. Cl.: 29**

**TRADEMARK**

**PRINCIPAL REGISTER**

STUEBER, SAMUEL (UNITED STATES INDIVIDUAL)  
2221 ORO-CHICO HWY  
DURHAM, CA 95938 AND

STUEBER, KATIE (UNITED STATES INDIVIDUAL)  
2221 ORO-CHICO HWY  
DURHAM, CA 95938

FOR: FLAVORED NUTS; NUT BUTTERS, NAMELY, ALMOND BUTTER; PROCESSED ALMONDS, IN CLASS 29 (U.S. CL. 46).

FIRST USE 11-1-2011; IN COMMERCE 12-1-2011.

NO CLAIM IS MADE TO THE EXCLUSIVE RIGHT TO USE "NUT COMPANY", APART FROM THE MARK AS SHOWN.

THE MARK CONSISTS OF A SQUIRREL WEARING AN APRON AND A CHEF'S HAT WHILE HOLDING AN ALMOND IN BOTH OUTSTRETCHED HANDS. THERE IS A CIRCLE BEHIND THE SQUIRREL. THE STYLIZED TEXT "AMMIN NUT COMPANY" IS WRITTEN UNDERNEATH THIS IMAGE.

THE WORDING "AMMIN" HAS NO MEANING IN A FOREIGN LANGUAGE.

SER. NO. 85-616,198, FILED 5-3-2012.

RICHARD WHITE, EXAMINING ATTORNEY



*David J. Kybas*

Director of the United States Patent and Trademark Office

# United States of America

United States Patent and Trademark Office

W  
O  
L  
F  
'  
S  
  
E  
Y  
E  
  
B  
O  
O  
K  
S

**Reg. No. 4,274,758**

VINT, JESSE LEE III (UNITED STATES INDIVIDUAL)  
6704 NE 14TH AVE  
VANCOUVER, WA 98665

**Registered Jan. 15, 2013**

**Int. Cl.: 41**

FOR: PUBLICATION OF BOOKS, IN CLASS 41 (U.S. CLS. 100, 101 AND 107).

**SERVICE MARK**

FIRST USE 9-17-2010; IN COMMERCE 9-17-2010.

**PRINCIPAL REGISTER**

NO CLAIM IS MADE TO THE EXCLUSIVE RIGHT TO USE "BOOKS" , APART FROM THE MARK AS SHOWN.

THE MARK CONSISTS OF THE WORDS "WOLF'S EYE BOOKS" WITH THE LETTER "O" IN "WOLF'S" REPRESENTED BY A STYLIZED WOLF'S EYE.

SER. NO. 85-616,513, FILED 5-4-2012.

WILLIAM ROSSMAN, EXAMINING ATTORNEY



*David J. Kyffers*

Director of the United States Patent and Trademark Office

# United States of America

United States Patent and Trademark Office

## EmPower Incentive Calculators

**Reg. No. 4,274,759**

**Registered Jan. 15, 2013**

**Int. Cl.: 42**

**SERVICE MARK**

**PRINCIPAL REGISTER**

QUESTLINE, INC. (OHIO CORPORATION)  
2025 RIVERSIDE DRIVE  
COLUMBUS, OH 43221

FOR: PROVIDING TEMPORARY USE OF ONLINE NON-DOWNLOADABLE SOFTWARE FEATURING A SUITE OF ONLINE ENERGY-EFFICIENCY NATURAL GAS AND ELECTRIC CALCULATORS THAT AID CUSTOMERS IN MAKING CAPITAL EXPENDITURE DECISIONS RELATED TO LIGHTING, HVAC, VARIABLE FREQUENCY DRIVES, CHILLERS, AND OTHER SYSTEMS, IN CLASS 42 (U.S. CLS. 100 AND 101).

FIRST USE 3-15-2012; IN COMMERCE 4-23-2012.

THE MARK CONSISTS OF STANDARD CHARACTERS WITHOUT CLAIM TO ANY PARTICULAR FONT, STYLE, SIZE, OR COLOR.

NO CLAIM IS MADE TO THE EXCLUSIVE RIGHT TO USE "INCENTIVE CALCULATORS", APART FROM THE MARK AS SHOWN.

SER. NO. 85-616,563, FILED 5-4-2012.

CHRISIE B. KING, EXAMINING ATTORNEY



*David J. Kyros*

Director of the United States Patent and Trademark Office



# United States of America

United States Patent and Trademark Office

## Madame Tresses

**Reg. No. 4,274,760**

**Registered Jan. 15, 2013**

**Int. Cl.: 26**

ESPOSITO, MICHELLE (UNITED STATES INDIVIDUAL)  
SUITE 458  
2870 PEACHTREE ROAD  
ATLANTA, GA 30305

FOR: HAIR EXTENSIONS, IN CLASS 26 (U.S. CLS. 37, 39, 40, 42 AND 50).

**TRADEMARK**

FIRST USE 1-1-2011; IN COMMERCE 1-1-2011.

**PRINCIPAL REGISTER**

THE MARK CONSISTS OF STANDARD CHARACTERS WITHOUT CLAIM TO ANY PARTICULAR FONT, STYLE, SIZE, OR COLOR.

NO CLAIM IS MADE TO THE EXCLUSIVE RIGHT TO USE "TRESSES", APART FROM THE MARK AS SHOWN.

SER. NO. 85-616,776, FILED 5-4-2012.

ROBIN CHOSID, EXAMINING ATTORNEY



*David J. Kyffers*

Director of the United States Patent and Trademark Office

# United States of America

United States Patent and Trademark Office

## Time To Cater

**Reg. No. 4,274,761**

**Registered Jan. 15, 2013**

**Int. Cl.: 43**

**SERVICE MARK**

**PRINCIPAL REGISTER**

REWARDS CATERING, LLC (MISSOURI LIMITED LIABILITY COMPANY), DBA TIME TO CATER  
10 S. LYLE AVE.  
CLAYTON, MO 63105

FOR: BOOKING OF CATERING SERVICES FOR OTHERS, IN CLASS 43 (U.S. CLS. 100 AND 101).

FIRST USE 1-1-2011; IN COMMERCE 3-1-2011.

THE MARK CONSISTS OF STANDARD CHARACTERS WITHOUT CLAIM TO ANY PARTICULAR FONT, STYLE, SIZE, OR COLOR.

NO CLAIM IS MADE TO THE EXCLUSIVE RIGHT TO USE "CATER", APART FROM THE MARK AS SHOWN.

SER. NO. 85-616,887, FILED 5-4-2012.

DORITT L. CARROLL, EXAMINING ATTORNEY



*David J. Kyffers*

Director of the United States Patent and Trademark Office

# United States of America

United States Patent and Trademark Office

## POKER FANTASY AMONG THIEVES

**Reg. No. 4,274,762**

**Registered Jan. 15, 2013**

**Int. Cl.: 9**

**TRADEMARK**

**PRINCIPAL REGISTER**

ECHANNEL NETWORKS, INC. (CANADA CORPORATION)  
9 CHALET ROAD  
TORONTO, ONTARIO, CANADA M2JR3V4

FOR: INTERACTIVE GAME SOFTWARE; COMPUTER GAME SOFTWARE; VIDEO GAME PROGRAMS AND CARTRIDGES; ELECTRONIC GAME PROGRAMS; GAME SOFTWARE FOR USE ON ANY COMPUTERIZED PLATFORM, INCLUDING GAME CONSOLES, GAME TERMINALS, HAND-HELD ELECTRONIC DEVICES, ELECTRONIC ENTERTAINMENT DEVICES, GAMBLING MACHINES, ARCADE GAME MACHINES, TELECOMMUNICATIONS DEVICES, MOBILE PHONES, AND ELECTRONIC COMMUNICATION DEVICES; DOWNLOADABLE INTERACTIVE, COMPUTER, VIDEO AND ELECTRONIC GAME PROGRAMS; GAMES, NAMELY, GAMBLING MACHINES; MACHINES FOR PLAYING GAMES OF CHANCE; GAMBLING MACHINES, IN CLASS 9 (U.S. CLS. 21, 23, 26, 36 AND 38).

FIRST USE 9-12-2010; IN COMMERCE 9-12-2010.

THE MARK CONSISTS OF STANDARD CHARACTERS WITHOUT CLAIM TO ANY PARTICULAR FONT, STYLE, SIZE, OR COLOR.

NO CLAIM IS MADE TO THE EXCLUSIVE RIGHT TO USE "POKER FANTASY", APART FROM THE MARK AS SHOWN.

SER. NO. 85-617,097, FILED 5-4-2012.

ARETHA SOMERVILLE, EXAMINING ATTORNEY



*David J. Kyros*

Director of the United States Patent and Trademark Office

# United States of America

United States Patent and Trademark Office

# BIOEVOLVE

**Reg. No. 4,274,763**

**Registered Jan. 15, 2013**

**Int. Cl.: 5**

**TRADEMARK**

**PRINCIPAL REGISTER**

REV COMPOUNDING PHARMACY LTD. (CANADA CORPORATION), DBA BIOSENSE  
COMPOUNDING PHARMACY  
235 - 13500 MAYCREST WAY  
RICHMOND, BC, CANADA V6V2N8

FOR: MEDICATED SKIN CREAM FOR NUMBING AND HEALING; VITAMINS; MINERAL  
FOOD SUPPLEMENTS; VITAMIN AND MINERAL SUPPLEMENTS, IN CLASS 5 (U.S. CLS.  
6, 18, 44, 46, 51 AND 52).

FIRST USE 2-16-2012; IN COMMERCE 2-16-2012.

THE MARK CONSISTS OF STANDARD CHARACTERS WITHOUT CLAIM TO ANY PAR-  
TICULAR FONT, STYLE, SIZE, OR COLOR.

PRIORITY CLAIMED UNDER SEC. 44(D) ON CANADA APPLICATION NO. 1,576,202, FILED  
5-3-2012.

SER. NO. 85-617,512, FILED 5-4-2012.

MICHAEL SOUDERS, EXAMINING ATTORNEY



*David J. Kyffers*

Director of the United States Patent and Trademark Office

# United States of America

United States Patent and Trademark Office

## BEYOND THE ULTIMATE

**Reg. No. 4,274,764**

**Registered Jan. 15, 2013**

**Int. Cl.: 38**

**SERVICE MARK**

**PRINCIPAL REGISTER**

CAMPUS CRUSADE FOR CHRIST, INC. (CALIFORNIA CORPORATION), AKA CAMPUS CRUSADE FOR CHRIST, CAMPUS CRUSADE FOR CHRIST INTERNATIONAL, AND CCCI  
ATTN: GENERAL COUNSEL'S OFFICE IP TEAM  
100 LAKE HART DRIVE-3500  
ORLANDO, FL 328320100

FOR: STREAMING OF AUDIO AND VIDEO MATERIAL VIA A GLOBAL COMPUTER NETWORK FEATURING INFORMATION RELATING TO RELIGION AND SPORTS, INCLUDING PERSONAL AND SPIRITUAL GROWTH, AND LIFE EXPERIENCES OF ATHLETES AND COACHES, IN CLASS 38 (U.S. CLS. 100, 101 AND 104).

FIRST USE 2-1-2007; IN COMMERCE 2-1-2007.

THE MARK CONSISTS OF STANDARD CHARACTERS WITHOUT CLAIM TO ANY PARTICULAR FONT, STYLE, SIZE, OR COLOR.

SER. NO. 85-617,534, FILED 5-4-2012.

PAUL E. FAHRENKOPF, EXAMINING ATTORNEY



*David J. Kyffers*

Director of the United States Patent and Trademark Office

# United States of America

United States Patent and Trademark Office

## BEYOND THE ULTIMATE

**Reg. No. 4,274,765**

**Registered Jan. 15, 2013**

**Int. Cl.: 16**

CAMPUS CRUSADE FOR CHRIST, INC. (CALIFORNIA CORPORATION), AKA CAMPUS CRUSADE FOR CHRIST, CAMPUS CRUSADE FOR CHRIST INTERNATIONAL, AND CCCI  
ATTN: GENERAL COUNSEL'S OFFICE IP TEAM  
100 LAKE HART DRIVE-3500  
ORLANDO, FL 328320100

**TRADEMARK**

**PRINCIPAL REGISTER**

FOR: PAPER GOODS AND PRINTED MATTER, NAMELY, DEVOTIONAL TRAINING GUIDES, TESTIMONY TRADING CARDS AND MOTIVATIONAL CARDS FEATURING INFORMATION RELATING TO RELIGION AND SPORTS, INCLUDING PERSONAL AND SPIRITUAL GROWTH, AND LIFE EXPERIENCES OF ATHLETES AND COACHES, IN CLASS 16 (U.S. CLS. 2, 5, 22, 23, 29, 37, 38 AND 50).

FIRST USE 10-6-2010; IN COMMERCE 10-6-2010.

THE MARK CONSISTS OF STANDARD CHARACTERS WITHOUT CLAIM TO ANY PARTICULAR FONT, STYLE, SIZE, OR COLOR.

SER. NO. 85-617,568, FILED 5-4-2012.

PAUL E. FAHRENKOPF, EXAMINING ATTORNEY



*David J. Kybas*

Director of the United States Patent and Trademark Office

# United States of America

United States Patent and Trademark Office

## ALLEGRO MEDIA GROUP

**Reg. No. 4,274,766**

**Registered Jan. 15, 2013**

**Int. Cls.: 9 and 35**

**TRADEMARK**

**SERVICE MARK**

**PRINCIPAL REGISTER**

ALLEGRO CORPORATION (OREGON CORPORATION), DBA ALLEGRO MEDIA GROUP  
20048 NE SAN RAFAEL STREET  
PORTLAND, OR 97230

FOR: CDS, DVDS, AND PHONOGRAPH RECORDS FEATURING MUSIC AND ENTERTAINMENT; THEATRICAL AND MUSICAL SOUND AND VIDEO RECORDINGS; DOCUMENTARY AND OTHER NON-FICTIONAL VIDEO RECORDINGS; DOWNLOADABLE PRE-RECORDED MUSIC AND VIDEOS, IN CLASS 9 (U.S. CLS. 21, 23, 26, 36 AND 38).

FIRST USE 9-30-2008; IN COMMERCE 9-30-2008.

FOR: DISTRIBUTORSHIP SERVICES IN THE FIELD OF PRE-RECORDED MUSICAL SOUND RECORDINGS AND PRE-RECORDED MUSICAL AND NON-MUSICAL VIDEO RECORDINGS; MARKETING AND PROMOTIONAL SERVICES FOR MUSIC AND VIDEO RECORDINGS; ONLINE RETAIL STORE SERVICES FEATURING CDS, DVDS, AND PHONOGRAPH RECORDS FEATURING MUSIC AND ENTERTAINMENT, IN CLASS 35 (U.S. CLS. 100, 101 AND 102).

FIRST USE 9-30-2008; IN COMMERCE 9-30-2008.

THE MARK CONSISTS OF STANDARD CHARACTERS WITHOUT CLAIM TO ANY PARTICULAR FONT, STYLE, SIZE, OR COLOR.

NO CLAIM IS MADE TO THE EXCLUSIVE RIGHT TO USE "MEDIA GROUP", APART FROM THE MARK AS SHOWN.

SER. NO. 85-617,593, FILED 5-4-2012.

MICHAEL ENGEL, EXAMINING ATTORNEY



*David J. Kyros*

Director of the United States Patent and Trademark Office

# United States of America

United States Patent and Trademark Office



**Reg. No. 4,274,767**

**Registered Jan. 15, 2013**

**Int. Cls.: 35 and 41**

**SERVICE MARK**

**PRINCIPAL REGISTER**

TV BOY LLC (NEW YORK LIMITED LIABILITY COMPANY)  
5-26 46TH AVENUE  
THIRD FLOOR  
LONG ISLAND CITY, NY 11101

FOR: PRODUCTION OF ADVERTISING MATTER AND COMMERCIALS, IN CLASS 35 (U.S. CLS. 100, 101 AND 102).

FIRST USE 3-1-2005; IN COMMERCE 3-15-2005.

FOR: ENTERTAINMENT, NAMELY, PRODUCTION OF HIDDEN CAMERA TELEVISION PROGRAMS; OPERATION OF VIDEO EQUIPMENT OR AUDIO EQUIPMENT ETC. FOR PRODUCTION OF RADIO OR TELEVISION PROGRAMS; PRODUCTION OF TELEVISION PROGRAMS; RENTAL OF FACILITIES AND EQUIPMENT FOR THE PRODUCTION OF TELEVISION PROGRAMS; TELEVISION, VIDEO AND MOVIE FILMING SERVICES, IN CLASS 41 (U.S. CLS. 100, 101 AND 107).

FIRST USE 3-1-2005; IN COMMERCE 3-15-2005.

NO CLAIM IS MADE TO THE EXCLUSIVE RIGHT TO USE "TV" AND "LLC" , APART FROM THE MARK AS SHOWN.

THE COLOR(S) ORANGE AND GRAY IS/ARE CLAIMED AS A FEATURE OF THE MARK.

THE MARK CONSISTS OF THE WORDS "TV.BOY" IN LARGE ORANGE LETTERS WITH A GRAY DOT IN BETWEEN "TV" AND "BOY", BUT WITH THE "O" DEPICTED IN GRAY AS A TELEVISION SET, AND A RECLINING BOY IN ALL GRAY WATCHING THE TELEVISION, AND THE LETTERS "LLC" IN SMALL ORANGE LETTERS NEXT TO THE "Y" IN "BOY".

SER. NO. 85-618,372, FILED 5-7-2012.

LAURIE KAUFMAN, EXAMINING ATTORNEY



*David J. Kyffers*

Director of the United States Patent and Trademark Office



# United States of America

United States Patent and Trademark Office



**Reg. No. 4,274,768**

**Registered Jan. 15, 2013**

**Int. Cls.: 9 and 35**

**TRADEMARK**

**SERVICE MARK**

**PRINCIPAL REGISTER**

ALLEGRO CORPORATION (OREGON CORPORATION), DBA ALLEGRO MEDIA GROUP  
20048 NE SAN RAFAEL STREET  
PORTLAND, OR 972307459

FOR: CDS, DVDS, AND PHONOGRAPH RECORDS FEATURING MUSIC AND ENTERTAINMENT; THEATRICAL AND MUSICAL SOUND AND VIDEO RECORDINGS; DOCUMENTARY AND OTHER NON-FICTIONAL VIDEO RECORDINGS; DOWNLOADABLE PRE-RECORDED MUSIC AND VIDEOS, IN CLASS 9 (U.S. CLS. 21, 23, 26, 36 AND 38).

FIRST USE 9-30-2008; IN COMMERCE 9-30-2008.

FOR: DISTRIBUTORSHIP SERVICES IN THE FIELD OF PRE-RECORDED MUSICAL SOUND RECORDINGS AND PRE-RECORDED MUSICAL AND NON-MUSICAL VIDEO RECORDINGS; MARKETING AND PROMOTIONAL SERVICES FOR MUSIC AND VIDEO RECORDINGS; ONLINE RETAIL STORE SERVICES FEATURING CDS, DVDS, AND PHONOGRAPH RECORDS FEATURING MUSIC AND ENTERTAINMENT, IN CLASS 35 (U.S. CLS. 100, 101 AND 102).

FIRST USE 9-30-2008; IN COMMERCE 9-30-2008.

NO CLAIM IS MADE TO THE EXCLUSIVE RIGHT TO USE "MEDIA GROUP", APART FROM THE MARK AS SHOWN.

THE COLOR(S) BLUE AND GREY IS/ARE CLAIMED AS A FEATURE OF THE MARK.

THE MARK CONSISTS OF THE WORD "ALLEGRO" APPEARING IN LARGE BLUE LOWER CASE LETTERS; THE WORDS "MEDIA" AND "GROUP" APPEARING BELOW THE WORD "ALLEGRO" ON EITHER SIDE OF THE TAIL OF THE "G" IN SMALLER GREY UPPER CASE LETTERS; AND A DESIGN APPEARING ON THE LEFT FEATURING A SMALL GREY CURVED TRIANGULAR SAIL SHAPE OVERLAYING A LARGER BLUE CURVED TRIANGULAR SAIL SHAPE.

SER. NO. 85-618,513, FILED 5-7-2012.

MICHAEL ENGEL, EXAMINING ATTORNEY



*David J. Kypos*

Director of the United States Patent and Trademark Office

# United States of America

United States Patent and Trademark Office



**Reg. No. 4,274,769**

**Registered Jan. 15, 2013**

**Int. Cl.: 36**

**SERVICE MARK**

**PRINCIPAL REGISTER**

NCMIC GROUP, INC. (IOWA CORPORATION)  
14001 UNIVERSITY AVENUE  
CLIVE, IA 503258258

FOR: CHARITABLE FOUNDATION SERVICES, NAMELY, PROVIDING FUNDRAISING ACTIVITIES, FUNDING, SCHOLARSHIPS AND/OR FINANCIAL ASSISTANCE FOR RESEARCH AND/OR EDUCATIONAL PROJECTS RELATING TO CHIROPRACTIC CARE AND/OR ALTERNATIVE APPROACHES TO HEALTHCARE, IN CLASS 36 (U.S. CLS. 100, 101 AND 102).

FIRST USE 4-15-2010; IN COMMERCE 4-15-2010.

OWNER OF U.S. REG. NOS. 1,694,844, 4,167,091 AND OTHERS.

NO CLAIM IS MADE TO THE EXCLUSIVE RIGHT TO USE "FOUNDATION", APART FROM THE MARK AS SHOWN.

THE MARK CONSISTS OF A DESIGN COMPRISING A CRESCENT SHAPE WITH ITS POINTS EXTENDED UPWARD WITH A SOLID CIRCLE APPEARING WITHIN CAVITY OF THE CRESCENT SHAPE. THE WORDING "NCMIC FOUNDATION" IS TO THE RIGHT OF THE DESIGN FEATURE.

SER. NO. 85-618,524, FILED 5-7-2012.

DAVID TAYLOR, EXAMINING ATTORNEY



*David J. Kyffers*

Director of the United States Patent and Trademark Office

# United States of America

United States Patent and Trademark Office

# WNV

**Reg. No. 4,274,770**

**Registered Jan. 15, 2013**

**Int. Cls.: 9 and 16**

**TRADEMARK**

**PRINCIPAL REGISTER**

NCS PEARSON, INC. (MINNESOTA CORPORATION)  
5601 GREEN VALLEY DRIVE  
BLOOMINGTON, MN 55437

FOR: COMPUTER SOFTWARE AND COMPUTER SOFTWARE PACKAGES, INCLUDING USER AND ASSOCIATED MANUALS, FOR USE IN TESTING, SCORING, INTERPRETING, AND GENERATING REPORTS PERTAINING TO COGNITIVE ABILITY, IN CLASS 9 (U.S. CLS. 21, 23, 26, 36 AND 38).

FIRST USE 12-0-2006; IN COMMERCE 12-0-2006.

FOR: PRINTED TEST MATERIALS FEATURING INDIVIDUALLY ADMINISTERED, NON-VERBAL ASSESSMENT TO MEASURE GENERAL COGNITIVE ABILITY, INCLUDING ACHIEVEMENT, PERSONALITY AND NEUROPSYCHOLOGICAL FUNCTIONING, NAMELY, ADMINISTRATION AND SCORING MANUAL, TECHNICAL AND INTERPRETIVE MANUAL, STIMULUS BOOK, RECORD FORMS, TEST BOOKLETS, SPATIAL SPAN BOARD, OBJECT ASSEMBLY PUZZLES, PICTURE ARRANGEMENT CARDS; PRINTED SCORING, INTERPRETING, AND REPORTING MATERIAL, AND TEST KITS COMPOSED PRIMARILY OF PRINTED TEST MATERIALS AND MANIPULATIVE SUCH AS SPATIAL SPAN BOARD, OBJECT ASSEMBLY PUZZLES, PICTURE ARRANGEMENT CARDS, IN CLASS 16 (U.S. CLS. 2, 5, 22, 23, 29, 37, 38 AND 50).

FIRST USE 12-0-2006; IN COMMERCE 12-0-2006.

THE MARK CONSISTS OF STANDARD CHARACTERS WITHOUT CLAIM TO ANY PARTICULAR FONT, STYLE, SIZE, OR COLOR.

SER. NO. 85-618,694, FILED 5-7-2012.

JOSETTE BEVERLY, EXAMINING ATTORNEY



*David J. Kyffers*

Director of the United States Patent and Trademark Office

# United States of America

United States Patent and Trademark Office

# Axtria

**Reg. No. 4,274,771**

**Registered Jan. 15, 2013**

**Int. Cls.: 35 and 42**

**SERVICE MARK**

**PRINCIPAL REGISTER**

AXTRIA, INC. (DELAWARE CORPORATION)  
400 CONNELL DRIVE, SUITE 1300  
BERKELEY HEIGHTS, NJ 07922

FOR: BUSINESS CONSULTING SERVICES IN THE FIELD OF DATA ANALYTICS, IN CLASS 35 (U.S. CLS. 100, 101 AND 102).

FIRST USE 3-31-2010; IN COMMERCE 3-31-2010.

FOR: CUSTOM DESIGN AND DEVELOPMENT OF COMPUTER SOFTWARE, IN CLASS 42 (U.S. CLS. 100 AND 101).

FIRST USE 3-31-2010; IN COMMERCE 3-31-2010.

THE MARK CONSISTS OF STANDARD CHARACTERS WITHOUT CLAIM TO ANY PARTICULAR FONT, STYLE, SIZE, OR COLOR.

SER. NO. 85-618,709, FILED 5-7-2012.

DAWN HAN, EXAMINING ATTORNEY



*David J. Kybas*

Director of the United States Patent and Trademark Office

# United States of America

United States Patent and Trademark Office

# AnswerHub

**Reg. No. 4,274,772**

**Registered Jan. 15, 2013**

**Int. Cl.: 42**

**SERVICE MARK**

**PRINCIPAL REGISTER**

DZONE INC. (NORTH CAROLINA CORPORATION)  
150 PRESTON EXECUTIVE DRIVE  
CARY, NC 27513

FOR: PROVIDING CUSTOMIZED ONLINE WEB PAGES FEATURING USER-DEFINED INFORMATION; PROVIDING CUSTOMIZED COMPUTER SEARCHING SERVICES, NAMELY, FOR USERS TO ASK AND ANSWER QUESTIONS ON A VARIETY OF TOPICS OF GENERAL INTEREST BY SEARCHING AND RETRIEVING INFORMATION AT THE CUSTOMER'S SPECIFIC REQUEST VIA A WEBPAGE; PROVIDING SEARCH ENGINES FOR OBTAINING INFORMATION REQUESTED BY USERS ON A GLOBAL COMPUTER NETWORK; PROVIDING CUSTOMIZED SEARCHING OF A WEBPAGE TO LOCATE SPECIFIC INFORMATION REQUESTED BY USERS; CREATING AN ON-LINE COMMUNITY FOR REGISTERED USERS TO PARTICIPATE IN DISCUSSIONS, GET FEEDBACK FROM THEIR PEERS, FROM VIRTUAL COMMUNITIES, AND ENGAGE IN SOCIAL NETWORKING; APPLICATION SERVICE PROVIDER FEATURING APPLICATION PROGRAMMING INTERFACE (API) SOFTWARE FOR USE IN BUILDING SOFTWARE APPLICATIONS, IN CLASS 42 (U.S. CLS. 100 AND 101).

FIRST USE 12-14-2011; IN COMMERCE 12-14-2011.

THE MARK CONSISTS OF THE STYLIZED TEXT "ANSWERHUB". THE LETTER "W" CONSISTS OF THE STYLIZED IMAGES OF TWO HUMAN FIGURES.

SER. NO. 85-618,798, FILED 5-7-2012.

DEBORAH MEINERS, EXAMINING ATTORNEY



*David J. Kyjars*

Director of the United States Patent and Trademark Office

# United States of America

United States Patent and Trademark Office



**Reg. No. 4,274,773**

NWACHUKWU, IHEANYI (UNITED STATES INDIVIDUAL)  
541 10TH STREET NW #239  
ATLANTA, GA 30318

**Registered Jan. 15, 2013**

**Int. Cl.: 41**

FOR: MULTIMEDIA ENTERTAINMENT SERVICES IN THE NATURE OF RECORDING, PRODUCTION AND POST-PRODUCTION SERVICES IN THE FIELDS OF MUSIC, VIDEO, AND FILMS, IN CLASS 41 (U.S. CLS. 100, 101 AND 107).

**SERVICE MARK**

FIRST USE 7-0-2011; IN COMMERCE 7-0-2011.

**PRINCIPAL REGISTER**

THE MARK CONSISTS OF A SHIELD WITH THE STYLIZED LETTERS "L.G.M" IN GRAY IN THE CENTER OF THE SHIELD. BELOW "L.G.M" ARE THE WORDS "LOYALTY. GOD. MONEY" IN GRAY. A LIGHT RED HORIZONTAL LINE APPEARS BOTH ABOVE AND BELOW THE WORDS "LOYALTY. GOD. MONEY". BELOW THE BOTTOM LIGHT RED LINE ARE THE WORDS "WEALTH. WISDOM" IN LIGHT RED. BELOW THE WORDS "WEALTH. WISDOM" IS A LIGHT RED STAR. FOUR LIGHT RED LINES APPEAR ON BOTH THE LEFT AND RIGHT OF THE STAR. THE BACKGROUND OF THE SHIELD CONSISTS OF A CITY SKYLINE WITH BLACK AND GRAY BUILDINGS AGAINST A YELLOW AND ORANGE SKY AT THE TOP, WHICH FADES TO BLACK AT THE BOTTOM. THE OUTLINE OF THE SHIELD IS GRAY, WITH AN ORANGE REFLECTION APPEARING ON THE RIGHT SIDE OF THE OUTLINE OF THE SHIELD. THE COLOR BLACK APPEARING IN THE REST OF THE MARK REPRESENTS BACKGROUND AND IS NOT PART OF THE MARK.

THE COLOR(S) BLACK, YELLOW, ORANGE, GRAY, AND LIGHT RED IS/ARE CLAIMED AS A FEATURE OF THE MARK.



SER. NO. 85-619,074, FILED 5-8-2012.

ANDREW LEASER, EXAMINING ATTORNEY

*David J. Kyros*

Director of the United States Patent and Trademark Office

# United States of America

United States Patent and Trademark Office

# SNOJAM

**Reg. No. 4,274,774**

**Registered Jan. 15, 2013**

**Int. Cl.: 35**

**SERVICE MARK**

**PRINCIPAL REGISTER**

SITOUR USA (DELAWARE CORPORATION)  
195 HURLEY AVENUE  
KINGSTON, NY 12401

FOR: PROMOTING SPORTS COMPETITIONS AND EVENTS OF OTHERS, IN CLASS 35  
(U.S. CLS. 100, 101 AND 102).

FIRST USE 7-1-1999; IN COMMERCE 7-1-1999.

THE MARK CONSISTS OF STANDARD CHARACTERS WITHOUT CLAIM TO ANY PARTICULAR FONT, STYLE, SIZE, OR COLOR.

OWNER OF U.S. REG. NO. 2,566,976.

SER. NO. 85-619,155, FILED 5-8-2012.

WENDY GOODMAN, EXAMINING ATTORNEY



*David J. Kybas*

Director of the United States Patent and Trademark Office

# United States of America

United States Patent and Trademark Office

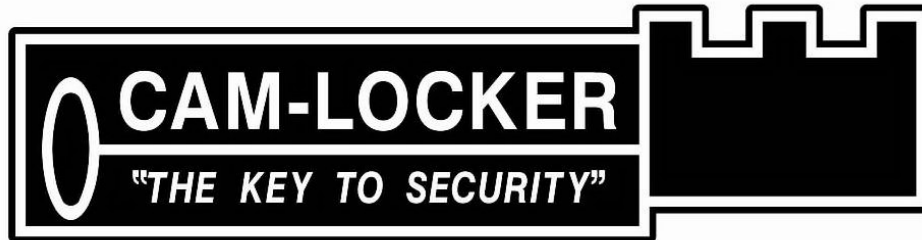

**Reg. No. 4,274,775**

AMERICAN ALUMINUM ACCESSORIES, INC. (FLORIDA CORPORATION)  
3291 US 19 SOUTH  
PERRY, FL 32348

**Registered Jan. 15, 2013**

**Int. Cl.: 6**

FOR: TOOL BOXES OF METAL, IN CLASS 6 (U.S. CLS. 2, 12, 13, 14, 23, 25 AND 50).

**TRADEMARK**

FIRST USE 11-20-1994; IN COMMERCE 1-16-1995.

**PRINCIPAL REGISTER**

THE MARK CONSISTS OF THE WORDS "CAM-LOCKER" AND "THE KEY TO SECURITY" DISPLAYED ON THE SHANK OF AN OUTLINE OF A FANCIFUL KEY.

SER. NO. 85-619,158, FILED 5-8-2012.

WENDY GOODMAN, EXAMINING ATTORNEY



*David J. Kyffers*

Director of the United States Patent and Trademark Office



# United States of America

United States Patent and Trademark Office



**Reg. No. 4,274,776**

FIBREBOND CORPORATION (LOUISIANA CORPORATION)  
1300 DAVENPORT DRIVE  
MINDEN, LA 71055

**Registered Jan. 15, 2013**

**Int. Cl.: 19**

FOR: PREFABRICATED NON-METAL BUILDINGS, IN CLASS 19 (U.S. CLS. 1, 12, 33 AND 50).

**TRADEMARK**

FIRST USE 8-13-2007; IN COMMERCE 8-13-2007.

**PRINCIPAL REGISTER**

THE MARK CONSISTS OF AN UPRIGHT LETTER "F" IN BLUE WITH GRAY SHADING INTERLEAVED WITH AN INVERTED LETTER "F" IN WHITE WITH GRAY SHADING.

THE COLOR(S) BLUE, GRAY AND WHITE IS/ARE CLAIMED AS A FEATURE OF THE MARK.

SER. NO. 85-619,178, FILED 5-8-2012.

SALLY SHIH, EXAMINING ATTORNEY



*David J. Kyffers*

Director of the United States Patent and Trademark Office

# United States of America

United States Patent and Trademark Office



**Reg. No. 4,274,777**

**Registered Jan. 15, 2013**

**Int. Cls.: 35, 40 and 42**

**SERVICE MARK**

**PRINCIPAL REGISTER**

ECHO ENGINEERING AND PRODUCTION SUPPLIES, INC. (INDIANA CORPORATION)  
5406 WEST 78TH STREET  
INDIANAPOLIS, IN 46268

FOR: CATALOG ORDERING SERVICE FEATURING HOOKS, GASKETS, SEALS, MOUNTINGS, VIBRATION DAMPERS, BUMPERS/CUSHIONS, BUSHINGS, GROMMETS, BELLOWS, SHOCK ABSORBER MOUNTS, PADS, WASHERS, HAND GRIPS, CAPS, SILICONE CAPS, VINYL CAPS, PLUGS, BUNGS, RUBBER-TO-METAL BOUNDING, NON-SKID SAFETY TAPE, CUSTOM MOLDED MASKING PRODUCTS, DIE-CUTS, CUSTOM DIE CUTS, PLATING AND SPIN DRY BASKETS, MOLDED MASKING KITS, CORDS, SILICONE SHEETS, SILICONE TUBING, VINYL TAPE, ADHESIVE TAPE FOR COMMERCIAL AND INDUSTRIAL PURPOSES, MASKING TAPE; ONLINE RETAIL STORE SERVICES FEATURING HOOKS, GASKETS, SEALS, MOUNTINGS, VIBRATION DAMPERS, BUMPERS/CUSHIONS, BUSHINGS, GROMMETS, BELLOWS, SHOCK ABSORBER MOUNTS, PADS, WASHERS, HAND GRIPS, CAPS, SILICONE CAPS, VINYL CAPS, PLUGS, BUNGS, RUBBER-TO-METAL BOUNDING, NON-SKID SAFETY TAPE, CUSTOM MOLDED MASKING PRODUCTS, DIE-CUTS, CUSTOM DIE CUTS, PLATING AND SPIN DRY BASKETS, MOLDED MASKING KITS, CORDS, SILICONE SHEETS, SILICONE TUBING, VINYL TAPE, ADHESIVE TAPE FOR COMMERCIAL AND INDUSTRIAL PURPOSES, MASKING TAPE, IN CLASS 35 (U.S. CLS. 100, 101 AND 102).

FIRST USE 0-0-1967; IN COMMERCE 0-0-1967.



FOR: CUSTOM MANUFACTURE OF HOOKS, GASKETS, SEALS, MOUNTINGS, VIBRATION DAMPERS, BUMPERS/CUSHIONS, BUSHINGS, GROMMETS, BELLOWS, SHOCK ABSORBER MOUNTS, PADS, WASHERS, HAND GRIPS, CAPS, SILICONE CAPS, VINYL CAPS, PLUGS, BUNGS, RUBBER-TO-METAL BOUNDING, NON-SKID SAFETY TAPE, CUSTOM MOLDED MASKING PRODUCTS, DIE-CUTS, CUSTOM DIE CUTS, PLATING AND SPIN DRY BASKETS, MOLDED MASKING KITS, CORDS, SILICONE SHEETS, SILICONE TUBING, VINYL TAPE, ADHESIVE TAPE FOR COMMERCIAL AND INDUSTRIAL PURPOSES, AND MASKING TAPE FOR OTHERS; CUSTOM MANUFACTURING OF RUBBER AND PLASTIC MOLDED PRODUCTS FOR OEM CUSTOMERS, IN CLASS 40 (U.S. CLS. 100, 103 AND 106).

FIRST USE 0-0-1967; IN COMMERCE 0-0-1967.

*David J. Kyjars*

Director of the United States Patent and Trademark Office

**Reg. No. 4,274,777** FOR: ENGINEERING SERVICES, NAMELY, ENGINEERING FOR THE PRODUCT DEVELOPMENT AND DESIGN OF RUBBER AND PLASTIC MOLDED PRODUCTS, IN CLASS 42 (U.S. CLS. 100 AND 101).

FIRST USE 0-0-1967; IN COMMERCE 0-0-1967.

THE MARK CONSISTS OF FOUR ARROWS ARRANGED HORIZONTALLY AND VERTICALLY CREATING A SQUARE.

SER. NO. 85-619,215, FILED 5-8-2012.

KRISTIN DAHLING, EXAMINING ATTORNEY

# United States of America

United States Patent and Trademark Office



**Reg. No. 4,274,778**

**Registered Jan. 15, 2013**

**Int. Cl.: 41**

**SERVICE MARK**

**PRINCIPAL REGISTER**

BAHCECIK, MERT (TURKEY INDIVIDUAL)  
KÜLTÜR MH.ESRA SK.KÜÇ. ÇAM.SITE H1BLK8/1  
ULUS,BESIKTAS,ISTANBUL, TURKEY

FOR: ARRANGING AND CONDUCTING SPECIAL EVENTS FOR SOCIAL ENTERTAINMENT PURPOSES; ARRANGING, ORGANIZING, CONDUCTING, AND HOSTING SOCIAL ENTERTAINMENT EVENTS; ENTERTAINMENT SERVICES IN THE NATURE OF PROVIDING SPORTS FACILITIES WHERE INDIVIDUALS OR GROUPS OF INDIVIDUALS CAN DAMAGE AND DESTROY PHYSICAL OBJECTS MANUALLY, WITH OR WITHOUT TOOLS FOR STRESS RELIEF PURPOSES; PROVIDING A WEBSITE FEATURING ENTERTAINMENT INFORMATION, IN CLASS 41 (U.S. CLS. 100, 101 AND 107).

FIRST USE 1-1-2010; IN COMMERCE 1-1-2010.

NO CLAIM IS MADE TO THE EXCLUSIVE RIGHT TO USE "THE DESTRUCTION COMPANY", APART FROM THE MARK AS SHOWN.

THE MARK CONSISTS OF A SLEDGEHAMMER DRAWING ALONGSIDE THE PHRASE OF "THE DESTRUCTION COMPANY" SHOWING THE WORDS VERTICALLY AS FOLLOWS: "THE" AT THE TOP, "DESTRUCTION" IN THE MIDDLE, AND "COMPANY" AT THE BOTTOM.

SER. NO. 85-619,218, FILED 5-8-2012.

BILL DAWE, EXAMINING ATTORNEY



*David J. Kyros*

Director of the United States Patent and Trademark Office

# United States of America

United States Patent and Trademark Office

## ENDOCRINOGRAPHY

**Reg. No. 4,274,779**

DIANA DERVAL (FRANCE INDIVIDUAL)  
KEIZERSGRACHT 44F

**Registered Jan. 15, 2013**

AMESTARDAM, NETHERLANDS 1015CR

**Int. Cl.: 35**

FOR: BUSINESS MARKETING SERVICES, MARKETING PLAN DEVELOPMENT; MARKET SEGMENTATION CONSULTATION; MARKET RESEARCH CONSULTATION, NAMELY, CONSUMER MARKETING CONSULTANCY SERVICES PARTICULARLY SPECIALIZING IN THE USE OF SENSORY PERCEPTIONS THAT IDENTIFY PREFERENCES OF PRODUCTS THAT MAKE UP THE CONSUMER'S EXPERIENCE, TRENDS AND BEHAVIORS FOR THE UNDERSTANDING AND PREDICTING OF CONSUMERS, BUSINESSES, AND MARKET TRENDS AND ACTIONS, TO AID IN MAXIMIZING THE DEVELOPMENT OF MARKETING PLANS FOR NEW PRODUCTS AND SERVICES, IN CLASS 35 (U.S. CLS. 100, 101 AND 102).

**SERVICE MARK**

**PRINCIPAL REGISTER**

FIRST USE 3-14-2007; IN COMMERCE 7-1-2010.

THE MARK CONSISTS OF STANDARD CHARACTERS WITHOUT CLAIM TO ANY PARTICULAR FONT, STYLE, SIZE, OR COLOR.

SER. NO. 85-619,279, FILED 5-8-2012.

BILL DAWE, EXAMINING ATTORNEY



*David J. Kypos*

Director of the United States Patent and Trademark Office

# United States of America

United States Patent and Trademark Office



**Reg. No. 4,274,780**

**Registered Jan. 15, 2013**

**Int. Cls.: 16, 25 and 41**

**TRADEMARK**

**SERVICE MARK**

**PRINCIPAL REGISTER**

UNIFIED SCHOOL DISTRICT 473 (KANSAS A UNIFIED PUBLIC SCHOOL DISTRICT), AKA  
CHAPMAN PUBLIC SCHOOLS  
822 NORTH MARSHALL  
CHAPMAN, KS 67431

FOR: PRINTED MATTER, NAMELY, PAPER SIGNS, BOOKS, MANUALS, CURRICULUM, NEWSLETTERS, INFORMATIONAL CARDS AND BROCHURES IN THE FIELD OF HIGH SCHOOL ATHLETICS, BAND, CHORAL, DRAMATIC PERFORMANCES, AND ART EXHIBITIONS, IN CLASS 16 (U.S. CLS. 2, 5, 22, 23, 29, 37, 38 AND 50).

FIRST USE 2-10-2012; IN COMMERCE 2-21-2012.

FOR: ATHLETIC APPAREL, NAMELY, SHIRTS, PANTS, JACKETS, FOOTWEAR, HATS AND CAPS, ATHLETIC UNIFORMS; WEARABLE GARMENTS AND CLOTHING, NAMELY, SHIRTS, IN CLASS 25 (U.S. CLS. 22 AND 39).

FIRST USE 2-10-2012; IN COMMERCE 2-21-2012.

FOR: EDUCATION SERVICES, NAMELY, PROVIDING KINDERGARTEN THROUGH 12TH GRADE (K-12) CLASSROOM INSTRUCTION; ENTERTAINMENT IN THE NATURE OF COMPETITIONS IN THE FIELD OF HIGH SCHOOL ATHLETICS, BAND, CHORAL, DRAMATIC PERFORMANCES, AND ART EXHIBITIONS, IN CLASS 41 (U.S. CLS. 100, 101 AND 107).

FIRST USE 2-10-2012; IN COMMERCE 2-21-2012.

THE MARK CONSISTS OF A STYLIZED DESIGN OF A LEPRECHAUN HEAD IN PROFILE WHERE THE LEPRECHAUN IS WEARING A HAT WITH A HIGHLIGHT AND A CLOVER ON THE CENTER OF THE HAT. THE LEPRECHAUN HAS HAIR AND BEARD, WITH THE EYE, NOSE AND MOUTH, AND A COLLAR.

SER. NO. 85-619,327, FILED 5-8-2012.

ELLEN PERKINS, EXAMINING ATTORNEY



*David J. Kyffers*

Director of the United States Patent and Trademark Office

# United States of America

United States Patent and Trademark Office



**Reg. No. 4,274,781**

**Registered Jan. 15, 2013**

**Int. Cl.: 39**

**SERVICE MARK**

**PRINCIPAL REGISTER**

SPOTTSWOODE WINERY, INC. (CALIFORNIA CORPORATION), DBA SPOTTSWOODE  
VINEYARD & WINERY  
1902 MADRONA AVENUE  
ST. HELENA, CA 94574

FOR: WINE CLUB SERVICES FEATURING PERIODIC SHIPMENTS OF WINE TO MEMBERS,  
IN CLASS 39 (U.S. CLS. 100 AND 105).

FIRST USE 2-0-2010; IN COMMERCE 2-0-2010.

OWNER OF U.S. REG. NOS. 1,563,666, 2,176,921, AND 4,142,390.

NO CLAIM IS MADE TO THE EXCLUSIVE RIGHT TO USE "CLUB" AND "ESTATE", APART  
FROM THE MARK AS SHOWN.

THE MARK CONSISTS OF THE WORDING "SPOTTSWOODE ESTATE" AND "SPOTT ON!  
CLUB" OVER A WATERMARK OF THE INITIALS "SW", ALL WITHIN TWO CONCENTRIC  
CIRCLES.

SER. NO. 85-619,488, FILED 5-8-2012.

GILBERT SWIFT, EXAMINING ATTORNEY



*David J. Kyffers*

Director of the United States Patent and Trademark Office

# United States of America

United States Patent and Trademark Office

## NPULSE TECHNOLOGIES

**Reg. No. 4,274,782**

**Registered Jan. 15, 2013**

**Int. Cl.: 9**

**TRADEMARK**

**PRINCIPAL REGISTER**

NPULSE TECHNOLOGIES, INC. (DELAWARE CORPORATION)  
375 FOUR LEAF LANE, SUITE 201  
CHARLOTTESVILLE, VA 22903

FOR: COMPUTER SOFTWARE AND HARDWARE FOR NETWORK AUDITING AND SECURITY MONITORING, TRAFFIC ANALYSIS AND REPORTING, USAGE, ACCOUNTING AND BILLING, FAULT ISOLATION, EVENT CORRELATION, NETWORK PERFORMANCE AND CAPACITY PLANNING, DISCOVERY AND CONFIGURATION MANAGEMENT, COMPLIANCE ASSURANCE, POLICY ENFORCEMENT, FORENSIC ANALYSIS AND TRENDING, APPLICATION PERFORMANCE MONITORING, SERVICE VERIFICATION AND ANALYTICS, AND POST-EVENT TROUBLESHOOTING AND ANALYSIS, IN CLASS 9 (U.S. CLS. 21, 23, 26, 36 AND 38).

FIRST USE 11-0-2009; IN COMMERCE 11-0-2009.

THE MARK CONSISTS OF STANDARD CHARACTERS WITHOUT CLAIM TO ANY PARTICULAR FONT, STYLE, SIZE, OR COLOR.

NO CLAIM IS MADE TO THE EXCLUSIVE RIGHT TO USE "TECHNOLOGIES", APART FROM THE MARK AS SHOWN.

SER. NO. 85-619,564, FILED 5-8-2012.

DAVID I, EXAMINING ATTORNEY



*David J. Kyffers*

Director of the United States Patent and Trademark Office



# United States of America

United States Patent and Trademark Office



**Reg. No. 4,274,783**

**Registered Jan. 15, 2013**

**Int. Cl.: 41**

**SERVICE MARK**

**PRINCIPAL REGISTER**

MARIA MARIA, LLC (VIRGINIA LIMITED LIABILITY COMPANY)  
STE. 100  
4080 LAFAYETTE CENTER DR.  
CHANTILLY, VA 20151

FOR: PERSONAL FITNESS TRAINING SERVICES AND CONSULTANCY; PHYSICAL FITNESS TRAINING OF INDIVIDUALS AND GROUPS, IN CLASS 41 (U.S. CLS. 100, 101 AND 107).

FIRST USE 1-1-2012; IN COMMERCE 1-1-2012.

NO CLAIM IS MADE TO THE EXCLUSIVE RIGHT TO USE "FITNESS", APART FROM THE MARK AS SHOWN.

THE COLOR(S) RED AND WHITE IS/ARE CLAIMED AS A FEATURE OF THE MARK.

THE MARK CONSISTS OF A RED OUTLINED DOUBLE CIRCLE (BOTH INSIDE CIRCLES ARE WHITE). INSIDE THE FIRST CIRCLE ARE THE WORDS "RIVETING FITNESS" IN RED WITH TWO RED AND WHITE DUMBBELSS, THE SLOGAN "TOGETHER...WE CAN DO IT!" IN RED, AND 4 RED DOTS (AT THE, LEFT, RIGHT, AND AT THE BOTTOM). INSIDE THE SECOND CIRCLE IS A RED AND WHITE POLKA DOT BANDANA.

SER. NO. 85-619,622, FILED 5-8-2012.

BRIAN PINO, EXAMINING ATTORNEY



*David J. Kyros*

Director of the United States Patent and Trademark Office

# United States of America

United States Patent and Trademark Office

## SEASONED ADVICE

**Reg. No. 4,274,784**

**Registered Jan. 15, 2013**

**Int. Cl.: 42**

**SERVICE MARK**

**PRINCIPAL REGISTER**

STACK EXCHANGE INC (DELAWARE CORPORATION)  
ONE EXCHANGE PLAZA FLOOR 25  
NEW YORK, NY 10006

FOR: COMPUTER SERVICES, NAMELY, PROVIDING CUSTOMIZED ONLINE WEB PAGES FEATURING USER-DEFINED INFORMATION; COMPUTER SERVICES, NAMELY, HOSTING A WEBPAGE FOR USERS TO ASK AND ANSWER QUESTIONS ON A VARIETY OF TOPICS OF GENERAL INTEREST, PROVIDING SEARCH ENGINES FOR OBTAINING INFORMATION REQUESTED BY USERS ON A GLOBAL COMPUTER NETWORK, PROVIDING CUSTOMIZED SEARCHING OF A WEBPAGE TO LOCATE SPECIFIC INFORMATION REQUESTED BY USERS, CREATING AN ON-LINE COMMUNITY FOR REGISTERED USERS TO PARTICIPATE IN DISCUSSIONS, GET FEEDBACK FROM THEIR PEERS, FORM VIRTUAL COMMUNITIES, AND ENGAGE IN SOCIAL NETWORKING; APPLICATION SERVICE PROVIDER FEATURING APPLICATION PROGRAMMING INTERFACE (API) SOFTWARE FOR USE IN BUILDING SOFTWARE APPLICATIONS, IN CLASS 42 (U.S. CLS. 100 AND 101).

FIRST USE 7-17-2010; IN COMMERCE 7-17-2010.

THE MARK CONSISTS OF STANDARD CHARACTERS WITHOUT CLAIM TO ANY PARTICULAR FONT, STYLE, SIZE, OR COLOR.

NO CLAIM IS MADE TO THE EXCLUSIVE RIGHT TO USE "ADVICE", APART FROM THE MARK AS SHOWN.

SER. NO. 85-619,624, FILED 5-8-2012.

JENNY PARK, EXAMINING ATTORNEY



*David J. Kybas*

Director of the United States Patent and Trademark Office

# United States of America

United States Patent and Trademark Office

## CLICKIN MOMS

**Reg. No. 4,274,785**

**Registered Jan. 15, 2013**

**Int. Cls.: 38 and 41**

**SERVICE MARK**

**PRINCIPAL REGISTER**

CLICKINMOMS LLC (ILLINOIS LIMITED LIABILITY COMPANY)  
327 FRANKLIN STREET  
GENEVA, IL 60134

FOR: PROVIDING AN ON-LINE FORUM FOR DIGITAL IMAGING SERVICES, PHOTOGRAPHY, AND PORTRAIT AND WEDDING PHOTOGRAPHY; PROVIDING ON-LINE FORUMS FOR TRANSMISSION OF MESSAGES AMONG COMPUTER USERS CONCERNING DIGITAL IMAGING SERVICES, PHOTOGRAPHY, AND PORTRAIT AND WEDDING PHOTOGRAPHY, IN CLASS 38 (U.S. CLS. 100, 101 AND 104).

FIRST USE 4-4-2008; IN COMMERCE 4-4-2008.

FOR: EDUCATION SERVICES, NAMELY, PROVIDING ON-LINE CLASSES, SEMINARS, WORKSHOPS IN THE FIELD OF DIGITAL IMAGING SERVICES, PHOTOGRAPHY, AND PORTRAIT AND WEDDING PHOTOGRAPHY; DIGITAL IMAGING SERVICES; PHOTOGRAPHY; PORTRAIT AND WEDDING PHOTOGRAPHY; ON-LINE JOURNALS, NAMELY, BLOGS FEATURING DIGITAL IMAGING SERVICES, PHOTOGRAPHY, AND PORTRAIT AND WEDDING PHOTOGRAPHY; PROVIDING A WEBSITE FEATURING INFORMATION ABOUT ARTISTIC STYLES; PROVIDING ON-LINE MAGAZINES IN THE FIELD OF DIGITAL IMAGING SERVICES, PHOTOGRAPHY, AND PORTRAIT AND WEDDING PHOTOGRAPHY, IN CLASS 41 (U.S. CLS. 100, 101 AND 107).

FIRST USE 4-4-2008; IN COMMERCE 4-4-2008.

THE MARK CONSISTS OF STANDARD CHARACTERS WITHOUT CLAIM TO ANY PARTICULAR FONT, STYLE, SIZE, OR COLOR.

NO CLAIM IS MADE TO THE EXCLUSIVE RIGHT TO USE "MOMS", APART FROM THE MARK AS SHOWN.

SER. NO. 85-619,709, FILED 5-8-2012.

ERIN FALK, EXAMINING ATTORNEY



*David J. Kyros*

Director of the United States Patent and Trademark Office

# United States of America

United States Patent and Trademark Office

## Platinum Elegance

**Reg. No. 4,274,786**

COUSIN CORPORATION OF AMERICA (FLORIDA CORPORATION)  
12333 ENTERPRISE BLVD  
LARGO, FL 33773

**Registered Jan. 15, 2013**

**Int. Cl.: 14**

FOR: JEWELRY FINDINGS PLATED WITH PLATINUM OVER A COPPER BASE WITH A LACQUER FINISH, IN CLASS 14 (U.S. CLS. 2, 27, 28 AND 50).

**TRADEMARK**

FIRST USE 1-1-2004; IN COMMERCE 1-1-2004.

**PRINCIPAL REGISTER**

THE MARK CONSISTS OF STANDARD CHARACTERS WITHOUT CLAIM TO ANY PARTICULAR FONT, STYLE, SIZE, OR COLOR.

OWNER OF U.S. REG. NOS. 2,934,892, 2,954,924, AND 2,962,363.

NO CLAIM IS MADE TO THE EXCLUSIVE RIGHT TO USE "PLATINUM", APART FROM THE MARK AS SHOWN.

SER. NO. 85-619,820, FILED 5-8-2012.

PATRICIA EVANKO, EXAMINING ATTORNEY



*David J. Kyros*

Director of the United States Patent and Trademark Office

# United States of America

United States Patent and Trademark Office

## Gold Elegance

**Reg. No. 4,274,787**

COUSIN CORPORATION OF AMERICA (FLORIDA CORPORATION)  
12333 ENTERPRISE BLVD  
LARGO, FL 33773

**Registered Jan. 15, 2013**

**Int. Cl.: 14**

FOR: JEWELRY FINDINGS WITH A COPPER BASE AND AN AVERAGE OF 1.0 MICRON OF 14K GOLD PLATING, IN CLASS 14 (U.S. CLS. 2, 27, 28 AND 50).

**TRADEMARK**

FIRST USE 1-1-2004; IN COMMERCE 1-1-2004.

**PRINCIPAL REGISTER**

THE MARK CONSISTS OF STANDARD CHARACTERS WITHOUT CLAIM TO ANY PARTICULAR FONT, STYLE, SIZE, OR COLOR.

OWNER OF U.S. REG. NOS. 2,934,892, 2,954,924, AND 2,962,363.

NO CLAIM IS MADE TO THE EXCLUSIVE RIGHT TO USE "GOLD", APART FROM THE MARK AS SHOWN.

SER. NO. 85-619,841, FILED 5-8-2012.

PATRICIA EVANKO, EXAMINING ATTORNEY



*David J. Kyffers*

Director of the United States Patent and Trademark Office

# United States of America

United States Patent and Trademark Office



**Reg. No. 4,274,788**

**Registered Jan. 15, 2013**

**Int. Cl.: 35**

**SERVICE MARK**

**PRINCIPAL REGISTER**

DANIEL SMART MANUFACTURING, INC. (MARYLAND CORPORATION)  
49 ATTENBOROUGH DR APT #103  
ROSEDALE, MD 21237

FOR: ELECTRONIC CATALOG SERVICES FEATURING GLOVES, JACKETS, LEATHER JACKETS, LEATHER VESTS, MOTORCYCLE GLOVES, MOTORCYCLE JACKETS, SCARVES, SHIRTS, T-SHIRTS, VESTS; MAIL ORDER CATALOG SERVICES FEATURING GLOVES, JACKETS, LEATHER JACKETS, LEATHER VESTS, MOTORCYCLE GLOVES, MOTORCYCLE JACKETS, SCARVES, SHIRTS, T-SHIRTS, VESTS; WHOLESALE DISTRIBUTORSHIPS FEATURING GLOVES, JACKETS, LEATHER JACKETS, LEATHER VESTS, MOTORCYCLE GLOVES, MOTORCYCLE JACKETS, SCARVES, SHIRTS, T-SHIRTS, VESTS, IN CLASS 35 (U.S. CLS. 100, 101 AND 102).

FIRST USE 7-15-2011; IN COMMERCE 7-15-2011.

OWNER OF U.S. REG. NO. 4,184,265.

THE NAME(S), PORTRAIT(S), AND/OR SIGNATURE(S) SHOWN IN THE MARK DOES NOT IDENTIFY A PARTICULAR LIVING INDIVIDUAL.

THE MARK CONSISTS OF THE LETTERS "DS" IN PARENTHESES AND THE TERMS "DANIEL SMART".

SER. NO. 85-619,845, FILED 5-8-2012.

ELIZABETH KAJUBI, EXAMINING ATTORNEY



*David J. Kyffers*

Director of the United States Patent and Trademark Office

# United States of America

United States Patent and Trademark Office

# Sky Gamblers

**Reg. No. 4,274,789**

**Registered Jan. 15, 2013**

**Int. Cl.: 9**

**TRADEMARK**

**PRINCIPAL REGISTER**

REVO SOLUTIONS S.R.L. (ROMANIA S.R.L. (ROMANIA))  
INTRAREA CALUSEI NR. 9, SECTOR 2  
BUCHAREST, ROMANIA

FOR: COMPUTER GAME PROGRAMMES DOWNLOADABLE VIA THE INTERNET; COMPUTER GAME PROGRAMS; COMPUTER GAME SOFTWARE; COMPUTER GAME SOFTWARE FOR USE ON MOBILE AND CELLULAR PHONES; COMPUTER-GAMING SOFTWARE; DOWNLOADABLE COMPUTER GAME PROGRAMS; DOWNLOADABLE ELECTRONIC GAME PROGRAMS; DOWNLOADABLE GAMES VIA THE INTERNET AND WIRELESS DEVICES; ELECTRONIC GAME PROGRAMS; ELECTRONIC GAME SOFTWARE; ELECTRONIC GAME SOFTWARE FOR CELLULAR TELEPHONES; ELECTRONIC GAME SOFTWARE FOR HANDHELD ELECTRONIC DEVICES; ELECTRONIC GAME SOFTWARE FOR WIRELESS DEVICES; FLIGHT SIMULATORS; INTERACTIVE GAME PROGRAMS; INTERACTIVE GAME SOFTWARE; INTERACTIVE VIDEO GAME PROGRAMS; VIDEO GAME SOFTWARE, IN CLASS 9 (U.S. CLS. 21, 23, 26, 36 AND 38).

FIRST USE 10-10-2011; IN COMMERCE 10-10-2011.

THE MARK CONSISTS OF STANDARD CHARACTERS WITHOUT CLAIM TO ANY PARTICULAR FONT, STYLE, SIZE, OR COLOR.

NO CLAIM IS MADE TO THE EXCLUSIVE RIGHT TO USE "GAMBLERS", APART FROM THE MARK AS SHOWN.

SER. NO. 85-619,868, FILED 5-8-2012.

MARGARET POWER, EXAMINING ATTORNEY



*David J. Kyros*

Director of the United States Patent and Trademark Office

# United States of America

United States Patent and Trademark Office



**Reg. No. 4,274,790**

MARIO CALEGARI (UNITED STATES INDIVIDUAL)  
307 JEFFERSON ST  
NEWARK, NJ 07105

**Registered Jan. 15, 2013**

**Int. Cl.: 41**

FOR: CONDUCTING ENTERTAINMENT EXHIBITIONS IN THE NATURE OF MUSIC FESTIVALS; ENTERTAINMENT IN THE NATURE OF MUSIC FESTIVALS, IN CLASS 41 (U.S. CLS. 100, 101 AND 107).

**SERVICE MARK**

FIRST USE 6-1-2010; IN COMMERCE 6-1-2010.

**PRINCIPAL REGISTER**

NO CLAIM IS MADE TO THE EXCLUSIVE RIGHT TO USE "PORTUGAL DAY MUSIC FESTIVAL", APART FROM THE MARK AS SHOWN.

THE COLOR(S) RED, YELLOW, GREEN, LIME GREEN, GRAY, AND BLACK IS/ARE CLAIMED AS A FEATURE OF THE MARK.

THE MARK CONSISTS OF THE WORDING "P.D.M.F." IN STYLIZED FONT IN THE COLOR OF RED WITH A BLACK BORDER. THE DOTS IN BETWEEN THE CHARACTERS "P.D.M.F" ARE IN THE COLOR OF GRAY WITH A BLACK BORDER. DIRECTLY BELOW, IS THE WORDING "PORTUGAL DAY" IN STYLIZED FONT IN THE COLOR OF YELLOW WITH A BLACK BORDER. THE CHARACTER "O" WITHIN THE WORDING "PORTUGAL" HAS A DESIGN THAT DEPICTS THE PORTUGAL FLAG WITHIN THE CHARACTER "O". DIRECTLY BELOW, IS THE WORDING "MUSIC FESTIVAL" IN STYLIZED FONT AND IN THE COLOR OF GREEN WITH A BLACK BORDER. THE CHARACTER "G" WITHIN THE WORDING "PORTUGAL" IS OVERLAPPING THE CHARACTER "E" WITHIN THE WORDING "FESTIVAL". BORDERING THE WORDING WITHIN THE LOGO IS A BORDER IN THE COLOR OF LIME GREEN.



SER. NO. 85-620,072, FILED 5-8-2012.

ANGELA DUONG, EXAMINING ATTORNEY

*David J. Kybas*

Director of the United States Patent and Trademark Office



# United States of America

United States Patent and Trademark Office

**NPULSE**  
TECHNOLOGIES



**Reg. No. 4,274,791**

**Registered Jan. 15, 2013**

**Int. Cl.: 9**

**TRADEMARK**

**PRINCIPAL REGISTER**

NPULSE TECHNOLOGIES, INC. (DELAWARE CORPORATION)  
375 FOUR LEAF LANE, SUITE 201  
CHARLOTTESVILLE, VA 22903

FOR: COMPUTER SOFTWARE AND HARDWARE FOR NETWORK AUDITING AND SECURITY MONITORING, TRAFFIC ANALYSIS AND REPORTING, USAGE, ACCOUNTING AND BILLING, FAULT ISOLATION, EVENT CORRELATION, NETWORK PERFORMANCE AND CAPACITY PLANNING, DISCOVERY AND CONFIGURATION MANAGEMENT, COMPLIANCE ASSURANCE, POLICY ENFORCEMENT, FORENSIC ANALYSIS AND TRENDING, APPLICATION PERFORMANCE MONITORING, SERVICE VERIFICATION AND ANALYTICS, AND POST-EVENT TROUBLESHOOTING AND ANALYSIS, IN CLASS 9 (U.S. CLS. 21, 23, 26, 36 AND 38).

FIRST USE 8-0-2011; IN COMMERCE 8-0-2011.

NO CLAIM IS MADE TO THE EXCLUSIVE RIGHT TO USE "TECHNOLOGIES", APART FROM THE MARK AS SHOWN.

THE MARK CONSISTS OF THE WORDS "NPULSE TECHNOLOGIES" TO THE LEFT OF A VERTICAL LINE. TO THE RIGHT OF THE LINE IS A STYLIZED LETTER "N" WITHIN A PULSE DESIGN.

SER. NO. 85-620,338, FILED 5-9-2012.

DAVID I, EXAMINING ATTORNEY



*David J. Kyffers*

Director of the United States Patent and Trademark Office

# United States of America

United States Patent and Trademark Office



**Reg. No. 4,274,792**

RANEYS, INC. (FLORIDA CORPORATION)  
1550 NW 38TH AVENUE  
OCALA, FL 34482

**Registered Jan. 15, 2013**

**Int. Cls.: 35 and 37**

FOR: RETAIL TRUCK PARTS AND ACCESSORIES STORE SERVICES, IN CLASS 35 (U.S. CLS. 100, 101 AND 102).

**SERVICE MARK**

FIRST USE 1-0-1993; IN COMMERCE 1-0-1993.

**PRINCIPAL REGISTER**

FOR: HEAVY DUTY TRUCK REPAIR AND MAINTENANCE SERVICES, IN CLASS 37 (U.S. CLS. 100, 103 AND 106).

FIRST USE 1-0-1993; IN COMMERCE 1-0-1993.

NO CLAIM IS MADE TO THE EXCLUSIVE RIGHT TO USE "TRUCK CENTER", APART FROM THE MARK AS SHOWN.

THE COLOR(S) GRAY AND BLACK IS/ARE CLAIMED AS A FEATURE OF THE MARK.

THE MARK CONSISTS OF THE WORDING "RANEY'S TRUCK CENTER" IN ITALICIZED CAPITAL LETTERS. THE WORD "RANEY'S" IS IN GRAY WITH BLACK OUTLINING AND IS ABOVE THE WORDS "TRUCK CENTER", WHICH ARE IN BLACK WITH THE LETTERS "NTER" PARTIALLY OUTLINED IN WHITE. BEHIND AND PARTIALLY SURROUNDING THE WORDS "RANEY'S TRUCK CENTER" IS A STYLIZED DESIGN OF A TRUCK IN MOTION. A GRAY ELLIPTICAL SHAPE OPENS AT THE LEFT AND ENDS AT THE RIGHT WITH A DESIGN REPRESENTING A TRUCK CAB. A SECOND ELLIPTICAL SHAPE IN LIGHTER GRAY OPENS AT THE LEFT, IS INSIDE THE LARGER ELLIPTICAL SHAPE, AND PARTIALLY TOUCHES THE FIRST ELLIPTICAL SHAPE AT ITS BASE. A THIRD ELLIPTICAL SHAPE BELOW THE CAB PORTION OF THE DESIGN REPRESENTS A WHEEL. THIS SHAPE IS SHOWN IN GRAY, WITH LIGHTER GRAY REPRESENTING SHADING.



SER. NO. 85-620,367, FILED 5-9-2012.

*David J. Kyffers*

MATTHEW GALAN, EXAMINING ATTORNEY

# United States of America

United States Patent and Trademark Office

## Allied Media Projects

**Reg. No. 4,274,793**

ALLIED MEDIA PROJECTS (MICHIGAN CORPORATION)  
4126 THIRD ST.  
DETROIT, MI 48201

**Registered Jan. 15, 2013**

**Int. Cl.: 41**

FOR: EDUCATION SERVICES, NAMELY, PROVIDING CLASSES, SEMINARS, WORKSHOPS, AND CONFERENCES IN THE FIELD OF MEDIA AND COMMUNICATIONS, ART, TECHNOLOGY, EDUCATION, AND SOCIAL JUSTICE, IN CLASS 41 (U.S. CLS. 100, 101 AND 107).

**SERVICE MARK**

**PRINCIPAL REGISTER**

FIRST USE 12-0-2001; IN COMMERCE 12-0-2001.

THE MARK CONSISTS OF STANDARD CHARACTERS WITHOUT CLAIM TO ANY PARTICULAR FONT, STYLE, SIZE, OR COLOR.

NO CLAIM IS MADE TO THE EXCLUSIVE RIGHT TO USE "MEDIA PROJECTS", APART FROM THE MARK AS SHOWN.

SER. NO. 85-620,378, FILED 5-9-2012.

MATTHEW GALAN, EXAMINING ATTORNEY



*David J. Kyffers*

Director of the United States Patent and Trademark Office

# United States of America

United States Patent and Trademark Office

# ART KILLS ARTISTS

**Reg. No. 4,274,794**

**Registered Jan. 15, 2013**

**Int. Cl.: 25**

**TRADEMARK**

**PRINCIPAL REGISTER**

FEATHER, JASON R. (UNITED STATES INDIVIDUAL)  
#304  
3047 UNIVERSITY AVE  
SAN DIEGO, CA 92104

FOR: HATS; JACKETS; PANTS; SHIRTS, IN CLASS 25 (U.S. CLS. 22 AND 39).

FIRST USE 6-18-2009; IN COMMERCE 6-18-2009.

THE MARK CONSISTS OF THE STACKED WORDS "ART KILLS ARTISTS" IN IMPACT FONT WITH "ART" ABOVE "KILLS", AND "KILLS" ABOVE "ARTISTS".

SER. NO. 85-620,386, FILED 5-9-2012.

ESTHER BELENKER, EXAMINING ATTORNEY



*David J. Kybas*

Director of the United States Patent and Trademark Office

# United States of America

United States Patent and Trademark Office

## Deep Blue Zee

**Reg. No. 4,274,795**

BRAIN POWER INCORPORATED (FLORIDA CORPORATION), AKA BPI  
4470 SW 74 AVENUE  
MIAMI, FL 33155

**Registered Jan. 15, 2013**

**Int. Cls.: 2 and 9**

FOR: COLORANTS, PAINTS AND DYES FOR GENERAL INDUSTRIAL USE, IN CLASS 2  
(U.S. CLS. 6, 11 AND 16).

**TRADEMARK**

FIRST USE 11-7-2011; IN COMMERCE 11-7-2011.

**PRINCIPAL REGISTER**

FOR: SUNGLASS LENSES, IN CLASS 9 (U.S. CLS. 21, 23, 26, 36 AND 38).

FIRST USE 11-7-2011; IN COMMERCE 11-7-2011.

THE MARK CONSISTS OF STANDARD CHARACTERS WITHOUT CLAIM TO ANY PARTICULAR FONT, STYLE, SIZE, OR COLOR.

NO CLAIM IS MADE TO THE EXCLUSIVE RIGHT TO USE "BLUE", APART FROM THE MARK AS SHOWN.

SER. NO. 85-620,530, FILED 5-9-2012.

SANI KHOURI, EXAMINING ATTORNEY



*David J. Kyffers*

Director of the United States Patent and Trademark Office

# United States of America

United States Patent and Trademark Office

## Nanofiber SOLUTIONS

**Reg. No. 4,274,796**

**Registered Jan. 15, 2013**

**Int. Cl.: 9**

**TRADEMARK**

**PRINCIPAL REGISTER**

NANOFIBER SOLUTIONS, LLC (OHIO LIMITED LIABILITY COMPANY), DBA NANOFIBER SOLUTIONS, LLC  
1275 KINNEAR RD.  
COLUMBUS, OH 43212

FOR: CELL CULTURE APPARATUS FOR LABORATORY USE, NAMELY, CELL CULTURE PLATES, DISHES, AND FLASKS, IN CLASS 9 (U.S. CLS. 21, 23, 26, 36 AND 38).

FIRST USE 4-1-2009; IN COMMERCE 4-1-2010.

THE MARK CONSISTS OF STANDARD CHARACTERS WITHOUT CLAIM TO ANY PARTICULAR FONT, STYLE, SIZE, OR COLOR.

NO CLAIM IS MADE TO THE EXCLUSIVE RIGHT TO USE "NANOFIBER", APART FROM THE MARK AS SHOWN.

SER. NO. 85-620,570, FILED 5-9-2012.

GRETTA YAO, EXAMINING ATTORNEY



*David J. Kybas*

Director of the United States Patent and Trademark Office

# United States of America

United States Patent and Trademark Office



**Reg. No. 4,274,797**

IOWA ROTOCAST PLASTICS, INC (IOWA CORPORATION)  
1712 MOELLERS DRIVE  
DECORAH, IA 52101

**Registered Jan. 15, 2013**

**Int. Cl.: 21**

FOR: PORTABLE COOLERS, NAMELY PORTABLE BEVERAGE OR ICE COOLERS MOUNTED ON TELESCOPING WHEELED CADDIES; ICE PAILS, IN CLASS 21 (U.S. CLS. 2, 13, 23, 29, 30, 33, 40 AND 50).

**TRADEMARK**

FIRST USE 9-1-1986; IN COMMERCE 9-1-1986.

**PRINCIPAL REGISTER**

THE MARK CONSISTS OF THE LITERAL ELEMENTS "IRP" WHEREIN THERE IS AN IMAGE OF OVAL INSIDE WHICH THE LETTERS "IRP" ARE WRITTEN AS SHOWN IN THE MARK.

SER. NO. 85-620,930, FILED 5-9-2012.

BRENDAN REGAN, EXAMINING ATTORNEY



*David J. Kybas*

Director of the United States Patent and Trademark Office

# United States of America

United States Patent and Trademark Office



**Reg. No. 4,274,798**

**Registered Jan. 15, 2013**

**Int. Cl.: 20**

**TRADEMARK**

**PRINCIPAL REGISTER**

QMT ASSOCIATES, INC. (VIRGINIA CORPORATION)  
8431 EUCLID AVENUE  
MANASSAS PARK, VA 20111

FOR: WIND CHIMES, IN CLASS 20 (U.S. CLS. 2, 13, 22, 25, 32 AND 50).

FIRST USE 5-1-2012; IN COMMERCE 5-1-2012.

OWNER OF U.S. REG. NO. 3,932,228.

NO CLAIM IS MADE TO THE EXCLUSIVE RIGHT TO USE "WINDCHIMES", APART FROM THE MARK AS SHOWN.

THE MARK CONSISTS OF THE WORDS "QMT WINDCHIMES" SET TO THE RIGHT OF A WINDCHIMES DESIGN, AND BELOW A MUSICAL STAFF WITH A TREBLE CLEF AND NOTES TRAILING OFF AS THOUGH BEING BLOWN IN THE WIND, ALL ENCIRCLED BY AN OVAL BORDER.

SER. NO. 85-620,940, FILED 5-9-2012.

NAAKWAMA ANKRAH, EXAMINING ATTORNEY



*David J. Kyros*

Director of the United States Patent and Trademark Office



# United States of America

United States Patent and Trademark Office



**Reg. No. 4,274,799**

GLOBAL VOTER SOLUTIONS, LLC (FLORIDA LIMITED LIABILITY COMPANY)  
13250 OULTON CIRCLE  
ORLANDO, FL 32832

**Registered Jan. 15, 2013**

**Int. Cl.: 42**

FOR: PROVIDING ON-LINE NON-DOWNLOADABLE SOFTWARE FOR PEOPLE OR ORGANIZATIONS TO CREATE A VOTING EVENT, VOTE ON THE ISSUE, CHANGE THEIR VOTE AT WILL AND TRACK THE INPUT AND DISPLAY IT IN A UNIQUE GRAPHICAL WAY, IN CLASS 42 (U.S. CLS. 100 AND 101).

**SERVICE MARK**

**PRINCIPAL REGISTER**

FIRST USE 6-16-2011; IN COMMERCE 6-16-2011.

NO CLAIM IS MADE TO THE EXCLUSIVE RIGHT TO USE "VOTE" AND ".COM", APART FROM THE MARK AS SHOWN.

THE COLOR(S) BLACK, RED, BLUE, AND WHITE IS/ARE CLAIMED AS A FEATURE OF THE MARK.

THE MARK CONSISTS OF THE BLACK WORDS "THEPEOPLES" TO THE LEFT, TO THE RIGHT OF THAT IS THE BLACK WORD "VOTE" WHICH IS INCLUDED IN A STANDARD CAMPAIGN TYPE VOTE BUTTON OF WHITE STARS ON A BLUE FIELD AND RED AND WHITE STRIPES. THERE IS A WHITE CURSOR ICON WITH A BLACK OUTLINE THAT APPEARS TO BE CLICKING ON THE CAMPAIGN BUTTON. THE BLACK TEXT ".COM" TO THE RIGHT OF THE BUTTON, AND THE RED WORDS "CLICK. LEARN. VOTE." CENTERED BELOW "THEPEOPLES".

SER. NO. 85-621,055, FILED 5-9-2012.

JOHN DWYER, EXAMINING ATTORNEY



*David J. Kybas*

Director of the United States Patent and Trademark Office

# United States of America

United States Patent and Trademark Office



**Reg. No. 4,274,800**

**Registered Jan. 15, 2013**

**Int. Cls.: 30, 35 and 43**

**TRADEMARK**

**SERVICE MARK**

**PRINCIPAL REGISTER**

HERRMANN GLOBAL INC. (DELAWARE CORPORATION)  
17 BATTERY PLACE  
SUITE 1307  
NEW YORK, NY 10004

FOR: BAKERY PRODUCTS, NAMELY, BREAD, PASTRIES AND SANDWICHES, IN CLASS 30 (U.S. CL. 46).

FIRST USE 4-1-2012; IN COMMERCE 4-1-2012.

FOR: RETAIL BAKERY SHOP, IN CLASS 35 (U.S. CLS. 100, 101 AND 102).

FIRST USE 4-1-2012; IN COMMERCE 4-1-2012.

FOR: RESTAURANT SERVICES, LIQUOR BAR AND CAFE SERVICES, CATERING, CARRY-OUT RESTAURANT SERVICES, IN CLASS 43 (U.S. CLS. 100 AND 101).

FIRST USE 4-1-2012; IN COMMERCE 4-1-2012.

THE MARK CONSISTS OF THE LETTERS "L" AND "B" INTERTWINED. THE COLOR BLACK APPEARS IN THE LETTERS AND THE COLOR GREEN APPEARS IN THE OUTLINE OF THE LETTERS.

THE COLOR(S) BLACK AND GREEN IS/ARE CLAIMED AS A FEATURE OF THE MARK.

SER. NO. 85-621,131, FILED 5-9-2012.

CARYN GLASSER, EXAMINING ATTORNEY



*David J. Kybas*

Director of the United States Patent and Trademark Office

# United States of America

United States Patent and Trademark Office

## Pawfection Photography

**Reg. No. 4,274,801**

**Registered Jan. 15, 2013**

**Int. Cl.: 41**

**SERVICE MARK**

**PRINCIPAL REGISTER**

TORRES, JENNIFER L (UNITED STATES INDIVIDUAL)  
APT 4  
1113 PALMER ROAD  
FORT WASHINGTON, MD 20744

FOR: PHOTOGRAPHY, IN CLASS 41 (U.S. CLS. 100, 101 AND 107).

FIRST USE 4-30-2012; IN COMMERCE 4-30-2012.

THE MARK CONSISTS OF STANDARD CHARACTERS WITHOUT CLAIM TO ANY PARTICULAR FONT, STYLE, SIZE, OR COLOR.

NO CLAIM IS MADE TO THE EXCLUSIVE RIGHT TO USE "PHOTOGRAPHY", APART FROM THE MARK AS SHOWN.

SER. NO. 85-621,242, FILED 5-9-2012.

KIMBERLY PARKS, EXAMINING ATTORNEY



*David J. Kyffers*

Director of the United States Patent and Trademark Office

# United States of America

United States Patent and Trademark Office



**Reg. No. 4,274,802**

**Registered Jan. 15, 2013**

**Int. Cl.: 37**

**SERVICE MARK**

**PRINCIPAL REGISTER**

LAKE POINTE CONSTRUCTION, LLC (TEXAS LIMITED LIABILITY COMPANY), DBA  
BLUE POOL CARE  
107 N. GOLIAD  
ROCKWALL, TX 75087

FOR: SWIMMING POOL CLEANING SERVICES; SWIMMING POOL MAINTENANCE, IN  
CLASS 37 (U.S. CLS. 100, 103 AND 106).

FIRST USE 5-7-2012; IN COMMERCE 5-7-2012.

NO CLAIM IS MADE TO THE EXCLUSIVE RIGHT TO USE "POOL CARE.NET", APART  
FROM THE MARK AS SHOWN.

THE MARK CONSISTS OF THE WORD "BLUE" ABOVE A WATER SPLASH DESIGN ABOVE  
THE WORDING "POOLCARE.NET".

SER. NO. 85-621,604, FILED 5-10-2012.

TARAH HARDY, EXAMINING ATTORNEY



*David J. Kyros*

Director of the United States Patent and Trademark Office

# United States of America

United States Patent and Trademark Office

# Vaxis Power

**Reg. No. 4,274,803**

**Registered Jan. 15, 2013**

**Int. Cl.: 7**

**TRADEMARK**

**PRINCIPAL REGISTER**

VAXIS POWER, LLC (TEXAS LIMITED LIABILITY COMPANY)  
9122 UPPERCOVE CIRCLE  
HOUSTON, TX 77064

FOR: WIND TURBINES, IN CLASS 7 (U.S. CLS. 13, 19, 21, 23, 31, 34 AND 35).

FIRST USE 1-10-2011; IN COMMERCE 1-10-2011.

THE MARK CONSISTS OF STANDARD CHARACTERS WITHOUT CLAIM TO ANY PARTICULAR FONT, STYLE, SIZE, OR COLOR.

NO CLAIM IS MADE TO THE EXCLUSIVE RIGHT TO USE "POWER", APART FROM THE MARK AS SHOWN.

SER. NO. 85-621,680, FILED 5-10-2012.

INGA ERVIN, EXAMINING ATTORNEY



*David J. Kyffers*

Director of the United States Patent and Trademark Office

# United States of America

United States Patent and Trademark Office

## FORWARD ►► HOME SECURITY

**Reg. No. 4,274,804**

**Registered Jan. 15, 2013**

**Int. Cl.: 45**

**SERVICE MARK**

**PRINCIPAL REGISTER**

FORWARD HOME SECURITY, INC. (TEXAS CORPORATION)  
550 EAST 15TH STREET  
SECOND FLOOR  
PLANO, TX 75070

FOR: MONITORING BURGLAR AND SECURITY ALARMS, IN CLASS 45 (U.S. CLS. 100 AND 101).

FIRST USE 1-5-2012; IN COMMERCE 1-5-2012.

NO CLAIM IS MADE TO THE EXCLUSIVE RIGHT TO USE "HOME SECURITY", APART FROM THE MARK AS SHOWN.

THE COLOR(S) BLACK, BLUE AND GRAY IS/ARE CLAIMED AS A FEATURE OF THE MARK.

THE MARK CONSISTS OF THE WORD "FORWARD" IN ALL CAPITAL LETTERS, FOLLOWED BY TWO LEFTWARE POINTING TRIANGLES, BENEATH WHICH APPEAR THE WORDS "HOME SECURITY" IN ALL CAPITAL LETTERS. THE COLOR BLACK APPEARS IN THE LETTERS OF "FORWARD". THE COLOR BLUE APPEARS IN THE TWO TRIANGLES. THE COLOR GRAY APPEARS IN THE LETTERS OF "HOME SECURITY".

SER. NO. 85-621,769, FILED 5-10-2012.

JESSICA FATHY, EXAMINING ATTORNEY



*David J. Kyros*

Director of the United States Patent and Trademark Office

# United States of America

United States Patent and Trademark Office



**Reg. No. 4,274,805**

**Registered Jan. 15, 2013**

**Int. Cl.: 40**

**SERVICE MARK**

**PRINCIPAL REGISTER**

THIS OLD FARM, INC. (INDIANA CORPORATION)  
9572 W. COUNTY ROAD 650 S  
COLFAX, IN 46035

FOR: FOOD PROCESSING, IN CLASS 40 (U.S. CLS. 100, 103 AND 106).

FIRST USE 1-0-2008; IN COMMERCE 1-0-2008.

NO CLAIM IS MADE TO THE EXCLUSIVE RIGHT TO USE "FARM" , APART FROM THE MARK AS SHOWN.

THE MARK CONSISTS OF A CIRCLE OF ARROWS CIRCLING A SCENE OF TALL GRASS, TWO HILLS AND SUNSHINE. AROUND THERE IS THE STYLIZED TEXT "THIS OLD FARM REJUVENATING THE LAND, ONE FARM AT A TIME".

SER. NO. 85-621,873, FILED 5-10-2012.

MATTHEW KLINE, EXAMINING ATTORNEY



*David J. Kybas*

Director of the United States Patent and Trademark Office

# United States of America

United States Patent and Trademark Office

**Jerome's**  
*Signature*-**PEDIC**  
MEMORY FOAM MATTRESSES

**Reg. No. 4,274,806**

JEROME'S FURNITURE WAREHOUSE, INC. (CALIFORNIA CORPORATION)  
16960 MESAMINT ST.  
SAN DIEGO, CA 92127

**Registered Jan. 15, 2013**

**Int. Cl.: 20**

FOR: MATTRESSES; SLEEP PRODUCTS, NAMELY, MATTRESSES, SPRING MATTRESSES, BOX SPRINGS AND MATTRESS FOUNDATIONS, IN CLASS 20 (U.S. CLS. 2, 13, 22, 25, 32 AND 50).

**TRADEMARK**

FIRST USE 8-21-2011; IN COMMERCE 8-21-2011.

**PRINCIPAL REGISTER**

OWNER OF U.S. REG. NOS. 3,676,435, 3,695,855, AND 3,867,374.

THE COLOR(S) BLACK, RED AND BLUE IS/ARE CLAIMED AS A FEATURE OF THE MARK.

NO CLAIM IS MADE TO THE EXCLUSIVE RIGHT TO USE "MEMORY FOAM MATTRESSES", APART FROM THE MARK AS SHOWN.

THE MARK CONSISTS OF THE STYLIZED WORD "JEROME'S" IN RED AND OUTLINED IN BLACK. BELOW THIS IS THE STYLIZED WORD "SIGNATURE-PEDIC". "SIGNATURE" IS BLACK AND IN CURSIVE FONT. THE LETTER "G" IN "SIGNATURE-PEDIC" EXTENDS ALONG THE BOTTOM OF THIS WORD. "-PEDIC" IS BLUE. AT THE VERY BOTTOM ARE THE WORDS "MEMORY FOAM MATTRESSES" IN BLACK.

SER. NO. 85-621,993, FILED 5-10-2012.

SIMON TENG, EXAMINING ATTORNEY



*David J. Kyros*

Director of the United States Patent and Trademark Office



# United States of America

United States Patent and Trademark Office

# SENTRYCON

**Reg. No. 4,274,807**

**Registered Jan. 15, 2013**

**Int. Cl.: 41**

**SERVICE MARK**

**PRINCIPAL REGISTER**

SENTRYNET INC (FLORIDA CORPORATION)  
517 N. BAYLEN STREET  
PENSACOLA, FL 32501

FOR: EDUCATIONAL SERVICES, NAMELY, CONDUCTING CLASSES, SEMINARS, CONFERENCES, WORKSHOPS AND FIELD TRIPS IN THE FIELDS OF MARKETING, SALES, HUMAN RESOURCES, CONTRACTS, INSURANCE, PRODUCT DEVELOPMENT, CUSTOMER SERVICE RETENTION AND PLEASE PROVIDE ANY FURTHER SUBJECT MATTER AND DISTRIBUTION OF COURSE MATERIALS IN CONNECTION THEREWITH, ALL RENDERED TO THE SECURITY INDUSTRY, IN CLASS 41 (U.S. CLS. 100, 101 AND 107).

FIRST USE 1-1-2012; IN COMMERCE 1-1-2012.

THE MARK CONSISTS OF STANDARD CHARACTERS WITHOUT CLAIM TO ANY PARTICULAR FONT, STYLE, SIZE, OR COLOR.

SER. NO. 85-622,123, FILED 5-10-2012.

DOMINICK J. SALEMI, EXAMINING ATTORNEY



*David J. Kyffers*

Director of the United States Patent and Trademark Office

# United States of America

United States Patent and Trademark Office

## Changing the World with Every Job

**Reg. No. 4,274,808**

**Registered Jan. 15, 2013**

**Int. Cl.: 42**

**SERVICE MARK**

**PRINCIPAL REGISTER**

JOB HABITAT, INC. (CALIFORNIA CORPORATION)  
2030 MAIN ST. 13TH FLOOR  
IRVINE, CA 92614

FOR: COMPUTER SERVICES, NAMELY, CREATING AN ON-LINE COMMUNITY FOR REGISTERED USERS TO ORGANIZE GROUPS AND EVENTS, PARTICIPATE IN DISCUSSIONS, AND ENGAGE IN SOCIAL, BUSINESS, EMPLOYMENT, AND ONLINE COMMUNITY NETWORKING; COMPUTER SERVICES, NAMELY, HOSTING ON-LINE WEB FACILITIES FOR OTHERS FOR ORGANIZING AND CONDUCTING MEETINGS, INTERVIEWS, EVENTS AND INTERACTIVE DISCUSSIONS VIA COMMUNICATION NETWORKS; APPLICATION SERVICE PROVIDER (ASP) SERVICES, NAMELY, HOSTING COMPUTER SOFTWARE APPLICATIONS OF OTHERS; APPLICATION SERVICE PROVIDER (ASP) FEATURING SOFTWARE TO ENABLE OR FACILITATE THE UPLOADING, DOWNLOADING, STREAMING, POSTING, DISPLAYING, BLOGGING, LINKING, SHARING OF AUDIO AND VIDEO CONTENT, PHOTOGRAPHIC IMAGES, TEXT, GRAPHICS AND DATA; PROVIDING AN ONLINE NETWORK SERVICE THAT ENABLES USERS TO TRANSFER PERSONAL IDENTITY DATA TO AND SHARE PERSONAL IDENTITY DATA WITH AND AMONG MULTIPLE WEBSITES; PROVIDING A WEB SITE FEATURING TECHNOLOGY THAT ENABLES ONLINE USERS TO CREATE PERSONAL PROFILES FEATURING EMPLOYMENT AND SOCIAL NETWORKING INFORMATION AND TO TRANSFER AND SHARE SUCH INFORMATION AMONG MULTIPLE WEBSITES; COMPUTER SERVICES, NAMELY, CREATING INDEXES OF INFORMATION, SITES AND OTHER RESOURCES AVAILABLE ON COMPUTER NETWORKS; PROVIDING TEMPORARY USE OF NON-DOWNLOADABLE SOFTWARE APPLICATIONS FOR ENABLING, FACILITATING, OR ENHANCING EMPLOYMENT SOCIAL NETWORKING, RECRUITMENT AND EMPLOYMENT, CREATING A VIRTUAL EMPLOYMENT COMMUNITY, AND TRANSMISSION OF AUDIO, VIDEO, PHOTOGRAPHIC IMAGES, TEXT, GRAPHICS AND DATA; PROVIDING TEMPORARY USE OF NON-DOWNLOADABLE SOFTWARE APPLICATIONS FOR ENABLING USERS TO SEARCH, LOCATE AND COMMUNICATE WITH OTHERS VIA ELECTRONIC COMMUNICATIONS NETWORKS TO PERFORM VIDEO AND ONLINE INTERVIEWS, TRACK ONLINE REFERENCE TO JOB OPPORTUNITIES, TRACK JOB CANDIDATES, NETWORK VIA MAIL, ONLINE CHAT, MESSAGES, AND INSTANT MESSAGE; COMPUTER SERVICES IN THE NATURE OF CUSTOMIZED WEB PAGES FEATURING USER-DEFINED INFORMATION IN THE FIELD OF JOB POSTINGS AND ONLINE JOB NETWORKING; PEER TO-BROWSER PHOTO SHARING SERVICES, NAMELY, PROVIDING A WEBSITE FEATURING TECHNOLOGY ENABLING USERS TO UPLOAD, VIEW, AND DOWNLOAD DIGITAL PHOTOS; PROVIDING A WEB SITE FEATURING TECHNOLOGY THAT ENABLES USERS



*David J. Kybas*

Director of the United States Patent and Trademark Office

**Reg. No. 4,274,808** TO UPLOAD AND SHARE VIDEO, PHOTOS, TEXT, GRAPHICS AND DATA, IN CLASS 42  
(U.S. CLS. 100 AND 101).

FIRST USE 2-17-2012; IN COMMERCE 2-17-2012.

THE MARK CONSISTS OF STANDARD CHARACTERS WITHOUT CLAIM TO ANY PARTICULAR FONT, STYLE, SIZE, OR COLOR.

SER. NO. 85-622,272, FILED 5-10-2012.

AMEEN IMAM, EXAMINING ATTORNEY

# United States of America

United States Patent and Trademark Office

## TA'LEEF COLLECTIVE

**Reg. No. 4,274,809**

**Registered Jan. 15, 2013**

**Int. Cls.: 41 and 45**

**SERVICE MARK**

**PRINCIPAL REGISTER**

TA'LEEF COLLECTIVE (CALIFORNIA CORPORATION)  
43170 OSGOOD ROAD  
FREMONT, CA 94539

FOR: EDUCATION SERVICES, NAMELY, PROVIDING LIVE AND ON-LINE CLASSES, CONFERENCES, SEMINARS, CONFERENCES, WORKSHOPS IN THE FIELDS OF RELIGIOUS INSTRUCTION, SPIRITUALITY, AND SELF-IMPROVEMENT AND DISTRIBUTION OF COURSE MATERIAL IN CONNECTION THEREWITH; EDUCATION SERVICES, NAMELY, PROVIDING FIELD TRIPS IN THE FIELDS OF RELIGIOUS INSTRUCTION, SPIRITUALITY, AND SELF-IMPROVEMENT AND DISTRIBUTION OF COURSE MATERIAL IN CONNECTION THEREWITH; EDUCATIONAL SERVICES, NAMELY, CONDUCTING PROGRAMS IN THE FIELD OF RELIGIOUS INSTRUCTION, SPIRITUALITY, AND SELF-IMPROVEMENT; PROVIDING SCIENCE EDUCATIONAL MENTORING SERVICES AND PROGRAMS; RELIGIOUS INSTRUCTION SERVICES, IN CLASS 41 (U.S. CLS. 100, 101 AND 107).

FIRST USE 5-1-2005; IN COMMERCE 5-1-2005.

FOR: CONDUCTING RELIGIOUS PRAYER SERVICES; PROVIDING A WEBSITE FEATURING INFORMATION ABOUT RELIGIOUS BELIEF SYSTEMS; RELIGIOUS AND SPIRITUAL SERVICES, NAMELY, PROVIDING GATHERINGS AND RETREATS TO DEVELOP AND ENHANCE THE SPIRITUAL LIVES OF INDIVIDUALS; RELIGIOUS SERVICES, NAMELY, PRAYER MEETINGS, IN CLASS 45 (U.S. CLS. 100 AND 101).

FIRST USE 5-1-2005; IN COMMERCE 5-1-2005.

THE MARK CONSISTS OF STANDARD CHARACTERS WITHOUT CLAIM TO ANY PARTICULAR FONT, STYLE, SIZE, OR COLOR.

NO CLAIM IS MADE TO THE EXCLUSIVE RIGHT TO USE "COLLECTIVE", APART FROM THE MARK AS SHOWN.

SER. NO. 85-622,284, FILED 5-10-2012.

TRACY WHITTAKER-BROWN, EXAMINING ATTORNEY



*David J. Kyffers*

Director of the United States Patent and Trademark Office

# United States of America

United States Patent and Trademark Office

[www.AnythingfromAmerica.com](http://www.AnythingfromAmerica.com)

**Reg. No. 4,274,810**

**Registered Jan. 15, 2013**

**Int. Cl.: 39**

**SERVICE MARK**

**PRINCIPAL REGISTER**

MOHAMMAD, SAID (UNITED STATES INDIVIDUAL)  
SUITE #3  
8710 JAMAICA AVENUE  
WOODHAVEN, NY 11421

FOR: FREIGHT FORWARDING SERVICES, NAMELY, PACKAGE FORWARDING AND MAIL FORWARDING SERVICES OF AMERICAN PRODUCTS, IN CLASS 39 (U.S. CLS. 100 AND 105).

FIRST USE 4-1-2009; IN COMMERCE 4-1-2009.

THE MARK CONSISTS OF STANDARD CHARACTERS WITHOUT CLAIM TO ANY PARTICULAR FONT, STYLE, SIZE, OR COLOR.

SER. NO. 85-622,317, FILED 5-10-2012.

SHAUNIA CARLYLE, EXAMINING ATTORNEY



*David J. Kybas*

Director of the United States Patent and Trademark Office

# United States of America

United States Patent and Trademark Office

# EDM

**Reg. No. 4,274,811**

J.P. INSTRUMENTS, INC. (CALIFORNIA CORPORATION)  
3185-B AIRWAY AVENUE  
COSTA MESA, CA 92626

**Registered Jan. 15, 2013**

**Int. Cl.: 9**

FOR: ELECTRONIC AVIONIC INSTRUMENTS, NAMELY, AIRCRAFT ENGINE PERFORMANCE INSTRUMENTS, IN CLASS 9 (U.S. CLS. 21, 23, 26, 36 AND 38).

**TRADEMARK**

FIRST USE 1-1-1991; IN COMMERCE 1-1-1991.

**PRINCIPAL REGISTER**

THE MARK CONSISTS OF STANDARD CHARACTERS WITHOUT CLAIM TO ANY PARTICULAR FONT, STYLE, SIZE, OR COLOR.

SER. NO. 85-622,332, FILED 5-10-2012.

KIMBERLY PARKS, EXAMINING ATTORNEY



*David J. Kyffers*

Director of the United States Patent and Trademark Office

# United States of America

United States Patent and Trademark Office



**Reg. No. 4,274,812**

DAMIAN WALSH JR. (UNITED STATES INDIVIDUAL)  
88 PENNSYLVANIA AVENUE  
LONG BEACH, NY 11561

**Registered Jan. 15, 2013**

**Int. Cl.: 43**

FOR: FAST-FOOD RESTAURANT SERVICES; RESTAURANTS FEATURING HOME DELIVERY; TAKE-OUT RESTAURANT SERVICES, IN CLASS 43 (U.S. CLS. 100 AND 101).

**SERVICE MARK**

FIRST USE 4-30-2012; IN COMMERCE 4-30-2012.

**PRINCIPAL REGISTER**

NO CLAIM IS MADE TO THE EXCLUSIVE RIGHT TO USE "RIBEYE" AND "CHEESESTEAKS", APART FROM THE MARK AS SHOWN.

THE COLOR(S) BLACK, WHITE AND RED IS/ARE CLAIMED AS A FEATURE OF THE MARK.

THE MARK CONSISTS OF THE WORD "RIBEYE" IN SOLID BLACK SOLID LETTERS, THE WORD "BROS" IN RED AND IN A VERTICAL SIDeways POSITION FACING LEFT. UNDER THESE WORDS IS THE WORD "CHEESESTEAKS" IN SOLID WHITE LETTERS IN A RED RECTANGULAR BOX UNDER THE AT THE BOTTOM OF THE MARK IS A RED RECTANGULAR BAR WITH TWO WHITE STARS AND A BLACK COW BETWEEN THE STARS.

SER. NO. 85-622,364, FILED 5-10-2012.

FLORENTINA BLANDU, EXAMINING ATTORNEY



*David J. Kyros*

Director of the United States Patent and Trademark Office

# United States of America

United States Patent and Trademark Office

# The Weimary

**Reg. No. 4,274,813**

TRAUBEN, LLC (TEXAS LIMITED LIABILITY COMPANY), DBA THE WEIMARY  
1101 SEDAN ROAD  
WEIMAR, TX 78962

**Registered Jan. 15, 2013**

**Int. Cl.: 40**

FOR: WINERY SERVICES, IN CLASS 40 (U.S. CLS. 100, 103 AND 106).

**SERVICE MARK**

FIRST USE 2-1-2012; IN COMMERCE 2-1-2012.

**PRINCIPAL REGISTER**

THE MARK CONSISTS OF STANDARD CHARACTERS WITHOUT CLAIM TO ANY PARTICULAR FONT, STYLE, SIZE, OR COLOR.

THE WORDING "THE WEIMARY" HAS NO MEANING IN A FOREIGN LANGUAGE.

SER. NO. 85-622,429, FILED 5-10-2012.

GRETTA YAO, EXAMINING ATTORNEY



*David J. Kybas*

Director of the United States Patent and Trademark Office



# United States of America

United States Patent and Trademark Office

# WORD URGE

**Reg. No. 4,274,814**

**Registered Jan. 15, 2013**

**Int. Cl.: 9**

**TRADEMARK**

**PRINCIPAL REGISTER**

ENLEXICA, INC. (CALIFORNIA CORPORATION)  
SUITE A6  
922 STATE STREET  
SANTA BARBARA, CA 93101

FOR: COMPUTER GAME SOFTWARE; COMPUTER GAME SOFTWARE DOWNLOADABLE FROM A GLOBAL COMPUTER NETWORK; COMPUTER GAME SOFTWARE FOR USE ON MOBILE AND CELLULAR PHONES, IN CLASS 9 (U.S. CLS. 21, 23, 26, 36 AND 38).

FIRST USE 2-24-2012; IN COMMERCE 2-24-2012.

THE MARK CONSISTS OF STANDARD CHARACTERS WITHOUT CLAIM TO ANY PARTICULAR FONT, STYLE, SIZE, OR COLOR.

NO CLAIM IS MADE TO THE EXCLUSIVE RIGHT TO USE "WORD", APART FROM THE MARK AS SHOWN.

SER. NO. 85-622,444, FILED 5-11-2012.

MEGHAN REINHART, EXAMINING ATTORNEY



*David J. Kyffers*

Director of the United States Patent and Trademark Office

# United States of America

United States Patent and Trademark Office

## Mojave Plastics

**Reg. No. 4,274,815**

**Registered Jan. 15, 2013**

**Int. Cl.: 9**

**TRADEMARK**

**PRINCIPAL REGISTER**

BURDINE, MICHAEL D. (UNITED STATES INDIVIDUAL)  
P.O. BOX 61634  
BOULDER CITY, NV 89006

FOR: AUDIO AND VIDEO RECORDINGS FEATURING MUSIC AND ARTISTIC PERFORMANCES; DIGITAL MUSIC DOWNLOADABLE FROM THE INTERNET; MUSICAL SOUND RECORDINGS, IN CLASS 9 (U.S. CLS. 21, 23, 26, 36 AND 38).

FIRST USE 0-0-2010; IN COMMERCE 1-3-2012.

THE MARK CONSISTS OF STANDARD CHARACTERS WITHOUT CLAIM TO ANY PARTICULAR FONT, STYLE, SIZE, OR COLOR.

NO CLAIM IS MADE TO THE EXCLUSIVE RIGHT TO USE "PLASTICS", APART FROM THE MARK AS SHOWN.

SER. NO. 85-622,447, FILED 5-11-2012.

MEGHAN REINHART, EXAMINING ATTORNEY



*David J. Kyffers*

Director of the United States Patent and Trademark Office

# United States of America

United States Patent and Trademark Office

# tengo orgullo

**Reg. No. 4,274,816**

MORUA, JUAN CARLOS (MEXICO INDIVIDUAL), DBA TENGO ORGULLO  
2609 SHADY BEND  
PEARLAND, TX 77581

**Registered Jan. 15, 2013**

**Int. Cl.: 35**

FOR: ON-LINE RETAIL STORE SERVICES FEATURING MALE CLOTHING, IN CLASS 35  
(U.S. CLS. 100, 101 AND 102).

**SERVICE MARK**

FIRST USE 5-10-2012; IN COMMERCE 5-10-2012.

**PRINCIPAL REGISTER**

THE MARK CONSISTS OF STANDARD CHARACTERS WITHOUT CLAIM TO ANY PARTICULAR FONT, STYLE, SIZE, OR COLOR.

THE ENGLISH TRANSLATION OF "TENGO ORGULLO" IN THE MARK IS "I HAVE PRIDE".

SER. NO. 85-622,465, FILED S.R. 5-11-2012 AM. P.R. 9-12-2012.

MIDGE BUTLER, EXAMINING ATTORNEY



*David J. Kyffers*

Director of the United States Patent and Trademark Office

# United States of America

United States Patent and Trademark Office

## DEAD LAWYER

**Reg. No. 4,274,817**

BERGER, WILLIAM J. (UNITED STATES INDIVIDUAL)  
700 HOLLY LANE  
BOCA RATON, FL 33486

**Registered Jan. 15, 2013**

**Int. Cls.: 9, 21, 25 and 26**

FOR: MOUSE PADS, IN CLASS 9 (U.S. CLS. 21, 23, 26, 36 AND 38).

**TRADEMARK**

FIRST USE 5-10-2012; IN COMMERCE 5-10-2012.

**PRINCIPAL REGISTER**

FOR: MUGS AND BEVERAGE GLASSWARE, IN CLASS 21 (U.S. CLS. 2, 13, 23, 29, 30, 33, 40 AND 50).

FIRST USE 5-10-2012; IN COMMERCE 5-10-2012.

FOR: T-SHIRTS, IN CLASS 25 (U.S. CLS. 22 AND 39).

FIRST USE 5-10-2012; IN COMMERCE 5-10-2012.

FOR: ORNAMENTAL NOVELTY BUTTONS, IN CLASS 26 (U.S. CLS. 37, 39, 40, 42 AND 50).

FIRST USE 5-10-2012; IN COMMERCE 5-10-2012.

THE MARK CONSISTS OF STANDARD CHARACTERS WITHOUT CLAIM TO ANY PARTICULAR FONT, STYLE, SIZE, OR COLOR.

SER. NO. 85-622,543, FILED 5-11-2012.

EDWARD NELSON, EXAMINING ATTORNEY



*David J. Kybas*

Director of the United States Patent and Trademark Office

# United States of America

United States Patent and Trademark Office

## Bedford Slims

**Reg. No. 4,274,818**

**Registered Jan. 15, 2013**

**Int. Cl.: 34**

**TRADEMARK**

**PRINCIPAL REGISTER**

RADD + MASSIVE INDUSTRIES, INC (NEW YORK CORPORATION)  
181 HAVEMEYER ST.  
#4E  
BROOKLYN, NY 11211

FOR: ELECTRONIC CIGARETTES, IN CLASS 34 (U.S. CLS. 2, 8, 9 AND 17).

FIRST USE 4-6-2011; IN COMMERCE 4-19-2011.

THE MARK CONSISTS OF STANDARD CHARACTERS WITHOUT CLAIM TO ANY PARTICULAR FONT, STYLE, SIZE, OR COLOR.

NO CLAIM IS MADE TO THE EXCLUSIVE RIGHT TO USE "SLIMS", APART FROM THE MARK AS SHOWN.

SER. NO. 85-622,602, FILED 5-11-2012.

CHRISIE B. KING, EXAMINING ATTORNEY



*David J. Kyffers*

Director of the United States Patent and Trademark Office

# United States of America

United States Patent and Trademark Office



**Reg. No. 4,274,819**

**Registered Jan. 15, 2013**

**Int. Cl.: 35**

**SERVICE MARK**

**PRINCIPAL REGISTER**

AMD DISTRIBUTION, INC (MINNESOTA CORPORATION)  
1021 KASTEN DRIVE  
P.O. BOX 227  
SPRING VALLEY, MN 55975

FOR: DISTRIBUTORSHIP SERVICES IN THE FIELD OF INSULATION, INSULATION INSTALLATION EQUIPMENT, AND AIR FILTRATION SYSTEMS, IN CLASS 35 (U.S. CLS. 100, 101 AND 102).

FIRST USE 1-1-2008; IN COMMERCE 1-1-2008.

NO CLAIM IS MADE TO THE EXCLUSIVE RIGHT TO USE "DISTRIBUTION", APART FROM THE MARK AS SHOWN.

THE MARK CONSISTS OF A SHADED CIRCLE WITH THE BLOCK LETTERS "AMD" OVER THE WORD "DISTRIBUTION" RUNNING THRU THE CIRCLE WITH A PARALLELOGRAM WITH AN ANGLED CHECK PATTERN TO THE RIGHT OF THE CIRCLE AND ABOVE THE SECOND HALF OF THE WORD "DISTRIBUTION" AND ANOTHER PARALLELOGRAM WITH A WAVE PATTERN ALSO TO THE RIGHT OF THE CIRCLE BELOW THE SECOND HALF OF THE WORD "DISTRIBUTION".

SER. NO. 85-622,650, FILED 5-11-2012.

BARBARA BROWN, EXAMINING ATTORNEY



*David J. Kyjars*

Director of the United States Patent and Trademark Office

# United States of America

United States Patent and Trademark Office

## TODAY'S STEEL STANDARD

**Reg. No. 4,274,820**

**Registered Jan. 15, 2013**

**Int. Cl.: 6**

**TRADEMARK**

**PRINCIPAL REGISTER**

MMFX TECHNOLOGIES CORPORATION (CALIFORNIA CORPORATION)  
2415 CAMPUS DRIVE  
SUITE 100  
IRVINE, CA 92612

FOR: CONCRETE REINFORCING STEEL, IN CLASS 6 (U.S. CLS. 2, 12, 13, 14, 23, 25 AND 50).

FIRST USE 3-0-2012; IN COMMERCE 3-0-2012.

THE MARK CONSISTS OF STANDARD CHARACTERS WITHOUT CLAIM TO ANY PARTICULAR FONT, STYLE, SIZE, OR COLOR.

NO CLAIM IS MADE TO THE EXCLUSIVE RIGHT TO USE "STEEL STANDARD", APART FROM THE MARK AS SHOWN.

SER. NO. 85-622,768, FILED 5-11-2012.

JIM RINGLE, EXAMINING ATTORNEY



*David J. Kyffers*

Director of the United States Patent and Trademark Office

# United States of America

United States Patent and Trademark Office

## *the* **super serious show.**

**Reg. No. 4,274,821**

**Registered Jan. 15, 2013**

**Int. Cl.: 41**

**SERVICE MARK**

**PRINCIPAL REGISTER**

MANDELKORN, JOEL (UNITED STATES INDIVIDUAL)  
12530 BRADDOCK DR  
APT. 206  
LOS ANGELES, CA 90066

FOR: ENTERTAINMENT MEDIA PRODUCTION SERVICES FOR MOTION PICTURES, TELEVISION AND INTERNET; ENTERTAINMENT SERVICES IN THE NATURE OF COMEDY SHOWS; ENTERTAINMENT SERVICES, NAMELY, MULTIMEDIA PRODUCTION SERVICES; PRESENTATION OF LIVE COMEDY SHOWS, IN CLASS 41 (U.S. CLS. 100, 101 AND 107).

FIRST USE 6-1-2010; IN COMMERCE 6-1-2010.

NO CLAIM IS MADE TO THE EXCLUSIVE RIGHT TO USE "SHOW", APART FROM THE MARK AS SHOWN.

THE MARK CONSISTS OF THE STYLIZED TEXT "THE SUPER SERIOUS SHOW."

SER. NO. 85-622,811, FILED 5-11-2012.

ALLISON HOLTZ, EXAMINING ATTORNEY



*David J. Kyffers*

Director of the United States Patent and Trademark Office



# United States of America

United States Patent and Trademark Office

## TRICOASTAL CAPITAL

**Reg. No. 4,274,822**

TRICOASTAL CAPITAL PARTNERS LLC (DELAWARE LIMITED LIABILITY COMPANY)  
300 INTERNATIONAL DRIVE, SUITE 100  
BUFFALO, NY 14221

**Registered Jan. 15, 2013**

**Int. Cl.: 36**

FOR: FINANCIAL SERVICES, NAMELY, MANAGEMENT OF AN INVESTMENT FUND, IN CLASS 36 (U.S. CLS. 100, 101 AND 102).

**SERVICE MARK**

FIRST USE 4-14-2004; IN COMMERCE 5-1-2004.

**PRINCIPAL REGISTER**

THE MARK CONSISTS OF STANDARD CHARACTERS WITHOUT CLAIM TO ANY PARTICULAR FONT, STYLE, SIZE, OR COLOR.

NO CLAIM IS MADE TO THE EXCLUSIVE RIGHT TO USE "CAPITAL", APART FROM THE MARK AS SHOWN.

SER. NO. 85-622,839, FILED 5-11-2012.

MARTHA FROMM, EXAMINING ATTORNEY



*David J. Kybas*

Director of the United States Patent and Trademark Office

# United States of America

United States Patent and Trademark Office

# Baldovino

**Reg. No. 4,274,823**

**Registered Jan. 15, 2013**

**Int. Cl.: 14**

**TRADEMARK**

**PRINCIPAL REGISTER**

SPARKLING JEWELRY INC (NEW YORK CORPORATION)  
48 48TH STREET WEST  
SUITE 1408  
NEW YORK, NY 10036

FOR: JEWELLERY, CLOCKS AND WATCHES, IN CLASS 14 (U.S. CLS. 2, 27, 28 AND 50).

FIRST USE 1-1-2010; IN COMMERCE 1-1-2010.

THE MARK CONSISTS OF STANDARD CHARACTERS WITHOUT CLAIM TO ANY PARTICULAR FONT, STYLE, SIZE, OR COLOR.

SER. NO. 85-622,844, FILED 5-11-2012.

MARTHA FROMM, EXAMINING ATTORNEY



*David J. Kybas*

Director of the United States Patent and Trademark Office

# United States of America

United States Patent and Trademark Office

## TICKET SUMMIT

**Reg. No. 4,274,824**

TICKET SOFTWARE LLC (CONNECTICUT LIMITED LIABILITY COMPANY)  
75 GERBER ROAD EAST  
SOUTH WINDSOR, CT 06074

**Registered Jan. 15, 2013**

**Int. Cl.: 35**

FOR: ARRANGING AND CONDUCTING TRADE SHOWS IN THE FIELD OF TICKET SALES,  
IN CLASS 35 (U.S. CLS. 100, 101 AND 102).

**SERVICE MARK**

FIRST USE 7-19-2006; IN COMMERCE 7-19-2006.

**PRINCIPAL REGISTER**

THE MARK CONSISTS OF STANDARD CHARACTERS WITHOUT CLAIM TO ANY PAR-  
TICULAR FONT, STYLE, SIZE, OR COLOR.

NO CLAIM IS MADE TO THE EXCLUSIVE RIGHT TO USE "SUMMIT", APART FROM THE  
MARK AS SHOWN.

SEC. 2(F).

SER. NO. 85-622,933, FILED 5-11-2012.

SUE LAWRENCE, EXAMINING ATTORNEY



*David J. Kyffers*

Director of the United States Patent and Trademark Office

# United States of America

United States Patent and Trademark Office



**Reg. No. 4,274,825**

**Registered Jan. 15, 2013**

**Int. Cl.: 35**

**SERVICE MARK**

**PRINCIPAL REGISTER**

DIRECTORS ADVANTAGE, INC. (NORTH CAROLINA CORPORATION)  
PO BOX 177  
CLINTON, NC 28329

FOR: PROVIDING A WEB SITE FEATURING A BUSINESS DIRECTORY OF FUNERAL HOMES, MORTUARY TRANSPORT SERVICES AND OTHER FUNERAL RELATED SERVICES, IN CLASS 35 (U.S. CLS. 100, 101 AND 102).

FIRST USE 2-0-2012; IN COMMERCE 2-0-2012.

THE MARK CONSISTS OF A BLACK SQUARE FILLED WITH YELLOW. INSIDE THE SQUARE IS THE ARTISTIC RENDERING OF AN AIRPLANE IN BLACK.

THE COLOR(S) YELLOW AND BLACK IS/ARE CLAIMED AS A FEATURE OF THE MARK.

SER. NO. 85-623,024, FILED 5-11-2012.

AMY KERTGATE, EXAMINING ATTORNEY



*David J. Kyffers*

Director of the United States Patent and Trademark Office

# United States of America

United States Patent and Trademark Office

## UNITED STATES HUNTER JUMPER ASSOCIATION

**Reg. No. 4,274,826**

UNITED STATES HUNTER JUMPER ASSOCIATION (NEW YORK CORPORATION)  
3870 CIGAR LANE  
LEXINGTON, KY 40511

**Registered Jan. 15, 2013**

**Int. Cls.: 16, 35, 41 and  
42**

FOR: PRINTED PUBLICATIONS, NAMELY, NEWSLETTERS, BROCHURES AND PAMPHLETS FEATURING THE HUNTER AND JUMPER DISCIPLINES OF EQUESTRIAN SPORT, IN CLASS 16 (U.S. CLS. 2, 5, 22, 23, 29, 37, 38 AND 50).

**TRADEMARK**

FIRST USE 10-17-2003; IN COMMERCE 10-17-2003.

**SERVICE MARK**

FOR: ASSOCIATION SERVICES, NAMELY, PROMOTING THE INTERESTS OF INDIVIDUALS IN THE HUNTER AND JUMPER DISCIPLINES OF EQUESTRIAN SPORT, IN CLASS 35 (U.S. CLS. 100, 101 AND 102).

**PRINCIPAL REGISTER**

FIRST USE 10-17-2003; IN COMMERCE 10-17-2003.

FOR: EDUCATION SERVICES, NAMELY, PROVIDING CLINICS AND MENTORING IN THE FIELD OF HORSES AND HUNTER AND JUMPER DISCIPLINES OF EQUESTRIAN SPORT, PROVIDING INCENTIVES TO EQUESTRIAN HUNTER AND JUMPERS TO DEMONSTRATE EXCELLENCE IN HUNTER AND JUMPER DISCIPLINES OF EQUESTRIAN SPORT; AND ORGANIZATION OF EQUESTRIAN HUNTER AND JUMPER COMPETITIONS; EDUCATIONAL SERVICES, NAMELY, DEVELOPING CURRICULUM FOR HUNTER AND JUMPER JUDGES AND STEWARDS IN THE FIELD OF EQUESTRIAN SPORTS, IN CLASS 41 (U.S. CLS. 100, 101 AND 107).

FIRST USE 10-17-2003; IN COMMERCE 10-17-2003.

FOR: DEVELOPING, SETTING AND PROVIDING STANDARDS, PRACTICES AND REGULATIONS FOR AWARDS PROGRAMS FOR THE HUNTER AND JUMPER DISCIPLINES OF EQUESTRIAN SPORTS; DEVELOPING, SETTING AND PROVIDING STANDARDS, PRACTICES AND REGULATIONS FOR COMPETITION CLASS FOR HUNTER SEAT EQUITATION STYLE OF RIDING; AND DEVELOPING STANDARDS AND PROCEDURES FOR CERTIFYING HUNTER AND JUMPER JUDGES AND STEWARDS, IN CLASS 42 (U.S. CLS. 100 AND 101).

FIRST USE 7-7-2004; IN COMMERCE 7-7-2004.



*David J. Kyjars*

Director of the United States Patent and Trademark Office

**Reg. No. 4,274,826** THE MARK CONSISTS OF STANDARD CHARACTERS WITHOUT CLAIM TO ANY PARTICULAR FONT, STYLE, SIZE, OR COLOR.

OWNER OF U.S. REG. NOS. 3,226,207, 4,070,039 AND OTHERS.

NO CLAIM IS MADE TO THE EXCLUSIVE RIGHT TO USE "ASSOCIATION", APART FROM THE MARK AS SHOWN.

SEC. 2(F).

SER. NO. 85-623,052, FILED 5-11-2012.

LOURDES AYALA, EXAMINING ATTORNEY

# United States of America

United States Patent and Trademark Office



**Reg. No. 4,274,827**

**Registered Jan. 15, 2013**

**Int. Cls.: 25 and 36**

**TRADEMARK**

**SERVICE MARK**

**PRINCIPAL REGISTER**

NATIONAL BASKETBALL RETIRED PLAYERS ASSOCIATION, INC. (NEW YORK CORPORATION)  
175 W. JACKSON BLVD., SUITE 1600  
CHICAGO, IL 60604

FOR: HATS; JACKETS; SHIRTS; SHORTS; SWEATERS; SWEATPANTS, IN CLASS 25 (U.S. CLS. 22 AND 39).

FIRST USE 1-1-2010; IN COMMERCE 1-1-2010.

FOR: CHARITABLE FUNDRAISING SERVICES, IN CLASS 36 (U.S. CLS. 100, 101 AND 102).

FIRST USE 1-1-2010; IN COMMERCE 1-1-2010.

OWNER OF U.S. REG. NO. 4,096,517.

THE COLOR(S) RED, WHITE, BLACK, BLUE AND ORANGE IS/ARE CLAIMED AS A FEATURE OF THE MARK.

THE MARK CONSISTS OF A RED HEART WITHIN A WHITE BORDER, WITHIN AN ORANGE AND BLACK BASKETBALL SURROUNDED BY A BLUE CIRCULAR BORDER CONTAINING THE WHITE WORDS "LEGENDS CARE", SURROUNDED BY A BLACK BORDER CIRCLE.

SER. NO. 85-623,149, FILED 5-11-2012.

DAVID ELTON, EXAMINING ATTORNEY



*David J. Kybas*

Director of the United States Patent and Trademark Office

# United States of America

United States Patent and Trademark Office

## LIL' RUNNERS

**Reg. No. 4,274,828**

**Registered Jan. 15, 2013**

**Int. Cl.: 25**

**TRADEMARK**

**PRINCIPAL REGISTER**

PS BRANDS, LLC (NEW YORK LIMITED LIABILITY COMPANY)  
10 WEST 33RD STREET  
SUITE 1105  
NEW YORK, NY 10001

FOR: FOOTWEAR; HOSIERY; SOCKS, IN CLASS 25 (U.S. CLS. 22 AND 39).

FIRST USE 2-15-2012; IN COMMERCE 2-15-2012.

THE MARK CONSISTS OF STANDARD CHARACTERS WITHOUT CLAIM TO ANY PARTICULAR FONT, STYLE, SIZE, OR COLOR.

SER. NO. 85-623,206, FILED 5-11-2012.

JACQUELINE A. LAVINE, EXAMINING ATTORNEY



*David J. Kybas*

Director of the United States Patent and Trademark Office



# United States of America

United States Patent and Trademark Office

# NTREPID

**Reg. No. 4,274,829**

**Registered Jan. 15, 2013**

**Int. Cls.: 9, 38 and 42**

**TRADEMARK**

**SERVICE MARK**

**PRINCIPAL REGISTER**

NTREPID CORPORATION (FLORIDA CORPORATION)  
12801 WORLDGATE DRIVE  
SUITE 800  
HERNDON, VA 20170

FOR: COMPUTER SOFTWARE FOR INFORMATION MANAGEMENT, NAMELY, USER PROFILE AND IDENTIFICATION INFORMATION; COMPUTER SOFTWARE USED FOR ENSURING SECURITY OF CUSTOMERS' ACCESS TO A GLOBAL COMPUTER NETWORK; COMPUTER SOFTWARE USED FOR TRACKING AND INDEXING, CAPTURING, STORING, AND MANAGING DATA, IN CLASS 9 (U.S. CLS. 21, 23, 26, 36 AND 38).

FIRST USE 10-0-2010; IN COMMERCE 12-0-2010.

FOR: PROVIDING TRANSMISSION OF INFORMATION OVER GLOBAL COMPUTER NETWORKS, IN CLASS 38 (U.S. CLS. 100, 101 AND 104).

FIRST USE 10-0-2010; IN COMMERCE 12-0-2010.

FOR: APPLICATION SERVICE PROVIDER, NAMELY, HOSTING, MANAGING, DEVELOPING, ANALYZING AND MAINTAINING APPLICATIONS, SOFTWARE, NETWORKS, AND WEBSITES OF OTHERS IN THE FIELDS OF NETWORK OPERATIONS, LINGUISTICS, ANALYTICS AND GEOSPATIAL TECHNOLOGIES; DESIGN AND DEVELOPMENT OF ELECTRONIC DATA SECURITY SYSTEMS, IN CLASS 42 (U.S. CLS. 100 AND 101).

FIRST USE 10-0-2010; IN COMMERCE 12-0-2010.

THE MARK CONSISTS OF STANDARD CHARACTERS WITHOUT CLAIM TO ANY PARTICULAR FONT, STYLE, SIZE, OR COLOR.

SER. NO. 85-623,507, FILED 5-11-2012.

RICHARD WHITE, EXAMINING ATTORNEY



*David J. Kyros*

Director of the United States Patent and Trademark Office

# United States of America

United States Patent and Trademark Office

# Donna Faye

**Reg. No. 4,274,830**

HEADLEY, TIFFANY (UNITED STATES INDIVIDUAL)  
2009 ABERDEEN DRIVE  
PAPILLION, NE 68133

**Registered Jan. 15, 2013**

**Int. Cl.: 25**

FOR: DRESSES; HATS; JACKETS; PANTS; SHIRTS; SHOES; SKIRTS, IN CLASS 25 (U.S. CLS. 22 AND 39).

**TRADEMARK**

FIRST USE 11-30-2011; IN COMMERCE 11-30-2011.

**PRINCIPAL REGISTER**

THE MARK CONSISTS OF STANDARD CHARACTERS WITHOUT CLAIM TO ANY PARTICULAR FONT, STYLE, SIZE, OR COLOR.

THE NAME(S), PORTRAIT(S), AND/OR SIGNATURE(S) SHOWN IN THE MARK DOES NOT IDENTIFY A PARTICULAR LIVING INDIVIDUAL.

SER. NO. 85-623,569, FILED 5-11-2012.

JOHN KELLY, EXAMINING ATTORNEY



*David J. Kyffers*

Director of the United States Patent and Trademark Office

# United States of America

United States Patent and Trademark Office

# NTREPID

**Reg. No. 4,274,831**

**Registered Jan. 15, 2013**

**Int. Cls.: 9, 38 and 42**

**TRADEMARK**

**SERVICE MARK**

**PRINCIPAL REGISTER**

NTREPID CORPORATION (FLORIDA CORPORATION)  
12801 WORLDGATE DRIVE  
SUITE 800  
HERNDON, VA 20170

FOR: COMPUTER SOFTWARE FOR INFORMATION MANAGEMENT, NAMELY, USER PROFILE AND IDENTIFICATION INFORMATION; COMPUTER SOFTWARE USED FOR ENSURING SECURITY OF CUSTOMERS' ACCESS TO A GLOBAL COMPUTER NETWORK; COMPUTER SOFTWARE USED FOR TRACKING AND INDEXING, CAPTURING, STORING, AND MANAGING DATA, IN CLASS 9 (U.S. CLS. 21, 23, 26, 36 AND 38).

FIRST USE 10-0-2010; IN COMMERCE 12-0-2010.

FOR: PROVIDING TRANSMISSION OF INFORMATION OVER GLOBAL COMPUTER NETWORKS, IN CLASS 38 (U.S. CLS. 100, 101 AND 104).

FIRST USE 10-0-2010; IN COMMERCE 12-0-2010.

FOR: APPLICATION SERVICE PROVIDER, NAMELY, HOSTING, MANAGING, DEVELOPING, ANALYZING AND MAINTAINING APPLICATIONS, SOFTWARE, NETWORKS, AND WEBSITES OF OTHERS IN THE FIELDS OF NETWORK OPERATIONS, LINGUISTICS, ANALYTICS AND GEOSPATIAL TECHNOLOGIES; DESIGN AND DEVELOPMENT OF ELECTRONIC DATA SECURITY SYSTEMS, IN CLASS 42 (U.S. CLS. 100 AND 101).

FIRST USE 10-0-2010; IN COMMERCE 12-0-2010.

THE MARK CONSISTS OF THE WORD "NTREPID" WITH THE "N" IN A THREE-DIMENSIONAL FONT.

SER. NO. 85-623,571, FILED 5-11-2012.

RICHARD WHITE, EXAMINING ATTORNEY



*David J. Kypos*

Director of the United States Patent and Trademark Office

**United States of America**  
United States Patent and Trademark Office

# LuckyCase

**Reg. No. 4,274,832**

RIVERA, ANNA M (UNITED STATES INDIVIDUAL)  
PO BOX 75  
LOMIRA, WI 53048

**Registered Jan. 15, 2013**

**Int. Cl.: 24**

FOR: FABRIC PILLOW CASES FOR U-SHAPED TRAVEL NECK PILLOWS, IN CLASS 24  
(U.S. CLS. 42 AND 50).

**TRADEMARK**

FIRST USE 2-15-2010; IN COMMERCE 5-1-2012.

**PRINCIPAL REGISTER**

THE MARK CONSISTS OF STANDARD CHARACTERS WITHOUT CLAIM TO ANY PARTICULAR FONT, STYLE, SIZE, OR COLOR.

SER. NO. 85-623,770, FILED S.R. 5-12-2012 AM. P.R. 9-5-2012.

WILLIAM VERHOSEK, EXAMINING ATTORNEY



*David J. Kybas*

Director of the United States Patent and Trademark Office

**United States of America**  
United States Patent and Trademark Office

# TWSS BBQ

**Reg. No. 4,274,833**

ZAAYER, BENJAMIN R (UNITED STATES INDIVIDUAL), DBA TWSS BBQ  
4917 N 129TH AVE  
OMAHA, NE 68164

**Registered Jan. 15, 2013**

**Int. Cl.: 43**

FOR: CATERING SERVICES, IN CLASS 43 (U.S. CLS. 100 AND 101).

**SERVICE MARK**

FIRST USE 3-1-2009; IN COMMERCE 7-9-2009.

**PRINCIPAL REGISTER**

THE MARK CONSISTS OF STANDARD CHARACTERS WITHOUT CLAIM TO ANY PARTICULAR FONT, STYLE, SIZE, OR COLOR.

NO CLAIM IS MADE TO THE EXCLUSIVE RIGHT TO USE "BBQ", APART FROM THE MARK AS SHOWN.

SER. NO. 85-623,857, FILED 5-13-2012.

BARBARA GAYNOR, EXAMINING ATTORNEY



*David J. Kyffers*

Director of the United States Patent and Trademark Office

# United States of America

United States Patent and Trademark Office

## MAGDOLINE SERIES

**Reg. No. 4,274,834**

BURDICK, STEPHEN J (UNITED STATES INDIVIDUAL), AKA MISHEN HOLLOBURD  
631 S.E. DOUGLAS ST.  
TOLEDO, OR 97391

**Registered Jan. 15, 2013**

**Int. Cl.: 16**

FOR: A SERIES OF BOOKS AND WRITTEN ARTICLES IN THE FIELD OF RELIGIOUS FICTION; RELIGIOUS BOOKS, IN CLASS 16 (U.S. CLS. 2, 5, 22, 23, 29, 37, 38 AND 50).

**TRADEMARK**

FIRST USE 3-23-2012; IN COMMERCE 3-23-2012.

**PRINCIPAL REGISTER**

THE MARK CONSISTS OF STANDARD CHARACTERS WITHOUT CLAIM TO ANY PARTICULAR FONT, STYLE, SIZE, OR COLOR.

NO CLAIM IS MADE TO THE EXCLUSIVE RIGHT TO USE "SERIES", APART FROM THE MARK AS SHOWN.

SER. NO. 85-623,860, FILED 5-13-2012.

MICHELLE DUBOIS, EXAMINING ATTORNEY



*David J. Kyffers*

Director of the United States Patent and Trademark Office

# United States of America

United States Patent and Trademark Office

The logo features a large, stylized red letter 'Y' with a white yarmulke (skull cap) hanging from its right side. To the right of the 'Y' is the word 'YAMACLAUS' in a bold, red, sans-serif font.

**Reg. No. 4,274,835**

MALISH, LARIK (UNITED STATES INDIVIDUAL), DBA YAMACLAUS CO.  
4477 OCEAN VALLEY LANE  
SAN DIEGO, CA 92130

**Registered Jan. 15, 2013**

**Int. Cl.: 25**

FOR: RELIGIOUS AND/OR NOVELTY HEADWEAR; SKULL CAPS, IN CLASS 25 (U.S. CLS. 22 AND 39).

**TRADEMARK**

FIRST USE 5-11-2012; IN COMMERCE 5-11-2012.

**PRINCIPAL REGISTER**

THE MARK CONSISTS OF THE ENLARGED LOWER-CASE LETTER "Y" WITH A NOVELTY RED YARMULKE HAVING WHITE BRIM AND TOPPED WITH A WHITE BALL, HUNG OVER THE RIGHT RISING MEMBER OF THE LETTER; FOLLOWED BY THE REMAINING LETTERS IN CAPS, WITH THE EXCEPTION OF THE "A"S SPELLING "AMACLAUS" IN RED.

THE COLOR(S) RED AND WHITE IS/ARE CLAIMED AS A FEATURE OF THE MARK.

SER. NO. 85-623,882, FILED 5-13-2012.

MICHELLE DUBOIS, EXAMINING ATTORNEY



*David J. Kyffers*

Director of the United States Patent and Trademark Office

# United States of America

United States Patent and Trademark Office

## Bluewater Rentals

**Reg. No. 4,274,836**

CLARK, RITA M. (FLORIDA SOLE PROPRIETORSHIP), DBA BLUEWATER RENTALS  
121 DROST DRIVE  
CUDJOE GARDENS, FL 33042

**Registered Jan. 15, 2013**

**Int. Cl.: 36**

FOR: ARRANGING OF LEASES AND RENTAL AGREEMENTS FOR REAL ESTATE, IN CLASS 36 (U.S. CLS. 100, 101 AND 102).

**SERVICE MARK**

FIRST USE 11-1-2002; IN COMMERCE 12-1-2002.

**PRINCIPAL REGISTER**

THE MARK CONSISTS OF STANDARD CHARACTERS WITHOUT CLAIM TO ANY PARTICULAR FONT, STYLE, SIZE, OR COLOR.

NO CLAIM IS MADE TO THE EXCLUSIVE RIGHT TO USE "RENTALS", APART FROM THE MARK AS SHOWN.

SER. NO. 85-623,894, FILED 5-13-2012.

MICHELLE DUBOIS, EXAMINING ATTORNEY



*David J. Kybas*

Director of the United States Patent and Trademark Office



# United States of America

United States Patent and Trademark Office

## e-magine A Traditional e-publishing Company

**Reg. No. 4,274,837**

**Registered Jan. 15, 2013**

**Int. Cl.: 41**

**SERVICE MARK**

**PRINCIPAL REGISTER**

YOUNG EMMANUEL (OHIO SOLE PROPRIETORSHIP), FORMERLY E-MAGINE  
PUBLISHING  
976 ENGLEWOOD RD  
CLEVELAND HEIGHTS, OH 44121

FOR: PUBLISHING OF BOOKS, E-BOOKS, AUDIO BOOKS, MUSIC AND ILLUSTRATIONS,  
IN CLASS 41 (U.S. CLS. 100, 101 AND 107).

FIRST USE 8-21-2011; IN COMMERCE 11-15-2011.

THE MARK CONSISTS OF STANDARD CHARACTERS WITHOUT CLAIM TO ANY PAR-  
TICULAR FONT, STYLE, SIZE, OR COLOR.

NO CLAIM IS MADE TO THE EXCLUSIVE RIGHT TO USE "E-PUBLISHING COMPANY",  
APART FROM THE MARK AS SHOWN.

SER. NO. 85-623,920, FILED 5-13-2012.

NAAKWAMA ANKRAH, EXAMINING ATTORNEY



*David J. Kyfos*

Director of the United States Patent and Trademark Office

# United States of America

United States Patent and Trademark Office

# Regio Gear

**Reg. No. 4,274,838**

MORUA, JUAN CARLOS (MEXICO INDIVIDUAL), DBA TENGO ORGULLO  
2609 SHADY BEND  
PEARLAND, TX 77581

**Registered Jan. 15, 2013**

**Int. Cl.: 25**

FOR: DRESS SHIRTS; POLO SHIRTS; T-SHIRTS, IN CLASS 25 (U.S. CLS. 22 AND 39).

FIRST USE 5-10-2012; IN COMMERCE 5-10-2012.

**TRADEMARK**

THE MARK CONSISTS OF STANDARD CHARACTERS WITHOUT CLAIM TO ANY PARTICULAR FONT, STYLE, SIZE, OR COLOR.

**PRINCIPAL REGISTER**

NO CLAIM IS MADE TO THE EXCLUSIVE RIGHT TO USE "GEAR", APART FROM THE MARK AS SHOWN.

THE ENGLISH TRANSLATION OF "REGIO" IN THE MARK IS "A CULTURAL TERM THAT REFERS TO REGION OF MOUNTAINS".

SER. NO. 85-623,939, FILED 5-13-2012.

MIDGE BUTLER, EXAMINING ATTORNEY



*David J. Kyffers*

Director of the United States Patent and Trademark Office

# United States of America

United States Patent and Trademark Office



**Reg. No. 4,274,839**

**Registered Jan. 15, 2013**

**Int. Cl.: 35**

**SERVICE MARK**

**PRINCIPAL REGISTER**

MONORAIL MANUFACTURERS ASSOCIATION, INC. (PENNSYLVANIA CORPORATION)  
8720 RED OAK BOULEVARD, SUITE 201  
CHARLOTTE, NC 28217

FOR: TRADE ASSOCIATION SERVICES, NAMELY, PROMOTING THE INTERESTS OF  
PATENTED TRACK, UNDERHUNG CRANE AND MONORAIL SYSTEM MANUFACTURERS  
, IN CLASS 35 (U.S. CLS. 100, 101 AND 102).

FIRST USE 3-14-2012; IN COMMERCE 3-14-2012.

NO CLAIM IS MADE TO THE EXCLUSIVE RIGHT TO USE "MONORAIL MANUFACTURERS  
ASSOCIATION WORKSTATION CRANES AND PATENTED TRACK SYSTEMS", APART  
FROM THE MARK AS SHOWN.

THE MARK CONSISTS OF THE LETTERS "MMA" INSIDE OF A RECTANGLE, A HOOK  
EXTENDING FROM THE BOTTOM OF THE RECTANGLE, FOUR DOTTED LINES TO THE  
LEFT OF THE HOOK, THE WORDS "MONORAIL MANUFACTURERS ASSOCIATION" TO  
THE RIGHT OF THE BOX, THE WORDS "WORKSTATION CRANES AND PATENTED  
TRACK SYSTEMS" TO THE RIGHT OF THE HOOK.

SER. NO. 85-624,000, FILED 5-14-2012.

MARGERY A. TIERNEY, EXAMINING ATTORNEY



*David J. Kyffers*

Director of the United States Patent and Trademark Office

# United States of America

United States Patent and Trademark Office

## BLOG TRENDS

**Reg. No. 4,274,840**

**Registered Jan. 15, 2013**

**Int. Cl.: 41**

**SERVICE MARK**

**PRINCIPAL REGISTER**

PIERCE, KAITLYN (UNITED STATES INDIVIDUAL)  
74 MERRIAM ST.  
APT. 2  
PITTSFIELD, MA 01201

FOR: EDUCATION SERVICES, NAMELY, PROVIDING ON-LINE PANEL DISCUSSIONS AND NON-DOWNLOADABLE WEBINARS IN THE FIELD OF BEAUTY SKILLS, LIFESTYLE HEALTH AND WELLNESS, AND COURSES OF INSTRUCTION IN THE FIELD OF BLOGGING ABOUT FASHION, IN CLASS 41 (U.S. CLS. 100, 101 AND 107).

FIRST USE 11-13-2011; IN COMMERCE 11-13-2011.

THE MARK CONSISTS OF STANDARD CHARACTERS WITHOUT CLAIM TO ANY PARTICULAR FONT, STYLE, SIZE, OR COLOR.

NO CLAIM IS MADE TO THE EXCLUSIVE RIGHT TO USE "BLOG", APART FROM THE MARK AS SHOWN.

SER. NO. 85-624,014, FILED 5-14-2012.

MATTHEW GALAN, EXAMINING ATTORNEY



*David J. Kyffers*

Director of the United States Patent and Trademark Office

# United States of America

United States Patent and Trademark Office



**Reg. No. 4,274,841**

**Registered Jan. 15, 2013**

**Int. Cl.: 41**

COLON CANCER ALLIANCE FOR RESEARCH AND EDUCATION FOR LYNCH SYNDROME  
(ILLINOIS NON-PROFIT CORPORATION)

127 WEST OAK STREET  
UNIT C  
CHICAGO, IL 60610

**SERVICE MARK**

FOR: EDUCATIONAL SERVICES, NAMELY, CONDUCTING PROGRAMS IN THE FIELD OF LYNCH SYNDROME, IN CLASS 41 (U.S. CLS. 100, 101 AND 107).

**PRINCIPAL REGISTER**

FIRST USE 5-11-2011; IN COMMERCE 5-11-2011.

NO CLAIM IS MADE TO THE EXCLUSIVE RIGHT TO USE "LYNCH SYNDROME", APART FROM THE MARK AS SHOWN.

THE MARK CONSISTS OF A STYLIZED DNA STRUCTURE WITH THE WORDS "CCARE LYNCH SYNDROME" TO THE RIGHT OF THE STRUCTURE. A LINE APPEARS BETWEEN THE TERM "CCARE" AND THE WORDING "LYNCH SYNDROME".

SER. NO. 85-624,039, FILED 5-14-2012.

MATTHEW GALAN, EXAMINING ATTORNEY



*David J. Kyffers*

Director of the United States Patent and Trademark Office

# United States of America

United States Patent and Trademark Office

## HATTERY LABS

**Reg. No. 4,274,842**

**Registered Jan. 15, 2013**

**Int. Cls.: 35 and 36**

**SERVICE MARK**

**PRINCIPAL REGISTER**

HATTERY LABS LLC (DELAWARE LIMITED LIABILITY COMPANY)  
414 BRANNAN STREET  
SAN FRANCISCO, CA 94107

FOR: BUSINESS ADMINISTRATION AND MANAGEMENT; BUSINESS MANAGEMENT CONSULTING; BUSINESS INCUBATOR SERVICES, NAMELY, BUSINESS MARKETING, BUSINESS MANAGEMENT, AND BUSINESS DEVELOPMENT SERVICES IN THE FORM OF START-UP SUPPORT FOR BUSINESSES OF OTHERS; BUSINESS NETWORKING SERVICES; BUSINESS COMMUNICATIONS SERVICES, NAMELY, PUBLIC RELATIONS, ADVERTISING, MARKETING AND PUBLICITY SERVICES; BUSINESS CONSULTATION SERVICES, NAMELY, START-UP BUSINESS COUNSELING, MARKETING AND PLANNING, IN CLASS 35 (U.S. CLS. 100, 101 AND 102).

FIRST USE 9-30-2011; IN COMMERCE 9-30-2011.

FOR: VENTURE CAPITAL FUNDING SERVICES TO EMERGING AND START-UP COMPANIES; FINANCIAL CONSULTATION SERVICES IN THE FIELDS OF VENTURE CAPITAL CONSULTATION AND CORPORATE INCUBATION SERVICES, NAMELY, PROVIDING FINANCING TO START-UPS, EMERGING BUSINESSES AND NON-PROFITS, IN CLASS 36 (U.S. CLS. 100, 101 AND 102).

FIRST USE 9-30-2011; IN COMMERCE 9-30-2011.

THE MARK CONSISTS OF STANDARD CHARACTERS WITHOUT CLAIM TO ANY PARTICULAR FONT, STYLE, SIZE, OR COLOR.

SER. NO. 85-624,070, FILED 5-14-2012.

JENNIFER DIXON, EXAMINING ATTORNEY



*David J. Kyffers*

Director of the United States Patent and Trademark Office

# United States of America

United States Patent and Trademark Office



**Reg. No. 4,274,843**

**Registered Jan. 15, 2013**

**Int. Cl.: 35**

**SERVICE MARK**

**PRINCIPAL REGISTER**

CRAVEN, VIRGINIA SEMMES (UNITED STATES INDIVIDUAL)  
701 GRAND CONCOURSE  
MIAMI SHORES, FL 33138

FOR: CHARITABLE SERVICES, NAMELY, PROVIDING A FREE ONLINE RESOURCE IN THE NATURE OF A WEBSITE FOR CONNECTING PEOPLE WHO HAVE SERVICE NEEDS WITH PEOPLE WHO ARE WILLING TO PROVIDE VOLUNTEER SERVICES, IN CLASS 35 (U.S. CLS. 100, 101 AND 102).

FIRST USE 6-1-2011; IN COMMERCE 6-1-2011.

NO CLAIM IS MADE TO THE EXCLUSIVE RIGHT TO USE "CONNECTIONS IN COMMUNITY SERVICE", APART FROM THE MARK AS SHOWN.

THE COLOR(S) BLACK, GREEN, ORANGE, BLUE, WHITE AND GRAY IS/ARE CLAIMED AS A FEATURE OF THE MARK.

THE MARK CONSISTS OF THE WORDS "HIRE GOOD", WITH THE WORD "HIRE" IN BLACK AND THE WORD "GOOD" IN GREEN AT THE BOTTOM OF A BLUE SEMI-CIRCLE WHICH CONTAINS THE WORDING "CONNECTIONS IN COMMUNITY SERVICE" IN WHITE FONT. BETWEEN THE WORDS "HIRE GOOD" AND THE SEMI-CIRCLE ARE THREE "V'S WITH CIRCLES ABOVE THEM REPRESENTING THREE HUMAN TORSOS WITH THEIR ARMS OUTSTRETCHED. THE CIRCLE AND "V" COMBINATION TO THE LEFT IS ORANGE, THE CIRCLE AND "V" COMBINATION IN THE MIDDLE IS BLUE, AND THE CIRCLE AND "V" COMBINATION TO THE RIGHT IS GREEN. THERE IS A GRAY SHADOW OF THE THREE CIRCLE AND "V" COMBINATIONS WHICH FALLS BEHIND THE WORDS "HIRE GOOD".

SER. NO. 85-624,081, FILED 5-14-2012.

JUHI KAVEESHVAR, EXAMINING ATTORNEY



*David J. Kyjars*

Director of the United States Patent and Trademark Office

# United States of America

United States Patent and Trademark Office

## Neck is the new abs

**Reg. No. 4,274,844**

PHILIPSON, ALAN S. (UNITED STATES INDIVIDUAL)  
12070 SW 22ND. CT.

**Registered Jan. 15, 2013**

DAVIE, FL 33325

**Int. Cl.: 28**

FOR: ACCESSORY FOR MANUALLY-OPERATED EXERCISE EQUIPMENT, NAMELY, ACCESSORY ATTACHMENT TO INCREASE MUSCLE RESISTANCE, IN CLASS 28 (U.S. CLS. 22, 23, 38 AND 50).

**TRADEMARK**

FIRST USE 5-1-2012; IN COMMERCE 5-1-2012.

**PRINCIPAL REGISTER**

THE MARK CONSISTS OF STANDARD CHARACTERS WITHOUT CLAIM TO ANY PARTICULAR FONT, STYLE, SIZE, OR COLOR.

SER. NO. 85-624,155, FILED 5-14-2012.

JILL PRATER, EXAMINING ATTORNEY



*David J. Kyffers*

Director of the United States Patent and Trademark Office



# United States of America

United States Patent and Trademark Office



**Reg. No. 4,274,845**

**Registered Jan. 15, 2013**

**Int. Cl.: 41**

**SERVICE MARK**

**PRINCIPAL REGISTER**

MJK IP HOLDING COMPANY, LLC (MASSACHUSETTS LIMITED LIABILITY COMPANY)  
20 BURNETT ROAD  
REVERE, MA 02151

FOR: PROVIDING CLASSES, WORKSHOPS, SEMINARS AND CAMPS IN THE FIELDS OF FITNESS, EXERCISE, BOXING, KICK BOXING AND MIXED MARTIAL ARTS , IN CLASS 41 (U.S. CLS. 100, 101 AND 107).

FIRST USE 2-3-2005; IN COMMERCE 9-1-2005.

NO CLAIM IS MADE TO THE EXCLUSIVE RIGHT TO USE "BOXING", APART FROM THE MARK AS SHOWN.

THE COLOR(S) BLACK, BLUE, RED, AND WHITE IS/ARE CLAIMED AS A FEATURE OF THE MARK.

THE MARK CONSISTS OF A BLACK DIAMOND, ON THE TOP HALF OF WHICH IS IMPOSED THE LETTERS "MK" IN LARGE BLUE TYPE WITH WHITE OUTLINING, AND ON THE BOTTOM HALF OF WHICH IS IMPOSED THE WORD "BOXING" IN SMALLER WHITE TYPE ON A RED, OBLONG BACKGROUND, AS WELL AS AN ILLUSTRATED PAIR OF RED BOXING GLOVES HANGING AT THE BOTTOM POINT OF THE BLACK DIAMOND BELOW THE LETTERING.

SER. NO. 85-624,157, FILED 5-14-2012.

MARTHA FROMM, EXAMINING ATTORNEY



*David J. Kybas*

Director of the United States Patent and Trademark Office

# United States of America

United States Patent and Trademark Office



**Reg. No. 4,274,846**

BLACKMAN, BRETT (UNITED STATES INDIVIDUAL)  
112 S PEARL  
PAOLA, KS 66071

**Registered Jan. 15, 2013**

**Int. Cl.: 35**

FOR: ON-LINE RETAIL STORE SERVICES FEATURING FURNITURE, BEDDING PRODUCTS, AND BEDDING ACCESSORIES; RETAIL STORE SERVICES FEATURING FURNITURE, BEDDING PRODUCTS, AND BEDDING ACCESSORIES , IN CLASS 35 (U.S. CLS. 100, 101 AND 102).

**SERVICE MARK**

**PRINCIPAL REGISTER**

FIRST USE 9-17-2011; IN COMMERCE 11-1-2011.

THE MARK CONSISTS OF THE TEXT "BEDMAX" WITH MOON STYLE GRAPHICS TO THE LEFT, REPRESENTING NIGHT.

SER. NO. 85-624,265, FILED 5-14-2012.

BARNEY CHARLON, EXAMINING ATTORNEY



*David J. Kyffers*

Director of the United States Patent and Trademark Office

# United States of America

United States Patent and Trademark Office

## TEACHING THE ART AND SPIRITUALITY OF CURRENCY TRADING

**Reg. No. 4,274,847**

LIONHEART TRADING (COLORADO LIMITED LIABILITY COMPANY)  
4483 EAST BENNINGTON AVE.  
CASTLE ROCK, CO 80104

**Registered Jan. 15, 2013**

**Int. Cl.: 41**

FOR: COACHING AND TEACHING IN THE FIELD OF FOREIGN CURRENCY TRADING  
IN FOREX MARKET, IN CLASS 41 (U.S. CLS. 100, 101 AND 107).

**SERVICE MARK**

FIRST USE 4-20-2012; IN COMMERCE 4-20-2012.

**PRINCIPAL REGISTER**

THE MARK CONSISTS OF STANDARD CHARACTERS WITHOUT CLAIM TO ANY PAR-  
TICULAR FONT, STYLE, SIZE, OR COLOR.

SER. NO. 85-624,273, FILED 5-14-2012.

CHRISTINA SOBRAL, EXAMINING ATTORNEY



*David J. Kyffers*

Director of the United States Patent and Trademark Office

# United States of America

United States Patent and Trademark Office

# BUOY TAGS

**Reg. No. 4,274,848**

**Registered Jan. 15, 2013**

**Int. Cl.: 20**

**TRADEMARK**

**PRINCIPAL REGISTER**

BUOY TAGS, LLC (CALIFORNIA LIMITED LIABILITY COMPANY)  
1523 GORDON STREET  
#7  
LOS ANGELES, CA 90028

FOR: MARKERS MADE OF PLASTIC MATERIAL FOR MARKING CABLES, NAMELY, CUSTOMIZABLE LABELS USED TO IDENTIFY CABLES, IN CLASS 20 (U.S. CLS. 2, 13, 22, 25, 32 AND 50).

FIRST USE 4-16-2012; IN COMMERCE 4-16-2012.

THE MARK CONSISTS OF STANDARD CHARACTERS WITHOUT CLAIM TO ANY PARTICULAR FONT, STYLE, SIZE, OR COLOR.

NO CLAIM IS MADE TO THE EXCLUSIVE RIGHT TO USE "TAGS", APART FROM THE MARK AS SHOWN.

SER. NO. 85-624,310, FILED 5-14-2012.

CAROLINE WOOD, EXAMINING ATTORNEY



*David J. Kyffers*

Director of the United States Patent and Trademark Office

# United States of America

United States Patent and Trademark Office

## PULLING DOWN THE MOON

**Reg. No. 4,274,849**

**Registered Jan. 15, 2013**

**Int. Cl.: 5**

**TRADEMARK**

**PRINCIPAL REGISTER**

PULLING DOWN THE MOON, INC. (ILLINOIS CORPORATION)  
900 NORTH KINGSBURY STREET RIVERWALK 6-A  
CHICAGO, IL 60610

FOR: VITAMINS AND DIETARY AND NUTRITIONAL SUPPLEMENTS, IN CLASS 5 (U.S. CLS. 6, 18, 44, 46, 51 AND 52).

FIRST USE 9-0-2009; IN COMMERCE 9-0-2009.

THE MARK CONSISTS OF STANDARD CHARACTERS WITHOUT CLAIM TO ANY PARTICULAR FONT, STYLE, SIZE, OR COLOR.

OWNER OF U.S. REG. NO. 3,240,241.

SER. NO. 85-624,368, FILED 5-14-2012.

DAVID COLLIER, EXAMINING ATTORNEY



*David J. Kyros*

Director of the United States Patent and Trademark Office

# United States of America

United States Patent and Trademark Office

## PHYSICIANS CHOICE DIALYSIS

**Reg. No. 4,274,850**

**Registered Jan. 15, 2013**

**Int. Cl.: 44**

PHYSICIANS CHOICE MANAGEMENT, LLC (PENNSYLVANIA LIMITED LIABILITY COMPANY)  
211 COMMERCE COURT  
SUITE 104  
POTTSTOWN, PA 19464

**SERVICE MARK**

FOR: MEDICAL SERVICES, NAMELY, DIALYSIS AND THE TREATMENT OF KIDNEY DISEASE, IN CLASS 44 (U.S. CLS. 100 AND 101).

**PRINCIPAL REGISTER**

FIRST USE 1-0-2004; IN COMMERCE 1-0-2004.

THE MARK CONSISTS OF STANDARD CHARACTERS WITHOUT CLAIM TO ANY PARTICULAR FONT, STYLE, SIZE, OR COLOR.

NO CLAIM IS MADE TO THE EXCLUSIVE RIGHT TO USE "PHYSICIANS" OR "DIALYSIS", APART FROM THE MARK AS SHOWN.

SER. NO. 85-624,387, FILED 5-14-2012.

KATHERINE CHANG, EXAMINING ATTORNEY



*David J. Kyffers*

Director of the United States Patent and Trademark Office

# United States of America

United States Patent and Trademark Office

# SMARTVIERA

**Reg. No. 4,274,851**

**Registered Jan. 15, 2013**

**Int. Cl.: 9**

**TRADEMARK**

**PRINCIPAL REGISTER**

PANASONIC CORPORATION (JAPAN CORPORATION)  
1006 OAZA KADOMA, KADOMA-SHI  
OSAKA, JAPAN 571-8501

FOR: TELEVISION SETS, IN CLASS 9 (U.S. CLS. 21, 23, 26, 36 AND 38).

FIRST USE 1-10-2012; IN COMMERCE 1-10-2012.

OWNER OF U.S. REG. NOS. 3,550,804, 4,168,747 AND OTHERS.

THE COLOR(S) BLACK, BLUE AND DARK BLUE IS/ARE CLAIMED AS A FEATURE OF THE MARK.

THE MARK CONSISTS OF THE STYLIZED LETTERS "SMAR" IN BLACK, THE LETTERS "TV" IN BLACK AND BLUE, THE STYLIZED LETTERS "IERA" IN BLACK AND AN INCOMPLETE CURVED CIRCLE IN BLUE AND DARK BLUE.

SER. NO. 85-624,433, FILED 5-14-2012.

EDWARD NELSON, EXAMINING ATTORNEY



*David J. Kyffers*

Director of the United States Patent and Trademark Office

# United States of America

United States Patent and Trademark Office

## GIFTS WITH PERSONAL-ITY

**Reg. No. 4,274,852**

BRONNER DISPLAY & SIGN ADVERTISING, INC. (MICHIGAN CORPORATION)  
25 CHRISTMAS LANE  
FRANKENMUTH, MI 48734

**Registered Jan. 15, 2013**

**Int. Cl.: 40**

FOR: DECORATING SERVICES, NAMELY, CUSTOM DECORATING OF CHRISTMAS AND HOLIDAY ORNAMENTS AND DECORATIONS, CAPS AND STOCKINGS FOR OTHERS , IN CLASS 40 (U.S. CLS. 100, 103 AND 106).

**SERVICE MARK**

FIRST USE 8-7-2007; IN COMMERCE 8-7-2007.

**PRINCIPAL REGISTER**

THE MARK CONSISTS OF STANDARD CHARACTERS WITHOUT CLAIM TO ANY PARTICULAR FONT, STYLE, SIZE, OR COLOR.

SER. NO. 85-624,459, FILED 5-14-2012.

DAVID ELTON, EXAMINING ATTORNEY



*David J. Kyfos*

Director of the United States Patent and Trademark Office



# United States of America

United States Patent and Trademark Office



**Reg. No. 4,274,853**

**Registered Jan. 15, 2013**

**Int. Cl.: 44**

PHYSICIANS CHOICE MANAGEMENT, LLC (PENNSYLVANIA LIMITED LIABILITY COMPANY)  
211 COMMERCE COURT  
SUITE 104  
POTTSTOWN, PA 19464

**SERVICE MARK**

FOR: MEDICAL SERVICES, NAMELY, DIALYSIS AND THE TREATMENT OF KIDNEY DISEASE, IN CLASS 44 (U.S. CLS. 100 AND 101).

**PRINCIPAL REGISTER**

FIRST USE 1-0-2004; IN COMMERCE 1-0-2004.

NO CLAIM IS MADE TO THE EXCLUSIVE RIGHT TO USE "PHYSICIANS" OR "DIALYSIS", APART FROM THE MARK AS SHOWN.

THE COLOR(S) GRAY AND GREEN IS/ARE CLAIMED AS A FEATURE OF THE MARK.

THE MARK CONSISTS OF THE WORDS "PHYSICIANS CHOICE DIALYSIS" IN GRAY WITH THE LETTER "O" OF "CHOICE" IN GREEN AND STYLIZED AS AN IMAGE OF A STETHOSCOPE IN GREEN, ALL ON A TRANSPARENT BACKGROUND.

SER. NO. 85-624,476, FILED 5-14-2012.

KATHERINE CHANG, EXAMINING ATTORNEY



*David J. Kyjars*

Director of the United States Patent and Trademark Office

# United States of America

United States Patent and Trademark Office

## Salisbury University

**Reg. No. 4,274,854**

SALISBURY UNIVERSITY (MARYLAND STATE UNIVERSITY)  
1101 HOLLOWAY HALL  
SALISBURY, MD 21801

**Registered Jan. 15, 2013**

**Int. Cl.: 41**

**SERVICE MARK**

**PRINCIPAL REGISTER**

FOR: EDUCATIONAL SERVICES, NAMELY, DEVELOPING, ARRANGING FOR AND PROVIDING COURSES OF INSTRUCTION AT THE UNDERGRADUATE, GRADUATE AND POSTGRADUATE UNIVERSITY LEVELS; CONTINUING AND COMMUNITY EDUCATION SERVICES, NAMELY, PROVIDING LIVE AND ON-LINE CONTINUING EDUCATION SEMINARS IN THE LEGAL, BUSINESS, ARTS, SCIENCES AND PUBLIC AFFAIRS FIELDS; DEVELOPING AND ARRANGING FOR AND PROVIDING SEMINARS, EDUCATIONAL CONFERENCES AND WORKSHOPS IN THE FIELDS OF AGRICULTURE AND NATURAL RESOURCES, ARCHITECTURE, ARTS AND HUMANITIES, BEHAVIORAL AND SOCIAL SCIENCES, BUSINESS, COMPUTER, MATHEMATICAL AND PHYSICAL SCIENCES, EDUCATION, ENGINEERING, HEALTH AND HUMAN PERFORMANCE, JOURNALISM, LIBRARY AND INFORMATION SERVICES, LIFE SCIENCES, AND PUBLIC AFFAIRS AND DISTRIBUTING COURSE, SEMINAR, CONFERENCE AND WORKSHOP MATERIALS IN CONNECTION THEREWITH IN THE FIELDS OF AGRICULTURE AND NATURAL RESOURCES, ARCHITECTURE, ARTS AND HUMANITIES, BEHAVIORAL AND SOCIAL SCIENCES, BUSINESS, COMPUTER, MATHEMATICAL AND PHYSICAL SCIENCES, EDUCATION, ENGINEERING, HEALTH AND HUMAN PERFORMANCE, JOURNALISM, LIBRARY AND INFORMATION SERVICES, LIFE SCIENCES, AND PUBLIC AFFAIRS; DEVELOPING EDUCATIONAL MANUALS FOR OTHERS IN THE FIELDS OF AGRICULTURE AND NATURAL RESOURCES, ARCHITECTURE, ARTS AND HUMANITIES, BEHAVIORAL AND SOCIAL SCIENCES, BUSINESS, COMPUTER, MATHEMATICAL AND PHYSICAL SCIENCES, EDUCATION, ENGINEERING, HEALTH AND HUMAN PERFORMANCE, JOURNALISM, LIBRARY AND INFORMATION SERVICES, LIFE SCIENCES, AND PUBLIC AFFAIRS; CONDUCTING EDUCATIONAL DEMONSTRATIONS, RESEARCH AND TESTING; ISSUING AWARDS AND/OR DEGREES TO PERSONS WHO DEMONSTRATE EXCELLENCE IN ACADEMIC AND RESEARCH ENDEAVORS; ORGANIZING AND OFFERING EDUCATIONAL, CULTURAL, SPORTING EVENTS AND ENTERTAINMENT PROGRAMS, PERFORMANCES AND EXHIBITIONS IN THE NATURE OF ART EXHIBITS, LIVE THEATRICAL PERFORMANCES, LIVE MUSICAL PERFORMANCES IN THE FORM OF OPERAS, MUSICALS, ORCHESTRAL, BAND, JAZZ AND STRING ENSEMBLES, LECTURES ON ISSUES AND TOPICS RELATED TO THE FIELDS OF AGRICULTURE AND NATURAL RESOURCES, ARCHITECTURE, ARTS AND HUMANITIES, BEHAVIORAL AND SOCIAL SCIENCES, BUSINESS, COMPUTER, MATHEMATICAL AND PHYSICAL SCIENCES, EDUCATION, ENGINEERING, HEALTH AND HUMAN PERFORMANCE, JOURNALISM,



*David J. Kybas*

Director of the United States Patent and Trademark Office

**Reg. No. 4,274,854** LIBRARY AND INFORMATION SERVICES, LIFE SCIENCES, AND PUBLIC AFFAIRS; PUBLISHING SCHOLARLY PUBLICATIONS, NAMELY, THESES, DISSERTATIONS, AND SCHOLARLY PAPERS, IN THE AFOREMENTIONED FIELDS, IN CLASS 41 (U.S. CLS. 100, 101 AND 107).

FIRST USE 7-1-2001; IN COMMERCE 7-1-2001.

THE MARK CONSISTS OF STANDARD CHARACTERS WITHOUT CLAIM TO ANY PARTICULAR FONT, STYLE, SIZE, OR COLOR.

OWNER OF U.S. REG. NOS. 3,969,216 AND 3,969,218.

NO CLAIM IS MADE TO THE EXCLUSIVE RIGHT TO USE "UNIVERSITY", APART FROM THE MARK AS SHOWN.

SEC. 2(F).

SER. NO. 85-624,560, FILED 5-14-2012.

B. PARADEWELAI, EXAMINING ATTORNEY

# United States of America

United States Patent and Trademark Office

# Mikky Ekko

**Reg. No. 4,274,855**

SUDDUTH, STEVE (UNITED STATES INDIVIDUAL)

**Registered Jan. 15, 2013**

P.O. BOX 120434  
NASHVILLE, TN 37212

**Int. Cl.: 41**

**SERVICE MARK**

**PRINCIPAL REGISTER**

FOR: ENTERTAINMENT IN THE NATURE OF VISUAL AND AUDIO PERFORMANCES, NAMELY, MUSICAL BAND, ROCK GROUP, GYMNASTIC, DANCE, AND BALLET PERFORMANCES; ENTERTAINMENT SERVICES BY A MUSICAL ARTIST AND PRODUCER, NAMELY, MUSICAL COMPOSITION FOR OTHERS AND PRODUCTION OF MUSICAL SOUND RECORDINGS; ENTERTAINMENT SERVICES IN THE NATURE OF LIVE MUSICAL PERFORMANCES; ENTERTAINMENT SERVICES IN THE NATURE OF RECORDING, PRODUCTION AND POST-PRODUCTION SERVICES IN THE FIELD OF MUSIC; ENTERTAINMENT, NAMELY, LIVE PERFORMANCES BY A MUSICAL BAND; MULTIMEDIA ENTERTAINMENT SERVICES IN THE NATURE OF RECORDING, PRODUCTION AND POST-PRODUCTION SERVICES IN THE FIELDS OF MUSIC, VIDEO, AND FILMS; MUSIC COMPOSITION SERVICES; MUSIC PRODUCTION SERVICES; MUSIC PUBLISHING SERVICES; SONG WRITING SERVICES, IN CLASS 41 (U.S. CLS. 100, 101 AND 107).

FIRST USE 8-20-2008; IN COMMERCE 8-20-2008.

THE MARK CONSISTS OF STANDARD CHARACTERS WITHOUT CLAIM TO ANY PARTICULAR FONT, STYLE, SIZE, OR COLOR.

THE NAME "MIKKY EKKO" IDENTIFIES THE STAGE NAME OF STEVE SUDDUTH, A LIVING INDIVIDUAL WHOSE CONSENT IS OF RECORD.

SER. NO. 85-624,686, FILED 5-14-2012.

DAVID YONTEF, EXAMINING ATTORNEY



*David J. Kyffers*

Director of the United States Patent and Trademark Office

# United States of America

United States Patent and Trademark Office

## WORLD CLASS QUEST

**Reg. No. 4,274,856**

ENCHANTED SPRINGS RANCH (TEXAS PARTNERSHIP)  
242 HIGHWAY 46 WEST  
BOERNE, TX 78006

**Registered Jan. 15, 2013**

**Int. Cl.: 41**

FOR: EDUCATIONAL SERVICES, NAMELY, PROVIDING SEMINARS AND COURSE TRAINING IN PERSONAL GROWTH, TEAM BUILDING, PROBLEM SOLVING, BUSINESS MANAGEMENT, CHANGE MANAGEMENT, LEADERSHIP AND MENTORING, IN CLASS 41 (U.S. CLS. 100, 101 AND 107).

**SERVICE MARK**

**PRINCIPAL REGISTER**

FIRST USE 4-29-2011; IN COMMERCE 4-29-2011.

THE MARK CONSISTS OF STANDARD CHARACTERS WITHOUT CLAIM TO ANY PARTICULAR FONT, STYLE, SIZE, OR COLOR.

NO CLAIM IS MADE TO THE EXCLUSIVE RIGHT TO USE "WORLD CLASS", APART FROM THE MARK AS SHOWN.

SER. NO. 85-624,806, FILED 5-14-2012.

TARAH HARDY, EXAMINING ATTORNEY



*David J. Kyffers*

Director of the United States Patent and Trademark Office

# United States of America

United States Patent and Trademark Office



**MADE IN  
PORTLAND**

**Reg. No. 4,274,857**

PLYWERK, INC. (OREGON CORPORATION)  
3975 NE MALLORY AVE.  
PORTLAND, OR 97212

**Registered Jan. 15, 2013**

**Int. Cl.: 16**

FOR: PHOTOGRAPH MOUNTS MADE OF BAMBOO OR WOOD, IN CLASS 16 (U.S. CLS. 2, 5, 22, 23, 29, 37, 38 AND 50).

**TRADEMARK**

FIRST USE 5-14-2012; IN COMMERCE 5-14-2012.

**PRINCIPAL REGISTER**

NO CLAIM IS MADE TO THE EXCLUSIVE RIGHT TO USE "MADE IN PORTLAND", APART FROM THE MARK AS SHOWN.

THE MARK CONSISTS OF THE WORDS "MADE IN PORTLAND" UNDER A STYLIZED DRAWING OF A LEAF.

SER. NO. 85-624,811, FILED 5-14-2012.

EMILY CARLSEN, EXAMINING ATTORNEY



*David J. Kyffers*

Director of the United States Patent and Trademark Office

# United States of America

United States Patent and Trademark Office



**Duffy's Irish Pub • DC Irish**

**Reg. No. 4,274,858**

**Registered Jan. 15, 2013**

**Int. Cl.: 43**

**SERVICE MARK**

**PRINCIPAL REGISTER**

DUFFY, ANDREW (UNITED STATES INDIVIDUAL)  
2106 VERMONT AVE NW  
WASHINGTON, DC 20001

FOR: BAR SERVICES; PUBS; RESTAURANT SERVICES, IN CLASS 43 (U.S. CLS. 100 AND 101).

FIRST USE 1-1-2009; IN COMMERCE 1-1-2009.

NO CLAIM IS MADE TO THE EXCLUSIVE RIGHT TO USE "IRISH PUB" AND "DC IRISH", APART FROM THE MARK AS SHOWN.

THE COLOR(S) GREEN AND RED IS/ARE CLAIMED AS A FEATURE OF THE MARK.

THE MARK CONSISTS OF THREE GREEN SHAMROCKS ABOVE TWO RED BARS, AND THE GREEN TEXT "DUFFY'S IRISH PUB • DC IRISH" BELOW THE BOTTOM BAR. THE COLOR WHITE REPRESENTS TRANSPARENT AREAS AND ARE NOT PART OF THE MARK.

SER. NO. 85-624,890, FILED 5-14-2012.

ALEX KEAM, EXAMINING ATTORNEY



*David J. Kyffers*

Director of the United States Patent and Trademark Office

# United States of America

United States Patent and Trademark Office



**Reg. No. 4,274,859**

**Registered Jan. 15, 2013**

**Int. Cl.: 42**

**SERVICE MARK**

**PRINCIPAL REGISTER**

ANTONE G. BARNES (UNITED STATES INDIVIDUAL)  
12115 CHIP SHOT LANE  
UPPER MARLBORO, MD 20772

FOR: ARCHITECTURAL DESIGN; DESIGN OF INTERIOR DECOR; DESIGN OF SPECIALTY INTERIOR AND EXTERIOR ENVIRONMENT SETTINGS; INTERIOR DECORATING; INTERIOR DECORATION CONSULTATION; INTERIOR DESIGN SERVICES; INTERIOR DESIGN SERVICES INCLUDING SPACE PLANNING, FURNITURE SELECTION, MATERIAL AND SURFACE SELECTION; INTERIOR STYLING SERVICES; LANDSCAPE ARCHITECTURAL DESIGN; LANDSCAPE LIGHTING DESIGN; PAINT MATCHING, NAMELY, COLOR ANALYSIS TO DETERMINE PROPER PAINT MIXTURE FOR MATCHING COLORS FOR INTERIOR DECORATING PURPOSES; PLANNING AND LAYOUT DESIGN SERVICES FOR INTERIOR AND EXTERIOR SPACES, IN CLASS 42 (U.S. CLS. 100 AND 101).

FIRST USE 7-1-2011; IN COMMERCE 12-4-2011.

NO CLAIM IS MADE TO THE EXCLUSIVE RIGHT TO USE "MODERN" AND "DESIGN", APART FROM THE MARK AS SHOWN.

THE COLOR(S) SILVER, BLACK, WHITE, ORANGE, BURGUNDY, AND BURNT ORANGE IS/ARE CLAIMED AS A FEATURE OF THE MARK.

THE MARK CONSISTS OF "MCD" IN SILVER AND "MODERN CLASS DESIGN" IN BLACK LETTERS ON WHITE BACKGROUND UNDER THE "MCD". THE BACK IS COVERED WITH ORANGE, BURGUNDY, BURNT ORANGE AND BLACK ALONG THE SIDES.

SER. NO. 85-624,896, FILED 5-14-2012.

ALEX KEAM, EXAMINING ATTORNEY



*David J. Kybas*

Director of the United States Patent and Trademark Office



# United States of America

United States Patent and Trademark Office

## Systematic Optical Surveillance

**Reg. No. 4,274,860**

**Registered Jan. 15, 2013**

**Int. Cl.: 41**

**SERVICE MARK**

**PRINCIPAL REGISTER**

MORGANDO, JOHN C. (UNITED STATES INDIVIDUAL)  
2160 E. FRY BLVD  
STE C5 #204  
SIERRA VISTA, AZ 85635

FOR: TRAINING SERVICES IN THE FIELD OF MILITARY, MILITARY TACTICS, AND STRATEGIES, IN CLASS 41 (U.S. CLS. 100, 101 AND 107).

FIRST USE 6-3-2004; IN COMMERCE 6-3-2004.

THE MARK CONSISTS OF STANDARD CHARACTERS WITHOUT CLAIM TO ANY PARTICULAR FONT, STYLE, SIZE, OR COLOR.

SEC. 2(F).

SER. NO. 85-624,908, FILED 5-14-2012.

KATHERINE M. DUBRAY, EXAMINING ATTORNEY



*David J. Kyffers*

Director of the United States Patent and Trademark Office

# United States of America

United States Patent and Trademark Office

## ADOBE SPRINGS CREATIONS

**Reg. No. 4,274,861**

ADOBE SPRINGS CREATIONS, LLC (CALIFORNIA LIMITED LIABILITY COMPANY)  
P.O. BOX 4011  
PASO ROBLES, CA 93447

**Registered Jan. 15, 2013**

**Int. Cl.: 29**

FOR: EDIBLE OILS, IN CLASS 29 (U.S. CL. 46).

**TRADEMARK**

FIRST USE 8-1-2009; IN COMMERCE 8-1-2009.

**PRINCIPAL REGISTER**

THE MARK CONSISTS OF STANDARD CHARACTERS WITHOUT CLAIM TO ANY PARTICULAR FONT, STYLE, SIZE, OR COLOR.

NO CLAIM IS MADE TO THE EXCLUSIVE RIGHT TO USE "ADOBE SPRINGS", APART FROM THE MARK AS SHOWN.

SER. NO. 85-624,986, FILED 5-14-2012.

AMY ALFIERI, EXAMINING ATTORNEY



*David J. Kyffers*

Director of the United States Patent and Trademark Office

# United States of America

United States Patent and Trademark Office

## JUST PLAIN CARING

**Reg. No. 4,274,862**

THE GVTC FOUNDATION (TEXAS CORPORATION)  
36101 FM 3159

**Registered Jan. 15, 2013**

NEW BRAUNFELS, TX 78132

**Int. Cls.: 35 and 36**

FOR: CHARITABLE SERVICES, NAMELY, ORGANIZING AND DEVELOPING PROJECTS THAT AIM TO IMPROVE THE LIVES OF UNDERPRIVILEGED AND IMPOVERISHED PEOPLE, AND ORGANIZING AND CONDUCTING VOLUNTEER PROGRAMS AND COMMUNITY SERVICE PROJECTS, IN CLASS 35 (U.S. CLS. 100, 101 AND 102).

**SERVICE MARK**

**PRINCIPAL REGISTER**

FIRST USE 12-31-2009; IN COMMERCE 12-31-2009.

FOR: CHARITABLE FOUNDATION SERVICES, NAMELY, PROVIDING FINANCIAL ASSISTANCE FOR PROGRAMS AND SERVICES OF OTHERS; AND CHARITABLE FUNDRAISING SERVICES, IN CLASS 36 (U.S. CLS. 100, 101 AND 102).

FIRST USE 12-31-2009; IN COMMERCE 12-31-2009.

THE MARK CONSISTS OF STANDARD CHARACTERS WITHOUT CLAIM TO ANY PARTICULAR FONT, STYLE, SIZE, OR COLOR.

SER. NO. 85-625,023, FILED 5-14-2012.

TINA MAI, EXAMINING ATTORNEY



*David J. Kybas*

Director of the United States Patent and Trademark Office

# United States of America

United States Patent and Trademark Office

## THE GVTC FOUNDATION

**Reg. No. 4,274,863**

THE GVTC FOUNDATION (TEXAS CORPORATION)  
36101 FM 3159

**Registered Jan. 15, 2013**

NEW BRAUNFELS, TX 78132

**Int. Cls.: 35 and 36**

FOR: CHARITABLE SERVICES, NAMELY, ORGANIZING AND DEVELOPING PROJECTS THAT AIM TO IMPROVE THE LIVES OF UNDERPRIVILEGED AND IMPOVERISHED PEOPLE, AND ORGANIZING AND CONDUCTING VOLUNTEER PROGRAMS AND COMMUNITY SERVICE PROJECTS, IN CLASS 35 (U.S. CLS. 100, 101 AND 102).

**SERVICE MARK**

**PRINCIPAL REGISTER**

FIRST USE 12-31-2009; IN COMMERCE 12-31-2009.

FOR: CHARITABLE FOUNDATION SERVICES, NAMELY, PROVIDING FINANCIAL ASSISTANCE FOR PROGRAMS AND SERVICES OF OTHERS; AND CHARITABLE FUNDRAISING SERVICES, IN CLASS 36 (U.S. CLS. 100, 101 AND 102).

FIRST USE 12-31-2009; IN COMMERCE 12-31-2009.

THE MARK CONSISTS OF STANDARD CHARACTERS WITHOUT CLAIM TO ANY PARTICULAR FONT, STYLE, SIZE, OR COLOR.

NO CLAIM IS MADE TO THE EXCLUSIVE RIGHT TO USE "FOUNDATION", APART FROM THE MARK AS SHOWN.

SER. NO. 85-625,027, FILED 5-14-2012.

TINA MAI, EXAMINING ATTORNEY



*David J. Kyros*

Director of the United States Patent and Trademark Office

# United States of America

United States Patent and Trademark Office

# DOPE HOP

**Reg. No. 4,274,864**

**Registered Jan. 15, 2013**

**Int. Cl.: 45**

4 SURE ENTERTAINMENT LLC (MARYLAND LIMITED LIABILITY COMPANY), DBA  
DOPE HOP  
3061 FREDRICK AVE  
SUITE 129  
BALTIMORE, MD 21223

**SERVICE MARK**

**PRINCIPAL REGISTER**

FOR: ON-LINE SOCIAL NETWORKING SERVICES, IN CLASS 45 (U.S. CLS. 100 AND 101).

FIRST USE 4-9-2011; IN COMMERCE 4-9-2011.

THE MARK CONSISTS OF STANDARD CHARACTERS WITHOUT CLAIM TO ANY PARTICULAR FONT, STYLE, SIZE, OR COLOR.

SER. NO. 85-625,084, FILED 5-14-2012.

CHERYL CLAYTON, EXAMINING ATTORNEY



*David J. Kyffers*

Director of the United States Patent and Trademark Office

# United States of America

United States Patent and Trademark Office

## Sedona Real Inn & Suites

**Reg. No. 4,274,865**

**Registered Jan. 15, 2013**

**Int. Cl.: 43**

**SERVICE MARK**

**PRINCIPAL REGISTER**

SEDONA REAL INN, LLC (NEVADA LIMITED LIABILITY COMPANY), DBA SEDONA  
REAL INN & SUITES  
95 ARROYO PINON DRIVE  
SEDONA, AZ 86336

FOR: HOTEL SERVICES, IN CLASS 43 (U.S. CLS. 100 AND 101).

FIRST USE 11-1-1996; IN COMMERCE 11-1-1996.

THE MARK CONSISTS OF STANDARD CHARACTERS WITHOUT CLAIM TO ANY PARTICULAR FONT, STYLE, SIZE, OR COLOR.

NO CLAIM IS MADE TO THE EXCLUSIVE RIGHT TO USE "SEDONA" AND "INN & SUITES", APART FROM THE MARK AS SHOWN.

SER. NO. 85-625,100, FILED 5-14-2012.

CHARLES L. JENKINS, EXAMINING ATTORNEY



*David J. Kybas*

Director of the United States Patent and Trademark Office

# United States of America

United States Patent and Trademark Office

## GREEN LIKE YOU'VE NEVER SEEN

**Reg. No. 4,274,866**

ECOLOGY, LLC (MISSOURI LIMITED LIABILITY COMPANY)  
P.O. BOX 15053

**Registered Jan. 15, 2013**

ST. LOUIS, MO 63110

**Int. Cl.: 3**

FOR: ENVIRONMENTALLY FRIENDLY CLEANING PREPARATIONS FOR HOUSEHOLD PURPOSES, IN CLASS 3 (U.S. CLS. 1, 4, 6, 50, 51 AND 52).

**TRADEMARK**

FIRST USE 5-9-2012; IN COMMERCE 5-9-2012.

**PRINCIPAL REGISTER**

THE MARK CONSISTS OF STANDARD CHARACTERS WITHOUT CLAIM TO ANY PARTICULAR FONT, STYLE, SIZE, OR COLOR.

SER. NO. 85-625,228, FILED 5-15-2012.

MATTHEW GALAN, EXAMINING ATTORNEY



*David J. Kybas*

Director of the United States Patent and Trademark Office

# United States of America

United States Patent and Trademark Office



## OVATION

**Reg. No. 4,274,867**

**Registered Jan. 15, 2013**

**Int. Cl.: 3**

**TRADEMARK**

**PRINCIPAL REGISTER**

DC LABS (DELAWARE CORPORATION)  
PO BOX 130008  
CARLSBAD, CA 92013

FOR: HAIR CARE PREPARATIONS, IN CLASS 3 (U.S. CLS. 1, 4, 6, 50, 51 AND 52).

FIRST USE 11-0-2007; IN COMMERCE 12-0-2007.

OWNER OF U.S. REG. NOS. 4,082,488, 4,082,489, AND 4,142,800.

THE MARK CONSISTS OF A CIRCLE WITH AN INTERIOR DESIGN OF CURVED LINES ABOVE THE WORD "OVATION".

SER. NO. 85-625,369, FILED 5-15-2012.

JOHN DWYER, EXAMINING ATTORNEY



*David J. Kybas*

Director of the United States Patent and Trademark Office



# United States of America

United States Patent and Trademark Office

# APERSEE

**Reg. No. 4,274,868**

APERSEE, LLC (MINNESOTA LIMITED LIABILITY COMPANY)  
1374 LINCOLN AVENUE  
ST. PAUL, MN 55105

**Registered Jan. 15, 2013**

**Int. Cl.: 35**

FOR: COMMERCIAL INFORMATION SERVICES IN THE FIELD OF LITIGATION SUPPORT PRODUCTS AND SERVICES, NAMELY, PROVIDING A WEBSITE FEATURING PRODUCT RATINGS, DESCRIPTIONS, AND PRICING FOR ELECTRONIC LITIGATION SUPPORT PRODUCTS AND SERVICES, INCLUDING A DATABASE OF ELECTRONIC LITIGATION SUPPORT PRODUCTS AND SERVICE PROVIDERS, IN CLASS 35 (U.S. CLS. 100, 101 AND 102).

**SERVICE MARK**

**PRINCIPAL REGISTER**

FIRST USE 9-30-2010; IN COMMERCE 1-30-2011.

THE MARK CONSISTS OF STANDARD CHARACTERS WITHOUT CLAIM TO ANY PARTICULAR FONT, STYLE, SIZE, OR COLOR.

THE WORD "APERSEE" HAS NO MEANING IN A FOREIGN LANGUAGE.

SER. NO. 85-625,443, FILED 5-15-2012.

JASON LOTT, EXAMINING ATTORNEY



*David J. Kybas*

Director of the United States Patent and Trademark Office

# United States of America

United States Patent and Trademark Office

# MyCurator

**Reg. No. 4,274,869**

MCT RESEARCH LLC (MAINE LIMITED LIABILITY COMPANY)  
1016 DON GASPAR AV  
SANTA FE, NM 87505

**Registered Jan. 15, 2013**

**Int. Cl.: 42**

FOR: CLOUD COMPUTING FEATURING SOFTWARE FOR USE AS A CONTENT CURATION TOOL IN THE NATURE OF SEARCH ENGINE THAT FILTERS FOR TARGETED INFORMATION, GATHERS THE RESULTING INFORMATION AND THEN ALLOWS USERS TO PERSONALIZE THE INFORMATION, IN CLASS 42 (U.S. CLS. 100 AND 101).

**SERVICE MARK**

**PRINCIPAL REGISTER**

FIRST USE 2-12-2012; IN COMMERCE 2-12-2012.

THE MARK CONSISTS OF STANDARD CHARACTERS WITHOUT CLAIM TO ANY PARTICULAR FONT, STYLE, SIZE, OR COLOR.

SER. NO. 85-625,468, FILED 5-15-2012.

KIM SAITO, EXAMINING ATTORNEY



*David J. Kyffers*

Director of the United States Patent and Trademark Office

# United States of America

United States Patent and Trademark Office



*Customers, Sales, Profits... Delivered!*

**Reg. No. 4,274,870**

**Registered Jan. 15, 2013**

**Int. Cl.: 35**

**SERVICE MARK**

**PRINCIPAL REGISTER**

CALVERT, PHILIP (ARIZONA CORPORATION)  
7418 EAST HELM DRIVE  
STE 108  
SCOTTSDALE, AZ 85260

FOR: BUSINESS MARKETING AND DIRECT MAIL CONSULTING SERVICES, IN CLASS 35 (U.S. CLS. 100, 101 AND 102).

FIRST USE 3-1-2003; IN COMMERCE 3-1-2003.

NO CLAIM IS MADE TO THE EXCLUSIVE RIGHT TO USE "DIRECT MARKETING CUSTOMERS SALES PROFITS", APART FROM THE MARK AS SHOWN.

THE MARK CONSISTS OF A MOUNTAIN WITH 6 DISTINCT ANGLES AND AN ATTACHED RISING SUN, ABOVE THE WORDS "PINNACLE DIRECT MARKETING", ABOVE THE WORDS, "CUSTOMERS, SALES, PROFITS... DELIVERED!".

SER. NO. 85-625,827, FILED 5-15-2012.

CHRIS WELLS, EXAMINING ATTORNEY



*David J. Kyffers*

Director of the United States Patent and Trademark Office

# United States of America

United States Patent and Trademark Office

# Little Inferno

**Reg. No. 4,274,871**

**Registered Jan. 15, 2013**

**Int. Cl.: 9**

**TRADEMARK**

**PRINCIPAL REGISTER**

EXPERIMENTAL GAMEPLAY GROUP, LLC (FLORIDA LIMITED LIABILITY COMPANY),  
DBA TOMORROW CORPORATION, LLC  
2854 MULFORD AVE  
WINTER PARK, FL 32789

FOR: COMPUTER PROGRAMS FOR VIDEO COMPUTER GAMES, COMPUTER VIDEO  
GAME SOFTWARE, COMPUTER GAME SOFTWARE DOWNLOADABLE FROM A GLOBAL  
COMPUTER NETWORK, IN CLASS 9 (U.S. CLS. 21, 23, 26, 36 AND 38).

FIRST USE 8-9-2010; IN COMMERCE 7-10-2012.

THE MARK CONSISTS OF STANDARD CHARACTERS WITHOUT CLAIM TO ANY PAR-  
TICULAR FONT, STYLE, SIZE, OR COLOR.

SER. NO. 85-625,835, FILED 5-15-2012.

LOURDES AYALA, EXAMINING ATTORNEY



*David J. Kybas*

Director of the United States Patent and Trademark Office

# United States of America

United States Patent and Trademark Office

## 2012 THE MAYAN PROPHECY

**Reg. No. 4,274,872**

**Registered Jan. 15, 2013**

**Int. Cl.: 33**

**TRADEMARK**

**PRINCIPAL REGISTER**

GEM SPIRITS, LLC (NEW JERSEY LIMITED LIABILITY COMPANY)  
4 WALTER FORAN BLVD.  
SUITE 406  
FLEMINGTON, NJ 08822

FOR: ALCOHOLIC BEVERAGES, NAMELY, TEQUILA, IN CLASS 33 (U.S. CLS. 47 AND 49).

FIRST USE 11-17-2010; IN COMMERCE 8-4-2011.

THE MARK CONSISTS OF STANDARD CHARACTERS WITHOUT CLAIM TO ANY PARTICULAR FONT, STYLE, SIZE, OR COLOR.

NO CLAIM IS MADE TO THE EXCLUSIVE RIGHT TO USE "2012", APART FROM THE MARK AS SHOWN.

SER. NO. 85-625,836, FILED 5-15-2012.

LOURDES AYALA, EXAMINING ATTORNEY



*David J. Kyffers*

Director of the United States Patent and Trademark Office

# United States of America

United States Patent and Trademark Office

## CHARLES HENRY

**Reg. No. 4,274,873**

MEREDITH FISHER, LLC (KENTUCKY LIMITED LIABILITY COMPANY)  
3904 WOODSTONE RIDGE WAY  
LOUISVILLE, KY 40241

**Registered Jan. 15, 2013**

**Int. Cl.: 25**

FOR: APPAREL, NAMELY, DRESSES, TOPS, PANTS, SKIRTS, JACKETS, T-SHIRTS, SWEATERS, AND COATS, IN CLASS 25 (U.S. CLS. 22 AND 39).

**TRADEMARK**

FIRST USE 2-0-2010; IN COMMERCE 2-0-2010.

**PRINCIPAL REGISTER**

THE MARK CONSISTS OF STANDARD CHARACTERS WITHOUT CLAIM TO ANY PARTICULAR FONT, STYLE, SIZE, OR COLOR.

THE NAME(S), PORTRAIT(S), AND/OR SIGNATURE(S) SHOWN IN THE MARK DOES NOT IDENTIFY A PARTICULAR LIVING INDIVIDUAL.

SER. NO. 85-625,872, FILED 5-15-2012.

LOURDES AYALA, EXAMINING ATTORNEY



*David J. Kybas*

Director of the United States Patent and Trademark Office

# United States of America

United States Patent and Trademark Office

## BOISE GARAGE DOOR

**Reg. No. 4,274,874**

BOISE GARAGE DOOR LLC (IDAHO LIMITED LIABILITY COMPANY)  
2372 E STATE ST  
EAGLE, ID 83616

**Registered Jan. 15, 2013**

**Int. Cl.: 37**

FOR: INSTALLATION, MAINTENANCE, AND REPAIR OF GARAGE DOORS, GARAGE DOOR OPENERS AND ACCESSORIES, IN CLASS 37 (U.S. CLS. 100, 103 AND 106).

**SERVICE MARK**

FIRST USE 12-31-1979; IN COMMERCE 4-14-1997.

**PRINCIPAL REGISTER**

THE MARK CONSISTS OF STANDARD CHARACTERS WITHOUT CLAIM TO ANY PARTICULAR FONT, STYLE, SIZE, OR COLOR.

NO CLAIM IS MADE TO THE EXCLUSIVE RIGHT TO USE "GARAGE DOOR", APART FROM THE MARK AS SHOWN.

SEC. 2(F).

SER. NO. 85-626,042, FILED 5-15-2012.

PRISCILLA MILTON, EXAMINING ATTORNEY



*David J. Kybas*

Director of the United States Patent and Trademark Office

# United States of America

United States Patent and Trademark Office



**Reg. No. 4,274,875**

**Registered Jan. 15, 2013**

**Int. Cls.: 35 and 41**

**SERVICE MARK**

**PRINCIPAL REGISTER**

DUTCH LIONS CAPITAL GROUP B.V. (NETHERLANDS CORPORATION)  
BIJDORP OOST 14  
2992 LA BARENDRECHT, NETHERLANDS

FOR: COORDINATION OF RECREATIONAL SPORTING OPPORTUNITIES FOR INDIVIDUALS WHO WISH TO PARTICIPATE IN TEAM LEAGUE SPORTS; AND MANAGEMENT OF AMATEUR AND PROFESSIONAL ATHLETES, IN CLASS 35 (U.S. CLS. 100, 101 AND 102).

FIRST USE 7-1-2009; IN COMMERCE 7-1-2009.

FOR: ENTERTAINMENT SERVICES, NAMELY, ORGANIZING, CONDUCTING AND STAGING PROFESSIONAL AND YOUTH SOCCER GAMES, IN CLASS 41 (U.S. CLS. 100, 101 AND 107).

FIRST USE 7-1-2009; IN COMMERCE 7-1-2009.

NO CLAIM IS MADE TO THE EXCLUSIVE RIGHT TO USE "DUTCH" AND "FC", APART FROM THE MARK AS SHOWN.

THE COLOR(S) BLUE, ORANGE AND WHITE IS/ARE CLAIMED AS A FEATURE OF THE MARK.

THE MARK CONSISTS OF A BLUE AND WHITE SHIELD OUTLINED IN DARK BLUE WITH THE WORDS "DUTCH LIONS" AT THE TOP OF THE SHIELD APPEARING IN BLUE AND THE LETTERS "FC" AT THE BOTTOM OF THE SHIELD REVERSED OUT IN WHITE AND A HERALDIC LION IN THE CENTER OF THE SHIELD APPEARING IN ORANGE AND WHITE.

SER. NO. 85-626,045, FILED 5-15-2012.

JOHN SCHUYLER YARD, EXAMINING ATTORNEY



*David J. Kybas*

Director of the United States Patent and Trademark Office



# United States of America

United States Patent and Trademark Office

SMART DATA. SMART PEOPLE.  
SMART DECISIONS.

**Reg. No. 4,274,876**

**Registered Jan. 15, 2013**

**Int. Cl.: 35**

**SERVICE MARK**

**PRINCIPAL REGISTER**

AXIOMETRICS INC. (TEXAS CORPORATION)  
14901 QUORUM  
SUITE 600  
DALLAS, TX 75254

FOR: COLLECTION, ANALYSIS, AND REPORTING OF BUSINESS ANALYTICS AND DATA  
IN THE FIELD OF REAL ESTATE, IN CLASS 35 (U.S. CLS. 100, 101 AND 102).

FIRST USE 5-10-2012; IN COMMERCE 5-10-2012.

THE MARK CONSISTS OF STANDARD CHARACTERS WITHOUT CLAIM TO ANY PAR-  
TICULAR FONT, STYLE, SIZE, OR COLOR.

SER. NO. 85-626,121, FILED 5-15-2012.

ELLEN BURNS, EXAMINING ATTORNEY



*David J. Kyffers*

Director of the United States Patent and Trademark Office

# United States of America

United States Patent and Trademark Office

## LONGEVITY

||| ■ ■ ■ *physical therapy*

**Reg. No. 4,274,877**

FUNCTION FOR LIFE PHYSICAL THERAPY, INC. (CALIFORNIA CORPORATION)  
227 N. EL CAMINO REAL, STE 103  
ENCINITAS, CA 92024

**Registered Jan. 15, 2013**

**Int. Cl.: 44**

FOR: PHYSICAL THERAPY, PHYSICAL REHABILITATION, AND SPORTS MEDICINE  
PHYSICAL REHABILITATION AND THERAPY, IN CLASS 44 (U.S. CLS. 100 AND 101).

**SERVICE MARK**

FIRST USE 1-1-2011; IN COMMERCE 1-1-2011.

**PRINCIPAL REGISTER**

NO CLAIM IS MADE TO THE EXCLUSIVE RIGHT TO USE "PHYSICAL THERAPY", APART  
FROM THE MARK AS SHOWN.

THE MARK CONSISTS OF STYLIZED WORD "LONGEVITY" IN CAPITALIZED LETTERS.  
UNDERNEATH THE LETTERS "EVITY" IS A LONG SHADED RECTANGLE CONTAINING  
THE STYLIZED WORDS "PHYSICAL THERAPY" IN LOWER CASE LETTERS. FOUR  
SMALLER RECTANGLES OF VARIOUS SIZE ARE TO THE LEFT OF THE LARGER  
RECTANGLE.

SER. NO. 85-626,179, FILED 5-15-2012.

ANDREA K. NADELMAN, EXAMINING ATTORNEY



*David J. Kybas*

Director of the United States Patent and Trademark Office

# United States of America

United States Patent and Trademark Office

## CORE CALMER

**Reg. No. 4,274,878**

**Registered Jan. 15, 2013**

**Int. Cl.: 5**

**TRADEMARK**

**PRINCIPAL REGISTER**

LARRABEE, STEPHANIE (UNITED STATES INDIVIDUAL)  
1616 EDISON ST.  
SANTA YNEZ, CA 93460 AND

LARRABEE, TERRENCE (UNITED STATES INDIVIDUAL)  
1616 EDISON ST.  
SANTA YNEZ, CA 93460

FOR: ANIMAL FEED SUPPLEMENTS; NON-MEDICATED ADDITIVES FOR ANIMAL FEED FOR USE AS NUTRITIONAL SUPPLEMENTS; NUTRITIONAL SUPPLEMENTS, IN CLASS 5 (U.S. CLS. 6, 18, 44, 46, 51 AND 52).

FIRST USE 3-31-2011; IN COMMERCE 2-29-2012.

THE MARK CONSISTS OF STANDARD CHARACTERS WITHOUT CLAIM TO ANY PARTICULAR FONT, STYLE, SIZE, OR COLOR.

OWNER OF U.S. REG. NOS. 3,900,540, 4,022,868 AND OTHERS.

NO CLAIM IS MADE TO THE EXCLUSIVE RIGHT TO USE "CALMER", APART FROM THE MARK AS SHOWN.

SER. NO. 85-626,223, FILED 5-15-2012.

KEVEN MITTLER, EXAMINING ATTORNEY



*David J. Kyros*

Director of the United States Patent and Trademark Office

# United States of America

United States Patent and Trademark Office

## REMARKABLE MARKET FORCE

**Reg. No. 4,274,879**

INFLUENCE, LLC (NEW HAMPSHIRE LIMITED LIABILITY COMPANY)  
4 MOEBUS TERRACE  
PORTSMOUTH, NH 03801

**Registered Jan. 15, 2013**

**Int. Cls.: 35 and 41**

FOR: BUSINESS CONSULTING AND INFORMATION SERVICES, IN CLASS 35 (U.S. CLS. 100, 101 AND 102).

**SERVICE MARK**

FIRST USE 5-1-2012; IN COMMERCE 5-1-2012.

**PRINCIPAL REGISTER**

FOR: BUSINESS TRAINING; EDUCATION SERVICES, NAMELY, PROVIDING LIVE AND ON-LINE CLASSES, SEMINARS, WORKSHOPS AND CONFERENCES IN THE FIELD OF BUSINESS; EDUCATIONAL SERVICES, NAMELY, PROVIDING ON-LINE CLASSES, SEMINARS, WORKSHOPS AND CONFERENCES IN THE FIELD OF BUSINESS; PROFESSIONAL COACHING SERVICES IN THE FIELD OF BUSINESS, IN CLASS 41 (U.S. CLS. 100, 101 AND 107).

FIRST USE 5-1-2012; IN COMMERCE 5-1-2012.

THE MARK CONSISTS OF STANDARD CHARACTERS WITHOUT CLAIM TO ANY PARTICULAR FONT, STYLE, SIZE, OR COLOR.

SER. NO. 85-626,597, FILED 5-16-2012.

KARANENDRA S. CHHINA, EXAMINING ATTORNEY



*David J. Kybas*

Director of the United States Patent and Trademark Office

# United States of America

United States Patent and Trademark Office

## FLAVORFUL UNDER 500

**Reg. No. 4,274,880**

**Registered Jan. 15, 2013**

**Int. Cl.: 43**

**SERVICE MARK**

**PRINCIPAL REGISTER**

RARE HOSPITALITY MANAGEMENT, INC. (DELAWARE CORPORATION)  
HORACE DAWSON  
1000 DARDEN CENTER DRIVE  
ORLANDO, FL 32837

FOR: RESTAURANT SERVICES, IN CLASS 43 (U.S. CLS. 100 AND 101).

FIRST USE 1-9-2012; IN COMMERCE 1-9-2012.

THE MARK CONSISTS OF STANDARD CHARACTERS WITHOUT CLAIM TO ANY PARTICULAR FONT, STYLE, SIZE, OR COLOR.

NO CLAIM IS MADE TO THE EXCLUSIVE RIGHT TO USE "UNDER 500", APART FROM THE MARK AS SHOWN.

SER. NO. 85-626,714, FILED 5-16-2012.

KRISTINA MORRIS, EXAMINING ATTORNEY



*David J. Kyffers*

Director of the United States Patent and Trademark Office

# United States of America

United States Patent and Trademark Office

# Chocofreeze

**Reg. No. 4,274,881**

**Registered Jan. 15, 2013**

**Int. Cl.: 1**

**TRADEMARK**

**PRINCIPAL REGISTER**

CONFECTIONERY ARTS INTERNATIONAL, LLC (CONNECTICUT LIMITED LIABILITY COMPANY)  
332 WASHINGTON AVE.  
NEW BRITAIN, CT 06051

FOR: CHEMICAL COOLING AGENT USED IN THE PREPARATION OF CHOCOLATE AND CONFECTIONERY; CHEMICAL SPRAY USED TO COOL CHOCOLATE AND CONFECTIONERY, IN CLASS 1 (U.S. CLS. 1, 5, 6, 10, 26 AND 46).

FIRST USE 12-1-1998; IN COMMERCE 12-1-1998.

THE MARK CONSISTS OF STANDARD CHARACTERS WITHOUT CLAIM TO ANY PARTICULAR FONT, STYLE, SIZE, OR COLOR.

SER. NO. 85-626,728, FILED 5-16-2012.

JOHN E. MICHOS, EXAMINING ATTORNEY



*David J. Kyffers*

Director of the United States Patent and Trademark Office

# United States of America

United States Patent and Trademark Office



**Reg. No. 4,274,882**

**Registered Jan. 15, 2013**

**Int. Cl.: 16**

**TRADEMARK**

**PRINCIPAL REGISTER**

NORTHWEST FLORIDA PROFESSIONAL BASEBALL LLC (FLORIDA LIMITED LIABILITY COMPANY)  
351 WEST CEDAR ST.  
PENSACOLA, FL 32502

FOR: PAPER GOODS AND PRINTED MATTER, NAMELY, AUTOGRAPH BOOKS, BINDERS, BOOKMARKS, BUMPER STICKERS, CALENDARS, CATALOGS IN THE FIELD OF BASEBALL, DECALS, MERCHANDISE BAGS, NEWSLETTERS IN THE FIELD OF BASEBALL, NOTE PADS, PAPER CONTAINERS, PAPER PENNANTS, PAPER GAME SCHEDULES, PENS, PENCILS, POSTCARDS, POSTERS, PRINTED AWARDS, PRINTED GAME TICKETS FOR SPORTING EVENTS, PRINTED GUIDES IN THE FIELD OF BASEBALL, REFERENCE BOOKS IN THE FIELD OF BASEBALL, SCORE BOOKS, SCORE CARDS, SCORE SHEETS, STATIONERY, STICKERS, STICKER ALBUMS AND TRADING CARDS, IN CLASS 16 (U.S. CLS. 2, 5, 22, 23, 29, 37, 38 AND 50).

FIRST USE 11-1-2011; IN COMMERCE 11-1-2011.

OWNER OF U.S. REG. NO. 4,165,721.

NO CLAIM IS MADE TO THE EXCLUSIVE RIGHT TO USE "PENSACOLA", APART FROM THE MARK AS SHOWN.

THE MARK CONSISTS OF A WAHOO FISH WITH A HOOK IN ITS MOUTH SWIMMING THROUGH WAVES WITH THE WORDING "PENSACOLA BLUE WAHOOS" ABOVE.

SER. NO. 85-626,751, FILED 5-16-2012.

DOMINIC J. FERRAIUOLO, EXAMINING ATTORNEY



*David J. Kybas*

Director of the United States Patent and Trademark Office

# United States of America

United States Patent and Trademark Office



**PENSCO**  
TRUST COMPANY

**Reg. No. 4,274,883**

PENSCO TRUST COMPANY LLC (NEW HAMPSHIRE LIMITED LIABILITY COMPANY)  
560 MISSION STREET, STE. 1300  
SAN FRANCISCO, CA 941052907

**Registered Jan. 15, 2013**

**Int. Cl.: 36**

FOR: INVESTMENT ADMINISTRATION OF RETIREMENT PLANS FOR OTHERS, IN CLASS  
36 (U.S. CLS. 100, 101 AND 102).

**SERVICE MARK**

FIRST USE 5-6-2011; IN COMMERCE 5-6-2011.

**PRINCIPAL REGISTER**

OWNER OF U.S. REG. NOS. 3,079,225 AND 3,079,226.

NO CLAIM IS MADE TO THE EXCLUSIVE RIGHT TO USE "TRUST COMPANY", APART  
FROM THE MARK AS SHOWN.

THE MARK CONSISTS OF THE WORDS "TRUST COMPANY" UNDER THE LARGER WORD  
"PENSCO" UNDER A SOLID SQUARE WITH A WHITE OUTLINED STYLIZED HORSE  
IMAGE INCLUDING THE HEAD AND NECK OF THE HORSE, WINGS AND THE UPPER  
PORTION OF THE FRONT LEGS.

SER. NO. 85-626,931, FILED 5-16-2012.

MARIA-VICTORIA SUAREZ, EXAMINING ATTORNEY



*David J. Kyjars*

Director of the United States Patent and Trademark Office



# United States of America

United States Patent and Trademark Office

## TAKEN PHOTO

**Reg. No. 4,274,884**

TONIA VANMOORHEM (UNITED STATES INDIVIDUAL)  
276 B STREET

**Registered Jan. 15, 2013**

SALT LAKE CITY, UT 84103

**Int. Cl.: 41**

FOR: PHOTOGRAPHY; PHOTOGRAPHY SERVICES, IN CLASS 41 (U.S. CLS. 100, 101 AND 107).

**SERVICE MARK**

FIRST USE 11-30-2004; IN COMMERCE 11-30-2004.

**PRINCIPAL REGISTER**

THE MARK CONSISTS OF STANDARD CHARACTERS WITHOUT CLAIM TO ANY PARTICULAR FONT, STYLE, SIZE, OR COLOR.

NO CLAIM IS MADE TO THE EXCLUSIVE RIGHT TO USE "PHOTO", APART FROM THE MARK AS SHOWN.

SER. NO. 85-627,038, FILED 5-16-2012.

DORITT L. CARROLL, EXAMINING ATTORNEY



*David J. Kyros*

Director of the United States Patent and Trademark Office

# United States of America

United States Patent and Trademark Office

## LONE STAR FILM FESTIVAL

**Reg. No. 4,274,885**

LONE STAR FILM SOCIETY, INC. (TEXAS CORPORATION)  
2501 FOREST PARK DRIVE, SUITE 2  
FORT WORTH, TX 76110

**Registered Jan. 15, 2013**

**Int. Cl.: 41**

FOR: ENTERTAINMENT SERVICES, NAMELY, PLANNING AND CONDUCTING A SERIES OF FILM FESTIVALS, IN CLASS 41 (U.S. CLS. 100, 101 AND 107).

**SERVICE MARK**

FIRST USE 5-1-2012; IN COMMERCE 5-1-2012.

**PRINCIPAL REGISTER**

THE MARK CONSISTS OF STANDARD CHARACTERS WITHOUT CLAIM TO ANY PARTICULAR FONT, STYLE, SIZE, OR COLOR.

OWNER OF U.S. REG. NOS. 3,727,065, 3,812,566, AND 3,878,609.

NO CLAIM IS MADE TO THE EXCLUSIVE RIGHT TO USE "FILM FESTIVAL", APART FROM THE MARK AS SHOWN.

SER. NO. 85-627,074, FILED 5-16-2012.

DOMINIC J. FERRAIUOLO, EXAMINING ATTORNEY



*David J. Kyffers*

Director of the United States Patent and Trademark Office

# United States of America

United States Patent and Trademark Office

# US VINYL

**Reg. No. 4,274,886**

U.S. VINYL MANUFACTURING CORPORATION (TEXAS CORPORATION)  
1766 BROOMTOWN ROAD  
LAFAYETTE, GA 30728

**Registered Jan. 15, 2013**

**Int. Cl.: 27**

FOR: VINYL WALL COVERINGS; WALLCOVERINGS, IN CLASS 27 (U.S. CLS. 19, 20, 37, 42 AND 50).

**TRADEMARK**

FIRST USE 3-0-1987; IN COMMERCE 3-0-1987.

**PRINCIPAL REGISTER**

THE MARK CONSISTS OF STANDARD CHARACTERS WITHOUT CLAIM TO ANY PARTICULAR FONT, STYLE, SIZE, OR COLOR.

OWNER OF U.S. REG. NOS. 1,839,655, 1,858,694, AND 2,561,883.

NO CLAIM IS MADE TO THE EXCLUSIVE RIGHT TO USE "VINYL", APART FROM THE MARK AS SHOWN.

SEC. 2(F).

SER. NO. 85-627,174, FILED 5-16-2012.

REGINA DRUMMOND, EXAMINING ATTORNEY



*David J. Kybas*

Director of the United States Patent and Trademark Office

# United States of America

United States Patent and Trademark Office



**Reg. No. 4,274,887**

**Registered Jan. 15, 2013**

**Int. Cls.: 29, 30 and 35**

**TRADEMARK**

**SERVICE MARK**

**PRINCIPAL REGISTER**

LIPARI FOODS OPERATING COMPANY, LLC (DELAWARE LIMITED LIABILITY COMPANY)  
26661 BUNERT ROAD  
WARREN, MI 48089

FOR: YOGURTS; CHEESE; PROCESSED MEAT; PRESERVED MEATS AND SAUSAGES; HAM; TURKEY; CHICKEN; PEPPERONI; MEATBALLS; BACON; TEXTURED VEGETABLE PROTEIN BITS HAVING A BACON FLAVOR; BEEF; HOT DOGS; BOLOGNA; CORNED BEEF; SALAMI; ROAST BEEF; PASTRAMI; PROCESSED SEAFOOD, PROCESSED PEPPERS; PICKLED JALAPENOS; PICKLES; PROCESSED OLIVES; PROCESSED STUFFED OLIVES; CANNED TOMATOES; DICED TOMATOES; TOMATO PASTE; PROCESSED ONIONS; COLE SLAW; BEAN DIP; DAIRY-BASED DIPS; LEGUME SALADS; FRUIT SALADS AND VEGETABLE SALADS, IN CLASS 29 (U.S. CL. 46).

FIRST USE 4-0-2002; IN COMMERCE 4-0-2002.

FOR: MACARONI SALAD; PASTA SALAD; TOMATO SAUCE; PASTA SAUCE; PIZZA SAUCE; MAYONNAISE; SALAD DRESSINGS; COLE SLAW DRESSING; BARBEQUE SAUCE; MUSTARD; HORSERADISH; RELISH; PIES; FLOUR FOR FOOD; SPICES; BAKING SPICES; FOOD SEASONINGS; SEASONING MIXES; TACO SEASONING; STEAK SEASONING; GARLIC SALT; GARLIC POWDER; ROASTED AND GROUND SESAME SEEDS; MUSTARD POWDER; GINGER; ONION SALT; CAPPUCINO; TAPIOCA PUDDING; DESSERT PUDDINGS; RICE PUDDING; PRETZELS; AND ICE CREAM, IN CLASS 30 (U.S. CL. 46).

FIRST USE 1-0-2000; IN COMMERCE 1-0-2000.

FOR: WHOLESALE FOOD DISTRIBUTORSHIP SERVICES; BUSINESS CONSULTATION SERVICES IN THE FOOD INDUSTRY, IN CLASS 35 (U.S. CLS. 100, 101 AND 102).

FIRST USE 1-0-2000; IN COMMERCE 1-0-2000.

NO CLAIM IS MADE TO THE EXCLUSIVE RIGHT TO USE "SINCE 1963", APART FROM THE MARK AS SHOWN.

THE MARK CONSISTS OF THE WORD "LIPARI" POSITIONED INSIDE A ROUNDED RECTANGLE WITH A DIAMOND LOCATED BELOW HAVING THE LETTERS "L" AND



*David J. Kyjars*

Director of the United States Patent and Trademark Office

**Reg. No. 4,274,887** "F" POSITIONED INSIDE; THE WORDS "SINCE" AND "1963" BEING POSITIONED ON EITHER SIDE OF THE DIAMOND.

SER. NO. 85-627,188, FILED 5-16-2012.

WENDY GOODMAN, EXAMINING ATTORNEY

# United States of America

United States Patent and Trademark Office

# SUNMEDICA

**Reg. No. 4,274,888**

**Registered Jan. 15, 2013**

**Int. Cl.: 10**

**TRADEMARK**

**PRINCIPAL REGISTER**

SUNMEDICA, INC. (CALIFORNIA CORPORATION)  
1661 ZACHI WAY  
REDDING, CA 96003

FOR: MEDICAL APPARATUS, NAMELY, ORTHOPEDIC BONE PLUG FOR USE AS A BONE CEMENT RESTRICTOR INSERTED IN THE FEMORAL CANAL WHEN A CEMENTED TOTAL JOINT REPLACEMENT SURGICAL PROCEDURE IS DONE; ORTHOPEDIC WRAP IN THE NATURE OF A NON-STERILE POSTOPERATIVE ORTHOPEDIC SUPPORT BANDAGE TO HOLD STERILE DRESSING IN PLACE WITHOUT THE USE OF TAPE; NON-STERILE SUPPORT BANDAGE FOR USE AS A WRAP TO HOLD COLD THERAPY PACKS OVER AN EXTREMITY; ORTHOPEDIC FIXATION DEVICE, NAMELY, HIP GRIPPING PELVIS POSITIONING DEVICE FOR USE IN HOLDING A PATIENT IN A LATERAL POSITION DURING SURGERY; AND ORTHOPEDIC FIXATION DEVICE, NAMELY, GRIPPING DEVICE FOR USE IN POSITIONING A PATIENT'S KNEE IN A FLEXED POSITION DURING SURGERY, IN CLASS 10 (U.S. CLS. 26, 39 AND 44).

FIRST USE 10-1-1999; IN COMMERCE 10-1-1999.

THE MARK CONSISTS OF STANDARD CHARACTERS WITHOUT CLAIM TO ANY PARTICULAR FONT, STYLE, SIZE, OR COLOR.

SER. NO. 85-627,403, FILED 5-16-2012.

LEE-ANNE BERNS, EXAMINING ATTORNEY



*David J. Kypos*

Director of the United States Patent and Trademark Office

# United States of America

United States Patent and Trademark Office



**Reg. No. 4,274,889**

**Registered Jan. 15, 2013**

**Int. Cl.: 42**

**SERVICE MARK**

**PRINCIPAL REGISTER**

MAD PIRATE DESIGN COMPANY, LLC (NEW HAMPSHIRE LIMITED LIABILITY COMPANY)  
10 BRANDY CIRCLE  
LITCHFIELD, NH 03052

FOR: GRAPHIC DESIGN SERVICES, IN CLASS 42 (U.S. CLS. 100 AND 101).

FIRST USE 4-1-2012; IN COMMERCE 4-1-2012.

NO CLAIM IS MADE TO THE EXCLUSIVE RIGHT TO USE "DESIGN COMPANY", APART FROM THE MARK AS SHOWN.

THE COLOR(S) BLACK, WHITE, AND RED IS/ARE CLAIMED AS A FEATURE OF THE MARK.

THE MARK CONSISTS OF A SKULL AND CROSSBONES INCLUDING AN EYE PATCH WITH A RED HIGHLIGHT ON THE FOREHEAD. THE SKULL IS OUTLINED IN BLACK ALONG WITH A BLACK SET OF CROSSBONES AND A BLACK EYE PATCH. THE INNER PART OF THE SKULL IS IN WHITE. TO THE RIGHT OF THE SKULL AND CROSSBONES IS THE STYLIZED TEXT "MAD PIRATE" IN RED. BELOW THERE IS A BLACK SWOOSH THAT IS BROKEN IN THE MIDDLE BY THE LETTER "P" IN "PIRATE". BELOW THE BLACK SWOOSH, IS THE STYLIZED TEXT "DESIGN COMPANY" IN BLACK.

SER. NO. 85-627,551, FILED 5-16-2012.

JAMES LOVELACE, EXAMINING ATTORNEY



*David J. Kyros*

Director of the United States Patent and Trademark Office

# United States of America

United States Patent and Trademark Office



**NORTHWESTERN COLLEGE**

**Reg. No. 4,274,890**

**Registered Jan. 15, 2013**

**Int. Cl.: 36**

**SERVICE MARK**

**PRINCIPAL REGISTER**

NORTHWESTERN COLLEGE (MINNESOTA NON-PROFIT CORPORATION)  
3003 SNELLING AVENUE NORTH  
ST. PAUL, MN 55113

FOR: CHARITABLE FUNDRAISING SERVICES, NAMELY, RAISING FUNDS FOR COLLEGE EDUCATION COSTS; COLLEGE COUNSELING SERVICES, NAMELY, ASSISTING STUDENTS IN APPLYING FOR SCHOLARSHIPS AND FINANCIAL AID; FINANCIAL ADMINISTRATION OF SCHOLARSHIP PROGRAMS; PROVIDING COLLEGE SCHOLARSHIPS; PROVIDING EDUCATIONAL SCHOLARSHIPS, IN CLASS 36 (U.S. CLS. 100, 101 AND 102).

FIRST USE 7-1-2008, THE MARK WAS FIRST USED ANYWHERE IN A DIFFERENT FORM OTHER THAN THAT SOUGHT TO BE REGISTERED AT LEAST AS EARLY AS 00/00/1972; IN COMMERCE 7-1-2008, THE MARK WAS FIRST USED IN COMMERCE IN A DIFFERENT FORM OTHER THAN THAT SOUGHT TO BE REGISTERED AT LEAST AS EARLY AS 00/00/1972 .

OWNER OF U.S. REG. NOS. 3,583,126 AND 3,672,519.

NO CLAIM IS MADE TO THE EXCLUSIVE RIGHT TO USE "COLLEGE", APART FROM THE MARK AS SHOWN.

THE MARK CONSISTS OF THE STYLIZED LETTERING "NORTHWESTERN COLLEGE" AND A SHIELD, WHEREIN THERE IS A CROWN DESIGN IN THE UPPER HALF OF THE SHIELD, WHEREIN AT THE BOTTOM CENTER OF THE CROWN IS A CROSS, WHEREIN UNDERNEATH THE CROSS IS A LETTER "N".

SER. NO. 85-627,713, FILED 5-17-2012.

TIMOTHY O. SCHIMPF, EXAMINING ATTORNEY



*David J. Kyffers*

Director of the United States Patent and Trademark Office



# United States of America

United States Patent and Trademark Office

# Avilinga

**Reg. No. 4,274,891**

LANGUAGE DIRECT CORPORATE SERVICES GMBH (SWITZERLAND CORPORATION)  
LINDENHOF 6

**Registered Jan. 15, 2013**

SARNEN, SWITZERLAND 6060

**Int. Cl.: 41**

FOR: TRANSLATION SERVICES, IN CLASS 41 (U.S. CLS. 100, 101 AND 107).

**SERVICE MARK**

FIRST USE 7-3-2011; IN COMMERCE 7-3-2011.

**PRINCIPAL REGISTER**

THE MARK CONSISTS OF STANDARD CHARACTERS WITHOUT CLAIM TO ANY PARTICULAR FONT, STYLE, SIZE, OR COLOR.

THE WORDING "AVILINGA" HAS NO MEANING IN A FOREIGN LANGUAGE.

SER. NO. 85-627,740, FILED 5-17-2012.

JERI J. FICKES, EXAMINING ATTORNEY



*David J. Kyffers*

Director of the United States Patent and Trademark Office

# United States of America

United States Patent and Trademark Office

## O2 FUR LIFE

**Reg. No. 4,274,892**

WAG'N ENTERPRISES, INC. (VIRGINIA CORPORATION)  
483B CARLISLE DRIVE  
HERNDON, VA 20170

**Registered Jan. 15, 2013**

**Int. Cl.: 10**

FOR: EMERGENCY KITS FOR ANIMALS CONSISTING PRIMARILY OF PET OXYGEN MASKS FOR MEDICAL USE, PET CARRYING BAGS, INSTRUCTION SHEETS FOR EMERGENCY CARE, LEASHES, ANIMAL INCIDENT REPORT FORMS, PET RESCUE NOTICE FORMS, DECALS AND TRAINING DVDS, IN CLASS 10 (U.S. CLS. 26, 39 AND 44).

**TRADEMARK**

**PRINCIPAL REGISTER**

FIRST USE 12-6-2007; IN COMMERCE 12-6-2007.

THE MARK CONSISTS OF STANDARD CHARACTERS WITHOUT CLAIM TO ANY PARTICULAR FONT, STYLE, SIZE, OR COLOR.

OWNER OF U.S. REG. NOS. 3,520,491 AND 4,202,407.

SER. NO. 85-627,786, FILED 5-17-2012.

LAURA KOVALSKY, EXAMINING ATTORNEY



*David J. Kyffers*

Director of the United States Patent and Trademark Office

# United States of America

United States Patent and Trademark Office

## MYLIVEPHOTOS.COM

**Reg. No. 4,274,893**

MYLIVEPHOTOS LLC (TEXAS LIMITED LIABILITY COMPANY)  
8521 ORLANDO SPRINGS DR.  
FORT WORTH, TX 76123

**Registered Jan. 15, 2013**

**Int. Cl.: 41**

FOR: PHOTOGRAPHY SERVICES; EVENT PHOTOGRAPHY SERVICES; PORTABLE EVENT PHOTOGRAPHY SERVICES, IN CLASS 41 (U.S. CLS. 100, 101 AND 107).

**SERVICE MARK**

FIRST USE 4-6-2011; IN COMMERCE 4-6-2011.

**PRINCIPAL REGISTER**

THE MARK CONSISTS OF STANDARD CHARACTERS WITHOUT CLAIM TO ANY PARTICULAR FONT, STYLE, SIZE, OR COLOR.

SER. NO. 85-627,798, FILED 5-17-2012.

DAVID TAYLOR, EXAMINING ATTORNEY



*David J. Kybas*

Director of the United States Patent and Trademark Office

# United States of America

United States Patent and Trademark Office

## Companion Plus

**Reg. No. 4,274,894**

PROPCO MARKETING (ILLINOIS CORPORATION)  
7360 N. LINCOLN AVE., SUITE 100  
LINCOLNWOOD, IL 60712

**Registered Jan. 15, 2013**

**Int. Cl.: 35**

FOR: ADVERTISING SERVICES, NAMELY, PROMOTING THE AIRLINE DEALS OF OTHERS  
IN THE AIRLINE INDUSTRY, IN CLASS 35 (U.S. CLS. 100, 101 AND 102).

**SERVICE MARK**

FIRST USE 10-1-2011; IN COMMERCE 10-1-2011.

**PRINCIPAL REGISTER**

THE MARK CONSISTS OF STANDARD CHARACTERS WITHOUT CLAIM TO ANY PAR-  
TICULAR FONT, STYLE, SIZE, OR COLOR.

NO CLAIM IS MADE TO THE EXCLUSIVE RIGHT TO USE "COMPANION", APART FROM  
THE MARK AS SHOWN.

SER. NO. 85-627,805, FILED 5-17-2012.

ZHALEH DELANEY, EXAMINING ATTORNEY



*David J. Kybas*

Director of the United States Patent and Trademark Office

# United States of America

United States Patent and Trademark Office

# Flashoids

Digital Flashcards

**Reg. No. 4,274,895**

TOWNE, JASON (UNITED STATES INDIVIDUAL)  
1814 YORKSHIRE DR.  
WINTER PARK, FL 32792

**Registered Jan. 15, 2013**

**Int. Cl.: 9**

FOR: ELECTRONIC DOWNLOADABLE FLASHCARDS, IN CLASS 9 (U.S. CLS. 21, 23, 26, 36 AND 38).

**TRADEMARK**

FIRST USE 3-9-2012; IN COMMERCE 3-9-2012.

**PRINCIPAL REGISTER**

NO CLAIM IS MADE TO THE EXCLUSIVE RIGHT TO USE "DIGITAL FLASHCARDS", APART FROM THE MARK AS SHOWN.

THE MARK CONSISTS OF THE STYLIZED TEXT "FLASHOIDS" ABOVE THE STYLIZED TEXT "DIGITAL FLASHCARDS". A STYLIZED FLASHING LIGHT BULB OVERLAPS THE LETTER "O" IN "FLASHOIDS". A ZIG ZAG LINE WRAPS AROUND THE TOP OF THE "O", REPRESENTING LIGHT.

SER. NO. 85-627,816, FILED 5-17-2012.

KATINA MISTER, EXAMINING ATTORNEY



*David J. Kyffers*

Director of the United States Patent and Trademark Office

# United States of America

United States Patent and Trademark Office



**Reg. No. 4,274,896**

**Registered Jan. 15, 2013**

**Int. Cl.: 25**

**TRADEMARK**

**PRINCIPAL REGISTER**

NORTHWEST FLORIDA PROFESSIONAL BASEBALL LLC (FLORIDA LIMITED LIABILITY COMPANY)  
351 WEST CEDAR ST.  
PENSACOLA, FL 32502

FOR: CLOTHING, NAMELY, APRONS, ATHLETIC UNIFORMS, BANDANAS, BOXER SHORTS, CAPS, CLOTH BABY BIBS, COATS, GOLF SHIRTS, GYM SHORTS, GYM SUITS, HATS, JACKETS, JERSEYS, JOGGING SUITS, KNIT SHIRTS, PAJAMAS, POLO SHIRTS, PONCHOS, PULLOVERS, RAIN COATS, RAINWEAR, SWEATERS, SWEAT PANTS, SWEAT SHIRTS, SWEAT SUITS, SOCKS, SPORT SHIRTS, T- SHIRTS, TANK TOPS, TIES, VISORS, WIND RESISTANT JACKETS AND WRISTBANDS, IN CLASS 25 (U.S. CLS. 22 AND 39).

FIRST USE 11-1-2011; IN COMMERCE 11-1-2011.

OWNER OF U.S. REG. NO. 4,165,721.

NO CLAIM IS MADE TO THE EXCLUSIVE RIGHT TO USE "PENSACOLA", APART FROM THE MARK AS SHOWN.

THE MARK CONSISTS OF A WAHOO FISH WITH A HOOK IN ITS MOUTH SWIMMING THROUGH WAVES WITH THE WORDING "PENSACOLA BLUE WAHOOS" ABOVE.

SER. NO. 85-627,894, FILED 5-17-2012.

DOMINIC J. FERRAIUOLO, EXAMINING ATTORNEY



*David J. Kybas*

Director of the United States Patent and Trademark Office

# United States of America

United States Patent and Trademark Office

# POINTBURST

**Reg. No. 4,274,897**

**Registered Jan. 15, 2013**

**Int. Cl.: 42**

**SERVICE MARK**

**PRINCIPAL REGISTER**

POINTBURST, LLC (TEXAS LIMITED LIABILITY COMPANY)  
SUITE 550  
3131 MCKINNEY AVE.  
DALLAS, TX 75204

FOR: DESIGNING, DEVELOPING AND MANAGING A SOFTWARE PROGRAM FOR OTHERS IN THE FIELD OF COMMUNICATION FOR USE IN MANAGING MULTIPLE SOCIAL NETWORKING SERVICE ACCOUNTS FOR A SOFTWARE USER, INCLUDING PUBLISHING MESSAGES, ARTICLES, DOCUMENTS AND VIDEOS THROUGH THE MULTIPLE SOCIAL NETWORKING SERVICE ACCOUNTS OF THE SOFTWARE USER AND THE SOFTWARE USER'S AFFILIATES, STATISTICS TRACKING AND MONITORING KEYWORD MENTIONS MADE ON SOCIAL NETWORKING WEBSITES; APPLICATION SERVICE PROVIDER FEATURING APPLICATION PROGRAMMING INTERFACE (API) SOFTWARE FOR USE IN SHORTENING UNIFORM RESOURCE LOCATORS, IN CLASS 42 (U.S. CLS. 100 AND 101).

FIRST USE 5-16-2012; IN COMMERCE 5-16-2012.

OWNER OF U.S. REG. NOS. 4,183,089 AND 4,183,090.

THE MARK CONSISTS OF THE TERM "POINTBURST" WHEREIN THE "O" IS AUGMENTED TO REPRESENT A BURSTING STAR.

SER. NO. 85-628,014, FILED 5-17-2012.

NANCY CLARKE, EXAMINING ATTORNEY



*David J. Kybas*

Director of the United States Patent and Trademark Office

# United States of America

United States Patent and Trademark Office



**Reg. No. 4,274,898**

**Registered Jan. 15, 2013**

**Int. Cl.: 41**

**SERVICE MARK**

**PRINCIPAL REGISTER**

AMERICAN HEALTHCARE INSTITUTE FOR CPR & FIRST AID, LLC (NEW JERSEY LIMITED LIABILITY COMPANY)  
4 OXFORD CT.  
ENGLISHTOWN, NJ 07726

FOR: EDUCATIONAL SERVICES, NAMELY, PROVIDING ONLINE INSTRUCTION IN THE FIELD OF HEALTHCARE RELATING TO CPR, BLS, BLOOD PATHOGEN AND FIRST AID FOR PROFESSIONAL CERTIFICATION AND RECERTIFICATION OF HEALTHCARE PROFESSIONALS VIA AN ONLINE WEBSITE, IN CLASS 41 (U.S. CLS. 100, 101 AND 107).

FIRST USE 5-16-2012; IN COMMERCE 5-16-2012.

NO CLAIM IS MADE TO THE EXCLUSIVE RIGHT TO USE "CPR", APART FROM THE MARK AS SHOWN.

THE COLOR(S) RED, BLUE, WHITE AND GRAY IS/ARE CLAIMED AS A FEATURE OF THE MARK.

THE MARK CONSISTS OF THE WORDS "CPR SELECT" IN WHITE FONT WITH A BLUE BORDER, THE WORDS "MYCPRCERTIFICATIONONLINE.COM" IN GRAY FONT, A RED HEART-SHAPED IMAGE ON THE LEFT OF THE FOREGOING WORDS WITH A WHITE JAGGED LINE SPREADING HORIZONTALLY THROUGH THE CENTER OF THE HEART-SHAPED IMAGE.

SER. NO. 85-628,085, FILED 5-17-2012.

WILLIAM JACKSON, EXAMINING ATTORNEY



*David J. Kyros*

Director of the United States Patent and Trademark Office



# United States of America

United States Patent and Trademark Office

## CONSCIOUS HIRING

**Reg. No. 4,274,899**

**Registered Jan. 15, 2013**

**Int. Cls.: 35 and 41**

**SERVICE MARK**

**PRINCIPAL REGISTER**

KEEN HIRE INC. (ILLINOIS CORPORATION)  
2005 DE LA CRUZ BLVD., SUITE 240  
SANTA CLARA, CA 95050

FOR: PROFESSIONAL STAFFING AND RECRUITING SERVICES; EMPLOYMENT HIRING, RECRUITING, RECRUITING CONSULTATION; PLACEMENT AND CAREER NETWORKING SERVICES; MANAGEMENT CONSULTING AND ADVISORY SERVICES IN THE AREAS OF TALENT MANAGEMENT, IN CLASS 35 (U.S. CLS. 100, 101 AND 102).

FIRST USE 1-0-2009; IN COMMERCE 1-0-2009.

FOR: EDUCATIONAL SERVICES, NAMELY, CONDUCTING SEMINARS IN THE FIELD OF PERSONNEL PLACEMENT AND DISTRIBUTION OF TRAINING MATERIAL IN CONNECTION THEREWITH; EDUCATIONAL SERVICES, NAMELY, PROVIDING TRAINING SEMINARS, WORKSHOPS AND COURSES FOR CERTIFICATION IN THE FIELD OF HUMAN RESOURCES AND HIRING PROCESSES, IN CLASS 41 (U.S. CLS. 100, 101 AND 107).

FIRST USE 1-0-2009; IN COMMERCE 1-0-2009.

THE MARK CONSISTS OF STANDARD CHARACTERS WITHOUT CLAIM TO ANY PARTICULAR FONT, STYLE, SIZE, OR COLOR.

NO CLAIM IS MADE TO THE EXCLUSIVE RIGHT TO USE "HIRING", APART FROM THE MARK AS SHOWN.

SER. NO. 85-628,109, FILED 5-17-2012.

CARYN GLASSER, EXAMINING ATTORNEY



*David J. Kybas*

Director of the United States Patent and Trademark Office

United States of America  
United States Patent and Trademark Office

**PLURES**  
**Technologies, Inc.**

**Reg. No. 4,274,900**

PLURES TECHNOLOGIES, INC. (DELAWARE CORPORATION)  
5297 PARKSIDE DRIVE, STE. 400, BOX 24  
CANANDAIGUA, NY 14424

**Registered Jan. 15, 2013**

**Int. Cl.: 42**

FOR: PRODUCT DEVELOPMENT SERVICES; CUSTOM DESIGN OF MICRO ELECTRO MECHANICAL SYSTEMS DEVICES AND MICROFLUIDIC DEVICES FOR OTHERS , IN CLASS 42 (U.S. CLS. 100 AND 101).

**SERVICE MARK**

FIRST USE 2-14-2012; IN COMMERCE 2-14-2012.

**PRINCIPAL REGISTER**

NO CLAIM IS MADE TO THE EXCLUSIVE RIGHT TO USE "TECHNOLOGIES, INC.", APART FROM THE MARK AS SHOWN.

THE COLOR(S) BLUE IS/ARE CLAIMED AS A FEATURE OF THE MARK.

THE MARK CONSISTS OF THE WORD "PLURES" APPEARING IN A BLUE COLOR AND STYLIZED WITH AN INITIAL CAPITAL "P". BELOW THE WORD "PLURES" ARE THE WORDS "TECHNOLOGIES, INC." THE TERMS "TECHNOLOGIES, INC." APPEAR IN A SMALLER FONT SIZE THAN "PLURES" AND ARE DARK BLUE AND STYLIZED WITH INITIAL CAPITAL LETTERS. THE "E" IN TECHNOLOGIES APPEARS UNDER THE "P" IN "PLURES".

THE ENGLISH TRANSLATION OF "PLURES" IS "MORE NUMEROUS", "SEVERAL" OR "MANY".

SER. NO. 85-628,149, FILED 5-17-2012.

TARAH HARDY, EXAMINING ATTORNEY



*David J. Kyros*

Director of the United States Patent and Trademark Office

# United States of America

United States Patent and Trademark Office

## AEA CERTIFIED FULLY REFINED

**Reg. No. 4,274,901**

AMERICAN EMU ASSOCIATION (TEXAS CORPORATION)  
1201 W. MAIN STREET, SUITE 24  
OTTAWA, IL 613502563

**Registered Jan. 15, 2013**

**CERTIFICATION MARK**

FOR: EMU OIL, IN CLASS A (U.S. CL. A).

**PRINCIPAL REGISTER**

FIRST USE 4-20-2004; IN COMMERCE 4-20-2004.

THE MARK CONSISTS OF STANDARD CHARACTERS WITHOUT CLAIM TO ANY PARTICULAR FONT, STYLE, SIZE, OR COLOR.

OWNER OF U.S. REG. NO. 3,022,543.

NO CLAIM IS MADE TO THE EXCLUSIVE RIGHT TO USE "CERTIFIED FULLY REFINED", APART FROM THE MARK AS SHOWN.

THE CERTIFICATION MARK, AS USED BY PERSONS AUTHORIZED BY THE CERTIFIER, CERTIFIES THAT THE EMU OIL MEETS MINIMUM STANDARDS OF GRADE, PURITY, COLOR AND QUALITY.

SER. NO. 85-628,238, FILED 5-17-2012.

WENDY GOODMAN, EXAMINING ATTORNEY



*David J. Kybas*

Director of the United States Patent and Trademark Office

# United States of America

United States Patent and Trademark Office

## Business Connect

**Reg. No. 4,274,902**

**Registered Jan. 15, 2013**

**Int. Cl.: 38**

**SERVICE MARK**

**PRINCIPAL REGISTER**

JOIBIZ LLC (GEORGIA CORPORATION)  
SUITE 413  
2870 PEACHTREE RD  
ATLANTA, GA 30305

FOR: TELEPHONE COMMUNICATION SERVICES, IN CLASS 38 (U.S. CLS. 100, 101 AND 104).

FIRST USE 5-1-2008; IN COMMERCE 5-1-2008.

THE MARK CONSISTS OF STANDARD CHARACTERS WITHOUT CLAIM TO ANY PARTICULAR FONT, STYLE, SIZE, OR COLOR.

NO CLAIM IS MADE TO THE EXCLUSIVE RIGHT TO USE "BUSINESS", APART FROM THE MARK AS SHOWN.

SER. NO. 85-628,262, FILED 5-17-2012.

WENDY GOODMAN, EXAMINING ATTORNEY



*David J. Kyffers*

Director of the United States Patent and Trademark Office

# United States of America

United States Patent and Trademark Office



**Reg. No. 4,274,903**

**Registered Jan. 15, 2013**

**Int. Cl.: 41**

**SERVICE MARK**

**PRINCIPAL REGISTER**

YOSEMITE ZIPLINES AND ADVENTURE RANCH, LLC (CALIFORNIA LIMITED LIABILITY COMPANY)  
4808 HIGHWAY 140  
MARIPOSA, CA 95338

FOR: ARRANGING AND CONDUCTING CANOPY TOURS AND ZIP LINE EVENTS FOR ENTERTAINMENT PURPOSES, IN CLASS 41 (U.S. CLS. 100, 101 AND 107).

FIRST USE 3-31-2011; IN COMMERCE 3-31-2011.

NO CLAIM IS MADE TO THE EXCLUSIVE RIGHT TO USE "YOSEMITE" AND "ZIPLINES AND ADVENTURE RANCH", APART FROM THE MARK AS SHOWN.

THE COLOR(S) BLACK, WHITE, DARK BROWN, LIGHT BROWN, GRAY, LIGHT GRAY, YELLOW, GREEN, DARK GREEN, LIGHT PEACH, TAN, DARK BLUE, LIGHT BLUE, AND RED IS/ARE CLAIMED AS A FEATURE OF THE MARK.

THE MARK CONSISTS OF A BAND WHICH IS LINED IN YELLOW AND FILLED IN WITH DARK BROWN. THE WORD "YOSEMITE" IN YELLOW LETTERING, LINED IN BLACK, APPEARS AT THE TOP OF THE BAND. THE WORD "ZIPLINES" APPEARS ACROSS THE LOWER CENTER IN WHITE LETTERING, LINED IN BLACK. THE WORDING "AND ADVENTURE RANCH" APPEARS AT THE BOTTOM IN YELLOW LETTERING, LINED IN BLACK. IN THE CENTER OF THE BAND, IS THE DESIGN OF A LIGHT BLUE SKY ABOVE DARK GREEN AND GREEN TREE TOPS. AGAINST THE BLUE SKY IS THE DESIGN OF A MINER SLIDING DOWN A ZIPLINE. THE ZIPLINE IS WHITE. THE MINER IS WEARING OVERALLS WHICH ARE DARK BLUE, WITH LIGHT GRAY CUFFS AND LIGHT GRAY BUTTONS, AND OUTLINED IN BLACK, A RED SHIRT OUTLINED IN BLACK, A TAN HAT WHICH IS OUTLINED IN BLACK AND LIGHT BROWN AND TAN BOOTS WHICH ARE OUTLINED IN BLACK. THE MINER HAS LIGHT PEACH SKIN, A WHITE BEARD, MUSTACHE AND HAIR, RED MOUTH, BLACK EYES AND EYEBROWS. ALL OF THE MINER'S PHYSICAL FEATURES ARE OUTLINED IN BLACK. THE MINER IS HOLDING A PICK WHICH IS GRAY AND LIGHT GRAY WITH A LIGHT BROWN HANDLE, AND OUTLINED IN BLACK.



*David J. Kappas*

Director of the United States Patent and Trademark Office

SER. NO. 85-628,276, FILED 5-17-2012.

WENDY GOODMAN, EXAMINING ATTORNEY

# United States of America

United States Patent and Trademark Office

# HIS RADIO

**Reg. No. 4,274,904**

**Registered Jan. 15, 2013**

**Int. Cl.: 38**

**SERVICE MARK**

**PRINCIPAL REGISTER**

RADIO TRAINING NETWORK, INC. (GEORGIA CORPORATION)  
2420 WADE HAMPTON BOULEVARD  
GREENVILLE, SC 29615

FOR: RADIO BROADCASTING SERVICES, IN CLASS 38 (U.S. CLS. 100, 101 AND 104).

FIRST USE 5-31-1984; IN COMMERCE 5-31-1984.

THE MARK CONSISTS OF STANDARD CHARACTERS WITHOUT CLAIM TO ANY PARTICULAR FONT, STYLE, SIZE, OR COLOR.

OWNER OF U.S. REG. NO. 3,232,406.

NO CLAIM IS MADE TO THE EXCLUSIVE RIGHT TO USE "RADIO", APART FROM THE MARK AS SHOWN.

SER. NO. 85-628,349, FILED 5-17-2012.

JAMES STEIN, EXAMINING ATTORNEY



*David J. Kyffers*

Director of the United States Patent and Trademark Office

# United States of America

United States Patent and Trademark Office



**Reg. No. 4,274,905**

**Registered Jan. 15, 2013**

**Int. Cl.: 36**

**SERVICE MARK**

**PRINCIPAL REGISTER**

GMARK MANAGEMENT, INC (NEW YORK CORPORATION), DBA THE GREEN TEAM  
HOME SELLING SYSTEM  
7 MAIN ST  
WARWICK, NY 10990

FOR: REAL ESTATE BROKERAGE; COMMERCIAL AND RESIDENTIAL REAL ESTATE  
AGENCY SERVICES, IN CLASS 36 (U.S. CLS. 100, 101 AND 102).

FIRST USE 6-6-2005; IN COMMERCE 6-6-2005.

THE MARK CONSISTS OF A HOUSE IN WHITE COLOR WITH GREEN OUTLINE IN FRONT  
OF A GREEN SOLID SQUARE AND THE LEFT EDGE OF THE GREEN SQUARE ENDS IN  
THE MIDDLE OF THE HOUSE, BUT IS SET TO THE BACKGROUND. THE OUTLINE OF  
THE HOUSE IS IN THE FOREGROUND AS SHOWN IN THE MARK.

THE COLOR(S) GREEN AND WHITE IS/ARE CLAIMED AS A FEATURE OF THE MARK.

SER. NO. 85-628,350, FILED 5-17-2012.

ALEXANDER L. POWERS, EXAMINING ATTORNEY



*David J. Kyffers*

Director of the United States Patent and Trademark Office

# United States of America

United States Patent and Trademark Office

## PREPEXPRESS

**Reg. No. 4,274,906**

**Registered Jan. 15, 2013**

**Int. Cl.: 9**

**TRADEMARK**

**PRINCIPAL REGISTER**

CONNECTICUT ATTORNEYS TITLE INSURANCE COMPANY (CONNECTICUT CORPORATION)  
101 CORPORATE PLACE  
ROCKY HILL, CT 06067

FOR: DOWNLOADABLE COMPUTER SOFTWARE FOR GENERATING TITLE INSURANCE AND REAL ESTATE CLOSING DOCUMENTS, IN CLASS 9 (U.S. CLS. 21, 23, 26, 36 AND 38).

FIRST USE 11-16-1993; IN COMMERCE 11-16-1993.

THE MARK CONSISTS OF STANDARD CHARACTERS WITHOUT CLAIM TO ANY PARTICULAR FONT, STYLE, SIZE, OR COLOR.

SER. NO. 85-628,394, FILED 5-17-2012.

JERI J. FICKES, EXAMINING ATTORNEY



*David J. Kyjars*

Director of the United States Patent and Trademark Office



# United States of America

United States Patent and Trademark Office

# MAD MEN

**Reg. No. 4,274,907**

LIONS GATE ENTERTAINMENT, INC. (DELAWARE CORPORATION)  
2700 COLORADO BOULEVARD  
SANTA MONICA, CA 90404

**Registered Jan. 15, 2013**

**Int. Cls.: 9, 14, 16, 21, 25,  
28, 34 and 41**

FOR: COMPUTER GAME PROGRAMS, CARTRIDGES, AND CASSETTES; DVDS FEATURING FICTIONAL DRAMA; MOTION PICTURE FILMS ABOUT FICTIONAL DRAMA; PRE-RECORDED ELECTRONIC MEDIA FEATURING FICTIONAL DRAMA, IN CLASS 9 (U.S. CLS. 21, 23, 26, 36 AND 38).

**TRADEMARK**

FIRST USE 7-1-2008; IN COMMERCE 7-1-2008.

**SERVICE MARK**

FOR: CLOCKS AND WATCHES; CUFF LINKS AND TIE CLIPS; JEWELRY AND IMITATION JEWELRY, IN CLASS 14 (U.S. CLS. 2, 27, 28 AND 50).

**PRINCIPAL REGISTER**

FIRST USE 2-28-2012; IN COMMERCE 2-28-2012.

FOR: ADDRESS BOOKS AND DIARIES; BOOKS IN THE FIELD OF FICTIONAL DRAMA; COMIC BOOKS; COMPUTER GAME INSTRUCTION MANUALS; NOTEBOOKS; POSTERS; STICKERS, IN CLASS 16 (U.S. CLS. 2, 5, 22, 23, 29, 37, 38 AND 50).

FIRST USE 7-29-2008; IN COMMERCE 7-29-2008.

FOR: BEER MUGS; BEVERAGeware; COFFEE CUPS, TEA CUPS AND MUGS; GLASS BEVERAGeware; PLATES; SHOT GLASSES, IN CLASS 21 (U.S. CLS. 2, 13, 23, 29, 30, 33, 40 AND 50).

FIRST USE 7-29-2008; IN COMMERCE 7-29-2008.

FOR: MEN'S SUITS, WOMEN'S SUITS; SWEAT SHIRTS; T-SHIRTS; TIES, IN CLASS 25 (U.S. CLS. 22 AND 39).

FIRST USE 7-29-2008; IN COMMERCE 7-29-2008.

FOR: ACTION FIGURES; BOARD GAMES; JIGSAW AND MANIPULATIVE PUZZLES; PLAYING CARDS, IN CLASS 28 (U.S. CLS. 22, 23, 38 AND 50).

FIRST USE 7-1-2010; IN COMMERCE 7-1-2010.



*David J. Kyjars*

Director of the United States Patent and Trademark Office

**Reg. No. 4,274,907** FOR: CIGARETTE LIGHTER HOLDER NOT OF PRECIOUS METAL, IN CLASS 34 (U.S. CLS. 2, 8, 9 AND 17).

FIRST USE 7-1-2008; IN COMMERCE 7-1-2008.

FOR: ENTERTAINMENT IN THE NATURE OF ON-GOING TELEVISION PROGRAMS IN THE FIELD OF FICTIONAL DRAMA, IN CLASS 41 (U.S. CLS. 100, 101 AND 107).

FIRST USE 7-19-2007; IN COMMERCE 7-19-2007.

THE MARK CONSISTS OF STANDARD CHARACTERS WITHOUT CLAIM TO ANY PARTICULAR FONT, STYLE, SIZE, OR COLOR.

OWNER OF U.S. REG. NOS. 3,341,791, 3,960,619 AND OTHERS.

SER. NO. 85-628,434, FILED 5-17-2012.

AMY C. KEAN, EXAMINING ATTORNEY

# United States of America

United States Patent and Trademark Office

## HERO HEALTH HIRE

**Reg. No. 4,274,908**

MAGELLAN HEALTH SERVICES, INC. (DELAWARE CORPORATION)  
6950 COLUMBIA GATEWAY DRIVE  
COLUMBIA, MD 21046

**Registered Jan. 15, 2013**

**Int. Cl.: 35**

FOR: PROVIDING EMPLOYMENT INFORMATION, NAMELY, PROVIDING INFORMATION TO PROSPECTIVE EMPLOYERS TO ENCOURAGE THE RECRUITING, HIRING AND TRAINING OF MILITARY VETERANS AND PROVIDING INFORMATION ABOUT JOB-SEEKING TO MILITARY VETERANS, IN CLASS 35 (U.S. CLS. 100, 101 AND 102).

**SERVICE MARK**

**PRINCIPAL REGISTER**

FIRST USE 6-22-2011; IN COMMERCE 6-22-2011.

THE MARK CONSISTS OF STANDARD CHARACTERS WITHOUT CLAIM TO ANY PARTICULAR FONT, STYLE, SIZE, OR COLOR.

NO CLAIM IS MADE TO THE EXCLUSIVE RIGHT TO USE "HEALTH HIRE", APART FROM THE MARK AS SHOWN.

SER. NO. 85-628,444, FILED 5-17-2012.

LINDA LAVACHE, EXAMINING ATTORNEY



*David J. Kyffers*

Director of the United States Patent and Trademark Office

# United States of America

United States Patent and Trademark Office

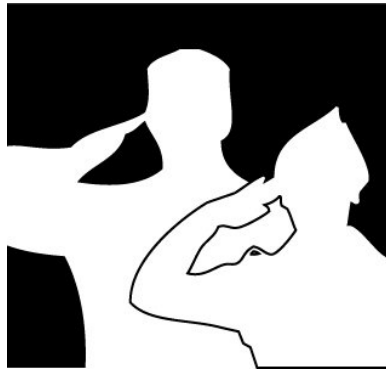

HERO  
HEALTH  
★ HIRE ★

**Reg. No. 4,274,909**

**Registered Jan. 15, 2013**

**Int. Cl.: 35**

**SERVICE MARK**

**PRINCIPAL REGISTER**

MAGELLAN HEALTH SERVICES, INC. (DELAWARE CORPORATION)  
6950 COLUMBIA GATEWAY DRIVE  
COLUMBIA, MD 21046

FOR: PROVIDING EMPLOYMENT INFORMATION, NAMELY, PROVIDING INFORMATION TO PROSPECTIVE EMPLOYERS TO ENCOURAGE THE RECRUITING, HIRING AND TRAINING OF MILITARY VETERANS AND PROVIDING INFORMATION ABOUT JOB-SEEKING TO MILITARY VETERANS, IN CLASS 35 (U.S. CLS. 100, 101 AND 102).

FIRST USE 6-22-2011; IN COMMERCE 6-22-2011.

NO CLAIM IS MADE TO THE EXCLUSIVE RIGHT TO USE "HEALTH HIRE", APART FROM THE MARK AS SHOWN.

THE MARK CONSISTS OF AN OUTLINE OF TWO FIGURES SALUTING TO THE RIGHT OF WHICH ARE THE WORDS "HERO HEALTH HIRE" ARRANGED VERTICALLY. THERE IS A STAR TO THE LEFT OF AND TO THE RIGHT OF THE WORD "HIRE".

SER. NO. 85-628,465, FILED 5-17-2012.

LINDA LAVACHE, EXAMINING ATTORNEY



*David J. Kyffers*

Director of the United States Patent and Trademark Office

# United States of America

United States Patent and Trademark Office

## CONNECT DIALOGUES

**Reg. No. 4,274,910**

**Registered Jan. 15, 2013**

**Int. Cls.: 9 and 41**

**TRADEMARK**

**SERVICE MARK**

**PRINCIPAL REGISTER**

CONNECT HEALTHCARE COMMUNICATIONS, INC. (PENNSYLVANIA CORPORATION)  
500 OFFICE CENTER DRIVE, SUITE 325  
FORT WASHINGTON, PA 19034

FOR: DOWNLOADABLE ELECTRONIC NEWSLETTERS IN THE FIELD OF MEDICINE, IN CLASS 9 (U.S. CLS. 21, 23, 26, 36 AND 38).

FIRST USE 2-0-2011; IN COMMERCE 2-0-2011.

FOR: EDUCATIONAL SERVICES, NAMELY, CONDUCTING PROGRAMS IN THE FIELD OF MEDICINE; EDUCATIONAL SERVICES, NAMELY, CONDUCTING CONFERENCES IN THE FIELD OF MEDICINE AND DISTRIBUTING COURSE MATERIALS IN CONNECTION THEREWITH, IN CLASS 41 (U.S. CLS. 100, 101 AND 107).

FIRST USE 10-22-2010; IN COMMERCE 10-22-2010.

THE MARK CONSISTS OF STANDARD CHARACTERS WITHOUT CLAIM TO ANY PARTICULAR FONT, STYLE, SIZE, OR COLOR.

NO CLAIM IS MADE TO THE EXCLUSIVE RIGHT TO USE "DIALOGUES" IN INTERNATIONAL CLASS 41, APART FROM THE MARK AS SHOWN.

SER. NO. 85-628,508, FILED 5-17-2012.

ANDREW LEASER, EXAMINING ATTORNEY



*David J. Kyjars*

Director of the United States Patent and Trademark Office

# United States of America

United States Patent and Trademark Office

## PRETTY THINGS BEER & ALE PROJECT

**Reg. No. 4,274,911**

PRETTY THINGS BEER AND ALE PROJECT, INC. (MASSACHUSETTS CORPORATION)  
P.O. BOX 426037  
CAMBRIDGE, MA 02142

**Registered Jan. 15, 2013**

**Int. Cl.: 32**

FOR: ALE; BEER; LAGER; STOUT, IN CLASS 32 (U.S. CLS. 45, 46 AND 48).

**TRADEMARK**

FIRST USE 12-0-2008; IN COMMERCE 5-0-2009.

**PRINCIPAL REGISTER**

THE MARK CONSISTS OF STANDARD CHARACTERS WITHOUT CLAIM TO ANY PARTICULAR FONT, STYLE, SIZE, OR COLOR.

NO CLAIM IS MADE TO THE EXCLUSIVE RIGHT TO USE "BEER & ALE", APART FROM THE MARK AS SHOWN.

SER. NO. 85-628,530, FILED 5-17-2012.

CATHERINE ROEHL, EXAMINING ATTORNEY



*David J. Kybas*

Director of the United States Patent and Trademark Office

# United States of America

United States Patent and Trademark Office

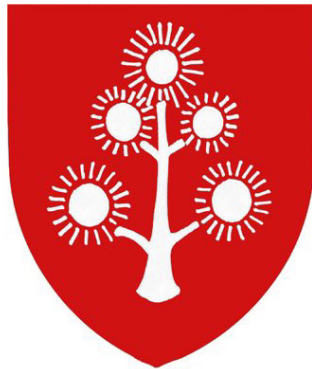

**Reg. No. 4,274,912**

**Registered Jan. 15, 2013**

**Int. Cl.: 32**

**TRADEMARK**

**PRINCIPAL REGISTER**

PRETTY THINGS BEER AND ALE PROJECT, INC. (MASSACHUSETTS CORPORATION)  
P.O. BOX 426037  
CAMBRIDGE, MA 02142

FOR: ALE; BEER; LAGER; STOUT, IN CLASS 32 (U.S. CLS. 45, 46 AND 48).

FIRST USE 12-0-2008; IN COMMERCE 5-0-2009.

THE MARK CONSISTS OF A STYLIZED TREE SHOWN IN WHITE, APPEARING ON A SHIELD DESIGN SHOWN IN RED. THE MARK APPEARS ON A TRANSPARENT BACKGROUND AND NO OTHER COLOR IS CLAIMED AS A FEATURE OF THE MARK.

THE COLOR(S) RED AND WHITE IS/ARE CLAIMED AS A FEATURE OF THE MARK.

SER. NO. 85-628,532, FILED 5-17-2012.

CATHERINE ROEHL, EXAMINING ATTORNEY



*David J. Kybas*

Director of the United States Patent and Trademark Office

# United States of America

United States Patent and Trademark Office

## Uplifted Productions, LLC

**Reg. No. 4,274,913**

UPLIFTED PRODUCTIONS, LLC (NEW YORK LIMITED LIABILITY COMPANY)  
4344 BOYD AVE  
BRONX, NY 10466

**Registered Jan. 15, 2013**

**Int. Cl.: 41**

FOR: ENTERTAINMENT SERVICES IN THE NATURE OF RECORDING, PRODUCTION AND POST-PRODUCTION SERVICES IN THE FIELD OF MUSIC, IN CLASS 41 (U.S. CLS. 100, 101 AND 107).

**SERVICE MARK**

FIRST USE 1-1-2003; IN COMMERCE 1-1-2003.

**PRINCIPAL REGISTER**

THE MARK CONSISTS OF STANDARD CHARACTERS WITHOUT CLAIM TO ANY PARTICULAR FONT, STYLE, SIZE, OR COLOR.

NO CLAIM IS MADE TO THE EXCLUSIVE RIGHT TO USE "PRODUCTIONS, LLC", APART FROM THE MARK AS SHOWN.

SER. NO. 85-628,559, FILED 5-17-2012.

JENNIFER MARTIN, EXAMINING ATTORNEY



*David J. Kyffers*

Director of the United States Patent and Trademark Office



# United States of America

United States Patent and Trademark Office

**M I C H A E L**  
**H A D D A D**

**Reg. No. 4,274,914**

HADDAD, MICHAEL (UNITED STATES INDIVIDUAL)  
10729 CUSHDON AVE.  
LOS ANGELES, CA 90064

**Registered Jan. 15, 2013**

**Int. Cl.: 36**

FOR: LEASING OF REAL ESTATE; REAL ESTATE AGENCIES; REAL ESTATE BROKERAGE;  
REAL ESTATE LISTING, IN CLASS 36 (U.S. CLS. 100, 101 AND 102).

**SERVICE MARK**

FIRST USE 1-2-2003; IN COMMERCE 1-2-2003.

**PRINCIPAL REGISTER**

THE NAME "MICHAEL HADDAD" IDENTIFIES A LIVING INDIVIDUAL WHOSE CONSENT IS OF RECORD.

THE MARK CONSISTS OF THE STYLIZED TEXT "MICHAEL HADDAD" INSIDE A RECTANGLE. THE RECTANGLE IS DIVIDED INTO TWO SECTIONS, WITH "MICHAEL" IN THE TOP SECTION, AND "HADDAD" IN THE BOTTOM SECTION.

SER. NO. 85-628,589, FILED 5-17-2012.

JASON BLAIR, EXAMINING ATTORNEY



*David J. Kyffers*

Director of the United States Patent and Trademark Office

# United States of America

United States Patent and Trademark Office



**Reg. No. 4,274,915**

BRUSHES BITES BOTTLES, LLC (MASSACHUSETTS LIMITED LIABILITY COMPANY)  
25 PARK AVE  
NATICK, MA 01760

**Registered Jan. 15, 2013**

**Int. Cl.: 41**

FOR: INSTRUCTION IN THE FIELD OF ART, IN CLASS 41 (U.S. CLS. 100, 101 AND 107).

**SERVICE MARK**

FIRST USE 11-8-2011; IN COMMERCE 11-8-2011.

**PRINCIPAL REGISTER**

NO CLAIM IS MADE TO THE EXCLUSIVE RIGHT TO USE "PAINT", APART FROM THE MARK AS SHOWN.

THE MARK CONSISTS OF THE STYLIZED TEXT "PALETES" IN LOWER CASE LETTERS USING DANIEL FONT WITH A STYLIZED IMAGE OF AN ARTIST'S PAINT BRUSH AND SWIRL OF PAINT AROUND THE TEXT. BELOW "PALETES" IS THE STYLIZED TEXT "EAT. DRINK. PAINT."

SER. NO. 85-628,602, FILED 5-17-2012.

ANDREA HACK, EXAMINING ATTORNEY



*David J. Kybas*

Director of the United States Patent and Trademark Office

# United States of America

United States Patent and Trademark Office

## Shrimp Imperio

**Reg. No. 4,274,916**

**Registered Jan. 15, 2013**

**Int. Cl.: 29**

**TRADEMARK**

**PRINCIPAL REGISTER**

OCEAN DUKE CORPORATION (CALIFORNIA CORPORATION)  
3450 FUJITA STREET  
TORRANCE, CA 90034

FOR: SEAFOOD, IN CLASS 29 (U.S. CL. 46).

FIRST USE 1-1-2011; IN COMMERCE 1-1-2011.

THE MARK CONSISTS OF STANDARD CHARACTERS WITHOUT CLAIM TO ANY PARTICULAR FONT, STYLE, SIZE, OR COLOR.

NO CLAIM IS MADE TO THE EXCLUSIVE RIGHT TO USE "SHRIMP", APART FROM THE MARK AS SHOWN.

THE ENGLISH TRANSLATION OF THE WORD "IMPERIO" IN THE MARK IS "EMPIRE".

SER. NO. 85-628,653, FILED 5-17-2012.

COLLEEN MULCRONE, EXAMINING ATTORNEY



*David J. Kyffers*

Director of the United States Patent and Trademark Office

# United States of America

United States Patent and Trademark Office

## CHOSEN FOODS

**Reg. No. 4,274,917**

**Registered Jan. 15, 2013**

**Int. Cl.: 29**

**TRADEMARK**

**PRINCIPAL REGISTER**

CHOSEN FOODS, INC. (DELAWARE CORPORATION)  
SUITE 102  
453 54TH STREET  
SAN DIEGO, CA 92114

FOR: PROCESSED EDIBLE CHIA SEEDS AND OIL; COOKING OIL, NAMELY, AVOCADO OIL; PROCESSED CACTUS POWDERS AND EXTRACTS FOR FOOD PURPOSES, IN CLASS 29 (U.S. CL. 46).

FIRST USE 8-0-2009; IN COMMERCE 7-0-2010.

THE MARK CONSISTS OF STANDARD CHARACTERS WITHOUT CLAIM TO ANY PARTICULAR FONT, STYLE, SIZE, OR COLOR.

NO CLAIM IS MADE TO THE EXCLUSIVE RIGHT TO USE "FOODS", APART FROM THE MARK AS SHOWN.

SER. NO. 85-628,708, FILED 5-17-2012.

JEFFERY COWARD, EXAMINING ATTORNEY



*David J. Kyffers*

Director of the United States Patent and Trademark Office

# United States of America

United States Patent and Trademark Office



# CHOSEN FOODS

**Reg. No. 4,274,918**

**Registered Jan. 15, 2013**

**Int. Cl.: 29**

**TRADEMARK**

**PRINCIPAL REGISTER**

CHOSEN FOODS, INC. (DELAWARE CORPORATION)  
453 54TH STREET  
SUITE 102  
SAN DIEGO, CA 92114

FOR: PROCESSED EDIBLE CHIA SEEDS AND OIL; COOKING OIL, NAMELY, AVOCADO OIL; PROCESSED CACTUS POWDERS AND EXTRACTS FOR FOOD PURPOSES, IN CLASS 29 (U.S. CL. 46).

FIRST USE 1-0-2012; IN COMMERCE 1-0-2012.

NO CLAIM IS MADE TO THE EXCLUSIVE RIGHT TO USE "FOODS", APART FROM THE MARK AS SHOWN.

THE COLOR(S) GREEN, ORANGE, RED AND WHITE IS/ARE CLAIMED AS A FEATURE OF THE MARK.

THE MARK CONSISTS OF THE GREEN WORD "CHOSEN" OVER THE GREEN WORD "FOODS" TO THE RIGHT OF A DESIGN CONSISTING OF A GREEN CIRCLE WITH ORANGE SUN-WHEEL SPOKES WITH WHITE OUTLINE RADIATING FROM A RED CENTER.

SER. NO. 85-628,721, FILED 5-17-2012.

JEFFERY COWARD, EXAMINING ATTORNEY



*David J. Kyjars*

Director of the United States Patent and Trademark Office

# United States of America

United States Patent and Trademark Office

# MandelBoard

**Reg. No. 4,274,919**

JORDAN POLLACK (UNITED STATES INDIVIDUAL)  
5 SYCAMORE RD  
SUDBURY, MA 01776

**Registered Jan. 15, 2013**

**Int. Cl.: 28**

FOR: SKATEBOARD DECKS; SKATEBOARDS; SNOWBOARDS; SURFBOARDS, IN CLASS 28 (U.S. CLS. 22, 23, 38 AND 50).

**TRADEMARK**

FIRST USE 5-17-2012; IN COMMERCE 5-17-2012.

**PRINCIPAL REGISTER**

THE MARK CONSISTS OF STANDARD CHARACTERS WITHOUT CLAIM TO ANY PARTICULAR FONT, STYLE, SIZE, OR COLOR.

SER. NO. 85-628,849, FILED 5-18-2012.

ZACHARY R. SPARER, EXAMINING ATTORNEY



*David J. Kybas*

Director of the United States Patent and Trademark Office

# United States of America

United States Patent and Trademark Office

## WOD ACROSS AMERICA

**Reg. No. 4,274,920**

**Registered Jan. 15, 2013**

**Int. Cls.: 25 and 41**

**TRADEMARK**

**SERVICE MARK**

**PRINCIPAL REGISTER**

THE ASB SPORTS GROUP LLC. (FLORIDA LIMITED LIABILITY COMPANY)  
801 BRICKELL BAY DRIVE (SUITE:1666)  
801 BRICKELL BAY DRIVE (SUITE:1666)  
MIAMI, FL 33131

FOR: ATHLETIC APPAREL, NAMELY, SHIRTS, PANTS, JACKETS, FOOTWEAR, HATS AND CAPS, ATHLETIC UNIFORMS; ATHLETIC UNIFORMS; BRAS; CAPS; FOOTWEAR; GLOVES; HATS; HEADBANDS; HEADWEAR; SHORTS; SOCKS; TIGHTS, IN CLASS 25 (U.S. CLS. 22 AND 39).

FIRST USE 2-1-2012; IN COMMERCE 3-1-2012.

FOR: ATHLETIC AND SPORTS EVENT SERVICES, NAMELY, ARRANGING, ORGANIZING, OPERATING AND CONDUCTING MARATHON RACES; ATHLETIC TRAINING SERVICES; CONSULTING SERVICES IN THE FIELDS OF FITNESS AND EXERCISE; EDUCATIONAL SERVICES, NAMELY, PROVIDING ONGOING TELEVISION PUBLIC SERVICE ANNOUNCEMENTS IN THE FIELD OF PHYSICAL FITNESS; ENTERTAINMENT IN THE NATURE OF COMPETITIONS IN THE FIELD OF WEIGHTLIFTING, CROSS-TRAINING, RUNNING, OVERALL PHYSICAL FITNESS; CONDUCTING NON-COMPETITIVE GROUP WALKING, RUNNING AND CROSS-TRAINING OUTINGS DESIGNED TO EMPHASIZE FUN AND PARTICIPATION; ORGANIZING PHYSICAL FITNESS COMPETITIONS; ENTERTAINMENT SERVICES, NAMELY, PROVIDING MOTIVATIONAL SPEAKERS AND PERSONAL APPEARANCES BY ATHLETES, SPORTS CELEBRITIES AND PHYSICAL FITNESS EXPERTS.; ENTERTAINMENT SERVICES, NAMELY, CONTEST AND INCENTIVE AWARD PROGRAMS DESIGNED TO REWARD PROGRAM PARTICIPANTS WHO EXERCISE, MAKE HEALTHY EATING CHOICES, AND ENGAGE IN OTHER HEALTH-PROMOTING ACTIVITIES; HEALTH CLUB SERVICES, NAMELY, PROVIDING INSTRUCTION AND EQUIPMENT IN THE FIELD OF PHYSICAL EXERCISE; PROVIDING FACILITIES FOR SPORTING EVENTS; PHYSICAL FITNESS STUDIO SERVICES, NAMELY, PROVIDING GROUP EXERCISE INSTRUCTION, EQUIPMENT AND FACILITIES; EDUCATIONAL SERVICES, NAMELY, ORGANIZING AND CONDUCTING CLASSES AND WORKSHOPS IN THE FIELD OF FITNESS; PHYSICAL FITNESS INSTRUCTION; PHYSICAL FITNESS TRAINING OF INDIVIDUALS AND GROUPS; PHYSICAL FITNESS TRAINING SERVICES, IN CLASS 41 (U.S. CLS. 100, 101 AND 107).

FIRST USE 2-1-2012; IN COMMERCE 3-1-2012.



*David J. Kyjars*

Director of the United States Patent and Trademark Office

**Reg. No. 4,274,920** THE MARK CONSISTS OF STANDARD CHARACTERS WITHOUT CLAIM TO ANY PARTICULAR FONT, STYLE, SIZE, OR COLOR.

SER. NO. 85-629,053, FILED 5-18-2012.

AMY KERTGATE, EXAMINING ATTORNEY



# United States of America

United States Patent and Trademark Office



**Reg. No. 4,274,921**

SHIN, YONG (UNITED STATES INDIVIDUAL)  
27 STORIG AVENUE  
CLOSTER, NJ 07624

**Registered Jan. 15, 2013**

**Int. Cls.: 29, 30 and 43**

FOR: GARDEN SALADS; SALADS, NAMELY, GARDEN SALADS, VEGETABLE SALADS, FRUIT SALADS; EGGS, IN CLASS 29 (U.S. CL. 46).

**TRADEMARK**

FIRST USE 9-1-2007; IN COMMERCE 9-1-2007.

**SERVICE MARK**

FOR: SANDWICHES; SANDWICHES, NAMELY, HAMBURGERS, PANINIS, VEGGIE BURGER SANDWICHES, SANDWICH WRAPS, IN CLASS 30 (U.S. CL. 46).

**PRINCIPAL REGISTER**

FIRST USE 9-1-2007; IN COMMERCE 9-1-2007.

FOR: RESTAURANT AND CATERING SERVICES, IN CLASS 43 (U.S. CLS. 100 AND 101).

FIRST USE 9-1-2007; IN COMMERCE 9-1-2007.

THE MARK CONSISTS OF THE WORD "TAST" WITH AN ACCENT OVER THE "A" AND A BOX WITH A STYLIZED LETTER "T" PLACED ON TOP OF THE WORD "TAST".

SER. NO. 85-629,069, FILED 5-18-2012.

KYLE PEETE, EXAMINING ATTORNEY



*David J. Kybas*

Director of the United States Patent and Trademark Office

# United States of America

United States Patent and Trademark Office

## ALPHACIDE ACTIVATOR

**Reg. No. 4,274,922**

ALPHA TECHNOLOGY U.S.A CORPORATION (FLORIDA CORPORATION)  
1340 BENNETT DRIVE  
LONGWOOD, FL 32750

**Registered Jan. 15, 2013**

**Int. Cl.: 5**

FOR: ALL PURPOSE DISINFECTANTS FOR CLEANING OF COW TEATS, IN CLASS 5 (U.S. CLS. 6, 18, 44, 46, 51 AND 52).

**TRADEMARK**

FIRST USE 6-16-2008; IN COMMERCE 6-16-2008.

**PRINCIPAL REGISTER**

THE MARK CONSISTS OF STANDARD CHARACTERS WITHOUT CLAIM TO ANY PARTICULAR FONT, STYLE, SIZE, OR COLOR.

OWNER OF U.S. REG. NO. 4,186,000.

NO CLAIM IS MADE TO THE EXCLUSIVE RIGHT TO USE "ACTIVATOR", APART FROM THE MARK AS SHOWN.

SER. NO. 85-629,147, FILED 5-18-2012.

LINDA E. BLOHM, EXAMINING ATTORNEY



*David J. Kyffers*

Director of the United States Patent and Trademark Office

# United States of America

United States Patent and Trademark Office

## ROAD TO THE GAMES

**Reg. No. 4,274,923**

**Registered Jan. 15, 2013**

**Int. Cls.: 25 and 41**

**TRADEMARK**

**SERVICE MARK**

**PRINCIPAL REGISTER**

THE ASB SPORTS GROUP LLC. (FLORIDA LIMITED LIABILITY COMPANY)  
801 BRICKELL BAY DRIVE (SUITE:1666)  
801 BRICKELL BAY DRIVE (SUITE:1666)  
MIAMI, FL 33131

FOR: ATHLETIC APPAREL, NAMELY, SHIRTS, PANTS, JACKETS, FOOTWEAR, HATS AND CAPS, ATHLETIC UNIFORMS; ATHLETIC UNIFORMS; BRAS; FOOTWEAR; GLOVES; HEADWEAR; SCIENTIFIC AND TECHNOLOGICAL APPAREL, NAMELY, SHIRTS, PANTS, JACKETS, FOOTWEAR, HATS AND CAPS, UNIFORMS; SHIRTS; SHORTS; SOCKS; TIGHTS; TOPS, IN CLASS 25 (U.S. CLS. 22 AND 39).

FIRST USE 2-1-2012; IN COMMERCE 3-1-2012.

FOR: ATHLETIC AND SPORTS EVENT SERVICES, NAMELY, ARRANGING, ORGANIZING, OPERATING AND CONDUCTING MARATHON RACES; ATHLETIC TRAINING SERVICES; CONSULTING SERVICES IN THE FIELDS OF FITNESS AND EXERCISE; EDUCATIONAL AND ENTERTAINMENT SERVICES, NAMELY, PROVIDING MOTIVATIONAL AND EDUCATIONAL SPEAKERS; EDUCATIONAL SERVICES, NAMELY, PROVIDING ONGOING PUBLIC SERVICE ANNOUNCEMENTS IN THE FIELD OF PHYSICAL FITNESS VIA A WEBSITE; EDUCATIONAL SERVICES, NAMELY, PROVIDING ONLINE INSTRUCTION IN THE FIELD PUBLIC SERVICE ANNOUNCEMENTS REGARDING PHYSICAL FITNESS VIA AN ONLINE WEBSITE, AND DISTRIBUTION OF TRAINING MATERIAL IN CONNECTION THEREWITH; ENTERTAINMENT IN THE NATURE OF COMPETITIONS IN THE FIELD OF WEIGHTLIFTING, CROSS-TRAINING, RUNNING, OVERALL PHYSICAL FITNESS; CONDUCTING NON-COMPETITIVE GROUP WALKING, RUNNING AND CROSS-TRAINING OUTINGS DESIGNED TO EMPHASIZE FUN AND PARTICIPATION; ORGANIZING PHYSICAL FITNESS COMPETITIONS; ENTERTAINMENT SERVICES, NAMELY, PROVIDING MOTIVATIONAL SPEAKERS AND PERSONAL APPEARANCES BY ATHLETES, SPORTS CELEBRITIES AND PHYSICAL FITNESS EXPERTS; ENTERTAINMENT IN THE NATURE OF WEIGHT LIFTING COMPETITIONS; ENTERTAINMENT SERVICES, NAMELY, CONTEST AND INCENTIVE AWARD PROGRAMS DESIGNED TO REWARD PROGRAM PARTICIPANTS WHO EXERCISE, MAKE HEALTHY EATING CHOICES, AND ENGAGE IN OTHER HEALTH-PROMOTING ACTIVITIES; HEALTH CLUB SERVICES, NAMELY, PROVIDING INSTRUCTION AND EQUIPMENT IN THE FIELD OF PHYSICAL EXERCISE; ENTERTAINMENT SERVICES IN THE NATURE OF LIVE MIXED MARTIAL ARTS (MMA) EVENTS; ENTERTAINMENT SERVICES, NAMELY, ARRANGING AND CONDUCTING PHYSICAL FITNESS COMPETITIONS; ENTERTAINMENT SERVICES, NAMELY, ORGAN-



*David J. Kybas*

Director of the United States Patent and Trademark Office

**Reg. No. 4,274,923** IZING AND CONDUCTING AN ARRAY OF ATHLETIC EVENTS RENDERED LIVE AND RECORDED FOR THE PURPOSE OF DISTRIBUTION THROUGH BROADCAST MEDIA; ORGANIZATION OF SPORTS COMPETITIONS; PROVIDING FACILITIES FOR SPORTING EVENTS; PHYSICAL FITNESS STUDIO SERVICES, NAMELY, PROVIDING GROUP EXERCISE INSTRUCTION, EQUIPMENT AND FACILITIES; EDUCATIONAL SERVICES, NAMELY, ORGANIZING AND CONDUCTING CLASSES AND WORKSHOPS IN THE FIELD OF FITNESS; PHYSICAL EDUCATION SERVICES; PHYSICAL FITNESS INSTRUCTION; PHYSICAL FITNESS TRAINING OF INDIVIDUALS AND GROUPS; PHYSICAL FITNESS TRAINING SERVICES; PROVIDING INFORMATION ON PHYSICAL EXERCISE, IN CLASS 41 (U.S. CLS. 100, 101 AND 107).

FIRST USE 2-1-2012; IN COMMERCE 3-1-2012.

THE MARK CONSISTS OF STANDARD CHARACTERS WITHOUT CLAIM TO ANY PARTICULAR FONT, STYLE, SIZE, OR COLOR.

SER. NO. 85-629,159, FILED 5-18-2012.

AMY KERTGATE, EXAMINING ATTORNEY

# United States of America

United States Patent and Trademark Office

## NMS LABS SYNCANN

**Reg. No. 4,274,924**

NATIONAL MEDICAL SERVICES, INC. (DELAWARE CORPORATION)  
3701 WELSH ROAD  
WILLOW GROVE, PA 19090

**Registered Jan. 15, 2013**

**Int. Cl.: 44**

FOR: DRUG TESTING FOR SUBSTANCE ABUSE; DRUG USE SCREENING SERVICES;  
DRUG USE TESTING SERVICES, IN CLASS 44 (U.S. CLS. 100 AND 101).

**SERVICE MARK**

FIRST USE 5-14-2012; IN COMMERCE 5-14-2012.

**PRINCIPAL REGISTER**

THE MARK CONSISTS OF STANDARD CHARACTERS WITHOUT CLAIM TO ANY PARTICULAR FONT, STYLE, SIZE, OR COLOR.

NO CLAIM IS MADE TO THE EXCLUSIVE RIGHT TO USE "LABS", APART FROM THE MARK AS SHOWN.

SER. NO. 85-629,240, FILED 5-18-2012.

BRIAN NEVILLE, EXAMINING ATTORNEY



*David J. Kybas*

Director of the United States Patent and Trademark Office

# United States of America

United States Patent and Trademark Office



**Reg. No. 4,274,925**

**Registered Jan. 15, 2013**

**Int. Cl.: 42**

**SERVICE MARK**

**PRINCIPAL REGISTER**

OMNIVUE BUSINESS SOLUTIONS, LLC (GEORGIA LIMITED LIABILITY COMPANY)  
SUITE 200  
1355 WINDWARD CONCOURSE  
ALPHARETTA, GA 30005

FOR: CONSULTING SERVICES IN THE FIELDS OF SELECTION, IMPLEMENTATION AND USE OF COMPUTER HARDWARE AND SOFTWARE SYSTEMS FOR OTHERS , IN CLASS 42 (U.S. CLS. 100 AND 101).

FIRST USE 3-31-2003; IN COMMERCE 3-31-2003.

OWNER OF U.S. REG. NO. 3,983,987.

THE MARK CONSISTS OF THE WORDS "OMNIVUE" AND "SEE YOUR WORLD" WITH THE DESIGN CENTERED ABOVE "OMNIVUE" AND THE DESIGN CONSISTING OF A SEMI-TRANSPARENT GLOBE WITH CIRCULAR SPOTS IN DIFFERENT SIZES.

SER. NO. 85-629,249, FILED 5-18-2012.

BRIAN NEVILLE, EXAMINING ATTORNEY



*David J. Kybas*

Director of the United States Patent and Trademark Office

# United States of America

United States Patent and Trademark Office

# GanbaMAX

**Reg. No. 4,274,926**

**Registered Jan. 15, 2013**

**Int. Cl.: 5**

**TRADEMARK**

**PRINCIPAL REGISTER**

GANBAMAX RESEARCH, INC. (CANADA CORPORATION)  
SUN LIFE PLAZA TOWER  
STE 1600 144-4 AVE SW  
CALGARY, ALBERTA, CANADA T2P3N4

FOR: (BASED ON USE IN COMMERCE) VITAMIN PREPARATIONS (BASED ON 44(D)  
PRIORITY APPLICATION) VITAMIN PREPARATIONS, IN CLASS 5 (U.S. CLS. 6, 18, 44, 46,  
51 AND 52).

FIRST USE 6-30-2009; IN COMMERCE 6-30-2009.

THE MARK CONSISTS OF STANDARD CHARACTERS WITHOUT CLAIM TO ANY PAR-  
TICULAR FONT, STYLE, SIZE, OR COLOR.

PRIORITY CLAIMED UNDER SEC. 44(D) ON JAPAN APPLICATION NO. 2012-766, FILED  
1-10-2012.

SER. NO. 85-629,345, FILED 5-18-2012.

LINDA ORNDORFF, EXAMINING ATTORNEY



*David J. Kyffers*

Director of the United States Patent and Trademark Office

# United States of America

United States Patent and Trademark Office

## MIDDLEBURG REAL ESTATE

**Reg. No. 4,274,927**

MIDDLEBURG REAL ESTATE, LLC (VIRGINIA LIMITED LIABILITY COMPANY)  
611 S 32ND STREET  
PURCELLVILLE, VA 20132

**Registered Jan. 15, 2013**

**Int. Cl.: 36**

FOR: REAL ESTATE BROKERAGE SERVICES AND REAL PROPERTY MANAGEMENT SERVICES, IN CLASS 36 (U.S. CLS. 100, 101 AND 102).

**SERVICE MARK**

FIRST USE 12-31-1939; IN COMMERCE 12-31-1939.

**PRINCIPAL REGISTER**

THE MARK CONSISTS OF STANDARD CHARACTERS WITHOUT CLAIM TO ANY PARTICULAR FONT, STYLE, SIZE, OR COLOR.

NO CLAIM IS MADE TO THE EXCLUSIVE RIGHT TO USE "REAL ESTATE", APART FROM THE MARK AS SHOWN.

SEC. 2(F).

SER. NO. 85-629,425, FILED 5-18-2012.

COLLEEN MULCRONE, EXAMINING ATTORNEY



*David J. Kybas*

Director of the United States Patent and Trademark Office



# United States of America

United States Patent and Trademark Office

## BONITACOLOR

**Reg. No. 4,274,928**

YONG BOK YI (UNITED STATES INDIVIDUAL)  
3041 BANDINI BLVD.  
VERNON, CA 90058

**Registered Jan. 15, 2013**

**Int. Cl.: 3**

FOR: NAIL POLISH, IN CLASS 3 (U.S. CLS. 1, 4, 6, 50, 51 AND 52).

**TRADEMARK**

FIRST USE 12-28-2011; IN COMMERCE 12-28-2011.

**PRINCIPAL REGISTER**

THE MARK CONSISTS OF STANDARD CHARACTERS WITHOUT CLAIM TO ANY PARTICULAR FONT, STYLE, SIZE, OR COLOR.

THE ENGLISH TRANSLATION OF "BONITA" IN THE MARK IS "NICE".

SER. NO. 85-629,437, FILED 5-18-2012.

COLLEEN MULCRONE, EXAMINING ATTORNEY



*David J. Kyffers*

Director of the United States Patent and Trademark Office

# United States of America

United States Patent and Trademark Office

## DRINKMORE WATER

**Reg. No. 4,274,929**

DRINKMORE DELIVERY, INC. (MARYLAND CORPORATION)  
7595-A RICKENBACKER DRIVE  
GAITHERSBURG, MD 20879

**Registered Jan. 15, 2013**

**Int. Cls.: 32, 39 and 40**

FOR: BOTTLED WATER, IN CLASS 32 (U.S. CLS. 45, 46 AND 48).

**TRADEMARK**

FIRST USE 9-0-1995; IN COMMERCE 3-0-1996.

**SERVICE MARK**

FOR: DELIVERY OF BOTTLED WATER, BOTTLED WATER COOLERS, AND OTHER BEVERAGES, IN CLASS 39 (U.S. CLS. 100 AND 105).

**PRINCIPAL REGISTER**

FIRST USE 9-0-1995; IN COMMERCE 3-0-1996.

FOR: BOTTLING AND LABELING OF WATER FOR OTHERS, IN CLASS 40 (U.S. CLS. 100, 103 AND 106).

FIRST USE 9-0-1995; IN COMMERCE 3-0-1996.

THE MARK CONSISTS OF STANDARD CHARACTERS WITHOUT CLAIM TO ANY PARTICULAR FONT, STYLE, SIZE, OR COLOR.

OWNER OF U.S. REG. NO. 1,913,814.

NO CLAIM IS MADE TO THE EXCLUSIVE RIGHT TO USE "WATER" , APART FROM THE MARK AS SHOWN.

SER. NO. 85-629,599, FILED 5-18-2012.

MARILYN IZZI, EXAMINING ATTORNEY



*David J. Kyffers*

Director of the United States Patent and Trademark Office

# United States of America

United States Patent and Trademark Office



**Reg. No. 4,274,930**

DRINKMORE DELIVERY, INC. (MARYLAND CORPORATION)  
7595-A RICKENBACKER DRIVE  
GAITHERSBURG, MD 20879

**Registered Jan. 15, 2013**

**Int. Cls.: 32, 39 and 40**

FOR: BOTTLED WATER, IN CLASS 32 (U.S. CLS. 45, 46 AND 48).

FIRST USE 11-0-1999; IN COMMERCE 11-0-1999.

**TRADEMARK**

FOR: DELIVERY OF BOTTLED WATER, BOTTLED WATER COOLERS, AND OTHER BEVERAGES, IN CLASS 39 (U.S. CLS. 100 AND 105).

**SERVICE MARK**

**PRINCIPAL REGISTER**

FIRST USE 11-0-1999; IN COMMERCE 11-0-1999.

FOR: BOTTLING AND LABELING OF WATER FOR OTHERS, IN CLASS 40 (U.S. CLS. 100, 103 AND 106).

FIRST USE 11-0-1999; IN COMMERCE 11-0-1999.

OWNER OF U.S. REG. NO. 1,913,814.

NO CLAIM IS MADE TO THE EXCLUSIVE RIGHT TO USE "WATER", APART FROM THE MARK AS SHOWN.



THE MARK CONSISTS OF THE STYLIZED WORDING "DRINKMORE" ABOVE THE STYLIZED WORDING "WATER", ALL INCLUDED WITHIN AN OVAL, WITH AN OUTER RING SURROUNDING THE OVAL. THE WORDING "WATER" IS INCLUDED WITHIN A HALF-OVAL SHAPE DESIGN.

SER. NO. 85-629,602, FILED 5-18-2012.

MARILYN IZZI, EXAMINING ATTORNEY

*David J. Kybas*

Director of the United States Patent and Trademark Office

# United States of America

United States Patent and Trademark Office



**WELL TRAVELED**  
**L I V I N G**

**Reg. No. 4,274,931**

**Registered Jan. 15, 2013**

**Int. Cl.: 11**

**TRADEMARK**

**PRINCIPAL REGISTER**

WELL TRAVELED IMPORTS, INC. (FLORIDA CORPORATION), DBA WELL TRAVELED LIVING  
716 SOUTH 8TH STREET  
AMELIA ISLAND, FL 32034

FOR: CHIMINEAS; ELECTRIC PATIO HEATERS; FIREPLACE HEARTHES; FIREPLACES; GAS PATIO HEATERS, IN CLASS 11 (U.S. CLS. 13, 21, 23, 31 AND 34).

FIRST USE 2-27-2010; IN COMMERCE 2-27-2010.

OWNER OF U.S. REG. NO. 3,137,861.

THE COLOR(S) GREEN, BROWN AND WHITE IS/ARE CLAIMED AS A FEATURE OF THE MARK.

THE MARK CONSISTS OF A STYLIZED GREEN GLOBE WITH WHITE CONTINENTS, THE STYLIZED WORDING "GO LIVE" APPEARING IN BROWN ACROSS THE MIDDLE OF THE GLOBE, AND GREEN SOUND WAVES RADIATING FROM THE LEFT SIDE OF THE GLOBE. THE STYLIZED WORDING "WELL TRAVELED LIVING" APPEARS TO THE RIGHT OF THE GLOBE WITH THE WORDS "WELL" AND "LIVING" APPEARING IN BROWN AND THE WORD "TRAVELED" APPEARING IN GREEN.

SER. NO. 85-629,616, FILED 5-18-2012.

AMY KERTGATE, EXAMINING ATTORNEY



*David J. Kyjars*

Director of the United States Patent and Trademark Office

# United States of America

United States Patent and Trademark Office



**Reg. No. 4,274,932**

**Registered Jan. 15, 2013**

**Int. Cl.: 3**

**TRADEMARK**

**PRINCIPAL REGISTER**

EARTHWHILE ENDEAVORS, INC. (CALIFORNIA CORPORATION)  
P.O. BOX 422911  
SAN FRANCISCO, CA 94142

FOR: NON-MEDICATED GROOMING PREPARATIONS FOR PETS, NAMELY, SHAMPOOS, CONDITIONERS, GROOMING SPRAYS AND WIPES FOR USE ON PETS' COATS AND SKIN, IN CLASS 3 (U.S. CLS. 1, 4, 6, 50, 51 AND 52).

FIRST USE 8-18-1999; IN COMMERCE 3-20-2002.

OWNER OF U.S. REG. NO. 3,073,642.

NO CLAIM IS MADE TO THE EXCLUSIVE RIGHT TO USE "PET CARE", APART FROM THE MARK AS SHOWN.

THE MARK CONSISTS OF TWO DOGS AND A CAT WITH THEIR FOREPAWS RESTING ON TOP OF A GLOBE OF THE WORLD WITH OUTLINES OF CONTINENTS THEREON WITH THE WORDS "EARTHWHILE PET CARE" DISPOSED IN FRONT OF THE GLOBE AND BELOW THE DOGS AND CAT.

SER. NO. 85-629,640, FILED 5-18-2012.

MICHAEL LITZAU, EXAMINING ATTORNEY



*David J. Kybas*

Director of the United States Patent and Trademark Office

# United States of America

United States Patent and Trademark Office

## PEACE AND SMILES BOX

**Reg. No. 4,274,933**

**Registered Jan. 15, 2013**

**Int. Cl.: 35**

**SERVICE MARK**

**PRINCIPAL REGISTER**

THE GIVING TREE (PENNSYLVANIA CORPORATION)  
245 MALLARD DRIVE  
NORTH WALES, PA 19454

FOR: CHARITABLE SERVICES, NAMELY, ORGANIZING AND CONDUCTING COMMUNITY SERVICE PROJECTS CONSISTING OF PREPARING AND DECORATING CONTAINERS FILLED WITH SCHOOL SUPPLIES, ACTIVITY BOOKS, AND TOYS, AND PROVIDING THE FILLED, DECORATED CONTAINERS TO PEDIATRIC PATIENTS IN HOSPITALS, IN CLASS 35 (U.S. CLS. 100, 101 AND 102).

FIRST USE 4-30-2012; IN COMMERCE 5-1-2012.

THE MARK CONSISTS OF STANDARD CHARACTERS WITHOUT CLAIM TO ANY PARTICULAR FONT, STYLE, SIZE, OR COLOR.

NO CLAIM IS MADE TO THE EXCLUSIVE RIGHT TO USE "BOX", APART FROM THE MARK AS SHOWN.

SER. NO. 85-629,676, FILED 5-18-2012.

KATHERINE STOIDES, EXAMINING ATTORNEY



*David J. Kyjars*

Director of the United States Patent and Trademark Office

# United States of America

United States Patent and Trademark Office

# BloomNation

**Reg. No. 4,274,934**

**Registered Jan. 15, 2013**

**Int. Cl.: 35**

**SERVICE MARK**

**PRINCIPAL REGISTER**

BLOOM NATION, LLC (DELAWARE LIMITED LIABILITY COMPANY)  
15007 VALLEY VISTA BLVD  
SHERMAN OAKS, CA 91403

FOR: TELEPHONIC AND ELECTRONIC ORDERING SERVICES IN THE FIELD OF FLOWERS, FLORAL PRODUCTS AND GIFTS; PROVIDING A SEARCHABLE DATABASE IN THE FIELD OF BUSINESS INFORMATION AVAILABLE VIA A GLOBAL COMPUTER NETWORK; PROVIDING A SEARCHABLE ON-LINE ADVERTISING GUIDE FEATURING THE GOODS AND SERVICES OF PARTICIPATING FLORISTS AND SHOPS; ADVERTISING SERVICES, NAMELY, PROVIDING ADVERTISING IN THE NATURE OF ON-LINE AND ELECTRONIC CLASSIFIED DIRECTORIES; PROVIDING A WEBSITE FEATURING EVALUATIVE FEEDBACK AND PRODUCT RATINGS OF CONSUMER GOODS AND SERVICES OF OTHERS IN THE FIELD OF FLORISTS, NAMELY, RATING SELLERS' GOODS AND SERVICES, THE VALUE AND PRICES OF SELLERS' GOODS AND SERVICES, SELLERS' PERFORMANCE, DELIVERY, AND OVERALL EXPERIENCE IN CONNECTION THEREWITH, IN CLASS 35 (U.S. CLS. 100, 101 AND 102).

FIRST USE 11-17-2010; IN COMMERCE 11-17-2010.

THE MARK CONSISTS OF STANDARD CHARACTERS WITHOUT CLAIM TO ANY PARTICULAR FONT, STYLE, SIZE, OR COLOR.

SER. NO. 85-629,916, FILED 5-18-2012.

ANDREA HACK, EXAMINING ATTORNEY



*David J. Kyffers*

Director of the United States Patent and Trademark Office

# United States of America

United States Patent and Trademark Office

# Apontech

**Reg. No. 4,274,935**

APONTECH.COM INC (TEXAS CORPORATION), DBA APONTECH  
16905 KORAT LN  
ROUND ROCK, TX 78681

**Registered Jan. 15, 2013**

**Int. Cl.: 42**

FOR: COMPUTER SOFTWARE DEVELOPMENT SERVICES, IN CLASS 42 (U.S. CLS. 100 AND 101).

**SERVICE MARK**

FIRST USE 3-1-2000; IN COMMERCE 3-1-2000.

**PRINCIPAL REGISTER**

THE MARK CONSISTS OF STANDARD CHARACTERS WITHOUT CLAIM TO ANY PARTICULAR FONT, STYLE, SIZE, OR COLOR.

SER. NO. 85-629,935, FILED S.R. 5-18-2012 AM. P.R. 9-12-2012.

KAREN K. BUSH, EXAMINING ATTORNEY



*David J. Kybas*

Director of the United States Patent and Trademark Office



# United States of America

United States Patent and Trademark Office

# Turmosaya

**Reg. No. 4,274,936**

LAFI SHALABI (UNITED STATES INDIVIDUAL), DBA SHALABI M.S. CORPORATION  
266 PACIFIC ST.

**Registered Jan. 15, 2013**

PATERSON, NJ 07503

**Int. Cl.: 29**

FOR: OLIVE OIL, IN CLASS 29 (U.S. CL. 46).

**TRADEMARK**

FIRST USE 1-1-2006; IN COMMERCE 1-1-2006.

**PRINCIPAL REGISTER**

THE MARK CONSISTS OF STANDARD CHARACTERS WITHOUT CLAIM TO ANY PARTICULAR FONT, STYLE, SIZE, OR COLOR.

SER. NO. 85-629,992, FILED 5-19-2012.

PAM WILLIS, EXAMINING ATTORNEY



*David J. Kyffers*

Director of the United States Patent and Trademark Office

# United States of America

United States Patent and Trademark Office

# VOICE

**Reg. No. 4,274,937**

**Registered Jan. 15, 2013**

**Int. Cl.: 41**

**SERVICE MARK**

**PRINCIPAL REGISTER**

CUSTOMER FOCUS, INC. (GEORGIA CORPORATION), DBA CUSTOMER FOCUS, INC.  
664 GLENOVER DRIVE  
ALPHARETTA, GA 30004

FOR: EDUCATIONAL SERVICES, NAMELY, CONDUCTING CLASSES, SEMINARS, CONFERENCES, WORKSHOPS, CLINICS IN THE FIELD OF HEALTHCARE SERVICE, SAFETY, AND QUALITY IMPROVEMENT AND DISTRIBUTION OF EDUCATIONAL MATERIALS IN CONNECTION THEREWITH, IN CLASS 41 (U.S. CLS. 100, 101 AND 107).

FIRST USE 10-1-2010; IN COMMERCE 10-1-2010.

THE MARK CONSISTS OF STANDARD CHARACTERS WITHOUT CLAIM TO ANY PARTICULAR FONT, STYLE, SIZE, OR COLOR.

OWNER OF U.S. REG. NO. 4,194,009.

SER. NO. 85-630,116, FILED 5-20-2012.

SHAUNIA CARLYLE, EXAMINING ATTORNEY



*David J. Kyffers*

Director of the United States Patent and Trademark Office

# United States of America

United States Patent and Trademark Office



**Reg. No. 4,274,938**

CLICKBOARD INC. (NEW YORK CORPORATION), DBA CLICKBOARD.ME  
2070 BYRON ROAD  
MERRICK, NY 11566

**Registered Jan. 15, 2013**

**Int. Cl.: 41**

FOR: ELECTRONIC GAMES SERVICES PROVIDED BY MEANS OF THE INTERNET, IN CLASS 41 (U.S. CLS. 100, 101 AND 107).

**SERVICE MARK**

FIRST USE 5-20-2012; IN COMMERCE 5-20-2012.

**PRINCIPAL REGISTER**

THE MARK CONSISTS OF WORD THE TERMS "CLICK BOARD" CONTAINED IN TWO RECTANGULAR BLUE BACKGROUNDS THAT ARE CONNECTED IN THE MIDDLE WITH THE TERM "CLICK" APPEARING IN YELLOW AND HAVING A YELLOW CIRCLE WITH A THICK BLUE AND THIN WHITE OUTLINE THAT CONTAINS A WHITE LETTER "C" DOTTING THE "I" OF "CLICK"; "BOARD" APPEARS IN ORANGE; THE BLUE RECTANGLE SHAPES ARE UNDERLINED BY A LIGHT BLUE LINE.

THE COLOR(S) YELLOW, ORANGE, WHITE, BLUE AND LIGHT BLUE IS/ARE CLAIMED AS A FEATURE OF THE MARK.

SER. NO. 85-630,181, FILED 5-20-2012.

ANTHONY RINKER, EXAMINING ATTORNEY



*David J. Kybas*

Director of the United States Patent and Trademark Office

# United States of America

United States Patent and Trademark Office

## INCREASING YOUR PROFITABILITY THAT IS OUR SPECIALTY

**Reg. No. 4,274,939**

**Registered Jan. 15, 2013**

**Int. Cl.: 35**

**SERVICE MARK**

**PRINCIPAL REGISTER**

EC PURCHASING.COM, INC. (DELAWARE CORPORATION)  
601 RIVERSIDE AVENUE  
JACKSONVILLE, FL 32204

FOR: PROCUREMENT OF BUSINESS PRODUCTS, NAMELY, ASSISTING OTHERS IN THE PURCHASE OF OFFICE SUPPLIES, OFFICE EQUIPMENT, AND OFFICE FURNITURE; PROCUREMENT OF BUSINESS SERVICES FOR OTHERS IN THE FIELD OF CREDIT SERVICES, PERSONAL INVESTMENTS, HEALTH CARE INSURANCE, BUY/SELL INSURANCE, KEY MAN INSURANCE, SPLIT DOLLAR INSURANCE, DEFERRED COMPENSATION, EXECUTIVE BONUSES, WEALTH TRANSFERS, CAPITAL PRESERVATION, VIATICAL SETTLEMENTS, ESTATE PLANNING, PENSION PLANS, PROFIT SHARING PLANS, 401K PLANS, HR-10 KEOGH PLANS, SEP PLANS, IRA PLANS, MUTUAL FUNDS AND ANNUITIES; AND ONLINE RETAIL AND WHOLESALE STORE SERVICES FEATURING OFFICE SUPPLIES, OFFICE EQUIPMENT AND OFFICE FURNITURE, IN CLASS 35 (U.S. CLS. 100, 101 AND 102).

FIRST USE 4-12-2012; IN COMMERCE 4-12-2012.

THE MARK CONSISTS OF STANDARD CHARACTERS WITHOUT CLAIM TO ANY PARTICULAR FONT, STYLE, SIZE, OR COLOR.

SER. NO. 85-630,229, FILED 5-21-2012.

JULIE WATSON, EXAMINING ATTORNEY



*David J. Kyffers*

Director of the United States Patent and Trademark Office

# United States of America

United States Patent and Trademark Office



**Reg. No. 4,274,940**

**Registered Jan. 15, 2013**

**Int. Cl.: 30**

**TRADEMARK**

**PRINCIPAL REGISTER**

ORT AMERICA, INC. (NEW YORK CORPORATION)  
75 MAIDEN LANE, 10TH FLOOR  
NEW YORK, NY 10038

FOR: HONEY, IN CLASS 30 (U.S. CL. 46).

FIRST USE 0-0-2011; IN COMMERCE 0-0-2011.

NO CLAIM IS MADE TO THE EXCLUSIVE RIGHT TO USE "HONEY", APART FROM THE MARK AS SHOWN.

THE COLOR(S) LIGHT BLUE, DARK BLUE AND GRAY IS/ARE CLAIMED AS A FEATURE OF THE MARK.

THE MARK CONSISTS OF THE GRAY WORDING "HONEY FROM THE HEART" ABOVE A LIGHT BLUE WRAPPED PRESENT WITH A DARK BLUE BOW THAT FORMS A STYLIZED HEART. THE WORD "HONEY" APPEARS WITHIN THE HEART AND THE WORDING "FROM THE HEART" APPEARS TO THE RIGHT OF IT. THE COLOR WHITE THAT APPEARS IN THE MARK REPRESENTS TRANSPARENT AREAS AND IS NOT BEING CLAIMED AS A FEATURE OF THE MARK.

SER. NO. 85-630,305, FILED 5-21-2012.

COURTNEY ALVAREZ, EXAMINING ATTORNEY



*David J. Kybas*

Director of the United States Patent and Trademark Office

# United States of America

United States Patent and Trademark Office



**Reg. No. 4,274,941**

AMERICAN PHYSIOLOGICAL SOCIETY (MISSOURI CORPORATION)  
9650 ROCKVILLE PIKE  
BETHSDA, MD 20814

**Registered Jan. 15, 2013**

**Int. Cls.: 16 and 41**

FOR: JOURNALS CONCERNING PHYSIOLOGY, IN CLASS 16 (U.S. CLS. 2, 5, 22, 23, 29, 37, 38 AND 50).

**TRADEMARK**

FIRST USE 2-1-2012; IN COMMERCE 2-1-2012.

**SERVICE MARK**

FOR: EDUCATIONAL SERVICES, NAMELY, DEVELOPING, ARRANGING, AND CONDUCTING EDUCATIONAL CONFERENCES AND PROGRAMS AND PROVIDING COURSES OF INSTRUCTION IN THE FIELD OF PHYSIOLOGY; ONLINE ELECTRONIC PUBLISHING OF BOOKS AND PERIODICALS IN THE FIELD OF PHYSIOLOGY; PUBLICATION OF JOURNALS IN THE FIELD OF PHYSIOLOGY, IN CLASS 41 (U.S. CLS. 100, 101 AND 107).

**PRINCIPAL REGISTER**

FIRST USE 2-1-2012; IN COMMERCE 2-1-2012.

OWNER OF U.S. REG. NOS. 2,627,988 AND 2,658,619.

THE COLOR(S) BURGANDY AND WHITE IS/ARE CLAIMED AS A FEATURE OF THE MARK.

THE MARK CONSISTS OF THE UNCAPITALIZED WHITE LETTERS "APS" IN A BURGUNDY CIRCLE.

SER. NO. 85-630,447, FILED 5-21-2012.

DAVID COLLIER, EXAMINING ATTORNEY



*David J. Kyffers*

Director of the United States Patent and Trademark Office

# United States of America

United States Patent and Trademark Office



**Reg. No. 4,274,942**

CRUZAN, PAUL (UNITED STATES INDIVIDUAL)  
48 BARBADOS DRIVE  
ALISO VIEJO, CA 92656 AND

**Registered Jan. 15, 2013**

**Int. Cl.: 41**

ADOFF, DANIEL (UNITED STATES INDIVIDUAL)  
48 BARBADOS DRIVE  
ALISO VIEJO, CA 92656

**SERVICE MARK**

**PRINCIPAL REGISTER**

FOR: WATER POLO INSTRUCTION, TRAINING, AND ARRANGING WATER POLO COMPETITIONS AND LEAGUE PLAY FOR ALL AGE GROUPS, IN CLASS 41 (U.S. CLS. 100, 101 AND 107).

FIRST USE 2-1-2012; IN COMMERCE 3-1-2012.

NO CLAIM IS MADE TO THE EXCLUSIVE RIGHT TO USE "CAPISTRANO VALLEY AQUATICS CLUB", APART FROM THE MARK AS SHOWN.

THE COLOR(S) YELLOW, WHITE, AND BLUE IS/ARE CLAIMED AS A FEATURE OF THE MARK.

THE MARK CONSISTS OF A DESIGN ELEMENT IN A FORM OF A SHIELD WITH YELLOW, WHITE, AND BLUE STRIPES, WITH THE BLUE OUTLINING BORDER THICKER AT THE BOTTOM, AND THE BLUE WORD ELEMENT "ALLIANCE" IN CAPITAL LETTERS TO THE RIGHT OF THE SHIELD, AND THE WORD ELEMENTS "A CAPISTRANO VALLEY AQUATICS CLUB" IN SMALL BLUE FONT UNDERNEATH.



SER. NO. 85-630,536, FILED 5-21-2012.

DORITT L. CARROLL, EXAMINING ATTORNEY

*David J. Kybas*

Director of the United States Patent and Trademark Office

# United States of America

United States Patent and Trademark Office

# Bike Blood

**Reg. No. 4,274,943**

**Registered Jan. 15, 2013**

**Int. Cl.: 4**

**TRADEMARK**

**PRINCIPAL REGISTER**

HARRIS, MATHEW (MASSACHUSETTS SOLE PROPRIETORSHIP), DBA PEAK  
PERFORMANCE BICYCLES  
77 WEST STATE ST.  
GRANBY, MA 01033

FOR: ALL PURPOSE LUBRICANTS, IN CLASS 4 (U.S. CLS. 1, 6 AND 15).

FIRST USE 10-10-2011; IN COMMERCE 10-21-2011.

THE MARK CONSISTS OF STANDARD CHARACTERS WITHOUT CLAIM TO ANY PARTICULAR FONT, STYLE, SIZE, OR COLOR.

NO CLAIM IS MADE TO THE EXCLUSIVE RIGHT TO USE "BIKE", APART FROM THE MARK AS SHOWN.

SER. NO. 85-630,554, FILED 5-21-2012.

NICHOLAS COLEMAN, EXAMINING ATTORNEY



*David J. Kyffers*

Director of the United States Patent and Trademark Office



# United States of America

United States Patent and Trademark Office

## NAPA NEIGHBOR

**Reg. No. 4,274,944**

NAPA VALLEY VINTNERS ASSOCIATION (CALIFORNIA CORPORATION)  
P.O. BOX 141

**Registered Jan. 15, 2013**

ST. HELENA, CA 94574

**Int. Cl.: 35**

FOR: ADMINISTRATION OF A PROGRAM FOR ENABLING PARTICIPANTS TO OBTAIN DISCOUNTS ON PRODUCTS AND SERVICES, IN CLASS 35 (U.S. CLS. 100, 101 AND 102).

**SERVICE MARK**

FIRST USE 12-31-2001; IN COMMERCE 12-31-2001.

**PRINCIPAL REGISTER**

THE MARK CONSISTS OF STANDARD CHARACTERS WITHOUT CLAIM TO ANY PARTICULAR FONT, STYLE, SIZE, OR COLOR.

NO CLAIM IS MADE TO THE EXCLUSIVE RIGHT TO USE "NAPA", APART FROM THE MARK AS SHOWN.

SER. NO. 85-630,623, FILED 5-21-2012.

PAUL E. FAHRENKOPF, EXAMINING ATTORNEY



*David J. Kyffers*

Director of the United States Patent and Trademark Office

# United States of America

United States Patent and Trademark Office

## Becky Barrick and Associates

**Reg. No. 4,274,945**

**Registered Jan. 15, 2013**

**Int. Cl.: 36**

**SERVICE MARK**

**PRINCIPAL REGISTER**

JB BARRICK LLC (WASHINGTON LIMITED LIABILITY COMPANY), AKA BECKY BARRICK AND ASSOCIATES  
11504 175TH AVE E  
BONNEY LAKE, WA 98391

FOR: REAL ESTATE BROKERAGE, IN CLASS 36 (U.S. CLS. 100, 101 AND 102).

FIRST USE 11-28-2011; IN COMMERCE 12-6-2011.

THE MARK CONSISTS OF STANDARD CHARACTERS WITHOUT CLAIM TO ANY PARTICULAR FONT, STYLE, SIZE, OR COLOR.

NO CLAIM IS MADE TO THE EXCLUSIVE RIGHT TO USE "ASSOCIATES", APART FROM THE MARK AS SHOWN.

THE NAME "BECKY BARRICK" IDENTIFIES A LIVING INDIVIDUAL WHOSE CONSENT IS OF RECORD.

SER. NO. 85-630,638, FILED 5-21-2012.

HEATHER SAPP, EXAMINING ATTORNEY



*David J. Kyffers*

Director of the United States Patent and Trademark Office

# United States of America

United States Patent and Trademark Office

## intimate lifestyles

**Reg. No. 4,274,946**

**Registered Jan. 15, 2013**

**Int. Cl.: 35**

**SERVICE MARK**

**PRINCIPAL REGISTER**

INTIMATE LIFESTYLE PRODUCTS INC. (CALIFORNIA CORPORATION)  
688 OLIVE AVE  
VENICE, CA 90291

FOR: ON-LINE RETAIL STORE SERVICES FEATURING INTIMATE ADULT PRODUCTS, INTIMATE LIFESTYLE PRODUCTS, AND ADULT SEXUAL WELLNESS PRODUCTS, IN CLASS 35 (U.S. CLS. 100, 101 AND 102).

FIRST USE 9-14-2000; IN COMMERCE 4-5-2012.

THE MARK CONSISTS OF STANDARD CHARACTERS WITHOUT CLAIM TO ANY PARTICULAR FONT, STYLE, SIZE, OR COLOR.

NO CLAIM IS MADE TO THE EXCLUSIVE RIGHT TO USE "INTIMATE", APART FROM THE MARK AS SHOWN.

SER. NO. 85-630,660, FILED 5-21-2012.

PATRICIA EVANKO, EXAMINING ATTORNEY



*David J. Kybas*

Director of the United States Patent and Trademark Office

# United States of America

United States Patent and Trademark Office

## FRIENDS IN KNEED

**Reg. No. 4,274,947**

GORDON, G. IRWIN (UNITED STATES INDIVIDUAL)  
3711 NORMANDY AVENUE  
DALLAS, TX 75205

**Registered Jan. 15, 2013**

**Int. Cl.: 42**

FOR: PROVIDING AN ONLINE COMMUNITY FOR REGISTERED USERS TO PARTICIPATE IN DISCUSSIONS, OBTAIN FEEDBACK FROM THEIR PEERS, FORM VIRTUAL COMMUNITIES, AND ENGAGE IN SOCIAL NETWORKING SERVICES IN THE FIELD OF SPORTS MEDICINE, IN CLASS 42 (U.S. CLS. 100 AND 101).

**SERVICE MARK**

**PRINCIPAL REGISTER**

FIRST USE 3-1-2012; IN COMMERCE 3-1-2012.

THE MARK CONSISTS OF STANDARD CHARACTERS WITHOUT CLAIM TO ANY PARTICULAR FONT, STYLE, SIZE, OR COLOR.

SER. NO. 85-630,708, FILED 5-21-2012.

TOBY BULLOFF, EXAMINING ATTORNEY



*David J. Kyffers*

Director of the United States Patent and Trademark Office

# United States of America

United States Patent and Trademark Office



**Reg. No. 4,274,948**

GORDON, G. IRWIN (UNITED STATES INDIVIDUAL)  
3711 NORMANDY AVENUE  
DALLAS, TX 75205

**Registered Jan. 15, 2013**

**Int. Cl.: 42**

FOR: PROVIDING AN ONLINE COMMUNITY FOR REGISTERED USERS TO PARTICIPATE IN DISCUSSIONS, OBTAIN FEEDBACK FROM THEIR PEERS, FORM VIRTUAL COMMUNITIES, AND ENGAGE IN SOCIAL NETWORKING SERVICES IN THE FIELD OF SPORTS MEDICINE, IN CLASS 42 (U.S. CLS. 100 AND 101).

**SERVICE MARK**

**PRINCIPAL REGISTER**

FIRST USE 3-1-2012; IN COMMERCE 3-1-2012.

THE MARK CONSISTS OF A CARTOON GREEN DINOSAUR WITH A YELLOW BANDAGE ON THE DINOSAUR'S RIGHT KNEE. THE DINOSAUR APPEARS AGAINST A WHITE BACKGROUND SURROUNDED BY A YELLOW CIRCLE OUTLINED IN GREEN AND BLACK. THE YELLOW CIRCLE CONTAINS THE WORDS "FRIENDS IN KNEED", IN GREEN, CENTERED WITHIN THE TOP ARC OF THE CIRCLE, AND THE WORDS "WWW.FRIENDSINKNEED.COM", ALSO IN GREEN, CENTERED WITHIN THE BOTTOM ARC OF THE CIRCLE.

THE COLOR(S) GREEN, YELLOW, BLACK AND WHITE IS/ARE CLAIMED AS A FEATURE OF THE MARK.

SER. NO. 85-630,710, FILED 5-21-2012.

TOBY BULLOFF, EXAMINING ATTORNEY



*David J. Kybas*

Director of the United States Patent and Trademark Office

# United States of America

United States Patent and Trademark Office

## Jerome's Modular

**Reg. No. 4,274,949**

JEROME'S FURNITURE WAREHOUSE, INC. (CALIFORNIA CORPORATION)  
16960 MESAMINT ST.

**Registered Jan. 15, 2013**

SAN DIEGO, CA 92127

**Int. Cl.: 20**

FOR: CUSHIONS; CUSTOM FURNITURE; FURNITURE; FURNITURE FITTINGS, NOT OF METAL; FURNITURE FOR HOUSE, OFFICE AND GARDEN; FURNITURE FRAMES; FURNITURE MADE FROM WOOD OR SUBSTITUTES FOR WOOD; FURNITURE OF METAL; FURNITURE PARTS; FUTONS; LIVING ROOM FURNITURE; METAL FURNITURE; RECLINERS; RESIDENTIAL AND COMMERCIAL FURNITURE; SEATING FURNITURE; SEATS; UPHOLSTERED FURNITURE, IN CLASS 20 (U.S. CLS. 2, 13, 22, 25, 32 AND 50).

**TRADEMARK**

**PRINCIPAL REGISTER**

FIRST USE 4-1-2008; IN COMMERCE 4-1-2008.

THE MARK CONSISTS OF STANDARD CHARACTERS WITHOUT CLAIM TO ANY PARTICULAR FONT, STYLE, SIZE, OR COLOR.

NO CLAIM IS MADE TO THE EXCLUSIVE RIGHT TO USE "MODULAR" , APART FROM THE MARK AS SHOWN.

SER. NO. 85-630,732, FILED 5-21-2012.

LINDA E. BLOHM, EXAMINING ATTORNEY



*David J. Kyffers*

Director of the United States Patent and Trademark Office

# United States of America

United States Patent and Trademark Office



**Reg. No. 4,274,950**

**Registered Jan. 15, 2013**

**Int. Cl.: 20**

**TRADEMARK**

**PRINCIPAL REGISTER**

JEROME'S FURNITURE WAREHOUSE, INC. (CALIFORNIA CORPORATION)  
16960 MESAMINT ST.  
SAN DIEGO, CA 92127

FOR: CUSHIONS; CUSTOM FURNITURE; FURNITURE; FURNITURE FITTINGS, NOT OF METAL; FURNITURE FOR HOUSE, OFFICE AND GARDEN; FURNITURE FRAMES; FURNITURE MADE FROM WOOD OR SUBSTITUTES FOR WOOD; FURNITURE OF METAL; FURNITURE PARTS; FUTONS; LIVING ROOM FURNITURE; METAL FURNITURE; RECLINERS; RESIDENTIAL AND COMMERCIAL FURNITURE; SEATING FURNITURE; SEATS; UPHOLSTERED FURNITURE, IN CLASS 20 (U.S. CLS. 2, 13, 22, 25, 32 AND 50).

FIRST USE 4-1-2008; IN COMMERCE 4-1-2008.

NO CLAIM IS MADE TO THE EXCLUSIVE RIGHT TO USE "MODULAR" AND "CUSTOMIZE THIS SET TO FIT YOUR SPACE!", APART FROM THE MARK AS SHOWN.

THE COLOR(S) RED AND WHITE IS/ARE CLAIMED AS A FEATURE OF THE MARK.

THE MARK CONSISTS OF A RED ROUND-EDGE SQUARE, AT THE TOP OF THE RED SQUARE IS THE NAME "JEROME'S" SHOWN IN THE COLOR WHITE. BELOW "JEROME'S" ARE THE LETTERS "MOD", IN THE COLOR RED, AND LOCATED WITH A WHITE RECTANGLE WITH CURVED EDGES. TO THE RIGHT OF RECTANGLE WITH THE LETTERS "MOD" IS THE LETTER "U" SHOWN IN THE COLOR RED AND LOCATED WITHIN A WHITE SQUARE WITH CURVED EDGES. THE "MOD" RECTANGLE AND "U" SQUARE ARE HORIZONTALLY ADJACENT TO ONE ANOTHER. THE LETTERS "LAR" ARE IN THE COLOR RED, AND ARE LOCATED IN A WHITE RECTANGLE WITH CURVED EDGES. THE "LAR" RECTANGLE IS VERTICALLY POSITIONED BELOW THE "U" SQUARE. THE "MOD" RECTANGLE, THE "U" SQUARE AND "LAR" RECTANGLE CREATE THE SHAPE OF A NINETY DEGREE ANGLE. THE PHRASE "CUSTOMIZE THIS SET TO FIT YOUR SPACE!", IS SHOWN IN THE COLOR WHITE AND IS POSITIONED BELOW THE "MOD" RECTANGLE AND ADJACENT TO THE "LAR" RECTANGLE.



SER. NO. 85-630,771, FILED 5-21-2012.

*David J. Kappas*

LINDA E. BLOHM, EXAMINING ATTORNEY

# United States of America

United States Patent and Trademark Office

# VibeNotes

**Reg. No. 4,274,951**

MOBILE MATEZ, INC (NEVADA CORPORATION), AKA MOBILE MATEZ  
7260 W AZURE DR #140-643

**Registered Jan. 15, 2013**

LAS VEGAS, NV 89130

**Int. Cl.: 45**

FOR: COMPUTER DATING SERVICES; DATING SERVICES; INTERNET BASED SOCIAL NETWORKING, INTRODUCTION, AND DATING SERVICES; ONLINE MATCHMAKING SERVICES VIA THE INTERNET , IN CLASS 45 (U.S. CLS. 100 AND 101).

**SERVICE MARK**

FIRST USE 5-3-2012; IN COMMERCE 5-15-2012.

**PRINCIPAL REGISTER**

THE MARK CONSISTS OF STANDARD CHARACTERS WITHOUT CLAIM TO ANY PARTICULAR FONT, STYLE, SIZE, OR COLOR.

SER. NO. 85-630,872, FILED 5-21-2012.

JIM RINGLE, EXAMINING ATTORNEY



*David J. Kyffers*

Director of the United States Patent and Trademark Office



# United States of America

United States Patent and Trademark Office

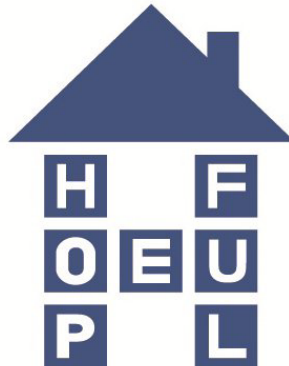

**Reg. No. 4,274,952**

HOPEFUL ENTERPRISE INC. (CALIFORNIA CORPORATION)  
11688 CLARK ST.  
ARCADIA, CA 91006

**Registered Jan. 15, 2013**

**Int. Cls.: 20 and 21**

FOR: MIRRORS, BATHROOM MIRRORS, VANITY MIRRORS, WINE RACKS, SHOE RACKS,  
IN CLASS 20 (U.S. CLS. 2, 13, 22, 25, 32 AND 50).

**TRADEMARK**

FIRST USE 3-30-2011; IN COMMERCE 5-1-2011.

**PRINCIPAL REGISTER**

FOR: KITCHEN ACCESSORIES, NAMELY, BREAD CONTAINERS, FOOD STORAGE CONTAINERS, EMPTY FRUIT BASKETS, MUG TREES, PAPER TOWEL HOLDERS, TRASH CANS, COCKTAIL SHAKERS; BATHROOM ACCESSORIES, NAMELY, WASTE BASKETS, TOWEL BARS AND TOWEL RINGS, TOILET BRUSH HOLDERS, SHOWER RACKS, AND LAUNDRY BASKETS, IN CLASS 21 (U.S. CLS. 2, 13, 23, 29, 30, 33, 40 AND 50).

FIRST USE 3-30-2011; IN COMMERCE 5-1-2011.

THE MARK CONSISTS OF A BLUE ROOF WITH A BLUE CHIMNEY WITH SEVEN BLUE BLOCKS UNDERNEATH THAT FORM THE LETTER "H" AND WITHIN EACH BLOCK APPEARS A WHITE LETTER THAT COMBINED SPELLS THE WORD "HOPEFUL".

THE COLOR(S) BLUE AND WHITE IS/ARE CLAIMED AS A FEATURE OF THE MARK.

SER. NO. 85-630,903, FILED 5-21-2012.

GIANCARLO CASTRO, EXAMINING ATTORNEY



*David J. Kybas*

Director of the United States Patent and Trademark Office

# United States of America

United States Patent and Trademark Office

## ERBERT & GERBERT'S BISTRO

**Reg. No. 4,274,953**

E & G FRANCHISE SYSTEMS, INC. (WISCONSIN CORPORATION)  
205 E. GRAND  
EAU CLAIRE, WI 54701

**Registered Jan. 15, 2013**

**Int. Cl.: 43**

FOR: RESTAURANT AND CAFE SERVICES, IN CLASS 43 (U.S. CLS. 100 AND 101).

**SERVICE MARK**

FIRST USE 8-26-2011; IN COMMERCE 8-26-2011.

**PRINCIPAL REGISTER**

THE MARK CONSISTS OF STANDARD CHARACTERS WITHOUT CLAIM TO ANY PARTICULAR FONT, STYLE, SIZE, OR COLOR.

OWNER OF U.S. REG. NOS. 2,557,729, 2,877,579, AND 3,980,443.

NO CLAIM IS MADE TO THE EXCLUSIVE RIGHT TO USE "BISTRO", APART FROM THE MARK AS SHOWN.

THE NAMES "ERBERT & GERBERT" DO NOT IDENTIFY LIVING INDIVIDUALS.

SER. NO. 85-630,956, FILED 5-21-2012.

DANIEL S. STRINGER, EXAMINING ATTORNEY



*David J. Kyfos*

Director of the United States Patent and Trademark Office

# United States of America

United States Patent and Trademark Office

# Nutritious U

**Reg. No. 4,274,954**

**Registered Jan. 15, 2013**

**Int. Cl.: 29**

**TRADEMARK**

**PRINCIPAL REGISTER**

LRS ENTERPRISES, LLC (COLORADO LIMITED LIABILITY COMPANY), DBA NUTRITIOUS  
U  
975 LINCOLN STREET, #5H  
DENVER, CO 80203

FOR: NUT AND SEED-BASED SNACK BARS, IN CLASS 29 (U.S. CL. 46).

FIRST USE 7-19-2011; IN COMMERCE 9-15-2011.

THE MARK CONSISTS OF STANDARD CHARACTERS WITHOUT CLAIM TO ANY PARTICULAR FONT, STYLE, SIZE, OR COLOR.

NO CLAIM IS MADE TO THE EXCLUSIVE RIGHT TO USE "NUTRITIOUS", APART FROM THE MARK AS SHOWN.

SER. NO. 85-630,968, FILED 5-21-2012.

EMILY CARLSEN, EXAMINING ATTORNEY



*David J. Kyffers*

Director of the United States Patent and Trademark Office

# United States of America

United States Patent and Trademark Office

## Missouri General Wind Turbine

**Reg. No. 4,274,955**

**Registered Jan. 15, 2013**

**Int. Cl.: 7**

**TRADEMARK**

**PRINCIPAL REGISTER**

MISSOURI WIND AND SOLAR, LLC (MISSOURI LIMITED LIABILITY COMPANY)  
332 COBBLESTONE DRIVE  
SEYMOUR, MO 65746

FOR: WIND TURBINES, IN CLASS 7 (U.S. CLS. 13, 19, 21, 23, 31, 34 AND 35).

FIRST USE 10-1-2007; IN COMMERCE 10-1-2007.

THE MARK CONSISTS OF STANDARD CHARACTERS WITHOUT CLAIM TO ANY PARTICULAR FONT, STYLE, SIZE, OR COLOR.

NO CLAIM IS MADE TO THE EXCLUSIVE RIGHT TO USE "MISSOURI" OR "WIND TURBINE", APART FROM THE MARK AS SHOWN.

SER. NO. 85-631,057, FILED 5-21-2012.

JAMES LOVELACE, EXAMINING ATTORNEY



*David J. Kyffers*

Director of the United States Patent and Trademark Office

# United States of America

United States Patent and Trademark Office



**Reg. No. 4,274,956**

CHANDLER, JACOB R. (UNITED STATES INDIVIDUAL)  
1075 DIAMOND RIDGE  
BOERNE, TX 78006

**Registered Jan. 15, 2013**

**Int. Cl.: 35**

FOR: PROMOTING THE GOODS AND SERVICES OF OTHERS BY MEANS OF OPERATING AN ON-LINE SHOPPING MALL WITH LINKS TO THE RETAIL WEB SITES OF OTHERS, IN CLASS 35 (U.S. CLS. 100, 101 AND 102).

**SERVICE MARK**

FIRST USE 8-1-2007; IN COMMERCE 10-1-2008.

**PRINCIPAL REGISTER**

THE MARK CONSISTS OF THE WORDING "COLLECTORCOMPARE". THE LETTERING "COLLECT" IS NAVY BLUE. THE LETTERING "COMPARE" IS ORANGE. THE LETTERING "OR" IS WHITE AGAINST AN ORANGE BACKGROUND INSIDE A STYLIZED NAVY BLUE MAGNIFYING.

THE COLOR(S) NAVY BLUE, ORANGE, AND WHITE IS/ARE CLAIMED AS A FEATURE OF THE MARK.

SER. NO. 85-631,060, FILED 5-21-2012.

WENDY GOODMAN, EXAMINING ATTORNEY



*David J. Kyffers*

Director of the United States Patent and Trademark Office

# United States of America

United States Patent and Trademark Office

## Missouri Rebel Wind Turbine

**Reg. No. 4,274,957**

MISSOURI WIND AND SOLAR, LLC (MISSOURI LIMITED LIABILITY COMPANY)  
332 COBBLESTONE DRIVE  
SEYMOUR, MO 65746

**Registered Jan. 15, 2013**

**Int. Cl.: 7**

FOR: WIND TURBINES, IN CLASS 7 (U.S. CLS. 13, 19, 21, 23, 31, 34 AND 35).

FIRST USE 10-1-2007; IN COMMERCE 10-1-2007.

**TRADEMARK**

THE MARK CONSISTS OF STANDARD CHARACTERS WITHOUT CLAIM TO ANY PARTICULAR FONT, STYLE, SIZE, OR COLOR.

**PRINCIPAL REGISTER**

NO CLAIM IS MADE TO THE EXCLUSIVE RIGHT TO USE "MISSOURI" OR "WIND TURBINE", APART FROM THE MARK AS SHOWN.

SER. NO. 85-631,061, FILED 5-21-2012.

JAMES LOVELACE, EXAMINING ATTORNEY



*David J. Kyffers*

Director of the United States Patent and Trademark Office

# United States of America

United States Patent and Trademark Office

## Missouri Raider Wind Turbine

**Reg. No. 4,274,958**

MISSOURI WIND AND SOLAR, LLC (MISSOURI LIMITED LIABILITY COMPANY)  
332 COBBLESTONE DRIVE  
SEYMOUR, MO 65746

**Registered Jan. 15, 2013**

**Int. Cl.: 7**

FOR: WIND TURBINES, IN CLASS 7 (U.S. CLS. 13, 19, 21, 23, 31, 34 AND 35).

**TRADEMARK**

FIRST USE 10-1-2007; IN COMMERCE 10-1-2007.

**PRINCIPAL REGISTER**

THE MARK CONSISTS OF STANDARD CHARACTERS WITHOUT CLAIM TO ANY PARTICULAR FONT, STYLE, SIZE, OR COLOR.

NO CLAIM IS MADE TO THE EXCLUSIVE RIGHT TO USE "MISSOURI" OR "WIND TURBINE", APART FROM THE MARK AS SHOWN.

SER. NO. 85-631,065, FILED 5-21-2012.

JAMES LOVELACE, EXAMINING ATTORNEY



*David J. Kyffers*

Director of the United States Patent and Trademark Office

# United States of America

United States Patent and Trademark Office

*Agua Dulce*  
HANDMADE COCKTAIL WEAR

**Reg. No. 4,274,959**

MARIANA AGUIRRE CAMOU (MEXICO INDIVIDUAL)  
BLVD. SOLIDARIDAD #310, COL. LAS QUINTAS  
HERMOSILLO, SONORA, MEXICO 83240

**Registered Jan. 15, 2013**

**Int. Cl.: 25**

FOR: HANDMADE DRESSING GOWNS; AND HANDMADE NIGHT GOWNS, IN CLASS 25  
(U.S. CLS. 22 AND 39).

**TRADEMARK**

FIRST USE 11-12-2011; IN COMMERCE 11-12-2011.

**PRINCIPAL REGISTER**

NO CLAIM IS MADE TO THE EXCLUSIVE RIGHT TO USE "HANDMADE COCKTAIL WEAR", APART FROM THE MARK AS SHOWN.

THE MARK CONSISTS OF THE HANDWRITING STYLE OF THE WORDS "AGUA DULCE" AND BELOW THIS ARE THE WORDS "HANDMADE COCKTAIL WEAR" IN REGULAR FONT.

THE ENGLISH TRANSLATION OF "AGUA DULCE" IN THE MARK IS "SWEET WATER".

SER. NO. 85-631,162, FILED 5-21-2012.

ALEXANDER L. POWERS, EXAMINING ATTORNEY



*David J. Kybas*

Director of the United States Patent and Trademark Office



# United States of America

United States Patent and Trademark Office

## KOA COFFEE PLANTATION

**Reg. No. 4,274,960**

**Registered Jan. 15, 2013**

**Int. Cl.: 30**

**TRADEMARK**

**PRINCIPAL REGISTER**

PARADISE BEVERAGES, INC. (HAWAII CORPORATION), DBA HAWAII COFFEE  
COMPANY  
94-1450 MOANIANI STREET  
WAIPAHU, HI 96797

FOR: COFFEE, IN CLASS 30 (U.S. CL. 46).

FIRST USE 9-24-2005; IN COMMERCE 9-24-2005.

THE MARK CONSISTS OF STANDARD CHARACTERS WITHOUT CLAIM TO ANY PARTICULAR FONT, STYLE, SIZE, OR COLOR.

OWNER OF U.S. REG. NO. 3,092,345.

NO CLAIM IS MADE TO THE EXCLUSIVE RIGHT TO USE "COFFEE PLANTATION", APART FROM THE MARK AS SHOWN.

SER. NO. 85-631,218, FILED 5-21-2012.

JEANIE LEE, EXAMINING ATTORNEY



*David J. Kyffers*

Director of the United States Patent and Trademark Office

# United States of America

United States Patent and Trademark Office

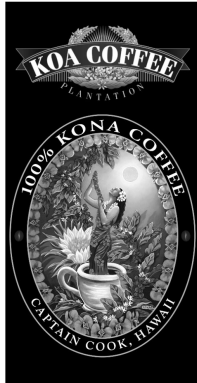

**Reg. No. 4,274,961**

**Registered Jan. 15, 2013**

**Int. Cl.: 30**

**TRADEMARK**

**PRINCIPAL REGISTER**

PARADISE BEVERAGES, INC. (HAWAII CORPORATION), DBA HAWAII COFFEE  
COMPANY  
94-1450 MOANIANI STREET  
WAIPAHU, HI 96797

FOR: KONA COFFEE, IN CLASS 30 (U.S. CL. 46).

FIRST USE 9-24-2005; IN COMMERCE 9-24-2005.

OWNER OF U.S. REG. NO. 3,092,345.

NO CLAIM IS MADE TO THE EXCLUSIVE RIGHT TO USE "COFFEE PLANTATION", "100% KONA COFFEE", AND "CAPTAIN COOK, HAWAII", APART FROM THE MARK AS SHOWN.

THE MARK CONSISTS OF THE WORDS "KOA COFFEE" ON A HORIZONTAL BANNER COMPRISED OF A RIBBON AND A WREATH OF FLOWERS ABOVE THE WORD "PLANTATION" WHICH SITS ALTOGETHER ABOVE A DESIGN OF A HAWAIIAN WOMAN STANDING IN A CUP OF COFFEE LOOKING SKYWARD AND HOLDING A FLOWER LEI AND SURROUNDED IN FLORA WITH A SUN IN THE BACKGROUND AND ALTOGETHER WITHIN A FRAME OF TWO CONCENTRIC OVALS EXHIBITING THE WORDS "100% KONA COFFEE" WITHIN THE UPPER SPACE BETWEEN THE OVALS AND THE WORDS "CAPTAIN COOK, HAWAII" WITHIN THE LOWER SPACE BETWEEN THE OVALS. THE MARK APPEARS ON A BLACK RECTANGULAR BACKGROUND, THE COLOR OF WHICH IS NOT CLAIMED AS A FEATURE OF THE MARK.

SER. NO. 85-631,223, FILED 5-21-2012.

JEANIE LEE, EXAMINING ATTORNEY



*David J. Kyjars*

Director of the United States Patent and Trademark Office

# United States of America

United States Patent and Trademark Office



**Reg. No. 4,274,962**

**Registered Jan. 15, 2013**

**Int. Cl.: 30**

**TRADEMARK**

**PRINCIPAL REGISTER**

PARADISE BEVERAGES, INC. (HAWAII CORPORATION), DBA HAWAII COFFEE  
COMPANY  
94-1450 MOANIANI STREET  
WAIPAHU, HI 96797

FOR: COFFEE, IN CLASS 30 (U.S. CL. 46).

FIRST USE 9-24-2005; IN COMMERCE 9-24-2005.

OWNER OF U.S. REG. NO. 3,092,345.

NO CLAIM IS MADE TO THE EXCLUSIVE RIGHT TO USE "CAPTAIN COOK, HAWAII",  
APART FROM THE MARK AS SHOWN.

THE MARK CONSISTS OF A DESIGN OF A HAWAIIAN WOMAN STANDING IN A CUP  
OF COFFEE LOOKING SKYWARD AND HOLDING A FLOWER LEI AND SURROUNDED  
IN FLORA WITH A SUN IN THE BACKGROUND AND ALTOGETHER WITHIN A FRAME  
OF TWO CONCENTRIC OVALS EXHIBITING THE WORDS "CAPTAIN COOK, HAWAII"  
WITHIN THE LOWER SPACE BETWEEN THE OVALS.

SER. NO. 85-631,225, FILED 5-21-2012.

JEANIE LEE, EXAMINING ATTORNEY



*David J. Kyffers*

Director of the United States Patent and Trademark Office

# United States of America

United States Patent and Trademark Office

## Obu Interactive

**Reg. No. 4,274,963**

**Registered Jan. 15, 2013**

**Int. Cls.: 35 and 42**

**SERVICE MARK**

**PRINCIPAL REGISTER**

OBU INTERACTIVE (DELAWARE LIMITED LIABILITY COMPANY)  
363 5TH AVENUE, SUITE 302  
SAN DIEGO, CA 92101

FOR: ADVERTISING AND MARKETING; ADVERTISING AND MARKETING SERVICES PROVIDED BY MEANS OF INDIRECT METHODS OF MARKETING COMMUNICATIONS, NAMELY, SOCIAL MEDIA, SEARCH ENGINE MARKETING, INQUIRY MARKETING, INTERNET MARKETING, MOBILE MARKETING, BLOGGING AND OTHER FORMS OF PASSIVE, SHARABLE OR VIRAL COMMUNICATIONS CHANNELS; ADVERTISING AND MARKETING SERVICES, NAMELY, PROMOTING THE GOODS AND SERVICES OF OTHERS; ADVERTISING SERVICES, NAMELY, PROMOTING AND MARKETING THE GOODS AND SERVICES OF OTHERS IN THE FIELD OF LAW VIA PRINT AND ELECTRONIC MEDIA; ADVERTISING, MARKETING AND PROMOTION SERVICES IN THE FIELD OF LAW; ONLINE ADVERTISING AND PROMOTIONAL SERVICES; PROMOTING, ADVERTISING AND MARKETING ON-LINE WEB SITES OF OTHERS, IN CLASS 35 (U.S. CLS. 100, 101 AND 102).

FIRST USE 4-1-2008; IN COMMERCE 7-1-2008.

FOR: COMPUTER SERVICES, NAMELY, CREATING, MAINTAINING, DESIGNING AND IMPLEMENTING WEB SITES FOR OTHERS; COMPUTER SERVICES, NAMELY, DESIGNING AND IMPLEMENTING WEB PAGES FOR OTHERS; COMPUTER SERVICES, NAMELY, DESIGNING AND IMPLEMENTING WEB SITES FOR OTHERS; COMPUTER SERVICES, NAMELY, HOSTING AND MAINTAINING AN ON-LINE WEB SITE FOR OTHERS IN THE FIELD OF LAW; COMPUTER SERVICES, NAMELY, MANAGING WEB SITES FOR OTHERS; CREATING AND DESIGNING WEB PAGES FOR OTHERS; CREATING AND MAINTAINING WEB SITES FOR OTHERS; CREATING WEB PAGES FOR OTHERS; CREATING, DESIGNING AND MAINTAINING WEB SITES; CREATION AND MAINTENANCE OF WEB SITES FOR OTHERS; CREATION, DESIGN, DEVELOPMENT AND MAINTENANCE OF WEB SITES FOR THIRD PARTIES; DESIGN AND MAINTENANCE OF WEB SITES FOR OTHERS; DESIGN OF HOME PAGES AND WEB SITES; DESIGNING AND DEVELOPING WEBPAGES ON THE INTERNET; DESIGNING WEBSITES FOR ADVERTISING PURPOSES, IN CLASS 42 (U.S. CLS. 100 AND 101).

FIRST USE 4-1-2008; IN COMMERCE 7-1-2008.



*David J. Kyjars*

Director of the United States Patent and Trademark Office

**Reg. No. 4,274,963** THE MARK CONSISTS OF STANDARD CHARACTERS WITHOUT CLAIM TO ANY PARTICULAR FONT, STYLE, SIZE, OR COLOR.

NO CLAIM IS MADE TO THE EXCLUSIVE RIGHT TO USE "INTERACTIVE", APART FROM THE MARK AS SHOWN.

SER. NO. 85-631,244, FILED 5-21-2012.

JASON LOTT, EXAMINING ATTORNEY

# United States of America

United States Patent and Trademark Office



**Reg. No. 4,274,964**

**Registered Jan. 15, 2013**

**Int. Cls.: 35 and 42**

**SERVICE MARK**

**PRINCIPAL REGISTER**

COMMUNISPACE CORPORATION (DELAWARE CORPORATION)  
290 CONGRESS STREET  
BOSTON, MA 02210

FOR: BUSINESS INFORMATION SERVICES, NAMELY, PREPARING BUSINESS REPORTS CONTAINING INFORMATION COLLECTED FROM REGISTERED USERS OF INTERACTIVE SOCIAL MEDIA WEBSITES, IN CLASS 35 (U.S. CLS. 100, 101 AND 102).

FIRST USE 9-0-2009; IN COMMERCE 9-0-2009.

FOR: COMPUTER SERVICES, NAMELY, DESIGNING, DEVELOPING, CREATING, IMPLEMENTING AND MAINTAINING ON-LINE WEBSITES FOR OTHERS FOR REGISTERED USERS TO PARTICIPATE IN CUSTOMER COMMUNITIES; COMPUTER SERVICES, NAMELY, HOSTING ON-LINE WEB FACILITIES FOR OTHERS FOR ORGANIZING AND CONDUCTING ONLINE MEETINGS, GATHERINGS, AND INTERACTIVE DISCUSSIONS; COMPUTER SOFTWARE CONSULTANCY; CONSULTING SERVICES IN THE FIELD OF DESIGN, DEVELOPMENT, CREATION, IMPLEMENTATION AND MAINTENANCE OF ON-LINE WEBSITES FOR OTHERS FOR REGISTERED USERS TO PARTICIPATE IN CUSTOMER COMMUNITIES, IN CLASS 42 (U.S. CLS. 100 AND 101).

FIRST USE 9-0-2009; IN COMMERCE 9-0-2009.

OWNER OF U.S. REG. NO. 3,717,960.

THE MARK CONSISTS OF THE WORD "COMMUNISPACE" IN LOWER CASE LETTERS BELOW A STYLIZED CAPITAL LETTER "C" WITH A TRIANGULAR SHAPE CUT INTO ONE PORTION OF THE "C".

SER. NO. 85-631,344, FILED 5-22-2012.

JUSTINE D. PARKER, EXAMINING ATTORNEY



*David J. Kybas*

Director of the United States Patent and Trademark Office

# United States of America

United States Patent and Trademark Office

# HARDCORE

**Reg. No. 4,274,965**

DR MUSIC, INC. (NEW JERSEY CORPORATION)  
7 PALISADE AVENUE  
EMERSON, NJ 07630

**Registered Jan. 15, 2013**

**Int. Cl.: 15**

FOR: GUITAR STRINGS; MUSICAL INSTRUMENT STRINGS; STRINGS FOR MUSICAL INSTRUMENTS, IN CLASS 15 (U.S. CLS. 2, 21 AND 36).

**TRADEMARK**

FIRST USE 5-15-2012; IN COMMERCE 5-15-2012.

**PRINCIPAL REGISTER**

THE MARK CONSISTS OF STANDARD CHARACTERS WITHOUT CLAIM TO ANY PARTICULAR FONT, STYLE, SIZE, OR COLOR.

OWNER OF U.S. REG. NO. 4,164,860.

SER. NO. 85-631,490, FILED 5-22-2012.

ALEXANDER L. POWERS, EXAMINING ATTORNEY



*David J. Kybas*

Director of the United States Patent and Trademark Office

# United States of America

United States Patent and Trademark Office

## FoodSmart Kids

**Reg. No. 4,274,966**

**Registered Jan. 15, 2013**

**Int. Cl.: 42**

**SERVICE MARK**

**PRINCIPAL REGISTER**

VMDO ARCHITECTS, P.C. (VIRGINIA CORPORATION), DBA VMDO ARCHITECTS  
200 EAST MARKET STREET  
CHARLOTTESVILLE, VA 22902

FOR: ARCHITECTURAL DESIGN; ARCHITECTURAL DESIGN IN THE FIELD OF K-12 PUBLIC SCHOOLS AND HIGHER EDUCATION INSTITUTIONS, IN CLASS 42 (U.S. CLS. 100 AND 101).

FIRST USE 10-24-2011; IN COMMERCE 10-24-2011.

THE MARK CONSISTS OF STANDARD CHARACTERS WITHOUT CLAIM TO ANY PARTICULAR FONT, STYLE, SIZE, OR COLOR.

NO CLAIM IS MADE TO THE EXCLUSIVE RIGHT TO USE "KIDS", APART FROM THE MARK AS SHOWN.

SER. NO. 85-631,589, FILED 5-22-2012.

NAAKWAMA ANKRAH, EXAMINING ATTORNEY



*David J. Kyffers*

Director of the United States Patent and Trademark Office



# United States of America

United States Patent and Trademark Office

## JUST EXTENSIONS

**Reg. No. 4,274,967**

**Registered Jan. 15, 2013**

**Int. Cl.: 44**

**SERVICE MARK**

**PRINCIPAL REGISTER**

HAILES HOLDINGS, LLC (MARYLAND LIMITED LIABILITY COMPANY)  
P.O. BOX 41051  
WASHINGTON, DC 20018

FOR: HAIR SALON SERVICES, IN CLASS 44 (U.S. CLS. 100 AND 101).

FIRST USE 1-18-2012; IN COMMERCE 1-18-2012.

THE MARK CONSISTS OF STANDARD CHARACTERS WITHOUT CLAIM TO ANY PARTICULAR FONT, STYLE, SIZE, OR COLOR.

NO CLAIM IS MADE TO THE EXCLUSIVE RIGHT TO USE "EXTENSIONS", APART FROM THE MARK AS SHOWN.

SER. NO. 85-631,666, FILED 5-22-2012.

COLLEEN DOMBROW, EXAMINING ATTORNEY



*David J. Kyffers*

Director of the United States Patent and Trademark Office

# United States of America

United States Patent and Trademark Office

## COMPLETE CONNECTED CARE

**Reg. No. 4,274,968**

**Registered Jan. 15, 2013**

**Int. Cl.: 44**

**SERVICE MARK**

**PRINCIPAL REGISTER**

LOWELL GENERAL HOSPITAL (MASSACHUSETTS CORPORATION)  
295 VARNUM AVENUE  
LOWELL, MA 01854

FOR: HEALTHCARE SERVICES, IN CLASS 44 (U.S. CLS. 100 AND 101).

FIRST USE 5-20-2012; IN COMMERCE 5-20-2012.

THE MARK CONSISTS OF STANDARD CHARACTERS WITHOUT CLAIM TO ANY PARTICULAR FONT, STYLE, SIZE, OR COLOR.

NO CLAIM IS MADE TO THE EXCLUSIVE RIGHT TO USE "CARE", APART FROM THE MARK AS SHOWN.

SER. NO. 85-631,669, FILED 5-22-2012.

DAVID I, EXAMINING ATTORNEY



*David J. Kyffers*

Director of the United States Patent and Trademark Office

# United States of America

United States Patent and Trademark Office

# DWVPV

**Reg. No. 4,274,969**

**Registered Jan. 15, 2013**

**Int. Cl.: 45**

**SERVICE MARK**

**PRINCIPAL REGISTER**

DAVIES WARD PHILLIPS & VINEBERG LLP (CANADA LIMITED LIABILITY PARTNERSHIP)  
1501 MCGILL COLLEGE AVENUE 26TH FLOOR  
MONTREAL, QUEBEC, CANADA H3A3N9

FOR: LEGAL SERVICES, IN CLASS 45 (U.S. CLS. 100 AND 101).

THE MARK CONSISTS OF STANDARD CHARACTERS WITHOUT CLAIM TO ANY PARTICULAR FONT, STYLE, SIZE, OR COLOR.

OWNER OF CANADA REG. NO. TMA592818, DATED 10-22-2003, EXPIRES 10-22-2018.

OWNER OF U.S. REG. NOS. 3,216,723 AND 3,250,121.

SER. NO. 85-631,920, FILED 5-22-2012.

LINDA E. BLOHM, EXAMINING ATTORNEY



*David J. Kyffers*

Director of the United States Patent and Trademark Office

# United States of America

United States Patent and Trademark Office

## DAVIES WARD PHILLIPS & VINEBERG

**Reg. No. 4,274,970**

**Registered Jan. 15, 2013**

**Int. Cl.: 45**

**SERVICE MARK**

**PRINCIPAL REGISTER**

DAVIES WARD PHILLIPS & VINEBERG LLP (CANADA LIMITED LIABILITY PARTNERSHIP)

1501 MCGILL COLLEGE AVENUE 26TH FLOOR  
MONTREAL, QUEBEC, CANADA H3A3N9

FOR: LEGAL SERVICES, IN CLASS 45 (U.S. CLS. 100 AND 101).

THE MARK CONSISTS OF STANDARD CHARACTERS WITHOUT CLAIM TO ANY PARTICULAR FONT, STYLE, SIZE, OR COLOR.

OWNER OF CANADA REG. NO. TMA592519, DATED 10-17-2003, EXPIRES 10-17-2018.

OWNER OF U.S. REG. NOS. 3,216,723 AND 3,250,121.

SER. NO. 85-631,930, FILED 5-22-2012.

LINDA E. BLOHM, EXAMINING ATTORNEY



*David J. Kyffers*

Director of the United States Patent and Trademark Office

# United States of America

United States Patent and Trademark Office

# MEDITHIN

**Reg. No. 4,274,971**

MIDWEST MEDITHIN, LLC (WISCONSIN LIMITED LIABILITY COMPANY)  
2605 KENNEDY ROAD, SUITE 100  
JANESVILLE, WI 53545

**Registered Jan. 15, 2013**

**Int. Cls.: 5 and 44**

FOR: VITAMINS AND NUTRITIONAL SUPPLEMENTS, IN CLASS 5 (U.S. CLS. 6, 18, 44, 46, 51 AND 52).

**TRADEMARK**

FIRST USE 2-0-2011; IN COMMERCE 2-0-2011.

**SERVICE MARK**

FOR: PROVIDING A WEBSITE FEATURING INFORMATION AND ADVICE IN THE FIELDS OF DIET, WEIGHT LOSS, DIET PLANNING AND LIFESTYLE WELLNESS; MEDICAL CLINIC PROVIDING WEIGHT LOSS SOLUTIONS, SERVICES AND PROGRAMS AND NUTRITION COUNSELING; WEIGHT REDUCTION DIET PLANNING AND SUPERVISION; PROVIDING WEIGHT LOSS PROGRAM SERVICES; PROVIDING INFORMATION ON MAINTAINING A HEALTHY LIFESTYLE AND LOSING WEIGHT; PHYSICIAN-SUPERVISED WEIGHT LOSS AND WEIGHT CONTROL SERVICES , IN CLASS 44 (U.S. CLS. 100 AND 101).

**PRINCIPAL REGISTER**

FIRST USE 2-0-2011; IN COMMERCE 2-0-2011.

THE MARK CONSISTS OF STANDARD CHARACTERS WITHOUT CLAIM TO ANY PARTICULAR FONT, STYLE, SIZE, OR COLOR.



OWNER OF U.S. REG. NO. 4,185,241.

SER. NO. 85-631,972, FILED 5-22-2012.

LINDA E. BLOHM, EXAMINING ATTORNEY

*David J. Kyros*

Director of the United States Patent and Trademark Office

# United States of America

United States Patent and Trademark Office

# IMPULSE

**Reg. No. 4,274,972**

FIKE CORPORATION (MISSOURI CORPORATION)  
704 SOUTH 10TH STREET  
BLUE SPRINGS, MO 64015

**Registered Jan. 15, 2013**

**Int. Cl.: 9**

FOR: COMPRESSED GAS CHEMICAL AGENT RELEASE VALVES FOR USE IN FIRE SUPPRESSION SYSTEMS, IN CLASS 9 (U.S. CLS. 21, 23, 26, 36 AND 38).

**TRADEMARK**

FIRST USE 4-30-2010; IN COMMERCE 4-30-2010.

**PRINCIPAL REGISTER**

THE MARK CONSISTS OF STANDARD CHARACTERS WITHOUT CLAIM TO ANY PARTICULAR FONT, STYLE, SIZE, OR COLOR.

SER. NO. 85-632,001, FILED 5-22-2012.

CAROLINE WOOD, EXAMINING ATTORNEY



*David J. Kyffers*

Director of the United States Patent and Trademark Office

# United States of America

United States Patent and Trademark Office



**Reg. No. 4,274,973**

BROKERING SOLUTIONS, LLC (KENTUCKY LIMITED LIABILITY COMPANY)  
50 ABERDEEN DRIVE  
GLASGOW, KY 42141

**Registered Jan. 15, 2013**

**Int. Cl.: 20**

FOR: CABINETS, NAMELY, KITCHEN CABINETS AND BATHROOM CABINETS; BATHROOM VANITIES, IN CLASS 20 (U.S. CLS. 2, 13, 22, 25, 32 AND 50).

**TRADEMARK**

FIRST USE 5-0-2011; IN COMMERCE 5-0-2011.

**PRINCIPAL REGISTER**

NO CLAIM IS MADE TO THE EXCLUSIVE RIGHT TO USE "CABINETRY", APART FROM THE MARK AS SHOWN.

THE MARK CONSISTS OF THE WORDS "WALNUT RIDGE CABINETRY" SUPERIMPOSED OVER THE DESIGN OF OPPOSING LAUREL BRANCHES WITH A RIBBON AT THE BOTTOM WHERE THE BRANCHES INTERSECT.

SER. NO. 85-632,042, FILED 5-22-2012.

KEVON CHISOLM, EXAMINING ATTORNEY



*David J. Kyffers*

Director of the United States Patent and Trademark Office

# United States of America

United States Patent and Trademark Office



**Reg. No. 4,274,974**

**Registered Jan. 15, 2013**

**Int. Cl.: 9**

**TRADEMARK**

**PRINCIPAL REGISTER**

PH CELLULAR, INC. (FLORIDA CORPORATION)  
3034 NW 82ND AVENUE  
MIAMI, FL 33122

FOR: PORTABLE POWER SUPPLY FOR MOBILE PHONES, COMPUTERS, TABLET COMPUTERS AND PORTABLE MEDIA PLAYERS; MOBILE PHONE ACCESSORIES, NAMELY, CHARGER, CASE, SPEAKER, CAR CHARGER, EAR PIECE, CABLE AND ADAPTOR, IN CLASS 9 (U.S. CLS. 21, 23, 26, 36 AND 38).

FIRST USE 5-10-2012; IN COMMERCE 5-10-2012.

OWNER OF U.S. REG. NOS. 3,652,111 AND 3,652,114.

THE MARK CONSISTS OF A STYLIZED PLUS SIGN WITH THE LETTERING "IPLUS" APPEARING IN THE CENTER AND RUNNING TO THE RIGHT. AN INCOMPLETE CIRCLE STARTS AND ENDS AT THE TOP AND THE BOTTOM OF THE LETTER "L" AND SURROUNDS THE LETTERS "IP".

SER. NO. 85-632,071, FILED 5-22-2012.

WENDY GOODMAN, EXAMINING ATTORNEY



*David J. Kybas*

Director of the United States Patent and Trademark Office



# United States of America

United States Patent and Trademark Office

# DejaCloud

**Reg. No. 4,274,975**

**Registered Jan. 15, 2013**

**Int. Cl.: 42**

**SERVICE MARK**

**PRINCIPAL REGISTER**

COMPANIONLINK SOFTWARE, INC. (OREGON CORPORATION)  
811 SW NAITO WAY SUITE 600  
PORTLAND, OR 97204

FOR: COMPUTER SERVICES, NAMELY, ACTING AS AN APPLICATION SERVICE PROVIDER IN THE FIELD OF INFORMATION MANAGEMENT TO HOST COMPUTER APPLICATION SOFTWARE FOR THE PURPOSE OF SYNCHRONIZATION OF DATA BETWEEN MULTIPLE COMPUTER PLATFORMS AND OTHER DEVICES, IN CLASS 42 (U.S. CLS. 100 AND 101).

FIRST USE 12-15-2011; IN COMMERCE 12-15-2011.

THE MARK CONSISTS OF STANDARD CHARACTERS WITHOUT CLAIM TO ANY PARTICULAR FONT, STYLE, SIZE, OR COLOR.

OWNER OF U.S. REG. NO. 3,928,653.

SER. NO. 85-632,099, FILED 5-22-2012.

CHARLOTTE CORWIN, EXAMINING ATTORNEY



*David J. Kyffers*

Director of the United States Patent and Trademark Office

# United States of America

United States Patent and Trademark Office

## Meteor Records

**Reg. No. 4,274,976**

**Registered Jan. 15, 2013**

**Int. Cl.: 9**

**TRADEMARK**

**PRINCIPAL REGISTER**

METEOR RECORDS, LLC (MARYLAND LIMITED LIABILITY COMPANY)  
24 TREADWELL COURT  
LUTHERVILLE, MD 21093

FOR: COMPACT DISCS, DVDS, AUDIO RECORDINGS, VINYL RECORDS, AND DOWNLOADABLE AUDIO FILES FEATURING MUSIC, IN CLASS 9 (U.S. CLS. 21, 23, 26, 36 AND 38).

FIRST USE 5-24-1989; IN COMMERCE 5-24-1989.

THE MARK CONSISTS OF STANDARD CHARACTERS WITHOUT CLAIM TO ANY PARTICULAR FONT, STYLE, SIZE, OR COLOR.

OWNER OF U.S. REG. NO. 2,435,444.

NO CLAIM IS MADE TO THE EXCLUSIVE RIGHT TO USE "RECORDS", APART FROM THE MARK AS SHOWN.

SER. NO. 85-632,120, FILED 5-22-2012.

ODESSA BIBBINS, EXAMINING ATTORNEY



*David J. Kyffers*

Director of the United States Patent and Trademark Office

# United States of America

United States Patent and Trademark Office

## UPTOWN PILATES

**Reg. No. 4,274,977**

UPTOWN PILATES, INC. (NEW YORK CORPORATION)  
136 WEST 72ND STREET  
NEW YORK, NY 10023

**Registered Jan. 15, 2013**

**Int. Cl.: 41**

FOR: PROVIDING FITNESS AND EXERCISE STUDIO SERVICES, NAMELY, PILATES INSTRUCTION AND TRAINING, IN CLASS 41 (U.S. CLS. 100, 101 AND 107).

**SERVICE MARK**

FIRST USE 12-0-2004; IN COMMERCE 4-10-2005.

**PRINCIPAL REGISTER**

THE MARK CONSISTS OF STANDARD CHARACTERS WITHOUT CLAIM TO ANY PARTICULAR FONT, STYLE, SIZE, OR COLOR.

NO CLAIM IS MADE TO THE EXCLUSIVE RIGHT TO USE "PILATES", APART FROM THE MARK AS SHOWN.

SER. NO. 85-632,122, FILED 5-22-2012.

KRISTIN CARLSON, EXAMINING ATTORNEY



*David J. Kybas*

Director of the United States Patent and Trademark Office

# United States of America

United States Patent and Trademark Office

## PRICEMYLOAN

**Reg. No. 4,274,978**

MERIDIANLINK, INC. (CALIFORNIA CORPORATION)  
1124 BRISTOL ST.  
COSTA MESA, CA 92626

**Registered Jan. 15, 2013**

**Int. Cl.: 42**

FOR: APPLICATION SERVICE PROVIDER (ASP) FEATURING SOFTWARE FOR USE FOR SEARCHING FOR MORTGAGE LOANS AND HOME LOANS, LOCKING MORTGAGE LOANS AND HOME LOANS, APPLYING FOR MORTGAGE LOANS AND HOME LOANS AND AUTOMATED UNDERWRITING FOR MORTGAGE LOANS AND HOME LOANS; PROVIDING A WEBSITE FEATURING NON-DOWNLOADABLE SOFTWARE FOR FOR SEARCHING FOR MORTGAGE LOANS AND HOME LOANS, LOCKING MORTGAGE LOANS AND HOME LOANS, APPLYING FOR MORTGAGE LOANS AND HOME LOANS AND AUTOMATED UNDERWRITING FOR MORTGAGE LOANS AND HOME LOANS, IN CLASS 42 (U.S. CLS. 100 AND 101).

**SERVICE MARK**

**PRINCIPAL REGISTER**

FIRST USE 1-24-2004; IN COMMERCE 1-24-2004.

THE MARK CONSISTS OF STANDARD CHARACTERS WITHOUT CLAIM TO ANY PARTICULAR FONT, STYLE, SIZE, OR COLOR.

OWNER OF U.S. REG. NO. 3,186,639.

SER. NO. 85-632,158, FILED 5-22-2012.

WILLIAM P. SHANAHAN, EXAMINING ATTORNEY



*David J. Kyros*

Director of the United States Patent and Trademark Office

# United States of America

United States Patent and Trademark Office



**Reg. No. 4,274,979**

**Registered Jan. 15, 2013**

**Int. Cl.: 29**

**TRADEMARK**

**PRINCIPAL REGISTER**

UMLAND LLC (ILLINOIS LIMITED LIABILITY COMPANY)  
120 BOULDER DRIVE  
GRIDLEY, IL 61744

FOR: FREEZE-DRIED YOGURT SNACK FOODS, IN CLASS 29 (U.S. CL. 46).

FIRST USE 10-7-2011; IN COMMERCE 2-1-2012.

THE MARK CONSISTS OF CIRCULAR PIECES FLOATING ABOVE THE STYLIZED TEXT "YOGUM'S". AT THE BOTTOM OF THE TEXT THERE IS A SWOOSH.

SER. NO. 85-632,222, FILED 5-22-2012.

HOWARD SMIGA, EXAMINING ATTORNEY



*David J. Kybas*

Director of the United States Patent and Trademark Office

# United States of America

United States Patent and Trademark Office

# SWAPFEST

**Reg. No. 4,274,980**

MID AMERICA MOTORWORKS, INC. (ILLINOIS CORPORATION)  
P.O. BOX 1368  
EFFINGHAM, IL 62401

**Registered Jan. 15, 2013**

**Int. Cl.: 35**

FOR: ORGANIZING, ARRANGING AND CONDUCTING SWAP MEET EXHIBITIONS IN THE FIELD OF NEW AND USED AUTOMOBILE PARTS, INCLUDING COLLECTIBLE AUTOMOBILE PARTS, FOR AUTOMOBILE COLLECTORS AND ENTHUSIASTS, IN CLASS 35 (U.S. CLS. 100, 101 AND 102).

**SERVICE MARK**

**PRINCIPAL REGISTER**

FIRST USE 1-0-2004; IN COMMERCE 1-0-2004.

THE MARK CONSISTS OF STANDARD CHARACTERS WITHOUT CLAIM TO ANY PARTICULAR FONT, STYLE, SIZE, OR COLOR.

OWNER OF U.S. REG. NOS. 3,102,364 AND 3,137,622.

SEC. 2(F).

SER. NO. 85-632,246, FILED 5-22-2012.

EMILY CHUO, EXAMINING ATTORNEY



*David J. Kyffers*

Director of the United States Patent and Trademark Office

# United States of America

United States Patent and Trademark Office



**Reg. No. 4,274,981**

**Registered Jan. 15, 2013**

**Int. Cl.: 37**

**SERVICE MARK**

**PRINCIPAL REGISTER**

CAPITOL SHINE LLC (VIRGINIA LIMITED LIABILITY COMPANY)  
APT 400  
1719 N TROY ST  
ARLINGTON, VA 22201

FOR: AUTOMOBILE CLEANING AND CAR WASHING; AUTOMOBILE DETAILING, IN CLASS 37 (U.S. CLS. 100, 103 AND 106).

FIRST USE 4-15-2011; IN COMMERCE 4-15-2011.

NO CLAIM IS MADE TO THE EXCLUSIVE RIGHT TO USE "PROFESSIONAL AUTODETAILING", APART FROM THE MARK AS SHOWN.

THE MARK CONSISTS OF THE WORD "CAPITOL" WITH AN IMAGE OF THE CAPITOL BUILDING TO THE LEFT OF THE WORD, WITH THE "L" OF THE "CAPITOL" THE SHAPE OF THE WASHINGTON MONUMENT. THE WORD "SHINE" WITH AN ASTERISK BLING MARK AT THE END. THE WORDS "PROFESSIONAL AUTODETAILING" BELOW AND RIGHT-JUSTIFIED.

SER. NO. 85-632,259, FILED 5-22-2012.

JANET LEE, EXAMINING ATTORNEY



*David J. Kyffers*

Director of the United States Patent and Trademark Office

# United States of America

United States Patent and Trademark Office

# TEXTEMPS

**Reg. No. 4,274,982**

GLENN L ROBERTS (UNITED STATES INDIVIDUAL), DBA TEX TEMPS  
2617C W. HOLCOMBE BLVD #202  
HOUSTON, TX 77030

**Registered Jan. 15, 2013**

**Int. Cl.: 35**

FOR: EMPLOYMENT HIRING, RECRUITING, PLACEMENT, STAFFING AND CAREER NETWORKING SERVICES, IN CLASS 35 (U.S. CLS. 100, 101 AND 102).

**SERVICE MARK**

FIRST USE 4-17-2012; IN COMMERCE 4-17-2012.

**PRINCIPAL REGISTER**

THE MARK CONSISTS OF STANDARD CHARACTERS WITHOUT CLAIM TO ANY PARTICULAR FONT, STYLE, SIZE, OR COLOR.

SER. NO. 85-632,271, FILED 5-22-2012.

MAYUR VAGHANI, EXAMINING ATTORNEY



*David J. Kybas*

Director of the United States Patent and Trademark Office



# United States of America

United States Patent and Trademark Office

## BIG CHOCOLATE

**Reg. No. 4,274,983**

**Registered Jan. 15, 2013**

**Int. Cl.: 25**

**TRADEMARK**

**PRINCIPAL REGISTER**

BIG CHOCOLATE, LLC (DELAWARE LIMITED LIABILITY COMPANY)  
C/O STRONG MANAGEMENT  
176-25 UNION TURNPIKE, #405  
FRESH MEADOWS, NY 11366

FOR: T-SHIRTS; SHIRTS; SWEATSHIRTS; HOODED SWEATSHIRTS, IN CLASS 25 (U.S. CLS. 22 AND 39).

FIRST USE 10-29-2010; IN COMMERCE 10-29-2010.

THE MARK CONSISTS OF STANDARD CHARACTERS WITHOUT CLAIM TO ANY PARTICULAR FONT, STYLE, SIZE, OR COLOR.

THE NAME "BIG CHOCOLATE" IDENTIFIES THE PSEUDONYM OF CAMERON ARGON, A LIVING INDIVIDUAL WHOSE CONSENT IS OF RECORD

SER. NO. 85-632,286, FILED 5-22-2012.

SUSAN BILLHEIMER, EXAMINING ATTORNEY



*David J. Kybas*

Director of the United States Patent and Trademark Office

# United States of America

United States Patent and Trademark Office

# ETIA

**Reg. No. 4,274,984**

**Registered Jan. 15, 2013**

**Int. Cl.: 5**

**TRADEMARK**

**PRINCIPAL REGISTER**

ALL STAR FOODS, INC. (ILLINOIS CORPORATION)  
200 E. EVERGREEN  
MOUNT PROSPECT, IL 60056

FOR: ANIMAL FEED SUPPLEMENTS; DIETARY AND NUTRITIONAL SUPPLEMENTS; DIETARY FOOD SUPPLEMENTS; DIETARY SUPPLEMENTAL DRINKS; DIETARY SUPPLEMENTS; DIETARY SUPPLEMENTS FOR ANIMALS; DIETARY SUPPLEMENTS FOR HUMAN CONSUMPTION; FEED SUPPLEMENTS FOR PETS AND LIVESTOCK; FOOD SUPPLEMENTS; HERBAL SUPPLEMENTS; HOMEOPATHIC SUPPLEMENTS; NUTRITIONAL DRINKS FOR ANIMALS; NUTRITIONAL SUPPLEMENT ENERGY BARS; NUTRITIONAL SUPPLEMENTS; NUTRITIONAL SUPPLEMENTS IN LOTION FORM SOLD AS A COMPONENT OF NUTRITIONAL SKIN CARE PRODUCTS; NUTRITIONAL SUPPLEMENTS IN THE FORM OF CAPSULES; SOY PROTEIN FOR USE AS A NUTRITIONAL SUPPLEMENT IN VARIOUS POWDERED AND READY-TO-DRINK BEVERAGES, IN CLASS 5 (U.S. CLS. 6, 18, 44, 46, 51 AND 52).

FIRST USE 2-14-2008; IN COMMERCE 2-14-2008.

THE MARK CONSISTS OF STANDARD CHARACTERS WITHOUT CLAIM TO ANY PARTICULAR FONT, STYLE, SIZE, OR COLOR.

OWNER OF U.S. REG. NOS. 3,509,466, 3,517,346, AND 4,167,118.

THE WORDING "ETIA" HAS NO MEANING IN A FOREIGN LANGUAGE.

SER. NO. 85-632,317, FILED 5-22-2012.

ZACHARY CROMER, EXAMINING ATTORNEY



*David J. Kypos*

Director of the United States Patent and Trademark Office

# United States of America

United States Patent and Trademark Office

## ECHALE PRIMO

**Reg. No. 4,274,985**

**Registered Jan. 15, 2013**

**Int. Cl.: 41**

**SERVICE MARK**

**PRINCIPAL REGISTER**

AZTECA INTERNATIONAL CORPORATION (DELAWARE CORPORATION)  
1139 GRAND CENTRAL AVENUE  
GLENDALE, CA 91201

FOR: ENTERTAINMENT SERVICES IN THE NATURE OF AN ONGOING TELEVISION SERIES AND PROGRAM IN THE FIELD OF MEXICAN CULTURE, HISTORY AND MUSIC, IN CLASS 41 (U.S. CLS. 100, 101 AND 107).

FIRST USE 5-19-2012; IN COMMERCE 5-19-2012.

THE MARK CONSISTS OF STANDARD CHARACTERS WITHOUT CLAIM TO ANY PARTICULAR FONT, STYLE, SIZE, OR COLOR.

THE ENGLISH TRANSLATION OF "ECHALE PRIMO" IN THE MARK IS GO AHEAD COUSIN.

SER. NO. 85-632,394, FILED 5-22-2012.

SUSAN BILLHEIMER, EXAMINING ATTORNEY



*David J. Kyffers*

Director of the United States Patent and Trademark Office

# United States of America

United States Patent and Trademark Office

## WE TAKE THE PAIN OUT OF PEST CONTROL

**Reg. No. 4,274,986**

**Registered Jan. 15, 2013**

**Int. Cl.: 37**

**SERVICE MARK**

**PRINCIPAL REGISTER**

PAYNE PEST MANAGEMENT (CALIFORNIA CORPORATION)  
10625 SCRIPPS RANCH BLVD  
STE F  
SAN DIEGO, CA 92131

FOR: TERMITE AND PEST CONTROL, IN CLASS 37 (U.S. CLS. 100, 103 AND 106).

FIRST USE 5-15-2006; IN COMMERCE 5-15-2006.

THE MARK CONSISTS OF STANDARD CHARACTERS WITHOUT CLAIM TO ANY PARTICULAR FONT, STYLE, SIZE, OR COLOR.

SER. NO. 85-632,518, FILED 5-23-2012.

KATHRYN COWARD, EXAMINING ATTORNEY



*David J. Kyffers*

Director of the United States Patent and Trademark Office

# United States of America

United States Patent and Trademark Office

## DIGITAL WONDER CABINET

**Reg. No. 4,274,987**

DIGITAL WONDER CABINET, LLC (TENNESSEE LIMITED LIABILITY COMPANY)  
4917 MADELINE DRIVE  
NASHVILLE, TN 37211

**Registered Jan. 15, 2013**

**Int. Cl.: 41**

FOR: MUSEUM CURATOR SERVICES, NAMELY, WEB, DIGITAL, VIDEO AND MEDIA  
CONTENT CURATORIAL SERVICES, IN CLASS 41 (U.S. CLS. 100, 101 AND 107).

**SERVICE MARK**

FIRST USE 3-8-2012; IN COMMERCE 3-8-2012.

**PRINCIPAL REGISTER**

THE MARK CONSISTS OF STANDARD CHARACTERS WITHOUT CLAIM TO ANY PAR-  
TICULAR FONT, STYLE, SIZE, OR COLOR.

NO CLAIM IS MADE TO THE EXCLUSIVE RIGHT TO USE "DIGITAL", APART FROM THE  
MARK AS SHOWN.

SER. NO. 85-632,552, FILED 5-23-2012.

FLORENTINA BLANDU, EXAMINING ATTORNEY



*David J. Kyffers*

Director of the United States Patent and Trademark Office

# United States of America

United States Patent and Trademark Office



**Reg. No. 4,274,988**

**Registered Jan. 15, 2013**

**Int. Cl.: 25**

**TRADEMARK**

**PRINCIPAL REGISTER**

CLASSIFIED INVESTIGATIONS BUREAU, INC (ILLINOIS CORPORATION), DBA  
INVESTIGATIONS & SECURITY BUREAU  
5326 VAN DYKE RD.  
INVESTIGATIONS & SECURITY BUREAU  
LUTZ, FL 33558

FOR: ATHLETIC APPAREL, NAMELY, SHIRTS, PANTS, JACKETS, FOOTWEAR, HATS  
AND CAPS, ATHLETIC UNIFORMS, IN CLASS 25 (U.S. CLS. 22 AND 39).

FIRST USE 12-1-2011; IN COMMERCE 5-1-2012.

THE MARK CONSISTS OF THE WORDING "INVESTIGATIONS & SECURITY BUREAU"  
IN BLUE STYLIZED FONT ARRANGED IN CIRCULAR FORM ON A GREY CIRCLE OUT-  
LINED IN BLACK. ALL OF THE ABOVE APPEARS AROUND A WHITE CIRCLE FEATURING  
A GREY EAGLE, OUTLINED IN BLACK, CLUTCHING A BRANCH AND ARROWS IN ITS  
TALONS. THE EAGLE APPEARS ON A BLACK STAR WITH CIRCULAR POINTS AND  
WITH A LARGER BLACK CIRCLE APPEARING ABOVE THE EAGLE'S HEAD, WITH THE  
LETTERS "CIB" APPEARING IN GREY ON THE BLACK CIRCLE AND THREE GREY STARS  
APPEARING ABOVE AND BELOW THE LETTERS "CIB".

THE COLOR(S) BLACK, BLUE, GREY, AND WHITE IS/ARE CLAIMED AS A FEATURE OF  
THE MARK.

SER. NO. 85-632,768, FILED 5-23-2012.

KAREN SEVERSON, EXAMINING ATTORNEY



*David J. Kybas*

Director of the United States Patent and Trademark Office

# United States of America

United States Patent and Trademark Office

## WALNUT RIDGE CABINETRY

**Reg. No. 4,274,989**

BROKERING SOLUTIONS, LLC (KENTUCKY LIMITED LIABILITY COMPANY)  
50 ABERDEEN DRIVE  
GLASGOW, KY 42141

**Registered Jan. 15, 2013**

**Int. Cl.: 20**

FOR: CABINETS, NAMELY KITCHEN CABINETS AND BATHROOM CABINETS; BATHROOM VANITIES, IN CLASS 20 (U.S. CLS. 2, 13, 22, 25, 32 AND 50).

**TRADEMARK**

FIRST USE 5-0-2011; IN COMMERCE 5-0-2011.

**PRINCIPAL REGISTER**

THE MARK CONSISTS OF STANDARD CHARACTERS WITHOUT CLAIM TO ANY PARTICULAR FONT, STYLE, SIZE, OR COLOR.

NO CLAIM IS MADE TO THE EXCLUSIVE RIGHT TO USE "CABINETRY", APART FROM THE MARK AS SHOWN.

SER. NO. 85-632,781, FILED 5-23-2012.

KEVON CHISOLM, EXAMINING ATTORNEY



*David J. Kyffers*

Director of the United States Patent and Trademark Office

# United States of America

United States Patent and Trademark Office

## SOLVIL ET TITUS

**Reg. No. 4,274,990**

SOLVIL ET TITUS SA (SWITZERLAND SOCIÉTÉ ANONYME (SA))  
ROUTE DES ACACIAS 6

**Registered Jan. 15, 2013**

LES ACACIAS-GENEVA, SWITZERLAND 1227

**Int. Cl.: 14**

FOR: WATCHES AND PARTS THEREFOR, IN CLASS 14 (U.S. CLS. 2, 27, 28 AND 50).

**TRADEMARK**

THE MARK CONSISTS OF STANDARD CHARACTERS WITHOUT CLAIM TO ANY PARTICULAR FONT, STYLE, SIZE, OR COLOR.

**PRINCIPAL REGISTER**

OWNER OF SWITZERLAND REG. NO. 378769, DATED 11-20-1990, EXPIRES 6-11-2020.

THE ENGLISH TRANSLATION OF "SOLVIL ET TITUS" IN THE MARK IS "SOLVIL AND TITUS".

SER. NO. 85-632,791, FILED 5-23-2012.

LINDA E. BLOHM, EXAMINING ATTORNEY



*David J. Kybas*

Director of the United States Patent and Trademark Office



# United States of America

United States Patent and Trademark Office



**Reg. No. 4,274,991**

**Registered Jan. 15, 2013**

**Int. Cl.: 25**

**TRADEMARK**

**PRINCIPAL REGISTER**

TRECENTO, LLC (NORTH CAROLINA LIMITED LIABILITY COMPANY)  
11528 JAMES JACK LANE  
CHARLOTTE, NC 28277

FOR: MEN'S, WOMEN'S AND CHILDREN'S CLOTHING, NAMELY, SHIRTS, SHORTS, PANTS, SKIRTS, JACKETS, COATS, HATS AND CAPS, IN CLASS 25 (U.S. CLS. 22 AND 39).

FIRST USE 1-0-2012; IN COMMERCE 1-0-2012.

OWNER OF U.S. REG. NO. 2,832,522.

THE MARK CONSISTS OF THREE SOLID CIRCULAR DOTS ABOVE THE WORD "TRECENTO" WRITTEN IN STYLIZED LETTERS.

THE ENGLISH TRANSLATION OF THE WORD "TRECENTO" IN THE MARK IS "THREE HUNDRED".

SER. NO. 85-632,812, FILED 5-23-2012.

JAMES GRIFFIN, EXAMINING ATTORNEY



*David J. Kybas*

Director of the United States Patent and Trademark Office

# United States of America

United States Patent and Trademark Office

# EYE OF JA

**Reg. No. 4,274,992**

EYE OF JA, L.L.C. (NEW JERSEY LIMITED LIABILITY COMPANY)  
37 BRAMS HILL DRIVE  
MAHWAH, NJ 07430

**Registered Jan. 15, 2013**

**Int. Cl.: 35**

FOR: RETAIL STORE SERVICES FEATURING JEWELRY, NAMELY, RINGS, BRACELETS, NECKLACES, EARRINGS, HEAD PIECES, AND BODY PIECES, AND CLOTHING, NAMELY, T-SHIRTS, IN CLASS 35 (U.S. CLS. 100, 101 AND 102).

**SERVICE MARK**

FIRST USE 8-10-2011; IN COMMERCE 8-10-2011.

**PRINCIPAL REGISTER**

THE MARK CONSISTS OF STANDARD CHARACTERS WITHOUT CLAIM TO ANY PARTICULAR FONT, STYLE, SIZE, OR COLOR.

SER. NO. 85-632,885, FILED 5-23-2012.

NICHOLAS COLEMAN, EXAMINING ATTORNEY



*David J. Kybas*

Director of the United States Patent and Trademark Office

# United States of America

United States Patent and Trademark Office

## SIMPLYHEALED PRACTITIONER

**Reg. No. 4,274,993**

**Registered Jan. 15, 2013**

**CERTIFICATION MARK**

**PRINCIPAL REGISTER**

CAROLYN COOPER INTERNATIONAL (UTAH CORPORATION)  
WWW.CAROLYNCOOPER.COM  
2883 EBONY CIRCLE  
ST. GEORGE, UT 84790

FOR: ENERGY HEALING SERVICES, IN CLASS B (U.S. CL. B).

FIRST USE 3-9-2011; IN COMMERCE 3-9-2011.

THE MARK CONSISTS OF STANDARD CHARACTERS WITHOUT CLAIM TO ANY PARTICULAR FONT, STYLE, SIZE, OR COLOR.

OWNER OF U.S. REG. NO. 4,066,297.

NO CLAIM IS MADE TO THE EXCLUSIVE RIGHT TO USE "PRACTITIONER", APART FROM THE MARK AS SHOWN.

THE CERTIFICATION MARK, AS USED BY AUTHORIZED PERSONS, CERTIFIES THAT THE SERVICES ARE BEING PERFORMED BY PROFESSIONALS WHO HAVE MET ESTABLISHED STANDARDS OF KNOWLEDGE, EXPERIENCE AND COMPETENCE REQUIRED TO EXCEL AS AN ENERGY HEALING PRACTITIONER.

SER. NO. 85-632,945, FILED 5-23-2012.

ZACHARY R. SPARER, EXAMINING ATTORNEY



*David J. Kybas*

Director of the United States Patent and Trademark Office

# United States of America

United States Patent and Trademark Office

# AVEMAR

**Reg. No. 4,274,994**

**Registered Jan. 15, 2013**

**Int. Cl.: 5**

**TRADEMARK**

**PRINCIPAL REGISTER**

BIROCHEM KUTATASI FEJLESZTESI ES KERESKEDELMI KFT (HUNGARY CORPORATION)  
HEGEDÜS GYULA U. 63  
BUDAPEST 1133, HUNGARY

FOR: DIETARY AND NUTRITIONAL SUPPLEMENTS; VETERINARY PREPARATIONS FOR USE AS IMMUNO-THERAPEUTIC, IMMUNO-STIMULANTS, ANTICANCER DRUGS AND ANTICANCER THERAPEUTIC AGENTS, IN CLASS 5 (U.S. CLS. 6, 18, 44, 46, 51 AND 52).

THE MARK CONSISTS OF STANDARD CHARACTERS WITHOUT CLAIM TO ANY PARTICULAR FONT, STYLE, SIZE, OR COLOR.

OWNER OF HUNGARY REG. NO. 153585, DATED 9-8-1998, EXPIRES 3-30-2018.

OWNER OF U.S. REG. NO. 2,599,892.

SER. NO. 85-632,972, FILED 5-23-2012.

LINDA LAVACHE, EXAMINING ATTORNEY



*David J. Kyjars*

Director of the United States Patent and Trademark Office

# United States of America

United States Patent and Trademark Office



**Reg. No. 4,274,995**

**Registered Jan. 15, 2013**

**Int. Cls.: 25 and 41**

BOARD OF TRUSTEES, ILLINOIS STATE UNIVERSITY (ILLINOIS STATE UNIVERSITY)  
CAMPUS BOX 3420  
2011 NORTH MAIN STREET  
NORMAL, IL 617903420

FOR: CLOTHING, NAMELY, SHIRTS AND HATS, IN CLASS 25 (U.S. CLS. 22 AND 39).

**TRADEMARK**

FIRST USE 8-1-2011; IN COMMERCE 8-1-2011.

**SERVICE MARK**

FOR: EDUCATION SERVICES, NAMELY, PROVIDING COURSES OF INSTRUCTION AT THE HIGH SCHOOL LEVEL, AND ENTERTAINMENT SERVICES, NAMELY, PROVIDING SPORTING COMPETITIONS AT THE HIGH SCHOOL LEVEL IN FOOTBALL, BASKETBALL, AND VOLLEYBALL, IN CLASS 41 (U.S. CLS. 100, 101 AND 107).

**PRINCIPAL REGISTER**

FIRST USE 8-1-2011; IN COMMERCE 8-1-2011.

THE MARK CONSISTS OF THE LETTER "U", THE LEFT PORTION OF WHICH IS GREEN WITH A STRIPE RUNNING DOWN THE MIDDLE AND THE RIGHT PORTION OF WHICH IS YELLOW WITH A STRIPE RUNNING DOWN THE MIDDLE.

THE COLOR(S) GREEN AND YELLOW IS/ARE CLAIMED AS A FEATURE OF THE MARK.

SER. NO. 85-633,031, FILED 5-23-2012.

JERI J. FICKES, EXAMINING ATTORNEY



*David J. Kybas*

Director of the United States Patent and Trademark Office

United States of America  
United States Patent and Trademark Office



**Keystone**

**Reg. No. 4,274,996**

KEYSTONE ANILINE CORPORATION (ILLINOIS CORPORATION)  
2501 W. FULTON STREET  
CHICAGO, IL 60612

**Registered Jan. 15, 2013**

**Int. Cl.: 2**

FOR: DYESTUFFS, PIGMENTS AND OTHER COLORANTS FOR USE IN THE MANUFACTURE OF AGRICULTURAL PRODUCTS, COATINGS, DETERGENTS, SOAPS, FURS, INKS, LEATHER, LEATHER GOODS, FLOWERS, METAL, PAINT, PAPER, PLASTICS, PLASTIC MOLDING COMPOUNDS, TEXTILES, WOOD, WAXES, CLEANING COMPOUNDS, OIL, LUBRICANTS AND OTHER RELATED PETROLEUM COMPOUNDS, IN CLASS 2 (U.S. CLS. 6, 11 AND 16).

**TRADEMARK**

**PRINCIPAL REGISTER**

FIRST USE 1-1-2012; IN COMMERCE 1-1-2012.

OWNER OF U.S. REG. NO. 3,284,550.

THE MARK CONSISTS OF THE WORD "KEYSTONE" WITH A DESIGN COMPRISED OF FOUR ARCHES ABOVE THE WORD.

SER. NO. 85-633,168, FILED 5-23-2012.

ALEXANDER L. POWERS, EXAMINING ATTORNEY



*David J. Kyffers*

Director of the United States Patent and Trademark Office

# United States of America

United States Patent and Trademark Office

## DIGITAL BRIDGE

**Reg. No. 4,274,997**

**Registered Jan. 15, 2013**

**Int. Cls.: 9 and 42**

**TRADEMARK**

**SERVICE MARK**

**PRINCIPAL REGISTER**

TIDEWORKS TECHNOLOGY, INC. (WASHINGTON CORPORATION)  
1131 SW KLUCKITAT WAY  
SEATTLE, WA 98134

FOR: COMPUTER SOFTWARE FOR MONITORING AND TRACKING PERFORMANCE METRICS ASSOCIATED WITH THE OPERATION OF FREIGHT AND CARGO TERMINALS; COMPUTER SOFTWARE FOR TRIGGERING ELECTRONIC MAIL OR MESSAGE ALERTS BASED ON COMPLIANCE WITH PERFORMANCE METRICS ASSOCIATED WITH THE OPERATION OF FREIGHT AND CARGO TERMINALS, IN CLASS 9 (U.S. CLS. 21, 23, 26, 36 AND 38).

FIRST USE 9-25-2007; IN COMMERCE 9-25-2007.

FOR: PROVIDING TEMPORARY USE OF NON-DOWNLOADABLE COMPUTER SOFTWARE FOR MONITORING AND TRACKING PERFORMANCE METRICS ASSOCIATED WITH THE OPERATION OF FREIGHT AND CARGO TERMINALS; PROVIDING TEMPORARY USE OF NON-DOWNLOADABLE COMPUTER SOFTWARE FOR TRIGGERING ELECTRONIC MAIL OR MESSAGE ALERTS BASED ON COMPLIANCE WITH PERFORMANCE METRICS ASSOCIATED WITH THE OPERATION OF FREIGHT AND CARGO TERMINALS, IN CLASS 42 (U.S. CLS. 100 AND 101).

FIRST USE 9-23-2009; IN COMMERCE 9-23-2009.

THE MARK CONSISTS OF STANDARD CHARACTERS WITHOUT CLAIM TO ANY PARTICULAR FONT, STYLE, SIZE, OR COLOR.

NO CLAIM IS MADE TO THE EXCLUSIVE RIGHT TO USE "DIGITAL", APART FROM THE MARK AS SHOWN.

SER. NO. 85-633,359, FILED 5-23-2012.

MAYUR VAGHANI, EXAMINING ATTORNEY



*David J. Kypos*

Director of the United States Patent and Trademark Office

# United States of America

United States Patent and Trademark Office



CAMBRIDGE  
HISTORICAL  
TOURS

**Reg. No. 4,274,998**

CAMBRIDGE HISTORICAL TOURS, INC. (MASSACHUSETTS CORPORATION)  
7 SCHOOL STREET  
ROXBURY, MA 02119

**Registered Jan. 15, 2013**

**Int. Cl.: 39**

FOR: CONDUCTING HISTORIC WALKING TOURS LED BY ACTOR-GUIDES IN PERIOD CLOTHING, IN CLASS 39 (U.S. CLS. 100 AND 105).

**SERVICE MARK**

FIRST USE 2-1-2012; IN COMMERCE 2-1-2012.

**PRINCIPAL REGISTER**

NO CLAIM IS MADE TO THE EXCLUSIVE RIGHT TO USE "CAMBRIDGE HISTORICAL TOURS", APART FROM THE MARK AS SHOWN.

THE MARK CONSISTS OF A GROUPING OF THREE STANDING MALE FIGURES FROM LEFT TO RIGHT, A COLONIAL MINUTEMAN, A NINETEENTH CENTURY GENTLEMEN WITH A WALKING STICK, AND A PILGRIM, SET IN A BORDERED OVAL WITH A BRIDGE IN THE BACKGROUND, EACH FIGURE WEARING MODERN SNEAKERS BUT OTHERWISE DRESSED IN OUTFITS FROM DIFFERENT PERIODS OF AMERICAN HISTORY. THE WORDING "CAMBRIDGE HISTORICAL TOURS" APPEARS TO THE LEFT OF THE DESIGN ELEMENT.

SER. NO. 85-633,405, FILED 5-23-2012.

JOHN SCHUYLER YARD, EXAMINING ATTORNEY



*David J. Kybas*

Director of the United States Patent and Trademark Office



# United States of America

United States Patent and Trademark Office

## IMPERIAL WEAPONS

**Reg. No. 4,274,999**

CLYDE ALAN HOLLIS (UNITED STATES INDIVIDUAL)  
53 BRENTMEADE DR.  
JACKSON, TN 38305

**Registered Jan. 15, 2013**

**Int. Cl.: 35**

FOR: RETAIL STORE SERVICES AND ON-LINE ORDERING SERVICES FEATURING MIEVEAL AND RENAISSANCE SWORDS, SHIELDS, ARMOR, KNIVES, DAGGERS, POLEARMS, AXES, ORIENTAL SWORDS, DISPLAY RACKS, AND MARTIAL ARTS SUPPLIES AND EQUIPMENT, IN CLASS 35 (U.S. CLS. 100, 101 AND 102).

**SERVICE MARK**

**PRINCIPAL REGISTER**

FIRST USE 6-27-2000; IN COMMERCE 6-27-2000.

THE MARK CONSISTS OF STANDARD CHARACTERS WITHOUT CLAIM TO ANY PARTICULAR FONT, STYLE, SIZE, OR COLOR.

NO CLAIM IS MADE TO THE EXCLUSIVE RIGHT TO USE "WEAPONS", APART FROM THE MARK AS SHOWN.

SER. NO. 85-633,459, FILED 5-23-2012.

JOHN SCHUYLER YARD, EXAMINING ATTORNEY



*David J. Kyffers*

Director of the United States Patent and Trademark Office

# United States of America

United States Patent and Trademark Office



**Reg. No. 4,275,000**

CLEAN AND SHEEN TEAM, THE (PENNSYLVANIA LIMITED LIABILITY COMPANY)  
6041 HAWTHORN DRIVE  
MOON TOWNSHIP, PA 15108

**Registered Jan. 15, 2013**

**Int. Cl.: 35**

FOR: BUSINESS DEVELOPMENT SERVICES, NAMELY, PROVIDING START-UP SUPPORT FOR BUSINESSES OF OTHERS, IN CLASS 35 (U.S. CLS. 100, 101 AND 102).

**SERVICE MARK**

FIRST USE 9-15-2011; IN COMMERCE 11-15-2011.

**PRINCIPAL REGISTER**

NO CLAIM IS MADE TO THE EXCLUSIVE RIGHT TO USE "TEAM", APART FROM THE MARK AS SHOWN.

THE COLOR(S) GREEN, AND GRAY IS/ARE CLAIMED AS A FEATURE OF THE MARK.

THE MARK CONSISTS OF TWO GRAY ARCHED LINES ABOVE THE GREEN STYLIZED TEXT "THE CLEAN & SHEEN TEAM".

SER. NO. 85-633,495, FILED 5-23-2012.

COLLEEN MULCRONE, EXAMINING ATTORNEY



*David J. Kyffers*

Director of the United States Patent and Trademark Office

# United States of America

United States Patent and Trademark Office

## Spirit Lollipals

**Reg. No. 4,275,001**

KENCRAFT, INC. (UTAH CORPORATION)  
119 EAST 200 NORTH  
ALPINE, UT 84003

**Registered Jan. 15, 2013**

**Int. Cl.: 30**

FOR: CANDY, IN CLASS 30 (U.S. CL. 46).

**TRADEMARK**

FIRST USE 1-1-2012; IN COMMERCE 1-1-2012.

**PRINCIPAL REGISTER**

THE MARK CONSISTS OF STANDARD CHARACTERS WITHOUT CLAIM TO ANY PARTICULAR FONT, STYLE, SIZE, OR COLOR.

OWNER OF U.S. REG. NO. 1,272,045.

SER. NO. 85-633,558, FILED 5-23-2012.

MARILYN IZZI, EXAMINING ATTORNEY



*David J. Kyffers*

Director of the United States Patent and Trademark Office

# United States of America

United States Patent and Trademark Office

## PACC: Promotions Advertising & Coupons Center

**Reg. No. 4,275,002**

**Registered Jan. 15, 2013**

**Int. Cl.: 35**

**SERVICE MARK**

**PRINCIPAL REGISTER**

MARITANO, RUBEN (UNITED STATES INDIVIDUAL)  
10722 ARROW RTE.  
NO. 512  
RANCHO CUCAMONGA, CA 91730

FOR: ADVERTISING AND PROMOTIONAL SERVICES; ADVERTISING AND PUBLICITY SERVICES, NAMELY, PROMOTING THE GOODS, SERVICES, BRAND IDENTITY AND COMMERCIAL INFORMATION AND NEWS OF THIRD PARTIES THROUGH PRINT, AUDIO, VIDEO, DIGITAL AND ON-LINE MEDIUM; ADVERTISING SERVICES, NAMELY, PROMOTING THE BRANDS, GOODS AND SERVICES OF OTHERS; ADVERTISING SERVICES, NAMELY, PROVIDING ADVERTISING SPACE IN A PERIODICAL, IN CLASS 35 (U.S. CLS. 100, 101 AND 102).

FIRST USE 10-2-2010; IN COMMERCE 10-2-2010.

THE MARK CONSISTS OF STANDARD CHARACTERS WITHOUT CLAIM TO ANY PARTICULAR FONT, STYLE, SIZE, OR COLOR.

NO CLAIM IS MADE TO THE EXCLUSIVE RIGHT TO USE "PROMOTIONS ADVERTISING & COUPONS CENTER", APART FROM THE MARK AS SHOWN.

SER. NO. 85-633,607, FILED 5-23-2012.

APRIL HESIK, EXAMINING ATTORNEY



*David J. Kyffers*

Director of the United States Patent and Trademark Office

# United States of America

United States Patent and Trademark Office

## TO LOVE, HONOR AND SPARKLE

**Reg. No. 4,275,003**

**Registered Jan. 15, 2013**

**Int. Cl.: 14**

**TRADEMARK**

**PRINCIPAL REGISTER**

ELEPHANT HEART JEWELRY (CALIFORNIA SOLE PROPRIETORSHIP)  
1107 FAIR OAKS AVE #28  
SOUTH PASADENA, CA 91030

FOR: JEWELRY, IN CLASS 14 (U.S. CLS. 2, 27, 28 AND 50).

FIRST USE 4-18-2012; IN COMMERCE 4-18-2012.

THE MARK CONSISTS OF STANDARD CHARACTERS WITHOUT CLAIM TO ANY PARTICULAR FONT, STYLE, SIZE, OR COLOR.

SER. NO. 85-633,610, FILED 5-23-2012.

APRIL HESIK, EXAMINING ATTORNEY



*David J. Kybas*

Director of the United States Patent and Trademark Office

# United States of America

United States Patent and Trademark Office

# Fruition

**Reg. No. 4,275,004**

FRUITION (OREGON LIMITED LIABILITY COMPANY)  
3624 SE 42ND AVENUE  
PORTLAND, OR 97206

**Registered Jan. 15, 2013**

**Int. Cl.: 41**

FOR: ENTERTAINMENT, NAMELY, LIVE PERFORMANCES BY A MUSICAL BAND, IN CLASS 41 (U.S. CLS. 100, 101 AND 107).

**SERVICE MARK**

FIRST USE 5-1-2007; IN COMMERCE 5-1-2007.

**PRINCIPAL REGISTER**

THE MARK CONSISTS OF STANDARD CHARACTERS WITHOUT CLAIM TO ANY PARTICULAR FONT, STYLE, SIZE, OR COLOR.

SER. NO. 85-633,715, FILED 5-23-2012.

MEREDITH MARESCA, EXAMINING ATTORNEY



*David J. Kyffers*

Director of the United States Patent and Trademark Office

# United States of America

United States Patent and Trademark Office

# Merroir

**Reg. No. 4,275,005**

**Registered Jan. 15, 2013**

**Int. Cl.: 43**

**SERVICE MARK**

**PRINCIPAL REGISTER**

RAPPAHANNOCK RIVER OYSTERS, LLC (VIRGINIA LIMITED LIABILITY COMPANY)  
784 LOCKLIES CREEK ROAD  
TOPPING, VA 23169

FOR: RESTAURANT SERVICES, IN CLASS 43 (U.S. CLS. 100 AND 101).

FIRST USE 7-15-2011; IN COMMERCE 7-15-2011.

THE MARK CONSISTS OF STANDARD CHARACTERS WITHOUT CLAIM TO ANY PARTICULAR FONT, STYLE, SIZE, OR COLOR.

THE WORDING "MERROIR" HAS NO MEANING IN A FOREIGN LANGUAGE.

SER. NO. 85-633,739, FILED 5-23-2012.

JESSICA FATHY, EXAMINING ATTORNEY



*David J. Kybas*

Director of the United States Patent and Trademark Office

# United States of America

United States Patent and Trademark Office

# REDii

**Reg. No. 4,275,006**

**Registered Jan. 15, 2013**

**Int. Cl.: 41**

**SERVICE MARK**

**PRINCIPAL REGISTER**

NORTH CAROLINA SUSTAINABLE ENTREPRENEURS GROUP (NORTH CAROLINA CORPORATION), DBA ENTREDOT  
3609 THRONDIKE DRIVE  
WAKE FOREST, NC 27587

FOR: EDUCATIONAL SERVICES, NAMELY, CONDUCTING PROGRAMS, WORKSHOPS AND SEMINARS IN THE FIELDS OF FASHION DESIGN ENTREPRENEURSHIP AND DISTRIBUTION OF TRAINING MATERIALS IN CONNECTION THEREWITH, IN CLASS 41 (U.S. CLS. 100, 101 AND 107).

FIRST USE 2-9-2012; IN COMMERCE 2-9-2012.

THE MARK CONSISTS OF STANDARD CHARACTERS WITHOUT CLAIM TO ANY PARTICULAR FONT, STYLE, SIZE, OR COLOR.

SER. NO. 85-633,762, FILED 5-24-2012.

VERNA BETH RIRIE, EXAMINING ATTORNEY



*David J. Kyffers*

Director of the United States Patent and Trademark Office



# United States of America

United States Patent and Trademark Office

WE DON'T WORK 8 TO 5, WE  
WORK START TO FINISH

**Reg. No. 4,275,007**

FRONTIER TITLE COMPANY -WH, L.L.C. (TEXAS LIMITED LIABILITY COMPANY)  
23501 CINCO RANCH BOULEVARD, SUITE B226  
KATY, TX 77494

**Registered Jan. 15, 2013**

**Int. Cls.: 36 and 45**

FOR: REAL ESTATE TITLE INSURANCE UNDERWRITING SERVICES, IN CLASS 36 (U.S. CLS. 100, 101 AND 102).

**SERVICE MARK**

FIRST USE 6-30-2011; IN COMMERCE 6-30-2011.

**PRINCIPAL REGISTER**

FOR: TITLE SEARCHING; REAL ESTATE CLOSING SERVICES; REAL ESTATE SETTLEMENT SERVICES, IN CLASS 45 (U.S. CLS. 100 AND 101).

FIRST USE 6-30-2011; IN COMMERCE 6-30-2011.

THE MARK CONSISTS OF STANDARD CHARACTERS WITHOUT CLAIM TO ANY PARTICULAR FONT, STYLE, SIZE, OR COLOR.

SER. NO. 85-633,797, FILED 5-24-2012.

MEREDITH MARESCA, EXAMINING ATTORNEY



*David J. Kyffers*

Director of the United States Patent and Trademark Office

# United States of America

United States Patent and Trademark Office

# GOSCOPE

**Reg. No. 4,275,008**

**Registered Jan. 15, 2013**

**Int. Cl.: 9**

**TRADEMARK**

**PRINCIPAL REGISTER**

GOSCOPE, LLC. (NORTH CAROLINA LIMITED LIABILITY COMPANY)  
9116 CASTLE GARDEN LANE  
CHARLOTTE, NC 28215

FOR: PORTABLE PHOTOGRAPHY EQUIPMENT, NAMELY, REFLECTORS, TRIPODS,  
LIGHT STANDS AND SUPPORTS AND BAGS SPECIALLY ADAPTED FOR THESE GOODS  
, IN CLASS 9 (U.S. CLS. 21, 23, 26, 36 AND 38).

FIRST USE 11-6-2011; IN COMMERCE 11-6-2011.

THE MARK CONSISTS OF STANDARD CHARACTERS WITHOUT CLAIM TO ANY PAR-  
TICULAR FONT, STYLE, SIZE, OR COLOR.

SER. NO. 85-633,803, FILED 5-24-2012.

MEREDITH MARESCA, EXAMINING ATTORNEY



*David J. Kyffers*

Director of the United States Patent and Trademark Office

# United States of America

United States Patent and Trademark Office

## SPLISH SPLASH PRESSURE WASHING

**Reg. No. 4,275,009**

**Registered Jan. 15, 2013**

**Int. Cl.: 37**

**SERVICE MARK**

**PRINCIPAL REGISTER**

SPLISH SPLASH PRESSURE WASHING (NORTH CAROLINA SOLE PROPRIETORSHIP)  
P.O. BOX 762  
INDIAN TRAIL, NC 28079

FOR: PRESSURE WASHING SERVICES FOR BUILDING EXTERIORS, PARKING LOTS,  
DRIVEWAYS, WALKWAYS, PATIOS, DECKS, AND HEAVY EQUIPMENT, IN CLASS 37  
(U.S. CLS. 100, 103 AND 106).

FIRST USE 3-2-2012; IN COMMERCE 3-2-2012.

THE MARK CONSISTS OF STANDARD CHARACTERS WITHOUT CLAIM TO ANY PAR-  
TICULAR FONT, STYLE, SIZE, OR COLOR.

NO CLAIM IS MADE TO THE EXCLUSIVE RIGHT TO USE "PRESSURE WASHING", APART  
FROM THE MARK AS SHOWN.

SER. NO. 85-633,838, FILED 5-24-2012.

IRA J. GOODSaid, EXAMINING ATTORNEY



*David J. Kyffers*

Director of the United States Patent and Trademark Office

# United States of America

United States Patent and Trademark Office



**Reg. No. 4,275,010**

**Registered Jan. 15, 2013**

**Int. Cl.: 37**

**SERVICE MARK**

**PRINCIPAL REGISTER**

SPLISH SPLASH PRESSURE WASHING (NORTH CAROLINA SOLE PROPRIETORSHIP)  
P.O. BOX 762  
INDIAN TRAIL, NC 28079

FOR: PRESSURE WASHING SERVICES FOR BUILDING EXTERIORS, PARKING LOTS, DRIVEWAYS, WALKWAYS, PATIOS, DECKS, AND HEAVY EQUIPMENT, IN CLASS 37 (U.S. CLS. 100, 103 AND 106).

FIRST USE 5-17-2012; IN COMMERCE 5-17-2012.

THE MARK CONSISTS OF A SMILING HOUSE IN A BATHTUB WITH BUBBLES AND A PRESSURE WASHER.

SER. NO. 85-633,844, FILED 5-24-2012.

IRA J. GOODSaid, EXAMINING ATTORNEY



*David J. Kyffers*

Director of the United States Patent and Trademark Office

# United States of America

United States Patent and Trademark Office

# ROAD TRIP!

**Reg. No. 4,275,011**

**Registered Jan. 15, 2013**

**Int. Cl.: 38**

**SERVICE MARK**

**PRINCIPAL REGISTER**

CLEAR CHANNEL BROADCASTING, INC. (NEVADA CORPORATION)  
200 E. BASSE ROAD  
SAN ANTONIO, TX 78209

FOR: BROADCASTING SERVICES VIA THE INTERNET AND WORLDWIDE WEB; DIGITAL AUDIO BROADCASTING SERVICES PROVIDED VIA A GLOBAL COMMUNICATIONS NETWORK; TELECOMMUNICATIONS SERVICES, NAMELY, PROVIDING TRANSMISSION OF VOICE, DATA, VIDEO, AND MEDIA CONTENT VIA A GLOBAL COMMUNICATIONS NETWORK, IN CLASS 38 (U.S. CLS. 100, 101 AND 104).

FIRST USE 3-27-2012; IN COMMERCE 3-27-2012.

THE MARK CONSISTS OF STANDARD CHARACTERS WITHOUT CLAIM TO ANY PARTICULAR FONT, STYLE, SIZE, OR COLOR.

SER. NO. 85-633,874, FILED 5-24-2012.

JESSICA FATHY, EXAMINING ATTORNEY



*David J. Kyffers*

Director of the United States Patent and Trademark Office

# United States of America

United States Patent and Trademark Office



**Reg. No. 4,275,012**

**Registered Jan. 15, 2013**

**Int. Cl.: 30**

**TRADEMARK**

**PRINCIPAL REGISTER**

TOUFAYAN BAKERY, INC. (NEW JERSEY CORPORATION)  
175 RAILROAD AVENUE  
RIDGEFIELD, NJ 07657

FOR: BREAD, PITA BREAD, PITA, WRAPS, SWEET BREADS, BREAD STICKS, ROLLS, FOCACCIA BREAD, FLAT BREADS, LAVASH, BAGELS, CROISSANTS, BREAD WITH OPEN CENTER, AND HOT DOG ROLLS , IN CLASS 30 (U.S. CL. 46).

FIRST USE 0-0-1991; IN COMMERCE 0-0-1991.

OWNER OF U.S. REG. NOS. 1,800,957 AND 3,117,119.

NO CLAIM IS MADE TO THE EXCLUSIVE RIGHT TO USE "QUALITY SINCE 1926" AND "BAKERIES", APART FROM THE MARK AS SHOWN.

SER. NO. 85-633,925, FILED 5-24-2012.

MARK SPARACINO, EXAMINING ATTORNEY



*David J. Kyffers*

Director of the United States Patent and Trademark Office

# United States of America

United States Patent and Trademark Office

# KIRBY

**Reg. No. 4,275,013**

**Registered Jan. 15, 2013**

**Int. Cl.: 28**

**TRADEMARK**

**PRINCIPAL REGISTER**

NINTENDO OF AMERICA (WASHINGTON CORPORATION)  
4600 150TH AVENUE NE  
REDMOND, WA 98052

FOR: PLUSH TOYS AND TOY KEY CHAINS, IN CLASS 28 (U.S. CLS. 22, 23, 38 AND 50).

FIRST USE 9-0-2010; IN COMMERCE 9-0-2010.

THE MARK CONSISTS OF STANDARD CHARACTERS WITHOUT CLAIM TO ANY PARTICULAR FONT, STYLE, SIZE, OR COLOR.

OWNER OF U.S. REG. NO. 2,988,000.

SER. NO. 85-633,927, FILED 5-24-2012.

TINA L. SNAPP, EXAMINING ATTORNEY



*David J. Kyffers*

Director of the United States Patent and Trademark Office

# United States of America

United States Patent and Trademark Office



**Reg. No. 4,275,014**

**Registered Jan. 15, 2013**

**Int. Cl.: 37**

**SERVICE MARK**

**PRINCIPAL REGISTER**

BRONCH TECH, INC. (DELAWARE CORPORATION)  
17 CREEK PARKWAY  
BOOTHWYN, PA 19061

FOR: MAINTENANCE AND REPAIR OF MEDICAL DIAGNOSTIC EQUIPMENT; MAINTENANCE OF MEDICAL APPARATUS AND INSTRUMENTS; REPAIR OF MEDICAL MACHINES AND APPARATUS; REPAIR OR MAINTENANCE OF MEDICAL MACHINES AND APPARATUS; REPAIR SERVICES FOR MEDICAL DIAGNOSTIC IMAGING, CLINICAL AND BIOMEDICAL EQUIPMENT; TECHNICAL SUPPORT SERVICES, NAMELY, TROUBLESHOOTING IN THE NATURE OF REPAIR OF MEDICAL EQUIPMENT, IN CLASS 37 (U.S. CLS. 100, 103 AND 106).

FIRST USE 7-1-1995; IN COMMERCE 7-1-1998.

THE MARK CONSISTS OF A PURPLE CIRCLE THAT IS DARK ON THE OUTSIDE AND SLOWLY DECREASES IN COLOR TO A WHITE BACKGROUND. AN ORANGE LETTER "B" IS IN THE CENTER OF THE CIRCLE WITH A PURPLE ENDOSCOPE SUPERIMPOSED ON THE LETTER "B" AND FOLLOWING THE OUTLINE OF THE "B".

THE COLOR(S) PURPLE, ORANGE, AND WHITE IS/ARE CLAIMED AS A FEATURE OF THE MARK.

SER. NO. 85-634,030, FILED 5-24-2012.

HENRY S. ZAK, EXAMINING ATTORNEY



*David J. Kyjars*

Director of the United States Patent and Trademark Office



# United States of America

United States Patent and Trademark Office

## THE VOICE OF PLASTICS RECYCLING

**Reg. No. 4,275,015**

**Registered Jan. 15, 2013**

**Int. Cl.: 35**

**SERVICE MARK**

**PRINCIPAL REGISTER**

ASSOCIATION OF POSTCONSUMER PLASTIC RECYCLERS (D.C. CORPORATION)  
SUITE 500  
1001 G STREET, NW  
WASHINGTON, DC 20001

FOR: ASSOCIATION SERVICES, NAMELY, PROMOTING THE INTERESTS OF POSTCONSUMER PLASTICS RECYCLERS, IN CLASS 35 (U.S. CLS. 100, 101 AND 102).

FIRST USE 9-1-2009; IN COMMERCE 9-1-2009.

THE MARK CONSISTS OF STANDARD CHARACTERS WITHOUT CLAIM TO ANY PARTICULAR FONT, STYLE, SIZE, OR COLOR.

NO CLAIM IS MADE TO THE EXCLUSIVE RIGHT TO USE "PLASTICS RECYCLING", APART FROM THE MARK AS SHOWN.

SER. NO. 85-634,111, FILED 5-24-2012.

MEGHAN REINHART, EXAMINING ATTORNEY



*David J. Kyros*

Director of the United States Patent and Trademark Office

# United States of America

United States Patent and Trademark Office



**Reg. No. 4,275,016**

**Registered Jan. 15, 2013**

**Int. Cl.: 36**

**SERVICE MARK**

**PRINCIPAL REGISTER**

MILAN'S MIRACLE FUND, INC. (MICHIGAN CORPORATION)  
1646 THORNAPPLE RIVER DR  
GRAND RAPIDS, MI 49546

FOR: CHARITABLE FOUNDATION SERVICES, NAMELY, PROVIDING FUNDRAISING ACTIVITIES TO SUPPORT MEDICAL RESEARCH AND PROCEDURES FOR THOSE IN NEED, IN CLASS 36 (U.S. CLS. 100, 101 AND 102).

FIRST USE 9-12-2009; IN COMMERCE 9-12-2009.

THE MARK CONSISTS OF A CHILD LIKE CARICATURE OF A SMILING SUN FACE WITH A PLURALITY OF ABSTRACT SUN RAYS EMITTING IN PART INTO ABSTRACT CLOUDS SURROUNDED BY AN ABSTRACT DOODLE FRAME. THE BODY OF THE SUN IS YELLOW; THE EYES AND MOUTH ARE BLACK; THE SUN RAYS ARE A MIXTURE OF PRIMARILY ALTERNATING YELLOW AND RED; THE CLOUD PORTIONS ARE BLUE; AND THE FRAME IS BLACK.

THE COLOR(S) YELLOW, BLACK, BLUE AND RED IS/ARE CLAIMED AS A FEATURE OF THE MARK.

SER. NO. 85-634,155, FILED 5-24-2012.

APRIL HESIK, EXAMINING ATTORNEY



*David J. Kybas*

Director of the United States Patent and Trademark Office

# United States of America

United States Patent and Trademark Office

# CSTC

**Reg. No. 4,275,017**

**Registered Jan. 15, 2013**

**Int. Cl.: 41**

**SERVICE MARK**

**PRINCIPAL REGISTER**

CALIFORNIA SAFETY TRAINING CORPORATION (CALIFORNIA CORPORATION)  
2130 BRUNDAGE LANE  
BAKERSFIELD, CA 93304

FOR: SAFETY TRAINING, NAMELY, TRAINING IN THE SAFE USE OF MACHINERY, NAMELY, FORKLIFTS, TRACTORS, ATV'S, COTTON PICKERS, CRANES, A-FRAME TRUCKS, TRACTORS, BACKHOES, CRAWLER TRACTORS, GRADERS, LOADERS, HOISTS, LIFTS, MANLIFTS, HAYBALERS; SAFETY TRAINING IN THE USE OF LAWN AND YARD EQUIPMENT, HAND TOOLS, NAMELY, RAKES, SHOVELS, AND SAWS; SAFETY TRAINING IN THE USE OF SELF-CONTAINED BREATHING APPARATI, PROTECTIVE BREATHING RESPIRATORS FOR USE IN HAZARDOUS ENVIRONMENTS, FOOD HANDLING AND PROCESSING, CONFINED SPACE ENVIRONMENTS; AND EMPLOYEE SAFETY TRAINING IN INDUSTRIAL OPERATIONS, NAMELY, AGRICULTURE, OIL, MANUFACTURING, MEDICAL, FOOD PROCESSING, AND PACKAGING, IN CLASS 41 (U.S. CLS. 100, 101 AND 107).

FIRST USE 0-0-1991; IN COMMERCE 0-0-1991.

THE MARK CONSISTS OF STANDARD CHARACTERS WITHOUT CLAIM TO ANY PARTICULAR FONT, STYLE, SIZE, OR COLOR.

OWNER OF U.S. REG. NO. 2,349,753.

SEC. 2(F).

SER. NO. 85-634,183, FILED 5-24-2012.

JILL PRATER, EXAMINING ATTORNEY



*David J. Kypos*

Director of the United States Patent and Trademark Office

# United States of America

United States Patent and Trademark Office

## i Love Irvine

**Reg. No. 4,275,018**

**Registered Jan. 15, 2013**

**Int. Cl.: 36**

**SERVICE MARK**

**PRINCIPAL REGISTER**

YONG, KINNEY (UNITED STATES INDIVIDUAL)  
1 FORT SUMTER  
IRVINE, CA 92620

FOR: REAL ESTATE SERVICES, NAMELY, RENTAL, BROKERAGE, LEASING AND MANAGEMENT OF COMMERCIAL PROPERTY, OFFICES AND OFFICE SPACE, IN CLASS 36 (U.S. CLS. 100, 101 AND 102).

FIRST USE 8-15-2002; IN COMMERCE 8-15-2002.

THE MARK CONSISTS OF STANDARD CHARACTERS WITHOUT CLAIM TO ANY PARTICULAR FONT, STYLE, SIZE, OR COLOR.

NO CLAIM IS MADE TO THE EXCLUSIVE RIGHT TO USE "IRVINE", APART FROM THE MARK AS SHOWN.

SER. NO. 85-634,184, FILED 5-24-2012.

KRISTIN CARLSON, EXAMINING ATTORNEY



*David J. Kyffers*

Director of the United States Patent and Trademark Office

# United States of America

United States Patent and Trademark Office

## Unirix Insurance Solution Suite

**Reg. No. 4,275,019**

**Registered Jan. 15, 2013**

**Int. Cl.: 42**

**SERVICE MARK**

**PRINCIPAL REGISTER**

UNIRIX, LLC (DELAWARE LIMITED LIABILITY COMPANY), AKA UNIRIX  
SUITE 336  
2 INTERNATIONAL PLAZA  
PHILADELPHIA, PA 19113

FOR: CONSULTING SERVICES IN THE FIELD OF SOFTWARE AS A SERVICE (SAAS);  
SOFTWARE AS A SERVICE (SAAS) SERVICES FEATURING SOFTWARE FOR INSURANCE  
INDUSTRY; SOFTWARE AS A SERVICE (SAAS) SERVICES FEATURING SOFTWARE FOR  
INSURANCE INDUSTRY; SOFTWARE AS A SERVICE (SAAS) SERVICES, NAMELY,  
HOSTING SOFTWARE FOR USE BY OTHERS FOR USE IN INSURANCE INDUSTRY, IN  
CLASS 42 (U.S. CLS. 100 AND 101).

FIRST USE 5-1-2012; IN COMMERCE 5-1-2012.

THE MARK CONSISTS OF STANDARD CHARACTERS WITHOUT CLAIM TO ANY PAR-  
TICULAR FONT, STYLE, SIZE, OR COLOR.

NO CLAIM IS MADE TO THE EXCLUSIVE RIGHT TO USE "INSURANCE SOLUTION  
SUITE", APART FROM THE MARK AS SHOWN.

SER. NO. 85-634,258, FILED 5-24-2012.

NAKIA HENRY, EXAMINING ATTORNEY



*David J. Kybas*

Director of the United States Patent and Trademark Office

# United States of America

United States Patent and Trademark Office

## Unirisx Underwriting Center

**Reg. No. 4,275,020**

**Registered Jan. 15, 2013**

**Int. Cl.: 42**

**SERVICE MARK**

**PRINCIPAL REGISTER**

UNIRISX, LLC (PENNSYLVANIA LIMITED LIABILITY COMPANY), AKA UNIRISX  
SUITE 336  
2 INTERNATIONAL PLAZA  
PHILADELPHIA, PA 19113

FOR: CONSULTING SERVICES IN THE FIELD OF SOFTWARE AS A SERVICE (SAAS);  
SOFTWARE AS A SERVICE (SAAS) SERVICES FEATURING SOFTWARE FOR INSURANCE  
INDUSTRY; SOFTWARE AS A SERVICE (SAAS) SERVICES FEATURING SOFTWARE FOR  
INSURANCE INDUSTRY; SOFTWARE AS A SERVICE (SAAS) SERVICES, NAMELY,  
HOSTING SOFTWARE FOR USE BY OTHERS FOR USE IN INSURANCE INDUSTRY, IN  
CLASS 42 (U.S. CLS. 100 AND 101).

FIRST USE 5-1-2012; IN COMMERCE 5-1-2012.

THE MARK CONSISTS OF STANDARD CHARACTERS WITHOUT CLAIM TO ANY PAR-  
TICULAR FONT, STYLE, SIZE, OR COLOR.

NO CLAIM IS MADE TO THE EXCLUSIVE RIGHT TO USE "UNDERWRITING CENTER",  
APART FROM THE MARK AS SHOWN.

SER. NO. 85-634,269, FILED 5-24-2012.

NAKIA HENRY, EXAMINING ATTORNEY



*David J. Kyffers*

Director of the United States Patent and Trademark Office

# United States of America

United States Patent and Trademark Office

# Bulx

**Reg. No. 4,275,021**

**Registered Jan. 15, 2013**

**Int. Cl.: 35**

**SERVICE MARK**

**PRINCIPAL REGISTER**

R&M GROUP LLC (NEW YORK LIMITED LIABILITY COMPANY)  
SUITE 210  
1100 SHAMES DRIVE  
WESTBURY, NY 11590

FOR: ON-LINE RETAIL STORE SERVICES FEATURING A WIDE VARIETY OF CONSUMER GOODS OF OTHERS, IN CLASS 35 (U.S. CLS. 100, 101 AND 102).

FIRST USE 8-12-2010; IN COMMERCE 8-12-2010.

THE MARK CONSISTS OF STANDARD CHARACTERS WITHOUT CLAIM TO ANY PARTICULAR FONT, STYLE, SIZE, OR COLOR.

SER. NO. 85-634,276, FILED 5-24-2012.

RAUL CORDOVA, EXAMINING ATTORNEY



*David J. Kybas*

Director of the United States Patent and Trademark Office

# United States of America

United States Patent and Trademark Office

## Unirisx Agency/Broker Center

**Reg. No. 4,275,022**

**Registered Jan. 15, 2013**

**Int. Cl.: 42**

**SERVICE MARK**

**PRINCIPAL REGISTER**

UNIRISX, LLC (PENNSYLVANIA LIMITED LIABILITY COMPANY), AKA UNIRISX  
SUITE 336  
2 INTERNATIONAL PLAZA  
PHILADELPHIA, PA 19113

FOR: CONSULTING SERVICES IN THE FIELD OF SOFTWARE AS A SERVICE (SAAS);  
SOFTWARE AS A SERVICE (SAAS) SERVICES FEATURING SOFTWARE FOR INSURANCE  
INDUSTRY; SOFTWARE AS A SERVICE (SAAS) SERVICES FEATURING SOFTWARE FOR  
INSURANCE INDUSTRY; SOFTWARE AS A SERVICE (SAAS) SERVICES, NAMELY,  
HOSTING SOFTWARE FOR USE BY OTHERS FOR USE IN INSURANCE INDUSTRY, IN  
CLASS 42 (U.S. CLS. 100 AND 101).

FIRST USE 5-1-2012; IN COMMERCE 5-1-2012.

THE MARK CONSISTS OF STANDARD CHARACTERS WITHOUT CLAIM TO ANY PAR-  
TICULAR FONT, STYLE, SIZE, OR COLOR.

NO CLAIM IS MADE TO THE EXCLUSIVE RIGHT TO USE "AGENCY/BROKER CENTER",  
APART FROM THE MARK AS SHOWN.

SER. NO. 85-634,285, FILED 5-24-2012.

NAKIA HENRY, EXAMINING ATTORNEY



*David J. Kyros*

Director of the United States Patent and Trademark Office



# United States of America

United States Patent and Trademark Office

# pacproinc

**Reg. No. 4,275,023**

**Registered Jan. 15, 2013**

**Int. Cls.: 7, 16, 17 and 42**

**TRADEMARK**

**SERVICE MARK**

**PRINCIPAL REGISTER**

PACKAGING PROGRESSIONS, INC. (PENNSYLVANIA CORPORATION)  
IRONBRIDGE CORPORATE CENTER  
102 G.P. CLEMENT DRIVE  
COLLEGEVILLE, PA 19426

FOR: CONVEYORS; PACKAGING MACHINES FOR FOOD , IN CLASS 7 (U.S. CLS. 13, 19, 21, 23, 31, 34 AND 35).

FIRST USE 9-26-2010; IN COMMERCE 9-26-2010.

FOR: PARCHMENT PAPER; SPECIALTY PAPERS, NAMELY, VEGETABLE PARCHMENT, FOR USE IN FOOD WRAPPING, PREPARATION, PROCESSING AND PACKAGING APPLICATIONS; WAX PAPER, IN CLASS 16 (U.S. CLS. 2, 5, 22, 23, 29, 37, 38 AND 50).

FIRST USE 9-26-2010; IN COMMERCE 9-26-2010.

FOR: PLASTIC FILMS USED AS PACKAGING FOR FOOD, IN CLASS 17 (U.S. CLS. 1, 5, 12, 13, 35 AND 50).

FIRST USE 9-26-2010; IN COMMERCE 9-26-2010.

FOR: CUSTOM DESIGN AND DEVELOPMENT OF MACHINERY, IN CLASS 42 (U.S. CLS. 100 AND 101).

FIRST USE 9-26-2010; IN COMMERCE 9-26-2010.

THE MARK CONSISTS OF STANDARD CHARACTERS WITHOUT CLAIM TO ANY PARTICULAR FONT, STYLE, SIZE, OR COLOR.

SER. NO. 85-634,335, FILED 5-24-2012.

TARA PATE, EXAMINING ATTORNEY



*David J. Kyros*

Director of the United States Patent and Trademark Office

# United States of America

United States Patent and Trademark Office

## Canine Sophisticate

**Reg. No. 4,275,024**

**Registered Jan. 15, 2013**

**Int. Cl.: 44**

**SERVICE MARK**

**PRINCIPAL REGISTER**

NICOLE MARIE STORY ENTERPRISES, LLC (PENNSYLVANIA LIMITED LIABILITY COMPANY), DBA CANINE SOPHISTICATE  
PO BOX 184  
LEETSDALE, PA 15056

FOR: DOG WALKING SERVICES, IN CLASS 44 (U.S. CLS. 100 AND 101).

FIRST USE 3-14-2012; IN COMMERCE 4-6-2012.

THE MARK CONSISTS OF STANDARD CHARACTERS WITHOUT CLAIM TO ANY PARTICULAR FONT, STYLE, SIZE, OR COLOR.

NO CLAIM IS MADE TO THE EXCLUSIVE RIGHT TO USE "CANINE", APART FROM THE MARK AS SHOWN.

SER. NO. 85-634,357, FILED 5-24-2012.

RUDY R. SINGLETON, EXAMINING ATTORNEY



*David J. Kybas*

Director of the United States Patent and Trademark Office

# United States of America

United States Patent and Trademark Office

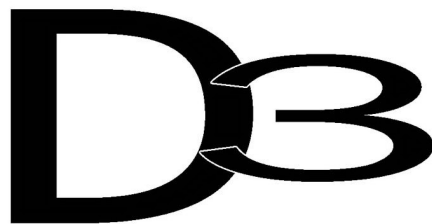

**Reg. No. 4,275,025**

**Registered Jan. 15, 2013**

**Int. Cls.: 7 and 12**

**TRADEMARK**

**PRINCIPAL REGISTER**

BLACKRIDGE GROUP (CALIFORNIA CORPORATION)  
1787 EAST 28TH STREET  
SIGNAL HILL, CA 90755

FOR: ENGINE EXHAUST SYSTEMS COMPRISED OF PIPES, COLLECTOR AND MUFFLER; ENGINE EXHAUST TIPS; ENGINE INJECTORS; ENGINE MUFFLERS; ENGINE TIMING COMPONENTS, NAMELY, CAM SPROCKETS AND CHAINS; EXHAUST SILENCERS FOR ENGINES; FANS FOR MOTORS AND ENGINES; FUEL INJECTOR PARTS FOR LAND AND WATER VEHICLE ENGINES; FUEL RAILS FOR ENGINES; RADIATORS FOR MOTORS AND ENGINES; RADIATORS FOR MOTORS AND ENGINES, IN CLASS 7 (U.S. CLS. 13, 19, 21, 23, 31, 34 AND 35).

FIRST USE 7-20-2010; IN COMMERCE 7-20-2010.

FOR: AUTOMOTIVE INTERIOR TRIM; METAL PARTS FOR VEHICLES, NAMELY, AUTOMOTIVE EXTERIOR AND INTERIOR METAL DECORATIVE AND PROTECTIVE TRIM; PLASTIC PARTS FOR VEHICLES, NAMELY, AUTOMOTIVE EXTERIOR AND INTERIOR PLASTIC EXTRUDED DECORATIVE AND PROTECTIVE TRIM, IN CLASS 12 (U.S. CLS. 19, 21, 23, 31, 35 AND 44).

FIRST USE 7-20-2010; IN COMMERCE 7-20-2010.

THE MARK CONSISTS OF A STYLIZED LETTER "D" WITH A STYLIZED OFFSET NUMERICAL "3".

SER. NO. 85-634,486, FILED 5-24-2012.

HOWARD SMIGA, EXAMINING ATTORNEY



*David J. Kyffers*

Director of the United States Patent and Trademark Office

# United States of America

United States Patent and Trademark Office

# Twiez

**Reg. No. 4,275,026**

BOONE, CHARLES M. (UNITED STATES INDIVIDUAL)  
8 ROSS AVENUE  
SOUTH NYACK, NY 10960

**Registered Jan. 15, 2013**

**Int. Cl.: 42**

FOR: COMPUTER SERVICES IN THE NATURE OF CUSTOMIZED WEB PAGES AND OTHER DATA FEED FORMATS FEATURING USER-DEFINED INFORMATION; COMPUTER SERVICES, NAMELY, CREATING, MAINTAINING, DESIGNING AND IMPLEMENTING WEB SITES FOR OTHERS; COMPUTER SERVICES, NAMELY, DESIGNING AND IMPLEMENTING WEB PAGES FOR OTHERS; COMPUTER SERVICES, NAMELY, DESIGNING AND IMPLEMENTING WEB SITES FOR OTHERS; COMPUTER SERVICES, NAMELY, DOMAIN FORWARDING SERVICES; COMPUTER SERVICES, NAMELY, INTERACTIVE HOSTING SERVICES WHICH ALLOW THE USER TO PUBLISH AND SHARE THEIR OWN CONTENT AND IMAGES ON-LINE; COMPUTER SERVICES, NAMELY, MANAGING WEB SITES FOR OTHERS; COMPUTER SERVICES, NAMELY, PROVIDING CUSTOMIZED WEB PAGES FEATURING USER-DEFINED INFORMATION; COMPUTER SERVICES, NAMELY, SEARCH ENGINE OPTIMIZATION; DOMAIN NAME SEARCH SERVICES, NAMELY, CONDUCTING ONLINE COMPUTERIZED SEARCHES FOR THE AVAILABILITY OF DOMAIN NAMES , IN CLASS 42 (U.S. CLS. 100 AND 101).

**SERVICE MARK**

**PRINCIPAL REGISTER**

FIRST USE 3-8-2012; IN COMMERCE 3-12-2012.

THE MARK CONSISTS OF STANDARD CHARACTERS WITHOUT CLAIM TO ANY PARTICULAR FONT, STYLE, SIZE, OR COLOR.

SER. NO. 85-634,573, FILED 5-24-2012.

DAVID YONTEF, EXAMINING ATTORNEY



*David J. Kypos*

Director of the United States Patent and Trademark Office

# United States of America

United States Patent and Trademark Office

# WIKIVERSITY

**Reg. No. 4,275,027**

WIKIMEDIA FOUNDATION, INC. (FLORIDA CORPORATION)  
149 NEW MONTGOMERY STREET, 3RD FLOOR  
SAN FRANCISCO, CA 94105

**Registered Jan. 15, 2013**

**Int. Cl.: 41**

FOR: ONLINE ELECTRONIC PUBLISHING OF LEARNING RESOURCES, LEARNING PROJECTS AND RESEARCH OF OTHERS FOR USE AT ALL LEVELS, IN CLASS 41 (U.S. CLS. 100, 101 AND 107).

**SERVICE MARK**

FIRST USE 8-15-2006; IN COMMERCE 8-15-2006.

**PRINCIPAL REGISTER**

THE MARK CONSISTS OF STANDARD CHARACTERS WITHOUT CLAIM TO ANY PARTICULAR FONT, STYLE, SIZE, OR COLOR.

SER. NO. 85-634,633, FILED 5-24-2012.

JESSICA FATHY, EXAMINING ATTORNEY



*David J. Kybas*

Director of the United States Patent and Trademark Office

# United States of America

United States Patent and Trademark Office

## PROTOCOL PASSPORT

**Reg. No. 4,275,028**

**Registered Jan. 15, 2013**

**Int. Cl.: 41**

**SERVICE MARK**

**PRINCIPAL REGISTER**

PROTOCOL & ETIQUETTE WORLDWIDE, LLC (TEXAS LIMITED LIABILITY COMPANY)  
SUITE 650-1305  
3300 BEE CAVE ROAD  
AUSTIN, TX 78746

FOR: EDUCATIONAL SERVICES, NAMELY, PROVIDING SEMINARS AS WELL AS PROVIDING TRAINING FOR PROFESSIONALS, CORPORATIONS, UNIVERSITIES, NON-PROFIT ORGANIZATIONS AND LAW FIRMS IN THE FIELDS OF BUSINESS ETIQUETTE AND PROTOCOL, INCLUDING INTERNATIONAL PROTOCOL, DINING ETIQUETTE, ELECTRONIC COMMUNICATIONS ETIQUETTE AND INTERNATIONAL DELEGATION PREPARATION; PROVIDING TRAINING TO PROFESSIONALS AND RECENT GRADUATES ON JOB INTERVIEWS AND BUSINESS NETWORKING, IN CLASS 41 (U.S. CLS. 100, 101 AND 107).

FIRST USE 5-21-2012; IN COMMERCE 5-21-2012.

THE MARK CONSISTS OF STANDARD CHARACTERS WITHOUT CLAIM TO ANY PARTICULAR FONT, STYLE, SIZE, OR COLOR.

NO CLAIM IS MADE TO THE EXCLUSIVE RIGHT TO USE "PROTOCOL", APART FROM THE MARK AS SHOWN.

SER. NO. 85-634,672, FILED 5-24-2012.

KATHERINE STOIDES, EXAMINING ATTORNEY



*David J. Kybas*

Director of the United States Patent and Trademark Office

# United States of America

United States Patent and Trademark Office

## Scream at the Sun

**Reg. No. 4,275,029**

HOWRY, CLINT R. (UNITED STATES INDIVIDUAL), DBA SCREAM AT THE SUN  
105 HILL ST.

**Registered Jan. 15, 2013**

MONTROSE, MN 55363

**Int. Cl.: 9**

FOR: COMPACT DISCS FEATURING MUSIC, IN CLASS 9 (U.S. CLS. 21, 23, 26, 36 AND 38).

**TRADEMARK**

FIRST USE 11-1-2011; IN COMMERCE 1-1-2012.

**PRINCIPAL REGISTER**

THE MARK CONSISTS OF STANDARD CHARACTERS WITHOUT CLAIM TO ANY PARTICULAR FONT, STYLE, SIZE, OR COLOR.

SER. NO. 85-634,676, FILED 5-24-2012.

SANDRA BUJA, EXAMINING ATTORNEY



*David J. Kyffers*

Director of the United States Patent and Trademark Office

# United States of America

United States Patent and Trademark Office

## VILLA HERMOSA

**Reg. No. 4,275,030**

**Registered Jan. 15, 2013**

**Int. Cls.: 43 and 45**

**SERVICE MARK**

**PRINCIPAL REGISTER**

SENIOR RESOURCE GROUP LLC (DELAWARE LIMITED LIABILITY COMPANY)  
500 STEVENS AVENUE, SUITE 100  
SOLANA BEACH, CA 92075

FOR: ASSISTED LIVING FACILITIES; PROVIDING ASSISTED LIVING CARE AND PROGRAMS, NAMELY, ADULT DAY CARE AND ELDER CARE; RETIREMENT HOMES AND RETIREMENT FACILITIES; PROVIDING ASSISTED LIVING FACILITIES; PROVIDING RETIREMENT HOMES AND INDEPENDENT LIVING RESIDENCES AND FACILITIES; PROVIDING ASSISTANCE TO SENIOR CITIZENS SEEKING TO DETERMINE IF ASSISTED LIVING FACILITIES ARE APPROPRIATE FOR THEIR NEEDS; MEAL PREPARATION SERVICES; PROVIDING COMMUNITY CENTERS FOR SOCIAL GATHERINGS AND MEETINGS, AND RESIDENTIAL HOTELS, IN CLASS 43 (U.S. CLS. 100 AND 101).

FIRST USE 7-0-2008; IN COMMERCE 7-0-2008.

FOR: PROVIDING NON-MEDICAL ASSISTED LIVING SERVICES FOR PERSONAL PURPOSES IN THE NATURE OF CONCIERGE SERVICES FOR OTHERS COMPRISING MAKING REQUESTED PERSONAL ARRANGEMENTS AND RESERVATIONS FOR CAR VALET SERVICES AND CAR WASH SERVICES, PRESCRIPTION PICKUP AND DELIVERY, AIRPORT TRANSPORTATION, VETERINARIAN TRANSPORTATION FOR PETS, DAILY TRASH REMOVAL, PACKAGE, NEWSPAPER AND DRY CLEANING PICKUP AND DELIVERY SERVICES, ARRANGEMENTS FOR MEDICAL AND DENTAL APPOINTMENTS, GROCERY SHOPPING AND DELIVERY; PERSONAL CARE ASSISTANCE IN THE NATURE OF BATHING, GROOMING AND PERSONAL MOBILITY, SCHEDULING APPOINTMENTS, ANSWERING THE TELEPHONE, CHECKING MESSAGES, MAIL SORTING AND PERSONAL CLERICAL ORGANIZING, FOR THE ELDERLY AND MOBILITY CHALLENGED PERSONS, IN CLASS 45 (U.S. CLS. 100 AND 101).

FIRST USE 7-0-2008; IN COMMERCE 7-0-2008.

THE MARK CONSISTS OF STANDARD CHARACTERS WITHOUT CLAIM TO ANY PARTICULAR FONT, STYLE, SIZE, OR COLOR.

THE ENGLISH TRANSLATION OF "HERMOSA" IS "BEAUTIFUL".

SER. NO. 85-634,757, FILED 5-24-2012.



*David J. Kyffers*

Director of the United States Patent and Trademark Office



**Reg. No. 4,275,030** ESTHER BELENKER, EXAMINING ATTORNEY

# United States of America

United States Patent and Trademark Office

## CMS HOSPITALITY

**Reg. No. 4,275,031**

**Registered Jan. 15, 2013**

**Int. Cl.: 35**

**SERVICE MARK**

**PRINCIPAL REGISTER**

CONCESSION MANAGEMENT SERVICES, INC. (CALIFORNIA CORPORATION), DBA  
CMS HOSPITALITY  
6033 WEST CENTURY BOULEVARD, SUITE 890  
LOS ANGELES, CA 90045

FOR: BUSINESS ASSISTANCE, ADVISORY AND CONSULTING SERVICES IN THE FIELD OF CONCESSIONS, RESTAURANT AND GIFT STORES; BUSINESS DEVELOPMENT, OPERATIONS AND MANAGEMENT SERVICES; NAMELY, BUSINESS CONSULTATION IN THE FIELDS OF TARGETED COMMUNICATIONS AND MARKET RESEARCH, STRATEGIC ALLIANCES, FINANCES, BUSINESS PROCESSES, BRAND MANAGEMENT, MARKET ACCESS, LICENSING AND FRANCHISING; CONCESSIONS, RESTAURANT AND GIFT STORE SERVICES; CONSULTATION IN THE FIELD OF TARGETED COMMUNICATIONS IN THE NATURE OF DIRECT MARKETING, MARKET RESEARCH, AND STRATEGIC PLANNING IN THE FIELD OF RESTAURANTS AND CONCESSION STANDS; CONSULTATION IN THE FIELD OF BUSINESS PROCESSES, BRAND MANAGEMENT, MARKET ACCESS, AND FRANCHISING IN THE FIELD OF RESTAURANTS AND CONCESSION STANDS; AND CONCESSION STANDS FEATURING FOOD AND BEVERAGES, IN CLASS 35 (U.S. CLS. 100, 101 AND 102).

FIRST USE 3-1-2010; IN COMMERCE 3-1-2010.

THE MARK CONSISTS OF STANDARD CHARACTERS WITHOUT CLAIM TO ANY PARTICULAR FONT, STYLE, SIZE, OR COLOR.

NO CLAIM IS MADE TO THE EXCLUSIVE RIGHT TO USE "HOSPITALITY", APART FROM THE MARK AS SHOWN.

SER. NO. 85-634,790, FILED 5-24-2012.

ANNE MADDEN, EXAMINING ATTORNEY



*David J. Kyffers*

Director of the United States Patent and Trademark Office

# United States of America

United States Patent and Trademark Office

## Whole Baked Goodness

**Reg. No. 4,275,032**

**Registered Jan. 15, 2013**

**Int. Cl.: 30**

**TRADEMARK**

**PRINCIPAL REGISTER**

KAREN W. MCGHEE (TENNESSEE CORPORATION), DBA WHOLE BAKED GOODNESS,  
INC  
4 BUCHI COURT  
NASHVILLE, TN 37204

FOR: BAKED GOODS, NAMELY, CRUMBLES, IN CLASS 30 (U.S. CL. 46).

FIRST USE 3-10-2010; IN COMMERCE 6-25-2011.

THE MARK CONSISTS OF STANDARD CHARACTERS WITHOUT CLAIM TO ANY PARTICULAR FONT, STYLE, SIZE, OR COLOR.

NO CLAIM IS MADE TO THE EXCLUSIVE RIGHT TO USE "BAKED", APART FROM THE MARK AS SHOWN.

SER. NO. 85-634,796, FILED 5-24-2012.

SAMUEL E. SHARPER JR., EXAMINING ATTORNEY



*David J. Kyffers*

Director of the United States Patent and Trademark Office

# United States of America

United States Patent and Trademark Office

## Tahoe Spice Works Inc.

**Reg. No. 4,275,033**

TAHOE SPICE WORKS INC. (NEVADA CORPORATION)  
PO BOX 5012  
STATELINE, NV 89449

**Registered Jan. 15, 2013**

**Int. Cl.: 30**

FOR: DRY SPICE RUBS FOR MEATS AND FISH; SPICES, IN CLASS 30 (U.S. CL. 46).

**TRADEMARK**

FIRST USE 5-9-2009; IN COMMERCE 5-9-2009.

**PRINCIPAL REGISTER**

THE MARK CONSISTS OF STANDARD CHARACTERS WITHOUT CLAIM TO ANY PARTICULAR FONT, STYLE, SIZE, OR COLOR.

NO CLAIM IS MADE TO THE EXCLUSIVE RIGHT TO USE "TAHOE SPICE" AND "INC.", APART FROM THE MARK AS SHOWN.

SER. NO. 85-634,845, FILED 5-24-2012.

TARAH HARDY, EXAMINING ATTORNEY



*David J. Kyffers*

Director of the United States Patent and Trademark Office

# United States of America

United States Patent and Trademark Office

## FRIENDS PLACE

**Reg. No. 4,275,034**

FRIENDS PLACE ADULT DAY SERVICES, INC. (TEXAS CORPORATION)  
1960 NANTUCKET DRIVE  
RICHARDSON, TX 75080

**Registered Jan. 15, 2013**

**Int. Cl.: 43**

FOR: PROVIDING ADULT DAY CARE SERVICES FOR SENIORS AND COGNITIVELY IMPAIRED INDIVIDUALS, IN CLASS 43 (U.S. CLS. 100 AND 101).

**SERVICE MARK**

FIRST USE 6-0-2004; IN COMMERCE 6-0-2004.

**PRINCIPAL REGISTER**

THE MARK CONSISTS OF STANDARD CHARACTERS WITHOUT CLAIM TO ANY PARTICULAR FONT, STYLE, SIZE, OR COLOR.

NO CLAIM IS MADE TO THE EXCLUSIVE RIGHT TO USE "PLACE", APART FROM THE MARK AS SHOWN.

SER. NO. 85-634,865, FILED 5-24-2012.

GRETCHEN ULRICH, EXAMINING ATTORNEY



*David J. Kybas*

Director of the United States Patent and Trademark Office

# United States of America

United States Patent and Trademark Office

## Visual Creatures

**Reg. No. 4,275,035**

VISUALCREATURES LLC (CALIFORNIA LIMITED LIABILITY COMPANY)  
428 LEWIS STREET

**Registered Jan. 15, 2013**

LOS ANGELES, CA 90042

**Int. Cl.: 41**

FOR: ANIMATION PRODUCTION SERVICES; FILM AND VIDEO PRODUCTION, IN CLASS 41 (U.S. CLS. 100, 101 AND 107).

**SERVICE MARK**

FIRST USE 6-8-2007; IN COMMERCE 6-8-2007.

**PRINCIPAL REGISTER**

THE MARK CONSISTS OF STANDARD CHARACTERS WITHOUT CLAIM TO ANY PARTICULAR FONT, STYLE, SIZE, OR COLOR.

SER. NO. 85-634,892, FILED 5-24-2012.

KRISTINA MORRIS, EXAMINING ATTORNEY



*David J. Kybas*

Director of the United States Patent and Trademark Office

# United States of America

United States Patent and Trademark Office



**Reg. No. 4,275,036**

**Registered Jan. 15, 2013**

**Int. Cl.: 30**

**TRADEMARK**

**PRINCIPAL REGISTER**

CHEF MERITO, INC. (CALIFORNIA CORPORATION)  
7915 SEPULVEDA BLVD.  
VAN NUYS, CA 91405

FOR: MARINADES, IN CLASS 30 (U.S. CL. 46).

FIRST USE 10-19-2011; IN COMMERCE 10-19-2011.

THE MARK CONSISTS OF IMAGE OF A MAN FROM THE SHOULDERS UP IN A CHEF'S HAT AND UNIFORM MAKING A GESTURE WITH HIS HAND WITH THUMB AND INDEX FINGERS TOUCHING IN THE SHAPE OF AN "O" AND REMAINING FINGERS EXTENDED UPWARD NEAR HIS MUSTACHE ON THE RIGHT SIDE OF HIS FACE.

SER. NO. 85-634,896, FILED 5-24-2012.

C. DIONNE CLYBURN, EXAMINING ATTORNEY



*David J. Kybas*

Director of the United States Patent and Trademark Office

# United States of America

United States Patent and Trademark Office

## PARTY TONIGHT FEEL GREAT TOMORROW

**Reg. No. 4,275,037**

NEVER HUNG OVER, LLC (TEXAS LIMITED LIABILITY COMPANY)  
115 SANDRA MURANDA WAY, APT. 622  
AUSTIN, TX 78703

**Registered Jan. 15, 2013**

**Int. Cl.: 5**

FOR: NUTRITIONAL AND DIETARY SUPPLEMENTS THAT RELIEVE AND PREVENT HANGOVERS, IN CLASS 5 (U.S. CLS. 6, 18, 44, 46, 51 AND 52).

**TRADEMARK**

FIRST USE 0-0-2011; IN COMMERCE 0-0-2011.

**PRINCIPAL REGISTER**

THE MARK CONSISTS OF STANDARD CHARACTERS WITHOUT CLAIM TO ANY PARTICULAR FONT, STYLE, SIZE, OR COLOR.

SER. NO. 85-634,935, FILED 5-24-2012.

SANJEEV VOHRA, EXAMINING ATTORNEY



*David J. Kyros*

Director of the United States Patent and Trademark Office



# United States of America

United States Patent and Trademark Office

## CAULK WIZARD

**Reg. No. 4,275,038**

VANCOUVER TOOL CORPORATION (CANADA CORPORATION)  
6187 MACDONALD ST  
VANCOUVER, CANADA

**Registered Jan. 15, 2013**

**Int. Cl.: 8**

FOR: MULTI-FUNCTION HAND TOOLS COMPRISED OF A CUTTER, SCRAPER, AND FINISHER USED TO FINISH CAULKING BEADS, IN CLASS 8 (U.S. CLS. 23, 28 AND 44).

**TRADEMARK**

FIRST USE 11-2-2010; IN COMMERCE 1-4-2011.

**PRINCIPAL REGISTER**

THE MARK CONSISTS OF STANDARD CHARACTERS WITHOUT CLAIM TO ANY PARTICULAR FONT, STYLE, SIZE, OR COLOR.

NO CLAIM IS MADE TO THE EXCLUSIVE RIGHT TO USE "CAULK", APART FROM THE MARK AS SHOWN.

SER. NO. 85-634,961, FILED 5-24-2012.

WILLIAM JACKSON, EXAMINING ATTORNEY



*David J. Kyffers*

Director of the United States Patent and Trademark Office

# United States of America

United States Patent and Trademark Office

# NanoZoomer

**Reg. No. 4,275,039**

HAMAMATSU PHOTONICS K.K. (JAPAN CORPORATION)  
1126-1, ICHINO-CHO, HIGASHI-KU

**Registered Jan. 15, 2013**

HAMAMATSU-SHI, SHIZUOKA, JAPAN 435-8558

**Int. Cl.: 10**

FOR: HIGH-SPEED DIGITAL SLIDE SCANNERS FOR DIAGNOSTIC IMAGING FOR MEDICAL USE, IN CLASS 10 (U.S. CLS. 26, 39 AND 44).

**TRADEMARK**

THE MARK CONSISTS OF STANDARD CHARACTERS WITHOUT CLAIM TO ANY PARTICULAR FONT, STYLE, SIZE, OR COLOR.

**PRINCIPAL REGISTER**

OWNER OF JAPAN REG. NO. 4749043, DATED 2-20-2004, EXPIRES 2-20-2014.

OWNER OF U.S. REG. NOS. 3,023,745 AND 3,131,846.

SER. NO. 85-634,993, FILED 5-24-2012.

DEBORAH MEINERS, EXAMINING ATTORNEY



*David J. Kybas*

Director of the United States Patent and Trademark Office

# United States of America

United States Patent and Trademark Office

## FOXHOLLOW FARM

**Reg. No. 4,275,040**

FOXHOLLOW COMMUNITY, LLC (KENTUCKY LIMITED LIABILITY COMPANY)  
8905 HIGHWAY 329  
CRESTWOOD, KY 40014

**Registered Jan. 15, 2013**

**Int. Cl.: 29**

FOR: BEEF; APPLESAUCE; CRUSHED PEPPERS; JELLIES; CANNED TOMATOES; SOUP,  
IN CLASS 29 (U.S. CL. 46).

**TRADEMARK**

FIRST USE 5-1-2007; IN COMMERCE 5-1-2007.

**PRINCIPAL REGISTER**

THE MARK CONSISTS OF STANDARD CHARACTERS WITHOUT CLAIM TO ANY PARTICULAR FONT, STYLE, SIZE, OR COLOR.

NO CLAIM IS MADE TO THE EXCLUSIVE RIGHT TO USE "FARM", APART FROM THE MARK AS SHOWN.

SER. NO. 85-635,124, FILED 5-25-2012.

LINDA MICKLEBURGH, EXAMINING ATTORNEY



*David J. Kyffers*

Director of the United States Patent and Trademark Office

# United States of America

United States Patent and Trademark Office



**Reg. No. 4,275,041**

ICARE MEDICAL, INC. (PUERTO RICO CORPORATION)  
64 CONDADO AVE. SUITE 4  
SAN JUAN, PUERTO RICO 00911

**Registered Jan. 15, 2013**

**Int. Cl.: 5**

FOR: IN-VITRO OVULATION PREDICTION TEST KIT FOR HOME USE; OVULATION TEST KITS; PREGNANCY TEST KITS FOR HOME USE; TEST STRIPS FOR MEASURING BLOOD GLUCOSE LEVELS , IN CLASS 5 (U.S. CLS. 6, 18, 44, 46, 51 AND 52).

**TRADEMARK**

FIRST USE 12-10-2010; IN COMMERCE 12-10-2010.

**PRINCIPAL REGISTER**

THE MARK CONSISTS OF THE WORDS "ICARE ADVANCED" IN A STYLIZED WHITE FONT. THE WORD "ADVANCED" IS PRESENTED BELOW THE WORD "ICARE". THE BACKGROUND OF THE MARK IS RED.

THE COLOR(S) RED AND WHITE IS/ARE CLAIMED AS A FEATURE OF THE MARK.

SER. NO. 85-635,137, FILED 5-25-2012.

JOHN SCHUYLER YARD, EXAMINING ATTORNEY



*David J. Kyffers*

Director of the United States Patent and Trademark Office

# United States of America

United States Patent and Trademark Office



**Reg. No. 4,275,042**

LUCKY 21, INC (NEW YORK CORPORATION)  
1905 3RD AVE  
NEW YORK, NY 10029

**Registered Jan. 15, 2013**

**Int. Cl.: 25**

FOR: BATHING SUITS; BELTS; BOOTS; COATS; DRESSES; FOOTWEAR; HOSIERY; KNIT TOPS; LINGERIE; PANTS; SANDALS; SHORTS; SKIRTS; SLIPPERS; SWEATERS; TANK TOPS; WOVEN TOPS, IN CLASS 25 (U.S. CLS. 22 AND 39).

**TRADEMARK**

FIRST USE 8-23-2010; IN COMMERCE 8-23-2010.

**PRINCIPAL REGISTER**

OWNER OF U.S. REG. NO. 3,999,666.

THE COLOR(S) PINK, YELLOW, TURQUOISE AND WHITE IS/ARE CLAIMED AS A FEATURE OF THE MARK IS/ARE CLAIMED AS A FEATURE OF THE MARK.

THE MARK CONSISTS OF THE WORDS "LUCKY 21" WRITTEN IN PINK WITH A YELLOW CIRCLE BEHIND THE "21", ALL ON A WHITE BACKGROUND, WITH TURQUOISE DOTS ABOVE AND BELOW THE WORDING.

SER. NO. 85-635,194, FILED 5-25-2012.

ARETHA SOMERVILLE, EXAMINING ATTORNEY



*David J. Kybas*

Director of the United States Patent and Trademark Office

**United States of America**  
United States Patent and Trademark Office

**Zona Black**

**Reg. No. 4,275,043**

**Registered Jan. 15, 2013**

**Int. Cl.: 35**

**SERVICE MARK**

**PRINCIPAL REGISTER**

ZONA BLACK INC. (FLORIDA CORPORATION)  
SUITE 209-17  
14750 SW 26 STREET  
MIAMI, FL 33185

FOR: ON-LINE RETAIL STORE SERVICES FEATURING CELLPHONES CELLPHONE ACCESSORIES, VIDEO GAMES, VIDEO GAME CONSOLES; RETAIL STORE SERVICES FEATURING CELLPHONES CELLPHONE ACCESSORIES, VIDEO GAMES, VIDEO GAME CONSOLES; WHOLESALE DISTRIBUTORSHIPS FEATURING CELLPHONES CELLPHONE ACCESSORIES, VIDEO GAMES, VIDEO GAME CONSOLES; WHOLESALE STORE SERVICES FEATURING CELLPHONES CELLPHONE ACCESSORIES, VIDEO GAMES, VIDEO GAME CONSOLES, IN CLASS 35 (U.S. CLS. 100, 101 AND 102).

FIRST USE 3-8-2012; IN COMMERCE 3-8-2012.

THE MARK CONSISTS OF THE WORDS "ZONA BLACK" WITH A CIRCLING LINE AT THE BOTTOM OF THE WORD "BLACK".

THE ENGLISH TRANSLATION OF "ZONA" IN THE MARK IS "ZONE".

SER. NO. 85-635,212, FILED 5-25-2012.

HEATHER BIDDULPH, EXAMINING ATTORNEY



*David J. Kyffers*

Director of the United States Patent and Trademark Office

# United States of America

United States Patent and Trademark Office

# One2snap

**Reg. No. 4,275,044**

SIMPLY 66, LLC (FLORIDA LIMITED LIABILITY COMPANY)  
7810 S DIXIE HIGHWAY  
WEST PALM BEACH, FL 33405

**Registered Jan. 15, 2013**

**Int. Cl.: 24**

FOR: CURTAINS; CURTAINS MADE OF TEXTILE FABRICS; CURTAINS OF TEXTILE OR PLASTIC; VINYL CURTAINS, IN CLASS 24 (U.S. CLS. 42 AND 50).

**TRADEMARK**

FIRST USE 5-1-2012; IN COMMERCE 5-1-2012.

**PRINCIPAL REGISTER**

THE MARK CONSISTS OF STANDARD CHARACTERS WITHOUT CLAIM TO ANY PARTICULAR FONT, STYLE, SIZE, OR COLOR.

SER. NO. 85-635,223, FILED 5-25-2012.

AMY KELLY, EXAMINING ATTORNEY



*David J. Kybas*

Director of the United States Patent and Trademark Office

# United States of America

United States Patent and Trademark Office

## Drop in. Stand out.

**Reg. No. 4,275,045**

**Registered Jan. 15, 2013**

**Int. Cl.: 44**

**SERVICE MARK**

**PRINCIPAL REGISTER**

LEMON TREE DEVELOPMENT, LLC (NEW JERSEY LIMITED LIABILITY COMPANY),  
DBA LEMON TREE  
55 EAGLE ROCK AVENUE, SUITE 6  
EAST HANOVER, NJ 07936

FOR: BARBER SHOP SERVICES; BEAUTY SALON SERVICES; BEAUTY SALONS; HAIR SALON SERVICES; HAIR SALON SERVICES, NAMELY, HAIR CUTTING, STYLING, COLORING, AND HAIR EXTENSION SERVICES; HAIRDRESSING SALONS, IN CLASS 44 (U.S. CLS. 100 AND 101).

FIRST USE 6-1-2011; IN COMMERCE 10-1-2011.

THE MARK CONSISTS OF STANDARD CHARACTERS WITHOUT CLAIM TO ANY PARTICULAR FONT, STYLE, SIZE, OR COLOR.

SER. NO. 85-635,225, FILED 5-25-2012.

MARK SHINER, EXAMINING ATTORNEY



*David J. Kybas*

Director of the United States Patent and Trademark Office



# United States of America

United States Patent and Trademark Office



**Reg. No. 4,275,046**

**Registered Jan. 15, 2013**

**Int. Cl.: 30**

**TRADEMARK**

**PRINCIPAL REGISTER**

ACACIA TRADING INTERNATIONAL LIMITED (BR. VIRGIN ISLANDS CORPORATION)  
3RD FLOOR, GENEVA PLACE, WATERFRONT DR.  
ROAD TOWN, TORTOLA, BR. VIRGIN ISLANDS

FOR: RICE, IN CLASS 30 (U.S. CL. 46).

FIRST USE 12-0-2002; IN COMMERCE 12-0-2002.

OWNER OF U.S. REG. NO. 3,343,948.

THE NAME(S), PORTRAIT(S), AND/OR SIGNATURE(S) SHOWN IN THE MARK DOES NOT IDENTIFY A PARTICULAR LIVING INDIVIDUAL.

THE MARK CONSISTS OF A STYLIZED RENDERING OF A MAN'S HEAD AND UPPER TORSO WEARING A HAT AND A SUIT ENCASED IN A STYLIZED RECTANGULAR OUTLINE.

SER. NO. 85-635,264, FILED 5-25-2012.

RENEE MCCRAY, EXAMINING ATTORNEY



*David J. Kybas*

Director of the United States Patent and Trademark Office

# United States of America

United States Patent and Trademark Office

## RICE MASTER'S

**Reg. No. 4,275,047**

**Registered Jan. 15, 2013**

**Int. Cl.: 30**

**TRADEMARK**

**PRINCIPAL REGISTER**

ACACIA TRADING INTERNATIONAL LIMITED (BR. VIRGIN ISLANDS CORPORATION)  
3RD FLOOR, GENEVA PLACE, WATERFRONT DR.  
ROAD TOWN, TORTOLA, BR. VIRGIN ISLANDS

FOR: RICE, IN CLASS 30 (U.S. CL. 46).

FIRST USE 12-0-2002; IN COMMERCE 12-0-2002.

THE MARK CONSISTS OF STANDARD CHARACTERS WITHOUT CLAIM TO ANY PARTICULAR FONT, STYLE, SIZE, OR COLOR.

OWNER OF U.S. REG. NO. 3,343,948.

NO CLAIM IS MADE TO THE EXCLUSIVE RIGHT TO USE "RICE", APART FROM THE MARK AS SHOWN.

SER. NO. 85-635,275, FILED 5-25-2012.

RENEE MCCRAY, EXAMINING ATTORNEY



*David J. Kyffers*

Director of the United States Patent and Trademark Office

# United States of America

United States Patent and Trademark Office



**Reg. No. 4,275,048**

GROUND UP ATHLETICS (TEXAS LIMITED LIABILITY COMPANY)  
26118 CROSSWOOD TRAILS LN  
CYPRESS, TX 77433

**Registered Jan. 15, 2013**

**Int. Cl.: 35**

FOR: RETAIL STORE SERVICES FEATURING ORTHOTICS FOR FOOTWEAR, IN CLASS 35 (U.S. CLS. 100, 101 AND 102).

**SERVICE MARK**

FIRST USE 12-1-2011; IN COMMERCE 4-0-2012.

**PRINCIPAL REGISTER**

NO CLAIM IS MADE TO THE EXCLUSIVE RIGHT TO USE "ATHLETICS", APART FROM THE MARK AS SHOWN.

THE MARK CONSISTS OF THE WORDS "GROUND UP" WITH "UP" PLACED VERTICALLY AND THE LETTER "P" IN A TRIANGLE, AND "ATHLETICS" BELOW THE LETTERS "ND".

SER. NO. 85-635,276, FILED 5-25-2012.

RICHARD WHITE, EXAMINING ATTORNEY



*David J. Kybas*

Director of the United States Patent and Trademark Office

# United States of America

United States Patent and Trademark Office

# ILLIFE

**Reg. No. 4,275,049**

**Registered Jan. 15, 2013**

**Int. Cl.: 25**

**TRADEMARK**

**PRINCIPAL REGISTER**

ROSS W. BOLLING (UNITED STATES INDIVIDUAL)  
115 BUCK ROAD  
WILMINGTON, DE 19807

FOR: T-SHIRTS, IN CLASS 25 (U.S. CLS. 22 AND 39).

FIRST USE 1-14-2012; IN COMMERCE 1-14-2012.

THE MARK CONSISTS OF STANDARD CHARACTERS WITHOUT CLAIM TO ANY PARTICULAR FONT, STYLE, SIZE, OR COLOR.

SER. NO. 85-635,292, FILED 5-25-2012.

LINDA M. KING, EXAMINING ATTORNEY



*David J. Kyffers*

Director of the United States Patent and Trademark Office

# United States of America

United States Patent and Trademark Office



**Reg. No. 4,275,050**

ALPHA NATURAL RESOURCES, INC. (DELAWARE CORPORATION)  
P.O. BOX 2345, ONE ALPHA PLACE  
ABINGDON, VA 24212

**Registered Jan. 15, 2013**

**Int. Cl.: 35**

FOR: EMPLOYMENT HIRING, RECRUITMENT, PLACEMENT, STAFFING FOR THE MINING INDUSTRY, IN CLASS 35 (U.S. CLS. 100, 101 AND 102).

**SERVICE MARK**

FIRST USE 4-9-2011; IN COMMERCE 4-9-2011.

**PRINCIPAL REGISTER**

THE MARK CONSISTS OF THE TERMS ARMED FORCES ARE IN GREEN; THE TERM TO IS IN BLACK; THE TERM ALPHA IS IN LIGHTER GRAY, WITH A DARKER GRAY PENTAGON, HAVING GREEN, BLACK, GRAY AND WHITE RECTANGLES DECORATIVELY POSITIONED THROUGHOUT.

THE COLOR(S) GREEN, GRAY, BLACK AND WHITE IS/ARE CLAIMED AS A FEATURE OF THE MARK.

SER. NO. 85-635,301, FILED 5-25-2012.

ARETHA SOMERVILLE, EXAMINING ATTORNEY



*David J. Kyffers*

Director of the United States Patent and Trademark Office

# United States of America

United States Patent and Trademark Office

## CHIRAL BALANCE

**Reg. No. 4,275,051**

**Registered Jan. 15, 2013**

**Int. Cl.: 5**

**TRADEMARK**

**PRINCIPAL REGISTER**

CHIRAL BALANCE LLC (TEXAS LIMITED LIABILITY COMPANY)  
SUITE B  
5802 BERKMAN DRIVE  
AUSTIN, TX 78723

FOR: DIETARY AND NUTRITIONAL SUPPLEMENTS, IN CLASS 5 (U.S. CLS. 6, 18, 44, 46, 51 AND 52).

FIRST USE 12-7-2005; IN COMMERCE 12-8-2005.

THE MARK CONSISTS OF STANDARD CHARACTERS WITHOUT CLAIM TO ANY PARTICULAR FONT, STYLE, SIZE, OR COLOR.

SER. NO. 85-635,312, FILED 5-25-2012.

ARETHA SOMERVILLE, EXAMINING ATTORNEY



*David J. Kyffers*

Director of the United States Patent and Trademark Office

# United States of America

United States Patent and Trademark Office

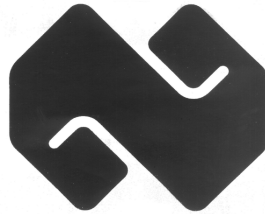

**Reg. No. 4,275,052**

**Registered Jan. 15, 2013**

**Int. Cl.: 18**

**TRADEMARK**

**PRINCIPAL REGISTER**

NITTA GELATIN INC. (JAPAN CORPORATION)  
4-26, SAKURAGAWA 4-CHOME  
NANIWA-KU, OSAKA-SHI  
OSAKA, JAPAN

FOR: EDIBLE COLLAGEN FOOD CASINGS, IN CLASS 18 (U.S. CLS. 1, 2, 3, 22 AND 41).

FIRST USE 7-31-2010; IN COMMERCE 7-31-2010.

OWNER OF U.S. REG. NOS. 3,701,063 AND 4,075,150.

THE MARK CONSISTS OF A STYLIZED "N" DESIGN.

SER. NO. 85-635,329, FILED 5-25-2012.

ANGELA M. MICHELI, EXAMINING ATTORNEY



*David J. Kybas*

Director of the United States Patent and Trademark Office

# United States of America

United States Patent and Trademark Office

# MAJEST

**Reg. No. 4,275,053**

**Registered Jan. 15, 2013**

**Int. Cl.: 41**

**SERVICE MARK**

**PRINCIPAL REGISTER**

MAJEST ASHBURN INC (VIRGINIA CORPORATION), DBA MAJEST MARTIAL ART  
100  
21030 SYCOLIN ROAD  
ASHBURN, VA 22026

FOR: CONDUCTING AFTER SCHOOL TUTORING PROGRAMS; MARTIAL ARTS INSTRUCTION; OPERATING OF MARTIAL ARTS' SCHOOLS; OPERATING OF MARTIAL ARTS' STUDIOS; ORGANIZING LIVE MIXED MARTIAL ARTS EVENTS AND COMPETITIONS; PRESENTATION OF MIXED MARTIAL ARTS (MMA) EVENTS; PROVIDING A WEB SITE FEATURING NON-DOWNLOADABLE INSTRUCTIONAL VIDEOS IN THE FIELD OF MARTIAL ARTS; PROVIDING AFTER SCHOOL EDUCATIONAL PROGRAMS FOR CHILDREN IN GRADES OF ELEMENTARY SCHOOL; PROVIDING AFTER SCHOOL EDUCATIONAL PROGRAMS IN THE FIELD OF MIXED MARTIAL ARTS AND TAEKWONDO AND PLAY FACILITIES FOR CHILDREN; PROVIDING CLASSES, WORKSHOPS, SEMINARS AND CAMPS IN THE FIELDS OF FITNESS, EXERCISE, BOXING, KICK BOXING AND MIXED MARTIAL ARTS; PROVIDING EDUCATION COURSES IN THE FIELD OF MIXED MARTIAL ARTS AND TAEKWONDO OFFERED THROUGH ONLINE, NON-DOWNLOADABLE VIDEOS AND INSTRUCTOR ASSISTANCE; PROVIDING EDUCATION IN THE FIELD OF MIXED MARTIAL ARTS AND TAEKWONDO RENDERED THROUGH VIDEO CONFERENCE; PROVIDING EDUCATION IN THE FIELD OF MIXED MARTIAL ARTS AND TAEKWONDO RENDERED THROUGH CORRESPONDENCE COURSES; PROVIDING GENERAL FITNESS AND MIXED MARTIAL ARTS FACILITIES THAT REQUIRE MEMBERSHIPS AND ARE FOCUSED IN THE FIELDS OF GENERAL FITNESS, EXERCISE, AND MIXED MARTIAL ARTS, IN CLASS 41 (U.S. CLS. 100, 101 AND 107).



FIRST USE 4-13-2010; IN COMMERCE 4-13-2010.

THE MARK CONSISTS OF STANDARD CHARACTERS WITHOUT CLAIM TO ANY PARTICULAR FONT, STYLE, SIZE, OR COLOR.

SER. NO. 85-635,344, FILED 5-25-2012.

TINA MAI, EXAMINING ATTORNEY

*David J. Kyffers*

Director of the United States Patent and Trademark Office



# United States of America

United States Patent and Trademark Office

# SCOTCHBOND

**Reg. No. 4,275,054**

3M COMPANY (DELAWARE CORPORATION)  
3M CENTER, 2501 HUDSON ROAD  
ST. PAUL, MN 55144

**Registered Jan. 15, 2013**

**Int. Cl.: 5**

FOR: ETCHING MATERIALS FOR DENTAL USE, IN CLASS 5 (U.S. CLS. 6, 18, 44, 46, 51 AND 52).

**TRADEMARK**

FIRST USE 12-0-1984; IN COMMERCE 12-0-1984.

**PRINCIPAL REGISTER**

THE MARK CONSISTS OF STANDARD CHARACTERS WITHOUT CLAIM TO ANY PARTICULAR FONT, STYLE, SIZE, OR COLOR.

OWNER OF U.S. REG. NO. 1,410,096.

SER. NO. 85-635,367, FILED 5-25-2012.

JANET LEE, EXAMINING ATTORNEY



*David J. Kyffers*

Director of the United States Patent and Trademark Office

**United States of America**  
United States Patent and Trademark Office

# MIXTURA

**Reg. No. 4,275,055**

**Registered Jan. 15, 2013**

**Int. Cl.: 41**

**SERVICE MARK**

**PRINCIPAL REGISTER**

MASON, LUBA (UNITED STATES INDIVIDUAL)  
#218  
328 8TH AVE  
NYC, NY 10001

FOR: ENTERTAINMENT SERVICES IN THE NATURE OF LIVE MUSICAL PERFORMANCES,  
IN CLASS 41 (U.S. CLS. 100, 101 AND 107).

FIRST USE 3-19-2012; IN COMMERCE 3-19-2012.

THE MARK CONSISTS OF STANDARD CHARACTERS WITHOUT CLAIM TO ANY PAR-  
TICULAR FONT, STYLE, SIZE, OR COLOR.

SER. NO. 85-635,368, FILED 5-25-2012.

JANET LEE, EXAMINING ATTORNEY



*David J. Kybas*

Director of the United States Patent and Trademark Office

**United States of America**  
United States Patent and Trademark Office

# EQUILINK

**Reg. No. 4,275,056**

**Registered Jan. 15, 2013**

**Int. Cl.: 42**

**SERVICE MARK**

**PRINCIPAL REGISTER**

LEXSTREAM, LLC (DELAWARE LIMITED LIABILITY COMPANY)  
24 COMMERCE STREET  
SUITE 500  
NEWARK, NJ 07102

FOR: PROVIDING TEMPORARY USE OF ON-LINE NON-DOWNLOADABLE SOFTWARE FOR ACCOUNTING, CALCULATION, ALLOCATION AND INTEGRATION OF EQUITY COMPENSATION INTO PAYROLL, ACCOUNTING AND/OR TAX SYSTEMS, IN CLASS 42 (U.S. CLS. 100 AND 101).

FIRST USE 10-15-2011; IN COMMERCE 11-1-2011.

THE MARK CONSISTS OF STANDARD CHARACTERS WITHOUT CLAIM TO ANY PARTICULAR FONT, STYLE, SIZE, OR COLOR.

SER. NO. 85-635,371, FILED 5-25-2012.

TARA PATE, EXAMINING ATTORNEY



*David J. Kyffers*

Director of the United States Patent and Trademark Office

# United States of America

United States Patent and Trademark Office

## DA VINCI SUPPLY CHAIN BUSINESS SUITE

**Reg. No. 4,275,057**

WOLIN DESIGN GROUP (CALIFORNIA CORPORATION)  
2207 W. ORANGEWOOD AVE.  
ORANGE, CA 92868

**Registered Jan. 15, 2013**

**Int. Cl.: 42**

FOR: PROVIDING ON-LINE NON-DOWNLOADABLE SOFTWARE FOR SUPPLY CHAIN LOGISTICS, IN CLASS 42 (U.S. CLS. 100 AND 101).

**SERVICE MARK**

FIRST USE 0-0-2002; IN COMMERCE 0-0-2002.

**PRINCIPAL REGISTER**

THE MARK CONSISTS OF STANDARD CHARACTERS WITHOUT CLAIM TO ANY PARTICULAR FONT, STYLE, SIZE, OR COLOR.

NO CLAIM IS MADE TO THE EXCLUSIVE RIGHT TO USE "SUPPLY CHAIN BUSINESS SUITE", APART FROM THE MARK AS SHOWN.

THE NAME(S), PORTRAIT(S), AND/OR SIGNATURE(S) SHOWN IN THE MARK DOES NOT IDENTIFY A PARTICULAR LIVING INDIVIDUAL.

SER. NO. 85-635,385, FILED 5-25-2012.

KEVIN CORWIN, EXAMINING ATTORNEY



*David J. Kyffers*

Director of the United States Patent and Trademark Office

# United States of America

United States Patent and Trademark Office

## CARTONLOGIC

**Reg. No. 4,275,058**

WOLIN DESIGN GROUP (CALIFORNIA CORPORATION)  
2207 W. ORANGEWOOD AVE.  
ORANGE, CA 92868

**Registered Jan. 15, 2013**

**Int. Cl.: 42**

FOR: SOFTWARE AS A SERVICE (SAAS) SERVICES FEATURING SOFTWARE FOR SUPPLY CHAIN LOGISTICS, IN CLASS 42 (U.S. CLS. 100 AND 101).

**SERVICE MARK**

FIRST USE 0-0-2011; IN COMMERCE 0-0-2011.

**PRINCIPAL REGISTER**

THE MARK CONSISTS OF STANDARD CHARACTERS WITHOUT CLAIM TO ANY PARTICULAR FONT, STYLE, SIZE, OR COLOR.

SER. NO. 85-635,390, FILED 5-25-2012.

KEVIN CORWIN, EXAMINING ATTORNEY



*David J. Kybas*

Director of the United States Patent and Trademark Office

# United States of America

United States Patent and Trademark Office

# mybackpacktags

**Reg. No. 4,275,059**

**Registered Jan. 15, 2013**

**Int. Cl.: 20**

**TRADEMARK**

**PRINCIPAL REGISTER**

CONFIDENT KIDS, LLC (OHIO LIMITED LIABILITY COMPANY)  
3820 COUNTRY CLUB PLACE  
CINCINNATI, OH 45208

FOR: PLASTIC HANG TAGS, IN CLASS 20 (U.S. CLS. 2, 13, 22, 25, 32 AND 50).

FIRST USE 3-28-2012; IN COMMERCE 5-25-2012.

THE MARK CONSISTS OF STANDARD CHARACTERS WITHOUT CLAIM TO ANY PARTICULAR FONT, STYLE, SIZE, OR COLOR.

SER. NO. 85-635,393, FILED 5-25-2012.

KARANENDRA S. CHHINA, EXAMINING ATTORNEY



*David J. Kybas*

Director of the United States Patent and Trademark Office

# United States of America

United States Patent and Trademark Office



**Reg. No. 4,275,060**

COCCIA REALTY, INC. (NEW JERSEY CORPORATION)  
636 KEARNY AVENUE  
KEARNY, NJ 07032

**Registered Jan. 15, 2013**

**Int. Cl.: 36**

FOR: REAL ESTATE AGENCY SERVICES, NAMELY, LEASING OF REAL ESTATE, REAL ESTATE APPRAISAL, REAL ESTATE BROKERAGE, REAL ESTATE MANAGEMENT, REAL ESTATE INVESTMENT AND REAL ESTATE LISTING, IN CLASS 36 (U.S. CLS. 100, 101 AND 102).

**SERVICE MARK**

**PRINCIPAL REGISTER**

FIRST USE 10-0-1988; IN COMMERCE 10-0-1989.

THE MARK CONSISTS OF THE WORD "COCCIA" IN WHITE WRITTEN IN THE BLACK OVAL.

SEC. 2(F).

SER. NO. 85-635,397, FILED 5-25-2012.

SANI KHOURI, EXAMINING ATTORNEY



*David J. Kybas*

Director of the United States Patent and Trademark Office

# United States of America

United States Patent and Trademark Office

## IPFONE INTELLIGENT VOICE

**Reg. No. 4,275,061**

**Registered Jan. 15, 2013**

**Int. Cl.: 38**

**SERVICE MARK**

**PRINCIPAL REGISTER**

INTERACTIVE SERVICES NETWORK, INC. (FLORIDA CORPORATION)  
1035 NE 125TH STREET, SUITE 300  
NORTH MIAMI, FL 33161

FOR: TELEPHONE COMMUNICATION SERVICES, VOICE OVER THE INTERNET PROTOCOL SERVICES, LOCAL AND LONG DISTANCE TELEPHONE SERVICES AND HOSTED TELECOMMUNICATIONS SERVICES, NAMELY, PROVIDING TELECOMMUNICATIONS CONNECTIONS TO A GLOBAL COMPUTER NETWORK, TELECOMMUNICATION ACCESS SERVICES, IN CLASS 38 (U.S. CLS. 100, 101 AND 104).

FIRST USE 10-31-2009; IN COMMERCE 10-31-2009.

THE MARK CONSISTS OF STANDARD CHARACTERS WITHOUT CLAIM TO ANY PARTICULAR FONT, STYLE, SIZE, OR COLOR.

OWNER OF U.S. REG. NOS. 3,057,281 AND 3,899,681.

NO CLAIM IS MADE TO THE EXCLUSIVE RIGHT TO USE "IP PHONE" AND "VOICE", APART FROM THE MARK AS SHOWN.

SER. NO. 85-635,399, FILED 5-25-2012.

WENDY JUN, EXAMINING ATTORNEY



*David J. Kyros*

Director of the United States Patent and Trademark Office



# United States of America

United States Patent and Trademark Office

## REAL ESTATE, JUST BETTER

**Reg. No. 4,275,062**

COCCIA REALTY, INC. (NEW JERSEY CORPORATION)  
636 KEARNY AVENUE  
KEARNY, NJ 07032

**Registered Jan. 15, 2013**

**Int. Cl.: 36**

FOR: REAL ESTATE AGENCY SERVICES, NAMELY, LEASING OF REAL ESTATE, REAL ESTATE APPRAISAL, REAL ESTATE BROKERAGE, REAL ESTATE MANAGEMENT, REAL ESTATE INVESTMENT AND REAL ESTATE LISTING, IN CLASS 36 (U.S. CLS. 100, 101 AND 102).

**SERVICE MARK**

**PRINCIPAL REGISTER**

FIRST USE 2-0-2012; IN COMMERCE 2-0-2012.

THE MARK CONSISTS OF STANDARD CHARACTERS WITHOUT CLAIM TO ANY PARTICULAR FONT, STYLE, SIZE, OR COLOR.

NO CLAIM IS MADE TO THE EXCLUSIVE RIGHT TO USE "REAL ESTATE", APART FROM THE MARK AS SHOWN.

SER. NO. 85-635,412, FILED 5-25-2012.

SANI KHOURI, EXAMINING ATTORNEY



*David J. Kyffers*

Director of the United States Patent and Trademark Office

# United States of America

United States Patent and Trademark Office

## EDISON MFG CO.

**Reg. No. 4,275,063**

EDISON MFG CO (CALIFORNIA SOLE PROPRIETORSHIP)  
3726 33RD ST.

**Registered Jan. 15, 2013**

SAN DIEGO, CA 92104

**Int. Cl.: 18**

FOR: BACKPACKS; DUFFLE BAGS; LEATHER KEY CHAINS; MESSENGER BAGS; TOTE BAGS; WALLETS, IN CLASS 18 (U.S. CLS. 1, 2, 3, 22 AND 41).

**TRADEMARK**

FIRST USE 3-12-2011; IN COMMERCE 3-12-2011.

**PRINCIPAL REGISTER**

THE MARK CONSISTS OF STANDARD CHARACTERS WITHOUT CLAIM TO ANY PARTICULAR FONT, STYLE, SIZE, OR COLOR.

NO CLAIM IS MADE TO THE EXCLUSIVE RIGHT TO USE "MFG CO.", APART FROM THE MARK AS SHOWN.

THE NAME(S), PORTRAIT(S), AND/OR SIGNATURE(S) SHOWN IN THE MARK DOES NOT IDENTIFY A PARTICULAR LIVING INDIVIDUAL.

SER. NO. 85-635,414, FILED 5-25-2012.

SANI KHOURI, EXAMINING ATTORNEY



*David J. Kyffers*

Director of the United States Patent and Trademark Office

# United States of America

United States Patent and Trademark Office

## show me where to go

**Reg. No. 4,275,064**

**Registered Jan. 15, 2013**

**Int. Cl.: 20**

**TRADEMARK**

**PRINCIPAL REGISTER**

CONFIDENT KIDS, LLC (OHIO LIMITED LIABILITY COMPANY)  
3820 COUNTRY CLUB PLACE  
CINCINNATI, OH 45208

FOR: PLASTIC HANG TAGS, IN CLASS 20 (U.S. CLS. 2, 13, 22, 25, 32 AND 50).

FIRST USE 3-21-2012; IN COMMERCE 5-25-2012.

THE MARK CONSISTS OF STANDARD CHARACTERS WITHOUT CLAIM TO ANY PARTICULAR FONT, STYLE, SIZE, OR COLOR.

SER. NO. 85-635,432, FILED 5-25-2012.

KARANENDRA S. CHHINA, EXAMINING ATTORNEY



*David J. Kybas*

Director of the United States Patent and Trademark Office

# United States of America

United States Patent and Trademark Office

# I-BAR

**Reg. No. 4,275,065**

**Registered Jan. 15, 2013**

**Int. Cl.: 11**

**TRADEMARK**

**PRINCIPAL REGISTER**

KONCEPT TECHNOLOGIES, INC. (CALIFORNIA CORPORATION)  
429 E. HUNTINGTON DRIVE  
MONROVIA, CA 91016

FOR: LIGHTING LAMPS, IN CLASS 11 (U.S. CLS. 13, 21, 23, 31 AND 34).

FIRST USE 2-7-2006; IN COMMERCE 2-7-2006.

THE MARK CONSISTS OF STANDARD CHARACTERS WITHOUT CLAIM TO ANY PARTICULAR FONT, STYLE, SIZE, OR COLOR.

SER. NO. 85-635,438, FILED 5-25-2012.

KEVEN MITTLER, EXAMINING ATTORNEY



*David J. Kyffers*

Director of the United States Patent and Trademark Office

# United States of America

United States Patent and Trademark Office

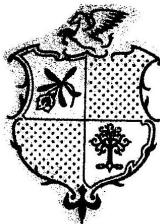

**Reg. No. 4,275,066**

NIELSEN-MASSEY VANILLAS, INC. (ILLINOIS CORPORATION)  
1550 SHIELDS DRIVE  
WAUKEGAN, IL 60085

**Registered Jan. 15, 2013**

**Int. Cl.: 30**

FOR: EXTRACTS, NOT ESSENTIAL OILS, USED AS FOOD FLAVORINGS; FOOD FLAVORING ADDITIVES, IN CLASS 30 (U.S. CL. 46).

**TRADEMARK**

FIRST USE 6-15-2011; IN COMMERCE 7-1-2011.

**PRINCIPAL REGISTER**

THE MARK CONSISTS OF SHIELDS OR CRESTS WITH FIGURATIVE ELEMENTS CONTAINED THEREIN OR SUPERIMPOSED THEREON; HORSES, WINGED (PEGASUS); PEGASUS (WINGED HORSE); FLEUR-DE-LIS; OTHER FLOWERS INCLUDING DAFFODILS AND IRISES; TREES OR BUSHES WITH A GENERALLY ROUND SHAPE, INCLUDING DECIDUOUS TREES; THE STIPLING IS A FEATURE OF THE MARK AND DOES NOT INDICATE COLOR.

SER. NO. 85-635,442, FILED 5-25-2012.

SUZANNE BLANE, EXAMINING ATTORNEY



*David J. Kybas*

Director of the United States Patent and Trademark Office

# United States of America

United States Patent and Trademark Office

EVERYONE LOVES A BARGAIN.

**Reg. No. 4,275,067**

E-DRIVE AUTOS, LLC (DELAWARE LIMITED LIABILITY COMPANY)  
701 MARKET ST. SUITE 112  
ST. AUGUSTINE, FL 32095

**Registered Jan. 15, 2013**

**Int. Cl.: 35**

FOR: ADVERTISING, MARKETING AND PROMOTION SERVICES IN THE FIELD OF  
AUTOMOTIVE SALES, IN CLASS 35 (U.S. CLS. 100, 101 AND 102).

**SERVICE MARK**

FIRST USE 3-1-2012; IN COMMERCE 3-1-2012.

**PRINCIPAL REGISTER**

THE MARK CONSISTS OF STANDARD CHARACTERS WITHOUT CLAIM TO ANY PAR-  
TICULAR FONT, STYLE, SIZE, OR COLOR.

SER. NO. 85-635,443, FILED 5-25-2012.

TINA BROWN, EXAMINING ATTORNEY



*David J. Kybas*

Director of the United States Patent and Trademark Office

# United States of America

United States Patent and Trademark Office

# MEGA JUMP

**Reg. No. 4,275,068**

GET SET GAMES, INC. (CANADA CORPORATION)  
30 DUNCAN ST., SUITE 601  
TORONTO, ONTARIO, CANADA M5V2C3

**Registered Jan. 15, 2013**

**Int. Cl.: 9**

FOR: DOWNLOADABLE FILES CONTAINING GAMES, IN CLASS 9 (U.S. CLS. 21, 23, 26, 36 AND 38).

**TRADEMARK**

FIRST USE 7-31-2010; IN COMMERCE 7-31-2010.

**PRINCIPAL REGISTER**

THE MARK CONSISTS OF STANDARD CHARACTERS WITHOUT CLAIM TO ANY PARTICULAR FONT, STYLE, SIZE, OR COLOR.

SER. NO. 85-635,461, FILED 5-25-2012.

JOHN KELLY, EXAMINING ATTORNEY



*David J. Kybas*

Director of the United States Patent and Trademark Office

# United States of America

United States Patent and Trademark Office

## DOUGHMAKERS

**Reg. No. 4,275,069**

FOX RUN USA, LLC (DELAWARE LIMITED LIABILITY COMPANY)  
1907 STOUT DRIVE  
IVYLAND, PA 18974

**Registered Jan. 15, 2013**

**Int. Cl.: 21**

FOR: BAKEWARE AND COOKWARE, NAMELY, METAL COOKING PANS, PIZZA PANS, BAKING SHEETS, AND JELLY ROLL PANS, IN CLASS 21 (U.S. CLS. 2, 13, 23, 29, 30, 33, 40 AND 50).

**TRADEMARK**

FIRST USE 2-0-1997; IN COMMERCE 2-0-1997.

**PRINCIPAL REGISTER**

THE MARK CONSISTS OF STANDARD CHARACTERS WITHOUT CLAIM TO ANY PARTICULAR FONT, STYLE, SIZE, OR COLOR.

SER. NO. 85-635,493, FILED 5-25-2012.

SUSAN RICHARDS, EXAMINING ATTORNEY



*David J. Kyffers*

Director of the United States Patent and Trademark Office



# United States of America

United States Patent and Trademark Office

## Celebrities On Hold

**Reg. No. 4,275,070**

LAFF PRODUCTIONS INC. (NEVADA CORPORATION)

**Registered Jan. 15, 2013**

3209 BURTON AVE  
LAS VEGAS, NV 89102

**Int. Cl.: 41**

FOR: PROVIDING VOICE OVERS FOR TAPES, RECORDS AND OTHER RECORDED MEDIA FOR ENTERTAINMENT AND EDUCATION PURPOSES, IN CLASS 41 (U.S. CLS. 100, 101 AND 107).

**SERVICE MARK**

FIRST USE 3-15-2012; IN COMMERCE 3-15-2012.

**PRINCIPAL REGISTER**

THE MARK CONSISTS OF STANDARD CHARACTERS WITHOUT CLAIM TO ANY PARTICULAR FONT, STYLE, SIZE, OR COLOR.

SER. NO. 85-635,496, FILED 5-25-2012.

SUSAN RICHARDS, EXAMINING ATTORNEY



*David J. Kyffers*

Director of the United States Patent and Trademark Office

# United States of America

United States Patent and Trademark Office



**Reg. No. 4,275,071**

D D & B MAGIASTRA L.L.C. (LOUISIANA LIMITED LIABILITY COMPANY)  
37249 AUDUBON PARK AVENUE  
GEISMAR, LA 70734

**Registered Jan. 15, 2013**

**Int. Cls.: 6 and 14**

FOR: SCULPTURES OF METAL, METAL WEATHER VANES, IN CLASS 6 (U.S. CLS. 2, 12, 13, 14, 23, 25 AND 50).

**TRADEMARK**

FIRST USE 11-0-2011; IN COMMERCE 11-0-2011.

**PRINCIPAL REGISTER**

FOR: JEWELRY; RINGS, EARRINGS, BRACELETS, CHARMS, PENDANTS, NECKLACES, BROACHES, ANKLETS, ORNAMENTAL PINS, CHOKERS, TIARAS, CROSSES; SCULPTURES MADE OF PRECIOUS METAL, IN CLASS 14 (U.S. CLS. 2, 27, 28 AND 50).

FIRST USE 11-0-2011; IN COMMERCE 11-0-2011.

THE MARK CONSISTS OF THE TERM "MAGIASTRA" IN STYLIZED LETTERING WITH THE LETTER "A" IN THE MARK CREATED BY AN ABSTRACT STAR DESIGN.

SER. NO. 85-635,501, FILED 5-25-2012.

PAULA MAHONEY, EXAMINING ATTORNEY



*David J. Kybas*

Director of the United States Patent and Trademark Office

# United States of America

United States Patent and Trademark Office

## CUT REACTION

**Reg. No. 4,275,072**

WM MEDIA GROUP, LLC (MINNESOTA LIMITED LIABILITY COMPANY)  
15524 EAGLE SHORE DRIVE  
APPLE VALLEY, MN 55124

**Registered Jan. 15, 2013**

**Int. Cl.: 42**

FOR: PROVIDING A WEBSITE FEATURING TEMPORARY USE OF NON-DOWNLOADABLE SOFTWARE ALLOWING USERS TO UPLOAD VIDEOS FOR SHARING WITH OTHERS FOR ENTERTAINMENT PURPOSES , IN CLASS 42 (U.S. CLS. 100 AND 101).

**SERVICE MARK**

FIRST USE 1-1-2012; IN COMMERCE 1-1-2012.

**PRINCIPAL REGISTER**

THE MARK CONSISTS OF STANDARD CHARACTERS WITHOUT CLAIM TO ANY PARTICULAR FONT, STYLE, SIZE, OR COLOR.

SER. NO. 85-635,527, FILED 5-25-2012.

TRACY FLETCHER, EXAMINING ATTORNEY



*David J. Kyros*

Director of the United States Patent and Trademark Office

# United States of America

United States Patent and Trademark Office

# MCP

**Reg. No. 4,275,073**

**Registered Jan. 15, 2013**

**Int. Cl.: 16**

**TRADEMARK**

**PRINCIPAL REGISTER**

AMERICAN SOCIETY FOR BIOCHEMISTRY AND MOLECULAR BIOLOGY (NEW YORK  
NON-PROFIT CORPORATION)  
9650 ROCKVILLE PIKE  
BETHESDA, MD 208143996

FOR: SCIENTIFIC JOURNAL IN THE FIELDS OF BIOCHEMISTRY AND MOLECULAR  
BIOLOGY, IN CLASS 16 (U.S. CLS. 2, 5, 22, 23, 29, 37, 38 AND 50).

FIRST USE 1-31-2002; IN COMMERCE 1-31-2002.

THE MARK CONSISTS OF STANDARD CHARACTERS WITHOUT CLAIM TO ANY PAR-  
TICULAR FONT, STYLE, SIZE, OR COLOR.

SER. NO. 85-635,538, FILED 5-25-2012.

AMEEN IMAM, EXAMINING ATTORNEY



*David J. Kyffers*

Director of the United States Patent and Trademark Office

# United States of America

United States Patent and Trademark Office

# PACE

**Reg. No. 4,275,074**

**Registered Jan. 15, 2013**

**Int. Cl.: 8**

**TRADEMARK**

**PRINCIPAL REGISTER**

DORCO CO., LTD. (REPUBLIC OF KOREA CORPORATION)  
931 GOLIM-DONG, CHEOIN-GU, YONGIN-SI  
KYUNGGI-DO, REPUBLIC OF KOREA

FOR: ELECTRIC SHAVERS, BLADES FOR ELECTRIC SHAVERS; RAZORS AND RAZOR BLADES; HOUSEHOLD KNIVES, UTILITY KNIVES, WORKING KNIVES, AND HAND TOOLS, NAMELY, KNIVES; CUTTING BLADES, SCRAPING BLADES, WALLPAPER REMOVAL BLADES, CARPET CUTTING BLADES, GLASS CUTTING BLADES, CHOPPING KNIVES, BACON BLADES, HOBBY KNIVES, UPHOLSTERY BLADES, FINISHING BLADES, IN CLASS 8 (U.S. CLS. 23, 28 AND 44).

FIRST USE 5-18-2007; IN COMMERCE 5-18-2007.

THE MARK CONSISTS OF STANDARD CHARACTERS WITHOUT CLAIM TO ANY PARTICULAR FONT, STYLE, SIZE, OR COLOR.

SER. NO. 85-635,550, FILED 5-25-2012.

PAM WILLIS, EXAMINING ATTORNEY



*David J. Kyffers*

Director of the United States Patent and Trademark Office

# United States of America

United States Patent and Trademark Office

We bring *beauty*  
to the world

**Reg. No. 4,275,075**

**Registered Jan. 15, 2013**

**Int. Cl.: 35**

**SERVICE MARK**

**PRINCIPAL REGISTER**

ERNST BENARY SAMENZUCHT GMBH (FED REP GERMANY GESELLSCHAFT MIT  
BESCHRÄNKTER HAFTUNG (GMBH))  
FRIEDRICH-BENARY-WEG 1  
HANN MUNDEN, FED REP GERMANY 34346

FOR: ADVERTISING, MARKETING AND PROMOTION SERVICES IN THE FIELD OF PLANT  
FLOWER INDUSTRY , IN CLASS 35 (U.S. CLS. 100, 101 AND 102).

FIRST USE 1-2-2012; IN COMMERCE 1-2-2012.

THE MARK CONSISTS OF THE WORDS "WE BRING BEAUTY TO THE WORLD" IN  
STYLIZED FORM.

SER. NO. 85-635,556, FILED 5-25-2012.

RONALD AIKENS, EXAMINING ATTORNEY



*David J. Kyffers*

Director of the United States Patent and Trademark Office

# United States of America

United States Patent and Trademark Office

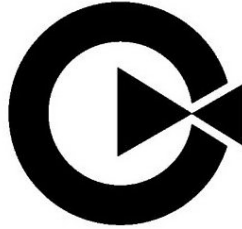

**C O M P L E T E**  
W E D O .

**Reg. No. 4,275,076**

**Registered Jan. 15, 2013**

**Int. Cl.: 41**

**SERVICE MARK**

**PRINCIPAL REGISTER**

COMPLETE MUSIC, INC. (NEBRASKA CORPORATION)  
7877 L STREET, SUITE 4  
OMAHA, NE 68127

FOR: PHOTOGRAPHY SERVICES; VIDEOGRAPHY SERVICES; RENTAL OF PORTABLE PHOTOGRAPHY AND/OR VIDEOGRAPHY BOOTHS FOR TAKING OF PICTURES AND VIDEOS; DISC JOCKEY SERVICES, IN CLASS 41 (U.S. CLS. 100, 101 AND 107).

FIRST USE 5-3-2012; IN COMMERCE 5-3-2012.

THE MARK CONSISTS OF A STYLIZED LETTER "C" WITH A TRIANGLE PLACED INSIDE THE LETTER AT THE OPENING OF THE "C" AND A SMALLER TRIANGLE PLACED OUTSIDE THE LETTER AT THE OPENING FACING THE LARGER TRIANGLE; ALL PLACED ABOVE THE WORD "COMPLETE" WITH THE WORDS "WE DO". PLACED BELOW THE WORD "COMPLETE" EVEN WITH THE END OF THE FINAL LETTER "E" IN THE WORD "COMPLETE".

SER. NO. 85-635,567, FILED 5-25-2012.

HEATHER SAPP, EXAMINING ATTORNEY



*David J. Kybas*

Director of the United States Patent and Trademark Office

# United States of America

United States Patent and Trademark Office

# I-TOWER

**Reg. No. 4,275,077**

**Registered Jan. 15, 2013**

**Int. Cl.: 11**

**TRADEMARK**

**PRINCIPAL REGISTER**

KONCEPT TECHNOLOGIES, INC. (CALIFORNIA CORPORATION)  
429 E. HUNTINGTON DRIVE  
MONROVIA, CA 91016

FOR: LIGHTING LAMPS, IN CLASS 11 (U.S. CLS. 13, 21, 23, 31 AND 34).

FIRST USE 3-7-2007; IN COMMERCE 3-7-2007.

THE MARK CONSISTS OF STANDARD CHARACTERS WITHOUT CLAIM TO ANY PARTICULAR FONT, STYLE, SIZE, OR COLOR.

SER. NO. 85-635,570, FILED 5-25-2012.

KEVEN MITTLER, EXAMINING ATTORNEY



*David J. Kyffers*

Director of the United States Patent and Trademark Office



# United States of America

United States Patent and Trademark Office

# UCX

**Reg. No. 4,275,078**

**Registered Jan. 15, 2013**

**Int. Cl.: 11**

**TRADEMARK**

**PRINCIPAL REGISTER**

KONCEPT TECHNOLOGIES, INC. (CALIFORNIA CORPORATION)  
429 E. HUNTINGTON DRIVE  
MONROVIA, CA 91016

FOR: LIGHTING LAMPS, IN CLASS 11 (U.S. CLS. 13, 21, 23, 31 AND 34).

FIRST USE 8-2-2011; IN COMMERCE 8-2-2011.

THE MARK CONSISTS OF STANDARD CHARACTERS WITHOUT CLAIM TO ANY PARTICULAR FONT, STYLE, SIZE, OR COLOR.

SER. NO. 85-635,604, FILED 5-25-2012.

KEVEN MITTLER, EXAMINING ATTORNEY



*David J. Kybas*

Director of the United States Patent and Trademark Office

# United States of America

United States Patent and Trademark Office



**Reg. No. 4,275,079**

**Registered Jan. 15, 2013**

**Int. Cl.: 42**

**SERVICE MARK**

**PRINCIPAL REGISTER**

APPOINTBOOK, INC. (CALIFORNIA CORPORATION)  
2261 MARKET STREET, #325  
SAN FRANCISCO, CA 94114

FOR: PROVIDING TEMPORARY USE OF ON-LINE NON-DOWNLOADABLE SOFTWARE AND APPLICATIONS FOR USE IN SEARCHING AND MANAGING PERSONAL AND PROFESSIONAL SCHEDULING, MARKETING, PROMOTIONS AND CLIENTS, IN CLASS 42 (U.S. CLS. 100 AND 101).

FIRST USE 6-5-2011; IN COMMERCE 6-5-2011.

THE MARK CONSISTS OF THE LETTER "A" IN STYLIZED FONT.

SER. NO. 85-635,605, FILED 5-25-2012.

ELLEN PERKINS, EXAMINING ATTORNEY



*David J. Kyffers*

Director of the United States Patent and Trademark Office

# United States of America

United States Patent and Trademark Office

## CROSSOVER RUN CARGO XXI

**Reg. No. 4,275,080**

**Registered Jan. 15, 2013**

**Int. Cl.: 33**

**TRADEMARK**

**PRINCIPAL REGISTER**

MAKE THE RUN SPIRITS COMPANY INC. (CANADA CORPORATION), DBA MAKE THE RUN SPIRITS CO.  
5090 ORBITOR DRIVE, UNIT 1  
MISSISSAUGA, ONTARIO, CANADA L4W5B5

FOR: WHISKY, IN CLASS 33 (U.S. CLS. 47 AND 49).

FIRST USE 5-9-2012; IN COMMERCE 5-9-2012.

THE MARK CONSISTS OF STANDARD CHARACTERS WITHOUT CLAIM TO ANY PARTICULAR FONT, STYLE, SIZE, OR COLOR.

SER. NO. 85-635,622, FILED 5-25-2012.

DAVID TAYLOR, EXAMINING ATTORNEY



*David J. Kyfos*

Director of the United States Patent and Trademark Office

# United States of America

United States Patent and Trademark Office

## Black & Orange

**Reg. No. 4,275,081**

A BURGER GRILLING COMPANY (VIRGINIA LIMITED LIABILITY COMPANY)  
9907 LEESBURG PIKE  
VIENNA, VA 22182

**Registered Jan. 15, 2013**

**Int. Cl.: 43**

FOR: RESTAURANT SERVICES, NAMELY, PROVIDING OF FOOD AND BEVERAGES FOR CONSUMPTION ON AND OFF THE PREMISES, IN CLASS 43 (U.S. CLS. 100 AND 101).

**SERVICE MARK**

FIRST USE 5-1-2011; IN COMMERCE 5-1-2011.

**PRINCIPAL REGISTER**

THE MARK CONSISTS OF STANDARD CHARACTERS WITHOUT CLAIM TO ANY PARTICULAR FONT, STYLE, SIZE, OR COLOR.

SER. NO. 85-635,632, FILED 5-25-2012.

DOMINICK J. SALEMI, EXAMINING ATTORNEY



*David J. Kyffers*

Director of the United States Patent and Trademark Office

# United States of America

United States Patent and Trademark Office

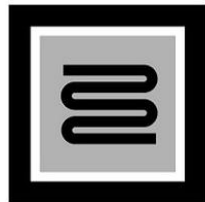

**C&L**  
**REFRIGERATION**

**Reg. No. 4,275,082**

**Registered Jan. 15, 2013**

**Int. Cl.: 37**

**SERVICE MARK**

**PRINCIPAL REGISTER**

C & L REFRIGERATION CORPORATION (CALIFORNIA CORPORATION)  
479 NIBUS STREET  
BREA, CA 92821

FOR: HVAC CONTRACTOR SERVICES, IN CLASS 37 (U.S. CLS. 100, 103 AND 106).

FIRST USE 7-1-2009; IN COMMERCE 7-1-2009.

NO CLAIM IS MADE TO THE EXCLUSIVE RIGHT TO USE "REFRIGERATION", APART FROM THE MARK AS SHOWN.

THE MARK CONSISTS OF THE WORDING C&L REFRIGERATION AND A SHADED SQUARE CONTAINING WAVY COIL-LIKE LINES SURROUNDED BY ANOTHER SQUARE.

SER. NO. 85-635,646, FILED 5-25-2012.

DOMINICK J. SALEMI, EXAMINING ATTORNEY



*David J. Kybas*

Director of the United States Patent and Trademark Office

# United States of America

United States Patent and Trademark Office

## BLENDING ARTISTRY AND TECHNOLOGY

**Reg. No. 4,275,083**

MED ART PROS SOUTH, LLC (TEXAS LIMITED LIABILITY COMPANY)  
17110 DALLAS PARKWAY SUITE 205  
DALLAS, TX 75248

**Registered Jan. 15, 2013**

**Int. Cl.: 40**

FOR: CUSTOM MANUFACTURING OF PROSTHETICS; MAKING OF PROSTHETIC DEVICES TO ORDER, IN CLASS 40 (U.S. CLS. 100, 103 AND 106).

**SERVICE MARK**

FIRST USE 3-23-2012; IN COMMERCE 3-23-2012.

**PRINCIPAL REGISTER**

THE MARK CONSISTS OF STANDARD CHARACTERS WITHOUT CLAIM TO ANY PARTICULAR FONT, STYLE, SIZE, OR COLOR.

SER. NO. 85-635,649, FILED 5-25-2012.

DOMINICK J. SALEMI, EXAMINING ATTORNEY



*David J. Kyros*

Director of the United States Patent and Trademark Office

# United States of America

United States Patent and Trademark Office

## CAMPUS TRADITIONS

**Reg. No. 4,275,084**

T-SHIRT INTERNATIONAL, INC. (WEST VIRGINIA CORPORATION)  
7730 SOUTH 6TH STREET  
OAK CREEK, WI 53154

**Registered Jan. 15, 2013**

**Int. Cl.: 25**

FOR: CLOTHING, NAMELY, T-SHIRTS, FLEECE SHIRTS, DENIM SHIRTS, JACKETS, PANTS AND HATS, IN CLASS 25 (U.S. CLS. 22 AND 39).

**TRADEMARK**

FIRST USE 4-1-2004; IN COMMERCE 4-1-2004.

**PRINCIPAL REGISTER**

THE MARK CONSISTS OF STANDARD CHARACTERS WITHOUT CLAIM TO ANY PARTICULAR FONT, STYLE, SIZE, OR COLOR.

OWNER OF U.S. REG. NOS. 2,940,611, 3,064,392, AND 3,107,690.

SER. NO. 85-635,655, FILED 5-25-2012.

DOMINICK J. SALEMI, EXAMINING ATTORNEY



*David J. Kybas*

Director of the United States Patent and Trademark Office

# United States of America

United States Patent and Trademark Office

SKATELL'S  
MANUFACTURING  
JEWELERS

**Reg. No. 4,275,085**

**Registered Jan. 15, 2013**

**Int. Cl.: 14**

**TRADEMARK**

**PRINCIPAL REGISTER**

SMJ, INC. (SOUTH CAROLINA CORPORATION)  
1036 JOHNNIE DODDS BLVD  
MT. PLEASANT, SC 29464

FOR: JEWELRY, IN CLASS 14 (U.S. CLS. 2, 27, 28 AND 50).

FIRST USE 1-1-1983; IN COMMERCE 1-1-1983.

NO CLAIM IS MADE TO THE EXCLUSIVE RIGHT TO USE "MANUFACTURING JEWELERS"  
, APART FROM THE MARK AS SHOWN.

THE MARK CONSISTS OF THE WORD "SKATELL'S" IS WRITTEN IN A LARGE STYLIZED  
FONT IN ALL CAPITAL LETTERS, WITH THE TWO "S" WRITTEN LARGER THAN THE  
REST OF THE WORDS, ABOVE THE WORDS "MANUFACTURING JEWELERS", WHICH  
ARE WRITTEN IN A STYLIZED FONT IN ALL CAPITALS BETWEEN THE TWO "S".

SER. NO. 85-635,673, FILED 5-25-2012.

CARYN GLASSER, EXAMINING ATTORNEY



*David J. Kyffers*

Director of the United States Patent and Trademark Office



# United States of America

United States Patent and Trademark Office



**Reg. No. 4,275,086**

**Registered Jan. 15, 2013**

**Int. Cls.: 35 and 44**

**SERVICE MARK**

**PRINCIPAL REGISTER**

LEMON TREE DEVELOPMENT, LLC (NEW JERSEY LIMITED LIABILITY COMPANY),  
DBA LEMON TREE  
55 EAGLE ROCK AVENUE, SUITE 6  
EAST HANOVER, NJ 07936

FOR: FRANCHISING, NAMELY, OFFERING BUSINESS MANAGEMENT ASSISTANCE IN  
THE ESTABLISHMENT AND/OR OPERATION OF SALONS, IN CLASS 35 (U.S. CLS. 100,  
101 AND 102).

FIRST USE 6-1-2011; IN COMMERCE 10-1-2011.

FOR: BARBER SHOP SERVICES; BEAUTY SALON SERVICES; BEAUTY SALONS; HAIR  
SALON SERVICES; HAIR SALON SERVICES, NAMELY, HAIR CUTTING, STYLING,  
COLORING, AND HAIR EXTENSION SERVICES; HAIRDRESSING SALONS, IN CLASS 44  
(U.S. CLS. 100 AND 101).

FIRST USE 6-1-2011; IN COMMERCE 10-1-2011.

OWNER OF U.S. REG. NOS. 1,204,072, 2,790,810, AND 4,044,841.

THE COLOR(S) YELLOW, DARK GREEN, LIGHT GREEN, AND WHITE IS/ARE CLAIMED  
AS A FEATURE OF THE MARK.

THE MARK CONSISTS OF THE WORDS "LEMON TREE", WITH THE WORD "LEMON"  
APPEARING IN DARK GREEN, THE LETTER "O" IN "LEMON" REPLACED WITH A  
STYLIZED YELLOW AND WHITE LEMON SLICE AND THE WORD "TREE" IN LIGHT  
GREEN UNDER THE WORD "LEMON", WITH A STYLIZED IMAGE OF A LEMON IN  
YELLOW AND A LEAF IN LIGHT GREEN TO THE RIGHT OF THE WORD "TREE".

SER. NO. 85-635,693, FILED 5-25-2012.

MARK SHINER, EXAMINING ATTORNEY



*David J. Kyffers*

Director of the United States Patent and Trademark Office

# United States of America

United States Patent and Trademark Office

## Chef of the Future

**Reg. No. 4,275,087**

RJM PRODUCTS COMPANY (NEW JERSEY PARTNERSHIP)  
1 DEAL LANE

**Registered Jan. 15, 2013**

LIVINGSTON, NJ 070393306

**Int. Cl.: 30**

FOR: COCOA-BASED CONDIMENTS AND SEASONINGS FOR FOOD AND DRINK; FOOD SEASONINGS; SEASONED COATING FOR MEAT, FISH, POULTRY; SEASONING MIXES; SEASONINGS; STEAK SEASONING , IN CLASS 30 (U.S. CL. 46).

**TRADEMARK**

FIRST USE 4-28-2009; IN COMMERCE 4-28-2009.

**PRINCIPAL REGISTER**

THE MARK CONSISTS OF STANDARD CHARACTERS WITHOUT CLAIM TO ANY PARTICULAR FONT, STYLE, SIZE, OR COLOR.

SER. NO. 85-635,697, FILED 5-25-2012.

DAVID ELTON, EXAMINING ATTORNEY



*David J. Kyffers*

Director of the United States Patent and Trademark Office

# United States of America

United States Patent and Trademark Office

ONLY WHAT MATTERS, MATTERS

**Reg. No. 4,275,088**

**Registered Jan. 15, 2013**

**Int. Cl.: 35**

**SERVICE MARK**

**PRINCIPAL REGISTER**

DIAZ & COOPER ADVERTISING, INC. (FLORIDA CORPORATION)  
SUITE 209  
9200 SOUTH DADELAND BOULEVARD  
MIAMI, FL 33156

FOR: ADVERTISING AGENCIES, IN CLASS 35 (U.S. CLS. 100, 101 AND 102).

FIRST USE 8-19-2009; IN COMMERCE 12-1-2009.

THE MARK CONSISTS OF STANDARD CHARACTERS WITHOUT CLAIM TO ANY PARTICULAR FONT, STYLE, SIZE, OR COLOR.

SER. NO. 85-635,710, FILED 5-25-2012.

CHRISIE B. KING, EXAMINING ATTORNEY



*David J. Kyffers*

Director of the United States Patent and Trademark Office

# United States of America

United States Patent and Trademark Office

## Our Farms Your Food

**Reg. No. 4,275,089**

**Registered Jan. 15, 2013**

**Int. Cls.: 29 and 31**

CONSOLIDATED HARVEST COMPANY LLC (DELAWARE LIMITED LIABILITY COMPANY), DBA HUDSON VALLEY HARVEST  
71ST FLOOR  
405 LEXINGTON AVENUE  
NEW YORK, NY 10174

**TRADEMARK**

**PRINCIPAL REGISTER**



*David J. Kyros*

Director of the United States Patent and Trademark Office

FOR: ARRANGEMENTS OF CUT FRUIT; BEEF; BEEF BOUILLON; BEEF JERKY; BEEF SLICES; BEEF STOCK; BOTTLED FRUITS; CANNED FRUITS AND VEGETABLES; CANNED OR BOTTLED FRUITS; CANNED OR BOTTLED VEGETABLES; CANNED PORK; CANNED PORK AND BEANS; CANNED VEGETABLES; CHICKEN; CHICKEN NUGGETS; COOKED FRUITS AND VEGETABLES; COOKED VEGETABLES; CORNED BEEF; CRYSTALLIZED FRUIT; CRYSTALLIZED FRUITS; CUT FRUITS; CUT VEGETABLES; DRIED BEEF; DRIED FRUIT AND VEGETABLES; DRIED FRUITS; DRIED VEGETABLES; DUCK EGGS; FROSTED FRUITS; FROZEN APPETIZERS CONSISTING PRIMARILY OF CHICKEN OR SEAFOOD; FROZEN FRUITS; FROZEN VEGETABLES; FROZEN, FROSTED, PRESERVED, PROCESSED, DRIED, COOKED OR CRYSTALLIZED FRUIT AND VEGETABLES EXTRACTS FOR USE IN PREPARED MEALS OR FOOD; FRUIT AND VEGETABLE GRANULES FOR USE IN PREPARED MEALS OR FOOD; FRUIT AND VEGETABLE SALADS; FRUIT BUTTERS; FRUIT CHIPS; FRUIT CONSERVES; FRUIT JELLIES; FRUIT PEEL; FRUIT PULP; FRUIT PUREES; FRUIT RINDS; FRUIT SALADS; FRUIT SALADS AND VEGETABLE SALADS; FRUITS, NAMELY, APPLES, PEARS, RASPBERRIES, BLUEBERRIES, STRAWBERRIES, BLACKBERRIES, BANANAS, TOMATOES, WATERMELONS,; HONEY BUTTER; MEAT, FISH, FRUIT AND VEGETABLE JELLIES; MEAT, FISH, FRUIT AND VEGETABLE PRESERVES; MEAT, FRUIT AND VEGETABLE JELLIES, JAMS; MEAT, FRUIT AND VEGETABLE JELLIES, JAMS, EGGS; MILK-BASED BEVERAGES CONTAINING MILK CONCENTRATES, VEGETABLE OIL AND ADDED NUTRIENTS; PICKLED VEGETABLES; PORK; PORK CUTLETS; PORK RINDS; POULTRY, NAMELY, CHICKEN, MEAT, FISH, DUCK; PRE-CUT VEGETABLE SALAD; PREPARED BEEF; PREPARED ENTREES CONSISTING PRIMARILY OF VEGETABLES, SOUPS, FRUIT SALADS AND VEGETABLE SALADS; PREPARED FOOD KITS COMPOSED OF MEAT, POULTRY, FISH, SEAFOOD, AND/OR VEGETABLES AND ALSO INCLUDING SAUCES OR SEASONINGS, READY FOR COOKING AND ASSEMBLY AS A MEAL; PRESERVED FRUIT AND VEGETABLES; PRESERVED FRUITS; PRESERVED FRUITS AND VEGETABLES; PRESERVED GINSENG FOR USE AS A VEGETABLE; PRESERVED VEGETABLES; PRESERVED, DRIED AND COOKED FRUIT AND VEGETABLES; PRESERVED, DRIED AND COOKED VEGETABLES; PRESERVED, DRIED, COOKED AND GRILLED VEGETABLES; PRESERVED, FROZEN, DRIED OR COOKED VEGETABLES; PROCESSED FRUITS; PROCESSED VEGETABLES; PROCESSED

**Reg. No. 4,275,089** VEGETABLES AND FRUITS; ROAST BEEF; SLICED VEGETABLES; SLICED VEGETABLES PRESERVED IN SOY SAUCE, SOYBEAN PASTE OR VINEGAR; SNACK MIX CONSISTING OF PRIMARILY OF PROCESSED NUTS, SEEDS, DRIED FRUIT AND ALSO INCLUDING CHOCOLATE; TINNED MEAT, FISH, VEGETABLES AND FRUITS; TINNED VEGETABLES; TURKEY; TURKEY BURGER PATTIES; VEGETABLE CHIPS; VEGETABLE JUICE FOR COOKING; VEGETABLE JUICES FOR COOKING; VEGETABLE-BASED FOOD BEVERAGES; VEGETABLES, INSTANT FROZEN; VEGETABLES, NAMELY, CORN, COLLARD GREENS, BROCCOLI, SWISS CHARD, KALE, EDAMAME, GREEN BEANS, SUMMER SQUASH, TOMATOES, BUTTERNUT SQUASH,; FRESH, PRESERVED AND FROZEN MEALS CONSISTING PRIMARILY OF MEAT, FISH, POULTRY OR VEGETABLES, IN CLASS 29 (U.S. CL. 46).

FIRST USE 8-31-2011; IN COMMERCE 8-31-2011.

FOR: FRESH FRUIT AND VEGETABLES; FRESH VEGETABLES; RAW VEGETABLES; SEEDS FOR FRUIT AND VEGETABLES; UNPROCESSED VEGETABLES; VEGETABLE SEEDS FOR PLANTING, IN CLASS 31 (U.S. CLS. 1 AND 46).

FIRST USE 8-31-2011; IN COMMERCE 8-31-2011.

THE MARK CONSISTS OF STANDARD CHARACTERS WITHOUT CLAIM TO ANY PARTICULAR FONT, STYLE, SIZE, OR COLOR.

SER. NO. 85-635,748, FILED 5-25-2012.

ROBERT STRUCK, EXAMINING ATTORNEY

# United States of America

United States Patent and Trademark Office



**Reg. No. 4,275,090**

BALDWIN, EILEEN L. (UNITED STATES INDIVIDUAL)  
6345 BLUE HERON LANE  
WARRENTON, VA 20187

**Registered Jan. 15, 2013**

**Int. Cls.: 30 and 35**

FOR: BAKERY GOODS, IN CLASS 30 (U.S. CL. 46).

FIRST USE 4-14-2012; IN COMMERCE 4-14-2012.

**TRADEMARK**

**SERVICE MARK**

FOR: RETAIL STORE SERVICES FEATURING BAKERY GOODS ACCESSIBLE ON-LINE AND BY TELEPHONE, FACSIMILE AND MAIL ORDER, IN CLASS 35 (U.S. CLS. 100, 101 AND 102).

**PRINCIPAL REGISTER**

FIRST USE 4-14-2012; IN COMMERCE 4-14-2012.

NO CLAIM IS MADE TO THE EXCLUSIVE RIGHT TO USE "PASTRIES THE HEIRLOOM BAKERY", APART FROM THE MARK AS SHOWN.

THE COLOR(S) CHOCOLATE BROWN, ROSE PINK, AND MUSTARD YELLOW IS/ARE CLAIMED AS A FEATURE OF THE MARK.

THE NAME "ELOISE" DOES NOT IDENTIFY A LIVING INDIVIDUAL.

THE MARK CONSISTS OF THE WORDS "ELOISE'S PASTRIES" IN ROSE PINK, IN FRONT OF VARIOUS CHOCOLATE BROWN BAKED GOODS IN A CHOCOLATE BROWN OUTLINED GLASS CAKE STAND THAT HAS A ROSE PINK BUTTERFLY AT ITS TOP, ALL ABOVE THE MUSTARD YELLOW WORDS "THE HEIRLOOM BAKERY".

SER. NO. 85-635,766, FILED 5-25-2012.

DORITT L. CARROLL, EXAMINING ATTORNEY



*David J. Kyros*

Director of the United States Patent and Trademark Office

# United States of America

United States Patent and Trademark Office



**Reg. No. 4,275,091**

7MILE SOLUTIONS, INC. (ILLINOIS CORPORATION)  
7540 CALDWELL  
NILES, IL 60714

**Registered Jan. 15, 2013**

**Int. Cl.: 11**

FOR: AN INDUSTRIAL OVEN (ELECTRIC) USED TO PROCESS THERMALLY RESPONSIVE TUBING FOR PROTECTIVE AND/OR ORGANIZATIONAL PURPOSES, IN CLASS 11 (U.S. CLS. 13, 21, 23, 31 AND 34).

**TRADEMARK**

FIRST USE 9-22-2000; IN COMMERCE 4-3-2001.

**PRINCIPAL REGISTER**

THE MARK CONSISTS OF BLOCK LETTERING OF THE WORDS "THE SHRINK" WITH EACH CHARACTER POSSESSING DIFFERENT FONT SIZES AND DEGREES OF BOLDNESS.

SER. NO. 85-635,782, FILED 5-25-2012.

RONALD AIKENS, EXAMINING ATTORNEY



*David J. Kyffers*

Director of the United States Patent and Trademark Office

# United States of America

United States Patent and Trademark Office

beauty**inside**

**Reg. No. 4,275,092**

**Registered Jan. 15, 2013**

**Int. Cl.: 35**

**SERVICE MARK**

**PRINCIPAL REGISTER**

ERNST BENARY SAMENZUCHT GMBH (FED REP GERMANY GESELLSCHAFT MIT  
BESCHRÄNKTER HAFTUNG (GMBH))  
FRIEDRICH-BENARY-WEG 1  
HANN MUNDEN, FED REP GERMANY 34346

FOR: ADVERTISING, MARKETING AND PROMOTION SERVICES IN THE FIELD OF PLANT  
FLOWER INDUSTRY , IN CLASS 35 (U.S. CLS. 100, 101 AND 102).

FIRST USE 1-2-2012; IN COMMERCE 1-2-2012.

THE MARK CONSISTS OF THE WORDS "BEAUTY" AND "INSIDE" TOGETHER WITHOUT  
SPACING, THE WORD "INSIDE" IS IN BOLD AND BOTH WORDS ARE IN STYLIZED  
FORM.

SER. NO. 85-635,787, FILED 5-25-2012.

RONALD AIKENS, EXAMINING ATTORNEY



*David J. Kyjars*

Director of the United States Patent and Trademark Office



# United States of America

United States Patent and Trademark Office

# MarineGEO

**Reg. No. 4,275,093**

**Registered Jan. 15, 2013**

**Int. Cl.: 42**

SMITHSONIAN INSTITUTION (UNITED STATES TRUST INSTRUMENTALITY OF THE UNITED STATES)  
P.O. BOX 37012  
SIB 302 MRC 012  
WASHINGTON, DC 200137012

**SERVICE MARK**

**PRINCIPAL REGISTER**

FOR: SCIENTIFIC RESEARCH FOR THE PUBLIC BENEFIT IN THE FIELD OF MARINE BIODIVERSITY, NAMELY, THE ESTABLISHMENT AND OPERATION OF A NETWORK OF GLOBAL EARTH OBSERVATORIES FOR MONITORING THE EFFECTS OF CLIMATE CHANGE IN MARINE ECOSYSTEMS, IN CLASS 42 (U.S. CLS. 100 AND 101).

FIRST USE 10-15-2010; IN COMMERCE 3-1-2011.

THE MARK CONSISTS OF STANDARD CHARACTERS WITHOUT CLAIM TO ANY PARTICULAR FONT, STYLE, SIZE, OR COLOR.

SER. NO. 85-635,804, FILED 5-25-2012.

MIAH ROSENBERG, EXAMINING ATTORNEY



*David J. Kybas*

Director of the United States Patent and Trademark Office

# United States of America

United States Patent and Trademark Office

# LocalUp

**Reg. No. 4,275,094**

**Registered Jan. 15, 2013**

**Int. Cl.: 42**

**SERVICE MARK**

**PRINCIPAL REGISTER**

LOCAL UP SOLUTIONS, LLC (MARYLAND LIMITED LIABILITY COMPANY)  
3500 BOSTON STREET, SUITE 432  
BALTIMORE, MD 21224

FOR: SOFTWARE AS A SERVICE (SAAS) SERVICES FEATURING SOFTWARE FOR PROVIDING A PLATFORM FOR ONLINE RESTAURANT ORDERING AND ADVERTISING , IN CLASS 42 (U.S. CLS. 100 AND 101).

FIRST USE 7-23-2009; IN COMMERCE 8-1-2009.

THE MARK CONSISTS OF STANDARD CHARACTERS WITHOUT CLAIM TO ANY PARTICULAR FONT, STYLE, SIZE, OR COLOR.

SER. NO. 85-635,822, FILED 5-25-2012.

INGRID C. EULIN, EXAMINING ATTORNEY



*David J. Kyffers*

Director of the United States Patent and Trademark Office

# United States of America

United States Patent and Trademark Office

# Maximus

**Reg. No. 4,275,095**

DRYJECT, INC (DELAWARE CORPORATION)  
307 LINCOLN AVENUE  
HATBORO, PA 19040

**Registered Jan. 15, 2013**

**Int. Cl.: 44**

FOR: AERATION SERVICES, NAMELY, AERATING OF GOLFING GREENS AND TURF-GRASS, IN CLASS 44 (U.S. CLS. 100 AND 101).

**SERVICE MARK**

FIRST USE 12-0-2011; IN COMMERCE 3-0-2012.

**PRINCIPAL REGISTER**

THE MARK CONSISTS OF STANDARD CHARACTERS WITHOUT CLAIM TO ANY PARTICULAR FONT, STYLE, SIZE, OR COLOR.

SER. NO. 85-635,826, FILED 5-25-2012.

JESSICA A. POWERS, EXAMINING ATTORNEY



*David J. Kybas*

Director of the United States Patent and Trademark Office

# United States of America

United States Patent and Trademark Office

# Super KMH

**Reg. No. 4,275,096**

ESSENTIALS, INC. (CALIFORNIA CORPORATION)  
14422 BEST AVE.

**Registered Jan. 15, 2013**

SANTA FE SPRINGS, CA 90670

**Int. Cl.: 5**

FOR: DIETARY SUPPLEMENTS; MINERAL SUPPLEMENTS, IN CLASS 5 (U.S. CLS. 6, 18, 44, 46, 51 AND 52).

**TRADEMARK**

FIRST USE 1-1-1990; IN COMMERCE 1-1-1990.

**PRINCIPAL REGISTER**

THE MARK CONSISTS OF STANDARD CHARACTERS WITHOUT CLAIM TO ANY PARTICULAR FONT, STYLE, SIZE, OR COLOR.

SER. NO. 85-635,839, FILED 5-25-2012.

KEVON CHISOLM, EXAMINING ATTORNEY



*David J. Kyffers*

Director of the United States Patent and Trademark Office

# United States of America

United States Patent and Trademark Office

## EQ is more important than IQ

**Reg. No. 4,275,097**

BORDERS, MARY ANN (UNITED STATES INDIVIDUAL)  
531 MAIN STREET, #527  
EL SEGUNDO, CA 90245

**Registered Jan. 15, 2013**

**Int. Cl.: 28**

FOR: EDUCATIONAL TOYS, NAMELY, BLOCKS USED TO TEACH CHILDREN AND ADULTS ABOUT THEIR FEELINGS, IN CLASS 28 (U.S. CLS. 22, 23, 38 AND 50).

**TRADEMARK**

FIRST USE 1-1-2011; IN COMMERCE 1-1-2011.

**PRINCIPAL REGISTER**

THE MARK CONSISTS OF STANDARD CHARACTERS WITHOUT CLAIM TO ANY PARTICULAR FONT, STYLE, SIZE, OR COLOR.

SER. NO. 85-635,859, FILED 5-25-2012.

LESLIE RICHARDS, EXAMINING ATTORNEY



*David J. Kyffers*

Director of the United States Patent and Trademark Office

# United States of America

United States Patent and Trademark Office

# something.

**Reg. No. 4,275,098**

AMANDA WEIR (UNITED STATES INDIVIDUAL)  
29500 HEATHERCLIFF ROAD #20  
MALIBU, CA 90265

**Registered Jan. 15, 2013**

**Int. Cl.: 14**

FOR: BODY JEWELRY; BRACELETS; BRONZE JEWELRY; CHARMS; COSTUME JEWELRY;  
DIAMOND JEWELRY; GEMSTONE JEWELRY; GOLD THREAD JEWELRY; HAIR JEWELRY  
IN THE NATURE OF JEWELRY FOR USE IN THE HAIR; JEWELRY, IN CLASS 14 (U.S.  
CLS. 2, 27, 28 AND 50).

**TRADEMARK**

**PRINCIPAL REGISTER**

FIRST USE 12-10-2011; IN COMMERCE 12-10-2011.

THE MARK CONSISTS OF STANDARD CHARACTERS WITHOUT CLAIM TO ANY PAR-  
TICULAR FONT, STYLE, SIZE, OR COLOR.

SER. NO. 85-635,868, FILED 5-25-2012.

LESLIE RICHARDS, EXAMINING ATTORNEY



*David J. Kyffers*

Director of the United States Patent and Trademark Office

# United States of America

United States Patent and Trademark Office

## JUDGE-YOUR-NEIGHBOR

**Reg. No. 4,275,099**

BYRON KATIE INTERNATIONAL, INC. (CALIFORNIA CORPORATION)  
309 E ALISO STREET  
OJAI, CA 93023

**Registered Jan. 15, 2013**

**Int. Cl.: 41**

FOR: EDUCATIONAL SERVICES, NAMELY, CONDUCTING SEMINARS, WORKSHOPS AND EDUCATIONAL RETREATS IN THE FIELDS OF STRESS MANAGEMENT AND SELF-HELP COUNSELING, AND DISTRIBUTION OF EDUCATIONAL MATERIALS IN CONNECTION THEREWITH, IN CLASS 41 (U.S. CLS. 100, 101 AND 107).

**SERVICE MARK**

**PRINCIPAL REGISTER**

FIRST USE 12-31-2002; IN COMMERCE 12-31-2002.

THE MARK CONSISTS OF STANDARD CHARACTERS WITHOUT CLAIM TO ANY PARTICULAR FONT, STYLE, SIZE, OR COLOR.

SER. NO. 85-635,907, FILED 5-25-2012.

IRA J. GOODSaid, EXAMINING ATTORNEY



*David J. Kyffers*

Director of the United States Patent and Trademark Office

# United States of America

United States Patent and Trademark Office

# TECHHEALTH

**Reg. No. 4,275,100**

**Registered Jan. 15, 2013**

**Int. Cls.: 9 and 36**

**TRADEMARK**

**SERVICE MARK**

**PRINCIPAL REGISTER**

TECHHEALTH, INC. (FLORIDA CORPORATION)  
14025 RIVEREDGE DRIVE, SUITE 400  
TAMPA, FL 33637

FOR: COMPUTER SOFTWARE FOR PROVIDING MULTIPLE-USER ACCESS TO COMPUTER NETWORKS FOR THE TRANSFER AND DISSEMINATION OF A WIDE RANGE OF INFORMATION IN THE FIELD OF HEALTH CARE GOODS AND SERVICES, FOR ACCESSING AN ONLINE DIRECTORY AND LOCATOR FOR HEALTH-RELATED GOODS AND SERVICES, FOR MANAGING COMMERCIAL TRANSACTIONS INVOLVING A GLOBAL COMMUNICATIONS NETWORK, AND FOR ADJUDICATING INSURANCE COVERAGE AND BENEFITS FOR HEALTH CARE PRODUCTS, EQUIPMENT AND SUPPLIES, AND ANCILLARY GOODS AND SERVICES, IN CLASS 9 (U.S. CLS. 21, 23, 26, 36 AND 38).

FIRST USE 11-0-2000; IN COMMERCE 11-0-2000.

FOR: PROVIDING ONLINE ADMINISTRATION OF INSURANCE COVERAGE AND HEALTH BENEFITS FOR PHARMACEUTICALS, NON-PHARMACEUTICAL HEALTH CARE PRODUCTS, NAMELY, MEDICAL EQUIPMENT AND SUPPLIES, DIAGNOSTIC EQUIPMENT AND SUPPLIES, EQUIPMENT AND SUPPLIES USED IN THE FIELDS OF INFUSION THERAPY, RESPIRATORY THERAPY, PHYSICAL REHABILITATION, AND ELECTROTHERAPY, AND ANCILLARY GOODS AND SERVICES, NAMELY, SUB-ACUTE AND SKILLED NURSING, HOME HEALTH SERVICES, INFUSION THERAPY, TRANSPORTATION SERVICES, HOME MODIFICATION SERVICES, DIAGNOSTIC IMAGING, RESPIRATORY THERAPY, INPATIENT PHYSICAL REHABILITATION, ELECTROTHERAPY, INTERPRETATION AND TRANSLATION SERVICES, AND LABORATORY SERVICES, IN CLASS 36 (U.S. CLS. 100, 101 AND 102).

FIRST USE 11-0-2000; IN COMMERCE 11-0-2000.

THE MARK CONSISTS OF STANDARD CHARACTERS WITHOUT CLAIM TO ANY PARTICULAR FONT, STYLE, SIZE, OR COLOR.

SER. NO. 85-635,911, FILED 5-25-2012.

CHARLES L. JENKINS, EXAMINING ATTORNEY



*David J. Kyros*

Director of the United States Patent and Trademark Office



# United States of America

United States Patent and Trademark Office

## HAUTE SAND

**Reg. No. 4,275,101**

**Registered Jan. 15, 2013**

**Int. Cl.: 25**

**TRADEMARK**

**PRINCIPAL REGISTER**

HAUTE SAND LLC (HAWAII LIMITED LIABILITY COMPANY), DBA HAUTE SAND  
HAWAII  
P.O. BOX 240763  
HONOLULU, HI 96824

FOR: T-SHIRTS, IN CLASS 25 (U.S. CLS. 22 AND 39).

FIRST USE 12-6-2011; IN COMMERCE 12-6-2011.

THE MARK CONSISTS OF STANDARD CHARACTERS WITHOUT CLAIM TO ANY PARTICULAR FONT, STYLE, SIZE, OR COLOR.

SER. NO. 85-635,920, FILED 5-25-2012.

ZACHARY BELLO, EXAMINING ATTORNEY



*David J. Kyffers*

Director of the United States Patent and Trademark Office

# United States of America

United States Patent and Trademark Office

## Cancun Tropical Drink

**Reg. No. 4,275,102**

PHARMADEL LLC (DELAWARE LIMITED LIABILITY COMPANY)  
178 VENTURE DR.  
SEAFORD, DE 19973

**Registered Jan. 15, 2013**

**Int. Cl.: 32**

FOR: COCONUT JUICE; COCONUT WATER; COCONUT-BASED BEVERAGES, IN CLASS 32 (U.S. CLS. 45, 46 AND 48).

**TRADEMARK**

FIRST USE 7-7-2011; IN COMMERCE 7-7-2011.

**PRINCIPAL REGISTER**

THE MARK CONSISTS OF STANDARD CHARACTERS WITHOUT CLAIM TO ANY PARTICULAR FONT, STYLE, SIZE, OR COLOR.

NO CLAIM IS MADE TO THE EXCLUSIVE RIGHT TO USE "TROPICAL DRINK", APART FROM THE MARK AS SHOWN.

SER. NO. 85-635,937, FILED 5-25-2012.

NAAKWAMA ANKRAH, EXAMINING ATTORNEY



*David J. Kyffers*

Director of the United States Patent and Trademark Office

# United States of America

United States Patent and Trademark Office

# TCLE

**Reg. No. 4,275,103**

THOMPSON COBURN LLP (MISSOURI LIMITED LIABILITY PARTNERSHIP)  
ONE US BANK PLAZA  
ST. LOUIS, MO 63101

**Registered Jan. 15, 2013**

**Int. Cl.: 41**

FOR: PROVIDING CONTINUING LEGAL EDUCATION COURSES AND SEMINARS; EDUCATION SERVICES, NAMELY, PROVIDING LIVE PRESENTATIONS, PRE-RECORDED PRESENTATIONS, AND NON-DOWNLOADABLE WEBINARS IN THE FIELD OF CONTINUING LEGAL EDUCATION, IN CLASS 41 (U.S. CLS. 100, 101 AND 107).

**SERVICE MARK**

**PRINCIPAL REGISTER**

FIRST USE 3-15-2012; IN COMMERCE 3-15-2012.

THE MARK CONSISTS OF STANDARD CHARACTERS WITHOUT CLAIM TO ANY PARTICULAR FONT, STYLE, SIZE, OR COLOR.

SER. NO. 85-635,944, FILED 5-25-2012.

COLLEEN KEARNEY, EXAMINING ATTORNEY



*David J. Kybas*

Director of the United States Patent and Trademark Office

# United States of America

United States Patent and Trademark Office

# TCLE

**Reg. No. 4,275,104**

THOMPSON COBURN LLP (MISSOURI LIMITED LIABILITY PARTNERSHIP)  
ONE US BANK PLAZA  
ST. LOUIS, MO 63101

**Registered Jan. 15, 2013**

**Int. Cl.: 41**

FOR: PROVIDING CONTINUING LEGAL EDUCATION COURSES AND SEMINARS; EDUCATION SERVICES, NAMELY, PROVIDING LIVE PRESENTATIONS, PRE-RECORDED PRESENTATIONS, AND NON-DOWNLOADABLE WEBINARS IN THE FIELD OF CONTINUING LEGAL EDUCATION, IN CLASS 41 (U.S. CLS. 100, 101 AND 107).

**SERVICE MARK**

**PRINCIPAL REGISTER**

FIRST USE 3-15-2012; IN COMMERCE 3-15-2012.

THE MARK CONSISTS OF THE LETTERS "TCLE" WITH A RAINBOW DESIGN BEHIND THE LETTERS "T" AND "C".

SER. NO. 85-635,956, FILED 5-25-2012.

COLLEEN KEARNEY, EXAMINING ATTORNEY



*David J. Kybas*

Director of the United States Patent and Trademark Office

# United States of America

United States Patent and Trademark Office

## FAITHFUL IRONS

**Reg. No. 4,275,105**

BRIAN RANDAL (UNITED STATES INDIVIDUAL), DBA FAITHFUL IRONS  
506 WEST GURLEY STREET  
PRESCOTT, AZ 86301

**Registered Jan. 15, 2013**

**Int. Cl.: 8**

FOR: APPARATUS FOR TATTOOING; TATTOO MACHINE PARTS, NAMELY, SPRINGS AND ARMATURE BARS; TATTOO MACHINES, IN CLASS 8 (U.S. CLS. 23, 28 AND 44).

**TRADEMARK**

FIRST USE 1-1-2012; IN COMMERCE 1-1-2012.

**PRINCIPAL REGISTER**

THE MARK CONSISTS OF STANDARD CHARACTERS WITHOUT CLAIM TO ANY PARTICULAR FONT, STYLE, SIZE, OR COLOR.

NO CLAIM IS MADE TO THE EXCLUSIVE RIGHT TO USE "IRONS", APART FROM THE MARK AS SHOWN.

SER. NO. 85-635,957, FILED 5-25-2012.

JEFFERY COWARD, EXAMINING ATTORNEY



*David J. Kyros*

Director of the United States Patent and Trademark Office

# United States of America

United States Patent and Trademark Office



**Reg. No. 4,275,106**

ROBERT UPTHEGROVE (UNITED STATES INDIVIDUAL)  
130 ARTHUR STREET  
PORT AUSTIN, MI 484676703

**Registered Jan. 15, 2013**

**Int. Cl.: 9**

FOR: LEVEL GAUGES, LEVEL INDICATORS, IN CLASS 9 (U.S. CLS. 21, 23, 26, 36 AND 38).

**TRADEMARK**

FIRST USE 4-1-2006; IN COMMERCE 4-1-2006.

**PRINCIPAL REGISTER**

THE MARK CONSISTS OF "THE MIGHTY TEE" WRITTEN ON THE ENLARGED BICEP OF A STYLIZED HAND.

SER. NO. 85-635,968, FILED 5-25-2012.

EUGENIA MARTIN, EXAMINING ATTORNEY



*David J. Kyffers*

Director of the United States Patent and Trademark Office

# United States of America

United States Patent and Trademark Office

# Fastbloc

**Reg. No. 4,275,107**

GUIDANCE SOFTWARE, INC. (DELAWARE CORPORATION)  
215 N. MARENGO AVE., SUITE 250  
PASADENA, CA 90036

**Registered Jan. 15, 2013**

**Int. Cl.: 9**

FOR: COMPUTER SOFTWARE FOR FORENSIC DUPLICATION OF DIGITAL MEDIA, IN CLASS 9 (U.S. CLS. 21, 23, 26, 36 AND 38).

**TRADEMARK**

FIRST USE 3-30-2001; IN COMMERCE 3-30-2001.

**PRINCIPAL REGISTER**

THE MARK CONSISTS OF STANDARD CHARACTERS WITHOUT CLAIM TO ANY PARTICULAR FONT, STYLE, SIZE, OR COLOR.

SER. NO. 85-635,972, FILED 5-25-2012.

MARLENE BELL, EXAMINING ATTORNEY



*David J. Kybas*

Director of the United States Patent and Trademark Office

# United States of America

United States Patent and Trademark Office

Where IT is all about YOU.

**Reg. No. 4,275,108**

**Registered Jan. 15, 2013**

**Int. Cl.: 42**

**SERVICE MARK**

**PRINCIPAL REGISTER**

RELIA IT INCORPORATED (ALABAMA CORPORATION), DBA RELIA IT  
129 STOVALL DRIVE  
FLORENCE, AL 35633

FOR: COMPUTER NETWORK DESIGN FOR OTHERS; COMPUTER SERVICES, NAMELY, COMPUTER SYSTEM ADMINISTRATION FOR OTHERS; COMPUTER SERVICES, NAMELY, REMOTE AND ON-SITE MANAGEMENT OF THE INFORMATION TECHNOLOGY (IT) SYSTEMS OF OTHERS; CONSULTING IN THE FIELD OF INFORMATION TECHNOLOGY; CONSULTING SERVICES IN THE FIELD OF COMPUTER-BASED INFORMATION SYSTEMS FOR BUSINESSES; CONSULTING SERVICES IN THE FIELDS OF SELECTION, IMPLEMENTATION AND USE OF COMPUTER HARDWARE AND SOFTWARE SYSTEMS FOR OTHERS; DESIGN, DEPLOYMENT AND MANAGEMENT OF WIRELESS NETWORKS FOR OTHERS; TECHNICAL SUPPORT SERVICES, NAMELY, TROUBLESHOOTING IN THE NATURE OF DIAGNOSING COMPUTER HARDWARE AND SOFTWARE PROBLEMS , IN CLASS 42 (U.S. CLS. 100 AND 101).

FIRST USE 1-27-2012; IN COMMERCE 1-27-2012.

THE MARK CONSISTS OF STANDARD CHARACTERS WITHOUT CLAIM TO ANY PARTICULAR FONT, STYLE, SIZE, OR COLOR.

SER. NO. 85-635,977, FILED 5-25-2012.

MARLENE BELL, EXAMINING ATTORNEY



*David J. Kybas*

Director of the United States Patent and Trademark Office



# United States of America

United States Patent and Trademark Office

# W5

**Reg. No. 4,275,109**

**Registered Jan. 15, 2013**

**Int. Cl.: 42**

**SERVICE MARK**

**PRINCIPAL REGISTER**

W5 TECHNOLOGIES, INC. (ALABAMA CORPORATION)  
120 RACHEL DRIVE  
HUNTSVILLE, AL 35806

FOR: COMPUTER SOFTWARE DEVELOPMENT IN THE FIELD OF TELECOMMUNICATIONS, IN CLASS 42 (U.S. CLS. 100 AND 101).

FIRST USE 12-0-1991; IN COMMERCE 12-0-1991.

THE MARK CONSISTS OF STANDARD CHARACTERS WITHOUT CLAIM TO ANY PARTICULAR FONT, STYLE, SIZE, OR COLOR.

SER. NO. 85-636,022, FILED 5-25-2012.

MATTHEW GALAN, EXAMINING ATTORNEY



*David J. Kybas*

Director of the United States Patent and Trademark Office

# United States of America

United States Patent and Trademark Office

# élan events

**Reg. No. 4,275,110**

**Registered Jan. 15, 2013**

**Int. Cl.: 41**

**SERVICE MARK**

**PRINCIPAL REGISTER**

HOPE RANDAL (UNITED STATES INDIVIDUAL), DBA ÉLAN EVENTS  
PO BOX 25141  
PRESCOTT VALLEY, AZ 86312

FOR: PARTY AND WEDDING PLANNING, COORDINATION AND CONSULTATION SERVICES; SPECIAL EVENT PLANNING FOR SOCIAL ENTERTAINMENT PURPOSES, IN CLASS 41 (U.S. CLS. 100, 101 AND 107).

FIRST USE 2-1-2012; IN COMMERCE 2-1-2012.

THE MARK CONSISTS OF STANDARD CHARACTERS WITHOUT CLAIM TO ANY PARTICULAR FONT, STYLE, SIZE, OR COLOR.

NO CLAIM IS MADE TO THE EXCLUSIVE RIGHT TO USE "EVENTS", APART FROM THE MARK AS SHOWN.

THE ENGLISH TRANSLATION OF "ÉLAN" IN THE MARK IS "DISTINCTIVE AND STYLISH ELEGANCE".

SER. NO. 85-636,037, FILED 5-25-2012.

WILLIAM JACKSON, EXAMINING ATTORNEY



*David J. Kypos*

Director of the United States Patent and Trademark Office

# United States of America

United States Patent and Trademark Office

# Rocktropolis

**Reg. No. 4,275,111**

ROCKTROPOLIS, LLC (MICHIGAN LIMITED LIABILITY COMPANY)  
4772 BIRNBAUM DRIVE  
BAY CITY, MI 48706

**Registered Jan. 15, 2013**

**Int. Cl.: 41**

FOR: MUSIC PRODUCTION SERVICES AND ENTERTAINMENT IN THE NATURE OF LIVE PERFORMANCES BY A MUSICAL BAND, IN CLASS 41 (U.S. CLS. 100, 101 AND 107).

**SERVICE MARK**

FIRST USE 3-29-2011; IN COMMERCE 3-29-2011.

**PRINCIPAL REGISTER**

THE MARK CONSISTS OF STANDARD CHARACTERS WITHOUT CLAIM TO ANY PARTICULAR FONT, STYLE, SIZE, OR COLOR.

SER. NO. 85-636,047, FILED 5-25-2012.

DAVID I, EXAMINING ATTORNEY



*David J. Kyffers*

Director of the United States Patent and Trademark Office

# United States of America

United States Patent and Trademark Office

# SERGE

**Reg. No. 4,275,112**

**Registered Jan. 15, 2013**

**Int. Cls.: 9 and 35**

**TRADEMARK**

**SERVICE MARK**

**PRINCIPAL REGISTER**

SERGE MEDIA, INC. (DELAWARE CORPORATION)  
10736 JEFFERSON BLVD., BOX 961  
CULVER CITY, CA 90320

FOR: COMPUTER SEARCH ENGINE SOFTWARE; COMPUTER SOFTWARE DEVELOPMENT TOOLS; COMPUTER SOFTWARE, NAMELY, SOFTWARE DEVELOPMENT TOOLS FOR THE CREATION OF MOBILE INTERNET APPLICATIONS AND CLIENT INTERFACES, IN CLASS 9 (U.S. CLS. 21, 23, 26, 36 AND 38).

FIRST USE 3-29-2012; IN COMMERCE 3-29-2012.

FOR: ADVERTISING AND MARKETING SERVICES PROVIDED BY MEANS OF INDIRECT METHODS OF MARKETING COMMUNICATIONS, NAMELY, SOCIAL MEDIA, SEARCH ENGINE MARKETING, INQUIRY MARKETING, INTERNET MARKETING, MOBILE MARKETING, BLOGGING AND OTHER FORMS OF PASSIVE, SHARABLE OR VIRAL COMMUNICATIONS CHANNELS, IN CLASS 35 (U.S. CLS. 100, 101 AND 102).

FIRST USE 3-29-2012; IN COMMERCE 3-29-2012.

THE MARK CONSISTS OF STANDARD CHARACTERS WITHOUT CLAIM TO ANY PARTICULAR FONT, STYLE, SIZE, OR COLOR.

SER. NO. 85-636,077, FILED 5-25-2012.

AMY ALFIERI, EXAMINING ATTORNEY



*David J. Kybas*

Director of the United States Patent and Trademark Office

# United States of America

United States Patent and Trademark Office

# Haute Nails

**Reg. No. 4,275,113**

HAUTE NAILS (TEXAS SOLE PROPRIETORSHIP)  
4107 WATER PARK CIRCLE  
MANSFIELD, TX 76063

**Registered Jan. 15, 2013**

**Int. Cl.: 3**

FOR: FALSE NAILS; NAIL PAINT; NAIL POLISH; NAIL TIPS, IN CLASS 3 (U.S. CLS. 1, 4, 6, 50, 51 AND 52).

**TRADEMARK**

FIRST USE 9-1-2011; IN COMMERCE 11-2-2011.

**PRINCIPAL REGISTER**

THE MARK CONSISTS OF STANDARD CHARACTERS WITHOUT CLAIM TO ANY PARTICULAR FONT, STYLE, SIZE, OR COLOR.

NO CLAIM IS MADE TO THE EXCLUSIVE RIGHT TO USE "NAILS", APART FROM THE MARK AS SHOWN.

SER. NO. 85-636,089, FILED 5-25-2012.

MORGAN WYNNE, EXAMINING ATTORNEY



*David J. Kyffers*

Director of the United States Patent and Trademark Office

# United States of America

United States Patent and Trademark Office

# obof

**Reg. No. 4,275,114**

**Registered Jan. 15, 2013**

**Int. Cl.: 25**

**TRADEMARK**

**PRINCIPAL REGISTER**

OBOF, L.L.C. (VIRGINIA LIMITED LIABILITY COMPANY)  
SUITE 500  
8300 BOONE BOULEVARD  
VIENNA, VA 22182

FOR: SWEATSHIRTS; T-SHIRTS, IN CLASS 25 (U.S. CLS. 22 AND 39).

FIRST USE 10-1-2005; IN COMMERCE 6-1-2007.

THE MARK CONSISTS OF STANDARD CHARACTERS WITHOUT CLAIM TO ANY PARTICULAR FONT, STYLE, SIZE, OR COLOR.

SER. NO. 85-636,112, FILED 5-25-2012.

LESLEY LAMOTHE, EXAMINING ATTORNEY



*David J. Kyffers*

Director of the United States Patent and Trademark Office

# United States of America

United States Patent and Trademark Office

## !KharmasRevenge!

**Reg. No. 4,275,115**

!KHARMASREVENGE! (GEORGIA SOLE PROPRIETORSHIP)  
742 PEEPLES ST.

**Registered Jan. 15, 2013**

ATLANTA, GA 30310

**Int. Cl.: 28**

FOR: BAGS FOR SKATEBOARDS; PROTECTIVE PADDING FOR SKATEBOARDING;  
SKATEBOARD DECKS; SKATEBOARD GRIP TAPES; SKATEBOARD TRUCKS; SKATE-  
BOARD WAX; SKATEBOARD WHEELS; SKATEBOARDS , IN CLASS 28 (U.S. CLS. 22, 23,  
38 AND 50).

**TRADEMARK**

**PRINCIPAL REGISTER**

FIRST USE 7-1-2011; IN COMMERCE 7-1-2011.

THE MARK CONSISTS OF STANDARD CHARACTERS WITHOUT CLAIM TO ANY PAR-  
TICULAR FONT, STYLE, SIZE, OR COLOR.

SER. NO. 85-636,116, FILED 5-25-2012.

LINDA MICKLEBURGH, EXAMINING ATTORNEY



*David J. Kyffers*

Director of the United States Patent and Trademark Office

# United States of America

United States Patent and Trademark Office

# SUNROAST

**Reg. No. 4,275,116**

**Registered Jan. 15, 2013**

**Int. Cl.: 30**

**TRADEMARK**

**PRINCIPAL REGISTER**

RISE & DINE RESTAURANTS, INC. (OHIO CORPORATION)  
SUITE 260  
274 MARCONI BLVD.  
COLUMBUS, OH 43215

FOR: COFFEE BEANS; GROUND COFFEE BEANS, IN CLASS 30 (U.S. CL. 46).

FIRST USE 3-1-2012; IN COMMERCE 3-1-2012.

THE MARK CONSISTS OF STANDARD CHARACTERS WITHOUT CLAIM TO ANY PARTICULAR FONT, STYLE, SIZE, OR COLOR.

SER. NO. 85-636,118, FILED 5-25-2012.

DOMINIC FATHY, EXAMINING ATTORNEY



*David J. Kybas*

Director of the United States Patent and Trademark Office



# United States of America

United States Patent and Trademark Office

# Green Stride

**Reg. No. 4,275,117**

**Registered Jan. 15, 2013**

**Int. Cl.: 41**

**SERVICE MARK**

**PRINCIPAL REGISTER**

BAILIN, ELI (UNITED STATES INDIVIDUAL)  
55 PROSPECT STREET  
AMESBURY, MA 01913

FOR: ARRANGING AND CONDUCTING ATHLETIC COMPETITIONS; ATHLETIC AND SPORTS EVENT SERVICES, NAMELY, ARRANGING, ORGANIZING, OPERATING AND CONDUCTING MARATHON RACES; ORGANIZING, ARRANGING, AND CONDUCTING RUNNING, RACING, HALF-MARATHON, MARATHON, 10K RUN, AND 5K RUN EVENTS, IN CLASS 41 (U.S. CLS. 100, 101 AND 107).

FIRST USE 11-1-2011; IN COMMERCE 11-1-2011.

THE MARK CONSISTS OF STANDARD CHARACTERS WITHOUT CLAIM TO ANY PARTICULAR FONT, STYLE, SIZE, OR COLOR.

SER. NO. 85-636,141, FILED 5-25-2012.

WILLIAM P. SHANAHAN, EXAMINING ATTORNEY



*David J. Kyffers*

Director of the United States Patent and Trademark Office

# United States of America

United States Patent and Trademark Office

# Mysh

**Reg. No. 4,275,118**

HAMEL, MARCUS G. (UNITED STATES INDIVIDUAL)  
4535 E. TUDOR RD.

**Registered Jan. 15, 2013**

BERRIEN SPRINGS, MI 49103

**Int. Cl.: 9**

FOR: DIGITAL MATERIALS, NAMELY, CDS, DVDS, AND DOWNLOADABLE AUDIO FILES FEATURING MUSIC, IN CLASS 9 (U.S. CLS. 21, 23, 26, 36 AND 38).

**TRADEMARK**

FIRST USE 10-1-2010; IN COMMERCE 2-25-2012.

**PRINCIPAL REGISTER**

THE MARK CONSISTS OF STANDARD CHARACTERS WITHOUT CLAIM TO ANY PARTICULAR FONT, STYLE, SIZE, OR COLOR.

SER. NO. 85-636,144, FILED 5-25-2012.

JASON BLAIR, EXAMINING ATTORNEY



*David J. Kyffers*

Director of the United States Patent and Trademark Office

United States of America  
United States Patent and Trademark Office

**SERGE**



**Reg. No. 4,275,119**

**Registered Jan. 15, 2013**

**Int. Cls.: 9 and 35**

**TRADEMARK**

**SERVICE MARK**

**PRINCIPAL REGISTER**

SERGE MEDIA, INC. (DELAWARE CORPORATION)  
10736 JEFFERSON BLVD., BOX 961  
CULVER CITY, CA 90320

FOR: COMPUTER SEARCH ENGINE SOFTWARE; COMPUTER SOFTWARE DEVELOPMENT TOOLS; COMPUTER SOFTWARE, NAMELY, SOFTWARE DEVELOPMENT TOOLS FOR THE CREATION OF MOBILE INTERNET APPLICATIONS AND CLIENT INTERFACES, IN CLASS 9 (U.S. CLS. 21, 23, 26, 36 AND 38).

FIRST USE 3-29-2012; IN COMMERCE 3-29-2012.

FOR: ADVERTISING AND MARKETING SERVICES PROVIDED BY MEANS OF INDIRECT METHODS OF MARKETING COMMUNICATIONS, NAMELY, SOCIAL MEDIA, SEARCH ENGINE MARKETING, INQUIRY MARKETING, INTERNET MARKETING, MOBILE MARKETING, BLOGGING AND OTHER FORMS OF PASSIVE, SHARABLE OR VIRAL COMMUNICATIONS CHANNELS, IN CLASS 35 (U.S. CLS. 100, 101 AND 102).

FIRST USE 3-29-2012; IN COMMERCE 3-29-2012.

THE MARK CONSISTS OF A STYLIZED WORD, "SERGE", WHEREIN THE "G" OVERLAPS THE "R", AND WHEREIN A GRAPHIC OF A SPY LENS WITH A SET OF CROSSHAIRS IS DISPOSED AT THE END OF THE FRONT LEG OF THE "R" AND UNDERNEATH THE "G".

SER. NO. 85-636,152, FILED 5-25-2012.

AMY ALFIERI, EXAMINING ATTORNEY



*David J. Kybas*

Director of the United States Patent and Trademark Office

# United States of America

United States Patent and Trademark Office

## MINI CASCADES

**Reg. No. 4,275,120**

THE HOMESTEAD L.C. (VIRGINIA LIMITED LIABILITY COMPANY)  
ROUTE 220  
HOT SPRINGS, VA 24445

**Registered Jan. 15, 2013**

**Int. Cl.: 41**

FOR: PROVIDING MINIATURE GOLF FACILITIES, IN CLASS 41 (U.S. CLS. 100, 101 AND 107).

**SERVICE MARK**

FIRST USE 3-1-2012; IN COMMERCE 3-1-2012.

**PRINCIPAL REGISTER**

THE MARK CONSISTS OF STANDARD CHARACTERS WITHOUT CLAIM TO ANY PARTICULAR FONT, STYLE, SIZE, OR COLOR.

SER. NO. 85-636,159, FILED 5-25-2012.

FLORENTINA BLANDU, EXAMINING ATTORNEY



*David J. Kybas*

Director of the United States Patent and Trademark Office

# United States of America

United States Patent and Trademark Office

# True Beer

**Reg. No. 4,275,121**

**Registered Jan. 15, 2013**

**Int. Cl.: 35**

**SERVICE MARK**

**PRINCIPAL REGISTER**

FERNALD, BRIAN (UNITED STATES INDIVIDUAL)  
65 MATHESOW DRIVE, UNIT L  
WEYMOUTH, MA 02189

FOR: ON-LINE RETAIL STORE SERVICES FEATURING BARWARE, BAR GLASSWARE, BEER BOOT GLASSWARE, BEER GLASSES, WINE GLASSES, PINT GLASSES, BEER MUGS, GOBLETS, SNIFTERS, GLASSWARE SETS, POKAL GLASSES, TULIP GLASSES, WEIZEN GLASSES, STANGE GLASSES, BAR TOWELS, COCKTAIL BITTERS, COCKTAIL SHAKERS, BAR COASTERS, COCKTAIL GARNISHES, ALCOHOL MIXES, BEVERAGE DISPENSERS, COCKTAIL SPICES, BAR SETS, BOTTLE OPENERS, COCKTAIL GLASSES, ALCOHOL FLASKS, BAR GAMES, BEER STEINS, BAR APPAREL, BAR SIGNS, BEER GADGETS, SHOT GLASSES, AND BAR ACCESSORIES; RETAIL GIFT SHOPS; RETAIL STORE SERVICES FEATURING A WIDE VARIETY OF CONSUMER GOODS OF OTHERS; RETAIL STORE SERVICES FEATURING BARWARE, BAR GLASSWARE, BEER BOOT GLASSWARE, BEER GLASSES, WINE GLASSES, PINT GLASSES, BEER MUGS, GOBLETS, SNIFTERS, GLASSWARE SETS, POKAL GLASSES, TULIP GLASSES, WEIZEN GLASSES, STANGE GLASSES, BAR TOWELS, COCKTAIL BITTERS, COCKTAIL SHAKERS, BAR COASTERS, COCKTAIL GARNISHES, ALCOHOL MIXES, BEVERAGE DISPENSERS, COCKTAIL SPICES, BAR SETS, BOTTLE OPENERS, COCKTAIL GLASSES, ALCOHOL FLASKS, BAR GAMES, BEER STEINS, BAR APPAREL, BAR SIGNS, BEER GADGETS, SHOT GLASSES, AND BAR ACCESSORIES; RETAIL BARWARE, GLASSWARE AND BAR ACCESSORY STORES, IN CLASS 35 (U.S. CLS. 100, 101 AND 102).

FIRST USE 3-1-2004; IN COMMERCE 3-1-2004.

THE MARK CONSISTS OF STANDARD CHARACTERS WITHOUT CLAIM TO ANY PARTICULAR FONT, STYLE, SIZE, OR COLOR.

OWNER OF U.S. REG. NO. 3,792,761.

NO CLAIM IS MADE TO THE EXCLUSIVE RIGHT TO USE "BEER", APART FROM THE MARK AS SHOWN.

SER. NO. 85-636,164, FILED 5-25-2012.

INGRID C. EULIN, EXAMINING ATTORNEY



*David J. Kyfos*

Director of the United States Patent and Trademark Office

# United States of America

United States Patent and Trademark Office

# TFG

**Reg. No. 4,275,122**

THE FAVERO GROUP, LLC (WASHINGTON LIMITED LIABILITY COMPANY)  
7744 20TH AVE NE  
SEATTLE, WA 98115

**Registered Jan. 15, 2013**

**Int. Cl.: 35**

FOR: BUSINESS CONSULTATION IN THE FIELD OF OPERATIONS OUTCOME ANALYSIS,  
IN CLASS 35 (U.S. CLS. 100, 101 AND 102).

**SERVICE MARK**

FIRST USE 4-30-2012; IN COMMERCE 5-1-2012.

**PRINCIPAL REGISTER**

THE MARK CONSISTS OF STANDARD CHARACTERS WITHOUT CLAIM TO ANY PAR-  
TICULAR FONT, STYLE, SIZE, OR COLOR.

SER. NO. 85-636,166, FILED 5-25-2012.

JOHN KELLY, EXAMINING ATTORNEY



*David J. Kyffers*

Director of the United States Patent and Trademark Office

# United States of America

United States Patent and Trademark Office

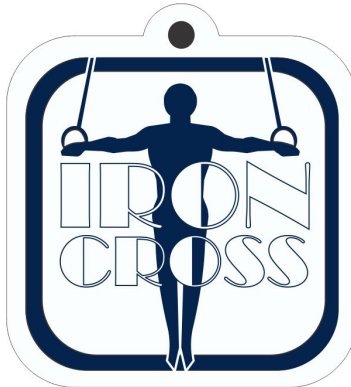

**Reg. No. 4,275,123**

**Registered Jan. 15, 2013**

**Int. Cl.: 25**

**TRADEMARK**

**PRINCIPAL REGISTER**

SNOWFLAKE DESIGNS, INC (CALIFORNIA CORPORATION)  
2893 LARKIN AVE  
CLOVIS, CA 93612

FOR: GYM SHORTS; LEOTARDS; SHIRTS; SINGLET, IN CLASS 25 (U.S. CLS. 22 AND 39).

FIRST USE 5-23-2012; IN COMMERCE 5-25-2012.

THE MARK CONSISTS OF A ROUNDED NAVY BLUE RECTANGLE ENCAPSULATING A NAVY BLUE MALE SILHOUETTE WITH ARMS OUTSTRETCHED FORMING AN IRON CROSS, NAVY BLUE GYMNASTICS RINGS WITH NAVY BLUE ROPE ATTACHED TO THE TOP PORTION OF THE RECTANGLE, THE WORDS "IRON CROSS" WITH WHITE LETTERING OUTLINED IN NAVY BLUE ARE SUPERIMPOSED ACROSS THE SILHOUETTE'S TORSO AND LEGS. A NAVY BLUE DOT APPEARS AT THE TOP OF THE RECTANGLE.

THE COLOR(S) NAVY BLUE AND WHITE IS/ARE CLAIMED AS A FEATURE OF THE MARK.

SER. NO. 85-636,171, FILED 5-25-2012.

ROBERT C. CLARK JR., EXAMINING ATTORNEY



*David J. Kybas*

Director of the United States Patent and Trademark Office

# United States of America

United States Patent and Trademark Office

# INFINISERUM

**Reg. No. 4,275,124**

HOMEOPATHIC HOLDINGS, LLC (UTAH LIMITED LIABILITY COMPANY)  
11142 HIGHLAND BLVD., #100  
HIGHLAND, UT 84003

**Registered Jan. 15, 2013**

**Int. Cl.: 3**

FOR: NON-MEDICATED ANTI-AGING SERUM CONTAINING ISOFLAVANES, PLANT EXTRACTS, AND LIPODIPEPTIDE BASED COMPOUNDS, IN CLASS 3 (U.S. CLS. 1, 4, 6, 50, 51 AND 52).

**TRADEMARK**

FIRST USE 5-8-2012; IN COMMERCE 5-8-2012.

**PRINCIPAL REGISTER**

THE MARK CONSISTS OF STANDARD CHARACTERS WITHOUT CLAIM TO ANY PARTICULAR FONT, STYLE, SIZE, OR COLOR.

SER. NO. 85-636,184, FILED 5-25-2012.

ELLEN PERKINS, EXAMINING ATTORNEY



*David J. Kyffers*

Director of the United States Patent and Trademark Office



# United States of America

United States Patent and Trademark Office

# RockBuster

**Reg. No. 4,275,125**

JEWETT CONSTRUCTION, INC. (TEXAS CORPORATION)

**Registered Jan. 15, 2013**

7641 N FM 39  
JEWETT, TX 75846

**Int. Cl.: 7**

FOR: DRILLING RIGS, IN CLASS 7 (U.S. CLS. 13, 19, 21, 23, 31, 34 AND 35).

**TRADEMARK**

FIRST USE 4-7-2010; IN COMMERCE 4-7-2010.

**PRINCIPAL REGISTER**

THE MARK CONSISTS OF STANDARD CHARACTERS WITHOUT CLAIM TO ANY PARTICULAR FONT, STYLE, SIZE, OR COLOR.

OWNER OF U.S. REG. NO. 3,763,160.

SER. NO. 85-636,192, FILED 5-25-2012.

MARILYN IZZI, EXAMINING ATTORNEY



*David J. Kyffers*

Director of the United States Patent and Trademark Office

# United States of America

United States Patent and Trademark Office

# MAXTEK

**Reg. No. 4,275,126**

**Registered Jan. 15, 2013**

**Int. Cl.: 9**

**TRADEMARK**

**PRINCIPAL REGISTER**

MAXTEK CORP. (CALIFORNIA CORPORATION)  
STE 210-108  
7426 CHERRY AVE  
FONTANA, CA 92336

FOR: BLANK DIGITAL STORAGE MEDIA; BLANK RECORDABLE CD-RS AND DVD-RS; BLANK RECORDABLE OPTICAL DISC; CAMERA CASES; CASES FOR DISKETTES AND COMPACT DISKS; CD SLEEVES; CD STORAGE RACKS; CD STORAGE WALLETS; DIGITAL AUDIO AND VIDEO RECORDERS AND PLAYERS, IN CLASS 9 (U.S. CLS. 21, 23, 26, 36 AND 38).

FIRST USE 3-8-2010; IN COMMERCE 3-8-2010.

THE MARK CONSISTS OF STANDARD CHARACTERS WITHOUT CLAIM TO ANY PARTICULAR FONT, STYLE, SIZE, OR COLOR.

SER. NO. 85-636,205, FILED 5-25-2012.

LINDA MICKLEBURGH, EXAMINING ATTORNEY



*David J. Kybas*

Director of the United States Patent and Trademark Office

# United States of America

United States Patent and Trademark Office

## Scented Journey

**Reg. No. 4,275,127**

SCENTED STUDIO (COLORADO LIMITED LIABILITY COMPANY)  
215 DETROIT STREET  
DENVER, CO 80206

**Registered Jan. 15, 2013**

**Int. Cl.: 41**

FOR: EDUCATIONAL SERVICES, NAMELY, PROVIDING WORKSHOPS THAT ENABLE PARTICIPANTS, TO LEARN THE HISTORY OF PERFUME AND COLOGNE, UNDERSTAND THE SCIENCE OF CREATING PERFUME AND COLOGNE, AND ALLOW PARTICIPANTS TO CREATE THEIR OWN PERFUME AND COLOGNE, IN CLASS 41 (U.S. CLS. 100, 101 AND 107).

**SERVICE MARK**

**PRINCIPAL REGISTER**

FIRST USE 9-1-2011; IN COMMERCE 10-14-2011.

THE MARK CONSISTS OF STANDARD CHARACTERS WITHOUT CLAIM TO ANY PARTICULAR FONT, STYLE, SIZE, OR COLOR.

SER. NO. 85-636,211, FILED 5-25-2012.

ELLEN PERKINS, EXAMINING ATTORNEY



*David J. Kyffers*

Director of the United States Patent and Trademark Office

# United States of America

United States Patent and Trademark Office



**Reg. No. 4,275,128**

**Registered Jan. 15, 2013**

**Int. Cl.: 41**

**SERVICE MARK**

**PRINCIPAL REGISTER**

PSYGON, INC. (NORTH CAROLINA CORPORATION)  
200 MAYWOOD WAY  
CHAPEL HILL, NC 27516

FOR: EDUCATION SERVICES, NAMELY, PROVIDING ONLINE COGNITIVE ASSESSMENTS AND TRAINING PROGRAMS THAT HELP IDENTIFY COGNITIVE STRENGTHS AND WEAKNESSES OF AN INDIVIDUAL, IN CLASS 41 (U.S. CLS. 100, 101 AND 107).

FIRST USE 4-29-2012; IN COMMERCE 4-29-2012.

THE MARK CONSISTS OF THE WORDING "PSYGON" IN A KOCH SNOWFLAKE FRACTAL DESIGN.

SER. NO. 85-636,239, FILED 5-25-2012.

TOBY BULLOFF, EXAMINING ATTORNEY



*David J. Kyffers*

Director of the United States Patent and Trademark Office

# United States of America

United States Patent and Trademark Office

know more. no less.

**Reg. No. 4,275,129**

PSYGON, INC. (NORTH CAROLINA CORPORATION)  
200 MAYWOOD WAY  
CHAPEL HILL, NC 27516

**Registered Jan. 15, 2013**

**Int. Cl.: 41**

FOR: EDUCATION SERVICES, NAMELY, PROVIDING ONLINE COGNITIVE ASSESSMENTS AND TRAINING PROGRAMS THAT HELP IDENTIFY COGNITIVE STRENGTHS AND WEAKNESSES OF AN INDIVIDUAL, IN CLASS 41 (U.S. CLS. 100, 101 AND 107).

**SERVICE MARK**

FIRST USE 4-29-2012; IN COMMERCE 4-29-2012.

**PRINCIPAL REGISTER**

THE MARK CONSISTS OF STANDARD CHARACTERS WITHOUT CLAIM TO ANY PARTICULAR FONT, STYLE, SIZE, OR COLOR.

SER. NO. 85-636,245, FILED 5-25-2012.

TOBY BULLOFF, EXAMINING ATTORNEY



*David J. Kyffers*

Director of the United States Patent and Trademark Office

# United States of America

United States Patent and Trademark Office

# Tailwashers

**Reg. No. 4,275,130**

**Registered Jan. 15, 2013**

**Int. Cl.: 44**

**SERVICE MARK**

**PRINCIPAL REGISTER**

T.R. WARNER ENTERPRISES, INC. (CALIFORNIA CORPORATION)  
1929 NORTH BRONSON AVENUE  
LOS ANGELES., CA 90046

FOR: ANIMAL GROOMING SERVICES; DOG GROOMING SERVICES; PET GROOMING SERVICES; PROVIDING SELF-SERVICE PET GROOMING FACILITIES, IN CLASS 44 (U.S. CLS. 100 AND 101).

FIRST USE 6-6-2006; IN COMMERCE 6-6-2006.

THE MARK CONSISTS OF STANDARD CHARACTERS WITHOUT CLAIM TO ANY PARTICULAR FONT, STYLE, SIZE, OR COLOR.

SER. NO. 85-636,254, FILED 5-25-2012.

MARTHA FROMM, EXAMINING ATTORNEY



*David J. Kyffers*

Director of the United States Patent and Trademark Office

**United States of America**  
United States Patent and Trademark Office

# B TOUCH

**Reg. No. 4,275,131**

**Registered Jan. 15, 2013**

**Int. Cl.: 3**

**TRADEMARK**

**PRINCIPAL REGISTER**

THACH, QUOC (UNITED STATES INDIVIDUAL)  
3327 FARRINGTON ST.  
FLUSHING, NY 11354

FOR: NAIL POLISH, IN CLASS 3 (U.S. CLS. 1, 4, 6, 50, 51 AND 52).

FIRST USE 1-12-2009; IN COMMERCE 1-12-2009.

THE MARK CONSISTS OF STANDARD CHARACTERS WITHOUT CLAIM TO ANY PARTICULAR FONT, STYLE, SIZE, OR COLOR.

SER. NO. 85-636,278, FILED 5-26-2012.

HOWARD B. LEVINE, EXAMINING ATTORNEY



*David J. Kyffers*

Director of the United States Patent and Trademark Office

# United States of America

United States Patent and Trademark Office

## ZETA CHI EPSILON

**Reg. No. 4,275,132**

ESTOESTA, RANDY, A. (UNITED STATES INDIVIDUAL)  
1196 LEXINGTON COURT  
SAN LUIS OBISPO, CA 93401

**Registered Jan. 15, 2013**

**Int. Cl.: 35**

FOR: ASSOCIATION SERVICES, NAMELY, ORGANIZING CHAPTERS OF A FRATERNITY AND PROMOTING THE INTERESTS OF THE MEMBERS THEREOF, IN CLASS 35 (U.S. CLS. 100, 101 AND 102).

**SERVICE MARK**

FIRST USE 1-1-1991; IN COMMERCE 1-1-1991.

**PRINCIPAL REGISTER**

THE MARK CONSISTS OF STANDARD CHARACTERS WITHOUT CLAIM TO ANY PARTICULAR FONT, STYLE, SIZE, OR COLOR.

SER. NO. 85-636,279, FILED 5-26-2012.

CYNTHIA TRIPI, EXAMINING ATTORNEY



*David J. Kyffers*

Director of the United States Patent and Trademark Office



# United States of America

United States Patent and Trademark Office

## American Metal Conspiracy

**Reg. No. 4,275,133**

**Registered Jan. 15, 2013**

**Int. Cl.: 41**

**SERVICE MARK**

**PRINCIPAL REGISTER**

SCHAFFEL, PARKER (UNITED STATES INDIVIDUAL)  
#307  
1641 INTERNATIONAL DR  
MCLEAN, VA 22102

FOR: ENTERTAINMENT, NAMELY, LIVE PERFORMANCES BY A MUSICAL BAND, IN CLASS 41 (U.S. CLS. 100, 101 AND 107).

FIRST USE 2-16-2012; IN COMMERCE 3-17-2012.

THE MARK CONSISTS OF STANDARD CHARACTERS WITHOUT CLAIM TO ANY PARTICULAR FONT, STYLE, SIZE, OR COLOR.

NO CLAIM IS MADE TO THE EXCLUSIVE RIGHT TO USE "AMERICAN METAL", APART FROM THE MARK AS SHOWN.

SER. NO. 85-636,292, FILED 5-26-2012.

COLLEEN KEARNEY, EXAMINING ATTORNEY



*David J. Kyffers*

Director of the United States Patent and Trademark Office

# United States of America

United States Patent and Trademark Office

## PIPER

ENTERPRISE SOLUTIONS

**Reg. No. 4,275,134**

**Registered Jan. 15, 2013**

**Int. Cl.: 42**

**SERVICE MARK**

**PRINCIPAL REGISTER**

PIPER ENTERPRISE SOLUTIONS (VIRGINIA LIMITED LIABILITY COMPANY)  
SUITE 410  
1604 SPRING HILL ROAD  
VIENNA, VA 22182

FOR: COMPUTER SERVICES, NAMELY, REMOTE AND ON-SITE MANAGEMENT OF THE INFORMATION TECHNOLOGY (IT) SYSTEMS OF OTHERS ; COMPUTER SERVICES, NAMELY, REMOTE AND ON-SITE MANAGEMENT OF THE INFORMATION TECHNOLOGY (IT) CLOUD COMPUTING SYSTEMS OF OTHERS ; COMPUTER SERVICES, NAMELY, ON-SITE MANAGEMENT OF THE INFORMATION TECHNOLOGY (IT) SYSTEMS ; COMPUTER TECHNICAL SUPPORT SERVICES, NAMELY, 24/7 SERVICE DESK/HELP DESK SERVICES FOR IT INFRASTRUCTURE, OPERATING SYSTEMS, DATABASE SYSTEMS, AND WEB APPLICATIONS ; CONSULTING IN THE FIELD OF IT PROJECT MANAGEMENT ; IT CONSULTING SERVICES ; IT INTEGRATION SERVICES ; PROFESSIONAL COMPUTER SERVICES, NAMELY, NETWORK ANALYSIS, LAN/WAN DESIGN, WIRELESS ENGINEERING, VIRTUALIZATION AND COMPUTER PROJECT MANAGEMENT ; CONSULTING SERVICES IN THE DESIGN AND IMPLEMENTATION OF COMPUTER-BASED INFORMATION SYSTEMS FOR BUSINESSES ; COMPUTER SERVICES, NAMELY, PROVIDING VIRTUAL AND NON VIRTUAL APPLICATION SERVERS, WEB SERVERS, FILE SERVERS, CO-LOCATION SERVERS, LOAD BALANCING SERVERS, REDUNDANCY SERVERS, MEDIA SERVERS AND DATABASE SERVERS OF VARIABLE CAPACITY TO THIRD PARTY COMPUTING AND DATA STORAGE FACILITIES , IN CLASS 42 (U.S. CLS. 100 AND 101).

FIRST USE 1-1-2011; IN COMMERCE 1-1-2011.

NO CLAIM IS MADE TO THE EXCLUSIVE RIGHT TO USE "ENTERPRISE SOLUTIONS", APART FROM THE MARK AS SHOWN.

THE MARK CONSISTS OF THE TEXT "PIPER" ABOVE A SHARP LINE WITH THE WORDS "ENTERPRISE SOLUTIONS" BELOW THE LINE.

SER. NO. 85-636,295, FILED 5-26-2012.

WENDY JUN, EXAMINING ATTORNEY



*David J. Kyffers*

Director of the United States Patent and Trademark Office

# United States of America

United States Patent and Trademark Office

## Love Miss Marie

**Reg. No. 4,275,135**

BOOKER, TIERRA (UNITED STATES INDIVIDUAL)  
11325 PINYON COURT  
FONTANA, CA 92337

**Registered Jan. 15, 2013**

**Int. Cl.: 35**

FOR: ON-LINE RETAIL STORE SERVICES FEATURING A WIDE VARIETY OF CONSUMER GOODS OF OTHERS, IN CLASS 35 (U.S. CLS. 100, 101 AND 102).

**SERVICE MARK**

FIRST USE 4-7-2009; IN COMMERCE 8-20-2010.

**PRINCIPAL REGISTER**

THE MARK CONSISTS OF STANDARD CHARACTERS WITHOUT CLAIM TO ANY PARTICULAR FONT, STYLE, SIZE, OR COLOR.

SER. NO. 85-636,299, FILED 5-26-2012.

SUNG IN, EXAMINING ATTORNEY



*David J. Kyfos*

Director of the United States Patent and Trademark Office

# United States of America

United States Patent and Trademark Office

## The Perfect Match

**Reg. No. 4,275,136**

ANN PARKER WEDDINGS, INC. (FLORIDA CORPORATION)  
134 ELYSIUM DRIVE

**Registered Jan. 15, 2013**

ROYAL PALM BEACH, FL 33411

**Int. Cl.: 41**

FOR: PARTY AND WEDDING PLANNING, COORDINATION AND CONSULTATION SERVICES, IN CLASS 41 (U.S. CLS. 100, 101 AND 107).

**SERVICE MARK**

FIRST USE 5-25-2012; IN COMMERCE 5-25-2012.

**PRINCIPAL REGISTER**

THE MARK CONSISTS OF STANDARD CHARACTERS WITHOUT CLAIM TO ANY PARTICULAR FONT, STYLE, SIZE, OR COLOR.

SER. NO. 85-636,303, FILED 5-26-2012.

COLLEEN KEARNEY, EXAMINING ATTORNEY



*David J. Kyros*

Director of the United States Patent and Trademark Office

# United States of America

United States Patent and Trademark Office

# Handimoms

**Reg. No. 4,275,137**

WALLER, MIKE S (ALABAMA LIMITED LIABILITY COMPANY), DBA HANDIMOMS  
6596 LYNN AVE

**Registered Jan. 15, 2013**

LEEDS, AL 35094 AND

**Int. Cl.: 37**

WALLER, AMY L (ALABAMA LIMITED LIABILITY COMPANY), DBA HANDIMOMS  
6596 LYNN AVE.  
LEEDS, AL 35094

**SERVICE MARK**

FOR: CLEANING OF RESIDENTIAL HOUSES, IN CLASS 37 (U.S. CLS. 100, 103 AND 106).

**PRINCIPAL REGISTER**

FIRST USE 1-12-2011; IN COMMERCE 1-15-2011.

THE MARK CONSISTS OF STANDARD CHARACTERS WITHOUT CLAIM TO ANY PARTICULAR FONT, STYLE, SIZE, OR COLOR.

SER. NO. 85-636,310, FILED 5-26-2012.

SUNG IN, EXAMINING ATTORNEY



*David J. Kyffers*

Director of the United States Patent and Trademark Office

# United States of America

United States Patent and Trademark Office

# RIMEL

**Reg. No. 4,275,138**

**Registered Jan. 15, 2013**

**Int. Cl.: 41**

**SERVICE MARK**

**PRINCIPAL REGISTER**

GARFIO, LETICIA (UNITED STATES INDIVIDUAL)  
1917 S 57TH CT  
CICERO, IL 60804 AND

GARFIO, ARACELI (UNITED STATES INDIVIDUAL)  
1917 S 57TH CT  
CICERO, IL 60804

FOR: ENTERTAINMENT, NAMELY, LIVE PERFORMANCES BY A MUSICAL BAND, IN CLASS 41 (U.S. CLS. 100, 101 AND 107).

FIRST USE 11-28-2011; IN COMMERCE 1-7-2012.

THE MARK CONSISTS OF STANDARD CHARACTERS WITHOUT CLAIM TO ANY PARTICULAR FONT, STYLE, SIZE, OR COLOR.

THE ENGLISH TRANSLATION OF "RIMEL" IN THE MARK IS "MASCARA".

SER. NO. 85-636,314, FILED 5-26-2012.

SUNG IN, EXAMINING ATTORNEY



*David J. Kyfos*

Director of the United States Patent and Trademark Office

# United States of America

United States Patent and Trademark Office

# Naturaldent

**Reg. No. 4,275,139**

**Registered Jan. 15, 2013**

**Int. Cl.: 10**

**TRADEMARK**

**PRINCIPAL REGISTER**

WU, MING-YUAN (TAIWAN INDIVIDUAL)  
2F, NO. 9, ALLEY 37, LANE 236, SEC. 5  
CHUNG-XIAO E. RD., XINYI DISTRICT  
TAIPEI CITY 110, TAIWAN

FOR: CUTTING AND GRINDING DISCS FOR DENTAL APPLICATIONS; CUT-OFF AND ABRASIVE WHEELS FOR DENTAL PURPOSES; DENTAL AND MEDICAL DRILL BITS FOR CUTTING TEETH OR BONE; DENTAL BROACHES; DENTAL BURRS; DENTAL CLIPS FOR SECURING PRE-EXISTING DENTURES; DENTAL DRILL BITS USED IN DENTAL MOTORS TO ENABLE DENTISTS TO CUT OR DRILL TEETH; DENTAL EXCAVATORS; DENTAL FIXTURES, NAMELY, PREFABRICATED PARTS FOR CROWNS, BRIDGES AND PONTICS; DENTAL HANDPIECES; DENTAL INSTRUMENTS, NAMELY, ORAL IRRIGATORS; DENTAL INSTRUMENTS, NAMELY, DISPOSABLE PROPHY ANGLES; DENTAL INSTRUMENTS, NAMELY, REUSABLE AND RECYCLABLE PROPHY ANGLES; DENTAL INSTRUMENTS, NAMELY, DENTAL ROOT FILES USED IN ROOT CANAL THERAPY PROCEDURES; DENTAL INSTRUMENTS, NAMELY, ROOT CANAL THERAPY INSTRUMENTS USED TO SHAVE THE INSIDE OF A ROOT CANAL; DENTAL INSTRUMENTS, NAMELY, PROPHY ANGLES; DENTAL MIRRORS; DENTAL PICKS; DISPOSABLE HEADREST COVERS FOR MEDICAL AND DENTAL EXAMINATION CHAIRS; DRILLING JIGS FOR SURGICAL AND DENTAL APPLICATIONS; DRILLS FOR DENTAL APPLICATIONS; ENDODONTIC CONTAINER FOR HOLDING DENTAL DRILL, DENTAL BURRS AND DENTAL FILES; FORCEPS FOR DENTAL TECHNICAL PURPOSES; MILLING APPARATUS FOR DENTAL PURPOSES; PLASTIC MATERIAL FOR PRODUCING, RELINING AND REPAIR OF DENTAL PROSTHESES; PROSTHETIC INSTRUMENTS FOR DENTAL PURPOSES; SURGICAL APPARATUS AND INSTRUMENTS FOR MEDICAL, DENTAL OR VETERINARY USE; CONTAINERS ESPECIALLY ADAPTED FOR THE DISPOSAL OF MEDICAL INSTRUMENTS, SYRINGES AND OTHER CONTAMINATED MEDICAL WASTE; CONTAINERS ESPECIALLY ADAPTED FOR THE DISPOSAL OF MEDICAL INSTRUMENTS AND SYRINGES; DISPOSABLE SYRINGES; HYPODERMIC SYRINGES; INJECTION SYRINGES, SYRINGE BARRELS; MEDICAL SYRINGES; SYRINGES FOR MEDICAL PURPOSES AND FOR INJECTIONS; INJECTION INSTRUMENTS WITHOUT NEEDLES; INJECTION INSTRUMENTS WITH NEEDLES; INJECTION NEEDLES; INJECTION NEEDLES FOR MEDICAL USE; NEEDLES FOR INJECTIONS; NEEDLES FOR MEDICAL USE; NEEDLES FOR MEDICAL PURPOSES; NEEDLE-BASED AND NEEDLE-FREE INJECTION SYSTEMS; PROBES FOR MEDICAL PURPOSES; INTRAVENOUS FEEDING BOTTLES; INTRAVENOUS FEEDING TUBES, IN CLASS 10 (U.S. CLS. 26, 39 AND 44).



*David J. Kyjars*

Director of the United States Patent and Trademark Office

**Reg. No. 4,275,139** FIRST USE 4-18-2012; IN COMMERCE 4-18-2012.

THE MARK CONSISTS OF STANDARD CHARACTERS WITHOUT CLAIM TO ANY PARTICULAR FONT, STYLE, SIZE, OR COLOR.

SER. NO. 85-636,316, FILED 5-26-2012.

MICHAEL WIENER, EXAMINING ATTORNEY



# United States of America

United States Patent and Trademark Office

# RockStarLaw

**Reg. No. 4,275,140**

**Registered Jan. 15, 2013**

**Int. Cl.: 45**

**SERVICE MARK**

**PRINCIPAL REGISTER**

KOSTIW, VINCENT J. (UNITED STATES INDIVIDUAL)  
#275  
2375 E. TROPICANA AVE.  
LAS VEGAS, NV 89119

FOR: LEGAL SERVICES, IN CLASS 45 (U.S. CLS. 100 AND 101).

FIRST USE 8-14-2000; IN COMMERCE 2-25-2004.

THE MARK CONSISTS OF STANDARD CHARACTERS WITHOUT CLAIM TO ANY PARTICULAR FONT, STYLE, SIZE, OR COLOR.

SER. NO. 85-636,324, FILED 5-26-2012.

SUZANNE BLANE, EXAMINING ATTORNEY



*David J. Kybas*

Director of the United States Patent and Trademark Office

# United States of America

United States Patent and Trademark Office

## Realities of Life

**Reg. No. 4,275,141**

OLIVER, WANDA MUIR (UNITED STATES INDIVIDUAL)  
P.O. BOX 1596

**Registered Jan. 15, 2013**

ELLCOTT CITY, MD 21041

**Int. Cl.: 25**

FOR: CLOTHING, NAMELY SHIRTS, IN CLASS 25 (U.S. CLS. 22 AND 39).

**TRADEMARK**

FIRST USE 5-25-2012; IN COMMERCE 5-25-2012.

**PRINCIPAL REGISTER**

THE MARK CONSISTS OF STANDARD CHARACTERS WITHOUT CLAIM TO ANY PARTICULAR FONT, STYLE, SIZE, OR COLOR.

SER. NO. 85-636,336, FILED 5-26-2012.

MARGARET POWER, EXAMINING ATTORNEY



*David J. Kybas*

Director of the United States Patent and Trademark Office

United States of America  
United States Patent and Trademark Office

# KILNSCOUT

**Reg. No. 4,275,142**

**Registered Jan. 15, 2013**

**Int. Cl.: 9**

**TRADEMARK**

**PRINCIPAL REGISTER**

SCS FOREST PRODUCTS INC (DELAWARE CORPORATION)  
#5F  
1500 WEST HAMPDEN AVENUE  
SHERIDAN, CO 80110

FOR: COMPUTER SOFTWARE AND HARDWARE FOR WIRELESS MOISTURE MEASUREMENT SYSTEMS; ELECTRIC OR ELECTRONIC SENSORS FOR WIRELESS MOISTURE MEASUREMENT, IN CLASS 9 (U.S. CLS. 21, 23, 26, 36 AND 38).

FIRST USE 5-3-2012; IN COMMERCE 5-3-2012.

THE MARK CONSISTS OF STANDARD CHARACTERS WITHOUT CLAIM TO ANY PARTICULAR FONT, STYLE, SIZE, OR COLOR.

SER. NO. 85-636,346, FILED 5-26-2012.

ROBIN CHOSID, EXAMINING ATTORNEY



*David J. Kybas*

Director of the United States Patent and Trademark Office

# United States of America

United States Patent and Trademark Office

# cleanbeams

**Reg. No. 4,275,143**

**Registered Jan. 15, 2013**

**Int. Cl.: 37**

**SERVICE MARK**

**PRINCIPAL REGISTER**

CLEANBEAMS LLC (NEW JERSEY LIMITED LIABILITY COMPANY)  
85 UPPER SADDLE RIVER RD.  
MONTVALE, NJ 07645

FOR: AUTOMOBILE RECONDITIONING SERVICES; AUTOMOBILE REPAIR AND MAINTENANCE; AUTOMOTIVE MAINTENANCE AND REPAIR, IN CLASS 37 (U.S. CLS. 100, 103 AND 106).

FIRST USE 4-28-2011; IN COMMERCE 10-29-2011.

THE MARK CONSISTS OF STANDARD CHARACTERS WITHOUT CLAIM TO ANY PARTICULAR FONT, STYLE, SIZE, OR COLOR.

SER. NO. 85-636,379, FILED 5-26-2012.

HEATHER THOMPSON, EXAMINING ATTORNEY



*David J. Kyffers*

Director of the United States Patent and Trademark Office

# United States of America

United States Patent and Trademark Office

# Gamelines

**Reg. No. 4,275,144**

**Registered Jan. 15, 2013**

**Int. Cl.: 9**

**TRADEMARK**

**PRINCIPAL REGISTER**

MICHAEL BENDER (UNITED STATES INDIVIDUAL)  
PO BOX 1861  
BETHEL ISLAND, CA 94511

FOR: COMPUTER APPLICATION SOFTWARE FOR NETWORK COMPUTERS, NAMELY, SOFTWARE FOR REPORTING THE RESULTS OF SPORTING EVENTS, IN CLASS 9 (U.S. CLS. 21, 23, 26, 36 AND 38).

FIRST USE 11-10-2010; IN COMMERCE 7-1-2011.

THE MARK CONSISTS OF STANDARD CHARACTERS WITHOUT CLAIM TO ANY PARTICULAR FONT, STYLE, SIZE, OR COLOR.

SER. NO. 85-636,381, FILED 5-26-2012.

HEATHER THOMPSON, EXAMINING ATTORNEY



*David J. Kyffers*

Director of the United States Patent and Trademark Office

# United States of America

United States Patent and Trademark Office

# EyeCalz

**Reg. No. 4,275,145**

**Registered Jan. 15, 2013**

**Int. Cl.: 16**

**TRADEMARK**

**PRINCIPAL REGISTER**

KRE8IVE KHAOS ENTERPRISES LLC (HAWAII LIMITED LIABILITY COMPANY), DBA  
K8K  
90 LAUMAKANI LP  
KIHEI, HI 96753

FOR: DECALS; STICKERS, IN CLASS 16 (U.S. CLS. 2, 5, 22, 23, 29, 37, 38 AND 50).

FIRST USE 5-10-2012; IN COMMERCE 5-22-2012.

THE MARK CONSISTS OF STANDARD CHARACTERS WITHOUT CLAIM TO ANY PARTICULAR FONT, STYLE, SIZE, OR COLOR.

SER. NO. 85-636,390, FILED 5-26-2012.

DORITT L. CARROLL, EXAMINING ATTORNEY



*David J. Kyffers*

Director of the United States Patent and Trademark Office

# United States of America

United States Patent and Trademark Office

# NEOiD

**Reg. No. 4,275,146**

**Registered Jan. 15, 2013**

**Int. Cl.: 9**

**TRADEMARK**

**PRINCIPAL REGISTER**

YUBICO INC (DELAWARE CORPORATION)  
228 HAMILTON AVENUE, 3RD FLOOR  
PALO ALTO, CA 94301

FOR: ENCODED ELECTRONIC CHIP CARDS CONTAINING PROGRAMMING USED TO GENERATE THE USER'S UNIQUE IDENTITY AND A ONETIME OR STATIC PASS CODE; ENCODED INTEGRATED CIRCUIT CARDS CONTAINING PROGRAMMING USED TO GENERATING THE USER'S UNIQUE IDENTITY AND A ONETIME OR STATIC PASS CODE; ENCODED SMART CARDS CONTAINING PROGRAMMING USED FOR GENERATING THE USER'S UNIQUE IDENTITY AND A ONETIME OR STATIC PASS CODE; ENCODED SMART CARDS CONTAINING PROGRAMMING USED TO GENERATE THE USER'S UNIQUE IDENTITY AND A ONETIME OR STATIC PASS CODE, IN CLASS 9 (U.S. CLS. 21, 23, 26, 36 AND 38).

FIRST USE 5-25-2012; IN COMMERCE 5-25-2012.

THE MARK CONSISTS OF STANDARD CHARACTERS WITHOUT CLAIM TO ANY PARTICULAR FONT, STYLE, SIZE, OR COLOR.

SER. NO. 85-636,403, FILED 5-26-2012.

STEVEN PEREZ, EXAMINING ATTORNEY



*David J. Kyros*

Director of the United States Patent and Trademark Office

# United States of America

United States Patent and Trademark Office

# Hydran-X

**Reg. No. 4,275,147**

**Registered Jan. 15, 2013**

**Int. Cl.: 3**

**TRADEMARK**

**PRINCIPAL REGISTER**

COLOR CHROME TECHNOLOGIES, INC. (FLORIDA CORPORATION), DBA WOW  
INNOVATIONS  
2345 SW 34TH STREET  
FORT LAUDERDALE, FL 33312

FOR: CHEMICAL CLEANERS DIRECTED TO THE SHIPPING AND MARINE INDUSTRIES,  
CONSTRUCTION AND BUILDING MAINTENANCE, POWER GENERATION, TEXTILE,  
CONSUMER PRODUCTS, AUTOMOTIVE INDUSTRIES, IN CLASS 3 (U.S. CLS. 1, 4, 6, 50,  
51 AND 52).

FIRST USE 1-15-2007; IN COMMERCE 1-15-2007.

THE MARK CONSISTS OF STANDARD CHARACTERS WITHOUT CLAIM TO ANY PAR-  
TICULAR FONT, STYLE, SIZE, OR COLOR.

SER. NO. 85-636,428, FILED 5-27-2012.

JOHN DWYER, EXAMINING ATTORNEY



*David J. Kyffers*

Director of the United States Patent and Trademark Office



# United States of America

United States Patent and Trademark Office

## Bella Skin Perfection Formula

**Reg. No. 4,275,148**

**Registered Jan. 15, 2013**

**Int. Cl.: 3**

**TRADEMARK**

**PRINCIPAL REGISTER**

BELLA SOAP COMPANY, INC. (CALIFORNIA CORPORATION)  
3769 DEL MAR AVENUE  
LOOMIS, CA 95650

FOR: BODY LOTION, IN CLASS 3 (U.S. CLS. 1, 4, 6, 50, 51 AND 52).

FIRST USE 12-20-2011; IN COMMERCE 1-24-2012.

THE MARK CONSISTS OF STANDARD CHARACTERS WITHOUT CLAIM TO ANY PARTICULAR FONT, STYLE, SIZE, OR COLOR.

OWNER OF U.S. REG. NOS. 3,829,550, 4,014,033, AND 4,020,696.

NO CLAIM IS MADE TO THE EXCLUSIVE RIGHT TO USE "SKIN PERFECTION FORMULA", APART FROM THE MARK AS SHOWN.

THE ENGLISH TRANSLATION OF BELLA IN THE MARK IS BEAUTIFUL.

SER. NO. 85-636,432, FILED 5-27-2012.

JOHN DWYER, EXAMINING ATTORNEY



*David J. Kyffers*

Director of the United States Patent and Trademark Office

# United States of America

United States Patent and Trademark Office

# OWS

**Reg. No. 4,275,149**

OAKTON WINE SHOP, LLC (VIRGINIA LIMITED LIABILITY COMPANY)  
2952A CHAIN BRIDGE ROAD  
OAKTON, VA 22124

**Registered Jan. 15, 2013**

**Int. Cl.: 35**

FOR: RETAIL STORE SERVICES FEATURING CHEESE, WINE, BEER, BREADS, AND OLIVE OIL, IN CLASS 35 (U.S. CLS. 100, 101 AND 102).

**SERVICE MARK**

FIRST USE 10-1-2011; IN COMMERCE 10-1-2011.

**PRINCIPAL REGISTER**

THE MARK CONSISTS OF STANDARD CHARACTERS WITHOUT CLAIM TO ANY PARTICULAR FONT, STYLE, SIZE, OR COLOR.

SER. NO. 85-636,434, FILED 5-27-2012.

MARY ROSSMAN, EXAMINING ATTORNEY



*David J. Kybas*

Director of the United States Patent and Trademark Office

# United States of America

United States Patent and Trademark Office

## REEL RELATIONS

**Reg. No. 4,275,150**

JEROME GLASSER (UNITED STATES INDIVIDUAL)  
2308 MT. VERNON AVENUE, 240  
ALEXANDRIA, VA 22301

**Registered Jan. 15, 2013**

**Int. Cl.: 28**

FOR: PLAYING CARDS AND CARD GAMES, IN CLASS 28 (U.S. CLS. 22, 23, 38 AND 50).

**TRADEMARK**

FIRST USE 10-27-1998; IN COMMERCE 6-26-1999.

**PRINCIPAL REGISTER**

THE MARK CONSISTS OF STANDARD CHARACTERS WITHOUT CLAIM TO ANY PARTICULAR FONT, STYLE, SIZE, OR COLOR.

SER. NO. 85-636,436, FILED 5-27-2012.

MARY ROSSMAN, EXAMINING ATTORNEY



*David J. Kyffers*

Director of the United States Patent and Trademark Office

# United States of America

United States Patent and Trademark Office

# Zero Trace

**Reg. No. 4,275,151**

**Registered Jan. 15, 2013**

**Int. Cl.: 11**

**TRADEMARK**

**PRINCIPAL REGISTER**

ZERO TRACE LLC (WYOMING LIMITED LIABILITY COMPANY)  
LEGAL  
2501 W. HAMPTON AVE.  
MILWAUKEE, WI 53209

FOR: OZONE GENERATORS THAT KILL MOLD AND MILDEW, IN CLASS 11 (U.S. CLS. 13, 21, 23, 31 AND 34).

FIRST USE 9-30-2010; IN COMMERCE 7-5-2011.

THE MARK CONSISTS OF STANDARD CHARACTERS WITHOUT CLAIM TO ANY PARTICULAR FONT, STYLE, SIZE, OR COLOR.

SER. NO. 85-636,437, FILED 5-27-2012.

MARY ROSSMAN, EXAMINING ATTORNEY



*David J. Kybas*

Director of the United States Patent and Trademark Office

# United States of America

United States Patent and Trademark Office

# Baitanator

**Reg. No. 4,275,152**

BAITANATOR, INC (TEXAS CORPORATION)  
2007 SEMINOLE ROAD  
LUBBOCK, TX 79331

**Registered Jan. 15, 2013**

**Int. Cl.: 28**

FOR: ARTIFICIAL FISHING BAIT; FISH HOOKS; FISHING BAIT HOLDER, IN CLASS 28 (U.S. CLS. 22, 23, 38 AND 50).

**TRADEMARK**

FIRST USE 5-1-2012; IN COMMERCE 5-1-2012.

**PRINCIPAL REGISTER**

THE MARK CONSISTS OF STANDARD CHARACTERS WITHOUT CLAIM TO ANY PARTICULAR FONT, STYLE, SIZE, OR COLOR.

SER. NO. 85-636,438, FILED 5-27-2012.

MARY ROSSMAN, EXAMINING ATTORNEY



*David J. Kyros*

Director of the United States Patent and Trademark Office

# United States of America

United States Patent and Trademark Office



**Reg. No. 4,275,153**

**Registered Jan. 15, 2013**

**Int. Cl.: 35**

**SERVICE MARK**

**PRINCIPAL REGISTER**

FIREMATTER LLC (CALIFORNIA LIMITED LIABILITY COMPANY)  
UNIT 203  
200 2ND STREET  
OAKLAND, CA 94607

FOR: BUSINESS MARKETING SERVICES, IN CLASS 35 (U.S. CLS. 100, 101 AND 102).

FIRST USE 9-3-2010; IN COMMERCE 3-10-2012.

THE MARK CONSISTS OF A SPHERE SURROUNDED BY THREE CONCENTRIC RINGS NEXT TO THE WORDING "FIREMATTER".

SER. NO. 85-636,455, FILED 5-27-2012.

MARY ROSSMAN, EXAMINING ATTORNEY



*David J. Kyjars*

Director of the United States Patent and Trademark Office

# United States of America

United States Patent and Trademark Office

## SOMEDAY IS NOW

**Reg. No. 4,275,154**

INFINITE SAFARI ADVENTURES, LLC (CALIFORNIA LIMITED LIABILITY COMPANY)  
11271 VENTURA BLVD., #127  
STUDIO CITY, CA 91604

**Registered Jan. 15, 2013**

**Int. Cl.: 39**

FOR: TOUR OPERATING AND ORGANISING, IN CLASS 39 (U.S. CLS. 100 AND 105).

**SERVICE MARK**

FIRST USE 11-15-2011; IN COMMERCE 11-15-2011.

**PRINCIPAL REGISTER**

THE MARK CONSISTS OF STANDARD CHARACTERS WITHOUT CLAIM TO ANY PARTICULAR FONT, STYLE, SIZE, OR COLOR.

SER. NO. 85-636,456, FILED 5-27-2012.

MARY ROSSMAN, EXAMINING ATTORNEY



*David J. Kyffers*

Director of the United States Patent and Trademark Office

# United States of America

United States Patent and Trademark Office

# Hungry Brains!

**Reg. No. 4,275,155**

TUCKER, DEVIN F. (UNITED STATES INDIVIDUAL)  
8409 WOODLAND MANOR DRIVE  
LAUREL, MD 20724

**Registered Jan. 15, 2013**

**Int. Cl.: 41**

FOR: CHILDREN'S EDUCATIONAL SERVICES, NAMELY, PROVIDING ACADEMIC PERFORMANCE EVALUATION, GUIDANCE AND MONITORING FOR CHILDREN PRE-KINDERGARTEN THROUGH GRADE 12 VIA THE INTERNET; CONDUCTING AFTER SCHOOL TUTORING PROGRAMS; EDUCATION SERVICES, NAMELY, PROVIDING HANDS-ON OPPORTUNITIES FOR CHILDREN IN THE FIELD OF INTUITIVE ENGINEERING THROUGH LIVE, BROADCAST, AND ON-LINE CLASSES, SEMINARS, WORKSHOPS, TRAINING AND CURRICULUM DEVELOPMENT FOR CHILDREN, PARENTS AND EDUCATORS; EDUCATION SERVICES, NAMELY, PROVIDING TUTORING IN THE FIELD OF SCIENCE, TECHNOLOGY, ENGINEERING, ENGLISH, AND MATH, IN CLASS 41 (U.S. CLS. 100, 101 AND 107).

**SERVICE MARK**

**PRINCIPAL REGISTER**

FIRST USE 9-1-2011; IN COMMERCE 2-1-2012.

THE MARK CONSISTS OF STANDARD CHARACTERS WITHOUT CLAIM TO ANY PARTICULAR FONT, STYLE, SIZE, OR COLOR.

SER. NO. 85-636,479, FILED 5-27-2012.

ROBIN CHOSID, EXAMINING ATTORNEY



*David J. Kyffers*

Director of the United States Patent and Trademark Office



# United States of America

United States Patent and Trademark Office

## Aortic Surgery Center of Excellence

**Reg. No. 4,275,156**

**Registered Jan. 15, 2013**

**Int. Cl.: 41**

**SERVICE MARK**

**PRINCIPAL REGISTER**

ACCREDITATION COUNCIL FOR SURGICAL QUALITY (WASHINGTON CORPORATION)  
250 MAIN STREET  
CAMBRIDGE, MA 021429998

FOR: PROVIDING RECOGNITION AND INCENTIVES BY THE WAY OF AWARDS TO  
DEMONSTRATE EXCELLENCE IN THE FIELD OF AORTIC SURGERY, IN CLASS 41 (U.S.  
CLS. 100, 101 AND 107).

FIRST USE 2-5-2010; IN COMMERCE 4-20-2010.

THE MARK CONSISTS OF STANDARD CHARACTERS WITHOUT CLAIM TO ANY PAR-  
TICULAR FONT, STYLE, SIZE, OR COLOR.

NO CLAIM IS MADE TO THE EXCLUSIVE RIGHT TO USE "AORTIC SURGERY CENTER",  
APART FROM THE MARK AS SHOWN.

SER. NO. 85-636,487, FILED 5-27-2012.

PAULA MAHONEY, EXAMINING ATTORNEY



*David J. Kyffers*

Director of the United States Patent and Trademark Office

# United States of America

United States Patent and Trademark Office

## Vascular Surgery Center of Excellence

**Reg. No. 4,275,157**

**Registered Jan. 15, 2013**

**Int. Cl.: 41**

**SERVICE MARK**

**PRINCIPAL REGISTER**

ACCREDITATION COUNCIL FOR SURGICAL QUALITY (WASHINGTON CORPORATION)  
250 MAIN STREET  
CAMBRIDGE, MA 021429998

FOR: PROVIDING RECOGNITION AND INCENTIVES BY THE WAY OF AWARDS TO  
DEMONSTRATE EXCELLENCE IN THE FIELD OF VASCULAR SURGERY, IN CLASS 41  
(U.S. CLS. 100, 101 AND 107).

FIRST USE 2-5-2010; IN COMMERCE 4-20-2010.

THE MARK CONSISTS OF STANDARD CHARACTERS WITHOUT CLAIM TO ANY PAR-  
TICULAR FONT, STYLE, SIZE, OR COLOR.

NO CLAIM IS MADE TO THE EXCLUSIVE RIGHT TO USE "VASCULAR SURGERY CEN-  
TER", APART FROM THE MARK AS SHOWN.

SER. NO. 85-636,491, FILED 5-27-2012.

PAULA MAHONEY, EXAMINING ATTORNEY



*David J. Kybas*

Director of the United States Patent and Trademark Office

United States of America  
United States Patent and Trademark Office

1 fatgirlthin

**Reg. No. 4,275,158**

PATTERSON, NAN H. (UNITED STATES INDIVIDUAL)  
307 WEATHERFORD CT.  
LAKE BLUFF, IL 60044

**Registered Jan. 15, 2013**

**Int. Cl.: 44**

FOR: PROVIDING A WEBSITE FEATURING INFORMATION AND ADVICE IN THE FIELDS OF DIET, WEIGHT LOSS, DIET PLANNING AND LIFESTYLE WELLNESS, IN CLASS 44 (U.S. CLS. 100 AND 101).

**SERVICE MARK**

FIRST USE 1-2-2012; IN COMMERCE 1-19-2012.

**PRINCIPAL REGISTER**

THE MARK CONSISTS OF STANDARD CHARACTERS WITHOUT CLAIM TO ANY PARTICULAR FONT, STYLE, SIZE, OR COLOR.

SER. NO. 85-636,494, FILED 5-27-2012.

CYNTHIA TRIPI, EXAMINING ATTORNEY



*David J. Kyfos*

Director of the United States Patent and Trademark Office

# United States of America

United States Patent and Trademark Office

## TEMPLAR LEGION

**Reg. No. 4,275,159**

TEMPLAR LEGION LLC (TEXAS LIMITED LIABILITY COMPANY)

**Registered Jan. 15, 2013**

538 W 21ST ST. #53988  
HOUSTON, TX 770083642

**Int. Cl.: 41**

FOR: EDUCATION SERVICES, NAMELY, PROVIDING ON-LINE INFORMATION AND COURSES IN THE FIELD OF BUSINESS LAW, IN CLASS 41 (U.S. CLS. 100, 101 AND 107).

**SERVICE MARK**

FIRST USE 5-24-2012; IN COMMERCE 5-24-2012.

**PRINCIPAL REGISTER**

THE MARK CONSISTS OF STANDARD CHARACTERS WITHOUT CLAIM TO ANY PARTICULAR FONT, STYLE, SIZE, OR COLOR.

SER. NO. 85-636,500, FILED 5-27-2012.

ARETHA SOMERVILLE, EXAMINING ATTORNEY



*David J. Kyffers*

Director of the United States Patent and Trademark Office

# United States of America

United States Patent and Trademark Office

## Challenge Your Beliefs!

**Reg. No. 4,275,160**

RIVERA, ANAMARIA (UNITED STATES INDIVIDUAL)  
18622 SW 49TH ST  
MIRAMAR, FL 33029

**Registered Jan. 15, 2013**

**Int. Cl.: 45**

FOR: PERSONAL GROWTH AND MOTIVATION CONSULTING SERVICES; PROVIDING A WEB SITE FEATURING INFORMATION AND CONTENT IN THE FIELDS OF PERSONAL RELATIONSHIPS, PERSONAL GROWTH AND MOTIVATION, AND SELF-FULFILLMENT, IN CLASS 45 (U.S. CLS. 100 AND 101).

**SERVICE MARK**

**PRINCIPAL REGISTER**

FIRST USE 5-25-2012; IN COMMERCE 5-25-2012.

THE MARK CONSISTS OF STANDARD CHARACTERS WITHOUT CLAIM TO ANY PARTICULAR FONT, STYLE, SIZE, OR COLOR.

SER. NO. 85-636,506, FILED 5-27-2012.

KEVIN CORWIN, EXAMINING ATTORNEY



*David J. Kyffers*

Director of the United States Patent and Trademark Office

# United States of America

United States Patent and Trademark Office

## KICK THE BUDDY

**Reg. No. 4,275,161**

**Registered Jan. 15, 2013**

**Int. Cls.: 9 and 41**

**TRADEMARK**

**SERVICE MARK**

**PRINCIPAL REGISTER**

SHELENGOVSKIY DMITRIY (BELARUS INDIVIDUAL)  
48 PRITYTSKOGO STR., APT. 47  
MINSK, BELARUS

FOR: COMPUTER GAME CARTRIDGES; COMPUTER GAME CARTRIDGES AND DISCS; COMPUTER GAME CASSETTES; COMPUTER GAME DISCS; COMPUTER GAME EQUIPMENT, NAMELY, DISCS; COMPUTER GAME PROGRAMS DOWNLOADABLE VIA THE INTERNET; COMPUTER GAME PROGRAMS; COMPUTER GAME SOFTWARE; COMPUTER GAME SOFTWARE DOWNLOADABLE FROM A GLOBAL COMPUTER NETWORK; COMPUTER GAME SOFTWARE FOCUSING ON ACHIEVING A SET OF GOALS, POSITIONS, OWNERSHIP, AND CREDENTIALS, AND PROFESSIONAL AND SOCIAL STATUS, AND GOOD FORTUNE NECESSARY TO SUCCEED PROFESSIONALLY AND PERSONALLY, AND NOT REFERRING EITHER TO A GROUP OF SOFTWARE FOR USE IN COMMERCE OR TO A GROUP OF OFFICES; COMPUTER GAME SOFTWARE FOR GAMING MACHINES INCLUDING SLOT MACHINES OR VIDEO LOTTERY TERMINALS; COMPUTER GAME SOFTWARE FOR PERSONAL COMPUTERS AND HOME VIDEO GAME CONSOLES; COMPUTER GAME SOFTWARE FOR USE ON MOBILE AND CELLULAR PHONES; COMPUTER GAME SOFTWARE FOR USE WITH PERSONAL COMPUTERS, HOME VIDEO GAME CONSOLES USED WITH TELEVISIONS AND ARCADE-BASED VIDEO GAME CONSOLES; COMPUTER GAME TAPES; COMPUTER PROGRAMS FOR PRE-RECORDED GAMES; COMPUTER PROGRAMS FOR VIDEO AND COMPUTER GAMES; COMPUTER SOFTWARE AND FIRMWARE FOR GAMES OF CHANCE ON ANY COMPUTERIZED PLATFORM, INCLUDING DEDICATED GAMING CONSOLES, VIDEO BASED SLOT MACHINES, REEL BASED SLOT MACHINES, AND VIDEO LOTTERY TERMINALS; COMPUTER SOFTWARE, NAMELY, GAME ENGINE SOFTWARE FOR VIDEO GAME DEVELOPMENT AND OPERATION; DOWNLOADABLE COMPUTER GAME PROGRAMS; DOWNLOADABLE COMPUTER GAME SOFTWARE VIA A GLOBAL COMPUTER NETWORK AND WIRELESS DEVICES; DOWNLOADABLE COMPUTER PROGRAMS FEATURING POSITIONABLE GAME PIECE FIGURES FOR USE IN THE FIELD OF COMPUTER GAMES; HIGH PERFORMANCE COMPUTER HARDWARE WITH SPECIALIZED FEATURES FOR ENHANCED GAME PLAYING ABILITY; INTERACTIVE MULTIMEDIA COMPUTER GAME PROGRAM; RECORDED COMPUTER GAME PROGRAMS; VIDEO AND COMPUTER GAME PROGRAMS, IN CLASS 9 (U.S. CLS. 21, 23, 26, 36 AND 38).



*David J. Kyjars*

FIRST USE 1-11-2011; IN COMMERCE 1-11-2011.

**Reg. No. 4,275,161** FOR: ENTERTAINMENT SERVICES, NAMELY, PROVIDING AN ON-LINE COMPUTER GAME; ENTERTAINMENT SERVICES, NAMELY, PROVIDING ON-LINE COMPUTER GAMES; ENTERTAINMENT SERVICES, NAMELY, PROVIDING ON-LINE REVIEWS OF MOVIES, BOOKS, MUSIC, COMPUTER GAMES; ENTERTAINMENT SERVICES, NAMELY, PROVIDING ONLINE COMPUTER GAMES THAT HELP MAINTAIN AN ACTIVE BRAIN AND THUS IMPROVE MEMORY, SPEED OF PROCESSING, AND THAT PROVIDE A VARIETY OF COGNITIVE BENEFITS THAT POSITIVELY IMPACT QUALITY OF LIFE; ENTERTAINMENT SERVICES, NAMELY, PROVIDING TEMPORARY USE OF NON-DOWNLOADABLE COMPUTER GAMES; ENTERTAINMENT SERVICES, NAMELY, PROVIDING TEMPORARY USE OF NON-DOWNLOADABLE COMPUTER LEARNING GAMES; PRODUCTION OF VIDEO AND COMPUTER GAME SOFTWARE; PROVIDING A COMPUTER GAME FOR USE NETWORK-WIDE BY NETWORK USERS; PROVIDING INFORMATION ON-LINE RELATING TO COMPUTER GAMES AND COMPUTER ENHANCEMENTS FOR GAMES; PROVISION OF INFORMATION RELATING TO ELECTRONIC COMPUTER GAMES PROVIDED VIA THE INTERNET; RENTAL OF COMPUTER GAME PROGRAMS; RENTAL OF COMPUTER GAME SOFTWARE, IN CLASS 41 (U.S. CLS. 100, 101 AND 107).

FIRST USE 1-11-2011; IN COMMERCE 1-11-2011.

THE MARK CONSISTS OF STANDARD CHARACTERS WITHOUT CLAIM TO ANY PARTICULAR FONT, STYLE, SIZE, OR COLOR.

SER. NO. 85-636,538, FILED 5-28-2012.

CAROLINE WOOD, EXAMINING ATTORNEY

# United States of America

United States Patent and Trademark Office

# Osube

**Reg. No. 4,275,162**

**Registered Jan. 15, 2013**

**Int. Cls.: 38 and 45**

**SERVICE MARK**

**PRINCIPAL REGISTER**

OSUBE LIMITED (HONG KONG LIMITED LIABILITY COMPANY), DBA  
WWW.CONCEPTUOUS.COM  
2410 FORTIS BANK TOWER  
WANCHAI, HONG KONG

FOR: STREAMING OF VIDEO MATERIAL ON THE INTERNET, IN CLASS 38 (U.S. CLS. 100, 101 AND 104).

FIRST USE 11-7-2011; IN COMMERCE 1-12-2012.

FOR: INTERNET-BASED SOCIAL NETWORKING SERVICES, IN CLASS 45 (U.S. CLS. 100 AND 101).

FIRST USE 11-7-2011; IN COMMERCE 1-12-2012.

THE MARK CONSISTS OF STANDARD CHARACTERS WITHOUT CLAIM TO ANY PARTICULAR FONT, STYLE, SIZE, OR COLOR.

SER. NO. 85-636,539, FILED 5-28-2012.

CAROLINE WOOD, EXAMINING ATTORNEY



*David J. Kyros*

Director of the United States Patent and Trademark Office



# United States of America

United States Patent and Trademark Office

# Fathom

**Reg. No. 4,275,163**

**Registered Jan. 15, 2013**

**Int. Cl.: 35**

**SERVICE MARK**

**PRINCIPAL REGISTER**

FATHOM SEO, LLC (OHIO LIMITED LIABILITY COMPANY), DBA FATHOM  
SUITE 100  
8200 SWEET VALLEY DRIVE  
VALLEY VIEW, OH 44125

FOR: BUSINESS MANAGEMENT CONSULTING WITH RELATION TO STRATEGY, MARKETING, SALES, OPERATION, PRODUCT DESIGN PARTICULARLY SPECIALIZING IN THE USE OF ANALYTIC AND STATISTIC MODELS FOR THE UNDERSTANDING AND PREDICTING OF CONSUMERS, BUSINESSES, AND MARKET TRENDS AND ACTIONS; BUSINESS MARKETING CONSULTING SERVICES; CONSULTING SERVICES IN THE FIELD OF INTERNET MARKETING; MARKET RESEARCH CONSULTATION; MARKETING CONSULTING; PLANNING, DESIGN, DEVELOPMENT, MAINTENANCE, TRACKING AND REPORTING OF ONLINE MARKETING ACTIVITIES FOR THIRD PARTIES; PROMOTING THE GOODS AND SERVICES OF OTHERS THROUGH SEARCH ENGINE REFERRAL TRAFFIC ANALYSIS AND REPORTING; PROMOTION AND MARKETING SERVICES AND RELATED CONSULTING; PROVIDING ADVERTISING, MARKETING AND PROMOTIONAL SERVICES, NAMELY, DEVELOPMENT OF ADVERTISING CAMPAIGNS FOR TELEVISION, PRINT MEDIA, WEB PAGES, RADIO BROADCASTS, NEWSPAPERS, MAGAZINES AND/OR ONLINE BANNERS; PROVIDING ONLINE BUSINESS MANAGEMENT SERVICES INCLUDING ACCOUNTING, MARKETING, BUSINESS PROJECT MANAGEMENT, AND BUSINESS DEVELOPMENT, IN CLASS 35 (U.S. CLS. 100, 101 AND 102).

FIRST USE 7-7-2003; IN COMMERCE 7-7-2003.

THE MARK CONSISTS OF STANDARD CHARACTERS WITHOUT CLAIM TO ANY PARTICULAR FONT, STYLE, SIZE, OR COLOR.

OWNER OF U.S. REG. NOS. 4,133,559 AND 4,133,560.

SER. NO. 85-636,553, FILED 5-28-2012.

CAROLINE WOOD, EXAMINING ATTORNEY



*David J. Kyjars*

Director of the United States Patent and Trademark Office

# United States of America

United States Patent and Trademark Office

## KEEPSNAPPIN

**Reg. No. 4,275,164**

**Registered Jan. 15, 2013**

**Int. Cl.: 25**

**TRADEMARK**

**PRINCIPAL REGISTER**

MATTHEW KENT WOHLGEMUTH (UNITED STATES INDIVIDUAL)  
1007 SANTA FE STREET  
ATCHISON, KS 66002

FOR: BASEBALL CAPS AND HATS; GYM PANTS; GYM SHORTS; HATS; HOODED PULLOVERS; HOODED SWEATSHIRTS; JACKETS; PANTS; SHIRTS; SHIRTS AND SHORT-SLEEVED SHIRTS; SHORTS; SWEAT PANTS; SWEAT SHIRTS; T-SHIRTS; TEE SHIRTS; WEARABLE GARMENTS AND CLOTHING, NAMELY, SHIRTS, IN CLASS 25 (U.S. CLS. 22 AND 39).

FIRST USE 10-1-2011; IN COMMERCE 10-1-2011.

THE MARK CONSISTS OF STANDARD CHARACTERS WITHOUT CLAIM TO ANY PARTICULAR FONT, STYLE, SIZE, OR COLOR.

SER. NO. 85-636,563, FILED 5-28-2012.

KATHERINE M. DUBRAY, EXAMINING ATTORNEY



*David J. Kyffers*

Director of the United States Patent and Trademark Office

# United States of America

United States Patent and Trademark Office

## EVENTECTIVE

**Reg. No. 4,275,165**

**Registered Jan. 15, 2013**

**Int. Cl.: 35**

**SERVICE MARK**

**PRINCIPAL REGISTER**

EVENTECTIVE, INC. (DELAWARE CORPORATION)  
480 CONGRESS STREET  
PORTLAND, ME 04101

FOR: PROVIDING BUSINESS MANAGEMENT, CONSULTATION AND INFORMATION FOR FACILITATING COMMERCIAL BUSINESS TRANSACTIONS OF OTHERS, NAMELY, REQUESTS FOR PROPOSAL FOR THE PURCHASE AND SELLING OF GOODS AND SERVICES AND INFORMATION ABOUT VENDOR AVAILABILITY FOR PLANNING, MANAGING AND CONDUCTING PUBLIC AND PRIVATE MEETINGS, FUNCTIONS, CONFERENCES, EXHIBITIONS, CONVENTIONS, TRADE SHOWS, AND EVENTS; ON-LINE BUSINESS CONSULTATION SERVICES IN THE FIELDS OF EVENT PLANNING, MEETING CONSOLIDATION AND PLANNING, AND VENDOR AVAILABILITY; ADVERTISING THE GOODS AND SERVICES OF OTHERS AND PROVIDING INFORMATION ABOUT VENDOR AVAILABILITY VIA A WEBSITE ON THE INTERNET; ON-LINE BUSINESS DIRECTORIES FEATURING BUSINESSES WHICH PROVIDE FACILITIES FOR PUBLIC AND PRIVATE MEETINGS, FUNCTIONS, CONFERENCES, EXHIBITIONS, CONVENTIONS, TRADE SHOWS, EVENTS AND INFORMATION ABOUT VENDOR AVAILABILITY; PROVIDING ONLINE DIRECTORY INFORMATION SERVICES FEATURING HYPERLINKS TO OTHER WEBSITES; PROVIDING DEMAND CREATION AND LEAD GENERATION ACTIVITIES AND SERVICES, NAMELY, PAY PER LEAD AND LEAD GENERATION FOR OTHERS; PAY PER CLICK ADVERTISING MANAGEMENT SERVICES FOR OTHERS; ON-LINE ADVERTISING AND VIDEO MARKETING SERVICES BY WAY OF PROVIDING MARKETING INFORMATION VIA WEBSITES ON A GLOBAL COMPUTER NETWORK FOR OTHERS, IN CLASS 35 (U.S. CLS. 100, 101 AND 102).



FIRST USE 12-9-2003; IN COMMERCE 8-12-2004.

THE MARK CONSISTS OF STANDARD CHARACTERS WITHOUT CLAIM TO ANY PARTICULAR FONT, STYLE, SIZE, OR COLOR.

OWNER OF U.S. REG. NO. 3,018,674.

SER. NO. 85-636,569, FILED 5-28-2012.

TINA BROWN, EXAMINING ATTORNEY

*David J. Kyros*

Director of the United States Patent and Trademark Office

# United States of America

United States Patent and Trademark Office

## BOLD ARRAY

**Reg. No. 4,275,166**

BOLD ARRAY, LLC (CALIFORNIA LIMITED LIABILITY COMPANY)  
25216 AVENIDA PACIFICA  
LAKE FOREST, CA 92630

**Registered Jan. 15, 2013**

**Int. Cls.: 35 and 42**

FOR: BRANDING SERVICES, NAMELY, CONSULTING, DEVELOPMENT, MANAGEMENT AND MARKETING OF BRANDS FOR BUSINESSES, IN CLASS 35 (U.S. CLS. 100, 101 AND 102).

**SERVICE MARK**

FIRST USE 6-27-2011; IN COMMERCE 6-27-2011.

**PRINCIPAL REGISTER**

FOR: PLANNING, DESIGN, DEVELOPMENT, MAINTENANCE AND OPTIMIZATION OF ONLINE WEBSITES FOR THIRD PARTIES; WEBSITE DESIGN AND DEVELOPMENT FOR OTHERS, IN CLASS 42 (U.S. CLS. 100 AND 101).

FIRST USE 6-27-2011; IN COMMERCE 6-27-2011.

THE MARK CONSISTS OF STANDARD CHARACTERS WITHOUT CLAIM TO ANY PARTICULAR FONT, STYLE, SIZE, OR COLOR.

SER. NO. 85-636,582, FILED 5-28-2012.

HEATHER BIDDULPH, EXAMINING ATTORNEY



*David J. Kyffers*

Director of the United States Patent and Trademark Office

# United States of America

United States Patent and Trademark Office

[B]

**Reg. No. 4,275,167**

BOLD ARRAY, LLC (CALIFORNIA LIMITED LIABILITY COMPANY)  
25216 AVENIDA PACIFICA  
LAKE FOREST, CA 92630

**Registered Jan. 15, 2013**

**Int. Cls.: 35 and 42**

FOR: BRANDING SERVICES, NAMELY, CONSULTING, DEVELOPMENT, MANAGEMENT AND MARKETING OF BRANDS FOR BUSINESSES, IN CLASS 35 (U.S. CLS. 100, 101 AND 102).

**SERVICE MARK**

FIRST USE 6-27-2011; IN COMMERCE 6-27-2011.

**PRINCIPAL REGISTER**

FOR: PLANNING, DESIGN, DEVELOPMENT, MAINTENANCE AND OPTIMIZATION OF ONLINE WEBSITES FOR THIRD PARTIES; WEBSITE DESIGN AND DEVELOPMENT FOR OTHERS, IN CLASS 42 (U.S. CLS. 100 AND 101).

FIRST USE 6-27-2011; IN COMMERCE 6-27-2011.

THE MARK CONSISTS OF AN UPPER CASE "B" WITHIN BRACKETS.

SER. NO. 85-636,584, FILED 5-28-2012.

HEATHER BIDDULPH, EXAMINING ATTORNEY



*David J. Kyffers*

Director of the United States Patent and Trademark Office

# United States of America

United States Patent and Trademark Office

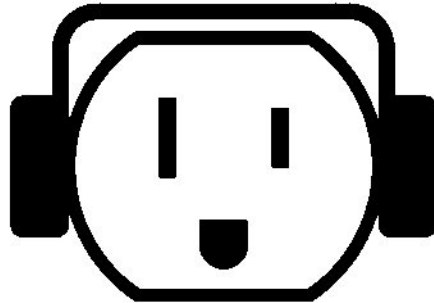

**Reg. No. 4,275,168**

**Registered Jan. 15, 2013**

**Int. Cl.: 41**

**SERVICE MARK**

**PRINCIPAL REGISTER**

DEBUCQUOY-DODLEY, DOMINIQUE (UNITED STATES INDIVIDUAL)  
APT 2A  
279 W 119 ST  
NEW YORK, NY 10026 AND

CAULDWELL, BENJAMIN AINSLEY (UNITED KINGDOM INDIVIDUAL)  
90 WEST STREET, APT 23D  
NEW YORK, NY 10006

FOR: ARRANGING AND CONDUCTING SPECIAL EVENTS FOR SOCIAL ENTERTAINMENT PURPOSES; DISC JOCKEY SERVICES; MUSIC PRODUCTION SERVICES, IN CLASS 41 (U.S. CLS. 100, 101 AND 107).

FIRST USE 2-1-2012; IN COMMERCE 2-1-2012.

THE MARK CONSISTS OF AN IMAGE OF A WALL SOCKET (I.E. RECEPTACLE) WITH THE BOTTOM HOLE FLIPPED UPSIDE-DOWN TO LOOK LIKE IT'S SMILING. THE SOCKET IS WEARING HEADPHONES.

SER. NO. 85-636,602, FILED 5-28-2012.

SAIMA MAKHDOOM, EXAMINING ATTORNEY



*David J. Kyros*

Director of the United States Patent and Trademark Office

# United States of America

United States Patent and Trademark Office

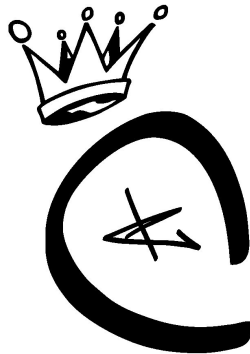

**Reg. No. 4,275,169**

**Registered Jan. 15, 2013**

**Int. Cl.: 25**

**TRADEMARK**

**PRINCIPAL REGISTER**

IRSHAD, FURRUKH (UNITED STATES INDIVIDUAL)  
31640 AVENIDA VALDEZ  
CATHEDRAL CITY, CA 92234

FOR: CLOTHING, NAMELY, SHORT-SLEEVED SHIRTS, PANTS, SHOES, JACKETS, SWEATERS, VESTS, TIES, HATS, LONG-SLEEVED SHIRTS, CREW NECK SHIRTS, AND T-SHIRTS, IN CLASS 25 (U.S. CLS. 22 AND 39).

FIRST USE 3-14-2010; IN COMMERCE 2-1-2011.

THE MARK CONSISTS OF A BIG LETTER "C" WITH A SMALL OPENING ON THE RIGHT SIDE. A STYLIZED LETTER "K" ON THE INSIDE CENTER REGION OF THE OPEN SPACE IN THE LETTER "C". THERE IS ALSO A STYLIZED CROWN ON THE TOP OF THE LETTER "C" TOWARDS THE LEFT SIDE AND IS AT AN ANGLE HOVERING OVER THE LETTER "C".

SER. NO. 85-636,603, FILED 5-28-2012.

KRISTINA MORRIS, EXAMINING ATTORNEY



*David J. Kyffers*

Director of the United States Patent and Trademark Office

# United States of America

United States Patent and Trademark Office



**Reg. No. 4,275,170**

UPCYCLITY INC. (CALIFORNIA CORPORATION)  
624 N ORANGE DRIVE  
LOS ANGELES, CA 90036

**Registered Jan. 15, 2013**

**Int. Cl.: 35**

FOR: OPERATING ON-LINE MARKETPLACES FOR SELLERS OF GOODS AND/OR SERVICES; PROVIDING A WEBSITE FEATURING AN ONLINE MARKETPLACE FOR EXCHANGING GOODS AND SERVICES WITH OTHER USERS , IN CLASS 35 (U.S. CLS. 100, 101 AND 102).

**SERVICE MARK**

**PRINCIPAL REGISTER**

FIRST USE 4-1-2012; IN COMMERCE 4-1-2012.

THE MARK CONSISTS OF THE WORDING "UP" IN STYLIZED FONT. THE CHARACTER "U" WITHIN THE WORDING "UP" HAS AN ARROW POINTING UPWARDS.

SER. NO. 85-636,620, FILED 5-28-2012.

PRISCILLA MILTON, EXAMINING ATTORNEY



*David J. Kyffers*

Director of the United States Patent and Trademark Office



# United States of America

United States Patent and Trademark Office

# UPcyclity

**Reg. No. 4,275,171**

UPCYCLITY INC. (CALIFORNIA CORPORATION)  
624 N ORANGE DRIVE  
LOS ANGELES, CA 90036

**Registered Jan. 15, 2013**

**Int. Cl.: 35**

FOR: OPERATING ON-LINE MARKETPLACES FOR SELLERS OF GOODS AND/OR SERVICES; PROVIDING A WEBSITE FEATURING AN ONLINE MARKETPLACE FOR EXCHANGING GOODS AND SERVICES WITH OTHER USERS , IN CLASS 35 (U.S. CLS. 100, 101 AND 102).

**SERVICE MARK**

**PRINCIPAL REGISTER**

FIRST USE 3-1-2011; IN COMMERCE 8-1-2011.

THE MARK CONSISTS OF STANDARD CHARACTERS WITHOUT CLAIM TO ANY PARTICULAR FONT, STYLE, SIZE, OR COLOR.

SER. NO. 85-636,621, FILED 5-28-2012.

PRISCILLA MILTON, EXAMINING ATTORNEY



*David J. Kyjars*

Director of the United States Patent and Trademark Office

# United States of America

United States Patent and Trademark Office

## Pomerstone Classic

**Reg. No. 4,275,172**

POMEROY, DAVID C (UNITED STATES INDIVIDUAL)  
7164 CUNNING CIRCLE  
BALTIMORE, MD 21220

**Registered Jan. 15, 2013**

**Int. Cl.: 41**

FOR: PROVIDING FACILITIES FOR WOMEN'S LACROSSE TOURNAMENTS, IN CLASS 41 (U.S. CLS. 100, 101 AND 107).

**SERVICE MARK**

FIRST USE 4-7-2011; IN COMMERCE 7-27-2011.

**PRINCIPAL REGISTER**

THE MARK CONSISTS OF STANDARD CHARACTERS WITHOUT CLAIM TO ANY PARTICULAR FONT, STYLE, SIZE, OR COLOR.

NO CLAIM IS MADE TO THE EXCLUSIVE RIGHT TO USE "CLASSIC", APART FROM THE MARK AS SHOWN.

SER. NO. 85-636,623, FILED 5-28-2012.

PRISCILLA MILTON, EXAMINING ATTORNEY



*David J. Kybas*

Director of the United States Patent and Trademark Office

# United States of America

United States Patent and Trademark Office

## FOOD'S BEST FRIEND

**Reg. No. 4,275,173**

SCOTT ZALKIND (UNITED STATES INDIVIDUAL)  
448 GROVE WAY  
HAYWARD, CA 94541

**Registered Jan. 15, 2013**

**Int. Cl.: 30**

FOR: CONDIMENT, NAMELY, PEPPER SAUCE; HOT SAUCE, IN CLASS 30 (U.S. CL. 46).

**TRADEMARK**

FIRST USE 4-3-2011; IN COMMERCE 4-3-2011.

**PRINCIPAL REGISTER**

THE MARK CONSISTS OF STANDARD CHARACTERS WITHOUT CLAIM TO ANY PARTICULAR FONT, STYLE, SIZE, OR COLOR.

SER. NO. 85-636,635, FILED 5-28-2012.

ALICIA COLLINS, EXAMINING ATTORNEY



*David J. Kybas*

Director of the United States Patent and Trademark Office

# United States of America

United States Patent and Trademark Office

## APPRAISALGUARD

**Reg. No. 4,275,174**

**Registered Jan. 15, 2013**

**Int. Cl.: 36**

**SERVICE MARK**

**PRINCIPAL REGISTER**

UPF SERVICES, LLC (DELAWARE LIMITED LIABILITY COMPANY)  
12410 E. MIRABEAU PARKWAY #100  
SPOKANE VALLEY, WA 99216

FOR: APPRAISAL OF REAL ESTATE; PROVIDING INFORMATION IN THE FIELD OF REAL ESTATE VIA THE INTERNET; REAL ESTATE CONSULTATION, IN CLASS 36 (U.S. CLS. 100, 101 AND 102).

FIRST USE 12-17-2009; IN COMMERCE 12-17-2009.

THE MARK CONSISTS OF STANDARD CHARACTERS WITHOUT CLAIM TO ANY PARTICULAR FONT, STYLE, SIZE, OR COLOR.

SER. NO. 85-636,656, FILED 5-28-2012.

EMILY CARLSEN, EXAMINING ATTORNEY



*David J. Kyffers*

Director of the United States Patent and Trademark Office

# United States of America

United States Patent and Trademark Office



**Reg. No. 4,275,175**

**Registered Jan. 15, 2013**

**Int. Cl.: 36**

**SERVICE MARK**

**PRINCIPAL REGISTER**

UPF SERVICES, LLC (DELAWARE LIMITED LIABILITY COMPANY)  
12410 E. MIRABEAU PARKWAY #100  
SPOKANE VALLEY, WA 99216

FOR: APPRAISAL OF REAL ESTATE; PROVIDING INFORMATION IN THE FIELD OF REAL ESTATE VIA THE INTERNET; REAL ESTATE CONSULTATION, IN CLASS 36 (U.S. CLS. 100, 101 AND 102).

FIRST USE 12-17-2009; IN COMMERCE 12-17-2009.

THE MARK CONSISTS OF A WIREFRAME DEPICTION OF A PORTION OF A HOME WITH THE WORD APPRAISALGUARD ADJACENT TO IT.

SER. NO. 85-636,658, FILED 5-28-2012.

EMILY CARLSEN, EXAMINING ATTORNEY



*David J. Kyffers*

Director of the United States Patent and Trademark Office

# United States of America

United States Patent and Trademark Office

# TicklePaks

**Reg. No. 4,275,176**

**Registered Jan. 15, 2013**

**Int. Cl.: 3**

**TRADEMARK**

**PRINCIPAL REGISTER**

ESSENTIAL ALTERNATIVES, INC. (FLORIDA CORPORATION)  
6208 SEMINOLE GARDENS CIRCLE  
RIVIERA BEACH, FL 33418

FOR: SACHETS, IN CLASS 3 (U.S. CLS. 1, 4, 6, 50, 51 AND 52).

FIRST USE 5-5-2010; IN COMMERCE 2-3-2012.

THE MARK CONSISTS OF STANDARD CHARACTERS WITHOUT CLAIM TO ANY PARTICULAR FONT, STYLE, SIZE, OR COLOR.

SER. NO. 85-636,661, FILED 5-28-2012.

MAUREEN DALL, EXAMINING ATTORNEY



*David J. Kybas*

Director of the United States Patent and Trademark Office

# United States of America

United States Patent and Trademark Office

## APPRAISALGUARD

**Reg. No. 4,275,177**

**Registered Jan. 15, 2013**

**Int. Cl.: 42**

**SERVICE MARK**

**PRINCIPAL REGISTER**

UPF SERVICES, LLC (DELAWARE LIMITED LIABILITY COMPANY)  
12410 E. MIRABEAU PARKWAY #100  
SPOKANE VALLEY, WA 99216

FOR: ACCREDITATION SERVICES, NAMELY, DEVELOPING AND ADMINISTERING STANDARDS AND PROCEDURES FOR CERTIFYING PROFESSIONALS IN THE FIELD OF REAL ESTATE APPRAISAL; APPLICATION SERVICE PROVIDER (ASP) FEATURING SOFTWARE FOR USE IN REAL ESTATE APPRAISAL MANAGEMENT; COMPUTER SERVICES, NAMELY, HOSTING AN INTERACTIVE WEB SITE THAT ALLOWS MANAGEMENT OF REAL ESTATE APPRAISAL SERVICES; PROVIDING A SECURE ELECTRONIC ONLINE SYSTEM FEATURING TECHNOLOGY WHICH ALLOWS MANAGEMENT OF REAL ESTATE APPRAISALS; PROVIDING A WEB HOSTING PLATFORM FOR MANAGING REAL ESTATE APPRAISALS; PROVIDING A WEB SITE FEATURING TECHNOLOGY THAT ENABLES USERS TO MANAGE REAL ESTATE APPRAISALS, IN CLASS 42 (U.S. CLS. 100 AND 101).

FIRST USE 12-17-2009; IN COMMERCE 12-17-2009.

THE MARK CONSISTS OF STANDARD CHARACTERS WITHOUT CLAIM TO ANY PARTICULAR FONT, STYLE, SIZE, OR COLOR.

SER. NO. 85-636,668, FILED 5-28-2012.

EMILY CARLSEN, EXAMINING ATTORNEY



*David J. Kybas*

Director of the United States Patent and Trademark Office

# United States of America

United States Patent and Trademark Office



**Reg. No. 4,275,178**

**Registered Jan. 15, 2013**

**Int. Cl.: 42**

**SERVICE MARK**

**PRINCIPAL REGISTER**

UPF SERVICES, LLC (DELAWARE LIMITED LIABILITY COMPANY)  
12410 E. MIRABEAU PARKWAY #100  
SPOKANE VALLEY, WA 99216

FOR: ACCREDITATION SERVICES, NAMELY, DEVELOPING AND ADMINISTERING STANDARDS AND PROCEDURES FOR CERTIFYING PROFESSIONALS IN THE FIELD OF REAL ESTATE APPRAISAL; APPLICATION SERVICE PROVIDER (ASP) FEATURING SOFTWARE FOR USE IN REAL ESTATE APPRAISAL MANAGEMENT; COMPUTER SERVICES, NAMELY, HOSTING AN INTERACTIVE WEB SITE THAT ALLOWS MANAGEMENT OF REAL ESTATE APPRAISAL SERVICES; PROVIDING A SECURE ELECTRONIC ONLINE SYSTEM FEATURING TECHNOLOGY WHICH ALLOWS MANAGEMENT OF REAL ESTATE APPRAISALS; PROVIDING A WEB HOSTING PLATFORM FOR MANAGING REAL ESTATE APPRAISALS; PROVIDING A WEB SITE FEATURING TECHNOLOGY THAT ENABLES USERS TO MANAGE REAL ESTATE APPRAISALS, IN CLASS 42 (U.S. CLS. 100 AND 101).

FIRST USE 12-17-2009; IN COMMERCE 12-17-2009.

THE MARK CONSISTS OF A WIREFRAME DEPICTION OF A PORTION OF A HOME WITH THE WORD "APPRAISALGUARD" ADJACENT TO IT.

SER. NO. 85-636,671, FILED 5-28-2012.

EMILY CARLSEN, EXAMINING ATTORNEY



*David J. Kybas*

Director of the United States Patent and Trademark Office



# United States of America

United States Patent and Trademark Office

# P-58

**Reg. No. 4,275,179**

**Registered Jan. 15, 2013**

**Int. Cl.: 1**

**TRADEMARK**

**PRINCIPAL REGISTER**

COSMOCEL, S.A. (MEXICO CORPORATION)  
VIA MATAMOROS NO. 1501  
COL. INDUSTRIAL NOGALAR  
S NICOLAS DE LOS GARZA, MEXICO

FOR: FERTILIZERS FOR AGRICULTURAL USE; PLANT NUTRITION PREPARATIONS, IN CLASS 1 (U.S. CLS. 1, 5, 6, 10, 26 AND 46).

FIRST USE 6-30-2011; IN COMMERCE 6-30-2011.

THE MARK CONSISTS OF STANDARD CHARACTERS WITHOUT CLAIM TO ANY PARTICULAR FONT, STYLE, SIZE, OR COLOR.

SER. NO. 85-636,674, FILED 5-28-2012.

DAVID TAYLOR, EXAMINING ATTORNEY



*David J. Kyffers*

Director of the United States Patent and Trademark Office

# United States of America

United States Patent and Trademark Office

## Fill A Backpack

**Reg. No. 4,275,180**

A PRECIOUS CHILD, INC. (COLORADO CORPORATION)  
557 BURBANK STREET, UNIT E  
BROOMFIELD, CO 80020

**Registered Jan. 15, 2013**

**Int. Cl.: 41**

FOR: CHARITABLE SERVICES, NAMELY, PROVIDING SCHOOL SUPPLIES TO CHILDREN IN NEED, IN CLASS 41 (U.S. CLS. 100, 101 AND 107).

**SERVICE MARK**

FIRST USE 11-11-2008; IN COMMERCE 11-11-2008.

**PRINCIPAL REGISTER**

THE MARK CONSISTS OF STANDARD CHARACTERS WITHOUT CLAIM TO ANY PARTICULAR FONT, STYLE, SIZE, OR COLOR.

SER. NO. 85-636,675, FILED 5-28-2012.

DANIEL BRODY, EXAMINING ATTORNEY



*David J. Kyffers*

Director of the United States Patent and Trademark Office

# United States of America

United States Patent and Trademark Office

# TRIPLEX

**Reg. No. 4,275,181**

**Registered Jan. 15, 2013**

**Int. Cl.: 1**

**TRADEMARK**

**PRINCIPAL REGISTER**

COSMOCEL, S.A. (MEXICO CORPORATION)  
VIA MATAMOROS NO. 1501  
COL. INDUSTRIAL NOGALAR  
S NICOLAS DE LOS GARZA, MEXICO 66480

FOR: FERTILIZERS FOR AGRICULTURAL USE; PLANT NUTRITION PREPARATIONS, IN CLASS 1 (U.S. CLS. 1, 5, 6, 10, 26 AND 46).

FIRST USE 6-30-2011; IN COMMERCE 6-30-2011.

THE MARK CONSISTS OF STANDARD CHARACTERS WITHOUT CLAIM TO ANY PARTICULAR FONT, STYLE, SIZE, OR COLOR.

SER. NO. 85-636,678, FILED 5-28-2012.

DAVID TAYLOR, EXAMINING ATTORNEY



*David J. Kyffers*

Director of the United States Patent and Trademark Office

**United States of America**  
United States Patent and Trademark Office

# RX-BIO

**Reg. No. 4,275,182**

**Registered Jan. 15, 2013**

**Int. Cl.: 1**

**TRADEMARK**

**PRINCIPAL REGISTER**

COSMOCEL, S.A. (MEXICO CORPORATION)  
VIA MATAMOROS NO. 1501  
COL. INDUSTRIAL NOGALAR  
S NICOLAS DE LOS GARZA, MEXICO 66480

FOR: FERTILIZERS FOR AGRICULTURAL USE; PLANT NUTRITION PREPARATIONS, IN CLASS 1 (U.S. CLS. 1, 5, 6, 10, 26 AND 46).

FIRST USE 6-30-2011; IN COMMERCE 6-30-2011.

THE MARK CONSISTS OF STANDARD CHARACTERS WITHOUT CLAIM TO ANY PARTICULAR FONT, STYLE, SIZE, OR COLOR.

THE WORDING RX-BIO HAS NO MEANING IN A FOREIGN LANGUAGE.

SER. NO. 85-636,685, FILED 5-28-2012.

DAVID TAYLOR, EXAMINING ATTORNEY



*David J. Kyffers*

Director of the United States Patent and Trademark Office

# United States of America

United States Patent and Trademark Office

# TURFRX

**Reg. No. 4,275,183**

**Registered Jan. 15, 2013**

**Int. Cl.: 1**

**TRADEMARK**

**PRINCIPAL REGISTER**

COSMOCEL, S.A. (MEXICO CORPORATION)  
VIA MATAMOROS NO. 1501  
COL. INDUSTRIAL NOGALAR  
S NICOLAS DE LOS GARZA, MEXICO 66480

FOR: FERTILIZERS FOR AGRICULTURAL USE; PLANT NUTRITION PREPARATIONS, IN CLASS 1 (U.S. CLS. 1, 5, 6, 10, 26 AND 46).

FIRST USE 6-30-2011; IN COMMERCE 6-30-2011.

THE MARK CONSISTS OF STANDARD CHARACTERS WITHOUT CLAIM TO ANY PARTICULAR FONT, STYLE, SIZE, OR COLOR.

THE WORDING TURFRX HAS NO MEANING IN A FOREIGN LANGUAGE.

SER. NO. 85-636,689, FILED 5-28-2012.

DAVID TAYLOR, EXAMINING ATTORNEY



*David J. Kyffers*

Director of the United States Patent and Trademark Office

# United States of America

United States Patent and Trademark Office

## Crescent Kings

**Reg. No. 4,275,184**

**Registered Jan. 15, 2013**

**Int. Cl.: 25**

**TRADEMARK**

**PRINCIPAL REGISTER**

IRSHAD, FURRUKH (UNITED STATES INDIVIDUAL)  
31640 AVENIDA VALDEZ  
CATHEDRAL CITY, CA 92234

FOR: CREW NECKS; HATS; JACKETS; LONG SLEEVED VESTS; PANTS; SHOES; SHORT-SLEEVED SHIRTS; SWEATERS; T-SHIRTS; TIES; VESTS, IN CLASS 25 (U.S. CLS. 22 AND 39).

FIRST USE 3-14-2010; IN COMMERCE 2-1-2011.

THE MARK CONSISTS OF STANDARD CHARACTERS WITHOUT CLAIM TO ANY PARTICULAR FONT, STYLE, SIZE, OR COLOR.

SER. NO. 85-636,695, FILED 5-28-2012.

KRISTINA MORRIS, EXAMINING ATTORNEY



*David J. Kyffers*

Director of the United States Patent and Trademark Office

# United States of America

United States Patent and Trademark Office



**Reg. No. 4,275,185**

**Registered Jan. 15, 2013**

**Int. Cl.: 25**

**TRADEMARK**

**PRINCIPAL REGISTER**

LIDELL & ROSE, INC. (CALIFORNIA CORPORATION)  
SUITE 412  
10736 JEFFERSON BLVD.  
CULVER CITY, CA 90230

FOR: A-SHIRTS; ANKLE SOCKS; ANKLETS; ANTI-PERSPIRANT SOCKS; APPAREL FOR DANCERS, NAMELY, TEE SHIRTS, SWEATSHIRTS, PANTS, LEGGINGS, SHORTS AND JACKETS; ATHLETIC APPAREL, NAMELY, SHIRTS, PANTS, JACKETS, FOOTWEAR, HATS AND CAPS, ATHLETIC UNIFORMS; ATHLETIC SHOES; BABIES' PANTS; BALLET SHOES; BALLOON PANTS; BALLROOM DANCING SHOES; BASEBALL CAPS AND HATS; BASEBALL SHOES; BEACH SHOES; BED JACKETS; BOAT SHOES; BODY SHIRTS; BOMBER JACKETS; BOWLING SHOES; BOXING SHOES; BRIEFS; BUTTON DOWN SHIRTS; BUTTON-FRONT ALOHA SHIRTS; CAMOUFLAGE JACKETS; CAMOUFLAGE PANTS; CAMOUFLAGE SHIRTS; CAMP SHIRTS; CANVAS SHOES; CAPRI PANTS; CARGO PANTS; CLEATS FOR ATTACHMENT TO SPORTS SHOES; CLIMBING SHOES; CLOTHING FOR ATHLETIC USE, NAMELY, PADDED PANTS; CLOTHING FOR ATHLETIC USE, NAMELY, PADDED SHIRTS; CLOTHING FOR BABIES, TODDLERS AND CHILDREN, TREATED WITH FIRE AND HEAT RETARDANTS, NAMELY, PAJAMAS, JACKETS, SHIRTS, PANTS, JUMPERS; CLOTHING SHIELDS, NAMELY, PADS APPLIED TO THE UNDERARMS OF SHIRTS, BLOUSES AND SWEATERS; CLOTHING, NAMELY, COWLS AND SMOKE RING SCARVES; COLLARED SHIRTS; COMPRESSION GARMENTS FOR ATHLETIC OR OTHER NON-MEDICAL USE, NAMELY, SHORT SLEEVE AND LONG SLEEVE T-SHIRTS, SHORTS, AND PANTS FOR MEN AND WOMEN; CROP PANTS; CYCLING SHOES; DANCE SHOES; DECK-SHOES; DENIM JACKETS; DENIMS; DISPOSABLE UNDERWEAR; DOWN JACKETS; DRESS PANTS; DRESS SHIRTS; DRIVERS; FISHERMEN'S JACKETS; FISHING SHIRTS; FITTED SHOE OR BOOT COVERING TO PROTECT THE SHOES OR BOOT FROM WATER OR OTHER DAMAGE; FLOOD PANTS; FOOTBALL SHOES; FUR COATS AND JACKETS; FUR HATS; FUR JACKETS; GIFT PACKAGES SOLD AS A UNIT CONSISTING PRIMARILY OF A SWEATSHIRT AND ALSO INCLUDING A PHOTO FRAME, A COFFEE MUG, AND A TOTE BAG; GOLF PANTS, SHIRTS AND SKIRTS; GOLF SHIRTS; GOLF SHOES; GYM PANTS; GYMNASTIC SHOES; HANDBALL SHOES; HAT BANDS; HATS; HATS FOR INFANTS, BABIES, TODDLERS AND CHILDREN; HEAD SCARVES; HEAVY JACKETS; HEEL PIECES FOR SHOES; HOCKEY SHOES; HOODED SWEAT SHIRTS; HOODED SWEATSHIRTS; HOODED SWEATSHIRTS FOR MEN, WOMEN, BOYS, GIRLS, AND INFANTS; HUNTING JACKETS; HUNTING PANTS; HUNTING SHIRTS; INFANTS' SHOES AND BOOTS; INSOLES; JACKET LINERS; JACKETS; JACKETS AND SOCKS; JAPANESE STYLE SOCKS (TABI COVERS); JAPANESE STYLE SOCKS (TABI); JEGGINGS, NAMELY, PANTS THAT



*David J. Kyros*

Director of the United States Patent and Trademark Office

**Reg. No. 4,275,185** ARE PARTIALLY JEANS AND PARTIALLY LEGGINGS; JOGGING PANTS; KNIT JACKETS; KNIT SHIRTS; KNITTED UNDERWEAR; LADIES' UNDERWEAR; LEATHER HATS; LEATHER JACKETS; LEATHER PANTS; LEATHER SHIRTS; LEATHER SHOES; LEISURE SHOES; LIGHT-REFLECTING JACKETS; LONG JACKETS; LONG UNDERWEAR; LONG-SLEEVED SHIRTS; LOUNGE PANTS; MATERNITY CLOTHING, NAMELY, T-SHIRTS, PANTS, SHORTS, BLOUSES, AND SKIRTS; MEN'S AND WOMEN'S JACKETS, COATS, TROUSERS, VESTS; MEN'S DRESS SOCKS; MEN'S SOCKS; MEN'S UNDERWEAR; MOISTURE-WICKING SPORTS PANTS; MOISTURE-WICKING SPORTS SHIRTS; MOTORCYCLE JACKETS; MOUNTAINEERING SHOES; NIGHT SHIRTS; NON-DISPOSABLE CLOTH TRAINING PANTS; NON-SLIP SOCKS; NURSE PANTS; OPEN-NECKED SHIRTS; OUTER JACKETS; OVER SHIRTS; PADDED JACKETS; PADDING JACKETS; PANTS; PAPER HATS FOR USE AS CLOTHING ITEMS; PAPER SHOES USED WHEN GOING THROUGH METAL DETECTORS TO KEEP FEET AND SOCKS CLEAN; PARTS OF CLOTHING, NAMELY, GUSSETS FOR TIGHTS, GUSSETS FOR STOCKINGS, GUSSETS FOR BATHING SUITS, GUSSETS FOR UNDERWEAR, GUSSETS FOR LEOTARDS AND GUSSETS FOR FOOTLETS; PARTY HATS; PERSPIRATION ABSORBENT STRAP TO BE USED IN THE BILL OF A HAT; PERSPIRATION ABSORBENT UNDERWEAR CLOTHING; PETTI-PANTS; PIQUE SHIRTS; POLO SHIRTS; POLYMER CUSTOM CUSHIONED SHOE INSERTS FOR PRIMARILY NON-ORTHOPEDIC PURPOSES; PROTECTIVE METAL MEMBERS FOR SHOES AND BOOTS; RAIN HATS; RAIN JACKETS; RAINPROOF JACKETS; REVERSIBLE JACKETS; RIDING SHOES; RUBBER SHOES; RUGBY SHIRTS; RUGBY SHOES; RUNNING PADS THAT STRAP ONTO SHOES; RUNNING SHOES; SANDALS AND BEACH SHOES; SCARVES; SCIENTIFIC AND TECHNOLOGICAL APPAREL, NAMELY, SHIRTS, PANTS, JACKETS, FOOTWEAR, HATS AND CAPS, UNIFORMS; SEDGE HATS (SUGE-GASA); SHELL JACKETS; SHIRT FRONTS; SHIRT INSERTS, NAMELY, DICKIES; SHIRT YOKES; SHIRTS; SHIRTS AND SHORT-SLEEVED SHIRTS; SHIRTS AND SLIPS; SHIRTS FOR INFANTS, BABIES, TODDLERS AND CHILDREN; SHIRTS FOR SUITS; SHOE ACCESSORIES, NAMELY, FITTED DECORATIVE COVERS FOR SHOES; SHOE COVERS FOR USE WHEN WEARING SHOES; SHOE DOWELS; SHOE INSERTS FOR PRIMARILY NON-ORTHOPEDIC PURPOSES; SHOE PEGS; SHOE SOLES; SHOE STRAPS; SHOE UPPERS; SHOES; SHOES SOLES FOR REPAIR; SHOES WITH HOOK AND PILE FASTENING TAPES; SHORT-SLEEVED OR LONG-SLEEVED T-SHIRTS; SHORT-SLEEVED SHIRTS; SHOULDER SCARVES; SILK SCARVES; SKI AND SNOWBOARD SHOES AND PARTS THEREOF; SKI JACKETS; SKI PANTS; SKIING SHOES; SLEEP PANTS; SLEEP SHIRTS; SLEEVED OR SLEEVELESS JACKETS; SLEEVES WORN SEPARATE AND APART FROM BLOUSES, SHIRTS AND OTHER TOPS; SLIPPER SOCKS; SMALL HATS; SMOKING JACKETS; SNAP CROTCH SHIRTS FOR INFANTS AND TODDLERS; SNOW PANTS; SNOWBOARD JACKETS; SNOWBOARD PANTS; SOCCER SHOES; SOCK SUSPENDERS; SOCKS; SOCKS AND STOCKINGS; SPORT SHIRTS; SPORTS CAPS AND HATS; SPORTS JACKETS; SPORTS PANTS; SPORTS SHIRTS; SPORTS SHIRTS WITH SHORT SLEEVES; STRETCH PANTS; STUFF JACKETS; SUEDE JACKETS; SUN PROTECTIVE CLOTHING, NAMELY, HATS, T-SHIRTS, SHORTS, AND PANTS; SWEAT JACKETS; SWEAT PANTS; SWEAT SHIRTS; SWEATPANTS; SWEATSHIRTS; SWEATSHIRTS FOR MEN, WOMEN, BOYS, GIRLS, AND INFANTS; T-SHIRTS; T-SHIRTS FOR MEN, WOMEN, BOYS, GIRLS, AND INFANTS; TAP PANTS; TAP SHOES; TEE SHIRTS; TENNIS SHOES; THERMAL SOCKS; THERMAL UNDERWEAR; THONGS; TOBOGGAN HATS, PANTS AND CAPS; TONGUE OR PULLSTRAP FOR SHOES AND BOOTS; TRACK AND FIELD SHOES; TRACK JACKETS; TRACK PANTS; TRAINING SHOES; TRAVEL CLOTHING CONTAINED IN A PACKAGE COMPRISING REVERSIBLE JACKETS, PANTS, SKIRTS, TOPS AND A BELT OR SCARF; TRIATHLON CLOTHING, NAMELY, TRIATHLON TIGHTS, TRIATHLON SHORTS, TRIATHLON SINGLET, TRIATHLON SHIRTS, TRIATHLON SUITS; TURTLE NECK SHIRTS; UNDERGARMENT ACCESSORIES, NAMELY, REMOVABLE SILICONE BUTTOCK ENHANCER PADS; UNDERGARMENTS; UNDERGARMENTS, NAMELY, WASPIES; UNDERWEAR; UNDERWEAR, NAMELY, BOY SHORTS; VOLLEYBALL SHOES; WATER REPELLING LEATHER SHOES AND BOOTS; WATER SOCKS; WATERPROOF JACKETS AND PANTS; WATERPROOF LEATHER SHOES; WATERPROOF LEATHER SHOES AND BOOTS; WEARABLE GARMENTS AND CLOTHING, NAMELY, SHIRTS; WELTS FOR BOOTS AND SHOES; WIND PANTS; WIND RESISTANT JACKETS; WIND SHIRTS; WIND-JACKETS; WOMEN'S CLOTHING, NAMELY, SHIRTS, DRESSES, SKIRTS,



**Reg. No. 4,275,185** BLOUSES; WOMEN'S HATS AND HOODS; WOMEN'S SHOES; WOMEN'S SHOES, NAMELY, FOLDABLE FLATS; WOMEN'S UNDERWEAR; WOODEN SHOES; WOOLLEN SOCKS; WOOLLY HATS; WORK SHOES AND BOOTS; WOVEN OR KNITTED UNDERWEAR; YOGA PANTS; YOGA SHIRTS, IN CLASS 25 (U.S. CLS. 22 AND 39).

FIRST USE 1-1-2011; IN COMMERCE 1-1-2011.

THE MARK CONSISTS OF OPEN WINGS WITHIN AN FULLY ENCLOSED CIRCLE.

SER. NO. 85-636,700, FILED 5-28-2012.

LEE-ANNE BERNS, EXAMINING ATTORNEY

# United States of America

United States Patent and Trademark Office

## Once Upon A Dance

**Reg. No. 4,275,186**

**Registered Jan. 15, 2013**

**Int. Cl.: 41**

**SERVICE MARK**

**PRINCIPAL REGISTER**

ONCE UPON A DANCE, LLC (NEW JERSEY LIMITED LIABILITY COMPANY), DBA ONCE UPON A DANCE, LLC  
1311 RT. 37 WEST  
TOMS RIVER, NJ 08755

FOR: DANCE SCHOOLS, IN CLASS 41 (U.S. CLS. 100, 101 AND 107).

FIRST USE 4-9-2007; IN COMMERCE 4-9-2007.

THE MARK CONSISTS OF STANDARD CHARACTERS WITHOUT CLAIM TO ANY PARTICULAR FONT, STYLE, SIZE, OR COLOR.

SER. NO. 85-636,702, FILED 5-28-2012.

DAVID TAYLOR, EXAMINING ATTORNEY



*David J. Kyros*

Director of the United States Patent and Trademark Office

# United States of America

United States Patent and Trademark Office

# PILLTALK

**Reg. No. 4,275,187**

RYAN KURIAKOSE (UNITED STATES INDIVIDUAL)  
696 SPRAGUE AVENUE  
FRANKLIN SQUARE, NY 11010

**Registered Jan. 15, 2013**

**Int. Cl.: 42**

FOR: PROVIDING A WEBSITE FEATURING INFORMATION ABOUT INVESTIGATIONAL MEDICAL DEVICES, DIAGNOSTIC AND DRUGS; PROVIDING MEDICAL AND SCIENTIFIC RESEARCH INFORMATION IN THE FIELD OF PHARMACEUTICALS AND CLINICAL TRIALS, IN CLASS 42 (U.S. CLS. 100 AND 101).

**SERVICE MARK**

**PRINCIPAL REGISTER**

FIRST USE 2-1-2012; IN COMMERCE 5-16-2012.

THE MARK CONSISTS OF STANDARD CHARACTERS WITHOUT CLAIM TO ANY PARTICULAR FONT, STYLE, SIZE, OR COLOR.

SER. NO. 85-636,703, FILED 5-28-2012.

DAVID TAYLOR, EXAMINING ATTORNEY



*David J. Kyffers*

Director of the United States Patent and Trademark Office

# United States of America

United States Patent and Trademark Office

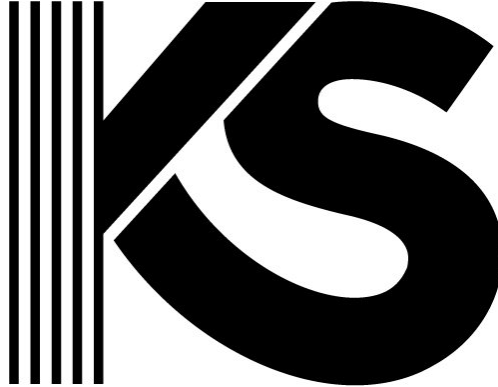

**Reg. No. 4,275,188**

**Registered Jan. 15, 2013**

**Int. Cl.: 45**

**SERVICE MARK**

**PRINCIPAL REGISTER**

LAW OFFICE OF KRISTINE A. SOVA, PLLC (NEW YORK LIMITED LIABILITY COMPANY),  
DBA LAW OFFICE OF KRISTINE A. SOVA  
6TH FLOOR  
411 LAFAYETTE STREET  
NEW YORK, NY 10003

FOR: LEGAL SERVICES, IN CLASS 45 (U.S. CLS. 100 AND 101).

FIRST USE 5-21-2012; IN COMMERCE 5-21-2012.

THE MARK CONSISTS OF STYLIZED LETTERS "KS".

SER. NO. 85-636,711, FILED 5-28-2012.

MIAH ROSENBERG, EXAMINING ATTORNEY



*David J. Kybas*

Director of the United States Patent and Trademark Office

# United States of America

United States Patent and Trademark Office

# WaveToGo

**Reg. No. 4,275,189**

WALNUTREE, LLC (CALIFORNIA LIMITED LIABILITY COMPANY)  
1139 WESTMINSTER AVE UNIT P  
ALHAMBRA, CA 91803

**Registered Jan. 15, 2013**

**Int. Cls.: 28 and 35**

FOR: PAINTBALL GUNS; PAINTBALLS, IN CLASS 28 (U.S. CLS. 22, 23, 38 AND 50).

**TRADEMARK**

FIRST USE 6-11-2009; IN COMMERCE 6-11-2009.

**SERVICE MARK**

FOR: ON-LINE RETAIL STORE SERVICES FEATURING PAINTBALL GUNS, PAINTBALL BARRELS, PAINTBALL ACCESSORIES, AND CELL PHONE ACCESSORIES, IN CLASS 35 (U.S. CLS. 100, 101 AND 102).

**PRINCIPAL REGISTER**

FIRST USE 4-24-2003; IN COMMERCE 4-24-2003.

THE MARK CONSISTS OF STANDARD CHARACTERS WITHOUT CLAIM TO ANY PARTICULAR FONT, STYLE, SIZE, OR COLOR.

SER. NO. 85-636,735, FILED 5-28-2012.

WILLIAM JACKSON, EXAMINING ATTORNEY



*David J. Kyfos*

Director of the United States Patent and Trademark Office

# United States of America

United States Patent and Trademark Office

## Coloring Your Event

**Reg. No. 4,275,190**

YA YA CREATIONS, INC (CALIFORNIA CORPORATION)  
13155 RAILROAD AVE  
CITY OF INDUSTRY, CA 91746

**Registered Jan. 15, 2013**

**Int. Cl.: 35**

FOR: ON-LINE RETAIL STORE SERVICES FEATURING WEDDING AND BRIDAL ACCESSORIES, IN CLASS 35 (U.S. CLS. 100, 101 AND 102).

**SERVICE MARK**

FIRST USE 8-1-2004; IN COMMERCE 8-1-2004.

**PRINCIPAL REGISTER**

THE MARK CONSISTS OF STANDARD CHARACTERS WITHOUT CLAIM TO ANY PARTICULAR FONT, STYLE, SIZE, OR COLOR.

SER. NO. 85-636,739, FILED 5-28-2012.

JESSICA A. POWERS, EXAMINING ATTORNEY



*David J. Kybas*

Director of the United States Patent and Trademark Office

# United States of America

United States Patent and Trademark Office

TMC  
NATIONAL SERVICES, LLC

**Reg. No. 4,275,191**

THE MATTHEWS COMPANY, INC. (CALIFORNIA CORPORATION)  
17220 NEWHOPE STREET, SUITES 108-110  
FOUNTAIN VALLEY, CA 92708

**Registered Jan. 15, 2013**

**Int. Cl.: 35**

FOR: PROJECT MANAGEMENT SERVICES FOR OTHERS FOR BUSINESS PURPOSES IN THE FIELD OF LAND SURVEYING, IN CLASS 35 (U.S. CLS. 100, 101 AND 102).

**SERVICE MARK**

FIRST USE 2-2-2012; IN COMMERCE 2-2-2012.

**PRINCIPAL REGISTER**

NO CLAIM IS MADE TO THE EXCLUSIVE RIGHT TO USE "NATIONAL SERVICES, LLC", APART FROM THE MARK AS SHOWN.

THE MARK CONSISTS OF THE WORDING "TMC NATIONAL SERVICES, LLC" WITH A SLASH BETWEEN "TMC" AND "NATIONAL".

SER. NO. 85-636,742, FILED 5-28-2012.

SAIMA MAKHDOOM, EXAMINING ATTORNEY



*David J. Kyffers*

Director of the United States Patent and Trademark Office

# United States of America

United States Patent and Trademark Office

# TOPPY

**Reg. No. 4,275,192**

**Registered Jan. 15, 2013**

**Int. Cl.: 31**

**TRADEMARK**

**PRINCIPAL REGISTER**

GIANNINI, DIRK (UNITED STATES INDIVIDUAL)  
1588 MOFFETT STREET, SUITE B  
SALINAS, CA 93905 AND

DAORO, SHELLEY (UNITED STATES INDIVIDUAL)  
1588 MOFFETT STREET  
SALINAS, CA 93905 AND

GIANNINI, LORI (UNITED STATES INDIVIDUAL)  
1588 MOFFETT STREET, SUITE B  
SALINAS, CA 93905

FOR: FRESH LETTUCE AND BROCCOLI, IN CLASS 31 (U.S. CLS. 1 AND 46).

FIRST USE 10-9-1940; IN COMMERCE 10-9-1940.

THE MARK CONSISTS OF STANDARD CHARACTERS WITHOUT CLAIM TO ANY PARTICULAR FONT, STYLE, SIZE, OR COLOR.

SER. NO. 85-636,754, FILED 5-28-2012.

EMILY CARLSEN, EXAMINING ATTORNEY



*David J. Kybas*

Director of the United States Patent and Trademark Office



# United States of America

United States Patent and Trademark Office

# DREAMLIGHT

**Reg. No. 4,275,193**

**Registered Jan. 15, 2013**

**Int. Cl.: 25**

**TRADEMARK**

**PRINCIPAL REGISTER**

DREAMLIGHT, INC. (VIRGINIA CORPORATION)  
1620 CENTERVILLE TURNPIKE #119  
VIRGINIA BEACH, VA 23464

FOR: GYMNASTIC CLOTHING, WORKOUT WEAR, FITNESS CLOTHING AND ATHLETIC APPAREL, NAMELY LEOTARDS, TANK SUITS, BODY SUITS, TOPS, T-SHIRTS, PANTS, JACKETS, SHORTS, WARM-UP OUTFITS AND UNDERGARMENTS, IN CLASS 25 (U.S. CLS. 22 AND 39).

FIRST USE 12-31-1989; IN COMMERCE 12-31-1989.

THE MARK CONSISTS OF STANDARD CHARACTERS WITHOUT CLAIM TO ANY PARTICULAR FONT, STYLE, SIZE, OR COLOR.

SER. NO. 85-636,787, FILED 5-29-2012.

JENNIFER MARTIN, EXAMINING ATTORNEY



*David J. Kyffers*

Director of the United States Patent and Trademark Office

# United States of America

United States Patent and Trademark Office

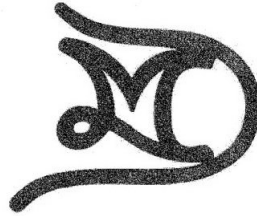

**Reg. No. 4,275,194**

**Registered Jan. 15, 2013**

**Int. Cl.: 44**

**SERVICE MARK**

**PRINCIPAL REGISTER**

COVES, MIGUEL (UNITED STATES INDIVIDUAL)  
262 EASTGATE DRIVE  
AIKEN, SC 29803

FOR: HORSE BREEDING AND STUD SERVICES; HORSE FARMS, IN CLASS 44 (U.S. CLS. 100 AND 101).

FIRST USE 7-20-2004; IN COMMERCE 7-20-2004.

THE MARK CONSISTS OF A STYLIZED LETTER "M" FLOWING INTO A STYLIZED LETTER "C" DISPOSED WITHIN AND FORMING A STYLIZED LETTER "D". THE LETTER "M" INCLUDES A FANCIFUL LOOP AT ITS BOTTOM LEFT THAT CONTINUES DOWNWARD TO THE RIGHT AND CONNECTS TO THE LETTER "C".

SER. NO. 85-636,791, FILED 5-29-2012.

GEORGE LORENZO, EXAMINING ATTORNEY



*David J. Kyffers*

Director of the United States Patent and Trademark Office

# United States of America

United States Patent and Trademark Office



**Reg. No. 4,275,195**

**Registered Jan. 15, 2013**

**Int. Cl.: 44**

**SERVICE MARK**

**PRINCIPAL REGISTER**

UHS OF DELAWARE, INC. (DELAWARE CORPORATION)  
367 SOUTH GULPH ROAD  
KING OF PRUSSIA, PA 194060958

FOR: HEALTHCARE; MEDICAL SERVICES, IN CLASS 44 (U.S. CLS. 100 AND 101).

FIRST USE 0-0-1998; IN COMMERCE 0-0-1998.

OWNER OF U.S. REG. NOS. 3,261,502 AND 3,998,725.

THE COLOR(S) GREEN AND YELLOW IS/ARE CLAIMED AS A FEATURE OF THE MARK.

THE MARK CONSISTS OF A DESIGN COMPRISING A ROTATED T-SHAPED POLYGON IN THE COLOR GREEN WITH A YELLOW SUNBURST IN THE RIGHT PORTION OF THE POLYGON.

SER. NO. 85-636,825, FILED 5-29-2012.

JAMES STEIN, EXAMINING ATTORNEY



*David J. Kyffers*

Director of the United States Patent and Trademark Office

# United States of America

United States Patent and Trademark Office

# SCREWWORDS

**Reg. No. 4,275,196**

**Registered Jan. 15, 2013**

**Int. Cl.: 14**

**TRADEMARK**

**PRINCIPAL REGISTER**

MINTED, LLC (VIRGINIA LIMITED LIABILITY COMPANY), DBA SCREWWORDS  
APARTMENT B  
1122 EAST MARKET STREET  
CHARLOTTESVILLE, VA 22902 AND

MANGANIELLO, CLAIRE E. (UNITED STATES INDIVIDUAL), AKA CLAIRE MANGOJELLO  
APARTMENT B  
1122 EAST MARKET STREET  
CHARLOTTESVILLE, VA 22902

FOR: JEWELRY, IN CLASS 14 (U.S. CLS. 2, 27, 28 AND 50).

FIRST USE 4-22-2012; IN COMMERCE 4-22-2012.

THE MARK CONSISTS OF STANDARD CHARACTERS WITHOUT CLAIM TO ANY PARTICULAR FONT, STYLE, SIZE, OR COLOR.

SER. NO. 85-636,832, FILED 5-29-2012.

IRA J. GOODSID, EXAMINING ATTORNEY



*David J. Kyffers*

Director of the United States Patent and Trademark Office

# United States of America

United States Patent and Trademark Office



**Reg. No. 4,275,197**

**Registered Jan. 15, 2013**

**Int. Cl.: 15**

**TRADEMARK**

**PRINCIPAL REGISTER**

GABBANELLI ACCORDIONS & IMPORTS, L.L.C. (TEXAS LIMITED LIABILITY COMPANY)  
4991 WEST BELLFORT AVE.  
HOUSTON, TX 77035

FOR: ACCORDIONS, IN CLASS 15 (U.S. CLS. 2, 21 AND 36).

FIRST USE 5-28-2012; IN COMMERCE 5-28-2012.

THE MARK CONSISTS OF CONCENTRIC CIRCLES HAVING AN EAGLE DISPOSED IN THE CENTER, THE EAGLE HAVING A CROWN DISPOSED ABOVE THE EAGLE'S HEAD AND A SHIELD DISPOSED ON THE EAGLE'S CHEST.

SER. NO. 85-636,834, FILED 5-29-2012.

GEORGE LORENZO, EXAMINING ATTORNEY



*David J. Kyffers*

Director of the United States Patent and Trademark Office

# United States of America

United States Patent and Trademark Office



**Reg. No. 4,275,198**

**Registered Jan. 15, 2013**

**Int. Cl.: 29**

**TRADEMARK**

**PRINCIPAL REGISTER**

GERBER POULTRY, INC. (OHIO CORPORATION)  
5889 KIDRON ROAD  
KIDRON, OH 44636

FOR: POULTRY PRODUCTS, NAMELY CHICKEN, IN CLASS 29 (U.S. CL. 46).

FIRST USE 8-31-2009; IN COMMERCE 8-31-2009.

THE MARK CONSISTS OF THE SILHOUETTE OF A CHICKEN WITH THE LETTERS "GP".

SER. NO. 85-636,836, FILED 5-29-2012.

JOHN DWYER, EXAMINING ATTORNEY



*David J. Kyffers*

Director of the United States Patent and Trademark Office

# United States of America

United States Patent and Trademark Office

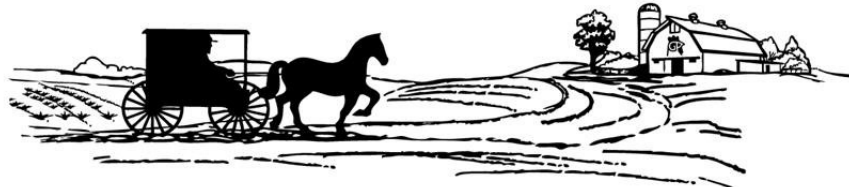

**Reg. No. 4,275,199**

**Registered Jan. 15, 2013**

**Int. Cl.: 29**

**TRADEMARK**

**PRINCIPAL REGISTER**

GERBER POULTRY, INC. (OHIO CORPORATION)  
5889 KIDRON ROAD  
KIDRON, OH 44636

FOR: POULTRY PRODUCTS, NAMELY CHICKEN, IN CLASS 29 (U.S. CL. 46).

FIRST USE 8-31-2009; IN COMMERCE 8-31-2009.

THE MARK CONSISTS OF FARM SCENE WITH AMISH WAGON AND HORSE ON ROAD  
APPROACHING BARN AND SILO WITH TREES.

SER. NO. 85-636,838, FILED 5-29-2012.

JOHN DWYER, EXAMINING ATTORNEY



*David J. Kybas*

Director of the United States Patent and Trademark Office

# United States of America

United States Patent and Trademark Office

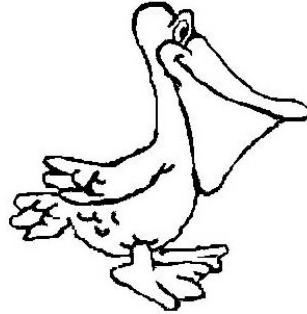

**Reg. No. 4,275,200**

**Registered Jan. 15, 2013**

**Int. Cl.: 43**

**SERVICE MARK**

**PRINCIPAL REGISTER**

PELICAN'S SNOBALLS TRADEMARKS, LLC (NORTH CAROLINA LIMITED LIABILITY COMPANY)  
216 U.S. HIGHWAY 70 WEST  
GARNER, NC 27529

FOR: RESTAURANT SERVICES, NAMELY, PROVIDING OF FOOD AND BEVERAGES FOR CONSUMPTION ON AND OFF THE PREMISES, IN CLASS 43 (U.S. CLS. 100 AND 101).

FIRST USE 6-1-2001; IN COMMERCE 6-1-2001.

THE MARK CONSISTS OF A CARTOON IMAGE OF A PELICAN.

SER. NO. 85-636,866, FILED 5-29-2012.

GEORGE LORENZO, EXAMINING ATTORNEY



*David J. Kybas*

Director of the United States Patent and Trademark Office



# United States of America

United States Patent and Trademark Office

# Sparkle Blu

**Reg. No. 4,275,201**

JONES, DIANE (UNITED STATES INDIVIDUAL)  
3745 GREENWAY LANE  
OWINGS MILLS, MD 21117

**Registered Jan. 15, 2013**

**Int. Cl.: 35**

FOR: SPECIAL EVENT PLANNING FOR BUSINESS PURPOSES, IN CLASS 35 (U.S. CLS. 100, 101 AND 102).

**SERVICE MARK**

FIRST USE 3-27-2012; IN COMMERCE 3-27-2012.

**PRINCIPAL REGISTER**

THE MARK CONSISTS OF STANDARD CHARACTERS WITHOUT CLAIM TO ANY PARTICULAR FONT, STYLE, SIZE, OR COLOR.

SER. NO. 85-636,870, FILED 5-29-2012.

DOMINIC FATHY, EXAMINING ATTORNEY



*David J. Kyffers*

Director of the United States Patent and Trademark Office

# United States of America

United States Patent and Trademark Office

# XACTAIR

**Reg. No. 4,275,202**

**Registered Jan. 15, 2013**

**Int. Cl.: 37**

**SERVICE MARK**

**PRINCIPAL REGISTER**

COINMACH CORPORATION (DELAWARE CORPORATION)  
303 SUNNYSIDE BLVD., SUITE 70  
PLAINVIEW, NY 11803

FOR: INSTALLATION, SERVICING AND REPAIR OF COIN OR CREDIT CARD ACTIVATED TIRE INFLATION MACHINES, VACUUM MACHINES FOR THE INSIDE OF VEHICLES AND WATER DISPENSING MACHINES FOR SERVICING VEHICLE ENGINES, NAMELY, MAINTAINING ENGINE COMPONENTS; OPERATION, NAMELY, THE RENTAL, INSTALLATION AND MAINTENANCE, OF COIN OR CREDIT CARD ACTIVATED TIRE INFLATION MACHINES, VACUUM MACHINES FOR THE INSIDE OF VEHICLES AND WATER DISPENSING MACHINES FOR SERVICING VEHICLE ENGINES, NAMELY, MAINTAINING ENGINE COMPONENTS, IN CLASS 37 (U.S. CLS. 100, 103 AND 106).

FIRST USE 1-0-2012; IN COMMERCE 1-0-2012.

THE MARK CONSISTS OF STANDARD CHARACTERS WITHOUT CLAIM TO ANY PARTICULAR FONT, STYLE, SIZE, OR COLOR.

SER. NO. 85-636,875, FILED 5-29-2012.

ANNE E. GUSTASON, EXAMINING ATTORNEY



*David J. Kyffers*

Director of the United States Patent and Trademark Office

# United States of America

United States Patent and Trademark Office

# XactAir

**Reg. No. 4,275,203**

**Registered Jan. 15, 2013**

**Int. Cl.: 37**

**SERVICE MARK**

**PRINCIPAL REGISTER**

COINMACH CORPORATION (DELAWARE CORPORATION)  
303 SUNNYSIDE BLVD., SUITE 70  
PLAINVIEW, NY 11803

FOR: INSTALLATION, SERVICING AND REPAIR OF COIN OR CREDIT CARD ACTIVATED TIRE INFLATION MACHINES, VACUUM MACHINES FOR THE INSIDE OF VEHICLES AND WATER DISPENSING MACHINES FOR SERVICING VEHICLE ENGINES, NAMELY, MAINTAINING ENGINE COMPONENTS; OPERATION, NAMELY, THE RENTAL, INSTALLATION AND MAINTENANCE, OF COIN OR CREDIT CARD ACTIVATED TIRE INFLATION MACHINES, VACUUM MACHINES FOR THE INSIDE OF VEHICLES AND WATER DISPENSING MACHINES FOR SERVICING VEHICLE ENGINES, NAMELY, MAINTAINING ENGINE COMPONENTS, IN CLASS 37 (U.S. CLS. 100, 103 AND 106).

FIRST USE 1-0-2012; IN COMMERCE 1-0-2012.

THE MARK CONSISTS OF THE LETTERS "XACTAIR" IN STYLIZED FONT.

SER. NO. 85-636,940, FILED 5-29-2012.

ANNE E. GUSTASON, EXAMINING ATTORNEY



*David J. Kybas*

Director of the United States Patent and Trademark Office

# United States of America

United States Patent and Trademark Office

## EVERCHANGING

**Reg. No. 4,275,204**

**Registered Jan. 15, 2013**

**Int. Cl.: 11**

**TRADEMARK**

**PRINCIPAL REGISTER**

GEMMY INDUSTRIES INCORPORATED (TEXAS CORPORATION)  
117 WRANGLER DRIVE  
COPPELL, TX 75019

FOR: GROUP OF LED LIGHTS LIGHTING IN A PATTERN, IN CLASS 11 (U.S. CLS. 13, 21, 23, 31 AND 34).

FIRST USE 11-30-2009; IN COMMERCE 11-30-2009.

THE MARK CONSISTS OF STANDARD CHARACTERS WITHOUT CLAIM TO ANY PARTICULAR FONT, STYLE, SIZE, OR COLOR.

SER. NO. 85-636,973, FILED 5-29-2012.

DANNEAN HETZEL, EXAMINING ATTORNEY



*David J. Kybas*

Director of the United States Patent and Trademark Office

# United States of America

United States Patent and Trademark Office

# XactAir

**Reg. No. 4,275,205**

**Registered Jan. 15, 2013**

**Int. Cl.: 37**

**SERVICE MARK**

**PRINCIPAL REGISTER**

COINMACH CORPORATION (DELAWARE CORPORATION)  
303 SUNNYSIDE BLVD., SUITE 70  
PLAINVIEW, NY 11803

FOR: INSTALLATION, SERVICING AND REPAIR OF COIN OR CREDIT CARD ACTIVATED TIRE INFLATION MACHINES, VACUUM MACHINES FOR THE INSIDE OF VEHICLES AND WATER DISPENSING MACHINES FOR SERVICING VEHICLE ENGINES, NAMELY, MAINTAINING ENGINE COMPONENTS; OPERATION, NAMELY, THE RENTAL, INSTALLATION AND MAINTENANCE, OF COIN OR CREDIT CARD ACTIVATED TIRE INFLATION MACHINES, VACUUM MACHINES FOR THE INSIDE OF VEHICLES AND WATER DISPENSING MACHINES FOR SERVICING VEHICLE ENGINES, NAMELY, MAINTAINING ENGINE COMPONENTS, IN CLASS 37 (U.S. CLS. 100, 103 AND 106).

FIRST USE 1-0-2012; IN COMMERCE 1-0-2012.

THE MARK CONSISTS OF THE LETTERS "XACTAIR" IN STYLIZED FONT WITH THE LETTERS "XACT" IN RED AND THE LETTERS "AIR" IN BLACK EXCEPT FOR THE TITTLE (DOT) OF THE LETTER "I" IN RED.

THE COLOR(S) BLACK AND RED IS/ARE CLAIMED AS A FEATURE OF THE MARK.

SER. NO. 85-636,976, FILED 5-29-2012.

ANNE E. GUSTASON, EXAMINING ATTORNEY



*David J. Kyros*

Director of the United States Patent and Trademark Office

# United States of America

United States Patent and Trademark Office

# hipaha

**Reg. No. 4,275,206**

HIPAHA, LLC (DELAWARE LIMITED LIABILITY COMPANY)  
54 BAYSIDE DRIVE  
FENWICK ISLAND, DE 19944

**Registered Jan. 15, 2013**

**Int. Cl.: 41**

FOR: CONDUCTING FITNESS CLASSES, IN CLASS 41 (U.S. CLS. 100, 101 AND 107).

**SERVICE MARK**

FIRST USE 7-24-2007; IN COMMERCE 7-24-2007.

**PRINCIPAL REGISTER**

THE MARK CONSISTS OF STANDARD CHARACTERS WITHOUT CLAIM TO ANY PARTICULAR FONT, STYLE, SIZE, OR COLOR.

SER. NO. 85-636,983, FILED 5-29-2012.

TASHIA BUNCH, EXAMINING ATTORNEY



*David J. Kybas*

Director of the United States Patent and Trademark Office

# United States of America

United States Patent and Trademark Office

# PRISMAGIC

**Reg. No. 4,275,207**

GEMMY INDUSTRIES INCORPORATED (TEXAS CORPORATION)  
117 WRANGLER DRIVE  
COPPELL, TX 75019

**Registered Jan. 15, 2013**

**Int. Cl.: 11**

FOR: STRING OF LED LIGHTS THAT PROVIDES SPECIAL AMBIENT ILLUMINATION AND LIGHTING IN A PATTERN, IN CLASS 11 (U.S. CLS. 13, 21, 23, 31 AND 34).

**TRADEMARK**

FIRST USE 7-31-2011; IN COMMERCE 7-31-2011.

**PRINCIPAL REGISTER**

THE MARK CONSISTS OF STANDARD CHARACTERS WITHOUT CLAIM TO ANY PARTICULAR FONT, STYLE, SIZE, OR COLOR.

SER. NO. 85-636,986, FILED 5-29-2012.

DANNEAN HETZEL, EXAMINING ATTORNEY



*David J. Kybas*

Director of the United States Patent and Trademark Office

# United States of America

United States Patent and Trademark Office

# FLEXTECH

**Reg. No. 4,275,208**

GEMMY INDUSTRIES INCORPORATED (TEXAS CORPORATION)  
117 WRANGLER DRIVE  
COPPELL, TX 75019

**Registered Jan. 15, 2013**

**Int. Cl.: 11**

FOR: FLAT RIBBON OF LED LIGHTS THAT ILLUMINATE IN MULTIPLE LIGHTING PATTERNS, IN CLASS 11 (U.S. CLS. 13, 21, 23, 31 AND 34).

**TRADEMARK**

FIRST USE 12-31-2011; IN COMMERCE 12-31-2011.

**PRINCIPAL REGISTER**

THE MARK CONSISTS OF STANDARD CHARACTERS WITHOUT CLAIM TO ANY PARTICULAR FONT, STYLE, SIZE, OR COLOR.

SER. NO. 85-636,999, FILED 5-29-2012.

DANNEAN HETZEL, EXAMINING ATTORNEY



*David J. Kybas*

Director of the United States Patent and Trademark Office



# United States of America

United States Patent and Trademark Office



Distribution of a Different Stripe

**Reg. No. 4,275,209**

**Registered Jan. 15, 2013**

**Int. Cls.: 35, 37 and 42**

**SERVICE MARK**

**PRINCIPAL REGISTER**

KBZ COMMUNICATIONS, INC. (PENNSYLVANIA CORPORATION)  
SUITE 308  
2003 S. EASTON ROAD  
DOYLESTOWN, PA 18901

FOR: DISTRIBUTORSHIP SERVICES FEATURING TELEPRESENCE, VIDEO CONFERENCE AND COMMUNICATION GOODS AND SERVICES, IN CLASS 35 (U.S. CLS. 100, 101 AND 102).

FIRST USE 8-13-2012; IN COMMERCE 8-13-2012.

FOR: INSTALLATION AND TECHNICAL SUPPORT, NAMELY, MAINTENANCE OF TELEPRESENCE, VIDEO CONFERENCING AND COMMUNICATIONS HARDWARE, IN CLASS 37 (U.S. CLS. 100, 103 AND 106).

FIRST USE 8-13-2012; IN COMMERCE 8-13-2012.

FOR: INSTALLATION AND TECHNICAL SUPPORT, NAMELY, TROUBLESHOOTING AND MAINTENANCE OF TELEPRESENCE, VIDEO CONFERENCING AND COMMUNICATIONS SOFTWARE, AND CONSULTING SERVICES RELATING THERETO; TECHNICAL SUPPORT, NAMELY, TROUBLESHOOTING AND ADMINISTRATION FOR OTHERS OF TELEPRESENCE, VIDEO CONFERENCING AND COMMUNICATIONS SYSTEMS, AND CONSULTING SERVICES RELATING THERETO, IN CLASS 42 (U.S. CLS. 100 AND 101).

FIRST USE 8-13-2012; IN COMMERCE 8-13-2012.

OWNER OF U.S. REG. NOS. 4,076,228 AND 4,076,254.

THE MARK CONSISTS OF A DESIGN CONSISTING OF STRIPES CENTERED ABOVE THE LETTERS "KBZ" WHICH IS CENTERED ABOVE THE WORDS "DISTRIBUTION OF A DIFFERENT STRIPE".

SER. NO. 85-637,010, FILED 5-29-2012.

DOMINICK J. SALEMI, EXAMINING ATTORNEY



*David J. Kyffers*

Director of the United States Patent and Trademark Office

# United States of America

United States Patent and Trademark Office



**Reg. No. 4,275,210**

**Registered Jan. 15, 2013**

**Int. Cl.: 16**

**TRADEMARK**

**PRINCIPAL REGISTER**

CHANNING BETE COMPANY, INC. (MASSACHUSETTS CORPORATION)  
ONE COMMUNITY PLACE  
SOUTH DEERFIELD, MA 01373

FOR: EDUCATIONAL KITS FOR DEVELOPING OF BETTER PARENT-SCHOOL COMMUNICATIONS AND PARENT INVOLVEMENT, PRIMARILY COMPOSED OF BOOKLETS AND DISPLAY STANDS AND POSTERS, AVAILABLE AS A UNIT OR AS REFILL SETS, IN CLASS 16 (U.S. CLS. 2, 5, 22, 23, 29, 37, 38 AND 50).

FIRST USE 10-5-1990; IN COMMERCE 12-24-1990.

OWNER OF U.S. REG. NO. 1,695,604.

THE MARK CONSISTS OF HANDS OVERLAPPING WITH TWO DOTS AND A SEMI-CIRCLE WHICH FORMS A SMILE IN THE PALMS OF THE HANDS.

SER. NO. 85-637,027, FILED 5-29-2012.

DOMINICK J. SALEMI, EXAMINING ATTORNEY



*David J. Kybas*

Director of the United States Patent and Trademark Office

# United States of America

United States Patent and Trademark Office

# UoPEOPLE

**Reg. No. 4,275,211**

**Registered Jan. 15, 2013**

**Int. Cl.: 41**

**SERVICE MARK**

**PRINCIPAL REGISTER**

UNIVERSITY OF THE PEOPLE (CALIFORNIA NON-PROFIT PUBLIC BENEFIT CORPORATION)  
225 S. LAKE AVENUE  
PASADENA, CA 91101

FOR: EDUCATIONAL SERVICES, NAMELY, PROVIDING ONLINE COURSES OF INSTRUCTION AT THE POST SECONDARY LEVEL AND DISTRIBUTION OF COURSE MATERIALS IN CONNECTION THEREWITH, IN CLASS 41 (U.S. CLS. 100, 101 AND 107).

FIRST USE 1-0-2009; IN COMMERCE 1-0-2009.

THE MARK CONSISTS OF STANDARD CHARACTERS WITHOUT CLAIM TO ANY PARTICULAR FONT, STYLE, SIZE, OR COLOR.

SER. NO. 85-637,071, FILED 5-29-2012.

KIM MONINGHOFF, EXAMINING ATTORNEY



*David J. Kybas*

Director of the United States Patent and Trademark Office

# United States of America

United States Patent and Trademark Office

## SECURING THE PERIMETER WITHIN

**Reg. No. 4,275,212**

**Registered Jan. 15, 2013**

**Int. Cl.: 9**

**TRADEMARK**

**PRINCIPAL REGISTER**

BEYONDTRUST SOFTWARE, INC. (CALIFORNIA CORPORATION)  
2173 SALK AVE, SUITE 200  
CARLSBAD, CA 92008

FOR: COMPUTER SOFTWARE PROGRAMS AND HARDWARE TO ASSIST IN SECURITY AND PRIVILEGE MANAGEMENT FOR COMPUTER OPERATING SYSTEMS, COMMUNICATION PROTOCOLS, AND SOFTWARE APPLICATIONS; COMPUTER SOFTWARE PROGRAMS TO ASSIST IN SYSTEMS ADMINISTRATION AND SECURITY ON OPERATING SYSTEMS FOR SERVER COMPUTERS, DESKTOP COMPUTERS, PORTABLE COMPUTERS, WORKSTATION COMPUTERS, AND NETWORK DEVICES AND APPLICATION SOFTWARE THAT SUPPORT REMOTE ACCESS PROTOCOLS; COMPUTER HARDWARE AND SOFTWARE PROGRAMS TO ASSIST IN PASSWORD MANAGEMENT AND SECURITY; COMPUTER SOFTWARE PROGRAMS TO ASSIST IN CENTRALIZED MANAGEMENT AND REPORTING; COMPUTER SOFTWARE PROGRAMS TO ASSIST IN INTEGRATING HOST CREDENTIALS INTO DIRECTORY SERVICES; COMPUTER SOFTWARE PROGRAMS THAT PROVIDE ACCESS TO MULTIPLE APPLICATIONS IN DIFFERENT OPERATING SYSTEMS; COMPUTER SOFTWARE PROGRAMS TO ASSIST IN DATA LEAK PROTECTION; COMPUTER SOFTWARE PROGRAMS TO ASSIST IN CLOUD AND VIRTUALIZATION MONITORING AND MANAGEMENT, IN CLASS 9 (U.S. CLS. 21, 23, 26, 36 AND 38).

FIRST USE 7-22-2011; IN COMMERCE 7-22-2011.

THE MARK CONSISTS OF STANDARD CHARACTERS WITHOUT CLAIM TO ANY PARTICULAR FONT, STYLE, SIZE, OR COLOR.

SER. NO. 85-637,090, FILED 5-29-2012.

JUSTINE D. PARKER, EXAMINING ATTORNEY



*David J. Kyffers*

Director of the United States Patent and Trademark Office

# United States of America

United States Patent and Trademark Office

## SHAKA PAWS

**Reg. No. 4,275,213**

JUSTIN KERNAN (UNITED STATES INDIVIDUAL)  
329 SALIDA DEL SOL  
SANTA BARBARA, CA 93109

**Registered Jan. 15, 2013**

**Int. Cl.: 21**

FOR: FEEDING VESSELS FOR PETS, IN CLASS 21 (U.S. CLS. 2, 13, 23, 29, 30, 33, 40 AND 50).

**TRADEMARK**

FIRST USE 12-15-2011; IN COMMERCE 12-15-2011.

**PRINCIPAL REGISTER**

THE MARK CONSISTS OF STANDARD CHARACTERS WITHOUT CLAIM TO ANY PARTICULAR FONT, STYLE, SIZE, OR COLOR.

SER. NO. 85-637,093, FILED 5-29-2012.

CHRISTINA SOBRAL, EXAMINING ATTORNEY



*David J. Kybas*

Director of the United States Patent and Trademark Office

# United States of America

United States Patent and Trademark Office



**Reg. No. 4,275,214**

**Registered Jan. 15, 2013**

**Int. Cl.: 30**

**TRADEMARK**

**PRINCIPAL REGISTER**

YING YAO (CHINA INDIVIDUAL)  
NO. 1-1 TOWN HOUSE GUIHUACHENG  
NO. 69 ZIJINHUA RD., XIHU  
HANGZHOU, CHINA 310012

FOR: ALIMENTARY PASTE (PASTAS AND NOODLES); BAKING POWDERS; COOKING POWDER, NAMELY, BACON-FLAVORED SEASONING POWDER; DRIED HERBS; EDIBLE SPICES; EXTRACTS USED AS FLAVORING; FLAVOR ENHANCERS USED IN FOOD AND BEVERAGE PRODUCTS; FLAVOURINGS; FLAVOURINGS AND SEASONINGS; GARLIC POWDER; MINCED GARLIC; MIXES IN THE NATURE OF CONCENTRATES, SYRUPS OR POWDERS USED IN THE PREPARATION OF TEA BASED BEVERAGES; NON-MEDICATED LOZENGES; POWDERED GARLIC; PROCESSED GARLIC FOR USE AS SEASONING; PROCESSED HERBS; RELISH; SEASONINGS; VEGETABLE CONCENTRATES USED FOR SEASONING; YEAST IN PILL FORM, NOT FOR MEDICAL USE, IN CLASS 30 (U.S. CL. 46).

FIRST USE 8-8-2008; IN COMMERCE 8-28-2008.

THE MARK CONSISTS OF A CIRCLE, THE DEPICTION OF A GARLIC BULB LOCATED IN THE UPPER PORTION OF THE CIRCLE WITH TWO CHINESE CHARACTERS WITHIN IT, AND THE STYLIZED WORDING "KANG HUO" IN THE LOWER PORTION OF THE CIRCLE.

THE NON-LATIN CHARACTERS IN THE MARK TRANSLITERATE TO "KANG HUO" AND THIS MEANS "BECOMING HEALTHY" IN ENGLISH.

THE ENGLISH TRANSLATION OF "KANG HUO" IN THE MARK IS "BECOMING HEALTHY".

SER. NO. 85-637,100, FILED 5-29-2012.

WILLIAM JACKSON, EXAMINING ATTORNEY



*David J. Kybas*

Director of the United States Patent and Trademark Office

# United States of America

United States Patent and Trademark Office

# JSC

**Reg. No. 4,275,215**

**Registered Jan. 15, 2013**

**Int. Cl.: 35**

**SERVICE MARK**

**PRINCIPAL REGISTER**

JENNY SERVICE COMPANY (NEVADA CORPORATION)  
SUITE 101  
150 EAST GREG STREET  
SPARKS, NV 89431

FOR: INSTITUTIONAL RETAIL COMMISSARY SERVICES FEATURING SUNDRIES, CANDY, FOOD, SNACKS, CONFECTIONS, BEVERAGES, AND HEALTH AND BEAUTY PRODUCTS, IN CLASS 35 (U.S. CLS. 100, 101 AND 102).

FIRST USE 7-0-1994; IN COMMERCE 7-0-1994.

THE MARK CONSISTS OF STANDARD CHARACTERS WITHOUT CLAIM TO ANY PARTICULAR FONT, STYLE, SIZE, OR COLOR.

OWNER OF U.S. REG. NO. 4,068,227.

SER. NO. 85-637,109, FILED 5-29-2012.

JIM RINGLE, EXAMINING ATTORNEY



*David J. Kyffers*

Director of the United States Patent and Trademark Office

# United States of America

United States Patent and Trademark Office

# JSC

**Reg. No. 4,275,216**

**Registered Jan. 15, 2013**

**Int. Cl.: 43**

**SERVICE MARK**

**PRINCIPAL REGISTER**

JENNY SERVICE COMPANY (NEVADA CORPORATION)  
SUITE 101  
150 EAST GREG STREET  
SPARKS, NV 89431

FOR: CANTEEN SERVICES, IN CLASS 43 (U.S. CLS. 100 AND 101).

FIRST USE 7-0-1994; IN COMMERCE 7-0-1994.

THE MARK CONSISTS OF STANDARD CHARACTERS WITHOUT CLAIM TO ANY PARTICULAR FONT, STYLE, SIZE, OR COLOR.

OWNER OF U.S. REG. NO. 4,068,227.

SER. NO. 85-637,115, FILED 5-29-2012.

JIM RINGLE, EXAMINING ATTORNEY



*David J. Kyffers*

Director of the United States Patent and Trademark Office



# United States of America

United States Patent and Trademark Office

## MADTRAVELERS FOUNDATION

**Reg. No. 4,275,217**

**Registered Jan. 15, 2013**

**Int. Cl.: 36**

**SERVICE MARK**

**PRINCIPAL REGISTER**

MADTRAVELERS FOUNDATION (NEW YORK NON-PROFIT CORPORATION)  
1133 BROADWAY, SUITE 706  
NEW YORK, NY 10010

FOR: CHARITABLE FOUNDATION SERVICES, NAMELY, PROVIDING FUNDRAISING ACTIVITIES, FUNDING, SCHOLARSHIPS AND/OR FINANCIAL ASSISTANCE FOR COLLEGE AND UNIVERSITY BOUND STUDENTS IN THE NATURE OF TRAVEL AND RELOCATION ASSISTANCE AND BASIC EDUCATIONAL SUPPLIES, IN CLASS 36 (U.S. CLS. 100, 101 AND 102).

FIRST USE 7-14-2010; IN COMMERCE 7-14-2010.

THE MARK CONSISTS OF STANDARD CHARACTERS WITHOUT CLAIM TO ANY PARTICULAR FONT, STYLE, SIZE, OR COLOR.

OWNER OF U.S. REG. NO. 3,784,107.

NO CLAIM IS MADE TO THE EXCLUSIVE RIGHT TO USE "FOUNDATION", APART FROM THE MARK AS SHOWN.

SER. NO. 85-637,158, FILED 5-29-2012.

MATTHEW GALAN, EXAMINING ATTORNEY



*David J. Kybas*

Director of the United States Patent and Trademark Office

# United States of America

United States Patent and Trademark Office

## A WOLNATION

**Reg. No. 4,275,218**

**Registered Jan. 15, 2013**

**Int. Cl.: 41**

**SERVICE MARK**

**PRINCIPAL REGISTER**

THANK YOU FOR LISTENING ENTERTAINMENT, INC. (CALIFORNIA CORPORATION)  
C/O BRUNO FINANCIAL  
141 DUESENBERG DRIVE, SUITE 8  
THOUSAND OAKS, CA 91362

FOR: ENTERTAINMENT, NAMELY, LIVE PERFORMANCES BY A MUSICAL GROUP;  
PROVIDING INFORMATION ABOUT PERFORMANCES, MUSIC, RECORDINGS, APPEAR-  
ANCES, NEWS, AND OTHER INFORMATION ABOUT A MUSICAL GROUP VIA A WEBSITE  
ON A GLOBAL COMPUTER NETWORK, IN CLASS 41 (U.S. CLS. 100, 101 AND 107).

FIRST USE 7-30-2009; IN COMMERCE 7-30-2009.

THE MARK CONSISTS OF STANDARD CHARACTERS WITHOUT CLAIM TO ANY PAR-  
TICULAR FONT, STYLE, SIZE, OR COLOR.

SER. NO. 85-637,174, FILED 5-29-2012.

KAREN BRACEY, EXAMINING ATTORNEY



*David J. Kyffers*

Director of the United States Patent and Trademark Office

# United States of America

United States Patent and Trademark Office

# TRANSITCAM

**Reg. No. 4,275,219**

**Registered Jan. 15, 2013**

**Int. Cl.: 9**

**TRADEMARK**

**PRINCIPAL REGISTER**

DIGITAL SAFETY TECHNOLOGIES, INC. (DELAWARE CORPORATION)  
3301 TERMINAL DRIVE, STE. 119  
RALEIGH, NC 27604

FOR: SECURITY AND SURVEILLANCE VIDEO SYSTEMS, NAMELY, DIGITAL VIDEO PLAYERS AND RECORDERS, VIDEO DISPLAY MONITORS, COMPUTER PERIPHERALS, AND COMPUTER SOFTWARE FOR USE WITH SECURITY AND SURVEILLANCE VIDEO SYSTEMS AND PRINTED MANUALS SOLD AS A UNIT THEREWITH, IN CLASS 9 (U.S. CLS. 21, 23, 26, 36 AND 38).

FIRST USE 10-4-2005; IN COMMERCE 10-4-2005.

THE MARK CONSISTS OF STANDARD CHARACTERS WITHOUT CLAIM TO ANY PARTICULAR FONT, STYLE, SIZE, OR COLOR.

OWNER OF U.S. REG. NO. 3,125,108.

SEC. 2(F).

SER. NO. 85-637,215, FILED 5-29-2012.

CHRISTINA SOBRAL, EXAMINING ATTORNEY



*David J. Kyffers*

Director of the United States Patent and Trademark Office

# United States of America

United States Patent and Trademark Office

## CHOOSE FREEDOM

**Reg. No. 4,275,220**

SOVEREIGN BRAND INC (FLORIDA CORPORATION)  
6118 YEATS MANOR DR  
TAMPA, FL 33616

**Registered Jan. 15, 2013**

**Int. Cl.: 25**

FOR: BELTS; DRESSES; INFANT WEAR; JACKETS; PAJAMAS; T-SHIRTS; TANK TOPS;  
THERMAL UNDERWEAR; TOPS, IN CLASS 25 (U.S. CLS. 22 AND 39).

**TRADEMARK**

FIRST USE 6-0-2011; IN COMMERCE 8-0-2011.

**PRINCIPAL REGISTER**

THE MARK CONSISTS OF STANDARD CHARACTERS WITHOUT CLAIM TO ANY PAR-  
TICULAR FONT, STYLE, SIZE, OR COLOR.

SER. NO. 85-637,237, FILED 5-29-2012.

SUSAN LESLIE DUBOIS, EXAMINING ATTORNEY



*David J. Kybas*

Director of the United States Patent and Trademark Office

# United States of America

United States Patent and Trademark Office



**Reg. No. 4,275,221**

**Registered Jan. 15, 2013**

**Int. Cl.: 3**

**TRADEMARK**

**PRINCIPAL REGISTER**

KING RESEARCH, INC. (WISCONSIN CORPORATION)  
7025 W. MARCIA ROAD  
MILWAUKEE, WI 53233

FOR: TALCUM POWDERS, IN CLASS 3 (U.S. CLS. 1, 4, 6, 50, 51 AND 52).

FIRST USE 2-29-2012; IN COMMERCE 2-29-2012.

THE MARK CONSISTS OF AN IMAGE OF A KING SUPPORTING A BARBER POLE.

SER. NO. 85-637,266, FILED 5-29-2012.

SUSAN LESLIE DUBOIS, EXAMINING ATTORNEY



*David J. Kyffers*

Director of the United States Patent and Trademark Office

# United States of America

United States Patent and Trademark Office

## COACHAPALOOZA

**Reg. No. 4,275,222**

**Registered Jan. 15, 2013**

**Int. Cl.: 41**

**SERVICE MARK**

**PRINCIPAL REGISTER**

ONE ENERGY INTERNATIONAL LLC (COLORADO LIMITED LIABILITY COMPANY)  
SUITE 203  
3980 BROADWAY AVE.  
BOULDER, CO 80304

FOR: CONDUCTING WORKSHOPS AND SEMINARS IN PERSONAL AWARENESS; CONDUCTING WORKSHOPS AND SEMINARS IN PERSONAL TRANSFORMATION, PERSONAL GROWTH AND PERSONAL DEVELOPMENT; LIFE COACHING SERVICES IN THE FIELD OF PERSONAL TRANSFORMATION, PERSONAL GROWTH AND PERSONAL DEVELOPMENT, IN CLASS 41 (U.S. CLS. 100, 101 AND 107).

FIRST USE 2-10-2012; IN COMMERCE 2-10-2012.

THE MARK CONSISTS OF STANDARD CHARACTERS WITHOUT CLAIM TO ANY PARTICULAR FONT, STYLE, SIZE, OR COLOR.

SER. NO. 85-637,278, FILED 5-29-2012.

KIM MONINGHOFF, EXAMINING ATTORNEY



*David J. Kybas*

Director of the United States Patent and Trademark Office

# United States of America

United States Patent and Trademark Office

# O'Grime

**Reg. No. 4,275,223**

O'GRIME LLC (FLORIDA LIMITED LIABILITY COMPANY)  
20028 NW 64 PL

**Registered Jan. 15, 2013**

HIALEAH, FL 33015

**Int. Cl.: 41**

FOR: ENTERTAINMENT SERVICES, NAMELY, MULTIMEDIA PRODUCTION SERVICES;  
MUSIC PRODUCTION SERVICES, IN CLASS 41 (U.S. CLS. 100, 101 AND 107).

**SERVICE MARK**

FIRST USE 3-15-2011; IN COMMERCE 3-15-2011.

**PRINCIPAL REGISTER**

THE MARK CONSISTS OF STANDARD CHARACTERS WITHOUT CLAIM TO ANY PARTICULAR FONT, STYLE, SIZE, OR COLOR.

SER. NO. 85-637,279, FILED 5-29-2012.

JOHN WILKE, EXAMINING ATTORNEY



*David J. Kyffers*

Director of the United States Patent and Trademark Office

# United States of America

United States Patent and Trademark Office

# AMION

**Reg. No. 4,275,224**

**Registered Jan. 15, 2013**

**Int. Cls.: 9 and 42**

**TRADEMARK**

**SERVICE MARK**

**PRINCIPAL REGISTER**

STUART KARON (UNITED STATES INDIVIDUAL)  
113 UPPER PASTURE ROAD  
NORWICH, VT 05055

FOR: DOWNLOADABLE CALENDARING AND SCHEDULING SOFTWARE, IN CLASS 9  
(U.S. CLS. 21, 23, 26, 36 AND 38).

FIRST USE 0-0-2003; IN COMMERCE 0-0-2003.

FOR: PROVIDING NON-DOWNLOADABLE SOFTWARE FOR SCHEDULING, CALENDAR-  
ING, REPORTING, AND INTERACTING AMONG HEALTHCARE PROVIDERS, IN CLASS  
42 (U.S. CLS. 100 AND 101).

FIRST USE 0-0-2001; IN COMMERCE 0-0-2001.

THE MARK CONSISTS OF STANDARD CHARACTERS WITHOUT CLAIM TO ANY PAR-  
TICULAR FONT, STYLE, SIZE, OR COLOR.

SER. NO. 85-637,300, FILED 5-29-2012.

EMILY CHUO, EXAMINING ATTORNEY



*David J. Kybas*

Director of the United States Patent and Trademark Office



# United States of America

United States Patent and Trademark Office

## BUILDING A REPUTATION

**Reg. No. 4,275,225**

ADI CONSTRUCTION OF VIRGINIA, LLC (MARYLAND LIMITED LIABILITY COMPANY)  
5601 JORDAN BLVD  
NEW MARKET, MD 21774

**Registered Jan. 15, 2013**

**Int. Cl.: 37**

FOR: BUILDING CONSTRUCTION SERVICES; CONSTRUCTION MANAGEMENT; GENERAL CONSTRUCTION CONTRACTING, IN CLASS 37 (U.S. CLS. 100, 103 AND 106).

**SERVICE MARK**

FIRST USE 4-11-2012; IN COMMERCE 4-12-2012.

**PRINCIPAL REGISTER**

THE MARK CONSISTS OF STANDARD CHARACTERS WITHOUT CLAIM TO ANY PARTICULAR FONT, STYLE, SIZE, OR COLOR.

SER. NO. 85-637,311, FILED 5-29-2012.

CATHERINE ROEHL, EXAMINING ATTORNEY



*David J. Kybas*

Director of the United States Patent and Trademark Office

# United States of America

United States Patent and Trademark Office



**Reg. No. 4,275,226**

**Registered Jan. 15, 2013**

**Int. Cl.: 25**

**TRADEMARK**

**PRINCIPAL REGISTER**

INSPIRED BY POSITIVE PATTY LLC (FLORIDA LIMITED LIABILITY COMPANY)  
590 5TH ST SW  
NAPLES, FL 34117

FOR: CLOTHING, NAMELY, JACKETS, COATS, FABRIC BELTS, LEATHER BELTS, CLOTH BELTS, T-SHIRTS, LONG SLEEVE T-SHIRTS, POLO SHIRTS, TANK TOPS, SWEATSHIRTS, HOODED SWEATSHIRTS, WIND SHIRTS, DRESS SHIRTS, BLOUSES, SWEAT SUITS, SWIMSUITS, SWEATERS, BLAZERS, VESTS, PARKAS, PULLOVERS, PONCHOS, WIND RESISTANT JACKETS, DRESSES, SKIRTS, HATS, CAPS, VISORS, BEANIES, CARDIGANS, PANTS, TROUSERS, SWEAT PANTS, CAPRIS, SHORTS, BOXING SHORTS, FIGHTING SHORTS, SWIM TRUNKS, BOARD SHORTS, WIND SHORTS, SNAP CROTCH SHORTS, SNAP CROTCH SHIRTS, BANDANAS, GLOVES, SCARVES, MITTENS, FOOTWEAR, SHOES, SANDALS, BOOTS, FLIP FLOPS, UNDERGARMENTS, PANTIES, UNDERWEAR, BOXERS, BRIEFS, SOCKS, NIGHT GOWNS, PAJAMAS, BATHROBES, BODYSUITS, ROMPERS, YOGA PANTS, SHORTS AND TOPS; BIKING PANTS, SHORTS AND TOPS; HIKING PANTS, SHORTS AND TOPS; LEOTARDS, TIGHTS, IN CLASS 25 (U.S. CLS. 22 AND 39).

FIRST USE 12-15-2011; IN COMMERCE 12-15-2011.

OWNER OF U.S. REG. NO. 4,047,019.

THE MARK CONSISTS OF A STYLIZED DRAWING OF A WOMANS FACE WITH A LARGE SMILE AND A BOW IN HER HAIR ON THE LEFT WITH THE STYLIZED LETTERING OF POSITIVE PATTY BELOW THE FACE.

SER. NO. 85-637,314, FILED 5-29-2012.

PRISCILLA MILTON, EXAMINING ATTORNEY



*David J. Kybas*

Director of the United States Patent and Trademark Office

# United States of America

United States Patent and Trademark Office

## THE POWER BEHIND THE PAINT

**Reg. No. 4,275,227**

**Registered Jan. 15, 2013**

**Int. Cl.: 35**

**SERVICE MARK**

**PRINCIPAL REGISTER**

NORED, INC. (NORTH DAKOTA CORPORATION), DBA GOOSENECK IMPLEMENT  
HWY 2 BYPASS EAST  
MINOT, ND 587020910

FOR: RETAIL STORE SERVICES FEATURING AGRICULTURAL MACHINERY AND  
EQUIPMENT AND RESIDENTIAL AND COMMERCIAL LAWN AND TURF CARE EQUIP-  
MENT, IN CLASS 35 (U.S. CLS. 100, 101 AND 102).

FIRST USE 8-31-2002; IN COMMERCE 8-31-2002.

THE MARK CONSISTS OF STANDARD CHARACTERS WITHOUT CLAIM TO ANY PAR-  
TICULAR FONT, STYLE, SIZE, OR COLOR.

SER. NO. 85-637,336, FILED 5-29-2012.

JEFFREY LOOK, EXAMINING ATTORNEY



*David J. Kybas*

Director of the United States Patent and Trademark Office

# United States of America

United States Patent and Trademark Office

ALL THE HELP YOU NEED FOR  
AS LONG AS IT TAKES

**Reg. No. 4,275,228**

FOR SALE BY OWNER SYSTEM LLC (ALASKA LIMITED LIABILITY COMPANY)  
280 W. 34TH AVE  
ANCHORAGE, AK 99503

**Registered Jan. 15, 2013**

**Int. Cl.: 41**

FOR: EDUCATIONAL SERVICES, NAMELY, CONDUCTING ONLINE TUTORIALS IN THE FIELD OF REAL ESTATE FOR THE PURPOSE OF INFORMING HOME OWNERS ON TOPICS RELATED SO SELLING THEIR PROPERTY ON THEIR OWN, IN CLASS 41 (U.S. CLS. 100, 101 AND 107).

**SERVICE MARK**

**PRINCIPAL REGISTER**

FIRST USE 3-1-1998; IN COMMERCE 3-1-1998.

THE MARK CONSISTS OF STANDARD CHARACTERS WITHOUT CLAIM TO ANY PARTICULAR FONT, STYLE, SIZE, OR COLOR.

SER. NO. 85-637,339, FILED 5-29-2012.

JOHN DALIER, EXAMINING ATTORNEY



*David J. Kyffers*

Director of the United States Patent and Trademark Office

# United States of America

## United States Patent and Trademark Office



**Reg. No. 4,275,229**

**Registered Jan. 15, 2013**

**Int. Cl.: 25**

**TRADEMARK**

**PRINCIPAL REGISTER**

INSPIRED BY POSITIVE PATTY LLC (FLORIDA LIMITED LIABILITY COMPANY)  
590 5TH ST SW  
NAPLES, FL 34117

FOR: CLOTHING, NAMELY, JACKETS, COATS, FABRIC BELTS, LEATHER BELTS, CLOTH BELTS, T-SHIRTS, LONG SLEEVE T-SHIRTS, POLO SHIRTS, TANK TOPS, SWEATSHIRTS, HOODED SWEATSHIRTS, WIND SHIRTS, DRESS SHIRTS, BLOUSES, SWEAT SUITS, SWIMSUITS, SWEATERS, BLAZERS, VESTS, PARKAS, PULLOVERS, PONCHOS, WIND RESISTANT JACKETS, DRESSES, SKIRTS, HATS, CAPS, VISORS, BEANIES, CARDIGANS, PANTS, TROUSERS, SWEAT PANTS, CAPRIS, SHORTS, BOXING SHORTS, FIGHTING SHORTS, SWIM TRUNKS, BOARD SHORTS, WIND SHORTS, SNAP CROTCH SHORTS, SNAP CROTCH SHIRTS, BANDANAS, GLOVES, SCARVES, MITTENS, FOOTWEAR, SHOES, SANDALS, BOOTS, FLIP FLOPS, UNDERGARMENTS, PANTIES, UNDERWEAR, BOXERS, BRIEFS, SOCKS, NIGHT GOWNS, PAJAMAS, BATHROBES, BODYSUITS, ROMPERS, YOGA PANTS, SHORTS AND TOPS; BIKING PANTS, SHORTS AND TOPS; HIKING PANTS, SHORTS AND TOPS; LEOTARDS, TIGHTS, IN CLASS 25 (U.S. CLS. 22 AND 39).

FIRST USE 12-15-2011; IN COMMERCE 12-15-2011.

OWNER OF U.S. REG. NO. 4,047,019.

THE MARK CONSISTS OF A STYLIZED GLOBE WITH THE STYLIZED LETTERING OF "INSPIRED BY POSITIVE PATTY" INSIDE THE GLOBE AND WITH 17 STICK FIGURE CHILDREN WITH ARMS OUTSTRETCHED SURROUNDING THE GLOBE.

SER. NO. 85-637,351, FILED 5-29-2012.

PRISCILLA MILTON, EXAMINING ATTORNEY



*David J. Kybas*

Director of the United States Patent and Trademark Office

# United States of America

United States Patent and Trademark Office

## BURN NOTE

**Reg. No. 4,275,230**

**Registered Jan. 15, 2013**

**Int. Cl.: 42**

**SERVICE MARK**

**PRINCIPAL REGISTER**

BURN NOTE INC. (DELAWARE CORPORATION)

3F  
20 ORCHARD ST  
NEW YORK, NY 10002

FOR: PROVIDING A WEBSITE THAT GIVES COMPUTER USERS THE ABILITY TO TRANSFER INFORMATION OVER THE INTERNET IN A PRIVATE AND SECURE MANNER AND WHICH AUTOMATICALLY DELETES TRANSFERRED INFORMATION, IN CLASS 42 (U.S. CLS. 100 AND 101).

FIRST USE 1-31-2012; IN COMMERCE 1-31-2012.

THE MARK CONSISTS OF STANDARD CHARACTERS WITHOUT CLAIM TO ANY PARTICULAR FONT, STYLE, SIZE, OR COLOR.

SER. NO. 85-637,357, FILED 5-29-2012.

JAY FLOWERS, EXAMINING ATTORNEY



*David J. Kyffers*

Director of the United States Patent and Trademark Office

# United States of America

United States Patent and Trademark Office

live outside 

**Reg. No. 4,275,231**

DK DESIGN LLC (ARKANSAS LIMITED LIABILITY COMPANY)

**Registered Jan. 15, 2013**

P.O. BOX 1423  
FAYETTEVILLE, AR 72702

**Int. Cl.: 44**

FOR: GARDEN CARE SERVICES; GARDEN DESIGN, INSTALLATION AND MAINTENANCE OF INTERIOR BOTANICAL DISPLAYS, STREETSCAPE CONTAINER PLANTINGS AND ROOFTOP GARDENS FOR OTHERS; GARDEN OR FLOWER BED CARE; GARDEN TREE PLANTING; LANDSCAPE DESIGN; LANDSCAPE GARDENING; LANDSCAPE GARDENING DESIGN FOR OTHERS, IN CLASS 44 (U.S. CLS. 100 AND 101).

**SERVICE MARK**

**PRINCIPAL REGISTER**

FIRST USE 3-27-2009; IN COMMERCE 3-27-2009.

THE MARK CONSISTS OF THE STYLIZED TEXT "LIVE OUTSIDE". TO THE RIGHT THERE IS THE STYLIZED TEXT "THE BOX" INSIDE A BOX.

SER. NO. 85-637,358, FILED 5-29-2012.

JAY FLOWERS, EXAMINING ATTORNEY



*David J. Kybas*

Director of the United States Patent and Trademark Office

# United States of America

United States Patent and Trademark Office

# GAMEBYTE

**Reg. No. 4,275,232**

**Registered Jan. 15, 2013**

**Int. Cl.: 35**

**SERVICE MARK**

**PRINCIPAL REGISTER**

INTERPRET, LLC (CALIFORNIA LIMITED LIABILITY COMPANY)  
227 BROADWAY, SUITE 300  
SANTA MONICA, CA 90401

FOR: BUSINESS MARKETING CONSULTING SERVICES; CONSULTING SERVICES IN THE FIELD OF INTERNET MARKETING; CONSUMER MARKETING RESEARCH AND CONSULTING RELATED THERETO; PROVIDING MARKETING CONSULTING IN THE FIELD OF COMPUTER GAMES, VIDEO GAMES, ONLINE GAMES, SOCIAL MEDIA GAMES, DOWNLOADABLE AND STREAMING COMPUTER GAMES; MARKETING SERVICES, NAMELY, CONDUCTING CONSUMER TRACKING BEHAVIOR RESEARCH AND CONSUMER TREND ANALYSIS; MARKETING ANALYSIS SERVICES, IN CLASS 35 (U.S. CLS. 100, 101 AND 102).

FIRST USE 5-14-2012; IN COMMERCE 5-14-2012.

THE MARK CONSISTS OF STANDARD CHARACTERS WITHOUT CLAIM TO ANY PARTICULAR FONT, STYLE, SIZE, OR COLOR.

SER. NO. 85-637,362, FILED 5-29-2012.

JAY FLOWERS, EXAMINING ATTORNEY



*David J. Kypos*

Director of the United States Patent and Trademark Office



# United States of America

United States Patent and Trademark Office

## LATE NIGHT LIBRARY

**Reg. No. 4,275,233**

**Registered Jan. 15, 2013**

**Int. Cl.: 41**

**SERVICE MARK**

**PRINCIPAL REGISTER**

LATE NIGHT LIBRARY (OREGON NON-PROFIT CORPORATION)  
7503 S.E. WOODSTOCK BOULEVARD  
PORTLAND, OR 97206

FOR: ENTERTAINMENT SERVICES, NAMELY, PROVIDING ON-LINE REVIEWS OF BOOKS;  
ENTERTAINMENT SERVICES, NAMELY, PROVIDING PODCASTS IN THE FIELD OF  
LITERATURE; PROVIDING A WEBSITE FOR ENTERTAINMENT PURPOSES FEATURING  
PODCASTS ABOUT LITERATURE, IN CLASS 41 (U.S. CLS. 100, 101 AND 107).

FIRST USE 4-30-2011; IN COMMERCE 4-30-2011.

THE MARK CONSISTS OF STANDARD CHARACTERS WITHOUT CLAIM TO ANY PAR-  
TICULAR FONT, STYLE, SIZE, OR COLOR.

NO CLAIM IS MADE TO THE EXCLUSIVE RIGHT TO USE "LIBRARY", APART FROM  
THE MARK AS SHOWN.

SER. NO. 85-637,374, FILED 5-29-2012.

JAY FLOWERS, EXAMINING ATTORNEY



*David J. Kyffers*

Director of the United States Patent and Trademark Office

# United States of America

United States Patent and Trademark Office

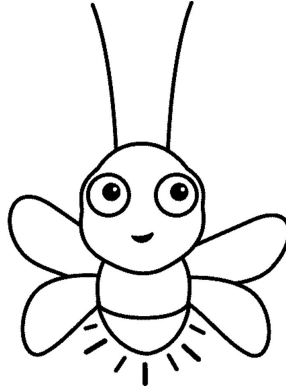

**Reg. No. 4,275,234**

**Registered Jan. 15, 2013**

**Int. Cl.: 9**

**TRADEMARK**

**PRINCIPAL REGISTER**

I PLAY, INC. (NORTH CAROLINA CORPORATION)  
2000 RIVERSIDE DRIVE, SUITE 9  
ASHEVILLE, NC 28804

FOR: CHAINS FOR SPECTACLES AND FOR SUNGLASSES; EAR PLUGS FOR SWIMMING; SNORKELS; SUNGLASSES; SUNGLASSES WITH WRAPAROUND BAND; SWIMMING FACE MASKS; SWIMMING GOGGLES, IN CLASS 9 (U.S. CLS. 21, 23, 26, 36 AND 38).

FIRST USE 9-0-2009; IN COMMERCE 9-0-2009.

THE MARK CONSISTS OF A DRAWING OF A LIGHTNING BUG OR FIREFLY.

SER. NO. 85-637,393, FILED 5-29-2012.

MARILYN IZZI, EXAMINING ATTORNEY



*David J. Kybas*

Director of the United States Patent and Trademark Office

# United States of America

United States Patent and Trademark Office

**Entre-SLAM**

**Reg. No. 4,275,235**

CHAMBERS-PRICE, CHRISTA (UNITED STATES INDIVIDUAL)  
1301 PONTIAC TRAIL  
ANN ARBOR, MI 48105 AND

**Registered Jan. 15, 2013**

**Int. Cl.: 35**

BALLEW, JEANNE (UNITED STATES INDIVIDUAL)  
1320 WRIGHT STREET  
ANN ARBOR, MI 48105

**SERVICE MARK**

**PRINCIPAL REGISTER**

FOR: ARRANGING AND CONDUCTING SPECIAL EVENTS FOR BUSINESS PURPOSES;  
BUSINESS NETWORKING, IN CLASS 35 (U.S. CLS. 100, 101 AND 102).

FIRST USE 2-1-2012; IN COMMERCE 3-1-2012.

THE MARK CONSISTS OF THE TEXT "ENTRE" WITH A DASH AND CAPITALIZED "SLAM".

SER. NO. 85-637,406, FILED 5-29-2012.

KAPIL BHANOT, EXAMINING ATTORNEY



*David J. Kyffers*

Director of the United States Patent and Trademark Office

# United States of America

United States Patent and Trademark Office

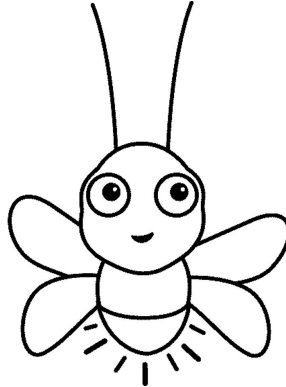

**Reg. No. 4,275,236**

**Registered Jan. 15, 2013**

**Int. Cl.: 16**

**TRADEMARK**

**PRINCIPAL REGISTER**

I PLAY, INC. (NORTH CAROLINA CORPORATION)  
2000 RIVERSIDE DRIVE, SUITE 9  
ASHEVILLE, NC 28804

FOR: CHILDREN'S BOOKS; DISPOSABLE SWIM PANTS FOR CHILDREN AND INFANTS;  
SCENTED DRAWER LINERS, IN CLASS 16 (U.S. CLS. 2, 5, 22, 23, 29, 37, 38 AND 50).

FIRST USE 9-0-2009; IN COMMERCE 9-0-2009.

THE MARK CONSISTS OF A DRAWING OF A LIGHTNING BUG OR FIREFLY.

SER. NO. 85-637,409, FILED 5-29-2012.

MARILYN IZZI, EXAMINING ATTORNEY



*David J. Kyffers*

Director of the United States Patent and Trademark Office

# United States of America

United States Patent and Trademark Office

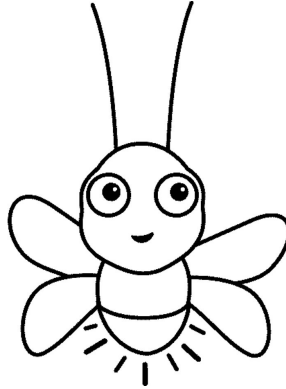

**Reg. No. 4,275,237**

**Registered Jan. 15, 2013**

**Int. Cl.: 18**

**TRADEMARK**

**PRINCIPAL REGISTER**

I PLAY, INC. (NORTH CAROLINA CORPORATION)  
2000 RIVERSIDE DRIVE, SUITE 9  
ASHEVILLE, NC 28804

FOR: BABY BACKPACKS; BACKPACKS, BOOK BAGS, SPORTS BAGS, BUM BAGS, WALLETS AND HANDBAGS; BEACH BAGS; CARRY-ALL BAGS; DIAPER BAGS; DUFFEL BAGS; LUGGAGE TAGS; MESSENGER BAGS; REUSABLE SHOPPING BAGS; TOTE BAGS; UMBRELLAS FOR CHILDREN, IN CLASS 18 (U.S. CLS. 1, 2, 3, 22 AND 41).

FIRST USE 9-0-2009; IN COMMERCE 9-0-2009.

THE MARK CONSISTS OF A DRAWING OF A LIGHTNING BUG OR FIREFLY.

SER. NO. 85-637,429, FILED 5-29-2012.

MARILYN IZZI, EXAMINING ATTORNEY



*David J. Kybas*

Director of the United States Patent and Trademark Office

# United States of America

United States Patent and Trademark Office

# Signal Ridge

**Reg. No. 4,275,238**

**Registered Jan. 15, 2013**

**Int. Cl.: 33**

**TRADEMARK**

**PRINCIPAL REGISTER**

SCOMMEGNA, ROGER (UNITED STATES INDIVIDUAL)  
STE #124  
120 BISHOPS WAY  
BROOKFIELD, WI 53005

FOR: DISTILLED SPIRITS; WINE, IN CLASS 33 (U.S. CLS. 47 AND 49).

FIRST USE 8-1-1999; IN COMMERCE 5-1-2006.

THE MARK CONSISTS OF STANDARD CHARACTERS WITHOUT CLAIM TO ANY PARTICULAR FONT, STYLE, SIZE, OR COLOR.

SER. NO. 85-637,432, FILED 5-29-2012.

AISHA CLARKE, EXAMINING ATTORNEY



*David J. Kyffers*

Director of the United States Patent and Trademark Office

# United States of America

United States Patent and Trademark Office

# NANOR

**Reg. No. 4,275,239**

**Registered Jan. 15, 2013**

**Int. Cl.: 11**

**TRADEMARK**

**PRINCIPAL REGISTER**

MITCHELL SWARTZ (UNITED STATES INDIVIDUAL)  
16 PEMBROKE ROAD  
WESTON, MA 02493

FOR: HEATING ELEMENTS, IN CLASS 11 (U.S. CLS. 13, 21, 23, 31 AND 34).

FIRST USE 9-1-2010; IN COMMERCE 1-30-2012.

THE MARK CONSISTS OF STANDARD CHARACTERS WITHOUT CLAIM TO ANY PARTICULAR FONT, STYLE, SIZE, OR COLOR.

SER. NO. 85-637,433, FILED 5-29-2012.

AISHA CLARKE, EXAMINING ATTORNEY



*David J. Kybas*

Director of the United States Patent and Trademark Office

# United States of America

United States Patent and Trademark Office

## Premium products, fair pricing.

**Reg. No. 4,275,240**

ILOCA SERVICES, INC. (ILLINOIS CORPORATION)  
1900 NORTH AURORA ROAD  
NAPERVILLE, IL 60563

**Registered Jan. 15, 2013**

**Int. Cl.: 35**

FOR: DEALERSHIPS IN THE FIELD OF SEMI-TRUCK TRAILERS, IN CLASS 35 (U.S. CLS. 100, 101 AND 102).

**SERVICE MARK**

FIRST USE 2-27-2012; IN COMMERCE 3-1-2012.

**PRINCIPAL REGISTER**

THE MARK CONSISTS OF STANDARD CHARACTERS WITHOUT CLAIM TO ANY PARTICULAR FONT, STYLE, SIZE, OR COLOR.

SER. NO. 85-637,434, FILED 5-29-2012.

AISHA CLARKE, EXAMINING ATTORNEY



*David J. Kybas*

Director of the United States Patent and Trademark Office



# United States of America

United States Patent and Trademark Office

# CYCLONE

**Reg. No. 4,275,241**

CASTLEWOOD SURGICAL, INC. (DELAWARE CORPORATION)  
91 MAIN STREET, SUITE 302  
CONCORD, MA 01742

**Registered Jan. 15, 2013**

**Int. Cl.: 10**

FOR: TISSUE HOLDER FOR CARDIOVASCULAR AND GENERAL SURGICAL USE, IN CLASS 10 (U.S. CLS. 26, 39 AND 44).

**TRADEMARK**

FIRST USE 12-28-2010; IN COMMERCE 12-28-2010.

**PRINCIPAL REGISTER**

THE MARK CONSISTS OF STANDARD CHARACTERS WITHOUT CLAIM TO ANY PARTICULAR FONT, STYLE, SIZE, OR COLOR.

SER. NO. 85-637,455, FILED 5-29-2012.

REBECCA SMITH, EXAMINING ATTORNEY



*David J. Kybas*

Director of the United States Patent and Trademark Office

United States of America  
United States Patent and Trademark Office

**TWINKO**

**Reg. No. 4,275,242**

THE OWL WORKSHOP (NEW YORK CORPORATION)  
129 MOTT ST. APT 3F  
NEW YORK, NY 10013

**Registered Jan. 15, 2013**

**Int. Cl.: 25**

FOR: CHILDREN'S AND INFANTS' CLOTH BIBS; SHIRTS FOR INFANTS, BABIES, TODDLERS AND CHILDREN; SNAP CROTCH SHIRTS FOR INFANTS AND TODDLERS, IN CLASS 25 (U.S. CLS. 22 AND 39).

**TRADEMARK**

FIRST USE 1-1-2009; IN COMMERCE 1-1-2009.

**PRINCIPAL REGISTER**

THE MARK CONSISTS OF THE WORD "TWINKO" WRITTEN IN A BOLD FONT WITH A FIVE-PRONGED STAR IN THE MIDDLE OF THE LETTER "O".

SER. NO. 85-637,480, FILED 5-29-2012.

MARILYN IZZI, EXAMINING ATTORNEY



*David J. Kyffers*

Director of the United States Patent and Trademark Office

# United States of America

United States Patent and Trademark Office

## REJUVASTAMP

**Reg. No. 4,275,243**

MARQUEZ, CLAIRE (UNITED STATES INDIVIDUAL)  
2538 CAMINO ENTRADA SUITE 201A  
SANTA FE, NM 87507

**Registered Jan. 15, 2013**

**Int. Cl.: 8**

FOR: TATTOO NEEDLES; TATTOO MACHINES, IN CLASS 8 (U.S. CLS. 23, 28 AND 44).

**TRADEMARK**

FIRST USE 10-8-2008; IN COMMERCE 10-8-2008.

**PRINCIPAL REGISTER**

THE MARK CONSISTS OF STANDARD CHARACTERS WITHOUT CLAIM TO ANY PARTICULAR FONT, STYLE, SIZE, OR COLOR.

SER. NO. 85-637,484, FILED 5-29-2012.

REBECCA EISINGER, EXAMINING ATTORNEY



*David J. Kybas*

Director of the United States Patent and Trademark Office

# United States of America

United States Patent and Trademark Office

# GTMAT

**Reg. No. 4,275,244**

**Registered Jan. 15, 2013**

**Int. Cl.: 17**

**TRADEMARK**

**PRINCIPAL REGISTER**

GT SOUND CONTROL, LLC (TEXAS LIMITED LIABILITY COMPANY), AKA GTMAT  
104 TRADESMAN DRIVE  
HUTTO, TX 78634

FOR: SOUNDPROOFING MATERIAL FOR USE IN AUTOMOBILES, TRUCKS, WATER-CRAFT, AIRCRAFT, BUILDINGS, APPLIANCES, OR OTHER MACHINERY, IN CLASS 17 (U.S. CLS. 1, 5, 12, 13, 35 AND 50).

FIRST USE 4-22-2012; IN COMMERCE 4-22-2012.

THE MARK CONSISTS OF STANDARD CHARACTERS WITHOUT CLAIM TO ANY PARTICULAR FONT, STYLE, SIZE, OR COLOR.

SER. NO. 85-637,492, FILED 5-29-2012.

DAVID I, EXAMINING ATTORNEY



*David J. Kyfos*

Director of the United States Patent and Trademark Office

# United States of America

United States Patent and Trademark Office

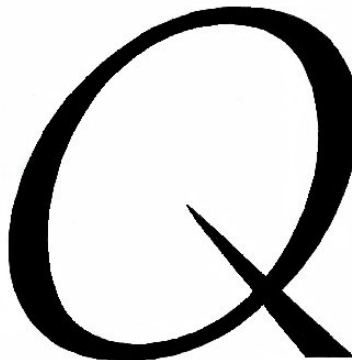

**Reg. No. 4,275,245**

**Registered Jan. 15, 2013**

**Int. Cls.: 35 and 45**

**SERVICE MARK**

**PRINCIPAL REGISTER**

INQUESTA CORPORATION (FLORIDA CORPORATION)  
SUITE 500  
2655 S LE JEUNE ROAD  
CORAL GABLES, FL 33134

FOR: BUSINESS MANAGEMENT AND CONSULTATION IN THE FIELD OF CASE MANAGEMENT, INTEGRATED JUSTICE, DATA CONVERSIONS, AND BUSINESS INTELLIGENCE; BUSINESS RISK MANAGEMENT CONSULTATION; CONSULTANCY AND ADVISORY SERVICES IN THE FIELD OF BUSINESS STRATEGY; DISASTER RECOVERY SERVICES, NAMELY, BUSINESS PLANNING AND BUSINESS CONTINUITY CONSULTING; POLITICAL CONSULTANCY; PROVIDING BUSINESS MANAGEMENT INFORMATION IN CONNECTION WITH CONSULTING AND ADVISORY SERVICES IN THE FIELD OF STRATEGIC PLANNING, IN CLASS 35 (U.S. CLS. 100, 101 AND 102).

FIRST USE 1-30-2002; IN COMMERCE 1-30-2002.

FOR: CONSULTATION IN THE FIELD OF DATA THEFT AND IDENTITY THEFT; CONSULTATION SERVICES CONCERNING HOMELAND SAFETY AND SECURITY ISSUES; CONSULTATION SERVICES IN THE FIELD OF THE SAFETY NEEDS OF COMMERCIAL AND INDUSTRIAL COMPANIES; CONSULTING AND LEGAL SERVICES IN THE FIELD OF PRIVACY AND SECURITY LAWS, REGULATIONS, AND REQUIREMENTS; CONSULTING IN THE FIELD OF WORKPLACE SAFETY; CONSULTING SERVICES IN THE FIELD OF COUNTER-TERRORISM; CONSULTING SERVICES IN THE FIELD OF HOMELAND SECURITY; CONSULTING SERVICES IN THE FIELD OF NATIONAL SECURITY; CONSULTING SERVICES IN THE FIELD OF PUBLIC SAFETY; CONSULTING SERVICES, NAMELY, CONSULTATION IN THE FIELDS OF PRODUCT AND DOCUMENT AUTHENTICATION AND TRACKING, AND BRAND MONITORING AND PROTECTION, TO PROTECT AGAINST COUNTERFEITING, TAMPERING, AND DIVERSION, AND TO ENSURE THE INTEGRITY OF GENUINE PRODUCTS AND DOCUMENTS; INTELLECTUAL PROPERTY CONSULTATION; PERSONAL SECURITY CONSULTATION; PROVIDING CONSULTATION AND INFORMATION IN THE FIELD OF EMERGENCY RESPONSE FOR COMMUNITIES; REGULATORY COMPLIANCE CONSULTING IN THE FIELD OF CONSUMER, MEDICAL AND FINANCIAL INFORMATION; SECURITY CONSULTANCY, IN CLASS 45 (U.S. CLS. 100 AND 101).

FIRST USE 1-30-2002; IN COMMERCE 1-30-2002.



*David J. Kyffers*

Director of the United States Patent and Trademark Office

**Reg. No. 4,275,245** THE MARK CONSISTS OF AN ITALICIZED "O" CROSSED BY A WEDGE AT 4 O'CLOCK TO FORM THE STEM OF A "Q".

SER. NO. 85-637,493, FILED 5-29-2012.

DAVID I, EXAMINING ATTORNEY

# United States of America

United States Patent and Trademark Office

YOUR SPACE. YOUR NEEDS.  
YOUR STYLE.

**Reg. No. 4,275,246**

KARNDÉAN INTERNATIONAL, LLC (DELAWARE LIMITED LIABILITY COMPANY)  
1100 PONTIAC COURT, BUSHY RUN CORP. PARK  
EXPORT, PA 15632

**Registered Jan. 15, 2013**

**Int. Cl.: 27**

FOR: FLOOR COVERINGS, IN CLASS 27 (U.S. CLS. 19, 20, 37, 42 AND 50).

**TRADEMARK**

FIRST USE 7-0-2011; IN COMMERCE 1-0-2012.

**PRINCIPAL REGISTER**

THE MARK CONSISTS OF STANDARD CHARACTERS WITHOUT CLAIM TO ANY PARTICULAR FONT, STYLE, SIZE, OR COLOR.

SER. NO. 85-637,506, FILED 5-29-2012.

ELLEN PERKINS, EXAMINING ATTORNEY



*David J. Kybas*

Director of the United States Patent and Trademark Office

# United States of America

United States Patent and Trademark Office

## CLEAN BREAK

**Reg. No. 4,275,247**

**Registered Jan. 15, 2013**

**Int. Cl.: 41**

**SERVICE MARK**

**PRINCIPAL REGISTER**

CONTENT & COMPANY, INC. (DELAWARE CORPORATION)  
SUITE 850  
11845 WEST OLYMPIC BOULEVARD  
LOS ANGELES, CA 90064

FOR: ENTERTAINMENT IN THE NATURE OF REALITY TELEVISION SERIES FEATURING ACTION SPORTS, IN CLASS 41 (U.S. CLS. 100, 101 AND 107).

FIRST USE 0-0-2010; IN COMMERCE 0-0-2010.

THE MARK CONSISTS OF STANDARD CHARACTERS WITHOUT CLAIM TO ANY PARTICULAR FONT, STYLE, SIZE, OR COLOR.

SER. NO. 85-637,519, FILED 5-29-2012.

ANDREA HACK, EXAMINING ATTORNEY



*David J. Kyffers*

Director of the United States Patent and Trademark Office



# United States of America

United States Patent and Trademark Office

# ACUPNOSIS

**Reg. No. 4,275,248**

MELAMED, LEONARD (UNITED STATES INDIVIDUAL), DBA ACUPUNCTHI CLINIC  
32062 KENYON CIRCLE  
SOLON, OH 44139

**Registered Jan. 15, 2013**

**Int. Cl.: 44**

FOR: HOLISTIC HEALTH SERVICES, IN CLASS 44 (U.S. CLS. 100 AND 101).

**SERVICE MARK**

FIRST USE 5-1-1985; IN COMMERCE 5-27-2012.

**PRINCIPAL REGISTER**

THE MARK CONSISTS OF STANDARD CHARACTERS WITHOUT CLAIM TO ANY PARTICULAR FONT, STYLE, SIZE, OR COLOR.

SER. NO. 85-637,548, FILED 5-29-2012.

MICHELLE DUBOIS, EXAMINING ATTORNEY



*David J. Kyffers*

Director of the United States Patent and Trademark Office

# United States of America

United States Patent and Trademark Office

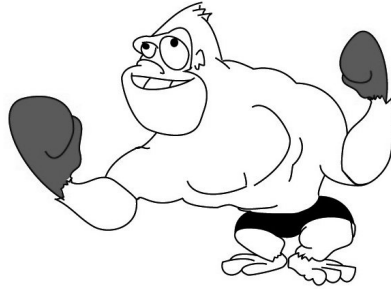

**Reg. No. 4,275,249**

**Registered Jan. 15, 2013**

**Int. Cl.: 41**

**SERVICE MARK**

**PRINCIPAL REGISTER**

CHEAPSHOT GORILLA PRODUCTIONS, LLC (DELAWARE LIMITED LIABILITY COMPANY)  
445 PARK AVENUE, 5TH FLOOR  
NEW YORK, NY 10022

FOR: PRODUCTION OF TELEVISION PROGRAMS, IN CLASS 41 (U.S. CLS. 100, 101 AND 107).

FIRST USE 12-29-2009; IN COMMERCE 2-2-2012.

THE MARK CONSISTS OF A STYLIZED GORILLA IN BOXING GLOVES AND SHORTS.

SER. NO. 85-637,554, FILED 5-29-2012.

MICHELLE DUBOIS, EXAMINING ATTORNEY



*David J. Kyffers*

Director of the United States Patent and Trademark Office

# United States of America

United States Patent and Trademark Office



**Reg. No. 4,275,250**

**Registered Jan. 15, 2013**

**Int. Cl.: 35**

**SERVICE MARK**

**PRINCIPAL REGISTER**

MEDFOCUS CAPITAL PARTNERS, INC. (FLORIDA CORPORATION)  
5134 STATION WAY  
5134 STATION WAY  
SARASOTA, FL 34233

FOR: OFFERING BUSINESS MANAGEMENT ASSISTANCE IN THE ESTABLISHMENT AND/OR OPERATION OF AN OPTICAL DISPENSARY IN OPHTHALMOLOGY AND/OR OPTOMETRIC MEDICAL PRACTICES, IN CLASS 35 (U.S. CLS. 100, 101 AND 102).

FIRST USE 4-20-2012; IN COMMERCE 4-20-2012.

THE MARK CONSISTS OF A BLUE CRESCENT ON THE LEFT AND A GREY LENS SHAPE ON THE RIGHT HAVING A CARVED OUT AREA ON THE LEFT SIDE OF THE LENS IN THE SHAPE OF A SMALLER CRESCENT. THERE IS A SPACE BETWEEN THE CRESCENT AND THE LENS.

THE COLOR(S) BLUE AND GREY IS/ARE CLAIMED AS A FEATURE OF THE MARK.

SER. NO. 85-637,570, FILED 5-29-2012.

SANJEEV VOHRA, EXAMINING ATTORNEY



*David J. Kyffers*

Director of the United States Patent and Trademark Office

# United States of America

United States Patent and Trademark Office



**Reg. No. 4,275,251**

BMW MOTORCYCLE OWNERS OF AMERICA, INC. (CALIFORNIA CORPORATION)  
509A OLD STATE ROAD  
ELLISVILLE, MO 63021

**Registered Jan. 15, 2013**

**Int. Cl.: 16**

FOR: MAGAZINES AND NEWSLETTERS, FEATURING INFORMATION ON MOTORCYCLES, MOTORCYCLE SAFETY, MOTORCYCLE SHOWS AND SUBJECT MATTER DIRECT TO MOTORCYCLE ENTHUSIASTS, IN CLASS 16 (U.S. CLS. 2, 5, 22, 23, 29, 37, 38 AND 50).

**TRADEMARK**

FIRST USE 4-0-2012; IN COMMERCE 4-0-2012.

**PRINCIPAL REGISTER**

THE MARK CONSISTS OF THE LETTERS "MOA." THE LETTER "O" IS STYLIZED TO LOOK LIKE THE EARTH.

SER. NO. 85-637,579, FILED 5-29-2012.

WENDY GOODMAN, EXAMINING ATTORNEY



*David J. Kyjars*

Director of the United States Patent and Trademark Office

# United States of America

United States Patent and Trademark Office



**Reg. No. 4,275,252**

STREET GRACE, INC. (GEORGIA CORPORATION)  
5995 FINANCIAL DRIVE  
NORCROSS, GA 30071

**Registered Jan. 15, 2013**

**Int. Cl.: 35**

FOR: CHARITABLE SERVICES, NAMELY, ORGANIZING AND DEVELOPING PROJECTS THAT AIM TO PROMOTE GLOBAL AWARENESS ABOUT HUMAN TRAFFICKING AND COMMERCIAL SEX INDUSTRY, IN CLASS 35 (U.S. CLS. 100, 101 AND 102).

**SERVICE MARK**

FIRST USE 2-1-2009; IN COMMERCE 2-1-2009.

**PRINCIPAL REGISTER**

THE MARK CONSISTS OF BACKGROUND GRAFFITI WITH THE WORD "STREET" ERASED INTO THE BACKGROUND GRAFFITI AND THE WORD "GRACE" WRITTEN IN ALL CAPITAL LETTERS BELOW THE GRAFFITI.

SER. NO. 85-637,586, FILED 5-29-2012.

GISELLE AGOSTO, EXAMINING ATTORNEY



*David J. Kybas*

Director of the United States Patent and Trademark Office

# United States of America

United States Patent and Trademark Office

# PEEKAMEET

**Reg. No. 4,275,253**

**Registered Jan. 15, 2013**

**Int. Cl.: 38**

**SERVICE MARK**

**PRINCIPAL REGISTER**

GEER, BRENDA (UNITED STATES INDIVIDUAL)  
P.O. BOX 1041  
PINE BUSH, NY 12566

FOR: COMMUNICATION SERVICES, NAMELY, PROVIDING ACCESS TO AN INTERACTIVE COMPUTER DATABASE FOR ELECTRONIC TRANSMISSION OF DATA AND DOCUMENTS TO FACILITATE USERS WITH COMMON INTERESTS TO COMMUNICATE, MEET AND GATHER; PROVIDING A WEBSITE FOR TRANSMISSION OF MESSAGES AMONG COMPUTER AND MOBILE DEVICE USERS WITH VARIED COMMON INTERESTS TO ASSIST THESE USERS AND GROUPS IN COORDINATING MEETINGS AND ACTIVITIES VIA A WEBSITE, ELECTRONIC AND OPTICAL COMMUNICATIONS NETWORKS; PROVIDING ON-LINE CHAT ROOMS FOR TRANSMISSION OF MESSAGES AMONG COMPUTER AND MOBILE DEVICE USERS WITH VARIED COMMON INTERESTS TO ASSIST THESE USERS AND GROUPS IN COORDINATING MEETINGS AND ACTIVITIES VIA A WEBSITE, ELECTRONIC AND OPTICAL COMMUNICATIONS NETWORKS; PROVIDING ON-LINE FORUMS FOR TRANSMISSION OF MESSAGES AMONG COMPUTER AND MOBILE DEVICE USERS CONCERNING A WIDE VARIETY OF SUBJECTS, IN CLASS 38 (U.S. CLS. 100, 101 AND 104).

FIRST USE 4-7-2012; IN COMMERCE 4-7-2012.

THE MARK CONSISTS OF STANDARD CHARACTERS WITHOUT CLAIM TO ANY PARTICULAR FONT, STYLE, SIZE, OR COLOR.

SER. NO. 85-637,589, FILED 5-29-2012.

JESSICA A. POWERS, EXAMINING ATTORNEY



*David J. Kyjars*

Director of the United States Patent and Trademark Office

United States of America  
United States Patent and Trademark Office

# LASERBOB

**Reg. No. 4,275,254**

**Registered Jan. 15, 2013**

**Int. Cl.: 9**

**TRADEMARK**

**PRINCIPAL REGISTER**

STABILA, INC. (ILLINOIS CORPORATION)  
332 INDUSTRIAL DRIVE  
P.O. BOX 402  
SOUTH ELGIN, IL 601700402

FOR: PLUMB BOBS, IN CLASS 9 (U.S. CLS. 21, 23, 26, 36 AND 38).

FIRST USE 9-28-2005; IN COMMERCE 11-11-2005.

THE MARK CONSISTS OF STANDARD CHARACTERS WITHOUT CLAIM TO ANY PARTICULAR FONT, STYLE, SIZE, OR COLOR.

OWNER OF U.S. REG. NO. 3,203,097.

SEC. 2(F).

SER. NO. 85-637,595, FILED 5-29-2012.

CHARLOTTE CORWIN, EXAMINING ATTORNEY



*David J. Kybas*

Director of the United States Patent and Trademark Office

# United States of America

United States Patent and Trademark Office

## The Time Bombs

**Reg. No. 4,275,255**

ELLIOTT, TIM (UNITED STATES INDIVIDUAL)  
6990 ORD VIEW ROAD  
APPLE VALLEY, CA 92308

**Registered Jan. 15, 2013**

**Int. Cl.: 41**

FOR: ENTERTAINMENT, NAMELY, LIVE PERFORMANCES BY A MUSICAL BAND, IN CLASS 41 (U.S. CLS. 100, 101 AND 107).

**SERVICE MARK**

FIRST USE 1-10-2010; IN COMMERCE 1-10-2010.

**PRINCIPAL REGISTER**

THE MARK CONSISTS OF STANDARD CHARACTERS WITHOUT CLAIM TO ANY PARTICULAR FONT, STYLE, SIZE, OR COLOR.

SER. NO. 85-637,624, FILED 5-29-2012.

GISELLE AGOSTO, EXAMINING ATTORNEY



*David J. Kyffers*

Director of the United States Patent and Trademark Office



# United States of America

United States Patent and Trademark Office

## Street GRACE

**Reg. No. 4,275,256**

STREET GRACE, INC. (GEORGIA CORPORATION)  
5995 FINANCIAL DRIVE  
NORCROSS, GA 30071

**Registered Jan. 15, 2013**

**Int. Cl.: 35**

FOR: CHARITABLE SERVICES, NAMELY, ORGANIZING AND DEVELOPING PROJECTS THAT AIM TO PROMOTE GLOBAL AWARENESS ABOUT HUMAN TRAFFICKING AND COMMERCIAL SEX INDUSTRY, IN CLASS 35 (U.S. CLS. 100, 101 AND 102).

**SERVICE MARK**

FIRST USE 2-1-2009; IN COMMERCE 2-1-2009.

**PRINCIPAL REGISTER**

THE MARK CONSISTS OF STANDARD CHARACTERS WITHOUT CLAIM TO ANY PARTICULAR FONT, STYLE, SIZE, OR COLOR.

SER. NO. 85-637,632, FILED 5-29-2012.

GISELLE AGOSTO, EXAMINING ATTORNEY



*David J. Kyros*

Director of the United States Patent and Trademark Office

# United States of America

United States Patent and Trademark Office

IF THEY'RE THERE, WE'RE  
WITH THEM.

**Reg. No. 4,275,257**

**Registered Jan. 15, 2013**

**Int. Cl.: 36**

**SERVICE MARK**

**PRINCIPAL REGISTER**

SUPPORT OUR TROOPS FOUNDATION, INC (FLORIDA CORPORATION)  
P.O. BOX 30  
DAYTONA BEACH, FL 32115

FOR: CHARITABLE FUNDRAISING, IN CLASS 36 (U.S. CLS. 100, 101 AND 102).

FIRST USE 9-7-2011; IN COMMERCE 9-7-2011.

THE MARK CONSISTS OF STANDARD CHARACTERS WITHOUT CLAIM TO ANY PARTICULAR FONT, STYLE, SIZE, OR COLOR.

SER. NO. 85-637,638, FILED 5-29-2012.

NICHOLAS ALTREE, EXAMINING ATTORNEY



*David J. Kyffers*

Director of the United States Patent and Trademark Office

# United States of America

United States Patent and Trademark Office

# iiW

**Reg. No. 4,275,258**

**Registered Jan. 15, 2013**

**Int. Cls.: 14 and 25**

**TRADEMARK**

**PRINCIPAL REGISTER**

IT IS WRITTEN, INC (MICHIGAN CORPORATION)  
2409 CONCORD RD.  
LANSING, MI 48910

FOR: BRACELETS; BROACHES; HAIR JEWELRY IN THE NATURE OF JEWELRY FOR USE IN THE HAIR; JEWELRY; JEWELRY FOR ATTACHMENT TO CLOTHING; JEWELRY FOR THE HEAD; JEWELRY, NAMELY, ANKLETS; LEATHER JEWELRY AND ACCESSORY BOXES; PINS BEING JEWELRY; RINGS; RINGS BEING JEWELRY; WOMEN'S JEWELRY, IN CLASS 14 (U.S. CLS. 2, 27, 28 AND 50).

FIRST USE 4-18-2012; IN COMMERCE 5-29-2012.

FOR: BELTS FOR CLOTHING; BOTTOMS; CLOTHING, NAMELY, KHAKIS; HEADBANDS FOR CLOTHING; JACKETS; LEATHER BELTS; TOPS; WEARABLE GARMENTS AND CLOTHING, NAMELY, SHIRTS; WOMEN'S CLOTHING, NAMELY, SHIRTS, DRESSES, SKIRTS, BLOUSES; WRIST BANDS, IN CLASS 25 (U.S. CLS. 22 AND 39).

FIRST USE 4-14-2012; IN COMMERCE 5-29-2012.

THE MARK CONSISTS OF STANDARD CHARACTERS WITHOUT CLAIM TO ANY PARTICULAR FONT, STYLE, SIZE, OR COLOR.

SER. NO. 85-637,644, FILED 5-29-2012.

JOHN WILKE, EXAMINING ATTORNEY



*David J. Kyros*

Director of the United States Patent and Trademark Office

# United States of America

United States Patent and Trademark Office

# NEWAY

**Reg. No. 4,275,259**

**Registered Jan. 15, 2013**

**Int. Cl.: 25**

**TRADEMARK**

**PRINCIPAL REGISTER**

WU, BIFA (UNITED STATES INDIVIDUAL)  
9651 E RUSH ST.  
SOUTH EL MONTE, CA 91733

FOR: ATHLETIC SHOES; CYCLING SHOES; DANCE SHOES; FOOTBALL SHOES; GOLF SHOES; GYMNASTIC SHOES; HANDBALL SHOES; LEATHER SHOES; LEISURE SHOES; RIDING SHOES; RUNNING SHOES; SANDALS AND BEACH SHOES; SOCCER SHOES; TENNIS SHOES; TRACK AND FIELD SHOES; TRAINING SHOES; VOLLEYBALL SHOES; WOMEN'S SHOES, IN CLASS 25 (U.S. CLS. 22 AND 39).

FIRST USE 10-1-2010; IN COMMERCE 1-15-2011.

THE MARK CONSISTS OF STANDARD CHARACTERS WITHOUT CLAIM TO ANY PARTICULAR FONT, STYLE, SIZE, OR COLOR.

SER. NO. 85-637,668, FILED 5-29-2012.

JOHN GARTNER, EXAMINING ATTORNEY



*David J. Kyffers*

Director of the United States Patent and Trademark Office

# United States of America

United States Patent and Trademark Office

# ABF

**Reg. No. 4,275,260**

ABF FREIGHT SYSTEM, INC. (DELAWARE CORPORATION)  
P.O. BOX 10048  
FORT SMITH, AR 79217

**Registered Jan. 15, 2013**

**Int. Cl.: 39**

FOR: FREIGHT TRANSPORTATION SERVICES BY TRUCK, AIRPLANE, TRAIN, SHIP OR A COMBINATION THEREOF, IN CLASS 39 (U.S. CLS. 100 AND 105).

**SERVICE MARK**

FIRST USE 7-1-1994; IN COMMERCE 7-1-1994.

**PRINCIPAL REGISTER**

THE MARK CONSISTS OF STANDARD CHARACTERS WITHOUT CLAIM TO ANY PARTICULAR FONT, STYLE, SIZE, OR COLOR.

OWNER OF U.S. REG. NOS. 1,209,063, 2,338,504 AND OTHERS.

SER. NO. 85-637,674, FILED 5-29-2012.

JOHN GARTNER, EXAMINING ATTORNEY



*David J. Kyffers*

Director of the United States Patent and Trademark Office

# United States of America

United States Patent and Trademark Office

## Be the Obvious Choice

**Reg. No. 4,275,261**

CHRIS DARLING (UNITED STATES INDIVIDUAL)  
20 SANFORD AVENUE  
NEWARK, DE 19713

**Registered Jan. 15, 2013**

**Int. Cl.: 35**

FOR: CONSULTING SERVICES IN THE FIELD OF INTERNET MARKETING; DEVELOPMENT OF MARKETING STRATEGIES, CONCEPTS AND TACTICS, NAMELY, AUDIENCE DEVELOPMENT, BRAND AWARENESS, ONLINE COMMUNITY BUILDING AND DIGITAL WORD OF MOUTH COMMUNICATIONS; MARKETING CONSULTING, IN CLASS 35 (U.S. CLS. 100, 101 AND 102).

**SERVICE MARK**

**PRINCIPAL REGISTER**

FIRST USE 3-1-2010; IN COMMERCE 3-1-2010.

THE MARK CONSISTS OF STANDARD CHARACTERS WITHOUT CLAIM TO ANY PARTICULAR FONT, STYLE, SIZE, OR COLOR.

SER. NO. 85-637,685, FILED 5-29-2012.

MARTHA SANTOMARTINO, EXAMINING ATTORNEY



*David J. Kyffers*

Director of the United States Patent and Trademark Office

# United States of America

United States Patent and Trademark Office



**Reg. No. 4,275,262**

**Registered Jan. 15, 2013**

**Int. Cl.: 14**

**TRADEMARK**

**PRINCIPAL REGISTER**

QAYTEN J.E.T. LIMITED (HONG KONG LIMITED LIABILITY COMPANY)  
FLAT 2503, BANK OF AMERICA TOWER  
12 HARCOURT ROAD  
CENTRAL, HONG KONG

FOR: PEARL JEWELRY, JEWELRY, WATCHES, IN CLASS 14 (U.S. CLS. 2, 27, 28 AND 50).

OWNER OF HONG KONG REG. NO. 301926171, DATED 5-25-2005, EXPIRES 5-25-2015.

THE COLOR(S) GRAY, PURPLE IS/ARE CLAIMED AS A FEATURE OF THE MARK.

THE MARK CONSISTS OF THE DESIGN OF A PALACE IN GRAY COLOR WITH THE PURPLE WORDING "QAYTEN" IN THE MIDDLE OF THE DESIGN. THE GRAY WORDING "J.E.T." APPEARS AT THE TOP OF THE PALACE. THERE ARE THREE PURPLE DOTS BELOW THE DESIGN OF THE PALACE.

SER. NO. 85-637,692, FILED 5-29-2012.

CIMMERIAN COLEMAN, EXAMINING ATTORNEY



*David J. Kybas*

Director of the United States Patent and Trademark Office

# United States of America

United States Patent and Trademark Office

# YONIKA

**Reg. No. 4,275,263**

**Registered Jan. 15, 2013**

**Int. Cl.: 25**

**TRADEMARK**

**PRINCIPAL REGISTER**

GRACE HATS (NEW YORK LIMITED LIABILITY COMPANY)  
269 W. 39TH STREET  
NYC, NY 10018

FOR: HATS, IN CLASS 25 (U.S. CLS. 22 AND 39).

FIRST USE 7-15-2005; IN COMMERCE 8-30-2005.

THE MARK CONSISTS OF STANDARD CHARACTERS WITHOUT CLAIM TO ANY PARTICULAR FONT, STYLE, SIZE, OR COLOR.

SER. NO. 85-637,710, FILED 5-29-2012.

JENNIFER MARTIN, EXAMINING ATTORNEY



*David J. Kybas*

Director of the United States Patent and Trademark Office



# United States of America

United States Patent and Trademark Office

# CWAI

**Reg. No. 4,275,264**

DAVID SIBEL (UNITED STATES INDIVIDUAL)  
164 SUMMIT DRIVE  
COLMAR, PA 18915

**Registered Jan. 15, 2013**

**Int. Cl.: 36**

FOR: FINANCIAL PLANNING FOR RETIREMENT, IN CLASS 36 (U.S. CLS. 100, 101 AND 102).

**SERVICE MARK**

FIRST USE 5-24-2012; IN COMMERCE 5-24-2012.

**PRINCIPAL REGISTER**

THE MARK CONSISTS OF STANDARD CHARACTERS WITHOUT CLAIM TO ANY PARTICULAR FONT, STYLE, SIZE, OR COLOR.

SER. NO. 85-637,712, FILED 5-29-2012.

KIM SAITO, EXAMINING ATTORNEY



*David J. Kybas*

Director of the United States Patent and Trademark Office

# United States of America

United States Patent and Trademark Office

## CLOUDSKIPPER

**Reg. No. 4,275,265**

**Registered Jan. 15, 2013**

**Int. Cl.: 9**

**TRADEMARK**

**PRINCIPAL REGISTER**

CLOUD TV, INC (DELAWARE CORPORATION)  
500 STANYAN ST, #305  
SAN FRANCISCO, CA 94117

FOR: COMPUTER APPLICATION SOFTWARE FOR MOBILE DEVICES, NAMELY, SOFTWARE THAT ALLOWS USERS TO SEARCH, ORGANIZE, PLAYBACK AND SHARE MUSIC FILES ALONG WITH THEIR ASSOCIATED IMAGES AND INFORMATION, IN CLASS 9 (U.S. CLS. 21, 23, 26, 36 AND 38).

FIRST USE 2-27-2009; IN COMMERCE 2-27-2009.

THE MARK CONSISTS OF STANDARD CHARACTERS WITHOUT CLAIM TO ANY PARTICULAR FONT, STYLE, SIZE, OR COLOR.

SER. NO. 85-637,729, FILED 5-29-2012.

KATHLEEN M. VANSTON, EXAMINING ATTORNEY



*David J. Kyffers*

Director of the United States Patent and Trademark Office

# United States of America

United States Patent and Trademark Office

# RYUWEL

**Reg. No. 4,275,266**

**Registered Jan. 15, 2013**

**Int. Cl.: 25**

**TRADEMARK**

**PRINCIPAL REGISTER**

AI MIND INTERNATIONAL INC (CALIFORNIA CORPORATION), DBA RYUWEL  
1145  
TOWNE AVE. SUITE # 5  
LOS ANGELES, CA 90021

FOR: WOMEN'S CLOTHING, NAMELY, SHIRTS, DRESSES, SKIRTS, BLOUSES, IN CLASS  
25 (U.S. CLS. 22 AND 39).

FIRST USE 2-1-2008; IN COMMERCE 2-1-2008.

THE MARK CONSISTS OF STANDARD CHARACTERS WITHOUT CLAIM TO ANY PAR-  
TICULAR FONT, STYLE, SIZE, OR COLOR.

SER. NO. 85-637,744, FILED 5-29-2012.

NAAKWAMA ANKRAH, EXAMINING ATTORNEY



*David J. Kyffers*

Director of the United States Patent and Trademark Office

# United States of America

United States Patent and Trademark Office

# LUC

**Reg. No. 4,275,267**

**Registered Jan. 15, 2013**

**Int. Cl.: 42**

**SERVICE MARK**

**PRINCIPAL REGISTER**

LUCAS, CHRISTOPHER (UNITED KINGDOM INDIVIDUAL)  
28 SOUTH SITGREAVES STREET  
EASTON, PA 18042

FOR: GRAPHIC ILLUSTRATION SERVICES FOR OTHERS; GRAPHIC DESIGN SERVICES;  
GRAPHIC ILLUSTRATION AND DRAWING SERVICES, NAMELY, PROVIDING GRAPHIC  
ILLUSTRATIONS AND DRAWINGS FOR USE IN PRINT MEDIA AND FOR BUSINESSES,  
IN CLASS 42 (U.S. CLS. 100 AND 101).

FIRST USE 4-1-2012; IN COMMERCE 4-10-2012.

THE MARK CONSISTS OF THE LITERAL ELEMENTS "LUC" WRITTEN IN STYLIZED  
FORM AS SHOWN IN THE MARK.

SER. NO. 85-637,765, FILED 5-29-2012.

MARY ROSSMAN, EXAMINING ATTORNEY



*David J. Kyffers*

Director of the United States Patent and Trademark Office

# United States of America

United States Patent and Trademark Office

# ANGIODERM

**Reg. No. 4,275,268**

USBIOLABS CORPORATION (CANADA CORPORATION)  
2172 ERIN CENTRE BLVD  
MISSISSAUGA, CANADA

**Registered Jan. 15, 2013**

**Int. Cl.: 3**

FOR: COSMETICS AND SKIN CARE PREPERATIONS, NAMELY, FACE, HAND, LEG, FOOT AND BODY SOAPS, CLEANSERS AND MOISTURIZERS; SUNBLOCKS AND SUNSCREENS, IN CLASS 3 (U.S. CLS. 1, 4, 6, 50, 51 AND 52).

**TRADEMARK**

FIRST USE 4-28-2011; IN COMMERCE 4-28-2011.

**PRINCIPAL REGISTER**

THE MARK CONSISTS OF STANDARD CHARACTERS WITHOUT CLAIM TO ANY PARTICULAR FONT, STYLE, SIZE, OR COLOR.

SER. NO. 85-637,778, FILED 5-29-2012.

KIM SAITO, EXAMINING ATTORNEY



*David J. Kyffers*

Director of the United States Patent and Trademark Office

# United States of America

United States Patent and Trademark Office

## Lessons On Board

**Reg. No. 4,275,269**

WARDE, DENIS (UNITED STATES INDIVIDUAL)

**Registered Jan. 15, 2013**

P.O. BOX 4000  
CARLSBAD, CA 92018

**Int. Cl.: 16**

FOR: PRINTED MATERIAL IN THE NATURE OF INSTRUCTION TIP DECALS FOR SPORTING GOODS, IN CLASS 16 (U.S. CLS. 2, 5, 22, 23, 29, 37, 38 AND 50).

**TRADEMARK**

FIRST USE 4-14-2012; IN COMMERCE 4-14-2012.

**PRINCIPAL REGISTER**

THE MARK CONSISTS OF STANDARD CHARACTERS WITHOUT CLAIM TO ANY PARTICULAR FONT, STYLE, SIZE, OR COLOR.

SER. NO. 85-637,781, FILED 5-29-2012.

ANNE MADDEN, EXAMINING ATTORNEY



*David J. Kybas*

Director of the United States Patent and Trademark Office

# United States of America

United States Patent and Trademark Office

Big or small \$1 stores it  
all

**Reg. No. 4,275,270**

**Registered Jan. 15, 2013**

**Int. Cl.: 39**

**SERVICE MARK**

**PRINCIPAL REGISTER**

BRRVS CORPORATION (CALIFORNIA CORPORATION)  
130 W. 3RD STREET  
TUSTIN, CA 92780

FOR: STORAGE OF RECREATIONAL VEHICLES, IN CLASS 39 (U.S. CLS. 100 AND 105).

FIRST USE 9-15-2009; IN COMMERCE 9-20-2009.

THE MARK CONSISTS OF STANDARD CHARACTERS WITHOUT CLAIM TO ANY PARTICULAR FONT, STYLE, SIZE, OR COLOR.

SER. NO. 85-637,800, FILED 5-29-2012.

SOPHIA S. KIM, EXAMINING ATTORNEY



*David J. Kybas*

Director of the United States Patent and Trademark Office

# United States of America

United States Patent and Trademark Office

# ON IT!

**Reg. No. 4,275,271**

**Registered Jan. 15, 2013**

**Int. Cl.: 3**

**TRADEMARK**

**PRINCIPAL REGISTER**

AMERICAN OIL AND CHEMICAL INC (CALIFORNIA CORPORATION)  
#3301  
705 W 9TH STREET  
LOS ANGELES, CA 90015

FOR: ALL-PURPOSE CLEANERS, IN CLASS 3 (U.S. CLS. 1, 4, 6, 50, 51 AND 52).

FIRST USE 12-15-2010; IN COMMERCE 12-15-2010.

THE MARK CONSISTS OF STANDARD CHARACTERS WITHOUT CLAIM TO ANY PARTICULAR FONT, STYLE, SIZE, OR COLOR.

SER. NO. 85-637,805, FILED 5-29-2012.

SOPHIA S. KIM, EXAMINING ATTORNEY



*David J. Kybas*

Director of the United States Patent and Trademark Office



# United States of America

United States Patent and Trademark Office



**Reg. No. 4,275,272**

**Registered Jan. 15, 2013**

**Int. Cl.: 25**

**TRADEMARK**

**PRINCIPAL REGISTER**

VETRONE, MICHAEL (UNITED STATES INDIVIDUAL)  
#1103  
88 E. SAN FERNANDO ST.  
SAN JOSE, CA 95113

FOR: HATS; SWEATSHIRTS; T-SHIRTS, IN CLASS 25 (U.S. CLS. 22 AND 39).

FIRST USE 9-0-2009; IN COMMERCE 9-0-2009.

THE MARK CONSISTS OF A CIRCLE WITH THE LETTERS "C" AND "A".

SER. NO. 85-637,806, FILED 5-29-2012.

SOPHIA S. KIM, EXAMINING ATTORNEY



*David J. Kyffers*

Director of the United States Patent and Trademark Office

# United States of America

United States Patent and Trademark Office

# CrawlApparel

**Reg. No. 4,275,273**

**Registered Jan. 15, 2013**

**Int. Cl.: 25**

**TRADEMARK**

**PRINCIPAL REGISTER**

VETRONE, MICHAEL (UNITED STATES INDIVIDUAL)  
#1103  
88 E. SAN FERNANDO ST.  
SAN JOSE, CA 95070

FOR: HATS; SWEATSHIRTS; T-SHIRTS, IN CLASS 25 (U.S. CLS. 22 AND 39).

FIRST USE 9-0-2009; IN COMMERCE 9-0-2009.

THE MARK CONSISTS OF STANDARD CHARACTERS WITHOUT CLAIM TO ANY PARTICULAR FONT, STYLE, SIZE, OR COLOR.

SER. NO. 85-637,807, FILED 5-29-2012.

SOPHIA S. KIM, EXAMINING ATTORNEY



*David J. Kybas*

Director of the United States Patent and Trademark Office

# United States of America

United States Patent and Trademark Office



**Reg. No. 4,275,274**

TRIBIE, CHRISTOPHER (UNITED STATES INDIVIDUAL)  
9561 NW 52ND ST  
SUNRISE, FL 33351

**Registered Jan. 15, 2013**

**Int. Cl.: 41**

FOR: ENTERTAINMENT SERVICES IN THE NATURE OF LIVE MUSICAL PERFORMANCES; ENTERTAINMENT SERVICES, NAMELY, MULTIMEDIA PRODUCTION SERVICES, IN CLASS 41 (U.S. CLS. 100, 101 AND 107).

**SERVICE MARK**

FIRST USE 8-0-2010; IN COMMERCE 6-0-2011.

**PRINCIPAL REGISTER**

THE MARK CONSISTS OF THE WORD "REBELLIOUS" IN DARK RED LETTERING AND "LEADERS" IS IN BLACK. THE HEADPIECE HAS BLACK AND RED STRIPES ON THE SIDES AND ON THE TOP IS GOLD, WHERE THE COBRA IS OUTLINED IN BLACK. THE MAN'S SKIN IS BROWN WITH BLACK OUTLINES OF HIS MOUTH, EYEBROWS, NOSE, CHIN ETC. HIS EYES ARE LIGHT BROWN WITH WHITE. HIS CHIN PIECE IS RED WITH BLACK DESIGNS AND A GOLD BALL ON THE END. HIS COLLAR IS BLACK AND RED STRIPED WITH A DARKER RED FADING INTO A BRIGHTER SHADE OF RED. IT ALSO HAS A LIGHTER RED DESIGN IN THE MIDDLE OF THE COLLAR. HIS HANDS ARE THE SAME BROWN AS HIS FACE WITH BLACK AND RED ARMBANDS OUTLINED IN GOLD. IN HIS HAND ON THE LEFT THERE IS A BLACK ETERNAL CROSS OUTLINED IN GOLD AND ON THE RIGHT A BLACK AND SILVER TRADITIONAL MICROPHONE.

THE COLOR(S) DARK RED, BLACK, BROWN, LIGHT BROWN, WHITE, GOLD, AND SILVER IS/ARE CLAIMED AS A FEATURE OF THE MARK.

SER. NO. 85-637,810, FILED 5-29-2012.

SOPHIA S. KIM, EXAMINING ATTORNEY



*David J. Kybas*

Director of the United States Patent and Trademark Office

# United States of America

United States Patent and Trademark Office

## PLEAT STREET

**Reg. No. 4,275,275**

PLEAT STREET, INC. (GEORGIA CORPORATION)  
1300 TWELVE OAKS CIRCLE NW  
ATLANTA, GA 30327

**Registered Jan. 15, 2013**

**Int. Cl.: 40**

FOR: CUSTOM CONSTRUCTION, FABRICATION, AND PRODUCTION OF DRAPERY, PILLOWS, SLIPCOVERS, AND BEDDING; SEWING SERVICES, NAMELY, CUSTOM CONSTRUCTION, STITCHING, AND TAILORING OF DRAPERY, PILLOWS, SLIPCOVERS, AND BEDDING, IN CLASS 40 (U.S. CLS. 100, 103 AND 106).

**SERVICE MARK**

**PRINCIPAL REGISTER**

FIRST USE 10-1-2010; IN COMMERCE 10-1-2010.

THE MARK CONSISTS OF STANDARD CHARACTERS WITHOUT CLAIM TO ANY PARTICULAR FONT, STYLE, SIZE, OR COLOR.

SER. NO. 85-637,827, FILED 5-29-2012.

MATTHEW KLINE, EXAMINING ATTORNEY



*David J. Kyros*

Director of the United States Patent and Trademark Office

# United States of America

United States Patent and Trademark Office

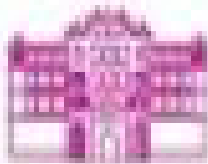

QAYTEN J.E.T. LIMITED



**Reg. No. 4,275,276**

**Registered Jan. 15, 2013**

**Int. Cl.: 14**

**TRADEMARK**

**PRINCIPAL REGISTER**

QAYTEN J.E.T. LIMITED (HONG KONG LIMITED LIABILITY COMPANY)  
FLAT 2503, BANK OF AMERICA TOWER  
12 HARCOURT ROAD  
CENTRAL, HONG KONG

FOR: PEARL JEWELRY, JEWELRY, WATCHES, IN CLASS 14 (U.S. CLS. 2, 27, 28 AND 50).

OWNER OF HONG KONG REG. NO. 301926180, DATED 5-25-2011, EXPIRES 5-25-2021.

THE COLOR(S) BROWN AND PURPLE IS/ARE CLAIMED AS A FEATURE OF THE MARK.

NO CLAIM IS MADE TO THE EXCLUSIVE RIGHT TO USE "LIMITED", APART FROM THE MARK AS SHOWN.

THE MARK CONSISTS OF THE DESIGN OF A PALACE IN PURPLE ABOVE THE WORDING "QAYTEN J.E.T. LIMITED" IN BROWN WITH THREE PURPLE DOTS BELOW.

THE WORD(S) "QAYTEN J.E.T." HAS NO MEANING IN A FOREIGN LANGUAGE.

SER. NO. 85-637,851, FILED 5-29-2012.

CIMMERIAN COLEMAN, EXAMINING ATTORNEY



*David J. Kybas*

Director of the United States Patent and Trademark Office

# United States of America

United States Patent and Trademark Office

## SEIZE THE GARMENT

**Reg. No. 4,275,277**

**Registered Jan. 15, 2013**

**Int. Cl.: 14**

**TRADEMARK**

**PRINCIPAL REGISTER**

DOG POUND, INC. (CALIFORNIA CORPORATION)  
8917 CYNTHIA STREET, UNIT 3  
WEST HOLLYWOOD, CA 90069

FOR: BROACHES; COSTUME JEWELRY; GEMSTONE JEWELRY; HAIR JEWELRY IN THE NATURE OF JEWELRY FOR USE IN THE HAIR; JEWELRY; JEWELRY AND IMITATION JEWELRY; JEWELRY FOR THE HEAD, IN CLASS 14 (U.S. CLS. 2, 27, 28 AND 50).

FIRST USE 2-0-2012; IN COMMERCE 2-0-2012.

THE MARK CONSISTS OF STANDARD CHARACTERS WITHOUT CLAIM TO ANY PARTICULAR FONT, STYLE, SIZE, OR COLOR.

SER. NO. 85-637,894, FILED 5-30-2012.

WILLIAM P. SHANAHAN, EXAMINING ATTORNEY



*David J. Kyffers*

Director of the United States Patent and Trademark Office

# United States of America

United States Patent and Trademark Office

# RTGS

**Reg. No. 4,275,278**

**Registered Jan. 15, 2013**

**Int. Cl.: 11**

**TRADEMARK**

**PRINCIPAL REGISTER**

RT GLOBAL SERVICES LLC (DELAWARE LIMITED LIABILITY COMPANY)  
8550 W CHARLESTON BLVD  
8550 W CHARLESTON BLVD STE 102-341  
LAS VEGAS, NV 89117

FOR: LED (LIGHT EMITTING DIODE) LIGHTING FIXTURES, IN CLASS 11 (U.S. CLS. 13, 21, 23, 31 AND 34).

FIRST USE 11-13-2010; IN COMMERCE 11-13-2010.

THE MARK CONSISTS OF STANDARD CHARACTERS WITHOUT CLAIM TO ANY PARTICULAR FONT, STYLE, SIZE, OR COLOR.

SER. NO. 85-637,909, FILED 5-30-2012.

JOHN DALIER, EXAMINING ATTORNEY



*David J. Kyffers*

Director of the United States Patent and Trademark Office

# United States of America

United States Patent and Trademark Office

# DL1961

**Reg. No. 4,275,279**

FAISAL AHMED (PAKISTAN INDIVIDUAL)  
530 SEVENTH AVENUE, SUITE 1505  
NEW YORK, NY 10018

**Registered Jan. 15, 2013**

**Int. Cl.: 25**

FOR: WOMEN'S AND MEN'S DENIM JEANS, SHIRTS AND JACKETS, IN CLASS 25 (U.S. CLS. 22 AND 39).

**TRADEMARK**

FIRST USE 6-0-1997; IN COMMERCE 6-0-1997.

**PRINCIPAL REGISTER**

THE MARK CONSISTS OF STANDARD CHARACTERS WITHOUT CLAIM TO ANY PARTICULAR FONT, STYLE, SIZE, OR COLOR.

SER. NO. 85-637,952, FILED 5-30-2012.

ANGELA M. MICHELI, EXAMINING ATTORNEY



*David J. Kybas*

Director of the United States Patent and Trademark Office



# United States of America

United States Patent and Trademark Office

## GREAT WHYTE HOPE

**Reg. No. 4,275,280**

DALE TYLER ROBINSON (UNITED STATES INDIVIDUAL)  
11324 TUCK COURT APT. 3  
INDIANAPOLIS, IN 46229

**Registered Jan. 15, 2013**

**Int. Cl.: 41**

FOR: ENTERTAINMENT SERVICES IN THE NATURE OF LIVE MUSICAL PERFORMANCES,  
IN CLASS 41 (U.S. CLS. 100, 101 AND 107).

**SERVICE MARK**

FIRST USE 5-29-2012; IN COMMERCE 5-29-2012.

**PRINCIPAL REGISTER**

THE MARK CONSISTS OF STANDARD CHARACTERS WITHOUT CLAIM TO ANY PARTICULAR FONT, STYLE, SIZE, OR COLOR.

SER. NO. 85-637,962, FILED 5-30-2012.

LINDA ORNDORFF, EXAMINING ATTORNEY



*David J. Kybas*

Director of the United States Patent and Trademark Office

# United States of America

United States Patent and Trademark Office

# I PLAY.

**Reg. No. 4,275,281**

**Registered Jan. 15, 2013**

**Int. Cl.: 9**

**TRADEMARK**

**PRINCIPAL REGISTER**

I PLAY, INC. (NORTH CAROLINA CORPORATION)  
2000 RIVERSIDE DRIVE, SUITE 9  
ASHEVILLE, NC 28804

FOR: CHAINS FOR SPECTACLES AND FOR SUNGLASSES; EAR PLUGS FOR SWIMMING; SNORKELS; SUNGLASSES; SUNGLASSES WITH WRAPAROUND BAND; SWIMMING FACE MASKS; SWIMMING GOGGLES, IN CLASS 9 (U.S. CLS. 21, 23, 26, 36 AND 38).

FIRST USE 1-1-2002; IN COMMERCE 1-1-2002.

THE MARK CONSISTS OF STANDARD CHARACTERS WITHOUT CLAIM TO ANY PARTICULAR FONT, STYLE, SIZE, OR COLOR.

OWNER OF U.S. REG. NOS. 2,115,786, 3,946,880, AND 3,946,881.

SER. NO. 85-637,986, FILED 5-30-2012.

MARILYN IZZI, EXAMINING ATTORNEY



*David J. Kybas*

Director of the United States Patent and Trademark Office

# United States of America

United States Patent and Trademark Office

# I PLAY.

**Reg. No. 4,275,282**

**Registered Jan. 15, 2013**

**Int. Cl.: 16**

**TRADEMARK**

**PRINCIPAL REGISTER**

I PLAY, INC. (NORTH CAROLINA CORPORATION)  
2000 RIVERSIDE DRIVE, SUITE 9  
ASHEVILLE, NC 28804

FOR: CHILDREN'S BOOKS; DISPOSABLE SWIM PANTS FOR CHILDREN AND INFANTS;  
SCENTED DRAWER LINERS, IN CLASS 16 (U.S. CLS. 2, 5, 22, 23, 29, 37, 38 AND 50).

FIRST USE 1-1-1996; IN COMMERCE 1-1-1996.

THE MARK CONSISTS OF STANDARD CHARACTERS WITHOUT CLAIM TO ANY PARTICULAR FONT, STYLE, SIZE, OR COLOR.

OWNER OF U.S. REG. NOS. 2,115,786, 3,946,880, AND 3,946,881.

SER. NO. 85-637,992, FILED 5-30-2012.

MARILYN IZZI, EXAMINING ATTORNEY



*David J. Kyffers*

Director of the United States Patent and Trademark Office

# United States of America

United States Patent and Trademark Office

# I PLAY.

**Reg. No. 4,275,283**

**Registered Jan. 15, 2013**

**Int. Cl.: 18**

**TRADEMARK**

**PRINCIPAL REGISTER**

I PLAY, INC. (NORTH CAROLINA CORPORATION)  
2000 RIVERSIDE DRIVE, SUITE 9  
ASHEVILLE, NC 28804

FOR: BABY BACKPACKS; BACKPACKS, BOOK BAGS, SPORTS BAGS, BUM BAGS, WALLETS AND HANDBAGS; BEACH BAGS; CARRY-ALL BAGS; DIAPER BAGS; DUFFEL BAGS; LUGGAGE TAGS; MESSENGER BAGS; REUSABLE SHOPPING BAGS; TOTE BAGS; UMBRELLAS FOR CHILDREN, IN CLASS 18 (U.S. CLS. 1, 2, 3, 22 AND 41).

FIRST USE 9-1-2006; IN COMMERCE 9-1-2006.

THE MARK CONSISTS OF STANDARD CHARACTERS WITHOUT CLAIM TO ANY PARTICULAR FONT, STYLE, SIZE, OR COLOR.

OWNER OF U.S. REG. NOS. 2,115,786, 3,946,880, AND 3,946,881.

SER. NO. 85-637,998, FILED 5-30-2012.

MARILYN IZZI, EXAMINING ATTORNEY



*David J. Kybas*

Director of the United States Patent and Trademark Office

# United States of America

United States Patent and Trademark Office



**Reg. No. 4,275,284**

MSJJ, LLC (TEXAS LIMITED LIABILITY COMPANY)  
16710 LEDGE CREEK  
SAN ANTONIO, TX 78232

**Registered Jan. 15, 2013**

**Int. Cl.: 37**

FOR: CLEANING OF PLAYGROUNDS; DISINFECTING; INSPECTION SERVICES IN THE COURSE OF CONSTRUCTION OF PLAYGROUNDS; MAINTENANCE AND/OR REPAIR OF PLAYGROUNDS, IN CLASS 37 (U.S. CLS. 100, 103 AND 106).

**SERVICE MARK**

FIRST USE 5-1-2012; IN COMMERCE 5-1-2012.

**PRINCIPAL REGISTER**

THE MARK CONSISTS OF THE STYLIZED TEXT "ADVENTURECLEAN" IN WHICH THE WORD "ADVENTURE" IS BLUE AND THE WORD "CLEAN" IS LIME GREEN. TO THE LEFT OF THE TEXT IS A BLUE HANDPRINT AND A LIME GREEN HANDPRINT.

THE COLOR(S) BLUE AND LIME GREEN IS/ARE CLAIMED AS A FEATURE OF THE MARK.

SER. NO. 85-638,015, FILED 5-30-2012.

JEFFREY LOOK, EXAMINING ATTORNEY



*David J. Kybas*

Director of the United States Patent and Trademark Office

# United States of America

United States Patent and Trademark Office

## Cornbread Red

**Reg. No. 4,275,285**

CHAPMAN, GREG (UNITED STATES INDIVIDUAL)  
P.O. BOX 10  
NEW HOPE, AL 35760

**Registered Jan. 15, 2013**

**Int. Cl.: 41**

FOR: ENTERTAINMENT SERVICES IN THE NATURE OF LIVE MUSICAL PERFORMANCES,  
IN CLASS 41 (U.S. CLS. 100, 101 AND 107).

**SERVICE MARK**

FIRST USE 1-1-2007; IN COMMERCE 1-1-2007.

**PRINCIPAL REGISTER**

THE MARK CONSISTS OF STANDARD CHARACTERS WITHOUT CLAIM TO ANY PAR-  
TICULAR FONT, STYLE, SIZE, OR COLOR.

SER. NO. 85-638,029, FILED 5-30-2012.

JEFFREY LOOK, EXAMINING ATTORNEY



*David J. Kyros*

Director of the United States Patent and Trademark Office

# United States of America

United States Patent and Trademark Office



**Reg. No. 4,275,286**

**Registered Jan. 15, 2013**

**Int. Cl.: 9**

**TRADEMARK**

**PRINCIPAL REGISTER**

I PLAY, INC. (NORTH CAROLINA CORPORATION)  
2000 RIVERSIDE DRIVE, SUITE 9  
ASHEVILLE, NC 28804

FOR: CHAINS FOR SPECTACLES AND FOR SUNGLASSES; EAR PLUGS FOR SWIMMING; SNORKELS; SUNGLASSES; SUNGLASSES WITH WRAPAROUND BAND; SWIMMING FACE MASKS; SWIMMING GOGGLES, IN CLASS 9 (U.S. CLS. 21, 23, 26, 36 AND 38).

FIRST USE 9-0-2009; IN COMMERCE 9-0-2009.

OWNER OF U.S. REG. NOS. 2,115,786, 3,946,880, AND 3,946,881.

THE MARK CONSISTS OF THE SENTENCE " I PLAY." CONTAINED WITHIN A CARTOON-IST'S SPEECH BUBBLE, WITH THE DOT OVER THE "I" STYLIZED TO REPRESENT A SHINING SUN.

SER. NO. 85-638,031, FILED 5-30-2012.

DANNEAN HETZEL, EXAMINING ATTORNEY



*David J. Kyffers*

Director of the United States Patent and Trademark Office

# United States of America

United States Patent and Trademark Office

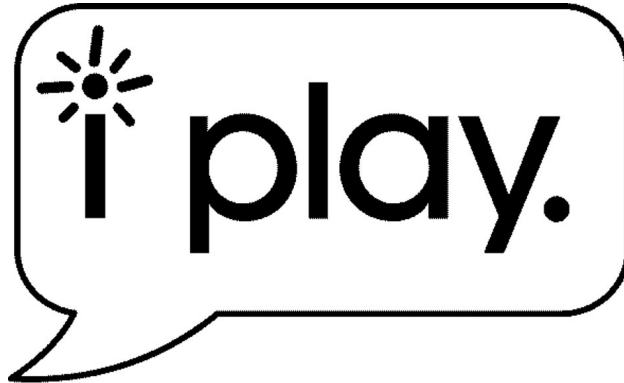

**Reg. No. 4,275,287**

**Registered Jan. 15, 2013**

**Int. Cl.: 16**

**TRADEMARK**

**PRINCIPAL REGISTER**

I PLAY, INC. (NORTH CAROLINA CORPORATION)  
2000 RIVERSIDE DRIVE, SUITE 9  
ASHEVILLE, NC 28804

FOR: CHILDREN'S BOOKS; DISPOSABLE SWIM PANTS FOR CHILDREN AND INFANTS;  
SCENTED DRAWER LINERS, IN CLASS 16 (U.S. CLS. 2, 5, 22, 23, 29, 37, 38 AND 50).

FIRST USE 9-0-2009; IN COMMERCE 9-0-2009.

OWNER OF U.S. REG. NOS. 2,115,786, 3,946,880, AND 3,946,881.

THE MARK CONSISTS OF THE SENTENCE " I PLAY." CONTAINED WITHIN A CARTOON-  
IST'S SPEECH BUBBLE, WITH THE DOT OVER THE "I" STYLIZED TO REPRESENT A  
SHINING SUN.

SER. NO. 85-638,041, FILED 5-30-2012.

DANNEAN HETZEL, EXAMINING ATTORNEY



*David J. Kyffers*

Director of the United States Patent and Trademark Office



United States of America  
United States Patent and Trademark Office

# GLOWCITY

**Reg. No. 4,275,288**

**Registered Jan. 15, 2013**

**Int. Cls.: 25 and 28**

**TRADEMARK**

**PRINCIPAL REGISTER**

GLOWCITY, LLC (NEW YORK LIMITED LIABILITY COMPANY)  
44 MAGNOLIA LANE  
WEBSTER, NY 14580

FOR: COSTUMES FOR USE IN THE AMUSEMENT INDUSTRY; GLOVES; HEADGEAR, NAMELY, NATURALLY OR ELECTRICALLY POWERED LIGHT-UP HATS; JACKETS; SHIRTS; TOPS; WEARABLE GARMENTS AND CLOTHING, NAMELY, SHIRTS, IN CLASS 25 (U.S. CLS. 22 AND 39).

FIRST USE 7-8-2009; IN COMMERCE 1-27-2010.

FOR: AMUSEMENT PRODUCTS, NAMELY, INFLATABLE BALLS; BALLS FOR SPORTS; BASKETBALLS; COSTUME MASKS; FACE MASKS; FOOTBALLS; SOCCER BALLS; TOY AND NOVELTY FACE MASKS, IN CLASS 28 (U.S. CLS. 22, 23, 38 AND 50).

FIRST USE 7-8-2009; IN COMMERCE 1-27-2010.

THE MARK CONSISTS OF STANDARD CHARACTERS WITHOUT CLAIM TO ANY PARTICULAR FONT, STYLE, SIZE, OR COLOR.

SER. NO. 85-638,052, FILED 5-30-2012.

BARBARA RUTLAND, EXAMINING ATTORNEY



*David J. Kyffers*

Director of the United States Patent and Trademark Office

# United States of America

United States Patent and Trademark Office



**Reg. No. 4,275,289**

**Registered Jan. 15, 2013**

**Int. Cl.: 18**

**TRADEMARK**

**PRINCIPAL REGISTER**

I PLAY, INC. (NORTH CAROLINA CORPORATION)  
2000 RIVERSIDE DRIVE, SUITE 9  
ASHEVILLE, NC 28804

FOR: BABY BACKPACKS; BACKPACKS, BOOK BAGS, SPORTS BAGS, BUM BAGS, WALLETS AND HANDBAGS; BEACH BAGS; CARRY-ALL BAGS; DIAPER BAGS; DUFFEL BAGS; LUGGAGE TAGS; MESSENGER BAGS; REUSABLE SHOPPING BAGS; TOTE BAGS; UMBRELLAS FOR CHILDREN, IN CLASS 18 (U.S. CLS. 1, 2, 3, 22 AND 41).

FIRST USE 9-0-2009; IN COMMERCE 9-0-2009.

OWNER OF U.S. REG. NOS. 2,115,786, 3,946,880, AND 3,946,881.

THE MARK CONSISTS OF THE SENTENCE " I PLAY." CONTAINED WITHIN A CARTOON-IST'S SPEECH BUBBLE, WITH THE DOT OVER THE "I" STYLIZED TO REPRESENT A SHINING SUN.

SER. NO. 85-638,054, FILED 5-30-2012.

DANNEAN HETZEL, EXAMINING ATTORNEY



*David J. Kyffers*

Director of the United States Patent and Trademark Office

# United States of America

United States Patent and Trademark Office

going GREEN one gallon at  
a time

**Reg. No. 4,275,290**

**Registered Jan. 15, 2013**

**Int. Cls.: 4, 37 and 40**

**TRADEMARK**

**SERVICE MARK**

**PRINCIPAL REGISTER**

GREENGALLON SOLUTIONS OF NORTH AMERICA (FLORIDA LIMITED LIABILITY COMPANY)  
7904 INTERSTATE COURT  
NORTH FORT MYERS, FL 33917

FOR: BIODIESEL FUEL; BIOFUEL; BIOFUELS; FOSSIL FUEL SUBSTITUTES, NAMELY, BIOFUELS; FUELS AND BIOFUELS BLENDED WITH CHEMICALS AND/OR BIOLOGICAL PRODUCTS, IN CLASS 4 (U.S. CLS. 1, 6 AND 15).

FIRST USE 12-17-2007; IN COMMERCE 12-17-2007.

FOR: RECYCLING SERVICES, NAMELY, COLLECTING USED FAT OR VEGETABLE OIL OR COOKING OIL FOR PURPOSES OF CONVERTING IT TO BIOFUEL OR BLENDING IT WITH PETROLEUM DIESEL TO CREATE BIODIESEL FUEL, IN CLASS 37 (U.S. CLS. 100, 103 AND 106).

FIRST USE 12-17-2007; IN COMMERCE 12-17-2007.

FOR: PRODUCTION, TREATMENT AND REFINEMENT OF FUEL, DIESEL FUEL, BIOFUEL AND BIODIESEL FUEL FOR OTHERS, IN CLASS 40 (U.S. CLS. 100, 103 AND 106).

FIRST USE 12-17-2007; IN COMMERCE 12-17-2007.

THE MARK CONSISTS OF STANDARD CHARACTERS WITHOUT CLAIM TO ANY PARTICULAR FONT, STYLE, SIZE, OR COLOR.

SER. NO. 85-638,056, FILED 5-30-2012.

BARBARA RUTLAND, EXAMINING ATTORNEY



*David J. Kyros*

Director of the United States Patent and Trademark Office

# United States of America

United States Patent and Trademark Office

# Age Old

**Reg. No. 4,275,291**

**Registered Jan. 15, 2013**

**Int. Cl.: 1**

**TRADEMARK**

**PRINCIPAL REGISTER**

ENP INVESTMENTS, LLC (INDIANA LIMITED LIABILITY COMPANY), DBA ENP TURF  
2000 WEST MAIN STREET  
MENDOTA, IL 61342

FOR: NATURAL FERTILIZERS, IN CLASS 1 (U.S. CLS. 1, 5, 6, 10, 26 AND 46).

FIRST USE 12-26-1996; IN COMMERCE 12-26-1996.

THE MARK CONSISTS OF STANDARD CHARACTERS WITHOUT CLAIM TO ANY PARTICULAR FONT, STYLE, SIZE, OR COLOR.

SER. NO. 85-638,073, FILED 5-30-2012.

INGRID C. EULIN, EXAMINING ATTORNEY



*David J. Kybas*

Director of the United States Patent and Trademark Office

# United States of America

United States Patent and Trademark Office

## Nutrition Snob

**Reg. No. 4,275,292**

MCCURDY, SUZANNE (UNITED STATES INDIVIDUAL)  
1517 MARBLEHEAD DR  
LEWISVILLE, TX 75067

**Registered Jan. 15, 2013**

**Int. Cl.: 25**

FOR: HOODED SWEATSHIRTS; TOPS, IN CLASS 25 (U.S. CLS. 22 AND 39).

**TRADEMARK**

FIRST USE 1-24-2012; IN COMMERCE 2-2-2012.

**PRINCIPAL REGISTER**

THE MARK CONSISTS OF STANDARD CHARACTERS WITHOUT CLAIM TO ANY PARTICULAR FONT, STYLE, SIZE, OR COLOR.

SER. NO. 85-638,096, FILED 5-30-2012.

MARK T. MULLEN, EXAMINING ATTORNEY



*David J. Kyffers*

Director of the United States Patent and Trademark Office

# United States of America

United States Patent and Trademark Office



**Reg. No. 4,275,293**

**Registered Jan. 15, 2013**

**Int. Cl.: 28**

**TRADEMARK**

**PRINCIPAL REGISTER**

ROWING INNOVATIONS, INC. (VERMONT CORPORATION)  
340 AVENUE D, SUITE #50  
WILLISTON, VT 05495

FOR: EXERCISE EQUIPMENT NAMELY, ROWING MACHINES; MANUALLY-OPERATED EXERCISE EQUIPMENT FOR PHYSICAL FITNESS PURPOSES; PHYSICAL FITNESS EQUIPMENT, NAMELY, ROWING MACHINES AND RESISTANCE MACHINES; ROWING TRAINING APPARATUS, NAMELY, DEVICES USED FOR ROWING STROKE ANALYSIS, IN CLASS 28 (U.S. CLS. 22, 23, 38 AND 50).

FIRST USE 7-22-2011; IN COMMERCE 7-22-2011.

THE MARK CONSISTS OF A DESIGN IN A SHAPE RESEMBLING A LETTER "S" SLANTED TO THE LEFT WITH AN UNATTACHED ROUND CIRCLE ABOVE IT DESIGNED TO RESEMBLE A HUMAN BODY ROWING, SURROUNDED BY A SOLID BORDER WITH ROUNDED CORNERS.

SER. NO. 85-638,097, FILED 5-30-2012.

MARK T. MULLEN, EXAMINING ATTORNEY



*David J. Kyffers*

Director of the United States Patent and Trademark Office

# United States of America

United States Patent and Trademark Office

# Lobsterscanfly

**Reg. No. 4,275,294**

NORADO, ANTHONY (UNITED STATES INDIVIDUAL)  
5 HORIZON CT  
MONROE, CT 06468

**Registered Jan. 15, 2013**

**Int. Cl.: 39**

FOR: TRANSPORTATION OF SEAFOOD IN REFRIGERATED CONDITIONS; SHIPPING OF GOODS, IN CLASS 39 (U.S. CLS. 100 AND 105).

**SERVICE MARK**

FIRST USE 1-1-2000; IN COMMERCE 1-1-2000.

**PRINCIPAL REGISTER**

THE MARK CONSISTS OF STANDARD CHARACTERS WITHOUT CLAIM TO ANY PARTICULAR FONT, STYLE, SIZE, OR COLOR.

SER. NO. 85-638,108, FILED 5-30-2012.

COURTNEY ALVAREZ, EXAMINING ATTORNEY



*David J. Kybas*

Director of the United States Patent and Trademark Office

# United States of America

United States Patent and Trademark Office

## Have you read me today?

**Reg. No. 4,275,295**

MOSLEY, CURTIS C. (UNITED STATES INDIVIDUAL)  
P.O. BOX 5439  
KINGWOOD, TX 773255439

**Registered Jan. 15, 2013**

**Int. Cl.: 16**

FOR: BOOK COVERS; BOOK HOLDERS; BOOK MARKS, IN CLASS 16 (U.S. CLS. 2, 5, 22, 23, 29, 37, 38 AND 50).

**TRADEMARK**

FIRST USE 4-11-2012; IN COMMERCE 4-11-2012.

**PRINCIPAL REGISTER**

THE MARK CONSISTS OF STANDARD CHARACTERS WITHOUT CLAIM TO ANY PARTICULAR FONT, STYLE, SIZE, OR COLOR.

SER. NO. 85-638,112, FILED 5-30-2012.

CHARLES L. JENKINS, EXAMINING ATTORNEY



*David J. Kybas*

Director of the United States Patent and Trademark Office



# United States of America

United States Patent and Trademark Office

# TrustGo

**Reg. No. 4,275,296**

**Registered Jan. 15, 2013**

**Int. Cl.: 42**

**SERVICE MARK**

**PRINCIPAL REGISTER**

TRUSTGO, INC. (CALIFORNIA CORPORATION)  
5723 MOORJANI STREET  
DUBLIN, CA 94568

FOR: COMPUTER VIRUS PROTECTION SERVICES, IN CLASS 42 (U.S. CLS. 100 AND 101).

FIRST USE 6-8-2011; IN COMMERCE 12-30-2011.

THE MARK CONSISTS OF STANDARD CHARACTERS WITHOUT CLAIM TO ANY PARTICULAR FONT, STYLE, SIZE, OR COLOR.

SER. NO. 85-638,116, FILED 5-30-2012.

DOMINIC FATHY, EXAMINING ATTORNEY



*David J. Kybas*

Director of the United States Patent and Trademark Office

# United States of America

United States Patent and Trademark Office

## The Kinderhook Tap

**Reg. No. 4,275,297**

**Registered Jan. 15, 2013**

**Int. Cl.: 43**

**SERVICE MARK**

**PRINCIPAL REGISTER**

THE KINDERHOOK TAP, LLC (ILLINOIS LIMITED LIABILITY COMPANY)  
#1N  
800 SOUTH OAK PARK AVE  
OAK PARK, IL 60304

FOR: BAR SERVICES; RESTAURANT SERVICES, IN CLASS 43 (U.S. CLS. 100 AND 101).

FIRST USE 12-31-2009; IN COMMERCE 8-1-2010.

THE MARK CONSISTS OF STANDARD CHARACTERS WITHOUT CLAIM TO ANY PARTICULAR FONT, STYLE, SIZE, OR COLOR.

NO CLAIM IS MADE TO THE EXCLUSIVE RIGHT TO USE "TAP", APART FROM THE MARK AS SHOWN.

THE WORDING "KINDERHOOK" HAS NO MEANING IN A FOREIGN LANGUAGE.

SER. NO. 85-638,128, FILED 5-30-2012.

ESTHER BELENKER, EXAMINING ATTORNEY



*David J. Kybas*

Director of the United States Patent and Trademark Office

# United States of America

United States Patent and Trademark Office

## HIGHERGROUND

**Reg. No. 4,275,298**

**Registered Jan. 15, 2013**

**Int. Cl.: 9**

**TRADEMARK**

**PRINCIPAL REGISTER**

HIGHERGROUND, INC. (CALIFORNIA CORPORATION)  
21201 VICTORY BLVD., SUITE 105  
CANOGA PARK, CA 91303

FOR: COMPUTER PROGRAMS USED TO PROVIDE ACCOUNTING AND MANAGEMENT FOR TELEPHONE SYSTEMS AND TO RECORD TELEPHONE CONVERSATIONS; COMPUTER SYSTEMS COMPRISING COMPUTER PROCESSING HARDWARE AND COMPUTER PROGRAMS FOR ACCOUNTING AND RECORDING TELEPHONE CONVERSATIONS AND MANAGEMENT OF TELECOMMUNICATION CALL CENTERS, IN CLASS 9 (U.S. CLS. 21, 23, 26, 36 AND 38).

FIRST USE 1-30-2002; IN COMMERCE 1-30-2002.

THE MARK CONSISTS OF STANDARD CHARACTERS WITHOUT CLAIM TO ANY PARTICULAR FONT, STYLE, SIZE, OR COLOR.

OWNER OF U.S. REG. NO. 2,818,326.

SER. NO. 85-638,149, FILED 5-30-2012.

JASON BLAIR, EXAMINING ATTORNEY



*David J. Kyffers*

Director of the United States Patent and Trademark Office

# United States of America

United States Patent and Trademark Office

# Alluring

**Reg. No. 4,275,299**

DISCOUNT EYELASHES (CALIFORNIA PARTNERSHIP)  
8741 VANS ST  
PARAMOUNT, CA 90723

**Registered Jan. 15, 2013**

**Int. Cl.: 3**

FOR: ADHESIVES FOR AFFIXING FALSE EYELASHES; COSMETIC PREPARATIONS FOR EYE LASHES; EYE MAKE-UP REMOVER; EYELASH TINT; FALSE EYELASHES; GEL EYE MASKS; GLUE REMOVERS; MAKE-UP REMOVER, IN CLASS 3 (U.S. CLS. 1, 4, 6, 50, 51 AND 52).

**TRADEMARK**

**PRINCIPAL REGISTER**

FIRST USE 9-1-2011; IN COMMERCE 9-1-2011.

THE MARK CONSISTS OF STANDARD CHARACTERS WITHOUT CLAIM TO ANY PARTICULAR FONT, STYLE, SIZE, OR COLOR.

SER. NO. 85-638,151, FILED 5-30-2012.

JASON BLAIR, EXAMINING ATTORNEY



*David J. Kyffers*

Director of the United States Patent and Trademark Office

# United States of America

United States Patent and Trademark Office

## Let's Get REAL With Chef Erica Wides

**Reg. No. 4,275,300**

**Registered Jan. 15, 2013**

**Int. Cl.: 9**

**TRADEMARK**

**PRINCIPAL REGISTER**

CHEFSMARTYPANTS LLC (NEW YORK LIMITED LIABILITY COMPANY)  
2H  
423 ATLANTIC AVE  
BROOKLYN, NY 11217

FOR: DOWNLOADABLE PODCASTS IN THE FIELD OF TEACHING AND DISCUSSING THE FINDING, PREPARING, AND EATING OF REAL FOOD, VERSUS ARTIFICIAL, INDUSTRIAL AND PACKAGED INDUSTRIAL FOOD; VIDEO RECORDINGS FEATURING VIDEOS THAT TEACH AND DISCUSS THE FINDING, PREPARING, AND EATING OF REAL FOOD, VERSUS ARTIFICIAL, INDUSTRIAL AND PACKAGED INDUSTRIAL FOOD, IN CLASS 9 (U.S. CLS. 21, 23, 26, 36 AND 38).

FIRST USE 9-1-2011; IN COMMERCE 9-1-2011.

THE MARK CONSISTS OF STANDARD CHARACTERS WITHOUT CLAIM TO ANY PARTICULAR FONT, STYLE, SIZE, OR COLOR.

THE NAME "ERICA WIDES" IDENTIFIES A LIVING INDIVIDUAL WHOSE CONSENT IS OF RECORD.

SER. NO. 85-638,154, FILED 5-30-2012.

LINDA ORNDORFF, EXAMINING ATTORNEY



*David J. Kyffers*

Director of the United States Patent and Trademark Office

# United States of America

United States Patent and Trademark Office

## SIN + SINNERS

**Reg. No. 4,275,301**

JULIA YUWEI CHI (UNITED STATES INDIVIDUAL)

**Registered Jan. 15, 2013**

5 CATALPA LANE  
VALLEY STREAM, NY 11581

**Int. Cl.: 25**

**TRADEMARK**

**PRINCIPAL REGISTER**

FOR: BEACH SHOES; BELTS; BELTS FOR CLOTHING; BELTS MADE OF LEATHER; BELTS OF TEXTILE; BOAT SHOES; BOWLING SHOES; CANVAS SHOES; CLIMBING SHOES; COATS FOR MEN AND WOMEN; DRIVERS; FABRIC BELTS; FOOTWEAR FOR MEN AND WOMEN; FOOTWEAR FOR WOMEN; GYMNAS TIC SHOES; LEATHER BELTS; LEATHER BOOTS; LEATHER COATS; LEATHER HATS; LEATHER HEADWEAR; LEATHER JACKETS; LEATHER PANTS; LEATHER SHIRTS; LEATHER SHOES; LEATHER SKIRTS; LEATHER SLIPPERS; LEATHER VESTS; LEISURE SHOES; LEOTARDS AND TIGHTS FOR WOMEN, MEN AND CHILDREN OF NYLON, COTTON OR OTHER TEXTILE FIBERS; MEN'S AND WOMEN'S JACKETS, COATS, TROUSERS, VESTS; RUBBER SHOES; RUNNING SHOES; SANDALS AND BEACH SHOES; SHOES; SWEATSHIRTS FOR WOMEN AND MEN; T-SHIRTS FOR WOMEN AND MEN; TENNIS SHOES; TRACK AND FIELD SHOES; TRAINING SHOES; WAIST BELTS; WATERPROOF LEATHER SHOES AND BOOTS; WOMEN'S CLOTHING, NAMELY, SHIRTS, DRESSES, SKIRTS, BLOUSES; WOMEN'S HATS AND HOODS; WOMEN'S SHOES; WOMEN'S UNDERWEAR, IN CLASS 25 (U.S. CLS. 22 AND 39).

FIRST USE 12-14-2011; IN COMMERCE 12-14-2011.

THE MARK CONSISTS OF STANDARD CHARACTERS WITHOUT CLAIM TO ANY PARTICULAR FONT, STYLE, SIZE, OR COLOR.

SER. NO. 85-638,165, FILED 5-30-2012.

GRETCHEN ULRICH, EXAMINING ATTORNEY



*David J. Kyffers*

Director of the United States Patent and Trademark Office

# United States of America

United States Patent and Trademark Office

# nFinity

**Reg. No. 4,275,302**

**Registered Jan. 15, 2013**

**Int. Cl.: 42**

**SERVICE MARK**

**PRINCIPAL REGISTER**

NGENX CORPORATION (NEVADA CORPORATION)  
8837 BOND STREET  
OVERLAND PARK, KS 66214

FOR: APPLICATION SERVICE PROVIDER (ASP), NAMELY, HOSTING COMPUTER SOFTWARE APPLICATIONS OF OTHERS; COMPUTER SERVICES, NAMELY, CLOUD HOSTING PROVIDER SERVICES; HOSTING OF DIGITAL CONTENT ON THE INTERNET; HOSTING THE SOFTWARE, WEBSITES AND OTHER COMPUTER APPLICATIONS OF OTHERS ON A VIRTUAL PRIVATE SERVER; SOFTWARE AS A SERVICE (SAAS) SERVICES, NAMELY, HOSTING SOFTWARE FOR USE BY OTHERS FOR USE FOR SPREADSHEETS, FOR WORD PROCESSING, FOR DATABASE MANAGEMENT, FOR PRESENTATION CREATION, FOR WEB-BROWSING, AND FOR E-MAIL, IN CLASS 42 (U.S. CLS. 100 AND 101).

FIRST USE 5-1-2012; IN COMMERCE 5-1-2012.

THE MARK CONSISTS OF STANDARD CHARACTERS WITHOUT CLAIM TO ANY PARTICULAR FONT, STYLE, SIZE, OR COLOR.

OWNER OF U.S. REG. NO. 3,115,720.

SER. NO. 85-638,166, FILED 5-30-2012.

RONALD MCMORROW, EXAMINING ATTORNEY



*David J. Kyros*

Director of the United States Patent and Trademark Office

# United States of America

United States Patent and Trademark Office

## SIMPLE FOCUS

**Reg. No. 4,275,303**

**Registered Jan. 15, 2013**

**Int. Cls.: 35 and 42**

**SERVICE MARK**

**PRINCIPAL REGISTER**

SIMPLE FOCUS, LLC (TENNESSEE LIMITED LIABILITY COMPANY)  
SUITE 226  
2129 SOUTH GERMANTOWN RD.  
GERMANTOWN, TN 38138

FOR: DEVELOPMENT OF PROMOTIONAL MATERIALS, NAMELY, MATERIALS BEARING LOGOS AND SLOGANS OF OTHERS; ADVERTISING AND MARKETING SERVICES, NAMELY, EXTENDING BRAND ATTRIBUTES BY PROMOTIONAL CAMPAIGNS FOR OTHERS; ADVERTISING AND MARKETING SERVICES, NAMELY, SEARCH ENGINE MARKETING SERVICES, IN CLASS 35 (U.S. CLS. 100, 101 AND 102).

FIRST USE 2-0-2011; IN COMMERCE 2-0-2011.

FOR: GRAPHIC ART DESIGN; WEBSITE DESIGN AND DEVELOPMENT FOR OTHERS; WEBSITE DESIGN USABILITY TESTING; COMPUTER SERVICES FOR OTHERS, NAMELY, SEARCH ENGINE OPTIMIZATION AND WEBSITE HOSTING SERVICES; INTERFACE DESIGN AND DEVELOPMENT FOR OTHERS; CONSULTING SERVICES IN THE FIELD OF WEBSITE INTERFACE DESIGN; DEVELOPMENT OF CONTENT MANAGEMENT SYSTEMS, IN CLASS 42 (U.S. CLS. 100 AND 101).

FIRST USE 2-0-2011; IN COMMERCE 2-0-2011.

THE MARK CONSISTS OF STANDARD CHARACTERS WITHOUT CLAIM TO ANY PARTICULAR FONT, STYLE, SIZE, OR COLOR.

SER. NO. 85-638,191, FILED 5-30-2012.

JACQUELINE A. LAVINE, EXAMINING ATTORNEY



*David J. Kyjars*

Director of the United States Patent and Trademark Office



# United States of America

United States Patent and Trademark Office

## ATHLETES FOR A BETTER WORLD

**Reg. No. 4,275,304**

**Registered Jan. 15, 2013**

**Int. Cl.: 41**

**SERVICE MARK**

**PRINCIPAL REGISTER**

ATHLETES FOR A BETTER WORLD, INC. (GEORGIA CORPORATION)  
SUITE 500  
1401 PEACHTREE STREET NE  
ATLANTA, GA 30309

FOR: EDUCATIONAL SERVICES, NAMELY, CONDUCTING WORKSHOPS AND SEMINARS IN THE FIELD OF CHARACTER DEVELOPMENT AND RESPONSIBLE LEADERSHIP AMONG ATHLETES AND OTHERS INVOLVED IN SPORTS AND DISTRIBUTION OF COURSE MATERIALS IN CONNECTION THEREWITH, IN CLASS 41 (U.S. CLS. 100, 101 AND 107).

FIRST USE 6-15-1998; IN COMMERCE 6-15-1998.

THE MARK CONSISTS OF STANDARD CHARACTERS WITHOUT CLAIM TO ANY PARTICULAR FONT, STYLE, SIZE, OR COLOR.

OWNER OF U.S. REG. NO. 2,397,213.

NO CLAIM IS MADE TO THE EXCLUSIVE RIGHT TO USE "ATHLETES", APART FROM THE MARK AS SHOWN.

SER. NO. 85-638,242, FILED 5-30-2012.

MORGAN WYNNE, EXAMINING ATTORNEY



*David J. Kyffers*

Director of the United States Patent and Trademark Office

# United States of America

United States Patent and Trademark Office

# PROPIlates

**Reg. No. 4,275,305**

**Registered Jan. 15, 2013**

**Int. Cls.: 41 and 44**

**SERVICE MARK**

**PRINCIPAL REGISTER**

FLORIDA FITNESS INTERNATIONAL INC. (FLORIDA CORPORATION)  
1861 HARBOR SHOPS DRIVE EAST  
FT. LAUDERDALE, FL 33316

FOR: CONSULTING AND HEALTH CLUB SERVICES IN THE FIELDS OF FITNESS AND EXERCISE; PHYSICAL FITNESS AND EXERCISE STUDIO SERVICES, NAMELY, PROVIDING GROUP AND INDIVIDUAL EXERCISE AND YOGA INSTRUCTION, EQUIPMENT, AND FACILITIES; PROVIDING PHYSICAL FITNESS AND EXERCISE STUDIO SERVICES, NAMELY, PILATES INSTRUCTION, TRAINING TECHNIQUES, APPARATUSES, EQUIPMENT AND FACILITIES; GROUP AND PERSONAL TRAINING IN CONNECTION WITH WEIGHT LOSS AND EXERCISE PROGRAMS, IN CLASS 41 (U.S. CLS. 100, 101 AND 107).

FIRST USE 10-5-1998; IN COMMERCE 10-5-1998.

FOR: MEDSPA SERVICES FOR HEALTH AND BEAUTY OF THE BODY AND SPIRIT; HEALTH SPA SERVICES, NAMELY, PROVIDING WEIGHT LOSS PROGRAMS; COUNSELING SERVICES IN THE FIELDS OF HEALTH, NUTRITION AND LIFESTYLE WELLNESS; PROVIDING HEALTHY LIFESTYLE AND NUTRITION SERVICES, NAMELY, PERSONAL ASSESSMENTS, PERSONALIZED ROUTINES, MAINTENANCE SCHEDULES, AND COUNSELING; SAUNA SERVICES; ACUPUNCTURE SERVICES; MASSAGE THERAPY SERVICES; ALTERNATIVE MEDICINE SERVICES, NAMELY, DETOXIFICATION SERVICES; CONSULTATION SERVICES IN THE FIELD OF MAKE-UP, NAMELY, MAKEUP CONSULTATION AND APPLICATION SERVICES; PROVIDING A WEBSITE FEATURING INFORMATION ABOUT HEALTH, WELLNESS AND NUTRITION, IN CLASS 44 (U.S. CLS. 100 AND 101).

FIRST USE 10-5-1998; IN COMMERCE 10-5-1998.

THE MARK CONSISTS OF STANDARD CHARACTERS WITHOUT CLAIM TO ANY PARTICULAR FONT, STYLE, SIZE, OR COLOR.

OWNER OF U.S. REG. NO. 3,044,908.

SEC. 2(F).

SER. NO. 85-638,246, FILED 5-30-2012.



*David J. Kyffers*

Director of the United States Patent and Trademark Office

**Reg. No. 4,275,305** ERNEST SHOSHO, EXAMINING ATTORNEY

# United States of America

United States Patent and Trademark Office

## WINNING MORE THAN THE GAME

**Reg. No. 4,275,306**

**Registered Jan. 15, 2013**

**Int. Cl.: 41**

**SERVICE MARK**

**PRINCIPAL REGISTER**

ATHLETES FOR A BETTER WORLD, INC. (GEORGIA CORPORATION)  
SUITE 500  
1401 PEACHTREE ST. NE  
ATLANTA, GA 30309

FOR: EDUCATIONAL SERVICES, NAMELY, CONDUCTING WORKSHOPS AND SEMINARS IN THE FIELD OF CHARACTER DEVELOPMENT AND RESPONSIBLE LEADERSHIP AMONG ATHLETES AND OTHERS INVOLVED IN SPORTS AND DISTRIBUTION OF COURSE MATERIALS IN CONNECTION THEREWITH, IN CLASS 41 (U.S. CLS. 100, 101 AND 107).

FIRST USE 6-15-1998; IN COMMERCE 6-15-1998.

THE MARK CONSISTS OF STANDARD CHARACTERS WITHOUT CLAIM TO ANY PARTICULAR FONT, STYLE, SIZE, OR COLOR.

OWNER OF U.S. REG. NO. 2,397,213.

SER. NO. 85-638,253, FILED 5-30-2012.

MORGAN WYNNE, EXAMINING ATTORNEY



*David J. Kyfos*

Director of the United States Patent and Trademark Office

# United States of America

United States Patent and Trademark Office

# REMUVIK

**Reg. No. 4,275,307**

**Registered Jan. 15, 2013**

**Int. Cl.: 5**

**TRADEMARK**

**PRINCIPAL REGISTER**

L'AUBEN GROUPE, S.A. DE C.V (MEXICO CORPORATION)  
AV. FUENTES DEL VALLE #203 PTE.  
FUENTES DEL VALLE, S. PEDRO GARZA GARCIA  
MONTERREY, NUEVO LEÓN, MEXICO

FOR: DIETARY AND NUTRITIONAL SUPPLEMENTS, IN CLASS 5 (U.S. CLS. 6, 18, 44, 46, 51 AND 52).

FIRST USE 1-9-2012; IN COMMERCE 1-9-2012.

THE MARK CONSISTS OF STANDARD CHARACTERS WITHOUT CLAIM TO ANY PARTICULAR FONT, STYLE, SIZE, OR COLOR.

THE WORDING "REMUVIK" HAS NO MEANING IN A FOREIGN LANGUAGE.

SER. NO. 85-638,267, FILED 5-30-2012.

BARNEY CHARLON, EXAMINING ATTORNEY



*David J. Kyffers*

Director of the United States Patent and Trademark Office

# United States of America

United States Patent and Trademark Office

# SUGARMADE

**Reg. No. 4,275,308**

**Registered Jan. 15, 2013**

**Int. Cl.: 16**

**TRADEMARK**

**PRINCIPAL REGISTER**

SUGARMADE, INC. (CALIFORNIA CORPORATION)  
SUITE 200  
2280 LINCOLN AVENUE  
SAN JOSE, CA 95125

FOR: TREE-FREE PAPER PRODUCTS, NAMELY, COPY PAPER, IN CLASS 16 (U.S. CLS. 2, 5, 22, 23, 29, 37, 38 AND 50).

FIRST USE 1-21-2010; IN COMMERCE 2-24-2011.

THE MARK CONSISTS OF STANDARD CHARACTERS WITHOUT CLAIM TO ANY PARTICULAR FONT, STYLE, SIZE, OR COLOR.

OWNER OF U.S. REG. NO. 3,730,679.

SER. NO. 85-638,292, FILED 5-30-2012.

DAWN FELDMAN, EXAMINING ATTORNEY



*David J. Kyffers*

Director of the United States Patent and Trademark Office

# United States of America

United States Patent and Trademark Office

## HOPE SHINES HERE

**Reg. No. 4,275,309**

**Registered Jan. 15, 2013**

**Int. Cl.: 35**

**SERVICE MARK**

**PRINCIPAL REGISTER**

BUCKNER INTERNATIONAL (TEXAS NON-PROFIT CORPORATION)  
SUITE 2000  
600 N. PEARL STREET  
DALLAS, TX 75201

FOR: CHARITABLE SERVICES, NAMELY, ORGANIZING AND DEVELOPING PROJECTS THAT AIM TO IMPROVE THE LIVES OF UNDERPRIVILEGED AND IMPOVERISHED PEOPLE; CHARITABLE SERVICES PROVIDING ADMINISTRATION AND MANAGEMENT OF CARE AND HOUSING FACILITIES FOR OTHERS, NAMELY, FOR CHILDREN AND THE ELDERLY IN NEED, AND UNDERPRIVILEGED AND IMPOVERISHED PEOPLE, IN CLASS 35 (U.S. CLS. 100, 101 AND 102).

FIRST USE 1-0-2012; IN COMMERCE 1-0-2012.

THE MARK CONSISTS OF STANDARD CHARACTERS WITHOUT CLAIM TO ANY PARTICULAR FONT, STYLE, SIZE, OR COLOR.

SER. NO. 85-638,298, FILED 5-30-2012.

DAWN FELDMAN, EXAMINING ATTORNEY



*David J. Kyffers*

Director of the United States Patent and Trademark Office

# United States of America

United States Patent and Trademark Office



**Reg. No. 4,275,310**

CHW, LLC (DELAWARE LIMITED LIABILITY COMPANY)  
8100 DENMARK ROAD  
CHARLOTTE, NC 28234

**Registered Jan. 15, 2013**

**Int. Cl.: 25**

FOR: TOPS, BOTTOMS, JACKETS, COATS, HOSIERY, SCARVES, GLOVES, SLIPPERS,  
HATS, IN CLASS 25 (U.S. CLS. 22 AND 39).

**TRADEMARK**

FIRST USE 9-29-2011; IN COMMERCE 9-29-2011.

**PRINCIPAL REGISTER**

THE MARK CONSISTS OF A STYLIZED "V" IN A CIRCLE.

SER. NO. 85-638,303, FILED 5-30-2012.

KATHRYN COWARD, EXAMINING ATTORNEY



*David J. Kyffers*

Director of the United States Patent and Trademark Office



# United States of America

United States Patent and Trademark Office

## TOP NOTCH RV

**Reg. No. 4,275,311**

TOP NOTCH MARINE, INC. (FLORIDA CORPORATION)  
2450 NORTH US 1  
FORT PIERCE, FL 34946

**Registered Jan. 15, 2013**

**Int. Cls.: 35 and 37**

FOR: RECREATIONAL VEHICLE DEALERSHIPS; RETAIL AND ON-LINE RETAIL STORES  
FEATURING RECREATIONAL VEHICLES, IN CLASS 35 (U.S. CLS. 100, 101 AND 102).

**SERVICE MARK**

FIRST USE 0-0-2007; IN COMMERCE 0-0-2007.

**PRINCIPAL REGISTER**

FOR: REPAIR AND MAINTENANCE OF RECREATIONAL VEHICLES, IN CLASS 37 (U.S.  
CLS. 100, 103 AND 106).

FIRST USE 0-0-2007; IN COMMERCE 0-0-2007.

THE MARK CONSISTS OF STANDARD CHARACTERS WITHOUT CLAIM TO ANY PAR-  
TICULAR FONT, STYLE, SIZE, OR COLOR.

OWNER OF U.S. REG. NO. 3,649,848.

NO CLAIM IS MADE TO THE EXCLUSIVE RIGHT TO USE "RV", APART FROM THE MARK  
AS SHOWN.

SER. NO. 85-638,316, FILED 5-30-2012.

REBECCA EISINGER, EXAMINING ATTORNEY



*David J. Kyros*

Director of the United States Patent and Trademark Office

# United States of America

United States Patent and Trademark Office



**Reg. No. 4,275,312**

**Registered Jan. 15, 2013**

**Int. Cls.: 36 and 44**

**SERVICE MARK**

**PRINCIPAL REGISTER**

AMERIGROUP CORPORATION (DELAWARE CORPORATION)  
4425 CORPORATION LANE SUITE 100  
VIRGINIA BEACH, VA 23462

FOR: ADMINISTRATION OF PRE-PAID HEALTH CARE PLANS, IN CLASS 36 (U.S. CLS. 100, 101 AND 102).

FIRST USE 2-0-2002; IN COMMERCE 2-0-2002.

FOR: HEALTH CARE IN THE NATURE OF HEALTH MAINTENANCE ORGANIZATIONS, IN CLASS 44 (U.S. CLS. 100 AND 101).

FIRST USE 2-0-2002; IN COMMERCE 2-0-2002.

THE MARK CONSISTS OF A BABY ANGEL IN PROFILE PLAYING A TRUMPET.

SER. NO. 85-638,340, FILED 5-30-2012.

SUSAN LESLIE DUBOIS, EXAMINING ATTORNEY



*David J. Kybas*

Director of the United States Patent and Trademark Office

# United States of America

United States Patent and Trademark Office

## CRAN BLASTER

**Reg. No. 4,275,313**

BUZZBALLZ, LLC (TEXAS LIMITED LIABILITY COMPANY)  
1711 BRIERCROFT CT., STE 100  
CARROLLTON, TX 75006

**Registered Jan. 15, 2013**

**Int. Cl.: 33**

FOR: ALCOHOLIC BEVERAGES EXCEPT BEERS, IN CLASS 33 (U.S. CLS. 47 AND 49).

**TRADEMARK**

FIRST USE 7-16-2010; IN COMMERCE 7-16-2010.

**PRINCIPAL REGISTER**

THE MARK CONSISTS OF STANDARD CHARACTERS WITHOUT CLAIM TO ANY PARTICULAR FONT, STYLE, SIZE, OR COLOR.

SER. NO. 85-638,345, FILED 5-30-2012.

EVIN L. KOZAK, EXAMINING ATTORNEY



*David J. Kyffers*

Director of the United States Patent and Trademark Office

# United States of America

United States Patent and Trademark Office

## keystonecollects.com

**Reg. No. 4,275,314**

**Registered Jan. 15, 2013**

**Int. Cl.: 36**

**SERVICE MARK**

**PRINCIPAL REGISTER**

KRATZENBERG & ASSOCIATES, INC. (PENNSYLVANIA CORPORATION), DBA  
KEYSTONE COLLECTIONS GROUP  
546 WENDEL ROAD  
IRWIN, PA 15642

FOR: TAX PAYMENT PROCESSING SERVICES, IN CLASS 36 (U.S. CLS. 100, 101 AND 102).

FIRST USE 6-1-2003; IN COMMERCE 6-1-2003.

THE MARK CONSISTS OF STANDARD CHARACTERS WITHOUT CLAIM TO ANY PARTICULAR FONT, STYLE, SIZE, OR COLOR.

SEC. 2(F).

SER. NO. 85-638,353, FILED 5-30-2012.

RENEE MCCRAY, EXAMINING ATTORNEY



*David J. Kyffers*

Director of the United States Patent and Trademark Office

# United States of America

United States Patent and Trademark Office

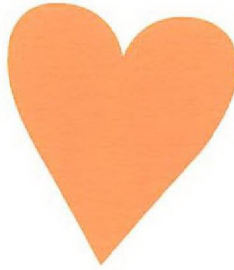

**Reg. No. 4,275,315**

DIGNITY-U-WEAR FOUNDATION, INC. (FLORIDA NON-PROFIT CORPORATION)  
136 N. MYRTLE AVENUE  
JACKSONVILLE, FL 32204

**Registered Jan. 15, 2013**

**Int. Cl.: 45**

FOR: CHARITABLE SERVICES, NAMELY, PROVIDING CLOTHING TO NEEDY PERSONS,  
IN CLASS 45 (U.S. CLS. 100 AND 101).

**SERVICE MARK**

FIRST USE 4-1-2012; IN COMMERCE 4-1-2012.

**PRINCIPAL REGISTER**

THE MARK CONSISTS OF ORANGE HEART.

THE COLOR(S) ORANGE IS/ARE CLAIMED AS A FEATURE OF THE MARK.

SER. NO. 85-638,425, FILED 5-30-2012.

DANIEL S. STRINGER, EXAMINING ATTORNEY



*David J. Kyffers*

Director of the United States Patent and Trademark Office

# United States of America

United States Patent and Trademark Office

# RecordEraser

**Reg. No. 4,275,316**

WALMER LAW OFFICES (PENNSYLVANIA LIMITED LIABILITY COMPANY)  
148 NORTH LIME STREET  
LANCASTER, PA 17602

**Registered Jan. 15, 2013**

**Int. Cl.: 45**

FOR: LEGAL SERVICES, IN CLASS 45 (U.S. CLS. 100 AND 101).

**SERVICE MARK**

FIRST USE 5-24-2012; IN COMMERCE 5-24-2012.

**PRINCIPAL REGISTER**

THE MARK CONSISTS OF STANDARD CHARACTERS WITHOUT CLAIM TO ANY PARTICULAR FONT, STYLE, SIZE, OR COLOR.

SER. NO. 85-638,463, FILED 5-30-2012.

COLLEEN DOMBROW, EXAMINING ATTORNEY



*David J. Kybas*

Director of the United States Patent and Trademark Office

# United States of America

United States Patent and Trademark Office

# AGENT ACE

**Reg. No. 4,275,317**

AGENT ACE, INC. (DELAWARE CORPORATION)  
9415 CULVER BLVD.  
CULVER CITY, CA 90232

**Registered Jan. 15, 2013**

**Int. Cl.: 35**

FOR: PROVIDING ON-LINE REFERRALS IN THE FIELD OF BUYING AND SELLING REAL ESTATE, IN CLASS 35 (U.S. CLS. 100, 101 AND 102).

**SERVICE MARK**

FIRST USE 10-0-2007; IN COMMERCE 1-0-2009.

**PRINCIPAL REGISTER**

THE MARK CONSISTS OF STANDARD CHARACTERS WITHOUT CLAIM TO ANY PARTICULAR FONT, STYLE, SIZE, OR COLOR.

NO CLAIM IS MADE TO THE EXCLUSIVE RIGHT TO USE "AGENT", APART FROM THE MARK AS SHOWN.

SER. NO. 85-638,466, FILED 5-30-2012.

KIMBERLY PERRY, EXAMINING ATTORNEY



*David J. Kyffers*

Director of the United States Patent and Trademark Office

# United States of America

United States Patent and Trademark Office

# GSM

**Reg. No. 4,275,318**

GOLDEN STATE MINT, LLC (FLORIDA LIMITED LIABILITY COMPANY)  
3601 SOUTH SANFORD AVENUE  
SANFORD, FL 32773

**Registered Jan. 15, 2013**

**Int. Cl.: 40**

FOR: CUSTOM MANUFACTURE OF PRECIOUS AND NON-PRECIOUS METALS INTO INGOTS, BARS, AND ROUNDS, IN CLASS 40 (U.S. CLS. 100, 103 AND 106).

**SERVICE MARK**

FIRST USE 1-3-2009; IN COMMERCE 1-3-2009.

**PRINCIPAL REGISTER**

THE MARK CONSISTS OF STANDARD CHARACTERS WITHOUT CLAIM TO ANY PARTICULAR FONT, STYLE, SIZE, OR COLOR.

SER. NO. 85-638,475, FILED 5-30-2012.

JOHN GARTNER, EXAMINING ATTORNEY



*David J. Kybas*

Director of the United States Patent and Trademark Office



# United States of America

United States Patent and Trademark Office



**Reg. No. 4,275,319**

**Registered Jan. 15, 2013**

**Int. Cl.: 28**

**TRADEMARK**

**PRINCIPAL REGISTER**

WINDY FIGHTGEAR (NETHERLANDS COMPANY)  
BURG DEN HAAN-GROENPARK 143  
AZ, VOORBURG, NETHERLANDS 2272

FOR: SPORTS EQUIPMENT FOR BOXING AND MARTIAL ARTS, NAMELY, BOXING GLOVES, BOXING BAGS, PUNCHING MITTS, BELLY PROTECTORS, GROIN PROTECTORS AND SHIN GUARDS, IN CLASS 28 (U.S. CLS. 22, 23, 38 AND 50).

FIRST USE 11-13-2006; IN COMMERCE 7-0-2011.

THE MARK CONSISTS OF THE DESIGN OF A GLOBE WITH PARALLELS AND MERIDIANS, AND THE PROMINENT STYLIZED WORD "WINDY" DEPICTED BETWEEN TWO MERIDIANS.

SER. NO. 85-638,482, FILED 5-30-2012.

STEVEN JACKSON, EXAMINING ATTORNEY



*David J. Kyffers*

Director of the United States Patent and Trademark Office

# United States of America

United States Patent and Trademark Office

# ZONAVITA

**Reg. No. 4,275,320**

DECOR CABINETS LTD. (CANADA CORPORATION)  
BOX 2110

**Registered Jan. 15, 2013**

MORDEN, CANADA R6M1B8

**Int. Cl.: 20**

FOR: CABINETS, NAMELY, KITCHEN CABINETS, BATH CABINETS, AND CABINET DOORS, IN CLASS 20 (U.S. CLS. 2, 13, 22, 25, 32 AND 50).

**TRADEMARK**

FIRST USE 4-30-2011; IN COMMERCE 1-1-2012.

**PRINCIPAL REGISTER**

THE MARK CONSISTS OF STANDARD CHARACTERS WITHOUT CLAIM TO ANY PARTICULAR FONT, STYLE, SIZE, OR COLOR.

SER. NO. 85-638,526, FILED 5-30-2012.

ALEXANDER L. POWERS, EXAMINING ATTORNEY



*David J. Kyros*

Director of the United States Patent and Trademark Office

# United States of America

United States Patent and Trademark Office



**Reg. No. 4,275,321**

**Registered Jan. 15, 2013**

**Int. Cl.: 28**

**TRADEMARK**

**PRINCIPAL REGISTER**

NOVATECH ENTERPRISE CO., LTD. (TAIWAN CORPORATION)  
NO. 17, LN. 423, SEC. 1, SHENLIN RD.,  
DAYA DIST.,  
TAICHUNG CITY, TAIWAN 428

FOR: REMOTE CONTROL TOYS, NAMELY, CARS, AIRPLANES AND BOATS, SCALE  
MODEL VEHICLES, SCALE MODEL AIRPLANES, AND RADIO CONTROLLED MODEL  
VEHICLES, IN CLASS 28 (U.S. CLS. 22, 23, 38 AND 50).

FIRST USE 1-20-2012; IN COMMERCE 3-6-2012.

THE MARK CONSISTS OF THE STYLIZED WORDING "XPERT".

SER. NO. 85-638,551, FILED 5-30-2012.

DARRYL SPRUILL, EXAMINING ATTORNEY



*David J. Kyffers*

Director of the United States Patent and Trademark Office

# United States of America

United States Patent and Trademark Office



**Reg. No. 4,275,322**

**Registered Jan. 15, 2013**

**Int. Cls.: 6 and 17**

**TRADEMARK**

**PRINCIPAL REGISTER**

DEL TORO GODOY CARLOS MANUEL (MEXICO INDIVIDUAL)  
LAZARO CARDENAS #1150  
GUADALAJARA, MEXICO 44490

FOR: ALUMINIUM AND ITS ALLOYS; ALUMINUM ALLOY; CASTINGS, FOILS, POWDER, AND ROLLED, DRAWN OR EXTRUDED SEMI-FINISHED ARTICLES OF ALUMINIUM OR ITS ALLOYS; DECORATIVE METAL SHEETS CONSISTING OF AN ALUMINUM OR STEEL SUBSTRATE AND A PRINTED FINISH TO ADD DESIGN, IN CLASS 6 (U.S. CLS. 2, 12, 13, 14, 23, 25 AND 50).

FOR: FOAM INSULATION FOR USE IN BUILDING AND CONSTRUCTION; FOAM SHEETING FOR USE AS A BUILDING INSULATION; HIGH-DENSITY POLYETHYLENE FILM WITH ADHESIVE BACK TO BE USED IN CARDBOARD AND CORRUGATED CONTAINERS AND BOXES; MOLDED FOAM INSULATED CONTAINER PACKING FOR COMMERCIAL TRANSPORTATION; THERMOPLASTIC AND FOAMED PLASTIC SECTIONS FOR USE IN THE MANUFACTURE OF WINDOWS, DOORS, FACADE GLAZINGS, AND PARTITION WALLS FOR USE AS BUILDING MATERIALS FOR HEAT-INSULATING APPLICATIONS; UNFITTED COVERING SHEETS AND WRAPS MADE OF POLYETHYLENE AND OTHER POLYMERS FOR STORING AND TRANSPORTING LUMBER, BUILDING MATERIALS AND OTHER SIMILAR COMMERCIAL AND INDUSTRIAL PRODUCTS, IN CLASS 17 (U.S. CLS. 1, 5, 12, 13, 35 AND 50).

OWNER OF MEXICO REG. NO. 1110989 AND 11, DATED 7-20-2009, EXPIRES 5-28-2019.

THE MARK CONSISTS OF THE WORD "KLIMET" UNDER FOUR FAN LIKE SHAPES FORMING A CIRCLE WITH A BLANK SPACE RIGHT IN THE MIDDLE, FORMING A CROSS.

THE WORDING KLIMET HAS NO MEANING IN A FOREIGN LANGUAGE.

SER. NO. 85-638,565, FILED 5-30-2012.

RUDY R. SINGLETON, EXAMINING ATTORNEY



*David J. Kyffers*

Director of the United States Patent and Trademark Office

# United States of America

United States Patent and Trademark Office

# SoftCode, Inc.

**Reg. No. 4,275,323**

SOFTCODE, INC. (MASSACHUSETTS CORPORATION)  
33 BOSTON POST ROAD WEST, SUITE 360  
MARLBOROUGH, MA 01752

**Registered Jan. 15, 2013**

**Int. Cl.: 9**

FOR: COMPUTER SOFTWARE FOR USE MANAGING CIVIL PROCESSES BY COUNTY SHERIFF DEPARTMENTS, IN CLASS 9 (U.S. CLS. 21, 23, 26, 36 AND 38).

**TRADEMARK**

FIRST USE 9-1-2000; IN COMMERCE 9-1-2000.

**PRINCIPAL REGISTER**

NO CLAIM IS MADE TO THE EXCLUSIVE RIGHT TO USE "INC.", APART FROM THE MARK AS SHOWN.

THE MARK CONSISTS OF THE WORDS "SOFTCODE, INC." OVER A TRIANGULAR SOLID WITH SMALL END UNDER THE 'S' TO LARGER END UNDER THE 'I'.

SER. NO. 85-638,568, FILED 5-30-2012.

RAMONA ORTIGA, EXAMINING ATTORNEY



*David J. Kyffers*

Director of the United States Patent and Trademark Office

# United States of America

United States Patent and Trademark Office

# SCORE

**Reg. No. 4,275,324**

**Registered Jan. 15, 2013**

**Int. Cl.: 10**

**TRADEMARK**

**PRINCIPAL REGISTER**

ULTIMATE WIREFORMS, INC. (CONNECTICUT CORPORATION)  
200 CENTRAL STREET  
BRISTOL, CT 06010

FOR: ORTHODONTIC APPLIANCES, IN CLASS 10 (U.S. CLS. 26, 39 AND 44).

FIRST USE 5-25-2012; IN COMMERCE 5-25-2012.

THE MARK CONSISTS OF STANDARD CHARACTERS WITHOUT CLAIM TO ANY PARTICULAR FONT, STYLE, SIZE, OR COLOR.

SER. NO. 85-638,574, FILED 5-30-2012.

CIMMERIAN COLEMAN, EXAMINING ATTORNEY



*David J. Kyffers*

Director of the United States Patent and Trademark Office

# United States of America

United States Patent and Trademark Office



**Reg. No. 4,275,325**

**Registered Jan. 15, 2013**

**Int. Cl.: 36**

**SERVICE MARK**

**PRINCIPAL REGISTER**

CONTINENTAL FINANCE COMPANY, LLC (DELAWARE LIMITED LIABILITY COMPANY)  
SUITE 108  
121 CONTINENTAL DRIVE  
NEWARK, DE 19713

FOR: CREDIT CARD SERVICES; ELECTRONIC CREDIT CARD TRANSACTIONS; ISSUANCE  
OF CREDIT CARDS; ISSUING CREDIT CARDS; ISSUING OF CREDIT CARDS , IN CLASS  
36 (U.S. CLS. 100, 101 AND 102).

FIRST USE 5-8-2012; IN COMMERCE 5-8-2012.

THE MARK CONSISTS OF IMAGE OF STONE TO THE LEFT OF THE STYLIZED WORD  
"CERULEAN" IN GRADIENT SHADES.

SER. NO. 85-638,597, FILED 5-30-2012.

MICHELE SWAIN, EXAMINING ATTORNEY



*David J. Kyros*

Director of the United States Patent and Trademark Office

# United States of America

United States Patent and Trademark Office

# mCaddy

**Reg. No. 4,275,326**

**Registered Jan. 15, 2013**

**Int. Cl.: 9**

**TRADEMARK**

**PRINCIPAL REGISTER**

TRION INTERACTIVE, LLC (NEW JERSEY LIMITED LIABILITY COMPANY)  
51 S. MYRTLE STREET  
HAMMONTON, NJ 08037

FOR: AD SERVER, NAMELY, A COMPUTER SERVER FOR STORING ADVERTISEMENTS AND DELIVERING ADVERTISEMENTS TO WEBSITES; ELECTRONIC ADVERTISEMENT AND MESSAGING DISPLAY UNIT WITH MULTI-NETWORKING (TCP/IP) CAPABILITIES AND REMOTE CONNECTIVITY, IN CLASS 9 (U.S. CLS. 21, 23, 26, 36 AND 38).

FIRST USE 5-15-2011; IN COMMERCE 8-15-2011.

THE MARK CONSISTS OF STANDARD CHARACTERS WITHOUT CLAIM TO ANY PARTICULAR FONT, STYLE, SIZE, OR COLOR.

SER. NO. 85-638,600, FILED 5-30-2012.

KATHERINE M. DUBRAY, EXAMINING ATTORNEY



*David J. Kybas*

Director of the United States Patent and Trademark Office



# United States of America

United States Patent and Trademark Office

# tectho

**Reg. No. 4,275,327**

**Registered Jan. 15, 2013**

**Int. Cl.: 17**

**TRADEMARK**

**PRINCIPAL REGISTER**

DEL TORO GODOY CARLOS MANUEL (MEXICO INDIVIDUAL)  
LAZARO CARDENAS #1150  
GUADALAJARA, MEXICO 44490

FOR: FOAM INSULATION FOR USE IN BUILDING AND CONSTRUCTION; FOAM SHEETING FOR USE AS A BUILDING INSULATION; HIGH-DENSITY POLYETHYLENE FILM WITH ADHESIVE BACK TO BE USED IN CARDBOARD AND CORRUGATED CONTAINERS AND BOXES; MOLDED FOAM INSULATED CONTAINER PACKING FOR COMMERCIAL TRANSPORTATION; THERMOPLASTIC AND FOAMED PLASTIC SECTIONS FOR USE IN THE MANUFACTURE OF WINDOWS, DOORS, FACADE GLAZINGS, AND PARTITION WALLS FOR USE AS BUILDING MATERIALS FOR HEAT-INSULATING APPLICATIONS; UNFITTED COVERING SHEETS AND WRAPS MADE OF POLYETHYLENE AND OTHER POLYMERS FOR STORING AND TRANSPORTING LUMBER, BUILDING MATERIALS AND OTHER SIMILAR COMMERCIAL AND INDUSTRIAL PRODUCTS, IN CLASS 17 (U.S. CLS. 1, 5, 12, 13, 35 AND 50).

THE MARK CONSISTS OF STANDARD CHARACTERS WITHOUT CLAIM TO ANY PARTICULAR FONT, STYLE, SIZE, OR COLOR.

OWNER OF MEXICO REG. NO. 1083832, DATED 2-12-2009, EXPIRES 6-12-2018.

THE WORDING TECTHO HAS NO MEANING IN A FOREIGN LANGUAGE.

SER. NO. 85-638,603, FILED 5-30-2012.

RUDY R. SINGLETON, EXAMINING ATTORNEY



*David J. Kyffers*

Director of the United States Patent and Trademark Office

# United States of America

United States Patent and Trademark Office

# Fat Meter

**Reg. No. 4,275,328**

DAPPER GENTLEMEN, LLC (ARIZONA LIMITED LIABILITY COMPANY)  
1325 N MELBA CT  
GILBERT, AZ 85233

**Registered Jan. 15, 2013**

**Int. Cl.: 9**

FOR: COMPUTER GAME SOFTWARE FOR USE ON MOBILE AND CELLULAR PHONES,  
IN CLASS 9 (U.S. CLS. 21, 23, 26, 36 AND 38).

**TRADEMARK**

FIRST USE 1-1-2010; IN COMMERCE 8-1-2010.

**PRINCIPAL REGISTER**

THE MARK CONSISTS OF STANDARD CHARACTERS WITHOUT CLAIM TO ANY PARTICULAR FONT, STYLE, SIZE, OR COLOR.

SER. NO. 85-638,605, FILED 5-30-2012.

RUDY R. SINGLETON, EXAMINING ATTORNEY



*David J. Kybas*

Director of the United States Patent and Trademark Office

# United States of America

United States Patent and Trademark Office

## Urban Offering

**Reg. No. 4,275,329**

URBAN OFFERING, INC. (ILLINOIS CORPORATION)  
800 ECHO LN.  
GLENVIEW, IL 60025

**Registered Jan. 15, 2013**

**Int. Cl.: 25**

FOR: BLAZERS; COATS FOR MEN AND WOMEN; DRESS SHIRTS; MEN'S SUITS, WOMEN'S SUITS; TIES, IN CLASS 25 (U.S. CLS. 22 AND 39).

**TRADEMARK**

FIRST USE 2-7-2011; IN COMMERCE 4-10-2011.

**PRINCIPAL REGISTER**

THE MARK CONSISTS OF STANDARD CHARACTERS WITHOUT CLAIM TO ANY PARTICULAR FONT, STYLE, SIZE, OR COLOR.

SER. NO. 85-638,612, FILED 5-30-2012.

DAVID ELTON, EXAMINING ATTORNEY



*David J. Kybas*

Director of the United States Patent and Trademark Office

# United States of America

United States Patent and Trademark Office

# TITANX

**Reg. No. 4,275,330**

PACIFIC SAFETY PRODUCTS INC. (CANADA CORPORATION)  
124 FOURTH AVENUE

**Registered Jan. 15, 2013**

ARNPRIOR, ONTARIO, CANADA K7S0A9

**Int. Cl.: 9**

FOR: BULLET RESISTANT CLOTHING AND BODY ARMOR FOR LAW ENFORCEMENT  
AND MILITARY USE, IN CLASS 9 (U.S. CLS. 21, 23, 26, 36 AND 38).

**TRADEMARK**

FIRST USE 7-0-2009; IN COMMERCE 7-0-2009.

**PRINCIPAL REGISTER**

THE MARK CONSISTS OF STANDARD CHARACTERS WITHOUT CLAIM TO ANY PAR-  
TICULAR FONT, STYLE, SIZE, OR COLOR.

SER. NO. 85-638,617, FILED 5-30-2012.

DAVID ELTON, EXAMINING ATTORNEY



*David J. Kyfos*

Director of the United States Patent and Trademark Office

# United States of America

United States Patent and Trademark Office

*Dimples*

**Reg. No. 4,275,331**

**Registered Jan. 15, 2013**

**Int. Cl.: 44**

**SERVICE MARK**

**PRINCIPAL REGISTER**

DIMPLES (NEW YORK CORPORATION)  
116-31 METROPOLITAN AVE  
RICHMOND HILL, NY 11418

FOR: BEAUTY SALON SERVICES; HAIR COLOR SALON SERVICES; HAIR SALON SERVICES; HAIR SALON SERVICES, NAMELY, HAIR CUTTING, STYLING, COLORING, AND HAIR EXTENSION SERVICES; HAIR SALON SERVICES, NAMELY, TREATMENTS TO PROTECT HAIR FROM EFFECTS OF EXPOSURE TO SUNLIGHT, HEAT, HUMIDITY AND CHLORINATED WATER; NAIL CARE SALONS; SKIN CARE SALONS, IN CLASS 44 (U.S. CLS. 100 AND 101).

FIRST USE 2-20-2012; IN COMMERCE 2-20-2012.

THE MARK CONSISTS OF THE WORD "DIMPLES" IN STYLIZED LETTERING, WITH THE LETTER "D" COMPRISED OF LOOPS AND A CURVE WITH AN OVAL SHAPE DOT ON THE TOP REPRESENTING A DIMPLE DESIGN, WITH THE LETTER "I" COMPRISED OF A CURVE WITH AN OVAL SHAPE DOT, REPRESENTING A DIMPLE DESIGN, AND A DESIGN OF A CURVE WITH AN OVAL SHAPE DOT AT THE BASE OF THE LETTER "S", REPRESENTING A DIMPLE DESIGN.

SER. NO. 85-638,652, FILED 5-30-2012.

KATHERINE STOIDES, EXAMINING ATTORNEY



*David J. Kyffers*

Director of the United States Patent and Trademark Office

# United States of America

United States Patent and Trademark Office

## HEARTS & PIECES

**Reg. No. 4,275,332**

**Registered Jan. 15, 2013**

**Int. Cl.: 25**

**TRADEMARK**

**PRINCIPAL REGISTER**

COSOVIC, SHEHRIJE (UNITED STATES INDIVIDUAL)  
535 W. 23RD STREET  
UNIT N5C  
NEW YORK, NY 10011

FOR: COATS; DRESSES; JACKETS; PANTS; SHIRTS; SKIRTS; SWEATERS; VESTS, IN CLASS 25 (U.S. CLS. 22 AND 39).

FIRST USE 3-1-2011; IN COMMERCE 8-1-2011.

THE MARK CONSISTS OF STANDARD CHARACTERS WITHOUT CLAIM TO ANY PARTICULAR FONT, STYLE, SIZE, OR COLOR.

OWNER OF U.S. REG. NO. 4,191,179.

SER. NO. 85-638,674, FILED 5-30-2012.

KATHERINE STOIDES, EXAMINING ATTORNEY



*David J. Kybas*

Director of the United States Patent and Trademark Office

# United States of America

United States Patent and Trademark Office

# Orange Chiller

**Reg. No. 4,275,333**

BUZZBALLZ, LLC (TEXAS LIMITED LIABILITY COMPANY)  
1711 BRIERCROFT COURT, SUITE 100  
CARROLLTON, TX 75006

**Registered Jan. 15, 2013**

**Int. Cl.: 33**

FOR: ALCOHOLIC BEVERAGES EXCEPT BEERS, IN CLASS 33 (U.S. CLS. 47 AND 49).

**TRADEMARK**

FIRST USE 7-16-2010; IN COMMERCE 7-16-2010.

**PRINCIPAL REGISTER**

THE MARK CONSISTS OF STANDARD CHARACTERS WITHOUT CLAIM TO ANY PARTICULAR FONT, STYLE, SIZE, OR COLOR.

NO CLAIM IS MADE TO THE EXCLUSIVE RIGHT TO USE "ORANGE", APART FROM THE MARK AS SHOWN.

SER. NO. 85-638,684, FILED 5-30-2012.

TIMOTHY FINNEGAN, EXAMINING ATTORNEY



*David J. Kyffers*

Director of the United States Patent and Trademark Office

# United States of America

United States Patent and Trademark Office



**Reg. No. 4,275,334**

**Registered Jan. 15, 2013**

**Int. Cls.: 35 and 41**

**SERVICE MARK**

**PRINCIPAL REGISTER**

MICHAEL B. LEHMANN (UNITED STATES INDIVIDUAL)  
1855- 8TH AVENUE  
SAN FRANCISCO, CA 94122

FOR: PROVIDING INFORMATION IN THE FIELD OF BUSINESS, ECONOMICS, AND THE USE OF STATISTICS TO ANALYZE BUSINESS AND ECONOMIC CONDITIONS AND TO FORECAST FUTURE TRENDS, IN CLASS 35 (U.S. CLS. 100, 101 AND 102).

FIRST USE 5-15-2012; IN COMMERCE 5-15-2012.

FOR: EDUCATIONAL SERVICES, NAMELY, CONDUCTING SEMINARS IN THE FIELD OF BUSINESS, ECONOMICS, AND THE USE OF STATISTICS TO ANALYZE BUSINESS AND ECONOMIC CONDITIONS AND TO FORECAST FUTURE TRENDS AND DISTRIBUTING COURSE MATERIALS IN CONNECTION THEREWITH, IN CLASS 41 (U.S. CLS. 100, 101 AND 107).

FIRST USE 5-15-2012; IN COMMERCE 5-15-2012.

OWNER OF U.S. REG. NOS. 1,413,694 AND 2,631,729.

NO CLAIM IS MADE TO THE EXCLUSIVE RIGHT TO USE "ECONOMIST", APART FROM THE MARK AS SHOWN.

THE MARK CONSISTS OF THE WORDS "BE YOUR OWN ECONOMIST" WITH AN ASCENDING ARROW BESIDE IT, ALL WITHIN A RECTAGULAR-SHAPED MONITOR ON A STAND.

SER. NO. 85-638,690, FILED 5-30-2012.

ELI HELLMAN, EXAMINING ATTORNEY



*David J. Kyffers*

Director of the United States Patent and Trademark Office



# United States of America

United States Patent and Trademark Office

# MT-10

**Reg. No. 4,275,335**

**Registered Jan. 15, 2013**

**Int. Cl.: 1**

**TRADEMARK**

**PRINCIPAL REGISTER**

MUSCLE PRODUCTS CORP. (PENNSYLVANIA CORPORATION)  
752 KILGORE ROAD  
JACKSON CENTER, PA 16133

FOR: CHEMICAL ADDITIVES FOR ENHANCING THE PERFORMANCE OF LUBRICATING OILS, GREASES AND INTERNAL COMBUSTION ENGINE FUELS; CHEMICAL POLYMERIC ADDITIVES FOR LUBRICANTS; POLYMERS AND POLYMERIC ADDITIVES FOR ENHANCING THE PERFORMANCE OF LUBRICANTS, IN CLASS 1 (U.S. CLS. 1, 5, 6, 10, 26 AND 46).

FIRST USE 2-10-1986; IN COMMERCE 2-10-1986.

THE MARK CONSISTS OF STANDARD CHARACTERS WITHOUT CLAIM TO ANY PARTICULAR FONT, STYLE, SIZE, OR COLOR.

SER. NO. 85-638,691, FILED 5-30-2012.

ELI HELLMAN, EXAMINING ATTORNEY



*David J. Kyffers*

Director of the United States Patent and Trademark Office

# United States of America

United States Patent and Trademark Office

## TORNADOBASE

**Reg. No. 4,275,336**

ENDEKA GROUP, INC (CALIFORNIA CORPORATION)  
6540 LUSK BLVD, STE. C175  
SAN DIEGO, CA 92121

**Registered Jan. 15, 2013**

**Int. Cl.: 38**

FOR: TELECOMMUNICATION SERVICES, NAMELY, PROVIDING INTERNET ACCESS VIA BROADBAND OPTICAL OR WIRELESS NETWORKS, IN CLASS 38 (U.S. CLS. 100, 101 AND 104).

**SERVICE MARK**

FIRST USE 5-1-2011; IN COMMERCE 5-1-2011.

**PRINCIPAL REGISTER**

THE MARK CONSISTS OF STANDARD CHARACTERS WITHOUT CLAIM TO ANY PARTICULAR FONT, STYLE, SIZE, OR COLOR.

SER. NO. 85-638,693, FILED 5-30-2012.

NAAKWAMA ANKRAH, EXAMINING ATTORNEY



*David J. Kyffers*

Director of the United States Patent and Trademark Office

# United States of America

United States Patent and Trademark Office

# SCOOT

**Reg. No. 4,275,337**

**Registered Jan. 15, 2013**

**Int. Cl.: 39**

**SERVICE MARK**

**PRINCIPAL REGISTER**

SCOOT PTE. LTD. (SINGAPORE PRIVATE LIMITED COMPANY)  
25 AIRLINE ROAD AIRLINE HOUSE  
SINGAPORE 819829, SINGAPORE

FOR: SERVICES FOR 1(A) AND 44(E) FILING BASIS: AIRLINE TRANSPORTATION SERVICES; TRAVEL AGENCY SERVICES, NAMELY, MAKING RESERVATIONS AND BOOKINGS FOR TRANSPORTATION; TRAVEL INFORMATION SERVICES; PROVIDING AIRLINE TRAVEL INFORMATION TO TRAVELERS REGARDING FARES, TIMETABLES AND SEATING, DESTINATIONS, BAGGAGE FEES AND SIZE LIMITS, TRAVELERS WITH SPECIAL NEEDS, PETS, AND IN FLIGHT ENTERTAINMENT; STORAGE OF LUGGAGE; SERVICES FOR 44(E) FILING BASIS: AIR TRANSPORTATION SERVICES FEATURING FREQUENT FLYER BONUS PROGRAMS, INCENTIVE PROGRAMS, MEMBERSHIP PRIVILEGES, LOYALTY RECOGNITION PROGRAMS, PRIORITY CHECK IN, SEATING, RESERVATION SERVICES, AND TICKET UPGRADES; TRAVEL, EXCURSION, HOLIDAY PACKAGES, AND CRUISE ARRANGEMENT ALL ASSOCIATED WITH AIRLINE TRAVEL; TRANSPORT OF CARGO BY AIR; TRANSPORTATION SERVICES, NAMELY, HANDLING OF BAGGAGE AND CARGO; HIRED CAR TRANSPORT, IN CLASS 39 (U.S. CLS. 100 AND 105).

FIRST USE 3-22-2012; IN COMMERCE 3-22-2012.

THE MARK CONSISTS OF STANDARD CHARACTERS WITHOUT CLAIM TO ANY PARTICULAR FONT, STYLE, SIZE, OR COLOR.

OWNER OF SINGAPORE REG. NO. T1107938D, DATED 6-20-2011, EXPIRES 6-20-2021.

SER. NO. 85-638,723, FILED 5-30-2012.

WILLIAM BRECKENFELD, EXAMINING ATTORNEY



*David J. Kyros*

Director of the United States Patent and Trademark Office

# United States of America

United States Patent and Trademark Office

## PINEAPPLE COLADA CHILLER

**Reg. No. 4,275,338**

**Registered Jan. 15, 2013**

**Int. Cl.: 33**

**TRADEMARK**

**PRINCIPAL REGISTER**

BUZZBALLZ, LLC (TEXAS LIMITED LIABILITY COMPANY)  
1711 BRIERCROFT COURT, STE 100  
CARROLLTON, TX 75006

FOR: ALCOHOLIC BEVERAGES EXCEPT BEERS, IN CLASS 33 (U.S. CLS. 47 AND 49).

FIRST USE 7-16-2010; IN COMMERCE 7-16-2010.

THE MARK CONSISTS OF STANDARD CHARACTERS WITHOUT CLAIM TO ANY PARTICULAR FONT, STYLE, SIZE, OR COLOR.

NO CLAIM IS MADE TO THE EXCLUSIVE RIGHT TO USE "PINEAPPLE COLADA", APART FROM THE MARK AS SHOWN.

SER. NO. 85-638,728, FILED 5-30-2012.

TIMOTHY FINNEGAN, EXAMINING ATTORNEY



*David J. Kyffers*

Director of the United States Patent and Trademark Office

# United States of America

United States Patent and Trademark Office

# I'm Lavenous

**Reg. No. 4,275,339**

**Registered Jan. 15, 2013**

**Int. Cl.: 25**

**TRADEMARK**

**PRINCIPAL REGISTER**

SUPERNOVICH, MIKE (UNITED STATES INDIVIDUAL)  
127 VISTA DRIVE  
CANONSBURG, PA 15317

FOR: T-SHIRTS, IN CLASS 25 (U.S. CLS. 22 AND 39).

FIRST USE 1-1-2000; IN COMMERCE 1-30-2000.

THE MARK CONSISTS OF STANDARD CHARACTERS WITHOUT CLAIM TO ANY PARTICULAR FONT, STYLE, SIZE, OR COLOR.

SER. NO. 85-638,733, FILED 5-30-2012.

WILLIAM BRECKENFELD, EXAMINING ATTORNEY



*David J. Kyfos*

Director of the United States Patent and Trademark Office

# United States of America

United States Patent and Trademark Office

## KITCHYCHICKS

**Reg. No. 4,275,340**

**Registered Jan. 15, 2013**

**Int. Cl.: 35**

**SERVICE MARK**

**PRINCIPAL REGISTER**

KITCHYCHICKS LLC (CALIFORNIA LIMITED LIABILITY COMPANY)  
C/O FOSTER PEPPER PLLC U.S. BANK BLDG.  
422 WEST RIVERSIDE AVENUE #1310  
SPOKANE, WA 992010302

FOR: ON-LINE RETAIL STORE SERVICES FEATURING BAKEWARE, HOUSEWARES AND BAKING SUPPLIES, IN CLASS 35 (U.S. CLS. 100, 101 AND 102).

FIRST USE 5-5-2011; IN COMMERCE 5-5-2011.

THE MARK CONSISTS OF STANDARD CHARACTERS WITHOUT CLAIM TO ANY PARTICULAR FONT, STYLE, SIZE, OR COLOR.

SER. NO. 85-638,735, FILED 5-30-2012.

WILLIAM BRECKENFELD, EXAMINING ATTORNEY



*David J. Kyfos*

Director of the United States Patent and Trademark Office

# United States of America

United States Patent and Trademark Office

## WEARDAILY RIDEDAILY

**Reg. No. 4,275,341**

CLUB APPAREL, LLC (IDAHO LIMITED LIABILITY COMPANY)  
P.O. BOX 2483  
KETCHUM, ID 83340

**Registered Jan. 15, 2013**

**Int. Cl.: 25**

FOR: COLLARED SHIRTS; CYCLING SHORTS; CYCLISTS' JERSEYS; JERSEYS; SHIRTS;  
SHORTS, IN CLASS 25 (U.S. CLS. 22 AND 39).

**TRADEMARK**

FIRST USE 3-1-2010; IN COMMERCE 3-1-2010.

**PRINCIPAL REGISTER**

THE MARK CONSISTS OF STANDARD CHARACTERS WITHOUT CLAIM TO ANY PARTICULAR FONT, STYLE, SIZE, OR COLOR.

SER. NO. 85-638,748, FILED 5-30-2012.

JANICE L. MCMORROW, EXAMINING ATTORNEY



*David J. Kybas*

Director of the United States Patent and Trademark Office

# United States of America

United States Patent and Trademark Office

## SOUR APPLE CHILLER

**Reg. No. 4,275,342**

BUZZBALLZ, LLC (TEXAS LIMITED LIABILITY COMPANY)  
1711 BRIERCROFT CT., STE 100  
CARROLLTON, TX 75006

**Registered Jan. 15, 2013**

**Int. Cl.: 33**

FOR: ALCOHOLIC BEVERAGES EXCEPT BEERS, IN CLASS 33 (U.S. CLS. 47 AND 49).

**TRADEMARK**

FIRST USE 7-16-2010; IN COMMERCE 7-16-2010.

**PRINCIPAL REGISTER**

THE MARK CONSISTS OF STANDARD CHARACTERS WITHOUT CLAIM TO ANY PARTICULAR FONT, STYLE, SIZE, OR COLOR.

NO CLAIM IS MADE TO THE EXCLUSIVE RIGHT TO USE "SOUR APPLE", APART FROM THE MARK AS SHOWN.

SER. NO. 85-638,769, FILED 5-30-2012.

TIMOTHY FINNEGAN, EXAMINING ATTORNEY



*David J. Kybas*

Director of the United States Patent and Trademark Office



# United States of America

United States Patent and Trademark Office

# REPEATER

**Reg. No. 4,275,343**

**Registered Jan. 15, 2013**

**Int. Cl.: 10**

**TRADEMARK**

**PRINCIPAL REGISTER**

BAXA CORPORATION (COLORADO CORPORATION), AKA BAXTER HEALTHCARE CORPORATION  
ONE BAXTER PARKWAY  
DEERFIELD, IL 60015

FOR: MEDICAL DEVICE PUMP FOR BATCH FILLING OF ORAL MEDICATIONS AND PHARMACY ADMIXTURE APPLICATIONS SUCH AS DRUG RECONSTITUTION AND THE FILLING OF IV BAGS, SYRINGES AND INFUSION DEVICES, NAMELY, AN AUTOMATED PHARMACY FLUID TRANSFER DEVICE, IN CLASS 10 (U.S. CLS. 26, 39 AND 44).

FIRST USE 12-31-1992; IN COMMERCE 12-31-1992.

THE MARK CONSISTS OF STANDARD CHARACTERS WITHOUT CLAIM TO ANY PARTICULAR FONT, STYLE, SIZE, OR COLOR.

SER. NO. 85-638,774, FILED 5-30-2012.

GEOFFREY FOSDICK, EXAMINING ATTORNEY



*David J. Kybas*

Director of the United States Patent and Trademark Office

# United States of America

United States Patent and Trademark Office

# VIC-3D

**Reg. No. 4,275,344**

VICTOR TECHNOLOGIES, LLC (INDIANA LIMITED LIABILITY COMPANY)  
P.O. BOX 7706

**Registered Jan. 15, 2013**

BLOOMINGTON, IN 474017706

**Int. Cl.: 9**

FOR: COMPUTER SOFTWARE FOR MODELING FORWARD AND INVERSE PROBLEMS IN EDDY-CURRENT NONDESTRUCTIVE EVALUATION (NDE) OF MATERIALS AND STRUCTURES , IN CLASS 9 (U.S. CLS. 21, 23, 26, 36 AND 38).

**TRADEMARK**

FIRST USE 6-1-1992; IN COMMERCE 6-1-1992.

**PRINCIPAL REGISTER**

THE MARK CONSISTS OF STANDARD CHARACTERS WITHOUT CLAIM TO ANY PARTICULAR FONT, STYLE, SIZE, OR COLOR.

SER. NO. 85-638,796, FILED 5-30-2012.

MARY CRAWFORD, EXAMINING ATTORNEY



*David J. Kyffers*

Director of the United States Patent and Trademark Office

# United States of America

United States Patent and Trademark Office

## STRAWBERRY CHILLER

**Reg. No. 4,275,345**

**Registered Jan. 15, 2013**

**Int. Cl.: 33**

**TRADEMARK**

**PRINCIPAL REGISTER**

BUZZBALLZ, LLC (TEXAS LIMITED LIABILITY COMPANY)  
1711 BRIERCROFT CT., STE 100  
CARROLLTON, TX 75006

FOR: ALCOHOLIC BEVERAGES EXCEPT BEERS, IN CLASS 33 (U.S. CLS. 47 AND 49).

FIRST USE 7-16-2010; IN COMMERCE 7-16-2010.

THE MARK CONSISTS OF STANDARD CHARACTERS WITHOUT CLAIM TO ANY PARTICULAR FONT, STYLE, SIZE, OR COLOR.

NO CLAIM IS MADE TO THE EXCLUSIVE RIGHT TO USE "STRAWBERRY", APART FROM THE MARK AS SHOWN.

SER. NO. 85-638,834, FILED 5-30-2012.

TIMOTHY FINNEGAN, EXAMINING ATTORNEY



*David J. Kybas*

Director of the United States Patent and Trademark Office

# United States of America

United States Patent and Trademark Office

# Mesa Airlines

**Reg. No. 4,275,346**

**Registered Jan. 15, 2013**

**Int. Cl.: 39**

**SERVICE MARK**

**PRINCIPAL REGISTER**

MESA AIR GROUP, INC. (NEVADA CORPORATION)  
410 NORTH 44TH STREET, SUITE 700  
PHOENIX, AZ 85008

FOR: AIRLINE TRANSPORTATION SERVICES, IN CLASS 39 (U.S. CLS. 100 AND 105).

FIRST USE 1-1-1983; IN COMMERCE 1-1-1983.

THE MARK CONSISTS OF STANDARD CHARACTERS WITHOUT CLAIM TO ANY PARTICULAR FONT, STYLE, SIZE, OR COLOR.

NO CLAIM IS MADE TO THE EXCLUSIVE RIGHT TO USE "AIRLINES", APART FROM THE MARK AS SHOWN.

SER. NO. 85-638,838, FILED 5-30-2012.

CHRISTOPHER LAW, EXAMINING ATTORNEY



*David J. Kyffers*

Director of the United States Patent and Trademark Office

# United States of America

United States Patent and Trademark Office

# StudioStars

**Reg. No. 4,275,347**

**Registered Jan. 15, 2013**

**Int. Cl.: 41**

**SERVICE MARK**

**PRINCIPAL REGISTER**

INTERNATIONAL SOUND PRODUCTIONS (COLORADO LIMITED LIABILITY COMPANY)  
616 WASHINGTON ST. #107  
616 WASHINGTON ST.  
DENVER, CO 80203

FOR: AUDIO RECORDING AND PRODUCTION; FILM AND VIDEO PRODUCTION; RECORDING STUDIO SERVICES, IN CLASS 41 (U.S. CLS. 100, 101 AND 107).

FIRST USE 1-1-2004; IN COMMERCE 1-1-2004.

THE MARK CONSISTS OF STANDARD CHARACTERS WITHOUT CLAIM TO ANY PARTICULAR FONT, STYLE, SIZE, OR COLOR.

SER. NO. 85-638,851, FILED 5-30-2012.

CHERYL CLAYTON, EXAMINING ATTORNEY



*David J. Kyffers*

Director of the United States Patent and Trademark Office

# United States of America

United States Patent and Trademark Office



**Reg. No. 4,275,348**

BLUE-GRACE I.P. LLC (FLORIDA LIMITED LIABILITY COMPANY)  
2846 S. FALKENBURG RD.  
RIVERVIEW, FL 33578

**Registered Jan. 15, 2013**

**Int. Cl.: 25**

FOR: T-SHIRTS, IN CLASS 25 (U.S. CLS. 22 AND 39).

**TRADEMARK**

FIRST USE 4-0-2012; IN COMMERCE 4-0-2012.

**PRINCIPAL REGISTER**

THE MARK CONSISTS OF THE WORD AEON IN A STYLIZED FONT. THE "N" IS BACKWARDS AND THERE IS AN ABSTRACT DESIGN RESEMBLING A BIOHAZARD SYMBOL EMANATING FROM THE CENTER OF THE "O".

SER. NO. 85-638,859, FILED 5-30-2012.

CHERYL CLAYTON, EXAMINING ATTORNEY



*David J. Kyffers*

Director of the United States Patent and Trademark Office

# United States of America

United States Patent and Trademark Office



**RAMCAST**

**Reg. No. 4,275,349**

RAMCAST ORNAMENTAL SUPPLY CO., INC. (CALIFORNIA CORPORATION)  
2201 E. FIRESTONE BLVD.  
LOS ANGELES, CA 90002

**Registered Jan. 15, 2013**

**Int. Cl.: 39**

FOR: DISTRIBUTION SERVICES, NAMELY, DELIVERY OF STEEL, IN CLASS 39 (U.S. CLS. 100 AND 105).

**SERVICE MARK**

FIRST USE 8-21-1984; IN COMMERCE 8-21-1984.

**PRINCIPAL REGISTER**

THE MARK CONSISTS OF THE STYLIZED TEXT "RAMCAST" WITH AN ABSTRACT DESIGN OF RAM HORNS WITH A SUNSET OUTLINE.

SER. NO. 85-638,876, FILED 5-30-2012.

NICHOLAS COLEMAN, EXAMINING ATTORNEY



*David J. Kyffers*

Director of the United States Patent and Trademark Office

# United States of America

United States Patent and Trademark Office

## BIG CHOCOLATE

**Reg. No. 4,275,350**

**Registered Jan. 15, 2013**

**Int. Cl.: 41**

**SERVICE MARK**

**PRINCIPAL REGISTER**

BIG CHOCOLATE, LLC (DELAWARE LIMITED LIABILITY COMPANY)  
176-25 UNION TURNPIKE, #405  
C/O STRONG MANAGEMENT  
FRESH MEADOWS, NY 11366

FOR: ENTERTAINMENT, NAMELY, LIVE PERFORMANCES BY A MUSICAL ARTIST; PROVIDING INFORMATION ABOUT PERFORMANCES, MUSIC, RECORDINGS, APPEARANCES, NEWS, AND OTHER INFORMATION ABOUT A MUSICAL ARTIST VIA A WEBSITE ON A GLOBAL COMPUTER NETWORK, IN CLASS 41 (U.S. CLS. 100, 101 AND 107).

FIRST USE 9-3-2010; IN COMMERCE 9-3-2010.

THE MARK CONSISTS OF STANDARD CHARACTERS WITHOUT CLAIM TO ANY PARTICULAR FONT, STYLE, SIZE, OR COLOR.

THE NAME "BIG CHOCOLATE" IDENTIFIES THE PSEUDONYM OF CAMERON ARGON, A LIVING INDIVIDUAL WHOSE CONSENT IS OF RECORD

SER. NO. 85-638,890, FILED 5-30-2012.

SUSAN BILLHEIMER, EXAMINING ATTORNEY



*David J. Kyffers*

Director of the United States Patent and Trademark Office



# United States of America

United States Patent and Trademark Office

# Bintelli

**Reg. No. 4,275,351**

**Registered Jan. 15, 2013**

**Int. Cl.: 12**

**TRADEMARK**

**PRINCIPAL REGISTER**

ROAD RAT MOTORS LLC (FLORIDA LIMITED LIABILITY COMPANY)

A  
7065 NW 22ND ST  
GAINESVILLE, FL 32653

FOR: MOTORCYCLES AND STRUCTURAL PARTS THEREFOR; MOTORIZED SCOOTERS AND STRUCTURAL PARTS THEREFOR, IN CLASS 12 (U.S. CLS. 19, 21, 23, 31, 35 AND 44).

FIRST USE 4-1-2012; IN COMMERCE 4-1-2012.

THE MARK CONSISTS OF STANDARD CHARACTERS WITHOUT CLAIM TO ANY PARTICULAR FONT, STYLE, SIZE, OR COLOR.

SER. NO. 85-638,891, FILED 5-30-2012.

NICHOLAS COLEMAN, EXAMINING ATTORNEY



*David J. Kyffers*

Director of the United States Patent and Trademark Office

# United States of America

United States Patent and Trademark Office

## BADGER METER

**Reg. No. 4,275,352**

**Registered Jan. 15, 2013**

**Int. Cl.: 9**

**TRADEMARK**

**PRINCIPAL REGISTER**

BADGER METER, INC. (WISCONSIN CORPORATION)  
4545 WEST BROWN DEER ROAD  
MILWAUKEE, WI 53223

FOR: FLOW METERS; CONTROL VALVES FOR REGULATING THE FLOW OF GASES AND LIQUIDS; REMOTE UTILITY METER READING SYSTEM, NAMELY RECEIVERS, TRANSMITTERS, COMPUTER SOFTWARE AND COMPUTER HARDWARE FOR OBTAINING, RECORDING, PROCESSING AND TRANSMITTING METER DATA, IN CLASS 9 (U.S. CLS. 21, 23, 26, 36 AND 38).

FIRST USE 0-0-1905; IN COMMERCE 0-0-1905.

THE MARK CONSISTS OF STANDARD CHARACTERS WITHOUT CLAIM TO ANY PARTICULAR FONT, STYLE, SIZE, OR COLOR.

OWNER OF U.S. REG. NOS. 417,553 AND 3,035,019.

NO CLAIM IS MADE TO THE EXCLUSIVE RIGHT TO USE "METER", APART FROM THE MARK AS SHOWN.

SER. NO. 85-638,893, FILED 5-30-2012.

SUSAN BILLHEIMER, EXAMINING ATTORNEY



*David J. Kybas*

Director of the United States Patent and Trademark Office

**United States of America**  
United States Patent and Trademark Office

# SPUNCAST

**Reg. No. 4,275,353**

SPUNCAST, INC. (WISCONSIN CORPORATION)  
W6499 RHINE ROAD  
WATERTOWN, WI 53098

**Registered Jan. 15, 2013**

**Int. Cl.: 40**

FOR: CUSTOM CENTRIFUGAL AND ALLOY CASTING SERVICES, IN CLASS 40 (U.S. CLS. 100, 103 AND 106).

**SERVICE MARK**

FIRST USE 6-11-1976; IN COMMERCE 2-4-1977.

**PRINCIPAL REGISTER**

THE MARK CONSISTS OF STANDARD CHARACTERS WITHOUT CLAIM TO ANY PARTICULAR FONT, STYLE, SIZE, OR COLOR.

SER. NO. 85-638,899, FILED 5-30-2012.

DORITT L. CARROLL, EXAMINING ATTORNEY



*David J. Kyffers*

Director of the United States Patent and Trademark Office

# United States of America

United States Patent and Trademark Office

## InsideOut Insights

**Reg. No. 4,275,354**

**Registered Jan. 15, 2013**

**Int. Cl.: 35**

**SERVICE MARK**

**PRINCIPAL REGISTER**

INSIDEOUT INSIGHTS (PENNSYLVANIA LIMITED LIABILITY COMPANY)  
1568 SACKETTSFORD ROAD  
IVYLAND, PA 18974

FOR: MARKET RESEARCH CONSULTATION, IN CLASS 35 (U.S. CLS. 100, 101 AND 102).

FIRST USE 10-1-2011; IN COMMERCE 10-1-2011.

THE MARK CONSISTS OF STANDARD CHARACTERS WITHOUT CLAIM TO ANY PARTICULAR FONT, STYLE, SIZE, OR COLOR.

SER. NO. 85-638,922, FILED 5-30-2012.

JENNIFER MARTIN, EXAMINING ATTORNEY



*David J. Kybas*

Director of the United States Patent and Trademark Office

# United States of America

United States Patent and Trademark Office

## GRAND NATIONAL

**Reg. No. 4,275,355**

GENERAL MOTORS LLC (DELAWARE LIMITED LIABILITY COMPANY)  
300 RENAISSANCE CENTER  
DETROIT, MI 482653000

**Registered Jan. 15, 2013**

**Int. Cl.: 27**

FOR: FLOOR MATS FOR AUTOMOBILES, IN CLASS 27 (U.S. CLS. 19, 20, 37, 42 AND 50).

**TRADEMARK**

FIRST USE 12-31-1994; IN COMMERCE 12-31-1994.

**PRINCIPAL REGISTER**

THE MARK CONSISTS OF STANDARD CHARACTERS WITHOUT CLAIM TO ANY PARTICULAR FONT, STYLE, SIZE, OR COLOR.

SER. NO. 85-638,992, FILED 5-30-2012.

HEATHER SAPP, EXAMINING ATTORNEY



*David J. Kyffers*

Director of the United States Patent and Trademark Office

# United States of America

United States Patent and Trademark Office

## Green Eggs and RAM

**Reg. No. 4,275,356**

GREEN EGGS AND RAM, INC. (SOUTH DAKOTA CORPORATION)  
1106 E 8TH ST  
SIOUX FALLS, SD 57103

**Registered Jan. 15, 2013**

**Int. Cl.: 37**

FOR: TECHNICAL SUPPORT SERVICES, NAMELY, TROUBLESHOOTING IN THE NATURE OF THE REPAIR OF COMPUTER HARDWARE, IN CLASS 37 (U.S. CLS. 100, 103 AND 106).

**SERVICE MARK**

FIRST USE 4-1-1996; IN COMMERCE 4-1-1996.

**PRINCIPAL REGISTER**

THE MARK CONSISTS OF STANDARD CHARACTERS WITHOUT CLAIM TO ANY PARTICULAR FONT, STYLE, SIZE, OR COLOR.

SER. NO. 85-638,998, FILED 5-30-2012.

JAMES GRIFFIN, EXAMINING ATTORNEY



*David J. Kyffers*

Director of the United States Patent and Trademark Office

# United States of America

United States Patent and Trademark Office

ABEJA



**Reg. No. 4,275,357**

**Registered Jan. 15, 2013**

**Int. Cl.: 14**

**TRADEMARK**

**PRINCIPAL REGISTER**

ZOZAC GROUP LLC (WASHINGTON LIMITED LIABILITY COMPANY)  
#E-429  
5114 POINT FOSDICK DR. NW  
GIG HARBOR, WA 98329

FOR: JEWELRY, IN CLASS 14 (U.S. CLS. 2, 27, 28 AND 50).

FIRST USE 1-15-2011; IN COMMERCE 1-15-2011.

THE MARK CONSISTS OF THE TEXT "ABEJA" ABOVE A STYLIZED DESIGN.

THE ENGLISH TRANSLATION OF 'ABEJA' IN THE MARK IS 'BEE'.

SER. NO. 85-639,000, FILED 5-30-2012.

JAMES GRIFFIN, EXAMINING ATTORNEY



*David J. Kyffers*

Director of the United States Patent and Trademark Office

# United States of America

United States Patent and Trademark Office

# iClin-Engager

**Reg. No. 4,275,358**

**Registered Jan. 15, 2013**

**Int. Cl.: 41**

**SERVICE MARK**

**PRINCIPAL REGISTER**

TOTAL THERAPEUTIC MANAGEMENT, INC. (GEORGIA CORPORATION)  
300 TOWNPARK DR BLDG 1, SUITE 100  
KENNESAW, GA 30144

FOR: EDUCATION SERVICES, NAMELY, PROVIDING ON-LINE ACADEMIC DETAILING SESSIONS IN THE FIELD OF CLINICIAN COMMUNICATIONS, IN CLASS 41 (U.S. CLS. 100, 101 AND 107).

FIRST USE 3-1-2012; IN COMMERCE 3-1-2012.

THE MARK CONSISTS OF STANDARD CHARACTERS WITHOUT CLAIM TO ANY PARTICULAR FONT, STYLE, SIZE, OR COLOR.

SER. NO. 85-639,002, FILED 5-30-2012.

JAMES GRIFFIN, EXAMINING ATTORNEY



*David J. Kyffers*

Director of the United States Patent and Trademark Office



# United States of America

United States Patent and Trademark Office

# 1800roper.com

**Reg. No. 4,275,359**

MARYFEED&SUPPLY (FLORIDA CORPORATION)  
8360 NW 143 TERR  
MIAMI LKS, FL 33016

**Registered Jan. 15, 2013**

**Int. Cls.: 25 and 35**

FOR: T-SHIRTS, IN CLASS 25 (U.S. CLS. 22 AND 39).

**TRADEMARK**

FIRST USE 11-0-2011; IN COMMERCE 11-0-2011.

**SERVICE MARK**

FOR: ON-LINE RETAIL STORE SERVICES FEATURING PET CLOTHING AND PET ACCESSORIES; RETAIL STORE SERVICES FEATURING PET CLOTHING AND PET ACCESSORIES, IN CLASS 35 (U.S. CLS. 100, 101 AND 102).

**PRINCIPAL REGISTER**

FIRST USE 11-0-2011; IN COMMERCE 11-0-2011.

THE MARK CONSISTS OF STANDARD CHARACTERS WITHOUT CLAIM TO ANY PARTICULAR FONT, STYLE, SIZE, OR COLOR.

SER. NO. 85-639,005, FILED 5-30-2012.

JAMES GRIFFIN, EXAMINING ATTORNEY



*David J. Kyffers*

Director of the United States Patent and Trademark Office

# United States of America

United States Patent and Trademark Office

# Betty Audish

**Reg. No. 4,275,360**

**Registered Jan. 15, 2013**

**Int. Cls.: 18 and 25**

**TRADEMARK**

**PRINCIPAL REGISTER**

AUDISH ACCESSORIES LLC (TEXAS LIMITED LIABILITY COMPANY)  
#C-351  
2800 E BROADWAY  
PEARLAND, TX 77581

FOR: HANDBAGS; WALLETS, IN CLASS 18 (U.S. CLS. 1, 2, 3, 22 AND 41).

FIRST USE 5-13-2004; IN COMMERCE 5-30-2004.

FOR: BLOUSES; DRESSES; JACKETS; SHOES; SKIRTS; T-SHIRTS, IN CLASS 25 (U.S. CLS. 22 AND 39).

FIRST USE 5-13-2004; IN COMMERCE 5-30-2004.

THE MARK CONSISTS OF STANDARD CHARACTERS WITHOUT CLAIM TO ANY PARTICULAR FONT, STYLE, SIZE, OR COLOR.

THE NAME "BETTY AUDISH" IDENTIFIES A LIVING INDIVIDUAL WHOSE CONSENT IS OF RECORD.

SER. NO. 85-639,011, FILED 5-30-2012.

JAMES GRIFFIN, EXAMINING ATTORNEY



*David J. Kyffers*

Director of the United States Patent and Trademark Office

# United States of America

United States Patent and Trademark Office

## PUT THE SMASHDOWN

**Reg. No. 4,275,361**

**Registered Jan. 15, 2013**

**Int. Cl.: 25**

**TRADEMARK**

**PRINCIPAL REGISTER**

SMASHDOWN SPORTS (CALIFORNIA SOLE PROPRIETORSHIP)  
P.O. BOX 40735  
PASADENA, CA 91114

FOR: T-SHIRTS, HATS, IN CLASS 25 (U.S. CLS. 22 AND 39).

FIRST USE 11-8-2003; IN COMMERCE 11-8-2003.

THE MARK CONSISTS OF STANDARD CHARACTERS WITHOUT CLAIM TO ANY PARTICULAR FONT, STYLE, SIZE, OR COLOR.

SER. NO. 85-639,024, FILED 5-30-2012.

HEATHER SAPP, EXAMINING ATTORNEY



*David J. Kybas*

Director of the United States Patent and Trademark Office

# United States of America

United States Patent and Trademark Office



**XIBANG**  
**喜邦**

**Reg. No. 4,275,362**

**Registered Jan. 15, 2013**

**Int. Cl.: 18**

**TRADEMARK**

**PRINCIPAL REGISTER**

GUANGZHOU XIBANG LEATHER CO., LTD. (CHINA LIMITED LIABILITY COMPANY)  
3/F, TOWER 2, JINSHI RD, SHILING TOWN, HUADU  
GUANGZHOU, GUANGDONG, CHINA

FOR: ANIMAL SKINS; BACKPACKS; BRIEFCASES; COSMETIC BAGS SOLD EMPTY;  
HANDBAGS; SPORT BAGS; TEXTILE SHOPPING BAGS; TRAVELLING BAGS; UMBRELLAS;  
WALLETS, IN CLASS 18 (U.S. CLS. 1, 2, 3, 22 AND 41).

FIRST USE 10-29-2010; IN COMMERCE 10-18-2011.

THE MARK CONSISTS OF THE LETTER "XB" IN STYLIZED FORM PLACED ON THE TOP OF THE TRADEMARK, THE WORD "XIBANG" PLACED IN THE MIDDLE OF THE TRADEMARK, THE TWO CHINESE CHARACTERS TRANSLITERATE AS "XI BANG" PLACES AT THE BOTTOM OF THE TRADEMARK.

THE NON-LATIN CHARACTERS IN THE MARK TRANSLITERATE TO "XI BANG" AND THIS HAS NO MEANING IN A FOREIGN LANGUAGE.

SER. NO. 85-639,101, FILED 5-31-2012.

MARK SHINER, EXAMINING ATTORNEY



*David J. Kybas*

Director of the United States Patent and Trademark Office

# United States of America

United States Patent and Trademark Office

# CuBands

**Reg. No. 4,275,363**

**Registered Jan. 15, 2013**

**Int. Cl.: 25**

**TRADEMARK**

**PRINCIPAL REGISTER**

CUBANDS, LLC (FLORIDA LIMITED LIABILITY COMPANY)  
9355 SW 83RD ST  
MIAMI, FL 33173

FOR: HEADBANDS, IN CLASS 25 (U.S. CLS. 22 AND 39).

FIRST USE 3-31-2012; IN COMMERCE 3-31-2012.

THE MARK CONSISTS OF STANDARD CHARACTERS WITHOUT CLAIM TO ANY PARTICULAR FONT, STYLE, SIZE, OR COLOR.

SER. NO. 85-639,128, FILED 5-31-2012.

ALYSSA STEEL, EXAMINING ATTORNEY



*David J. Kyffers*

Director of the United States Patent and Trademark Office

# United States of America

United States Patent and Trademark Office

# PhonePRO

**Reg. No. 4,275,364**

PHONEPRO, INC. (INDIANA CORPORATION)  
2301 EAST 45TH STREET  
INDIANAPOLIS, IN 46205

**Registered Jan. 15, 2013**

**Int. Cls.: 35 and 41**

FOR: BUSINESS MARKETING CONSULTING SERVICES, IN CLASS 35 (U.S. CLS. 100, 101 AND 102).

**SERVICE MARK**

FIRST USE 2-15-2011; IN COMMERCE 2-15-2011.

**PRINCIPAL REGISTER**

FOR: EDUCATIONAL SERVICES, NAMELY, CONDUCTING WORKSHOPS AND SEMINARS IN THE FIELD OF TELEMARKETING DEVELOPMENT TRAINING FOR BUSINESSES WHICH RELY PRIMARILY ON THE TELEPHONE FOR SALES AND CUSTOMER CONTACT, IN CLASS 41 (U.S. CLS. 100, 101 AND 107).

FIRST USE 2-15-2011; IN COMMERCE 2-15-2011.

THE MARK CONSISTS OF STANDARD CHARACTERS WITHOUT CLAIM TO ANY PARTICULAR FONT, STYLE, SIZE, OR COLOR.

OWNER OF U.S. REG. NO. 2,558,230.

SER. NO. 85-639,165, FILED 5-31-2012.

MORGAN WYNNE, EXAMINING ATTORNEY



*David J. Kybas*

Director of the United States Patent and Trademark Office

# United States of America

United States Patent and Trademark Office

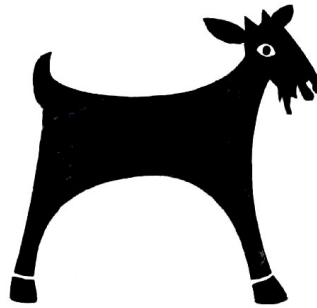

**Reg. No. 4,275,365**

**Registered Jan. 15, 2013**

**Int. Cl.: 41**

**SERVICE MARK**

**PRINCIPAL REGISTER**

NATIONAL YIDDISH BOOK CENTER, INC. (MASSACHUSETTS CORPORATION)  
1021 WEST STREET  
AMHERST, MA 01002

FOR: EDUCATIONAL SERVICES, NAMELY, PROVIDING CLASSES AND SEMINARS IN THE FIELDS OF YIDDISH, AWARENESS OF YIDDISH CULTURE, AND JEWISH LITERATURE; EDUCATIONAL SERVICES, NAMELY, PROVIDING RECORDED ORAL HISTORIES VIA AN INTERNET WEBSITE; ONLINE LIBRARY SERVICES, NAMELY PROVIDING ELECTRONIC LIBRARY SERVICES WHICH FEATURE BOOKS VIA AN ONLINE COMPUTER NETWORK; ORGANIZATION OF EXHIBITIONS FOR CULTURAL AND EDUCATIONAL PURPOSES REGARDING THE FIELDS OF YIDDISH, AWARENESS OF YIDDISH CULTURE, AND JEWISH LITERATURE; PROVIDING A WEBSITE FEATURING BLOGS AND INFORMATION IN THE FIELDS OF YIDDISH, AWARENESS OF THE YIDDISH CULTURE, AND JEWISH LITERATURE, IN CLASS 41 (U.S. CLS. 100, 101 AND 107).

FIRST USE 3-26-2012; IN COMMERCE 3-26-2012.

THE MARK CONSISTS OF AN IMAGE OF A GOAT.

SER. NO. 85-639,172, FILED 5-31-2012.

DARRYL SPRUILL, EXAMINING ATTORNEY



*David J. Kybas*

Director of the United States Patent and Trademark Office

# United States of America

United States Patent and Trademark Office

# DISFECT

**Reg. No. 4,275,366**

DISFECT, L.L.C. (TENNESSEE LIMITED LIABILITY COMPANY)  
1271 POPLAR AVE.; SUITE 103  
MEMPHIS, TN 38104

**Registered Jan. 15, 2013**

**Int. Cl.: 5**

FOR: ALL PURPOSE DISINFECTANTS; SANITIZING PREPARATIONS FOR USE IN INSTITUTIONAL AND INDUSTRIAL AREAS, IN CLASS 5 (U.S. CLS. 6, 18, 44, 46, 51 AND 52).

**TRADEMARK**

FIRST USE 5-11-2012; IN COMMERCE 5-11-2012.

**PRINCIPAL REGISTER**

THE MARK CONSISTS OF STANDARD CHARACTERS WITHOUT CLAIM TO ANY PARTICULAR FONT, STYLE, SIZE, OR COLOR.

SER. NO. 85-639,175, FILED 5-31-2012.

LINDA M. KING, EXAMINING ATTORNEY



*David J. Kybas*

Director of the United States Patent and Trademark Office



# United States of America

United States Patent and Trademark Office

# MONEYWIZ

**Reg. No. 4,275,367**

SILVERWIZ LTD. (BULGARIA LIMITED COMPANY (LTD.))  
BANISHORA BL. 42A ENT.B FL.4 AP.34  
SOFIA, BULGARIA 1233

**Registered Jan. 15, 2013**

**Int. Cl.: 9**

FOR: SOFTWARE FOR PERSONAL FINANCE ACCOUNTING AND FOR MAKING AND MONITORING PERSONAL BUDGETS, IN CLASS 9 (U.S. CLS. 21, 23, 26, 36 AND 38).

**TRADEMARK**

FIRST USE 0-0-2011; IN COMMERCE 0-0-2011.

**PRINCIPAL REGISTER**

THE MARK CONSISTS OF STANDARD CHARACTERS WITHOUT CLAIM TO ANY PARTICULAR FONT, STYLE, SIZE, OR COLOR.

SER. NO. 85-639,177, FILED 5-31-2012.

MORGAN WYNNE, EXAMINING ATTORNEY



*David J. Kybas*

Director of the United States Patent and Trademark Office

# United States of America

United States Patent and Trademark Office

## GRAND NATIONAL

**Reg. No. 4,275,368**

**Registered Jan. 15, 2013**

**Int. Cl.: 12**

**TRADEMARK**

**PRINCIPAL REGISTER**

GENERAL MOTORS LLC (DELAWARE LIMITED LIABILITY COMPANY)  
300 RENAISSANCE CENTER  
DETROIT, MI 482653000

FOR: BADGES FOR VEHICLES, FITTED COVERS FOR VEHICLES, FENDER MATS FOR VEHICLES, HORN BUTTON INSERTS FOR VEHICLES, TRUNK LINERS FOR VEHICLES, IN CLASS 12 (U.S. CLS. 19, 21, 23, 31, 35 AND 44).

FIRST USE 12-31-1984; IN COMMERCE 12-31-1984.

THE MARK CONSISTS OF STANDARD CHARACTERS WITHOUT CLAIM TO ANY PARTICULAR FONT, STYLE, SIZE, OR COLOR.

SER. NO. 85-639,179, FILED 5-31-2012.

HEATHER SAPP, EXAMINING ATTORNEY



*David J. Kyros*

Director of the United States Patent and Trademark Office

# United States of America

United States Patent and Trademark Office

## Everything Is All Good

**Reg. No. 4,275,369**

DUNCAN, ADRIAN (UNITED STATES INDIVIDUAL)  
112-11 205TH ST.

**Registered Jan. 15, 2013**

ST. ALBANS, NY 11412

**Int. Cl.: 41**

FOR: DISC JOCKEY SERVICES, IN CLASS 41 (U.S. CLS. 100, 101 AND 107).

**SERVICE MARK**

FIRST USE 6-1-2007; IN COMMERCE 6-1-2007.

**PRINCIPAL REGISTER**

THE MARK CONSISTS OF STANDARD CHARACTERS WITHOUT CLAIM TO ANY PARTICULAR FONT, STYLE, SIZE, OR COLOR.

SER. NO. 85-639,186, FILED 5-31-2012.

KAPIL BHANOT, EXAMINING ATTORNEY



*David J. Kyffers*

Director of the United States Patent and Trademark Office

# United States of America

United States Patent and Trademark Office

## STARPROJECT

**Reg. No. 4,275,370**

**Registered Jan. 15, 2013**

**Int. Cl.: 9**

**TRADEMARK**

**PRINCIPAL REGISTER**

INFOR GLOBAL SOLUTIONS (MICHIGAN), INC. (MICHIGAN CORPORATION)  
30600 TELEGRAPH ROAD  
BINGHAM FARMS, MI 48025

FOR: PROJECT MANAGEMENT COMPUTER SOFTWARE FOR USE IN THE FIELDS OF ARCHITECTURE, ENGINEERING AND CONSTRUCTION, IN CLASS 9 (U.S. CLS. 21, 23, 26, 36 AND 38).

FIRST USE 11-0-1996; IN COMMERCE 11-0-1996.

THE MARK CONSISTS OF STANDARD CHARACTERS WITHOUT CLAIM TO ANY PARTICULAR FONT, STYLE, SIZE, OR COLOR.

SER. NO. 85-639,189, FILED 5-31-2012.

ERNEST SHOSHO, EXAMINING ATTORNEY



*David J. Kyffers*

Director of the United States Patent and Trademark Office

# United States of America

United States Patent and Trademark Office

## FIRST EQUIPMENT QUALITY

**Reg. No. 4,275,371**

WORLDPAAC, INC. (DELAWARE CORPORATION)  
37137 HICKORY STREET  
NEWARK, CA 94560

**Registered Jan. 15, 2013**

**Int. Cls.: 6, 7 and 12**

FOR: AUTOMOTIVE PARTS MADE OF RUBBER, METAL AND PLASTIC, NAMELY, IDLER ARM REPAIR KITS COMPRISED OF METAL WASHERS, IN CLASS 6 (U.S. CLS. 2, 12, 13, 14, 23, 25 AND 50).

**TRADEMARK**

FIRST USE 12-0-2006; IN COMMERCE 12-0-2006.

**PRINCIPAL REGISTER**

FOR: AUTOMOTIVE PARTS MADE OF RUBBER, METAL AND PLASTIC, NAMELY, LINK BUSHINGS, RUBBER BUSHINGS; SUB FRAME BUSHINGS, SWAY BAR BUSHINGS, TIE ROD BUSHINGS, TRAILING ARM BUSHINGS; TIMING BELT ROLLER, TIMING BELT TENSIONER, IN CLASS 7 (U.S. CLS. 13, 19, 21, 23, 31, 34 AND 35).

FIRST USE 12-0-2006; IN COMMERCE 12-0-2006.

FOR: AUTOMOTIVE COMPONENTS MADE OF RUBBER, METAL AND PLASTIC, FOR UNDER CAR CHASSIS PARTS, NAMELY, AXLES, MOTOR MOUNTS, STEERING LINKAGE, BALL JOINTS, TIE RODS, AIR CONDITIONER IDLER PULLEY, ACCESSORY BELT IDLER PULLEY, AIR CLEANER MOUNT, AIR MASS METER HOSE, CONSTANT VELOCITY BOOT, CONTROL ARM; LAND VEHICLE PARTS, NAMELY, DIFFERENTIAL MOUNTS, DRIVESHAFT SUPPORT, ENGINE MOUNT, ENGINE MOUNT BRACKET, ENGINE MOUNT STOP, EXHAUST HANGER, RADIATOR MOUNT, SHIFTER HOUSING, SPRING SEAT, STEERING RACK BOOT, STRUT BEARING, STRUT BUMP STOP, STRUT DUST SLEEVE, STRUT MOUNT, SUBFRAME BUSHING KITS COMPRISED OF MULTIPLE RUBBER BUSHINGS WITH METAL WASHERS AND BOLTS, SUBFRAME MOUNT, SWAY BAR LINK, THROTTLE BODY FLANGE, TRANSMISSION MOUNT; VEHICLE PARTS, NAMELY, SHOCK BELLOWS, SHOCK BUMP STOP, SHOCK MOUNT; CONTROL ARM BUSHING KITS COMPRISED OF MULTIPLE BUSHINGS MADE OF METAL CASINGS WITH RUBBER ENDS, IN CLASS 12 (U.S. CLS. 19, 21, 23, 31, 35 AND 44).

FIRST USE 12-0-2006; IN COMMERCE 12-0-2006.

THE MARK CONSISTS OF STANDARD CHARACTERS WITHOUT CLAIM TO ANY PARTICULAR FONT, STYLE, SIZE, OR COLOR.



*David J. Kyffers*

Director of the United States Patent and Trademark Office

**Reg. No. 4,275,371** OWNER OF U.S. REG. NO. 3,589,127.

NO CLAIM IS MADE TO THE EXCLUSIVE RIGHT TO USE "EQUIPMENT QUALITY",  
APART FROM THE MARK AS SHOWN.

SER. NO. 85-639,210, FILED 5-31-2012.

DAVID C. REIHNER, EXAMINING ATTORNEY

# United States of America

United States Patent and Trademark Office

# HELM

**Reg. No. 4,275,372**

**Registered Jan. 15, 2013**

**Int. Cl.: 35**

**SERVICE MARK**

**PRINCIPAL REGISTER**

AVANTAS, LLC (NEBRASKA LIMITED LIABILITY COMPANY)  
SUITE 400  
11128 JOHN GALT BOULEVARD  
OMAHA, NE 68137

FOR: CONSULTING, STRATEGIC PLANNING, AND ADVISORY SERVICES, ALL IN THE FIELD OF HEALTHCARE LABOR MANAGEMENT, IN CLASS 35 (U.S. CLS. 100, 101 AND 102).

FIRST USE 7-1-2012; IN COMMERCE 7-1-2012.

THE MARK CONSISTS OF STANDARD CHARACTERS WITHOUT CLAIM TO ANY PARTICULAR FONT, STYLE, SIZE, OR COLOR.

SER. NO. 85-639,243, FILED 5-31-2012.

ALYSSA STEEL, EXAMINING ATTORNEY



*David J. Kyjars*

Director of the United States Patent and Trademark Office

# United States of America

United States Patent and Trademark Office

NOBODY CARES.

**Reg. No. 4,275,373**

**Registered Jan. 15, 2013**

**Int. Cls.: 16 and 25**

**TRADEMARK**

**PRINCIPAL REGISTER**

TWO WORDS PERIOD, LLC (MARYLAND LIMITED LIABILITY COMPANY)  
401 BEARDS DOCK CROSSING  
ANNAPOLIS, MD 21403

FOR: BLANK CARDS; BUSINESS CARDS; NOTEBOOKS; PAPER NAPKINS; STATIONERY;  
STICKERS, IN CLASS 16 (U.S. CLS. 2, 5, 22, 23, 29, 37, 38 AND 50).

FIRST USE 2-28-2012; IN COMMERCE 4-10-2012.

FOR: COLLARED SHIRTS; T-SHIRTS, IN CLASS 25 (U.S. CLS. 22 AND 39).

FIRST USE 2-28-2012; IN COMMERCE 4-10-2012.

THE MARK CONSISTS OF THE PHRASE "NOBODY CARES." WRITTEN IN THE FONT  
COPPERPLATE GOTHIC LIGHT.

SER. NO. 85-639,255, FILED 5-31-2012.

DORITT L. CARROLL, EXAMINING ATTORNEY



*David J. Kyffers*

Director of the United States Patent and Trademark Office



# United States of America

United States Patent and Trademark Office

# OrangeBidz

**Reg. No. 4,275,374**

**Registered Jan. 15, 2013**

**Int. Cl.: 35**

**SERVICE MARK**

**PRINCIPAL REGISTER**

CONSUMER INTERACTIVE LLC (CALIFORNIA LIMITED LIABILITY COMPANY)  
569 N MOUNTAIN AVE STE B  
UPLAND, CA 91786

FOR: ON-LINE AUCTION SERVICES, IN CLASS 35 (U.S. CLS. 100, 101 AND 102).

FIRST USE 9-1-2010; IN COMMERCE 2-25-2011.

THE MARK CONSISTS OF STANDARD CHARACTERS WITHOUT CLAIM TO ANY PARTICULAR FONT, STYLE, SIZE, OR COLOR.

SER. NO. 85-639,262, FILED 5-31-2012.

ALYSSA STEEL, EXAMINING ATTORNEY



*David J. Kyros*

Director of the United States Patent and Trademark Office

# United States of America

United States Patent and Trademark Office

# Modnoc

**Reg. No. 4,275,375**

MADE IN LAS VEGAS (NEVADA CORPORATION)  
12277 BLUEBIRD CANYON PLACE  
LAS VEGAS, NV 89138

**Registered Jan. 15, 2013**

**Int. Cl.: 25**

FOR: MEN'S AND WOMEN'S BRIEFS, BOXERS, AND SHORTS, IN CLASS 25 (U.S. CLS. 22 AND 39).

**TRADEMARK**

FIRST USE 10-0-2011; IN COMMERCE 11-0-2011.

**PRINCIPAL REGISTER**

THE MARK CONSISTS OF STANDARD CHARACTERS WITHOUT CLAIM TO ANY PARTICULAR FONT, STYLE, SIZE, OR COLOR.

SER. NO. 85-639,265, FILED 5-31-2012.

EDWARD NELSON, EXAMINING ATTORNEY



*David J. Kybas*

Director of the United States Patent and Trademark Office

# United States of America

United States Patent and Trademark Office

# AccelCRKI

**Reg. No. 4,275,376**

CLINIWORKS, INC. (DELAWARE CORPORATION)  
245 FIRST STREET, SUITE 1800  
CAMBRIDGE, MA 02142

**Registered Jan. 15, 2013**

**Int. Cl.: 42**

FOR: COMPUTER SERVICES, NAMELY, CREATING COMPUTER NETWORK-BASED INDEXES OF INFORMATION, WEBSITES AND RESOURCES, IN CLASS 42 (U.S. CLS. 100 AND 101).

**SERVICE MARK**

FIRST USE 9-11-2011; IN COMMERCE 9-11-2011.

**PRINCIPAL REGISTER**

THE MARK CONSISTS OF STANDARD CHARACTERS WITHOUT CLAIM TO ANY PARTICULAR FONT, STYLE, SIZE, OR COLOR.

SER. NO. 85-639,275, FILED 5-31-2012.

JOHN GARTNER, EXAMINING ATTORNEY



*David J. Kyffers*

Director of the United States Patent and Trademark Office

# United States of America

United States Patent and Trademark Office

## Black Dog Real Estate, Inc.

**Reg. No. 4,275,377**

PADGETT, JUSTIN (UNITED STATES INDIVIDUAL)  
2035 NEVADA ST.  
SAN MARCOS, TX 78666

**Registered Jan. 15, 2013**

**Int. Cl.: 36**

FOR: REAL ESTATE AGENCIES, IN CLASS 36 (U.S. CLS. 100, 101 AND 102).

**SERVICE MARK**

FIRST USE 9-15-2009; IN COMMERCE 9-15-2009.

**PRINCIPAL REGISTER**

THE MARK CONSISTS OF STANDARD CHARACTERS WITHOUT CLAIM TO ANY PARTICULAR FONT, STYLE, SIZE, OR COLOR.

NO CLAIM IS MADE TO THE EXCLUSIVE RIGHT TO USE "REAL ESTATE, INC.", APART FROM THE MARK AS SHOWN.

SER. NO. 85-639,321, FILED 5-31-2012.

LYNDSEY KUYKENDALL, EXAMINING ATTORNEY



*David J. Kyffers*

Director of the United States Patent and Trademark Office

# United States of America

United States Patent and Trademark Office



**Reg. No. 4,275,378**

**Registered Jan. 15, 2013**

**Int. Cl.: 32**

**TRADEMARK**

**PRINCIPAL REGISTER**

TROPICANA PRODUCTS, INC. (DELAWARE CORPORATION)  
1001 13TH AVENUE EAST  
BRADENTON, FL 34208

FOR: FRUIT JUICES AND FRUIT JUICE DRINKS, IN CLASS 32 (U.S. CLS. 45, 46 AND 48).

FIRST USE 4-30-2012; IN COMMERCE 4-30-2012.

OWNER OF U.S. REG. NOS. 630,572, 1,303,002 AND OTHERS.

THE MARK CONSISTS OF THE WORD "TROPICANA" ARCHED WITH AN UNDERLINE UNDER THE WORD AND A LEAF DESIGN ABOVE THE "I". UNDER THE WORD "TROPICANA" IS THE WORD "SEASONS" IN ALL CAPS.

SER. NO. 85-639,341, FILED 5-31-2012.

RONALD AIKENS, EXAMINING ATTORNEY



*David J. Kyffers*

Director of the United States Patent and Trademark Office

# United States of America

United States Patent and Trademark Office

## Freedom From Obesity

**Reg. No. 4,275,379**

**Registered Jan. 15, 2013**

**Int. Cl.: 44**

**SERVICE MARK**

**PRINCIPAL REGISTER**

MERRIMAN II, GEORGE R. (UNITED STATES INDIVIDUAL)  
949 OLIVE STREET  
SHREVEPORT, LA 71104 AND

MERRIMAN, KATY (UNITED STATES INDIVIDUAL)  
949 OLIVE STREET  
SHREVEPORT, LA 71104

FOR: COSMETIC SURGERY SERVICES; DIETARY AND NUTRITIONAL GUIDANCE; NUTRITION COUNSELING; PROVIDING INFORMATION IN THE FIELD OF SURGICAL WEIGHT LOSS; PROVIDING INFORMATION ON MAINTAINING A HEALTHY LIFESTYLE AND LOSING WEIGHT; PROVIDING WEIGHT LOSS PROGRAM SERVICES; SERVICES RENDERED BY A DIETICIAN, IN CLASS 44 (U.S. CLS. 100 AND 101).

FIRST USE 5-30-2007; IN COMMERCE 6-15-2007.

THE MARK CONSISTS OF STANDARD CHARACTERS WITHOUT CLAIM TO ANY PARTICULAR FONT, STYLE, SIZE, OR COLOR.

SER. NO. 85-639,350, FILED 5-31-2012.

RONALD AIKENS, EXAMINING ATTORNEY



*David J. Kyffers*

Director of the United States Patent and Trademark Office

# United States of America

United States Patent and Trademark Office

## TRANSCRIBE

**Reg. No. 4,275,380**

VENTRESS INC. (SOUTH CAROLINA CORPORATION)  
607 JENKINS BRIDGE ROAD  
SIMPSONVILLE, SC 29680

**Registered Jan. 15, 2013**

**Int. Cl.: 27**

FOR: WALL COVERINGS WITH A DRY ERASE FILM, IN CLASS 27 (U.S. CLS. 19, 20, 37, 42 AND 50).

**TRADEMARK**

FIRST USE 11-8-2010; IN COMMERCE 11-8-2010.

**PRINCIPAL REGISTER**

THE MARK CONSISTS OF STANDARD CHARACTERS WITHOUT CLAIM TO ANY PARTICULAR FONT, STYLE, SIZE, OR COLOR.

SER. NO. 85-639,359, FILED 5-31-2012.

TINA MAI, EXAMINING ATTORNEY



*David J. Kyffers*

Director of the United States Patent and Trademark Office

# United States of America

United States Patent and Trademark Office

la  
MaroCCaine

**Reg. No. 4,275,381**

**Registered Jan. 15, 2013**

**Int. Cl.: 30**

**TRADEMARK**

**PRINCIPAL REGISTER**

ENCORE SPECIALTY FOODS, LLC (MASSACHUSETTS LIMITED LIABILITY COMPANY)  
SUITE 1107  
350 LINCOLN STREET  
HINGHAM, MA 02043

FOR: HOT SAUCE; SAUCES, IN CLASS 30 (U.S. CL. 46).

FIRST USE 4-12-2012; IN COMMERCE 4-12-2012.

THE MARK CONSISTS OF THE WORDS "LA MAROCCAINE" IN STYLIZED FONT.

THE ENGLISH TRANSLATION OF "LA MAROCCAINE" IN THE MARK IS "THE MOROCCAN ONE".

SER. NO. 85-639,375, FILED 5-31-2012.

KRISTIN CARLSON, EXAMINING ATTORNEY



David J. Kyros

Director of the United States Patent and Trademark Office



# United States of America

United States Patent and Trademark Office

# VICORE

**Reg. No. 4,275,382**

VICORE FITNESS, L.L.C. (UTAH LIMITED LIABILITY COMPANY)  
14476 SOUTH 980 WEST, SUITE 100  
BLUFFDALE, UT 84065

**Registered Jan. 15, 2013**

**Int. Cl.: 28**

FOR: FITNESS EQUIPMENT, NAMELY BENCHES AND CHAIRS THAT INCORPORATE AN INSTABILITY SUPPORT BLADDER, IN CLASS 28 (U.S. CLS. 22, 23, 38 AND 50).

**TRADEMARK**

FIRST USE 3-0-2010; IN COMMERCE 3-0-2010.

**PRINCIPAL REGISTER**

THE MARK CONSISTS OF STANDARD CHARACTERS WITHOUT CLAIM TO ANY PARTICULAR FONT, STYLE, SIZE, OR COLOR.

SER. NO. 85-639,380, FILED 5-31-2012.

MICHAEL WEBSTER, EXAMINING ATTORNEY



*David J. Kybas*

Director of the United States Patent and Trademark Office

# United States of America

United States Patent and Trademark Office

## Choose Prosperity

**Reg. No. 4,275,383**

**Registered Jan. 15, 2013**

**Int. Cl.: 35**

**SERVICE MARK**

**PRINCIPAL REGISTER**

SAMPLE & BAILEY CPAS, P.C. (COLORADO PROFESSIONAL CORPORATION)  
SHORES 4, SUITE 200  
375 E. HORSETOOTH RD.  
FORT COLLINS, CO 80524

FOR: ACCOUNT AUDITING; BUSINESS ADVISORY SERVICES, CONSULTANCY AND INFORMATION; BUSINESS AUDITING; TAX AND TAXATION PLANNING, ADVICE, INFORMATION AND CONSULTANCY SERVICES; TAX PREPARATION, IN CLASS 35 (U.S. CLS. 100, 101 AND 102).

FIRST USE 12-5-2011; IN COMMERCE 1-4-2012.

THE MARK CONSISTS OF STANDARD CHARACTERS WITHOUT CLAIM TO ANY PARTICULAR FONT, STYLE, SIZE, OR COLOR.

SER. NO. 85-639,393, FILED 5-31-2012.

TARA PATE, EXAMINING ATTORNEY



*David J. Kybas*

Director of the United States Patent and Trademark Office

# United States of America

United States Patent and Trademark Office

## LOS POTRILLOS

**Reg. No. 4,275,384**

JUAN MARTIN VILLASEÑOR SALAZAR (MEXICO INDIVIDUAL)  
RIO GUADALQUIVIR 1106, VILLAS DE ORIENTE  
S NICOLAS D/L GZA, NL, MEXICO 66470

**Registered Jan. 15, 2013**

**Int. Cl.: 4**

FOR: CHARCOAL; CHARCOAL BRIQUETTES; WOOD CHIPS FOR SMOKING AND GRILLING, IN CLASS 4 (U.S. CLS. 1, 6 AND 15).

**TRADEMARK**

FIRST USE 5-15-2012; IN COMMERCE 5-15-2012.

**PRINCIPAL REGISTER**

THE MARK CONSISTS OF STANDARD CHARACTERS WITHOUT CLAIM TO ANY PARTICULAR FONT, STYLE, SIZE, OR COLOR.

THE ENGLISH TRANSLATION OF "LOS POTRILLOS" IN THE MARK IS "THE LITTLE FOALS".

SER. NO. 85-639,404, FILED 5-31-2012.

ANTHONY RINKER, EXAMINING ATTORNEY



*David J. Kybas*

Director of the United States Patent and Trademark Office

# United States of America

United States Patent and Trademark Office

# G ZEES

**Reg. No. 4,275,385**

**Registered Jan. 15, 2013**

**Int. Cl.: 31**

**TRADEMARK**

**PRINCIPAL REGISTER**

ZUKE'S LLC (DELAWARE LIMITED LIABILITY COMPANY)  
PO BOX 3210  
2257 MAIN AVENUE  
DURANGO, CO 81301

FOR: CAT FOOD; CAT TREATS; PET FOOD; PET TREATS, IN CLASS 31 (U.S. CLS. 1 AND 46).

FIRST USE 4-30-2012; IN COMMERCE 4-30-2012.

THE MARK CONSISTS OF STANDARD CHARACTERS WITHOUT CLAIM TO ANY PARTICULAR FONT, STYLE, SIZE, OR COLOR.

SER. NO. 85-639,420, FILED 5-31-2012.

SUNG IN, EXAMINING ATTORNEY



*David J. Kyffers*

Director of the United States Patent and Trademark Office

# United States of America

United States Patent and Trademark Office

# Acosys

**Reg. No. 4,275,386**

**Registered Jan. 15, 2013**

**Int. Cl.: 42**

**SERVICE MARK**

**PRINCIPAL REGISTER**

ACOSYS LIMITED (HONG KONG LIMITED LIABILITY COMPANY)  
11/F, AXA CENTRE,  
151 GLOUCESTER ROAD  
HONG KONG, HONG KONG

FOR: RESEARCH AND DEVELOPMENT OF COMPUTER SOFTWARE, IN CLASS 42 (U.S. CLS. 100 AND 101).

FIRST USE 3-29-2006; IN COMMERCE 6-0-2007.

THE MARK CONSISTS OF STANDARD CHARACTERS WITHOUT CLAIM TO ANY PARTICULAR FONT, STYLE, SIZE, OR COLOR.

SER. NO. 85-639,421, FILED 5-31-2012.

CHARLOTTE CORWIN, EXAMINING ATTORNEY



*David J. Kyffers*

Director of the United States Patent and Trademark Office

# United States of America

United States Patent and Trademark Office

# Acobot

**Reg. No. 4,275,387**

**Registered Jan. 15, 2013**

**Int. Cl.: 42**

**SERVICE MARK**

**PRINCIPAL REGISTER**

ACOSYS LIMITED (HONG KONG LIMITED LIABILITY COMPANY)  
11/F, AXA CENTRE,  
151 GLOUCESTER ROAD  
HONG KONG, HONG KONG

FOR: SOFTWARE AS A SERVICE (SAAS) SERVICES FEATURING SOFTWARE FOR  
AUTOMATED LIVE CHAT BETWEEN HUMAN AND MACHINE, IN CLASS 42 (U.S. CLS.  
100 AND 101).

FIRST USE 3-1-2011; IN COMMERCE 3-1-2011.

THE MARK CONSISTS OF STANDARD CHARACTERS WITHOUT CLAIM TO ANY PAR-  
TICULAR FONT, STYLE, SIZE, OR COLOR.

SER. NO. 85-639,434, FILED 5-31-2012.

CHARLOTTE CORWIN, EXAMINING ATTORNEY



*David J. Kyffers*

Director of the United States Patent and Trademark Office

# United States of America

United States Patent and Trademark Office

# ATOMSPLIT

**Reg. No. 4,275,388**

**Registered Jan. 15, 2013**

**Int. Cl.: 41**

**SERVICE MARK**

**PRINCIPAL REGISTER**

ATOMEDIA, LLC (GEORGIA LIMITED LIABILITY COMPANY)  
912 HOLCOMB BRIDGE RD, SUITE 203  
ROSWELL, GA 30076

FOR: ENTERTAINMENT SERVICES, NAMELY, PROVIDING A WEB SITE FEATURING NON-DOWNLOADABLE MUSICAL PERFORMANCES, MUSICAL VIDEOS, RELATED FILM CLIPS, PHOTOGRAPHS, AND OTHER MULTIMEDIA MATERIALS FEATURING MUSIC-THEMED COMIC STRIPS AND COMIC STRIP CHARACTERS, IN CLASS 41 (U.S. CLS. 100, 101 AND 107).

FIRST USE 6-15-2007; IN COMMERCE 6-15-2007.

THE MARK CONSISTS OF STANDARD CHARACTERS WITHOUT CLAIM TO ANY PARTICULAR FONT, STYLE, SIZE, OR COLOR.

SER. NO. 85-639,436, FILED 5-31-2012.

DANNEAN HETZEL, EXAMINING ATTORNEY



*David J. Kyffers*

Director of the United States Patent and Trademark Office

**United States of America**  
United States Patent and Trademark Office

# SOFTCAFE

**Reg. No. 4,275,389**

**Registered Jan. 15, 2013**

**Int. Cl.: 9**

**TRADEMARK**

**PRINCIPAL REGISTER**

SOFTCAFE (MARYLAND LIMITED LIABILITY COMPANY)  
PO BOX 91  
CABIN JOHN, MD 20818

FOR: COMPUTER SOFTWARE FOR USE IN THE HOSPITALITY INDUSTRY FOR  
DESIGNING AND GENERATING MENUS, IN CLASS 9 (U.S. CLS. 21, 23, 26, 36 AND 38).

FIRST USE 1-1-1995; IN COMMERCE 1-1-1995.

THE MARK CONSISTS OF STANDARD CHARACTERS WITHOUT CLAIM TO ANY PAR-  
TICULAR FONT, STYLE, SIZE, OR COLOR.

SER. NO. 85-639,444, FILED 5-31-2012.

RAMONA ORTIGA, EXAMINING ATTORNEY



*David J. Kyffers*

Director of the United States Patent and Trademark Office



# United States of America

United States Patent and Trademark Office

## PALACIO DEL RIO

**Reg. No. 4,275,390**

PALACIO DEL RIO, INC. (DELAWARE CORPORATION)  
200 S. ALAMO STREET  
SAN ANTONIO, TX 78205

**Registered Jan. 15, 2013**

**Int. Cl.: 43**

FOR: HOTEL SERVICES; PROVISION OF CONFERENCE, EXHIBITION AND MEETING FACILITIES, IN CLASS 43 (U.S. CLS. 100 AND 101).

**SERVICE MARK**

FIRST USE 4-0-1968; IN COMMERCE 4-0-1968.

**PRINCIPAL REGISTER**

THE MARK CONSISTS OF STANDARD CHARACTERS WITHOUT CLAIM TO ANY PARTICULAR FONT, STYLE, SIZE, OR COLOR.

THE ENGLISH TRANSLATION OF "PALACIO DEL RIO" IN THE MARK IS "RIVER PALACE".

SER. NO. 85-639,450, FILED 5-31-2012.

RAMONA ORTIGA, EXAMINING ATTORNEY



*David J. Kyffers*

Director of the United States Patent and Trademark Office

# United States of America

United States Patent and Trademark Office

## NATURENUTRITION

**Reg. No. 4,275,391**

**Registered Jan. 15, 2013**

**Int. Cls.: 29 and 30**

**TRADEMARK**

**PRINCIPAL REGISTER**

GUNLER INC (FLORIDA CORPORATION)  
BLDG 8 SUITE 8210  
9595 SIX PINES DR  
THE WOODLANDS, TX 77380

FOR: BAKED BEANS; CANOLA OIL; CORN OIL; DRIED BEANS; MEAT; POTATO SKINS; POTATO-BASED SNACK FOODS; PROCESSED BEANS; PROCESSED POTATOES; SOY BEAN OIL; SUNFLOWER OIL; TOMATO PUREE; VEGETABLE OILS AND FATS, IN CLASS 29 (U.S. CL. 46).

FIRST USE 9-21-2011; IN COMMERCE 5-23-2012.

FOR: RICE, IN CLASS 30 (U.S. CL. 46).

FIRST USE 9-21-2011; IN COMMERCE 5-23-2012.

THE MARK CONSISTS OF STANDARD CHARACTERS WITHOUT CLAIM TO ANY PARTICULAR FONT, STYLE, SIZE, OR COLOR.

SER. NO. 85-639,458, FILED 5-31-2012.

DANNEAN HETZEL, EXAMINING ATTORNEY



*David J. Kypos*

Director of the United States Patent and Trademark Office

# United States of America

United States Patent and Trademark Office

# Hotsnapz

**Reg. No. 4,275,392**

STRATIKORE, INC. (INDIANA CORPORATION)  
PO BOX 689  
LAPORTE, IN 46352

**Registered Jan. 15, 2013**

**Int. Cl.: 11**

FOR: HEATING PADS NOT FOR MEDICAL PURPOSES; NON-ELECTRIC POCKET WARMERS, NAMELY, CHEMICALLY-ACTIVATED HEATING PACKETS FOR WARMING HANDS, IN CLASS 11 (U.S. CLS. 13, 21, 23, 31 AND 34).

**TRADEMARK**

FIRST USE 8-15-2003; IN COMMERCE 10-15-2003.

**PRINCIPAL REGISTER**

THE MARK CONSISTS OF STANDARD CHARACTERS WITHOUT CLAIM TO ANY PARTICULAR FONT, STYLE, SIZE, OR COLOR.

SER. NO. 85-639,463, FILED 5-31-2012.

DANNEAN HETZEL, EXAMINING ATTORNEY



*David J. Kyjars*

Director of the United States Patent and Trademark Office

# United States of America

United States Patent and Trademark Office

## VANDERTRAMP

**Reg. No. 4,275,393**

ATOMEDIA, LLC (GEORGIA LIMITED LIABILITY COMPANY)  
912 HOLCOMB BRIDGE RD, SUITE 203  
ROSWELL, GA 30076

**Registered Jan. 15, 2013**

**Int. Cl.: 9**

FOR: DOWNLOADABLE MUSICAL SOUND RECORDINGS; DOWNLOADABLE VIDEO RECORDINGS FEATURING ANIMATED CHARACTERS.; MUSICAL SOUND RECORDINGS; MUSICAL VIDEO RECORDINGS , IN CLASS 9 (U.S. CLS. 21, 23, 26, 36 AND 38).

**TRADEMARK**

FIRST USE 4-15-2004; IN COMMERCE 4-15-2004.

**PRINCIPAL REGISTER**

THE MARK CONSISTS OF STANDARD CHARACTERS WITHOUT CLAIM TO ANY PARTICULAR FONT, STYLE, SIZE, OR COLOR.

SER. NO. 85-639,466, FILED 5-31-2012.

DANNEAN HETZEL, EXAMINING ATTORNEY



*David J. Kyffers*

Director of the United States Patent and Trademark Office

**United States of America**  
United States Patent and Trademark Office

# THOMPSON CLASS

**Reg. No. 4,275,394**

BGNA, INC. (CALIFORNIA CORPORATION)  
3805 RAVEN COURT  
AGOURA HILLS, CA 91301

**Registered Jan. 15, 2013**

**Int. Cl.: 18**

FOR: WALLETS, IN CLASS 18 (U.S. CLS. 1, 2, 3, 22 AND 41).

**TRADEMARK**

FIRST USE 3-1-2012; IN COMMERCE 3-1-2012.

**PRINCIPAL REGISTER**

THE MARK CONSISTS OF THE WORDS "THOMPSON" AND "CLASS" IN A CUSTOMIZED FONT.

SER. NO. 85-639,485, FILED 5-31-2012.

ANDREA K. NADELMAN, EXAMINING ATTORNEY



*David J. Kybas*

Director of the United States Patent and Trademark Office

# United States of America

United States Patent and Trademark Office



innerguru

**Reg. No. 4,275,395**

**Registered Jan. 15, 2013**

**Int. Cl.: 25**

**TRADEMARK**

**PRINCIPAL REGISTER**

LUCKY DOGS CORP. (COLORADO CORPORATION), DBA INNER GURU  
3021 EDISON CT  
BOULDER, CO 80301

FOR: WEARABLE GARMENTS AND CLOTHING, NAMELY, SHIRTS, IN CLASS 25 (U.S. CLS. 22 AND 39).

FIRST USE 4-20-2012; IN COMMERCE 5-26-2012.

THE MARK CONSISTS OF A SMILING FROG IN THE LOTUS POSITION WITH ITS HANDS IN MUDRAS INSIDE OF A RINGED CIRCLE WITH THE WORDS "INNER GURU" BELOW THE CIRCLE.

SER. NO. 85-639,491, FILED 5-31-2012.

KEVIN CORWIN, EXAMINING ATTORNEY



*David J. Kybas*

Director of the United States Patent and Trademark Office

# United States of America

United States Patent and Trademark Office

# LIVEWIRE

**Reg. No. 4,275,396**

APEX BRANDS, INC. (DELAWARE CORPORATION)  
1000 LUFKIN ROAD  
APEX, NC 27539

**Registered Jan. 15, 2013**

**Int. Cl.: 7**

FOR: ELECTRIC POWER TOOLS, NAMELY, NUT RUNNERS, IN CLASS 7 (U.S. CLS. 13, 19, 21, 23, 31, 34 AND 35).

**TRADEMARK**

FIRST USE 0-0-2007; IN COMMERCE 0-0-2007.

**PRINCIPAL REGISTER**

THE MARK CONSISTS OF STANDARD CHARACTERS WITHOUT CLAIM TO ANY PARTICULAR FONT, STYLE, SIZE, OR COLOR.

SER. NO. 85-639,513, FILED 5-31-2012.

GEOFFREY FOSDICK, EXAMINING ATTORNEY



*David J. Kyffers*

Director of the United States Patent and Trademark Office

# United States of America

United States Patent and Trademark Office

## GRAND NATIONAL

**Reg. No. 4,275,397**

GENERAL MOTORS LLC (DELAWARE LIMITED LIABILITY COMPANY)  
300 RENAISSANCE CENTER  
DETROIT, MI 482653000

**Registered Jan. 15, 2013**

**Int. Cl.: 25**

FOR: CLOTHING, NAMELY HATS, T-SHIRTS, JACKETS, SWEAT SHIRTS, POLO SHIRTS,  
IN CLASS 25 (U.S. CLS. 22 AND 39).

**TRADEMARK**

FIRST USE 3-2-2008; IN COMMERCE 3-2-2008.

**PRINCIPAL REGISTER**

THE MARK CONSISTS OF STANDARD CHARACTERS WITHOUT CLAIM TO ANY PAR-  
TICULAR FONT, STYLE, SIZE, OR COLOR.

SER. NO. 85-639,518, FILED 5-31-2012.

HEATHER SAPP, EXAMINING ATTORNEY



*David J. Kybas*

Director of the United States Patent and Trademark Office



# United States of America

United States Patent and Trademark Office

# DOGGYLOOT

**Reg. No. 4,275,398**

DOGGYLOOT (ILLINOIS LIMITED LIABILITY COMPANY)  
213 N RACINE AVE  
CHICAGO, IL 60607

**Registered Jan. 15, 2013**

**Int. Cl.: 35**

FOR: ON-LINE RETAIL STORE SERVICES FEATURING ANIMAL AND PET-RELATED PRODUCTS, IN CLASS 35 (U.S. CLS. 100, 101 AND 102).

**SERVICE MARK**

FIRST USE 2-1-2011; IN COMMERCE 2-1-2011.

**PRINCIPAL REGISTER**

THE MARK CONSISTS OF STANDARD CHARACTERS WITHOUT CLAIM TO ANY PARTICULAR FONT, STYLE, SIZE, OR COLOR.

SER. NO. 85-639,521, FILED 5-31-2012.

ESTHER BELENKER, EXAMINING ATTORNEY



*David J. Kybas*

Director of the United States Patent and Trademark Office

# United States of America

United States Patent and Trademark Office

## Bungie Aerospace

**Reg. No. 4,275,399**

**Registered Jan. 15, 2013**

**Int. Cl.: 9**

**TRADEMARK**

**PRINCIPAL REGISTER**

BUNGIE AEROSPACE CORPORATION (DELAWARE CORPORATION)  
550 106TH AVENUE N.E. SUITE 207  
BELLEVUE, WA 980045088

FOR: COMPUTER GAME PROGRAMMES DOWNLOADABLE VIA THE INTERNET; COMPUTER GAME SOFTWARE DOWNLOADABLE FROM A GLOBAL COMPUTER NETWORK; COMPUTER GAME SOFTWARE FOR USE ON MOBILE AND CELLULAR PHONES, IN CLASS 9 (U.S. CLS. 21, 23, 26, 36 AND 38).

FIRST USE 9-8-2011; IN COMMERCE 9-8-2011.

THE MARK CONSISTS OF STANDARD CHARACTERS WITHOUT CLAIM TO ANY PARTICULAR FONT, STYLE, SIZE, OR COLOR.

SER. NO. 85-639,522, FILED 5-31-2012.

ESTHER BELENKER, EXAMINING ATTORNEY



*David J. Kyffers*

Director of the United States Patent and Trademark Office

# United States of America

United States Patent and Trademark Office



**Reg. No. 4,275,400**

**Registered Jan. 15, 2013**

**Int. Cl.: 43**

**SERVICE MARK**

**PRINCIPAL REGISTER**

JDT ENTERPRISES LLC (NEW JERSEY LIMITED LIABILITY COMPANY)  
209 FIRST AVENUE  
MANASQUAN, NJ 08736

FOR: CATERING SERVICES; RESTAURANT SERVICES FEATURING A MENU OF MACARONI AND CHEESE; RESTAURANT SERVICES, INCLUDING SIT-DOWN SERVICE OF FOOD AND TAKE-OUT RESTAURANT SERVICES, IN CLASS 43 (U.S. CLS. 100 AND 101).

FIRST USE 5-25-2012; IN COMMERCE 5-25-2012.

THE MARK CONSISTS OF THE STYLIZED TEXT "SHREDD" WHERE THE LETTER "S" IS FORMED BY TWO ELBOWS OF MACARONI AND A SMALL POOL OF LIQUID IS POSITIONED AT THE BOTTOM OF THE "S".

SER. NO. 85-639,535, FILED 5-31-2012.

DAVID ELTON, EXAMINING ATTORNEY



*David J. Kyffers*

Director of the United States Patent and Trademark Office

# United States of America

United States Patent and Trademark Office

# DRAGONVALE

**Reg. No. 4,275,401**

BACKFLIP STUDIOS, INC. (DELAWARE CORPORATION)  
1690 38TH STREET  
BOULDER, CO 80301

**Registered Jan. 15, 2013**

**Int. Cl.: 9**

FOR: COMPUTER SOFTWARE AND DOWNLOADABLE SOFTWARE IN THE FIELD OF GAMES FOR USE ON COMPUTERS AND MOBILE COMMUNICATIONS DEVICES, IN CLASS 9 (U.S. CLS. 21, 23, 26, 36 AND 38).

**TRADEMARK**

FIRST USE 9-14-2011; IN COMMERCE 9-14-2011.

**PRINCIPAL REGISTER**

THE MARK CONSISTS OF STANDARD CHARACTERS WITHOUT CLAIM TO ANY PARTICULAR FONT, STYLE, SIZE, OR COLOR.

SER. NO. 85-639,541, FILED 5-31-2012.

JERI J. FICKES, EXAMINING ATTORNEY



*David J. Kybas*

Director of the United States Patent and Trademark Office

# United States of America

United States Patent and Trademark Office



**Reg. No. 4,275,402**

**Registered Jan. 15, 2013**

**Int. Cl.: 41**

**SERVICE MARK**

**PRINCIPAL REGISTER**

ACADEMY OF RADIOLOGY PHYSICIAN EXTENDERS (WYOMING CORPORATION)  
P.O. BOX 1626, 225 DUPONT DRIVE  
LANDER, WY 82520

FOR: EDUCATIONAL SERVICES, NAMELY, OFFERING ONLINE CONTINUING EDUCATION COURSES IN MEDICAL IMAGING; EDUCATIONAL SERVICES, NAMELY, OFFERING EDUCATIONAL SEMINARS AND CONFERENCES IN MEDICAL IMAGING; PROVIDING MENTORING TO HEALTH CARE WORKERS ON TOPICS RELATED TO MEDICAL IMAGING; PROVIDING MENTORING TO INDIVIDUALS ENROLLED IN MEDICAL IMAGING EDUCATIONAL PROGRAMS, IN CLASS 41 (U.S. CLS. 100, 101 AND 107).

FIRST USE 10-15-2008; IN COMMERCE 3-15-2009.

NO CLAIM IS MADE TO THE EXCLUSIVE RIGHT TO USE "ACADEMY FOR RADIOLOGY PHYSICIAN EXTENDERS" AND "IMAGING", APART FROM THE MARK AS SHOWN.

THE MARK CONSISTS OF SHIELD DESIGN OUTLINED AND CONTAINING THE WORDS "ACADEMY FOR RADIOLOGY PHYSICIAN EXTENDERS"; THE MARK CONSISTS OF A BANNER DESIGN APPEARING ACROSS THE BOTTOM OF THE SHIELD; THE WORDING "IMAGING EXCELLENCE" APPEARS ACROSS THE CENTER PORTION OF THE BANNER AND IS FLANKED BY THE LETTERING "ARPE" AT THE RIGHT AND LEFT ENDS OF THE BANNER DESIGN; AN OVAL DESIGN CONTAINING A STYLIZED ATOMIC SYMBOL APPEARS AT THE BOTTOM OF THE SHIELD DESIGN.

SER. NO. 85-639,553, FILED 5-31-2012.

SKYE YOUNG, EXAMINING ATTORNEY



*David J. Kybas*

Director of the United States Patent and Trademark Office

# United States of America

United States Patent and Trademark Office



**Reg. No. 4,275,403**

BMW MOTORCYCLE OWNERS OF AMERICA, INC. (CALIFORNIA CORPORATION)  
509A OLD STATE ROAD  
ELLISVILLE, MO 63021

**Registered Jan. 15, 2013**

**Int. Cl.: 35**

FOR: CLUB SERVICES, NAMELY, PROMOTING THE INTERESTS OF MOTORCYCLE ENTHUSIASTS, IN CLASS 35 (U.S. CLS. 100, 101 AND 102).

**SERVICE MARK**

FIRST USE 4-0-2012; IN COMMERCE 4-0-2012.

**PRINCIPAL REGISTER**

THE MARK CONSISTS OF THE LETTERS "MOA." THE LETTER "O" IS STYLIZED TO LOOK LIKE THE EARTH.

SER. NO. 85-639,619, FILED 5-31-2012.

WENDY GOODMAN, EXAMINING ATTORNEY



*David J. Kyffers*

Director of the United States Patent and Trademark Office

# United States of America

United States Patent and Trademark Office

## RIGHTSLINE

**Reg. No. 4,275,404**

**Registered Jan. 15, 2013**

**Int. Cl.: 35**

**SERVICE MARK**

**PRINCIPAL REGISTER**

RIGHTSLINE.COM, INC. (DELAWARE CORPORATION)  
9100 WILSHIRE BLVD. SUITE 520E  
BEVERLY HILLS, CA 90212

FOR: BUSINESS MANAGEMENT; BUSINESS MANAGEMENT AND CONSULTATION IN THE FIELD OF TRACKING OWNERSHIP RIGHTS IN THEATRICAL, LITERARY AND COMMERCIAL MEDIUMS IN THE AREA OF BOOKS, FILMS, SCRIPTS, PUBLICITY, ART AS WELL AS MERCHANDISING RELATING TO BOOKS, FILMS, SCRIPTS, PUBLICITY AND ART; DATABASE MANAGEMENT, IN CLASS 35 (U.S. CLS. 100, 101 AND 102).

FIRST USE 6-19-2000; IN COMMERCE 6-19-2000.

THE MARK CONSISTS OF STANDARD CHARACTERS WITHOUT CLAIM TO ANY PARTICULAR FONT, STYLE, SIZE, OR COLOR.

SEC. 2(F).

SER. NO. 85-639,639, FILED 5-31-2012.

TINA BROWN, EXAMINING ATTORNEY



*David J. Kyffers*

Director of the United States Patent and Trademark Office

# United States of America

United States Patent and Trademark Office

## GRAND NATIONAL

**Reg. No. 4,275,405**

GENERAL MOTORS LLC (DELAWARE LIMITED LIABILITY COMPANY)  
300 RENAISSANCE CENTER  
DETROIT, MI 482653000

**Registered Jan. 15, 2013**

**Int. Cl.: 6**

FOR: NON-LUMINOUS AND NON-MECHANICAL METAL SIGNS, METAL KEY CHAINS, METAL LICENSE PLATES, IN CLASS 6 (U.S. CLS. 2, 12, 13, 14, 23, 25 AND 50).

**TRADEMARK**

FIRST USE 1-1-1998; IN COMMERCE 1-1-1998.

**PRINCIPAL REGISTER**

THE MARK CONSISTS OF STANDARD CHARACTERS WITHOUT CLAIM TO ANY PARTICULAR FONT, STYLE, SIZE, OR COLOR.

SER. NO. 85-639,655, FILED 5-31-2012.

HEATHER SAPP, EXAMINING ATTORNEY



*David J. Kyffers*

Director of the United States Patent and Trademark Office



# United States of America

United States Patent and Trademark Office

## GRAND NATIONAL

**Reg. No. 4,275,406**

**Registered Jan. 15, 2013**

**Int. Cl.: 20**

**TRADEMARK**

**PRINCIPAL REGISTER**

GENERAL MOTORS LLC (DELAWARE LIMITED LIABILITY COMPANY)  
300 RENAISSANCE CENTER  
DETROIT, MI 482653000

FOR: VINYL BANNERS, IN CLASS 20 (U.S. CLS. 2, 13, 22, 25, 32 AND 50).

FIRST USE 11-30-2006; IN COMMERCE 11-30-2006.

THE MARK CONSISTS OF STANDARD CHARACTERS WITHOUT CLAIM TO ANY PARTICULAR FONT, STYLE, SIZE, OR COLOR.

SER. NO. 85-639,695, FILED 5-31-2012.

HEATHER SAPP, EXAMINING ATTORNEY



*David J. Kyffers*

Director of the United States Patent and Trademark Office

# United States of America

United States Patent and Trademark Office



**Reg. No. 4,275,407**

CBERRYTECH, INC. (MISSOURI CORPORATION), DBA THE TOY NINJA  
717 SIDNEY LANE  
WILLARD, MO 65781

**Registered Jan. 15, 2013**

**Int. Cl.: 35**

FOR: ON-LINE RETAIL STORE SERVICES FEATURING TOYS, VIDEO GAMES, CLOTHING AND VARIOUS CONSUMER GOODS, IN CLASS 35 (U.S. CLS. 100, 101 AND 102).

**SERVICE MARK**

FIRST USE 3-0-2012; IN COMMERCE 3-0-2012.

**PRINCIPAL REGISTER**

NO CLAIM IS MADE TO THE EXCLUSIVE RIGHT TO USE "TOY", APART FROM THE MARK AS SHOWN.

THE COLOR(S) BLACK, WHITE, GRAY AND PEACH IS/ARE CLAIMED AS A FEATURE OF THE MARK.

THE NAME(S), PORTRAIT(S), AND/OR SIGNATURE(S) SHOWN IN THE MARK DOES NOT IDENTIFY A PARTICULAR LIVING INDIVIDUAL.

THE MARK CONSISTS OF A STYLIZED IMAGE OF A CROUCHING NINJA WITH A BLACK MASK AND OUTFIT, PEACH SKIN, BLACK AND WHITE EYES, HOLDING A GRAY SWORD IN HIS LEFT HAND. THERE IS A GRAY ROUND SHADOW CAST BELOW THE NINJA. TO THE RIGHT OF HIM ARE THE BLACK STYLIZED WORDS THE TOY NINJA.

SER. NO. 85-639,709, FILED 5-31-2012.

EDWARD FENNESSY, EXAMINING ATTORNEY



*David J. Kybas*

Director of the United States Patent and Trademark Office

# United States of America

United States Patent and Trademark Office

# EZ-CRIMP

**Reg. No. 4,275,408**

MARKEN MANUFACTURING, INC. (MINNESOTA CORPORATION)  
2081 E CENTER CIRCLE  
PLYMOUTH, MN 55441

**Registered Jan. 15, 2013**

**Int. Cl.: 7**

FOR: MACHINES FOR CRIMPING OF WIRE, CABLE, HOSE, TUBE, PIPE, INSULATORS AND OTHER MALLEABLE PRODUCTS, IN CLASS 7 (U.S. CLS. 13, 19, 21, 23, 31, 34 AND 35).

**TRADEMARK**

FIRST USE 8-29-2011; IN COMMERCE 8-29-2011.

**PRINCIPAL REGISTER**

THE MARK CONSISTS OF STANDARD CHARACTERS WITHOUT CLAIM TO ANY PARTICULAR FONT, STYLE, SIZE, OR COLOR.

SER. NO. 85-639,721, FILED 5-31-2012.

CAROLINE WOOD, EXAMINING ATTORNEY



*David J. Kybas*

Director of the United States Patent and Trademark Office

# United States of America

United States Patent and Trademark Office



**Reg. No. 4,275,409**

BREWER, VIRGINIA (UNITED STATES INDIVIDUAL)  
POB 237

**Registered Jan. 15, 2013**

SAUNDESSTOWN, RI 02874

**Int. Cl.: 25**

FOR: CLOTHING, NAMELY, MEN'S AND WOMEN'S SHIRTS, VESTS, PANTS, SHORTS, JACKETS, AND BELTS, IN CLASS 25 (U.S. CLS. 22 AND 39).

**TRADEMARK**

FIRST USE 9-21-1999; IN COMMERCE 9-21-1999.

**PRINCIPAL REGISTER**

THE MARK CONSISTS OF THREE STYLIZED LETTERS "C" AS SHOWN IN THE MARK.

SER. NO. 85-639,745, FILED 5-31-2012.

JENNIFER MARTIN, EXAMINING ATTORNEY



*David J. Kyffers*

Director of the United States Patent and Trademark Office

# United States of America

United States Patent and Trademark Office

## FAB FATALE

**Reg. No. 4,275,410**

JENNIFER LEALE (UNITED STATES INDIVIDUAL)

**Registered Jan. 15, 2013**

P.O. BOX 14902  
TALLAHASSEE, FL 32317

**Int. Cl.: 41**

FOR: ON-LINE ELECTRONIC NEWSLETTERS DELIVERED BY E-MAIL IN THE FIELD OF BEAUTY, FASHION, HOME DECOR, DO IT YOURSELF PROJECTS AND MANICURES, BEAUTY AND FASHION PRODUCT REVIEWS, RECIPES AND POSTS DISPLAYING OUTFITS CONSISTING OF FASHION, CLOTHING AND ACCESSORIES; ON-LINE JOURNALS, NAMELY, BLOGS FEATURING INFORMATION AND PHOTOGRAPHS REGARDING BEAUTY, FASHION, HOME DECOR, DO-IT-YOURSELF PROJECTS AND MANICURES, BEAUTY AND FASHION PRODUCT REVIEWS, RECIPES AND POSTS DISPLAYING OUTFITS CONSISTING OF FASHION, CLOTHING AND ACCESSORIES, IN CLASS 41 (U.S. CLS. 100, 101 AND 107).

**SERVICE MARK**

**PRINCIPAL REGISTER**

FIRST USE 10-26-2011; IN COMMERCE 10-26-2011.

THE MARK CONSISTS OF STANDARD CHARACTERS WITHOUT CLAIM TO ANY PARTICULAR FONT, STYLE, SIZE, OR COLOR.

SER. NO. 85-639,774, FILED 5-31-2012.

NAAKWAMA ANKRAH, EXAMINING ATTORNEY



*David J. Kypos*

Director of the United States Patent and Trademark Office

# United States of America

United States Patent and Trademark Office



**Reg. No. 4,275,411**

**Registered Jan. 15, 2013**

**Int. Cl.: 9**

**TRADEMARK**

**PRINCIPAL REGISTER**

RAVID, INC. (DELAWARE CORPORATION)  
10 SODEN ST #13  
CAMBRIDGE, MA 02139

FOR: COMPUTER SOFTWARE THAT PROVIDES WEB-BASED ACCESS TO APPLICATIONS AND SERVICES THROUGH A WEB OPERATING SYSTEM OR PORTAL INTERFACE, IN CLASS 9 (U.S. CLS. 21, 23, 26, 36 AND 38).

FIRST USE 8-14-2011; IN COMMERCE 8-14-2011.

THE MARK CONSISTS OF A RED CURVED CORNERED COMMENT BOX WITH A WHITE ISOSCELES TRIANGLE ON ITS SIDE, WITH THE TOP ANGLE POINTING TO THE RIGHT AND CENTERED IN THE MIDDLE OF THE RED BOX, AND A STYLIZED RED LETTER "R", A STYLIZED YELLOW LETTER "A", A STYLIZED ORANGE LETTER "V", A STYLIZED GREEN LETTER "I", AND A STYLIZED BLUE LETTER "D".

THE COLOR(S) WHITE, RED, YELLOW, ORANGE, GREEN, AND BLUE IS/ARE CLAIMED AS A FEATURE OF THE MARK.

SER. NO. 85-639,804, FILED 5-31-2012.

SHAUNIA CARLYLE, EXAMINING ATTORNEY



*David J. Kyffers*

Director of the United States Patent and Trademark Office

# United States of America

United States Patent and Trademark Office

# PLEIADES

**Reg. No. 4,275,412**

THACKREY, SEAN HALEY (UNITED STATES INDIVIDUAL), DBA THACKREY & CO.  
240 OVERLOOK DR.  
BOLINAS, CA 94924

**Registered Jan. 15, 2013**

**Int. Cl.: 33**

FOR: WINES, IN CLASS 33 (U.S. CLS. 47 AND 49).

**TRADEMARK**

FIRST USE 0-0-1991; IN COMMERCE 0-0-1991.

**PRINCIPAL REGISTER**

THE MARK CONSISTS OF STANDARD CHARACTERS WITHOUT CLAIM TO ANY PARTICULAR FONT, STYLE, SIZE, OR COLOR.

SER. NO. 85-639,848, FILED 5-31-2012.

DORITT L. CARROLL, EXAMINING ATTORNEY



*David J. Kybas*

Director of the United States Patent and Trademark Office

# United States of America

United States Patent and Trademark Office



**Reg. No. 4,275,413**

**Registered Jan. 15, 2013**

**Int. Cl.: 35**

DD APARTMENTS, LLC (MARYLAND LIMITED LIABILITY COMPANY), DBA  
FRESHRENT.COM  
5114 EDGEMOOR LANE  
5114 EDGEMOOR LANE  
BETHESDA, MD 20814

**SERVICE MARK**

**PRINCIPAL REGISTER**

FOR: PROVIDING A SEARCHABLE ONLINE ADVERTISING WEBSITE AND INFORMATIONAL GUIDE FEATURING THE GOODS AND SERVICES OF OTHER VENDORS VIA THE INTERNET IN THE FIELD OF APARTMENT RENTALS; PROVIDING AN INTERACTIVE REAL ESTATE WEBSITE WHICH PROMOTES HOUSING AND APARTMENT PROPERTIES THROUGH OFFERING PROSPECTIVE TENANTS VIDEO WALK THROUGHs, PROPERTY DESCRIPTIONS, TEXT, PRICE, LOCATION, MAPS AND OTHER INFORMATION THAT WOULD BE INFLUENTIAL TO A PROSPECTIVE TENANT IN MAKING A RENTAL DECISION, IN CLASS 35 (U.S. CLS. 100, 101 AND 102).

FIRST USE 4-24-2012; IN COMMERCE 4-24-2012.

THE MARK CONSISTS OF THE WORD "FRESH" IN GREEN LETTERS, THE WORD "RENT" IN BLUE LETTERS, THE WORD "RENT" IS FOLLOWED BY ".COM" IN LOWER CASE GRAY LETTERS. IN FRONT OF THE WORD "FRESH" IS A PAIR OF GREEN LEAVES WITH FOUR WHITE SQUARES ON THE RIGHT LEAF IN A WINDOW PANE FORMATION.

THE COLOR(S) WHITE, GREEN, BLUE AND GRAY IS/ARE CLAIMED AS A FEATURE OF THE MARK.

SER. NO. 85-639,864, FILED 5-31-2012.

CHRISIE B. KING, EXAMINING ATTORNEY



*David J. Kybas*

Director of the United States Patent and Trademark Office



# United States of America

United States Patent and Trademark Office

# FREAKNIGHT

**Reg. No. 4,275,414**

**Registered Jan. 15, 2013**

**Int. Cl.: 41**

**SERVICE MARK**

**PRINCIPAL REGISTER**

CONSCIOUS ENTERTAINMENT GROUP, LLC (WASHINGTON LIMITED LIABILITY COMPANY)  
1952 1ST AVE SOUTH, #1A  
SEATTLE, WA 98134

FOR: ARRANGING AND CONDUCTING OF CONCERTS; ARRANGING, ORGANIZING, CONDUCTING, AND HOSTING SOCIAL ENTERTAINMENT EVENTS; CONCERT BOOKING; ENTERTAINMENT IN THE NATURE OF LIVE MUSIC CONCERTS, DISC JOCKEY CONCERTS, MUSICAL AND ARTISTIC PERFORMANCES, MUSIC TOURS, CARNIVALS, CIRCUSES, SPORTING EVENTS, DANCE PARTIES, NIGHT CLUBS, ART EXHIBITIONS AND MUSIC FESTIVALS; ENTERTAINMENT, NAMELY, ORGANIZING AND PRODUCING MUSICAL EVENTS; ENTERTAINMENT SERVICES IN THE NATURE OF PRESENTING LIVE MUSICAL PERFORMANCES; ENTERTAINMENT, NAMELY, LIVE MUSIC CONCERTS; PRESENTATION OF LIVE SHOW PERFORMANCES; PRESENTATION OF MUSICAL PERFORMANCE, IN CLASS 41 (U.S. CLS. 100, 101 AND 107).

FIRST USE 0-0-1996; IN COMMERCE 0-0-1996.

THE MARK CONSISTS OF STANDARD CHARACTERS WITHOUT CLAIM TO ANY PARTICULAR FONT, STYLE, SIZE, OR COLOR.

SER. NO. 85-639,876, FILED 5-31-2012.

JEANIE LEE, EXAMINING ATTORNEY



*David J. Kyffers*

Director of the United States Patent and Trademark Office

# United States of America

United States Patent and Trademark Office

# VELOCITEK

**Reg. No. 4,275,415**

**Registered Jan. 15, 2013**

**Int. Cl.: 9**

**TRADEMARK**

**PRINCIPAL REGISTER**

VELOCITEK, LLC (NEVADA LIMITED LIABILITY COMPANY)  
271 B KAHIKO ST  
PAIA, HI 96779

FOR: ELECTRIC NAVIGATIONAL INSTRUMENTS; ELECTRONIC NAVIGATIONAL AND POSITIONING APPARATUS AND INSTRUMENTS; DIRECTIONAL COMPASSES; COMPUTER HARDWARE AND PERIPHERALS; SOFTWARE FOR USE IN NAVIGATION AND TRACKING; GLOBAL POSITIONING SYSTEMS (GPS) AND PARTS AND FITTINGS THEREFOR, IN CLASS 9 (U.S. CLS. 21, 23, 26, 36 AND 38).

FIRST USE 9-5-2005; IN COMMERCE 9-5-2005.

THE MARK CONSISTS OF STANDARD CHARACTERS WITHOUT CLAIM TO ANY PARTICULAR FONT, STYLE, SIZE, OR COLOR.

SER. NO. 85-639,877, FILED 5-31-2012.

SANDRA BUJA, EXAMINING ATTORNEY



*David J. Kyffers*

Director of the United States Patent and Trademark Office

# United States of America

United States Patent and Trademark Office

# WAM!

**Reg. No. 4,275,416**

**Registered Jan. 15, 2013**

**Int. Cl.: 35**

**SERVICE MARK**

**PRINCIPAL REGISTER**

WOMEN ACTION & THE MEDIA (MASSACHUSETTS CORPORATION), AKA WAM!  
7 TEMPLE STREET  
CAMBRIDGE, MA 02139

FOR: CHARITABLE SERVICES, NAMELY, ORGANIZING AND DEVELOPING WOMEN'S ECONOMIC DEVELOPMENT AND HEALTH PROJECTS IN SUPPORT OF NGO (NON-GOVERNMENTAL ORGANIZATION) PROGRAMS; CHARITABLE SERVICES, NAMELY, ORGANIZING WOMEN'S GROUPS TO UNDERTAKE PROJECTS WHICH BENEFIT THE HOMELESS, ABUSED, AT RISK WOMEN AND WOMEN IN TRANSITION AND IN PAIN, WHILE ENCOURAGING EMPOWERMENT AMONG WOMEN OF ALL AGES AND ETHNICITIES; PROVIDING A WEBSITE FEATURING INFORMATION ABOUT POLITICAL ISSUES; PROVIDING AN INTERNET WEBSITE FEATURING NEWS AND INFORMATION IN THE FIELD OF NATIONAL AND INTERNATIONAL POLITICS; PUBLIC ADVOCACY TO PROMOTE AWARENESS OF GENDER INEQUALITY IN THE MEDIA , IN CLASS 35 (U.S. CLS. 100, 101 AND 102).

FIRST USE 6-1-2004; IN COMMERCE 6-1-2004.

THE MARK CONSISTS OF STANDARD CHARACTERS WITHOUT CLAIM TO ANY PARTICULAR FONT, STYLE, SIZE, OR COLOR.

SER. NO. 85-639,878, FILED 5-31-2012.

ZHALEH DELANEY, EXAMINING ATTORNEY



*David J. Kyjars*

Director of the United States Patent and Trademark Office

# United States of America

United States Patent and Trademark Office

# ViewPoint

**Reg. No. 4,275,417**

**Registered Jan. 15, 2013**

**Int. Cl.: 42**

**SERVICE MARK**

**PRINCIPAL REGISTER**

INDECOMM CORPORATION (CAYMAN ISLANDS LIMITED LIABILITY COMPANY)  
C/O M&C CORPORATE SERVICES LIMITED  
PO BOX 309GT, UGLAND HOUSE, SOUTH CHURCH  
GEORGETOWN GRANDCAYMAN, CAYMAN ISLANDS

FOR: PROVIDING TEMPORARY USE OF NONDOWNLOADABLE COMPUTER SOFTWARE FOR DOCUMENT MANAGEMENT IN CONNECTION WITH REAL ESTATE TRANSACTIONS; PROVIDING TEMPORARY USE OF NONDOWNLOADABLE COMPUTER SOFTWARE FOR CHECKING STATUS OF AND MANAGING REAL ESTATE TRANSACTION RECORDALS; PROVIDING TEMPORARY USE OF NONDOWNLOADABLE COMPUTER SOFTWARE FOR COMMUNICATION AMONG AGENTS AND LENDERS IN CONNECTION WITH REAL ESTATE TRANSACTIONS, IN CLASS 42 (U.S. CLS. 100 AND 101).

FIRST USE 12-0-2009; IN COMMERCE 6-0-2011.

THE MARK CONSISTS OF THE COMPOUND WORD "VIEWPOINT" IN STYLIZED FONT WITH THE TERM "VIEW" IN THE COLOR RED AND THE TERM "POINT" IN THE COLOR BLUE.

THE COLOR(S) RED AND BLUE IS/ARE CLAIMED AS A FEATURE OF THE MARK.

SER. NO. 85-639,880, FILED 5-31-2012.

JENNY PARK, EXAMINING ATTORNEY



*David J. Kyffers*

Director of the United States Patent and Trademark Office

# United States of America

United States Patent and Trademark Office

# DATAWARE

**Reg. No. 4,275,418**

**Registered Jan. 15, 2013**

**Int. Cl.: 16**

**TRADEMARK**

**PRINCIPAL REGISTER**

ART STYLE PRINTING, INC. (TEXAS CORPORATION), DBA DATAWARE  
P.O. BOX 740947  
HOUSTON, TX 77274

FOR: PAPER GOODS USED TO SUPPORT A COMPUTER SYSTEMS INSTALLATION---  
NAMELY, COLOR CODED NUMERICAL FILING MARKERS, PUNCH CARDS, MULTI-  
PART CONTINUOUS FEED PAPER AND FORMS OF A TYPE USED PRIMARILY WITH  
COMPUTER INSTALLATION AND AUTOMATED WORD PROCESSING SYSTEMS; LABELS;  
BARCODE LABELS, IN CLASS 16 (U.S. CLS. 2, 5, 22, 23, 29, 37, 38 AND 50).

FIRST USE 10-1-1974; IN COMMERCE 10-1-1974.

THE MARK CONSISTS OF STANDARD CHARACTERS WITHOUT CLAIM TO ANY PAR-  
TICULAR FONT, STYLE, SIZE, OR COLOR.

SER. NO. 85-639,900, FILED 5-31-2012.

JENNIFER DIXON, EXAMINING ATTORNEY



*David J. Kyfos*

Director of the United States Patent and Trademark Office

# United States of America

United States Patent and Trademark Office

## BROADHAVEN

**Reg. No. 4,275,419**

**Registered Jan. 15, 2013**

**Int. Cl.: 36**

**SERVICE MARK**

**PRINCIPAL REGISTER**

BROADHAVEN CAPITAL PARTNERS, LLC (DELAWARE LIMITED LIABILITY COMPANY)  
SUITE 630  
5215 OLD ORCHARD ROAD  
SKOKIE, IL 60077

FOR: INVESTMENT BANKING SERVICES; FINANCIAL AND INVESTMENT SERVICES, NAMELY, ASSET AND INVESTMENT ACQUISITION, CONSULTATION, ADVISORY AND DEVELOPMENT; ADVICE RELATING TO INVESTMENTS; FINANCIAL CONSULTING AND ADVISING IN THE FIELD OF MERGERS AND ACQUISITIONS; PRIVATE PLACEMENTS OF SECURITIES AND DERIVATIVES FOR OTHERS, IN CLASS 36 (U.S. CLS. 100, 101 AND 102).

FIRST USE 10-1-2009; IN COMMERCE 10-1-2009.

THE MARK CONSISTS OF STANDARD CHARACTERS WITHOUT CLAIM TO ANY PARTICULAR FONT, STYLE, SIZE, OR COLOR.

SER. NO. 85-639,907, FILED 5-31-2012.

INGRID C. EULIN, EXAMINING ATTORNEY



*David J. Kyffers*

Director of the United States Patent and Trademark Office

# United States of America

United States Patent and Trademark Office



LEWIS GROSS, DDS  
**HOLISTIC DENTISTS**  
MERCURY & BPA FREE

**Reg. No. 4,275,420**

DR. LEWIS GROSS (UNITED STATES INDIVIDUAL)  
17 PARK PLACE  
NEW YORK, NY 10007

**Registered Jan. 15, 2013**

**Int. Cl.: 44**

FOR: HOLISTIC DENTISTRY SERVICES; PROVIDING A WEBSITE FEATURING INFORMATION ON HOLISTIC DENTISTRY, IN CLASS 44 (U.S. CLS. 100 AND 101).

**SERVICE MARK**

FIRST USE 4-1-2000; IN COMMERCE 4-1-2000.

**PRINCIPAL REGISTER**

NO CLAIM IS MADE TO THE EXCLUSIVE RIGHT TO USE "DDS HOLISTIC DENTISTS MERCURY & BPA FREE", APART FROM THE MARK AS SHOWN.

THE NAME "LEWIS GROSS" IDENTIFIES A LIVING INDIVIDUAL WHOSE CONSENT IS OF RECORD.

THE MARK CONSISTS OF THE STYLIZED WORDS "LEWIS GROSS, DDS" ABOVE THE STYLIZED WORDS "HOLISTIC DENTISTS" ABOVE THE STYLIZED WORDS "MERCURY & BPA FREE". THE WORDS "LEWIS GROSS, DDS" ARE JUSTIFIED RIGHT IN RELATION TO THE WORDS "HOLISTIC DENTISTS" AND THERE IS A SOLID HORIZONTAL LINE THAT PROCEEDS THE WORDS. TO THE LEFT OF THE DESCRIBED WORDS IS A DRAWING MADE OF A CIRCLE, THE LEFT HALF OF WHICH IS SOLID, THE RIGHT HALF HAS A HORIZONTAL LINE PATTERN. INSIDE THE DESCRIBED CIRCLE IS A TOOTH BEHIND THREE ABSTRACT HUMAN FIGURES.



SER. NO. 85-639,914, FILED 5-31-2012.

BARNEY CHARLON, EXAMINING ATTORNEY

*David J. Kyros*

Director of the United States Patent and Trademark Office

# United States of America

United States Patent and Trademark Office

# SHE BEE

**Reg. No. 4,275,421**

SHEBEE LLC (NEW YORK LIMITED LIABILITY COMPANY)  
302 W. 106TH STREET  
NEW YORK, NY 10025

**Registered Jan. 15, 2013**

**Int. Cl.: 14**

FOR: FINE AND COSTUME JEWELRY, IN CLASS 14 (U.S. CLS. 2, 27, 28 AND 50).

**TRADEMARK**

FIRST USE 3-1-2011; IN COMMERCE 4-1-2011.

**PRINCIPAL REGISTER**

THE MARK CONSISTS OF STANDARD CHARACTERS WITHOUT CLAIM TO ANY PARTICULAR FONT, STYLE, SIZE, OR COLOR.

SER. NO. 85-639,941, FILED 5-31-2012.

FRED CARL, EXAMINING ATTORNEY



*David J. Kyffers*

Director of the United States Patent and Trademark Office



# United States of America

United States Patent and Trademark Office

# AL-u-Fresh

**Reg. No. 4,275,422**

ALLIED CONVERTERS, INC. (NEW YORK CORPORATION)  
64 DRAKE AVENUE  
NEW ROCHELLE, NY 10802

**Registered Jan. 15, 2013**

**Int. Cl.: 17**

FOR: PLASTIC FILM FOR COMMERCIAL AND INDUSTRIAL USE, IN CLASS 17 (U.S. CLS. 1, 5, 12, 13, 35 AND 50).

**TRADEMARK**

FIRST USE 5-7-2012; IN COMMERCE 5-7-2012.

**PRINCIPAL REGISTER**

THE MARK CONSISTS OF STANDARD CHARACTERS WITHOUT CLAIM TO ANY PARTICULAR FONT, STYLE, SIZE, OR COLOR.

SER. NO. 85-639,959, FILED 5-31-2012.

HOWARD SMIGA, EXAMINING ATTORNEY



*David J. Kyffers*

Director of the United States Patent and Trademark Office

# United States of America

United States Patent and Trademark Office

## UNDUTCHABLES

**Reg. No. 4,275,423**

**Registered Jan. 15, 2013**

**Int. Cl.: 16**

**TRADEMARK**

**PRINCIPAL REGISTER**

WHITE-BOUCKE, PUBLISHING, INC. (COLORADO CORPORATION)  
1205 HAWK RIDGE ROAD  
LAFAYETTE, CO 80026

FOR: CALENDARS, IN CLASS 16 (U.S. CLS. 2, 5, 22, 23, 29, 37, 38 AND 50).

FIRST USE 12-1-1989; IN COMMERCE 12-1-1989.

THE MARK CONSISTS OF STANDARD CHARACTERS WITHOUT CLAIM TO ANY PARTICULAR FONT, STYLE, SIZE, OR COLOR.

SER. NO. 85-639,962, FILED 5-31-2012.

AMY C. KEAN, EXAMINING ATTORNEY



*David J. Kybas*

Director of the United States Patent and Trademark Office

# United States of America

United States Patent and Trademark Office

## project filter

**Reg. No. 4,275,424**

**Registered Jan. 15, 2013**

**Int. Cl.: 35**

**SERVICE MARK**

**PRINCIPAL REGISTER**

IDAHO DEPARTMENT OF HEALTH AND WELFARE (IDAHO STATE AGENCY)  
6TH FLOOR, HEALTH EDUCATION  
450 WEST STATE STREET  
BOISE, ID 83720

FOR: ASSOCIATION SERVICES, NAMELY, PROMOTING PUBLIC AWARENESS OF  
QUITTING TOBACCO, IN CLASS 35 (U.S. CLS. 100, 101 AND 102).

FIRST USE 1-1-2006; IN COMMERCE 1-1-2006.

THE MARK CONSISTS OF STANDARD CHARACTERS WITHOUT CLAIM TO ANY PAR-  
TICULAR FONT, STYLE, SIZE, OR COLOR.

SER. NO. 85-639,973, FILED 5-31-2012.

AMY C. KEAN, EXAMINING ATTORNEY



*David J. Kappas*

Director of the United States Patent and Trademark Office

# United States of America

United States Patent and Trademark Office

## Appropriate Response

**Reg. No. 4,275,425**

**Registered Jan. 15, 2013**

**Int. Cl.: 41**

**SERVICE MARK**

**PRINCIPAL REGISTER**

PAMELA WEISS (UNITED STATES INDIVIDUAL), DBA APPROPRIATE RESPONSE  
#5  
738 6TH AVENUE  
SAN FRANCISCO, CA 94118

FOR: LIFE COACHING SERVICES IN THE FIELD OF MEDITATION PRACTICE, CULTIVATION OF MINDFULNESS, COMMUNICATION SKILLS, SELF-AWARENESS, GAINING ACCESS TO PERSONAL STRENGTHS, BUILDING SATISFYING RELATIONSHIPS, DEVELOPING THE CAPACITY TO MAKE CLEAR DECISIONS, SPEAK POWERFULLY, AND TAKE APPROPRIATE ACTION; PROVIDING A WEBSITE FEATURING NON-DOWNLOADABLE PUBLICATIONS IN THE NATURE OF ARTICLES AND COMMENTARY IN THE FIELD OF MEDITATION PRACTICE, CULTIVATION OF MINDFULNESS, COMMUNICATION SKILLS, SELF-AWARENESS, GAINING ACCESS TO PERSONAL STRENGTHS, BUILDING SATISFYING RELATIONSHIPS, DEVELOPING THE CAPACITY TO MAKE CLEAR DECISIONS, SPEAK POWERFULLY, AND TAKE APPROPRIATE ACTION, IN CLASS 41 (U.S. CLS. 100, 101 AND 107).

FIRST USE 1-1-2008; IN COMMERCE 1-1-2008.

THE MARK CONSISTS OF STANDARD CHARACTERS WITHOUT CLAIM TO ANY PARTICULAR FONT, STYLE, SIZE, OR COLOR.

SER. NO. 85-640,020, FILED 5-31-2012.

TIMOTHY O. SCHIMPF, EXAMINING ATTORNEY



*David J. Kyffers*

Director of the United States Patent and Trademark Office

# United States of America

United States Patent and Trademark Office

# wpexplorer

**Reg. No. 4,275,426**

**Registered Jan. 15, 2013**

**Int. Cls.: 35 and 42**

**SERVICE MARK**

**PRINCIPAL REGISTER**

CLARKE, ALEXANDER (UNITED STATES INDIVIDUAL)  
APT. #3534  
9205 QUESTOR PLACE  
SAN DIEGO, CA 92108

FOR: ADVERTISING SERVICES; ON-LINE ADVERTISING SERVICES FOR OTHERS, IN CLASS 35 (U.S. CLS. 100, 101 AND 102).

FIRST USE 10-18-2009; IN COMMERCE 10-18-2009.

FOR: WEBSITE DEVELOPMENT FOR OTHERS, IN CLASS 42 (U.S. CLS. 100 AND 101).

FIRST USE 10-18-2009; IN COMMERCE 10-18-2009.

THE MARK CONSISTS OF STANDARD CHARACTERS WITHOUT CLAIM TO ANY PARTICULAR FONT, STYLE, SIZE, OR COLOR.

SER. NO. 85-640,034, FILED 5-31-2012.

ALAIN LAPTER, EXAMINING ATTORNEY



*David J. Kyros*

Director of the United States Patent and Trademark Office

# United States of America

United States Patent and Trademark Office



**Reg. No. 4,275,427**

**Registered Jan. 15, 2013**

**Int. Cl.: 21**

**TRADEMARK**

**PRINCIPAL REGISTER**

FARRIS, BARRY (UNITED STATES INDIVIDUAL)  
PO BOX 4  
POLLOCK PINES, CA 95726

FOR: PET DRINKING BOWLS, IN CLASS 21 (U.S. CLS. 2, 13, 23, 29, 30, 33, 40 AND 50).

FIRST USE 1-15-2010; IN COMMERCE 5-2-2012.

THE MARK CONSISTS OF AN ANIMAL PAW PRINT WITH WATER WAVES BELOW IT.

SER. NO. 85-640,035, FILED 5-31-2012.

ALAIN LAPTER, EXAMINING ATTORNEY



*David J. Kyffers*

Director of the United States Patent and Trademark Office

# United States of America

United States Patent and Trademark Office

# diadeloso

**Reg. No. 4,275,428**

**Registered Jan. 15, 2013**

**Int. Cls.: 25 and 41**

**TRADEMARK**

**SERVICE MARK**

**PRINCIPAL REGISTER**

PGK CONSULTING (TEXAS LIMITED LIABILITY COMPANY)  
1218 SPEIGHT AVE  
WACO, TX 76706

FOR: BUTTON DOWN SHIRTS; POLO SHIRTS; T-SHIRTS; TANK TOPS, IN CLASS 25 (U.S. CLS. 22 AND 39).

FIRST USE 2-1-1966; IN COMMERCE 4-1-1966.

FOR: ORGANIZING COMMUNITY FESTIVALS FEATURING A VARIETY OF ACTIVITIES, NAMELY, SPORTING EVENTS, ART EXHIBITIONS, FLEA MARKETS, ETHNIC DANCES AND THE LIKE, IN CLASS 41 (U.S. CLS. 100, 101 AND 107).

FIRST USE 2-1-1966; IN COMMERCE 4-1-1966.

THE MARK CONSISTS OF STANDARD CHARACTERS WITHOUT CLAIM TO ANY PARTICULAR FONT, STYLE, SIZE, OR COLOR.

THE ENGLISH TRANSLATION OF "DIA DEL OSO" IS "DAY OF THE BEAR."

SER. NO. 85-640,036, FILED 5-31-2012.

IRA J. GOODSaid, EXAMINING ATTORNEY



*David J. Kyros*

Director of the United States Patent and Trademark Office

# United States of America

United States Patent and Trademark Office



**Reg. No. 4,275,429**

**Registered Jan. 15, 2013**

**Int. Cl.: 37**

**SERVICE MARK**

**PRINCIPAL REGISTER**

AUTO MD SERVICES, INC (FLORIDA CORPORATION)  
PO BOX 318  
JENSEN BEACH, FL 34958

FOR: AUTOMOBILE DETAILING, IN CLASS 37 (U.S. CLS. 100, 103 AND 106).

FIRST USE 1-1-2008; IN COMMERCE 1-1-2008.

NO CLAIM IS MADE TO THE EXCLUSIVE RIGHT TO USE "MOBILE DETAILING" AND "EST. 1998", APART FROM THE MARK AS SHOWN.

THE COLOR(S) RED, BLACK AND SILVER/GRAY IS/ARE CLAIMED AS A FEATURE OF THE MARK.

THE MARK CONSISTS OF SILVER/GRAY OUTLINE OF AN OVAL WITH A SHINY STAR BURST IN THE UPPER RIGHT SIDE AND THE LOWER LEFT SIDE. THE UPPER PART OF THE INSIDE OF THE OVAL IS FILLED IN WITH BLACK AND CONTAINS THE TEXT "CARBUFFS" IN SILVER/GRAY. THE LOWER PART OF THE OVAL IS FILLED IN WITH RED AND CONTAINS THE TEXT "MOBILE DETAILING EST. 1998" IN SILVER/GRAY.

SER. NO. 85-640,041, FILED 5-31-2012.

LUCY ARANT, EXAMINING ATTORNEY



*David J. Kybas*

Director of the United States Patent and Trademark Office



# United States of America

United States Patent and Trademark Office

## Crystal Dreams

**Reg. No. 4,275,430**

**Registered Jan. 15, 2013**

**Int. Cl.: 41**

**SERVICE MARK**

**PRINCIPAL REGISTER**

FAMOUS LLC (ARIZONA LIMITED LIABILITY COMPANY)  
STE. 219  
414 S. MILL AVE  
TEMPE, AZ 85281

FOR: ENTERTAINMENT IN THE NATURE OF A TOURING MUSIC FESTIVAL FEATURING LIVE MUSICAL AND DANCE PERFORMANCES, IN CLASS 41 (U.S. CLS. 100, 101 AND 107).

FIRST USE 4-26-1997; IN COMMERCE 4-26-1997.

THE MARK CONSISTS OF STANDARD CHARACTERS WITHOUT CLAIM TO ANY PARTICULAR FONT, STYLE, SIZE, OR COLOR.

SER. NO. 85-640,052, FILED 5-31-2012.

JENNIFER MARTIN, EXAMINING ATTORNEY



*David J. Kybas*

Director of the United States Patent and Trademark Office

# United States of America

United States Patent and Trademark Office

## DUO DAMN UR OPINION

**Reg. No. 4,275,431**

LEA CUTHBERTSON (UNITED STATES INDIVIDUAL)  
3655 GRANDVIEW DRIVE  
MORGANTON, NC 28655 AND

**Registered Jan. 15, 2013**

**Int. Cl.: 41**

JODY CUTHBERTSON (UNITED STATES INDIVIDUAL)  
3655 GRANDVIEW DRIVE  
MORGANTON, NC 28655

**SERVICE MARK**

**PRINCIPAL REGISTER**

FOR: ENTERTAINMENT SERVICES IN THE NATURE OF LIVE MUSICAL PERFORMANCES;  
PROVIDING A WEBSITE FOR ENTERTAINMENT PURPOSES FEATURING STREAMING  
MUSIC, STREAMING VIDEO, ARTICLES, PHOTOS, PERFORMANCE DATES AND BLOGS  
ABOUT THE MUSICAL BAND DUO, IN CLASS 41 (U.S. CLS. 100, 101 AND 107).

FIRST USE 1-1-2000; IN COMMERCE 1-1-2000.

THE MARK CONSISTS OF STANDARD CHARACTERS WITHOUT CLAIM TO ANY PAR-  
TICULAR FONT, STYLE, SIZE, OR COLOR.

SER. NO. 85-640,055, FILED 5-31-2012.

JENNIFER MARTIN, EXAMINING ATTORNEY



*David J. Kybas*

Director of the United States Patent and Trademark Office

# United States of America

United States Patent and Trademark Office

# El's Bells

**Reg. No. 4,275,432**

**Registered Jan. 15, 2013**

**Int. Cl.: 31**

**TRADEMARK**

**PRINCIPAL REGISTER**

S. STAMOULES, INC. (CALIFORNIA CORPORATION)  
904 SOUTH LYON AVENUE  
MENDOTA, CA 93640

FOR: FRESH FRUIT AND VEGETABLES, IN CLASS 31 (U.S. CLS. 1 AND 46).

FIRST USE 7-1-2008; IN COMMERCE 7-1-2008.

THE MARK CONSISTS OF STANDARD CHARACTERS WITHOUT CLAIM TO ANY PARTICULAR FONT, STYLE, SIZE, OR COLOR.

SER. NO. 85-640,074, FILED 5-31-2012.

MATTHEW EINSTEIN, EXAMINING ATTORNEY



*David J. Kybas*

Director of the United States Patent and Trademark Office

# United States of America

United States Patent and Trademark Office

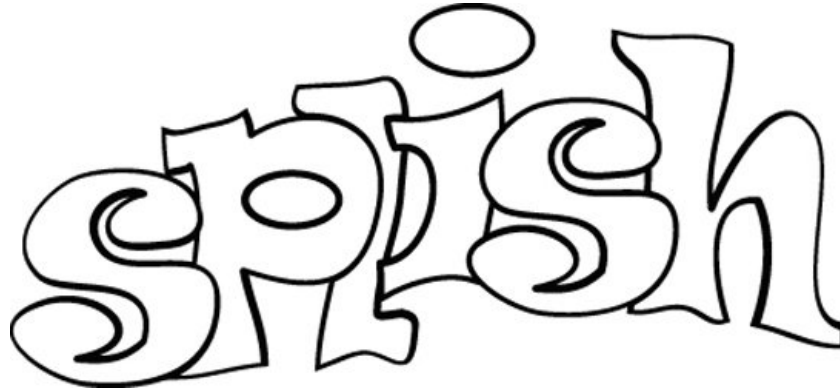

**Reg. No. 4,275,433**

**Registered Jan. 15, 2013**

**Int. Cl.: 25**

**TRADEMARK**

**PRINCIPAL REGISTER**

SPLISH, INC. (CALIFORNIA CORPORATION)  
2055 HOEFNER AVENUE  
COMMERCE, CA 90040

FOR: SWIMWEAR, IN CLASS 25 (U.S. CLS. 22 AND 39).

FIRST USE 9-1-2002; IN COMMERCE 9-1-2002.

OWNER OF U.S. REG. NO. 3,524,715.

THE MARK CONSISTS OF THE WORD "SPLISH" IN STYLIZED FORM.

SER. NO. 85-640,076, FILED 5-31-2012.

FRANK LATTUCA, EXAMINING ATTORNEY



*David J. Kyffers*

Director of the United States Patent and Trademark Office

# United States of America

United States Patent and Trademark Office

# pornclerk

**Reg. No. 4,275,434**

LEVINE, KRISTINE (UNITED STATES INDIVIDUAL)  
5531 SW PASADENA DR  
PORTLAND, OR 97219

**Registered Jan. 15, 2013**

**Int. Cl.: 41**

FOR: ON-LINE JOURNALS, NAMELY, BLOGS FEATURING SOCIAL COMMENTARY AND ENTERTAINMENT, IN CLASS 41 (U.S. CLS. 100, 101 AND 107).

**SERVICE MARK**

FIRST USE 9-1-2000; IN COMMERCE 5-1-2005.

**PRINCIPAL REGISTER**

THE MARK CONSISTS OF STANDARD CHARACTERS WITHOUT CLAIM TO ANY PARTICULAR FONT, STYLE, SIZE, OR COLOR.

SER. NO. 85-640,127, FILED 5-31-2012.

MICHELE SWAIN, EXAMINING ATTORNEY



*David J. Kybas*

Director of the United States Patent and Trademark Office

# United States of America

United States Patent and Trademark Office

## SCOTT TUCKER

**Reg. No. 4,275,435**

**Registered Jan. 15, 2013**

**Int. Cl.: 41**

**SERVICE MARK**

**PRINCIPAL REGISTER**

LEVEL 5 MOTORSPORTS, LLC (NEVADA LIMITED LIABILITY COMPANY)  
871 CORONADO CENTER DRIVE  
HENDERSON, NV 89052

FOR: ENTERTAINMENT SERVICES IN THE NATURE OF PARTICIPATING IN PROFESSIONAL AUTOMOBILE RACES AND RELATED EXHIBITIONS, IN CLASS 41 (U.S. CLS. 100, 101 AND 107).

FIRST USE 8-9-2011; IN COMMERCE 8-9-2011.

THE MARK CONSISTS OF STANDARD CHARACTERS WITHOUT CLAIM TO ANY PARTICULAR FONT, STYLE, SIZE, OR COLOR.

THE NAME(S), PORTRAIT(S), AND/OR SIGNATURE(S) SHOWN IN THE MARK IDENTIFIES "SCOTT TUCKER", WHOSE CONSENT(S) TO REGISTER IS MADE OF RECORD.

SER. NO. 85-640,153, FILED 5-31-2012.

HOWARD B. LEVINE, EXAMINING ATTORNEY



*David J. Kyffers*

Director of the United States Patent and Trademark Office

# United States of America

United States Patent and Trademark Office

# FETCH

**Reg. No. 4,275,436**

**Registered Jan. 15, 2013**

**Int. Cl.: 39**

**SERVICE MARK**

**PRINCIPAL REGISTER**

FETCH STORAGE, LLC (MASSACHUSETTS LIMITED LIABILITY COMPANY)  
UNIT #1F  
86 LOS ANGELES ST.  
NEWTON, MA 024581019

FOR: MOVING AND STORAGE OF GOODS, IN CLASS 39 (U.S. CLS. 100 AND 105).

FIRST USE 12-31-2006; IN COMMERCE 12-31-2006.

THE MARK CONSISTS OF STANDARD CHARACTERS WITHOUT CLAIM TO ANY PARTICULAR FONT, STYLE, SIZE, OR COLOR.

SER. NO. 85-640,161, FILED 5-31-2012.

LUCY ARANT, EXAMINING ATTORNEY



*David J. Kybas*

Director of the United States Patent and Trademark Office

# United States of America

United States Patent and Trademark Office

# LAVENOUS

**Reg. No. 4,275,437**

**Registered Jan. 15, 2013**

**Int. Cls.: 25 and 41**

**TRADEMARK**

**SERVICE MARK**

**PRINCIPAL REGISTER**

SUPERNOVICH, MICHAEL (UNITED STATES INDIVIDUAL)  
127 VISTA DRIVE  
CANONSBURG, PA 15317

FOR: HATS; T-SHIRTS, IN CLASS 25 (U.S. CLS. 22 AND 39).

FIRST USE 1-1-2000; IN COMMERCE 1-1-2000.

FOR: ENTERTAINMENT IN THE NATURE OF LIVE PERFORMANCES BY MAGICIAN, COMEDIAN, MUSICIAN, AND INSPIRATIONAL SPEAKER, IN CLASS 41 (U.S. CLS. 100, 101 AND 107).

FIRST USE 1-1-2000; IN COMMERCE 1-1-2000.

THE MARK CONSISTS OF STANDARD CHARACTERS WITHOUT CLAIM TO ANY PARTICULAR FONT, STYLE, SIZE, OR COLOR.

SER. NO. 85-640,197, FILED 5-31-2012.

WILLIAM BRECKENFELD, EXAMINING ATTORNEY



*David J. Kyfos*

Director of the United States Patent and Trademark Office



# United States of America

United States Patent and Trademark Office



**Reg. No. 4,275,438**

JOHN BRIAN LOSH, INC. (WASHINGTON CORPORATION)  
2110 WESTERN AVENUE  
SEATTLE, WA 98121

**Registered Jan. 15, 2013**

**Int. Cls.: 16, 35 and 36**

FOR: PUBLICATIONS, NAMELY, DIRECTORIES AND MAGAZINES ABOUT THE REAL ESTATE INDUSTRY, IN CLASS 16 (U.S. CLS. 2, 5, 22, 23, 29, 37, 38 AND 50).

**TRADEMARK**

FIRST USE 12-1-2011; IN COMMERCE 12-1-2011.

**SERVICE MARK**

FOR: ADVERTISING AND MARKETING SERVICES FOR REAL ESTATE AGENTS AND BROKERS, NAMELY, PROVIDING INTERNET, WEB BASED, SOCIAL MEDIA, PRINT, EMAIL, AND MOBILE MARKETING AND ADVERTISING SERVICES FOR REAL ESTATE AGENTS AND BROKERS; REFERRALS IN THE FIELD OF REAL ESTATE, IN CLASS 35 (U.S. CLS. 100, 101 AND 102).

**PRINCIPAL REGISTER**

FIRST USE 12-1-2011; IN COMMERCE 12-1-2011.

FOR: REAL ESTATE SERVICES, NAMELY, PROVIDING INFORMATION ON THE SUBJECT OF REAL ESTATE, REAL ESTATE BROKERS AND AGENTS, AND REAL ESTATE LISTINGS, IN CLASS 36 (U.S. CLS. 100, 101 AND 102).

FIRST USE 12-1-2011; IN COMMERCE 12-1-2011.

THE MARK CONSISTS OF A STYLIZED REPRESENTATION OF A LION-HEAD DOORKNOCKER.

SER. NO. 85-640,198, FILED 5-31-2012.

JANET LEE, EXAMINING ATTORNEY



*David J. Kybas*

Director of the United States Patent and Trademark Office

# United States of America

United States Patent and Trademark Office

## MAGNETAPICKS

**Reg. No. 4,275,439**

**Registered Jan. 15, 2013**

**Int. Cl.: 15**

**TRADEMARK**

**PRINCIPAL REGISTER**

MAGNETA ENTERPRISES LLC (FLORIDA LIMITED LIABILITY COMPANY)  
4401 NW 167TH STREET  
MIAMI, FL 33014

FOR: GUITAR PICKS, IN CLASS 15 (U.S. CLS. 2, 21 AND 36).

FIRST USE 2-5-2009; IN COMMERCE 10-29-2010.

THE MARK CONSISTS OF STANDARD CHARACTERS WITHOUT CLAIM TO ANY PARTICULAR FONT, STYLE, SIZE, OR COLOR.

SER. NO. 85-640,246, FILED 5-31-2012.

DAVID TAYLOR, EXAMINING ATTORNEY



*David J. Kyffers*

Director of the United States Patent and Trademark Office

# United States of America

United States Patent and Trademark Office

# Mr.



**Reg. No. 4,275,440**

**Registered Jan. 15, 2013**

**Int. Cl.: 25**

**TRADEMARK**

**PRINCIPAL REGISTER**

GARRETT GERSON (UNITED STATES INDIVIDUAL)  
327 S. LATIGO CANYON RD  
MALIBU, CA 90265

FOR: HATS; MEN'S UNDERWEAR; PANTS; SHIRTS; SHORTS; SOCKS; TANK TOPS; UNDERWEAR, IN CLASS 25 (U.S. CLS. 22 AND 39).

FIRST USE 2-1-2012; IN COMMERCE 5-1-2012.

THE MARK CONSISTS OF THE WORD "MR." WITH A STYLIZED MUSTACHE UNDER IT. THERE ARE BROKEN LINES IN THE INSIDE PART OF THE MUSTACHE CREATING AN OUTLINE. THE WORDS "BY GERSON" ARE ON THE BOTTOM RIGHT UNDER THE MUSTACHE.

SER. NO. 85-640,251, FILED 5-31-2012.

DAVID TAYLOR, EXAMINING ATTORNEY



*David J. Kyffers*

Director of the United States Patent and Trademark Office

# United States of America

United States Patent and Trademark Office

# MOBIPLEX

**Reg. No. 4,275,441**

**Registered Jan. 15, 2013**

**Int. Cls.: 9 and 42**

**TRADEMARK**

**SERVICE MARK**

**PRINCIPAL REGISTER**

MOBIPLEX, INC. (DELAWARE CORPORATION), DBA MOBIPLEX  
5441 CASTLE MANOR DRIVE  
SAN JOSE, CA 95129

FOR: ELECTRONIC SENSORS FOR TRACKING, RECORDING, MONITORING, AND ANALYZING MOVEMENT AND ENVIRONMENTAL CONDITIONS TO IMPROVE ATHLETIC PERFORMANCE; DOWNLOADABLE COMPUTER SOFTWARE FOR TRACKING, RECORDING, MONITORING, AND ANALYZING MOVEMENT AND ENVIRONMENTAL CONDITIONS TO IMPROVE ATHLETIC PERFORMANCE, IN CLASS 9 (U.S. CLS. 21, 23, 26, 36 AND 38).

FIRST USE 5-27-2010; IN COMMERCE 10-2-2010.

FOR: PROVIDING TEMPORARY USE OF ONLINE NON-DOWNLOADABLE COMPUTER SOFTWARE FOR TRACKING, RECORDING, MONITORING, AND ANALYZING MOVEMENT AND ENVIRONMENTAL CONDITIONS TO IMPROVE ATHLETIC PERFORMANCE, IN CLASS 42 (U.S. CLS. 100 AND 101).

FIRST USE 5-27-2010; IN COMMERCE 10-2-2010.

THE MARK CONSISTS OF STANDARD CHARACTERS WITHOUT CLAIM TO ANY PARTICULAR FONT, STYLE, SIZE, OR COLOR.

SER. NO. 85-640,253, FILED 5-31-2012.

COURTNEY ALVAREZ, EXAMINING ATTORNEY



*David J. Kyjars*

Director of the United States Patent and Trademark Office

# United States of America

United States Patent and Trademark Office

## Urban Dictionary

**Reg. No. 4,275,442**

**Registered Jan. 15, 2013**

**Int. Cl.: 16**

**TRADEMARK**

**PRINCIPAL REGISTER**

URBAN DICTIONARY, LLC (DELAWARE LIMITED LIABILITY COMPANY)  
548 MARKET ST. # 82617  
SAN FRANCISCO, CA 94104

FOR: SERIES OF BOOKS IN THE NATURE OF A CONTEMPORARY ENGLISH LANGUAGE LEXICON OF SLANG TERMS AND THEIR MEANINGS; CALENDARS, IN CLASS 16 (U.S. CLS. 2, 5, 22, 23, 29, 37, 38 AND 50).

FIRST USE 12-15-1999; IN COMMERCE 10-1-2005.

THE MARK CONSISTS OF STANDARD CHARACTERS WITHOUT CLAIM TO ANY PARTICULAR FONT, STYLE, SIZE, OR COLOR.

OWNER OF U.S. REG. NO. 2,980,155.

NO CLAIM IS MADE TO THE EXCLUSIVE RIGHT TO USE "DICTIONARY", APART FROM THE MARK AS SHOWN.

SEC. 2(F).

SER. NO. 85-640,297, FILED 5-31-2012.

COLLEEN DOMBROW, EXAMINING ATTORNEY



*David J. Kybas*

Director of the United States Patent and Trademark Office

# United States of America

United States Patent and Trademark Office

# PLATINO

**Reg. No. 4,275,443**

EVE HAIR, INC. (CALIFORNIA CORPORATION)  
3935 PARAMOUNT BLVD  
LAKEWOOD, CA 90712

**Registered Jan. 15, 2013**

**Int. Cl.: 26**

FOR: CLOWN WIGS; HAIR PIECES AND WIGS; TAPE FOR FIXING WIGS; WIG CAPS; WIGS; WIGS, HAIRPIECES, AND ADD-IN AND ADD-ON HAIR ACCESSORIES CONSTRUCTED PRIMARILY OF SYNTHETIC AND/OR HUMAN HAIR, IN CLASS 26 (U.S. CLS. 37, 39, 40, 42 AND 50).

**TRADEMARK**

**PRINCIPAL REGISTER**

FIRST USE 4-1-2012; IN COMMERCE 5-1-2012.

THE MARK CONSISTS OF STANDARD CHARACTERS WITHOUT CLAIM TO ANY PARTICULAR FONT, STYLE, SIZE, OR COLOR.

SER. NO. 85-640,326, FILED 5-31-2012.

MARK T. MULLEN, EXAMINING ATTORNEY



*David J. Kyffers*

Director of the United States Patent and Trademark Office

# United States of America

United States Patent and Trademark Office

# LIFECODE

**Reg. No. 4,275,444**

**Registered Jan. 15, 2013**

**Int. Cl.: 42**

**SERVICE MARK**

**PRINCIPAL REGISTER**

A-LIFE MEDICAL, INC. (CALIFORNIA CORPORATION)  
6195 LUSK BOULEVARD, SUITE 120  
SAN DIEGO, CA 92121

FOR: SOFTWARE AS A SERVICE (SAAS) SERVICES, NAMELY COMPUTER SOFTWARE FOR USE IN TRANSCRIBING MEDICAL TERMINOLOGY INTO CODES WHICH ARE USED FOR INSURANCE AND BILLING TRANSACTIONS, COST ACCOUNTING, AND RESOURCE UTILIZATION ASSESSMENTS, AND AUDITING, AND QUALITY ASSURANCE ASSESSMENTS; PROVIDING TEMPORARY USE OF ONLINE NON-DOWNLOADABLE SOFTWARE FOR USE IN TRANSCRIBING MEDICAL TERMINOLOGY INTO CODES WHICH ARE USED FOR INSURANCE AND BILLING TRANSACTIONS, COST ACCOUNTING, AND RESOURCE UTILIZATION ASSESSMENTS, AND AUDITING, AND QUALITY ASSURANCE ASSESSMENTS, IN CLASS 42 (U.S. CLS. 100 AND 101).

FIRST USE 10-14-1998; IN COMMERCE 10-14-1998.

THE MARK CONSISTS OF STANDARD CHARACTERS WITHOUT CLAIM TO ANY PARTICULAR FONT, STYLE, SIZE, OR COLOR.

OWNER OF U.S. REG. NO. 2,399,582.

SER. NO. 85-640,327, FILED 5-31-2012.

MARIA-VICTORIA SUAREZ, EXAMINING ATTORNEY



*David J. Kybas*

Director of the United States Patent and Trademark Office

# United States of America

United States Patent and Trademark Office

# POP-pourri

**Reg. No. 4,275,445**

**Registered Jan. 15, 2013**

**Int. Cl.: 30**

**TRADEMARK**

**PRINCIPAL REGISTER**

STEFONAY B SINCLAIRE (WASHINGTON SOLE PROPRIETORSHIP), DBA ALIVE  
PRODUCTS MARKETING  
1331 165TH AVE S.E.  
BELLEVUE, WA 98008

FOR: FLAVOR-COATED POPPED POPCORN, IN CLASS 30 (U.S. CL. 46).

FIRST USE 12-15-2010; IN COMMERCE 12-20-2010.

THE MARK CONSISTS OF STANDARD CHARACTERS WITHOUT CLAIM TO ANY PARTICULAR FONT, STYLE, SIZE, OR COLOR.

SER. NO. 85-640,329, FILED 5-31-2012.

MARIA-VICTORIA SUAREZ, EXAMINING ATTORNEY



*David J. Kybas*

Director of the United States Patent and Trademark Office



# United States of America

United States Patent and Trademark Office

# SCARLET

**Reg. No. 4,275,446**

EVE HAIR, INC. (CALIFORNIA CORPORATION)  
3935 PARAMOUNT BLVD.  
LAKEWOOD, CA 90712

**Registered Jan. 15, 2013**

**Int. Cl.: 26**

FOR: CLOWN WIGS; HAIR PIECES AND WIGS; TAPE FOR FIXING WIGS; WIG CAPS; WIGS; WIGS, HAIRPIECES, AND ADD-IN AND ADD-ON HAIR ACCESSORIES CONSTRUCTED PRIMARILY OF SYNTHETIC AND/OR HUMAN HAIR, IN CLASS 26 (U.S. CLS. 37, 39, 40, 42 AND 50).

**TRADEMARK**

**PRINCIPAL REGISTER**

FIRST USE 4-1-2012; IN COMMERCE 5-1-2012.

THE MARK CONSISTS OF STANDARD CHARACTERS WITHOUT CLAIM TO ANY PARTICULAR FONT, STYLE, SIZE, OR COLOR.

SER. NO. 85-640,340, FILED 5-31-2012.

MARK T. MULLEN, EXAMINING ATTORNEY



*David J. Kyffers*

Director of the United States Patent and Trademark Office

# United States of America

United States Patent and Trademark Office

## AS TIME GROWS OLD, THE QUR'AN GROWS YOUNG; ITS SIGNS BECOME APPARENT

**Reg. No. 4,275,447**

OSMAN BIRGEOGLU (UNITED STATES INDIVIDUAL)  
1844 E. DONNER DRIVE  
PHOENIX, AZ 85042

**Registered Jan. 15, 2013**

**Int. Cl.: 16**

FOR: PRINTED MATTER, NAMELY, BOOKS AND MAGAZINES IN THE FIELD OF FAITH AND RELIGION, IN CLASS 16 (U.S. CLS. 2, 5, 22, 23, 29, 37, 38 AND 50).

**TRADEMARK**

FIRST USE 3-22-2012; IN COMMERCE 3-30-2012.

**PRINCIPAL REGISTER**

THE MARK CONSISTS OF STANDARD CHARACTERS WITHOUT CLAIM TO ANY PARTICULAR FONT, STYLE, SIZE, OR COLOR.

SER. NO. 85-640,342, FILED 5-31-2012.

KYLE PEETE, EXAMINING ATTORNEY



*David J. Kybas*

Director of the United States Patent and Trademark Office

# United States of America

United States Patent and Trademark Office

## Your Stuff Shared. Every Time.

**Reg. No. 4,275,448**

THE HOTH CORP (ILLINOIS CORPORATION)  
7307 GREENBRIDGE LANE  
LONG GROVE, IL 60060

**Registered Jan. 15, 2013**

**Int. Cl.: 42**

FOR: PROVIDING TEMPORARY USE OF A WEB-BASED SOFTWARE APPLICATION FOR USE IN SOCIAL SHARING, IN CLASS 42 (U.S. CLS. 100 AND 101).

**SERVICE MARK**

FIRST USE 3-1-2012; IN COMMERCE 3-1-2012.

**PRINCIPAL REGISTER**

THE MARK CONSISTS OF STANDARD CHARACTERS WITHOUT CLAIM TO ANY PARTICULAR FONT, STYLE, SIZE, OR COLOR.

SER. NO. 85-640,353, FILED 5-31-2012.

REGINA DRUMMOND, EXAMINING ATTORNEY



*David J. Kyffers*

Director of the United States Patent and Trademark Office

# United States of America

United States Patent and Trademark Office

# Siljewel

**Reg. No. 4,275,449**

**Registered Jan. 15, 2013**

**Int. Cl.: 14**

**TRADEMARK**

**PRINCIPAL REGISTER**

BOWERS, LAURA (UNITED STATES INDIVIDUAL)

P  
812 LONG DRIVE  
ABERDEEN, MD 21001

FOR: JEWELRY, IN CLASS 14 (U.S. CLS. 2, 27, 28 AND 50).

FIRST USE 6-0-2009; IN COMMERCE 6-0-2009.

THE MARK CONSISTS OF STANDARD CHARACTERS WITHOUT CLAIM TO ANY PARTICULAR FONT, STYLE, SIZE, OR COLOR.

SER. NO. 85-640,361, FILED 5-31-2012.

REGINA DRUMMOND, EXAMINING ATTORNEY



*David J. Kybas*

Director of the United States Patent and Trademark Office

# United States of America

United States Patent and Trademark Office

# SeaVea

**Reg. No. 4,275,450**

**Registered Jan. 15, 2013**

**Int. Cl.: 42**

**SERVICE MARK**

**PRINCIPAL REGISTER**

ASIA PACIFIC ROBOTICS CORPORATION PTY LTD (AUSTRALIA LIMITED LIABILITY COMPANY)  
13 CUNNINGHAM CLOSE  
ASPENDALE GARDENS, AUSTRALIA

FOR: COMPUTER SERVICES, NAMELY, CREATING AN ON-LINE COMMUNITY FOR REGISTERED USERS TO PARTICIPATE IN DISCUSSIONS, GET FEEDBACK FROM THEIR PEERS, FORM VIRTUAL COMMUNITIES, AND ENGAGE IN SOCIAL NETWORKING SERVICES IN THE FIELD OF LAW, IN CLASS 42 (U.S. CLS. 100 AND 101).

FIRST USE 1-4-2012; IN COMMERCE 1-4-2012.

THE MARK CONSISTS OF STANDARD CHARACTERS WITHOUT CLAIM TO ANY PARTICULAR FONT, STYLE, SIZE, OR COLOR.

SER. NO. 85-640,364, FILED 5-31-2012.

REGINA DRUMMOND, EXAMINING ATTORNEY



*David J. Kyffers*

Director of the United States Patent and Trademark Office

# United States of America

United States Patent and Trademark Office

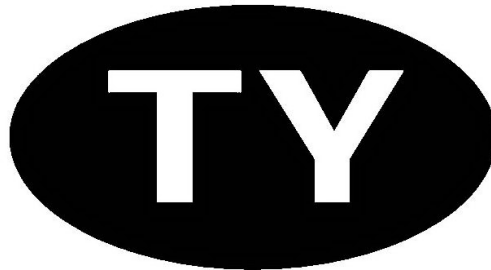

**Reg. No. 4,275,451**

**Registered Jan. 15, 2013**

**Int. Cl.: 16**

**TRADEMARK**

**PRINCIPAL REGISTER**

US TAIYANG PACKING PRODUCTS CO., LTD (NEW YORK CORPORATION)  
1ST FLOOR  
1099 FLUSHING AVE  
BROOKLYN, NY 11237

FOR: GENERAL PURPOSE PLASTIC BAGS, IN CLASS 16 (U.S. CLS. 2, 5, 22, 23, 29, 37, 38 AND 50).

FIRST USE 4-1-2012; IN COMMERCE 4-1-2012.

THE MARK CONSISTS OF AN ELLIPSE WITH THE STYLIZED TEXT "TY".

SER. NO. 85-640,397, FILED 5-31-2012.

AISHA CLARKE, EXAMINING ATTORNEY



*David J. Kyffers*

Director of the United States Patent and Trademark Office

# United States of America

United States Patent and Trademark Office

# SiteSpeed

**Reg. No. 4,275,452**

**Registered Jan. 15, 2013**

**Int. Cl.: 35**

**SERVICE MARK**

**PRINCIPAL REGISTER**

ATTRACTA ONLINE SERVICES, INC. (CALIFORNIA CORPORATION), DBA ATTRACTA  
SUITE 6  
625 IMPERIAL WAY  
NAPA, CA 94559

FOR: ADVERTISING AND MARKETING SERVICES PROVIDED BY MEANS OF INDIRECT METHODS OF MARKETING COMMUNICATIONS, NAMELY, SOCIAL MEDIA, SEARCH ENGINE MARKETING, INQUIRY MARKETING, INTERNET MARKETING, MOBILE MARKETING, BLOGGING AND OTHER FORMS OF PASSIVE, SHARABLE OR VIRAL COMMUNICATIONS CHANNELS, IN CLASS 35 (U.S. CLS. 100, 101 AND 102).

FIRST USE 5-31-2012; IN COMMERCE 5-31-2012.

THE MARK CONSISTS OF STANDARD CHARACTERS WITHOUT CLAIM TO ANY PARTICULAR FONT, STYLE, SIZE, OR COLOR.

SER. NO. 85-640,417, FILED 5-31-2012.

ANNE MADDEN, EXAMINING ATTORNEY



*David J. Kyffers*

Director of the United States Patent and Trademark Office

# United States of America

United States Patent and Trademark Office

# naked earth

**Reg. No. 4,275,453**

**Registered Jan. 15, 2013**

**Int. Cl.: 3**

**TRADEMARK**

**PRINCIPAL REGISTER**

GLENN GARAMELLA (UNITED STATES INDIVIDUAL)  
2404 SW 23RD CRANBROOK DR.  
BOYNTON BEACH, FL 33436

FOR: AFTER SHAVE LOTIONS; AFTER-SHAVE GEL; ANTI-BACTERIAL SOAP; ANTI-CAVITY DENTAL RINSES; AROMATIC BODY CARE PRODUCTS, NAMELY, BODY LOTION, SHOWER GEL, CUTICLE CREAM, SHAMPOO, CONDITIONER, NON-MEDICATED LIP BALM, SOAP, BODY POLISH, BODY AND FOOT SCRUB AND NON-MEDICATED FOOT CREAM; AROMATIC ESSENTIAL OILS; BABY OIL; BAR SOAP; BATH SOAPS; BEAUTY CREAMS FOR BODY CARE; BEAUTY GELS; BODY AND BEAUTY CARE COSMETICS; BODY SPRAY USED AS A PERSONAL DEODORANT AND AS FRAGRANCE; COSMETIC SUN OILS; DENTAL BLEACHING GELS; DEODORANT FOR PERSONAL USE; DEODORANT SOAP; DEODORANTS FOR PETS; DEODORIZERS FOR PETS; DETERGENT SOAP; FRAGRANCED FACIAL MOISTURIZER; FRAGRANCES AND PERFUMERY; HAIR CARE PREPARATIONS CONSISTING OF ORGANIC COCONUT VIRGIN OIL AND COCONUT VIRGIN OIL; HAND SOAPS; HOME DENTAL CARE PRODUCTS FOR DOGS AND CATS, NAMELY, TOOTHPASTE; LAUNDRY SOAP; LIQUID SOAP; MASSAGE LOTIONS; MASSAGE OIL; NON-MEDICATED DENTAL RINSE; NON-MEDICATED MOUTH WASH AND RINSE; PET FRAGRANCES; ROOM FRAGRANCES; SHAMPOOS; SHAVING CREAMS; SHAVING FOAM; SHAVING GEL; SHAVING PREPARATIONS; SHAVING SOAPS; SPRAY CLEANERS FOR FRESHENING ATHLETIC MOUTH GUARDS; SUN-TANNING OILS; TOOTHPASTE AND MOUTHWASHES, IN CLASS 3 (U.S. CLS. 1, 4, 6, 50, 51 AND 52).

FIRST USE 5-1-2012; IN COMMERCE 5-1-2012.

THE MARK CONSISTS OF STANDARD CHARACTERS WITHOUT CLAIM TO ANY PARTICULAR FONT, STYLE, SIZE, OR COLOR.

SER. NO. 85-640,472, FILED 6-1-2012.

ALICIA COLLINS, EXAMINING ATTORNEY



*David J. Kypos*

Director of the United States Patent and Trademark Office



# United States of America

United States Patent and Trademark Office

# naked earth

**Reg. No. 4,275,454**

**Registered Jan. 15, 2013**

**Int. Cl.: 5**

**TRADEMARK**

**PRINCIPAL REGISTER**

GLENN GAREMELLA (UNITED STATES INDIVIDUAL)  
2404 SW 23RD CRANBROOK DR.  
BOYNTON BEACH, FL 33436

FOR: DIETARY AND NUTRITIONAL SUPPLEMENTS; DIETARY SUPPLEMENT DRINK MIXES; DIETARY SUPPLEMENTAL DRINKS; DIETARY SUPPLEMENTS; DIETARY SUPPLEMENTS FOR HUMAN CONSUMPTION; GUMMY VITAMINS; LIQUID NUTRITIONAL SUPPLEMENT; LIQUID VITAMIN SUPPLEMENTS; MEDICATED MOUTH CARE AND TREATMENT PREPARATIONS; MEDICATED MOUTH WASHES; MEDICATED OILS CONTAINING VITAMINS AND MINERALS; MEDICATED TOOTHPASTE; MEDICINAL PREPARATIONS FOR THE MOUTH AND AS SPRAYS; MINERAL NUTRITIONAL SUPPLEMENTS; MIXED VITAMIN PREPARATIONS; NUTRITIONAL AND DIETARY SUPPLEMENTS FORMED AND PACKAGED AS BARS; NUTRITIONAL SUPPLEMENT ENERGY BARS; NUTRITIONAL SUPPLEMENT SHAKES; VITAMIN AND MINERAL PREPARATIONS FOR MEDICAL USE; VITAMIN DROPS; VITAMIN OILS FOR HUMAN CONSUMPTION; VITAMIN PREPARATIONS; VITAMINS, IN CLASS 5 (U.S. CLS. 6, 18, 44, 46, 51 AND 52).

FIRST USE 5-1-2012; IN COMMERCE 5-1-2012.

THE MARK CONSISTS OF STANDARD CHARACTERS WITHOUT CLAIM TO ANY PARTICULAR FONT, STYLE, SIZE, OR COLOR.

SER. NO. 85-640,473, FILED 6-1-2012.

ALICIA COLLINS, EXAMINING ATTORNEY



*David J. Kyffers*

Director of the United States Patent and Trademark Office

# United States of America

United States Patent and Trademark Office

## POSTENTIAL

**Reg. No. 4,275,455**

**Registered Jan. 15, 2013**

**Int. Cl.: 16**

**TRADEMARK**

**PRINCIPAL REGISTER**

RATUSHNY, VLADIMIR (UNITED STATES INDIVIDUAL)  
1220 SANSOM STREET APT. 7S  
PHILADELPHIA, PA 19107

FOR: ADHESIVE LABELS; ADHESIVE NOTE PADS; ADHESIVE NOTE PAPER; FILE CARDS;  
FILING CARDS; GREETING CARDS; INDEX CARDS; POST CARDS; STATIONERY , IN  
CLASS 16 (U.S. CLS. 2, 5, 22, 23, 29, 37, 38 AND 50).

FIRST USE 5-17-2012; IN COMMERCE 5-17-2012.

THE MARK CONSISTS OF STANDARD CHARACTERS WITHOUT CLAIM TO ANY PAR-  
TICULAR FONT, STYLE, SIZE, OR COLOR.

SER. NO. 85-640,487, FILED 6-1-2012.

ALICIA COLLINS, EXAMINING ATTORNEY



*David J. Kyffers*

Director of the United States Patent and Trademark Office

# United States of America

United States Patent and Trademark Office

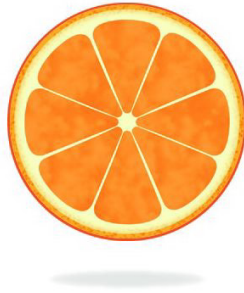

**Reg. No. 4,275,456**

**Registered Jan. 15, 2013**

**Int. Cl.: 42**

**SERVICE MARK**

**PRINCIPAL REGISTER**

FORWARD HEALTH GROUP, INC. (MINNESOTA CORPORATION)  
SUITE 601  
44 EAST MIFFLIN STREET  
MADISON, WI 53703

FOR: SOFTWARE AS A SERVICE (SAAS) SERVICES FEATURING SOFTWARE FOR  
MANAGING HEALTHCARE QUALITY DATA, IN CLASS 42 (U.S. CLS. 100 AND 101).

FIRST USE 5-0-2011; IN COMMERCE 2-1-2012.

THE MARK CONSISTS OF A STYLIZED CROSS SECTION OF A SLICE OF ORANGE, DE-  
PICTED IN YELLOW AND IN SEVERAL SHADES OF ORANGE, WITH A SHADOW OF  
THE SLICE OF FRUIT DEPICTED BENEATH IT IN GREY.

THE COLOR(S) ORANGE, YELLOW AND GREY IS/ARE CLAIMED AS A FEATURE OF  
THE MARK.

SER. NO. 85-640,489, FILED 6-1-2012.

KATHERINE STOIDES, EXAMINING ATTORNEY



*David J. Kybas*

Director of the United States Patent and Trademark Office

# United States of America

United States Patent and Trademark Office

## JOHN'S FARMS

**Reg. No. 4,275,457**

**Registered Jan. 15, 2013**

**Int. Cl.: 31**

**TRADEMARK**

**PRINCIPAL REGISTER**

YANTAI YUMMY PET FOOD CO. LTD. (CHINA LIMITED COMPANY (LTD.))  
NORTH OF HUWANG VILLAGE  
XINZHUANG TOWN  
ZHAOYUAN CITY SHANDONG, CHINA

FOR: PET FOODS, IN CLASS 31 (U.S. CLS. 1 AND 46).

FIRST USE 5-23-2012; IN COMMERCE 5-23-2012.

THE MARK CONSISTS OF STANDARD CHARACTERS WITHOUT CLAIM TO ANY PARTICULAR FONT, STYLE, SIZE, OR COLOR.

SER. NO. 85-640,491, FILED 6-1-2012.

SHAUNIA CARLYLE, EXAMINING ATTORNEY



*David J. Kyros*

Director of the United States Patent and Trademark Office

# United States of America

United States Patent and Trademark Office

## DOGBREEDSTORE.COM

**Reg. No. 4,275,458**

CALENDARS.COM, L.L.C. (DELAWARE LIMITED LIABILITY COMPANY)

**Registered Jan. 15, 2013**

6411 BURLESON ROAD  
AUSTIN, TX 78744

**Int. Cl.: 35**

**SERVICE MARK**

**PRINCIPAL REGISTER**

FOR: ON-LINE RETAIL STORE SERVICES FEATURING BOOKS, GUIDE BOOKS, BOOK COVERS, BOOK HOLDERS, BOOK RESTS, BOOK STANDS, CALENDARS, SPECIALTY CALENDARS FEATURING DOGS, CALENDAR DESK PADS, CALENDAR DESK STANDS, CALENDAR STANDS, LEASH HOOKS, DOG LEASHES, DOG COLLARS, DOG CLOTHING AND APPAREL, DOG PARKAS, BOOK MARKERS, DOG BOWLS, NON-METAL PIGGY BANKS, ELECTRIC NIGHT LIGHTS, PICTURE FRAMES, SALT AND PEPPER SHAKERS, NON-LUMINOUS, NON-MECHANICAL SIGNS NOT OF METAL, HOUSEHOLD UTENSILS, COOKIE JARS, SOAP DISHES, ELECTRIC AND NON-ELECTRIC TOOTH BRUSHES, CUPS, DOOR MATS, BATH MATS, FLOOR MATS FOR VEHICLES, PLASTIC PLACE MATS FOR PET BOWLS, MUGS, BEER MUGS, EARTHENWARE MUGS, GLASS MUGS, PORCELAIN MUGS, NOTE PADS, NON-METAL AND NON-LEATHER KEY CHAINS, KEY FOBS NOT OF METAL, POSTCARDS, BLANK OR PARTIALLY PRINTED POSTCARDS, PICTURE POSTCARDS, COLD CAST RESIN FIGURINES, FABRIC FIGURINES, FIGURINES, CERAMIC FIGURINES, CLAY DOUGH FIGURINES, GLASS FIGURINES, PORCELAIN FIGURINES, SHIRTS, T-SHIRTS, SWEAT SHIRTS AND PANTS, SPORT AND GOLF SHIRTS, KNIT SHIRTS, NIGHT AND SLEEP SHIRTS, POLO SHIRTS, WIND SHIRTS, PET TOYS, DOG TOYS, PLUSH TOYS, AND SOFT SCULPTURE PLUSH TOYS; PROMOTING THE GOODS AND SERVICES OF OTHERS BY PROVIDING A WEB SITE AT WHICH USERS CAN PURCHASE SPECIALTY CALENDARS FEATURING INDIVIDUAL DOG BREEDS, REFERENCE AND GUIDE BOOKS ON THE TOPIC OF DOGS AND DOG BREEDS; PROVIDING A WEB SITE WHICH FEATURES ADVERTISEMENTS FOR THE GOODS AND SERVICES OF OTHERS ON A GLOBAL COMPUTER NETWORK, IN CLASS 35 (U.S. CLS. 100, 101 AND 102).



FIRST USE 7-13-2004; IN COMMERCE 7-13-2004.

THE MARK CONSISTS OF STANDARD CHARACTERS WITHOUT CLAIM TO ANY PARTICULAR FONT, STYLE, SIZE, OR COLOR.

OWNER OF U.S. REG. NOS. 3,022,224 AND 3,112,778.

SEC. 2(F).

*David J. Kybas*

Director of the United States Patent and Trademark Office

**Reg. No. 4,275,458** SER. NO. 85-640,527, FILED 6-1-2012.

LUCY ARANT, EXAMINING ATTORNEY

# United States of America

United States Patent and Trademark Office

# EVMCC

**Reg. No. 4,275,459**

**Registered Jan. 15, 2013**

**Int. Cl.: 45**

**SERVICE MARK**

**PRINCIPAL REGISTER**

EVANGELICAL MARIAN CATHOLIC CHURCH INC (DELAWARE CORPORATION)  
13286 CONVENT GARDEN RD  
BROOKSVILLE, FL 34613

FOR: CONDUCTING RELIGIOUS PRAYER SERVICES; MINISTERIAL SERVICES, NAMELY, HOLDING SPIRITUAL RETREATS TO ASSIST RELIGIOUS LEADERS, BOTH CLERGY AND LAY, TO DEVELOP AND ENHANCE THEIR SPIRITUAL LIVES; PROVIDING A WEBSITE FEATURING INFORMATION FOR LOCAL CHURCH LEADERS IN THE FIELD OF CHRISTIAN GROWTH; PROVIDING AND CONDUCTING NON-DENOMINATIONAL, NON-RELIGIOUS CIVIL MARRIAGE CEREMONIES; RELIGIOUS AND SPIRITUAL SERVICES, NAMELY, PROVIDING GATHERINGS AND RETREATS TO DEVELOP AND ENHANCE THE SPIRITUAL LIVES OF INDIVIDUALS; RELIGIOUS MASS INTENTIONS SERVICES, NAMELY, PROVIDING FOR THE ARRANGEMENT OF MASS INTENTIONS FOR THE DECEASED AND OR LIVING, IN CLASS 45 (U.S. CLS. 100 AND 101).

FIRST USE 12-0-1998; IN COMMERCE 12-0-1998.

THE MARK CONSISTS OF STANDARD CHARACTERS WITHOUT CLAIM TO ANY PARTICULAR FONT, STYLE, SIZE, OR COLOR.

SER. NO. 85-640,553, FILED 6-1-2012.

FONG HSU, EXAMINING ATTORNEY



*David J. Kyros*

Director of the United States Patent and Trademark Office

# United States of America

United States Patent and Trademark Office



IN LOVE WITH A BUG

CREATING HEIRLOOMS WITH KEEPSAKES, CAPTURED MEMORIES, AND LOVE

**Reg. No. 4,275,460**

IN LOVE WITH A BUG, LLC (MINNESOTA LIMITED LIABILITY COMPANY)  
5325 WILLISTON RD

**Registered Jan. 15, 2013**

MINNETONKA, MN 55345

**Int. Cl.: 42**

FOR: CUSTOM DESIGN AND DEVELOPMENT OF FRAMED KEEPSAKES AND HANDMADE ITEMS, IN CLASS 42 (U.S. CLS. 100 AND 101).

**SERVICE MARK**

FIRST USE 4-27-2012; IN COMMERCE 4-27-2012.

**PRINCIPAL REGISTER**

THE MARK CONSISTS OF A LADY BUG WITH A HEART ON IT'S BACK, ALONG WITH THE UNDERLINED TEXT "IN LOVE WITH A BUG" AND TAGLINE "CREATING HEIRLOOMS WITH KEEPSAKES, CAPTURED MEMORIES, AND LOVE" BELOW.

SER. NO. 85-640,557, FILED 6-1-2012.

NATALIE POLZER, EXAMINING ATTORNEY



*David J. Kybas*

Director of the United States Patent and Trademark Office



# United States of America

United States Patent and Trademark Office

## SPOOKYLICIOUS

**Reg. No. 4,275,461**

**Registered Jan. 15, 2013**

**Int. Cl.: 30**

**TRADEMARK**

**PRINCIPAL REGISTER**

KELLOGG NORTH AMERICA COMPANY (DELAWARE CORPORATION)  
ONE KELLOGG SQUARE, PO BOX 3599  
BATTLE CREEK, MI 490163599

FOR: TOASTER PASTRIES, IN CLASS 30 (U.S. CL. 46).

FIRST USE 9-6-2011; IN COMMERCE 9-6-2011.

THE MARK CONSISTS OF STANDARD CHARACTERS WITHOUT CLAIM TO ANY PARTICULAR FONT, STYLE, SIZE, OR COLOR.

SER. NO. 85-640,558, FILED 6-1-2012.

NICHOLAS ALTREE, EXAMINING ATTORNEY



*David J. Kyffers*

Director of the United States Patent and Trademark Office

# United States of America

United States Patent and Trademark Office

# Burnin'

**Reg. No. 4,275,462**

KEANE, WILLIAM (UNITED STATES INDIVIDUAL)  
5913 FOUNTAIN AVENUE  
HOLLYWOOD, CA 90028

**Registered Jan. 15, 2013**

**Int. Cl.: 41**

FOR: ENTERTAINMENT, NAMELY, LIVE PERFORMANCES BY A MUSICAL BAND, IN CLASS 41 (U.S. CLS. 100, 101 AND 107).

**SERVICE MARK**

FIRST USE 10-1-2011; IN COMMERCE 10-1-2011.

**PRINCIPAL REGISTER**

THE MARK CONSISTS OF STANDARD CHARACTERS WITHOUT CLAIM TO ANY PARTICULAR FONT, STYLE, SIZE, OR COLOR.

SER. NO. 85-640,559, FILED 6-1-2012.

FONG HSU, EXAMINING ATTORNEY



*David J. Kybas*

Director of the United States Patent and Trademark Office

# United States of America

United States Patent and Trademark Office

# Tara Normal

**Reg. No. 4,275,463**

**Registered Jan. 15, 2013**

**Int. Cl.: 16**

**TRADEMARK**

**PRINCIPAL REGISTER**

NOELDECHEN, HOWARD (UNITED STATES INDIVIDUAL)  
APT H  
3503 KINGSLEY CT  
PASADENA, MD 21122

FOR: COMIC BOOKS; SERIES OF FICTION BOOKS, IN CLASS 16 (U.S. CLS. 2, 5, 22, 23, 29, 37, 38 AND 50).

FIRST USE 9-29-2007; IN COMMERCE 4-22-2009.

THE MARK CONSISTS OF STANDARD CHARACTERS WITHOUT CLAIM TO ANY PARTICULAR FONT, STYLE, SIZE, OR COLOR.

THE NAME(S), PORTRAIT(S), AND/OR SIGNATURE(S) SHOWN IN THE MARK DOES NOT IDENTIFY A PARTICULAR LIVING INDIVIDUAL.

SER. NO. 85-640,565, FILED 6-1-2012.

LEIGH LOWRY, EXAMINING ATTORNEY



*David J. Kybas*

Director of the United States Patent and Trademark Office

# United States of America

United States Patent and Trademark Office

## MeetingResult

**Reg. No. 4,275,464**

**Registered Jan. 15, 2013**

**Int. Cl.: 9**

**TRADEMARK**

**PRINCIPAL REGISTER**

MEETINGRESULT LLC (VIRGINIA LIMITED LIABILITY COMPANY)  
SUITE 700  
2010 CORPORATE RIDGE  
MCLEAN, VA 22102

FOR: COMPUTER SOFTWARE THAT PROVIDES WEB-BASED ACCESS TO APPLICATIONS AND SERVICES THROUGH A WEB OPERATING SYSTEM OR PORTAL INTERFACE , IN CLASS 9 (U.S. CLS. 21, 23, 26, 36 AND 38).

FIRST USE 6-17-2010; IN COMMERCE 6-17-2010.

THE MARK CONSISTS OF STANDARD CHARACTERS WITHOUT CLAIM TO ANY PARTICULAR FONT, STYLE, SIZE, OR COLOR.

SER. NO. 85-640,591, FILED 6-1-2012.

GINA FINK, EXAMINING ATTORNEY



*David J. Kyffers*

Director of the United States Patent and Trademark Office

United States of America  
United States Patent and Trademark Office

# FLOCKSIL

**Reg. No. 4,275,465**

**Registered Jan. 15, 2013**

**Int. Cl.: 1**

**TRADEMARK**

**PRINCIPAL REGISTER**

LORD CORPORATION (PENNSYLVANIA CORPORATION)  
111 LORD DRIVE  
CARY, NC 27511

FOR: ADHESIVE COMPOSITION FOR ATTACHING FLOCKING MATERIALS TO ELASTOMERS, PLASTICS, METALS, WOOD, GLASS, CERAMIC, CONCRETE AND SIMILAR RIGID AND FLEXIBLE MATERIALS, IN CLASS 1 (U.S. CLS. 1, 5, 6, 10, 26 AND 46).

FIRST USE 3-1-2006; IN COMMERCE 3-1-2006.

THE MARK CONSISTS OF STANDARD CHARACTERS WITHOUT CLAIM TO ANY PARTICULAR FONT, STYLE, SIZE, OR COLOR.

SER. NO. 85-640,593, FILED 6-1-2012.

GINA FINK, EXAMINING ATTORNEY



*David J. Kyffers*

Director of the United States Patent and Trademark Office

# United States of America

United States Patent and Trademark Office

# NoBrella

**Reg. No. 4,275,466**

KAZYAKA,STEPHEN R. (UNITED STATES INDIVIDUAL)  
48 BIG TRAIL  
SHERMAN, CT 06784

**Registered Jan. 15, 2013**

**Int. Cl.: 21**

FOR: FLOWER POTS; FLOWER VASES; HOLDERS FOR FLOWERS AND PLANTS;  
PLANTERS FOR FLOWERS AND PLANTS; VASES, IN CLASS 21 (U.S. CLS. 2, 13, 23, 29,  
30, 33, 40 AND 50).

**TRADEMARK**

FIRST USE 9-7-2011; IN COMMERCE 2-2-2012.

**PRINCIPAL REGISTER**

THE MARK CONSISTS OF STANDARD CHARACTERS WITHOUT CLAIM TO ANY PAR-  
TICULAR FONT, STYLE, SIZE, OR COLOR.

SER. NO. 85-640,596, FILED 6-1-2012.

GINA FINK, EXAMINING ATTORNEY



*David J. Kyffers*

Director of the United States Patent and Trademark Office

# United States of America

United States Patent and Trademark Office

# MANU-RX

**Reg. No. 4,275,467**

ENSOL, LLC (OKLAHOMA LIMITED LIABILITY COMPANY)  
P.O. BOX 7

**Registered Jan. 15, 2013**

BETHANY, OK 73008

**Int. Cl.: 1**

FOR: BACTERIAL ADDITIVE FOR BREAKDOWN OF ANIMAL AND HUMAN WASTE;  
BACTERIA FOR WASTE WATER TREATMENT, IN CLASS 1 (U.S. CLS. 1, 5, 6, 10, 26 AND  
46).

**TRADEMARK**

FIRST USE 5-1-1991; IN COMMERCE 5-1-1991.

**PRINCIPAL REGISTER**

THE MARK CONSISTS OF STANDARD CHARACTERS WITHOUT CLAIM TO ANY PAR-  
TICULAR FONT, STYLE, SIZE, OR COLOR.

SER. NO. 85-640,614, FILED 6-1-2012.

KEVEN MITTLER, EXAMINING ATTORNEY



*David J. Kyffers*

Director of the United States Patent and Trademark Office

# United States of America

United States Patent and Trademark Office

## FCA: Focus, Concentrate & Attack

**Reg. No. 4,275,468**

MTC ENTERISES, INC. (DELAWARE CORPORATION)  
3 SUNNY KNOLLS COURT  
WAYNE, NJ 07470

**Registered Jan. 15, 2013**

**Int. Cl.: 36**

FOR: FINANCIAL PLANNING; INSURANCE BROKERAGE, IN CLASS 36 (U.S. CLS. 100, 101 AND 102).

**SERVICE MARK**

FIRST USE 3-27-2006; IN COMMERCE 3-27-2006.

**PRINCIPAL REGISTER**

THE MARK CONSISTS OF STANDARD CHARACTERS WITHOUT CLAIM TO ANY PARTICULAR FONT, STYLE, SIZE, OR COLOR.

SER. NO. 85-640,616, FILED 6-1-2012.

SANDRA BUJA, EXAMINING ATTORNEY



*David J. Kyffers*

Director of the United States Patent and Trademark Office



# United States of America

United States Patent and Trademark Office

## METAL SUPERMARKETS

**Reg. No. 4,275,469**

**Registered Jan. 15, 2013**

**Int. Cl.: 35**

**SERVICE MARK**

**PRINCIPAL REGISTER**

METAL SUPERMARKETS IP INC. (CANADA CORPORATION)  
520 ABILENE DRIVE, 2ND FLOOR  
MISSISSAUGA, ONTARIO, CANADA L5T2H7

FOR: DISTRIBUTORSHIP SERVICES IN THE FIELD OF METALS AND METAL ALLOYS, STEEL AND STEEL ALLOYS; WHOLESALE AND RETAIL STORE SERVICES FEATURING METALS AND METAL ALLOYS, STEEL AND STEEL ALLOYS; ON-LINE WHOLESALE AND ON-LINE RETAIL STORE SERVICES FEATURING METALS AND METAL ALLOYS, STEEL AND STEEL ALLOYS, IN CLASS 35 (U.S. CLS. 100, 101 AND 102).

FIRST USE 2-0-1990; IN COMMERCE 2-0-1990.

THE MARK CONSISTS OF STANDARD CHARACTERS WITHOUT CLAIM TO ANY PARTICULAR FONT, STYLE, SIZE, OR COLOR.

OWNER OF U.S. REG. NO. 3,638,672.

NO CLAIM IS MADE TO THE EXCLUSIVE RIGHT TO USE "METAL", APART FROM THE MARK AS SHOWN.

SEC. 2(F).

SER. NO. 85-640,645, FILED 6-1-2012.

DANIEL S. STRINGER, EXAMINING ATTORNEY



*David J. Kyffers*

Director of the United States Patent and Trademark Office

# United States of America

United States Patent and Trademark Office

# Taylor Targets

**Reg. No. 4,275,470**

**Registered Jan. 15, 2013**

**Int. Cl.: 28**

**TRADEMARK**

**PRINCIPAL REGISTER**

CHRIS SQUARED, INC. (ARKANSAS CORPORATION)  
9648 LEDGE DRIVE  
SPRINGDALE, AR 72762

FOR: FIREARM TARGETS; TARGETS, IN CLASS 28 (U.S. CLS. 22, 23, 38 AND 50).

FIRST USE 8-24-2010; IN COMMERCE 8-24-2010.

THE MARK CONSISTS OF STANDARD CHARACTERS WITHOUT CLAIM TO ANY PARTICULAR FONT, STYLE, SIZE, OR COLOR.

NO CLAIM IS MADE TO THE EXCLUSIVE RIGHT TO USE "TARGETS", APART FROM THE MARK AS SHOWN.

SER. NO. 85-640,675, FILED 6-1-2012.

KATINA MISTER, EXAMINING ATTORNEY



*David J. Kyffers*

Director of the United States Patent and Trademark Office

# United States of America

United States Patent and Trademark Office



**Reg. No. 4,275,471**

**Registered Jan. 15, 2013**

**COLLECTIVE  
MEMBERSHIP**

**PRINCIPAL REGISTER**

SHARED AGENCY SERVICES, LLC (GEORGIA LIMITED LIABILITY COMPANY)  
2009 MONTREAL ROAD  
TUCKER, GA 30084

FOR: INDICATING MEMBERSHIP IN A(N) ORGANIZATION OF INSURANCE AGENCIES THAT PROVIDE BROKERAGE SERVICES AND CONSULTING IN THE FIELD OF INSURANCE, IN CLASS 200 (U.S. CL. 200).

FIRST USE 4-5-2012; IN COMMERCE 4-5-2012.

THE MARK CONSISTS OF A DESIGN ELEMENT INCLUDING A STACK OF THREE RECTANGULAR OBJECTS WITH CURVED CORNERS OVERLAID WITH A STYLIZED "S" FOLLOWED BY THE LITERAL ELEMENT LETTERS "SECURERISK".

SER. NO. 85-640,693, FILED 6-1-2012.

CAITLIN WATTS-FITZGERALD, EXAMINING ATTORNEY



*David J. Kybas*

Director of the United States Patent and Trademark Office

# United States of America

United States Patent and Trademark Office

## SERVE SAFE FOOD

**Reg. No. 4,275,472**

WILEY, BARBARA (UNITED STATES INDIVIDUAL)  
43201 ASHBURY DR  
NOVI, MI 48375

**Registered Jan. 15, 2013**

**Int. Cl.: 21**

FOR: GLOVES FOR HOUSEHOLD PURPOSES, IN CLASS 21 (U.S. CLS. 2, 13, 23, 29, 30, 33, 40 AND 50).

**TRADEMARK**

FIRST USE 4-22-2008; IN COMMERCE 4-22-2008.

**PRINCIPAL REGISTER**

THE MARK CONSISTS OF STANDARD CHARACTERS WITHOUT CLAIM TO ANY PARTICULAR FONT, STYLE, SIZE, OR COLOR.

SER. NO. 85-640,698, FILED 6-1-2012.

WENDY GOODMAN, EXAMINING ATTORNEY



*David J. Kybas*

Director of the United States Patent and Trademark Office

# United States of America

United States Patent and Trademark Office



**Reg. No. 4,275,473**

MARZOLLO, JEAN (UNITED STATES INDIVIDUAL)  
437 LANE GATE ROAD  
COLD SPRING, NY 10516 AND

**Registered Jan. 15, 2013**

**Int. Cl.: 27**

WICK, WALTER (UNITED STATES INDIVIDUAL)  
10 BRIDGE STREET  
WINSTED, CT 06098

**TRADEMARK**

**PRINCIPAL REGISTER**

FOR: FOAM MATS FOR USE ON PLAY AREA SURFACES, IN CLASS 27 (U.S. CLS. 19, 20, 37, 42 AND 50).

FIRST USE 6-1-2010; IN COMMERCE 6-1-2010.

OWNER OF U.S. REG. NOS. 2,757,287, 2,843,567, AND 2,901,973.

THE MARK CONSISTS OF THE WORDS I SPY IN STYLIZED LETTERING, WITH THE DESIGN OF A MAGNIFYING GLASS PARTIALLY OVER THE WORD "I".

SER. NO. 85-640,713, FILED 6-1-2012.

CIMMERIAN COLEMAN, EXAMINING ATTORNEY



*David J. Kyffers*

Director of the United States Patent and Trademark Office

# United States of America

United States Patent and Trademark Office



**Reg. No. 4,275,474**

**Registered Jan. 15, 2013**

**Int. Cl.: 28**

**TRADEMARK**

**PRINCIPAL REGISTER**

MARZOLLO, JEAN (UNITED STATES INDIVIDUAL)  
437 LANE GATE ROAD  
COLD SPRING, NY 10516 AND

WICK, WALTER (UNITED STATES INDIVIDUAL)  
10 BRIDGE STREET  
WINSTED, CT 06098

FOR: CARD GAMES; BOARD GAMES, IN CLASS 28 (U.S. CLS. 22, 23, 38 AND 50).

FIRST USE 6-1-1995; IN COMMERCE 6-1-1995.

OWNER OF U.S. REG. NOS. 2,757,287, 2,843,567, AND 2,901,973.

THE MARK CONSISTS OF THE WORDS "I SPY" IN STYLIZED LETTERING, WITH THE DESIGN OF A MAGNIFYING GLASS PARTIALLY OVER THE WORD "I".

SER. NO. 85-640,721, FILED 6-1-2012.

CIMMERIAN COLEMAN, EXAMINING ATTORNEY



*David J. Kyffers*

Director of the United States Patent and Trademark Office

# United States of America

United States Patent and Trademark Office

## JOHN WILLIE

**Reg. No. 4,275,475**

**Registered Jan. 15, 2013**

**Int. Cl.: 25**

**TRADEMARK**

**PRINCIPAL REGISTER**

LARRY MCGEARTY (UNITED STATES INDIVIDUAL)  
135 PROSPECT PARK SW #A9  
BROOKLYN, NY 11218

FOR: APRONS; ATHLETIC APPAREL, NAMELY, SHIRTS, PANTS, JACKETS, FOOTWEAR, HATS AND CAPS, ATHLETIC UNIFORMS; ATHLETIC FOOTWEAR; ATHLETIC SHOES; ATHLETIC TIGHTS; ATHLETIC UNIFORMS; BABY BODYSUITS; BABY BOTTOMS; BABY BUNTING; BABY DOLL PYJAMAS; BABY LAYETTES FOR CLOTHING; BATHING COSTUMES; BATHROBES; BEACH COVER-UPS; BLAZERS; BLOUSES; BOARD SHORTS; BODY SHIRTS; BOOTS; BOTTOMS; BOW TIES; BRAS; BRIEFS; CLOTHING FOR BABIES, TODDLERS AND CHILDREN, TREATED WITH FIRE AND HEAT RETARDANTS, NAMELY, PAJAMAS, JACKETS, SHIRTS, PANTS, JUMPERS; CREW NECK SWEATERS; CREW NECKS; CROP PANTS; DRESS SHIRTS; DRESS SUITS; DRESSES; FOOTWEAR; HEADWEAR; HOODED PULLOVERS; HOODED SWEAT SHIRTS; JEANS; JEGGINGS, NAMELY, PANTS THAT ARE PARTIALLY JEANS AND PARTIALLY LEGGINGS; JERSEYS; SHIRTS; SHOES; SKULL CAPS; SWIMSUITS; T-SHIRTS; TANK TOPS; TOPS; WOMEN'S CLOTHING, NAMELY, SHIRTS, DRESSES, SKIRTS, BLOUSES; WOMEN'S SHOES; WOMEN'S TOPS, NAMELY, CAMIS; WOMEN'S UNDERWEAR; WRAPS; YOGA PANTS; YOGA SHIRTS, IN CLASS 25 (U.S. CLS. 22 AND 39).

FIRST USE 1-1-2010; IN COMMERCE 5-1-2012.

THE MARK CONSISTS OF STANDARD CHARACTERS WITHOUT CLAIM TO ANY PARTICULAR FONT, STYLE, SIZE, OR COLOR.

THE NAME(S), PORTRAIT(S), AND/OR SIGNATURE(S) SHOWN IN THE MARK DOES NOT IDENTIFY A PARTICULAR LIVING INDIVIDUAL.

SER. NO. 85-640,726, FILED 6-1-2012.

CIMMERIAN COLEMAN, EXAMINING ATTORNEY



*David J. Kyros*

Director of the United States Patent and Trademark Office

# United States of America

United States Patent and Trademark Office

## SANDRA WEIL

**Reg. No. 4,275,476**

SANDRA WEIL-NAPADENSCHI (FED REP GERMANY INDIVIDUAL)  
LUCIO ANNEO SENECA NO. 429-3  
COL. PALMITAS, MEXICO, MEXICO 11560

**Registered Jan. 15, 2013**

**Int. Cl.: 25**

FOR: WOMEN'S CLOTHING, NAMELY SHIRTS, PANTS, SHORTS, BLOUSES, BUSTIERS, DRESSES, SKIRTS, JACKETS AND JUMPSUITS, IN CLASS 25 (U.S. CLS. 22 AND 39).

**TRADEMARK**

FIRST USE 3-30-2012; IN COMMERCE 3-30-2012.

**PRINCIPAL REGISTER**

THE MARK CONSISTS OF STANDARD CHARACTERS WITHOUT CLAIM TO ANY PARTICULAR FONT, STYLE, SIZE, OR COLOR.

THE NAME(S), PORTRAIT(S), AND/OR SIGNATURE(S) SHOWN IN THE MARK IDENTIFIES SANDRA WEIL, WHOSE CONSENT(S) TO REGISTER IS MADE OF RECORD.

SER. NO. 85-640,727, FILED 6-1-2012.

CIMMERIAN COLEMAN, EXAMINING ATTORNEY



*David J. Kyffers*

Director of the United States Patent and Trademark Office



# United States of America

United States Patent and Trademark Office



**Reg. No. 4,275,477**

**Registered Jan. 15, 2013**

**Int. Cl.: 35**

**SERVICE MARK**

**PRINCIPAL REGISTER**

SHEPHERD DATA SERVICES, INC. (MINNESOTA CORPORATION)  
SUITE 400  
527 MARQUETTE AVENUE  
MINNEAPOLIS, MN 55402

FOR: DATA ENTRY SERVICES; BUSINESS MANAGEMENT CONSULTANCY FOR THE ANALYSIS AND THE IMPLEMENTATION OF MANAGEMENT PROJECTS; DATA PROCESSING OF ELECTRONIC MAIL AND OTHER ELECTRONIC FILES IN THE NATURE OF BUSINESS RECORDS, BUSINESS DATA, AND ELECTRONIC VERSIONS OF PAPER BUSINESS DOCUMENTS, IN CLASS 35 (U.S. CLS. 100, 101 AND 102).

FIRST USE 1-19-2011; IN COMMERCE 1-19-2011.

THE MARK CONSISTS OF A SILHOUETTE OF A GERMAN SHEPHERD'S HEAD AND CHEST WITH AN ARCH ADJACENT TO AND OPENING TOWARD THE SILHOUETTE TO FORM A CAPITAL LETTER "D".

SER. NO. 85-640,738, FILED 6-1-2012.

MATTHEW GALAN, EXAMINING ATTORNEY



*David J. Kybas*

Director of the United States Patent and Trademark Office

# United States of America

United States Patent and Trademark Office

# SCORE

**Reg. No. 4,275,478**

**Registered Jan. 15, 2013**

**Int. Cl.: 5**

**TRADEMARK**

**PRINCIPAL REGISTER**

SCORE NUTRITION, LLC (GEORGIA LIMITED LIABILITY COMPANY)  
STE 410A-151  
1100 HAMMOND DR NE  
ATLANTA, GA 30328

FOR: FOOD SUPPLEMENTS FOR MALE ENHANCEMENT, IN CLASS 5 (U.S. CLS. 6, 18, 44, 46, 51 AND 52).

FIRST USE 8-31-2010; IN COMMERCE 8-31-2010.

THE MARK CONSISTS OF STANDARD CHARACTERS WITHOUT CLAIM TO ANY PARTICULAR FONT, STYLE, SIZE, OR COLOR.

SER. NO. 85-640,739, FILED 6-1-2012.

WENDY JUN, EXAMINING ATTORNEY



*David J. Kyffers*

Director of the United States Patent and Trademark Office

# United States of America

United States Patent and Trademark Office

# BERRICLE

**Reg. No. 4,275,479**

BERRICLE, LLC (NEW YORK LIMITED LIABILITY COMPANY)  
3137 46TH STREET, 1FL  
ASTORIA, NY 11103

**Registered Jan. 15, 2013**

**Int. Cl.: 35**

FOR: ON-LINE RETAIL STORE SERVICES FEATURING JEWELRY, HANDBAGS, CLOTHING, FASHION ACCESSORIES AND BEAUTY PRODUCTS; ON-LINE WHOLESALE STORE SERVICES FEATURING JEWELRY, HANDBAGS, CLOTHING, FASHION ACCESSORIES AND BEAUTY PRODUCTS, IN CLASS 35 (U.S. CLS. 100, 101 AND 102).

**SERVICE MARK**

**PRINCIPAL REGISTER**

FIRST USE 0-0-2011; IN COMMERCE 0-0-2011.

THE MARK CONSISTS OF STANDARD CHARACTERS WITHOUT CLAIM TO ANY PARTICULAR FONT, STYLE, SIZE, OR COLOR.

SER. NO. 85-640,806, FILED 6-1-2012.

LINDSEY RUBIN, EXAMINING ATTORNEY



*David J. Kyffers*

Director of the United States Patent and Trademark Office

# United States of America

United States Patent and Trademark Office

## THE OFFICIAL LONG ISLAND HAT

**Reg. No. 4,275,480**

RAFAEL MORALES (UNITED STATES INDIVIDUAL)  
28 RACHELS WAY  
HOLBROOK, NY 11741

**Registered Jan. 15, 2013**

**Int. Cl.: 25**

FOR: ATHLETIC APPAREL, NAMELY, SHIRTS, PANTS, JACKETS, FOOTWEAR, HATS AND CAPS, ATHLETIC UNIFORMS; BASEBALL CAPS AND HATS; HATS; SPORTS CAPS AND HATS, IN CLASS 25 (U.S. CLS. 22 AND 39).

**TRADEMARK**

FIRST USE 11-15-2011; IN COMMERCE 1-1-2012.

**PRINCIPAL REGISTER**

THE MARK CONSISTS OF STANDARD CHARACTERS WITHOUT CLAIM TO ANY PARTICULAR FONT, STYLE, SIZE, OR COLOR.

NO CLAIM IS MADE TO THE EXCLUSIVE RIGHT TO USE "LONG ISLAND HAT", APART FROM THE MARK AS SHOWN.

SER. NO. 85-640,836, FILED 6-1-2012.

DAVID C. REIHNER, EXAMINING ATTORNEY



*David J. Kyffers*

Director of the United States Patent and Trademark Office

# United States of America

United States Patent and Trademark Office



**Reg. No. 4,275,481**

**Registered Jan. 15, 2013**

**Int. Cl.: 41**

**SERVICE MARK**

**PRINCIPAL REGISTER**

WHOLE FITNESS, LLC (ARIZONA LIMITED LIABILITY COMPANY), DBA THE WORLD OF ATHLETICS CENTER  
2726 N. LAYTON CIRCLE  
MESA, AZ 85207

FOR: SPORTS TRAINING SERVICES, IN CLASS 41 (U.S. CLS. 100, 101 AND 107).

FIRST USE 12-31-2010; IN COMMERCE 12-31-2010.

THE NAME(S), PORTRAIT(S), AND/OR SIGNATURE(S) SHOWN IN THE MARK IDENTIFIES JOHN GODINA, WHOSE CONSENT(S) TO REGISTER IS MADE OF RECORD.

THE MARK CONSISTS OF A MAN ENGAGED IN A SPORT.

SER. NO. 85-640,853, FILED 6-1-2012.

REBECCA EISINGER, EXAMINING ATTORNEY



*David J. Kybas*

Director of the United States Patent and Trademark Office

# United States of America

United States Patent and Trademark Office

# JANUS

**Reg. No. 4,275,482**

**Registered Jan. 15, 2013**

**Int. Cl.: 37**

**SERVICE MARK**

**PRINCIPAL REGISTER**

HOFFMAN, KEVIN (UNITED STATES INDIVIDUAL)  
12 SYCAMORE LANE  
AVON, CT 06001

FOR: REFURBISHING OF AIRCRAFT, IN CLASS 37 (U.S. CLS. 100, 103 AND 106).

FIRST USE 5-21-2012; IN COMMERCE 6-1-2012.

THE MARK CONSISTS OF STANDARD CHARACTERS WITHOUT CLAIM TO ANY PARTICULAR FONT, STYLE, SIZE, OR COLOR.

SER. NO. 85-640,854, FILED 6-1-2012.

REBECCA EISINGER, EXAMINING ATTORNEY



*David J. Kybas*

Director of the United States Patent and Trademark Office

# United States of America

United States Patent and Trademark Office

## HOLLANDJUNGLE

**Reg. No. 4,275,483**

**Registered Jan. 15, 2013**

**Int. Cl.: 41**

**SERVICE MARK**

**PRINCIPAL REGISTER**

AMALGAMATED BUSINESS PRINCIPLES, LLC (FLORIDA LIMITED LIABILITY COMPANY), DBA HOLLANDJUNGLE  
318 INDIAN TRACE #237  
WESTON, FL 33326

FOR: AUDIO AND VIDEO RECORDING SERVICES; COMPOSITION OF MUSIC FOR OTHERS; CONSULTATION AND ADVICE REGARDING MUSICAL SELECTIONS AND ARRANGEMENTS FOR SOUND RECORDINGS AND LIVE PERFORMANCES; EDITING OR RECORDING OF SOUNDS AND IMAGES; ENTERTAINMENT IN THE NATURE OF VISUAL AND AUDIO PERFORMANCES BY MUSICAL ARTISTS.; ENTERTAINMENT IN THE NATURE OF VISUAL AND AUDIO PERFORMANCES, AND MUSICAL, VARIETY, NEWS AND COMEDY SHOWS; ENTERTAINMENT INFORMATION SERVICES, NAMELY, PROVIDING INFORMATION AND NEWS RELEASES ABOUT A MUSICAL ARTIST; ENTERTAINMENT SERVICES BY A MUSICAL ARTIST AND PRODUCER, NAMELY, MUSICAL COMPOSITION FOR OTHERS AND PRODUCTION OF MUSICAL SOUND RECORDINGS; ENTERTAINMENT SERVICES IN THE NATURE OF LIVE MUSICAL PERFORMANCES; ENTERTAINMENT SERVICES IN THE NATURE OF PRESENTING LIVE MUSICAL PERFORMANCES; ENTERTAINMENT SERVICES IN THE NATURE OF RECORDING, PRODUCTION AND POST-PRODUCTION SERVICES IN THE FIELD OF MUSIC; ENTERTAINMENT SERVICES, NAMELY, DANCE EVENTS BY A RECORDING ARTIST; ENTERTAINMENT SERVICES, NAMELY, NON-DOWNLOADABLE RINGTONES, PRE-RECORDED MUSIC, AND GRAPHICS PRESENTED TO MOBILE COMMUNICATIONS DEVICES VIA A GLOBAL COMPUTER NETWORK AND WIRELESS NETWORKS; ENTERTAINMENT SERVICES, NAMELY, PRODUCTION OF SPECIAL EFFECTS INCLUDING MODEL-MAKING SERVICES, COMPUTER-GENERATED IMAGERY AND COMPUTER-GENERATED GRAPHICS FOR THE PRODUCTION OF MOTION PICTURES, VIDEOS, AND MOVIE TRAILERS; ENTERTAINMENT SERVICES, NAMELY, PROVIDING A WEB SITE FEATURING NON-DOWNLOADABLE MUSICAL PERFORMANCES, MUSICAL VIDEOS, RELATED FILM CLIPS, PHOTOGRAPHS, AND OTHER MULTIMEDIA MATERIALS FEATURING MUSICAL ARTISTS; ENTERTAINMENT SERVICES, NAMELY, PROVIDING ADVICE AND INFORMATION FOR MUSIC, VIDEO AND FILM CONCEPT AND SCRIPT DEVELOPMENT; ENTERTAINMENT SERVICES, NAMELY, PROVIDING INFORMATION ABOUT A RECORDING ARTIST VIA AN ONLINE NETWORK; ENTERTAINMENT SERVICES, NAMELY, PROVIDING NON-DOWNLOADABLE PLAYBACK OF MUSIC VIA GLOBAL COMMUNICATIONS NETWORKS; ENTERTAINMENT, NAMELY, LIVE MUSIC CONCERTS; ENTERTAINMENT, NAMELY, LIVE PERFORMANCES BY A MUSICAL BAND; ENTERTAINMENT, NAMELY, LIVE PERFORMANCES BY MUSICAL BANDS; FILM AND VIDEO FILM PRO-



*David J. Kybas*

Director of the United States Patent and Trademark Office

**Reg. No. 4,275,483** DDUCTION; FILM AND VIDEO PRODUCTION; FILM AND VIDEO PRODUCTION CONSULTING SERVICES; LIVE PERFORMANCES BY A MUSICAL GROUP; MULTIMEDIA ENTERTAINMENT SERVICES IN THE NATURE OF DEVELOPMENT, PRODUCTION AND POST-PRODUCTION SERVICES IN THE FIELDS OF VIDEO AND FILMS; MULTIMEDIA ENTERTAINMENT SERVICES IN THE NATURE OF RECORDING, PRODUCTION AND POST-PRODUCTION SERVICES IN THE FIELDS OF MUSIC, VIDEO, AND FILMS; MUSIC COMPOSITION AND TRANSCRIPTION FOR OTHERS; MUSIC COMPOSITION FOR OTHERS; MUSIC COMPOSITION SERVICES; MUSIC PRODUCTION SERVICES; MUSIC SELECTION SERVICES FOR USE IN TELEVISION, FILM, RADIO AND VIDEO GAMES; MUSIC VIDEO PRODUCTION; POST-PRODUCTION EDITING SERVICES IN THE FIELD OF MUSIC, VIDEOS AND FILM; PRESENTATION OF MUSICAL PERFORMANCE; PRODUCTION OF AUDIO RECORDING; PRODUCTION OF MUSICAL SOUND RECORDING; PRODUCTION OF MUSICAL VIDEOS; PRODUCTION OF SOUND AND MUSIC VIDEO RECORDINGS; PRODUCTION OF SOUND RECORDINGS; PROVIDING A DATABASE FEATURING INFORMATION ABOUT ARTISTS; PROVIDING A WEBSITE FEATURING INFORMATION ABOUT ARTISTIC STYLES; PROVIDING A WEBSITE FEATURING INFORMATION IN THE FIELD OF MUSIC AND ENTERTAINMENT; PROVIDING AN INTERNET WEBSITE PORTAL FEATURING LINKS TO MUSICAL ARTIST WEBSITES AND MUSIC PERFORMANCE TICKET INFORMATION; PROVISION OF INFORMATION RELATING TO LIVE PERFORMANCES, ROAD SHOWS, LIVE STAGE EVENTS, THEATRICAL PERFORMANCES, LIVE MUSIC CONCERTS AND AUDIENCE PARTICIPATION IN SUCH EVENTS; PROVISION OF INFORMATION RELATING TO MUSIC; RECORD MASTER PRODUCTION; RECORD MASTERING; RECORD PRODUCTION; RECORDING STUDIO SERVICES; RECORDING STUDIOS; RENTAL OF FACILITIES AND EQUIPMENT FOR THE PRODUCTION OF RADIO AND TELEVISION PROGRAMS, MUSICAL AND THEATRICAL PRODUCTIONS, NAMELY, PERFORMANCE VENUES, STUDIOS, SETS, DRESSING ROOMS; RENTAL OF MUSICAL INSTRUMENTS; SOUND RECORDING STUDIOS; THEATRICAL AND MUSICAL FLOOR SHOWS PROVIDED AT DISCOTHEQUES AND NIGHTCLUBS; THEATRICAL AND MUSICAL FLOOR SHOWS PROVIDED AT PERFORMANCE VENUES; VIDEO EDITING; VIDEO MASTERING SERVICES; VIDEO PRODUCTION SERVICES; VIDEO TAPE EDITING; VIDEO TAPE FILM PRODUCTION, IN CLASS 41 (U.S. CLS. 100, 101 AND 107).

FIRST USE 8-17-2008; IN COMMERCE 8-17-2008.

THE MARK CONSISTS OF STANDARD CHARACTERS WITHOUT CLAIM TO ANY PARTICULAR FONT, STYLE, SIZE, OR COLOR.

SER. NO. 85-640,855, FILED 6-1-2012.

HEATHER SAPP, EXAMINING ATTORNEY



# United States of America

United States Patent and Trademark Office

## Ambidextrous Ale

**Reg. No. 4,275,484**

**Registered Jan. 15, 2013**

**Int. Cl.: 32**

**TRADEMARK**

**PRINCIPAL REGISTER**

INDIAN PEAKS BREWING COMPANY (COLORADO CORPORATION), DBA LEFT HAND BREWING COMPANY  
1265 BOSTON AVE  
LONGMONT, CO 80501

FOR: BEER, ALE, LAGER, STOUT AND PORTER, IN CLASS 32 (U.S. CLS. 45, 46 AND 48).

FIRST USE 12-11-2011; IN COMMERCE 1-6-2012.

THE MARK CONSISTS OF STANDARD CHARACTERS WITHOUT CLAIM TO ANY PARTICULAR FONT, STYLE, SIZE, OR COLOR.

NO CLAIM IS MADE TO THE EXCLUSIVE RIGHT TO USE "ALE", APART FROM THE MARK AS SHOWN.

SER. NO. 85-640,867, FILED 6-1-2012.

AMY ALFIERI, EXAMINING ATTORNEY



*David J. Kyffers*

Director of the United States Patent and Trademark Office

# United States of America

United States Patent and Trademark Office

## DIRTY LAUNDRY

**Reg. No. 4,275,485**

**Registered Jan. 15, 2013**

**Int. Cl.: 18**

**TRADEMARK**

**PRINCIPAL REGISTER**

LONGLAT, INC. (NEW JERSEY CORPORATION)  
141 LANZA AVENUE, #18C  
GARFIELD, NJ 07026

FOR: LUGGAGE, IN CLASS 18 (U.S. CLS. 1, 2, 3, 22 AND 41).

FIRST USE 4-30-2011; IN COMMERCE 4-30-2011.

THE MARK CONSISTS OF STANDARD CHARACTERS WITHOUT CLAIM TO ANY PARTICULAR FONT, STYLE, SIZE, OR COLOR.

SER. NO. 85-640,883, FILED 6-1-2012.

DEZMONA MIZELLE, EXAMINING ATTORNEY



*David J. Kybas*

Director of the United States Patent and Trademark Office

# United States of America

United States Patent and Trademark Office

## "Thanks Lester"

**Reg. No. 4,275,486**

**Registered Jan. 15, 2013**

**Int. Cl.: 45**

**SERVICE MARK**

**PRINCIPAL REGISTER**

LMM INVESTMENTS, LLC (GEORGIA LIMITED LIABILITY COMPANY)  
563 WALNUT STREET  
MACON, GA 31201

FOR: LEGAL SERVICES, IN CLASS 45 (U.S. CLS. 100 AND 101).

FIRST USE 9-24-2010; IN COMMERCE 9-24-2010.

THE MARK CONSISTS OF STANDARD CHARACTERS WITHOUT CLAIM TO ANY PARTICULAR FONT, STYLE, SIZE, OR COLOR.

SER. NO. 85-640,913, FILED 6-1-2012.

ANDREW LEASER, EXAMINING ATTORNEY



*David J. Kybas*

Director of the United States Patent and Trademark Office

# United States of America

United States Patent and Trademark Office

# AGRILAC

**Reg. No. 4,275,487**

SPANGENBERG, JENS (UNITED STATES INDIVIDUAL)  
5518 NW 72ND AVE  
MIAMI, FL 33166

**Registered Jan. 15, 2013**

**Int. Cl.: 35**

FOR: WHOLE DISTRIBUTORSHIP SERVICES, RETAIL STORE SERVICES AND ONLINE RETAIL STORE SERVICES FEATURING A FULL LINE OF MILKING EQUIPMENT AND DAIRY FARM EQUIPMENT INCLUDING PARTS AND ACCESSORIES, IN CLASS 35 (U.S. CLS. 100, 101 AND 102).

**SERVICE MARK**

**PRINCIPAL REGISTER**

FIRST USE 0-0-1993; IN COMMERCE 0-0-1993.

THE MARK CONSISTS OF STANDARD CHARACTERS WITHOUT CLAIM TO ANY PARTICULAR FONT, STYLE, SIZE, OR COLOR.

SER. NO. 85-640,924, FILED 6-1-2012.

ANDREW LEASER, EXAMINING ATTORNEY



*David J. Kyffers*

Director of the United States Patent and Trademark Office

# United States of America

United States Patent and Trademark Office

# WILD HEART

**Reg. No. 4,275,488**

WILSON, DEBORAH (UNITED STATES INDIVIDUAL)  
8562 WEST 200 NORTH  
TIPTON, IN 46072

**Registered Jan. 15, 2013**

**Int. Cl.: 36**

FOR: CHARITABLE FUND RAISING SERVICES, IN CLASS 36 (U.S. CLS. 100, 101 AND 102).

**SERVICE MARK**

FIRST USE 3-1-2001; IN COMMERCE 3-1-2001.

**PRINCIPAL REGISTER**

THE MARK CONSISTS OF STANDARD CHARACTERS WITHOUT CLAIM TO ANY PARTICULAR FONT, STYLE, SIZE, OR COLOR.

SER. NO. 85-640,942, FILED 6-1-2012.

HEATHER BIDDULPH, EXAMINING ATTORNEY



*David J. Kybas*

Director of the United States Patent and Trademark Office

# United States of America

United States Patent and Trademark Office

## "Thanks Lester"

**Reg. No. 4,275,489**

LMM INVESTMENTS, LLC (GEORGIA LIMITED LIABILITY COMPANY)  
563 WALNUT STREET  
MACON, GA 31204

**Registered Jan. 15, 2013**

**Int. Cl.: 25**

FOR: PROMOTIONAL ITEMS, NAMELY, T-SHIRTS, IN CLASS 25 (U.S. CLS. 22 AND 39).

**TRADEMARK**

FIRST USE 9-24-2010; IN COMMERCE 9-24-2010.

**PRINCIPAL REGISTER**

THE MARK CONSISTS OF STANDARD CHARACTERS WITHOUT CLAIM TO ANY PARTICULAR FONT, STYLE, SIZE, OR COLOR.

SER. NO. 85-640,945, FILED 6-1-2012.

ANDREW LEASER, EXAMINING ATTORNEY



*David J. Kybas*

Director of the United States Patent and Trademark Office

# United States of America

United States Patent and Trademark Office

# SWEAT PINK

**Reg. No. 4,275,490**

FIT APPROACH, LLC (CALIFORNIA LIMITED LIABILITY COMPANY)  
2411 CHESTNUT ST., #305  
SAN FRANCISCO, CA 94123

**Registered Jan. 15, 2013**

**Int. Cls.: 25, 26 and 41**

FOR: T-SHIRTS; TANK TOPS, IN CLASS 25 (U.S. CLS. 22 AND 39).

FIRST USE 7-5-2011; IN COMMERCE 10-13-2011.

**TRADEMARK**

FOR: SHOE LACES, IN CLASS 26 (U.S. CLS. 37, 39, 40, 42 AND 50).

**SERVICE MARK**

FIRST USE 7-5-2011; IN COMMERCE 7-7-2011.

**PRINCIPAL REGISTER**

FOR: CONDUCTING FITNESS CLASSES, IN CLASS 41 (U.S. CLS. 100, 101 AND 107).

FIRST USE 7-5-2011; IN COMMERCE 11-11-2011.

THE MARK CONSISTS OF STANDARD CHARACTERS WITHOUT CLAIM TO ANY PARTICULAR FONT, STYLE, SIZE, OR COLOR.

SER. NO. 85-640,948, FILED 6-1-2012.

ANDREW LEASER, EXAMINING ATTORNEY



*David J. Kyros*

Director of the United States Patent and Trademark Office

# United States of America

United States Patent and Trademark Office

# SWEAT PINK

**Reg. No. 4,275,491**

FIT APPROACH, LLC (CALIFORNIA LIMITED LIABILITY COMPANY)  
2411 CHESTNUT ST., #305  
SAN FRANCISCO, CA 94123

**Registered Jan. 15, 2013**

**Int. Cl.: 35**

FOR: PROMOTING THE INTERESTS OF PEOPLE CONCERNED WITH HEALTH, EXERCISE,  
AND FITNESS ISSUES, IN CLASS 35 (U.S. CLS. 100, 101 AND 102).

**SERVICE MARK**

FIRST USE 7-5-2011; IN COMMERCE 1-1-2012.

**PRINCIPAL REGISTER**

THE MARK CONSISTS OF STANDARD CHARACTERS WITHOUT CLAIM TO ANY PAR-  
TICULAR FONT, STYLE, SIZE, OR COLOR.

SER. NO. 85-640,953, FILED 6-1-2012.

ANDREW LEASER, EXAMINING ATTORNEY



*David J. Kybas*

Director of the United States Patent and Trademark Office



# United States of America

United States Patent and Trademark Office

## VISUALIZE THE POSSIBILITIES

**Reg. No. 4,275,492**

RESTORATION ROBOTICS, INC. (DELAWARE CORPORATION)  
128 BAYTECH DRIVE  
SAN JOSE, CA 95134

**Registered Jan. 15, 2013**

**Int. Cl.: 44**

FOR: MEDICAL AND AESTHETIC SERVICES IN THE FIELD OF HAIR RESTORATION, HAIR TRANSPLANTATION AND HAIR LOSS, NAMELY, PROVIDING INFORMATION IN THE FIELD OF HAIR RESTORATION, HAIR TRANSPLANTATION AND HAIR LOSS BY MEANS OF WRITTEN, AUDIO-VISUAL, ELECTRONIC MATERIALS AND WEBSITES, IN CLASS 44 (U.S. CLS. 100 AND 101).

**SERVICE MARK**

**PRINCIPAL REGISTER**

FIRST USE 8-26-2011; IN COMMERCE 8-26-2011.

THE MARK CONSISTS OF STANDARD CHARACTERS WITHOUT CLAIM TO ANY PARTICULAR FONT, STYLE, SIZE, OR COLOR.

SER. NO. 85-640,961, FILED 6-1-2012.

HEATHER SAPP, EXAMINING ATTORNEY



*David J. Kyffers*

Director of the United States Patent and Trademark Office

United States of America  
United States Patent and Trademark Office

socialRNA

**Reg. No. 4,275,493**

SOCIALRNA, LLC (ILLINOIS LIMITED LIABILITY COMPANY)  
35 E WACKER DR STE 1000  
CHICAGO, IL 60601

**Registered Jan. 15, 2013**

**Int. Cl.: 35**

FOR: INFORMATION, ADVISORY AND CONSULTANCY SERVICES RELATING TO BUSINESS AND MANAGEMENT OR BUSINESS ADMINISTRATION, INCLUDING SUCH SERVICES PROVIDED ON LINE OR VIA THE INTERNET, IN CLASS 35 (U.S. CLS. 100, 101 AND 102).

**SERVICE MARK**

**PRINCIPAL REGISTER**

FIRST USE 3-29-2012; IN COMMERCE 5-16-2012.

THE MARK CONSISTS OF STANDARD CHARACTERS WITHOUT CLAIM TO ANY PARTICULAR FONT, STYLE, SIZE, OR COLOR.

SER. NO. 85-640,963, FILED 6-1-2012.

MATTHEW EINSTEIN, EXAMINING ATTORNEY



*David J. Kyros*

Director of the United States Patent and Trademark Office

# United States of America

United States Patent and Trademark Office

# JJC's-BBQ

**Reg. No. 4,275,494**

JOSEPH CARLSON (UNITED STATES INDIVIDUAL)  
415 NW 41 ST AVE  
DEERFLIED BEACH, FL 33442

**Registered Jan. 15, 2013**

**Int. Cl.: 43**

FOR: CATERING SERVICES; MOBILE CAFE SERVICES FOR PROVIDING FOOD AND DRINK, IN CLASS 43 (U.S. CLS. 100 AND 101).

**SERVICE MARK**

FIRST USE 5-7-2008; IN COMMERCE 6-10-2008.

**PRINCIPAL REGISTER**

THE MARK CONSISTS OF STANDARD CHARACTERS WITHOUT CLAIM TO ANY PARTICULAR FONT, STYLE, SIZE, OR COLOR.

THE NAME(S), PORTRAIT(S), AND/OR SIGNATURE(S) SHOWN IN THE MARK DOES NOT IDENTIFY A PARTICULAR LIVING INDIVIDUAL.

SER. NO. 85-640,996, FILED 6-1-2012.

JEAN IM, EXAMINING ATTORNEY



*David J. Kyfos*

Director of the United States Patent and Trademark Office

# United States of America

United States Patent and Trademark Office

## MOSAIC WEIGHTED BLANKETS

**Reg. No. 4,275,495**

**Registered Jan. 15, 2013**

**Int. Cl.: 10**

**TRADEMARK**

**PRINCIPAL REGISTER**

MOSAIC WEIGHTED BLANKETS, LLC (TEXAS LIMITED LIABILITY COMPANY)  
1102 S. AUSTIN AVE., STE. 110-173  
AUSTIN, TX 78626

FOR: THERAPEUTIC WEIGHTED PRODUCTS, NAMELY, WEIGHTED BLANKETS, LAP PADS AND VESTS DESIGNED FOR CLINICAL AND HOME USE TO PROVIDE PROPRIO-CEPTIVE INPUT TO THE BODY, IN CLASS 10 (U.S. CLS. 26, 39 AND 44).

FIRST USE 5-31-2012; IN COMMERCE 5-31-2012.

THE MARK CONSISTS OF STANDARD CHARACTERS WITHOUT CLAIM TO ANY PARTICULAR FONT, STYLE, SIZE, OR COLOR.

NO CLAIM IS MADE TO THE EXCLUSIVE RIGHT TO USE "WEIGHTED BLANKETS", APART FROM THE MARK AS SHOWN.

SER. NO. 85-641,010, FILED 6-1-2012.

ZHALEH DELANEY, EXAMINING ATTORNEY



*David J. Kyffers*

Director of the United States Patent and Trademark Office

# United States of America

United States Patent and Trademark Office



**Reg. No. 4,275,496**

WILSON, DEBORAH (UNITED STATES INDIVIDUAL)  
8562 WEST 200 NORTH  
TIPTON, IN 46072

**Registered Jan. 15, 2013**

**Int. Cl.: 36**

FOR: CHARITABLE FUND RAISING SERVICES, IN CLASS 36 (U.S. CLS. 100, 101 AND 102).

**SERVICE MARK**

FIRST USE 3-1-2001; IN COMMERCE 3-1-2001.

**PRINCIPAL REGISTER**

THE MARK CONSISTS OF A HEART WITH WINGS AND HALO.

SER. NO. 85-641,018, FILED 6-1-2012.

HEATHER BIDDULPH, EXAMINING ATTORNEY



*David J. Kybas*

Director of the United States Patent and Trademark Office

# United States of America

United States Patent and Trademark Office

## THE FINISHED EDGE

**Reg. No. 4,275,497**

**Registered Jan. 15, 2013**

**Int. Cl.: 21**

**TRADEMARK**

**PRINCIPAL REGISTER**

HARRY D. KOENIG & COMPANY, INC. (NEW YORK CORPORATION)  
7 MAIN STREET BOX 125  
EAST ROCKAWAY, NY 11518

FOR: APPLICATORS FOR APPLYING MAKEUP, FOUNDATION, AND COSMETICS; FOAM APPLICATORS FOR APPLYING MAKEUP, FOUNDATION, AND COSMETICS , IN CLASS 21 (U.S. CLS. 2, 13, 23, 29, 30, 33, 40 AND 50).

FIRST USE 5-1-2012; IN COMMERCE 5-1-2012.

THE MARK CONSISTS OF STANDARD CHARACTERS WITHOUT CLAIM TO ANY PARTICULAR FONT, STYLE, SIZE, OR COLOR.

SER. NO. 85-641,038, FILED 6-1-2012.

ANNE MADDEN, EXAMINING ATTORNEY



*David J. Kybas*

Director of the United States Patent and Trademark Office

**United States of America**  
United States Patent and Trademark Office

# CERTRAX

**Reg. No. 4,275,498**

CERTRAX, LLC (NEW JERSEY LIMITED LIABILITY COMPANY)  
6 MAIDEN LANE, 7TH FLR  
NEW YORK, NY 10038

**Registered Jan. 15, 2013**

**Int. Cl.: 35**

FOR: TRACKING AND MONITORING INSURANCE COMPLIANCE, IN CLASS 35 (U.S. CLS. 100, 101 AND 102).

**SERVICE MARK**

FIRST USE 1-0-2009; IN COMMERCE 1-0-2009.

**PRINCIPAL REGISTER**

THE MARK CONSISTS OF STANDARD CHARACTERS WITHOUT CLAIM TO ANY PARTICULAR FONT, STYLE, SIZE, OR COLOR.

SER. NO. 85-641,057, FILED 6-1-2012.

NICHOLAS ALTREE, EXAMINING ATTORNEY



*David J. Kybas*

Director of the United States Patent and Trademark Office

# United States of America

United States Patent and Trademark Office

*Dr. Sao*

**Reg. No. 4,275,499**

JEFF SAO MD (UNITED STATES INDIVIDUAL)  
721 EL MONTE ST.  
SAN GABRIEL, CA 91776

**Registered Jan. 15, 2013**

**Int. Cl.: 30**

FOR: CHILI SAUCE, IN CLASS 30 (U.S. CL. 46).

**TRADEMARK**

FIRST USE 5-28-2012; IN COMMERCE 5-28-2012.

**PRINCIPAL REGISTER**

THE NAME DR. SAO IDENTIFIES A LIVING INDIVIDUAL WHOSE CONSENT IS OF RECORD.

THE MARK CONSISTS OF STYLIZED DESIGN FOR THE WORDS DR.SAO.

SER. NO. 85-641,076, FILED 6-1-2012.

CHRISTOPHER BUONGIORNO, EXAMINING ATTORNEY



*David J. Kyffers*

Director of the United States Patent and Trademark Office



# United States of America

United States Patent and Trademark Office

# TeacherMatch

**Reg. No. 4,275,500**

TEACHERMATCH LLC (DELAWARE LIMITED LIABILITY COMPANY)  
46111 N RAVENSWOOD, UNIT 207  
CHICAGO, IL 60640

**Registered Jan. 15, 2013**

**Int. Cl.: 35**

FOR: HUMAN RESOURCE ANALYSIS AND CONSULTING SERVICES; HUMAN RESOURCES CONSULTANCY; HUMAN RESOURCES CONSULTATION; HUMAN RESOURCES MANAGEMENT; HUMAN RESOURCES SERVICES, NAMELY, PERSONNEL SELECTION FOR OTHERS, IN CLASS 35 (U.S. CLS. 100, 101 AND 102).

**SERVICE MARK**

**PRINCIPAL REGISTER**

FIRST USE 12-15-2011; IN COMMERCE 3-20-2012.

THE MARK CONSISTS OF STANDARD CHARACTERS WITHOUT CLAIM TO ANY PARTICULAR FONT, STYLE, SIZE, OR COLOR.

SER. NO. 85-641,086, FILED 6-1-2012.

CHRISTOPHER BUONGIORNO, EXAMINING ATTORNEY



*David J. Kyffers*

Director of the United States Patent and Trademark Office

# United States of America

United States Patent and Trademark Office

# RZO

**Reg. No. 4,275,501**

**Registered Jan. 15, 2013**

**Int. Cl.: 5**

**TRADEMARK**

**PRINCIPAL REGISTER**

RUIQI ZHENDING ORGANIZATION LLC (HAWAII LIMITED LIABILITY COMPANY), DBA  
RZO BEVERAGE  
98-1395 NOLA STREET, APT C  
PEARL CITY, HI 96782

FOR: NUTRITIONALLY FORTIFIED BEVERAGES, IN CLASS 5 (U.S. CLS. 6, 18, 44, 46, 51  
AND 52).

FIRST USE 5-11-2010; IN COMMERCE 5-11-2010.

THE MARK CONSISTS OF STANDARD CHARACTERS WITHOUT CLAIM TO ANY PAR-  
TICULAR FONT, STYLE, SIZE, OR COLOR.

SER. NO. 85-641,099, FILED 6-1-2012.

DAVID C. REIHNER, EXAMINING ATTORNEY



*David J. Kyffers*

Director of the United States Patent and Trademark Office

United States of America  
United States Patent and Trademark Office

Steele's

**Reg. No. 4,275,502**

SPECIALTY RETAILERS, INC. (TEXAS CORPORATION)  
10201 SOUTH MAIN STREET  
HOUSTON, TX 77025

**Registered Jan. 15, 2013**

**Int. Cl.: 35**

FOR: RETAIL DISCOUNT DEPARTMENT STORE SERVICES FEATURING CLOTHING, JEWELRY, FRAGRANCES, SHOES, SKIN CARE ITEMS, HANDBAGS, ELECTRONICS, LINENS, PAPER ITEMS, AUTO PARTS AND LUGGAGE, IN CLASS 35 (U.S. CLS. 100, 101 AND 102).

**SERVICE MARK**

**PRINCIPAL REGISTER**

FIRST USE 11-1-2011; IN COMMERCE 11-1-2011.

THE MARK CONSISTS OF A STYLIZED FORM OF THE WORD "STEELE'S" WITH THE APOSTROPHE BEING IN THE SHAPE OF A LEAF.

SER. NO. 85-641,101, FILED 6-1-2012.

ANDREA HACK, EXAMINING ATTORNEY



*David J. Kyjars*

Director of the United States Patent and Trademark Office

# United States of America

United States Patent and Trademark Office

# KALIN

**Reg. No. 4,275,503**

**Registered Jan. 15, 2013**

**Int. Cl.: 14**

**TRADEMARK**

**PRINCIPAL REGISTER**

KALIN MANCHEV (BULGARIA INDIVIDUAL)  
53 PINE ISLE COURT  
HENDERSON, NV 89074

FOR: COSTUME JEWELRY; INEXPENSIVE NON-JEWELRY WATCHES; JEWELRY; JEWELRY WATCHES; WATCH BANDS; WATCH FACES; WATCH STRAPS; WATCHES, IN CLASS 14 (U.S. CLS. 2, 27, 28 AND 50).

FIRST USE 5-10-2012; IN COMMERCE 5-10-2012.

THE MARK CONSISTS OF STANDARD CHARACTERS WITHOUT CLAIM TO ANY PARTICULAR FONT, STYLE, SIZE, OR COLOR.

THE NAME(S), PORTRAIT(S), AND/OR SIGNATURE(S) SHOWN IN THE MARK IDENTIFIES APPLICANT KALIN MANCHEV, WHOSE CONSENT(S) TO REGISTER IS MADE OF RECORD.

SER. NO. 85-641,102, FILED 6-1-2012.

WENDY JUN, EXAMINING ATTORNEY



*David J. Kyffers*

Director of the United States Patent and Trademark Office

# United States of America

United States Patent and Trademark Office

## Bay Ridge Pizza

**Reg. No. 4,275,504**

GASPARE PIZZA, INC. (NEW YORK CORPORATION)  
7704 5TH AVENUE  
BROOKLYN, NY 11209

**Registered Jan. 15, 2013**

**Int. Cls.: 30 and 43**

FOR: PIZZA, IN CLASS 30 (U.S. CL. 46).

**TRADEMARK**

FIRST USE 3-31-1979; IN COMMERCE 3-31-1979.

**SERVICE MARK**

FOR: RESTAURANT AND CATERING SERVICES; RESTAURANT SERVICES FEATURING PIZZA AND ITALIAN CUISINE, IN CLASS 43 (U.S. CLS. 100 AND 101).

**PRINCIPAL REGISTER**

FIRST USE 3-31-1979; IN COMMERCE 3-31-1979.

THE MARK CONSISTS OF STANDARD CHARACTERS WITHOUT CLAIM TO ANY PARTICULAR FONT, STYLE, SIZE, OR COLOR.

NO CLAIM IS MADE TO THE EXCLUSIVE RIGHT TO USE "PIZZA", APART FROM THE MARK AS SHOWN.

SEC. 2(F).

SER. NO. 85-641,125, FILED 6-1-2012.

DAWN FELDMAN, EXAMINING ATTORNEY



*David J. Kyros*

Director of the United States Patent and Trademark Office

# United States of America

United States Patent and Trademark Office

## NO EXCUSES

**Reg. No. 4,275,505**

**Registered Jan. 15, 2013**

**Int. Cls.: 35 and 39**

**SERVICE MARK**

**PRINCIPAL REGISTER**

COYOTE LOGISTICS, LLC (ILLINOIS LIMITED LIABILITY COMPANY)  
191 EAST DEERPATH ROAD  
LAKE FOREST, IL 60045

FOR: TRANSPORTATION LOGISTICS SERVICES, NAMELY, ARRANGING FOR THE TRANSPORTATION OF GOODS FOR OTHERS, AND SCHEDULING SHIPMENTS FOR USERS OF TRANSPORTATION SERVICES; FREIGHT LOGISTICS MANAGEMENT, IN CLASS 35 (U.S. CLS. 100, 101 AND 102).

FIRST USE 7-11-2011; IN COMMERCE 7-11-2011.

FOR: FREIGHT FORWARDING AND BROKERING; SUPPLY CHAIN LOGISTICS AND REVERSE LOGISTICS SERVICES, NAMELY, TRANSPORTATION OF FREIGHT AND PROPERTY BY LAND, SEA, AIR, OR RAIL; DELIVERY OF GOODS BY TRUCK, IN CLASS 39 (U.S. CLS. 100 AND 105).

FIRST USE 7-11-2011; IN COMMERCE 7-11-2011.

THE MARK CONSISTS OF STANDARD CHARACTERS WITHOUT CLAIM TO ANY PARTICULAR FONT, STYLE, SIZE, OR COLOR.

SER. NO. 85-641,130, FILED 6-1-2012.

MORGAN WYNNE, EXAMINING ATTORNEY



*David J. Kyros*

Director of the United States Patent and Trademark Office

# United States of America

United States Patent and Trademark Office

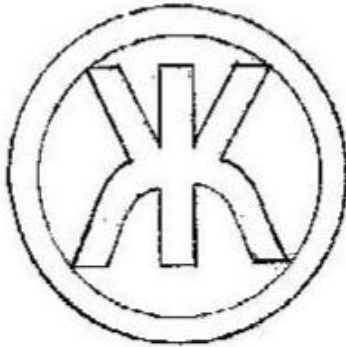

**Reg. No. 4,275,506**

KALIN MANCHEV (BULGARIA INDIVIDUAL)  
53 PINE ISLE COURT  
HENDERSON, NV 89074

**Registered Jan. 15, 2013**

**Int. Cl.: 14**

FOR: COSTUME JEWELRY; INEXPENSIVE NON-JEWELRY WATCHES; JEWELRY; JEWELRY WATCHES; WATCH BANDS; WATCH FACES; WATCH STRAPS; WATCHES, IN CLASS 14 (U.S. CLS. 2, 27, 28 AND 50).

**TRADEMARK**

FIRST USE 5-10-2012; IN COMMERCE 5-10-2012.

**PRINCIPAL REGISTER**

OWNER OF U.S. REG. NO. 4,207,004.

THE MARK CONSISTS OF THE CYRILLIC LETTER ZHE INSIDE TWO CONCENTRIC CIRCLES.

SER. NO. 85-641,133, FILED 6-1-2012.

WENDY JUN, EXAMINING ATTORNEY



*David J. Kybas*

Director of the United States Patent and Trademark Office

**United States of America**  
United States Patent and Trademark Office

# Mi Granjita

**Reg. No. 4,275,507**

**Registered Jan. 15, 2013**

**Int. Cl.: 29**

**TRADEMARK**

**PRINCIPAL REGISTER**

LOS ALTOS FOOD PRODUCTS, INC. (CALIFORNIA CORPORATION)  
450 BALDWIN PARK BOULEVARD  
450 BALDWIN PARK BOULEVARD  
CITY OF INDUSTRY, CA 91746

FOR: SOUR CREAM, IN CLASS 29 (U.S. CL. 46).

FIRST USE 9-17-2009; IN COMMERCE 9-29-2009.

THE MARK CONSISTS OF STANDARD CHARACTERS WITHOUT CLAIM TO ANY PARTICULAR FONT, STYLE, SIZE, OR COLOR.

THE ENGLISH TRANSLATION OF "MI GRANJITA" IN THE MARK IS "MY LITTLE FARM".

SER. NO. 85-641,148, FILED 6-1-2012.

ALYSSA STEEL, EXAMINING ATTORNEY



*David J. Kyjars*

Director of the United States Patent and Trademark Office



# United States of America

United States Patent and Trademark Office

## Heart | Tone | Legend

**Reg. No. 4,275,508**

**Registered Jan. 15, 2013**

**Int. Cl.: 15**

**TRADEMARK**

**PRINCIPAL REGISTER**

DREADNOUGHT, INC. (DELAWARE CORPORATION)  
SUITE 202  
103 FOULK ROAD  
WILMINGTON, DE 19803

FOR: STRINGED MUSICAL INSTRUMENTS, IN CLASS 15 (U.S. CLS. 2, 21 AND 36).

FIRST USE 4-27-2012; IN COMMERCE 4-27-2012.

OWNER OF U.S. REG. NO. 4,123,041.

SER. NO. 85-641,149, FILED 6-1-2012.

MARK RADEMACHER, EXAMINING ATTORNEY



*David J. Kybas*

Director of the United States Patent and Trademark Office

# United States of America

United States Patent and Trademark Office

# iCreated

**Reg. No. 4,275,509**

LEIBOWITZ, DAVID SCOTT (UNITED STATES INDIVIDUAL)  
333 VANDELINDA AVE.  
TEANECK, NJ 07666

**Registered Jan. 15, 2013**

**Int. Cl.: 9**

FOR: COMPUTER APPLICATION SOFTWARE FOR MOBILE PHONES, PORTABLE MEDIA PLAYERS, TABLET COMPUTERS, HANDHELD COMPUTERS AND DESKTOP COMPUTERS, NAMELY, SOFTWARE FOR DISPLAYING ARTWORK GENERATED ON A MOBILE DEVICE AND A UNIQUE LISTING OF ART AND PHOTOGRAPH APPLICATIONS; DOWNLOADABLE SOFTWARE IN THE NATURE OF A MOBILE APPLICATION FOR DISPLAYING ARTWORK GENERATED ON A MOBILE DEVICE AND A UNIQUE LISTING OF ART AND PHOTOGRAPH APPLICATIONS, IN CLASS 9 (U.S. CLS. 21, 23, 26, 36 AND 38).

**TRADEMARK**

**PRINCIPAL REGISTER**

FIRST USE 7-0-2009; IN COMMERCE 7-0-2009.

THE MARK CONSISTS OF STANDARD CHARACTERS WITHOUT CLAIM TO ANY PARTICULAR FONT, STYLE, SIZE, OR COLOR.

SER. NO. 85-641,181, FILED 6-1-2012.

WILLIAM P. SHANAHAN, EXAMINING ATTORNEY



*David J. Kybas*

Director of the United States Patent and Trademark Office

# United States of America

United States Patent and Trademark Office

## SNAP DRAGON

**Reg. No. 4,275,510**

PH TECHNOLOGIES, LLC. (INDIANA LIMITED LIABILITY COMPANY)  
P.O. BOX 2525

**Registered Jan. 15, 2013**

HENDERSONVILLE, TN 37077

**Int. Cl.: 24**

FOR: DECORATIVE HOME AND GARDEN BANNERS AND FLAGS OF TEXTILE, IN CLASS 24 (U.S. CLS. 42 AND 50).

**TRADEMARK**

FIRST USE 5-25-2012; IN COMMERCE 5-25-2012.

**PRINCIPAL REGISTER**

THE MARK CONSISTS OF STANDARD CHARACTERS WITHOUT CLAIM TO ANY PARTICULAR FONT, STYLE, SIZE, OR COLOR.

SER. NO. 85-641,228, FILED 6-1-2012.

JENNIFER MARTIN, EXAMINING ATTORNEY



*David J. Kybas*

Director of the United States Patent and Trademark Office

# United States of America

United States Patent and Trademark Office



## ***Snap Dragon***

**Reg. No. 4,275,511**

PH TECHNOLOGIES, LLC. (INDIANA LIMITED LIABILITY COMPANY)  
P.O. BOX 2525

**Registered Jan. 15, 2013**

HENDERSONVILLE, TN 37077

**Int. Cl.: 24**

FOR: DECORATIVE HOME AND GARDEN BANNERS AND FLAGS OF TEXTILE, IN CLASS 24 (U.S. CLS. 42 AND 50).

**TRADEMARK**

FIRST USE 5-25-2012; IN COMMERCE 5-25-2012.

**PRINCIPAL REGISTER**

THE MARK CONSISTS OF THE WORDS "SNAP DRAGON" TO THE RIGHT OF A STYLIZED DRAGON HEAD.

SER. NO. 85-641,254, FILED 6-1-2012.

JENNIFER MARTIN, EXAMINING ATTORNEY



*David J. Kybas*

Director of the United States Patent and Trademark Office

# United States of America

United States Patent and Trademark Office

# UPS READY

**Reg. No. 4,275,512**

**Registered Jan. 15, 2013**

**Int. Cl.: 42**

**SERVICE MARK**

**PRINCIPAL REGISTER**

UNITED PARCEL SERVICE OF AMERICA, INC. (DELAWARE CORPORATION)  
55 GLENLAKE PARKWAY, NE  
ATLANTA, GA 30328

FOR: PROVIDING A WEB SITE FEATURING TEMPORARY USE OF NON-DOWNLOADABLE SOFTWARE FOR USE IN THE TRANSPORTATION AND DELIVERY FIELD, NAMELY FOR PROVISION OF CURRENT SHIPPING STATUS, PACKAGE DETAILS, SHIPPING SERVICE OPTIONS AND COSTS, PACKAGE ARRIVAL DATES AND DELIVERY NOTIFICATION, PREPARING AND PRINTING OF SHIPPING LABELS, DOCUMENTS AND INVOICES, FOR PROVIDING PROOF OF DELIVERY DOCUMENTATION, AND FOR THE RECEIPT, TRANSMISSION AND PROCESSING OF CUSTOMER IDENTIFYING SHIPPING ACCOUNT INFORMATION, IN CLASS 42 (U.S. CLS. 100 AND 101).

FIRST USE 3-0-2004; IN COMMERCE 3-0-2004.

THE MARK CONSISTS OF STANDARD CHARACTERS WITHOUT CLAIM TO ANY PARTICULAR FONT, STYLE, SIZE, OR COLOR.

OWNER OF U.S. REG. NO. 3,199,191.

SER. NO. 85-641,290, FILED 6-1-2012.

HOWARD B. LEVINE, EXAMINING ATTORNEY



*David J. Kyros*

Director of the United States Patent and Trademark Office

# United States of America

United States Patent and Trademark Office

# ELLI & NOOLI

**Reg. No. 4,275,513**

**Registered Jan. 15, 2013**

**Int. Cl.: 24**

**TRADEMARK**

**PRINCIPAL REGISTER**

ELLI AND NOOLI (CALIFORNIA LIMITED LIABILITY COMPANY)  
#301  
11735 DOROTHY STR.  
LOS ANGELES, CA 90049

FOR: BABY BLANKETS, IN CLASS 24 (U.S. CLS. 42 AND 50).

FIRST USE 10-1-2010; IN COMMERCE 1-1-2012.

THE MARK CONSISTS OF THE STYLIZED TEXT "ELLI & NOOLI".

SER. NO. 85-641,301, FILED 6-1-2012.

CHRISTINA SOBRAL, EXAMINING ATTORNEY



*David J. Kyffers*

Director of the United States Patent and Trademark Office

# United States of America

United States Patent and Trademark Office



**Reg. No. 4,275,514**

**Registered Jan. 15, 2013**

**Int. Cl.: 42**

**SERVICE MARK**

**PRINCIPAL REGISTER**

CALSYS, INC. (CALIFORNIA CORPORATION)  
#178  
2700 AUGUSTINE DRIVE  
SANTA CLARA, CA 95054

FOR: DESIGN AND DEVELOPMENT OF COMPUTER HARDWARE, SOFTWARE AND INTEGRATED CIRCUITS, IN CLASS 42 (U.S. CLS. 100 AND 101).

FIRST USE 1-1-2010; IN COMMERCE 1-1-2010.

THE MARK CONSISTS OF THE BLUE STYLIZED WORD "CALSYS" BELOW TWO ARCHES, THE LEFT BEING ORANGE AND THE RIGHT BLUE.

THE COLOR(S) BLUE AND ORANGE IS/ARE CLAIMED AS A FEATURE OF THE MARK.

SER. NO. 85-641,324, FILED 6-1-2012.

TOBY BULLOFF, EXAMINING ATTORNEY



*David J. Kyffers*

Director of the United States Patent and Trademark Office

# United States of America

United States Patent and Trademark Office



**Reg. No. 4,275,515**

PURPLE MILKMAN LLC (CALIFORNIA LIMITED LIABILITY COMPANY)  
7938 PLAYMOR TERRACE  
SAN DIEGO, CA 92122

**Registered Jan. 15, 2013**

**Int. Cl.: 35**

FOR: RESELLER SERVICES, NAMELY, DISTRIBUTORSHIP SERVICES IN THE FIELD OF WINE, IN CLASS 35 (U.S. CLS. 100, 101 AND 102).

**SERVICE MARK**

FIRST USE 3-1-2012; IN COMMERCE 3-1-2012.

**PRINCIPAL REGISTER**

THE MARK CONSISTS OF A MAN WITH A BOTTLE OF WINE IN ONE HAND AND A WINE GLASS IN THE OTHER. THE MAN IS WEARING A HAT AND IS IN A RUNNING POSE. BELOW THE MAN IS A THIN OVAL SHADOW.

SER. NO. 85-641,362, FILED 6-1-2012.

KEVIN DINALLO, EXAMINING ATTORNEY



*David J. Kybas*

Director of the United States Patent and Trademark Office



# United States of America

United States Patent and Trademark Office

A TASTE SO HEALTHY YOU CAN  
FEEL IT

**Reg. No. 4,275,516**

SAN MIGUEL PRODUCE, INC. (CALIFORNIA CORPORATION)  
4444 NAVALAIR ROAD  
OXNARD, CA 93033

**Registered Jan. 15, 2013**

**Int. Cl.: 29**

FOR: FRESH CUT VEGETABLES; FRESH SLICED VEGETABLES; PRE-CUT VEGETABLE SALADS; AND VEGETABLE SALADS, IN CLASS 29 (U.S. CL. 46).

**TRADEMARK**

FIRST USE 11-8-2011; IN COMMERCE 11-8-2011.

**PRINCIPAL REGISTER**

THE MARK CONSISTS OF STANDARD CHARACTERS WITHOUT CLAIM TO ANY PARTICULAR FONT, STYLE, SIZE, OR COLOR.

SER. NO. 85-641,411, FILED 6-1-2012.

MATTHEW GALAN, EXAMINING ATTORNEY



*David J. Kyffers*

Director of the United States Patent and Trademark Office

# United States of America

United States Patent and Trademark Office

## SCHOOL'S OUT PLAY'S IN

**Reg. No. 4,275,517**

**Registered Jan. 15, 2013**

**Int. Cl.: 41**

**SERVICE MARK**

**PRINCIPAL REGISTER**

TRIFECTA MANAGEMENT GROUP, INC. (DELAWARE CORPORATION)  
SUITE 240  
28035 DOROTHY DRIVE  
AGOURA HILLS, CA 91301

FOR: AMUSEMENT CENTERS, IN CLASS 41 (U.S. CLS. 100, 101 AND 107).

FIRST USE 4-26-2012; IN COMMERCE 4-26-2012.

THE MARK CONSISTS OF STANDARD CHARACTERS WITHOUT CLAIM TO ANY PARTICULAR FONT, STYLE, SIZE, OR COLOR.

SER. NO. 85-641,424, FILED 6-1-2012.

HEATHER SAPP, EXAMINING ATTORNEY



*David J. Kybas*

Director of the United States Patent and Trademark Office

# United States of America

United States Patent and Trademark Office

# PHYTODREN

**Reg. No. 4,275,518**

R. WALKER COMPANIES, LLC (UTAH LIMITED LIABILITY COMPANY)  
3520 N UNIVERSITY AVE STE 100  
PROVO, UT 84604

**Registered Jan. 15, 2013**

**Int. Cl.: 5**

FOR: DIETARY AND NUTRITIONAL SUPPLEMENTS USED FOR WEIGHT LOSS, IN CLASS 5 (U.S. CLS. 6, 18, 44, 46, 51 AND 52).

**TRADEMARK**

FIRST USE 1-6-2012; IN COMMERCE 1-6-2012.

**PRINCIPAL REGISTER**

THE MARK CONSISTS OF STANDARD CHARACTERS WITHOUT CLAIM TO ANY PARTICULAR FONT, STYLE, SIZE, OR COLOR.

SER. NO. 85-641,453, FILED 6-1-2012.

JULIE GUTTADAURO, EXAMINING ATTORNEY



*David J. Kyffers*

Director of the United States Patent and Trademark Office

# United States of America

United States Patent and Trademark Office



**Reg. No. 4,275,519**

BRAR BUSINESS ENTERPRISES (CALIFORNIA CORPORATION)  
10524 HAGEMAN RD SUITE C-1  
BAKERSFIELD, CA 93312

**Registered Jan. 15, 2013**

**Int. Cl.: 43**

FOR: BAR SERVICES; RESTAURANT SERVICES; RESTAURANTS FEATURING HOME DELIVERY; TAKE-OUT RESTAURANT SERVICES, IN CLASS 43 (U.S. CLS. 100 AND 101).

**SERVICE MARK**

FIRST USE 8-10-2010; IN COMMERCE 8-10-2010.

**PRINCIPAL REGISTER**

THE MARK CONSISTS OF A SHIELD-LIKE CREST DESIGN FEATURING A STYLIZED REPRESENTATION OF A SLICE OF PIZZA FORMING A CENTRAL TRIANGLE BETWEEN TWO SHADED TRIANGLES.

SER. NO. 85-641,467, FILED 6-1-2012.

LYNDSEY KUYKENDALL, EXAMINING ATTORNEY



*David J. Kyffers*

Director of the United States Patent and Trademark Office

# United States of America

United States Patent and Trademark Office

# Jessily

**Reg. No. 4,275,520**

JESSILY LLC (VIRGINIA LIMITED LIABILITY COMPANY)  
9017 BEATTY DR  
ALEXANDRIA, VA 22308

**Registered Jan. 15, 2013**

**Int. Cl.: 18**

FOR: HANDBAGS, IN CLASS 18 (U.S. CLS. 1, 2, 3, 22 AND 41).

**TRADEMARK**

FIRST USE 9-1-2011; IN COMMERCE 12-1-2011.

**PRINCIPAL REGISTER**

THE MARK CONSISTS OF STANDARD CHARACTERS WITHOUT CLAIM TO ANY PARTICULAR FONT, STYLE, SIZE, OR COLOR.

SER. NO. 85-641,517, FILED 6-1-2012.

DEBORAH MEINERS, EXAMINING ATTORNEY



*David J. Kybas*

Director of the United States Patent and Trademark Office

# United States of America

United States Patent and Trademark Office

# Thermo Vape

**Reg. No. 4,275,521**

THERMO-ESSENCE TECHNOLOGIES LLC (UTAH LIMITED LIABILITY COMPANY)  
3624 MACINTOSH LANE  
COTTONWOOD HEIGHTS, UT 84121

**Registered Jan. 15, 2013**

**Int. Cl.: 11**

FOR: ELECTRIC VAPORIZERS, IN CLASS 11 (U.S. CLS. 13, 21, 23, 31 AND 34).

**TRADEMARK**

FIRST USE 10-26-2011; IN COMMERCE 10-26-2011.

**PRINCIPAL REGISTER**

THE MARK CONSISTS OF STANDARD CHARACTERS WITHOUT CLAIM TO ANY PARTICULAR FONT, STYLE, SIZE, OR COLOR.

SER. NO. 85-641,535, FILED 6-1-2012.

ERNEST SHOSHO, EXAMINING ATTORNEY



*David J. Kyffers*

Director of the United States Patent and Trademark Office

# United States of America

United States Patent and Trademark Office

## SUN PAINTS & COATINGS

**Reg. No. 4,275,522**

**Registered Jan. 15, 2013**

**Int. Cl.: 2**

**TRADEMARK**

**PRINCIPAL REGISTER**

SUN COATINGS INC. (FLORIDA CORPORATION)  
4701 E 7TH AVE.  
TAMPA, FL 33605

FOR: PAINTS; PRIMERS, IN CLASS 2 (U.S. CLS. 6, 11 AND 16).

FIRST USE 12-0-2007; IN COMMERCE 12-0-2007.

THE MARK CONSISTS OF STANDARD CHARACTERS WITHOUT CLAIM TO ANY PARTICULAR FONT, STYLE, SIZE, OR COLOR.

OWNER OF U.S. REG. NO. 3,427,638.

NO CLAIM IS MADE TO THE EXCLUSIVE RIGHT TO USE "PAINTS & COATINGS", APART FROM THE MARK AS SHOWN.

SER. NO. 85-641,540, FILED 6-2-2012.

VIVIAN MICZNIK FIRST, EXAMINING ATTORNEY



*David J. Kyffers*

Director of the United States Patent and Trademark Office

# United States of America

United States Patent and Trademark Office

# SVTP

**Reg. No. 4,275,523**

**Registered Jan. 15, 2013**

**Int. Cl.: 9**

**TRADEMARK**

**PRINCIPAL REGISTER**

SILICON VALLEY TECHNOLOGY PARTNERS (CALIFORNIA PARTNERSHIP)  
12645 CAMBRIDGE DR  
SARATOGA, CA 95070

FOR: APPARATUS FOR CONVERTING ELECTRONIC RADIATION TO ELECTRICAL ENERGY, NAMELY, PHOTOVOLTAIC SOLAR HYBRID MODULES; APPARATUS FOR CONVERTING ELECTRONIC RADIATION TO ELECTRICAL ENERGY, NAMELY, PHOTOVOLTAIC SOLAR MODULES; COMMUNICATION SOFTWARE FOR PROVIDING ACCESS TO THE INTERNET; COMPUTER APPLICATION SOFTWARE FOR MOBILE PHONES, NAMELY, SOFTWARE FOR USE IN PROVIDING ACCESS TO THE INTERNET; COMPUTER HARDWARE AND SOFTWARE FOR SETTING UP AND CONFIGURING WIDE AREA NETWORKS; COMPUTER SOFTWARE FOR ADMINISTRATION OF COMPUTER LOCAL AREA NETWORKS; COMPUTER SOFTWARE FOR ADMINISTRATION OF COMPUTER NETWORKS; PHOTOVOLTAIC SOLAR MODULES FOR PRODUCTION OF ELECTRICITY; SOLAR CELLS; SOLAR PANELS FOR PRODUCTION OF ELECTRICITY; WAN (WIDE AREA NETWORK) OPERATING SOFTWARE, IN CLASS 9 (U.S. CLS. 21, 23, 26, 36 AND 38).

FIRST USE 2-1-2010; IN COMMERCE 2-1-2010.

THE MARK CONSISTS OF STANDARD CHARACTERS WITHOUT CLAIM TO ANY PARTICULAR FONT, STYLE, SIZE, OR COLOR.

SER. NO. 85-641,548, FILED 6-2-2012.

ANTHONY RINKER, EXAMINING ATTORNEY



*David J. Kyros*

Director of the United States Patent and Trademark Office



# United States of America

United States Patent and Trademark Office

# Rate A Reel

**Reg. No. 4,275,524**

RATE A REEL, LLC (CALIFORNIA LIMITED LIABILITY COMPANY)  
28526 BRIDGE WATER LN.  
MENIFEE, CA 92584

**Registered Jan. 15, 2013**

**Int. Cl.: 35**

FOR: EXECUTIVE SEARCH AND PLACEMENT SERVICES; PROMOTIONAL SERVICES, NAMELY, PROVIDING A WEBSITE FEATURING THE ONLINE PORTFOLIO OF ARTISTS TO SHOWCASE THEIR TALENT; PROVIDING A WEB SITE FEATURING THE RATINGS, REVIEWS AND RECOMMENDATIONS ON EMPLOYERS AND EMPLOYEES AND PLACES OF EMPLOYMENT FOR USE BY EMPLOYEES, EMPLOYERS, BUSINESS OWNERS, AND CONSUMERS, IN CLASS 35 (U.S. CLS. 100, 101 AND 102).

**SERVICE MARK**

**PRINCIPAL REGISTER**

FIRST USE 1-8-2010; IN COMMERCE 1-25-2011.

THE MARK CONSISTS OF STANDARD CHARACTERS WITHOUT CLAIM TO ANY PARTICULAR FONT, STYLE, SIZE, OR COLOR.

SER. NO. 85-641,552, FILED 6-2-2012.

ANTHONY RINKER, EXAMINING ATTORNEY



*David J. Kyffers*

Director of the United States Patent and Trademark Office

# United States of America

United States Patent and Trademark Office

# ASHBROOK

**Reg. No. 4,275,525**

STALLINGS, CAMERON (UNITED STATES INDIVIDUAL)  
2811 SE 121 AVE  
PORTLAND, OR 97266

**Registered Jan. 15, 2013**

**Int. Cl.: 25**

FOR: CLOTHING, NAMELY, T-SHIRTS, SWEATSHIRTS, BUTTON UP SHIRTS, HATS, SOCKS, JACKETS, PANTS, DENIMS, FOOTWEAR, HEADWEAR, TOPS, BOTTOMS, AND SHIRTS, IN CLASS 25 (U.S. CLS. 22 AND 39).

**TRADEMARK**

FIRST USE 2-20-2011; IN COMMERCE 2-20-2011.

**PRINCIPAL REGISTER**

THE MARK CONSISTS OF STANDARD CHARACTERS WITHOUT CLAIM TO ANY PARTICULAR FONT, STYLE, SIZE, OR COLOR.

SER. NO. 85-641,563, FILED 6-2-2012.

TINA MAI, EXAMINING ATTORNEY



*David J. Kyffers*

Director of the United States Patent and Trademark Office

# United States of America

United States Patent and Trademark Office

## PARKING MANIA

**Reg. No. 4,275,526**

MOBIRATE, LTD (RUSSIAN FED. LIMITED COMPANY (LTD.))  
KRASNOARMEYSKAYA 64, 32  
ULYANOVSK, RUSSIAN FED.

**Registered Jan. 15, 2013**

**Int. Cl.: 9**

FOR: COMPUTER GAME PROGRAMS; COMPUTER PROGRAMS FOR VIDEO AND COMPUTER GAMES; VIDEO GAME SOFTWARE, IN CLASS 9 (U.S. CLS. 21, 23, 26, 36 AND 38).

**TRADEMARK**

FIRST USE 9-19-2009; IN COMMERCE 9-19-2009.

**PRINCIPAL REGISTER**

THE MARK CONSISTS OF STANDARD CHARACTERS WITHOUT CLAIM TO ANY PARTICULAR FONT, STYLE, SIZE, OR COLOR.

SER. NO. 85-641,581, FILED 6-2-2012.

ANTHONY RINKER, EXAMINING ATTORNEY



*David J. Kybas*

Director of the United States Patent and Trademark Office

# United States of America

United States Patent and Trademark Office

# BollyGrooves

**Reg. No. 4,275,527**

KAMRAN, SHELLY (UNITED STATES INDIVIDUAL)  
6220 CORLISS AVE. N  
SEATTLE, WA 98103

**Registered Jan. 15, 2013**

**Int. Cl.: 41**

FOR: ARRANGING AND CONDUCTING SPECIAL EVENTS FOR SOCIAL ENTERTAINMENT PURPOSES; DANCE EVENTS, IN CLASS 41 (U.S. CLS. 100, 101 AND 107).

**SERVICE MARK**

FIRST USE 1-5-2007; IN COMMERCE 1-5-2007.

**PRINCIPAL REGISTER**

THE MARK CONSISTS OF STANDARD CHARACTERS WITHOUT CLAIM TO ANY PARTICULAR FONT, STYLE, SIZE, OR COLOR.

SER. NO. 85-641,596, FILED 6-2-2012.

WENDY GOODMAN, EXAMINING ATTORNEY



*David J. Kybas*

Director of the United States Patent and Trademark Office

# United States of America

United States Patent and Trademark Office

# NameStation

**Reg. No. 4,275,528**

**Registered Jan. 15, 2013**

**Int. Cls.: 35 and 42**

**SERVICE MARK**

**PRINCIPAL REGISTER**

NAMESTATION INC. (DELAWARE CORPORATION), DBA NAMESTATION  
37 VESTRY ST. #3  
NEW YORK, NY 10013

FOR: SERVICES RELATING TO THE ANALYSIS, EVALUATION, CREATION AND BRAND ESTABLISHMENT OF TRADEMARKS, TRADE NAMES AND DOMAIN NAMES , IN CLASS 35 (U.S. CLS. 100, 101 AND 102).

FIRST USE 10-12-2008; IN COMMERCE 10-12-2008.

FOR: DOMAIN NAME SEARCH SERVICES, NAMELY, CONDUCTING ONLINE COMPUTERIZED SEARCHES FOR THE AVAILABILITY OF DOMAIN NAMES , IN CLASS 42 (U.S. CLS. 100 AND 101).

FIRST USE 10-12-2008; IN COMMERCE 10-12-2008.

THE MARK CONSISTS OF STANDARD CHARACTERS WITHOUT CLAIM TO ANY PARTICULAR FONT, STYLE, SIZE, OR COLOR.

SER. NO. 85-641,609, FILED 6-2-2012.

ESTHER BELENKER, EXAMINING ATTORNEY



*David J. Kybas*

Director of the United States Patent and Trademark Office

# United States of America

United States Patent and Trademark Office

# dosha guru

**Reg. No. 4,275,529**

**Registered Jan. 15, 2013**

**Int. Cl.: 44**

**SERVICE MARK**

**PRINCIPAL REGISTER**

VEDALYTICS (IOWA CORPORATION)  
1008 HEAVENLY LANE  
FAIRFIELD, IA 52556

FOR: WEB-BASED HEALTH ASSESSMENT SERVICES, NAMELY, A SERIES OF HEALTH-RELATED QUESTIONS FOR RESPONSE FROM THE USER THAT RESULT IN A REPORT THAT PROVIDES HEALTH-RELATED INFORMATION IN THE FORM OF RECOMMENDED EDUCATIONAL RESOURCES AND TREATMENT INFORMATION, IN CLASS 44 (U.S. CLS. 100 AND 101).

FIRST USE 12-18-2011; IN COMMERCE 4-24-2012.

THE MARK CONSISTS OF STANDARD CHARACTERS WITHOUT CLAIM TO ANY PARTICULAR FONT, STYLE, SIZE, OR COLOR.

NO CLAIM IS MADE TO THE EXCLUSIVE RIGHT TO USE "DOSHA", APART FROM THE MARK AS SHOWN.

SER. NO. 85-641,622, FILED 6-2-2012.

WENDY JUN, EXAMINING ATTORNEY



*David J. Kyffers*

Director of the United States Patent and Trademark Office

# United States of America

United States Patent and Trademark Office

## PARTY POPPER

**Reg. No. 4,275,530**

GETAGADGET, INC. (TEXAS CORPORATION)  
6406 BURLESON ROAD, STE. 120  
AUSTIN, TX 78744

**Registered Jan. 15, 2013**

**Int. Cl.: 21**

FOR: BOTTLE OPENERS; NEOPRENE ZIPPERED BOTTLE HOLDERS, IN CLASS 21 (U.S. CLS. 2, 13, 23, 29, 30, 33, 40 AND 50).

**TRADEMARK**

FIRST USE 6-1-2009; IN COMMERCE 6-1-2009.

**PRINCIPAL REGISTER**

THE MARK CONSISTS OF STANDARD CHARACTERS WITHOUT CLAIM TO ANY PARTICULAR FONT, STYLE, SIZE, OR COLOR.

SER. NO. 85-641,644, FILED 6-2-2012.

HOWARD SMIGA, EXAMINING ATTORNEY



*David J. Kybas*

Director of the United States Patent and Trademark Office

# United States of America

United States Patent and Trademark Office

THE Party  
POPPER

**Reg. No. 4,275,531**

GETAGADGET, INC. (TEXAS CORPORATION)  
6406 BURLESON ROAD, STE. 120  
AUSTIN, TX 78744

**Registered Jan. 15, 2013**

**Int. Cl.: 21**

FOR: BOTTLE OPENERS; NEOPRENE ZIPPERED BOTTLE HOLDERS, IN CLASS 21 (U.S. CLS. 2, 13, 23, 29, 30, 33, 40 AND 50).

**TRADEMARK**

FIRST USE 6-1-2009; IN COMMERCE 6-1-2009.

**PRINCIPAL REGISTER**

THE MARK CONSISTS OF THE WORDS "THE PARTY POPPER".

SER. NO. 85-641,654, FILED 6-2-2012.

HOWARD SMIGA, EXAMINING ATTORNEY



*David J. Kyffers*

Director of the United States Patent and Trademark Office



# United States of America

United States Patent and Trademark Office

# BLISSED IN

**Reg. No. 4,275,532**

BORUCKI, REBEKAH (UNITED STATES INDIVIDUAL), DBA BEXLIFE  
196 LONG SWAMP ROAD  
NEW EGYPT, NJ 08533

**Registered Jan. 15, 2013**

**Int. Cl.: 25**

FOR: LONG-SLEEVED SHIRTS; MUSCLE TOPS; SHORT-SLEEVED OR LONG-SLEEVED T-SHIRTS; SPORTS BRAS; SWEAT SHIRTS; T-SHIRTS; TANK TOPS; TOPS; WOMEN'S ATHLETIC TOPS WITH BUILT-IN BRAS; WOMEN'S TOPS, NAMELY, CAMIS; YOGA SHIRTS, IN CLASS 25 (U.S. CLS. 22 AND 39).

**TRADEMARK**

**PRINCIPAL REGISTER**

FIRST USE 9-30-2011; IN COMMERCE 9-30-2011.

THE MARK CONSISTS OF STANDARD CHARACTERS WITHOUT CLAIM TO ANY PARTICULAR FONT, STYLE, SIZE, OR COLOR.

SER. NO. 85-641,717, FILED 6-3-2012.

JOHN KELLY, EXAMINING ATTORNEY



*David J. Kyffers*

Director of the United States Patent and Trademark Office

United States of America  
United States Patent and Trademark Office

# QUINOLA

**Reg. No. 4,275,533**

JANE A PETERS (UNITED STATES INDIVIDUAL)  
1046 MAYFAIR LANE  
GRANTS PASS, OR 97527

**Registered Jan. 15, 2013**

**Int. Cl.: 30**

FOR: GRAIN-BASED SNACK FOODS; PROCESSED CEREAL-BASED FOOD TO BE USED AS A BREAKFAST FOOD, SNACK FOOD OR INGREDIENT FOR MAKING OTHER FOODS; READY TO EAT, CEREAL DERIVED FOOD BARS , IN CLASS 30 (U.S. CL. 46).

**TRADEMARK**

FIRST USE 4-28-2012; IN COMMERCE 6-3-2012.

**PRINCIPAL REGISTER**

THE MARK CONSISTS OF STANDARD CHARACTERS WITHOUT CLAIM TO ANY PARTICULAR FONT, STYLE, SIZE, OR COLOR.

SER. NO. 85-641,733, FILED 6-3-2012.

DOMINIC J. FERRAIUOLO, EXAMINING ATTORNEY



*David J. Kyffers*

Director of the United States Patent and Trademark Office

# United States of America

United States Patent and Trademark Office

## Think Outside My Box

**Reg. No. 4,275,534**

**Registered Jan. 15, 2013**

**Int. Cl.: 44**

**SERVICE MARK**

**PRINCIPAL REGISTER**

WANKE, HILARY B (UNITED STATES INDIVIDUAL)  
2425 L ST. NW #208  
WASHINGTON, DC 20037

FOR: PROVIDING A WEB SITE FEATURING INFORMATION ON HEALTH AND NUTRITION; PROVIDING A WEBSITE FEATURING INFORMATION ABOUT HEALTH AND WELLNESS, NAMELY, WOMEN'S HEALTH; PROVIDING A WEBSITE FEATURING INFORMATION ABOUT HEALTH, WELLNESS AND NUTRITION; PROVIDING HEALTH INFORMATION; PROVIDING INFORMATION, NEWS AND COMMENTARY IN THE FIELD OF NUTRITION, HEALTH AND WELLNESS; PROVIDING ON-LINE INFORMATION, NEWS AND COMMENTARY IN THE FIELD OF HEALTH AND WELLNESS RELATING TO WOMEN, IN CLASS 44 (U.S. CLS. 100 AND 101).

FIRST USE 5-5-2012; IN COMMERCE 5-8-2012.

THE MARK CONSISTS OF STANDARD CHARACTERS WITHOUT CLAIM TO ANY PARTICULAR FONT, STYLE, SIZE, OR COLOR.

SER. NO. 85-641,742, FILED 6-3-2012.

LINDA ORNDORFF, EXAMINING ATTORNEY



*David J. Kypos*

Director of the United States Patent and Trademark Office

# United States of America

United States Patent and Trademark Office

# KGTV

**Reg. No. 4,275,535**

**Registered Jan. 15, 2013**

**Int. Cl.: 38**

**SERVICE MARK**

**PRINCIPAL REGISTER**

SCRIPPS MEDIA, INC. (DELAWARE CORPORATION)  
SUITE 2800  
312 WALNUT STREET  
CINCINNATI, OH 45202

FOR: TELEVISION BROADCASTING SERVICES, IN CLASS 38 (U.S. CLS. 100, 101 AND 104).

FIRST USE 0-0-1972; IN COMMERCE 0-0-1972.

THE MARK CONSISTS OF STANDARD CHARACTERS WITHOUT CLAIM TO ANY PARTICULAR FONT, STYLE, SIZE, OR COLOR.

SER. NO. 85-641,764, FILED 6-3-2012.

ELLEN PERKINS, EXAMINING ATTORNEY



*David J. Kybas*

Director of the United States Patent and Trademark Office

# United States of America

United States Patent and Trademark Office

# KERO

**Reg. No. 4,275,536**

**Registered Jan. 15, 2013**

**Int. Cl.: 38**

**SERVICE MARK**

**PRINCIPAL REGISTER**

SCRIPPS MEDIA, INC. (DELAWARE CORPORATION)  
SUITE 2800  
312 WALNUT STREET  
CINCINNATI, OH 45202

FOR: TELEVISION BROADCASTING SERVICES, IN CLASS 38 (U.S. CLS. 100, 101 AND 104).

FIRST USE 0-0-1972; IN COMMERCE 0-0-1972.

THE MARK CONSISTS OF STANDARD CHARACTERS WITHOUT CLAIM TO ANY PARTICULAR FONT, STYLE, SIZE, OR COLOR.

SER. NO. 85-641,767, FILED 6-3-2012.

ELLEN PERKINS, EXAMINING ATTORNEY



*David J. Kyffers*

Director of the United States Patent and Trademark Office

# United States of America

United States Patent and Trademark Office

# SLIMAZING

**Reg. No. 4,275,537**

**Registered Jan. 15, 2013**

**Int. Cl.: 25**

**TRADEMARK**

**PRINCIPAL REGISTER**

UNDER WHERE INTIMATES INC (NEW JERSEY CORPORATION)  
29 STULTS ROAD  
DAYTON, NJ 08810

FOR: SHAPEWEAR, NAMELY, BRIEFS, PANTIES, BRAS, GIRDLES, CORSETS, THIGH SHAPERS, GARTER BELTS, WAIST SHAPERS; SLEEPWEAR; UNDERWEAR; WOMEN'S UNDERWEAR, IN CLASS 25 (U.S. CLS. 22 AND 39).

FIRST USE 4-1-2011; IN COMMERCE 4-1-2011.

THE MARK CONSISTS OF STANDARD CHARACTERS WITHOUT CLAIM TO ANY PARTICULAR FONT, STYLE, SIZE, OR COLOR.

SER. NO. 85-641,770, FILED 6-3-2012.

MEGHAN REINHART, EXAMINING ATTORNEY



*David J. Kybas*

Director of the United States Patent and Trademark Office

**United States of America**  
United States Patent and Trademark Office

# EBOSSER

**Reg. No. 4,275,538**

CRAFTWELL INC. (NEW YORK CORPORATION)  
11-17 43RD AVENUE

**Registered Jan. 15, 2013**

LONG ISLAND CITY, NY 11101

**Int. Cl.: 7**

FOR: ELECTRONIC EMBOSsing AND DIE CUTTING MACHINE, IN CLASS 7 (U.S. CLS. 13, 19, 21, 23, 31, 34 AND 35).

**TRADEMARK**

FIRST USE 1-5-2011; IN COMMERCE 1-5-2011.

**PRINCIPAL REGISTER**

THE MARK CONSISTS OF STANDARD CHARACTERS WITHOUT CLAIM TO ANY PARTICULAR FONT, STYLE, SIZE, OR COLOR.

SER. NO. 85-641,771, FILED 6-3-2012.

MEGHAN REINHART, EXAMINING ATTORNEY



*David J. Kybas*

Director of the United States Patent and Trademark Office

# United States of America

United States Patent and Trademark Office

## SKINFULLY SWEET

**Reg. No. 4,275,539**

UNDER WHERE INTIMATES INC (NEW JERSEY CORPORATION)  
25 STULTS ROAD  
DAYTON, NJ 08810

**Registered Jan. 15, 2013**

**Int. Cl.: 25**

FOR: SHAPEWEAR, NAMELY, BRIEFS, PANTIES, BRAS, GIRDLES, CORSETS, THIGH SHAPERS, GARTER BELTS, WAIST SHAPERS; SLEEPWEAR; UNDERWEAR; WOMEN'S CLOTHING, NAMELY, SHIRTS, DRESSES, SKIRTS, BLOUSES; WOMEN'S UNDERWEAR, IN CLASS 25 (U.S. CLS. 22 AND 39).

**TRADEMARK**

**PRINCIPAL REGISTER**

FIRST USE 4-1-2011; IN COMMERCE 4-1-2011.

THE MARK CONSISTS OF STANDARD CHARACTERS WITHOUT CLAIM TO ANY PARTICULAR FONT, STYLE, SIZE, OR COLOR.

SER. NO. 85-641,772, FILED 6-3-2012.

MEGHAN REINHART, EXAMINING ATTORNEY



*David J. Kyros*

Director of the United States Patent and Trademark Office



# United States of America

United States Patent and Trademark Office

## The Cure For The Common Inbox

**Reg. No. 4,275,540**

ASHANTI ENTERPRISES, INC (CANADA CORPORATION)  
3473 E 24 AVENUE

**Registered Jan. 15, 2013**

VANCOUVER, BC, CANADA V5R1G5

**Int. Cl.: 42**

FOR: PROVIDING A SECURE ELECTRONIC ONLINE SYSTEM FEATURING TECHNOLOGY WHICH ALLOWS CONSUMERS TO VIEW ALL OF THEIR ELECTRONIC AND DIGITAL RECEIPTS ON OUR WEBSITE, IN CLASS 42 (U.S. CLS. 100 AND 101).

**SERVICE MARK**

FIRST USE 6-2-2012; IN COMMERCE 6-2-2012.

**PRINCIPAL REGISTER**

THE MARK CONSISTS OF STANDARD CHARACTERS WITHOUT CLAIM TO ANY PARTICULAR FONT, STYLE, SIZE, OR COLOR.

SER. NO. 85-641,791, FILED 6-3-2012.

ELLEN PERKINS, EXAMINING ATTORNEY



*David J. Kybas*

Director of the United States Patent and Trademark Office

# United States of America

United States Patent and Trademark Office

# Frankenword

**Reg. No. 4,275,541**

RENFRO, JESSE L (UNITED STATES INDIVIDUAL)  
511 N. CURSON AVE.  
LOS ANGELES, CA 90036 AND

**Registered Jan. 15, 2013**

**Int. Cl.: 9**

FARMER, ANDREW H (UNITED STATES INDIVIDUAL)  
359 WALLER ST. APT 1  
SAN FRANCISCO, CA 94117

**TRADEMARK**

**PRINCIPAL REGISTER**

FOR: COMPUTER GAME SOFTWARE, IN CLASS 9 (U.S. CLS. 21, 23, 26, 36 AND 38).

FIRST USE 3-10-2012; IN COMMERCE 5-1-2012.

THE MARK CONSISTS OF STANDARD CHARACTERS WITHOUT CLAIM TO ANY PARTICULAR FONT, STYLE, SIZE, OR COLOR.

SER. NO. 85-641,794, FILED 6-3-2012.

KIM MONINGHOFF, EXAMINING ATTORNEY



*David J. Kyffers*

Director of the United States Patent and Trademark Office

# United States of America

United States Patent and Trademark Office

# CALTRAIN

**Reg. No. 4,275,542**

**Registered Jan. 15, 2013**

**Int. Cl.: 39**

**SERVICE MARK**

**PRINCIPAL REGISTER**

PENINSULA CORRIDOR JOINT POWERS BOARD (CALIFORNIA A JOINT POWERS AGENCY ESTABLISHED PURSUANT TO CALIFORNIA GOVERNMENT CODE SECTIONS 6500 ET SEQ.)  
1250 SAN CARLOS AVENUE, P.O. BOX 3006  
SAN CARLOS, CA 94070

FOR: TRANSPORTATION SERVICES, NAMELY, TRANSPORTATION OF PASSENGERS AND/OR GOODS BY RAIL AND BUS; PROVIDING INFORMATION ABOUT TRANSPORTATION SERVICES, NAMELY, TRANSPORTATION OF PASSENGERS AND/OR GOODS BY RAIL AND BUS, IN CLASS 39 (U.S. CLS. 100 AND 105).

FIRST USE 7-1-1992; IN COMMERCE 7-1-1992.

THE MARK CONSISTS OF STANDARD CHARACTERS WITHOUT CLAIM TO ANY PARTICULAR FONT, STYLE, SIZE, OR COLOR.

OWNER OF U.S. REG. NO. 2,307,748.

SER. NO. 85-641,845, FILED 6-3-2012.

GIANCARLO CASTRO, EXAMINING ATTORNEY



*David J. Kyffers*

Director of the United States Patent and Trademark Office

# United States of America

United States Patent and Trademark Office

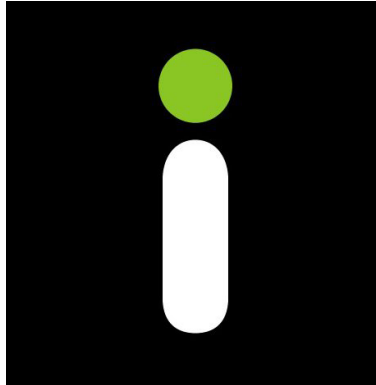

**Reg. No. 4,275,543**

**Registered Jan. 15, 2013**

**Int. Cl.: 42**

**SERVICE MARK**

**PRINCIPAL REGISTER**

IMGUR LLC (CALIFORNIA LIMITED LIABILITY COMPANY)  
929 MARKET ST., SUITE 400  
SAN FRANCISCO, CA 94103

FOR: PROVIDING A WEBSITE THAT GIVES COMPUTER USERS THE ABILITY TO UPLOAD, EXCHANGE AND SHARE PHOTOS AND IMAGES, IN CLASS 42 (U.S. CLS. 100 AND 101).

FIRST USE 3-1-2009; IN COMMERCE 3-1-2009.

THE MARK CONSISTS OF A SANS-SERIF, ROUNDED-EDGE, LOWER-CASE LETTER "I" WHEREBY THE LOWER PART OF THE "I" IS WHITE AND THE DOT ON THE "I" IS GREEN, ON A BLACK BACKGROUND.

THE COLOR(S) WHITE, GREEN, AND BLACK IS/ARE CLAIMED AS A FEATURE OF THE MARK.

SER. NO. 85-641,856, FILED 6-3-2012.

GIANCARLO CASTRO, EXAMINING ATTORNEY



*David J. Kybas*

Director of the United States Patent and Trademark Office

# United States of America

United States Patent and Trademark Office

# UNDERIFIC

**Reg. No. 4,275,544**

UNDER WHERE INTIMATES INC (NEW JERSEY CORPORATION)  
25 STULTS ROAD  
DAYTON, NJ 08810

**Registered Jan. 15, 2013**

**Int. Cl.: 25**

FOR: LADIES' UNDERWEAR; SHAPEWEAR, NAMELY, BRIEFS, PANTIES, BRAS, GIRDLES, CORSETS, THIGH SHAPERS, GARTER BELTS, WAIST SHAPERS; UNDERWEAR; WOMEN'S UNDERWEAR, IN CLASS 25 (U.S. CLS. 22 AND 39).

**TRADEMARK**

FIRST USE 4-1-2011; IN COMMERCE 4-1-2011.

**PRINCIPAL REGISTER**

THE MARK CONSISTS OF STANDARD CHARACTERS WITHOUT CLAIM TO ANY PARTICULAR FONT, STYLE, SIZE, OR COLOR.

SER. NO. 85-641,864, FILED 6-4-2012.

MEGHAN REINHART, EXAMINING ATTORNEY



*David J. Kyffers*

Director of the United States Patent and Trademark Office

# United States of America

United States Patent and Trademark Office

# WaiverVault

**Reg. No. 4,275,545**

**Registered Jan. 15, 2013**

**Int. Cl.: 39**

**SERVICE MARK**

**PRINCIPAL REGISTER**

SW DEVELOPMENT, LLC (OREGON LIMITED LIABILITY COMPANY), DBA  
SMARTWAIVER  
233 S.W. WILSON AVE., SUITE 1  
BEND, OR 97702

FOR: ARCHIVAL SERVICES, NAMELY, COLLECTION AND STORAGE OF HISTORICAL  
RECORDS AND DOCUMENTS; ELECTRONIC STORAGE OF FILES AND DOCUMENTS ,  
IN CLASS 39 (U.S. CLS. 100 AND 105).

FIRST USE 12-15-2011; IN COMMERCE 12-15-2011.

THE MARK CONSISTS OF STANDARD CHARACTERS WITHOUT CLAIM TO ANY PAR-  
TICULAR FONT, STYLE, SIZE, OR COLOR.

SER. NO. 85-641,866, FILED 6-4-2012.

KYLE PEETE, EXAMINING ATTORNEY



*David J. Kyffers*

Director of the United States Patent and Trademark Office

# United States of America

United States Patent and Trademark Office

## PITHY NOTES

**Reg. No. 4,275,546**

**Registered Jan. 15, 2013**

**Int. Cl.: 41**

**SERVICE MARK**

**PRINCIPAL REGISTER**

PITHY NOTES, LLC (WASHINGTON LIMITED LIABILITY COMPANY)  
13459 94TH PLACE NE  
KIRKLAND, WA 980341855

FOR: DIGITAL PUBLISHING SERVICE, IN CLASS 41 (U.S. CLS. 100, 101 AND 107).

FIRST USE 3-5-2011; IN COMMERCE 3-5-2011.

THE MARK CONSISTS OF STANDARD CHARACTERS WITHOUT CLAIM TO ANY PARTICULAR FONT, STYLE, SIZE, OR COLOR.

SER. NO. 85-641,869, FILED 6-4-2012.

KYLE PEETE, EXAMINING ATTORNEY



*David J. Kyffers*

Director of the United States Patent and Trademark Office

# United States of America

United States Patent and Trademark Office

*yarose*

**Reg. No. 4,275,547**

**Registered Jan. 15, 2013**

**Int. Cl.: 41**

SHANGHAI MEIGUI SHAMO CULTURE COMMUNICATIONS CO., LTD. (CHINA LIMITED COMPANY (LTD.))  
NO. 1411, BUILDING 1  
JIANGUO W. ROAD  
SHANGHAI, CHINA

**SERVICE MARK**

**PRINCIPAL REGISTER**

FOR: DANCE CLUB SERVICES; DANCE INSTRUCTION; DISCOTHEQUES; EDUCATION SERVICES, NAMELY, PROVIDING CLASSES AND INSTRUCTION IN THE FIELD OF DANCE; ENTERTAINMENT INFORMATION; ENTERTAINMENT SERVICES, NAMELY, PROVIDING ON-LINE COMPUTER GAMES; HEALTH CLUB SERVICES, NAMELY, PROVIDING INSTRUCTION AND EQUIPMENT IN THE FIELD OF PHYSICAL EXERCISE; ORGANISATION OF GAMES; PRESENTATION OF LIVE SHOW PERFORMANCES; PROVIDING INFORMATION, NEWS AND COMMENTARY IN THE FIELD OF RECREATION AND LEISURE ACTIVITIES, IN CLASS 41 (U.S. CLS. 100, 101 AND 107).

FIRST USE 5-20-2008; IN COMMERCE 3-5-2009.

THE MARK CONSISTS OF THE STYLIZED WORD "YAROSE".

THE WORDING "YAROSE" HAS NO MEANING IN A FOREIGN LANGUAGE.

SER. NO. 85-641,881, FILED 6-4-2012.

JEFFERY COWARD, EXAMINING ATTORNEY



*David J. Kybas*

Director of the United States Patent and Trademark Office



# United States of America

United States Patent and Trademark Office

# NOLLYWOOD

**Reg. No. 4,275,548**

**Registered Jan. 15, 2013**

**Int. Cl.: 35**

**SERVICE MARK**

**PRINCIPAL REGISTER**

OPARA, NICHOLAS (UNITED STATES INDIVIDUAL)  
15012 N45TH WAY  
PHOENIX, AZ 85032

FOR: ON-LINE RETAIL STORE SERVICES FEATURING T-SHIRTS, INFANTS' AND CHILDREN'S UNDERWEAR, POLO SHIRTS, HOODED SWEATSHIRTS, AND SWEATSHIRTS, IN CLASS 35 (U.S. CLS. 100, 101 AND 102).

FIRST USE 11-25-2002; IN COMMERCE 11-25-2002.

THE MARK CONSISTS OF STANDARD CHARACTERS WITHOUT CLAIM TO ANY PARTICULAR FONT, STYLE, SIZE, OR COLOR.

SER. NO. 85-641,889, FILED 6-4-2012.

KELLEY WELLS, EXAMINING ATTORNEY



*David J. Kyffers*

Director of the United States Patent and Trademark Office

# United States of America

United States Patent and Trademark Office

# BellaLuxe

**Reg. No. 4,275,549**

MITZI HALE (UNITED STATES INDIVIDUAL)  
1821 SUSQUEHANNOCK DR  
MCLEAN, VA 22101

**Registered Jan. 15, 2013**

**Int. Cl.: 44**

FOR: EYELASH EXTENSION APPLICATION SERVICES, IN CLASS 44 (U.S. CLS. 100 AND 101).

**SERVICE MARK**

FIRST USE 6-1-2008; IN COMMERCE 10-1-2008.

**PRINCIPAL REGISTER**

THE MARK CONSISTS OF STANDARD CHARACTERS WITHOUT CLAIM TO ANY PARTICULAR FONT, STYLE, SIZE, OR COLOR.

THE ENGLISH TRANSLATION OF "BELLA" IN THE MARK IS "BEAUTIFUL".

SER. NO. 85-641,895, FILED 6-4-2012.

DORITT L. CARROLL, EXAMINING ATTORNEY



*David J. Kyjars*

Director of the United States Patent and Trademark Office

# United States of America

United States Patent and Trademark Office

# SKITOO!

**Reg. No. 4,275,550**

**Registered Jan. 15, 2013**

**Int. Cl.: 42**

**SERVICE MARK**

**PRINCIPAL REGISTER**

SKITOO, LLC (PENNSYLVANIA LIMITED LIABILITY COMPANY)  
26 HAMPSHIRE DRIVE  
IVYLAND, PA 18974

FOR: PROVIDING A WEBSITE FEATURING A MEDIA AGGREGATOR AND SEARCH ENGINE FOR INTERNET CONTENT; PROVIDING A WEBSITE FEATURING A SEARCH ENGINE FOR INTERNET CONTENT; PROVIDING A WEBSITE FEATURING TECHNOLOGY THAT ENABLES USERS TO BROWSE AND ACCESS WEBSITES OF OTHERS WITHOUT ENTERING TEXT, IN CLASS 42 (U.S. CLS. 100 AND 101).

FIRST USE 10-1-2010; IN COMMERCE 10-1-2010.

THE MARK CONSISTS OF STANDARD CHARACTERS WITHOUT CLAIM TO ANY PARTICULAR FONT, STYLE, SIZE, OR COLOR.

SER. NO. 85-641,955, FILED 6-4-2012.

EUGENIA MARTIN, EXAMINING ATTORNEY



*David J. Kybas*

Director of the United States Patent and Trademark Office

# United States of America

United States Patent and Trademark Office

## SMARTER MARKETS

**Reg. No. 4,275,551**

BENCHMARK SOLUTIONS HOLDINGS, INC. (DELAWARE CORPORATION)  
101 PARK AVENUE, 7TH FLOOR  
NEW YORK, NY 10178

**Registered Jan. 15, 2013**

**Int. Cl.: 35**

FOR: FINANCIAL SERVICES, NAMELY, ANALYZING MARKET DATA AND PRICING ANALYTICS SERVICES FOR MEASURING THE PERFORMANCE OF FINANCIAL MARKETS FOR ASSET CLASSES WITHIN THE CAPITAL MARKETS, INCLUDING FIXED INCOME PRODUCTS, IN CLASS 35 (U.S. CLS. 100, 101 AND 102).

**SERVICE MARK**

**PRINCIPAL REGISTER**

FIRST USE 5-18-2012; IN COMMERCE 5-30-2012.

THE MARK CONSISTS OF STANDARD CHARACTERS WITHOUT CLAIM TO ANY PARTICULAR FONT, STYLE, SIZE, OR COLOR.

SER. NO. 85-641,985, FILED 6-4-2012.

INGRID C. EULIN, EXAMINING ATTORNEY



*David J. Kyffers*

Director of the United States Patent and Trademark Office

# United States of America

United States Patent and Trademark Office



**Reg. No. 4,275,552**

**Registered Jan. 15, 2013**

**Int. Cl.: 44**

**SERVICE MARK**

**PRINCIPAL REGISTER**

THE CENTER FOR ORTHOPEDIC AND RESEARCH EXCELLENCE, INC. (ARIZONA CORPORATION)  
4647 NORTH 32ND STREET  
PHOENIX, AZ 85027

FOR: PROVIDING MEDICAL INFORMATION FOR USE BY MEDICAL PRACTITIONERS USED TO FURTHER RELATIONSHIPS WITH HOSPITALS, PAYORS AND INDUSTRY PARTNERS , IN CLASS 44 (U.S. CLS. 100 AND 101).

FIRST USE 5-28-2011; IN COMMERCE 5-28-2011.

THE MARK CONSISTS OF TWO CONCENTRIC ANGULAR IMAGES WITH CIRCLES WITH THE OUTLINE OF A RECTANGLE IN THE CENTER.

SER. NO. 85-641,999, FILED 6-4-2012.

ELLEN PERKINS, EXAMINING ATTORNEY



*David J. Kybas*

Director of the United States Patent and Trademark Office

# United States of America

United States Patent and Trademark Office

# Zen Bronze

**Reg. No. 4,275,553**

**Registered Jan. 15, 2013**

**Int. Cl.: 44**

**SERVICE MARK**

**PRINCIPAL REGISTER**

ZEN BRONZE, LLC (CONNECTICUT LIMITED LIABILITY COMPANY), FORMERLY  
DONNA BUSCEMI WELLNESS CENTER, LLC  
1081 EAST PUTNAM AVENUE  
RIVERSIDE, CT 06878

FOR: AIRBRUSH SKIN TANNING SERVICES FOR HUMANS FOR COSMETIC PURPOSES,  
IN CLASS 44 (U.S. CLS. 100 AND 101).

FIRST USE 8-7-2009; IN COMMERCE 0-0-2010.

THE MARK CONSISTS OF STANDARD CHARACTERS WITHOUT CLAIM TO ANY PAR-  
TICULAR FONT, STYLE, SIZE, OR COLOR.

NO CLAIM IS MADE TO THE EXCLUSIVE RIGHT TO USE "BRONZE", APART FROM THE  
MARK AS SHOWN.

SER. NO. 85-642,003, FILED 6-4-2012.

ROBIN CHOSID, EXAMINING ATTORNEY



*David J. Kyffers*

Director of the United States Patent and Trademark Office

# United States of America

United States Patent and Trademark Office

## DREAM BIG. BUILD SMART.

**Reg. No. 4,275,554**

LOGAN DEVELOPERS INC. (NORTH CAROLINA CORPORATION), DBA LOGAN HOMES  
60 GREGORY RD NE #1  
LELAND, NC 28451

**Registered Jan. 15, 2013**

**Int. Cl.: 37**

FOR: CONSTRUCTION OF RESIDENTIAL PROPERTIES, IN CLASS 37 (U.S. CLS. 100, 103 AND 106).

**SERVICE MARK**

FIRST USE 4-1-2012; IN COMMERCE 4-1-2012.

**PRINCIPAL REGISTER**

THE MARK CONSISTS OF STANDARD CHARACTERS WITHOUT CLAIM TO ANY PARTICULAR FONT, STYLE, SIZE, OR COLOR.

SER. NO. 85-642,004, FILED 6-4-2012.

EVIN L. KOZAK, EXAMINING ATTORNEY



*David J. Kybas*

Director of the United States Patent and Trademark Office

# United States of America

United States Patent and Trademark Office

## "Non-scents"

**Reg. No. 4,275,555**

BORING GOATS LLC (OREGON LIMITED LIABILITY COMPANY)  
9600 SE 302ND LN  
BORING, OR 97009

**Registered Jan. 15, 2013**

**Int. Cl.: 3**

FOR: NON-SCENTED SKINCARE PREPARATIONS, SOLELY, GOAT-MILK BASED SOAPS, LOTIONS, LIP BALMS AND FACE AND BODY CREAMS, IN CLASS 3 (U.S. CLS. 1, 4, 6, 50, 51 AND 52).

**TRADEMARK**

FIRST USE 12-18-2011; IN COMMERCE 12-18-2011.

**PRINCIPAL REGISTER**

THE MARK CONSISTS OF STANDARD CHARACTERS WITHOUT CLAIM TO ANY PARTICULAR FONT, STYLE, SIZE, OR COLOR.

SER. NO. 85-642,040, FILED 6-4-2012.

LINDA MICKLEBURGH, EXAMINING ATTORNEY



*David J. Kyffers*

Director of the United States Patent and Trademark Office



# United States of America

United States Patent and Trademark Office



**Reg. No. 4,275,556**

**Registered Jan. 15, 2013**

**Int. Cls.: 35 and 36**

**SERVICE MARK**

**PRINCIPAL REGISTER**

D/CAMERA GROUP, LLC (MARYLAND LIMITED LIABILITY COMPANY)  
WORK  
1410 FOREST DRIVE, SUITE 33  
ANNAPOLIS, MD 21403

FOR: BUSINESS CONSULTING SERVICES IN THE FIELD OF WORKERS COMPENSATION;  
BUSINESS MANAGEMENT CONSULTING; BUSINESS RISK MANAGEMENT CONSULTA-  
TION; MANAGEMENT AND BUSINESS CONSULTING SERVICES IN THE FIELD OF HIRING  
EMPLOYEES, IN CLASS 35 (U.S. CLS. 100, 101 AND 102).

FIRST USE 3-1-2012; IN COMMERCE 3-1-2012.

FOR: CONSULTING AND INFORMATION CONCERNING INSURANCE; INSURANCE  
CONSULTING IN THE FIELD OF WORKERS COMPENSATION INSURANCE, IN CLASS  
36 (U.S. CLS. 100, 101 AND 102).

FIRST USE 3-1-2012; IN COMMERCE 3-1-2012.

THE MARK CONSISTS OF A WHITE SHIELD WITH THICK BLACK OUTLINE WITH A  
SECOND INNER SHIELD WITH A THIN BLACK OUTLINE. OVERLAPPING CAPITAL  
LETTERS "HA" ARE PLACED IN THE INNER SHIELD. THE LETTER "H" IS IN THE COLOR  
GOLD AND THE LETTER "A" IS IN THE COLOR BLACK. UNDERNEATH AND CENTERED  
UNDER THE OVERLAPPING LETTERS "HA" ARE THE WORDS "HIRING ALARM". THE  
WORD "HIRING" IS IN ALL BLACK CAPITAL LETTERS AND THE WORD "ALARM" IS  
IN ALL GOLD CAPITAL LETTERS.

THE COLOR(S) WHITE, GOLD AND BLACK IS/ARE CLAIMED AS A FEATURE OF THE  
MARK.

SER. NO. 85-642,042, FILED 6-4-2012.

RICHARD WHITE, EXAMINING ATTORNEY



*David J. Kybas*

Director of the United States Patent and Trademark Office

# United States of America

United States Patent and Trademark Office

# SPIRAL

**Reg. No. 4,275,557**

PAK PRODUCTS, LLC (CONNECTICUT LIMITED LIABILITY COMPANY)  
8B HERMAN DRIVE  
SIMSBURY, CT 06070

**Registered Jan. 15, 2013**

**Int. Cl.: 5**

FOR: ANTISEPTIC WIPES; DISPOSABLE SANITIZING WIPES; SANITIZING WIPES, IN CLASS 5 (U.S. CLS. 6, 18, 44, 46, 51 AND 52).

**TRADEMARK**

FIRST USE 1-1-2012; IN COMMERCE 1-1-2012.

**PRINCIPAL REGISTER**

THE MARK CONSISTS OF STANDARD CHARACTERS WITHOUT CLAIM TO ANY PARTICULAR FONT, STYLE, SIZE, OR COLOR.

SER. NO. 85-642,049, FILED 6-4-2012.

JANICE KIM, EXAMINING ATTORNEY



*David J. Kybas*

Director of the United States Patent and Trademark Office

# United States of America

United States Patent and Trademark Office

## COCOA PUFFS

**Reg. No. 4,275,558**

**Registered Jan. 15, 2013**

**Int. Cl.: 3**

**TRADEMARK**

**PRINCIPAL REGISTER**

GENERAL MILLS IP HOLDINGS II, LLC (DELAWARE LIMITED LIABILITY COMPANY)  
NUMBER ONE GENERAL MILLS BOULEVARD  
MINNEAPOLIS, MN 55426

FOR: LIP BALM, IN CLASS 3 (U.S. CLS. 1, 4, 6, 50, 51 AND 52).

FIRST USE 9-30-2005; IN COMMERCE 9-30-2005.

THE MARK CONSISTS OF STANDARD CHARACTERS WITHOUT CLAIM TO ANY PARTICULAR FONT, STYLE, SIZE, OR COLOR.

OWNER OF U.S. REG. NOS. 902,727, 3,537,012 AND OTHERS.

NO CLAIM IS MADE TO THE EXCLUSIVE RIGHT TO USE "COCOA", APART FROM THE MARK AS SHOWN.

SER. NO. 85-642,053, FILED 6-4-2012.

ALAIN LAPTER, EXAMINING ATTORNEY



*David J. Kybas*

Director of the United States Patent and Trademark Office

# United States of America

United States Patent and Trademark Office

# THE SCOOP

**Reg. No. 4,275,559**

CABI, LLC (CALIFORNIA LIMITED LIABILITY COMPANY)  
18915 LAUREL PARK ROAD  
RANCHO DOMINGUEZ, CA 90220

**Registered Jan. 15, 2013**

**Int. Cl.: 41**

FOR: EDUCATIONAL SERVICES, NAMELY PROVIDING CONFERENCES AND SEMINARS IN THE FIELD OF DIRECT SOLICITATION BY SALES AGENTS OF APPLICANT'S CLOTHING AND CLOTHING ACCESSORIES, IN CLASS 41 (U.S. CLS. 100, 101 AND 107).

**SERVICE MARK**

FIRST USE 12-15-2002; IN COMMERCE 12-15-2002.

**PRINCIPAL REGISTER**

THE MARK CONSISTS OF STANDARD CHARACTERS WITHOUT CLAIM TO ANY PARTICULAR FONT, STYLE, SIZE, OR COLOR.

OWNER OF U.S. REG. NO. 2,965,045.

SER. NO. 85-642,068, FILED 6-4-2012.

RENEE MCCRAY, EXAMINING ATTORNEY



*David J. Kyffers*

Director of the United States Patent and Trademark Office

# United States of America

United States Patent and Trademark Office



**Reg. No. 4,275,560**

**Registered Jan. 15, 2013**

**Int. Cl.: 41**

**SERVICE MARK**

**PRINCIPAL REGISTER**

PLUG DJ, LLC (CALIFORNIA LIMITED LIABILITY COMPANY)  
SUITE 1019  
1600 VINE ST.  
LOS ANGELES, CA 90028

FOR: ENTERTAINMENT SERVICES, NAMELY, PROVIDING A WEB SITE FEATURING NON-DOWNLOADABLE MUSICAL PERFORMANCES, MUSICAL VIDEOS, RELATED FILM CLIPS, PHOTOGRAPHS, AND OTHER MULTIMEDIA MATERIALS FEATURING COMEDY, SPORTS, FILM, GAMING, ANIMALS, AND ANIMATION, IN CLASS 41 (U.S. CLS. 100, 101 AND 107).

FIRST USE 2-24-2012; IN COMMERCE 2-24-2012.

THE MARK CONSISTS OF A MINIMALISTIC LOOKING REPRESENTATION OF A PAIR OF AUDIO HEADPHONES WITH A CURVED SHAPE RESEMBLING AN UPSIDE-DOWN LETTER U FORMING THE HEADBAND PORTION OF THE HEADPHONES AND TWO VERTICAL LINES REPRESENTING THE EAR-PIECES OF THE HEADPHONES PARTIALLY INSIDE THE OPENING OF THE U-SHAPE BUT NOT TOUCHING THE LINES AT ALL. IN ADDITIONAL THE STRING "PLUG.DJ" ACCOMPANIES THE HEADPHONE GRAPHIC.

SER. NO. 85-642,075, FILED 6-4-2012.

COLLEEN KEARNEY, EXAMINING ATTORNEY



*David J. Kyros*

Director of the United States Patent and Trademark Office

# United States of America

United States Patent and Trademark Office

## The World Needs More Love Letters

**Reg. No. 4,275,561**

**Registered Jan. 15, 2013**

**Int. Cl.: 45**

**SERVICE MARK**

**PRINCIPAL REGISTER**

BRENCHER, HANNAH K. (UNITED STATES INDIVIDUAL), DBA THE WORLD NEEDS MORE LOVE LETTERS  
33 BELVEDERE ROAD  
NORTH HAVEN, CT 06473

FOR: PERSONAL LETTER WRITING FOR OTHERS, IN CLASS 45 (U.S. CLS. 100 AND 101).

FIRST USE 10-1-2010; IN COMMERCE 9-1-2011.

THE MARK CONSISTS OF STANDARD CHARACTERS WITHOUT CLAIM TO ANY PARTICULAR FONT, STYLE, SIZE, OR COLOR.

SER. NO. 85-642,139, FILED 6-4-2012.

THEODORE MCBRIDE, EXAMINING ATTORNEY



*David J. Kybas*

Director of the United States Patent and Trademark Office

# United States of America

United States Patent and Trademark Office

"Once you go goat, you'll  
never go back"

**Reg. No. 4,275,562**

BORING GOATS LLC (OREGON LIMITED LIABILITY COMPANY)  
9600 SE 302ND LN  
BORING, OR 97009

**Registered Jan. 15, 2013**

**Int. Cl.: 3**

FOR: BODY LOTIONS; LIP BALM; SOAPS FOR BODY CARE, IN CLASS 3 (U.S. CLS. 1, 4, 6, 50, 51 AND 52).

**TRADEMARK**

FIRST USE 7-24-2010; IN COMMERCE 7-24-2010.

**PRINCIPAL REGISTER**

THE MARK CONSISTS OF STANDARD CHARACTERS WITHOUT CLAIM TO ANY PARTICULAR FONT, STYLE, SIZE, OR COLOR.

SER. NO. 85-642,146, FILED 6-4-2012.

LINDA MICKLEBURGH, EXAMINING ATTORNEY



*David J. Kybas*

Director of the United States Patent and Trademark Office

# United States of America

United States Patent and Trademark Office



**Reg. No. 4,275,563**

**Registered Jan. 15, 2013**

**Int. Cl.: 25**

**TRADEMARK**

**PRINCIPAL REGISTER**

OZARK SHARK, LLC (MISSOURI LIMITED LIABILITY COMPANY)  
336 HUCKLEBERRY HILL DRIVE  
SUNRISE BEACH, MO 65079

FOR: CAPS; SHORTS; T-SHIRTS; TANK TOPS, IN CLASS 25 (U.S. CLS. 22 AND 39).

FIRST USE 6-1-2012; IN COMMERCE 8-1-2012.

THE MARK CONSISTS OF A STYLIZED REPRESENTATION OF A GREEN AND YELLOW BASS FISH WEARING A GRAY SHARK FIN THAT IS BELTED ON WITH A BROWN BELT AND GOLD BUCKLE, AS WELL AS A BLUE, RED, AND ORANGE BASEBALL CAP THAT HAS THE WORD "ZARK" WRITTEN ACROSS IT IN BLACK AND OUTLINED IN YELLOW. THE FISH HAS BLUE, WHITE, BLACK, AND RED BLOODSHOT EYES AND A RED MOUTH FILLED WITH A PINK TONGUE AND CROOKED GOLD TEETH. BLUE WATER DROPLETS ARE DRIPPING FROM THE FISH AND IT APPEARS ON A BLUE STARBURST PATTERN BACKGROUND. THE DESIGN IS OUTLINED AND DETAILED IN BLACK AND HAS WHITE HIGHLIGHTING AND SPARKLES.

THE COLOR(S) GREEN, BROWN, YELLOW, BLUE, BLACK, GRAY, WHITE, RED, PINK, ORANGE, AND GOLD IS/ARE CLAIMED AS A FEATURE OF THE MARK.

SER. NO. 85-642,165, FILED 6-4-2012.

JASON LOTT, EXAMINING ATTORNEY



*David J. Kyffers*

Director of the United States Patent and Trademark Office



# United States of America

United States Patent and Trademark Office

# SkinnyTan

**Reg. No. 4,275,564**

CINDY KEMPER (UNITED STATES INDIVIDUAL)  
19340 SUMMIT ASH CT  
LEESBURG, VA 20175

**Registered Jan. 15, 2013**

**Int. Cl.: 44**

FOR: TANNING SALONS, NAMELY, TANNING SALONS FEATURING SPRAY TANNING SOLUTIONS, IN CLASS 44 (U.S. CLS. 100 AND 101).

**SERVICE MARK**

FIRST USE 11-0-2011; IN COMMERCE 11-0-2011.

**PRINCIPAL REGISTER**

THE MARK CONSISTS OF STANDARD CHARACTERS WITHOUT CLAIM TO ANY PARTICULAR FONT, STYLE, SIZE, OR COLOR.

SER. NO. 85-642,209, FILED 6-4-2012.

HEATHER THOMPSON, EXAMINING ATTORNEY



*David J. Kybas*

Director of the United States Patent and Trademark Office

# United States of America

United States Patent and Trademark Office

# ¡Ay Que Rico!

**Reg. No. 4,275,565**

OLIVO, RICHARD A. (UNITED STATES INDIVIDUAL), DBA RICO'S  
P.O. BOX 920501  
EL PASO, TX 79902

**Registered Jan. 15, 2013**

**Int. Cl.: 30**

FOR: CHIMICHURRI SAUCE; DIPPING SAUCES; HOT SAUCE; PICANTE SAUCE; PICO DE GALLO SAUCE; SALSA; TOMATO-BASED SALSA, IN CLASS 30 (U.S. CL. 46).

**TRADEMARK**

FIRST USE 7-21-1985; IN COMMERCE 9-1-1997.

**PRINCIPAL REGISTER**

THE MARK CONSISTS OF STANDARD CHARACTERS WITHOUT CLAIM TO ANY PARTICULAR FONT, STYLE, SIZE, OR COLOR.

THE ENGLISH TRANSLATION OF "¡AY QUE RICO!" IN THE MARK IS "OH, HOW TASTY!".

SER. NO. 85-642,228, FILED 6-4-2012.

AISHA CLARKE, EXAMINING ATTORNEY



*David J. Kybas*

Director of the United States Patent and Trademark Office

# United States of America

United States Patent and Trademark Office

RECYCLING TODAY. LANDFILL  
FREE TOMORROW.

**Reg. No. 4,275,566**

GREEN INNOVATIONS, LLC (OHIO LIMITED LIABILITY COMPANY)  
6075 COCHRAN ROAD  
SOLON, OH 44139

**Registered Jan. 15, 2013**

**Int. Cl.: 40**

FOR: WASTE MANAGEMENT SERVICES AND RECYCLING SERVICES, AND CONSULTATION IN CONNECTION THEREWITH, IN CLASS 40 (U.S. CLS. 100, 103 AND 106).

**SERVICE MARK**

FIRST USE 3-7-2012; IN COMMERCE 3-7-2012.

**PRINCIPAL REGISTER**

THE MARK CONSISTS OF STANDARD CHARACTERS WITHOUT CLAIM TO ANY PARTICULAR FONT, STYLE, SIZE, OR COLOR.

SER. NO. 85-642,257, FILED 6-4-2012.

TIMOTHY FINNEGAN, EXAMINING ATTORNEY



*David J. Kybas*

Director of the United States Patent and Trademark Office

# United States of America

United States Patent and Trademark Office

## Precision Works

**Reg. No. 4,275,567**

**Registered Jan. 15, 2013**

**Int. Cl.: 44**

**SERVICE MARK**

**PRINCIPAL REGISTER**

N-OF-ONE THERAPEUTICS, INC. (DELAWARE CORPORATION)  
SUITE 115  
400 FIFTH AVENUE  
WALTHAM, MA 02451

FOR: HEALTH CARE SERVICES, NAMELY, PROVIDING A DATABASE IN THE FIELD OF BIOMARKER AND GENOMIC MEDICINE WITH SYSTEMS FOR OUTPUT OF CUSTOMIZED KNOWLEDGE AND INFORMATION AND FEATURING INPUTTING AND COLLECTION OF DATA AND INFORMATION ALL FOR TREATMENT AND DIAGNOSTIC PURPOSES, IN CLASS 44 (U.S. CLS. 100 AND 101).

FIRST USE 5-25-2012; IN COMMERCE 5-25-2012.

THE MARK CONSISTS OF STANDARD CHARACTERS WITHOUT CLAIM TO ANY PARTICULAR FONT, STYLE, SIZE, OR COLOR.

SER. NO. 85-642,260, FILED 6-4-2012.

CHRISTINE MARTIN, EXAMINING ATTORNEY



*David J. Kyffers*

Director of the United States Patent and Trademark Office

# United States of America

United States Patent and Trademark Office

# ORTHOMIND

**Reg. No. 4,275,568**

ORTHOMIND, LLC (GEORGIA LIMITED LIABILITY COMPANY)

**Registered Jan. 15, 2013**

P.O. BOX 29965  
ATLANTA, GA 30359

**Int. Cl.: 42**

FOR: COMPUTER SERVICES, NAMELY, CREATING AN ON-LINE COMMUNITY FOR REGISTERED USERS TO PARTICIPATE IN DISCUSSIONS, GET FEEDBACK FROM THEIR PEERS, FORM VIRTUAL COMMUNITIES, COLLABORATE WITH EACH OTHER, SHARE INFORMATION, AND ENGAGE IN SOCIAL, PROFESSIONAL, AND BUSINESS NETWORKING; CREATING AN ON-LINE COMMUNITY FOR ORTHOPAEDIC SURGEONS, IN CLASS 42 (U.S. CLS. 100 AND 101).

**SERVICE MARK**

**PRINCIPAL REGISTER**

FIRST USE 5-0-2008; IN COMMERCE 5-0-2008.

THE MARK CONSISTS OF STANDARD CHARACTERS WITHOUT CLAIM TO ANY PARTICULAR FONT, STYLE, SIZE, OR COLOR.

SER. NO. 85-642,272, FILED 6-4-2012.

HEATHER SAPP, EXAMINING ATTORNEY



*David J. Kyffers*

Director of the United States Patent and Trademark Office

# United States of America

United States Patent and Trademark Office

## NIKKI HASKELL

**Reg. No. 4,275,569**

**Registered Jan. 15, 2013**

**Int. Cl.: 5**

**TRADEMARK**

**PRINCIPAL REGISTER**

NIKKI HASKELL (UNITED STATES INDIVIDUAL)  
215 EAST 68TH STREET  
SUITE 33A  
NEW YORK, NY 10021

FOR: DIETARY AND NUTRITIONAL SUPPLEMENTS; DIETARY AND NUTRITIONAL SUPPLEMENTS USED FOR WEIGHT LOSS; DIETARY SUPPLEMENTAL DRINKS; DIETARY SUPPLEMENTAL DRINKS IN THE NATURE OF VITAMIN AND MINERAL BEVERAGES, IN CLASS 5 (U.S. CLS. 6, 18, 44, 46, 51 AND 52).

FIRST USE 5-17-1986; IN COMMERCE 5-17-1986.

THE MARK CONSISTS OF STANDARD CHARACTERS WITHOUT CLAIM TO ANY PARTICULAR FONT, STYLE, SIZE, OR COLOR.

OWNER OF U.S. REG. NOS. 3,546,377, 3,546,379 AND OTHERS.

THE NAME(S), PORTRAIT(S), AND/OR SIGNATURE(S) SHOWN IN THE MARK IDENTIFIES "NIKKI HASKELL", WHOSE CONSENT(S) TO REGISTER IS MADE OF RECORD.

SER. NO. 85-642,283, FILED 6-4-2012.

SAIMA MAKHDOOM, EXAMINING ATTORNEY



*David J. Kyffers*

Director of the United States Patent and Trademark Office

# United States of America

United States Patent and Trademark Office

## ADVANCED REVIVAL

**Reg. No. 4,275,570**

CUTEX NAILS, LLC (MISSOURI LIMITED LIABILITY COMPANY)  
100 INDUSTRIAL DR.  
FESTUS, MO 63028

**Registered Jan. 15, 2013**

**Int. Cl.: 3**

FOR: NAIL POLISH REMOVERS, IN CLASS 3 (U.S. CLS. 1, 4, 6, 50, 51 AND 52).

**TRADEMARK**

FIRST USE 1-0-2012; IN COMMERCE 1-0-2012.

**PRINCIPAL REGISTER**

THE MARK CONSISTS OF STANDARD CHARACTERS WITHOUT CLAIM TO ANY PARTICULAR FONT, STYLE, SIZE, OR COLOR.

SER. NO. 85-642,321, FILED 6-4-2012.

LEE-ANNE BERNS, EXAMINING ATTORNEY



*David J. Kyffers*

Director of the United States Patent and Trademark Office

**United States of America**  
United States Patent and Trademark Office

# BASEWORX

**Reg. No. 4,275,571**

CUTEX NAILS, LLC (MISSOURI LIMITED LIABILITY COMPANY)  
100 INDUSTRIAL DR.  
FESTUS, MO 63028

**Registered Jan. 15, 2013**

**Int. Cl.: 3**

FOR: NAIL POLISH BASE COATS, IN CLASS 3 (U.S. CLS. 1, 4, 6, 50, 51 AND 52).

**TRADEMARK**

FIRST USE 1-0-2012; IN COMMERCE 1-0-2012.

**PRINCIPAL REGISTER**

THE MARK CONSISTS OF STANDARD CHARACTERS WITHOUT CLAIM TO ANY PARTICULAR FONT, STYLE, SIZE, OR COLOR.

SER. NO. 85-642,328, FILED 6-4-2012.

LEE-ANNE BERNS, EXAMINING ATTORNEY



*David J. Kyffers*

Director of the United States Patent and Trademark Office



# United States of America

United States Patent and Trademark Office

## KARMAK FUSION

**Reg. No. 4,275,572**

**Registered Jan. 15, 2013**

**Int. Cl.: 9**

**TRADEMARK**

**PRINCIPAL REGISTER**

KARMAK, INC. (ILLINOIS CORPORATION)  
P.O. BOX 680  
1 KARMAK PLAZA  
CARLINVILLE, IL 62626

FOR: COMPUTER SOFTWARE, NAMELY, AN INVENTORY AND BUSINESS MANAGEMENT PROGRAM FOR USE IN THE HEAVY DUTY TRUCK VEHICLE AND REPLACEMENT PARTS INDUSTRY, IN CLASS 9 (U.S. CLS. 21, 23, 26, 36 AND 38).

FIRST USE 11-16-2011; IN COMMERCE 11-16-2011.

THE MARK CONSISTS OF STANDARD CHARACTERS WITHOUT CLAIM TO ANY PARTICULAR FONT, STYLE, SIZE, OR COLOR.

OWNER OF U.S. REG. NOS. 2,251,245, 2,251,249, AND 2,336,654.

SER. NO. 85-642,355, FILED 6-4-2012.

COLLEEN MULCRONE, EXAMINING ATTORNEY



*David J. Kybas*

Director of the United States Patent and Trademark Office

# United States of America

United States Patent and Trademark Office

## The Size of the Check Matters

**Reg. No. 4,275,573**

**Registered Jan. 15, 2013**

**Int. Cl.: 45**

**SERVICE MARK**

**PRINCIPAL REGISTER**

PARKER WAICHMAN LLP (NEW YORK LIMITED PARTNERSHIP)  
6 HARBOR PARK DRIVE  
PORT WASHINGTON, NY 11050

FOR: LEGAL SERVICES, IN CLASS 45 (U.S. CLS. 100 AND 101).

FIRST USE 6-4-2012; IN COMMERCE 6-4-2012.

THE MARK CONSISTS OF STANDARD CHARACTERS WITHOUT CLAIM TO ANY PARTICULAR FONT, STYLE, SIZE, OR COLOR.

SER. NO. 85-642,356, FILED 6-4-2012.

JOHN SCHUYLER YARD, EXAMINING ATTORNEY



*David J. Kybas*

Director of the United States Patent and Trademark Office

# United States of America

United States Patent and Trademark Office

# TRIX

**Reg. No. 4,275,574**

**Registered Jan. 15, 2013**

**Int. Cl.: 3**

**TRADEMARK**

**PRINCIPAL REGISTER**

GENERAL MILLS IP HOLDINGS II, LLC (DELAWARE LIMITED LIABILITY COMPANY)  
NUMBER ONE GENERAL MILLS BOULEVARD  
MINNEAPOLIS, MN 55426

FOR: LIP BALM, IN CLASS 3 (U.S. CLS. 1, 4, 6, 50, 51 AND 52).

FIRST USE 9-30-2005; IN COMMERCE 9-30-2005.

THE MARK CONSISTS OF STANDARD CHARACTERS WITHOUT CLAIM TO ANY PARTICULAR FONT, STYLE, SIZE, OR COLOR.

OWNER OF U.S. REG. NOS. 1,552,170, 3,153,686 AND OTHERS.

SER. NO. 85-642,365, FILED 6-4-2012.

ALAIN LAPTER, EXAMINING ATTORNEY



*David J. Kybas*

Director of the United States Patent and Trademark Office

# United States of America

United States Patent and Trademark Office

# Schapiro's

**Reg. No. 4,275,575**

SCHAPIRO, DANIEL (UNITED STATES INDIVIDUAL)  
6791 PORTSIDE DRIVE  
BOCA RATON, FL 33496 AND

**Registered Jan. 15, 2013**

**Int. Cl.: 33**

SCHAPIRO, EDWARD (UNITED STATES INDIVIDUAL)  
6791 PORTSIDE DRIVE  
BOCA RATON, FL 33496 AND

**TRADEMARK**

**PRINCIPAL REGISTER**

SCHAPIRO, SAM (UNITED STATES INDIVIDUAL)  
6791 PORTSIDE DRIVE  
BOCA RATON, FL 33496

FOR: WINES AND FORTIFIED WINES; WINES AND LIQUEURS; WINES AND SPARKLING WINES, IN CLASS 33 (U.S. CLS. 47 AND 49).

FIRST USE 1-1-1962; IN COMMERCE 4-1-1962.

THE MARK CONSISTS OF THE SURNAME, "SCHAPIRO'S", IN A STYLISTIC FONT.

SEC. 2(F).

SER. NO. 85-642,375, FILED 6-4-2012.

LESLEY LAMOTHE, EXAMINING ATTORNEY



*David J. Kyjars*

Director of the United States Patent and Trademark Office

# United States of America

United States Patent and Trademark Office

## The Size of Your Check Matters

**Reg. No. 4,275,576**

**Registered Jan. 15, 2013**

**Int. Cl.: 45**

**SERVICE MARK**

**PRINCIPAL REGISTER**

PARKER WAICHMAN LLP (NEW YORK LIMITED PARTNERSHIP)  
6 HARBOR PARK DRIVE  
PORT WASHINGTON, NY 11050

FOR: LEGAL SERVICES, IN CLASS 45 (U.S. CLS. 100 AND 101).

FIRST USE 6-4-2012; IN COMMERCE 6-4-2012.

THE MARK CONSISTS OF STANDARD CHARACTERS WITHOUT CLAIM TO ANY PARTICULAR FONT, STYLE, SIZE, OR COLOR.

SER. NO. 85-642,384, FILED 6-4-2012.

JOHN SCHUYLER YARD, EXAMINING ATTORNEY



*David J. Kyffers*

Director of the United States Patent and Trademark Office

# United States of America

United States Patent and Trademark Office

# NMX

**Reg. No. 4,275,577**

**Registered Jan. 15, 2013**

**Int. Cl.: 41**

**SERVICE MARK**

**PRINCIPAL REGISTER**

BLOGWORLD, LLC (CALIFORNIA LIMITED LIABILITY COMPANY)  
29991 CANYON HILLS RD., STE. 1709-531  
LAKE ELSINORE, CA 92532

FOR: EDUCATIONAL SERVICES, NAMELY, DEVELOPING, ARRANGING, AND CONDUCTING EDUCATIONAL CONFERENCES AND PROGRAMS AND PROVIDING COURSES OF INSTRUCTION IN THE FIELD OF BLOGGING, VIDEO BLOGGING (VLOGGING), PODCASTING, WEB TV, SOCIAL MEDIA, ONLINE CONTENT AGGREGATION, LIVE VIDEO OR AUDIO BROADCASTING VIA THE INTERNET, AND WRITING FICTION AND NON-FICTION STORIES OR NEWS ITEMS FOR DISTRIBUTION ONLINE, IN CLASS 41 (U.S. CLS. 100, 101 AND 107).

FIRST USE 6-2-2012; IN COMMERCE 6-2-2012.

THE MARK CONSISTS OF STANDARD CHARACTERS WITHOUT CLAIM TO ANY PARTICULAR FONT, STYLE, SIZE, OR COLOR.

SER. NO. 85-642,414, FILED 6-4-2012.

MICHAEL LITZAU, EXAMINING ATTORNEY



*David J. Kyffers*

Director of the United States Patent and Trademark Office

**United States of America**  
United States Patent and Trademark Office

# LIPODROPS

**Reg. No. 4,275,578**

GOLDKLANG, JAY (UNITED STATES INDIVIDUAL)  
4799 FARIVILLE CT.  
MARIETTA, GA 30062

**Registered Jan. 15, 2013**

**Int. Cl.: 5**

FOR: DIETARY AND NUTRITIONAL SUPPLEMENTS USED FOR WEIGHT LOSS, IN CLASS 5 (U.S. CLS. 6, 18, 44, 46, 51 AND 52).

**TRADEMARK**

FIRST USE 5-0-2012; IN COMMERCE 5-0-2012.

**PRINCIPAL REGISTER**

THE MARK CONSISTS OF STANDARD CHARACTERS WITHOUT CLAIM TO ANY PARTICULAR FONT, STYLE, SIZE, OR COLOR.

SER. NO. 85-642,418, FILED 6-4-2012.

JIM RINGLE, EXAMINING ATTORNEY



*David J. Kyffers*

Director of the United States Patent and Trademark Office

# United States of America

United States Patent and Trademark Office

# PINE RIVER

**Reg. No. 4,275,579**

PINE RIVER PRE-PACK, INC. (WISCONSIN CORPORATION)  
10134 PINE RIVER ROAD  
NEWTON, WI 53063

**Registered Jan. 15, 2013**

**Int. Cls.: 29 and 30**

FOR: CHEESE; CHEESE SPREADS; DEHYDRATED FRUIT SNACKS; SAUSAGES; SHELLLED NUTS, IN CLASS 29 (U.S. CL. 46).

**TRADEMARK**

FIRST USE 10-1-1963; IN COMMERCE 10-1-1963.

**PRINCIPAL REGISTER**

FOR: CANDIES; CARAMEL POPCORN; CHOCOLATE; CHOCOLATE CONFECTIONS; CHOCOLATE COVERED PRETZELS, IN CLASS 30 (U.S. CL. 46).

FIRST USE 11-20-1986; IN COMMERCE 1-1-1987.

THE MARK CONSISTS OF STANDARD CHARACTERS WITHOUT CLAIM TO ANY PARTICULAR FONT, STYLE, SIZE, OR COLOR.

OWNER OF U.S. REG. NO. 1,274,450.

SER. NO. 85-642,438, FILED 6-4-2012.

IRA J. GOODSaid, EXAMINING ATTORNEY



*David J. Kybas*

Director of the United States Patent and Trademark Office



# United States of America

United States Patent and Trademark Office

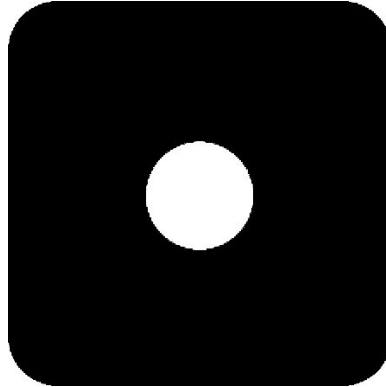

**Reg. No. 4,275,580**

ROUNDISM, LLC (ILLINOIS LIMITED LIABILITY COMPANY)  
300 RIDGE RD.  
BARRINGTON, IL 60010

**Registered Jan. 15, 2013**

**Int. Cl.: 35**

FOR: ART GALLERY SERVICES; COMPUTERIZED ON-LINE ORDERING FEATURING GENERAL MERCHANDISE AND GENERAL CONSUMER GOODS; COMPUTERIZED ON-LINE ORDERING SERVICES IN THE FIELD OF PREEXISTENT AND COMMISSIONED ART-RELATED MERCHANDISE, IN CLASS 35 (U.S. CLS. 100, 101 AND 102).

**SERVICE MARK**

**PRINCIPAL REGISTER**

FIRST USE 4-11-2012; IN COMMERCE 4-11-2012.

THE MARK CONSISTS OF GEOMETRIC SHAPE COMPRISING A POLYGON WITH ROUNDED CORNERS AND A CENTRAL HOLE.

SER. NO. 85-642,458, FILED 6-4-2012.

PRISCILLA MILTON, EXAMINING ATTORNEY



*David J. Kybas*

Director of the United States Patent and Trademark Office

# United States of America

United States Patent and Trademark Office

## EZFINGERPRINTS

**Reg. No. 4,275,581**

EZFINGERPRINTS, LLC (FLORIDA LIMITED LIABILITY COMPANY)  
1180 PONCE DE LEON BLVD. 701  
CLEARWATER, FL 33756

**Registered Jan. 15, 2013**

**Int. Cl.: 45**

FOR: BACKGROUND INVESTIGATION SERVICES; FINGERPRINTING SERVICES, IN CLASS 45 (U.S. CLS. 100 AND 101).

**SERVICE MARK**

FIRST USE 2-1-2011; IN COMMERCE 2-1-2011.

**PRINCIPAL REGISTER**

THE MARK CONSISTS OF STANDARD CHARACTERS WITHOUT CLAIM TO ANY PARTICULAR FONT, STYLE, SIZE, OR COLOR.

SER. NO. 85-642,507, FILED 6-4-2012.

EUGENIA MARTIN, EXAMINING ATTORNEY



*David J. Kybas*

Director of the United States Patent and Trademark Office

# United States of America

United States Patent and Trademark Office

## SHARP PARTS

**Reg. No. 4,275,582**

BOB THOMAS DEALERSHIPS, INC. (INDIANA CORPORATION)  
8623 E. WASHINGTON  
INDIANAPOLIS, IN 46219

**Registered Jan. 15, 2013**

**Int. Cl.: 35**

FOR: WHOLESALE STORE SERVICES FEATURING AUTO PARTS, IN CLASS 35 (U.S. CLS. 100, 101 AND 102).

**SERVICE MARK**

FIRST USE 8-1-2007; IN COMMERCE 8-1-2007.

**PRINCIPAL REGISTER**

THE MARK CONSISTS OF STANDARD CHARACTERS WITHOUT CLAIM TO ANY PARTICULAR FONT, STYLE, SIZE, OR COLOR.

NO CLAIM IS MADE TO THE EXCLUSIVE RIGHT TO USE "PARTS", APART FROM THE MARK AS SHOWN.

SER. NO. 85-642,535, FILED 6-4-2012.

TINA L. SNAPP, EXAMINING ATTORNEY



*David J. Kyffers*

Director of the United States Patent and Trademark Office

# United States of America

United States Patent and Trademark Office

# DUO

**Reg. No. 4,275,583**

**Registered Jan. 15, 2013**

**Int. Cl.: 31**

**TRADEMARK**

**PRINCIPAL REGISTER**

BFN OPERATIONS, LLC (DELAWARE LIMITED LIABILITY COMPANY)  
SUITE 250  
1400 CIVIC PLACE  
SOUTHLAKE, TX 76092

FOR: LIVE PLANTS, IN CLASS 31 (U.S. CLS. 1 AND 46).

FIRST USE 1-1-2012; IN COMMERCE 1-1-2012.

THE MARK CONSISTS OF STANDARD CHARACTERS WITHOUT CLAIM TO ANY PARTICULAR FONT, STYLE, SIZE, OR COLOR.

SER. NO. 85-642,539, FILED 6-4-2012.

WENDY GOODMAN, EXAMINING ATTORNEY



*David J. Kybas*

Director of the United States Patent and Trademark Office

# United States of America

United States Patent and Trademark Office

# TRIO

**Reg. No. 4,275,584**

**Registered Jan. 15, 2013**

**Int. Cl.: 31**

**TRADEMARK**

**PRINCIPAL REGISTER**

BFN OPERATIONS, LLC (DELAWARE LIMITED LIABILITY COMPANY)  
SUITE 250  
1400 CIVIC PLACE  
SOUTHLAKE, TX 76092

FOR: LIVE PLANTS, IN CLASS 31 (U.S. CLS. 1 AND 46).

FIRST USE 1-1-2012; IN COMMERCE 1-1-2012.

THE MARK CONSISTS OF STANDARD CHARACTERS WITHOUT CLAIM TO ANY PARTICULAR FONT, STYLE, SIZE, OR COLOR.

SER. NO. 85-642,562, FILED 6-4-2012.

WENDY GOODMAN, EXAMINING ATTORNEY



*David J. Kybas*

Director of the United States Patent and Trademark Office

# United States of America

United States Patent and Trademark Office

# BRIDALERT

**Reg. No. 4,275,585**

**Registered Jan. 15, 2013**

**Int. Cl.: 35**

**SERVICE MARK**

**PRINCIPAL REGISTER**

SHAFFER, MARK (UNITED STATES INDIVIDUAL)  
SUITE 102  
3320 N. BUFFALO  
LAS VEGAS, NV 89129

FOR: BRIDAL REGISTRY SERVICES; MARKETING SERVICES; PROMOTION AND MARKETING SERVICES AND RELATED CONSULTING, IN CLASS 35 (U.S. CLS. 100, 101 AND 102).

FIRST USE 6-4-2012; IN COMMERCE 6-4-2012.

THE MARK CONSISTS OF STANDARD CHARACTERS WITHOUT CLAIM TO ANY PARTICULAR FONT, STYLE, SIZE, OR COLOR.

SER. NO. 85-642,574, FILED 6-4-2012.

MAUREEN DALL, EXAMINING ATTORNEY



*David J. Kybas*

Director of the United States Patent and Trademark Office

# United States of America

United States Patent and Trademark Office

## CHINOOK SEEDERY

**Reg. No. 4,275,586**

CHINOOK NATURALS, LLC (COLORADO LIMITED LIABILITY COMPANY)  
70 GLENMORE DRIVE  
ENGLEWOOD, CO 80113

**Registered Jan. 15, 2013**

**Int. Cl.: 29**

FOR: SNACK MIX CONSISTING OF PRIMARILY OF PROCESSED NUTS, SEEDS, DRIED FRUIT AND ALSO INCLUDING CHOCOLATE, IN CLASS 29 (U.S. CL. 46).

**TRADEMARK**

FIRST USE 5-31-2012; IN COMMERCE 5-31-2012.

**PRINCIPAL REGISTER**

THE MARK CONSISTS OF STANDARD CHARACTERS WITHOUT CLAIM TO ANY PARTICULAR FONT, STYLE, SIZE, OR COLOR.

SER. NO. 85-642,581, FILED 6-4-2012.

JOHN WILKE, EXAMINING ATTORNEY



*David J. Kybas*

Director of the United States Patent and Trademark Office

# United States of America

United States Patent and Trademark Office

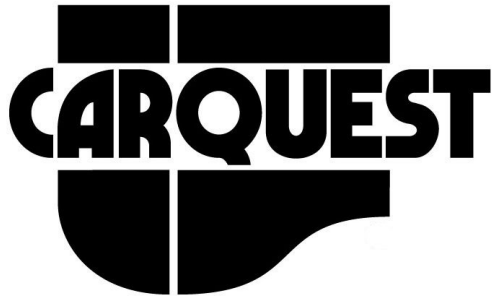

**Reg. No. 4,275,587**

CARQUEST CORPORATION (DELAWARE CORPORATION)  
P.O. BOX 26929  
RALEIGH, NC 276116929

**Registered Jan. 15, 2013**

**Int. Cl.: 35**

FOR: WHOLESALE AND RETAIL STORE SERVICES IN THE FIELD OF AUTOMOTIVE PARTS, ACCESSORIES, AND PAINT; DISTRIBUTORSHIP SERVICES IN THE FIELD OF AUTOMOTIVE PARTS, ACCESSORIES, AND PAINT, IN CLASS 35 (U.S. CLS. 100, 101 AND 102).

**SERVICE MARK**

**PRINCIPAL REGISTER**

FIRST USE 4-26-1973; IN COMMERCE 4-26-1973.

OWNER OF U.S. REG. NOS. 994,165, 1,650,501, AND 2,245,423.

THE MARK CONSISTS OF A SHIELD WITH THE WORD "CARQUEST" IN THE MIDDLE.

SER. NO. 85-642,616, FILED 6-4-2012.

KIM MONINGHOFF, EXAMINING ATTORNEY



*David J. Kyffers*

Director of the United States Patent and Trademark Office



# United States of America

United States Patent and Trademark Office

# RED ALDER

**Reg. No. 4,275,588**

**Registered Jan. 15, 2013**

**Int. Cl.: 36**

**SERVICE MARK**

**PRINCIPAL REGISTER**

RED ALDER GP, LLC (DELAWARE LIMITED LIABILITY COMPANY)  
215 GATES AVENUE, APT. 1  
BROOKLYN, NY 11238

FOR: FINANCIAL SERVICES, NAMELY, OPERATION AND MANAGEMENT OF HEDGE FUNDS, COMMODITY POOLS AND OTHER COLLECTIVE INVESTMENT VEHICLES, AND TRADING FOR OTHERS OF SECURITIES, OPTIONS, FUTURES, DERIVATIVES, DEBT INSTRUMENTS AND COMMODITIES, IN CLASS 36 (U.S. CLS. 100, 101 AND 102).

FIRST USE 5-14-2012; IN COMMERCE 5-14-2012.

THE MARK CONSISTS OF STANDARD CHARACTERS WITHOUT CLAIM TO ANY PARTICULAR FONT, STYLE, SIZE, OR COLOR.

SER. NO. 85-642,646, FILED 6-4-2012.

HENRY S. ZAK, EXAMINING ATTORNEY



*David J. Kyffers*

Director of the United States Patent and Trademark Office

# United States of America

United States Patent and Trademark Office

## WHILE YOU'RE NOT HOME

**Reg. No. 4,275,589**

**Registered Jan. 15, 2013**

**Int. Cl.: 45**

**SERVICE MARK**

**PRINCIPAL REGISTER**

WHILE YOU'RE NOT HOME, LLC (COLORADO LIMITED LIABILITY COMPANY), DBA  
WHILE YOU'RE NOT HOME  
2717 WIND RIVER LANE SUITE 133  
DENTON, TX 76210

FOR: HOME SITTING, IN CLASS 45 (U.S. CLS. 100 AND 101).

FIRST USE 3-25-2009; IN COMMERCE 5-8-2009.

THE MARK CONSISTS OF STANDARD CHARACTERS WITHOUT CLAIM TO ANY PARTICULAR FONT, STYLE, SIZE, OR COLOR.

SER. NO. 85-642,666, FILED 6-4-2012.

MEREDITH MARESCA, EXAMINING ATTORNEY



*David J. Kybas*

Director of the United States Patent and Trademark Office

# United States of America

United States Patent and Trademark Office

## SIGNET HEALTH

**Reg. No. 4,275,590**

SIGNET HEALTH CORPORATION (TEXAS CORPORATION), DBA SIGNET HEALTH  
2717 WIND RIVER LANE SUITE 133  
DENTON, TX 75035

**Registered Jan. 15, 2013**

**Int. Cl.: 35**

FOR: BUSINESS AND MANAGEMENT CONSULTING FOR HEALTHCARE PROVIDERS  
AND RELATED BUSINESSES, IN CLASS 35 (U.S. CLS. 100, 101 AND 102).

**SERVICE MARK**

FIRST USE 12-9-1999; IN COMMERCE 12-9-1999.

**PRINCIPAL REGISTER**

THE MARK CONSISTS OF STANDARD CHARACTERS WITHOUT CLAIM TO ANY PAR-  
TICULAR FONT, STYLE, SIZE, OR COLOR.

NO CLAIM IS MADE TO THE EXCLUSIVE RIGHT TO USE "HEALTH", APART FROM THE  
MARK AS SHOWN.

SER. NO. 85-642,686, FILED 6-4-2012.

HEATHER SAPP, EXAMINING ATTORNEY



*David J. Kyffers*

Director of the United States Patent and Trademark Office

# United States of America

United States Patent and Trademark Office

# VersaTrust

**Reg. No. 4,275,591**

**Registered Jan. 15, 2013**

**Int. Cl.: 42**

AMERICAN INTEGRATION, INC. (TEXAS CORPORATION), DBA AMERICAN  
INTEGRATION, INC.  
SUITE 110  
6310 SOUTHWEST BLVD  
FORT WORTH, TX 76109

**SERVICE MARK**

**PRINCIPAL REGISTER**

FOR: COMPUTER SERVICES, NAMELY, CLOUD HOSTING PROVIDER SERVICES; COMPUTER SERVICES, NAMELY, COMPUTER SYSTEM ADMINISTRATION FOR OTHERS; COMPUTER SERVICES, NAMELY, FILTERING OF UNWANTED E-MAILS; COMPUTER SERVICES, NAMELY, INTEGRATION OF COMPUTER SOFTWARE INTO MULTIPLE SYSTEMS AND NETWORKS; COMPUTER SERVICES, NAMELY, INTEGRATION OF PRIVATE AND PUBLIC CLOUD COMPUTING ENVIRONMENTS; COMPUTER SERVICES, NAMELY, INTERNET PROTOCOL ADDRESS MANAGEMENT; COMPUTER SERVICES, NAMELY, ON-SITE MANAGEMENT OF INFORMATION TECHNOLOGY (IT) SYSTEMS; COMPUTER SERVICES, NAMELY, REMOTE AND ON-SITE MANAGEMENT OF SERVERS, NETWORKS, IT, TELECOM DEVICES AND SOFTWARE OF OTHERS; COMPUTER SERVICES, NAMELY, REMOTE MANAGEMENT OF THE INFORMATION TECHNOLOGY (IT) SYSTEMS OF OTHERS; PROFESSIONAL COMPUTER SERVICES, NAMELY, NETWORK ANALYSIS, LAN/WAN DESIGN, WIRELESS ENGINEERING, VIRTUALIZATION AND COMPUTER PROJECT MANAGEMENT, IN CLASS 42 (U.S. CLS. 100 AND 101).

FIRST USE 9-14-2011; IN COMMERCE 1-30-2012.

THE MARK CONSISTS OF STANDARD CHARACTERS WITHOUT CLAIM TO ANY PARTICULAR FONT, STYLE, SIZE, OR COLOR.

SER. NO. 85-642,687, FILED 6-4-2012.

MORGAN WYNNE, EXAMINING ATTORNEY



*David J. Kyros*

Director of the United States Patent and Trademark Office

# United States of America

United States Patent and Trademark Office

More Choice. Unbiased  
Advice. Better Insurance.

**Reg. No. 4,275,592**

**Registered Jan. 15, 2013**

**Int. Cl.: 36**

**SERVICE MARK**

**PRINCIPAL REGISTER**

LGAA (UTAH LIMITED LIABILITY COMPANY), DBA LEAVITT GROUP AGENCY  
ASSOCIATION  
216 SOUTH 200 WEST  
CEDAR CITY, UT 84720

FOR: INSURANCE AGENCY AND BROKERAGE, IN CLASS 36 (U.S. CLS. 100, 101 AND 102).

FIRST USE 2-1-2011; IN COMMERCE 9-1-2011.

THE MARK CONSISTS OF STANDARD CHARACTERS WITHOUT CLAIM TO ANY PARTICULAR FONT, STYLE, SIZE, OR COLOR.

NO CLAIM IS MADE TO THE EXCLUSIVE RIGHT TO USE "INSURANCE", APART FROM THE MARK AS SHOWN.

SER. NO. 85-642,741, FILED 6-4-2012.

JILL PRATER, EXAMINING ATTORNEY



*David J. Kyffers*

Director of the United States Patent and Trademark Office

# United States of America

United States Patent and Trademark Office

## OVER UNDER

**Reg. No. 4,275,593**

**Registered Jan. 15, 2013**

**Int. Cls.: 18 and 25**

**TRADEMARK**

**PRINCIPAL REGISTER**

OVER UNDER CLOTHIERS, LLC (FLORIDA LIMITED LIABILITY COMPANY)  
2133 BELOTE PLACE  
JACKSONVILLE, FL 32207

FOR: ANIMAL LEASHES; BANDS OF LEATHER; COLLARS FOR PETS; DOG COLLARS;  
DOG LEASHES; LEATHER CREDIT CARD CASES; LEATHER CREDIT CARD HOLDER;  
LEATHER CREDIT CARD WALLETS; LEATHER KEY CHAINS; LEATHER LEASHES;  
LEATHER STRAPS; WALLETS; WALLETS MADE OF LEATHER OR OTHER MATERIALS,  
IN CLASS 18 (U.S. CLS. 1, 2, 3, 22 AND 41).

FIRST USE 3-2-2012; IN COMMERCE 3-2-2012.

FOR: BASEBALL CAPS AND HATS; BELTS; CAMP SHIRTS; COLLARED SHIRTS; HATS;  
HUNTING SHIRTS; POLO SHIRTS; SHORT-SLEEVED OR LONG-SLEEVED T-SHIRTS; T-  
SHIRTS; WEARABLE GARMENTS AND CLOTHING, NAMELY, SHIRTS, IN CLASS 25 (U.S.  
CLS. 22 AND 39).

FIRST USE 3-2-2012; IN COMMERCE 3-2-2012.

THE MARK CONSISTS OF STANDARD CHARACTERS WITHOUT CLAIM TO ANY PAR-  
TICULAR FONT, STYLE, SIZE, OR COLOR.

SER. NO. 85-642,755, FILED 6-4-2012.

JILL PRATER, EXAMINING ATTORNEY



*David J. Kyffers*

Director of the United States Patent and Trademark Office

# United States of America

United States Patent and Trademark Office



**Reg. No. 4,275,594**

4GE MEDIA GROUP (CALIFORNIA LIMITED LIABILITY COMPANY)  
2554 PAHVANT ST  
OCEANSIDE, CA 92054

**Registered Jan. 15, 2013**

**Int. Cl.: 41**

FOR: PROVIDING A WEBSITE FEATURING INFORMATION RELATING TO THE SPORT OF LAND VEHICLE RACING, IN CLASS 41 (U.S. CLS. 100, 101 AND 107).

**SERVICE MARK**

FIRST USE 1-1-1999; IN COMMERCE 1-1-1999.

**PRINCIPAL REGISTER**

THE MARK CONSISTS OF THE UPPER CASE LETTERS "RDC" WITH DROP SHADOW ON TOP. THE LOWER CASE WORDING "RACE-DEZERT.COM" WITH DROP SHADOW AT BOTTOM. THE LETTER "Z" SPANS OVER THE FIRST PART OF THE WORD, WHILE IT UNDERLINES THE SECOND HALF.

SER. NO. 85-642,775, FILED 6-4-2012.

AHSEN KHAN, EXAMINING ATTORNEY



*David J. Kybas*

Director of the United States Patent and Trademark Office

# United States of America

United States Patent and Trademark Office

# Coat Candy

**Reg. No. 4,275,595**

AART2WEAR LLC (FLORIDA LIMITED LIABILITY COMPANY)  
10652 NORTHGREEN DRIVE  
WELLINGTON, FL 33449

**Registered Jan. 15, 2013**

**Int. Cl.: 25**

FOR: CLOTHING, NAMELY, NECK TUBES; HATS; NECK GAITERS; SCARVES; SWEATERS;  
VESTS, IN CLASS 25 (U.S. CLS. 22 AND 39).

**TRADEMARK**

FIRST USE 10-0-2011; IN COMMERCE 10-0-2011.

**PRINCIPAL REGISTER**

THE MARK CONSISTS OF STANDARD CHARACTERS WITHOUT CLAIM TO ANY PARTICULAR FONT, STYLE, SIZE, OR COLOR.

SER. NO. 85-642,814, FILED 6-4-2012.

MICHAEL SOUDERS, EXAMINING ATTORNEY



*David J. Kyffers*

Director of the United States Patent and Trademark Office



# United States of America

United States Patent and Trademark Office

# FixxGlove

**Reg. No. 4,275,596**

DANMIC GLOBAL, LLC (CALIFORNIA LIMITED LIABILITY COMPANY)  
2188 VIZCAYA CIRCLE  
CAMPBELL, CA 95008

**Registered Jan. 15, 2013**

**Int. Cl.: 10**

FOR: MEDICAL DEVICES, NAMELY, HAND ORTHOSES DESIGNED FOR CERTAIN POST-SURGICAL TREATMENT, IN CLASS 10 (U.S. CLS. 26, 39 AND 44).

**TRADEMARK**

FIRST USE 9-8-2011; IN COMMERCE 9-8-2011.

**PRINCIPAL REGISTER**

THE MARK CONSISTS OF STANDARD CHARACTERS WITHOUT CLAIM TO ANY PARTICULAR FONT, STYLE, SIZE, OR COLOR.

SER. NO. 85-642,848, FILED 6-4-2012.

LINDA M. KING, EXAMINING ATTORNEY



*David J. Kybas*

Director of the United States Patent and Trademark Office

# United States of America

United States Patent and Trademark Office

# TRUSTEDSEC

**Reg. No. 4,275,597**

**Registered Jan. 15, 2013**

**Int. Cl.: 42**

**SERVICE MARK**

**PRINCIPAL REGISTER**

TRUSTEDSEC, LLC (OHIO LIMITED LIABILITY COMPANY)  
207 SANDSTONE RIDGE WAY  
BEREA, OH 44017

FOR: COMPUTER SECURITY CONSULTANCY, IN CLASS 42 (U.S. CLS. 100 AND 101).

FIRST USE 10-3-2011; IN COMMERCE 11-3-2011.

THE MARK CONSISTS OF STANDARD CHARACTERS WITHOUT CLAIM TO ANY PARTICULAR FONT, STYLE, SIZE, OR COLOR.

SER. NO. 85-642,849, FILED 6-4-2012.

LINDA ORNDORFF, EXAMINING ATTORNEY



*David J. Kyffers*

Director of the United States Patent and Trademark Office

# United States of America

United States Patent and Trademark Office

## SPIDER BALL

**Reg. No. 4,275,598**

**Registered Jan. 15, 2013**

**Int. Cls.: 36 and 41**

**SERVICE MARK**

**PRINCIPAL REGISTER**

BENTLY HOLDINGS CORPORATION (CALIFORNIA CORPORATION)  
240 STOCKTON STREET, 8TH FLOOR  
SAN FRANCISCO, CA 94108

FOR: CHARITABLE FUNDRAISING SERVICES BY MEANS OF ORGANIZING AND CONDUCTING SPECIAL EVENTS; CHARITABLE FUNDRAISING TO SUPPORT LOCAL ORGANIZATIONS AND COMMUNITIES BY MEANS OF SPONSORING SOCIAL EVENTS, IN CLASS 36 (U.S. CLS. 100, 101 AND 102).

FIRST USE 10-31-2006; IN COMMERCE 10-31-2006.

FOR: ENTERTAINMENT SERVICES, NAMELY, CONDUCTING PARTIES; ORGANIZING, ARRANGING, AND CONDUCTING SOCIAL EVENTS, IN CLASS 41 (U.S. CLS. 100, 101 AND 107).

FIRST USE 10-31-2006; IN COMMERCE 10-31-2006.

THE MARK CONSISTS OF STANDARD CHARACTERS WITHOUT CLAIM TO ANY PARTICULAR FONT, STYLE, SIZE, OR COLOR.

SER. NO. 85-642,873, FILED 6-4-2012.

CAITLIN WATTS-FITZGERALD, EXAMINING ATTORNEY



*David J. Kyros*

Director of the United States Patent and Trademark Office

# United States of America

United States Patent and Trademark Office

## BEACHY KEEN

**Reg. No. 4,275,599**

**Registered Jan. 15, 2013**

**Int. Cl.: 4**

**TRADEMARK**

**PRINCIPAL REGISTER**

INTOBLU, LLC (FLORIDA LIMITED LIABILITY COMPANY)  
616 SEASAGE DRIVE  
DELRAY BEACH, FL 33483

FOR: CANDLES, IN CLASS 4 (U.S. CLS. 1, 6 AND 15).

FIRST USE 4-26-2012; IN COMMERCE 4-26-2012.

THE MARK CONSISTS OF STANDARD CHARACTERS WITHOUT CLAIM TO ANY PARTICULAR FONT, STYLE, SIZE, OR COLOR.

SER. NO. 85-642,876, FILED 6-4-2012.

KELLEY WELLS, EXAMINING ATTORNEY



*David J. Kyffers*

Director of the United States Patent and Trademark Office

# United States of America

United States Patent and Trademark Office

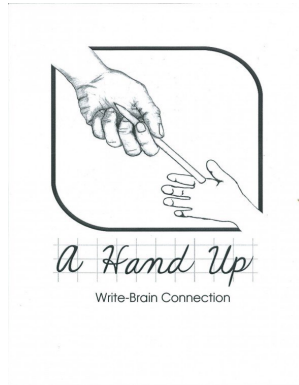

**Reg. No. 4,275,600**

**Registered Jan. 15, 2013**

**Int. Cl.: 16**

**TRADEMARK**

**PRINCIPAL REGISTER**

A HAND UP, LLC (FLORIDA LIMITED LIABILITY COMPANY)  
838 JOHNSON AVENUE  
LAKELAND, FL 33801

FOR: EDUCATIONAL KITS SOLD AS A UNIT IN THE FIELD OF HANDWRITING INSTRUCTION CONSISTING PRIMARILY OF PRINTED INSTRUCTIONAL MATERIALS AND ALSO INCLUDING AUDIO CDS; EDUCATIONAL KITS SOLD AS A UNIT IN THE FIELD OF HANDWRITING INSTRUCTION CONSISTING PRIMARILY OF EDUCATIONAL BOOKS AND ALSO INCLUDING DVDS AND T-SHIRTS; EDUCATIONAL KITS SOLD AS A UNIT IN THE FIELD OF HANDWRITING INSTRUCTION CONSISTING PRIMARILY OF EDUCATIONAL BOOKS, FLASH CARDS AND WORKSHEETS, AND ALSO INCLUDING AN EDUCATIONAL DVD; EDUCATIONAL KITS SOLD AS A UNIT IN THE FIELD OF HANDWRITING INSTRUCTION CONSISTING PRIMARILY OF A TEACHING MANUAL AND ALSO INCLUDING DVDS; EDUCATIONAL PUBLICATIONS, NAMELY, TRAINING MANUALS IN THE FIELD OF HANDWRITING INSTRUCTION; PACKAGED KITS COMPRISING PRINTED INSTRUCTIONAL, EDUCATIONAL, AND TEACHING MATERIALS FOR EDUCATIONAL ACTIVITIES IN THE FIELD OF HANDWRITING INSTRUCTION; PRINTED EDUCATIONAL MATERIALS IN THE FIELD OF HANDWRITING INSTRUCTION; PRINTED INSTRUCTIONAL, EDUCATIONAL, AND TEACHING MATERIALS IN THE FIELD OF HANDWRITING INSTRUCTION; PRINTED MATERIAL, NAMELY, SURVEYS AND ASSESSMENTS IN THE FIELD OF EDUCATOR TRAINING AND PERFORMANCE , IN CLASS 16 (U.S. CLS. 2, 5, 22, 23, 29, 37, 38 AND 50).

FIRST USE 1-6-2012; IN COMMERCE 3-25-2012.

THE MARK CONSISTS OF THE LOGO INCLUDES AN ADULT HAND IN THE UPPER LEFT CORNER HANDING A SHARPENED PENCIL TO A CHILD'S HAND IN THE LOWER RIGHT CORNER. THIS LOGO IS OUTLINED BY A THICK BORDER. BENEATH THE LOGO ARE THE WORDS: "A HAND UP" ON A GRIDDED BACKGROUND. BENEATH THE WORDS "A HAND UP" IS THE TAGLINE: "WRITE-BRAIN CONNECTION".

SER. NO. 85-642,885, FILED 6-4-2012.

EUGENIA MARTIN, EXAMINING ATTORNEY



*David J. Kyros*

Director of the United States Patent and Trademark Office

# United States of America

United States Patent and Trademark Office

# SNAP

**Reg. No. 4,275,601**

**Registered Jan. 15, 2013**

**Int. Cl.: 13**

**TRADEMARK**

**PRINCIPAL REGISTER**

SNAP FIREWORKS, INC. (WISCONSIN CORPORATION)  
220 E. WISCONSIN AVE, P.O. BOX 203  
READSTOWN, WI 54652

FOR: FIREWORKS, IN CLASS 13 (U.S. CLS. 2 AND 9).

FIRST USE 11-4-2009; IN COMMERCE 9-7-2012.

THE MARK CONSISTS OF STANDARD CHARACTERS WITHOUT CLAIM TO ANY PARTICULAR FONT, STYLE, SIZE, OR COLOR.

OWNER OF U.S. REG. NO. 3,993,162.

SER. NO. 85-642,921, FILED 6-4-2012.

LEIGH LOWRY, EXAMINING ATTORNEY



*David J. Kyffers*

Director of the United States Patent and Trademark Office

# United States of America

United States Patent and Trademark Office

# DREAMBELLY

**Reg. No. 4,275,602**

FAIRHAVEN HEALTH, LLC (WASHINGTON LIMITED LIABILITY COMPANY)  
1200 HARRIS AVENUE, SUITE 403  
BELLINGHAM, WA 98225

**Registered Jan. 15, 2013**

**Int. Cl.: 3**

FOR: NON-MEDICATED SKIN CARE CREAMS AND LOTIONS, IN CLASS 3 (U.S. CLS. 1, 4, 6, 50, 51 AND 52).

**TRADEMARK**

FIRST USE 7-1-2008; IN COMMERCE 7-1-2008.

**PRINCIPAL REGISTER**

THE MARK CONSISTS OF STANDARD CHARACTERS WITHOUT CLAIM TO ANY PARTICULAR FONT, STYLE, SIZE, OR COLOR.

SER. NO. 85-642,926, FILED 6-4-2012.

LEIGH LOWRY, EXAMINING ATTORNEY



*David J. Kyffers*

Director of the United States Patent and Trademark Office

# United States of America

United States Patent and Trademark Office

# SNAP

**Reg. No. 4,275,603**

**Registered Jan. 15, 2013**

**Int. Cl.: 35**

**SERVICE MARK**

**PRINCIPAL REGISTER**

SNAP FIREWORKS, INC. (WISCONSIN CORPORATION)  
220 E. WISCONSIN AVE, P.O. BOX 203  
READSTOWN, WI 54652

FOR: WHOLESALE AND RETAIL STORE SERVICES AND ON-LINE RETAIL AND WHOLESALE STORE SERVICES FEATURING FIREWORKS AND FIREWORKS-RELATED PRODUCTS, IN CLASS 35 (U.S. CLS. 100, 101 AND 102).

FIRST USE 11-4-2009; IN COMMERCE 1-1-2010.

THE MARK CONSISTS OF STANDARD CHARACTERS WITHOUT CLAIM TO ANY PARTICULAR FONT, STYLE, SIZE, OR COLOR.

OWNER OF U.S. REG. NO. 3,993,162.

SER. NO. 85-642,929, FILED 6-4-2012.

LEIGH LOWRY, EXAMINING ATTORNEY



*David J. Kyffers*

Director of the United States Patent and Trademark Office



# United States of America

United States Patent and Trademark Office

# Wraparillo

**Reg. No. 4,275,604**

**Registered Jan. 15, 2013**

**Int. Cl.: 34**

**TRADEMARK**

**PRINCIPAL REGISTER**

HIGH GRADE HERBAL INC. (FLORIDA CORPORATION), DBA NATURAL LEAF INC.  
UNIT #7B  
1340 STIRLING ROAD  
DANIA, FL 33004

FOR: HAND-ROLLING TOBACCO; SMOKING TOBACCO; TOBACCO, CIGARS AND CIGARETTES, IN CLASS 34 (U.S. CLS. 2, 8, 9 AND 17).

FIRST USE 5-21-2012; IN COMMERCE 5-21-2012.

THE MARK CONSISTS OF STANDARD CHARACTERS WITHOUT CLAIM TO ANY PARTICULAR FONT, STYLE, SIZE, OR COLOR.

SER. NO. 85-642,960, FILED 6-4-2012.

KIM MONINGHOFF, EXAMINING ATTORNEY



*David J. Kybas*

Director of the United States Patent and Trademark Office

# United States of America

United States Patent and Trademark Office

## ODDLYWOOD

**Reg. No. 4,275,605**

**Registered Jan. 15, 2013**

**Int. Cls.: 16, 25 and 28**

**TRADEMARK**

**PRINCIPAL REGISTER**

MATTEO RODARO (ITALY INDIVIDUAL)  
VIA L. GALVANI, 12/3  
REANA DEL ROJALE (UD), ITALY 33010

FOR: ADHESIVES FOR STATIONERY OR HOUSEHOLD PURPOSES; ADVERTISING PAMPHLETS; BIBS OF PAPER; BINDERS; BUSINESS RECORD BOOKS; CALENDARS; CARTOON PRINTS; COIN ALBUMS; FOLDERS; GREETING CARDS; NEWSPAPERS; NOTEBOOKS; PAPER FOR WRAPPING AND PACKAGING; PAPER MACHE FIGURINES; PAPER NAPKINS; PHOTO ALBUMS; PICTURES; POSTERS; PRINTED MATTER, NAMELY, NEWSPAPERS, PHOTOGRAPHS, MAGAZINES, BOOKS, PRINTED PERIODICALS, NEWSLETTERS, AND BROCHURES ALL IN THE FIELDS OF SECURITIES, OPTIONS AND OTHER FINANCIAL INSTRUMENTS; PRINTS; SELF-ADHESIVE TAPES FOR STATIONERY AND HOUSEHOLD PURPOSES; STAMP ALBUMS; STATIONERY; TABLE CLOTHS OF PAPER; TOILET PAPER, IN CLASS 16 (U.S. CLS. 2, 5, 22, 23, 29, 37, 38 AND 50).

FOR: BABIES' PANTS; BABY BODYSUITS; BABY BOTTOMS; BABY TOPS; CAPS; COATS; DRESSES; DRESSING GOWNS AND BATH ROBES; FOOTWEAR; GLOVES; HATS; HEADWEAR; JACKETS; JERSEYS; KNIT SHIRTS; PANTS; SCARVES; SHAWLS; SHIRTS; SKIRTS; SLIPS; SOCKS; STOCKINGS; SWEATERS; T-SHIRTS; UNDERWEAR, IN CLASS 25 (U.S. CLS. 22 AND 39).

FOR: BALLS FOR GAMES; BALLS FOR SPORTS; BOARD GAMES; CHILDREN'S MULTIPLE ACTIVITY TOYS; DOLLS; MECHANICAL TOYS; PLAYING CARDS; STUFFED AND PLUSH TOYS; STUFFED TOY ANIMALS; TOYS, NAMELY, BEAN BAG ANIMALS, IN CLASS 28 (U.S. CLS. 22, 23, 38 AND 50).

THE MARK CONSISTS OF STANDARD CHARACTERS WITHOUT CLAIM TO ANY PARTICULAR FONT, STYLE, SIZE, OR COLOR.

OWNER OF ERPN CMNTY TM OFC REG. NO. 010619112, DATED 5-22-2012, EXPIRES 2-6-2022.

SER. NO. 85-642,961, FILED 6-4-2012.

DAVID C. REIHNER, EXAMINING ATTORNEY



*David J. Kyffers*

Director of the United States Patent and Trademark Office

# United States of America

United States Patent and Trademark Office



**Reg. No. 4,275,606**

**Registered Jan. 15, 2013**

**Int. Cl.: 41**

**SERVICE MARK**

**PRINCIPAL REGISTER**

AISEN SHIATSU SCHOOL, INC. (HAWAII CORPORATION)  
SUITE 601  
1314 S. KING STREET  
HONOLULU, HI 96814

FOR: EDUCATIONAL SERVICES IN THE NATURE OF SHIATSU SCHOOLS, IN CLASS 41  
(U.S. CLS. 100, 101 AND 107).

FIRST USE 5-7-1986; IN COMMERCE 5-7-1986.

THE MARK CONSISTS OF A CIRCLE, INSIDE OF WHICH ARE THREE LILLY FLOWERS  
INTERSPERSED BETWEEN THREE LEAVES WITH THE STEMS OF EACH JOINING A  
SMALL CIRCLE IN THE MIDDLE LIKE SPOKES OF A WHEEL.

SER. NO. 85-642,973, FILED 6-4-2012.

RUSS HERMAN, EXAMINING ATTORNEY



*David J. Kybas*

Director of the United States Patent and Trademark Office

# United States of America

United States Patent and Trademark Office

Waiola

**Reg. No. 4,275,607**

**Registered Jan. 15, 2013**

**Int. Cl.: 32**

**TRADEMARK**

**PRINCIPAL REGISTER**

WAIOLA LIFE LLC (HAWAII LIMITED LIABILITY COMPANY), DBA WAIOLA  
641 KEEAUMOKU STREET, SUITE 5  
HONOLULU, HI 96814

FOR: COCONUT WATER, IN CLASS 32 (U.S. CLS. 45, 46 AND 48).

FIRST USE 3-1-2011; IN COMMERCE 3-15-2011.

OWNER OF U.S. REG. NO. 4,082,707.

THE COLOR(S) GREEN AND NAVY IS/ARE CLAIMED AS A FEATURE OF THE MARK.

THE MARK CONSISTS OF THE WORD "WAIOLA" (IN NAVY) WITH THE LETTER "W" IN THE WORD CAPITALIZED AND THE REMAINING LETTERS IN THE WORD IN LOWER CASE. THERE IS AN ABSTRACT DEPICTION OF A LIQUID DROP (IN GREEN) SITUATED IMMEDIATELY ABOVE THE LOWER CASE LETTER "I" REPLACING THE DIACRITIC OR THE DOT IN THE LOWER CASE LETTER "I".

THE ENGLISH TRANSLATION OF "WAIOLA" IN THE MARK IS "WATER OF LIFE".

SER. NO. 85-642,985, FILED 6-4-2012.

SARA BENJAMIN, EXAMINING ATTORNEY



*David J. Kyffers*

Director of the United States Patent and Trademark Office

# United States of America

United States Patent and Trademark Office

## JUMP-N-JIMMY'S

**Reg. No. 4,275,608**

**Registered Jan. 15, 2013**

**Int. Cl.: 41**

**SERVICE MARK**

**PRINCIPAL REGISTER**

JUMP-N-JIMMY'S, LLC (VIRGINIA LIMITED LIABILITY COMPANY)  
6614 JAMES MADISON HIGHWAY  
HAYMARKET, VA 20169

FOR: ENTERTAINMENT SERVICES, NAMELY, PROVIDING FACILITIES FOR RECREATIONAL ACTIVITIES FEATURING INFLATABLE PLAY EQUIPMENT FOR CHILDREN'S PARTIES, IN CLASS 41 (U.S. CLS. 100, 101 AND 107).

FIRST USE 10-1-2009; IN COMMERCE 11-1-2009.

THE MARK CONSISTS OF STANDARD CHARACTERS WITHOUT CLAIM TO ANY PARTICULAR FONT, STYLE, SIZE, OR COLOR.

SER. NO. 85-643,032, FILED 6-5-2012.

JASON LOTT, EXAMINING ATTORNEY



*David J. Kyffers*

Director of the United States Patent and Trademark Office

# United States of America

United States Patent and Trademark Office

# JNJ

**Reg. No. 4,275,609**

**Registered Jan. 15, 2013**

**Int. Cl.: 41**

**SERVICE MARK**

**PRINCIPAL REGISTER**

JUMP-N-JIMMY'S, LLC (VIRGINIA LIMITED LIABILITY COMPANY)  
6614 JAMES MADISON HIGHWAY  
HAYMARKET, VA 20169

FOR: ENTERTAINMENT SERVICES, NAMELY, PROVIDING FACILITIES FOR RECREATIONAL ACTIVITIES FEATURING INFLATABLE PLAY EQUIPMENT FOR CHILDREN'S PARTIES, IN CLASS 41 (U.S. CLS. 100, 101 AND 107).

FIRST USE 10-1-2009; IN COMMERCE 11-1-2009.

THE MARK CONSISTS OF STANDARD CHARACTERS WITHOUT CLAIM TO ANY PARTICULAR FONT, STYLE, SIZE, OR COLOR.

SER. NO. 85-643,035, FILED 6-5-2012.

JASON LOTT, EXAMINING ATTORNEY



*David J. Kybas*

Director of the United States Patent and Trademark Office

# United States of America

United States Patent and Trademark Office

## STOCK-IN-A-SOCK

**Reg. No. 4,275,610**

**Registered Jan. 15, 2013**

**Int. Cl.: 29**

**TRADEMARK**

**PRINCIPAL REGISTER**

OEHRING, RACHAEL (UNITED STATES INDIVIDUAL)  
14 BELLWOOD FARMS LANE  
GREENVILLE, SC 29607

FOR: SOUP MIXES; SOUPS; STOCK; STOCK CUBES, IN CLASS 29 (U.S. CL. 46).

FIRST USE 5-15-2012; IN COMMERCE 5-15-2012.

THE MARK CONSISTS OF STANDARD CHARACTERS WITHOUT CLAIM TO ANY PARTICULAR FONT, STYLE, SIZE, OR COLOR.

SER. NO. 85-643,062, FILED 6-5-2012.

ROBIN CHOSID, EXAMINING ATTORNEY



*David J. Kyffers*

Director of the United States Patent and Trademark Office

# United States of America

United States Patent and Trademark Office

# SYNAPSHOT

**Reg. No. 4,275,611**

**Registered Jan. 15, 2013**

**Int. Cl.: 9**

**TRADEMARK**

**PRINCIPAL REGISTER**

XCPT COMMUNICATION TECHNOLOGIES, LLC (DELAWARE LIMITED LIABILITY COMPANY)  
1990 MAIN STREET, SUITE 750  
SARASOTA, FL 34236

FOR: COMPUTER SOFTWARE FOR MANAGING, CAPTURING, RENDERING, INTERPRETING, ADJUSTING, ENHANCING AND PROCESSING PICTURES, X-RAYS, IMAGES AND DIGITAL CONTENT IN THE FIELD OF DENTISTRY FOR DIAGNOSIS AND TREATMENT, IN CLASS 9 (U.S. CLS. 21, 23, 26, 36 AND 38).

FIRST USE 7-30-2012; IN COMMERCE 7-30-2012.

THE MARK CONSISTS OF STANDARD CHARACTERS WITHOUT CLAIM TO ANY PARTICULAR FONT, STYLE, SIZE, OR COLOR.

SER. NO. 85-643,073, FILED 6-5-2012.

NICHOLAS COLEMAN, EXAMINING ATTORNEY



*David J. Kybas*

Director of the United States Patent and Trademark Office



# United States of America

United States Patent and Trademark Office

# CivilMobile

**Reg. No. 4,275,612**

**Registered Jan. 15, 2013**

**Int. Cl.: 42**

**SERVICE MARK**

**PRINCIPAL REGISTER**

SOFTCODE, INC. (MASSACHUSETTS CORPORATION)  
33 BOSTON POST ROAD WEST, SUITE 360  
MARLBOROUGH, MA 01752

FOR: PROVIDING A WEBSITE FEATURING ON-LINE NON-DOWNLOADABLE SOFTWARE THAT ENABLES COUNTY SHERIFF DEPARTMENTS TO MANAGE CIVIL PROCESSES, IN CLASS 42 (U.S. CLS. 100 AND 101).

FIRST USE 4-9-2005; IN COMMERCE 4-9-2005.

THE MARK CONSISTS OF STANDARD CHARACTERS WITHOUT CLAIM TO ANY PARTICULAR FONT, STYLE, SIZE, OR COLOR.

OWNER OF U.S. REG. NOS. 3,102,318 AND 4,138,508.

SER. NO. 85-643,137, FILED 6-5-2012.

RAMONA ORTIGA, EXAMINING ATTORNEY



*David J. Kyffers*

Director of the United States Patent and Trademark Office

# United States of America

United States Patent and Trademark Office

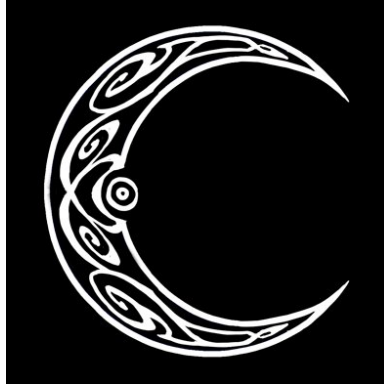

**Reg. No. 4,275,613**

**Registered Jan. 15, 2013**

**Int. Cl.: 33**

**TRADEMARK**

**PRINCIPAL REGISTER**

CURVATURE WINES, LLC (FLORIDA LIMITED LIABILITY COMPANY)  
1 MORTON SQUARE, 11DW  
NEW YORK, NY 10014

FOR: WINE, IN CLASS 33 (U.S. CLS. 47 AND 49).

FIRST USE 3-30-2010; IN COMMERCE 3-30-2010.

THE MARK CONSISTS OF CRESCENT-SHAPED DRAWING WITH SWIRLS.

SER. NO. 85-643,174, FILED 6-5-2012.

WILLIAM ROSSMAN, EXAMINING ATTORNEY



*David J. Kyffers*

Director of the United States Patent and Trademark Office

# United States of America

United States Patent and Trademark Office

## Flint and Tinder

**Reg. No. 4,275,614**

FLINT AND TINDER, LLC (DELAWARE LIMITED LIABILITY COMPANY)  
33 NASSAU AVENUE, ROOM 22  
BROOKLYN, NY 11222

**Registered Jan. 15, 2013**

**Int. Cl.: 25**

FOR: BOXER BRIEFS; BOXER SHORTS; BRIEFS; BRIEFS; KNITTED UNDERWEAR; MEN'S UNDERWEAR; UNDERWEAR, IN CLASS 25 (U.S. CLS. 22 AND 39).

**TRADEMARK**

FIRST USE 4-23-2012; IN COMMERCE 4-23-2012.

**PRINCIPAL REGISTER**

THE MARK CONSISTS OF STANDARD CHARACTERS WITHOUT CLAIM TO ANY PARTICULAR FONT, STYLE, SIZE, OR COLOR.

SER. NO. 85-643,198, FILED 6-5-2012.

AMY C. KEAN, EXAMINING ATTORNEY



*David J. Kappas*

Director of the United States Patent and Trademark Office

# United States of America

United States Patent and Trademark Office

## PUT YOUR MONEY TO WORK

**Reg. No. 4,275,615**

GENEX STRATEGIES, INC. (CANADA CORPORATION)

**Registered Jan. 15, 2013**

1803 - 323 JERVIS STREET  
VANCOUVER, BC, CANADA V6C3P8

**Int. Cl.: 36**

FOR: FINANCIAL FACTORING SERVICES, NAMELY, PURCHASING OF DEFERRED STREAMS OF PAYMENT IN THE NATURE OF STRUCTURED SETTLEMENTS AND ANNUITIES, IN CLASS 36 (U.S. CLS. 100, 101 AND 102).

**SERVICE MARK**

FIRST USE 2-1-2004; IN COMMERCE 2-1-2004.

**PRINCIPAL REGISTER**

THE MARK CONSISTS OF STANDARD CHARACTERS WITHOUT CLAIM TO ANY PARTICULAR FONT, STYLE, SIZE, OR COLOR.

SER. NO. 85-643,210, FILED 6-5-2012.

AMY C. KEAN, EXAMINING ATTORNEY



*David J. Kappas*

Director of the United States Patent and Trademark Office

# United States of America

United States Patent and Trademark Office

## COME TO EXPECT MORE

**Reg. No. 4,275,616**

**Registered Jan. 15, 2013**

**Int. Cl.: 36**

**SERVICE MARK**

**PRINCIPAL REGISTER**

NUVEEN INVESTMENTS, INC. (DELAWARE CORPORATION)  
333 WEST WACKER DRIVE  
CHICAGO, IL 60606

FOR: FINANCIAL SERVICES, NAMELY FINANCIAL INVESTMENT AND UNDERWRITING SERVICES IN THE FIELD OF STOCKS, BONDS, MUTUAL FUNDS AND SECURITIES, IN CLASS 36 (U.S. CLS. 100, 101 AND 102).

FIRST USE 4-27-2012; IN COMMERCE 4-27-2012.

THE MARK CONSISTS OF STANDARD CHARACTERS WITHOUT CLAIM TO ANY PARTICULAR FONT, STYLE, SIZE, OR COLOR.

SER. NO. 85-643,222, FILED 6-5-2012.

KARANENDRA S. CHHINA, EXAMINING ATTORNEY



*David J. Kybas*

Director of the United States Patent and Trademark Office

# United States of America

United States Patent and Trademark Office

## GRAM & DUN

**Reg. No. 4,275,617**

TEXAZ PLAZA RESTAURANT, LLC (MISSOURI LIMITED LIABILITY COMPANY)  
600 WARD PARKWAY

**Registered Jan. 15, 2013**

KANSAS CITY, MO 64112

**Int. Cl.: 43**

FOR: RESTAURANT AND BAR SERVICES, IN CLASS 43 (U.S. CLS. 100 AND 101).

**SERVICE MARK**

FIRST USE 10-1-2011; IN COMMERCE 11-22-2011.

**PRINCIPAL REGISTER**

THE MARK CONSISTS OF STANDARD CHARACTERS WITHOUT CLAIM TO ANY PARTICULAR FONT, STYLE, SIZE, OR COLOR.

SER. NO. 85-643,227, FILED 6-5-2012.

KARANENDRA S. CHHINA, EXAMINING ATTORNEY



*David J. Kybas*

Director of the United States Patent and Trademark Office

# United States of America

United States Patent and Trademark Office

## POWERING SMALL BUSINESS

**Reg. No. 4,275,618**

**Registered Jan. 15, 2013**

**Int. Cl.: 36**

**SERVICE MARK**

**PRINCIPAL REGISTER**

GRAND RIVER BANK (MICHIGAN CHARTERED BANK)  
4471 WILSON AVENUE SW  
GRANDVILLE, MI 49418

FOR: BANKING SERVICES, IN CLASS 36 (U.S. CLS. 100, 101 AND 102).

FIRST USE 4-30-2009; IN COMMERCE 4-30-2009.

THE MARK CONSISTS OF STANDARD CHARACTERS WITHOUT CLAIM TO ANY PARTICULAR FONT, STYLE, SIZE, OR COLOR.

SER. NO. 85-643,237, FILED 6-5-2012.

ALLISON HOLTZ, EXAMINING ATTORNEY



*David J. Kybas*

Director of the United States Patent and Trademark Office

# United States of America

United States Patent and Trademark Office

# CORE INK

**Reg. No. 4,275,619**

**Registered Jan. 15, 2013**

**Int. Cl.: 16**

**TRADEMARK**

**PRINCIPAL REGISTER**

THE CENTER FOR ORTHOPEDIC AND RESEARCH EXCELLENCE, INC. (ARIZONA CORPORATION)  
3010 WEST AGUA FRIA FREEWAY, SUITE 101  
PHOENIX., AZ 85027

FOR: GENERAL FEATURE MAGAZINE IN THE FIELD OF ORTHOPEDIC MEDICINE, IN CLASS 16 (U.S. CLS. 2, 5, 22, 23, 29, 37, 38 AND 50).

FIRST USE 3-1-2007; IN COMMERCE 3-1-2007.

THE MARK CONSISTS OF STANDARD CHARACTERS WITHOUT CLAIM TO ANY PARTICULAR FONT, STYLE, SIZE, OR COLOR.

OWNER OF U.S. REG. NOS. 3,090,825 AND 3,133,583.

SER. NO. 85-643,238, FILED 6-5-2012.

ELLEN PERKINS, EXAMINING ATTORNEY



*David J. Kyffers*

Director of the United States Patent and Trademark Office



# United States of America

United States Patent and Trademark Office

## POWERING LOCAL BUSINESS

**Reg. No. 4,275,620**

GRAND RIVER BANK (MICHIGAN CHARTERED BANK)  
4471 WILSON AVENUE SW  
GRANDVILLE, MI 49418

**Registered Jan. 15, 2013**

**Int. Cl.: 36**

FOR: BANKING SERVICES, IN CLASS 36 (U.S. CLS. 100, 101 AND 102).

**SERVICE MARK**

FIRST USE 4-30-2009; IN COMMERCE 4-30-2009.

**PRINCIPAL REGISTER**

THE MARK CONSISTS OF STANDARD CHARACTERS WITHOUT CLAIM TO ANY PARTICULAR FONT, STYLE, SIZE, OR COLOR.

SER. NO. 85-643,249, FILED 6-5-2012.

ALLISON HOLTZ, EXAMINING ATTORNEY



*David J. Kybas*

Director of the United States Patent and Trademark Office

# United States of America

United States Patent and Trademark Office



**Reg. No. 4,275,621**

VALUE ADDED PRODUCTS (OKLAHOMA COOPERATIVE ASSOCIATION)  
2101 COLLEGE BLVD.  
ALVA, OK 737179733

**Registered Jan. 15, 2013**

**Int. Cl.: 30**

FOR: BREAD DOUGHS; CINNAMON ROLLS; CROISSANTS; DANISH PASTRIES; DOUGH;  
FROZEN DOUGH FOR USE AS PIZZA, BREAD OR OTHER BREAD-TYPE PRODUCTS;  
PIZZA CRUST; PIZZA DOUGH, IN CLASS 30 (U.S. CL. 46).

**TRADEMARK**

FIRST USE 2-13-2001; IN COMMERCE 2-13-2001.

**PRINCIPAL REGISTER**

THE MARK CONSISTS OF A STYLIZED REPRESENTATION OF THE LETTERS "VAP"  
WITH TWO STALKS OF WHEAT.

SER. NO. 85-643,256, FILED 6-5-2012.

JEFFERY COWARD, EXAMINING ATTORNEY



*David J. Kyfos*

Director of the United States Patent and Trademark Office

# United States of America

United States Patent and Trademark Office

## WILEY'S ONE-EYED WHEAT

**Reg. No. 4,275,622**

BT CONCEPTS LLC (OKLAHOMA LIMITED LIABILITY COMPANY)  
1101 W. WATERLOO ROAD  
EDMOND, OK 73025

**Registered Jan. 15, 2013**

**Int. Cl.: 32**

FOR: BEER, ALE AND LAGER, IN CLASS 32 (U.S. CLS. 45, 46 AND 48).

**TRADEMARK**

FIRST USE 6-29-2011; IN COMMERCE 6-29-2011.

**PRINCIPAL REGISTER**

THE MARK CONSISTS OF STANDARD CHARACTERS WITHOUT CLAIM TO ANY PARTICULAR FONT, STYLE, SIZE, OR COLOR.

NO CLAIM IS MADE TO THE EXCLUSIVE RIGHT TO USE "WHEAT", APART FROM THE MARK AS SHOWN.

THE NAME(S), PORTRAIT(S), AND/OR SIGNATURE(S) SHOWN IN THE MARK DOES NOT IDENTIFY A PARTICULAR LIVING INDIVIDUAL.

SER. NO. 85-643,287, FILED 6-5-2012.

WILLIAM ROSSMAN, EXAMINING ATTORNEY



*David J. Kyfos*

Director of the United States Patent and Trademark Office

# United States of America

United States Patent and Trademark Office

## protect the hood!

**Reg. No. 4,275,623**

JOHNSON, SABRINA ANGELA (UNITED STATES INDIVIDUAL)  
1059 PORTLAND AVENUE  
ROCHESTER, NY 14621

**Registered Jan. 15, 2013**

**Int. Cl.: 16**

FOR: LITHOGRAPHIC WORKS OF ART; NOTEBOOKS; POSTERS; PRINTS, IN CLASS 16  
(U.S. CLS. 2, 5, 22, 23, 29, 37, 38 AND 50).

**TRADEMARK**

FIRST USE 6-0-2010; IN COMMERCE 6-0-2011.

**PRINCIPAL REGISTER**

THE MARK CONSISTS OF STANDARD CHARACTERS WITHOUT CLAIM TO ANY PARTICULAR FONT, STYLE, SIZE, OR COLOR.

SER. NO. 85-643,292, FILED 6-5-2012.

LAURA KOVALSKY, EXAMINING ATTORNEY



*David J. Kyffers*

Director of the United States Patent and Trademark Office

# United States of America

United States Patent and Trademark Office

## 46 STAR OKLAHOMA AMBER ALE

**Reg. No. 4,275,624**

BT CONCEPTS LLC (OKLAHOMA LIMITED LIABILITY COMPANY)  
1101 W. WATERLOO ROAD  
EDMOND, OK 73025

**Registered Jan. 15, 2013**

**Int. Cl.: 32**

FOR: BEER, ALE AND LAGER, IN CLASS 32 (U.S. CLS. 45, 46 AND 48).

**TRADEMARK**

FIRST USE 6-29-2011; IN COMMERCE 6-29-2011.

**PRINCIPAL REGISTER**

THE MARK CONSISTS OF STANDARD CHARACTERS WITHOUT CLAIM TO ANY PARTICULAR FONT, STYLE, SIZE, OR COLOR.

NO CLAIM IS MADE TO THE EXCLUSIVE RIGHT TO USE "OKLAHOMA AMBER ALE", APART FROM THE MARK AS SHOWN.

SER. NO. 85-643,293, FILED 6-5-2012.

WILLIAM ROSSMAN, EXAMINING ATTORNEY



*David J. Kyffers*

Director of the United States Patent and Trademark Office

# United States of America

United States Patent and Trademark Office

## REMINGTON RED ALE

**Reg. No. 4,275,625**

BT CONCEPTS LLC (OKLAHOMA LIMITED LIABILITY COMPANY)  
1101 W. WATERLOO ROAD  
EDMOND, OK 73025

**Registered Jan. 15, 2013**

**Int. Cl.: 32**

FOR: BEER, ALE AND LAGER, IN CLASS 32 (U.S. CLS. 45, 46 AND 48).

**TRADEMARK**

FIRST USE 6-29-2011; IN COMMERCE 6-29-2011.

**PRINCIPAL REGISTER**

THE MARK CONSISTS OF STANDARD CHARACTERS WITHOUT CLAIM TO ANY PARTICULAR FONT, STYLE, SIZE, OR COLOR.

NO CLAIM IS MADE TO THE EXCLUSIVE RIGHT TO USE "RED ALE", APART FROM THE MARK AS SHOWN.

SER. NO. 85-643,298, FILED 6-5-2012.

WILLIAM ROSSMAN, EXAMINING ATTORNEY



*David J. Kyffers*

Director of the United States Patent and Trademark Office

# United States of America

United States Patent and Trademark Office

## OLD KING KÖLSCH

**Reg. No. 4,275,626**

BT CONCEPTS LLC (OKLAHOMA LIMITED LIABILITY COMPANY)  
1101 W. WATERLOO ROAD  
EDMOND, OK 73025

**Registered Jan. 15, 2013**

**Int. Cl.: 32**

FOR: BEER, ALE AND LAGER, IN CLASS 32 (U.S. CLS. 45, 46 AND 48).

**TRADEMARK**

FIRST USE 6-29-2011; IN COMMERCE 6-29-2011.

**PRINCIPAL REGISTER**

THE MARK CONSISTS OF STANDARD CHARACTERS WITHOUT CLAIM TO ANY PARTICULAR FONT, STYLE, SIZE, OR COLOR.

NO CLAIM IS MADE TO THE EXCLUSIVE RIGHT TO USE "KÖLSCH", APART FROM THE MARK AS SHOWN.

THE NAME(S), PORTRAIT(S), AND/OR SIGNATURE(S) SHOWN IN THE MARK DOES NOT IDENTIFY A PARTICULAR LIVING INDIVIDUAL.

THE ENGLISH TRANSLATION OF "KÖLSCH" IN THE MARK IS A "STRONG LAGER".

SER. NO. 85-643,303, FILED 6-5-2012.

WILLIAM ROSSMAN, EXAMINING ATTORNEY



*David J. Kyfos*

Director of the United States Patent and Trademark Office

# United States of America

United States Patent and Trademark Office

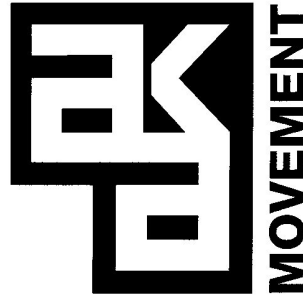

**Reg. No. 4,275,627**

A.K.A. SKATERS INC. (FLORIDA CORPORATION)  
17638 SW 135 CT  
MIAMI, FL 33177

**Registered Jan. 15, 2013**

**Int. Cl.: 25**

FOR: FOOTWEAR; LONG-SLEEVED SHIRTS; PANTS; POLO SHIRTS; SHIRTS; SHORTS;  
SOCKS; T-SHIRTS; UNDERWEAR, IN CLASS 25 (U.S. CLS. 22 AND 39).

**TRADEMARK**

FIRST USE 11-1-2010; IN COMMERCE 1-1-2011.

**PRINCIPAL REGISTER**

THE MARK CONSISTS OF A STYLIZED VERSION OF THE LETTERS "AKA" (WHICH REPRESENTS ALSO KNOWN AS) IN A MONDRIAN TYPE DESIGN, FOLLOWED BY THE WORD "MOVEMENT" ALONG THE RIGHT SIDE GOING FROM BOTTOM TO TOP.

SER. NO. 85-643,305, FILED 6-5-2012.

KATINA MISTER, EXAMINING ATTORNEY



*David J. Kyffers*

Director of the United States Patent and Trademark Office



# United States of America

United States Patent and Trademark Office

# HARPER

**Reg. No. 4,275,628**

HARPER TRUCKS, INC. (KANSAS CORPORATION)

**Registered Jan. 15, 2013**

P. O. BOX 12330  
WICHITA, KS 67277

**Int. Cl.: 12**

FOR: HAND TRUCKS, IN CLASS 12 (U.S. CLS. 19, 21, 23, 31, 35 AND 44).

**TRADEMARK**

FIRST USE 12-31-1992; IN COMMERCE 12-31-1992.

**PRINCIPAL REGISTER**

THE MARK CONSISTS OF STANDARD CHARACTERS WITHOUT CLAIM TO ANY PARTICULAR FONT, STYLE, SIZE, OR COLOR.

SER. NO. 85-643,322, FILED 6-5-2012.

LINDA MICKLEBURGH, EXAMINING ATTORNEY



*David J. Kyffers*

Director of the United States Patent and Trademark Office

# United States of America

United States Patent and Trademark Office

# Fast. Real Fast.

**Reg. No. 4,275,629**

DARI-MART STORES, INC. (OREGON CORPORATION)  
125 E 6TH AVE  
JUNCTION CITY, OR 97448

**Registered Jan. 15, 2013**

**Int. Cl.: 35**

FOR: RETAIL STORE SERVICES FEATURING DAIRY, ALCOHOL, TOBACCO, AND CONVENIENCE PRODUCTS, IN CLASS 35 (U.S. CLS. 100, 101 AND 102).

**SERVICE MARK**

FIRST USE 2-1-2011; IN COMMERCE 2-1-2011.

**PRINCIPAL REGISTER**

THE MARK CONSISTS OF STANDARD CHARACTERS WITHOUT CLAIM TO ANY PARTICULAR FONT, STYLE, SIZE, OR COLOR.

SER. NO. 85-643,326, FILED 6-5-2012.

TARAH HARDY, EXAMINING ATTORNEY



*David J. Kyffers*

Director of the United States Patent and Trademark Office

# United States of America

United States Patent and Trademark Office

## DRIVE FOR THE COVER

**Reg. No. 4,275,630**

**Registered Jan. 15, 2013**

**Int. Cl.: 35**

**SERVICE MARK**

**PRINCIPAL REGISTER**

NATIONAL ASSOCIATION FOR STOCK CAR AUTO RACING, INC. (FLORIDA CORPORATION)  
ONE DAYTONA BOULEVARD  
DAYTONA BEACH, FL 32114

FOR: ADVERTISING, MARKETING AND PROMOTION SERVICES IN THE FIELD OF VIDEO GAMES, IN CLASS 35 (U.S. CLS. 100, 101 AND 102).

FIRST USE 5-24-2012; IN COMMERCE 5-24-2012.

THE MARK CONSISTS OF STANDARD CHARACTERS WITHOUT CLAIM TO ANY PARTICULAR FONT, STYLE, SIZE, OR COLOR.

SER. NO. 85-643,335, FILED 6-5-2012.

ELIZABETH KAJUBI, EXAMINING ATTORNEY



*David J. Kybas*

Director of the United States Patent and Trademark Office

# United States of America

United States Patent and Trademark Office

## Thairapy The Journey is Your Reward

**Reg. No. 4,275,631**

**Registered Jan. 15, 2013**

**Int. Cl.: 3**

**TRADEMARK**

**PRINCIPAL REGISTER**

T & G HAIR INC (CALIFORNIA CORPORATION)  
24931 SEAGATE DRIVE  
DANA POINT, CA 92629

FOR: HAIR CONDITIONER; HAIR CONDITIONERS; HAIR CREAMS; HAIR GEL; HAIR GEL AND HAIR MOUSSE; HAIR GELS; HAIR LOTIONS; HAIR MASKS; HAIR MOUSSE; HAIR MOUSSES; HAIR NOURISHERS; HAIR SHAMPOO; HAIR SHAMPOOS AND CONDITIONERS; HAIR SPRAY; HAIR SPRAYS; HAIR SPRAYS AND HAIR GELS; HAIR STYLING GEL; HAIR STYLING SPRAY; HAIR WAX; HAIRSPRAY; MOUSSE FOR HAIR, IN CLASS 3 (U.S. CLS. 1, 4, 6, 50, 51 AND 52).

FIRST USE 2-22-2011; IN COMMERCE 2-22-2011.

THE MARK CONSISTS OF STANDARD CHARACTERS WITHOUT CLAIM TO ANY PARTICULAR FONT, STYLE, SIZE, OR COLOR.

SER. NO. 85-643,344, FILED 6-5-2012.

ALEXANDER L. POWERS, EXAMINING ATTORNEY



*David J. Kyffers*

Director of the United States Patent and Trademark Office

# United States of America

United States Patent and Trademark Office

## The Pest Guru

**Reg. No. 4,275,632**

THE PEST GURU (TEXAS PARTNERSHIP)  
5455 TIMBER CREEK PLACE DR # 1408  
HOUSTON, TX 77084

**Registered Jan. 15, 2013**

**Int. Cl.: 37**

FOR: PEST CONTROL, IN CLASS 37 (U.S. CLS. 100, 103 AND 106).

**SERVICE MARK**

FIRST USE 12-1-2010; IN COMMERCE 12-1-2010.

**PRINCIPAL REGISTER**

THE MARK CONSISTS OF STANDARD CHARACTERS WITHOUT CLAIM TO ANY PARTICULAR FONT, STYLE, SIZE, OR COLOR.

NO CLAIM IS MADE TO THE EXCLUSIVE RIGHT TO USE "PEST", APART FROM THE MARK AS SHOWN.

SER. NO. 85-643,366, FILED 6-5-2012.

ALLISON SCHRODY, EXAMINING ATTORNEY



*David J. Kybas*

Director of the United States Patent and Trademark Office

# United States of America

United States Patent and Trademark Office

# helmold

**Reg. No. 4,275,633**

**Registered Jan. 15, 2013**

**Int. Cls.: 6, 7 and 8**

**TRADEMARK**

**PRINCIPAL REGISTER**

BÖHLER-UDDEHOLM PRECISION STRIP LLC (DELAWARE LIMITED LIABILITY COMPANY)  
3052 INTERSTATE PARKWAY  
BRUNSWICK, OH 44212

FOR: REFINED STEELS AND SPECIAL STEELS; REFINED STEEL ALLOYS; STRIP STEEL FOR USE IN THE FURTHER MANUFACTURE OF RULES AND RULE DIES THAT ARE USED FOR STAMPING OF CARDBOARD, PAPER, PLASTIC, LEATHER, TEXTILES, RUBBER AND COMPOSITE, IN CLASS 6 (U.S. CLS. 2, 12, 13, 14, 23, 25 AND 50).

FIRST USE 10-1-2011, THE MARK WAS FIRST USED ANYWHERE IN A DIFFERENT FORM OTHER THAN THAT SOUGHT TO BE REGISTERED AT LEAST AS EARLY AS 00/00/1997; IN COMMERCE 10-1-2011, THE MARK WAS FIRST USED IN COMMERCE IN A DIFFERENT FORM OTHER THAN THAT SOUGHT TO BE REGISTERED AT LEAST AS EARLY AS 00/00/1997.

FOR: MACHINES, MACHINE TOOLS AND PARTS FOR THE PACKAGING INDUSTRY, IN PARTICULAR, STEEL RULES, RULE DIES, PUNCHES, BENDERS, NOTCHERS, CUTTERS, POWER-OPERATED MITER MACHINES AND SAWS, IN CLASS 7 (U.S. CLS. 13, 19, 21, 23, 31, 34 AND 35).

FIRST USE 10-1-2011, THE MARK WAS FIRST USED ANYWHERE IN A DIFFERENT FORM OTHER THAN THAT SOUGHT TO BE REGISTERED AT LEAST AS EARLY AS 00/00/1997; IN COMMERCE 10-1-2011, THE MARK WAS FIRST USED IN COMMERCE IN A DIFFERENT FORM OTHER THAN THAT SOUGHT TO BE REGISTERED AT LEAST AS EARLY AS 00/00/1997.

FOR: HAND OPERATED TOOLS AND INSTRUMENTS FOR THE PACKAGING INDUSTRY, IN PARTICULAR, PUNCHES, BENDERS, MITER BOXES AND SAWS; ACCESSORIES FOR THE AFOREMENTIONED TOOLS USED IN THE PACKAGING INDUSTRY, NAMELY, BENDING DIES, MANDRELS, SLOT-BENDING DIES, CUTTING TOOLS AND NOTCHES, IN CLASS 8 (U.S. CLS. 23, 28 AND 44).

FIRST USE 10-1-2011, THE MARK WAS FIRST USED ANYWHERE IN A DIFFERENT FORM OTHER THAN THAT SOUGHT TO BE REGISTERED AT LEAST AS EARLY AS 00/00/1997; IN COMMERCE 10-1-2011, THE MARK WAS FIRST USED IN COMMERCE IN A DIFFERENT



*David J. Kyjars*

Director of the United States Patent and Trademark Office

**Reg. No. 4,275,633** FORM OTHER THAN THAT SOUGHT TO BE REGISTERED AT LEAST AS EARLY AS 00/00/1997.

OWNER OF U.S. REG. NOS. 3,487,128 AND 3,487,129.

THE MARK CONSISTS OF THE LETTERS "HELMOLD" AND A FORM IN THE SHAPE OF THE LETTER "V".

SER. NO. 85-643,372, FILED 6-5-2012.

RONALD AIKENS, EXAMINING ATTORNEY

# United States of America

United States Patent and Trademark Office

## BETTER METHOD. AMAZING OUTCOMES.

**Reg. No. 4,275,634**

**Registered Jan. 15, 2013**

**Int. Cl.: 41**

**SERVICE MARK**

**PRINCIPAL REGISTER**

WEST SIDE MONTESSORI CENTER (OHIO CORPORATION)  
7115 WEST BANCROFT STREET  
TOLEDO, OH 43615

FOR: EDUCATIONAL SERVICES, NAMELY, PROVIDING COURSES OF INSTRUCTION  
AT THE PRE-KINDERGARTEN THROUGH 8TH GRADE LEVEL, IN CLASS 41 (U.S. CLS.  
100, 101 AND 107).

FIRST USE 6-0-2011; IN COMMERCE 6-0-2011.

THE MARK CONSISTS OF STANDARD CHARACTERS WITHOUT CLAIM TO ANY PAR-  
TICULAR FONT, STYLE, SIZE, OR COLOR.

SER. NO. 85-643,404, FILED 6-5-2012.

DAYNA BROWNE, EXAMINING ATTORNEY



*David J. Kyffers*

Director of the United States Patent and Trademark Office



# United States of America

United States Patent and Trademark Office

# toyluxe

**Reg. No. 4,275,635**

ANDRYKOWSKI, DOREEN (UNITED STATES INDIVIDUAL)  
2332 EAST DARTMOUTH AVENUE  
ENGLEWOOD, CO 80113

**Registered Jan. 15, 2013**

**Int. Cl.: 35**

FOR: ON-LINE RETAIL STORE SERVICES FEATURING TOYS, IN CLASS 35 (U.S. CLS. 100, 101 AND 102).

**SERVICE MARK**

FIRST USE 11-12-2011; IN COMMERCE 11-12-2011.

**PRINCIPAL REGISTER**

THE MARK CONSISTS OF STANDARD CHARACTERS WITHOUT CLAIM TO ANY PARTICULAR FONT, STYLE, SIZE, OR COLOR.

SER. NO. 85-643,407, FILED 6-5-2012.

BARBARA RUTLAND, EXAMINING ATTORNEY



*David J. Kybas*

Director of the United States Patent and Trademark Office

**United States of America**  
United States Patent and Trademark Office

**FARMBAND**

**Reg. No. 4,275,636**

MICHAEL SALVATORIELLO (UNITED STATES INDIVIDUAL)  
38 EAST WHEELOCK ST.  
HANOVER, NH 03755

**Registered Jan. 15, 2013**

**Int. Cl.: 25**

FOR: WRIST BANDS, IN CLASS 25 (U.S. CLS. 22 AND 39).

**TRADEMARK**

FIRST USE 6-0-2010; IN COMMERCE 6-0-2010.

**PRINCIPAL REGISTER**

THE MARK CONSISTS OF STANDARD CHARACTERS WITHOUT CLAIM TO ANY PARTICULAR FONT, STYLE, SIZE, OR COLOR.

SER. NO. 85-643,413, FILED 6-5-2012.

BARBARA BROWN, EXAMINING ATTORNEY



*David J. Kyffers*

Director of the United States Patent and Trademark Office

# United States of America

United States Patent and Trademark Office



**Reg. No. 4,275,637**

**Registered Jan. 15, 2013**

**Int. Cls.: 35 and 38**

**SERVICE MARK**

**PRINCIPAL REGISTER**

RANCH NETWORK, LLC (DELAWARE LIMITED LIABILITY COMPANY)  
SUITE 120-302  
811 NINTH STREET  
DURHAM, NC 27705

FOR: OPERATING ON-LINE MARKETPLACES FOR SELLERS OF GOODS AND/OR SERVICES, IN CLASS 35 (U.S. CLS. 100, 101 AND 102).

FIRST USE 7-10-2012; IN COMMERCE 7-10-2012.

FOR: PROVIDING ON-LINE ELECTRONIC BULLETIN BOARDS FOR TRANSMISSION OF MESSAGES AMONG COMPUTER USERS CONCERNING AGRICULTURAL RELATED TOPICS INCLUDING JOB LISTINGS AND COMMERCIAL NOTICES, IN CLASS 38 (U.S. CLS. 100, 101 AND 104).

FIRST USE 7-10-2012; IN COMMERCE 7-10-2012.

THE MARK CONSISTS OF A CIRCLE WITH THE LETTER "R" NEAR THE TOP OF THE CIRCLE AND THE LETTER "N" CONNECTING TO THE BOTTOM OF THE "R" CAUSING A BREAK IN THE CIRCLE.

SER. NO. 85-643,421, FILED 6-5-2012.

NICHOLAS ALTREE, EXAMINING ATTORNEY



*David J. Kybas*

Director of the United States Patent and Trademark Office

# United States of America

United States Patent and Trademark Office

## Sunny Day Publishing

**Reg. No. 4,275,638**

**Registered Jan. 15, 2013**

**Int. Cl.: 41**

**SERVICE MARK**

**PRINCIPAL REGISTER**

SUNNY DAY PUBLISHING, LLC (OHIO LIMITED LIABILITY COMPANY)  
3290 FORESTMEADOW DRIVE  
CUYAHUGA FALLS, OH 44233

FOR: BOOK PUBLISHING, IN CLASS 41 (U.S. CLS. 100, 101 AND 107).

FIRST USE 9-3-2009; IN COMMERCE 9-3-2009.

THE MARK CONSISTS OF STANDARD CHARACTERS WITHOUT CLAIM TO ANY PARTICULAR FONT, STYLE, SIZE, OR COLOR.

NO CLAIM IS MADE TO THE EXCLUSIVE RIGHT TO USE "PUBLISHING", APART FROM THE MARK AS SHOWN.

SER. NO. 85-643,424, FILED 6-5-2012.

LINDA MICKLEBURGH, EXAMINING ATTORNEY



*David J. Kyffers*

Director of the United States Patent and Trademark Office

# United States of America

United States Patent and Trademark Office

# VaultWorks

**Reg. No. 4,275,639**

SPEAR MARKETING, INC. (TEXAS CORPORATION)  
413 COLUMBIA DRIVE  
ROCKWALL, TX 75032

**Registered Jan. 15, 2013**

**Int. Cl.: 42**

FOR: PROVIDING TEMPORARY USE OF ON-LINE NON-DOWNLOADABLE SOFTWARE FOR USE IN CASH MANAGEMENT, IN CLASS 42 (U.S. CLS. 100 AND 101).

**SERVICE MARK**

FIRST USE 1-1-2000; IN COMMERCE 1-1-2000.

**PRINCIPAL REGISTER**

THE MARK CONSISTS OF STANDARD CHARACTERS WITHOUT CLAIM TO ANY PARTICULAR FONT, STYLE, SIZE, OR COLOR.

SER. NO. 85-643,433, FILED 6-5-2012.

LINDA MICKLEBURGH, EXAMINING ATTORNEY



*David J. Kyffers*

Director of the United States Patent and Trademark Office

# United States of America

United States Patent and Trademark Office

# Chez Jay

**Reg. No. 4,275,640**

JAYS TAVERN (CALIFORNIA CORPORATION)  
1657 OCEAN AVE.

**Registered Jan. 15, 2013**

SANTA MONICA, CA 90401

**Int. Cl.: 43**

FOR: BAR SERVICES; RESTAURANT SERVICES, IN CLASS 43 (U.S. CLS. 100 AND 101).

**SERVICE MARK**

FIRST USE 7-4-1959; IN COMMERCE 7-4-1959.

**PRINCIPAL REGISTER**

THE MARK CONSISTS OF STANDARD CHARACTERS WITHOUT CLAIM TO ANY PARTICULAR FONT, STYLE, SIZE, OR COLOR.

SER. NO. 85-643,456, FILED 6-5-2012.

LINDA M. KING, EXAMINING ATTORNEY



*David J. Kyffers*

Director of the United States Patent and Trademark Office

# United States of America

United States Patent and Trademark Office

# ZYTENZ

**Reg. No. 4,275,641**

EXCITEMENT DIETETICS, LLC (UTAH LIMITED LIABILITY COMPANY)  
3520 N UNIVERSITY AVE STE 100  
PROVO, UT 84604

**Registered Jan. 15, 2013**

**Int. Cl.: 5**

FOR: DIETARY AND NUTRITIONAL SUPPLEMENTS; HERBAL MALE ENHANCEMENT CAPSULES, IN CLASS 5 (U.S. CLS. 6, 18, 44, 46, 51 AND 52).

**TRADEMARK**

FIRST USE 10-27-2010; IN COMMERCE 10-27-2010.

**PRINCIPAL REGISTER**

THE MARK CONSISTS OF STANDARD CHARACTERS WITHOUT CLAIM TO ANY PARTICULAR FONT, STYLE, SIZE, OR COLOR.

SER. NO. 85-643,461, FILED 6-5-2012.

CHERYL CLAYTON, EXAMINING ATTORNEY



*David J. Kyffers*

Director of the United States Patent and Trademark Office

# United States of America

United States Patent and Trademark Office

## БАРХАТНЫЙ СЕЗОН

**Reg. No. 4,275,642**

**Registered Jan. 15, 2013**

**Int. Cl.: 41**

**SERVICE MARK**

**PRINCIPAL REGISTER**

NINA B. MOSHKINA (RUSSIAN FED. INDIVIDUAL)  
C/O PATENTBAR INTERNATIONAL PC  
1087 BEACON ST. SUITE 303  
NEWTON, MA 02459

FOR: ENTERTAINMENT IN THE NATURE OF VISUAL AND AUDIO PERFORMANCES BY SINGERS AND MUSICIANS; ENTERTAINMENT SERVICES IN THE NATURE OF LIVE MUSICAL PERFORMANCES; ENTERTAINMENT, NAMELY, LIVE PERFORMANCES BY A MUSICAL BAND; LIVE PERFORMANCES BY A MUSICAL GROUP, IN CLASS 41 (U.S. CLS. 100, 101 AND 107).

FIRST USE 12-1-2011; IN COMMERCE 12-1-2011.

THE MARK CONSISTS OF TWO WORDS IN CYRILLIC LETTERS.

THE NON-LATIN CHARACTERS IN THE MARK TRANSLITERATE TO BARHATNYI SEZON AND THIS MEANS THE VELVET SEASON IN ENGLISH.

THE ENGLISH TRANSLATION OF THE RUSSIAN WORDS IN THE MARK IS THE VELVET SEASON.

SER. NO. 85-643,464, FILED 6-5-2012.

CHERYL CLAYTON, EXAMINING ATTORNEY



*David J. Kyffers*

Director of the United States Patent and Trademark Office



# United States of America

United States Patent and Trademark Office

# CLOTS

**Reg. No. 4,275,643**

**Registered Jan. 15, 2013**

**Int. Cl.: 41**

**SERVICE MARK**

**PRINCIPAL REGISTER**

SOCIETY OF INTERVENTIONAL RADIOLOGY (ILLINOIS CORPORATION), DBA SIR  
SUITE 400N  
3975 FAIR RIDGE DRIVE  
FAIRFAX, VA 22033

FOR: CONTINUING EDUCATION SERVICES, NAMELY, PROVIDING LIVE AND ON-LINE  
CONTINUING PROFESSIONAL EDUCATION SEMINARS IN THE FIELD OF INTERVEN-  
TIONAL RADIOLOGY AND STROKE EDUCATION, IN CLASS 41 (U.S. CLS. 100, 101 AND  
107).

FIRST USE 8-1-2009; IN COMMERCE 8-1-2009.

THE MARK CONSISTS OF STANDARD CHARACTERS WITHOUT CLAIM TO ANY PAR-  
TICULAR FONT, STYLE, SIZE, OR COLOR.

SER. NO. 85-643,479, FILED 6-5-2012.

THEODORE MCBRIDE, EXAMINING ATTORNEY



*David J. Kyffers*

Director of the United States Patent and Trademark Office

# United States of America

United States Patent and Trademark Office

## LA REBEL MOTORS

**Reg. No. 4,275,644**

**Registered Jan. 15, 2013**

**Int. Cl.: 25**

**TRADEMARK**

**PRINCIPAL REGISTER**

7TH REVOLUTION CLOTHING, LLC (CALIFORNIA LIMITED LIABILITY COMPANY)  
15466 LOS GATOS BLVD #109-193  
1457 SHASTA AVE  
LOS GATOS, CA 95032

FOR: JEANS; SHIRTS, IN CLASS 25 (U.S. CLS. 22 AND 39).

FIRST USE 4-4-2012; IN COMMERCE 4-4-2012.

THE MARK CONSISTS OF STANDARD CHARACTERS WITHOUT CLAIM TO ANY PARTICULAR FONT, STYLE, SIZE, OR COLOR.

NO CLAIM IS MADE TO THE EXCLUSIVE RIGHT TO USE "LA", APART FROM THE MARK AS SHOWN.

SER. NO. 85-643,487, FILED 6-5-2012.

KATHLEEN LORENZO, EXAMINING ATTORNEY



*David J. Kybas*

Director of the United States Patent and Trademark Office

# United States of America

United States Patent and Trademark Office

# Trébuchet

**Reg. No. 4,275,645**

**Registered Jan. 15, 2013**

**Int. Cl.: 32**

**TRADEMARK**

**PRINCIPAL REGISTER**

LADYFACE ALE COMPANIE, LLC (CALIFORNIA LIMITED LIABILITY COMPANY), DBA  
LADYFACE ALEHOUSE & BRASSERIE  
29281 AGOURA ROAD  
AGOURA HILLS, CA 91301

FOR: ALE, IN CLASS 32 (U.S. CLS. 45, 46 AND 48).

FIRST USE 1-25-2012; IN COMMERCE 1-25-2012.

THE MARK CONSISTS OF STANDARD CHARACTERS WITHOUT CLAIM TO ANY PARTICULAR FONT, STYLE, SIZE, OR COLOR.

SER. NO. 85-643,490, FILED 6-5-2012.

THEODORE MCBRIDE, EXAMINING ATTORNEY



*David J. Kybas*

Director of the United States Patent and Trademark Office

# United States of America

United States Patent and Trademark Office

# Zuga

**Reg. No. 4,275,646**

**Registered Jan. 15, 2013**

**Int. Cl.: 10**

**TRADEMARK**

**PRINCIPAL REGISTER**

ZUGA MEDICAL, INC. (OHIO CORPORATION)  
1163 EAST 40TH STREET STE 202  
CLEVELAND, OH 44114

FOR: DENTAL AND MEDICAL DRILL BITS FOR CUTTING TEETH OR BONE; DENTAL BURRS; DENTAL DRILL BITS USED IN DENTAL MOTORS TO ENABLE DENTISTS TO CUT OR DRILL TEETH; DENTAL DRILLS; DENTAL HANDPIECES; DENTAL IMPLANTS; DENTAL INSTRUMENTS, NAMELY, RULER, DIRECTIONAL GUIDE, STOP GUIDE; DENTAL PROSTHESES; DRILLS FOR DENTAL APPLICATIONS; DRILLS FOR DENTAL USE; ENDODONTIC CONTAINER FOR HOLDING DENTAL DRILL, DENTAL BURRS AND DENTAL FILES; FIXATION IMPLANTS COMPRISED OF ARTIFICIAL MATERIAL; OS-SEOINTEGRATED IMPLANTS MADE OF ARTIFICIAL MATTER; X-RAY APPARATUS FOR DENTAL IMAGING, IN CLASS 10 (U.S. CLS. 26, 39 AND 44).

FIRST USE 8-3-2009; IN COMMERCE 6-1-2012.

THE MARK CONSISTS OF STANDARD CHARACTERS WITHOUT CLAIM TO ANY PARTICULAR FONT, STYLE, SIZE, OR COLOR.

SER. NO. 85-643,512, FILED 6-5-2012.

AISHA CLARKE, EXAMINING ATTORNEY



*David J. Kybas*

Director of the United States Patent and Trademark Office

# United States of America

United States Patent and Trademark Office

## LIBERTY POWERPAD

**Reg. No. 4,275,647**

**Registered Jan. 15, 2013**

**Int. Cl.: 9**

**TRADEMARK**

**PRINCIPAL REGISTER**

LIBERTY POWER CORP, L.L.C. (DELAWARE LIMITED LIABILITY COMPANY)  
1901 W. CYPRESS CREEK ROAD, SUITE 600  
FORT LAUDERDALE, FL 33309

FOR: COMPUTER SOFTWARE FOR ENROLLMENT AND REGISTRATION OF CUSTOMERS  
IN THE FIELD OF ELECTRIC ENERGY SERVICE, IN CLASS 9 (U.S. CLS. 21, 23, 26, 36 AND  
38).

FIRST USE 6-27-2012; IN COMMERCE 6-27-2012.

THE MARK CONSISTS OF STANDARD CHARACTERS WITHOUT CLAIM TO ANY PAR-  
TICULAR FONT, STYLE, SIZE, OR COLOR.

OWNER OF U.S. REG. NOS. 2,918,452, 3,593,731, AND 4,142,090.

SER. NO. 85-643,592, FILED 6-5-2012.

ROBERT STRUCK, EXAMINING ATTORNEY



*David J. Kybas*

Director of the United States Patent and Trademark Office

# United States of America

United States Patent and Trademark Office

## AMP UP THE TRAINING

**Reg. No. 4,275,648**

**Registered Jan. 15, 2013**

**Int. Cl.: 28**

**TRADEMARK**

**PRINCIPAL REGISTER**

TECH VALLEY TECHNOLOGIES (NEW YORK CORPORATION)  
SUITE 2  
267 BALLARD ROAD  
WILTON, NY 12831

FOR: TARGETS NAMELY PRECISION SCORING TARGETS, HUMAN INTERACTIVE TARGETS, MULTI-PURPOSE LIVE FIRE TARGETS, URBAN TARGETS, THERMAL INFANTRY SILHOUETTE TARGETS, THERMAL ARMOR BLANKET TARGETS, INFANTRY COMBAT IDENTIFICATION TARGETS, VEHICLE COMBAT IDENTIFICATION TARGETS, PHOTOREALISTIC TARGETS, IN CLASS 28 (U.S. CLS. 22, 23, 38 AND 50).

FIRST USE 11-29-2010; IN COMMERCE 11-29-2010.

THE MARK CONSISTS OF STANDARD CHARACTERS WITHOUT CLAIM TO ANY PARTICULAR FONT, STYLE, SIZE, OR COLOR.

SER. NO. 85-643,613, FILED 6-5-2012.

EUGENIA MARTIN, EXAMINING ATTORNEY



*David J. Kybas*

Director of the United States Patent and Trademark Office

# United States of America

United States Patent and Trademark Office

# UNIPIXEL

**Reg. No. 4,275,649**

**Registered Jan. 15, 2013**

**Int. Cls.: 40 and 42**

**SERVICE MARK**

**PRINCIPAL REGISTER**

UNI-PIXEL DISPLAYS, INC. (TEXAS CORPORATION)  
SUITE 100  
8708 TECHNOLOGY FOREST PLACE  
THE WOODLANDS, TX 77381

FOR: CUSTOM MANUFACTURE OF FILMS, SHEETS AND OPTICAL FILM FOR OTHERS  
IN THE COMPUTER INDUSTRY, IN CLASS 40 (U.S. CLS. 100, 103 AND 106).

FIRST USE 8-31-2010; IN COMMERCE 8-31-2010.

FOR: ENGINEERING AND DEVELOPMENT OF FILMS AND SHEETS USED IN THE  
MANUFACTURING OF PRINTED CIRCUIT BOARDS; DESIGN, ENGINEERING AND DE-  
VELOPMENT OF OPTICAL FILM USING A HIGH-FIDELITY, SINGLE-PASS, ROLL-TO-  
ROLL PROCESS FOR OTHERS; CUSTOM MODIFICATION OF EXISTING OPTICAL FILM  
TO PRODUCE NEW PRINTED ELECTRONIC CIRCUIT PRODUCTS FOR OTHERS, IN CLASS  
42 (U.S. CLS. 100 AND 101).

FIRST USE 8-31-2010; IN COMMERCE 8-31-2010.

THE MARK CONSISTS OF STANDARD CHARACTERS WITHOUT CLAIM TO ANY PAR-  
TICULAR FONT, STYLE, SIZE, OR COLOR.

SER. NO. 85-643,635, FILED 6-5-2012.

DOMINICK J. SALEMI, EXAMINING ATTORNEY



*David J. Kyffers*

Director of the United States Patent and Trademark Office

# United States of America

United States Patent and Trademark Office

# AAIMCo

**Reg. No. 4,275,650**

**Registered Jan. 15, 2013**

**Int. Cl.: 35**

**SERVICE MARK**

**PRINCIPAL REGISTER**

AMERICAN ASSOCIATION OF INSURANCE MANAGEMENT CONSULTANTS, CORP.  
(MICHIGAN CORPORATION)  
8980 LAKES AT 610 DRIVE  
HOUSTON, TX 77054

FOR: TRADE ASSOCIATION SERVICES, NAMELY, PROMOTING THE INTERESTS OF INSURANCE MANAGEMENT CONSULTANTS, IN CLASS 35 (U.S. CLS. 100, 101 AND 102).

FIRST USE 0-0-1979; IN COMMERCE 0-0-1979.

THE MARK CONSISTS OF STANDARD CHARACTERS WITHOUT CLAIM TO ANY PARTICULAR FONT, STYLE, SIZE, OR COLOR.

SER. NO. 85-643,642, FILED 6-5-2012.

KEVIN CORWIN, EXAMINING ATTORNEY



*David J. Kyffers*

Director of the United States Patent and Trademark Office



# United States of America

United States Patent and Trademark Office

## LIFE IN MOTION

**Reg. No. 4,275,651**

**Registered Jan. 15, 2013**

**Int. Cl.: 37**

**SERVICE MARK**

**PRINCIPAL REGISTER**

BAY MEADOWS MAIN TRACK INVESTORS, LLC (DELAWARE LIMITED LIABILITY COMPANY)  
4 EMBARCADERO CENTER, SUITE 3300  
SAN FRANCISCO, CA 94111

FOR: REAL ESTATE DEVELOPMENT, IN CLASS 37 (U.S. CLS. 100, 103 AND 106).

FIRST USE 1-15-2012; IN COMMERCE 1-15-2012.

THE MARK CONSISTS OF STANDARD CHARACTERS WITHOUT CLAIM TO ANY PARTICULAR FONT, STYLE, SIZE, OR COLOR.

SER. NO. 85-643,671, FILED 6-5-2012.

DOMINICK J. SALEMI, EXAMINING ATTORNEY



*David J. Kybas*

Director of the United States Patent and Trademark Office

# United States of America

United States Patent and Trademark Office

# StartupWorld

**Reg. No. 4,275,652**

**Registered Jan. 15, 2013**

**Int. Cl.: 41**

**SERVICE MARK**

**PRINCIPAL REGISTER**

BLUE PLANET SOLUTIONS, INC. (NEW JERSEY CORPORATION)  
SUITE# 108  
116 MILLBURN AVENUE  
MILLBURN, NJ 07041

FOR: PROVIDING EDUCATIONAL MENTORING SERVICES AND PROGRAMS IN THE FIELD OF TECHNOLOGY, ENTREPRENEURSHIP AND EMPLOYABILITY, IN CLASS 41 (U.S. CLS. 100, 101 AND 107).

FIRST USE 12-25-2011; IN COMMERCE 12-25-2011.

THE MARK CONSISTS OF ONE WORD "STARTUPWORLD" WITH "S" CAPITAL AND "STARTUP" IN BLACK COLOR; "WORLD" WITH CAPITAL "W" IN BLUE COLOR, THE LETTER "O" PARTLY BLUE AND PARTLY RED AND LETTERS "RLD" IN BLUE COLOR.

THE COLOR(S) BLACK, BLUE AND RED IS/ARE CLAIMED AS A FEATURE OF THE MARK.

SER. NO. 85-643,707, FILED 6-5-2012.

REBECCA SMITH, EXAMINING ATTORNEY



*David J. Kyros*

Director of the United States Patent and Trademark Office

# United States of America

United States Patent and Trademark Office

## IT STARTS WITH THE DIAMOND IN YOUR MIND

**Reg. No. 4,275,653**

BLUE NILE, INC. (DELAWARE CORPORATION)  
411 1ST AVENUE SOUTH, SUITE 700  
SEATTLE, WA 98104

**Registered Jan. 15, 2013**

**Int. Cl.: 35**

FOR: ONLINE RETAIL STORE SERVICES IN THE FIELD OF DIAMONDS AND JEWELRY,  
IN CLASS 35 (U.S. CLS. 100, 101 AND 102).

**SERVICE MARK**

FIRST USE 6-4-2012; IN COMMERCE 6-4-2012.

**PRINCIPAL REGISTER**

THE MARK CONSISTS OF STANDARD CHARACTERS WITHOUT CLAIM TO ANY PAR-  
TICULAR FONT, STYLE, SIZE, OR COLOR.

SER. NO. 85-643,788, FILED 6-5-2012.

SHAVELL MCPHERSON, EXAMINING ATTORNEY



*David J. Kybas*

Director of the United States Patent and Trademark Office

# United States of America

United States Patent and Trademark Office

# YAPYZAL

**Reg. No. 4,275,654**

**Registered Jan. 15, 2013**

**Int. Cl.: 35**

**SERVICE MARK**

**PRINCIPAL REGISTER**

FLYING SAUCER HOLDINGS, LLC (DELAWARE LIMITED LIABILITY COMPANY)  
SUITE 103  
7556 US HWY 70  
BARTLETT, TN 38133

FOR: ON-LINE BUSINESS NETWORKING SERVICES; PROMOTING THE GOODS AND SERVICES OF OTHERS BY MEANS OF DISTRIBUTING ADVERTISING ON THE INTERNET; PROVIDING MARKETING CONSULTING IN THE FIELD OF SOCIAL MEDIA, IN CLASS 35 (U.S. CLS. 100, 101 AND 102).

FIRST USE 1-4-2012; IN COMMERCE 1-4-2012.

THE MARK CONSISTS OF STANDARD CHARACTERS WITHOUT CLAIM TO ANY PARTICULAR FONT, STYLE, SIZE, OR COLOR.

SER. NO. 85-643,805, FILED 6-5-2012.

ESTHER BELENKER, EXAMINING ATTORNEY



*David J. Kyffers*

Director of the United States Patent and Trademark Office

# United States of America

United States Patent and Trademark Office

WHERE SMALL BUSINESS IS  
BIG BUSINESS

**Reg. No. 4,275,655**

**Registered Jan. 15, 2013**

**Int. Cl.: 35**

**SERVICE MARK**

**PRINCIPAL REGISTER**

FLYING SAUCER HOLDINGS, LLC (DELAWARE LIMITED LIABILITY COMPANY)  
SUITE 103  
7556 US HWY 70  
BARTLETT, TN 38133

FOR: ON-LINE BUSINESS NETWORKING SERVICES; PROMOTING THE GOODS AND SERVICES OF OTHERS BY MEANS OF DISTRIBUTING ADVERTISING ON THE INTERNET; PROVIDING MARKETING CONSULTING IN THE FIELD OF SOCIAL MEDIA, IN CLASS 35 (U.S. CLS. 100, 101 AND 102).

FIRST USE 1-4-2012; IN COMMERCE 1-4-2012.

THE MARK CONSISTS OF STANDARD CHARACTERS WITHOUT CLAIM TO ANY PARTICULAR FONT, STYLE, SIZE, OR COLOR.

SER. NO. 85-643,826, FILED 6-5-2012.

ESTHER BELENKER, EXAMINING ATTORNEY



*David J. Kyjars*

Director of the United States Patent and Trademark Office

# United States of America

United States Patent and Trademark Office

# Godtype

**Reg. No. 4,275,656**

**Registered Jan. 15, 2013**

**Int. Cl.: 41**

**SERVICE MARK**

**PRINCIPAL REGISTER**

FLEITAS, MILTON (UNITED STATES INDIVIDUAL)  
13865 PAUMA VISTA DR  
VALLEY CENTER, CA 92082

FOR: PROVIDING A WEBSITE FEATURING BLOGS AND NON-DOWNLOADABLE PUBLICATIONS IN THE NATURE OF ARTICLES IN THE FIELD(S) OF PHILOSOPHY AND SCIENCE, IN CLASS 41 (U.S. CLS. 100, 101 AND 107).

FIRST USE 12-15-1999; IN COMMERCE 12-24-2011.

THE MARK CONSISTS OF STANDARD CHARACTERS WITHOUT CLAIM TO ANY PARTICULAR FONT, STYLE, SIZE, OR COLOR.

SER. NO. 85-643,829, FILED 6-5-2012.

SUSAN RICHARDS, EXAMINING ATTORNEY



*David J. Kybas*

Director of the United States Patent and Trademark Office

# United States of America

United States Patent and Trademark Office

## Dedicated to a Higher Standard of Living

**Reg. No. 4,275,657**

**Registered Jan. 15, 2013**

**Int. Cls.: 36 and 37**

**SERVICE MARK**

**PRINCIPAL REGISTER**

THE MOUNT VERNON COMPANY, INC. (MASSACHUSETTS CORPORATION)  
9122.001  
29 COMMONWEALTH AVENUE  
BOSTON, MA 02116

FOR: RESIDENTIAL, COMMERCIAL, AND VACATION REAL ESTATE LEASING AND  
MANAGEMENT SERVICES, IN CLASS 36 (U.S. CLS. 100, 101 AND 102).

FIRST USE 5-27-2004; IN COMMERCE 5-27-2004.

FOR: RESIDENTIAL, COMMERCIAL, AND VACATION REAL ESTATE DEVELOPMENT  
SERVICES, IN CLASS 37 (U.S. CLS. 100, 103 AND 106).

FIRST USE 5-27-2004; IN COMMERCE 5-27-2004.

THE MARK CONSISTS OF STANDARD CHARACTERS WITHOUT CLAIM TO ANY PAR-  
TICULAR FONT, STYLE, SIZE, OR COLOR.

SER. NO. 85-643,838, FILED 6-5-2012.

BARBARA BROWN, EXAMINING ATTORNEY



*David J. Kyjars*

Director of the United States Patent and Trademark Office

# United States of America

United States Patent and Trademark Office

## Son of Baconator

**Reg. No. 4,275,658**

**Registered Jan. 15, 2013**

**Int. Cl.: 30**

**TRADEMARK**

**PRINCIPAL REGISTER**

OLDEMARK LLC (DELAWARE LIMITED LIABILITY COMPANY)  
4288 WEST DUBLIN-GRANVILLE ROAD  
DUBLIN, OH 43017

FOR: SANDWICHES, IN CLASS 30 (U.S. CL. 46).

FIRST USE 12-12-2011; IN COMMERCE 12-12-2011.

THE MARK CONSISTS OF STANDARD CHARACTERS WITHOUT CLAIM TO ANY PARTICULAR FONT, STYLE, SIZE, OR COLOR.

OWNER OF U.S. REG. NO. 3,450,411.

SER. NO. 85-643,840, FILED 6-5-2012.

BARBARA BROWN, EXAMINING ATTORNEY



*David J. Kyffers*

Director of the United States Patent and Trademark Office



# United States of America

United States Patent and Trademark Office



**Reg. No. 4,275,659**

**Registered Jan. 15, 2013**

**Int. Cl.: 35**

**SERVICE MARK**

**PRINCIPAL REGISTER**

YMARKETING, LLC (CALIFORNIA LIMITED LIABILITY COMPANY)  
3050 PULLMAN ST.  
COSTA MESA, CA 92626

FOR: SOCIAL MEDIA STRATEGY AND MARKETING CONSULTANCY FOCUSING ON HELPING CLIENTS CREATE AND EXTEND THEIR PRODUCT AND BRAND STRATEGIES BY BUILDING VIRALLY ENGAGING MARKETING SOLUTIONS, IN CLASS 35 (U.S. CLS. 100, 101 AND 102).

FIRST USE 4-8-2010; IN COMMERCE 4-8-2010.

THE MARK CONSISTS OF A ROUNDED CORNERED SQUARE, COLORED ORANGE, WITH A STYLIZED LOWER CASE "Y" INSIDE IT, COLORED WHITE.

THE COLOR(S) ORANGE AND WHITE IS/ARE CLAIMED AS A FEATURE OF THE MARK.

SER. NO. 85-643,871, FILED 6-5-2012.

WILLIAM VERHOSEK, EXAMINING ATTORNEY



*David J. Kybas*

Director of the United States Patent and Trademark Office

# United States of America

United States Patent and Trademark Office

# HEXBRIGHT

**Reg. No. 4,275,660**

**Registered Jan. 15, 2013**

**Int. Cl.: 11**

**TRADEMARK**

**PRINCIPAL REGISTER**

C2 ROBOTICS, INC. (CALIFORNIA CORPORATION)  
270 LUNETTA DRIVE  
SAN LUIS OBISPO, CA 93405

FOR: FLASHLIGHTS, IN CLASS 11 (U.S. CLS. 13, 21, 23, 31 AND 34).

FIRST USE 4-1-2011; IN COMMERCE 5-24-2011.

THE MARK CONSISTS OF STANDARD CHARACTERS WITHOUT CLAIM TO ANY PARTICULAR FONT, STYLE, SIZE, OR COLOR.

SER. NO. 85-643,958, FILED 6-5-2012.

ANTHONY RINKER, EXAMINING ATTORNEY



*David J. Kybas*

Director of the United States Patent and Trademark Office

# United States of America

United States Patent and Trademark Office

# SSB

**Reg. No. 4,275,661**

ANNA LOUISE PIERRE (UNITED STATES INDIVIDUAL)  
13117 SW 54 CT  
MIRAMAR, FL 33027

**Registered Jan. 15, 2013**

**Int. Cls.: 18 and 25**

FOR: BACKPACKS, BOOK BAGS, SPORTS BAGS, BUM BAGS, WALLETS AND HANDBAGS;  
BOOK BAGS, IN CLASS 18 (U.S. CLS. 1, 2, 3, 22 AND 41).

**TRADEMARK**

FIRST USE 6-1-2012; IN COMMERCE 6-1-2012.

**PRINCIPAL REGISTER**

FOR: CAPS; JEANS; T-SHIRTS, IN CLASS 25 (U.S. CLS. 22 AND 39).

FIRST USE 6-1-2012; IN COMMERCE 6-1-2012.

THE MARK CONSISTS OF STANDARD CHARACTERS WITHOUT CLAIM TO ANY PARTICULAR FONT, STYLE, SIZE, OR COLOR.

SER. NO. 85-643,964, FILED 6-5-2012.

ANTHONY RINKER, EXAMINING ATTORNEY



*David J. Kybas*

Director of the United States Patent and Trademark Office

**United States of America**  
United States Patent and Trademark Office

**CABANA**

**Reg. No. 4,275,662**

**Registered Jan. 15, 2013**

**Int. Cl.: 12**

**TRADEMARK**

**PRINCIPAL REGISTER**

MONAHAN PRODUCTS LLC (MASSACHUSETTS LIMITED LIABILITY COMPANY)  
SUITE 3  
60 SHARP STREET  
HINGHAM, MA 02043

FOR: CAR SEAT COVERS FOR INFANTS AND TODDLERS, IN CLASS 12 (U.S. CLS. 19, 21, 23, 31, 35 AND 44).

FIRST USE 10-19-2010; IN COMMERCE 10-19-2010.

THE MARK CONSISTS OF STANDARD CHARACTERS WITHOUT CLAIM TO ANY PARTICULAR FONT, STYLE, SIZE, OR COLOR.

SER. NO. 85-643,968, FILED 6-5-2012.

CURTIS FRENCH, EXAMINING ATTORNEY



*David J. Kyffers*

Director of the United States Patent and Trademark Office

# United States of America

United States Patent and Trademark Office

# RESPIT

**Reg. No. 4,275,663**

**Registered Jan. 15, 2013**

**Int. Cl.: 5**

**TRADEMARK**

**PRINCIPAL REGISTER**

SKINVET CLINIC, LLC (OREGON LIMITED LIABILITY COMPANY)  
SUITE 120  
15800 SW UPPER BOONES FERRY ROAD  
LAKE OSWEGO, OR 97035

FOR: VETERINARY PHARMACEUTICAL PRODUCTS, NAMELY, ALLERGENIC EXTRACTS  
FOR THERAPEUTIC USE, IN CLASS 5 (U.S. CLS. 6, 18, 44, 46, 51 AND 52).

FIRST USE 9-30-2009; IN COMMERCE 9-30-2009.

THE MARK CONSISTS OF STANDARD CHARACTERS WITHOUT CLAIM TO ANY PAR-  
TICULAR FONT, STYLE, SIZE, OR COLOR.

SER. NO. 85-643,976, FILED 6-5-2012.

TRACY CROSS, EXAMINING ATTORNEY



*David J. Kyffers*

Director of the United States Patent and Trademark Office

# United States of America

United States Patent and Trademark Office

# TIOJA

**Reg. No. 4,275,664**

**Registered Jan. 15, 2013**

**Int. Cl.: 33**

**TRADEMARK**

**PRINCIPAL REGISTER**

SAN SABA WINE CELLARS LLC (TEXAS LIMITED LIABILITY COMPANY)  
316 E. WALLACE STREET  
SAN SABA, TX 76877

FOR: WINE, IN CLASS 33 (U.S. CLS. 47 AND 49).

FIRST USE 6-1-2012; IN COMMERCE 6-1-2012.

THE MARK CONSISTS OF STANDARD CHARACTERS WITHOUT CLAIM TO ANY PARTICULAR FONT, STYLE, SIZE, OR COLOR.

SER. NO. 85-643,981, FILED 6-5-2012.

STEPHANIE ALI, EXAMINING ATTORNEY



*David J. Kybas*

Director of the United States Patent and Trademark Office

# United States of America

United States Patent and Trademark Office

# Swan Energy

**Reg. No. 4,275,665**

**Registered Jan. 15, 2013**

**Int. Cl.: 37**

**SERVICE MARK**

**PRINCIPAL REGISTER**

SWAN ENERGY INC. (DELAWARE CORPORATION)  
SUITE 200  
8100 E MAPLEWOOD AVE  
GREENWOOD VILLAGE, CO 80111

FOR: OIL AND GAS DRILLING, IN CLASS 37 (U.S. CLS. 100, 103 AND 106).

FIRST USE 5-0-2010; IN COMMERCE 5-0-2010.

THE MARK CONSISTS OF STANDARD CHARACTERS WITHOUT CLAIM TO ANY PARTICULAR FONT, STYLE, SIZE, OR COLOR.

NO CLAIM IS MADE TO THE EXCLUSIVE RIGHT TO USE "ENERGY", APART FROM THE MARK AS SHOWN.

SER. NO. 85-643,984, FILED 6-5-2012.

STEPHANIE ALI, EXAMINING ATTORNEY



*David J. Kybas*

Director of the United States Patent and Trademark Office

# United States of America

United States Patent and Trademark Office

# decorify

**Reg. No. 4,275,666**

TALKTORIAL LLC (PENNSYLVANIA LIMITED LIABILITY COMPANY)  
5104 KELLY RD  
WARRINGTON, PA 18976

**Registered Jan. 15, 2013**

**Int. Cl.: 35**

FOR: ON-LINE RETAIL STORE SERVICES FEATURING A WIDE VARIETY OF CONSUMER GOODS OF OTHERS, IN CLASS 35 (U.S. CLS. 100, 101 AND 102).

**SERVICE MARK**

FIRST USE 2-8-2009; IN COMMERCE 1-1-2011.

**PRINCIPAL REGISTER**

THE MARK CONSISTS OF STANDARD CHARACTERS WITHOUT CLAIM TO ANY PARTICULAR FONT, STYLE, SIZE, OR COLOR.

SER. NO. 85-644,018, FILED 6-5-2012.

TRACY CROSS, EXAMINING ATTORNEY



*David J. Kybas*

Director of the United States Patent and Trademark Office



# United States of America

United States Patent and Trademark Office

## Ready or Knot

**Reg. No. 4,275,667**

READY OR KNOT WEDDINGS LLC (NEBRASKA LIMITED LIABILITY COMPANY)  
9512 OAK CIRCLE  
OMAHA, NE 68124

**Registered Jan. 15, 2013**

**Int. Cl.: 35**

FOR: RETAIL STORE SERVICES AND ONLINE RETAIL FEATURING BRIDAL AND BRIDESMAID ATTIRE AND ACCESSORIES, IN CLASS 35 (U.S. CLS. 100, 101 AND 102).

**SERVICE MARK**

FIRST USE 4-1-2012; IN COMMERCE 6-1-2012.

**PRINCIPAL REGISTER**

THE MARK CONSISTS OF STANDARD CHARACTERS WITHOUT CLAIM TO ANY PARTICULAR FONT, STYLE, SIZE, OR COLOR.

SER. NO. 85-644,034, FILED 6-5-2012.

SKYE YOUNG, EXAMINING ATTORNEY



*David J. Kybas*

Director of the United States Patent and Trademark Office

# United States of America

United States Patent and Trademark Office

## Course Walker

**Reg. No. 4,275,668**

B3SK SOFTWARE LLC (VIRGINIA LIMITED LIABILITY COMPANY)  
3220 MEADOWBROOK LN  
CHESAPEAKE, VA 23321

**Registered Jan. 15, 2013**

**Int. Cl.: 9**

FOR: COMPUTER SOFTWARE FOR USE IN AIDING THE USER IN LAYING OUT AND VISUALIZING DOG AGILITY COURSES WITH TWO AND THREE DIMENSIONAL VIEWS USING PERSONAL COMPUTER GAMING HARDWARE, IN CLASS 9 (U.S. CLS. 21, 23, 26, 36 AND 38).

**TRADEMARK**

**PRINCIPAL REGISTER**

FIRST USE 1-26-2012; IN COMMERCE 4-28-2012.

THE MARK CONSISTS OF STANDARD CHARACTERS WITHOUT CLAIM TO ANY PARTICULAR FONT, STYLE, SIZE, OR COLOR.

SER. NO. 85-644,039, FILED 6-5-2012.

SKYE YOUNG, EXAMINING ATTORNEY



*David J. Kyffers*

Director of the United States Patent and Trademark Office

# United States of America

United States Patent and Trademark Office

## FLABBY TO FIT

**Reg. No. 4,275,669**

THANE INTERNATIONAL, INC. (DELAWARE CORPORATION)  
78-140 CALLE TAMPICO  
LA QUINTA, CA 92253

**Registered Jan. 15, 2013**

**Int. Cl.: 28**

FOR: MANUALLY-OPERATED EXERCISE EQUIPMENT, IN CLASS 28 (U.S. CLS. 22, 23, 38 AND 50).

**TRADEMARK**

FIRST USE 5-17-2012; IN COMMERCE 5-17-2012.

**PRINCIPAL REGISTER**

THE MARK CONSISTS OF STANDARD CHARACTERS WITHOUT CLAIM TO ANY PARTICULAR FONT, STYLE, SIZE, OR COLOR.

SER. NO. 85-644,067, FILED 6-5-2012.

ROBIN CHOSID, EXAMINING ATTORNEY



*David J. Kyffers*

Director of the United States Patent and Trademark Office

# United States of America

United States Patent and Trademark Office

# EMI JAY

**Reg. No. 4,275,670**

**Registered Jan. 15, 2013**

**Int. Cls.: 14, 25 and 26**

EMI-JAY, INC. (CALIFORNIA CORPORATION)  
SUITE 301  
16200 VENTURA BLVD.  
ENCINO, CA 91436

FOR: BRACELETS; NECKLACES, IN CLASS 14 (U.S. CLS. 2, 27, 28 AND 50).

**TRADEMARK**

FIRST USE 6-6-2009; IN COMMERCE 6-6-2009.

**PRINCIPAL REGISTER**

FOR: HEADBANDS , IN CLASS 25 (U.S. CLS. 22 AND 39).

FIRST USE 6-6-2009; IN COMMERCE 6-6-2009.

FOR: HAIR ACCESSORIES, NAMELY, HAIR BANDS, HAIR TIES, HAIR BOWS, PONYTAIL HOLDERS, HAIR ELASTICS, HAIR ORNAMENTS, HAIR CLIPS, IN CLASS 26 (U.S. CLS. 37, 39, 40, 42 AND 50).

FIRST USE 6-6-2009; IN COMMERCE 6-6-2009.

THE MARK CONSISTS OF STANDARD CHARACTERS WITHOUT CLAIM TO ANY PARTICULAR FONT, STYLE, SIZE, OR COLOR.

SER. NO. 85-644,093, FILED 6-5-2012.

ROBIN CHOSID, EXAMINING ATTORNEY



*David J. Kyros*

Director of the United States Patent and Trademark Office

# United States of America

United States Patent and Trademark Office

# BARBICAN

**Reg. No. 4,275,671**

SAHARA ENTERPRISE INC. (PENNSYLVANIA CORPORATION)  
12514 KNIGHTS ROAD  
PHILADELPHIA, PA 19154

**Registered Jan. 15, 2013**

**Int. Cl.: 32**

FOR: NON-ALCOHOLIC MALT BEVERAGE, IN CLASS 32 (U.S. CLS. 45, 46 AND 48).

**TRADEMARK**

FIRST USE 5-10-2012; IN COMMERCE 5-10-2012.

**PRINCIPAL REGISTER**

THE MARK CONSISTS OF STANDARD CHARACTERS WITHOUT CLAIM TO ANY PARTICULAR FONT, STYLE, SIZE, OR COLOR.

SER. NO. 85-644,133, FILED 6-5-2012.

WENDY GOODMAN, EXAMINING ATTORNEY



*David J. Kybas*

Director of the United States Patent and Trademark Office

# United States of America

United States Patent and Trademark Office



**Reg. No. 4,275,672**

**Registered Jan. 15, 2013**

**Int. Cl.: 25**

**TRADEMARK**

**PRINCIPAL REGISTER**

ELISSA CONOSCENTE (AUSTRALIA INDIVIDUAL), DBA SUNZI  
1159 POST ROAD  
1159 POST ROAD  
SCARSDALE, NY 10583

FOR: SWIMSUITS, IN CLASS 25 (U.S. CLS. 22 AND 39).

FIRST USE 1-1-2012; IN COMMERCE 5-15-2012.

THE MARK CONSISTS OF A PICTURE OF A HIBISCUS FLOWER WITH EXTENDED LEAVES. UNDERNEATH THE WORD "SUNZI" IS WRITTEN WITH THE FOLLOWING CHARACTERISTICS: THE "S" HAS A STYLIZED CROSS STROKE WITH A BALL TERMINAL TO THE LEFT. THE "U" HAS AN ASCENDER WITH A BALL TERMINAL TO THE LEFT. THE "N" HAS A DESCENDER WITH A BALL TERMINAL TO THE RIGHT.

SER. NO. 85-644,153, FILED 6-5-2012.

CHERYL CLAYTON, EXAMINING ATTORNEY



*David J. Kybas*

Director of the United States Patent and Trademark Office

# United States of America

United States Patent and Trademark Office



**Reg. No. 4,275,673**

**Registered Jan. 15, 2013**

**Int. Cl.: 7**

**TRADEMARK**

**PRINCIPAL REGISTER**

NINGBO STEED TOOLS CO.,LTD. (CHINA LIMITED LIABILITY COMPANY)  
FANGJIADA, GULIN TOWN, YINZHOU DISTRICT  
NINGBO, ZHEJIANG, CHINA

FOR: AGRICULTURAL MACHINERY, NAMELY, COMBINES; AGRICULTURAL MACHINERY, NAMELY, THRESHERS; AGRICULTURAL MACHINERY, NAMELY, TILLERS; AGRICULTURAL SEED PLANTING MACHINE; COMPRESSED AIR MACHINES; ELECTRIC GLUE GUNS; ELECTRIC HAND-HELD DRILLS; GAS-OPERATED SOLDERING IRONS; HAND-HELD ELECTRIC-POWERED FOOD PROCESSORS; PAINT SPRAY GUNS; PNEUMATIC HAMMERS; PUMPS FOR MACHINES; VALVES BEING PARTS OF MACHINES, IN CLASS 7 (U.S. CLS. 13, 19, 21, 23, 31, 34 AND 35).

FIRST USE 3-17-2009; IN COMMERCE 3-17-2009.

THE MARK CONSISTS OF A RUNNING HORSE WITH WING AND STYLIZED WORD "HYMAIR" AND THEY ARE CONTAINED IN AN UNCOMPLETED CIRCLE.

SER. NO. 85-644,158, FILED 6-5-2012.

CHERYL CLAYTON, EXAMINING ATTORNEY



*David J. Kybas*

Director of the United States Patent and Trademark Office

# United States of America

United States Patent and Trademark Office

## Helping The Disabled Get Social Security Is Our Only Business

**Reg. No. 4,275,674**

SOCIAL SECURITY DISABILITY CONSULTANTS, INC. (MISSISSIPPI CORPORATION)  
12178 HWY 49 N., SUITE C  
GULFPORT, MS 39503

**Registered Jan. 15, 2013**

**Int. Cl.: 45**

FOR: REPRESENTATION OF PERSONS FOR SOCIAL SECURITY AND DISABILITY RELATED CLAIMS, IN CLASS 45 (U.S. CLS. 100 AND 101).

**SERVICE MARK**

FIRST USE 1-1-1993; IN COMMERCE 1-1-1993.

**PRINCIPAL REGISTER**

THE MARK CONSISTS OF STANDARD CHARACTERS WITHOUT CLAIM TO ANY PARTICULAR FONT, STYLE, SIZE, OR COLOR.

SER. NO. 85-644,160, FILED 6-5-2012.

CHERYL CLAYTON, EXAMINING ATTORNEY



*David J. Kyffers*

Director of the United States Patent and Trademark Office



# United States of America

United States Patent and Trademark Office

# Lashevan

**Reg. No. 4,275,675**

LASHEVAN USA, INC. (CALIFORNIA CORPORATION)  
18 STARFLOWER  
IRVINE, CA 92604

**Registered Jan. 15, 2013**

**Int. Cl.: 25**

FOR: BOXER BRIEFS; BRIEFS; LONG JOHNS; MEN'S UNDERWEAR; UNDERSHIRTS;  
UNDERWEAR, IN CLASS 25 (U.S. CLS. 22 AND 39).

**TRADEMARK**

FIRST USE 10-26-2011; IN COMMERCE 10-26-2011.

**PRINCIPAL REGISTER**

THE MARK CONSISTS OF STANDARD CHARACTERS WITHOUT CLAIM TO ANY PARTICULAR FONT, STYLE, SIZE, OR COLOR.

SER. NO. 85-644,170, FILED 6-6-2012.

DARRYL SPRUILL, EXAMINING ATTORNEY



*David J. Kybas*

Director of the United States Patent and Trademark Office

# United States of America

United States Patent and Trademark Office

# PIDDX

**Reg. No. 4,275,676**

**Registered Jan. 15, 2013**

**Int. Cl.: 35**

**SERVICE MARK**

**PRINCIPAL REGISTER**

PIDDX, INC. (MASSACHUSETTS CORPORATION)  
340 COOLEY ST, SUITE 127  
340 COOLEY ST, SUITE 127  
SPRINGFIELD, MA 01128

FOR: PROVIDING INFORMATION ABOUT THE GOODS AND SERVICES OF OTHERS VIA THE GLOBAL COMPUTER NETWORK, IN CLASS 35 (U.S. CLS. 100, 101 AND 102).

FIRST USE 7-28-2011; IN COMMERCE 7-28-2011.

THE MARK CONSISTS OF STANDARD CHARACTERS WITHOUT CLAIM TO ANY PARTICULAR FONT, STYLE, SIZE, OR COLOR.

SER. NO. 85-644,180, FILED 6-6-2012.

WENDY JUN, EXAMINING ATTORNEY



*David J. Kyffers*

Director of the United States Patent and Trademark Office

# United States of America

United States Patent and Trademark Office

## GROWTH SPURT

**Reg. No. 4,275,677**

**Registered Jan. 15, 2013**

**Int. Cl.: 3**

**TRADEMARK**

**PRINCIPAL REGISTER**

MAURICE RASGON, INC. (CALIFORNIA CORPORATION), DBA COSMETIC DESIGN  
GROUP  
5673 SELMARAIN DR.  
CULVER CITY, CA 90230

FOR: NAIL HARDENERS; NAIL STRENGTHENERS, IN CLASS 3 (U.S. CLS. 1, 4, 6, 50, 51  
AND 52).

FIRST USE 1-0-2011; IN COMMERCE 1-0-2011.

THE MARK CONSISTS OF STANDARD CHARACTERS WITHOUT CLAIM TO ANY PAR-  
TICULAR FONT, STYLE, SIZE, OR COLOR.

SER. NO. 85-644,181, FILED 6-6-2012.

ALEXANDER L. POWERS, EXAMINING ATTORNEY



*David J. Kyffers*

Director of the United States Patent and Trademark Office

# United States of America

United States Patent and Trademark Office

## Bridge The Ridge

**Reg. No. 4,275,678**

**Registered Jan. 15, 2013**

**Int. Cl.: 3**

**TRADEMARK**

**PRINCIPAL REGISTER**

MAURICE RASGON, INC. (CALIFORNIA CORPORATION), DBA COSMETIC DESIGN  
GROUP  
5673 SELMARAIN DR.  
CULVER CITY, CA 90230

FOR: NAIL POLISH BASE COAT; NAIL VARNISH FOR COSMETIC PURPOSES; NON-MEDICATED NAIL CARE PREPARATIONS, IN CLASS 3 (U.S. CLS. 1, 4, 6, 50, 51 AND 52).

FIRST USE 1-0-2011; IN COMMERCE 1-0-2011.

THE MARK CONSISTS OF STANDARD CHARACTERS WITHOUT CLAIM TO ANY PARTICULAR FONT, STYLE, SIZE, OR COLOR.

SER. NO. 85-644,186, FILED 6-6-2012.

ALEXANDER L. POWERS, EXAMINING ATTORNEY



*David J. Kypos*

Director of the United States Patent and Trademark Office

# United States of America

United States Patent and Trademark Office

## DIVISIONX

**Reg. No. 4,275,679**

**Registered Jan. 15, 2013**

**Int. Cl.: 42**

**SERVICE MARK**

**PRINCIPAL REGISTER**

DIVISIONX, INC. (TEXAS CORPORATION)  
2316 KLATTENHOFF DRIVE  
AUSTIN, TX 78728

FOR: SOFTWARE AS A SERVICE (SAAS) SERVICES, NAMELY, HOSTING SOFTWARE FOR USE BY OTHERS FOR USE IN CONNECTION WITH DEVELOPING, MANAGING, MONITORING, ANALYZING USAGE OF, UPDATING, ADVERTISING, MARKETING, DESIGNING, INTEGRATING, CUSTOMIZING, CONFIGURING, AND MAINTAINING WEB SITES, INTRANETS, EXTRANETS, MAILING-LISTS, MOBILE SITES AND APPLICATIONS, AND OTHER CONTENT REPOSITORIES; SOFTWARE AS A SERVICE (SAAS) SERVICES FEATURING SOFTWARE FOR ENABLING OTHERS TO DEVELOP, MANAGE, MONITOR, ANALYZE USAGE OF, UPDATE, ADVERTISE, MARKET, DESIGN, INTEGRATE, CUSTOMIZE, CONFIGURE, AND MAINTAIN WEB SITES, INTRANETS, EXTRANETS, MAILING-LISTS, MOBILE SITES AND APPLICATIONS, AND OTHER CONTENT REPOSITORIES, IN CLASS 42 (U.S. CLS. 100 AND 101).

FIRST USE 9-22-1998; IN COMMERCE 9-22-1998.

THE MARK CONSISTS OF STANDARD CHARACTERS WITHOUT CLAIM TO ANY PARTICULAR FONT, STYLE, SIZE, OR COLOR.

SER. NO. 85-644,187, FILED 6-6-2012.

HELENE LIWINSKI, EXAMINING ATTORNEY



*David J. Kyros*

Director of the United States Patent and Trademark Office

# United States of America

United States Patent and Trademark Office



**Reg. No. 4,275,680**

3-T SAUCES, LLC (CALIFORNIA LIMITED LIABILITY COMPANY)  
P.O. BOX 5452  
NAPA, CA 94581

**Registered Jan. 15, 2013**

**Int. Cl.: 30**

FOR: BARBEQUE SAUCE, IN CLASS 30 (U.S. CL. 46).

**TRADEMARK**

FIRST USE 5-30-2012; IN COMMERCE 5-30-2012.

**PRINCIPAL REGISTER**

THE MARK CONSISTS OF A CREST WITH THE LETTERS "TTT" POSITIONED INSIDE,  
AND A COW, A PIG AND A CHICKEN POSITIONED AROUND THE OUTSIDE.

SER. NO. 85-644,277, FILED 6-6-2012.

ROBERT STRUCK, EXAMINING ATTORNEY



*David J. Kyffers*

Director of the United States Patent and Trademark Office

**United States of America**  
United States Patent and Trademark Office

# HELL-VILLE

**Reg. No. 4,275,681**

RANDS, TIMOTHY PAUL (SOUTH AFRICA INDIVIDUAL)  
5 HEROLD STREET

**Registered Jan. 15, 2013**

STELLENBOSCH, W. CAPE, SOUTH AFRICA

**Int. Cl.: 33**

FOR: ALCOHOLIC BEVERAGES EXCEPT BEERS, IN CLASS 33 (U.S. CLS. 47 AND 49).

**TRADEMARK**

THE MARK CONSISTS OF STANDARD CHARACTERS WITHOUT CLAIM TO ANY PARTICULAR FONT, STYLE, SIZE, OR COLOR.

**PRINCIPAL REGISTER**

OWNER OF SOUTH AFRICA REG. NO. 2008/17783, DATED 8-1-2008, EXPIRES 8-1-2018.

SER. NO. 85-644,319, FILED 6-6-2012.

BRIAN CALLAGHAN, EXAMINING ATTORNEY



*David J. Kyros*

Director of the United States Patent and Trademark Office

# United States of America

United States Patent and Trademark Office

## KELLY'S FOUR PLUS

**Reg. No. 4,275,682**

CROSSROAD LLC (DELAWARE LIMITED LIABILITY COMPANY)  
P.O. BOX 95  
NEW CANAAN, CT 06840

**Registered Jan. 15, 2013**

**Int. Cl.: 30**

FOR: GRANOLA, IN CLASS 30 (U.S. CL. 46).

**TRADEMARK**

FIRST USE 3-15-2012; IN COMMERCE 3-15-2012.

**PRINCIPAL REGISTER**

THE MARK CONSISTS OF STANDARD CHARACTERS WITHOUT CLAIM TO ANY PARTICULAR FONT, STYLE, SIZE, OR COLOR.

SER. NO. 85-644,320, FILED 6-6-2012.

BRIAN CALLAGHAN, EXAMINING ATTORNEY



*David J. Kyffers*

Director of the United States Patent and Trademark Office



# United States of America

United States Patent and Trademark Office

## READYREACH

**Reg. No. 4,275,683**

INDIANA MILLS & MANUFACTURING, INC (INDIANA CORPORATION)  
18881 U.S. 31 NORTH  
WESTFIELD, IN 46074

**Registered Jan. 15, 2013**

**Int. Cl.: 12**

FOR: VEHICLE SAFETY AND RESTRAINT SYSTEMS, NAMELY, VEHICLE SEAT BELT BUCKLES AND GUIDES IN THE NATURE OF A DEVICE FOR STEADYING OR DIRECTING THE MOTION OF A SEAT BELT FOR PASSENGER PROTECTION, IN CLASS 12 (U.S. CLS. 19, 21, 23, 31, 35 AND 44).

**TRADEMARK**

**PRINCIPAL REGISTER**

FIRST USE 2-29-2012; IN COMMERCE 2-29-2012.

THE MARK CONSISTS OF STANDARD CHARACTERS WITHOUT CLAIM TO ANY PARTICULAR FONT, STYLE, SIZE, OR COLOR.

SER. NO. 85-644,336, FILED 6-6-2012.

ANNE MADDEN, EXAMINING ATTORNEY



*David J. Kyffers*

Director of the United States Patent and Trademark Office

# United States of America

United States Patent and Trademark Office

*Love Life Freedom*

**Reg. No. 4,275,684**

SHE RECORDS (NEW JERSEY LIMITED LIABILITY COMPANY)  
33 BROOKWOOD DRIVE  
MAPLEWOOD, NJ 07040

**Registered Jan. 15, 2013**

**Int. Cl.: 9**

FOR: AUDIO RECORDINGS FEATURING MUSIC, IN CLASS 9 (U.S. CLS. 21, 23, 26, 36 AND 38).

**TRADEMARK**

FIRST USE 1-0-2010; IN COMMERCE 1-0-2010.

**PRINCIPAL REGISTER**

THE MARK CONSISTS OF THE STYLIZED TEXT "LOVE LIFE FREEDOM".

SER. NO. 85-644,386, FILED 6-6-2012.

DEBORAH LOBO, EXAMINING ATTORNEY



*David J. Kybas*

Director of the United States Patent and Trademark Office

# United States of America

United States Patent and Trademark Office

# BEXLIFE

**Reg. No. 4,275,685**

**Registered Jan. 15, 2013**

**Int. Cl.: 9**

**TRADEMARK**

**PRINCIPAL REGISTER**

BORUCKI, REBEKAH (UNITED STATES INDIVIDUAL), DBA BEXLIFE  
196 LONG SWAMP ROAD  
NEW EGYPT, NJ 08533

FOR: DIGITAL MEDIA, NAMELY, PRE-RECORDED DVDS, DOWNLOADABLE AUDIO AND VIDEO RECORDINGS, AND CDS FEATURING AND PROMOTING FITNESS, NUTRITION, ORGANIC FARMING, WORKOUTS AND YOGA; DOWNLOADABLE WEBCASTS IN THE FIELD OF YOGA, FITNESS, NUTRITION, WORKOUTS, ORGANIC FARMING; ELECTRONIC PUBLICATIONS, NAMELY, EBOOKS FEATURING YOGA, WORKOUTS, FITNESS, NUTRITION AND ORGANIC FARMING INFORMATION RECORDED ON COMPUTER MEDIA, IN CLASS 9 (U.S. CLS. 21, 23, 26, 36 AND 38).

FIRST USE 12-31-2009; IN COMMERCE 12-31-2009.

THE MARK CONSISTS OF STANDARD CHARACTERS WITHOUT CLAIM TO ANY PARTICULAR FONT, STYLE, SIZE, OR COLOR.

SER. NO. 85-644,391, FILED 6-6-2012.

JOHN KELLY, EXAMINING ATTORNEY



*David J. Kyffers*

Director of the United States Patent and Trademark Office

# United States of America

United States Patent and Trademark Office

## TALES FROM THE FAR SIDE

**Reg. No. 4,275,686**

FARWORKS, INC. (WASHINGTON CORPORATION)

**Registered Jan. 15, 2013**

4616 25TH AVE. NE #33  
SEATTLE, WA 98105

**Int. Cl.: 9**

FOR: DIGITAL MEDIA, NAMELY, PRE-RECORDED DVDS, DIGITAL VIDEO DISCS, AND DIGITAL VERSATILE DISCS FEATURING ANIMATED ENTERTAINMENT, MOTION PICTURE FILMS, ANIMATED CHARACTERS AND MUSIC, IN CLASS 9 (U.S. CLS. 21, 23, 26, 36 AND 38).

**TRADEMARK**

**PRINCIPAL REGISTER**

FIRST USE 12-18-2007; IN COMMERCE 12-18-2007.

THE MARK CONSISTS OF STANDARD CHARACTERS WITHOUT CLAIM TO ANY PARTICULAR FONT, STYLE, SIZE, OR COLOR.

OWNER OF U.S. REG. NOS. 1,292,219 AND 3,017,858.

SER. NO. 85-644,421, FILED 6-6-2012.

CIMMERIAN COLEMAN, EXAMINING ATTORNEY



*David J. Kyffers*

Director of the United States Patent and Trademark Office

# United States of America

United States Patent and Trademark Office

## FARWORKS, INC.

**Reg. No. 4,275,687**

FARWORKS, INC. (WASHINGTON CORPORATION)

**Registered Jan. 15, 2013**

4616 25TH AVENUE NE, #33  
SEATTLE, WA 98105

**Int. Cl.: 9**

FOR: DIGITAL MEDIA, NAMELY, PRE-RECORDED DVDS, DIGITAL VIDEO DISCS, AND DIGITAL VERSATILE DISCS FEATURING ANIMATED ENTERTAINMENT, MOTION PICTURE FILMS, ANIMATED CHARACTERS AND MUSIC, IN CLASS 9 (U.S. CLS. 21, 23, 26, 36 AND 38).

**TRADEMARK**

**PRINCIPAL REGISTER**

FIRST USE 12-18-2007; IN COMMERCE 12-18-2007.

THE MARK CONSISTS OF STANDARD CHARACTERS WITHOUT CLAIM TO ANY PARTICULAR FONT, STYLE, SIZE, OR COLOR.

OWNER OF U.S. REG. NOS. 2,709,082 AND 2,709,083.

NO CLAIM IS MADE TO THE EXCLUSIVE RIGHT TO USE "INC.", APART FROM THE MARK AS SHOWN.

SER. NO. 85-644,444, FILED 6-6-2012.

CIMMERIAN COLEMAN, EXAMINING ATTORNEY



*David J. Kyfos*

Director of the United States Patent and Trademark Office

# United States of America

United States Patent and Trademark Office

# CONNECTFYI

**Reg. No. 4,275,688**

RENOVO CORPORATION (FLORIDA CORPORATION)  
856 THIRD AVENUE S  
NAPLES, FL 34102

**Registered Jan. 15, 2013**

**Int. Cl.: 9**

FOR: COMPUTER SOFTWARE FOR USE IN REPORTING ACCOUNTING TRANSACTIONS,  
IN CLASS 9 (U.S. CLS. 21, 23, 26, 36 AND 38).

**TRADEMARK**

FIRST USE 5-31-2012; IN COMMERCE 5-31-2012.

**PRINCIPAL REGISTER**

THE MARK CONSISTS OF STANDARD CHARACTERS WITHOUT CLAIM TO ANY PAR-  
TICULAR FONT, STYLE, SIZE, OR COLOR.

SER. NO. 85-644,499, FILED 6-6-2012.

ALLISON SCHRODY, EXAMINING ATTORNEY



*David J. Kybas*

Director of the United States Patent and Trademark Office

# United States of America

United States Patent and Trademark Office

# TMRW

**Reg. No. 4,275,689**

**Registered Jan. 15, 2013**

**Int. Cl.: 35**

**SERVICE MARK**

**PRINCIPAL REGISTER**

ENK INTERNATIONAL, LLC (DELAWARE LIMITED LIABILITY COMPANY)  
12TH FLOOR  
3 EAST 54TH STREET  
NEW YORK, NY 10022

FOR: ARRANGING AND CONDUCTING TRADE SHOW EXHIBITIONS IN THE FIELD OF CLOTHING AND FASHION ACCESSORIES, IN CLASS 35 (U.S. CLS. 100, 101 AND 102).

FIRST USE 12-1-2009; IN COMMERCE 12-1-2009.

THE MARK CONSISTS OF STANDARD CHARACTERS WITHOUT CLAIM TO ANY PARTICULAR FONT, STYLE, SIZE, OR COLOR.

SER. NO. 85-644,544, FILED 6-6-2012.

ESTHER BELENKER, EXAMINING ATTORNEY



*David J. Kyffers*

Director of the United States Patent and Trademark Office

# United States of America

United States Patent and Trademark Office

## BUCK GROWL

**Reg. No. 4,275,690**

**Registered Jan. 15, 2013**

**Int. Cl.: 28**

**TRADEMARK**

**PRINCIPAL REGISTER**

FLAMBEAU, INC. (WISCONSIN CORPORATION)  
TRADEMARK ADMINISTRATOR  
801 LYNN AVENUE  
BARABOO, WI 53913

FOR: HUNTING GAME CALLS, IN CLASS 28 (U.S. CLS. 22, 23, 38 AND 50).

FIRST USE 10-1-2005; IN COMMERCE 10-1-2005.

THE MARK CONSISTS OF STANDARD CHARACTERS WITHOUT CLAIM TO ANY PARTICULAR FONT, STYLE, SIZE, OR COLOR.

OWNER OF U.S. REG. NO. 3,214,404.

SEC. 2(F).

SER. NO. 85-644,548, FILED 6-6-2012.

ESTHER BELENKER, EXAMINING ATTORNEY



*David J. Kybas*

Director of the United States Patent and Trademark Office



# United States of America

United States Patent and Trademark Office

## DOUBLE TAKE

**Reg. No. 4,275,691**

**Registered Jan. 15, 2013**

**Int. Cl.: 28**

**TRADEMARK**

**PRINCIPAL REGISTER**

R&R GAMES, INC. (FLORIDA CORPORATION)  
P. O BOX 130195  
TAMPA, FL 33681

FOR: BOARD GAMES, IN CLASS 28 (U.S. CLS. 22, 23, 38 AND 50).

FIRST USE 7-8-2012; IN COMMERCE 7-8-2012.

THE MARK CONSISTS OF STANDARD CHARACTERS WITHOUT CLAIM TO ANY PARTICULAR FONT, STYLE, SIZE, OR COLOR.

SER. NO. 85-644,557, FILED 6-6-2012.

RON FAIRBANKS, EXAMINING ATTORNEY



*David J. Kyfos*

Director of the United States Patent and Trademark Office

# United States of America

United States Patent and Trademark Office

# Transformus

**Reg. No. 4,275,692**

TRANSFORMUS, L.L.C. (NORTH CAROLINA LIMITED LIABILITY COMPANY)  
PO BOX 86

**Registered Jan. 15, 2013**

ROCKY POINT, NC 28457

**Int. Cl.: 41**

FOR: CONDUCTING ENTERTAINMENT EXHIBITIONS IN THE NATURE OF ART FESTIVALS, IN CLASS 41 (U.S. CLS. 100, 101 AND 107).

**SERVICE MARK**

FIRST USE 7-18-2008; IN COMMERCE 7-18-2008.

**PRINCIPAL REGISTER**

THE MARK CONSISTS OF STANDARD CHARACTERS WITHOUT CLAIM TO ANY PARTICULAR FONT, STYLE, SIZE, OR COLOR.

SER. NO. 85-644,616, FILED 6-6-2012.

ANNE MADDEN, EXAMINING ATTORNEY



*David J. Kyjars*

Director of the United States Patent and Trademark Office

# United States of America

United States Patent and Trademark Office

# GIANNONI

**Reg. No. 4,275,693**

**Registered Jan. 15, 2013**

**Int. Cl.: 11**

**TRADEMARK**

**PRINCIPAL REGISTER**

GIANNONI, SIG. ROCCO (ITALY INDIVIDUAL)  
VIA FIORI OSCURI, 3  
MILANO, ITALY 20121 AND

GIANNONI FRANCE (FRANCE SOCIÉTÉ PAR ACTIONS SIMPLIFIÉE (SAS))  
ZON DE L'AEROPOLE  
MORLAIX, FRANCE

FOR: HEATING INSTALLATIONS, NAMELY, HEATING BOILERS, HEATING ELEMENTS AND THEIR PARTS, NAMELY, GAS-WATER HEAT EXCHANGERS, STAINLESS STEEL PLATE HEAT EXCHANGERS AND THREE WAY VALVES, IN CLASS 11 (U.S. CLS. 13, 21, 23, 31 AND 34).

FIRST USE 1-31-2003; IN COMMERCE 1-31-2003.

THE MARK CONSISTS OF STANDARD CHARACTERS WITHOUT CLAIM TO ANY PARTICULAR FONT, STYLE, SIZE, OR COLOR.

SEC. 2(F).

SER. NO. 85-644,650, FILED 6-6-2012.

HEATHER THOMPSON, EXAMINING ATTORNEY



*David J. Kyros*

Director of the United States Patent and Trademark Office

# United States of America

United States Patent and Trademark Office

## BAL-MUKUND

**Reg. No. 4,275,694**

JAGADGURU KRIPALUJI YOG (TEXAS CORPORATION)  
7405 STONEY POINT DRIVE  
PLANO, TX 75025

**Registered Jan. 15, 2013**

**Int. Cls.: 41 and 45**

FOR: RELIGIOUS INSTRUCTION SERVICES, IN CLASS 41 (U.S. CLS. 100, 101 AND 107).

**SERVICE MARK**

FIRST USE 11-30-2009; IN COMMERCE 11-30-2009.

**PRINCIPAL REGISTER**

FOR: RELIGIOUS AND SPIRITUAL SERVICES, NAMELY, PROVIDING GATHERINGS AND RETREATS TO DEVELOP AND ENHANCE THE SPIRITUAL LIVES OF INDIVIDUALS, IN CLASS 45 (U.S. CLS. 100 AND 101).

FIRST USE 11-30-2009; IN COMMERCE 11-30-2009.

THE MARK CONSISTS OF STANDARD CHARACTERS WITHOUT CLAIM TO ANY PARTICULAR FONT, STYLE, SIZE, OR COLOR.

THE ENGLISH TRANSLATION OF BAL-MUKUND IN THE MARK IS CHILD-GOD.

SER. NO. 85-644,652, FILED 6-6-2012.

STEPHANIE ALI, EXAMINING ATTORNEY



*David J. Kyros*

Director of the United States Patent and Trademark Office

# United States of America

United States Patent and Trademark Office

# Nativehire

**Reg. No. 4,275,695**

**Registered Jan. 15, 2013**

**Int. Cl.: 35**

SOUTHERN CALIFORNIA TRIBAL CHAIRMEN'S ASSOCIATION (CALIFORNIA CORPORATION)

36146 PALA TEMECULA ROAD, PALA, CA

36146 PALA TEMECULA ROAD, PALA, CA

PALA, CA 92059

**SERVICE MARK**

**PRINCIPAL REGISTER**

FOR: PROVIDING AN ON-LINE SEARCHABLE DATABASE FEATURING EMPLOYMENT OPPORTUNITIES; PROVIDING EMPLOYMENT INFORMATION; PROVIDING ONLINE DATABASES FEATURING INFORMATION RELATING TO EMPLOYERS AND EMPLOYEES AND PLACES OF EMPLOYMENT, IN CLASS 35 (U.S. CLS. 100, 101 AND 102).

FIRST USE 4-5-2012; IN COMMERCE 4-5-2012.

THE MARK CONSISTS OF STANDARD CHARACTERS WITHOUT CLAIM TO ANY PARTICULAR FONT, STYLE, SIZE, OR COLOR.

SER. NO. 85-644,663, FILED 6-6-2012.

SKYE YOUNG, EXAMINING ATTORNEY



*David J. Kyffers*

Director of the United States Patent and Trademark Office

# United States of America

United States Patent and Trademark Office

## MILLIONAIRE'S ROW CRUISE

**Reg. No. 4,275,696**

**Registered Jan. 15, 2013**

**Int. Cl.: 39**

**SERVICE MARK**

**PRINCIPAL REGISTER**

SIGHTSEEING TOURS MANAGEMENT, INC. (FLORIDA CORPORATION)  
555 NE 15TH STREET, SUITE 102  
MIAMI, FL 33132

FOR: CONDUCTING SIGHTSEEING TOURS BY BOAT; ORGANIZATION, BOOKING AND ARRANGEMENT OF EXCURSIONS, DAY TRIPS AND SIGHTSEEING TOURS; YACHT AND BOAT CHARTER SERVICES; YACHT CHARTERING, IN CLASS 39 (U.S. CLS. 100 AND 105).

FIRST USE 12-31-1960; IN COMMERCE 12-31-1960.

THE MARK CONSISTS OF STANDARD CHARACTERS WITHOUT CLAIM TO ANY PARTICULAR FONT, STYLE, SIZE, OR COLOR.

NO CLAIM IS MADE TO THE EXCLUSIVE RIGHT TO USE "CRUISE", APART FROM THE MARK AS SHOWN.

SER. NO. 85-644,716, FILED 6-6-2012.

PRISCILLA MILTON, EXAMINING ATTORNEY



*David J. Kybas*

Director of the United States Patent and Trademark Office

# United States of America

United States Patent and Trademark Office



**Reg. No. 4,275,697**

KELLY SMITH (UNITED STATES INDIVIDUAL)  
6122 KATELLA AVE  
CYPRESS, CA 90630

**Registered Jan. 15, 2013**

**Int. Cl.: 9**

FOR: MULTIMEDIA PROJECTORS, IN CLASS 9 (U.S. CLS. 21, 23, 26, 36 AND 38).

**TRADEMARK**

FIRST USE 6-6-2012; IN COMMERCE 6-6-2012.

**PRINCIPAL REGISTER**

THE MARK CONSISTS OF FOUR BEAMS OF LIGHT WITH THE WORD VOLARE NEXT TO IT.

THE ENGLISH TRANSLATION OF "VOLARE" IN THE MARK IS "TO FLY".

SER. NO. 85-644,721, FILED 6-6-2012.

NORA BUCHANAN WILL, EXAMINING ATTORNEY



*David J. Kyffers*

Director of the United States Patent and Trademark Office

# United States of America

United States Patent and Trademark Office

## GROUCHY'S COFFEE

**Reg. No. 4,275,698**

DAVID A FULLERTON (UNITED STATES INDIVIDUAL)  
843 HOPE STREET, #3  
PROVIDENCE, RI 02906

**Registered Jan. 15, 2013**

**Int. Cl.: 30**

FOR: COFFEE; COFFEE BEANS; GROUND COFFEE BEANS; ROASTED COFFEE BEANS,  
IN CLASS 30 (U.S. CL. 46).

**TRADEMARK**

FIRST USE 5-29-2012; IN COMMERCE 5-29-2012.

**PRINCIPAL REGISTER**

THE MARK CONSISTS OF STANDARD CHARACTERS WITHOUT CLAIM TO ANY PAR-  
TICULAR FONT, STYLE, SIZE, OR COLOR.

NO CLAIM IS MADE TO THE EXCLUSIVE RIGHT TO USE "COFFEE", APART FROM THE  
MARK AS SHOWN.

SER. NO. 85-644,724, FILED 6-6-2012.

NORA BUCHANAN WILL, EXAMINING ATTORNEY



*David J. Kybas*

Director of the United States Patent and Trademark Office



United States of America  
United States Patent and Trademark Office

RESMAN

**Reg. No. 4,275,699**

RESMAN AS (NORWAY CORPORATION)  
363 N. SAM HOUSTON PARKWAY E. SUITE 1100  
HOUSTON, TX 77060

**Registered Jan. 15, 2013**

**Int. Cl.: 42**

FOR: OIL PROSPECTING; OIL PROSPECTING, NAMELY, WELL LOGGING AND TESTING;  
OIL-FIELD SURVEYS, IN CLASS 42 (U.S. CLS. 100 AND 101).

**SERVICE MARK**

FIRST USE 8-0-2005; IN COMMERCE 8-0-2005.

**PRINCIPAL REGISTER**

THE MARK CONSISTS OF THE WORD "RESMAN" IN A STYLIZED FONT. THE LETTER "A" IN THE WORD "RESMAN" CONTAINS A DOT IN THE CENTER AND THE CROSSING LINE NORMALLY SEEN IN THE LETTER IS DISPLAYED AT THE BOTTOM OF THE DIAGONAL LINES FORMING THE LETTER. THE HORIZONTAL LINE DOES NOT CONNECT WITH THE DIAGONAL LINES.

SER. NO. 85-644,734, FILED 6-6-2012.

STEPHANIE ALI, EXAMINING ATTORNEY



*David J. Kyffers*

Director of the United States Patent and Trademark Office

# United States of America

United States Patent and Trademark Office

# RESMAN

WIRELESS RESERVOIR SURVEILLANCE

**Reg. No. 4,275,700**

RESMAN AS (NORWAY CORPORATION)  
363 N. SAM HOUSTON PARKWAY E. SUITE 1100  
HOUSTON, TX 77060

**Registered Jan. 15, 2013**

**Int. Cl.: 42**

FOR: OIL PROSPECTING; OIL PROSPECTING, NAMELY, WELL LOGGING AND TESTING;  
OIL-FIELD SURVEYS, IN CLASS 42 (U.S. CLS. 100 AND 101).

**SERVICE MARK**

FIRST USE 10-0-2011; IN COMMERCE 10-0-2011.

**PRINCIPAL REGISTER**

NO CLAIM IS MADE TO THE EXCLUSIVE RIGHT TO USE "WIRELESS RESERVOIR SURVEILLANCE", APART FROM THE MARK AS SHOWN.

THE MARK CONSISTS OF THE WORDS "RESMAN WIRELESS RESERVOIR SURVEILLANCE" IN A STYLIZED FONT. THE LETTER "A" IN THE WORD "RESMAN" CONTAINS A DOT IN THE CENTER AND THE CROSSING LINE NORMALLY SEEN IN THE LETTER "A" IS DISPLAYED AT THE BOTTOM OF THE DIAGONAL LINES FORMING THE LETTER. THE HORIZONTAL LINE DOES NOT CONNECT WITH THE DIAGONAL LINES. BELOW THE WORD "RESMAN" ARE THE WORDS "WIRELESS RESERVOIR SURVEILLANCE".

SER. NO. 85-644,772, FILED 6-6-2012.

STEPHANIE ALI, EXAMINING ATTORNEY



*David J. Kyros*

Director of the United States Patent and Trademark Office

# United States of America

United States Patent and Trademark Office

# Findsider

**Reg. No. 4,275,701**

FINDSIDER (NEW YORK LIMITED LIABILITY COMPANY)  
1500 BROADWAY, SUITE 1900  
NEW YORK, NY 10036

**Registered Jan. 15, 2013**

**Int. Cl.: 36**

FOR: PROVIDING INFORMATION IN THE FIELD OF REAL ESTATE VIA THE INTERNET;  
REAL ESTATE ACQUISITION SERVICES; REAL ESTATE BROKERAGE; REAL ESTATE  
CONSULTANCY, IN CLASS 36 (U.S. CLS. 100, 101 AND 102).

**SERVICE MARK**

FIRST USE 5-1-2012; IN COMMERCE 5-1-2012.

**PRINCIPAL REGISTER**

THE MARK CONSISTS OF STANDARD CHARACTERS WITHOUT CLAIM TO ANY PAR-  
TICULAR FONT, STYLE, SIZE, OR COLOR.

SER. NO. 85-644,848, FILED 6-6-2012.

LEIGH LOWRY, EXAMINING ATTORNEY



*David J. Kybas*

Director of the United States Patent and Trademark Office

# United States of America

United States Patent and Trademark Office

## Fifth Row Center

**Reg. No. 4,275,702**

FIFTH ROW CENTER, INCORPORATED (GEORGIA CORPORATION)  
5509 MAIN ST.

**Registered Jan. 15, 2013**

FLOWERY BRANCH, GA 30542

**Int. Cl.: 41**

FOR: ENTERTAINMENT IN THE NATURE OF THEATER PRODUCTIONS ; PROVIDING THEATER ARTS STUDIO SERVICES ; ENTERTAINMENT IN THE NATURE OF A THEATER CAMP, IN CLASS 41 (U.S. CLS. 100, 101 AND 107).

**SERVICE MARK**

FIRST USE 1-0-2008; IN COMMERCE 1-0-2008.

**PRINCIPAL REGISTER**

THE MARK CONSISTS OF STANDARD CHARACTERS WITHOUT CLAIM TO ANY PARTICULAR FONT, STYLE, SIZE, OR COLOR.

SER. NO. 85-644,869, FILED 6-6-2012.

RUSS HERMAN, EXAMINING ATTORNEY



*David J. Kyros*

Director of the United States Patent and Trademark Office

# United States of America

United States Patent and Trademark Office

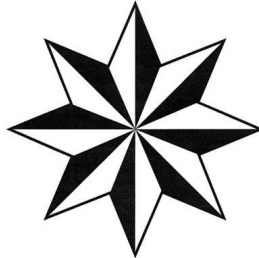

**Reg. No. 4,275,703**

THADDEUS APPAREL GROUP, INC. (NEW YORK CORPORATION)  
255 W. 23RD STREET #2BW  
NEW YORK, NY 10011

**Registered Jan. 15, 2013**

**Int. Cl.: 25**

FOR: CLOTHING, NAMELY, SHIRTS, SWEATERS, PANTS, SHORTS, JACKETS, OVERCOATS, SUITS, SPORTS COATS, VESTS, SCARVES AND BATHING SUITS, IN CLASS 25 (U.S. CLS. 22 AND 39).

**TRADEMARK**

FIRST USE 1-17-2011; IN COMMERCE 1-17-2011.

**PRINCIPAL REGISTER**

THE MARK CONSISTS OF EIGHT POINT STAR DESIGN.

SER. NO. 85-644,872, FILED 6-6-2012.

APRIL HESIK, EXAMINING ATTORNEY



*David J. Kyffers*

Director of the United States Patent and Trademark Office

# United States of America

United States Patent and Trademark Office

## DESTINATION SUN

**Reg. No. 4,275,704**

**Registered Jan. 15, 2013**

**Int. Cls.: 18 and 25**

**TRADEMARK**

**PRINCIPAL REGISTER**

DISCOUNT SOUVENIRS, LLC. (FLORIDA LIMITED LIABILITY COMPANY)  
3300 NW 112 AVE., UNIT 13  
DORAL, FL 33172

FOR: ALL-PURPOSE REUSABLE CARRYING BAGS; BACKPACKS, BOOK BAGS, SPORTS BAGS, BUM BAGS, WALLETS AND HANDBAGS; BARREL BAGS; BEACH BAGS; BOOK BAGS; CANVAS SHOPPING BAGS; EVENING BAGS; HOBO BAGS; KNITTED BAGS, NOT OF PRECIOUS METALS; LEATHER BAGS AND WALLETS; MESH SHOPPING BAGS; MESSENGER BAGS; REUSABLE TEXTILE PRODUCE BAGS TO CARRY PRODUCE FROM GROCERY STORES AND FARMER'S MARKETS; SACK PACKS, NAMELY, DRAWSTRING BAGS USED AS BACKPACKS; SCHOOL BAGS; SHOULDER BAGS; SLING BAGS; SOUVENIR BAGS; STRING BAGS FOR SHOPPING; TEXTILE SHOPPING BAGS; TOTE BAGS, IN CLASS 18 (U.S. CLS. 1, 2, 3, 22 AND 41).

FIRST USE 5-1-2012; IN COMMERCE 5-1-2012.

FOR: APRONS; ATHLETIC APPAREL, NAMELY, SHIRTS, PANTS, JACKETS, FOOTWEAR, HATS AND CAPS, ATHLETIC UNIFORMS; BASEBALL CAPS AND HATS; BOTTOMS; BUCKET CAPS; BUTTON DOWN SHIRTS; BUTTON-FRONT ALOHA SHIRTS; CAMP SHIRTS; CAPS; CAPS WITH VISORS; CHILDREN'S AND INFANTS' CLOTH BIBS; COLLARED SHIRTS; DRESS SHIRTS; DRESSES; DRESSES THAT MAY ALSO BE USED AS TOWELS; GOLF PANTS, SHIRTS AND SKIRTS; HATS; HEADGEAR, NAMELY, HATS, CAPS; HOODED SWEATSHIRTS; JUMPER DRESSES; KNIT DRESSES; KNIT SHIRTS; KNITTED CAPS; LONG-SLEEVED SHIRTS; OPEN-NECKED SHIRTS; PIQUE SHIRTS; POLO SHIRTS; SARONGS; SHIRTS; SHIRTS FOR INFANTS, BABIES, TODDLERS AND CHILDREN; SHORT-SLEEVED OR LONG-SLEEVED T-SHIRTS; SKIRTS AND DRESSES; SLEEP SHIRTS; SPORTS CAPS AND HATS; SPORTS SHIRTS; SWEAT SHIRTS; SWEATSHIRTS; T-SHIRTS; TEE SHIRTS; WEARABLE GARMENTS AND CLOTHING, NAMELY, SHIRTS; WOMEN'S CLOTHING, NAMELY, SHIRTS, DRESSES, SKIRTS, BLOUSES; WOMEN'S HATS AND HOODS; WOVEN DRESSES, IN CLASS 25 (U.S. CLS. 22 AND 39).

FIRST USE 5-1-2012; IN COMMERCE 5-1-2012.

THE MARK CONSISTS OF STANDARD CHARACTERS WITHOUT CLAIM TO ANY PARTICULAR FONT, STYLE, SIZE, OR COLOR.

SER. NO. 85-644,981, FILED 6-6-2012.



*David J. Kappas*

Director of the United States Patent and Trademark Office

**Reg. No. 4,275,704** JULIE GUTTADAURO, EXAMINING ATTORNEY

# United States of America

United States Patent and Trademark Office

# SLIP KEY

**Reg. No. 4,275,705**

**Registered Jan. 15, 2013**

**Int. Cl.: 19**

**TRADEMARK**

**PRINCIPAL REGISTER**

CLEARLAKE LAVA, INC. (CALIFORNIA CORPORATION)  
C/O THE LAW OFFICE OF KEVIN M. WELCH  
P.O. BOX 494  
HERMOSA BEACH, CA 90254

FOR: MODULAR CONCRETE BLOCKS FOR LANDSCAPING AND FABRICATING GARDEN AND PLANTER BOXES, IN CLASS 19 (U.S. CLS. 1, 12, 33 AND 50).

FIRST USE 5-23-2012; IN COMMERCE 5-23-2012.

THE MARK CONSISTS OF STANDARD CHARACTERS WITHOUT CLAIM TO ANY PARTICULAR FONT, STYLE, SIZE, OR COLOR.

SER. NO. 85-645,031, FILED 6-6-2012.

ZACHARY BELLO, EXAMINING ATTORNEY



*David J. Kybas*

Director of the United States Patent and Trademark Office



# United States of America

United States Patent and Trademark Office

# LAZY STAR

**Reg. No. 4,275,706**

**Registered Jan. 15, 2013**

**Int. Cl.: 25**

**TRADEMARK**

**PRINCIPAL REGISTER**

MILLERSTONICHCREATIVEGROUP (NEVADA LIMITED LIABILITY COMPANY)  
4800 AZUCENA RD.  
WOODLAND HILLS, CA 91364

FOR: BIKINIS; JACKETS; LEATHER JACKETS; ROBES; SWEAT PANTS; SWEAT SHIRTS;  
SWIM TRUNKS; T-SHIRTS; TANK TOPS; WALKING SHORTS, IN CLASS 25 (U.S. CLS. 22  
AND 39).

FIRST USE 1-15-2012; IN COMMERCE 1-15-2012.

THE MARK CONSISTS OF STANDARD CHARACTERS WITHOUT CLAIM TO ANY PAR-  
TICULAR FONT, STYLE, SIZE, OR COLOR.

SER. NO. 85-645,041, FILED 6-6-2012.

SANDRA BUJA, EXAMINING ATTORNEY



*David J. Kyffers*

Director of the United States Patent and Trademark Office

# United States of America

United States Patent and Trademark Office



**Reg. No. 4,275,707**

**Registered Jan. 15, 2013**

**Int. Cl.: 35**

**SERVICE MARK**

**PRINCIPAL REGISTER**

NORED, INC. (NORTH DAKOTA CORPORATION), DBA GOOSENECK IMPLEMENT  
HWY 2 BYPASS EAST  
MINOT, ND 587020910

FOR: RETAIL STORE SERVICES FEATURING AGRICULTURAL MACHINERY AND EQUIPMENT AND RESIDENTIAL AND COMMERCIAL LAWN AND TURF CARE EQUIPMENT, IN CLASS 35 (U.S. CLS. 100, 101 AND 102).

FIRST USE 4-30-2002; IN COMMERCE 4-30-2002.

THE MARK CONSISTS OF AN IMAGE OF A GOOSE IN FLIGHT FROM LEFT TO RIGHT WITH WINGS OUTSTRETCHED.

SER. NO. 85-645,056, FILED 6-6-2012.

JEFFREY LOOK, EXAMINING ATTORNEY



*David J. Kybas*

Director of the United States Patent and Trademark Office

# United States of America

United States Patent and Trademark Office

# NUTRILYTICS

**Reg. No. 4,275,708**

**Registered Jan. 15, 2013**

**Int. Cl.: 44**

**SERVICE MARK**

**PRINCIPAL REGISTER**

MELISSA LUKON (UNITED STATES INDIVIDUAL)  
#1336  
4200 BRIDGEVIEW DRIVE  
FORT WORTH, TX 76109

FOR: NUTRITION COUNSELING; PROVIDING A WEBSITE FEATURING INFORMATION ABOUT HEALTH, WELLNESS AND NUTRITION; PROVIDING HEALTHY LIFESTYLE AND NUTRITION SERVICES, NAMELY, PERSONAL ASSESSMENTS, PERSONALIZED ROUTINES, MAINTENANCE SCHEDULES, AND COUNSELING, IN CLASS 44 (U.S. CLS. 100 AND 101).

FIRST USE 11-1-2011; IN COMMERCE 11-1-2011.

THE MARK CONSISTS OF STANDARD CHARACTERS WITHOUT CLAIM TO ANY PARTICULAR FONT, STYLE, SIZE, OR COLOR.

SER. NO. 85-645,077, FILED 6-6-2012.

EDWARD FENNESSY, EXAMINING ATTORNEY



*David J. Kyffers*

Director of the United States Patent and Trademark Office

# United States of America

United States Patent and Trademark Office

# QuRT

**Reg. No. 4,275,709**

QUALCOMM INCORPORATED (DELAWARE CORPORATION)  
5775 MOREHOUSE DRIVE  
SAN DIEGO, CA 921211714

**Registered Jan. 15, 2013**

**Int. Cl.: 9**

FOR: COMPUTER SOFTWARE AND FIRMWARE FOR OPERATING SYSTEM PROGRAMS,  
IN CLASS 9 (U.S. CLS. 21, 23, 26, 36 AND 38).

**TRADEMARK**

FIRST USE 6-17-2011; IN COMMERCE 6-17-2011.

**PRINCIPAL REGISTER**

THE MARK CONSISTS OF STANDARD CHARACTERS WITHOUT CLAIM TO ANY PAR-  
TICULAR FONT, STYLE, SIZE, OR COLOR.

SER. NO. 85-645,081, FILED 6-6-2012.

DORITT L. CARROLL, EXAMINING ATTORNEY



*David J. Kyffers*

Director of the United States Patent and Trademark Office

# United States of America

United States Patent and Trademark Office

## WORLD WISER COMMITTEE

**Reg. No. 4,275,710**

WORLD WISER COMMITTEE (CALIFORNIA CORPORATION)  
707 WEST VALLEY BLVD.  
ALHAMBRA, CA 91803

**Registered Jan. 15, 2013**

**Int. Cl.: 41**

FOR: ENTERTAINMENT SERVICES, NAMELY, ORGANIZING AND CONDUCTING ATHLETIC EVENTS FOR NONPROFIT PURPOSES, IN CLASS 41 (U.S. CLS. 100, 101 AND 107).

**SERVICE MARK**

FIRST USE 5-24-2012; IN COMMERCE 5-24-2012.

**PRINCIPAL REGISTER**

THE MARK CONSISTS OF STANDARD CHARACTERS WITHOUT CLAIM TO ANY PARTICULAR FONT, STYLE, SIZE, OR COLOR.

NO CLAIM IS MADE TO THE EXCLUSIVE RIGHT TO USE "WORLD" AND "COMMITTEE", APART FROM THE MARK AS SHOWN.

SER. NO. 85-645,124, FILED 6-6-2012.

DEZMONA MIZELLE, EXAMINING ATTORNEY



*David J. Kyffers*

Director of the United States Patent and Trademark Office

United States of America  
United States Patent and Trademark Office

M&M  
Thread Salon

**Reg. No. 4,275,711**

**Registered Jan. 15, 2013**

**Int. Cl.: 44**

**SERVICE MARK**

**PRINCIPAL REGISTER**

ANIL PANDEY (UNITED STATES INDIVIDUAL), DBA M&M THREAD SALON  
UNIT E  
2106 OTIS DRIVE  
ALAMEDA, CA 94501

FOR: COSMETIC SERVICES, NAMELY, NON-PERMANENT HAIR REMOVAL; PERSONAL HAIR REMOVAL SERVICES, IN CLASS 44 (U.S. CLS. 100 AND 101).

FIRST USE 2-0-2007; IN COMMERCE 2-0-2007.

NO CLAIM IS MADE TO THE EXCLUSIVE RIGHT TO USE "THREAD SALON", APART FROM THE MARK AS SHOWN.

THE MARK CONSISTS OF THE STYLIZED CHARACTERS "M&M" ABOVE THE WORDS "THREAD SALON" IN STYLIZED FONT.

SER. NO. 85-645,132, FILED 6-6-2012.

CHERYL CLAYTON, EXAMINING ATTORNEY



David J. Kyffers

Director of the United States Patent and Trademark Office

# United States of America

United States Patent and Trademark Office

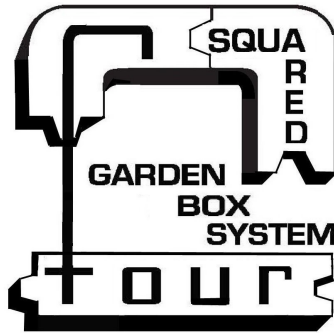

**Reg. No. 4,275,712**

**Registered Jan. 15, 2013**

**Int. Cl.: 19**

**TRADEMARK**

**PRINCIPAL REGISTER**

CLEARLAKE LAVA, INC. (CALIFORNIA CORPORATION)  
P.O. BOX 494  
C/O THE LAW OFFICE OF KEVIN M. WELCH  
HERMOSA BEACH, CA 90254

FOR: MODULAR CONCRETE BLOCKS FOR LANDSCAPING AND FABRICATING GARDEN AND PLANTER BOXES, IN CLASS 19 (U.S. CLS. 1, 12, 33 AND 50).

FIRST USE 5-23-2012; IN COMMERCE 5-23-2012.

NO CLAIM IS MADE TO THE EXCLUSIVE RIGHT TO USE "FOUR SQUARED GARDEN BOX SYSTEM", APART FROM THE MARK AS SHOWN.

THE MARK COMPRISES A TOP PERSPECTIVE VIEW OF TWO ADJOINED CORNER GARDEN BOX BLOCKS SITUATED ABOVE ONE HORIZONTALLY SITUATED STRAIGHT GARDEN BOX BLOCK. THE WORD "SQUARED" APPEARS WITHING THE RIGHT MOST OF THE TWO CORNER GARDEN BOX BLOCKS AND THE WORD "FOUR" APPEARS WITHING THE STRAIGHT GARDEN BOX BLOCK EXCEPT FOR THE LETTER "F" WHICH EXTENDS FROM THE STRAIGHT GARDEN BOX BLOCK TO THE LEFT MOST OF THE TWO CORNER GARDEN BOX BLOCKS. THE WORDS "GARDEN BOX SYSTEM" APPEARS BETWEEN THE THE TWO CORNER GARDEN BOX BLOCKS AND THE STRAIGHT GARDEN BOX BLOCK.

SER. NO. 85-645,133, FILED 6-6-2012.

ZACHARY BELLO, EXAMINING ATTORNEY



*David J. Kyffers*

Director of the United States Patent and Trademark Office

# United States of America

United States Patent and Trademark Office

## ULTRA PLAN

**Reg. No. 4,275,713**

**Registered Jan. 15, 2013**

**Int. Cls.: 5 and 29**

**TRADEMARK**

**PRINCIPAL REGISTER**

HI-HEALTH SUPERMART CORPORATION (ARIZONA CORPORATION)  
7428 E. KAREN DRIVE  
SCOTTSDALE, AZ 85260

FOR: NUTRITIONAL AND DIETARY SUPPLEMENTS FORMED AND PACKAGED AS BARS; NUTRITIONAL SUPPLEMENT IN THE NATURE OF A NUTRIENT-DENSE, PROTEIN-BASED DRINK MIX; NUTRITIONAL SUPPLEMENTS; NUTRITIONAL SUPPLEMENTS IN THE FORM OF CAPSULES, TABLETS, GELS, LIQUIDS, DROPS, POWDERS, GRANULES, OILS, WAFERS AND LOZENGES; POWDERED NUTRITIONAL SUPPLEMENT DRINK MIX; PROTEIN DIETARY SUPPLEMENTS; PROTEIN SUPPLEMENT SHAKES; VITAMIN AND MINERAL SUPPLEMENTS; VITAMIN SUPPLEMENTS; WHEY PROTEIN SUPPLEMENTS, IN CLASS 5 (U.S. CLS. 6, 18, 44, 46, 51 AND 52).

FIRST USE 4-1-1980; IN COMMERCE 4-1-1980.

FOR: SOY-BASED FOOD BARS; SOY-BASED FOOD BARS ALSO CONTAINING WHEY PROTEIN, IN CLASS 29 (U.S. CL. 46).

FIRST USE 1-31-2001; IN COMMERCE 1-31-2001.

THE MARK CONSISTS OF STANDARD CHARACTERS WITHOUT CLAIM TO ANY PARTICULAR FONT, STYLE, SIZE, OR COLOR.

OWNER OF U.S. REG. NO. 1,211,213.

SER. NO. 85-645,179, FILED 6-6-2012.

BRIAN CALLAGHAN, EXAMINING ATTORNEY



*David J. Kyros*

Director of the United States Patent and Trademark Office



# United States of America

United States Patent and Trademark Office

# OPTIM

**Reg. No. 4,275,714**

**Registered Jan. 15, 2013**

**Int. Cl.: 5**

**TRADEMARK**

**PRINCIPAL REGISTER**

HI-HEALTH SUPERMART CORPORATION (ARIZONA CORPORATION)  
7428 E. KAREN DRIVE  
SCOTTSDALE, AZ 85260

FOR: DIETARY AND NUTRITIONAL SUPPLEMENTS; LIQUID NUTRITIONAL SUPPLEMENT; NUTRITIONAL SUPPLEMENT IN THE NATURE OF A NUTRIENT-DENSE, PROTEIN-BASED DRINK MIX; NUTRITIONAL SUPPLEMENTS IN THE FORM OF TABLETS, CAPSULES, POWDERS AND LIQUIDS, IN CLASS 5 (U.S. CLS. 6, 18, 44, 46, 51 AND 52).

FIRST USE 1-1-1990; IN COMMERCE 1-1-1990.

THE MARK CONSISTS OF STANDARD CHARACTERS WITHOUT CLAIM TO ANY PARTICULAR FONT, STYLE, SIZE, OR COLOR.

OWNER OF U.S. REG. NO. 3,005,732.

SER. NO. 85-645,255, FILED 6-6-2012.

BRIAN CALLAGHAN, EXAMINING ATTORNEY



*David J. Kyffers*

Director of the United States Patent and Trademark Office

# United States of America

United States Patent and Trademark Office

# HIPPOSTICK

**Reg. No. 4,275,715**

GREG JENSEN (UNITED STATES INDIVIDUAL), DBA HIPPOSTICK  
P.O. BOX 7235

**Registered Jan. 15, 2013**

CAPISTRANO BEACH, CA 92624 AND

**Int. Cl.: 12**

DANNY CHING (UNITED STATES INDIVIDUAL), DBA HIPPOSTICK

P.O. BOX 7235

CAPISTRANO BEACH, CA 92624

**TRADEMARK**

FOR: CANOE PADDLES; KAYAK PADDLES; OUTRIGGER PADDLES, IN CLASS 12 (U.S. CLS. 19, 21, 23, 31, 35 AND 44).

**PRINCIPAL REGISTER**

FIRST USE 2-1-2012; IN COMMERCE 2-1-2012.

THE MARK CONSISTS OF STANDARD CHARACTERS WITHOUT CLAIM TO ANY PARTICULAR FONT, STYLE, SIZE, OR COLOR.

SER. NO. 85-645,295, FILED 6-6-2012.

HEATHER THOMPSON, EXAMINING ATTORNEY



*David J. Kyros*

Director of the United States Patent and Trademark Office

# United States of America

United States Patent and Trademark Office



**Reg. No. 4,275,716**

**Registered Jan. 15, 2013**

**Int. Cl.: 25**

**TRADEMARK**

**PRINCIPAL REGISTER**

IROK EVENTS, LLC (NEVADA LIMITED LIABILITY COMPANY)  
10624 S. EASTERN AVE, #A-566  
HENDERSON, NV 89052

FOR: HOODS; JACKETS; JERSEYS; LEATHER BELTS; SHORT SETS; TOPS; WEARABLE GARMENTS AND CLOTHING, NAMELY, SHIRTS; WOMEN'S CLOTHING, NAMELY, SHIRTS, DRESSES, SKIRTS, BLOUSES, IN CLASS 25 (U.S. CLS. 22 AND 39).

FIRST USE 6-1-2005; IN COMMERCE 6-1-2005.

THE MARK CONSISTS OF A LOWER CASE LETTER "I" CONNECTED TO THE CAPITAL LETTER "R" FOLLOWED BY CAPITAL LETTER "O" CONNECTED TO CAPITAL LETTER "K".

SER. NO. 85-645,296, FILED 6-6-2012.

HEATHER THOMPSON, EXAMINING ATTORNEY



*David J. Kybas*

Director of the United States Patent and Trademark Office

# United States of America

United States Patent and Trademark Office

# BENCHMARK

**Reg. No. 4,275,717**

HODGDON POWDER COMPANY, INC. (KANSAS CORPORATION)  
6430 VISTA DR  
SHAWNEE, KS 66218

**Registered Jan. 15, 2013**

**Int. Cl.: 13**

FOR: GUNPOWDER, IN CLASS 13 (U.S. CLS. 2 AND 9).

**TRADEMARK**

FIRST USE 1-31-2000; IN COMMERCE 1-31-2000.

**PRINCIPAL REGISTER**

THE MARK CONSISTS OF STANDARD CHARACTERS WITHOUT CLAIM TO ANY PARTICULAR FONT, STYLE, SIZE, OR COLOR.

SER. NO. 85-645,316, FILED 6-6-2012.

ARETHA SOMERVILLE, EXAMINING ATTORNEY



*David J. Kyffers*

Director of the United States Patent and Trademark Office

# United States of America

United States Patent and Trademark Office

## WHERE YOUR STUFF BELONGS

**Reg. No. 4,275,718**

**Registered Jan. 15, 2013**

**Int. Cl.: 42**

**SERVICE MARK**

**PRINCIPAL REGISTER**

PERFECTCOLLECTOR INC. (DELAWARE CORPORATION)  
300 NORTH LASALLE STREET, SUITE 4925  
CHICAGO, IL 60654

FOR: HOSTING AN ON-LINE COMMUNITY WEB SITE FEATURING SHARED COMMUNICATIONS BETWEEN COMMUNITY MEMBERS INTERESTED IN IDENTIFYING, AUTHENTICATING, VALUING, AUCTIONING, BUYING, SELLING, EXCHANGING, DONATING, DEVISING, MAINTAINING, DISPLAYING AND MANAGING TANGIBLE PERSONAL PROPERTY; PROVIDING A WEB SITE FEATURING TECHNOLOGY THAT ENABLES USERS TO STORE, MANAGE, EXCHANGE AND DISPLAY INFORMATION, IMAGES AND OTHER ELECTRONIC DATA CONCERNING TANGIBLE PERSONAL PROPERTY, PARTICULARLY INFORMATION FOR IDENTIFYING, AUTHENTICATING, VALUING, AUCTIONING, BUYING, SELLING, EXCHANGING, DONATING, DEVISING, MAINTAINING, DISPLAYING AND MANAGING TANGIBLE PERSONAL PROPERTY , IN CLASS 42 (U.S. CLS. 100 AND 101).

FIRST USE 4-26-2012; IN COMMERCE 4-26-2012.

THE MARK CONSISTS OF STANDARD CHARACTERS WITHOUT CLAIM TO ANY PARTICULAR FONT, STYLE, SIZE, OR COLOR.

SER. NO. 85-645,325, FILED 6-6-2012.

STEPHANIE ALI, EXAMINING ATTORNEY



*David J. Kyjars*

Director of the United States Patent and Trademark Office

# United States of America

United States Patent and Trademark Office

## IN A HURRY

**Reg. No. 4,275,719**

**Registered Jan. 15, 2013**

**Int. Cl.: 3**

**TRADEMARK**

**PRINCIPAL REGISTER**

MAURICE RASGON, INC. (CALIFORNIA CORPORATION), DBA COSMETIC DESIGN  
GROUP  
5673 SELMARAIN DR.  
CULVER CITY, CA 90230

FOR: NAIL POLISH TOP COAT; NAIL VARNISHES, IN CLASS 3 (U.S. CLS. 1, 4, 6, 50, 51  
AND 52).

FIRST USE 11-0-2005; IN COMMERCE 11-0-2005.

THE MARK CONSISTS OF STANDARD CHARACTERS WITHOUT CLAIM TO ANY PAR-  
TICULAR FONT, STYLE, SIZE, OR COLOR.

SER. NO. 85-645,331, FILED 6-6-2012.

ALEXANDER L. POWERS, EXAMINING ATTORNEY



*David J. Kyffers*

Director of the United States Patent and Trademark Office

# United States of America

United States Patent and Trademark Office

If you're not wearing  
it.....Sell it!

**Reg. No. 4,275,720**

D.L. SIVAS & CO. (CALIFORNIA CORPORATION)  
6775 N. BLACKSTONE AVENUE, SUITE 101  
FRESNO, CA 93710

**Registered Jan. 15, 2013**

**Int. Cl.: 36**

FOR: PROVIDING MONETARY EXCHANGE SERVICES, NAMELY, EXCHANGING GOLD OF OTHERS FOR CASH, IN CLASS 36 (U.S. CLS. 100, 101 AND 102).

**SERVICE MARK**

FIRST USE 6-1-2009; IN COMMERCE 12-4-2009.

**PRINCIPAL REGISTER**

THE MARK CONSISTS OF STANDARD CHARACTERS WITHOUT CLAIM TO ANY PARTICULAR FONT, STYLE, SIZE, OR COLOR.

SER. NO. 85-645,337, FILED 6-6-2012.

DARRYL SPRUILL, EXAMINING ATTORNEY



*David J. Kyffers*

Director of the United States Patent and Trademark Office

# United States of America

United States Patent and Trademark Office

## SOUNDGARDEN

**Reg. No. 4,275,721**

**Registered Jan. 15, 2013**

**Int. Cl.: 6**

**TRADEMARK**

**PRINCIPAL REGISTER**

SOUNDGARDEN (WASHINGTON PARTNERSHIP)  
C/O KING, HOLMES, PATERNO & BERLINER  
1900 AVENUE OF THE STARS, 26TH FLOOR  
LOS ANGELES, CA 90067

FOR: METAL KEY CHAINS, IN CLASS 6 (U.S. CLS. 2, 12, 13, 14, 23, 25 AND 50).

FIRST USE 6-6-2011; IN COMMERCE 10-6-2011.

THE MARK CONSISTS OF STANDARD CHARACTERS WITHOUT CLAIM TO ANY PARTICULAR FONT, STYLE, SIZE, OR COLOR.

SER. NO. 85-645,347, FILED 6-6-2012.

STEPHANIE ALI, EXAMINING ATTORNEY



*David J. Kybas*

Director of the United States Patent and Trademark Office



# United States of America

United States Patent and Trademark Office

## SOUNDGARDEN

**Reg. No. 4,275,722**

**Registered Jan. 15, 2013**

**Int. Cl.: 21**

**TRADEMARK**

**PRINCIPAL REGISTER**

SOUNDGARDEN (WASHINGTON PARTNERSHIP)  
C/O KING, HOLMES, PATERNO & BERLINER  
1900 AVENUE OF THE STARS, 26TH FLOOR  
LOS ANGELES, CA 90067

FOR: BEVERAGEWARE, IN CLASS 21 (U.S. CLS. 2, 13, 23, 29, 30, 33, 40 AND 50).

FIRST USE 6-6-2011; IN COMMERCE 6-6-2011.

THE MARK CONSISTS OF STANDARD CHARACTERS WITHOUT CLAIM TO ANY PARTICULAR FONT, STYLE, SIZE, OR COLOR.

SER. NO. 85-645,352, FILED 6-6-2012.

STEPHANIE ALI, EXAMINING ATTORNEY



*David J. Kyffers*

Director of the United States Patent and Trademark Office

# United States of America

United States Patent and Trademark Office

## SOUNDGARDEN

**Reg. No. 4,275,723**

**Registered Jan. 15, 2013**

**Int. Cl.: 25**

**TRADEMARK**

**PRINCIPAL REGISTER**

SOUNDGARDEN (WASHINGTON PARTNERSHIP)  
C/O KING, HOLMES, PATERNO & BERLINER  
1900 AVENUE OF THE STARS, 26TH FLOOR  
LOS ANGELES, CA 90067

FOR: CLOTHING, NAMELY T-SHIRTS, SWEATSHIRTS, JACKETS AND HOODED SHIRTS,  
IN CLASS 25 (U.S. CLS. 22 AND 39).

FIRST USE 7-16-1988; IN COMMERCE 7-16-1988.

THE MARK CONSISTS OF STANDARD CHARACTERS WITHOUT CLAIM TO ANY PAR-  
TICULAR FONT, STYLE, SIZE, OR COLOR.

SER. NO. 85-645,353, FILED 6-6-2012.

STEPHANIE ALI, EXAMINING ATTORNEY



*David J. Kyffers*

Director of the United States Patent and Trademark Office

# United States of America

United States Patent and Trademark Office

## SOUNDGARDEN

**Reg. No. 4,275,724**

**Registered Jan. 15, 2013**

**Int. Cl.: 26**

**TRADEMARK**

**PRINCIPAL REGISTER**

SOUNDGARDEN (WASHINGTON PARTNERSHIP)  
C/O KING, HOLMES, PATERNO & BERLINER  
1900 AVENUE OF THE STARS, 26TH FLOOR  
LOS ANGELES, CA 90067

FOR: BELT BUCKLES; ORNAMENTAL NOVELTY BUTTONS, IN CLASS 26 (U.S. CLS. 37, 39, 40, 42 AND 50).

FIRST USE 6-6-2011; IN COMMERCE 6-6-2011.

THE MARK CONSISTS OF STANDARD CHARACTERS WITHOUT CLAIM TO ANY PARTICULAR FONT, STYLE, SIZE, OR COLOR.

SER. NO. 85-645,354, FILED 6-6-2012.

STEPHANIE ALI, EXAMINING ATTORNEY



*David J. Kyffers*

Director of the United States Patent and Trademark Office

# United States of America

United States Patent and Trademark Office



**Reg. No. 4,275,725**

**Registered Jan. 15, 2013**

**Int. Cl.: 25**

**TRADEMARK**

**PRINCIPAL REGISTER**

MONSTER T-SHIRTS, LLC (SOUTH CAROLINA LIMITED LIABILITY COMPANY), DBA  
EAT MORE TEES  
1227 ROSEWOOD DRIVE  
COLUMBIA, SC 29205

FOR: BASEBALL CAPS AND HATS; SHORT-SLEEVED OR LONG-SLEEVED T-SHIRTS,  
IN CLASS 25 (U.S. CLS. 22 AND 39).

FIRST USE 3-16-2011; IN COMMERCE 3-16-2011.

THE MARK CONSISTS OF THE WORDS "ITSA GIRL THING" IN STYLIZED LETTERS  
ALONG WITH A STYLIZED REPRESENTATION OF A FLOWER.

SER. NO. 85-645,358, FILED 6-6-2012.

STEPHANIE ALI, EXAMINING ATTORNEY



*David J. Kyffers*

Director of the United States Patent and Trademark Office

# United States of America

United States Patent and Trademark Office



**Reg. No. 4,275,726**

ZJH HOLDINGS LLC (UTAH LIMITED LIABILITY COMPANY)  
121 OAKWOOD CIR.  
SPRINGVILLE, UT 84663

**Registered Jan. 15, 2013**

**Int. Cl.: 25**

FOR: BELTS FOR CLOTHING, IN CLASS 25 (U.S. CLS. 22 AND 39).

**TRADEMARK**

FIRST USE 1-7-2012; IN COMMERCE 1-7-2012.

**PRINCIPAL REGISTER**

THE MARK CONSISTS OF A GENERAL U SHAPE WITH THREE VERTICAL LINES ON ONE SIDE AND A VERTICAL LINE ON THE OTHER WITH A CURVED END.

SER. NO. 85-645,360, FILED 6-6-2012.

TRACY CROSS, EXAMINING ATTORNEY



*David J. Kybas*

Director of the United States Patent and Trademark Office

# United States of America

United States Patent and Trademark Office



**Reg. No. 4,275,727**

**Registered Jan. 15, 2013**

**Int. Cl.: 16**

**TRADEMARK**

**PRINCIPAL REGISTER**

SAMANTHA MCCULLOUGH (UNITED STATES INDIVIDUAL), DBA STINKY ART  
COMPANY  
1501 DORWALDT BLVD  
SCHENECTADY, NY 12309

FOR: BLANK CARDS; BOOKMARKS; BUMPER STICKERS; CHILDREN'S BOOKS; CHILDREN'S WALL STICKERS AND MURALS; DECORATIVE DECALS FOR VEHICLE WINDOWS; GREETINGS CARDS AND POSTCARDS; MAGNETIC BUMPER STICKERS; NOTE CARDS; POSTERS; PRINTED ART REPRODUCTIONS; STICKERS; TEMPORARY TATTOOS, IN CLASS 16 (U.S. CLS. 2, 5, 22, 23, 29, 37, 38 AND 50).

FIRST USE 7-3-2004; IN COMMERCE 7-3-2004.

THE MARK CONSISTS OF AN ORIGINAL DOG DRAWING AND TEXT IN STYLIZED FORM, WHICH SAYS "STINKY DOG".

SER. NO. 85-645,362, FILED 6-6-2012.

STEPHANIE ALI, EXAMINING ATTORNEY



*David J. Kyffers*

Director of the United States Patent and Trademark Office

# United States of America

United States Patent and Trademark Office

## BEAT THE HEAT

**Reg. No. 4,275,728**

**Registered Jan. 15, 2013**

**Int. Cl.: 3**

**TRADEMARK**

**PRINCIPAL REGISTER**

DEMERT BRANDS, INC. (FLORIDA CORPORATION)  
SUITE 102  
15402 NORTH NEBRASKA AVENUE  
LUTZ, FL 33549

FOR: HAIR CARE PRODUCTS, NAMELY, HAIR SPRAY, IN CLASS 3 (U.S. CLS. 1, 4, 6, 50, 51 AND 52).

FIRST USE 12-0-2009; IN COMMERCE 12-0-2009.

THE MARK CONSISTS OF STANDARD CHARACTERS WITHOUT CLAIM TO ANY PARTICULAR FONT, STYLE, SIZE, OR COLOR.

SER. NO. 85-645,467, FILED 6-7-2012.

MARGERY A. TIERNEY, EXAMINING ATTORNEY



*David J. Kybas*

Director of the United States Patent and Trademark Office

# United States of America

United States Patent and Trademark Office

## SHE'S A TEASE

**Reg. No. 4,275,729**

**Registered Jan. 15, 2013**

**Int. Cl.: 3**

**TRADEMARK**

**PRINCIPAL REGISTER**

DEMERT BRANDS, INC. (FLORIDA CORPORATION)  
SUITE 102  
15402 NORTH NEBRASKA AVENUE  
LUTZ, FL 33549

FOR: HAIR CARE PRODUCTS, NAMELY, HAIR SPRAY, IN CLASS 3 (U.S. CLS. 1, 4, 6, 50, 51 AND 52).

FIRST USE 12-0-2009; IN COMMERCE 12-0-2009.

THE MARK CONSISTS OF STANDARD CHARACTERS WITHOUT CLAIM TO ANY PARTICULAR FONT, STYLE, SIZE, OR COLOR.

SER. NO. 85-645,486, FILED 6-7-2012.

MARGERY A. TIERNEY, EXAMINING ATTORNEY



*David J. Kyffers*

Director of the United States Patent and Trademark Office



# United States of America

United States Patent and Trademark Office

# MISS FREEZE

**Reg. No. 4,275,730**

**Registered Jan. 15, 2013**

**Int. Cl.: 3**

**TRADEMARK**

**PRINCIPAL REGISTER**

DEMERT BRANDS, INC. (FLORIDA CORPORATION)  
SUITE 102  
15402 NORTH NEBRASKA AVENUE  
LUTZ, FL 33549

FOR: HAIR CARE PRODUCTS, NAMELY, HAIR SPRAY, IN CLASS 3 (U.S. CLS. 1, 4, 6, 50, 51 AND 52).

FIRST USE 6-0-2011; IN COMMERCE 6-0-2011.

THE MARK CONSISTS OF STANDARD CHARACTERS WITHOUT CLAIM TO ANY PARTICULAR FONT, STYLE, SIZE, OR COLOR.

SER. NO. 85-645,510, FILED 6-7-2012.

MARGERY A. TIERNEY, EXAMINING ATTORNEY



*David J. Kyffers*

Director of the United States Patent and Trademark Office

# United States of America

United States Patent and Trademark Office

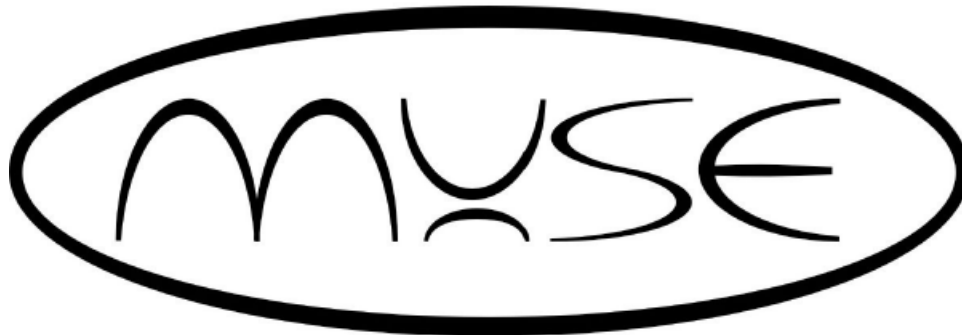

**Reg. No. 4,275,731**

ALTINEX, INC. (CALIFORNIA CORPORATION)  
592 APOLLO STREET  
BREA, CA 92821

**Registered Jan. 15, 2013**

**Int. Cl.: 9**

FOR: DISTRIBUTION AMPLIFIERS FOR AUDIO AND VIDEO SIGNALS; MATRIX SWITCHERS FOR AUDIO AND VIDEO SIGNALS; TRANSMITTERS AND RECEIVERS FOR AUDIO AND VIDEO SIGNALS FOR TRANSMISSION OVER TWISTED PAIR CABLES, IN CLASS 9 (U.S. CLS. 21, 23, 26, 36 AND 38).

**TRADEMARK**

**PRINCIPAL REGISTER**

FIRST USE 6-7-2012; IN COMMERCE 6-7-2012.

THE MARK CONSISTS OF A HORIZONTALLY DISPOSED OVAL WITH STYLIZED LETTERS "M", "X", "S", "E" INSIDE THE OVAL.

SER. NO. 85-646,095, FILED 6-7-2012.

DAVID I, EXAMINING ATTORNEY



*David J. Kyffers*

Director of the United States Patent and Trademark Office

# United States of America

United States Patent and Trademark Office

## EXECUTIVE PRESENTATION SKILLS

**Reg. No. 4,275,732**

COMMUNISPOND, INC. (NEW YORK CORPORATION)

**Registered Jan. 15, 2013**

5 LAURAS LANE  
EAST HAMPTON, NY 11937

**Int. Cl.: 41**

FOR: EDUCATIONAL SERVICES, NAMELY, CONDUCTING SEMINARS FOR BUSINESS PROFESSIONALS IN THE FIELD OF DEVELOPING PRESENTATION SKILLS, INCLUDING THE USE OF SOFTWARE AND VISUAL AIDS, AND THE DISTRIBUTION OF SOURCE MATERIALS IN CONNECTION THEREWITH; PROFESSIONAL COACHING SERVICES IN THE FIELD OF PRESENTATION SKILLS, IN CLASS 41 (U.S. CLS. 100, 101 AND 107).

**SERVICE MARK**

**PRINCIPAL REGISTER**

FIRST USE 7-0-1990; IN COMMERCE 7-0-1990.

THE MARK CONSISTS OF STANDARD CHARACTERS WITHOUT CLAIM TO ANY PARTICULAR FONT, STYLE, SIZE, OR COLOR.

OWNER OF U.S. REG. NO. 1,712,851.

NO CLAIM IS MADE TO THE EXCLUSIVE RIGHT TO USE "PRESENTATION SKILLS", APART FROM THE MARK AS SHOWN.

SEC. 2(F).

SER. NO. 85-646,290, FILED 6-7-2012.

LAURIE KAUFMAN, EXAMINING ATTORNEY



*David J. Kybas*

Director of the United States Patent and Trademark Office

# United States of America

United States Patent and Trademark Office

## GAMBLER'S CHOICE

**Reg. No. 4,275,733**

**Registered Jan. 15, 2013**

**Int. Cl.: 29**

**TRADEMARK**

**PRINCIPAL REGISTER**

KMB FOODS, INC. (UTAH CORPORATION)  
SUITE 222  
4505 WASATCH BLVD.  
SALT LAKE CITY, UT 84124

FOR: JERKY, IN CLASS 29 (U.S. CL. 46).

FIRST USE 8-1-2004; IN COMMERCE 8-1-2004.

THE MARK CONSISTS OF STANDARD CHARACTERS WITHOUT CLAIM TO ANY PARTICULAR FONT, STYLE, SIZE, OR COLOR.

SER. NO. 85-646,330, FILED 6-7-2012.

JOHN GARTNER, EXAMINING ATTORNEY



*David J. Kyffers*

Director of the United States Patent and Trademark Office

# United States of America

United States Patent and Trademark Office

## STHS HEALTH FORUM

**Reg. No. 4,275,734**

**Registered Jan. 15, 2013**

**Int. Cl.: 41**

**SERVICE MARK**

**PRINCIPAL REGISTER**

UHS OF DELAWARE, INC. (DELAWARE CORPORATION)  
367 SOUTH GULPH ROAD  
KING OF PRUSSIA, PA 194060958

FOR: PROVIDING ON-LINE NEWSLETTERS IN THE FIELD OF HOSPITAL AND MEDICAL CENTER INFORMATION, HEALTHCARE, AND MEDICINE, IN CLASS 41 (U.S. CLS. 100, 101 AND 107).

FIRST USE 2-6-2012; IN COMMERCE 2-6-2012.

THE MARK CONSISTS OF STANDARD CHARACTERS WITHOUT CLAIM TO ANY PARTICULAR FONT, STYLE, SIZE, OR COLOR.

NO CLAIM IS MADE TO THE EXCLUSIVE RIGHT TO USE "HEALTH FORUM", APART FROM THE MARK AS SHOWN.

SER. NO. 85-646,337, FILED 6-7-2012.

JAMES STEIN, EXAMINING ATTORNEY



*David J. Kyffers*

Director of the United States Patent and Trademark Office

# United States of America

United States Patent and Trademark Office



**Reg. No. 4,275,735**

WORLD WISER COMMITTEE (CALIFORNIA CORPORATION)  
707 WEST VALLEY BLVD.  
ALHAMBRA, CA 91803

**Registered Jan. 15, 2013**

**Int. Cl.: 41**

FOR: ENTERTAINMENT SERVICES, NAMELY, ORGANIZING AND CONDUCTING ATHLETIC EVENTS FOR NONPROFIT PURPOSES, IN CLASS 41 (U.S. CLS. 100, 101 AND 107).

**SERVICE MARK**

FIRST USE 5-24-2012; IN COMMERCE 5-24-2012.

**PRINCIPAL REGISTER**

NO CLAIM IS MADE TO THE EXCLUSIVE RIGHT TO USE "WORLD" AND "COMMITTEE", APART FROM THE MARK AS SHOWN.

THE COLOR(S) BLUE, YELLOW, GREEN, BLACK, ORANGE, LIGHT BLUE, RED, AND LIGHT GREEN IS/ARE CLAIMED AS A FEATURE OF THE MARK.

THE MARK CONSISTS OF A CIRCULAR FIGURE OF SEVEN PEOPLE IN SEVEN COLORS: BLUE, RED, LIGHT BLUE, YELLOW, GREEN, ORANGE AND BLACK HOLDING HANDS AROUND A LIGHT GREEN CIRCLE. WITHIN THE CIRCLE ARE THE WORDS "WORLD WISER COMMITTEE", IN BLACK. THE WHITE SEEN IN THE MARK IS FOR BACKGROUND PURPOSES AND IS NOT CLAIMED AS A FEATURE OF THE MARK.

SER. NO. 85-646,374, FILED 6-7-2012.

DEZMONA MIZELLE, EXAMINING ATTORNEY



*David J. Kybas*

Director of the United States Patent and Trademark Office

# United States of America

United States Patent and Trademark Office

## A SIMPLE ACT OF KINDNESS... CAN LEAVE A HEARTPRINT THAT LASTS A LIFETIME

**Reg. No. 4,275,736**

ADAIR, JOHN P. (UNITED STATES INDIVIDUAL)  
1414 KALOTE PLACE  
HILO, HI 96720

**Registered Jan. 15, 2013**

**Int. Cl.: 14**

FOR: JEWELRY, IN CLASS 14 (U.S. CLS. 2, 27, 28 AND 50).

**TRADEMARK**

FIRST USE 6-1-2001; IN COMMERCE 6-1-2001.

**PRINCIPAL REGISTER**

THE MARK CONSISTS OF STANDARD CHARACTERS WITHOUT CLAIM TO ANY PARTICULAR FONT, STYLE, SIZE, OR COLOR.

SER. NO. 85-646,441, FILED 6-7-2012.

HENRY S. ZAK, EXAMINING ATTORNEY



*David J. Kybas*

Director of the United States Patent and Trademark Office

United States of America  
United States Patent and Trademark Office

開平腐乳

**Reg. No. 4,275,737**

NORTHERN FOOD I/E INC. (NEW YORK CORPORATION), DBA NORTHERN FOOD  
117 STATE STREET  
WESTBURY, NY 11590

**Registered Jan. 15, 2013**

**Int. Cl.: 29**

FOR: BEAN CURD; FERMENTED BEAN CURD; PRESERVED SOYA BEANS FOR FOOD,  
IN CLASS 29 (U.S. CL. 46).

**TRADEMARK**

FIRST USE 8-1-2005; IN COMMERCE 8-1-2005.

**PRINCIPAL REGISTER**

NO CLAIM IS MADE TO THE EXCLUSIVE RIGHT TO USE "THE LAST TWO NON-LATIN  
CHARACTERS TRANSLITERATED TO FU AND RU", APART FROM THE MARK AS SHOWN.

THE NON-LATIN CHARACTERS IN THE MARK TRANSLITERATE TO "KAI", "PING",  
"FU" AND "RU" AND THIS MEANS "OPEN AND PLAIN FERMENTED BEANCURD" IN  
ENGLISH.

THE MARK CONSISTS OF FOUR CHINESE CHARACTERS IN ONE ROW IN A STYLIZED  
FONT.

THE ENGLISH TRANSLATION OF NON-LARTIN CHARACTERS IN THE MARK IS "OPEN,  
PLAIN, FERMENTED BEANCURD".

SER. NO. 85-646,459, FILED 6-7-2012.

JILL PRATER, EXAMINING ATTORNEY



*David J. Kyjars*

Director of the United States Patent and Trademark Office



# United States of America

United States Patent and Trademark Office

We Take Care of Our  
Players Like Old Vegas  
Used Too!

**Reg. No. 4,275,738**

**Registered Jan. 15, 2013**

**Int. Cl.: 41**

**SERVICE MARK**

**PRINCIPAL REGISTER**

BAJA TAVERNS LLC (NEVADA LIMITED LIABILITY COMPANY)  
STE E  
4790 S FORT APACHE RD  
LAS VEGAS, NV 89147

FOR: CASINOS; ENTERTAINMENT SERVICES, NAMELY, CASINO GAMING; PROVIDING CASINO SERVICES FEATURING A CASINO PLAYERS REWARDS PROGRAM , IN CLASS 41 (U.S. CLS. 100, 101 AND 107).

FIRST USE 12-0-2010; IN COMMERCE 12-0-2010.

THE MARK CONSISTS OF STANDARD CHARACTERS WITHOUT CLAIM TO ANY PARTICULAR FONT, STYLE, SIZE, OR COLOR.

SER. NO. 85-646,487, FILED 6-7-2012.

ANDREA HACK, EXAMINING ATTORNEY



*David J. Kyffers*

Director of the United States Patent and Trademark Office

# United States of America

United States Patent and Trademark Office

# XTORM

**Reg. No. 4,275,739**

**Registered Jan. 15, 2013**

**Int. Cl.: 9**

**TRADEMARK**

**PRINCIPAL REGISTER**

ALERO TECHNOLOGY, INC. (CALIFORNIA CORPORATION)  
11622 EL CAMINO REAL, SUITE 100  
SAN DIEGO, CA 92130

FOR: COMPUTER APPLICATION SOFTWARE FOR ENTERPRISE AND APPLICATIONS MANAGEMENT, NAMELY, SOFTWARE FOR DATA MANAGEMENT, WORKFLOW, ELECTRONIC DOCUMENT MANAGEMENT AND FOR FINDING, ACCESSING, SECURING, MANAGING, TRANSFERRING, MANIPULATING AND APPLYING INTEGRATED DATA.; COMPUTER E-COMMERCE SOFTWARE TO ALLOW USERS TO PERFORM ELECTRONIC BUSINESS TRANSACTIONS VIA A GLOBAL COMPUTER NETWORK; COMPUTER PROGRAMMES FOR DOCUMENT MANAGEMENT; COMPUTER SOFTWARE FOR APPLICATION AND DATABASE INTEGRATION; COMPUTER SOFTWARE FOR COMPUTER SYSTEM AND APPLICATION DEVELOPMENT, DEPLOYMENT AND MANAGEMENT; COMPUTER SOFTWARE FOR THE COLLECTION, EDITING, ORGANIZING, MODIFYING, BOOK MARKING, TRANSMISSION, STORAGE AND SHARING OF DATA AND INFORMATION; COMPUTER SOFTWARE FOR DATA MANAGEMENT, WORKFLOW, ELECTRONIC DOCUMENT MANAGEMENT AND FOR FINDING, ACCESSING, SECURING, MANAGING, TRANSFERRING, MANIPULATING AND APPLYING INTEGRATED DATA.; DATABASE MANAGEMENT SOFTWARE FOR DATA MANAGEMENT, WORKFLOW, ELECTRONIC DOCUMENT MANAGEMENT AND FOR FINDING, ACCESSING, SECURING, MANAGING, TRANSFERRING, MANIPULATING AND APPLYING INTEGRATED DATA, IN CLASS 9 (U.S. CLS. 21, 23, 26, 36 AND 38).

FIRST USE 10-21-2001; IN COMMERCE 10-21-2001.

THE MARK CONSISTS OF STANDARD CHARACTERS WITHOUT CLAIM TO ANY PARTICULAR FONT, STYLE, SIZE, OR COLOR.

SER. NO. 85-646,546, FILED 6-7-2012.

COLLEEN KEARNEY, EXAMINING ATTORNEY



*David J. Kyros*

Director of the United States Patent and Trademark Office

# United States of America

United States Patent and Trademark Office



## GRAB-A-DESK

WE TAKE CARE OF THE REST

**Reg. No. 4,275,740**

**Registered Jan. 15, 2013**

**Int. Cl.: 36**

**SERVICE MARK**

**PRINCIPAL REGISTER**

ROUNDTREE RENTALS LTD. (OHIO LIMITED LIABILITY COMPANY)  
3636 N. HIGH STREET  
COLUMBUS, OH 43214

FOR: LEASING OF OFFICE SPACE, IN CLASS 36 (U.S. CLS. 100, 101 AND 102).

FIRST USE 6-8-2012; IN COMMERCE 6-8-2012.

THE MARK CONSISTS OF A RED TRAPEZOID WITH PARALLEL TOP AND BOTTOM SIDES AND LEFT AND RIGHT SIDES INTERSECTING AT EQUAL ANGLES APPEARS AT THE TOP OF THE MARK. BELOW THE RED TRAPEZOID IS BLACK TEXT WITH RED DASHES "GRAB-A-DESK". BELOW "GRAB-A-DESK" IS THE BLACK TEXT "WE TAKE CARE OF THE REST".

THE COLOR(S) BLACK AND RED IS/ARE CLAIMED AS A FEATURE OF THE MARK.

SER. NO. 85-646,736, FILED 6-8-2012.

VERNA BETH RIRIE, EXAMINING ATTORNEY



*David J. Kyffers*

Director of the United States Patent and Trademark Office

# United States of America

United States Patent and Trademark Office



**Reg. No. 4,275,741**

**Registered Jan. 15, 2013**

**Int. Cl.: 20**

**TRADEMARK**

**PRINCIPAL REGISTER**

KINGDOM MANUFACTURING LLC (UNITED STATES LIMITED LIABILITY COMPANY)  
320 S 66TH ST  
HOUSTON, TX 77011

FOR: ZIPPERED MATTRESS COMPONENTS, NAMELY, ELASTIC GEL, FOAM, OR LATEX MATERIALS LOCATED ON THE TOP UPHOLSTERY LAYER OF MATTRESSES SOLD AS AN INTEGRAL COMPONENT OF THE MATTRESSES; MATTRESS CUSHIONS; MATTRESS FOUNDATIONS; MATTRESS TOPPERS; MATTRESSES, IN CLASS 20 (U.S. CLS. 2, 13, 22, 25, 32 AND 50).

FIRST USE 6-1-2012; IN COMMERCE 6-10-2012.

THE MARK CONSISTS OF CAPITAL "E" WITH LOWER CASE "UPHORI" AND A MOON SHAPE IMAGE USED AS A LETTER "C" THE A CAPITAL "S" WITH LOWER CASE "LEEP" NO SPACES SPELLING "EUPHORICSLEEP".

SER. NO. 85-646,790, FILED 6-8-2012.

WILLIAM ROSSMAN, EXAMINING ATTORNEY



*David J. Kyffers*

Director of the United States Patent and Trademark Office

# United States of America

United States Patent and Trademark Office

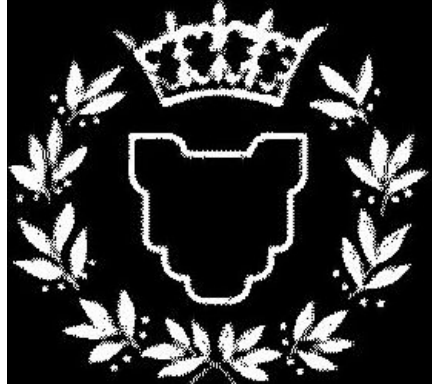

**Reg. No. 4,275,742**

**Registered Jan. 15, 2013**

**Int. Cls.: 3, 6, 14, 16, 18, 20, 21, 24, 25, 28, 31 and 35**

SOCIO X INC. (NEW YORK CORPORATION), DBA POOCHCLUB  
136 EAST 56TH STREET, PH D  
NEW YORK, NY 10022

FOR: PET SHAMPOO AND CONDITIONER, IN CLASS 3 (U.S. CLS. 1, 4, 6, 50, 51 AND 52).

FIRST USE 11-1-2011; IN COMMERCE 11-1-2011.

FOR: METAL DOG TAGS; METAL KEY CHAINS, IN CLASS 6 (U.S. CLS. 2, 12, 13, 14, 23, 25 AND 50).

FIRST USE 8-12-2010; IN COMMERCE 8-12-2010.

FOR: JEWELRY; KEYCHAINS OF METAL, IN CLASS 14 (U.S. CLS. 2, 27, 28 AND 50).

FIRST USE 8-12-2010; IN COMMERCE 8-12-2010.

FOR: STATIONERY AND INVITATION CARDS; PRINTED BROCHURES FEATURING INFORMATION ABOUT DIET AND FOOD FOR DOGS AND PETS, IN CLASS 16 (U.S. CLS. 2, 5, 22, 23, 29, 37, 38 AND 50).

FIRST USE 1-0-2002; IN COMMERCE 5-3-2011.

FOR: ANIMAL LEASHES; DOG LEASHES; LEASHES FOR ANIMALS; PET PRODUCTS, NAMELY, PET RESTRAINING DEVICES CONSISTING OF LEASHES, COLLARS, HARNESSES, RESTRAINING STRAPS, AND LEASHES WITH LOCKING DEVICES; PET TAGS SPECIALLY ADAPTED FOR ATTACHING TO PET LEASHES OR COLLARS; DOG APPAREL; PET APPAREL, IN CLASS 18 (U.S. CLS. 1, 2, 3, 22 AND 41).

FIRST USE 11-1-2011; IN COMMERCE 11-1-2011.

FOR: DOG BEDS; PILLOWS, IN CLASS 20 (U.S. CLS. 2, 13, 22, 25, 32 AND 50).

FIRST USE 12-16-2010; IN COMMERCE 12-16-2010.

FOR: PET FEEDING AND DRINKING BOWLS; DISHES AND PLATES, IN CLASS 21 (U.S. CLS. 2, 13, 23, 29, 30, 33, 40 AND 50).

**TRADEMARK**

**SERVICE MARK**

**PRINCIPAL REGISTER**



*David J. Kyros*

Director of the United States Patent and Trademark Office

**Reg. No. 4,275,742** FIRST USE 2-14-2011; IN COMMERCE 5-3-2011.

FOR: PET BLANKETS AND BED LINENS, IN CLASS 24 (U.S. CLS. 42 AND 50).

FIRST USE 12-16-2010; IN COMMERCE 12-16-2010.

FOR: APPAREL, NAMELY, POLO SHIRTS, SWEATSHIRTS, BLOUSES, T-SHIRTS, SHIRTS, SWEATERS, AND HATS; AND SLIPPERS, IN CLASS 25 (U.S. CLS. 22 AND 39).

FIRST USE 5-3-2011; IN COMMERCE 5-3-2011.

FOR: TOYS, NAMELY, STUFFED AND PLUSH TOYS, IN CLASS 28 (U.S. CLS. 22, 23, 38 AND 50).

FIRST USE 5-7-2011; IN COMMERCE 5-7-2011.

FOR: CAT FOOD; DOG FOOD; PET BEVERAGES; PET FOOD; PET TREATS, IN CLASS 31 (U.S. CLS. 1 AND 46).

FIRST USE 9-21-2010; IN COMMERCE 9-21-2010.

FOR: ONLINE RETAIL STORE SERVICES FEATURING, PET FOOD, METAL DOG TAGS, DOG BEDS, PET FEEDING AND DRINKING BOWLS, DISHES AND PLATES, PET BLANKETS AND BED LINENS, PET SHAMPOO AND CONDITIONER; ONLINE RETAIL STORE SERVICES FEATURING ANIMAL LEASHES, PET RESTRAINING DEVICES CONSISTING OF LEASHES, COLLARS, HARNESSSES, RESTRAINING STRAPS, LEASHES WITH LOCKING DEVICES, PET TAGS, DOG APPAREL AND PET TOYS; ONLINE RETAIL STORE SERVICES FEATURING STATIONERY AND CLOTHING FOR MEN, WOMEN AND CHILDREN, IN CLASS 35 (U.S. CLS. 100, 101 AND 102).

FIRST USE 2-0-2011; IN COMMERCE 2-0-2011.

OWNER OF U.S. REG. NO. 3,947,987.

THE MARK CONSISTS OF AN OPEN CROWN ABOVE A STYLIZED DOG HEAD AND A LAUREL WREATH SURROUNDING THE DOG HEAD AND CROWN.

SER. NO. 85-647,261, FILED 6-8-2012.

BERYL GARDNER, EXAMINING ATTORNEY

# United States of America

United States Patent and Trademark Office

## THE NO FINE PRINT DENTAL PLAN

**Reg. No. 4,275,743**

**Registered Jan. 15, 2013**

**Int. Cl.: 35**

**SERVICE MARK**

**PRINCIPAL REGISTER**

OREGON DENTAL, P.C. (OREGON CORPORATION)  
SUITE 200  
1800 VALLEY RIVER DRIVE  
EUGENE, OR 97401

FOR: ADMINISTRATION OF A PROGRAM FOR ENABLING PARTICIPANTS TO OBTAIN DISCOUNTS ON PRODUCTS AND SERVICES, IN CLASS 35 (U.S. CLS. 100, 101 AND 102).

FIRST USE 5-11-2012; IN COMMERCE 5-11-2012.

THE MARK CONSISTS OF STANDARD CHARACTERS WITHOUT CLAIM TO ANY PARTICULAR FONT, STYLE, SIZE, OR COLOR.

NO CLAIM IS MADE TO THE EXCLUSIVE RIGHT TO USE "DENTAL PLAN", APART FROM THE MARK AS SHOWN.

SER. NO. 85-648,289, FILED 6-11-2012.

MARILYN IZZI, EXAMINING ATTORNEY



*David J. Kyffers*

Director of the United States Patent and Trademark Office

# United States of America

United States Patent and Trademark Office

# KMS

**Reg. No. 4,275,744**

**Registered Jan. 15, 2013**

**Int. Cl.: 42**

**SERVICE MARK**

**PRINCIPAL REGISTER**

FCI HOLDINGS DELAWARE, INC. (DELAWARE CORPORATION)  
1105 NORTH MARKET STREET, SUITE 1300  
WILMINGTON, DE 19801

FOR: ENGINEERING SERVICES, NAMELY, CONDUCTING RESEARCH, AND ANALYZING GEOLOGIC STRESS AND MATTER TO PROVIDE STRUCTURAL ANALYSIS, NUMERICAL MODELING, 3-D MODELING, AND TO DEVELOP STRUCTURAL SUPPORT AND PRODUCTS FOR UNDERGROUND MINES AND TUNNELS, AS WELL AS FOR CIVIL CONSTRUCTION PRODUCTS, IN CLASS 42 (U.S. CLS. 100 AND 101).

FIRST USE 0-0-1997; IN COMMERCE 0-0-1997.

THE MARK CONSISTS OF STANDARD CHARACTERS WITHOUT CLAIM TO ANY PARTICULAR FONT, STYLE, SIZE, OR COLOR.

SER. NO. 85-648,400, FILED 6-11-2012.

ARETHA SOMERVILLE, EXAMINING ATTORNEY



*David J. Kybas*

Director of the United States Patent and Trademark Office



# United States of America

United States Patent and Trademark Office

## KNIGHTHAWK

**Reg. No. 4,275,745**

**Registered Jan. 15, 2013**

**Int. Cl.: 9**

**TRADEMARK**

**PRINCIPAL REGISTER**

HARRIS CORPORATION (DELAWARE CORPORATION)  
1025 WEST NASA BOULEVARD  
MELBOURNE, FL 32919

FOR: CELLULAR BASE STATIONS, NAMELY, RUGGEDIZED MOBILE TACTICAL CELLULAR BASE STATIONS FOR PROVIDING DATA AND VOICE COMMUNICATIONS TO AND FROM THE BATTLEFIELD, IN CLASS 9 (U.S. CLS. 21, 23, 26, 36 AND 38).

FIRST USE 11-1-2010; IN COMMERCE 2-24-2011.

THE MARK CONSISTS OF STANDARD CHARACTERS WITHOUT CLAIM TO ANY PARTICULAR FONT, STYLE, SIZE, OR COLOR.

SER. NO. 85-648,508, FILED 6-11-2012.

KIMBERLY PERRY, EXAMINING ATTORNEY



*David J. Kyffers*

Director of the United States Patent and Trademark Office

# United States of America

United States Patent and Trademark Office



**Reg. No. 4,275,746**

**Registered Jan. 15, 2013**

**Int. Cl.: 45**

**SERVICE MARK**

**PRINCIPAL REGISTER**

SMITHAMUNDSEN LLC (ILLINOIS LIMITED LIABILITY COMPANY)  
150 N. MICHIGAN AVE. STE. 3300  
CHICAGO, IL 606017524

FOR: LEGAL SERVICES, IN CLASS 45 (U.S. CLS. 100 AND 101).

FIRST USE 7-6-2006; IN COMMERCE 7-6-2006.

THE MARK CONSISTS OF THE LETTERS "S" AND "A" IN WHITE CONTAINED IN A TAN RECTANGLE, BOTH LETTERS BEING IN UPPER CASE AND IN A STYLIZED FONT.

THE COLOR(S) TAN AND WHITE IS/ARE CLAIMED AS A FEATURE OF THE MARK.

SER. NO. 85-648,924, FILED 6-11-2012.

MICHELE SWAIN, EXAMINING ATTORNEY



*David J. Kyffers*

Director of the United States Patent and Trademark Office

# United States of America

United States Patent and Trademark Office

# SmithAmundsen

**Reg. No. 4,275,747**

SMITHAMUNDSEN LLC (ILLINOIS LIMITED LIABILITY COMPANY)  
150 N. MICHIGAN AVE. STE. 3300  
CHICAGO, IL 606017524

**Registered Jan. 15, 2013**

**Int. Cl.: 45**

FOR: LEGAL SERVICES, IN CLASS 45 (U.S. CLS. 100 AND 101).

**SERVICE MARK**

FIRST USE 7-6-2006; IN COMMERCE 7-6-2006.

**PRINCIPAL REGISTER**

THE NAME(S), PORTRAIT(S), AND/OR SIGNATURE(S) SHOWN IN THE MARK IDENTIFIES GLEN E. AMUNDSEN AND LAWRENCE R. SMITH, WHOSE CONSENT(S) TO REGISTER IS MADE OF RECORD.

THE COLOR(S) BLUE AND TAN IS/ARE CLAIMED AS A FEATURE OF THE MARK.

THE MARK CONSISTS OF THE WORD "SMITH" IN THE COLOR BLUE, IMMEDIATELY FOLLOWED WITHOUT ANY SPACE BY THE WORD "AMUNDSEN" IN THE COLOR TAN, WITH THE FIRST LETTER "S" AND THE SIXTH LETTER "A" BEING IN UPPER CASE AND THE REMAINDER OF THE LETTERS BEING IN LOWER CASE, ALL IN A STYLIZED FONT.

SER. NO. 85-648,939, FILED 6-11-2012.

MICHELE SWAIN, EXAMINING ATTORNEY



*David J. Kyjars*

Director of the United States Patent and Trademark Office

# United States of America

United States Patent and Trademark Office

## Findsider Ranking

**Reg. No. 4,275,748**

FINDSIDER (NEW YORK LIMITED LIABILITY COMPANY)  
1500 BROADWAY, SUITE 1900  
NEW YORK, NY 10036

**Registered Jan. 15, 2013**

**Int. Cl.: 36**

FOR: PROVIDING INFORMATION IN THE FIELD OF REAL ESTATE VIA THE INTERNET;  
REAL ESTATE ACQUISITION SERVICES; REAL ESTATE BROKERAGE; REAL ESTATE  
CONSULTANCY, IN CLASS 36 (U.S. CLS. 100, 101 AND 102).

**SERVICE MARK**

FIRST USE 5-1-2012; IN COMMERCE 5-1-2012.

**PRINCIPAL REGISTER**

THE MARK CONSISTS OF STANDARD CHARACTERS WITHOUT CLAIM TO ANY PAR-  
TICULAR FONT, STYLE, SIZE, OR COLOR.

NO CLAIM IS MADE TO THE EXCLUSIVE RIGHT TO USE "RANKING", APART FROM  
THE MARK AS SHOWN.

SER. NO. 85-649,482, FILED 6-12-2012.

LEIGH LOWRY, EXAMINING ATTORNEY



*David J. Kyros*

Director of the United States Patent and Trademark Office

# United States of America

United States Patent and Trademark Office

## Findsider Opinion

**Reg. No. 4,275,749**

FINDSIDER (NEW YORK LIMITED LIABILITY COMPANY)  
1500 BROADWAY, SUITE 1900  
NEW YORK, NY 10036

**Registered Jan. 15, 2013**

**Int. Cl.: 36**

FOR: PROVIDING INFORMATION IN THE FIELD OF REAL ESTATE VIA THE INTERNET;  
REAL ESTATE ACQUISITION SERVICES; REAL ESTATE BROKERAGE; REAL ESTATE  
CONSULTANCY, IN CLASS 36 (U.S. CLS. 100, 101 AND 102).

**SERVICE MARK**

FIRST USE 5-1-2012; IN COMMERCE 5-1-2012.

**PRINCIPAL REGISTER**

THE MARK CONSISTS OF STANDARD CHARACTERS WITHOUT CLAIM TO ANY PAR-  
TICULAR FONT, STYLE, SIZE, OR COLOR.

NO CLAIM IS MADE TO THE EXCLUSIVE RIGHT TO USE "OPINION", APART FROM THE  
MARK AS SHOWN.

SER. NO. 85-649,518, FILED 6-12-2012.

LEIGH LOWRY, EXAMINING ATTORNEY



*David J. Kybas*

Director of the United States Patent and Trademark Office

# United States of America

United States Patent and Trademark Office



**Reg. No. 4,275,750**

**Registered Jan. 15, 2013**

**Int. Cl.: 35**

**SERVICE MARK**

**PRINCIPAL REGISTER**

WATER ENVIRONMENT FEDERATION, INC. (VIRGINIA CORPORATION)  
601 WYTHE STREET  
ALEXANDRIA, VA 22314

FOR: PROMOTING PUBLIC AWARENESS OF THE VALUE AND IMPORTANCE OF WATER, WATER RELATED ISSUES AND THE WATER PROFESSION AND WATER PROFESSIONALS, IN CLASS 35 (U.S. CLS. 100, 101 AND 102).

FIRST USE 2-14-2012; IN COMMERCE 2-14-2012.

NO CLAIM IS MADE TO THE EXCLUSIVE RIGHT TO USE "WORLD WATER MONITORING", APART FROM THE MARK AS SHOWN.

THE MARK CONSISTS OF THE WORDS "WORLD WATER MONITORING CHALLENGE" SHOWN WITH A GRAPHIC OF THE PLANET. THE WORDS "TEST. SHARE. PROTECT" SHOWN ALONG THE EDGE OF THE PLANET GRAPHIC.

SER. NO. 85-649,551, FILED 6-12-2012.

CARYN GLASSER, EXAMINING ATTORNEY



*David J. Kybas*

Director of the United States Patent and Trademark Office

# United States of America

United States Patent and Trademark Office

# Aart2wear

**Reg. No. 4,275,751**

AART2WEAR LLC (FLORIDA LIMITED LIABILITY COMPANY)  
10652 NORTHGREEN DRIVE  
WELLINGTON, FL 33449

**Registered Jan. 15, 2013**

**Int. Cl.: 25**

FOR: CLOTHING, NAMELY, NECK TUBES; HATS; NECK GAITERS; SCARVES; SWEATERS;  
VESTS, IN CLASS 25 (U.S. CLS. 22 AND 39).

**TRADEMARK**

FIRST USE 10-0-2011; IN COMMERCE 10-0-2011.

**PRINCIPAL REGISTER**

THE MARK CONSISTS OF STANDARD CHARACTERS WITHOUT CLAIM TO ANY PARTICULAR FONT, STYLE, SIZE, OR COLOR.

SER. NO. 85-649,863, FILED 6-12-2012.

MICHAEL SOUDERS, EXAMINING ATTORNEY



*David J. Kyros*

Director of the United States Patent and Trademark Office

# United States of America

United States Patent and Trademark Office

## BIG CHOCOLATE

**Reg. No. 4,275,752**

**Registered Jan. 15, 2013**

**Int. Cl.: 9**

**TRADEMARK**

**PRINCIPAL REGISTER**

BIG CHOCOLATE, LLC (DELAWARE LIMITED LIABILITY COMPANY)  
176-25 UNION TURNPIKE, #405  
C/O STRONG MANAGEMENT  
FRESH MEADOWS, NY 11366

FOR: SERIES OF MUSICAL SOUND RECORDINGS; SERIES OF MUSICAL VIDEO RECORDINGS; DOWNLOADABLE MUSICAL SOUND RECORDINGS; DOWNLOADABLE MUSIC VIDEO RECORDINGS FEATURING MUSIC AND ARTISTIC PERFORMANCES; AUDIOVISUAL RECORDINGS FEATURING MUSIC AND ARTISTIC PERFORMANCES; DOWNLOADABLE AUDIOVISUAL RECORDINGS FEATURING MUSIC AND ARTISTIC PERFORMANCES, IN CLASS 9 (U.S. CLS. 21, 23, 26, 36 AND 38).

FIRST USE 8-3-2008; IN COMMERCE 8-21-2009.

THE MARK CONSISTS OF STANDARD CHARACTERS WITHOUT CLAIM TO ANY PARTICULAR FONT, STYLE, SIZE, OR COLOR.

THE NAME "BIG CHOCOLATE" IDENTIFIES THE PSEUDONYM OF CAMERON ARGON, A LIVING INDIVIDUAL WHOSE CONSENT IS OF RECORD.

SER. NO. 85-649,901, FILED 6-12-2012.

SUSAN BILLHEIMER, EXAMINING ATTORNEY



*David J. Kyffers*

Director of the United States Patent and Trademark Office



# United States of America

United States Patent and Trademark Office

# DERMAVITÁL

**Reg. No. 4,275,753**

**Registered Jan. 15, 2013**

**Int. Cl.: 3**

**TRADEMARK**

**PRINCIPAL REGISTER**

INTERNATIONAL COMMERCIAL TELEVISION, INC. (FLORIDA CORPORATION)  
487 DEVON PARK DRIVE, SUITE 212  
WAYNE, PA 19087

FOR: SKIN CARE PREPARATIONS, NAMELY, CLEANSING EMULSIONS FOR FACE AND BODY, SKIN MOISTURIZERS, SKIN LOTIONS, SKIN TONERS, BATH GELS, CREAMS FOR FACE, NECK, HANDS, EYE, BODY, AND FOOT, ANTI-WRINKLE CREAMS, CELLULITE REDUCTION CREAMS, AND DEPILATORY CREAMS, IN CLASS 3 (U.S. CLS. 1, 4, 6, 50, 51 AND 52).

FIRST USE 12-27-1999; IN COMMERCE 12-27-1999.

THE MARK CONSISTS OF STANDARD CHARACTERS WITHOUT CLAIM TO ANY PARTICULAR FONT, STYLE, SIZE, OR COLOR.

SER. NO. 85-649,940, FILED 6-12-2012.

JENNIFER MARTIN, EXAMINING ATTORNEY



*David J. Kyffers*

Director of the United States Patent and Trademark Office

# United States of America

United States Patent and Trademark Office

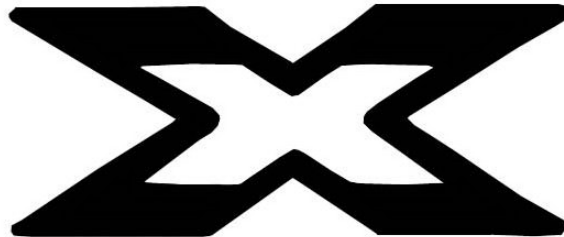

**Reg. No. 4,275,754**

**Registered Jan. 15, 2013**

**Int. Cl.: 9**

**TRADEMARK**

**PRINCIPAL REGISTER**

TSAI, NIECO MING HUAN (UNITED STATES INDIVIDUAL)  
4641 DISTRICT BLVD  
VERNON, CA 90058

FOR: CASES FOR EYEGLASSES AND SUNGLASSES; CASES FOR SPECTACLES AND SUNGLASSES; CHAINS FOR SPECTACLES AND FOR SUNGLASSES; EYEWEAR, NAMELY, SUNGLASSES, EYEGLASSES AND OPHTHALMIC FRAMES AND CASES THEREFOR; FRAMES FOR SPECTACLES AND SUNGLASSES; LENSES FOR SUNGLASSES; SPECTACLES AND SUNGLASSES; SUNGLASS CHAINS AND CORDS; SUNGLASS LENSES; SUNGLASSES; SUNGLASSES AND SPECTACLES, IN CLASS 9 (U.S. CLS. 21, 23, 26, 36 AND 38).

FIRST USE 6-1-2012; IN COMMERCE 6-1-2012.

THE MARK CONSISTS OF STYLIZED LETTER "X" WITH A SMALLER "X" CUT OUT IN THE CENTER.

SER. NO. 85-650,021, FILED 6-12-2012.

CHARLOTTE CORWIN, EXAMINING ATTORNEY



*David J. Kyffers*

Director of the United States Patent and Trademark Office

# United States of America

United States Patent and Trademark Office

# Houndstooth

**Reg. No. 4,275,755**

DARLENE SHAFER (UNITED STATES INDIVIDUAL)  
1547 BANNING AVE.  
WILMINGTON, CA 90744 AND

**Registered Jan. 15, 2013**

**Int. Cl.: 44**

KATHRYN SHAFER (UNITED STATES INDIVIDUAL)  
1547 BANNING AVE  
WILMINGTON, CA 90744

**SERVICE MARK**

**PRINCIPAL REGISTER**

FOR: DENTIST SERVICES; PET CARE SERVICES, NAMELY, ADMINISTRATION OF MEDICATION; PET CARE SERVICES, NAMELY, DOG WALKING, DOG BATHING AND NON-MEDICATED PET GROOMING; PET CARE SERVICES, NAMELY, DOG WALKING, DOG BATHING, NON-MEDICATED PET GROOMING AND IN-HOME MEDICAL CARE; PET DENTIST SERVICES; PET GROOMING SERVICES; PET HOSPITAL SERVICES; PROVIDING INFORMATION AND ADVICE IN THE FIELD OF PET HEALTH; PROVIDING ON-LINE INFORMATION VIA THE INTERNET IN THE FIELDS OF ANIMALS AND PETS, RELATING TO BREEDING, SELECTION OF THE ANIMALS AND PETS, GROOMING, FEEDING AND NUTRITION; PROVIDING SELF-SERVICE PET GROOMING FACILITIES; PROVIDING SELF-SERVICE PET WASHING FACILITIES; VETERINARY DENTISTRY, IN CLASS 44 (U.S. CLS. 100 AND 101).

FIRST USE 1-1-1993; IN COMMERCE 6-1-1993.

THE MARK CONSISTS OF STANDARD CHARACTERS WITHOUT CLAIM TO ANY PARTICULAR FONT, STYLE, SIZE, OR COLOR.

SER. NO. 85-650,201, FILED 6-12-2012.

SCOTT BIBB, EXAMINING ATTORNEY



*David J. Kybas*

Director of the United States Patent and Trademark Office

# United States of America

United States Patent and Trademark Office

# Nutrioli

**Reg. No. 4,275,756**

**Registered Jan. 15, 2013**

**Int. Cl.: 29**

**TRADEMARK**

**PRINCIPAL REGISTER**

RAGASA INDUSTRIAS, S.A. DE C.V. (MEXICO CORPORATION)  
AV. DR. JOSE ELEUTERIO GONZALEZ  
# 2815, COL. MITRAS NORTE  
MONTERREY, NUEVO LEON, MEXICO 64320

FOR: EDIBLE OILS AND FATS, IN CLASS 29 (U.S. CL. 46).

OWNER OF MEXICO REG. NO. 1254603, DATED 11-29-2011, EXPIRES 7-1-2021.

OWNER OF U.S. REG. NOS. 2,665,069 AND 4,117,403.

THE MARK CONSISTS OF THE WORD "NUTRIOLI" IN STYLIZED FORM, UNDER THE WORD APPEARS A RIBBON OR SCROLL DESIGN.

THE WORDING NUTRIOLI HAS NO MEANING IN A FOREIGN LANGUAGE.

SER. NO. 85-650,414, FILED 6-13-2012.

MICHAEL WIENER, EXAMINING ATTORNEY



*David J. Kybas*

Director of the United States Patent and Trademark Office

# United States of America

United States Patent and Trademark Office

# SMITTY

**Reg. No. 4,275,757**

**Registered Jan. 15, 2013**

**Int. Cl.: 41**

**SERVICE MARK**

**PRINCIPAL REGISTER**

AMERICAN EXPRESS MARKETING & DEVELOPMENT CORP. (DELAWARE CORPORATION)  
200 VESEY STREET  
NEW YORK, NY 10285

FOR: PROVIDING RECOGNITION AND INCENTIVES BY THE WAY OF AWARDS TO DEMONSTRATE EXCELLENCE IN THE FIELD OF BEST PROMOTIONAL USE OF SOCIAL MEDIA , IN CLASS 41 (U.S. CLS. 100, 101 AND 107).

FIRST USE 6-6-2012; IN COMMERCE 6-6-2012.

THE MARK CONSISTS OF STANDARD CHARACTERS WITHOUT CLAIM TO ANY PARTICULAR FONT, STYLE, SIZE, OR COLOR.

SER. NO. 85-650,676, FILED 6-13-2012.

DAVID HOFFMAN, EXAMINING ATTORNEY



*David J. Kyffers*

Director of the United States Patent and Trademark Office

# United States of America

United States Patent and Trademark Office

## INSIDE THE DREAM

**Reg. No. 4,275,758**

**Registered Jan. 15, 2013**

**Int. Cl.: 41**

**SERVICE MARK**

**PRINCIPAL REGISTER**

AMERICAN EXPRESS MARKETING & DEVELOPMENT CORP. (DELAWARE CORPORATION)  
200 VESEY STREET  
NEW YORK, NY 10285

FOR: ENTERTAINMENT SERVICES, NAMELY, CONTEST AND INCENTIVE AWARD PROGRAMS DESIGNED TO REWARD PROGRAM PARTICIPANTS WHO PARTICIPATE IN A CHAT MODULE WITH OPPORTUNITIES TO WIN PRIZES, IN CLASS 41 (U.S. CLS. 100, 101 AND 107).

FIRST USE 5-23-2012; IN COMMERCE 5-23-2012.

THE MARK CONSISTS OF STANDARD CHARACTERS WITHOUT CLAIM TO ANY PARTICULAR FONT, STYLE, SIZE, OR COLOR.

SER. NO. 85-650,767, FILED 6-13-2012.

DAVID HOFFMAN, EXAMINING ATTORNEY



*David J. Kyffers*

Director of the United States Patent and Trademark Office

# United States of America

United States Patent and Trademark Office

## INSIDE THE DREAM

**Reg. No. 4,275,759**

**Registered Jan. 15, 2013**

**Int. Cl.: 41**

**SERVICE MARK**

**PRINCIPAL REGISTER**

AMERICAN EXPRESS MARKETING & DEVELOPMENT CORP. (DELAWARE CORPORATION)  
200 VESEY STREET  
NEW YORK, NY 10285

FOR: ENTERTAINMENT, NAMELY, A CONTINUING SERIES OF VIGNETTES THAT ARE USING ARCHIVED FOOTAGE AS WELL AS CONTENT CAPTURED DURING A VIDEO SHOW BROADCAST OVER TELEVISION, SATELLITE, AUDIO, AND VIDEO MEDIA, IN CLASS 41 (U.S. CLS. 100, 101 AND 107).

FIRST USE 5-23-2012; IN COMMERCE 5-23-2012.

THE MARK CONSISTS OF STANDARD CHARACTERS WITHOUT CLAIM TO ANY PARTICULAR FONT, STYLE, SIZE, OR COLOR.

SER. NO. 85-650,815, FILED 6-13-2012.

DAVID HOFFMAN, EXAMINING ATTORNEY



*David J. Kyfos*

Director of the United States Patent and Trademark Office

# United States of America

United States Patent and Trademark Office

## Where's the Beef

**Reg. No. 4,275,760**

**Registered Jan. 15, 2013**

**Int. Cl.: 25**

**TRADEMARK**

**PRINCIPAL REGISTER**

OLDEMARK LLC (DELAWARE LIMITED LIABILITY COMPANY)  
4288 WEST DUBLIN-GRANVILLE ROAD  
DUBLIN, OH 43017

FOR: T-SHIRTS, IN CLASS 25 (U.S. CLS. 22 AND 39).

FIRST USE 9-27-2011; IN COMMERCE 9-27-2011.

THE MARK CONSISTS OF STANDARD CHARACTERS WITHOUT CLAIM TO ANY PARTICULAR FONT, STYLE, SIZE, OR COLOR.

OWNER OF U.S. REG. NOS. 1,410,896 AND 1,414,006.

SER. NO. 85-651,069, FILED 6-13-2012.

BARBARA BROWN, EXAMINING ATTORNEY



*David J. Kyjars*

Director of the United States Patent and Trademark Office



# United States of America

United States Patent and Trademark Office

## BIKE GUARD

**Reg. No. 4,275,761**

NORCO PRODUCTS LTD. (CANADA CORPORATION)  
1465 KEBET WAY

**Registered Jan. 15, 2013**

PORT COQUITLAM, B.C., CANADA V3C6L3

**Int. Cl.: 6**

FOR: (BASED ON USE IN COMMERCE) BICYCLE LOCKS(BASED ON 44(E)) BICYCLE LOCKS, IN CLASS 6 (U.S. CLS. 2, 12, 13, 14, 23, 25 AND 50).

**TRADEMARK**

FIRST USE 9-30-1985; IN COMMERCE 6-3-2011.

**PRINCIPAL REGISTER**

THE MARK CONSISTS OF STANDARD CHARACTERS WITHOUT CLAIM TO ANY PARTICULAR FONT, STYLE, SIZE, OR COLOR.

OWNER OF CANADA REG. NO. 426462, DATED 4-22-1994, EXPIRES 4-22-2024.

NO CLAIM IS MADE TO THE EXCLUSIVE RIGHT TO USE "BIKE", APART FROM THE MARK AS SHOWN.

SER. NO. 85-651,895, FILED 6-14-2012.

FLORENTINA BLANDU, EXAMINING ATTORNEY



*David J. Kyffers*

Director of the United States Patent and Trademark Office

# United States of America

United States Patent and Trademark Office

## DREAM LUMI

**Reg. No. 4,275,762**

L'OREAL USA CREATIVE, INC. (DELAWARE CORPORATION)  
575 FIFTH AVENUE  
NEW YORK, NY 10017

**Registered Jan. 15, 2013**

**Int. Cl.: 3**

FOR: COSMETICS, NAMELY, CONCEALERS, IN CLASS 3 (U.S. CLS. 1, 4, 6, 50, 51 AND 52).

**TRADEMARK**

FIRST USE 1-0-2012; IN COMMERCE 1-0-2012.

**PRINCIPAL REGISTER**

THE MARK CONSISTS OF STANDARD CHARACTERS WITHOUT CLAIM TO ANY PARTICULAR FONT, STYLE, SIZE, OR COLOR.

OWNER OF U.S. REG. NOS. 2,950,384, 3,319,406 AND OTHERS.

SER. NO. 85-651,946, FILED 6-14-2012.

CHERYL CLAYTON, EXAMINING ATTORNEY



*David J. Kyffers*

Director of the United States Patent and Trademark Office

# United States of America

United States Patent and Trademark Office

# Good To Go

**Reg. No. 4,275,763**

**Registered Jan. 15, 2013**

**Int. Cl.: 30**

**TRADEMARK**

**PRINCIPAL REGISTER**

HEB GROCERY COMPANY LP (TEXAS LIMITED PARTNERSHIP)  
CORPORATE LAW DEPARTMENT  
646 SOUTH MAIN  
SAN ANTONIO, TX 78204

FOR: PIZZA KITS COMPRISED OF INGREDIENTS FOR PREPARING PIZZA, IN CLASS 30  
(U.S. CL. 46).

FIRST USE 6-0-2003; IN COMMERCE 6-0-2003.

THE MARK CONSISTS OF STANDARD CHARACTERS WITHOUT CLAIM TO ANY PARTICULAR FONT, STYLE, SIZE, OR COLOR.

OWNER OF U.S. REG. NO. 2,625,614.

SER. NO. 85-653,076, FILED 6-15-2012.

ARETHA SOMERVILLE, EXAMINING ATTORNEY



*David J. Kyffers*

Director of the United States Patent and Trademark Office

# United States of America

United States Patent and Trademark Office

# DejaConnect

**Reg. No. 4,275,764**

**Registered Jan. 15, 2013**

**Int. Cl.: 9**

**TRADEMARK**

**PRINCIPAL REGISTER**

COMPANIONLINK SOFTWARE, INC. (OREGON CORPORATION)  
COMPANIONLINK.COM  
811 SW NAITO WAY SUITE 600  
PORTLAND, OR 97204

FOR: COMPUTER APPLICATION SOFTWARE FOR DATA PROCESSING, INCLUDING MOBILE PHONES, MEDIA PLAYERS, HOME MEDIA CENTERS, LAPTOPS AND COMPUTERS, NAMELY, SOFTWARE FOR SYNCHRONIZING OFFICE DATA MANAGEMENT INFORMATION INCLUDING CONTACTS, CALENDAR, AND NOTES BETWEEN VARIOUS DEVICES, IN CLASS 9 (U.S. CLS. 21, 23, 26, 36 AND 38).

FIRST USE 3-8-2012; IN COMMERCE 3-8-2012.

THE MARK CONSISTS OF STANDARD CHARACTERS WITHOUT CLAIM TO ANY PARTICULAR FONT, STYLE, SIZE, OR COLOR.

OWNER OF U.S. REG. NO. 3,928,653.

SER. NO. 85-653,580, FILED 6-15-2012.

CHARLOTTE CORWIN, EXAMINING ATTORNEY



*David J. Kyffers*

Director of the United States Patent and Trademark Office

# United States of America

United States Patent and Trademark Office

# BackpackCEO

**Reg. No. 4,275,765**

BRAZIEL, REGINALD (UNITED STATES INDIVIDUAL)  
4290 REDSTAR CT.

**Registered Jan. 15, 2013**

RIVERSIDE, CA 92505

**Int. Cl.: 35**

FOR: PROVIDING INFORMATION AND ADVICE ON THE SUBJECT OF STRATEGIES FOR ACHIEVING SUCCESS IN BUSINESS AND BALANCE IN PERSONAL LIFE VIA A GLOBAL COMPUTER NETWORK, IN CLASS 35 (U.S. CLS. 100, 101 AND 102).

**SERVICE MARK**

FIRST USE 1-1-2012; IN COMMERCE 1-1-2012.

**PRINCIPAL REGISTER**

THE MARK CONSISTS OF STANDARD CHARACTERS WITHOUT CLAIM TO ANY PARTICULAR FONT, STYLE, SIZE, OR COLOR.

SER. NO. 85-653,582, FILED 6-15-2012.

ELIZABETH KAJUBI, EXAMINING ATTORNEY



*David J. Kybas*

Director of the United States Patent and Trademark Office

# United States of America

United States Patent and Trademark Office

# Findsider

**Reg. No. 4,275,766**

FINDSIDER (NEW YORK LIMITED LIABILITY COMPANY)  
1500 BROADWAY, SUITE 1900  
NEW YORK, NY 10036

**Registered Jan. 15, 2013**

**Int. Cl.: 36**

FOR: PROVIDING INFORMATION IN THE FIELD OF REAL ESTATE VIA THE INTERNET;  
REAL ESTATE ACQUISITION SERVICES; REAL ESTATE BROKERAGE; REAL ESTATE  
CONSULTANCY, IN CLASS 36 (U.S. CLS. 100, 101 AND 102).

**SERVICE MARK**

FIRST USE 5-1-2012; IN COMMERCE 5-1-2012.

**PRINCIPAL REGISTER**

SER. NO. 85-653,684, FILED 6-15-2012.

LEIGH LOWRY, EXAMINING ATTORNEY

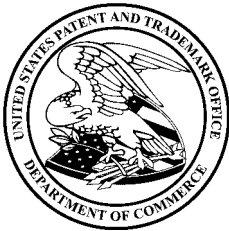

*David J. Kyffers*

Director of the United States Patent and Trademark Office

# United States of America

United States Patent and Trademark Office

DELIBERATELY MADE BETTER  
IN THE USA

**Reg. No. 4,275,767**

**Registered Jan. 15, 2013**

**Int. Cl.: 35**

**SERVICE MARK**

**PRINCIPAL REGISTER**

METROPOLITAN VACUUM CLEANER CO., INC. (NEW YORK CORPORATION)  
PO BOX 149  
ONE RAMAPO AVE.  
SUFFERN, NY 10901

FOR: WHOLESALE DISTRIBUTORSHIP SERVICES IN THE FIELD OF ELECTRIC VACUUM  
CLEANERS AND BLOWERS, IN CLASS 35 (U.S. CLS. 100, 101 AND 102).

FIRST USE 12-1-1977; IN COMMERCE 12-1-1977.

THE MARK CONSISTS OF STANDARD CHARACTERS WITHOUT CLAIM TO ANY PAR-  
TICULAR FONT, STYLE, SIZE, OR COLOR.

SER. NO. 85-653,991, FILED 6-17-2012.

MICHAEL ENGEL, EXAMINING ATTORNEY



*David J. Kyffers*

Director of the United States Patent and Trademark Office

# United States of America

United States Patent and Trademark Office

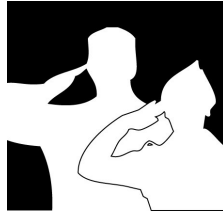

HERO  
HEALTH  
★ HIRE ★

**Reg. No. 4,275,768**

**Registered Jan. 15, 2013**

**Int. Cl.: 35**

**SERVICE MARK**

**PRINCIPAL REGISTER**

MAGELLAN HEALTH SERVICES, INC. (DELAWARE CORPORATION)  
6950 COLUMBIA GATEWAY DRIVE  
COLUMBIA, MD 21046

FOR: PROVIDING EMPLOYMENT INFORMATION, NAMELY, PROVIDING INFORMATION TO PROSPECTIVE EMPLOYERS TO ENCOURAGE THE RECRUITING, HIRING AND TRAINING OF MILITARY VETERANS AND PROVIDING INFORMATION ABOUT JOB-SEEKING TO MILITARY VETERANS, IN CLASS 35 (U.S. CLS. 100, 101 AND 102).

FIRST USE 6-22-2011; IN COMMERCE 6-22-2011.

NO CLAIM IS MADE TO THE EXCLUSIVE RIGHT TO USE "HEALTH HIRE", APART FROM THE MARK AS SHOWN.

THE MARK CONSISTS OF AN OUTLINE OF TWO FIGURES SALUTING UNDERNEATH OF WHICH ARE THE WORDS "HERO HEALTH HIRE" ARRANGED VERTICALLY. THERE IS A STAR TO THE LEFT OF AND TO THE RIGHT OF THE WORD "HIRE".

SER. NO. 85-654,498, FILED 6-18-2012.

LINDA LAVACHE, EXAMINING ATTORNEY



*David J. Kybas*

Director of the United States Patent and Trademark Office



# United States of America

## United States Patent and Trademark Office



**Reg. No. 4,275,769**

SEDCO, CORP. (PUERTO RICO CORPORATION)  
P.O. BOX 362257

**Registered Jan. 15, 2013**

SAN JUAN, PUERTO RICO 009362257

**Int. Cls.: 6, 8, 16, 21 and 22**

FOR: HARDWARE, NAMELY, METAL BRACKETS FOR GENERAL USE; METAL BATHROOM HARDWARE, NAMELY, PULLS; METAL CLASPS FOR DOOR SECURITY HARDWARE; METAL WINDOW CRANKS, IN CLASS 6 (U.S. CLS. 2, 12, 13, 14, 23, 25 AND 50).

**TRADEMARK**

FIRST USE 9-25-1991; IN COMMERCE 9-25-1991.

**PRINCIPAL REGISTER**

FOR: HAND TOOLS, NAMELY, PAINT SCRAPERS; HAND TOOLS, NAMELY, FLOATS, SCREWDRIVERS, TROWELS, PLIERS, LEVELS, HACKSAW FRAMES, WRENCH, DRILLS, IN CLASS 8 (U.S. CLS. 23, 28 AND 44).

FIRST USE 9-25-1991; IN COMMERCE 9-25-1991.

FOR: PAINT APPLICATORS; PAINT BRUSHES; PAINT ROLLER COVERS; PAINT ROLLER HANDLES; PAINT ROLLERS; PAINT STIRRERS; PAINT TRAYS, IN CLASS 16 (U.S. CLS. 2, 5, 22, 23, 29, 37, 38 AND 50).

FIRST USE 9-25-1991; IN COMMERCE 9-25-1991.

FOR: SPRAYER NOZZLES FOR GARDEN HOSES, IN CLASS 21 (U.S. CLS. 2, 13, 23, 29, 30, 33, 40 AND 50).

FIRST USE 9-25-1991; IN COMMERCE 9-25-1991.

FOR: NYLON WEED TRIMMER LINE, IN CLASS 22 (U.S. CLS. 1, 2, 7, 19, 22, 42 AND 50).

FIRST USE 9-25-1991; IN COMMERCE 9-25-1991.

THE MARK CONSISTS OF SPECIAL AND STYLIZED LETTERS THAT FORM THE NAME "SEDCO" AND THE IMAGE OF AN ALLIGATOR UNDER THE NAME.

THE WORDING SEDCO HAS NO MEANING IN A FOREIGN LANGUAGE.

SER. NO. 85-654,733, FILED 6-18-2012.

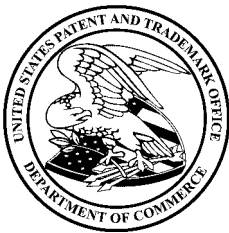

*David J. Kybas*

Director of the United States Patent and Trademark Office

**Reg. No. 4,275,769** TRACY CROSS, EXAMINING ATTORNEY

# United States of America

United States Patent and Trademark Office

# UNIFLEX

**Reg. No. 4,275,770**

SEDCO, CORP. (PUERTO RICO CORPORATION)  
P.O. BOX 362257

**Registered Jan. 15, 2013**

SAN JUAN, PUERTO RICO 009362257

**Int. Cl.: 7**

FOR: ABRASIVE DISKS FOR POWER-OPERATED GRINDERS; ABRASIVE DISKS FOR POWER-OPERATED SANDERS; ABRASIVE WHEELS FOR POWER-OPERATED GRINDERS; POWER-OPERATED ABRASIVE WHEELS, IN CLASS 7 (U.S. CLS. 13, 19, 21, 23, 31, 34 AND 35).

**TRADEMARK**

**PRINCIPAL REGISTER**

FIRST USE 7-11-2002; IN COMMERCE 7-11-2002.

THE MARK CONSISTS OF STANDARD CHARACTERS WITHOUT CLAIM TO ANY PARTICULAR FONT, STYLE, SIZE, OR COLOR.

SER. NO. 85-654,781, FILED 6-18-2012.

TRACY CROSS, EXAMINING ATTORNEY



*David J. Kyffers*

Director of the United States Patent and Trademark Office

# United States of America

United States Patent and Trademark Office

# Moneyball

**Reg. No. 4,275,771**

BERDAN, GREG (UNITED STATES INDIVIDUAL)  
604 N FREYA STREET  
SPOKANE, WA 99202

**Registered Jan. 15, 2013**

**Int. Cl.: 16**

FOR: MONEY CLIPS, IN CLASS 16 (U.S. CLS. 2, 5, 22, 23, 29, 37, 38 AND 50).

**TRADEMARK**

FIRST USE 9-18-2009; IN COMMERCE 4-21-2010.

**PRINCIPAL REGISTER**

THE MARK CONSISTS OF STANDARD CHARACTERS WITHOUT CLAIM TO ANY PARTICULAR FONT, STYLE, SIZE, OR COLOR.

SER. NO. 85-654,831, FILED 6-18-2012.

HEATHER THOMPSON, EXAMINING ATTORNEY



*David J. Kybas*

Director of the United States Patent and Trademark Office

# United States of America

United States Patent and Trademark Office

## WHERE HEROES EAT

**Reg. No. 4,275,772**

**Registered Jan. 15, 2013**

**Int. Cl.: 43**

**SERVICE MARK**

**PRINCIPAL REGISTER**

THE STATION BURGER CO., LLC (KENTUCKY LIMITED LIABILITY COMPANY)  
P.O. BOX 9547  
1025 STATE ST  
BOWLING GREEN, KY 421029547

FOR: RESTAURANT SERVICES, IN CLASS 43 (U.S. CLS. 100 AND 101).

FIRST USE 1-4-2011; IN COMMERCE 1-4-2011.

THE MARK CONSISTS OF STANDARD CHARACTERS WITHOUT CLAIM TO ANY PARTICULAR FONT, STYLE, SIZE, OR COLOR.

SER. NO. 85-655,461, FILED 6-19-2012.

PRISCILLA MILTON, EXAMINING ATTORNEY



*David J. Kyffers*

Director of the United States Patent and Trademark Office

# United States of America

United States Patent and Trademark Office

# GETAGADGET

**Reg. No. 4,275,773**

GETAGADGET, INC. (TEXAS CORPORATION)  
6406 BURLESON ROAD, STE. 120  
AUSTIN, TX 78744

**Registered Jan. 15, 2013**

**Int. Cls.: 9, 11, 14, 16, 18,  
21, 28 and 34**

FOR: DECORATIVE MAGNETS; DECORATIVE REFRIGERATOR MAGNETS; FRIDGE MAGNETS; LIGHT PENS; MAGNETS; NOSE CLIPS FOR DIVERS AND SWIMMERS; NOSE CLIPS FOR SWIMMING; REFRIGERATOR MAGNETS; SWIM GOGGLES; SWIMMING GOGGLES, IN CLASS 9 (U.S. CLS. 21, 23, 26, 36 AND 38).

**TRADEMARK**

FIRST USE 4-1-2000; IN COMMERCE 4-1-2000.

**PRINCIPAL REGISTER**

FOR: FLASHLIGHT POINTERS; FLASHLIGHTS, IN CLASS 11 (U.S. CLS. 13, 21, 23, 31 AND 34).

FIRST USE 4-1-2000; IN COMMERCE 4-1-2000.

FOR: KEY CHAINS AS JEWELLERY, IN CLASS 14 (U.S. CLS. 2, 27, 28 AND 50).

FIRST USE 4-1-2000; IN COMMERCE 4-1-2000.

FOR: BALL PENS; BALL POINT PENS; BALL-POINT PENS; BALLPOINT PENS; INK PENS; MARKING PENS; PENS, IN CLASS 16 (U.S. CLS. 2, 5, 22, 23, 29, 37, 38 AND 50).

FIRST USE 4-1-2000; IN COMMERCE 4-1-2000.

FOR: ALL-PURPOSE REUSABLE CARRYING BAGS; BACKPACKS, BOOK BAGS, SPORTS BAGS, BUM BAGS, WALLETS AND HANDBAGS; BEACH BAGS; DUFFLE BAGS; HIP BAGS; SOUVENIR BAGS; TOTE BAGS; WALLETS; WRISTLET BAGS, IN CLASS 18 (U.S. CLS. 1, 2, 3, 22 AND 41).

FIRST USE 4-1-2000; IN COMMERCE 4-1-2000.

FOR: BOTTLE OPENERS; BOTTLE SLEEVES COMPOSED OF LIQUID-ABSORBING MICRO FIBER FABRIC; BUCKETS; DECORATIVE SAND BOTTLES; NEOPRENE ZIPPERED BOTTLE HOLDERS; PLASTIC BUCKETS; PORTABLE BEVERAGE CONTAINER HOLDER; PORTABLE BEVERAGE COOLERS; PORTABLE COOLERS; PORTABLE ICE CHESTS FOR FOOD AND BEVERAGES, IN CLASS 21 (U.S. CLS. 2, 13, 23, 29, 30, 33, 40 AND 50).



*David J. Kyffers*

Director of the United States Patent and Trademark Office

**Reg. No. 4,275,773** FIRST USE 4-1-2000; IN COMMERCE 4-1-2000.

FOR: BADMINTON RACKETS; BADMINTON SETS; BEACH BALLS; FOOTBALLS; PADDLE BALL GAMES; PADDLE BALLS; PLUSH TOYS; SAND TOYS; SANDBOX TOYS; SPORT BALLS; STUFFED AND PLUSH TOYS; STUFFED TOY ANIMALS; STUFFED TOYS; TOY ANIMALS; VOLLEYBALLS; WATER SQUIRTING TOYS; WATER TOYS, IN CLASS 28 (U.S. CLS. 22, 23, 38 AND 50).

FIRST USE 4-1-2000; IN COMMERCE 4-1-2000.

FOR: LIGHTERS FOR SMOKERS, IN CLASS 34 (U.S. CLS. 2, 8, 9 AND 17).

FIRST USE 4-1-2000; IN COMMERCE 4-1-2000.

THE MARK CONSISTS OF STANDARD CHARACTERS WITHOUT CLAIM TO ANY PARTICULAR FONT, STYLE, SIZE, OR COLOR.

SER. NO. 85-656,381, FILED 6-20-2012.

HOWARD SMIGA, EXAMINING ATTORNEY

# United States of America

United States Patent and Trademark Office



**Reg. No. 4,275,774**

**Registered Jan. 15, 2013**

**Int. Cl.: 12**

**TRADEMARK**

**PRINCIPAL REGISTER**

HONDA MOTOR CO., LTD. (JAPAN CORPORATION)  
1-1, 2-CHOME, MINAMI-AOYAMA, MINATO-KU  
TOKYO, JAPAN 107-8556

FOR: AUTOMOBILES AND STRUCTURAL PARTS THEREOF, IN CLASS 12 (U.S. CLS. 19, 21, 23, 31, 35 AND 44).

FIRST USE 8-23-1990; IN COMMERCE 8-23-1990.

OWNER OF U.S. REG. NOS. 1,779,621, 2,964,304 AND OTHERS.

THE MARK CONSISTS OF A MISCELLANEOUS DESIGN.

SEC. 2(F).

SER. NO. 85-656,486, FILED 6-20-2012.

GRETTA YAO, EXAMINING ATTORNEY



*David J. Kybas*

Director of the United States Patent and Trademark Office



# United States of America

United States Patent and Trademark Office

## U BUY WE FRY

**Reg. No. 4,275,775**

AMANA FOOD SERVICES INC. (MICHIGAN CORPORATION)

**Registered Jan. 15, 2013**

P.O. BOX 7157  
DEARBORN, MI 48121

**Int. Cls.: 35 and 43**

FOR: RETAIL GROCERY AND PREPARED FOOD STORES, IN CLASS 35 (U.S. CLS. 100, 101 AND 102).

**SERVICE MARK**

FIRST USE 6-4-2004; IN COMMERCE 6-4-2004.

**PRINCIPAL REGISTER**

FOR: RESTAURANT SERVICES , IN CLASS 43 (U.S. CLS. 100 AND 101).

FIRST USE 6-4-2004; IN COMMERCE 6-4-2004.

THE MARK CONSISTS OF STANDARD CHARACTERS WITHOUT CLAIM TO ANY PARTICULAR FONT, STYLE, SIZE, OR COLOR.

SER. NO. 85-656,941, FILED 6-20-2012.

ELIZABETH KAJUBI, EXAMINING ATTORNEY



*David J. Kybas*

Director of the United States Patent and Trademark Office

# United States of America

United States Patent and Trademark Office

## YOU BUY WE FRY

**Reg. No. 4,275,776**

AMANA FOOD SERVICES INC. (MICHIGAN CORPORATION)

**Registered Jan. 15, 2013**

P.O. BOX 7157  
DEARBORN, MI 48121

**Int. Cls.: 35 and 43**

FOR: RETAIL GROCERY AND PREPARED FOOD STORES, IN CLASS 35 (U.S. CLS. 100, 101 AND 102).

**SERVICE MARK**

FIRST USE 6-4-2004; IN COMMERCE 6-4-2004.

**PRINCIPAL REGISTER**

FOR: RESTAURANT SERVICES , IN CLASS 43 (U.S. CLS. 100 AND 101).

FIRST USE 6-4-2004; IN COMMERCE 6-4-2004.

THE MARK CONSISTS OF STANDARD CHARACTERS WITHOUT CLAIM TO ANY PARTICULAR FONT, STYLE, SIZE, OR COLOR.

SER. NO. 85-657,006, FILED 6-20-2012.

ELIZABETH KAJUBI, EXAMINING ATTORNEY



*David J. Kybas*

Director of the United States Patent and Trademark Office

# United States of America

United States Patent and Trademark Office

# RAPID SLIDE

**Reg. No. 4,275,777**

APEX BRANDS, INC. (DELAWARE CORPORATION)  
1000 LUFKIN ROAD  
APEX, NC 27539

**Registered Jan. 15, 2013**

**Int. Cl.: 8**

FOR: HAND TOOLS, NAMELY, WRENCHES, IN CLASS 8 (U.S. CLS. 23, 28 AND 44).

**TRADEMARK**

FIRST USE 12-1-2005; IN COMMERCE 12-1-2005.

**PRINCIPAL REGISTER**

THE MARK CONSISTS OF STANDARD CHARACTERS WITHOUT CLAIM TO ANY PARTICULAR FONT, STYLE, SIZE, OR COLOR.

OWNER OF U.S. REG. NO. 3,113,301.

SEC. 2(F).

SER. NO. 85-657,241, FILED 6-20-2012.

GEOFFREY FOSDICK, EXAMINING ATTORNEY



*David J. Kyffers*

Director of the United States Patent and Trademark Office

# United States of America

United States Patent and Trademark Office

# BLU-KROME

**Reg. No. 4,275,778**

**Registered Jan. 15, 2013**

**Int. Cl.: 6**

**TRADEMARK**

**PRINCIPAL REGISTER**

APEX BRANDS, INC. (DELAWARE CORPORATION)  
1000 LUFKIN ROAD  
APEX, NC 27539

FOR: STEEL CHAINS, IN CLASS 6 (U.S. CLS. 2, 12, 13, 14, 23, 25 AND 50).

FIRST USE 9-12-1960; IN COMMERCE 9-12-1960.

THE MARK CONSISTS OF STANDARD CHARACTERS WITHOUT CLAIM TO ANY PARTICULAR FONT, STYLE, SIZE, OR COLOR.

OWNER OF U.S. REG. NO. 729,883.

SEC. 2(F).

SER. NO. 85-657,281, FILED 6-20-2012.

GEOFFREY FOSDICK, EXAMINING ATTORNEY



*David J. Kybas*

Director of the United States Patent and Trademark Office

# United States of America

United States Patent and Trademark Office



**Reg. No. 4,275,779**

**Registered Jan. 15, 2013**

**Int. Cls.: 25 and 26**

**TRADEMARK**

**PRINCIPAL REGISTER**

PROFOOT, INC. (NEW YORK CORPORATION)  
74 20TH STREET  
BROOKLYN, NY 11232

FOR: HEEL PADS, INSOLES AND INSERTS FOR FOOTWEAR FOR CUSHIONING AND SUPPORTING THE FEET, IN CLASS 25 (U.S. CLS. 22 AND 39).

FIRST USE 5-26-2012; IN COMMERCE 5-26-2012.

FOR: SHOE ORNAMENTS NOT OF PRECIOUS METAL, NAMELY, DECORATIVE CLIPS THAT CAN BE ATTACHED TO SHOES AND THAT MAY ALSO BE ATTACHED TO CLOTHING AND HEADWEAR, IN CLASS 26 (U.S. CLS. 37, 39, 40, 42 AND 50).

FIRST USE 5-26-2012; IN COMMERCE 5-26-2012.

OWNER OF U.S. REG. NO. 2,586,391.

THE COLOR(S) GREEN AND BLACK IS/ARE CLAIMED AS A FEATURE OF THE MARK.

THE MARK CONSISTS OF THE WORD "STEP" IN BLACK ABOVE A GREEN CIRCLE BESIDE THE NUMBER "1" IN GREEN.

SER. NO. 85-657,544, FILED 6-21-2012.

ELISSA GARBER KON, EXAMINING ATTORNEY



*David J. Kybas*

Director of the United States Patent and Trademark Office

# United States of America

United States Patent and Trademark Office

## PR AT PARTNERS

**Reg. No. 4,275,780**

**Registered Jan. 15, 2013**

**Int. Cl.: 44**

**SERVICE MARK**

**PRINCIPAL REGISTER**

PARTNERS HAIR DESIGN GROUPING, INC. (VIRGINIA CORPORATION)  
P.O. BOX 3532  
FALLS CHURCH, VA 22042

FOR: BEAUTY CONSULTATION SERVICES; BEAUTY CONSULTATION SERVICES IN THE SELECTION AND USE OF COSMETICS, FRAGRANCES, BEAUTY AIDS, PERSONAL CARE PRODUCTS, AND BATH, BODY AND BEAUTY PRODUCTS; BEAUTY SALON SERVICES; BEAUTY SALONS; BEAUTY SPA SERVICES, NAMELY, COSMETIC BODY CARE; HAIR COLOR SALON SERVICES; HAIR SALON SERVICES; HAIR SALON SERVICES, NAMELY, HAIR CUTTING, STYLING, COLORING, AND HAIR EXTENSION SERVICES; HAIR SALON SERVICES, NAMELY, TREATMENTS TO PROTECT HAIR FROM EFFECTS OF EXPOSURE TO SUNLIGHT, HEAT, HUMIDITY AND CHLORINATED WATER; HAIRDRESSING SALONS, IN CLASS 44 (U.S. CLS. 100 AND 101).

FIRST USE 9-29-2002; IN COMMERCE 9-29-2002.

THE MARK CONSISTS OF STANDARD CHARACTERS WITHOUT CLAIM TO ANY PARTICULAR FONT, STYLE, SIZE, OR COLOR.

OWNER OF U.S. REG. NOS. 2,379,726, 2,511,609 AND OTHERS.

SER. NO. 85-657,549, FILED 6-21-2012.

JULIE WATSON, EXAMINING ATTORNEY



*David J. Kybas*

Director of the United States Patent and Trademark Office

# United States of America

United States Patent and Trademark Office



**Reg. No. 4,275,781**

**Registered Jan. 15, 2013**

**Int. Cl.: 44**

**SERVICE MARK**

**PRINCIPAL REGISTER**

PARTNERS HAIR DESIGN GROUPING, INC. (VIRGINIA CORPORATION)  
P.O. BOX 3532  
FALLS CHURCH, VA 22042

FOR: BEAUTY CONSULTATION SERVICES; BEAUTY CONSULTATION SERVICES IN THE SELECTION AND USE OF COSMETICS, FRAGRANCES, BEAUTY AIDS, PERSONAL CARE PRODUCTS, AND BATH, BODY AND BEAUTY PRODUCTS; BEAUTY SALON SERVICES; BEAUTY SALONS; HAIR COLOR SALON SERVICES; HAIR SALON SERVICES; HAIR SALON SERVICES, NAMELY, HAIR CUTTING, STYLING, COLORING, AND HAIR EXTENSION SERVICES; HAIR SALON SERVICES, NAMELY, TREATMENTS TO PROTECT HAIR FROM EFFECTS OF EXPOSURE TO SUNLIGHT, HEAT, HUMIDITY AND CHLORINATED WATER; HAIRDRESSING SALONS, IN CLASS 44 (U.S. CLS. 100 AND 101).

FIRST USE 8-3-2009; IN COMMERCE 8-3-2009.

OWNER OF U.S. REG. NOS. 2,494,512, 3,349,230 AND OTHERS.

THE MARK CONSISTS OF CAPITAL LETTERS "PR" IN A CIRCLE, SURROUNDED BY A CONCENTRIC CIRCLE-RING CONTAINING THE WRAPPED TEXT "PR AT PARTNERS" ON THE UPPER HALF, AND "YOUR FRESH LOOK" ON THE LOWER HALF, ALL WRAPPED IN A CONCENTRIC CIRCLE OUTLINE.

SER. NO. 85-657,577, FILED 6-21-2012.

JULIE WATSON, EXAMINING ATTORNEY



*David J. Kyffers*

Director of the United States Patent and Trademark Office

# United States of America

United States Patent and Trademark Office

## ONE FRESH CUT THREE FRESH LOOKS

**Reg. No. 4,275,782**

PARTNERS HAIR DESIGN GROUPING, INC. (VIRGINIA CORPORATION)  
P.O. BOX 3532

**Registered Jan. 15, 2013**

FALLS CHURCH, VA 22042

**Int. Cl.: 44**

FOR: BEAUTY CONSULTATION SERVICES; BEAUTY CONSULTATION SERVICES IN THE SELECTION AND USE OF COSMETICS, FRAGRANCES, BEAUTY AIDS, PERSONAL CARE PRODUCTS, AND BATH, BODY AND BEAUTY PRODUCTS; BEAUTY SALON SERVICES; HAIR COLOR SALON SERVICES; HAIR SALON SERVICES; HAIR SALON SERVICES, NAMELY, HAIR CUTTING, STYLING, COLORING, AND HAIR EXTENSION SERVICES; HAIR SALON SERVICES, NAMELY, TREATMENTS TO PROTECT HAIR FROM EFFECTS OF EXPOSURE TO SUNLIGHT, HEAT, HUMIDITY AND CHLORINATED WATER, IN CLASS 44 (U.S. CLS. 100 AND 101).

**SERVICE MARK**

**PRINCIPAL REGISTER**

FIRST USE 1-1-2012; IN COMMERCE 1-1-2012.

THE MARK CONSISTS OF STANDARD CHARACTERS WITHOUT CLAIM TO ANY PARTICULAR FONT, STYLE, SIZE, OR COLOR.

OWNER OF U.S. REG. NOS. 2,887,580, 2,911,584, AND 3,349,230.

SER. NO. 85-657,607, FILED 6-21-2012.

JULIE WATSON, EXAMINING ATTORNEY



*David J. Kyffers*

Director of the United States Patent and Trademark Office



# United States of America

United States Patent and Trademark Office

# BLU DRY

**Reg. No. 4,275,783**

PARTNERS HAIR DESIGN GROUPING, INC. (VIRGINIA CORPORATION)  
P.O. BOX 3532

**Registered Jan. 15, 2013**

FALLS CHURCH, VA 22042

**Int. Cl.: 21**

FOR: HAIR BRUSHES, IN CLASS 21 (U.S. CLS. 2, 13, 23, 29, 30, 33, 40 AND 50).

**TRADEMARK**

FIRST USE 1-1-2012; IN COMMERCE 1-1-2012.

**PRINCIPAL REGISTER**

THE MARK CONSISTS OF STANDARD CHARACTERS WITHOUT CLAIM TO ANY PARTICULAR FONT, STYLE, SIZE, OR COLOR.

OWNER OF U.S. REG. NOS. 3,340,957 AND 3,340,958.

SER. NO. 85-657,632, FILED 6-21-2012.

JULIE WATSON, EXAMINING ATTORNEY



*David J. Kyffers*

Director of the United States Patent and Trademark Office

# United States of America

United States Patent and Trademark Office



**Reg. No. 4,275,784**

**Registered Jan. 15, 2013**

**Int. Cl.: 35**

**SERVICE MARK**

**PRINCIPAL REGISTER**

UNITED PARCEL SERVICE OF AMERICA, INC. (DELAWARE CORPORATION)  
55 GLENLAKE PARKWAY, NE  
ATLANTA, GA 30328

FOR: BUSINESS SERVICES, NAMELY, SHIPMENT INFORMATION MANAGEMENT SERVICES, SHIPMENT PROCESSING, PREPARING SHIPPING DOCUMENTS AND INVOICES, TRACKING DOCUMENTS, AND PACKAGES OVER COMPUTER NETWORKS, INTRANETS AND INTERNETS; MONITORING, MANAGING AND TRACKING OF PACKAGE SHIPMENTS, IN CLASS 35 (U.S. CLS. 100, 101 AND 102).

FIRST USE 5-1-2012; IN COMMERCE 5-1-2012.

OWNER OF U.S. REG. NOS. 966,774, 4,112,524 AND OTHERS.

THE MARK CONSISTS OF A SHIELD DESIGN WITH THE NAME "UPS" IN LOWER CASE, THE PHRASE "UPS MY CHOICE" AND A DRAWING OF A HOUSE INSIDE A HEART-SHAPED DESIGN.

SER. NO. 85-657,639, FILED 6-21-2012.

HOWARD B. LEVINE, EXAMINING ATTORNEY



*David J. Kyros*

Director of the United States Patent and Trademark Office

# United States of America

United States Patent and Trademark Office



UPS MY CHOICE 

**Reg. No. 4,275,785**

**Registered Jan. 15, 2013**

**Int. Cl.: 35**

**SERVICE MARK**

**PRINCIPAL REGISTER**

UNITED PARCEL SERVICE OF AMERICA, INC. (DELAWARE CORPORATION)  
55 GLENLAKE PARKWAY, NE  
ATLANTA, GA 30328

FOR: BUSINESS SERVICES, NAMELY, SHIPMENT INFORMATION MANAGEMENT SERVICES, SHIPMENT PROCESSING, PREPARING SHIPPING DOCUMENTS AND INVOICES, TRACKING DOCUMENTS, AND PACKAGES OVER COMPUTER NETWORKS, INTRANETS AND INTERNETS; MONITORING, MANAGING AND TRACKING OF PACKAGE SHIPMENTS, IN CLASS 35 (U.S. CLS. 100, 101 AND 102).

FIRST USE 5-1-2012; IN COMMERCE 5-1-2012.

OWNER OF U.S. REG. NOS. 966,774, 4,112,524 AND OTHERS.

THE MARK CONSISTS OF A SHIELD DESIGN WITH THE NAME "UPS" IN LOWER CASE AND BELOW IT ARE THE PHRASE "UPS MY CHOICE" AND A DRAWING OF A HOUSE INSIDE A HEART-SHAPED DESIGN.

SER. NO. 85-658,119, FILED 6-21-2012.

HOWARD B. LEVINE, EXAMINING ATTORNEY



*David J. Kyros*

Director of the United States Patent and Trademark Office

# United States of America

United States Patent and Trademark Office

## KNOWLEDGE WHERE YOU ARE

**Reg. No. 4,275,786**

THOMPSON COBURN LLP (MISSOURI LIMITED LIABILITY PARTNERSHIP)  
ONE US BANK PLAZA  
ST. LOUIS, MO 63101

**Registered Jan. 15, 2013**

**Int. Cl.: 41**

FOR: PROVIDING CONTINUING LEGAL EDUCATION COURSES AND SEMINARS; EDUCATION SERVICES, NAMELY, PROVIDING LEGAL PRESENTATIONS, PRE-RECORDED PRESENTATIONS, AND NON-DOWNLOADABLE WEBINARS IN THE FIELD OF CONTINUING LEGAL EDUCATION, IN CLASS 41 (U.S. CLS. 100, 101 AND 107).

**SERVICE MARK**

**PRINCIPAL REGISTER**

FIRST USE 3-15-2012; IN COMMERCE 3-15-2012.

THE MARK CONSISTS OF STANDARD CHARACTERS WITHOUT CLAIM TO ANY PARTICULAR FONT, STYLE, SIZE, OR COLOR.

SER. NO. 85-658,142, FILED 6-21-2012.

COLLEEN KEARNEY, EXAMINING ATTORNEY



*David J. Kybas*

Director of the United States Patent and Trademark Office

# United States of America

United States Patent and Trademark Office

# LoyaltyOS

**Reg. No. 4,275,787**

**Registered Jan. 15, 2013**

**Int. Cls.: 9 and 42**

**TRADEMARK**

**SERVICE MARK**

**PRINCIPAL REGISTER**

SPARKBASE, INC. (OHIO CORPORATION)  
#4404  
3615 SUPERIOR AVE.  
CLEVELAND, OH 44114

FOR: COMPUTER SOFTWARE FOR USE IN ACCESSING CUSTOMER LOYALTY AND GIFT APPLICATIONS, PROGRAMS AND INFRASTRUCTURES AND INTEGRATING THEM INTO EXISTING APPLICATIONS, PROGRAMS, AND INFRASTRUCTURES, IN CLASS 9 (U.S. CLS. 21, 23, 26, 36 AND 38).

FIRST USE 5-1-2012; IN COMMERCE 5-5-2012.

FOR: COMPUTER SOFTWARE INTEGRATION SERVICES DESIGNED TO ALLOW USERS TO ACCESS CUSTOMER LOYALTY AND GIFT APPLICATIONS, PROGRAMS AND INFRASTRUCTURES AND INTEGRATE THEM INTO EXISTING APPLICATIONS, PROGRAMS, AND INFRASTRUCTURES; COMPUTER SOFTWARE CONSULTING SERVICES RELATING TO SOFTWARE FOR USE IN ACCESSING CUSTOMER LOYALTY AND GIFT APPLICATIONS, PROGRAMS AND INFRASTRUCTURES AND INTEGRATING THEM INTO EXISTING APPLICATIONS, PROGRAMS, AND INFRASTRUCTURES, IN CLASS 42 (U.S. CLS. 100 AND 101).

FIRST USE 5-1-2012; IN COMMERCE 5-5-2012.

THE MARK CONSISTS OF STANDARD CHARACTERS WITHOUT CLAIM TO ANY PARTICULAR FONT, STYLE, SIZE, OR COLOR.

SER. NO. 85-658,325, FILED 6-21-2012.

NICHOLAS ALTREE, EXAMINING ATTORNEY



*David J. Kyjars*

Director of the United States Patent and Trademark Office

# United States of America

United States Patent and Trademark Office

## THE NAPSACK

**Reg. No. 4,275,788**

**Registered Jan. 15, 2013**

**Int. Cl.: 25**

**TRADEMARK**

**PRINCIPAL REGISTER**

POLER, LLC (NEVADA LIMITED LIABILITY COMPANY)  
4961 WINDPLAY DR  
EL DORADO HILLS, CA 95762

FOR: ANORAKS; COATS; JACKETS, IN CLASS 25 (U.S. CLS. 22 AND 39).

FIRST USE 11-7-2011; IN COMMERCE 11-7-2011.

THE MARK CONSISTS OF STANDARD CHARACTERS WITHOUT CLAIM TO ANY PARTICULAR FONT, STYLE, SIZE, OR COLOR.

SER. NO. 85-658,463, FILED 6-21-2012.

PAULA MAHONEY, EXAMINING ATTORNEY



*David J. Kybas*

Director of the United States Patent and Trademark Office

# United States of America

United States Patent and Trademark Office

## SKIN THAT KNOWS NO AGE

**Reg. No. 4,275,789**

HOMEOPATHIC HOLDINGS, LLC (UTAH LIMITED LIABILITY COMPANY)  
11142 HIGHLAND BLVD., #100  
HIGHLAND, UT 84003

**Registered Jan. 15, 2013**

**Int. Cl.: 3**

FOR: NON-MEDICATED ANTI-AGING SERUM, IN CLASS 3 (U.S. CLS. 1, 4, 6, 50, 51 AND 52).

**TRADEMARK**

FIRST USE 5-8-2012; IN COMMERCE 5-8-2012.

**PRINCIPAL REGISTER**

THE MARK CONSISTS OF STANDARD CHARACTERS WITHOUT CLAIM TO ANY PARTICULAR FONT, STYLE, SIZE, OR COLOR.

SER. NO. 85-658,492, FILED 6-21-2012.

ELLEN PERKINS, EXAMINING ATTORNEY



*David J. Kyffers*

Director of the United States Patent and Trademark Office

# United States of America

United States Patent and Trademark Office

## THE TICKER TAPE MONTHLY

**Reg. No. 4,275,790**

TD AMERITRADE IP COMPANY, INC. (DELAWARE CORPORATION)  
4211 SOUTH 102ND STREET  
OMAHA, NE 68127

**Registered Jan. 15, 2013**

**Int. Cl.: 9**

FOR: DOWNLOADABLE ELECTRONIC PUBLICATIONS IN THE NATURE OF MAGAZINES, NEWSLETTERS AND REPORTS IN THE FIELD OF FINANCIAL AND SECURITIES ADVICE AND INFORMATION, IN CLASS 9 (U.S. CLS. 21, 23, 26, 36 AND 38).

**TRADEMARK**

FIRST USE 1-31-2012; IN COMMERCE 1-31-2012.

**PRINCIPAL REGISTER**

THE MARK CONSISTS OF STANDARD CHARACTERS WITHOUT CLAIM TO ANY PARTICULAR FONT, STYLE, SIZE, OR COLOR.

NO CLAIM IS MADE TO THE EXCLUSIVE RIGHT TO USE "MONTHLY", APART FROM THE MARK AS SHOWN.

SER. NO. 85-658,989, FILED 6-22-2012.

ANNE MADDEN, EXAMINING ATTORNEY



*David J. Kybas*

Director of the United States Patent and Trademark Office



# United States of America

United States Patent and Trademark Office

## THE TICKER TAPE MONTHLY

**Reg. No. 4,275,791**

TD AMERITRADE IP COMPANY, INC. (DELAWARE CORPORATION)  
4211 SOUTH 102ND STREET  
OMAHA, NE 68127

**Registered Jan. 15, 2013**

**Int. Cl.: 41**

FOR: PROVIDING ON-LINE PUBLICATIONS IN THE NATURE OF MAGAZINES, NEWS-LETTERS AND REPORTS IN THE FIELD OF FINANCIAL AND SECURITIES ADVICE AND INFORMATION, IN CLASS 41 (U.S. CLS. 100, 101 AND 107).

**SERVICE MARK**

FIRST USE 1-31-2012; IN COMMERCE 1-31-2012.

**PRINCIPAL REGISTER**

THE MARK CONSISTS OF STANDARD CHARACTERS WITHOUT CLAIM TO ANY PARTICULAR FONT, STYLE, SIZE, OR COLOR.

NO CLAIM IS MADE TO THE EXCLUSIVE RIGHT TO USE "MONTHLY", APART FROM THE MARK AS SHOWN.

SER. NO. 85-659,014, FILED 6-22-2012.

ANNE MADDEN, EXAMINING ATTORNEY



*David J. Kyffers*

Director of the United States Patent and Trademark Office

# United States of America

United States Patent and Trademark Office

# BRAIN POINT

**Reg. No. 4,275,792**

SHAMIR OPTICAL INDUSTRY LTD. (ISRAEL CORPORATION)  
KIBBUTZ SHAMIR  
UPPER GALILEE 12135, ISRAEL

**Registered Jan. 15, 2013**

**Int. Cl.: 9**

FOR: OPTICAL LENSES FOR SPECTACLES; SPECTACLES; CONTAINERS FOR OPTICAL LENSES AND SPECTACLES; CASES, HOLDERS, PARTS AND FITTINGS FOR THE AFOREMENTIONED GOODS; COMPUTER SOFTWARE FOR PRODUCTION OF OPTICAL LENSES, IN CLASS 9 (U.S. CLS. 21, 23, 26, 36 AND 38).

**TRADEMARK**

**PRINCIPAL REGISTER**

THE MARK CONSISTS OF STANDARD CHARACTERS WITHOUT CLAIM TO ANY PARTICULAR FONT, STYLE, SIZE, OR COLOR.

OWNER OF ISRAEL REG. NO. 232503, DATED 8-3-2011, EXPIRES 9-5-2020.

SER. NO. 85-659,891, FILED 6-24-2012.

HEATHER SAPP, EXAMINING ATTORNEY



*David J. Kyffers*

Director of the United States Patent and Trademark Office

United States of America  
United States Patent and Trademark Office

# BAREFOOT

**Reg. No. 4,275,793**

BAREFOOT TECHNOLOGIES CORP. (NEW HAMPSHIRE CORPORATION)  
41 LIBERTY HILL RD#1  
HENNIKER, NH 03242

**Registered Jan. 15, 2013**

**Int. Cl.: 9**

FOR: COMPUTER SOFTWARE FOR BUSINESS AUTOMATION, NAMELY FOR TRACKING CUSTOMER ORDERS AND INQUIRIES, TRACKING INVENTORY, AND GENERATING REPORTS IN THE FIELD OF LEASING SERVICES, IN CLASS 9 (U.S. CLS. 21, 23, 26, 36 AND 38).

**TRADEMARK**

**PRINCIPAL REGISTER**

FIRST USE 4-12-1999; IN COMMERCE 12-0-1999.

THE MARK CONSISTS OF STANDARD CHARACTERS WITHOUT CLAIM TO ANY PARTICULAR FONT, STYLE, SIZE, OR COLOR.

SER. NO. 85-659,897, FILED 6-24-2012.

KATHLEEN LORENZO, EXAMINING ATTORNEY



*David J. Kyffers*

Director of the United States Patent and Trademark Office

# United States of America

United States Patent and Trademark Office

# Engage

**Reg. No. 4,275,794**

**Registered Jan. 15, 2013**

**Int. Cl.: 42**

**SERVICE MARK**

**PRINCIPAL REGISTER**

QUESTLINE, INC. (OHIO CORPORATION)  
2025 RIVERSIDE DRIVE  
COLUMBUS, OH 43221

FOR: PROVIDING TEMPORARY USE OF ONLINE, NON-DOWNLOADABLE CROSS-CHANNEL DIGITAL COMMUNICATIONS COMPUTER SOFTWARE IN THE FIELD OF MARKETING WHICH ALLOWS ENERGY UTILITIES TO COMMUNICATE WITH THEIR BUSINESS AND RESIDENTIAL CUSTOMERS FOR USE IN EMAIL, MOBILE, AND FAX APPLICATIONS, IN CLASS 42 (U.S. CLS. 100 AND 101).

FIRST USE 6-2-2012; IN COMMERCE 9-7-2012.

THE MARK CONSISTS OF STANDARD CHARACTERS WITHOUT CLAIM TO ANY PARTICULAR FONT, STYLE, SIZE, OR COLOR.

SER. NO. 85-660,481, FILED 6-25-2012.

CHRISIE B. KING, EXAMINING ATTORNEY



*David J. Kyffers*

Director of the United States Patent and Trademark Office

# United States of America

United States Patent and Trademark Office

# NAA

**Reg. No. 4,275,795**

DIGITAL LIGHTWAVE, INC. (DELAWARE CORPORATION)  
1780 102ND AVENUE NORTH; SUITE 500  
ST. PETERSBURG, FL 33716

**Registered Jan. 15, 2013**

**Int. Cl.: 9**

FOR: ELECTRONIC TESTING EQUIPMENT, NAMELY, TELECOMMUNICATION LINE INTEGRITY TESTING APPARATUS, IN CLASS 9 (U.S. CLS. 21, 23, 26, 36 AND 38).

**TRADEMARK**

FIRST USE 1-0-1999; IN COMMERCE 3-22-1999.

**PRINCIPAL REGISTER**

THE MARK CONSISTS OF STANDARD CHARACTERS WITHOUT CLAIM TO ANY PARTICULAR FONT, STYLE, SIZE, OR COLOR.

SER. NO. 85-660,993, FILED 6-25-2012.

STEPHANIE ALI, EXAMINING ATTORNEY



*David J. Kyffers*

Director of the United States Patent and Trademark Office

# United States of America

United States Patent and Trademark Office

# ONA

**Reg. No. 4,275,796**

DIGITAL LIGHTWAVE, INC. (DELAWARE CORPORATION)  
1780 102ND AVENUE NORTH; SUITE 500  
ST. PETERSBURG, FL 33716

**Registered Jan. 15, 2013**

**Int. Cl.: 9**

FOR: ELECTRONIC TESTING EQUIPMENT, NAMELY, TELECOMMUNICATION LINE INTEGRITY TESTING APPARATUS, IN CLASS 9 (U.S. CLS. 21, 23, 26, 36 AND 38).

**TRADEMARK**

FIRST USE 6-30-2001; IN COMMERCE 6-30-2001.

**PRINCIPAL REGISTER**

THE MARK CONSISTS OF STANDARD CHARACTERS WITHOUT CLAIM TO ANY PARTICULAR FONT, STYLE, SIZE, OR COLOR.

SER. NO. 85-661,050, FILED 6-25-2012.

STEPHANIE ALI, EXAMINING ATTORNEY



*David J. Kyffers*

Director of the United States Patent and Trademark Office

# United States of America

United States Patent and Trademark Office

Justice delivered with one  
person in mind... You.

**Reg. No. 4,275,797**

PARKER WAICHMAN LLP (NEW YORK LIMITED PARTNERSHIP)  
6 HARBOR PARK DRIVE  
PORT WASHINGTON, NY 11050

**Registered Jan. 15, 2013**

**Int. Cl.: 45**

FOR: LEGAL SERVICES, IN CLASS 45 (U.S. CLS. 100 AND 101).

**SERVICE MARK**

FIRST USE 6-26-2012; IN COMMERCE 6-26-2012.

**PRINCIPAL REGISTER**

THE MARK CONSISTS OF STANDARD CHARACTERS WITHOUT CLAIM TO ANY PARTICULAR FONT, STYLE, SIZE, OR COLOR.

SER. NO. 85-661,679, FILED 6-26-2012.

JOHN SCHUYLER YARD, EXAMINING ATTORNEY



*David J. Kybas*

Director of the United States Patent and Trademark Office

# United States of America

United States Patent and Trademark Office

## SOCIAL RELOAD

**Reg. No. 4,275,798**

**Registered Jan. 15, 2013**

**Int. Cl.: 41**

**SERVICE MARK**

**PRINCIPAL REGISTER**

DISCOVERY COMMUNICATIONS, LLC (DELAWARE LIMITED LIABILITY COMPANY)  
ONE DISCOVERY PLACE  
SILVER SPRING, MD 20910

FOR: ENTERTAINMENT AND EDUCATIONAL SERVICES IN THE NATURE OF TELEVISION AND MULTIMEDIA PROGRAM SERIES FEATURING SUBJECTS OF GENERAL HUMAN INTEREST DISTRIBUTED VIA VARIOUS PLATFORMS ACROSS MULTIPLE FORMS OF TRANSMISSION MEDIA; PROVIDING ENTERTAINMENT INFORMATION TO OTHERS VIA A GLOBAL COMPUTER NETWORK, IN CLASS 41 (U.S. CLS. 100, 101 AND 107).

FIRST USE 4-20-2012; IN COMMERCE 4-20-2012.

THE MARK CONSISTS OF STANDARD CHARACTERS WITHOUT CLAIM TO ANY PARTICULAR FONT, STYLE, SIZE, OR COLOR.

SER. NO. 85-662,158, FILED 6-26-2012.

TRICIA SONNEBORN, EXAMINING ATTORNEY



*David J. Kybas*

Director of the United States Patent and Trademark Office



United States of America  
United States Patent and Trademark Office

**ACURA**  
**A D V A N C E .**

**Reg. No. 4,275,799**

HONDA MOTOR CO., LTD. (JAPAN CORPORATION)  
1-1, 2-CHOME, MINAMI-AOYAMA, MINATO-KU  
TOKYO, JAPAN 107-8556

**Registered Jan. 15, 2013**

**Int. Cl.: 35**

FOR: AUTOMOBILE DEALERSHIP SERVICES; WHOLESALE AND RETAIL STORE SERVICES FEATURING AUTOMOBILES AND PARTS AND ACCESSORIES FOR AUTOMOBILES , IN CLASS 35 (U.S. CLS. 100, 101 AND 102).

**SERVICE MARK**

FIRST USE 10-12-2007; IN COMMERCE 10-12-2007.

**PRINCIPAL REGISTER**

OWNER OF U.S. REG. NOS. 1,407,602, 2,964,304 AND OTHERS.

THE MARK CONSISTS OF A STYLIZED REPRESENTATION OF THE WORDING "ACURA ADVANCE".

SER. NO. 85-662,208, FILED 6-26-2012.

GRETTA YAO, EXAMINING ATTORNEY



*David J. Kyros*

Director of the United States Patent and Trademark Office

# United States of America

United States Patent and Trademark Office



**Reg. No. 4,275,800**

**Registered Jan. 15, 2013**

**Int. Cl.: 41**

**SERVICE MARK**

**PRINCIPAL REGISTER**

RUN ON, INC. (TEXAS CORPORATION)  
4950 KELLER SPRINGS, SUITE 340  
ADDISON, TX 75001

FOR: ENTERTAINMENT SERVICES, NAMELY, COORDINATING, DIRECTING, AND PROVIDING RUNNING AND WALKING EVENTS AND COMPETITIONS, IN CLASS 41 (U.S. CLS. 100, 101 AND 107).

FIRST USE 6-1-2012; IN COMMERCE 6-1-2012.

NO CLAIM IS MADE TO THE EXCLUSIVE RIGHT TO USE "RUN" AND "5K", APART FROM THE MARK AS SHOWN.

THE COLOR(S) BLUE, WHITE, LIGHT BLUE AND GREY IS/ARE CLAIMED AS A FEATURE OF THE MARK.

THE MARK CONSISTS OF A BLUE CLOUD THAT HAS A LIGHT BLUE DOTTED LINE INTERIOR BORDER. INSIDE THE CLOUD IS THE STYLIZED WORDING "RUN PROUD 5K" AND 2 STARS. THE WORD "RUN" IS WHITE WITH AN INTERIOR GRAY LINE, THE WORD "PROUD" IS WHITE, AND THE WORD "5K" IS GRAY. ONE STAR IS BLUE AND OUTLINED IN LIGHT BLUE. THE OTHER STAR IS WHITE AND OUTLINED IN LIGHT BLUE.

SER. NO. 85-663,051, FILED 6-27-2012.

KIM SAITO, EXAMINING ATTORNEY



*David J. Kybas*

Director of the United States Patent and Trademark Office

# United States of America

United States Patent and Trademark Office

## CLARIDAD ES CALIDAD

**Reg. No. 4,275,801**

**Registered Jan. 15, 2013**

**Int. Cl.: 29**

**TRADEMARK**

**PRINCIPAL REGISTER**

RAGASA INDUSTRIAS, S.A. DE C.V. (MEXICO CORPORATION)  
AV DR JOSE ELEUTERIO GONZALEZ #2815  
COL. MITRAS NORTE  
MONTERREY, NUEVO LEON, MEXICO 64320

FOR: EDIBLE OILS AND FATS, IN CLASS 29 (U.S. CL. 46).

THE MARK CONSISTS OF STANDARD CHARACTERS WITHOUT CLAIM TO ANY PARTICULAR FONT, STYLE, SIZE, OR COLOR.

OWNER OF MEXICO REG. NO. 48164, DATED 6-26-2008, EXPIRES 5-26-2018.

THE ENGLISH TRANSLATION OF "CLARIDAD ES CALIDAD" IN THE MARK IS "CLARITY IS QUALITY".

SER. NO. 85-663,587, FILED 6-28-2012.

MICHAEL WIENER, EXAMINING ATTORNEY



*David J. Kybas*

Director of the United States Patent and Trademark Office

# United States of America

United States Patent and Trademark Office

## NUTRIOLI CHOP, CHOP, CHOP

**Reg. No. 4,275,802**

**Registered Jan. 15, 2013**

**Int. Cl.: 29**

**TRADEMARK**

**PRINCIPAL REGISTER**

RAGASA INDUSTRIAS, S.A. DE C.V. (MEXICO CORPORATION)  
AV DR JOSE ELEUTERIO GONZALEZ #2815  
COL. MITRAS NORTE  
MONTERREY, NUEVO LEON, MEXICO 64320

FOR: EDIBLE OILS AND FATS, IN CLASS 29 (U.S. CL. 46).

THE MARK CONSISTS OF STANDARD CHARACTERS WITHOUT CLAIM TO ANY PARTICULAR FONT, STYLE, SIZE, OR COLOR.

OWNER OF MEXICO REG. NO. 48036, DATED 6-19-2008, EXPIRES 5-20-2018.

OWNER OF U.S. REG. NOS. 2,665,069 AND 4,117,403.

THE WORDING NUTRIOLI HAS NO MEANING IN A FOREIGN LANGUAGE.

SER. NO. 85-663,595, FILED 6-28-2012.

MICHAEL WIENER, EXAMINING ATTORNEY



*David J. Kyfos*

Director of the United States Patent and Trademark Office

# United States of America

United States Patent and Trademark Office

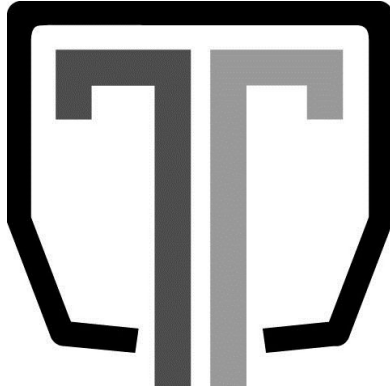

**Reg. No. 4,275,803**

**Registered Jan. 15, 2013**

**Int. Cl.: 9**

**TRADEMARK**

**PRINCIPAL REGISTER**

GORBEL, INC. (NEW YORK CORPORATION)  
600 FISHERS RUN, P.O. BOX. 593  
FISHERS, NY 14453

FOR: FALL PROTECTION EQUIPMENT FOR FALL RESTRAINT AND FALL ARREST, NAMELY, BARS, ANCHORS, HARNESSSES, LINES, LANYARDS, CARABINERS AND ANCHORAGE CONNECTORS; FALL PROTECTION EQUIPMENT FOR FALL RESTRAINT AND FALL ARREST, NAMELY, HARNESSSES; SAFETY EQUIPMENT, NAMELY, A LIFELINE SYSTEM FOR HORIZONTAL OR VERTICAL MOVEMENT TO WHICH A WORKER IS ATTACHED FOR PROTECTION AGAINST FALL HAZARDS, COMPOSED OF AN ANCHOR IN AN ENCLOSED ROLLING TRACK, HARNESS, AND LANYARD OR SELF-RETRACTING LIFELINE, IN CLASS 9 (U.S. CLS. 21, 23, 26, 36 AND 38).

FIRST USE 6-1-2012; IN COMMERCE 6-3-2012.

THE MARK CONSISTS OF THE LETTER "T" ENCLOSED BY THE OUTLINE OF AN IRREGULAR HEXAGONAL SHIELD, WITH THE BOTTOM OF THE "T" EXCEEDING, BUT NOT INTERSECTING, THE BOTTOM SIDE OF THE SHIELD; THE TOP OF THE SHIELD IS FLAT; THE TWO SIDES ADJACENT TO THE TOP OF THE SHIELD ARE ORIENTED AT 90 DEGREES IN RELATION TO THE TOP OF THE SHIELD; THE "T" IS COMPOSED OF TWO UPSIDE DOWN ADJACENT "J" SHAPES, FACING LEFT AND RIGHT, RESPECTIVELY.

SER. NO. 85-663,680, FILED 6-28-2012.

THEODORE MCBRIDE, EXAMINING ATTORNEY



*David J. Kypos*

Director of the United States Patent and Trademark Office

# United States of America

United States Patent and Trademark Office



**Reg. No. 4,275,804**

**Registered Jan. 15, 2013**

**Int. Cl.: 41**

**SERVICE MARK**

**PRINCIPAL REGISTER**

RUN ON, INC. (TEXAS CORPORATION)  
4950 KELLER SPRINGS, SUITE 340  
ADDISON, TX 75001

FOR: ENTERTAINMENT SERVICES NAMELY PROVIDING, COORDINATING, AND DIRECTING RUNNING AND WALKING EVENTS AND COMPETITIONS, IN CLASS 41 (U.S. CLS. 100, 101 AND 107).

FIRST USE 1-14-2006; IN COMMERCE 1-14-2006.

NO CLAIM IS MADE TO THE EXCLUSIVE RIGHT TO USE "5M & 10M", APART FROM THE MARK AS SHOWN.

THE COLOR(S) BLUE, GRAY, AND WHITE IS/ARE CLAIMED AS A FEATURE OF THE MARK.

THE MARK CONSISTS OF A BLUE POLYGON SHAPE WITH TWO CONCAVE SIDES LOCATED ON OPPOSITE ENDS OUTLINED IN WHITE WITH A GRAY BORDER, WITHIN THE SHAPE IS A WHITE SNOWFLAKE, BELOW ARE THE STYLIZED TERMS "TOO COLD" IN GRAY, BELOW ARE THE STYLIZED TERMS "TO HOLD" IN WHITE, BELOW ARE THE STYLIZED TERMS "5M & 10M" IN GRAY.

SER. NO. 85-663,766, FILED 6-28-2012.

KIM SAITO, EXAMINING ATTORNEY



*David J. Kybas*

Director of the United States Patent and Trademark Office

# United States of America

United States Patent and Trademark Office



**Reg. No. 4,275,805**

**Registered Jan. 15, 2013**

**Int. Cl.: 42**

**SERVICE MARK**

**PRINCIPAL REGISTER**

WIKIMEDIA FOUNDATION, INC. (FLORIDA CORPORATION)  
149 NEW MONTGOMERY STREET, 3RD FLOOR  
SAN FRANCISCO, CA 94105

FOR: PROVIDING VIRTUAL COMPUTER SYSTEMS AND VIRTUAL COMPUTER ENVIRONMENTS THROUGH CLOUD COMPUTING; COMPUTER SERVICES, NAMELY, ACTING AS AN APPLICATION SERVICES PROVIDER FOR THIRD PARTIES FEATURING REMOTE HOSTING OF OPERATING SYSTEMS AND COMPUTER APPLICATIONS; COMPUTER SERVICES, NAMELY, PROVIDING A VIRTUAL COMPUTING ENVIRONMENT ACCESSIBLE VIA THE INTERNET FOR REGISTERED USERS FOR ACCESS TO DATABASES AND SOFTWARE DEVELOPMENT TOOLS, IN CLASS 42 (U.S. CLS. 100 AND 101).

FIRST USE 10-14-2011; IN COMMERCE 10-14-2011.

THE MARK CONSISTS OF A STYLIZED UNICORN IN WHITE ON A GREEN CIRCLE, PARTIALLY SURROUNDED BY TWO BLUE ARCS AND ONE RED ARC.

THE COLOR(S) BLUE, RED, GREEN, WHITE IS/ARE CLAIMED AS A FEATURE OF THE MARK.

SER. NO. 85-663,909, FILED 6-28-2012.

JESSICA FATHY, EXAMINING ATTORNEY



*David J. Kybas*

Director of the United States Patent and Trademark Office

# United States of America

United States Patent and Trademark Office

## DECK THE TRAILS

**Reg. No. 4,275,806**

RUN ON, INC. (TEXAS CORPORATION)  
4950 KELLER SPRINGS, SUITE 340  
ADDISON, TX 75001

**Registered Jan. 15, 2013**

**Int. Cl.: 41**

FOR: ENTERTAINMENT SERVICES NAMELY PROVIDING, COORDINATING, AND DIRECTING RUNNING AND WALKING EVENTS AND COMPETITIONS, IN CLASS 41 (U.S. CLS. 100, 101 AND 107).

**SERVICE MARK**

FIRST USE 10-10-2011; IN COMMERCE 10-10-2011.

**PRINCIPAL REGISTER**

THE MARK CONSISTS OF STANDARD CHARACTERS WITHOUT CLAIM TO ANY PARTICULAR FONT, STYLE, SIZE, OR COLOR.

SER. NO. 85-663,939, FILED 6-28-2012.

KIM SAITO, EXAMINING ATTORNEY



*David J. Kybas*

Director of the United States Patent and Trademark Office



# United States of America

United States Patent and Trademark Office

## Active Pet and Play

**Reg. No. 4,275,807**

**Registered Jan. 15, 2013**

**Int. Cl.: 27**

**TRADEMARK**

**PRINCIPAL REGISTER**

UNITED SPORTS SURFACING OF AMERICA, INC. (CALIFORNIA CORPORATION), AKA  
USSA, INC.  
4000 BARRANCA PARKWAY STE.250  
IRVINE, CA 92604

FOR: SYNTHETIC GRASS, IN CLASS 27 (U.S. CLS. 19, 20, 37, 42 AND 50).

FIRST USE 1-25-2004; IN COMMERCE 2-1-2004.

THE MARK CONSISTS OF STANDARD CHARACTERS WITHOUT CLAIM TO ANY PARTICULAR FONT, STYLE, SIZE, OR COLOR.

SER. NO. 85-664,777, FILED 6-28-2012.

HEATHER SAPP, EXAMINING ATTORNEY



*David J. Kybas*

Director of the United States Patent and Trademark Office

# United States of America

United States Patent and Trademark Office

# WINDTUBES

**Reg. No. 4,275,808**

AIR DIMENSIONAL DESIGN INC. (CALIFORNIA CORPORATION)  
7051 1/2 VINELAND AVE.

**Registered Jan. 15, 2013**

NORTH HOLLYWOOD, CA 91605

**Int. Cl.: 28**

FOR: BALLOONS; INFLATABLE TOYS; PLAY BALLOONS; TOY BALLOONS, IN CLASS 28 (U.S. CLS. 22, 23, 38 AND 50).

**TRADEMARK**

FIRST USE 1-1-1989; IN COMMERCE 1-30-1990.

**PRINCIPAL REGISTER**

THE MARK CONSISTS OF STANDARD CHARACTERS WITHOUT CLAIM TO ANY PARTICULAR FONT, STYLE, SIZE, OR COLOR.

SER. NO. 85-665,671, FILED 6-29-2012.

MICHAEL SOUDERS, EXAMINING ATTORNEY



*David J. Kyros*

Director of the United States Patent and Trademark Office

# United States of America

United States Patent and Trademark Office

## BABIES FOR YUM

**Reg. No. 4,275,809**

THE NEST COLLECTIVE, INC. (DELAWARE CORPORATION)  
1485 PARK AVENUE, SUITE 200  
EMERYVILLE, CA 94608

**Registered Jan. 15, 2013**

**Int. Cl.: 5**

FOR: FOOD FOR INFANTS AND BABIES, NAMELY ORGANIC PREPARED MEALS AND ORGANIC PREPARED SNACKS, IN CLASS 5 (U.S. CLS. 6, 18, 44, 46, 51 AND 52).

**TRADEMARK**

FIRST USE 2-1-2012; IN COMMERCE 2-1-2012.

**PRINCIPAL REGISTER**

THE MARK CONSISTS OF STANDARD CHARACTERS WITHOUT CLAIM TO ANY PARTICULAR FONT, STYLE, SIZE, OR COLOR.

SER. NO. 85-666,031, FILED 6-29-2012.

CHARLOTTE CORWIN, EXAMINING ATTORNEY



*David J. Kybas*

Director of the United States Patent and Trademark Office

# United States of America

United States Patent and Trademark Office

red alder

**Reg. No. 4,275,810**

RED ALDER GP, LLC (DELAWARE LIMITED LIABILITY COMPANY)  
215 GATES AVENUE, APT. 1  
BROOKLYN, NY 11238

**Registered Jan. 15, 2013**

**Int. Cl.: 36**

FOR: FINANCIAL SERVICES, NAMELY, OPERATION AND MANAGEMENT OF HEDGE FUNDS, COMMODITY POOLS AND OTHER COLLECTIVE INVESTMENT VEHICLES, AND TRADING FOR OTHERS OF SECURITIES, OPTIONS, FUTURES, DERIVATIVES, DEBT INSTRUMENTS AND COMMODITIES, IN CLASS 36 (U.S. CLS. 100, 101 AND 102).

**SERVICE MARK**

**PRINCIPAL REGISTER**

FIRST USE 6-21-2012; IN COMMERCE 6-21-2012.

THE MARK CONSISTS OF THE WORDS RED ALDER WITH A TREE IMAGE REPLACING THE LETTER "L" IN ALDER, ALL IN THE COLOR RED.

THE COLOR(S) RED IS/ARE CLAIMED AS A FEATURE OF THE MARK.

SER. NO. 85-666,928, FILED 7-2-2012.

HENRY S. ZAK, EXAMINING ATTORNEY



*David J. Kybas*

Director of the United States Patent and Trademark Office

# United States of America

United States Patent and Trademark Office

# TBANN

**Reg. No. 4,275,811**

**Registered Jan. 15, 2013**

**Int. Cl.: 41**

**SERVICE MARK**

**PRINCIPAL REGISTER**

RUNNELS, DAMEON (UNITED STATES INDIVIDUAL)  
2904 VALLEY SPRING DR  
PLANO, TX 75025

FOR: PROVIDING NEWS, INFORMATION AND COMMENTARY IN THE FIELD OF CURRENT EVENTS RELATING TO POLITICS, THE MEDIA, ENTERTAINMENT, SPORTS, COMEDY, BUSINESS, HEALTHY LIVING AND LIFESTYLE, WELLNESS, FASHION, PERSONAL BEAUTY, ENVIRONMENTALLY CONSCIOUS AND GREEN ISSUES, FOOD, TECHNOLOGY, TRAVEL, EDUCATION, BOOKS, FINE ARTS, AND PERFORMING ARTS, IN CLASS 41 (U.S. CLS. 100, 101 AND 107).

FIRST USE 10-5-2011; IN COMMERCE 4-9-2012.

THE MARK CONSISTS OF STANDARD CHARACTERS WITHOUT CLAIM TO ANY PARTICULAR FONT, STYLE, SIZE, OR COLOR.

SER. NO. 85-667,816, FILED 7-3-2012.

MEGHAN REINHART, EXAMINING ATTORNEY



*David J. Kyffers*

Director of the United States Patent and Trademark Office

# United States of America

United States Patent and Trademark Office

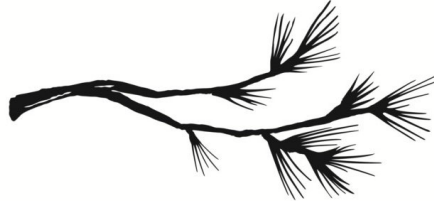

**Reg. No. 4,275,812**

**Registered Jan. 15, 2013**

**Int. Cl.: 43**

**SERVICE MARK**

**PRINCIPAL REGISTER**

TRUSTEES OF DARTMOUTH COLLEGE (NEW HAMPSHIRE NON-PROFIT CORPORATION)  
DARTMOUTH COLLEGE  
HANOVER, NH 03755

FOR: RESTAURANT AND HOTEL SERVICES, IN CLASS 43 (U.S. CLS. 100 AND 101).

FIRST USE 6-1-2012; IN COMMERCE 6-1-2012.

THE MARK CONSISTS OF A PINE TREE BRANCH.

SER. NO. 85-667,968, FILED 7-3-2012.

KATHLEEN LORENZO, EXAMINING ATTORNEY



*David J. Kybas*

Director of the United States Patent and Trademark Office

# United States of America

United States Patent and Trademark Office

# MOBIRATE

**Reg. No. 4,275,813**

**Registered Jan. 15, 2013**

**Int. Cl.: 9**

**TRADEMARK**

**PRINCIPAL REGISTER**

MOBIRATE, LTD (RUSSIAN FED. LIMITED COMPANY (LTD.))  
KRASNOARMEYSKAYA 64, 32  
ULYANOVSK, RUSSIAN FED.

FOR: COMPUTER GAME SOFTWARE FOR USE ON MOBILE AND CELLULAR PHONES;  
VIDEO AND COMPUTER GAME PROGRAMS; VIDEO GAME SOFTWARE, IN CLASS 9  
(U.S. CLS. 21, 23, 26, 36 AND 38).

FIRST USE 9-30-2004; IN COMMERCE 9-30-2004.

THE MARK CONSISTS OF STANDARD CHARACTERS WITHOUT CLAIM TO ANY PAR-  
TICULAR FONT, STYLE, SIZE, OR COLOR.

SER. NO. 85-668,868, FILED 7-4-2012.

ANTHONY RINKER, EXAMINING ATTORNEY



*David J. Kybas*

Director of the United States Patent and Trademark Office

# United States of America

United States Patent and Trademark Office

## Black and Orange

**Reg. No. 4,275,814**

A BURGER GRILLING COMPANY (VIRGINIA LIMITED LIABILITY COMPANY)  
9907 LEESBURG PIKE  
VIENNA, VA 22182

**Registered Jan. 15, 2013**

**Int. Cl.: 43**

FOR: RESTAURANT SERVICES, NAMELY, PROVIDING OF FOOD AND BEVERAGES FOR CONSUMPTION ON AND OFF THE PREMISES, IN CLASS 43 (U.S. CLS. 100 AND 101).

**SERVICE MARK**

FIRST USE 5-1-2011; IN COMMERCE 5-1-2011.

**PRINCIPAL REGISTER**

THE MARK CONSISTS OF STANDARD CHARACTERS WITHOUT CLAIM TO ANY PARTICULAR FONT, STYLE, SIZE, OR COLOR.

SER. NO. 85-669,064, FILED 7-5-2012.

DOMINICK J. SALEMI, EXAMINING ATTORNEY



*David J. Kyffers*

Director of the United States Patent and Trademark Office



# United States of America

United States Patent and Trademark Office

## ROYAL BUILDING PRODUCTS

**Reg. No. 4,275,815**

**Registered Jan. 15, 2013**

**Int. Cl.: 17**

**TRADEMARK**

**PRINCIPAL REGISTER**

ROYAL GROUP, INC. (CANADA CORPORATION)  
30 ROYAL GROUP CRESCENT  
WOODBIDGE, ON, CANADA L4H1X9

FOR: EXTRUDED PVC PRODUCT USED TO PRODUCE FRAMES, SASHES AND ACCESSORIES FOR USE IN THE MANUFACTURE OF WINDOWS AND DOORS, IN CLASS 17 (U.S. CLS. 1, 5, 12, 13, 35 AND 50).

FIRST USE 11-0-2011; IN COMMERCE 11-0-2011.

THE MARK CONSISTS OF STANDARD CHARACTERS WITHOUT CLAIM TO ANY PARTICULAR FONT, STYLE, SIZE, OR COLOR.

OWNER OF U.S. REG. NOS. 1,621,210, 2,723,258 AND OTHERS.

NO CLAIM IS MADE TO THE EXCLUSIVE RIGHT TO USE "BUILDING PRODUCTS", APART FROM THE MARK AS SHOWN.

SER. NO. 85-669,144, FILED 7-5-2012.

MICHAEL LITZAU, EXAMINING ATTORNEY



*David J. Kyffers*

Director of the United States Patent and Trademark Office

# United States of America

United States Patent and Trademark Office

## ROYAL BUILDING PRODUCTS

**Reg. No. 4,275,816**

**Registered Jan. 15, 2013**

**Int. Cl.: 42**

**SERVICE MARK**

**PRINCIPAL REGISTER**

ROYAL GROUP, INC. (CANADA CORPORATION)  
30 ROYAL GROUP CRESCENT  
WOODBIDGE, ON, CANADA L4H1X9

FOR: DESIGN AND DEVELOPMENT OF COLORIZING SYSTEM TO PROTECT THE EXTERIOR OF WINDOW AND DOOR FRAMES, IN CLASS 42 (U.S. CLS. 100 AND 101).

FIRST USE 11-0-2011; IN COMMERCE 11-0-2011.

THE MARK CONSISTS OF STANDARD CHARACTERS WITHOUT CLAIM TO ANY PARTICULAR FONT, STYLE, SIZE, OR COLOR.

OWNER OF U.S. REG. NOS. 1,621,210, 2,723,258 AND OTHERS.

NO CLAIM IS MADE TO THE EXCLUSIVE RIGHT TO USE "BUILDING PRODUCTS", APART FROM THE MARK AS SHOWN.

SER. NO. 85-669,352, FILED 7-5-2012.

MICHAEL LITZAU, EXAMINING ATTORNEY



*David J. Kyffers*

Director of the United States Patent and Trademark Office

# United States of America

United States Patent and Trademark Office

# FOOD CLUB

**Reg. No. 4,275,817**

TOPCO HOLDINGS, INC. (WISCONSIN CORPORATION)  
7711 GROSS POINT ROAD  
SKOKIE, IL 60077

**Registered Jan. 15, 2013**

**Int. Cl.: 21**

FOR: PLASTIC, FOAM AND PAPER DINNERWARE INCLUDING PLATES, CUPS, BOWLS, BEVERAGeware, IN CLASS 21 (U.S. CLS. 2, 13, 23, 29, 30, 33, 40 AND 50).

**TRADEMARK**

FIRST USE 3-0-2007; IN COMMERCE 3-0-2007.

**PRINCIPAL REGISTER**

THE MARK CONSISTS OF STANDARD CHARACTERS WITHOUT CLAIM TO ANY PARTICULAR FONT, STYLE, SIZE, OR COLOR.

OWNER OF U.S. REG. NOS. 650,608, 1,610,724 AND OTHERS.

SER. NO. 85-669,379, FILED 7-5-2012.

KEVIN CORWIN, EXAMINING ATTORNEY



*David J. Kybas*

Director of the United States Patent and Trademark Office

**United States of America**  
United States Patent and Trademark Office

# FOOD CLUB

**Reg. No. 4,275,818**

**Registered Jan. 15, 2013**

**Int. Cl.: 16**

**TRADEMARK**

**PRINCIPAL REGISTER**

TOPCO HOLDINGS, INC. (WISCONSIN CORPORATION)  
7711 GROSS POINT ROAD  
SKOKIE, IL 60077

FOR: PAPER TOWELS, PAPER NAPKINS, FACIAL TISSUE, BATH TISSUE, DISPOSABLE PAPER WIPES FOR HOUSEHOLD CLEANING NOT IMPREGNATED WITH CHEMICALS OR COMPOUNDS, IN CLASS 16 (U.S. CLS. 2, 5, 22, 23, 29, 37, 38 AND 50).

FIRST USE 3-0-2007; IN COMMERCE 3-0-2007.

THE MARK CONSISTS OF STANDARD CHARACTERS WITHOUT CLAIM TO ANY PARTICULAR FONT, STYLE, SIZE, OR COLOR.

OWNER OF U.S. REG. NOS. 650,608, 1,610,724 AND OTHERS.

SER. NO. 85-669,381, FILED 7-5-2012.

KEVIN CORWIN, EXAMINING ATTORNEY



*David J. Kyffers*

Director of the United States Patent and Trademark Office

# United States of America

United States Patent and Trademark Office

## DIRTY FINGERNAIL CLUB

**Reg. No. 4,275,819**

**Registered Jan. 15, 2013**

**Int. Cl.: 41**

**SERVICE MARK**

**PRINCIPAL REGISTER**

BONNIE PLANTS, INC. (ALABAMA CORPORATION)  
1729 HIGHWAY 223  
UNION SPRINGS, AL 36089

FOR: EDUCATIONAL SERVICES, NAMELY, PROVIDING ONLINE INSTRUCTION IN THE FIELD OF GARDENING AND AGRICULTURE; PROVIDING ONLINE NEWSLETTERS IN THE FIELD OF GARDENING AND AGRICULTURE VIA E-MAIL; PROVIDING RECOGNITION AND INCENTIVES BY THE WAY OF AWARDS AND CONTESTS TO DEMONSTRATE EXCELLENCE IN THE FIELD OF GARDENING AND AGRICULTURE, IN CLASS 41 (U.S. CLS. 100, 101 AND 107).

FIRST USE 6-0-2012; IN COMMERCE 6-0-2012.

THE MARK CONSISTS OF STANDARD CHARACTERS WITHOUT CLAIM TO ANY PARTICULAR FONT, STYLE, SIZE, OR COLOR.

SER. NO. 85-669,893, FILED 7-5-2012.

CHARLES L. JENKINS, EXAMINING ATTORNEY



*David J. Kyffers*

Director of the United States Patent and Trademark Office

# United States of America

United States Patent and Trademark Office

# Eudemon

**Reg. No. 4,275,820**

**Registered Jan. 15, 2013**

**Int. Cl.: 9**

**TRADEMARK**

**PRINCIPAL REGISTER**

HUAWEI TECHNOLOGIES CO., LTD. (CHINA LIMITED COMPANY (LTD.))  
BUILDING B1-3-A, HUAWEI INDUSTRIAL BASE,  
BANTIAN, LONGGANG DISTRICT  
SHENZHEN, CHINA 518129

FOR: COMPUTER HARDWARE, NAMELY, FIREWALLS; COMPUTER SOFTWARE FOR THE CREATION OF FIREWALLS; COMPUTER HARDWARE AND SOFTWARE FOR COMPUTER NETWORK SECURITY, SOLD AS A UNIT, NAMELY, UNIFIED THREAT MANAGEMENT (UTM) APPLIANCES, IN CLASS 9 (U.S. CLS. 21, 23, 26, 36 AND 38).

FIRST USE 1-1-2003; IN COMMERCE 1-1-2003.

THE MARK CONSISTS OF STANDARD CHARACTERS WITHOUT CLAIM TO ANY PARTICULAR FONT, STYLE, SIZE, OR COLOR.

SER. NO. 85-670,157, FILED 7-6-2012.

BRIAN NEVILLE, EXAMINING ATTORNEY



*David J. Kyffers*

Director of the United States Patent and Trademark Office

# United States of America

United States Patent and Trademark Office

# SPRITE

**Reg. No. 4,275,821**

**Registered Jan. 15, 2013**

**Int. Cl.: 3**

**TRADEMARK**

**PRINCIPAL REGISTER**

THE COCA-COLA COMPANY (DELAWARE CORPORATION)  
ONE COCA-COLA PLAZA  
ATLANTA, GA 30313

FOR: LIP BALM; LIP GLOSS, IN CLASS 3 (U.S. CLS. 1, 4, 6, 50, 51 AND 52).

FIRST USE 9-30-2006; IN COMMERCE 9-30-2006.

THE MARK CONSISTS OF STANDARD CHARACTERS WITHOUT CLAIM TO ANY PARTICULAR FONT, STYLE, SIZE, OR COLOR.

SER. NO. 85-670,296, FILED 7-6-2012.

COLLEEN KEARNEY, EXAMINING ATTORNEY



*David J. Kyffers*

Director of the United States Patent and Trademark Office

# United States of America

United States Patent and Trademark Office

## SHOP NORTHERN VALLEY

**Reg. No. 4,275,822**

**Registered Jan. 15, 2013**

**Int. Cl.: 16**

**TRADEMARK**

**PRINCIPAL REGISTER**

NORTH JERSEY MEDIA GROUP INC. (NEW JERSEY CORPORATION)  
1 GARRET MOUNTAIN PLAZA  
WOODLAND PARK, NJ 07424

FOR: MAGAZINE SUPPLEMENTS TO NEWSPAPERS IN THE NATURE OF NEWSPAPER  
ADVERTISING INSERTS PROMOTING THE GOODS AND SERVICES OF OTHERS , IN  
CLASS 16 (U.S. CLS. 2, 5, 22, 23, 29, 37, 38 AND 50).

FIRST USE 6-30-2011; IN COMMERCE 6-30-2011.

THE MARK CONSISTS OF STANDARD CHARACTERS WITHOUT CLAIM TO ANY PAR-  
TICULAR FONT, STYLE, SIZE, OR COLOR.

NO CLAIM IS MADE TO THE EXCLUSIVE RIGHT TO USE "NORTHERN VALLEY", APART  
FROM THE MARK AS SHOWN.

SER. NO. 85-670,330, FILED 7-6-2012.

Laurie Kaufman, Examining Attorney



*David J. Kybas*

Director of the United States Patent and Trademark Office



# United States of America

United States Patent and Trademark Office

## INTERACTIVES

**Reg. No. 4,275,823**

**Registered Jan. 15, 2013**

**Int. Cl.: 42**

**SERVICE MARK**

**PRINCIPAL REGISTER**

PHARMACY AND HEALTHCARE COMMUNICATIONS, LLC (NEW JERSEY LIMITED LIABILITY COMPANY)  
666 PLAINSBORO ROAD  
PLAINSBORO, NJ 08536

FOR: HOSTING ON-LINE WEB FACILITIES FOR OTHERS TO SHARE CONTENT AND PARTICIPATE IN DISCUSSIONS IN THE FIELD OF PHARMACY, IN CLASS 42 (U.S. CLS. 100 AND 101).

FIRST USE 5-25-2012; IN COMMERCE 5-25-2012.

THE MARK CONSISTS OF STANDARD CHARACTERS WITHOUT CLAIM TO ANY PARTICULAR FONT, STYLE, SIZE, OR COLOR.

SER. NO. 85-670,348, FILED 7-6-2012.

MICHAEL WIENER, EXAMINING ATTORNEY



*David J. Kyffers*

Director of the United States Patent and Trademark Office

# United States of America

United States Patent and Trademark Office

## INTERACTIVES

**Reg. No. 4,275,824**

**Registered Jan. 15, 2013**

**Int. Cl.: 16**

**TRADEMARK**

**PRINCIPAL REGISTER**

PHARMACY AND HEALTHCARE COMMUNICATIONS, LLC (NEW JERSEY LIMITED LIABILITY COMPANY)  
666 PLAINSBORO ROAD  
PLAINSBORO, NJ 08536

FOR: PUBLICATIONS, NAMELY, ARTICLES IN THE FIELDS OF PHARMACY, IN CLASS 16 (U.S. CLS. 2, 5, 22, 23, 29, 37, 38 AND 50).

FIRST USE 5-25-2012; IN COMMERCE 5-25-2012.

THE MARK CONSISTS OF STANDARD CHARACTERS WITHOUT CLAIM TO ANY PARTICULAR FONT, STYLE, SIZE, OR COLOR.

SER. NO. 85-670,375, FILED 7-6-2012.

MICHAEL WIENER, EXAMINING ATTORNEY



*David J. Kyffers*

Director of the United States Patent and Trademark Office

# United States of America

United States Patent and Trademark Office

## WORLD OF MADAGASCAR

**Reg. No. 4,275,825**

**Registered Jan. 15, 2013**

**Int. Cl.: 28**

**TRADEMARK**

**PRINCIPAL REGISTER**

DREAMWORKS ANIMATION L.L.C. (DELAWARE LIMITED LIABILITY COMPANY)  
1000 FLOWER STREET  
GLENDALE, CA 91201

FOR: PLUSH TOYS, STUFFED TOYS, ACTION FIGURES AND ACCESSORIES THEREFOR,  
TOY VEHICLES, TOY PLANES, PLAY TENTS, PLAY TUNNELS, IN CLASS 28 (U.S. CLS.  
22, 23, 38 AND 50).

FIRST USE 6-1-2012; IN COMMERCE 6-1-2012.

THE MARK CONSISTS OF STANDARD CHARACTERS WITHOUT CLAIM TO ANY PAR-  
TICULAR FONT, STYLE, SIZE, OR COLOR.

OWNER OF U.S. REG. NOS. 3,011,693, 3,620,525 AND OTHERS.

SER. NO. 85-670,754, FILED 7-6-2012.

ANN E. SAPPENFIELD, EXAMINING ATTORNEY



*David J. Kybas*

Director of the United States Patent and Trademark Office

# United States of America

United States Patent and Trademark Office



**Reg. No. 4,275,826**

ELEVATION FRANCHISE VENTURES, LLC (DELAWARE LIMITED LIABILITY COMPANY)  
4100 N. FAIRFAX DR., STE. 730  
ARLINGTON, VA 22203

**Registered Jan. 15, 2013**

**Int. Cl.: 43**

FOR: RESTAURANT SERVICES, IN CLASS 43 (U.S. CLS. 100 AND 101).

**SERVICE MARK**

FIRST USE 10-20-2011; IN COMMERCE 11-10-2011.

**PRINCIPAL REGISTER**

THE MARK CONSISTS OF A HAMBURGER WITH WINGS AND A HALO.

SER. NO. 85-670,789, FILED 7-6-2012.

SAIMA MAKHDOOM, EXAMINING ATTORNEY



*David J. Kyffers*

Director of the United States Patent and Trademark Office

# United States of America

United States Patent and Trademark Office

# PowerRank

**Reg. No. 4,275,827**

**Registered Jan. 15, 2013**

**Int. Cl.: 35**

**SERVICE MARK**

**PRINCIPAL REGISTER**

GWB CAPITAL LLC (CONNECTICUT LIMITED LIABILITY COMPANY)  
133 STANWICH ROAD  
GREENWICH, CT 06830

FOR: BUSINESS NETWORKING; BUSINESS NETWORKING OF PEER TO PEER LEARNING GROUPS OF HIGH NET WORTH INDIVIDUALS; ON-LINE BUSINESS NETWORKING SERVICES; ON-LINE PROFESSIONAL NETWORKING SERVICES; PROVIDING BUSINESS INFORMATION IN THE FIELD OF SOCIAL MEDIA; PROVIDING MARKETING CONSULTING IN THE FIELD OF SOCIAL MEDIA, IN CLASS 35 (U.S. CLS. 100, 101 AND 102).

FIRST USE 5-23-2012; IN COMMERCE 5-23-2012.

THE MARK CONSISTS OF STANDARD CHARACTERS WITHOUT CLAIM TO ANY PARTICULAR FONT, STYLE, SIZE, OR COLOR.

SER. NO. 85-671,438, FILED 7-9-2012.

JOHN DALIER, EXAMINING ATTORNEY



*David J. Kybas*

Director of the United States Patent and Trademark Office

# United States of America

United States Patent and Trademark Office

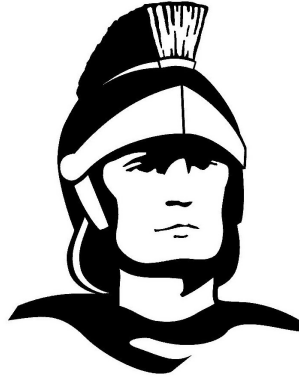

**Reg. No. 4,275,828**

**Registered Jan. 15, 2013**

**Int. Cl.: 40**

**SERVICE MARK**

**PRINCIPAL REGISTER**

CMC GROUP, INC. (OHIO CORPORATION)  
12836 SOUTH DIXIE HIGHWAY  
BOWLING GREEN, OH 43402

FOR: PRINTING SERVICES, NAMELY, CUSTOM PRINTING OF LABELS, TAGS, BAGS, RIBBONS, PACKAGING, MARKETING MATERIALS, ADVERTISEMENTS, HOLOGRAMS, PARKING PERMITS, IDENTIFICATION CARDS, AND SECURITY SEALS, IN CLASS 40 (U.S. CLS. 100, 103 AND 106).

FIRST USE 6-11-1996; IN COMMERCE 6-11-1996.

THE MARK CONSISTS OF THE BUST OF A MAN WEARING A HELMET.

SER. NO. 85-671,604, FILED 7-9-2012.

DAVID TOOLEY, EXAMINING ATTORNEY



*David J. Kyffers*

Director of the United States Patent and Trademark Office

# United States of America

United States Patent and Trademark Office

## Good Neighbor Grant

**Reg. No. 4,275,829**

**Registered Jan. 15, 2013**

**Int. Cl.: 36**

**SERVICE MARK**

**PRINCIPAL REGISTER**

STATE FARM MUTUAL AUTOMOBILE INSURANCE COMPANY (ILLINOIS CORPORATION)

A3  
ONE STATE FARM PLAZA  
BLOOMINGTON, IL 61710

FOR: CHARITABLE FUND RAISING SERVICES, IN CLASS 36 (U.S. CLS. 100, 101 AND 102).

FIRST USE 7-0-1999; IN COMMERCE 7-0-2000.

THE MARK CONSISTS OF STANDARD CHARACTERS WITHOUT CLAIM TO ANY PARTICULAR FONT, STYLE, SIZE, OR COLOR.

OWNER OF U.S. REG. NO. 2,597,620.

NO CLAIM IS MADE TO THE EXCLUSIVE RIGHT TO USE "GRANT", APART FROM THE MARK AS SHOWN.

SER. NO. 85-672,909, FILED 7-10-2012.

ERIN FALK, EXAMINING ATTORNEY



*David J. Kyffers*

Director of the United States Patent and Trademark Office

# United States of America

United States Patent and Trademark Office

# CUBITRON

**Reg. No. 4,275,830**

3M COMPANY (DELAWARE CORPORATION)  
3M CENTER, 2501 HUDSON ROAD  
ST. PAUL, MN 55144

**Registered Jan. 15, 2013**

**Int. Cls.: 3 and 7**

FOR: ABRASIVES IN THE FORM OF BELTS, BANDS, WHEELS, AND DISCS, IN CLASS 3 (U.S. CLS. 1, 4, 6, 50, 51 AND 52).

**TRADEMARK**

FIRST USE 12-31-1981; IN COMMERCE 12-31-1981.

**PRINCIPAL REGISTER**

FOR: ABRASIVES IN THE FORM OF BELTS, BANDS, WHEELS, AND DISCS FOR USE ON POWER TOOLS; ABRASIVE GRINDING WHEELS FOR USE ON POWER TOOLS, IN CLASS 7 (U.S. CLS. 13, 19, 21, 23, 31, 34 AND 35).

FIRST USE 12-31-1981; IN COMMERCE 12-31-1981.

THE MARK CONSISTS OF STANDARD CHARACTERS WITHOUT CLAIM TO ANY PARTICULAR FONT, STYLE, SIZE, OR COLOR.

OWNER OF U.S. REG. NO. 1,431,655.

SER. NO. 85-673,637, FILED 7-11-2012.

JANET LEE, EXAMINING ATTORNEY



*David J. Kyros*

Director of the United States Patent and Trademark Office



# United States of America

United States Patent and Trademark Office

THE ECO   
WINDOW

**Reg. No. 4,275,831**

**Registered Jan. 15, 2013**

**Int. Cl.: 19**

**TRADEMARK**

**PRINCIPAL REGISTER**

ROYAL GROUP, INC. (CANADA CORPORATION)  
30 ROYAL GROUP CRESCENT  
WOODBIDGE, ON, CANADA L4H1X9

FOR: NON-METAL WINDOWS, PATIO DOORS, AND RELATED ACCESSORIES, NAMELY, WINDOW CASINGS, WINDOW PANES, WINDOW SILLS, WINDOW SHUTTERS, WINDOW SCREENS, WINDOW JAMBS, SASH FASTENERS, IN CLASS 19 (U.S. CLS. 1, 12, 33 AND 50).

FIRST USE 1-0-2009; IN COMMERCE 1-0-2009.

NO CLAIM IS MADE TO THE EXCLUSIVE RIGHT TO USE "WINDOW", APART FROM THE MARK AS SHOWN.

THE MARK CONSISTS OF THE WORDS "THE ECO WINDOW" IN A STYLIZED FONT. THE "O" IN THE WORD "ECO" IS COMPRISED OF THREE ARROWS FORMING A CIRCLE WITH A LEAF IN THE CENTER WITH A SMALLER LEAF DESIGN TO THE RIGHT OF THE WORDS "THE ECO".

SER. NO. 85-673,769, FILED 7-11-2012.

MICHAEL LITZAU, EXAMINING ATTORNEY



*David J. Kybas*

Director of the United States Patent and Trademark Office

# United States of America

United States Patent and Trademark Office

# ROYAL

**Reg. No. 4,275,832**

**Registered Jan. 15, 2013**

**Int. Cl.: 17**

**TRADEMARK**

**PRINCIPAL REGISTER**

ROYAL GROUP, INC. (CANADA CORPORATION)  
30 ROYAL GROUP CRESCENT  
WOODBIDGE, ON, CANADA L4H1X9

FOR: EXTRUDED PVC PRODUCT USED TO PRODUCE FRAMES, SASHES AND ACCESSORIES FOR USE IN THE MANUFACTURE OF WINDOWS AND DOORS, IN CLASS 17 (U.S. CLS. 1, 5, 12, 13, 35 AND 50).

FIRST USE 11-0-2011; IN COMMERCE 11-0-2011.

OWNER OF U.S. REG. NOS. 1,621,210, 2,723,258 AND OTHERS.

THE MARK CONSISTS OF A CROWN SYMBOL FOLLOWED BY THE WORD "ROYAL".

SER. NO. 85-673,872, FILED 7-11-2012.

MICHAEL LITZAU, EXAMINING ATTORNEY



*David J. Kyffers*

Director of the United States Patent and Trademark Office

**United States of America**  
United States Patent and Trademark Office

**OLD BAY**

**Reg. No. 4,275,833**

MCCORMICK & COMPANY, INCORPORATED (MARYLAND CORPORATION)  
18 LOVETON CIRCLE  
SPARKS, MD 21152

**Registered Jan. 15, 2013**

**Int. Cl.: 43**

FOR: RESTAURANT SERVICES, IN CLASS 43 (U.S. CLS. 100 AND 101).

**SERVICE MARK**

FIRST USE 0-0-2009; IN COMMERCE 0-0-2009.

**PRINCIPAL REGISTER**

THE MARK CONSISTS OF STANDARD CHARACTERS WITHOUT CLAIM TO ANY PARTICULAR FONT, STYLE, SIZE, OR COLOR.

SER. NO. 85-674,260, FILED 7-11-2012.

HEATHER SAPP, EXAMINING ATTORNEY



*David J. Kybas*

Director of the United States Patent and Trademark Office

# United States of America

United States Patent and Trademark Office



**Reg. No. 4,275,834**

THE MCGRAW-HILL COMPANIES, INC. (NEW YORK CORPORATION)  
1221 AVENUE OF THE AMERICAS  
NEW YORK, NY 10020

**Registered Jan. 15, 2013**

**Int. Cl.: 16**

FOR: SERIES OF TEXTBOOKS IN THE FIELDS OF ANTHROPOLOGY, AMERICAN GOVERNMENT, BUSINESS, COMMUNICATIONS, ENGLISH, EDUCATION, HEALTH, HISTORY, PHILOSOPHY, POLITICAL SCIENCE, PUBLIC SPEAKING, PSYCHOLOGY, SOCIOLOGY, AND SPANISH, IN CLASS 16 (U.S. CLS. 2, 5, 22, 23, 29, 37, 38 AND 50).

**TRADEMARK**

**PRINCIPAL REGISTER**

FIRST USE 1-0-2008; IN COMMERCE 1-0-2008.

THE MARK CONSISTS OF AN UPPERCASE LETTER M IN THE COLOR WHITE CENTERED ON A RED SQUARE BACKGROUND.

THE COLOR(S) RED AND WHITE IS/ARE CLAIMED AS A FEATURE OF THE MARK.

SER. NO. 85-674,682, FILED 7-11-2012.

MICHELLE DUBOIS, EXAMINING ATTORNEY



*David J. Kybas*

Director of the United States Patent and Trademark Office

# United States of America

United States Patent and Trademark Office



**Reg. No. 4,275,835**

**Registered Jan. 15, 2013**

**Int. Cl.: 25**

**TRADEMARK**

**PRINCIPAL REGISTER**

ALGIERZ, DANIEL LUCAS LEVY (UNITED STATES INDIVIDUAL)  
7002 RAMSGATE PLACE #7  
LOS ANGELES, CA 90045

FOR: BELTS; HATS; SWEATSHIRTS; T-SHIRTS; TOPS, IN CLASS 25 (U.S. CLS. 22 AND 39).

FIRST USE 7-8-2009; IN COMMERCE 7-8-2009.

THE MARK CONSISTS OF A PAIR OF SCREWS THAT ARE CROSSED, WITH A LITERAL ELEMENT THAT READS "SCREWED UP!" THE WORDS ARE IN WHITE. THE SCREWS ARE SILVER AND BLACK.

THE COLOR(S) BLACK, WHITE, AND SILVER IS/ARE CLAIMED AS A FEATURE OF THE MARK.

SER. NO. 85-674,764, FILED 7-12-2012.

TAMARA FRAZIER, EXAMINING ATTORNEY



*David J. Kybas*

Director of the United States Patent and Trademark Office

# United States of America

United States Patent and Trademark Office

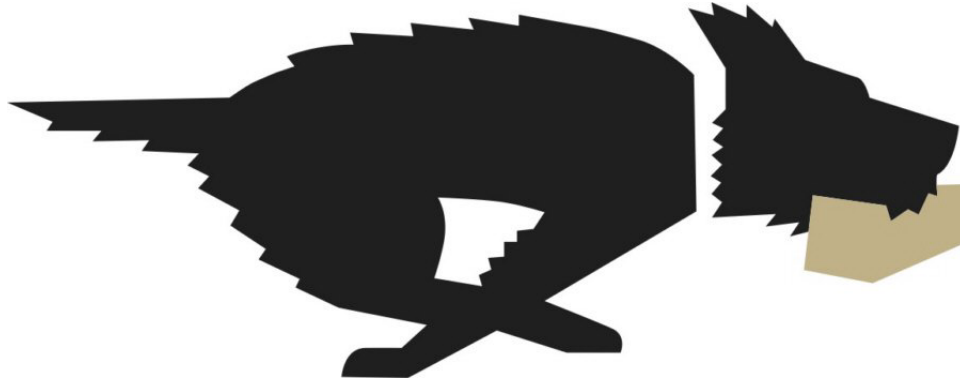

**Reg. No. 4,275,836**

**Registered Jan. 15, 2013**

**Int. Cl.: 39**

**SERVICE MARK**

**PRINCIPAL REGISTER**

FETCH STORAGE, LLC (MASSACHUSETTS LIMITED LIABILITY COMPANY)  
UNIT #1F  
86 LOS ANGELES ST.  
NEWTON, MA 024581019

FOR: MOVING AND STORAGE OF GOODS, IN CLASS 39 (U.S. CLS. 100 AND 105).

FIRST USE 2-28-2006; IN COMMERCE 2-28-2006.

THE MARK CONSISTS OF A BLACK DOG IN MID-STRIDE APPEARING TO RUN FROM LEFT TO RIGHT HOLDING A BROWN PARCEL IN ITS MOUTH.

THE COLOR(S) BLACK AND BROWN IS/ARE CLAIMED AS A FEATURE OF THE MARK.

SER. NO. 85-675,228, FILED 7-12-2012.

LUCY ARANT, EXAMINING ATTORNEY



*David J. Kybas*

Director of the United States Patent and Trademark Office

# United States of America

United States Patent and Trademark Office

## M WE LISTEN

**Reg. No. 4,275,837**

**Registered Jan. 15, 2013**

**Int. Cl.: 16**

**TRADEMARK**

**PRINCIPAL REGISTER**

THE MCGRAW-HILL COMPANIES, INC. (NEW YORK CORPORATION)  
1221 AVENUE OF THE AMERICAS  
NEW YORK, NY 10020

FOR: SERIES OF TEXTBOOKS IN THE FIELDS OF ANTHROPOLOGY, AMERICAN GOVERNMENT, BUSINESS, COMMUNICATIONS, ENGLISH, EDUCATION, HEALTH, HISTORY, PHILOSOPHY, POLITICAL SCIENCE, PUBLIC SPEAKING, PSYCHOLOGY, SOCIOLOGY, AND SPANISH, IN CLASS 16 (U.S. CLS. 2, 5, 22, 23, 29, 37, 38 AND 50).

FIRST USE 1-0-2008; IN COMMERCE 1-0-2008.

THE MARK CONSISTS OF STANDARD CHARACTERS WITHOUT CLAIM TO ANY PARTICULAR FONT, STYLE, SIZE, OR COLOR.

SER. NO. 85-675,563, FILED 7-12-2012.

MICHELLE DUBOIS, EXAMINING ATTORNEY



*David J. Kyffers*

Director of the United States Patent and Trademark Office

# United States of America

United States Patent and Trademark Office

## Handbag Republic

**Reg. No. 4,275,838**

**Registered Jan. 15, 2013**

**Int. Cl.: 18**

**TRADEMARK**

**PRINCIPAL REGISTER**

HANDBAG REPUBLIC INC (CALIFORNIA CORPORATION)  
18217 RAILROAD STREET  
CITY OF INDUSTRY, CA 91748

FOR: HANDBAGS, IN CLASS 18 (U.S. CLS. 1, 2, 3, 22 AND 41).

FIRST USE 1-1-2012; IN COMMERCE 1-1-2012.

THE MARK CONSISTS OF STANDARD CHARACTERS WITHOUT CLAIM TO ANY PARTICULAR FONT, STYLE, SIZE, OR COLOR.

NO CLAIM IS MADE TO THE EXCLUSIVE RIGHT TO USE "HANDBAG", APART FROM THE MARK AS SHOWN.

SER. NO. 85-676,313, FILED 7-13-2012.

SUNG IN, EXAMINING ATTORNEY



*David J. Kyffers*

Director of the United States Patent and Trademark Office



# United States of America

United States Patent and Trademark Office



**Reg. No. 4,275,839**

THE MCGRAW-HILL COMPANIES, INC. (NEW YORK CORPORATION)  
1221 AVENUE OF THE AMERICAS  
NEW YORK, NY 10020

**Registered Jan. 15, 2013**

**Int. Cl.: 16**

FOR: SERIES OF TEXTBOOKS IN THE FIELDS OF ANTHROPOLOGY, AMERICAN GOVERNMENT, BUSINESS, COMMUNICATIONS, ENGLISH, EDUCATION, HEALTH, HISTORY, PHILOSOPHY, POLITICAL SCIENCE, PUBLIC SPEAKING, PSYCHOLOGY, SOCIOLOGY, AND SPANISH, IN CLASS 16 (U.S. CLS. 2, 5, 22, 23, 29, 37, 38 AND 50).

**TRADEMARK**

**PRINCIPAL REGISTER**

FIRST USE 1-0-2008; IN COMMERCE 1-0-2008.

THE MARK CONSISTS OF THE UPPERCASE LETTER "M" IN THE COLOR WHITE CENTERED ON A SQUARE RED BACKGROUND ABOVE THE TERMS "WE LISTEN" IN WHITE LOWERCASE LETTERS ON A RECTANGULAR RED BACKGROUND.

THE COLOR(S) RED AND WHITE IS/ARE CLAIMED AS A FEATURE OF THE MARK.

SER. NO. 85-676,528, FILED 7-13-2012.

MICHELLE DUBOIS, EXAMINING ATTORNEY



*David J. Kybas*

Director of the United States Patent and Trademark Office

# United States of America

United States Patent and Trademark Office

## OSTERIA VIA STATO

**Reg. No. 4,275,840**

**Registered Jan. 15, 2013**

**Int. Cl.: 43**

**SERVICE MARK**

**PRINCIPAL REGISTER**

LETTUCE ENTERTAIN YOU ENTERPRISES, INC. (ILLINOIS CORPORATION)  
5419 NORTH SHERIDAN ROAD  
CHICAGO, IL 60640

FOR: RESTAURANT SERVICES, IN CLASS 43 (U.S. CLS. 100 AND 101).

FIRST USE 11-0-2004; IN COMMERCE 11-0-2004.

THE MARK CONSISTS OF STANDARD CHARACTERS WITHOUT CLAIM TO ANY PARTICULAR FONT, STYLE, SIZE, OR COLOR.

OWNER OF U.S. REG. NOS. 3,263,493 AND 3,449,159.

NO CLAIM IS MADE TO THE EXCLUSIVE RIGHT TO USE "OSTERIA", APART FROM THE MARK AS SHOWN.

THE ENGLISH TRANSLATION OF "OSTERIA VIA STATO" IN THE MARK IS STATE STREET TAVERN OR INN.

SEC. 2(F).

SER. NO. 85-676,858, FILED 7-13-2012.

FONG HSU, EXAMINING ATTORNEY



*David J. Kyffers*

Director of the United States Patent and Trademark Office

# United States of America

United States Patent and Trademark Office

## SURF WASHED

**Reg. No. 4,275,841**

D-GENERATION, INC. (FLORIDA CORPORATION)  
P.O. BOX 30

**Registered Jan. 15, 2013**

DAYTONA BEACH, FL 32115

**Int. Cl.: 25**

FOR: HATS; PANTS; SHIRTS, IN CLASS 25 (U.S. CLS. 22 AND 39).

**TRADEMARK**

FIRST USE 3-5-2003; IN COMMERCE 3-5-2003.

**PRINCIPAL REGISTER**

THE MARK CONSISTS OF STANDARD CHARACTERS WITHOUT CLAIM TO ANY PARTICULAR FONT, STYLE, SIZE, OR COLOR.

NO CLAIM IS MADE TO THE EXCLUSIVE RIGHT TO USE "WASHED", APART FROM THE MARK AS SHOWN.

SER. NO. 85-677,197, FILED 7-14-2012.

VIVIAN MICZNIK FIRST, EXAMINING ATTORNEY



*David J. Kyffers*

Director of the United States Patent and Trademark Office

# United States of America

United States Patent and Trademark Office

# InstaConnect

**Reg. No. 4,275,842**

SYNAPSE RESEARCH INC. (NEW YORK CORPORATION)  
7 HEIGHTS RD.

**Registered Jan. 15, 2013**

PLANDOME, NY 11030

**Int. Cl.: 35**

FOR: CONSUMER SURVEY SERVICES, IN CLASS 35 (U.S. CLS. 100, 101 AND 102).

**SERVICE MARK**

FIRST USE 1-1-2012; IN COMMERCE 6-0-2012.

**PRINCIPAL REGISTER**

THE MARK CONSISTS OF STANDARD CHARACTERS WITHOUT CLAIM TO ANY PARTICULAR FONT, STYLE, SIZE, OR COLOR.

SER. NO. 85-677,671, FILED 7-16-2012.

SAIMA MAKHDOOM, EXAMINING ATTORNEY



*David J. Kyffers*

Director of the United States Patent and Trademark Office

# United States of America

United States Patent and Trademark Office



**Reg. No. 4,275,843**

**Registered Jan. 15, 2013**

**Int. Cl.: 33**

**TRADEMARK**

**PRINCIPAL REGISTER**

SAZERAC COMPANY, INC. (LOUISIANA CORPORATION)  
3850 N. CAUSEWAY BLVD., SUITE 1695  
METAIRIE, LA 70002

FOR: WHISKEY, IN CLASS 33 (U.S. CLS. 47 AND 49).

FIRST USE 4-0-2007; IN COMMERCE 4-0-2007.

OWNER OF U.S. REG. NO. 3,734,227.

THE MARK CONSISTS OF AN IMAGE OF A FIREBALL.

SER. NO. 85-677,878, FILED 7-16-2012.

DAVID TAYLOR, EXAMINING ATTORNEY



*David J. Kyffers*

Director of the United States Patent and Trademark Office

# United States of America

United States Patent and Trademark Office

# AEP Energy

**Reg. No. 4,275,844**

**Registered Jan. 15, 2013**

**Int. Cl.: 35**

**SERVICE MARK**

**PRINCIPAL REGISTER**

AMERICAN ELECTRIC POWER COMPANY, INC. (NEW YORK CORPORATION)  
LEGAL DEPARTMENT - 29TH FLOOR  
1 RIVERSIDE PLAZA  
COLUMBUS, OH 43215

FOR: RETAIL ELECTRICITY PROVIDER SERVICES THAT ALLOW CUSTOMERS TO PURCHASE ELECTRICITY; RETAIL ELECTRICITY PROVIDER SERVICES THAT ALLOW CUSTOMERS TO PURCHASE RENEWABLE ENERGY, IN CLASS 35 (U.S. CLS. 100, 101 AND 102).

FIRST USE 7-1-2012; IN COMMERCE 7-1-2012.

THE MARK CONSISTS OF STANDARD CHARACTERS WITHOUT CLAIM TO ANY PARTICULAR FONT, STYLE, SIZE, OR COLOR.

OWNER OF U.S. REG. NOS. 1,489,672, 2,266,249 AND OTHERS.

NO CLAIM IS MADE TO THE EXCLUSIVE RIGHT TO USE "ENERGY", APART FROM THE MARK AS SHOWN.

SER. NO. 85-678,681, FILED 7-17-2012.

CHRISTINA SOBRAL, EXAMINING ATTORNEY



*David J. Kyros*

Director of the United States Patent and Trademark Office

# United States of America

United States Patent and Trademark Office

## AMERICAN JOURNAL OF PHYSIOLOGY

**Reg. No. 4,275,845**

AMERICAN PHYSIOLOGICAL SOCIETY (MISSOURI CORPORATION)

**Registered Jan. 15, 2013**

9650 ROCKVILLE PIKE  
BETHESDA, MD 20814

**Int. Cls.: 16 and 41**

FOR: JOURNALS CONCERNING PHYSIOLOGY; PUBLICATIONS, NAMELY, JOURNALS  
IN THE FIELDS OF PHYSIOLOGY, IN CLASS 16 (U.S. CLS. 2, 5, 22, 23, 29, 37, 38 AND 50).

**TRADEMARK**

FIRST USE 1-1-1899; IN COMMERCE 1-1-1899.

**SERVICE MARK**

FOR: PUBLICATION OF JOURNALS; PUBLISHING AND ISSUING OF SCIENTIFIC PAPERS  
IN THE FIELD OF PHYSIOLOGY; PUBLISHING OF ELECTRONIC PUBLICATIONS, IN  
CLASS 41 (U.S. CLS. 100, 101 AND 107).

**PRINCIPAL REGISTER**

FIRST USE 1-1-1998; IN COMMERCE 1-1-1998.

THE MARK CONSISTS OF STANDARD CHARACTERS WITHOUT CLAIM TO ANY PAR-  
TICULAR FONT, STYLE, SIZE, OR COLOR.

NO CLAIM IS MADE TO THE EXCLUSIVE RIGHT TO USE "JOURNAL", APART FROM  
THE MARK AS SHOWN.

SEC. 2(F).

SER. NO. 85-679,132, FILED 7-17-2012.

DAVID COLLIER, EXAMINING ATTORNEY



*David J. Kypos*

Director of the United States Patent and Trademark Office

# United States of America

United States Patent and Trademark Office

## JOURNAL OF NEUROPHYSIOLOGY

**Reg. No. 4,275,846**

AMERICAN PHYSIOLOGICAL SOCIETY (MISSOURI CORPORATION)  
9650 ROCKVILLE PIKE  
BETHESDA, MD 20814

**Registered Jan. 15, 2013**

**Int. Cls.: 16 and 41**

FOR: PUBLICATIONS, NAMELY, SCIENTIFIC JOURNALS IN THE FIELDS OF PHYSIOLOGY, IN CLASS 16 (U.S. CLS. 2, 5, 22, 23, 29, 37, 38 AND 50).

**TRADEMARK**

FIRST USE 1-1-1939; IN COMMERCE 1-1-1939.

**SERVICE MARK**

FOR: PUBLISHING AND ISSUING OF SCIENTIFIC PAPERS IN THE FIELD OF PHYSIOLOGY; PUBLISHING OF ELECTRONIC PUBLICATIONS, IN CLASS 41 (U.S. CLS. 100, 101 AND 107).

**PRINCIPAL REGISTER**

FIRST USE 1-1-1939; IN COMMERCE 1-1-1939.

THE MARK CONSISTS OF STANDARD CHARACTERS WITHOUT CLAIM TO ANY PARTICULAR FONT, STYLE, SIZE, OR COLOR.

NO CLAIM IS MADE TO THE EXCLUSIVE RIGHT TO USE "JOURNAL", APART FROM THE MARK AS SHOWN.

SEC. 2(F).

SER. NO. 85-679,299, FILED 7-17-2012.

DAVID COLLIER, EXAMINING ATTORNEY



*David J. Kyjars*

Director of the United States Patent and Trademark Office



# United States of America

United States Patent and Trademark Office

## PHYSIOLOGICAL REVIEWS

**Reg. No. 4,275,847**

AMERICAN PHYSIOLOGICAL SOCIETY (MISSOURI CORPORATION)  
9650 ROCKVILLE PIKE  
BETHESDA, MD 20814

**Registered Jan. 15, 2013**

**Int. Cls.: 16 and 41**

FOR: PUBLICATIONS, NAMELY, SCIENTIFIC JOURNALS IN THE FIELDS OF  
PHYSIOLOGY, IN CLASS 16 (U.S. CLS. 2, 5, 22, 23, 29, 37, 38 AND 50).

**TRADEMARK**

FIRST USE 1-1-1922; IN COMMERCE 1-1-1922.

**SERVICE MARK**

FOR: PUBLISHING AND ISSUING OF SCIENTIFIC PAPERS IN THE FIELD OF PHYSIOLOGY;  
PUBLISHING OF ELECTRONIC PUBLICATIONS, IN CLASS 41 (U.S. CLS. 100, 101 AND  
107).

**PRINCIPAL REGISTER**

FIRST USE 1-1-1922; IN COMMERCE 1-1-1922.

THE MARK CONSISTS OF STANDARD CHARACTERS WITHOUT CLAIM TO ANY PAR-  
TICULAR FONT, STYLE, SIZE, OR COLOR.

OWNER OF U.S. REG. NO. 3,467,392.

NO CLAIM IS MADE TO THE EXCLUSIVE RIGHT TO USE "REVIEWS" , APART FROM  
THE MARK AS SHOWN.

SEC. 2(F).

SER. NO. 85-679,320, FILED 7-17-2012.

DAVID COLLIER, EXAMINING ATTORNEY



*David J. Kypos*

Director of the United States Patent and Trademark Office

# United States of America

United States Patent and Trademark Office



**Reg. No. 4,275,848**

**Registered Jan. 15, 2013**

**Int. Cl.: 13**

**TRADEMARK**

**PRINCIPAL REGISTER**

STURM, RUGER & COMPANY, INC. (DELAWARE CORPORATION)  
1 LACEY PLACE  
SOUTHPORT, CT 06890

FOR: FIREARMS AND FIREARMS ACCESSORIES, NAMELY, GUN CASES, AMMUNITION BAGS, RANGE BAGS, SLINGS, GUN CLEANING PRODUCTS, AND CHEEK PADS, IN CLASS 13 (U.S. CLS. 2 AND 9).

FIRST USE 12-20-2011; IN COMMERCE 12-20-2011.

OWNER OF U.S. REG. NO. 3,368,576.

NO CLAIM IS MADE TO THE EXCLUSIVE RIGHT TO USE "AMERICAN RIFLE", APART FROM THE MARK AS SHOWN.

THE MARK CONSISTS OF THE WORDING "RUGER AMERICAN RIFLE" WITH AN IMAGE OF A STYLIZED EAGLE UPON WHICH THE LETTER "R" IS SUPERIMPOSED TO THE LEFT OF THE WORDING AND AN IMAGE OF THREE SHOOTING STARS TO THE RIGHT OF THE WORDING.

SER. NO. 85-680,756, FILED 7-18-2012.

EUGENIA MARTIN, EXAMINING ATTORNEY



*David J. Kyffers*

Director of the United States Patent and Trademark Office

United States of America  
United States Patent and Trademark Office

CUTEX

**Reg. No. 4,275,849**

CUTEX NAILS, LLC (MISSOURI LIMITED LIABILITY COMPANY)  
100 INDUSTRIAL DR.  
FESTUS, MO 63028

**Registered Jan. 15, 2013**

**Int. Cl.: 3**

FOR: NAIL POLISH BASE COATS; NAIL POLISH REMOVERS; NAIL CARE PREPARATIONS,  
IN CLASS 3 (U.S. CLS. 1, 4, 6, 50, 51 AND 52).

**TRADEMARK**

FIRST USE 1-0-2012, THE MARK WAS FIRST USED ANYWHERE IN A DIFFERENT FORM  
OTHER THAN THAT SOUGHT TO BE REGISTERED AT LEAST AS EARLY AS 00/00/1912;  
IN COMMERCE 1-0-2012, THE MARK WAS FIRST USED IN COMMERCE IN A DIFFERENT  
FORM OTHER THAN THAT SOUGHT TO BE REGISTERED AT LEAST AS EARLY AS  
00/00/1912.

**PRINCIPAL REGISTER**

OWNER OF U.S. REG. NOS. 2,511,752, 3,024,694 AND OTHERS.

THE MARK CONSISTS OF THE WORD "CUTEX" IN A STYLIZED FORMAT.

SER. NO. 85-681,681, FILED 7-19-2012.

LEE-ANNE BERNS, EXAMINING ATTORNEY



*David J. Kybas*

Director of the United States Patent and Trademark Office

# United States of America

United States Patent and Trademark Office

## SERVICENOW

**Reg. No. 4,275,850**

BB&T CORPORATION (NORTH CAROLINA CORPORATION)

**Registered Jan. 15, 2013**

P.O. BOX 1255  
WINSTON-SALEM, NC 271011255

**Int. Cl.: 36**

FOR: INSURANCE SERVICES, NAMELY, INSURANCE BROKERAGE IN THE FIELD OF COMMERCIAL PROPERTY, CASUALTY, WORKERS' COMPENSATION, AUTOMOBILE AND EMPLOYMENT PRACTICES INSURANCE, IN CLASS 36 (U.S. CLS. 100, 101 AND 102).

**SERVICE MARK**

**PRINCIPAL REGISTER**

FIRST USE 1-31-2005; IN COMMERCE 1-31-2005.

THE MARK CONSISTS OF STANDARD CHARACTERS WITHOUT CLAIM TO ANY PARTICULAR FONT, STYLE, SIZE, OR COLOR.

SER. NO. 85-682,378, FILED 7-20-2012.

LEIGH LOWRY, EXAMINING ATTORNEY



*David J. Kyffers*

Director of the United States Patent and Trademark Office

# United States of America

United States Patent and Trademark Office

# AEP Energy

**Reg. No. 4,275,851**

**Registered Jan. 15, 2013**

**Int. Cls.: 35, 37 and 42**

**SERVICE MARK**

**PRINCIPAL REGISTER**

AMERICAN ELECTRIC POWER COMPANY, INC. (NEW YORK CORPORATION)  
LEGAL DEPARTMENT - 29TH FLOOR  
1 RIVERSIDE PLAZA  
COLUMBUS, OH 43215

FOR: CONSULTATION IN THE FIELD OF ENERGY EFFICIENCY; CONSULTING SERVICES IN THE FIELD OF ENERGY EFFICIENCY FOR COMMERCIAL AND INSTITUTIONAL FACILITIES; CONSULTING SERVICES IN THE FIELD OF ENERGY USAGE MANAGEMENT AND ENERGY EFFICIENCY; CONSULTING SERVICES IN THE FIELDS OF ENERGY CONSUMPTION AND USAGE CONSERVATION, IN CLASS 35 (U.S. CLS. 100, 101 AND 102).

FIRST USE 7-1-2012; IN COMMERCE 7-1-2012.

FOR: INSTALLATION OF ENERGY USE MANAGEMENT SYSTEMS, IN CLASS 37 (U.S. CLS. 100, 103 AND 106).

FIRST USE 7-1-2012; IN COMMERCE 7-1-2012.

FOR: DESIGN SERVICES IN THE FIELD OF ENERGY USAGE MANAGEMENT SYSTEMS, IN CLASS 42 (U.S. CLS. 100 AND 101).

FIRST USE 7-1-2012; IN COMMERCE 7-1-2012.

THE MARK CONSISTS OF STANDARD CHARACTERS WITHOUT CLAIM TO ANY PARTICULAR FONT, STYLE, SIZE, OR COLOR.

OWNER OF U.S. REG. NOS. 1,489,672, 2,266,249 AND OTHERS.

NO CLAIM IS MADE TO THE EXCLUSIVE RIGHT TO USE "ENERGY", APART FROM THE MARK AS SHOWN.

SER. NO. 85-682,485, FILED 7-20-2012.

CHRISTINA SOBRAL, EXAMINING ATTORNEY



*David J. Kyffers*

Director of the United States Patent and Trademark Office

# United States of America

United States Patent and Trademark Office



**Reg. No. 4,275,852**

**Registered Jan. 15, 2013**

**Int. Cls.: 35, 37 and 42**

**SERVICE MARK**

**PRINCIPAL REGISTER**

AMERICAN ELECTRIC POWER COMPANY, INC. (NEW YORK CORPORATION)  
LEGAL DEPARTMENT - 29TH FLOOR  
1 RIVERSIDE PLAZA  
COLUMBUS, OH 43215

FOR: CONSULTATION IN THE FIELD OF ENERGY EFFICIENCY; CONSULTING SERVICES IN THE FIELD OF ENERGY EFFICIENCY FOR COMMERCIAL AND INSTITUTIONAL FACILITIES; CONSULTING SERVICES IN THE FIELD OF ENERGY USAGE MANAGEMENT AND ENERGY EFFICIENCY; CONSULTING SERVICES IN THE FIELDS OF ENERGY CONSUMPTION AND USAGE CONSERVATION, IN CLASS 35 (U.S. CLS. 100, 101 AND 102).

FIRST USE 7-1-2012; IN COMMERCE 7-1-2012.

FOR: INSTALLATION OF ENERGY USE MANAGEMENT SYSTEMS, IN CLASS 37 (U.S. CLS. 100, 103 AND 106).

FIRST USE 7-1-2012; IN COMMERCE 7-1-2012.

FOR: DESIGN SERVICES IN THE FIELD OF ENERGY USAGE MANAGEMENT SYSTEMS, IN CLASS 42 (U.S. CLS. 100 AND 101).

FIRST USE 7-1-2012; IN COMMERCE 7-1-2012.

OWNER OF U.S. REG. NOS. 1,489,672, 2,266,249 AND OTHERS.

THE COLOR(S) RED, WHITE, AND GRAY IS/ARE CLAIMED AS A FEATURE OF THE MARK.

NO CLAIM IS MADE TO THE EXCLUSIVE RIGHT TO USE "ENERGY", APART FROM THE MARK AS SHOWN.

THE MARK CONSISTS OF RED PARALLELOGRAM OVERLAID WITH THE LETTERS "A", "E", "P" IN WHITE CAPITAL LETTERS, THE PARALLELOGRAM IS LOCATED TO THE LEFT OF THE WORD "ENERGY", WHICH APPEARS IN GRAY CAPITAL LETTERS.

SER. NO. 85-682,549, FILED 7-20-2012.



*David J. Kyffers*

Director of the United States Patent and Trademark Office

**Reg. No. 4,275,852** CHRISTINA SOBRAL, EXAMINING ATTORNEY

# United States of America

United States Patent and Trademark Office

## DOLL AND COMPANY

**Reg. No. 4,275,853**

**Registered Jan. 15, 2013**

**Int. Cls.: 25 and 35**

**TRADEMARK**

**SERVICE MARK**

**PRINCIPAL REGISTER**

CHYNNA DOLLS (CALIFORNIA CORPORATION)  
2434 FENDER AVE, SUITE E  
FULLERTON, CA 92831

FOR: APPAREL FOR DANCERS, NAMELY, TEE SHIRTS, SWEATSHIRTS, PANTS, LEGGINGS, SHORTS AND JACKETS; ATHLETIC APPAREL, NAMELY, SHIRTS, PANTS, JACKETS, FOOTWEAR, HATS AND CAPS, ATHLETIC UNIFORMS; BATHING COSTUMES; BATHING COSTUMES FOR WOMEN; BATHING SUITS; BIKINIS; DRESSES; DRESSES THAT MAY ALSO BE USED AS TOWELS; DRESSING GOWNS AND BATH ROBES; JUMPER DRESSES; SWIMWEAR, IN CLASS 25 (U.S. CLS. 22 AND 39).

FIRST USE 5-1-2012; IN COMMERCE 5-1-2012.

FOR: COMPUTERIZED ON-LINE RETAIL STORE SERVICES IN THE FIELD OF WOMEN'S CLOTHING; DISCOUNT STORES IN THE FIELD OF WOMEN'S CLOTHING; ON-LINE RETAIL STORE SERVICES FEATURING WOMEN'S CLOTHING; RETAIL APPAREL STORES; RETAIL WOMEN'S CLOTHING STORES, IN CLASS 35 (U.S. CLS. 100, 101 AND 102).

FIRST USE 7-15-2012; IN COMMERCE 7-15-2012.

THE MARK CONSISTS OF STANDARD CHARACTERS WITHOUT CLAIM TO ANY PARTICULAR FONT, STYLE, SIZE, OR COLOR.

OWNER OF U.S. REG. NO. 4,106,928.

NO CLAIM IS MADE TO THE EXCLUSIVE RIGHT TO USE "COMPANY", APART FROM THE MARK AS SHOWN.

SER. NO. 85-682,848, FILED 7-20-2012.

ANTHONY RINKER, EXAMINING ATTORNEY



*David J. Kypos*

Director of the United States Patent and Trademark Office



# United States of America

United States Patent and Trademark Office

# DENGUEVAK

**Reg. No. 4,275,854**

SANOPI PASTEUR (FRANCE SOCIÉTÉ ANONYME (SA))  
2, AVENUE PONT PASTEUR  
69007 LYON, FRANCE

**Registered Jan. 15, 2013**

**Int. Cl.: 5**

FOR: PHARMACEUTICAL PRODUCTS, NAMELY, VACCINES, IN CLASS 5 (U.S. CLS. 6, 18, 44, 46, 51 AND 52).

**TRADEMARK**

THE MARK CONSISTS OF STANDARD CHARACTERS WITHOUT CLAIM TO ANY PARTICULAR FONT, STYLE, SIZE, OR COLOR.

**PRINCIPAL REGISTER**

PRIORITY CLAIMED UNDER SEC. 44(D) ON FRANCE APPLICATION NO. 3891614, FILED 1-25-2012, REG. NO. 12/3891614, DATED 1-25-2012, EXPIRES 1-25-2022.

SER. NO. 85-683,198, FILED 7-20-2012.

MORGAN WYNNE, EXAMINING ATTORNEY



*David J. Kybas*

Director of the United States Patent and Trademark Office

# United States of America

United States Patent and Trademark Office



**Reg. No. 4,275,855**

RUBIO, EDUARDO (UNITED STATES INDIVIDUAL)  
CALLE SAN JUSTO #151 APT 206  
SAN JUAN, PUERTO RICO 00901

**Registered Jan. 15, 2013**

**Int. Cl.: 43**

FOR: RESTAURANT SERVICES, INCLUDING SIT-DOWN SERVICE OF FOOD AND TAKE-OUT RESTAURANT SERVICES, IN CLASS 43 (U.S. CLS. 100 AND 101).

**SERVICE MARK**

FIRST USE 8-14-2010; IN COMMERCE 8-14-2010.

**PRINCIPAL REGISTER**

NO CLAIM IS MADE TO THE EXCLUSIVE RIGHT TO USE "PIZZA RUSTICA", APART FROM THE MARK AS SHOWN.

THE MARK CONSISTS OF THE WORD "PIRILO" WITH A PLAID BERET SITTING ATOP OF THE "O"; AND THE WORDS "PIZZA RÚSTICA" ARE BELOW.

THE ENGLISH TRANSLATION OF "RUSTICA" IN THE MARK IS "RUSTIC".

SER. NO. 85-683,241, FILED 7-20-2012.

LINDA MICKLEBURGH, EXAMINING ATTORNEY



*David J. Kyros*

Director of the United States Patent and Trademark Office

# United States of America

United States Patent and Trademark Office

# 3 PERCENT

**Reg. No. 4,275,856**

FORMAN MILLS, INC. (PENNSYLVANIA CORPORATION)  
1070 THOMAS BUSCH MEMORIAL HIGHWAY  
PENNSAUKEN, NJ 08110

**Registered Jan. 15, 2013**

**Int. Cl.: 25**

FOR: TANK-TOPS, WARM-UP SUITS, SWEAT PANTS, SWEATSHIRTS, KNIT SHIRTS,  
GOLF SHIRTS, SWEATERS AND CAPS, IN CLASS 25 (U.S. CLS. 22 AND 39).

**TRADEMARK**

FIRST USE 1-1-2012; IN COMMERCE 1-1-2012.

**PRINCIPAL REGISTER**

THE MARK CONSISTS OF STANDARD CHARACTERS WITHOUT CLAIM TO ANY PAR-  
TICULAR FONT, STYLE, SIZE, OR COLOR.

OWNER OF U.S. REG. NOS. 3,050,802, 3,117,794, AND 3,366,248.

SER. NO. 85-683,809, FILED 7-23-2012.

STEVEN JACKSON, EXAMINING ATTORNEY



*David J. Kyffers*

Director of the United States Patent and Trademark Office

# United States of America

United States Patent and Trademark Office

# OCEANSTOR

**Reg. No. 4,275,857**

**Registered Jan. 15, 2013**

**Int. Cls.: 9 and 42**

**TRADEMARK**

**SERVICE MARK**

**PRINCIPAL REGISTER**

HUAWEI TECHNOLOGIES CO., LTD. (CHINA LIMITED COMPANY (LTD.))  
BUILDING B1-3-A, HUAWEI INDUSTRIAL BASE,  
BANTIAN, LONGGANG DISTRICT  
SHENZHEN, CHINA 518129

FOR: COMPUTER HARDWARE AND SOFTWARE FOR UPLOAD, STORAGE, RETRIEVAL, DOWNLOAD, TRANSMISSION AND DELIVERY OF DIGITAL CONTENT; COMPUTER STORAGE DEVICES, NAMELY, HIGH-SPEED STORAGE SUBSYSTEMS FOR STORAGE AND BACKUP OF ELECTRONIC DATA EITHER LOCALLY OR VIA A TELECOMMUNICATIONS NETWORK; SOLID STATE DRIVES, IN CLASS 9 (U.S. CLS. 21, 23, 26, 36 AND 38).

FIRST USE 10-1-2007; IN COMMERCE 10-1-2008.

FOR: COMPUTER SERVICES, NAMELY, PROVIDING VIRTUAL AND NON VIRTUAL APPLICATION SERVERS, WEB SERVERS, FILE SERVERS, CO-LOCATION SERVERS, LOAD BALANCING SERVERS, REDUNDANCY SERVERS, MEDIA SERVERS AND DATABASE SERVERS OF VARIABLE CAPACITY TO THIRD PARTY COMPUTING AND DATA STORAGE FACILITIES; COMPUTER SERVICES, NAMELY, CLOUD HOSTING PROVIDER SERVICES; CONSULTING SERVICES IN THE FIELD OF CLOUD COMPUTING, IN CLASS 42 (U.S. CLS. 100 AND 101).

FIRST USE 10-1-2007; IN COMMERCE 10-1-2008.

THE MARK CONSISTS OF STANDARD CHARACTERS WITHOUT CLAIM TO ANY PARTICULAR FONT, STYLE, SIZE, OR COLOR.

SER. NO. 85-685,155, FILED 7-24-2012.

BRIAN NEVILLE, EXAMINING ATTORNEY



*David J. Kyjars*

Director of the United States Patent and Trademark Office

# United States of America

United States Patent and Trademark Office

# Varigence

**Reg. No. 4,275,858**

**Registered Jan. 15, 2013**

**Int. Cls.: 9 and 42**

**TRADEMARK**

**SERVICE MARK**

**PRINCIPAL REGISTER**

VARIGENCE, INC. (SOUTH CAROLINA CORPORATION)  
30 COLLIER LANE  
GREER, SC 29650

FOR: COMPUTER SOFTWARE FOR MANAGING, RETRIEVING, TRACKING, ANALYZING AND REPORTING BUSINESS INFORMATION AND DATA, FOR USE IN THE FIELDS OF BUSINESS INTELLIGENCE AND DATA ANALYSIS; COMPUTER SOFTWARE DEVELOPMENT TOOLS, IN CLASS 9 (U.S. CLS. 21, 23, 26, 36 AND 38).

FIRST USE 10-0-2008; IN COMMERCE 10-0-2008.

FOR: PROVIDING CONSULTATION IN THE FIELD OF PROGRAMMING, DESIGN, DEVELOPMENT, IMPLEMENTATION, INSTALLATION AND UPDATING OF COMPUTER SOFTWARE OF OTHERS; CONSULTATION IN THE FIELD OF DESIGN OF COMPUTER SOFTWARE OF OTHERS FOR COMMERCIAL ANALYSIS; CONSULTATION IN THE FIELD OF DESIGN AND DEVELOPMENT OF COMPUTER SOFTWARE FOR DATABASE MANAGEMENT; CONSULTATION IN THE FIELD OF INTEGRATION OF COMPUTER SOFTWARE INTO MULTIPLE SYSTEMS AND NETWORKS; CONSULTATION IN THE FIELD OF COMPUTER SOFTWARE FOR COMPUTER SYSTEM AND APPLICATION DEPLOYMENT FOR OTHERS; TECHNICAL SUPPORT SERVICES, NAMELY, TROUBLESHOOTING OF COMPUTER SOFTWARE PROBLEMS; COMPUTER DATABASE DEVELOPMENT SERVICES; INFORMATION TECHNOLOGY CONSULTATION SERVICES, IN CLASS 42 (U.S. CLS. 100 AND 101).

FIRST USE 10-0-2008; IN COMMERCE 10-0-2008.

THE MARK CONSISTS OF STANDARD CHARACTERS WITHOUT CLAIM TO ANY PARTICULAR FONT, STYLE, SIZE, OR COLOR.

SER. NO. 85-685,166, FILED 7-24-2012.

DAWN HAN, EXAMINING ATTORNEY



*David J. Kyros*

Director of the United States Patent and Trademark Office

# United States of America

United States Patent and Trademark Office

# ADVANTIS

**Reg. No. 4,275,859**

**Registered Jan. 15, 2013**

**Int. Cl.: 35**

**SERVICE MARK**

**PRINCIPAL REGISTER**

ARCH CHEMICALS, INC. (VIRGINIA CORPORATION)  
P.O. BOX 5204  
501 MERRITT 7  
NORWALK, CT 068565204

FOR: WHOLESALE DISTRIBUTORSHIPS FEATURING WATER TREATMENT EQUIPMENT AND PRODUCTS FOR SWIMMING POOLS, SPAS, AND HOT TUBS, IN CLASS 35 (U.S. CLS. 100, 101 AND 102).

FIRST USE 1-0-2001; IN COMMERCE 1-0-2001.

THE MARK CONSISTS OF STANDARD CHARACTERS WITHOUT CLAIM TO ANY PARTICULAR FONT, STYLE, SIZE, OR COLOR.

SER. NO. 85-685,545, FILED 7-24-2012.

GILBERT SWIFT, EXAMINING ATTORNEY



*David J. Kyffers*

Director of the United States Patent and Trademark Office

# United States of America

United States Patent and Trademark Office

## AQUAHARVEST

**Reg. No. 4,275,860**

**Registered Jan. 15, 2013**

**Int. Cl.: 29**

**TRADEMARK**

**PRINCIPAL REGISTER**

BONAMAR CORPORATION (FLORIDA CORPORATION)  
SUITE 17  
5900 NW 97 AVENUE  
DORAL, FL 33178

FOR: CRABS, IN CLASS 29 (U.S. CL. 46).

FIRST USE 12-27-2004; IN COMMERCE 12-27-2004.

THE MARK CONSISTS OF STANDARD CHARACTERS WITHOUT CLAIM TO ANY PARTICULAR FONT, STYLE, SIZE, OR COLOR.

SER. NO. 85-687,257, FILED 7-26-2012.

DAYNA BROWNE, EXAMINING ATTORNEY



*David J. Kybas*

Director of the United States Patent and Trademark Office

# United States of America

United States Patent and Trademark Office

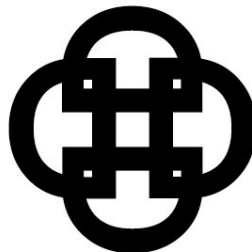

**Reg. No. 4,275,861**

**Registered Jan. 15, 2013**

**Int. Cl.: 25**

**TRADEMARK**

**PRINCIPAL REGISTER**

CHYNNA DOLLS (CALIFORNIA CORPORATION)  
2434 FENDER AVE SUITE I  
FULLERTON, CA 92831

FOR: BATHING COSTUMES; BATHING COSTUMES FOR WOMEN; BATHING SUITS;  
BEACH COVER-UPS; BEACH COVERUPS; BIKINIS; COVERUPS; PANTIES; PANTIES,  
SHORTS AND BRIEFS; SWIMWEAR, IN CLASS 25 (U.S. CLS. 22 AND 39).

FIRST USE 7-15-2012; IN COMMERCE 7-15-2012.

THE MARK CONSISTS OF THE LETTER "D" ARRANGED 4 TIMES WITH THE STRAIGHT  
SIDES AND THE CORNERS OF THE D'S IN AN INTERLOCKING 4 SIDED PATTERN WITH  
EACH OF THE 4 CURVED SIDES FACING OUTWARD.

SER. NO. 85-688,214, FILED 7-26-2012.

ANTHONY RINKER, EXAMINING ATTORNEY



*David J. Kybas*

Director of the United States Patent and Trademark Office



# United States of America

United States Patent and Trademark Office

# MOA

**Reg. No. 4,275,862**

BMW MOTORCYCLE OWNERS OF AMERICA, INC. (CALIFORNIA CORPORATION)  
509A OLD STATE ROAD  
ELLISVILLE, MO 63021

**Registered Jan. 15, 2013**

**Int. Cl.: 35**

FOR: CLUB SERVICES, NAMELY, PROMOTING THE INTERESTS OF MOTORCYCLE ENTHUSIASTS, IN CLASS 35 (U.S. CLS. 100, 101 AND 102).

**SERVICE MARK**

FIRST USE 4-1-2012; IN COMMERCE 4-1-2012.

**PRINCIPAL REGISTER**

THE MARK CONSISTS OF STANDARD CHARACTERS WITHOUT CLAIM TO ANY PARTICULAR FONT, STYLE, SIZE, OR COLOR.

SER. NO. 85-688,349, FILED 7-27-2012.

WENDY GOODMAN, EXAMINING ATTORNEY



*David J. Kyffers*

Director of the United States Patent and Trademark Office

# United States of America

United States Patent and Trademark Office

# MOA

**Reg. No. 4,275,863**

**Registered Jan. 15, 2013**

**Int. Cl.: 16**

**TRADEMARK**

**PRINCIPAL REGISTER**

BMW MOTORCYCLE OWNERS OF AMERICA, INC. (CALIFORNIA CORPORATION)  
509A OLD STATE ROAD  
ELLISVILLE, MO 63021

FOR: MAGAZINES AND NEWSLETTERS, FEATURING INFORMATION ON MOTORCYCLES, MOTORCYCLE SAFETY, MOTORCYCLE SHOWS AND SUBJECT MATTER DIRECT TO MOTORCYCLE ENTHUSIASTS, IN CLASS 16 (U.S. CLS. 2, 5, 22, 23, 29, 37, 38 AND 50).

FIRST USE 4-1-2012; IN COMMERCE 4-1-2012.

THE MARK CONSISTS OF STANDARD CHARACTERS WITHOUT CLAIM TO ANY PARTICULAR FONT, STYLE, SIZE, OR COLOR.

SER. NO. 85-688,352, FILED 7-27-2012.

WENDY GOODMAN, EXAMINING ATTORNEY



*David J. Kyffers*

Director of the United States Patent and Trademark Office

# United States of America

United States Patent and Trademark Office

# FINISH LINE

**Reg. No. 4,275,864**

**Registered Jan. 15, 2013**

**Int. Cl.: 8**

**TRADEMARK**

**PRINCIPAL REGISTER**

SUNBEAM PRODUCTS, INC. (DELAWARE CORPORATION)  
2381 EXECUTIVE CENTER DRIVE  
BOCA RATON, FL 33431

FOR: ELECTRIC HAIR TRIMMER, IN CLASS 8 (U.S. CLS. 23, 28 AND 44).

FIRST USE 1-1-1995; IN COMMERCE 1-1-1995.

THE MARK CONSISTS OF STANDARD CHARACTERS WITHOUT CLAIM TO ANY PARTICULAR FONT, STYLE, SIZE, OR COLOR.

SER. NO. 85-688,486, FILED 7-27-2012.

KATHERINE M. DUBRAY, EXAMINING ATTORNEY



*David J. Kyffers*

Director of the United States Patent and Trademark Office

# United States of America

United States Patent and Trademark Office

# WorkCompers

**Reg. No. 4,275,865**

PROBELGIN, INC (WYOMING CORPORATION)  
109 W 17TH STREET  
CHEYENNE, WY 82001

**Registered Jan. 15, 2013**

**Int. Cl.: 35**

FOR: BUSINESS ORGANIZATION AND MANAGEMENT CONSULTANCY INCLUDING PERSONNEL MANAGEMENT; BUSINESS ORGANIZATION AND OPERATION CONSULTANCY; BUSINESS RECORDS MANAGEMENT, IN CLASS 35 (U.S. CLS. 100, 101 AND 102).

**SERVICE MARK**

**PRINCIPAL REGISTER**

FIRST USE 7-27-2012; IN COMMERCE 7-27-2012.

THE MARK CONSISTS OF STANDARD CHARACTERS WITHOUT CLAIM TO ANY PARTICULAR FONT, STYLE, SIZE, OR COLOR.

SER. NO. 85-688,714, FILED 7-27-2012.

HOWARD SMIGA, EXAMINING ATTORNEY



*David J. Kyffers*

Director of the United States Patent and Trademark Office

# United States of America

United States Patent and Trademark Office

## PENSCO SUCCESSORCUSTODIAN

**Reg. No. 4,275,866**

PENSCO TRUST COMPANY LLC (NEW HAMPSHIRE LIMITED LIABILITY COMPANY)  
560 MISSION STREET, STE. 1300  
SAN FRANCISCO, CA 941052907

**Registered Jan. 15, 2013**

**Int. Cl.: 36**

FOR: CONSULTING SERVICES IN THE FIELD OF FINANCIAL CUSTODY SERVICES;  
FINANCIAL CUSTODY SERVICES, NAMELY, PROVIDING SERVICES TO CLIENTS AND  
CLIENT ADVISORS RELATING TO CUSTODIAL ACCOUNTS AND CUSTODY TRANS-  
ITIONS, IN CLASS 36 (U.S. CLS. 100, 101 AND 102).

**SERVICE MARK**

**PRINCIPAL REGISTER**

FIRST USE 6-26-2012; IN COMMERCE 6-26-2012.

THE MARK CONSISTS OF STANDARD CHARACTERS WITHOUT CLAIM TO ANY PAR-  
TICULAR FONT, STYLE, SIZE, OR COLOR.

OWNER OF U.S. REG. NOS. 3,079,225 AND 3,079,226.

NO CLAIM IS MADE TO THE EXCLUSIVE RIGHT TO USE "SUCCESSOR CUSTODIAN",  
APART FROM THE MARK AS SHOWN.

SER. NO. 85-688,903, FILED 7-27-2012.

MARIA-VICTORIA SUAREZ, EXAMINING ATTORNEY



*David J. Kybas*

Director of the United States Patent and Trademark Office

# United States of America

United States Patent and Trademark Office

## PENSCO ADVISORADVANTAGE

**Reg. No. 4,275,867**

**Registered Jan. 15, 2013**

**Int. Cl.: 36**

**SERVICE MARK**

**PRINCIPAL REGISTER**

PENSCO TRUST COMPANY LLC (NEW HAMPSHIRE LIMITED LIABILITY COMPANY)  
560 MISSION STREET, STE. 1300  
SAN FRANCISCO, CA 941052907

FOR: CONSULTING SERVICES IN THE FIELD OF FINANCIAL CUSTODY SERVICES;  
FINANCIAL CUSTODY SERVICES, NAMELY, PROVIDING SERVICES TO CLIENTS AND  
CLIENT ADVISORS RELATING TO CUSTODIAL ACCOUNTS AND CUSTODY TRANS-  
ACTIONS, IN CLASS 36 (U.S. CLS. 100, 101 AND 102).

FIRST USE 6-26-2012; IN COMMERCE 6-26-2012.

THE MARK CONSISTS OF STANDARD CHARACTERS WITHOUT CLAIM TO ANY PAR-  
TICULAR FONT, STYLE, SIZE, OR COLOR.

OWNER OF U.S. REG. NOS. 3,079,225 AND 3,079,226.

SER. NO. 85-688,919, FILED 7-27-2012.

MARIA-VICTORIA SUAREZ, EXAMINING ATTORNEY



*David J. Kybas*

Director of the United States Patent and Trademark Office

# United States of America

United States Patent and Trademark Office

## PENSCO ADVANTAGETEAM

**Reg. No. 4,275,868**

**Registered Jan. 15, 2013**

**Int. Cl.: 36**

**SERVICE MARK**

**PRINCIPAL REGISTER**

PENSCO TRUST COMPANY LLC (NEW HAMPSHIRE LIMITED LIABILITY COMPANY)  
560 MISSION STREET, STE. 1300  
SAN FRANCISCO, CA 941052907

FOR: CONSULTING SERVICES IN THE FIELD OF FINANCIAL CUSTODY SERVICES;  
FINANCIAL CUSTODY SERVICES, NAMELY, PROVIDING SERVICES TO CLIENTS AND  
CLIENT ADVISORS RELATING TO CUSTODIAL ACCOUNTS AND CUSTODY TRANS-  
ACTIONS, IN CLASS 36 (U.S. CLS. 100, 101 AND 102).

FIRST USE 6-26-2012; IN COMMERCE 6-26-2012.

THE MARK CONSISTS OF STANDARD CHARACTERS WITHOUT CLAIM TO ANY PAR-  
TICULAR FONT, STYLE, SIZE, OR COLOR.

OWNER OF U.S. REG. NOS. 3,079,225 AND 3,079,226.

SER. NO. 85-688,943, FILED 7-27-2012.

MARIA-VICTORIA SUAREZ, EXAMINING ATTORNEY



*David J. Kybas*

Director of the United States Patent and Trademark Office

# United States of America

United States Patent and Trademark Office

# Vivid

**Reg. No. 4,275,869**

**Registered Jan. 15, 2013**

**Int. Cl.: 9**

**TRADEMARK**

**PRINCIPAL REGISTER**

VARIGENCE, INC. (SOUTH CAROLINA CORPORATION)  
30 COLLIER LANE  
GREER, SC 29650

FOR: COMPUTER SOFTWARE FOR ANALYZING, SEARCHING, FORMATTING, AND EXPLORING THE AVAILABILITY AND STRUCTURE OF DATA IN AN ELECTRONIC SPREADSHEET, IN CLASS 9 (U.S. CLS. 21, 23, 26, 36 AND 38).

FIRST USE 5-12-2009; IN COMMERCE 10-9-2009.

THE MARK CONSISTS OF STANDARD CHARACTERS WITHOUT CLAIM TO ANY PARTICULAR FONT, STYLE, SIZE, OR COLOR.

SER. NO. 85-689,063, FILED 7-27-2012.

DAWN HAN, EXAMINING ATTORNEY



*David J. Kybas*

Director of the United States Patent and Trademark Office



# United States of America

United States Patent and Trademark Office

## DIAMONDBACK

**Reg. No. 4,275,870**

METAL-FAB, INC. (KANSAS CORPORATION)

**Registered Jan. 15, 2013**

P.O. BOX 1138  
WICHITA, KS 67201

**Int. Cl.: 6**

FOR: FLEXIBLE CORRUGATED STAINLESS STEEL TUBING FOR USE WITH COMBUSTIBLE GASES, IN CLASS 6 (U.S. CLS. 2, 12, 13, 14, 23, 25 AND 50).

**TRADEMARK**

FIRST USE 12-1-2000; IN COMMERCE 12-1-2000.

**PRINCIPAL REGISTER**

THE MARK CONSISTS OF STANDARD CHARACTERS WITHOUT CLAIM TO ANY PARTICULAR FONT, STYLE, SIZE, OR COLOR.

SER. NO. 85-689,132, FILED 7-27-2012.

KIMBERLY PARKS, EXAMINING ATTORNEY



*David J. Kybas*

Director of the United States Patent and Trademark Office

# United States of America

United States Patent and Trademark Office

## PENSCO ADVISORADVANTAGE PROGRAM

**Reg. No. 4,275,871**

PENSCO TRUST COMPANY LLC (NEW HAMPSHIRE LIMITED LIABILITY COMPANY)  
560 MISSION STREET, STE. 1300  
SAN FRANCISCO, CA 941052907

**Registered Jan. 15, 2013**

**Int. Cl.: 36**

FOR: CONSULTING SERVICES IN THE FIELD OF FINANCIAL CUSTODY SERVICES;  
FINANCIAL CUSTODY SERVICES, NAMELY, PROVIDING SERVICES TO CLIENTS AND  
CLIENT ADVISORS RELATING TO CUSTODIAL ACCOUNTS AND CUSTODY TRANS-  
ACTIONS, IN CLASS 36 (U.S. CLS. 100, 101 AND 102).

**SERVICE MARK**

**PRINCIPAL REGISTER**

FIRST USE 6-26-2012; IN COMMERCE 6-26-2012.

THE MARK CONSISTS OF STANDARD CHARACTERS WITHOUT CLAIM TO ANY PAR-  
TICULAR FONT, STYLE, SIZE, OR COLOR.

OWNER OF U.S. REG. NOS. 3,079,225 AND 3,079,226.

NO CLAIM IS MADE TO THE EXCLUSIVE RIGHT TO USE "PROGRAM", APART FROM  
THE MARK AS SHOWN.

SER. NO. 85-689,317, FILED 7-27-2012.

MARIA-VICTORIA SUAREZ, EXAMINING ATTORNEY



*David J. Kybas*

Director of the United States Patent and Trademark Office

# United States of America

United States Patent and Trademark Office

# Mist

**Reg. No. 4,275,872**

**Registered Jan. 15, 2013**

**Int. Cl.: 9**

**TRADEMARK**

**PRINCIPAL REGISTER**

VARIGENCE, INC. (SOUTH CAROLINA CORPORATION)  
30 COLLIER LANE  
GREER, SC 29650

FOR: COMPUTER SOFTWARE DEVELOPMENT TOOLS FOR USE IN THE FIELDS OF BUSINESS INTELLIGENCE, DATA INTEGRATION, DATA QUALITY AND DATABASE MANAGEMENT; COMPUTER SOFTWARE FOR DATABASE MANAGEMENT FOR DESIGNING BUSINESS AND INFORMATION SOLUTIONS, IN CLASS 9 (U.S. CLS. 21, 23, 26, 36 AND 38).

FIRST USE 5-0-2009; IN COMMERCE 5-0-2009.

THE MARK CONSISTS OF STANDARD CHARACTERS WITHOUT CLAIM TO ANY PARTICULAR FONT, STYLE, SIZE, OR COLOR.

SER. NO. 85-689,393, FILED 7-28-2012.

DAWN HAN, EXAMINING ATTORNEY



*David J. Kyffers*

Director of the United States Patent and Trademark Office

# United States of America

United States Patent and Trademark Office

## GYM IN A BOTTLE

**Reg. No. 4,275,873**

TRACIE MARTYN, INC. (NEW YORK CORPORATION)  
101 FIFTH AVENUE  
NEW YORK, NY 10003

**Registered Jan. 15, 2013**

**Int. Cl.: 5**

FOR: DIETARY AND NUTRITIONAL SUPPLEMENTS, IN CLASS 5 (U.S. CLS. 6, 18, 44, 46, 51 AND 52).

**TRADEMARK**

FIRST USE 10-24-2011; IN COMMERCE 11-17-2011.

**PRINCIPAL REGISTER**

THE MARK CONSISTS OF STANDARD CHARACTERS WITHOUT CLAIM TO ANY PARTICULAR FONT, STYLE, SIZE, OR COLOR.

SER. NO. 85-690,569, FILED 7-30-2012.

SUNG IN, EXAMINING ATTORNEY



*David J. Kyfos*

Director of the United States Patent and Trademark Office

# United States of America

United States Patent and Trademark Office

## LIGHT ENERGY IN A BOTTLE

**Reg. No. 4,275,874**

TRACIE MARTYN, INC. (NEW YORK CORPORATION)  
101 FIFTH AVENUE  
NEW YORK, NY 10003

**Registered Jan. 15, 2013**

**Int. Cl.: 5**

FOR: DIETARY AND NUTRITIONAL SUPPLEMENTS, IN CLASS 5 (U.S. CLS. 6, 18, 44, 46, 51 AND 52).

**TRADEMARK**

FIRST USE 10-24-2011; IN COMMERCE 11-17-2011.

**PRINCIPAL REGISTER**

THE MARK CONSISTS OF STANDARD CHARACTERS WITHOUT CLAIM TO ANY PARTICULAR FONT, STYLE, SIZE, OR COLOR.

SER. NO. 85-690,587, FILED 7-30-2012.

SUNG IN, EXAMINING ATTORNEY



*David J. Kyffers*

Director of the United States Patent and Trademark Office

# United States of America

United States Patent and Trademark Office

## LIVE LAUGH LOVE

**Reg. No. 4,275,875**

**Registered Jan. 15, 2013**

**Int. Cl.: 11**

**TRADEMARK**

**PRINCIPAL REGISTER**

D-GENERATION, INC. (FLORIDA CORPORATION)  
P.O. BOX 30  
DAYTONA BEACH, FL 32115

FOR: FLASHLIGHTS, IN CLASS 11 (U.S. CLS. 13, 21, 23, 31 AND 34).

FIRST USE 10-15-2010; IN COMMERCE 10-15-2010.

THE MARK CONSISTS OF STANDARD CHARACTERS WITHOUT CLAIM TO ANY PARTICULAR FONT, STYLE, SIZE, OR COLOR.

OWNER OF U.S. REG. NOS. 3,997,859, 4,181,740 AND OTHERS.

SER. NO. 85-692,035, FILED 8-1-2012.

VIVIAN MICZNIK FIRST, EXAMINING ATTORNEY



*David J. Kybas*

Director of the United States Patent and Trademark Office

# United States of America

United States Patent and Trademark Office

# GTO

**Reg. No. 4,275,876**

GENERAL MOTORS LLC (DELAWARE LIMITED LIABILITY COMPANY)  
300 RENAISSANCE CENTER  
DETROIT, MI 482653000

**Registered Jan. 15, 2013**

**Int. Cl.: 12**

FOR: UPHOLSTERY FOR MOTOR LAND VEHICLES; EXTERIOR AND INTERIOR BADGES FOR MOTOR LAND VEHICLES, IN CLASS 12 (U.S. CLS. 19, 21, 23, 31, 35 AND 44).

**TRADEMARK**

FIRST USE 10-21-1998; IN COMMERCE 10-21-1998.

**PRINCIPAL REGISTER**

THE MARK CONSISTS OF STANDARD CHARACTERS WITHOUT CLAIM TO ANY PARTICULAR FONT, STYLE, SIZE, OR COLOR.

SER. NO. 85-692,047, FILED 8-1-2012.

HEATHER SAPP, EXAMINING ATTORNEY



*David J. Kyffers*

Director of the United States Patent and Trademark Office

# United States of America

United States Patent and Trademark Office

# GTO

**Reg. No. 4,275,877**

**Registered Jan. 15, 2013**

**Int. Cl.: 16**

**TRADEMARK**

**PRINCIPAL REGISTER**

GENERAL MOTORS LLC (DELAWARE LIMITED LIABILITY COMPANY)  
300 RENAISSANCE CENTER  
DETROIT, MI 482653000

FOR: DECALS, IN CLASS 16 (U.S. CLS. 2, 5, 22, 23, 29, 37, 38 AND 50).

FIRST USE 11-19-1998; IN COMMERCE 11-19-1998.

THE MARK CONSISTS OF STANDARD CHARACTERS WITHOUT CLAIM TO ANY PARTICULAR FONT, STYLE, SIZE, OR COLOR.

SER. NO. 85-692,053, FILED 8-1-2012.

HEATHER SAPP, EXAMINING ATTORNEY



*David J. Kybas*

Director of the United States Patent and Trademark Office



# United States of America

United States Patent and Trademark Office

# L88

**Reg. No. 4,275,878**

GENERAL MOTORS LLC (DELAWARE LIMITED LIABILITY COMPANY)  
300 RENAISSANCE CENTER  
DETROIT, MI 482653000

**Registered Jan. 15, 2013**

**Int. Cl.: 12**

FOR: EXTERIOR AND INTERIOR BADGES FOR MOTOR LAND VEHICLES, IN CLASS 12  
(U.S. CLS. 19, 21, 23, 31, 35 AND 44).

**TRADEMARK**

FIRST USE 10-21-1998; IN COMMERCE 10-21-1998.

**PRINCIPAL REGISTER**

THE MARK CONSISTS OF STANDARD CHARACTERS WITHOUT CLAIM TO ANY PARTICULAR FONT, STYLE, SIZE, OR COLOR.

SER. NO. 85-692,067, FILED 8-1-2012.

HEATHER SAPP, EXAMINING ATTORNEY



*David J. Kyffers*

Director of the United States Patent and Trademark Office

# United States of America

United States Patent and Trademark Office

# TTYPE

**Reg. No. 4,275,879**

**Registered Jan. 15, 2013**

**Int. Cl.: 12**

**TRADEMARK**

**PRINCIPAL REGISTER**

GENERAL MOTORS LLC (DELAWARE LIMITED LIABILITY COMPANY)  
300 RENAISSANCE CENTER  
DETROIT, MI 482653000

FOR: TRUNK LINING KITS FOR MOTOR LAND VEHICLES, IN CLASS 12 (U.S. CLS. 19, 21, 23, 31, 35 AND 44).

FIRST USE 4-22-2010; IN COMMERCE 4-22-2010.

THE MARK CONSISTS OF STANDARD CHARACTERS WITHOUT CLAIM TO ANY PARTICULAR FONT, STYLE, SIZE, OR COLOR.

SER. NO. 85-692,079, FILED 8-1-2012.

HEATHER SAPP, EXAMINING ATTORNEY



*David J. Kybas*

Director of the United States Patent and Trademark Office

# United States of America

United States Patent and Trademark Office

# TTYPE

**Reg. No. 4,275,880**

**Registered Jan. 15, 2013**

**Int. Cl.: 27**

**TRADEMARK**

**PRINCIPAL REGISTER**

GENERAL MOTORS LLC (DELAWARE LIMITED LIABILITY COMPANY)  
300 RENAISSANCE CENTER  
DETROIT, MI 482653000

FOR: FLOOR MATS FOR MOTOR LAND VEHICLES, IN CLASS 27 (U.S. CLS. 19, 20, 37, 42 AND 50).

FIRST USE 1-1-2002; IN COMMERCE 1-1-2002.

THE MARK CONSISTS OF STANDARD CHARACTERS WITHOUT CLAIM TO ANY PARTICULAR FONT, STYLE, SIZE, OR COLOR.

SER. NO. 85-692,104, FILED 8-1-2012.

HEATHER SAPP, EXAMINING ATTORNEY



*David J. Kybas*

Director of the United States Patent and Trademark Office

# United States of America

United States Patent and Trademark Office

# GSX

**Reg. No. 4,275,881**

**Registered Jan. 15, 2013**

**Int. Cl.: 12**

**TRADEMARK**

**PRINCIPAL REGISTER**

GENERAL MOTORS LLC (DELAWARE LIMITED LIABILITY COMPANY)  
300 RENAISSANCE CENTER  
DETROIT, MI 482653000

FOR: UPHOLSTERY FOR MOTOR LAND PASSENGER VEHICLES; EXTERIOR AND INTERIOR BADGES FOR MOTOR LAND PASSENGER VEHICLES, IN CLASS 12 (U.S. CLS. 19, 21, 23, 31, 35 AND 44).

FIRST USE 10-21-1998; IN COMMERCE 10-21-1998.

THE MARK CONSISTS OF STANDARD CHARACTERS WITHOUT CLAIM TO ANY PARTICULAR FONT, STYLE, SIZE, OR COLOR.

SER. NO. 85-692,211, FILED 8-1-2012.

HEATHER SAPP, EXAMINING ATTORNEY



*David J. Kyffers*

Director of the United States Patent and Trademark Office

# United States of America

United States Patent and Trademark Office

# GSX

**Reg. No. 4,275,882**

**Registered Jan. 15, 2013**

**Int. Cl.: 16**

**TRADEMARK**

**PRINCIPAL REGISTER**

GENERAL MOTORS LLC (DELAWARE LIMITED LIABILITY COMPANY)  
300 RENAISSANCE CENTER  
DETROIT, MI 482653000

FOR: DECALS, IN CLASS 16 (U.S. CLS. 2, 5, 22, 23, 29, 37, 38 AND 50).

FIRST USE 10-21-1998; IN COMMERCE 10-21-1998.

THE MARK CONSISTS OF STANDARD CHARACTERS WITHOUT CLAIM TO ANY PARTICULAR FONT, STYLE, SIZE, OR COLOR.

SER. NO. 85-692,224, FILED 8-1-2012.

HEATHER SAPP, EXAMINING ATTORNEY



*David J. Kyffers*

Director of the United States Patent and Trademark Office

# United States of America

United States Patent and Trademark Office



**Reg. No. 4,275,883**

**Registered Jan. 15, 2013**

**Int. Cl.: 30**

**TRADEMARK**

**PRINCIPAL REGISTER**

J&J SNACK FOODS CORP. (NEW JERSEY CORPORATION)  
6000 CENTRAL HIGHWAY  
PENNSAUKEN, NJ 08109

FOR: PASTRIES, IN CLASS 30 (U.S. CL. 46).

FIRST USE 9-0-2010; IN COMMERCE 9-0-2010.

OWNER OF U.S. REG. NOS. 2,044,589, 3,618,663 AND OTHERS.

NO CLAIM IS MADE TO THE EXCLUSIVE RIGHT TO USE "CHURROS", APART FROM THE MARK AS SHOWN.

THE MARK CONSISTS OF A TRIANGULAR BACKGROUND WITH A SHINING SUN BETWEEN TWO PALM TREES, BENEATH THE SUN AND PALM TREES IS A SMALL BANNER WITH THE STYLIZED CURSIVE WORDING "CALIFORNIA", AND BENEATH THE SMALL BANNER IS A LARGER BANNER WITH THE CAPITAL WORDING "CHURROS".

SEC. 2(F) AS TO "CALIFORNIA CHURROS".

SER. NO. 85-694,222, FILED 8-2-2012.

NICHOLAS COLEMAN, EXAMINING ATTORNEY



*David J. Kyros*

Director of the United States Patent and Trademark Office

# United States of America

United States Patent and Trademark Office

# JOKKO

**Reg. No. 4,275,884**

**Registered Jan. 15, 2013**

**Int. Cl.: 28**

**TRADEMARK**

**PRINCIPAL REGISTER**

SWAG COMPANY, INC. (CALIFORNIA CORPORATION)  
P.O. BOX 33556  
SAN DIEGO, CA 92101

FOR: PET TOYS, IN CLASS 28 (U.S. CLS. 22, 23, 38 AND 50).

FIRST USE 7-25-2012; IN COMMERCE 7-25-2012.

THE MARK CONSISTS OF STANDARD CHARACTERS WITHOUT CLAIM TO ANY PARTICULAR FONT, STYLE, SIZE, OR COLOR.

SER. NO. 85-694,447, FILED 8-3-2012.

KEVIN CORWIN, EXAMINING ATTORNEY



*David J. Kybas*

Director of the United States Patent and Trademark Office

# United States of America

United States Patent and Trademark Office

# INKPOINTS

**Reg. No. 4,275,885**

**Registered Jan. 15, 2013**

**Int. Cl.: 2**

**TRADEMARK**

**PRINCIPAL REGISTER**

INKJETMADNESS.COM, INC. (CALIFORNIA CORPORATION)  
#103  
2205 1ST STREET  
SIMI VALLEY, CA 93065

FOR: PRINTERS' INK; TONER CARTRIDGES, IN CLASS 2 (U.S. CLS. 6, 11 AND 16).

FIRST USE 11-17-2004; IN COMMERCE 11-17-2004.

THE MARK CONSISTS OF STANDARD CHARACTERS WITHOUT CLAIM TO ANY PARTICULAR FONT, STYLE, SIZE, OR COLOR.

SER. NO. 85-694,610, FILED 8-3-2012.

ALEXANDER L. POWERS, EXAMINING ATTORNEY



*David J. Kyffers*

Director of the United States Patent and Trademark Office



# United States of America

United States Patent and Trademark Office

## SURF IN THE POCKET

**Reg. No. 4,275,886**

**Registered Jan. 15, 2013**

**Int. Cl.: 25**

**TRADEMARK**

**PRINCIPAL REGISTER**

CALDERON, PAUL (UNITED STATES INDIVIDUAL)  
#201  
1237 SOUTH VICTORIA AVE  
OXNARD, CA 93035

FOR: BASEBALL CAPS; HOODED SWEAT SHIRTS; T-SHIRTS, IN CLASS 25 (U.S. CLS. 22 AND 39).

FIRST USE 4-1-2012; IN COMMERCE 6-1-2012.

THE MARK CONSISTS OF STANDARD CHARACTERS WITHOUT CLAIM TO ANY PARTICULAR FONT, STYLE, SIZE, OR COLOR.

SER. NO. 85-695,247, FILED 8-3-2012.

CHARLOTTE CORWIN, EXAMINING ATTORNEY



*David J. Kyffers*

Director of the United States Patent and Trademark Office

# United States of America

United States Patent and Trademark Office

# ChoiceEvent

**Reg. No. 4,275,887**

**Registered Jan. 15, 2013**

**Int. Cl.: 35**

**SERVICE MARK**

**PRINCIPAL REGISTER**

THE CORPORATE MARKETPLACE, INC. (DELAWARE CORPORATION)  
SUITE 300  
6946 POST ROAD  
NORTH KINGSTON, RI 02852

FOR: COMPUTERIZED ONLINE ORDERING SERVICES IN THE FIELD OF GENERAL MERCHANDISE AND GENERAL CONSUMER GOODS IN CONNECTION WITH EMPLOYEE, CORPORATE AND PROMOTIONAL INCENTIVE AWARD PROGRAMS; ONLINE RETAIL STORE SERVICES FEATURING GENERAL MERCHANDISE AND GENERAL CONSUMER GOODS IN CONNECTION WITH EMPLOYEE, CORPORATE AND PROMOTIONAL INCENTIVE AWARD PROGRAMS; RETAIL STORE SERVICES FEATURING A WIDE VARIETY OF CONSUMER GOODS OF OTHERS IN CONNECTION WITH EMPLOYEE, CORPORATE AND PROMOTIONAL INCENTIVE AWARD PROGRAMS, IN CLASS 35 (U.S. CLS. 100, 101 AND 102).

FIRST USE 7-1-2012; IN COMMERCE 7-1-2012.

THE MARK CONSISTS OF STANDARD CHARACTERS WITHOUT CLAIM TO ANY PARTICULAR FONT, STYLE, SIZE, OR COLOR.

SER. NO. 85-695,864, FILED 8-6-2012.

RUDY R. SINGLETON, EXAMINING ATTORNEY



*David J. Kyffers*

Director of the United States Patent and Trademark Office

# United States of America

United States Patent and Trademark Office

## ChoiceEvents

**Reg. No. 4,275,888**

**Registered Jan. 15, 2013**

**Int. Cl.: 35**

**SERVICE MARK**

**PRINCIPAL REGISTER**

THE CORPORATE MARKETPLACE, INC. (DELAWARE CORPORATION)  
SUITE 300  
6946 POST ROAD  
NORTH KINGSTON, RI 02852

FOR: COMPUTERIZED ONLINE ORDERING SERVICES IN THE FIELD OF GENERAL MERCHANDISE AND GENERAL CONSUMER GOODS IN CONNECTION WITH EMPLOYEE, CORPORATE AND PROMOTIONAL INCENTIVE AWARD PROGRAMS; ONLINE RETAIL STORE SERVICES FEATURING GENERAL MERCHANDISE AND GENERAL CONSUMER GOODS IN CONNECTION WITH EMPLOYEE, CORPORATE AND PROMOTIONAL INCENTIVE AWARD PROGRAMS; RETAIL STORE SERVICES FEATURING A WIDE VARIETY OF CONSUMER GOODS OF OTHERS IN CONNECTION WITH EMPLOYEE, CORPORATE AND PROMOTIONAL INCENTIVE AWARD PROGRAMS, IN CLASS 35 (U.S. CLS. 100, 101 AND 102).

FIRST USE 7-1-2012; IN COMMERCE 7-1-2012.

THE MARK CONSISTS OF STANDARD CHARACTERS WITHOUT CLAIM TO ANY PARTICULAR FONT, STYLE, SIZE, OR COLOR.

SER. NO. 85-695,883, FILED 8-6-2012.

RUDY R. SINGLETON, EXAMINING ATTORNEY



*David J. Kyros*

Director of the United States Patent and Trademark Office

# United States of America

United States Patent and Trademark Office

## FollowOne International

**Reg. No. 4,275,889**

**Registered Jan. 15, 2013**

**Int. Cl.: 35**

**SERVICE MARK**

**PRINCIPAL REGISTER**

FOLLOW ONE INTERNATIONAL, INC. (FLORIDA CORPORATION)  
715 GLEN EAGLE DR  
WINTER SPRINGS, FL 32708

FOR: ADMINISTRATION OF CULTURAL AND EDUCATIONAL EXCHANGE PROGRAMS; CHARITABLE SERVICES, NAMELY, ORGANIZING AND CONDUCTING VOLUNTEER PROGRAMS AND COMMUNITY SERVICE PROJECTS; CHARITABLE SERVICES, NAMELY, ORGANIZING AND DEVELOPING PROJECTS THAT AIM TO IMPROVE THE LIVES OF UNDERPRIVILEGED AND IMPOVERISHED PEOPLE; DEVELOPING AND COORDINATING VOLUNTEER PROJECTS FOR CHARITABLE ORGANIZATIONS, IN CLASS 35 (U.S. CLS. 100, 101 AND 102).

FIRST USE 6-14-2004; IN COMMERCE 6-14-2004.

THE MARK CONSISTS OF STANDARD CHARACTERS WITHOUT CLAIM TO ANY PARTICULAR FONT, STYLE, SIZE, OR COLOR.

NO CLAIM IS MADE TO THE EXCLUSIVE RIGHT TO USE "INTERNATIONAL", APART FROM THE MARK AS SHOWN.

SER. NO. 85-695,991, FILED 8-6-2012.

DAWN HAN, EXAMINING ATTORNEY



*David J. Kyffers*

Director of the United States Patent and Trademark Office

# United States of America

United States Patent and Trademark Office

## GIVE LAUGH LOVE

**Reg. No. 4,275,890**

D-GENERATION, INC. (FLORIDA CORPORATION)

**Registered Jan. 15, 2013**

P.O. BOX 30  
DAYTONA BEACH, FL 32115

**Int. Cl.: 28**

FOR: CHRISTMAS TREE ORNAMENTS AND DECORATIONS, IN CLASS 28 (U.S. CLS. 22, 23, 38 AND 50).

**TRADEMARK**

FIRST USE 2-19-2007; IN COMMERCE 2-19-2007.

**PRINCIPAL REGISTER**

THE MARK CONSISTS OF STANDARD CHARACTERS WITHOUT CLAIM TO ANY PARTICULAR FONT, STYLE, SIZE, OR COLOR.

OWNER OF U.S. REG. NOS. 3,997,859, 4,181,740 AND OTHERS.

SER. NO. 85-696,785, FILED 8-7-2012.

VIVIAN MICZNIK FIRST, EXAMINING ATTORNEY



*David J. Kybas*

Director of the United States Patent and Trademark Office

# United States of America

United States Patent and Trademark Office



**Reg. No. 4,275,891**

**Registered Jan. 15, 2013**

**Int. Cl.: 41**

**SERVICE MARK**

**PRINCIPAL REGISTER**

TRUSTEES OF DARTMOUTH COLLEGE (NEW HAMPSHIRE NON-PROFIT CORPORATION)  
DARTMOUTH COLLEGE  
HANOVER, NH 03755

FOR: EDUCATIONAL SERVICES, NAMELY OFFERING PROGRAMS FEATURING LITERATURE, LECTURES AND CONSULTATION TO ASSIST STUDENT ATHLETES TO DEVELOP AND ENHANCE INTELLECTUAL, PHYSICAL AND PERSONAL SKILLS, IN CLASS 41 (U.S. CLS. 100, 101 AND 107).

FIRST USE 7-14-2011; IN COMMERCE 7-14-2011.

OWNER OF U.S. REG. NOS. 987,129, 1,226,625, AND 2,158,219.

THE MARK CONSISTS OF A PINNACLE WITH THE CHARACTERS "DP2" SUPERIMPOSED ON THE TOP PORTION THEREOF AND THE WORDS "DARTMOUTH PEAK PERFORMANCE" DISPLAYED DIRECTLY BENEATH IN THE BOTTOM PORTION OF THE PINNACLE.

SER. NO. 85-697,349, FILED 8-7-2012.

KATHLEEN LORENZO, EXAMINING ATTORNEY



*David J. Kybas*

Director of the United States Patent and Trademark Office

# United States of America

United States Patent and Trademark Office

## APPLE VACATIONS

**Reg. No. 4,275,892**

**Registered Jan. 15, 2013**

**Int. Cl.: 43**

**SERVICE MARK**

**PRINCIPAL REGISTER**

THE CORYN GROUP II, LLC (DELAWARE LIMITED LIABILITY COMPANY)  
7 CAMPUS BOULEVARD  
NEWTOWN SQUARE, PA 19073

FOR: ARRANGING AND PROVIDING TRAVEL VACATION PACKAGES, NAMELY, MAKING RESERVATIONS AND BOOKINGS FOR TEMPORARY LODGING, IN CLASS 43 (U.S. CLS. 100 AND 101).

FIRST USE 8-0-1979; IN COMMERCE 8-0-1979.

THE MARK CONSISTS OF STANDARD CHARACTERS WITHOUT CLAIM TO ANY PARTICULAR FONT, STYLE, SIZE, OR COLOR.

OWNER OF U.S. REG. NO. 1,462,268.

NO CLAIM IS MADE TO THE EXCLUSIVE RIGHT TO USE "VACATIONS", APART FROM THE MARK AS SHOWN.

SER. NO. 85-697,764, FILED 8-7-2012.

LESLIE RICHARDS, EXAMINING ATTORNEY



*David J. Kyffers*

Director of the United States Patent and Trademark Office

# United States of America

United States Patent and Trademark Office



**Reg. No. 4,275,893**

**Registered Jan. 15, 2013**

**Int. Cls.: 9 and 41**

**TRADEMARK**

**SERVICE MARK**

**PRINCIPAL REGISTER**

SONY MUSIC ENTERTAINMENT (DELAWARE PARTNERSHIP)  
RM. 2325  
550 MADISON AVENUE  
NEW YORK, NY 10022

FOR: MUSICAL SOUND RECORDINGS; AUDIOVISUAL RECORDINGS FEATURING MUSIC AND MUSICAL BASED ENTERTAINMENT; DOWNLOADABLE MUSICAL SOUND AND DOWNLOADABLE AUDIOVISUAL RECORDINGS FEATURING MUSIC AND MUSICAL BASED ENTERTAINMENT; DOWNLOADABLE RINGTONES, GRAPHICS AND MUSIC VIA A GLOBAL COMPUTER NETWORK AND WIRELESS DEVICES, IN CLASS 9 (U.S. CLS. 21, 23, 26, 36 AND 38).

FIRST USE 7-24-2012; IN COMMERCE 7-24-2012.

FOR: ENTERTAINMENT, NAMELY, ORGANIZING AND PRODUCING MUSICAL EVENTS; ENTERTAINMENT, NAMELY, LIVE MUSIC CONCERTS; PROVIDING ONLINE ENTERTAINMENT, NAMELY, PROVIDING TEMPORARY USE OF NON-DOWNLOADABLE SOUND AND AUDIOVISUAL RECORDINGS IN THE FIELD OF MUSIC AND MUSICAL BASED ENTERTAINMENT; PROVIDING A WEBSITE OVER A GLOBAL COMPUTER NETWORK FEATURING INFORMATION ON MUSICAL ARTISTS, TOURS OF MUSICAL ARTISTS, SOUND RECORDINGS, POPULAR CULTURE AND EVENTS AND MUSICAL BASED ENTERTAINMENT; DISTRIBUTION OF DIGITAL PROGRAMS FOR OTHERS, NAMELY, ONLINE RADIO AND TELEVISION PROGRAMS, IN CLASS 41 (U.S. CLS. 100, 101 AND 107).

FIRST USE 7-24-2012; IN COMMERCE 7-24-2012.

THE MARK CONSISTS OF A CARTOON TIGER'S HEAD, BEARING A FIVE-POINTED STAR ON EACH CHEEK, WEARING A BASEBALL CAP PULLED LOW OVER ITS EYES AND BEARING THE LITERAL ELEMENT "CTMD" ENCLOSED IN AN UNSHADED RECTANGLE.

SER. NO. 85-698,400, FILED 8-8-2012.

RON FAIRBANKS, EXAMINING ATTORNEY



*David J. Kyffers*

Director of the United States Patent and Trademark Office



# United States of America

United States Patent and Trademark Office



**Reg. No. 4,275,894**

**Registered Jan. 15, 2013**

**Int. Cl.: 4**

**TRADEMARK**

**PRINCIPAL REGISTER**

GREEN RENEWABLE, INC. (NEW YORK CORPORATION)  
28 TAYLOR AVE PO BOX 248  
BERLIN, NY 12022

FOR: FIREWOOD; WOOD HEATING PELLETS, IN CLASS 4 (U.S. CLS. 1, 6 AND 15).

FIRST USE 6-26-2009; IN COMMERCE 5-24-2012.

NO CLAIM IS MADE TO THE EXCLUSIVE RIGHT TO USE "FIRE FUELS", APART FROM THE MARK AS SHOWN.

THE COLOR(S) RED ORANGE, PASTEL ORANGE, BLACK, GOLD, BROWN AND WHITE IS/ARE CLAIMED AS A FEATURE OF THE MARK.

THE MARK CONSISTS OF THE STYLIZED WORDS "FIRE FUELS", IN WHITE, CONTAINING A RED ORANGE AND PASTEL ORANGE COLORED FLAME IN THE "U" OF "FUELS", ALL DEPICTED WITHIN A BLACK OVAL LABEL IMAGE WITH GOLD AND BROWN SHADOWS, HIGHLIGHTS AND INTERNAL GLOW TO CREATE A DIMENSIONAL LOOKING IMAGE.

SER. NO. 85-698,409, FILED S.R. 8-8-2012 AM. P.R. 9-20-2012.

KATHERINE STOIDES, EXAMINING ATTORNEY



*David J. Kybas*

Director of the United States Patent and Trademark Office

# United States of America

United States Patent and Trademark Office

# LITEWAY

**Reg. No. 4,275,895**

**Registered Jan. 15, 2013**

**Int. Cl.: 12**

**TRADEMARK**

**PRINCIPAL REGISTER**

ARTSANA S.P.A. (ITALY CORPORATION)  
VIA SALDARINI CATELLI, 1  
GRANDATE (COMO), ITALY 22070

FOR: STROLLERS, IN CLASS 12 (U.S. CLS. 19, 21, 23, 31, 35 AND 44).

FIRST USE 11-30-2008; IN COMMERCE 11-30-2008.

THE MARK CONSISTS OF STANDARD CHARACTERS WITHOUT CLAIM TO ANY PARTICULAR FONT, STYLE, SIZE, OR COLOR.

SER. NO. 85-699,194, FILED 8-9-2012.

ANNE FARRELL, EXAMINING ATTORNEY



*David J. Kybas*

Director of the United States Patent and Trademark Office

**United States of America**  
United States Patent and Trademark Office

# TURBO-JET

**Reg. No. 4,275,896**

GENERAL MOTORS LLC (DELAWARE LIMITED LIABILITY COMPANY)  
300 RENAISSANCE CENTER  
DETROIT, MI 482653000

**Registered Jan. 15, 2013**

**Int. Cl.: 12**

FOR: EXTERIOR AND INTERIOR BADGES FOR MOTOR LAND VEHICLES, IN CLASS 12  
(U.S. CLS. 19, 21, 23, 31, 35 AND 44).

**TRADEMARK**

FIRST USE 10-21-1998; IN COMMERCE 10-21-1998.

**PRINCIPAL REGISTER**

THE MARK CONSISTS OF STANDARD CHARACTERS WITHOUT CLAIM TO ANY PARTICULAR FONT, STYLE, SIZE, OR COLOR.

SER. NO. 85-699,313, FILED 8-9-2012.

HEATHER SAPP, EXAMINING ATTORNEY



*David J. Kyffers*

Director of the United States Patent and Trademark Office

# United States of America

United States Patent and Trademark Office

# TURBO-JET

**Reg. No. 4,275,897**

**Registered Jan. 15, 2013**

**Int. Cl.: 16**

**TRADEMARK**

**PRINCIPAL REGISTER**

GENERAL MOTORS LLC (DELAWARE LIMITED LIABILITY COMPANY)  
300 RENAISSANCE CENTER  
DETROIT, MI 482653000

FOR: DECALS, IN CLASS 16 (U.S. CLS. 2, 5, 22, 23, 29, 37, 38 AND 50).

FIRST USE 6-23-2000; IN COMMERCE 6-23-2000.

THE MARK CONSISTS OF STANDARD CHARACTERS WITHOUT CLAIM TO ANY PARTICULAR FONT, STYLE, SIZE, OR COLOR.

SER. NO. 85-699,368, FILED 8-9-2012.

HEATHER SAPP, EXAMINING ATTORNEY



*David J. Kyffers*

Director of the United States Patent and Trademark Office

# United States of America

United States Patent and Trademark Office

## FUEL FOR THE DRIVEN

**Reg. No. 4,275,898**

**Registered Jan. 15, 2013**

**Int. Cl.: 5**

**TRADEMARK**

**PRINCIPAL REGISTER**

ISI BRANDS INC. (MICHIGAN CORPORATION)  
3133 ORCHARD VISTA DRIVE  
GRAND RAPIDS, MI 49546

FOR: DIETARY SUPPLEMENTS, IN CLASS 5 (U.S. CLS. 6, 18, 44, 46, 51 AND 52).

FIRST USE 3-9-2011; IN COMMERCE 3-9-2011.

THE MARK CONSISTS OF STANDARD CHARACTERS WITHOUT CLAIM TO ANY PARTICULAR FONT, STYLE, SIZE, OR COLOR.

SER. NO. 85-699,377, FILED 8-9-2012.

LINDA ESTRADA, EXAMINING ATTORNEY



*David J. Kyffers*

Director of the United States Patent and Trademark Office

**United States of America**  
United States Patent and Trademark Office

**TURBO-FIRE**

**Reg. No. 4,275,899**

GENERAL MOTORS LLC (DELAWARE LIMITED LIABILITY COMPANY)  
300 RENAISSANCE CENTER  
DETROIT, MI 482653000

**Registered Jan. 15, 2013**

**Int. Cl.: 16**

FOR: DECALS, IN CLASS 16 (U.S. CLS. 2, 5, 22, 23, 29, 37, 38 AND 50).

**TRADEMARK**

FIRST USE 6-23-2000; IN COMMERCE 6-23-2000.

**PRINCIPAL REGISTER**

THE MARK CONSISTS OF STANDARD CHARACTERS WITHOUT CLAIM TO ANY PARTICULAR FONT, STYLE, SIZE, OR COLOR.

SER. NO. 85-699,411, FILED 8-9-2012.

HEATHER SAPP, EXAMINING ATTORNEY



*David J. Kybas*

Director of the United States Patent and Trademark Office

# United States of America

United States Patent and Trademark Office



THOMPSON  
COBURN LLP

**Reg. No. 4,275,900**

**Registered Jan. 15, 2013**

**Int. Cl.: 45**

**SERVICE MARK**

**PRINCIPAL REGISTER**

THOMPSON COBURN LLP (MISSOURI LIMITED LIABILITY PARTNERSHIP)  
ONE US BANK PLAZA  
ST. LOUIS, MO 63101

FOR: LEGAL SERVICES, IN CLASS 45 (U.S. CLS. 100 AND 101).

FIRST USE 7-30-2012; IN COMMERCE 7-30-2012.

OWNER OF U.S. REG. NOS. 2,424,851 AND 2,440,282.

THE COLOR(S) BLACK, WHITE, BURGUNDY AND GREY IS/ARE CLAIMED AS A FEATURE OF THE MARK.

NO CLAIM IS MADE TO THE EXCLUSIVE RIGHT TO USE "LLP", APART FROM THE MARK AS SHOWN.

THE MARK CONSISTS OF A BURGUNDY SQUARE, A GREY BAR EXTENDING GENERALLY FROM THE LOWER MIDDLE PORTION OF THE SQUARE TO THE UPPER RIGHT PORTION OF THE SQUARE, AND A WHITE ARC EXTENDING GENERALLY UPWARDLY FROM THE LOWER LEFT PORTION OF THE SQUARE TO THE RIGHT EDGE PORTION OF THE SQUARE AND CROSSING OVER THE GREY BAR. TO THE RIGHT OF THE SQUARE ARE THE WORDS "THOMPSON COBURN LLP" IN BLACK.

SER. NO. 85-699,851, FILED 8-9-2012.

COLLEEN KEARNEY, EXAMINING ATTORNEY



*David J. Kybas*

Director of the United States Patent and Trademark Office

# United States of America

United States Patent and Trademark Office

# Pro Flexibles

**Reg. No. 4,275,901**

STRATEGIC PARTNERS, INC. (CALIFORNIA CORPORATION)  
9800 DE SOTO AVE.  
CHATSWORTH, CA 91311

**Registered Jan. 15, 2013**

**Int. Cl.: 25**

FOR: BOTTOMS; PANTS; SCRUBS NOT FOR MEDICAL PURPOSES; SHIRTS; TOPS; UNIFORMS, IN CLASS 25 (U.S. CLS. 22 AND 39).

**TRADEMARK**

FIRST USE 4-10-2011; IN COMMERCE 4-10-2011.

**PRINCIPAL REGISTER**

THE MARK CONSISTS OF STANDARD CHARACTERS WITHOUT CLAIM TO ANY PARTICULAR FONT, STYLE, SIZE, OR COLOR.

NO CLAIM IS MADE TO THE EXCLUSIVE RIGHT TO USE "FLEXIBLES", APART FROM THE MARK AS SHOWN.

SER. NO. 85-702,038, FILED 8-13-2012.

RONALD AIKENS, EXAMINING ATTORNEY



*David J. Kyffers*

Director of the United States Patent and Trademark Office



# United States of America

United States Patent and Trademark Office

# DAYTRIP

**Reg. No. 4,275,902**

**Registered Jan. 15, 2013**

**Int. Cl.: 9**

**TRADEMARK**

**PRINCIPAL REGISTER**

BUCKLE BRANDS, INC. (NEBRASKA CORPORATION)  
2407 W. 24TH STREET  
KEARNEY, NE 68845

FOR: SUNGLASSES, IN CLASS 9 (U.S. CLS. 21, 23, 26, 36 AND 38).

FIRST USE 9-20-2010; IN COMMERCE 9-20-2010.

THE MARK CONSISTS OF STANDARD CHARACTERS WITHOUT CLAIM TO ANY PARTICULAR FONT, STYLE, SIZE, OR COLOR.

OWNER OF U.S. REG. NOS. 3,752,011 AND 3,963,391.

SER. NO. 85-703,880, FILED 8-15-2012.

KATHRYN COWARD, EXAMINING ATTORNEY



*David J. Kyffers*

Director of the United States Patent and Trademark Office

# United States of America

United States Patent and Trademark Office

# BKE

**Reg. No. 4,275,903**

**Registered Jan. 15, 2013**

**Int. Cls.: 3, 9 and 18**

**TRADEMARK**

**PRINCIPAL REGISTER**

BUCKLE BRANDS, INC. (NEBRASKA CORPORATION)  
2407 W. 24TH STREET  
KEARNEY, NE 68845

FOR: COLOGNE, IN CLASS 3 (U.S. CLS. 1, 4, 6, 50, 51 AND 52).

FIRST USE 12-21-2004; IN COMMERCE 12-21-2004.

FOR: SUNGLASSES, IN CLASS 9 (U.S. CLS. 21, 23, 26, 36 AND 38).

FIRST USE 2-15-2003; IN COMMERCE 2-15-2003.

FOR: PURSES, CLUTCH PURSES, COSMETIC BAGS SOLD EMPTY, WALLETS, IN CLASS 18 (U.S. CLS. 1, 2, 3, 22 AND 41).

FIRST USE 7-15-2006; IN COMMERCE 7-15-2006.

THE MARK CONSISTS OF STANDARD CHARACTERS WITHOUT CLAIM TO ANY PARTICULAR FONT, STYLE, SIZE, OR COLOR.

OWNER OF U.S. REG. NOS. 2,447,957, 3,752,278 AND OTHERS.

SER. NO. 85-703,896, FILED 8-15-2012.

KATHRYN COWARD, EXAMINING ATTORNEY



*David J. Kyros*

Director of the United States Patent and Trademark Office

# United States of America

United States Patent and Trademark Office

FROM GREAT STARTS COME  
GREAT THINGS

**Reg. No. 4,275,904**

KELLOGG NORTH AMERICA COMPANY (DELAWARE CORPORATION)  
ONE KELLOGG SQUARE, PO BOX 3599  
BATTLE CREEK, MI 490163599

**Registered Jan. 15, 2013**

**Int. Cl.: 30**

FOR: PROCESSED CEREAL-BASED FOOD TO BE USED AS A BREAKFAST FOOD, SNACK  
FOOD OR INGREDIENT FOR MAKING OTHER FOODS, IN CLASS 30 (U.S. CL. 46).

**TRADEMARK**

FIRST USE 1-0-2012; IN COMMERCE 1-0-2012.

**PRINCIPAL REGISTER**

THE MARK CONSISTS OF STANDARD CHARACTERS WITHOUT CLAIM TO ANY PAR-  
TICULAR FONT, STYLE, SIZE, OR COLOR.

SER. NO. 85-704,138, FILED 8-15-2012.

NICHOLAS ALTREE, EXAMINING ATTORNEY



*David J. Kyffers*

Director of the United States Patent and Trademark Office

# United States of America

United States Patent and Trademark Office

## HP PROTECTSMART

**Reg. No. 4,275,905**

HEWLETT-PACKARD DEVELOPMENT COMPANY, L.P. (TEXAS LIMITED PARTNERSHIP)  
11445 COMPAQ CENTER DRIVE WEST  
HOUSTON, TX 77070

**Registered Jan. 15, 2013**

**Int. Cl.: 9**

FOR: COMPUTER SOFTWARE FOR PROTECTION OF HARD DRIVE CONTENT, IN CLASS  
9 (U.S. CLS. 21, 23, 26, 36 AND 38).

**TRADEMARK**

FIRST USE 4-22-2010; IN COMMERCE 4-22-2010.

**PRINCIPAL REGISTER**

THE MARK CONSISTS OF STANDARD CHARACTERS WITHOUT CLAIM TO ANY PAR-  
TICULAR FONT, STYLE, SIZE, OR COLOR.

OWNER OF U.S. REG. NOS. 3,084,776, 3,412,631 AND OTHERS.

NO CLAIM IS MADE TO THE EXCLUSIVE RIGHT TO USE "PROTECT SMART", APART  
FROM THE MARK AS SHOWN.

SER. NO. 85-704,337, FILED 8-15-2012.

CAROLINE WOOD, EXAMINING ATTORNEY



*David J. Kybas*

Director of the United States Patent and Trademark Office

# United States of America

United States Patent and Trademark Office

## MIDBOARD HUB

**Reg. No. 4,275,906**

TATUM MOTORSPORTS, LLC (ARIZONA LIMITED LIABILITY COMPANY)  
8741 N. 79TH AVENUE  
PEORIA, AZ 85345

**Registered Jan. 15, 2013**

**Int. Cl.: 12**

FOR: DISC BRAKES FOR LAND VEHICLES, IN CLASS 12 (U.S. CLS. 19, 21, 23, 31, 35 AND 44).

**TRADEMARK**

FIRST USE 7-31-1999; IN COMMERCE 7-31-1999.

**PRINCIPAL REGISTER**

THE MARK CONSISTS OF STANDARD CHARACTERS WITHOUT CLAIM TO ANY PARTICULAR FONT, STYLE, SIZE, OR COLOR.

NO CLAIM IS MADE TO THE EXCLUSIVE RIGHT TO USE "HUB", APART FROM THE MARK AS SHOWN.

SER. NO. 85-704,599, FILED 8-15-2012.

MORGAN WYNNE, EXAMINING ATTORNEY



*David J. Kyffers*

Director of the United States Patent and Trademark Office

# United States of America

United States Patent and Trademark Office

# PIDDX

**Reg. No. 4,275,907**

**Registered Jan. 15, 2013**

**Int. Cl.: 25**

**TRADEMARK**

**PRINCIPAL REGISTER**

PIDDX, INC. (MASSACHUSETTS CORPORATION)  
340 COOLEY ST, SUITE 127  
340 COOLEY ST, SUITE 127  
SPRINGFIELD, MA 01128

FOR: T-SHIRTS; WEARABLE GARMENTS AND CLOTHING, NAMELY, SHIRTS, IN CLASS 25 (U.S. CLS. 22 AND 39).

FIRST USE 7-28-2011; IN COMMERCE 7-28-2011.

THE MARK CONSISTS OF STANDARD CHARACTERS WITHOUT CLAIM TO ANY PARTICULAR FONT, STYLE, SIZE, OR COLOR.

SER. NO. 85-704,877, FILED 8-16-2012.

WENDY JUN, EXAMINING ATTORNEY



*David J. Kyffers*

Director of the United States Patent and Trademark Office

# United States of America

United States Patent and Trademark Office

# CMPLX6

**Reg. No. 4,275,908**

**Registered Jan. 15, 2013**

**Int. Cl.: 32**

**TRADEMARK**

**PRINCIPAL REGISTER**

THE COCA-COLA COMPANY (DELAWARE CORPORATION)  
ONE COCA-COLA PLAZA  
ATLANTA, GA 30313

FOR: ENERGY DRINKS, IN CLASS 32 (U.S. CLS. 45, 46 AND 48).

FIRST USE 2-0-2012; IN COMMERCE 2-0-2012.

THE MARK CONSISTS OF STANDARD CHARACTERS WITHOUT CLAIM TO ANY PARTICULAR FONT, STYLE, SIZE, OR COLOR.

SER. NO. 85-705,069, FILED 8-16-2012.

COLLEEN KEARNEY, EXAMINING ATTORNEY



*David J. Kyros*

Director of the United States Patent and Trademark Office

# United States of America

United States Patent and Trademark Office

## CHATEAU DE SANCERRE

**Reg. No. 4,275,909**

**Registered Jan. 15, 2013**

**Int. Cl.: 33**

**TRADEMARK**

**PRINCIPAL REGISTER**

SOCIETE DES PRODUITS MARNIER LAPOSTOLLE (FRANCE SOCIÉTÉ ANONYME (SA))  
91, BOULEVARD HAUSSMANN  
PARIS, FRANCE 75008

FOR: ALCOHOLIC BEVERAGES EXCEPT BEERS, IN CLASS 33 (U.S. CLS. 47 AND 49).

FIRST USE 1-0-2000; IN COMMERCE 1-0-2000.

THE MARK CONSISTS OF STANDARD CHARACTERS WITHOUT CLAIM TO ANY PARTICULAR FONT, STYLE, SIZE, OR COLOR.

OWNER OF U.S. REG. NO. 3,950,207.

NO CLAIM IS MADE TO THE EXCLUSIVE RIGHT TO USE "CHATEAU", APART FROM THE MARK AS SHOWN.

SEC. 2(F).

SER. NO. 85-705,904, FILED 8-16-2012.

IRA J. GOODSaid, EXAMINING ATTORNEY



*David J. Kybas*

Director of the United States Patent and Trademark Office



# United States of America

United States Patent and Trademark Office



**Reg. No. 4,275,910**

**Registered Jan. 15, 2013**

**Int. Cl.: 33**

**TRADEMARK**

**PRINCIPAL REGISTER**

SOCIETE DES PRODUITS MARNIER LAPOSTOLLE (FRANCE SOCIÉTÉ ANONYME (SA))  
91, BOULEVARD HAUSSMANN  
PARIS, FRANCE 75008

FOR: ALCOHOLIC BEVERAGES EXCEPT BEERS, IN CLASS 33 (U.S. CLS. 47 AND 49).

FIRST USE 0-0-1974; IN COMMERCE 0-0-1974.

NO CLAIM IS MADE TO THE EXCLUSIVE RIGHT TO USE "CUVEE", APART FROM THE MARK AS SHOWN.

THE MARK CONSISTS OF A WARRIOR HOLDING A PIKE WHILE RIDING A HORSE INSIDE A LIGHT SQUARE ABOVE THE WORDS "CUVEE DE CONNETABLE".

THE ENGLISH TRANSLATION OF "CONNETABLE" IN THE MARK IS "CONSTABLE".

SER. NO. 85-705,924, FILED 8-16-2012.

IRA J. GOODSaid, EXAMINING ATTORNEY



*David J. Kyffers*

Director of the United States Patent and Trademark Office

# United States of America

United States Patent and Trademark Office



**Reg. No. 4,275,911**

**Registered Jan. 15, 2013**

**Int. Cl.: 33**

**TRADEMARK**

**PRINCIPAL REGISTER**

SOCIETE DES PRODUITS MARNIER LAPOSTOLLE (FRANCE SOCIÉTÉ ANONYME (SA))  
91, BOULEVARD HAUSSMANN  
PARIS, FRANCE 75008

FOR: ALCOHOLIC BEVERAGES EXCEPT BEERS, IN CLASS 33 (U.S. CLS. 47 AND 49).

FIRST USE 1-0-1940; IN COMMERCE 1-0-1940.

OWNER OF U.S. REG. NOS. 312,050 AND 1,534,521.

THE MARK CONSISTS OF A SHIELD THAT HAS A STAR IN THE UPPER LEFT CORNER, A DIAGONAL STRIPE, AND A CASTLE NEXT TO A ROUND POT IN THE BOTTOM RIGHT CORNER. HERALDIC LIONS FACE EACH OTHER ON EITHER SIDE OF THE SHIELD. ABOVE THE SHIELD ARE FIVE CONNECTED CASTLES FORMING AN ARCH.

SER. NO. 85-705,934, FILED 8-16-2012.

IRA J. GOODSAY, EXAMINING ATTORNEY



*David J. Kyffers*

Director of the United States Patent and Trademark Office

# United States of America

United States Patent and Trademark Office

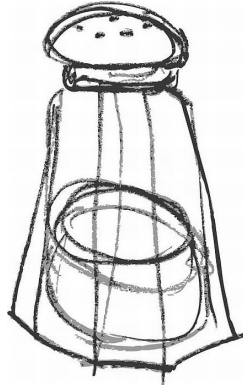

**Reg. No. 4,275,912**

**Registered Jan. 15, 2013**

**Int. Cl.: 43**

**SERVICE MARK**

**PRINCIPAL REGISTER**

CPH SALT, LLC (COLORADO LIMITED LIABILITY COMPANY), DBA ABOVE THE SALT  
316 EAST HOPKINS AVENUE  
ASPEN, CO 81611

FOR: BAR SERVICES; RESTAURANT SERVICES; SERVING FOOD AND DRINKS, IN CLASS  
43 (U.S. CLS. 100 AND 101).

FIRST USE 3-15-2012; IN COMMERCE 3-15-2012.

THE MARK CONSISTS OF A STYLIZED DRAWING-IMAGE OF A SALT SHAKER.

SER. NO. 85-706,256, FILED 8-17-2012.

NAAKWAMA ANKRAH, EXAMINING ATTORNEY



*David J. Kyfos*

Director of the United States Patent and Trademark Office

# United States of America

United States Patent and Trademark Office

## Château de Sancerre

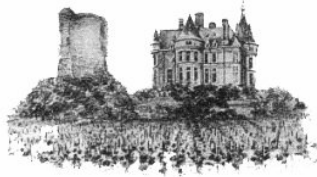

**Reg. No. 4,275,913**

**Registered Jan. 15, 2013**

**Int. Cl.: 33**

**TRADEMARK**

**PRINCIPAL REGISTER**

SOCIETE DES PRODUITS MARNIER LAPOSTOLLE (FRANCE SOCIÉTÉ ANONYME (SA))  
91, BOULEVARD HAUSSMANN  
PARIS, FRANCE 75008

FOR: ALCOHOLIC BEVERAGES EXCEPT BEERS, IN CLASS 33 (U.S. CLS. 47 AND 49).

FIRST USE 0-0-1962; IN COMMERCE 0-0-1962.

OWNER OF U.S. REG. NO. 3,950,207.

NO CLAIM IS MADE TO THE EXCLUSIVE RIGHT TO USE "CHATEAU", APART FROM THE MARK AS SHOWN.

THE MARK CONSISTS OF THE WORDS "CHATEAU DE SANCERRE" ABOVE A DRAWING OF A CASTLE WITH OUTLYING TOWER.

SEC. 2(F).

SER. NO. 85-706,406, FILED 8-17-2012.

IRA J. GOODSaid, EXAMINING ATTORNEY



*David J. Kyros*

Director of the United States Patent and Trademark Office

# United States of America

United States Patent and Trademark Office

# wealthtor

**Reg. No. 4,275,914**

DAVID SIBEL (UNITED STATES INDIVIDUAL)  
164 SUMMIT DRIVE  
COLMAR, PA 18915

**Registered Jan. 15, 2013**

**Int. Cl.: 35**

FOR: PUBLIC ADVOCACY TO PROMOTE AWARENESS OF BOTH THE BENEFITS OF HOME OWNERSHIP AND INVESTMENT REAL ESTATE TO BUILD LASTING WEALTH, IN CLASS 35 (U.S. CLS. 100, 101 AND 102).

**SERVICE MARK**

FIRST USE 8-1-2012; IN COMMERCE 8-1-2012.

**PRINCIPAL REGISTER**

THE MARK CONSISTS OF STANDARD CHARACTERS WITHOUT CLAIM TO ANY PARTICULAR FONT, STYLE, SIZE, OR COLOR.

SER. NO. 85-706,413, FILED 8-17-2012.

KIM SAITO, EXAMINING ATTORNEY



*David J. Kybas*

Director of the United States Patent and Trademark Office

# United States of America

United States Patent and Trademark Office

# BELL AIRE

**Reg. No. 4,275,915**

BELLEMARQUE, LLC (PENNSYLVANIA LIMITED LIABILITY COMPANY)  
103 ROTARY DRIVE, SUITE 5  
WEST HAZELTON, PA 18202

**Registered Jan. 15, 2013**

**Int. Cl.: 16**

FOR: CONSUMER AND INDUSTRIAL PAPER PRODUCTS, NAMELY, NAPKINS AND TOWELS, IN CLASS 16 (U.S. CLS. 2, 5, 22, 23, 29, 37, 38 AND 50).

**TRADEMARK**

FIRST USE 1-0-2010; IN COMMERCE 1-0-2010.

**PRINCIPAL REGISTER**

THE MARK CONSISTS OF STANDARD CHARACTERS WITHOUT CLAIM TO ANY PARTICULAR FONT, STYLE, SIZE, OR COLOR.

SER. NO. 85-706,794, FILED 8-17-2012.

GINA HAYES, EXAMINING ATTORNEY



*David J. Kyffers*

Director of the United States Patent and Trademark Office

# United States of America

United States Patent and Trademark Office

## WORK THE NETWORK

**Reg. No. 4,275,916**

**Registered Jan. 15, 2013**

**Int. Cl.: 25**

**TRADEMARK**

**PRINCIPAL REGISTER**

PIDDX, INC. (MASSACHUSETTS CORPORATION)  
340 COOLEY ST  
SUITE 127  
SPRINGFIELD, MA 01128

FOR: T-SHIRTS; WEARABLE GARMENTS AND CLOTHING, NAMELY, SHIRTS, IN CLASS 25 (U.S. CLS. 22 AND 39).

FIRST USE 7-28-2011; IN COMMERCE 7-28-2011.

THE MARK CONSISTS OF STANDARD CHARACTERS WITHOUT CLAIM TO ANY PARTICULAR FONT, STYLE, SIZE, OR COLOR.

OWNER OF U.S. REG. NO. 4,189,850.

SER. NO. 85-707,399, FILED 8-20-2012.

WENDY JUN, EXAMINING ATTORNEY



*David J. Kyffers*

Director of the United States Patent and Trademark Office

# United States of America

United States Patent and Trademark Office

# DURASAFE

**Reg. No. 4,275,917**

**Registered Jan. 15, 2013**

**Int. Cl.: 20**

**TRADEMARK**

**PRINCIPAL REGISTER**

BENUMOF, BENJAMIN (UNITED STATES INDIVIDUAL)  
SUITE 4  
1520 N. EL CAMINO REAL  
SAN CLEMENTE, CA 92672 AND

WILSON, RICK (UNITED STATES INDIVIDUAL)  
SUITE 4  
1520 N. EL CAMINO REAL  
SAN CLEMENTE, CA 92672

FOR: EDGE GUARDS AND PROTECTORS FOR SIGNAGE OF VARIOUS MATERIALS AND DIMENSIONS, NAMELY, NONMETAL HOLDERS FOR SIGNS MADE OF MARINE GRADE RECYCLED POLYMER MATERIAL AND OTHER PLASTICS, FOR THE PURPOSE OF PROVIDING PROTECTION FROM SHARP AND RIGID EDGES, IN CLASS 20 (U.S. CLS. 2, 13, 22, 25, 32 AND 50).

FIRST USE 7-30-2012; IN COMMERCE 7-30-2012.

THE MARK CONSISTS OF STANDARD CHARACTERS WITHOUT CLAIM TO ANY PARTICULAR FONT, STYLE, SIZE, OR COLOR.

SER. NO. 85-707,507, FILED 8-20-2012.

ANDREA K. NADELMAN, EXAMINING ATTORNEY



*David J. Kybas*

Director of the United States Patent and Trademark Office



# United States of America

United States Patent and Trademark Office



**Reg. No. 4,275,918**

**Registered Jan. 15, 2013**

**Int. Cl.: 25**

**TRADEMARK**

**PRINCIPAL REGISTER**

SONY MUSIC ENTERTAINMENT (DELAWARE PARTNERSHIP)  
RM. 2325  
550 MADISON AVENUE  
NEW YORK, NY 10022

FOR: CLOTHING, NAMELY, T-SHIRTS, SHIRTS, BLOUSES, SWEATERS, VESTS, PANTS, JEANS, SHORTS, DRESSES, SKIRTS, JACKETS, BLAZERS, SUITS, COATS, SLEEPWEAR, SWIMWEAR, LOUNGEWEAR, JOGGING SUITS, SWEATSHIRTS, HOODED SWEATSHIRTS, SOCKS, UNDERWEAR, BOXER SHORTS, NIGHTSHIRTS, LINGERIE, ATHLETIC PANTS AND TOPS; HEADWEAR; FOOTWEAR; CLOTHING ACCESSORIES, NAMELY, SCARVES, GLOVES, BELTS, TIES, MITTENS, WRISTBANDS, AND HEADBANDS, IN CLASS 25 (U.S. CLS. 22 AND 39).

FIRST USE 8-20-2012; IN COMMERCE 8-20-2012.

THE MARK CONSISTS OF A CARTOON TIGER'S HEAD, BEARING A FIVE-POINTED STAR ON EACH CHEEK, WEARING A BASEBALL CAP PULLED LOW OVER ITS EYES AND BEARING THE LITERAL ELEMENT "CTMD" ENCLOSED IN AN UNSHADED RECTANGLE.

SER. NO. 85-707,813, FILED 8-20-2012.

RON FAIRBANKS, EXAMINING ATTORNEY



*David J. Kyjars*

Director of the United States Patent and Trademark Office

# United States of America

United States Patent and Trademark Office

## WORK THE NETWORK

**Reg. No. 4,275,919**

**Registered Jan. 15, 2013**

**Int. Cl.: 35**

**SERVICE MARK**

**PRINCIPAL REGISTER**

PIDDX, INC. (MASSACHUSETTS CORPORATION)  
340 COOLEY ST  
SUITE 127  
SPRINGFIELD, MA 01128

FOR: PROMOTING THE GOODS AND SERVICES OF OTHERS VIA A GLOBAL COMPUTER NETWORK; PROVIDING PRICING INFORMATION ABOUT THE GOODS AND SERVICES OF OTHERS VIA THE GLOBAL COMPUTER NETWORK; PROVIDING RATINGS VIA A GLOBAL COMPUTER NETWORK FOR HOME PRODUCTS AND SERVICES RECOMMENDED BY CONSUMERS, IN CLASS 35 (U.S. CLS. 100, 101 AND 102).

FIRST USE 7-28-2011; IN COMMERCE 7-28-2011.

THE MARK CONSISTS OF STANDARD CHARACTERS WITHOUT CLAIM TO ANY PARTICULAR FONT, STYLE, SIZE, OR COLOR.

OWNER OF U.S. REG. NO. 4,189,850.

SER. NO. 85-708,444, FILED 8-21-2012.

WENDY JUN, EXAMINING ATTORNEY



*David J. Kyffers*

Director of the United States Patent and Trademark Office

# United States of America

United States Patent and Trademark Office

## MAGNACAL BALANCE

**Reg. No. 4,275,920**

CABADOS, RICK H (UNITED STATES INDIVIDUAL)  
2141 PALOMAR AIRPORT ROAD #320  
CARLSBAD, CA 92011

**Registered Jan. 15, 2013**

**Int. Cl.: 1**

FOR: PLANT FOOD AND PLANT GROWTH NUTRIENTS CONTAINING MAGNESIUM AND CALCIUM, IN CLASS 1 (U.S. CLS. 1, 5, 6, 10, 26 AND 46).

**TRADEMARK**

FIRST USE 7-1-2012; IN COMMERCE 7-1-2012.

**PRINCIPAL REGISTER**

THE MARK CONSISTS OF STANDARD CHARACTERS WITHOUT CLAIM TO ANY PARTICULAR FONT, STYLE, SIZE, OR COLOR.

SER. NO. 85-708,713, FILED 8-21-2012.

LINDA POWELL, EXAMINING ATTORNEY



*David J. Kyffers*

Director of the United States Patent and Trademark Office

# United States of America

United States Patent and Trademark Office

# ASCEND

**Reg. No. 4,275,921**

**Registered Jan. 15, 2013**

**Int. Cl.: 43**

**SERVICE MARK**

**PRINCIPAL REGISTER**

CHOICE HOTELS INTERNATIONAL, INC. (DELAWARE CORPORATION)  
10750 COLUMBIA PIKE  
SILVER SPRING, MD 20901

FOR: HOTEL AND MOTEL SERVICES, HOTEL AND MOTEL RESERVATION SERVICES FOR OTHERS, AND ONLINE HOTEL AND MOTEL RESERVATION SERVICES FOR OTHERS, IN CLASS 43 (U.S. CLS. 100 AND 101).

FIRST USE 10-24-2008; IN COMMERCE 10-24-2008.

THE MARK CONSISTS OF STANDARD CHARACTERS WITHOUT CLAIM TO ANY PARTICULAR FONT, STYLE, SIZE, OR COLOR.

OWNER OF U.S. REG. NOS. 3,577,603 AND 3,647,257.

SER. NO. 85-708,888, FILED 8-21-2012.

ANGELA DUONG, EXAMINING ATTORNEY



*David J. Kybas*

Director of the United States Patent and Trademark Office

# United States of America

United States Patent and Trademark Office

## CITGO IN ACTION

**Reg. No. 4,275,922**

**Registered Jan. 15, 2013**

**Int. Cl.: 35**

**SERVICE MARK**

**PRINCIPAL REGISTER**

CITGO PETROLEUM CORPORATION (DELAWARE CORPORATION)  
1293 ELDRIDGE PARKWAY  
HOUSTON, TX 77077

FOR: CHARITABLE SERVICES, NAMELY, ORGANIZING AND CONDUCTING VOLUNTEER PROGRAMS AND COMMUNITY SERVICE PROJECTS, IN CLASS 35 (U.S. CLS. 100, 101 AND 102).

FIRST USE 6-0-2012; IN COMMERCE 6-0-2012.

THE MARK CONSISTS OF STANDARD CHARACTERS WITHOUT CLAIM TO ANY PARTICULAR FONT, STYLE, SIZE, OR COLOR.

OWNER OF U.S. REG. NO. 4,053,575.

SER. NO. 85-709,223, FILED 8-21-2012.

SUZANNE BLANE, EXAMINING ATTORNEY



*David J. Kyffers*

Director of the United States Patent and Trademark Office

# United States of America

United States Patent and Trademark Office

## ONLY 1 TOWEL WILL DO IT!

**Reg. No. 4,275,923**

**Registered Jan. 15, 2013**

**Int. Cl.: 16**

**TRADEMARK**

**PRINCIPAL REGISTER**

BELLEMARQUE, LLC (PENNSYLVANIA LIMITED LIABILITY COMPANY)  
103 ROTARY DRIVE, SUITE 5  
WEST HAZELTON, PA 18202

FOR: PAPER TOWELS, IN CLASS 16 (U.S. CLS. 2, 5, 22, 23, 29, 37, 38 AND 50).

FIRST USE 1-0-2010; IN COMMERCE 1-0-2010.

THE MARK CONSISTS OF STANDARD CHARACTERS WITHOUT CLAIM TO ANY PARTICULAR FONT, STYLE, SIZE, OR COLOR.

NO CLAIM IS MADE TO THE EXCLUSIVE RIGHT TO USE "TOWEL", APART FROM THE MARK AS SHOWN.

SER. NO. 85-709,601, FILED 8-22-2012.

GINA HAYES, EXAMINING ATTORNEY



*David J. Kyffers*

Director of the United States Patent and Trademark Office

# United States of America

United States Patent and Trademark Office

# RARECYTE

**Reg. No. 4,275,924**

**Registered Jan. 15, 2013**

**Int. Cl.: 9**

**TRADEMARK**

**PRINCIPAL REGISTER**

RARECYTE, INC. (DELAWARE CORPORATION)  
SUITE 100  
228 9TH AVENUE NORTH  
SEATTLE, WA 98109

FOR: LABORATORY APPARATUS AND INSTRUMENTS FOR THE DETECTION OF CIRCULATING TUMOR CELLS AND CIRCULATING EPITHELIAL CELLS, FOR CELL SEPARATION, AND FOR HEMATOLOGY APPLICATIONS, IN CLASS 9 (U.S. CLS. 21, 23, 26, 36 AND 38).

FIRST USE 7-10-2012; IN COMMERCE 7-10-2012.

THE MARK CONSISTS OF STANDARD CHARACTERS WITHOUT CLAIM TO ANY PARTICULAR FONT, STYLE, SIZE, OR COLOR.

SER. NO. 85-710,406, FILED 8-22-2012.

KEVIN DINALLO, EXAMINING ATTORNEY



*David J. Kyffers*

Director of the United States Patent and Trademark Office

# United States of America

United States Patent and Trademark Office

## LUCKY CHARMS

**Reg. No. 4,275,925**

**Registered Jan. 15, 2013**

**Int. Cl.: 3**

**TRADEMARK**

**PRINCIPAL REGISTER**

GENERAL MILLS IP HOLDINGS II, LLC (DELAWARE LIMITED LIABILITY COMPANY)  
NUMBER ONE GENERAL MILLS BOULEVARD  
MINNEAPOLIS, MN 55426

FOR: LIP BALM, IN CLASS 3 (U.S. CLS. 1, 4, 6, 50, 51 AND 52).

FIRST USE 9-30-2005; IN COMMERCE 9-30-2005.

THE MARK CONSISTS OF STANDARD CHARACTERS WITHOUT CLAIM TO ANY PARTICULAR FONT, STYLE, SIZE, OR COLOR.

OWNER OF U.S. REG. NOS. 759,322, 3,422,726 AND OTHERS.

SER. NO. 85-711,845, FILED 8-24-2012.

ALAIN LAPTER, EXAMINING ATTORNEY



*David J. Kyffers*

Director of the United States Patent and Trademark Office



# United States of America

United States Patent and Trademark Office

# LOANSPQ

**Reg. No. 4,275,926**

**Registered Jan. 15, 2013**

**Int. Cl.: 42**

**SERVICE MARK**

**PRINCIPAL REGISTER**

MERIDIANLINK, INC. (CALIFORNIA CORPORATION)  
1124 BRISTOL ST.  
COSTA MESA, CA 92626

FOR: APPLICATION SERVICE PROVIDER (ASP) FEATURING SOFTWARE FOR USE FOR LOAN AND CREDIT QUALIFICATION, APPLICATIONS, PROCESSING, AND MANAGEMENT; APPLICATION SERVICE PROVIDER FEATURING APPLICATION PROGRAMMING INTERFACE (API) SOFTWARE FOR LOAN AND CREDIT QUALIFICATION, APPLICATIONS, PROCESSING, AND MANAGEMENT; CONSULTING SERVICES IN THE FIELD OF PROVIDING ONLINE, NON-DOWNLOADABLE SOFTWARE AND APPLICATIONS; SOFTWARE AS A SERVICE (SAAS) SERVICES, NAMELY, HOSTING SOFTWARE FOR USE BY OTHERS FOR USE FOR LOAN AND CREDIT QUALIFICATION, APPLICATIONS, PROCESSING, AND MANAGEMENT, IN CLASS 42 (U.S. CLS. 100 AND 101).

FIRST USE 12-1-2002; IN COMMERCE 12-1-2002.

THE MARK CONSISTS OF STANDARD CHARACTERS WITHOUT CLAIM TO ANY PARTICULAR FONT, STYLE, SIZE, OR COLOR.

OWNER OF U.S. REG. NO. 3,211,432.

SER. NO. 85-711,956, FILED 8-24-2012.

WILLIAM P. SHANAHAN, EXAMINING ATTORNEY



*David J. Kybas*

Director of the United States Patent and Trademark Office

# United States of America

United States Patent and Trademark Office

## TELL YOUR STORY

**Reg. No. 4,275,927**

**Registered Jan. 15, 2013**

**Int. Cl.: 16**

**TRADEMARK**

**PRINCIPAL REGISTER**

SHUTTERFLY, INC. (DELAWARE CORPORATION)  
2800 BRIDGE PARKWAY  
REDWOOD CITY, CA 94065

FOR: SCRAPBOOKS, SCRAPBOOK PAGES, SCRAPBOOK ALBUMS, PHOTO ALBUMS, PHOTO BOOKS, AND BOOKS CONTAINING PHOTOS OR IMAGES, IN CLASS 16 (U.S. CLS. 2, 5, 22, 23, 29, 37, 38 AND 50).

FIRST USE 10-2-2007; IN COMMERCE 10-2-2007.

THE MARK CONSISTS OF STANDARD CHARACTERS WITHOUT CLAIM TO ANY PARTICULAR FONT, STYLE, SIZE, OR COLOR.

SER. NO. 85-711,994, FILED 8-24-2012.

KEVON CHISOLM, EXAMINING ATTORNEY



*David J. Kyffers*

Director of the United States Patent and Trademark Office

# United States of America

United States Patent and Trademark Office



**PROFESSIONAL  
CONTRACTOR  
ASSOCIATION**

**Reg. No. 4,275,928**

**Registered Jan. 15, 2013**

**Int. Cls.: 35 and 41**

**SERVICE MARK**

**PRINCIPAL REGISTER**

A. O. SMITH CORPORATION (DELAWARE CORPORATION)  
11270 WEST PARK PLACE  
MILWAUKEE, WI 53224

FOR: ARRANGING AND CONDUCTING INCENTIVE REWARD PROGRAMS TO PROMOTE THE SALE OF WATER HEATING PRODUCTS, IN CLASS 35 (U.S. CLS. 100, 101 AND 102).

FIRST USE 7-1-1999; IN COMMERCE 7-1-1999.

FOR: PROVIDING TRAINING AND SEMINARS TO PROFESSIONAL ASSOCIATION MEMBERS IN THE USE, OPERATION AND REPAIR, SALE, AND MARKETING OF PLUMBING SYSTEMS, HEATING SYSTEMS, WATER HEATING PRODUCTS, AND BOILERS, IN CLASS 41 (U.S. CLS. 100, 101 AND 107).

FIRST USE 7-1-1999; IN COMMERCE 7-1-1999.

OWNER OF U.S. REG. NO. 2,685,216.

NO CLAIM IS MADE TO THE EXCLUSIVE RIGHT TO USE "PROFESSIONAL CONTRACTOR ASSOCIATION", APART FROM THE MARK AS SHOWN.

THE MARK CONSISTS OF THE LETTERS "PCA" IN AN OVAL, TO THE LEFT OF THE WORDS "PROFESSIONAL CONTRACTOR ASSOCIATION", WITH "PROFESSIONAL" BEING ABOVE THE WORD "CONTRACTOR", AND "CONTRACTOR" BEING ABOVE THE WORD "ASSOCIATION".

SER. NO. 85-712,174, FILED 8-24-2012.

ANDREW RHIM, EXAMINING ATTORNEY



*David J. Kybas*

Director of the United States Patent and Trademark Office

United States of America  
United States Patent and Trademark Office

# FOSTECH

**Reg. No. 4,275,929**

FOSTECH OUTDOORS, L.L.C. (INDIANA LIMITED LIABILITY COMPANY)  
9290 W. COUNTY ROAD 750 S.  
PARIS CROSSING, IN 47270

**Registered Jan. 15, 2013**

**Int. Cl.: 35**

FOR: ON-LINE RETAIL STORE SERVICES FEATURING FIREARM ATTACHMENTS AND  
FIREARM ACCESSORIES, IN CLASS 35 (U.S. CLS. 100, 101 AND 102).

**SERVICE MARK**

FIRST USE 6-21-2011; IN COMMERCE 6-21-2011.

**PRINCIPAL REGISTER**

THE MARK CONSISTS OF STANDARD CHARACTERS WITHOUT CLAIM TO ANY PAR-  
TICULAR FONT, STYLE, SIZE, OR COLOR.

SER. NO. 85-713,462, FILED 8-27-2012.

NAAKWAMA ANKRAH, EXAMINING ATTORNEY



*David J. Kyros*

Director of the United States Patent and Trademark Office

# United States of America

United States Patent and Trademark Office

The **GREEN** Room

**Reg. No. 4,275,930**

**Registered Jan. 15, 2013**

**Int. Cl.: 43**

**SERVICE MARK**

**PRINCIPAL REGISTER**

SEMINOLE TRIBE OF FLORIDA (UNITED STATES FEDERALLY-RECOGNIZED INDIAN TRIBE)  
6300 STIRLING ROAD  
HOLLYWOOD, FL 33024

FOR: RESTAURANT SERVICES, IN CLASS 43 (U.S. CLS. 100 AND 101).

FIRST USE 3-11-2004; IN COMMERCE 3-11-2004.

NO CLAIM IS MADE TO THE EXCLUSIVE RIGHT TO USE "ROOM", APART FROM THE MARK AS SHOWN.

THE COLOR(S) GREEN, BLACK, AND WHITE IS/ARE CLAIMED AS A FEATURE OF THE MARK.

THE MARK CONSISTS OF THE WORDS "THE GREEN ROOM" IN A STYLIZED FONT. THE WORDS "THE" AND "ROOM" ARE BLACK AND THE WORD "GREEN" IS WHITE ON A BACKGROUND OF A GREEN GUITAR PICK.

SER. NO. 85-713,701, FILED 8-27-2012.

KATHY DE JONGE, EXAMINING ATTORNEY



*David J. Kyffers*

Director of the United States Patent and Trademark Office

# United States of America

United States Patent and Trademark Office

## THE GREEN ROOM

**Reg. No. 4,275,931**

**Registered Jan. 15, 2013**

**Int. Cl.: 43**

**SERVICE MARK**

**PRINCIPAL REGISTER**

SEMINOLE TRIBE OF FLORIDA (UNITED STATES FEDERALLY-RECOGNIZED INDIAN TRIBE)  
6300 STIRLING ROAD  
HOLLYWOOD, FL 33024

FOR: RESTAURANT SERVICES, IN CLASS 43 (U.S. CLS. 100 AND 101).

FIRST USE 3-11-2004; IN COMMERCE 3-11-2004.

THE MARK CONSISTS OF STANDARD CHARACTERS WITHOUT CLAIM TO ANY PARTICULAR FONT, STYLE, SIZE, OR COLOR.

NO CLAIM IS MADE TO THE EXCLUSIVE RIGHT TO USE "ROOM", APART FROM THE MARK AS SHOWN.

SER. NO. 85-713,716, FILED 8-27-2012.

KATHY DE JONGE, EXAMINING ATTORNEY



*David J. Kyffers*

Director of the United States Patent and Trademark Office

# United States of America

United States Patent and Trademark Office

# REUP

**Reg. No. 4,275,932**

TRACFONE WIRELESS, INC. (DELAWARE CORPORATION)  
9700 N.W. 112 AVENUE  
MIAMI, FL 33178

**Registered Jan. 15, 2013**

**Int. Cl.: 36**

FOR: PREPAID CARD SERVICES IN THE NATURE OF MAKING PAYMENT FOR ADDING AIRTIME TO PREPAID OR PAY-AS-YOU-GO WIRELESS SERVICES, IN CLASS 36 (U.S. CLS. 100, 101 AND 102).

**SERVICE MARK**

FIRST USE 12-31-2009; IN COMMERCE 12-31-2009.

**PRINCIPAL REGISTER**

THE MARK CONSISTS OF STANDARD CHARACTERS WITHOUT CLAIM TO ANY PARTICULAR FONT, STYLE, SIZE, OR COLOR.

SER. NO. 85-713,866, FILED 8-27-2012.

PAM WILLIS, EXAMINING ATTORNEY



*David J. Kybas*

Director of the United States Patent and Trademark Office

# United States of America

United States Patent and Trademark Office

# Adobera

**Reg. No. 4,275,933**

**Registered Jan. 15, 2013**

**Int. Cl.: 29**

**TRADEMARK**

**PRINCIPAL REGISTER**

LOS ALTOS FOOD PRODUCTS, INC. (CALIFORNIA CORPORATION)  
450 BALDWIN PARK BLVD.  
CITY OF INDUSTRY, CA 91746

FOR: CHEESE, IN CLASS 29 (U.S. CL. 46).

FIRST USE 12-31-1989; IN COMMERCE 12-31-1989.

THE MARK CONSISTS OF STANDARD CHARACTERS WITHOUT CLAIM TO ANY PARTICULAR FONT, STYLE, SIZE, OR COLOR.

THE ENGLISH TRANSLATION OF "ADOBERA" IN THE MARK IS "MUD BRICK".

SER. NO. 85-714,019, FILED 8-27-2012.

ALYSSA STEEL, EXAMINING ATTORNEY



*David J. Kyffers*

Director of the United States Patent and Trademark Office



# United States of America

United States Patent and Trademark Office



**Reg. No. 4,275,934**

FOSTECH OUTDOORS, L.L.C. (INDIANA LIMITED LIABILITY COMPANY)  
9290 WEST COUNTY ROAD 750 SOUTH  
PARIS CROSSING, IN 47270

**Registered Jan. 15, 2013**

**Int. Cl.: 35**

FOR: ON-LINE RETAIL STORE SERVICES FEATURING FIREARM ATTACHMENTS AND  
FIREARM ACCESSORIES, IN CLASS 35 (U.S. CLS. 100, 101 AND 102).

**SERVICE MARK**

FIRST USE 6-21-2011; IN COMMERCE 6-21-2011.

**PRINCIPAL REGISTER**

THE MARK CONSISTS OF A RIFLE POSITIONED VERTICALLY TO CREATE THE LETTER  
"F" PLACED INSIDE A TARGET SCOPE IMAGE.

SER. NO. 85-714,383, FILED 8-28-2012.

NAAKWAMA ANKRAH, EXAMINING ATTORNEY



*David J. Kyros*

Director of the United States Patent and Trademark Office

# United States of America

United States Patent and Trademark Office



**Reg. No. 4,275,935**

**Registered Jan. 15, 2013**

**Int. Cl.: 43**

**SERVICE MARK**

**PRINCIPAL REGISTER**

SEMINOLE TRIBE OF FLORIDA (UNITED STATES FEDERALLY-RECOGNIZED INDIAN TRIBE)  
6300 STIRLING ROAD  
HOLLYWOOD, FL 33024

FOR: RESTAURANT SERVICES, IN CLASS 43 (U.S. CLS. 100 AND 101).

FIRST USE 12-0-1999; IN COMMERCE 12-0-1999.

NO CLAIM IS MADE TO THE EXCLUSIVE RIGHT TO USE "RESTAURANT AND LOUNGE", APART FROM THE MARK AS SHOWN.

THE COLOR(S) YELLOW, ORANGE, GREEN, PURPLE, BRICK RED, AND BLACK IS/ARE CLAIMED AS A FEATURE OF THE MARK.

THE MARK CONSISTS OF THE STYLIZED WORD "JOSIAH" IN YELLOW WITH AN ORANGE AND BRICK RED BORDER ON A LIGHTER BRICK RED BACKGROUND SURROUNDED BY ANOTHER BORDER OF YELLOW AND PURPLE. BENEATH "JOSIAH" ARE THE THREE WORDS "RESTAURANT AND LOUNGE" WITH "RESTAURANT" AND "LOUNGE" IN YELLOW AND "AND" BETWEEN THEM IN BRICK RED. ALL THREE WORDS ARE BORDERED WITH BLACK. THE WORDS ARE ON A LIGHT BRICK RED BACKGROUND WITH A YELLOW AND DARKER BRICK RED BORDER. THE WORD "AND" HAS STYLIZED LINES ABOVE AND BENEATH IT. THERE ARE STYLIZED ARROWHEADS IN RED WITH A BLACK BORDER TO THE LEFT AND RIGHT OF THE THREE WORDS. THE SPACE BETWEEN THE WORD "JOSIAH" AND "RESTAURANT AND LOUNGE" IS GREEN WITH A DIAMOND PATTERN ON BRICK RED, PURPLE, AND LIGHTER BRICK RED IN THE CENTER WITH FIVE PURPLE LINES OF VARYING LENGTHS EXTENDING TO THE LEFT AND RIGHT OF THE DIAMOND. ABOVE THE WORD "JOSIAH" IS A PARTIAL SUN IN ORANGE WITH THE SILHOUETTE IN BLACK OF A COWBOY ON A REARING HORSE ROPING A CALF, IN FRONT OF THE SUN. THE COWBOY'S AND THE HORSE'S HEADS EXTEND ABOVE THE SUN. THE COLOR WHITE IN THE BACKGROUND IS NOT CLAIMED.

SER. NO. 85-714,389, FILED 8-28-2012.

KATHY DE JONGE, EXAMINING ATTORNEY



*David J. Kybas*

Director of the United States Patent and Trademark Office

# United States of America

United States Patent and Trademark Office

# ZELAS

**Reg. No. 4,275,936**

MITSUBISHI CHEMICAL CORPORATION (JAPAN CORPORATION)  
1-1-1, MARUNOUCHI 1-CHOME, CHIYODA-KU  
TOKYO, JAPAN 100-8251

**Registered Jan. 15, 2013**

**Int. Cl.: 11**

FOR: UNPROCESSED THERMOPLASTIC ELASTOMER FOR USE IN MANUFACTURING  
IN A WIDE VARIETY OF INDUSTRIES, IN CLASS 11 (U.S. CLS. 13, 21, 23, 31 AND 34).

**TRADEMARK**

FIRST USE 9-23-2001; IN COMMERCE 9-23-2001.

**PRINCIPAL REGISTER**

THE MARK CONSISTS OF STANDARD CHARACTERS WITHOUT CLAIM TO ANY PAR-  
TICULAR FONT, STYLE, SIZE, OR COLOR.

OWNER OF U.S. REG. NO. 2,589,027.

SER. NO. 85-714,701, FILED 8-28-2012.

PAUL E. FAHRENKOPF, EXAMINING ATTORNEY



*David J. Kybas*

Director of the United States Patent and Trademark Office

# United States of America

United States Patent and Trademark Office



**Reg. No. 4,275,937**

**Registered Jan. 15, 2013**

**Int. Cl.: 41**

CAHUILLA BAND OF MISSION INDIANS (UNITED STATES FEDERALLY-RECOGNIZED INDIAN TRIBE), DBA CAHUILLA CASINO  
P.O. BOX 391760, ANZA, CA 92539  
52702 HIGHWAY 371  
ANZA, CA 92539

**SERVICE MARK**

**PRINCIPAL REGISTER**

FOR: CONDUCTING AND PROVIDING FACILITIES FOR SPECIAL EVENTS FEATURING CASINO AND GAMING CONTESTS AND TOURNAMENTS; ENTERTAINMENT SERVICES, NAMELY, CASINO GAMING; GAMING SERVICES IN THE NATURE OF CASINO GAMING; PROVIDING CASINO FACILITIES; PROVIDING CASINO SERVICES FEATURING A CASINO PLAYERS REWARDS PROGRAM; PROVIDING CASINO SERVICES FEATURING STORED VALUE MEMBERSHIP CARDS FOR REDEEMING CASH, DISCOUNTS, AND OTHER BENEFITS, IN CLASS 41 (U.S. CLS. 100, 101 AND 107).

FIRST USE 9-1-2009; IN COMMERCE 9-1-2009.

NO CLAIM IS MADE TO THE EXCLUSIVE RIGHT TO USE "CASINO" , APART FROM THE MARK AS SHOWN.

THE COLOR(S) WARM RED, ORANGE, BLACK AND WHITE IS/ARE CLAIMED AS A FEATURE OF THE MARK.

THE MARK CONSISTS OF THE WORDING "CAHUILLA CASINO" WITH A DESIGN FEATURING A ROADRUNNER (RUNNING BIRD) AND CIRCLE; THE WORD "CAHUILLA" IS IN WARM RED SHADED TO ORANGE AND BORDERED IN BLACK; THE WORD "CASINO" IS IN BLACK; THE ROADRUNNER IS IN BLACK AND WHITE; AND THE CIRCLE IS IN WARM RED SHADED TO ORANGE WITH A BAND OF WHITE AROUND THE PERIMETER OF THE CIRCLE.

SER. NO. 85-714,815, FILED 8-28-2012.

KATHY DE JONGE, EXAMINING ATTORNEY



*David J. Kyffers*

Director of the United States Patent and Trademark Office

# United States of America

United States Patent and Trademark Office



**Reg. No. 4,275,938**

**Registered Jan. 15, 2013**

**Int. Cl.: 41**

**SERVICE MARK**

**PRINCIPAL REGISTER**

SEMINOLE TRIBE OF FLORIDA (UNITED STATES FEDERALLY-RECOGNIZED INDIAN TRIBE)  
6300 STIRLING ROAD  
HOLLYWOOD, FL 33024

FOR: ENTERTAINMENT SERVICES, NAMELY, PERSONAL APPEARANCES BY A GROUP OF CASINO EMPLOYEES ACTING AS GOODWILL AMBASSADORS AND CASINO GAMING, IN CLASS 41 (U.S. CLS. 100, 101 AND 107).

FIRST USE 2-12-2009; IN COMMERCE 2-12-2009.

NO CLAIM IS MADE TO THE EXCLUSIVE RIGHT TO USE "GIRLS", APART FROM THE MARK AS SHOWN.

THE MARK CONSISTS OF THE SILHOUETTE OF A WOMAN IN HIGH-HEEL SHOES, WITH WIND-BLOWN HAIR, AND STRADDLING A STYLIZED LETTER "Z", ABOVE THE STYLIZED WORD "ZIGZAG". THE WORD "GIRLZ" IS BELOW THE WORD "ZIGZAG".

SER. NO. 85-714,902, FILED 8-28-2012.

KATHLEEN M. VANSTON, EXAMINING ATTORNEY



*David J. Kyjars*

Director of the United States Patent and Trademark Office

# United States of America

United States Patent and Trademark Office

rag & bone

**Reg. No. 4,275,939**

**Registered Jan. 15, 2013**

**Int. Cls.: 25 and 35**

**TRADEMARK**

**SERVICE MARK**

**PRINCIPAL REGISTER**

RAG & BONE HOLDINGS, LLC (NEW YORK LIMITED LIABILITY COMPANY)  
425 WEST 13TH STREET, 3RD FLOOR  
NEW YORK, NY 10014

FOR: FOOTWEAR, NAMELY, SHOES, BOOTS, SANDALS, SLIPPERS, SOCKS AND HO-SIERY, IN CLASS 25 (U.S. CLS. 22 AND 39).

FIRST USE 2-1-2009; IN COMMERCE 2-1-2009.

FOR: RETAIL STORES FEATURING CLOTHES, FOOTWEAR, LEATHER GOODS, ACCESSOR-IES AND RELATED MERCHANDISE, IN CLASS 35 (U.S. CLS. 100, 101 AND 102).

FIRST USE 8-30-2008; IN COMMERCE 8-30-2008.

OWNER OF U.S. REG. NOS. 2,906,967, 3,981,493 AND OTHERS.

THE MARK CONSISTS OF THE WORDS "RAG" AND "BONE", SEPARATED BY AN AM-PERSAND, ALL IN A FANCIFUL FONT.

SER. NO. 85-715,182, FILED 8-28-2012.

MARK SPARACINO, EXAMINING ATTORNEY



*David J. Kybas*

Director of the United States Patent and Trademark Office

# United States of America

United States Patent and Trademark Office

## ZIG ZAG GIRLZ

**Reg. No. 4,275,940**

**Registered Jan. 15, 2013**

**Int. Cl.: 41**

**SERVICE MARK**

**PRINCIPAL REGISTER**

SEMINOLE TRIBE OF FLORIDA (UNITED STATES FEDERALLY-RECOGNIZED INDIAN TRIBE)  
6300 STIRLING ROAD  
HOLLYWOOD, FL 33024

FOR: ENTERTAINMENT SERVICES, NAMELY, CASINO GAMING; ENTERTAINMENT SERVICES, NAMELY, PERSONAL APPEARANCES BY A GROUP OF CASINO EMPLOYEES ACTING AS GOODWILL AMBASSADORS, IN CLASS 41 (U.S. CLS. 100, 101 AND 107).

FIRST USE 2-12-2009; IN COMMERCE 2-12-2009.

THE MARK CONSISTS OF STANDARD CHARACTERS WITHOUT CLAIM TO ANY PARTICULAR FONT, STYLE, SIZE, OR COLOR.

NO CLAIM IS MADE TO THE EXCLUSIVE RIGHT TO USE "GIRLS", APART FROM THE MARK AS SHOWN.

SER. NO. 85-715,533, FILED 8-29-2012.

KATHY DE JONGE, EXAMINING ATTORNEY



*David J. Kyffers*

Director of the United States Patent and Trademark Office

# United States of America

United States Patent and Trademark Office



**Reg. No. 4,275,941**

**Registered Jan. 15, 2013**

**Int. Cls.: 41 and 43**

**SERVICE MARK**

**PRINCIPAL REGISTER**

SEMINOLE TRIBE OF FLORIDA (UNITED STATES FEDERALLY-RECOGNIZED INDIAN TRIBE)  
6300 STIRLING ROAD  
HOLLYWOOD, FL 33024

FOR: ENTERTAINMENT SERVICES IN THE NATURE OF LIVE MUSICAL PERFORMANCES, IN CLASS 41 (U.S. CLS. 100, 101 AND 107).

FIRST USE 2-12-2009; IN COMMERCE 2-12-2009.

FOR: BAR SERVICES, IN CLASS 43 (U.S. CLS. 100 AND 101).

FIRST USE 2-12-2009; IN COMMERCE 2-12-2009.

NO CLAIM IS MADE TO THE EXCLUSIVE RIGHT TO USE "LOUNGE", APART FROM THE MARK AS SHOWN.

THE COLOR(S) BLACK, RED, GREY, AND WHITE IS/ARE CLAIMED AS A FEATURE OF THE MARK.

THE MARK CONSISTS OF THE STYLIZED WORD "ZIGZAG", DEPICTED WITH THE FIRST THREE LETTERS IN BLACK AND THE LAST THREE LETTERS IN RED, AND ALL LETTERS OUTLINED IN A JAGGED EDGE OF WHITE ON A SHADED GREY BACKGROUND OUTLINE. THE WORD IS SUPERIMPOSED ON TWO OFFSET VERTICAL RECTANGLES, THE LOWER LEFT ONE IN RED AND THE HIGHER RIGHT ONE IN BLACK. BELOW THE BLACK RECTANGLE IS THE STYLIZED WORD "LOUNGE" IN BLACK. THE COLOR WHITE IN THE BACKGROUND IS NOT CLAIMED.

SER. NO. 85-715,581, FILED 8-29-2012.

KATHY DE JONGE, EXAMINING ATTORNEY



*David J. Kyjars*

Director of the United States Patent and Trademark Office



# United States of America

United States Patent and Trademark Office

## ZIG ZAG LOUNGE

**Reg. No. 4,275,942**

**Registered Jan. 15, 2013**

**Int. Cls.: 41 and 43**

**SERVICE MARK**

**PRINCIPAL REGISTER**

SEMINOLE TRIBE OF FLORIDA (UNITED STATES FEDERALLY-RECOGNIZED INDIAN TRIBE)  
6300 STIRLING ROAD  
HOLLYWOOD, FL 33024

FOR: ENTERTAINMENT SERVICES IN THE NATURE OF LIVE MUSICAL PERFORMANCES, IN CLASS 41 (U.S. CLS. 100, 101 AND 107).

FIRST USE 2-12-2009; IN COMMERCE 2-12-2009.

FOR: BAR SERVICES, IN CLASS 43 (U.S. CLS. 100 AND 101).

FIRST USE 2-12-2009; IN COMMERCE 2-12-2009.

THE MARK CONSISTS OF STANDARD CHARACTERS WITHOUT CLAIM TO ANY PARTICULAR FONT, STYLE, SIZE, OR COLOR.

NO CLAIM IS MADE TO THE EXCLUSIVE RIGHT TO USE "LOUNGE", APART FROM THE MARK AS SHOWN.

SER. NO. 85-715,589, FILED 8-29-2012.

KATHY DE JONGE, EXAMINING ATTORNEY



*David J. Kyffers*

Director of the United States Patent and Trademark Office

# United States of America

United States Patent and Trademark Office

rag & bone

**Reg. No. 4,275,943**

**Registered Jan. 15, 2013**

**Int. Cl.: 25**

**TRADEMARK**

**PRINCIPAL REGISTER**

RAG & BONE HOLDINGS, LLC (NEW YORK LIMITED LIABILITY COMPANY)  
425 WEST 13TH STREET, 3RD FLOOR  
NEW YORK, NY 10014

FOR: WOMEN'S APPAREL, NAMELY, SHIRTS, BLOUSES, DRESSES, SKIRTS, SWEATERS,  
JACKETS AND COATS, JEANS, PANTS AND SHORTS, IN CLASS 25 (U.S. CLS. 22 AND  
39).

FIRST USE 11-1-2005; IN COMMERCE 11-1-2005.

OWNER OF U.S. REG. NOS. 2,906,967, 3,981,493 AND OTHERS.

THE MARK CONSISTS OF THE WORDS "RAG" AND "BONE", SEPARATED BY AN AM-  
PERSAND, ALL IN A FANCIFUL FONT.

SER. NO. 85-716,308, FILED 8-29-2012.

MARK SPARACINO, EXAMINING ATTORNEY



*David J. Kyffers*

Director of the United States Patent and Trademark Office

# United States of America

United States Patent and Trademark Office

## BEST OF THE BLUES

**Reg. No. 4,275,944**

BUCKLE BRANDS, INC. (NEBRASKA CORPORATION)  
2407 W. 24TH STREET  
KEARNEY, NE 68845

**Registered Jan. 15, 2013**

**Int. Cl.: 41**

FOR: SWEEPSTAKE SERVICES; SWEEPSTAKE SERVICES PROVIDED OVER A GLOBAL COMPUTER NETWORK, IN CLASS 41 (U.S. CLS. 100, 101 AND 107).

**SERVICE MARK**

FIRST USE 7-9-2012; IN COMMERCE 7-9-2012.

**PRINCIPAL REGISTER**

THE MARK CONSISTS OF STANDARD CHARACTERS WITHOUT CLAIM TO ANY PARTICULAR FONT, STYLE, SIZE, OR COLOR.

SER. NO. 85-716,310, FILED 8-29-2012.

KATHRYN COWARD, EXAMINING ATTORNEY



*David J. Kyjars*

Director of the United States Patent and Trademark Office

# United States of America

United States Patent and Trademark Office



**Reg. No. 4,275,945**

**Registered Jan. 15, 2013**

**Int. Cl.: 35**

**SERVICE MARK**

**PRINCIPAL REGISTER**

AMERICAN ELECTRIC POWER COMPANY, INC. (NEW YORK CORPORATION)  
LEGAL DEPARTMENT - 29TH FLOOR  
1 RIVERSIDE PLAZA  
COLUMBUS, OH 43215

FOR: RETAIL ELECTRICITY PROVIDER SERVICES THAT ALLOW CUSTOMERS TO PURCHASE ELECTRICITY; RETAIL ELECTRICITY PROVIDER SERVICES THAT ALLOW CUSTOMERS TO PURCHASE RENEWABLE ENERGY, IN CLASS 35 (U.S. CLS. 100, 101 AND 102).

FIRST USE 7-1-2012; IN COMMERCE 7-1-2012.

OWNER OF U.S. REG. NOS. 1,489,672, 2,266,249 AND OTHERS.

THE COLOR(S) RED, WHITE, AND GRAY IS/ARE CLAIMED AS A FEATURE OF THE MARK.

NO CLAIM IS MADE TO THE EXCLUSIVE RIGHT TO USE "ENERGY", APART FROM THE MARK AS SHOWN.

THE MARK CONSISTS OF RED PARALLELOGRAM OVERLAID WITH THE LETTERS "A", "E", "P" IN WHITE CAPITAL LETTERS, THE PARALLELOGRAM IS LOCATED TO THE LEFT OF THE WORD "ENERGY", WHICH APPEARS IN GRAY CAPITAL LETTERS.

SER. NO. 85-717,107, FILED 8-30-2012.

CHRISTINA SOBRAL, EXAMINING ATTORNEY



*David J. Kyjars*

Director of the United States Patent and Trademark Office

# United States of America

United States Patent and Trademark Office

# LIPOCLEN

**Reg. No. 4,275,946**

EXCITEMENT DIETETICS, LLC (UTAH LIMITED LIABILITY COMPANY)  
965 NORTH 1430 WEST  
OREM, UT 84057

**Registered Jan. 15, 2013**

**Int. Cl.: 5**

FOR: DIETARY AND NUTRITIONAL SUPPLEMENTS; DIETARY AND NUTRITIONAL SUPPLEMENTS USED FOR WEIGHT LOSS, IN CLASS 5 (U.S. CLS. 6, 18, 44, 46, 51 AND 52).

**TRADEMARK**

FIRST USE 8-10-2009; IN COMMERCE 8-10-2009.

**PRINCIPAL REGISTER**

THE MARK CONSISTS OF STANDARD CHARACTERS WITHOUT CLAIM TO ANY PARTICULAR FONT, STYLE, SIZE, OR COLOR.

SER. NO. 85-723,260, FILED 9-7-2012.

CHERYL CLAYTON, EXAMINING ATTORNEY



*David J. Kyffers*

Director of the United States Patent and Trademark Office

# United States of America

United States Patent and Trademark Office

# AVATROPIN

**Reg. No. 4,275,947**

EXCITEMENT DIETETICS, LLC (UTAH LIMITED LIABILITY COMPANY)  
965 NORTH 1430 WEST  
OREM, UT 84057

**Registered Jan. 15, 2013**

**Int. Cl.: 5**

FOR: DIETARY AND NUTRITIONAL SUPPLEMENTS; DIETARY AND NUTRITIONAL SUPPLEMENTS USED FOR WEIGHT LOSS, IN CLASS 5 (U.S. CLS. 6, 18, 44, 46, 51 AND 52).

**TRADEMARK**

FIRST USE 4-14-2011; IN COMMERCE 4-14-2011.

**PRINCIPAL REGISTER**

THE MARK CONSISTS OF STANDARD CHARACTERS WITHOUT CLAIM TO ANY PARTICULAR FONT, STYLE, SIZE, OR COLOR.

SER. NO. 85-723,457, FILED 9-7-2012.

CHERYL CLAYTON, EXAMINING ATTORNEY



*David J. Kyffers*

Director of the United States Patent and Trademark Office

# United States of America

United States Patent and Trademark Office

# TWITCH

**Reg. No. 4,275,948**

**Registered Jan. 15, 2013**

**Int. Cls.: 9, 38 and 45**

**TRADEMARK**

**SERVICE MARK**

**PRINCIPAL REGISTER**

JUSTIN.TV, INC. (DELAWARE CORPORATION)  
#800  
23 GEARY ST.  
SAN FRANCISCO, CA 94108

FOR: COMPUTER SOFTWARE FOR BROADCASTING, ELECTRONIC TRANSMISSION, AND STREAMING OF GAMING DIGITAL MEDIA CONTENT, IN CLASS 9 (U.S. CLS. 21, 23, 26, 36 AND 38).

FIRST USE 7-25-2012; IN COMMERCE 7-25-2012.

FOR: STREAMING OF AUDIO, VISUAL AND AUDIOVISUAL GAMING CONTENT VIA A GLOBAL COMPUTER NETWORK; ELECTRONIC TRANSMISSION AND STREAMING OF GAMING DIGITAL MEDIA CONTENT FOR OTHERS; ENTERTAINMENT SERVICES, NAMELY, PROVIDING A WEBSITE FOR LIVESTREAMING GAMING CONTENT, IN CLASS 38 (U.S. CLS. 100, 101 AND 104).

FIRST USE 6-5-2012; IN COMMERCE 6-5-2012.

FOR: ONLINE SOCIAL NETWORKING SERVICES, IN CLASS 45 (U.S. CLS. 100 AND 101).

FIRST USE 6-5-2012; IN COMMERCE 6-5-2012.

THE MARK CONSISTS OF STANDARD CHARACTERS WITHOUT CLAIM TO ANY PARTICULAR FONT, STYLE, SIZE, OR COLOR.

OWNER OF U.S. REG. NO. 4,087,877.

SER. NO. 85-727,657, FILED 9-12-2012.

REBECCA SMITH, EXAMINING ATTORNEY



*David J. Kyjars*

Director of the United States Patent and Trademark Office

# United States of America

United States Patent and Trademark Office

# L88

**Reg. No. 4,275,949**

**Registered Jan. 15, 2013**

**Int. Cl.: 16**

**TRADEMARK**

**PRINCIPAL REGISTER**

GENERAL MOTORS LLC (DELAWARE LIMITED LIABILITY COMPANY)  
300 RENAISSANCE CENTER  
DETROIT, MI 482653000

FOR: DECALS, IN CLASS 16 (U.S. CLS. 2, 5, 22, 23, 29, 37, 38 AND 50).

FIRST USE 10-21-1998; IN COMMERCE 10-21-1998.

THE MARK CONSISTS OF STANDARD CHARACTERS WITHOUT CLAIM TO ANY PARTICULAR FONT, STYLE, SIZE, OR COLOR.

SER. NO. 85-729,319, FILED 9-14-2012.

HEATHER SAPP, EXAMINING ATTORNEY



*David J. Kyffers*

Director of the United States Patent and Trademark Office



# United States of America

United States Patent and Trademark Office

# BROOD

**Reg. No. 4,275,950**

**Registered Jan. 15, 2013**

**Int. Cl.: 25**

**TRADEMARK**

**PRINCIPAL REGISTER**

BROOD GROUP HOLDINGS, LLC (NEW YORK LIMITED LIABILITY COMPANY)  
C/O SERKAN SARIER  
260 W BROADWAY, SUITE 3  
NEW YORK, NY 10013

FOR: BLOUSES; COATS; DRESS PANTS; DRESS SHIRTS; DRESS SUITS; DRESSES;  
EVENING DRESSES; FOOTWEAR FOR WOMEN; GLOVES; GOWNS; KNIT DRESSES;  
LEGGINGS; WOMEN'S JACKETS, COATS, TROUSERS, VESTS; WOMEN'S SUITS; MITTENS;  
PANTS; SHOES; SHORTS; SKIRTS AND DRESSES; SWEATERS; T-SHIRTS; TROUSERS,  
IN CLASS 25 (U.S. CLS. 22 AND 39).

FIRST USE 1-15-2011; IN COMMERCE 1-15-2011.

THE MARK CONSISTS OF STANDARD CHARACTERS WITHOUT CLAIM TO ANY PARTICULAR FONT, STYLE, SIZE, OR COLOR.

SER. NO. 85-976,489, FILED 3-3-2012.

BARBARA A. GOLD, EXAMINING ATTORNEY



*David J. Kybas*

Director of the United States Patent and Trademark Office

# United States of America

United States Patent and Trademark Office

## DIZZY GILLESPIE

**Reg. No. 4,275,951**

**Registered Jan. 15, 2013**

**Int. Cl.: 15**

**TRADEMARK**

**PRINCIPAL REGISTER**

TRUST UNDER THE LAST WILL AND TESTAMENT OF LORRAINE GILLESPIE (NEW JERSEY TRUST)  
211 KING STREET  
CHAPPAQUA, NY 10514

FOR: MOUTHPIECES FOR MUSICAL INSTRUMENTS, IN CLASS 15 (U.S. CLS. 2, 21 AND 36).

FIRST USE 1-19-2012; IN COMMERCE 1-19-2012.

THE MARK CONSISTS OF STANDARD CHARACTERS WITHOUT CLAIM TO ANY PARTICULAR FONT, STYLE, SIZE, OR COLOR.

THE NAME(S), PORTRAIT(S), AND/OR SIGNATURE(S) SHOWN IN THE MARK DOES NOT IDENTIFY A PARTICULAR LIVING INDIVIDUAL.

SER. NO. 85-976,847, FILED 8-16-2011.

ROBERT C. CLARK JR., EXAMINING ATTORNEY



*David J. Kyffers*

Director of the United States Patent and Trademark Office

# United States of America

United States Patent and Trademark Office

## THE CHICAGO SCHOOL OF HOT YOGA

**Reg. No. 4,275,952**

**Registered Jan. 15, 2013**

**Int. Cls.: 3, 5, 24, 25, 28  
and 32**

**TRADEMARK**

**PRINCIPAL REGISTER**

THE CHICAGO SCHOOL OF HOT YOGA, INC. (ILLINOIS CORPORATION)  
SECOND FLOOR  
2442 N. LINCOLN AVENUE  
CHICAGO, IL 60614

FOR: COSMETICS, NON-MEDICATED LIP CARE PREPARATIONS, SHAMPOOS, NON-MEDICATED HAND CLEANSERS, HAND CREAMS, CLEANERS FOR YOGA MATS AND YOGA BLOCKS, IN CLASS 3 (U.S. CLS. 1, 4, 6, 50, 51 AND 52).

FIRST USE 6-30-2010; IN COMMERCE 6-30-2010.

FOR: MEDICATED SUN, SCREEN PREPARATIONS, MEDICATED LIP CARE PREPARATIONS, VITAMINS, NUTRITIONAL SUPPLEMENTS, HEALTH AND ENERGY VITAMIN FORMED AND PACKAGED AS BARS, IN CLASS 5 (U.S. CLS. 6, 18, 44, 46, 51 AND 52).

FIRST USE 6-30-2010; IN COMMERCE 6-30-2010.

FOR: TOWELS, IN CLASS 24 (U.S. CLS. 42 AND 50).

FIRST USE 6-30-2010; IN COMMERCE 6-30-2010.

FOR: CLOTHING, NAMELY, T-SHIRTS, SWEATSHIRTS, HEADBANDS, SWEATBANDS, SWEATPANTS, SHORTS, YOGA PANTS, YOGA TOPS, JOGGING SUITS, HATS AND CAPS, IN CLASS 25 (U.S. CLS. 22 AND 39).

FIRST USE 6-30-2010; IN COMMERCE 6-30-2010.

FOR: YOGA BLOCKS AND YOGA MATS, IN CLASS 28 (U.S. CLS. 22, 23, 38 AND 50).

FIRST USE 6-30-2010; IN COMMERCE 6-30-2010.

FOR: BOTTLED AND FLAVORED WATER, IN CLASS 32 (U.S. CLS. 45, 46 AND 48).

FIRST USE 6-30-2010; IN COMMERCE 6-30-2010.

THE MARK CONSISTS OF STANDARD CHARACTERS WITHOUT CLAIM TO ANY PARTICULAR FONT, STYLE, SIZE, OR COLOR.



*David J. Kybas*

Director of the United States Patent and Trademark Office

**Reg. No. 4,275,952** NO CLAIM IS MADE TO THE EXCLUSIVE RIGHT TO USE "CHICAGO" FOR INTERNATIONAL CLASSES 3, 5, 24, 25, 28 AND 32, AND "HOT YOGA" FOR INTERNATIONAL CLASSES 25, 28 AND INTERNATIONAL CLASS 3 WITH RESPECT TO CLEANSERS FOR YOGA MATS AND YOGA BLOCKS, APART FROM THE MARK AS SHOWN.

SER. NO. 85-977,133, FILED 1-27-2011.

TARA PATE, EXAMINING ATTORNEY

# United States of America

United States Patent and Trademark Office

## CITRUS LANE

**Reg. No. 4,275,953**

**Registered Jan. 15, 2013**

**Int. Cls.: 35 and 41**

**SERVICE MARK**

**PRINCIPAL REGISTER**

CITRUS LANE, INC. (DELAWARE CORPORATION)  
SUITE B  
211 S. WHISMAN ROAD  
MOUNTAIN VIEW, CA 94041

FOR: ONLINE RETAIL STORE SERVICES FEATURING PRODUCTS FOR BABIES AND CHILDREN AND PRODUCTS FOR PARENTS IN THE FIELD OF PARENTING AND CARE PACKAGES, IN CLASS 35 (U.S. CLS. 100, 101 AND 102).

FIRST USE 7-7-2011; IN COMMERCE 7-7-2011.

FOR: ONLINE JOURNALS, NAMELY, BLOGS, FEATURING TOPICS OF INTEREST ABOUT BABIES, CHILDREN, PREGNANCY AND PARENTING; ONLINE ELECTRONIC NEWSLETTERS DELIVERED BY EMAIL IN THE FIELD OF BABIES, CHILDREN, PREGNANCY AND PARENTING, IN CLASS 41 (U.S. CLS. 100, 101 AND 107).

FIRST USE 7-7-2011; IN COMMERCE 7-7-2011.

THE MARK CONSISTS OF STANDARD CHARACTERS WITHOUT CLAIM TO ANY PARTICULAR FONT, STYLE, SIZE, OR COLOR.

SER. NO. 85-977,398, FILED 7-26-2011.

MICHELLE DUBOIS, EXAMINING ATTORNEY



*David J. Kybas*

Director of the United States Patent and Trademark Office

# United States of America

United States Patent and Trademark Office



**Reg. No. 4,275,954**

**Registered Jan. 15, 2013**

**Int. Cls.: 25 and 28**

**TRADEMARK**

**PRINCIPAL REGISTER**

PINNACLE ENTERTAINMENT, INC. (DELAWARE CORPORATION)  
8918 SPANISH RIDGE AVENUE  
LAS VEGAS, NV 89148

FOR: CLOTHING, NAMELY, T-SHIRTS, SWEATSHIRTS, HATS AND CAPS, IN CLASS 25 (U.S. CLS. 22 AND 39).

FIRST USE 8-11-2011; IN COMMERCE 8-11-2011.

FOR: GAMING EQUIPMENT, NAMELY, POKER CHIPS AND PLAYING CARDS, IN CLASS 28 (U.S. CLS. 22, 23, 38 AND 50).

FIRST USE 8-11-2011; IN COMMERCE 8-11-2011.

NO CLAIM IS MADE TO THE EXCLUSIVE RIGHT TO USE "POKER", APART FROM THE MARK AS SHOWN.

THE COLOR(S) RED, WHITE, BLUE AND GRAY IS/ARE CLAIMED AS A FEATURE OF THE MARK.

THE MARK CONSISTS OF THE WORDS "EPIC POKER" IN WHITE WITHIN A RED AND BLUE RECTANGLE WITH ROUNDED CORNERS AND GRAY BORDER. THERE IS WHITE SHADING IN THE TOP INSIDE CORNERS AND THE BOTTOM RIGHT INSIDE CORNER.

SER. NO. 85-977,592, FILED 6-24-2011.

AHSEN KHAN, EXAMINING ATTORNEY



*David J. Kybas*

Director of the United States Patent and Trademark Office

# United States of America

United States Patent and Trademark Office

## BRIGHT GREEN

**Reg. No. 4,275,955**

**Registered Jan. 15, 2013**

**Int. Cls.: 3, 5, 6, 11, 16,  
and 21**

**TRADEMARK**

**PRINCIPAL REGISTER**

SAFEWAY INC. (DELAWARE CORPORATION)  
5918 STONERIDGE MALL ROAD  
PLEASANTON, CA 94588

FOR: LAUNDRY DETERGENT, LAUNDRY BLEACH, LIQUID FABRIC SOFTENER, FABRIC SOFTENER SHEETS, ALL-PURPOSE CLEANER, FURNITURE CARE PRODUCTS, NAMELY, FURNITURE POLISHES, GLASS CLEANER; DISHWASHING DETERGENTS, DISHWASHING DETERGENT ADDITIVES, NAMELY, DECALCIFYING PREPARATIONS FOR CLEANING METAL POTS AND PANS, AUTOMATIC DISHWASHING DETERGENTS IN THE FORMS OF TABLETS, LIQUIDS, GELS AND POWDERS; ALL OF THE AFOREMENTIONED GOODS BEING MANUFACTURED IN AN ENVIRONMENTALLY FRIENDLY MANNER AND/OR CONSISTING OF ENVIRONMENTALLY FRIENDLY COMPONENTS, IN CLASS 3 (U.S. CLS. 1, 4, 6, 50, 51 AND 52).

FIRST USE 3-28-2010; IN COMMERCE 3-28-2010.

FOR: DISINFECTANT TOILET BOWL CLEANERS BEING MANUFACTURED IN AN ENVIRONMENTALLY FRIENDLY MANNER AND/OR CONSISTING OF ENVIRONMENTALLY FRIENDLY COMPONENTS, IN CLASS 5 (U.S. CLS. 6, 18, 44, 46, 51 AND 52).

FIRST USE 3-28-2010; IN COMMERCE 3-28-2010.

FOR: ALUMINUM FOIL BEING MANUFACTURED IN AN ENVIRONMENTALLY FRIENDLY MANNER AND/OR CONSISTING OF ENVIRONMENTALLY FRIENDLY COMPONENTS, IN CLASS 6 (U.S. CLS. 2, 12, 13, 14, 23, 25 AND 50).

FIRST USE 9-22-2011; IN COMMERCE 9-22-2011.

FOR: LIGHT BULBS; WATER FILTRATION PRODUCTS, NAMELY, FILTERS FOR DRINKING WATER; ALL OF THE AFOREMENTIONED GOODS BEING MANUFACTURED IN AN ENVIRONMENTALLY FRIENDLY MANNER AND/OR CONSISTING OF ENVIRONMENTALLY FRIENDLY COMPONENTS, IN CLASS 11 (U.S. CLS. 13, 21, 23, 31 AND 34).

FIRST USE 3-28-2010; IN COMMERCE 3-28-2010.

FOR: BATH TISSUE, PAPER TOWELS AND PAPER NAPKINS, FACIAL TISSUE, REUSABLE PLASTIC FOOD STORAGE BAGS FOR HOUSEHOLD USE; GARBAGE BAGS OF PLASTIC,



*David J. Kyros*

Director of the United States Patent and Trademark Office

**Reg. No. 4,275,955** TRASH BAGS; ALL OF THE AFOREMENTIONED GOODS BEING MANUFACTURED IN AN ENVIRONMENTALLY FRIENDLY MANNER AND/OR CONSISTING OF ENVIRONMENTALLY FRIENDLY COMPONENTS, IN CLASS 16 (U.S. CLS. 2, 5, 22, 23, 29, 37, 38 AND 50).

FIRST USE 3-28-2010; IN COMMERCE 3-28-2010.

FOR: PAPER PLATES BEING MANUFACTURED IN AN ENVIRONMENTALLY FRIENDLY MANNER AND/OR CONSISTING OF ENVIRONMENTALLY FRIENDLY COMPONENTS, IN CLASS 21 (U.S. CLS. 2, 13, 23, 29, 30, 33, 40 AND 50).

FIRST USE 10-5-2011; IN COMMERCE 10-5-2011.

THE MARK CONSISTS OF STANDARD CHARACTERS WITHOUT CLAIM TO ANY PARTICULAR FONT, STYLE, SIZE, OR COLOR.

NO CLAIM IS MADE TO THE EXCLUSIVE RIGHT TO USE "GREEN", APART FROM THE MARK AS SHOWN.

SN 76-685,502, FILED 1-3-2008.

ANDREA HACK, EXAMINING ATTORNEY



# United States of America

United States Patent and Trademark Office

# RUM BUM

**Reg. No. 4,275,956**

RUM BUM DISTRIBUTORS, INC. (FLORIDA LIMITED LIABILITY COMPANY)  
128 N.W. 25TH STREET  
MIAMI, FL 33127

**Registered Jan. 15, 2013**

**Int. Cl.: 25**

FOR: CLOTHING, NAMELY, SHIRTS, PANTS, SHORTS, FOOTWEAR AND HEADGEAR,  
NAMELY, HATS AND CAPS, IN CLASS 25 (U.S. CLS. 22 AND 39).

**TRADEMARK**

FIRST USE 8-16-2012; IN COMMERCE 8-16-2012.

**PRINCIPAL REGISTER**

THE MARK CONSISTS OF STANDARD CHARACTERS WITHOUT CLAIM TO ANY PAR-  
TICULAR FONT, STYLE, SIZE, OR COLOR.

SN 76-688,182, FILED 3-31-2008.

ALICE BENMAMAN, EXAMINING ATTORNEY



*David J. Kyffers*

Director of the United States Patent and Trademark Office

# United States of America

United States Patent and Trademark Office

## BRIEF ENCOUNTER

**Reg. No. 4,275,957**

**Registered Jan. 15, 2013**

**Int. Cl.: 25**

**TRADEMARK**

**PRINCIPAL REGISTER**

HOLLAND, LANIER (UNITED STATES INDIVIDUAL)  
8424-A SANTA MONICA BLVD.  
#196  
LOS ANGELES, CA 90069

FOR: ATHLETIC APPAREL, NAMELY, SHIRTS, PANTS, JACKETS, FOOTWEAR, HATS AND CAPS, ATHLETIC UNIFORMS, CARGO PANTS, DENIMS, SWEAT PANTS, BRIEFS, DRESS SHIRTS, HOODED SWEAT SHIRTS, SHORT SLEEVED SHIRTS, SWEAT SHIRTS, T-SHIRTS, WEARABLE GARMENTS AND CLOTHING, NAMELY, SHIRTS, BERMUDA SHORTS, BOXER SHORTS, GYM SHORTS, UNDERWEAR, NAMELY, BOY SHORTS, BELTS, SWIMWEAR, DRESSES, BATHING SUITS, MEN'S SUITS, WOMEN'S SUITS, IN CLASS 25 (U.S. CLS. 22 AND 39).

FIRST USE 9-15-2011; IN COMMERCE 10-1-2012.

THE MARK CONSISTS OF STANDARD CHARACTERS WITHOUT CLAIM TO ANY PARTICULAR FONT, STYLE, SIZE, OR COLOR.

SN 76-692,503, FILED 9-2-2008.

NAAKWAMA ANKRAH, EXAMINING ATTORNEY



*David J. Kyffers*

Director of the United States Patent and Trademark Office

# United States of America

United States Patent and Trademark Office

# Body FX

**Reg. No. 4,275,958**

BODY FX LLC (UNITED STATES LIMITED LIABILITY COMPANY)  
5644 KEANRY MESA RD. SUITE T  
SAN DIEGO, CA 92101

**Registered Jan. 15, 2013**

**Int. Cl.: 9**

FOR: DVD CASES; DVDS FEATURING FITNESS MATERIAL, NAMELY, EXERCISE ROUTINES, FITNESS PROGRAMS, IN CLASS 9 (U.S. CLS. 21, 23, 26, 36 AND 38).

**TRADEMARK**

FIRST USE 9-1-2011; IN COMMERCE 9-1-2011.

**PRINCIPAL REGISTER**

THE MARK CONSISTS OF STANDARD CHARACTERS WITHOUT CLAIM TO ANY PARTICULAR FONT, STYLE, SIZE, OR COLOR.

SN 76-701,509, FILED 2-12-2010.

ALLISON HOLTZ, EXAMINING ATTORNEY



*David J. Kybas*

Director of the United States Patent and Trademark Office

**United States of America**  
United States Patent and Trademark Office

# TurfRider

**Reg. No. 4,275,959**

SUTONG CHINA TIRE RESOURCES (TEXAS CORPORATION)  
4849 CRANSWICK ROAD  
HOUSTON, TX 77041

**Registered Jan. 15, 2013**

**Int. Cl.: 12**

FOR: TIRES, IN CLASS 12 (U.S. CLS. 19, 21, 23, 31, 35 AND 44).

**TRADEMARK**

FIRST USE 8-2-2012; IN COMMERCE 8-2-2012.

**PRINCIPAL REGISTER**

THE MARK CONSISTS OF STANDARD CHARACTERS WITHOUT CLAIM TO ANY PARTICULAR FONT, STYLE, SIZE, OR COLOR.

SN 76-701,751, FILED 2-22-2010.

KATHERINE CONNOLLY, EXAMINING ATTORNEY



*David J. Kybas*

Director of the United States Patent and Trademark Office

# United States of America

United States Patent and Trademark Office

## GIORGIO MILANO

**Reg. No. 4,275,960**

DESIGN TIME WATCH, INC (NEW YORK CORPORATION)  
1270 BROADWAY, SUITE 1206  
NEW YORK, NY 10001

**Registered Jan. 15, 2013**

**Int. Cl.: 9**

FOR: SUNGLASSES, IN CLASS 9 (U.S. CLS. 21, 23, 26, 36 AND 38).

**TRADEMARK**

FIRST USE 8-0-2012; IN COMMERCE 8-0-2012.

**PRINCIPAL REGISTER**

THE MARK CONSISTS OF STANDARD CHARACTERS WITHOUT CLAIM TO ANY PARTICULAR FONT, STYLE, SIZE, OR COLOR.

OWNER OF U.S. REG. NO. 3,461,048.

THE NAME "GIORIGIO MILANO" DOES NOT IDENTIFY ANY PARTICULAR LIVING INDIVIDUAL

SN 76-702,894, FILED 5-10-2010.

RENEE MCCRAY, EXAMINING ATTORNEY



*David J. Kyffers*

Director of the United States Patent and Trademark Office

# United States of America

United States Patent and Trademark Office

# APPLEGATE

**Reg. No. 4,275,961**

**Registered Jan. 15, 2013**

**Int. Cls.: 30 and 43**

**TRADEMARK**

**SERVICE MARK**

**PRINCIPAL REGISTER**

APPLEGATE FARM HOMEMADE ICE CREAM, INC. (NEW JERSEY CORPORATION)  
616 GROVE STREET  
UPPER MONTCLAIR, NJ 07043

FOR: ICE CREAM, BAKED GOODS, NAMELY, PIES AND CAKES; COOKIES, BISCUITS AND CONFECTIONARIES, NAMELY, COOKIES AND CHOCOLATES, IN CLASS 30 (U.S. CL. 46).

FIRST USE 11-13-2012; IN COMMERCE 11-13-2012.

FOR: RESTAURANT SERVICES, IN CLASS 43 (U.S. CLS. 100 AND 101).

FIRST USE 11-13-2012; IN COMMERCE 11-13-2012.

THE MARK CONSISTS OF STANDARD CHARACTERS WITHOUT CLAIM TO ANY PARTICULAR FONT, STYLE, SIZE, OR COLOR.

OWNER OF U.S. REG. NOS. 1,988,083, 3,379,973, AND 3,379,974.

SN 76-704,212, FILED 8-23-2010.

INGA ERVIN, EXAMINING ATTORNEY



*David J. Kyffers*

Director of the United States Patent and Trademark Office

# United States of America

United States Patent and Trademark Office

# CUBIX

**Reg. No. 4,275,962**

**Registered Jan. 15, 2013**

**Int. Cl.: 6**

**TRADEMARK**

**PRINCIPAL REGISTER**

NCI GROUP, INC. (NEVADA CORPORATION)  
10943 N. SAM HOUSTON PARKWAY WEST  
HOUSTON, TX 77064

FOR: GENERAL PURPOSE METAL STORAGE UNITS, IN CLASS 6 (U.S. CLS. 2, 12, 13, 14, 23, 25 AND 50).

FIRST USE 10-20-2010; IN COMMERCE 10-20-2010.

THE MARK CONSISTS OF STANDARD CHARACTERS WITHOUT CLAIM TO ANY PARTICULAR FONT, STYLE, SIZE, OR COLOR.

SN 76-704,784, FILED 10-5-2010.

NANCY CLARKE, EXAMINING ATTORNEY



*David J. Kyffers*

Director of the United States Patent and Trademark Office

# United States of America

United States Patent and Trademark Office



*delunne*

**Reg. No. 4,275,963**

JEFFREY LOU (UNITED STATES INDIVIDUAL)  
2714 RIVER AVE.  
ROSEMEAD, CA 91770

**Registered Jan. 15, 2013**

**Int. Cl.: 12**

FOR: VEHICLES, NAMELY, AUTOMOBILES AND TRUCKS, IN CLASS 12 (U.S. CLS. 19, 21, 23, 31, 35 AND 44).

**TRADEMARK**

FIRST USE 10-1-2012; IN COMMERCE 10-1-2012.

**PRINCIPAL REGISTER**

SN 76-706,182, FILED 1-31-2011.

INGRID C. EULIN, EXAMINING ATTORNEY



*David J. Kybas*

Director of the United States Patent and Trademark Office



# United States of America

United States Patent and Trademark Office



**Reg. No. 4,275,964**

SANDRA E. ARMIJO (UNITED STATES INDIVIDUAL)  
1712 CALLEJON VERONICA  
SANTA FE, NM 87501

**Registered Jan. 15, 2013**

**Int. Cl.: 25**

FOR: APPAREL FOR WOMEN, MEN, CHILDREN, NAMELY, PANTS, SHIRTS, JACKETS, SHORTS, DRESSES, SHOES, UNDERWEAR, SKIRTS, VESTS, HATS AND SOCKS; BUSINESS PROMOTIONAL APPAREL, NAMELY, POLO SHIRTS, T-SHIRTS, SHOES, PANTS AND HATS, IN CLASS 25 (U.S. CLS. 22 AND 39).

**TRADEMARK**

**PRINCIPAL REGISTER**

FIRST USE 7-1-2012; IN COMMERCE 7-1-2012.

THE MARK CONSISTS OF THE LETTERS "GZUS" AND A STYLIZED LATIN CROSS WHEREIN THE LETTERS "GZ" ARE SEPARATED FROM THE LETTERS "US" BY THE STYLIZED LATIN CROSS.

SN 76-706,285, FILED 2-4-2011.

MARK RADEMACHER, EXAMINING ATTORNEY



*David J. Kybas*

Director of the United States Patent and Trademark Office

# United States of America

United States Patent and Trademark Office

# 2117

**Reg. No. 4,275,965**

ACTIVE BOARDER CORP. (MINNESOTA CORPORATION)  
200 SOUTH OWASSO BLVD.  
ST. PAUL, MN 55117

**Registered Jan. 15, 2013**

**Int. Cl.: 25**

FOR: CLOTHING, NAMELY, BLOUSES, CAPS, COATS; FOOTWEAR, NAMELY, BOOTS, SANDALS, SHOES, SKI BOOTS, SLIPPERS, SNEAKERS, AND LOW-CUT SPORTS SHOES; GLOVES, HATS, HEAD BANDS, JACKETS WITH AND WITHOUT HOODS, MITTENS; PANTS; RAIN WEAR, NAMELY, PONCHOS, RAINCOATS, AND RAIN PANTS; SOCKS, SHIRTS, SHORTS, SWEATSHIRTS, TEE-SHIRTS, VESTS AND WIND RESISTANT JACKETS, IN CLASS 25 (U.S. CLS. 22 AND 39).

**TRADEMARK**

**PRINCIPAL REGISTER**

FIRST USE 7-15-2012; IN COMMERCE 7-15-2012.

THE MARK CONSISTS OF STANDARD CHARACTERS WITHOUT CLAIM TO ANY PARTICULAR FONT, STYLE, SIZE, OR COLOR.

SN 76-707,281, FILED 4-15-2011.

MARC LEIPZIG, EXAMINING ATTORNEY



*David J. Kybas*

Director of the United States Patent and Trademark Office

# United States of America

United States Patent and Trademark Office

## myCoolSlim

**Reg. No. 4,275,966**

FREEZEFATFAST, LLC (MASSACHUSETTS LIMITED LIABILITY COMPANY)  
831 BEACON STREET, #133  
NEWTON, MA 02459

**Registered Jan. 15, 2013**

**Int. Cl.: 25**

FOR: COMPRESSION GARMENTS FOR NON-MEDICAL USE IN BODY TISSUE CONTOURING, NAMELY, CLOTHING BOTTOMS, WRAPS AND BELTS WITH POCKETS FOR TEMPERATURE REDUCING DEVICES, IN CLASS 25 (U.S. CLS. 22 AND 39).

**TRADEMARK**

FIRST USE 11-1-2012; IN COMMERCE 11-1-2012.

**PRINCIPAL REGISTER**

THE MARK CONSISTS OF STANDARD CHARACTERS WITHOUT CLAIM TO ANY PARTICULAR FONT, STYLE, SIZE, OR COLOR.

SN 76-707,395, FILED 4-25-2011.

ANTHONY RINKER, EXAMINING ATTORNEY



*David J. Kybas*

Director of the United States Patent and Trademark Office

# United States of America

United States Patent and Trademark Office

House  
WORKS

**Reg. No. 4,275,967**

**Registered Jan. 15, 2013**

**Int. Cls.: 37 and 42**

**SERVICE MARK**

**PRINCIPAL REGISTER**

RYLAND ORGANIZATION COMPANY (CALIFORNIA CORPORATION)  
24025 PARK SORRENTO  
CALABASAS, CA 91302

FOR: CONSTRUCTION SERVICES, NAMELY, PLANNING, LAYING OUT AND CONSTRUCTION OF NEW RESIDENTIAL HOMES BASED ON DESIGN AND CONSTRUCTION CRITERIA THAT PROVIDES HIGHER ENERGY EFFICIENCIES AND IMPROVED ENVIRONMENTAL QUALITY CONTROL FEATURES; PROVIDING INFORMATION VIA THE INTERNET AND WORLD WIDE WEB RELATING TO BUILDING CONSTRUCTION OPTIONS THAT PROVIDE HIGHER ENERGY EFFICIENCIES AND IMPROVED ENVIRONMENTAL QUALITY CONTROL FEATURES; CONSULTATION IN THE FIELD OF BUILDING CONSTRUCTION, NAMELY, PROVIDING CONSULTATION TO POTENTIAL HOME BUYERS REGARDING CONSTRUCTION OPTIONS THAT PROVIDE HIGHER ENERGY EFFICIENCIES AND IMPROVED ENVIRONMENTAL QUALITY CONTROL FEATURES, IN CLASS 37 (U.S. CLS. 100, 103 AND 106).

FIRST USE 8-15-2011; IN COMMERCE 8-15-2011.

FOR: PROVIDING CONSULTATION SERVICES TO NEW HOME BUYERS RELATING TO RESIDENTIAL HOME DESIGNS, SPECIFICALLY, DESIGNS THAT PROVIDE HIGHER ENERGY EFFICIENCIES AND IMPROVED ENVIRONMENTAL QUALITY CONTROL FEATURES; PROVIDING INFORMATION VIA THE INTERNET AND WORLD WIDE WEB ABOUT DESIGNING RESIDENTIAL HOMES THAT PROVIDE HIGHER ENERGY EFFICIENCIES AND IMPROVED ENVIRONMENTAL QUALITY CONTROL FEATURES, IN CLASS 42 (U.S. CLS. 100 AND 101).

FIRST USE 8-15-2011; IN COMMERCE 8-15-2011.

OWNER OF U.S. REG. NO. 3,961,986.

NO CLAIM IS MADE TO THE EXCLUSIVE RIGHT TO USE "HOUSE", APART FROM THE MARK AS SHOWN.

SN 76-708,456, FILED 7-21-2011.

JOSETTE BEVERLY, EXAMINING ATTORNEY



*David J. Kyffers*

Director of the United States Patent and Trademark Office

# United States of America

United States Patent and Trademark Office

## A BETTER WAY TO BURGER

**Reg. No. 4,275,968**

GLT FOODS (DELAWARE LIMITED LIABILITY COMPANY), DBA FRIENDS FOODS LLC,  
2211 MICHELSON, SUITE 300  
IRVINE, CA 92612

**Registered Jan. 15, 2013**

**Int. Cl.: 29**

FOR: VEGGIE BURGER PATTIES, CHILI, BEEF, ROAST BEEF, SLICED MEAT, PEPPERONI,  
CHICKEN, VEGETABLE-BASED MEAT SUBSTITUTES, IN CLASS 29 (U.S. CL. 46).

**TRADEMARK**

FIRST USE 8-3-2011; IN COMMERCE 8-3-2011.

**PRINCIPAL REGISTER**

THE MARK CONSISTS OF STANDARD CHARACTERS WITHOUT CLAIM TO ANY PAR-  
TICULAR FONT, STYLE, SIZE, OR COLOR.

SN 76-708,492, FILED 7-26-2011.

BERYL GARDNER, EXAMINING ATTORNEY



*David J. Kyffers*

Director of the United States Patent and Trademark Office

# United States of America

United States Patent and Trademark Office

## INSTAGATE PRO

**Reg. No. 4,275,969**

**Registered Jan. 15, 2013**

**Int. Cl.: 9**

**TRADEMARK**

**PRINCIPAL REGISTER**

AMX LLC (DELAWARE LIMITED LIABILITY COMPANY)  
3000 RESEARCH DRIVE  
RICHARDSON, TX 75082

FOR: FEATURE OF HIGH-DEFINITION MULTIMEDIA INTERFACE APPARATUS AND COMPONENT CABLES SOLD AS A UNIT, NAMELY, AN HIGH-DEFINITION MULTIMEDIA INTERFACE SWITCH FEATURING HIGH-BANDWIDTH DIGITAL CONTENT PROTECTION MANAGEMENT WHICH ELIMINATES THE SWITCHING LIMITATIONS WHICH ARE TYPICALLY ASSOCIATED WITH HIGH-BANDWIDTH DIGITAL CONTENT PROTECTION WITH KEY LIMITED SOURCE DEVICES, IN CLASS 9 (U.S. CLS. 21, 23, 26, 36 AND 38).

FIRST USE 6-0-2011; IN COMMERCE 6-0-2011.

THE MARK CONSISTS OF STANDARD CHARACTERS WITHOUT CLAIM TO ANY PARTICULAR FONT, STYLE, SIZE, OR COLOR.

OWNER OF U.S. REG. NO. 3,955,165.

NO CLAIM IS MADE TO THE EXCLUSIVE RIGHT TO USE "PRO" , APART FROM THE MARK AS SHOWN.

SN 76-708,613, FILED 8-5-2011.

DAVID MURRAY, EXAMINING ATTORNEY



*David J. Kyros*

Director of the United States Patent and Trademark Office

# United States of America

United States Patent and Trademark Office

## BottleTalkers

**Reg. No. 4,275,970**

SEV-REND CORPORATION (MISSOURI CORPORATION)  
5301 HORSESHOE LAKE ROAD  
COLLINSVILLE, IL 62234

**Registered Jan. 15, 2013**

**Int. Cl.: 16**

FOR: A POINT OF PURCHASE LABELING ADVERTISING DISPLAY MADE PRIMARILY  
COMPOSED OF PAPERBOARD, IN CLASS 16 (U.S. CLS. 2, 5, 22, 23, 29, 37, 38 AND 50).

**TRADEMARK**

FIRST USE 8-25-2011; IN COMMERCE 10-14-2011.

**PRINCIPAL REGISTER**

SN 76-708,710, FILED 8-12-2011.

NAPOLEON SHARMA, EXAMINING ATTORNEY

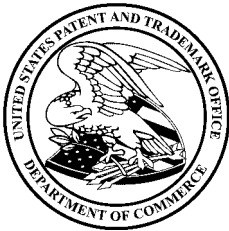

*David J. Kyffers*

Director of the United States Patent and Trademark Office

# United States of America

United States Patent and Trademark Office

## ONE DEGREE AWAY

**Reg. No. 4,275,971**

LIPSCOMB UNIVERSITY (TENNESSEE CORPORATION)  
3901 GRANNY WHITE PIKE  
NASHVILLE, TN 372043951

**Registered Jan. 15, 2013**

**Int. Cl.: 41**

FOR: EDUCATIONAL SERVICES, NAMELY, PROVIDING COURSES OF INSTRUCTION FOR A GRADUATE PROGRAM; EDUCATIONAL SERVICES, NAMELY, PROVIDING AN ONLINE GRADUATE PROGRAM, IN CLASS 41 (U.S. CLS. 100, 101 AND 107).

**SERVICE MARK**

FIRST USE 4-17-2012; IN COMMERCE 11-1-2012.

**PRINCIPAL REGISTER**

THE MARK CONSISTS OF STANDARD CHARACTERS WITHOUT CLAIM TO ANY PARTICULAR FONT, STYLE, SIZE, OR COLOR.

NO CLAIM IS MADE TO THE EXCLUSIVE RIGHT TO USE "DEGREE", APART FROM THE MARK AS SHOWN.

SN 76-708,898, FILED 8-29-2011.

INGA ERVIN, EXAMINING ATTORNEY



*David J. Kybas*

Director of the United States Patent and Trademark Office



United States of America  
United States Patent and Trademark Office

FIGHT WITH  
EVERY SWIPE

**Reg. No. 4,275,972**

ACE CASH EXPRESS, INC. (TEXAS CORPORATION)  
1231 GREENWAY DRIVE, SUITE 600  
IRVING, TX 75038

**Registered Jan. 15, 2013**

**Int. Cls.: 35 and 36**

FOR: CHARITABLE SERVICES, NAMELY, PROMOTING PUBLIC AWARENESS OF CANCER; CHARITABLE SERVICES, NAMELY, PROMOTING PUBLIC AWARENESS OF BREAST CANCER, IN CLASS 35 (U.S. CLS. 100, 101 AND 102).

**SERVICE MARK**

FIRST USE 9-0-2011; IN COMMERCE 9-0-2011.

**PRINCIPAL REGISTER**

FOR: CHARITABLE SERVICES, NAMELY, RAISING MONEY FOR CANCER AWARENESS THROUGH PROMOTIONS AND/OR INCENTIVES ASSOCIATE WITH USE OF PREPAID DEBIT CARD SERVICES; PREPAID DEBIT CARD; CHARITABLE FUNDRAISING SERVICES; PREPAID DEBIT CARD PROGRAM TO DONATE PROCEEDS TO BREAST CANCER ORGANIZATIONS, IN CLASS 36 (U.S. CLS. 100, 101 AND 102).

FIRST USE 9-0-2011; IN COMMERCE 9-0-2011.

THE MARK CONSISTS OF STANDARD CHARACTERS WITHOUT CLAIM TO ANY PARTICULAR FONT, STYLE, SIZE, OR COLOR.

SN 76-709,550, FILED 10-27-2011.

ALEXANDER L. POWERS, EXAMINING ATTORNEY



*David J. Kypos*

Director of the United States Patent and Trademark Office

# United States of America

United States Patent and Trademark Office

## The E COnditioner

**Reg. No. 4,275,973**

JR PETERS INNOVATIONS, LLC (NEW JERSEY LIMITED LIABILITY CORPORATION)  
404 BALTIMORE AVENUE  
POINT PLEASANT BEACH, NJ 08742

**Registered Jan. 15, 2013**

**Int. Cl.: 11**

FOR: FITTED COVERS FOR USE IN THE INTERIOR PORTION OF DOMESTIC AIR CONDITIONERS, IN CLASS 11 (U.S. CLS. 13, 21, 23, 31 AND 34).

**TRADEMARK**

FIRST USE 7-30-2012; IN COMMERCE 7-30-2012.

**PRINCIPAL REGISTER**

THE MARK CONSISTS OF STANDARD CHARACTERS WITHOUT CLAIM TO ANY PARTICULAR FONT, STYLE, SIZE, OR COLOR.

SN 76-710,547, FILED 2-7-2012.

RAUL CORDOVA, EXAMINING ATTORNEY



*David J. Kybas*

Director of the United States Patent and Trademark Office

# United States of America

United States Patent and Trademark Office

## GLOBAUXSOURCE

**Reg. No. 4,275,974**

**Registered Jan. 15, 2013**

**Int. Cl.: 35**

**SERVICE MARK**

**PRINCIPAL REGISTER**

GLOBAUXSOURCE, LLC (FLORIDA LIMITED LIABILITY COMPANY)  
981 HWY 98E  
SUITE 3415  
DESTIN, FL 32541

FOR: BUSINESS SERVICES, NAMELY, ARRANGING OF BUSINESS CONFERENCES AND BUSINESS MEETING PLANNING, IN CLASS 35 (U.S. CLS. 100, 101 AND 102).

FIRST USE 2-26-2012; IN COMMERCE 2-26-2012.

THE MARK CONSISTS OF STANDARD CHARACTERS WITHOUT CLAIM TO ANY PARTICULAR FONT, STYLE, SIZE, OR COLOR.

SN 76-710,572, FILED 2-8-2012.

AISHA SALEM, EXAMINING ATTORNEY



*David J. Kyros*

Director of the United States Patent and Trademark Office

# United States of America

United States Patent and Trademark Office

# BOBBER

**Reg. No. 4,275,975**

RATTE, GEOFFREY S. (UNITED STATES INDIVIDUAL)  
721 PARK AVENUE  
SAINT PAUL, MN 55115

**Registered Jan. 15, 2013**

**Int. Cl.: 28**

FOR: TOYS AND SPORTING GOODS, INCLUDING GAMES AND PLAYTHINGS, NAMELY, ACTION FIGURES AND ACCESSORIES THEREFOR; TOY FISHING GEARS; PLUSH TOYS; BALLOONS; BATHTUB TOYS; RIDE-ON TOYS; EQUIPMENT SOLD AS A UNIT FOR PLAYING CARD GAMES; TOY VEHICLES; DOLLS; ELECTRONIC HAND-HELD GAME UNIT; GAME EQUIPMENT SOLD AS A UNIT FOR PLAYING A BOARD GAME, A CARD GAME, STAND ALONE VIDEO OUTPUT GAME MACHINES; JIGSAW AND MANIPULATIVE PUZZLES; WATER SQUIRTING TOYS; BALLS, NAMELY, PLAYGROUND BALLS, SOCCER BALLS, BASEBALLS, BASKETBALLS; BASEBALL GLOVES; SWIMMING FLOATS FOR RECREATIONAL USE; KICKBOARD FLOTATION DEVICES FOR RECREATIONAL USE; SURFBOARDS; SWIM BOARDS FOR RECREATIONAL USE; SWIM FINS; AND CHRISTMAS TREE ORNAMENTS, IN CLASS 28 (U.S. CLS. 22, 23, 38 AND 50).

**TRADEMARK**

**PRINCIPAL REGISTER**

FIRST USE 1-15-2012; IN COMMERCE 1-15-2012.

SN 76-710,581, FILED 2-9-2012.

RAUL CORDOVA, EXAMINING ATTORNEY



*David J. Kyros*

Director of the United States Patent and Trademark Office

# United States of America

United States Patent and Trademark Office

# SPINNER

**Reg. No. 4,275,976**

RATTE, GEOFFREY S. (UNITED STATES INDIVIDUAL)  
721 PARK AVENUE  
SAINT PAUL, MN 55115

**Registered Jan. 15, 2013**

**Int. Cl.: 28**

FOR: TOYS AND SPORTING GOODS, INCLUDING GAMES AND PLAYTHINGS, NAMELY, ACTION FIGURES AND ACCESSORIES THEREFOR; TOY FISHING GEARS; PLUSH TOYS; BALLOONS; BATHTUB TOYS; RIDE-ON TOYS; EQUIPMENT SOLD AS A UNIT FOR PLAYING CARD GAMES; TOY VEHICLES; DOLLS; ELECTRONIC HAND-HELD GAME UNIT; GAME EQUIPMENT SOLD AS A UNIT FOR PLAYING A BOARD GAME, A CARD GAME, STAND ALONE VIDEO OUTPUT GAME MACHINES; JIGSAW AND MANIPULATIVE PUZZLES; WATER SQUIRTING TOYS; BALLS, NAMELY, PLAYGROUND BALLS, SOCCER BALLS, BASEBALLS, BASKETBALLS; BASEBALL GLOVES; SWIMMING FLOATS FOR RECREATIONAL USE; KICKBOARD FLOTATION DEVICES FOR RECREATIONAL USE; SURFBOARDS; SWIM BOARDS FOR RECREATIONAL USE; SWIM FINS; AND CHRISTMAS TREE ORNAMENTS, IN CLASS 28 (U.S. CLS. 22, 23, 38 AND 50).

**TRADEMARK**

**PRINCIPAL REGISTER**

FIRST USE 1-15-2012; IN COMMERCE 1-15-2012.

SN 76-710,582, FILED 2-9-2012.

RAUL CORDOVA, EXAMINING ATTORNEY



*David J. Kyffers*

Director of the United States Patent and Trademark Office

# United States of America

United States Patent and Trademark Office

# EVERDROBE

**Reg. No. 4,275,977**

BIZHILL INC (CALIFORNIA CORPORATION)  
335 E. ALBERTONI ST #200-220  
CARSON, CA 90746

**Registered Jan. 15, 2013**

**Int. Cl.: 42**

FOR: COMPUTER AND SMARTPHONE SERVICES, NAMELY, CREATING AN ON-LINE COMMUNITY FOR USERS TO POST PHOTOS OF THEIR OUTFITS AND RECEIVE RATINGS FROM OTHERS, IN CLASS 42 (U.S. CLS. 100 AND 101).

**SERVICE MARK**

FIRST USE 6-2-2012; IN COMMERCE 6-2-2012.

**PRINCIPAL REGISTER**

THE MARK CONSISTS OF STANDARD CHARACTERS WITHOUT CLAIM TO ANY PARTICULAR FONT, STYLE, SIZE, OR COLOR.

SN 76-710,813, FILED 3-5-2012.

RAUL CORDOVA, EXAMINING ATTORNEY



*David J. Kyffers*

Director of the United States Patent and Trademark Office

# United States of America

United States Patent and Trademark Office

## BIG PICTURE TALENT MANAGEMENT

**Reg. No. 4,275,978**

**Registered Jan. 15, 2013**

**Int. Cls.: 35 and 42**

**SERVICE MARK**

**PRINCIPAL REGISTER**

HALOGEN SOFTWARE, INC. (CANADA CORPORATION)  
495 MARCH ROAD  
SUITE 500  
OTTAWA, CANADA K2K3G1

FOR: BUSINESS CONSULTATION SERVICES RELATED TO THE MANAGEMENT OF HUMAN RESOURCES, IN CLASS 35 (U.S. CLS. 100, 101 AND 102).

FIRST USE 9-19-2011; IN COMMERCE 9-19-2011.

FOR: COMPUTER SERVICES, NAMELY, PROVIDING ON-LINE TEMPORARY USE OF HOSTED, NON-DOWNLOADABLE SOFTWARE FOR USE IN MANAGEMENT OF HUMAN RESOURCES, IN CLASS 42 (U.S. CLS. 100 AND 101).

FIRST USE 9-19-2011; IN COMMERCE 9-19-2011.

THE MARK CONSISTS OF STANDARD CHARACTERS WITHOUT CLAIM TO ANY PARTICULAR FONT, STYLE, SIZE, OR COLOR.

NO CLAIM IS MADE TO THE EXCLUSIVE RIGHT TO USE "TALENT MANAGEMENT", APART FROM THE MARK AS SHOWN.

SN 76-979,140, FILED 5-13-2011.

NATALIE POLZER, EXAMINING ATTORNEY



*David J. Kybas*

Director of the United States Patent and Trademark Office

# United States of America

United States Patent and Trademark Office

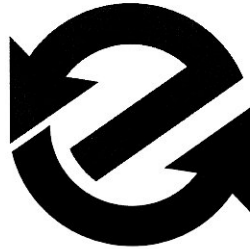

**Reg. No. 4,275,979**

**Registered Jan. 15, 2013**

**Int. Cl.: 12**

**TRADEMARK**

**PRINCIPAL REGISTER**

ELIG BRAKE INDUSTRIAL CO., LTD. (TAIWAN CORPORATION)  
KING SHAN HSIANG  
4FL., NO. 11, PA TEH ST.  
TAIPEI HSIEN, TAIWAN

FOR: BRAKES FOR BICYCLES, REAR BRAKES FOR BICYCLES AND LAND VEHICLES, FRONT BRAKES FOR BICYCLES AND LAND VEHICLES, DISK BRAKE LINING SHOE FOR BICYCLES, BRAKE DISKS FOR BICYCLES AND LAND VEHICLES, BRAKE ROTORS FOR BICYCLES AND LAND VEHICLES, WINDSHIELD WIPERS, BRAKE DRUMS, WHEEL COVERS, BRAKE SHOES FOR BICYCLES AND LAND VEHICLES, BRAKE LININGS FOR BICYCLES AND LAND VEHICLES, BRAKE PEDALS FOR BICYCLES AND LAND VEHICLES, MASTER CYLINDERS, WHEEL CYLINDERS, BACK-UP WARNING ALARMS FOR VEHICLES, SEMI-SOLID BRAKE LINING PADS FOR BICYCLES AND LAND VEHICLES, DISK BRAKE LINING ROTORS FOR BICYCLES AND LAND VEHICLES, ANTI-LOCK BRAKE SYSTEM, AUTOMOBILE ALUMINUM WHEEL RIMS, PEDALS FOR CARS, TRUCK AND WAGONS, BRAKES FOR MOTORCYCLES, IN CLASS 12 (U.S. CLS. 19, 21, 23, 31, 35 AND 44).

FIRST USE 1-6-2006; IN COMMERCE 10-31-2007.

SN 77-043,462, FILED 11-14-2006.

MICHELE SWAIN, EXAMINING ATTORNEY



*David J. Kyjars*

Director of the United States Patent and Trademark Office



# United States of America

United States Patent and Trademark Office



**Reg. No. 4,275,980**

**Registered Jan. 15, 2013**

**Int. Cl.: 41**

**SERVICE MARK**

**PRINCIPAL REGISTER**

MUSIC MAKERS HOLDINGS LLC (MARYLAND LIMITED LIABILITY COMPANY)  
7200 WISCONSIN AVENUE  
SUITE 601  
BETHESDA, MD 20814

FOR: EDUCATION AND ENTERTAINMENT SERVICES, NAMELY, PROVIDING TRAINING AND INSTRUCTION IN THE FIELDS OF POP, CLASSICAL, AND ROCK MUSIC AND PERFORMANCE ARTS; OPERATING SCHOOLS IN THE FIELDS OF POP, CLASSICAL, AND ROCK MUSIC AND PERFORMANCE ARTS; PROVIDING PHYSICAL FACILITIES FOR THE REHEARSAL AND RECORDING OF PERFORMANCES IN POP, CLASSICAL, AND ROCK MUSIC; PROVIDING INSTRUCTOR TRAINING SERVICES IN THE FIELDS OF POP, CLASSICAL, AND ROCK MUSIC AND PERFORMANCE ARTS; ORGANIZING AND CONDUCTING CONCERTS AND COMPETITIONS IN THE FIELDS OF POP, CLASSICAL, AND ROCK MUSIC AND PERFORMANCE ARTS; PROVIDING RECOGNITION AND INCENTIVES TO INDIVIDUALS WHO DEMONSTRATE EXCELLENCE IN THE FIELDS OF POP, CLASSICAL, AND ROCK MUSIC AND PERFORMANCE ARTS; PROVIDING WEB SITES IN THE FIELDS OF POP, CLASSICAL, AND ROCK MUSIC AND PERFORMANCE ARTS, IN CLASS 41 (U.S. CLS. 100, 101 AND 107).

FIRST USE 7-1-2007; IN COMMERCE 7-1-2007.

NO CLAIM IS MADE TO THE EXCLUSIVE RIGHT TO USE "AMERICA'S MUSIC SCHOOL", APART FROM THE MARK AS SHOWN.



THE MARK CONSISTS OF THE STYLIZED CHARACTERS "B2" SET DIRECTLY ABOVE THE STYLIZED LETTER "R" AND A SILHOUETTE OF A PERSON PLAYING GUITAR. THE STYLIZED WORDING "BACH TO ROCK" IS SET IMMEDIATELY BELOW THESE CHARACTERS AND THE STYLIZED WORDING "AMERICA'S MUSIC SCHOOL", WITH A FIVE-POINT STAR BEFORE "AMERICA'S" AND AFTER "SCHOOL", IS SET IMMEDIATELY BELOW "BACH TO ROCK".

SN 77-055,523, FILED 12-1-2006.

INGRID C. EULIN, EXAMINING ATTORNEY

*David J. Kyros*

Director of the United States Patent and Trademark Office

# United States of America

United States Patent and Trademark Office



**Reg. No. 4,275,981**

BARBIERI, TRAVIS RYAN (UNITED STATES INDIVIDUAL)  
7814 S. 37TH WAY  
PHOENIX, AZ 85042

**Registered Jan. 15, 2013**

**Int. Cl.: 32**

FOR: SOFT DRINKS FLAVORED WITH TEA, IN CLASS 32 (U.S. CLS. 45, 46 AND 48).

**TRADEMARK**

FIRST USE 10-23-2012; IN COMMERCE 10-23-2012.

**PRINCIPAL REGISTER**

THE MARK CONSISTS OF (FROM LEFT TO RIGHT) THE CAPITALIZED LETTERS "CO" FOLLOWED BY THE LOWERCASE, SUBSCRIPT LETTERS "TEA". THE ARRANGEMENT OF THE LETTERS IS A PLAY ON THE FORMULA FOR CARBON DIOXIDE, USED TO REPRESENT THE PRODUCT: A CARBONATED ICED TEA.

SN 77-124,976, FILED 3-7-2007.

COLLEEN DOMBROW, EXAMINING ATTORNEY



*David J. Kyffers*

Director of the United States Patent and Trademark Office

# United States of America

United States Patent and Trademark Office

# ELEGANCE

**Reg. No. 4,275,982**

**Registered Jan. 15, 2013**

**Int. Cl.: 3**

**TRADEMARK**

**PRINCIPAL REGISTER**

PROCTER & GAMBLE INTERNATIONAL OPERATIONS S.A. (SWITZERLAND CORPORATION)  
1213 PETIT-LANCY 1  
47 ROUTE DE SAINT-GEORGES  
GENEVA, SWITZERLAND 1213

FOR: PERFUMERIES, COLOGNE, ESSENTIAL OILS FOR PERSONAL USE, IN CLASS 3 (U.S. CLS. 1, 4, 6, 50, 51 AND 52).

FIRST USE 10-31-2010; IN COMMERCE 10-31-2010.

THE MARK CONSISTS OF STANDARD CHARACTERS WITHOUT CLAIM TO ANY PARTICULAR FONT, STYLE, SIZE, OR COLOR.

SN 77-184,602, FILED 5-18-2007.

MARK SPARACINO, EXAMINING ATTORNEY



*David J. Kybas*

Director of the United States Patent and Trademark Office

# United States of America

United States Patent and Trademark Office

## ACE FITNESS

**Reg. No. 4,275,983**

AMERICAN COUNCIL ON EXERCISE (CALIFORNIA CORPORATION)  
4851 PARAMOUNT DRIVE  
SAN DIEGO, CA 92123

**Registered Jan. 15, 2013**

**Int. Cls.: 9, 16, 25, 35, 41,  
42, and 44**

FOR: DIGITAL MEDIA, NAMELY, CDS AND DVDS FEATURING INFORMATION ON HEALTH AND FITNESS, IN CLASS 9 (U.S. CLS. 21, 23, 26, 36 AND 38).

FIRST USE 11-15-2012; IN COMMERCE 11-28-2012.

**TRADEMARK**

FOR: PRINTED INSTRUCTIONAL, EDUCATIONAL, AND TEACHING MATERIALS IN THE FIELD OF HEALTH AND FITNESS, IN CLASS 16 (U.S. CLS. 2, 5, 22, 23, 29, 37, 38 AND 50).

**SERVICE MARK**

**PRINCIPAL REGISTER**

FIRST USE 8-6-2012; IN COMMERCE 11-15-2012.

FOR: GYM SHORTS; HEADWEAR; JACKETS; MUSCLE TOPS; POLO SHIRTS; SHIRTS; SHORT-SLEEVED OR LONG-SLEEVED T-SHIRTS; SWEAT PANTS; SWEAT SHIRTS; SWEAT SHORTS, IN CLASS 25 (U.S. CLS. 22 AND 39).

FIRST USE 11-15-2012; IN COMMERCE 11-28-2012.

FOR: PROVIDING AN ON-LINE SEARCHABLE DATABASE FEATURING CLASSIFIED AD LISTINGS AND EMPLOYMENT OPPORTUNITIES; PROVIDING AN ONLINE DIRECTORY INFORMATION SERVICE FEATURING INFORMATION REGARDING HEALTH AND FITNESS, IN CLASS 35 (U.S. CLS. 100, 101 AND 102).

FIRST USE 11-15-2012; IN COMMERCE 11-15-2012.

FOR: EDUCATIONAL SERVICES, NAMELY, PROVIDING CLASSES, SEMINARS, AND EDUCATIONAL TESTING IN THE FIELD OF HEALTH AND FITNESS, IN CLASS 41 (U.S. CLS. 100, 101 AND 107).

FIRST USE 11-15-2012; IN COMMERCE 11-26-2012.

FOR: SCIENTIFIC RESEARCH, IN CLASS 42 (U.S. CLS. 100 AND 101).

FIRST USE 8-15-2012; IN COMMERCE 11-21-2012.



*David J. Kyros*

Director of the United States Patent and Trademark Office

**Reg. No. 4,275,983** FOR: PROVIDING INFORMATION AND NEWS IN THE FIELD OF HEALTH AND FITNESS,  
IN CLASS 44 (U.S. CLS. 100 AND 101).

FIRST USE 1-1-2012; IN COMMERCE 11-28-2012.

THE MARK CONSISTS OF STANDARD CHARACTERS WITHOUT CLAIM TO ANY PARTICULAR FONT, STYLE, SIZE, OR COLOR.

OWNER OF U.S. REG. NOS. 1,898,868, 3,244,688, AND OTHERS.

NO CLAIM IS MADE TO THE EXCLUSIVE RIGHT TO USE "FITNESS", APART FROM THE MARK AS SHOWN.

SN 77-226,048, FILED 7-10-2007.

LINDA E. BLOHM, EXAMINING ATTORNEY

# United States of America

United States Patent and Trademark Office

# LOVECAST

**Reg. No. 4,275,984**

**Registered Jan. 15, 2013**

**Int. Cl.: 45**

**SERVICE MARK**

**PRINCIPAL REGISTER**

OUTLOOK AMUSEMENTS, INC. (CALIFORNIA CORPORATION)  
2900 W ALAMEDA AVENUE  
SUITE 400  
BURBANK, CA 91505

FOR: PSYCHIC AND ASTROLOGICAL READING SERVICES; PROVIDING HOROSCOPE INFORMATION VIA TELEPHONE, ELECTRONIC DEVICES AND ALL OTHER MEANS OF COMMUNICATIONS, IN CLASS 45 (U.S. CLS. 100 AND 101).

FIRST USE 4-25-2006; IN COMMERCE 4-25-2006.

THE MARK CONSISTS OF STANDARD CHARACTERS WITHOUT CLAIM TO ANY PARTICULAR FONT, STYLE, SIZE, OR COLOR.

SN 77-316,995, FILED 10-30-2007.

BRENDAN MCCAULEY, EXAMINING ATTORNEY



*David J. Kyffers*

Director of the United States Patent and Trademark Office

# United States of America

United States Patent and Trademark Office



**Reg. No. 4,275,985**

PRO-CERT ORGANIC SYSTEMS, LTD. (CANADA LIMITED COMPANY (LTD.))  
BOX 100A, R.R. #3, 475 VALLEY ROAD  
SASKATOON, CANADA

**Registered Jan. 15, 2013**

**CERTIFICATION MARK**

FOR: ORGANIC FOOD PRODUCTS, IN CLASS A (U.S. CL. A).

**GOODS**

FIRST USE 7-1-2007; IN COMMERCE 1-1-2008.

**SERVICES**

FOR: AGRICULTURAL ORGANIC FOOD GROWING AND ORGANIC FOOD PROCESSING,  
IN CLASS B (U.S. CL. B).

**PRINCIPAL REGISTER**

FIRST USE 7-1-2007; IN COMMERCE 1-1-2008.

NO CLAIM IS MADE TO THE EXCLUSIVE RIGHT TO USE "ORGANIC", APART FROM  
THE MARK AS SHOWN.

THE COLOR(S) RED, GREEN AND BLACK IS/ARE CLAIMED AS A FEATURE OF THE  
MARK.

THE MARK CONSISTS OF A RED ELLIPSE CONTAINING THE WORDS "PRO-CERT OR-  
GANIC" IN BLACK, SURROUNDED BY A PARTIAL GREEN ELLIPSE.

THE CERTIFICATION MARK, AS USED BY PERSONS AUTHORIZED BY THE CERTIFIER,  
CERTIFIES THAT THE GOODS AND/OR SERVICES PROVIDED HAVE BEEN GROWN,  
PRODUCED, HANDLED AND PERFORMED ORGANICALLY AND SHOW PROPER COM-  
PLIANCE WITH ORGANIC STANDARDS AND REGULATIONS.

SN 77-319,858, FILED 11-2-2007.

SUSAN STIGLITZ, EXAMINING ATTORNEY



*David J. Kyjars*

Director of the United States Patent and Trademark Office

# United States of America

United States Patent and Trademark Office

## BOTTOMS UP

**Reg. No. 4,275,986**

**Registered Jan. 15, 2013**

**Int. Cls.: 29 and 30**

**TRADEMARK**

**PRINCIPAL REGISTER**

SETHI, RASHU (INDIA INDIVIDUAL)  
B-21, FATEH NAGAR, P.O. TILAK NAGAR  
NEW DELHI, INDIA

FOR: SNACK FOODS, NAMELY, PROCESSED ALMONDS, PROCESSED PEAS, DRIED LENTILS, POTATO CRISPS AND POTATO CHIPS, AND MEAT-BASED SNACK FOODS; RAISINS; PRESERVED, DRIED AND COOKED FRUITS AND VEGETABLES; SOUPS; BOMBAY MIX, CONSISTING PRIMARILY OF FRIED LENTILS, PEANUTS AND CHICKPEAS, IN CLASS 29 (U.S. CL. 46).

FIRST USE 11-7-2012; IN COMMERCE 11-7-2012.

FOR: SNACK FOODS, NAMELY, GRAIN-BASED SNACK FOODS, CEREAL-BASED SNACK FOODS, FLOUR-BASED SNACK FOODS, PRETZELS, AND CHEESE FLAVORED PUFFED CORN SNACKS; BREADS; CANDY, IN CLASS 30 (U.S. CL. 46).

FIRST USE 11-6-2012; IN COMMERCE 11-6-2012.

THE MARK CONSISTS OF STANDARD CHARACTERS WITHOUT CLAIM TO ANY PARTICULAR FONT, STYLE, SIZE, OR COLOR.

SN 77-361,731, FILED 12-31-2007.

KIM MONINGHOFF, EXAMINING ATTORNEY



*David J. Kyros*

Director of the United States Patent and Trademark Office



# United States of America

United States Patent and Trademark Office

# Octet

**Reg. No. 4,275,987**

OCTET FINANCE (USA), LLC (CALIFORNIA LIMITED LIABILITY COMPANY)  
401 B STREET, SUITE 1200  
SAN DIEGO, CA 92101

**Registered Jan. 15, 2013**

**Int. Cl.: 36**

FOR: COMMERCIAL LENDING SERVICES FOR THE FUNDING OF DOMESTIC AND EXPORT SALES AND PURCHASES; PROVIDING ELECTRONIC PROCESSING OF ELECTRONIC PAYMENTS VIA A GLOBAL COMPUTER NETWORK, IN CLASS 36 (U.S. CLS. 100, 101 AND 102).

**SERVICE MARK**

**PRINCIPAL REGISTER**

FIRST USE 2-0-2008; IN COMMERCE 3-4-2010.

SN 77-365,866, FILED 1-7-2008.

SALLY SHIH, EXAMINING ATTORNEY



*David J. Kyros*

Director of the United States Patent and Trademark Office

# United States of America

United States Patent and Trademark Office

## TAKE ME OUT

**Reg. No. 4,275,988**

**Registered Jan. 15, 2013**

**Int. Cl.: 41**

**SERVICE MARK**

**PRINCIPAL REGISTER**

FREMANTLEMEDIA NORTH AMERICA INC (DELAWARE CORPORATION)  
3RD FLOOR  
4000 WEST ALAMEDA AVE.  
BURBANK, CA 91505

FOR: ENTERTAINMENT SERVICES IN THE NATURE OF A TELEVISION SERIES IN THE FIELD OF DATING, ROMANCE, LIVE ACTION, COMEDY AND DRAMA; ENTERTAINMENT SERVICES, NAMELY, PROVIDING AN ON-LINE COMPUTER GAME; PROVIDING DIGITIZED PRINT AND VISUAL INFORMATION ABOUT A TELEVISION SERIES VIA A GLOBAL COMPUTER NETWORK; SWEEPSTAKES, IN CLASS 41 (U.S. CLS. 100, 101 AND 107).

FIRST USE 6-7-2012; IN COMMERCE 6-7-2012.

THE MARK CONSISTS OF STANDARD CHARACTERS WITHOUT CLAIM TO ANY PARTICULAR FONT, STYLE, SIZE, OR COLOR.

SN 77-371,668, FILED 1-15-2008.

DEZMONA MIZELLE, EXAMINING ATTORNEY



*David J. Kypos*

Director of the United States Patent and Trademark Office

# United States of America

United States Patent and Trademark Office

# FORTHRIGHT

**Reg. No. 4,275,989**

**Registered Jan. 15, 2013**

**Int. Cls.: 35, 36, 41, and  
45**

DISPUTE MANAGEMENT SERVICES, LLC (DELAWARE LIMITED LIABILITY COMPANY)  
6465 WAYZATA BOULEVARD  
SUITE 450  
MINNEAPOLIS, MN 55426

FOR: BUSINESS ADMINISTRATION SERVICES RELATING TO ALTERNATIVE DISPUTE  
RESOLUTION BUSINESSES , IN CLASS 35 (U.S. CLS. 100, 101 AND 102).

**SERVICE MARK**

FIRST USE 5-1-2008; IN COMMERCE 4-1-2011.

**PRINCIPAL REGISTER**

FOR: FINANCIAL CLAIMS PROCESSING SERVICES RELATED TO THE INSURANCE,  
MEDICAL, GOVERNMENT, AND ALTERNATIVE DISPUTE RESOLUTION FIELDS, IN  
CLASS 36 (U.S. CLS. 100, 101 AND 102).

FIRST USE 5-1-2008; IN COMMERCE 11-1-2010.

FOR: FINANCIAL CLAIMS PROCESSING SERVICES RELATED TO THE INSURANCE,  
MEDICAL, GOVERNMENT, AND ALTERNATIVE DISPUTE RESOLUTION FIELDS, IN  
CLASS 41 (U.S. CLS. 100, 101 AND 107).

FIRST USE 4-1-2011; IN COMMERCE 4-1-2011.

FOR: ALTERNATIVE DISPUTE RESOLUTION SERVICES IN THE NATURE OF ARBITRA-  
TION AND MEDIATION SERVICES, IN CLASS 45 (U.S. CLS. 100 AND 101).

FIRST USE 4-1-2011; IN COMMERCE 4-1-2011.

THE MARK CONSISTS OF STANDARD CHARACTERS WITHOUT CLAIM TO ANY PAR-  
TICULAR FONT, STYLE, SIZE, OR COLOR.

SN 77-411,049, FILED 3-3-2008.

MARC LEIPZIG, EXAMINING ATTORNEY



*David J. Kyffers*

Director of the United States Patent and Trademark Office

# United States of America

United States Patent and Trademark Office

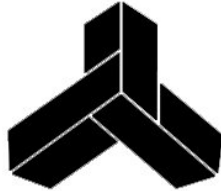

**Reg. No. 4,275,990**

**Registered Jan. 15, 2013**

**Int. Cls.: 35, 36, 41, and 45**

DISPUTE MANAGEMENT SERVICES, LLC (DELAWARE LIMITED LIABILITY COMPANY)  
6465 WAYZATA BOULEVARD  
SUITE 450  
MINNEAPOLIS, MN 55426

FOR: BUSINESS ADMINISTRATION SERVICES RELATING TO ALTERNATIVE DISPUTE RESOLUTION BUSINESSES, IN CLASS 35 (U.S. CLS. 100, 101 AND 102).

**SERVICE MARK**

FIRST USE 5-1-2008; IN COMMERCE 4-1-2011.

**PRINCIPAL REGISTER**

FOR: FINANCIAL CLAIMS PROCESSING SERVICES RELATED TO THE INSURANCE, MEDICAL, GOVERNMENT, AND ALTERNATIVE DISPUTE RESOLUTION FIELDS, IN CLASS 36 (U.S. CLS. 100, 101 AND 102).

FIRST USE 5-1-2008; IN COMMERCE 11-1-2010.

FOR: EDUCATIONAL SERVICES, NAMELY, PROVIDING ALTERNATIVE DISPUTE RESOLUTION SEMINARS, LECTURES, AND COURSES IN THE FIELD OF GOVERNMENT, IN CLASS 41 (U.S. CLS. 100, 101 AND 107).

FIRST USE 4-1-2011; IN COMMERCE 4-1-2011.

FOR: ALTERNATIVE DISPUTE RESOLUTION SERVICES IN THE NATURE OF ARBITRATION AND MEDIATION SERVICES, IN CLASS 45 (U.S. CLS. 100 AND 101).

FIRST USE 4-1-2011; IN COMMERCE 4-1-2011.

THE MARK CONSISTS OF A DESIGN COMPOSED OF INTERLOCKING QUADRILATERALS IN AN OVERALL TRIANGULAR FORM.

SN 77-411,223, FILED 3-3-2008.

MARC LEIPZIG, EXAMINING ATTORNEY



*David J. Kyffers*

Director of the United States Patent and Trademark Office

# United States of America

United States Patent and Trademark Office

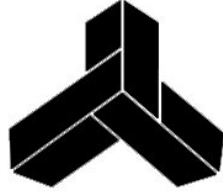

## FORTHRIGHT

**Reg. No. 4,275,991**

DISPUTE MANAGEMENT SERVICES, LLC (DELAWARE LIMITED LIABILITY COMPANY)  
6465 WAYZATA BOULEVARD  
MINNEAPOLIS, MN 55426

**Registered Jan. 15, 2013**

**Int. Cls.: 35, 36, 41, and  
45**

FOR: BUSINESS ADMINISTRATION SERVICES RELATING TO ALTERNATIVE DISPUTE RESOLUTION BUSINESSES, IN CLASS 35 (U.S. CLS. 100, 101 AND 102).

FIRST USE 5-1-2008; IN COMMERCE 4-1-2011.

**SERVICE MARK**

FOR: FINANCIAL CLAIMS PROCESSING SERVICES RELATED TO THE INSURANCE, MEDICAL, GOVERNMENT, AND ALTERNATIVE DISPUTE RESOLUTION FIELDS, IN CLASS 36 (U.S. CLS. 100, 101 AND 102).

**PRINCIPAL REGISTER**

FIRST USE 5-1-2008; IN COMMERCE 11-1-2010.

FOR: EDUCATIONAL SERVICES, NAMELY, PROVIDING ALTERNATIVE DISPUTE RESOLUTION SEMINARS, LECTURES, AND COURSES IN THE FIELD OF GOVERNMENT, IN CLASS 41 (U.S. CLS. 100, 101 AND 107).

FIRST USE 4-1-2011; IN COMMERCE 4-1-2011.

FOR: ALTERNATIVE DISPUTE RESOLUTION SERVICES IN THE NATURE OF ARBITRATION AND MEDIATION SERVICES, IN CLASS 45 (U.S. CLS. 100 AND 101).

FIRST USE 4-1-2011; IN COMMERCE 4-1-2011.

THE MARK CONSISTS OF THE WORD "FORTHRIGHT", AS WELL AS A DESIGN ELEMENT COMPOSED OF INTERLOCKING QUADRILATERALS IN AN OVERALL TRIANGULAR FORM.

SN 77-411,226, FILED 3-3-2008.

MARC LEIPZIG, EXAMINING ATTORNEY



*David J. Kyros*

Director of the United States Patent and Trademark Office

# United States of America

United States Patent and Trademark Office

## HOME OF GOLF

**Reg. No. 4,275,992**

**Registered Jan. 15, 2013**

**Int. Cl.: 9**

**TRADEMARK**

**PRINCIPAL REGISTER**

ST ANDREWS LINKS LTD (UNITED KINGDOM CORPORATION)  
PILMOUR HOUSE  
ST. ANDREWS, FIFE KY16, UNITED KINGDOM

FOR: PRERECORDED CDS, CD-ROMS RELATING TO GOLF; COMPUTER GAMES SOFTWARE; COMPUTER AND VIDEO GAME CARTRIDGES; COMPUTER GAME SOFTWARE FOR HAND-HELD UNITS FOR PLAYING VIDEO GAMES; VIDEO TAPES, LASER DISCS AND DVD'S FEATURING GOLFING ACTIVITIES, THE SPORT OF GOLF AND THE HISTORY OF GOLF, IN CLASS 9 (U.S. CLS. 21, 23, 26, 36 AND 38).

FIRST USE 7-0-2010; IN COMMERCE 7-0-2010.

THE MARK CONSISTS OF STANDARD CHARACTERS WITHOUT CLAIM TO ANY PARTICULAR FONT, STYLE, SIZE, OR COLOR.

OWNER OF ERPN CMNTY TM OFC REG. NO. 007231053, DATED 6-5-2009, EXPIRES 9-12-2018.

NO CLAIM IS MADE TO THE EXCLUSIVE RIGHT TO USE "GOLF" , APART FROM THE MARK AS SHOWN.

SN 77-419,549, FILED 3-12-2008.

BARBARA GAYNOR, EXAMINING ATTORNEY



*David J. Kyffers*

Director of the United States Patent and Trademark Office

# United States of America

United States Patent and Trademark Office



**Reg. No. 4,275,993**

FORTENBERRY, DOUGLAS (UNITED STATES INDIVIDUAL)  
1711 EASTFORK LN.  
WYLIE, TX 75098

**Registered Jan. 15, 2013**

**Int. Cl.: 41**

FOR: PROVIDING MOTIVATIONAL SPEAKING SERVICES IN THE FIELD OF PERSONAL AND PROFESSIONAL GROWTH, LIFE MANAGEMENT, CHANGE MANAGEMENT, TEAM WORK AND PRODUCTIVITY, IN CLASS 41 (U.S. CLS. 100, 101 AND 107).

**SERVICE MARK**

FIRST USE 2-0-2009; IN COMMERCE 2-0-2009.

**PRINCIPAL REGISTER**

THE MARK CONSISTS OF A CARTOON IMAGE OF A PERSON IN A WHEEL CHAIR TO THE LEFT OF THE STYLIZED TEXT "WHATEVER IT TAKES".

SN 77-429,490, FILED 3-24-2008.

MICHAEL TANNER, EXAMINING ATTORNEY



*David J. Kybas*

Director of the United States Patent and Trademark Office

# United States of America

United States Patent and Trademark Office

## DIGITCARDS

**Reg. No. 4,275,994**

**Registered Jan. 15, 2013**

**Int. Cls.: 16, 28, and 30**

**TRADEMARK**

**PRINCIPAL REGISTER**

HOME FOCUS DEVELOPMENT LTD. (BR.VIRGIN ISLANDS CORPORATION)  
P.O. BOX 3444  
TRUSTNET CHAMBERS LIMITED  
ROAD TOWN, BR.VIRGIN ISLANDS

FOR: CARDBOARD AND PAPER ARTICLES, NAMELY, BOXES OF PAPER OR BOXES OF CARDBOARD; ALBUMS, NAMELY, ALBUMS FOR STICKERS AND TRADING CARDS; TRADING CARDS; STICKERS; COLLECTIBLE ITEMS, NAMELY, TRADING CARDS AND STICKERS, IN CLASS 16 (U.S. CLS. 2, 5, 22, 23, 29, 37, 38 AND 50).

FIRST USE 11-30-2012; IN COMMERCE 11-30-2012.

FOR: GAMES AND TOYS, NAMELY, CARD GAMES; ROLE PLAY GAMES; COLLECTIBLE ITEMS, NAMELY, ACTION FIGURES, AND PLASTIC TOY FIGURINES; PLASTIC TOYS, NAMELY, PLASTIC CHARACTER TOYS; TOY CONTAINERS, NAMELY, TOY BOXES; EQUIPMENT SOLD AS A UNIT FOR PLAYING CARD GAMES; GAME BOARDS FOR TRADING CARD GAMES; BALLOONS, IN CLASS 28 (U.S. CLS. 22, 23, 38 AND 50).

FIRST USE 11-30-2012; IN COMMERCE 11-30-2012.

FOR: CONFECTIONERY, NAMELY, SWEETS, GUM DROPS, BOILED SWEETS, LOLLIPOPS OF ANY KIND, PASTILLES, WINE GUM CANDY, FRUIT JELLIES, BUBBLE GUM, CHEWING GUM, JELLY BEANS, CANDY STRIPS, MARSHMALLOWS, CANDY FOAM, IN CLASS 30 (U.S. CL. 46).

FIRST USE 11-30-2012; IN COMMERCE 11-30-2012.

THE MARK CONSISTS OF STANDARD CHARACTERS WITHOUT CLAIM TO ANY PARTICULAR FONT, STYLE, SIZE, OR COLOR.

PRIORITY CLAIMED UNDER SEC. 44(D) ON ERPN CMNTY TM OFC APPLICATION NO. 006706485, FILED 2-28-2008, REG. NO. 006706485, DATED 2-9-2009, EXPIRES 2-28-2018.

SN 77-432,797, FILED 3-27-2008.

BRENDAN MCCAULEY, EXAMINING ATTORNEY



*David J. Kyffers*

Director of the United States Patent and Trademark Office



# United States of America

United States Patent and Trademark Office

## 1800 HOT WATER HEATER

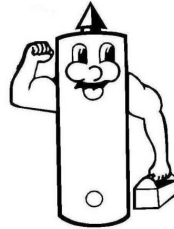

**1800HOTWATER.COM**

**Reg. No. 4,275,995**

**Registered Jan. 15, 2013**

**Int. Cl.: 37**

**SERVICE MARK**

**PRINCIPAL REGISTER**

BILUK MEDIA, LLC (NEW JERSEY LIMITED LIABILITY COMPANY)  
P.O. BOX 1802  
UNION, NJ 07083

FOR: PLUMBING CONTRACTOR SERVICES; HEATING CONTRACTOR SERVICES; AIR  
CONDITIONING CONTRACTOR SERVICES, IN CLASS 37 (U.S. CLS. 100, 103 AND 106).

FIRST USE 1-1-2009; IN COMMERCE 9-28-2012.

NO CLAIM IS MADE TO THE EXCLUSIVE RIGHT TO USE "1 800" AND "HOT WATER  
HEATER" AND "1800HOTWATER.COM", APART FROM THE MARK AS SHOWN.

THE MARK CONSISTS OF A HOT WATER HEATER CHARACTER WITH A SMILING FACE,  
HOLDING A TOOL BOX; BETWEEN THE WORDS "1 800 HOT WATER HEATER  
1800HOTWATER.COM".

SN 77-438,921, FILED 4-3-2008.

RENEE SERVANCE, EXAMINING ATTORNEY



*David J. Kyffers*

Director of the United States Patent and Trademark Office

# United States of America

United States Patent and Trademark Office



**Reg. No. 4,275,996**

**Registered Jan. 15, 2013**

**CERTIFICATION MARK**

**GOODS**

**PRINCIPAL REGISTER**

IBD - ASSOCIADO DE CERTIFICACAO INSTITUTO BIODINAMICO (BRAZIL ASSOCIATION)

RUA PRUDENTE DE MORAES, 530  
BOTUCATU / SP, BRAZIL 18602-060

FOR: PRESERVED, DRIED AND COOKED FRUIT AND VEGETABLES; JELLIES AND JAMS; COMPOTES; EDIBLE OILS AND FATS; SUGAR; HONEY; ESSENTIAL OILS , IN CLASS A (U.S. CL. A).

FIRST USE 12-0-2009; IN COMMERCE 12-0-2009.

NO CLAIM IS MADE TO THE EXCLUSIVE RIGHT TO USE "ECOSOCIAL CERTIFIED", APART FROM THE MARK AS SHOWN.

THE COLOR(S) GREEN AND WHITE IS/ARE CLAIMED AS A FEATURE OF THE MARK.

THE MARK CONSISTS OF GREEN BACKGROUND WITH WHITE STYLIZED HAND AND FOREARM AND WHITE TEXT "ECOSOCIAL CERTIFIED IBD".

THE CERTIFICATION MARK, AS INTENDED TO BE USED BY AUTHORIZED PERSONS, IS INTENDED TO CERTIFY THAT THE GOODS ARE PRODUCED AND TRADED IN ACCORDANCE WITH SPECIFIC STANDARDS REGARDING ENVIRONMENTAL CONSERVATION, FAIR LABOR PRACTICES AND FAIR TRADE.

SN 77-450,300, FILED 4-16-2008.

SUSAN STIGLITZ, EXAMINING ATTORNEY



*David J. Kyjars*

Director of the United States Patent and Trademark Office

# United States of America

United States Patent and Trademark Office

FREQUE  
FREQUENCY  
Apparel

**Reg. No. 4,275,997**

CARR, DUKE (UNITED STATES INDIVIDUAL)  
137 BOYD STREET  
STATEN ISLAND, NY 10304

**Registered Jan. 15, 2013**

**Int. Cl.: 25**

FOR: BEANIES; BOTTOMS; HATS; HOODED SWEAT SHIRTS; T-SHIRTS; TANK TOPS;  
TOPS, IN CLASS 25 (U.S. CLS. 22 AND 39).

**TRADEMARK**

FIRST USE 9-10-2004; IN COMMERCE 5-14-2009.

**PRINCIPAL REGISTER**

NO CLAIM IS MADE TO THE EXCLUSIVE RIGHT TO USE "APPAREL", APART FROM  
THE MARK AS SHOWN.

THE MARK CONSISTS OF "FREQUE FREQUENCY APPAREL".

SN 77-516,693, FILED 7-8-2008.

CURTIS FRENCH, EXAMINING ATTORNEY



*David J. Kybas*

Director of the United States Patent and Trademark Office

# United States of America

United States Patent and Trademark Office



**Reg. No. 4,275,998**

**Registered Jan. 15, 2013**

**Int. Cls.: 35 and 36**

ATOMICO INVESTMENT HOLDINGS LIMITED (BR. VIRGIN ISLANDS LIMITED COMPANY (LTD.))  
333 WATERFRONT DRIVE, ROAD TOWN  
GENEVA PLACE 2ND FLOOR  
TORTOLA, BR. VIRGIN ISLANDS

**SERVICE MARK**

**PRINCIPAL REGISTER**

FOR: BUSINESS MANAGEMENT SERVICES; BUSINESS MANAGEMENT CONSULTANCY SERVICES; BUSINESS ADMINISTRATION CONSULTANCY; BUSINESS OFFICE FUNCTIONS; ADVICE RELATING TO THE ORGANISATION AND MANAGEMENT OF BUSINESS; ADMINISTRATION OF BUSINESS AFFAIRS, NAMELY, HELP IN THE MANAGEMENT OF BUSINESS AFFAIRS OR COMMERCIAL FUNCTIONS OF AN INDUSTRIAL OR COMMERCIAL ENTERPRISE; ADVISORY SERVICES RELATING TO BUSINESS MANAGEMENT AND ORGANISATION; ADVISORY SERVICES RELATING TO THE ACQUISITION OF BUSINESSES; BUSINESS ADVICE; BUSINESS ASSISTANCE RELATING TO THE FORMATION OF COMMERCIAL UNDERTAKINGS; BUSINESS CONSULTING AND INFORMATION SERVICES; BUSINESS RESEARCH SERVICES; BUSINESS INFORMATION, ADVISORY AND CONSULTANCY SERVICES, ALL RELATING TO THE AFORESAID SERVICES, IN CLASS 35 (U.S. CLS. 100, 101 AND 102).

FIRST USE 6-0-2006; IN COMMERCE 6-0-2006.



*David J. Kyffers*

Director of the United States Patent and Trademark Office

FOR: FINANCIAL SERVICES, NAMELY, INVESTMENT AND FINANCING SERVICES; FINANCIAL ANALYSIS AND RESEARCH SERVICES; CORPORATE FINANCE SERVICES, NAMELY, CONSULTATION IN THE FIELDS OF ASSET SALES AND CAPITAL STRUCTURE; FINANCIAL SERVICES, NAMELY, ASSISTING OTHERS WITH THE COMPLETION OF FINANCIAL TRANSACTIONS FOR STOCKS, BONDS, SECURITIES AND EQUITIES; CAPITAL INVESTMENT SERVICES; FINANCIAL ADVICE; VENTURE CAPITAL SERVICES; VENTURE CAPITAL MANAGEMENT SERVICES; VENTURE CAPITAL FUND MANAGEMENT; VENTURE CAPITAL FUNDING SERVICES TO EMERGING AND START-UP COMPANIES; VENTURE CAPITAL SERVICES, NAMELY, PROVIDING FINANCING TO START-UP AND EMERGING COMPANIES; INVESTMENT MANAGEMENT SERVICES IN THE FIELD OF ACQUIRING JOINT VENTURES; PROVIDING WORKING CAPITAL FINANCING TO SMALL BUSINESSES AND SMALL BUSINESS OWNERS; ADMINISTRATION OF FINANCIAL AFFAIRS, NAMELY, ADMINISTRATION OF TRANSACTIONS INVOLVING FUNDS DRAWN FROM SECURITIES, STOCKS, FUNDS, EQUITIES, BONDS, CASH, OR OTHER TYPES OF FINANCIAL INVESTMENTS IN RETIREMENT PLANS; FINANCIAL CONSULTING SERVICES; FINANCIAL ADVISORY AND CONSULTANCY SERVICES;

**Reg. No. 4,275,998** INFORMATION, ADVISORY AND CONSULTANCY SERVICES, ALL RELATING TO THE AFORESAID SERVICES; ASSET MANAGEMENT SERVICES, INVESTMENT MANAGEMENT SERVICES AND INVESTMENT ADVISORY SERVICES; PRIVATE EQUITY FUND SERVICES; OPERATION AND MANAGEMENT OF INVESTMENT FUNDS; FINANCIAL INVESTMENT SERVICES IN THE FIELD OF VENTURE CAPITAL, PRIVATE EQUITY FUNDS; FINANCIAL ANALYSIS, RESEARCH MANAGEMENT AND CONSULTATION IN CONNECTION THEREWITH; FINANCIAL INVESTMENT SERVICES IN THE FIELD OF DERIVATIVES, INVESTMENT BANKING AND FUNDS, IN CLASS 36 (U.S. CLS. 100, 101 AND 102).

FIRST USE 6-0-2006; IN COMMERCE 6-0-2006.

THE MARK CONSISTS OF A SERIES OF CONCENTRIC CIRCLES AND A DOT WITHIN THE OUTER MOST CIRCLE.

SN 77-552,567, FILED 8-21-2008.

EDWARD NELSON, EXAMINING ATTORNEY

# United States of America

United States Patent and Trademark Office



**Reg. No. 4,275,999**

GSC TECHNOLOGIES CORPORATION (CANADA CORPORATION)  
160 VANIER STREET  
ST. JEAN, CANADA J3B3R4

**Registered Jan. 15, 2013**

**Int. Cl.: 12**

FOR: CANOES, PEDAL BOATS, KAYAKS AND ACCESSORIES THEREOF, NAMELY, PADDLES, WATER DEFLECTING SKIRTS, CARTOP CARRIER KITS, SEAT CUSHIONS AND BACK RESTS, THIGH BRACES SPECIALLY ADAPTED FOR INSTALLATION IN KAYAKS OR CANOES, IN CLASS 12 (U.S. CLS. 19, 21, 23, 31, 35 AND 44).

**TRADEMARK**

**PRINCIPAL REGISTER**

FIRST USE 6-11-2012; IN COMMERCE 6-11-2012.

OWNER OF U.S. REG. NOS. 3,610,017 AND 3,610,033.

NO CLAIM IS MADE TO THE EXCLUSIVE RIGHT TO USE "SPORT", APART FROM THE MARK AS SHOWN.

THE MARK CONSISTS OF A CROSS WITHIN AN OCTAGON PRECEDING THE WORDS "SWISS SPORT" ALL OF WHICH ARE ENCIRCLED BY A LONG OVAL.

SN 77-571,410, FILED 9-16-2008.

ELIZABETH KAJUBI, EXAMINING ATTORNEY



*David J. Kybas*

Director of the United States Patent and Trademark Office

# United States of America

United States Patent and Trademark Office

# YOTAGS

**Reg. No. 4,276,000**

YOTAGS, INC. (CALIFORNIA CORPORATION)  
25 CHERRY STREET  
DENVER, CO 80220

**Registered Jan. 15, 2013**

**Int. Cl.: 45**

FOR: PROVIDING A WEBSITE THAT GIVES USERS THE ABILITY TO LIST FOUND ITEMS,  
IN CLASS 45 (U.S. CLS. 100 AND 101).

**SERVICE MARK**

FIRST USE 12-1-2012; IN COMMERCE 12-1-2012.

**PRINCIPAL REGISTER**

THE MARK CONSISTS OF STANDARD CHARACTERS WITHOUT CLAIM TO ANY PAR-  
TICULAR FONT, STYLE, SIZE, OR COLOR.

SN 77-573,878, FILED 9-18-2008.

MARLENE BELL, EXAMINING ATTORNEY



*David J. Kybas*

Director of the United States Patent and Trademark Office

# United States of America

United States Patent and Trademark Office

## THE SOUND OF CHANGE

**Reg. No. 4,276,001**

**Registered Jan. 15, 2013**

**Int. Cl.: 28**

**TRADEMARK**

**PRINCIPAL REGISTER**

RHYTHM HOLDING LIMITED (SAMOA CORPORATION)  
3 CONNAUGHT ROAD WEST  
UNIT 7B, 7/F, YARLEY COMMERCIAL BUILDING  
HONG KONG, HONG KONG

FOR: SPORTING GOODS AND PARTS, FITTINGS AND ACCESSORIES FOR THE FOREGOING GOODS, NAMELY, SNOWBOARDS, IN CLASS 28 (U.S. CLS. 22, 23, 38 AND 50).

FIRST USE 9-27-2012; IN COMMERCE 9-27-2012.

THE MARK CONSISTS OF STANDARD CHARACTERS WITHOUT CLAIM TO ANY PARTICULAR FONT, STYLE, SIZE, OR COLOR.

SN 77-587,053, FILED 10-7-2008.

MARTHA FROMM, EXAMINING ATTORNEY



*David J. Kybas*

Director of the United States Patent and Trademark Office



# United States of America

United States Patent and Trademark Office



**Reg. No. 4,276,002**

**Registered Jan. 15, 2013**

**Int. Cls.: 3 and 5**

**TRADEMARK**

**PRINCIPAL REGISTER**

FIRST QUALITY PRODUCTS, INC. (NEW YORK CORPORATION)  
80 CUTTERMILL ROAD, SUITE 500  
GREAT NECK, NY 11021

FOR: PRE-MOISTENED NON-MEDICATED HYGIENIC CLEANSING WIPES, IN CLASS 3  
(U.S. CLS. 1, 4, 6, 50, 51 AND 52).

FIRST USE 2-29-2012; IN COMMERCE 2-29-2012.

FOR: ADULT INCONTINENCE PRODUCTS, NAMELY, PROTECTIVE UNDERWEAR, IN-  
CONTINENCE BLADDER CONTROL PADS, IN CLASS 5 (U.S. CLS. 6, 18, 44, 46, 51 AND  
52).

FIRST USE 1-31-2012; IN COMMERCE 1-31-2012.

THE GREY IN THE MARK IS FOR SHADING PURPOSES ONLY.

THE MARK CONSISTS OF A STYLIZED CIRCLE.

SN 77-587,183, FILED 10-7-2008.

KATHERINE STOIDES, EXAMINING ATTORNEY



*David J. Kybas*

Director of the United States Patent and Trademark Office

# United States of America

United States Patent and Trademark Office

# HOMEWISSE

**Reg. No. 4,276,003**

**Registered Jan. 15, 2013**

**Int. Cl.: 6**

**TRADEMARK**

**PRINCIPAL REGISTER**

LUX PRODUCTS CORPORATION (DELAWARE CORPORATION)  
SUITE I  
6000 COMMERCE PARKWAY  
MT. LAUREL, NJ 08054

FOR: METAL GRAB BARS FOR USE IN BATHTUBS AND SHOWERS, IN CLASS 6 (U.S. CLS. 2, 12, 13, 14, 23, 25 AND 50).

FIRST USE 9-21-2012; IN COMMERCE 9-21-2012.

THE MARK CONSISTS OF STANDARD CHARACTERS WITHOUT CLAIM TO ANY PARTICULAR FONT, STYLE, SIZE, OR COLOR.

SN 77-590,363, FILED 10-10-2008.

BARNEY CHARLON, EXAMINING ATTORNEY



*David J. Kyffers*

Director of the United States Patent and Trademark Office

# United States of America

United States Patent and Trademark Office



**Reg. No. 4,276,004**

**Registered Jan. 15, 2013**

**Int. Cl.: 42**

**SERVICE MARK**

**PRINCIPAL REGISTER**

XEL PHARMACEUTICALS, INC. (DELAWARE CORPORATION)  
12382 SOUTH GATEWAY PARK PLACE, STE B800  
DRAPER, UT 84020

FOR: RESEARCH AND DEVELOPMENT OF DRUG DELIVERY SYSTEMS, IN CLASS 42  
(U.S. CLS. 100 AND 101).

FIRST USE 1-1-2008; IN COMMERCE 6-1-2008.

OWNER OF U.S. REG. NOS. 2,845,260, 2,860,543, AND 2,970,981.

NO CLAIM IS MADE TO THE EXCLUSIVE RIGHT TO USE "PHARMACEUTICALS", APART  
FROM THE MARK AS SHOWN.

THE MARK CONSISTS OF A LEAF DESIGN AND THE WORDING "XEL PHARMACEUTIC-  
ALS" WHERE THE "X" APPEARS INSIDE THE LEAF AND THE "EL" APPEARS TO THE  
RIGHT OF THE LEAF AND THE LETTERS "PHARM" APPEAR INSIDE THE LEAF AND  
THE LETTERS "ACEUTICALS" APPEARS TO THE RIGHT OF THE LEAF.

SN 77-604,461, FILED 10-30-2008.

KATHLEEN LORENZO, EXAMINING ATTORNEY



*David J. Kyjars*

Director of the United States Patent and Trademark Office

# United States of America

United States Patent and Trademark Office

## SPECTROPHONIC SOUND

**Reg. No. 4,276,005**

**Registered Jan. 15, 2013**

**Int. Cl.: 41**

**SERVICE MARK**

**PRINCIPAL REGISTER**

SQUEAK E. CLEAN PRODUCTIONS, INC. (CALIFORNIA CORPORATION)  
C/O HABER CORPORATION  
16830 VENTURA BLVD., SUITE 501  
ENCINO, CA 91436

FOR: RECORD PRODUCTION SERVICES, IN CLASS 41 (U.S. CLS. 100, 101 AND 107).

FIRST USE 6-29-2010; IN COMMERCE 6-29-2010.

THE MARK CONSISTS OF STANDARD CHARACTERS WITHOUT CLAIM TO ANY PARTICULAR FONT, STYLE, SIZE, OR COLOR.

NO CLAIM IS MADE TO THE EXCLUSIVE RIGHT TO USE "SOUND", APART FROM THE MARK AS SHOWN.

SN 77-610,984, FILED 11-10-2008.

COLLEEN DOMBROW, EXAMINING ATTORNEY



*David J. Kyjars*

Director of the United States Patent and Trademark Office

# United States of America

United States Patent and Trademark Office

## CHERRY CHIP BA DA BING

**Reg. No. 4,276,006**

**Registered Jan. 15, 2013**

**Int. Cl.: 30**

**TRADEMARK**

**PRINCIPAL REGISTER**

INDULGE, INC. (CANADA CORPORATION)  
210 SHIELDS COURT  
MARKHAM, ONTARIO, CANADA L3R8V2

FOR: ICE CREAM, IN CLASS 30 (U.S. CL. 46).

FIRST USE 11-30-2012; IN COMMERCE 11-30-2012.

THE MARK CONSISTS OF STANDARD CHARACTERS WITHOUT CLAIM TO ANY PARTICULAR FONT, STYLE, SIZE, OR COLOR.

NO CLAIM IS MADE TO THE EXCLUSIVE RIGHT TO USE "CHERRY CHIP", APART FROM THE MARK AS SHOWN.

SN 77-613,870, FILED 11-13-2008.

KELLY BOULTON, EXAMINING ATTORNEY



*David J. Kybas*

Director of the United States Patent and Trademark Office

# United States of America

United States Patent and Trademark Office



**Reg. No. 4,276,007**

**Registered Jan. 15, 2013**

**Int. Cl.: 25**

**TRADEMARK**

**PRINCIPAL REGISTER**

THE BOARD OF REGENTS OF THE UNIVERSITY OF TEXAS SYSTEM (TEXAS STATE AGENCY)  
201 WEST 7TH STREET  
AUSTIN, TX 78701 AND

TEXAS A&M UNIVERSITY (TEXAS INSTITUTION OF HIGHER EDUCATION)  
TEXAS A & M SYSTEM BUILDING, SUITE 2079  
200 TECHNOLOGY WAY  
COLLEGE STATION, TX 77840

FOR: CLOTHING, NAMELY, SHIRTS, IN CLASS 25 (U.S. CLS. 22 AND 39).

FIRST USE 11-25-2010; IN COMMERCE 11-25-2010.

OWNER OF U.S. REG. NOS. 3,675,572 AND 4,176,106.

SEC. 2(F) AS TO "LONE STAR".

NO CLAIM IS MADE TO THE EXCLUSIVE RIGHT TO USE "THE DESIGN OF THE STATE OF TEXAS", APART FROM THE MARK AS SHOWN.

THE MARK CONSISTS OF STYLIZED STAR BACKGROUND WITH THE WORDS "LONE STAR SHOWDOWN, ATM" AND THE ABBREVIATION FOR (VERSUS) "VS" AND AN OUTLINE OF THE STATE OF TEXAS AND A LONGHORN STEER HEAD SUPERIMPOSED.

SN 77-615,575, FILED 11-17-2008.

ESTHER BELENKER, EXAMINING ATTORNEY



*David J. Kyffers*

Director of the United States Patent and Trademark Office

# United States of America

United States Patent and Trademark Office

## TOUCHPOINT TV

**Reg. No. 4,276,008**

MSW RESEARCH, INC. (NEW YORK CORPORATION)  
1111 MARCHUS AVENUE  
NEW HYDE PARK, NY 11042

**Registered Jan. 15, 2013**

**Int. Cl.: 35**

FOR: MARKETING SERVICES, NAMELY, CONSUMER MARKETING RESEARCH AND CONDUCTING PUBLIC OPINION SURVEYS, IN CLASS 35 (U.S. CLS. 100, 101 AND 102).

**SERVICE MARK**

FIRST USE 10-23-2012; IN COMMERCE 10-23-2012.

**PRINCIPAL REGISTER**

THE MARK CONSISTS OF STANDARD CHARACTERS WITHOUT CLAIM TO ANY PARTICULAR FONT, STYLE, SIZE, OR COLOR.

NO CLAIM IS MADE TO THE EXCLUSIVE RIGHT TO USE "TV", APART FROM THE MARK AS SHOWN.

SN 77-631,501, FILED 12-11-2008.

JAMES MACFARLANE, EXAMINING ATTORNEY



*David J. Kyffers*

Director of the United States Patent and Trademark Office

# United States of America

United States Patent and Trademark Office

## TOUCHPOINT PRINT

**Reg. No. 4,276,009**

MSW RESEARCH, INC. (NEW YORK CORPORATION)  
1111 MARCHUS AVENUE  
NEW HYDE PARK, NY 11042

**Registered Jan. 15, 2013**

**Int. Cl.: 35**

FOR: MARKETING SERVICES, NAMELY, CONSUMER MARKETING RESEARCH AND CONDUCTING PUBLIC OPINION SURVEYS, IN CLASS 35 (U.S. CLS. 100, 101 AND 102).

**SERVICE MARK**

FIRST USE 10-23-2012; IN COMMERCE 10-23-2012.

**PRINCIPAL REGISTER**

THE MARK CONSISTS OF STANDARD CHARACTERS WITHOUT CLAIM TO ANY PARTICULAR FONT, STYLE, SIZE, OR COLOR.

NO CLAIM IS MADE TO THE EXCLUSIVE RIGHT TO USE "PRINT", APART FROM THE MARK AS SHOWN.

SN 77-631,506, FILED 12-11-2008.

JAMES MACFARLANE, EXAMINING ATTORNEY



*David J. Kyffers*

Director of the United States Patent and Trademark Office



# United States of America

United States Patent and Trademark Office



**Reg. No. 4,276,010**

THE CHANG GROUP, INC. (FLORIDA CORPORATION)  
13375 MCGREGOR BLVD.  
FORT MYERS, FL 33919

**Registered Jan. 15, 2013**

**Int. Cls.: 35 and 36**

FOR: REAL ESTATE MARKETING SERVICES IN THE FIELD OF SINGLE FAMILY HOUSES, IN CLASS 35 (U.S. CLS. 100, 101 AND 102).

**SERVICE MARK**

FIRST USE 5-25-2011; IN COMMERCE 5-25-2011.

**PRINCIPAL REGISTER**

FOR: HOUSING SERVICES, NAMELY, REAL PROPERTY ACQUISITION AND CONSUMER FINANCING TO FACILITATE HOME OWNERSHIP; RENTAL OF HOMES, IN CLASS 36 (U.S. CLS. 100, 101 AND 102).

FIRST USE 11-12-2008; IN COMMERCE 11-12-2008.

NO CLAIM IS MADE TO THE EXCLUSIVE RIGHT TO USE "HOMES", APART FROM THE MARK AS SHOWN.

THE COLOR(S) LIGHT BLUE, DARK BLUE, YELLOW, BLACK AND GREEN IS/ARE CLAIMED AS A FEATURE OF THE MARK.

THE MARK CONSISTS OF A CIRCLE OUTLINED IN BLACK WITH THE TOP PORTION OF THE CIRCLE IN YELLOW AND THE BOTTOM PORTION IN LIGHT BLUE. PALE BLUE CURVED LINES EMANATE FROM LEFT OF THE CIRCLE AND DARK BLUE CURVED LINES EMANATE FROM THE RIGHT PORTION OF THE CIRCLE AND TOUCH A DARK BLUE HOUSE. THE LANGUAGE "FRESH START", IN THE COLOR GREEN, APPEARS ON TOP OF THE CIRCLE AND CURVED LINES. THE TERM "HOMES" APPEARS TO THE BOTTOM RIGHT OF THE DRAWING AND IS IN THE COLORS DARK BLUE NEAR THE TOP OF EACH LETTER AND LIGHT BLUE NEAR THE BOTTOM OF EACH LETTER.

SN 77-640,926, FILED 12-29-2008.

LAURIE MAYES, EXAMINING ATTORNEY



*David J. Kyros*

Director of the United States Patent and Trademark Office

# United States of America

United States Patent and Trademark Office

# SUPERFLUFF

**Reg. No. 4,276,011**

PACIFIC COAST FEATHER COMPANY (WASHINGTON CORPORATION)  
P.O. BOX 80385  
SEATTLE, WA 98108

**Registered Jan. 15, 2013**

**Int. Cls.: 20 and 24**

FOR: PILLOWS, IN CLASS 20 (U.S. CLS. 2, 13, 22, 25, 32 AND 50).

**TRADEMARK**

FIRST USE 1-1-2011; IN COMMERCE 1-1-2011.

**PRINCIPAL REGISTER**

FOR: COMFORTERS AND FEATHERBEDS , IN CLASS 24 (U.S. CLS. 42 AND 50).

FIRST USE 10-1-2010; IN COMMERCE 10-1-2010.

THE MARK CONSISTS OF STANDARD CHARACTERS WITHOUT CLAIM TO ANY PARTICULAR FONT, STYLE, SIZE, OR COLOR.

SN 77-645,906, FILED 1-8-2009.

JUDITH HELFMAN, EXAMINING ATTORNEY



*David J. Kybas*

Director of the United States Patent and Trademark Office

# United States of America

United States Patent and Trademark Office

## LOVE AMERICA

**Reg. No. 4,276,012**

ANDERSON, MICHAEL B (UNITED STATES INDIVIDUAL)  
1841 SOUTH SHERMAN STREET  
DENVER, CO 80210

**Registered Jan. 15, 2013**

**Int. Cl.: 25**

FOR: BASEBALL CAPS; SHORT-SLEEVED OR LONG-SLEEVED T-SHIRTS; T-SHIRTS, IN CLASS 25 (U.S. CLS. 22 AND 39).

**TRADEMARK**

FIRST USE 6-10-2011; IN COMMERCE 6-10-2011.

**PRINCIPAL REGISTER**

THE MARK CONSISTS OF STANDARD CHARACTERS WITHOUT CLAIM TO ANY PARTICULAR FONT, STYLE, SIZE, OR COLOR.

NO CLAIM IS MADE TO THE EXCLUSIVE RIGHT TO USE "AMERICA", APART FROM THE MARK AS SHOWN.

SN 77-656,142, FILED 1-25-2009.

RON FAIRBANKS, EXAMINING ATTORNEY



*David J. Kyffers*

Director of the United States Patent and Trademark Office

# United States of America

United States Patent and Trademark Office

# FLASHCUBE

**Reg. No. 4,276,013**

GRIDIRON SYSTEMS, INC. (DELAWARE CORPORATION)

**Registered Jan. 15, 2013**

726 PALOMAR AVENUE  
SUNNYVALE, CA 94085

**Int. Cl.: 9**

FOR: COMPUTER HARDWARE AND SOFTWARE, NAMELY, FOR MANAGING ACCESS TO DISK DRIVES AND DATA STORAGE DEVICES; AND DATA STORAGE DEVICES, NAMELY, HARD DRIVES, FLASH DRIVES, AND NETWORK CACHING MEMORY, IN CLASS 9 (U.S. CLS. 21, 23, 26, 36 AND 38).

**TRADEMARK**

**PRINCIPAL REGISTER**

FIRST USE 4-22-2012; IN COMMERCE 8-13-2012.

THE MARK CONSISTS OF STANDARD CHARACTERS WITHOUT CLAIM TO ANY PARTICULAR FONT, STYLE, SIZE, OR COLOR.

SN 77-658,830, FILED 1-28-2009.

JORDAN BAKER, EXAMINING ATTORNEY



*David J. Kyffers*

Director of the United States Patent and Trademark Office

# United States of America

United States Patent and Trademark Office

## novaflux technologies

**Reg. No. 4,276,014**

NOVAFLUX TECHNOLOGIES (NEW JERSEY CORPORATION)  
1 WALL STREET  
PRINCETON, NJ 08540

**Registered Jan. 15, 2013**

**Int. Cl.: 10**

FOR: STERILIZATION UNITS FOR MEDICAL PURPOSES, IN CLASS 10 (U.S. CLS. 26, 39 AND 44).

**TRADEMARK**

FIRST USE 9-15-2011; IN COMMERCE 3-18-2012.

**PRINCIPAL REGISTER**

THE MARK CONSISTS OF STANDARD CHARACTERS WITHOUT CLAIM TO ANY PARTICULAR FONT, STYLE, SIZE, OR COLOR.

NO CLAIM IS MADE TO THE EXCLUSIVE RIGHT TO USE "TECHNOLOGIES", APART FROM THE MARK AS SHOWN.

SN 77-668,199, FILED 2-11-2009.

KEVIN CORWIN, EXAMINING ATTORNEY



*David J. Kyffers*

Director of the United States Patent and Trademark Office

# United States of America

United States Patent and Trademark Office

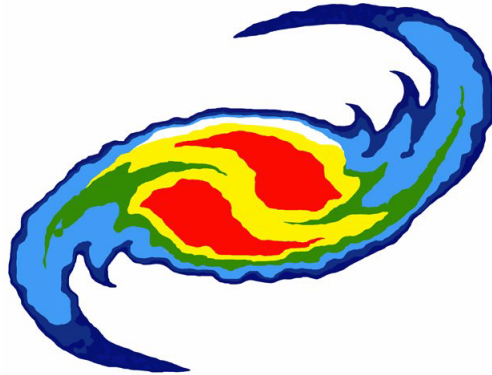

**Reg. No. 4,276,015**

**Registered Jan. 15, 2013**

**Int. Cl.: 10**

**TRADEMARK**

**PRINCIPAL REGISTER**

NOVAFLUX TECHNOLOGIES (NEW JERSEY CORPORATION)  
1 WALL STREET  
PRINCETON, NJ 08540

FOR: STERILIZATION UNITS FOR MEDICAL PURPOSES, IN CLASS 10 (U.S. CLS. 26, 39 AND 44).

FIRST USE 9-15-2011; IN COMMERCE 3-18-2012.

THE MARK CONSISTS OF A VORTEX SHAPED STORM SYSTEM LOGO WITH TWO VARIATIONS OF BLUE ON THE OUTER SIDES WITH AN INNER COMBINATION OF GREEN, YELLOW, WHITE AND TWO RED CENTERS ALL FLOWING WITH AND INTO EACH OTHER.

THE COLOR(S) BLUE, GREEN, YELLOW, RED, WHITE IS/ARE CLAIMED AS A FEATURE OF THE MARK.

SN 77-668,267, FILED 2-11-2009.

KEVIN CORWIN, EXAMINING ATTORNEY



*David J. Kybas*

Director of the United States Patent and Trademark Office

# United States of America

United States Patent and Trademark Office

# LSVT

**Reg. No. 4,276,016**

**Registered Jan. 15, 2013**

**Int. Cls.: 9, 41, and 44**

**TRADEMARK**

**SERVICE MARK**

**PRINCIPAL REGISTER**

LSVT GLOBAL, INC. (COLORADO CORPORATION)  
6890 E. SUNRISE DR.  
SUITE 120, #241  
TUCSON, AZ 85750

FOR: DIGITAL MEDIA, NAMELY, PRE-RECORDED DVDS AND VIDEO TAPES FEATURING STRETCHES AND EXERCISES , IN CLASS 9 (U.S. CLS. 21, 23, 26, 36 AND 38).

FIRST USE 0-0-2008; IN COMMERCE 0-0-2008.

FOR: PROVIDING A WEBSITE FEATURING NON-DOWNLOADABLE INSTRUCTIONAL VIDEOS IN THE FIELD OF SPEECH, PHYSICAL AND OCCUPATIONAL THERAPY, IN CLASS 41 (U.S. CLS. 100, 101 AND 107).

FIRST USE 0-0-2008; IN COMMERCE 0-0-2008.

FOR: PHYSICAL AND OCCUPATIONAL THERAPY SERVICES, IN CLASS 44 (U.S. CLS. 100 AND 101).

FIRST USE 0-0-2007; IN COMMERCE 0-0-2007.

THE MARK CONSISTS OF STANDARD CHARACTERS WITHOUT CLAIM TO ANY PARTICULAR FONT, STYLE, SIZE, OR COLOR.

SN 77-674,181, FILED 2-19-2009.

JESSICA A. POWERS, EXAMINING ATTORNEY



*David J. Kybas*

Director of the United States Patent and Trademark Office

# United States of America

United States Patent and Trademark Office

## ENRICHING THE LIVES OF ENTREPRENEURS

**Reg. No. 4,276,017**

CCA GLOBAL PARTNERS, INC. (DELAWARE CORPORATION)  
4301 EARTH CITY EXPRESSWAY  
EARTH CITY, MO 63045

**Registered Jan. 15, 2013**

**Int. Cls.: 35, 41, and 42**

FOR: PROVIDING BUSINESS MANAGEMENT CONSULTATION SERVICES TO AFFILIATE MEMBERS, NAMELY, CONSULTATION IN THE FIELD OF COST MANAGEMENT, CUSTOMER SERVICE, AND SELECTING PRODUCTS FOR WHOLESALE AND RETAIL CARPET AND FLOORING STORES, IN CLASS 35 (U.S. CLS. 100, 101 AND 102).

**SERVICE MARK**

**PRINCIPAL REGISTER**

FIRST USE 2-29-2012; IN COMMERCE 2-29-2012.

FOR: EDUCATIONAL SERVICES, NAMELY, PROVIDING CLASSES, SEMINARS IN THE FIELD OF OPENING AND OPERATING RETAIL CARPET AND FLOORING STORES, IN CLASS 41 (U.S. CLS. 100, 101 AND 107).

FIRST USE 2-29-2012; IN COMMERCE 2-29-2012.

FOR: CONSULTATION PROVIDED TO BUSINESSES IN THE FIELD OF INTERIOR STORE AND FIXTURE DESIGN AND LAYOUT OF PRODUCTS FOR WHOLESALE AND RETAIL CARPET AND FLOORING STORES, IN CLASS 42 (U.S. CLS. 100 AND 101).

FIRST USE 2-29-2012; IN COMMERCE 2-29-2012.

THE MARK CONSISTS OF STANDARD CHARACTERS WITHOUT CLAIM TO ANY PARTICULAR FONT, STYLE, SIZE, OR COLOR.

NO CLAIM IS MADE TO THE EXCLUSIVE RIGHT TO USE "ENTREPRENEURS", APART FROM THE MARK AS SHOWN.

SN 77-676,234, FILED 2-23-2009.

MARY CRAWFORD, EXAMINING ATTORNEY



*David J. Kyffers*

Director of the United States Patent and Trademark Office



# United States of America

United States Patent and Trademark Office

# INTELLISKIN

**Reg. No. 4,276,018**

**Registered Jan. 15, 2013**

**Int. Cl.: 25**

**TRADEMARK**

**PRINCIPAL REGISTER**

INTELLISKIN USA, LLC (CALIFORNIA LIMITED LIABILITY COMPANY)  
20162 SW BIRCH STREET, SUITE 125  
NEWPORT BEACH, CA 926600787

FOR: WOMEN'S BRAS, IN CLASS 25 (U.S. CLS. 22 AND 39).

FIRST USE 9-20-2011; IN COMMERCE 9-20-2011.

THE MARK CONSISTS OF STANDARD CHARACTERS WITHOUT CLAIM TO ANY PARTICULAR FONT, STYLE, SIZE, OR COLOR.

SN 77-676,443, FILED 2-23-2009.

ANDREW LEASER, EXAMINING ATTORNEY



*David J. Kyffers*

Director of the United States Patent and Trademark Office

# United States of America

United States Patent and Trademark Office

## HASBRO STUDIOS

**Reg. No. 4,276,019**

**Registered Jan. 15, 2013**

**Int. Cl.: 41**

**SERVICE MARK**

**PRINCIPAL REGISTER**

HASBRO, INC. (RHODE ISLAND CORPORATION)  
1027 NEWPORT AVENUE  
PAWTUCKET, RI 02862

FOR: ENTERTAINMENT SERVICES, NAMELY, PRODUCTION AND DISTRIBUTION OF TELEVISION SHOWS, MOVIES AND GAME SHOWS, IN CLASS 41 (U.S. CLS. 100, 101 AND 107).

FIRST USE 8-4-2009; IN COMMERCE 8-4-2009.

THE MARK CONSISTS OF STANDARD CHARACTERS WITHOUT CLAIM TO ANY PARTICULAR FONT, STYLE, SIZE, OR COLOR.

OWNER OF U.S. REG. NOS. 742,643, 3,043,737, AND OTHERS.

NO CLAIM IS MADE TO THE EXCLUSIVE RIGHT TO USE "STUDIOS", APART FROM THE MARK AS SHOWN.

SN 77-676,824, FILED 2-24-2009.

LINDA MICKLEBURGH, EXAMINING ATTORNEY



*David J. Kyffers*

Director of the United States Patent and Trademark Office

# United States of America

United States Patent and Trademark Office



**Reg. No. 4,276,020**

**Registered Jan. 15, 2013**

**Int. Cl.: 35**

**SERVICE MARK**

**PRINCIPAL REGISTER**

LED SOURCE, LLC (FLORIDA LIMITED LIABILITY COMPANY)  
SUITE 4  
3101 FAIRLANE FARMS ROAD  
WELLINGTON, FL 33414

FOR: DISTRIBUTORSHIPS IN THE FIELD OF LED LIGHTING FIXTURES AND LED LIGHTING SYSTEMS; ON-LINE RETAIL STORE SERVICES FEATURING LED LIGHTING FIXTURES AND LED LIGHTING SYSTEMS, IN CLASS 35 (U.S. CLS. 100, 101 AND 102).

FIRST USE 11-16-2012; IN COMMERCE 11-16-2012.

NO CLAIM IS MADE TO THE EXCLUSIVE RIGHT TO USE "LED SALES.COM", APART FROM THE MARK AS SHOWN.

THE MARK CONSISTS OF A LOGO WITH A LARGE BALL SYMBOLIZING A GREENER PLANET ENCOMPASSING A SMALLER BALL. THE TERM "LED" IS SUPERIMPOSED ON THE LARGE BALL. TO THE RIGHT OF THE LARGE BALL IS THE WORDING ".COM" AND "SALES".

SN 77-677,582, FILED 2-24-2009.

KIM MONINGHOFF, EXAMINING ATTORNEY



*David J. Kyffers*

Director of the United States Patent and Trademark Office

# United States of America

United States Patent and Trademark Office

# GREENSMART

**Reg. No. 4,276,021**

**Registered Jan. 15, 2013**

**Int. Cls.: 10 and 21**

**TRADEMARK**

**PRINCIPAL REGISTER**

MEDLINE INDUSTRIES, INC. (ILLINOIS CORPORATION)  
ONE MEDLINE PLACE  
MUNDELEIN, IL 60060

FOR: OPERATING ROOM TOWELS FOR MEDICAL AND SURGICAL USE, MEDICAL GOWNS, MEDICAL TRAYS FOR HOLDING MEDICAL AND SURGICAL INSTRUMENTS, IN CLASS 10 (U.S. CLS. 26, 39 AND 44).

FIRST USE 6-10-2010; IN COMMERCE 6-10-2010.

FOR: PLASTIC CONTAINERS, NAMELY, BASINS, IN CLASS 21 (U.S. CLS. 2, 13, 23, 29, 30, 33, 40 AND 50).

FIRST USE 11-2-2011; IN COMMERCE 11-2-2011.

THE MARK CONSISTS OF STANDARD CHARACTERS WITHOUT CLAIM TO ANY PARTICULAR FONT, STYLE, SIZE, OR COLOR.

SN 77-682,530, FILED 3-3-2009.

LESLEY LAMOTHE, EXAMINING ATTORNEY



*David J. Kyfos*

Director of the United States Patent and Trademark Office

# United States of America

United States Patent and Trademark Office

## SENECA VALLEY RAIDERS

**Reg. No. 4,276,022**

**Registered Jan. 15, 2013**

**Int. Cl.: 25**

**TRADEMARK**

**PRINCIPAL REGISTER**

SENECA VALLEY SCHOOL DISTRICT (PENNSYLVANIA MUNICIPAL CORPORATION)  
124 SENECA SCHOOL ROAD  
HARMONY, PA 16037

FOR: PAJAMAS; PANTS; SHIRTS; SLEEPWEAR; SWEAT SHIRTS; TOPS; ALL USED IN CONNECTION WITH ELEMENTARY MIDDLE SCHOOL AND HIGH SCHOOL ACADEMIC, EXTRA-CURRICULAR AND ATHLETIC PROGRAMS, IN CLASS 25 (U.S. CLS. 22 AND 39).

FIRST USE 10-17-2011; IN COMMERCE 10-17-2011.

THE MARK CONSISTS OF STANDARD CHARACTERS WITHOUT CLAIM TO ANY PARTICULAR FONT, STYLE, SIZE, OR COLOR.

SN 77-683,789, FILED 3-4-2009.

MATTHEW MCDOWELL, EXAMINING ATTORNEY



*David J. Kyros*

Director of the United States Patent and Trademark Office

# United States of America

United States Patent and Trademark Office

## MONSTER HUNTER

**Reg. No. 4,276,023**

CAPCOM CO., LTD. (JAPAN CORPORATION)  
3-1-3 UCHIHIRANOMACHI, CHUO-KU  
OSAKA, JAPAN

**Registered Jan. 15, 2013**

**Int. Cl.: 9**

FOR: PRE-RECORDED CINEMATOGRAPHIC FILMS, VIDEO TAPES, VIDEO CASSETTES, VIDEO DISCS, CDS, DVDS, AND HIGH-DEFINITION DVDS FEATURING ANIMATED CARTOONS, MUSIC, AND MOTION PICTURE FILMS ABOUT ACTION, ADVENTURE, DRAMA AND COMEDY; DOWNLOADABLE GRAPHICS AND MUSIC VIA A GLOBAL COMPUTER NETWORK, OTHER THAN FOR MOBILE PHONES, IN CLASS 9 (U.S. CLS. 21, 23, 26, 36 AND 38).

**TRADEMARK**

**PRINCIPAL REGISTER**

FIRST USE 3-30-2006; IN COMMERCE 8-21-2010.

THE MARK CONSISTS OF STANDARD CHARACTERS WITHOUT CLAIM TO ANY PARTICULAR FONT, STYLE, SIZE, OR COLOR.

SN 77-684,216, FILED 3-5-2009.

LESLIE RICHARDS, EXAMINING ATTORNEY



*David J. Kyffers*

Director of the United States Patent and Trademark Office

# United States of America

United States Patent and Trademark Office

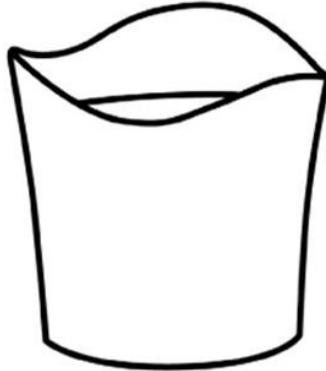

**Reg. No. 4,276,024**

**Registered Jan. 15, 2013**

**Int. Cl.: 3**

**TRADEMARK**

**PRINCIPAL REGISTER**

THE PROCTER & GAMBLE COMPANY (OHIO CORPORATION)  
ONE PROCTER & GAMBLE PLAZA  
CINCINNATI, OH 45202

FOR: MOUTHWASH, IN CLASS 3 (U.S. CLS. 1, 4, 6, 50, 51 AND 52).

FIRST USE 8-24-2009; IN COMMERCE 8-24-2009.

THE MARK CONSISTS OF THE OVERALL CONTOURED CONFIGURATION OF A CAP FOR A MOUTHWASH BOTTLE HAVING A NARROW BASE WITH SIDES THAT FLARE OUT TOWARDS THE TOP AND TERMINATE IN A UNDULATING WAVE PATTERN AROUND A RECESSED CENTRAL CORE.

SN 77-685,045, FILED 3-6-2009.

GRETCHEN ULRICH, EXAMINING ATTORNEY



*David J. Kybas*

Director of the United States Patent and Trademark Office

# United States of America

United States Patent and Trademark Office



**Reg. No. 4,276,025**

ELIANE CARVALHO COELHO TURNER (UNITED STATES INDIVIDUAL)  
5118 WOODVIEW CT.  
DEARBORN, MI 48126

**Registered Jan. 15, 2013**

**Int. Cl.: 43**

FOR: TAKE-OUT RESTAURANT SERVICES FEATURING HOME AND BUSINESS DELIVERY, IN CLASS 43 (U.S. CLS. 100 AND 101).

**SERVICE MARK**

FIRST USE 11-16-2012; IN COMMERCE 11-16-2012.

**PRINCIPAL REGISTER**

NO CLAIM IS MADE TO THE EXCLUSIVE RIGHT TO USE "BRAZILIAN PIZZERIA", APART FROM THE MARK AS SHOWN.

THE COLOR(S) GREEN, BLUE, YELLOW, PINK, TAN, PEACH, GRAY, WHITE AND BLACK IS/ARE CLAIMED AS A FEATURE OF THE MARK.

THE NAME(S), PORTRAIT(S), AND/OR SIGNATURE(S) SHOWN IN THE MARK DOES NOT IDENTIFY A PARTICULAR LIVING INDIVIDUAL.

THE MARK CONSISTS OF THE FOLLOWING: THE WORDING "NONNA FLORA" APPEARS IN THE COLOR GREEN WITH "FLORA" BEING OUTLINED IN BLACK AND TAN; THE WORDING "BRAZILIAN PIZZERIA" APPEARS IN THE COLOR BLUE; THE WOMAN HAS GRAY HAIR, WITH FLOWERS IN HER HAIR IN THE COLORS PINK, TAN, AND BLACK; HER SKIN IS IN THE COLORS PEACH AND TAN, WITH BLUE EYES, PINK LIPS, AND WHITE TEETH; HER SHIRT IS IN THE COLORS BLUE AND GREEN; HER APRON IS IN THE COLOR YELLOW WITH PINK, TAN, AND BLACK FLOWERS ABOVE A YELLOW SWIRL THAT IS OUTLINED IN BLACK AND TAN.

THE ENGLISH TRANSLATION OF "NONNA" IN THE MARK IS "GRANDMOTHER".

SN 77-687,306, FILED 3-10-2009.

COLLEEN DOMBROW, EXAMINING ATTORNEY



*David J. Kybas*

Director of the United States Patent and Trademark Office



# United States of America

United States Patent and Trademark Office

# SPREE

**Reg. No. 4,276,026**

SHASTA BEVERAGES, INC. (DELAWARE CORPORATION)  
26901 INDUSTRIAL BLVD  
HAYWARD, CA 94545

**Registered Jan. 15, 2013**

**Int. Cl.: 32**

FOR: SOFT DRINKS, NAMELY, CARBONATED SOFT DRINKS, IN CLASS 32 (U.S. CLS. 45, 46 AND 48).

**TRADEMARK**

FIRST USE 9-28-2012; IN COMMERCE 9-28-2012.

**PRINCIPAL REGISTER**

THE MARK CONSISTS OF STANDARD CHARACTERS WITHOUT CLAIM TO ANY PARTICULAR FONT, STYLE, SIZE, OR COLOR.

OWNER OF U.S. REG. NO. 1,247,268.

SN 77-688,070, FILED 3-11-2009.

CHARLOTTE CORWIN, EXAMINING ATTORNEY



*David J. Kybas*

Director of the United States Patent and Trademark Office

# United States of America

United States Patent and Trademark Office

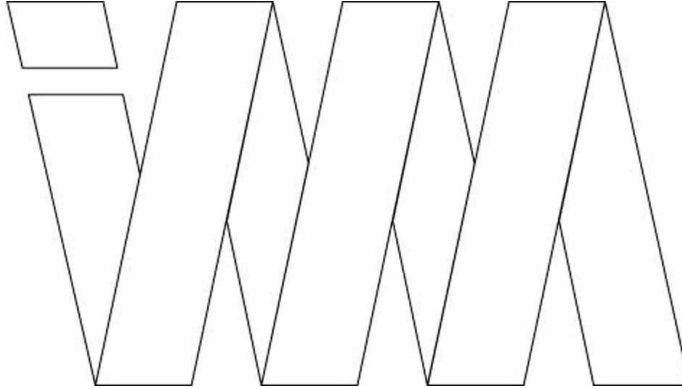

**Reg. No. 4,276,027**

**Registered Jan. 15, 2013**

**Int. Cl.: 36**

**SERVICE MARK**

**PRINCIPAL REGISTER**

INTERNATIONAL MONEY MANAGEMENT, INC. (FLORIDA CORPORATION)  
19200 VON KARMAN, SUITE 600  
IRVINE, CA 92612

FOR: DEBIT CARD SERVICES, IN CLASS 36 (U.S. CLS. 100, 101 AND 102).

FIRST USE 10-0-2012; IN COMMERCE 10-0-2012.

THE MARK CONSISTS OF A COIL DESIGN ORIENTED HORIZONTALLY, WITH A PARALLELOGRAM ADJACENT TO THE UPPER LEFT HAND SIDE OF THE COIL.

SN 77-692,106, FILED 3-16-2009.

NANCY CLARKE, EXAMINING ATTORNEY



*David J. Kybas*

Director of the United States Patent and Trademark Office

# United States of America

United States Patent and Trademark Office

## GENTLE SOULS

**Reg. No. 4,276,028**

KENNETH COLE PRODUCTIONS (LIC), LLC (DELAWARE LIMITED LIABILITY COMPANY)  
603 W 50TH STREET  
NEW YORK, NY 10019

**Registered Jan. 15, 2013**

**Int. Cl.: 35**

FOR: ONLINE RETAIL STORE SERVICES FEATURING FOOTWEAR, IN CLASS 35 (U.S. CLS. 100, 101 AND 102).

**SERVICE MARK**

FIRST USE 9-27-2011; IN COMMERCE 9-27-2011.

**PRINCIPAL REGISTER**

THE MARK CONSISTS OF STANDARD CHARACTERS WITHOUT CLAIM TO ANY PARTICULAR FONT, STYLE, SIZE, OR COLOR.

OWNER OF U.S. REG. NO. 2,943,676.

SN 77-692,814, FILED 3-17-2009.

GINA HAYES, EXAMINING ATTORNEY



*David J. Kyffers*

Director of the United States Patent and Trademark Office

# United States of America

United States Patent and Trademark Office

# SAlife

**Reg. No. 4,276,029**

**Registered Jan. 15, 2013**

**Int. Cls.: 35 and 38**

**SERVICE MARK**

**PRINCIPAL REGISTER**

BORDER MEDIA BUSINESS TRUST (DELAWARE TRUST)  
8750 N. CENTRAL EXPRESSWAY, SUITE 645  
DALLAS, TX 75231

FOR: ADVERTISING BY TRANSMISSION OF ON-LINE PUBLICITY FOR THIRD PARTIES THROUGH ELECTRONIC COMMUNICATIONS NETWORKS; ADVERTISING, INCLUDING PROMOTION RELATING TO THE SALE OF ARTICLES AND SERVICES FOR THIRD PARTIES BY THE TRANSMISSION OF ADVERTISING MATERIAL AND THE DISSEMINATION OF ADVERTISING MESSAGES ON COMPUTER NETWORKS; DISSEMINATION OF ADVERTISING FOR OTHERS VIA AN ON-LINE COMMUNICATIONS NETWORK ON THE INTERNET, IN CLASS 35 (U.S. CLS. 100, 101 AND 102).

FIRST USE 9-1-2011; IN COMMERCE 9-1-2011.

FOR: COMMUNICATION VIA RADIO AND TELEVISION TRANSMISSIONS; PROVIDING ON-LINE COMMUNICATIONS LINKS WHICH TRANSFER THE WEB SITE USER TO OTHER LOCAL AND GLOBAL WEB PAGES; MOBILE MEDIA SERVICES IN THE NATURE OF ELECTRONIC TRANSMISSION OF ENTERTAINMENT MEDIA CONTENT, IN CLASS 38 (U.S. CLS. 100, 101 AND 104).

FIRST USE 9-1-2011; IN COMMERCE 9-1-2011.

THE MARK CONSISTS OF STANDARD CHARACTERS WITHOUT CLAIM TO ANY PARTICULAR FONT, STYLE, SIZE, OR COLOR.

SN 77-693,913, FILED 3-18-2009.

HELENE LIWINSKI, EXAMINING ATTORNEY



*David J. Kybas*

Director of the United States Patent and Trademark Office

# United States of America

United States Patent and Trademark Office

## CHEMOCENTRYX

**Reg. No. 4,276,030**

CHEMOCENTRYX, INC. (DELAWARE CORPORATION)  
850 MAUDE AVENUE  
MOUNTAIN VIEW, CA 94043

**Registered Jan. 15, 2013**

**Int. Cl.: 5**

FOR: PHARMACEUTICAL PREPARATIONS FOR USE IN THE TREATMENT OF HUMAN DISEASE, NAMELY, INFLAMMATORY AND AUTOIMMUNE DISEASES, DISORDERS AND SYNDROMES, SUCH AS CHEMOKINE-MEDIATED DISEASES, IN CLASS 5 (U.S. CLS. 6, 18, 44, 46, 51 AND 52).

**TRADEMARK**

**PRINCIPAL REGISTER**

FIRST USE 10-12-2011; IN COMMERCE 10-12-2011.

THE MARK CONSISTS OF STANDARD CHARACTERS WITHOUT CLAIM TO ANY PARTICULAR FONT, STYLE, SIZE, OR COLOR.

OWNER OF U.S. REG. NO. 2,776,052.

SN 77-694,544, FILED 3-19-2009.

LINDA M. KING, EXAMINING ATTORNEY



*David J. Kybas*

Director of the United States Patent and Trademark Office

# United States of America

United States Patent and Trademark Office

## Matrix Premix

**Reg. No. 4,276,031**

THE D. S. BROWN COMPANY (OHIO CORPORATION)  
300 EAST CHERRY STREET  
NORTH BALTIMORE, OH 458721058

**Registered Jan. 15, 2013**

**Int. Cl.: 17**

FOR: PRE-PACKAGED BRIDGE EXPANSION JOINT FILLER, IN CLASS 17 (U.S. CLS. 1, 5, 12, 13, 35 AND 50).

**TRADEMARK**

FIRST USE 10-7-2009; IN COMMERCE 10-7-2009.

**PRINCIPAL REGISTER**

NO CLAIM IS MADE TO THE EXCLUSIVE RIGHT TO USE "PREMIX", APART FROM THE MARK AS SHOWN.

SN 77-696,995, FILED 3-23-2009.

WENDY GOODMAN, EXAMINING ATTORNEY



*David J. Kybas*

Director of the United States Patent and Trademark Office

# United States of America

United States Patent and Trademark Office

# AHA

**Reg. No. 4,276,032**

**Registered Jan. 15, 2013**

**Int. Cls.: 9, 38, 39, and 42**

**TRADEMARK**

**SERVICE MARK**

**PRINCIPAL REGISTER**

HARMAN INTERNATIONAL INDUSTRIES, INCORPORATED (DELAWARE CORPORATION)  
8500 BALBOA BLVD.  
NORTHRIDGE, CA 91329

FOR: COMPUTER SOFTWARE THAT ENABLES THE WIRELESS TRANSMISSION AND PROVISION OF REAL-TIME INFORMATION REGARDING TRAFFIC, ROAD CONDITIONS, POINTS OF INTEREST, TOPICS OF GENERAL INTEREST AND ONLINE CONTENT VIA WIRELESS TRANSMISSIONS TO MOBILE COMMUNICATIONS DEVICES, MOBILE PHONES, AND ELECTRONIC DEVICES INSTALLED IN AUTOMOBILES AND OTHER VEHICLES, AND TO ENABLE AUTOMOBILE AND VEHICLE DRIVERS AND PASSENGERS TO COMMUNICATE WITH EACH OTHER AND SHARE REAL-TIME DATA, INFORMATION, OBSERVATIONS, COMMENTARY, OPINIONS, AND MULTIMEDIA AND ONLINE CONTENT VIA WIRELESS COMMUNICATIONS DEVICES MOBILE PHONES, AND ELECTRONIC DEVICES INSTALLED IN AUTOMOBILES AND OTHER VEHICLES, AND TO AGGREGATE SUCH DATA, INFORMATION, OBSERVATIONS, COMMENTARY, OPINIONS, AND OTHER CONTENT FOR TRANSMISSION OR BROADCAST BY OTHERS VIA THE INTERNET, RADIO OR TELEVISION, IN CLASS 9 (U.S. CLS. 21, 23, 26, 36 AND 38).

FIRST USE 9-30-2009; IN COMMERCE 9-30-2009.

FOR: PROVIDING REAL-TIME DATA, INFORMATION, OBSERVATIONS, COMMENTARY, OPINIONS AND OTHER CONTENT PROVIDED BY AUTOMOBILE DRIVERS AND PASSENGERS FOR TRANSMISSION OR BROADCAST BY OTHERS VIA THE INTERNET, RADIO OR TELEVISION. ENABLING AUTOMOBILE AND VEHICLE DRIVERS AND PASSENGERS TO COMMUNICATE WITH EACH OTHER AND SHARE REAL-TIME DATA, INFORMATION, OBSERVATIONS, COMMENTARY, OPINIONS, AND MULTIMEDIA AND ONLINE CONTENT VIA WIRELESS HANDHELD DEVICES FOR MOBILE COMMUNICATIONS, MOBILE PHONES AND ELECTRONIC DEVICES INSTALLED IN AUTOMOBILES AND OTHER VEHICLES, IN CLASS 38 (U.S. CLS. 100, 101 AND 104).

FIRST USE 9-30-2009; IN COMMERCE 9-30-2009.

FOR: PROVIDING REAL-TIME INFORMATION REGARDING TRAFFIC, ROAD CONDITIONS, NAVIGATION, AND POINT-OF-INTEREST INFORMATION VIA TELECOMMUNICATION NETWORKS, CELLULAR TELEPHONES AND WIRELESS NAVIGATION DEVICES, IN CLASS 39 (U.S. CLS. 100 AND 105).



*David J. Kyffers*

Director of the United States Patent and Trademark Office

**Reg. No. 4,276,032** FIRST USE 9-30-2009; IN COMMERCE 9-30-2009.

FOR: DESIGN AND DEVELOPMENT OF COMPUTER SOFTWARE RELATED TO COMPUTER SOFTWARE THAT ENABLES THE WIRELESS TRANSMISSION AND PROVISION OF REAL-TIME INFORMATION REGARDING TRAFFIC, ROAD CONDITIONS, POINTS OF INTEREST, TOPICS OF GENERAL INTEREST AND ONLINE CONTENT VIA WIRELESS TRANSMISSION TO MOBILE COMMUNICATIONS DEVICES, MOBILE PHONES AND ELECTRONIC DEVICES INSTALLED IN AUTOMOBILES AND OTHER VEHICLES, AND TO ENABLE AUTOMOBILE AND VEHICLE DRIVERS AND PASSENGERS TO COMMUNICATE WITH EACH OTHER AND SHARE REAL-TIME DATA, INFORMATION, OBSERVATIONS, COMMENTARY, OPINIONS AND MULTIMEDIA AND ONLINE CONTENT VIA WIRELESS COMMUNICATIONS DEVICES, MOBILE PHONES, AND ELECTRONIC DEVICES INSTALLED IN AUTOMOBILES AND OTHER VEHICLES, AND TO AGGREGATE SUCH DATA, INFORMATION, OBSERVATIONS, COMMENTARY, OPINIONS AND OTHER CONTENT FOR TRANSMISSION OR BROADCAST BY OTHERS VIA THE INTERNET, RADIO OR TELEVISION, IN CLASS 42 (U.S. CLS. 100 AND 101).

FIRST USE 9-30-2009; IN COMMERCE 9-30-2009.

THE MARK CONSISTS OF STANDARD CHARACTERS WITHOUT CLAIM TO ANY PARTICULAR FONT, STYLE, SIZE, OR COLOR.

SN 77-697,348, FILED 3-23-2009.

INGA ERVIN, EXAMINING ATTORNEY



# United States of America

United States Patent and Trademark Office

## INFORMATION FOR BETTER SHOPPING

**Reg. No. 4,276,033**

**Registered Jan. 15, 2013**

**Int. Cls.: 16, 35, 41, and 45**

BETTER BRAND INITIATIVES, LLC (DELAWARE LIMITED LIABILITY COMPANY)  
41ST FLOOR  
512 7TH AVENUE  
NEW YORK, NY 10018

FOR: BROCHURES, PAMPHLETS, POSTERS, PRINTED POINT OF PURCHASE DISPLAYS, FLYERS, CATALOGUES, AND MAGAZINES CONCERNING OTHERS' PRODUCTS, IN CLASS 16 (U.S. CLS. 2, 5, 22, 23, 29, 37, 38 AND 50).

**TRADEMARK**

FIRST USE 3-9-2009; IN COMMERCE 3-9-2009.

**SERVICE MARK**

**PRINCIPAL REGISTER**

FOR: ADVERTISING AND MARKETING SERVICES, NAMELY, ADVERTISING AND MARKETING VIA AUDIO, VISUAL, INTERNET AND PRINT MEDIA, PRINT NEWSPAPERS, SIGNS AND POSTERS, POINT OF PURCHASE DISPLAYS, BROCHURES, LEAFLETS, FLYERS, PRODUCT PACKAGING FOR OTHERS; COMMERCIAL ADMINISTRATION OF THE LICENSING OF ADVERTISEMENT, INTELLECTUAL PROPERTY, ADVERTISING SLOGANS, AND ADVERTISING DESIGN IMAGES FOR USE BY OTHERS; AND PROVIDING CONSUMER INFORMATION TO EDUCATE CONSUMERS REGARDING THE SELECTION OF PRODUCTS AND SERVICES TO BE PURCHASED, IN CLASS 35 (U.S. CLS. 100, 101 AND 102).

FIRST USE 3-9-2009; IN COMMERCE 3-9-2009.

FOR: EDUCATIONAL SERVICES, NAMELY, PROVIDING ONLINE PUBLICATIONS IN THE NATURE OF ELECTRONIC NEWSLETTERS FEATURING COLLECTIONS OF CONSUMER PRODUCT REVIEWS, ALL TO INFORM AND EDUCATE CONSUMERS ON CONSUMER PRODUCTS AND SERVICES AND ON SHOPPING HABITS, IN CLASS 41 (U.S. CLS. 100, 101 AND 107).

FIRST USE 3-9-2009; IN COMMERCE 3-9-2009.

FOR: LICENSING OF ADVERTISEMENTS, INTELLECTUAL PROPERTY, ADVERTISING SLOGANS, AND ADVERTISING DESIGN IMAGES FOR USE BY OTHERS, IN CLASS 45 (U.S. CLS. 100 AND 101).

FIRST USE 3-9-2009; IN COMMERCE 3-9-2009.



*David J. Kyjars*

Director of the United States Patent and Trademark Office

**Reg. No. 4,276,033** THE MARK CONSISTS OF STANDARD CHARACTERS WITHOUT CLAIM TO ANY PARTICULAR FONT, STYLE, SIZE, OR COLOR.

NO CLAIM IS MADE TO THE EXCLUSIVE RIGHT TO USE "INFORMATION" OR "SHOPPING", APART FROM THE MARK AS SHOWN.

SN 77-698,084, FILED 3-24-2009.

HEATHER THOMPSON, EXAMINING ATTORNEY

# United States of America

United States Patent and Trademark Office

# THAT'S SILLY!

**Reg. No. 4,276,034**

HIGHLIGHTS FOR CHILDREN, INC. (DELAWARE CORPORATION)  
1800 WATERMARK DRIVE  
COLUMBUS, OH 43215

**Registered Jan. 15, 2013**

**Int. Cl.: 28**

FOR: PUZZLES, IN CLASS 28 (U.S. CLS. 22, 23, 38 AND 50).

**TRADEMARK**

FIRST USE 9-0-2010; IN COMMERCE 9-0-2010.

**PRINCIPAL REGISTER**

THE MARK CONSISTS OF STANDARD CHARACTERS WITHOUT CLAIM TO ANY PARTICULAR FONT, STYLE, SIZE, OR COLOR.

SN 77-701,703, FILED 3-29-2009.

TINA BROWN, EXAMINING ATTORNEY



*David J. Kyffers*

Director of the United States Patent and Trademark Office

# United States of America

United States Patent and Trademark Office

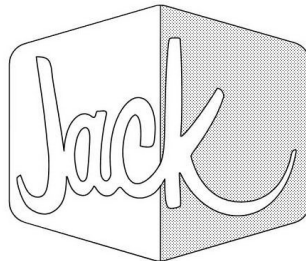

**Reg. No. 4,276,035**

**Registered Jan. 15, 2013**

**Int. Cls.: 29 and 30**

**TRADEMARK**

**PRINCIPAL REGISTER**

JACK IN THE BOX INC. (DELAWARE CORPORATION)  
9330 BALBOA AVENUE  
SAN DIEGO, CA 92123

FOR: CHICKEN BREAST STRIPS, IN CLASS 29 (U.S. CL. 46).

FIRST USE 11-1-2012; IN COMMERCE 11-1-2012.

FOR: SANDWICHES, NAMELY, HAMBURGER, CHICKEN, IN CLASS 30 (U.S. CL. 46).

FIRST USE 11-1-2012; IN COMMERCE 11-1-2012.

OWNER OF U.S. REG. NOS. 841,334, 1,957,318, AND OTHERS.

THE STIPPLING IS FOR SHADING PURPOSES ONLY.

THE MARK CONSISTS OF THE WORD "JACK" WHICH WRAPS AROUND TWO CONTIGUOUS SIDES OF A BOX.

SN 77-710,058, FILED 4-8-2009.

HELENE LIWINSKI, EXAMINING ATTORNEY



*David J. Kybas*

Director of the United States Patent and Trademark Office

# United States of America

United States Patent and Trademark Office

## IMAGINATIONS NETWORK

**Reg. No. 4,276,036**

**Registered Jan. 15, 2013**

**Int. Cls.: 35 and 36**

**SERVICE MARK**

**PRINCIPAL REGISTER**

IMAGINATIONS GROUP, INC. (MARYLAND NON-STOCK CORPORATION)  
ATTN.: STEFANIE HARRINGTON, PROGRAM DIR.  
221 BAY FRONT ROAD  
PASADENA, MD 21122

FOR: PROVIDING AN INTERNET WEBSITE PORTAL FEATURING BUSINESS INFORMATION IN THE FIELD OF ECONOMIC DEVELOPMENT, IN CLASS 35 (U.S. CLS. 100, 101 AND 102).

FIRST USE 9-29-2009; IN COMMERCE 9-29-2009.

FOR: PROVIDING AN INTERNET WEBSITE PORTAL FEATURING INFORMATION IN THE FIELD OF FINANCE AND MICROFINANCE, ECONOMIC DEVELOPMENT, SPECIFICALLY, FINANCIAL RESEARCH INFORMATION AND FINANCIAL POLICY INFORMATION, CHARITABLE FUND RAISING, GRANTS, SPECIFICALLY, INFORMATION ON OBTAINING GRANTS, AND LOAN FINANCING, IN CLASS 36 (U.S. CLS. 100, 101 AND 102).

FIRST USE 9-29-2009; IN COMMERCE 9-29-2009.

THE MARK CONSISTS OF STANDARD CHARACTERS WITHOUT CLAIM TO ANY PARTICULAR FONT, STYLE, SIZE, OR COLOR.

OWNER OF U.S. REG. NOS. 3,145,980, 4,084,502, AND OTHERS.

NO CLAIM IS MADE TO THE EXCLUSIVE RIGHT TO USE "NETWORK", APART FROM THE MARK AS SHOWN.

SN 77-713,141, FILED 4-14-2009.

RUDY R. SINGLETON, EXAMINING ATTORNEY



*David J. Kyffers*

Director of the United States Patent and Trademark Office

# United States of America

United States Patent and Trademark Office

# TTOR

**Reg. No. 4,276,037**

TOR CONSULTANCY LTD (PENNSYLVANIA CORPORATION)  
6542-A LOWER YORK RD. STE. 201  
NEW HOPE, PA 18938

**Registered Jan. 15, 2013**

**Int. Cl.: 35**

FOR: BUSINESS MANAGEMENT CONSULTING AND ADVISORY SERVICES, IN CLASS 35 (U.S. CLS. 100, 101 AND 102).

**SERVICE MARK**

FIRST USE 4-29-2010; IN COMMERCE 4-29-2010.

**PRINCIPAL REGISTER**

THE MARK CONSISTS OF STANDARD CHARACTERS WITHOUT CLAIM TO ANY PARTICULAR FONT, STYLE, SIZE, OR COLOR.

SN 77-713,695, FILED 4-14-2009.

DAVID HOFFMAN, EXAMINING ATTORNEY



*David J. Kyffers*

Director of the United States Patent and Trademark Office

# United States of America

United States Patent and Trademark Office

## THE ENERGETIC ELECTRICIAN

**Reg. No. 4,276,038**

CLOCKWORK IP, LLC (DELAWARE LIMITED LIABILITY COMPANY)  
50 CENTRAL AVE. SUITE 920  
SARASOTA, FL 34236

**Registered Jan. 15, 2013**

**Int. Cl.: 37**

FOR: REPAIR, MAINTENANCE, AND INSTALLATION OF ELECTRICAL WIRING, OUTLETS, LIGHT FIXTURES, AND ELECTRICAL PANELS, IN CLASS 37 (U.S. CLS. 100, 103 AND 106).

**SERVICE MARK**

FIRST USE 11-22-2009; IN COMMERCE 11-22-2009.

**PRINCIPAL REGISTER**

THE MARK CONSISTS OF STANDARD CHARACTERS WITHOUT CLAIM TO ANY PARTICULAR FONT, STYLE, SIZE, OR COLOR.

NO CLAIM IS MADE TO THE EXCLUSIVE RIGHT TO USE "ELECTRICIAN", APART FROM THE MARK AS SHOWN.

SN 77-716,485, FILED 4-17-2009.

INGA ERVIN, EXAMINING ATTORNEY



*David J. Kyffers*

Director of the United States Patent and Trademark Office

# United States of America

United States Patent and Trademark Office

# BIG AIR

**Reg. No. 4,276,039**

**Registered Jan. 15, 2013**

**Int. Cl.: 25**

**TRADEMARK**

**PRINCIPAL REGISTER**

JUSTIN JACKSON (UNITED STATES INDIVIDUAL)  
204 W. 114TH CT  
JENKS, OK 74037

FOR: CAPS, IN CLASS 25 (U.S. CLS. 22 AND 39).

FIRST USE 4-20-2009; IN COMMERCE 11-26-2012.

THE MARK CONSISTS OF STANDARD CHARACTERS WITHOUT CLAIM TO ANY PARTICULAR FONT, STYLE, SIZE, OR COLOR.

SN 77-718,106, FILED 4-20-2009.

TEJBIR SINGH, EXAMINING ATTORNEY



*David J. Kyffers*

Director of the United States Patent and Trademark Office



# United States of America

United States Patent and Trademark Office

# Glastec

**Reg. No. 4,276,040**

FINE, KENNETH D. (UNITED STATES INDIVIDUAL)  
10875 PLANO RD., SUITE 123  
DALLAS, TX 75238

**Registered Jan. 15, 2013**

**Int. Cl.: 21**

FOR: BEVERAGE GLASSWARE, IN CLASS 21 (U.S. CLS. 2, 13, 23, 29, 30, 33, 40 AND 50).

**TRADEMARK**

FIRST USE 11-14-2012; IN COMMERCE 11-14-2012.

**PRINCIPAL REGISTER**

THE MARK CONSISTS OF STANDARD CHARACTERS WITHOUT CLAIM TO ANY PARTICULAR FONT, STYLE, SIZE, OR COLOR.

SN 77-718,763, FILED 4-21-2009.

JOHN WILKE, EXAMINING ATTORNEY



*David J. Kybas*

Director of the United States Patent and Trademark Office

# United States of America

United States Patent and Trademark Office

# Monticello

**Reg. No. 4,276,041**

UNITED STATES STOVE COMPANY (TENNESSEE CORPORATION)  
227 INDUSTRIAL DRIVE  
SOUTH PITTSBURG, TN 37380

**Registered Jan. 15, 2013**

**Int. Cl.: 11**

FOR: ELECTRIC STOVES; FIREPLACE INSERTS IN THE NATURE OF STOVES; GAS STOVES; SLOW-BURNING STOVES; SOLID FUEL BURNING STOVES; WOOD BURNING STOVES, IN CLASS 11 (U.S. CLS. 13, 21, 23, 31 AND 34).

**TRADEMARK**

FIRST USE 11-1-2012; IN COMMERCE 11-1-2012.

**PRINCIPAL REGISTER**

THE MARK CONSISTS OF STANDARD CHARACTERS WITHOUT CLAIM TO ANY PARTICULAR FONT, STYLE, SIZE, OR COLOR.

SN 77-719,800, FILED 4-22-2009.

JESSICA A. POWERS, EXAMINING ATTORNEY



*David J. Kyjars*

Director of the United States Patent and Trademark Office

# United States of America

United States Patent and Trademark Office

## KORK-EASE KOUTURE

**Reg. No. 4,276,042**

**Registered Jan. 15, 2013**

**Int. Cl.: 25**

**TRADEMARK**

**PRINCIPAL REGISTER**

COLUMBIA INSURANCE COMPANY (NEBRASKA CORPORATION)  
3024 HARNEY STREET  
OMAHA, NE 68131

FOR: FOOTWEAR, IN CLASS 25 (U.S. CLS. 22 AND 39).

FIRST USE 10-24-2009; IN COMMERCE 10-24-2009.

THE MARK CONSISTS OF STANDARD CHARACTERS WITHOUT CLAIM TO ANY PARTICULAR FONT, STYLE, SIZE, OR COLOR.

NO CLAIM IS MADE TO THE EXCLUSIVE RIGHT TO USE "COUTURE", APART FROM THE MARK AS SHOWN.

SN 77-721,603, FILED 4-24-2009.

TASNEEM HUSSAIN, EXAMINING ATTORNEY



*David J. Kyffers*

Director of the United States Patent and Trademark Office

# United States of America

United States Patent and Trademark Office

# SOUVENIRS

**Reg. No. 4,276,043**

**Registered Jan. 15, 2013**

**Int. Cl.: 41**

**SERVICE MARK**

**PRINCIPAL REGISTER**

HOLLYWOOD GAMES, INC. (CALIFORNIA CORPORATION)  
C/O JESS MORGAN INC., 5900 WILSHIRE BLVD  
SUITE 2300  
LOS ANGELES, CA 90036

FOR: ENTERTAINMENT SERVICES IN THE NATURE OF GAME SHOWS; ENTERTAINMENT SERVICES, NAMELY, PROVIDING AN ON-LINE COMPUTER GAME, IN CLASS 41 (U.S. CLS. 100, 101 AND 107).

FIRST USE 8-22-2011; IN COMMERCE 8-22-2011.

THE MARK CONSISTS OF STANDARD CHARACTERS WITHOUT CLAIM TO ANY PARTICULAR FONT, STYLE, SIZE, OR COLOR.

OWNER OF U.S. REG. NO. 1,887,982.

SN 77-722,087, FILED 4-24-2009.

PRISCILLA MILTON, EXAMINING ATTORNEY



*David J. Kyros*

Director of the United States Patent and Trademark Office

# United States of America

United States Patent and Trademark Office

# CUTIES

**Reg. No. 4,276,044**

**Registered Jan. 15, 2013**

**Int. Cl.: 32**

**TRADEMARK**

**PRINCIPAL REGISTER**

MARICOPA PACKERS, L.P. (CALIFORNIA LIMITED PARTNERSHIP)  
11444 WEST OLYMPIC BLVD., 10TH FLOOR  
LOS ANGELES, CA 90064

FOR: FRUIT DRINKS AND FRUIT JUICES; FRUIT JUICES; NON-ALCOHOLIC BEVERAGES CONTAINING FRUIT JUICES; NON-ALCOHOLIC FRUIT JUICE BEVERAGES; ORANGE JUICE; ORANGE JUICE BEVERAGES, IN CLASS 32 (U.S. CLS. 45, 46 AND 48).

FIRST USE 7-1-2011; IN COMMERCE 7-1-2011.

THE MARK CONSISTS OF STANDARD CHARACTERS WITHOUT CLAIM TO ANY PARTICULAR FONT, STYLE, SIZE, OR COLOR.

OWNER OF U.S. REG. NOS. 2,884,674, 3,318,343, AND OTHERS.

SN 77-723,513, FILED 4-27-2009.

HANNO RITTNER, EXAMINING ATTORNEY



*David J. Kyros*

Director of the United States Patent and Trademark Office

# United States of America

United States Patent and Trademark Office

# GO BANANAS

**Reg. No. 4,276,045**

ESMERALDA FARMS, INC. (FLORIDA CORPORATION)  
1800 N.W. 89TH PLACE  
DORAL, FL 33172

**Registered Jan. 15, 2013**

**Int. Cl.: 31**

FOR: FRESH CUT FLOWERS, NAMELY, ROSES, IN CLASS 31 (U.S. CLS. 1 AND 46).

**TRADEMARK**

FIRST USE 11-13-2012; IN COMMERCE 11-13-2012.

**PRINCIPAL REGISTER**

THE MARK CONSISTS OF STANDARD CHARACTERS WITHOUT CLAIM TO ANY PARTICULAR FONT, STYLE, SIZE, OR COLOR.

SN 77-724,545, FILED 4-28-2009.

SETH A. RAPPAPORT, EXAMINING ATTORNEY



*David J. Kyffers*

Director of the United States Patent and Trademark Office

# United States of America

United States Patent and Trademark Office

# O2 LIVING

**Reg. No. 4,276,046**

O2 LIVE LLC (NEW YORK LIMITED LIABILITY COMPANY), DBA O2 LIVING,  
792 ROUTE 35

**Registered Jan. 15, 2013**

CROSS RIVER, NY 10518

**Int. Cl.: 43**

FOR: CAFE; CAFE AND RESTAURANT SERVICES; CAFE SERVICES, NAMELY,  
PROVIDING CAFE SERVICES IN A FUNERAL HOME ENVIRONMENT; CAFE-RESTAUR-  
ANTS; CAFES; MOBILE CAFE SERVICES FOR PROVIDING FOOD AND DRINK; RESTAUR-  
ANT AND CAFE SERVICES, IN CLASS 43 (U.S. CLS. 100 AND 101).

**SERVICE MARK**

**PRINCIPAL REGISTER**

FIRST USE 9-1-2009; IN COMMERCE 11-1-2011.

THE MARK CONSISTS OF STANDARD CHARACTERS WITHOUT CLAIM TO ANY PAR-  
TICULAR FONT, STYLE, SIZE, OR COLOR.

SN 77-724,616, FILED 4-29-2009.

TARAH HARDY, EXAMINING ATTORNEY



*David J. Kyffers*

Director of the United States Patent and Trademark Office

# United States of America

United States Patent and Trademark Office

# PENDLETON

**Reg. No. 4,276,047**

**Registered Jan. 15, 2013**

**Int. Cl.: 32**

**TRADEMARK**

**PRINCIPAL REGISTER**

PENDLETON WOOLEN MILLS, INC. (OREGON CORPORATION)  
220 NW BROADWAY  
PORTLAND, OR 97209

FOR: BEER, IN CLASS 32 (U.S. CLS. 45, 46 AND 48).

FIRST USE 10-31-2012; IN COMMERCE 10-31-2012.

THE MARK CONSISTS OF STANDARD CHARACTERS WITHOUT CLAIM TO ANY PARTICULAR FONT, STYLE, SIZE, OR COLOR.

SEC. 2(F).

OWNER OF U.S. REG. NOS. 2,953,861 AND 3,574,742.

SN 77-725,135, FILED 4-29-2009.

CAROLINE WOOD, EXAMINING ATTORNEY



*David J. Kyffers*

Director of the United States Patent and Trademark Office



# United States of America

United States Patent and Trademark Office

# K'DORABLE

**Reg. No. 4,276,048**

**Registered Jan. 15, 2013**

**Int. Cl.: 14**

**TRADEMARK**

**PRINCIPAL REGISTER**

COMBINE INTERNATIONAL, INC. (MICHIGAN CORPORATION)  
354 INDUSCO COURT  
TROY, MI 48083

FOR: JEWELRY, IN CLASS 14 (U.S. CLS. 2, 27, 28 AND 50).

FIRST USE 0-0-2009; IN COMMERCE 0-0-2009.

THE MARK CONSISTS OF STANDARD CHARACTERS WITHOUT CLAIM TO ANY PARTICULAR FONT, STYLE, SIZE, OR COLOR.

SN 77-727,968, FILED 5-4-2009.

NAKIA HENRY, EXAMINING ATTORNEY



*David J. Kyffers*

Director of the United States Patent and Trademark Office

# United States of America

United States Patent and Trademark Office

# COLOTIVITY

**Reg. No. 4,276,049**

**Registered Jan. 15, 2013**

**Int. Cl.: 42**

**SERVICE MARK**

**PRINCIPAL REGISTER**

SJ SEGUNDO HOLDING COMPANY, LLC (CALIFORNIA LIMITED LIABILITY COMPANY)  
#316  
214 MAIN STREET  
EL SEGUNDO, CA 90245

FOR: BACK-UP SERVICES FOR COMPUTER HARD DRIVE DATA; COMPUTER COLOCATION SERVICES, NAMELY, PROVIDING FACILITIES FOR THE LOCATION OF COMPUTER SERVERS WITH THE EQUIPMENT OF OTHERS, IN CLASS 42 (U.S. CLS. 100 AND 101).

FIRST USE 3-1-2012; IN COMMERCE 3-1-2012.

THE MARK CONSISTS OF STANDARD CHARACTERS WITHOUT CLAIM TO ANY PARTICULAR FONT, STYLE, SIZE, OR COLOR.

SN 77-730,811, FILED 5-6-2009.

MICHELE SWAIN, EXAMINING ATTORNEY



*David J. Kyffers*

Director of the United States Patent and Trademark Office

# United States of America

United States Patent and Trademark Office

## Career Lofts

**Reg. No. 4,276,050**

UNITED AMERICAN PROPERTIES, INC. (NEVADA CORPORATION)  
4699 JAMBOREE ROAD  
NEWPORT BEACH, CA 92660

**Registered Jan. 15, 2013**

**Int. Cl.: 37**

FOR: REAL ESTATE DEVELOPMENT AND CONSTRUCTION OF COMMERCIAL, RESIDENTIAL AND HOTEL PROPERTY, IN CLASS 37 (U.S. CLS. 100, 103 AND 106).

**SERVICE MARK**

FIRST USE 6-1-2009; IN COMMERCE 4-13-2012.

**PRINCIPAL REGISTER**

THE MARK CONSISTS OF STANDARD CHARACTERS WITHOUT CLAIM TO ANY PARTICULAR FONT, STYLE, SIZE, OR COLOR.

NO CLAIM IS MADE TO THE EXCLUSIVE RIGHT TO USE "LOFTS", APART FROM THE MARK AS SHOWN.

SN 77-731,339, FILED 5-7-2009.

TEJBIR SINGH, EXAMINING ATTORNEY



*David J. Kyffers*

Director of the United States Patent and Trademark Office

# United States of America

United States Patent and Trademark Office

## ZÉPHYRANTHE

**Reg. No. 4,276,051**

INTERNATIONAL EDGE, INC. (NEW JERSEY CORPORATION)  
79 TWO BRIDGES ROAD  
FAIRFIELD, NJ 07004

**Registered Jan. 15, 2013**

**Int. Cl.: 3**

FOR: FACIAL MASK AND FACE CREAM, IN CLASS 3 (U.S. CLS. 1, 4, 6, 50, 51 AND 52).

**TRADEMARK**

FIRST USE 4-4-2012; IN COMMERCE 4-4-2012.

**PRINCIPAL REGISTER**

THE MARK CONSISTS OF STANDARD CHARACTERS WITHOUT CLAIM TO ANY PARTICULAR FONT, STYLE, SIZE, OR COLOR.

SN 77-734,962, FILED 5-12-2009.

SOPHIA S. KIM, EXAMINING ATTORNEY



*David J. Kyffers*

Director of the United States Patent and Trademark Office

# United States of America

United States Patent and Trademark Office

## Isaac Mizrahi

**Reg. No. 4,276,052**

**Registered Jan. 15, 2013**

**Int. Cl.: 3**

**TRADEMARK**

**PRINCIPAL REGISTER**

IM BRANDS, LLC (DELAWARE LIMITED LIABILITY COMPANY)  
475 TENTH AVENUE  
4TH FLOOR  
NEW YORK, NY 10018

FOR: COSMETICS; COSMETICS AND MAKE-UP; COSMETICS IN GENERAL, INCLUDING PERFUMES, IN CLASS 3 (U.S. CLS. 1, 4, 6, 50, 51 AND 52).

FIRST USE 9-6-2012; IN COMMERCE 9-6-2012.

THE MARK CONSISTS OF STANDARD CHARACTERS WITHOUT CLAIM TO ANY PARTICULAR FONT, STYLE, SIZE, OR COLOR.

OWNER OF U.S. REG. NOS. 1,524,672, 3,293,902, AND OTHERS.

THE NAME(S), PORTRAIT(S), AND/OR SIGNATURE(S) SHOWN IN THE MARK IDENTIFIES "ISAAC MIZRAHI", WHOSE CONSENT(S) TO REGISTER IS MADE OF RECORD.

SN 77-738,086, FILED 5-15-2009.

AMEEN IMAM, EXAMINING ATTORNEY



*David J. Kypos*

Director of the United States Patent and Trademark Office

# United States of America

United States Patent and Trademark Office



**Reg. No. 4,276,053**

**Registered Jan. 15, 2013**

**Int. Cl.: 28**

**TRADEMARK**

**PRINCIPAL REGISTER**

CITY OF NEW YORK, BY AND THROUGH ITS FIRE DEPARTMENT (NEW YORK MUNICIPAL CORPORATION)  
9 METROTECH CENTER  
BROOKLYN, NY 11201

FOR: TOYS AND SPORTING GOODS, NAMELY, TOY MODEL CARS, TOY FIRE HELMETS, SNOW GLOBES, TOY VEHICLES, JIGSAW PUZZLES, PLAYING CARDS, STUFFED TOY ANIMALS, TOY DOLLS AND ACCESSORIES THEREFOR, CHRISTMAS TREE ORNAMENTS, IN CLASS 28 (U.S. CLS. 22, 23, 38 AND 50).

FIRST USE 7-25-2012; IN COMMERCE 7-25-2012.

OWNER OF U.S. REG. NOS. 2,606,740, 3,191,341, AND OTHERS.

NO CLAIM IS MADE TO THE EXCLUSIVE RIGHT TO USE "N.Y.", APART FROM THE MARK AS SHOWN.

THE MARK CONSISTS OF A STYLIZED VERSION OF A MALTESE CROSS WITH THE LETTERS "F.D." IN THE TOP POINT, "N.Y." IN THE BOTTOM POINT, A FIRE EXTINGUISHER IN THE RIGHT POINT, AND A HOOK AND LADDER IN THE LEFT POINT.

SN 77-738,321, FILED 5-15-2009.

NICHOLAS COLEMAN, EXAMINING ATTORNEY



*David J. Kybas*

Director of the United States Patent and Trademark Office

# United States of America

United States Patent and Trademark Office

## LA JOLLA DE CORTES

**Reg. No. 4,276,054**

**Registered Jan. 15, 2013**

**Int. Cl.: 36**

**SERVICE MARK**

**PRINCIPAL REGISTER**

DESARROLLO INMOBILIARIO MARINA VALLARTA, S.A. DE C.V. (MEXICO CORPORATION)  
CALZ. LAZARO CARDENAS NO. 3422 2DO PISO  
GUADALAJARA, MEXICO 45040

FOR: REAL ESTATE TIME-SHARING; VACATION REAL ESTATE TIME SHARE EXCHANGE SERVICES; VACATION REAL ESTATE TIME-SHARING , IN CLASS 36 (U.S. CLS. 100, 101 AND 102).

FIRST USE 4-1-2011; IN COMMERCE 4-1-2011.

THE MARK CONSISTS OF STANDARD CHARACTERS WITHOUT CLAIM TO ANY PARTICULAR FONT, STYLE, SIZE, OR COLOR.

THE ENGLISH TRANSLATION OF "LA JOLLA DE CORTES" IN THE MARK IS THE JEWEL OF CORTES.

SN 77-738,516, FILED 5-15-2009.

LINDSEY RUBIN, EXAMINING ATTORNEY



*David J. Kybas*

Director of the United States Patent and Trademark Office

# United States of America

United States Patent and Trademark Office

## SKIN-CARING

**Reg. No. 4,276,055**

SCA HYGIENE PRODUCTS AB (SWEDEN CORPORATION)

**Registered Jan. 15, 2013**

SE-405 03  
GOTEBORG, SWEDEN

**Int. Cl.: 5**

FOR: ADULT DIAPERS AND OTHER ABSORBENT ARTICLES, NAMELY, INCONTINENCE PADS FOR SANITARY PURPOSES AND FOR USE BY PERSONS SUFFERING FROM INCONTINENCE; INCONTINENCE GARMENTS, NAMELY, PANTS FOR USE BY PERSONS SUFFERING FROM INCONTINENCE, IN CLASS 5 (U.S. CLS. 6, 18, 44, 46, 51 AND 52).

**TRADEMARK**

**PRINCIPAL REGISTER**

FIRST USE 6-26-1987; IN COMMERCE 6-26-1987.

THE MARK CONSISTS OF STANDARD CHARACTERS WITHOUT CLAIM TO ANY PARTICULAR FONT, STYLE, SIZE, OR COLOR.

OWNER OF U.S. REG. NO. 1,692,289.

SN 77-740,446, FILED 5-19-2009.

KATHRYN COWARD, EXAMINING ATTORNEY



*David J. Kyffers*

Director of the United States Patent and Trademark Office



# United States of America

United States Patent and Trademark Office

## PORTAGE BY SOUNDBARRIER

**Reg. No. 4,276,056**

CARRIBEAN ELECTRONICS ENTERPRISES, INC. (FLORIDA CORPORATION)  
7091 N.W. 51ST STREET  
MIAMI, FL 33166

**Registered Jan. 15, 2013**

**Int. Cl.: 9**

FOR: LOUDSPEAKERS, MICROPHONES, STEREO AMPLIFIERS, IN CLASS 9 (U.S. CLS. 21, 23, 26, 36 AND 38).

**TRADEMARK**

FIRST USE 3-26-2012; IN COMMERCE 3-26-2012.

**PRINCIPAL REGISTER**

THE MARK CONSISTS OF STANDARD CHARACTERS WITHOUT CLAIM TO ANY PARTICULAR FONT, STYLE, SIZE, OR COLOR.

OWNER OF U.S. REG. NOS. 2,828,979, 3,021,517, AND OTHERS.

SN 77-741,478, FILED 5-20-2009.

SUSAN RICHARDS, EXAMINING ATTORNEY



*David J. Kybas*

Director of the United States Patent and Trademark Office

# United States of America

United States Patent and Trademark Office

# PIX

**Reg. No. 4,276,057**

PUBLIX ASSET MANAGEMENT COMPANY (FLORIDA CORPORATION)  
3300 PUBLIX CORPORATE PARKWAY  
LAKELAND, FL 33811

**Registered Jan. 15, 2013**

**Int. Cl.: 35**

FOR: RETAIL CONVENIENCE STORE AND GASOLINE SERVICES, IN CLASS 35 (U.S. CLS. 100, 101 AND 102).

**SERVICE MARK**

FIRST USE 10-8-2001; IN COMMERCE 10-8-2001.

**PRINCIPAL REGISTER**

THE MARK CONSISTS OF STANDARD CHARACTERS WITHOUT CLAIM TO ANY PARTICULAR FONT, STYLE, SIZE, OR COLOR.

OWNER OF U.S. REG. NOS. 2,636,829, 2,743,806, AND OTHERS.

SN 77-748,614, FILED 6-1-2009.

LINDA POWELL, EXAMINING ATTORNEY



*David J. Kyffers*

Director of the United States Patent and Trademark Office

# United States of America

United States Patent and Trademark Office

## Odor Defense

**Reg. No. 4,276,058**

TRANS WESTERN POLYMERS, INC. (CALIFORNIA CORPORATION)  
7539 LAS POSITAS RD  
LIVERMORE, CA 94551

**Registered Jan. 15, 2013**

**Int. Cl.: 16**

FOR: TRASH BAGS, IN CLASS 16 (U.S. CLS. 2, 5, 22, 23, 29, 37, 38 AND 50).

**TRADEMARK**

FIRST USE 11-5-2012; IN COMMERCE 11-5-2012.

**PRINCIPAL REGISTER**

THE MARK CONSISTS OF STANDARD CHARACTERS WITHOUT CLAIM TO ANY PARTICULAR FONT, STYLE, SIZE, OR COLOR.

NO CLAIM IS MADE TO THE EXCLUSIVE RIGHT TO USE "ODOR", APART FROM THE MARK AS SHOWN.

SN 77-748,646, FILED 6-1-2009.

CHARLOTTE CORWIN, EXAMINING ATTORNEY



*David J. Kyffers*

Director of the United States Patent and Trademark Office

# United States of America

United States Patent and Trademark Office

# I-SONIC

**Reg. No. 4,276,059**

**Registered Jan. 15, 2013**

**Int. Cl.: 9**

**TRADEMARK**

**PRINCIPAL REGISTER**

POLK AUDIO, INC. (MARYLAND CORPORATION)  
ATTENTION: LEGAL DEPARTMENT  
5601 METRO DRIVE  
BALTIMORE, MD 21215

FOR: WIRELESS INDOOR AND OUTDOOR SPEAKERS; WIRELESS RECEIVERS AND TRANSMITTERS FOR PORTABLE MEDIA PLAYERS, IN CLASS 9 (U.S. CLS. 21, 23, 26, 36 AND 38).

FIRST USE 7-1-2012; IN COMMERCE 7-1-2012.

THE MARK CONSISTS OF STANDARD CHARACTERS WITHOUT CLAIM TO ANY PARTICULAR FONT, STYLE, SIZE, OR COLOR.

OWNER OF U.S. REG. NOS. 3,175,609, 3,662,005, AND OTHERS.

SN 77-749,285, FILED 6-1-2009.

JUSTINE D. PARKER, EXAMINING ATTORNEY



*David J. Kyffers*

Director of the United States Patent and Trademark Office

# United States of America

United States Patent and Trademark Office

# ADASUVE

**Reg. No. 4,276,060**

ALEXZA PHARMACEUTICALS, INC. (DELAWARE CORPORATION)  
2091 STIERLIN COURT  
MOUNTAIN VIEW, CA 94043

**Registered Jan. 15, 2013**

**Int. Cl.: 5**

FOR: PHARMACEUTICAL PREPARATIONS FOR THE TREATMENT OF DISEASES AND CONDITIONS OF THE CENTRAL NERVOUS SYSTEM, IN CLASS 5 (U.S. CLS. 6, 18, 44, 46, 51 AND 52).

**TRADEMARK**

FIRST USE 11-2-2012; IN COMMERCE 11-2-2012.

**PRINCIPAL REGISTER**

THE MARK CONSISTS OF STANDARD CHARACTERS WITHOUT CLAIM TO ANY PARTICULAR FONT, STYLE, SIZE, OR COLOR.

SN 77-752,342, FILED 6-4-2009.

TINA L. SNAPP, EXAMINING ATTORNEY



*David J. Kyffers*

Director of the United States Patent and Trademark Office

# United States of America

United States Patent and Trademark Office

## BONE CRUSHER

**Reg. No. 4,276,061**

GREGG RITZ IP, LLC (DELAWARE LIMITED LIABILITY COMPANY)  
12 AUTUMN LANE  
STRATHAM, NH 03885

**Registered Jan. 15, 2013**

**Int. Cl.: 28**

FOR: ARCHERY IMPLEMENTS, NAMELY, BOWS FOR ARCHERY AND HUNTING, IN CLASS 28 (U.S. CLS. 22, 23, 38 AND 50).

**TRADEMARK**

FIRST USE 10-0-2012; IN COMMERCE 10-0-2012.

**PRINCIPAL REGISTER**

THE MARK CONSISTS OF STANDARD CHARACTERS WITHOUT CLAIM TO ANY PARTICULAR FONT, STYLE, SIZE, OR COLOR.

SN 77-756,283, FILED 6-10-2009.

KATHY DE JONGE, EXAMINING ATTORNEY



*David J. Kybas*

Director of the United States Patent and Trademark Office

# United States of America

United States Patent and Trademark Office

# RILLOWRAPS

**Reg. No. 4,276,062**

**Registered Jan. 15, 2013**

**Int. Cl.: 34**

**TRADEMARK**

**PRINCIPAL REGISTER**

BBK TOBACCO & FOODS LLP (ARIZONA LIMITED LIABILITY PARTNERSHIP), DBA  
HBI INTERNATIONAL,  
3315 W BUCKEYE RD #4  
PHOENIX, AZ 85009

FOR: CIGAR TUBES; CIGARETTE ROLLING PAPERS; TOBACCO, CIGARS AND CIGAR-  
ETTES, IN CLASS 34 (U.S. CLS. 2, 8, 9 AND 17).

FIRST USE 4-14-2012; IN COMMERCE 4-14-2012.

THE MARK CONSISTS OF STANDARD CHARACTERS WITHOUT CLAIM TO ANY PAR-  
TICULAR FONT, STYLE, SIZE, OR COLOR.

SN 77-779,053, FILED 7-11-2009.

MARIAM MAHMOUDI, EXAMINING ATTORNEY



*David J. Kyffers*

Director of the United States Patent and Trademark Office

# United States of America

United States Patent and Trademark Office

## CHOCOLATE WITH BENEFITS

**Reg. No. 4,276,063**

HERO NUTRITIONALS, LLC (CALIFORNIA LIMITED LIABILITY COMPANY)  
991 CALLE NEGOCIO  
SAN CLEMENTE, CA 92673

**Registered Jan. 15, 2013**

**Int. Cl.: 5**

FOR: CHOCOLATE-BASED NUTRACEUTRICALS FOR USE AS A DIETARY SUPPLEMENT,  
IN CLASS 5 (U.S. CLS. 6, 18, 44, 46, 51 AND 52).

**TRADEMARK**

FIRST USE 10-1-2011; IN COMMERCE 10-1-2011.

**PRINCIPAL REGISTER**

THE MARK CONSISTS OF STANDARD CHARACTERS WITHOUT CLAIM TO ANY PAR-  
TICULAR FONT, STYLE, SIZE, OR COLOR.

NO CLAIM IS MADE TO THE EXCLUSIVE RIGHT TO USE "CHOCOLATE", APART FROM  
THE MARK AS SHOWN.

SN 77-782,659, FILED 7-16-2009.

MATTHEW MCDOWELL, EXAMINING ATTORNEY



*David J. Kybas*

Director of the United States Patent and Trademark Office



# United States of America

United States Patent and Trademark Office

# KISS GIRLS

**Reg. No. 4,276,064**

**Registered Jan. 15, 2013**

**Int. Cl.: 16**

**TRADEMARK**

**PRINCIPAL REGISTER**

KISS CATALOG, LTD. (NEW YORK CORPORATION)  
18 HOOK MOUNTAIN ROAD, SUITE 203  
C/O JOSEPH YOUNG ASSOCIATES, LTD.  
PINE BROOK, NJ 070589785

FOR: COMIC BOOKS, IN CLASS 16 (U.S. CLS. 2, 5, 22, 23, 29, 37, 38 AND 50).

FIRST USE 10-24-2012; IN COMMERCE 10-24-2012.

THE MARK CONSISTS OF STANDARD CHARACTERS WITHOUT CLAIM TO ANY PARTICULAR FONT, STYLE, SIZE, OR COLOR.

OWNER OF U.S. REG. NOS. 1,153,088, 1,894,876, AND 2,800,903.

NO CLAIM IS MADE TO THE EXCLUSIVE RIGHT TO USE "GIRLS", APART FROM THE MARK AS SHOWN.

SN 77-791,556, FILED 7-28-2009.

JOHN E. MICHOS, EXAMINING ATTORNEY



*David J. Kyffers*

Director of the United States Patent and Trademark Office

# United States of America

United States Patent and Trademark Office



**Reg. No. 4,276,065**

RIVER LIGHT V. L.P. (DELAWARE LIMITED PARTNERSHIP)  
11 WEST 19TH STREET, 7TH FLOOR  
NEW YORK, NY 10011

**Registered Jan. 15, 2013**

**Int. Cl.: 16**

FOR: CALENDARS; NOTE CARDS; PASSPORT COVERS; PEN AND PENCIL CASES; PENCILS; STATIONERY, IN CLASS 16 (U.S. CLS. 2, 5, 22, 23, 29, 37, 38 AND 50).

**TRADEMARK**

FIRST USE 9-30-2008; IN COMMERCE 9-30-2008.

**PRINCIPAL REGISTER**

OWNER OF U.S. REG. NOS. 3,024,142, 3,029,795, AND 3,563,326.

THE MARK CONSISTS OF AN UPRIGHT "T" DIRECTLY BELOW AN INVERTED "T" ALL SURROUNDED BY A CIRCLE.

SN 77-803,663, FILED 8-13-2009.

NICHOLAS COLEMAN, EXAMINING ATTORNEY



*David J. Kybas*

Director of the United States Patent and Trademark Office

# United States of America

United States Patent and Trademark Office

## MARTHA STEWART CLEAN

**Reg. No. 4,276,066**

**Registered Jan. 15, 2013**

**Int. Cl.: 3**

**TRADEMARK**

**PRINCIPAL REGISTER**

MARTHA STEWART LIVING OMNIMEDIA, INC. (DELAWARE CORPORATION)  
601 WEST 26TH STREET, 10TH FLOOR  
NEW YORK, NY 100011101

FOR: DETERGENTS FOR HOUSEHOLD USE; CLEANING PREPARATIONS; LAUNDRY DETERGENTS; STAIN REMOVERS; FABRIC SOFTENERS; DISHWASHER DETERGENTS; DISH WASHING DETERGENTS; HAND SOAPS; ALL-PURPOSE CLEANERS; GLASS AND SURFACE CLEANERS; CARPET CLEANERS; WOOD FLOOR CLEANERS; TOILET BOWL DETERGENTS; BATHROOM CLEANERS; BATHROOM TUB AND TILE CLEANERS, IN CLASS 3 (U.S. CLS. 1, 4, 6, 50, 51 AND 52).

FIRST USE 10-0-2009; IN COMMERCE 10-0-2009.

THE MARK CONSISTS OF STANDARD CHARACTERS WITHOUT CLAIM TO ANY PARTICULAR FONT, STYLE, SIZE, OR COLOR.

OWNER OF U.S. REG. NOS. 2,186,451, 3,475,303, AND OTHERS.

NO CLAIM IS MADE TO THE EXCLUSIVE RIGHT TO USE "CLEAN", APART FROM THE MARK AS SHOWN.

THE NAME(S), PORTRAIT(S), AND/OR SIGNATURE(S) SHOWN IN THE MARK IDENTIFIES "MARTHA STEWART", WHOSE CONSENT(S) TO REGISTER IS MADE OF RECORD.

SN 77-824,056, FILED 9-10-2009.

DOUGLAS LEE, EXAMINING ATTORNEY



*David J. Kyros*

Director of the United States Patent and Trademark Office

# United States of America

United States Patent and Trademark Office

# GET IN

**Reg. No. 4,276,067**

**Registered Jan. 15, 2013**

**Int. Cl.: 16**

**TRADEMARK**

**PRINCIPAL REGISTER**

APPLAUD, LLC (OHIO LIMITED LIABILITY COMPANY)  
LEGAL  
300 E-BUSINESS WAY, SUITE 200  
CINCINNATI, OH 45241

FOR: MEMORY BOOKS, IN CLASS 16 (U.S. CLS. 2, 5, 22, 23, 29, 37, 38 AND 50).

FIRST USE 9-1-2009; IN COMMERCE 3-1-2010.

THE MARK CONSISTS OF STANDARD CHARACTERS WITHOUT CLAIM TO ANY PARTICULAR FONT, STYLE, SIZE, OR COLOR.

SN 77-831,000, FILED 9-21-2009.

RENEE SERVANCE, EXAMINING ATTORNEY



*David J. Kybas*

Director of the United States Patent and Trademark Office

# United States of America

United States Patent and Trademark Office

## FIVE-EIGHTY PRESS

**Reg. No. 4,276,068**

**Registered Jan. 15, 2013**

**Int. Cl.: 41**

**SERVICE MARK**

**PRINCIPAL REGISTER**

THE INNOVATIVE EDGE, LLC (CALIFORNIA LIMITED LIABILITY COMPANY)  
735 LAWTON STREET  
SAN FRANCISCO, CA 94122

FOR: BOOK PUBLISHING, IN CLASS 41 (U.S. CLS. 100, 101 AND 107).

FIRST USE 10-24-2012; IN COMMERCE 10-24-2012.

THE MARK CONSISTS OF STANDARD CHARACTERS WITHOUT CLAIM TO ANY PARTICULAR FONT, STYLE, SIZE, OR COLOR.

NO CLAIM IS MADE TO THE EXCLUSIVE RIGHT TO USE "PRESS", APART FROM THE MARK AS SHOWN.

SN 77-840,985, FILED 10-4-2009.

BRIAN NEVILLE, EXAMINING ATTORNEY



*David J. Kyffers*

Director of the United States Patent and Trademark Office

# United States of America

United States Patent and Trademark Office

# iFIX-IT

**Reg. No. 4,276,069**

**Registered Jan. 15, 2013**

**Int. Cl.: 20**

**TRADEMARK**

**PRINCIPAL REGISTER**

HANDI-FOIL CORPORATION (ILLINOIS CORPORATION)  
135 E. HINTZ RD.  
WHEELING, IL 60090

FOR: NON-METALLIC PICTURE AND MIRROR HANGING AND MOUNTING HARDWARE, NAMELY, A KIT CONSISTING OF PLASTIC HOLDERS WITH SCREWS; AND NON-METALLIC FASTENING ANCHORS FOR SECURING FIXTURES AND SUPPORTS TO WALLS, NON-METALLIC WASHERS FOR HOUSEHOLD USE; ADHESIVE FELT PADS FOR APPLICATION TO THE BOTTOM OF FURNITURE TO PROTECT FLOORS, IN CLASS 20 (U.S. CLS. 2, 13, 22, 25, 32 AND 50).

FIRST USE 4-15-2012; IN COMMERCE 4-15-2012.

THE MARK CONSISTS OF STANDARD CHARACTERS WITHOUT CLAIM TO ANY PARTICULAR FONT, STYLE, SIZE, OR COLOR.

SN 77-841,238, FILED 10-5-2009.

ARETHA SOMERVILLE, EXAMINING ATTORNEY



*David J. Kyros*

Director of the United States Patent and Trademark Office

# United States of America

United States Patent and Trademark Office

# iShareHistory

**Reg. No. 4,276,070**

UNIVERSITY OF WEST FLORIDA (FLORIDA STATE UNIVERSITY)  
11000 UNIVERSITY PARKWAY  
PENSACOLA, FL 325145750

**Registered Jan. 15, 2013**

**Int. Cl.: 39**

FOR: PROVIDING AND SHARING TRAVEL AND GUIDED TOUR AND GEOGRAPHIC INFORMATION, MAP IMAGES AND TRIP ROUTES TO AND AMONG TELEPHONE, COMPUTER AND PDA USERS , IN CLASS 39 (U.S. CLS. 100 AND 105).

**SERVICE MARK**

FIRST USE 8-1-2012; IN COMMERCE 8-1-2012.

**PRINCIPAL REGISTER**

THE MARK CONSISTS OF STANDARD CHARACTERS WITHOUT CLAIM TO ANY PARTICULAR FONT, STYLE, SIZE, OR COLOR.

SN 77-842,506, FILED 10-6-2009.

PAUL E. FAHRENKOPF, EXAMINING ATTORNEY



*David J. Kyffers*

Director of the United States Patent and Trademark Office

# United States of America

United States Patent and Trademark Office

## MELA SCIENCES

**Reg. No. 4,276,071**

**Registered Jan. 15, 2013**

**Int. Cl.: 10**

**TRADEMARK**

**PRINCIPAL REGISTER**

MELA SCIENCES, INC. (DELAWARE CORPORATION), DBA MELA SCIENCES,  
50 SOUTH BUCKHOUT STREET  
SUITE 1  
IRVINGTON, NY 10533

FOR: MEDICAL DEVICES, NAMELY, ELECTRO-OPTICAL DEVICES INCORPORATING BOTH HARDWARE AND SOFTWARE FOR OBTAINING IMAGES IN DIFFERENT SPECTRAL BANDS AND SOFTWARE FOR ANALYZING THE IMAGES FOR USE IN ANALYZING SKIN LESIONS AND DETERMINING THE EXISTENCE OF MELANOMA; INSTRUMENTATION COMPRISING COMPUTER-ASSISTED OPTICAL IMAGES AND IMAGE ANALYZERS FOR USE IN THE DETECTION OF CUTANEOUS MELANOMA AND OTHER PATHOLOGY OF SKIN AND TISSUES, IN CLASS 10 (U.S. CLS. 26, 39 AND 44).

FIRST USE 2-23-2012; IN COMMERCE 2-23-2012.

THE MARK CONSISTS OF STANDARD CHARACTERS WITHOUT CLAIM TO ANY PARTICULAR FONT, STYLE, SIZE, OR COLOR.

OWNER OF U.S. REG. NOS. 2,713,699 AND 3,659,168.

NO CLAIM IS MADE TO THE EXCLUSIVE RIGHT TO USE "SCIENCES", APART FROM THE MARK AS SHOWN.

SN 77-843,064, FILED 10-7-2009.

MEGHAN REINHART, EXAMINING ATTORNEY



*David J. Kyjars*

Director of the United States Patent and Trademark Office



# United States of America

United States Patent and Trademark Office



**NATIONAL  
BANK**

**FINANCIAL GROUP**

**Reg. No. 4,276,072**

**Registered Jan. 15, 2013**

**Int. Cl.: 36**

**SERVICE MARK**

**PRINCIPAL REGISTER**

NATIONAL BANK OF CANADA (CANADA CORPORATION)  
600, DE LA GAUCHETIERE STREET WEST  
MONTREAL, QUEBEC, CANADA H3B4L2

FOR: BANKING, TRUST SERVICES, NAMELY, TRUST COMPANY SERVICES; SECURITIES, NAMELY, SECURITY BROKERAGE, SECURITIES DEALER SERVICES, NAMELY, BROKERAGE SERVICES IN THE FIELD OF SECURITIES; PROVIDING A WEB SITE FEATURING PERSONAL FINANCIAL INFORMATION AND FINANCIAL ADVICE; ELECTRONIC COMMERCE SERVICES, NAMELY, ONLINE BANKING AND ELECTRONIC BILL PAYMENT SERVICES; AUTOMATED TELLER MACHINE SERVICE; PROVIDING FINANCIAL INFORMATION, NAMELY, THE DISSEMINATION OF FINANCIAL INFORMATION ELECTRONICALLY VIA AN INTERNET-BASED DATABASE; ELECTRONIC FUNDS TRANSFER; HOLDING COMPANY, AND OTHER FINANCIAL AND NON-FINANCIAL SERVICES, NAMELY, FINANCIAL ANALYSIS AND CONSULTATION; FINANCIAL SERVICES IN THE NATURE OF PROVIDING FINANCIAL EXCHANGE OF DATA BETWEEN FINANCIAL INSTITUTIONS AND THEIR CUSTOMERS; FINANCIAL FORECASTING; FINANCIAL GUARANTEE AND SURETY MORTGAGES; FINANCIAL SERVICES, NAMELY, PROVIDING FINANCIAL INFORMATION, NAMELY, COMPANY ANNUAL REPORTS, CREDIT CARD INTEREST RATES, RATES OF EXCHANGE, STOCK EXCHANGE QUOTATIONS, LOAN INFORMATION; FINANCIAL INFORMATION PROVIDED BY ELECTRONIC MEANS; INVESTMENT BANKING SERVICES; INVESTMENT SERVICES IN THE FIELD OF COMMODITIES, GOLD, INVESTMENT NOTES, MUTUAL FUNDS, REAL ESTATE, STOCKS, SECURITIES, ESCROW ACCOUNTS, PORTFOLIO MANAGEMENT BANKING PRODUCTS, NAMELY, MONETARY DEPOSITS; FINANCIAL PLANNING; FINANCIAL RESEARCH; FINANCIAL VALUATION OF PERSONAL PROPERTY AND REAL ESTATE; DEBIT AND CREDIT CARD SERVICES; ESTATE PLANNING, IN CLASS 36 (U.S. CLS. 100, 101 AND 102).

FIRST USE 2-0-2008; IN COMMERCE 4-4-2011.

OWNER OF CANADA REG. NO. TMA760654, DATED 3-2-2010, EXPIRES 3-2-2025.

NO CLAIM IS MADE TO THE EXCLUSIVE RIGHT TO USE "NATIONAL BANK" AND "FINANCIAL GROUP", APART FROM THE MARK AS SHOWN.

THE MARK CONSISTS OF A STYLIZED LETTER "N" TO THE LEFT OF "NATIONAL" ABOVE "BANK" ABOVE A HORIZONTAL LINE ABOVE "FINANCIAL GROUP".



*David J. Kyros*

Director of the United States Patent and Trademark Office

**Reg. No. 4,276,072** SN 77-844,331, FILED 10-8-2009.

NAPOLEON SHARMA, EXAMINING ATTORNEY

# United States of America

United States Patent and Trademark Office



**Reg. No. 4,276,073**

DEFENSE ELECTRONICS CORPORATION (FLORIDA CORPORATION)

**Registered Jan. 15, 2013**

3690 70TH AVENUE NORTH  
PINELLAS PARK, FL 33781

**Int. Cl.: 9**

FOR: ELECTRONIC COMPONENTS, NAMELY, ELECTRONIC CONTROLS FOR USE WITH MILITARY, INDUSTRIAL AND COMMERCIAL ELECTRONIC AND ELECTRICAL EQUIPMENT; POWER ELECTRONICS, NAMELY, POWER SUPPLIES FOR USE WITH MILITARY, INDUSTRIAL AND COMMERCIAL ELECTRONIC AND ELECTRICAL EQUIPMENT; INTELLIGENT POWER MANAGEMENT DEVICES, NAMELY, POWER FACTOR REGULATORS AND POWER VOLTAGE REGULATORS FOR USE WITH MILITARY, INDUSTRIAL AND COMMERCIAL ELECTRONIC AND ELECTRICAL EQUIPMENT; INTEGRATED CIRCUIT CARDS AND NON-INTEGRATED CIRCUIT CARDS, NAMELY, BLANK INTEGRATED CIRCUIT CARDS AND INTEGRATED CIRCUIT BOARDS AND NON-INTEGRATED CIRCUIT BOARD ASSEMBLIES, NAMELY, BLANK CIRCUIT BOARDS; ENCAPSULATED AND EMBEDDED DEVICES, NAMELY, CIRCUIT BOARDS AND DISCRETE COMPONENTS, NAMELY, ELECTRICAL COMPONENTS IN THE NATURE OF PROTECTION RELAYS FOR PROTECTING MILITARY, INDUSTRIAL AND COMMERCIAL ELECTRONIC AND ELECTRICAL EQUIPMENT; APPARATUS FOR TRANSMISSION OF COMMUNICATION; ELECTRONIC COMMUNICATION DEVICES, NAMELY, TELEMETRY DATA SENSOR COMMUNICATIONS LINKS COMPRISED OF ELECTRONIC TRANSMITTERS, ELECTRONIC RECEIVERS, AND MICROPROCESSORS AND REMOTE MONITORING SUBSYSTEMS COMPRISED OF COMPUTER HARDWARE AND OPERATING SOFTWARE AND ELECTRONIC TRANSMITTERS FOR TRANSMITTING AUDIO, VIDEO AND TEXTUAL INFORMATION; SATELLITE COMMUNICATION EQUIPMENT, NAMELY, ANTENNAS; MICROWAVE SENSING EQUIPMENT, NAMELY, ELECTRONIC SENSORS FOR DETECTING MICROWAVES; WIRELESS COMMUNICATION EQUIPMENT, NAMELY, TRANSMITTERS AND RECEIVERS FOR WIRELESS NETWORKS; SENSING COMPUTER HARDWARE, NAMELY, ELECTRONIC TEST AND ANALYSIS EQUIPMENT AND DATA ACQUISITION DEVICES FOR POWER CONTROL AND MONITORING DEVICES; SUBMINIATURE ELECTRONIC SENSORS FOR SENSING VISUAL OBJECTS AND ACOUSTIC INFORMATION; ELECTRONIC DATA LOGGERS FOR CAPTURING INFORMATION FROM MILITARY, INDUSTRIAL AND COMMERCIAL DATA ACQUISITION SENSORS; ELECTRIC AND ELECTRONIC TELEMETRY SENSORS, VIDEO SENSORS AND ACOUSTICAL SENSORS FOR USE IN SENSING THE PRESENCE OF INDIVIDUALS OR OBJECTS FOR SECURITY PURPOSES; ELECTRONIC SENSORS, NAMELY, NETWORKED SENSORS FOR USE IN SURVEILLANCE AND MONITORING; ELECTRONIC UNATTENDED GROUND SENSORS

**TRADEMARK**

**PRINCIPAL REGISTER**



*David J. Kybas*

Director of the United States Patent and Trademark Office

**Reg. No. 4,276,073** FOR USE IN SURVEILLANCE AND MONITORING, IN CLASS 9 (U.S. CLS. 21, 23, 26, 36 AND 38).

FIRST USE 6-30-2011; IN COMMERCE 6-30-2011.

NO CLAIM IS MADE TO THE EXCLUSIVE RIGHT TO USE "DEFENSE ELECTRONICS CORPORATION", APART FROM THE MARK AS SHOWN.

THE MARK CONSISTS OF THE STYLIZED LETTERS "DEC" WITH A SINGLE STAR LOCATED TO THE LEFT OF THE "D" AND A SINGLE STAR LOCATED TO THE RIGHT OF THE "C" WITH ALL CONTAINED WITHIN A RECTANGLE; BELOW "DEC" IS THE STYLIZED WORDING "DEFENSE ELECTRONICS CORPORATION".

SN 77-844,980, FILED 10-9-2009.

MARY CRAWFORD, EXAMINING ATTORNEY

# United States of America

United States Patent and Trademark Office

## SUPER EPHED

**Reg. No. 4,276,074**

DICKEY INVESTMENTS, LLC (INDIANA LIMITED LIABILITY COMPANY)  
15268 STONY CREEK WAY  
NOBLESVILLE, IN 46061

**Registered Jan. 15, 2013**

**Int. Cl.: 5**

FOR: DIETARY SUPPLEMENTS; BRONCHODILATORS; DECONGESTANTS; EXPECTORANTS, IN CLASS 5 (U.S. CLS. 6, 18, 44, 46, 51 AND 52).

**TRADEMARK**

FIRST USE 11-27-2012; IN COMMERCE 11-27-2012.

**PRINCIPAL REGISTER**

THE MARK CONSISTS OF STANDARD CHARACTERS WITHOUT CLAIM TO ANY PARTICULAR FONT, STYLE, SIZE, OR COLOR.

OWNER OF U.S. REG. NOS. 2,784,790 AND 2,952,572.

NO CLAIM IS MADE TO THE EXCLUSIVE RIGHT TO USE "SUPER", APART FROM THE MARK AS SHOWN.

SN 77-845,880, FILED 10-9-2009.

ROBERT C. CLARK JR., EXAMINING ATTORNEY



*David J. Kybas*

Director of the United States Patent and Trademark Office

# United States of America

United States Patent and Trademark Office

## LEAVE YOU FEELING ENERGIZED

**Reg. No. 4,276,075**

**Registered Jan. 15, 2013**

**Int. Cl.: 43**

**SERVICE MARK**

**PRINCIPAL REGISTER**

THE CRIMSON CUP, INC. (OHIO CORPORATION)  
700 ALUM CREEK DRIVE, SUITE 400  
COLUMBUS, OH 43205

FOR: COFFEE AND TEA BARS, IN CLASS 43 (U.S. CLS. 100 AND 101).

FIRST USE 4-1-2012; IN COMMERCE 4-1-2012.

THE MARK CONSISTS OF STANDARD CHARACTERS WITHOUT CLAIM TO ANY PARTICULAR FONT, STYLE, SIZE, OR COLOR.

SN 77-846,931, FILED 10-12-2009.

RENEE MCCRAY, EXAMINING ATTORNEY



*David J. Kybas*

Director of the United States Patent and Trademark Office

# United States of America

United States Patent and Trademark Office

LEAVE OTHERS VERY ENERGIZED

**Reg. No. 4,276,076**

**Registered Jan. 15, 2013**

**Int. Cl.: 43**

**SERVICE MARK**

**PRINCIPAL REGISTER**

THE CRIMSON CUP, INC. (OHIO CORPORATION)  
700 ALUM CREEK DRIVE, SUITE 400  
COLUMBUS, OH 43205

FOR: COFFEE AND TEA BARS, IN CLASS 43 (U.S. CLS. 100 AND 101).

FIRST USE 4-1-2012; IN COMMERCE 4-1-2012.

THE MARK CONSISTS OF STANDARD CHARACTERS WITHOUT CLAIM TO ANY PARTICULAR FONT, STYLE, SIZE, OR COLOR.

SN 77-846,933, FILED 10-12-2009.

RENEE MCCRAY, EXAMINING ATTORNEY



*David J. Kybas*

Director of the United States Patent and Trademark Office

# United States of America

United States Patent and Trademark Office



**Reg. No. 4,276,077**

**Registered Jan. 15, 2013**

**Int. Cl.: 42**

**SERVICE MARK**

**PRINCIPAL REGISTER**

MOTT STREET GROUP, INC. (NEW YORK CORPORATION)  
116 MOTT ST.  
#20  
NEW YORK, NY 10013

FOR: PROVISION OF SEARCH ENGINES FOR THE INTERNET, IN CLASS 42 (U.S. CLS. 100 AND 101).

FIRST USE 9-10-2012; IN COMMERCE 9-10-2012.

THE MARK CONSISTS OF THE NUMBER "24" FOLLOWED BY A BIRD FOLLOWED BY THE NUMBER "7" FOLLOWED BY THE WORD "COM" WRITTEN VERTICALLY WITH AND THE WORD ANYTHING FOLLOWED BY A DOT FOLLOWED BY THE WORD ANYTIME FOLLOWED BY A DOT FOLLOWED BY THE WORD ANYWHERE APPEAR IN A SEMI-CIRCLE BELOW THE NUMBER "24" AND LEADING TO THE BIRD.

SN 77-849,761, FILED 10-15-2009.

KATHERINE E. HALMEN, EXAMINING ATTORNEY



*David J. Kybas*

Director of the United States Patent and Trademark Office



# United States of America

United States Patent and Trademark Office

# JUNTOS

**Reg. No. 4,276,078**

**Registered Jan. 15, 2013**

**Int. Cl.: 25**

**TRADEMARK**

**PRINCIPAL REGISTER**

JUNTOS TRADITIONALLY INCORPORATED (FLORIDA CORPORATION)  
3031 S MIAMI AVE  
MIAMI, FL 33129

FOR: BEACH SHOES; LEATHER SHOES; SHOES, IN CLASS 25 (U.S. CLS. 22 AND 39).

FIRST USE 10-25-2012; IN COMMERCE 10-25-2012.

THE MARK CONSISTS OF STANDARD CHARACTERS WITHOUT CLAIM TO ANY PARTICULAR FONT, STYLE, SIZE, OR COLOR.

THE ENGLISH TRANSLATION OF "JUNTOS" IN THE MARK IS "TOGETHERNESS".

SN 77-850,999, FILED 10-16-2009.

BERNICE MIDDLETON, EXAMINING ATTORNEY



*David J. Kyffers*

Director of the United States Patent and Trademark Office

# United States of America

United States Patent and Trademark Office

## FAST CUP PACKER

**Reg. No. 4,276,079**

NORSE DAIRY SYSTEMS, LLC (DELAWARE LIMITED LIABILITY COMPANY)  
P.O. BOX 1869  
COLUMBUS, OH 43216

**Registered Jan. 15, 2013**

**Int. Cl.: 7**

FOR: AN AUTOMATED PACKING SYSTEM FOR PACKING FROZEN NOVELTY CUPS INTO BULK PACK CARTONS, IN CLASS 7 (U.S. CLS. 13, 19, 21, 23, 31, 34 AND 35).

**TRADEMARK**

FIRST USE 8-10-2012; IN COMMERCE 8-10-2012.

**PRINCIPAL REGISTER**

THE MARK CONSISTS OF STANDARD CHARACTERS WITHOUT CLAIM TO ANY PARTICULAR FONT, STYLE, SIZE, OR COLOR.

NO CLAIM IS MADE TO THE EXCLUSIVE RIGHT TO USE "CUP PACKER", APART FROM THE MARK AS SHOWN.

SN 77-853,136, FILED 10-20-2009.

FLORENTINA BLANDU, EXAMINING ATTORNEY



*David J. Kyffers*

Director of the United States Patent and Trademark Office

# United States of America

United States Patent and Trademark Office

# LEADER

**Reg. No. 4,276,080**

NEW YORK AIR BRAKE LLC (DELAWARE LIMITED LIABILITY COMPANY)  
748 STARBUCK AVENUE  
WATERTOWN, NY 13601

**Registered Jan. 15, 2013**

**Int. Cl.: 12**

FOR: LOCOMOTIVE CONSOLE PARTS, NAMELY, LOCOMOTIVE MONITORING SYSTEM SOLD AS AN INTEGRAL PART OF LOCOMOTIVES FEATURING SOFTWARE AND PROCESSOR TO PROCESS, INTEGRATE, AND DISPLAY REAL-TIME INFORMATION AND DATA, IN CLASS 12 (U.S. CLS. 19, 21, 23, 31, 35 AND 44).

**TRADEMARK**

**PRINCIPAL REGISTER**

FIRST USE 12-9-1991; IN COMMERCE 9-15-1996.

THE MARK CONSISTS OF STANDARD CHARACTERS WITHOUT CLAIM TO ANY PARTICULAR FONT, STYLE, SIZE, OR COLOR.

OWNER OF U.S. REG. NOS. 2,354,682, 2,354,683, AND OTHERS.

SN 77-853,785, FILED 10-21-2009.

MARGARET POWER, EXAMINING ATTORNEY



*David J. Kybas*

Director of the United States Patent and Trademark Office

# United States of America

United States Patent and Trademark Office

# VECTRA

**Reg. No. 4,276,081**

**Registered Jan. 15, 2013**

**Int. Cls.: 42 and 44**

**SERVICE MARK**

**PRINCIPAL REGISTER**

CRESCENDO BIOSCIENCE, INC. (DELAWARE CORPORATION)  
341 OYSTER POINT BLVD.  
SOUTH SAN FRANCISCO, CA 94080

FOR: MEDICAL LABORATORY SERVICES PROVIDED TO PHYSICIANS AND CLINICIANS RELATED TO HUMAN AUTOIMMUNE AND INFLAMMATORY DISEASES AND CONDITIONS; MEDICAL RESEARCH INFORMATION PROVIDED TO PHYSICIANS AND CLINICIANS IN CONNECTION WITH HUMAN AUTOIMMUNE AND INFLAMMATORY DISEASES AND CONDITIONS, IN CLASS 42 (U.S. CLS. 100 AND 101).

FIRST USE 11-30-2010; IN COMMERCE 11-30-2010.

FOR: MEDICAL TESTING SERVICES PROVIDED TO PHYSICIANS AND CLINICIANS RELATED TO HUMAN AUTOIMMUNE AND INFLAMMATORY DISEASES AND CONDITIONS, IN CLASS 44 (U.S. CLS. 100 AND 101).

FIRST USE 11-30-2010; IN COMMERCE 11-30-2010.

THE MARK CONSISTS OF STANDARD CHARACTERS WITHOUT CLAIM TO ANY PARTICULAR FONT, STYLE, SIZE, OR COLOR.

SN 77-856,377, FILED 10-23-2009.

ERIN FALK, EXAMINING ATTORNEY



*David J. Kyjars*

Director of the United States Patent and Trademark Office

# United States of America

United States Patent and Trademark Office

# WAVECREST

**Reg. No. 4,276,082**

COHEREX MEDICAL, INC. (DELAWARE CORPORATION)  
3598 WEST 1820 SOUTH  
SALT LAKE CITY, UT 84104

**Registered Jan. 15, 2013**

**Int. Cl.: 10**

FOR: MEDICAL DEVICES, NAMELY, ANCHORING MECHANISM FOR MEDICAL DEVICES,  
IN CLASS 10 (U.S. CLS. 26, 39 AND 44).

**TRADEMARK**

FIRST USE 12-9-2010; IN COMMERCE 12-9-2010.

**PRINCIPAL REGISTER**

THE MARK CONSISTS OF STANDARD CHARACTERS WITHOUT CLAIM TO ANY PAR-  
TICULAR FONT, STYLE, SIZE, OR COLOR.

SN 77-859,220, FILED 10-28-2009.

LIEF MARTIN, EXAMINING ATTORNEY



*David J. Kyffers*

Director of the United States Patent and Trademark Office

# United States of America

United States Patent and Trademark Office

## METALICUS AUSTRALIA

**Reg. No. 4,276,083**

**Registered Jan. 15, 2013**

**Int. Cl.: 25**

**TRADEMARK**

**PRINCIPAL REGISTER**

METALICUS PTY LIMITED (AUSTRALIA COMPANY)  
17 HARDNER ROAD  
MOUNT WAVERLEY, VICTORIA, AUSTRALIA 3149

FOR: CLOTHING, NAMELY, SINGLETS, SWEATERS, PANTS, SKIRTS, DRESSES, LEGGINGS, CARDIGANS, JACKETS AND SHORTS; HOSIERY, IN CLASS 25 (U.S. CLS. 22 AND 39).

FIRST USE 6-1-2012; IN COMMERCE 6-1-2012.

THE MARK CONSISTS OF STANDARD CHARACTERS WITHOUT CLAIM TO ANY PARTICULAR FONT, STYLE, SIZE, OR COLOR.

OWNER OF U.S. REG. NO. 3,329,637.

NO CLAIM IS MADE TO THE EXCLUSIVE RIGHT TO USE "AUSTRALIA", APART FROM THE MARK AS SHOWN.

SN 77-862,607, FILED 11-2-2009.

GIANCARLO CASTRO, EXAMINING ATTORNEY



*David J. Kyffers*

Director of the United States Patent and Trademark Office

# United States of America

United States Patent and Trademark Office

**DRS**  
DIGITAL REFERENCE STANDARD

**Reg. No. 4,276,084**

R&B FILMS AND VIDEO SERVICES, LTD. (NEW YORK CORPORATION)  
1057 LAKEVILLE ROAD  
NEW HYDE PARK, NY 11040

**Registered Jan. 15, 2013**

**Int. Cl.: 9**

FOR: CONSUMER ELECTRONICS HOME ENTERTAINMENT PRODUCTS, NAMELY, AUDIO AND VIDEO CABLES, DIGITAL AUDIO AND VIDEO CABLES, ELECTRICAL COMPUTER INTERCONNECT CABLES, PLUG ADAPTORS, ELECTRICAL POWER AND POWER EXTENSION CORDS, HIGH-DEFINITION MULTIMEDIA INTERFACE CABLES, TELEVISION AND VIDEO GAME CONSOLE REMOTE CONTROLS; PRERECORDED MEDIA PRODUCTS, NAMELY, PRERECORDED OPTICAL DISCS, HIGH DEFINITION DIGITAL DISCS; COMPUTER HARDWARE, NAMELY, FLASH MEMORY CARDS, MEMORY CARDS, IN CLASS 9 (U.S. CLS. 21, 23, 26, 36 AND 38).

**TRADEMARK**

**PRINCIPAL REGISTER**

FIRST USE 7-24-2012; IN COMMERCE 7-24-2012.

NO CLAIM IS MADE TO THE EXCLUSIVE RIGHT TO USE "DIGITAL REFERENCE STANDARD", APART FROM THE MARK AS SHOWN.

THE MARK CONSISTS OF THE STYLIZED LETTERS "DRS" ABOVE THE STYLIZED WORDING "DIGITAL REFERENCE STANDARD".

SN 77-864,373, FILED 11-3-2009.

ALYSSA STEEL, EXAMINING ATTORNEY



*David J. Kyffers*

Director of the United States Patent and Trademark Office

# United States of America

United States Patent and Trademark Office

## IMMUNOCIDIN

**Reg. No. 4,276,085**

BIONICHE LIFE SCIENCES INC. (CANADA CORPORATION)  
231 DUNDAS STREET EAST  
BELLEVILLE, ONTARIO, CANADA K8N1E2

**Registered Jan. 15, 2013**

**Int. Cl.: 5**

FOR: BIOLOGICAL PREPARATION FOR THE STIMULATION OF THE IMMUNE SYSTEM,  
IN CLASS 5 (U.S. CLS. 6, 18, 44, 46, 51 AND 52).

**TRADEMARK**

FIRST USE 10-23-2012; IN COMMERCE 10-23-2012.

**PRINCIPAL REGISTER**

THE MARK CONSISTS OF STANDARD CHARACTERS WITHOUT CLAIM TO ANY PARTICULAR FONT, STYLE, SIZE, OR COLOR.

THE WORDING "IMMUNOCIDIN" HAS NO MEANING IN A FOREIGN LANGUAGE.

SN 77-864,645, FILED 11-4-2009.

BILL DAWE, EXAMINING ATTORNEY



*David J. Kyffers*

Director of the United States Patent and Trademark Office



# United States of America

United States Patent and Trademark Office

## NEUROVANCE

**Reg. No. 4,276,086**

**Registered Jan. 15, 2013**

**Int. Cl.: 42**

**SERVICE MARK**

**PRINCIPAL REGISTER**

EUTHYMICS BIOSCIENCE, INC. (DELAWARE CORPORATION)  
43 THORNDIKE STREET, SUITE S1-3  
CAMBRIDGE, MA 02141

FOR: LABORATORY RESEARCH IN THE FIELD OF TREATMENT AND OR PROPHYLAXIS OF DISORDERS OF THE CENTRAL NERVOUS SYSTEM; PHARMACEUTICAL RESEARCH AND DEVELOPMENT; PHARMACEUTICAL RESEARCH SERVICES; RESEARCH AND DEVELOPMENT OF TECHNOLOGY IN THE FIELD OF DRUG DISCOVERY, PHARMACEUTICALS, ALL RELATED TO THE TREATMENT OF DISORDERS OF THE CENTRAL NERVOUS SYSTEM, IN CLASS 42 (U.S. CLS. 100 AND 101).

FIRST USE 10-18-2012; IN COMMERCE 10-18-2012.

THE MARK CONSISTS OF STANDARD CHARACTERS WITHOUT CLAIM TO ANY PARTICULAR FONT, STYLE, SIZE, OR COLOR.

SN 77-864,680, FILED 11-4-2009.

BILL DAWE, EXAMINING ATTORNEY



*David J. Kyfos*

Director of the United States Patent and Trademark Office

United States of America  
United States Patent and Trademark Office

# ECO-SMART

**Reg. No. 4,276,087**

ULTRATECH INTERNATIONAL, INC. (FLORIDA CORPORATION)  
11542 DAVIS CREEK CT.  
JACKSONVILLE, FL 32256

**Registered Jan. 15, 2013**

**Int. Cls.: 19 and 20**

FOR: PLASTIC CONTAINMENT POOLS FOR RETENTION OF LARGE-SCALE LIQUID SPILLS OR RELEASES, PLASTIC DECKING, PLASTIC STRUCTURES FOR STORAGE OF LIQUID-CONTAINING DRUMS, IN CLASS 19 (U.S. CLS. 1, 12, 33 AND 50).

**TRADEMARK**

FIRST USE 11-15-2012; IN COMMERCE 11-15-2012.

**PRINCIPAL REGISTER**

FOR: PLASTIC PALLETS, PLASTIC LIQUID-RETAINING PALLETS, PLASTIC COVERS FOR LIQUID-CONTAINING DRUMS, PLASTIC INDUSTRIAL CONTAINERS FOR STORAGE OF LIQUID-CONTAINING DRUMS, IN CLASS 20 (U.S. CLS. 2, 13, 22, 25, 32 AND 50).

FIRST USE 11-15-2012; IN COMMERCE 11-15-2012.

THE MARK CONSISTS OF STANDARD CHARACTERS WITHOUT CLAIM TO ANY PARTICULAR FONT, STYLE, SIZE, OR COLOR.

SN 77-872,164, FILED 11-13-2009.

TARAH HARDY, EXAMINING ATTORNEY



*David J. Kyfos*

Director of the United States Patent and Trademark Office

# United States of America

United States Patent and Trademark Office

## NATURALLY YUMMI

**Reg. No. 4,276,088**

**Registered Jan. 15, 2013**

**Int. Cl.: 5**

**TRADEMARK**

**PRINCIPAL REGISTER**

HERO NUTRITIONALS, LLC (CALIFORNIA LIMITED LIABILITY COMPANY)  
LEGAL DEPARTMENT  
991 CALLE NEGOCIO  
SAN CLEMENTE, CA 92673

FOR: DIETARY AND NUTRITIONAL SUPPLEMENTS; VITAMINS AND VITAMIN PREPARATIONS, IN CLASS 5 (U.S. CLS. 6, 18, 44, 46, 51 AND 52).

FIRST USE 9-1-2012; IN COMMERCE 9-1-2012.

THE MARK CONSISTS OF STANDARD CHARACTERS WITHOUT CLAIM TO ANY PARTICULAR FONT, STYLE, SIZE, OR COLOR.

OWNER OF U.S. REG. NOS. 2,330,056, 2,815,488, AND OTHERS.

SN 77-873,295, FILED 11-16-2009.

MARY CRAWFORD, EXAMINING ATTORNEY



*David J. Kyjars*

Director of the United States Patent and Trademark Office

# United States of America

United States Patent and Trademark Office

# STRIDE

**Reg. No. 4,276,089**

**Registered Jan. 15, 2013**

**Int. Cl.: 11**

**TRADEMARK**

**PRINCIPAL REGISTER**

WATKINS MANUFACTURING CORPORATION (CALIFORNIA CORPORATION)  
1280 PARK CENTER DRIVE  
VISTA, CA 92081

FOR: HOT TUBS AND SPAS IN THE NATURE OF HEATED POOLS, IN CLASS 11 (U.S. CLS. 13, 21, 23, 31 AND 34).

FIRST USE 11-6-2012; IN COMMERCE 11-6-2012.

THE MARK CONSISTS OF STANDARD CHARACTERS WITHOUT CLAIM TO ANY PARTICULAR FONT, STYLE, SIZE, OR COLOR.

SN 77-874,397, FILED 11-17-2009.

KRISTIN DAHLING, EXAMINING ATTORNEY



*David J. Kyffers*

Director of the United States Patent and Trademark Office

# United States of America

United States Patent and Trademark Office

## VOCABULARY THEIR WAY

**Reg. No. 4,276,090**

PEARSON EDUCATION, INC. (DELAWARE CORPORATION)  
ONE LAKE STREET

**Registered Jan. 15, 2013**

UPPER SADDLE RIVER, NJ 07458

**Int. Cl.: 16**

FOR: PRINTED MATERIALS, NAMELY, TEXTBOOKS, ACTIVITY BOOKS, ACTIVITY GUIDES, TEACHER'S GUIDES, AND WORKBOOKS IN THE FIELD OF PHONICS, VOCABULARY, AND SPELLING, IN CLASS 16 (U.S. CLS. 2, 5, 22, 23, 29, 37, 38 AND 50).

**TRADEMARK**

FIRST USE 5-26-2009; IN COMMERCE 5-26-2009.

**PRINCIPAL REGISTER**

THE MARK CONSISTS OF STANDARD CHARACTERS WITHOUT CLAIM TO ANY PARTICULAR FONT, STYLE, SIZE, OR COLOR.

OWNER OF U.S. REG. NOS. 3,260,939, 3,462,392, AND 3,503,179.

NO CLAIM IS MADE TO THE EXCLUSIVE RIGHT TO USE "VOCABULARY", APART FROM THE MARK AS SHOWN.

SN 77-874,789, FILED 11-17-2009.

HEATHER THOMPSON, EXAMINING ATTORNEY



*David J. Kybas*

Director of the United States Patent and Trademark Office

# United States of America

United States Patent and Trademark Office

## NExBTL

**Reg. No. 4,276,091**

**Registered Jan. 15, 2013**

**Int. Cl.: 4**

**TRADEMARK**

**PRINCIPAL REGISTER**

NESTE OIL OYJ (FINLAND CORPORATION)  
KEILARANTA 21  
02150 ESPOO, FINLAND

FOR: DIESEL OILS, IN CLASS 4 (U.S. CLS. 1, 6 AND 15).

FIRST USE 0-0-2007; IN COMMERCE 4-0-2012.

THE MARK CONSISTS OF THE WORDING "NEXBTL" IN STYLIZED FORM.

SN 77-877,093, FILED 11-20-2009.

DAVID H. STINE, EXAMINING ATTORNEY



*David J. Kyffers*

Director of the United States Patent and Trademark Office

# United States of America

United States Patent and Trademark Office

# Holo-Lens

**Reg. No. 4,276,092**

HAZEN PAPER COMPANY (MASSACHUSETTS CORPORATION)  
240 SOUTH WATER STREET  
HOLYOKE, MA 01041

**Registered Jan. 15, 2013**

**Int. Cl.: 16**

FOR: RECYCLABLE HOLOGRAPHIC AND NON-HOLOGRAPHIC PAPERBOARD HAVING  
A METALLIC COATING, IN CLASS 16 (U.S. CLS. 2, 5, 22, 23, 29, 37, 38 AND 50).

**TRADEMARK**

FIRST USE 11-1-2009; IN COMMERCE 11-1-2009.

**PRINCIPAL REGISTER**

THE MARK CONSISTS OF STANDARD CHARACTERS WITHOUT CLAIM TO ANY PAR-  
TICULAR FONT, STYLE, SIZE, OR COLOR.

THE WORDING "HOLO-LENS" HAS NO MEANING IN A FOREIGN LANGUAGE.

SN 77-877,729, FILED 11-20-2009.

BILL DAWE, EXAMINING ATTORNEY



*David J. Kyffers*

Director of the United States Patent and Trademark Office

# United States of America

United States Patent and Trademark Office

# Sleeve Plus

**Reg. No. 4,276,093**

THIBAUT, JACQUES (CANADA INDIVIDUAL)  
627 BELLEVUE EST, CAP-SAINT-IGNACE  
QUEBEC, CANADA G0R1H0

**Registered Jan. 15, 2013**

**Int. Cl.: 8**

FOR: PRECISION HAND TOOL, NAMELY, A RING TIGHTENER FOR WATER TIGHT PIPE CONNECTIONS, IN CLASS 8 (U.S. CLS. 23, 28 AND 44).

**TRADEMARK**

FIRST USE 9-4-2012; IN COMMERCE 9-4-2012.

**PRINCIPAL REGISTER**

THE MARK CONSISTS OF STANDARD CHARACTERS WITHOUT CLAIM TO ANY PARTICULAR FONT, STYLE, SIZE, OR COLOR.

NO CLAIM IS MADE TO THE EXCLUSIVE RIGHT TO USE "SLEEVE", APART FROM THE MARK AS SHOWN.

SN 77-880,075, FILED 11-24-2009.

MARGERY A. TIERNEY, EXAMINING ATTORNEY



*David J. Kybas*

Director of the United States Patent and Trademark Office



# United States of America

United States Patent and Trademark Office

## BLOOMING GREEN

**Reg. No. 4,276,094**

BERKLEY PACKAGING COMPANY, INC. (PENNSYLVANIA CORPORATION)  
29 VIRGINIA AVENUE  
UNIONTOWN, PA 15401

**Registered Jan. 15, 2013**

**Int. Cl.: 3**

FOR: NATURAL HOUSEHOLD CLEANING PRODUCTS, NAMELY, ALL-PURPOSE CLEANERS; DEGREASING PREPARATIONS FOR HOUSEHOLD USE; GLASS, BATHROOM, TOILET, AND DISH CLEANSERS, FABRIC SOFTENERS AND LAUNDRY DETERGENTS, IN CLASS 3 (U.S. CLS. 1, 4, 6, 50, 51 AND 52).

**TRADEMARK**

**PRINCIPAL REGISTER**

FIRST USE 10-9-2012; IN COMMERCE 10-9-2012.

THE MARK CONSISTS OF STANDARD CHARACTERS WITHOUT CLAIM TO ANY PARTICULAR FONT, STYLE, SIZE, OR COLOR.

NO CLAIM IS MADE TO THE EXCLUSIVE RIGHT TO USE "GREEN", APART FROM THE MARK AS SHOWN.

SN 77-882,727, FILED 11-30-2009.

ALLISON HOLTZ, EXAMINING ATTORNEY



*David J. Kyffers*

Director of the United States Patent and Trademark Office

# United States of America

United States Patent and Trademark Office



**Reg. No. 4,276,095**

**Registered Jan. 15, 2013**

**Int. Cl.: 20**

**TRADEMARK**

**PRINCIPAL REGISTER**

VENKO TROPHIES & AWARDS, INC. (CALIFORNIA CORPORATION)  
1221 BRICKELL AVENUE  
C/O GREENBERG TRAUIG, P.A.  
MIAMI, FL 33131

FOR: NON-METAL TROPHIES; STATUES OF PLASTIC; FIGURES OF PLASTIC; AWARDS, NAMELY, WALL PLAQUES OF PLASTIC; AWARDS, NAMELY, COMMEMORATIVE CUPS OF PLASTIC, IN CLASS 20 (U.S. CLS. 2, 13, 22, 25, 32 AND 50).

FIRST USE 2-8-2010; IN COMMERCE 2-8-2010.

NO CLAIM IS MADE TO THE EXCLUSIVE RIGHT TO USE "TROPHIES", APART FROM THE MARK AS SHOWN.

THE MARK CONSISTS OF THE WORDS "VENKO TROPHIES" WITH THE "V" IN "VENKO" IN STYLIZED FORM HAVING A "V" DISPOSED PARTIALLY WITHIN THE OPEN SPACE BETWEEN THE LEFT AND RIGHT SIDES OF ANOTHER "V".

THE ENGLISH TRANSLATION OF THE ESPERANTO WORD "VENKO" IN THE MARK IS "VICTORY".

SN 77-883,907, FILED 12-2-2009.

ELLEN BURNS, EXAMINING ATTORNEY



*David J. Kybas*

Director of the United States Patent and Trademark Office

# United States of America

United States Patent and Trademark Office

## CAROLINA TREADZ

**Reg. No. 4,276,096**

COLUMBIA INSURANCE COMPANY (NEBRASKA CORPORATION)  
3024 HARNEY STREET  
OMAHA, NE 68131

**Registered Jan. 15, 2013**

**Int. Cl.: 25**

FOR: FOOTWEAR, IN CLASS 25 (U.S. CLS. 22 AND 39).

**TRADEMARK**

FIRST USE 5-8-2010; IN COMMERCE 5-8-2010.

**PRINCIPAL REGISTER**

THE MARK CONSISTS OF STANDARD CHARACTERS WITHOUT CLAIM TO ANY PARTICULAR FONT, STYLE, SIZE, OR COLOR.

SN 77-888,493, FILED 12-8-2009.

DANNEAN HETZEL, EXAMINING ATTORNEY



*David J. Kyffers*

Director of the United States Patent and Trademark Office

# United States of America

United States Patent and Trademark Office

# NPG

**Reg. No. 4,276,097**

**Registered Jan. 15, 2013**

**Int. Cls.: 9, 36, 37, 39,  
and 42**

**TRADEMARK**

**SERVICE MARK**

**PRINCIPAL REGISTER**

NO PANIC COMPUTING INC. (CANADA CORPORATION)  
SUITE 120  
25 ROYAL CREST COURT  
MARKHAM, ONTARIO, CANADA L3R9X4

FOR: COMPUTERS; COMPUTER HARDWARE; COMPUTER PERIPHERALS; COMPUTER SOFTWARE FOR COMPUTER SECURITY, DATA ENCRYPTION, ON-LINE DATA BACK-UP AND RECOVERY, AND TECHNICAL SUPPORT RELATING TO COMPUTERS, COMPUTER HARDWARE, COMPUTER PERIPHERALS, COMPUTER SOFTWARE, AND COMMUNICATION AND CONSUMER ELECTRONICS PRODUCTS, IN CLASS 9 (U.S. CLS. 21, 23, 26, 36 AND 38).

FIRST USE 0-0-2008; IN COMMERCE 9-28-2009.

FOR: PROVIDING WARRANTIES ON GOODS MANUFACTURED BY OTHERS, NAMELY, COMPUTERS, COMPUTER HARDWARE, AND COMPUTER PERIPHERALS, IN CLASS 36 (U.S. CLS. 100, 101 AND 102).

FIRST USE 0-0-2008; IN COMMERCE 9-28-2009.

FOR: MAINTENANCE AND REPAIR OF DESKTOP COMPUTERS, NOTEBOOK COMPUTERS, AND TABLET COMPUTERS, ALL FEATURING TECHNOLOGY THAT AUTOMATICALLY AND REMOTELY MONITORS THE USER'S OPERATING SYSTEM FOR QUALITY AND COMPLETENESS WHILE PROVIDING SECURE DATA BACKUP, MONITORING OF THE INTEGRITY OF THE ENCRYPTION SYSTEM, AND CHECKING FOR VIRUSES OR TAMPERING ATTACKS, IN CLASS 37 (U.S. CLS. 100, 103 AND 106).

FIRST USE 0-0-2008; IN COMMERCE 9-28-2009.

FOR: ELECTRONIC STORAGE OF DATA, IN CLASS 39 (U.S. CLS. 100 AND 105).

FIRST USE 0-0-2008; IN COMMERCE 9-28-2009.

FOR: COMPUTER SERVICES IN THE AREAS OF BACK UP, ENCRYPTION, PROTECTION, REPAIR, AND RECOVERY OF COMPUTER DATA; TROUBLESHOOTING SERVICES, NAMELY, DIAGNOSING PROBLEMS RELATING TO SOFTWARE FOR DESKTOP COMPUTERS, NOTEBOOK COMPUTERS, TABLET COMPUTERS, SMART PHONES, AND PDAS;



*David J. Kyros*

Director of the United States Patent and Trademark Office

**Reg. No. 4,276,097** CONSULTING SERVICES IN THE FIELD OF DESIGN, SELECTION, IMPLEMENTATION, AND USE OF COMPUTER HARDWARE AND SOFTWARE SYSTEMS FOR OTHERS; TROUBLESHOOTING SERVICES, NAMELY, DIAGNOSING PROBLEMS RELATING TO DESKTOP COMPUTERS, NOTEBOOK COMPUTERS, TABLET COMPUTERS, SMART PHONES, AND PDAS, IN CLASS 42 (U.S. CLS. 100 AND 101).

FIRST USE 0-0-2008; IN COMMERCE 9-28-2009.

THE MARK CONSISTS OF A STYLIZED REPRESENTATION OF THE LETTERS "NPC".

SN 77-899,496, FILED 12-22-2009.

MICHAEL ENGEL, EXAMINING ATTORNEY

# United States of America

United States Patent and Trademark Office

## W·A·I·POINTES

**Reg. No. 4,276,098**

SPECTRUM HEALTH INNOVATIONS, LLC (MICHIGAN LIMITED LIABILITY COMPANY)  
100 MICHIGAN ST NE  
GRAND RAPIDS, MI 49503

**Registered Jan. 15, 2013**

**Int. Cls.: 41 and 44**

FOR: PROVIDING EDUCATIONAL SERVICES, NAMELY, CONDUCTING PROGRAMS FOR WOMEN'S HEALTH CARE, IN CLASS 41 (U.S. CLS. 100, 101 AND 107).

**SERVICE MARK**

FIRST USE 5-12-2010; IN COMMERCE 5-12-2010.

**PRINCIPAL REGISTER**

FOR: PROVIDING HEALTH CARE SERVICES FOCUSED ON WOMEN'S HEALTH; PROVIDING INFORMATION IN THE FIELD OF WOMEN'S HEALTH, IN CLASS 44 (U.S. CLS. 100 AND 101).

FIRST USE 5-12-2010; IN COMMERCE 5-12-2010.

THE MARK CONSISTS OF STANDARD CHARACTERS WITHOUT CLAIM TO ANY PARTICULAR FONT, STYLE, SIZE, OR COLOR.

SN 77-906,821, FILED 1-7-2010.

JASON TURNER, EXAMINING ATTORNEY



*David J. Kybas*

Director of the United States Patent and Trademark Office

# United States of America

United States Patent and Trademark Office

## KRYSTAL KOLOURS

**Reg. No. 4,276,099**

AGC FLAT GLASS NORTH AMERICA, INC. (DELAWARE CORPORATION)  
11175 CICERO DR., SUITE 400  
ALPHARETTA, GA 30022

**Registered Jan. 15, 2013**

**Int. Cls.: 19, 20, and 21**

FOR: BACK PAINTED GLASS, NAMELY, BUILDING GLASS, IN CLASS 19 (U.S. CLS. 1, 12, 33 AND 50).

**TRADEMARK**

FIRST USE 5-0-2010; IN COMMERCE 5-0-2010.

**PRINCIPAL REGISTER**

FOR: BACK PAINTED GLASS, NAMELY, MIRRORS, IN CLASS 20 (U.S. CLS. 2, 13, 22, 25, 32 AND 50).

FIRST USE 5-0-2010; IN COMMERCE 5-0-2010.

FOR: BACK PAINTED GLASS, NAMELY, MOSAIC ART TILES MADE OF GLASS, NOT FOR CONSTRUCTION, IN CLASS 21 (U.S. CLS. 2, 13, 23, 29, 30, 33, 40 AND 50).

FIRST USE 5-0-2010; IN COMMERCE 5-0-2010.

THE MARK CONSISTS OF STANDARD CHARACTERS WITHOUT CLAIM TO ANY PARTICULAR FONT, STYLE, SIZE, OR COLOR.

NO CLAIM IS MADE TO THE EXCLUSIVE RIGHT TO USE "COLORS", APART FROM THE MARK AS SHOWN.

SN 77-912,053, FILED 1-14-2010.

RUDY R. SINGLETON, EXAMINING ATTORNEY



*David J. Kyffers*

Director of the United States Patent and Trademark Office

# United States of America

United States Patent and Trademark Office

# TROLLA

**Reg. No. 4,276,100**

**Registered Jan. 15, 2013**

**Int. Cl.: 28**

**TRADEMARK**

**PRINCIPAL REGISTER**

MATTEL, INC. (DELAWARE CORPORATION)  
M1-1518  
333 CONTINENTAL BOULEVARD  
EL SEGUNDO, CA 90245

FOR: TOY ACTION FIGURES AND ACCESSORIES THEREFOR, IN CLASS 28 (U.S. CLS. 22, 23, 38 AND 50).

FIRST USE 11-15-2012; IN COMMERCE 11-15-2012.

THE MARK CONSISTS OF STANDARD CHARACTERS WITHOUT CLAIM TO ANY PARTICULAR FONT, STYLE, SIZE, OR COLOR.

SN 77-919,058, FILED 1-25-2010.

MICHAEL SOUDERS, EXAMINING ATTORNEY



*David J. Kybas*

Director of the United States Patent and Trademark Office



# United States of America

United States Patent and Trademark Office

## ANDREW & SUZANNE

**Reg. No. 4,276,101**

**Registered Jan. 15, 2013**

**Int. Cl.: 25**

**TRADEMARK**

**PRINCIPAL REGISTER**

G-III LEATHER FASHIONS, INC. (NEW YORK CORPORATION)  
512 SEVENTH AVENUE  
NEW YORK, NY 100184202

FOR: OUTERWEAR, NAMELY, COATS, IN CLASS 25 (U.S. CLS. 22 AND 39).

FIRST USE 3-10-2010; IN COMMERCE 3-10-2010.

THE MARK CONSISTS OF STANDARD CHARACTERS WITHOUT CLAIM TO ANY PARTICULAR FONT, STYLE, SIZE, OR COLOR.

SN 77-924,985, FILED 2-1-2010.

ELLEN B. AWRICH, EXAMINING ATTORNEY



*David J. Kybas*

Director of the United States Patent and Trademark Office

**United States of America**  
United States Patent and Trademark Office

**AEROGREEN**

**Reg. No. 4,276,102**

JERRY L. MCKINNEY (UNITED STATES INDIVIDUAL)

**Registered Jan. 15, 2013**

P. O. BOX 697  
SILSBEE, TX 77656

**Int. Cl.: 11**

FOR: ENVIRONMENTALLY FRIENDLY ONSITE WASTEWATER TREATMENT SYSTEMS,  
IN CLASS 11 (U.S. CLS. 13, 21, 23, 31 AND 34).

**TRADEMARK**

FIRST USE 5-11-2012; IN COMMERCE 5-11-2012.

**PRINCIPAL REGISTER**

THE MARK CONSISTS OF STANDARD CHARACTERS WITHOUT CLAIM TO ANY PAR-  
TICULAR FONT, STYLE, SIZE, OR COLOR.

SN 77-930,311, FILED 2-8-2010.

JANICE KIM, EXAMINING ATTORNEY



*David J. Kybas*

Director of the United States Patent and Trademark Office

# United States of America

United States Patent and Trademark Office

## TRAVELING HERE AND THERE

**Reg. No. 4,276,103**

ELISON MEDIA, LLC (IOWA LIMITED LIABILITY COMPANY)  
10605 JUSTIN DR.

**Registered Jan. 15, 2013**

URBANDALE, IA 50322

**Int. Cl.: 9**

FOR: DOWNLOADABLE SOFTWARE IN THE NATURE OF A MOBILE APPLICATION FOR MAKING CONNECTIONS WITH TRAVELERS, ACCRUING TRAVEL MILES AND REWARDS, IN CLASS 9 (U.S. CLS. 21, 23, 26, 36 AND 38).

**TRADEMARK**

FIRST USE 3-1-2010; IN COMMERCE 3-1-2010.

**PRINCIPAL REGISTER**

THE MARK CONSISTS OF STANDARD CHARACTERS WITHOUT CLAIM TO ANY PARTICULAR FONT, STYLE, SIZE, OR COLOR.

SN 77-931,779, FILED 2-9-2010.

BRIAN CALLAGHAN, EXAMINING ATTORNEY



*David J. Kyffers*

Director of the United States Patent and Trademark Office

# United States of America

United States Patent and Trademark Office

# USEALUSA

**Reg. No. 4,276,104**

MURPHY, JOSEPH (UNITED STATES INDIVIDUAL)  
33 SHEPARD DRIVE  
NEWINGTON, CT 06111

**Registered Jan. 15, 2013**

**Int. Cl.: 19**

FOR: HEATABLE RUBBERIZED TAR-BASED ASPHALT CRACK SEALANTS FOR USE IN FILLING THIN CRACKS IN ASPHALT PAVEMENT IN DRIVEWAYS, PARKING LOTS, AIRPORT RUNWAYS, ROADS, HIGHWAYS AND THE LIKE , IN CLASS 19 (U.S. CLS. 1, 12, 33 AND 50).

**TRADEMARK**

**PRINCIPAL REGISTER**

FIRST USE 6-1-2011; IN COMMERCE 6-1-2011.

THE MARK CONSISTS OF STANDARD CHARACTERS WITHOUT CLAIM TO ANY PARTICULAR FONT, STYLE, SIZE, OR COLOR.

SN 77-933,533, FILED 2-11-2010.

KATHERINE CONNOLLY, EXAMINING ATTORNEY



*David J. Kyros*

Director of the United States Patent and Trademark Office

# United States of America

United States Patent and Trademark Office

# DYNANAIL

**Reg. No. 4,276,105**

**Registered Jan. 15, 2013**

**Int. Cl.: 10**

**TRADEMARK**

**PRINCIPAL REGISTER**

MEDSHAPE, INC. (GEORGIA CORPORATION)  
1575 NORTHSIDE DRIVE NW  
SUITE 440  
ATLANTA, GA 30318

FOR: INTRAMEDULLARY NAILS, IN CLASS 10 (U.S. CLS. 26, 39 AND 44).

FIRST USE 10-0-2012; IN COMMERCE 10-0-2012.

THE MARK CONSISTS OF STANDARD CHARACTERS WITHOUT CLAIM TO ANY PARTICULAR FONT, STYLE, SIZE, OR COLOR.

SN 77-934,386, FILED 2-12-2010.

ALLISON HOLTZ, EXAMINING ATTORNEY



*David J. Kyffers*

Director of the United States Patent and Trademark Office

# United States of America

United States Patent and Trademark Office

## APGAR SCORE

**Reg. No. 4,276,106**

**Registered Jan. 15, 2013**

**Int. Cl.: 41**

**SERVICE MARK**

**PRINCIPAL REGISTER**

COUNTRY MOUSE LLC (VERMONT LIMITED LIABILITY COMPANY)  
632 HILLS POINT ROAD  
CHARLOTTE, VT 05445

FOR: ARRANGING AND CONDUCTING INCENTIVE AWARD PROGRAMS TO ENCOURAGE THE FREQUENT, CONTINUED AND EFFECTIVE PRACTICE OF PHYSICAL EXERCISE; COUNSELING SERVICES IN THE FIELD OF PHYSICAL FITNESS; ENCOURAGING AMATEUR SPORTS AND PHYSICAL EDUCATION BY ORGANIZING, SANCTIONING, CONDUCTING, REGULATING AND GOVERNING AMATEUR ATHLETIC PROGRAMS AND ACTIVITIES; HEALTH CLUB SERVICES, NAMELY, PROVIDING INSTRUCTION AND EQUIPMENT IN THE FIELD OF PHYSICAL EXERCISE; PHYSICAL EDUCATION; PHYSICAL EDUCATION SERVICES; PHYSICAL FITNESS CONDITIONING CLASSES; PHYSICAL FITNESS CONSULTATION; PHYSICAL FITNESS INSTRUCTION; PHYSICAL FITNESS TRAINING SERVICES; PROVIDING ASSISTANCE, PERSONAL TRAINING AND PHYSICAL FITNESS CONSULTATION TO CORPORATE CLIENTS TO HELP THEIR EMPLOYEES MAKE PHYSICAL FITNESS, STRENGTH, CONDITIONING, AND EXERCISE ALTERATIONS IN THEIR DAILY LIVING; PROVIDING ASSISTANCE, PERSONAL TRAINING AND PHYSICAL FITNESS CONSULTATION TO INDIVIDUALS TO HELP THEM MAKE PHYSICAL FITNESS, STRENGTH, CONDITIONING, AND EXERCISE IMPROVEMENT IN THEIR DAILY LIVING; PROVIDING INFORMATION ON PHYSICAL EXERCISE, IN CLASS 41 (U.S. CLS. 100, 101 AND 107).

FIRST USE 1-1-1988; IN COMMERCE 1-1-1988.

THE MARK CONSISTS OF STANDARD CHARACTERS WITHOUT CLAIM TO ANY PARTICULAR FONT, STYLE, SIZE, OR COLOR.

NO CLAIM IS MADE TO THE EXCLUSIVE RIGHT TO USE "SCORE", APART FROM THE MARK AS SHOWN.

SN 77-937,645, FILED 2-17-2010.

DOMINIC FATHY, EXAMINING ATTORNEY



*David J. Kyffers*

Director of the United States Patent and Trademark Office

# United States of America

United States Patent and Trademark Office

# VETYVERIO

**Reg. No. 4,276,107**

DIPTYQUE S.A.S (FRANCE SOCIÉTÉ PAR ACTIONS SIMPLIFIÉE (SAS))  
34, BOULEVARD SAINT GERMAIN  
PARIS 75005, FRANCE

**Registered Jan. 15, 2013**

**Int. Cl.: 3**

FOR: PERFUMERY, TOILET WATERS; SOAPS, NAMELY, SHOWER GELS, IN CLASS 3  
(U.S. CLS. 1, 4, 6, 50, 51 AND 52).

**TRADEMARK**

FIRST USE 4-12-2010; IN COMMERCE 5-10-2010.

**PRINCIPAL REGISTER**

THE MARK CONSISTS OF STANDARD CHARACTERS WITHOUT CLAIM TO ANY PARTICULAR FONT, STYLE, SIZE, OR COLOR.

THE WORD(S) "VETYVERIO" HAS NO MEANING IN A FOREIGN LANGUAGE.

SN 77-941,895, FILED 2-22-2010.

ERIN FALK, EXAMINING ATTORNEY



*David J. Kybas*

Director of the United States Patent and Trademark Office

# United States of America

United States Patent and Trademark Office

## CARTER BOND

**Reg. No. 4,276,108**

HENNESSY DESIGN GROUP PTY LTD (AUSTRALIA CORPORATION)  
11 COURT ROAD  
DOUBLE BAY, AUSTRALIA NSW2028

**Registered Jan. 15, 2013**

**Int. Cl.: 9**

FOR: OPTICAL FRAMES AND SUNGLASSES, IN CLASS 9 (U.S. CLS. 21, 23, 26, 36 AND 38).

**TRADEMARK**

FIRST USE 12-31-2010; IN COMMERCE 12-31-2010.

**PRINCIPAL REGISTER**

THE MARK CONSISTS OF STANDARD CHARACTERS WITHOUT CLAIM TO ANY PARTICULAR FONT, STYLE, SIZE, OR COLOR.

OWNER OF AUSTRALIA REG. NO. 1296318, DATED 4-28-2009, EXPIRES 4-28-2019.

THE NAME(S), PORTRAIT(S), AND/OR SIGNATURE(S) SHOWN IN THE MARK DOES NOT IDENTIFY A PARTICULAR LIVING INDIVIDUAL.

SN 77-949,711, FILED 3-3-2010.

ALICE BENMAMAN, EXAMINING ATTORNEY



*David J. Kyros*

Director of the United States Patent and Trademark Office



# United States of America

United States Patent and Trademark Office



**Reg. No. 4,276,109**

**Registered Jan. 15, 2013**

**Int. Cl.: 44**

**SERVICE MARK**

**PRINCIPAL REGISTER**

AFFINITY REHABILITATION, LLP (NEW YORK LIMITED LIABILITY PARTNERSHIP)  
3 OVERLOOK TRAIL  
SUGAR LOAF, NY 10981

FOR: MANAGEMENT OF REHABILITATION THERAPY SERVICES DIRECTLY TO OTHER HEALTHCARE PROVIDERS, NAMELY, HEALTH CARE SERVICES IN THE NATURE OF MANAGEMENT OF OCCUPATIONAL AND SPEECH PATHOLOGY/LANGUAGE THERAPY PROGRAMS; HEALTHCARE SERVICES, NAMELY, MANAGEMENT OF LONG TERM ACUTE NURSING CARE AND POST ACUTE HOME NURSING CARE, IN CLASS 44 (U.S. CLS. 100 AND 101).

FIRST USE 3-31-2009; IN COMMERCE 3-31-2009.

NO CLAIM IS MADE TO THE EXCLUSIVE RIGHT TO USE "REHABILITATION", APART FROM THE MARK AS SHOWN.

THE MARK CONSISTS OF A STYLIZED HEART DESIGN AND THE WORD "AFFINITY" ON THE RIGHT, IN STYLIZED LETTERING, AND THE WORD "REHABILITATION" BELOW IN ALL CAPITAL LETTERS.

SN 77-954,517, FILED 3-9-2010.

TAMARA FRAZIER, EXAMINING ATTORNEY



*David J. Kyros*

Director of the United States Patent and Trademark Office

# United States of America

United States Patent and Trademark Office

# ENLITE

**Reg. No. 4,276,110**

MEDTRONIC MINIMED, INC. (DELAWARE CORPORATION)  
18000 DEVONSHIRE STREET  
NORTHRIDGE, CA 91325

**Registered Jan. 15, 2013**

**Int. Cl.: 10**

FOR: MEDICAL EQUIPMENT, NAMELY, INSTRUMENTS AND SENSORS FOR MEASURING BLOOD GLUCOSE LEVELS AND INSTRUMENTS AND SENSORS FOR DIABETES MONITORING, IN CLASS 10 (U.S. CLS. 26, 39 AND 44).

**TRADEMARK**

FIRST USE 4-11-2011; IN COMMERCE 4-11-2011.

**PRINCIPAL REGISTER**

THE MARK CONSISTS OF STANDARD CHARACTERS WITHOUT CLAIM TO ANY PARTICULAR FONT, STYLE, SIZE, OR COLOR.

SN 77-955,657, FILED 3-10-2010.

HENRY S. ZAK, EXAMINING ATTORNEY



*David J. Kyffers*

Director of the United States Patent and Trademark Office

# United States of America

United States Patent and Trademark Office

# EWOWorx

**Reg. No. 4,276,111**

**Registered Jan. 15, 2013**

**Int. Cls.: 9 and 42**

**TRADEMARK**

**SERVICE MARK**

**PRINCIPAL REGISTER**

BYERS ENGINEERING COMPANY (GEORGIA CORPORATION)  
6285 BARFIELD ROAD  
ATLANTA, GA 30328

FOR: COMPUTER SOFTWARE, NAMELY, COMPUTER SOFTWARE FOR INTEGRATING CUSTOMER, NETWORK, AND GEOGRAPHIC INFORMATION SYSTEM DATA FOR PLANNING, PROVISIONING, MANAGEMENT AND MAINTENANCE OF TELECOMMUNICATIONS NETWORKS, FACILITIES AND INFRASTRUCTURE, IN CLASS 9 (U.S. CLS. 21, 23, 26, 36 AND 38).

FIRST USE 8-27-2012; IN COMMERCE 8-27-2012.

FOR: PROVIDING TEMPORARY USE OF ON-LINE NON-DOWNLOADABLE COMPUTER SOFTWARE, COMPUTER SYSTEMS DESIGN CONSULTATION, AND CUSTOMIZATION OF COMPUTER SOFTWARE, ALL OF THE FOREGOING RELATING TO THE INTEGRATION OF CUSTOMER, NETWORK, AND GEOGRAPHIC INFORMATION SYSTEM DATA FOR PLANNING, PROVISIONING, MANAGEMENT AND MAINTENANCE OF UTILITIES NETWORKS, FACILITIES AND INFRASTRUCTURE, IN CLASS 42 (U.S. CLS. 100 AND 101).

FIRST USE 5-16-2012; IN COMMERCE 5-16-2012.

THE MARK CONSISTS OF STANDARD CHARACTERS WITHOUT CLAIM TO ANY PARTICULAR FONT, STYLE, SIZE, OR COLOR.

SN 77-958,493, FILED 3-14-2010.

MARGARET POWER, EXAMINING ATTORNEY



*David J. Kyros*

Director of the United States Patent and Trademark Office

# United States of America

United States Patent and Trademark Office



**Reg. No. 4,276,112**

**Registered Jan. 15, 2013**

**Int. Cls.: 39 and 44**

**SERVICE MARK**

**PRINCIPAL REGISTER**

INPRAXI S.A.S. (COLOMBIA CORPORATION)  
CALLE 5 SUR NO. 22-290  
TORRE 5, OFICINA 2001  
MEDELLÍN, COLOMBIA

FOR: MEDICAL TOURISM SERVICES, NAMELY, MAKING TRANSPORTATION RESERVATIONS AND BOOKINGS FOR TRAVEL TO ANOTHER COUNTRY IN ORDER TO OBTAIN HEALTH CARE, IN CLASS 39 (U.S. CLS. 100 AND 105).

FIRST USE 1-1-2010; IN COMMERCE 1-1-2010.

FOR: PROVIDING ON-LINE MEDICAL PROFILES AND MEDICAL RECORD ANALYSIS SERVICES DESIGNED TO PROVIDE PATIENTS WITH CUSTOM TAILORED MEDICAL INFORMATION ABOUT RECOMMENDED RESOURCES AND TREATMENTS AS WELL AS THE RANGE OF POSSIBLE DIAGNOSES AND THERAPIES, INCLUDING SURGERIES, ASSOCIATED WITH A DEFINED SET OF SYMPTOMS AND/OR MEDICAL OR AESTHETIC CONCERNS, IN CLASS 44 (U.S. CLS. 100 AND 101).

FIRST USE 1-1-2010; IN COMMERCE 1-1-2010.

THE MARK CONSISTS OF TWO OPPOSING ABSTRACT FLUNG BIRD DESIGNS WHICH ARE CONNECTED AT THE BODY PORTION OF THE BIRDS. THE BIRD ON THE UPPER PORTION OF THE DESIGN APPEARS IN GREEN. THE BIRD ON THE LOWER PORTION APPEARS IN BLUE. TO THE RIGHT OF THE BIRD DESIGNS ARE THE TERMS "FLYCLINIC" IN PROMINENT STYLIZED LETTERS. THE TERM "FLY" IS IN GREEN. THE TERM "CLINIC" IS IN BLUE.

THE COLOR(S) GREEN AND BLUE IS/ARE CLAIMED AS A FEATURE OF THE MARK.

SN 77-964,151, FILED 3-20-2010.

PAULA MAHONEY, EXAMINING ATTORNEY



*David J. Kypos*

Director of the United States Patent and Trademark Office

# United States of America

United States Patent and Trademark Office

# Tru Chef

**Reg. No. 4,276,113**

DILLARD'S, INC. (DELAWARE CORPORATION)  
1600 CANTRELL ROAD  
LITTLE ROCK, AR 72201

**Registered Jan. 15, 2013**

**Int. Cl.: 21**

FOR: COOKWARE, NAMELY, POTS AND PANS, HOUSEHOLD UTENSILS, NAMELY, SPATULAS, TURNERS AND WHISKS, IN CLASS 21 (U.S. CLS. 2, 13, 23, 29, 30, 33, 40 AND 50).

**TRADEMARK**

FIRST USE 8-1-2011; IN COMMERCE 8-1-2011.

**PRINCIPAL REGISTER**

THE MARK CONSISTS OF STANDARD CHARACTERS WITHOUT CLAIM TO ANY PARTICULAR FONT, STYLE, SIZE, OR COLOR.

NO CLAIM IS MADE TO THE EXCLUSIVE RIGHT TO USE "CHEF", APART FROM THE MARK AS SHOWN.

SN 77-965,081, FILED 3-22-2010.

EDWARD FENNESSY, EXAMINING ATTORNEY



*David J. Kyffers*

Director of the United States Patent and Trademark Office

# United States of America

United States Patent and Trademark Office

# OXSTEEL

**Reg. No. 4,276,114**

**Registered Jan. 15, 2013**

**Int. Cls.: 1 and 21**

**TRADEMARK**

**PRINCIPAL REGISTER**

OXANE MATERIALS, INC. (DELAWARE CORPORATION)  
PINE FOREST OFFICE BLDG. #21  
467 WEST 38TH STREET  
HOUSTON, TX 77018

FOR: CHEMICAL FOR USE AS A FLUID LOSS ADDITIVE EMPLOYED TO MINIMIZE FLUID LOSSES IN SUBTERRANEAN FORMATIONS; CHEMICAL AGENTS FOR USE IN TREATMENT, SERVICING, AND WORKING OF OIL WELLS AND GAS WELLS, NAMELY, SUBTERRANEAN FORMATION FILLING AGENTS, PROPPANTS AND ABRASIVE AGENTS FOR SUBTERRANEAN FORMATIONS, IN CLASS 1 (U.S. CLS. 1, 5, 6, 10, 26 AND 46).

FIRST USE 7-21-2012; IN COMMERCE 7-21-2012.

FOR: CERAMIC MATERIALS FOR USE IN THE OIL WELL AND GAS WELL INDUSTRY, NAMELY, CERAMIC PELLETS, SHOTS, AND SPHERES FOR USE IN OIL WELL AND GAS WELL HYDRAULIC FRACTURING, AND AS GRAVEL PACK MATERIALS FOR SAND CONTROL OPERATION, AND FOR USE AS STRENGTHENING AGENTS FOR SUBTERRANEAN FORMATIONS, IN CLASS 21 (U.S. CLS. 2, 13, 23, 29, 30, 33, 40 AND 50).

FIRST USE 7-21-2012; IN COMMERCE 7-21-2012.

THE MARK CONSISTS OF STANDARD CHARACTERS WITHOUT CLAIM TO ANY PARTICULAR FONT, STYLE, SIZE, OR COLOR.

SN 77-965,193, FILED 3-22-2010.

KAREN SEVERSON, EXAMINING ATTORNEY



*David J. Kybas*

Director of the United States Patent and Trademark Office

# United States of America

United States Patent and Trademark Office

# VERIFI

**Reg. No. 4,276,115**

FMC CORPORATION (DELAWARE CORPORATION)  
1735 MARKET STREET  
PHILADELPHIA, PA 19103

**Registered Jan. 15, 2013**

**Int. Cl.: 21**

FOR: INSECT TRAPS FOR USE IN THE PEST CONTROL INDUSTRY TO DETECT AND MONITOR INSECTS, IN CLASS 21 (U.S. CLS. 2, 13, 23, 29, 30, 33, 40 AND 50).

**TRADEMARK**

FIRST USE 6-22-2012; IN COMMERCE 6-22-2012.

**PRINCIPAL REGISTER**

THE MARK CONSISTS OF STANDARD CHARACTERS WITHOUT CLAIM TO ANY PARTICULAR FONT, STYLE, SIZE, OR COLOR.

SN 77-966,456, FILED 3-23-2010.

COLLEEN KEARNEY, EXAMINING ATTORNEY



*David J. Kybas*

Director of the United States Patent and Trademark Office

# United States of America

United States Patent and Trademark Office

## W CAPITAL GROUP

**Reg. No. 4,276,116**

**Registered Jan. 15, 2013**

**Int. Cl.: 36**

**SERVICE MARK**

**PRINCIPAL REGISTER**

W CAPITAL MANAGEMENT, LLC (DELAWARE LIMITED LIABILITY COMPANY)  
FIFTH FLOOR  
ONE EAST 52ND STREET  
NEW YORK, NY 10022

FOR: FINANCIAL SERVICES, NAMELY, PRIVATE EQUITY FUND INVESTMENT MANAGEMENT AND INVESTMENT MANAGEMENT SERVICES, IN CLASS 36 (U.S. CLS. 100, 101 AND 102).

FIRST USE 10-26-2012; IN COMMERCE 10-26-2012.

THE MARK CONSISTS OF STANDARD CHARACTERS WITHOUT CLAIM TO ANY PARTICULAR FONT, STYLE, SIZE, OR COLOR.

OWNER OF U.S. REG. NO. 2,895,259.

NO CLAIM IS MADE TO THE EXCLUSIVE RIGHT TO USE "CAPITAL GROUP", APART FROM THE MARK AS SHOWN.

SN 77-966,898, FILED 3-24-2010.

KYLE PEETE, EXAMINING ATTORNEY



*David J. Kyffers*

Director of the United States Patent and Trademark Office



# United States of America

United States Patent and Trademark Office



**Reg. No. 4,276,117**

**Registered Jan. 15, 2013**

**Int. Cl.: 30**

**TRADEMARK**

**PRINCIPAL REGISTER**

BABY BLUES BOTTLING LLC (CALIFORNIA LIMITED LIABILITY COMPANY)  
444 LINCOLN BLVD  
VENICE, CA 90291

FOR: BARBEQUE SAUCE, IN CLASS 30 (U.S. CL. 46).

FIRST USE 12-4-2004; IN COMMERCE 12-4-2004.

NO CLAIM IS MADE TO THE EXCLUSIVE RIGHT TO USE "VENICE" OR "BBQ" , APART FROM THE MARK AS SHOWN.

THE COLOR(S) BLUE, BLACK AND WHITE IS/ARE CLAIMED AS A FEATURE OF THE MARK.

THE MARK CONSISTS OF A RECTANGULAR SHAPE. THE SHORT SIDES RUN FROM TOP TO BOTTOM AND THE LONGER SIDES FROM LEFT TO RIGHT. THE SHORT SIDES OF THE RECTANGLE ARE STRAIGHT. BOTH OF THE LONGER SIDES (OR THE TOP AND BOTTOM) CURVE IN AN OBLIQUE ARC. THE CONTOURS OF THIS RECTANGULAR SHAPE ARE IN BLACK. WITHIN THE CONTOURS IS A WHITE LINE THAT IS THEN FOLLOWED A GRADUATED BLACK LINE. WITHIN THIS GRADUATED BLACK LINE IS A BLUE BACKGROUND. AT THE TOP OF THE BLUE BACKGROUND IS THE WORD "VENICE" IN ALL CAPITALS AND IN ALL WHITE. BELOW "VENICE" ON THE BLUE BACKGROUND AND ON A DIAGONAL IS THE PHRASE "BABY BLUES". "BABY BLUES" IS IN CURSIVE AND IS IN WHITE. BELOW "BABY BLUES" ON THE BOTTOM RIGHT CORNER STILL WITHIN THE BLUE BACKGROUND IS "BBQ" IN CAPITALS AND IN WHITE. THE FIRST "B" IS SEPARATED FROM THE SECOND "B" WITH A CIRCULAR DOT. THE SECOND "B" IS SEPARATED FROM THE "Q" WITH A CIRCULAR DOT. BETWEEN "BABY BLUES" AND "BBQ" ARE THREE DIAMONDS IN WHITE. THE FIRST DIAMOND IS SLIGHTLY SMALLER THAN THE SECOND DIAMOND. THE SECOND DIAMOND IS SLIGHTLY SMALLER THAN THE THIRD DIAMOND.



SN 77-983,127, FILED 5-20-2009.

VERNA BETH RIRIE, EXAMINING ATTORNEY

*David J. Kyffers*

Director of the United States Patent and Trademark Office

# United States of America

United States Patent and Trademark Office

# amazon basics

**Reg. No. 4,276,118**

**Registered Jan. 15, 2013**

**Int. Cl.: 9**

**TRADEMARK**

**PRINCIPAL REGISTER**

AMAZON TECHNOLOGIES, INC. (NEVADA CORPORATION)  
ATTN: TRADEMARKS  
PO BOX 8102  
RENO, NV 89507

FOR: APPARATUS FOR REPRODUCTION OF SOUND; AUDIO SPEAKERS; BATTERIES AND BATTERY CHARGERS; BLANK COMPUTER DISCS; BLANK DIGITAL STORAGE MEDIA; BLANK ELECTRONIC STORAGE MEDIA; BLANK SMART CARDS; COMPUTER CABLES; BATTERY CHARGERS FOR PORTABLE ELECTRONIC DEVICES AND HAND-HELD DEVICES; CALCULATORS; CAMERA CASES; CAMERA TRIPODS; COMPUTER PERIPHERALS; COMPUTER MICE; COMPUTER NETWORK ROUTERS AND HUBS; COMPUTER ACCESSORIES, NAMELY, COMPUTER LEADS FOR EXTERNAL COMPUTER CABLING IN THE NATURE OF FIREWIRE LEADS, USB LEADS; USB-HUBS; FLASH CARD READERS; HEADPHONES; PROJECTORS, NAMELY, SOUND PROJECTORS AND AMPLIFIERS; DVD BURNERS; DVD DRIVES; MEMORY CARDS; COMPUTER PERIPHERALS IN THE NATURE OF WIRELESS CARDS; MEDIA PLAYERS; MEDIA PLAYER COMPONENTS AND ACCESSORIES, NAMELY, PROTECTIVE COVERS AND CASES FOR PORTABLE MEDIA PLAYERS, CHARGERS, ELECTRICAL AND POWER CABLES; LOUD SPEAKERS; AUDIO ELECTRONIC COMPONENTS AND ACCESSORIES, NAMELY, CHARGERS, ELECTRICAL AND POWER CABLES; VIDEO ELECTRONICS COMPONENTS AND ACCESSORIES, NAMELY, ELECTRICAL AND POWER CABLES AND CHARGERS; DIGITAL ELECTRONIC COMPONENTS AND ACCESSORIES, NAMELY, HOLSTERS, CARRYING CASES, AND FITTED PLASTIC FILMS KNOWN AS SKINS FOR COVERING AND PROVIDING A SCRATCH PROOF BARRIER OR PROTECTION SPECIFICALLY DESIGNED FOR COMPUTERS, DIGITAL AUDIO AND MEDIA PLAYERS, MP3 PLAYERS, MOBILE PHONES, PERSONAL DIGITAL ASSISTANTS; VIDEO ELECTRONICS AND COMPONENTS AND ACCESSORIES THEREFORE IN THE NATURE OF CORDS, ADAPTERS, BATTERY CHARGERS, PERIPHERALS, AND STYLUSES; STANDS SPECIALLY DESIGNED FOR PERSONAL DIGITAL DEVICES IN THE NATURE OF CAMERAS, DIGITAL AUDIO AND MEDIA PLAYERS, MP3 PLAYERS, GLOBAL POSITIONING SYSTEMS, PERSONAL DIGITAL ASSISTANTS, ELECTRONIC BOOK READERS, AND CAMCORDERS; BAGS AND CASES SPECIFICALLY ADAPTED FOR HOLDING ELECTRONICS AND ACCESSORIES IN THE NATURE OF COMPUTERS, CAMERAS, CAMCORDERS, DIGITAL AUDIO AND MEDIA PLAYERS, MP3 PLAYERS, MOBILE TELEPHONES, GLOBAL POSITIONING SYSTEMS, PERSONAL DIGITAL ASSISTANTS, VIDEO ELECTRONICS AND ELECTRONIC BOOK READERS AND COMPONENTS AND ACCESSORIES THEREFORE IN THE NATURE OF ELECTRIC CABLES, AND CAMERA TRIPODS, COMPUTER PERIPHERALS, MEDIA



*David J. Kyros*

Director of the United States Patent and Trademark Office

**Reg. No. 4,276,118** PLAYERS, USB HARDWARE, AND BATTERY CHARGERS; CAMERA CASES; ELECTRIC CABLES; USB CABLES; VIDEO CABLES; EXTENSION CABLES; ELECTRICAL AND POWER CABLES; ELECTRIC CONNECTORS; CABLE CONNECTORS; PLUG CONNECTORS; CONVERTERS; USB HARDWARE; KEYBOARDS; COMPUTER AND MEMORY STORAGE DEVICES, NAMELY, BLANK FLASH DRIVES, USB DRIVES, DIGITAL USB STORAGE CARDS AND CARD READERS; PRINTER COMPONENTS AND ACCESSORIES, NAMELY, CABLES, IN CLASS 9 (U.S. CLS. 21, 23, 26, 36 AND 38).

FIRST USE 9-19-2009; IN COMMERCE 9-19-2009.

OWNER OF U.S. REG. NOS. 2,167,345, 2,857,590, AND OTHERS.

THE MARK CONSISTS OF THE STYLIZED LETTERS FOR THE WORD "AMAZON" WITH DESIGN ELEMENT OF A CURVED ARROW OR SMILE PLACED BELOW THE WORD GOING FROM THE LETTER "A" TO THE LETTER "Z", ALONG WITH THE STYLIZED LETTERS FOR THE WORD "BASICS".

SN 77-983,416, FILED 6-5-2009.

HEATHER THOMPSON, EXAMINING ATTORNEY

# United States of America

United States Patent and Trademark Office



**Reg. No. 4,276,119**

**Registered Jan. 15, 2013**

**Int. Cl.: 36**

**SERVICE MARK**

**PRINCIPAL REGISTER**

BENNER-ORTEGA, JONATHAN (UNITED STATES INDIVIDUAL), DBA METRO LIVING,  
SUITE 14  
746 WALKER ROAD  
GREAT FALLS, VA 22066

FOR: REAL ESTATE BROKERAGE SERVICES, IN CLASS 36 (U.S. CLS. 100, 101 AND 102).

FIRST USE 0-0-2006; IN COMMERCE 0-0-2006.

THE MARK CONSISTS OF STYLIZED CAPITAL LETTERS WITH THE IMAGES OF FAMOUS WASHINGTON D.C. BUILDINGS NEXT TO THE WORDS, NAMELY THE U.S. CAPITAL BUILDING, THE WASHINGTON MONUMENT AND THE LINCOLN MEMORIAL.

SN 78-668,494, FILED 7-12-2005.

DAVID YONTEF, EXAMINING ATTORNEY



*David J. Kybas*

Director of the United States Patent and Trademark Office

# United States of America

United States Patent and Trademark Office

## SPIN TO WIN

**Reg. No. 4,276,120**

**Registered Jan. 15, 2013**

**Int. Cl.: 41**

**SERVICE MARK**

**PRINCIPAL REGISTER**

THE TRUSTEE OF THE REUBEN B. KLAMER LIVING TRUST, A CALIFORNIA TRUST,  
THE SOLE TRUSTEE COMPRISING REUBEN B. KLAMER, A UNITED STATES CITIZEN  
(CALIFORNIA TRUST)  
C/O TOYLAB  
10635 ROSELLE STREET, SUITE C  
SAN DIEGO, CA 92121

FOR: ENTERTAINMENT SERVICES, NAMELY, ON-GOING TELEVISION PROGRAMS  
FEATURING GAMES AND ENTERTAINMENT AND LIVE-ACTION TELEVISION SHOWS,  
IN CLASS 41 (U.S. CLS. 100, 101 AND 107).

FIRST USE 9-0-2011; IN COMMERCE 9-0-2011.

THE MARK CONSISTS OF STANDARD CHARACTERS WITHOUT CLAIM TO ANY PAR-  
TICULAR FONT, STYLE, SIZE, OR COLOR.

SN 78-864,269, FILED 4-18-2006.

TIMOTHY FINNEGAN, EXAMINING ATTORNEY



*David J. Kyffers*

Director of the United States Patent and Trademark Office

# United States of America

United States Patent and Trademark Office



**Reg. No. 4,276,121**

**Registered Jan. 15, 2013**

**Int. Cls.: 12 and 25**

**TRADEMARK**

**PRINCIPAL REGISTER**

WHEEL PROS, LLC (DELAWARE LIMITED LIABILITY COMPANY)  
44 UNION BOULEVARD  
SUITE 620  
LAKEWOOD, CO 80228

FOR: PARTS AND ACCESSORIES FOR AUTOMOTIVE VEHICLES, NAMELY, WHEELS AND COMPONENTS THEREOF; ALL OF THE FOREGOING NOT RELATING TO BASEBALL OR SOFTBALL OR TO A BASEBALL OR SOFTBALL TEAM, IN CLASS 12 (U.S. CLS. 19, 21, 23, 31, 35 AND 44).

FIRST USE 1-31-2007; IN COMMERCE 1-31-2007.

FOR: HATS, JACKETS, SHIRTS, TROUSERS, SHORTS, GLOVES AND UNDERGARMENTS FOR MEN, WOMEN AND CHILDREN; ALL OF THE FOREGOING NOT RELATING TO BASEBALL OR SOFTBALL OR A BASEBALL OR SOFTBALL TEAM, IN CLASS 25 (U.S. CLS. 22 AND 39).

FIRST USE 1-31-2007; IN COMMERCE 1-31-2007.

OWNER OF U.S. REG. NOS. 1,113,095, 2,435,511, AND OTHERS.

NO CLAIM IS MADE TO THE EXCLUSIVE RIGHT TO USE "RACING" AS TO INTERNATIONAL CLASSES 7, 11, 12 AND 25, APART FROM THE MARK AS SHOWN.

SN 78-981,468, FILED 7-26-2006.

NICHOLAS ALTREE, EXAMINING ATTORNEY



*David J. Kypos*

Director of the United States Patent and Trademark Office

# United States of America

United States Patent and Trademark Office

## IPOD

**Reg. No. 4,276,122**

**Registered Jan. 15, 2013**

**Int. Cl.: 35**

**SERVICE MARK**

**PRINCIPAL REGISTER**

APPLE INC. (CALIFORNIA CORPORATION)  
1 INFINITE LOOP  
CUPERTINO, CA 95014

FOR: RETAIL STORE SERVICES AND RETAIL STORE SERVICES PROVIDED VIA COMMUNICATIONS NETWORKS FEATURING COMPUTERS, COMPUTER SOFTWARE, COMPUTER PERIPHERALS AND CONSUMER ELECTRONICS, AND AUDIO-VISUAL AND MUSIC-RELATED PRODUCTS; PRODUCT DEMONSTRATIONS PROVIDED IN-STORE AND VIA COMMUNICATIONS NETWORKS; INFORMATION AND CONSULTATION IN CONNECTION WITH ALL OF THE FOREGOING, IN CLASS 35 (U.S. CLS. 100, 101 AND 102).

FIRST USE 12-31-2005; IN COMMERCE 12-31-2005.

THE MARK CONSISTS OF STANDARD CHARACTERS WITHOUT CLAIM TO ANY PARTICULAR FONT, STYLE, SIZE, OR COLOR.

OWNER OF U.S. REG. NO. 2,835,698.

SN 78-981,523, FILED 11-23-2004.

RAUL CORDOVA, EXAMINING ATTORNEY



*David J. Kybas*

Director of the United States Patent and Trademark Office

# United States of America

United States Patent and Trademark Office

## VIVA LA VAPE

**Reg. No. 4,276,123**

GLOW INDUSTRIES, INC. (OHIO CORPORATION)  
12962 ECKEL JUNCTION ROAD  
PERRYSBURG, OH 43551

**Registered Jan. 15, 2013**

**Int. Cl.: 11**

FOR: ELECTRIC AND BATTERY OPERATED AROMATHERAPY VAPORIZERS, IN CLASS 11 (U.S. CLS. 13, 21, 23, 31 AND 34).

**TRADEMARK**

FIRST USE 1-0-2010; IN COMMERCE 1-0-2010.

**PRINCIPAL REGISTER**

THE MARK CONSISTS OF STANDARD CHARACTERS WITHOUT CLAIM TO ANY PARTICULAR FONT, STYLE, SIZE, OR COLOR.

NO CLAIM IS MADE TO THE EXCLUSIVE RIGHT TO USE "VAPE", APART FROM THE MARK AS SHOWN.

THE ENGLISH TRANSLATION OF "VIVA LA VAPE" IN THE MARK IS LONG LIVE THE VAPE.

SN 85-005,358, FILED 4-2-2010.

SUSAN STIGLITZ, EXAMINING ATTORNEY



*David J. Kybas*

Director of the United States Patent and Trademark Office



# United States of America

United States Patent and Trademark Office

## THE DOG'S WAY

**Reg. No. 4,276,124**

SEATTLE FAMILY DOG TRAINING (WASHINGTON SOLE PROPRIETORSHIP)  
15117 210TH AVE NE  
WOODINVILLE, WA 98077

**Registered Jan. 15, 2013**

**Int. Cl.: 9**

FOR: PRE-RECORDED DIGITAL MEDIA FEATURING DOG TRAINING AND INSTRUCTION,  
IN CLASS 9 (U.S. CLS. 21, 23, 26, 36 AND 38).

**TRADEMARK**

FIRST USE 10-23-2012; IN COMMERCE 10-23-2012.

**PRINCIPAL REGISTER**

THE MARK CONSISTS OF STANDARD CHARACTERS WITHOUT CLAIM TO ANY PARTICULAR FONT, STYLE, SIZE, OR COLOR.

SN 85-010,466, FILED 4-9-2010.

EVELYN BRADLEY, EXAMINING ATTORNEY



*David J. Kybas*

Director of the United States Patent and Trademark Office

# United States of America

United States Patent and Trademark Office

## INVESCO PLANFORWARD

**Reg. No. 4,276,125**

**Registered Jan. 15, 2013**

**Int. Cl.: 16**

**TRADEMARK**

**PRINCIPAL REGISTER**

INVESCO HOLDING COMPANY LIMITED (UNITED KINGDOM COMPANY)  
1555 PEACHTREE STREET NE  
ATLANTA, GA 30309

FOR: PRINTED MATERIALS, NAMELY, BROCHURES AND NEWSLETTERS RELATING TO FINANCIAL, INVESTMENT, BROKERAGE, AND RETIREMENT PLANNING SERVICES, IN CLASS 16 (U.S. CLS. 2, 5, 22, 23, 29, 37, 38 AND 50).

FIRST USE 9-30-2011; IN COMMERCE 9-30-2011.

THE MARK CONSISTS OF STANDARD CHARACTERS WITHOUT CLAIM TO ANY PARTICULAR FONT, STYLE, SIZE, OR COLOR.

OWNER OF U.S. REG. NOS. 1,825,441, 3,740,542, AND OTHERS.

SN 85-014,899, FILED 4-15-2010.

INGA ERVIN, EXAMINING ATTORNEY



*David J. Kyffers*

Director of the United States Patent and Trademark Office

# United States of America

United States Patent and Trademark Office

## LESSONS OF A LIFETIME

**Reg. No. 4,276,126**

TOM WATSON PRODUCTIONS, LLC (MISSOURI LIMITED LIABILITY COMPANY)  
1901 W. 47TH PLACE  
OVERLAND PARK, KS 66205

**Registered Jan. 15, 2013**

**Int. Cl.: 9**

FOR: DIGITAL MEDIA, NAMELY, DVDS FEATURING GOLF INSTRUCTIONS, IN CLASS 9 (U.S. CLS. 21, 23, 26, 36 AND 38).

**TRADEMARK**

FIRST USE 4-24-2010; IN COMMERCE 4-24-2010.

**PRINCIPAL REGISTER**

THE MARK CONSISTS OF STANDARD CHARACTERS WITHOUT CLAIM TO ANY PARTICULAR FONT, STYLE, SIZE, OR COLOR.

NO CLAIM IS MADE TO THE EXCLUSIVE RIGHT TO USE "LESSONS", APART FROM THE MARK AS SHOWN.

SN 85-015,151, FILED 4-15-2010.

ELIZABETH HUGHITT, EXAMINING ATTORNEY



*David J. Kybas*

Director of the United States Patent and Trademark Office

# United States of America

United States Patent and Trademark Office

## 100% SPEEDLAB

**Reg. No. 4,276,127**

BOINNARD, LUDOVIC (FRANCE INDIVIDUAL)  
818 NANTASKET COURT  
SAN DIEGO, CA 92109

**Registered Jan. 15, 2013**

**Int. Cl.: 25**

FOR: SHIRTS; T-SHIRTS, IN CLASS 25 (U.S. CLS. 22 AND 39).

**TRADEMARK**

FIRST USE 9-15-2012; IN COMMERCE 9-15-2012.

**PRINCIPAL REGISTER**

THE MARK CONSISTS OF STANDARD CHARACTERS WITHOUT CLAIM TO ANY PARTICULAR FONT, STYLE, SIZE, OR COLOR.

OWNER OF U.S. REG. NO. 1,554,593.

SN 85-019,993, FILED 4-21-2010.

KATHRYN COWARD, EXAMINING ATTORNEY



*David J. Kybas*

Director of the United States Patent and Trademark Office

# United States of America

United States Patent and Trademark Office

## IMAGEWORKS

**Reg. No. 4,276,128**

AFP IMAGING CORPORATION (NEW YORK CORPORATION)  
250 CLEARBROOK ROAD  
ELMSFORD, NY 10523

**Registered Jan. 15, 2013**

**Int. Cl.: 42**

FOR: TECHNICAL SUPPORT SERVICES, NAMELY, PROVIDING TECHNICAL ADVICE IN DIAGNOSING TECHNICAL PROBLEMS FOR MEDICAL, DENTAL AND VETERINARY IMAGING APPARATUS, IN CLASS 42 (U.S. CLS. 100 AND 101).

**SERVICE MARK**

FIRST USE 5-12-2012; IN COMMERCE 5-12-2012.

**PRINCIPAL REGISTER**

THE MARK CONSISTS OF STANDARD CHARACTERS WITHOUT CLAIM TO ANY PARTICULAR FONT, STYLE, SIZE, OR COLOR.

SN 85-021,671, FILED 4-23-2010.

LINDA MICKLEBURGH, EXAMINING ATTORNEY



*David J. Kybas*

Director of the United States Patent and Trademark Office

# United States of America

United States Patent and Trademark Office

## SOSPONSORED.COM

**Reg. No. 4,276,129**

**Registered Jan. 15, 2013**

**Int. Cl.: 35**

**SERVICE MARK**

**PRINCIPAL REGISTER**

SOSPONSORED CORPORATION (MASSACHUSETTS CORPORATION)  
22 SPENCER STREET REAR  
STONEHAM, MA 02180

FOR: ADVERTISING AND PROMOTIONAL SERVICES; PLACING ADVERTISEMENTS FOR OTHERS; PROMOTING THE GOODS AND SERVICES OF OTHERS BY ARRANGING FOR SPONSORS TO AFFILIATE THEIR GOODS AND SERVICES WITH ORGANIZATIONS THAT HOST COMPETITIONS AND EVENTS BY AFFIXING THE SPONSOR'S LOGO TO MERCHANDISE OFFERED BY THE HOSTING ORGANIZATIONS, IN CLASS 35 (U.S. CLS. 100, 101 AND 102).

FIRST USE 11-6-2012; IN COMMERCE 11-6-2012.

THE MARK CONSISTS OF STANDARD CHARACTERS WITHOUT CLAIM TO ANY PARTICULAR FONT, STYLE, SIZE, OR COLOR.

SN 85-022,435, FILED 4-24-2010.

MATTHEW KLINE, EXAMINING ATTORNEY



*David J. Kappas*

Director of the United States Patent and Trademark Office

United States of America  
United States Patent and Trademark Office

KARMA

**Reg. No. 4,276,130**

FISKER AUTOMOTIVE, INC. (DELAWARE CORPORATION)  
5515 E. LA PALMA  
ANAHEIM, CA 92807

**Registered Jan. 15, 2013**

**Int. Cl.: 12**

FOR: AUTOMOBILES; STRUCTURAL PARTS FOR AUTOMOBILES, IN CLASS 12 (U.S. CLS. 19, 21, 23, 31, 35 AND 44).

**TRADEMARK**

FIRST USE 12-0-2011; IN COMMERCE 12-0-2011.

**PRINCIPAL REGISTER**

THE MARK CONSISTS OF STANDARD CHARACTERS WITHOUT CLAIM TO ANY PARTICULAR FONT, STYLE, SIZE, OR COLOR.

SN 85-024,517, FILED 4-27-2010.

VIVIAN MICZNIK FIRST, EXAMINING ATTORNEY



*David J. Kybas*

Director of the United States Patent and Trademark Office

# United States of America

United States Patent and Trademark Office

# SDBIC

**Reg. No. 4,276,131**

**Registered Jan. 15, 2013**

**Int. Cl.: 36**

**SERVICE MARK**

**PRINCIPAL REGISTER**

SAFE DEPOSIT BOX INSURANCE COVERAGE, LLC (DELAWARE LIMITED LIABILITY COMPANY)  
25 GROVE STREET  
ELGIN, IL 60120

FOR: INSURANCE SERVICES, NAMELY, WRITING PROPERTY AND CASUALTY INSURANCE, IN CLASS 36 (U.S. CLS. 100, 101 AND 102).

FIRST USE 8-30-2012; IN COMMERCE 8-30-2012.

THE MARK CONSISTS OF STANDARD CHARACTERS WITHOUT CLAIM TO ANY PARTICULAR FONT, STYLE, SIZE, OR COLOR.

SN 85-024,566, FILED 4-27-2010.

HOWARD B. LEVINE, EXAMINING ATTORNEY



*David J. Kybas*

Director of the United States Patent and Trademark Office



# United States of America

United States Patent and Trademark Office

## A SMARTER COMMUNITY

**Reg. No. 4,276,132**

ERA FRANCHISE SYSTEMS LLC (DELAWARE LIMITED LIABILITY COMPANY)  
1 CAMPUS DRIVE  
PARSIPPANY, NJ 07054

**Registered Jan. 15, 2013**

**Int. Cl.: 36**

FOR: REAL ESTATE BROKERAGE, IN CLASS 36 (U.S. CLS. 100, 101 AND 102).

**SERVICE MARK**

FIRST USE 3-25-2010; IN COMMERCE 3-25-2010.

**PRINCIPAL REGISTER**

THE MARK CONSISTS OF STANDARD CHARACTERS WITHOUT CLAIM TO ANY PARTICULAR FONT, STYLE, SIZE, OR COLOR.

SN 85-026,180, FILED 4-29-2010.

SAMUEL E. SHARPER JR., EXAMINING ATTORNEY



*David J. Kybas*

Director of the United States Patent and Trademark Office

# United States of America

United States Patent and Trademark Office

## CLUB BEACHBODY

**Reg. No. 4,276,133**

**Registered Jan. 15, 2013**

**Int. Cls.: 38 and 41**

**SERVICE MARK**

**PRINCIPAL REGISTER**

BEACHBODY, LLC (CALIFORNIA LIMITED LIABILITY COMPANY)  
3301 EXPOSITION BOULEVARD  
THIRD FLOOR  
SANTA MONICA, CA 90404

FOR: PROVIDING ON-LINE ELECTRONIC BULLETIN BOARDS FOR TRANSMISSION OF MESSAGES AMONG COMPUTER USERS CONCERNING EXERCISE; AUDIO AND VIDEO BROADCASTING SERVICES OVER THE INTERNET OR OTHER COMMUNICATIONS NETWORK FEATURING THE UPLOADED, POSTED, AND TAGGED AUDIO AND VIDEO CLIPS OF OTHERS; ELECTRONIC TRANSMISSION OF MESSAGES AND DATA, NAMELY, ELECTRONICALLY TRANSMITTING INFORMATION, AUDIO, AND VIDEO CLIPS; PROVIDING INTERNET ACCESS THAT ALLOWS USERS TO ACCESS INFORMATION, AUDIO, AND VIDEO WEBSITES, ONLINE FORUMS, CHAT ROOMS, LISTSERVERS AND BLOGS; PROVIDING ON-LINE CHAT ROOMS AND ELECTRONIC BULLETIN BOARDS FOR TRANSMISSION OF MESSAGES AMONG USERS IN THE FIELD OF GENERAL INTEREST, IN CLASS 38 (U.S. CLS. 100, 101 AND 104).

FIRST USE 10-2-2012; IN COMMERCE 10-2-2012.

FOR: PROVIDING A WEB SITE FEATURING ON-LINE INSTRUCTION IN THE FIELD OF PHYSICAL EXERCISE AND NUTRITION AND TRACKING PROGRESS OF WORKOUTS; EDUCATIONAL SERVICES AND ON-LINE EDUCATIONAL SERVICES, NAMELY, PROVIDING INSTRUCTION IN THE FIELDS OF EXERCISE EQUIPMENT, PHYSICAL EXERCISE AND NUTRITION, AND INSTRUCTIONAL MATERIALS DISTRIBUTED IN CONNECTION THEREWITH; PHYSICAL FITNESS TRAINING SERVICES, NAMELY, TRACKING PROGRESS OF WORKOUTS FOR OTHERS; ENTERTAINMENT SERVICES, NAMELY, CONDUCTING CONTESTS; EDUCATION AND ENTERTAINMENT SERVICES, NAMELY, PROVIDING A WEBSITE FEATURING NON-DOWNLOADABLE AUDIO CLIPS, VIDEO CLIPS, MUSICAL PERFORMANCES, MUSICAL VIDEOS, FILM CLIPS, PHOTOGRAPHS, AND INFORMATION IN THE FIELD OF EXERCISE; BLOGS FEATURING INFORMATION AND AUDIO CLIPS, VIDEO CLIPS, MUSICAL PERFORMANCES, MUSICAL VIDEOS, FILM CLIPS, PHOTOGRAPHS, AND OTHER MULTIMEDIA MATERIALS IN THE FIELD OF EXERCISE AND NUTRITION, IN CLASS 41 (U.S. CLS. 100, 101 AND 107).



*David J. Kyffers*

FIRST USE 10-2-2012; IN COMMERCE 10-2-2012.

**Reg. No. 4,276,133** THE MARK CONSISTS OF STANDARD CHARACTERS WITHOUT CLAIM TO ANY PARTICULAR FONT, STYLE, SIZE, OR COLOR.

OWNER OF U.S. REG. NOS. 2,862,904, 3,767,380, AND OTHERS.

SN 85-026,631, FILED 4-29-2010.

KATHERINE E. HALMEN, EXAMINING ATTORNEY

# United States of America

United States Patent and Trademark Office

# 4DD

**Reg. No. 4,276,134**

4DD HOLDINGS, LLC (DELAWARE LIMITED LIABILITY COMPANY)  
17609 DARNESTOWN ROAD  
BOYDS, MD 20841

**Registered Jan. 15, 2013**

**Int. Cl.: 42**

FOR: DESIGN AND DEVELOPMENT OF COMPUTER SOFTWARE, IN CLASS 42 (U.S. CLS. 100 AND 101).

**SERVICE MARK**

FIRST USE 4-1-2010; IN COMMERCE 4-1-2010.

**PRINCIPAL REGISTER**

THE MARK CONSISTS OF STANDARD CHARACTERS WITHOUT CLAIM TO ANY PARTICULAR FONT, STYLE, SIZE, OR COLOR.

SN 85-027,412, FILED 4-30-2010.

ROBERT STRUCK, EXAMINING ATTORNEY



*David J. Kybas*

Director of the United States Patent and Trademark Office

# United States of America

United States Patent and Trademark Office

## Maqui Supreme

**Reg. No. 4,276,135**

ONLY NATURAL, INC. (NEW YORK CORPORATION)  
31 SARATOGA BOULEVARD  
ISLAND PARK, NY 11558

**Registered Jan. 15, 2013**

**Int. Cl.: 5**

FOR: DIETARY AND NUTRITIONAL SUPPLEMENTS, IN CLASS 5 (U.S. CLS. 6, 18, 44, 46, 51 AND 52).

**TRADEMARK**

FIRST USE 9-20-2012; IN COMMERCE 9-20-2012.

**PRINCIPAL REGISTER**

THE MARK CONSISTS OF STANDARD CHARACTERS WITHOUT CLAIM TO ANY PARTICULAR FONT, STYLE, SIZE, OR COLOR.

NO CLAIM IS MADE TO THE EXCLUSIVE RIGHT TO USE "MAQUI", APART FROM THE MARK AS SHOWN.

SN 85-028,390, FILED 5-3-2010.

HEATHER THOMPSON, EXAMINING ATTORNEY



*David J. Kybas*

Director of the United States Patent and Trademark Office

# United States of America

United States Patent and Trademark Office

# TRUBLEND

**Reg. No. 4,276,136**

INVISTA NORTH AMERICA S.A R.L. (LUXEMBOURG CORPORATION)  
4123 E. 37TH STREET N., LEGAL DEPARTMENT  
WICHITA, KS 67550

**Registered Jan. 15, 2013**

**Int. Cl.: 22**

FOR: SYNTHETIC FIBERS USED IN THE MANUFACTURE OF CARPET, IN CLASS 22 (U.S. CLS. 1, 2, 7, 19, 22, 42 AND 50).

**TRADEMARK**

FIRST USE 1-17-2012; IN COMMERCE 1-17-2012.

**PRINCIPAL REGISTER**

THE MARK CONSISTS OF STANDARD CHARACTERS WITHOUT CLAIM TO ANY PARTICULAR FONT, STYLE, SIZE, OR COLOR.

SN 85-029,876, FILED 5-4-2010.

GIANCARLO CASTRO, EXAMINING ATTORNEY



*David J. Kybas*

Director of the United States Patent and Trademark Office

# United States of America

United States Patent and Trademark Office

마시는 홍초

**Reg. No. 4,276,137**

**Registered Jan. 15, 2013**

**Int. Cls.: 30 and 32**

**TRADEMARK**

**PRINCIPAL REGISTER**

DAESANG CORPORATION (REPUBLIC OF KOREA CORPORATION)  
96-48, SINSUL-DONG, DONGDAEMUN-KU  
SEOUL, REPUBLIC OF KOREA

FOR: VINEGAR, IN CLASS 30 (U.S. CL. 46).

FIRST USE 0-0-2005; IN COMMERCE 5-0-2009.

FOR: NON-ALCOHOLIC BEVERAGES MADE FROM VINEGAR, IN CLASS 32 (U.S. CLS. 45, 46 AND 48).

FIRST USE 0-0-2005; IN COMMERCE 5-0-2009.

THE MARK CONSISTS OF FIVE KOREAN CHARACTERS.

THE FIRST THREE NON-LATIN CHARACTERS TRANSLITERATE TO "MA SI NUN", AND THIS MEANS "DRINKING" IN ENGLISH. THE LAST TWO NON-LATIN CHARACTERS TRANSLITERATE TO "HONGCHO", AND THIS HAS NO MEANING IN A FOREIGN LANGUAGE.

SN 85-030,614, FILED 5-5-2010.

STEVEN R. FINE, EXAMINING ATTORNEY



*David J. Kybas*

Director of the United States Patent and Trademark Office

# United States of America

United States Patent and Trademark Office

# XCISE

**Reg. No. 4,276,138**

LINA MEDICAL APS (DENMARK CORPORATION)  
FORMERVAGEN 5  
DK-2600 GLOSTRUP, DENMARK

**Registered Jan. 15, 2013**

**Int. Cl.: 10**

FOR: SURGICAL INSTRUMENTS, NAMELY, ROTARY SCALPEL, IN CLASS 10 (U.S. CLS. 26, 39 AND 44).

**TRADEMARK**

FIRST USE 5-20-2011; IN COMMERCE 5-20-2011.

**PRINCIPAL REGISTER**

THE MARK CONSISTS OF STANDARD CHARACTERS WITHOUT CLAIM TO ANY PARTICULAR FONT, STYLE, SIZE, OR COLOR.

SN 85-037,420, FILED 5-13-2010.

BILL DAWE, EXAMINING ATTORNEY



*David J. Kyffers*

Director of the United States Patent and Trademark Office



# United States of America

United States Patent and Trademark Office

## DUCHESS SILHOUETTE

**Reg. No. 4,276,139**

**Registered Jan. 15, 2013**

**Int. Cl.: 41**

**SERVICE MARK**

**PRINCIPAL REGISTER**

3 IMPRESSIONS, LLC (ARIZONA LIMITED LIABILITY COMPANY)  
9221 EASE BASELINE ROAD, SUITE A 109-600  
MESA, AZ 85209

FOR: EDUCATION SERVICES, NAMELY, CONDUCTING LIVE CLASSES, WORKSHOPS, CONFERENCES, AND PRESENTATIONS IN THE FIELDS OF PERSONAL IMAGE RECOMMENDATIONS INCLUDING APPROPRIATE ATTIRE, HAIR STYLING, MAKEUP, POSTURE, BODY LANGUAGE, VERBAL AND NON-VERBAL COMMUNICATIONS, AND DISTRIBUTION OF PRINTED MATERIALS IN CONNECTION WITH ALL OF THE FOREGOING IN HARD COPY OR ELECTRONIC FORMAT; EDUCATION IN THE FIELD OF PERSONAL IMAGE RECOMMENDATIONS INCLUDING APPROPRIATE ATTIRE, HAIR STYLING, MAKEUP, POSTURE, BODY LANGUAGE, VERBAL AND NON-VERBAL COMMUNICATIONS RENDERED THROUGH VIDEO CONFERENCE, ON-LINE CLASSES, TELEPHONIC INSTRUCTION, SEMINARS, CONFERENCES, WORKSHOPS, WEBINARS, TELESEMINARS AND TELECLASSES; EDUCATIONAL SERVICES, NAMELY, CONDUCTING ON-LINE EXHIBITIONS AND DISPLAYS AND INTERACTIVE EXHIBITS IN THE FIELDS OF PERSONAL IMAGE RECOMMENDATIONS INCLUDING APPROPRIATE ATTIRE, HAIR STYLING, MAKEUP, POSTURE, BODY LANGUAGE, VERBAL AND NON-VERBAL COMMUNICATIONS; EDUCATIONAL SERVICES, NAMELY, PROVIDING A CONTINUING PRERECORDED AUDIO PROGRAM IN THE FIELDS OF PERSONAL IMAGE RECOMMENDATIONS INCLUDING APPROPRIATE ATTIRE, HAIR STYLING, MAKEUP, POSTURE, BODY LANGUAGE, VERBAL AND NON-VERBAL COMMUNICATIONS ACCESSIBLE OVER THE INTERNET; EDUCATIONAL AND ENTERTAINMENT SERVICES, NAMELY, PROVIDING MOTIVATIONAL SPEAKING SERVICES AND CONDUCTING ONE-ON-ONE OR GROUP MENTORING IN THE FIELDS OF PERSONAL IMAGE RECOMMENDATIONS INCLUDING APPROPRIATE ATTIRE, HAIR STYLING, MAKEUP, POSTURE, BODY LANGUAGE, VERBAL AND NON-VERBAL COMMUNICATIONS, AND DISTRIBUTION OF PRINTED MATERIALS IN CONNECTION WITH ALL OF THE FOREGOING IN HARD COPY OR ELECTRONIC FORMAT, IN CLASS 41 (U.S. CLS. 100, 101 AND 107).



FIRST USE 7-23-2011; IN COMMERCE 7-23-2011.

THE MARK CONSISTS OF STANDARD CHARACTERS WITHOUT CLAIM TO ANY PARTICULAR FONT, STYLE, SIZE, OR COLOR.

SN 85-037,531, FILED 5-13-2010.

*David J. Kyros*

Director of the United States Patent and Trademark Office

**Reg. No. 4,276,139** KATHERINE E. HALMEN, EXAMINING ATTORNEY

# United States of America

United States Patent and Trademark Office

## DALLAS CHAPARRALS

**Reg. No. 4,276,140**

**Registered Jan. 15, 2013**

**Int. Cl.: 25**

**TRADEMARK**

**PRINCIPAL REGISTER**

NBA PROPERTIES, INC. (NEW YORK CORPORATION)  
OLYMPIC TOWER - 645 FIFTH AVENUE  
NEW YORK, NY 10022

FOR: CLOTHING, NAMELY, HOSIERY, FOOTWEAR, BASKETBALL SHOES, BASKETBALL SNEAKERS, T-SHIRTS, SHIRTS, POLO SHIRTS, SWEATSHIRTS, SWEATPANTS, PANTS, TANK TOPS, JERSEYS, SHORTS, PAJAMAS, SPORT SHIRTS, RUGBY SHIRTS, SWEATERS, BELTS, TIES, NIGHTSHIRTS, HATS, CAPS, VISORS, WARM-UP SUITS, WARM-UP PANTS, WARM-UP TOPS/SHOOTING SHIRTS, JACKETS, WIND RESISTANT JACKETS, PARKAS, COATS, BABY BIBS NOT OF PAPER, HEAD BANDS, WRIST BANDS, APRONS, UNDERGARMENTS, BOXER SHORTS, SLACKS, EAR MUFFS, GLOVES, MITTENS, SCARVES, WOVEN AND KNIT SHIRTS, JERSEY DRESSES, DRESSES, CHEERLEADING DRESSES AND UNIFORMS, SWIM WEAR, BATHING SUITS, SWIMSUITS, BIKINIS, TANKINIS, SWIM TRUNKS, BATHING TRUNKS, BOARD SHORTS, WET SUITS, BEACH COVER-UPS, BATHING SUIT COVER-UPS, BATHING SUIT WRAPS, SANDALS, BEACH SANDALS, BEACH HATS, SUN VISORS, SWIM CAPS, BATHING CAPS, NOVELTY HEADWEAR WITH ATTACHED WIGS, IN CLASS 25 (U.S. CLS. 22 AND 39).

FIRST USE 1-1-2011; IN COMMERCE 1-1-2011.

THE MARK CONSISTS OF STANDARD CHARACTERS WITHOUT CLAIM TO ANY PARTICULAR FONT, STYLE, SIZE, OR COLOR.

OWNER OF U.S. REG. NO. 2,845,419.

NO CLAIM IS MADE TO THE EXCLUSIVE RIGHT TO USE "DALLAS", APART FROM THE MARK AS SHOWN.

SN 85-042,718, FILED 5-19-2010.

SETH A. RAPPAPORT, EXAMINING ATTORNEY



*David J. Kypos*

Director of the United States Patent and Trademark Office

# United States of America

United States Patent and Trademark Office

## BROTHER NATURE

**Reg. No. 4,276,141**

**Registered Jan. 15, 2013**

**Int. Cl.: 32**

**TRADEMARK**

**PRINCIPAL REGISTER**

CRAFT BREW ALLIANCE, INC. (WASHINGTON CORPORATION)  
929 NORTH RUSSELL STREET  
PORTLAND, OR 97227

FOR: BEER, IN CLASS 32 (U.S. CLS. 45, 46 AND 48).

FIRST USE 6-1-2012; IN COMMERCE 6-1-2012.

THE MARK CONSISTS OF STANDARD CHARACTERS WITHOUT CLAIM TO ANY PARTICULAR FONT, STYLE, SIZE, OR COLOR.

SN 85-042,988, FILED 5-19-2010.

KATHERINE CHANG, EXAMINING ATTORNEY



*David J. Kybas*

Director of the United States Patent and Trademark Office

# United States of America

United States Patent and Trademark Office

## NATURAL CREMATION-AAD

**Reg. No. 4,276,142**

**Registered Jan. 15, 2013**

**Int. Cls.: 11, 40, and 41**

**TRADEMARK**

**SERVICE MARK**

**PRINCIPAL REGISTER**

ECO-GREEN CREMATION SYSTEMS, INC. (FLORIDA CORPORATION)

B

6371-2 ARC WAY  
FORT MYERS, FL 33966

FOR: CREMATION OVENS USED IN THE ORGANIC CREMATION OF THE BODIES OF HUMANS AND PETS, INCORPORATING PRESSURE VESSELS, BOILERS AND CHEMICALS, IN CLASS 11 (U.S. CLS. 13, 21, 23, 31 AND 34).

FIRST USE 2-1-2012; IN COMMERCE 2-1-2012.

FOR: CONSULTATION SERVICES IN THE FIELD OF THE ORGANIC CREMATION OF THE BODIES OF HUMANS AND PETS, IN CLASS 40 (U.S. CLS. 100, 103 AND 106).

FIRST USE 2-1-2012; IN COMMERCE 2-1-2012.

FOR: TRAINING SERVICES IN THE FIELD OF THE ORGANIC CREMATION OF THE BODIES OF HUMANS AND PETS, IN CLASS 41 (U.S. CLS. 100, 101 AND 107).

FIRST USE 2-1-2012; IN COMMERCE 2-1-2012.

THE MARK CONSISTS OF STANDARD CHARACTERS WITHOUT CLAIM TO ANY PARTICULAR FONT, STYLE, SIZE, OR COLOR.

NO CLAIM IS MADE TO THE EXCLUSIVE RIGHT TO USE "NATURAL CREMATION", APART FROM THE MARK AS SHOWN.

SN 85-047,327, FILED 5-25-2010.

DARRYL SPRUILL, EXAMINING ATTORNEY



*David J. Kyffers*

Director of the United States Patent and Trademark Office

# United States of America

United States Patent and Trademark Office

## GLAM & GLOW

**Reg. No. 4,276,143**

KIMAYA USA, INC. (NEW JERSEY CORPORATION)  
700 PENHORN AVENUE - UNIT #3  
SECAUCUS, NJ 07094

**Registered Jan. 15, 2013**

**Int. Cl.: 14**

FOR: WATCHES AND JEWELRY, IN CLASS 14 (U.S. CLS. 2, 27, 28 AND 50).

**TRADEMARK**

FIRST USE 10-18-2012; IN COMMERCE 10-18-2012.

**PRINCIPAL REGISTER**

THE MARK CONSISTS OF STANDARD CHARACTERS WITHOUT CLAIM TO ANY PARTICULAR FONT, STYLE, SIZE, OR COLOR.

SN 85-049,371, FILED 5-27-2010.

EVIN L. KOZAK, EXAMINING ATTORNEY



*David J. Kyffers*

Director of the United States Patent and Trademark Office

# United States of America

United States Patent and Trademark Office

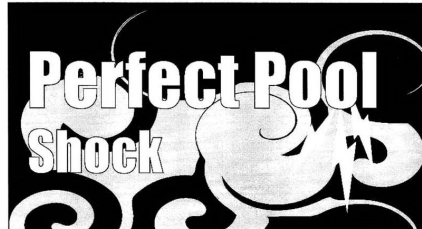

**Reg. No. 4,276,144**

**Registered Jan. 15, 2013**

**Int. Cl.: 1**

**TRADEMARK**

**PRINCIPAL REGISTER**

STELLAR TECHNOLOGY COMPANY (MISSOURI CORPORATION)  
1647 SAUGET BUSINESS BOULEVARD  
SAUGET, IL 62206

FOR: WATER TREATMENT CHEMICALS FOR USE IN SWIMMING POOLS AND SPAS, IN CLASS 1 (U.S. CLS. 1, 5, 6, 10, 26 AND 46).

FIRST USE 9-29-2010; IN COMMERCE 2-11-2011.

NO CLAIM IS MADE TO THE EXCLUSIVE RIGHT TO USE "POOL SHOCK", APART FROM THE MARK AS SHOWN.

THE MARK CONSISTS OF THE STYLIZED WORDING "PERFECT POOL SHOCK" WHERE THE TERM "PERFECT POOL" APPEARS WITH LIGHTNING BOLTS COMING FROM THE BOTTOM OF THE SECOND "O" IN "POOL". THE WORD "SHOCK" APPEARS BENEATH THE WORD "PERFECT". ALL THE WORDING IN THE MARK IS SUPERIMPOSED UPON A RECTANGULAR BACKGROUND DISPLAYING A FANCIFUL DESIGN OF SWIRLING WATER.

SN 85-052,652, FILED 6-2-2010.

GEOFFREY FOSDICK, EXAMINING ATTORNEY



*David J. Kypos*

Director of the United States Patent and Trademark Office

# United States of America

United States Patent and Trademark Office

# X-PRESSIN

**Reg. No. 4,276,145**

BASF CORPORATION (DELAWARE CORPORATION)  
100 PARK AVENUE  
FLORHAM PARK, NJ 07932

**Registered Jan. 15, 2013**

**Int. Cl.: 1**

FOR: BOTANICAL EXTRACTS OR CHEMICALS ADDITIVES FOR USE IN MAKING COSMETICS, IN CLASS 1 (U.S. CLS. 1, 5, 6, 10, 26 AND 46).

**TRADEMARK**

FIRST USE 11-1-2011; IN COMMERCE 11-1-2011.

**PRINCIPAL REGISTER**

THE MARK CONSISTS OF STANDARD CHARACTERS WITHOUT CLAIM TO ANY PARTICULAR FONT, STYLE, SIZE, OR COLOR.

SN 85-058,787, FILED 6-9-2010.

JIM RINGLE, EXAMINING ATTORNEY



*David J. Kyffers*

Director of the United States Patent and Trademark Office



# United States of America

United States Patent and Trademark Office



**Reg. No. 4,276,146**

VERONA HOLDINGS LLC (CALIFORNIA LIMITED LIABILITY COMPANY)  
13443 BARBADOS WAY  
DEL MAR, CA 92014

**Registered Jan. 15, 2013**

**Int. Cls.: 16, 21, and 25**

FOR: BUMPER STICKERS; PAPER BANNERS; POSTERS, IN CLASS 16 (U.S. CLS. 2, 5, 22, 23, 29, 37, 38 AND 50).

**TRADEMARK**

FIRST USE 8-15-2012; IN COMMERCE 8-15-2012.

**PRINCIPAL REGISTER**

FOR: MUGS, IN CLASS 21 (U.S. CLS. 2, 13, 23, 29, 30, 33, 40 AND 50).

FIRST USE 8-15-2012; IN COMMERCE 8-15-2012.

FOR: APRONS; HATS; JACKETS; SHIRTS; SWEAT SHIRTS; T-SHIRTS, IN CLASS 25 (U.S. CLS. 22 AND 39).

FIRST USE 8-15-2012; IN COMMERCE 8-15-2012.

THE MARK CONSISTS OF A PEACE SYMBOL WITH A FLEXED, MUSCLED ARM WEAVED THROUGH THE PEACE SYMBOL.

SN 85-058,809, FILED 6-9-2010.

FLORENTINA BLANDU, EXAMINING ATTORNEY



*David J. Kybas*

Director of the United States Patent and Trademark Office

# United States of America

United States Patent and Trademark Office

# FleetMail

**Reg. No. 4,276,147**

**Registered Jan. 15, 2013**

**Int. Cl.: 38**

**SERVICE MARK**

**PRINCIPAL REGISTER**

KNYAZEV ALEXANDER (RUSSIAN FED. INDIVIDUAL), DBA PROGRAMMER,  
ANISIMOVA ST., 7-10  
VLADIVOSTOK, RUSSIAN FED. 690078

FOR: DATA COMMUNICATION BY ELECTRONIC MAIL; ELECTRONIC MAIL AND MESSAGING SERVICES; ELECTRONIC MESSAGE SENDING; ELECTRONIC MESSAGE TRANSMISSION; ELECTRONIC MESSAGING; ELECTRONIC MESSAGING SYSTEM, NAMELY, ELECTRONIC QUEUING SERVICES; ELECTRONIC STORE-AND-FORWARD MESSAGING; ELECTRONIC TRANSMISSION OF MAIL AND MESSAGES; ELECTRONIC TRANSMISSION OF MESSAGES; ELECTRONIC TRANSMISSION OF MESSAGES AND DATA; MESSAGE COLLECTION AND TRANSMISSION; MESSAGE SENDING AND RECEIVING SERVICES; PROVIDING E-MAIL AND INSTANT MESSAGING SERVICES; PROVIDING TELECOMMUNICATION CONNECTIVITY SERVICES FOR TRANSFER OF IMAGES, MESSAGES, AUDIO, VISUAL, AUDIOVISUAL AND MULTIMEDIA WORKS; SATELLITE COMMUNICATION SERVICES; TRANSMISSION OF MESSAGES; TRANSMISSION OF MESSAGES OVER ELECTRONIC MEDIA; WIRELESS DIGITAL MESSAGING SERVICES, IN CLASS 38 (U.S. CLS. 100, 101 AND 104).

FIRST USE 5-12-2012; IN COMMERCE 8-15-2012.

THE MARK CONSISTS OF STANDARD CHARACTERS WITHOUT CLAIM TO ANY PARTICULAR FONT, STYLE, SIZE, OR COLOR.

PRIORITY CLAIMED UNDER SEC. 44(D) ON HONG KONG APPLICATION NO. 301591939, FILED 4-20-2010.

SN 85-059,020, FILED 6-9-2010.

ELLEN PERKINS, EXAMINING ATTORNEY



*David J. Kybas*

Director of the United States Patent and Trademark Office

# United States of America

United States Patent and Trademark Office



**Reg. No. 4,276,148**

**Registered Jan. 15, 2013**

**Int. Cl.: 41**

**SERVICE MARK**

**PRINCIPAL REGISTER**

WOODALL RODGERS PARK FOUNDATION (TEXAS NON-PROFIT CORPORATION)  
1909 WOODALL RODGERS FREEWAY, SUITE 100  
DALLAS, TX 75201

FOR: RECREATIONAL PARK SERVICES, IN CLASS 41 (U.S. CLS. 100, 101 AND 107).

FIRST USE 10-27-2012; IN COMMERCE 10-27-2012.

THE MARK CONSISTS OF A STYLIZED TREE.

SN 85-059,636, FILED 6-10-2010.

ANNE FARRELL, EXAMINING ATTORNEY



*David J. Kyffers*

Director of the United States Patent and Trademark Office

# United States of America

United States Patent and Trademark Office

# L-Box

**Reg. No. 4,276,149**

INNOVASIS, INC. (UTAH CORPORATION)  
614 EAST 3900 SOUTH  
SALT LAKE CITY, UT 84107

**Registered Jan. 15, 2013**

**Int. Cl.: 10**

FOR: MEDICAL DEVICES, NAMELY, SPINAL IMPLANTS COMPOSED OF ARTIFICIAL MATERIALS, IN CLASS 10 (U.S. CLS. 26, 39 AND 44).

**TRADEMARK**

FIRST USE 11-30-2012; IN COMMERCE 11-30-2012.

**PRINCIPAL REGISTER**

THE MARK CONSISTS OF STANDARD CHARACTERS WITHOUT CLAIM TO ANY PARTICULAR FONT, STYLE, SIZE, OR COLOR.

SN 85-060,879, FILED 6-11-2010.

BARBARA GAYNOR, EXAMINING ATTORNEY



*David J. Kyffers*

Director of the United States Patent and Trademark Office

# United States of America

United States Patent and Trademark Office

# Concept

by BORN

**Reg. No. 4,276,150**

**Registered Jan. 15, 2013**

**Int. Cl.: 25**

**TRADEMARK**

**PRINCIPAL REGISTER**

COLUMBIA INSURANCE COMPANY (NEBRASKA CORPORATION)  
3024 HARNEY STREET  
OMAHA, NE 68131

FOR: FOOTWEAR, IN CLASS 25 (U.S. CLS. 22 AND 39).

FIRST USE 6-1-2010; IN COMMERCE 6-1-2010.

OWNER OF U.S. REG. NOS. 1,981,495, 3,542,937, AND OTHERS.

THE MARK CONSISTS OF THE STYLIZED WORDING "CONCEPT BY BORN" WITH A CROWN DESIGN INSIDE THE "O" IN THE WORD "CONCEPT" AND A CROWN DESIGN INSIDE THE "O" IN THE WORD "BORN".

SN 85-063,369, FILED 6-15-2010.

ROBERT STRUCK, EXAMINING ATTORNEY



*David J. Kyffers*

Director of the United States Patent and Trademark Office

# United States of America

United States Patent and Trademark Office

# ANGEL

**Reg. No. 4,276,151**

**Registered Jan. 15, 2013**

**Int. Cl.: 28**

**TRADEMARK**

**PRINCIPAL REGISTER**

ANGEL PLAYING CARDS CO., LTD. (JAPAN CORPORATION)  
CHUO-KU, OSAKA-SHI  
10-1 KAWARAYAMACHI 2-CHOME  
OSAKA, JAPAN 542-0066

FOR: PLAYING CARDS, NONE OF THE FOREGOING RELATING TO BASEBALL OR SOFTBALL OR TO A BASEBALL OR SOFTBALL TEAM, IN CLASS 28 (U.S. CLS. 22, 23, 38 AND 50).

FIRST USE 8-29-2012; IN COMMERCE 8-29-2012.

THE MARK CONSISTS OF STANDARD CHARACTERS WITHOUT CLAIM TO ANY PARTICULAR FONT, STYLE, SIZE, OR COLOR.

SN 85-065,287, FILED 6-17-2010.

RENEE SERVANCE, EXAMINING ATTORNEY



*David J. Kyros*

Director of the United States Patent and Trademark Office

# United States of America

United States Patent and Trademark Office

# OMNEURON

**Reg. No. 4,276,152**

OMNEURON, INC. (DELAWARE CORPORATION)  
99 EL CAMINO REAL  
MENLO PARK, CA 94025

**Registered Jan. 15, 2013**

**Int. Cl.: 44**

FOR: MEDICAL AND PHARMACEUTICAL CONSULTATION; MEDICAL TESTING FOR DIAGNOSTIC AND TREATMENT PURPOSES; MAGNETIC RESONANCE IMAGING INTERPRETATION AND ANALYSIS FOR MEDICAL PURPOSES AND MEDICAL DIAGNOSTIC AND TREATMENT PURPOSES, IN CLASS 44 (U.S. CLS. 100 AND 101).

**SERVICE MARK**

**PRINCIPAL REGISTER**

FIRST USE 3-26-2010; IN COMMERCE 3-26-2010.

THE MARK CONSISTS OF STANDARD CHARACTERS WITHOUT CLAIM TO ANY PARTICULAR FONT, STYLE, SIZE, OR COLOR.

OWNER OF U.S. REG. NO. 3,797,587.

SN 85-066,181, FILED 6-18-2010.

DAVID TOOLEY, EXAMINING ATTORNEY



*David J. Kyffers*

Director of the United States Patent and Trademark Office

# United States of America

United States Patent and Trademark Office

## INUIT CANDY

**Reg. No. 4,276,153**

EDGAR HUGO (UNITED STATES INDIVIDUAL)  
18851 NE 29 AVENUE, SUITE 700  
AVENTURA, FL 33180

**Registered Jan. 15, 2013**

**Int. Cl.: 29**

FOR: SALMON FISH FROM INUIT, IN CLASS 29 (U.S. CL. 46).

**TRADEMARK**

FIRST USE 11-21-2012; IN COMMERCE 11-21-2012.

**PRINCIPAL REGISTER**

THE MARK CONSISTS OF STANDARD CHARACTERS WITHOUT CLAIM TO ANY PARTICULAR FONT, STYLE, SIZE, OR COLOR.

NO CLAIM IS MADE TO THE EXCLUSIVE RIGHT TO USE "INUIT", APART FROM THE MARK AS SHOWN.

SN 85-067,021, FILED 6-19-2010.

ZACHARY BELLO, EXAMINING ATTORNEY



*David J. Kyffers*

Director of the United States Patent and Trademark Office



# United States of America

United States Patent and Trademark Office

## KARDASHIAN KHAOS

**Reg. No. 4,276,154**

**Registered Jan. 15, 2013**

**Int. Cl.: 35**

**SERVICE MARK**

**PRINCIPAL REGISTER**

KIMSAPRINCESS INC. (CALIFORNIA CORPORATION)  
21731 VENTURA BLVD., SUITE 300  
C/O BOULEVARD MANAGEMENT, INC.  
WOODLAND HILLS, CA 91364 AND

2DIE4KOURT INC. (CALIFORNIA CORPORATION)  
21731 VENTURA BLVD., SUITE 300  
WOODLAND HILLS, CA 91364 AND

KHLOMONEY, INC. (CALIFORNIA CORPORATION)  
21731 VENTURA BLVD., SUITE 300  
WOODLAND HILLS, CA 91364 AND

JENNER COMMUNICATIONS, INC. (CALIFORNIA CORPORATION)  
21731 VENTURA BLVD., SUITE 300  
WOODLAND HILLS, CA 91364

FOR: RETAIL STORE SERVICES, ONLINE RETAIL STORE SERVICES AND MAIL ORDER SERVICES, ALL FEATURING GIFTS AND A VARIETY OF OTHER CONSUMER PRODUCTS AND SERVICES, IN CLASS 35 (U.S. CLS. 100, 101 AND 102).

FIRST USE 11-1-2011; IN COMMERCE 11-1-2011.

THE MARK CONSISTS OF STANDARD CHARACTERS WITHOUT CLAIM TO ANY PARTICULAR FONT, STYLE, SIZE, OR COLOR.

SN 85-068,407, FILED 6-22-2010.

CURTIS FRENCH, EXAMINING ATTORNEY



*David J. Kyros*

Director of the United States Patent and Trademark Office

# United States of America

United States Patent and Trademark Office

# ELR

**Reg. No. 4,276,155**

**Registered Jan. 15, 2013**

**Int. Cl.: 7**

**TRADEMARK**

**PRINCIPAL REGISTER**

WESTINGHOUSE ELECTRIC COMPANY LLC (DELAWARE LIMITED LIABILITY COMPANY)  
SUITE 141  
1000 WESTINGHOUSE DRIVE  
CRANBERRY TOWNSHIP, PA 16066

FOR: MECHANICAL SEALS, IN CLASS 7 (U.S. CLS. 13, 19, 21, 23, 31, 34 AND 35).

FIRST USE 10-25-2012; IN COMMERCE 10-25-2012.

THE MARK CONSISTS OF STANDARD CHARACTERS WITHOUT CLAIM TO ANY PARTICULAR FONT, STYLE, SIZE, OR COLOR.

SN 85-071,634, FILED 6-25-2010.

BILL DAWE, EXAMINING ATTORNEY



*David J. Kyffers*

Director of the United States Patent and Trademark Office

# United States of America

United States Patent and Trademark Office

## STEERING YOU IN THE RIGHT DIRECTION!

**Reg. No. 4,276,156**

FLAMING RIVER INDUSTRIES, INC. (OHIO CORPORATION)  
800 POERTNER DRIVE  
BEREA, OH 44017

**Registered Jan. 15, 2013**

**Int. Cl.: 25**

FOR: APPAREL, NAMELY, T-SHIRTS; APPAREL, NAMELY, SHIRTS AND JACKETS, IN CLASS 25 (U.S. CLS. 22 AND 39).

**TRADEMARK**

FIRST USE 10-15-2012; IN COMMERCE 10-15-2012.

**PRINCIPAL REGISTER**

THE MARK CONSISTS OF STANDARD CHARACTERS WITHOUT CLAIM TO ANY PARTICULAR FONT, STYLE, SIZE, OR COLOR.

SN 85-075,941, FILED 7-1-2010.

JEFF DEFORD, EXAMINING ATTORNEY



*David J. Kybas*

Director of the United States Patent and Trademark Office

# United States of America

United States Patent and Trademark Office



**Reg. No. 4,276,157**

SEATTLE GENETICS, INC. (DELAWARE CORPORATION)  
21823 30TH DRIVE S.E.  
BOTHELL, WA 98021

**Registered Jan. 15, 2013**

**Int. Cls.: 5 and 42**

FOR: PHARMACEUTICAL PREPARATIONS FOR USE IN HUMANS FOR THE TREATMENT OF CANCER AND IMMUNOLOGICAL DISEASES; PHARMACEUTICAL PREPARATIONS FOR THE TREATMENT OF CANCER AND FOR USE IN ONCOLOGY, IN CLASS 5 (U.S. CLS. 6, 18, 44, 46, 51 AND 52).

**TRADEMARK**

**SERVICE MARK**

FIRST USE 11-0-1997; IN COMMERCE 1-0-1998.

**PRINCIPAL REGISTER**

FOR: BIOTECHNOLOGY RESEARCH, NAMELY, RESEARCH AND DEVELOPMENT OF PHARMACEUTICAL PREPARATIONS FOR USE IN HUMANS; RESEARCH AND DEVELOPMENT OF PHARMACEUTICAL PREPARATIONS FOR THE TREATMENT OF CANCER AND FOR USE IN ONCOLOGY, IN CLASS 42 (U.S. CLS. 100 AND 101).

FIRST USE 11-0-1997; IN COMMERCE 1-0-1998.

OWNER OF U.S. REG. NOS. 3,173,668 AND 3,212,578.

SEC. 2(F) AS TO "SEATTLEGENETICS".

THE MARK CONSISTS OF A CIRCLE WITH A TRIANGLE-SHAPED LONG DASH INTERSECTING THE UPPER LEFT-HAND SIDE AND THE LETTERS "SEATTLEGENETICS".

SN 85-075,974, FILED 7-1-2010.

KATHERINE CHANG, EXAMINING ATTORNEY



*David J. Kyjars*

Director of the United States Patent and Trademark Office

# United States of America

United States Patent and Trademark Office

## VELA MOBILE

**Reg. No. 4,276,158**

**Registered Jan. 15, 2013**

**Int. Cl.: 9**

**TRADEMARK**

**PRINCIPAL REGISTER**

VELA SYSTEMS, INC. (DELAWARE CORPORATION)  
164 MIDDLESEX TURNPIKE  
BURLINGTON, MA 01803

FOR: SOFTWARE, NAMELY, DOWNLOADABLE COMPUTER SOFTWARE USED AS A MOBILE INSPECTION AND COMMUNICATION MANAGEMENT PLATFORM FOR CAPITAL AND CONSTRUCTION PROJECTS, INCLUDING, BUT NOT LIMITED TO, SITE SURVEYS, TRAFFIC INVENTORIES, CLOSEOUT INSPECTIONS, ONGOING VALIDATION AND MAINTENANCE OF FACILITIES; MOBILE COMPUTING DEVICES, NAMELY, TABLET COMPUTERS, LAPTOPS, COMPUTERS, AND PDAS FOR USE AS A MOBILE INSPECTION AND COMMUNICATION MANAGEMENT PLATFORMS FOR CAPITAL AND CONSTRUCTION PROJECTS, INCLUDING, BUT NOT LIMITED TO, SITE SURVEYS, TRAFFIC INVENTORIES, CLOSEOUT INSPECTIONS, ONGOING VALIDATION AND MAINTENANCE OF FACILITIES, IN CLASS 9 (U.S. CLS. 21, 23, 26, 36 AND 38).

FIRST USE 1-1-2010; IN COMMERCE 1-1-2010.

THE MARK CONSISTS OF STANDARD CHARACTERS WITHOUT CLAIM TO ANY PARTICULAR FONT, STYLE, SIZE, OR COLOR.

OWNER OF U.S. REG. NOS. 3,287,565, 3,446,013, AND 3,603,062.

NO CLAIM IS MADE TO THE EXCLUSIVE RIGHT TO USE "MOBILE", APART FROM THE MARK AS SHOWN.

SN 85-076,873, FILED 7-2-2010.

NICHOLAS COLEMAN, EXAMINING ATTORNEY



*David J. Kyros*

Director of the United States Patent and Trademark Office

# United States of America

United States Patent and Trademark Office

## STAY CONNECTED @ CONRAD

**Reg. No. 4,276,159**

**Registered Jan. 15, 2013**

**Int. Cl.: 38**

**SERVICE MARK**

**PRINCIPAL REGISTER**

HLT CONRAD IP LLC (DELAWARE LIMITED LIABILITY COMPANY)  
7930 JONES BRANCH DRIVE  
MCLEAN, VA 22102

FOR: PROVIDING HIGH SPEED ACCESS TO AREA NETWORKS AND GLOBAL COMPUTER INFORMATION NETWORKS, IN CLASS 38 (U.S. CLS. 100, 101 AND 104).

FIRST USE 6-30-2011; IN COMMERCE 6-30-2011.

THE MARK CONSISTS OF STANDARD CHARACTERS WITHOUT CLAIM TO ANY PARTICULAR FONT, STYLE, SIZE, OR COLOR.

OWNER OF U.S. REG. NOS. 2,577,833, 3,365,776, AND OTHERS.

SN 85-079,475, FILED 7-7-2010.

WON TEAK OH, EXAMINING ATTORNEY



*David J. Kyffers*

Director of the United States Patent and Trademark Office

# United States of America

United States Patent and Trademark Office

## HOPE SPRINGS

**Reg. No. 4,276,160**

**Registered Jan. 15, 2013**

**Int. Cl.: 16**

**TRADEMARK**

**PRINCIPAL REGISTER**

GUIDEPOSTS A CHURCH CORPORATION (NEW YORK CORPORATION)  
39 OLD RIDGEBURY ROAD  
DANBURY, CT 06810

FOR: BLANK JOURNALS; GREETING CARDS; DAILY PLANNERS; POSTERS, IN CLASS  
16 (U.S. CLS. 2, 5, 22, 23, 29, 37, 38 AND 50).

FIRST USE 5-0-2011; IN COMMERCE 5-0-2011.

THE MARK CONSISTS OF STANDARD CHARACTERS WITHOUT CLAIM TO ANY PAR-  
TICULAR FONT, STYLE, SIZE, OR COLOR.

SN 85-083,295, FILED 7-13-2010.

BILL DAWE, EXAMINING ATTORNEY



*David J. Kyfos*

Director of the United States Patent and Trademark Office

# United States of America

United States Patent and Trademark Office

## HOPE SPRINGS

**Reg. No. 4,276,161**

**Registered Jan. 15, 2013**

**Int. Cl.: 21**

**TRADEMARK**

**PRINCIPAL REGISTER**

GUIDEPOSTS A CHURCH CORPORATION (NEW YORK CORPORATION)  
39 OLD RIDGEBURY ROAD  
DANBURY, CT 06810

FOR: COFFEE MUGS; DRINKING CUPS, IN CLASS 21 (U.S. CLS. 2, 13, 23, 29, 30, 33, 40 AND 50).

FIRST USE 5-0-2011; IN COMMERCE 5-0-2011.

THE MARK CONSISTS OF STANDARD CHARACTERS WITHOUT CLAIM TO ANY PARTICULAR FONT, STYLE, SIZE, OR COLOR.

SN 85-083,339, FILED 7-13-2010.

BILL DAWE, EXAMINING ATTORNEY



*David J. Kyffers*

Director of the United States Patent and Trademark Office



# United States of America

United States Patent and Trademark Office

## MAC EXTENDED PLAY LASH

**Reg. No. 4,276,162**

**Registered Jan. 15, 2013**

**Int. Cl.: 3**

**TRADEMARK**

**PRINCIPAL REGISTER**

ESTEE LAUDER COSMETICS LTD. (CANADA CORPORATION)  
161 COMMANDER BLVD  
AGINCOURT, ONTARIO, CANADA M1S3K9

FOR: COSMETICS, IN CLASS 3 (U.S. CLS. 1, 4, 6, 50, 51 AND 52).

FIRST USE 5-7-2012; IN COMMERCE 5-7-2012.

THE MARK CONSISTS OF STANDARD CHARACTERS WITHOUT CLAIM TO ANY PARTICULAR FONT, STYLE, SIZE, OR COLOR.

OWNER OF U.S. REG. NOS. 1,642,532, 3,023,827, AND OTHERS.

NO CLAIM IS MADE TO THE EXCLUSIVE RIGHT TO USE "LASH", APART FROM THE MARK AS SHOWN.

SN 85-085,213, FILED 7-15-2010.

KATHLEEN LORENZO, EXAMINING ATTORNEY



*David J. Kyffers*

Director of the United States Patent and Trademark Office

# United States of America

United States Patent and Trademark Office

## *Scratch Millionaire*

**Reg. No. 4,276,163**

MCKINNON, RONALD, L (UNITED STATES INDIVIDUAL)  
55 WESTMINSTER DR.  
LUMBERTON, NJ 08048 AND

**Registered Jan. 15, 2013**

**Int. Cl.: 25**

ANDERSON, JOSEPH, B (UNITED STATES INDIVIDUAL)  
55 WESTMINSTER DR.  
LUMBERTON, NJ 08048

**TRADEMARK**

**PRINCIPAL REGISTER**

FOR: SHORT-SLEEVED OR LONG-SLEEVED T-SHIRTS, IN CLASS 25 (U.S. CLS. 22 AND 39).

FIRST USE 8-11-2011; IN COMMERCE 8-11-2011.

THE MARK CONSISTS OF "SCRATCH MILLIONAIRE" WITH A STRIKE THROUGH EFFECT ACROSS THE WORD "SCRATCH".

SN 85-086,393, FILED 7-16-2010.

RON FAIRBANKS, EXAMINING ATTORNEY



*David J. Kybas*

Director of the United States Patent and Trademark Office

# United States of America

United States Patent and Trademark Office

# BeePharm

**Reg. No. 4,276,164**

BEEPHARM LLC (NEW YORK LIMITED LIABILITY COMPANY)  
15 HEIGHTS RD  
NORTHPORT, NY 11768

**Registered Jan. 15, 2013**

**Int. Cls.: 3, 5, and 30**

FOR: AFTER SUN CREAMS; AGE SPOT REDUCING CREAMS; ANTI-AGING CREAM; ANTI-AGING CREAMS; ANTI-WRINKLE CREAM; ANTI-WRINKLE CREAMS; AROMATIC BODY CARE PRODUCTS, NAMELY, BODY LOTION, SHOWER GEL, CUTICLE CREAM, SHAMPOO, CONDITIONER, NON-MEDICATED LIP BALM, SOAP, BODY POLISH, BODY AND FOOT SCRUB AND NON-MEDICATED FOOT CREAM; AROMATIC PREPARATIONS, NAMELY, FACE CREAM, LEG CREAM, MASSAGE LOTION, MASSAGE CREAM; BEAUTY CREAMS; BEAUTY CREAMS FOR BODY CARE; BEAUTY GELS; BEAUTY LOTIONS; BEAUTY MASKS; BEAUTY SERUMS; BODY AND BEAUTY CARE COSMETICS; COSMETIC CREAMS FOR SKIN CARE; COSMETIC PREPARATIONS, NAMELY, FIRING CREAMS; CREAMS FOR CELLULITE REDUCTION; EXFOLIANT CREAMS; EYE CREAM; FACE AND BODY BEAUTY CREAMS; FACE AND BODY CREAMS; FACE CREAMS FOR COSMETIC USE; FACIAL BEAUTY MASKS; HAND CREAM; HAND CREAMS; LIP CREAM; MAKE-UP REMOVING MILK, GEL, LOTIONS AND CREAMS; MASSAGE CREAMS; MOISTURIZING CREAMS; NIGHT CREAM; SKIN AND BODY TOPICAL LOTIONS, CREAMS AND OILS FOR COSMETIC USE; SKIN CREAM; SKIN CREAMS; SKIN CREAMS IN LIQUID AND IN SOLID FORM; SKIN CREAMS IN LIQUID AND SOLID; SUN CREAMS; SUNSCREEN CREAM; SUNSCREEN CREAMS, IN CLASS 3 (U.S. CLS. 1, 4, 6, 50, 51 AND 52).

**TRADEMARK**

**PRINCIPAL REGISTER**



FIRST USE 6-8-2007; IN COMMERCE 7-15-2011.

FOR: ANTI-ITCH CREAM; AROMATHERAPY CREAMS FOR BODY, CELLULITE, VARICOSE VEINS, AGE SPOTS; BEE POLLEN FOR USE AS A DIETARY FOOD SUPPLEMENT; BEE VENOM FOR MEDICINAL OR THERAPEUTIC PURPOSES; GELS, CREAMS AND SOLUTIONS FOR DERMATOLOGICAL USE; HERBAL TOPICAL CREAMS, GELS, SALVES, SPRAYS, POWDER, BALMS, LINIMENT AND OINTMENTS FOR THE RELIEF OF ACHES AND PAIN; PROPOLIS FOR MEDICINAL OR THERAPEUTIC PURPOSES; SPORTS CREAM FOR RELIEF OF PAIN, IN CLASS 5 (U.S. CLS. 6, 18, 44, 46, 51 AND 52).

FIRST USE 6-8-2007; IN COMMERCE 7-15-2011.

*David J. Kyjars*

FOR: HONEY; PROPOLIS FOR HUMAN CONSUMPTION; ROYAL JELLY FOR FOOD PURPOSES, IN CLASS 30 (U.S. CL. 46).

**Reg. No. 4,276,164** FIRST USE 6-8-2007; IN COMMERCE 7-15-2011.

THE MARK CONSISTS OF STANDARD CHARACTERS WITHOUT CLAIM TO ANY PARTICULAR FONT, STYLE, SIZE, OR COLOR.

SN 85-087,533, FILED 7-19-2010.

CIMMERIAN COLEMAN, EXAMINING ATTORNEY

# United States of America

United States Patent and Trademark Office

## GENEROSITY QUOTIENT

**Reg. No. 4,276,165**

GALLAGHER LEADERSHIP, LLC (PENNSYLVANIA LIMITED LIABILITY COMPANY)  
819 HOMESTEAD AVENUE  
HAVERTOWN, PA 19083

**Registered Jan. 15, 2013**

**Int. Cl.: 41**

FOR: EDUCATION SERVICES, NAMELY, CONDUCTING SEMINARS IN THE FIELDS OF LEADERSHIP AND MANAGEMENT; EDUCATIONAL SERVICES, NAMELY, DEVELOPING CURRICULUM, ASSESSMENTS AND SURVEYS FOR USE BY OTHERS WHEN TEACHING LEADERSHIP AND MANAGEMENT SKILLS, IN CLASS 41 (U.S. CLS. 100, 101 AND 107).

**SERVICE MARK**

**PRINCIPAL REGISTER**

FIRST USE 7-31-2011; IN COMMERCE 7-31-2011.

THE MARK CONSISTS OF STANDARD CHARACTERS WITHOUT CLAIM TO ANY PARTICULAR FONT, STYLE, SIZE, OR COLOR.

SN 85-093,914, FILED 7-27-2010.

MELISSA VALLILLO, EXAMINING ATTORNEY



*David J. Kyffers*

Director of the United States Patent and Trademark Office

# United States of America

United States Patent and Trademark Office

## JANET'S JEWELRY BOX

**Reg. No. 4,276,166**

FRAGMENTS, INC. (NEW YORK CORPORATION)  
110 GREENE STREET, SUITE 801  
NEW YORK, NY 10012

**Registered Jan. 15, 2013**

**Int. Cl.: 35**

FOR: RETAIL STORE SERVICES FEATURING JEWELRY; ONLINE RETAIL STORE SERVICES FEATURING JEWELRY, IN CLASS 35 (U.S. CLS. 100, 101 AND 102).

**SERVICE MARK**

FIRST USE 5-15-2001; IN COMMERCE 5-15-2001.

**PRINCIPAL REGISTER**

THE MARK CONSISTS OF STANDARD CHARACTERS WITHOUT CLAIM TO ANY PARTICULAR FONT, STYLE, SIZE, OR COLOR.

NO CLAIM IS MADE TO THE EXCLUSIVE RIGHT TO USE "JEWELRY BOX", APART FROM THE MARK AS SHOWN.

SN 85-094,018, FILED 7-27-2010.

JANICE KIM, EXAMINING ATTORNEY



*David J. Kybas*

Director of the United States Patent and Trademark Office

# United States of America

United States Patent and Trademark Office

## Brock Motors

**Reg. No. 4,276,167**

BROCK MOTORS LLC (OKLAHOMA LIMITED LIABILITY COMPANY)  
PO BOX 70  
OILTON, OK 74052

**Registered Jan. 15, 2013**

**Int. Cl.: 7**

FOR: ELECTRIC MOTORS FOR MACHINES; ELECTRIC MOTORS, AND THEIR PARTS, NOT FOR LAND VEHICLES; ELECTRIC MOTORS, NOT FOR LAND VEHICLES; MOTORS OTHER THAN FOR LAND VEHICLES, IN CLASS 7 (U.S. CLS. 13, 19, 21, 23, 31, 34 AND 35).

**TRADEMARK**

**PRINCIPAL REGISTER**

FIRST USE 1-1-2011; IN COMMERCE 1-1-2012.

THE MARK CONSISTS OF STANDARD CHARACTERS WITHOUT CLAIM TO ANY PARTICULAR FONT, STYLE, SIZE, OR COLOR.

NO CLAIM IS MADE TO THE EXCLUSIVE RIGHT TO USE "MOTORS", APART FROM THE MARK AS SHOWN.

SN 85-099,405, FILED 8-3-2010.

DAVID HOFFMAN, EXAMINING ATTORNEY



*David J. Kyfos*

Director of the United States Patent and Trademark Office

# United States of America

United States Patent and Trademark Office

# ACCESS+

**Reg. No. 4,276,168**

**Registered Jan. 15, 2013**

**Int. Cl.: 9**

**TRADEMARK**

**PRINCIPAL REGISTER**

RAD DATA COMMUNICATIONS LTD. (ISRAEL CORPORATION)  
24 RAOUL WALLENBERG ST.  
TEL AVIV, ISRAEL 69719

FOR: DATA COMMUNICATIONS AND TELECOMMUNICATIONS MULTIPLEXERS, MODEMS, PSEUDOWIRE GATEWAYS, AND CARRIER ETHERNET ACCESS EQUIPMENT WORKING IN CONJUNCTION AS AN INTEGRATED SYSTEM FOR THE TRANSPORT AND AGGREGATION OF DATA, VOICE AND LAN TRAFFIC OVER FIBER AND COPPER INFRASTRUCTURE, NONE OF THE FOREGOING TO INCLUDE ACCESS CONTROL AND ALARM MONITORING SYSTEMS OR COMPUTER SOFTWARE FOR SUCH SYSTEMS, IN CLASS 9 (U.S. CLS. 21, 23, 26, 36 AND 38).

FIRST USE 10-22-2012; IN COMMERCE 10-22-2012.

THE MARK CONSISTS OF STANDARD CHARACTERS WITHOUT CLAIM TO ANY PARTICULAR FONT, STYLE, SIZE, OR COLOR.

SN 85-101,409, FILED 8-5-2010.

KAREN K. BUSH, EXAMINING ATTORNEY



*David J. Kyros*

Director of the United States Patent and Trademark Office



# United States of America

United States Patent and Trademark Office

## MOUNTAIN HAM

**Reg. No. 4,276,169**

HECKETT, NICHOLAS (UNITED STATES INDIVIDUAL)  
P.O. BOX 186  
CLIFTON, VA 20124

**Registered Jan. 15, 2013**

**Int. Cl.: 29**

FOR: PORK; HAM; CURED, DRIED OR PROCESSED PORK MEAT, IN CLASS 29 (U.S. CL. 46).

**TRADEMARK**

FIRST USE 10-11-2012; IN COMMERCE 10-11-2012.

**PRINCIPAL REGISTER**

THE MARK CONSISTS OF STANDARD CHARACTERS WITHOUT CLAIM TO ANY PARTICULAR FONT, STYLE, SIZE, OR COLOR.

NO CLAIM IS MADE TO THE EXCLUSIVE RIGHT TO USE "HAM", APART FROM THE MARK AS SHOWN.

SN 85-104,870, FILED 8-11-2010.

LINDA E. BLOHM, EXAMINING ATTORNEY



*David J. Kyffers*

Director of the United States Patent and Trademark Office

United States of America  
United States Patent and Trademark Office

# M-PHASIS

**Reg. No. 4,276,170**

MIDWEST MEDICAL SUPPLY CO., LLC (MISSOURI LIMITED LIABILITY COMPANY)  
13400 LAKEFRONT DR.  
EARTH CITY, MO 63045

**Registered Jan. 15, 2013**

**Int. Cls.: 3, 5, and 10**

FOR: DISPOSABLE WIPES IMPREGNATED WITH A SKIN CLEANSING PREPARATION,  
IN CLASS 3 (U.S. CLS. 1, 4, 6, 50, 51 AND 52).

**TRADEMARK**

FIRST USE 9-0-2010; IN COMMERCE 9-0-2010.

**PRINCIPAL REGISTER**

FOR: COTTON SWABS FOR MEDICAL AND SURGICAL PURPOSES; DISPOSABLE PADS  
IMPREGNATED WITH ALCOHOL FOR MEDICAL AND SURGICAL PURPOSES; GAUZE  
FOR MEDICAL AND SURGICAL PURPOSES, IN CLASS 5 (U.S. CLS. 6, 18, 44, 46, 51 AND  
52).

FIRST USE 9-0-2010; IN COMMERCE 9-0-2010.

FOR: GLOVES AND MITTS FOR MEDICAL AND SURGICAL PURPOSES; TONGUE DE-  
PRESSORS; CRUTCHES, IN CLASS 10 (U.S. CLS. 26, 39 AND 44).

FIRST USE 9-0-2010; IN COMMERCE 9-0-2010.

THE MARK CONSISTS OF STANDARD CHARACTERS WITHOUT CLAIM TO ANY PAR-  
TICULAR FONT, STYLE, SIZE, OR COLOR.

SN 85-105,276, FILED 8-11-2010.

VERNA BETH RIRIE, EXAMINING ATTORNEY



*David J. Kyros*

Director of the United States Patent and Trademark Office

# United States of America

United States Patent and Trademark Office

## SNAP LABEL

**Reg. No. 4,276,171**

**Registered Jan. 15, 2013**

**Int. Cl.: 35**

**SERVICE MARK**

**PRINCIPAL REGISTER**

WRIGHT OF THOMASVILLE, INC. (NORTH CAROLINA CORPORATION)  
P.O. BOX 1069  
5115 PROSPECT STREET EXT.  
THOMASVILLE, NC 27360

FOR: MARKETING CONSULTING SERVICES FOR OTHERS, NAMELY, DESIGN OF PROMOTIONAL, INFORMATIONAL, OR ADVERTISING MATERIALS CARRYING TWO DIMENSIONAL BAR CODE INFORMATION, IN CLASS 35 (U.S. CLS. 100, 101 AND 102).

FIRST USE 7-26-2010; IN COMMERCE 7-26-2010.

THE MARK CONSISTS OF STANDARD CHARACTERS WITHOUT CLAIM TO ANY PARTICULAR FONT, STYLE, SIZE, OR COLOR.

NO CLAIM IS MADE TO THE EXCLUSIVE RIGHT TO USE "LABEL", APART FROM THE MARK AS SHOWN.

SN 85-106,235, FILED 8-12-2010.

MIDGE BUTLER, EXAMINING ATTORNEY



*David J. Kypos*

Director of the United States Patent and Trademark Office

# United States of America

United States Patent and Trademark Office

## MAGIC BULLET BIG SHOT

**Reg. No. 4,276,172**

HOMELAND HOUSEWARES, LLC (CALIFORNIA LIMITED LIABILITY COMPANY)  
11755 WILSHIRE BLVD, SUITE 1200  
LOS ANGELES, CA 90025

**Registered Jan. 15, 2013**

**Int. Cl.: 7**

FOR: ELECTRONIC APPLIANCES, NAMELY, KITCHEN FOOD PROCESSORS, IN CLASS  
7 (U.S. CLS. 13, 19, 21, 23, 31, 34 AND 35).

**TRADEMARK**

FIRST USE 10-22-2012; IN COMMERCE 10-22-2012.

**PRINCIPAL REGISTER**

THE MARK CONSISTS OF STANDARD CHARACTERS WITHOUT CLAIM TO ANY PAR-  
TICULAR FONT, STYLE, SIZE, OR COLOR.

OWNER OF U.S. REG. NOS. 2,947,492, 3,043,999, AND OTHERS.

SN 85-106,659, FILED 8-12-2010.

BRIDGETT SMITH, EXAMINING ATTORNEY



*David J. Kyffers*

Director of the United States Patent and Trademark Office

# United States of America

United States Patent and Trademark Office

## TRICORBRAUN

design & engineering

the power of options

**Reg. No. 4,276,173**

**Registered Jan. 15, 2013**

**Int. Cl.: 42**

**SERVICE MARK**

**PRINCIPAL REGISTER**

TRICORBRAUN INC. (MISSOURI CORPORATION)  
10330 OLD OLIVE STREET ROAD  
ST. LOUIS, MO 63141

FOR: PACKAGING DESIGN FOR OTHERS, DESIGN FOR OTHERS IN THE FIELD OF ENGINEERING MANUFACTURING LINES FOR THE PRODUCTION OF PACKAGING MATERIALS; CUSTOM DESIGN AND ENGINEERING OF MOLDS AND MACHINE TOOLS FOR USE IN PRODUCTION OF PACKAGING MATERIALS, IN CLASS 42 (U.S. CLS. 100 AND 101).

FIRST USE 5-9-2012; IN COMMERCE 5-9-2012.

NO CLAIM IS MADE TO THE EXCLUSIVE RIGHT TO USE "DESIGN & ENGINEERING", APART FROM THE MARK AS SHOWN.

THE MARK CONSISTS OF THE WORD "TRICORBRAUN" IN CAPITAL LETTERS WITH THE LOWER CASE WORDS "DESIGN & ENGINEERING" BELOW "TRICORBRAUN", AND THE LOWER CASE WORDS "THE POWER OF OPTIONS" BELOW THE WORDS "DESIGN & ENGINEERING".

SN 85-109,092, FILED 8-17-2010.

SUSAN RICHARDS, EXAMINING ATTORNEY



*David J. Kyjars*

Director of the United States Patent and Trademark Office

# United States of America

United States Patent and Trademark Office

## CIBU LOTUS FLOWER

**Reg. No. 4,276,174**

**Registered Jan. 15, 2013**

**Int. Cl.: 3**

**TRADEMARK**

**PRINCIPAL REGISTER**

BUBBLES, INC. (D.C. CORPORATION)  
1577 SPRING HILL ROAD, SUITE 500  
VIENNA, VA 22182

FOR: SOAPS, GELS AND SALTS FOR THE BATH AND SHOWER, TOILET WATER, PERFUME, DEODORANTS FOR PERSONAL USE, SKIN, FACE, HAND AND BODY OILS, CREAMS, MILKS, LOTIONS, GELS AND POWDERS, AFTER SUN LOTIONS, SUN BLOCK AND SUN SCREEN PREPARATIONS, COSMETICS, AND MAKEUP; HAIR CARE PRODUCTS, NAMELY, SHAMPOOS, CONDITIONERS AND STYLING PREPARATIONS; HAIR CARE PREPARATIONS, NAMELY, COLORING AND DECOLORANT PREPARATIONS, PERMANENT WAVING AND CURLING PREPARATIONS, IN CLASS 3 (U.S. CLS. 1, 4, 6, 50, 51 AND 52).

FIRST USE 8-19-2010; IN COMMERCE 8-19-2010.

THE MARK CONSISTS OF STANDARD CHARACTERS WITHOUT CLAIM TO ANY PARTICULAR FONT, STYLE, SIZE, OR COLOR.

NO CLAIM IS MADE TO THE EXCLUSIVE RIGHT TO USE "LOTUS FLOWER", APART FROM THE MARK AS SHOWN.

SN 85-111,304, FILED 8-19-2010.

ARETHA SOMERVILLE, EXAMINING ATTORNEY



*David J. Kypos*

Director of the United States Patent and Trademark Office

# United States of America

United States Patent and Trademark Office

## EVE OF A NEW DAWN

**Reg. No. 4,276,175**

COTTLE, DONALD R. (UNITED STATES INDIVIDUAL)  
14 DORAL DRIVE  
MORAGA, CA 94556

**Registered Jan. 15, 2013**

**Int. Cl.: 41**

FOR: ENTERTAINMENT IN THE NATURE OF LIVE STAGE PERFORMANCES IN THE NATURE OF THEATRICAL MUSICAL PLAYS, IN CLASS 41 (U.S. CLS. 100, 101 AND 107).

**SERVICE MARK**

FIRST USE 8-1-2010; IN COMMERCE 8-1-2010.

**PRINCIPAL REGISTER**

THE MARK CONSISTS OF STANDARD CHARACTERS WITHOUT CLAIM TO ANY PARTICULAR FONT, STYLE, SIZE, OR COLOR.

SN 85-111,922, FILED 8-20-2010.

THEODORE MCBRIDE, EXAMINING ATTORNEY



*David J. Kybas*

Director of the United States Patent and Trademark Office

# United States of America

United States Patent and Trademark Office



**Reg. No. 4,276,176**

**Registered Jan. 15, 2013**

**Int. Cl.: 35**

**SERVICE MARK**

**PRINCIPAL REGISTER**

GOVERNMENT CONTRACT SOLUTIONS, INC. (VIRGINIA CORPORATION)  
7900 WESTPARK DRIVE SUITE T500  
MCLEAN, VA 22102

FOR: EMPLOYMENT AGENCY SERVICES FOR FULL-TIME AND TEMPORARY STAFFING FOR LONG-TERM AND SHORT-TERM STAFFING; LONG-TERM, SHORT-TERM AND TEMPORARY JOB PLACEMENT OF CONSULTANTS, DESIGNERS, ANALYSTS, PROGRAMMERS, TECHNICAL PERSONNEL, ENGINEERING PERSONNEL, AND INDUSTRIAL PERSONNEL; MANAGEMENT OF LONG-TERM AND SHORT-TERM JOB PLACEMENT; PROVIDING IN-CLIENT STAFFING SUPPORT, NAMELY, MANAGING THE HIRING OF ADDITIONAL STAFF FOR OTHERS; BUSINESS MANAGEMENT SERVICES IN THE FIELDS OF INFORMATION AND DATA MANAGEMENT, PROGRAMMATIC AND ACQUISITION SUPPORT, TECHNICAL DATA DOCUMENTATION AND PROVISIONING, TRAINING, LOGISTICS SUPPORT ANALYSIS, PROGRAM PLANNING AND EVALUATION, STUDIES AND ANALYSES, AND DATA COLLECTION, PROCESSING AND ANALYSIS; TECHNICAL BUSINESS CONSULTING AND BUSINESS MANAGEMENT CONSULTING AND SUPPORT IN THE FIELDS OF STAFFING PROGRAMS AND BUSINESS ACQUISITION SUPPORT, ANALYTICAL SERVICES, AND LIFE CYCLE SUPPORT SERVICES; BUSINESS MANAGEMENT AND OPERATION ASSISTANCE FOR BUSINESSES AND GOVERNMENT; BUSINESS MANAGEMENT AND BUSINESS CONSULTING SERVICES; COMMERCIAL ASSISTANCE RELATING TO SYSTEM IMPLEMENTATION AND SYSTEM INTEGRATION; BUSINESS CONSULTING SERVICES AND STRATEGIC PLANNING OF INFORMATION MANAGEMENT AND INFORMATION TECHNOLOGY; ADVISORY SERVICES RELATING TO BUSINESS MANAGEMENT AND BUSINESS OPERATIONS AND FINANCIAL RECORDS MANAGEMENT, IN CLASS 35 (U.S. CLS. 100, 101 AND 102).

FIRST USE 9-1-2010; IN COMMERCE 9-1-2010.

OWNER OF U.S. REG. NOS. 2,230,450 AND 2,810,166.

NO CLAIM IS MADE TO THE EXCLUSIVE RIGHT TO USE "EXPERTS", APART FROM THE MARK AS SHOWN.

THE MARK CONSISTS OF THE STYLIZED TERM "GCS" IN LOWER CASE LETTERS WITH A HORIZONTAL BAR IN THE BOTTOM OF THE LETTER "G" WITH THE TEXT "EXPERTS ENGAGED IN YOUR SUCCESS" UNDERNEATH THE TERM "GCS" AND WITHIN THE HORIZONTAL BAR IN THE BOTTOM OF THE LETTER "G".



*David J. Kybas*

Director of the United States Patent and Trademark Office



**Reg. No. 4,276,176** THE WORDING "GCS" HAS NO MEANING IN A FOREIGN LANGUAGE.

SN 85-112,155, FILED 8-20-2010.

COLLEEN KEARNEY, EXAMINING ATTORNEY

# United States of America

United States Patent and Trademark Office



**Reg. No. 4,276,177**

**Registered Jan. 15, 2013**

**Int. Cl.: 35**

**SERVICE MARK**

**PRINCIPAL REGISTER**

GOVERNMENT CONTRACT SOLUTIONS, INC. (VIRGINIA CORPORATION)  
7900 WESTPARK DRIVE SUITE T500  
MCLEAN, VA 22102

FOR: EMPLOYMENT AGENCY SERVICES FOR FULL-TIME AND TEMPORARY STAFFING FOR LONG-TERM AND SHORT-TERM STAFFING; LONG-TERM, SHORT-TERM AND TEMPORARY JOB PLACEMENT OF CONSULTANTS, DESIGNERS, ANALYSTS, PROGRAMMERS, TECHNICAL PERSONNEL, ENGINEERING PERSONNEL, AND INDUSTRIAL PERSONNEL; MANAGEMENT OF LONG-TERM AND SHORT-TERM JOB PLACEMENT; PROVIDING IN-CLIENT STAFFING SUPPORT, NAMELY, MANAGING THE HIRING OF ADDITIONAL STAFF FOR OTHERS; BUSINESS MANAGEMENT SERVICES IN THE FIELDS OF INFORMATION AND DATA MANAGEMENT, PROGRAMMATIC AND ACQUISITION SUPPORT, TECHNICAL DATA DOCUMENTATION AND PROVISIONING, TRAINING, LOGISTICS SUPPORT ANALYSIS, PROGRAM PLANNING AND EVALUATION, STUDIES AND ANALYSES, AND DATA COLLECTION, PROCESSING AND ANALYSIS; TECHNICAL BUSINESS CONSULTING AND BUSINESS MANAGEMENT CONSULTING AND SUPPORT IN THE FIELDS OF STAFFING PROGRAMS AND BUSINESS ACQUISITION SUPPORT, ANALYTICAL SERVICES, AND LIFE CYCLE SUPPORT SERVICES; BUSINESS MANAGEMENT AND OPERATION ASSISTANCE FOR BUSINESSES AND GOVERNMENT; BUSINESS MANAGEMENT AND BUSINESS CONSULTING SERVICES; COMMERCIAL ASSISTANCE RELATING TO SYSTEM IMPLEMENTATION AND SYSTEM INTEGRATION; BUSINESS CONSULTING SERVICES AND STRATEGIC PLANNING OF INFORMATION MANAGEMENT AND INFORMATION TECHNOLOGY; ADVISORY SERVICES RELATING TO BUSINESS MANAGEMENT AND BUSINESS OPERATIONS AND FINANCIAL RECORDS MANAGEMENT, IN CLASS 35 (U.S. CLS. 100, 101 AND 102).

FIRST USE 9-1-2010; IN COMMERCE 9-1-2010.

OWNER OF U.S. REG. NOS. 2,230,450 AND 2,810,166.

THE MARK CONSISTS OF THE STYLIZED TEXT "GCS" IN LOWERCASE LETTERS WITH A HORIZONTAL BREAK IN THE BOTTOM OF THE LETTER "G".

THE WORDING "GCS" HAS NO MEANING IN A FOREIGN LANGUAGE.

SN 85-112,161, FILED 8-20-2010.



*David J. Kyjars*

Director of the United States Patent and Trademark Office

**Reg. No. 4,276,177** COLLEEN KEARNEY, EXAMINING ATTORNEY

# United States of America

United States Patent and Trademark Office

# VIRTUALITY

**Reg. No. 4,276,178**

**Registered Jan. 15, 2013**

**Int. Cl.: 9**

**TRADEMARK**

**PRINCIPAL REGISTER**

SBG LABS INC. (CALIFORNIA CORPORATION)  
1288 HAMMERWOOD AVENUE  
SUNNYVALE, CA 94089

FOR: LIQUID CRYSTAL DISPLAYS AND POLYMER DISPERSED LIQUID CRYSTAL DISPLAYS FOR HEAD MOUNTED VIDEO DISPLAYS AND WEARABLE VIDEO DISPLAYS; TRANSPARENT LIQUID CRYSTAL DISPLAYS; TRANSPARENT POLYMER DISPERSED LIQUID CRYSTAL DISPLAYS; TRANSPARENT LIQUID CRYSTAL DISPLAYS FOR OVERLAYING VISUAL DATA ON AN EXTERNAL SCENE; TRANSPARENT POLYMER DISPERSED LIQUID CRYSTAL DISPLAYS FOR OVERLAYING VISUAL DATA ON AN EXTERNAL SCENE; SYMBOLOGY DISPLAYS, NAMELY, LIQUID CRYSTAL DISPLAYS AND POLYMER DISPERSED LIQUID CRYSTAL DISPLAYS FOR DISPLAYING SYMBOLIC DATA; DIFFRACTIVE DISPLAYS, NAMELY, LIQUID CRYSTAL DISPLAYS AND POLYMER DISPERSED LIQUID CRYSTAL DISPLAYS BASED ON DIFFRACTIVE OPTICAL PRINCIPLES; LASER DISPLAYS, NAMELY, LIQUID CRYSTAL DISPLAYS AND POLYMER DISPERSED LIQUID CRYSTAL DISPLAYS USING LASERS AS ILLUMINATION SOURCES; EDGE-LIT DISPLAYS, NAMELY, LIQUID CRYSTAL DISPLAYS AND POLYMER DISPERSED LIQUID CRYSTAL DISPLAYS IN WHICH ILLUMINATION IS ADMITTED VIA THE EDGE OF THE DISPLAY, IN CLASS 9 (U.S. CLS. 21, 23, 26, 36 AND 38).

FIRST USE 11-30-1990; IN COMMERCE 11-30-1990.

THE MARK CONSISTS OF STANDARD CHARACTERS WITHOUT CLAIM TO ANY PARTICULAR FONT, STYLE, SIZE, OR COLOR.

SN 85-112,473, FILED 8-20-2010.

DAVID YONTEF, EXAMINING ATTORNEY



*David J. Kypos*

Director of the United States Patent and Trademark Office

# United States of America

United States Patent and Trademark Office

## SPORTS GUARD

**Reg. No. 4,276,179**

LAUNDRY FRESH, INC. (NEW YORK CORPORATION)

**Registered Jan. 15, 2013**

P.O. BOX 220445  
GREAT NECK, NY 11022

**Int. Cl.: 2**

FOR: COATINGS IN THE NATURE OF SPRAYS, PREPARATIONS AND SOLUTIONS IN THE NATURE OF PROTECTIVE SURFACE COATINGS TO PROTECT AGAINST STAINS AND ODORS CAUSED BY GROWTH OF MOLD, MILDEW, BACTERIA AND FUNGI, IN CLASS 2 (U.S. CLS. 6, 11 AND 16).

**TRADEMARK**

**PRINCIPAL REGISTER**

FIRST USE 10-4-2012; IN COMMERCE 10-4-2012.

THE MARK CONSISTS OF STANDARD CHARACTERS WITHOUT CLAIM TO ANY PARTICULAR FONT, STYLE, SIZE, OR COLOR.

NO CLAIM IS MADE TO THE EXCLUSIVE RIGHT TO USE "GUARD", APART FROM THE MARK AS SHOWN.

SN 85-112,707, FILED 8-20-2010.

LESLEY LAMOTHE, EXAMINING ATTORNEY



*David J. Kyffers*

Director of the United States Patent and Trademark Office

# United States of America

United States Patent and Trademark Office

## LAUNDRY GUARD

**Reg. No. 4,276,180**

LAUNDRY FRESH, INC. (NEW YORK CORPORATION)  
P.O. BOX 220445  
GREAT NECK, NY 11022

**Registered Jan. 15, 2013**

**Int. Cl.: 1**

FOR: FABRIC PROTECTANT FOR CLOTHING IN THE NATURE OF MOISTENED WOVEN SHEETS, IN CLASS 1 (U.S. CLS. 1, 5, 6, 10, 26 AND 46).

**TRADEMARK**

FIRST USE 10-4-2012; IN COMMERCE 10-4-2012.

**PRINCIPAL REGISTER**

THE MARK CONSISTS OF STANDARD CHARACTERS WITHOUT CLAIM TO ANY PARTICULAR FONT, STYLE, SIZE, OR COLOR.

NO CLAIM IS MADE TO THE EXCLUSIVE RIGHT TO USE "GUARD", APART FROM THE MARK AS SHOWN.

SN 85-112,713, FILED 8-20-2010.

LESLEY LAMOTHE, EXAMINING ATTORNEY



*David J. Kybas*

Director of the United States Patent and Trademark Office

# United States of America

United States Patent and Trademark Office

# KEEPSY

**Reg. No. 4,276,181**

**Registered Jan. 15, 2013**

**Int. Cls.: 16 and 42**

**TRADEMARK**

**SERVICE MARK**

**PRINCIPAL REGISTER**

STORYJUMPER, INC. (DELAWARE CORPORATION)  
648 MENLO AVENUE, SUITE 12  
MENLO PARK, CA 94025

FOR: BOOKS, NAMELY, PHOTO BOOKS; CHILDREN'S BOOKS; STORY BOOKS; PRINTED STORIES IN ILLUSTRATED FORM; BOOKS, FEATURING STORIES, IMAGES OF CHARACTERS, PEOPLE, AND THINGS, ARTWORK, AND PHOTOGRAPHS; SCRAPBOOKS; PHOTO ALBUMS; GREETING CARDS; STATIONERY; CALENDARS, IN CLASS 16 (U.S. CLS. 2, 5, 22, 23, 29, 37, 38 AND 50).

FIRST USE 11-10-2010; IN COMMERCE 11-10-2010.

FOR: COMPUTER SERVICES, NAMELY, CREATING AN ON-LINE COMMUNITY FOR REGISTERED USERS TO DEVELOP AND COLLABORATE ON ELECTRONIC GREETINGS, SCRAPBOOKS, BOOKS, PHOTO ALBUMS, PHOTO SLIDE SHOWS, AND CALENDARS AND TO SHARE CONTENT WITH OTHER REGISTERED USERS AND WITH OTHERS; PROVIDING A WEB-BASED SERVICE FEATURING TECHNOLOGY IN THE NATURE OF A WEB SITE FEATURING TEMPORARY USE OF NON-DOWNLOADABLE SOFTWARE ALLOWING WEB SITE USERS TO ORGANIZE, VIEW, CREATE, AND MANAGE THE PRODUCTION AND PUBLICATION OF ELECTRONIC GREETING CARDS, ELECTRONIC SCRAPBOOKS, ELECTRONIC BOOKS, PHOTO ALBUMS, PHOTO SLIDE SHOWS, ELECTRONIC CALENDARS, AND RELATED DIGITAL CONTENT; PROVIDING TEMPORARY USE OF ONLINE NON-DOWNLOADABLE SOFTWARE THAT ALLOWS USERS TO ORGANIZE AND COLLECT CONTRIBUTIONS FROM MULTIPLE USERS TO ENABLE THE POOLING OF MONEY FOR GROUP PURCHASES OR CONTRIBUTIONS TO THIRD-PARTY RECIPIENTS, IN CLASS 42 (U.S. CLS. 100 AND 101).

FIRST USE 7-13-2010; IN COMMERCE 7-13-2010.

THE MARK CONSISTS OF STANDARD CHARACTERS WITHOUT CLAIM TO ANY PARTICULAR FONT, STYLE, SIZE, OR COLOR.

SN 85-114,947, FILED 8-24-2010.

RONALD DELGIZZI, EXAMINING ATTORNEY



*David J. Kyffers*

Director of the United States Patent and Trademark Office

# United States of America

United States Patent and Trademark Office

## INSPIRING BUSINESS PERFORMANCE

**Reg. No. 4,276,182**

**Registered Jan. 15, 2013**

**Int. Cl.: 9**

**TRADEMARK**

**PRINCIPAL REGISTER**

INSPERITY, INC. (DELAWARE CORPORATION)  
19001 CRESCENT SPRINGS DRIVE  
KINGWOOD, TX 77339

FOR: COMPUTER SOFTWARE FOR USE IN THE FIELD OF HUMAN RESOURCES AND EMPLOYEE MANAGEMENT FOR CUSTOMIZED JOB DESCRIPTIONS, CUSTOMIZED PERFORMANCE EVALUATIONS, RECRUITING AND APPLICANT TRACKING, TIME AND ATTENDANCE MANAGEMENT, AND LEARNING MANAGEMENT, AND INSTRUCTIONAL MATERIALS PROVIDED THEREWITH, NAMELY, PRINTED INSTRUCTIONAL MATERIALS PACKAGED WITH THE SOFTWARE AND DOWNLOADABLE ELECTRONIC INSTRUCTIONAL MATERIALS; COMPUTER SOFTWARE FOR SMALL BUSINESS ACCOUNTING APPLICATIONS, EMPLOYEE AND CONTRACTOR EXPENSE MANAGEMENT, AND PAYROLL, AND INSTRUCTIONAL MATERIALS PROVIDED THEREWITH, NAMELY, PRINTED INSTRUCTIONAL MATERIALS PACKAGED WITH THE SOFTWARE AND DOWNLOADABLE ELECTRONIC INSTRUCTIONAL MATERIALS; COMPUTER SOFTWARE FOR DATABASE MANAGEMENT IN THE FIELD OF HUMAN RESOURCES AND EMPLOYEE MANAGEMENT AND INSTRUCTIONAL MATERIALS SOLD THEREWITH, NAMELY, PRINTED INSTRUCTIONAL MATERIALS PACKAGED WITH THE SOFTWARE AND DOWNLOADABLE ELECTRONIC INSTRUCTIONAL MATERIALS, IN CLASS 9 (U.S. CLS. 21, 23, 26, 36 AND 38).

FIRST USE 3-3-2011; IN COMMERCE 3-3-2011.

THE MARK CONSISTS OF STANDARD CHARACTERS WITHOUT CLAIM TO ANY PARTICULAR FONT, STYLE, SIZE, OR COLOR.

NO CLAIM IS MADE TO THE EXCLUSIVE RIGHT TO USE "BUSINESS PERFORMANCE", APART FROM THE MARK AS SHOWN.

SN 85-116,151, FILED 8-26-2010.

JENNIFER DIXON, EXAMINING ATTORNEY



*David J. Kyffers*

Director of the United States Patent and Trademark Office



# United States of America

United States Patent and Trademark Office

**Bevicon** 佰维康

**Reg. No. 4,276,183**

**Registered Jan. 15, 2013**

**Int. Cl.: 5**

**TRADEMARK**

**PRINCIPAL REGISTER**

NINGBO WISELY MEDICAL DEVICES CO., LTD. (CHINA LIMITED LIABILITY COMPANY)  
TONGPENZHA, ZHONGGONGMIAO ST., YINZHOU  
NINGBO 315192, CHINA

FOR: BONE GROWTH MEDIA CONSISTING OF BIOLOGICAL MATERIALS FOR MEDICAL PURPOSES; DIAGNOSTIC PREPARATIONS FOR MEDICAL PURPOSES; ENZYMES FOR MEDICAL PURPOSES; GERMICIDES; MEDICATED LOTIONS FOR SKIN, HAIR, SUNBURN, FACE, BODY; PHARMACEUTICAL PREPARATIONS AND SUBSTANCES FOR THE TREATMENT OF VIRAL, METABOLIC, ENDOCRINE, MUSCULOSKELETAL, CARDIOVASCULAR, CARDIOPULMONARY, GENITOURINARY, SEXUAL DYSFUNCTION, ONCOLOGICAL, HEPATOLOGICAL, OPHTHALMIC, RESPIRATORY, NEUROLOGICAL, GASTROINTESTINAL, HORMONAL, DERMATOLOGICAL, PSYCHIATRIC AND IMMUNE SYSTEM RELATED DISEASES AND DISORDERS; PHARMACEUTICAL PREPARATIONS FOR THE PREVENTION AND TREATMENT OF DISORDERS OF THE NERVOUS SYSTEM, THE IMMUNE SYSTEM, THE CARDIO-VASCULAR SYSTEM, THE METABOLIC SYSTEM, THE RESPIRATORY SYSTEM, THE MUSCULO-SKELETAL SYSTEM, THE GENITOURINARY SYSTEM; FOR THE TREATMENT OF INFLAMMATORY DISORDERS; FOR USE IN DERMATOLOGY, ONCOLOGY, HEMATOLOGY AND IN TISSUE AND ORGAN TRANSPLANTATION, IN OPHTHALMOLOGY AND FOR GASTROENTEROLOGICAL DISORDERS; PHARMACEUTICAL PREPARATIONS FOR THE PREVENTION AND TREATMENT OF OCULAR DISORDERS OR DISEASES, BACTERIA-BASED DISEASES OR DISORDERS, AUTOIMMUNE DISEASES OR DISORDERS, KIDNEY DISEASES OR DISORDERS, AND DIABETES; PHARMACEUTICAL PREPARATIONS, NAMELY, A DRUG DELIVERY SYSTEM COMPRISING POLYMER-BASED ORAL TABLETS FOR THE CONTINUOUS RELEASE OF A WIDE VARIETY OF THERAPEUTIC AGENTS; STERILISING PREPARATIONS; VACCINES; VITAMIN PREPARATIONS, IN CLASS 5 (U.S. CLS. 6, 18, 44, 46, 51 AND 52).



FIRST USE 9-25-2011; IN COMMERCE 9-25-2011.

THE MARK CONSISTS OF THE STYLIZED WORD "BEVICON" WITH A CURVED LINE UNDERLINING THE WORD, AND THREE CHINESE CHARACTERS.

THE NON-LATIN CHARACTERS IN THE MARK TRANSLITERATE TO "BAI WEI KANG" AND THIS MEANS "HUNDRED", "MAINTAIN, SAFEGUARD, PRESERVE" AND "WELL-BEING, HEALTH" IN ENGLISH.

*David J. Kybas*

Director of the United States Patent and Trademark Office

**Reg. No. 4,276,183** THE ENGLISH TRANSLATION OF "BAI WEI KANG" IN THE MARK IS HUNDRED,  
MAINTAIN, SAFEGUARD, PRESERVE AND WELL-BEING, HEALTH.

SN 85-117,136, FILED 8-27-2010.

KELLY BOULTON, EXAMINING ATTORNEY

# United States of America

United States Patent and Trademark Office

L'BEL

PROTÈGE  
EXPERT

**Reg. No. 4,276,184**

EBEL INTERNATIONAL LTD. (BERMUDA CORPORATION)  
CEDAR HOUSE, 41 CEDAR AVENUE  
HAMILTON, BERMUDA HM12

**Registered Jan. 15, 2013**

**Int. Cl.: 3**

FOR: SOLAR PROTECTION PRODUCTS FOR USE ON THE FACE AND BODY, NAMELY, SUN BLOCK CREAMS AND LOTIONS, REFRESHING AND MOISTURIZING CREAMS AND LOTIONS, IN CLASS 3 (U.S. CLS. 1, 4, 6, 50, 51 AND 52).

**TRADEMARK**

FIRST USE 6-0-2011; IN COMMERCE 6-0-2011.

**PRINCIPAL REGISTER**

THE MARK CONSISTS OF THE WORDING "L'BEL" ABOVE THE WORDING "PROTEGE EXPERT".

SN 85-117,539, FILED 8-27-2010.

KHANH LE, EXAMINING ATTORNEY



*David J. Kybas*

Director of the United States Patent and Trademark Office

# United States of America

United States Patent and Trademark Office



**Reg. No. 4,276,185**

PRITCHARD, ANDREW F. (UNITED KINGDOM INDIVIDUAL)  
3622 PETE DYE BOULEVARD  
CARMEL, IN 46033

**Registered Jan. 15, 2013**

**Int. Cl.: 35**

FOR: BUSINESS CONSULTING, IN CLASS 35 (U.S. CLS. 100, 101 AND 102).

**SERVICE MARK**

FIRST USE 8-12-2010; IN COMMERCE 2-25-2011.

**PRINCIPAL REGISTER**

NO CLAIM IS MADE TO THE EXCLUSIVE RIGHT TO USE "CUSTOMER STRATEGY, OPERATIONS ASSESSMENT AND REALIGNMENT", APART FROM THE MARK AS SHOWN.

THE COLOR(S) YELLOW, BLACK AND WHITE IS/ARE CLAIMED AS A FEATURE OF THE MARK.

THE MARK CONSISTS OF THE WORD "C-SOAR" IN YELLOW LETTERS AND STYLIZED FONT. THE PHRASE "CUSTOMER STRATEGY, OPERATIONS ASSESSMENT AND REALIGNMENT" APPEARS BELOW THE WORD "C-SOAR", EACH WORD GENERALLY IN WHITE WITH THE FIRST LETTER OF EACH TERM IN YELLOW. THE COLOR BLACK IN THE MARK REPRESENTS A BACKGROUND AND IS NOT PART OF THE MARK.

SN 85-117,773, FILED 8-27-2010.

SKYE YOUNG, EXAMINING ATTORNEY



*David J. Kybas*

Director of the United States Patent and Trademark Office

# United States of America

United States Patent and Trademark Office

## INTELLIGENT WHITELISTING

**Reg. No. 4,276,186**

**Registered Jan. 15, 2013**

**Int. Cl.: 9**

**TRADEMARK**

**PRINCIPAL REGISTER**

LUMENSION SECURITY, INC. (DELAWARE CORPORATION)  
8660 E. HARTFORD DRIVE, SUITE 300  
SCOTTSDALE, AZ 85255

FOR: COMPUTER SOFTWARE THAT COMBINES ANTIVIRUS, APPLICATION CONTROL AND PATCH MANAGEMENT APPLICATIONS INTO A SEAMLESS WORKFLOW ON A SINGLE CONSOLE FOR THE PURPOSE OF IDENTIFYING SPECIAL CHARACTERISTICS AND ACCEPTABILITY OF OTHER COMPUTER SOFTWARE, IN CLASS 9 (U.S. CLS. 21, 23, 26, 36 AND 38).

FIRST USE 10-2-2012; IN COMMERCE 10-2-2012.

THE MARK CONSISTS OF STANDARD CHARACTERS WITHOUT CLAIM TO ANY PARTICULAR FONT, STYLE, SIZE, OR COLOR.

NO CLAIM IS MADE TO THE EXCLUSIVE RIGHT TO USE "WHITELISTING", APART FROM THE MARK AS SHOWN.

SN 85-119,105, FILED 8-30-2010.

DAVID TAYLOR, EXAMINING ATTORNEY



*David J. Kyfos*

Director of the United States Patent and Trademark Office

# United States of America

United States Patent and Trademark Office

## CALIFORNIA'S LEGENDARY ROAD STOP

**Reg. No. 4,276,187**

WW NUT TREE, LLC (CALIFORNIA LIMITED LIABILITY COMPANY)  
2535 TOWNSGATE ROAD, SUITE 310  
WESTLAKE VILLAGE, CA 91361

**Registered Jan. 15, 2013**

**Int. Cls.: 36 and 41**

FOR: LEASING AND MANAGEMENT OF RETAIL STORE FACILITIES, RESTAURANTS, FOOD AND BEVERAGE RETAIL FACILITIES, OFFICE BUILDINGS, AND COMMERCIAL BUSINESS OUTLETS, IN CLASS 36 (U.S. CLS. 100, 101 AND 102).

**SERVICE MARK**

FIRST USE 7-1-2009; IN COMMERCE 7-1-2009.

**PRINCIPAL REGISTER**

FOR: ENTERTAINMENT SERVICES, NAMELY, PROVIDING AMUSEMENT ARCADES, AMUSEMENT CENTERS, AMUSEMENT PARK RIDES, FACILITIES FOR ENTERTAINMENT EXHIBITIONS; ENTERTAINMENT SERVICES IN THE NATURE OF AN AMUSEMENT PARK ATTRACTION, NAMELY, A THEMED AREA; PROVIDING RECREATIONAL FACILITIES FOR SPECIAL EVENTS, NAMELY, PRIVATE FUNCTIONS, PARTIES AND SOCIAL RECEPTIONS; PROVIDING RECREATIONAL AREAS IN THE NATURE OF CHILDREN'S PLAYGROUNDS, IN CLASS 41 (U.S. CLS. 100, 101 AND 107).

FIRST USE 7-1-2009; IN COMMERCE 7-1-2009.

THE MARK CONSISTS OF STANDARD CHARACTERS WITHOUT CLAIM TO ANY PARTICULAR FONT, STYLE, SIZE, OR COLOR.

NO CLAIM IS MADE TO THE EXCLUSIVE RIGHT TO USE "CALIFORNIA'S" AND "ROAD STOP", APART FROM THE MARK AS SHOWN.

SN 85-119,240, FILED 8-30-2010.

AMY C. KEAN, EXAMINING ATTORNEY



*David J. Kappas*

Director of the United States Patent and Trademark Office

# United States of America

United States Patent and Trademark Office

## ENDLESS SUMMER

**Reg. No. 4,276,188**

**Registered Jan. 15, 2013**

**Int. Cls.: 35, 42, and 43**

**SERVICE MARK**

**PRINCIPAL REGISTER**

BRUCE BROWN FILMS, LLC (CALIFORNIA LIMITED LIABILITY COMPANY)  
SUITE 220  
3858 W. CARSON STREET  
TORRANCE, CA 90503

FOR: FRANCHISE SERVICES, NAMELY, OFFERING BUSINESS MANAGEMENT ASSISTANCE IN THE ESTABLISHMENT AND OPERATION OF RESTAURANTS, IN CLASS 35 (U.S. CLS. 100, 101 AND 102).

FIRST USE 3-30-2012; IN COMMERCE 3-30-2012.

FOR: COMPUTER SERVICES, NAMELY, PROVIDING A WEB SITE FOR OTHERS THAT AUTOMATES PARTY AND ENTERTAINMENT EVENTS MANAGEMENT THAT CONSISTS OF GUEST LISTS, GUEST INFORMATION, RESTAURANT INFORMATION, GIFT REGISTRY INFORMATION, GIFT COST SHARING, AND INVITATION CREATION AND DELIVERY, IN CLASS 42 (U.S. CLS. 100 AND 101).

FIRST USE 3-30-2012; IN COMMERCE 3-30-2012.

FOR: RESTAURANT, BAR AND CATERING SERVICES , IN CLASS 43 (U.S. CLS. 100 AND 101).

FIRST USE 0-0-1997; IN COMMERCE 0-0-1999.

THE MARK CONSISTS OF STANDARD CHARACTERS WITHOUT CLAIM TO ANY PARTICULAR FONT, STYLE, SIZE, OR COLOR.

SN 85-121,852, FILED 9-2-2010.

BARBARA A. GOLD, EXAMINING ATTORNEY



*David J. Kyffers*

Director of the United States Patent and Trademark Office

# United States of America

United States Patent and Trademark Office



**Reg. No. 4,276,189**

**Registered Jan. 15, 2013**

**COLLECTIVE  
MEMBERSHIP**

**PRINCIPAL REGISTER**

MINORITY CORPORATE COUNSEL ASSOCIATION, INC. (NEW YORK NON-PROFIT CORPORATION)  
1111 PENNSYLVANIA AVENUE, NW  
WASHINGTON, DC 20004

FOR: INDICATING MEMBERSHIP IN A NETWORK OF LAW FIRMS COMMITTED TO THE IMPROVEMENT OF THE HIRING, RETENTION AND PROMOTION OF DIVERSE ATTORNEYS, IN CLASS 200 (U.S. CL. 200).

FIRST USE 11-30-2010; IN COMMERCE 11-30-2010.

NO CLAIM IS MADE TO THE EXCLUSIVE RIGHT TO USE "FIRM AFFILIATE NETWORK" AND "MINORITY CORPORATE COUNSEL ASSOCIATION", APART FROM THE MARK AS SHOWN.

THE MARK CONSISTS OF A SEAL IN WHICH THE WORDS "FIRM AFFILIATE NETWORK" APPEAR. UNDERNEATH THE SEAL IS A RIBBON IN WHICH THE WORDS "MCCA MINORITY CORPORATE COUNSEL ASSOCIATION" APPEAR.

SN 85-122,990, FILED 9-3-2010.

NAKIA HENRY, EXAMINING ATTORNEY



*David J. Kybas*

Director of the United States Patent and Trademark Office



# United States of America

United States Patent and Trademark Office



**Reg. No. 4,276,190**

**Registered Jan. 15, 2013**

**Int. Cls.: 9 and 25**

**TRADEMARK**

**PRINCIPAL REGISTER**

KIDO SPORTS CO., LTD (REPUBLIC OF KOREA LTD)  
657-3 DEUNGCHON-DONG  
GANGSEO-GU  
SEOUL 157-030, REPUBLIC OF KOREA

FOR: SAFETY PRODUCTS, NAMELY, SAFETY HELMETS, SPORTS HELMETS, MOTOR-CYCLE HELMETS; SPORTS PROTECTIVE GEAR FOR MOTORCYCLING, NAMELY, PROTECTIVE PADS, ARM GUARDS, ELBOW GUARDS, WRIST GUARDS, KNEE GUARDS, SHIN GUARDS, LEG GUARDS, FOREARM GUARDS, IN CLASS 9 (U.S. CLS. 21, 23, 26, 36 AND 38).

FIRST USE 2-28-2007; IN COMMERCE 6-30-2007.

FOR: CLOTHING, NAMELY, LEATHER JACKETS, JACKETS, LEATHER PANTS, PANTS, SHIRTS, T-SHIRTS, GYM SHORTS AND SHIRTS, JOGGING SUITS, VESTS, JEANS, BELTS AND ACCESSORIES, NAMELY, HATS, SCARVES, GLOVES AND MITTENS, IN CLASS 25 (U.S. CLS. 22 AND 39).

FIRST USE 2-28-2007; IN COMMERCE 6-30-2007.

THE MARK CONSISTS OF A STYLIZED LETTER "S".

SN 85-124,940, FILED 9-8-2010.

JOHN E. MICHOS, EXAMINING ATTORNEY



*David J. Kybas*

Director of the United States Patent and Trademark Office

# United States of America

United States Patent and Trademark Office



**Reg. No. 4,276,191**

**Registered Jan. 15, 2013**

**Int. Cl.: 28**

**TRADEMARK**

**PRINCIPAL REGISTER**

GUIDEPOSTS A CHURCH CORPORATION (NEW YORK CORPORATION)  
39 OLD RIDGEBURY ROAD, SUITE 2AB  
DANBURY, CT 06801

FOR: CHRISTMAS TREE ORNAMENTS; HOLIDAY TREE DECORATIONS FOR CHRISTMAS,  
IN CLASS 28 (U.S. CLS. 22, 23, 38 AND 50).

FIRST USE 12-1-2011; IN COMMERCE 12-1-2011.

THE MARK CONSISTS OF A STICK FIGURE GIRL IN A FLOWERED DRESS.

SN 85-128,784, FILED 9-14-2010.

CHRISTINA SOBRAL, EXAMINING ATTORNEY



*David J. Kyffers*

Director of the United States Patent and Trademark Office

# United States of America

United States Patent and Trademark Office

## ELEVENTH HOUR

**Reg. No. 4,276,192**

**Registered Jan. 15, 2013**

**Int. Cl.: 25**

**TRADEMARK**

**PRINCIPAL REGISTER**

REYES, BRIAN (UNITED STATES INDIVIDUAL)  
1236 IBIS DRIVE  
PATTERSON, CA 95363 AND

GARNER, AARON (UNITED STATES INDIVIDUAL)  
1236 IBIS DRIVE  
PATTERSON, CA 95363

FOR: BEANIES; HATS; JACKETS; JEANS; SWEATERS; T-SHIRTS, IN CLASS 25 (U.S. CLS. 22 AND 39).

FIRST USE 6-16-2009; IN COMMERCE 3-12-2012.

THE MARK CONSISTS OF STANDARD CHARACTERS WITHOUT CLAIM TO ANY PARTICULAR FONT, STYLE, SIZE, OR COLOR.

NO CLAIM IS MADE TO THE EXCLUSIVE RIGHT TO USE "APPAREL", APART FROM THE MARK AS SHOWN.

SN 85-128,945, FILED 9-14-2010.

KELLY BOULTON, EXAMINING ATTORNEY



*David J. Kyffers*

Director of the United States Patent and Trademark Office

# United States of America

United States Patent and Trademark Office

**girl scouts** 

**Reg. No. 4,276,193**

**Registered Jan. 15, 2013**

**Int. Cls.: 29 and 30**

**TRADEMARK**

**PRINCIPAL REGISTER**

GIRL SCOUTS OF THE UNITED STATES OF AMERICA (D.C. CONGRESSIONALLY  
CHARTERED NON-PROFIT CORPORATION)  
420 FIFTH AVENUE  
NEW YORK, NY 100182798

FOR: NUT PRODUCTS, NAMELY, CANDIED NUTS, FLAVORED NUTS AND TRAIL MIXES  
CONSISTING PRIMARILY OF PROCESSED NUTS, IN CLASS 29 (U.S. CL. 46).

FIRST USE 9-0-2012; IN COMMERCE 9-0-2012.

FOR: COOKIES, CHOCOLATE CANDIES AND CHOCOLATE COVERED NUTS, IN CLASS  
30 (U.S. CL. 46).

FIRST USE 9-0-2011; IN COMMERCE 9-0-2011.

OWNER OF U.S. REG. NOS. 1,142,655, 1,318,643, AND OTHERS.

THE MARK CONSISTS OF THE WORDS "GIRL SCOUTS" IN LOWERCASE LETTERS WITH  
THE DESIGN OF A CLOVER WITH THREE ALTERNATING PROFILES OF A WOMAN'S  
FACE WITHIN THE BORDERS OF THE CLOVER, TO THE IMMEDIATE RIGHT, SLIGHTLY  
ABOVE THE WORD "SCOUTS".

SN 85-134,214, FILED 9-21-2010.

MARK PILARO, EXAMINING ATTORNEY



*David J. Kybas*

Director of the United States Patent and Trademark Office

# United States of America

United States Patent and Trademark Office

## VETERANS ON WALL STREET

**Reg. No. 4,276,194**

**Registered Jan. 15, 2013**

**Int. Cls.: 35 and 41**

**SERVICE MARK**

**PRINCIPAL REGISTER**

DEUTSCHE BANK AG (FED REP GERMANY CORPORATION)  
60 WALL STREET  
NEW YORK, NY 10005

FOR: CHARITABLE SERVICES, NAMELY, ORGANIZING AND CONDUCTING VOLUNTEER PROGRAMS AND COMMUNITY SERVICE PROJECTS FOR MILITARY VETERANS IN THE FINANCIAL INDUSTRY; PROVIDING AN ONLINE DATABASE IN THE FIELD OF EMPLOYMENT OPPORTUNITIES FEATURING INFORMATION FOR MILITARY VETERANS WORKING IN THE FINANCIAL INDUSTRY, IN CLASS 35 (U.S. CLS. 100, 101 AND 102).

FIRST USE 9-1-2010; IN COMMERCE 9-1-2010.

FOR: CONDUCTING EDUCATIONAL CONFERENCES ON TOPICS OF INTEREST TO MILITARY VETERANS WORKING IN THE FINANCIAL INDUSTRY, IN CLASS 41 (U.S. CLS. 100, 101 AND 107).

FIRST USE 9-1-2010; IN COMMERCE 9-1-2010.

THE MARK CONSISTS OF STANDARD CHARACTERS WITHOUT CLAIM TO ANY PARTICULAR FONT, STYLE, SIZE, OR COLOR.

SN 85-136,389, FILED 9-23-2010.

MATTHEW MCDOWELL, EXAMINING ATTORNEY



*David J. Kyffers*

Director of the United States Patent and Trademark Office

# United States of America

United States Patent and Trademark Office

# Spit Happens Homer, Alaska

**Reg. No. 4,276,195**

PAUL MATTHEW JOHNSON (UNITED STATES INDIVIDUAL)  
124 EAST 23RD AVE.  
ANCHORAGE, AK 99503

**Registered Jan. 15, 2013**

**Int. Cls.: 16, 21, and 25**

FOR: BUMPER STICKERS, IN CLASS 16 (U.S. CLS. 2, 5, 22, 23, 29, 37, 38 AND 50).

**TRADEMARK**

FIRST USE 6-15-1997; IN COMMERCE 7-1-1999.

**PRINCIPAL REGISTER**

FOR: COFFEE CUPS, IN CLASS 21 (U.S. CLS. 2, 13, 23, 29, 30, 33, 40 AND 50).

FIRST USE 6-15-1997; IN COMMERCE 7-1-1999.

FOR: ATHLETIC APPAREL, NAMELY, SHIRTS, PANTS, JACKETS, FOOTWEAR, HATS AND CAPS, ATHLETIC UNIFORMS; SHORT-SLEEVED AND LONG-SLEEVED T-SHIRTS, IN CLASS 25 (U.S. CLS. 22 AND 39).

FIRST USE 6-15-1997; IN COMMERCE 7-1-1999.

THE MARK CONSISTS OF STANDARD CHARACTERS WITHOUT CLAIM TO ANY PARTICULAR FONT, STYLE, SIZE, OR COLOR.

NO CLAIM IS MADE TO THE EXCLUSIVE RIGHT TO USE "HOMER, ALASKA", APART FROM THE MARK AS SHOWN.

SN 85-139,234, FILED 9-27-2010.

DAVID C. REIHNER, EXAMINING ATTORNEY



*David J. Kybas*

Director of the United States Patent and Trademark Office

# United States of America

United States Patent and Trademark Office

## OLDE CAPE COD POPPED CRISPS

**Reg. No. 4,276,196**

**Registered Jan. 15, 2013**

**Int. Cls.: 29 and 30**

**TRADEMARK**

**PRINCIPAL REGISTER**

CAINS FOODS, L.P. (DELAWARE LIMITED PARTNERSHIP)  
P.O. BOX 347  
114 EAST MAIN STREET  
AYER, MA 01432

FOR: POTATO-BASED SNACK FOODS; VEGETABLE-BASED SNACK FOODS; POTATO CHIPS, IN CLASS 29 (U.S. CL. 46).

FIRST USE 3-7-2011; IN COMMERCE 3-7-2011.

FOR: CORN-BASED SNACK FOODS; MULTI-GRAIN BASED SNACK FOODS; CORN CHIPS, IN CLASS 30 (U.S. CL. 46).

FIRST USE 4-6-2012; IN COMMERCE 4-6-2012.

THE MARK CONSISTS OF STANDARD CHARACTERS WITHOUT CLAIM TO ANY PARTICULAR FONT, STYLE, SIZE, OR COLOR.

OWNER OF U.S. REG. NOS. 2,554,557, 3,760,161, AND OTHERS.

NO CLAIM IS MADE TO THE EXCLUSIVE RIGHT TO USE "POPPED CRISPS", APART FROM THE MARK AS SHOWN.

SN 85-139,811, FILED 9-28-2010.

DOMINIC J. FERRAIUOLO, EXAMINING ATTORNEY



*David J. Kyros*

Director of the United States Patent and Trademark Office

# United States of America

United States Patent and Trademark Office

## KEY LIME RUNNER

**Reg. No. 4,276,197**

**Registered Jan. 15, 2013**

**Int. Cl.: 12**

**TRADEMARK**

**PRINCIPAL REGISTER**

K.L.R., LLC (FLORIDA LIMITED LIABILITY COMPANY)  
806 W. SECOND AVENUE  
WINDERMERE, FL 34786

FOR: BOATS, IN CLASS 12 (U.S. CLS. 19, 21, 23, 31, 35 AND 44).

FIRST USE 2-1-2012; IN COMMERCE 5-11-2012.

THE MARK CONSISTS OF STANDARD CHARACTERS WITHOUT CLAIM TO ANY PARTICULAR FONT, STYLE, SIZE, OR COLOR.

SN 85-143,190, FILED 10-1-2010.

MATTHEW PAPPAS, EXAMINING ATTORNEY



*David J. Kypas*

Director of the United States Patent and Trademark Office



# United States of America

United States Patent and Trademark Office

# Snooz'n

**Reg. No. 4,276,198**

BEST SHOT MARKETING, LLC (NEVADA LIMITED LIABILITY COMPANY)  
401 N TRYON STREET, SUITE 1080  
CHARLOTTE, NC 28202

**Registered Jan. 15, 2013**

**Int. Cl.: 5**

FOR: HERBAL DRINKS USED TO AID IN SLEEP AND RELAXATION; NUTRITIONALLY FORTIFIED BEVERAGES, IN CLASS 5 (U.S. CLS. 6, 18, 44, 46, 51 AND 52).

**TRADEMARK**

FIRST USE 10-31-2010; IN COMMERCE 10-31-2010.

**PRINCIPAL REGISTER**

THE MARK CONSISTS OF STANDARD CHARACTERS WITHOUT CLAIM TO ANY PARTICULAR FONT, STYLE, SIZE, OR COLOR.

SN 85-143,242, FILED 10-1-2010.

B. PARADEWELAI, EXAMINING ATTORNEY



*David J. Kyffers*

Director of the United States Patent and Trademark Office

# United States of America

United States Patent and Trademark Office

## PLAYGROUND SESSIONS

**Reg. No. 4,276,199**

**Registered Jan. 15, 2013**

**Int. Cl.: 9**

**TRADEMARK**

**PRINCIPAL REGISTER**

PLAYGROUND SESSIONS, INC. (DELAWARE CORPORATION)  
32 AVENUE OF THE AMERICAS, 19TH FLOOR  
NEW YORK, NY 10013

FOR: DOWNLOADABLE EDUCATIONAL COMPUTER SOFTWARE IN THE FIELD OF  
MUSIC EDUCATION AND MUSICAL INSTRUMENTS, IN CLASS 9 (U.S. CLS. 21, 23, 26, 36  
AND 38).

FIRST USE 11-1-2011; IN COMMERCE 11-1-2011.

THE MARK CONSISTS OF STANDARD CHARACTERS WITHOUT CLAIM TO ANY PAR-  
TICULAR FONT, STYLE, SIZE, OR COLOR.

SN 85-143,518, FILED 10-1-2010.

CURTIS FRENCH, EXAMINING ATTORNEY



*David J. Kybas*

Director of the United States Patent and Trademark Office

# United States of America

United States Patent and Trademark Office

## AMERICAN KICKASS

**Reg. No. 4,276,200**

AKA CIGARS, INC. (TEXAS CORPORATION)  
2050 N. COLLINS BOULEVARD, SUITE 102  
RICHARDSON, TX 750802656

**Registered Jan. 15, 2013**

**Int. Cls.: 14 and 25**

FOR: JEWELRY; DOG TAGS IN THE NATURE OF JEWELRY FOR HUMAN DECORATIVE WEAR, IN CLASS 14 (U.S. CLS. 2, 27, 28 AND 50).

**TRADEMARK**

FIRST USE 10-1-2012; IN COMMERCE 10-20-2012.

**PRINCIPAL REGISTER**

FOR: CLOTHING, NAMELY, SHIRTS, JACKETS, HATS; CAPS, IN CLASS 25 (U.S. CLS. 22 AND 39).

FIRST USE 10-1-2012; IN COMMERCE 10-20-2012.

THE MARK CONSISTS OF STANDARD CHARACTERS WITHOUT CLAIM TO ANY PARTICULAR FONT, STYLE, SIZE, OR COLOR.

SN 85-144,321, FILED 10-4-2010.

BRIAN NEVILLE, EXAMINING ATTORNEY



*David J. Kybas*

Director of the United States Patent and Trademark Office

# United States of America

United States Patent and Trademark Office

# TRUE POWER

**Reg. No. 4,276,201**

TRUE POWER, LLC (MASSACHUSETTS LIMITED LIABILITY COMPANY)  
34 PROSPECT STREET  
MELROSE, MA 02176

**Registered Jan. 15, 2013**

**Int. Cl.: 14**

FOR: BRACELETS; JEWELRY; WATCHES, IN CLASS 14 (U.S. CLS. 2, 27, 28 AND 50).

**TRADEMARK**

FIRST USE 11-24-2010; IN COMMERCE 11-24-2010.

**PRINCIPAL REGISTER**

THE MARK CONSISTS OF THE WORDS "TRUE POWER" WITH A CIRCLE COMPOSED OF THREE BOLD CURVED LINES IN BETWEEN THE WORDS "TRUE" AND "POWER".

SN 85-144,687, FILED 10-4-2010.

BRIAN NEVILLE, EXAMINING ATTORNEY



*David J. Kyffers*

Director of the United States Patent and Trademark Office

# United States of America

United States Patent and Trademark Office

# TRUE POWER

**Reg. No. 4,276,202**

TRUE POWER, LLC (MASSACHUSETTS LIMITED LIABILITY COMPANY)  
34 PROSPECT STREET  
MELROSE, MA 02176

**Registered Jan. 15, 2013**

**Int. Cl.: 28**

FOR: GOLF GLOVES, IN CLASS 28 (U.S. CLS. 22, 23, 38 AND 50).

**TRADEMARK**

FIRST USE 2-10-2012; IN COMMERCE 2-10-2012.

**PRINCIPAL REGISTER**

THE MARK CONSISTS OF THE WORDS "TRUE POWER" WITH A CIRCLE, WHICH IS COMPOSED OF THREE BOLD CURVED LINES IN BETWEEN THE WORDS "TRUE" AND "POWER".

SN 85-144,698, FILED 10-4-2010.

BRIAN NEVILLE, EXAMINING ATTORNEY



*David J. Kybas*

Director of the United States Patent and Trademark Office

# United States of America

United States Patent and Trademark Office

# CHF N

**Reg. No. 4,276,203**

**Registered Jan. 15, 2013**

**CERTIFICATION MARK**

**SERVICES**

**PRINCIPAL REGISTER**

AMERICAN ASSOCIATION OF HEART FAILURE NURSES, INC. (CALIFORNIA NON-PROFIT CORPORATION)  
15000 COMMERCE PARKWAY, SUITE C  
MT. LAUREL, NJ 08054

FOR: NURSING SERVICES, IN CLASS B (U.S. CL. B).

FIRST USE 6-0-2011; IN COMMERCE 6-0-2011.

THE MARK CONSISTS OF STANDARD CHARACTERS WITHOUT CLAIM TO ANY PARTICULAR FONT, STYLE, SIZE, OR COLOR.

THE CERTIFICATION MARK, AS INTENDED TO BE USED BY AUTHORIZED PERSONS, IS INTENDED TO CERTIFY THAT THE PERSON'S SERVICES HAVE DEMONSTRATED A PARTICULAR LEVEL OF COMPETENCY IN THE FIELD OF NURSING BY HAVING MET CERTAIN EDUCATIONAL AND EXPERIENTIAL STANDARDS FOR NURSING SET BY THE CERTIFIER. THE CERTIFIER DOES NOT ENGAGE IN THE PRODUCTION OR MARKETING OF THE SERVICES TO WHICH THE MARK IS APPLIED.

SN 85-145,646, FILED 10-5-2010.

ANDREW LEASER, EXAMINING ATTORNEY



*David J. Kyjars*

Director of the United States Patent and Trademark Office

# United States of America

United States Patent and Trademark Office



**Reg. No. 4,276,204**

**Registered Jan. 15, 2013**

**Int. Cl.: 43**

**SERVICE MARK**

**PRINCIPAL REGISTER**

MANSIONS ON FIFTH, LLC (PENNSYLVANIA LIMITED LIABILITY COMPANY)  
5105 FIFTH AVENUE  
PITTSBURGH, PA 15232

FOR: HOTEL SERVICES; RESTAURANT, CATERING, BAR AND LOUNGE SERVICES; RESORT AND LODGING SERVICES; PROVISION OF GENERAL PURPOSE FACILITIES FOR MEETINGS, CONFERENCES, AND EXHIBITIONS; PROVISION OF BANQUET AND SOCIAL FUNCTION FACILITIES FOR SPECIAL OCCASIONS; AND RESERVATION SERVICES FOR HOTEL ACCOMMODATIONS, IN CLASS 43 (U.S. CLS. 100 AND 101).

FIRST USE 6-30-2010; IN COMMERCE 9-30-2010.

THE MARK CONSISTS OF THE LETTER "V" WITH THE LETTER "M" APPEARING ON TOP OF THE LETTER "V" AND A LEAF DESIGN APPEARING ABOVE THE LETTERS.

SN 85-148,286, FILED 10-8-2010.

EMILY CARLSEN, EXAMINING ATTORNEY



*David J. Kybas*

Director of the United States Patent and Trademark Office

# United States of America

United States Patent and Trademark Office

# DJ KITTY

**Reg. No. 4,276,205**

TAMPA BAY RAYS BASEBALL LTD. (FLORIDA LIMITED PARTNERSHIP)  
ONE TROPICANA DRIVE, TROPICANA FIELD  
ST. PETERSBURG, FL 33705

**Registered Jan. 15, 2013**

**Int. Cl.: 25**

FOR: CLOTHING, NAMELY, CAPS, HATS, VISORS, SHIRTS, T-SHIRTS, TANK TOPS, PULLOVERS, SHORTS, PANTS, BASEBALL UNIFORMS, JERSEYS, SWEATSHIRTS, SLEEPWEAR, JACKETS, CLOTH BIBS, INFANT WEAR, CREEPERS, IN CLASS 25 (U.S. CLS. 22 AND 39).

**TRADEMARK**

**PRINCIPAL REGISTER**

FIRST USE 9-23-2011; IN COMMERCE 9-23-2011.

THE MARK CONSISTS OF STANDARD CHARACTERS WITHOUT CLAIM TO ANY PARTICULAR FONT, STYLE, SIZE, OR COLOR.

SN 85-148,490, FILED 10-8-2010.

KEVIN DINALLO, EXAMINING ATTORNEY



*David J. Kybas*

Director of the United States Patent and Trademark Office



**United States of America**  
United States Patent and Trademark Office

# ECOSOLAR

**Reg. No. 4,276,206**

SOOFERIAN, DANNY (UNITED STATES INDIVIDUAL)  
451-E CONSTITUTION AVENUE  
CAMARILLO, CA 93012

**Registered Jan. 15, 2013**

**Int. Cl.: 11**

FOR: LIGHTING FIXTURES; SOLAR LIGHT FIXTURES, NAMELY, INDOOR AND OUTDOOR SOLAR POWERED LIGHTING UNITS AND FIXTURES, IN CLASS 11 (U.S. CLS. 13, 21, 23, 31 AND 34).

**TRADEMARK**

FIRST USE 10-30-2012; IN COMMERCE 10-30-2012.

**PRINCIPAL REGISTER**

THE MARK CONSISTS OF STANDARD CHARACTERS WITHOUT CLAIM TO ANY PARTICULAR FONT, STYLE, SIZE, OR COLOR.

SN 85-150,039, FILED 10-11-2010.

PAUL MORENO, EXAMINING ATTORNEY



*David J. Kyffers*

Director of the United States Patent and Trademark Office

# United States of America

United States Patent and Trademark Office



**Reg. No. 4,276,207**

**Registered Jan. 15, 2013**

**Int. Cl.: 30**

**TRADEMARK**

**PRINCIPAL REGISTER**

ESSEX HOLDINGS, INC. (FLORIDA CORPORATION)  
210  
9314 FORREST HILL BLVD  
WELLINGTON, FL 33411

FOR: RICE, IN CLASS 30 (U.S. CL. 46).

FIRST USE 10-1-2012; IN COMMERCE 10-1-2012.

THE MARK CONSISTS OF A DEPICTION OF A CURVED LINE INTERSECTED BY AN IRREGULAR FIVE-POINTED STAR APPEARING ABOVE THE WORDS "MAX STAR CHOICE".

SN 85-150,238, FILED 10-12-2010.

RONALD MCMORROW, EXAMINING ATTORNEY



*David J. Kyffers*

Director of the United States Patent and Trademark Office

# United States of America

United States Patent and Trademark Office

## INSPIRED LIVING

**Reg. No. 4,276,208**

WILLOWSFORD, L.L.C. (DELAWARE LIMITED LIABILITY COMPANY)  
44095 PIPELINE PLAZA, SUITE 140  
ASHBURN, VA 20147

**Registered Jan. 15, 2013**

**Int. Cls.: 35, 36, and 37**

FOR: PROVIDING AN INTERACTIVE REAL ESTATE WEBSITE WHICH PROMOTES RESIDENTIAL HOUSING AND LIVING COMMUNITIES BY CONNECTING BUYERS AND SELLERS AND OFFERING PROSPECTIVE RESIDENTS PROPERTY AND HOME DESCRIPTIONS, PRICE, LOCATION, AND MAPS THAT WOULD BE INFLUENTIAL TO A PROSPECTIVE BUYER MAKING A BUYING DECISION; PROVIDING A WEBSITE FEATURING NEWS AND INFORMATION RELATING TO A RESIDENTIAL COMMUNITY'S FARMER'S MARKET; PROVIDING A WEBSITE FEATURING NEWS AND INFORMATION RELATING TO BUSINESS MANAGEMENT IN THE FIELD OF CONSERVING LAND FOR FISHING AND WILDLIFE; PROVIDING A WEBSITE FEATURING NEWS AND INFORMATION IN THE FIELD OF NATURAL RESOURCE MANAGEMENT; CHARITABLE SERVICES, NAMELY, ORGANIZING AND DEVELOPING PROJECTS TO PROMOTE PUBLIC AWARENESS OF AGRICULTURE AND THE CONSERVATION OF LAND, WILDLIFE AND NATURAL RESOURCES; REAL ESTATE MARKETING SERVICES, NAMELY, ONLINE SERVICES FEATURING THE PROMOTION OF RESIDENTIAL NEW CONSTRUCTION, IN CLASS 35 (U.S. CLS. 100, 101 AND 102).

**SERVICE MARK**

**PRINCIPAL REGISTER**

FIRST USE 11-0-2010; IN COMMERCE 11-0-2010.



FOR: REAL ESTATE SERVICES, NAMELY, BROKERAGE, LEASING AND MANAGEMENT OF RESIDENTIAL AND COMMERCIAL PROPERTY; REAL ESTATE PROPERTY MANAGEMENT; REAL ESTATE SERVICES, NAMELY, PROPERTY MANAGEMENT FOR HOMEOWNERS ASSOCIATION; RESIDENTIAL COMMUNITY PROPERTY MANAGEMENT SERVICES; REAL ESTATE LISTING SERVICES; LEASING OF REAL ESTATE TO OTHERS FOR THE PURPOSE OF CULTIVATING THE LAND, IN CLASS 36 (U.S. CLS. 100, 101 AND 102).

FIRST USE 11-0-2010; IN COMMERCE 11-0-2010.

*David J. Kyros*

Director of the United States Patent and Trademark Office

FOR: CONSTRUCTION, REAL ESTATE AND LAND DEVELOPMENT SERVICES, NAMELY, CONSTRUCTION, PLANNING AND LAYING OUT OF RESIDENTIAL AND/OR COMMERCIAL COMMUNITIES HAVING AMENITIES INCLUDING SWIMMING POOLS, FITNESS FACILITIES, NATURE TRAILS, COMMUNITY CENTERS, COMMUNITY GARDENS AND OTHER OUTDOOR FACILITIES; SUBDIVIDING AND DEVELOPING REAL ESTATE

**Reg. No. 4,276,208** PROPERTY FOR OTHERS; CONSULTATION IN BUILDING CONSTRUCTION SUPERVISION,  
IN CLASS 37 (U.S. CLS. 100, 103 AND 106).

FIRST USE 11-0-2010; IN COMMERCE 11-0-2010.

THE MARK CONSISTS OF STANDARD CHARACTERS WITHOUT CLAIM TO ANY PARTICULAR FONT, STYLE, SIZE, OR COLOR.

SN 85-150,369, FILED 10-12-2010.

DAWN FELDMAN, EXAMINING ATTORNEY

# United States of America

United States Patent and Trademark Office

## SERONDA SENIOR SERVICES

**Reg. No. 4,276,209**

**Registered Jan. 15, 2013**

**Int. Cl.: 45**

**SERVICE MARK**

**PRINCIPAL REGISTER**

SERONDA SENIOR SERVICES FRANCHISING, INC. (CALIFORNIA CORPORATION)  
1085 PAULINE WAY  
SAN LUIS OBISPO, CA 93401

FOR: HOME SITTING; PLACEMENT SERVICES FOR A PET WHEN THE OWNER DIES AND THERE IS NO ONE TO CARE FOR THE PET AND SUBSEQUENT MONITORING OF THE CARE PROVIDED FOR THE PET; PROVIDING PATIENT ADVOCATE SERVICES TO HOSPITAL PATIENTS AND PATIENTS IN LONG TERM CARE FACILITIES, IN CLASS 45 (U.S. CLS. 100 AND 101).

FIRST USE 10-4-2012; IN COMMERCE 10-4-2012.

THE MARK CONSISTS OF STANDARD CHARACTERS WITHOUT CLAIM TO ANY PARTICULAR FONT, STYLE, SIZE, OR COLOR.

NO CLAIM IS MADE TO THE EXCLUSIVE RIGHT TO USE "SENIOR SERVICES", APART FROM THE MARK AS SHOWN.

THE ENGLISH TRANSLATION OF THE ASTURIAN WORD "SERONDA" IN THE MARK IS "AUTUMN".

SN 85-151,586, FILED 10-13-2010.

LINDA ESTRADA, EXAMINING ATTORNEY



*David J. Kyjars*

Director of the United States Patent and Trademark Office

# United States of America

United States Patent and Trademark Office



**Reg. No. 4,276,210**

**Registered Jan. 15, 2013**

**Int. Cl.: 29**

**TRADEMARK**

**PRINCIPAL REGISTER**

TAOKAENOI FOOD & MARKETING CO. LTD. (THAILAND LIMITED LIABILITY COMPANY)  
93/5-7 MOO 5 RATTANATHIBETH ROAD  
BANGRAKNOI, NONTHABURI, THAILAND 11000

FOR: DRIED EDIBLE SEAWEED AND SEAWEED SNACKS, IN CLASS 29 (U.S. CL. 46).

FIRST USE 7-4-2012; IN COMMERCE 7-4-2012.

THE MARK CONSISTS OF THE LETTERS "KO NO MI" ADJACENT THREE SMALL JAPANESE CHARACTERS IN A DARK BACKGROUND, BOTH IN A CIRCULAR BACKGROUND, ABOVE AND TO THE LEFT OF A STYLIZED SUMO WRESTLER CHARACTER.

THE NON-LATIN CHARACTERS IN THE MARK TRANSLITERATE TO "SUMO" AND THIS MEANS "SUMO" IN ENGLISH.

THE ENGLISH TRANSLATION OF "KO NO MI" IN THE MARK IS "FAVORITE".

SN 85-152,680, FILED 10-14-2010.

JORDAN BAKER, EXAMINING ATTORNEY



*David J. Kybas*

Director of the United States Patent and Trademark Office

# United States of America

United States Patent and Trademark Office

## Pig-N-Whistle

**Reg. No. 4,276,211**

**Registered Jan. 15, 2013**

**Int. Cl.: 43**

**SERVICE MARK**

**PRINCIPAL REGISTER**

RUPERT, WILLIAM (UNITED STATES INDIVIDUAL), DBA PIG-N-WHISTLE,  
PNWU901500@AOL.COM  
3134 WOODLAND PINE DR  
LAKELAND, TN 38002

FOR: CAFE-RESTAURANTS, IN CLASS 43 (U.S. CLS. 100 AND 101).

FIRST USE 12-31-2005; IN COMMERCE 12-31-2005.

THE MARK CONSISTS OF STANDARD CHARACTERS WITHOUT CLAIM TO ANY PARTICULAR FONT, STYLE, SIZE, OR COLOR.

SN 85-153,434, FILED 10-15-2010.

PAM WILLIS, EXAMINING ATTORNEY



*David J. Kybas*

Director of the United States Patent and Trademark Office

# United States of America

United States Patent and Trademark Office

## HOPE IS DELICIOUS

**Reg. No. 4,276,212**

**Registered Jan. 15, 2013**

**Int. Cl.: 43**

**SERVICE MARK**

**PRINCIPAL REGISTER**

JON BON JOVI SOUL FOUNDATION (PENNSYLVANIA NON-PROFIT CORPORATION)  
C/O EDELSTEIN, LAIRD & SOBEL  
9255 SUNSET BOULEVARD, SUITE 800  
LOS ANGELES, CA 90069

FOR: CHARITABLE SERVICES, NAMELY, PROVIDING FOOD TO NEEDY PERSONS, IN CLASS 43 (U.S. CLS. 100 AND 101).

FIRST USE 10-19-2011; IN COMMERCE 10-19-2011.

THE MARK CONSISTS OF STANDARD CHARACTERS WITHOUT CLAIM TO ANY PARTICULAR FONT, STYLE, SIZE, OR COLOR.

SN 85-154,241, FILED 10-15-2010.

BRENDAN MCCAULEY, EXAMINING ATTORNEY



*David J. Kyros*

Director of the United States Patent and Trademark Office



United States of America  
United States Patent and Trademark Office

**HOPE**  
**DELICIOUS**

**Reg. No. 4,276,213**

**Registered Jan. 15, 2013**

**Int. Cl.: 43**

**SERVICE MARK**

**PRINCIPAL REGISTER**

JON BON JOVI SOUL FOUNDATION (PENNSYLVANIA NON-PROFIT CORPORATION)  
C/O EDELSTEIN LAIRD & SOBEL LLP  
9255 SUNSET BOULEVARD, SUITE 800  
LOS ANGELES, CA 90069

FOR: CHARITABLE SERVICES, NAMELY, PROVIDING FOOD TO NEEDY PERSONS, IN CLASS 43 (U.S. CLS. 100 AND 101).

FIRST USE 10-19-2011; IN COMMERCE 10-19-2011.

THE MARK CONSISTS OF THE WORDS "HOPE IS DELICIOUS" WITH THE WORD "IS" INSIDE THE "O" OF "HOPE".

SN 85-154,242, FILED 10-15-2010.

BRENDAN MCCAULEY, EXAMINING ATTORNEY



*David J. Kyros*

Director of the United States Patent and Trademark Office

# United States of America

United States Patent and Trademark Office

## SIMPLY AROMACHIQUE

**Reg. No. 4,276,214**

SPA DE SOLEIL, INC. (CALIFORNIA CORPORATION)  
10443 ARMINTA STREET  
SUN VALLEY, CA 91352

**Registered Jan. 15, 2013**

**Int. Cls.: 3 and 5**

FOR: NON-MEDICATED SKIN CARE PRODUCTS AND FACIAL AND BODY TREATMENTS, NAMELY, SKIN CREAMS, FACIAL CREAMS, FACIAL LOTIONS, FACIAL CLEANSERS, FACIAL MASKS, BODY CREAMS, BODY LOTIONS, BODY CLEANSERS AND BODY MASKS, IN CLASS 3 (U.S. CLS. 1, 4, 6, 50, 51 AND 52).

**TRADEMARK**

**PRINCIPAL REGISTER**

FIRST USE 2-22-2012; IN COMMERCE 2-22-2012.

FOR: MEDICATED SKIN CARE PRODUCTS AND FACIAL AND BODY TREATMENTS, NAMELY, SKIN CREAMS, FACIAL CREAMS, FACIAL LOTIONS, FACIAL CLEANSERS, FACIAL MASKS, BODY CREAMS, BODY LOTIONS, BODY CLEANSERS AND BODY MASKS, IN CLASS 5 (U.S. CLS. 6, 18, 44, 46, 51 AND 52).

FIRST USE 2-22-2012; IN COMMERCE 2-22-2012.

THE MARK CONSISTS OF STANDARD CHARACTERS WITHOUT CLAIM TO ANY PARTICULAR FONT, STYLE, SIZE, OR COLOR.

SN 85-155,005, FILED 10-18-2010.

CHRISTINA SOBRAL, EXAMINING ATTORNEY



*David J. Kybas*

Director of the United States Patent and Trademark Office

# United States of America

United States Patent and Trademark Office

# GRPRO

**Reg. No. 4,276,215**

**Registered Jan. 15, 2013**

**Int. Cl.: 10**

**TRADEMARK**

**PRINCIPAL REGISTER**

COOLSYSTEMS, INC. (CALIFORNIA CORPORATION)  
1800 SUTTER STREET, SUITE 500  
CONCORD, CA 94520

FOR: MEDICAL EQUIPMENT, NAMELY, THERMAL THERAPY DEVICES FOR CONTROLLING BODY TEMPERATURE, HYPERTHERMIA AND HYPOTHERMIA CARE AND LOCALIZED HOT/COLD THERAPY AND PARTS AND ACCESSORIES THEREFOR, NAMELY, MEDICAL THERAPEUTIC WRAPS PERMITTING SIMULTANEOUS COMPRESSION AND FLUID CIRCULATION, MEDICAL THERAPEUTIC COMPRESSION WRAP SLEEVES, CONNECTOR HOSES FOR THERMAL THERAPY DEVICES, IN CLASS 10 (U.S. CLS. 26, 39 AND 44).

FIRST USE 2-0-2011; IN COMMERCE 2-0-2011.

THE MARK CONSISTS OF STANDARD CHARACTERS WITHOUT CLAIM TO ANY PARTICULAR FONT, STYLE, SIZE, OR COLOR.

SN 85-155,160, FILED 10-18-2010.

LAURA KOVALSKY, EXAMINING ATTORNEY



*David J. Kyffers*

Director of the United States Patent and Trademark Office

# United States of America

United States Patent and Trademark Office



**Reg. No. 4,276,216**

**Registered Jan. 15, 2013**

**Int. Cl.: 35**

**SERVICE MARK**

**PRINCIPAL REGISTER**

SHINKUNAS & LINDGREN, P.C. (ALABAMA CORPORATION)  
109B NORTH JEFFERSON STREET  
HUNTSVILLE, AL 35801

FOR: ACCOUNTING SERVICES; TAX AND TAXATION PLANNING, ADVICE, INFORMATION AND CONSULTANCY SERVICES; TAX PREPARATION; TAX FILING SERVICES , IN CLASS 35 (U.S. CLS. 100, 101 AND 102).

FIRST USE 11-15-2012; IN COMMERCE 11-15-2012.

THE MARK CONSISTS OF THREE SQUARES, ONE ON TOP OF THE OTHER, THE TOP ONE HAVING A CROSS SHAPE IN THE MIDDLE, THE MIDDLE SQUARE HAVING THE SHAPE OF AN "X" WITH A CIRCLE BENEATH IT, AND THE BOTTOM SQUARE, HAVING A SMALL CIRCLE CENTERED IN THE TOP PORTION OF THE BOX.

SN 85-155,811, FILED 10-19-2010.

ELLEN BURNS, EXAMINING ATTORNEY



*David J. Kyffers*

Director of the United States Patent and Trademark Office

# United States of America

United States Patent and Trademark Office

## EMPRESS OF THE JADE

**Reg. No. 4,276,217** INTEGRATIVE HEALTH SYSTEMS, LLC (CALIFORNIA LIMITED LIABILITY COMPANY)  
415 3/4 N. LARCHMONT BLVD.  
**Registered Jan. 15, 2013** LOS ANGELES, CA 90004

**Int. Cl.: 5** FOR: DIETARY AND NUTRITIONAL SUPPLEMENTS, IN CLASS 5 (U.S. CLS. 6, 18, 44, 46,  
51 AND 52).

**TRADEMARK** FIRST USE 1-1-2010; IN COMMERCE 1-1-2010.

**PRINCIPAL REGISTER** THE MARK CONSISTS OF STANDARD CHARACTERS WITHOUT CLAIM TO ANY PAR-  
TICULAR FONT, STYLE, SIZE, OR COLOR.

SN 85-156,470, FILED 10-19-2010.

COLLEEN KEARNEY, EXAMINING ATTORNEY



*David J. Kybas*

Director of the United States Patent and Trademark Office

# United States of America

United States Patent and Trademark Office

## EMPRESS OF THE SEA

**Reg. No. 4,276,218**

INTEGRATIVE HEALTH SYSTEMS, LLC (CALIFORNIA LIMITED LIABILITY COMPANY)  
415 3/4 N. LARCHMONT BLVD.

**Registered Jan. 15, 2013**

LOS ANGELES, CA 90004

**Int. Cl.: 5**

FOR: DIETARY AND NUTRITIONAL SUPPLEMENTS, IN CLASS 5 (U.S. CLS. 6, 18, 44, 46, 51 AND 52).

**TRADEMARK**

FIRST USE 8-1-2011; IN COMMERCE 8-1-2011.

**PRINCIPAL REGISTER**

THE MARK CONSISTS OF STANDARD CHARACTERS WITHOUT CLAIM TO ANY PARTICULAR FONT, STYLE, SIZE, OR COLOR.

SN 85-156,476, FILED 10-19-2010.

COLLEEN KEARNEY, EXAMINING ATTORNEY



*David J. Kybas*

Director of the United States Patent and Trademark Office

# United States of America

United States Patent and Trademark Office

## PORTALS TO DESTINY

**Reg. No. 4,276,219**

**Registered Jan. 15, 2013**

**Int. Cl.: 16**

**TRADEMARK**

**PRINCIPAL REGISTER**

INTEGRATIVE HEALTH SYSTEMS, LLC (CALIFORNIA LIMITED LIABILITY COMPANY)  
415 3/4 N. LARCHMONT BLVD.  
LOS ANGELES, CA 90004

FOR: PRINTED MATTER, NAMELY, BOOKS, BOOKLETS, PRINTED PERIODICALS, MANUALS, PRESS RELEASES, JOURNALS, WRITTEN ARTICLES, WRITTEN PROTOCOLS, PRINTED REPORTS, CURRICULUM, NEWSLETTERS, PAMPHLETS, BROCHURES, LEAFLETS, FLYERS, POSTERS, WORKBOOKS, TEXTBOOKS, TEACHING MATERIALS, INSTRUCTIONAL MATERIALS, AND EDUCATIONAL MATERIALS IN THE FIELDS OF HEALTH, WELLNESS, TOXICOLOGY, BOTANY, INTEGRATIVE MEDICINE, FAR INFRARED RADIANT HEAT THERAPY, HOLISTIC DETOXIFICATION PRINCIPLES, IN CLASS 16 (U.S. CLS. 2, 5, 22, 23, 29, 37, 38 AND 50).

FIRST USE 2-1-2011; IN COMMERCE 2-1-2011.

THE MARK CONSISTS OF STANDARD CHARACTERS WITHOUT CLAIM TO ANY PARTICULAR FONT, STYLE, SIZE, OR COLOR.

SN 85-156,510, FILED 10-19-2010.

COLLEEN KEARNEY, EXAMINING ATTORNEY



*David J. Kyros*

Director of the United States Patent and Trademark Office

# United States of America

United States Patent and Trademark Office

# NETPRO

**Reg. No. 4,276,220**

**Registered Jan. 15, 2013**

**Int. Cl.: 42**

**SERVICE MARK**

**PRINCIPAL REGISTER**

PHT CORPORATION (DELAWARE CORPORATION)  
500 RUTHERFORD AVENUE  
BOSTON, MA 02129

FOR: APPLICATION SERVICE PROVIDER SERVICES FEATURING SOFTWARE FOR THE COLLECTION, MANAGEMENT AND REPORTING BY OTHERS OF CLINICAL RESEARCH AND MARKETING; PROVIDING A DATABASE FEATURING MEDICAL AND SCIENTIFIC RESEARCH INFORMATION PERTAINING TO CLINICAL TRIALS OF PHARMACEUTICALS; PROVIDING A WEBSITE FEATURING MEDICAL AND SCIENTIFIC RESEARCH INFORMATION PERTAINING TO CLINICAL TRIALS OF PHARMACEUTICALS, IN CLASS 42 (U.S. CLS. 100 AND 101).

FIRST USE 1-31-2012; IN COMMERCE 1-31-2012.

THE MARK CONSISTS OF STANDARD CHARACTERS WITHOUT CLAIM TO ANY PARTICULAR FONT, STYLE, SIZE, OR COLOR.

SN 85-158,183, FILED 10-21-2010.

KAREN SEVERSON, EXAMINING ATTORNEY



*David J. Kyros*

Director of the United States Patent and Trademark Office



# United States of America

United States Patent and Trademark Office

**B**  
**HERE**  

---

**beyond your expectations**

**Reg. No. 4,276,221**

**Registered Jan. 15, 2013**

**Int. Cl.: 43**

**SERVICE MARK**

**PRINCIPAL REGISTER**

SILVERTON CASINO, LLC (NEVADA LIMITED LIABILITY COMPANY)  
3333 BLUE DIAMOND ROAD  
LAS VEGAS, NV 89139

FOR: BAR AND COCKTAIL LOUNGE SERVICES; CAFE AND RESTAURANT SERVICES;  
CATERING SERVICES; COCKTAIL LOUNGES; HOTEL ACCOMMODATION SERVICES;  
PROVIDING TEMPORARY TRAILER PARK FACILITIES; PUBS; RESTAURANT SERVICES;  
SERVICES FOR THE RESERVATION OF ROOMS; SERVING FOOD AND DRINKS; TAVERN  
SERVICES, IN CLASS 43 (U.S. CLS. 100 AND 101).

FIRST USE 4-1-2011; IN COMMERCE 4-1-2011.

THE MARK CONSISTS OF THE LETTER "B", THEN BELOW THE WORD "HERE", THEN  
A THICK LINE BELOW THAT AND THE PHRASE "BEYOND YOUR EXPECTATIONS" ON  
THE BOTTOM.

SN 85-159,048, FILED 10-22-2010.

BILL DAWE, EXAMINING ATTORNEY



*David J. Kyfos*

Director of the United States Patent and Trademark Office

# United States of America

United States Patent and Trademark Office

**B**  
**HERE**  

---

**beyond your expectations**

**Reg. No. 4,276,222**

SILVERTON CASINO, LLC (NEVADA LIMITED LIABILITY COMPANY)  
3333 BLUE DIAMOND ROAD  
LAS VEGAS, NV 89139

**Registered Jan. 15, 2013**

**Int. Cl.: 41**

FOR: ARRANGING AND CONDUCTING NIGHTCLUB ENTERTAINMENT EVENTS; ARRANGING AND CONDUCTING NIGHTCLUB PARTIES; ARRANGING AND CONDUCTING OF CONCERTS; CASINOS; CONDUCTING AND PROVIDING FACILITIES FOR SPECIAL EVENTS FEATURING CASINO AND GAMING CONTESTS AND TOURNAMENTS; ENTERTAINMENT INFORMATION; GAMING SERVICES IN THE NATURE OF CASINO GAMING; NIGHT CLUBS; PROVIDING FITNESS AND EXERCISE FACILITIES; WAGERING SERVICES, IN CLASS 41 (U.S. CLS. 100, 101 AND 107).

**SERVICE MARK**

**PRINCIPAL REGISTER**

FIRST USE 4-1-2011; IN COMMERCE 4-1-2011.

THE MARK CONSISTS OF THE LETTER "B", THEN BELOW THE WORD "HERE", THEN A THICK LINE BELOW THAT AND THE PHRASE "BEYOND YOUR EXPECTATIONS" ON THE BOTTOM.

SN 85-159,055, FILED 10-22-2010.

BILL DAWE, EXAMINING ATTORNEY



*David J. Kyfos*

Director of the United States Patent and Trademark Office

# United States of America

United States Patent and Trademark Office

## "REAL MBE'S - REAL OPPORTUNITIES!"

**Reg. No. 4,276,223**

**Registered Jan. 15, 2013**

**Int. Cl.: 35**

**SERVICE MARK**

**PRINCIPAL REGISTER**

FIZZ TECHNOLOGIES, LLC (ARIZONA LIMITED LIABILITY COMPANY)  
SUITE 230  
7135 EAST CAMELBACK ROAD  
SCOTTSDALE, AZ 85251

FOR: ONLINE BUSINESS SERVICES, NAMELY, MATCHING BUSINESSES NEEDING GOODS AND SERVICES WITH MINORITY-OWNED PROVIDERS OF GOODS AND SERVICES; PROVIDING A WEB SITE WHEREBY BUYERS OF GOODS OR SERVICES LOCATE AND RECEIVE QUOTATIONS FROM MULTIPLE MINORITY-OWNED COMPETITIVE SOURCES AND MINORITY-OWNED SELLERS OF GOODS OR SERVICES IDENTIFY AND BID ON MULTIPLE NEW SALES OPPORTUNITIES, IN CLASS 35 (U.S. CLS. 100, 101 AND 102).

FIRST USE 3-15-2012; IN COMMERCE 3-15-2012.

THE MARK CONSISTS OF STANDARD CHARACTERS WITHOUT CLAIM TO ANY PARTICULAR FONT, STYLE, SIZE, OR COLOR.

NO CLAIM IS MADE TO THE EXCLUSIVE RIGHT TO USE "MBE'S" , APART FROM THE MARK AS SHOWN.

SN 85-159,209, FILED 10-22-2010.

BARBARA GAYNOR, EXAMINING ATTORNEY



*David J. Kybas*

Director of the United States Patent and Trademark Office

# United States of America

United States Patent and Trademark Office

# AVENGERS

**Reg. No. 4,276,224**

**Registered Jan. 15, 2013**

**Int. Cl.: 24**

**TRADEMARK**

**PRINCIPAL REGISTER**

MARVEL CHARACTERS, INC. (DELAWARE CORPORATION)  
1600 ROSECRANS AVENUE  
MANHATTAN BEACH, CA 90266

FOR: BEACH TOWELS; BED BLANKETS; CHILDREN'S BLANKETS; CHILDREN'S TOWELS;  
PILLOW COVERS; TEXTILE WALL HANGINGS; TOWELS, IN CLASS 24 (U.S. CLS. 42 AND  
50).

FIRST USE 4-1-2012; IN COMMERCE 4-1-2012.

THE MARK CONSISTS OF STANDARD CHARACTERS WITHOUT CLAIM TO ANY PAR-  
TICULAR FONT, STYLE, SIZE, OR COLOR.

OWNER OF U.S. REG. NOS. 885,486, 3,282,768, AND OTHERS.

SN 85-159,391, FILED 10-22-2010.

WON TEAK OH, EXAMINING ATTORNEY



*David J. Kyffers*

Director of the United States Patent and Trademark Office

# United States of America

United States Patent and Trademark Office

# Nu Haiku

**Reg. No. 4,276,225**

SPOONER, LIONELL O'NEIL (UNITED STATES INDIVIDUAL)  
P.O. BOX 13271  
GREENSBORO, NC 27415

**Registered Jan. 15, 2013**

**Int. Cl.: 25**

FOR: BODY LINEN; CAPS; TOPS; WEARABLE GARMENTS AND CLOTHING, NAMELY, SHIRTS, IN CLASS 25 (U.S. CLS. 22 AND 39).

**TRADEMARK**

FIRST USE 8-11-2011; IN COMMERCE 8-16-2011.

**PRINCIPAL REGISTER**

THE MARK CONSISTS OF STANDARD CHARACTERS WITHOUT CLAIM TO ANY PARTICULAR FONT, STYLE, SIZE, OR COLOR.

NO CLAIM IS MADE TO THE EXCLUSIVE RIGHT TO USE "HAIKU", APART FROM THE MARK AS SHOWN.

SN 85-159,624, FILED 10-22-2010.

CARYN GLASSER, EXAMINING ATTORNEY



*David J. Kybas*

Director of the United States Patent and Trademark Office

# United States of America

United States Patent and Trademark Office

## BARBER LOVE

**Reg. No. 4,276,226**

ECHOLS, LADON (UNITED STATES INDIVIDUAL)  
320 NW 33RD ST.  
MIAMI, FL 33127 AND

**Registered Jan. 15, 2013**

**Int. Cl.: 25**

POOLE, WANZA (UNITED STATES INDIVIDUAL)  
19 EAST SCHOOL HOUSE LANE  
PHILADELPHIA, PA 19144

**TRADEMARK**

**PRINCIPAL REGISTER**

FOR: ATHLETIC APPAREL, NAMELY, SHIRTS, PANTS, JACKETS, FOOTWEAR, HATS AND CAPS, ATHLETIC UNIFORMS; ATHLETIC FOOTWEAR; BASEBALL CAPS AND HATS; BODY SHIRTS; BOXER SHORTS; BUCKET CAPS; BUTTON DOWN SHIRTS; COLLARED SHIRTS; HEAD SCARVES; SCARVES; SHIRTS; SWEATSHIRTS, IN CLASS 25 (U.S. CLS. 22 AND 39).

FIRST USE 1-1-2011; IN COMMERCE 1-1-2011.

THE MARK CONSISTS OF STANDARD CHARACTERS WITHOUT CLAIM TO ANY PARTICULAR FONT, STYLE, SIZE, OR COLOR.

SN 85-160,095, FILED 10-25-2010.

CORY BOONE, EXAMINING ATTORNEY



*David J. Kyffers*

Director of the United States Patent and Trademark Office

# United States of America

United States Patent and Trademark Office



**Reg. No. 4,276,227**

**Registered Jan. 15, 2013**

**Int. Cl.: 25**

**TRADEMARK**

**PRINCIPAL REGISTER**

BLEND INDUSTRIES LLC (NEW YORK LIMITED LIABILITY COMPANY), DBA  
BROOKLYNMOTORS,  
8 LOMBARDI PLACE  
PLAINVIEW, NY 11803

FOR: T-SHIRTS; TEE SHIRTS; ATHLETIC APPAREL, NAMELY, SHIRTS, HOODED SWEAT SHIRTS; KNIT SHIRTS; LONG-SLEEVED SHIRTS; SHORT-SLEEVED SHIRTS, IN CLASS 25 (U.S. CLS. 22 AND 39).

FIRST USE 3-1-2010; IN COMMERCE 3-1-2010.

NO CLAIM IS MADE TO THE EXCLUSIVE RIGHT TO USE "BROOKLYN", APART FROM THE MARK AS SHOWN.

THE MARK CONSISTS OF AN ENGINE SPARK PLUG WITH WINGS ON THE OUTSIDE. A CIRCLE IN THE MIDDLE OF THE SPARK PLUG THAT CONSISTS ON THE BRAND NAME "BROOKLYN MOTORS" WITH TWO DOTS SEPARATING THE TERMS AND A PICTURE OF ENGINE CYLINDER HEADS IN THE INSIDE THE INNER CIRCLE.

SN 85-160,852, FILED 10-25-2010.

BRIDGETT SMITH, EXAMINING ATTORNEY



*David J. Kyffers*

Director of the United States Patent and Trademark Office

# United States of America

United States Patent and Trademark Office

# HRE

**Reg. No. 4,276,228**

**Registered Jan. 15, 2013**

**Int. Cls.: 12 and 25**

**TRADEMARK**

**PRINCIPAL REGISTER**

PHOENIX WHEEL CO., INC. (CALIFORNIA CORPORATION), DBA HRE PERFORMANCE WHEELS,  
2611 COMMERCE WAY, SUITE D  
VISTA, CA 92081

FOR: WHEELS FOR AUTOMOBILES, SPORT UTILITY VEHICLES, TRUCKS, AND VANS, IN CLASS 12 (U.S. CLS. 19, 21, 23, 31, 35 AND 44).

FIRST USE 6-21-2011; IN COMMERCE 6-21-2011.

FOR: APPAREL, NAMELY, T-SHIRTS; HEADGEAR, NAMELY, HATS; OUTERWEAR, NAMELY, HOODED SWEAT SHIRTS, IN CLASS 25 (U.S. CLS. 22 AND 39).

FIRST USE 10-27-2011; IN COMMERCE 10-27-2011.

THE MARK CONSISTS OF STANDARD CHARACTERS WITHOUT CLAIM TO ANY PARTICULAR FONT, STYLE, SIZE, OR COLOR.

OWNER OF U.S. REG. NOS. 2,970,444 AND 2,970,445.

SN 85-161,681, FILED 10-26-2010.

SUE LAWRENCE, EXAMINING ATTORNEY



*David J. Kybas*

Director of the United States Patent and Trademark Office



# United States of America

United States Patent and Trademark Office

# somnopro

**Reg. No. 4,276,229**

**Registered Jan. 15, 2013**

**Int. Cl.: 20**

**TRADEMARK**

**PRINCIPAL REGISTER**

BELLAREST INTERNATIONAL (SHANGHAI)CO.,LTD (CHINA LIMITED LIABILITY COMPANY)  
BLD. 2  
1055 ZHANGXIANG ROAD, ANTING TOWN  
JIADING, SHANGHAI, 201814, CHINA

FOR: BEDSTEADS OF WOOD; FURNITURE; MATTRESSES; BED FITTINGS, NOT OF METAL, NAMELY, BED FRAMES, BED HEADBOARDS, BED RAILS AND BED RESTS; PILLOWS; CUSHIONS; BOLSTERS, IN CLASS 20 (U.S. CLS. 2, 13, 22, 25, 32 AND 50).

FIRST USE 8-3-2012; IN COMMERCE 8-3-2012.

THE MARK CONSISTS OF STANDARD CHARACTERS WITHOUT CLAIM TO ANY PARTICULAR FONT, STYLE, SIZE, OR COLOR.

SN 85-161,922, FILED 10-26-2010.

JAY FLOWERS, EXAMINING ATTORNEY



*David J. Kyffers*

Director of the United States Patent and Trademark Office

United States of America  
United States Patent and Trademark Office

The Girls 

**Reg. No. 4,276,230**

THE T COMPANY (NEW YORK CORPORATION)  
6 LUNDY LANE

**Registered Jan. 15, 2013**

LARCHMONT, NY 10538

**Int. Cl.: 25**

FOR: CLOTHING, NAMELY, SHIRTS, TANKTOPS, PANTS, SHORTS, SKIRTS, SOCKS,  
ATHLETIC PANTS, HATS, IN CLASS 25 (U.S. CLS. 22 AND 39).

**TRADEMARK**

FIRST USE 3-13-2012; IN COMMERCE 3-13-2012.

**PRINCIPAL REGISTER**

NO CLAIM IS MADE TO THE EXCLUSIVE RIGHT TO USE "GIRLS", APART FROM THE  
MARK AS SHOWN.

THE MARK CONSISTS OF THE WORDS "THE GIRLS" IN A STYLIZED FORMAT WITH  
THE LETTERS "T" AND "G" CAPITALIZED WITH THE SILHOUETTE OF A PERSON WITH  
PONYTAIL AND ONE HAND ON HIP TO THE RIGHT.

SN 85-162,767, FILED 10-27-2010.

KELLY TRUSILO, EXAMINING ATTORNEY



*David J. Kybas*

Director of the United States Patent and Trademark Office

# United States of America

United States Patent and Trademark Office

# LILLIAN

**Reg. No. 4,276,231**

**Registered Jan. 15, 2013**

**Int. Cl.: 24**

**TRADEMARK**

**PRINCIPAL REGISTER**

KING ZAK INDUSTRIES, INC. (NEW YORK CORPORATION)  
3 POLICE DRIVE  
GOSHEN, NY 10924

FOR: PLASTIC TABLE COVERS, IN CLASS 24 (U.S. CLS. 42 AND 50).

FIRST USE 11-19-2012; IN COMMERCE 11-19-2012.

THE MARK CONSISTS OF STANDARD CHARACTERS WITHOUT CLAIM TO ANY PARTICULAR FONT, STYLE, SIZE, OR COLOR.

SN 85-163,525, FILED 10-28-2010.

ROBERT C. CLARK JR., EXAMINING ATTORNEY



*David J. Kybas*

Director of the United States Patent and Trademark Office

# United States of America

United States Patent and Trademark Office

## INDULGE IN OUR FAMILY TRADITION

**Reg. No. 4,276,232**

**Registered Jan. 15, 2013**

**Int. Cl.: 30**

**TRADEMARK**

**PRINCIPAL REGISTER**

PAPA BEN'S KITCHEN (NEVADA LIMITED LIABILITY COMPANY)  
2500 BLAIRSDEN STREET  
LAS VEGAS, NV 89134

FOR: COOKIE MIXES; COOKIES; PRETZELS, IN CLASS 30 (U.S. CL. 46).

FIRST USE 6-6-2012; IN COMMERCE 6-6-2012.

THE MARK CONSISTS OF STANDARD CHARACTERS WITHOUT CLAIM TO ANY PARTICULAR FONT, STYLE, SIZE, OR COLOR.

SN 85-164,546, FILED 10-29-2010.

TINA MAI, EXAMINING ATTORNEY



*David J. Kyffers*

Director of the United States Patent and Trademark Office

# United States of America

United States Patent and Trademark Office

# FAVE

**Reg. No. 4,276,233**

S.T. AGRI GLOBAL, INC. (NEW JERSEY CORPORATION)  
8 HART DRIVE  
MIDDLETOWN, NJ 07748

**Registered Jan. 15, 2013**

**Int. Cl.: 32**

FOR: REDUCED CALORIE FRUIT AND VEGETABLE JUICES, IN CLASS 32 (U.S. CLS. 45, 46 AND 48).

**TRADEMARK**

FIRST USE 7-24-2012; IN COMMERCE 7-24-2012.

**PRINCIPAL REGISTER**

THE MARK CONSISTS OF STANDARD CHARACTERS WITHOUT CLAIM TO ANY PARTICULAR FONT, STYLE, SIZE, OR COLOR.

SN 85-165,512, FILED 10-30-2010.

DAVID C. REIHNER, EXAMINING ATTORNEY



*David J. Kybas*

Director of the United States Patent and Trademark Office

# United States of America

United States Patent and Trademark Office

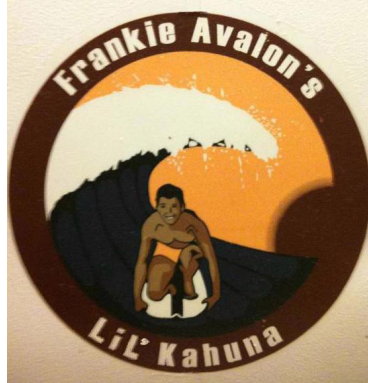

**Reg. No. 4,276,234**

**Registered Jan. 15, 2013**

**Int. Cl.: 28**

**TRADEMARK**

**PRINCIPAL REGISTER**

AVALON, FRANKIE (UNITED STATES INDIVIDUAL), DBA FRANTONE MUSIC, INC.,  
4303 SPRING FOREST LANE  
WESTLAKE VILLAGE, CA 91368

FOR: SURFBOARDS; CHILDREN'S SURFBOARDS, IN CLASS 28 (U.S. CLS. 22, 23, 38 AND 50).

FIRST USE 11-1-2012; IN COMMERCE 11-15-2012.

THE MARK CONSISTS OF A TAN MALE SURFER IN A GOLDEN YELLOW SWIMSUIT ON A WHITE WITH BLACK STRIPED SURFBOARD, RIDING A NAVY BLUE WAVE WITH WHITE FOAM, AGAINST THE BACKDROP OF A GOLDEN YELLOW SKY, ENCIRCLED IN BURGUNDY AND WITH THE WORDS "FRANKIE AVALON'S LIL' KAHUNA" IN WHITE. THE BACKGROUND IS A GRADATION OF BURGUNDY AND NAVY BLUE THAT BECOME LIGHTER TOWARDS THE TOP.

THE COLOR(S) TAN, GOLDEN YELLOW, WHITE, NAVY BLUE, BLACK AND BURGUNDY IS/ARE CLAIMED AS A FEATURE OF THE MARK.

SN 85-166,418, FILED 11-1-2010.

JANET LEE, EXAMINING ATTORNEY



*David J. Kyffers*

Director of the United States Patent and Trademark Office

# United States of America

United States Patent and Trademark Office

## SURESCRIPTS CLINICAL MESSAGE PORTAL

**Reg. No. 4,276,235**

**Registered Jan. 15, 2013**

**Int. Cl.: 42**

**SERVICE MARK**

**PRINCIPAL REGISTER**

SURESCRIPTS, LLC (DELAWARE LIMITED LIABILITY COMPANY)  
2800 CRYSTAL DRIVE, 10TH FLOOR  
ARLINGTON, VA 22202

FOR: COMPUTER SERVICES, NAMELY, PROVIDING A WEB-BASED SYSTEM AND ON-LINE PORTAL FEATURING ON-LINE, NON-DOWNLOADABLE SOFTWARE THAT ALLOWS PHYSICIANS AND OTHER HEALTHCARE PROVIDERS TO ACCESS, UPDATE, AND EXCHANGE PATIENT INFORMATION AND OTHER CLINICAL DATA, IN CLASS 42 (U.S. CLS. 100 AND 101).

FIRST USE 11-30-2010; IN COMMERCE 11-30-2010.

THE MARK CONSISTS OF STANDARD CHARACTERS WITHOUT CLAIM TO ANY PARTICULAR FONT, STYLE, SIZE, OR COLOR.

OWNER OF U.S. REG. NOS. 2,821,535, 3,066,314, AND OTHERS.

NO CLAIM IS MADE TO THE EXCLUSIVE RIGHT TO USE "CLINICAL MESSAGE PORTAL", APART FROM THE MARK AS SHOWN.

SN 85-167,517, FILED 11-2-2010.

MICHAEL SOUDERS, EXAMINING ATTORNEY



*David J. Kyjars*

Director of the United States Patent and Trademark Office

# United States of America

United States Patent and Trademark Office

## SURESCRIPTS MESSAGE STREAM

**Reg. No. 4,276,236**

**Registered Jan. 15, 2013**

**Int. Cl.: 42**

**SERVICE MARK**

**PRINCIPAL REGISTER**

SURESCRIPTS, LLC (DELAWARE LIMITED LIABILITY COMPANY)  
2800 CRYSTAL DRIVE, 10TH FLOOR  
ARLINGTON, VA 22202

FOR: PROVIDING TEMPORARY USE OF ON-LINE NON-DOWNLOADABLE SOFTWARE DEVELOPMENT TOOLS FOR SECURE CLINICAL MESSAGE MANAGEMENT AND WORKFLOW MANAGEMENT TO BE USED WITHIN HEALTH INFORMATION NETWORKS AND HEALTH INFORMATION TECHNOLOGY SYSTEMS, AND AN ELECTRONIC MEDICAL AND HEALTH INFORMATION NETWORK; APPLICATION SERVICE PROVIDER (ASP) FEATURING SOFTWARE FOR USE IN PROVIDING OPERATORS OF REGIONAL, PROPRIETARY AND OTHER CLINICAL INFORMATION NETWORKS AND HEALTH INFORMATION TECHNOLOGY VENDORS THE OPPORTUNITY TO CONNECT THEIR PHYSICIANS AND OTHER HEALTHCARE PROVIDERS TO A NATIONAL SECURE ELECTRONIC NETWORK TO ACCESS, UPDATE AND EXCHANGE PATIENT INFORMATION AND OTHER CLINICAL DATA, IN CLASS 42 (U.S. CLS. 100 AND 101).

FIRST USE 11-30-2010; IN COMMERCE 11-30-2010.

THE MARK CONSISTS OF STANDARD CHARACTERS WITHOUT CLAIM TO ANY PARTICULAR FONT, STYLE, SIZE, OR COLOR.

OWNER OF U.S. REG. NOS. 2,821,535, 3,066,314, AND OTHERS.

NO CLAIM IS MADE TO THE EXCLUSIVE RIGHT TO USE "MESSAGE STREAM", APART FROM THE MARK AS SHOWN.

SN 85-167,519, FILED 11-2-2010.

MICHAEL SOUDERS, EXAMINING ATTORNEY



*David J. Kyros*

Director of the United States Patent and Trademark Office



# United States of America

United States Patent and Trademark Office

# EARZEE

**Reg. No. 4,276,237**

**Registered Jan. 15, 2013**

**Int. Cl.: 9**

**TRADEMARK**

**PRINCIPAL REGISTER**

PETER ALAN FISH (AUSTRALIA INDIVIDUAL)  
2B BRUCE AVENUE  
KILLARA NSW 2071, AUSTRALIA

FOR: WIRELESS DEVICES FOR COMMUNICATION AND CONTROL OF VOICE, DATA AND MUSIC, NAMELY, WIRELESS COMMUNICATION DEVICES FEATURING VOICE TRANSMISSION, IN CLASS 9 (U.S. CLS. 21, 23, 26, 36 AND 38).

FIRST USE 9-30-2012; IN COMMERCE 9-30-2012.

THE MARK CONSISTS OF STANDARD CHARACTERS WITHOUT CLAIM TO ANY PARTICULAR FONT, STYLE, SIZE, OR COLOR.

SN 85-167,982, FILED 11-3-2010.

ERNEST SHOSHO, EXAMINING ATTORNEY



*David J. Kybas*

Director of the United States Patent and Trademark Office

# United States of America

United States Patent and Trademark Office

## GOLD CLASS

**Reg. No. 4,276,238**

**Registered Jan. 15, 2013**

**Int. Cl.: 9**

**TRADEMARK**

**PRINCIPAL REGISTER**

ARISTOCRAT TECHNOLOGIES AUSTRALIA PTY LTD. (AUSTRALIA CORPORATION)  
BUILDING A, PINNACLE OFFICE PARK  
85 EPPING ROAD  
NORTH RYDE, NSW, AUSTRALIA 2113

FOR: ELECTRONIC GAMING MACHINES, NAMELY, DEVICES WHICH ACCEPT A WAGER,  
IN CLASS 9 (U.S. CLS. 21, 23, 26, 36 AND 38).

FIRST USE 11-19-2012; IN COMMERCE 11-19-2012.

THE MARK CONSISTS OF STANDARD CHARACTERS WITHOUT CLAIM TO ANY PAR-  
TICULAR FONT, STYLE, SIZE, OR COLOR.

SN 85-168,167, FILED 11-3-2010.

GINA FINK, EXAMINING ATTORNEY



*David J. Kyffers*

Director of the United States Patent and Trademark Office

# United States of America

United States Patent and Trademark Office

# ALOHA Y'ALL

**Reg. No. 4,276,239**

MOORE, JEFF (UNITED STATES INDIVIDUAL)  
6722 BEACH DR.

**Registered Jan. 15, 2013**

PANAMA CITY BEACH, FL 32408

**Int. Cl.: 25**

FOR: HATS; JACKETS; SWEAT SHIRTS; T-SHIRTS, IN CLASS 25 (U.S. CLS. 22 AND 39).

**TRADEMARK**

FIRST USE 3-28-2011; IN COMMERCE 3-28-2011.

**PRINCIPAL REGISTER**

THE MARK CONSISTS OF STANDARD CHARACTERS WITHOUT CLAIM TO ANY PARTICULAR FONT, STYLE, SIZE, OR COLOR.

SN 85-168,660, FILED 11-3-2010.

NELSON SNYDER, EXAMINING ATTORNEY



*David J. Kyffers*

Director of the United States Patent and Trademark Office

# United States of America

United States Patent and Trademark Office

## POLAR POSSUMS

**Reg. No. 4,276,240**

**Registered Jan. 15, 2013**

**Int. Cl.: 25**

**TRADEMARK**

**PRINCIPAL REGISTER**

PARIS ACCESSORIES, INC. (NEW YORK CORPORATION)  
21ST FLOOR  
1385 BROADWAY  
NEW YORK, NY 10018

FOR: FOOTWEAR, NAMELY, SOCKS AND HOSIERY, IN CLASS 25 (U.S. CLS. 22 AND 39).

FIRST USE 8-14-2012; IN COMMERCE 9-10-2012.

THE MARK CONSISTS OF STANDARD CHARACTERS WITHOUT CLAIM TO ANY PARTICULAR FONT, STYLE, SIZE, OR COLOR.

SN 85-170,010, FILED 11-5-2010.

GILBERT SWIFT, EXAMINING ATTORNEY



*David J. Kybas*

Director of the United States Patent and Trademark Office

# United States of America

United States Patent and Trademark Office

# Hooemade

**Reg. No. 4,276,241**

**Registered Jan. 15, 2013**

**Int. Cl.: 11**

**TRADEMARK**

**PRINCIPAL REGISTER**

HOOE, JOSEPH, DAVID (UNITED STATES INDIVIDUAL)  
3005 HAMMONDS FERRY ROAD  
BALTIMORE, MD 21227

FOR: ELECTRIC GRILLS; ELECTRIC OUTDOOR GRILLS; FOLDING PORTABLE CHARCOAL, PROPANE AND GAS FIRED BARBECUES, STOVES, AND GRILLS; GAS GRILLS; GRILL ACCESSORIES, NAMELY, CHARCOAL GRILL CONVERSION UNITS FOR CONVERTING CHARCOAL GRILLS TO ELECTRIC SMOKERS; GRILL ACCESSORIES, NAMELY, WARMING TRAYS, IN CLASS 11 (U.S. CLS. 13, 21, 23, 31 AND 34).

FIRST USE 2-9-2011; IN COMMERCE 11-20-2012.

THE MARK CONSISTS OF STANDARD CHARACTERS WITHOUT CLAIM TO ANY PARTICULAR FONT, STYLE, SIZE, OR COLOR.

SN 85-170,847, FILED 11-6-2010.

JIM RINGLE, EXAMINING ATTORNEY



*David J. Kyffers*

Director of the United States Patent and Trademark Office

# United States of America

United States Patent and Trademark Office



**Reg. No. 4,276,242**

**Registered Jan. 15, 2013**

**Int. Cl.: 1**

**TRADEMARK**

**PRINCIPAL REGISTER**

MORINAGA NYUGYO KABUSHIKI KAISHA (JAPAN CORPORATION), TA MORINAGA  
MILK INDUSTRY CO., LTD.,  
33-1, SHIBA 5-CHOME, MINATO-KU  
TOKYO, JAPAN

FOR: NUTRITIONAL BIOCHEMICAL ADDITIVES FOR USE IN THE MANUFACTURE OF  
FOOD AND FOOD SUPPLEMENTS; LACTIC ACID BACTERIUM FOR USE IN THE MANU-  
FACTURE OF FOOD AND FOOD SUPPLEMENTS; BIFIDOBACTERIUM FOR USE IN THE  
MANUFACTURE OF FOOD AND FOOD SUPPLEMENTS; LACTOFERRIN FOR USE IN THE  
MANUFACTURE OF FOOD AND FOOD SUPPLEMENTS, IN CLASS 1 (U.S. CLS. 1, 5, 6, 10,  
26 AND 46).

FIRST USE 4-30-1992; IN COMMERCE 3-31-2006.

OWNER OF U.S. REG. NOS. 3,196,118, 3,353,983, AND 3,467,778.

THE MARK CONSISTS OF A STYLIZED LETTER "M" ABOVE THE WORD "MORINAGA".

THE WORDING "MORINAGA" HAS NO MEANING IN A FOREIGN LANGUAGE.

SN 85-171,245, FILED 11-8-2010.

LOURDES AYALA, EXAMINING ATTORNEY



*David J. Kybas*

Director of the United States Patent and Trademark Office

# United States of America

United States Patent and Trademark Office

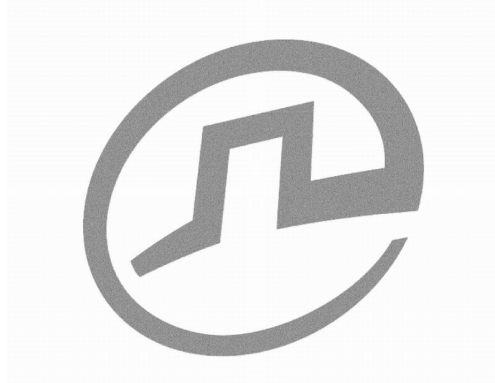

**Reg. No. 4,276,243**

**Registered Jan. 15, 2013**

**Int. Cls.: 9, 40, and 42**

**TRADEMARK**

**SERVICE MARK**

**PRINCIPAL REGISTER**

PULSE ELECTRONICS CORPORATION (PENNSYLVANIA CORPORATION)  
1210 NORTHBROOK DRIVE, SUITE 470  
TREVOSE, PA 19053

FOR: ELECTRONIC APPARATUS, COMPONENTS, DEVICES AND EQUIPMENT, NAMELY, DIGITAL SUBSCRIBER LINE (DSL) FILTERS, DSL SPLITTERS, DSL SPLITTER FILTER MODULES, INDUCTORS, TRANSFORMERS, INTEGRATED CONNECTOR MODULES FOR SERVERS, DISCRETE MAGNETIC TRANSFORMERS, CONNECTORS, ANTENNAE, POWER TRANSFORMERS, POWER INDUCTORS, OPEN FRAME TRANSFORMERS, ENCAPSULATED TRANSFORMERS, CURRENT SENSE MAGNETICS FOR HIGH-FREQUENCY SWITCHING, GATE DRIVE AND ISOLATION TRANSFORMERS, COMMON MODE CHOKES FOR USE IN ADSL AND VDSL INTERFACES, RF CHIP INDUCTORS, RF SPLITTER/COMBINER FOR USE IN CABLE MEDIA, BALUNS AND TRANSFORMERS, MULTIPLEXERS, NAMELY, DIPLEXERS, LOW PASS FILTERS, DATA BUS COUPLERS, INTERFACE TRANSFORMERS, COILS, SMART METERS, ENERGY MONITORS FOR MONITORING ENERGY USE BY DATA COMMUNICATION COMPONENTS, AND CURRENT SENSORS, IN CLASS 9 (U.S. CLS. 21, 23, 26, 36 AND 38).

FIRST USE 11-8-2010; IN COMMERCE 11-8-2010.

FOR: MANUFACTURE OF ELECTRONIC APPARATUS, COMPONENTS, DEVICES AND EQUIPMENT TO THE ORDER AND/OR SPECIFICATION OF OTHERS, IN CLASS 40 (U.S. CLS. 100, 103 AND 106).

FIRST USE 11-8-2010; IN COMMERCE 11-8-2010.

FOR: DESIGN FOR OTHERS IN THE FIELD OF ELECTRONIC APPARATUS, COMPONENTS, DEVICES AND EQUIPMENT, IN CLASS 42 (U.S. CLS. 100 AND 101).

FIRST USE 11-8-2010; IN COMMERCE 11-8-2010.

THE MARK CONSISTS OF AN UNCOMPLETE CIRCLE WITH A HALF SQUARE IN THE MIDDLE.

SN 85-171,998, FILED 11-8-2010.

ROBERT C. CLARK JR., EXAMINING ATTORNEY



*David J. Kyffers*

Director of the United States Patent and Trademark Office

# United States of America

United States Patent and Trademark Office

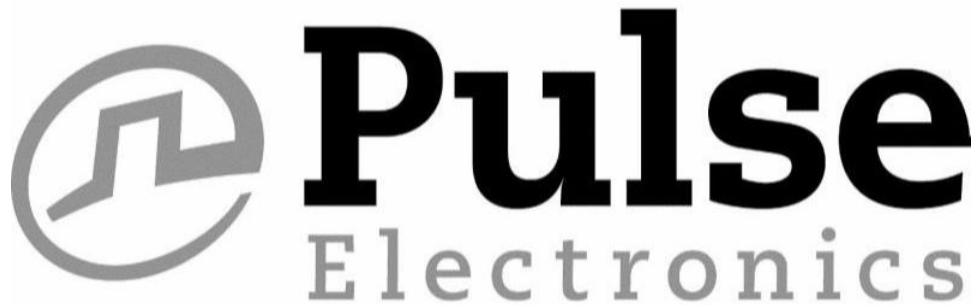

**Reg. No. 4,276,244**

**Registered Jan. 15, 2013**

**Int. Cls.: 9, 40, and 42**

**TRADEMARK**

**SERVICE MARK**

**PRINCIPAL REGISTER**

PULSE ELECTRONICS CORPORATION (PENNSYLVANIA CORPORATION)  
1210 NORTHBROOK DRIVE, SUITE 470  
TREVOSE, PA 19053

FOR: ELECTRONIC APPARATUS, COMPONENTS, DEVICES AND EQUIPMENT, NAMELY, DIGITAL SUBSCRIBER LINE (DSL) FILTERS, DSL SPLITTERS, DSL SPLITTER FILTER MODULES, INDUCTORS, TRANSFORMERS, INTEGRATED CONNECTOR MODULES FOR SERVERS, DISCRETE MAGNETIC TRANSFORMERS, CONNECTORS, ANTENNAE, POWER TRANSFORMERS, POWER INDUCTORS, OPEN FRAME TRANSFORMERS, ENCAPSULATED TRANSFORMERS, CURRENT SENSE MAGNETICS FOR HIGH-FREQUENCY SWITCHING, GATE DRIVE AND ISOLATION TRANSFORMERS, COMMON MODE CHOKES FOR USE IN ADSL AND VDSL INTERFACES, RF CHIP INDUCTORS, RF SPLITTER/COMBINER FOR USE IN CABLE MEDIA, BALUNS AND TRANSFORMERS, MULTIPLEXERS, NAMELY, DIPLEXERS, LOW PASS FILTERS, DATA BUS COUPLERS, INTERFACE TRANSFORMERS, COILS, SMART METERS, ENERGY MONITORS FOR MONITORING ENERGY USE BY DATA COMMUNICATION COMPONENTS, AND CURRENT SENSORS, IN CLASS 9 (U.S. CLS. 21, 23, 26, 36 AND 38).

FIRST USE 11-8-2010; IN COMMERCE 11-8-2010.

FOR: MANUFACTURE OF ELECTRONIC APPARATUS, COMPONENTS, DEVICES AND EQUIPMENT TO THE ORDER AND/OR SPECIFICATION OF OTHERS, IN CLASS 40 (U.S. CLS. 100, 103 AND 106).

FIRST USE 11-8-2010; IN COMMERCE 11-8-2010.

FOR: DESIGN FOR OTHERS IN THE FIELD OF ELECTRONIC APPARATUS, COMPONENTS, DEVICES AND EQUIPMENT, IN CLASS 42 (U.S. CLS. 100 AND 101).

FIRST USE 11-8-2010; IN COMMERCE 11-8-2010.

NO CLAIM IS MADE TO THE EXCLUSIVE RIGHT TO USE "ELECTRONICS", APART FROM THE MARK AS SHOWN.

THE MARK CONSISTS OF AN UNCOMPLETED CIRCLE WITH A HALF SQUARE IN THE MIDDLE AND THE WORDS "PULSE ELECTRONICS" TO THE RIGHT.



*David J. Kyffers*

Director of the United States Patent and Trademark Office



**Reg. No. 4,276,244** SN 85-172,007, FILED 11-8-2010.

ROBERT C. CLARK JR., EXAMINING ATTORNEY

# United States of America

United States Patent and Trademark Office

Milliken

**Reg. No. 4,276,245**

MILLIKEN & COMPANY (DELAWARE CORPORATION)  
920 MILLIKEN ROAD, M495  
SPARTANBURG, SC 29303

**Registered Jan. 15, 2013**

**Int. Cl.: 35**

FOR: MANAGEMENT AND BUSINESS CONSULTING SERVICES IN THE FIELD OF MANUFACTURING AND PERFORMANCE IMPROVEMENT, IN CLASS 35 (U.S. CLS. 100, 101 AND 102).

**SERVICE MARK**

FIRST USE 3-16-2012; IN COMMERCE 3-16-2012.

**PRINCIPAL REGISTER**

OWNER OF U.S. REG. NOS. 896,986, 3,648,244, AND OTHERS.

SEC. 2(F).

THE MARK CONSISTS OF "MILLIKEN" IN CURSIVE WRITING.

SN 85-172,351, FILED 11-9-2010.

LINDA ESTRADA, EXAMINING ATTORNEY



David J. Kyffers

Director of the United States Patent and Trademark Office

# United States of America

United States Patent and Trademark Office

## MD-7 BEAUTY CENTER

**Reg. No. 4,276,246**

LA CAVIAR USA, INC. (HAWAII CORPORATION)  
297 KINGSBURY GRADE, SUITE 100, MB 4470  
STATELINE, NV 89449

**Registered Jan. 15, 2013**

**Int. Cls.: 35 and 44**

FOR: DISTRIBUTORSHIPS IN THE FIELD OF SKIN CARE PRODUCTS; RETAIL STORE SERVICES FEATURING SKIN CARE PRODUCTS; WHOLESALE AND RETAIL STORE SERVICES AND ON-LINE RETAIL AND WHOLESALE STORE SERVICES FEATURING SKIN CARE PRODUCTS, IN CLASS 35 (U.S. CLS. 100, 101 AND 102).

**SERVICE MARK**

**PRINCIPAL REGISTER**

FIRST USE 3-1-2012; IN COMMERCE 3-1-2012.

FOR: COSMETIC FACE CARE SERVICES; COSMETIC SKIN CARE SERVICES; FACIAL TREATMENT SERVICES, NAMELY, COSMETIC PEELS; SKIN CARE SALONS, IN CLASS 44 (U.S. CLS. 100 AND 101).

FIRST USE 3-1-2012; IN COMMERCE 3-1-2012.

THE MARK CONSISTS OF STANDARD CHARACTERS WITHOUT CLAIM TO ANY PARTICULAR FONT, STYLE, SIZE, OR COLOR.

NO CLAIM IS MADE TO THE EXCLUSIVE RIGHT TO USE "BEAUTY CENTER", APART FROM THE MARK AS SHOWN.

SN 85-173,101, FILED 11-9-2010.

KATHERINE CHANG, EXAMINING ATTORNEY



*David J. Kyros*

Director of the United States Patent and Trademark Office

# United States of America

United States Patent and Trademark Office



**Reg. No. 4,276,247**

**Registered Jan. 15, 2013**

**Int. Cl.: 37**

**SERVICE MARK**

**PRINCIPAL REGISTER**

G. LOOMIS, INC. (WASHINGTON CORPORATION)  
1359 DOWN RIVER DRIVE  
WOODLAND, WA 98674

FOR: MAINTENANCE AND REPAIR OF FISHING TACKLE AND FISHING RODS AND PROVIDING REPLACEMENT PARTS AS PART OF THE MAINTENANCE AND REPAIR SERVICES, MAINTENANCE AND REPAIR OF FISHING TACKLE AND FISHING RODS, IN CLASS 37 (U.S. CLS. 100, 103 AND 106).

FIRST USE 5-1-2010; IN COMMERCE 7-1-2010.

OWNER OF U.S. REG. NOS. 2,469,517, 2,922,865, AND 3,912,090.

THE MARK CONSISTS OF THE ACE OF SPADES WITH A STYLIZED LETTER "A" IN THE UPPER LEFT AND LOWER RIGHT CORNERS, THE LETTERS "NRX" IN THE UPPER RIGHT AND LOWER LEFT CORNERS, A SKELETON FISH DESIGN AND THE NUMBER "187" DISPOSED WITHIN A LARGE STYLIZED SPADE IN THE CENTER OF THE CARD, AND A SMALLER STYLIZED SPADE WITH THE SKELETON FISH DESIGN DISPOSED BELOW THE STYLIZED LETTER "A" IN THE UPPER LEFT AND LOWER RIGHT CORNERS.

SN 85-174,996, FILED 11-11-2010.

ERIN FALK, EXAMINING ATTORNEY



*David J. Kybas*

Director of the United States Patent and Trademark Office

# United States of America

United States Patent and Trademark Office

# FOES-BOOK

**Reg. No. 4,276,248**

PIRINCCI, JAY (UNITED STATES INDIVIDUAL)  
301 174 ST. APT. 914

**Registered Jan. 15, 2013**

SUNNY ISLES BEACH, FL 33160

**Int. Cls.: 35 and 41**

FOR: PROVIDING A WEBSITE FEATURING THE GOODS AND SERVICES OF OTHER VENDORS; PROVIDING A WEB SITE WHICH FEATURES ADVERTISEMENTS FOR THE GOODS AND SERVICES OF OTHERS ON A GLOBAL COMPUTER NETWORK; PROMOTING THE GOODS AND SERVICES OF OTHERS VIA A GLOBAL COMPUTER NETWORK; PROVIDING A WEB SITE WHERE USERS CAN POST RATINGS, REVIEWS AND RECOMMENDATIONS ON PRODUCTS AND SERVICES FOR COMMERCIAL PURPOSES; PROVIDING A WEBSITE THAT DISPLAYS REVIEWS, RECOMMENDATIONS AND INFORMATION RELATING TO PRODUCTS, SERVICES, AND EVENTS IN THE FIELD OF BUSINESS FOR COMMERCIAL PURPOSES; PROVIDING A WEBSITE FEATURING INFORMATION RELATING TO GOVERNMENT AFFAIRS, IN CLASS 35 (U.S. CLS. 100, 101 AND 102).

**SERVICE MARK**

**PRINCIPAL REGISTER**

FIRST USE 1-1-2005; IN COMMERCE 3-1-2006.

FOR: PROVIDING A WEBSITE THAT DISPLAYS REVIEWS, RECOMMENDATIONS AND INFORMATION RELATING TO PRODUCTS, SERVICES, AND EVENTS IN THE FIELDS OF POP CULTURE, ENTERTAINMENT, EDUCATION, AND SPORTS, ALL EXCLUSIVELY FOR NON-BUSINESS AND NON-COMMERCIAL TRANSACTIONS AND PURPOSES, IN CLASS 41 (U.S. CLS. 100, 101 AND 107).

FIRST USE 1-1-2005; IN COMMERCE 3-1-2006.

THE MARK CONSISTS OF STANDARD CHARACTERS WITHOUT CLAIM TO ANY PARTICULAR FONT, STYLE, SIZE, OR COLOR.

SN 85-176,062, FILED 11-12-2010.

WENDY JUN, EXAMINING ATTORNEY



*David J. Kyros*

Director of the United States Patent and Trademark Office

# United States of America

United States Patent and Trademark Office

## BUILDING THE FUTURE OF LIFE SCIENCE

**Reg. No. 4,276,249**

**Registered Jan. 15, 2013**

**Int. Cls.: 35, 36, 37, and  
42**

**SERVICE MARK**

**PRINCIPAL REGISTER**

ALEXANDRIA REAL ESTATE EQUITIES, INC. (MARYLAND CORPORATION)  
385 E. COLORADO BLVD., SUITE 299  
PASADENA, CA 91101

FOR: BUSINESS ADMINISTRATION AND MANAGEMENT; BUSINESS MANAGEMENT CONSULTING; BUSINESS INCUBATOR SERVICES, NAMELY, BUSINESS MARKETING, BUSINESS MANAGEMENT, AND BUSINESS DEVELOPMENT SERVICES IN THE FORM OF START-UP SUPPORT FOR BUSINESSES OF OTHERS; BUSINESS NETWORKING SERVICES; BUSINESS COMMUNICATIONS SERVICES, NAMELY, PUBLIC RELATIONS, ADVERTISING, MARKETING AND PUBLICITY SERVICES; RENTAL AND LEASING OF OFFICE MACHINERY AND EQUIPMENT, IN CLASS 35 (U.S. CLS. 100, 101 AND 102).

FIRST USE 5-0-2012; IN COMMERCE 5-0-2012.

FOR: REAL ESTATE MANAGEMENT; FINANCIAL SERVICES, NAMELY, FINANCIAL CONSULTATION, FINANCIAL ANALYSIS, FINANCIAL PLANNING, FINANCIAL MANAGEMENT, FINANCING SERVICES, PROVIDING WORKING CAPITAL, NAMELY, DEBT AND EQUITY CAPITAL, TANGIBLE AND INTANGIBLE ASSET FINANCING, AND FINANCIAL PORTFOLIO MANAGEMENT; BUSINESS INCUBATOR SERVICES, NAMELY, PROVIDING DEBT AND EQUITY FINANCING TO EMERGING AND START-UP COMPANIES, IN CLASS 36 (U.S. CLS. 100, 101 AND 102).

FIRST USE 5-0-2012; IN COMMERCE 5-0-2012.

FOR: REAL ESTATE DEVELOPMENT; BUILDING CONSTRUCTION AND REPAIR; MAINTENANCE AND REPAIR OF BUILDINGS, ELECTRICAL SYSTEMS, HEATING AND AIR CONDITIONING SYSTEMS AND PLUMBING SYSTEMS, IN CLASS 37 (U.S. CLS. 100, 103 AND 106).

FIRST USE 5-0-2012; IN COMMERCE 5-0-2012.

FOR: ARCHITECTURAL DESIGN SERVICES; ENGINEERING SERVICES; RENTAL AND LEASING OF COMPUTERS, IN CLASS 42 (U.S. CLS. 100 AND 101).

FIRST USE 5-0-2012; IN COMMERCE 5-0-2012.



*David J. Kyffers*

Director of the United States Patent and Trademark Office

**Reg. No. 4,276,249** THE MARK CONSISTS OF STANDARD CHARACTERS WITHOUT CLAIM TO ANY PARTICULAR FONT, STYLE, SIZE, OR COLOR.

SN 85-176,656, FILED 11-15-2010.

RONALD DELGIZZI, EXAMINING ATTORNEY

# United States of America

United States Patent and Trademark Office



**Reg. No. 4,276,250**

**Registered Jan. 15, 2013**

**Int. Cl.: 30**

**TRADEMARK**

**PRINCIPAL REGISTER**

SUNKIST GROWERS, INC. (CALIFORNIA CORPORATION)  
14130 RIVERSIDE DRIVE  
SHERMAN OAKS, CA 91423

FOR: ICE CREAM; SORBET, IN CLASS 30 (U.S. CL. 46).

FIRST USE 10-17-2011; IN COMMERCE 10-17-2011.

OWNER OF U.S. REG. NOS. 301,278, 3,690,581, AND OTHERS.

SN 85-176,743, FILED 11-15-2010.

REBECCA POVARCHUK, EXAMINING ATTORNEY



*David J. Kyffers*

Director of the United States Patent and Trademark Office



# United States of America

United States Patent and Trademark Office

## JOSEPH HENRY WINE

**Reg. No. 4,276,251**

**Registered Jan. 15, 2013**

**Int. Cl.: 33**

NORTH COAST VINEYARD SERVICES INC. (CALIFORNIA CORPORATION)  
SUITE 110  
26853 MOUNTAIN PINE RD.  
CLOVERDALE, CA 95425

FOR: WINE, IN CLASS 33 (U.S. CLS. 47 AND 49).

**TRADEMARK**

FIRST USE 10-12-2012; IN COMMERCE 10-12-2012.

**PRINCIPAL REGISTER**

THE MARK CONSISTS OF STANDARD CHARACTERS WITHOUT CLAIM TO ANY PARTICULAR FONT, STYLE, SIZE, OR COLOR.

NO CLAIM IS MADE TO THE EXCLUSIVE RIGHT TO USE "WINE", APART FROM THE MARK AS SHOWN.

THE NAME(S), PORTRAIT(S), AND/OR SIGNATURE(S) SHOWN IN THE MARK DOES NOT IDENTIFY A PARTICULAR LIVING INDIVIDUAL.

SN 85-177,074, FILED 11-15-2010.

REBECCA EISINGER, EXAMINING ATTORNEY



*David J. Kybas*

Director of the United States Patent and Trademark Office

# United States of America

United States Patent and Trademark Office

# FLEXSLEEVE

**Reg. No. 4,276,252**

GRAPHIC PACKAGING INTERNATIONAL, INC. (DELAWARE CORPORATION)  
814 LIVINGSTON COURT  
ATLANTA, GA 30067

**Registered Jan. 15, 2013**

**Int. Cl.: 7**

FOR: WRAPPING AND PACKAGING MACHINERY, IN CLASS 7 (U.S. CLS. 13, 19, 21, 23, 31, 34 AND 35).

**TRADEMARK**

FIRST USE 10-31-2010; IN COMMERCE 10-31-2012.

**PRINCIPAL REGISTER**

THE MARK CONSISTS OF STANDARD CHARACTERS WITHOUT CLAIM TO ANY PARTICULAR FONT, STYLE, SIZE, OR COLOR.

SN 85-177,955, FILED 11-16-2010.

MARGARET POWER, EXAMINING ATTORNEY



*David J. Kybas*

Director of the United States Patent and Trademark Office

# United States of America

United States Patent and Trademark Office

YOUR HEART. GOD'S LOVE.

**Reg. No. 4,276,253**

**Registered Jan. 15, 2013**

**Int. Cl.: 45**

**SERVICE MARK**

**PRINCIPAL REGISTER**

DAYSPRING CARDS, INC. (ILLINOIS CORPORATION)  
P.O. BOX 1010  
21154 HIGHWAY 16 EAST  
SILOAM SPRINGS, AR 72761

FOR: PROVIDING A SELECTION OF ON-LINE ELECTRONIC GREETING CARDS, IN CLASS 45 (U.S. CLS. 100 AND 101).

FIRST USE 11-30-2010; IN COMMERCE 11-30-2010.

THE MARK CONSISTS OF STANDARD CHARACTERS WITHOUT CLAIM TO ANY PARTICULAR FONT, STYLE, SIZE, OR COLOR.

SN 85-178,113, FILED 11-16-2010.

DANNEAN HETZEL, EXAMINING ATTORNEY



*David J. Kyffers*

Director of the United States Patent and Trademark Office

# United States of America

United States Patent and Trademark Office



**Reg. No. 4,276,254**

INFASTECH DECORAH LLC (DELAWARE LIMITED LIABILITY COMPANY)  
1301 KERR DRIVE  
DECORAH, IA 52101

**Registered Jan. 15, 2013**

**Int. Cls.: 6, 7, 8, 12, and 42**

FOR: METAL FASTENERS AND METAL COMPOSITE FASTENERS, NAMELY, SCREWS, NUTS, BOLTS AND RIVETS; ANCHORS; MASONRY ANCHORS; METAL THREADED FASTENERS; METAL SELF-DRILLING FASTENERS; METAL SELF-TAPPING FASTENERS; METAL THREAD FORMING FASTENERS; METAL THREAD-ROLLING FASTENERS; METAL DRILL SCREWS; METAL HARDWARE, NAMELY, WASHERS; METAL SOCKET SCREWS; PIERCE AND CLINCH FASTENERS MADE OF METAL; METAL CLINCH NUTS; METAL CLINCH STUDS; METAL SLEEVE AND BOLT ASSEMBLY FASTENERS; METAL EXPLOSION VENTING FASTENERS; METAL THREADED FASTENERS FOR USE IN ELECTRONICS PRODUCTS; METAL FASTENERS FOR USE IN THE CONSTRUCTION INDUSTRY, NAMELY, SCREWS, SELF-DRILLING SCREWS, THREAD FORMING SCREWS, THREADED ROD ANCHORS, MASONRY ANCHORS, MASONRY SCREWS; METAL MECHANICAL FASTENING AND INSTALLATION PRODUCTS, NAMELY, SCREWS, NUTS, BOLTS, AND RIVETS; METAL RIVET-TYPE BLIND FASTENERS; THREADED FASTENER INSERTS MADE OF METAL; COLD-HEADED AND COLD-FORMED METAL SPECIALTIES, NAMELY, SCREWS, BOLTS, RIVETS, PINS; METAL PINS FOR INDUSTRIAL AND ELECTRICAL APPLICATIONS; METAL DOWEL PINS; METAL THREADED FASTENERS FOR MAGNESIUM PRODUCTS; METAL THREADED INSERTS FOR USE WITH MAGNESIUM PRODUCTS; SELF-SEALING METAL THREADED PLUGS; METAL THREADED FASTENERS FOR USE WITH PLASTICS AND COMPOSITE MATERIALS; METAL THREADED FASTENERS WITH A CORROSION RESISTANT COATING; METAL THREADED FASTENERS WITH A PERFORMANCE COATING; METAL FASTENER SYSTEMS COMPRISING SCREWS AND WASHERS SOLD TOGETHER AS A UNIT; ENGINEERED MECHANICAL FASTENERS AND COMPONENTS IN THE NATURE OF METAL THREADED FASTENER, RIVETS AND BLIND FASTENERS, IN CLASS 6 (U.S. CLS. 2, 12, 13, 14, 23, 25 AND 50).

**TRADEMARK**

**SERVICE MARK**

**PRINCIPAL REGISTER**



FIRST USE 10-1-2010; IN COMMERCE 10-1-2010.

*David J. Kybas*

Director of the United States Patent and Trademark Office

FOR: POWER TOOLS, NAMELY, POWER SCREW DRIVERS AND POWER DRILLS; AUTOMATED AND SEMI-AUTOMATED TOOLS, NAMELY, POWER SCREW DRIVERS, POWER DRILLS, RIVET SETTING TOOLS; POWER-OPERATED INSTALLATION SYSTEMS FOR THREADED FASTENERS AND RIVETS COMPRISING MAGAZINE-FED AND BOWL-FED POWER TOOLS FOR PLACING THREADED FASTENERS AND RIVETS; MACHINE

**Reg. No. 4,276,254** TOOLS FOR RIVETING METAL AND PLASTICS; POWER-OPERATED RIVET GUNS; AIR-POWERED TOOLS, NAMELY, RIVET HAMMERS; POWER-OPERATED SCREW DRIVER BITS; POWER-OPERATED BLIND FASTENING SYSTEMS COMPRISING ELECTRICALLY-POWERED TOOLS FOR PLACING BLIND FASTENERS AND AIR-POWERED TOOLS FOR PLACING BLIND FASTENERS; POWER-OPERATED THREADED FASTENING SYSTEMS COMPRISING AUTOMATED AND SEMI-AUTOMATED POWER TOOLS FOR PLACING THREADED FASTENERS; POWER-OPERATED HIGH SPEED RIVET FASTENING SYSTEMS COMPRISING HIGH SPEED RIVET SETTING TOOLS, IN CLASS 7 (U.S. CLS. 13, 19, 21, 23, 31, 34 AND 35).

FIRST USE 10-1-2010; IN COMMERCE 10-1-2010.

FOR: HAND TOOLS FOR DRIVING FASTENERS, NAMELY, SCREW DRIVERS AND DRILLS; HAND-OPERATED TOOLS FOR RIVETING METAL AND PLASTICS; HAND-OPERATED RIVETING TOOLS, IN CLASS 8 (U.S. CLS. 23, 28 AND 44).

FIRST USE 10-1-2010; IN COMMERCE 10-1-2010.

FOR: FASTENERS SPECIALLY ADAPTED FOR USE IN AUTOMOBILES AND AUTOMOTIVE PARTS AND COMPONENTS, NAMELY, THREADED FASTENERS, SELF-DRILLING FASTENERS AND SELF-TAPING FASTENERS FOR USE IN INTERCONNECTING ENGINE COMPONENTS, TO MOUNT ENGINES TO FRAMES, TO ATTACH TRIM TO AUTOMOBILES; FASTENERS SPECIALLY ADAPTED FOR USE IN MOTORCYCLES AND MOTORCYCLE PARTS, NAMELY, SPOKE NUTS FOR CONNECTING WHEEL SPOKES TO RIMS, IN CLASS 12 (U.S. CLS. 19, 21, 23, 31, 35 AND 44).

FIRST USE 10-1-2010; IN COMMERCE 10-1-2010.

FOR: ENGINEERING SERVICES; CUSTOM DESIGN AND ENGINEERING OF FASTENERS, THREADED FASTENERS, RIVETS AND FASTENING SYSTEMS; DESIGN SERVICES FOR FASTENERS, THREADED FASTENERS, RIVETS, AND FASTENING SYSTEMS; DESIGN SERVICES FOR FASTENERS FOR CONSTRUCTION USE, IN CLASS 42 (U.S. CLS. 100 AND 101).

FIRST USE 10-1-2010; IN COMMERCE 10-1-2010.

THE MARK CONSISTS OF THE WORD "INFASTECH" WITH A CIRCLE DOTTING THE LETTER "I", WITH A ROUND, STYLIZED FASTENER DESIGN CENTERED ON THE DOT OF THE LETTER "I".

THE COLOR(S) GREEN, BLUE, RED, AND BLACK IS/ARE CLAIMED AS A FEATURE OF THE MARK.

SN 85-178,187, FILED 11-16-2010.

LAURA KOVALSKY, EXAMINING ATTORNEY

# United States of America

United States Patent and Trademark Office

## PLANTS VS. ZOMBIES

**Reg. No. 4,276,255**

ELECTRONIC ARTS INC. (DELAWARE CORPORATION)  
209 REDWOOD SHORES PARKWAY  
REDWOOD CITY, CA 94065

**Registered Jan. 15, 2013**

**Int. Cls.: 9, 16, 28, and  
41**

FOR: INTERACTIVE GAME SOFTWARE; COMPUTER GAME SOFTWARE; VIDEO GAME PROGRAMS AND CARTRIDGES; ELECTRONIC GAME PROGRAMS; GAME SOFTWARE FOR USE ON ANY COMPUTERIZED PLATFORM, INCLUDING GAME CONSOLES, GAME TERMINALS, HAND-HELD ELECTRONIC DEVICES, ELECTRONIC ENTERTAINMENT DEVICES, TELECOMMUNICATIONS DEVICES, MOBILE PHONES, AND ELECTRONIC COMMUNICATION DEVICES; DOWNLOADABLE INTERACTIVE, COMPUTER, VIDEO AND ELECTRONIC GAME PROGRAMS, IN CLASS 9 (U.S. CLS. 21, 23, 26, 36 AND 38).

**TRADEMARK**

**SERVICE MARK**

**PRINCIPAL REGISTER**

FIRST USE 5-31-2009; IN COMMERCE 5-31-2009.

FOR: TRADING CARDS, IN CLASS 16 (U.S. CLS. 2, 5, 22, 23, 29, 37, 38 AND 50).

FIRST USE 10-25-2012; IN COMMERCE 10-25-2012.

FOR: DISPOSABLE TICKET SETS FOR PLAYING GAMES OF CHANCE; SCRATCH CARDS FOR PLAYING LOTTERY GAMES; CARD GAMES; TOY FIGURES; STUFFED AND PLUSH TOYS; FANTASY CHARACTER TOYS; TRADING CARD GAMES, IN CLASS 28 (U.S. CLS. 22, 23, 38 AND 50).

FIRST USE 10-31-2011; IN COMMERCE 10-31-2011.

FOR: ENTERTAINMENT SERVICES, NAMELY, PROVIDING GAMES OF CHANCE VIA THE INTERNET, IN CLASS 41 (U.S. CLS. 100, 101 AND 107).

FIRST USE 9-30-2012; IN COMMERCE 9-30-2012.

THE MARK CONSISTS OF STANDARD CHARACTERS WITHOUT CLAIM TO ANY PARTICULAR FONT, STYLE, SIZE, OR COLOR.

OWNER OF U.S. REG. NO. 3,851,667.

SN 85-178,427, FILED 11-16-2010.



*David J. Kyffers*

Director of the United States Patent and Trademark Office

**Reg. No. 4,276,255** JEFF DEFORD, EXAMINING ATTORNEY

# United States of America

United States Patent and Trademark Office

GO  
ON

**Reg. No. 4,276,256**

**Registered Jan. 15, 2013**

**Int. Cl.: 8**

**TRADEMARK**

**PRINCIPAL REGISTER**

TRADEMARK TOOLS INC. (CANADA CORPORATION)  
21 STAFFERN DRIVE  
CONCORD, ONTARIO, CANADA L4K2X2

FOR: HAND TOOLS, NAMELY, HAMMERS, MULTI-FUNCTION TOOLS COMPRISED OF SCREWDRIVERS, IN CLASS 8 (U.S. CLS. 23, 28 AND 44).

FIRST USE 3-1-2011; IN COMMERCE 10-1-2011.

THE MARK CONSISTS OF THE WORD "GO" IN HOLLOW BLOCK LETTERS DIRECTLY ABOVE THE WORD "ON" IN SOLID BLOCK LETTERS.

SN 85-178,678, FILED 11-17-2010.

ZACHARY BELLO, EXAMINING ATTORNEY



*David J. Kyffers*

Director of the United States Patent and Trademark Office



# United States of America

United States Patent and Trademark Office

## RECLAIM YOUR VISION

**Reg. No. 4,276,257**

NOVARTIS AG (SWITZERLAND CORPORATION)  
CH-4002

**Registered Jan. 15, 2013**

BASEL, SWITZERLAND

**Int. Cl.: 44**

FOR: PROVIDING MEDICAL INFORMATION IN THE FIELD OF OPHTHALMOLOGY, IN CLASS 44 (U.S. CLS. 100 AND 101).

**SERVICE MARK**

FIRST USE 12-31-2010; IN COMMERCE 12-31-2010.

**PRINCIPAL REGISTER**

THE MARK CONSISTS OF STANDARD CHARACTERS WITHOUT CLAIM TO ANY PARTICULAR FONT, STYLE, SIZE, OR COLOR.

SN 85-179,177, FILED 11-17-2010.

JAMES LOVELACE, EXAMINING ATTORNEY



*David J. Kybas*

Director of the United States Patent and Trademark Office

# United States of America

United States Patent and Trademark Office

# TRUMP

**Reg. No. 4,276,258**

DONALD J. TRUMP (UNITED STATES INDIVIDUAL)  
725 FIFTH AVENUE  
NEW YORK, NY 10022

**Registered Jan. 15, 2013**

**Int. Cls.: 16, 19, and 21**

FOR: DESK ACCESSORIES, NAMELY, DESK PADS, PAPER WEIGHTS, BUSINESS CARD HOLDERS, IN CLASS 16 (U.S. CLS. 2, 5, 22, 23, 29, 37, 38 AND 50).

**TRADEMARK**

FIRST USE 2-17-2010; IN COMMERCE 2-17-2010.

**PRINCIPAL REGISTER**

FOR: WOOD FLOORING AND FLOOR TILES, WOOD MOLDINGS, WOOD PANELING, WOOD SIDING, WALL PANELS AND DOORS NOT OF METAL, IN CLASS 19 (U.S. CLS. 1, 12, 33 AND 50).

FIRST USE 10-25-2012; IN COMMERCE 10-25-2012.

FOR: GLASSES, CUPS, BOWLS, DECANTERS; BEVERAGE GLASSWARE, IN CLASS 21 (U.S. CLS. 2, 13, 23, 29, 30, 33, 40 AND 50).

FIRST USE 10-14-2010; IN COMMERCE 10-14-2010.

THE MARK CONSISTS OF STANDARD CHARACTERS WITHOUT CLAIM TO ANY PARTICULAR FONT, STYLE, SIZE, OR COLOR.

OWNER OF U.S. REG. NOS. 3,655,340, 3,712,766, AND OTHERS.

SN 85-179,714, FILED 11-18-2010.

HOWARD B. LEVINE, EXAMINING ATTORNEY



*David J. Kybas*

Director of the United States Patent and Trademark Office

# United States of America

## United States Patent and Trademark Office



**Reg. No. 4,276,259**

DONALD J. TRUMP (UNITED STATES INDIVIDUAL)  
725 FIFTH AVENUE  
NEW YORK, NY 10022

**Registered Jan. 15, 2013**

**Int. Cls.: 16, 19, and 21**

FOR: DESK ACCESSORIES, NAMELY, DESK PADS, PAPER WEIGHTS, BUSINESS CARD HOLDERS, IN CLASS 16 (U.S. CLS. 2, 5, 22, 23, 29, 37, 38 AND 50).

**TRADEMARK**

FIRST USE 2-17-2010; IN COMMERCE 2-17-2010.

**PRINCIPAL REGISTER**

FOR: WOOD FLOORING AND FLOOR TILES, WOOD MOLDINGS, WOOD PANELING, WOOD SIDING, WALL PANELS AND DOORS NOT OF METAL, IN CLASS 19 (U.S. CLS. 1, 12, 33 AND 50).

FIRST USE 10-25-2012; IN COMMERCE 10-25-2012.

FOR: GLASSES, CUPS, BOWLS, DECANTERS; BEVERAGE GLASSWARE, IN CLASS 21 (U.S. CLS. 2, 13, 23, 29, 30, 33, 40 AND 50).

FIRST USE 10-14-2010; IN COMMERCE 10-14-2010.

OWNER OF U.S. REG. NOS. 3,392,370, 3,712,766, AND OTHERS.



THE MARK CONSISTS OF A HERALDIC COAT OF ARMS CONSISTING OF A SHIELD OR CREST AND OTHER DESIGNS. A SHIELD APPEARS IN THE CENTER OF THE DESIGN. THE SHIELD CONTAINS THREE LIONS, TWO CHEVRONS MADE OF REPEATING RECTANGLES, AND MANY SMALL ORBS WITH CROSSES. THE SHIELD IS TOPPED BY A KNIGHT'S HELMET. ABOVE THE HELMET, AN EXTENDED ARM RAISES A SPEAR. AN ORGANIC LEAF OR MANTLING DESIGN STARTS FROM THE HELMET AND FALLS TO FRAME THE SHIELD. BELOW THE SHIELD, THERE IS A BANNER CARRYING THE NAME "TRUMP".

SN 85-179,727, FILED 11-18-2010.

*David J. Kappas*

HOWARD B. LEVINE, EXAMINING ATTORNEY

# United States of America

United States Patent and Trademark Office

## FLIP IT TIP IT SIP IT

**Reg. No. 4,276,260**

**Registered Jan. 15, 2013**

**Int. Cl.: 32**

**TRADEMARK**

**PRINCIPAL REGISTER**

KRAFT FOODS GROUP BRANDS LLC (DELAWARE LIMITED LIABILITY COMPANY)  
THREE LAKES DRIVE  
NORTHFIELD, IL 60093

FOR: PREPARATIONS FOR MAKING BEVERAGES, NAMELY, FRUIT DRINKS, SOFT DRINKS, TEA-FLAVORED DRINKS, FLAVORED WATERS, SPORTS DRINKS AND ENERGY DRINKS , IN CLASS 32 (U.S. CLS. 45, 46 AND 48).

FIRST USE 8-31-2011; IN COMMERCE 8-31-2011.

THE MARK CONSISTS OF STANDARD CHARACTERS WITHOUT CLAIM TO ANY PARTICULAR FONT, STYLE, SIZE, OR COLOR.

SN 85-180,296, FILED 11-18-2010.

RONALD MCMORROW, EXAMINING ATTORNEY



*David J. Kyjars*

Director of the United States Patent and Trademark Office

# United States of America

United States Patent and Trademark Office

# F CUBED

**Reg. No. 4,276,261**

**Registered Jan. 15, 2013**

**Int. Cl.: 10**

**TRADEMARK**

**PRINCIPAL REGISTER**

F CUBED, LLC (ILLINOIS LIMITED LIABILITY COMPANY)  
278 JOSHUA DRIVE  
HAWTHORNE WOODS, IL 60047

FOR: PORTABLE DEVICE FOR RAPID AND DIRECT PROCESSING, DETECTION, ANALYSIS, AND IDENTIFICATION OF GENETIC MATERIALS AND PROTEIN IN TISSUE, BLOOD, SALIVA AND URINE SAMPLES FOR MEDICAL DIAGNOSTIC USE, AND SOFTWARE SOLD THEREWITH AS A UNIT, IN CLASS 10 (U.S. CLS. 26, 39 AND 44).

FIRST USE 5-1-2011; IN COMMERCE 9-27-2012.

THE MARK CONSISTS OF STANDARD CHARACTERS WITHOUT CLAIM TO ANY PARTICULAR FONT, STYLE, SIZE, OR COLOR.

SN 85-182,587, FILED 11-22-2010.

KELLEY WELLS, EXAMINING ATTORNEY



*David J. Kyffers*

Director of the United States Patent and Trademark Office

# United States of America

United States Patent and Trademark Office



**Reg. No. 4,276,262**

**Registered Jan. 15, 2013**

**Int. Cl.: 35**

**SERVICE MARK**

**PRINCIPAL REGISTER**

WORLD INTERNSHIPS INC. (FLORIDA CORPORATION)  
WORLD INTERNSHIPS  
324 EAST OAK STREET  
FORT COLLINS, CO 80524

FOR: INTERNSHIP PLACEMENT SERVICES, IN CLASS 35 (U.S. CLS. 100, 101 AND 102).

FIRST USE 2-2-2010; IN COMMERCE 3-15-2010.

NO CLAIM IS MADE TO THE EXCLUSIVE RIGHT TO USE "WORLD INTERNSHIPS", APART FROM THE MARK AS SHOWN.

THE COLOR(S) PURPLE, YELLOW, GREEN, WHITE IS/ARE CLAIMED AS A FEATURE OF THE MARK.

THE MARK CONSISTS OF A RING WITH A STYLIZED WEAVE OF THE COLORS GREEN, YELLOW AND PURPLE. THE WEAVE OF COLORS CONSISTS OF TWO YELLOW BANDS AT THE TOP AND BOTTOM OF THE CIRCLE, TWO GREEN BANDS AT THE TOP LEFT AND BOTTOM RIGHT, AND TWO PURPLE BANDS, AT THE BOTTOM LEFT AND TOP RIGHT OF THE CIRCLE. A THIN WHITE SPACE SEPARATES EACH OF THE BANDS. THE TOP OF THE RING IS YELLOW AND AS YOU MOVE CLOCKWISE ALONG THE RING. THE THICKNESS OF THE RING IS ROUGHLY FIFTEEN PERCENT OF THE DIAMETER OF THE ENTIRE RING. INSIDE THE RING IS A BLUE CIRCLE. THERE IS A SPACE BETWEEN THE BLUE CIRCLE AND THE RING THAT ARE ROUGHLY EQUAL TO THE THICKNESS OF THE RING, IN WHITE. INSIDE THE BLUE CIRCLE IS A LETTER "W" AND A LETTER "I". BOTH LETTERS ARE IN WHITE TEXT. AT A DISTANCE ROUGHLY TWICE THE WIDTH OF THE RING, TO THE RIGHT OF THE RING ARE THE WORDS "WORLD INTERNSHIPS". THE TWO WORDS ARE ON TOP OF EACH OTHER AND TOGETHER SPAN THE ROUGHLY NINETY PERCENT OF THE HEIGHT OF THE RING. THE WORD "WORLD" IS IN BLACK FONT AND IS ON TOP OF "WORD INTERNSHIPS", WHICH IS ALSO IN BLACK FONT. UNDERNEATH THE WORD "INTERNSHIPS" IS THE PHRASE "A WORLD OF EXPERIENCE". THESE WORDS ARE WRITTEN IN GREY FONT HORIZONTALLY UNDERNEATH THE WORD "INTERNSHIPS". THE FONT SIZE OF THE GREY WORDS IS ROUGHLY FORTY PERCENT OF THE SIZE OF THE WORDS "WORLD" AND "INTERNSHIPS". UNDERNEATH THE RING IS A SLIGHT GREY SHADOW THAT IS THE SAME COLOR AND IS AT THE SAME HEIGHT AS THE BOTTOM OF THE GREY WORDS "A WORLD OF EXPERIENCE".



*David J. Kybas*

Director of the United States Patent and Trademark Office

**Reg. No. 4,276,262** SN 85-182,944, FILED 11-22-2010.

DAVID HOFFMAN, EXAMINING ATTORNEY

# United States of America

United States Patent and Trademark Office



**Reg. No. 4,276,263**

AVATAR PROPERTIES INC. (FLORIDA CORPORATION)  
201 ALHAMBRA CIRCLE, 12TH FLOOR  
CORAL GABLES, FL 33134

**Registered Jan. 15, 2013**

**Int. Cls.: 18 and 28**

FOR: GENERAL PURPOSE TOTE BAGS FOR TENNIS AND GOLF, IN CLASS 18 (U.S. CLS. 1, 2, 3, 22 AND 41).

**TRADEMARK**

FIRST USE 11-15-2012; IN COMMERCE 11-15-2012.

**PRINCIPAL REGISTER**

FOR: GOLF BALLS, TENNIS BALLS, TOTE BAGS SPECIFICALLY ADAPTED FOR GOLF AND TENNIS EQUIPMENT, IN CLASS 28 (U.S. CLS. 22, 23, 38 AND 50).

FIRST USE 11-15-2012; IN COMMERCE 11-15-2012.

OWNER OF U.S. REG. NO. 2,377,808.

THE MARK CONSISTS OF STYLIZED "V" INCLUDING A CIRCLE LOCATED ABOVE AND IN THE MIDDLE OF THE EXTENDED ARMS OF THE LETTER.

SN 85-183,177, FILED 11-23-2010.

ANDREW LEASER, EXAMINING ATTORNEY



*David J. Kybas*

Director of the United States Patent and Trademark Office



United States of America  
United States Patent and Trademark Office

GLOSTIK

**Reg. No. 4,276,264**

AP&G CO., INC. (NEW YORK CORPORATION)  
170 53RD STREET  
BROOKLYN, NY 11232

**Registered Jan. 15, 2013**

**Int. Cl.: 21**

FOR: INSECT TRAP, IN CLASS 21 (U.S. CLS. 2, 13, 23, 29, 30, 33, 40 AND 50).

**TRADEMARK**

FIRST USE 3-15-2012; IN COMMERCE 3-15-2012.

**PRINCIPAL REGISTER**

THE MARK CONSISTS OF STANDARD CHARACTERS WITHOUT CLAIM TO ANY PARTICULAR FONT, STYLE, SIZE, OR COLOR.

SN 85-184,382, FILED 11-24-2010.

CHRISTINA SOBRAL, EXAMINING ATTORNEY



*David J. Kyffers*

Director of the United States Patent and Trademark Office

# United States of America

United States Patent and Trademark Office

# MT

**Reg. No. 4,276,265**

GUSTAV MAGENWIRTH GMBH & CO. KG (FED REP GERMANY GMBH & CO. KG)  
STUTTGARTER STR. 48  
72574 BAD URACH, FED REP GERMANY

**Registered Jan. 15, 2013**

**Int. Cl.: 12**

FOR: BICYCLE DISC BRAKES AND STRUCTURAL PARTS THEREOF, IN CLASS 12 (U.S. CLS. 19, 21, 23, 31, 35 AND 44).

**TRADEMARK**

FIRST USE 12-31-2011; IN COMMERCE 12-31-2011.

**PRINCIPAL REGISTER**

THE MARK CONSISTS OF STANDARD CHARACTERS WITHOUT CLAIM TO ANY PARTICULAR FONT, STYLE, SIZE, OR COLOR.

PRIORITY CLAIMED UNDER SEC. 44(D) ON FED REP GERMANY APPLICATION NO. 302010032619, FILED 5-29-2010, REG. NO. 302010032619, DATED 7-14-2010, EXPIRES 5-29-2020.

SN 85-185,485, FILED 11-26-2010.

KRISTINA MORRIS, EXAMINING ATTORNEY



*David J. Kybas*

Director of the United States Patent and Trademark Office

# United States of America

United States Patent and Trademark Office

# GUAVALIFE

**Reg. No. 4,276,266**

AMERILAB TECHNOLOGIES, INC. (MINNESOTA CORPORATION)  
2765 NIAGARA LANE NORTH  
PLYMOUTH, MN 55447

**Registered Jan. 15, 2013**

**Int. Cl.: 5**

FOR: NUTRITIONAL SUPPLEMENT CONTAINING GUAVA IN EFFERVESCENT AND TABLET FORM USED TO BOOST THE IMMUNE SYSTEM AND PROVIDE HIGH ANTIOXIDANTS, IN CLASS 5 (U.S. CLS. 6, 18, 44, 46, 51 AND 52).

**TRADEMARK**

FIRST USE 11-5-2012; IN COMMERCE 11-5-2012.

**PRINCIPAL REGISTER**

THE MARK CONSISTS OF STANDARD CHARACTERS WITHOUT CLAIM TO ANY PARTICULAR FONT, STYLE, SIZE, OR COLOR.

OWNER OF U.S. REG. NO. 3,799,333.

SN 85-185,631, FILED 11-27-2010.

EDWARD NELSON, EXAMINING ATTORNEY



*David J. Kyffers*

Director of the United States Patent and Trademark Office

# United States of America

United States Patent and Trademark Office

# UNIGLIDE

**Reg. No. 4,276,267**

COOK INCORPORATED (INDIANA CORPORATION)  
750 DANIELS WAY  
BLOOMINGTON, IN 47402

**Registered Jan. 15, 2013**

**Int. Cl.: 10**

FOR: MEDICAL DEVICE, NAMELY, A HYDROPHILIC WIRE GUIDE, IN CLASS 10 (U.S. CLS. 26, 39 AND 44).

**TRADEMARK**

FIRST USE 9-1-2012; IN COMMERCE 9-1-2012.

**PRINCIPAL REGISTER**

THE MARK CONSISTS OF STANDARD CHARACTERS WITHOUT CLAIM TO ANY PARTICULAR FONT, STYLE, SIZE, OR COLOR.

SN 85-185,876, FILED 11-29-2010.

PATRICIA EVANKO, EXAMINING ATTORNEY



*David J. Kybas*

Director of the United States Patent and Trademark Office

# United States of America

United States Patent and Trademark Office

# PRIMAL

**Reg. No. 4,276,268**

**Registered Jan. 15, 2013**

**Int. Cl.: 28**

**TRADEMARK**

**PRINCIPAL REGISTER**

PRIMAL VANTAGE COMPANY, INC. (NEW JERSEY CORPORATION)  
685 ROUTE 10 EAST  
RANDOLPH, NJ 07860

FOR: HUNTING TREE STANDS, IN CLASS 28 (U.S. CLS. 22, 23, 38 AND 50).

FIRST USE 5-31-2012; IN COMMERCE 5-31-2012.

THE MARK CONSISTS OF STANDARD CHARACTERS WITHOUT CLAIM TO ANY PARTICULAR FONT, STYLE, SIZE, OR COLOR.

SN 85-188,271, FILED 12-1-2010.

CHRISTINE MARTIN, EXAMINING ATTORNEY



*David J. Kybas*

Director of the United States Patent and Trademark Office

**United States of America**  
United States Patent and Trademark Office

# DUROAIR

**Reg. No. 4,276,269**

**Registered Jan. 15, 2013**

**Int. Cl.: 11**

**TRADEMARK**

**PRINCIPAL REGISTER**

DUROAIR CORP. (CANADA CORPORATION)  
SUITE 303  
43 CHURCH ST.  
ST. CATHARINES, ON, CANADA L2R1H7

FOR: AIR CLEANING UNITS; AIR FILTERING INSTALLATIONS; AIR FILTERS FOR INDUSTRIAL INSTALLATIONS; AIR FILTERS FOR DOMESTIC USE; INDUSTRIAL AIR FILTER MACHINES; INDUSTRIAL AIR PURIFIERS, IN CLASS 11 (U.S. CLS. 13, 21, 23, 31 AND 34).

FIRST USE 12-31-2011; IN COMMERCE 12-31-2011.

THE MARK CONSISTS OF STANDARD CHARACTERS WITHOUT CLAIM TO ANY PARTICULAR FONT, STYLE, SIZE, OR COLOR.

SN 85-188,913, FILED 12-2-2010.

BILL DAWE, EXAMINING ATTORNEY



*David J. Kyffers*

Director of the United States Patent and Trademark Office

United States of America  
United States Patent and Trademark Office

**Duroair**

**Reg. No. 4,276,270**

**Registered Jan. 15, 2013**

**Int. Cl.: 11**

**TRADEMARK**

**PRINCIPAL REGISTER**

DUROAIR CORP. (CANADA CORPORATION)  
SUITE 303  
43 CHURCH ST.  
ST. CATHARINES, ON, CANADA L2R1H7

FOR: AIR CLEANING UNITS; AIR FILTERING INSTALLATIONS; AIR FILTERS FOR INDUSTRIAL INSTALLATIONS; AIR FILTERS FOR DOMESTIC USE; INDUSTRIAL AIR FILTER MACHINES; INDUSTRIAL AIR PURIFIERS, IN CLASS 11 (U.S. CLS. 13, 21, 23, 31 AND 34).

FIRST USE 12-31-2011; IN COMMERCE 12-31-2011.

THE MARK CONSISTS OF THE WORD "DUROAIR" WITH THE LETTER "D" WITH TWO CURVED LINES APPEARING IN THE MIDDLE OF THE LETTER.

SN 85-188,924, FILED 12-2-2010.

BILL DAWE, EXAMINING ATTORNEY



*David J. Kybas*

Director of the United States Patent and Trademark Office

# United States of America

United States Patent and Trademark Office

## L'I' BIG HAULERS

**Reg. No. 4,276,271**

**Registered Jan. 15, 2013**

**Int. Cl.: 28**

**TRADEMARK**

**PRINCIPAL REGISTER**

BACHMANN INDUSTRIES, INC. (PENNSYLVANIA CORPORATION)  
1400 E. ERIE AVENUE  
PHILADELPHIA, PA 19124

FOR: TOY TRAINS AND TOY TRAIN SETS, IN CLASS 28 (U.S. CLS. 22, 23, 38 AND 50).

FIRST USE 10-0-2012; IN COMMERCE 10-0-2012.

THE MARK CONSISTS OF STANDARD CHARACTERS WITHOUT CLAIM TO ANY PARTICULAR FONT, STYLE, SIZE, OR COLOR.

NO CLAIM IS MADE TO THE EXCLUSIVE RIGHT TO USE "HAULERS", APART FROM THE MARK AS SHOWN.

SN 85-188,953, FILED 12-2-2010.

MARK RADEMACHER, EXAMINING ATTORNEY



*David J. Kyffers*

Director of the United States Patent and Trademark Office



# United States of America

United States Patent and Trademark Office

## HOME AGAIN HEALTH CARE

**Reg. No. 4,276,272**

HOME AGAIN HEALTH CARE, LLC (MASSACHUSETTS LIMITED LIABILITY COMPANY)  
9 ELIZABETH DRIVE  
WILMINGTON, MA 01887

**Registered Jan. 15, 2013**

**Int. Cl.: 44**

FOR: MEDICAL SERVICES, NAMELY, PROVIDING LIMITED IN-HOME PATIENT CARE SERVICES IN THE NATURE OF PERSONAL MEDICAL SERVICES FOR INDIVIDUALS INCLUDING CHECKING VITAL SIGNS, MED COMPLIANCE AND INDIVIDUAL HYGIENE, SCHEDULING DOCTOR APPOINTMENTS, PICKING UP PRESCRIPTIONS, CHECKING MEDICAL EQUIPMENT AND SUPPLIES, AND PROVIDING ON-LINE INFORMATION RELATED TO THE PERSONAL MEDICAL SERVICES, FOR INDIVIDUALS WHO HAVE BEEN DISCHARGED FROM HOSPITALIZATION OR ARE OTHERWISE IN NEED OF IN-HOME MEDICAL CARE, IN CLASS 44 (U.S. CLS. 100 AND 101).

**SERVICE MARK**

**PRINCIPAL REGISTER**

FIRST USE 1-1-2012; IN COMMERCE 1-1-2012.

THE MARK CONSISTS OF STANDARD CHARACTERS WITHOUT CLAIM TO ANY PARTICULAR FONT, STYLE, SIZE, OR COLOR.

NO CLAIM IS MADE TO THE EXCLUSIVE RIGHT TO USE "HOME" AND "HEALTH CARE", APART FROM THE MARK AS SHOWN.

SN 85-189,934, FILED 12-3-2010.

BARNEY CHARLON, EXAMINING ATTORNEY



*David J. Kyros*

Director of the United States Patent and Trademark Office

# United States of America

United States Patent and Trademark Office

## Jewish standard

**Reg. No. 4,276,273**

**Registered Jan. 15, 2013**

**Int. Cl.: 33**

**TRADEMARK**

**PRINCIPAL REGISTER**

OBSHCHESTVO S OGRANICHENNOY OTVETSTVENNOSTYU "VL ENTERPRISES" (RUSSIAN FED. CORPORATION)  
DMITROVSKOYE SH., D. 33, KORP. 5  
MOSCOW, RUSSIAN FED. 127550

FOR: VODKA, IN CLASS 33 (U.S. CLS. 47 AND 49).

FIRST USE 8-0-2012; IN COMMERCE 8-0-2012.

THE MARK CONSISTS OF STANDARD CHARACTERS WITHOUT CLAIM TO ANY PARTICULAR FONT, STYLE, SIZE, OR COLOR.

NO CLAIM IS MADE TO THE EXCLUSIVE RIGHT TO USE "JEWISH", APART FROM THE MARK AS SHOWN.

SN 85-192,387, FILED 12-7-2010.

MATTHEW MCDOWELL, EXAMINING ATTORNEY



*David J. Kybas*

Director of the United States Patent and Trademark Office

# United States of America

United States Patent and Trademark Office

# ÜBERLISS

**Reg. No. 4,276,274**

SALON COMMODITIES, INC. (ILLINOIS CORPORATION)  
1999 NORTH 15TH AVENUE  
MELROSE PARK, IL 60160

**Registered Jan. 15, 2013**

**Int. Cl.: 3**

FOR: HAIR PRODUCTS, NAMELY, MASKS, HAIR RESTORATION LOTIONS FOR HAIR FIBER EXPANSION; HAIR RESTORATION LOTIONS FOR STRENGTHENING HAIR FIBER RESTRUCTURE, IN CLASS 3 (U.S. CLS. 1, 4, 6, 50, 51 AND 52).

**TRADEMARK**

FIRST USE 6-1-2012; IN COMMERCE 6-1-2012.

**PRINCIPAL REGISTER**

THE MARK CONSISTS OF STANDARD CHARACTERS WITHOUT CLAIM TO ANY PARTICULAR FONT, STYLE, SIZE, OR COLOR.

SN 85-192,997, FILED 12-8-2010.

SAIMA MAKHDOOM, EXAMINING ATTORNEY



*David J. Kyros*

Director of the United States Patent and Trademark Office

# United States of America

United States Patent and Trademark Office



**Reg. No. 4,276,275**

**Registered Jan. 15, 2013**

**Int. Cl.: 9**

**TRADEMARK**

**PRINCIPAL REGISTER**

YE, JIANFEI (CHINA INDIVIDUAL)  
SUITE 8-2-201, WU HUA XIAO QU  
WEN YI XI ROAD  
HANGZHOU, CHINA 310012 AND

YE, NICOLE (UNITED STATES INDIVIDUAL)  
SUITE 8-2-201 WU HUA XIAO QU  
WEN YI XI ROAD  
HANGZHOU, CHINA 310012

FOR: COMPUTER APPLICATION SOFTWARE FOR MOBILE PHONE OR HAND-HELD DEVICE, NAMELY, SOFTWARE FOR RIDE-SHARING, CARPOOLING AND COOPERATIVE PASSENGER TRANSPORT AND CARGO TRANSPORT, AS WELL AS THE VEHICLE DISPATCH, SUPPLY CHAIN MANAGEMENT AND LOGISTICS MANAGEMENT; COMPUTER GAME PROGRAMMES DOWNLOADABLE VIA THE INTERNET; COMPUTER GAME SOFTWARE FOR USE ON MOBILE AND CELLULAR PHONES; COMPUTER PROGRAMS FOR USING THE INTERNET AND THE WORLD WIDE WEB; COMPUTER SOFTWARE, NAMELY, SOFTWARE DEVELOPMENT TOOLS FOR THE CREATION OF MOBILE INTERNET APPLICATIONS AND CLIENT INTERFACES; CONTINGENCY RESPONSE COMMUNICATION SYSTEM DESIGNED TO PROVIDE RADIO INTEROPERABILITY, STREAMING VIDEO, WIRELESS INTERNET, AND VOIP PHONE; DIGITAL MUSIC DOWNLOADABLE FROM THE INTERNET; DIGITAL MUSIC SYSTEMS THAT SYNCHRONIZES DIGITAL RADIO FILES STORED ON A HOME UNIT, A CAR UNIT, OR PORTABLE UNIT AND THAT MAY BE BACKED UP TO AN INTERNET DEPOSITORY; DOWNLOADABLE IMAGE FILE CONTAINING ARTWORK, TEXT, AUDIO, VIDEO, GAMES AND INTERNET WEB LINKS RELATING TO SPORTING AND CULTURAL ACTIVITIES; DOWNLOADABLE SCIENTIFIC AND MEDICAL DATA VIA THE INTERNET; INTERNET DIGITAL VIDEO RECORDERS; INTERNET PHONES; INTERNET RADIOS; INTERNET SERVERS; IP (INTERNET PROTOCOL) CAMERAS; IP (INTERNET PROTOCOL) SPEED DOME CAMERAS, IN CLASS 9 (U.S. CLS. 21, 23, 26, 36 AND 38).

FIRST USE 5-1-2009; IN COMMERCE 11-1-2011.

NO CLAIM IS MADE TO THE EXCLUSIVE RIGHT TO USE "PICK RIDE", APART FROM THE MARK AS SHOWN.



*David J. Kyjars*

Director of the United States Patent and Trademark Office

**Reg. No. 4,276,275** THE COLOR(S) GREEN, RED, GREY AND WHITE IS/ARE CLAIMED AS A FEATURE OF THE MARK.

THE MARK CONSISTS OF THE STYLIZED WORD "PICKRIDE" AGAINST A WHITE BACKGROUND. THE OUTLINE OF THE BACKGROUND IS SHOWN IN GREY, BUT THE GREY USED IN THIS CONTEXT IS NOT A FEATURE OF THE MARK. THE WORDING APPEARS IN GREEN WITH THE EXCEPTION OF THE LETTER "I" WHICH IS SYMBOLIZED AS A LOCATION MARK USUALLY SEEN IN AN ELECTRONIC MAP: THE DOT OF THE "I" APPEARS AS A POLISHED RED DOT CONNECTED TO A GREY POLE. THE STYLIZATION FOR THE "PICK" PORTION OF THE MARK DIFFERS FROM THE STYLIZATION USED FOR THE "RIDE" PORTION OF THE MARK.

SN 85-193,760, FILED 12-8-2010.

JERI J. FICKES, EXAMINING ATTORNEY

# United States of America

United States Patent and Trademark Office

## JONATHAN ADLER

**Reg. No. 4,276,276**

**Registered Jan. 15, 2013**

**Int. Cls.: 24 and 26**

**TRADEMARK**

**PRINCIPAL REGISTER**

JONATHAN ADLER ENTERPRISES (UNITED STATES LIMITED LIABILITY COMPANY)  
333 HUDSON STREET  
7TH FLOOR  
NEW YORK, NY 10013

FOR: FABRICS AND TEXTILES FOR USE IN THE MANUFACTURE OF HOME FURNISHINGS, NAMELY, UPHOLSTERY, FURNITURE, DRAPERIES, WALL COVERINGS, LINENS, CURTAINS, PILLOWS, BEDSHEETS, QUILTS AND CURTAIN TIE-BACKS; WOVEN, PRINTED, NATURAL AND SYNTHETIC FIBER DECORATIVE FABRICS, IN CLASS 24 (U.S. CLS. 42 AND 50).

FIRST USE 10-1-2012; IN COMMERCE 10-1-2012.

FOR: FABRIC AND FURNISHING TRIMMINGS, NAMELY, ORNAMENTAL RIBBONS MADE OF TEXTILES, LACE TRIMMING, TASSELS, BRAIDS, DECORATIVE CORDS AND FRINGES, IN CLASS 26 (U.S. CLS. 37, 39, 40, 42 AND 50).

FIRST USE 10-1-2012; IN COMMERCE 10-1-2012.

THE MARK CONSISTS OF STANDARD CHARACTERS WITHOUT CLAIM TO ANY PARTICULAR FONT, STYLE, SIZE, OR COLOR.

OWNER OF U.S. REG. NO. 2,860,439.

THE NAME JONATHAN ADLER IDENTIFIES A LIVING INDIVIDUAL WHOSE CONSENT IS OF RECORD.

SN 85-196,056, FILED 12-12-2010.

WILLIAM BRECKENFELD, EXAMINING ATTORNEY



*David J. Kybas*

Director of the United States Patent and Trademark Office

# United States of America

United States Patent and Trademark Office

# EDVATION

**Reg. No. 4,276,277**

SCHOOLKIT.COM INC. (WASHINGTON CORPORATION)  
400 112TH AVE. N.E., SUITE 240  
BELLEVUE, WA 98004

**Registered Jan. 15, 2013**

**Int. Cl.: 41**

FOR: EDUCATIONAL ASSESSMENT, IN CLASS 41 (U.S. CLS. 100, 101 AND 107).

**SERVICE MARK**

FIRST USE 6-30-2011; IN COMMERCE 6-30-2011.

**PRINCIPAL REGISTER**

THE MARK CONSISTS OF STANDARD CHARACTERS WITHOUT CLAIM TO ANY PARTICULAR FONT, STYLE, SIZE, OR COLOR.

SN 85-196,934, FILED 12-13-2010.

LINDA LAVACHE, EXAMINING ATTORNEY



*David J. Kyffers*

Director of the United States Patent and Trademark Office

# United States of America

United States Patent and Trademark Office

## STARMARK ACADEMY

**Reg. No. 4,276,278**

STARMARK PET PRODUCTS, INC. (TEXAS CORPORATION)  
200 COUNTY ROAD 197  
HUTTO, TX 78634

**Registered Jan. 15, 2013**

**Int. Cl.: 41**

FOR: DOG TRAINING AND OTHER PET EDUCATIONAL SERVICES, NAMELY, CONDUCTING CLASSES IN THE FIELD OF PROFESSIONAL DOG TRAINING AND DOG TRAINING BUSINESS MANAGEMENT, AND DISTRIBUTING COURSE MATERIAL IN CONNECTION THEREWITH, IN CLASS 41 (U.S. CLS. 100, 101 AND 107).

**SERVICE MARK**

**PRINCIPAL REGISTER**

FIRST USE 11-29-2012; IN COMMERCE 11-29-2012.

THE MARK CONSISTS OF STANDARD CHARACTERS WITHOUT CLAIM TO ANY PARTICULAR FONT, STYLE, SIZE, OR COLOR.

NO CLAIM IS MADE TO THE EXCLUSIVE RIGHT TO USE "ACADEMY", APART FROM THE MARK AS SHOWN.

SN 85-197,706, FILED 12-14-2010.

RENEE MCCRAY, EXAMINING ATTORNEY



*David J. Kybas*

Director of the United States Patent and Trademark Office



# United States of America

United States Patent and Trademark Office

# SKYGUARD

**Reg. No. 4,276,279**

**Registered Jan. 15, 2013**

**Int. Cl.: 9**

**TRADEMARK**

**PRINCIPAL REGISTER**

WGI INNOVATIONS, LTD. (TEXAS LIMITED PARTNERSHIP)  
602 FOUNTAIN PARKWAY  
GRAND PRAIRIE, TX 75050

FOR: STATIONARY SURVEILLANCE AND SECURITY CAMERAS NOT FOR VEHICLE TRACKING; WIRELESS TRANSCEIVERS AND SOFTWARE FOR COMMUNICATING WITH STATIONARY SURVEILLANCE AND SECURITY CAMERAS NOT FOR VEHICLE TRACKING, IN CLASS 9 (U.S. CLS. 21, 23, 26, 36 AND 38).

FIRST USE 9-7-2011; IN COMMERCE 9-7-2011.

THE MARK CONSISTS OF STANDARD CHARACTERS WITHOUT CLAIM TO ANY PARTICULAR FONT, STYLE, SIZE, OR COLOR.

SN 85-197,830, FILED 12-14-2010.

KATHERINE CHANG, EXAMINING ATTORNEY



*David J. Kyffers*

Director of the United States Patent and Trademark Office

# United States of America

United States Patent and Trademark Office

# CULTIVATE

**Reg. No. 4,276,280**

CHIPOTLE MEXICAN GRILL, INC. (DELAWARE CORPORATION)  
1401 WYNKOOP ST., SUITE 500  
DENVER, CO 80202

**Registered Jan. 15, 2013**

**Int. Cl.: 43**

FOR: RESTAURANT SERVICES AND TAKE-OUT RESTAURANT SERVICES, INCLUDING TAKE-OUT RESTAURANT SERVICES AT FOOD FESTIVALS, SPECIFICALLY EXCLUDING RESTAURANT SERVICES FEATURING FROZEN YOGURT AND FROZEN YOGURT BASED DESSERTS, IN CLASS 43 (U.S. CLS. 100 AND 101).

**SERVICE MARK**

**PRINCIPAL REGISTER**

FIRST USE 10-1-2011; IN COMMERCE 10-1-2011.

THE MARK CONSISTS OF STANDARD CHARACTERS WITHOUT CLAIM TO ANY PARTICULAR FONT, STYLE, SIZE, OR COLOR.

SN 85-197,849, FILED 12-14-2010.

DAYNA BROWNE, EXAMINING ATTORNEY



*David J. Kyffers*

Director of the United States Patent and Trademark Office

# United States of America

United States Patent and Trademark Office

# DIMESPRING

**Reg. No. 4,276,281**

**Registered Jan. 15, 2013**

**Int. Cl.: 36**

**SERVICE MARK**

**PRINCIPAL REGISTER**

REMARK MEDIA, INC. (DELAWARE CORPORATION)  
SUITE 1500  
SIX CONCOURSE PARKWAY  
ATLANTA, GA 30328

FOR: FINANCIAL INFORMATION; FINANCIAL INFORMATION PROVIDED BY ELECTRONIC MEANS; PROVIDING FINANCIAL INFORMATION, IN CLASS 36 (U.S. CLS. 100, 101 AND 102).

FIRST USE 12-15-2010; IN COMMERCE 4-3-2012.

THE MARK CONSISTS OF STANDARD CHARACTERS WITHOUT CLAIM TO ANY PARTICULAR FONT, STYLE, SIZE, OR COLOR.

SN 85-198,486, FILED 12-15-2010.

DEZMONA MIZELLE, EXAMINING ATTORNEY



*David J. Kybas*

Director of the United States Patent and Trademark Office

**United States of America**  
United States Patent and Trademark Office

# Krackoon

**Reg. No. 4,276,282**

**Registered Jan. 15, 2013**

**Int. Cl.: 9**

**TRADEMARK**

**PRINCIPAL REGISTER**

LANDI, JERRY (UNITED STATES INDIVIDUAL)  
3200 GIEGERICH PLACE  
PH  
BRONX, NY 10465

FOR: DIGITAL MATERIALS, NAMELY, CDS, DVDS, DOWNLOADABLE AUDIO FILES IN THE FIELD OF HORROR; MOTION PICTURE FILMS IN THE FIELD OF HORROR, IN CLASS 9 (U.S. CLS. 21, 23, 26, 36 AND 38).

FIRST USE 3-27-2010; IN COMMERCE 9-15-2012.

THE MARK CONSISTS OF STANDARD CHARACTERS WITHOUT CLAIM TO ANY PARTICULAR FONT, STYLE, SIZE, OR COLOR.

SN 85-198,638, FILED 12-15-2010.

DEIRDRE ROBERTSON, EXAMINING ATTORNEY



*David J. Kybas*

Director of the United States Patent and Trademark Office

**United States of America**  
United States Patent and Trademark Office

# TRIGGER

**Reg. No. 4,276,283**

**Registered Jan. 15, 2013**

**Int. Cl.: 12**

**TRADEMARK**

**PRINCIPAL REGISTER**

CYCLING SPORTS GROUP, INC. (DELAWARE CORPORATION)  
16 TROWBRIDGE DRIVE  
BETHEL, CT 06801

FOR: BICYCLE FRAMES; BICYCLES, IN CLASS 12 (U.S. CLS. 19, 21, 23, 31, 35 AND 44).

FIRST USE 9-0-2012; IN COMMERCE 9-0-2012.

THE MARK CONSISTS OF STANDARD CHARACTERS WITHOUT CLAIM TO ANY PARTICULAR FONT, STYLE, SIZE, OR COLOR.

SN 85-200,594, FILED 12-17-2010.

ALICE BENMAMAN, EXAMINING ATTORNEY



*David J. Kybas*

Director of the United States Patent and Trademark Office

# United States of America

United States Patent and Trademark Office



**Reg. No. 4,276,284**

EASTER, JOHN D. (UNITED STATES INDIVIDUAL)  
23 LAKE STREET  
CONCORD, NH 03301

**Registered Jan. 15, 2013**

**Int. Cl.: 25**

FOR: CLOTHING, NAMELY, HATS, T-SHIRTS, SWEATSHIRTS, IN CLASS 25 (U.S. CLS. 22 AND 39).

**TRADEMARK**

FIRST USE 1-7-2011; IN COMMERCE 2-15-2011.

**PRINCIPAL REGISTER**

THE MARK CONSISTS OF A "K" AND A "T" SHAPED AS A CROSS FOLLOWED BY A BACKWARD "K", TWO ARROWS POINTING DOWN ON BOTH SIDES OF THE MARK WHILE INSIDE THE MARK THERE IS A "V" WITH A LINE ON AN ANGLE ON BOTH SIDES OF THE "V" ABOVE THE WORDS "KNOW THE KING".

SN 85-201,543, FILED 12-20-2010.

CHARLES L. JENKINS, EXAMINING ATTORNEY



*David J. Kybas*

Director of the United States Patent and Trademark Office

# United States of America

United States Patent and Trademark Office

## Oh my Goodness Coming Clean

**Reg. No. 4,276,285**

SCENTSIBLE, LLC (TEXAS LIMITED LIABILITY COMPANY), DBA POO-POURRI,  
4901 KELLER SPRINGS ROAD, STE. 106D  
ADDISON, TX 75001

**Registered Jan. 15, 2013**

**Int. Cl.: 3**

FOR: DISINFECTANT SOAPS; HAND SOAPS, IN CLASS 3 (U.S. CLS. 1, 4, 6, 50, 51 AND 52).

**TRADEMARK**

FIRST USE 1-5-2011; IN COMMERCE 1-5-2011.

**PRINCIPAL REGISTER**

THE MARK CONSISTS OF STANDARD CHARACTERS WITHOUT CLAIM TO ANY PARTICULAR FONT, STYLE, SIZE, OR COLOR.

SN 85-202,484, FILED 12-21-2010.

GIANCARLO CASTRO, EXAMINING ATTORNEY



*David J. Kyjars*

Director of the United States Patent and Trademark Office

# United States of America

United States Patent and Trademark Office

# Guilele

**Reg. No. 4,276,286**

**Registered Jan. 15, 2013**

**Int. Cl.: 15**

**TRADEMARK**

**PRINCIPAL REGISTER**

GS INTER, INC. (CALIFORNIA CORPORATION)  
1455 19TH ST  
SANTA MONICA, CA 90404

FOR: ACOUSTIC GUITARS; GUITARS, IN CLASS 15 (U.S. CLS. 2, 21 AND 36).

FIRST USE 12-21-2010; IN COMMERCE 12-21-2010.

THE MARK CONSISTS OF STANDARD CHARACTERS WITHOUT CLAIM TO ANY PARTICULAR FONT, STYLE, SIZE, OR COLOR.

SN 85-203,112, FILED 12-21-2010.

DAVID HOFFMAN, EXAMINING ATTORNEY



*David J. Kyffers*

Director of the United States Patent and Trademark Office



# United States of America

United States Patent and Trademark Office

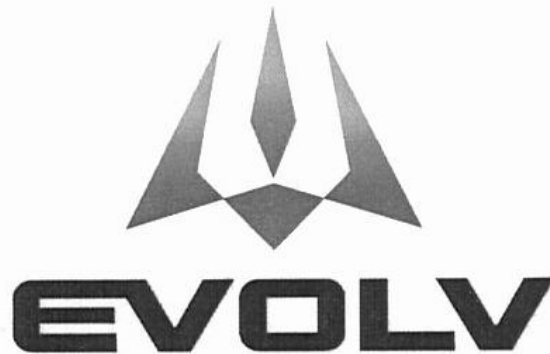

**Reg. No. 4,276,287**

**Registered Jan. 15, 2013**

**Int. Cl.: 11**

**TRADEMARK**

**PRINCIPAL REGISTER**

UNILUX ADVANCED MANUFACTURING, LLC (NEW YORK LIMITED LIABILITY COMPANY)  
30 COMMERCE PARK DRIVE  
SCHENECTADY, NY 12203

FOR: COMMERCIAL BOILERS, IN CLASS 11 (U.S. CLS. 13, 21, 23, 31 AND 34).

FIRST USE 12-13-2011; IN COMMERCE 12-13-2011.

THE MARK CONSISTS OF A FLAME DESIGN WITH THE WORD "EVOLV" BELOW THE FLAME.

SN 85-203,600, FILED 12-22-2010.

PATRICIA EVANKO, EXAMINING ATTORNEY



*David J. Kybas*

Director of the United States Patent and Trademark Office

# United States of America

United States Patent and Trademark Office

# EVOLV

**Reg. No. 4,276,288**

**Registered Jan. 15, 2013**

**Int. Cl.: 11**

**TRADEMARK**

**PRINCIPAL REGISTER**

UNILUX ADVANCED MANUFACTURING, LLC (NEW YORK LIMITED LIABILITY COMPANY)  
30 COMMERCE PARK DRIVE  
SCHENECTADY, NY 12309

FOR: COMMERCIAL BOILERS, IN CLASS 11 (U.S. CLS. 13, 21, 23, 31 AND 34).

FIRST USE 12-13-2011; IN COMMERCE 12-13-2011.

THE MARK CONSISTS OF STANDARD CHARACTERS WITHOUT CLAIM TO ANY PARTICULAR FONT, STYLE, SIZE, OR COLOR.

SN 85-203,616, FILED 12-22-2010.

PATRICIA EVANKO, EXAMINING ATTORNEY



*David J. Kybas*

Director of the United States Patent and Trademark Office

# United States of America

United States Patent and Trademark Office

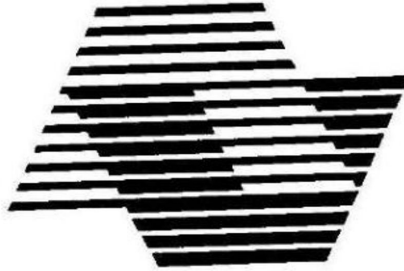

**Reg. No. 4,276,289**

**Registered Jan. 15, 2013**

**Int. Cl.: 41**

**SERVICE MARK**

**PRINCIPAL REGISTER**

AVNET, INC. (NEW YORK CORPORATION)  
2211 SOUTH 47TH STREET  
PHOENIX, AZ 85034

FOR: EDUCATION, NAMELY, PROVIDING OF TRAINING THROUGH CLASSROOM, ON-SITE, AND SEMINAR INSTRUCTION, ARRANGING AND CONDUCTING CONFERENCES, DISCUSSION FORUMS, EXHIBITIONS, PROGRAMS, SEMINARS, SYMPOSIUMS AND WORKSHOPS, ALL WITH RESPECT TO COMPUTER HARDWARE AND SOFTWARE, AND INFORMATION AND ADVICE REGARDING THE AFOREMENTIONED SERVICES, IN CLASS 41 (U.S. CLS. 100, 101 AND 107).

FIRST USE 1-1-2003; IN COMMERCE 1-1-2003.

OWNER OF U.S. REG. NOS. 1,700,991 AND 2,705,815.

THE MARK CONSISTS OF STYLIZED LETTER "A" INTERLOCKING WITH A STYLIZED LETTER "V".

SN 85-205,466, FILED 12-23-2010.

BARBARA BROWN, EXAMINING ATTORNEY



*David J. Kybas*

Director of the United States Patent and Trademark Office

# United States of America

United States Patent and Trademark Office

# AVNET

**Reg. No. 4,276,290**

**Registered Jan. 15, 2013**

**Int. Cl.: 41**

**SERVICE MARK**

**PRINCIPAL REGISTER**

AVNET, INC. (NEW YORK CORPORATION)  
2211 SOUTH 47TH STREET  
PHOENIX, AZ 85034

FOR: EDUCATION, NAMELY, PROVIDING OF TRAINING THROUGH CLASSROOM, ON-SITE, AND SEMINAR INSTRUCTION, ARRANGING AND CONDUCTING CONFERENCES, DISCUSSION FORUMS, EXHIBITIONS, PROGRAMS, SEMINARS, SYMPOSIUMS AND WORKSHOPS, ALL WITH RESPECT TO COMPUTER HARDWARE AND SOFTWARE, AND INFORMATION AND ADVICE REGARDING THE AFOREMENTIONED SERVICES, IN CLASS 41 (U.S. CLS. 100, 101 AND 107).

FIRST USE 1-1-2003; IN COMMERCE 1-1-2003.

THE MARK CONSISTS OF STANDARD CHARACTERS WITHOUT CLAIM TO ANY PARTICULAR FONT, STYLE, SIZE, OR COLOR.

OWNER OF U.S. REG. NOS. 1,481,121, 2,237,995, AND 3,145,418.

SN 85-205,467, FILED 12-23-2010.

BARBARA BROWN, EXAMINING ATTORNEY



*David J. Kyffers*

Director of the United States Patent and Trademark Office

# United States of America

United States Patent and Trademark Office



**Reg. No. 4,276,291**

EASY 2 SWALLOW LLC (ILLINOIS LIMITED LIABILITY COMPANY)  
22272 PEPPER RD, UNIT F  
LAKE BARRINGTON, IL 60010

**Registered Jan. 15, 2013**

**Int. Cl.: 5**

FOR: VITAMINS, MINERALS AND DIETARY SUPPLEMENTS, IN CLASS 5 (U.S. CLS. 6, 18, 44, 46, 51 AND 52).

**TRADEMARK**

FIRST USE 3-24-2011; IN COMMERCE 3-24-2011.

**PRINCIPAL REGISTER**

NO CLAIM IS MADE TO THE EXCLUSIVE RIGHT TO USE "EASY2SWALLOW" AND THE DESCRIPTIVE DESIGN OF A PILL CAPSULE., APART FROM THE MARK AS SHOWN.

THE COLOR(S) GREEN IS/ARE CLAIMED AS A FEATURE OF THE MARK.

THE MARK CONSISTS OF "EASY2SWALLOW" WITH A CAPSULE IN A OVAL ON THE LEFT HAND SIDE OF THE WORDS ALL IN THE COLOR GREEN.

SN 85-205,979, FILED 12-27-2010.

JACQUELINE A. LAVINE, EXAMINING ATTORNEY



*David J. Kybas*

Director of the United States Patent and Trademark Office

# United States of America

United States Patent and Trademark Office

## MARY KAY LASH & BROW BUILDING SERUM

**Reg. No. 4,276,292**

**Registered Jan. 15, 2013**

**Int. Cl.: 3**

**TRADEMARK**

**PRINCIPAL REGISTER**

MARY KAY INC. (DELAWARE CORPORATION)  
16251 DALLAS PARKWAY  
TMKB 11  
ADDISON, TX 75001

FOR: COSMETICS; EYELASH AND EYEBROW CONDITIONER, EYELASH AND EYEBROW ENHANCER, EYELASH AND EYEBROW SERUM FOR CONDITIONING AND ENHANCING THE APPEARANCE OF EYELASHES AND EYEBROWS, IN CLASS 3 (U.S. CLS. 1, 4, 6, 50, 51 AND 52).

FIRST USE 5-1-2012; IN COMMERCE 5-1-2012.

THE MARK CONSISTS OF STANDARD CHARACTERS WITHOUT CLAIM TO ANY PARTICULAR FONT, STYLE, SIZE, OR COLOR.

NO CLAIM IS MADE TO THE EXCLUSIVE RIGHT TO USE "LASH & BROW BUILDING SERUM", APART FROM THE MARK AS SHOWN.

"MARY KAY" DOES NOT IDENTIFY A LIVING INDIVIDUAL.

SN 85-206,314, FILED 12-28-2010.

MICHAEL ENGEL, EXAMINING ATTORNEY



*David J. Kyros*

Director of the United States Patent and Trademark Office

# United States of America

United States Patent and Trademark Office

# FRATTY

**Reg. No. 4,276,293**

**Registered Jan. 15, 2013**

**Int. Cl.: 25**

**TRADEMARK**

**PRINCIPAL REGISTER**

PICKIN' COTTON COMMUNICATIONS, LLC (DELAWARE LIMITED LIABILITY COMPANY)  
232 IVORY STREET  
LAFAYETTE, LA 70506

FOR: ADULT NOVELTY GAG CLOTHING ITEM, NAMELY, SOCKS; BABY LAYETTES FOR CLOTHING; BELTS; BELTS FOR CLOTHING; BELTS MADE OUT OF CLOTH; BIBS NOT OF CLOTH OR PAPER; BOTTOMS; CHILDREN'S AND INFANTS' CLOTH BIBS; CHILDREN'S CLOTH EATING BIBS; CLOTH BIBS; CLOTH BIBS FOR ADULT DINERS; CLOTH BIBS FOR USE BY SENIOR CITIZENS OR PHYSICALLY- OR MENTALLY-CHALLENGED PERSONS; CLOTH DIAPERS; CLOTHING EXTENSION USED TO EXTEND THE NORMAL SIZE RANGE OF CLOTHING ITEMS TO ACCOMMODATE PREGNANCY SIZE CHANGES; CLOTHING FOR ATHLETIC USE, NAMELY, PADDED ELBOW COMPRESSION SLEEVES BEING PART OF AN ATHLETIC GARMENT; CLOTHING FOR ATHLETIC USE, NAMELY, PADDED PANTS; CLOTHING FOR ATHLETIC USE, NAMELY, PADDED SHIRTS; CLOTHING FOR ATHLETIC USE, NAMELY, PADDED SHORTS; CLOTHING FOR BABIES, TODDLERS AND CHILDREN, TREATED WITH FIRE AND HEAT RETARDANTS, NAMELY, PAJAMAS, JACKETS, SHIRTS, PANTS, JUMPERS; CLOTHING FOR WEAR IN JUDO PRACTICES; CLOTHING FOR WEAR IN WRESTLING GAMES; CLOTHING ITEMS, NAMELY, ADHESIVE POCKETS THAT MAY BE AFFIXED DIRECTLY TO THE BODY AS A DECORATIVE PIECE OF CLOTHING WITH UTILITY; CLOTHING ITEMS, NAMELY, ADHESIVE POCKETS THAT MAY BE AFFIXED DIRECTLY TO THE INSIDE OF CLOTHING FOR STORAGE AND SAFEKEEPING OF PERSONAL ITEMS; CLOTHING SHIELDS, NAMELY, PADS APPLIED TO THE UNDERARMS OF SHIRTS, BLOUSES AND SWEATERS; CLOTHING, NAMELY, ARM WARMERS; CLOTHING, NAMELY, ATHLETIC SLEEVES; CLOTHING, NAMELY, BASE LAYERS; CLOTHING, NAMELY, FOLK COSTUMES; CLOTHING, NAMELY, HAND-WARMERS; CLOTHING, NAMELY, KHAKIS; CLOTHING, NAMELY, KNEE WARMERS; CLOTHING, NAMELY, MATERNITY BANDS; CLOTHING, NAMELY, NECK TUBES; CLOTHING, NAMELY, THOBES; CLOTHING, NAMELY, WRAP-AROUNDS; CORSETS; DUSTERS; EYESHADES; FOULARDS; GLOVES AS CLOTHING; HEADBANDS FOR CLOTHING; HOODS; INFANT AND TODDLER ONE PIECE CLOTHING; INFANT CLOTH DIAPERS; INSERTS SPECIALLY ADAPTED FOR CLOTH DIAPERS MADE OF BAMBOO; INSERTS SPECIALLY ADAPTED FOR CLOTH DIAPERS MADE OF HEMP; INSERTS SPECIALLY ADAPTED FOR CLOTH DIAPERS MADE OF MICROFIBER; JACKETS; JERSEYS; LEATHER BELTS; MANTLES; MUFFLERS; NON-DISPOSABLE CLOTH TRAINING PANTS; PAPER HATS FOR USE AS CLOTHING ITEMS; PARTS OF CLOTHING, NAMELY, GUSSETS FOR TIGHTS, GUSSETS FOR STOCKINGS, GUSSETS FOR BATHING SUITS, GUSSETS FOR UNDERWEAR, GUSSETS FOR LEOTARDS AND GUSSETS FOR



*David J. Kyros*

Director of the United States Patent and Trademark Office

**Reg. No. 4,276,293** FOOTLETS; PARTS OF CLOTHING, NAMELY, UNDERARM GUSSETS; PARTY HATS; PERSPIRATION ABSORBENT UNDERWEAR CLOTHING; POCKET SQUARES; SHIRTS; SHORT SETS; SHOULDER WRAPS; SHOULDER WRAPS FOR CLOTHING; SWADDLING CLOTHES; TIES; TOPS; TRAVEL CLOTHING CONTAINED IN A PACKAGE COMPRISING REVERSIBLE JACKETS, PANTS, SKIRTS, TOPS AND A BELT OR SCARF; TRIATHLON CLOTHING, NAMELY, TRIATHLON TIGHTS, TRIATHLON SHORTS, TRIATHLON SING-LETS, TRIATHLON SHIRTS, TRIATHLON SUITS; UNDERARM CLOTHING SHIELDS; WEARABLE GARMENTS AND CLOTHING, NAMELY, SHIRTS; WRAPS, IN CLASS 25 (U.S. CLS. 22 AND 39).

FIRST USE 12-30-2010; IN COMMERCE 11-3-2012.

THE MARK CONSISTS OF STANDARD CHARACTERS WITHOUT CLAIM TO ANY PAR-TICULAR FONT, STYLE, SIZE, OR COLOR.

SN 85-207,681, FILED 12-30-2010.

DEZMONA MIZELLE, EXAMINING ATTORNEY



# United States of America

United States Patent and Trademark Office



**Reg. No. 4,276,294**

**Registered Jan. 15, 2013**

**Int. Cl.: 30**

DENIS J. SAVARD (CANADA INDIVIDUAL)  
C/O DENIS SAVARD ENTERPRISE, INC.  
620 ENTERPRISE DRIVE  
OAKBROOK, IL 60523

FOR: FRESH PIZZA; PIZZA; PIZZAS, IN CLASS 30 (U.S. CL. 46).

**TRADEMARK**

FIRST USE 4-0-2011; IN COMMERCE 4-0-2011.

**PRINCIPAL REGISTER**

NO CLAIM IS MADE TO THE EXCLUSIVE RIGHT TO USE "PIZZA", APART FROM THE MARK AS SHOWN.

THE NAME AND PORTRAIT "DENIS J. SAVARD" IDENTIFIES A LIVING INDIVIDUAL WHOSE CONSENT IS OF RECORD.

THE MARK CONSISTS OF A DESIGN OF CONCENTRIC CIRCLES CONTAINING THE IMAGE OF "DENIS SAVARD" IN HOCKEY ATTIRE. IN BETWEEN THE CONCENTRIC CIRCLES IS THE NAME "DENIS SAVARD" FLANKED BY MULTIPLE FIVE-POINT STARS. UNDERNEATH THE CONCENTRIC CIRCLES IS A RECTANGULAR BANNER CONTAINING THE WORD "SAVY'S" AND IMMEDIATELY UNDERNEATH IS ANOTHER RECTANGULAR BANNER CONTAINING THE WORD "PIZZA".

SN 85-209,273, FILED 1-3-2011.

HAI-LY LAM, EXAMINING ATTORNEY



*David J. Kyros*

Director of the United States Patent and Trademark Office

# United States of America

United States Patent and Trademark Office

# TEXAKING

**Reg. No. 4,276,295**

TURBO AIR, INC. (CALIFORNIA CORPORATION)  
1250 VICTORIA STREET  
CARSON, CA 90746

**Registered Jan. 15, 2013**

**Int. Cl.: 11**

FOR: AIR CONDITIONERS; REFRIGERATORS, IN CLASS 11 (U.S. CLS. 13, 21, 23, 31 AND 34).

**TRADEMARK**

FIRST USE 10-16-2012; IN COMMERCE 10-16-2012.

**PRINCIPAL REGISTER**

THE MARK CONSISTS OF STANDARD CHARACTERS WITHOUT CLAIM TO ANY PARTICULAR FONT, STYLE, SIZE, OR COLOR.

SN 85-210,909, FILED 1-5-2011.

MAUREEN DALL, EXAMINING ATTORNEY



*David J. Kybas*

Director of the United States Patent and Trademark Office

# United States of America

United States Patent and Trademark Office



**Reg. No. 4,276,296**

**Registered Jan. 15, 2013**

**Int. Cls.: 3 and 5**

**TRADEMARK**

**PRINCIPAL REGISTER**

AGABANG & COMPANY (REPUBLIC OF KOREA CORPORATION)  
678-36, YOUKSAM-DONG, GANGNAM-GU  
SEOUL, REPUBLIC OF KOREA

FOR: NON-MEDICATED HAIR CARE PREPARATIONS; NON-MEDICATED SKIN OR BODY CARE PREPARATIONS; SKIN CLEANSER; SOAPS AND DETERGENTS; DENTIFRICES, NON-MEDICATED BATH PREPARATIONS, IN CLASS 3 (U.S. CLS. 1, 4, 6, 50, 51 AND 52).

FIRST USE 6-9-2009; IN COMMERCE 8-14-2012.

FOR: BABY FOODS; SKIN OR BODY CARE PREPARATIONS FOR PHARMACEUTICAL OR MEDICAL PURPOSES, IN CLASS 5 (U.S. CLS. 6, 18, 44, 46, 51 AND 52).

FIRST USE 6-9-2009; IN COMMERCE 8-14-2012.

THE MARK CONSISTS OF AN ANGEL SPRINKLING DUST PARTICLES ABOVE THE TERM "ANGEL'S MAGIC PUTTO".

SN 85-212,379, FILED 1-6-2011.

WON TEAK OH, EXAMINING ATTORNEY



*David J. Kypos*

Director of the United States Patent and Trademark Office

# United States of America

United States Patent and Trademark Office

# MICHI

**Reg. No. 4,276,297**

**Registered Jan. 15, 2013**

**Int. Cl.: 10**

**TRADEMARK**

**PRINCIPAL REGISTER**

SILK ROAD MEDICAL, INC. (DELAWARE CORPORATION)  
735 NORTH PASTORIA AVENUE  
SUNNYVALE, CA 94085

FOR: MEDICAL DEVICES FOR THE TREATMENT OF VASCULAR, CARDIOVASCULAR AND NEUROVASCULAR DISEASES, ILLNESSES AND CONDITIONS, IN CLASS 10 (U.S. CLS. 26, 39 AND 44).

FIRST USE 10-3-2011; IN COMMERCE 10-3-2011.

THE MARK CONSISTS OF STANDARD CHARACTERS WITHOUT CLAIM TO ANY PARTICULAR FONT, STYLE, SIZE, OR COLOR.

THE ENGLISH TRANSLATION OF "MICHI" IS "THE WAY" OR "THE PATH".

SN 85-213,282, FILED 1-7-2011.

LINDA MICKLEBURGH, EXAMINING ATTORNEY



*David J. Kyjars*

Director of the United States Patent and Trademark Office

**United States of America**  
United States Patent and Trademark Office

# InWorldz

**Reg. No. 4,276,298**

**Registered Jan. 15, 2013**

**Int. Cl.: 42**

**SERVICE MARK**

**PRINCIPAL REGISTER**

INWORLDZ, LLC (NEW YORK LIMITED LIABILITY COMPANY)  
6035 SOUTH TRANSIT ROAD  
37  
LOCKPORT, NY 14094

FOR: COMPUTER PROGRAMMING SERVICES, NAMELY, CONTENT CREATION FOR VIRTUAL WORLDS AND THREE DIMENSIONAL PLATFORMS, IN CLASS 42 (U.S. CLS. 100 AND 101).

FIRST USE 3-31-2010; IN COMMERCE 3-31-2010.

THE MARK CONSISTS OF STANDARD CHARACTERS WITHOUT CLAIM TO ANY PARTICULAR FONT, STYLE, SIZE, OR COLOR.

SN 85-214,306, FILED 1-10-2011.

CHARLOTTE CORWIN, EXAMINING ATTORNEY



*David J. Kybas*

Director of the United States Patent and Trademark Office

# United States of America

United States Patent and Trademark Office

# PACI-PETS

**Reg. No. 4,276,299**

**Registered Jan. 15, 2013**

**Int. Cl.: 28**

**TRADEMARK**

**PRINCIPAL REGISTER**

BROMEL INC. (CALIFORNIA CORPORATION)  
22406 FRIAR ST.  
WOODLAND HILLS, CA 91367

FOR: PLUSH TOYS, IN CLASS 28 (U.S. CLS. 22, 23, 38 AND 50).

FIRST USE 8-11-2011; IN COMMERCE 10-15-2012.

THE MARK CONSISTS OF STANDARD CHARACTERS WITHOUT CLAIM TO ANY PARTICULAR FONT, STYLE, SIZE, OR COLOR.

SN 85-215,121, FILED 1-11-2011.

LESLEY LAMOTHE, EXAMINING ATTORNEY



*David J. Kybas*

Director of the United States Patent and Trademark Office

# United States of America

United States Patent and Trademark Office

## SIMPLE HELP IN A BOX

**Reg. No. 4,276,300**

SIMPLE HELP IN A BOX U.S. LLC (COLORADO LIMITED LIABILITY COMPANY)  
4201 WESTSHORE WAY  
FORT COLLINS, CO 80525 AND

**Registered Jan. 15, 2013**

**Int. Cl.: 16**

SIMPLE HELP IN A BOX CANADA INC. (CANADA CORPORATION)  
2092 MARNE STREET  
VICTORIA, BC, CANADA V8S4J8

**TRADEMARK**

**PRINCIPAL REGISTER**

FOR: SELF HELP EDUCATIONAL KITS COMPRISING PRINTED INSTRUCTIONS AND EDUCATIONAL MATERIALS IN THE FIELD OF PERSONAL DEVELOPMENT, IN CLASS 16 (U.S. CLS. 2, 5, 22, 23, 29, 37, 38 AND 50).

FIRST USE 7-1-2012; IN COMMERCE 8-31-2012.

THE MARK CONSISTS OF STANDARD CHARACTERS WITHOUT CLAIM TO ANY PARTICULAR FONT, STYLE, SIZE, OR COLOR.

SN 85-215,912, FILED 1-12-2011.

BARBARA BROWN, EXAMINING ATTORNEY



*David J. Kyjars*

Director of the United States Patent and Trademark Office

# United States of America

United States Patent and Trademark Office

## BOX IT OUT

**Reg. No. 4,276,301**

**Registered Jan. 15, 2013**

**Int. Cl.: 16**

**TRADEMARK**

**PRINCIPAL REGISTER**

SIMPLE HELP IN A BOX U.S. LLC (COLORADO LIMITED LIABILITY COMPANY)  
4201 WESTSHORE WAY  
FORT COLLINS, CO 80525 AND

SIMPLE HELP IN A BOX CANADA INC. (CANADA CORPORATION)  
2092 MARNE STREET  
VICTORIA, BC, CANADA V8S4J8

FOR: SELF HELP EDUCATIONAL KITS COMPRISING PRINTED INSTRUCTIONS AND EDUCATIONAL MATERIALS IN THE FIELD OF CONFLICT RESOLUTION, IN CLASS 16 (U.S. CLS. 2, 5, 22, 23, 29, 37, 38 AND 50).

FIRST USE 7-1-2012; IN COMMERCE 8-31-2012.

THE MARK CONSISTS OF STANDARD CHARACTERS WITHOUT CLAIM TO ANY PARTICULAR FONT, STYLE, SIZE, OR COLOR.

SN 85-215,928, FILED 1-12-2011.

BARBARA BROWN, EXAMINING ATTORNEY



*David J. Kybas*

Director of the United States Patent and Trademark Office



# United States of America

United States Patent and Trademark Office

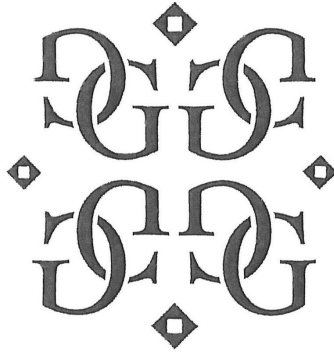

**Reg. No. 4,276,302**

**Registered Jan. 15, 2013**

**Int. Cl.: 9**

**TRADEMARK**

**PRINCIPAL REGISTER**

GUESS?, INC. (DELAWARE CORPORATION)  
1444 SOUTH ALAMEDA STREET  
LOS ANGELES, CA 90021

FOR: COVERS AND CASES FOR PORTABLE ELECTRONIC DEVICES, PERSONAL ELECTRONIC DEVICES, CELL PHONES, MOBILE PHONES, TELEPHONES, COMPUTERS, LAPTOP COMPUTERS, TABLET COMPUTERS, NOTEBOOK COMPUTERS, MP3 PLAYERS, PORTABLE MUSIC PLAYERS, PERSONAL DIGITAL ASSISTANTS, ELECTRONIC READING DEVICES, DIGITAL CAMERAS, AND CAMERAS; EYEWEAR, IN CLASS 9 (U.S. CLS. 21, 23, 26, 36 AND 38).

FIRST USE 10-25-2008; IN COMMERCE 5-1-2012.

OWNER OF U.S. REG. NO. 3,895,911.

THE MARK CONSISTS OF FOUR SETS OF TWO INTERLOCKING "G"'S SURROUNDED BY FOUR DIAMONDS.

SN 85-216,132, FILED 1-12-2011.

MARIA-VICTORIA SUAREZ, EXAMINING ATTORNEY



*David J. Kyffers*

Director of the United States Patent and Trademark Office

# United States of America

United States Patent and Trademark Office

ECOURA

Lily BRIDAL

**Reg. No. 4,276,303**

**Registered Jan. 15, 2013**

**Int. Cl.: 14**

**TRADEMARK**

**PRINCIPAL REGISTER**

JEWELX NEW YORK, LTD. (NEW YORK CORPORATION)  
529 FIFTH AVENUE, 18TH FLOOR  
NEW YORK, NY 10017

FOR: JEWELRY, NAMELY, GOLD, PLATINUM, TITANIUM AND SILVER JEWELRY; AND GOLD, PLATINUM, TITANIUM AND SILVER JEWELRY WITH PRECIOUS STONES, NAMELY, DIAMONDS, RUBIES, EMERALDS, SAPPHIRES, AND SEMI-PRECIOUS COLORED STONES EMBEDDED THEREIN, AND PEARLS EMBEDDED THEREIN, IN CLASS 14 (U.S. CLS. 2, 27, 28 AND 50).

FIRST USE 2-21-2012; IN COMMERCE 2-21-2012.

THE MARK CONSISTS OF THE LITERAL ELEMENT "ECOURA LILY BRIDAL" REPRESENTED IN STYLIZED FONT AND A DESIGN CONSISTING OF A STYLIZED LEAF BETWEEN THE LETTERS "O" AND THE "U" IN "ECOURA" WHEREIN THE ENTIRE WORD "ECOURA" AND THE LEAF DESIGN ARE IN THE COLOR GREEN, AND BENEATH THE WORD "ECOURA" ARE THE WORDS "LILY BRIDAL" IN THE COLOR BLACK, THE WORD "LILY" REPRESENTED IN STYLIZED CURSIVE FONT AND THE WORD "BRIDAL" REPRESENTED IN STYLIZED UPPERCASE LETTERS.

THE COLOR(S) GREEN AND BLACK IS/ARE CLAIMED AS A FEATURE OF THE MARK.

SN 85-220,186, FILED 1-18-2011.

RONALD DELGIZZI, EXAMINING ATTORNEY



*David J. Kybas*

Director of the United States Patent and Trademark Office

# United States of America

United States Patent and Trademark Office

# VCONNECT

**Reg. No. 4,276,304**

**Registered Jan. 15, 2013**

**Int. Cl.: 42**

**SERVICE MARK**

**PRINCIPAL REGISTER**

WIRELESS MATRIX USA, INC. (DELAWARE CORPORATION)  
13645 DULLES TECHNOLOGY DRIVE, SUITE 100  
HERNDON, VA 20171

FOR: ONLINE NON-DOWNLOADABLE SOFTWARE FOR PROVIDING REPORTS, REGULATORY COMPLIANCE INFORMATION, METRICS, GRAPHS, TRENDS ON THE MAINTENANCE, PERFORMANCE, AND TRENDS ON FUEL CONSUMPTION, TOTAL COST OF OWNERSHIP AND CARBON FOOTPRINT OF FLEET VEHICLES, IN CLASS 42 (U.S. CLS. 100 AND 101).

FIRST USE 9-16-2012; IN COMMERCE 9-16-2012.

THE MARK CONSISTS OF STANDARD CHARACTERS WITHOUT CLAIM TO ANY PARTICULAR FONT, STYLE, SIZE, OR COLOR.

SN 85-223,148, FILED 1-21-2011.

FRANK LATTUCA, EXAMINING ATTORNEY



*David J. Kyffers*

Director of the United States Patent and Trademark Office

# United States of America

United States Patent and Trademark Office



**Reg. No. 4,276,305**

**Registered Jan. 15, 2013**

**Int. Cl.: 25**

**TRADEMARK**

**PRINCIPAL REGISTER**

ROYAL BLOOD LINE (TEXAS PARTNERSHIP)  
926 W. INTERSTATE 30 APT 303  
GARLAND, TX 75043

FOR: POLO SHIRTS; T-SHIRTS, IN CLASS 25 (U.S. CLS. 22 AND 39).

FIRST USE 11-12-2012; IN COMMERCE 11-12-2012.

THE MARK CONSISTS OF AN ANKH DESIGN WITH A CROWN ON THE TOP. THE ANKH CONTAINS THE NAMES "MOSES", "JESUS" AND "MUHAMMAD" AT POINTS INSIDE THE ANKH. ABOVE THE ANKH DESIGN IS THE WORDING "ROYAL BLOOD LINE".

SN 85-223,763, FILED 1-21-2011.

DANIEL CAPSHAW, EXAMINING ATTORNEY



*David J. Kyffers*

Director of the United States Patent and Trademark Office

# United States of America

United States Patent and Trademark Office

# SunShot

**Reg. No. 4,276,306**

**Registered Jan. 15, 2013**

**Int. Cls.: 35, 41, and 42**

UNITED STATES DEPARTMENT OF ENERGY (UNITED STATES AGENCY OF THE UNITED STATES GOVERNMENT)

GC-62

1000 INDEPENDENCE AVENUE, S.W.

WASHINGTON, DC 20585

**SERVICE MARK**

**PRINCIPAL REGISTER**

FOR: PROMOTING PUBLIC AWARENESS OF THE NEED TO DEVELOP SOLAR ENERGY SYSTEMS TO PROVIDE LOW-COST ELECTRICITY; PROVIDING INFORMATION IN ENERGY EFFICIENCY AND ENERGY USAGE CONVERSATION FIELDS REGARDING THE NEED TO DEVELOP SOLAR ENERGY SYSTEMS TO PROVIDE LOW-COST ELECTRICITY; ADMINISTRATION, BY ARRANGING AND CONDUCTING, COMPETITIONS TO DEVELOP SOLAR ENERGY SYSTEMS TO PROVIDE LOW-COST ELECTRICITY FOR BUSINESS AND COMMERCIAL PURPOSES, IN CLASS 35 (U.S. CLS. 100, 101 AND 102).

FIRST USE 8-12-2010; IN COMMERCE 8-12-2010.

FOR: ENTERTAINMENT AND EDUCATION SERVICES, NAMELY, ARRANGING AND CONDUCTING COMPETITIONS FOR THE DEVELOPMENT OF SOLAR ENERGY SYSTEMS TO PROVIDE LOW-COST ELECTRICITY, IN CLASS 41 (U.S. CLS. 100, 101 AND 107).

FIRST USE 8-12-2010; IN COMMERCE 8-10-2010.

FOR: PROVIDING INFORMATION IN THE RENEWABLE AND ALTERNATIVE ENERGY DEVELOPMENT FIELDS REGARDING THE NEED TO DEVELOP SOLAR ENERGY SYSTEMS TO PROVIDE LOW-COST ENERGY, IN CLASS 42 (U.S. CLS. 100 AND 101).

FIRST USE 8-12-2010; IN COMMERCE 8-10-2012.

THE MARK CONSISTS OF STANDARD CHARACTERS WITHOUT CLAIM TO ANY PARTICULAR FONT, STYLE, SIZE, OR COLOR.

SN 85-224,444, FILED 1-24-2011.

JUDITH HELFMAN, EXAMINING ATTORNEY



*David J. Kyffers*

Director of the United States Patent and Trademark Office

# United States of America

United States Patent and Trademark Office

# 4V

**Reg. No. 4,276,307**

CRUCIBLE INDUSTRIES LLC (DELAWARE LIMITED LIABILITY COMPANY)  
575 STATE FAIR BOULEVARD  
SOLVAY, NY 13209

**Registered Jan. 15, 2013**

**Int. Cl.: 6**

FOR: TOOL STEEL IN THE FORM OF COMPACTS, BLOOMS, BILLETS, ROUND BARS, FLAT BARS, SHEETS, AND PLATES, IN CLASS 6 (U.S. CLS. 2, 12, 13, 14, 23, 25 AND 50).

**TRADEMARK**

FIRST USE 12-0-2010; IN COMMERCE 12-0-2010.

**PRINCIPAL REGISTER**

THE MARK CONSISTS OF STANDARD CHARACTERS WITHOUT CLAIM TO ANY PARTICULAR FONT, STYLE, SIZE, OR COLOR.

OWNER OF U.S. REG. NOS. 2,108,470, 2,456,240, AND OTHERS.

SN 85-227,672, FILED 1-27-2011.

ANDREW LEASER, EXAMINING ATTORNEY



*David J. Kybas*

Director of the United States Patent and Trademark Office

# United States of America

United States Patent and Trademark Office



**Reg. No. 4,276,308**

THE DALE FOUNDATION (ILLINOIS CORPORATION)  
444 N. MICHIGAN AVENUE, SUITE 900  
CHICAGO, IL 60611

**Registered Jan. 15, 2013**

**Int. Cl.: 41**

FOR: EDUCATIONAL SERVICES IN THE FIELD OF ORAL HEALTHCARE, NAMELY, CONDUCTING ONLINE CLASSES AND WORKSHOPS, CONDUCTING INFORMAL ONLINE PROGRAMS, ONLINE TRAINING; EDUCATIONAL RESEARCH SERVICES RELATING TO ORAL HEALTHCARE, IN CLASS 41 (U.S. CLS. 100, 101 AND 107).

**SERVICE MARK**

**PRINCIPAL REGISTER**

FIRST USE 8-12-2011; IN COMMERCE 8-12-2011.

NO CLAIM IS MADE TO THE EXCLUSIVE RIGHT TO USE "FOUNDATION", APART FROM THE MARK AS SHOWN.

THE MARK CONSISTS OF A TRIANGLE WITH A SEMI-CIRCLE THROUGH IT AND THE WORDS "THE DALE FOUNDATION" AFTER WITH AN ARC OVER THE LETTERS "DAT".

SN 85-227,988, FILED 1-27-2011.

SAIMA MAKHDOOM, EXAMINING ATTORNEY



*David J. Kybas*

Director of the United States Patent and Trademark Office

# United States of America

United States Patent and Trademark Office



**Reg. No. 4,276,309**

THE DALE FOUNDATION (ILLINOIS CORPORATION)  
444 N. MICHIGAN AVENUE, SUITE 900  
CHICAGO, IL 60611

**Registered Jan. 15, 2013**

**Int. Cl.: 41**

FOR: EDUCATIONAL SERVICES IN THE FIELD OF ORAL HEALTHCARE, NAMELY, CONDUCTING ONLINE CLASSES AND WORKSHOPS, CONDUCTING INFORMAL ONLINE PROGRAMS, ONLINE TRAINING.; EDUCATIONAL RESEARCH SERVICES RELATING TO ORAL HEALTHCARE, IN CLASS 41 (U.S. CLS. 100, 101 AND 107).

**SERVICE MARK**

**PRINCIPAL REGISTER**

FIRST USE 8-17-2012; IN COMMERCE 8-17-2012.

NO CLAIM IS MADE TO THE EXCLUSIVE RIGHT TO USE "FOUNDATION", APART FROM THE MARK AS SHOWN.

THE COLOR(S) PURPLE AND BLACK IS/ARE CLAIMED AS A FEATURE OF THE MARK.

THE MARK CONSISTS OF A PURPLE TRIANGLE WITH A SEMI-CIRCLE THROUGH IT AND WORDS "THE DALE FOUNDATION" APPEAR IN BLACK WITH A PURPLE ARC OVER THE LETTERS DAT.

SN 85-227,994, FILED 1-27-2011.

SAIMA MAKHDOOM, EXAMINING ATTORNEY



*David J. Kyffers*

Director of the United States Patent and Trademark Office



# United States of America

United States Patent and Trademark Office

# ACCESS ONE

**Reg. No. 4,276,310**

**Registered Jan. 15, 2013**

**Int. Cl.: 36**

**SERVICE MARK**

**PRINCIPAL REGISTER**

CAPITAL ONE FINANCIAL CORPORATION (DELAWARE CORPORATION)  
12077-0270 / BECKY DIMMETT  
15000 CAPITAL ONE DRIVE  
RICHMOND, VA 23238

FOR: BANKING SERVICES, IN CLASS 36 (U.S. CLS. 100, 101 AND 102).

FIRST USE 3-30-2011; IN COMMERCE 3-30-2011.

THE MARK CONSISTS OF STANDARD CHARACTERS WITHOUT CLAIM TO ANY PARTICULAR FONT, STYLE, SIZE, OR COLOR.

SN 85-228,018, FILED 1-27-2011.

KATHERINE STOIDES, EXAMINING ATTORNEY



*David J. Kybas*

Director of the United States Patent and Trademark Office

# United States of America

United States Patent and Trademark Office

## WHEN IT MATTERS

**Reg. No. 4,276,311**

**Registered Jan. 15, 2013**

**Int. Cl.: 35**

**SERVICE MARK**

**PRINCIPAL REGISTER**

NTIVA, INC. (VIRGINIA CORPORATION)  
7900 WEST PARK DR. SUITE A50 - A 70  
MCLEAN, VA 22102

FOR: RETAIL STORE SERVICES FEATURING COMPUTER HARDWARE, SOFTWARE, NETWORK AND NETWORKING COMPONENTS, TELECOMMUNICATIONS PRODUCTS AND SERVICES, CABLING AND WIRING, IN CLASS 35 (U.S. CLS. 100, 101 AND 102).

FIRST USE 4-4-1991; IN COMMERCE 4-4-1991.

THE MARK CONSISTS OF STANDARD CHARACTERS WITHOUT CLAIM TO ANY PARTICULAR FONT, STYLE, SIZE, OR COLOR.

SN 85-229,191, FILED 1-28-2011.

GIANCARLO CASTRO, EXAMINING ATTORNEY



*David J. Kyjars*

Director of the United States Patent and Trademark Office

# United States of America

United States Patent and Trademark Office



**Reg. No. 4,276,312**

HASTINGS, SCOTT (UNITED STATES INDIVIDUAL)  
151 N. WHITE MOUNTAIN RD. SUITE E  
SHOW LOW, AZ 85901

**Registered Jan. 15, 2013**

**Int. Cl.: 35**

FOR: COST MANAGEMENT FOR THE HEALTH BENEFIT PLANS OF OTHERS, IN CLASS 35 (U.S. CLS. 100, 101 AND 102).

**SERVICE MARK**

FIRST USE 8-1-2011; IN COMMERCE 10-1-2011.

**PRINCIPAL REGISTER**

THE MARK CONSISTS OF THE STYLIZED TEXT "BIDONHEALTH.COM" WITH A CURSOR OF A HAND POINTING TO THE "O" AND A CADUCEUS INSIDE THE "O".

SN 85-230,636, FILED 1-31-2011.

JOHN HWANG, EXAMINING ATTORNEY



*David J. Kyjars*

Director of the United States Patent and Trademark Office

# United States of America

United States Patent and Trademark Office

# ObjectAssure

**Reg. No. 4,276,313**

DATADIRECT NETWORKS, INC. (CALIFORNIA CORPORATION)  
9351 DEERING AVENUE  
CHATSWORTH, CA 91311

**Registered Jan. 15, 2013**

**Int. Cl.: 9**

FOR: HIGH CAPACITY DATA STORAGE SYSTEMS COMPRISING BLANK ELECTRONIC STORAGE MEDIA; HIGH CAPACITY DATA STORAGE SYSTEMS COMPRISING COMPUTER HARDWARE AND COMPUTER SOFTWARE FOR OPERATING THE DATA STORAGE SYSTEMS, IN CLASS 9 (U.S. CLS. 21, 23, 26, 36 AND 38).

**TRADEMARK**

**PRINCIPAL REGISTER**

FIRST USE 11-0-2010; IN COMMERCE 7-0-2011.

THE MARK CONSISTS OF STANDARD CHARACTERS WITHOUT CLAIM TO ANY PARTICULAR FONT, STYLE, SIZE, OR COLOR.

SN 85-230,760, FILED 1-31-2011.

MARILYN IZZI, EXAMINING ATTORNEY



*David J. Kyffers*

Director of the United States Patent and Trademark Office

# United States of America

United States Patent and Trademark Office

# CAL

**Reg. No. 4,276,314**

**Registered Jan. 15, 2013**

**Int. Cl.: 9**

**TRADEMARK**

**PRINCIPAL REGISTER**

LA BOSCHINY, INC. (CALIFORNIA CORPORATION)  
1889 PETALUMA DRIVE  
CHULA VISTA, CA 91913

FOR: SOFTWARE FOR DETERMINING METAL BENDING PARAMETERS, IN CLASS 9  
(U.S. CLS. 21, 23, 26, 36 AND 38).

FIRST USE 11-30-2011; IN COMMERCE 11-30-2011.

THE MARK CONSISTS OF THE LETTERS "CAL".

SN 85-231,573, FILED 2-1-2011.

LIEF MARTIN, EXAMINING ATTORNEY



*David J. Kybas*

Director of the United States Patent and Trademark Office

# United States of America

United States Patent and Trademark Office

## REMOTE SAFE SOLUTION

**Reg. No. 4,276,315**

**Registered Jan. 15, 2013**

**Int. Cl.: 36**

**SERVICE MARK**

**PRINCIPAL REGISTER**

THE PNC FINANCIAL SERVICES GROUP, INC. (PENNSYLVANIA CORPORATION)  
249 FIFTH AVENUE  
MAIL STOP P1 POPP 21 1  
PITTSBURGH, PA 15222

FOR: CASH MANAGEMENT SYSTEM CONSISTING OF A REMOTE ELECTRONIC CURRENCY ACCEPTOR THAT RECEIVES AND VALIDATES CASH, TOTALS AND RECONCILES THE CASH RECEIPTS, AND ELECTRONICALLY TRANSMITS THE CASH RECEIPT TOTALS AND STORES CASH FOR LATER RETRIEVAL, IN CLASS 36 (U.S. CLS. 100, 101 AND 102).

FIRST USE 8-31-2011; IN COMMERCE 8-31-2011.

THE MARK CONSISTS OF STANDARD CHARACTERS WITHOUT CLAIM TO ANY PARTICULAR FONT, STYLE, SIZE, OR COLOR.

NO CLAIM IS MADE TO THE EXCLUSIVE RIGHT TO USE "REMOTE" OR "SOLUTION", APART FROM THE MARK AS SHOWN.

SN 85-234,367, FILED 2-4-2011.

SUSAN LESLIE DUBOIS, EXAMINING ATTORNEY



*David J. Kyffers*

Director of the United States Patent and Trademark Office

# United States of America

United States Patent and Trademark Office

## Everyone Has a Price

**Reg. No. 4,276,316**

INFOSTREAM GROUP, INC. (NEVADA CORPORATION)  
220 E. FLAMINGO RD #126

**Registered Jan. 15, 2013**

LAS VEGAS, NV 89169

**Int. Cl.: 45**

FOR: INTERNET-BASED DATING, SOCIAL INTRODUCTION AND SOCIAL NETWORKING SERVICES, IN CLASS 45 (U.S. CLS. 100 AND 101).

**SERVICE MARK**

FIRST USE 4-8-2011; IN COMMERCE 4-8-2011.

**PRINCIPAL REGISTER**

THE MARK CONSISTS OF STANDARD CHARACTERS WITHOUT CLAIM TO ANY PARTICULAR FONT, STYLE, SIZE, OR COLOR.

SN 85-234,945, FILED 2-4-2011.

JAMES LOVELACE, EXAMINING ATTORNEY



*David J. Kyffers*

Director of the United States Patent and Trademark Office

# United States of America

United States Patent and Trademark Office

## GET YOUR HEAD IN THE GAME

**Reg. No. 4,276,317**

RPC ACQUISITION CORP. (MINNESOTA CORPORATION)  
7201 METRO BOULEVARD  
MINNEAPOLIS, MN 55439

**Registered Jan. 15, 2013**

**Int. Cl.: 44**

FOR: HAIR CUTTING SERVICES; HAIR SALON SERVICES; HAIR STYLING, IN CLASS 44  
(U.S. CLS. 100 AND 101).

**SERVICE MARK**

FIRST USE 2-0-2011; IN COMMERCE 2-0-2011.

**PRINCIPAL REGISTER**

THE MARK CONSISTS OF STANDARD CHARACTERS WITHOUT CLAIM TO ANY PARTICULAR FONT, STYLE, SIZE, OR COLOR.

SN 85-236,401, FILED 2-8-2011.

ANDREA K. NADELMAN, EXAMINING ATTORNEY



*David J. Kybas*

Director of the United States Patent and Trademark Office



# United States of America

United States Patent and Trademark Office



**Reg. No. 4,276,318**

COFFEE BEAN INTERNATIONAL, INC. (OREGON CORPORATION)  
9120 NE ALDERWOOD ROAD  
PORTLAND, OR 97220

**Registered Jan. 15, 2013**

**Int. Cl.: 30**

FOR: COFFEE, IN CLASS 30 (U.S. CL. 46).

**TRADEMARK**

FIRST USE 10-30-2012; IN COMMERCE 10-30-2012.

**PRINCIPAL REGISTER**

NO CLAIM IS MADE TO THE EXCLUSIVE RIGHT TO USE "COFFEE COMPANY", APART FROM THE MARK AS SHOWN.

THE MARK CONSISTS OF THE NUMBER "1" AND LETTER "K" IN A THREE-DIMENSIONAL DESIGN; LOCATED UNDERNEATH THE "1K" DESIGN ARE THE WORDS "COFFEE COMPANY" IN A SMALLER SIZED FONT; IN THE BACKGROUND OF "1K COFFEE COMPANY" IS A STYLIZED HOT AIR BALLOON DESIGN WITH A MULE HANGING FROM THE HOT AIR BALLOON.

SN 85-238,347, FILED 2-9-2011.

DAVID HOFFMAN, EXAMINING ATTORNEY



*David J. Kyffers*

Director of the United States Patent and Trademark Office

# United States of America

United States Patent and Trademark Office

## Word Detective

**Reg. No. 4,276,319**

**Registered Jan. 15, 2013**

**Int. Cl.: 42**

**SERVICE MARK**

**PRINCIPAL REGISTER**

INMATE CALLING SOLUTIONS, LLC (CALIFORNIA LIMITED LIABILITY COMPANY),  
DBA ICSOLUTIONS,  
CONTRACTS & REGULATORY  
2200 DANBURY STREET  
SAN ANTONIO, TX 78217

FOR: PROVIDING TEMPORARY USE OF NON-DOWNLOADABLE SOFTWARE APPLICATION FOR DESKTOP, LAPTOP AND HAND-HELD COMPUTERS, NAMELY, SOFTWARE-DRIVEN SERVICE APPLICATION FOR IDENTIFYING KEYWORDS IN AN AUDIO STREAM, IN CLASS 42 (U.S. CLS. 100 AND 101).

FIRST USE 10-12-2012; IN COMMERCE 10-12-2012.

THE MARK CONSISTS OF STANDARD CHARACTERS WITHOUT CLAIM TO ANY PARTICULAR FONT, STYLE, SIZE, OR COLOR.

NO CLAIM IS MADE TO THE EXCLUSIVE RIGHT TO USE "WORD", APART FROM THE MARK AS SHOWN.

SN 85-240,381, FILED 2-11-2011.

KAREN K. BUSH, EXAMINING ATTORNEY



*David J. Kyffers*

Director of the United States Patent and Trademark Office

# United States of America

United States Patent and Trademark Office

# POWERLITE

**Reg. No. 4,276,320**

**Registered Jan. 15, 2013**

**Int. Cl.: 11**

**TRADEMARK**

**PRINCIPAL REGISTER**

POWERSECURE, INC. (DELAWARE CORPORATION)  
1609 HERITAGE COMMERCE COURT  
WAKE FOREST, NC 27587

FOR: LED LIGHTING FIXTURES FOR OUTDOOR LIGHTING STANDARDS FOR STREET AND ROADWAY LIGHTING IN THE FIELD OF MUNICIPAL AND COMMERCIAL LIGHTING, IN CLASS 11 (U.S. CLS. 13, 21, 23, 31 AND 34).

FIRST USE 1-18-2011; IN COMMERCE 5-11-2012.

THE MARK CONSISTS OF STANDARD CHARACTERS WITHOUT CLAIM TO ANY PARTICULAR FONT, STYLE, SIZE, OR COLOR.

SN 85-240,838, FILED 2-12-2011.

LIEF MARTIN, EXAMINING ATTORNEY



*David J. Kyffers*

Director of the United States Patent and Trademark Office

# United States of America

United States Patent and Trademark Office

**CATALYST**   
**INSIGHT**

**Reg. No. 4,276,321**

CATALYST REPOSITORY SYSTEMS, INC. (DELAWARE CORPORATION)  
1860 BLAKE STREET, SUITE 740  
DENVER, CO 80202

**Registered Jan. 15, 2013**

**Int. Cl.: 42**

FOR: APPLICATION SERVICE PROVIDER (ASP) AND SOFTWARE AS A SERVICE (SAAS) PROVIDER SERVICES FEATURING SOFTWARE FOR PROVIDING ONLINE DOCUMENT PROCESSING, ANALYTICS, SEARCH, REVIEW AND PRODUCTION BY ELECTRONIC MEANS FOR USE IN THE FIELDS OF ELECTRONIC DISCOVERY, LITIGATION SUPPORT, REGULATORY AND INTERNAL INVESTIGATIONS AND FINANCIAL AND MERGER AND ACQUISITION DUE DILIGENCE; COMPUTER PROJECT MANAGEMENT SERVICES; COMPUTER PROJECT MANAGEMENT SERVICES, NAMELY, DESIGNING WORKFLOWS, DATA LOADING, PREPARING AND PRESENTING CUSTOM REPORTS REGARDING THE PERFORMANCE OF AND RESULTS PRODUCED BY THE SOFTWARE APPLICATION AND REPORTS REGARDING THE PROGRESS OF THE COMPUTER PROJECT MANAGEMENT, CUSTOMIZATION OF SOFTWARE, AND QUALITY CONTROL FOR OTHERS RELATED TO ELECTRONIC DOCUMENT PROCESSING, ANALYTICS, SEARCH, REVIEW AND PRODUCTION FOR USE IN THE FIELDS OF ELECTRONIC DISCOVERY, LITIGATION SUPPORT, REGULATORY AND INTERNAL INVESTIGATIONS AND FINANCIAL AND MERGER AND ACQUISITION DUE DILIGENCE; SEARCHING, RETRIEVING, AND ORGANIZING INFORMATION, SITES, AND OTHER RESOURCES AVAILABLE ON COMPUTER NETWORKS FOR OTHERS FOR USE IN THE FIELDS OF ELECTRONIC DISCOVERY, LITIGATION SUPPORT, REGULATORY INVESTIGATIONS AND FINANCIAL AND MERGER AND ACQUISITION DUE DILIGENCE, IN CLASS 42 (U.S. CLS. 100 AND 101).

**SERVICE MARK**

**PRINCIPAL REGISTER**



FIRST USE 12-31-2011; IN COMMERCE 12-31-2011.

OWNER OF U.S. REG. NOS. 3,191,695, 3,260,092, AND 3,285,592.

THE COLOR(S) BLUE AND ORANGE IS/ARE CLAIMED AS A FEATURE OF THE MARK.

THE MARK CONSISTS OF THE WORD "CATALYST" IN BLUE AND THE WORD "INSIGHT" IN ORANGE WITH AN ORANGE LIGHTNING BOLT ABOVE THE SECOND "I".

*David J. Kyros*

SN 85-240,862, FILED 2-12-2011.

MICHAEL SOUDERS, EXAMINING ATTORNEY

# United States of America

United States Patent and Trademark Office

## CATALYST INSIGHT

**Reg. No. 4,276,322**

**Registered Jan. 15, 2013**

**Int. Cl.: 42**

**SERVICE MARK**

**PRINCIPAL REGISTER**

CATALYST REPOSITORY SYSTEMS, INC. (DELAWARE CORPORATION)  
1860 BLAKE STREET, SUITE 740  
DENVER, CO 80202

FOR: APPLICATION SERVICE PROVIDER (ASP) AND SOFTWARE AS A SERVICE (SAAS) PROVIDER SERVICES FEATURING SOFTWARE FOR PROVIDING ONLINE DOCUMENT PROCESSING, ANALYTICS, SEARCH, REVIEW AND PRODUCTION BY ELECTRONIC MEANS FOR USE IN THE FIELDS OF ELECTRONIC DISCOVERY, LITIGATION SUPPORT, REGULATORY AND INTERNAL INVESTIGATIONS AND FINANCIAL AND MERGER AND ACQUISITION DUE DILIGENCE; COMPUTER PROJECT MANAGEMENT SERVICES; COMPUTER PROJECT MANAGEMENT SERVICES, NAMELY, DESIGNING WORKFLOWS, DATA LOADING, PREPARING AND PRESENTING CUSTOM REPORTS REGARDING THE PERFORMANCE OF AND RESULTS PRODUCED BY THE SOFTWARE APPLICATION AND REPORTS REGARDING THE PROGRESS OF THE COMPUTER PROJECT MANAGEMENT, CUSTOMIZATION OF SOFTWARE, AND QUALITY CONTROL FOR OTHERS RELATED TO ELECTRONIC DOCUMENT PROCESSING, ANALYTICS, SEARCH, REVIEW AND PRODUCTION FOR USE IN THE FIELDS OF ELECTRONIC DISCOVERY, LITIGATION SUPPORT, REGULATORY AND INTERNAL INVESTIGATIONS AND FINANCIAL AND MERGER AND ACQUISITION DUE DILIGENCE; SEARCHING, RETRIEVING, AND ORGANIZING INFORMATION, SITES, AND OTHER RESOURCES AVAILABLE ON COMPUTER NETWORKS FOR OTHERS FOR USE IN THE FIELDS OF ELECTRONIC DISCOVERY, LITIGATION SUPPORT, REGULATORY INVESTIGATIONS AND FINANCIAL AND MERGER AND ACQUISITION DUE DILIGENCE, IN CLASS 42 (U.S. CLS. 100 AND 101).

FIRST USE 12-31-2011; IN COMMERCE 12-31-2011.

THE MARK CONSISTS OF STANDARD CHARACTERS WITHOUT CLAIM TO ANY PARTICULAR FONT, STYLE, SIZE, OR COLOR.

OWNER OF U.S. REG. NOS. 3,191,695, 3,260,092, AND 3,285,592.

SN 85-240,863, FILED 2-12-2011.

MICHAEL SOUDERS, EXAMINING ATTORNEY



*David J. Kyros*

Director of the United States Patent and Trademark Office

# United States of America

United States Patent and Trademark Office

## STRANGER & STRANGER

**Reg. No. 4,276,323**

**Registered Jan. 15, 2013**

**Int. Cls.: 33, 35, and 42**

STRANGER & STRANGER INC (NEW YORK CORPORATION)  
5TH FLOOR  
42 GREENE STREET  
NEW YORK, NY 10013

FOR: WINE, SPIRITS, IN CLASS 33 (U.S. CLS. 47 AND 49).

**TRADEMARK**

FIRST USE 5-14-1994; IN COMMERCE 7-7-2008.

**SERVICE MARK**

FOR: ADVERTISING AND MARKETING SERVICES, BUSINESS AND MARKET RESEARCH SERVICES; BUSINESS, EVALUATION AND MARKETING CONSULTANCY SERVICES RELATING TO BRANDING AND REBRANDING OF PRODUCTS; BUSINESS ADVISORY SERVICES IN THE NATURE OF PACKAGING DESIGN AND NAME GENERATION AND BRANDING FOR WINES, SPIRITS, AND BEERS, BUSINESS ADMINISTRATION AND MANAGEMENT SERVICES, PROVIDING OFFICE FUNCTIONS; INFORMATION ADVISORY AND CONSULTANCY SERVICES RELATING TO ALL THE AFORESAID SERVICE; SERVICES RELATING TO THE ANALYSIS, EVALUATION, CREATION AND BRAND ESTABLISHMENT OF TRADEMARKS, TRADE NAMES AND DOMAIN NAMES; ADVERTISING SERVICES, NAMELY, CREATING CORPORATE AND BRAND IDENTITY FOR OTHERS; CORPORATE IDENTITY SERVICES, IN CLASS 35 (U.S. CLS. 100, 101 AND 102).

**PRINCIPAL REGISTER**

FIRST USE 5-14-1994; IN COMMERCE 7-7-2008.



FOR: COMMERCIAL ART DESIGN; GRAPHIC ART DESIGN; DESIGN, CREATION, HOSTING AND MAINTENANCE OF INTERNET AND INTRANET WEB SITES FOR THIRD PARTIES; COMPUTER SOFTWARE DESIGN, DEVELOPMENT, RENTAL, MAINTENANCE AND UPDATING; ADVISORY SERVICES RELATING TO PRODUCT TESTING; INFORMATION, ADVISORY AND CONSULTANCY SERVICES RELATING TO ALL THE AFORESAID SERVICES, IN CLASS 42 (U.S. CLS. 100 AND 101).

FIRST USE 5-14-1994; IN COMMERCE 7-7-2008.

THE MARK CONSISTS OF STANDARD CHARACTERS WITHOUT CLAIM TO ANY PARTICULAR FONT, STYLE, SIZE, OR COLOR.

*David J. Kyros*

SN 85-241,162, FILED 2-14-2011.

**Reg. No. 4,276,323** WILLIAM P. SHANAHAN, EXAMINING ATTORNEY

# United States of America

United States Patent and Trademark Office

## AUDI PRE SENSE

**Reg. No. 4,276,324**

AUDI AG (FED REP GERMANY CORPORATION)  
85045

**Registered Jan. 15, 2013**

INGOLSTADT, FED REP GERMANY

**Int. Cls.: 9 and 12**

FOR: AUTOMOTIVE PREVENTATIVE OCCUPANT PROTECTION SYSTEM CONSISTING OF RADAR OBJECT DETECTORS FOR USE ON VEHICLES, VIDEO CAMERAS FOR MONITORING ROAD AND TRAFFIC, ADAPTIVE CRUISE CONTROL FOR MOTOR VEHICLES AND BRAKE CONTROLLERS, IN CLASS 9 (U.S. CLS. 21, 23, 26, 36 AND 38).

**TRADEMARK**

**PRINCIPAL REGISTER**

FIRST USE 12-1-2006; IN COMMERCE 11-25-2010.

FOR: LAND VEHICLES AND THEIR STRUCTURAL PARTS, IN CLASS 12 (U.S. CLS. 19, 21, 23, 31, 35 AND 44).

FIRST USE 12-1-2009; IN COMMERCE 11-25-2010.

THE MARK CONSISTS OF STANDARD CHARACTERS WITHOUT CLAIM TO ANY PARTICULAR FONT, STYLE, SIZE, OR COLOR.

OWNER OF FED REP GERMANY REG. NO. 302009030628, DATED 7-3-2009, EXPIRES 5-31-2019.

OWNER OF U.S. REG. NOS. 708,352, 2,083,439, AND OTHERS.

SN 85-241,396, FILED 2-14-2011.

KYLE PEETE, EXAMINING ATTORNEY



*David J. Kybas*

Director of the United States Patent and Trademark Office



# United States of America

United States Patent and Trademark Office

## INSTANT ON

**Reg. No. 4,276,325**

**Registered Jan. 15, 2013**

**Int. Cl.: 42**

**SERVICE MARK**

**PRINCIPAL REGISTER**

ATLAS DATABASE SOFTWARE CORPORATION (CALIFORNIA CORPORATION)  
BLDG. C, SUITE 200  
26679 WEST AGOURA ROAD  
CALABASAS, CA 91302

FOR: APPLICATION SERVICE PROVIDER (ASP) FEATURING SOFTWARE FOR USE IN ORIGINATING, COLLECTING, ORGANIZING, STORING, ANALYZING, AND COMMUNICATING MEDICAL RECORDS, PATIENT INFORMATION, CLINICAL HISTORIES, AND LABORATORY TEST RESULTS; APPLICATION SERVICE PROVIDER (ASP) FEATURING SOFTWARE FOR USE IN FACILITATING HEALTH INFORMATION EXCHANGE BY ORIGINATING, COLLECTING, ORGANIZING, STORING, ANALYZING AND COMMUNICATING HEALTH INFORMATION; APPLICATION SERVICE PROVIDER (ASP) FEATURING SOFTWARE FOR USE IN PROVIDING ACCESS TO ELECTRONIC MEDICAL RECORDS AND ELECTRONIC HEALTH RECORDS; APPLICATION SERVICE PROVIDER (ASP) FEATURING SOFTWARE FOR USE IN PROVIDING REMOTE ACCESS TO THE AFOREMENTIONED RECORDS AND INFORMATION AND TRANSMISSION OF SUCH RECORDS BETWEEN USERS, AND FOR USE IN SYSTEM INTEGRATION AND INTEROPERABILITY AMONG SOFTWARE APPLICATIONS IN THE FIELD OF MEDICAL RECORDS, HEALTH RECORDS, AND PATIENT INFORMATION, WHERE SUCH APPLICATIONS ARE USED WITHIN A LOCAL NETWORK OR ACROSS NETWORKS, INCLUDING THE INTERNET, IN CLASS 42 (U.S. CLS. 100 AND 101).

FIRST USE 11-18-2010; IN COMMERCE 11-18-2010.

THE MARK CONSISTS OF STANDARD CHARACTERS WITHOUT CLAIM TO ANY PARTICULAR FONT, STYLE, SIZE, OR COLOR.

SN 85-241,656, FILED 2-14-2011.

DOUGLAS LEE, EXAMINING ATTORNEY



*David J. Kyffers*

Director of the United States Patent and Trademark Office

# United States of America

United States Patent and Trademark Office



**Reg. No. 4,276,326**

ENERGY MANAGEMENT RESOURCES OF MISSOURI, INC. (MISSOURI CORPORATION)  
1536 NE 96TH STREET  
LIBERTY, MO 64068

**Registered Jan. 15, 2013**

**Int. Cl.: 35**

FOR: BUSINESS CONSULTING AND ADVISORY SERVICES IN THE FIELD OF ENERGY EFFICIENCY, ENERGY REQUIREMENTS, ENERGY REGULATION, TAX EXEMPTION EVALUATION, TARIFF OPTIMIZATION, RISK ASSESSMENT, BUDGET PREPARATION, BILLING ANALYSIS, AUDITING, CONTRACT NEGOTIATIONS, CARBON MANAGEMENT IN THE FIELD OF ENERGY; CONDUCTING ENERGY AUDITS; ENERGY USAGE AND EFFICIENCY MANAGEMENT SERVICES; ENERGY PROCUREMENT SERVICES; ENERGY PRICE COMPARISON SERVICES; ENERGY USAGE MANAGEMENT AND INFORMATION SERVICES, IN CLASS 35 (U.S. CLS. 100, 101 AND 102).

**SERVICE MARK**

**PRINCIPAL REGISTER**

FIRST USE 6-1-2012; IN COMMERCE 6-1-2012.

NO CLAIM IS MADE TO THE EXCLUSIVE RIGHT TO USE "ENERGY" , APART FROM THE MARK AS SHOWN.

THE MARK CONSISTS OF THREE DIAGONAL BARS THAT COME TO A POINT ON BOTH ENDS. AT THE BOTTOM OF EACH DIAGONAL BAR IS A SHADED CIRCLE IMAGE. TO THE RIGHT OF THE BARS IS THE WORDS "ENERGY EXPRESS".

SN 85-241,676, FILED 2-14-2011.

JENNIFER BUTTON, EXAMINING ATTORNEY



*David J. Kyjars*

Director of the United States Patent and Trademark Office

# United States of America

United States Patent and Trademark Office

# HEARTWISE

**Reg. No. 4,276,327**

**Registered Jan. 15, 2013**

**Int. Cl.: 29**

**TRADEMARK**

**PRINCIPAL REGISTER**

AP FOODS INCORPORATED (NEVADA CORPORATION)  
SUITE 208  
8650 W. TROPICANA  
LAS VEGAS, NV 89147

FOR: MARGARINE, EDIBLE OILS AND FATS AND VEGETABLE OILS, IN CLASS 29 (U.S. CL. 46).

FIRST USE 10-0-2011; IN COMMERCE 10-0-2011.

THE MARK CONSISTS OF STANDARD CHARACTERS WITHOUT CLAIM TO ANY PARTICULAR FONT, STYLE, SIZE, OR COLOR.

SN 85-242,612, FILED 2-15-2011.

SAMUEL E. SHARPER JR., EXAMINING ATTORNEY



*David J. Kyffers*

Director of the United States Patent and Trademark Office

# United States of America

United States Patent and Trademark Office

## ENERGY WISR

**Reg. No. 4,276,328**

**Registered Jan. 15, 2013**

**Int. Cl.: 35**

**SERVICE MARK**

**PRINCIPAL REGISTER**

ENERGY MANAGEMENT RESOURCES OF MISSOURI, INC. (MISSOURI CORPORATION)  
1536 NE 96TH STREET  
LIBERTY, MO 64068

FOR: BUSINESS CONSULTING AND ADVISORY SERVICES IN THE FIELD OF ENERGY EFFICIENCY, ENERGY REQUIREMENTS, ENERGY REGULATION, TAX EXEMPTION EVALUATION, RISK ASSESSMENT, BUDGET PREPARATION, BILLING ANALYSIS, AUDITING, CONTRACT NEGOTIATIONS, CARBON MANAGEMENT IN THE FIELD OF ENERGY; CONDUCTING ENERGY AUDITS; ENERGY USAGE AND EFFICIENCY MANAGEMENT SERVICES; ENERGY PROCUREMENT SERVICES; ENERGY PRICE COMPARISON SERVICES; ENERGY USAGE MANAGEMENT AND INFORMATION SERVICES, IN CLASS 35 (U.S. CLS. 100, 101 AND 102).

FIRST USE 11-16-2012; IN COMMERCE 11-16-2012.

THE MARK CONSISTS OF STANDARD CHARACTERS WITHOUT CLAIM TO ANY PARTICULAR FONT, STYLE, SIZE, OR COLOR.

NO CLAIM IS MADE TO THE EXCLUSIVE RIGHT TO USE "ENERGY", APART FROM THE MARK AS SHOWN.

SN 85-242,704, FILED 2-15-2011.

JENNIFER BUTTON, EXAMINING ATTORNEY



*David J. Kyros*

Director of the United States Patent and Trademark Office

# United States of America

United States Patent and Trademark Office

# EMPOWER

**Reg. No. 4,276,329**

**Registered Jan. 15, 2013**

**Int. Cl.: 35**

**SERVICE MARK**

**PRINCIPAL REGISTER**

ENERGY MANAGEMENT RESOURCES OF MISSOURI, INC. (MISSOURI CORPORATION)  
1536 NE 96TH STREET  
LIBERTY, MO 64068

FOR: BUSINESS CONSULTING AND ADVISORY SERVICES IN THE FIELD OF ENERGY EFFICIENCY, ENERGY REQUIREMENTS, ENERGY REGULATION, TAX EXEMPTION EVALUATION, RISK ASSESSMENT, BUDGET PREPARATION, BILLING ANALYSIS, AUDITING, CONTRACT NEGOTIATIONS, CARBON MANAGEMENT IN THE FIELD OF ENERGY; CONDUCTING ENERGY AUDITS; ENERGY USAGE AND EFFICIENCY MANAGEMENT SERVICES; ENERGY PROCUREMENT SERVICES; ENERGY PRICE COMPARISON SERVICES; ENERGY USAGE MANAGEMENT AND INFORMATION SERVICES, IN CLASS 35 (U.S. CLS. 100, 101 AND 102).

FIRST USE 11-15-2012; IN COMMERCE 11-15-2012.

THE MARK CONSISTS OF STANDARD CHARACTERS WITHOUT CLAIM TO ANY PARTICULAR FONT, STYLE, SIZE, OR COLOR.

SN 85-242,711, FILED 2-15-2011.

JENNIFER BUTTON, EXAMINING ATTORNEY



*David J. Kypos*

Director of the United States Patent and Trademark Office

# United States of America

United States Patent and Trademark Office

## MIRACLE LEAVE-IN LITE

**Reg. No. 4,276,330**

IT'S A 10, INC. (FLORIDA CORPORATION)  
153 NURMI DRIVE  
FORT LAUDERDALE, FL 33301

**Registered Jan. 15, 2013**

**Int. Cl.: 3**

FOR: HAIR CARE PRODUCTS, NAMELY, LEAVE IN CONDITIONING AIDS, IN CLASS 3  
(U.S. CLS. 1, 4, 6, 50, 51 AND 52).

**TRADEMARK**

FIRST USE 2-16-2012; IN COMMERCE 2-16-2012.

**PRINCIPAL REGISTER**

THE MARK CONSISTS OF STANDARD CHARACTERS WITHOUT CLAIM TO ANY PARTICULAR FONT, STYLE, SIZE, OR COLOR.

OWNER OF U.S. REG. NOS. 3,760,933, 3,760,956, AND 3,761,012.

NO CLAIM IS MADE TO THE EXCLUSIVE RIGHT TO USE "LEAVE-IN LIGHT", APART FROM THE MARK AS SHOWN.

SN 85-243,510, FILED 2-16-2011.

INGA ERVIN, EXAMINING ATTORNEY



*David J. Kybas*

Director of the United States Patent and Trademark Office

# United States of America

United States Patent and Trademark Office

# peerpurchase

**Reg. No. 4,276,331**

**Registered Jan. 15, 2013**

**Int. Cl.: 35**

**SERVICE MARK**

**PRINCIPAL REGISTER**

FISHER, TAYLOR (UNITED STATES INDIVIDUAL)  
10660 242ND PL. NE  
REDMOND, WA 98053

FOR: SOCIAL COMMERCE INTERNET MARKETPLACE AND SERVICES, NAMELY, ADMINISTRATION OF A PROGRAM FOR ENABLING PARTICIPANTS TO OBTAIN GROUP DISCOUNTS ON PRODUCTS AND SERVICES; ONLINE SERVICE FOR CONNECTING SOCIAL NETWORK USERS WITH RETAILERS FOR THE PURPOSE OF FACILITATING DISCOUNTED PURCHASES; PROVIDING GROUP BUYING SERVICES TO INTERNET RETAILERS, NAMELY, OPERATING ON-LINE MARKETPLACES FOR SELLERS OF GOODS AND/OR SERVICES; PRODUCT PROMOTION AND AWARENESS, NAMELY, ADVERTISING AND PROMOTIONAL SERVICES THROUGH SOCIAL NETWORKING CHANNELS AND SERVICES; PROGRESSIVE PRICE DISCOUNTS THROUGH COLLECTIVE PARTICIPATION, NAMELY, PROMOTING THE GOODS AND SERVICES OF OTHERS BY PROVIDING AN INTERACTIVE WEBSITE WHERE USERS CAN INCREASE THE VALUE OF AN ONLINE DISCOUNT BEING OFFERED BY PURCHASING THE GOODS AND SERVICES ASSOCIATED WITH THAT DISCOUNT IN THE FORM OF AN ONLINE COUPON, VOUCHER OR GIFT CARD; PROMOTING THE SALE OF GOODS AND SERVICES OF OTHERS THROUGH ELECTRONIC COUPONING, PROMOTIONS AND DISCOUNTS; PRODUCT PROMOTION AND AWARENESS THROUGH SOCIAL NETWORKING CHANNELS AND SERVICES IN THE NATURE OF PROMOTING THE GOODS AND SERVICES OF OTHERS, NAMELY, PROVIDING INFORMATION REGARDING DISCOUNTS, COUPONS, REBATES, VOUCHERS AND SPECIAL OFFERS FOR THE GOODS AND SERVICES OF OTHERS, IN CLASS 35 (U.S. CLS. 100, 101 AND 102).



FIRST USE 2-15-2012; IN COMMERCE 5-1-2012.

THE MARK CONSISTS OF STANDARD CHARACTERS WITHOUT CLAIM TO ANY PARTICULAR FONT, STYLE, SIZE, OR COLOR.

SN 85-244,411, FILED 2-16-2011.

MATTHEW MCDOWELL, EXAMINING ATTORNEY

*David J. Kyffers*

Director of the United States Patent and Trademark Office

# United States of America

United States Patent and Trademark Office

**OSKAR'S SAUSAGE GRILL** 

**Reg. No. 4,276,332**

RICHTER, HANS W. (UNITED STATES INDIVIDUAL)  
34 VALLEY VIEW AVE  
SAN RAFAEL, CA 94901

**Registered Jan. 15, 2013**

**Int. Cl.: 35**

FOR: CONCESSION STANDS FEATURING FOOD AND DRINKS; MOBILE STREET VENDOR SERVICES FEATURING FOOD AND DRINK; MOBILE VENDING IN THE FIELD OF FOOD AND DRINKS, IN CLASS 35 (U.S. CLS. 100, 101 AND 102).

**SERVICE MARK**

FIRST USE 10-1-2012; IN COMMERCE 10-1-2012.

**PRINCIPAL REGISTER**

NO CLAIM IS MADE TO THE EXCLUSIVE RIGHT TO USE "SAUSAGE GRILL", APART FROM THE MARK AS SHOWN.

THE COLOR(S) RED, BLACK, YELLOW, WHITE IS/ARE CLAIMED AS A FEATURE OF THE MARK.

THE NAME(S), PORTRAIT(S), AND/OR SIGNATURE(S) SHOWN IN THE MARK DOES NOT IDENTIFY A PARTICULAR LIVING INDIVIDUAL.

THE MARK CONSISTS OF A YELLOW RECTANGLE; RED LETTERING WITH WORDS "OSKAR'S SAUSAGE GRILL" APPEAR WITH BLACK SHADOWING; TO THE RIGHT OF THE TEXT APPEARS A WHITE CHEF'S HAT WITH A BLACK OUTLINE.

SN 85-246,594, FILED 2-18-2011.

JASON TURNER, EXAMINING ATTORNEY



*David J. Kyjars*

Director of the United States Patent and Trademark Office



# United States of America

United States Patent and Trademark Office



**Reg. No. 4,276,333**

**Registered Jan. 15, 2013**

**Int. Cl.: 16**

**TRADEMARK**

**PRINCIPAL REGISTER**

CHILDS, ARCYNTA L. (D.C. SOLE PROPRIETORSHIP), DBA HOMEGIRL NYC,  
1429 FORT STEVENS DRIVE NW  
WASHINGTON, DC 20011

FOR: MAGAZINES FEATURING TEENS, IN CLASS 16 (U.S. CLS. 2, 5, 22, 23, 29, 37, 38 AND 50).

FIRST USE 1-12-2011; IN COMMERCE 5-13-2011.

NO CLAIM IS MADE TO THE EXCLUSIVE RIGHT TO USE "NYC", APART FROM THE MARK AS SHOWN.

THE COLOR(S) GREEN, BLUE, ORANGE, BLACK AND WHITE IS/ARE CLAIMED AS A FEATURE OF THE MARK.

THE MARK CONSISTS OF THE WORDING "HOMEGIRL" IN WHITE, AND THE LETTERS "N" IN BLACK INSIDE A GREEN CIRCLE, "Y" IN WHITE INSIDE A BLUE CIRCLE, AND "C" IN BLACK INSIDE AN ORANGE CIRCLE; THE BLACK RECTANGLE IS NOT PART OF THE MARK BUT REPRESENTS TRANSPARENT BACKGROUND.

SN 85-247,139, FILED 2-20-2011.

AMY KELLY, EXAMINING ATTORNEY



*David J. Kyffers*

Director of the United States Patent and Trademark Office

# United States of America

United States Patent and Trademark Office

## ECZEMA ESSENTIALS

**Reg. No. 4,276,334**

JOHNSON & JOHNSON (NEW JERSEY CORPORATION)  
ONE JOHNSON & JOHNSON PLAZA  
NEW BRUNSWICK, NJ 089337001

**Registered Jan. 15, 2013**

**Int. Cls.: 3 and 5**

FOR: NON-MEDICATED SKIN CARE PREPARATIONS, IN CLASS 3 (U.S. CLS. 1, 4, 6, 50, 51 AND 52).

**TRADEMARK**

FIRST USE 1-22-2012; IN COMMERCE 1-22-2012.

**PRINCIPAL REGISTER**

FOR: MEDICATED SKIN CARE PREPARATIONS, IN CLASS 5 (U.S. CLS. 6, 18, 44, 46, 51 AND 52).

FIRST USE 1-22-2012; IN COMMERCE 1-22-2012.

THE MARK CONSISTS OF STANDARD CHARACTERS WITHOUT CLAIM TO ANY PARTICULAR FONT, STYLE, SIZE, OR COLOR.

NO CLAIM IS MADE TO THE EXCLUSIVE RIGHT TO USE "ECZEMA", APART FROM THE MARK AS SHOWN.

SN 85-249,264, FILED 2-23-2011.

BERYL GARDNER, EXAMINING ATTORNEY



*David J. Kyffers*

Director of the United States Patent and Trademark Office

# United States of America

United States Patent and Trademark Office

# TEOT WAWKI

**Reg. No. 4,276,335**

**Registered Jan. 15, 2013**

**Int. Cl.: 25**

**TRADEMARK**

**PRINCIPAL REGISTER**

BILLINGSLEA, TODD (UNITED STATES INDIVIDUAL)  
#5  
3901 W. 86TH AVE UNIT  
ANCHORAGE, AK 99502

FOR: CLOTHING, NAMELY, TOPS, BOTTOMS, T-SHIRTS, IN CLASS 25 (U.S. CLS. 22 AND 39).

FIRST USE 1-15-2011; IN COMMERCE 8-7-2011.

THE MARK CONSISTS OF STANDARD CHARACTERS WITHOUT CLAIM TO ANY PARTICULAR FONT, STYLE, SIZE, OR COLOR.

SN 85-250,212, FILED 2-24-2011.

MAYUR VAGHANI, EXAMINING ATTORNEY



*David J. Kybas*

Director of the United States Patent and Trademark Office

# United States of America

United States Patent and Trademark Office

## "Yell Turk Creole Rice"

**Reg. No. 4,276,336**

ADAMS, REGINALD (UNITED STATES INDIVIDUAL)  
3132 BANNEKER DR. NE  
WASHINGTON, DC 20018 AND

**Registered Jan. 15, 2013**

**Int. Cl.: 29**

ADAMS, SHARON (UNITED STATES INDIVIDUAL)  
3132 BANNEKER DR. NE  
WASHINGTON, DC 20018

**TRADEMARK**

**PRINCIPAL REGISTER**

FOR: PREPARED ENTREES CONSISTING PRIMARILY OF MEAT, FISH, POULTRY OR VEGETABLES, IN CLASS 29 (U.S. CL. 46).

FIRST USE 3-26-2010; IN COMMERCE 5-28-2011.

THE MARK CONSISTS OF STANDARD CHARACTERS WITHOUT CLAIM TO ANY PARTICULAR FONT, STYLE, SIZE, OR COLOR.

NO CLAIM IS MADE TO THE EXCLUSIVE RIGHT TO USE "CREOLE RICE", APART FROM THE MARK AS SHOWN.

SN 85-251,278, FILED 2-24-2011.

TAMARA FRAZIER, EXAMINING ATTORNEY



*David J. Kybas*

Director of the United States Patent and Trademark Office

# United States of America

United States Patent and Trademark Office

## VITAMINS WITHOUT

**Reg. No. 4,276,337**

**Registered Jan. 15, 2013**

**Int. Cl.: 5**

**TRADEMARK**

**PRINCIPAL REGISTER**

SOURCE OF HEALTH, INC. (CALIFORNIA CORPORATION)  
1055 BAY BLVD, STE A  
CHULA VISTA, CA 91911

FOR: ENZYME FOOD SUPPLEMENTS, MINERAL SUPPLEMENTS, MEDICINAL HERBS,  
PROCESSED FOOD ADAPTED FOR MEDICAL PURPOSES, ALL CONTAINING VITAMINS  
WITH PROVEN EFFICACY, IN CLASS 5 (U.S. CLS. 6, 18, 44, 46, 51 AND 52).

FIRST USE 1-20-2006; IN COMMERCE 1-20-2006.

THE MARK CONSISTS OF STANDARD CHARACTERS WITHOUT CLAIM TO ANY PAR-  
TICULAR FONT, STYLE, SIZE, OR COLOR.

NO CLAIM IS MADE TO THE EXCLUSIVE RIGHT TO USE "VITAMINS", APART FROM  
THE MARK AS SHOWN.

SN 85-252,938, FILED 2-28-2011.

HENRY S. ZAK, EXAMINING ATTORNEY



*David J. Kyros*

Director of the United States Patent and Trademark Office

# United States of America

United States Patent and Trademark Office

# Pink Tube

**Reg. No. 4,276,338**

GAPOIP, LLC (FLORIDA LIMITED LIABILITY COMPANY)  
12388 SW 82 AVENUE  
PINECREST, FL 33156

**Registered Jan. 15, 2013**

**Int. Cl.: 41**

FOR: ENTERTAINMENT SERVICES, NAMELY, PROVIDING A WEB SITE FEATURING PHOTOGRAPHIC, AUDIO, VIDEO AND PROSE PRESENTATIONS FEATURING ADULT-ORIENTED SUBJECT MATTER, IN CLASS 41 (U.S. CLS. 100, 101 AND 107).

**SERVICE MARK**

FIRST USE 12-3-2011; IN COMMERCE 12-3-2011.

**PRINCIPAL REGISTER**

THE MARK CONSISTS OF STANDARD CHARACTERS WITHOUT CLAIM TO ANY PARTICULAR FONT, STYLE, SIZE, OR COLOR.

SN 85-253,711, FILED 2-28-2011.

ESTHER BELENKER, EXAMINING ATTORNEY



*David J. Kyfos*

Director of the United States Patent and Trademark Office

# United States of America

United States Patent and Trademark Office

## PROTECT - TECH

**Reg. No. 4,276,339**

GRT DEVELOPMENT PTY LTD (AUSTRALIA PRIVATE LIMITED COMPANY)  
PO BOX NEUTRAL BAY  
SYDNEY, AUSTRALIA

**Registered Jan. 15, 2013**

**Int. Cl.: 24**

FOR: FABRICS FOR TEXTILE USE; FABRICS FOR THE USE IN THE PROTECTION OF SKIN FROM ABRASION DURING SPORTS OR MOTION ACTIVITIES, IN CLASS 24 (U.S. CLS. 42 AND 50).

**TRADEMARK**

FIRST USE 10-30-2012; IN COMMERCE 10-30-2012.

**PRINCIPAL REGISTER**

THE MARK CONSISTS OF STANDARD CHARACTERS WITHOUT CLAIM TO ANY PARTICULAR FONT, STYLE, SIZE, OR COLOR.

SN 85-253,975, FILED 2-28-2011.

ESTHER BELENKER, EXAMINING ATTORNEY



*David J. Kyffers*

Director of the United States Patent and Trademark Office

# United States of America

United States Patent and Trademark Office

## WEARABLE . GIFTABLE . MEANINGFUL

**Reg. No. 4,276,340**

**Registered Jan. 15, 2013**

**Int. Cls.: 14, 18, and 25**

**TRADEMARK**

**PRINCIPAL REGISTER**

ALEXA'S ANGELS, INC. (COLORADO CORPORATION)  
621 INNOVATION CIRCLE, SUITE A-2  
WINDSOR, CO 80550

FOR: JEWELRY, IN CLASS 14 (U.S. CLS. 2, 27, 28 AND 50).

FIRST USE 12-10-2009; IN COMMERCE 12-10-2009.

FOR: HANDBAGS; PURSES; PURSE ORGANIZERS FOR USE IN PURSES; TOTE BAGS, IN CLASS 18 (U.S. CLS. 1, 2, 3, 22 AND 41).

FIRST USE 12-10-2009; IN COMMERCE 12-10-2009.

FOR: CLOTHING, NAMELY, SHIRTS, T-SHIRTS, SCARVES AND SASHES, IN CLASS 25 (U.S. CLS. 22 AND 39).

FIRST USE 12-10-2009; IN COMMERCE 12-10-2009.

THE MARK CONSISTS OF STANDARD CHARACTERS WITHOUT CLAIM TO ANY PARTICULAR FONT, STYLE, SIZE, OR COLOR.

NO CLAIM IS MADE TO THE EXCLUSIVE RIGHT TO USE "WEARABLE", APART FROM THE MARK AS SHOWN.

SN 85-254,374, FILED 3-1-2011.

KYLE PEETE, EXAMINING ATTORNEY



*David J. Kyffers*

Director of the United States Patent and Trademark Office



# United States of America

United States Patent and Trademark Office

# MEDROVER

**Reg. No. 4,276,341**

TRANSLAGIC CORPORATION (DELAWARE CORPORATION)  
10825 E. 47TH AVENUE  
DENVER, CO 80239

**Registered Jan. 15, 2013**

**Int. Cl.: 12**

FOR: MOBILE CART FOR CONTROLLABLY DISPENSING MEDICATIONS AND MEDICAL SUPPLIES, NOT INCLUDING MOTORIZED VEHICLES, IN CLASS 12 (U.S. CLS. 19, 21, 23, 31, 35 AND 44).

**TRADEMARK**

FIRST USE 11-30-2011; IN COMMERCE 11-30-2011.

**PRINCIPAL REGISTER**

THE MARK CONSISTS OF STANDARD CHARACTERS WITHOUT CLAIM TO ANY PARTICULAR FONT, STYLE, SIZE, OR COLOR.

SN 85-254,444, FILED 3-1-2011.

WILLIAM P. SHANAHAN, EXAMINING ATTORNEY



*David J. Kyffers*

Director of the United States Patent and Trademark Office

# United States of America

United States Patent and Trademark Office

## The Annuity Guy

**Reg. No. 4,276,342**

**Registered Jan. 15, 2013**

**Int. Cl.: 36**

**SERVICE MARK**

**PRINCIPAL REGISTER**

PATTON, JAMES (UNITED STATES INDIVIDUAL)  
21900 BURBANK BLVD.  
3RD FLOOR  
WOODLAND HILLS, CA 91367

FOR: FINANCIAL ADVISORY AND CONSULTANCY SERVICES; INVESTMENT MANAGEMENT OF AND DISTRIBUTION OF ANNUITIES, IN CLASS 36 (U.S. CLS. 100, 101 AND 102).

FIRST USE 6-19-2012; IN COMMERCE 9-19-2012.

THE MARK CONSISTS OF STANDARD CHARACTERS WITHOUT CLAIM TO ANY PARTICULAR FONT, STYLE, SIZE, OR COLOR.

NO CLAIM IS MADE TO THE EXCLUSIVE RIGHT TO USE "ANNUITY", APART FROM THE MARK AS SHOWN.

SN 85-255,120, FILED 3-1-2011.

MATTHEW KLINE, EXAMINING ATTORNEY



*David J. Kyros*

Director of the United States Patent and Trademark Office

United States of America  
United States Patent and Trademark Office

3 FRESH

**Reg. No. 4,276,343**

ARAMARK CORPORATION (DELAWARE CORPORATION)  
1101 MARKET STREET, 29TH FLOOR  
PHILADELPHIA, PA 19107

**Registered Jan. 15, 2013**

**Int. Cl.: 43**

FOR: RESTAURANTS; RESTAURANT SERVICES; CONTRACT FOOD SERVICES PROVIDED AT THE WORKPLACE LOCATIONS OF OTHERS, IN CLASS 43 (U.S. CLS. 100 AND 101).

**SERVICE MARK**

FIRST USE 8-0-2012; IN COMMERCE 8-0-2012.

**PRINCIPAL REGISTER**

THE MARK CONSISTS OF STANDARD CHARACTERS WITHOUT CLAIM TO ANY PARTICULAR FONT, STYLE, SIZE, OR COLOR.

SN 85-255,290, FILED 3-2-2011.

BARBARA BROWN, EXAMINING ATTORNEY



*David J. Kybas*

Director of the United States Patent and Trademark Office

United States of America  
United States Patent and Trademark Office

**3fresh**

**Reg. No. 4,276,344**

ARAMARK CORPORATION (DELAWARE CORPORATION)  
1101 MARKET STREET, 29TH FLOOR  
PHILADELPHIA, PA 19107

**Registered Jan. 15, 2013**

**Int. Cl.: 43**

FOR: RESTAURANTS; RESTAURANT SERVICES; CONTRACT FOOD SERVICES PROVIDED AT THE WORKPLACE LOCATIONS OF OTHERS, IN CLASS 43 (U.S. CLS. 100 AND 101).

**SERVICE MARK**

FIRST USE 8-0-2012; IN COMMERCE 8-0-2012.

**PRINCIPAL REGISTER**

THE MARK CONSISTS OF THE STYLIZED WORDING "3FRESH" WITH "3" APPEARING IN A RECTANGLE.

SN 85-255,297, FILED 3-2-2011.

BARBARA BROWN, EXAMINING ATTORNEY



*David J. Kybas*

Director of the United States Patent and Trademark Office

# United States of America

United States Patent and Trademark Office

## ADVANCING SCIENCE, IMPROVING CARE

**Reg. No. 4,276,345**

INFECTIOUS DISEASES SOCIETY OF AMERICA (D.C. NON-PROFIT CORPORATION)  
1300 WILSON BOULEVARD, SUITE 300  
ARLINGTON, VA 22209

**Registered Jan. 15, 2013**

**Int. Cl.: 41**

FOR: EDUCATIONAL SERVICES, NAMELY, CONDUCTING CONFERENCES IN THE FIELD OF HEALTH AND DISEASES AND DISTRIBUTION OF COURSE MATERIAL IN CONNECTION THEREWITH, IN CLASS 41 (U.S. CLS. 100, 101 AND 107).

**SERVICE MARK**

FIRST USE 4-0-2011; IN COMMERCE 3-0-2012.

**PRINCIPAL REGISTER**

THE MARK CONSISTS OF STANDARD CHARACTERS WITHOUT CLAIM TO ANY PARTICULAR FONT, STYLE, SIZE, OR COLOR.

SN 85-256,537, FILED 3-3-2011.

ASMAT KHAN, EXAMINING ATTORNEY



*David J. Kyros*

Director of the United States Patent and Trademark Office

# United States of America

United States Patent and Trademark Office



**KAPITAL**  
TRADING

**Reg. No. 4,276,346**

**Registered Jan. 15, 2013**

**Int. Cl.: 36**

**SERVICE MARK**

**PRINCIPAL REGISTER**

KAPITAL TECHNOLOGIES, LLC (DELAWARE LIMITED LIABILITY COMPANY)  
411 S. WELLS STREET  
SUITE 120  
CHICAGO, IL 606073927

FOR: FINANCIAL SERVICES, NAMELY, TRADING OF SECURITIES, COMMODITIES, FUTURES CONTRACTS, SECURITY FUTURES CONTRACTS, FORWARD CONTRACTS, FOREIGN EXCHANGE TRANSACTIONS, SWAP CONTRACTS, EXCHANGE-FOR-PHYSICAL OR SPOT COMMODITIES, OPTIONS OR WARRANTS AND OTHER INVESTMENT INSTRUMENTS, IN CLASS 36 (U.S. CLS. 100, 101 AND 102).

FIRST USE 8-0-2009; IN COMMERCE 8-0-2009.

NO CLAIM IS MADE TO THE EXCLUSIVE RIGHT TO USE "CAPITAL TRADING", APART FROM THE MARK AS SHOWN.

THE COLOR(S) RED, BLACK AND WHITE IS/ARE CLAIMED AS A FEATURE OF THE MARK.

THE MARK CONSISTS OF A BLACK CUBE SURROUNDED BY A WHITE HEXAGON SHAPED BORDER; THE WHITE BORDER IS THEN SURROUNDED BY A RED HEXAGON SHAPED BORDER; TO THE RIGHT OF THE DESIGN ARE THE WORDS "KAPITAL TRADING"; THE WORD "KAPITAL" IS IN BLACK EXCEPT THAT THE LOWER PORTION OF THE LETTER "K" IS IN RED; THE WORD "TRADING" IS IN BLACK.

SN 85-256,854, FILED 3-3-2011.

RON FAIRBANKS, EXAMINING ATTORNEY



*David J. Kybas*

Director of the United States Patent and Trademark Office

# United States of America

United States Patent and Trademark Office

# ISED

**Reg. No. 4,276,347**

**Registered Jan. 15, 2013**

**Int. Cl.: 10**

**TRADEMARK**

**PRINCIPAL REGISTER**

ALCOR SCIENTIFIC, INC. (RHODE ISLAND CORPORATION)  
BUILDING F23  
11 KNIGHT STREET  
WARWICK, RI 02886

FOR: HEMATOLOGY ANALYZERS FOR MEDICAL DIAGNOSTIC USES; MEDICAL DIAGNOSTIC INSTRUMENTS FOR THE ANALYSIS OF BODY FLUIDS, IN CLASS 10 (U.S. CLS. 26, 39 AND 44).

FIRST USE 7-15-2012; IN COMMERCE 11-13-2012.

THE MARK CONSISTS OF STANDARD CHARACTERS WITHOUT CLAIM TO ANY PARTICULAR FONT, STYLE, SIZE, OR COLOR.

SN 85-257,933, FILED 3-4-2011.

KATHLEEN LORENZO, EXAMINING ATTORNEY



*David J. Kyjars*

Director of the United States Patent and Trademark Office

# United States of America

United States Patent and Trademark Office

## SHADOWSTREAM

**Reg. No. 4,276,348**

**Registered Jan. 15, 2013**

**Int. Cl.: 9**

**TRADEMARK**

**PRINCIPAL REGISTER**

STORAGECRAFT TECHNOLOGY CORPORATION (UTAH CORPORATION)  
11850 ELECTION ROAD  
SUITE 120  
DRAPER, UT 84020

FOR: COMPUTER SOFTWARE THAT SEPARATES A COMPUTER FILE INTO PACKETS, TRANSFERS THOSE PACKETS AT HIGH SPEED OVER A HIGH-LATENCY LINK, AND VALIDATES AND REASSEMBLES THOSE PACKETS INTO THE ORIGINAL COMPUTER FILE AT THE DESTINATION WITHOUT THE DELAY CAUSED BY ACKNOWLEDGMENT OF RECEIPT ON A PACKET-BY-PACKET BASIS, IN CLASS 9 (U.S. CLS. 21, 23, 26, 36 AND 38).

FIRST USE 9-26-2011; IN COMMERCE 9-26-2011.

THE MARK CONSISTS OF STANDARD CHARACTERS WITHOUT CLAIM TO ANY PARTICULAR FONT, STYLE, SIZE, OR COLOR.

OWNER OF U.S. REG. NO. 3,856,613.

SN 85-258,350, FILED 3-4-2011.

KATHERINE STOIDES, EXAMINING ATTORNEY



*David J. Kyros*

Director of the United States Patent and Trademark Office



# United States of America

United States Patent and Trademark Office



**Reg. No. 4,276,349**

**Registered Jan. 15, 2013**

**Int. Cl.: 16**

**TRADEMARK**

**PRINCIPAL REGISTER**

GLAXO GROUP LIMITED (UNITED KINGDOM CORPORATION)  
BERKELEY AVENUE  
GLAXO WELLCOME HOUSE  
GREENFORD, MIDDLESEX, UNITED KINGDOM UB60NN

FOR: PRINTED EDUCATIONAL MATERIALS, NAMELY, BROCHURES AND PAMPHLETS  
FEATURING HEALTH INFORMATION, IN CLASS 16 (U.S. CLS. 2, 5, 22, 23, 29, 37, 38 AND  
50).

FIRST USE 9-30-2011; IN COMMERCE 9-30-2011.

NO CLAIM IS MADE TO THE EXCLUSIVE RIGHT TO USE "WOMEN'S HEALTH" AND  
"HEALTH & WELLNESS", APART FROM THE MARK AS SHOWN.

THE MARK CONSISTS OF THE WORDS "WOMEN'S HEALTH" ABOVE A HORIZONTAL  
LINE WITH THE WORDS "EMBRACING HEALTH & WELLNESS" BELOW THE HORIZONTAL  
LINE AND TO THE LEFT IS A RING-LIKE DESIGN COMPOSED OF A DOT WITH TWO  
SEMI-CIRCLES TO THE LEFT AND RIGHT OF THE DOT.

SN 85-259,383, FILED 3-7-2011.

KAPIL BHANOT, EXAMINING ATTORNEY



*David J. Kyros*

Director of the United States Patent and Trademark Office

# United States of America

United States Patent and Trademark Office

## Kennel Creek Pet Resort

**Reg. No. 4,276,350**

**Registered Jan. 15, 2013**

**Int. Cl.: 43**

**SERVICE MARK**

**PRINCIPAL REGISTER**

CHRISTOPHER T. SAILORS (UNITED STATES INDIVIDUAL), DBA KENNEL CREEK PET RESORT,  
10750 EL MONTE  
LEAWOOD, KS 66211

FOR: PET BOARDING SERVICES, IN CLASS 43 (U.S. CLS. 100 AND 101).

FIRST USE 8-1-2011; IN COMMERCE 9-1-2011.

THE MARK CONSISTS OF STANDARD CHARACTERS WITHOUT CLAIM TO ANY PARTICULAR FONT, STYLE, SIZE, OR COLOR.

NO CLAIM IS MADE TO THE EXCLUSIVE RIGHT TO USE "KENNEL" OR "PET RESORT", APART FROM THE MARK AS SHOWN.

SN 85-260,830, FILED 3-8-2011.

ALYSSA STEEL, EXAMINING ATTORNEY



*David J. Kyffers*

Director of the United States Patent and Trademark Office

# United States of America

United States Patent and Trademark Office

## HURON EDUCATION

**Reg. No. 4,276,351**

HURON CONSULTING GROUP INC. (DELAWARE CORPORATION)  
550 WEST VAN BUREN STREET  
CHICAGO, IL 60607

**Registered Jan. 15, 2013**

**Int. Cls.: 35, 36, and 42**

FOR: CONSULTING SERVICES IN THE FIELD OF HIGHER EDUCATION ADMINISTRATION, BUSINESS MANAGEMENT OF EDUCATIONAL RESEARCH, BUSINESS ORGANIZATION, BUSINESS EXPANSION, ALL PROVIDED TO HIGHER EDUCATION INSTRUCTIONS, IN CLASS 35 (U.S. CLS. 100, 101 AND 102).

**SERVICE MARK**

**PRINCIPAL REGISTER**

FIRST USE 6-0-2011; IN COMMERCE 6-0-2011.

FOR: CONSULTING SERVICES PROVIDED TO HIGHER EDUCATION INSTRUCTION IN THE FIELDS OF FINANCIAL MANAGEMENT AND STRATEGY, IN CLASS 36 (U.S. CLS. 100, 101 AND 102).

FIRST USE 6-0-2011; IN COMMERCE 6-0-2011.

FOR: COMPUTER CONSULTATION IN THE FIELDS OF PRODUCT DISTRIBUTION MANAGEMENT AND DISTRIBUTION CHANNEL MANAGEMENT; MAINTENANCE AND SUPPORT SERVICES FOR COMPUTER SOFTWARE THAT MANAGES PRODUCT DISTRIBUTION AND DISTRIBUTION CHANNELS; COMPUTER SERVICES, NAMELY, DESIGNING AND IMPLEMENTING NETWORK WEB PAGES FOR OTHERS; AND COMPUTER CONSULTING SERVICES PROVIDED TO HIGHER EDUCATIONAL INSTITUTIONS IN THE FIELD OF INFORMATION TECHNOLOGY, IN CLASS 42 (U.S. CLS. 100 AND 101).

FIRST USE 6-0-2011; IN COMMERCE 6-0-2011.

THE MARK CONSISTS OF STANDARD CHARACTERS WITHOUT CLAIM TO ANY PARTICULAR FONT, STYLE, SIZE, OR COLOR.

NO CLAIM IS MADE TO THE EXCLUSIVE RIGHT TO USE "EDUCATION", APART FROM THE MARK AS SHOWN.

SN 85-261,252, FILED 3-8-2011.

DOMINICK J. SALEMI, EXAMINING ATTORNEY



*David J. Kyfos*

Director of the United States Patent and Trademark Office

# United States of America

United States Patent and Trademark Office

## HURON LIFE SCIENCES

**Reg. No. 4,276,352**

HURON CONSULTING GROUP INC. (DELAWARE CORPORATION)  
550 WEST VAN BUREN STREET  
CHICAGO, IL 60607

**Registered Jan. 15, 2013**

**Int. Cls.: 35, 42, and 45**

FOR: CONSULTING SERVICES TO ASSIST LIFE SCIENCES ORGANIZATIONS AND AFFILIATES IN THE FIELDS OF BUSINESS AND PROGRAM MANAGEMENT, FAIR MARKET VALUE DETERMINATION FOR FEE FOR SERVICE ACTIVITIES; BUSINESS CONSULTATION IN THE FIELDS OF PRODUCT DISTRIBUTION MANAGEMENT AND DISTRIBUTION CHANNEL MANAGEMENT; CONSULTING SERVICES TO ASSIST HOSPITALS, ACADEMIC MEDICAL CENTERS AND INDEPENDENT RESEARCH ORGANIZATIONS WITH OPERATIONAL AND ORGANIZATIONAL EFFECTIVENESS IN THE FIELD OF CLINICAL RESEARCH; CONSULTING SERVICES IN THE FIELD CLINICAL RESEARCH BILLING COMPLIANCE, IN CLASS 35 (U.S. CLS. 100, 101 AND 102).

**SERVICE MARK**

**PRINCIPAL REGISTER**

FIRST USE 7-0-2011; IN COMMERCE 7-0-2011.

FOR: MAINTENANCE AND SUPPORT AND TROUBLESHOOTING SERVICES FOR COMPUTER SOFTWARE THAT MANAGES PRODUCT DISTRIBUTION AND DISTRIBUTION CHANNELS; COMPUTER SERVICES, NAMELY, DESIGNING AND IMPLEMENTING NETWORK WEB PAGES FOR OTHERS; CONSULTING SERVICES TO ASSIST HOSPITALS, ACADEMIC MEDICAL CENTERS AND INDEPENDENT RESEARCH ORGANIZATIONS WITH THE ASSESSMENT, VENDOR SELECTION AND SOFTWARE IMPLEMENTATION, NAMELY, BUSINESS PROCESS IMPLEMENTATION RELATED TO THE SOFTWARE, OF CLINICAL RESEARCH TECHNOLOGY, IN CLASS 42 (U.S. CLS. 100 AND 101).

FIRST USE 7-0-2011; IN COMMERCE 7-0-2011.

FOR: CONSULTING SERVICES TO ASSIST LIFE SCIENCES ORGANIZATIONS AND AFFILIATES IN THE FIELDS OF REGULATORY COMPLIANCE TO INCLUDE AGGREGATE SPEND DISCLOSURE REPORTING, CORPORATE INTEGRITY AGREEMENTS, INDEPENDENT REVIEW ORGANIZATION PROCEDURES AND DEFERRED PROSECUTION AGREEMENTS, AND GOVERNMENT PRICE REPORTING; ADVICE FOR RESPONSIBLE AND ETHICAL CLINICAL RESEARCH; ASSESSMENT AND IMPLEMENTATION SERVICES FOR COMPLIANCE WITH HUMAN RESEARCH PROTECTION AND AN ORGANIZATION'S COMMITTEE THAT APPROVES, MONITORS, AND REVIEWS BIOMEDICAL AND BEHAVIORAL RESEARCH INVOLVING HUMANS, IN CLASS 45 (U.S. CLS. 100 AND 101).



*David J. Kyjars*

Director of the United States Patent and Trademark Office

**Reg. No. 4,276,352** FIRST USE 7-0-2011; IN COMMERCE 7-0-2011.

THE MARK CONSISTS OF STANDARD CHARACTERS WITHOUT CLAIM TO ANY PARTICULAR FONT, STYLE, SIZE, OR COLOR.

OWNER OF U.S. REG. NOS. 3,568,857, 3,986,679, AND OTHERS.

NO CLAIM IS MADE TO THE EXCLUSIVE RIGHT TO USE "LIFE SCIENCES" , APART FROM THE MARK AS SHOWN.

SN 85-261,257, FILED 3-8-2011.

DOMINICK J. SALEMI, EXAMINING ATTORNEY

# United States of America

United States Patent and Trademark Office



**Reg. No. 4,276,353**

CASTO, MICHELE (ITALY INDIVIDUAL)  
VIA DEI PIOPI, 18  
AZZANO DECIMO, ITALY 33082

**Registered Jan. 15, 2013**

**Int. Cl.: 9**

FOR: IN-SYSTEM SEMICONDUCTOR DEVICE PROGRAMMER AND TEST PLATFORM,  
IN CLASS 9 (U.S. CLS. 21, 23, 26, 36 AND 38).

**TRADEMARK**

FIRST USE 9-17-2012; IN COMMERCE 9-17-2012.

**PRINCIPAL REGISTER**

THE MARK CONSISTS OF THE LITERAL ELEMENTS "MANTADIGITAL" WHEREIN THE LETTER "M" IS IN WHITE COLOR, "ANTA" ARE IN BLUE COLOR AND THE WORD "DIGITAL" IS IN BLACK COLOR. THERE IS A BLACK IMAGE OF A MANTA RAY ON THE LEFT SIDE OF THE WORD "MANTADIGITAL" WITH AN ARC OF BLACK AND GRAY DOTS ABOVE THE WORD "MANTADIGITAL".

THE COLOR(S) WHITE, BLUE, BLACK AND GRAY IS/ARE CLAIMED AS A FEATURE OF THE MARK.

SN 85-261,705, FILED 3-9-2011.

BRIAN NEVILLE, EXAMINING ATTORNEY



*David J. Kybas*

Director of the United States Patent and Trademark Office

# United States of America

United States Patent and Trademark Office

# JINGLE

**Reg. No. 4,276,354**

**Registered Jan. 15, 2013**

**Int. Cl.: 9**

**TRADEMARK**

**PRINCIPAL REGISTER**

HALLMARK LICENSING LLC (KANSAS LIMITED LIABILITY COMPANY)  
2440 PERSHING ROAD  
MD 339  
KANSAS CITY, MO 64108

FOR: PRE-RECORDED COMPACT DISCS, VIDEO CASSETTES, DIGITAL VIDEO DISCS, CD-ROM DISCS AND MOTION PICTURE FILMS, ALL THE FOREGOING FEATURING ANIMATED MUSIC AND STORIES; VIDEO GAMES AND COMPUTER GAME PROGRAMS ALL FEATURING CHILDREN'S STORYBOOKS FOR MOBILE DEVICES, PERSONAL COMPUTERS, PC TABLETS; ELECTRONIC GAME PROGRAMS FEATURING CHILDREN'S STORYBOOKS; DOWNLOADABLE ELECTRONIC GAME PROGRAMS FEATURING CHILDREN'S STORYBOOKS; ELECTRONIC COMPUTER GAME SOFTWARE FEATURING CHILDREN'S STORYBOOKS; DOWNLOADABLE ELECTRONIC COMPUTER GAME PROGRAMS FEATURING CHILDREN'S STORYBOOKS; INTERACTIVE GAME PROGRAMS FEATURING CHILDREN'S STORYBOOKS; INTERACTIVE COMPUTER GAME SOFTWARE FEATURING CHILDREN'S STORYBOOKS, NONE OF THE AFORESAID GOODS RELATING TO MUSIC EDUCATION, IN CLASS 9 (U.S. CLS. 21, 23, 26, 36 AND 38).

FIRST USE 11-26-2011; IN COMMERCE 11-26-2011.

THE MARK CONSISTS OF STANDARD CHARACTERS WITHOUT CLAIM TO ANY PARTICULAR FONT, STYLE, SIZE, OR COLOR.

SN 85-265,815, FILED 3-14-2011.

BERYL GARDNER, EXAMINING ATTORNEY



*David J. Kybas*

Director of the United States Patent and Trademark Office

# United States of America

United States Patent and Trademark Office

# EVIL

**Reg. No. 4,276,355**

**Registered Jan. 15, 2013**

**Int. Cl.: 2**

**TRADEMARK**

**PRINCIPAL REGISTER**

TWO COUSINS GLOBAL IMPORTS (NEW YORK LIMITED LIABILITY COMPANY), DBA  
MAD CAT DISTRIBUTION,  
11A BROADFIELD PLACE  
GLEN COVE, NY 11542

FOR: TATTOO COLORS; TATTOO INKS; TATTOOING INK, IN CLASS 2 (U.S. CLS. 6, 11  
AND 16).

FIRST USE 6-1-2012; IN COMMERCE 6-1-2012.

THE MARK CONSISTS OF STANDARD CHARACTERS WITHOUT CLAIM TO ANY PAR-  
TICULAR FONT, STYLE, SIZE, OR COLOR.

SN 85-266,140, FILED 3-14-2011.

PAULA MAHONEY, EXAMINING ATTORNEY



*David J. Kybas*

Director of the United States Patent and Trademark Office



# United States of America

United States Patent and Trademark Office

# NAPCO

**Reg. No. 4,276,356**

**Registered Jan. 15, 2013**

**Int. Cls.: 35, 40, and 41**

**SERVICE MARK**

**PRINCIPAL REGISTER**

NORTH AMERICAN PUBLISHING COMPANY (PENNSYLVANIA CORPORATION)  
SUITE 1200  
1500 SPRING GARDEN STREET  
PHILADELPHIA, PA 19130

FOR: ADVERTISING SERVICES, NAMELY, PROVIDING ADVERTISING SPACE IN PRINT AND ONLINE PERIODICALS; LIST RENTAL SERVICES FOR DIRECT MARKETING PURPOSES, NAMELY, PROVIDING LISTS CONTAINING BUSINESS AND CONSUMER IDENTIFYING INFORMATION; CONDUCTING, ARRANGING AND ORGANIZING TRADE SHOWS, CONFERENCES AND TRADE FAIRS FOR BUSINESS PURPOSES IN THE FIELDS OF PUBLISHING, MARKETING, ADVERTISING, PRINTING AND PACKAGING, DIRECT MARKETING, PROMOTIONAL PRODUCTS, CONSUMER ELECTRONICS AND RETAILING, TELEVISION PROGRAMMING, IN CLASS 35 (U.S. CLS. 100, 101 AND 102).

FIRST USE 7-9-2012; IN COMMERCE 7-9-2012.

FOR: REPRINT SERVICES IN THE FIELDS OF PUBLISHING, MARKETING, ADVERTISING, PRINTING AND PACKAGING, DIRECT MARKETING, PROMOTIONAL PRODUCTS, CONSUMER ELECTRONICS AND RETAILING, TELEVISION PROGRAMMING, NAMELY, PRINTING, IN CLASS 40 (U.S. CLS. 100, 103 AND 106).

FIRST USE 7-9-2012; IN COMMERCE 7-9-2012.

FOR: ARRANGING AND CONDUCTING ON-LINE NON-DOWNLOADABLE WEBINARS IN THE FIELD OF PUBLISHING, MARKETING, ADVERTISING, PRINTING AND PACKAGING, DIRECT MARKETING, PROMOTIONAL PRODUCTS, CONSUMER ELECTRONICS AND RETAILING, TELEVISION PROGRAMMING; CONDUCTING, ARRANGING AND ORGANIZING EDUCATIONAL CONFERENCES IN THE FIELDS OF PUBLISHING, MARKETING, ADVERTISING, PRINTING AND PACKAGING, DIRECT MARKETING, PROMOTIONAL PRODUCTS, CONSUMER ELECTRONICS AND RETAILING, TELEVISION PROGRAMMING; PROVIDING A WEBSITE FEATURING NON-DOWNLOADABLE NEWS ARTICLES IN THE FIELDS OF PUBLISHING, MARKETING, ADVERTISING, PRINTING AND PACKAGING, DIRECT MARKETING, PROMOTIONAL PRODUCTS, CONSUMER ELECTRONICS AND RETAILING, TELEVISION PROGRAMMING; NEWSLETTERS SENT VIA ELECTRONIC MAIL, IN CLASS 41 (U.S. CLS. 100, 101 AND 107).

FIRST USE 7-9-2012; IN COMMERCE 7-9-2012.



*David J. Kyjars*

Director of the United States Patent and Trademark Office

**Reg. No. 4,276,356** THE MARK CONSISTS OF STANDARD CHARACTERS WITHOUT CLAIM TO ANY PARTICULAR FONT, STYLE, SIZE, OR COLOR.

THE WORDING "NAPCO" HAS NO MEANING IN A FOREIGN LANGUAGE.

SN 85-270,593, FILED 3-18-2011.

BRIAN PINO, EXAMINING ATTORNEY

United States of America  
United States Patent and Trademark Office

**COMIC SUTRA**  
THE ART OF <sup>DEVIANT</sup>SEX

**Reg. No. 4,276,357**

SHARTED, LLC (FLORIDA LIMITED LIABILITY COMPANY)  
PO BOX 150718  
CAPE CORAL, FL 33915

**Registered Jan. 15, 2013**

**Int. Cl.: 16**

FOR: A SERIES OF BOOKS, WRITTEN ARTICLES, HANDOUTS AND WORKSHEETS IN THE FIELD OF HUMOR; PUBLICATIONS, NAMELY, BOOKS IN THE FIELDS OF HUMOR, IN CLASS 16 (U.S. CLS. 2, 5, 22, 23, 29, 37, 38 AND 50).

**TRADEMARK**

FIRST USE 2-18-2011; IN COMMERCE 2-18-2011.

**PRINCIPAL REGISTER**

NO CLAIM IS MADE TO THE EXCLUSIVE RIGHT TO USE "COMIC" AND "SEX", APART FROM THE MARK AS SHOWN.

THE COLOR(S) WHITE, BLACK, RED IS/ARE CLAIMED AS A FEATURE OF THE MARK.

THE MARK CONSISTS OF RED AND WHITE STYLIZED LETTERING OF "COMIC SUTRA" THAT IS THREE-DIMENSIONAL IN APPEARANCE. DIRECTLY BENEATH, IN BLACK LETTERING, THE WORDING "THE ART OF DEVIANT SEX" APPEARS. A BLACK CARAT APPEARS BETWEEN "OF" AND "SEX" TO INDICATE INSERTION OF THE WORD "DEVIANT".

SN 85-271,036, FILED 3-18-2011.

INGRID C. EULIN, EXAMINING ATTORNEY



*David J. Kyjars*

Director of the United States Patent and Trademark Office

# United States of America

United States Patent and Trademark Office

## RANDOM ACTS OF GREENNESS

**Reg. No. 4,276,358**

**Registered Jan. 15, 2013**

**Int. Cls.: 39 and 42**

**SERVICE MARK**

**PRINCIPAL REGISTER**

ORLANDO UTILITIES COMMISSION (FLORIDA STATUTORY COMMISSION)  
100 WEST ANDERSON STREET  
ORLANDO, FL 32801

FOR: PUBLIC UTILITY SERVICES IN THE NATURE OF WATER DISTRIBUTION; PUBLIC UTILITY SERVICES IN THE NATURE OF ELECTRICITY DISTRIBUTION , IN CLASS 39 (U.S. CLS. 100 AND 105).

FIRST USE 4-22-2011; IN COMMERCE 4-22-2011.

FOR: CONSULTING SERVICES IN THE FIELDS OF ENERGY AND WATER MEASUREMENT TO IMPROVE ENERGY AND WATER EFFICIENCY, IN CLASS 42 (U.S. CLS. 100 AND 101).

FIRST USE 4-22-2011; IN COMMERCE 4-22-2011.

THE MARK CONSISTS OF STANDARD CHARACTERS WITHOUT CLAIM TO ANY PARTICULAR FONT, STYLE, SIZE, OR COLOR.

OWNER OF U.S. REG. NOS. 2,454,746, 3,947,151, AND OTHERS.

SN 85-271,146, FILED 3-18-2011.

ANTHONY RINKER, EXAMINING ATTORNEY



*David J. Kybas*

Director of the United States Patent and Trademark Office

# United States of America

United States Patent and Trademark Office

## OUC RANDOM ACTS OF GREENNESS

**Reg. No. 4,276,359**

**Registered Jan. 15, 2013**

**Int. Cls.: 39 and 42**

**SERVICE MARK**

**PRINCIPAL REGISTER**

ORLANDO UTILITIES COMMISSION (FLORIDA STATUTORY COMMISSION)  
100 WEST ANDERSON STREET  
ORLANDO, FL 32801

FOR: PUBLIC UTILITY SERVICES IN THE NATURE OF WATER DISTRIBUTION; PUBLIC UTILITY SERVICES IN THE NATURE OF ELECTRICITY DISTRIBUTION , IN CLASS 39 (U.S. CLS. 100 AND 105).

FIRST USE 4-22-2011; IN COMMERCE 4-22-2011.

FOR: CONSULTING SERVICES IN THE FIELDS OF ENERGY AND WATER MEASUREMENT TO IMPROVE ENERGY AND WATER EFFICIENCY, IN CLASS 42 (U.S. CLS. 100 AND 101).

FIRST USE 4-22-2011; IN COMMERCE 4-22-2011.

THE MARK CONSISTS OF STANDARD CHARACTERS WITHOUT CLAIM TO ANY PARTICULAR FONT, STYLE, SIZE, OR COLOR.

OWNER OF U.S. REG. NOS. 2,454,746, 3,947,151, AND OTHERS.

SN 85-271,156, FILED 3-18-2011.

ANTHONY RINKER, EXAMINING ATTORNEY



*David J. Kybas*

Director of the United States Patent and Trademark Office

# United States of America

United States Patent and Trademark Office



## BIPEDAL DOG

**Reg. No. 4,276,360**

**Registered Jan. 15, 2013**

**Int. Cl.: 41**

**SERVICE MARK**

**PRINCIPAL REGISTER**

BIPEDAL DOG (WASHINGTON SOLE PROPRIETORSHIP)  
816 PENINSULA AVE., APT. C  
BURLINGAME, CA 94010

FOR: MAGAZINE PUBLISHING; PUBLISHING OF BOOKS, E-BOOKS, AUDIO BOOKS, MUSIC AND ILLUSTRATIONS; PUBLISHING OF ELECTRONIC PUBLICATIONS; PUBLISHING OF WEB MAGAZINES, IN CLASS 41 (U.S. CLS. 100, 101 AND 107).

FIRST USE 3-20-2011; IN COMMERCE 3-20-2011.

THE MARK CONSISTS OF STYLIZED DRAWING OF A DOG WALKING ON HIND LEGS WITH THE WORDING "BIPEDAL DOG" BELOW.

SN 85-271,761, FILED 3-20-2011.

MARK SPARACINO, EXAMINING ATTORNEY



*David J. Kyffers*

Director of the United States Patent and Trademark Office

# United States of America

United States Patent and Trademark Office

SH

**Reg. No. 4,276,361**

**Registered Jan. 15, 2013**

**Int. Cl.: 39**

**SERVICE MARK**

**PRINCIPAL REGISTER**

SABER HELICOPTERS, INC. (TEXAS CORPORATION)  
SUITE 1000  
8122 DATAPOINT DR.  
SAN ANTONIO, TX 78229

FOR: AIR CHARTER SERVICES; AIR CHARTER TRANSPORTATION SERVICES; CHARTERING OF HELICOPTERS; HELICOPTER TRANSPORT, IN CLASS 39 (U.S. CLS. 100 AND 105).

FIRST USE 6-0-2011; IN COMMERCE 6-0-2011.

THE MARK CONSISTS OF A STYLIZED RENDITION OF THE LETTERS "SH" WITH CURVED LINES ABOVE THE STYLIZED LETTERING.

SN 85-272,589, FILED 3-21-2011.

KATHERINE STOIDES, EXAMINING ATTORNEY



*David J. Kybas*

Director of the United States Patent and Trademark Office

# United States of America

United States Patent and Trademark Office

## SUPERCACHE EXPRESS

**Reg. No. 4,276,362**

SUPERSPEED LLC (DELAWARE LIMITED LIABILITY COMPANY)  
327 BOSTON POST ROAD  
SUDBURY, MA 01776

**Registered Jan. 15, 2013**

**Int. Cl.: 9**

FOR: COMPUTER SOFTWARE FOR USE IN ACCELERATING AND OPTIMIZING THE PERFORMANCE OF COMPUTER DISK DRIVES; ELECTRONIC PUBLICATIONS, NAMELY, INSTRUCTION MANUALS FEATURING INFORMATION ABOUT COMPUTER SOFTWARE FOR USE IN ACCELERATING AND OPTIMIZING THE PERFORMANCE OF COMPUTER DISK DRIVES RECORDED ON COMPUTER MEDIA, IN CLASS 9 (U.S. CLS. 21, 23, 26, 36 AND 38).

**TRADEMARK**

**PRINCIPAL REGISTER**

FIRST USE 11-13-2012; IN COMMERCE 11-13-2012.

THE MARK CONSISTS OF STANDARD CHARACTERS WITHOUT CLAIM TO ANY PARTICULAR FONT, STYLE, SIZE, OR COLOR.

NO CLAIM IS MADE TO THE EXCLUSIVE RIGHT TO USE "EXPRESS", APART FROM THE MARK AS SHOWN.

SN 85-273,659, FILED 3-22-2011.

SIMON TENG, EXAMINING ATTORNEY



*David J. Kyffers*

Director of the United States Patent and Trademark Office



# United States of America

United States Patent and Trademark Office

## Get Some, Get Hooked

**Reg. No. 4,276,363**

CARTER, RICHARD CAMERON (UNITED STATES INDIVIDUAL)  
295 ROAD 54  
TEN SLEEP, WY 82442 AND

**Registered Jan. 15, 2013**

**Int. Cl.: 25**

CARTER, JAYNE ANDREA (UNITED STATES INDIVIDUAL)  
295 ROAD 54  
TEN SLEEP, WY 82442

**TRADEMARK**

**PRINCIPAL REGISTER**

FOR: CAMOUFLAGE PANTS; CAMOUFLAGE SHIRTS; FISHING SHIRTS; GOLF PANTS, SHIRTS AND SKIRTS; GOLF SHIRTS; HOODED SWEAT SHIRTS; HUNTING PANTS; HUNTING SHIRTS; POLO SHIRTS; SHIRTS AND SHORT-SLEEVED SHIRTS; SWEAT SHIRTS; T-SHIRTS; TEE SHIRTS; WATERPROOF JACKETS AND PANTS, IN CLASS 25 (U.S. CLS. 22 AND 39).

FIRST USE 3-10-2011; IN COMMERCE 10-1-2011.

THE MARK CONSISTS OF STANDARD CHARACTERS WITHOUT CLAIM TO ANY PARTICULAR FONT, STYLE, SIZE, OR COLOR.

SN 85-274,334, FILED 3-23-2011.

TINA MAI, EXAMINING ATTORNEY



*David J. Kyros*

Director of the United States Patent and Trademark Office

# United States of America

United States Patent and Trademark Office

## APO

**Reg. No. 4,276,364**

**Registered Jan. 15, 2013**

**Int. Cl.: 9**

**TRADEMARK**

**PRINCIPAL REGISTER**

ZS ASSOCIATES, INC. (ILLINOIS CORPORATION)  
1800 SHERMAN AVENUE  
EVANSTON, IL 60201

FOR: SALES AND MARKETING SOFTWARE WITH A FOCUS ON ANALYTICS FOR DATABASE MANAGEMENT, PROVIDING STATISTICAL ANALYSIS AND PRODUCING REPORTS, SALES COMPENSATION MANAGEMENT, INFORMATION MANAGEMENT AND REPORTING, TERRITORY AND ACCOUNT PLANNING, MARKETING CAMPAIGN DESIGN AND MANAGEMENT, AND MANAGEMENT OF OTHER BUSINESS OPERATIONS, ALL OF THE FOREGOING FOR THE PURPOSE OF ENABLING COMPANIES TO OUT-SOURCE AND IMPROVE THEIR SALES AND MARKETING OPERATIONS, IN CLASS 9 (U.S. CLS. 21, 23, 26, 36 AND 38).

FIRST USE 8-14-2012; IN COMMERCE 8-14-2012.

THE MARK CONSISTS OF STANDARD CHARACTERS WITHOUT CLAIM TO ANY PARTICULAR FONT, STYLE, SIZE, OR COLOR.

SN 85-275,160, FILED 3-23-2011.

LESLIE RICHARDS, EXAMINING ATTORNEY



*David J. Kyffers*

Director of the United States Patent and Trademark Office

# United States of America

United States Patent and Trademark Office

## HAPPY HAULER LLC

**Reg. No. 4,276,365**

WHILEY, PHILIP (UNITED STATES INDIVIDUAL)  
PO BOX 70884  
SEATTLE, WA 98127

**Registered Jan. 15, 2013**

**Int. Cl.: 39**

FOR: GARBAGE COLLECTION, IN CLASS 39 (U.S. CLS. 100 AND 105).

**SERVICE MARK**

FIRST USE 10-25-1999; IN COMMERCE 10-25-1999.

**PRINCIPAL REGISTER**

THE MARK CONSISTS OF STANDARD CHARACTERS WITHOUT CLAIM TO ANY PARTICULAR FONT, STYLE, SIZE, OR COLOR.

NO CLAIM IS MADE TO THE EXCLUSIVE RIGHT TO USE "HAULER LLC", APART FROM THE MARK AS SHOWN.

SN 85-275,268, FILED 3-24-2011.

KYLE PEETE, EXAMINING ATTORNEY



*David J. Kyffers*

Director of the United States Patent and Trademark Office

# United States of America

United States Patent and Trademark Office



**Reg. No. 4,276,366**

**Registered Jan. 15, 2013**

**Int. Cl.: 39**

**SERVICE MARK**

**PRINCIPAL REGISTER**

WHILEY, PHILIP (UNITED STATES INDIVIDUAL)  
PO BOX 70884  
SEATTLE, WA 98127

FOR: GARBAGE COLLECTION, IN CLASS 39 (U.S. CLS. 100 AND 105).

FIRST USE 10-25-1999; IN COMMERCE 10-25-1999.

NO CLAIM IS MADE TO THE EXCLUSIVE RIGHT TO USE "HAULER" , APART FROM THE MARK AS SHOWN.

THE COLOR(S) BROWN IS/ARE CLAIMED AS A FEATURE OF THE MARK.

THE COLORS BLACK, WHITE AND/OR GRAY ARE NOT BEING CLAIMED AS COLORS IN THE MARK. THE COLORS BLACK, WHITE AND OR GRAY REPRESENT BACKGROUND, OUTLINING, SHADING AND/OR TRANSPARENT AREAS AND ARE NOT PART OF THE MARK.

THE MARK CONSISTS OF THE WORDS "HAPPY HAULER" IN BROWN COLOR SEPARATED BY AN IMAGE OF ANT HOLDING A GARBAGE CONTAINER IN ITS LEFT HAND ON WHICH THE NUMBER "500" IS WRITTEN AS SHOWN IN THE MARK.

SN 85-275,273, FILED 3-24-2011.

KYLE PEETE, EXAMINING ATTORNEY



*David J. Kyros*

Director of the United States Patent and Trademark Office

# United States of America

United States Patent and Trademark Office



## GameMaster

**Reg. No. 4,276,367**

**Registered Jan. 15, 2013**

**Int. Cls.: 9 and 28**

**TRADEMARK**

**PRINCIPAL REGISTER**

BRIGHT HARVEST OVERSEAS INC. (BR. VIRGIN ISLANDS CORPORATION)  
PALM GROVE HOUSE, P.O. BOX 438  
ROAD TOWN  
TORTOLA, BR. VIRGIN ISLANDS

FOR: ELECTRONIC PENS; HEADPHONES; VIDEO GAME CARTRIDGES, MARKETING TO APPEAL TO AND INTENDED FOR USE BY CHILDREN BETWEEN THE AGES OF 6 TO 13, AND NOT FOR USE IN CONNECTION WITH GAMING MACHINES OR THE GAMING INDUSTRY; GAMES ADAPTED FOR USE WITH TELEVISION RECEIVERS, MARKETING TO APPEAL TO AND INTENDED FOR USE BY CHILDREN BETWEEN THE AGES OF 6 TO 13, AND NOT FOR USE IN CONNECTION WITH GAMING MACHINES OR THE GAMING INDUSTRY; AMUSEMENT APPARATUS FOR USE WITH TELEVISION RECEIVERS ONLY, MARKETING TO APPEAL TO AND INTENDED FOR USE BY CHILDREN BETWEEN THE AGES OF 6 TO 13, AND NOT FOR USE IN CONNECTION WITH GAMING MACHINES OR THE GAMING INDUSTRY; MICROPHONES; ELECTRIC PLUGS, SOCKETS, CONTACTS; PERSONAL STEREO; CHARGERS FOR ELECTRIC BATTERIES; GAME MEMORY CARTRIDGE, MARKETING TO APPEAL TO AND INTENDED FOR USE BY CHILDREN BETWEEN THE AGES OF 6 TO 13, AND NOT FOR USE IN CONNECTION WITH GAMING MACHINES OR THE GAMING INDUSTRY; DATA TRANSFER CABLE FOR HAND-HELD GAME CONSOLES, NAMELY, ELECTRONIC CABLES, MARKETING TO APPEAL TO AND INTENDED FOR USE BY CHILDREN BETWEEN THE AGES OF 6 TO 13, AND NOT FOR USE IN CONNECTION WITH GAMING MACHINES OR THE GAMING INDUSTRY; IMAGE OUTPUT CABLE FOR HAND-HELD GAME CONSOLES, NAMELY, COAXIAL CABLES, MARKETING TO APPEAL TO AND INTENDED FOR USE BY CHILDREN BETWEEN THE AGES OF 6 TO 13, AND NOT FOR USE IN CONNECTION WITH GAMING MACHINES OR THE GAMING INDUSTRY; ELECTRONIC DOCKING STATION FOR HAND-HELD GAME CONSOLES, MARKETING TO APPEAL TO AND INTENDED FOR USE BY CHILDREN BETWEEN THE AGES OF 6 TO 13, AND NOT FOR USE IN CONNECTION WITH GAMING MACHINES OR THE GAMING INDUSTRY, IN CLASS 9 (U.S. CLS. 21, 23, 26, 36 AND 38).

FIRST USE 4-1-2012; IN COMMERCE 4-1-2012.

FOR: FITTED COVERS SPECIALLY ADAPTED TO PROTECT THE SCREEN OF HAND-HELD VIDEO GAME CONSOLES; PROTECTION BAG, NAMELY, PROTECTIVE CARRYING CASES SPECIALLY ADAPTED FOR HAND-HELD VIDEO GAME CONSOLES; HARD-SHELL PROTECTION CASE FOR HAND-HELD VIDEO GAME CONSOLES, IN CLASS 28 (U.S. CLS. 22, 23, 38 AND 50).



*David J. Kybas*

Director of the United States Patent and Trademark Office

**Reg. No. 4,276,367** FIRST USE 4-1-2012; IN COMMERCE 4-1-2012.

NO CLAIM IS MADE TO THE EXCLUSIVE RIGHT TO USE "GAME" , APART FROM THE MARK AS SHOWN.

THE MARK CONSISTS OF A DESIGN OF A ROBOT FLOWED BY THE WORDING "GAME" IN STYLIZED FONT INSIDE A RECTANGULAR BACKGROUND AND THE WORDING "MASTER" IN STYLIZED FONT.

SN 85-275,689, FILED 3-24-2011.

INGRID C. EULIN, EXAMINING ATTORNEY

# United States of America

United States Patent and Trademark Office

# UPSIDE

**Reg. No. 4,276,368**

**Registered Jan. 15, 2013**

**Int. Cl.: 20**

**TRADEMARK**

**PRINCIPAL REGISTER**

SHADY CHARACTERS LLC (DELAWARE LIMITED LIABILITY COMPANY)  
810 GREENWOOD ROAD  
WILMINGTON, DE 19807

FOR: FABRIC WINDOW SHADES, IN CLASS 20 (U.S. CLS. 2, 13, 22, 25, 32 AND 50).

FIRST USE 11-28-2012; IN COMMERCE 11-28-2012.

THE MARK CONSISTS OF STANDARD CHARACTERS WITHOUT CLAIM TO ANY PARTICULAR FONT, STYLE, SIZE, OR COLOR.

SN 85-276,045, FILED 3-24-2011.

MAYUR VAGHANI, EXAMINING ATTORNEY



*David J. Kybas*

Director of the United States Patent and Trademark Office

# United States of America

United States Patent and Trademark Office

## SUMMIT SERIES

**Reg. No. 4,276,369**

BOSTONTEC, INC. (MICHIGAN CORPORATION)  
2700 JAMES SAVAGE ROAD  
MIDLAND, MI 48642

**Registered Jan. 15, 2013**

**Int. Cl.: 20**

FOR: HEIGHT ADJUSTABLE TABLES HAVING MULTI-USE WORK SURFACES FOR USE IN A WIDE VARIETY OF FIELDS AND WORKSTATIONS HAVING MULTI-USE WORK SURFACES FOR USE IN A WIDE VARIETY OF FIELDS, IN CLASS 20 (U.S. CLS. 2, 13, 22, 25, 32 AND 50).

**TRADEMARK**

**PRINCIPAL REGISTER**

FIRST USE 7-13-2012; IN COMMERCE 7-13-2012.

THE MARK CONSISTS OF STANDARD CHARACTERS WITHOUT CLAIM TO ANY PARTICULAR FONT, STYLE, SIZE, OR COLOR.

NO CLAIM IS MADE TO THE EXCLUSIVE RIGHT TO USE "SERIES", APART FROM THE MARK AS SHOWN.

SN 85-276,688, FILED 3-25-2011.

EDWARD NELSON, EXAMINING ATTORNEY



*David J. Kyfos*

Director of the United States Patent and Trademark Office



# United States of America

United States Patent and Trademark Office



Internet  
Museum  
System

**Reg. No. 4,276,370**

KE SOFTWARE PTY LTD. (AUSTRALIA CORPORATION)  
57 UNIVERSITY STREET  
CARLTON, VICTORIA, AUSTRALIA 3053

**Registered Jan. 15, 2013**

**Int. Cls.: 35, 37, and 42**

FOR: PROVIDING AN ON-LINE COMMERCIAL INFORMATION DIRECTORY ON THE INTERNET FEATURING MUSEUM COLLECTIONS, IN CLASS 35 (U.S. CLS. 100, 101 AND 102).

**SERVICE MARK**

FIRST USE 11-9-2010; IN COMMERCE 11-9-2010.

**PRINCIPAL REGISTER**

FOR: TECHNICAL SUPPORT SERVICES, NAMELY, TROUBLESHOOTING IN THE NATURE OF THE REPAIR OF COMPUTER HARDWARE USED FOR MUSEUM COLLECTIONS MANAGEMENT SYSTEMS FOR THE PURPOSE OF ELECTRONICALLY STORING DATA IN AND RETRIEVING DATA, CAPTURING AND DISPLAYING TEXTUAL, GRAPHIC, AUDIO AND AUDIOVISUAL DATA, MANAGING AND DISPLAYING STORED DATA, COLLECTING AND DISPLAYING DATA FROM A COLLECTIONS MANAGEMENT SYSTEM USING WEB BROWSERS AND OTHER DISPLAY DEVICES, IN CLASS 37 (U.S. CLS. 100, 103 AND 106).

FIRST USE 11-9-2010; IN COMMERCE 11-9-2010.

FOR: COMPUTER HARDWARE AND SOFTWARE CONSULTING SERVICES IN THE FIELD OF ELECTRONIC MUSEUM COLLECTION DATABASES, NAMELY, MUSEUM COLLECTIONS MANAGEMENT SYSTEMS USED FOR THE PURPOSE OF ELECTRONICALLY STORING AND RETRIEVING DATA, CAPTURING AND DISPLAYING TEXTUAL, GRAPHIC, AUDIO AND AUDIOVISUAL DATA, MANAGING AND DISPLAYING STORED DATA, COLLECTING AND DISPLAYING DATA FROM A COLLECTIONS MANAGEMENT SYSTEM USING WEB BROWSERS AND OTHER DISPLAY DEVICES; TECHNICAL SUPPORT SERVICES, NAMELY, TROUBLESHOOTING OF COMPUTER SOFTWARE PROBLEMS IN MUSEUM COLLECTIONS MANAGEMENT SYSTEMS USED FOR THE PURPOSE OF ELECTRONICALLY STORING DATA IN AND RETRIEVING DATA, CAPTURING AND DISPLAYING TEXTUAL, GRAPHIC, AUDIO AND AUDIOVISUAL DATA, MANAGING AND DISPLAYING STORED DATA, COLLECTING AND DISPLAYING DATA FROM A COLLECTIONS MANAGEMENT SYSTEM USING WEB BROWSERS AND OTHER DISPLAY DEVICES; COMPUTER CONSULTING SERVICES IN RELATION TO COMPUTER SOFTWARE THAT MANAGES ELECTRONIC MUSEUM COLLECTIONS, ART GALLERY COLLECTIONS, BOTANIC GARDENS AND HERBARIA COLLECTIONS, HISTORICAL SOCIETY



*David J. Kyros*

Director of the United States Patent and Trademark Office

**Reg. No. 4,276,370** COLLECTIONS, ARCHIVES AND OTHER ELECTRONIC COLLECTIONS STORED IN ELECTRONIC COLLECTIONS MANAGEMENT SYSTEMS OR ELECTRONIC DATABASES; AND COMPUTER SERVICES, NAMELY, PROVIDING SEARCH ENGINES FOR OBTAINING INFORMATION ABOUT MUSEUM COLLECTIONS ON A GLOBAL COMPUTER NETWORK; COMPUTER SOFTWARE CONSULTING SERVICES IN THE FIELD OF SOFTWARE USED FOR MANAGING MUSEUM COLLECTIONS, ART GALLERY COLLECTIONS, BOTANIC GARDENS AND HERBARIA COLLECTIONS, HISTORICAL SOCIETY COLLECTIONS, ARCHIVES AND OTHER ELECTRONIC COLLECTIONS STORED IN COLLECTIONS MANAGEMENT SYSTEMS OR ELECTRONIC DATABASES, IN CLASS 42 (U.S. CLS. 100 AND 101).

FIRST USE 11-9-2010; IN COMMERCE 11-9-2010.

NO CLAIM IS MADE TO THE EXCLUSIVE RIGHT TO USE "INTERNET MUSEUM SYSTEM", APART FROM THE MARK AS SHOWN.

THE MARK CONSISTS OF A RECTANGLE CONTAINING THE LETTERS "IMU", WITH A RECTANGLE BEHIND THE LETTER "I". FOLLOWING THE RECTANGLE IS THE WORDING "INTERNET MUSEUM SYSTEM".

SN 85-276,966, FILED 3-25-2011.

ALYSSA STEEL, EXAMINING ATTORNEY

# United States of America

United States Patent and Trademark Office



**Reg. No. 4,276,371**

**Registered Jan. 15, 2013**

**Int. Cl.: 38**

**SERVICE MARK**

**PRINCIPAL REGISTER**

FRESS EMERGENCY SERVICE, S.L. (SPAIN LIMITED LIABILITY COMPANY)  
CALLE SANTA CATALINA, 8 ENTRESUELO  
MURICA, SPAIN 30004

FOR: TELECOMMUNICATIONS SERVICES FOR ACCESS TO AND USE OF EMERGENCY INFORMATION BY EMERGENCY ADMINISTRATION PERSONNEL; ELECTRONIC TRANSMISSION OF DATA AND VOICE MESSAGES, SIGNALS AND MEDICAL SOUNDS RELATED TO HEALTH EMERGENCIES AND PERSONAL WELL BEING, IN CLASS 38 (U.S. CLS. 100, 101 AND 104).

FIRST USE 12-0-2011; IN COMMERCE 12-0-2011.

PRIORITY CLAIMED UNDER SEC. 44(D) ON SPAIN APPLICATION NO. M2.968.681-4, FILED 2-10-2011.

THE COLOR(S) GRAY AND RED IS/ARE CLAIMED AS A FEATURE OF THE MARK.

THE MARK CONSISTS OF THE WORDING "FRESS" IN LOWER CASE LETTERS. THE LETTERS IN THE WORDING ARE SHOWN IN GRAY, EXCEPT FOR THE LETTER "E" WHICH IS IN RED. FROM THE TOP PART OF THE LETTER "E" THE RED HAND IS DRAWN WITH OPEN FINGERS LEANING TOWARDS THE RIGHT JUST ABOVE THE "E" AND THE FIRST "S".

THE WORDING "FRESS" HAS NO MEANING IN A FOREIGN LANGUAGE.

SN 85-277,285, FILED 3-25-2011.

ANTHONY RINKER, EXAMINING ATTORNEY



*David J. Kybas*

Director of the United States Patent and Trademark Office

# United States of America

United States Patent and Trademark Office

# RISA

**Reg. No. 4,276,372**

AUGUSTUS SMILES, LLC (GEORGIA LIMITED LIABILITY COMPANY)  
429 SUPERIOR AVE  
DECATUR, GA 30030

**Registered Jan. 15, 2013**

**Int. Cl.: 3**

**TRADEMARK**

**PRINCIPAL REGISTER**

FOR: 2-IN-1 SOAP FOR USE AS SHAMPOO AND CONDITIONER; 2-IN-1 LAUNDRY DETERGENT FOR USE AS A RINSING AGENT; 3-IN-1 SOAP FOR USE AS A SOAP, SHAMPOO AND CONDITIONER; 3-IN-1 LAUNDRY DETERGENT FOR USE AS ONE OR MORE OF A RINSING AGENT, A FABRIC SOFTENER, AND A FABRIC FRESHENER; AFTER-SHAVE LIQUID; AFTER-SHAVE LOTION; AIR FRAGRANCING PREPARATIONS; AROMATIC BODY CARE PRODUCTS, NAMELY, BODY LOTION, SHAMPOO, CONDITIONER, NON-MEDICATED LIP BALM, SOAP; BABY SHAMPOO; BAR SOAP; BATH AND SHOWER GELS AND SALTS NOT FOR MEDICAL PURPOSES; BATH SOAP; BATH SOAP IN LIQUID, SOLID OR GEL FORM; DETERGENT SOAP; DETERGENTS FOR HOUSEHOLD USE; EXFOLIATES FOR SKIN, HAIR, AND SCALP; FACE AND BODY LOTIONS; FRAGRANCES FOR AUTOMOBILES; HAIR SHAMPOO; HAIR SHAMPOOS AND CONDITIONERS; HAND SOAPS; HANDMADE SOAP BARS; LAUNDRY DETERGENT; LAUNDRY DETERGENTS; LAUNDRY SOAP; LIP BALM; LIQUID BATH SOAPS; LIQUID SOAP; LIQUID SOAPS; LIQUID SOAPS FOR HANDS, FACE AND BODY; LIQUID SOAPS FOR HANDS AND FACE; LOTIONS FOR FACE AND BODY CARE; NATURAL SOAP BARS; NATURALLY HANDMADE SOAP BARS; NON-MEDICATED SKIN CARE PREPARATIONS; NON-MEDICATED SCALP CARE PREPARATIONS; NON-MEDICATED NAIL CARE PREPARATIONS; NON-MEDICATED FOOT CARE PREPARATIONS; NON-MEDICATED FACIAL CARE PREPARATIONS; NON-MEDICATED HAND CARE PREPARATIONS; NON-MEDICATED BALMS FOR USE ON HAIR, SKIN, LIPS, FACE, HANDS, LEGS, ARMS, FEET, TORSO, NECK, BACK; ORGANIC SOAP BARS; PET SHAMPOO; PET SHAMPOO AND CONDITIONER; PRE-SHAVE LIQUID; SCENT ELIMINATING SHAMPOO AND SOAP FOR USE ASSOCIATED WITH HUNTING AND OUTDOOR RECREATION; SHAMPOOS; SHAVING LOTION; SHAVING SOAP; SHAVING SOAPS; SHAVING LOTIONS; SKIN, HAIR, OR SCALP EXFOLIATE; SOAPS AND DETERGENTS; SOAPS FOR BODY CARE; SOAPS FOR PERSONAL USE; WASHING PREPARATIONS, IN CLASS 3 (U.S. CLS. 1, 4, 6, 50, 51 AND 52).



FIRST USE 1-1-2012; IN COMMERCE 1-1-2012.

*David J. Kyros*

THE MARK CONSISTS OF STANDARD CHARACTERS WITHOUT CLAIM TO ANY PARTICULAR FONT, STYLE, SIZE, OR COLOR.

THE ENGLISH TRANSLATION OF "RISA" IN THE MARK IS "LAUGH".

Director of the United States Patent and Trademark Office

**Reg. No. 4,276,372** SN 85-278,629, FILED 3-28-2011.

BRIAN PINO, EXAMINING ATTORNEY

# United States of America

United States Patent and Trademark Office

## GXP XPLOER

**Reg. No. 4,276,373**

BAE SYSTEMS INFORMATION SOLUTIONS INC. (DELAWARE CORPORATION)  
10920 TECHNOLOGY PLACE  
SAN DIEGO, CA 92127

**Registered Jan. 15, 2013**

**Int. Cl.: 9**

FOR: COMPUTER SOFTWARE FOR LOCATING, SELECTING, STORING AND MANAGING GEOGRAPHIC DATA ON A LOCAL NETWORK, NAMELY, IMAGES, TERRAIN, FEATURES, VIDEOS, DOCUMENTS AND OTHER FILES THROUGH SIMPLE AND ADVANCED SEARCHES, IN CLASS 9 (U.S. CLS. 21, 23, 26, 36 AND 38).

**TRADEMARK**

**PRINCIPAL REGISTER**

FIRST USE 6-30-2010; IN COMMERCE 6-30-2010.

THE MARK CONSISTS OF STANDARD CHARACTERS WITHOUT CLAIM TO ANY PARTICULAR FONT, STYLE, SIZE, OR COLOR.

OWNER OF U.S. REG. NO. 3,146,208.

SN 85-278,702, FILED 3-28-2011.

MICHAEL WIENER, EXAMINING ATTORNEY



*David J. Kybas*

Director of the United States Patent and Trademark Office

# United States of America

United States Patent and Trademark Office

# BucketLife

**Reg. No. 4,276,374**

BUCKETLIFE.COM, INC. (TEXAS CORPORATION)  
12306 BLUE WATER DR  
AUSTIN, TX 78758

**Registered Jan. 15, 2013**

**Int. Cl.: 45**

FOR: ON-LINE SOCIAL NETWORKING SERVICES, IN CLASS 45 (U.S. CLS. 100 AND 101).

**SERVICE MARK**

FIRST USE 3-30-2012; IN COMMERCE 3-30-2012.

**PRINCIPAL REGISTER**

THE MARK CONSISTS OF STANDARD CHARACTERS WITHOUT CLAIM TO ANY PARTICULAR FONT, STYLE, SIZE, OR COLOR.

SN 85-280,064, FILED 3-29-2011.

JERI J. FICKES, EXAMINING ATTORNEY



*David J. Kyffers*

Director of the United States Patent and Trademark Office

# United States of America

United States Patent and Trademark Office

## SOMMELIETTE

**Reg. No. 4,276,375**

THE SOMMELIETTE, LLC (ARIZONA LIMITED LIABILITY COMPANY)  
1625 E. PALMAIRE AVE.  
PHOENIX, AZ 85020

**Registered Jan. 15, 2013**

**Int. Cls.: 33 and 43**

FOR: ALCOHOLIC BEVERAGES, NAMELY, WINE, IN CLASS 33 (U.S. CLS. 47 AND 49).

**TRADEMARK**

FIRST USE 10-15-2012; IN COMMERCE 10-18-2012.

**SERVICE MARK**

FOR: INFORMATION SERVICES, NAMELY, PROVIDING A WEB SITE FEATURING AUDIO, VIDEO, PHOTOGRAPHIC AND PROSE PRESENTATIONS FEATURING WINE AND VINICULTURE, IN CLASS 43 (U.S. CLS. 100 AND 101).

**PRINCIPAL REGISTER**

FIRST USE 10-14-2012; IN COMMERCE 10-15-2012.

THE MARK CONSISTS OF STANDARD CHARACTERS WITHOUT CLAIM TO ANY PARTICULAR FONT, STYLE, SIZE, OR COLOR.

SN 85-280,516, FILED 3-29-2011.

BRIAN NEVILLE, EXAMINING ATTORNEY



*David J. Kyffers*

Director of the United States Patent and Trademark Office



# United States of America

United States Patent and Trademark Office



**Reg. No. 4,276,376**

**Registered Jan. 15, 2013**

**Int. Cl.: 9**

**TRADEMARK**

**PRINCIPAL REGISTER**

COMUNITEL LLC (FLORIDA LIMITED LIABILITY COMPANY)  
2700 GLADES CIR BLDG C  
WESTON, FL 33327

FOR: CELL PHONES; GPS NAVIGATION DEVICE; WIRELESS COMMUNICATION DEVICES FOR VOICE, DATA OR IMAGE TRANSMISSION, IN CLASS 9 (U.S. CLS. 21, 23, 26, 36 AND 38).

FIRST USE 9-1-2012; IN COMMERCE 9-1-2012.

NO CLAIM IS MADE TO THE EXCLUSIVE RIGHT TO USE "MOVILES", APART FROM THE MARK AS SHOWN.

THE COLOR(S) RED, WHITE AND GRAY IS/ARE CLAIMED AS A FEATURE OF THE MARK.

THE MARK CONSISTS OF A LARGE RED CHECKMARK ARC, PARTIALLY CHECKERED IN WHITE SQUARES; WITH THE ARC ABOVE THE WORD, "MOVILES", IN GREY MIRRORED LETTERING.

THE ENGLISH TRANSLATION OF "MOVILES" IN THE MARK IS MOBILE.

SN 85-280,736, FILED 3-30-2011.

JOHN KELLY, EXAMINING ATTORNEY



*David J. Kybas*

Director of the United States Patent and Trademark Office

# United States of America

United States Patent and Trademark Office

## LA VIDA ES PRIMERO

**Reg. No. 4,276,377**

JOHNSON & JOHNSON (NEW JERSEY CORPORATION)  
ONE JOHNSON & JOHNSON PLAZA  
NEW BRUNSWICK, NJ 089337001

**Registered Jan. 15, 2013**

**Int. Cl.: 44**

FOR: PROVIDING INFORMATION RELATING TO BLOOD GLUCOSE MONITORING DEVICES AND DIABETES IN GENERAL, IN CLASS 44 (U.S. CLS. 100 AND 101).

**SERVICE MARK**

FIRST USE 11-1-2011; IN COMMERCE 11-1-2011.

**PRINCIPAL REGISTER**

THE MARK CONSISTS OF STANDARD CHARACTERS WITHOUT CLAIM TO ANY PARTICULAR FONT, STYLE, SIZE, OR COLOR.

THE ENGLISH TRANSLATION OF "LA VIDA ES PRIMERO" IN THE MARK IS "LIFE IS FIRST".

SN 85-280,789, FILED 3-30-2011.

MATTHEW MCDOWELL, EXAMINING ATTORNEY



*David J. Kyffers*

Director of the United States Patent and Trademark Office

# United States of America

United States Patent and Trademark Office

# TOTAL M-1

**Reg. No. 4,276,378**

**Registered Jan. 15, 2013**

**Int. Cls.: 35 and 42**

**SERVICE MARK**

**PRINCIPAL REGISTER**

PRICEWATERHOUSECOOPERS LLP (DELAWARE LIMITED LIABILITY PARTNERSHIP)  
300 MADISON AVENUE  
NEW YORK, NY 10017

FOR: PROVIDING AN ON-LINE DATABASE FEATURING INFORMATION RELATED TO TAX ADJUSTMENTS FOR MUTUAL FUNDS AND INVESTMENT PARTNERSHIPS , IN CLASS 35 (U.S. CLS. 100, 101 AND 102).

FIRST USE 6-30-2011; IN COMMERCE 6-30-2011.

FOR: PROVIDING TEMPORARY USE OF NON-DOWNLOADABLE SOFTWARE FOR USE IN TAX RETURN ADJUSTMENTS, PLANNING, CALCULATION AND ANALYSIS, IN CLASS 42 (U.S. CLS. 100 AND 101).

FIRST USE 6-30-2011; IN COMMERCE 6-30-2011.

THE MARK CONSISTS OF STANDARD CHARACTERS WITHOUT CLAIM TO ANY PARTICULAR FONT, STYLE, SIZE, OR COLOR.

NO CLAIM IS MADE TO THE EXCLUSIVE RIGHT TO USE "M-1" , APART FROM THE MARK AS SHOWN.

SN 85-281,053, FILED 3-30-2011.

ANN E. SAPPENFIELD, EXAMINING ATTORNEY



*David J. Kyros*

Director of the United States Patent and Trademark Office

# United States of America

United States Patent and Trademark Office

# PUTNAM

**Reg. No. 4,276,379**

**Registered Jan. 15, 2013**

**Int. Cl.: 36**

**SERVICE MARK**

**PRINCIPAL REGISTER**

PUTNAM INVESTMENTS, LLC (DELAWARE LIMITED LIABILITY COMPANY)  
ONE POST OFFICE SQUARE  
BOSTON, MA 02109

FOR: MUTUAL FUND INVESTMENT, BROKERAGE, MANAGEMENT, AND DISTRIBUTION SERVICES; MUTUAL FUND ADMINISTRATION SERVICES AND INVESTMENT ADVICE AND CONSULTATION SERVICES; FINANCIAL SERVICES, NAMELY, INVESTMENT MANAGEMENT, FINANCIAL MANAGEMENT, FINANCIAL ANALYSIS, CONSULTATION, MANAGEMENT AND PLANNING SERVICES; FINANCIAL PLANNING; SECURITIES BROKERAGE SERVICES; MONEY MANAGEMENT; RETIREMENT PLAN ADMINISTRATION SERVICES; FINANCIAL ADMINISTRATION AND INVESTMENT MANAGEMENT SERVICES; PROVIDING FINANCIAL NEWS AND INFORMATION, INFORMATION ABOUT RETIREMENT PLANNING, INVESTMENT ACCOUNT INFORMATION, RESEARCH IN THE FIELDS OF INVESTMENT AND FINANCE, AND INFORMATION ABOUT MUTUAL FUND PERFORMANCE; PROVIDING FINANCIAL INFORMATION BY ELECTRONIC MEANS; PROVIDING PERSONALIZED INVESTMENT INFORMATION, INVESTMENT ACCOUNT MANAGEMENT AND SECURITIES BROKERAGE SERVICES, ALL BY MEANS OF WIRELESS COMMUNICATION DEVICES AND BY MEANS OF THE INTERNET; DISSEMINATION OF FINANCIAL INFORMATION RELATING TO THE TRANSITION FROM WORK TO RETIREMENT OR FROM ONE JOB TO ANOTHER; PROVIDING ONLINE INFORMATION ABOUT SECURITIES PRICES; FINANCIAL ADVISORY SERVICES; RESEARCH IN THE FIELD OF INVESTMENTS AND FINANCE; ALL EXCLUDING INSURANCE AND REINSURANCE UNDERWRITING SERVICES, IN CLASS 36 (U.S. CLS. 100, 101 AND 102).

FIRST USE 0-0-1937; IN COMMERCE 0-0-1937.

THE MARK CONSISTS OF STANDARD CHARACTERS WITHOUT CLAIM TO ANY PARTICULAR FONT, STYLE, SIZE, OR COLOR.

SEC. 2(F).

OWNER OF U.S. REG. NOS. 2,513,241 AND 2,968,084.

SN 85-281,151, FILED 3-30-2011.

RUDY R. SINGLETON, EXAMINING ATTORNEY



*David J. Kyros*

Director of the United States Patent and Trademark Office

# United States of America

United States Patent and Trademark Office

## PUTNAM INVESTMENTS

**Reg. No. 4,276,380**

**Registered Jan. 15, 2013**

**Int. Cl.: 36**

**SERVICE MARK**

**PRINCIPAL REGISTER**

PUTNAM INVESTMENTS, LLC (DELAWARE LIMITED LIABILITY COMPANY)  
ONE POST OFFICE SQUARE  
BOSTON, MA 02109

FOR: MUTUAL FUND INVESTMENT, BROKERAGE, MANAGEMENT, AND DISTRIBUTION SERVICES; MUTUAL FUND ADMINISTRATION SERVICES AND INVESTMENT ADVICE AND CONSULTATION SERVICES; FINANCIAL SERVICES, NAMELY, INVESTMENT MANAGEMENT, FINANCIAL MANAGEMENT, FINANCIAL ANALYSIS, CONSULTATION, MANAGEMENT AND PLANNING SERVICES; FINANCIAL PLANNING; SECURITIES BROKERAGE SERVICES; MONEY MANAGEMENT; RETIREMENT PLAN ADMINISTRATION SERVICES; FINANCIAL ADMINISTRATION AND INVESTMENT MANAGEMENT SERVICES; PROVIDING FINANCIAL NEWS AND INFORMATION, INFORMATION ABOUT RETIREMENT PLANNING, INVESTMENT ACCOUNT INFORMATION, RESEARCH IN THE FIELDS OF INVESTMENT AND FINANCE, AND INFORMATION ABOUT MUTUAL FUND PERFORMANCE; PROVIDING FINANCIAL INFORMATION BY ELECTRONIC MEANS; PROVIDING PERSONALIZED INVESTMENT INFORMATION, INVESTMENT ACCOUNT MANAGEMENT AND SECURITIES BROKERAGE SERVICES, ALL BY MEANS OF WIRELESS COMMUNICATION DEVICES AND BY MEANS OF THE INTERNET; DISSEMINATION OF FINANCIAL INFORMATION RELATING TO THE TRANSITION FROM WORK TO RETIREMENT OR FROM ONE JOB TO ANOTHER; PROVIDING ONLINE INFORMATION ABOUT SECURITIES PRICES; FINANCIAL ADVISORY SERVICES; RESEARCH IN THE FIELD OF INVESTMENTS AND FINANCE; ALL EXCLUDING INSURANCE AND REINSURANCE UNDERWRITING SERVICES, IN CLASS 36 (U.S. CLS. 100, 101 AND 102).

FIRST USE 0-0-1937; IN COMMERCE 0-0-1992.

THE MARK CONSISTS OF STANDARD CHARACTERS WITHOUT CLAIM TO ANY PARTICULAR FONT, STYLE, SIZE, OR COLOR.

SEC. 2(F) AS TO "PUTNAM".

OWNER OF U.S. REG. NOS. 2,513,241 AND 2,968,084.

NO CLAIM IS MADE TO THE EXCLUSIVE RIGHT TO USE "INVESTMENTS", APART FROM THE MARK AS SHOWN.

SN 85-281,157, FILED 3-30-2011.



*David J. Kybas*

Director of the United States Patent and Trademark Office

**Reg. No. 4,276,380** RUDY R. SINGLETON, EXAMINING ATTORNEY

# United States of America

United States Patent and Trademark Office

## PUTNAM MUTUAL FUNDS

**Reg. No. 4,276,381**

**Registered Jan. 15, 2013**

**Int. Cl.: 36**

**SERVICE MARK**

**PRINCIPAL REGISTER**

PUTNAM INVESTMENTS, LLC (DELAWARE LIMITED LIABILITY COMPANY)  
ONE POST OFFICE SQUARE  
BOSTON, MA 02109

FOR: MUTUAL FUND INVESTMENT, BROKERAGE, MANAGEMENT, AND DISTRIBUTION SERVICES; MUTUAL FUND ADMINISTRATION SERVICES AND INVESTMENT ADVICE AND CONSULTATION SERVICES; FINANCIAL SERVICES, NAMELY, INVESTMENT MANAGEMENT, FINANCIAL MANAGEMENT, FINANCIAL ANALYSIS, CONSULTATION, MANAGEMENT AND PLANNING SERVICES; FINANCIAL PLANNING; SECURITIES BROKERAGE SERVICES; MONEY MANAGEMENT; RETIREMENT PLAN ADMINISTRATION SERVICES; FINANCIAL ADMINISTRATION AND INVESTMENT MANAGEMENT SERVICES; PROVIDING FINANCIAL NEWS AND INFORMATION, INFORMATION ABOUT RETIREMENT PLANNING, INVESTMENT ACCOUNT INFORMATION, RESEARCH IN THE FIELDS OF INVESTMENT AND FINANCE, AND INFORMATION ABOUT MUTUAL FUND PERFORMANCE; PROVIDING FINANCIAL INFORMATION BY ELECTRONIC MEANS; PROVIDING PERSONALIZED INVESTMENT INFORMATION, INVESTMENT ACCOUNT MANAGEMENT AND SECURITIES BROKERAGE SERVICES, ALL BY MEANS OF WIRELESS COMMUNICATION DEVICES AND BY MEANS OF THE INTERNET; DISSEMINATION OF FINANCIAL INFORMATION RELATING TO THE TRANSITION FROM WORK TO RETIREMENT OR FROM ONE JOB TO ANOTHER; PROVIDING ONLINE INFORMATION ABOUT SECURITIES PRICES; FINANCIAL ADVISORY SERVICES; RESEARCH IN THE FIELD OF INVESTMENTS AND FINANCE; ALL EXCLUDING INSURANCE AND REINSURANCE UNDERWRITING SERVICES, IN CLASS 36 (U.S. CLS. 100, 101 AND 102).

FIRST USE 0-0-1937; IN COMMERCE 0-0-1957.

THE MARK CONSISTS OF STANDARD CHARACTERS WITHOUT CLAIM TO ANY PARTICULAR FONT, STYLE, SIZE, OR COLOR.

SEC. 2(F) AS TO "PUTNAM".

OWNER OF U.S. REG. NOS. 2,513,241 AND 2,968,084.

NO CLAIM IS MADE TO THE EXCLUSIVE RIGHT TO USE "MUTUAL FUNDS", APART FROM THE MARK AS SHOWN.

SN 85-281,171, FILED 3-30-2011.



*David J. Kyros*

Director of the United States Patent and Trademark Office

**Reg. No. 4,276,381** RUDY R. SINGLETON, EXAMINING ATTORNEY



# United States of America

United States Patent and Trademark Office

# WHENi

**Reg. No. 4,276,382**

JUDD, DONALD (UNITED STATES INDIVIDUAL)  
1300 BRAZOS DRIVE  
BENBROOK, TX 76126

**Registered Jan. 15, 2013**

**Int. Cl.: 42**

FOR: COMPUTER SOFTWARE TECHNOLOGY CONSULTING, IN CLASS 42 (U.S. CLS. 100 AND 101).

**SERVICE MARK**

FIRST USE 2-15-2011; IN COMMERCE 8-3-2011.

**PRINCIPAL REGISTER**

THE MARK CONSISTS OF STANDARD CHARACTERS WITHOUT CLAIM TO ANY PARTICULAR FONT, STYLE, SIZE, OR COLOR.

SN 85-282,482, FILED 3-31-2011.

BARBARA RUTLAND, EXAMINING ATTORNEY



*David J. Kybas*

Director of the United States Patent and Trademark Office

# United States of America

United States Patent and Trademark Office

## GOLDEN PAWS

**Reg. No. 4,276,383**

IGT (NEVADA CORPORATION)  
9295 PROTOTYPE DRIVE  
RENO, NV 895218986

**Registered Jan. 15, 2013**

**Int. Cl.: 9**

FOR: GAMING MACHINES, NAMELY, DEVICES WHICH ACCEPT A WAGER, IN CLASS 9 (U.S. CLS. 21, 23, 26, 36 AND 38).

**TRADEMARK**

FIRST USE 5-12-2012; IN COMMERCE 5-12-2012.

**PRINCIPAL REGISTER**

THE MARK CONSISTS OF STANDARD CHARACTERS WITHOUT CLAIM TO ANY PARTICULAR FONT, STYLE, SIZE, OR COLOR.

SN 85-282,875, FILED 3-31-2011.

HEATHER BIDDULPH, EXAMINING ATTORNEY



*David J. Kybas*

Director of the United States Patent and Trademark Office

# United States of America

United States Patent and Trademark Office

# BERNARD

**Reg. No. 4,276,384**

LAPIERRE EQUIPMENT INC. (CANADA CORPORATION)  
99, RUE DE L'ESCALE

**Registered Jan. 15, 2013**

ST.-LUDGER, BEAUCE QC, CANADA G0M1W0

**Int. Cl.: 7**

FOR: MAPLE SUGARING EQUIPMENT, NAMELY, MACHINES USED FOR EXTRACTING MAPLE SAP FROM A VACUUM-TUBING SYSTEM, IN CLASS 7 (U.S. CLS. 13, 19, 21, 23, 31, 34 AND 35).

**TRADEMARK**

FIRST USE 6-12-2012; IN COMMERCE 6-12-2012.

**PRINCIPAL REGISTER**

THE MARK CONSISTS OF STANDARD CHARACTERS WITHOUT CLAIM TO ANY PARTICULAR FONT, STYLE, SIZE, OR COLOR.

SN 85-283,739, FILED 4-1-2011.

RUDY R. SINGLETON, EXAMINING ATTORNEY



*David J. Kyffers*

Director of the United States Patent and Trademark Office

# United States of America

United States Patent and Trademark Office

# DEJA MI

**Reg. No. 4,276,385**

**Registered Jan. 15, 2013**

**Int. Cl.: 9**

**TRADEMARK**

**PRINCIPAL REGISTER**

DEJA MI, INC. (NORTH CAROLINA CORPORATION)  
6413 RUSHINGBROOK DR.  
RALEIGH, NC 27612

FOR: PROVIDING A DOWNLOADABLE MOBILE APPLICATION FEATURING SHARED COMMUNICATIONS THROUGH LOCATION SPECIFIC PHOTOGRAPHS, AUDIO, VIDEO AND OTHER DIGITAL CONTENT FOR PURPOSES OF PROVIDING REAL-TIME, CROWD-SOURCED VIEWS OF SOCIAL EVENTS, COMMUNITY EVENTS, BARS, RESTAURANTS, CLUBS AND MUSIC SHOWS, IN CLASS 9 (U.S. CLS. 21, 23, 26, 36 AND 38).

FIRST USE 7-19-2011; IN COMMERCE 7-19-2011.

THE MARK CONSISTS OF STANDARD CHARACTERS WITHOUT CLAIM TO ANY PARTICULAR FONT, STYLE, SIZE, OR COLOR.

THE WORDING "DEJA MI" HAS NO MEANING IN A FOREIGN LANGUAGE.

SN 85-284,056, FILED 4-1-2011.

ALICE BENMAMAN, EXAMINING ATTORNEY



*David J. Kyffers*

Director of the United States Patent and Trademark Office

# United States of America

United States Patent and Trademark Office

# SOFTGUARD

**Reg. No. 4,276,386**

**Registered Jan. 15, 2013**

**Int. Cls.: 9 and 42**

**TRADEMARK**

**SERVICE MARK**

**PRINCIPAL REGISTER**

BANDA, DANIEL GUSTAVO (ARGENTINA INDIVIDUAL)  
20900 NE 30 AVE - SUITE 200  
AVENTURA, FL 33180

FOR: COMPUTER SOFTWARE FOR BUILDING SECURITY SYSTEMS COMPRISED OF A REMOTE CENTRAL STATION ALARM NOTIFICATION SYSTEM, IN CLASS 9 (U.S. CLS. 21, 23, 26, 36 AND 38).

FIRST USE 1-28-2005; IN COMMERCE 4-5-2011.

FOR: COMPUTER SOFTWARE DEVELOPMENT IN THE FIELD OF BUILDING SECURITY SYSTEMS COMPRISED OF A REMOTE CENTRAL STATION ALARM NOTIFICATION SYSTEM, IN CLASS 42 (U.S. CLS. 100 AND 101).

FIRST USE 1-28-2005; IN COMMERCE 4-5-2011.

THE MARK CONSISTS OF STANDARD CHARACTERS WITHOUT CLAIM TO ANY PARTICULAR FONT, STYLE, SIZE, OR COLOR.

SN 85-285,047, FILED 4-4-2011.

KYLE PEETE, EXAMINING ATTORNEY



*David J. Kybas*

Director of the United States Patent and Trademark Office

# United States of America

United States Patent and Trademark Office

# Phusion Rx

**Reg. No. 4,276,387**

HUGHES, DAVID C (UNITED STATES INDIVIDUAL)  
17 COVENTRY SHOPPERS PARK  
COVENTRY, RI 02816

**Registered Jan. 15, 2013**

**Int. Cl.: 35**

FOR: MAIL ORDER PHARMACY SERVICES; PHARMACEUTICAL SERVICES, NAMELY, PROCESSING ONLINE AND TELEPHONE PRESCRIPTION ORDERS IN RETAIL AND CENTRAL FILL PHARMACIES; RETAIL PHARMACY SERVICES; RETAIL VETERINARY PHARMACY SERVICES; SPECIALIZED RETAIL PHARMACY SERVICES FOR PATIENTS WITH PARTICULAR MEDICAL CONDITIONS, IN CLASS 35 (U.S. CLS. 100, 101 AND 102).

**SERVICE MARK**

**PRINCIPAL REGISTER**

FIRST USE 5-1-2011; IN COMMERCE 7-18-2011.

THE MARK CONSISTS OF STANDARD CHARACTERS WITHOUT CLAIM TO ANY PARTICULAR FONT, STYLE, SIZE, OR COLOR.

NO CLAIM IS MADE TO THE EXCLUSIVE RIGHT TO USE "RX", APART FROM THE MARK AS SHOWN.

SN 85-285,140, FILED 4-4-2011.

HELENE LIWINSKI, EXAMINING ATTORNEY



*David J. Kyjars*

Director of the United States Patent and Trademark Office

# United States of America

United States Patent and Trademark Office

# eDASH

**Reg. No. 4,276,388**

**Registered Jan. 15, 2013**

**Int. Cl.: 9**

**TRADEMARK**

**PRINCIPAL REGISTER**

THE SOLUTION FOUNDRY, LLC (GEORGIA LIMITED LIABILITY COMPANY)  
2230 TOWNE LAKE PARKWAY  
WOODSTOCK, GA 30189

FOR: COMPUTER SOFTWARE DESIGNED TO ASSIST IN THE COORDINATION AND MANAGEMENT OF BUSINESS OPERATIONS, NAMELY, SOFTWARE TO IDENTIFY, MANAGE, TRACK AND REPORT ON BUSINESS OPERATIONS, NAMELY, COMPLIANCE WITH LEGAL REQUIREMENTS, WORK TASKS, ASSIGNMENT/COMPLETION OF TASKS, WORK FLOW, DEADLINES AND SCHEDULING; DATABASE MANAGEMENT SOFTWARE FOR USE IN ENVIRONMENTAL HEALTH AND SAFETY RELATED COMPLIANCE, IN CLASS 9 (U.S. CLS. 21, 23, 26, 36 AND 38).

FIRST USE 3-1-2011; IN COMMERCE 3-1-2011.

THE MARK CONSISTS OF STANDARD CHARACTERS WITHOUT CLAIM TO ANY PARTICULAR FONT, STYLE, SIZE, OR COLOR.

SN 85-285,466, FILED 4-4-2011.

JULIE VEPPUMTHARA, EXAMINING ATTORNEY



*David J. Kyjars*

Director of the United States Patent and Trademark Office

# United States of America

United States Patent and Trademark Office

## WELLBEINGGO

**Reg. No. 4,276,389**

**Registered Jan. 15, 2013**

**Int. Cls.: 9, 42, and 44**

**TRADEMARK**

**SERVICE MARK**

**PRINCIPAL REGISTER**

HEALTHWAYS, INC. (DELAWARE CORPORATION)  
701 COOL SPRINGS BLVD  
FRANKLIN, TN 37067

FOR: DOWNLOADABLE SOFTWARE IN THE NATURE OF MOBILE APPLICATIONS IN THE FIELD OF HEALTH AND WELLNESS, IN CLASS 9 (U.S. CLS. 21, 23, 26, 36 AND 38).

FIRST USE 7-0-2011; IN COMMERCE 7-0-2011.

FOR: APPLICATION SERVICE PROVIDER (ASP) FEATURING SOFTWARE FOR USE STORING, TRACKING AND MONITORING PERSONAL HEALTH INFORMATION IN THE FIELD OF HEALTH AND WELLNESS, IN CLASS 42 (U.S. CLS. 100 AND 101).

FIRST USE 7-0-2011; IN COMMERCE 7-0-2011.

FOR: PROVIDING INFORMATION IN THE FIELD OF HEALTH AND WELLNESS, IN CLASS 44 (U.S. CLS. 100 AND 101).

FIRST USE 7-0-2011; IN COMMERCE 7-0-2011.

THE MARK CONSISTS OF STANDARD CHARACTERS WITHOUT CLAIM TO ANY PARTICULAR FONT, STYLE, SIZE, OR COLOR.

SN 85-285,666, FILED 4-4-2011.

ARETHA SOMERVILLE, EXAMINING ATTORNEY



*David J. Kybas*

Director of the United States Patent and Trademark Office



# United States of America

United States Patent and Trademark Office

## MISSION WINGS

**Reg. No. 4,276,390**

**Registered Jan. 15, 2013**

**Int. Cl.: 45**

**SERVICE MARK**

**PRINCIPAL REGISTER**

MISSION WINGS (MICHIGAN NON-PROFIT CORPORATION)  
3661 W. NORTH TERRITORIAL  
WHITMORE LAKE, MI 48189

FOR: CHARITABLE SERVICES, NAMELY, PROVIDING AIRCRAFT AND AIRCRAFT-RELATED SUPPORT AND TRAINING TO MISSIONARIES, IN CLASS 45 (U.S. CLS. 100 AND 101).

FIRST USE 3-1-2011; IN COMMERCE 3-1-2011.

THE MARK CONSISTS OF STANDARD CHARACTERS WITHOUT CLAIM TO ANY PARTICULAR FONT, STYLE, SIZE, OR COLOR.

SN 85-286,059, FILED 4-5-2011.

KATINA MISTER, EXAMINING ATTORNEY



*David J. Kyffers*

Director of the United States Patent and Trademark Office

# United States of America

United States Patent and Trademark Office

**Stacker  
Bottle**

**Reg. No. 4,276,391**

CONVENIENCE NUTRITION, LLC (MISSOURI LIMITED LIABILITY COMPANY)  
3435 EAST FARM ROAD 194  
OZARK, MO 65721

**Registered Jan. 15, 2013**

**Int. Cl.: 20**

FOR: CONTAINERS, NOT MADE OF METAL, FOR COMMERCIAL USE, BEING INTER-LOCKING AND STACKABLE CONTAINERS, SOLD EMPTY, FOR POWDERED NUTRITIONAL SUPPLEMENTS, IN CLASS 20 (U.S. CLS. 2, 13, 22, 25, 32 AND 50).

**TRADEMARK**

FIRST USE 9-30-2011; IN COMMERCE 9-30-2011.

**PRINCIPAL REGISTER**

THE MARK CONSISTS OF AN IMAGE OF THREE STYLIZED BOTTLES STACKED ALONG THE LEFT SIDE OF THE MARK AND THE WORD "STACKER" ON TOP OF THE WORD "BOTTLE", BOTH WORDS TO THE RIGHT OF THE STACKED BOTTLES.

SN 85-286,796, FILED 4-5-2011.

RUDY R. SINGLETON, EXAMINING ATTORNEY



*David J. Kybas*

Director of the United States Patent and Trademark Office

# United States of America

United States Patent and Trademark Office

## COMFORTABLY NUMB

**Reg. No. 4,276,392**

BLAINE LABS, INC. (CALIFORNIA CORPORATION)  
11037 LOCKPORT PLACE  
SANTA FE SPRINGS, CA 90670

**Registered Jan. 15, 2013**

**Int. Cl.: 10**

FOR: MEDICAL DEVICES, NAMELY, HAND-HELD MOTORIZED, VIBRATING DEVICES USED NEAR INJECTION SITES FOR REDUCING PAIN DURING HYPODERMIC NEEDLE INJECTIONS, IN CLASS 10 (U.S. CLS. 26, 39 AND 44).

**TRADEMARK**

FIRST USE 12-6-2011; IN COMMERCE 10-31-2012.

**PRINCIPAL REGISTER**

THE MARK CONSISTS OF STANDARD CHARACTERS WITHOUT CLAIM TO ANY PARTICULAR FONT, STYLE, SIZE, OR COLOR.

NO CLAIM IS MADE TO THE EXCLUSIVE RIGHT TO USE "NUMB", APART FROM THE MARK AS SHOWN.

SN 85-286,802, FILED 4-5-2011.

JANET LEE, EXAMINING ATTORNEY



*David J. Kyros*

Director of the United States Patent and Trademark Office

# United States of America

United States Patent and Trademark Office

# On-Stage

**Reg. No. 4,276,393**

**Registered Jan. 15, 2013**

**Int. Cl.: 9**

**TRADEMARK**

**PRINCIPAL REGISTER**

THE MUSIC PEOPLE INC. (CONNECTICUT CORPORATION)  
154 WOODLAWN ROAD SUITE C  
BERLIN, CT 06037

FOR: ELECTRICAL CABLES FOR MUSIC INSTRUMENTS, AUDIO HEADPHONES, MICROPHONES, SPEAKER ENCLOSURES, IN CLASS 9 (U.S. CLS. 21, 23, 26, 36 AND 38).

FIRST USE 4-6-2011; IN COMMERCE 4-6-2011.

THE MARK CONSISTS OF STANDARD CHARACTERS WITHOUT CLAIM TO ANY PARTICULAR FONT, STYLE, SIZE, OR COLOR.

OWNER OF U.S. REG. NO. 1,333,271.

SN 85-286,901, FILED 4-5-2011.

REGINA DRUMMOND, EXAMINING ATTORNEY



*David J. Kyffers*

Director of the United States Patent and Trademark Office

# United States of America

United States Patent and Trademark Office

## DEHOONATHON

**Reg. No. 4,276,394**

WALSH, JOHN (AUSTRALIA INDIVIDUAL)  
9 PFAFF STREET

**Registered Jan. 15, 2013**

YEPPON, AUSTRALIA 4703

**Int. Cl.: 35**

FOR: ADVERTISING AND PUBLICITY SERVICES OF THE ACTIVITIES AND EVENTS OF CHARITABLE ORGANIZATIONS, IN CLASS 35 (U.S. CLS. 100, 101 AND 102).

**SERVICE MARK**

FIRST USE 11-13-2012; IN COMMERCE 11-13-2012.

**PRINCIPAL REGISTER**

THE MARK CONSISTS OF STANDARD CHARACTERS WITHOUT CLAIM TO ANY PARTICULAR FONT, STYLE, SIZE, OR COLOR.

SN 85-287,408, FILED 4-6-2011.

JENNIFER MARTIN, EXAMINING ATTORNEY



*David J. Kyffers*

Director of the United States Patent and Trademark Office

# United States of America

United States Patent and Trademark Office



**Reg. No. 4,276,395**

LITTLE SHAKER, INC. (MARYLAND CORPORATION)  
10691 EASTERDAY ROAD  
MYERSVILLE, MD 21773

**Registered Jan. 15, 2013**

**Int. Cl.: 25**

FOR: SHORT-SLEEVED OR LONG-SLEEVED T-SHIRTS; T-SHIRTS, IN CLASS 25 (U.S. CLS. 22 AND 39).

**TRADEMARK**

FIRST USE 3-22-2011; IN COMMERCE 4-1-2011.

**PRINCIPAL REGISTER**

THE MARK CONSISTS OF THE WORDS "LITTLE" AND "SHAKER" WITH AN IMAGE OF A SALT SHAKER BETWEEN THESE WORDS. IN THE CENTER OF THE SALT SHAKER IS AN IMAGE OF A HEART. ABOVE THE SALT SHAKER IMAGE ARE ELEVEN (11) HEARTS OF VARIOUS SIZES. BEHIND THE SALT SHAKER IMAGE, THE ELEVEN (11) HEARTS, AND THE WORDS "LITTLE" AND "SHAKER" ARE LINES ARRANGED IN A FAN SHAPE EMANATING FROM BEHIND THE SALT SHAKER. UNDERNEATH THE "LITTLE SHAKER" WORDING AND DESIGN ELEMENTS APPEAR THE WORDS "SHAKE", "LOVE", AND "SERVE".

SN 85-287,421, FILED 4-6-2011.

KATHERINE CONNOLLY, EXAMINING ATTORNEY



*David J. Kybas*

Director of the United States Patent and Trademark Office

# United States of America

United States Patent and Trademark Office

# LIFESCRIPT

**Reg. No. 4,276,396**

LIFESCRIPT, INC. (DELAWARE CORPORATION)

**Registered Jan. 15, 2013**

26001 PALA  
MISSION VIEJO, CA 92691

**Int. Cls.: 35, 41, and 44**

FOR: PROVIDING AN ON-LINE DIRECTORY INFORMATION SERVICE FEATURING INFORMATION REGARDING HEALTH CARE PROVIDERS AND HEALTH CARE CENTERS, IN CLASS 35 (U.S. CLS. 100, 101 AND 102).

**SERVICE MARK**

FIRST USE 6-30-2010; IN COMMERCE 6-30-2010.

**PRINCIPAL REGISTER**

FOR: PROVIDING A WEBSITE FEATURING INFORMATION ABOUT FITNESS, IN CLASS 41 (U.S. CLS. 100, 101 AND 107).

FIRST USE 11-30-2002; IN COMMERCE 11-30-2002.

FOR: PROVIDING A WEBSITE FEATURING INFORMATION ABOUT HEALTH, NUTRITION, DIET, WEIGHT LOSS, HEALTH CARE AND HEALTH CARE-RELATED EVENTS, IN CLASS 44 (U.S. CLS. 100 AND 101).

FIRST USE 11-30-2002; IN COMMERCE 11-30-2002.

THE MARK CONSISTS OF STANDARD CHARACTERS WITHOUT CLAIM TO ANY PARTICULAR FONT, STYLE, SIZE, OR COLOR.

OWNER OF U.S. REG. NO. 2,810,923.

SN 85-287,982, FILED 4-6-2011.

HEATHER THOMPSON, EXAMINING ATTORNEY



*David J. Kyjars*

Director of the United States Patent and Trademark Office

# United States of America

United States Patent and Trademark Office

## Driver Science

**Reg. No. 4,276,397**

**Registered Jan. 15, 2013**

**Int. Cls.: 9 and 36**

**TRADEMARK**

**SERVICE MARK**

**PRINCIPAL REGISTER**

DRIVECAM, INC. (CALIFORNIA CORPORATION)  
8911 BALBOA AVENUE  
SAN DIEGO, CA 92123

FOR: VIDEO EVENT RECORDERS; COMPUTER SOFTWARE FOR ANALYZING DATA FROM VIDEO EVENT RECORDERS FOR USE IN THE FIELD OF DRIVER RISK MANAGEMENT, IMPROVING DRIVER SAFETY AND REDUCING RISKY DRIVING BEHAVIOR; DRIVING PERFORMANCE MANAGEMENT SOFTWARE, IN CLASS 9 (U.S. CLS. 21, 23, 26, 36 AND 38).

FIRST USE 4-1-2011; IN COMMERCE 4-1-2011.

FOR: FINANCIAL RISK MANAGEMENT CONSULTING SERVICES RELATED TO DRIVER BEHAVIOR, NAMELY, MANAGEMENT AND REDUCTION OF THE FINANCIAL RISK CREATED BY DRIVERS BY REDUCING RISKY DRIVING BEHAVIOR, IN CLASS 36 (U.S. CLS. 100, 101 AND 102).

FIRST USE 4-1-2011; IN COMMERCE 4-1-2011.

THE MARK CONSISTS OF STANDARD CHARACTERS WITHOUT CLAIM TO ANY PARTICULAR FONT, STYLE, SIZE, OR COLOR.

NO CLAIM IS MADE TO THE EXCLUSIVE RIGHT TO USE "DRIVER", APART FROM THE MARK AS SHOWN.

SN 85-287,986, FILED 4-6-2011.

JIM RINGLE, EXAMINING ATTORNEY



*David J. Kybas*

Director of the United States Patent and Trademark Office



# United States of America

United States Patent and Trademark Office

# ROOSERVICE

**Reg. No. 4,276,398**

**Registered Jan. 15, 2013**

**Int. Cls.: 35 and 39**

**SERVICE MARK**

**PRINCIPAL REGISTER**

TEZZE, LLC (DELAWARE LIMITED LIABILITY COMPANY)  
#406  
2413 W. ALGONQUIN ROAD  
ALGONQUIN, IL 60102

FOR: PERSONAL TRAVEL ASSISTANCE SERVICES, NAMELY, ARRANGING FOR THE TRANSPORTATION AND DELIVERY OF A TRAVELER'S PERSONAL GOODS; PROCUREMENT SERVICES, NAMELY, PURCHASING PERSONAL CONSUMER GOODS FOR OTHERS, IN CLASS 35 (U.S. CLS. 100, 101 AND 102).

FIRST USE 10-0-2012; IN COMMERCE 10-0-2012.

FOR: TRANSPORTATION OF PERSONAL GOODS; PACKING, DELIVERY AND STORAGE OF PERSONAL GOODS OF OTHERS, IN CLASS 39 (U.S. CLS. 100 AND 105).

FIRST USE 10-0-2012; IN COMMERCE 10-0-2012.

THE MARK CONSISTS OF STANDARD CHARACTERS WITHOUT CLAIM TO ANY PARTICULAR FONT, STYLE, SIZE, OR COLOR.

SN 85-289,710, FILED 4-8-2011.

KATHLEEN M. VANSTON, EXAMINING ATTORNEY



*David J. Kybas*

Director of the United States Patent and Trademark Office

# United States of America

United States Patent and Trademark Office

## Love and Wool

**Reg. No. 4,276,399**

SALLY MOON LEE (UNITED STATES INDIVIDUAL), DBA LOVE AND WOOL,  
P.O. BOX 220154  
PORTLAND, OR 97269

**Registered Jan. 15, 2013**

**Int. Cl.: 35**

FOR: ON-LINE RETAIL STORE SERVICES FEATURING ARTS AND CRAFTS AND FIBER  
ART MADE OF WOOL AND OTHER MATERIALS, IN CLASS 35 (U.S. CLS. 100, 101 AND  
102).

**SERVICE MARK**

FIRST USE 11-14-2012; IN COMMERCE 11-20-2012.

**PRINCIPAL REGISTER**

THE MARK CONSISTS OF STANDARD CHARACTERS WITHOUT CLAIM TO ANY PAR-  
TICULAR FONT, STYLE, SIZE, OR COLOR.

NO CLAIM IS MADE TO THE EXCLUSIVE RIGHT TO USE "WOOL", APART FROM THE  
MARK AS SHOWN.

SN 85-290,053, FILED 4-8-2011.

BRIAN PINO, EXAMINING ATTORNEY



*David J. Kyffers*

Director of the United States Patent and Trademark Office

# United States of America

United States Patent and Trademark Office



**Reg. No. 4,276,400**

BENNETT, BRIAN (NEW ZEALAND INDIVIDUAL)  
4110 MEDING ST.  
SAVANNAH, GA 31405

**Registered Jan. 15, 2013**

**Int. Cl.: 12**

FOR: SAILBOATS, IN CLASS 12 (U.S. CLS. 19, 21, 23, 31, 35 AND 44).

**TRADEMARK**

FIRST USE 6-1-2011; IN COMMERCE 8-1-2011.

**PRINCIPAL REGISTER**

NO CLAIM IS MADE TO THE EXCLUSIVE RIGHT TO USE "DESIGN" , APART FROM THE MARK AS SHOWN.

THE MARK CONSISTS OF THE TEXT "VX ONE DESIGN" IN STYLIZED FONT.

SN 85-291,051, FILED 4-9-2011.

DAVID H. STINE, EXAMINING ATTORNEY



*David J. Kyffers*

Director of the United States Patent and Trademark Office

# United States of America

United States Patent and Trademark Office

## MEDPOINT DIGITAL

**Reg. No. 4,276,401**

**Registered Jan. 15, 2013**

**Int. Cl.: 35**

MEDPOINT COMMUNICATIONS, INC. (ILLINOIS CORPORATION), DBA MEDPOINT DIGITAL, INC.,  
SUITE 500  
909 DAVIS STREET  
EVANSTON, IL 60201

**SERVICE MARK**

**PRINCIPAL REGISTER**

FOR: DEVELOPMENT OF MEDICAL PRODUCT MARKETING STRATEGIES, CONCEPTS AND TACTICS, NAMELY, AUDIENCE DEVELOPMENT, BRAND AWARENESS, ONLINE COMMUNITY BUILDING AND DIGITAL WORD OF MOUTH COMMUNICATIONS; BUSINESS CONSULTING AND INFORMATION MANAGEMENT IN THE FIELD OF CLINICAL TRIALS, NAMELY, MANAGEMENT AND COMPILATION OF DIGITAL AND WEB SITE BASED SYSTEMS AND PROVIDING CLINICAL RESEARCH ADVERSE EVENT ADJUDICATION DIGITAL SYSTEMS TO MEDICAL, BIOPHARMACEUTICAL AND BIOTECHNOLOGY COMPANIES TO ASSIST THEM WITH CLINICAL RESEARCH, CLINICAL TRIALS AND APPLICATIONS FOR DRUG APPROVAL IN THE FIELD OF CLINICAL TRIALS FOR BUSINESS PURPOSES , IN CLASS 35 (U.S. CLS. 100, 101 AND 102).

FIRST USE 7-28-2011; IN COMMERCE 7-28-2011.

THE MARK CONSISTS OF STANDARD CHARACTERS WITHOUT CLAIM TO ANY PARTICULAR FONT, STYLE, SIZE, OR COLOR.

NO CLAIM IS MADE TO THE EXCLUSIVE RIGHT TO USE "DIGITAL", APART FROM THE MARK AS SHOWN.

SN 85-291,510, FILED 4-11-2011.

JULIE GUTTADAURO, EXAMINING ATTORNEY



*David J. Kyros*

Director of the United States Patent and Trademark Office

# United States of America

United States Patent and Trademark Office

*I ♥ My Balls*

**Reg. No. 4,276,402**

DELGADO, JOSHUA (UNITED STATES INDIVIDUAL)  
5478 BAJA DR.  
SAN DIEGO, CA 92115

**Registered Jan. 15, 2013**

**Int. Cl.: 14**

FOR: ANKLE BRACELETS; CHARITY BRACELETS; IDENTIFICATION BRACELETS; NYLON ANKLE BRACELETS; NYLON BRACELETS; PLASTIC BRACELETS IN THE NATURE OF JEWELRY; RUBBER OR SILICON WRISTBANDS IN THE NATURE OF A BRACELET; SLAP BRACELETS; SLAPBAND BRACELETS, IN CLASS 14 (U.S. CLS. 2, 27, 28 AND 50).

**TRADEMARK**

**PRINCIPAL REGISTER**

FIRST USE 10-25-2011; IN COMMERCE 10-25-2011.

THE MARK CONSISTS OF THE LITERAL ELEMENTS "I MY BALLS" WHEREIN THERE IS A IMAGE OF A HEART BETWEEN THE WORDS "I" AND "MY" AS SHOWN IN THE MARK.

SN 85-291,848, FILED 4-11-2011.

KATINA MISTER, EXAMINING ATTORNEY



*David J. Kybas*

Director of the United States Patent and Trademark Office

# United States of America

United States Patent and Trademark Office

## EUROWEST DECORATIVE SURFACES

**Reg. No. 4,276,403**

STONEPEAK CERAMICS, INC. (ILLINOIS CORPORATION)  
314 WEST SUPERIOR STREET  
CHICAGO, IL 60610

**Registered Jan. 15, 2013**

**Int. Cl.: 19**

FOR: NON-METAL BUILDING MATERIALS, NAMELY, TILES AND SLABS FOR COVERING WALLS AND FLOORS MADE OF STONEWARE; MOSAIC TILES FOR COVERING WALLS AND FLOORS MADE OF CERAMIC OR STONEWARE, CERAMIC TILES FOR COVERING WALLS AND FLOORS, IN CLASS 19 (U.S. CLS. 1, 12, 33 AND 50).

**TRADEMARK**

**PRINCIPAL REGISTER**

FIRST USE 12-31-2008; IN COMMERCE 12-31-2008.

THE MARK CONSISTS OF STANDARD CHARACTERS WITHOUT CLAIM TO ANY PARTICULAR FONT, STYLE, SIZE, OR COLOR.

NO CLAIM IS MADE TO THE EXCLUSIVE RIGHT TO USE "DECORATIVE SURFACES", APART FROM THE MARK AS SHOWN.

SN 85-291,950, FILED 4-11-2011.

RUSS HERMAN, EXAMINING ATTORNEY



*David J. Kyfos*

Director of the United States Patent and Trademark Office

# United States of America

United States Patent and Trademark Office

## Vital Quarantine

**Reg. No. 4,276,404**

**Registered Jan. 15, 2013**

**Int. Cls.: 9 and 42**

**TRADEMARK**

**SERVICE MARK**

**PRINCIPAL REGISTER**

VIA INFORMATION TOOLS, INC. (MICHIGAN CORPORATION)  
1092 BUSINESS LANE  
NAPLES, FL 34110

FOR: COMPUTER SOFTWARE FOR PROVIDING AN ON-LINE DATABASE IN THE FIELD OF TRANSACTION PROCESSING TO UPLOAD TRANSACTIONAL DATA, PROVIDE STATISTICAL ANALYSIS, AND PRODUCE NOTIFICATIONS AND REPORTS; COMPUTER SOFTWARE FOR THE FIELD OF WAREHOUSING AND DISTRIBUTION, TO MANAGE TRANSACTIONAL DATA, PROVIDE STATISTICAL ANALYSIS, AND PRODUCE NOTIFICATIONS AND REPORTS; COMPUTER SOFTWARE THAT PROVIDES REAL-TIME, INTEGRATED BUSINESS MANAGEMENT INTELLIGENCE BY COMBINING INFORMATION FROM VARIOUS DATABASES AND PRESENTING IT IN AN EASY-TO-UNDERSTAND USER INTERFACE; COMPUTER SOFTWARE TO MONITOR AND CONTROL FACTORY MANUFACTURING PROCESSES; FACTORY AUTOMATION SOFTWARE, NAMELY, SOFTWARE TO INTEGRATE MANUFACTURING MACHINE OPERATIONS, TRACK PROBLEMS AND GENERATE PRODUCTION REPORTS; INDUSTRIAL PROCESS CONTROL SOFTWARE; SOFTWARE FOR MONITORING AND CONTROLLING COMMUNICATION BETWEEN COMPUTERS AND AUTOMATED MACHINE SYSTEMS, IN CLASS 9 (U.S. CLS. 21, 23, 26, 36 AND 38).

FIRST USE 4-1-2011; IN COMMERCE 6-1-2011.



*David J. Kyffers*

Director of the United States Patent and Trademark Office

FOR: APPLICATION SERVICE PROVIDER FEATURING SOFTWARE FOR USE IN PROVIDING AN ON-LINE DATABASE IN THE FIELD OF TRANSACTION PROCESSING TO UPLOAD TRANSACTIONAL DATA, PROVIDE STATISTICAL ANALYSIS, AND PRODUCE NOTIFICATIONS AND REPORTS; PLATFORM AS A SERVICE (PAAS) FEATURING COMPUTER SOFTWARE PLATFORMS FOR CONFIGURATION OF FUNCTIONALITY SUPPORTING LOT TRACEABILITY, PRODUCT TRACKING AND GENEALOGY, RESOURCE ALLOCATION AND STATUS, PERFORMANCE ANALYSIS, PROCESS VALIDATION AND MANAGEMENT, SERIALIZATION AND LABELING, DATA COLLECTION AND ACQUISITION, QUALITY MANAGEMENT, DISPATCHING OF PRODUCTION UNITS, INVENTORY VISIBILITY, AND COMMUNICATION TO BOTH INDUSTRIAL CONTROLS AND BUSINESS OPERATIONS SYSTEMS; PROVIDING A WEBSITE FEATURING RESOURCES, NAMELY, NON-DOWNLOADABLE SOFTWARE FOR CONFIGURATION OF FUNCTIONALITY SUPPORTING LOT TRACEABILITY, PRODUCT TRACKING AND GENEALOGY, RESOURCE ALLOCATION AND STATUS, PERFORMANCE ANALYSIS, PROCESS VALIDATION AND MANAGEMENT, SERIALIZATION AND LABELING, DATA COLLECTION AND ACQUISITION.

**Reg. No. 4,276,404** ITION, QUALITY MANAGEMENT, DISPATCHING OF PRODUCTION UNITS, INVENTORY VISIBILITY, AND COMMUNICATION TO BOTH INDUSTRIAL CONTROLS AND BUSINESS OPERATIONS SYSTEMS; SOFTWARE AS A SERVICE (SAAS) SERVICES FEATURING SOFTWARE FOR CONFIGURATION OF FUNCTIONALITY SUPPORTING LOT TRACEABILITY, PRODUCT TRACKING AND GENEALOGY, RESOURCE ALLOCATION AND STATUS, PERFORMANCE ANALYSIS, PROCESS VALIDATION AND MANAGEMENT, SERIALIZATION AND LABELING, DATA COLLECTION AND ACQUISITION, QUALITY MANAGEMENT, DISPATCHING OF PRODUCTION UNITS, INVENTORY VISIBILITY, AND COMMUNICATION TO BOTH INDUSTRIAL CONTROLS AND BUSINESS OPERATIONS SYSTEMS IN THE FIELD OF MANUFACTURING EXECUTION SYSTEMS, IN CLASS 42 (U.S. CLS. 100 AND 101).

FIRST USE 4-1-2011; IN COMMERCE 6-1-2011.

THE MARK CONSISTS OF STANDARD CHARACTERS WITHOUT CLAIM TO ANY PARTICULAR FONT, STYLE, SIZE, OR COLOR.

SN 85-292,112, FILED 4-11-2011.

SUSAN STIGLITZ, EXAMINING ATTORNEY



# United States of America

United States Patent and Trademark Office

## EASY ACCESS BANDAGES

**Reg. No. 4,276,405**

**Registered Jan. 15, 2013**

**Int. Cls.: 5 and 10**

**TRADEMARK**

**PRINCIPAL REGISTER**

GENUINE FIRST AID INTERNATIONAL LTD. (BR. VIRGIN ISLANDS CORPORATION)  
JAYLA PLACE, WICKHAMS CAY  
ROAD TOWN, TORTOLA, BR. VIRGIN ISLANDS VG1110

FOR: ADHESIVE BANDAGES; ADHESIVE FOR BANDAGES FOR SKIN WOUNDS; ADHESIVE TAPES FOR MEDICAL PURPOSES; BANDAGES FOR DRESSINGS; BANDAGES FOR SKIN WOUNDS; BURN DRESSINGS; EYE DROPS; EYE PATCHES FOR MEDICAL PURPOSES; EYE WASHES; FIRST AID KITS; FIRST AID KITS FOR DOMESTIC OR OTHER NON-PROFESSIONAL USE; GAUZE; GAUZE FOR DRESSINGS; IRRIGATING SOLUTIONS FOR EYE USE; MEDICAL ADHESIVE TAPE; MEDICAL AND SURGICAL DRESSINGS; MEDICAL DRESSINGS; MOLE SKIN FOR USE AS A MEDICAL BANDAGE; SALINE WASH FOR MEDICAL PURPOSES; SELF ADHESIVE DRESSINGS; SURGICAL BANDAGES; SURGICAL DRESSINGS; WOUND DRESSINGS; WOUND DRESSINGS, NAMELY, PLEDGETS, IN CLASS 5 (U.S. CLS. 6, 18, 44, 46, 51 AND 52).

FIRST USE 8-1-2012; IN COMMERCE 8-1-2012.

FOR: BANDAGES FOR ANATOMICAL JOINTS; CHEMICALLY ACTIVATED HOT AND COLD GEL PACKS FOR MEDICAL PURPOSES; COMPRESSION BANDAGES; CPR (CARDIOPULMONARY RESUSCITATION) MASKS; DRESSING FORCEPS; ELASTIC BANDAGES; EYE DROPPERS; FINGER SPLINTS; FORCEPS FOR MEDICAL USE; GLOVES FOR MEDICAL USE; GLOVES FOR USE IN HOSPITALS; LATEX MEDICAL GLOVES; MEDICAL EXAMINATION GLOVES; MEDICAL GLOVES; NITRILE GLOVES FOR MEDICAL USE; PROTECTIVE GLOVES FOR MEDICAL USE; SLINGS; SPLINTS; SPLINTS; SUPPORT BANDAGES; SUPPORTIVE BANDAGES; SURGICAL GLOVES; THERAPEUTIC APPARATUS, NAMELY, CHEMICALLY ACTIVATED ANTI-CELLULITE WRAPS, ICE PACKS, COMPRESSES, AND COMPRESSION BANDAGES; THERMAL PACKS FOR FIRST AID PURPOSES, IN CLASS 10 (U.S. CLS. 26, 39 AND 44).

FIRST USE 8-1-2012; IN COMMERCE 8-1-2012.

THE MARK CONSISTS OF STANDARD CHARACTERS WITHOUT CLAIM TO ANY PARTICULAR FONT, STYLE, SIZE, OR COLOR.

NO CLAIM IS MADE TO THE EXCLUSIVE RIGHT TO USE "BANDAGES", APART FROM THE MARK AS SHOWN.



*David J. Kyjars*

Director of the United States Patent and Trademark Office

**Reg. No. 4,276,405** SN 85-293,542, FILED 4-13-2011.

DARRYL SPRUILL, EXAMINING ATTORNEY

United States of America  
United States Patent and Trademark Office

# ARQUISTE

**Reg. No. 4,276,406**

HUBER PARFUMS, LTD. (NEW YORK CORPORATION)  
19 WEST 9TH STREET, UNIT 3  
NEW YORK, NY 10011

**Registered Jan. 15, 2013**

**Int. Cl.: 3**

FOR: PERFUMES; PERFUMERY, IN CLASS 3 (U.S. CLS. 1, 4, 6, 50, 51 AND 52).

**TRADEMARK**

FIRST USE 9-21-2011; IN COMMERCE 9-21-2011.

**PRINCIPAL REGISTER**

THE MARK CONSISTS OF STANDARD CHARACTERS WITHOUT CLAIM TO ANY PARTICULAR FONT, STYLE, SIZE, OR COLOR.

THE WORDING "ARQUISTE" HAS NO MEANING IN A FOREIGN LANGUAGE.

SN 85-293,637, FILED 4-13-2011.

MATTHEW PAPPAS, EXAMINING ATTORNEY



*David J. Kyffers*

Director of the United States Patent and Trademark Office

# United States of America

United States Patent and Trademark Office

# BABYBIRD

**Reg. No. 4,276,407**

**Registered Jan. 15, 2013**

**Int. Cls.: 25 and 35**

**TRADEMARK**

**SERVICE MARK**

**PRINCIPAL REGISTER**

BABYBIRD LLC (OHIO LIMITED LIABILITY COMPANY)  
716 NORTH HIGH STREET  
COLUMBUS, OH 43215

FOR: CLOTHING FOR INFANTS, TODDLERS, AND CHILDREN, NAMELY, SHIRTS, LONG-SLEEVED SHIRTS, SHORT-SLEEVED SHIRTS, T-SHIRTS, SWEATSHIRTS, NIGHT SHIRTS, PANTS, SHORTS, SWEAT PANTS, SOCKS, BOOTIES, HATS, CAPS, ONE PIECE GARMENTS, CLOTH DIAPERS, PAJAMAS, SLEEPERS, CLOTH BIBS, BEACH WEAR, SWIMSUITS, COATS, JACKETS, DRESSES, JUMPERS, PULLOVERS, HOODED SWEATSHIRTS, SCARVES, SWEATERS, SKIRTS, UNDERPANTS, AND UNDERSHIRTS, IN CLASS 25 (U.S. CLS. 22 AND 39).

FIRST USE 5-0-2010; IN COMMERCE 5-0-2010.

FOR: RETAIL STORE SERVICES AND ON-LINE RETAIL STORE SERVICES FEATURING CLOTHING, HEADGEAR, FOOTWEAR, AND CLOTHING ACCESSORIES FOR INFANTS, TODDLERS, AND CHILDREN, IN CLASS 35 (U.S. CLS. 100, 101 AND 102).

FIRST USE 5-0-2010; IN COMMERCE 5-0-2010.

THE MARK CONSISTS OF STANDARD CHARACTERS WITHOUT CLAIM TO ANY PARTICULAR FONT, STYLE, SIZE, OR COLOR.

SN 85-293,932, FILED 4-13-2011.

NATALIE POLZER, EXAMINING ATTORNEY



*David J. Kyffers*

Director of the United States Patent and Trademark Office

# United States of America

United States Patent and Trademark Office

# BRAVUCOS

**Reg. No. 4,276,408**

**Registered Jan. 15, 2013**

**Int. Cl.: 30**

**TRADEMARK**

**PRINCIPAL REGISTER**

MONTES Y CIA, S.A. DE C.V. (MEXICO CORPORATION)  
MIGUEL MONTES CASTELLANOS # 32  
PONCITLAN, JALISCO., MEXICO C.P.45950

FOR: CANDY, IN CLASS 30 (U.S. CL. 46).

FIRST USE 1-1-2009; IN COMMERCE 1-1-2009.

THE MARK CONSISTS OF STANDARD CHARACTERS WITHOUT CLAIM TO ANY PARTICULAR FONT, STYLE, SIZE, OR COLOR.

SN 85-294,555, FILED 4-13-2011.

SUSAN LESLIE DUBOIS, EXAMINING ATTORNEY



*David J. Kyffers*

Director of the United States Patent and Trademark Office

# United States of America

United States Patent and Trademark Office

## ELECTRIFIED GAMES

**Reg. No. 4,276,409**

ELECTRIFIED GAMES, INC. (CALIFORNIA CORPORATION)  
100 SMITH RANCH ROAD, SUITE 120  
SAN RAFAEL, CA 94903

**Registered Jan. 15, 2013**

**Int. Cl.: 9**

FOR: DOWNLOADABLE COMPUTER GAME SOFTWARE, IN CLASS 9 (U.S. CLS. 21, 23, 26, 36 AND 38).

**TRADEMARK**

FIRST USE 9-26-2012; IN COMMERCE 9-26-2012.

**PRINCIPAL REGISTER**

THE MARK CONSISTS OF STANDARD CHARACTERS WITHOUT CLAIM TO ANY PARTICULAR FONT, STYLE, SIZE, OR COLOR.

NO CLAIM IS MADE TO THE EXCLUSIVE RIGHT TO USE "GAMES", APART FROM THE MARK AS SHOWN.

SN 85-294,993, FILED 4-14-2011.

ESTHER BELENKER, EXAMINING ATTORNEY



*David J. Kybas*

Director of the United States Patent and Trademark Office

**United States of America**  
United States Patent and Trademark Office

# ENGAGE

**Reg. No. 4,276,410**

ENTHONE INC. (DELAWARE CORPORATION)  
350 FRONTAGE ROAD  
WEST HAVEN, CT 06516

**Registered Jan. 15, 2013**

**Int. Cl.: 9**

FOR: DOWNLOADABLE SOFTWARE USED BY CUSTOMERS TO MANAGE AND ANALYZE CHEMISTRY AT CUSTOMER SITES, IN CLASS 9 (U.S. CLS. 21, 23, 26, 36 AND 38).

**TRADEMARK**

FIRST USE 2-1-2011; IN COMMERCE 4-1-2011.

**PRINCIPAL REGISTER**

THE MARK CONSISTS OF STANDARD CHARACTERS WITHOUT CLAIM TO ANY PARTICULAR FONT, STYLE, SIZE, OR COLOR.

SN 85-295,212, FILED 4-14-2011.

JORDAN BAKER, EXAMINING ATTORNEY



*David J. Kyffers*

Director of the United States Patent and Trademark Office

# United States of America

United States Patent and Trademark Office

## ZDN Zombie Defense Network

**Reg. No. 4,276,411**

X-SANGUINE, LLC (CALIFORNIA LIMITED LIABILITY COMPANY)  
9406 HITO COURT  
SAN DIEGO, CA 92129

**Registered Jan. 15, 2013**

**Int. Cl.: 38**

FOR: CHAT ROOM SERVICES FOR SOCIAL NETWORKING, IN CLASS 38 (U.S. CLS. 100, 101 AND 104).

**SERVICE MARK**

FIRST USE 12-23-2011; IN COMMERCE 12-23-2011.

**PRINCIPAL REGISTER**

THE MARK CONSISTS OF STANDARD CHARACTERS WITHOUT CLAIM TO ANY PARTICULAR FONT, STYLE, SIZE, OR COLOR.

NO CLAIM IS MADE TO THE EXCLUSIVE RIGHT TO USE "NETWORK", APART FROM THE MARK AS SHOWN.

SN 85-295,701, FILED 4-14-2011.

DAWN HAN, EXAMINING ATTORNEY



*David J. Kyffers*

Director of the United States Patent and Trademark Office



# United States of America

United States Patent and Trademark Office

## CAPSUBLEND

**Reg. No. 4,276,412**

MEDISCA INC. (NEW YORK CORPORATION)  
661 ROUTE 3, UNIT C  
PLATTSBURGH, NY 12901

**Registered Jan. 15, 2013**

**Int. Cl.: 1**

FOR: PRE-MIXED EXCIPIENT BLENDS FOR USE IN THE PREPARATION OF COMPOUNDED CAPSULES FOR PHARMACEUTICALS, IN CLASS 1 (U.S. CLS. 1, 5, 6, 10, 26 AND 46).

**TRADEMARK**

FIRST USE 5-31-2011; IN COMMERCE 5-31-2011.

**PRINCIPAL REGISTER**

THE MARK CONSISTS OF STANDARD CHARACTERS WITHOUT CLAIM TO ANY PARTICULAR FONT, STYLE, SIZE, OR COLOR.

SN 85-296,669, FILED 4-15-2011.

JESSICA A. POWERS, EXAMINING ATTORNEY



*David J. Kyffers*

Director of the United States Patent and Trademark Office

# United States of America

United States Patent and Trademark Office

# TRUMOTION

**Reg. No. 4,276,413**

PARKER INTANGIBLES LLC (DELAWARE LIMITED LIABILITY COMPANY)  
6035 PARKLAND BLVD.  
CLEVELAND, OH 44124

**Registered Jan. 15, 2013**

**Int. Cl.: 9**

FOR: PRESSURE REGULATORS FOR HIGH PURITY GASES, IN CLASS 9 (U.S. CLS. 21, 23, 26, 36 AND 38).

**TRADEMARK**

FIRST USE 7-11-2011; IN COMMERCE 7-11-2011.

**PRINCIPAL REGISTER**

THE MARK CONSISTS OF STANDARD CHARACTERS WITHOUT CLAIM TO ANY PARTICULAR FONT, STYLE, SIZE, OR COLOR.

SN 85-297,397, FILED 4-18-2011.

NAAKWAMA ANKRAH, EXAMINING ATTORNEY



*David J. Kyfos*

Director of the United States Patent and Trademark Office

# United States of America

United States Patent and Trademark Office

## AGE OF MONTESSORI

**Reg. No. 4,276,414**

**Registered Jan. 15, 2013**

**Int. Cl.: 41**

**SERVICE MARK**

**PRINCIPAL REGISTER**

AGE OF MONTESSORI (MONTANA CORPORATION)  
1103 REEVES ROAD WEST, SUITE D  
BOZEMAN, MT 59718

FOR: EDUCATIONAL SERVICES, NAMELY, CONDUCTING COURSES, CLASSES, SEMINARS, WORKSHOPS AND ON-THE-JOB TRAINING IN THE FIELD OF THE MONTESSORI METHOD AND DISTRIBUTION OF COURSE MATERIAL IN CONNECTION THEREWITH; EDUCATIONAL SERVICES, NAMELY, PROVIDING ON-LINE COURSES, CLASSES AND SEMINARS IN THE FIELD OF THE MONTESSORI METHOD; PROVIDING A WEBSITE FEATURING NON-DOWNLOADABLE PUBLICATIONS IN THE NATURE OF NEWSLETTERS AND TRAINING MATERIALS IN THE FIELD OF THE MONTESSORI METHOD; PROVIDING ON-LINE NEWSLETTERS IN THE FIELD OF THE MONTESSORI METHOD; PROVIDING ON-LINE TRAINING COURSES, CLASSES AND SEMINARS IN THE FIELD OF THE MONTESSORI METHOD, IN CLASS 41 (U.S. CLS. 100, 101 AND 107).

FIRST USE 9-30-2011; IN COMMERCE 9-30-2011.

THE MARK CONSISTS OF STANDARD CHARACTERS WITHOUT CLAIM TO ANY PARTICULAR FONT, STYLE, SIZE, OR COLOR.

NO CLAIM IS MADE TO THE EXCLUSIVE RIGHT TO USE "MONTESSORI", APART FROM THE MARK AS SHOWN.

SN 85-297,448, FILED 4-18-2011.

ZACHARY BELLO, EXAMINING ATTORNEY



*David J. Kyros*

Director of the United States Patent and Trademark Office

# United States of America

United States Patent and Trademark Office

## Exercise R Die

**Reg. No. 4,276,415**

NELSON, ZURI (UNITED STATES INDIVIDUAL)  
2208 CARRINGTON PARK  
JONESBORO, GA 30236

**Registered Jan. 15, 2013**

**Int. Cl.: 25**

FOR: COATS; HATS; HEADBANDS; JACKETS; PANTS; POLO SHIRTS; SHOES; SHORTS;  
SOCKS; SWEATSHIRTS; T-SHIRTS; UNDERWEAR; WRISTBANDS, IN CLASS 25 (U.S.  
CLS. 22 AND 39).

**TRADEMARK**

FIRST USE 1-1-2010; IN COMMERCE 3-1-2011.

**PRINCIPAL REGISTER**

THE MARK CONSISTS OF STANDARD CHARACTERS WITHOUT CLAIM TO ANY PAR-  
TICULAR FONT, STYLE, SIZE, OR COLOR.

SN 85-297,664, FILED 4-18-2011.

JAY FLOWERS, EXAMINING ATTORNEY



*David J. Kyffers*

Director of the United States Patent and Trademark Office

# United States of America

United States Patent and Trademark Office



**Reg. No. 4,276,416**

BEELER, JEFF D (UNITED STATES INDIVIDUAL)  
108 KNOWLES ST  
ISLAMORADA, FL 33036

**Registered Jan. 15, 2013**

**Int. Cl.: 28**

FOR: TREESTANDS FOR HUNTING, IN CLASS 28 (U.S. CLS. 22, 23, 38 AND 50).

**TRADEMARK**

FIRST USE 1-0-2012; IN COMMERCE 1-0-2012.

**PRINCIPAL REGISTER**

THE MARK CONSISTS OF THE STYLIZED IMAGE OF A PAIR OF ANTLERS, WITH THE WORDING "HUNTINATOR." LOCATED BELOW THE FOREGOING.

SN 85-298,218, FILED 4-18-2011.

ALYSSA STEEL, EXAMINING ATTORNEY



*David J. Kybas*

Director of the United States Patent and Trademark Office

# United States of America

United States Patent and Trademark Office

I ♥  
WINE

**Reg. No. 4,276,417**

**Registered Jan. 15, 2013**

**Int. Cls.: 18, 21, 25, and  
33**

MANNY O. WINES LIMITED (HONG KONG PRIVATE LIMITED COMPANY)  
ROOMS 1007-1012, 10/F, K. WAH CENTRE  
191 JAVA ROAD, NORTH POINT  
HONG KONG, HONG KONG

FOR: UMBRELLAS, WINE BAGS WITH HANDLES FOR CARRYING OR HOLDING WINE,  
IN CLASS 18 (U.S. CLS. 1, 2, 3, 22 AND 41).

**TRADEMARK**

FIRST USE 5-28-2012; IN COMMERCE 5-28-2012.

**PRINCIPAL REGISTER**

FOR: WINE GLASSES, WINE OPENERS, WINE DECANTERS, WINE BUCKETS, IN CLASS  
21 (U.S. CLS. 2, 13, 23, 29, 30, 33, 40 AND 50).

FIRST USE 5-28-2012; IN COMMERCE 5-28-2012.

FOR: SHIRTS, T-SHIRTS, APRONS, HEADWEAR, IN CLASS 25 (U.S. CLS. 22 AND 39).

FIRST USE 5-28-2012; IN COMMERCE 5-28-2012.

FOR: WINE, IN CLASS 33 (U.S. CLS. 47 AND 49).

FIRST USE 5-28-2012; IN COMMERCE 5-28-2012.



NO CLAIM IS MADE TO THE EXCLUSIVE RIGHT TO USE "WINE" IN INTERNATIONAL  
CLASSES 018, 021, 033, APART FROM THE MARK AS SHOWN.

THE COLOR(S) BLACK AND RED IS/ARE CLAIMED AS A FEATURE OF THE MARK.

THE MARK CONSISTS OF THE LETTER "I" IN BLACK TO THE LEFT OF A RED HEART  
ALL ABOVE THE WORD "WINE" IN BLACK.

SN 85-298,505, FILED 4-19-2011.

DAVID I, EXAMINING ATTORNEY

*David J. Kyffers*

Director of the United States Patent and Trademark Office

# United States of America

United States Patent and Trademark Office

## Association of International Certified Professional Accountants



**Reg. No. 4,276,418**

**Registered Jan. 15, 2013**

**Int. Cl.: 35**

**SERVICE MARK**

**PRINCIPAL REGISTER**

AMERICAN INSTITUTE OF CERTIFIED PUBLIC ACCOUNTANTS (D.C. NON-PROFIT CORPORATION)  
1211 AVENUE OF THE AMERICAS  
NEW YORK, NY 10036

FOR: ASSOCIATION SERVICES, NAMELY, PROMOTING THE INTERESTS OF ACCOUNTANTS, CERTIFIED ACCOUNTANTS, CHARTERED ACCOUNTANTS, AND MANAGEMENT ACCOUNTANTS; AND PROVIDING INFORMATION AND ADVICE IN THE FIELDS OF ACCOUNTANCY AND FINANCIAL REPORTING, IN CLASS 35 (U.S. CLS. 100, 101 AND 102).

FIRST USE 1-1-2012; IN COMMERCE 1-1-2012.

NO CLAIM IS MADE TO THE EXCLUSIVE RIGHT TO USE "ASSOCIATION OF INTERNATIONAL CERTIFIED PROFESSIONAL ACCOUNTANTS", APART FROM THE MARK AS SHOWN.

THE MARK CONSISTS OF THE WORDS "ASSOCIATION OF INTERNATIONAL CERTIFIED PROFESSIONAL ACCOUNTANTS" ADJACENT TO A SPHERE FORMED BY PARTIAL AND STAGGERED BANDS.

SN 85-299,519, FILED 4-20-2011.

NICHOLAS COLEMAN, EXAMINING ATTORNEY



*David J. Kybas*

Director of the United States Patent and Trademark Office

# United States of America

United States Patent and Trademark Office

**Cachitos**

**Reg. No. 4,276,419**

**Registered Jan. 15, 2013**

**Int. Cl.: 30**

**TRADEMARK**

**PRINCIPAL REGISTER**

Montes y Cia, S.A. de C.V. (Mexico Corporation)  
Miguel Montes Castellanos # 32  
Poncitlan, Jalisco., Mexico C.P.45950

FOR: CANDY, IN CLASS 30 (U.S. CL. 46).

FIRST USE 9-1-2010; IN COMMERCE 9-1-2010.

OWNER OF U.S. REG. NO. 1,613,109.

THE COLOR(S) RED AND LIGHT BROWN IS/ARE CLAIMED AS A FEATURE OF THE MARK.

THE MARK CONSISTS OF THE WORD "CACHITOS" IN RED WITH LIGHT BROWN LINING AROUND THE LETTERS.

THE ENGLISH TRANSLATION OF "CACHITOS" IN THE MARK IS "A BIT".

SN 85-300,055, FILED 4-20-2011.

SUSAN LESLIE DUBOIS, EXAMINING ATTORNEY



*David J. Kyffers*

Director of the United States Patent and Trademark Office



# United States of America

United States Patent and Trademark Office



**Reg. No. 4,276,420**

**Registered Jan. 15, 2013**

**Int. Cl.: 30**

**TRADEMARK**

**PRINCIPAL REGISTER**

MONTES Y CIA, S.A. DE C.V. (MEXICO CORPORATION)  
MIGUEL MONTES CASTELLANOS # 32  
PONCITLAN, JALISCO., MEXICO C.P.45950

FOR: CANDY, IN CLASS 30 (U.S. CL. 46).

FIRST USE 9-1-2010; IN COMMERCE 9-1-2010.

OWNER OF U.S. REG. NO. 1,613,110.

THE COLOR(S) RED, WHITE, AND BLACK IS/ARE CLAIMED AS A FEATURE OF THE MARK.

THE MARK CONSISTS OF THE WORD "TOMY" IN RED WITH A WHITE BORDER AND A BLACK BORDER AROUND THE LETTERS.

THE WORDING "TOMY" HAS NO MEANING IN A FOREIGN LANGUAGE.

SN 85-300,109, FILED 4-20-2011.

SUSAN LESLIE DUBOIS, EXAMINING ATTORNEY



*David J. Kybas*

Director of the United States Patent and Trademark Office

# United States of America

United States Patent and Trademark Office

## PEOPLE FIRST, THEN MONEY, THEN THINGS

**Reg. No. 4,276,421**

**Registered Jan. 15, 2013**

**Int. Cl.: 36**

**SERVICE MARK**

**PRINCIPAL REGISTER**

SUZE ORMAN, TRUSTEE OF THE SUZE ORMAN REVOCABLE TRUST DATED MAY 11, 1998 (CALIFORNIA TRUST)  
C/OB. KARROLL, PROVIDENT FINANCIAL MGMT  
2850 OCEAN PARK BLVD., SUITE 300  
SANTA MONICA, CA 90405

FOR: DEBIT CARD SERVICES, IN CLASS 36 (U.S. CLS. 100, 101 AND 102).

FIRST USE 12-31-2011; IN COMMERCE 12-31-2011.

THE MARK CONSISTS OF STANDARD CHARACTERS WITHOUT CLAIM TO ANY PARTICULAR FONT, STYLE, SIZE, OR COLOR.

OWNER OF U.S. REG. NO. 2,781,364.

SN 85-300,264, FILED 4-20-2011.

KEVIN DINALLO, EXAMINING ATTORNEY



*David J. Kybas*

Director of the United States Patent and Trademark Office

# United States of America

United States Patent and Trademark Office

## WOW LEATHER

**Reg. No. 4,276,422**

FENDERHOOKS LLC (FLORIDA LIMITED LIABILITY COMPANY)  
409 24TH ST

**Registered Jan. 15, 2013**

WEST PALM BEACH, FL 33407

**Int. Cl.: 12**

FOR: FENDER HOOKS FOR BOATS, IN CLASS 12 (U.S. CLS. 19, 21, 23, 31, 35 AND 44).

**TRADEMARK**

FIRST USE 10-0-2012; IN COMMERCE 10-0-2012.

**PRINCIPAL REGISTER**

THE MARK CONSISTS OF STANDARD CHARACTERS WITHOUT CLAIM TO ANY PARTICULAR FONT, STYLE, SIZE, OR COLOR.

NO CLAIM IS MADE TO THE EXCLUSIVE RIGHT TO USE "LEATHER", APART FROM THE MARK AS SHOWN.

SN 85-300,631, FILED 4-21-2011.

SUSAN STIGLITZ, EXAMINING ATTORNEY



*David J. Kyffers*

Director of the United States Patent and Trademark Office

# United States of America

United States Patent and Trademark Office

## WINNING IN BUSINESS

**Reg. No. 4,276,423**

CALIPER CORPORATION (NEW JERSEY CORPORATION)  
506 CARNEGIE CENTER, SUITE 300  
PRINCETON, NJ 08540

**Registered Jan. 15, 2013**

**Int. Cl.: 41**

FOR: ENTERTAINMENT SERVICES, NAMELY, PROVIDING ON-GOING WEBCASTS, PODCASTS, AND RADIO AND TELEVISION PROGRAMS FEATURING INTERVIEWS WITH SUCCESSFUL PEOPLE IN BUSINESS, IN CLASS 41 (U.S. CLS. 100, 101 AND 107).

**SERVICE MARK**

FIRST USE 0-0-2009; IN COMMERCE 0-0-2009.

**PRINCIPAL REGISTER**

THE MARK CONSISTS OF STANDARD CHARACTERS WITHOUT CLAIM TO ANY PARTICULAR FONT, STYLE, SIZE, OR COLOR.

NO CLAIM IS MADE TO THE EXCLUSIVE RIGHT TO USE "BUSINESS", APART FROM THE MARK AS SHOWN.

SN 85-300,751, FILED 4-21-2011.

BARBARA A. GOLD, EXAMINING ATTORNEY



*David J. Kyffers*

Director of the United States Patent and Trademark Office

# United States of America

United States Patent and Trademark Office

# getchya sum

**Reg. No. 4,276,424**

**Registered Jan. 15, 2013**

**Int. Cl.: 25**

**TRADEMARK**

**PRINCIPAL REGISTER**

VAUGHAN, STEVEN (UNITED STATES INDIVIDUAL)  
1405 WARBLER TERRACE  
CANTONMENT, FL 32533

FOR: T-SHIRTS, IN CLASS 25 (U.S. CLS. 22 AND 39).

FIRST USE 7-5-2011; IN COMMERCE 10-15-2011.

THE MARK CONSISTS OF STANDARD CHARACTERS WITHOUT CLAIM TO ANY PARTICULAR FONT, STYLE, SIZE, OR COLOR.

SN 85-300,935, FILED 4-21-2011.

SHARON MEIER, EXAMINING ATTORNEY



*David J. Kyffers*

Director of the United States Patent and Trademark Office

# United States of America

United States Patent and Trademark Office

## VANTAGE POINT SEVEN

**Reg. No. 4,276,425**

MALVAEZ, MARCOS (UNITED STATES INDIVIDUAL)  
12238 212ST

**Registered Jan. 15, 2013**

HAWAIIAN GARDENS, CA 90716

**Int. Cl.: 25**

FOR: CLOTHING, NAMELY, TOPS, BOTTOMS, HATS, SHIRTS, PANTS, SHOES, IN CLASS 25 (U.S. CLS. 22 AND 39).

**TRADEMARK**

FIRST USE 10-31-2012; IN COMMERCE 10-31-2012.

**PRINCIPAL REGISTER**

THE MARK CONSISTS OF STANDARD CHARACTERS WITHOUT CLAIM TO ANY PARTICULAR FONT, STYLE, SIZE, OR COLOR.

SN 85-301,235, FILED 4-21-2011.

CHRISTINA SOBRAL, EXAMINING ATTORNEY



*David J. Kyros*

Director of the United States Patent and Trademark Office

# United States of America

United States Patent and Trademark Office

## MONIQUE LHUILLIER

**Reg. No. 4,276,426**

MONIQUE LHUILLIER LICENSING, LLC (CALIFORNIA LIMITED LIABILITY COMPANY)  
1201 S. GRAND AVE, 3RD FLOOR  
LOS ANGELES, CA 90015

**Registered Jan. 15, 2013**

**Int. Cl.: 3**

FOR: REEDS AND SCENTED OILS SOLD AS A UNIT FOR USE IN ROOM SCENT DIFFUSERS, IN CLASS 3 (U.S. CLS. 1, 4, 6, 50, 51 AND 52).

**TRADEMARK**

FIRST USE 0-0-2011; IN COMMERCE 0-0-2011.

**PRINCIPAL REGISTER**

THE MARK CONSISTS OF STANDARD CHARACTERS WITHOUT CLAIM TO ANY PARTICULAR FONT, STYLE, SIZE, OR COLOR.

OWNER OF U.S. REG. NOS. 3,894,154, 3,897,563, AND OTHERS.

THE NAME(S), PORTRAIT(S), AND/OR SIGNATURE(S) SHOWN IN THE MARK IDENTIFIES MONIQUE LHUILLIER BUGBEE, WHOSE CONSENT(S) TO REGISTER IS MADE OF RECORD.

SN 85-302,470, FILED 4-22-2011.

CHRISTINA SOBRAL, EXAMINING ATTORNEY



*David J. Kybas*

Director of the United States Patent and Trademark Office

# United States of America

United States Patent and Trademark Office



**SOLUTIONS**  
Insurance Agencies

**Reg. No. 4,276,427**

TJB AGENCIES LLC (MINNESOTA LIMITED LIABILITY COMPANY)  
5629 GRAND AVENUE  
DULUTH, MN 55807

**Registered Jan. 15, 2013**

**Int. Cl.: 36**

FOR: FINANCIAL RISK MANAGEMENT CONSULTATION; INSURANCE AGENCIES, IN CLASS 36 (U.S. CLS. 100, 101 AND 102).

**SERVICE MARK**

FIRST USE 6-15-2011; IN COMMERCE 6-15-2011.

**PRINCIPAL REGISTER**

NO CLAIM IS MADE TO THE EXCLUSIVE RIGHT TO USE "INSURANCE AGENCIES", APART FROM THE MARK AS SHOWN.

THE MARK CONSISTS OF A CIRCLE WITH A STYLIZED LETTER "S" IMBEDDED WITHIN THE CIRCLE. ALONG RIGHT SIDE IN LARGE LETTERS IS "SOLUTIONS" WITH THE WORDS "INSURANCE AGENCIES" LOCATED BENEATH AND OF THE SAME WIDTH AS "SOLUTIONS".

SN 85-303,005, FILED 4-23-2011.

ANDREW LEASER, EXAMINING ATTORNEY



*David J. Kypos*

Director of the United States Patent and Trademark Office



# United States of America

United States Patent and Trademark Office

# TRIATHLON

**Reg. No. 4,276,428**

SCHIPPER & COMPANY U.S.A., INC. (CONNECTICUT CORPORATION)  
747 BARNUM AVE.

**Registered Jan. 15, 2013**

BRIDGEPORT, CT 06608

**Int. Cl.: 31**

FOR: TULIP BULBS SOLD WHOLESALE TO THOSE IN THE FLOWER INDUSTRY, IN CLASS 31 (U.S. CLS. 1 AND 46).

**TRADEMARK**

FIRST USE 6-30-2010; IN COMMERCE 6-30-2010.

**PRINCIPAL REGISTER**

THE MARK CONSISTS OF STANDARD CHARACTERS WITHOUT CLAIM TO ANY PARTICULAR FONT, STYLE, SIZE, OR COLOR.

SN 85-303,224, FILED 4-25-2011.

MATTHEW MCDOWELL, EXAMINING ATTORNEY



*David J. Kybas*

Director of the United States Patent and Trademark Office

# United States of America

United States Patent and Trademark Office

## SIMPLY BRILLIANT PRESS

**Reg. No. 4,276,429**

DUMAS HOLDINGS, LLC (CALIFORNIA LIMITED LIABILITY COMPANY)  
1666 LADD ROAD  
MODESTO, CA 95356

**Registered Jan. 15, 2013**

**Int. Cl.: 35**

FOR: CATALOG ORDERING SERVICE FEATURING STATIONERY, BUSINESS FORMS AND BUSINESS CARDS; COPYING OF DOCUMENTS; DIRECT MAIL ADVERTISING SERVICES; DOCUMENT REPRODUCTION; PHOTOCOPYING; PROVIDING FACILITIES FOR THE USE OF OFFICE EQUIPMENT AND MACHINERY, IN CLASS 35 (U.S. CLS. 100, 101 AND 102).

**SERVICE MARK**

**PRINCIPAL REGISTER**

FIRST USE 10-0-2012; IN COMMERCE 10-0-2012.

THE MARK CONSISTS OF STANDARD CHARACTERS WITHOUT CLAIM TO ANY PARTICULAR FONT, STYLE, SIZE, OR COLOR.

NO CLAIM IS MADE TO THE EXCLUSIVE RIGHT TO USE "PRESS", APART FROM THE MARK AS SHOWN.

SN 85-304,299, FILED 4-25-2011.

DOMINIC J. FERRAIUOLO, EXAMINING ATTORNEY



*David J. Kyffers*

Director of the United States Patent and Trademark Office

# United States of America

United States Patent and Trademark Office

## SIMPLY BRILLIANT PRESS

**Reg. No. 4,276,430**

**Registered Jan. 15, 2013**

**Int. Cl.: 40**

**SERVICE MARK**

**PRINCIPAL REGISTER**

DUMAS HOLDINGS, LLC (CALIFORNIA LIMITED LIABILITY COMPANY)  
1666 LADD ROAD  
MODESTO, CA 95356

FOR: DESIGN PRINTING FOR OTHERS; DIGITAL ON-DEMAND PRINTING SERVICES OF BOOKS AND OTHER DOCUMENTS; LITHOGRAPHIC PRINTING; PHOTOGRAPHIC PRINTING; PRINTING; TYPESETTING, IN CLASS 40 (U.S. CLS. 100, 103 AND 106).

FIRST USE 10-0-2012; IN COMMERCE 10-0-2012.

THE MARK CONSISTS OF STANDARD CHARACTERS WITHOUT CLAIM TO ANY PARTICULAR FONT, STYLE, SIZE, OR COLOR.

NO CLAIM IS MADE TO THE EXCLUSIVE RIGHT TO USE "PRESS", APART FROM THE MARK AS SHOWN.

SN 85-304,304, FILED 4-25-2011.

DOMINIC J. FERRAIUOLO, EXAMINING ATTORNEY



*David J. Kyros*

Director of the United States Patent and Trademark Office

# United States of America

United States Patent and Trademark Office

## THE WINE CHASERS

**Reg. No. 4,276,431**

**Registered Jan. 15, 2013**

**Int. Cls.: 35 and 39**

**SERVICE MARK**

**PRINCIPAL REGISTER**

KANE ENTERPRISES (PENNSYLVANIA SOLE PROPRIETORSHIP)  
1911 PENN STREET  
HUNTINGDON, PA 16652

FOR: MARKETING SERVICES, NAMELY, PROVIDING VIDEOS AND STILL PHOTOGRAPHY TO PROMOTE THE GOODS AND SERVICES OF OTHERS, IN CLASS 35 (U.S. CLS. 100, 101 AND 102).

FIRST USE 5-27-2011; IN COMMERCE 5-27-2011.

FOR: ARRANGING OF TOURS; TOUR CONDUCTING OR ESCORTING; TOUR OPERATING AND ORGANIZING; TRAVEL AND TOUR INFORMATION SERVICES, IN CLASS 39 (U.S. CLS. 100 AND 105).

FIRST USE 9-12-2012; IN COMMERCE 9-12-2012.

THE MARK CONSISTS OF STANDARD CHARACTERS WITHOUT CLAIM TO ANY PARTICULAR FONT, STYLE, SIZE, OR COLOR.

NO CLAIM IS MADE TO THE EXCLUSIVE RIGHT TO USE "WINE", APART FROM THE MARK AS SHOWN.

SN 85-305,729, FILED 4-27-2011.

MICHAEL ENGEL, EXAMINING ATTORNEY



*David J. Kypos*

Director of the United States Patent and Trademark Office

# United States of America

United States Patent and Trademark Office

## SOUL DRIFTER

**Reg. No. 4,276,432**

AMERICAN FUSION (CALIFORNIA CORPORATION), DBA CA OFFPRICE,  
1708 GAGE AVE

**Registered Jan. 15, 2013**

MONTEBELLO, CA 90640

**Int. Cls.: 25 and 42**

FOR: APPAREL FOR DANCERS, NAMELY, TEE SHIRTS, SWEATSHIRTS, PANTS, LEG-  
GINGS, SHORTS AND JACKETS, IN CLASS 25 (U.S. CLS. 22 AND 39).

**TRADEMARK**

FIRST USE 6-0-2011; IN COMMERCE 6-0-2011.

**SERVICE MARK**

FOR: CUSTOM DESIGN OF T-SHIRTS BASED ON PERSONAL SELECTIONS MADE BY  
THE CUSTOMER, IN CLASS 42 (U.S. CLS. 100 AND 101).

**PRINCIPAL REGISTER**

FIRST USE 6-0-2011; IN COMMERCE 6-0-2011.

THE MARK CONSISTS OF STANDARD CHARACTERS WITHOUT CLAIM TO ANY PAR-  
TICULAR FONT, STYLE, SIZE, OR COLOR.

SN 85-305,840, FILED 4-27-2011.

SUSAN BILLHEIMER, EXAMINING ATTORNEY



*David J. Kyros*

Director of the United States Patent and Trademark Office

# United States of America

United States Patent and Trademark Office

## Make Moves

**Reg. No. 4,276,433**

CADORETTE, JASON (UNITED STATES INDIVIDUAL)  
2515 MARINA BAY DRIVE WEST  
FORT LAUDERDALE, FL 33312

**Registered Jan. 15, 2013**

**Int. Cl.: 25**

FOR: CLOTHING AND APPAREL, NAMELY, SHORT SLEEVE T-SHIRTS, LONG SLEEVE T-SHIRTS, SWEATSHIRTS, HOODED SWEATSHIRTS, TANK TOPS; HATS, IN CLASS 25 (U.S. CLS. 22 AND 39).

**TRADEMARK**

FIRST USE 4-15-2012; IN COMMERCE 4-15-2012.

**PRINCIPAL REGISTER**

THE MARK CONSISTS OF STANDARD CHARACTERS WITHOUT CLAIM TO ANY PARTICULAR FONT, STYLE, SIZE, OR COLOR.

SN 85-306,615, FILED 4-27-2011.

ROBIN CHOSID, EXAMINING ATTORNEY



*David J. Kyffers*

Director of the United States Patent and Trademark Office

# United States of America

United States Patent and Trademark Office

## BRADFORD CUTLERY

**Reg. No. 4,276,434**

**Registered Jan. 15, 2013**

**Int. Cl.: 8**

**TRADEMARK**

**PRINCIPAL REGISTER**

CASEMARK, INC. (DELAWARE CORPORATION)  
1105 NORTH MARKET STREET, SUITE 1300  
WILMINGTON, DE 19801

FOR: KNIVES AND CUTLERY, IN CLASS 8 (U.S. CLS. 23, 28 AND 44).

FIRST USE 10-16-2012; IN COMMERCE 10-16-2012.

THE MARK CONSISTS OF STANDARD CHARACTERS WITHOUT CLAIM TO ANY PARTICULAR FONT, STYLE, SIZE, OR COLOR.

NO CLAIM IS MADE TO THE EXCLUSIVE RIGHT TO USE "CUTLERY", APART FROM THE MARK AS SHOWN.

SN 85-307,564, FILED 4-28-2011.

MATTHEW MCDOWELL, EXAMINING ATTORNEY



*David J. Kyffers*

Director of the United States Patent and Trademark Office

# United States of America

United States Patent and Trademark Office

## VIRTUES YOGA

**Reg. No. 4,276,435**

ZOLCINSKI, KATHRYN S (UNITED STATES INDIVIDUAL), DBA VIRTUES YOGA,  
2719 IRONBOUND RD  
WILLIAMSBURG, VA 23185

**Registered Jan. 15, 2013**

**Int. Cl.: 41**

FOR: YOGA INSTRUCTION, IN CLASS 41 (U.S. CLS. 100, 101 AND 107).

**SERVICE MARK**

FIRST USE 8-1-2012; IN COMMERCE 8-1-2012.

**PRINCIPAL REGISTER**

THE MARK CONSISTS OF STANDARD CHARACTERS WITHOUT CLAIM TO ANY PARTICULAR FONT, STYLE, SIZE, OR COLOR.

NO CLAIM IS MADE TO THE EXCLUSIVE RIGHT TO USE "YOGA", APART FROM THE MARK AS SHOWN.

SN 85-308,013, FILED 4-29-2011.

APRIL ROACH, EXAMINING ATTORNEY



*David J. Kyfos*

Director of the United States Patent and Trademark Office



# United States of America

United States Patent and Trademark Office

# MUROSITY

**Reg. No. 4,276,436**

PARKVIEW HEALTH SYSTEM, INC. (INDIANA NON-PROFIT CORPORATION)  
10501 CORPORATE DRIVE  
FORT WAYNE, IN 46845

**Registered Jan. 15, 2013**

**Int. Cl.: 35**

FOR: CHARITABLE SERVICES, NAMELY, ORGANIZING AND CONDUCTING VOLUNTEER PROGRAMS AND COMMUNITY SERVICE PROJECTS AIMED AT ENCOURAGING CHARACTER, COMPASSION AND GOOD CITIZENSHIP, IN CLASS 35 (U.S. CLS. 100, 101 AND 102).

**SERVICE MARK**

**PRINCIPAL REGISTER**

FIRST USE 3-24-2011; IN COMMERCE 4-14-2011.

THE MARK CONSISTS OF STANDARD CHARACTERS WITHOUT CLAIM TO ANY PARTICULAR FONT, STYLE, SIZE, OR COLOR.

SN 85-308,062, FILED 4-29-2011.

HOWARD B. LEVINE, EXAMINING ATTORNEY



*David J. Kyffers*

Director of the United States Patent and Trademark Office

# United States of America

United States Patent and Trademark Office

## SOLAR ECHOES

**Reg. No. 4,276,437**

COREFUN STUDIOS, LLC (MARYLAND LIMITED LIABILITY COMPANY)  
8696 WHEATFIELD WAY  
ELLCOTT CITY, MD 21043

**Registered Jan. 15, 2013**

**Int. Cl.: 16**

FOR: ROLE PLAYING GAME EQUIPMENT IN THE NATURE OF GAME BOOK MANUALS,  
IN CLASS 16 (U.S. CLS. 2, 5, 22, 23, 29, 37, 38 AND 50).

**TRADEMARK**

FIRST USE 10-23-2012; IN COMMERCE 10-23-2012.

**PRINCIPAL REGISTER**

THE MARK CONSISTS OF STANDARD CHARACTERS WITHOUT CLAIM TO ANY PAR-  
TICULAR FONT, STYLE, SIZE, OR COLOR.

SN 85-308,327, FILED 4-29-2011.

ANGELA DUONG, EXAMINING ATTORNEY



*David J. Kybas*

Director of the United States Patent and Trademark Office

# United States of America

United States Patent and Trademark Office

## SOLAR ECHOES

**Reg. No. 4,276,438**

**Registered Jan. 15, 2013**

**Int. Cl.: 28**

**TRADEMARK**

**PRINCIPAL REGISTER**

COREFUN STUDIOS, LLC (MARYLAND LIMITED LIABILITY COMPANY)  
8696 WHEATFIELD WAY  
ELLCOTT CITY, MD 21043

FOR: ROLE PLAYING GAMES, IN CLASS 28 (U.S. CLS. 22, 23, 38 AND 50).

FIRST USE 10-23-2012; IN COMMERCE 10-23-2012.

THE MARK CONSISTS OF STANDARD CHARACTERS WITHOUT CLAIM TO ANY PARTICULAR FONT, STYLE, SIZE, OR COLOR.

SN 85-308,345, FILED 4-29-2011.

ANGELA DUONG, EXAMINING ATTORNEY



*David J. Kybas*

Director of the United States Patent and Trademark Office

# United States of America

United States Patent and Trademark Office

## VELVET UNPLUGGED

**Reg. No. 4,276,439**

HARD ROCK CAFE INTERNATIONAL (USA), INC. (FLORIDA CORPORATION)  
6100 OLD PARK LANE  
ORLANDO, FL 32835

**Registered Jan. 15, 2013**

**Int. Cl.: 41**

FOR: ENTERTAINMENT SERVICES IN THE FORM OF LIVE MUSIC PERFORMANCES PERFORMED INSIDE HARD ROCK HOTELS, IN CLASS 41 (U.S. CLS. 100, 101 AND 107).

**SERVICE MARK**

FIRST USE 9-2-2011; IN COMMERCE 9-2-2011.

**PRINCIPAL REGISTER**

THE MARK CONSISTS OF STANDARD CHARACTERS WITHOUT CLAIM TO ANY PARTICULAR FONT, STYLE, SIZE, OR COLOR.

OWNER OF U.S. REG. NOS. 2,589,942 AND 3,817,271.

NO CLAIM IS MADE TO THE EXCLUSIVE RIGHT TO USE "UNPLUGGED", APART FROM THE MARK AS SHOWN.

SN 85-308,409, FILED 4-29-2011.

PAULA MAHONEY, EXAMINING ATTORNEY



*David J. Kyros*

Director of the United States Patent and Trademark Office

# United States of America

United States Patent and Trademark Office



network of hope

**Reg. No. 4,276,440**

NETWORK OF HOPE (PENNSYLVANIA CORPORATION)  
2326 DUNCAN AVENUE  
ALLISON PARK, PA 15101

**Registered Jan. 15, 2013**

**Int. Cls.: 44 and 45**

FOR: CONSULTATION AND ADVICE IN THE FIELD OF DRUG REHABILITATION AND DRUG ABUSE RECOVERY, IN CLASS 44 (U.S. CLS. 100 AND 101).

**SERVICE MARK**

FIRST USE 3-31-2010; IN COMMERCE 3-31-2010.

**PRINCIPAL REGISTER**

FOR: ABUSE RECOVERY SERVICES, NAMELY, CONSULTATION AND ADVICE FOR VICTIMS OF ABUSE COMPRISING INTERVIEWING THE VICTIM, IDENTIFYING WHAT THE PROBLEM IS AND SUGGESTING WHERE HELP CAN BE OBTAINED; CONSULTATION AND ADVICE IN THE FIELD OF YOUTH ENRICHMENT, NAMELY, PROVIDING EMOTIONAL SUPPORT SERVICES FOR TROUBLED AND AT-RISK YOUTH AND THEIR FAMILIES, IN CLASS 45 (U.S. CLS. 100 AND 101).

FIRST USE 3-31-2010; IN COMMERCE 3-31-2010.

NO CLAIM IS MADE TO THE EXCLUSIVE RIGHT TO USE "NETWORK" , APART FROM THE MARK AS SHOWN.

THE MARK CONSISTS OF THREE SEGMENTED, STYLIZED HUMAN FORMS IN THE COLORS GREEN, BLUE AND ORANGE ARRANGED RADIALLY ABOUT A COMMON CENTER THAT IS POSITIONED ABOVE THE PHRASE "NETWORK OF HOPE" IN THE COLOR GRAY.

SN 85-308,602, FILED 4-29-2011.

JUSTINE D. PARKER, EXAMINING ATTORNEY



*David J. Kybas*

Director of the United States Patent and Trademark Office

# United States of America

United States Patent and Trademark Office

## Katy's Courage

**Reg. No. 4,276,441**

STEWART, JAMES WILLIAM (UNITED STATES INDIVIDUAL)  
34 SOUTH HARBOR DRIVE  
SAG HARBOR, NY 11963 AND

**Registered Jan. 15, 2013**

**Int. Cls.: 14, 35, 36, and  
41**

COLLINS, BRIGID PATRICIA (UNITED STATES INDIVIDUAL)  
34 SOUTH HARBOR DRIVE  
SAG HARBOR, NY 11963

**TRADEMARK**

FOR: CHARITY BRACELETS; LAPEL PINS, IN CLASS 14 (U.S. CLS. 2, 27, 28 AND 50).

**SERVICE MARK**

FIRST USE 3-0-2012; IN COMMERCE 3-0-2012.

**PRINCIPAL REGISTER**

FOR: CHARITABLE SERVICES, NAMELY, COORDINATION OF NON-MONETARY CONTRIBUTIONS TO CHARITIES AND NON-PROFITS, IN CLASS 35 (U.S. CLS. 100, 101 AND 102).

FIRST USE 3-0-2012; IN COMMERCE 3-0-2012.

FOR: CHARITABLE FUNDRAISING, IN CLASS 36 (U.S. CLS. 100, 101 AND 102).

FIRST USE 3-0-2012; IN COMMERCE 3-0-2012.

FOR: ORGANIZING AND CONDUCTING A RUNNING EVENT THE PROCEEDS OF WHICH ARE DONATED TO CHARITY, IN CLASS 41 (U.S. CLS. 100, 101 AND 107).

FIRST USE 3-12-2012; IN COMMERCE 3-0-2012.

THE MARK CONSISTS OF STANDARD CHARACTERS WITHOUT CLAIM TO ANY PARTICULAR FONT, STYLE, SIZE, OR COLOR.

SN 85-308,642, FILED 4-29-2011.

JULIE GUTTADAURO, EXAMINING ATTORNEY



*David J. Kyffers*

Director of the United States Patent and Trademark Office

# United States of America

United States Patent and Trademark Office

## STR/KE MOVEMENT

**Reg. No. 4,276,442**

ASPECT RATIO CREATIVE INC. (CANADA CORPORATION)  
6555 MADRONA CR

**Registered Jan. 15, 2013**

WEST VANCOUVER, CANADA V7W-2J7

**Int. Cl.: 25**

FOR: CLOTHING, NAMELY, TOPS, BOTTOMS, SHIRTS, T-SHIRTS, PANTS, JEANS, SHORTS, HOODED SWEATSHIRTS, POLO SHIRTS, JACKETS, SWEATERS, DENIM PANTS, SOCKS, HATS, BEANIES, FLEECE PULLOVERS; HEADWEAR; FOOTWEAR, IN CLASS 25 (U.S. CLS. 22 AND 39).

**TRADEMARK**

**PRINCIPAL REGISTER**

FIRST USE 4-8-2011; IN COMMERCE 4-8-2011.

THE MARK CONSISTS OF STANDARD CHARACTERS WITHOUT CLAIM TO ANY PARTICULAR FONT, STYLE, SIZE, OR COLOR.

SN 85-309,053, FILED 4-30-2011.

ELISSA GARBER KON, EXAMINING ATTORNEY



*David J. Kyffers*

Director of the United States Patent and Trademark Office

# United States of America

United States Patent and Trademark Office



**Reg. No. 4,276,443**

**Registered Jan. 15, 2013**

**Int. Cl.: 38**

**SERVICE MARK**

**PRINCIPAL REGISTER**

NEUTRAL TANDEM, INC. (DELAWARE CORPORATION)  
550 WEST ADAMS STREET, SUITE 900  
CHICAGO, IL 60661

FOR: TELECOMMUNICATION SERVICES, NAMELY, ETHERNET BASED CONNECTIVITY SERVICES, IN CLASS 38 (U.S. CLS. 100, 101 AND 104).

FIRST USE 4-4-2011; IN COMMERCE 4-4-2011.

THE MARK CONSISTS OF A RECTANGLE WITH THE TOP HALF OF A CLOUD AT THE BOTTOM OF THE RECTANGLE WITH THE WORDS "ETHERCLOUD" ABOVE THE CLOUD.

SN 85-309,065, FILED 4-30-2011.

HEATHER THOMPSON, EXAMINING ATTORNEY



*David J. Kyffers*

Director of the United States Patent and Trademark Office



# United States of America

United States Patent and Trademark Office

## THOR SHIELD

**Reg. No. 4,276,444**

**Registered Jan. 15, 2013**

**Int. Cls.: 35 and 45**

**SERVICE MARK**

**PRINCIPAL REGISTER**

WEST CORPORATION (DELAWARE CORPORATION)  
11808 MIRACLE HILLS DRIVE  
OMAHA, NE 68154

FOR: OPERATION AND MANAGEMENT OF TELEPHONE CALL CENTERS FOR OTHERS;  
LOGISTICS MANAGEMENT IN THE FIELD OF 911 EMERGENCY SERVICES, IN CLASS  
35 (U.S. CLS. 100, 101 AND 102).

FIRST USE 10-28-2011; IN COMMERCE 10-28-2011.

FOR: MONITORING TELEPHONE CALLS FROM SUBSCRIBERS AND NOTIFYING  
EMERGENCY FACILITIES; PROVIDING CONSULTATION AND INFORMATION IN THE  
FIELD OF EMERGENCY RESPONSE FOR COMMUNITIES; EMERGENCY RESPONSE  
ALARM MONITORING SERVICES, NAMELY, MONITORING OF ALERT DEVICES BY A  
REMOTE MONITORING CENTER FOR THE DISPATCH OF EMERGENCY PUBLIC HEALTH  
AND SECURITY SERVICES AND NOTIFICATION TO THIRD PARTIES, IN CLASS 45 (U.S.  
CLS. 100 AND 101).

FIRST USE 10-28-2011; IN COMMERCE 10-28-2011.

THE MARK CONSISTS OF STANDARD CHARACTERS WITHOUT CLAIM TO ANY PAR-  
TICULAR FONT, STYLE, SIZE, OR COLOR.

OWNER OF U.S. REG. NO. 3,571,519.

SN 85-309,637, FILED 5-2-2011.

CHRISIE B. KING, EXAMINING ATTORNEY



*David J. Kybas*

Director of the United States Patent and Trademark Office

# United States of America

United States Patent and Trademark Office

# PUREFIRE

**Reg. No. 4,276,445**

WINDFLAME, INC. (MINNESOTA CORPORATION)  
506 KENNY ROAD  
ST. PAUL, MN 55130

**Registered Jan. 15, 2013**

**Int. Cl.: 4**

FOR: ALCOHOL BASED FUEL FOR FIREPLACE AND BURNER UNITS, NAMELY, ETHANOL BASED FUEL, IN CLASS 4 (U.S. CLS. 1, 6 AND 15).

**TRADEMARK**

FIRST USE 11-30-2011; IN COMMERCE 11-30-2011.

**PRINCIPAL REGISTER**

THE MARK CONSISTS OF STANDARD CHARACTERS WITHOUT CLAIM TO ANY PARTICULAR FONT, STYLE, SIZE, OR COLOR.

SN 85-309,827, FILED 5-2-2011.

SAIMA MAKHDOOM, EXAMINING ATTORNEY



*David J. Kybas*

Director of the United States Patent and Trademark Office

# United States of America

United States Patent and Trademark Office

# faveMe

**Reg. No. 4,276,446**

**Registered Jan. 15, 2013**

**Int. Cl.: 35**

**SERVICE MARK**

**PRINCIPAL REGISTER**

TWTMOB (CALIFORNIA LIMITED LIABILITY COMPANY)  
940 N HAYWORTH AVE #9  
WEST HOLLYWOOD, CA 90046

FOR: ADVERTISEMENT FOR OTHERS ON THE INTERNET; ADVERTISEMENT VIA MOBILE PHONE NETWORKS; ADVERTISING AGENCIES, NAMELY, PROMOTING THE GOODS AND SERVICES OF OTHERS; ADVERTISING AGENCY SPECIALIZING IN THE DESIGN AND EXECUTION OF WORD OF MOUTH, VIRAL, BUZZ AND EXPERIENTIAL MARKETING PROGRAMS; ADVERTISING AND ADVERTISEMENT SERVICES; ADVERTISING AND MARKETING; ADVERTISING AND PROMOTIONAL SERVICES; ADVERTISING AND PUBLICITY SERVICES; ADVERTISING ON THE INTERNET FOR OTHERS; ADVERTISING SERVICES; ADVERTISING SERVICES, NAMELY, CREATING CORPORATE AND BRAND IDENTITY FOR OTHERS; ADVERTISING SERVICES, NAMELY, PROMOTING THE BRANDS, GOODS AND SERVICES OF OTHERS; ADVERTISING VIA ELECTRONIC MEDIA AND SPECIFICALLY THE INTERNET; ADVERTISING, MARKETING AND PROMOTION SERVICES; ADVERTISING, PROMOTION, AND MARKETING SERVICES IN THE NATURE OF TWEETS FOR CORPORATE CUSTOMERS, IN CLASS 35 (U.S. CLS. 100, 101 AND 102).

FIRST USE 12-19-2011; IN COMMERCE 12-19-2011.

THE MARK CONSISTS OF STANDARD CHARACTERS WITHOUT CLAIM TO ANY PARTICULAR FONT, STYLE, SIZE, OR COLOR.

SN 85-309,917, FILED 5-2-2011.

MARK T. MULLEN, EXAMINING ATTORNEY



*David J. Kyffers*

Director of the United States Patent and Trademark Office

# United States of America

United States Patent and Trademark Office

## SPARKLE ON WITH A RELAXING SCENT!

**Reg. No. 4,276,447**

COLGATE-PALMOLIVE COMPANY (DELAWARE CORPORATION)  
300 PARK AVENUE  
NEW YORK, NY 10022

**Registered Jan. 15, 2013**

**Int. Cl.: 3**

FOR: DISH WASHING DETERGENT, IN CLASS 3 (U.S. CLS. 1, 4, 6, 50, 51 AND 52).

**TRADEMARK**

FIRST USE 8-1-2011; IN COMMERCE 8-1-2011.

**PRINCIPAL REGISTER**

THE MARK CONSISTS OF STANDARD CHARACTERS WITHOUT CLAIM TO ANY PARTICULAR FONT, STYLE, SIZE, OR COLOR.

NO CLAIM IS MADE TO THE EXCLUSIVE RIGHT TO USE "SCENT", APART FROM THE MARK AS SHOWN.

SN 85-310,022, FILED 5-2-2011.

KATHERINE STOIDES, EXAMINING ATTORNEY



*David J. Kybas*

Director of the United States Patent and Trademark Office

# United States of America

United States Patent and Trademark Office

## SPARKLE ON WITH A REFRESHING SCENT!

**Reg. No. 4,276,448**

COLGATE-PALMOLIVE COMPANY (DELAWARE CORPORATION)  
300 PARK AVENUE  
NEW YORK, NY 10022

**Registered Jan. 15, 2013**

**Int. Cl.: 3**

FOR: DISH WASHING DETERGENT, IN CLASS 3 (U.S. CLS. 1, 4, 6, 50, 51 AND 52).

FIRST USE 8-1-2011; IN COMMERCE 8-1-2011.

**TRADEMARK**

THE MARK CONSISTS OF STANDARD CHARACTERS WITHOUT CLAIM TO ANY PARTICULAR FONT, STYLE, SIZE, OR COLOR.

**PRINCIPAL REGISTER**

NO CLAIM IS MADE TO THE EXCLUSIVE RIGHT TO USE "SCENT", APART FROM THE MARK AS SHOWN.

SN 85-310,063, FILED 5-2-2011.

KATHERINE STOIDES, EXAMINING ATTORNEY



*David J. Kyffers*

Director of the United States Patent and Trademark Office

# United States of America

United States Patent and Trademark Office

## SPARKLE ON WITH AN EXHILARATING SCENT!

**Reg. No. 4,276,449**

COLGATE-PALMOLIVE COMPANY (DELAWARE CORPORATION)  
300 PARK AVENUE  
NEW YORK, NY 10022

**Registered Jan. 15, 2013**

**Int. Cl.: 3**

FOR: DISH WASHING DETERGENT, IN CLASS 3 (U.S. CLS. 1, 4, 6, 50, 51 AND 52).

**TRADEMARK**

FIRST USE 8-1-2011; IN COMMERCE 8-1-2011.

**PRINCIPAL REGISTER**

THE MARK CONSISTS OF STANDARD CHARACTERS WITHOUT CLAIM TO ANY PARTICULAR FONT, STYLE, SIZE, OR COLOR.

NO CLAIM IS MADE TO THE EXCLUSIVE RIGHT TO USE "SCENT", APART FROM THE MARK AS SHOWN.

SN 85-310,118, FILED 5-2-2011.

KATHERINE STOIDES, EXAMINING ATTORNEY



*David J. Kyffers*

Director of the United States Patent and Trademark Office

# United States of America

United States Patent and Trademark Office

## GRABBA SWEET BOTTOM

**Reg. No. 4,276,450**

**Registered Jan. 15, 2013**

**Int. Cl.: 30**

**TRADEMARK**

**PRINCIPAL REGISTER**

SWEET BOTTOM, LLC (NEVADA LIMITED LIABILITY COMPANY)  
PO BOX 355  
MOUNT PLEASANT, SC 29465

FOR: BAKERY DESSERTS; BAKERY GOODS, IN CLASS 30 (U.S. CL. 46).

FIRST USE 5-11-2011; IN COMMERCE 5-11-2011.

THE MARK CONSISTS OF STANDARD CHARACTERS WITHOUT CLAIM TO ANY PARTICULAR FONT, STYLE, SIZE, OR COLOR.

OWNER OF U.S. REG. NO. 3,991,252.

NO CLAIM IS MADE TO THE EXCLUSIVE RIGHT TO USE "SWEET", APART FROM THE MARK AS SHOWN.

SN 85-310,401, FILED 5-2-2011.

ANDREW RHIM, EXAMINING ATTORNEY



*David J. Kyffers*

Director of the United States Patent and Trademark Office

# United States of America

United States Patent and Trademark Office

# KORACLE

**Reg. No. 4,276,451**

**Registered Jan. 15, 2013**

**Int. Cl.: 44**

**SERVICE MARK**

**PRINCIPAL REGISTER**

RO, YOUNG WOO (REPUBLIC OF KOREA INDIVIDUAL)  
8-1106, WOOSUNG APT., 32/3,  
503 DAECHE-DONG, GANGNAM-GU  
SEOUL, REPUBLIC OF KOREA

FOR: COSMETIC AND PLASTIC SURGERY; DENTISTRY; DERMATOLOGY SERVICES; MEDICAL SERVICES; MEDICAL SERVICES, NAMELY, ORTHOPEDIC SURGERY, DENTAL CLINIC SERVICES, OTOLARYNGOLOGIST SERVICES, OPHTHALMIC CLINIC SERVICES, ORIENTAL MEDICINE CLINIC SERVICES, PHYSICIAN SERVICES, OBSTETRICS AND GYNECOLOGY SERVICES, UROLOGIST SERVICES, OBESITY CLINIC SERVICES, PEDIATRIC HOSPITAL SERVICES, NEUROPSYCHIATRIC CLINIC SERVICES, SERVICES OF MEDICAL EXAMINATION, HAIR-LOSS CLINIC SERVICES, SERVICES OF MEDICAL DIAGNOSIS; ORTHODONTIST SERVICES, HAIR IMPLANTATION, MEDICAL CLINIC SERVICES, AND HOSPITAL SERVICES; SURGERY, IN CLASS 44 (U.S. CLS. 100 AND 101).

FIRST USE 11-2-2012; IN COMMERCE 11-2-2012.

THE MARK CONSISTS OF STANDARD CHARACTERS WITHOUT CLAIM TO ANY PARTICULAR FONT, STYLE, SIZE, OR COLOR.

SN 85-310,492, FILED 5-3-2011.

KIMBERLY FRYE, EXAMINING ATTORNEY



*David J. Kypos*

Director of the United States Patent and Trademark Office



# United States of America

United States Patent and Trademark Office

# Lilly Pulitzer

**Reg. No. 4,276,452**

SUGARTOWN WORLDWIDE LLC (DELAWARE LIMITED LIABILITY COMPANY)  
222 PIEDMONT AVE., NE  
ATLANTA, GA 30308

**Registered Jan. 15, 2013**

**Int. Cl.: 20**

FOR: FURNITURE, IN CLASS 20 (U.S. CLS. 2, 13, 22, 25, 32 AND 50).

**TRADEMARK**

FIRST USE 10-1-2010; IN COMMERCE 10-1-2010.

**PRINCIPAL REGISTER**

THE MARK CONSISTS OF STANDARD CHARACTERS WITHOUT CLAIM TO ANY PARTICULAR FONT, STYLE, SIZE, OR COLOR.

OWNER OF U.S. REG. NOS. 1,990,353, 2,152,933, AND OTHERS.

THE NAME(S), PORTRAIT(S), AND/OR SIGNATURE(S) SHOWN IN THE MARK IDENTIFIES A LIVING PERSON, WHOSE CONSENT(S) TO REGISTER IS MADE OF RECORD.

SN 85-311,068, FILED 5-3-2011.

JOSETTE BEVERLY, EXAMINING ATTORNEY



*David J. Kyffers*

Director of the United States Patent and Trademark Office

# United States of America

United States Patent and Trademark Office

# AVH

**Reg. No. 4,276,453**

AXINN, VELTROP & HARKRIDER LLP (NEW YORK LIMITED LIABILITY PARTNERSHIP)  
114 WEST 47TH STREET  
NEW YORK, NY 10036

**Registered Jan. 15, 2013**

**Int. Cls.: 35 and 45**

FOR: BUSINESS CONSULTATION; BUSINESS ACQUISITION AND MERGER CONSULTATION, AND BUSINESS PLANNING, IN CLASS 35 (U.S. CLS. 100, 101 AND 102).

**SERVICE MARK**

FIRST USE 1-0-2008; IN COMMERCE 1-0-2008.

**PRINCIPAL REGISTER**

FOR: LEGAL SERVICES, IN CLASS 45 (U.S. CLS. 100 AND 101).

FIRST USE 1-0-2008; IN COMMERCE 1-0-2008.

THE MARK CONSISTS OF STANDARD CHARACTERS WITHOUT CLAIM TO ANY PARTICULAR FONT, STYLE, SIZE, OR COLOR.

SN 85-311,747, FILED 5-4-2011.

KHANH LE, EXAMINING ATTORNEY



*David J. Kybas*

Director of the United States Patent and Trademark Office

# United States of America

United States Patent and Trademark Office

sleeve  
seal

**Reg. No. 4,276,454**

**Registered Jan. 15, 2013**

**Int. Cls.: 7 and 40**

**TRADEMARK**

**SERVICE MARK**

**PRINCIPAL REGISTER**

SLEEVE SEAL, LLC (ARKANSAS LIMITED LIABILITY COMPANY)  
3300 SOUTH WOODROW STREET  
LITTLE ROCK, AR 722046550

FOR: AUTOMATIC INDUSTRIAL LABELING MACHINES FOR APPLYING LABELS, SEALERS, AND TAMPER EVIDENT BINDING MATERIALS TO CONTAINERS AND BOTTLES, IN CLASS 7 (U.S. CLS. 13, 19, 21, 23, 31, 34 AND 35).

FIRST USE 10-31-2010; IN COMMERCE 10-31-2010.

FOR: CUSTOM PRINTING OF LABELS AND PLASTIC FILMS, IN CLASS 40 (U.S. CLS. 100, 103 AND 106).

FIRST USE 10-31-2010; IN COMMERCE 10-31-2010.

NO CLAIM IS MADE TO THE EXCLUSIVE RIGHT TO USE "SLEEVE SEAL", APART FROM THE MARK AS SHOWN.

THE MARK CONSISTS OF THE WORD "SLEEVE" ABOVE THE WORD "SEAL" WITH THE SHAPE OF A BOTTLE BEGINNING AT THE TOP OF THE "L" IN "SEAL", RUNNING ALONG THE SIDE OF THE "L", AND UNDERLINING THE WORD "SEAL".

SN 85-312,417, FILED 5-4-2011.

KIMBERLY FRYE, EXAMINING ATTORNEY



*David J. Kyros*

Director of the United States Patent and Trademark Office

# United States of America

United States Patent and Trademark Office

# BAMBOX

**Reg. No. 4,276,455**

BAMSHAFT, INC. (MARYLAND CORPORATION)  
519 AUGUSTA DRIVE  
ARNOLD, MD 21012

**Registered Jan. 15, 2013**

**Int. Cl.: 28**

FOR: LACROSSE STICK HANDLES, IN CLASS 28 (U.S. CLS. 22, 23, 38 AND 50).

**TRADEMARK**

FIRST USE 11-11-2012; IN COMMERCE 11-11-2012.

**PRINCIPAL REGISTER**

THE MARK CONSISTS OF STANDARD CHARACTERS WITHOUT CLAIM TO ANY PARTICULAR FONT, STYLE, SIZE, OR COLOR.

OWNER OF U.S. REG. NO. 3,795,748.

SN 85-312,488, FILED 5-4-2011.

MARGERY A. TIERNEY, EXAMINING ATTORNEY



*David J. Kyffers*

Director of the United States Patent and Trademark Office

# United States of America

United States Patent and Trademark Office

## OB GOLDEN LAGER

**Reg. No. 4,276,456**

**Registered Jan. 15, 2013**

**Int. Cl.: 32**

**TRADEMARK**

**PRINCIPAL REGISTER**

ORIENTAL BREWERY CO., LTD. (REPUBLIC OF KOREA CORPORATION)  
52, JOONGSAM-RI, HYUNDO-MYON  
CHEONGWON-GUN  
CHUNGCHEONGBUK-DO, REPUBLIC OF KOREA 363-823

FOR: BEER; BEER WORT; EXTRACTS OF HOPS FOR MAKING BEER, IN CLASS 32 (U.S. CLS. 45, 46 AND 48).

FIRST USE 3-22-2011; IN COMMERCE 5-18-2011.

THE MARK CONSISTS OF STANDARD CHARACTERS WITHOUT CLAIM TO ANY PARTICULAR FONT, STYLE, SIZE, OR COLOR.

PRIORITY CLAIMED UNDER SEC. 44(D) ON REPUBLIC OF KOREA APPLICATION NO. 45-2011-356, FILED 1-27-2011.

OWNER OF U.S. REG. NOS. 1,429,471 AND 2,129,733.

NO CLAIM IS MADE TO THE EXCLUSIVE RIGHT TO USE "GOLDEN LAGER", APART FROM THE MARK AS SHOWN.

SN 85-312,545, FILED 5-4-2011.

KHANH LE, EXAMINING ATTORNEY



*David J. Kyffers*

Director of the United States Patent and Trademark Office

# United States of America

United States Patent and Trademark Office

sleeve  
seal

US Shrink Labeling Solutions

**Reg. No. 4,276,457**

SLEEVE SEAL, LLC (ARKANSAS LIMITED LIABILITY COMPANY)  
3300 SOUTH WOODROW STREET  
LITTLE ROCK, AR 722046550

**Registered Jan. 15, 2013**

**Int. Cl.: 40**

FOR: CUSTOM PRINTING OF LABELS AND PLASTIC FILMS, IN CLASS 40 (U.S. CLS. 100, 103 AND 106).

**SERVICE MARK**

FIRST USE 10-31-2010; IN COMMERCE 10-31-2010.

**PRINCIPAL REGISTER**

NO CLAIM IS MADE TO THE EXCLUSIVE RIGHT TO USE "SLEEVE SEAL US SHRINK LABELING SOLUTIONS", APART FROM THE MARK AS SHOWN.

THE MARK CONSISTS OF THE WORD "SLEEVE" ABOVE THE WORD "SEAL" WITH THE SHAPE OF A BOTTLE BEGINNING AT THE TOP OF THE "L" IN "SEAL", RUNNING ALONG THE SIDE OF THE "L", AND UNDERLINING THE WORD "SEAL" WITH THE WORDS "US SHRINK LABELING SOLUTIONS" UNDERNEATH.

SN 85-312,673, FILED 5-4-2011.

KIMBERLY FRYE, EXAMINING ATTORNEY



*David J. Kyffers*

Director of the United States Patent and Trademark Office

# United States of America

United States Patent and Trademark Office

# Tool Collar

**Reg. No. 4,276,458**

**Registered Jan. 15, 2013**

**Int. Cl.: 9**

**TRADEMARK**

**PRINCIPAL REGISTER**

TY-FLOT, INC. (NEW HAMPSHIRE CORPORATION)  
305 MASSABESIC STREET  
MANCHESTER, NH 03103

FOR: SAFETY EQUIPMENT, NAMELY, A HAND TOOL HARNESS FOR USE IN TETHERING TOOLS TO A WORKER SO THAT THE TOOLS WILL NOT FALL OR IMPEDE THE SAFETY OF OTHERS, IN CLASS 9 (U.S. CLS. 21, 23, 26, 36 AND 38).

FIRST USE 7-26-2011; IN COMMERCE 7-26-2011.

THE MARK CONSISTS OF STANDARD CHARACTERS WITHOUT CLAIM TO ANY PARTICULAR FONT, STYLE, SIZE, OR COLOR.

NO CLAIM IS MADE TO THE EXCLUSIVE RIGHT TO USE "TOOL", APART FROM THE MARK AS SHOWN.

SN 85-312,981, FILED 5-5-2011.

MATTHEW KLINE, EXAMINING ATTORNEY



*David J. Kyffers*

Director of the United States Patent and Trademark Office

# United States of America

United States Patent and Trademark Office

## MASTERCARD PRICEASSURE

**Reg. No. 4,276,459**

**Registered Jan. 15, 2013**

**Int. Cls.: 35, 39, and 42**

**SERVICE MARK**

**PRINCIPAL REGISTER**

MASTERCARD INTERNATIONAL INCORPORATED (DELAWARE CORPORATION)  
2000 PURCHASE STREET  
PURCHASE, NY 10577

FOR: PROMOTING THE SALE OF THE GOODS AND SERVICES OF OTHERS THROUGH THE DISTRIBUTION OF PRINTED MATERIALS AND ELECTRONIC OFFERS; CONTESTS AND INCENTIVE AWARD PROGRAMS TO PROMOTE THE SALE OF THE PRODUCTS AND SERVICES OF OTHERS; PROMOTING THE GOODS AND SERVICES OF OTHERS BY MEANS OF DISCOUNTS AND INCENTIVES, IN CLASS 35 (U.S. CLS. 100, 101 AND 102).

FIRST USE 5-10-2011; IN COMMERCE 5-10-2011.

FOR: PROVIDING ON-LINE TRANSPORTATION BOOKING AND RESERVATION SERVICES AND TRAVEL AND TOUR TICKET BOOKING AND RESERVATION SERVICES, IN CLASS 39 (U.S. CLS. 100 AND 105).

FIRST USE 5-10-2011; IN COMMERCE 5-10-2011.

FOR: PROVIDING TEMPORARY USE OF NON-DOWNLOADABLE SOFTWARE WHICH ALLOWS FOR THE TRACKING OF FLIGHT ITINERARIES AND ONLINE TRAVEL AGENTS TO MONITOR FLIGHT, RENTAL CAR AND HOTEL PRICES AND ALERTS USERS TO PRICE CHANGES; PROVIDING TEMPORARY USE OF NON-DOWNLOADABLE SOFTWARE WHICH PROVIDES ALERTS TO USERS REGARDING CHANGES IN FLIGHT PRICES TO FACILITATE OBTAINING TRAVEL CREDITS AND/OR REFUNDS; PROVIDING TEMPORARY USE OF NON-DOWNLOADABLE SOFTWARE WHICH ALLOWS USERS TO MONITOR FLIGHTS; PROVIDING A WEBSITE FEATURING TECHNOLOGY THAT ENABLES USERS TO MAKE RESERVATIONS AND BOOKINGS FOR TRANSPORTATION, TRAVEL AND TOUR TICKETS, RESTAURANTS AND TEMPORARY LODGING VIA THE INTERNET AND SECURING PAYMENT THEREFOR, IN CLASS 42 (U.S. CLS. 100 AND 101).

FIRST USE 5-10-2011; IN COMMERCE 5-10-2011.

THE MARK CONSISTS OF STANDARD CHARACTERS WITHOUT CLAIM TO ANY PARTICULAR FONT, STYLE, SIZE, OR COLOR.

OWNER OF U.S. REG. NOS. 1,890,786, 2,870,383, AND OTHERS.



*David J. Kappas*

Director of the United States Patent and Trademark Office



**Reg. No. 4,276,459** SN 85-313,308, FILED 5-5-2011.

LEIGH LOWRY, EXAMINING ATTORNEY

# United States of America

United States Patent and Trademark Office

## PRICEASSURE

**Reg. No. 4,276,460**

**Registered Jan. 15, 2013**

**Int. Cls.: 35, 39, and 42**

**SERVICE MARK**

**PRINCIPAL REGISTER**

MASTERCARD INTERNATIONAL INCORPORATED (DELAWARE CORPORATION)  
2000 PURCHASE STREET  
PURCHASE, NY 10577

FOR: PROMOTING THE SALE OF THE GOODS AND SERVICES OF OTHERS THROUGH THE DISTRIBUTION OF PRINTED MATERIALS AND ELECTRONIC OFFERS; CONTESTS AND INCENTIVE AWARD PROGRAMS TO PROMOTE THE SALE OF THE PRODUCTS AND SERVICES OF OTHERS; PROMOTING THE GOODS AND SERVICES OF OTHERS BY MEANS OF DISCOUNTS AND INCENTIVES, IN CLASS 35 (U.S. CLS. 100, 101 AND 102).

FIRST USE 5-10-2011; IN COMMERCE 5-10-2011.

FOR: PROVIDING ON-LINE TRANSPORTATION BOOKING AND RESERVATION SERVICES AND TRAVEL AND TOUR TICKET BOOKING AND RESERVATION SERVICES, IN CLASS 39 (U.S. CLS. 100 AND 105).

FIRST USE 5-10-2011; IN COMMERCE 5-10-2011.

FOR: PROVIDING TEMPORARY USE OF NON-DOWNLOADABLE SOFTWARE WHICH ALLOWS FOR THE TRACKING OF FLIGHT ITINERARIES AND ONLINE TRAVEL AGENTS TO MONITOR FLIGHT, RENTAL CAR AND HOTEL PRICES AND ALERTS USERS TO PRICE CHANGES; PROVIDING TEMPORARY USE OF NON-DOWNLOADABLE SOFTWARE WHICH PROVIDES ALERTS TO USERS REGARDING CHANGES IN FLIGHT PRICES TO FACILITATE OBTAINING TRAVEL CREDITS AND/OR REFUNDS; PROVIDING TEMPORARY USE OF NON-DOWNLOADABLE SOFTWARE WHICH ALLOWS USERS TO MONITOR FLIGHTS; PROVIDING A WEBSITE FEATURING TECHNOLOGY THAT ENABLES USERS TO MAKE RESERVATIONS AND BOOKINGS FOR TRANSPORTATION, TRAVEL AND TOUR TICKETS, RESTAURANTS AND TEMPORARY LODGING VIA THE INTERNET AND SECURING PAYMENT THEREFOR, IN CLASS 42 (U.S. CLS. 100 AND 101).

FIRST USE 5-10-2011; IN COMMERCE 5-10-2011.

THE MARK CONSISTS OF STANDARD CHARACTERS WITHOUT CLAIM TO ANY PARTICULAR FONT, STYLE, SIZE, OR COLOR.

SN 85-313,312, FILED 5-5-2011.



*David J. Kyjars*

Director of the United States Patent and Trademark Office

**Reg. No. 4,276,460** LEIGH LOWRY, EXAMINING ATTORNEY

# United States of America

United States Patent and Trademark Office

# JASONSHOUSE

**Reg. No. 4,276,461**

JASON'S HOUSE, INC. (DELAWARE CORPORATION)  
2720 BRIARHURST DR. #7  
HOUSTON, TX 77057

**Registered Jan. 15, 2013**

**Int. Cl.: 36**

FOR: RESIDENTIAL REAL ESTATE AGENCY SERVICES, IN CLASS 36 (U.S. CLS. 100, 101 AND 102).

**SERVICE MARK**

FIRST USE 10-24-2012; IN COMMERCE 10-24-2012.

**PRINCIPAL REGISTER**

THE MARK CONSISTS OF STANDARD CHARACTERS WITHOUT CLAIM TO ANY PARTICULAR FONT, STYLE, SIZE, OR COLOR.

SN 85-313,440, FILED 5-5-2011.

JORDAN BAKER, EXAMINING ATTORNEY



*David J. Kybas*

Director of the United States Patent and Trademark Office

# United States of America

United States Patent and Trademark Office

# Keras

**Reg. No. 4,276,462**

**Registered Jan. 15, 2013**

**Int. Cl.: 5**

**TRADEMARK**

**PRINCIPAL REGISTER**

KERAPLAST TECHNOLOGIES, LLC (TEXAS LIMITED LIABILITY COMPANY)  
SUITE 102  
19206 HUEBNER RD  
SAN ANTONIO, TX 78258

FOR: MEDICATED SKIN CARE PREPARATIONS, IN CLASS 5 (U.S. CLS. 6, 18, 44, 46, 51 AND 52).

FIRST USE 9-19-2012; IN COMMERCE 9-19-2012.

THE MARK CONSISTS OF STANDARD CHARACTERS WITHOUT CLAIM TO ANY PARTICULAR FONT, STYLE, SIZE, OR COLOR.

SN 85-314,563, FILED 5-6-2011.

LINDA POWELL, EXAMINING ATTORNEY



*David J. Kyffers*

Director of the United States Patent and Trademark Office

# United States of America

United States Patent and Trademark Office

# RAU

**Reg. No. 4,276,463**

**Registered Jan. 15, 2013**

**Int. Cl.: 30**

**TRADEMARK**

**PRINCIPAL REGISTER**

MYERS, DAREN W. (CALIFORNIA PARTNERSHIP)  
1065 1/2 HORNBLEND STREET  
SAN DIEGO, CA 92109

FOR: COCOA, IN CLASS 30 (U.S. CL. 46).

FIRST USE 3-1-2012; IN COMMERCE 7-1-2012.

THE MARK CONSISTS OF STANDARD CHARACTERS WITHOUT CLAIM TO ANY PARTICULAR FONT, STYLE, SIZE, OR COLOR.

SN 85-315,225, FILED 5-8-2011.

GEOFFREY FOSDICK, EXAMINING ATTORNEY



*David J. Kybas*

Director of the United States Patent and Trademark Office

# United States of America

United States Patent and Trademark Office

## Tiki Motorsports

**Reg. No. 4,276,464**

SCHERMERHORN, CURT A. (UNITED STATES INDIVIDUAL), DBA TIKI MOTORSPORTS,  
13414 ESPERAR DRIVE  
EL CAJON, CA 92021

**Registered Jan. 15, 2013**

**Int. Cl.: 25**

FOR: WEARING APPAREL, NAMELY, SHIRTS, T-SHIRTS, SHORTS, PANTS, SWEATSHIRTS,  
SWEATPANTS, HATS, VISORS, SHOES, BELTS, IN CLASS 25 (U.S. CLS. 22 AND 39).

**TRADEMARK**

FIRST USE 5-31-2011; IN COMMERCE 9-10-2012.

**PRINCIPAL REGISTER**

THE MARK CONSISTS OF STANDARD CHARACTERS WITHOUT CLAIM TO ANY PAR-  
TICULAR FONT, STYLE, SIZE, OR COLOR.

NO CLAIM IS MADE TO THE EXCLUSIVE RIGHT TO USE "MOTORSPORTS", APART  
FROM THE MARK AS SHOWN.

SN 85-315,232, FILED 5-8-2011.

ALYSSA STEEL, EXAMINING ATTORNEY



*David J. Kybas*

Director of the United States Patent and Trademark Office

# United States of America

United States Patent and Trademark Office

## Cleveland is the City

**Reg. No. 4,276,465**

HOMAGE, LLC (OHIO LIMITED LIABILITY COMPANY)  
5759 WESTBOURNE AVENUE  
COLUMBUS, OH 43213

**Registered Jan. 15, 2013**

**Int. Cl.: 25**

FOR: T-SHIRTS, SWEATSHIRTS, HATS AND ATHLETIC APPAREL, NAMELY, SHIRTS, PANTS, JACKETS, AND FOOTWEAR, IN CLASS 25 (U.S. CLS. 22 AND 39).

**TRADEMARK**

FIRST USE 4-30-2010; IN COMMERCE 4-30-2010.

**PRINCIPAL REGISTER**

THE MARK CONSISTS OF STANDARD CHARACTERS WITHOUT CLAIM TO ANY PARTICULAR FONT, STYLE, SIZE, OR COLOR.

NO CLAIM IS MADE TO THE EXCLUSIVE RIGHT TO USE "CLEVELAND", APART FROM THE MARK AS SHOWN.

SN 85-315,615, FILED 5-9-2011.

ANNE E. GUSTASON, EXAMINING ATTORNEY



*David J. Kybas*

Director of the United States Patent and Trademark Office



# United States of America

United States Patent and Trademark Office

## EMPIRE RESEARCH GROUP

**Reg. No. 4,276,466**

**Registered Jan. 15, 2013**

**Int. Cl.: 35**

**SERVICE MARK**

**PRINCIPAL REGISTER**

KALEIDOSCOPE MEDIA GROUP, INC (CALIFORNIA CORPORATION), DBA CHET HOLMES INTERNATIONAL,  
7212 MULHOLLAND DR.  
LOS ANGELES, CA 90068

FOR: MARKET RESEARCH AND ANALYSIS, IN CLASS 35 (U.S. CLS. 100, 101 AND 102).

FIRST USE 12-0-2003; IN COMMERCE 3-0-2004.

THE MARK CONSISTS OF STANDARD CHARACTERS WITHOUT CLAIM TO ANY PARTICULAR FONT, STYLE, SIZE, OR COLOR.

NO CLAIM IS MADE TO THE EXCLUSIVE RIGHT TO USE "RESEARCH GROUP", APART FROM THE MARK AS SHOWN.

SN 85-316,034, FILED 5-9-2011.

ANDREW RHIM, EXAMINING ATTORNEY



*David J. Kybas*

Director of the United States Patent and Trademark Office

# United States of America

United States Patent and Trademark Office

## HYBRID-FYRE

**Reg. No. 4,276,467**

TRAVIS INDUSTRIES, INC. (WASHINGTON CORPORATION)  
4800 HARBOUR POINTE BLVD. SW  
MUKILTEO, WA 98275

**Registered Jan. 15, 2013**

**Int. Cl.: 11**

FOR: WOOD-BURNING FIREPLACES; FIREPLACE INSERTS IN THE NATURE OF HEAT EXCHANGERS, SOLID FUEL BURNERS, AND STOVES; WOOD-BURNING STOVES , IN CLASS 11 (U.S. CLS. 13, 21, 23, 31 AND 34).

**TRADEMARK**

FIRST USE 4-16-2012; IN COMMERCE 4-16-2012.

**PRINCIPAL REGISTER**

THE MARK CONSISTS OF STANDARD CHARACTERS WITHOUT CLAIM TO ANY PARTICULAR FONT, STYLE, SIZE, OR COLOR.

SN 85-316,232, FILED 5-9-2011.

CHRISTINA SOBRAL, EXAMINING ATTORNEY



*David J. Kyffers*

Director of the United States Patent and Trademark Office

# United States of America

United States Patent and Trademark Office

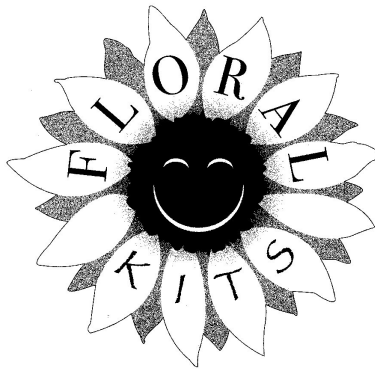

**Reg. No. 4,276,468**

**Registered Jan. 15, 2013**

**Int. Cl.: 35**

**SERVICE MARK**

**PRINCIPAL REGISTER**

MURPHY'S MEMORIES (NEW YORK CORPORATION)  
32 TODD HILL RD  
POUGHKEEPSIE, NY 12603

FOR: FLORIST SERVICES IN THE NATURE OF PREPARATION OF CUSTOMIZED FLORAL ARRANGEMENT KITS WITH SELECTED ITEMS REGARDING A PARTICULAR OCCASION OR THEME, IN CLASS 35 (U.S. CLS. 100, 101 AND 102).

FIRST USE 3-20-2012; IN COMMERCE 5-15-2012.

NO CLAIM IS MADE TO THE EXCLUSIVE RIGHT TO USE "FLORAL KITS", APART FROM THE MARK AS SHOWN.

THE STIPPLING IS FOR SHADING PURPOSES ONLY.

THE MARK CONSISTS OF A HAPPY FACE WITH PETALS ALL AROUND. THE STYLIZED TEXT "FLORAL KITS" APPEARS AROUND.

SN 85-316,813, FILED 5-10-2011.

MARK T. MULLEN, EXAMINING ATTORNEY



*David J. Kyffers*

Director of the United States Patent and Trademark Office

# United States of America

United States Patent and Trademark Office

# GUYOLOGY

**Reg. No. 4,276,469**

GIRLOLOGY LLC (SOUTH CAROLINA LIMITED LIABILITY COMPANY)  
P.O. BOX 1419  
MT PLEASANT, SC 29465

**Registered Jan. 15, 2013**

**Int. Cl.: 41**

FOR: EDUCATION SERVICES, NAMELY, PROVIDING LIVE AND ON-LINE CLASSES, SEMINARS AND WORKSHOPS IN THE FIELD OF MALE HEALTHY SEXUALITY AND COMMUNICATION BETWEEN ADOLESCENT BOYS AND PARENTS, IN CLASS 41 (U.S. CLS. 100, 101 AND 107).

**SERVICE MARK**

**PRINCIPAL REGISTER**

FIRST USE 5-1-2012; IN COMMERCE 5-1-2012.

THE MARK CONSISTS OF STANDARD CHARACTERS WITHOUT CLAIM TO ANY PARTICULAR FONT, STYLE, SIZE, OR COLOR.

OWNER OF U.S. REG. NO. 2,962,466.

SN 85-317,761, FILED 5-11-2011.

SHAUNIA CARLYLE, EXAMINING ATTORNEY



*David J. Kyffers*

Director of the United States Patent and Trademark Office

# United States of America

United States Patent and Trademark Office

# Ananda Nidra

**Reg. No. 4,276,470**

KAILASH CENTER FOR PERSONAL DEVELOPMENT, INC (NEW YORK CORPORATION)  
1992 COMMERCE STREET, #218  
YORKTOWN HEIGHTS, NY 10598

**Registered Jan. 15, 2013**

**Int. Cls.: 9 and 41**

FOR: DIGITAL MEDIA, NAMELY, CDS, AND DOWNLOADABLE AUDIO FILES FEATURING MEDITATION, IN CLASS 9 (U.S. CLS. 21, 23, 26, 36 AND 38).

**TRADEMARK**

FIRST USE 10-25-2012; IN COMMERCE 10-25-2012.

**SERVICE MARK**

FOR: MEDITATION TRAINING, IN CLASS 41 (U.S. CLS. 100, 101 AND 107).

**PRINCIPAL REGISTER**

FIRST USE 10-22-2011; IN COMMERCE 10-22-2011.

THE MARK CONSISTS OF STANDARD CHARACTERS WITHOUT CLAIM TO ANY PARTICULAR FONT, STYLE, SIZE, OR COLOR.

NO CLAIM IS MADE TO THE EXCLUSIVE RIGHT TO USE "NIDRA", APART FROM THE MARK AS SHOWN.

SN 85-317,924, FILED 5-11-2011.

DAVID COLLIER, EXAMINING ATTORNEY



*David J. Kyros*

Director of the United States Patent and Trademark Office

# United States of America

United States Patent and Trademark Office

# PLEEB

**Reg. No. 4,276,471**

ARTHUR A. SCOTSON (UNITED STATES INDIVIDUAL)  
177 SOUTH 1930 EAST  
SPANISH FORK, UT 84660

**Registered Jan. 15, 2013**

**Int. Cl.: 42**

**SERVICE MARK**

**PRINCIPAL REGISTER**

FOR: COMPUTER SERVICES, NAMELY, HOSTING ELECTRONIC FACILITIES FOR OTHERS FOR INTERACTIVE DISCUSSIONS VIA THE INTERNET; COMPUTER SERVICES, NAMELY, CREATING AN ON-LINE COMMUNITY FOR REGISTERED USERS TO PARTICIPATE IN DISCUSSIONS AND SHARE INFORMATION RELATED TO POLITICAL ISSUES, LEGISLATION, AND CAMPAIGNS, AND ENGAGE IN SOCIAL, POLITICAL AND COMMUNITY NETWORKING; PROVIDING TEMPORARY USE OF ON-LINE NON-DOWNLOADABLE SOFTWARE FOR ALLOWING WEB SITE USERS TO COMMUNICATE POLITICAL INFORMATION FOR PURPOSES OF SOCIAL, POLITICAL AND COMMUNITY NETWORKING, POLLING, DEBATING, DISCUSSIONS, CAMPAIGNING, LOBBYING; PROVIDING A WEB SITE FEATURING TEMPORARY USE OF NON-DOWNLOADABLE SOFTWARE ENABLING USERS TO SEARCH, LOCATE AND COMMUNICATE WITH OTHERS VIA ELECTRONIC COMMUNICATIONS NETWORKS TO DISCUSS POLITICAL ISSUES, LEGISLATION, AND CAMPAIGNS, VOTE ON POSITIONS, LEGISLATION, AND POLITICAL ISSUES, AND CONDUCT SURVEYS AND POLLS; COMPUTER SERVICES IN THE NATURE OF CUSTOMIZED WEB PAGES FEATURING USER-DEFINED INFORMATION, PERSONAL PROFILES, AND IMAGES; COMPUTER SERVICES, NAMELY, CREATING AN ON-LINE COMMUNITY FOR REGISTERED USERS TO PARTICIPATE IN DISCUSSIONS, GET FEEDBACK FROM THEIR PEERS, FORM VIRTUAL COMMUNITIES, AND ENGAGE IN SOCIAL NETWORKING FEATURING SOCIAL MEDIA, IN CLASS 42 (U.S. CLS. 100 AND 101).



FIRST USE 7-1-2012; IN COMMERCE 8-27-2012.

THE MARK CONSISTS OF STANDARD CHARACTERS WITHOUT CLAIM TO ANY PARTICULAR FONT, STYLE, SIZE, OR COLOR.

SN 85-318,317, FILED 5-11-2011.

CAROLINE WOOD, EXAMINING ATTORNEY

*David J. Kybas*

Director of the United States Patent and Trademark Office

# United States of America

United States Patent and Trademark Office



**SITEKICK**

**Reg. No. 4,276,472**

WILLIAMS, BENJAMIN HUNTER (UNITED STATES INDIVIDUAL)  
429 W YORK ST, 2D  
NORFOLK, VA 23510

**Registered Jan. 15, 2013**

**Int. Cl.: 42**

FOR: COMPUTER SERVICES, NAMELY, SEARCH ENGINE OPTIMIZATION; WEBSITE DESIGN AND DEVELOPMENT FOR OTHERS, IN CLASS 42 (U.S. CLS. 100 AND 101).

**SERVICE MARK**

FIRST USE 11-21-2012; IN COMMERCE 11-21-2012.

**PRINCIPAL REGISTER**

THE MARK CONSISTS OF THE UNDERLINED WORDING "SITEKICK" WITH A FIVE POINT STAR INCORPORATING SEVERAL TRIANGLES. THE STAR IS SUPERIMPOSED OVER A SHADED CIRCLE. EACH POINT OF THE STAR HAS AN INCOMPLETE CIRCLE. A CIRCLE IS DISPLAYED AT THE CENTER OF THE STAR. PORTIONS OF THE STAR ARE SHADED.

SN 85-318,385, FILED 5-11-2011.

EVELYN BRADLEY, EXAMINING ATTORNEY



*David J. Kybas*

Director of the United States Patent and Trademark Office

# United States of America

United States Patent and Trademark Office

# Stereobot

**Reg. No. 4,276,473**

OJOO LTD. (CYPRUS LIMITED COMPANY (LTD.))  
BOUBOULINAS 11, 1ST FLOOR  
NICOSIA, 1060, CYPRUS

**Registered Jan. 15, 2013**

**Int. Cls.: 41 and 42**

FOR: ONLINE MUSIC PRODUCTION LIBRARY FOR USE IN TV, FILM, VIDEO GAMES AND OTHER AUDIO-VISUAL PRODUCTS, NAMELY, PROVIDING NON-DOWNLOADABLE PLAYBACK OF MUSIC VIA GLOBAL COMMUNICATIONS NETWORKS, IN CLASS 41 (U.S. CLS. 100, 101 AND 107).

**SERVICE MARK**

**PRINCIPAL REGISTER**

FIRST USE 9-10-2012; IN COMMERCE 9-10-2012.

FOR: ONLINE MUSIC PRODUCTION LIBRARY FOR USE IN TV, FILM, VIDEO GAMES AND OTHER AUDIO-VISUAL PRODUCTS, NAMELY, PROVIDING A WEBSITE THAT GIVES USERS THE ABILITY TO PURCHASE DOWNLOADABLE MUSIC, IN CLASS 42 (U.S. CLS. 100 AND 101).

FIRST USE 9-10-2012; IN COMMERCE 9-10-2012.

THE MARK CONSISTS OF STANDARD CHARACTERS WITHOUT CLAIM TO ANY PARTICULAR FONT, STYLE, SIZE, OR COLOR.

SN 85-319,373, FILED 5-12-2011.

ROSELLE HERRERA, EXAMINING ATTORNEY



*David J. Kyffers*

Director of the United States Patent and Trademark Office



# United States of America

United States Patent and Trademark Office

# RADPACK

**Reg. No. 4,276,474**

**Registered Jan. 15, 2013**

**Int. Cl.: 30**

**TRADEMARK**

**PRINCIPAL REGISTER**

SWEETWORKS, INC. (DELAWARE CORPORATION)  
3500 GENESEE STREET  
BUFFALO, NY 14225

FOR: BUBBLEGUM, IN CLASS 30 (U.S. CL. 46).

FIRST USE 5-30-2012; IN COMMERCE 5-30-2012.

THE MARK CONSISTS OF STANDARD CHARACTERS WITHOUT CLAIM TO ANY PARTICULAR FONT, STYLE, SIZE, OR COLOR.

NO CLAIM IS MADE TO THE EXCLUSIVE RIGHT TO USE "PACK", APART FROM THE MARK AS SHOWN.

SN 85-320,281, FILED 5-13-2011.

HANNO RITTNER, EXAMINING ATTORNEY



*David J. Kyffers*

Director of the United States Patent and Trademark Office

# United States of America

United States Patent and Trademark Office

## DREAM IT'S POSSIBLE.

**Reg. No. 4,276,475**

**Registered Jan. 15, 2013**

**Int. Cls.: 35 and 36**

**SERVICE MARK**

**PRINCIPAL REGISTER**

MATTRESS FIRM, INC. (DELAWARE CORPORATION)  
5815 GULF FREEWAY  
HOUSTON, TX 77023

FOR: PROMOTING THE PUBLIC INTEREST AND AWARENESS IN CANCER RESEARCH AND EDUCATION FOR CHARITABLE FUNDRAISING PURPOSES, IN CLASS 35 (U.S. CLS. 100, 101 AND 102).

FIRST USE 5-11-2011; IN COMMERCE 5-11-2011.

FOR: CHARITABLE FUNDRAISING SERVICES, NAMELY, RAISING MONEY FOR PANCREATIC CANCER DETECTION, RESEARCH, EDUCATION AND TREATMENT, IN CLASS 36 (U.S. CLS. 100, 101 AND 102).

FIRST USE 6-23-2011; IN COMMERCE 6-23-2011.

THE MARK CONSISTS OF STANDARD CHARACTERS WITHOUT CLAIM TO ANY PARTICULAR FONT, STYLE, SIZE, OR COLOR.

SN 85-320,671, FILED 5-13-2011.

WENDY GOODMAN, EXAMINING ATTORNEY



*David J. Kybas*

Director of the United States Patent and Trademark Office

# United States of America

United States Patent and Trademark Office



**Reg. No. 4,276,476**

**Registered Jan. 15, 2013**

**Int. Cl.: 3**

**TRADEMARK**

**PRINCIPAL REGISTER**

NORHLAND CHEMICAL CORP. (MINNESOTA CORPORATION)  
1170 EAGAN INDUSTRIAL RD  
EAGAN, MN 55121

FOR: AEROSOL SPRAY FOR CLEANING CONDENSER COILS OF AIR FILTERS FOR AIR CONDITIONING, HEATING AND AIR FILTRATION UNITS; AUTOMOBILE CARPET AND UPHOLSTERY CLEANING PREPARATIONS; AUTOMOBILE TIRE CLEANING AND POLISHING PREPARATIONS; AUTOMOBILE, TIRE, GLASS AND WHEEL CLEANING PREPARATIONS; AUTOMOTIVE CLEANING PREPARATIONS; CARPET CLEANING PREPARATIONS; CLEANING AGENTS AND PREPARATIONS; CLEANING AGENTS FOR CLEANING SURFACES; CLEANING PREPARATIONS; CLEANING PREPARATIONS FOR CLEANING SURFACES; CLEANING PREPARATIONS FOR CLEANSING DRAINS; CLEANING PREPARATIONS FOR HOUSEHOLD PURPOSES; CLEANING, POLISHING AND SCOURING PREPARATIONS; CLEANING, SCOURING AND POLISHING PREPARATIONS AND SUBSTANCES; CLEANING, WASHING AND POLISHING PREPARATIONS; FLOOR STRIPPING/CLEANING PREPARATION; GENERAL PURPOSE CLEANING, POLISHING, AND ABRASIVE LIQUIDS AND POWDERS; GLASS CLEANING PREPARATIONS; HAND CLEANERS; HAND CLEANING GELS; HAND CLEANING PREPARATIONS; HOUSEHOLD CLEANING PREPARATIONS, IN CLASS 3 (U.S. CLS. 1, 4, 6, 50, 51 AND 52).

FIRST USE 0-0-1997; IN COMMERCE 0-0-1997.

THE MARK CONSISTS OF A "GREEN TREE" WITH BLUE AND GREEN COLOR FOR THE WORDS-"GREEN TREE".

THE COLOR(S) GREEN AND BLUE IS/ARE CLAIMED AS A FEATURE OF THE MARK.

SN 85-321,435, FILED 5-16-2011.

CURTIS FRENCH, EXAMINING ATTORNEY



*David J. Kyffers*

Director of the United States Patent and Trademark Office

# United States of America

United States Patent and Trademark Office

# MPAD

**Reg. No. 4,276,477**

**Registered Jan. 15, 2013**

**Int. Cl.: 9**

**TRADEMARK**

**PRINCIPAL REGISTER**

CYWEE GROUP LIMITED (BR. VIRGIN ISLANDS CORPORATION)  
PALM GROVE HOUSE  
P.O. BOX 438, ROAD TOWN  
TORTOLA, BR. VIRGIN ISLANDS

FOR: VIDEO GAME PROGRAMS; INTERACTIVE ENTERTAINMENT GAME SOFTWARE AND COMPUTER GAME SOFTWARE FOR USE ON MOBILE AND CELLULAR PHONES; GLOBAL POSITIONING SYSTEMS COMPRISING COMPUTERS; MAPPING SOFTWARE; COMPUTER SOFTWARE FOR STORING, MAINTAINING AND DELIVERING MULTI-MEDIA FILES, VIDEOS, AUDIO AND MAPPING FILES AND MANAGING DISTRIBUTION PROCESSES TO END-USERS; PORTABLE ELECTRONIC DEVICES INCORPORATING GLOBAL POSITIONING SYSTEM (GPS) AND MOBILE PHONES; COMPUTER APPLICATION SOFTWARE FOR COLLECTING, EDITING, ORGANIZING, MODIFYING, TRANSMITTING, STORING IMAGE CONTENT TO EXTERNAL DISPLAY SCREEN OR MONITOR FOR DISPLAY; WIRELESS TRANSCEIVERS WITH COLLECTION AND DISPLAY TECHNOLOGY FOR ELECTRONIC TRANSMISSION OF MESSAGES AND DATA; COMPUTER SOFTWARE THAT COLLECTS, STORES, CARRIES DOWNLOADABLE MUSICAL SOUND AND VIDEO RECORDS, IN CLASS 9 (U.S. CLS. 21, 23, 26, 36 AND 38).

FIRST USE 11-7-2012; IN COMMERCE 11-7-2012.

THE MARK CONSISTS OF STANDARD CHARACTERS WITHOUT CLAIM TO ANY PARTICULAR FONT, STYLE, SIZE, OR COLOR.

SN 85-321,718, FILED 5-16-2011.

LINDA POWELL, EXAMINING ATTORNEY



*David J. Kypos*

Director of the United States Patent and Trademark Office

# United States of America

United States Patent and Trademark Office

## PARTY PEACOCK

**Reg. No. 4,276,478**

BERRY PLASTICS CORPORATION (DELAWARE CORPORATION)  
101 OAKLEY STREET, P.O. BOX 959  
EVANSVILLE, IN 477060959

**Registered Jan. 15, 2013**

**Int. Cl.: 16**

FOR: FOOD WRAPPING PLASTIC FILM FOR HOUSEHOLD USE; PLASTIC FOOD STORAGE BAGS FOR HOUSEHOLD USE, IN CLASS 16 (U.S. CLS. 2, 5, 22, 23, 29, 37, 38 AND 50).

**TRADEMARK**

FIRST USE 11-15-2012; IN COMMERCE 11-15-2012.

**PRINCIPAL REGISTER**

THE MARK CONSISTS OF STANDARD CHARACTERS WITHOUT CLAIM TO ANY PARTICULAR FONT, STYLE, SIZE, OR COLOR.

NO CLAIM IS MADE TO THE EXCLUSIVE RIGHT TO USE "PARTY", APART FROM THE MARK AS SHOWN.

SN 85-321,834, FILED 5-16-2011.

JUDITH HELFMAN, EXAMINING ATTORNEY



*David J. Kyffers*

Director of the United States Patent and Trademark Office

# United States of America

United States Patent and Trademark Office

# Deliboy Slots

**Reg. No. 4,276,479**

CANTER, GARY (UNITED STATES INDIVIDUAL)  
PO BOX 361568  
LOS ANGELES, CA 90036 AND

**Registered Jan. 15, 2013**

**Int. Cl.: 9**

CANTER, TRACI (UNITED STATES INDIVIDUAL)  
446 S. HIGHLAND AVE.  
LOS ANGELES, CA 90036

**TRADEMARK**

**PRINCIPAL REGISTER**

FOR: SLOT MACHINES, IN CLASS 9 (U.S. CLS. 21, 23, 26, 36 AND 38).

FIRST USE 1-1-2011; IN COMMERCE 1-1-2012.

THE MARK CONSISTS OF STANDARD CHARACTERS WITHOUT CLAIM TO ANY PARTICULAR FONT, STYLE, SIZE, OR COLOR.

NO CLAIM IS MADE TO THE EXCLUSIVE RIGHT TO USE "SLOTS", APART FROM THE MARK AS SHOWN.

SN 85-321,871, FILED 5-16-2011.

CAROLINE WOOD, EXAMINING ATTORNEY



*David J. Kybas*

Director of the United States Patent and Trademark Office

# United States of America

United States Patent and Trademark Office

# RotaPod

**Reg. No. 4,276,480**

MIM MFG. LLC (CONNECTICUT LIMITED LIABILITY COMPANY), DBA MIM MFG. LLC,  
1455 SOUTHFORD ROAD  
SOUTHBURY, CT 06488

**Registered Jan. 15, 2013**

**Int. Cl.: 13**

FOR: FIREARM ATTACHMENTS, NAMELY, MOUNTS FOR ATTACHING ACCESSORIES  
TO A FIREARM, IN CLASS 13 (U.S. CLS. 2 AND 9).

**TRADEMARK**

FIRST USE 8-1-2011; IN COMMERCE 8-1-2011.

**PRINCIPAL REGISTER**

THE MARK CONSISTS OF STANDARD CHARACTERS WITHOUT CLAIM TO ANY PAR-  
TICULAR FONT, STYLE, SIZE, OR COLOR.

SN 85-322,719, FILED 5-17-2011.

TRACY FLETCHER, EXAMINING ATTORNEY



*David J. Kybas*

Director of the United States Patent and Trademark Office

# United States of America

United States Patent and Trademark Office

## LOVE PEACE & JAZZ

**Reg. No. 4,276,481**

PIXLEY, GAYLA (UNITED STATES INDIVIDUAL)  
1256 S. STANLEY AVE  
LOS ANGELES, CA 90019 AND

**Registered Jan. 15, 2013**

**Int. Cl.: 25**

PIXLEY, CALVIN (UNITED STATES INDIVIDUAL)  
1256 S. STANLEY AVE  
LOS ANGELES, CA 90019

**TRADEMARK**

FOR: HATS; JACKETS; T-SHIRTS, IN CLASS 25 (U.S. CLS. 22 AND 39).

**PRINCIPAL REGISTER**

FIRST USE 10-15-2011; IN COMMERCE 3-24-2012.

THE MARK CONSISTS OF STANDARD CHARACTERS WITHOUT CLAIM TO ANY PARTICULAR FONT, STYLE, SIZE, OR COLOR.

SN 85-323,029, FILED 5-17-2011.

NAKIA HENRY, EXAMINING ATTORNEY



*David J. Kybas*

Director of the United States Patent and Trademark Office



# United States of America

United States Patent and Trademark Office

## AMBROSIA AND

**Reg. No. 4,276,482**

**Registered Jan. 15, 2013**

**Int. Cl.: 45**

**SERVICE MARK**

**PRINCIPAL REGISTER**

CALL, TAYLOR (UNITED STATES INDIVIDUAL)  
5642 CALLOWHILL ST.  
PITTSBURGH, PA 15206

FOR: SPIRITUAL COUNSELING, IN CLASS 45 (U.S. CLS. 100 AND 101).

FIRST USE 5-17-2011; IN COMMERCE 6-1-2012.

THE MARK CONSISTS OF STANDARD CHARACTERS WITHOUT CLAIM TO ANY PARTICULAR FONT, STYLE, SIZE, OR COLOR.

SN 85-323,462, FILED 5-18-2011.

ALEXANDER L. POWERS, EXAMINING ATTORNEY



*David J. Kybas*

Director of the United States Patent and Trademark Office

# United States of America

United States Patent and Trademark Office

## VALLEY CENTER

**Reg. No. 4,276,483**

HEINRICH-STEINBERG, KATRINA B. (UNITED STATES INDIVIDUAL)  
P.O. BOX 1845

**Registered Jan. 15, 2013**

RANCHO MIRAGE, CA 922701081

**Int. Cl.: 37**

FOR: LAND DEVELOPMENT SERVICES, NAMELY, PLANNING AND LAYING OUT OF RESIDENTIAL AND/OR COMMERCIAL COMMUNITIES; REAL ESTATE DEVELOPMENT, IN CLASS 37 (U.S. CLS. 100, 103 AND 106).

**SERVICE MARK**

FIRST USE 6-4-2012; IN COMMERCE 6-4-2012.

**PRINCIPAL REGISTER**

THE MARK CONSISTS OF STANDARD CHARACTERS WITHOUT CLAIM TO ANY PARTICULAR FONT, STYLE, SIZE, OR COLOR.

NO CLAIM IS MADE TO THE EXCLUSIVE RIGHT TO USE "CENTER", APART FROM THE MARK AS SHOWN.

SN 85-324,421, FILED 5-18-2011.

RON FAIRBANKS, EXAMINING ATTORNEY



*David J. Kyros*

Director of the United States Patent and Trademark Office

# United States of America

United States Patent and Trademark Office

## Certus

**Reg. No. 4,276,484**

WHITE, BRANTLEY E. (UNITED STATES INDIVIDUAL)  
1400 WEST NORTHWOOD  
GREENSBORO, NC 27408

**Registered Jan. 15, 2013**

**Int. Cls.: 36 and 37**

FOR: REAL ESTATE MANAGEMENT SERVICES, IN CLASS 36 (U.S. CLS. 100, 101 AND 102).

**SERVICE MARK**

FIRST USE 6-1-2011; IN COMMERCE 6-1-2011.

**PRINCIPAL REGISTER**

FOR: BUILDING CONSTRUCTION; REAL ESTATE DEVELOPMENT, IN CLASS 37 (U.S. CLS. 100, 103 AND 106).

FIRST USE 6-1-2011; IN COMMERCE 6-1-2011.

THE MARK CONSISTS OF STANDARD CHARACTERS WITHOUT CLAIM TO ANY PARTICULAR FONT, STYLE, SIZE, OR COLOR.

SN 85-324,885, FILED 5-19-2011.

JEFF DEFORD, EXAMINING ATTORNEY



*David J. Kybas*

Director of the United States Patent and Trademark Office

# United States of America

United States Patent and Trademark Office



**Reg. No. 4,276,485**

**Registered Jan. 15, 2013**

**Int. Cl.: 43**

**SERVICE MARK**

**PRINCIPAL REGISTER**

FC LOBSTER PARTNERS, LLC (NEVADA LIMITED LIABILITY COMPANY)  
3883 HOWARD HUGHES PARKWAY, SUITE 500  
LAS VEGAS, NV 89169

FOR: FOOD PREPARATION SERVICES; RESTAURANT SERVICES, IN CLASS 43 (U.S. CLS. 100 AND 101).

FIRST USE 8-27-2011; IN COMMERCE 8-27-2011.

NO CLAIM IS MADE TO THE EXCLUSIVE RIGHT TO USE "LOBSTER" AND "U.S.A.", APART FROM THE MARK AS SHOWN.

THE MARK CONSISTS OF THE WORDING "LOBSTER ME U.S.A." WITH EACH WORD BEING DISPLAYED ON A SEPARATE LINE AND WITH THE IMAGE OF A CRAWLING LOBSTER APPEARING BETWEEN THE LETTERS "M" AND "E".

SN 85-325,399, FILED 5-19-2011.

MEGHAN REINHART, EXAMINING ATTORNEY



*David J. Kybas*

Director of the United States Patent and Trademark Office

# United States of America

United States Patent and Trademark Office

## Software Carpenter

**Reg. No. 4,276,486**

SOFTWARE CARPENTER INC (NORTH CAROLINA CORPORATION)  
439 WEST WORTHINGTON AVE  
CHARLOTTE, NC 28203

**Registered Jan. 15, 2013**

**Int. Cl.: 9**

FOR: COMPUTER SOFTWARE FOR COMPUTER SYSTEM AND APPLICATION DEVELOPMENT, DEPLOYMENT AND MANAGEMENT, IN CLASS 9 (U.S. CLS. 21, 23, 26, 36 AND 38).

**TRADEMARK**

FIRST USE 4-15-2011; IN COMMERCE 4-15-2011.

**PRINCIPAL REGISTER**

THE MARK CONSISTS OF STANDARD CHARACTERS WITHOUT CLAIM TO ANY PARTICULAR FONT, STYLE, SIZE, OR COLOR.

NO CLAIM IS MADE TO THE EXCLUSIVE RIGHT TO USE "SOFTWARE", APART FROM THE MARK AS SHOWN.

SN 85-325,655, FILED 5-20-2011.

TRACY WHITTAKER-BROWN, EXAMINING ATTORNEY



*David J. Kyffers*

Director of the United States Patent and Trademark Office

# United States of America

United States Patent and Trademark Office

## THE PRINCESS & THE POPSTAR

**Reg. No. 4,276,487**

**Registered Jan. 15, 2013**

**Int. Cl.: 9**

**TRADEMARK**

**PRINCIPAL REGISTER**

MATTEL, INC. (DELAWARE CORPORATION)  
M1-1518  
333 CONTINENTAL BOULEVARD  
EL SEGUNDO, CA 90245

FOR: VIDEO GAME SOFTWARE FOR TABLET COMPUTERS AND FOR MOBILE DEVICES  
IN THE NATURE OF CELLULAR PHONES, SMART PHONES AND PERSONAL DIGITAL  
ASSISTANTS, IN CLASS 9 (U.S. CLS. 21, 23, 26, 36 AND 38).

FIRST USE 9-6-2012; IN COMMERCE 9-6-2012.

THE MARK CONSISTS OF STANDARD CHARACTERS WITHOUT CLAIM TO ANY PAR-  
TICULAR FONT, STYLE, SIZE, OR COLOR.

SN 85-325,788, FILED 5-20-2011.

WENDY GOODMAN, EXAMINING ATTORNEY



*David J. Kybas*

Director of the United States Patent and Trademark Office

# United States of America

United States Patent and Trademark Office

## The Suburban Monk

**Reg. No. 4,276,488**

THE SUBURBAN MONK, LLC (NEW JERSEY LIMITED LIABILITY COMPANY)  
50 GRANDVIEW PLACE  
NORTH CALDWELL, NJ 07006

**Registered Jan. 15, 2013**

**Int. Cl.: 28**

FOR: COLLECTABLE TOY FIGURES; TOY FIGURES, IN CLASS 28 (U.S. CLS. 22, 23, 38 AND 50).

**TRADEMARK**

FIRST USE 7-1-2012; IN COMMERCE 7-1-2012.

**PRINCIPAL REGISTER**

THE MARK CONSISTS OF STANDARD CHARACTERS WITHOUT CLAIM TO ANY PARTICULAR FONT, STYLE, SIZE, OR COLOR.

SN 85-326,016, FILED 5-20-2011.

SHARON MEIER, EXAMINING ATTORNEY



*David J. Kybas*

Director of the United States Patent and Trademark Office

# United States of America

United States Patent and Trademark Office

# WHITE HOT

**Reg. No. 4,276,489**

**Registered Jan. 15, 2013**

**Int. Cl.: 5**

**TRADEMARK**

**PRINCIPAL REGISTER**

WEIDER GLOBAL NUTRITION, LLC (NEVADA LIMITED LIABILITY COMPANY)  
2212 E WILLIAMS FIELD ROAD  
SUITE 230  
GILBERT, AZ 85295

FOR: DIETARY SUPPLEMENTS; DIETARY SUPPLEMENTS FOR HUMAN CONSUMPTION,  
IN CLASS 5 (U.S. CLS. 6, 18, 44, 46, 51 AND 52).

FIRST USE 1-31-2012; IN COMMERCE 1-31-2012.

THE MARK CONSISTS OF STANDARD CHARACTERS WITHOUT CLAIM TO ANY PAR-  
TICULAR FONT, STYLE, SIZE, OR COLOR.

SN 85-326,621, FILED 5-20-2011.

PAUL E. FAHRENKOPF, EXAMINING ATTORNEY



*David J. Kybas*

Director of the United States Patent and Trademark Office



# United States of America

United States Patent and Trademark Office

N . HOOLYWOOD

**Reg. No. 4,276,490**

**Registered Jan. 15, 2013**

**Int. Cl.: 14**

**TRADEMARK**

**PRINCIPAL REGISTER**

MISTER HOLLYWOOD CO., LTD. (JAPAN CORPORATION)  
14-37, SHIMACHI 1-CHOME, NISHI-KU  
OSAKA, JAPAN 550-0013

FOR: JEWELRY, NAMELY, EMBLEMS OF PRECIOUS METAL FOR PLACEMENT ON CLOTHING, NECKLACES, BRACELETS, PENDANTS AND RINGS, IN CLASS 14 (U.S. CLS. 2, 27, 28 AND 50).

FIRST USE 9-14-2011; IN COMMERCE 9-14-2011.

OWNER OF U.S. REG. NO. 3,568,566.

THE MARK CONSISTS OF THE WORDS "N . HOOLYWOOD" STYLIZED.

SN 85-327,864, FILED 5-23-2011.

GRETCHEN ULRICH, EXAMINING ATTORNEY



*David J. Kyffers*

Director of the United States Patent and Trademark Office

# United States of America

United States Patent and Trademark Office

## LIVE THE WORD, UNLOCK THE MIRACULOUS

**Reg. No. 4,276,491**

**Registered Jan. 15, 2013**

**Int. Cl.: 45**

**SERVICE MARK**

**PRINCIPAL REGISTER**

MARILYN HICKEY MINISTRIES (COLORADO NON-PROFIT CORPORATION)  
8081 E ORCHARD ROAD  
GREENWOOD VILLAGE, CO 80111

FOR: CHRISTIAN MINISTRY SERVICES, IN CLASS 45 (U.S. CLS. 100 AND 101).

FIRST USE 7-0-2011; IN COMMERCE 7-0-2011.

THE MARK CONSISTS OF STANDARD CHARACTERS WITHOUT CLAIM TO ANY PARTICULAR FONT, STYLE, SIZE, OR COLOR.

SN 85-328,462, FILED 5-24-2011.

DOMINICK J. SALEMI, EXAMINING ATTORNEY



*David J. Kybas*

Director of the United States Patent and Trademark Office

# United States of America

United States Patent and Trademark Office

## DOUBLETREE RESORTS BY HILTON

**Reg. No. 4,276,492**

**Registered Jan. 15, 2013**

**Int. Cl.: 43**

**SERVICE MARK**

**PRINCIPAL REGISTER**

HLT DOMESTIC IP LLC (DELAWARE LIMITED LIABILITY COMPANY)  
7930 JONES BRANCH DRIVE, SUITE 1100  
MCLEAN, VA 22102

FOR: RENTAL OF TEMPORARY ACCOMMODATIONS, NAMELY, HOTEL ROOMS; RESERVATIONS OF HOTEL ROOMS FOR TRAVELERS; PROVIDING TEMPORARY ACCOMMODATIONS, NAMELY, HOTEL ROOMS; HOTEL, MOTEL, BAR, CAFE, RESTAURANT, BANQUETING AND CATERING SERVICES, RENTAL OF ROOMS FOR HOLDING SOCIAL FUNCTIONS, CONFERENCES, CONVENTIONS, EXHIBITIONS, SEMINARS AND MEETINGS, IN CLASS 43 (U.S. CLS. 100 AND 101).

FIRST USE 3-15-2012; IN COMMERCE 3-15-2012.

THE MARK CONSISTS OF STANDARD CHARACTERS WITHOUT CLAIM TO ANY PARTICULAR FONT, STYLE, SIZE, OR COLOR.

OWNER OF U.S. REG. NOS. 1,094,809, 2,522,248, AND OTHERS.

NO CLAIM IS MADE TO THE EXCLUSIVE RIGHT TO USE "RESORTS" , APART FROM THE MARK AS SHOWN.

SN 85-329,497, FILED 5-25-2011.

MICHAEL WEBSTER, EXAMINING ATTORNEY



*David J. Kyffers*

Director of the United States Patent and Trademark Office

# United States of America

United States Patent and Trademark Office



## LOADSTAR

**Reg. No. 4,276,493**

**Registered Jan. 15, 2013**

**Int. Cls.: 35 and 39**

HUTCHISON INTERNATIONAL PORTS ENTERPRISES LIMITED (BR. VIRGIN ISLANDS CORPORATION)  
CRAIGMUIR CHAMBERS  
WICKHAMS CAY  
ROAD TOWN, TORTOLA, BR. VIRGIN ISLANDS

**SERVICE MARK**

**PRINCIPAL REGISTER**

FOR: BUSINESS SERVICES, NAMELY, FREIGHT INFORMATION MANAGEMENT SERVICES, SHIPMENT PROCESSING, TRACKING DOCUMENTS, PACKAGES AND FREIGHT OVER COMPUTER NETWORKS; PROVIDING TRACKING SERVICES AND INFORMATION CONCERNING TRACKING OF ASSETS IN TRANSIT, NAMELY, VEHICLES, TRAILERS, DRIVERS, CARGO AND DELIVERY CONTAINERS; CONSULTANCY AND ADVISORY SERVICES IN THE FIELD OF INVENTORY CONTROL, IN CLASS 35 (U.S. CLS. 100, 101 AND 102).

FIRST USE 5-4-2011; IN COMMERCE 5-4-2011.

FOR: CONSULTANCY AND ADVISORY SERVICES IN THE FIELD OF FREIGHT SHIPPING AND GLOBAL TRANSPORTATION OF CARGO, IN CLASS 39 (U.S. CLS. 100 AND 105).

FIRST USE 5-4-2011; IN COMMERCE 5-4-2011.

THE MARK CONSISTS OF THE TERM "LOADSTAR" BELOW A DARK BALL WITH LIGHT SHADING OF AN ARC BISECTING IT AND A FOUR-POINTED STAR IN A CIRCLE APPEARING AT THE NARROW POINT OF THE ARC AND A CIRCULAR SHADOW BELOW THE BALL.

SN 85-329,558, FILED 5-25-2011.

JULIE VEPPUMTHARA, EXAMINING ATTORNEY



*David J. Kybas*

Director of the United States Patent and Trademark Office

# United States of America

United States Patent and Trademark Office

# GRILLINI

**Reg. No. 4,276,494**

SUNBEAM PRODUCTS, INC. (DELAWARE CORPORATION)  
2381 EXECUTIVE CENTER DRIVE  
BOCA RATON, FL 33431

**Registered Jan. 15, 2013**

**Int. Cl.: 11**

FOR: ELECTRIC GRILLS, GRIDDLES, AND SKILLETS, AND ACCESSORIES THEREFOR, NAMELY, GRILL PLATES SOLD AS PARTS OF GRILLS, GRIDDLE PLATES SOLD AS PARTS OF GRILLS, DRIP CUPS SOLD AS PARTS OF GRILLS AND HAND-OPERATED CLEANING TOOLS SPECIALLY ADAPTED FOR CLEANING GRILL PLATES SOLD AS PARTS OF GRILLS, IN CLASS 11 (U.S. CLS. 13, 21, 23, 31 AND 34).

**TRADEMARK**

**PRINCIPAL REGISTER**

FIRST USE 8-31-2011; IN COMMERCE 8-31-2011.

THE MARK CONSISTS OF STANDARD CHARACTERS WITHOUT CLAIM TO ANY PARTICULAR FONT, STYLE, SIZE, OR COLOR.

SN 85-330,686, FILED 5-26-2011.

LEIGH LOWRY, EXAMINING ATTORNEY



*David J. Kyfos*

Director of the United States Patent and Trademark Office

# United States of America

United States Patent and Trademark Office

## Pearce Pointe Sailing

**Reg. No. 4,276,495**

PEARCE, DOUGLAS (UNITED STATES INDIVIDUAL)  
1929 EDENBRIDGE WAY  
FOREST HILLS, TN 372155807

**Registered Jan. 15, 2013**

**Int. Cl.: 39**

FOR: CONDUCTING BOAT CHARTERS; RENTAL OF BOATS, IN CLASS 39 (U.S. CLS. 100 AND 105).

**SERVICE MARK**

FIRST USE 1-1-2011; IN COMMERCE 4-1-2011.

**PRINCIPAL REGISTER**

THE MARK CONSISTS OF STANDARD CHARACTERS WITHOUT CLAIM TO ANY PARTICULAR FONT, STYLE, SIZE, OR COLOR.

NO CLAIM IS MADE TO THE EXCLUSIVE RIGHT TO USE "SAILING", APART FROM THE MARK AS SHOWN.

SN 85-330,928, FILED 5-26-2011.

DAVID I, EXAMINING ATTORNEY



*David J. Kyffers*

Director of the United States Patent and Trademark Office

# United States of America

United States Patent and Trademark Office

## WESTERN STAR

**Reg. No. 4,276,496**

**Registered Jan. 15, 2013**

**Int. Cl.: 36**

**SERVICE MARK**

**PRINCIPAL REGISTER**

FCOA, LLC (DELAWARE LIMITED LIABILITY COMPANY)  
5600 BEACH TREE LANE  
CALEDONIA, MI 49316

FOR: INSURANCE UNDERWRITING OF PROPERTY AND CASUALTY INSURANCE; INSURANCE CLAIMS PROCESSING, INSURANCE CLAIMS ADMINISTRATION, AND INSURANCE AGENCY SERVICES; PROVIDING INFORMATION IN INSURANCE MATTERS, IN CLASS 36 (U.S. CLS. 100, 101 AND 102).

FIRST USE 6-1-2012; IN COMMERCE 6-1-2012.

THE MARK CONSISTS OF STANDARD CHARACTERS WITHOUT CLAIM TO ANY PARTICULAR FONT, STYLE, SIZE, OR COLOR.

SN 85-331,025, FILED 5-26-2011.

MIDGE BUTLER, EXAMINING ATTORNEY



*David J. Kyffers*

Director of the United States Patent and Trademark Office

# United States of America

United States Patent and Trademark Office

# SUPERTRANS

**Reg. No. 4,276,497**

SUPERSHUTTLE INTERNATIONAL, INC. (DELAWARE CORPORATION)  
14500 N. NORTHSIGHT BOULEVARD, SUITE 329  
SCOTTSDALE, AZ 85260

**Registered Jan. 15, 2013**

**Int. Cl.: 39**

FOR: TRANSPORTATION OF PASSENGERS AND/OR GOODS BY MOTOR VEHICLES;  
TRANSPORTATION RESERVATION SERVICES; DOOR-TO-DOOR TRANSPORTATION  
SERVICES OF PASSENGERS BY MOTOR VEHICLES, IN CLASS 39 (U.S. CLS. 100 AND  
105).

**SERVICE MARK**

**PRINCIPAL REGISTER**

FIRST USE 3-31-2012; IN COMMERCE 3-31-2012.

THE MARK CONSISTS OF STANDARD CHARACTERS WITHOUT CLAIM TO ANY PAR-  
TICULAR FONT, STYLE, SIZE, OR COLOR.

SN 85-331,283, FILED 5-26-2011.

MICHAEL ENGEL, EXAMINING ATTORNEY



*David J. Kyffers*

Director of the United States Patent and Trademark Office



# United States of America

United States Patent and Trademark Office

# ARABELLA

**Reg. No. 4,276,498**

RICHLINE GROUP, INC. (DELAWARE CORPORATION)  
1385 BROADWAY  
NEW YORK, NY 10018

**Registered Jan. 15, 2013**

**Int. Cl.: 14**

FOR: JEWELRY, IN CLASS 14 (U.S. CLS. 2, 27, 28 AND 50).

**TRADEMARK**

FIRST USE 9-1-2011; IN COMMERCE 9-1-2011.

**PRINCIPAL REGISTER**

THE MARK CONSISTS OF STANDARD CHARACTERS WITHOUT CLAIM TO ANY PARTICULAR FONT, STYLE, SIZE, OR COLOR.

SN 85-331,379, FILED 5-26-2011.

GRETTA YAO, EXAMINING ATTORNEY



*David J. Kybas*

Director of the United States Patent and Trademark Office

# United States of America

United States Patent and Trademark Office

## TERUMO BCT

**Reg. No. 4,276,499**

**Registered Jan. 15, 2013**

**Int. Cls.: 5, 9, and 10**

**TRADEMARK**

**PRINCIPAL REGISTER**

TERUMO KABUSHIKI KAISHA (JAPAN CORPORATION), DBA TERUMO CORPORATION, 44-1, 2-CHOME, HATAGAYA SHIBUYA-KU, TOKYO, JAPAN

FOR: PHARMACEUTICAL AND THERAPEUTIC PREPARATIONS FOR USE IN BLOOD COMPONENT TECHNOLOGY, BLOOD TRANSFUSION, CELL THERAPIES AND REDUCING PATHOGENS; ANTICOAGULANTS; SOLUTIONS FOR MEDICAL AND CLINICAL USE IN STORING AND TREATING CELLS, BLOOD AND BLOOD COMPONENTS, IN CLASS 5 (U.S. CLS. 6, 18, 44, 46, 51 AND 52).

FIRST USE 4-30-2012; IN COMMERCE 4-30-2012.

FOR: COMPUTER SOFTWARE USED FOR DIAGNOSTIC EVALUATION, ANALYSIS, TREATMENT AND HANDLING OF BLOOD, BLOOD COMPONENTS AND BODILY FLUIDS; COMPUTER SOFTWARE FOR MEASURING AND PREDICTING BLOOD COMPONENT PRODUCT YIELDS, FOR PATHOGEN REDUCTION, FOR GENERATING BLOOD COMPONENT DONOR REPORTS AND FOR MANAGING BLOOD COMPONENT COLLECTION FACILITIES AND BLOOD COMPONENT AND CELL CULTURE APPARATUS, IN CLASS 9 (U.S. CLS. 21, 23, 26, 36 AND 38).

FIRST USE 6-11-2012; IN COMMERCE 6-11-2012.

FOR: MEDICAL DIAGNOSTIC APPARATUS, ANALYTICAL APPARATUS FOR MEDICAL PURPOSES; MEDICAL APPARATUS AND INSTRUMENTS FOR COLLECTING, HANDLING, STORING, PROCESSING, TRANSFUSING, SEPARATING, MIXING, FILTERING, WASHING, CLEANSING AND THERAPEUTICALLY TREATING BLOOD, BLOOD COMPONENTS AND BIOLOGIC FLUIDS; MEDICAL APPARATUS AND INSTRUMENTS FOR MEDICAL APHERESIS; MEDICAL APPARATUS AND INSTRUMENTS FOR PROCESSING AND THERAPEUTICALLY TREATING BONE MARROW; MEDICAL APPARATUS FOR COLLECTING AND CULTURING CELLS FOR THERAPEUTIC BLOOD TREATMENT; MEDICAL APPARATUS AND INSTRUMENTS FOR REDUCING PATHOGENS IN BLOOD AND BLOOD COMPONENTS; IRRADIATORS FOR ILLUMINATING BLOOD PRODUCTS FOR MEDICAL PURPOSES; BLOOD CONTAINERS, BLOOD TUBING SETS, BLOOD COLLECTION BAGS AND BLOOD STORAGE BAGS FOR MEDICAL PURPOSES, IN CLASS 10 (U.S. CLS. 26, 39 AND 44).

FIRST USE 5-4-2012; IN COMMERCE 5-4-2012.



*David J. Kappas*

Director of the United States Patent and Trademark Office

**Reg. No. 4,276,499** THE MARK CONSISTS OF STANDARD CHARACTERS WITHOUT CLAIM TO ANY PARTICULAR FONT, STYLE, SIZE, OR COLOR.

OWNER OF U.S. REG. NOS. 890,553 AND 1,394,681.

THE WORDING "TERUMO" HAS NO MEANING IN A FOREIGN LANGUAGE.

SN 85-331,423, FILED 5-26-2011.

ELI HELLMAN, EXAMINING ATTORNEY

# United States of America

United States Patent and Trademark Office

# HAM IT UP

**Reg. No. 4,276,500**

**Registered Jan. 15, 2013**

**Int. Cl.: 31**

**TRADEMARK**

**PRINCIPAL REGISTER**

SOCIETE DES PRODUITS NESTLE S.A. (SWITZERLAND SOCIÉTÉ ANONYME (SA))  
BRAND IP LEGAL  
CASE POSTALE 353  
VEVEY, SWITZERLAND 1800

FOR: PET FOOD, IN CLASS 31 (U.S. CLS. 1 AND 46).

FIRST USE 4-15-2012; IN COMMERCE 4-15-2012.

THE MARK CONSISTS OF STANDARD CHARACTERS WITHOUT CLAIM TO ANY PARTICULAR FONT, STYLE, SIZE, OR COLOR.

SN 85-332,064, FILED 5-27-2011.

VIVIAN MICZNIK FIRST, EXAMINING ATTORNEY



*David J. Kybas*

Director of the United States Patent and Trademark Office

# United States of America

United States Patent and Trademark Office

## INNOVATORS IN EVIDENCE BASED SOURCING

**Reg. No. 4,276,501**

**Registered Jan. 15, 2013**

**Int. Cl.: 35**

**SERVICE MARK**

**PRINCIPAL REGISTER**

HEALTH INDUSTRY GROUP PURCHASING ASSOCIATION, INC. (D.C. CORPORATION)  
2025 M STREET, SUITE 800  
WASHINGTON, DC 20036

FOR: ASSOCIATION SERVICES, NAMELY, PROMOTING THE INTERESTS OF HEALTHCARE INDUSTRY ORGANIZATIONS BY PROMOTING DIALOG BETWEEN HEALTH INDUSTRY ORGANIZATIONS ENGAGED IN SOURCING, BUYING, CONTRACTING, GROUP PURCHASING AND OTHER INDUSTRY ENTITIES ON THE ISSUES OF MUTUAL INTERESTS IN CONNECTION WITH THE HEALTHCARE SUPPLY CHAIN AND OTHERS; LOBBYING SERVICES, NAMELY, PROMOTING THE INTERESTS OF HEALTHCARE INDUSTRY ORGANIZATIONS BY WORKING COLLABORATIVELY WITH ALL LEGISLATIVE AND REGULATORY AUTHORITIES TO ENSURE FAIR AND EFFICIENT PRACTICES IN AN OPEN AND COMPETITIVE MARKET, IN CLASS 35 (U.S. CLS. 100, 101 AND 102).

FIRST USE 10-0-2011; IN COMMERCE 10-0-2011.

THE MARK CONSISTS OF STANDARD CHARACTERS WITHOUT CLAIM TO ANY PARTICULAR FONT, STYLE, SIZE, OR COLOR.

NO CLAIM IS MADE TO THE EXCLUSIVE RIGHT TO USE "EVIDENCE BASED SOURCING", APART FROM THE MARK AS SHOWN.

SN 85-332,576, FILED 5-27-2011.

SIMON TENG, EXAMINING ATTORNEY



*David J. Kybas*

Director of the United States Patent and Trademark Office

# United States of America

United States Patent and Trademark Office

## THE BIRTH PLACE AT TEXOMA MEDICAL CENTER

**Reg. No. 4,276,502**

**Registered Jan. 15, 2013**

**Int. Cl.: 44**

**SERVICE MARK**

**PRINCIPAL REGISTER**

UHS OF DELAWARE, INC. (DELAWARE CORPORATION)  
367 SOUTH GULPH ROAD  
KING OF PRUSSIA, PA 194060958

FOR: HEALTHCARE; MEDICAL SERVICES, IN CLASS 44 (U.S. CLS. 100 AND 101).

FIRST USE 8-0-2011; IN COMMERCE 8-0-2011.

THE MARK CONSISTS OF STANDARD CHARACTERS WITHOUT CLAIM TO ANY PARTICULAR FONT, STYLE, SIZE, OR COLOR.

SEC. 2(F) AS TO "TEXOMA MEDICAL CENTER".

OWNER OF U.S. REG. NOS. 2,804,443, 3,504,010, AND 3,900,344.

NO CLAIM IS MADE TO THE EXCLUSIVE RIGHT TO USE "BIRTH PLACE" AND "MEDICAL CENTER", APART FROM THE MARK AS SHOWN.

SN 85-333,901, FILED 5-31-2011.

MARGARET POWER, EXAMINING ATTORNEY



*David J. Kyffers*

Director of the United States Patent and Trademark Office

# United States of America

United States Patent and Trademark Office

## Camellia Care

**Reg. No. 4,276,503**

**Registered Jan. 15, 2013**

**Int. Cl.: 3**

**TRADEMARK**

**PRINCIPAL REGISTER**

MADRE LABS, INC. (CALIFORNIA CORPORATION)  
306 W. SIERRA MADRE BLVD.  
SIERRA MADRE, CA 91024

FOR: FACIAL CREAMS, IN CLASS 3 (U.S. CLS. 1, 4, 6, 50, 51 AND 52).

FIRST USE 9-15-2011; IN COMMERCE 9-15-2011.

THE MARK CONSISTS OF STANDARD CHARACTERS WITHOUT CLAIM TO ANY PARTICULAR FONT, STYLE, SIZE, OR COLOR.

NO CLAIM IS MADE TO THE EXCLUSIVE RIGHT TO USE "CAMELLIA", APART FROM THE MARK AS SHOWN.

SN 85-334,333, FILED 5-31-2011.

ANGELA M. MICHELI, EXAMINING ATTORNEY



*David J. Kyffers*

Director of the United States Patent and Trademark Office

# United States of America

United States Patent and Trademark Office

# SXSW ECO

**Reg. No. 4,276,504**

SXSW, INC. (TEXAS CORPORATION)

**Registered Jan. 15, 2013**

P.O. BOX 685289  
AUSTIN, TX 78768

**Int. Cl.: 41**

FOR: EDUCATIONAL AND ENTERTAINMENT SERVICES, NAMELY, CONDUCTING CONFERENCES AND SEMINARS CONCERNING ENVIRONMENTAL ISSUES AND SOLUTIONS, IN CLASS 41 (U.S. CLS. 100, 101 AND 107).

**SERVICE MARK**

FIRST USE 6-22-2011; IN COMMERCE 6-22-2011.

**PRINCIPAL REGISTER**

THE MARK CONSISTS OF STANDARD CHARACTERS WITHOUT CLAIM TO ANY PARTICULAR FONT, STYLE, SIZE, OR COLOR.

OWNER OF U.S. REG. NOS. 2,043,596, 3,773,290, AND OTHERS.

SN 85-335,133, FILED 6-1-2011.

JUSTINE D. PARKER, EXAMINING ATTORNEY



*David J. Kyffers*

Director of the United States Patent and Trademark Office



United States of America  
United States Patent and Trademark Office

# BLAZER

**Reg. No. 4,276,505**

BENVENUE MEDICAL, INC. (DELAWARE CORPORATION)  
3052 BUNKER HILL LANE, SUITE 120  
SANTA CLARA, CA 95054

**Registered Jan. 15, 2013**

**Int. Cl.: 10**

FOR: SURGICAL DEVICES, NAMELY, GUIDEWIRES, SURGICAL EQUIPMENT, NAMELY, NEEDLES, GUIDE PINS, OBTURATORS AND CANNULAS AND SURGICAL ACCESSORIES ALL FOR USE IN SPINAL REPAIR PROCEDURES, IN CLASS 10 (U.S. CLS. 26, 39 AND 44).

**TRADEMARK**

FIRST USE 7-20-2010; IN COMMERCE 7-20-2010.

**PRINCIPAL REGISTER**

THE MARK CONSISTS OF STANDARD CHARACTERS WITHOUT CLAIM TO ANY PARTICULAR FONT, STYLE, SIZE, OR COLOR.

SN 85-335,429, FILED 6-1-2011.

MARIA-VICTORIA SUAREZ, EXAMINING ATTORNEY



*David J. Kyffers*

Director of the United States Patent and Trademark Office

# United States of America

United States Patent and Trademark Office

## WHEREWARE

**Reg. No. 4,276,506**

**Registered Jan. 15, 2013**

**Int. Cls.: 9 and 41**

**TRADEMARK**

**SERVICE MARK**

**PRINCIPAL REGISTER**

BTWXT GAMES INC. (CANADA CORPORATION)  
SUITE 614, 602 W. HASTINGS ST.  
VANCOUVER, BC, CANADA V6B1B1

FOR: VIDEO GAME SOFTWARE; COMPUTER PROGRAMS FOR VIDEO AND COMPUTER GAMES; DOWNLOADABLE VIRTUAL GOODS, NAMELY, VIRTUAL OBJECTS FOR USE IN VIDEO GAMES, AND COMPUTER PROGRAMS FEATURING VIRTUAL OBJECTS FOR USE IN VIDEO GAMES, IN CLASS 9 (U.S. CLS. 21, 23, 26, 36 AND 38).

FIRST USE 9-4-2012; IN COMMERCE 9-4-2012.

FOR: ENTERTAINMENT SERVICES, NAMELY, ADMINISTRATING, TRACKING AND RECORDING VIRTUAL OBJECTS WITHIN ONLINE VIDEO GAMES; ENTERTAINMENT SERVICES, NAMELY, PROVIDING ON-LINE COMPUTER GAMES AND NON-DOWNLOADABLE INTERACTIVE VIDEO GAMES VIA THE INTERNET; ENTERTAINMENT SERVICES, NAMELY, PROVIDING TEMPORARY ONLINE USE OF NON-DOWNLOADABLE ELECTRONIC GAMES, INTERACTIVE GAMES, COMPUTER GAMES AND VIDEO GAMES IN MOBILE WIRELESS FORM, IN CLASS 41 (U.S. CLS. 100, 101 AND 107).

FIRST USE 9-4-2012; IN COMMERCE 9-11-2012.

THE MARK CONSISTS OF STANDARD CHARACTERS WITHOUT CLAIM TO ANY PARTICULAR FONT, STYLE, SIZE, OR COLOR.

SN 85-336,352, FILED 6-2-2011.

MIDGE BUTLER, EXAMINING ATTORNEY



*David J. Kyffers*

Director of the United States Patent and Trademark Office

# United States of America

United States Patent and Trademark Office



**Reg. No. 4,276,507**

**Registered Jan. 15, 2013**

**Int. Cl.: 35**

UNITED SERVICES AUTOMOBILE ASSOCIATION (TEXAS UNINCORPORATED  
RECIPROCAL INTER-INSURANCE EXCHANGE)

USAA TRADEMARK DEPARTMENT  
9800 FREDERICKSBURG RD.  
SAN ANTONIO, TX 78288

**SERVICE MARK**

FOR: PROMOTING PUBLIC AWARENESS OF THE NEED FOR DIVERSITY IN THE WORK  
ENVIRONMENT AND IN BUSINESS, IN CLASS 35 (U.S. CLS. 100, 101 AND 102).

**PRINCIPAL REGISTER**

FIRST USE 7-31-2011; IN COMMERCE 7-31-2011.

OWNER OF U.S. REG. NOS. 2,319,728, 2,423,168, AND OTHERS.

NO CLAIM IS MADE TO THE EXCLUSIVE RIGHT TO USE "DIVERSITY", APART FROM  
THE MARK AS SHOWN.

THE MARK CONSISTS OF A CIRCULAR BORDER AND BANNER SURROUNDING AN  
EAGLE DESIGN AND FACIAL SILHOUETTES, THE WORDING "MANY FACES. ONE  
MISSION" APPEARS IN THE UPPER PORTION OF THE CIRCLE, THE LETTERS "USAA"  
APPEAR BELOW THE EAGLE DESIGN, THE WORDING "DIVERSITY" APPEARS ON THE  
BANNER, AND A FIVE-POINT STAR APPEAR OVER EACH SILHOUETTE.

SN 85-336,455, FILED 6-2-2011.

ALICIA COLLINS, EXAMINING ATTORNEY



*David J. Kybas*

Director of the United States Patent and Trademark Office

# United States of America

United States Patent and Trademark Office

## TRADERSCIRCLE.COM

**Reg. No. 4,276,508**

**Registered Jan. 15, 2013**

**Int. Cl.: 42**

**SERVICE MARK**

**PRINCIPAL REGISTER**

YAKUBOV, ZELMAN (UNITED STATES INDIVIDUAL)  
3003 AVENUE X  
APT. 5F  
BROOKLYN, NY 11235

FOR: COMPUTER SERVICES, NAMELY, CREATING AN ON-LINE COMMUNITY FOR REGISTERED USERS TO IN ENGAGE IN SOCIAL NETWORKING AND PARTICIPATE IN DISCUSSIONS IN THE FIELDS OF FINANCIAL INSTRUMENTS AND TRACKING OF INVESTMENTS, IN CLASS 42 (U.S. CLS. 100 AND 101).

FIRST USE 8-13-2012; IN COMMERCE 8-13-2012.

THE MARK CONSISTS OF STANDARD CHARACTERS WITHOUT CLAIM TO ANY PARTICULAR FONT, STYLE, SIZE, OR COLOR.

SN 85-336,478, FILED 6-2-2011.

DAVID ELTON, EXAMINING ATTORNEY



*David J. Kyffers*

Director of the United States Patent and Trademark Office

# United States of America

United States Patent and Trademark Office

## NOSTALGIA PARK

**Reg. No. 4,276,509**

ARISTACARE, LLC (NEW JERSEY LIMITED LIABILITY COMPANY)  
51 CRAGWOOD ROAD  
SOUTH PLAINFIELD, NJ 07080

**Registered Jan. 15, 2013**

**Int. Cl.: 44**

FOR: HEALTHCARE SERVICES, NAMELY, NURSING HOME SERVICES; PROVIDING LONG TERM CARE FACILITIES; NURSING CARE SERVICES; MEDICAL AND HEALTHCARE SERVICES FOR PERSONS WITH DEMENTIA AND ALZHEIMER'S DISEASE, IN CLASS 44 (U.S. CLS. 100 AND 101).

**SERVICE MARK**

**PRINCIPAL REGISTER**

FIRST USE 2-28-2009; IN COMMERCE 6-23-2009.

THE MARK CONSISTS OF STANDARD CHARACTERS WITHOUT CLAIM TO ANY PARTICULAR FONT, STYLE, SIZE, OR COLOR.

SN 85-337,283, FILED 6-3-2011.

LIEF MARTIN, EXAMINING ATTORNEY



*David J. Kyffers*

Director of the United States Patent and Trademark Office

# United States of America

United States Patent and Trademark Office

## ACES & EIGHTS CORPORATION

**Reg. No. 4,276,510**

**Registered Jan. 15, 2013**

**Int. Cls.: 9 and 42**

**TRADEMARK**

**SERVICE MARK**

**PRINCIPAL REGISTER**

ACES AND EIGHTS CORPORATION (WEST VIRGINIA CORPORATION)  
3000 TECHNOLOGY DRIVE, SUITE 400  
FAIRMONT, WV 26554

FOR: MULTI-MODAL HANDHELD BIOMETRIC COLLECTION, ENROLLMENT AND TRANSMISSION DEVICES FOR DETECTING, COLLECTING AND ENROLLING FINGER PRINTS, FACIAL PHOTOGRAPHS, IRISES, AND/OR VOICES; SOFTWARE FOR USE IN ASSOCIATION WITH THE COLLECTION, VERIFICATION AND PROCESSING OF BIOMETRIC INFORMATION, FORENSIC DATA OR OTHER INTELLIGENCE INFORMATION; SOFTWARE FOR USE IN CONDUCTING AND PROCESSING ANALYTICS AND TECHNICAL EXPLOITATION, IN CLASS 9 (U.S. CLS. 21, 23, 26, 36 AND 38).

FIRST USE 12-15-2011; IN COMMERCE 12-15-2011.

FOR: PRODUCT AND HARDWARE DESIGN AND DEVELOPMENT IN BIOMETRIC COLLECTION AND VERIFICATION, FORENSIC COLLECTION AND ANALYSIS, INTELLIGENCE, AND TECHNICAL EXPLOITATION; CLOUD COMPUTING FEATURING SOFTWARE FOR USE IN ASSOCIATION WITH THE COLLECTION, VERIFICATION AND PROCESSING OF BIOMETRIC INFORMATION, FORENSIC DATA OR OTHER INTELLIGENCE INFORMATION, AND SOFTWARE FOR USE IN CONDUCTING AND PROCESSING ANALYTICS AND TECHNICAL EXPLOITATION; SOFTWARE DEVELOPMENT FOR OTHERS FOR USE IN ASSOCIATION WITH THE COLLECTION, VERIFICATION AND PROCESSING OF BIOMETRICS INFORMATION, FORENSIC DATA, OR OTHER INTELLIGENCE INFORMATION; SOFTWARE DEVELOPMENT FOR OTHERS FOR USE IN ASSOCIATION WITH CONDUCTING AND PROCESSING ANALYTICS AND TECHNICAL EXPLOITATION, IN CLASS 42 (U.S. CLS. 100 AND 101).

FIRST USE 5-17-2011; IN COMMERCE 5-17-2011.

THE MARK CONSISTS OF STANDARD CHARACTERS WITHOUT CLAIM TO ANY PARTICULAR FONT, STYLE, SIZE, OR COLOR.

NO CLAIM IS MADE TO THE EXCLUSIVE RIGHT TO USE "CORPORATION", APART FROM THE MARK AS SHOWN.

SN 85-337,597, FILED 6-3-2011.



*David J. Kyffers*

Director of the United States Patent and Trademark Office

**Reg. No. 4,276,510** KATHLEEN LORENZO, EXAMINING ATTORNEY

# United States of America

United States Patent and Trademark Office

## Glamsterbands

**Reg. No. 4,276,511**

**Registered Jan. 15, 2013**

**Int. Cl.: 14**

**TRADEMARK**

**PRINCIPAL REGISTER**

SHELLEY AND ELIOT, LLC (FLORIDA LIMITED LIABILITY COMPANY)  
279 W. KEY PALM ROAD  
BOCA RATON, FL 33432

FOR: BANGLE BRACELETS; BRACELETS; BRACELETS MADE OF RUBBER, PLASTIC, LEATHER, SEMI-PRECIOUS METALS, OR STEEL; CHARITY BRACELETS; CHARMS; CHARMS FOR COLLAR JEWELRY AND BRACELET; IDENTIFICATION BRACELETS; PLASTIC BRACELETS IN THE NATURE OF JEWELRY; RUBBER OR SILICON WRISTBANDS IN THE NATURE OF A BRACELET, IN CLASS 14 (U.S. CLS. 2, 27, 28 AND 50).

FIRST USE 7-21-2012; IN COMMERCE 7-21-2012.

THE MARK CONSISTS OF STANDARD CHARACTERS WITHOUT CLAIM TO ANY PARTICULAR FONT, STYLE, SIZE, OR COLOR.

SN 85-337,877, FILED 6-3-2011.

CHRISTINA SOBRAL, EXAMINING ATTORNEY



*David J. Kyffers*

Director of the United States Patent and Trademark Office



# United States of America

United States Patent and Trademark Office

The logo for InsuraSphere features the word "Insura" in a standard sans-serif font, followed by "Sphere" in a larger, bold sans-serif font. Above the letter "S" in "Sphere" is a stylized globe icon composed of horizontal lines with arrows pointing to the right.

**Reg. No. 4,276,512**

INSURANCE DATA PROCESSING, INC. (PENNSYLVANIA CORPORATION)  
8101 WASHINGTON LANE  
SYNCOTE, PA 19095

**Registered Jan. 15, 2013**

**Int. Cls.: 36 and 42**

FOR: PROVIDING A WEB SITE FEATURING A PORTAL AND NON-DOWNLOADABLE SOFTWARE FOR USE BY INSURANCE CARRIERS IN PROVIDING DATA MANAGEMENT FOR INSURANCE AGENCIES AND MANAGING GENERAL AGENTS, IN CLASS 36 (U.S. CLS. 100, 101 AND 102).

**SERVICE MARK**

**PRINCIPAL REGISTER**

FIRST USE 10-29-2012; IN COMMERCE 10-29-2012.

FOR: SOFTWARE AS A SERVICE (SAAS) SERVICES FOR INSURANCE CARRIERS, MANAGING GENERAL AGENTS AND INSURANCE AGENTS, NAMELY, HOSTING SOFTWARE FOR USE BY OTHERS FOR DATABASE MANAGEMENT, DOCUMENT MANAGEMENT, INSURANCE POLICY ADMINISTRATION, INSURANCE CLAIMS PROCESSING AND SERVICES, INSURANCE POLICY BILLING, ACCOUNTING AND PAYMENT FUNCTIONS, CUSTOMER RELATIONSHIP MANAGEMENT AND CUSTOMER COMMUNICATIONS; COMPUTER SERVICES, NAMELY, CREATING AND MAINTAINING WEB SITES FOR OTHERS; COMPUTER TECHNICAL SUPPORT SERVICES, NAMELY, 24/7 SERVICE DESK/HELP DESK SERVICES FOR IT INFRASTRUCTURE, OPERATING SYSTEMS, DATABASE SYSTEMS, AND WEB APPLICATIONS, IN CLASS 42 (U.S. CLS. 100 AND 101).

FIRST USE 10-29-2012; IN COMMERCE 10-29-2012.

THE MARK CONSISTS OF THE WORD "INSURASPHERE" WITH A PARTIAL GLOBE ON TOP OF THE WORD, CONSISTING OF LINES WITH ARROWS.

SN 85-339,012, FILED 6-6-2011.

JOHN WILKE, EXAMINING ATTORNEY



*David J. Kypos*

Director of the United States Patent and Trademark Office

# United States of America

United States Patent and Trademark Office

## INSURASPHERE

**Reg. No. 4,276,513**

**Registered Jan. 15, 2013**

**Int. Cls.: 36 and 42**

**SERVICE MARK**

**PRINCIPAL REGISTER**

INSURANCE DATA PROCESSING, INC. (PENNSYLVANIA CORPORATION)  
8101 WASHINGTON LANE  
WYNCOTE, PA 19095

FOR: PROVIDING A WEB SITE FEATURING A PORTAL AND NON-DOWNLOADABLE SOFTWARE FOR USE BY INSURANCE CARRIERS IN PROVIDING DATA MANAGEMENT FOR INSURANCE AGENCIES AND MANAGING GENERAL AGENTS, IN CLASS 36 (U.S. CLS. 100, 101 AND 102).

FIRST USE 10-29-2012; IN COMMERCE 10-29-2012.

FOR: SOFTWARE AS A SERVICE (SAAS) SERVICES FOR INSURANCE CARRIERS, MANAGING GENERAL AGENTS AND INSURANCE AGENTS, NAMELY, HOSTING SOFTWARE FOR USE BY OTHERS FOR DATABASE MANAGEMENT, DOCUMENT MANAGEMENT, INSURANCE POLICY ADMINISTRATION, INSURANCE CLAIMS PROCESSING AND SERVICES, INSURANCE POLICY BILLING, ACCOUNTING AND PAYMENT FUNCTIONS, CUSTOMER RELATIONSHIP MANAGEMENT AND CUSTOMER COMMUNICATIONS; COMPUTER SERVICES, NAMELY, CREATING AND MAINTAINING WEB SITES FOR OTHERS; COMPUTER TECHNICAL SUPPORT SERVICES, NAMELY, 24/7 SERVICE DESK/HELP DESK SERVICES FOR IT INFRASTRUCTURE, OPERATING SYSTEMS, DATABASE SYSTEMS, AND WEB APPLICATIONS, IN CLASS 42 (U.S. CLS. 100 AND 101).

FIRST USE 10-29-2012; IN COMMERCE 10-29-2012.

THE MARK CONSISTS OF STANDARD CHARACTERS WITHOUT CLAIM TO ANY PARTICULAR FONT, STYLE, SIZE, OR COLOR.

SN 85-339,053, FILED 6-6-2011.

JOHN WILKE, EXAMINING ATTORNEY



*David J. Kypos*

Director of the United States Patent and Trademark Office

# United States of America

United States Patent and Trademark Office



**Reg. No. 4,276,514**

**Registered Jan. 15, 2013**

**Int. Cls.: 35 and 41**

**SERVICE MARK**

**PRINCIPAL REGISTER**

BNP MEDIA II, LLC (MICHIGAN LIMITED LIABILITY COMPANY)  
SUITE 700  
2401 W. BIG BEAVER RD.  
TROY, MI 48084

FOR: ARRANGING AND CONDUCTING ONLINE TRADESHOW EXHIBITIONS IN THE FIELD OF SUSTAINABLE BUILDING, IN CLASS 35 (U.S. CLS. 100, 101 AND 102).

FIRST USE 9-1-2010; IN COMMERCE 8-4-2011.

FOR: EDUCATION SERVICES, NAMELY, PROVIDING ONLINE CONFERENCES AND WEBINARS IN THE FIELD OF SUSTAINABLE BUILDING, IN CLASS 41 (U.S. CLS. 100, 101 AND 107).

FIRST USE 9-1-2010; IN COMMERCE 8-4-2011.

NO CLAIM IS MADE TO THE EXCLUSIVE RIGHT TO USE "VIRTUAL GREEN EXPO", APART FROM THE MARK AS SHOWN.

THE MARK CONSISTS OF THE WORD "VIRTUAL" DISPOSED HORIZONTALLY ON A FIRST LINE, THE WORD "GREEN" IN A STYLIZED FONT DISPOSED HORIZONTALLY ON A SECOND LINE BELOW THE FIRST LINE, AND WHEREIN THE WORDS "VIRTUAL" AND "GREEN" ARE SLIGHTLY OFFSET FROM EACH OTHER AND THE WORD "VIRTUAL" SLIGHTLY OVERLAPS THE TOP PORTION OF THE WORD "GREEN". THE MARK FURTHER CONSISTS OF THE WORD "EXPO" DISPOSED VERTICALLY AT THE END OF THE WORD "GREEN", AND AN ILLUSTRATION OF A GLOBE DISPOSED IN THE BACKGROUND BEHIND A PORTION OF THE WORD "GREEN".

SN 85-339,589, FILED 6-7-2011.

WILLIAM VERHOSEK, EXAMINING ATTORNEY



*David J. Kyjars*

Director of the United States Patent and Trademark Office

# United States of America

United States Patent and Trademark Office

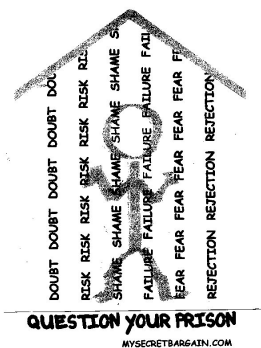

**Reg. No. 4,276,515**

**Registered Jan. 15, 2013**

**Int. Cl.: 45**

**SERVICE MARK**

**PRINCIPAL REGISTER**

MILLER, JOYCE (UNITED STATES INDIVIDUAL)  
6742 NEWBURG ROAD  
ROCKFORD, IL 61108 AND

MILLER, CRAIG (UNITED STATES INDIVIDUAL)  
6742 NEWBURG ROAD  
ROCKFORD, IL 61108

FOR: PROVIDING ON-LINE INFORMATION IN THE FIELD OF SPIRITUALITY, SELF-HELP, AND PERSONAL EMPOWERMENT SUBJECT MATTERS, IN CLASS 45 (U.S. CLS. 100 AND 101).

FIRST USE 11-28-2012; IN COMMERCE 11-28-2012.

THE STIPLING IS FOR SHADING PURPOSES ONLY.

THE MARK CONSISTS OF A STICK FIGURE PERSON BEHIND BARS TOPPED WITH A ROOF. THE BARS ARE MADE OUT OF THE STYLIZED TEXT "DOUBT RISK SHAME FAILURE FEAR REJECTION". BELOW THE HORIZONTAL LINE THAT APPEARS BENEATH THE BARS IS THE STYLIZED TEXT "QUESTION YOUR PRISON" AND BELOW THAT IS THE WORDING "MYSECRETBARGAIN.COM."

SN 85-340,486, FILED 6-7-2011.

ELLEN BURNS, EXAMINING ATTORNEY



*David J. Kybas*

Director of the United States Patent and Trademark Office

# United States of America

United States Patent and Trademark Office

# CRUZER FIT

**Reg. No. 4,276,516**

**Registered Jan. 15, 2013**

**Int. Cl.: 9**

**TRADEMARK**

**PRINCIPAL REGISTER**

SANDISK CORPORATION (DELAWARE CORPORATION)  
601 MCCARTHY BOULEVARD  
MILPITAS, CA 95035

FOR: BLANK USB FLASH DRIVES; PRE-RECORDED USB FLASH DRIVES FEATURING SOFTWARE FOR SECURITY AND ENCRYPTION OF DATA; EXTERNAL COMPUTER HARD DRIVE WITH A USB CONNECTION, IN CLASS 9 (U.S. CLS. 21, 23, 26, 36 AND 38).

FIRST USE 2-0-2010; IN COMMERCE 2-0-2010.

THE MARK CONSISTS OF STANDARD CHARACTERS WITHOUT CLAIM TO ANY PARTICULAR FONT, STYLE, SIZE, OR COLOR.

OWNER OF U.S. REG. NOS. 2,754,118, 3,104,782, AND OTHERS.

SN 85-341,074, FILED 6-8-2011.

MAYUR VAGHANI, EXAMINING ATTORNEY



*David J. Kybas*

Director of the United States Patent and Trademark Office

# United States of America

United States Patent and Trademark Office

## COMPLETE SHEET

**Reg. No. 4,276,517**

SKIP HOP, INC. (NEW YORK CORPORATION)  
50 WEST 23RD ST., 10TH FLOOR  
NEW YORK, NY 10010

**Registered Jan. 15, 2013**

**Int. Cl.: 24**

FOR: INFANT AND TODDLER BEDDING, NAMELY, BLANKETS, CRIB BUMPERS, SHEETS, DUVETS, COMFORTERS, IN CLASS 24 (U.S. CLS. 42 AND 50).

**TRADEMARK**

FIRST USE 10-1-2011; IN COMMERCE 10-1-2011.

**PRINCIPAL REGISTER**

THE MARK CONSISTS OF STANDARD CHARACTERS WITHOUT CLAIM TO ANY PARTICULAR FONT, STYLE, SIZE, OR COLOR.

NO CLAIM IS MADE TO THE EXCLUSIVE RIGHT TO USE "SHEET", APART FROM THE MARK AS SHOWN.

SN 85-343,092, FILED 6-10-2011.

JENNIFER MARTIN, EXAMINING ATTORNEY



*David J. Kybas*

Director of the United States Patent and Trademark Office

# United States of America

United States Patent and Trademark Office

LIVE CONNECTED. LIVE WELL.

**Reg. No. 4,276,518**

**Registered Jan. 15, 2013**

**Int. Cls.: 35 and 36**

**SERVICE MARK**

**PRINCIPAL REGISTER**

BOZEMAN DEACONESS REAL ESTATE DEVELOPMENT CORP. (MONTANA CORPORATION)  
915 HIGHLAND BLVD.  
BOZEMAN, MT 59715

FOR: REAL ESTATE SALES MANAGEMENT, IN CLASS 35 (U.S. CLS. 100, 101 AND 102).

FIRST USE 1-31-2012; IN COMMERCE 1-31-2012.

FOR: REAL ESTATE SERVICES, NAMELY, PROPERTY MANAGEMENT, IN CLASS 36 (U.S. CLS. 100, 101 AND 102).

FIRST USE 1-31-2012; IN COMMERCE 1-31-2012.

THE MARK CONSISTS OF STANDARD CHARACTERS WITHOUT CLAIM TO ANY PARTICULAR FONT, STYLE, SIZE, OR COLOR.

SN 85-343,463, FILED 6-10-2011.

PRISCILLA MILTON, EXAMINING ATTORNEY



*David J. Kybas*

Director of the United States Patent and Trademark Office

# United States of America

United States Patent and Trademark Office

# CKLASS

**Reg. No. 4,276,519**

**Registered Jan. 15, 2013**

**Int. Cl.: 18**

**TRADEMARK**

**PRINCIPAL REGISTER**

MUÑOZ WATANABE, ENRIQUE GUILLERMO (MEXICO INDIVIDUAL)  
646 H STREET  
CHULA VISTA, CA 91910

FOR: ALL PURPOSE SPORT BAGS; ALL-PURPOSE ATHLETIC BAGS; ALL-PURPOSE CARRYING BAGS; AMENITY BAGS SOLD EMPTY; ANIMAL SKINS AND HIDES; BACK-PACKS, BOOK BAGS, SPORTS BAGS, BUM BAGS, WALLETS AND HANDBAGS; HARNESSES AND SADDLERY; LEATHER AND IMITATION LEATHER; LEATHER BAGS, SUITCASES AND WALLETS; PARASOLS; UMBRELLAS AND PARASOLS; WHIPS, IN CLASS 18 (U.S. CLS. 1, 2, 3, 22 AND 41).

FIRST USE 11-14-2012; IN COMMERCE 11-14-2012.

THE MARK CONSISTS OF STANDARD CHARACTERS WITHOUT CLAIM TO ANY PARTICULAR FONT, STYLE, SIZE, OR COLOR.

OWNER OF U.S. REG. NO. 2,926,989.

SN 85-343,760, FILED 6-10-2011.

BARBARA BROWN, EXAMINING ATTORNEY



*David J. Kyffers*

Director of the United States Patent and Trademark Office



# United States of America

United States Patent and Trademark Office

# CKLASS

**Reg. No. 4,276,520**

**Registered Jan. 15, 2013**

**Int. Cl.: 33**

**TRADEMARK**

**PRINCIPAL REGISTER**

MUÑOZ WATANABE, ENRIQUE GUILLERMO (MEXICO INDIVIDUAL)  
646 H STREET  
CHULA VISTA, CA 91910

FOR: ALCOHOLIC BEVERAGES EXCEPT BEERS; SPIRITS, IN CLASS 33 (U.S. CLS. 47 AND 49).

FIRST USE 11-14-2012; IN COMMERCE 11-14-2012.

THE MARK CONSISTS OF STANDARD CHARACTERS WITHOUT CLAIM TO ANY PARTICULAR FONT, STYLE, SIZE, OR COLOR.

OWNER OF U.S. REG. NO. 2,926,989.

SN 85-343,770, FILED 6-10-2011.

BARBARA BROWN, EXAMINING ATTORNEY



*David J. Kybas*

Director of the United States Patent and Trademark Office

# United States of America

United States Patent and Trademark Office

## PORTION PAL

**Reg. No. 4,276,521**

FUNDAMETAL DESIGNS INC. (CANADA CORPORATION)

**Registered Jan. 15, 2013**

215 - 1515 BROADWAY STREET  
PORT COQUITLAM, BC, CANADA V3C6M2

**Int. Cl.: 21**

FOR: HAND-OPERATED PUMP DISPENSERS THAT DISPENSE PRESET PORTIONS OF  
CONDIMENTS, PASTES, CREAMS AND GELS, FOR USE IN COMMERCIAL FOOD PRE-  
PARATION AND NOT FOR MEDICAL USE OR FOR USE IN DIETING, IN CLASS 21 (U.S.  
CLS. 2, 13, 23, 29, 30, 33, 40 AND 50).

**TRADEMARK**

**PRINCIPAL REGISTER**

FIRST USE 7-5-2011; IN COMMERCE 7-5-2011.

THE MARK CONSISTS OF STANDARD CHARACTERS WITHOUT CLAIM TO ANY PAR-  
TICULAR FONT, STYLE, SIZE, OR COLOR.

NO CLAIM IS MADE TO THE EXCLUSIVE RIGHT TO USE "PORTION", APART FROM  
THE MARK AS SHOWN.

SN 85-345,768, FILED 6-14-2011.

KATHLEEN M. VANSTON, EXAMINING ATTORNEY



*David J. Kybas*

Director of the United States Patent and Trademark Office

# United States of America

United States Patent and Trademark Office

## Bayside Breast Aug

**Reg. No. 4,276,522**

**Registered Jan. 15, 2013**

**Int. Cl.: 44**

**SERVICE MARK**

**PRINCIPAL REGISTER**

NICCOLE, DEVON (UNITED STATES INDIVIDUAL)  
1116 PACIFIC COAST HIGHWAY  
HUNTINGTON BEACH, CA 92625

FOR: COSMETIC AND PLASTIC SURGERY, IN CLASS 44 (U.S. CLS. 100 AND 101).

FIRST USE 11-29-2011; IN COMMERCE 11-29-2011.

THE MARK CONSISTS OF STANDARD CHARACTERS WITHOUT CLAIM TO ANY PARTICULAR FONT, STYLE, SIZE, OR COLOR.

NO CLAIM IS MADE TO THE EXCLUSIVE RIGHT TO USE "BREAST AUG", APART FROM THE MARK AS SHOWN.

SN 85-346,266, FILED 6-14-2011.

KARANENDRA S. CHHINA, EXAMINING ATTORNEY



*David J. Kyffers*

Director of the United States Patent and Trademark Office

# United States of America

United States Patent and Trademark Office



**Reg. No. 4,276,523**

**Registered Jan. 15, 2013**

**Int. Cl.: 41**

**SERVICE MARK**

**PRINCIPAL REGISTER**

HAROLD R CULLER JR (UNITED STATES INDIVIDUAL), AKA DWAYNE READE,  
417 MORGAN AVE. SUITE 6F  
BROOKLYN, NY 11211

FOR: ENTERTAINMENT IN THE NATURE OF VISUAL AND AUDIO PERFORMANCES, NAMELY, MUSICAL BAND, ROCK GROUP, GYMNASTIC, DANCE, AND BALLET PERFORMANCES; ENTERTAINMENT SERVICES IN THE NATURE OF LIVE MUSICAL PERFORMANCES; ENTERTAINMENT SERVICES IN THE NATURE OF PRESENTING LIVE MUSICAL PERFORMANCES; ENTERTAINMENT SERVICES IN THE NATURE OF RECORDING, PRODUCTION AND POST-PRODUCTION SERVICES IN THE FIELD OF MUSIC; ENTERTAINMENT SERVICES, NAMELY, PROVIDING NON-DOWNLOADABLE PLAYBACK OF MUSIC VIA GLOBAL COMMUNICATIONS NETWORKS; ENTERTAINMENT, NAMELY, LIVE MUSIC CONCERTS; HOSTING A BACK TO SCHOOL EVENT IN A SHOPPING CENTER FEATURING PRIZES, GAMES, MUSIC, AND A FASHION SHOW; LIVE PERFORMANCES BY A MUSICAL GROUP; MULTIMEDIA ENTERTAINMENT SERVICES IN THE NATURE OF RECORDING, PRODUCTION AND POST-PRODUCTION SERVICES IN THE FIELDS OF MUSIC, VIDEO, AND FILMS; MUSIC COMPOSITION FOR OTHERS; MUSIC PRODUCTION SERVICES; MUSIC PUBLISHING SERVICES; MUSIC SELECTION SERVICES FOR USE IN TELEVISION, FILM, RADIO AND VIDEO GAMES; MUSIC VIDEO PRODUCTION; MUSICAL EVENT BOOKING AGENCIES; ORGANIZATION OF EXHIBITIONS FOR MUSICAL ENTERTAINMENT; PLANNING ARRANGEMENT OF SHOWING MOVIES, SHOWS, PLAYS OR MUSICAL PERFORMANCES; POEM AND LYRIC WRITING; PRESENTATION OF MUSICAL PERFORMANCE; PRODUCTION OF MUSICAL SOUND RECORDING; SONG WRITING SERVICES; WRITING OF TEXTS; WRITING OF TEXTS OTHER THAN PUBLICITY TEXTS, IN CLASS 41 (U.S. CLS. 100, 101 AND 107).

FIRST USE 5-13-2011; IN COMMERCE 5-13-2011.

HAROLD R CULLER JR CONSENTS TO REGISTRATION OF HIS PSEUDONYM D'WAYNE READE.

THE COLOR(S) BLUE, RED, BLACK, WHITE, YELLOW AND GRAY IS/ARE CLAIMED AS A FEATURE OF THE MARK.

THE MARK CONSISTS OF THE WORDING "D'WAYNE READE" WITH THE "W" IN "D'WAYNE" CONSISTING OF A WHITE STRAIGHT JACKET WITH YELLOW FEATURES, "R" IN "READE" CONSISTING OF A PHARMACEUTICAL "RX" SYMBOL, THE FIRST "E"



*David J. Kyjars*

Director of the United States Patent and Trademark Office

**Reg. No. 4,276,523** AND "A" IN "READE" CONSISTING OF TWO PILLS, AND THE "D" IN "READE" CONSISTING OF A RESEMBLANCE OF A BB NOTE IN MUSICAL TERMS. THE "DAYNE" IN "D'WAYNE" IS BLUE WITH A RED AND BLACK OUTLINE AND A GRAYISH SHADOW, "RX" AND "DE" IN "READE" ARE RED WITH A BLUE AND BLACK OUTLINE AND A GRAYISH SHADOW, THE "E" DESIGN IN "READE" IS BLUE WITH A BLACK OUTLINE, AND THE "A" DESIGN IN "READE" IS RED WITH A BLACK OUTLINE. THERE IS A BLACK VINYL RECORD IN BETWEEN "D'WAYNE" & "READE" THAT CONTAINS ALTERNATING GRAYISH AREAS AND A GRAY CENTER. THE CENTER CONTAINS THE BLUE WORDING "PUSH DOWN & TURN", "TO OPEN", AND "CLOSE TIGHTLY" WITHIN A YELLOW ARROW-BASED DESIGN. THE BACKGROUND IS WHITE WITH A GRAY DESIGN.

SN 85-346,346, FILED 6-14-2011.

KARANENDRA S. CHHINA, EXAMINING ATTORNEY

# United States of America

United States Patent and Trademark Office

# Evolved

**Reg. No. 4,276,524**

ASSAR, RAED (UNITED STATES INDIVIDUAL)  
1923 EASTERN DRIVE  
JACKSONVILLE BEACH, FL 32250

**Registered Jan. 15, 2013**

**Int. Cl.: 9**

FOR: MOTION PICTURE FILMS ABOUT SCIENCE FICTION, IN CLASS 9 (U.S. CLS. 21, 23, 26, 36 AND 38).

**TRADEMARK**

FIRST USE 1-8-2012; IN COMMERCE 1-8-2012.

**PRINCIPAL REGISTER**

THE MARK CONSISTS OF STANDARD CHARACTERS WITHOUT CLAIM TO ANY PARTICULAR FONT, STYLE, SIZE, OR COLOR.

SN 85-346,544, FILED 6-15-2011.

NATALIE POLZER, EXAMINING ATTORNEY



*David J. Kybas*

Director of the United States Patent and Trademark Office

# United States of America

United States Patent and Trademark Office

# Drip-N-Gro

**Reg. No. 4,276,525**

IP HOLDINGS LLC (WASHINGTON LIMITED LIABILITY COMPANY)  
5408 NE 88TH ST. #A-101  
VANCOUVER, WA 98665

**Registered Jan. 15, 2013**

**Int. Cl.: 21**

FOR: HORTICULTURAL, PLASTIC BUCKETS HANGING FROM FREE STANDING PLATFORM INCORPORATING A MICRO-DRIP IRRIGATION SYSTEM FOR USE IN GROWING ANY TYPE OF VEGETABLE, PLANT OR SHRUB, IN CLASS 21 (U.S. CLS. 2, 13, 23, 29, 30, 33, 40 AND 50).

**TRADEMARK**

**PRINCIPAL REGISTER**

FIRST USE 10-31-2012; IN COMMERCE 10-31-2012.

THE MARK CONSISTS OF STANDARD CHARACTERS WITHOUT CLAIM TO ANY PARTICULAR FONT, STYLE, SIZE, OR COLOR.

SN 85-346,845, FILED 6-15-2011.

ELIZABETH KAJUBI, EXAMINING ATTORNEY



*David J. Kyffers*

Director of the United States Patent and Trademark Office

# United States of America

United States Patent and Trademark Office

## MILL CREEK CAPITAL

**Reg. No. 4,276,526**

**Registered Jan. 15, 2013**

**Int. Cl.: 36**

**SERVICE MARK**

**PRINCIPAL REGISTER**

MILL CREEK CAPITAL ADVISORS, LLC (DELAWARE LIMITED LIABILITY COMPANY)  
EIGHT TOWER BRIDGE  
161 WASHINGTON STREET, SUITE 1500  
CONSHOHOCKEN, PA 19428

FOR: FINANCIAL SERVICES, NAMELY, FUNDS INVESTMENT; INVESTMENT OF FUNDS FOR OTHERS; INVESTMENT SERVICES, NAMELY, ASSET ACQUISITION, CONSULTATION, DEVELOPMENT AND MANAGEMENT SERVICES; FINANCIAL SERVICES, NAMELY, THE MANAGEMENT AND ADMINISTRATION OF INVESTMENT FUNDS; FINANCIAL INVESTMENT SERVICES, NAMELY, SECURITIES INVESTMENT; FINANCIAL ADVISORY SERVICES; FINANCIAL ADMINISTRATION SERVICES IN THE FIELD OF INVESTMENT FUNDS; FINANCIAL PLANNING FOR FINANCIAL ASSET ALLOCATION; FINANCIAL MANAGEMENT SERVICES; FINANCIAL ANALYSIS SERVICES; FINANCIAL RESEARCH SERVICES; PROVIDING FINANCIAL SERVICES WITH RESPECT TO SECURITIES AND OTHER FINANCIAL INSTRUMENTS AND PRODUCTS, NAMELY, MONEY MANAGEMENT SERVICES; FINANCIAL SERVICES, NAMELY, INVESTMENT ADVICE, INVESTMENT MANAGEMENT, INVESTMENT CONSULTATION AND INVESTMENT OF FUNDS FOR OTHERS; PROVIDING INFORMATION AND RESEARCH IN THE FIELD OF FINANCE AND FINANCIAL INVESTMENTS; CAPITAL INVESTMENT CONSULTING SERVICES; PROVIDING ADVICE RELATED TO INVESTMENTS, IN CLASS 36 (U.S. CLS. 100, 101 AND 102).

FIRST USE 11-29-2012; IN COMMERCE 11-29-2012.

THE MARK CONSISTS OF STANDARD CHARACTERS WITHOUT CLAIM TO ANY PARTICULAR FONT, STYLE, SIZE, OR COLOR.

NO CLAIM IS MADE TO THE EXCLUSIVE RIGHT TO USE "CAPITAL", APART FROM THE MARK AS SHOWN.

SN 85-347,241, FILED 6-15-2011.

JENNIFER BUTTON, EXAMINING ATTORNEY



*David J. Kyffers*

Director of the United States Patent and Trademark Office



# United States of America

United States Patent and Trademark Office

# OPTIFILL

**Reg. No. 4,276,527**

**Registered Jan. 15, 2013**

**Int. Cl.: 35**

**SERVICE MARK**

**PRINCIPAL REGISTER**

ASHLAND LICENSING AND INTELLECTUAL PROPERTY LLC (DELAWARE LIMITED LIABILITY COMPANY)  
5200 BLAZER PARKWAY  
DUBLIN, OH 43017

FOR: MARKETING SERVICES, NAMELY, CHEMICAL MARKETING FOR THE PAPER MANUFACTURING INDUSTRY; MARKETING SERVICES, NAMELY, MARKETING TO CONVEY THE BENEFITS OF A MULTI-CHEMICAL PRODUCT APPROACH TO PROVIDING HIGHER FILLER CAPABILITIES TO THE PAPER MANUFACTURING INDUSTRY, IN CLASS 35 (U.S. CLS. 100, 101 AND 102).

FIRST USE 4-20-2012; IN COMMERCE 4-20-2012.

THE MARK CONSISTS OF STANDARD CHARACTERS WITHOUT CLAIM TO ANY PARTICULAR FONT, STYLE, SIZE, OR COLOR.

SN 85-347,694, FILED 6-16-2011.

REBECCA SMITH, EXAMINING ATTORNEY



*David J. Kyffers*

Director of the United States Patent and Trademark Office

# United States of America

United States Patent and Trademark Office

## LOBSTER MAINE-IA

**Reg. No. 4,276,528**

LB BRANDS, LLC (MAINE LIMITED LIABILITY COMPANY)  
PO BOX 239  
PORT CLYDE, ME 04855

**Registered Jan. 15, 2013**

**Int. Cl.: 30**

FOR: ICE CREAM, IN CLASS 30 (U.S. CL. 46).

**TRADEMARK**

FIRST USE 7-31-2011; IN COMMERCE 7-31-2011.

**PRINCIPAL REGISTER**

THE MARK CONSISTS OF STANDARD CHARACTERS WITHOUT CLAIM TO ANY PARTICULAR FONT, STYLE, SIZE, OR COLOR.

NO CLAIM IS MADE TO THE EXCLUSIVE RIGHT TO USE "LOBSTER", APART FROM THE MARK AS SHOWN.

SN 85-348,704, FILED 6-17-2011.

THOMAS MANOR, EXAMINING ATTORNEY



*David J. Kyffers*

Director of the United States Patent and Trademark Office

# United States of America

United States Patent and Trademark Office

# XO EC

**Reg. No. 4,276,529**

**Registered Jan. 15, 2013**

**Int. Cl.: 14**

**TRADEMARK**

**PRINCIPAL REGISTER**

ERICA COURTNEY, INC. (CALIFORNIA CORPORATION)  
7465 BEVERLY BLVD.  
LOS ANGELES, CA 90036

FOR: JEWELRY, IN CLASS 14 (U.S. CLS. 2, 27, 28 AND 50).

FIRST USE 7-8-2011; IN COMMERCE 7-8-2011.

THE MARK CONSISTS OF STANDARD CHARACTERS WITHOUT CLAIM TO ANY PARTICULAR FONT, STYLE, SIZE, OR COLOR.

SN 85-348,938, FILED 6-17-2011.

MAUREEN DALL, EXAMINING ATTORNEY



*David J. Kyffers*

Director of the United States Patent and Trademark Office

# United States of America

United States Patent and Trademark Office



**ENHANCED**  
OILFIELD TECHNOLOGIES

**Reg. No. 4,276,530**

**Registered Jan. 15, 2013**

**Int. Cl.: 7**

**TRADEMARK**

**PRINCIPAL REGISTER**

KEY ENERGY SERVICES, LLC (TEXAS LIMITED LIABILITY COMPANY)  
1301 MCKINNEY STREET - SUITE 1800  
HOUSTON, TX 770103057

FOR: POWER-OPERATED DOWNHOLE AND SURFACE TOOLS AND EQUIPMENT USED IN THE DRILLING, COMPLETION, AND WORKOVER OF OIL AND GAS WELLS, NAMELY, PRESSURE ISOLATION PACKERS, ANCHORING TOOLS FOR THE PERMANENT OR TEMPORARY INSTALLATION OF TUBULARS AND CASINGS, AND DEPLOYMENT TOOLS FOR THE DEPLOYMENT AND SUBSEQUENT PERMANENT OR TEMPORARY INSTALLATION OF TUBULARS, CASINGS, AND PRESSURE ISOLATION PACKERS IN WELLBORES, IN CLASS 7 (U.S. CLS. 13, 19, 21, 23, 31, 34 AND 35).

FIRST USE 8-0-2012; IN COMMERCE 9-0-2012.

NO CLAIM IS MADE TO THE EXCLUSIVE RIGHT TO USE "ENHANCED OILFIELD TECHNOLOGIES", APART FROM THE MARK AS SHOWN.

THE MARK CONSISTS OF THE WORDS "ENHANCED OILFIELD TECHNOLOGIES" IN CONJUNCTION WITH A DIAMOND DESIGN. THE DIAMOND DESIGN INCLUDES NINE SMALLER, CLOSELY SPACED SOLID DIAMONDS WHICH DEFINE THE OVERALL DIAMOND SHAPE OF THE DESIGN. THE INTERIOR SMALLER DIAMOND IS SPLIT INTO TWO TRIANGLES.

SN 85-349,590, FILED 6-17-2011.

STEVEN JACKSON, EXAMINING ATTORNEY



*David J. Kybas*

Director of the United States Patent and Trademark Office

# United States of America

United States Patent and Trademark Office

# BIOCAL-PET

**Reg. No. 4,276,531**

BIOCALTH INTERNATIONAL, INC. (DELAWARE CORPORATION)  
1871 WRIGHT AVENUE  
LA VERNE, CA 91750

**Registered Jan. 15, 2013**

**Int. Cl.: 5**

FOR: CALCIUM SUPPLEMENTS FOR DOGS, CATS, HORSES, FISH AND REPTILES, IN CLASS 5 (U.S. CLS. 6, 18, 44, 46, 51 AND 52).

**TRADEMARK**

FIRST USE 12-2-2011; IN COMMERCE 12-2-2011.

**PRINCIPAL REGISTER**

THE MARK CONSISTS OF STANDARD CHARACTERS WITHOUT CLAIM TO ANY PARTICULAR FONT, STYLE, SIZE, OR COLOR.

SN 85-350,767, FILED 6-20-2011.

DAVID YONTEF, EXAMINING ATTORNEY



*David J. Kybas*

Director of the United States Patent and Trademark Office

# United States of America

United States Patent and Trademark Office

## BUDGET BUDDY

**Reg. No. 4,276,532**

**Registered Jan. 15, 2013**

**Int. Cl.: 42**

**SERVICE MARK**

**PRINCIPAL REGISTER**

1ST ADVANTAGE FEDERAL CREDIT UNION (VIRGINIA FEDERALLY CHARTERED CREDIT UNION)  
P.O. BOX 2116  
NEWPORT NEWS, VA 23609

FOR: PROVIDING A WEBSITE FEATURING NON-DOWNLOADABLE SOFTWARE, NAMELY, A NON-DOWNLOADABLE TOOL THAT ALLOWS ONE TO MANAGE FINANCES, VIEW ACCOUNT ACTIVITY, SET FINANCIAL GOALS, AGGREGATE ALL FINANCIAL ACCOUNTS FROM MULTIPLE FINANCIAL INSTITUTIONS, CREATE BUDGETS, TRACK CASH FLOWS, KNOW YOUR NET WORTH, RECEIVE ALERTS WHEN CERTAIN CRITERIA ARE MET SUCH AS A GOAL OR A BUDGET, BECOME INVOLVED IN A COMMUNITY WHERE YOU CAN ASK QUESTIONS ABOUT FINANCES, AND RECEIVE INFORMATION ON GREAT FINANCIAL DEALS, IN CLASS 42 (U.S. CLS. 100 AND 101).

FIRST USE 12-1-2011; IN COMMERCE 12-1-2011.

THE MARK CONSISTS OF STANDARD CHARACTERS WITHOUT CLAIM TO ANY PARTICULAR FONT, STYLE, SIZE, OR COLOR.

NO CLAIM IS MADE TO THE EXCLUSIVE RIGHT TO USE "BUDGET", APART FROM THE MARK AS SHOWN.

SN 85-351,561, FILED 6-21-2011.

KELLY TRUSILO, EXAMINING ATTORNEY



*David J. Kyffers*

Director of the United States Patent and Trademark Office

# United States of America

United States Patent and Trademark Office



**Reg. No. 4,276,533**

**Registered Jan. 15, 2013**

**Int. Cl.: 42**

**SERVICE MARK**

**PRINCIPAL REGISTER**

1ST ADVANTAGE FEDERAL CREDIT UNION (VIRGINIA FEDERALLY CHARTERED CREDIT UNION)  
P.O. BOX 2116  
NEWPORT NEWS, VA 23609

FOR: PROVIDING A WEBSITE FEATURING NON-DOWNLOADABLE SOFTWARE, NAMELY, A NON-DOWNLOADABLE TOOL THAT ALLOWS ONE TO MANAGE FINANCES, VIEW ACCOUNT ACTIVITY, SET FINANCIAL GOALS, AGGREGATE ALL FINANCIAL ACCOUNTS FROM MULTIPLE FINANCIAL INSTITUTIONS, CREATE BUDGETS, TRACK CASH FLOWS, KNOW YOUR NET WORTH, RECEIVE ALERTS WHEN CERTAIN CRITERIA ARE MET SUCH AS A GOAL OR A BUDGET, BECOME INVOLVED IN A COMMUNITY WHERE YOU CAN ASK QUESTIONS ABOUT FINANCES, AND RECEIVE INFORMATION ON GREAT FINANCIAL DEALS, IN CLASS 42 (U.S. CLS. 100 AND 101).

FIRST USE 12-1-2011; IN COMMERCE 12-1-2011.

NO CLAIM IS MADE TO THE EXCLUSIVE RIGHT TO USE "BUDGET" , APART FROM THE MARK AS SHOWN.

THE COLOR(S) GREEN, GREY, BLACK, WHITE, BLUE, BROWN, AND PEACH IS/ARE CLAIMED AS A FEATURE OF THE MARK.

THE MARK CONSISTS OF A MAN WITH A PEACH COLORED FACE AND HANDS, BROWN HAIR, GLASSES, NOSE AND MOUTH AND BROWN AND WHITE EYES, IN A BLUE, BLACK AND WHITE SUIT HOLDING A GREEN DOLLAR SIGN NEXT TO THE WORD "BUDGET" IN GREEN OVER THE WORD "BUDDY" IN GREY.

SN 85-351,574, FILED 6-21-2011.

KELLY TRUSILO, EXAMINING ATTORNEY



*David J. Kybas*

Director of the United States Patent and Trademark Office

# United States of America

United States Patent and Trademark Office

# ALISA PAN

**Reg. No. 4,276,534**

PAN, LEI BING (CHINA INDIVIDUAL)  
2882-B1 WALNUT AVE.  
TUSTIN, CA 92780

**Registered Jan. 15, 2013**

**Int. Cl.: 25**

FOR: WOMEN'S CLOTHING, NAMELY, DRESSES, GOWNS, SKIRTS, TOPS, BRAS AND UNDERSKIRTS; WOMEN'S ACCESSORIES, NAMELY, BRAS AND CAPELETS, IN CLASS 25 (U.S. CLS. 22 AND 39).

**TRADEMARK**

FIRST USE 5-20-2012; IN COMMERCE 5-20-2012.

**PRINCIPAL REGISTER**

THE MARK CONSISTS OF STANDARD CHARACTERS WITHOUT CLAIM TO ANY PARTICULAR FONT, STYLE, SIZE, OR COLOR.

THE NAME(S), PORTRAIT(S), AND/OR SIGNATURE(S) SHOWN IN THE MARK IDENTIFIES "ALISA PAN", WHOSE CONSENT(S) TO REGISTER IS MADE OF RECORD.

SN 85-351,639, FILED 6-21-2011.

COURTNEY ALVAREZ, EXAMINING ATTORNEY



*David J. Kyffers*

Director of the United States Patent and Trademark Office



# United States of America

United States Patent and Trademark Office

## QI (CHI) WATER

**Reg. No. 4,276,535**

KIM, JOHN JUNGMIN (UNITED STATES INDIVIDUAL)  
901 N. PACIFIC COAST HWY, SUITE 106  
REDONDO BEACH, CA 90277

**Registered Jan. 15, 2013**

**Int. Cl.: 32**

FOR: DRINKING WATER; MINERAL AND AERATED WATER; PURIFIED BOTTLED DRINKING WATER; SPRING WATER, IN CLASS 32 (U.S. CLS. 45, 46 AND 48).

**TRADEMARK**

FIRST USE 9-14-2012; IN COMMERCE 9-14-2012.

**PRINCIPAL REGISTER**

THE MARK CONSISTS OF STANDARD CHARACTERS WITHOUT CLAIM TO ANY PARTICULAR FONT, STYLE, SIZE, OR COLOR.

NO CLAIM IS MADE TO THE EXCLUSIVE RIGHT TO USE "WATER", APART FROM THE MARK AS SHOWN.

SN 85-352,023, FILED 6-21-2011.

JENNY PARK, EXAMINING ATTORNEY



*David J. Kybas*

Director of the United States Patent and Trademark Office

# United States of America

United States Patent and Trademark Office

# MOTV

**Reg. No. 4,276,536**

**Registered Jan. 15, 2013**

**Int. Cl.: 38**

**SERVICE MARK**

**PRINCIPAL REGISTER**

MOTV, LLC (CALIFORNIA LIMITED LIABILITY COMPANY)  
8750 WILSHIRE BLVD., SUITE 200  
BEVERLY HILLS, CA 90211

FOR: BROADCASTING SERVICES, NAMELY, TRANSMISSION OF ADVERTISING, PROGRAMS, NEWS, VIDEOS AND OTHER MULTIMEDIA CONTENT VIA THE INTERNET AND OTHER COMMUNICATIONS NETWORKS, IN CLASS 38 (U.S. CLS. 100, 101 AND 104).

FIRST USE 11-1-2011; IN COMMERCE 11-1-2011.

THE MARK CONSISTS OF STANDARD CHARACTERS WITHOUT CLAIM TO ANY PARTICULAR FONT, STYLE, SIZE, OR COLOR.

SN 85-352,174, FILED 6-21-2011.

WILLIAM ROSSMAN, EXAMINING ATTORNEY



*David J. Kyros*

Director of the United States Patent and Trademark Office

# United States of America

United States Patent and Trademark Office

## BE A FORCE OF BEAUTY

**Reg. No. 4,276,537**

BARE ESSENTUALS BEAUTY, INC. (DELAWARE CORPORATION)  
71 STEVENSON STREET, 22ND FLOOR  
SAN FRANCISCO, CA 94105

**Registered Jan. 15, 2013**

**Int. Cl.: 3**

FOR: COSMETICS, IN CLASS 3 (U.S. CLS. 1, 4, 6, 50, 51 AND 52).

**TRADEMARK**

FIRST USE 6-0-2012; IN COMMERCE 6-0-2012.

**PRINCIPAL REGISTER**

THE MARK CONSISTS OF STANDARD CHARACTERS WITHOUT CLAIM TO ANY PARTICULAR FONT, STYLE, SIZE, OR COLOR.

SN 85-353,279, FILED 6-22-2011.

FRANK LATTUCA, EXAMINING ATTORNEY



*David J. Kyffers*

Director of the United States Patent and Trademark Office

United States of America  
United States Patent and Trademark Office

krush 

**Reg. No. 4,276,538**

AMERICAN DE ROSA LAMPARTS, LLC (DELAWARE LIMITED LIABILITY COMPANY)  
1945 SOUTH TUBEWAY  
COMMERCE, CA 92602

**Registered Jan. 15, 2013**

**Int. Cl.: 11**

FOR: PORTABLE LAMPS, IN CLASS 11 (U.S. CLS. 13, 21, 23, 31 AND 34).

**TRADEMARK**

FIRST USE 3-15-2012; IN COMMERCE 3-15-2012.

**PRINCIPAL REGISTER**

THE MARK CONSISTS OF THE LITERAL ELEMENT "KRUSH" WHEREIN THE HEAD OF THE LETTER "H" IS DEPICTING A LAMP WITH STRING SWITCH AS SHOWN IN THE MARK.

SN 85-353,691, FILED 6-23-2011.

MICHAEL WEBSTER, EXAMINING ATTORNEY



*David J. Kybas*

Director of the United States Patent and Trademark Office

# United States of America

United States Patent and Trademark Office

## GOPHER GUARD

**Reg. No. 4,276,539**

ORIGIN POINT BRANDS, LLC (DELAWARE LIMITED LIABILITY COMPANY)  
2453 KING STREET EXTENSION  
CHARLESTON, SC 29045

**Registered Jan. 15, 2013**

**Int. Cl.: 6**

FOR: METAL WIRE FENCING ENCLOSURE FOR USE AS A ROOT PROTECTOR, IN CLASS 6 (U.S. CLS. 2, 12, 13, 14, 23, 25 AND 50).

**TRADEMARK**

FIRST USE 8-22-2012; IN COMMERCE 8-22-2012.

**PRINCIPAL REGISTER**

THE MARK CONSISTS OF STANDARD CHARACTERS WITHOUT CLAIM TO ANY PARTICULAR FONT, STYLE, SIZE, OR COLOR.

NO CLAIM IS MADE TO THE EXCLUSIVE RIGHT TO USE "GOPHER", APART FROM THE MARK AS SHOWN.

SN 85-355,331, FILED 6-24-2011.

GISELLE AGOSTO, EXAMINING ATTORNEY



*David J. Kybas*

Director of the United States Patent and Trademark Office

# United States of America

United States Patent and Trademark Office

# VXLED

**Reg. No. 4,276,540**

RAB LIGHTING INC. (NEW YORK CORPORATION)  
170 LUDLOW AVENUE  
NORTHVALE, NJ 07647

**Registered Jan. 15, 2013**

**Int. Cl.: 11**

FOR: ELECTRIC LIGHTING FIXTURES; LED (LIGHT EMITTING DIODE) LIGHTING FIXTURES; LIGHTING FIXTURES, IN CLASS 11 (U.S. CLS. 13, 21, 23, 31 AND 34).

**TRADEMARK**

FIRST USE 3-23-2011; IN COMMERCE 3-23-2011.

**PRINCIPAL REGISTER**

THE MARK CONSISTS OF STANDARD CHARACTERS WITHOUT CLAIM TO ANY PARTICULAR FONT, STYLE, SIZE, OR COLOR.

OWNER OF U.S. REG. NOS. 3,821,419 AND 3,843,323.

SN 85-355,416, FILED 6-24-2011.

BRENDAN MCCAULEY, EXAMINING ATTORNEY



*David J. Kybas*

Director of the United States Patent and Trademark Office

# United States of America

United States Patent and Trademark Office

## Sense Understand Respond Evaluate

**Reg. No. 4,276,541**

**Registered Jan. 15, 2013**

**Int. Cl.: 45**

**SERVICE MARK**

**PRINCIPAL REGISTER**

SREDZINSKI JAMES R (UNITED STATES INDIVIDUAL), DBA JRS ASSOCIATES,  
475 HOMESTEAD  
LAGRANGE PARK, IL 60526

FOR: SAFETY CONSULTING SERVICES IN THE FIELDS OF HAZARD ASSESSMENTS  
AND ABATEMENT PROCEDURES, IN CLASS 45 (U.S. CLS. 100 AND 101).

FIRST USE 8-9-2010; IN COMMERCE 1-19-2011.

THE MARK CONSISTS OF STANDARD CHARACTERS WITHOUT CLAIM TO ANY PAR-  
TICULAR FONT, STYLE, SIZE, OR COLOR.

SEC. 2(F).

NO CLAIM IS MADE TO THE EXCLUSIVE RIGHT TO USE "SENSE UNDERSTAND RE-  
SPOND EVALUATE", APART FROM THE MARK AS SHOWN.

THE WORDING "SENSE UNDERSTAND RESPOND EVALUATE" HAS NO MEANING IN  
A FOREIGN LANGUAGE.

SN 85-355,529, FILED 6-24-2011.

JAMES A. RAUEN, EXAMINING ATTORNEY



*David J. Kybas*

Director of the United States Patent and Trademark Office

# United States of America

United States Patent and Trademark Office

# nudge

**Reg. No. 4,276,542**

CARMEN MONCADA-TERRY (UNITED STATES INDIVIDUAL)  
520 F STREET NE  
WASHINGTON, DC 20002

**Registered Jan. 15, 2013**

**Int. Cl.: 25**

FOR: BELTS FOR CLOTHING; BOTTOMS; CLOTH BIBS; DRESSES; HEADWEAR; PULLOVERS; SHORT-SLEEVED OR LONG-SLEEVED T-SHIRTS; SOCKS; SWIMWEAR; T-SHIRTS; TOPS; UNDERWEAR; WRIST BANDS , IN CLASS 25 (U.S. CLS. 22 AND 39).

**TRADEMARK**

FIRST USE 5-1-2011; IN COMMERCE 6-27-2011.

**PRINCIPAL REGISTER**

THE MARK CONSISTS OF STANDARD CHARACTERS WITHOUT CLAIM TO ANY PARTICULAR FONT, STYLE, SIZE, OR COLOR.

SN 85-356,363, FILED 6-25-2011.

PAM WILLIS, EXAMINING ATTORNEY



*David J. Kybas*

Director of the United States Patent and Trademark Office



# United States of America

United States Patent and Trademark Office

## CENTURYLINK

**Reg. No. 4,276,543**

**Registered Jan. 15, 2013**

**Int. Cl.: 43**

**SERVICE MARK**

**PRINCIPAL REGISTER**

CENTURYLINK, INC. (LOUISIANA CORPORATION)  
100 CENTURYLINK DR.  
MONROE, LA 71203

FOR: ARENA SERVICES, NAMELY, PROVIDING FACILITIES FOR BUSINESS EVENTS, CONSUMER SHOWS, TRADE SHOWS, ARTISTIC ACTIVITIES, COMMUNITY ACTIVITIES, ENTERTAINMENT, PUBLIC EVENTS, SPORTING EVENTS AND TOURNAMENTS, EDUCATIONAL EVENTS, CONVENTIONS AND EXHIBITIONS, IN CLASS 43 (U.S. CLS. 100 AND 101).

FIRST USE 8-1-2011; IN COMMERCE 8-1-2011.

THE MARK CONSISTS OF STANDARD CHARACTERS WITHOUT CLAIM TO ANY PARTICULAR FONT, STYLE, SIZE, OR COLOR.

SN 85-356,851, FILED 6-27-2011.

RONALD MCMORROW, EXAMINING ATTORNEY



*David J. Kybas*

Director of the United States Patent and Trademark Office

# United States of America

United States Patent and Trademark Office

# CHEER

**Reg. No. 4,276,544**

BRICKMAN, ANDREW L. (UNITED STATES INDIVIDUAL)  
12020 SW 94 STREET  
MIAMI, FL 33186

**Registered Jan. 15, 2013**

**Int. Cl.: 42**

FOR: PROVIDING AN INTERACTIVE WEBSITE FEATURING TECHNOLOGY THAT ALLOWS USERS TO ENTER, ACCESS AND SHARE INFORMATION IN THE FIELDS OF EDUCATION, HEALTH, AND ECONOMIC RESOURCES, IN CLASS 42 (U.S. CLS. 100 AND 101).

**SERVICE MARK**

**PRINCIPAL REGISTER**

FIRST USE 9-1-2010; IN COMMERCE 9-1-2010.

THE MARK CONSISTS OF STANDARD CHARACTERS WITHOUT CLAIM TO ANY PARTICULAR FONT, STYLE, SIZE, OR COLOR.

SN 85-357,680, FILED 6-28-2011.

JOHN WILKE, EXAMINING ATTORNEY



*David J. Kybas*

Director of the United States Patent and Trademark Office

# United States of America

United States Patent and Trademark Office

# BARK

**Reg. No. 4,276,545**

**Registered Jan. 15, 2013**

**Int. Cl.: 18**

**TRADEMARK**

**PRINCIPAL REGISTER**

BARK ELEMENTS, LLC (DELAWARE LIMITED LIABILITY COMPANY), DBA BARK,  
SUITE #450  
29201 TELEGRAPH RD  
SOUTHFIELD, MI 48034

FOR: DOG APPAREL; DOG CLOTHING; DOG COATS; DOG COLLARS; DOG COLLARS  
AND LEADS; DOG LEASHES, IN CLASS 18 (U.S. CLS. 1, 2, 3, 22 AND 41).

FIRST USE 6-10-2010, THE MARK WAS FIRST USED ANYWHERE IN A DIFFERENT FORM  
OTHER THAN THAT SOUGHT TO BE REGISTERED AT LEAST AS EARLY AS 06/10/2010;  
IN COMMERCE 9-21-2012, THE MARK WAS FIRST USED IN COMMERCE IN A DIFFERENT  
FORM OTHER THAN THAT SOUGHT TO BE REGISTERED AT LEAST AS EARLY AS  
09/10/2010.

THE MARK CONSISTS OF STANDARD CHARACTERS WITHOUT CLAIM TO ANY PAR-  
TICULAR FONT, STYLE, SIZE, OR COLOR.

OWNER OF U.S. REG. NO. 3,969,956.

SN 85-358,428, FILED 6-28-2011.

MATTHEW MCDOWELL, EXAMINING ATTORNEY



*David J. Kyros*

Director of the United States Patent and Trademark Office

# United States of America

United States Patent and Trademark Office

## CLOUD CATCHER

**Reg. No. 4,276,546**

**Registered Jan. 15, 2013**

**Int. Cl.: 9**

**TRADEMARK**

**PRINCIPAL REGISTER**

SANDISK CORPORATION (DELAWARE CORPORATION)  
601 MCCARTHY BOULEVARD  
MILPITAS, CA 95035

FOR: SOFTWARE FOR DATA BACK-UP FROM THE INTERNET, IN CLASS 9 (U.S. CLS. 21, 23, 26, 36 AND 38).

FIRST USE 5-0-2012; IN COMMERCE 5-0-2012.

THE MARK CONSISTS OF STANDARD CHARACTERS WITHOUT CLAIM TO ANY PARTICULAR FONT, STYLE, SIZE, OR COLOR.

NO CLAIM IS MADE TO THE EXCLUSIVE RIGHT TO USE "CLOUD", APART FROM THE MARK AS SHOWN.

SN 85-358,734, FILED 6-28-2011.

MAYUR VAGHANI, EXAMINING ATTORNEY



*David J. Kybas*

Director of the United States Patent and Trademark Office

# United States of America

United States Patent and Trademark Office

## COOL & CLEAN

**Reg. No. 4,276,547**

**Registered Jan. 15, 2013**

**Int. Cl.: 20**

**TRADEMARK**

**PRINCIPAL REGISTER**

AMERICAN TEXTILE COMPANY (PENNSYLVANIA CORPORATION)  
10 NORTH LINDEN STREET, RIDC RIVERPLACE  
DUQUESNE, PA 15110

FOR: PILLOWS, IN CLASS 20 (U.S. CLS. 2, 13, 22, 25, 32 AND 50).

FIRST USE 3-26-2012; IN COMMERCE 3-26-2012.

THE MARK CONSISTS OF STANDARD CHARACTERS WITHOUT CLAIM TO ANY PARTICULAR FONT, STYLE, SIZE, OR COLOR.

SN 85-360,298, FILED 6-30-2011.

JAY BESCH, EXAMINING ATTORNEY



*David J. Kyffers*

Director of the United States Patent and Trademark Office

**United States of America**  
United States Patent and Trademark Office

# Hemburger

**Reg. No. 4,276,548**

**Registered Jan. 15, 2013**

**Int. Cl.: 29**

**TRADEMARK**

**PRINCIPAL REGISTER**

IMAJEN, LLC (OREGON LIMITED LIABILITY COMPANY), DBA CHEZ GOURMET,  
25977 SW CANYON CREEK RD STE G  
WILSONVILLE, OR 97070

FOR: VEGGIE BURGER PATTIES, IN CLASS 29 (U.S. CL. 46).

FIRST USE 10-1-2012; IN COMMERCE 10-1-2012.

THE MARK CONSISTS OF STANDARD CHARACTERS WITHOUT CLAIM TO ANY PARTICULAR FONT, STYLE, SIZE, OR COLOR.

SN 85-360,785, FILED 6-30-2011.

CURTIS FRENCH, EXAMINING ATTORNEY



*David J. Kyffers*

Director of the United States Patent and Trademark Office

# United States of America

United States Patent and Trademark Office

# REALCARE

**Reg. No. 4,276,549**

**Registered Jan. 15, 2013**

**Int. Cl.: 9**

**TRADEMARK**

**PRINCIPAL REGISTER**

REALITYWORKS, INC. (WISCONSIN CORPORATION)  
2709 MONDOVI ROAD  
EAU CLAIRE, WI 54701

FOR: DIGITAL MATERIALS, NAMELY, DVDS FEATURING AND PROMOTING EDUCATIONAL DOLLS AND INSTRUCTIONAL, EDUCATIONAL, AND TEACHING MATERIALS IN THE FIELD OF PREGNANCY DETERRENCE AND INFANT CARE, DIGITAL MEDIA, NAMELY, CDS, AND DOWNLOADABLE FILES FEATURING INSTRUCTIONAL, EDUCATIONAL, AND TEACHING MATERIALS IN THE FIELD OF PREGNANCY DETERRENCE AND INFANT CARE, IN CLASS 9 (U.S. CLS. 21, 23, 26, 36 AND 38).

FIRST USE 7-19-2012; IN COMMERCE 7-19-2012.

THE MARK CONSISTS OF STANDARD CHARACTERS WITHOUT CLAIM TO ANY PARTICULAR FONT, STYLE, SIZE, OR COLOR.

OWNER OF U.S. REG. NOS. 3,385,061, 3,580,303, AND OTHERS.

SN 85-360,838, FILED 6-30-2011.

KATHLEEN LORENZO, EXAMINING ATTORNEY



*David J. Kyffers*

Director of the United States Patent and Trademark Office

# United States of America

United States Patent and Trademark Office

## NEW VITALITY

**Reg. No. 4,276,550**

**Registered Jan. 15, 2013**

**Int. Cl.: 35**

**SERVICE MARK**

**PRINCIPAL REGISTER**

NAC MARKETING COMPANY, LLC (DELAWARE LIMITED LIABILITY COMPANY)  
260 SMITH STREET  
FARMINGDALE, NY 11735

FOR: PROMOTING THE GOODS OF OTHERS BY TELEPHONE, RADIO AND TELEVISION ADVERTISING, AND DIRECT MAIL ADVERTISING; DIRECT MARKETING SERVICES; ONLINE RETAIL STORE SERVICES FEATURING A WIDE ARRAY OF CONSUMER PRODUCTS AND MERCHANDISE IN THE FIELD OF HEALTH, BEAUTY, FITNESS AND NUTRITION, IN CLASS 35 (U.S. CLS. 100, 101 AND 102).

FIRST USE 1-8-1998; IN COMMERCE 1-8-1998.

THE MARK CONSISTS OF STANDARD CHARACTERS WITHOUT CLAIM TO ANY PARTICULAR FONT, STYLE, SIZE, OR COLOR.

OWNER OF U.S. REG. NO. 2,702,638.

SN 85-361,183, FILED 6-30-2011.

MATTHEW MCDOWELL, EXAMINING ATTORNEY



*David J. Kyros*

Director of the United States Patent and Trademark Office



# United States of America

United States Patent and Trademark Office

## NEW VITALITY

**Reg. No. 4,276,551**

NAC MARKETING COMPANY, LLC (DELAWARE LIMITED LIABILITY COMPANY)  
260 SMITH STREET  
FARMINGDALE, NY 11735

**Registered Jan. 15, 2013**

**Int. Cl.: 41**

FOR: PROVIDING ELECTRONIC NEWSLETTERS IN THE FIELD OF HEALTH, FITNESS AND NUTRITION DELIVERED BY E-MAIL, IN CLASS 41 (U.S. CLS. 100, 101 AND 107).

**SERVICE MARK**

FIRST USE 1-2-2008; IN COMMERCE 1-2-2008.

**PRINCIPAL REGISTER**

THE MARK CONSISTS OF STANDARD CHARACTERS WITHOUT CLAIM TO ANY PARTICULAR FONT, STYLE, SIZE, OR COLOR.

OWNER OF U.S. REG. NO. 2,702,638.

SN 85-361,185, FILED 6-30-2011.

MATTHEW MCDOWELL, EXAMINING ATTORNEY



*David J. Kyffers*

Director of the United States Patent and Trademark Office

# United States of America

United States Patent and Trademark Office



**Reg. No. 4,276,552**

**Registered Jan. 15, 2013**

**Int. Cl.: 41**

**SERVICE MARK**

**PRINCIPAL REGISTER**

RIDE360 LLC (TEXAS LIMITED LIABILITY COMPANY), DBA REVOLUTION STUDIO OF AUSTIN,  
2009 ASHBY AVE #A  
AUSTIN, TX 78704

FOR: PROVIDING PHYSICAL FITNESS INSTRUCTION AND CONSULTATION IN THE FIELD OF INDOOR CYCLING; PROVIDING FITNESS AND EXERCISE FACILITIES FOR INDOOR CYCLING, IN CLASS 41 (U.S. CLS. 100, 101 AND 107).

FIRST USE 6-3-2011; IN COMMERCE 10-26-2012.

THE MARK CONSISTS OF A SQUARE SHAPED MARK WITH A CIRCULAR BIKE CHAIN IMAGE IN THE CENTER.

SN 85-361,200, FILED 6-30-2011.

LINDSEY RUBIN, EXAMINING ATTORNEY



*David J. Kyffers*

Director of the United States Patent and Trademark Office

# United States of America

United States Patent and Trademark Office

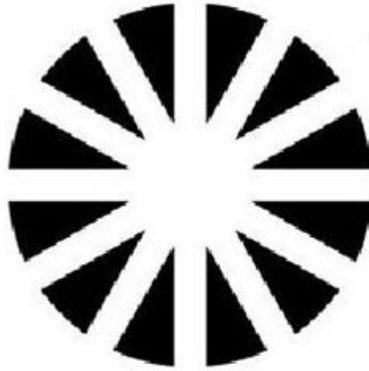

**Reg. No. 4,276,553**

CENTURYLINK, INC. (LOUISIANA CORPORATION)  
100 CENTURYLINK DR.  
MONROE, LA 71203

**Registered Jan. 15, 2013**

**Int. Cl.: 35**

FOR: PROMOTING BUSINESS, SPORTS AND ENTERTAINMENT EVENTS OF OTHERS,  
IN CLASS 35 (U.S. CLS. 100, 101 AND 102).

**SERVICE MARK**

FIRST USE 8-1-2011; IN COMMERCE 8-1-2011.

**PRINCIPAL REGISTER**

THE MARK CONSISTS OF A DESIGN IN NATURE OF TWELVE SMALL TRIANGLES AR-  
RANGED IN A CIRCLE.

SN 85-362,814, FILED 7-5-2011.

RONALD MCMORROW, EXAMINING ATTORNEY



*David J. Kybas*

Director of the United States Patent and Trademark Office

# United States of America

United States Patent and Trademark Office

**PAX** | BAR & EATERY

**Reg. No. 4,276,554**

CREATIVE FOOD GROUP, LLC (NEW JERSEY LIMITED LIABILITY COMPANY)  
1 PENN PLAZA, SUITE 1612  
NEW YORK, NY 10119

**Registered Jan. 15, 2013**

**Int. Cl.: 43**

FOR: BAR AND RESTAURANT SERVICES, IN CLASS 43 (U.S. CLS. 100 AND 101).

**SERVICE MARK**

FIRST USE 4-12-2012; IN COMMERCE 4-12-2012.

**PRINCIPAL REGISTER**

NO CLAIM IS MADE TO THE EXCLUSIVE RIGHT TO USE "BAR & EATERY", APART FROM THE MARK AS SHOWN.

THE MARK CONSISTS OF "PAX" IN ALL CAPS WITH A VERTICAL LINE TO THE RIGHT AND "BAR&EATERY" WRITTEN IN SMALLER FONT.

SN 85-362,819, FILED 7-5-2011.

TARAH HARDY, EXAMINING ATTORNEY



*David J. Kyffers*

Director of the United States Patent and Trademark Office

# United States of America

United States Patent and Trademark Office

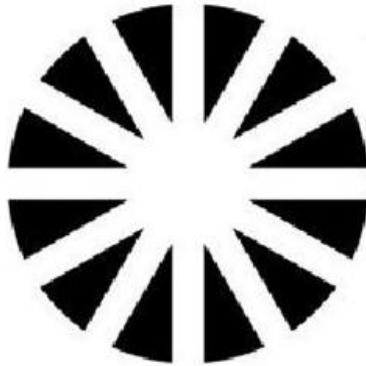

**Reg. No. 4,276,555**

**Registered Jan. 15, 2013**

**Int. Cl.: 43**

**SERVICE MARK**

**PRINCIPAL REGISTER**

CENTURYLINK, INC. (LOUISIANA CORPORATION)  
100 CENTURYLINK DR.  
MONROE, LA 71203

FOR: ARENA SERVICES, NAMELY, PROVIDING FACILITIES FOR BUSINESS EVENTS, CONSUMER SHOWS, TRADE SHOWS, ARTISTIC ACTIVITIES, COMMUNITY ACTIVITIES, ENTERTAINMENT EVENTS, PUBLIC EVENTS, SPORTING EVENTS AND TOURNAMENTS, EDUCATIONAL EVENTS, CONVENTIONS AND EXHIBITIONS, IN CLASS 43 (U.S. CLS. 100 AND 101).

FIRST USE 8-1-2011; IN COMMERCE 8-1-2011.

THE MARK CONSISTS OF A DESIGN IN NATURE OF TWELVE SMALL TRIANGLES ARRANGED IN A CIRCLE.

SN 85-362,877, FILED 7-5-2011.

RONALD MCMORROW, EXAMINING ATTORNEY



*David J. Kybas*

Director of the United States Patent and Trademark Office

# United States of America

United States Patent and Trademark Office

# New Life

**Reg. No. 4,276,556**

**Registered Jan. 15, 2013**

**Int. Cl.: 5**

**TRADEMARK**

**PRINCIPAL REGISTER**

E-PRESCRIPTIONSTRATEGIES (PENNSYLVANIA LIMITED LIABILITY COMPANY), DBA  
PHARMACEUTICAL AND NUTRITIONAL INTERNATIONAL (P & N INTERNATIONAL),  
105 BLACKSHIRE ROAD  
KENNETT SQUARE, PA 19348

FOR: INFANT FORMULA, IN CLASS 5 (U.S. CLS. 6, 18, 44, 46, 51 AND 52).

FIRST USE 1-5-2011; IN COMMERCE 1-5-2011.

THE MARK CONSISTS OF STANDARD CHARACTERS WITHOUT CLAIM TO ANY PAR-  
TICULAR FONT, STYLE, SIZE, OR COLOR.

SN 85-363,213, FILED 7-5-2011.

KEVIN DINALLO, EXAMINING ATTORNEY



*David J. Kybas*

Director of the United States Patent and Trademark Office

# United States of America

United States Patent and Trademark Office

# SURPAT

**Reg. No. 4,276,557**

**Registered Jan. 15, 2013**

**Int. Cls.: 18, 24, and 25**

**TRADEMARK**

**PRINCIPAL REGISTER**

OBSHTSHESTVO S OGRANICHENNOY OTVETSTVENNOSTYU "KORPUS VYZHIVANIYA"  
(RUSSIAN FED. CORPORATION)  
UL. LADOZHSKAYA 7  
105005 MOSCOW, RUSSIAN FED.

FOR: BACKPACKS, NAMELY, RUCKSACKS; BAGS FOR CLIMBERS IN THE NATURE OF ALL-PURPOSE CARRYING BAGS; BAGS FOR SPORTS; GARMENT BAGS FOR TRAVEL; UNFITTED VANITY CASES, IN CLASS 18 (U.S. CLS. 1, 2, 3, 22 AND 41).

FIRST USE 3-0-2009; IN COMMERCE 3-0-2012.

FOR: ADHESIVE FABRIC FOR APPLICATION BY HEAT; CLOTH BANNERS; BATH LINEN, EXCEPT CLOTHING; BED BLANKETS; BED COVERS; BED COVERS OF PAPER; BED LINEN; BILLIARD CLOTH; BOLTING CLOTH; BROCADES; BUCKRAM; CLOTH BUNTING; CALICO; CANVAS FOR TAPESTRY OR EMBROIDERY; CHEESE CLOTH; CHENILLE FABRIC; CHEVIOT FABRIC; CLOTH, NAMELY, FELT CLOTH, FLAX CLOTH, OIL CLOTH; TABLE LINEN, NAMELY, COASTERS; COTTON FABRICS; UNFITTED COVERINGS OF PLASTIC FOR FURNITURE; UNFITTED FURNITURE COVERS NOT OF PAPER, NAMELY, UNFITTED SLIP COVERS FOR FURNITURE; COVERS FOR CUSHIONS; CREPE CLOTH; CREPON FABRIC; CURTAIN LOOPS OF TEXTILE MATERIAL; CURTAINS OF TEXTILE OR PLASTIC; DAMASK; DIAPERED LINEN FABRIC; DIMITY; DOOR CURTAINS OF TEXTILE OR PLASTIC; DRUGGET FABRIC; EIDERDOWN COVERS; EIDERDOWNS; ELASTIC FABRICS FOR CLOTHING; ELASTIC YARN MIXED FABRICS; ESPARTO FABRIC; FABRIC, NAMELY, COTTON FABRIC, CURTAIN FABRIC, CASHMERE FABRIC; FABRIC FOR BOOTS AND SHOES; FABRIC OF IMITATION ANIMAL SKINS; FABRIC, IMPERVIOUS TO GASES, FOR AERONAUTICAL BALLOONS; FABRICS FOR TEXTILE USE; FACE TOWELS OF TEXTILE; FELTS; FIBREGLASS FABRICS FOR TEXTILE USE; FITTED TOILET LID COVERS OF FABRIC; FLAGS, NOT OF PAPER, NAMELY, CLOTH FLAGS, FABRIC FLAGS, NYLON FLAGS; FLANNEL; FRIEZE; UNFITTED FURNITURE COVERINGS OF TEXTILE; GAUZE FABRIC; GUMMED WATERPROOF CLOTH; HAIRCLOTH, NAMELY, SACKCLOTH; HANDKERCHIEFS OF TEXTILE; TEXTILE USED AS LINING FOR HATS; HEMP CLOTH; HEMP FABRIC, NAMELY, TRUE HEMP FABRICS, HEMP BASE MIXED FABRICS, HEMP YARN FABRICS; HOUSEHOLD LINEN; JERSEY FABRICS FOR CLOTHING; JUTE FABRIC; KNITTED FABRIC; LABELS OF CLOTH; LINEN CLOTH; LINGERIE FABRIC; LINEN LINING FABRIC FOR SHOES; TEXTILE USED AS LINING FOR CLOTHING; MARABOUTS, NAMELY, FABRIC MADE FROM SILK DYED IN THE GUM; MATTRESS COVERS; MOLE SKIN; MOSQUITO NETS; NET CURTAINS; NON-WOVEN TEXTILE FABRICS;



*David J. Kyros*

Director of the United States Patent and Trademark Office

**Reg. No. 4,276,557** OILCLOTH FOR USE AS TABLECLOTHS; PILLOW SHAMS; PILLOWCASES; PLACE MATS, NOT OF PAPER; SEMI-FINISHED PLASTIC PRODUCTS, NAMELY, WOVEN ARAMID FABRICS FOR USE IN THE MANUFACTURE OF PROTECTIVE CLOTHING AND HELMETS AND IN HARD ARMOR; CALICO, NAMELY, PRINTED CALICO CLOTH; PRINTERS' BLANKETS OF TEXTILE; RAMIE FABRIC; RAYON FABRIC; SANITARY FLANNEL, NAMELY, FLANNEL CLOTH FOR USE IN MAKING SANITARY NAPKINS; SERVIETTES OF TEXTILE; TEXTILE GOODS, NAMELY, A SYNTHETIC SHEET WITH FRAGRANCE FOR THE PURPOSE OF INSERTING INTO PILLOW SLIP AND UNDER FITTED SHEET TO EMIT FRAGRANCE; SHOWER CURTAINS OF TEXTILE AND PLASTIC; SHROUDS; SILK CLOTH; SILK FABRICS FOR PRINTING PATTERNS; TABLE LINEN; TABLE NAPKINS OF TEXTILE; FABRIC TABLE RUNNERS; TABLE CLOTHS NOT OF PAPER; TABLE MATS NOT OF PAPER; TAFFETA; TEXTILE SUBSTITUTE MATERIALS MADE FROM SYNTHETIC MATERIALS; TICK, NAMELY, LINEN AND COTTON FABRIC USED IN UPHOLSTERING AND AS A COVERING FOR MATTRESSES AND PILLOWS; FUTON TICKS, NAMELY, UNSTUFFED FUTON COVERS NOT OF PAPER; TISSUES OF TEXTILE FOR REMOVING MAKE-UP; TOWELS OF TEXTILE; TRACED CLOTHS FOR EMBROIDERY; TRAVELLING RUGS; TRELIS, NAMELY, FABRIC HAVING A REPEATING PATTERN FORMED BY PRINTING AND STITCHING; TULLE; UPHOLSTERY FABRICS; VELVET; WALL HANGINGS OF TEXTILE; WASHING MITTS; WOOLEN FABRIC; ZEPHYR FABRIC, NAMELY, WOVEN COTTON FABRIC HAVING AN EQUAL NUMBER OF THREADS BOTH WARP AND WEFT, EITHER ONE OR BOTH MAY BE COLORED, IN CLASS 24 (U.S. CLS. 42 AND 50).

FIRST USE 3-0-2009; IN COMMERCE 3-0-2012.

FOR: BANDANAS; JACKETS; LEGGINGS; READY-MADE CLOTHING, NAMELY, SHIRTS, T-SHIRTS, PANTS; WAISTCOATS; BED CLOTHES, NAMELY, PAJAMAS, PAJAMA BOTTOMS; BABY BUNTING, IN CLASS 25 (U.S. CLS. 22 AND 39).

FIRST USE 3-0-2009; IN COMMERCE 3-0-2012.

THE MARK CONSISTS OF STANDARD CHARACTERS WITHOUT CLAIM TO ANY PARTICULAR FONT, STYLE, SIZE, OR COLOR.

THE WORDING "SURPAT" HAS NO MEANING IN A FOREIGN LANGUAGE.

SN 85-364,676, FILED 7-6-2011.

JAY BESCH, EXAMINING ATTORNEY



# United States of America

United States Patent and Trademark Office

## Down To Fish

**Reg. No. 4,276,558**

**Registered Jan. 15, 2013**

**Int. Cl.: 25**

**TRADEMARK**

**PRINCIPAL REGISTER**

DOWN TO FISH, LLC (FLORIDA LIMITED LIABILITY COMPANY)  
720 PELL RD  
OSTEEN, FL 32764

FOR: ATHLETIC APPAREL, NAMELY, SHIRTS, PANTS, JACKETS, FOOTWEAR, HATS AND CAPS, ATHLETIC UNIFORMS; COLLARED SHIRTS; FISHING SHIRTS; HATS; HOODED SWEAT SHIRTS; LONG-SLEEVED SHIRTS; POLO SHIRTS; SHIRTS; SHIRTS AND SHORT-SLEEVED SHIRTS; SHORT-SLEEVED OR LONG-SLEEVED T-SHIRTS; SHORT-SLEEVED SHIRTS; SWEAT SHIRTS; T-SHIRTS; TEE SHIRTS, IN CLASS 25 (U.S. CLS. 22 AND 39).

FIRST USE 6-29-2011; IN COMMERCE 8-23-2011.

THE MARK CONSISTS OF STANDARD CHARACTERS WITHOUT CLAIM TO ANY PARTICULAR FONT, STYLE, SIZE, OR COLOR.

NO CLAIM IS MADE TO THE EXCLUSIVE RIGHT TO USE "FISH", APART FROM THE MARK AS SHOWN.

SN 85-364,815, FILED 7-7-2011.

THOMAS MANOR, EXAMINING ATTORNEY



*David J. Kyros*

Director of the United States Patent and Trademark Office

# United States of America

United States Patent and Trademark Office

# SureFISH

**Reg. No. 4,276,559**

AGILENT TECHNOLOGIES, INC. (DELAWARE CORPORATION)  
5301 STEVENS CREEK BLVD.  
SANTA CLARA, CA 95051

**Registered Jan. 15, 2013**

**Int. Cl.: 1**

FOR: LABORATORY REAGENTS FOR USE IN SCIENTIFIC RESEARCH, MOLECULAR BIOLOGY AND DNA LABELING, IN CLASS 1 (U.S. CLS. 1, 5, 6, 10, 26 AND 46).

**TRADEMARK**

FIRST USE 3-5-2012; IN COMMERCE 3-5-2012.

**PRINCIPAL REGISTER**

THE MARK CONSISTS OF STANDARD CHARACTERS WITHOUT CLAIM TO ANY PARTICULAR FONT, STYLE, SIZE, OR COLOR.

SN 85-364,885, FILED 7-7-2011.

JOHN E. MICHOS, EXAMINING ATTORNEY



*David J. Kybas*

Director of the United States Patent and Trademark Office

# United States of America

United States Patent and Trademark Office

## PAMPER & PLAY

**Reg. No. 4,276,560**

**Registered Jan. 15, 2013**

**Int. Cl.: 41**

**SERVICE MARK**

**PRINCIPAL REGISTER**

CABLK, CAROLE (UNITED STATES INDIVIDUAL)  
333  
5007 STONEY CREEK ROAD  
CULVER CITY, CA 90230

FOR: CHILDREN'S ENTERTAINMENT AND AMUSEMENT CENTERS, NAMELY, INTERACTIVE PLAY AREAS, IN CLASS 41 (U.S. CLS. 100, 101 AND 107).

FIRST USE 8-1-2011; IN COMMERCE 11-1-2011.

THE MARK CONSISTS OF STANDARD CHARACTERS WITHOUT CLAIM TO ANY PARTICULAR FONT, STYLE, SIZE, OR COLOR.

NO CLAIM IS MADE TO THE EXCLUSIVE RIGHT TO USE "PLAY", APART FROM THE MARK AS SHOWN.

SN 85-365,931, FILED 7-7-2011.

ELISSA GARBER KON, EXAMINING ATTORNEY



*David J. Kybas*

Director of the United States Patent and Trademark Office

# United States of America

United States Patent and Trademark Office

# Capellia

**Reg. No. 4,276,561**

**Registered Jan. 15, 2013**

**Int. Cl.: 26**

**TRADEMARK**

**PRINCIPAL REGISTER**

KANG, CURTIS (UNITED STATES INDIVIDUAL), DBA HAIR COUTURE,  
14545 VALLEY VIEW AVE., SUITE N  
SANTA FE SPRINGS, CA 906705230

FOR: HAIR EXTENSIONS, IN CLASS 26 (U.S. CLS. 37, 39, 40, 42 AND 50).

FIRST USE 10-30-2012; IN COMMERCE 10-30-2012.

THE MARK CONSISTS OF STANDARD CHARACTERS WITHOUT CLAIM TO ANY PARTICULAR FONT, STYLE, SIZE, OR COLOR.

SN 85-365,977, FILED 7-7-2011.

MARGERY A. TIERNEY, EXAMINING ATTORNEY



*David J. Kybas*

Director of the United States Patent and Trademark Office

# United States of America

United States Patent and Trademark Office

# vCapacity

**Reg. No. 4,276,562**

**Registered Jan. 15, 2013**

**Int. Cl.: 9**

**TRADEMARK**

**PRINCIPAL REGISTER**

REFLEX SYSTEMS LLC (GEORGIA LIMITED LIABILITY COMPANY), DBA REFLEX SYSTEMS,  
53 PERIMETER CENTER EAST SUITE 175  
ATLANTA, GA 30346

FOR: COMPUTER SOFTWARE FOR ENABLING USERS TO VISUALIZE AND MONITOR VIRTUAL AND PHYSICAL COMPUTER INFRASTRUCTURES, AND TO ANALYZE, CORRELATE AND MANAGE IT SYSTEMS TO OVERSEE PERFORMANCE, CAPACITY, TRENDING, AND MODELING REQUIREMENTS RELATED TO COMPUTER MANAGEMENT AND COMPUTER SECURITY IN VIRTUAL AND PHYSICAL COMPUTER INFRASTRUCTURES, IN CLASS 9 (U.S. CLS. 21, 23, 26, 36 AND 38).

FIRST USE 6-15-2011; IN COMMERCE 8-15-2011.

THE MARK CONSISTS OF STANDARD CHARACTERS WITHOUT CLAIM TO ANY PARTICULAR FONT, STYLE, SIZE, OR COLOR.

SN 85-366,318, FILED 7-8-2011.

LINDA E. BLOHM, EXAMINING ATTORNEY



*David J. Kyros*

Director of the United States Patent and Trademark Office

# United States of America

United States Patent and Trademark Office

## The Stevens Creativity, Imagination and Leadership Training

**Reg. No. 4,276,563**

**Registered Jan. 15, 2013**

**Int. Cl.: 41**

**SERVICE MARK**

**PRINCIPAL REGISTER**

STEVENS, VICTORIA (UNITED STATES INDIVIDUAL)  
#6  
844 16TH ST  
SANTA MONICA, CA 90403

FOR: TRAINING SERVICES IN THE FIELD OF TEACHER TRAINING, PROFESSIONAL DEVELOPMENT IN CREATIVE THINKING PEDAGOGY, CURRICULUM DEVELOPMENT, AND ASSESSMENT ACROSS CONTENT DOMAINS IN THE NATURE OF PROFESSIONAL DEVELOPMENT TRAINING FOR PRE-K THROUGH 12TH GRADE TEACHERS WHO TEACH METHODS OF DEVELOPING SKILLS RELATED TO CREATIVITY, IMAGINATION, INNOVATION, EMPATHY, SELF-REGULATION AND LEADERSHIP FOR LIFELONG LEARNING AND SUCCESS POST-GRADUATION FROM HIGH SCHOOL AND EDUCATION CONSULTING RELATED THERETO; INSTRUCTION IN THE FIELD OF TEACHER TRAINING, PROFESSIONAL DEVELOPMENT IN CREATIVE THINKING PEDAGOGY, CURRICULUM DEVELOPMENT, AND ASSESSMENT ACROSS CONTENT DOMAINS IN THE NATURE OF PROFESSIONAL DEVELOPMENT TRAINING FOR PRE-K THROUGH 12TH GRADE TEACHERS WHO TEACH METHODS OF DEVELOPING SKILLS RELATED TO CREATIVITY, IMAGINATION, INNOVATION, EMPATHY, SELF-REGULATION AND LEADERSHIP FOR LIFELONG LEARNING AND SUCCESS POST-GRADUATION FROM HIGH SCHOOL AND EDUCATION CONSULTING RELATED THERETO, IN CLASS 41 (U.S. CLS. 100, 101 AND 107).

FIRST USE 3-0-2011; IN COMMERCE 3-0-2011.

THE MARK CONSISTS OF STANDARD CHARACTERS WITHOUT CLAIM TO ANY PARTICULAR FONT, STYLE, SIZE, OR COLOR.

NO CLAIM IS MADE TO THE EXCLUSIVE RIGHT TO USE "CREATIVITY, IMAGINATION AND LEADERSHIP TRAINING", APART FROM THE MARK AS SHOWN.

SN 85-367,408, FILED 7-10-2011.

SALLY SHIH, EXAMINING ATTORNEY



*David J. Kyffers*

Director of the United States Patent and Trademark Office

# United States of America

United States Patent and Trademark Office

## PINNACLE PRECISION ACCESS SYSTEM

**Reg. No. 4,276,564**

TERUMO KABUSHIKI KAISHA (TERUMO CORPORATION) (JAPAN CORPORATION)  
44-1, 2-CHOME, HATAGAYA, SHIBUYA-KU  
TOKYO, JAPAN

**Registered Jan. 15, 2013**

**Int. Cl.: 10**

FOR: MEDICAL KIT FOR VASCULAR ACCESS, COMPRISED OF AN INTRODUCER  
SHEATH, DILATOR, NEEDLE AND GUIDEWIRE, IN CLASS 10 (U.S. CLS. 26, 39 AND 44).

**TRADEMARK**

FIRST USE 10-1-2012; IN COMMERCE 10-1-2012.

**PRINCIPAL REGISTER**

THE MARK CONSISTS OF STANDARD CHARACTERS WITHOUT CLAIM TO ANY PAR-  
TICULAR FONT, STYLE, SIZE, OR COLOR.

OWNER OF U.S. REG. NO. 2,090,417.

NO CLAIM IS MADE TO THE EXCLUSIVE RIGHT TO USE "PRECISION ACCESS SYSTEM",  
APART FROM THE MARK AS SHOWN.

SN 85-368,042, FILED 7-11-2011.

ZACHARY BELLO, EXAMINING ATTORNEY



*David J. Kybas*

Director of the United States Patent and Trademark Office

# United States of America

United States Patent and Trademark Office

## EDIBLE MILWAUKEE

**Reg. No. 4,276,565**

EDIBLE COMMUNITIES, INC. (NEW MEXICO CORPORATION)  
2645 TODOS SANTOS LANE  
SANTA BARBARA, CA 93105

**Registered Jan. 15, 2013**

**Int. Cl.: 16**

FOR: MAGAZINES FEATURING TOURISM, CULINARY AND AGRICULTURE INDUSTRIES AND PUBLICATIONS, NAMELY, MAGAZINES AND NEWSLETTERS DEALING WITH CONNECTING CONSUMERS WITH LOCAL GROWERS, FOOD RETAILERS, CHEFS AND FOOD ARTISANS, IN CLASS 16 (U.S. CLS. 2, 5, 22, 23, 29, 37, 38 AND 50).

**TRADEMARK**

**PRINCIPAL REGISTER**

FIRST USE 9-11-2012; IN COMMERCE 9-11-2012.

THE MARK CONSISTS OF STANDARD CHARACTERS WITHOUT CLAIM TO ANY PARTICULAR FONT, STYLE, SIZE, OR COLOR.

OWNER OF U.S. REG. NOS. 3,281,405, 3,281,407, AND OTHERS.

NO CLAIM IS MADE TO THE EXCLUSIVE RIGHT TO USE "MILWAUKEE", APART FROM THE MARK AS SHOWN.

SN 85-368,174, FILED 7-11-2011.

SALLY SHIH, EXAMINING ATTORNEY



*David J. Kyffers*

Director of the United States Patent and Trademark Office



# United States of America

United States Patent and Trademark Office



**Reg. No. 4,276,566**

**Registered Jan. 15, 2013**

**Int. Cl.: 25**

**TRADEMARK**

**PRINCIPAL REGISTER**

VERA, JUAN (UNITED STATES INDIVIDUAL)  
30820 EMPEROR DRIVE  
CANYON LAKE, CA 92587

FOR: CLOTHING, NAMELY, T-SHIRTS, SWEATSHIRTS, SHORTS, PANTS; HEADWEAR;  
AND FOOTWEAR, IN CLASS 25 (U.S. CLS. 22 AND 39).

FIRST USE 2-15-2012; IN COMMERCE 2-15-2012.

NO CLAIM IS MADE TO THE EXCLUSIVE RIGHT TO USE "MMA", APART FROM THE  
MARK AS SHOWN.

THE MARK CONSISTS OF THE WORDING "DOWN2SCRAP" ABOVE AN OVAL CONTAIN-  
ING THE DESIGN OF FISTS AND FINGERS FORMING THE LETTERS "MMA".

SN 85-368,179, FILED 7-11-2011.

MARC LEIPZIG, EXAMINING ATTORNEY



*David J. Kyffers*

Director of the United States Patent and Trademark Office

# United States of America

United States Patent and Trademark Office

# ARTISTIQUE

**Reg. No. 4,276,567**

RICHLINE GROUP, INC. (DELAWARE CORPORATION)  
1385 BROADWAY  
NEW YORK, NY 10018

**Registered Jan. 15, 2013**

**Int. Cl.: 14**

FOR: JEWELRY, IN CLASS 14 (U.S. CLS. 2, 27, 28 AND 50).

**TRADEMARK**

FIRST USE 1-31-2012; IN COMMERCE 1-31-2012.

**PRINCIPAL REGISTER**

THE MARK CONSISTS OF STANDARD CHARACTERS WITHOUT CLAIM TO ANY PARTICULAR FONT, STYLE, SIZE, OR COLOR.

SN 85-368,280, FILED 7-11-2011.

GRETTA YAO, EXAMINING ATTORNEY



*David J. Kyffers*

Director of the United States Patent and Trademark Office

# United States of America

United States Patent and Trademark Office

# SKY-TILES

**Reg. No. 4,276,568**

**Registered Jan. 15, 2013**

**Int. Cl.: 27**

**TRADEMARK**

**PRINCIPAL REGISTER**

INTERFACE, INC. (GEORGIA CORPORATION)  
2859 PACES FERRY ROAD  
SUITE 2000  
ATLANTA, GA 30339

FOR: CARPET TILES FOR USE IN CONNECTION WITH AIRCRAFT, IN CLASS 27 (U.S. CLS. 19, 20, 37, 42 AND 50).

FIRST USE 5-31-2012; IN COMMERCE 5-31-2012.

THE MARK CONSISTS OF STANDARD CHARACTERS WITHOUT CLAIM TO ANY PARTICULAR FONT, STYLE, SIZE, OR COLOR.

SN 85-369,111, FILED 7-12-2011.

MICHAEL ENGEL, EXAMINING ATTORNEY



*David J. Kyffers*

Director of the United States Patent and Trademark Office

# United States of America

United States Patent and Trademark Office

## Be Healthy! Be Happy!

**Reg. No. 4,276,569**

**Registered Jan. 15, 2013**

**Int. Cl.: 16**

**TRADEMARK**

**PRINCIPAL REGISTER**

SLEEPING GIANT PUBLISHING, LLC (NEVADA LIMITED LIABILITY COMPANY)  
10941 KEYMAR DRIVE  
LAS VEGAS, NV 89135

FOR: A SERIES OF BOOKS AND WRITTEN ARTICLES IN THE FIELD OF MEDICINE, HEALTH SCIENCE, PSYCHOLOGY, EXERCISE, AND HEALTHY LIVING.; A SERIES OF BOOKS, WRITTEN ARTICLES, HANDOUTS AND WORKSHEETS IN THE FIELD OF MEDICINE, HEALTH SCIENCE, PSYCHOLOGY, EXERCISE, AND HEALTHY LIVING, IN CLASS 16 (U.S. CLS. 2, 5, 22, 23, 29, 37, 38 AND 50).

FIRST USE 9-1-2011; IN COMMERCE 9-1-2011.

THE MARK CONSISTS OF STANDARD CHARACTERS WITHOUT CLAIM TO ANY PARTICULAR FONT, STYLE, SIZE, OR COLOR.

SN 85-369,609, FILED 7-12-2011.

WILLIAM ROSSMAN, EXAMINING ATTORNEY



*David J. Kyffers*

Director of the United States Patent and Trademark Office

# United States of America

United States Patent and Trademark Office

## Shiatsu + Rest

**Reg. No. 4,276,570**

**Registered Jan. 15, 2013**

**Int. Cl.: 10**

**TRADEMARK**

**PRINCIPAL REGISTER**

CONAIR CORPORATION (DELAWARE CORPORATION)  
ONE CUMMINGS POINT ROAD  
STAMFORD, CT 06902

FOR: MASSAGE APPARATUS, IN CLASS 10 (U.S. CLS. 26, 39 AND 44).

FIRST USE 10-31-2011; IN COMMERCE 10-31-2011.

THE MARK CONSISTS OF STANDARD CHARACTERS WITHOUT CLAIM TO ANY PARTICULAR FONT, STYLE, SIZE, OR COLOR.

NO CLAIM IS MADE TO THE EXCLUSIVE RIGHT TO USE "SHIATSU", APART FROM THE MARK AS SHOWN.

SN 85-371,025, FILED 7-14-2011.

YAT SYE, LEE, EXAMINING ATTORNEY



*David J. Kyffers*

Director of the United States Patent and Trademark Office

# United States of America

United States Patent and Trademark Office

## Body + Rest

**Reg. No. 4,276,571**

**Registered Jan. 15, 2013**

**Int. Cl.: 10**

**TRADEMARK**

**PRINCIPAL REGISTER**

CONAIR CORPORATION (DELAWARE CORPORATION)  
ONE CUMMINGS POINT ROAD  
STAMFORD, CT 06902

FOR: MASSAGE APPARATUS, IN CLASS 10 (U.S. CLS. 26, 39 AND 44).

FIRST USE 10-31-2011; IN COMMERCE 10-31-2011.

THE MARK CONSISTS OF STANDARD CHARACTERS WITHOUT CLAIM TO ANY PARTICULAR FONT, STYLE, SIZE, OR COLOR.

NO CLAIM IS MADE TO THE EXCLUSIVE RIGHT TO USE "BODY", APART FROM THE MARK AS SHOWN.

SN 85-371,042, FILED 7-14-2011.

YAT SYE, LEE, EXAMINING ATTORNEY



*David J. Kyffers*

Director of the United States Patent and Trademark Office

# United States of America

United States Patent and Trademark Office



**Reg. No. 4,276,572**

OLIVER, AL (UNITED STATES INDIVIDUAL)  
1220 13TH STREET  
PORTSMOUTH, OH 45662

**Registered Jan. 15, 2013**

**Int. Cl.: 25**

FOR: ATHLETIC APPAREL, NAMELY, SHIRTS, PANTS, JACKETS, FOOTWEAR, HATS AND CAPS, ATHLETIC UNIFORMS, IN CLASS 25 (U.S. CLS. 22 AND 39).

**TRADEMARK**

FIRST USE 4-2-2012; IN COMMERCE 4-2-2012.

**PRINCIPAL REGISTER**

THE NAME "AL OLIVER" IDENTIFIES A LIVING INDIVIDUAL WHOSE CONSENT IS OF RECORD.

THE MARK CONSISTS OF IMAGE OF A BASEBALL PLAYER SWINGING A BAT. BEHIND THE BASEBALL PLAYER IS A BASEBALL DIAMOND WITH THE NAME "AL OLIVER" AT THE TOP. ABOVE THE BASEBALL DIAMOND ARE THE WORDS "LIFE'S A HIT... BELOW THE BASEBALL PLAYER ARE THE WORDS "DON'T STRIKE OUT!".

SN 85-371,207, FILED 7-14-2011.

MARK SPARACINO, EXAMINING ATTORNEY



*David J. Kybas*

Director of the United States Patent and Trademark Office

# United States of America

United States Patent and Trademark Office

## STARBUCKS VIA

**Reg. No. 4,276,573**

**Registered Jan. 15, 2013**

**Int. Cl.: 32**

**TRADEMARK**

**PRINCIPAL REGISTER**

STARBUCKS CORPORATION (WASHINGTON CORPORATION), DBA STARBUCKS COFFEE COMPANY,  
2401 UTAH AVENUE SOUTH  
SEATTLE, WA 98134

FOR: OTHER NON-ALCOHOLIC DRINKS; SOFT DRINKS; ENERGY DRINKS; FRUIT DRINKS AND FRUIT JUICES; FRUIT DRINKS AND SOFT DRINKS CONTAINING FRUIT JUICES; LIQUID AND POWDERED BEVERAGE MIXES; FRUIT JUICE-BASED BEVERAGES; JUICE-BASED BEVERAGES, IN CLASS 32 (U.S. CLS. 45, 46 AND 48).

FIRST USE 7-10-2012; IN COMMERCE 7-10-2012.

THE MARK CONSISTS OF STANDARD CHARACTERS WITHOUT CLAIM TO ANY PARTICULAR FONT, STYLE, SIZE, OR COLOR.

OWNER OF U.S. REG. NOS. 1,815,938, 3,610,224, AND OTHERS.

SN 85-371,320, FILED 7-14-2011.

JOHN WILKE, EXAMINING ATTORNEY



*David J. Kyfos*

Director of the United States Patent and Trademark Office



# United States of America

United States Patent and Trademark Office



**Reg. No. 4,276,574**

**Registered Jan. 15, 2013**

**Int. Cls.: 6, 19, 35, and 40**

**TRADEMARK**

**SERVICE MARK**

**PRINCIPAL REGISTER**

TRULITE GLASS & ALUMINUM SOLUTIONS, LLC (DELAWARE LIMITED LIABILITY COMPANY)  
800 FAIRWAY DRIVE, STE. 200  
DEERFIELD BEACH, FL 33441

FOR: METAL BUILDING PRODUCTS, NAMELY, GLASS FRAMING SYSTEMS, CONSISTING PRIMARILY OF SPACER BARS, CURTAIN WALLS, ENTRANCE DOORS AND WINDOWS, FRAMES AND MULLIONS FOR USE IN RESIDENTIAL, RETAIL, INDUSTRIAL AND COMMERCIAL BUILDINGS, STOREFRONTS AND ENTRANCEWAYS, IN CLASS 6 (U.S. CLS. 2, 12, 13, 14, 23, 25 AND 50).

FIRST USE 8-0-2011; IN COMMERCE 8-0-2011.

FOR: BUILDING MATERIALS AND ARCHITECTURAL PRODUCTS, NAMELY, COMMON SHEET GLASS, LAMINATED FLAT GLASS, WIRE GLASS, NAMELY, A SAFETY GLASS WITH REINFORCING METAL WIRE, INSULATED GLASS, HEAT-TREATED GLASS, NON-METAL SPANDREL, GLASS HANDRAILS, CLAD AND GLASS DOORS, IN CLASS 19 (U.S. CLS. 1, 12, 33 AND 50).

FIRST USE 8-0-2011; IN COMMERCE 8-0-2011.

FOR: DISTRIBUTORSHIP SERVICES IN THE FIELD OF GLASS, METAL AND NON-METAL GLASS-RELATED PRODUCTS AND METAL AND NON-METAL ARCHITECTURAL PRODUCTS, IN CLASS 35 (U.S. CLS. 100, 101 AND 102).

FIRST USE 8-0-2011; IN COMMERCE 8-0-2011.

FOR: MANUFACTURING OF BUILDING PRODUCTS FOR OTHERS, NAMELY, ALUMINUM FRAMING SYSTEMS FOR GLASS, STOREFRONTS, CURTAIN WALLS, DOORS AND WINDOWS FOR OTHERS; FABRICATION OF GLASS PRODUCTS FOR OTHERS, NAMELY, INSULATED, LAMINATED, TEMPERED, DECORATIVE, BULLET AND BLAST RESISTANT GLASS, AND MIRRORS, IN CLASS 40 (U.S. CLS. 100, 103 AND 106).

FIRST USE 8-0-2011; IN COMMERCE 8-0-2011.

NO CLAIM IS MADE TO THE EXCLUSIVE RIGHT TO USE "GLASS & ALUMINUM SOLUTIONS", APART FROM THE MARK AS SHOWN.



*David J. Kyffers*

Director of the United States Patent and Trademark Office

**Reg. No. 4,276,574** THE MARK CONSISTS OF A DOUBLE "V" DESIGN FOLLOWED BY THE WORDS "TRULITE  
GLASS & ALUMINUM SOLUTIONS".

SN 85-371,740, FILED 7-14-2011.

TINA MAI, EXAMINING ATTORNEY

# United States of America

United States Patent and Trademark Office

## ARE YOU READY ?

**Reg. No. 4,276,575**

WENTZ, JAY (UNITED STATES INDIVIDUAL)  
PO BOX 2583

**Registered Jan. 15, 2013**

RANCHO SANTA FE, CA 92067

**Int. Cls.: 9, 14, 16, 18, 25,  
and 28**

FOR: PRE-RECORDED CD'S, VIDEO TAPES, LASER DISKS AND DVD'S FEATURING MUSICAL AND RELIGIOUS CONTENT UNRELATED TO MATH OR SCIENCE, IN CLASS 9 (U.S. CLS. 21, 23, 26, 36 AND 38).

**TRADEMARK**

FIRST USE 9-12-2012; IN COMMERCE 9-13-2012.

**PRINCIPAL REGISTER**

FOR: WATCHES, IN CLASS 14 (U.S. CLS. 2, 27, 28 AND 50).

FIRST USE 9-12-2012; IN COMMERCE 9-13-2012.

FOR: PUBLICATIONS, NAMELY, BOOKS AND HANDOUTS IN THE FIELD OF RELIGION; BIBLES DISTRIBUTED IN PRINT FORM; PUBLICATIONS, NAMELY, MAGAZINES IN THE FIELD OF RELIGION UNRELATED TO CAREER OR WORK ISSUES FOR YOUTHS, OR MATH, SCIENCE, OR OUTDOOR SURVIVAL OR ADVENTURE; BOOKS AND BOOKLETS IN THE FIELD OF RELIGION, DISTRIBUTED IN PRINT FORM; RELIGIOUS BOOKS; AND RELIGIOUS CIRCULAR LETTERS, IN CLASS 16 (U.S. CLS. 2, 5, 22, 23, 29, 37, 38 AND 50).

FIRST USE 9-12-2012; IN COMMERCE 9-13-2012.

FOR: BAGS FOR SPORTS, BEACH BAGS, DUFFEL BAGS, IN CLASS 18 (U.S. CLS. 1, 2, 3, 22 AND 41).

FIRST USE 9-12-2012; IN COMMERCE 9-13-2012.

FOR: CLOTHING, NAMELY, T-SHIRTS, TANK TOPS, JACKETS, JERSEYS, SHORTS, PANTS, SWEATSHIRTS, SWEAT PANTS, HEAD WEAR, FOOTWEAR, SANDALS, SNEAKERS, BOOTS, SHOES, SOCKS, DRESSES, LEOTARDS, BELTS, UNDERGARMENTS; MEN'S, WOMEN'S AND CHILDREN'S CLOTHING, NAMELY, T-SHIRTS, TANK TOPS, JACKETS, JERSEYS, SHORTS, PANTS, SWEATSHIRTS, SWEAT PANTS, HEAD WEAR, FOOTWEAR, SANDALS, SNEAKERS, BOOTS, SHOES, SOCKS, DRESSES, LEOTARDS, BELTS, UNDERGARMENTS, IN CLASS 25 (U.S. CLS. 22 AND 39).

FIRST USE 9-12-2012; IN COMMERCE 9-13-2012.



*David J. Kyffers*

Director of the United States Patent and Trademark Office

**Reg. No. 4,276,575** FOR: BAGS ESPECIALLY DESIGNED FOR SURFBOARDS, GOLF CLUB BAGS, IN CLASS 28 (U.S. CLS. 22, 23, 38 AND 50).

FIRST USE 9-12-2012; IN COMMERCE 9-13-2012.

THE MARK CONSISTS OF STANDARD CHARACTERS WITHOUT CLAIM TO ANY PARTICULAR FONT, STYLE, SIZE, OR COLOR.

SN 85-371,831, FILED 7-14-2011.

SHARON MEIER, EXAMINING ATTORNEY

# United States of America

United States Patent and Trademark Office

## MSC CareSync+

**Reg. No. 4,276,576**

MSC GROUP, INC. (DELAWARE CORPORATION)  
841 PRUDENTIAL DRIVE; SUITE 900  
JACKSONVILLE, FL 32207

**Registered Jan. 15, 2013**

**Int. Cl.: 35**

FOR: CUSTOMER COST CONTAINMENT PROGRAM IN THE FIELDS OF WORKER'S COMPENSATION AND HEALTH CARE, IN CLASS 35 (U.S. CLS. 100, 101 AND 102).

**SERVICE MARK**

FIRST USE 6-1-2011; IN COMMERCE 6-1-2011.

**PRINCIPAL REGISTER**

OWNER OF U.S. REG. NO. 3,678,818.

THE COLOR(S) GRAY, BLUE AND GREEN IS/ARE CLAIMED AS A FEATURE OF THE MARK.

THE MARK CONSISTS OF THE LETTERS "MSC" IN GRAY, THE WORD "CARESYNC+" WHEREIN "CARE" IS IN GREEN CONNECTED TO "SYNC" IN BLUE CONNECTED TO THE SYMBOL "+" IN GRAY TO FORM A SINGLE "CARESYNC+".

SN 85-371,981, FILED 7-14-2011.

DARRYL SPRUILL, EXAMINING ATTORNEY



*David J. Kyfos*

Director of the United States Patent and Trademark Office

# United States of America

United States Patent and Trademark Office

# WAYVIEW

**Reg. No. 4,276,577**

**Registered Jan. 15, 2013**

**Int. Cl.: 41**

**SERVICE MARK**

**PRINCIPAL REGISTER**

TACONIC PARTNERS, LLC (MINNESOTA LIMITED LIABILITY COMPANY)  
SUITE 2000  
30 7TH STREET E  
ST. PAUL, MN 55101

FOR: EDUCATIONAL SERVICES, NAMELY, CONDUCTING WORKSHOPS IN THE FIELD OF SMALL GROUP CONSENSUS AND STRATEGIC PLANNING FOR NON-PROFIT AND COMMERCIAL ORGANIZATIONS, IN CLASS 41 (U.S. CLS. 100, 101 AND 107).

FIRST USE 11-1-2012; IN COMMERCE 11-1-2012.

THE MARK CONSISTS OF STANDARD CHARACTERS WITHOUT CLAIM TO ANY PARTICULAR FONT, STYLE, SIZE, OR COLOR.

SN 85-372,216, FILED 7-15-2011.

TASHIA BUNCH, EXAMINING ATTORNEY



*David J. Kyros*

Director of the United States Patent and Trademark Office

# United States of America

United States Patent and Trademark Office

# RW PRIME

**Reg. No. 4,276,578**

**Registered Jan. 15, 2013**

**Int. Cl.: 43**

**SERVICE MARK**

**PRINCIPAL REGISTER**

GENTING INTELLECTUAL PROPERTY PTE LTD (SINGAPORE CORPORATION)  
3 ANSON ROAD # 27-01  
SPRINGLEAF TOWER, SINGAPORE 079909

FOR: PROVIDING FOOD AND DRINK; PROVISION OF SERVICES FOR RESTAURANTS, CAFES, CAFETERIAS AND TAKEOUT RESTAURANT SERVICES; MAKING RESTAURANT RESERVATIONS AND BOOKING; CATERING SERVICES FOR FOOD AND DRINK; CATERING OF WEDDING RECEPTIONS; PROVISION OF COCKTAIL LOUNGE, BAR, WINE BAR, BISTRO; PROVISION OF INFORMATION ABOUT SERVICES FOR PROVIDING FOOD AND DRINKS VIA ALL MEANS OF COMMUNICATION, INCLUDING ONLINE FROM A COMPUTER DATABASE OR THE GLOBAL COMMUNICATIONS NETWORK, IN CLASS 43 (U.S. CLS. 100 AND 101).

FIRST USE 10-28-2011; IN COMMERCE 10-28-2011.

THE MARK CONSISTS OF STANDARD CHARACTERS WITHOUT CLAIM TO ANY PARTICULAR FONT, STYLE, SIZE, OR COLOR.

SN 85-372,323, FILED 7-15-2011.

VIVIAN MICZNIK FIRST, EXAMINING ATTORNEY



*David J. Kyffers*

Director of the United States Patent and Trademark Office

# United States of America

United States Patent and Trademark Office



**Reg. No. 4,276,579**

**Registered Jan. 15, 2013**

**Int. Cl.: 43**

**SERVICE MARK**

**PRINCIPAL REGISTER**

GENTING INTELLECTUAL PROPERTY PTE LTD (SINGAPORE CORPORATION)  
3 ANSON ROAD # 27-01  
SPRINGLEAF TOWER, SINGAPORE 079909

FOR: PROVIDING FOOD AND DRINK; PROVISION OF SERVICES FOR RESTAURANTS, CAFES, CAFETERIAS AND TAKEOUT RESTAURANT SERVICES; MAKING RESTAURANT RESERVATIONS AND BOOKING; CATERING SERVICES FOR FOOD AND DRINK; CATERING OF WEDDING RECEPTIONS; PROVISION OF COCKTAIL LOUNGE, BAR, WINE BAR, BISTRO; PROVISION OF INFORMATION ABOUT SERVICES FOR PROVIDING FOOD AND DRINKS VIA ALL MEANS OF COMMUNICATION, INCLUDING ONLINE FROM A COMPUTER DATABASE OR THE GLOBAL COMMUNICATIONS NETWORK, IN CLASS 43 (U.S. CLS. 100 AND 101).

FIRST USE 10-28-2011; IN COMMERCE 10-28-2011.

THE MARK CONSISTS OF AN IMAGE OF HALF A BULL'S FACE ON THE LEFT SIDE OF THE MARK, AND HALF A WINE GLASS ON THE RIGHT SIDE OF THE MARK.

SN 85-372,354, FILED 7-15-2011.

VIVIAN MICZNIK FIRST, EXAMINING ATTORNEY



*David J. Kyffers*

Director of the United States Patent and Trademark Office



# United States of America

United States Patent and Trademark Office

## LA DOLCE VITA

**Reg. No. 4,276,580**

FOOD DISTRIBUTORS, INC. (NEW YORK CORPORATION)  
18 WILSHER DRIVE  
MONSEY, NY 10901

**Registered Jan. 15, 2013**

**Int. Cl.: 29**

FOR: CHEESE, IN CLASS 29 (U.S. CL. 46).

**TRADEMARK**

FIRST USE 1-1-2002; IN COMMERCE 1-1-2002.

**PRINCIPAL REGISTER**

THE MARK CONSISTS OF STANDARD CHARACTERS WITHOUT CLAIM TO ANY PARTICULAR FONT, STYLE, SIZE, OR COLOR.

THE ENGLISH TRANSLATION OF "LA DOLCE VITA" IN THE MARK IS "THE SWEET LIFE".

SN 85-373,093, FILED 7-16-2011.

RUSS HERMAN, EXAMINING ATTORNEY



*David J. Kybas*

Director of the United States Patent and Trademark Office

# United States of America

United States Patent and Trademark Office

## True Meaning Of MAMA'S BOY MINDFUL APPRECIATIVE MANNERED ARTICULATE SPIRITUAL BEHAVED OBJECTIVE YOUNGMAN

**Reg. No. 4,276,581**

WILSON, LAVELLE (UNITED STATES INDIVIDUAL)  
3532 WEST 99TH STREET  
CLEVELAND, OH 44102

**Registered Jan. 15, 2013**

**Int. Cl.: 25**

**TRADEMARK**

**PRINCIPAL REGISTER**

FOR: A-SHIRTS; APPAREL FOR DANCERS, NAMELY, TEE SHIRTS, SWEATSHIRTS, PANTS, LEGGINGS, SHORTS AND JACKETS; ATHLETIC APPAREL, NAMELY, SHIRTS, PANTS, JACKETS, FOOTWEAR, HATS AND CAPS, ATHLETIC UNIFORMS; BASEBALL CAPS AND HATS; BED JACKETS; BODY SHIRTS; BOMBER JACKETS; BUTTON DOWN SHIRTS; BUTTON-FRONT ALOHA SHIRTS; CAMOUFLAGE JACKETS; CAMOUFLAGE SHIRTS; CAMP SHIRTS; CHEF'S HATS; CLOTHING FOR ATHLETIC USE, NAMELY, PADDED SHIRTS; CLOTHING FOR BABIES, TODDLERS AND CHILDREN, TREATED WITH FIRE AND HEAT RETARDANTS, NAMELY, PAJAMAS, JACKETS, SHIRTS, PANTS, JUMPERS; COLLARED SHIRTS; DENIM JACKETS; DOWN JACKETS; DRESS SHIRTS; GOLF SHIRTS; HATS; HATS FOR INFANTS, BABIES, TODDLERS AND CHILDREN; HEAVY JACKETS; HOODED SWEAT SHIRTS; JACKETS; JACKETS AND SOCKS; KNIT JACKETS; KNIT SHIRTS; LEATHER JACKETS; LONG JACKETS; LONG-SLEEVED SHIRTS; MEN'S AND WOMEN'S JACKETS, COATS, TROUSERS, VESTS; NIGHT SHIRTS; OPEN-NECKED SHIRTS; OUTER JACKETS; OVER SHIRTS; PADDED JACKETS; PADDING JACKETS; PIQUE SHIRTS; POLO SHIRTS; RAIN JACKETS; RAINPROOF JACKETS; REVERSIBLE JACKETS; SHIRT FRONTS; SHIRTS AND SHORT-SLEEVED SHIRTS; SHIRTS AND SLIPS; SHIRTS FOR INFANTS, BABIES, TODDLERS AND CHILDREN; SHIRTS FOR SUITS; SHORT-SLEEVED OR LONG-SLEEVED T-SHIRTS; SHORT-SLEEVED SHIRTS; SLEEP SHIRTS; SLEEVED OR SLEEVELESS JACKETS; SLEEVES WORN SEPARATE AND APART FROM BLOUSES, SHIRTS AND OTHER TOPS; SMALL HATS; SNAP CROTCH SHIRTS FOR INFANTS AND TODDLERS; SNOWBOARD JACKETS; SPORT SHIRTS; SPORTS CAPS AND HATS; SPORTS JACKETS; SPORTS SHIRTS; SPORTS SHIRTS WITH SHORT SLEEVES; STUFF JACKETS; SWEAT JACKETS; SWEAT SHIRTS; T-SHIRTS; TEE SHIRTS; TRACK JACKETS; WEARABLE GARMENTS AND CLOTHING, NAMELY, SHIRTS; WIND RESISTANT JACKETS; WIND-JACKETS, IN CLASS 25 (U.S. CLS. 22 AND 39).



FIRST USE 3-2-2012; IN COMMERCE 3-2-2012.

THE MARK CONSISTS OF STANDARD CHARACTERS WITHOUT CLAIM TO ANY PARTICULAR FONT, STYLE, SIZE, OR COLOR.

SN 85-374,259, FILED 7-18-2011.

*David J. Kypas*

Director of the United States Patent and Trademark Office

**Reg. No. 4,276,581** LESLIE RICHARDS, EXAMINING ATTORNEY

# United States of America

United States Patent and Trademark Office



**Reg. No. 4,276,582**

**Registered Jan. 15, 2013**

**Int. Cl.: 30**

**TRADEMARK**

**PRINCIPAL REGISTER**

NEBRASKA POPCORN, INC. (NEBRASKA CORPORATION), AKA NEBRASKA POPCORN SALES, INC.,  
85824 519TH AVENUE  
CLEARWATER, NE 68726

FOR: PROCESSED UNPOPPED POPCORN, IN CLASS 30 (U.S. CL. 46).

FIRST USE 7-1-2011; IN COMMERCE 7-25-2011.

NO CLAIM IS MADE TO THE EXCLUSIVE RIGHT TO USE "BRAND" AND "POPCORN", APART FROM THE MARK AS SHOWN.

THE COLOR(S) RED, WHITE, BLUE, YELLOW IS/ARE CLAIMED AS A FEATURE OF THE MARK.

THE MARK CONSISTS OF RED, WHITE, AND YELLOW RAYS RADIATING OUT FROM A CENTRAL YELLOW AND BLUE KERNEL OF POPPED POPCORN WITH THE RAYS NARROWING TO POINTS AS THEY GET FURTHER FROM THE CENTER; THE NINE POINTS OF THE RAYS ALSO HAVE YELLOW AND BLUE KERNELS OF POPPED POPCORN AT THE NARROW POINT OF EACH RAY; THIS IS ALL ON A WHITE BACKGROUND WITH THE WORDS "BIG BANG BRAND POPCORN" WRITTEN OVER THE TOP OF THE RAYS IN BLUE.

SN 85-374,751, FILED 7-19-2011.

KEVON CHISOLM, EXAMINING ATTORNEY



*David J. Kyros*

Director of the United States Patent and Trademark Office

# United States of America

United States Patent and Trademark Office

**FINO**  
**FAILURE IS NO OPTION**

**Reg. No. 4,276,583**

**Registered Jan. 15, 2013**

**Int. Cl.: 25**

**TRADEMARK**

**PRINCIPAL REGISTER**

FINO, INC. (GEORGIA CORPORATION)  
33 HAMILTON BLVD  
CARTERSVILLE, GA 30120

FOR: BATHING SUITS; BEANIES; CAPS; HATS; JACKETS; JERSEYS; SHORTS; SOCKS;  
SWEAT SHIRTS; SWEATPANTS; T-SHIRTS; TANK-TOPS; WRISTBANDS, IN CLASS 25  
(U.S. CLS. 22 AND 39).

FIRST USE 11-21-2011; IN COMMERCE 11-21-2011.

THE MARK CONSISTS OF THE WORDING "FINO FAILURE IS NO OPTION" IN STYLIZED  
FONT, WITH THE TERM "FINO" PLACED ABOVE THE WORDS "FAILURE IS NO OPTION".

SN 85-374,904, FILED 7-19-2011.

CURTIS FRENCH, EXAMINING ATTORNEY



*David J. Kyffers*

Director of the United States Patent and Trademark Office

# United States of America

United States Patent and Trademark Office

# JFI

**Reg. No. 4,276,584**

AIR RUTTER INTERNATIONAL LLC (DELAWARE LIMITED LIABILITY COMPANY)  
4310 DONALD DOUGLAS DRIVE #202  
LONG BEACH, CA 90808

**Registered Jan. 15, 2013**

**Int. Cls.: 35, 37, and 39**

FOR: BUSINESS MANAGEMENT SERVICES, NAMELY, AIRCRAFT MANAGEMENT FOR OTHERS; AIRCRAFT ACQUISITION SERVICES, NAMELY, PURCHASING AIRCRAFT ON BEHALF OF OTHERS, IN CLASS 35 (U.S. CLS. 100, 101 AND 102).

**SERVICE MARK**

FIRST USE 10-1-2012; IN COMMERCE 10-1-2012.

**PRINCIPAL REGISTER**

FOR: AIRCRAFT MAINTENANCE AND REPAIR SERVICES, IN CLASS 37 (U.S. CLS. 100, 103 AND 106).

FIRST USE 10-15-2012; IN COMMERCE 10-15-2012.

FOR: LEASING OF AIRCRAFT; AIR CHARTER SERVICES, IN CLASS 39 (U.S. CLS. 100 AND 105).

FIRST USE 10-1-2012; IN COMMERCE 10-1-2012.

THE MARK CONSISTS OF STANDARD CHARACTERS WITHOUT CLAIM TO ANY PARTICULAR FONT, STYLE, SIZE, OR COLOR.

SN 85-375,045, FILED 7-19-2011.

ALAIN LAPTER, EXAMINING ATTORNEY



*David J. Kyffers*

Director of the United States Patent and Trademark Office

# United States of America

United States Patent and Trademark Office

## INATURE LLC

**Reg. No. 4,276,585**

INATURE ORGANICS, LLC (COLORADO LIMITED LIABILITY COMPANY)  
1720 SOUTH MONACO PARKWAY  
DENVER, CO 80224

**Registered Jan. 15, 2013**

**Int. Cl.: 1**

FOR: PREPARATIONS FOR FORTIFYING PLANTS, NAMELY, PLANT CONDITIONER IN SPRAY FORM, IN CLASS 1 (U.S. CLS. 1, 5, 6, 10, 26 AND 46).

**TRADEMARK**

FIRST USE 1-11-2011; IN COMMERCE 3-4-2011.

**PRINCIPAL REGISTER**

THE MARK CONSISTS OF STANDARD CHARACTERS WITHOUT CLAIM TO ANY PARTICULAR FONT, STYLE, SIZE, OR COLOR.

NO CLAIM IS MADE TO THE EXCLUSIVE RIGHT TO USE "LLC", APART FROM THE MARK AS SHOWN.

SN 85-375,552, FILED 7-19-2011.

SHANNON TWOHIG, EXAMINING ATTORNEY



*David J. Kybas*

Director of the United States Patent and Trademark Office

# United States of America

United States Patent and Trademark Office

# SuperTrees

**Reg. No. 4,276,586**

**Registered Jan. 15, 2013**

**Int. Cl.: 44**

**SERVICE MARK**

**PRINCIPAL REGISTER**

SUPERTREES INCORPORATED (OREGON CORPORATION)  
10301 S. KRAXBERGER RD.  
CANBY, OR 97013

FOR: TREE NURSERIES; GARDEN TREE PLANTING; RESIDENTIAL AND MUNICIPAL TREE CARE SERVICES; RESIDENTIAL, COMMERCIAL PROPERTY, AND MUNICIPAL TREE REMOVAL SERVICES; AGRICULTURAL SERVICES, NAMELY, PLANTING, GROWING, FERTILIZING, PRUNING AND SELECTING TREES FOR OTHERS; HAZARD TREE IDENTIFICATION FOR TREE REMOVAL PURPOSES; RESIDENTIAL, COMMERCIAL PROPERTY AND MUNICIPAL TREE IDENTIFICATION FOR HORTICULTURAL PURPOSE AND TREE REMOVAL PURPOSES; LANDSCAPE MAINTENANCE, IN CLASS 44 (U.S. CLS. 100 AND 101).

FIRST USE 4-1-2004; IN COMMERCE 3-15-2006.

THE MARK CONSISTS OF STANDARD CHARACTERS WITHOUT CLAIM TO ANY PARTICULAR FONT, STYLE, SIZE, OR COLOR.

SEC. 2(F).

OWNER OF U.S. REG. NO. 3,253,327.

SN 85-376,376, FILED 7-20-2011.

LIEF MARTIN, EXAMINING ATTORNEY



*David J. Kyros*

Director of the United States Patent and Trademark Office



# United States of America

United States Patent and Trademark Office

# FOODFAN

**Reg. No. 4,276,587**

**Registered Jan. 15, 2013**

**Int. Cl.: 35**

**SERVICE MARK**

**PRINCIPAL REGISTER**

FOODFAN, INC. (FLORIDA CORPORATION)  
11800 AVENUE OF THE PGA  
PALM BEACH GARDENS, FL 33418

FOR: PROVIDING INFORMATION, NAMELY, COMPILATIONS, RANKINGS, RATINGS, REVIEWS, REFERRALS AND RECOMMENDATIONS RELATING TO RESTAURANTS USING A GLOBAL COMPUTER NETWORK FOR COMMERCIAL PURPOSES; PROVIDING A SEARCHABLE ON-LINE ADVERTISING WEBSITE AND GUIDE FEATURING THE GOODS AND SERVICES OF OTHERS VIA THE INTERNET; ADVERTISING AND MARKETING; PROVIDING AN ON-LINE DIRECTORY INFORMATION SERVICE FEATURING INFORMATION REGARDING RESTAURANTS; PROMOTIONAL SERVICES, NAMELY, PROMOTING THE GOODS OF OTHERS BY MEANS OF PROVIDING ONLINE RESTAURANT MENUS; PROMOTIONAL SERVICES, NAMELY, PROMOTING THE GOODS OF OTHERS BY MEANS OF PROVIDING ONLINE COUPONS AND CONDUCTING PROMOTIONAL CONTESTS; ON-LINE ORDERING SERVICES IN THE FIELD OF RESTAURANT TAKE-OUT AND DELIVERY; ON-LINE ORDERING SERVICES FEATURING RESTAURANT MEALS, IN CLASS 35 (U.S. CLS. 100, 101 AND 102).

FIRST USE 4-1-2012; IN COMMERCE 10-19-2012.

THE MARK CONSISTS OF STANDARD CHARACTERS WITHOUT CLAIM TO ANY PARTICULAR FONT, STYLE, SIZE, OR COLOR.

SN 85-376,881, FILED 7-21-2011.

ZACHARY BELLO, EXAMINING ATTORNEY



*David J. Kyffers*

Director of the United States Patent and Trademark Office

# United States of America

United States Patent and Trademark Office

# X SERIES

**Reg. No. 4,276,588**

**Registered Jan. 15, 2013**

**Int. Cl.: 10**

**TRADEMARK**

**PRINCIPAL REGISTER**

ZOLL MEDICAL CORPORATION (MASSACHUSETTS CORPORATION)  
269 MILL ROAD  
CHELMSFORD, MA 018244105

FOR: DEFIBRILLATORS; DEFIBRILLATORS WITH COMMUNICATION HARDWARE AND COMMUNICATION SOFTWARE; DEFIBRILLATOR PARTS AND ACCESSORIES, IN CLASS 10 (U.S. CLS. 26, 39 AND 44).

FIRST USE 3-27-2012; IN COMMERCE 3-27-2012.

THE MARK CONSISTS OF STANDARD CHARACTERS WITHOUT CLAIM TO ANY PARTICULAR FONT, STYLE, SIZE, OR COLOR.

OWNER OF U.S. REG. NOS. 3,057,534, 3,163,823, AND 3,436,773.

NO CLAIM IS MADE TO THE EXCLUSIVE RIGHT TO USE "SERIES", APART FROM THE MARK AS SHOWN.

SN 85-377,057, FILED 7-21-2011.

TARAH HARDY, EXAMINING ATTORNEY



*David J. Kyfos*

Director of the United States Patent and Trademark Office

# United States of America

United States Patent and Trademark Office

## FRESH DECOR

**Reg. No. 4,276,589**

**Registered Jan. 15, 2013**

**Int. Cls.: 3, 5, and 11**

**TRADEMARK**

**PRINCIPAL REGISTER**

SAFEWAY INC. (DELAWARE CORPORATION)  
5918 STONERIDGE MALL ROAD  
PLEASANTON, CA 94588

FOR: ODOR REMOVERS FOR PETS, IN CLASS 3 (U.S. CLS. 1, 4, 6, 50, 51 AND 52).

FIRST USE 2-4-2012; IN COMMERCE 2-4-2012.

FOR: REFILLS FOR AIR FRESHENERS; AIR FRESHENER SPRAYS, IN CLASS 5 (U.S. CLS. 6, 18, 44, 46, 51 AND 52).

FIRST USE 2-1-2012; IN COMMERCE 2-1-2012.

FOR: DISPENSING UNITS FOR AIR FRESHENERS, IN CLASS 11 (U.S. CLS. 13, 21, 23, 31 AND 34).

FIRST USE 2-4-2012; IN COMMERCE 2-4-2012.

THE MARK CONSISTS OF STANDARD CHARACTERS WITHOUT CLAIM TO ANY PARTICULAR FONT, STYLE, SIZE, OR COLOR.

NO CLAIM IS MADE TO THE EXCLUSIVE RIGHT TO USE "FRESH", APART FROM THE MARK AS SHOWN.

SN 85-377,321, FILED 7-21-2011.

ANNE E. GUSTASON, EXAMINING ATTORNEY



*David J. Kyffers*

Director of the United States Patent and Trademark Office

# United States of America

United States Patent and Trademark Office



**Reg. No. 4,276,590**

**Registered Jan. 15, 2013**

**Int. Cl.: 33**

**TRADEMARK**

**PRINCIPAL REGISTER**

THE NEW ZEALAND WINE COMPANY LIMITED (NEW ZEALAND CORPORATION)  
13 WAIHOPAI VALLEY ROAD  
RENWICK BLENHEIM, NEW ZEALAND

FOR: WINE, IN CLASS 33 (U.S. CLS. 47 AND 49).

FIRST USE 11-0-2011; IN COMMERCE 11-0-2011.

NO CLAIM IS MADE TO THE EXCLUSIVE RIGHT TO USE "VINEYARD", APART FROM THE MARK AS SHOWN.

THE STIPPLING IS FOR SHADING PURPOSES ONLY.

THE MARK CONSISTS OF A SCENIC LANDSCAPE OF TREES JOINED WITH THE LETTERS "L", "K", AND "H" FOUND IN THE WORDS "BLACK BIRCH MOUNTAIN" ABOVE A HORIZONTAL LINE AND THE WORD "VINEYARD" FOUND BELOW THE HORIZONTAL LINE AS THE FOREGROUND; AND A MOUNTAINSCAPE AS THE BACKGROUND.

SN 85-377,445, FILED 7-21-2011.

DARRYL SPRUILL, EXAMINING ATTORNEY



*David J. Kyffers*

Director of the United States Patent and Trademark Office

# United States of America

United States Patent and Trademark Office

## WINNING WINGS

**Reg. No. 4,276,591**

**Registered Jan. 15, 2013**

**Int. Cl.: 9**

**TRADEMARK**

**PRINCIPAL REGISTER**

BALLY GAMING, INC. (NEVADA CORPORATION), DBA BALLY TECHNOLOGIES,  
ATT: LEGAL DEPARTMENT  
6601 SOUTH BERMUDA ROAD  
LAS VEGAS, NV 89119

FOR: GAMING MACHINES, NAMELY, DEVICES WHICH ACCEPT A WAGER AND GAMING SOFTWARE THAT GENERATES OR DISPLAYS OUTCOMES FOR GAMING MACHINES, IN CLASS 9 (U.S. CLS. 21, 23, 26, 36 AND 38).

FIRST USE 9-3-2011; IN COMMERCE 9-3-2011.

THE MARK CONSISTS OF STANDARD CHARACTERS WITHOUT CLAIM TO ANY PARTICULAR FONT, STYLE, SIZE, OR COLOR.

SN 85-377,867, FILED 7-21-2011.

MARIA-VICTORIA SUAREZ, EXAMINING ATTORNEY



*David J. Kybas*

Director of the United States Patent and Trademark Office

# United States of America

United States Patent and Trademark Office

# Mr. Bingle

**Reg. No. 4,276,592**

DILLARD'S (DELAWARE CORPORATION)  
1600 CANTRELL ROAD  
LITTLE ROCK, AR 72201

**Registered Jan. 15, 2013**

**Int. Cl.: 25**

FOR: BOXER SHORTS; ROBES; SLEEP PANTS; SLEEP SHIRTS; T-SHIRTS, IN CLASS 25  
(U.S. CLS. 22 AND 39).

**TRADEMARK**

FIRST USE 11-14-1949; IN COMMERCE 11-14-1949.

**PRINCIPAL REGISTER**

THE MARK CONSISTS OF STANDARD CHARACTERS WITHOUT CLAIM TO ANY PARTICULAR FONT, STYLE, SIZE, OR COLOR.

OWNER OF U.S. REG. NOS. 535,774, 3,395,209, AND OTHERS.

SN 85-378,122, FILED 7-22-2011.

ANGELA M. MICHELLI, EXAMINING ATTORNEY



*David J. Kybas*

Director of the United States Patent and Trademark Office

# United States of America

United States Patent and Trademark Office

# DEALPOINT

**Reg. No. 4,276,593**

**Registered Jan. 15, 2013**

**Int. Cl.: 35**

**SERVICE MARK**

**PRINCIPAL REGISTER**

DEALPOINT INC. (DELAWARE CORPORATION)  
SUITE 258  
1253 SPRINGFIELD AVENUE  
NEW PROVIDENCE, NJ 079741935

FOR: PROMOTING THE GOODS AND SERVICES OF OTHERS BY MEANS OF THE ISSUANCE OF LOYALTY REWARDS CARDS; PROMOTING THE GOODS AND SERVICES OF OTHERS BY PROVIDING A WEB SITE AT WHICH USERS CAN LINK TO MERCHANT PROFILE INFORMATION INCLUDING BUSINESS NAME, LOGO, LOCATION, CONTACT INFORMATION, CUSTOMER REVIEWS, CUSTOMER RATINGS; PROMOTING THE GOODS AND SERVICES OF OTHERS BY PROVIDING A WEB SITE FEATURING DISCOUNT VOUCHERS, REBATES, PRICE-COMPARISON INFORMATION, PRODUCT REVIEWS, DISCOUNT INFORMATION; PROMOTING THE GOODS AND SERVICES OF OTHERS BY PROVIDING AN INTERACTIVE WEB SITE WHERE USERS CAN INCREASE THE CURRENT VALUE OF AN ONLINE DISCOUNT BEING OFFERED BY PURCHASING THE GOODS AND SERVICES ASSOCIATED WITH THAT DISCOUNT IN THE FORM OF AN ONLINE COUPON, VOUCHER OR GIFT CARD; PROMOTING THE GOODS AND SERVICES OF OTHERS BY PROVIDING HYPERTEXT LINKS TO THE WEB SITES OF OTHERS; PROMOTING THE SALE OF GOODS AND SERVICES OF OTHERS BY DISTRIBUTING ADVERTISING MATERIAL, COUPONS AND DISCOUNT OFFERS VIA TEXT MESSAGES, VIA EMAIL, VIA WEB SITE, AND/OR VIA DOWNLOADABLE FILES; PROMOTING THE SALE OF GOODS AND SERVICES OF OTHERS BY PROVIDING AN INTERACTIVE WEB SITE THROUGH WHICH USERS CAN GENERATE CUSTOMIZED DISCOUNTS OR BENEFITS IN RETURN FOR CONDUCTING A TRANSACTION MEETING SPECIFIED MERCHANT CRITERIA, IN CLASS 35 (U.S. CLS. 100, 101 AND 102).



FIRST USE 6-10-2012; IN COMMERCE 6-10-2012.

THE MARK CONSISTS OF STANDARD CHARACTERS WITHOUT CLAIM TO ANY PARTICULAR FONT, STYLE, SIZE, OR COLOR.

SN 85-378,343, FILED 7-22-2011.

KAREN BRACEY, EXAMINING ATTORNEY

*David J. Kyffers*

Director of the United States Patent and Trademark Office

# United States of America

United States Patent and Trademark Office

## WIN AMERICA

**Reg. No. 4,276,594**

**Registered Jan. 15, 2013**

**Int. Cls.: 16 and 25**

**TRADEMARK**

**PRINCIPAL REGISTER**

LUSTGARTEN, ALLAN (UNITED STATES INDIVIDUAL)  
7560 MIRABELLA DRIVE  
BOCA RATON, FL 33433

FOR: PAPER GOODS, NAMELY, POSTERS, GREETING CARDS AND STICKERS, IN CLASS 16 (U.S. CLS. 2, 5, 22, 23, 29, 37, 38 AND 50).

FIRST USE 3-0-2010; IN COMMERCE 3-0-2010.

FOR: CLOTHING, NAMELY, HATS, CAPS, T-SHIRTS AND SWEATSHIRTS, IN CLASS 25 (U.S. CLS. 22 AND 39).

FIRST USE 3-0-2010; IN COMMERCE 3-0-2010.

THE MARK CONSISTS OF STANDARD CHARACTERS WITHOUT CLAIM TO ANY PARTICULAR FONT, STYLE, SIZE, OR COLOR.

NO CLAIM IS MADE TO THE EXCLUSIVE RIGHT TO USE "AMERICA", APART FROM THE MARK AS SHOWN.

SN 85-378,498, FILED 7-22-2011.

CHARLES L. JENKINS, EXAMINING ATTORNEY



*David J. Kybas*

Director of the United States Patent and Trademark Office



# United States of America

United States Patent and Trademark Office

## DRILLING ENTERPRISE

**Reg. No. 4,276,595**

**Registered Jan. 15, 2013**

**Int. Cls.: 9 and 42**

PETROTECHNICAL DATA SYSTEMS AMERICAN HOLDING LLC (DELAWARE LIMITED LIABILITY COMPANY)  
OFFICE VM KROESE LANGE KLEIWEG 60C  
RIJSWIJK  
ZUID HOLLAND, NETHERLANDS 2288GK

**TRADEMARK**

**SERVICE MARK**

**PRINCIPAL REGISTER**

FOR: COMPUTER SOFTWARE FOR ACCESSING INFORMATION DIRECTORIES THAT MAY BE DOWNLOADED FROM A GLOBAL COMPUTER NETWORK; COMPUTER SOFTWARE FOR DATA MANAGEMENT IN THE OIL AND GAS PRODUCTION SECTOR THAT MAY BE DOWNLOADED FROM A GLOBAL COMPUTER NETWORK; DOWNLOADABLE SOFTWARE FOR DATA MANAGEMENT IN THE OIL AND GAS PRODUCTION SECTOR; ELECTRONIC SOFTWARE UPDATES, NAMELY, DOWNLOADABLE COMPUTER SOFTWARE AND ASSOCIATED DATA FILES FOR UPDATING COMPUTER SOFTWARE IN THE FIELDS OF DATA MANAGEMENT IN THE OIL AND GAS PRODUCTION SECTOR, PROVIDED VIA COMPUTER AND COMMUNICATION NETWORKS, IN CLASS 9 (U.S. CLS. 21, 23, 26, 36 AND 38).

FIRST USE 4-1-2012; IN COMMERCE 4-1-2012.

FOR: PROVIDING NON-DOWNLOADABLE ONLINE COMPUTER SOFTWARE FOR CREATING WORKFLOW SOLUTIONS; PROVIDING NON-DOWNLOADABLE ONLINE COMPUTER SOFTWARE FOR ACCESSING INFORMATION DIRECTORIES; PROVIDING NON-DOWNLOADABLE ONLINE COMPUTER SOFTWARE FOR DATA MANAGEMENT IN THE OIL AND GAS PRODUCTION SECTOR, IN CLASS 42 (U.S. CLS. 100 AND 101).

FIRST USE 4-1-2012; IN COMMERCE 4-1-2012.

THE MARK CONSISTS OF STANDARD CHARACTERS WITHOUT CLAIM TO ANY PARTICULAR FONT, STYLE, SIZE, OR COLOR.

NO CLAIM IS MADE TO THE EXCLUSIVE RIGHT TO USE "DRILLING", APART FROM THE MARK AS SHOWN.

SN 85-378,706, FILED 7-22-2011.

BRIAN NEVILLE, EXAMINING ATTORNEY



*David J. Kyffers*

Director of the United States Patent and Trademark Office

# United States of America

United States Patent and Trademark Office

OUR LIFE'S WORK IS IN YOUR  
HANDS.

**Reg. No. 4,276,596**

DENEEN POTTERY, INC. (MINNESOTA CORPORATION)  
2325 ENDICOTT STREET  
ST. PAUL, MN 55114

**Registered Jan. 15, 2013**

**Int. Cl.: 21**

FOR: COFFEE CUPS, TEA CUPS AND MUGS; COFFEE MUGS; EARTHENWARE MUGS;  
GLASS MUGS; MUGS; PITCHERS; PORCELAIN MUGS, IN CLASS 21 (U.S. CLS. 2, 13, 23,  
29, 30, 33, 40 AND 50).

**TRADEMARK**

FIRST USE 1-1-2011; IN COMMERCE 1-1-2011.

**PRINCIPAL REGISTER**

THE MARK CONSISTS OF STANDARD CHARACTERS WITHOUT CLAIM TO ANY PAR-  
TICULAR FONT, STYLE, SIZE, OR COLOR.

SN 85-379,017, FILED 7-22-2011.

KIMBERLY FRYE, EXAMINING ATTORNEY



*David J. Kybas*

Director of the United States Patent and Trademark Office

# United States of America

United States Patent and Trademark Office

**SMART** →  
← **TRACK**

**Reg. No. 4,276,597**

ENCORE WIRE CORPORATION (DELAWARE CORPORATION)  
1329 MILLWOOD ROAD  
MCKINNEY, TX 75069

**Registered Jan. 15, 2013**

**Int. Cl.: 35**

FOR: GLOBAL POSITIONING SYSTEM TRACKING SERVICES FOR WIRE AND CABLE SHIPMENTS FOR OTHERS, IN CLASS 35 (U.S. CLS. 100, 101 AND 102).

**SERVICE MARK**

FIRST USE 3-5-2012; IN COMMERCE 3-5-2012.

**PRINCIPAL REGISTER**

NO CLAIM IS MADE TO THE EXCLUSIVE RIGHT TO USE "TRACK", APART FROM THE MARK AS SHOWN.

THE MARK CONSISTS OF THE WORD "SMART" WITH AN ARROW EXTENDING TO THE RIGHT OFF OF THE "T" IN "SMART" DIRECTLY ABOVE THE WORD "TRACK" WITH AN ARROW EXTENDING TO THE LEFT OFF OF THE "T" IN "TRACK".

SN 85-380,136, FILED 7-25-2011.

MICHAEL ENGEL, EXAMINING ATTORNEY



*David J. Kyros*

Director of the United States Patent and Trademark Office

# United States of America

United States Patent and Trademark Office

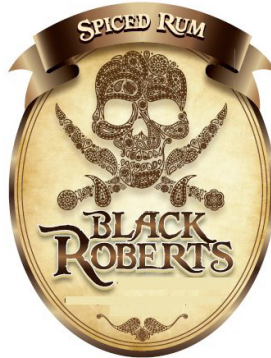

**Reg. No. 4,276,598**

**Registered Jan. 15, 2013**

**Int. Cl.: 33**

**TRADEMARK**

**PRINCIPAL REGISTER**

CLUB CARIBE DISTILLERS LLC (PUERTO RICO LIMITED LIABILITY COMPANY)  
P.O. BOX 51985  
TOA BAJA, PUERTO RICO 00950

FOR: RUM, IN CLASS 33 (U.S. CLS. 47 AND 49).

FIRST USE 8-1-2011; IN COMMERCE 8-1-2011.

NO CLAIM IS MADE TO THE EXCLUSIVE RIGHT TO USE "SPICED RUM", APART FROM THE MARK AS SHOWN.

THE COLOR(S) BEIGE, GOLD AND BROWN IS/ARE CLAIMED AS A FEATURE OF THE MARK.

THE MARK CONSISTS OF A GOLD OVAL WITH TWO THIN CONCENTRIC OVALS INSIDE. ON THE TOP PART, THERE IS A GOLD BANNER WITH THE WORDS "SPICED RUM" IN BEIGE. THE BACKGROUND INSIDE THE OVAL IS BEIGE, WITH A SKULL AND BONES DESIGN IN BROWN ON TOP OF THE BEIGE BACKGROUND. BELOW SAID DESIGN, ARE THE WORDS "BLACK ROBERTS" IN BROWN. BELOW IS AN INTRICATE DESIGN IN BROWN COLOR.

SN 85-380,716, FILED 7-26-2011.

TASHIA BUNCH, EXAMINING ATTORNEY



*David J. Kyros*

Director of the United States Patent and Trademark Office

# United States of America

United States Patent and Trademark Office

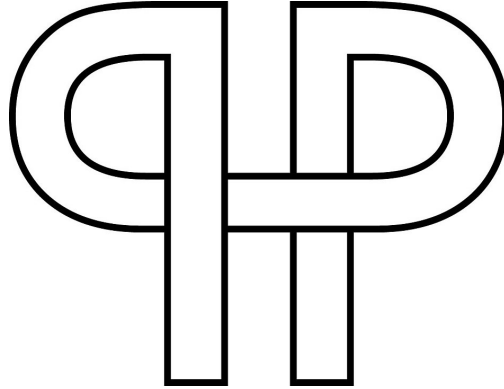

**Reg. No. 4,276,599**

AUSTIN COX (UNITED STATES INDIVIDUAL)  
27655 SELFRIDGE LN.  
CARMEL, CA 93923

**Registered Jan. 15, 2013**

**Int. Cl.: 25**

FOR: BUTTON DOWN SHIRTS; COLLARED SHIRTS; DRESS SHIRTS; T-SHIRTS, IN CLASS 25 (U.S. CLS. 22 AND 39).

**TRADEMARK**

FIRST USE 7-1-2012; IN COMMERCE 7-1-2012.

**PRINCIPAL REGISTER**

THE MARK CONSISTS OF TWO "P'S" BACK TO BACK FLOWING TOGETHER.

SN 85-381,338, FILED 7-26-2011.

ROBERT C. CLARK JR., EXAMINING ATTORNEY



*David J. Kybas*

Director of the United States Patent and Trademark Office

# United States of America

United States Patent and Trademark Office

# Sunbeam

**Reg. No. 4,276,600**

SUNBEAM PRODUCTS, INC. (DELAWARE CORPORATION)  
2381 EXECUTIVE CENTER DRIVE  
BOCA RATON, FL 33431

**Registered Jan. 15, 2013**

**Int. Cl.: 11**

FOR: HOUSEHOLD ELECTRIC KITCHEN APPLIANCES, NAMELY, DESSERT MAKERS, WHOPIE PIE MAKERS, FORTUNE COOKIE MAKERS, COOKIE MAKERS AND COOKIE PRESSERS, IN CLASS 11 (U.S. CLS. 13, 21, 23, 31 AND 34).

**TRADEMARK**

FIRST USE 8-1-2011; IN COMMERCE 8-1-2011.

**PRINCIPAL REGISTER**

THE MARK CONSISTS OF THE LITERAL ELEMENT "SUNBEAM" WITH AN OVERLYING ARCH HAVING TAPERED ENDS WITH ONE TAPERED END CONNECTED TO THE TOP OF THE LETTER "S" IN THE LITERAL ELEMENT AND THE OTHER TAPERED END TERMINATING OVER THE LETTER "M" IN THE LITERAL ELEMENT.

SN 85-381,480, FILED 7-26-2011.

JENNIFER BUTTON, EXAMINING ATTORNEY



*David J. Kybas*

Director of the United States Patent and Trademark Office

# United States of America

United States Patent and Trademark Office

## TECHNETICS

**Reg. No. 4,276,601**

**Registered Jan. 15, 2013**

**Int. Cls.: 40 and 42**

**SERVICE MARK**

**PRINCIPAL REGISTER**

TECHNETICS GROUP LLC (NORTH CAROLINA LIMITED LIABILITY COMPANY)  
5605 CARNEGIE BLVD.  
CHARLOTTE, NC 28209

FOR: MANUFACTURE OF ENGINEERED POLYMER PARTS AND PRODUCTS TO THE ORDER AND/OR SPECIFICATION OF OTHERS; PROTOTYPE FABRICATION OF NEW POLYMER PRODUCTS TO THE ORDER AND/OR SPECIFICATION OF OTHERS; MACHINE SHOP SERVICES, NAMELY, MACHINING PARTS FOR OTHERS; PARTS MOLDING; MANUFACTURE OF METAL, ELASTOMER, AND INFLATABLE SEALS AND SEALING SYSTEMS TO THE ORDER AND SPECIFICATION OF OTHERS; CUSTOM MANUFACTURE OF METAL SEALS, METAL BELLOWS, WIRE CLOTH FILTERS AND STRAINERS, PRECISION BURST DISCS, LATCHING SOLENOID VALVES, PRESSURE REGULATORS, RELIEF VALVES, AND CHECK VALVES, ALL PRODUCTS FOR USE IN FLUID CONTROL; MANUFACTURE OF PLASTIC PARTS, TAPES, FILMS, AND FIBERS TO THE ORDER AND/OR SPECIFICATION OF OTHERS; PROTOTYPE FABRICATION OF NEW PLASTIC PRODUCTS TO THE ORDER AND/OR SPECIFICATION OF OTHERS; MOLDING SERVICES, NAMELY, CREATING CUSTOM MOLDED PTFE SHAPES AND PARTS THROUGH COMPRESSION MOLDING, ISOSTATIC MOLDING, AND AUTO MOLDING; ETCHING OF FLUOROPOLYMER SHEETS, TUBING, AND THREE-DIMENSIONAL SHAPES; MANUFACTURE OF PLASTIC PARTS TO THE ORDER AND/OR SPECIFICATION OF OTHERS, IN CLASS 40 (U.S. CLS. 100, 103 AND 106).

FIRST USE 1-0-2012; IN COMMERCE 1-0-2012.



FOR: DESIGN AND DEVELOPMENT OF ENGINEERED METAL, ELASTOMER, AND INFLATABLE SEALS AND SEALING SYSTEMS; ENGINEERING SERVICES; DESIGN AND DEVELOPMENT OF METAL SEALS, METAL BELLOWS, WIRE CLOTH FILTERS AND STRAINERS, PRECISION BURST DISCS, LATCHING SOLENOID VALVES, PRESSURE REGULATORS, RELIEF VALVES, AND CHECK VALVES, ALL PRODUCTS FOR USE IN FLUID CONTROL, IN CLASS 42 (U.S. CLS. 100 AND 101).

FIRST USE 1-0-2012; IN COMMERCE 1-0-2012.

*David J. Kyros*

THE MARK CONSISTS OF STANDARD CHARACTERS WITHOUT CLAIM TO ANY PARTICULAR FONT, STYLE, SIZE, OR COLOR.

SN 85-381,675, FILED 7-26-2011.

**Reg. No. 4,276,601** KARANENDRA S. CHHINA, EXAMINING ATTORNEY



# United States of America

United States Patent and Trademark Office

## TRAVEL PICK

**Reg. No. 4,276,602**

**Registered Jan. 15, 2013**

**Int. Cls.: 5 and 18**

**TRADEMARK**

**PRINCIPAL REGISTER**

TRAVEL PICK, INC. (OREGON CORPORATION)  
23700 SW STAFFORD ROAD  
TUALATIN, OR 97062

FOR: INCONTINENCE CARE KIT COMPRISING OF A CARRYING CASE, REUSABLE AND WASHABLE WET/DRY BAG, A CLEAR PLASTIC LIQUID TOILETRY BAG, PHONE CASE, SCISSORS, TRAVEL SIZE ANTIBACTERIAL SANITIZER GEL, ESSENTIAL OIL ODOR SPRAY, BODY SPRAY, MOISTURE BARRIER OINTMENT, TALC FREE BODY POWDER, SLIDER RE-CLOSABLE BAG WITH SLIDE SEAL, SCENTED GARBAGE BAGS, BATH TISSUE SIZE TOILET PAPER DISPENSER WITH TOILET PAPER, PACKAGE OF TISSUES, FLUSHABLE WIPES, DISPOSABLE UNDERPADS, NON LATEX AND POWDER FREE GLOVES, MOUTH LOZENGES FOR DRY MOUTH RELIEF, ADULT DIAPERS, AND INCONTINENCE PADS, ALL SOLD AS A UNIT IN A BAG, IN CLASS 5 (U.S. CLS. 6, 18, 44, 46, 51 AND 52).

FIRST USE 5-15-2012; IN COMMERCE 5-15-2012.

FOR: CARRY-ALL BAGS, IN CLASS 18 (U.S. CLS. 1, 2, 3, 22 AND 41).

FIRST USE 11-2-2011; IN COMMERCE 11-2-2011.

THE MARK CONSISTS OF STANDARD CHARACTERS WITHOUT CLAIM TO ANY PARTICULAR FONT, STYLE, SIZE, OR COLOR.

NO CLAIM IS MADE TO THE EXCLUSIVE RIGHT TO USE "TRAVEL", APART FROM THE MARK AS SHOWN.

SN 85-381,685, FILED 7-26-2011.

ESTHER BELENKER, EXAMINING ATTORNEY



*David J. Kypos*

Director of the United States Patent and Trademark Office

# United States of America

United States Patent and Trademark Office

## THE BELGIAN GIRL

**Reg. No. 4,276,603**

THE BELGIAN BOY, INC. (NEW YORK CORPORATION)  
102 BRADHURST AVENUE, #1108  
NEW YORK, NY 10039

**Registered Jan. 15, 2013**

**Int. Cl.: 25**

FOR: BATHROBES; BELTS; CARDIGANS; COATS; GLOVES; HATS; HOODED SWEAT-SHIRTS; INFANTWEAR; JACKETS; LOUNGEWEAR; PANTS; SCARVES; SHIRTS; SLEEP-WEAR; SOCKS; SWEATERS; SWIMWEAR; T-SHIRTS; TANK-TOPS; TIES; UNDERWEAR, IN CLASS 25 (U.S. CLS. 22 AND 39).

**TRADEMARK**

**PRINCIPAL REGISTER**

FIRST USE 8-22-2012; IN COMMERCE 9-14-2012.

THE MARK CONSISTS OF STANDARD CHARACTERS WITHOUT CLAIM TO ANY PARTICULAR FONT, STYLE, SIZE, OR COLOR.

NO CLAIM IS MADE TO THE EXCLUSIVE RIGHT TO USE "GIRL", APART FROM THE MARK AS SHOWN.

SN 85-381,811, FILED 7-26-2011.

JEAN IM, EXAMINING ATTORNEY



*David J. Kyros*

Director of the United States Patent and Trademark Office

# United States of America

United States Patent and Trademark Office

# PUREPULSE

**Reg. No. 4,276,604**

UNITED TECHNOLOGIES CORPORATION (DELAWARE CORPORATION)  
1 FINANCIAL PLAZA  
HARTFORD, CT 06103

**Registered Jan. 15, 2013**

**Int. Cl.: 40**

FOR: MATERIAL TREATMENT SERVICES, NAMELY, REMOVING COATINGS FROM AIRCRAFT MACHINE PRECISION PARTS, IN CLASS 40 (U.S. CLS. 100, 103 AND 106).

**SERVICE MARK**

FIRST USE 3-30-2012; IN COMMERCE 3-30-2012.

**PRINCIPAL REGISTER**

THE MARK CONSISTS OF STANDARD CHARACTERS WITHOUT CLAIM TO ANY PARTICULAR FONT, STYLE, SIZE, OR COLOR.

SN 85-383,196, FILED 7-28-2011.

ANDREA BUTLER, EXAMINING ATTORNEY



*David J. Kyffers*

Director of the United States Patent and Trademark Office

# United States of America

United States Patent and Trademark Office



**Reg. No. 4,276,605**

**Registered Jan. 15, 2013**

**Int. Cl.: 25**

**TRADEMARK**

**PRINCIPAL REGISTER**

SMART ASS FISH, LLC (NEW JERSEY LIMITED LIABILITY COMPANY)  
1002 MONTAUK DRIVE  
FORKED RIVER, NJ 08731

FOR: HATS; SHIRTS, IN CLASS 25 (U.S. CLS. 22 AND 39).

FIRST USE 5-1-2011; IN COMMERCE 7-1-2011.

NO CLAIM IS MADE TO THE EXCLUSIVE RIGHT TO USE "COMPANY" OR "KEY WEST",  
APART FROM THE MARK AS SHOWN.

THE MARK CONSISTS OF AN UPRIGHT FISH WITH TEETH AND HORN-RIMMED GLASSES  
AND A FIN ON ITS HEAD. THE FISH ALSO HAS TWO FINS FOR HANDS. BEHIND THE  
FISH IS A CIRCLE. ACROSS THE FISH AND CIRCLE IN A CURVED FORMATION IS THE  
STYLIZED TEXT "SMART ASS". ARCHING AROUND THE LOWER EDGE OF THE CIRCLE  
IS THE STYLIZED TEXT "FISH COMPANY". ARCHING BELOW THIS TEXT IS THE  
STYLIZED TEXT ". KEY WEST .".

SN 85-384,301, FILED 7-29-2011.

DAVID H. STINE, EXAMINING ATTORNEY



*David J. Kybas*

Director of the United States Patent and Trademark Office

# United States of America

United States Patent and Trademark Office

# SPORTPIX

**Reg. No. 4,276,606**

**Registered Jan. 15, 2013**

**Int. Cl.: 9**

**TRADEMARK**

**PRINCIPAL REGISTER**

HOUSE ADVANTAGE, LLC (NEVADA LIMITED LIABILITY COMPANY)  
SUITE 140  
1140 N. TOWN CENTER DRIVE  
LAS VEGAS, NV 89144

FOR: COMPUTER SOFTWARE FOR TRACKING AND FACILITATING GAMES, PROMOTIONS AND BONUSES IN THE GAMING INDUSTRY AND SOCIAL MEDIA ENVIRONMENTS, IN CLASS 9 (U.S. CLS. 21, 23, 26, 36 AND 38).

FIRST USE 7-1-2011; IN COMMERCE 8-4-2011.

THE MARK CONSISTS OF STANDARD CHARACTERS WITHOUT CLAIM TO ANY PARTICULAR FONT, STYLE, SIZE, OR COLOR.

SN 85-384,675, FILED 7-29-2011.

MARC LEIPZIG, EXAMINING ATTORNEY



*David J. Kyffers*

Director of the United States Patent and Trademark Office

# United States of America

United States Patent and Trademark Office

# FLEXTIME

**Reg. No. 4,276,607**

**Registered Jan. 15, 2013**

**Int. Cl.: 9**

**TRADEMARK**

**PRINCIPAL REGISTER**

WGI INNOVATIONS, LTD. (TEXAS LIMITED PARTNERSHIP)  
602 FOUNTAIN PARKWAY  
GRAND PRAIRIE, TX 75050

FOR: CAMERAS; CAMERA SHUTTERS, IN CLASS 9 (U.S. CLS. 21, 23, 26, 36 AND 38).

FIRST USE 4-13-2012; IN COMMERCE 4-13-2012.

THE MARK CONSISTS OF STANDARD CHARACTERS WITHOUT CLAIM TO ANY PARTICULAR FONT, STYLE, SIZE, OR COLOR.

SN 85-384,923, FILED 7-29-2011.

JENNY PARK, EXAMINING ATTORNEY



*David J. Kybas*

Director of the United States Patent and Trademark Office

# United States of America

United States Patent and Trademark Office

# SABIYA

**Reg. No. 4,276,608**

**Registered Jan. 15, 2013**

**Int. Cl.: 23**

**TRADEMARK**

**PRINCIPAL REGISTER**

PURTHREAD TECHNOLOGIES, INC. (DELAWARE CORPORATION)  
30 HILL STREET  
SAN FRANCISCO, CA 94110

FOR: YARN, IN CLASS 23 (U.S. CL. 43).

FIRST USE 3-29-2012; IN COMMERCE 8-15-2012.

THE MARK CONSISTS OF STANDARD CHARACTERS WITHOUT CLAIM TO ANY PARTICULAR FONT, STYLE, SIZE, OR COLOR.

SN 85-385,149, FILED 7-29-2011.

MARTHA FROMM, EXAMINING ATTORNEY



*David J. Kybas*

Director of the United States Patent and Trademark Office

# United States of America

United States Patent and Trademark Office

## 4D LIPO

**Reg. No. 4,276,609**

4 DYNAMIC INVESTMENTS LLC (FLORIDA LIMITED LIABILITY COMPANY)  
465 BRICKELL AVENUE, APT. 2405  
MIAMI, FL 33131

**Registered Jan. 15, 2013**

**Int. Cls.: 41 and 44**

FOR: INSTRUCTIONAL SERVICES, NAMELY, CONDUCTING CLASSES AND SEMINARS  
IN THE FIELD OF LIPOSCULPTING, IN CLASS 41 (U.S. CLS. 100, 101 AND 107).

**SERVICE MARK**

FIRST USE 10-0-2012; IN COMMERCE 10-0-2012.

**PRINCIPAL REGISTER**

FOR: LIPOSCULPTING SERVICES, IN CLASS 44 (U.S. CLS. 100 AND 101).

FIRST USE 10-0-2012; IN COMMERCE 10-0-2012.

THE MARK CONSISTS OF STANDARD CHARACTERS WITHOUT CLAIM TO ANY PARTICULAR FONT, STYLE, SIZE, OR COLOR.

NO CLAIM IS MADE TO THE EXCLUSIVE RIGHT TO USE "LIPO", APART FROM THE MARK AS SHOWN.

SN 85-386,160, FILED 8-1-2011.

JACQUELINE A. LAVINE, EXAMINING ATTORNEY



*David J. Kybas*

Director of the United States Patent and Trademark Office



# United States of America

United States Patent and Trademark Office

# GOLDCAP

**Reg. No. 4,276,610**

FAIRCHILD INDUSTRIAL PRODUCTS COMPANY (DELAWARE CORPORATION)  
3920 WESTPOINT BLVD.

**Registered Jan. 15, 2013**

WINSTON SALEM, NC 27103

**Int. Cl.: 9**

FOR: CONTROL VALVES FOR REGULATING THE FLOW OR THE PRESSURE OF GASES AND LIQUIDS, NAMELY, PNEUMATIC REGULATORS, PNEUMATIC VOLUME BOOSTERS, ELECTRO-PNEUMATIC TRANSDUCERS AND ELECTRO-PNEUMATIC RELAYS; PNEUMATIC COMPONENTS, NAMELY, PRESSURE GAUGES, PRESSURE SENSORS AND PRESSURE TRANSMITTERS, AND ELECTRONIC CONTROLS FOR PNEUMATIC CONTROL DEVICES, NAMELY, ELECTRO-PNEUMATIC VALVE POSITIONERS, AND DIGITAL VALVE POSITIONERS, IN CLASS 9 (U.S. CLS. 21, 23, 26, 36 AND 38).

**TRADEMARK**

**PRINCIPAL REGISTER**

FIRST USE 9-1-2011; IN COMMERCE 9-1-2011.

THE MARK CONSISTS OF STANDARD CHARACTERS WITHOUT CLAIM TO ANY PARTICULAR FONT, STYLE, SIZE, OR COLOR.

SN 85-389,955, FILED 8-4-2011.

CHARLOTTE CORWIN, EXAMINING ATTORNEY



*David J. Kyffers*

Director of the United States Patent and Trademark Office

# United States of America

United States Patent and Trademark Office

## WHEY PHASE

**Reg. No. 4,276,611**

4 DIMENSION NUTRITION, LLC (CONNECTICUT LIMITED LIABILITY COMPANY)  
56 ARBOR STREET, SUITE 304-B  
HARTFORD, CT 06106

**Registered Jan. 15, 2013**

**Int. Cl.: 5**

FOR: NUTRITIONAL SUPPLEMENTS CONTAINING WHEY IN SUBSTANTIAL PART, IN CLASS 5 (U.S. CLS. 6, 18, 44, 46, 51 AND 52).

**TRADEMARK**

FIRST USE 8-22-2012; IN COMMERCE 9-20-2012.

**PRINCIPAL REGISTER**

THE MARK CONSISTS OF STANDARD CHARACTERS WITHOUT CLAIM TO ANY PARTICULAR FONT, STYLE, SIZE, OR COLOR.

NO CLAIM IS MADE TO THE EXCLUSIVE RIGHT TO USE "WHEY", APART FROM THE MARK AS SHOWN.

SN 85-390,596, FILED 8-5-2011.

MARY CRAWFORD, EXAMINING ATTORNEY



*David J. Kyjars*

Director of the United States Patent and Trademark Office

# United States of America

United States Patent and Trademark Office



**Reg. No. 4,276,612**

WHALEN FURNITURE MANUFACTURING INC. (CALIFORNIA CORPORATION)  
1578 AIR WING ROAD  
SAN DIEGO, CA 92154

**Registered Jan. 15, 2013**

**Int. Cl.: 20**

FOR: ENTERTAINMENT CENTERS; FURNITURE; SHELVES; TELEVISION STANDS, IN CLASS 20 (U.S. CLS. 2, 13, 22, 25, 32 AND 50).

**TRADEMARK**

FIRST USE 7-8-2012; IN COMMERCE 7-8-2012.

**PRINCIPAL REGISTER**

NO CLAIM IS MADE TO THE EXCLUSIVE RIGHT TO USE "GAMING THEATER", APART FROM THE MARK AS SHOWN.

THE MARK CONSISTS OF THE WORDS "GAMING" ABOVE THE WORD "THEATER" WITH "T" OF "THEATER" MERGED INTO THE "G" OF "GAMING".

SN 85-391,181, FILED 8-5-2011.

GISELLE AGOSTO, EXAMINING ATTORNEY



*David J. Kybas*

Director of the United States Patent and Trademark Office

# United States of America

United States Patent and Trademark Office



**Reg. No. 4,276,613**

**Registered Jan. 15, 2013**

**Int. Cl.: 3**

**TRADEMARK**

**PRINCIPAL REGISTER**

JOHNSON & JOHNSON (NEW JERSEY CORPORATION)  
ONE JOHNSON & JOHNSON PLAZA  
NEW BRUNSWICK, NJ 089337001

FOR: NON-MEDICATED SUNSCREEN, IN CLASS 3 (U.S. CLS. 1, 4, 6, 50, 51 AND 52).

FIRST USE 6-1-2012; IN COMMERCE 6-1-2012.

THE MARK CONSISTS OF THE DESIGN OF THE SUN AND FANCIFUL PLANTS.

SN 85-391,760, FILED 8-8-2011.

DAVID C. REIHNER, EXAMINING ATTORNEY



*David J. Kybas*

Director of the United States Patent and Trademark Office

# United States of America

United States Patent and Trademark Office



**Reg. No. 4,276,614**

MLS CANADA LP (CANADA LIMITED PARTNERSHIP)  
199 BAY STREET, SUITE 2800  
TORONTO, ONTARIO, CANADA M5L1A9

**Registered Jan. 15, 2013**

**Int. Cls.: 9, 16, 25, 28,  
and 41**

FOR: COMPUTER AND VIDEO GAME SOFTWARE; MAGNETS; COMPUTER VIDEO GAME PROGRAMS; COMPUTER GAME PROGRAMS; COMPUTER AND VIDEO GAME DISCS; PROTECTIVE COVERS SPECIALLY ADAPTED FOR PERSONAL ELECTRONIC DEVICES, IN CLASS 9 (U.S. CLS. 21, 23, 26, 36 AND 38).

**TRADEMARK**

FIRST USE 3-10-2012; IN COMMERCE 3-10-2012.

**SERVICE MARK**

FOR: POSTERS; DECALS; TRADING CARDS; STICKERS; PRINTED MEDIA GUIDES RELATING TO A PROFESSIONAL SOCCER TEAM; SOUVENIR SOCCER PROGRAMS; YEARBOOKS IN THE FIELD OF SOCCER; PRINTED EVENT ADMISSION TICKETS; PHOTO PRINTS; MAGAZINES FEATURING INFORMATION IN THE FIELD OF SOCCER; CALENDARS, PAMPHLETS IN THE FIELD OF SOCCER, IN CLASS 16 (U.S. CLS. 2, 5, 22, 23, 29, 37, 38 AND 50).

**PRINCIPAL REGISTER**

FIRST USE 3-10-2012; IN COMMERCE 3-10-2012.

FOR: T-SHIRTS; FLEECE TOPS; JERSEYS; HATS; CAPS; VISORS; BEANIES; SHORTS; SWEAT SUITS; JACKETS; HOODED SWEATSHIRTS; SCARVES, POLO SHIRT, IN CLASS 25 (U.S. CLS. 22 AND 39).



FIRST USE 3-10-2012; IN COMMERCE 3-10-2012.

FOR: SOCCER BALLS; PLUSH TOY ANIMALS; PUZZLES, IN CLASS 28 (U.S. CLS. 22, 23, 38 AND 50).

FIRST USE 3-10-2012; IN COMMERCE 3-10-2012.

FOR: ENTERTAINMENT SERVICES, NAMELY, SOCCER EXHIBITIONS RENDERED LIVE IN A STADIUM, AND THROUGH THE MEDIA OF TELEVISION AND RADIO AND VIA THE INTERNET; PROVISION OF ENTERTAINMENT IN THE NATURE OF NON-DOWNLOADABLE PRE-RECORDED FILM CLIPS FROM SOCCER GAMES, PRESENTED VIA MOBILE COMMUNICATION DEVICES; PROVISION OF INFORMATION IN THE FIELD OF SOCCER VIA THE INTERNET AND MOBILE DEVICES; ENTERTAINMENT SERVICES,

*David J. Kyffers*

Director of the United States Patent and Trademark Office

**Reg. No. 4,276,614** NAMELY, PROVIDING A SERIES OF LIVE TELEVISION PROGRAMS, RADIO PROGRAMS AND WEBCASTS IN THE FIELD OF SOCCER COMPETITIONS, IN CLASS 41 (U.S. CLS. 100, 101 AND 107).

FIRST USE 3-12-2012; IN COMMERCE 3-12-2012.

NO CLAIM IS MADE TO THE EXCLUSIVE RIGHT TO USE "MONTRÉAL", APART FROM THE MARK AS SHOWN.

THE MARK CONSISTS OF A SHIELD DESIGN, BISECTED BY THE WORDS "IMPACT MONTRÉAL" ON TWO LINES OF TEXT IN A STYLIZED FONT ON A BANNER. THE UPPER SECTION OF THE SHIELD CONTAINS A PARTIAL IMAGE OF A FLEUR-DE-LIS TO THE LEFT OF CENTER AND FOUR STARS ARRAYED IN A SEMI-CIRCLE ON THE RIGHT. THE BOTTOM SECTION OF THE SHIELD CONTAINS 11 VERTICAL STRIPES.

SN 85-391,824, FILED 8-8-2011.

BRENDAN REGAN, EXAMINING ATTORNEY

# United States of America

United States Patent and Trademark Office

## MOTIVATIONS

**Reg. No. 4,276,615**

**Registered Jan. 15, 2013**

**Int. Cl.: 16**

**TRADEMARK**

**PRINCIPAL REGISTER**

SOUTHWORTH COMPANY (MASSACHUSETTS CORPORATION)  
265 MAIN STREET  
AGAWAM, MA 01001

FOR: PENS; PENCILS; JOURNALS, NAMELY, BLANK JOURNALS; NOTE CARDS;  
HOLDERS FOR PAPER GIFT CARDS; MEMO CUBE PADS, IN CLASS 16 (U.S. CLS. 2, 5,  
22, 23, 29, 37, 38 AND 50).

FIRST USE 11-1-2011; IN COMMERCE 11-1-2011.

THE MARK CONSISTS OF STANDARD CHARACTERS WITHOUT CLAIM TO ANY PAR-  
TICULAR FONT, STYLE, SIZE, OR COLOR.

OWNER OF U.S. REG. NO. 4,012,245.

SN 85-393,133, FILED 8-9-2011.

BARBARA RUTLAND, EXAMINING ATTORNEY



*David J. Kyffers*

Director of the United States Patent and Trademark Office

# United States of America

United States Patent and Trademark Office

## TRANSIT STEEL

**Reg. No. 4,276,616**

**Registered Jan. 15, 2013**

**Int. Cl.: 6**

**TRADEMARK**

**PRINCIPAL REGISTER**

DUFFICY STEEL CORPORATION (COLORADO CORPORATION)  
10730 W ILIFF AVE  
LAKEWOOD, CO 80227

FOR: ARCHITECTURAL METALWORK; BUILDING MATERIALS, NAMELY, COMPOSITE PANELS COMPOSED PRIMARILY OF METAL; BUILDING WALL FRAMING MADE PRIMARILY OF METAL; FRAMEWORKS OF METAL; GAZEBOS PRIMARILY OF METAL; GIRDERS OF METAL; IRON GATES; JOISTS OF IRON OR STEEL; METAL BEAMS; METAL BOLLARDS; METAL GAZEBOS; METAL GUARD RAILS; METAL JOISTS; METAL LADDERS; METAL RESIDENTIAL AND AGRICULTURAL SHELTERS; METAL ROOF TRUSSES; METAL SHELTER STRUCTURES; METAL STAIRCASES; METAL STORAGE SHEDS; METAL STORAGE SHELTERS; METAL STORM SHELTERS; METAL TRELLISES; PERGOLAS PRIMARILY OF METAL; PRE-FABRICATED METAL ARCHITECTURAL COLUMNS; PRE-FABRICATED METAL BUILDING ASSEMBLY KITS; PREFABRICATED BUILDINGS MADE SUBSTANTIALLY OF METAL; PREFABRICATED METAL BRIDGES; PREFABRICATED METAL BUILDINGS; PREFABRICATED METAL PLATFORMS; STAIRS OF METAL; STEEL FRAMES FOR BUILDING; WALL PANELS OF METAL, IN CLASS 6 (U.S. CLS. 2, 12, 13, 14, 23, 25 AND 50).

FIRST USE 5-30-2012; IN COMMERCE 5-30-2012.

THE MARK CONSISTS OF STANDARD CHARACTERS WITHOUT CLAIM TO ANY PARTICULAR FONT, STYLE, SIZE, OR COLOR.

NO CLAIM IS MADE TO THE EXCLUSIVE RIGHT TO USE "STEEL", APART FROM THE MARK AS SHOWN.

SN 85-393,510, FILED 8-9-2011.

LIEF MARTIN, EXAMINING ATTORNEY



*David J. Kyros*

Director of the United States Patent and Trademark Office



# United States of America

United States Patent and Trademark Office



**Reg. No. 4,276,617**

**Registered Jan. 15, 2013**

**Int. Cls.: 16, 35, 36, and 41**

**TRADEMARK**

**SERVICE MARK**

**PRINCIPAL REGISTER**

W.K. KELLOGG FOUNDATION (MICHIGAN NON-PROFIT CORPORATION)  
ONE MICHIGAN AVENUE EAST  
BATTLE CREEK, MI 490174012

FOR: PRINTED PUBLICATIONS, NAMELY, BOOKS, BOOKLETS, PAMPHLETS, BROCHURES, REPORTS, WORK BOOKS AND WHITE PAPERS IN THE FIELDS OF HEALTH, FAMILY ECONOMIC SECURITY, EARLY CHILDHOOD EDUCATION AND HIGHER EDUCATION, PHILANTHROPY, VOLUNTEERISM, COMMUNITY DEVELOPMENT, CHILD DEVELOPMENT, HEALTH AND WELFARE, RACIAL INEQUITY, RACIAL HEALING, JUVENILE JUSTICE, AND ECONOMIC SUCCESS, IN CLASS 16 (U.S. CLS. 2, 5, 22, 23, 29, 37, 38 AND 50).

FIRST USE 11-7-2011; IN COMMERCE 11-7-2011.

FOR: CHARITABLE SERVICES, NAMELY, ORGANIZING AND CONDUCTING VOLUNTEER OUTREACH PROGRAMS DESIGNED TO PROMOTE RACIAL HEALING, ADDRESS RACIAL INEQUITY, AND BRIDGE RACIAL GAPS IN THE AREAS OF EDUCATION, HEALTH, JUVENILE JUSTICE, ECONOMIC SUCCESS, AND THE MEDIA; CHARITABLE SERVICES, NAMELY, ORGANIZING AND CONDUCTING VOLUNTEER PROGRAMS AND COMMUNITY SERVICES PROGRAMS DESIGNED TO PROMOTE RACIAL HEALING, ADDRESS RACIAL INEQUITY, AND BRIDGE RACIAL GAPS IN THE AREAS OF EDUCATION, HEALTH, JUVENILE JUSTICE, ECONOMIC SUCCESS, AND THE MEDIA, IN CLASS 35 (U.S. CLS. 100, 101 AND 102).

FIRST USE 11-7-2011; IN COMMERCE 11-7-2011.

FOR: PROVIDING GRANTS, EDUCATIONAL SCHOLARSHIPS AND FINANCING AND LOAN SERVICES FOR RESEARCH AND PROGRAMS IN THE FIELD OF HEALTH, FAMILY ECONOMIC SECURITY, EARLY CHILDHOOD EDUCATION AND HIGHER EDUCATION, PHILANTHROPY AND VOLUNTEERISM, COMMUNITY DEVELOPMENT, CHILD DEVELOPMENT, HEALTH AND WELFARE; PROVIDING GRANTS, EDUCATIONAL SCHOLARSHIPS AND FINANCING AND LOAN SERVICES FOR RESEARCH AND PROGRAMS IN THE FIELD OF FOOD SYSTEMS, NAMELY, FOOD SAFETY, QUALITY, DISTRIBUTION, AND HEALTHFUL EATING FOR THE HEALTH, DEVELOPMENT AND WELFARE OF IMPOVERISHED AND UNDERPRIVILEGED CHILDREN, FAMILIES, AND COMMUNITIES; CHARITABLE FUNDRAISING SERVICES FOR OTHERS, NAMELY, RAISING FUNDS FOR PROGRAMS FOR FAMILY ECONOMIC SECURITY, EARLY CHILDHOOD EDUCATION



*David J. Kyjars*

Director of the United States Patent and Trademark Office

**Reg. No. 4,276,617** AND HIGHER EDUCATION, PHILANTHROPY AND VOLUNTEERISM, COMMUNITY DEVELOPMENT, CHILD DEVELOPMENT, HEALTH AND WELFARE; CHARITABLE FUND RAISING SERVICES FOR RESEARCH PROGRAMS IN THE FIELD OF FOOD SYSTEMS, NAMELY, FOOD SAFETY, QUALITY, DISTRIBUTION, AND HEALTHFUL EATING FOR THE HEALTH, DEVELOPMENT AND WELFARE OF IMPOVERISHED AND UNDERPRIVILEGED CHILDREN, FAMILIES, AND COMMUNITIES; CHARITABLE FUNDRAISING SERVICES, NAMELY, RAISING FUNDS FOR PROGRAMS DESIGNED TO PROMOTE RACIAL HEALING, ADDRESS RACIAL INEQUITY, AND BRIDGE RACIAL GAPS IN THE AREAS OF EDUCATION, HEALTH, JUVENILE JUSTICE, ECONOMIC SUCCESS, AND THE MEDIA; PROVIDING GRANTS, EDUCATIONAL SCHOLARSHIPS AND FINANCING AND LOAN SERVICES FOR RESEARCH AND EDUCATIONAL PROGRAMS, NAMELY, EDUCATIONAL AND CAREER COUNSELING AND GUIDANCE, FOR OUT OF SCHOOL YOUTHS, THAT PROVIDE ALTERNATIVES TO HIGH SCHOOL DIPLOMAS AND ASSOCIATES DEGREES, IN CLASS 36 (U.S. CLS. 100, 101 AND 102).

FIRST USE 11-7-2011; IN COMMERCE 11-7-2011.

FOR: ARRANGING AND CONDUCTING EDUCATIONAL CONFERENCES, SEMINARS AND WORKSHOPS IN THE FIELD OF HEALTH, FAMILY ECONOMIC SECURITY, EARLY CHILDHOOD EDUCATION AND HIGHER EDUCATION, PHILANTHROPY AND VOLUNTEERISM, COMMUNITY DEVELOPMENT, CHILD DEVELOPMENT, HEALTH AND WELFARE; ARRANGING AND CONDUCTING EDUCATIONAL CONFERENCES, SEMINARS AND WORKSHOPS IN THE FIELD OF FOOD SYSTEMS, NAMELY, FOOD SAFETY, QUALITY, DISTRIBUTION, AND HEALTHFUL EATING FOR THE HEALTH, DEVELOPMENT AND WELFARE OF IMPOVERISHED AND UNDERPRIVILEGED CHILDREN, FAMILIES, AND COMMUNITIES; ARRANGING AND CONDUCTING EDUCATIONAL CONFERENCES TO PROMOTE RACIAL HEALING, ADDRESS RACIAL INEQUITY, AND BRIDGE RACIAL GAPS IN THE AREAS OF EDUCATION, HEALTH, JUVENILE JUSTICE, ECONOMIC SUCCESS, AND THE MEDIA; EDUCATIONAL PROGRAMS, NAMELY, EDUCATIONAL AND CAREER COUNSELING AND GUIDANCE, FOR OUT OF SCHOOL YOUTHS, THAT PROVIDE ALTERNATIVES TO HIGH SCHOOL DIPLOMAS AND ASSOCIATES DEGREES; PROVIDING ON-LINE EDUCATIONAL PUBLICATIONS IN THE NATURE JOURNALS, NEWSLETTERS, CURRICULUM GUIDES IN THE FIELD OF ISSUES RELATING TO OUT OF SCHOOL YOUTHS SEEKING ALTERNATIVES TO HIGH SCHOOL DIPLOMAS AND ASSOCIATES DEGREES FOR ASSISTING COMMUNITY BASED ORGANIZATIONS AND SOCIAL ENTERPRISES FOR SUPPORTING OUT OF SCHOOL YOUTHS IN THE PROCESS OF SECURING ENTRY LEVEL EMPLOYMENT, IN CLASS 41 (U.S. CLS. 100, 101 AND 107).

FIRST USE 11-7-2011; IN COMMERCE 11-7-2011.

THE MARK CONSISTS OF THE LETTERS "WKKF" IN WHITE WITH THE LETTERS "WK" ABOVE THE LETTERS "KF", THE LETTERS "K" ALIGNED VERTICALLY FORMING A VERTICAL LINE WHERE THE LETTERS MEET, WITH THE LETTERS INSIDE AN ORANGE SQUARE.

THE COLOR(S) ORANGE AND WHITE IS/ARE CLAIMED AS A FEATURE OF THE MARK.

SN 85-394,404, FILED 8-10-2011.

JOHN SCHUYLER YARD, EXAMINING ATTORNEY

# United States of America

United States Patent and Trademark Office

# OAK LAWN

**Reg. No. 4,276,618**

**Registered Jan. 15, 2013**

**Int. Cls.: 6 and 19**

**TRADEMARK**

**PRINCIPAL REGISTER**

MASONITE INTERNATIONAL CORPORATION (CANADA CORPORATION)  
2771 RUTHERFORD ROAD  
CONCORD, ONTARIO, CANADA L4K2N6

FOR: METAL DOORS; DOOR LITES, SIDE LITES AND TRANSOM LITES IN THE NATURE OF GLASS AND PLASTIC PANELS WHICH ARE SOLD AS AN INTEGRAL COMPONENT OF METAL ENTRY DOORS AND DOOR ENTRANCEWAYS, IN CLASS 6 (U.S. CLS. 2, 12, 13, 14, 23, 25 AND 50).

FIRST USE 1-26-2012; IN COMMERCE 11-7-2012.

FOR: NON METAL DOORS; DOOR LITES, SIDE LITES AND TRANSOM LITES, ALL IN THE NATURE OF GLASS AND PLASTIC PANELS FOR DOORS AND DOOR ENTRANCEWAYS; DOOR LITES, SIDE LITES AND TRANSOM LITES IN THE NATURE OF GLASS AND PLASTIC PANELS WHICH ARE SOLD AS AN INTEGRAL COMPONENT OF NON METAL ENTRY DOORS AND DOOR ENTRANCEWAYS, IN CLASS 19 (U.S. CLS. 1, 12, 33 AND 50).

FIRST USE 1-26-2012; IN COMMERCE 11-7-2012.

THE MARK CONSISTS OF STANDARD CHARACTERS WITHOUT CLAIM TO ANY PARTICULAR FONT, STYLE, SIZE, OR COLOR.

SN 85-394,640, FILED 8-10-2011.

ELIZABETH KAJUBI, EXAMINING ATTORNEY



*David J. Kyros*

Director of the United States Patent and Trademark Office

# United States of America

United States Patent and Trademark Office

## CANDY APPLE

**Reg. No. 4,276,619**

KIK-WEAR, INC. (CALIFORNIA CORPORATION)  
1036 SOUTH GRAND AVENUE  
LOS ANGELES, CA 900151404

**Registered Jan. 15, 2013**

**Int. Cl.: 25**

FOR: TOPS, BOTTOMS, HEADWEAR AND FOOTWEAR, IN CLASS 25 (U.S. CLS. 22 AND 39).

**TRADEMARK**

FIRST USE 11-24-2010; IN COMMERCE 11-24-2010.

**PRINCIPAL REGISTER**

THE MARK CONSISTS OF STANDARD CHARACTERS WITHOUT CLAIM TO ANY PARTICULAR FONT, STYLE, SIZE, OR COLOR.

SN 85-394,668, FILED 8-10-2011.

JOHN DALIER, EXAMINING ATTORNEY



*David J. Kyffers*

Director of the United States Patent and Trademark Office

# United States of America

United States Patent and Trademark Office

## Digital Bulldogs

**Reg. No. 4,276,620**

**Registered Jan. 15, 2013**

**Int. Cl.: 35**

**SERVICE MARK**

**PRINCIPAL REGISTER**

MEDIA BULLDOGS, LLC (DELAWARE LIMITED LIABILITY COMPANY)  
4613 N. UNIVERSITY DRIVE - SUITE 573  
CORAL SPRINGS, FL 33067

FOR: ADVERTISING AND MARKETING SERVICES PROVIDED BY MEANS OF INDIRECT METHODS OF MARKETING COMMUNICATIONS, NAMELY, SOCIAL MEDIA, SEARCH ENGINE MARKETING, INQUIRY MARKETING, INTERNET MARKETING, MOBILE MARKETING, BLOGGING AND OTHER FORMS OF PASSIVE, SHARABLE OR VIRAL COMMUNICATIONS CHANNELS; ADVERTISING ON THE INTERNET FOR OTHERS; ADVERTISING, PROMOTION AND MARKETING SERVICES IN THE NATURE OF E-MAIL BLAST CAMPAIGNS FOR OTHERS; CONSULTING SERVICES IN THE FIELD OF INTERNET MARKETING; THE BRINGING TOGETHER, FOR THE BENEFIT OF OTHERS, OF A VARIETY OF GOODS AND SERVICES, ENABLING CUSTOMERS TO CONVENIENTLY VIEW AND PURCHASE THOSE GOODS AND SERVICES FROM AN INTERNET WEB SITE PARTICULARLY SPECIALIZING IN THE MARKETING OF THE SALE OF GOODS AND SERVICES OF OTHERS, IN CLASS 35 (U.S. CLS. 100, 101 AND 102).

FIRST USE 8-8-2011; IN COMMERCE 8-8-2011.

THE MARK CONSISTS OF STANDARD CHARACTERS WITHOUT CLAIM TO ANY PARTICULAR FONT, STYLE, SIZE, OR COLOR.

NO CLAIM IS MADE TO THE EXCLUSIVE RIGHT TO USE "DIGITAL", APART FROM THE MARK AS SHOWN.

SN 85-394,931, FILED 8-10-2011.

ALEXANDER L. POWERS, EXAMINING ATTORNEY



*David J. Kyffers*

Director of the United States Patent and Trademark Office

# United States of America

United States Patent and Trademark Office



**Reg. No. 4,276,621**

VM PRODUCTS INC. (TEXAS CORPORATION)  
P.O. BOX 211385  
BEDFORD, TX 76095

**Registered Jan. 15, 2013**

**Int. Cl.: 21**

FOR: BAIT STATIONS FOR RODENTS, IN CLASS 21 (U.S. CLS. 2, 13, 23, 29, 30, 33, 40 AND 50).

**TRADEMARK**

FIRST USE 6-18-2012; IN COMMERCE 6-18-2012.

**PRINCIPAL REGISTER**

THE MARK CONSISTS OF A MOUSE ABOVE A BROKEN LINE ENDING WITH AN ARROW POINTING UP AND IN FRONT OF THE FACE OF THE MOUSE ALL ABOVE THE STYLIZED WORDS "EZ MOVER".

SN 85-395,116, FILED 8-11-2011.

CURTIS FRENCH, EXAMINING ATTORNEY



*David J. Kybas*

Director of the United States Patent and Trademark Office

# United States of America

United States Patent and Trademark Office

# EZ MOVER

**Reg. No. 4,276,622**

VM PRODUCTS INC. (TEXAS CORPORATION)

**Registered Jan. 15, 2013**

P.O. BOX 211385  
BEDFORD, TX 76095

**Int. Cl.: 21**

FOR: BAIT STATIONS FOR RODENTS, IN CLASS 21 (U.S. CLS. 2, 13, 23, 29, 30, 33, 40 AND 50).

**TRADEMARK**

FIRST USE 6-18-2012; IN COMMERCE 6-18-2012.

**PRINCIPAL REGISTER**

THE MARK CONSISTS OF STANDARD CHARACTERS WITHOUT CLAIM TO ANY PARTICULAR FONT, STYLE, SIZE, OR COLOR.

SN 85-395,126, FILED 8-11-2011.

CURTIS FRENCH, EXAMINING ATTORNEY



*David J. Kybas*

Director of the United States Patent and Trademark Office

# United States of America

United States Patent and Trademark Office

## Quantum Theaters

**Reg. No. 4,276,623**

**Registered Jan. 15, 2013**

**Int. Cl.: 41**

**SERVICE MARK**

**PRINCIPAL REGISTER**

QUANTUM MEDIA SYSTEMS (CALIFORNIA CORPORATION)  
2 EASTBOURNE BAY  
LAGUNA NIGUEL, CA 92677

FOR: CINEMA THEATERS, IN CLASS 41 (U.S. CLS. 100, 101 AND 107).

FIRST USE 1-15-2012; IN COMMERCE 1-15-2012.

THE MARK CONSISTS OF STANDARD CHARACTERS WITHOUT CLAIM TO ANY PARTICULAR FONT, STYLE, SIZE, OR COLOR.

NO CLAIM IS MADE TO THE EXCLUSIVE RIGHT TO USE "THEATERS", APART FROM THE MARK AS SHOWN.

SN 85-395,245, FILED 8-11-2011.

PAULA MAHONEY, EXAMINING ATTORNEY



*David J. Kybas*

Director of the United States Patent and Trademark Office



# United States of America

United States Patent and Trademark Office



**Reg. No. 4,276,624**

**Registered Jan. 15, 2013**

**Int. Cl.: 25**

**TRADEMARK**

**PRINCIPAL REGISTER**

HIGGINS, THOMAS (UNITED STATES INDIVIDUAL)  
309 PALOMARES AVE.  
VENTURA, CA 93003

FOR: SHIRTS, IN CLASS 25 (U.S. CLS. 22 AND 39).

FIRST USE 12-1-2011; IN COMMERCE 12-1-2011.

THE MARK CONSISTS OF AN OUTLINED COFFEE MUG WITH A LIQUID INSIDE, CIRCLED BY 8 STICK FIGURE TYPE PEOPLE HOLDING HANDS, AND THE WORDS, "CAN'T WE ALL JUST CHAI AND GET ALONG?" WRITTEN AROUND (360) THE LOGO.

SN 85-395,284, FILED 8-11-2011.

DOMINICK J. SALEMI, EXAMINING ATTORNEY



*David J. Kyffers*

Director of the United States Patent and Trademark Office

# United States of America

United States Patent and Trademark Office



**Reg. No. 4,276,625**

**Registered Jan. 15, 2013**

**Int. Cl.: 36**

**SERVICE MARK**

**PRINCIPAL REGISTER**

LEAF COMMERCIAL CAPITAL, INC. (DELAWARE CORPORATION)  
ONE COMMERCE SQUARE  
2005 MARKET STREET, 14TH FLOOR  
PHILADELPHIA, PA 19103

FOR: EQUIPMENT FINANCING SERVICES; COMMERCIAL LENDING SERVICES, IN CLASS 36 (U.S. CLS. 100, 101 AND 102).

FIRST USE 6-0-2012; IN COMMERCE 6-0-2012.

OWNER OF U.S. REG. NOS. 2,779,578 AND 2,788,809.

THE MARK CONSISTS OF A SQUARE WITH ROUNDED EDGES CONTAINING A LEAF SHAPE WITH A LINE TAPERED AT EACH END INTERSECTING AND EXTENDING PAST THE BOTTOM LEFT CORNER OF THE SQUARE AND TERMINATING AT THE TIP OF THE LEAF SHAPE CREATING THE STEM OF THE LEAF TO THE LEFT OF THE WORD "LEAF".

SN 85-395,400, FILED 8-11-2011.

WARREN L. OLANDRIA, EXAMINING ATTORNEY



*David J. Kyros*

Director of the United States Patent and Trademark Office

# United States of America

United States Patent and Trademark Office

## TO OUR CUSTOMERS MPS MEANS MANAGED PRINT SAVINGS

**Reg. No. 4,276,626**

**Registered Jan. 15, 2013**

**Int. Cl.: 37**

**SERVICE MARK**

**PRINCIPAL REGISTER**

CLARITY IMAGING TECHNOLOGIES, INC. (DELAWARE CORPORATION)  
PARK 80 WEST  
250 PEHLE AVENUE, SUITE 402  
SADDLE BROOK, NJ 07663

FOR: TECHNICAL SUPPORT SERVICES IN THE FIELD OF PRINTER FLEETS AND THEIR CONSUMABLES, NAMELY, TROUBLESHOOTING IN THE NATURE OF REPAIR OF COMPUTER HARDWARE, PROACTIVE REPLACEMENT OF COMPUTER HARDWARE AND INSTALLATION OF TONER CARTRIDGES, IN ORDER TO BOOST EFFICIENCIES AND REDUCE OUTPUT COSTS, IN CLASS 37 (U.S. CLS. 100, 103 AND 106).

FIRST USE 12-31-2011; IN COMMERCE 12-31-2011.

THE MARK CONSISTS OF STANDARD CHARACTERS WITHOUT CLAIM TO ANY PARTICULAR FONT, STYLE, SIZE, OR COLOR.

SN 85-395,537, FILED 8-11-2011.

BRIAN CALLAGHAN, EXAMINING ATTORNEY



*David J. Kybas*

Director of the United States Patent and Trademark Office

# United States of America

United States Patent and Trademark Office

# XENARC

**Reg. No. 4,276,627**

**Registered Jan. 15, 2013**

**Int. Cl.: 9**

**TRADEMARK**

**PRINCIPAL REGISTER**

XENARC TECHNOLOGIES CORPORATION (CALIFORNIA CORPORATION)  
24 HAMMOND  
UNIT F  
IRVINE, CA 92618

FOR: ELECTRONIC LCD ADVERTISEMENT DISPLAY UNIT WITH MULTI-NETWORKING (TCP/IP) CAPABILITIES; ELECTRONIC LCD DISPLAY UNIT WITH MULTI-NETWORKING (TCP/IP) CAPABILITIES; LCD MONITORS FOR SECURITY PURPOSES; LCD PANELS; LIQUID CRYSTAL DISPLAY (LCD) MONITORS, IN CLASS 9 (U.S. CLS. 21, 23, 26, 36 AND 38).

FIRST USE 2-28-2002; IN COMMERCE 2-28-2002.

THE MARK CONSISTS OF THE TERM "XENARC" IN STYLIZED LETTERING IN THE COLOR BLACK WITH THE EXCEPTION OF THE LEFT BOTTOM OF THE LETTER "X" WHICH FORMS A TRIANGLE APPEARING IN THE COLOR BLUE.

THE COLOR(S) BLUE AND BLACK IS/ARE CLAIMED AS A FEATURE OF THE MARK.

SN 85-395,866, FILED 8-11-2011.

CAROL SPILS, EXAMINING ATTORNEY



*David J. Kyfos*

Director of the United States Patent and Trademark Office

# United States of America

United States Patent and Trademark Office

# iversity

**Reg. No. 4,276,628**

**Registered Jan. 15, 2013**

**Int. Cl.: 42**

**SERVICE MARK**

**PRINCIPAL REGISTER**

IVERSITY GMBH (FED REP GERMANY LIMITED LIABILITY COMPANY)  
DAHLWITZER STRASSE 78  
15366 NEUENHAGEN, FED REP GERMANY

FOR: COMPUTER SERVICES, NAMELY, CREATING AN ON-LINE COMMUNITY FOR REGISTERED USERS TO ORGANIZE COURSES, GROUPS AND CONFERENCES, TO MANAGE DATES AND TO SHARE AND ORGANIZE FILES, LITERATURE, LINKS, PICTURES AND OTHER ACADEMIC CONTENT AND TO INTERACT WITH EACH OTHER THROUGH MESSAGES, COMMENTS AS WELL AS ASSIGNMENTS AND RESEARCH TASKS, IN CLASS 42 (U.S. CLS. 100 AND 101).

FIRST USE 4-12-2008; IN COMMERCE 5-5-2008.

THE MARK CONSISTS OF STANDARD CHARACTERS WITHOUT CLAIM TO ANY PARTICULAR FONT, STYLE, SIZE, OR COLOR.

SN 85-396,496, FILED 8-12-2011.

ALEX KEAM, EXAMINING ATTORNEY



*David J. Kybas*

Director of the United States Patent and Trademark Office

# United States of America

United States Patent and Trademark Office

## CENTURYLINK IQ

**Reg. No. 4,276,629**

**Registered Jan. 15, 2013**

**Int. Cl.: 38**

**SERVICE MARK**

**PRINCIPAL REGISTER**

CENTURYLINK, INC. (LOUISIANA CORPORATION)  
100 CENTURYLINK DRIVE  
MONROE, LA 71203

FOR: ELECTRONIC, ELECTRIC, AND DIGITAL TRANSMISSION OF VOICE, DATA, IMAGES, SIGNALS, AND MESSAGES; RENTAL OF TELECOMMUNICATION EQUIPMENT, IN CLASS 38 (U.S. CLS. 100, 101 AND 104).

FIRST USE 8-30-2011; IN COMMERCE 8-30-2011.

THE MARK CONSISTS OF STANDARD CHARACTERS WITHOUT CLAIM TO ANY PARTICULAR FONT, STYLE, SIZE, OR COLOR.

SN 85-396,790, FILED 8-12-2011.

RONALD MCMORROW, EXAMINING ATTORNEY



*David J. Kyros*

Director of the United States Patent and Trademark Office

# United States of America

United States Patent and Trademark Office

## CENTURYLINK IQ

**Reg. No. 4,276,630**

**Registered Jan. 15, 2013**

**Int. Cl.: 42**

**SERVICE MARK**

**PRINCIPAL REGISTER**

CENTURYLINK, INC. (LOUISIANA CORPORATION)  
100 CENTURYLINK DRIVE  
MONROE, LA 71203

FOR: DESIGNING, INTEGRATING, OPERATING, AND MONITORING VOICE, DATA AND VIDEO COMMUNICATIONS NETWORKS; COMPUTER SERVICES, NAMELY, VIRUS PROTECTION, DATA BACK UP AND RECOVERY SERVICES; COMPUTER SYSTEM SECURITY SERVICES, NAMELY, RESTRICTING ACCESS TO AND BY COMPUTER NETWORKS TO AND OF UNDESIREED WEB SITES, MEDIA AND INDIVIDUALS, APPLICATION SERVICES PROVIDER SERVICES, NAMELY, HOSTING SOFTWARE ON A COMPUTER SERVER FOR OTHERS FOR REMOTE ACCESS TO NETWORKS, IN CLASS 42 (U.S. CLS. 100 AND 101).

FIRST USE 8-30-2011; IN COMMERCE 8-30-2011.

THE MARK CONSISTS OF STANDARD CHARACTERS WITHOUT CLAIM TO ANY PARTICULAR FONT, STYLE, SIZE, OR COLOR.

SN 85-396,804, FILED 8-12-2011.

RONALD MCMORROW, EXAMINING ATTORNEY



*David J. Kyffers*

Director of the United States Patent and Trademark Office

# United States of America

United States Patent and Trademark Office

## Translational Software

**Reg. No. 4,276,631**

TRANSLATIONAL SOFTWARE INCORPORATED (WASHINGTON CORPORATION)  
2203 70TH AVENUE SE  
MERCER ISLAND, WA 98040

**Registered Jan. 15, 2013**

**Int. Cl.: 9**

FOR: COMPUTER SOFTWARE FOR CONTROLLING AND MANAGING PATIENT MEDICAL INFORMATION, IN CLASS 9 (U.S. CLS. 21, 23, 26, 36 AND 38).

**TRADEMARK**

FIRST USE 7-23-2012; IN COMMERCE 7-23-2012.

**PRINCIPAL REGISTER**

THE MARK CONSISTS OF STANDARD CHARACTERS WITHOUT CLAIM TO ANY PARTICULAR FONT, STYLE, SIZE, OR COLOR.

NO CLAIM IS MADE TO THE EXCLUSIVE RIGHT TO USE "SOFTWARE", APART FROM THE MARK AS SHOWN.

SN 85-397,134, FILED 8-12-2011.

MATTHEW MCDOWELL, EXAMINING ATTORNEY



*David J. Kybas*

Director of the United States Patent and Trademark Office



# United States of America

United States Patent and Trademark Office



*Lady Walker*

**Reg. No. 4,276,632**

YVETTE WALKER (UNITED STATES INDIVIDUAL), DBA LADY WALKER,  
PO BOX 330-756  
BROOKLYN, NY 11233

**Registered Jan. 15, 2013**

**Int. Cl.: 25**

FOR: DENIM JACKETS; DENIMS; JACKETS; LADIES' UNDERWEAR; LONG-SLEEVED SHIRTS; SHIRTS; SHORT-SLEEVED OR LONG-SLEEVED T-SHIRTS; SOCKS AND STOCKINGS, IN CLASS 25 (U.S. CLS. 22 AND 39).

**TRADEMARK**

FIRST USE 10-9-2012; IN COMMERCE 10-9-2012.

**PRINCIPAL REGISTER**

THE MARK CONSISTS OF A VERTICAL OVAL CONTAINING THE IMAGE OF A LADY. BELOW IS THE WORDING "LADY WALKER" IN SCRIPT.

SN 85-398,468, FILED 8-15-2011.

KATHERINE CHANG, EXAMINING ATTORNEY



*David J. Kybas*

Director of the United States Patent and Trademark Office

# United States of America

United States Patent and Trademark Office

# LA MER

**Reg. No. 4,276,633**

**Registered Jan. 15, 2013**

**Int. Cl.: 33**

**TRADEMARK**

**PRINCIPAL REGISTER**

CARR, DEIRDRE (UNITED STATES INDIVIDUAL)  
995 MAIN STREET OLD KINGS HIGHWAY  
DENNIS, MA 02638

FOR: WINES, IN CLASS 33 (U.S. CLS. 47 AND 49).

FIRST USE 4-0-2012; IN COMMERCE 4-0-2012.

THE MARK CONSISTS OF STANDARD CHARACTERS WITHOUT CLAIM TO ANY PARTICULAR FONT, STYLE, SIZE, OR COLOR.

THE ENGLISH TRANSLATION OF "LA MER" IN THE MARK IS "THE SEA".

SN 85-398,479, FILED 8-15-2011.

RAUL CORDOVA, EXAMINING ATTORNEY



*David J. Kyffers*

Director of the United States Patent and Trademark Office

# United States of America

United States Patent and Trademark Office

## FORT FRIEND

**Reg. No. 4,276,634**

KAREN J. CURRIER (UNITED STATES INDIVIDUAL)  
PO BOX 133

**Registered Jan. 15, 2013**

HOLDERNESS, NH 032450133

**Int. Cl.: 28**

FOR: TOYS, NAMELY, BEAN BAGS FOR USE BY CHILDREN IN CONSTRUCTING PLAY STRUCTURES, IN CLASS 28 (U.S. CLS. 22, 23, 38 AND 50).

**TRADEMARK**

FIRST USE 12-23-2011; IN COMMERCE 12-23-2011.

**PRINCIPAL REGISTER**

THE MARK CONSISTS OF STANDARD CHARACTERS WITHOUT CLAIM TO ANY PARTICULAR FONT, STYLE, SIZE, OR COLOR.

SN 85-399,483, FILED 8-16-2011.

KATHERINE STOIDES, EXAMINING ATTORNEY



*David J. Kybas*

Director of the United States Patent and Trademark Office

# United States of America

United States Patent and Trademark Office

# CCLF

**Reg. No. 4,276,635**

**Registered Jan. 15, 2013**

**Int. Cl.: 36**

**SERVICE MARK**

**PRINCIPAL REGISTER**

THE DEPOSITORY TRUST AND CLEARING CORPORATION (NEW YORK CORPORATION)  
55 WATER STREET  
NEW YORK, NY 10041

FOR: FINANCIAL SERVICES, NAMELY, BUSINESS LIQUIDATION SERVICES IN THE FORM OF FACILITATING LIQUIDATIONS RESULTING FROM A DEFAULT BY A FINANCIAL SERVICES FIRM; PROVIDING AND ARRANGING FINANCING FOR PURPOSES OF THE SETTLEMENT OF POSITIONS ON BEHALF OF DISTRESSED FINANCIAL SERVICES FIRMS; PROVIDING ANALYSIS OF FINANCIAL DELIVERY OBLIGATIONS TO DISTRESSED FINANCIAL SERVICES FIRMS; FINANCIAL ANALYSIS OF LIQUIDITY REQUIREMENTS FOR DISTRESSED FINANCIAL SERVICES FIRM; BUSINESS LIQUIDATION SERVICES IN THE FORM OF REDISTRIBUTING SECURITIES AMONG FINANCIAL SERVICES FIRMS AS PART OF A LIQUIDATION OF A DISTRESSED FINANCIAL SERVICES FIRM; FINANCIAL ANALYSIS AND CALCULATIONS OF CAPS OF FINANCING REQUIREMENTS FOR FINANCIAL SERVICES FIRMS, IN CLASS 36 (U.S. CLS. 100, 101 AND 102).

FIRST USE 5-5-2010; IN COMMERCE 5-5-2010.

THE MARK CONSISTS OF STANDARD CHARACTERS WITHOUT CLAIM TO ANY PARTICULAR FONT, STYLE, SIZE, OR COLOR.

SN 85-400,553, FILED 8-17-2011.

HANNO RITTNER, EXAMINING ATTORNEY



*David J. Kybas*

Director of the United States Patent and Trademark Office

# United States of America

United States Patent and Trademark Office

## Home Team Residential Maintenance and Repair Services

**Reg. No. 4,276,636**

HIBBARD, WILLIAM, DALTON (NEW YORK CORPORATION)  
4804 TRANSIT ROAD  
DEPEW, NY 14043

**Registered Jan. 15, 2013**

**Int. Cls.: 36 and 37**

FOR: PREPAID PREVENTIVE MAINTENANCE SERVICE PLANS FOR HEATING, VENTILATING AND AIR CONDITIONING SYSTEMS, IN CLASS 36 (U.S. CLS. 100, 101 AND 102).

**SERVICE MARK**

FIRST USE 9-26-2012; IN COMMERCE 9-26-2012.

**PRINCIPAL REGISTER**

FOR: HANDYMAN SERVICE, NAMELY, BUILDING REPAIR AND MAINTENANCE; HOUSING SERVICES, NAMELY, REPAIR, IMPROVEMENT, AND CONSTRUCTION OF RESIDENTIAL REAL PROPERTY; REPAIR OF HOUSEHOLD APPLIANCES AND OF RESIDENTIAL HEATING, PLUMBING, AIR CONDITIONING, AND ELECTRICAL SYSTEMS, IN CLASS 37 (U.S. CLS. 100, 103 AND 106).

FIRST USE 9-26-2012; IN COMMERCE 9-26-2012.

THE MARK CONSISTS OF STANDARD CHARACTERS WITHOUT CLAIM TO ANY PARTICULAR FONT, STYLE, SIZE, OR COLOR.

NO CLAIM IS MADE TO THE EXCLUSIVE RIGHT TO USE "RESIDENTIAL MAINTENANCE AND REPAIR SERVICES", APART FROM THE MARK AS SHOWN.

SN 85-401,623, FILED 8-18-2011.

MATTHEW MCDOWELL, EXAMINING ATTORNEY



*David J. Kybas*

Director of the United States Patent and Trademark Office

# United States of America

United States Patent and Trademark Office



**Reg. No. 4,276,637**

**Registered Jan. 15, 2013**

**Int. Cl.: 21**

**TRADEMARK**

**PRINCIPAL REGISTER**

RICKS, NOEL (UNITED STATES INDIVIDUAL)  
170 GREEN KEMP ROAD  
VIRGINIA BEACH, VA 23462

FOR: HOUSEHOLD SOY WAX CANDLES, IN CLASS 21 (U.S. CLS. 2, 13, 23, 29, 30, 33, 40 AND 50).

FIRST USE 1-5-2012; IN COMMERCE 1-5-2012.

NO CLAIM IS MADE TO THE EXCLUSIVE RIGHT TO USE "CANDLEWORKS", APART FROM THE MARK AS SHOWN.

THE COLOR(S) WHITE, BLACK, GRAY, BROWN, YELLOW AND ORANGE IS/ARE CLAIMED AS A FEATURE OF THE MARK.

THE MARK CONSISTS OF A DESIGN WITH THE TERMS "OLDE SOUTHERN" ACROSS THE TOP IN BLACK, THE TERM "CANDLEWORKS" IN BLACK ACROSS THE BOTTOM WITHIN A WHITE AND BLACK BANNER DESIGN; AND THE CENTER BETWEEN THE WORDS COMPRISING A BLACK ROUNDED BACKGROUND WITH A GRAY FANCY BORDER, CONTAINING A CANDLE IN YELLOW, ORANGE, AND BROWN IN THE CENTER.

SN 85-402,276, FILED 8-19-2011.

HELENE LIWINSKI, EXAMINING ATTORNEY



*David J. Kybas*

Director of the United States Patent and Trademark Office

# United States of America

United States Patent and Trademark Office

## CUTIE CRITTERS

**Reg. No. 4,276,638**

SAFDIE & CO. INC. (CANADA CORPORATION)  
8191 MONTVIEW

**Registered Jan. 15, 2013**

MOUNT ROYAL, QUEBEC, CANADA H4P2P2

**Int. Cl.: 20**

FOR: HOUSEHOLD ITEMS, NAMELY, CUSHIONS, PILLOWS, PILLOW SETS PRIMARILY COMPRISING A PILLOW WITH AN ATTACHED BLANKET, PILLOW AND BLANKET SETS PRIMARILY COMPRISING PILLOWS, IN CLASS 20 (U.S. CLS. 2, 13, 22, 25, 32 AND 50).

**TRADEMARK**

**PRINCIPAL REGISTER**

FIRST USE 8-8-2012; IN COMMERCE 8-8-2012.

THE MARK CONSISTS OF STANDARD CHARACTERS WITHOUT CLAIM TO ANY PARTICULAR FONT, STYLE, SIZE, OR COLOR.

SN 85-403,381, FILED 8-22-2011.

BERYL GARDNER, EXAMINING ATTORNEY



*David J. Kyffers*

Director of the United States Patent and Trademark Office

# United States of America

United States Patent and Trademark Office

## ETERNAL SPRING TAI CHI

**Reg. No. 4,276,639**

TAI CHI CHUAN CENTER, INC. (NEW YORK CORPORATION)  
156 WEST 44TH ST. - 2ND FLR.  
NEW YORK, NY 10036

**Registered Jan. 15, 2013**

**Int. Cl.: 41**

FOR: EDUCATIONAL SERVICES, NAMELY, PROVIDING SEMINARS AND INSTRUCTIONAL CLASSES IN THE FIELD OF TAI CHI FOR PERSONS OVER FIFTY YEARS OF AGE , IN CLASS 41 (U.S. CLS. 100, 101 AND 107).

**SERVICE MARK**

FIRST USE 5-21-2002; IN COMMERCE 5-21-2002.

**PRINCIPAL REGISTER**

THE MARK CONSISTS OF STANDARD CHARACTERS WITHOUT CLAIM TO ANY PARTICULAR FONT, STYLE, SIZE, OR COLOR.

NO CLAIM IS MADE TO THE EXCLUSIVE RIGHT TO USE "TAI CHI", APART FROM THE MARK AS SHOWN.

SN 85-403,541, FILED 8-22-2011.

KAPIL BHANOT, EXAMINING ATTORNEY



*David J. Kyffers*

Director of the United States Patent and Trademark Office



# United States of America

United States Patent and Trademark Office

# Escape Smart

**Reg. No. 4,276,640**

ESCAPE SMART PARTNERS LLC (NEW JERSEY LIMITED LIABILITY COMPANY)  
111 OAKWOOD COURT  
SAYLORSBURG, PA 18353

**Registered Jan. 15, 2013**

**Int. Cl.: 41**

FOR: EDUCATIONAL SERVICES, NAMELY, CONDUCTING PROGRAMS IN THE FIELD OF FIRE SAFETY; EDUCATIONAL SERVICES, NAMELY, PROVIDING ON SITE TRAINING AND CONDUCTING EDUCATIONAL PROGRAMS IN THE FIELDS OF FIRE SURVIVAL AND PREVENTION AND DISTRIBUTION OF COURSE MATERIAL IN CONNECTION THEREWITH; PRODUCTION AND DISTRIBUTION OF VIDEOS IN THE FIELD OF FIRE SAFETY, IN CLASS 41 (U.S. CLS. 100, 101 AND 107).

**SERVICE MARK**

**PRINCIPAL REGISTER**

FIRST USE 11-1-2012; IN COMMERCE 11-1-2012.

THE MARK CONSISTS OF STANDARD CHARACTERS WITHOUT CLAIM TO ANY PARTICULAR FONT, STYLE, SIZE, OR COLOR.

NO CLAIM IS MADE TO THE EXCLUSIVE RIGHT TO USE "ESCAPE", APART FROM THE MARK AS SHOWN.

SN 85-403,561, FILED 8-22-2011.

KATHERINE E. HALMEN, EXAMINING ATTORNEY



*David J. Kybas*

Director of the United States Patent and Trademark Office

# United States of America

United States Patent and Trademark Office

## ACS SYNTHETIC BIOLOGY

**Reg. No. 4,276,641**

**Registered Jan. 15, 2013**

**Int. Cl.: 41**

**SERVICE MARK**

**PRINCIPAL REGISTER**

AMERICAN CHEMICAL SOCIETY (UNITED STATES FEDERALLY CHARTERED CORPORATION)  
1155 SIXTEENTH STREET, NW  
WASHINGTON, DC 20036

FOR: PROVIDING AN ONLINE SCIENTIFIC JOURNAL CONTAINING ARTICLES AND INFORMATION IN THE FIELD OF SYNTHETIC BIOLOGY, IN CLASS 41 (U.S. CLS. 100, 101 AND 107).

FIRST USE 1-20-2012; IN COMMERCE 1-20-2012.

THE MARK CONSISTS OF STANDARD CHARACTERS WITHOUT CLAIM TO ANY PARTICULAR FONT, STYLE, SIZE, OR COLOR.

OWNER OF U.S. REG. NOS. 1,082,875, 3,121,332, AND OTHERS.

NO CLAIM IS MADE TO THE EXCLUSIVE RIGHT TO USE "SYNTHETIC BIOLOGY", APART FROM THE MARK AS SHOWN.

SN 85-403,616, FILED 8-22-2011.

HELENE LIWINSKI, EXAMINING ATTORNEY



*David J. Kybas*

Director of the United States Patent and Trademark Office

# United States of America

United States Patent and Trademark Office

## Eternal Spring Chi Kung

**Reg. No. 4,276,642**

TAI CHI CHUAN CENTER, INC. (NEW YORK CORPORATION)  
156 WEST 44TH ST. - 2ND FLR.  
NEW YORK, NY 10036

**Registered Jan. 15, 2013**

**Int. Cl.: 41**

FOR: PROVIDING INSTRUCTION IN CHI KUNG AND RELATED EXERCISES FOR PEOPLE OF ALL AGES, LEVELS AND PHYSICAL CONDITIONS INCLUDING PEOPLE WITH SPECIAL CONDITIONS SUCH AS PARKINSON'S AND ALZHEIMER'S DISEASE, IN CLASS 41 (U.S. CLS. 100, 101 AND 107).

**SERVICE MARK**

**PRINCIPAL REGISTER**

FIRST USE 2-4-2003; IN COMMERCE 2-4-2003.

THE MARK CONSISTS OF STANDARD CHARACTERS WITHOUT CLAIM TO ANY PARTICULAR FONT, STYLE, SIZE, OR COLOR.

NO CLAIM IS MADE TO THE EXCLUSIVE RIGHT TO USE "CHI KUNG", APART FROM THE MARK AS SHOWN.

SN 85-403,634, FILED 8-22-2011.

KAPIL BHANOT, EXAMINING ATTORNEY



*David J. Kybas*

Director of the United States Patent and Trademark Office

# United States of America

United States Patent and Trademark Office

## PERV-PATCH

**Reg. No. 4,276,643**

OZARK BUILDING MATERIALS CO., INC. (MISSOURI CORPORATION)  
2833 BRECKENRIDGE INDUSTRIAL COURT  
ST. LOUIS, MO 63144

**Registered Jan. 15, 2013**

**Int. Cl.: 19**

FOR: CEMENT BASED PATCHING MATERIAL FOR CONCRETE, IN CLASS 19 (U.S. CLS. 1, 12, 33 AND 50).

**TRADEMARK**

FIRST USE 3-9-2012; IN COMMERCE 3-9-2012.

**PRINCIPAL REGISTER**

THE MARK CONSISTS OF STANDARD CHARACTERS WITHOUT CLAIM TO ANY PARTICULAR FONT, STYLE, SIZE, OR COLOR.

SN 85-403,676, FILED 8-22-2011.

JOHN GARTNER, EXAMINING ATTORNEY



*David J. Kyffers*

Director of the United States Patent and Trademark Office

# United States of America

United States Patent and Trademark Office

## WRINKLES ARE FAR FROM SIGHT

**Reg. No. 4,276,644**

**Registered Jan. 15, 2013**

**Int. Cl.: 3**

**TRADEMARK**

**PRINCIPAL REGISTER**

SHISEIDO COMPANY, LIMITED (JAPAN CORPORATION)  
7-5-5 GINZA, CHUO-KU  
TOKYO, JAPAN 104-0061

FOR: SKIN CARE PRODUCTS, NAMELY, CREAMS, LOTIONS, NON-MEDICATED SKIN SERUMS, MILKY CREAMS, MASSAGE CREAMS AND MASKS, IN CLASS 3 (U.S. CLS. 1, 4, 6, 50, 51 AND 52).

FIRST USE 2-1-2012; IN COMMERCE 2-1-2012.

THE MARK CONSISTS OF STANDARD CHARACTERS WITHOUT CLAIM TO ANY PARTICULAR FONT, STYLE, SIZE, OR COLOR.

SN 85-404,108, FILED 8-22-2011.

BRIDGETT SMITH, EXAMINING ATTORNEY



*David J. Kyffers*

Director of the United States Patent and Trademark Office

# United States of America

United States Patent and Trademark Office



**Reg. No. 4,276,645**

**Registered Jan. 15, 2013**

**Int. Cl.: 43**

**SERVICE MARK**

**PRINCIPAL REGISTER**

MCLAIN, ANTOINETTE L. (D.C. SOLE PROPRIETORSHIP), DBA STREET CREAM,  
738 RIDGE ROAD S.E.  
WASHINGTON, DC 20019

FOR: ICE CREAM SHOP SERVICES IN THE NATURE OF A RESTAURANT, IN CLASS 43  
(U.S. CLS. 100 AND 101).

FIRST USE 7-1-2012; IN COMMERCE 7-1-2012.

THE MARK CONSISTS OF THE WORDING "STREET CREAM" IN WHICH "STREET" IS  
OUTLINED IN WHITE WITH BLACK FILL AND "CREAM" IS OUTLINED IN BLACK WITH  
WHITE FILL, ALL ON A RED BRICK BACKGROUND WITH BLACK MORTAR; BELOW  
THESE ELEMENTS IS STREET ASPHALT IN BLACK AND GREY. A STREET LIGHT IN  
GREY AND BLACK IS LOCATED LEFT OF THE LITERAL ELEMENTS WITH GREEN,  
YELLOW, AND RED LIGHTS.

THE COLOR(S) RED, BLACK, WHITE, GREY, GREEN AND YELLOW IS/ARE CLAIMED  
AS A FEATURE OF THE MARK.

SN 85-404,210, FILED S.R. 8-22-2011; AM. P.R. 7-6-2012.

LINDA POWELL, EXAMINING ATTORNEY



*David J. Kyffers*

Director of the United States Patent and Trademark Office

# United States of America

United States Patent and Trademark Office

# WOLLAR

**Reg. No. 4,276,646**

**Registered Jan. 15, 2013**

**Int. Cls.: 35 and 36**

**SERVICE MARK**

**PRINCIPAL REGISTER**

UNIPOINT TECHNOLOGIES, INC. (MASSACHUSETTS CORPORATION)  
P.O. BOX 81362  
WELLESLEY HILLS, MA 02481

FOR: ADVERTISING, MARKETING, AND PROMOTION SERVICES; PROMOTING THE GOODS AND SERVICES OF OTHERS VIA A GLOBAL COMPUTER NETWORK; PROVIDING INCENTIVE AWARD PROGRAMS FOR CUSTOMERS THROUGH THE ISSUANCE AND PROCESSING OF REWARD VIRTUAL CURRENCY WHICH CAN BE EXCHANGED FOR THE PURCHASE OF THE GOODS AND SERVICES OF OTHERS, IN CLASS 35 (U.S. CLS. 100, 101 AND 102).

FIRST USE 11-0-2011; IN COMMERCE 11-0-2011.

FOR: FINANCIAL SERVICES, NAMELY, PROVIDING A VIRTUAL CURRENCY FOR USE BY MEMBERS OF AN ON-LINE COMMUNITY VIA A GLOBAL COMPUTER NETWORK, IN CLASS 36 (U.S. CLS. 100, 101 AND 102).

FIRST USE 11-0-2011; IN COMMERCE 11-0-2011.

THE MARK CONSISTS OF STANDARD CHARACTERS WITHOUT CLAIM TO ANY PARTICULAR FONT, STYLE, SIZE, OR COLOR.

SN 85-404,631, FILED 8-23-2011.

GIANCARLO CASTRO, EXAMINING ATTORNEY



*David J. Kybas*

Director of the United States Patent and Trademark Office

# United States of America

United States Patent and Trademark Office

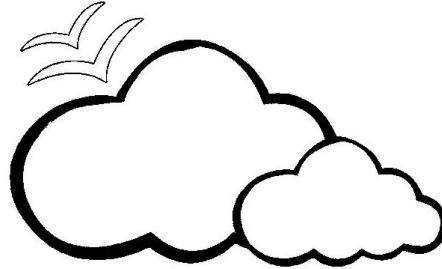

## CLOUDWORD

**Reg. No. 4,276,647**

**Registered Jan. 15, 2013**

**Int. Cl.: 9**

**TRADEMARK**

**PRINCIPAL REGISTER**

COHEN, YOGEV DAVID (ISRAEL INDIVIDUAL)  
#4B  
323 WEST 42ND ST.  
NEW YORK, NY 10036

FOR: COMPUTER APPLICATION SOFTWARE FOR MOBILE PHONES, PORTABLE MEDIA PLAYERS, HANDHELD COMPUTERS, COMPUTER, AND TABLET COMPUTERS, NAMELY, SOFTWARE FOR PRODUCTIVITY RICH TEXT EDITING, RICH TEXT EDITING, CHANGING FONT SIZE, CHANGING FONT COLORS AND BACKGROUND COLORS, RULERS, ALIGNING TEXT, REDOING, UNDOING, AND RECORDING VOICE AND PLAY RECORDINGS, EDITING PICTURES, SENDING EMAIL, USE IN GLOSSARIES, DEFINING YOUR OWN TERMS AND THE ABILITY TO CLICK ON THOSE TERMS AND SEE DEFINITIONS, SAVING FILES, OPENING FILES, RENAMING FILES, CREATING RELATIONSHIPS BETWEEN FILES, SPEAKING TEXT, TEXTING THAT WAS TYPED THAT WILL BE HEARD BY AN AUTOMATIC VOICE, INTERTWINING WEBSITES, VIEWING WEBSITES WITH NOTES, USING RICH TEXT EDITOR TYPE, COPYING, SELECTING AND PASTING ON THE SAME PAGE WHILE SURFING ONLINE, FOR CALENDAR ORGANIZING, ADDING NOTES, EDITING NOTES, MARKING DAYS, ADDING EVENTS, COMPRISING DOCUMENTS, ADDING ATTACHMENTS, MEMORIZING SYSTEMS, SCHEDULING LISTS TO DO BY TIME, MARKING LIST ORGANIZERS, EDITING LISTS, AND POP UP NOTES, SHARING NOTES AND DOCUMENTS WITH OTHER USERS, SHARING DISPLAYS WITH OTHER USERS, HAVING TEXT AND VIDEO CHATS WITH OTHER USERS, HAVING GROUP TEXT AND VIDEO CHATS WITH OTHER USERS, DRAWING ON NOTES, EXPORTING NEW EDIT NOTES, IN CLASS 9 (U.S. CLS. 21, 23, 26, 36 AND 38).

FIRST USE 8-2-2010; IN COMMERCE 8-2-2010.

THE STIPPLING IS FOR SHADING PURPOSES ONLY.

THE MARK CONSISTS OF TWO CLOUDS, ONE OF THE CLOUDS IS BIGGER THAN THE SECOND ONE AND PLACED ON THE LEFT SIDE, AND ON THE TOP LEFT SIDE OF THE BIGGER CLOUD ARE TWO BIRDS ABOVE EACH OTHER. UNDERNEATH THE STYLIZED DESIGN IS THE TEXT "CLOUDWORD".



*David J. Kyros*

SN 85-405,722, FILED 8-24-2011.

SANI KHOURI, EXAMINING ATTORNEY



# United States of America

United States Patent and Trademark Office

# QuatreActiv

**Reg. No. 4,276,648**

ALLERGY RESEARCH GROUP, LLC (CALIFORNIA LIMITED LIABILITY COMPANY)  
2300 NORTH LOOP ROAD  
ALAMEDA, CA 94502

**Registered Jan. 15, 2013**

**Int. Cl.: 5**

FOR: DIETARY AND NUTRITIONAL SUPPLEMENTS, IN CLASS 5 (U.S. CLS. 6, 18, 44, 46, 51 AND 52).

**TRADEMARK**

FIRST USE 8-24-2011; IN COMMERCE 8-24-2011.

**PRINCIPAL REGISTER**

THE MARK CONSISTS OF STANDARD CHARACTERS WITHOUT CLAIM TO ANY PARTICULAR FONT, STYLE, SIZE, OR COLOR.

SN 85-405,799, FILED 8-24-2011.

ESTHER BELENKER, EXAMINING ATTORNEY



*David J. Kyffers*

Director of the United States Patent and Trademark Office

# United States of America

United States Patent and Trademark Office

# NANOFUSING

**Reg. No. 4,276,649**

AKRON PAINT & VARNISH, INC. (OHIO CORPORATION)  
1390 FIRESTONE PARKWAY  
AKRON, OH 44301

**Registered Jan. 15, 2013**

**Int. Cl.: 40**

FOR: FORMULATING, PROCESSING AND MIXING OF RESINS, LIQUID CONCENTRATES, COATING AND PAINTS, IN CLASS 40 (U.S. CLS. 100, 103 AND 106).

**SERVICE MARK**

FIRST USE 7-13-2012; IN COMMERCE 7-13-2012.

**PRINCIPAL REGISTER**

THE MARK CONSISTS OF STANDARD CHARACTERS WITHOUT CLAIM TO ANY PARTICULAR FONT, STYLE, SIZE, OR COLOR.

SN 85-406,764, FILED 8-25-2011.

COLLEEN KEARNEY, EXAMINING ATTORNEY



*David J. Kybas*

Director of the United States Patent and Trademark Office

# United States of America

United States Patent and Trademark Office

# CORVA

**Reg. No. 4,276,650**

**Registered Jan. 15, 2013**

**Int. Cl.: 44**

**SERVICE MARK**

**PRINCIPAL REGISTER**

CORVA, LLC (DELAWARE LIMITED LIABILITY COMPANY)  
SUITE 800  
5613 DTC PARKWAY  
GREENWOOD VILLAGE, CO 80111

FOR: HEALTH CARE; HEALTH CARE SERVICES, NAMELY, DISEASE MANAGEMENT PROGRAMS, IN CLASS 44 (U.S. CLS. 100 AND 101).

FIRST USE 8-29-2011; IN COMMERCE 10-1-2012.

THE MARK CONSISTS OF STANDARD CHARACTERS WITHOUT CLAIM TO ANY PARTICULAR FONT, STYLE, SIZE, OR COLOR.

SN 85-406,844, FILED 8-25-2011.

HAI-LY LAM, EXAMINING ATTORNEY



*David J. Kyffers*

Director of the United States Patent and Trademark Office

# United States of America

United States Patent and Trademark Office

# DC EDGE

**Reg. No. 4,276,651**

**Registered Jan. 15, 2013**

**Int. Cl.: 9**

**TRADEMARK**

**PRINCIPAL REGISTER**

BLACKROCK INSTITUTIONAL TRUST COMPANY, N.A. (UNITED STATES FEDERALLY  
CHARTERED BANKING INSTITUTION)  
400 HOWARD STREET  
SAN FRANCISCO, CA 94105

FOR: ELECTRONIC PUBLICATIONS, NAMELY, DOWNLOADABLE MAGAZINES IN THE  
FIELD OF DEFINED CONTRIBUTION PLANS , IN CLASS 9 (U.S. CLS. 21, 23, 26, 36 AND  
38).

FIRST USE 12-3-2012; IN COMMERCE 12-3-2012.

THE MARK CONSISTS OF STANDARD CHARACTERS WITHOUT CLAIM TO ANY PAR-  
TICULAR FONT, STYLE, SIZE, OR COLOR.

NO CLAIM IS MADE TO THE EXCLUSIVE RIGHT TO USE "DC", APART FROM THE MARK  
AS SHOWN.

SN 85-407,044, FILED 8-25-2011.

IRA J. GOODSaid, EXAMINING ATTORNEY



*David J. Kyffers*

Director of the United States Patent and Trademark Office

# United States of America

United States Patent and Trademark Office

# DC EDGE

**Reg. No. 4,276,652**

**Registered Jan. 15, 2013**

**Int. Cl.: 16**

**TRADEMARK**

**PRINCIPAL REGISTER**

BLACKROCK INSTITUTIONAL TRUST COMPANY, N.A. (UNITED STATES FEDERALLY  
CHARTERED BANKING INSTITUTION)  
400 HOWARD STREET  
SAN FRANCISCO, CA 94105

FOR: MAGAZINES AND NEWSLETTERS IN THE FIELD OF DEFINED CONTRIBUTION  
PLANS, IN CLASS 16 (U.S. CLS. 2, 5, 22, 23, 29, 37, 38 AND 50).

FIRST USE 12-3-2012; IN COMMERCE 12-3-2012.

THE MARK CONSISTS OF STANDARD CHARACTERS WITHOUT CLAIM TO ANY PAR-  
TICULAR FONT, STYLE, SIZE, OR COLOR.

NO CLAIM IS MADE TO THE EXCLUSIVE RIGHT TO USE "DC", APART FROM THE MARK  
AS SHOWN.

SN 85-407,062, FILED 8-25-2011.

IRA J. GOODSID, EXAMINING ATTORNEY



*David J. Kyffers*

Director of the United States Patent and Trademark Office

# United States of America

United States Patent and Trademark Office



**Reg. No. 4,276,653**

**Registered Jan. 15, 2013**

**Int. Cl.: 41**

**SERVICE MARK**

**PRINCIPAL REGISTER**

CLARION COUNCIL FOR EDUCATIONAL GREATNESS, INC. (FLORIDA CORPORATION)  
2100 N OCEAN BLVD UNIT 30A  
FORT LAUDERDALE, FL 33305

FOR: PROMOTING ACHIEVEMENT AND EXCELLENCE IN EDUCATION, NAMELY, PROVIDING RECOGNITION AND INCENTIVES BY WAY OF CELEBRATIONS AND ISSUANCE OF REWARDS TO CHARTER SCHOOL TEACHERS WHO HAVE DEMONSTRATED EXCEPTIONAL EFFORT IN TEACHING, IN CLASS 41 (U.S. CLS. 100, 101 AND 107).

FIRST USE 3-15-2012; IN COMMERCE 3-15-2012.

THE MARK CONSISTS OF THE WORDS "THE NEW AMERICAN HERO" UNDER AN APPLE DEVICE WHICH APPEARS WITH AN AMERICAN-THEMED FLAG IMPRINTED THEREON, WHERE ALL THE LETTERING APPEARS IN BLUE, AND THE APPLE DEVICE APPEARS WITH WHITE STARS ON A BLUE BACKGROUND AND ALTERNATING RED AND WHITE STRIPES, WITH A GREEN LEAF AND BROWN STEM.

THE COLOR(S) GREEN, BLUE, BROWN, WHITE, AND RED IS/ARE CLAIMED AS A FEATURE OF THE MARK.

SN 85-407,103, FILED 8-25-2011.

ELLEN PERKINS, EXAMINING ATTORNEY



*David J. Kybas*

Director of the United States Patent and Trademark Office

# United States of America

United States Patent and Trademark Office

# OSOLO

**Reg. No. 4,276,654**

**Registered Jan. 15, 2013**

**Int. Cl.: 25**

**TRADEMARK**

**PRINCIPAL REGISTER**

DABES, SAM (UNITED STATES INDIVIDUAL)  
2ND FLR.  
544 74TH ST.  
BROOKLYN, NY 11209

FOR: JACKETS; PANTS; SHOES; SWEATSHIRTS, IN CLASS 25 (U.S. CLS. 22 AND 39).

FIRST USE 10-10-2012; IN COMMERCE 10-10-2012.

THE MARK CONSISTS OF STANDARD CHARACTERS WITHOUT CLAIM TO ANY PARTICULAR FONT, STYLE, SIZE, OR COLOR.

SN 85-407,308, FILED 8-25-2011.

NANCY CLARKE, EXAMINING ATTORNEY



*David J. Kyffers*

Director of the United States Patent and Trademark Office

# United States of America

United States Patent and Trademark Office

## Texas Wine Camp

**Reg. No. 4,276,655**

**Registered Jan. 15, 2013**

**Int. Cl.: 43**

**SERVICE MARK**

**PRINCIPAL REGISTER**

JONES, GARY (UNITED STATES INDIVIDUAL)  
1819 BRANCH HOLLOW LN  
GRAPEVINE, TX 76051 AND

JONES, CYNTHIA (UNITED STATES INDIVIDUAL)  
1819 BRANCH HOLLOW LN  
GRAPEVINE, TX 76051

FOR: PROVIDING A WEB SITE WHERE USERS CAN POST REVIEWS AND RECOMMENDATIONS ON WINES FOR WINE APPRECIATION PURPOSES AND WHERE USERS CAN GET INFORMATION ABOUT WINE CHARACTERISTICS; NONE OF THE FOREGOING SERVICES INVOLVE THE PROVISION OF INFORMATION ABOUT CAMPS OR OTHER OVERNIGHT WINE-RELATED EXCURSIONS, IN CLASS 43 (U.S. CLS. 100 AND 101).

FIRST USE 8-21-2011; IN COMMERCE 4-17-2012.

THE MARK CONSISTS OF STANDARD CHARACTERS WITHOUT CLAIM TO ANY PARTICULAR FONT, STYLE, SIZE, OR COLOR.

NO CLAIM IS MADE TO THE EXCLUSIVE RIGHT TO USE "TEXAS WINE", APART FROM THE MARK AS SHOWN.

SN 85-407,677, FILED 8-25-2011.

SHAILA SETTLES, EXAMINING ATTORNEY



*David J. Kybas*

Director of the United States Patent and Trademark Office



# United States of America

United States Patent and Trademark Office



**Reg. No. 4,276,656**

TRANSLATIONAL SOFTWARE INCORPORATED (WASHINGTON CORPORATION)  
2203 70TH AVENUE SE  
MERCER ISLAND, WA 98040

**Registered Jan. 15, 2013**

**Int. Cl.: 9**

FOR: COMPUTER SOFTWARE FOR CONTROLLING AND MANAGING PATIENT MEDICAL INFORMATION, IN CLASS 9 (U.S. CLS. 21, 23, 26, 36 AND 38).

**TRADEMARK**

FIRST USE 7-23-2012; IN COMMERCE 7-23-2012.

**PRINCIPAL REGISTER**

NO CLAIM IS MADE TO THE EXCLUSIVE RIGHT TO USE "SOFTWARE", APART FROM THE MARK AS SHOWN.

THE MARK CONSISTS OF A GRAPHIC REPRESENTATION OF A PARTIAL DNA HELIX WITH THE WORD "TRANSLATIONAL" TO THE RIGHT OF THE DNA HELIX AND THE WORD "SOFTWARE" WHICH IS ALSO POSITIONED NEXT TO THE DNA HELIX BUT BELOW THE WORD "TRANSLATIONAL".

SN 85-408,556, FILED 8-26-2011.

MATTHEW MCDOWELL, EXAMINING ATTORNEY



*David J. Kybas*

Director of the United States Patent and Trademark Office

# United States of America

United States Patent and Trademark Office

## CRYSTAL VELVET

**Reg. No. 4,276,657**

MOORE, CAROLYN ANN (UNITED STATES INDIVIDUAL)  
28680 EVENING BREEZE DRIVE  
YORBA LINDA, CA 92887

**Registered Jan. 15, 2013**

**Int. Cl.: 25**

FOR: WOMEN'S SPECIAL-OCCASION LINGERIE AND NIGHTWEAR CLOTHING, NAMELY, BUSTIERS, CORSETS, BRAS, UNDERWEAR, PANTIES, NIGHTGOWNS, NIGHTDRESSES, TEDDIES, PAJAMAS, ROBES, BATHROBES, DRESSING GOWNS, NEGLIGEEES, PEIGNOIRS AND LOUNGEWEAR, IN CLASS 25 (U.S. CLS. 22 AND 39).

**TRADEMARK**

**PRINCIPAL REGISTER**

FIRST USE 3-5-2012; IN COMMERCE 3-5-2012.

THE MARK CONSISTS OF STANDARD CHARACTERS WITHOUT CLAIM TO ANY PARTICULAR FONT, STYLE, SIZE, OR COLOR.

NO CLAIM IS MADE TO THE EXCLUSIVE RIGHT TO USE "VELVET", APART FROM THE MARK AS SHOWN.

SN 85-409,056, FILED 8-27-2011.

MICHAEL LITZAU, EXAMINING ATTORNEY



*David J. Kyros*

Director of the United States Patent and Trademark Office

# United States of America

United States Patent and Trademark Office

# Sharktooth

**Reg. No. 4,276,658**

SHARKTOOTH PRODUCTIONS L.L.C. (NEVADA LIMITED LIABILITY COMPANY)  
1647 KNOX AVE.

**Registered Jan. 15, 2013**

RENO, NV 89509

**Int. Cls.: 9 and 41**

FOR: PRE-RECORDED ELECTRONIC AND DIGITAL MEDIA FEATURING FICTION, SCIENCE FICTION, ACTION, ADVENTURE, ANIMATION, DRAMA, OR MUSIC; FILM CLIPS FEATURING SCIENCE FICTION, ACTION, ADVENTURE, ANIMATION, DRAMA, OR MUSIC, IN CLASS 9 (U.S. CLS. 21, 23, 26, 36 AND 38).

**TRADEMARK**

**SERVICE MARK**

FIRST USE 5-20-2012; IN COMMERCE 8-20-2012.

**PRINCIPAL REGISTER**

FOR: FILM AND VIDEO PRODUCTION; RENTAL OF PHOTOGRAPHIC EQUIPMENT; TELEVISION, VIDEO AND MOVIE FILMING SERVICES, IN CLASS 41 (U.S. CLS. 100, 101 AND 107).

FIRST USE 5-20-2012; IN COMMERCE 8-20-2012.

THE MARK CONSISTS OF STANDARD CHARACTERS WITHOUT CLAIM TO ANY PARTICULAR FONT, STYLE, SIZE, OR COLOR.

SN 85-409,128, FILED 8-28-2011.

DOMINICK J. SALEMI, EXAMINING ATTORNEY



*David J. Kybas*

Director of the United States Patent and Trademark Office

# United States of America

United States Patent and Trademark Office

## BERT'S GARLIC SWEET PICKLED

**Reg. No. 4,276,659**

NELSON, BERT (UNITED STATES INDIVIDUAL)  
4500 KENDALL WAY  
WEST RICHLAND, WA 993537776

**Registered Jan. 15, 2013**

**Int. Cl.: 29**

FOR: SWEET PICKLED GARLIC, IN CLASS 29 (U.S. CL. 46).

**TRADEMARK**

FIRST USE 12-7-2011; IN COMMERCE 12-7-2011.

**PRINCIPAL REGISTER**

THE MARK CONSISTS OF STANDARD CHARACTERS WITHOUT CLAIM TO ANY PARTICULAR FONT, STYLE, SIZE, OR COLOR.

NO CLAIM IS MADE TO THE EXCLUSIVE RIGHT TO USE "GARLIC SWEET PICKLED", APART FROM THE MARK AS SHOWN.

SN 85-409,496, FILED 8-29-2011.

ERIN FALK, EXAMINING ATTORNEY



*David J. Kybas*

Director of the United States Patent and Trademark Office

# United States of America

United States Patent and Trademark Office

## SHERMAN & CLARK

**Reg. No. 4,276,660**

**Registered Jan. 15, 2013**

**Int. Cls.: 3 and 5**

**TRADEMARK**

**PRINCIPAL REGISTER**

CONCEPT LABORATORIES, INC. (ILLINOIS CORPORATION)  
1400 W. WABANSIA AVE.  
CHICAGO, IL 60642

FOR: CLEANING, SCOURING AND POLISHING PREPARATIONS AND SUBSTANCES;  
COSMETIC PREPARATIONS; NON-MEDICATED SKIN CARE PREPARATIONS, IN CLASS  
3 (U.S. CLS. 1, 4, 6, 50, 51 AND 52).

FIRST USE 12-30-2011; IN COMMERCE 12-30-2011.

FOR: PREPARATION FOR THE RELIEF OF PAIN; TOPICAL ANALGESICS, IN CLASS 5  
(U.S. CLS. 6, 18, 44, 46, 51 AND 52).

FIRST USE 1-24-2012; IN COMMERCE 1-24-2012.

THE MARK CONSISTS OF STANDARD CHARACTERS WITHOUT CLAIM TO ANY PAR-  
TICULAR FONT, STYLE, SIZE, OR COLOR.

SN 85-409,692, FILED 8-29-2011.

GEORGE LORENZO, EXAMINING ATTORNEY



*David J. Kypos*

Director of the United States Patent and Trademark Office

# United States of America

United States Patent and Trademark Office

## TWISTED SOUTH

**Reg. No. 4,276,661**

TWISTED SOUTH, L.L.C. (TEXAS LIMITED LIABILITY COMPANY)  
PO BOX 323  
BYHALIA, MS 38611

**Registered Jan. 15, 2013**

**Int. Cl.: 35**

FOR: RETAIL VARIETY STORE SERVICES, IN CLASS 35 (U.S. CLS. 100, 101 AND 102).

**SERVICE MARK**

FIRST USE 1-1-2010; IN COMMERCE 1-1-2010.

**PRINCIPAL REGISTER**

THE MARK CONSISTS OF STANDARD CHARACTERS WITHOUT CLAIM TO ANY PARTICULAR FONT, STYLE, SIZE, OR COLOR.

OWNER OF U.S. REG. NO. 3,899,627.

SN 85-409,875, FILED 8-29-2011.

MARY ROSSMAN, EXAMINING ATTORNEY



*David J. Kyffers*

Director of the United States Patent and Trademark Office

# United States of America

United States Patent and Trademark Office

## TWISTED SOUTH

**Reg. No. 4,276,662**

TWISTED SOUTH, L.L.C. (TEXAS LIMITED LIABILITY COMPANY)  
PO BOX 323  
BYHALIA, MS 38611

**Registered Jan. 15, 2013**

**Int. Cl.: 38**

FOR: TELEVISION AND RADIO BROADCASTING SERVICES, IN CLASS 38 (U.S. CLS. 100, 101 AND 104).

**SERVICE MARK**

FIRST USE 1-1-2010; IN COMMERCE 1-1-2010.

**PRINCIPAL REGISTER**

THE MARK CONSISTS OF STANDARD CHARACTERS WITHOUT CLAIM TO ANY PARTICULAR FONT, STYLE, SIZE, OR COLOR.

OWNER OF U.S. REG. NO. 3,899,627.

NO CLAIM IS MADE TO THE EXCLUSIVE RIGHT TO USE "SOUTH", APART FROM THE MARK AS SHOWN.

SN 85-409,880, FILED 8-29-2011.

MARY ROSSMAN, EXAMINING ATTORNEY



*David J. Kyffers*

Director of the United States Patent and Trademark Office

# United States of America

United States Patent and Trademark Office

## SALUTE TO SENIOR SERVICE

**Reg. No. 4,276,663**

**Registered Jan. 15, 2013**

**Int. Cl.: 41**

**SERVICE MARK**

**PRINCIPAL REGISTER**

HOME INSTEAD, INC. (NEBRASKA CORPORATION)  
13323 CALIFORNIA STREET  
OMAHA, NE 68154

FOR: PROVIDING RECOGNITION AND INCENTIVES BY THE WAY OF AWARDS AND CONTESTS TO SENIOR CITIZENS WHO DEMONSTRATE EXCELLENCE IN THE FIELD OF COMMUNITY SERVICE, IN CLASS 41 (U.S. CLS. 100, 101 AND 107).

FIRST USE 1-13-2012; IN COMMERCE 1-13-2012.

THE MARK CONSISTS OF STANDARD CHARACTERS WITHOUT CLAIM TO ANY PARTICULAR FONT, STYLE, SIZE, OR COLOR.

NO CLAIM IS MADE TO THE EXCLUSIVE RIGHT TO USE "SENIOR SERVICE", APART FROM THE MARK AS SHOWN.

SN 85-410,641, FILED 8-30-2011.

LINDA MICKLEBURGH, EXAMINING ATTORNEY



*David J. Kyffers*

Director of the United States Patent and Trademark Office



# United States of America

United States Patent and Trademark Office

# FLEXTIME+

**Reg. No. 4,276,664**

**Registered Jan. 15, 2013**

**Int. Cl.: 9**

**TRADEMARK**

**PRINCIPAL REGISTER**

WGI INNOVATIONS, LTD. (TEXAS LIMITED PARTNERSHIP)  
602 FOUNTAIN PARKWAY  
GRAND PRAIRIE, TX 75050

FOR: CAMERAS; CAMERA SHUTTERS, IN CLASS 9 (U.S. CLS. 21, 23, 26, 36 AND 38).

FIRST USE 4-13-2012; IN COMMERCE 4-13-2012.

THE MARK CONSISTS OF STANDARD CHARACTERS WITHOUT CLAIM TO ANY PARTICULAR FONT, STYLE, SIZE, OR COLOR.

SN 85-410,649, FILED 8-30-2011.

JENNY PARK, EXAMINING ATTORNEY



*David J. Kybas*

Director of the United States Patent and Trademark Office

# United States of America

United States Patent and Trademark Office

# VITALYTICS

**Reg. No. 4,276,665**

**Registered Jan. 15, 2013**

**Int. Cl.: 35**

**SERVICE MARK**

**PRINCIPAL REGISTER**

MADE HOLDINGS, LLC (FLORIDA LIMITED LIABILITY COMPANY)  
1011 LAKE COUNTY DRIVE  
GREENSBORO, GA 30642

FOR: CONSUMER SURVEY SERVICES IN THE NATURE OF AUDIENCE MEASUREMENT SURVEYS, MEDIA EXPOSURE MEASUREMENT SURVEYS; BUSINESS RESEARCH AND MARKET RESEARCH; MARKET RESEARCH SERVICES REGARDING AUDIENCE MEASUREMENT AND MEDIA EXPOSURE MEASUREMENT; PROVIDING A WEBSITE FEATURING BUSINESS RESEARCH AND MARKET RESEARCH INFORMATION TO CUSTOMERS; MARKET MANIPULATION RESEARCH AND ANALYSIS; MARKETING SERVICES, NAMELY, CONDUCTING CONSUMER TRACKING BEHAVIOR RESEARCH AND CONSUMER TREND ANALYSIS, IN CLASS 35 (U.S. CLS. 100, 101 AND 102).

FIRST USE 9-28-2010; IN COMMERCE 9-28-2010.

THE MARK CONSISTS OF STANDARD CHARACTERS WITHOUT CLAIM TO ANY PARTICULAR FONT, STYLE, SIZE, OR COLOR.

SN 85-411,140, FILED 8-30-2011.

MARTHA FROMM, EXAMINING ATTORNEY



*David J. Kyfos*

Director of the United States Patent and Trademark Office

# United States of America

United States Patent and Trademark Office



CULINARY INSTITUTE  
NIAGARA FALLS

**Reg. No. 4,276,666**

NIAGARA COUNTY COMMUNITY COLLEGE (NEW YORK CORPORATION)  
3111 SAUNDERS SETTLEMENT ROAD  
SANBORN, NY 14132

**Registered Jan. 15, 2013**

**Int. Cl.: 25**

FOR: CHEF COATS, CHEF HATS, APRONS, POLO SHIRTS, T-SHIRTS, SWEATSHIRTS,  
BASEBALL HATS, IN CLASS 25 (U.S. CLS. 22 AND 39).

**TRADEMARK**

FIRST USE 8-30-2012; IN COMMERCE 8-30-2012.

**PRINCIPAL REGISTER**

NO CLAIM IS MADE TO THE EXCLUSIVE RIGHT TO USE "CULINARY INSTITUTE" AND  
"NIAGARA FALLS", APART FROM THE MARK AS SHOWN.

THE MARK CONSISTS OF STYLIZED DESIGN OF CHEF'S HAT WITH THE WORDS  
"CULINARY INSTITUTE" AND THEN "NIAGARA FALLS" STACKED BELOW THE DESIGN.

SN 85-411,373, FILED 8-31-2011.

JEFF DEFORD, EXAMINING ATTORNEY



*David J. Kyffers*

Director of the United States Patent and Trademark Office

# United States of America

United States Patent and Trademark Office



**Reg. No. 4,276,667**

**Registered Jan. 15, 2013**

**Int. Cls.: 6, 8, 9, 16, 21,  
and 30**

**TRADEMARK**

**PRINCIPAL REGISTER**

NIAGARA COUNTY COMMUNITY COLLEGE (NEW YORK CORPORATION)  
3111 SAUNDERS SETTLEMENT ROAD  
SANBORN, NY 14132

FOR: KEY CHAINS MADE OF METAL, IN CLASS 6 (U.S. CLS. 2, 12, 13, 14, 23, 25 AND 50).

FIRST USE 11-7-2012; IN COMMERCE 11-7-2012.

FOR: WOODEN SPOONS; KNIVES; HAND TOOLS, NAMELY, METAL SPATULAS; NYLON CASES FOR HOLDING KNIVES, IN CLASS 8 (U.S. CLS. 23, 28 AND 44).

FIRST USE 11-7-2012; IN COMMERCE 11-7-2012.

FOR: FOOD THERMOMETERS, IN CLASS 9 (U.S. CLS. 21, 23, 26, 36 AND 38).

FIRST USE 11-7-2012; IN COMMERCE 11-7-2012.

FOR: COOKBOOKS, DRINK COASTERS MADE OF PAPER OR CARDBOARD, PENS, IN CLASS 16 (U.S. CLS. 2, 5, 22, 23, 29, 37, 38 AND 50).

FIRST USE 11-7-2012; IN COMMERCE 11-7-2012.

FOR: HOUSEHOLD UTENSILS, NAMELY, METAL SPATULAS, MUGS, DRINK COASTERS MADE OF GLASS OR LEATHER, IN CLASS 21 (U.S. CLS. 2, 13, 23, 29, 30, 33, 40 AND 50).

FIRST USE 8-29-2012; IN COMMERCE 8-29-2012.

FOR: COFFEE PACKETS, ASSORTED CHOCOLATE BARS, GIFT BASKETS CONTAINING CANDY, FRUIT AND PLUSH TOYS, IN CLASS 30 (U.S. CL. 46).

FIRST USE 11-7-2012; IN COMMERCE 11-7-2012.

NO CLAIM IS MADE TO THE EXCLUSIVE RIGHT TO USE "CULINARY INSTITUTE" AND "NIAGARA FALLS", APART FROM THE MARK AS SHOWN.

THE MARK CONSISTS OF A VERTICAL RECTANGLE WITH MULTIPLE BORDERS SEPARATED IN THE CENTER INTO TWO BOXES, A DESIGN OF STYLIZED CHEF'S HAT



*David J. Kybas*

Director of the United States Patent and Trademark Office

**Reg. No. 4,276,667** APPEARS IN THE UPPER BOX AND THE WORDS "CULINARY INSTITUTE" STACKED AND "NIAGARA FALLS" STACKED APPEAR IN THE LOWER BOX SEPARATED BY A LINE.

SN 85-411,380, FILED 8-31-2011.

JEFF DEFORD, EXAMINING ATTORNEY

United States of America  
United States Patent and Trademark Office

# LUREPAL

**Reg. No. 4,276,668**

CHARLES E. REPINE (UNITED STATES INDIVIDUAL)  
136 SANDY LAKE CIR.

**Registered Jan. 15, 2013**

FAYETTEVILLE, GA 30214

**Int. Cl.: 28**

FOR: FISH HOOK HOLDER AND PROTECTOR, NAMELY, A CASE FOR FISH HOOKS;  
FISH HOOK STORAGE APPARATUS, NAMELY, A CASE FOR FISH HOOKS; STORAGE  
APPARATUS COMPRISING HOOKS, SUPPORT ARMS, AND SHELVING SPECIALLY AD-  
APTED FOR SPORTS EQUIPMENT, IN CLASS 28 (U.S. CLS. 22, 23, 38 AND 50).

**TRADEMARK**

**PRINCIPAL REGISTER**

FIRST USE 7-20-2005; IN COMMERCE 7-20-2005.

THE MARK CONSISTS OF STANDARD CHARACTERS WITHOUT CLAIM TO ANY PAR-  
TICULAR FONT, STYLE, SIZE, OR COLOR.

SN 85-411,900, FILED 8-31-2011.

MARLENE BELL, EXAMINING ATTORNEY



*David J. Kybas*

Director of the United States Patent and Trademark Office

# United States of America

United States Patent and Trademark Office

## VANGUARD FOODS

**Reg. No. 4,276,669**

PLYMOUTH POULTRY COMPANY (WASHINGTON CORPORATION)  
4500 7TH AVENUE SOUTH  
SEATTLE, WA 98108

**Registered Jan. 15, 2013**

**Int. Cl.: 29**

FOR: MEAT; SMOKED MEATS; RAW, FROZEN, AND PROCESSED MEAT; MEAT-BASED SNACK FOODS, IN CLASS 29 (U.S. CL. 46).

**TRADEMARK**

FIRST USE 6-20-2012; IN COMMERCE 6-20-2012.

**PRINCIPAL REGISTER**

THE MARK CONSISTS OF STANDARD CHARACTERS WITHOUT CLAIM TO ANY PARTICULAR FONT, STYLE, SIZE, OR COLOR.

NO CLAIM IS MADE TO THE EXCLUSIVE RIGHT TO USE "FOODS", APART FROM THE MARK AS SHOWN.

SN 85-412,362, FILED 8-31-2011.

MATTHEW MCDOWELL, EXAMINING ATTORNEY



*David J. Kybas*

Director of the United States Patent and Trademark Office

# United States of America

United States Patent and Trademark Office

## Lumi Lumi Balls

**Reg. No. 4,276,670**

**Registered Jan. 15, 2013**

**Int. Cl.: 19**

**TRADEMARK**

**PRINCIPAL REGISTER**

TOM RALSTON CONCRETE, INC. (CALIFORNIA CORPORATION), DBA TOM RALSTON  
CONCRETE,  
P.O. BOX 2310  
SANTA CRUZ, CA 95063

FOR: CAST STONE GARDEN AND HOUSEHOLD ORNAMENTS; STEPPING AND FOOTING  
STONES OF CONCRETE OR WOOD FOR USE IN LAWNS AND PATHWAYS; WORKS OF  
ART OF CONCRETE, IN CLASS 19 (U.S. CLS. 1, 12, 33 AND 50).

FIRST USE 1-9-2012; IN COMMERCE 1-9-2012.

THE MARK CONSISTS OF STANDARD CHARACTERS WITHOUT CLAIM TO ANY PAR-  
TICULAR FONT, STYLE, SIZE, OR COLOR.

NO CLAIM IS MADE TO THE EXCLUSIVE RIGHT TO USE "BALLS", APART FROM THE  
MARK AS SHOWN.

SN 85-412,473, FILED 8-31-2011.

WARREN L. OLANDRIA, EXAMINING ATTORNEY



*David J. Kyffers*

Director of the United States Patent and Trademark Office



# United States of America

United States Patent and Trademark Office

# TENERISSIMO

**Reg. No. 4,276,671**

PREGEL AMERICA, INC. (NORTH CAROLINA CORPORATION)  
4450 FORTUNE AVENUE, NW  
CONCORD, NC 28027

**Registered Jan. 15, 2013**

**Int. Cls.: 29, 30, and 32**

FOR: YOGURT-BASED CONCENTRATES, POWDERS, AND SYRUPS USED IN THE PREPARATION OF YOGURT-BASED BEVERAGES, IN CLASS 29 (U.S. CL. 46).

**TRADEMARK**

FIRST USE 2-0-2010; IN COMMERCE 5-0-2011.

**PRINCIPAL REGISTER**

FOR: YOGURT-BASED CONCENTRATES, POWDERS, AND SYRUPS USED IN THE PREPARATION OF FROZEN YOGURT DESSERTS; CONCENTRATES, POWDERS, AND SYRUPS USED IN THE PREPARATION OF COFFEE-BASED CHILLED, BLENDED BEVERAGES; CONCENTRATES, POWDERS, AND SYRUPS USED IN THE PREPARATION OF FROZEN CONFECTIONS, FROZEN FRUIT-BASED CONFECTIONS, AND FROZEN YOGURT CONFECTIONS, IN CLASS 30 (U.S. CL. 46).

FIRST USE 2-0-2010; IN COMMERCE 5-0-2011.

FOR: CONCENTRATES, POWDERS, AND SYRUPS USED IN THE PREPARATION OF FRUIT-BASED SMOOTHIE BEVERAGES, IN CLASS 32 (U.S. CLS. 45, 46 AND 48).

FIRST USE 2-0-2010; IN COMMERCE 5-0-2011.

THE MARK CONSISTS OF STANDARD CHARACTERS WITHOUT CLAIM TO ANY PARTICULAR FONT, STYLE, SIZE, OR COLOR.

THE ENGLISH TRANSLATION OF THE ITALIAN WORDING "TENERISSIMO" IS MOST TENDER.

SN 85-412,787, FILED 9-1-2011.

JUDITH HELFMAN, EXAMINING ATTORNEY



*David J. Kyros*

Director of the United States Patent and Trademark Office

# United States of America

United States Patent and Trademark Office



**Reg. No. 4,276,672**

**Registered Jan. 15, 2013**

**CERTIFICATION MARK**

**GOODS**

**PRINCIPAL REGISTER**

AMERICAN FEED INDUSTRY ASSOCIATION (ILLINOIS CORPORATION)  
SUITE 916  
2101 WILSON BOULEVARD  
ARLINGTON, VA 22201

FOR: PET FOOD, IN CLASS A (U.S. CL. A).

FIRST USE 9-26-2012; IN COMMERCE 9-26-2012.

OWNER OF U.S. REG. NO. 3,649,193.

NO CLAIM IS MADE TO THE EXCLUSIVE RIGHT TO USE "CERTIFIED FACILITY" AND "ASSURED & APPROVED PET FOOD MANUFACTURER", APART FROM THE MARK AS SHOWN.

THE MARK CONSISTS OF THE LITERAL ELEMENTS "CERTIFIED FACILITY" AS PART OF A CIRCULAR OUTER BORDER THAT IS AROUND A SOLID INNER RING WITH THE LITERAL ELEMENTS "ASSURED & APPROVED" IN THE UPPER PART OF THE RING AND "PET FOOD MANUFACTURER" IN THE LOWER HALF OF THE RING, WITH THE INNER CIRCLE OF THE RING HAVING A SOLID PROFILE OF A DOG TO THE LEFT AND A SMALLER SOLID PROFILE OF A CAT TO THE RIGHT WITH THE PROFILES BEING SEPARATED WITH A CHECK MARK.

THE CERTIFICATION MARK, AS USED OR INTENDED TO BE USED BY PERSONS AUTHORIZED BY THE CERTIFIER, CERTIFIES OR IS INTENDED TO CERTIFY THAT THE GOODS PROVIDED CONFORM TO STANDARDS ESTABLISHED BY THE CERTIFIER RESPECTING THE SAFETY AND WHOLESOMENESS OF THE PRODUCT BEING CERTIFIED.

SN 85-413,456, FILED 9-1-2011.

KATHLEEN KOLACZ, EXAMINING ATTORNEY



*David J. Kyffers*

Director of the United States Patent and Trademark Office

# United States of America

United States Patent and Trademark Office

# SWISS NAVY

**Reg. No. 4,276,673**

**Registered Jan. 15, 2013**

**Int. Cl.: 10**

**TRADEMARK**

**PRINCIPAL REGISTER**

M.D. SCIENCE LAB, L.L.C. (FLORIDA LIMITED LIABILITY COMPANY)  
2131 BLOUNT ROAD  
POMPANO BEACH, FL 33069

FOR: CONDOMS, IN CLASS 10 (U.S. CLS. 26, 39 AND 44).

FIRST USE 7-0-2011; IN COMMERCE 7-0-2011.

THE MARK CONSISTS OF STANDARD CHARACTERS WITHOUT CLAIM TO ANY PARTICULAR FONT, STYLE, SIZE, OR COLOR.

OWNER OF U.S. REG. NOS. 3,407,031 AND 3,606,069.

SN 85-413,768, FILED 9-2-2011.

JOHN GARTNER, EXAMINING ATTORNEY



*David J. Kyffers*

Director of the United States Patent and Trademark Office

# United States of America

United States Patent and Trademark Office

# Bluerave

**Reg. No. 4,276,674**

**Registered Jan. 15, 2013**

**Int. Cl.: 9**

**TRADEMARK**

**PRINCIPAL REGISTER**

GALAXY ZONE (NEVADA CORPORATION)  
848 N. RAINBOW BLVD # 2281  
LAS VEGAS, NV 89107

FOR: ELECTRICAL COMPONENTS AND ACCESSORIES, NAMELY, ADAPTERS, CONNECTORS, ELECTRICAL POWER DISTRIBUTION BLOCKS, FUSES, FUSE HOLDERS, CAPACITORS; WIRING HARNESES CONSISTING OF CABLES AND CONNECTORS, RESISTORS, SWITCHES, BATTERY TERMINAL CONNECTORS, POWER CABLES, SPEAKER CABLES, COAXIAL CABLES, ANTENNAS, NOISE METERS; MOBILE VIDEO SYSTEMS AND ACCESSORIES, NAMELY, AMPLIFIERS, EQUALIZERS, TWEETERS, WOOFERS, SIGNAL SPLITTER SIGNAL BOOSTERS, RADIO RECEIVERS, INTERCOMS, WIRELESS REMOTE CONTROL UNITS FOR THE MOBILE VIDEO SYSTEMS, VIDEO RECEIVERS, CD PLAYERS, COMPACT DISCS PLAYERS, DIGITAL VIDEO DISC PLAYERS, DIGITAL VIDEO RECORDERS, EXTENSION CORDS; ELECTRICAL COMPONENTS, NAMELY, WIRES, ROUTERS, TRANSISTORS, RESISTORS, AUTOMOBILE SPEAKERS AND STEREO TUNERS, TELEVISION CABLES ACTUATORS; AUTO AND VEHICLE LIGHTING SYSTEMS CONSISTING OF LIGHTING CONTROL PANELS; PROGRAMMABLE VEHICLE LOCKING SYSTEMS CONSISTING OF ELECTRONIC CYLINDRICAL LOCKSETS AND KEYPADS; VEHICLE SECURITY SYSTEMS CONSISTING OF A SECURITY ALARM, ANTI-INTRUSION ALARMS, ULTRASONIC OBJECT DETECTORS FOR USE ON VEHICLES; PARKING PROXIMITY SENSORS, IN CLASS 9 (U.S. CLS. 21, 23, 26, 36 AND 38).

FIRST USE 12-1-2011; IN COMMERCE 6-1-2012.

THE MARK CONSISTS OF STANDARD CHARACTERS WITHOUT CLAIM TO ANY PARTICULAR FONT, STYLE, SIZE, OR COLOR.

SN 85-414,638, FILED 9-2-2011.

JILL PRATER, EXAMINING ATTORNEY



*David J. Kyffers*

Director of the United States Patent and Trademark Office

# United States of America

United States Patent and Trademark Office

## PHYSICIAN'S CHOICE BY GEMCARE HEALTH PLAN

**Reg. No. 4,276,675**

GEMCARE HEALTH PLAN, INC. (CALIFORNIA CORPORATION)  
4550 CALIFORNIA AVENUE, SUITE 100  
BAKERSFIELD, CA 93309

**Registered Jan. 15, 2013**

**Int. Cl.: 36**

FOR: ADMINISTRATION AND ORGANIZATION OF PRE-PAID HEALTH CARE PLANS AND HEALTH MAINTENANCE ORGANIZATION SERVICE PLANS, AND PROVIDING HEALTH CARE BENEFIT PLAN ADMINISTRATION SERVICES, IN CLASS 36 (U.S. CLS. 100, 101 AND 102).

**SERVICE MARK**

**PRINCIPAL REGISTER**

FIRST USE 9-28-2011; IN COMMERCE 9-28-2011.

THE MARK CONSISTS OF STANDARD CHARACTERS WITHOUT CLAIM TO ANY PARTICULAR FONT, STYLE, SIZE, OR COLOR.

NO CLAIM IS MADE TO THE EXCLUSIVE RIGHT TO USE "HEALTH PLAN", APART FROM THE MARK AS SHOWN.

SN 85-416,115, FILED 9-6-2011.

KARANENDRA S. CHHINA, EXAMINING ATTORNEY



*David J. Kybas*

Director of the United States Patent and Trademark Office

# United States of America

United States Patent and Trademark Office

## ISLAND LIVING

**Reg. No. 4,276,676**

HOMEGOODS, INC. (DELAWARE CORPORATION)  
770 COCHITUATE ROAD  
FRAMINGHAM, MA 01701

**Registered Jan. 15, 2013**

**Int. Cl.: 21**

FOR: DINNERWARE; SERVINGWARE FOR SERVING FOOD AND DRINKS; BEVERAGE GLASSWARE; DECORATIVE BASKETS MADE OF WICKER, STRAW, WOOD OR CLOTH; BOWLS AND VASES MADE OF NON-PRECIOUS METAL; CERAMIC FIGURINES, IN CLASS 21 (U.S. CLS. 2, 13, 23, 29, 30, 33, 40 AND 50).

**TRADEMARK**

**PRINCIPAL REGISTER**

FIRST USE 10-1-2011; IN COMMERCE 10-1-2011.

THE MARK CONSISTS OF STANDARD CHARACTERS WITHOUT CLAIM TO ANY PARTICULAR FONT, STYLE, SIZE, OR COLOR.

SN 85-416,332, FILED 9-7-2011.

VIVIAN MICZNIK FIRST, EXAMINING ATTORNEY



*David J. Kyffers*

Director of the United States Patent and Trademark Office

# United States of America

United States Patent and Trademark Office

# TACOS BERO

**Reg. No. 4,276,677**

**Registered Jan. 15, 2013**

**Int. Cl.: 43**

**SERVICE MARK**

**PRINCIPAL REGISTER**

EL TACO GRANDE MEXICAN FOOD, LLC (UTAH LIMITED LIABILITY COMPANY)  
2267 NORTH 600 WEST  
PLEASANT GROVE, UT 84062

FOR: FAST-FOOD RESTAURANTS; RESTAURANT SERVICES FEATURING MEXICAN FOOD; RESTAURANT SERVICES, INCLUDING SIT-DOWN SERVICE OF FOOD AND TAKE-OUT RESTAURANT SERVICES; RESTAURANT SERVICES, NAMELY, PROVIDING OF FOOD AND BEVERAGES FOR CONSUMPTION ON AND OFF THE PREMISES, IN CLASS 43 (U.S. CLS. 100 AND 101).

FIRST USE 9-5-2011; IN COMMERCE 11-1-2012.

THE MARK CONSISTS OF STANDARD CHARACTERS WITHOUT CLAIM TO ANY PARTICULAR FONT, STYLE, SIZE, OR COLOR.

NO CLAIM IS MADE TO THE EXCLUSIVE RIGHT TO USE "TACOS", APART FROM THE MARK AS SHOWN.

THE WORDING "BERO" HAS NO MEANING IN A FOREIGN LANGUAGE.

SN 85-416,690, FILED 9-7-2011.

ALLISON HOLTZ, EXAMINING ATTORNEY



*David J. Kyros*

Director of the United States Patent and Trademark Office

# United States of America

United States Patent and Trademark Office

## WALK AWAY LIGHT DELAY

**Reg. No. 4,276,678**

PALM COAST IMPORTS, LLC (DELAWARE LIMITED LIABILITY COMPANY)  
3059 FOREST HILL IRENE ROAD  
GERMANTOWN, TN 38138

**Registered Jan. 15, 2013**

**Int. Cl.: 9**

FOR: LIGHT ACTIVATION SWITCHES FOR CEILING FAN MOUNTED LIGHTS AND FOR CEILING AND WALL MOUNTED LIGHTS, SOLD AS AN INTEGRAL COMPONENT FEATURE OF WALL REMOTE CONTROL UNITS FOR LIGHTS AND CEILING FANS, IN CLASS 9 (U.S. CLS. 21, 23, 26, 36 AND 38).

**TRADEMARK**

**PRINCIPAL REGISTER**

FIRST USE 10-31-2011; IN COMMERCE 3-31-2012.

THE MARK CONSISTS OF STANDARD CHARACTERS WITHOUT CLAIM TO ANY PARTICULAR FONT, STYLE, SIZE, OR COLOR.

NO CLAIM IS MADE TO THE EXCLUSIVE RIGHT TO USE "LIGHT DELAY", APART FROM THE MARK AS SHOWN.

SN 85-416,887, FILED 9-7-2011.

JOHN SCHUYLER YARD, EXAMINING ATTORNEY



*David J. Kybas*

Director of the United States Patent and Trademark Office



# United States of America

United States Patent and Trademark Office

# **SEASENG**

**Reg. No. 4,276,679**

**Registered Jan. 15, 2013**

**Int. Cl.: 12**

**TRADEMARK**

**PRINCIPAL REGISTER**

ZHEJIANG SEASENG INDUSTRY CO., LTD (CHINA LIMITED LIABILITY COMPANY)  
LINJIANG INDUSTRIAL ZONE  
BAILONGQIAO TOWN, WUCHENG DISTRICT  
JINHUA, ZHEJIANG, CHINA

FOR: BICYCLE PUMPS; BICYCLE RACKS FOR VEHICLES; BICYCLE STANDS; BICYCLE WHEELS, RIMS AND STRUCTURAL PARTS THEREFOR; ELECTRIC DRIVES FOR VEHICLES; HANDLEBAR CONTROLS FOR MOPEDS; HUBS FOR VEHICLE WHEELS, NAMELY, FOR MOTORCYCLES; MOPEDS; MOTOR CYCLES; NON-MOTORIZED TWO-WHEELED CYCLE WITH HANDBRAKES WHICH IS PUSHED NOT PEDALED; TIRES FOR VEHICLES, IN CLASS 12 (U.S. CLS. 19, 21, 23, 31, 35 AND 44).

FIRST USE 1-1-2012; IN COMMERCE 1-1-2012.

THE MARK CONSISTS OF THE TERM "SEASENG" REPRESENTED IN STYLIZED FONT.

THE WORDING "SEASENG" HAS NO MEANING IN A FOREIGN LANGUAGE.

SN 85-417,210, FILED 9-8-2011.

RONALD DELGIZZI, EXAMINING ATTORNEY



*David J. Kyfos*

Director of the United States Patent and Trademark Office

# United States of America

United States Patent and Trademark Office

## BATTLEFIELD GAMERS

**Reg. No. 4,276,680**

VANTRUMP, MICHAEL (UNITED STATES INDIVIDUAL)  
P.O. BOX 344  
JUPITER, FL 33468

**Registered Jan. 15, 2013**

**Int. Cl.: 45**

FOR: ONLINE SOCIAL NETWORKING SERVICES PROVIDED THROUGH A GAMING COMMUNITY WEBSITE, IN CLASS 45 (U.S. CLS. 100 AND 101).

**SERVICE MARK**

FIRST USE 8-15-2011; IN COMMERCE 10-1-2011.

**PRINCIPAL REGISTER**

THE MARK CONSISTS OF STANDARD CHARACTERS WITHOUT CLAIM TO ANY PARTICULAR FONT, STYLE, SIZE, OR COLOR.

NO CLAIM IS MADE TO THE EXCLUSIVE RIGHT TO USE "GAMERS", APART FROM THE MARK AS SHOWN.

SN 85-418,134, FILED 9-8-2011.

MARIA-VICTORIA SUAREZ, EXAMINING ATTORNEY



*David J. Kybas*

Director of the United States Patent and Trademark Office

# United States of America

United States Patent and Trademark Office

## McManus Studios

**Reg. No. 4,276,681**

MCMANUS STUDIOS LLC (DELAWARE LIMITED LIABILITY COMPANY)

**Registered Jan. 15, 2013**

929 E. 2ND ST., #206  
LOS ANGELES, CA 90012

**Int. Cl.: 35**

FOR: DISTRIBUTORSHIP SERVICES IN THE FIELD OF MUSICAL AND NON-MUSICAL SOUND RECORDINGS AND VIDEO RECORDINGS; ENTERTAINMENT MARKETING SERVICES, NAMELY, MARKETING, PROMOTION AND ADVERTISING FOR RECORDING AND PERFORMING ARTISTS; MANAGEMENT OF PERFORMING AND RECORDING ARTISTS; ON-LINE RETAIL STORE SERVICES FEATURING DOWNLOADABLE PRE-RECORDED MUSIC AND VIDEO; PERSONAL MANAGEMENT SERVICES FOR ENTERTAINERS; PERSONAL MANAGEMENT SERVICES FOR MUSICAL PERFORMERS; PROMOTIONAL SERVICES, NAMELY, PROVIDING A WEBSITE AT WHICH ARTISTS CAN SHOWCASE THEIR TALENTS VIA AN ONLINE PORTFOLIO, IN CLASS 35 (U.S. CLS. 100, 101 AND 102).

**SERVICE MARK**

**PRINCIPAL REGISTER**

FIRST USE 11-27-2011; IN COMMERCE 11-27-2011.

THE MARK CONSISTS OF STANDARD CHARACTERS WITHOUT CLAIM TO ANY PARTICULAR FONT, STYLE, SIZE, OR COLOR.

NO CLAIM IS MADE TO THE EXCLUSIVE RIGHT TO USE "STUDIOS", APART FROM THE MARK AS SHOWN.

SN 85-418,271, FILED 9-8-2011.

RON FAIRBANKS, EXAMINING ATTORNEY



*David J. Kyros*

Director of the United States Patent and Trademark Office

# United States of America

United States Patent and Trademark Office

# API

**Reg. No. 4,276,682**

AUBURN UNIVERSITY (ALABAMA STATE UNIVERSITY)  
303 SAMFORD HALL  
AUBURN, AL 36849

**Registered Jan. 15, 2013**

**Int. Cl.: 25**

FOR: FLEECE TOPS; HEADWEAR; SHIRTS; T-SHIRTS, IN CLASS 25 (U.S. CLS. 22 AND 39).

**TRADEMARK**

FIRST USE 0-0-1938; IN COMMERCE 0-0-1938.

**PRINCIPAL REGISTER**

THE MARK CONSISTS OF STANDARD CHARACTERS WITHOUT CLAIM TO ANY PARTICULAR FONT, STYLE, SIZE, OR COLOR.

SN 85-418,410, FILED 9-9-2011.

B. PARADEWELAI, EXAMINING ATTORNEY



*David J. Kybas*

Director of the United States Patent and Trademark Office

# United States of America

United States Patent and Trademark Office

# DINAMUNDO

**Reg. No. 4,276,683**

**Registered Jan. 15, 2013**

**Int. Cl.: 9**

**TRADEMARK**

**PRINCIPAL REGISTER**

DINAMUNDO, INC. (DELAWARE CORPORATION)  
45 5TH AVENUE  
SAN FRANCISCO, CA 94118

FOR: COMPUTER APPLICATION SOFTWARE FOR MOBILE PHONES, SMART PHONES, AND HANDHELD COMPUTERS, NAMELY, SOFTWARE FOR SOCIAL NETWORKING IN THE FIELD OF LEISURE ACTIVITIES; COMPUTER SOFTWARE FOR SOCIAL NETWORKING IN THE FIELD OF LEISURE ACTIVITIES, IN CLASS 9 (U.S. CLS. 21, 23, 26, 36 AND 38).

FIRST USE 6-13-2012; IN COMMERCE 6-13-2012.

THE MARK CONSISTS OF STANDARD CHARACTERS WITHOUT CLAIM TO ANY PARTICULAR FONT, STYLE, SIZE, OR COLOR.

SN 85-419,071, FILED 9-9-2011.

INGA ERVIN, EXAMINING ATTORNEY



*David J. Kyffers*

Director of the United States Patent and Trademark Office

# United States of America

United States Patent and Trademark Office

# DINAMUNDO

**Reg. No. 4,276,684**

DINAMUNDO, INC. (DELAWARE CORPORATION)  
45 5TH AVENUE  
SAN FRANCISCO, CA 94118

**Registered Jan. 15, 2013**

**Int. Cl.: 45**

FOR: SOCIAL INTRODUCTION AND SOCIAL NETWORKING SERVICES, IN CLASS 45  
(U.S. CLS. 100 AND 101).

**SERVICE MARK**

FIRST USE 6-13-2012; IN COMMERCE 6-13-2012.

**PRINCIPAL REGISTER**

THE MARK CONSISTS OF STANDARD CHARACTERS WITHOUT CLAIM TO ANY PARTICULAR FONT, STYLE, SIZE, OR COLOR.

SN 85-419,088, FILED 9-9-2011.

INGA ERVIN, EXAMINING ATTORNEY



*David J. Kyffers*

Director of the United States Patent and Trademark Office

# United States of America

United States Patent and Trademark Office

# WKKF

**Reg. No. 4,276,685**

**Registered Jan. 15, 2013**

**Int. Cls.: 16, 35, 36, and 41**

**TRADEMARK**

**SERVICE MARK**

**PRINCIPAL REGISTER**

W.K. KELLOGG FOUNDATION (MICHIGAN NON-PROFIT CORPORATION)  
ONE MICHIGAN AVENUE EAST  
BATTLE CREEK, MI 490174012

FOR: PRINTED PUBLICATIONS, NAMELY, BOOKS, BOOKLETS, PAMPHLETS, BROCHURES, REPORTS, WORK BOOKS AND WHITE PAPERS IN THE FIELDS OF HEALTH, FAMILY ECONOMIC SECURITY, EARLY CHILDHOOD EDUCATION AND HIGHER EDUCATION, PHILANTHROPY, VOLUNTEERISM, COMMUNITY DEVELOPMENT, CHILD DEVELOPMENT, HEALTH AND WELFARE, RACIAL INEQUITY, RACIAL HEALING, JUVENILE JUSTICE, AND ECONOMIC SUCCESS, IN CLASS 16 (U.S. CLS. 2, 5, 22, 23, 29, 37, 38 AND 50).

FIRST USE 11-7-2011; IN COMMERCE 11-7-2011.

FOR: CHARITABLE SERVICES, NAMELY, ORGANIZING AND CONDUCTING VOLUNTEER OUTREACH PROGRAMS DESIGNED TO PROMOTE RACIAL HEALING, ADDRESS RACIAL INEQUITY, AND BRIDGE RACIAL GAPS IN THE AREAS OF EDUCATION, HEALTH, JUVENILE JUSTICE, ECONOMIC SUCCESS, AND THE MEDIA; CHARITABLE SERVICES, NAMELY, ORGANIZING AND CONDUCTING VOLUNTEER PROGRAMS AND COMMUNITY SERVICES PROGRAMS DESIGNED TO PROMOTE RACIAL HEALING, ADDRESS RACIAL INEQUITY, AND BRIDGE RACIAL GAPS IN THE AREAS OF EDUCATION, HEALTH, JUVENILE JUSTICE, ECONOMIC SUCCESS, AND THE MEDIA, IN CLASS 35 (U.S. CLS. 100, 101 AND 102).

FIRST USE 11-7-2011; IN COMMERCE 11-7-2011.

FOR: PROVIDING GRANTS, EDUCATIONAL SCHOLARSHIPS AND FINANCING AND LOAN SERVICES FOR RESEARCH AND PROGRAMS IN THE FIELD OF HEALTH, FAMILY ECONOMIC SECURITY, EARLY CHILDHOOD EDUCATION AND HIGHER EDUCATION, PHILANTHROPY AND VOLUNTEERISM, COMMUNITY DEVELOPMENT, CHILD DEVELOPMENT, HEALTH AND WELFARE; PROVIDING GRANTS, EDUCATIONAL SCHOLARSHIPS AND FINANCING AND LOAN SERVICES FOR RESEARCH AND PROGRAMS IN THE FIELD OF FOOD SYSTEMS, NAMELY, FOOD SAFETY, QUALITY, DISTRIBUTION, AND HEALTHFUL EATING FOR THE HEALTH, DEVELOPMENT AND WELFARE OF IMPOVERISHED AND UNDERPRIVILEGED CHILDREN, FAMILIES, AND COMMUNITIES; CHARITABLE FUNDRAISING SERVICES FOR OTHERS, NAMELY, RAISING FUNDS FOR PROGRAMS FOR FAMILY ECONOMIC SECURITY, EARLY CHILDHOOD EDUCATION



*David J. Kyffers*

Director of the United States Patent and Trademark Office

**Reg. No. 4,276,685** AND HIGHER EDUCATION, PHILANTHROPY AND VOLUNTEERISM, COMMUNITY DEVELOPMENT, CHILD DEVELOPMENT, HEALTH AND WELFARE; CHARITABLE FUND RAISING SERVICES FOR RESEARCH PROGRAMS IN THE FIELD OF FOOD SYSTEMS, NAMELY, FOOD SAFETY, QUALITY, DISTRIBUTION, AND HEALTHFUL EATING FOR THE HEALTH, DEVELOPMENT AND WELFARE OF IMPOVERISHED AND UNDERPRIVILEGED CHILDREN, FAMILIES, AND COMMUNITIES; CHARITABLE FUNDRAISING SERVICES, NAMELY, RAISING FUNDS FOR PROGRAMS DESIGNED TO PROMOTE RACIAL HEALING, ADDRESS RACIAL INEQUITY, AND BRIDGE RACIAL GAPS IN THE AREAS OF EDUCATION, HEALTH, JUVENILE JUSTICE, ECONOMIC SUCCESS, AND THE MEDIA; PROVIDING GRANTS, EDUCATIONAL SCHOLARSHIPS AND FINANCING AND LOAN SERVICES FOR RESEARCH AND EDUCATIONAL PROGRAMS, NAMELY, EDUCATIONAL AND CAREER COUNSELING AND GUIDANCE, FOR OUT OF SCHOOL YOUTHS, THAT PROVIDE ALTERNATIVES TO HIGH SCHOOL DIPLOMAS AND ASSOCIATES DEGREES, IN CLASS 36 (U.S. CLS. 100, 101 AND 102).

FIRST USE 11-7-2011; IN COMMERCE 11-7-2011.

FOR: ARRANGING AND CONDUCTING EDUCATIONAL CONFERENCES, SEMINARS AND WORKSHOPS IN THE FIELD OF HEALTH, FAMILY ECONOMIC SECURITY, EARLY CHILDHOOD EDUCATION AND HIGHER EDUCATION, PHILANTHROPY AND VOLUNTEERISM, COMMUNITY DEVELOPMENT, CHILD DEVELOPMENT, HEALTH AND WELFARE; ARRANGING AND CONDUCTING EDUCATIONAL CONFERENCES, SEMINARS AND WORKSHOPS IN THE FIELD OF FOOD SYSTEMS, NAMELY, FOOD SAFETY, QUALITY, DISTRIBUTION, AND HEALTHFUL EATING FOR THE HEALTH, DEVELOPMENT AND WELFARE OF IMPOVERISHED AND UNDERPRIVILEGED CHILDREN, FAMILIES, AND COMMUNITIES; ARRANGING AND CONDUCTING EDUCATIONAL CONFERENCES TO PROMOTE RACIAL HEALING, ADDRESS RACIAL INEQUITY, AND BRIDGE RACIAL GAPS IN THE AREAS OF EDUCATION, HEALTH, JUVENILE JUSTICE, ECONOMIC SUCCESS, AND THE MEDIA; EDUCATIONAL PROGRAMS, NAMELY, EDUCATIONAL AND CAREER COUNSELING AND GUIDANCE, FOR OUT OF SCHOOL YOUTHS, THAT PROVIDE ALTERNATIVES TO HIGH SCHOOL DIPLOMAS AND ASSOCIATES DEGREES; PROVIDING ON-LINE EDUCATIONAL PUBLICATIONS IN THE NATURE JOURNALS, NEWSLETTERS, CURRICULUM GUIDES IN THE FIELD OF ISSUES RELATING TO OUT OF SCHOOL YOUTHS SEEKING ALTERNATIVES TO HIGH SCHOOL DIPLOMAS AND ASSOCIATES DEGREES FOR ASSISTING COMMUNITY BASED ORGANIZATIONS AND SOCIAL ENTERPRISES FOR SUPPORTING OUT OF SCHOOL YOUTHS IN THE PROCESS OF SECURING ENTRY LEVEL EMPLOYMENT, IN CLASS 41 (U.S. CLS. 100, 101 AND 107).

FIRST USE 11-7-2011; IN COMMERCE 11-7-2011.

THE MARK CONSISTS OF STANDARD CHARACTERS WITHOUT CLAIM TO ANY PARTICULAR FONT, STYLE, SIZE, OR COLOR.

SN 85-419,940, FILED 9-12-2011.

JOHN SCHUYLER YARD, EXAMINING ATTORNEY



# United States of America

United States Patent and Trademark Office

## PRIMEMOBILE

**Reg. No. 4,276,686**

**Registered Jan. 15, 2013**

**Int. Cl.: 9**

**TRADEMARK**

**PRINCIPAL REGISTER**

GREENWAY MEDICAL TECHNOLOGIES, INC. (DELAWARE CORPORATION)  
121 GREENWAY BOULEVARD  
CARROLLTON, GA 30117

FOR: MEDICAL SOFTWARE FOR ENABLING PHYSICIANS AND MEDICAL FIRMS TO VIEW, ACCESS, ANALYZE, SECURE, TRANSCRIBE, STORE AND MAINTAIN MEDICAL RECORDS AND PATIENT DATA, IN CLASS 9 (U.S. CLS. 21, 23, 26, 36 AND 38).

FIRST USE 4-30-2007; IN COMMERCE 4-30-2007.

THE MARK CONSISTS OF STANDARD CHARACTERS WITHOUT CLAIM TO ANY PARTICULAR FONT, STYLE, SIZE, OR COLOR.

SN 85-420,633, FILED 9-12-2011.

NAPOLEON SHARMA, EXAMINING ATTORNEY



*David J. Kyffers*

Director of the United States Patent and Trademark Office

United States of America  
United States Patent and Trademark Office

# RECODIA

**Reg. No. 4,276,687**

**Registered Jan. 15, 2013**

**Int. Cl.: 9**

**TRADEMARK**

**PRINCIPAL REGISTER**

RECODIA CO., LTD (REPUBLIC OF KOREA LIMITED LIABILITY COMPANY)  
108~109 KYUNGGI TECHNOPARK RIT CENTER  
SA-DONG, SANGROK-GU  
ANSAN CITY, KYUNGGI-DO, REPUBLIC OF KOREA 426-901

FOR: CCTV DEVICES FOR A VEHICLE, NAMELY, MULTI-PURPOSE CAMERAS; DIGITAL CAMERAS WITH A HANDHELD VIDEO CAMERA; VIDEO RECORDERS; VIDEO CAMERAS (CAMCORDERS); AUDIO AND VIDEO PORTABLE DIGITAL VIDEO RECORDER, IN CLASS 9 (U.S. CLS. 21, 23, 26, 36 AND 38).

FIRST USE 3-1-2007; IN COMMERCE 7-9-2012.

THE MARK CONSISTS OF THE WORDS "RECODIA" IN BLACK WITH A DOT IN THE CENTER OF THE "O".

THE WORDING "RECODIA" HAS NO MEANING IN A FOREIGN LANGUAGE.

SN 85-422,132, FILED 9-14-2011.

ARETHA SOMERVILLE, EXAMINING ATTORNEY



*David J. Kyffers*

Director of the United States Patent and Trademark Office

# United States of America

United States Patent and Trademark Office



**Reg. No. 4,276,688**

**Registered Jan. 15, 2013**

**Int. Cl.: 28**

**TRADEMARK**

**PRINCIPAL REGISTER**

SUN SHINE HANDCRAFTS (DONGGUAN) CO.LTD (CHINA LIMITED COMPANY (LTD.))  
SILVER CAPITAL INDUSTRIAL ZONE  
LIAOBU TOWN, DONGGUAN  
GUANGDONG, CHINA

FOR: CANDLE HOLDERS FOR CHRISTMAS TREES; CHRISTMAS TREE ORNAMENTS;  
CHRISTMAS TREE STANDS; CHRISTMAS TREES OF SYNTHETIC MATERIAL; DOLLS'  
HOUSES; DOLLS' ROOMS; KALEIDOSCOPIES; PLUSH TOYS; TEDDY BEARS; TOY CARS,  
IN CLASS 28 (U.S. CLS. 22, 23, 38 AND 50).

FIRST USE 2-11-2012; IN COMMERCE 6-1-2012.

NO CLAIM IS MADE TO THE EXCLUSIVE RIGHT TO USE "HOME DECO", APART FROM  
THE MARK AS SHOWN.

THE MARK CONSISTS OF AN INCOMPLETE HEART DESIGN AND A CURVE INSIDE,  
AND THE WORDS "SWEET STORY HOME DECO" BELOW THE DESIGN WHERE THE  
WORDS "HOME DECO" ARE IN SMALLER SIZE.

SN 85-423,115, FILED 9-15-2011.

REBECCA SMITH, EXAMINING ATTORNEY



*David J. Kyffers*

Director of the United States Patent and Trademark Office

# United States of America

United States Patent and Trademark Office



**Reg. No. 4,276,689**

**Registered Jan. 15, 2013**

**Int. Cl.: 3**

**TRADEMARK**

**PRINCIPAL REGISTER**

OPTIMUM REFLECTIONS INC (TEXAS CORPORATION)  
#107  
625 MANCO RD.  
LEWISVILLE, TX 75067

FOR: AUTOMOBILE POLISH, IN CLASS 3 (U.S. CLS. 1, 4, 6, 50, 51 AND 52).

FIRST USE 11-26-2011; IN COMMERCE 11-26-2011.

NO CLAIM IS MADE TO THE EXCLUSIVE RIGHT TO USE "1 TIME", APART FROM THE MARK AS SHOWN.

THE STIPPLING IS FOR SHADING PURPOSES ONLY.

THE MARK CONSISTS OF A FOUR-POINT SHIELD WITH THE STYLIZED TEXT "SPS" IN THE UPPER CENTER OF THE SHIELD. THE STYLIZED TEXT "1X" IS IN THE LOWER HALF OF THE SHIELD.

SN 85-423,254, FILED 9-15-2011.

DAWN HAN, EXAMINING ATTORNEY



*David J. Kyffers*

Director of the United States Patent and Trademark Office

# United States of America

United States Patent and Trademark Office

THE POWER TO HEAL. IT'S IN  
YOUR BLOOD.

**Reg. No. 4,276,690**

**Registered Jan. 15, 2013**

**Int. Cls.: 40 and 44**

**SERVICE MARK**

**PRINCIPAL REGISTER**

COMMUNITY BLOOD CENTER OF THE CAROLINAS, INC. (NORTH CAROLINA CORPORATION)  
4447 SOUTH BOULEVARD  
CHARLOTTE, NC 28209

FOR: BLOOD PROCESSING FOR TRANSPLANTS, IN CLASS 40 (U.S. CLS. 100, 103 AND 106).

FIRST USE 3-29-2012; IN COMMERCE 3-29-2012.

FOR: BLOOD BANK SERVICES; BLOOD BANKS; COLLECTION AND PRESERVATION OF HUMAN BLOOD, IN CLASS 44 (U.S. CLS. 100 AND 101).

FIRST USE 3-29-2012; IN COMMERCE 3-29-2012.

THE MARK CONSISTS OF STANDARD CHARACTERS WITHOUT CLAIM TO ANY PARTICULAR FONT, STYLE, SIZE, OR COLOR.

OWNER OF U.S. REG. NO. 3,788,626.

SN 85-423,498, FILED 9-15-2011.

RONALD MCMORROW, EXAMINING ATTORNEY



*David J. Kybas*

Director of the United States Patent and Trademark Office

# United States of America

United States Patent and Trademark Office

## Rolling with Sticks

**Reg. No. 4,276,691**

QAJAQ ROLLS (DELAWARE LIMITED LIABILITY COMPANY)  
8935 WOODHILL DRIVE  
SAVAGE, MN 55378

**Registered Jan. 15, 2013**

**Int. Cl.: 16**

FOR: GUIDE BOOKS FEATURING KAYAKING, IN CLASS 16 (U.S. CLS. 2, 5, 22, 23, 29, 37, 38 AND 50).

**TRADEMARK**

FIRST USE 9-15-2011; IN COMMERCE 9-30-2011.

**PRINCIPAL REGISTER**

THE MARK CONSISTS OF STANDARD CHARACTERS WITHOUT CLAIM TO ANY PARTICULAR FONT, STYLE, SIZE, OR COLOR.

SN 85-423,575, FILED 9-15-2011.

JOHN DALIER, EXAMINING ATTORNEY



*David J. Kybas*

Director of the United States Patent and Trademark Office

# United States of America

United States Patent and Trademark Office

# RAMCO

**Reg. No. 4,276,692**

**Registered Jan. 15, 2013**

**Int. Cl.: 25**

**TRADEMARK**

**PRINCIPAL REGISTER**

ICS NORTH AMERICA CORPORATION (NORTH CAROLINA CORPORATION)  
323 CORBAN AVENUE SW  
CONCORD, NC 28025

FOR: CLOTHING, NAMELY, SHIRTS, PANTS, SHORTS, JERSEYS, UNDERWEAR, SPORTSWEAR, NAMELY, JERSEYS, T-SHIRTS, SHORTS, SHIRTS, PANTS, JACKETS, VESTS, AND SWEAT SHIRTS, ATHLETIC WEAR, NAMELY, UNIFORMS FOR SOCCER, BASKETBALL, BASEBALL, AND FOOTBALL, AND TEAM WEAR, NAMELY, JERSEYS, T-SHIRTS, SHORTS, SHIRTS, PANTS, JACKETS, VESTS, AND SWEAT SHIRTS, EACH WITH LOGOS, IN CLASS 25 (U.S. CLS. 22 AND 39).

FIRST USE 9-24-2012; IN COMMERCE 9-24-2012.

THE MARK CONSISTS OF STANDARD CHARACTERS WITHOUT CLAIM TO ANY PARTICULAR FONT, STYLE, SIZE, OR COLOR.

SN 85-423,668, FILED 9-15-2011.

ESTHER BELENKER, EXAMINING ATTORNEY



*David J. Kyffers*

Director of the United States Patent and Trademark Office

# United States of America

United States Patent and Trademark Office

## SEALECTABLES

**Reg. No. 4,276,693**

**Registered Jan. 15, 2013**

**Int. Cl.: 29**

**TRADEMARK**

**PRINCIPAL REGISTER**

CHANG INTERNATIONAL, INC. (WASHINGTON CORPORATION)  
1611 MARKET STREET  
KIRKLAND, WA 98033

FOR: SEAFOOD, IN CLASS 29 (U.S. CL. 46).

FIRST USE 5-17-2012; IN COMMERCE 5-17-2012.

THE MARK CONSISTS OF STANDARD CHARACTERS WITHOUT CLAIM TO ANY PARTICULAR FONT, STYLE, SIZE, OR COLOR.

SN 85-423,931, FILED 9-15-2011.

DAVID I, EXAMINING ATTORNEY



*David J. Kyfos*

Director of the United States Patent and Trademark Office



# United States of America

United States Patent and Trademark Office

## HAIR CARE SIMPLIFIED

**Reg. No. 4,276,694**

**Registered Jan. 15, 2013**

**Int. Cls.: 3 and 35**

**TRADEMARK**

**SERVICE MARK**

**PRINCIPAL REGISTER**

TNG WORLDWIDE, INC. (MICHIGAN CORPORATION)  
23200 HAGGERTY ROAD  
FARMINGTON HILLS, MI 48335

FOR: HAIR CARE PREPARATIONS; NON-MEDICATED LEAVE-IN TREATMENT FOR HAIR; CONDITIONERS; HAIR CARE PREPARATIONS; HAIR CONDITIONERS; HAIR MASKS; HAIR SPRAY; HAIR SPRAYS; HAIRSPRAY; SHAMPOO-CONDITIONERS; SHAMPOOS, IN CLASS 3 (U.S. CLS. 1, 4, 6, 50, 51 AND 52).

FIRST USE 1-2-2012; IN COMMERCE 1-2-2012.

FOR: RETAIL STORE, MAIL ORDER CATALOG, AND ONLINE ORDERING SERVICES FEATURING BEAUTY PRODUCTS, IN CLASS 35 (U.S. CLS. 100, 101 AND 102).

FIRST USE 10-1-2010; IN COMMERCE 10-1-2010.

THE MARK CONSISTS OF STANDARD CHARACTERS WITHOUT CLAIM TO ANY PARTICULAR FONT, STYLE, SIZE, OR COLOR.

NO CLAIM IS MADE TO THE EXCLUSIVE RIGHT TO USE "HAIR CARE", APART FROM THE MARK AS SHOWN.

SN 85-424,489, FILED 9-16-2011.

ANDREW LEASER, EXAMINING ATTORNEY



*David J. Kyros*

Director of the United States Patent and Trademark Office

# United States of America

United States Patent and Trademark Office

## INDIA PALACE

**Reg. No. 4,276,695**

HOMEGOODS, INC. (DELAWARE CORPORATION)  
770 COCHITUATE ROAD  
FRAMINGHAM, MA 01701

**Registered Jan. 15, 2013**

**Int. Cls.: 8, 16, 19, 20, 21,  
24, and 27**

FOR: NON-ELECTRIC KNIVES; NON-ELECTRIC VEGETABLE PEELERS; CUTTERS FOR WINE BOTTLE FOIL; LAWN AND GARDEN TOOLS, NAMELY, TROWELS, SHOVELS, RAKES, MANUAL GRASS CLIPPERS, HAND-OPERATED SHEARS, CULTIVATORS, AND WEEDING FORKS; ZESTERS, IN CLASS 8 (U.S. CLS. 23, 28 AND 44).

**TRADEMARK**

FIRST USE 10-1-2011; IN COMMERCE 10-1-2011.

**PRINCIPAL REGISTER**

FOR: BOOKS, NAMELY, BOOKS CONTAINING REMOVABLE WINE LABELS, COOK-BOOKS, CALENDARS, ADDRESS BOOKS, PICTURE BOOKS, AND RECIPE BOOKS; CALENDARS; DESK ACCESSORIES, NAMELY, DESK BLOTTERS, DESK PADS, PENS, PENCILS, PEN AND PENCIL HOLDERS, LETTER HOLDERS, LETTER TRAYS, AND LETTER OPENERS; PAPER GOODS AND PRINTED MATTER, NAMELY, GIFT WRAP PAPER, GIFT BAGS, PAPER GUEST HAND TOWELS, PAPER NAPKINS, STATIONERY, STATIONERY BOXES, WRITING PADS, AND BLANK JOURNALS; PAPERWEIGHTS; PHOTO STORAGE BOXES; PHOTOGRAPH ALBUMS; PHOTOGRAPHIC PRINTS, ART PRINTS, ART REPRODUCTIONS, AND POSTERS; SHOE BOXES AND HAT BOXES MADE OF CARDBOARD; PAPER TABLE LINENS; DECORATIVE CARDBOARD BOXES; CARDBOARD BOXES IN THE SHAPE OF CHESTS, IN CLASS 16 (U.S. CLS. 2, 5, 22, 23, 29, 37, 38 AND 50).

FIRST USE 10-1-2011; IN COMMERCE 10-1-2011.

FOR: FIGURINES AND DECORATIVE STATUARY MADE OF STONE, CONCRETE OR MARBLE; GARDEN STEPPING STONES OF CAST STONE FOR USE IN LAWNS AND PATHWAYS, IN CLASS 19 (U.S. CLS. 1, 12, 33 AND 50).

FIRST USE 10-1-2011; IN COMMERCE 10-1-2011.

FOR: DECORATIVE CORKS; DECORATIVE GARDEN FINIALS OF CAST STONE; DECORATIVE GARDEN STATUARY MADE OF PLASTER; DECORATIVE PILLOWS; FURNITURE; NON-METAL GARDEN STAKES; NON-METAL HOSE GUARDS FOR PROTECTING PLANTS FROM GARDEN HOSES; PICTURE FRAMES; PILLOWS; SHELVING; SHOWER CURTAIN HOOKS AND SHOWER CURTAIN RINGS; WIND CHIMES; WINE RACKS; ROBE HOOKS



*David J. Kybas*

Director of the United States Patent and Trademark Office

**Reg. No. 4,276,695** NOT OF METAL; DECORATIVE WOODEN BOXES; NON-METAL CHESTS; PLASTIC BOXES, IN CLASS 20 (U.S. CLS. 2, 13, 22, 25, 32 AND 50).

FIRST USE 10-1-2011; IN COMMERCE 10-1-2011.

FOR: BARWARE, NAMELY, COCKTAIL SHAKERS, SELTZER BOTTLES, WINE CHARMS NOT OF METAL, NAMELY, CHARMS THAT ATTACH TO BEVERAGE GLASSWARE FOR IDENTIFICATION PURPOSES, CORKSCREWS, WINE COOLERS, ICE BUCKETS, WINE BUCKETS, FLASKS, COCKTAIL PICKS, DRINK STIRRERS, AND BOTTLE OPENERS; BATHROOM ACCESSORIES, NAMELY, SOAP DISHES, SOAP DISPENSERS, TOOTHBRUSH HOLDERS, WASTEBASKETS, BATHROOM TUMBLERS, LOTION PUMP DISPENSERS SOLD EMPTY, TOWEL BARS, TOILET TISSUE HOLDERS, FACIAL TISSUE DISPENSERS, BATH AND SHOWER CADDIES, AND LAUNDRY HAMPERS FOR HOUSEHOLD USE; BEVERAGE GLASSWARE; BIRD BATHS; BIRD HOUSES; BOWLS AND VASES MADE OF NON-PRECIOUS METAL; CANDLE HOLDERS AND CANDLESTICKS MADE OF CRYSTAL OR GLASS; CERAMIC FIGURINES; COASTERS NOT OF PAPER AND OTHER THAN TABLE LINEN; COLANDERS AND STRAINERS FOR HOUSEHOLD USE; CONTAINERS FOR HOUSEHOLD AND KITCHEN USE, NOT OF PRECIOUS METAL; COOKWARE AND BAKEWARE, NAMELY, POTS AND PANS, SKILLETS, AND STEAMERS; BASKETS FOR DOMESTIC USE NOT OF METAL; DINNERWARE; KITCHEN UTENSILS AND GADGETS, NAMELY, SERVING SPOONS, SLOTTED SPOONS, SPATULAS, LADLES, SERVING TONGS, GARLIC PRESSES, FOOD SPREADER KNIVES, AND VEGETABLE WASHING BRUSHES; MIXING BOWLS; NAPKIN RINGS NOT OF PRECIOUS METAL; PICNIC BASKETS SOLD EMPTY; TABLE PLACE CARD HOLDERS NOT OF PRECIOUS METAL; PLANTERS FOR FLOWERS AND PLANTS; SALT AND PEPPER SHAKERS; SERVING BASKETS AND BREAD BASKETS MADE OF WOOD, WICKER AND GLASS; SERVINGWARE FOR SERVING FOOD AND DRINKS; SPICE RACKS; TEA POTS AND TEA KETTLES; TERRARIUMS FOR PLANTS; TRIVETS, CUTTING BOARDS, CHEESE BOARDS, CANISTERS; URNS; UTENSILS FOR BARBECUES, NAMELY, FORKS, TONGS, SPATULAS, SKEWERS, GRILL BASKETS, AND GRILL BRUSHES; VASES; WATERING CANS, IN CLASS 21 (U.S. CLS. 2, 13, 23, 29, 30, 33, 40 AND 50).

FIRST USE 10-1-2011; IN COMMERCE 10-1-2011.

FOR: BATH LINEN; BED LINEN; WINDOW CURTAINS AND DRAPERIES; KITCHEN LINENS; SHOWER CURTAINS AND SHOWER CURTAIN LINERS; TABLE LINEN, IN CLASS 24 (U.S. CLS. 42 AND 50).

FIRST USE 10-1-2011; IN COMMERCE 10-1-2011.

FOR: RUGS, BATH RUGS, AND BATH MATS, IN CLASS 27 (U.S. CLS. 19, 20, 37, 42 AND 50).

FIRST USE 10-1-2011; IN COMMERCE 10-1-2011.

THE MARK CONSISTS OF STANDARD CHARACTERS WITHOUT CLAIM TO ANY PARTICULAR FONT, STYLE, SIZE, OR COLOR.

NO CLAIM IS MADE TO THE EXCLUSIVE RIGHT TO USE "INDIA", APART FROM THE MARK AS SHOWN.

SN 85-424,634, FILED 9-16-2011.

VIVIAN MICZNIK FIRST, EXAMINING ATTORNEY

# United States of America

United States Patent and Trademark Office

# Oui Agree

**Reg. No. 4,276,696**

**Registered Jan. 15, 2013**

**Int. Cl.: 42**

**SERVICE MARK**

**PRINCIPAL REGISTER**

COLLABORATIVE AGREEMENTS, LLC (TEXAS LIMITED LIABILITY COMPANY)  
COLLABORATIVE AGREEMENTS, LLC  
9600 ESCARPMENT BLVD., SUITE 745-60  
AUSTIN, TX 78749

FOR: PROVIDING TEMPORARY USE OF ON-LINE NON-DOWNLOADABLE SOFTWARE THAT ENABLES MULTIPLE PARTIES TO COLLABORATIVELY DRAFT AND MODIFY DOCUMENTS IN WHICH THE PARTIES MAY AGREE TO FIXING ALL OR A PORTION OF THE DOCUMENT THAT CANNOT BE ALTERED WITHOUT CONSENT OF THE AGREEING PARTIES, IN CLASS 42 (U.S. CLS. 100 AND 101).

FIRST USE 10-8-2012; IN COMMERCE 10-8-2012.

THE MARK CONSISTS OF STANDARD CHARACTERS WITHOUT CLAIM TO ANY PARTICULAR FONT, STYLE, SIZE, OR COLOR.

THE ENGLISH TRANSLATION OF "OUI" IS "YES".

SN 85-424,664, FILED 9-16-2011.

ELLEN B. AWRICH, EXAMINING ATTORNEY



*David J. Kyffers*

Director of the United States Patent and Trademark Office

# United States of America

United States Patent and Trademark Office

## FREE TO PLAY. YOUR WAY.

**Reg. No. 4,276,697**

SONY ONLINE ENTERTAINMENT LLC (DELAWARE LIMITED LIABILITY COMPANY)  
8928 TERMAN COURT  
SAN DIEGO, CA 92121

**Registered Jan. 15, 2013**

**Int. Cls.: 9 and 41**

FOR: COMPUTER GAME SOFTWARE AND VIDEO GAME SOFTWARE; PROVIDING DOWNLOADABLE MULTIPLAYER, REAL TIME FREE TO PLAY COMPUTER AND VIDEO GAME SOFTWARE VIA AN ONLINE WEBSITE FOR ENTERTAINMENT PURPOSES, IN CLASS 9 (U.S. CLS. 21, 23, 26, 36 AND 38).

**TRADEMARK**

**SERVICE MARK**

FIRST USE 12-7-2011; IN COMMERCE 12-7-2011.

**PRINCIPAL REGISTER**

FOR: ENTERTAINMENT SERVICES, NAMELY, OPERATING A MULTIPLAYER, REAL TIME FREE TO PLAY GAME FOR OTHERS VIA THE INTERNET, LOCAL AREA COMPUTER NETWORKS AND MOBILE NETWORKS, IN CLASS 41 (U.S. CLS. 100, 101 AND 107).

FIRST USE 12-7-2011; IN COMMERCE 12-7-2011.

THE MARK CONSISTS OF STANDARD CHARACTERS WITHOUT CLAIM TO ANY PARTICULAR FONT, STYLE, SIZE, OR COLOR.

NO CLAIM IS MADE TO THE EXCLUSIVE RIGHT TO USE "FREE TO PLAY", APART FROM THE MARK AS SHOWN.

SN 85-424,953, FILED 9-16-2011.

AMY KELLY, EXAMINING ATTORNEY



*David J. Kyros*

Director of the United States Patent and Trademark Office

# United States of America

United States Patent and Trademark Office

## Organic Payments

**Reg. No. 4,276,698**

WEBBER, IZABELA (BRAZIL INDIVIDUAL)  
260 CAGNEY LANE #314  
NEWPORT BEACH, CA 92663

**Registered Jan. 15, 2013**

**Int. Cl.: 36**

FOR: ELECTRONIC PAYMENT, NAMELY, ELECTRONIC PROCESSING AND TRANSMISSION OF BILL PAYMENT DATA; MERCHANT SERVICES, NAMELY, PAYMENT TRANSACTION PROCESSING SERVICES; PROCESSING ELECTRONIC PAYMENTS MADE THROUGH PREPAID CARDS; PROVIDING ELECTRONIC PROCESSING OF ELECTRONIC FUNDS TRANSFER, ACH, CREDIT CARD, DEBIT CARD, ELECTRONIC CHECK AND ELECTRONIC PAYMENTS, IN CLASS 36 (U.S. CLS. 100, 101 AND 102).

**SERVICE MARK**

**PRINCIPAL REGISTER**

FIRST USE 8-8-2012; IN COMMERCE 10-22-2012.

THE MARK CONSISTS OF STANDARD CHARACTERS WITHOUT CLAIM TO ANY PARTICULAR FONT, STYLE, SIZE, OR COLOR.

NO CLAIM IS MADE TO THE EXCLUSIVE RIGHT TO USE "PAYMENTS", APART FROM THE MARK AS SHOWN.

SN 85-424,957, FILED 9-16-2011.

BILL DAWE, EXAMINING ATTORNEY



*David J. Kyfos*

Director of the United States Patent and Trademark Office

# United States of America

United States Patent and Trademark Office

## TitanSoft ECAT

**Reg. No. 4,276,699**

**Registered Jan. 15, 2013**

**Int. Cl.: 35**

**SERVICE MARK**

**PRINCIPAL REGISTER**

TITANSOFT, LLC (CALIFORNIA LIMITED LIABILITY COMPANY)  
HTTP://TITANSOFTGROUP.COM  
BONSALL, CA 92003

FOR: ASSISTANCE AND CONSULTANCY SERVICES IN THE FIELD OF BUSINESS MANAGEMENT OF COMPANIES IN THE ENERGY SECTOR; BUSINESS CONSULTING AND ADVISORY SERVICES IN THE FIELD OF ENERGY EFFICIENCY; BUSINESS CONSULTING SERVICES FOR THE ELECTRIC ENERGY INDUSTRY; BUSINESS CONSULTING SERVICES IN THE FIELDS OF ENERGY MEASUREMENT TO IMPROVE ENERGY EFFICIENCY WITHIN RESIDENTIAL, COMMERCIAL, INDUSTRIAL AND INSTITUTIONAL FACILITIES; CONSULTATION IN THE FIELD OF ENERGY EFFICIENCY; CONSULTING SERVICES IN THE FIELD OF ENERGY EFFICIENCY FOR COMMERCIAL AND INSTITUTIONAL FACILITIES; CONSULTING SERVICES IN THE FIELD OF ENERGY USAGE MANAGEMENT AND ENERGY EFFICIENCY; CONSULTING SERVICES IN THE FIELDS OF ENERGY CONSUMPTION AND USAGE CONSERVATION TO IMPROVE ENERGY EFFICIENCY; ENERGY AUDITING; ENERGY USAGE MANAGEMENT; ENERGY USAGE MANAGEMENT INFORMATION SERVICES; INFORMATION IN THE FIELD OF ENERGY EFFICIENCY; PROVIDING A WEB-BASED ON-LINE PORTAL THAT PROVIDES CUSTOMER ACCESS TO THEIR ELECTRIC BILL ACCOUNT INFORMATION, ENERGY USAGE PATTERN INFORMATION, AND ENERGY CONSUMPTION AND USAGE DATA, FOR PURPOSES OF UTILITY ACCOUNT BUSINESS MANAGEMENT AND ENERGY USAGE MANAGEMENT; PROVISION OF INFORMATION, ADVICE AND CONSULTANCY IN RELATION TO ENERGY EFFICIENCY, IN CLASS 35 (U.S. CLS. 100, 101 AND 102).

FIRST USE 9-1-2012; IN COMMERCE 9-1-2012.

THE MARK CONSISTS OF STANDARD CHARACTERS WITHOUT CLAIM TO ANY PARTICULAR FONT, STYLE, SIZE, OR COLOR.

NO CLAIM IS MADE TO THE EXCLUSIVE RIGHT TO USE "ECAT", APART FROM THE MARK AS SHOWN.

SN 85-425,542, FILED 9-18-2011.

NATALIE POLZER, EXAMINING ATTORNEY



*David J. Kyros*

Director of the United States Patent and Trademark Office

# United States of America

United States Patent and Trademark Office

# BIG IRON

**Reg. No. 4,276,700**

XY POWERSPORTS, LLC (DELAWARE LIMITED LIABILITY COMPANY)  
2630 GLENDALE-MILFORD ROAD, SUITE 100  
EVENDALE, OH 45241

**Registered Jan. 15, 2013**

**Int. Cl.: 12**

FOR: ALL-TERRAIN VEHICLES; FOUR-WHEELED UTILITY TERRAIN VEHICLES, IN CLASS 12 (U.S. CLS. 19, 21, 23, 31, 35 AND 44).

**TRADEMARK**

FIRST USE 8-1-2012; IN COMMERCE 8-1-2012.

**PRINCIPAL REGISTER**

THE MARK CONSISTS OF STANDARD CHARACTERS WITHOUT CLAIM TO ANY PARTICULAR FONT, STYLE, SIZE, OR COLOR.

SN 85-425,705, FILED 9-19-2011.

JOHN HWANG, EXAMINING ATTORNEY



*David J. Kybas*

Director of the United States Patent and Trademark Office



# United States of America

United States Patent and Trademark Office

## COMMUNITY COMMERCE

**Reg. No. 4,276,701**

**Registered Jan. 15, 2013**

**Int. Cls.: 41 and 44**

**SERVICE MARK**

**PRINCIPAL REGISTER**

MONAVIE LLC (DELAWARE LIMITED LIABILITY COMPANY)  
10855 S. RIVER FRONT PARKWAY, SUITE 100  
SOUTH JORDAN, UT 84095

FOR: EDUCATION SERVICES, NAMELY, PROVIDING SEMINARS IN THE FIELD OF NUTRITION AND WELLNESS; EDUCATIONAL SERVICES, NAMELY, CONDUCTING INFORMAL ON-LINE PROGRAMS IN THE FIELDS OF NUTRITION AND WELLNESS, AND PRINTABLE MATERIALS DISTRIBUTED THEREWITH; EDUCATIONAL SERVICES, NAMELY, CONDUCTING SEMINARS IN THE FIELDS OF NUTRITION AND WELLNESS AND DISTRIBUTION OF TRAINING MATERIALS IN CONNECTION THEREWITH; EDUCATIONAL SERVICES, NAMELY, PROVIDING ON-LINE SEMINARS IN THE FIELD OF NUTRITION AND WELLNESS; PROVIDING A WEB SITE THAT FEATURES INFORMAL INSTRUCTION ON NUTRITION AND WELLNESS, IN CLASS 41 (U.S. CLS. 100, 101 AND 107).

FIRST USE 11-19-2012; IN COMMERCE 11-19-2012.

FOR: DIETARY AND NUTRITIONAL GUIDANCE; PROVIDING A WEB SITE FEATURING INFORMATION ON HEALTH AND NUTRITION; PROVIDING A WEBSITE FEATURING INFORMATION ABOUT HEALTH, WELLNESS AND NUTRITION; PROVIDING AN ON-LINE COMPUTER DATABASE FEATURING INFORMATION REGARDING HEALTH AND NUTRITION; PROVIDING ASSISTANCE, FITNESS EVALUATION AND CONSULTATION TO INDIVIDUALS TO HELP THEM MAKE HEALTH, WELLNESS AND NUTRITIONAL CHANGES IN THEIR DAILY LIVING TO IMPROVE HEALTH; PROVIDING INFORMATION ABOUT DIETARY SUPPLEMENTS AND NUTRITION, IN CLASS 44 (U.S. CLS. 100 AND 101).

FIRST USE 11-19-2012; IN COMMERCE 11-19-2012.

THE MARK CONSISTS OF STANDARD CHARACTERS WITHOUT CLAIM TO ANY PARTICULAR FONT, STYLE, SIZE, OR COLOR.

NO CLAIM IS MADE TO THE EXCLUSIVE RIGHT TO USE "COMMERCE", APART FROM THE MARK AS SHOWN.

SN 85-426,224, FILED 9-19-2011.



*David J. Kyjars*

Director of the United States Patent and Trademark Office

**Reg. No. 4,276,701** DAWN HAN, EXAMINING ATTORNEY

# United States of America

United States Patent and Trademark Office



**Reg. No. 4,276,702**

**Registered Jan. 15, 2013**

**Int. Cl.: 35**

**SERVICE MARK**

**PRINCIPAL REGISTER**

COTTERWEB ENTERPRISES, INC. (DELAWARE CORPORATION)  
#300  
1295 NORTHLAND DRIVE  
MENDOTA HEIGHTS, MN 55120

FOR: ONLINE CONSUMER LOYALTY SERVICES FOR MARKETING PURPOSES, NAMELY, PROVIDING INCENTIVE REWARD PROGRAMS TO PROMOTE CONSUMERS READING EMAIL ADVERTISING MESSAGES, COMPLETING ONLINE MARKET RESEARCH SURVEYS, CONDUCTING ONLINE SHOPPING AND PLAYING ONLINE GAMES, IN CLASS 35 (U.S. CLS. 100, 101 AND 102).

FIRST USE 6-1-2011; IN COMMERCE 6-1-2011.

THE MARK CONSISTS OF A STYLIZED DESIGN FEATURING AN ENVELOPE WITH A DOLLAR SIGN SYMBOL, AND LINES DEPICTING SPEED OR PROPULSION TO THE LEFT.

SN 85-426,970, FILED 9-20-2011.

AMY KELLY, EXAMINING ATTORNEY



*David J. Kybas*

Director of the United States Patent and Trademark Office

# United States of America

United States Patent and Trademark Office

## TECHPOINT FOUNDATION FOR YOUTH

**Reg. No. 4,276,703**

**Registered Jan. 15, 2013**

**Int. Cl.: 36**

**SERVICE MARK**

**PRINCIPAL REGISTER**

TECHPOINT FOUNDATION, INC. (INDIANA NON-PROFIT CORPORATION), DBA  
TECHPOINT FOUNDATION FOR YOUTH,  
615 NORTH ALABAMA STREET, SUITE 119  
INDIANAPOLIS, IN 46204

FOR: CHARITABLE FUNDRAISING SERVICES; PHILANTHROPIC SERVICES CONCERNING  
MONETARY DONATIONS; VENTURE CAPITAL FINANCING SERVICES, IN CLASS 36  
(U.S. CLS. 100, 101 AND 102).

FIRST USE 12-31-2011; IN COMMERCE 12-31-2011.

THE MARK CONSISTS OF STANDARD CHARACTERS WITHOUT CLAIM TO ANY PAR-  
TICULAR FONT, STYLE, SIZE, OR COLOR.

NO CLAIM IS MADE TO THE EXCLUSIVE RIGHT TO USE "FOUNDATION FOR YOUTH",  
APART FROM THE MARK AS SHOWN.

SN 85-427,270, FILED 9-20-2011.

JILL PRATER, EXAMINING ATTORNEY



*David J. Kyffers*

Director of the United States Patent and Trademark Office

# United States of America

United States Patent and Trademark Office

EXPEDITION  
SERIES

**Reg. No. 4,276,704**

**Registered Jan. 15, 2013**

**Int. Cl.: 9**

**TRADEMARK**

**PRINCIPAL REGISTER**

THE WILL-BURT COMPANY, INC. (OHIO CORPORATION)  
169 SOUTH MAIN STREET  
ORRVILLE, OH 44667

FOR: TRIPODS, NAMELY, A TRIPOD WITH A TELESCOPING MAST FEATURE USED TO ELEVATE ANTENNAS, SURVEILLANCE AND TARGET ACQUISITION EQUIPMENT, AND ELEVATED TESTING EQUIPMENT, AND ACCESSORIES THEREFOR, NAMELY, CARRYING PACKS, GUY COLLARS, MULTIPLE MOUNTING COLLARS, MOUNTING AND ADAPTER PLATES, AND EXTENSION ARMS, IN CLASS 9 (U.S. CLS. 21, 23, 26, 36 AND 38).

FIRST USE 10-0-2010; IN COMMERCE 10-0-2010.

NO CLAIM IS MADE TO THE EXCLUSIVE RIGHT TO USE "SERIES", APART FROM THE MARK AS SHOWN.

THE MARK CONSISTS OF THE WORD "EXPEDITION" WITH A MAST OVER THE FIRST I IN "EXPEDITION" AND THE WORD "SERIES".

SN 85-428,979, FILED 9-22-2011.

DOMINICK J. SALEMI, EXAMINING ATTORNEY



*David J. Kyffers*

Director of the United States Patent and Trademark Office

# United States of America

United States Patent and Trademark Office

## NDX Source

**Reg. No. 4,276,705**

**Registered Jan. 15, 2013**

**Int. Cls.: 35 and 42**

**SERVICE MARK**

**PRINCIPAL REGISTER**

NEWSPAPER DATA EXCHANGE LLC (MISSOURI LIMITED LIABILITY COMPANY)  
SUITE 305  
1819 CLARKSON ROAD  
CHESTERFIELD, MO 63017

FOR: PROVIDING A COMMERCIAL INFORMATION INDEX IN THE NATURE OF COMMERCIAL INFORMATION FOR MARKETING USE BY RETAILERS AND ADVERTISING AGENCIES, IN CLASS 35 (U.S. CLS. 100, 101 AND 102).

FIRST USE 11-15-2011; IN COMMERCE 11-15-2011.

FOR: COMPUTER SERVICES, NAMELY, CREATING COMPUTER NETWORK-BASED INDEXES OF ELECTRONIC COMMERCIAL INFORMATION FOR MARKETING USE BY RETAILERS AND ADVERTISING AGENCIES; APPLICATION SERVICE PROVIDER FEATURING APPLICATION PROGRAMMING INTERFACE (API) SOFTWARE FOR USE RETRIEVING ELECTRONIC COMMERCIAL INFORMATION FOR MARKETING USE BY RETAILERS AND ADVERTISING AGENCIES, IN CLASS 42 (U.S. CLS. 100 AND 101).

FIRST USE 11-15-2011; IN COMMERCE 11-15-2011.

THE MARK CONSISTS OF STANDARD CHARACTERS WITHOUT CLAIM TO ANY PARTICULAR FONT, STYLE, SIZE, OR COLOR.

SN 85-428,985, FILED 9-22-2011.

TRACY FLETCHER, EXAMINING ATTORNEY



*David J. Kyros*

Director of the United States Patent and Trademark Office

# United States of America

United States Patent and Trademark Office

# BRACEON

**Reg. No. 4,276,706**

LEATT CORPORATION (NEVADA CORPORATION)  
5348 VEGAS DRIVE, #775  
LAS VEGAS, NV 89108

**Registered Jan. 15, 2013**

**Int. Cl.: 9**

FOR: SAFETY EQUIPMENT, NAMELY, A BODY PROTECTOR FOR THE PROTECTION OF THE BODY FOR MOTORIZED VEHICLE OPERATORS AND RIDERS FOR USE IN CONJUNCTION WITH A PROTECTIVE NECK BRACE FOR USE IN CONJUNCTION WITH A FULL FACE OR OPEN FACE PROTECTIVE HELMET TO PREVENT SPINAL CORD INJURY; MOTOR VEHICLE ACCESSORIES, NAMELY, A BODY PROTECTOR FOR USE IN CONJUNCTION WITH A PROTECTIVE NECK BRACE FOR USE IN CONJUNCTION WITH A FULL FACE OR OPEN FACE PROTECTIVE HELMET TO PREVENT SPINAL CORD INJURY, TO OPERATORS OF MOTORIZED VEHICLES INCLUDING MOTORCYCLES, SUPERBIKES, MOTORCROSS, GO-KARTS, ATVS, PERSONAL WATERCRAFTS, SNOW MOBILES, MOUNTAIN BIKES, BICYCLES, BMX, CARS, TRUCKS, BOATS AND MILITARY VEHICLES, IN CLASS 9 (U.S. CLS. 21, 23, 26, 36 AND 38).

**TRADEMARK**

**PRINCIPAL REGISTER**

FIRST USE 11-1-2010; IN COMMERCE 11-1-2010.

THE MARK CONSISTS OF STANDARD CHARACTERS WITHOUT CLAIM TO ANY PARTICULAR FONT, STYLE, SIZE, OR COLOR.

SN 85-429,145, FILED 9-22-2011.

CHRISTOPHER LAW, EXAMINING ATTORNEY



*David J. Kyffers*

Director of the United States Patent and Trademark Office

# United States of America

United States Patent and Trademark Office

# ONE

## [OF A KIND]

THE CAMPAIGN FOR UNIVERSITY OF PUGET SOUND

**Reg. No. 4,276,707**

**Registered Jan. 15, 2013**

**Int. Cl.: 41**

**SERVICE MARK**

**PRINCIPAL REGISTER**

THE UNIVERSITY OF PUGET SOUND (WASHINGTON CORPORATION)  
1500 N WARNER ST. #1075  
TACOMA, WA 984161075

FOR: EDUCATIONAL SERVICES, NAMELY, PROVIDING COURSES OF INSTRUCTION AT THE COLLEGE AND GRADUATE LEVEL, IN CLASS 41 (U.S. CLS. 100, 101 AND 107).

FIRST USE 10-29-2011; IN COMMERCE 10-29-2011.

THE MARK CONSISTS OF THE WORD "ONE" OVER THE WORDS "OF A KIND" IN BRACKETS ALL OVER THE WORDS "THE CAMPAIGN FOR UNIVERSITY OF PUGET SOUND".

SEC. 2(F) AS TO "UNIVERSITY OF PUGET SOUND".

SN 85-429,231, FILED 9-22-2011.

JEFF DEFORD, EXAMINING ATTORNEY



*David J. Kyffers*

Director of the United States Patent and Trademark Office



# United States of America

United States Patent and Trademark Office

KNITTER'S  

---

P R I D E

**Reg. No. 4,276,708**

M/S TRI-STAR PRODUCTS PVT. LTD. (INDIA COMPANY)  
B-43, SECTOR 80, NOIDA-201 305  
U.P., INDIA

**Registered Jan. 15, 2013**

**Int. Cl.: 26**

FOR: BUTTONS, HOOKS AND EYES, PINS, NAMELY, KNITTING PINS, CROCHET PINS,  
AND NEEDLES, IN CLASS 26 (U.S. CLS. 37, 39, 40, 42 AND 50).

**TRADEMARK**

FIRST USE 8-30-2011; IN COMMERCE 8-30-2011.

**PRINCIPAL REGISTER**

NO CLAIM IS MADE TO THE EXCLUSIVE RIGHT TO USE "KNITTER'S", APART FROM  
THE MARK AS SHOWN.

THE MARK CONSISTS OF THE WORD "KNITTER'S" WHICH IS UNDERLINED, OVER THE  
LETTERS "P R I D E".

SN 85-429,422, FILED 9-22-2011.

ALLISON HOLTZ, EXAMINING ATTORNEY



*David J. Kyros*

Director of the United States Patent and Trademark Office

# United States of America

United States Patent and Trademark Office



**Reg. No. 4,276,709**

**Registered Jan. 15, 2013**

**Int. Cl.: 3**

**TRADEMARK**

**PRINCIPAL REGISTER**

ATIFI, ZALMAI (AFGHANISTAN INDIVIDUAL)  
811, 8FLR, GROSNEVOR HT, SHEIKH ZAYED RD  
DUBAI, UNITED ARAB EMIR.

FOR: COLOGNE; COLOGNES, PERFUMES AND COSMETICS; COSMETICS; FACIAL  
CLEANSERS; MAKE-UP; MAKE-UP REMOVER; PERFUME; PERFUMES; PERFUMES AND  
COLOGNES , IN CLASS 3 (U.S. CLS. 1, 4, 6, 50, 51 AND 52).

FIRST USE 5-7-2012; IN COMMERCE 5-7-2012.

NO CLAIM IS MADE TO THE EXCLUSIVE RIGHT TO USE "BEAUTY", APART FROM THE  
MARK AS SHOWN.

THE MARK CONSISTS OF THE WORDING "JOY & BEAUTY" OVER THE WORDING "HOT  
STAR" WITH CURVED LINES ENCIRCLING AND SURROUNDED BY FIVE POINT STARS  
APPEARING ABOVE AND BELOW THE WORDING.

SN 85-429,742, FILED 9-22-2011.

BARBARA BROWN, EXAMINING ATTORNEY



*David J. Kypos*

Director of the United States Patent and Trademark Office

# United States of America

United States Patent and Trademark Office

# FiberHi

**Reg. No. 4,276,710**

**Registered Jan. 15, 2013**

**Int. Cl.: 5**

**TRADEMARK**

**PRINCIPAL REGISTER**

HUBEI KONSON KONJAC GUM (CHINA LIMITED LIABILITY COMPANY)  
652 WULUO ROAD  
WUHAN, HUBEI, CHINA, CHINA

FOR: NUTRITIONAL MEAL REPLACEMENT BARS CONTAINING FIBER ADAPTED FOR MEDICAL USE FOR INDIVIDUALS UNDERGOING MEDICAL TREATMENTS; DIETARY SUPPLEMENTAL DRINKS CONTAINING FIBER; DIETARY SUPPLEMENTS IN THE NATURE OF WEIGHT LOSS POWDERS CONTAINING FIBER; HERBAL DRINKS CONTAINING FIBER USED TO AID IN SLEEP AND RELAXATION; NUTRITIONAL DRINKS FOR ANIMALS CONTAINING FIBER; NUTRITIONAL SUPPLEMENTS, NAMELY, CARBOHYDRATES IN POWDERED FORM CONTAINING FIBER; POWDERED FRUIT-FLAVORED DIETARY SUPPLEMENT DRINK MIX CONTAINING FIBER; POWDERED NUTRITIONAL SUPPLEMENT CONCENTRATE CONTAINING FIBER; POWDERED NUTRITIONAL SUPPLEMENT DRINK MIX CONTAINING FIBER; POWDERED NUTRITIONAL SUPPLEMENT DRINK MIX AND CONCENTRATE CONTAINING FIBER, IN CLASS 5 (U.S. CLS. 6, 18, 44, 46, 51 AND 52).

FIRST USE 2-15-2012; IN COMMERCE 4-16-2012.

THE MARK CONSISTS OF STYLIZED LETTERS "F I B E R H I".

SN 85-429,984, FILED 9-22-2011.

KIMBERLY PERRY, EXAMINING ATTORNEY



*David J. Kyros*

Director of the United States Patent and Trademark Office

# United States of America

United States Patent and Trademark Office



**Reg. No. 4,276,711**

**Registered Jan. 15, 2013**

**Int. Cl.: 20**

**TRADEMARK**

**PRINCIPAL REGISTER**

WAYNE D. FEY (UNITED STATES INDIVIDUAL)  
12 TRAILRIDGE ROAD  
ASHEVILLE, NC 28804

FOR: REBAR INSTALLATION AND RETAINING SYSTEM CONSISTING OF NON-METAL BRACKETS, CHAIRS AND CONNECTORS FOR SECURING A GROUP OF RODS AND BARS TO FORM A GRID FOR REINFORCING AND REHABILITATING DETERIORATED PILINGS FOR BRIDGES, IN CLASS 20 (U.S. CLS. 2, 13, 22, 25, 32 AND 50).

FIRST USE 1-31-2012; IN COMMERCE 1-31-2012.

NO CLAIM IS MADE TO THE EXCLUSIVE RIGHT TO USE "BAR", APART FROM THE MARK AS SHOWN.

THE COLOR(S) YELLOW, ORANGE, RED, BROWN, GREEN, LIGHT BLUE, DARK BLUE, GREY AND BLACK IS/ARE CLAIMED AS A FEATURE OF THE MARK.

THE MARK CONSISTS OF THE IMAGE OF A MAN HOLDING TWO GREY BEAMS IN EACH HAND, WEARING A YELLOW, ORANGE AND RED SOMBRERO HAT, A GREEN BANDOLIER, A LIGHT BLUE SHIRT, DARK BLUE PANTS AND BROWN BOOTS. THE WORDS "BAR BANDIT" ARE WRITTEN IN STYLIZED LETTERING IN BLACK. THE WORD "BAR" IS POSITIONED TO THE LEFT OF THE IMAGE AND THE WORD "BANDIT" IS POSITIONED TO THE RIGHT; BOTH ARE CASTING A GREY SHADOW.

SN 85-430,347, FILED 9-23-2011.

VIVIAN MICZNIK FIRST, EXAMINING ATTORNEY



*David J. Kybas*

Director of the United States Patent and Trademark Office

# United States of America

United States Patent and Trademark Office



**Reg. No. 4,276,712**

**Registered Jan. 15, 2013**

**Int. Cl.: 6**

**TRADEMARK**

**PRINCIPAL REGISTER**

FEY, WAYNE D. (UNITED STATES INDIVIDUAL)  
12 TRAILBRIDGE ROAD  
ASHEVILLE, NC 28804

FOR: PREFABRICATED ALUMINUM FORMS FOR CONCRETE RESTORATION FOR DETERIORATING BRIDGE OR STRUCTURE PILES, DESIGNED FOR BELOW WATER INSTALLATION WITHOUT A DIVING TEAM, IN CLASS 6 (U.S. CLS. 2, 12, 13, 14, 23, 25 AND 50).

FIRST USE 1-31-2012; IN COMMERCE 1-31-2012.

THE MARK CONSISTS OF THE WORD "ENCAP" WRITTEN IN STYLIZED GREY LETTERING, WITH THE LETTERS "E" AND "C" CAPITALIZED. THE BOTTOM PORTION OF EACH LETTER IS ILLUSTRATED TO RESEMBLE PROGRESSIVE CONCRETE RESTORATION OF STRUCTURE PILES WITH THE FIRST LETTER "E" SHOWING VISIBLY DETERIORATED, BROWN STRUCTURE PILES AND EACH LETTER AFTER SHOWING PROGRESSIVELY ENCOMPASSED AND REPAIRED STRUCTURE PILES UNTIL THE LETTER "P" WHERE NO STRUCTURE PILES ARE VISIBLE. THE BOTTOM HALF OF THE ENTIRE WORD IS SUBMERSED IN BLUE WATER, WITH A WHITE PATH BETWEEN THE LETTERS "N" AND "C." THE WHITE AREA ABOVE THE BLUE WATER REPRESENTS BACKGROUND AND/OR A TRANSPARENT AREA AND IS NOT PART OF THE MARK

THE COLOR(S) BLUE, GREY, WHITE AND BROWN IS/ARE CLAIMED AS A FEATURE OF THE MARK.

SN 85-430,567, FILED 9-23-2011.

VIVIAN MICZNIK FIRST, EXAMINING ATTORNEY



*David J. Kyjars*

Director of the United States Patent and Trademark Office

# United States of America

United States Patent and Trademark Office

## CLEARVIEW SAFE LIGHT

**Reg. No. 4,276,713**

LIBERTY SAFE AND SECURITY PRODUCTS, INC. (UTAH CORPORATION)  
1199 W UTAH AVE  
PAYSON, UT 84651

**Registered Jan. 15, 2013**

**Int. Cl.: 11**

FOR: LIGHTS FOR SAFES, IN CLASS 11 (U.S. CLS. 13, 21, 23, 31 AND 34).

**TRADEMARK**

FIRST USE 6-30-2011; IN COMMERCE 3-29-2012.

**PRINCIPAL REGISTER**

THE MARK CONSISTS OF STANDARD CHARACTERS WITHOUT CLAIM TO ANY PARTICULAR FONT, STYLE, SIZE, OR COLOR.

NO CLAIM IS MADE TO THE EXCLUSIVE RIGHT TO USE "SAFE LIGHT", APART FROM THE MARK AS SHOWN.

SN 85-431,734, FILED 9-26-2011.

SARA BENJAMIN, EXAMINING ATTORNEY



*David J. Kyffers*

Director of the United States Patent and Trademark Office

# United States of America

United States Patent and Trademark Office

# SEQUENCE

**Reg. No. 4,276,714**

SEQUENCE EVENTS, LLC (NEW YORK LIMITED LIABILITY COMPANY)  
205 EAST 85TH STREET - #8L  
NEW YORK, NY 10028

**Registered Jan. 15, 2013**

**Int. Cl.: 35**

FOR: EVENT PLANNING SERVICES FOR COMMERCIAL, PROMOTIONAL OR ADVERTISING PURPOSES, IN CLASS 35 (U.S. CLS. 100, 101 AND 102).

**SERVICE MARK**

FIRST USE 11-1-2011; IN COMMERCE 11-1-2011.

**PRINCIPAL REGISTER**

THE MARK CONSISTS OF STANDARD CHARACTERS WITHOUT CLAIM TO ANY PARTICULAR FONT, STYLE, SIZE, OR COLOR.

SN 85-431,911, FILED 9-26-2011.

ZHALEH DELANEY, EXAMINING ATTORNEY



*David J. Kybas*

Director of the United States Patent and Trademark Office

# United States of America

United States Patent and Trademark Office



**Reg. No. 4,276,715**

INDUSTRIAL COMERCIAL SAN MARTIN, S.A. (NICARAGUA CORPORATION)  
CARRETERA PANAMERICANA, KILOMETRO 65 1/2  
NANDAINE, GRANADA, NICARAGUA

**Registered Jan. 15, 2013**

**Int. Cl.: 29**

FOR: MEAT; MEAT EXTRACTS; POULTRY; MEAT; MEAT EXTRACTS; POULTRY, IN  
CLASS 29 (U.S. CL. 46).

**TRADEMARK**

FIRST USE 9-5-1995; IN COMMERCE 9-5-1995.

**PRINCIPAL REGISTER**

PRIORITY CLAIMED UNDER SEC. 44(D) ON MEXICO APPLICATION NO. 1166197, FILED  
3-25-2011.

OWNER OF U.S. REG. NO. 3,438,820.

THE MARK CONSISTS OF A GEAR WHEEL THROUGH WHOSE CENTER APPEARS A  
COW'S HEAD FACING FORWARD.

SN 85-432,257, FILED 9-26-2011.

MATTHEW EINSTEIN, EXAMINING ATTORNEY



*David J. Kyros*

Director of the United States Patent and Trademark Office



United States of America  
United States Patent and Trademark Office

PANELMAX

**Reg. No. 4,276,716**

GRABBER CONSTRUCTION PRODUCTS, INC. (NEVADA CORPORATION)  
20 WEST MAIN STREET COURT, SUITE 200  
ALPINE, UT 84004

**Registered Jan. 15, 2013**

**Int. Cls.: 1, 2, and 7**

FOR: ADHESIVES USED IN INDUSTRY, IN CLASS 1 (U.S. CLS. 1, 5, 6, 10, 26 AND 46).

FIRST USE 1-1-2011; IN COMMERCE 1-1-2011.

**TRADEMARK**

FOR: PRIMER, IN CLASS 2 (U.S. CLS. 6, 11 AND 16).

**PRINCIPAL REGISTER**

FIRST USE 1-1-2011; IN COMMERCE 1-1-2011.

FOR: POWER TOOLS, NAMELY, ROUTER HEADS FOR CUTTING AND MILLING BUILDING MATERIALS; VACUUM UNIT, IN THE NATURE OF A VACUUM CLEANER FOR DUST CONTROL; ROUTER BITS; MULTIFUNCTION PROCESSING TABLES, NAMELY, TABLES ESPECIALLY ADAPTED TO HOLD POWERED MACHINERY, IN CLASS 7 (U.S. CLS. 13, 19, 21, 23, 31, 34 AND 35).

FIRST USE 1-1-2011; IN COMMERCE 1-1-2011.

THE MARK CONSISTS OF STANDARD CHARACTERS WITHOUT CLAIM TO ANY PARTICULAR FONT, STYLE, SIZE, OR COLOR.

SN 85-432,600, FILED 9-27-2011.

DAVID I, EXAMINING ATTORNEY



*David J. Kyfos*

Director of the United States Patent and Trademark Office

# United States of America

United States Patent and Trademark Office

# One Twelve Creative

**Reg. No. 4,276,717**

ONE TWELVE CREATIVE LLC (NEW JERSEY LIMITED LIABILITY COMPANY)  
14 GUINEVERE ROAD

**Registered Jan. 15, 2013**

MONROE TOWNSHIP, NJ 08831

**Int. Cls.: 35, 41, and 42**

FOR: CREATIVE MARKETING DESIGN SERVICES, IN CLASS 35 (U.S. CLS. 100, 101 AND 102).

**SERVICE MARK**

FIRST USE 4-29-2010; IN COMMERCE 6-11-2010.

**PRINCIPAL REGISTER**

FOR: PROVIDING A WEBSITE FEATURING NON-DOWNLOADABLE PUBLICATIONS IN THE NATURE OF BOOKS, MAGAZINES, BROCHURES IN THE FIELD OF MARKETING, IN CLASS 41 (U.S. CLS. 100, 101 AND 107).

FIRST USE 2-9-2012; IN COMMERCE 6-11-2012.

FOR: COMPUTER GRAPHICS DESIGN SERVICES, NAMELY, CREATING OF MARKETING MATERIALS, PACKAGE DESIGN, LOGOS, BROCHURES, POINT OF PURCHASE DISPLAYS, FASHION DESIGNS, ORIGINAL ILLUSTRATIONS, BOOK COVER DESIGNS; HOMEPAGE AND WEBPAGE DESIGN, IN CLASS 42 (U.S. CLS. 100 AND 101).

FIRST USE 7-11-2010; IN COMMERCE 7-11-2010.

NO CLAIM IS MADE TO THE EXCLUSIVE RIGHT TO USE "CREATIVE", APART FROM THE MARK AS SHOWN.

THE MARK CONSISTS OF "ONE TWELVE CREATIVE" SPELLED IN THE FONT BENCHLEY.

SN 85-432,893, FILED 9-27-2011.

GEOFFREY FOSDICK, EXAMINING ATTORNEY



*David J. Kypos*

Director of the United States Patent and Trademark Office

# United States of America

United States Patent and Trademark Office

# epMAIL

**Reg. No. 4,276,718**

**Registered Jan. 15, 2013**

**Int. Cl.: 35**

**SERVICE MARK**

**PRINCIPAL REGISTER**

GEORGE C. LITTLEJOHN (UNITED STATES INDIVIDUAL)  
561 STANTON WOODS DRIVE, S.E.  
CONYERS, GA 30094

FOR: COMMERCIAL MAIL RECEIVING AGENCY, NAMELY, PROVIDING SPECIALIZED MAIL MANAGEMENT SERVICES; MAIL SERVICES, NAMELY, RECEIVING AND PROCESSING INTERNATIONAL AND DOMESTIC MAIL FOR INFUSION INTO ESTABLISHED POSTAL SERVICES; MAIL SORTING, HANDLING AND RECEIVING, IN CLASS 35 (U.S. CLS. 100, 101 AND 102).

FIRST USE 8-23-2011; IN COMMERCE 8-14-2012.

THE MARK CONSISTS OF STANDARD CHARACTERS WITHOUT CLAIM TO ANY PARTICULAR FONT, STYLE, SIZE, OR COLOR.

SN 85-432,920, FILED 9-27-2011.

EDWARD NELSON, EXAMINING ATTORNEY



*David J. Kyffers*

Director of the United States Patent and Trademark Office

# United States of America

United States Patent and Trademark Office



**Reg. No. 4,276,719**

**Registered Jan. 15, 2013**

**Int. Cl.: 25**

**TRADEMARK**

**PRINCIPAL REGISTER**

TD PROMOTIONS, INC. (CALIFORNIA CORPORATION)  
7535 SAN FERNANDO RD.  
BURBANK, CA 91505

FOR: BANDANAS; SHORTS, IN CLASS 25 (U.S. CLS. 22 AND 39).

FIRST USE 9-27-2011; IN COMMERCE 10-31-2012.

THE MARK CONSISTS OF A SILHOUETTE OF A FOOTBALL GOAL POST.

SN 85-432,938, FILED 9-27-2011.

CURTIS FRENCH, EXAMINING ATTORNEY



*David J. Kyffers*

Director of the United States Patent and Trademark Office

# United States of America

United States Patent and Trademark Office

# Hipiti

**Reg. No. 4,276,720**

**Registered Jan. 15, 2013**

**Int. Cl.: 35**

**SERVICE MARK**

**PRINCIPAL REGISTER**

KATKAR FLINK CORPORATION (DELAWARE CORPORATION)  
2998 LARKIN ST., SUITE 2  
SAN FRANCISCO, CA 94109

FOR: PROMOTING THE SALE OF GOODS AND SERVICES OF OTHERS BY DISTRIBUTING COUPONS, CONDUCTING PROMOTIONAL CONTESTS, AND PROVIDING A WEBSITE AND MOBILE APPLICATION FEATURING COUPONS, PRICE-COMPARISON INFORMATION, PRODUCT REVIEWS, LINKS TO THE RETAIL WEBSITES OF OTHERS, NEW PRODUCT ARRIVAL INFORMATION, STORE EVENT INFORMATION, AND DISCOUNT INFORMATION; BUSINESS DATA ANALYSIS, NAMELY, PROVIDING DATA ANALYSIS FOR OTHERS IN THE FIELD OF CONSUMER SHOPPING BEHAVIOR; PROVIDING BUSINESS INFORMATION IN THE FIELD OF CONSUMER SHOPPING BEHAVIOR, IN CLASS 35 (U.S. CLS. 100, 101 AND 102).

FIRST USE 9-1-2011; IN COMMERCE 4-1-2012.

THE MARK CONSISTS OF STANDARD CHARACTERS WITHOUT CLAIM TO ANY PARTICULAR FONT, STYLE, SIZE, OR COLOR.

THE WORDING APPEARING IN THE MARK HAS NO MEANING IN A FOREIGN LANGUAGE.

SN 85-432,990, FILED 9-27-2011.

JIM RINGLE, EXAMINING ATTORNEY



*David J. Kybas*

Director of the United States Patent and Trademark Office

# United States of America

United States Patent and Trademark Office

## LUMINOUS GEOMETRY

**Reg. No. 4,276,721**

PINNACLE ARCHITECTURAL LIGHTING, INC. (COLORADO CORPORATION)  
12655 E. 42ND AVE, SUITE 50  
DENVER, CO 80239

**Registered Jan. 15, 2013**

**Int. Cl.: 11**

FOR: LIGHTING FIXTURES AND REPLACEMENT PARTS THEREFOR, IN CLASS 11 (U.S. CLS. 13, 21, 23, 31 AND 34).

**TRADEMARK**

FIRST USE 11-7-2012; IN COMMERCE 11-7-2012.

**PRINCIPAL REGISTER**

THE MARK CONSISTS OF STANDARD CHARACTERS WITHOUT CLAIM TO ANY PARTICULAR FONT, STYLE, SIZE, OR COLOR.

NO CLAIM IS MADE TO THE EXCLUSIVE RIGHT TO USE "LUMINOUS", APART FROM THE MARK AS SHOWN.

SN 85-433,034, FILED 9-27-2011.

MARC LEIPZIG, EXAMINING ATTORNEY



*David J. Kyffers*

Director of the United States Patent and Trademark Office

# United States of America

United States Patent and Trademark Office



**Reg. No. 4,276,722**

**Registered Jan. 15, 2013**

**Int. Cls.: 9 and 41**

**TRADEMARK**

**SERVICE MARK**

**PRINCIPAL REGISTER**

HSU, KEIKO (UNITED STATES INDIVIDUAL)  
UNIT 704  
152 LOMBARD STREET  
SAN FRANCISCO, CA 94111

FOR: AUDIO AND VIDEO RECORDINGS FEATURING PERSONAL DEVELOPMENT; DIGITAL MEDIA, NAMELY, PRE-RECORDED DVDS, DOWNLOADABLE AUDIO AND VIDEO RECORDINGS, AND CDS FEATURING AND PROMOTING PERSONAL DEVELOPMENT; DOWNLOADABLE ELECTRONIC PUBLICATIONS IN THE NATURE OF ARTICLES, SPECIAL REPORTS, EBOOKS, WORKBOOKS, CHECKLISTS, AND PROGRAM MATERIALS, NAMELY, WRITTEN DOCUMENTS, DOWNLOADABLE AUDIO MATERIALS AND DOWNLOADABLE TEXT FILES IN THE FIELD OF PERSONAL DEVELOPMENT, IN CLASS 9 (U.S. CLS. 21, 23, 26, 36 AND 38).

FIRST USE 9-30-2008; IN COMMERCE 9-30-2008.

FOR: EDUCATION SERVICES, NAMELY, PROVIDING LIVE AND ON-LINE CLASSES, SEMINARS, WORKSHOPS, TELECLASSES, WEBINARS IN THE FIELD OF PERSONAL DEVELOPMENT; ENTERTAINMENT SERVICES, NAMELY, AN ON-GOING SERIES FEATURING PERSONAL DEVELOPMENT INFORMATION PROVIDED THROUGH TELEVISION, RADIO, WEBCASTS, INTERNET; ON-LINE ELECTRONIC NEWSLETTERS DELIVERED BY E-MAIL IN THE FIELD OF PERSONAL DEVELOPMENT; ON-LINE JOURNALS, NAMELY, BLOGS FEATURING PERSONAL DEVELOPMENT INFORMATION; PERSONAL COACHING SERVICES IN THE FIELD OF PERSONAL DEVELOPMENT; PROVIDING GROUP COACHING IN THE FIELD OF PERSONAL DEVELOPMENT, IN CLASS 41 (U.S. CLS. 100, 101 AND 107).

FIRST USE 9-30-2008; IN COMMERCE 9-30-2008.

THE MARK CONSISTS OF THE DESIGN OF A "W" COMPRISED OF TWO "V'S", ONE IN GOLD AND THE OTHER IN BLUE, WITH THE DESIGN OF SIX ORANGE RIBBONS APPEARING BEHIND THE "W" DESIGN.

THE COLOR(S) BLUE, GOLD AND ORANGE IS/ARE CLAIMED AS A FEATURE OF THE MARK.

SN 85-433,178, FILED 9-27-2011.



*David J. Kappas*

Director of the United States Patent and Trademark Office

**Reg. No. 4,276,722** SAIMA MAKHDOOM, EXAMINING ATTORNEY



# United States of America

United States Patent and Trademark Office

# LOST GIRLS

**Reg. No. 4,276,723**

NOTHING BUT GOLD PRODUCTIONS (NEW YORK CORPORATION)  
620 W 42ND STREET, APT. 54A  
NEW YORK, NY 10036

**Registered Jan. 15, 2013**

**Int. Cl.: 45**

FOR: CHARITABLE SERVICES, NAMELY, PROVIDING CLOTHING TO NEEDY PERSONS,  
IN CLASS 45 (U.S. CLS. 100 AND 101).

**SERVICE MARK**

FIRST USE 10-3-2011; IN COMMERCE 10-3-2011.

**PRINCIPAL REGISTER**

THE MARK CONSISTS OF STANDARD CHARACTERS WITHOUT CLAIM TO ANY PAR-  
TICULAR FONT, STYLE, SIZE, OR COLOR.

SN 85-433,585, FILED 9-27-2011.

MATTHEW EINSTEIN, EXAMINING ATTORNEY



*David J. Kyffers*

Director of the United States Patent and Trademark Office

# United States of America

United States Patent and Trademark Office

## GREENHOOK GINSMITHS

**Reg. No. 4,276,724**

GREEN FARMS II, LLC (NEW YORK LIMITED LIABILITY COMPANY)  
208 DUPONT STREET  
BROOKLYN, NY 11222

**Registered Jan. 15, 2013**

**Int. Cl.: 33**

FOR: LIQUOR AND LIQUEUR BEVERAGES, NAMELY, GIN, VODKA, WHISKEY, RUM, BRANDY, AND SPECIALTY LIQUORS, IN CLASS 33 (U.S. CLS. 47 AND 49).

**TRADEMARK**

FIRST USE 8-0-2011; IN COMMERCE 8-0-2011.

**PRINCIPAL REGISTER**

THE MARK CONSISTS OF STANDARD CHARACTERS WITHOUT CLAIM TO ANY PARTICULAR FONT, STYLE, SIZE, OR COLOR.

SN 85-433,789, FILED 9-28-2011.

CHRISTINA SOBRAL, EXAMINING ATTORNEY



*David J. Kybas*

Director of the United States Patent and Trademark Office

# United States of America

United States Patent and Trademark Office

# BLACKTIP

**Reg. No. 4,276,725**

FITPOWDER LLC (ILLINOIS LIMITED LIABILITY COMPANY)  
26W400 CHURCHILL ROAD  
WINFIELD, IL 60190

**Registered Jan. 15, 2013**

**Int. Cl.: 9**

FOR: COMPUTER DOCKING STATION, IN CLASS 9 (U.S. CLS. 21, 23, 26, 36 AND 38).

**TRADEMARK**

FIRST USE 3-28-2012; IN COMMERCE 3-28-2012.

**PRINCIPAL REGISTER**

THE MARK CONSISTS OF STANDARD CHARACTERS WITHOUT CLAIM TO ANY PARTICULAR FONT, STYLE, SIZE, OR COLOR.

SN 85-434,337, FILED 9-28-2011.

RAUL CORDOVA, EXAMINING ATTORNEY



*David J. Kyffers*

Director of the United States Patent and Trademark Office

# United States of America

United States Patent and Trademark Office

# DIS

**Reg. No. 4,276,726**

**Registered Jan. 15, 2013**

**Int. Cls.: 35, 41, and 42**

**SERVICE MARK**

**PRINCIPAL REGISTER**

DIS MAGAZINE LLC (NEW YORK LIMITED LIABILITY COMPANY)  
LAUREN BOYLE  
376 S. 3RD ST. #8  
BROOKLYN, NY 11211

FOR: ADVERTISING AND MARKETING CONSULTANCY; ADVERTISING CONSULTATION;  
BRAND IMAGERY CONSULTING SERVICES, IN CLASS 35 (U.S. CLS. 100, 101 AND 102).

FIRST USE 3-15-2010; IN COMMERCE 6-1-2012.

FOR: PHOTOGRAPHY; PROVIDING ON-LINE MAGAZINES IN THE FIELD OF FASHION,  
ART, DESIGN, CULTURE, MUSIC, LIFESTYLE, IN CLASS 41 (U.S. CLS. 100, 101 AND 107).

FIRST USE 3-15-2010; IN COMMERCE 3-15-2010.

FOR: DRESS DESIGNING; FASHION DESIGN CONSULTING SERVICES; FOOTWEAR  
DESIGN SERVICES, IN CLASS 42 (U.S. CLS. 100 AND 101).

FIRST USE 3-15-2010; IN COMMERCE 10-14-2010.

THE MARK CONSISTS OF STANDARD CHARACTERS WITHOUT CLAIM TO ANY PAR-  
TICULAR FONT, STYLE, SIZE, OR COLOR.

SN 85-434,595, FILED 9-28-2011.

SHARON MEIER, EXAMINING ATTORNEY



*David J. Kybas*

Director of the United States Patent and Trademark Office

# United States of America

United States Patent and Trademark Office

## ON FILM STUDIOS

**Reg. No. 4,276,727**

KVILVANG, JOHN L (UNITED STATES INDIVIDUAL)  
4592 WELLFLEET DR.

**Registered Jan. 15, 2013**

HUNTINGTON BEACH, CA 92649

**Int. Cl.: 9**

FOR: CAMERA TRIPODS; CAMERAS, IN CLASS 9 (U.S. CLS. 21, 23, 26, 36 AND 38).

**TRADEMARK**

FIRST USE 9-28-2011; IN COMMERCE 9-28-2011.

**PRINCIPAL REGISTER**

THE MARK CONSISTS OF STANDARD CHARACTERS WITHOUT CLAIM TO ANY PARTICULAR FONT, STYLE, SIZE, OR COLOR.

NO CLAIM IS MADE TO THE EXCLUSIVE RIGHT TO USE "FILM STUDIOS", APART FROM THE MARK AS SHOWN.

SN 85-434,806, FILED 9-28-2011.

ALEX KEAM, EXAMINING ATTORNEY



*David J. Kyffers*

Director of the United States Patent and Trademark Office

# United States of America

United States Patent and Trademark Office

## STATE OF MIND

**Reg. No. 4,276,728**

EDUCATIONAL GAMES E (EDGE), LLC (TEXAS LIMITED LIABILITY COMPANY)  
1200 BINZ ST., #1410  
HOUSTON, TX 77004

**Registered Jan. 15, 2013**

**Int. Cl.: 28**

FOR: GEOGRAPHY TRADING CARD GAME, INCLUDING RULES OF PLAY, IN CLASS 28  
(U.S. CLS. 22, 23, 38 AND 50).

**TRADEMARK**

FIRST USE 2-15-2012; IN COMMERCE 2-15-2012.

**PRINCIPAL REGISTER**

THE MARK CONSISTS OF STANDARD CHARACTERS WITHOUT CLAIM TO ANY PARTICULAR FONT, STYLE, SIZE, OR COLOR.

SN 85-434,972, FILED 9-29-2011.

LINDSEY RUBIN, EXAMINING ATTORNEY



*David J. Kybas*

Director of the United States Patent and Trademark Office

# United States of America

United States Patent and Trademark Office

## PANAMA JACK HOME

**Reg. No. 4,276,729**

**Registered Jan. 15, 2013**

**Int. Cl.: 20**

**TRADEMARK**

**PRINCIPAL REGISTER**

PANAMA JACK INTERNATIONAL, INC. (FLORIDA CORPORATION)  
230 ERNESTINE STREET  
ORLANDO, FL 32801

FOR: SOFT SCULPTURE WALL DECORATIONS; WALL PLAQUES MADE OF PLASTIC OR WOOD; STOOLS; WALL DECORATIONS MADE OF WOOD, WAX, PLASTER OR PLASTIC; BEACH CHAIRS; ARMCHAIRS; FURNITURE, OUTDOOR FURNITURE, MIRRORS, PICTURE FRAMES, PILLOWS, WOOD BOXES; BEDS, BENCHES, CHAIRS, COLD CAST RESIN FIGURINES, CUSHIONS; WINE RACKS; BUNK BEDS; FUTONS, FUTON MATTRESSES, BEDS, BED FRAMES; BED HEADBOARDS; BED RAILS; BED RESTS; FOOT RESTS, OTTOMANS, IN CLASS 20 (U.S. CLS. 2, 13, 22, 25, 32 AND 50).

FIRST USE 11-14-2012; IN COMMERCE 11-14-2012.

THE MARK CONSISTS OF STANDARD CHARACTERS WITHOUT CLAIM TO ANY PARTICULAR FONT, STYLE, SIZE, OR COLOR.

OWNER OF U.S. REG. NOS. 1,325,935, 1,354,252, AND OTHERS.

NO CLAIM IS MADE TO THE EXCLUSIVE RIGHT TO USE "HOME", APART FROM THE MARK AS SHOWN.

THE NAME(S), PORTRAIT(S), AND/OR SIGNATURE(S) SHOWN IN THE MARK DOES NOT IDENTIFY A PARTICULAR LIVING INDIVIDUAL.

SN 85-434,979, FILED 9-29-2011.

COLLEEN DOMBROW, EXAMINING ATTORNEY



*David J. Kyffers*

Director of the United States Patent and Trademark Office

# United States of America

United States Patent and Trademark Office

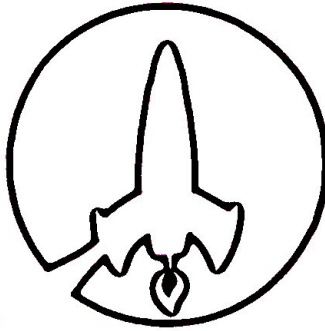

**Reg. No. 4,276,730**

ASTRONOMY KLUB, THE (GEORGIA LIMITED LIABILITY COMPANY)  
9792 MUSKET RIDGE CIRCLE  
JONESBORO, GA 30238

**Registered Jan. 15, 2013**

**Int. Cl.: 25**

FOR: BEANIES; HATS; JACKETS; PANTS; POLO SHIRTS; SCARVES; SHORTS; SWEAT SHIRTS; T-SHIRTS, IN CLASS 25 (U.S. CLS. 22 AND 39).

**TRADEMARK**

FIRST USE 7-12-2012; IN COMMERCE 8-24-2012.

**PRINCIPAL REGISTER**

THE MARK CONSISTS OF A SILHOUETTE OF A ROCKET WITH A FLAME AT THE BOTTOM OF IT SURROUNDED BY A CIRCLE. THE CIRCLE HAS A SLIGHT OPENING ON THE LEFT SIDE OF THE ROCKET'S FIN.

SN 85-434,988, FILED 9-29-2011.

ROBIN MITTLER, EXAMINING ATTORNEY



*David J. Kybas*

Director of the United States Patent and Trademark Office



# United States of America

United States Patent and Trademark Office

# Brokerade

**Reg. No. 4,276,731**

**Registered Jan. 15, 2013**

**Int. Cl.: 42**

**SERVICE MARK**

**PRINCIPAL REGISTER**

HERRERA, DAVID (UNITED STATES INDIVIDUAL)  
2087 BLACKHEATH LANE  
ROSEVILLE, CA 95678

FOR: COMPUTER SERVICES, NAMELY, PROVIDING A WEBSITE FOR THE USE IN THE REAL ESTATE INDUSTRY FEATURING TECHNOLOGY THAT ENABLES USERS TO BROADCAST AND RECEIVE E-MAIL, REGARDING THEIR REAL ESTATE AVAILABILITY AND NEEDED REAL ESTATE REQUIREMENTS OVER THE INTERNET AND TO ALSO GET ACCESS TO A REAL ESTATE DATABASE AND REAL TIME REAL ESTATE PROPERTY DEAL BOARD; REAL ESTATE INFORMATION SERVICES, NAMELY, CREATING ON-LINE VIRTUAL COMMUNITIES FOR REGISTERED USERS TO ORGANIZE GROUPS AND PARTICIPATE IN DISCUSSIONS REGARDING REAL ESTATE; HOSTING ON-LINE WEB FACILITIES FOR OTHERS FOR ORGANIZING AND CONDUCTING MEETINGS AND INTERACTIVE DISCUSSIONS VIA COMMUNICATION NETWORKS ON THE SUBJECT MATTER OF REAL ESTATE; APPLICATION SERVICE PROVIDER (ASP) FEATURING SOFTWARE TO ENABLE OR FACILITATE THE UPLOADING, DOWNLOADING, POSTING, DISPLAYING, BLOGGING, LINKING, SHARING CONTENT, USERS' PHOTOGRAPHIC IMAGES, TEXT AND DATA ALL IN THE FIELD OF REAL ESTATE; COMPUTER SERVICES, NAMELY, CREATING INDEXES OF INFORMATION, SITES AND OTHER RESOURCES AVAILABLE ON COMPUTER NETWORKS IN THE FIELD OF REAL ESTATE; PEER-TO-BROWSER PHOTO SHARING SERVICES, NAMELY, PROVIDING A WEBSITE FEATURING TECHNOLOGY ENABLING USERS TO UPLOAD, VIEW, AND DOWNLOAD DIGITAL PHOTOS IN THE FIELD OF REAL ESTATE; PROVIDING A WEB SITE FEATURING TECHNOLOGY THAT ENABLES USERS TO UPLOAD AND SHARE PROFILES, THAT INCLUDE, PHOTOS, TEXT, GRAPHICS AND DATA IN THE FIELD OF REAL ESTATE, IN CLASS 42 (U.S. CLS. 100 AND 101).



FIRST USE 2-1-2006; IN COMMERCE 6-12-2011.

THE MARK CONSISTS OF STANDARD CHARACTERS WITHOUT CLAIM TO ANY PARTICULAR FONT, STYLE, SIZE, OR COLOR.

SN 85-435,010, FILED 9-29-2011.

YAT SYE, LEE, EXAMINING ATTORNEY

*David J. Kyros*

Director of the United States Patent and Trademark Office

# United States of America

United States Patent and Trademark Office

## PANAMA JACK HOME

**Reg. No. 4,276,732**

**Registered Jan. 15, 2013**

**Int. Cl.: 21**

**TRADEMARK**

**PRINCIPAL REGISTER**

PANAMA JACK INTERNATIONAL, INC. (FLORIDA CORPORATION)  
230 ERNESTINE STREET  
ORLANDO, FL 32801

FOR: CERAMIC FIGURINES, NON-METAL DECORATIVE BOXES, NAMELY, GLASS, CHINA, CRYSTAL, EARTHENWARE, OR PORCELAIN BOXES; BASKETS OF WICKER, STRAW, WOOD AND CLOTH; BEER MUGS; BEVERAGE GLASSWARE; BEVERAGE WARE; BOTTLE OPENERS; BOWLS; SCULPTURES AND FIGURINES OF CHINA, CRYSTAL, EARTHENWARE, GLASS PORCELAIN OR TERRA COTTA; CANDLE HOLDERS NOT OF PRECIOUS METAL; COASTERS NOT OF PAPER AND NOT BEING TABLE LINEN; COFFEE CUPS; FOAM DRINK HOLDERS, IN CLASS 21 (U.S. CLS. 2, 13, 23, 29, 30, 33, 40 AND 50).

FIRST USE 11-14-2012; IN COMMERCE 11-14-2012.

THE MARK CONSISTS OF STANDARD CHARACTERS WITHOUT CLAIM TO ANY PARTICULAR FONT, STYLE, SIZE, OR COLOR.

OWNER OF U.S. REG. NOS. 1,325,935, 1,354,252, AND OTHERS.

NO CLAIM IS MADE TO THE EXCLUSIVE RIGHT TO USE "HOME", APART FROM THE MARK AS SHOWN.

THE NAME(S), PORTRAIT(S), AND/OR SIGNATURE(S) SHOWN IN THE MARK DOES NOT IDENTIFY A PARTICULAR LIVING INDIVIDUAL.

SN 85-435,025, FILED 9-29-2011.

COLLEEN DOMBROW, EXAMINING ATTORNEY



*David J. Kyros*

Director of the United States Patent and Trademark Office

# United States of America

United States Patent and Trademark Office

## PANAMA JACK OUTDOOR

**Reg. No. 4,276,733**

**Registered Jan. 15, 2013**

**Int. Cl.: 20**

**TRADEMARK**

**PRINCIPAL REGISTER**

PANAMA JACK INTERNATIONAL, INC. (FLORIDA CORPORATION)  
230 ERNESTINE STREET  
ORLANDO, FL 32801

FOR: SOFT SCULPTURE WALL DECORATIONS; WALL PLAQUES MADE OF PLASTIC OR WOOD; STOOLS; WALL DECORATIONS MADE OF WOOD, WAX, PLASTER OR PLASTIC; BEACH CHAIRS; ARMCHAIRS; FURNITURE, OUTDOOR FURNITURE, PILLOWS, WOOD BOXES; BEDS, BENCHES, CHAIRS, COLD CAST RESIN FIGURINES, CUSHIONS; FOOT RESTS, OTTOMANS, IN CLASS 20 (U.S. CLS. 2, 13, 22, 25, 32 AND 50).

FIRST USE 11-14-2012; IN COMMERCE 11-14-2012.

THE MARK CONSISTS OF STANDARD CHARACTERS WITHOUT CLAIM TO ANY PARTICULAR FONT, STYLE, SIZE, OR COLOR.

OWNER OF U.S. REG. NOS. 1,325,935, 1,354,252, AND OTHERS.

NO CLAIM IS MADE TO THE EXCLUSIVE RIGHT TO USE "OUTDOOR", APART FROM THE MARK AS SHOWN.

THE NAME(S), PORTRAIT(S), AND/OR SIGNATURE(S) SHOWN IN THE MARK DOES NOT IDENTIFY A PARTICULAR LIVING INDIVIDUAL.

SN 85-435,079, FILED 9-29-2011.

COLLEEN DOMBROW, EXAMINING ATTORNEY



*David J. Kyffers*

Director of the United States Patent and Trademark Office

# United States of America

United States Patent and Trademark Office

## THE WORLD IS YOUR WORKPLACE

**Reg. No. 4,276,734**

**Registered Jan. 15, 2013**

**Int. Cl.: 42**

**SERVICE MARK**

**PRINCIPAL REGISTER**

THE QUIGG CORPORATION DBA VANDOVER (DELAWARE CORPORATION)  
SUITE 500  
1801 PARK 270 DRIVE  
ST. LOUIS, MO 63146

FOR: PROVIDING AN INTERACTIVE WEBSITE FEATURING TECHNOLOGY THAT EN-  
ABLES COMPANIES AND ORGANIZATIONS TO ADMINISTER AND MANAGE EMPLOYEE  
RELOCATION PROGRAMS , IN CLASS 42 (U.S. CLS. 100 AND 101).

FIRST USE 9-12-2011; IN COMMERCE 1-0-2012.

THE MARK CONSISTS OF STANDARD CHARACTERS WITHOUT CLAIM TO ANY PAR-  
TICULAR FONT, STYLE, SIZE, OR COLOR.

SN 85-435,138, FILED 9-29-2011.

ANN E. SAPPENFIELD, EXAMINING ATTORNEY



*David J. Kybas*

Director of the United States Patent and Trademark Office

# United States of America

United States Patent and Trademark Office

# OXYGEN

**Reg. No. 4,276,735**

**Registered Jan. 15, 2013**

**Int. Cl.: 14**

**TRADEMARK**

**PRINCIPAL REGISTER**

CITIME FRANCE (FRANCE PARTNERSHIP)  
162, RUE DU FAUBOURG SAINT-HONORÉ  
PARIS, FRANCE 75008

FOR: PRECIOUS METALS AND THEIR ALLOYS OR COATED THEREWITH, JEWELRY, PRECIOUS STONES, CLOCKS, WATCHES AND CHRONOMETRIC INSTRUMENTS, IN CLASS 14 (U.S. CLS. 2, 27, 28 AND 50).

FIRST USE 11-3-2009; IN COMMERCE 11-3-2009.

THE MARK CONSISTS OF STANDARD CHARACTERS WITHOUT CLAIM TO ANY PARTICULAR FONT, STYLE, SIZE, OR COLOR.

SN 85-435,147, FILED 9-29-2011.

ANN E. SAPPENFIELD, EXAMINING ATTORNEY



*David J. Kyros*

Director of the United States Patent and Trademark Office

# United States of America

United States Patent and Trademark Office

## PANAMA JACK FURNITURE

**Reg. No. 4,276,736**

**Registered Jan. 15, 2013**

**Int. Cl.: 20**

**TRADEMARK**

**PRINCIPAL REGISTER**

PANAMA JACK INTERNATIONAL, INC. (FLORIDA CORPORATION)  
230 ERNESTINE STREET  
ORLANDO, FL 32801

FOR: SOFT SCULPTURE WALL DECORATIONS; WALL PLAQUES MADE OF PLASTIC OR WOOD; STOOLS; WALL DECORATIONS MADE OF WOOD, WAX, PLASTER OR PLASTIC; BEACH CHAIRS; ARMCHAIRS; FURNITURE, OUTDOOR FURNITURE, MIRRORS, PICTURE FRAMES, PILLOWS, WOOD BOXES; BEDS, BENCHES, CHAIRS, COLD CAST RESIN FIGURINES, CUSHIONS; WINE RACKS; BUNK BEDS; FUTONS, FUTON MATTRESSES, BEDS, BED FRAMES; BED HEADBOARDS; BED RAILS; BED RESTS; FOOT RESTS, OTTOMANS, IN CLASS 20 (U.S. CLS. 2, 13, 22, 25, 32 AND 50).

FIRST USE 11-14-2012; IN COMMERCE 11-14-2012.

THE MARK CONSISTS OF STANDARD CHARACTERS WITHOUT CLAIM TO ANY PARTICULAR FONT, STYLE, SIZE, OR COLOR.

OWNER OF U.S. REG. NOS. 1,325,935, 1,354,252, AND OTHERS.

NO CLAIM IS MADE TO THE EXCLUSIVE RIGHT TO USE "FURNITURE", APART FROM THE MARK AS SHOWN.

THE NAME(S), PORTRAIT(S), AND/OR SIGNATURE(S) SHOWN IN THE MARK DOES NOT IDENTIFY A PARTICULAR LIVING INDIVIDUAL.

SN 85-435,225, FILED 9-29-2011.

COLLEEN DOMBROW, EXAMINING ATTORNEY



*David J. Kybas*

Director of the United States Patent and Trademark Office

# United States of America

United States Patent and Trademark Office

# Rasa Flow

**Reg. No. 4,276,737**

KATJA SCHOLZ (FED REP GERMANY INDIVIDUAL)  
1319 EMERSON ST NW  
WASHINGTON, DC 20011 AND

**Registered Jan. 15, 2013**

**Int. Cl.: 41**

RYAN ARNOLDY (UNITED STATES INDIVIDUAL)  
1319 EMERSON ST NW  
WASHINGTON, DC 20011

**SERVICE MARK**

**PRINCIPAL REGISTER**

FOR: PROVIDING PHYSICAL FITNESS AND EXERCISE SERVICE, NAMELY, INDOOR CYCLING AND YOGA INSTRUCTION; YOGA INSTRUCTION, IN CLASS 41 (U.S. CLS. 100, 101 AND 107).

FIRST USE 3-1-2002; IN COMMERCE 3-1-2002.

THE MARK CONSISTS OF STANDARD CHARACTERS WITHOUT CLAIM TO ANY PARTICULAR FONT, STYLE, SIZE, OR COLOR.

THE ENGLISH TRANSLATION OF "RASA" IN THE MARK IS "PSYCHO ENERGY STATE", "FLAVOR", "ESSENCE" OR "MOOD".

SN 85-435,692, FILED 9-29-2011.

JULIE GUTTADAURO, EXAMINING ATTORNEY



*David J. Kyros*

Director of the United States Patent and Trademark Office

# United States of America

United States Patent and Trademark Office

# BEADZILLA

**Reg. No. 4,276,738**

AEXCEL CORPORATION (OHIO CORPORATION)  
7373 PRODUCTION DRIVE  
MENTOR, OH 440604858

**Registered Jan. 15, 2013**

**Int. Cl.: 7**

FOR: POWER-OPERATED APPLICATOR, NAMELY, AUTOMATIC MULTI-USE APPLICATOR FOR USE WITH RETRO-REFLECTIVITY AND ANTI-SKID AGENTS AND PRODUCTS, IN CLASS 7 (U.S. CLS. 13, 19, 21, 23, 31, 34 AND 35).

**TRADEMARK**

FIRST USE 7-25-2012; IN COMMERCE 7-25-2012.

**PRINCIPAL REGISTER**

THE MARK CONSISTS OF STANDARD CHARACTERS WITHOUT CLAIM TO ANY PARTICULAR FONT, STYLE, SIZE, OR COLOR.

SN 85-435,720, FILED 9-29-2011.

DAWN HAN, EXAMINING ATTORNEY



*David J. Kyffers*

Director of the United States Patent and Trademark Office



# United States of America

United States Patent and Trademark Office



**Reg. No. 4,276,739**

REVOLUTION TAXIDERMY SUPPLY INC. (WISCONSIN CORPORATION)  
13250 W. STATE RD. 77  
HAYWARD, WI 54843

**Registered Jan. 15, 2013**

**Int. Cl.: 25**

FOR: NOVELTY SPORTS-RELATED HATS, IN CLASS 25 (U.S. CLS. 22 AND 39).

**TRADEMARK**

FIRST USE 5-21-2011; IN COMMERCE 8-11-2012.

**PRINCIPAL REGISTER**

THE MARK CONSISTS OF THE WORDS "TROPHYHATS.COM" WITH THE "T" STYLIZED IN THE SHAPE OF A HAT AND ALSO FORMING THE "H" IN HATS.

SN 85-436,201, FILED 9-30-2011.

DORITT L. CARROLL, EXAMINING ATTORNEY



*David J. Kyffers*

Director of the United States Patent and Trademark Office

# United States of America

United States Patent and Trademark Office



**Reg. No. 4,276,740**

**Registered Jan. 15, 2013**

**Int. Cl.: 35**

**SERVICE MARK**

**PRINCIPAL REGISTER**

O ROSS ENTERPRISES, INC (FLORIDA CORPORATION)  
2412 ANTLIA DRIVE  
ORLANDO, FL 32828

FOR: BUSINESS CONSULTING SERVICES IN THE FIELD OF BUSINESS MANAGEMENT, MARKETING AND FINANCIAL SERVICES FOR EARLY STAGE AND STARTUP BUSINESSES, IN CLASS 35 (U.S. CLS. 100, 101 AND 102).

FIRST USE 3-20-2012; IN COMMERCE 3-20-2012.

NO CLAIM IS MADE TO THE EXCLUSIVE RIGHT TO USE "ENTREPRENEURIAL LEADERSHIP", APART FROM THE MARK AS SHOWN.

THE COLOR(S) CHROME BLUE, ORANGE, YELLOW AND BLACK IS/ARE CLAIMED AS A FEATURE OF THE MARK.

THE MARK CONSISTS OF "FUEL" IN STYLIZED CHROME BLUE LETTERS WITH A CHROME BLUE FLAME WITH A YELLOW OUTLINE AND AN ORANGE LOOP WITH CIRCLES AT EACH END SURROUNDING IT SITTING IN THE UPPER PORTION OF THE "U" IN "FUEL", THE WORDING "FRIENDS UNITED IN ENTREPRENEURIAL LEADERSHIP" APPEARS IN BLACK LETTERS BENEATH THE WORD "FUEL" AND THE DESIGN.

SN 85-436,223, FILED 9-30-2011.

RONALD MCMORROW, EXAMINING ATTORNEY



*David J. Kyros*

Director of the United States Patent and Trademark Office

# United States of America

United States Patent and Trademark Office



**Reg. No. 4,276,741**

SOPPARI ALLIANCE PRODIGY, INC. (CALIFORNIA CORPORATION)  
1010 CRENSHAW BLVD STE 250  
TORRANCE, CA 90501

**Registered Jan. 15, 2013**

**Int. Cl.: 11**

FOR: BICYCLE LIGHTS; FLASHLIGHTS, IN CLASS 11 (U.S. CLS. 13, 21, 23, 31 AND 34).

**TRADEMARK**

FIRST USE 3-0-2012; IN COMMERCE 3-0-2012.

**PRINCIPAL REGISTER**

THE MARK CONSISTS OF THE STYLIZED WORDING "X FIRE", WITH THE LETTER "X" IN RED, AND THE WORD "FIRE" IN BLACK.

THE COLOR(S) RED AND BLACK IS/ARE CLAIMED AS A FEATURE OF THE MARK.

SN 85-436,595, FILED 9-30-2011.

MARGERY A. TIERNEY, EXAMINING ATTORNEY



*David J. Kybas*

Director of the United States Patent and Trademark Office

# United States of America

United States Patent and Trademark Office

# TRINITY + MINDED MARKETPLACE

**Reg. No. 4,276,742**

GRIFFITH, TODD (UNITED STATES INDIVIDUAL)  
1747 ASBURY ROAD  
CORSIKA, PA 15829

**Registered Jan. 15, 2013**

**Int. Cl.: 35**

FOR: BUSINESS ASSOCIATION SERVICES, NAMELY, PROMOTING THE GOODS AND SERVICES OF MEMBER CHRISTIAN-OWNED BUSINESSES TO CONSUMERS, ADMINISTERING A PROGRAM ENABLING PARTICIPANTS TO OBTAIN DISCOUNTS ON PRODUCTS AND SERVICES FROM MEMBER BUSINESSES TO MEMBER CONSUMERS, AND PROMOTING AWARENESS OF CHRISTIAN VALUES AND PRACTICES AMONG CHRISTIAN-OWNED BUSINESSES, IN CLASS 35 (U.S. CLS. 100, 101 AND 102).

**SERVICE MARK**

**PRINCIPAL REGISTER**

FIRST USE 12-3-2012; IN COMMERCE 12-3-2012.

NO CLAIM IS MADE TO THE EXCLUSIVE RIGHT TO USE "MARKETPLACE", APART FROM THE MARK AS SHOWN.

THE MARK CONSISTS OF THE WORDS "TRINITY MINDED" ABOVE THE WORD "MARKETPLACE". THE "T" OF "MARKETPLACE" IS FORMED BY THE CROSS IN THE CENTER OF THE MARK.

SN 85-437,070, FILED 9-30-2011.

KRISTIN DAHLING, EXAMINING ATTORNEY



*David J. Kyros*

Director of the United States Patent and Trademark Office

# United States of America

United States Patent and Trademark Office

## upgrade to nature

**Reg. No. 4,276,743**

PARLEY COSMETICS (FLORIDA LIMITED LIABILITY COMPANY)  
5001 COLLINS AVE. PH 3  
MIAMI BEACH, FL 33140

**Registered Jan. 15, 2013**

**Int. Cl.: 3**

FOR: COLOGNES, PERFUMES AND COSMETICS, IN CLASS 3 (U.S. CLS. 1, 4, 6, 50, 51 AND 52).

**TRADEMARK**

FIRST USE 10-30-2012; IN COMMERCE 10-30-2012.

**PRINCIPAL REGISTER**

THE MARK CONSISTS OF STANDARD CHARACTERS WITHOUT CLAIM TO ANY PARTICULAR FONT, STYLE, SIZE, OR COLOR.

SN 85-437,297, FILED 10-2-2011.

JUSTINE D. PARKER, EXAMINING ATTORNEY



*David J. Kybas*

Director of the United States Patent and Trademark Office

# United States of America

United States Patent and Trademark Office

# RobustSolutions

**Reg. No. 4,276,744**

**Registered Jan. 15, 2013**

**Int. Cl.: 35**

**SERVICE MARK**

**PRINCIPAL REGISTER**

ROBUSTENERGY LLC (TEXAS LIMITED LIABILITY COMPANY)  
100 CONGRESS AVENUE SUITE 2000  
AUSTIN, TX 78701

FOR: CONDUCTING ENERGY AUDITS OF COMMERCIAL AND INSTITUTIONAL FACILITIES FOR THE PURPOSE OF IMPROVING ENERGY EFFICIENCY; CONSULTATION IN THE FIELD OF ENERGY EFFICIENCY; CONSULTING SERVICES IN THE FIELDS OF ENERGY CONSUMPTION AND USAGE CONSERVATION TO IMPROVE ENERGY EFFICIENCY; ENERGY USAGE MANAGEMENT, IN CLASS 35 (U.S. CLS. 100, 101 AND 102).

FIRST USE 8-4-2011; IN COMMERCE 5-13-2012.

THE MARK CONSISTS OF STANDARD CHARACTERS WITHOUT CLAIM TO ANY PARTICULAR FONT, STYLE, SIZE, OR COLOR.

SN 85-437,368, FILED 10-3-2011.

JESSICA A. POWERS, EXAMINING ATTORNEY



*David J. Kyros*

Director of the United States Patent and Trademark Office

# United States of America

United States Patent and Trademark Office

# WOLF

**Reg. No. 4,276,745**

THE WOLF ORGANIZATION, INC. (PENNSYLVANIA CORPORATION)  
20 WEST MARKET STREET, PO BOX 1267  
YORK, PA 17405

**Registered Jan. 15, 2013**

**Int. Cl.: 35**

FOR: DISTRIBUTORSHIP SERVICES IN THE FIELD OF BUILDING SUPPLIES, IN CLASS 35 (U.S. CLS. 100, 101 AND 102).

**SERVICE MARK**

FIRST USE 9-30-2009; IN COMMERCE 9-30-2009.

**PRINCIPAL REGISTER**

OWNER OF U.S. REG. NOS. 2,163,439 AND 3,901,472.

THE MARK CONSISTS OF THE WORD "WOLF" WITH THE HEAD OF A WOLF IN THE "O".

SN 85-437,587, FILED 10-3-2011.

DOUGLAS LEE, EXAMINING ATTORNEY



*David J. Kyffers*

Director of the United States Patent and Trademark Office

# United States of America

United States Patent and Trademark Office

**WOLF**

**Reg. No. 4,276,746**

**Registered Jan. 15, 2013**

**Int. Cl.: 35**

**SERVICE MARK**

**PRINCIPAL REGISTER**

THE WOLF ORGANIZATION, INC. (PENNSYLVANIA CORPORATION)  
20 WEST MARKET STREET, PO BOX 1267  
YORK, PA 17405

FOR: DISTRIBUTORSHIP SERVICES IN THE FIELD OF BUILDING SUPPLIES, IN CLASS  
35 (U.S. CLS. 100, 101 AND 102).

FIRST USE 8-31-2009; IN COMMERCE 8-31-2009.

OWNER OF U.S. REG. NOS. 2,163,439 AND 3,901,472.

THE COLOR(S) GREEN AND BLACK IS/ARE CLAIMED AS A FEATURE OF THE MARK.

THE MARK CONSISTS OF THE WORD "WOLF" IN GREEN LETTERS WITH THE HEAD  
OF A WOLF IN BLACK IN THE LETTER "O".

SN 85-437,600, FILED 10-3-2011.

DOUGLAS LEE, EXAMINING ATTORNEY



*David J. Kyffers*

Director of the United States Patent and Trademark Office



# United States of America

United States Patent and Trademark Office

## ALTAMODA BY MW

**Reg. No. 4,276,747**

**Registered Jan. 15, 2013**

**Int. Cl.: 25**

**TRADEMARK**

**PRINCIPAL REGISTER**

TMW MARKETING COMPANY, INC. (CALIFORNIA CORPORATION)  
40650 ENCYCLOPEDIA CIRCLE  
FREMONT, CA 945382453

FOR: MEN'S CLOTHING, NAMELY, SUITS, IN CLASS 25 (U.S. CLS. 22 AND 39).

FIRST USE 1-0-2012; IN COMMERCE 1-0-2012.

THE MARK CONSISTS OF STANDARD CHARACTERS WITHOUT CLAIM TO ANY PARTICULAR FONT, STYLE, SIZE, OR COLOR.

OWNER OF U.S. REG. NOS. 2,367,145, 3,164,046, AND OTHERS.

NO CLAIM IS MADE TO THE EXCLUSIVE RIGHT TO USE "ALTA MODA", APART FROM THE MARK AS SHOWN.

THE ENGLISH TRANSLATION OF "ALTA MODA" IN THE MARK IS HIGH FASHION.

SN 85-437,759, FILED 10-3-2011.

MICHAEL LITZAU, EXAMINING ATTORNEY



*David J. Kyffers*

Director of the United States Patent and Trademark Office

# United States of America

United States Patent and Trademark Office



**Reg. No. 4,276,748**

**Registered Jan. 15, 2013**

**Int. Cl.: 42**

**SERVICE MARK**

**PRINCIPAL REGISTER**

SAFE PERSONS NETWORK, LLC (DELAWARE LIMITED LIABILITY COMPANY)  
341 RAVEN CIRCLE  
WYOMING, DE 19934

FOR: PROVIDING A WEBSITE FEATURING NON-DOWNLOADABLE SOFTWARE FOR BACKGROUND SCREENINGS; PROVIDING A WEBSITE FEATURING ON-LINE NON-DOWNLOADABLE SOFTWARE THAT ENABLES USERS TO OBTAIN BACKGROUND SCREENINGS AND TO RECEIVE AUTOMATIC ALERTS WHEN NEW OR UPDATED INFORMATION BECOMES AVAILABLE, IN CLASS 42 (U.S. CLS. 100 AND 101).

FIRST USE 11-2-2011; IN COMMERCE 11-2-2011.

NO CLAIM IS MADE TO THE EXCLUSIVE RIGHT TO USE "E", APART FROM THE MARK AS SHOWN.

THE MARK CONSISTS OF THE LITERAL ELEMENT "EWARN" WITH THE "E" APPEARING ON A BALL WITH A CURVED BAND WITH THE WORD "WARN" TO THE RIGHT OF THE "E".

SN 85-437,997, FILED 10-3-2011.

FONG HSU, EXAMINING ATTORNEY



*David J. Kyffers*

Director of the United States Patent and Trademark Office

United States of America  
United States Patent and Trademark Office

# SUREedge

**Reg. No. 4,276,749**

SURELINE SYSTEMS, INC. (DELAWARE CORPORATION)  
13063 LA VISTA DR.  
SARATOGA, CA 95070

**Registered Jan. 15, 2013**

**Int. Cls.: 9 and 42**

FOR: COMPUTER STORAGE DEVICES, NAMELY, HIGH-SPEED STORAGE SUBSYSTEMS FOR STORAGE AND BACKUP OF ELECTRONIC DATA EITHER LOCALLY OR VIA A TELECOMMUNICATIONS NETWORK, IN CLASS 9 (U.S. CLS. 21, 23, 26, 36 AND 38).

**TRADEMARK**

FIRST USE 10-1-2011; IN COMMERCE 10-1-2011.

**SERVICE MARK**

FOR: REMOTE ONLINE BACKUP OF COMPUTER DATA, IN CLASS 42 (U.S. CLS. 100 AND 101).

**PRINCIPAL REGISTER**

FIRST USE 10-1-2011; IN COMMERCE 10-2-2011.

THE MARK CONSISTS OF STANDARD CHARACTERS WITHOUT CLAIM TO ANY PARTICULAR FONT, STYLE, SIZE, OR COLOR.

SN 85-438,316, FILED 10-4-2011.

AMY C. KEAN, EXAMINING ATTORNEY



*David J. Kappas*

Director of the United States Patent and Trademark Office

# United States of America

United States Patent and Trademark Office

# CUZCO

**Reg. No. 4,276,750**

**Registered Jan. 15, 2013**

**Int. Cls.: 6 and 19**

**TRADEMARK**

**PRINCIPAL REGISTER**

MASONITE INTERNATIONAL CORPORATION (CANADA CORPORATION)  
2771 RUTHERFORD ROAD  
CONCORD, ONTARIO, CANADA L4K2N6

FOR: DOOR LITES, SIDE LITES AND TRANSOM LITES IN THE NATURE OF GLASS AND PLASTIC PANELS WHICH ARE SOLD AS AN INTEGRAL COMPONENT OF METAL ENTRY DOORS AND DOOR ENTRANCEWAYS, IN CLASS 6 (U.S. CLS. 2, 12, 13, 14, 23, 25 AND 50).

FIRST USE 5-31-2012; IN COMMERCE 5-31-2012.

FOR: DOOR LITES, SIDE LITES AND TRANSOM LITES, ALL IN THE NATURE OF GLASS AND PLASTIC PANELS FOR DOORS AND DOOR ENTRANCEWAYS; DOOR LITES, SIDE LITES AND TRANSOM LITES IN THE NATURE OF GLASS AND PLASTIC PANELS WHICH ARE SOLD AS AN INTEGRAL COMPONENT OF NON-METAL ENTRY DOORS AND DOOR ENTRANCEWAYS, IN CLASS 19 (U.S. CLS. 1, 12, 33 AND 50).

FIRST USE 5-31-2012; IN COMMERCE 5-31-2012.

THE MARK CONSISTS OF STANDARD CHARACTERS WITHOUT CLAIM TO ANY PARTICULAR FONT, STYLE, SIZE, OR COLOR.

SN 85-438,709, FILED 10-4-2011.

ALLISON SCHRODY, EXAMINING ATTORNEY



*David J. Kyffers*

Director of the United States Patent and Trademark Office

# United States of America

United States Patent and Trademark Office

## DERIVATIVES360

**Reg. No. 4,276,751**

**Registered Jan. 15, 2013**

**Int. Cl.: 36**

**SERVICE MARK**

**PRINCIPAL REGISTER**

THE BANK OF NEW YORK MELLON CORPORATION (DELAWARE CORPORATION)  
15TH FLOOR  
ONE WALL STREET  
NEW YORK, NY 10286

FOR: FINANCIAL SERVICES, NAMELY, THE TRADING OF FINANCIAL DERIVATIVE PRODUCTS FOR OTHERS, AND DERIVATIVES TRADE EXECUTION SERVICES FOR OTHERS INCLUDING PROVIDING DOCUMENTATION, APPROVAL AND CUSTODY OF TRADED FINANCIAL DERIVATIVES, IN CLASS 36 (U.S. CLS. 100, 101 AND 102).

FIRST USE 6-22-2009; IN COMMERCE 6-22-2009.

THE MARK CONSISTS OF STANDARD CHARACTERS WITHOUT CLAIM TO ANY PARTICULAR FONT, STYLE, SIZE, OR COLOR.

SN 85-438,780, FILED 10-4-2011.

DAVID H. STINE, EXAMINING ATTORNEY



*David J. Kybas*

Director of the United States Patent and Trademark Office

# United States of America

United States Patent and Trademark Office

## GOT HAIR? GET WAXED!

**Reg. No. 4,276,752**

BODY WAXING COMPANY (FLORIDA CORPORATION)

**Registered Jan. 15, 2013**

5607 SW 74TH ST.  
MIAMI, FL 33143

**Int. Cls.: 25 and 44**

FOR: HATS; HOODED SWEAT SHIRTS; SHIRTS; SHORT-SLEEVED OR LONG-SLEEVED T-SHIRTS; SWEAT PANTS; SWEAT SHIRTS; T-SHIRTS, IN CLASS 25 (U.S. CLS. 22 AND 39).

**TRADEMARK**

FIRST USE 3-0-2012; IN COMMERCE 3-0-2012.

**SERVICE MARK**

FOR: BODY WAXING SERVICES; BODY WAXING SERVICES FOR THE HUMAN BODY, IN CLASS 44 (U.S. CLS. 100 AND 101).

**PRINCIPAL REGISTER**

FIRST USE 3-0-2012; IN COMMERCE 3-0-2012.

THE MARK CONSISTS OF STANDARD CHARACTERS WITHOUT CLAIM TO ANY PARTICULAR FONT, STYLE, SIZE, OR COLOR.

SN 85-439,048, FILED 10-4-2011.

SANDRA BUJA, EXAMINING ATTORNEY



*David J. Kyfos*

Director of the United States Patent and Trademark Office

# United States of America

United States Patent and Trademark Office

# bridgepoint

EDUCATION

**Reg. No. 4,276,753**

**Registered Jan. 15, 2013**

**Int. Cl.: 41**

**SERVICE MARK**

**PRINCIPAL REGISTER**

BRIDGEPOINT EDUCATION, INC. (DELAWARE CORPORATION)  
SUITE 600  
13500 EVENING CREEK DR. NORTH  
SAN DIEGO, CA 92128

FOR: EDUCATIONAL SERVICES, NAMELY, DEVELOPING AND PROVIDING LIVE CLASSROOM COURSES OF INSTRUCTION, AND ONLINE AND OTHER DISTANCE LEARNING COURSES OF INSTRUCTION, AT THE POST-SECONDARY, UNDERGRADUATE AND GRADUATE LEVELS INCLUDING DEGREE PROGRAMS, IN CLASS 41 (U.S. CLS. 100, 101 AND 107).

FIRST USE 2-9-2012; IN COMMERCE 2-9-2012.

OWNER OF U.S. REG. NO. 2,961,509.

THE COLOR(S) BLUE IS/ARE CLAIMED AS A FEATURE OF THE MARK.

NO CLAIM IS MADE TO THE EXCLUSIVE RIGHT TO USE "EDUCATION", APART FROM THE MARK AS SHOWN.

THE MARK CONSISTS OF THE TERM "BRIDGEPOINT" IN LOWERCASE LETTERS WITH THE TERM "EDUCATION" IN SMALLER CAPITAL LETTERS UNDERNEATH THE "OINT" PORTION OF THE WORD "BRIDGPOINT". THE ENTIRE TEXT IS BLUE.

SN 85-439,058, FILED 10-4-2011.

LAURA KOVALSKY, EXAMINING ATTORNEY



*David J. Kyffers*

Director of the United States Patent and Trademark Office

# United States of America

United States Patent and Trademark Office

# REVOLV

**Reg. No. 4,276,754**

STYLE CREST ENTERPRISES, INC. (OHIO CORPORATION)  
2450 ENTERPRISE STREET  
FREMONT, OH 43420

**Registered Jan. 15, 2013**

**Int. Cl.: 11**

FOR: HEATING AND AIR CONDITIONING UNITS; ACCESSORIES FOR HEATING AND AIR CONDITIONING UNITS, NAMELY, FURNACES, CONDENSORS BEING PARTS OF HVAC EQUIPMENT, LINE SETS BEING PARTS OF HVAC EQUIPMENT AND COILS BEING PARTS OF HVAC EQUIPMENT, IN CLASS 11 (U.S. CLS. 13, 21, 23, 31 AND 34).

**TRADEMARK**

**PRINCIPAL REGISTER**

FIRST USE 1-5-2011; IN COMMERCE 1-5-2011.

THE MARK CONSISTS OF STANDARD CHARACTERS WITHOUT CLAIM TO ANY PARTICULAR FONT, STYLE, SIZE, OR COLOR.

SN 85-439,104, FILED 10-4-2011.

PATRICIA EVANKO, EXAMINING ATTORNEY



*David J. Kyffers*

Director of the United States Patent and Trademark Office



# United States of America

United States Patent and Trademark Office

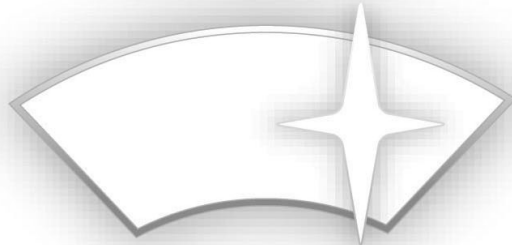

**Reg. No. 4,276,755**

**Registered Jan. 15, 2013**

**Int. Cl.: 3**

SPLASH PRODUCTS, INC. (MINNESOTA CORPORATION)  
1380 CORPORATE CENTER CURVE  
SUITE 200  
EAGAN, MN 55121

FOR: WINDSHIELD WASHER FLUID, IN CLASS 3 (U.S. CLS. 1, 4, 6, 50, 51 AND 52).

**TRADEMARK**

FIRST USE 8-1-2010; IN COMMERCE 8-1-2010.

**PRINCIPAL REGISTER**

THE MARK CONSISTS OF A DRAWING OF THE SHAPE OF AN ARC WITH A STAR DESIGN SUPERIMPOSED ON THE RIGHT HAND SIDE OF THE ARC. SHADING APPEARS AROUND THE OUTSIDE BORDER OF THE ARC AND AROUND THE STAR DESIGN.

SN 85-439,681, FILED 10-5-2011.

KEVIN DINALLO, EXAMINING ATTORNEY



*David J. Kybas*

Director of the United States Patent and Trademark Office

# United States of America

United States Patent and Trademark Office



**Reg. No. 4,276,756**

SPLASH PRODUCTS, INC. (MINNESOTA CORPORATION)  
1380 CORPORATE CENTER CURVE SUITE 200  
EAGAN, MN 55121

**Registered Jan. 15, 2013**

**Int. Cls.: 1 and 3**

FOR: CHEMICAL PREPARATIONS FOR MELTING SNOW AND ICE, IN CLASS 1 (U.S. CLS. 1, 5, 6, 10, 26 AND 46).

**TRADEMARK**

FIRST USE 8-1-2010; IN COMMERCE 8-1-2010.

**PRINCIPAL REGISTER**

FOR: WINDSHIELD WASHER FLUID, IN CLASS 3 (U.S. CLS. 1, 4, 6, 50, 51 AND 52).

FIRST USE 8-1-2010; IN COMMERCE 8-1-2010.

THE MARK CONSISTS OF A DRAWING OF AN ICE CRYSTAL WITH THREE DROPS OF WATER EXTENDING FROM THE CENTER AND BOTTOM OF THE CRYSTAL.

SN 85-439,706, FILED 10-5-2011.

KEVIN DINALLO, EXAMINING ATTORNEY



*David J. Kybas*

Director of the United States Patent and Trademark Office

# United States of America

United States Patent and Trademark Office

# PETPEAZ

**Reg. No. 4,276,757**

ETAVONNI PRODUCTS LLC (DELAWARE LIMITED LIABILITY COMPANY)  
3535 S. PRAIRIE AVE SUITE 4  
CHICAGO, IL 606531097

**Registered Jan. 15, 2013**

**Int. Cl.: 11**

FOR: HEATING AND COOLING PACKS FILLED WITH CHEMICAL SUBSTANCES THAT REACT WHEN REQUIRED TO WARM OR COOL THE BODY, IN CLASS 11 (U.S. CLS. 13, 21, 23, 31 AND 34).

**TRADEMARK**

FIRST USE 11-14-2012; IN COMMERCE 11-14-2012.

**PRINCIPAL REGISTER**

THE MARK CONSISTS OF STANDARD CHARACTERS WITHOUT CLAIM TO ANY PARTICULAR FONT, STYLE, SIZE, OR COLOR.

SN 85-439,729, FILED 10-5-2011.

CHRISTINE MARTIN, EXAMINING ATTORNEY



*David J. Kyffers*

Director of the United States Patent and Trademark Office

# United States of America

United States Patent and Trademark Office

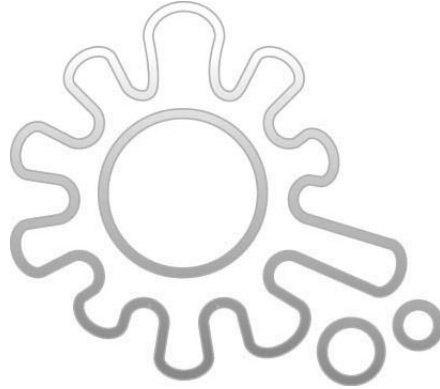

**Reg. No. 4,276,758**

**Registered Jan. 15, 2013**

**Int. Cl.: 3**

**TRADEMARK**

**PRINCIPAL REGISTER**

SPLASH PRODUCTS, INC. (MINNESOTA CORPORATION)  
1380 CORPORATE CENTER CURVE SUITE 200  
EAGAN, MN 55121

FOR: WINDSHIELD WASHER FLUID, IN CLASS 3 (U.S. CLS. 1, 4, 6, 50, 51 AND 52).

FIRST USE 8-1-2010; IN COMMERCE 8-1-2010.

THE MARK CONSISTS OF A SPLAT DESIGN THAT RESEMBLES A GEAR OR COGWHEEL. THE DESIGN HAS A CIRCULAR CENTER WITH COGS OF VARIOUS LENGTHS EXTENDING FROM THE CENTER. TWO SMALLER CIRCLES APPEAR OUTSIDE THE COGWHEEL DESIGN AT THE LOWER RIGHT HAND CORNER.

SN 85-439,744, FILED 10-5-2011.

KEVIN DINALLO, EXAMINING ATTORNEY



*David J. Kyffers*

Director of the United States Patent and Trademark Office

# United States of America

United States Patent and Trademark Office



**Reg. No. 4,276,759**

**Registered Jan. 15, 2013**

**Int. Cls.: 1 and 3**

**TRADEMARK**

**PRINCIPAL REGISTER**

SPLASH PRODUCTS, INC. (MINNESOTA CORPORATION)  
1380 CORPORATE CENTER CURVE SUITE 200  
EAGAN, MN 55121

FOR: ANTIFREEZE, IN CLASS 1 (U.S. CLS. 1, 5, 6, 10, 26 AND 46).

FIRST USE 8-1-2010; IN COMMERCE 8-1-2010.

FOR: WINDSHIELD WASHER FLUID, IN CLASS 3 (U.S. CLS. 1, 4, 6, 50, 51 AND 52).

FIRST USE 8-1-2010; IN COMMERCE 8-1-2010.

THE MARK CONSISTS OF A DRAWING OF A THERMOMETER. A SNOWFLAKE IS SHOWN INSIDE THE BULB OF THE THERMOMETER. THE READING ON THE THERMOMETER INDICATES A TEMPERATURE OF LESS THAN ZERO DEGREES.

SN 85-439,831, FILED 10-5-2011.

KEVIN DINALLO, EXAMINING ATTORNEY



*David J. Kybas*

Director of the United States Patent and Trademark Office

# United States of America

United States Patent and Trademark Office



**Reg. No. 4,276,760**

**Registered Jan. 15, 2013**

**Int. Cl.: 16**

**TRADEMARK**

**PRINCIPAL REGISTER**

PRGCO, LLC (OHIO LIMITED LIABILITY COMPANY)  
111 N. CANAL STREET  
CHICAGO, IL 60606

FOR: GREETING CARDS, IN CLASS 16 (U.S. CLS. 2, 5, 22, 23, 29, 37, 38 AND 50).

FIRST USE 1-31-2012; IN COMMERCE 1-31-2012.

THE MARK CONSISTS OF THE STYLIZED WORDING "DETOUR" IN BLACK AND OUTLINED IN WHITE, "FIND THE UNEXPECTED" IN BLACK, ON AN ORANGE, CURVY, DOWNWARD-FACING ARROW OUTLINED IN WHITE AND GRAY.

THE COLOR(S) BLACK, WHITE, ORANGE AND GRAY IS/ARE CLAIMED AS A FEATURE OF THE MARK.

SN 85-439,859, FILED 10-5-2011.

HOWARD B. LEVINE, EXAMINING ATTORNEY



*David J. Kyffers*

Director of the United States Patent and Trademark Office

# United States of America

United States Patent and Trademark Office

# SPORTSPEAZ

**Reg. No. 4,276,761**

**Registered Jan. 15, 2013**

**Int. Cl.: 11**

**TRADEMARK**

**PRINCIPAL REGISTER**

ETAVONNI PRODUCTS LLC (ILLINOIS LIMITED LIABILITY COMPANY)  
3535 S. PRAIRIE AVE SUITE 4  
CHICAGO, IL 60660

FOR: HEATING AND COOLING PACKS FILLED WITH CHEMICAL SUBSTANCES THAT REACT WHEN REQUIRED TO WARM OR COOL THE BODY, IN CLASS 11 (U.S. CLS. 13, 21, 23, 31 AND 34).

FIRST USE 11-13-2012; IN COMMERCE 11-13-2012.

THE MARK CONSISTS OF STANDARD CHARACTERS WITHOUT CLAIM TO ANY PARTICULAR FONT, STYLE, SIZE, OR COLOR.

SN 85-439,876, FILED 10-5-2011.

CHRISTINE MARTIN, EXAMINING ATTORNEY



*David J. Kyffers*

Director of the United States Patent and Trademark Office

# United States of America

United States Patent and Trademark Office



**Reg. No. 4,276,762**

**Registered Jan. 15, 2013**

**Int. Cl.: 3**

**TRADEMARK**

**PRINCIPAL REGISTER**

SPLASH PRODUCTS, INC. (MINNESOTA CORPORATION)  
SUITE 200  
1380 CORPORATE CENTER CURVE  
EAGAN, MN 55121

FOR: WINDSHIELD WASHER FLUID, IN CLASS 3 (U.S. CLS. 1, 4, 6, 50, 51 AND 52).

FIRST USE 8-1-2010; IN COMMERCE 8-1-2010.

THE MARK CONSISTS OF A DRAWING OF A THERMOMETER. A SNOWFLAKE IS SHOWN INSIDE THE BULB OF THE THERMOMETER. THE THERMOMETER INDICATES A TEMPERATURE READING OF 22 DEGREES FARENHEIT.

SN 85-439,884, FILED 10-5-2011.

KEVIN DINALLO, EXAMINING ATTORNEY



*David J. Kyffers*

Director of the United States Patent and Trademark Office



# United States of America

United States Patent and Trademark Office



**Reg. No. 4,276,763**

**Registered Jan. 15, 2013**

**Int. Cl.: 3**

**TRADEMARK**

**PRINCIPAL REGISTER**

NAPROLAB S.A. (COLOMBIA CORPORATION)  
CARRERA 1D 1 NO.45B-29  
CALI VALLE DEL CAUCA, COLOMBIA

FOR: COSMETICS; HAIR BALSAM; HAIR CARE CREAMS; HAIR CARE LOTIONS; HAIR CONDITIONERS; HAIR CREAMS; HAIR MASKS; HAIR POMADES; SHAMPOOS, IN CLASS 3 (U.S. CLS. 1, 4, 6, 50, 51 AND 52).

FIRST USE 3-10-1997; IN COMMERCE 11-30-2011.

THE MARK CONSISTS OF A CIRCLE INSIDE OF WHICH APPEARS A SMALL TREE. BELOW IT APPEARS THE WORD "NAPROLAB" IN STYLIZED LETTERS.

THE WORDING "NAPROLAB" HAS NO MEANING IN A FOREIGN LANGUAGE.

SN 85-440,279, FILED 10-5-2011.

ESTHER A. BORSUK, EXAMINING ATTORNEY



*David J. Kybas*

Director of the United States Patent and Trademark Office

# United States of America

United States Patent and Trademark Office

## What R U Hungry 4?

**Reg. No. 4,276,764**

HEALTHCORPS, INC. (NEW YORK CORPORATION)  
505 8TH AVENUE, SUITE 1101  
NEW YORK, NY 10018

**Registered Jan. 15, 2013**

**Int. Cl.: 41**

FOR: EDUCATIONAL AND ENTERTAINMENT SERVICES, NAMELY, THE PRODUCTION AND DISTRIBUTION OF AUDIO, VIDEO, AND MULTIMEDIA PROGRAMMING IN THE FIELDS OF PUBLIC INTEREST CONCERNING NUTRITION, WELLNESS, HEALTH, DIET, AND FITNESS, IN CLASS 41 (U.S. CLS. 100, 101 AND 107).

**SERVICE MARK**

**PRINCIPAL REGISTER**

FIRST USE 4-3-2012; IN COMMERCE 4-3-2012.

THE MARK CONSISTS OF STANDARD CHARACTERS WITHOUT CLAIM TO ANY PARTICULAR FONT, STYLE, SIZE, OR COLOR.

SN 85-440,361, FILED 10-5-2011.

DOMINICK J. SALEMI, EXAMINING ATTORNEY



*David J. Kyffers*

Director of the United States Patent and Trademark Office

# United States of America

United States Patent and Trademark Office

# WRUH4?

**Reg. No. 4,276,765**

HEALTHCORPS, INC. (NEW YORK CORPORATION)  
505 8TH AVENUE, SUITE 1101  
NEW YORK, NY 10018

**Registered Jan. 15, 2013**

**Int. Cl.: 41**

FOR: EDUCATIONAL AND ENTERTAINMENT SERVICES, NAMELY, THE PRODUCTION AND DISTRIBUTION OF AUDIO, VIDEO, AND MULTIMEDIA PROGRAMMING IN THE FIELDS OF PUBLIC INTEREST CONCERNING NUTRITION, WELLNESS, HEALTH, DIET, AND FITNESS, IN CLASS 41 (U.S. CLS. 100, 101 AND 107).

**SERVICE MARK**

**PRINCIPAL REGISTER**

FIRST USE 4-3-2012; IN COMMERCE 4-3-2012.

THE MARK CONSISTS OF STANDARD CHARACTERS WITHOUT CLAIM TO ANY PARTICULAR FONT, STYLE, SIZE, OR COLOR.

SN 85-440,365, FILED 10-5-2011.

DOMINICK J. SALEMI, EXAMINING ATTORNEY



*David J. Kypos*

Director of the United States Patent and Trademark Office

# United States of America

United States Patent and Trademark Office

# BRAINSSS

**Reg. No. 4,276,766**

**Registered Jan. 15, 2013**

**Int. Cl.: 9**

**TRADEMARK**

**PRINCIPAL REGISTER**

LONELY FEW LLC (CALIFORNIA LIMITED LIABILITY COMPANY)  
171 S HOLLENBECK AVE  
COVINA, CA 91722

FOR: COMPUTER GAME PROGRAMMES DOWNLOADABLE VIA THE INTERNET; COMPUTER GAME PROGRAMS; COMPUTER GAME PROGRAMS, CARTRIDGES, AND CASSETTES; COMPUTER GAME SOFTWARE; COMPUTER GAME SOFTWARE DOWNLOADABLE FROM A GLOBAL COMPUTER NETWORK; COMPUTER GAME SOFTWARE FOR PERSONAL COMPUTERS AND HOME VIDEO GAME CONSOLES; COMPUTER GAME SOFTWARE FOR USE ON MOBILE AND CELLULAR PHONES; COMPUTER GAME SOFTWARE FOR USE WITH PERSONAL COMPUTERS, HOME VIDEO GAME CONSOLES USED WITH TELEVISIONS AND ARCADE-BASED VIDEO GAME CONSOLES; DOWNLOADABLE COMPUTER GAME PROGRAMS; DOWNLOADABLE COMPUTER GAME SOFTWARE VIA A GLOBAL COMPUTER NETWORK AND WIRELESS DEVICES; DOWNLOADABLE GRAPHICS FOR MOBILE PHONES; DOWNLOADABLE MUSICAL SOUND RECORDINGS; DOWNLOADABLE RING TONES AND GRAPHICS FOR MOBILE PHONES; DOWNLOADABLE RING TONES, GRAPHICS AND MUSIC VIA A GLOBAL COMPUTER NETWORK AND WIRELESS DEVICES; DOWNLOADABLE RING TONES, MUSIC, VISUAL AND/OR AUDIBLE MEDIA, ELECTRONIC GAMES VIA THE INTERNET AND WIRELESS DEVICES; INTERACTIVE MULTIMEDIA COMPUTER GAME PROGRAM; INTERACTIVE VIDEO GAME PROGRAMS; VIDEO AND COMPUTER GAME PROGRAMS, IN CLASS 9 (U.S. CLS. 21, 23, 26, 36 AND 38).

FIRST USE 10-12-2010; IN COMMERCE 5-6-2012.

THE MARK CONSISTS OF STANDARD CHARACTERS WITHOUT CLAIM TO ANY PARTICULAR FONT, STYLE, SIZE, OR COLOR.

SN 85-440,374, FILED 10-5-2011.

DOMINICK J. SALEMI, EXAMINING ATTORNEY



*David J. Kyros*

Director of the United States Patent and Trademark Office

# United States of America

United States Patent and Trademark Office

# Balmira

**Reg. No. 4,276,767**

**Registered Jan. 15, 2013**

**Int. Cl.: 14**

**TRADEMARK**

**PRINCIPAL REGISTER**

ABMIYA (D.C. LIMITED LIABILITY COMPANY)  
4828 QUEBEC STREET, NW  
WASHINGTON, DC 20016

FOR: JEWELRY, IN CLASS 14 (U.S. CLS. 2, 27, 28 AND 50).

FIRST USE 9-30-2011; IN COMMERCE 9-30-2011.

THE MARK CONSISTS OF STANDARD CHARACTERS WITHOUT CLAIM TO ANY PARTICULAR FONT, STYLE, SIZE, OR COLOR.

SN 85-440,497, FILED 10-6-2011.

INGA ERVIN, EXAMINING ATTORNEY



*David J. Kybas*

Director of the United States Patent and Trademark Office

# United States of America

United States Patent and Trademark Office

## SP-FIX ARC

**Reg. No. 4,276,768**

**Registered Jan. 15, 2013**

**Int. Cl.: 10**

**TRADEMARK**

**PRINCIPAL REGISTER**

GLOBUS MEDICAL, INC (DELAWARE CORPORATION), DBA GLOBUS MEDICAL, INC,  
VALLEY FORGE BUSINESS CENTER  
2560 GENERAL ARMISTEAD AVENUE  
AUDUBON, PA 19403

FOR: SPINAL IMPLANTS CONSISTING OF ARTIFICIAL MATERIALS AND SURGICAL  
INSTRUMENTS FOR USE IN SPINAL PROCEDURES PERFORMED BY SPINAL SURGEONS,  
IN CLASS 10 (U.S. CLS. 26, 39 AND 44).

FIRST USE 1-25-2011; IN COMMERCE 1-25-2011.

THE MARK CONSISTS OF STANDARD CHARACTERS WITHOUT CLAIM TO ANY PAR-  
TICULAR FONT, STYLE, SIZE, OR COLOR.

NO CLAIM IS MADE TO THE EXCLUSIVE RIGHT TO USE "ARC", APART FROM THE  
MARK AS SHOWN.

SN 85-440,544, FILED 10-6-2011.

CARYN GLASSER, EXAMINING ATTORNEY



*David J. Kyros*

Director of the United States Patent and Trademark Office

# United States of America

United States Patent and Trademark Office

## Recreation To The Next Level

**Reg. No. 4,276,769**

LEVEL-TREK CORPORATION (CALIFORNIA CORPORATION)

**Registered Jan. 15, 2013**

P.O. BOX 8416  
ROWLAND HEIGHTS, CA 91748

**Int. Cl.: 20**

FOR: LEVELING DEVICE IN THE NATURE OF PLASTIC, STACKABLE BLOCKS FOR USE IN CONNECTION WITH A VEHICLE; PLASTIC WHEEL CHOCKS, IN CLASS 20 (U.S. CLS. 2, 13, 22, 25, 32 AND 50).

**TRADEMARK**

FIRST USE 10-6-2011; IN COMMERCE 10-28-2012.

**PRINCIPAL REGISTER**

THE MARK CONSISTS OF STANDARD CHARACTERS WITHOUT CLAIM TO ANY PARTICULAR FONT, STYLE, SIZE, OR COLOR.

SN 85-440,651, FILED 10-6-2011.

JOHN HWANG, EXAMINING ATTORNEY



*David J. Kyffers*

Director of the United States Patent and Trademark Office

# United States of America

United States Patent and Trademark Office

## DARK CORRIDORS

**Reg. No. 4,276,770**

SOUNDLIGHTMIND, INC. (NEW YORK CORPORATION)  
11 PEEL STREET  
SELKIRK, NY 12158

**Registered Jan. 15, 2013**

**Int. Cl.: 16**

FOR: BOOKS, NAMELY, MYSTERY AND THRILLER BOOKS, IN CLASS 16 (U.S. CLS. 2, 5, 22, 23, 29, 37, 38 AND 50).

**TRADEMARK**

FIRST USE 3-12-2012; IN COMMERCE 3-12-2012.

**PRINCIPAL REGISTER**

THE MARK CONSISTS OF STANDARD CHARACTERS WITHOUT CLAIM TO ANY PARTICULAR FONT, STYLE, SIZE, OR COLOR.

SN 85-440,916, FILED 10-6-2011.

EMILY CARLSEN, EXAMINING ATTORNEY



*David J. Kyffers*

Director of the United States Patent and Trademark Office



United States of America  
United States Patent and Trademark Office

**BUBBA**

**Reg. No. 4,276,771**

BUBBA FOODS, LLC (DELAWARE LIMITED LIABILITY COMPANY)  
4339 ROOSEVELT BOULEVARD, SUITE 400  
JACKSONVILLE, FL 32210

**Registered Jan. 15, 2013**

**Int. Cl.: 29**

FOR: UNCOOKED HAMBURGER PATTIES, IN CLASS 29 (U.S. CL. 46).

**TRADEMARK**

FIRST USE 5-0-1982; IN COMMERCE 12-0-1993.

**PRINCIPAL REGISTER**

OWNER OF U.S. REG. NOS. 2,659,731, 2,901,596, AND 3,941,200.

THE MARK CONSISTS OF THE WORD "BUBBA" IN STYLIZED LETTERING.

SN 85-440,989, FILED 10-6-2011.

NATALIE POLZER, EXAMINING ATTORNEY



*David J. Kybas*

Director of the United States Patent and Trademark Office

# United States of America

United States Patent and Trademark Office

# FreeMyApps

**Reg. No. 4,276,772**

APPEXCHANGER.COM, INC. (DELAWARE CORPORATION)  
101 ARCH STREET, SUITE 304  
BOSTON, MA 02110

**Registered Jan. 15, 2013**

**Int. Cls.: 35 and 42**

FOR: PROMOTING THE GOODS OF OTHERS BY THE ONLINE DISTRIBUTION OF GIFT CODES THAT ENTITLE THE RECIPIENT TO OBTAIN THIRD-PARTY SOFTWARE PROGRAMS, IN CLASS 35 (U.S. CLS. 100, 101 AND 102).

**SERVICE MARK**

FIRST USE 5-19-2011; IN COMMERCE 5-19-2011.

**PRINCIPAL REGISTER**

FOR: PROVIDING AN INTERACTIVE WEBSITE FEATURING TECHNOLOGY THAT ALLOWS USERS TO DOWNLOAD VARIOUS THIRD-PARTY COMPUTER PROGRAMS AND OTHER DIGITAL CONTENT, INCLUDING BUT NOT LIMITED TO COMPUTER APPLICATIONS, AUDIO, VIDEO, TEXT AND MULTIMEDIA CONTENT ONTO COMPUTERS, HANDHELD ELECTRONIC DEVICES AND OTHER CONSUMER ELECTRONICS, IN CLASS 42 (U.S. CLS. 100 AND 101).

FIRST USE 12-13-2011; IN COMMERCE 12-13-2011.

THE MARK CONSISTS OF STANDARD CHARACTERS WITHOUT CLAIM TO ANY PARTICULAR FONT, STYLE, SIZE, OR COLOR.

SN 85-440,992, FILED 10-6-2011.

LAURIE MAYES, EXAMINING ATTORNEY



*David J. Kyffers*

Director of the United States Patent and Trademark Office

# United States of America

United States Patent and Trademark Office

# Kickster

**Reg. No. 4,276,773**

**Registered Jan. 15, 2013**

**Int. Cl.: 12**

**TRADEMARK**

**PRINCIPAL REGISTER**

TREK BICYCLE CORPORATION (WISCONSIN CORPORATION)  
801 WEST MADISON STREET  
WATERLOO, WI 53594

FOR: BICYCLE FRAMES; BICYCLES, IN CLASS 12 (U.S. CLS. 19, 21, 23, 31, 35 AND 44).

FIRST USE 8-1-2012; IN COMMERCE 8-1-2012.

THE MARK CONSISTS OF STANDARD CHARACTERS WITHOUT CLAIM TO ANY PARTICULAR FONT, STYLE, SIZE, OR COLOR.

SN 85-441,044, FILED 10-6-2011.

AHSEN KHAN, EXAMINING ATTORNEY



*David J. Kybas*

Director of the United States Patent and Trademark Office

# United States of America

United States Patent and Trademark Office

**ATOMIC**  
CHEWABLE  
ENERGY **TABS**

**Reg. No. 4,276,774**

ATOMIC TABS, LLC (OKLAHOMA LIMITED LIABILITY COMPANY)  
4025 S. 217TH E. AVE  
BROKEN ARROW, OK 74014

**Registered Jan. 15, 2013**

**Int. Cl.: 5**

FOR: ENERGY BOOSTING CHEWABLE FLAVORED TABLETS, IN CLASS 5 (U.S. CLS. 6, 18, 44, 46, 51 AND 52).

**TRADEMARK**

FIRST USE 1-0-2012; IN COMMERCE 4-23-2012.

**PRINCIPAL REGISTER**

NO CLAIM IS MADE TO THE EXCLUSIVE RIGHT TO USE "TABS" AND "CHEWABLE ENERGY", APART FROM THE MARK AS SHOWN.

THE MARK CONSISTS OF THE WORD "ATOMIC" WITH DROP-SHADOWED LETTERS AND THE WORD "TABS", ALSO WITH DROP-SHADOWED LETTERS, APPEARING UNDER AND OFFSET TO THE RIGHT OF THE WORD "ATOMIC". THE WORDS "CHEWABLE ENERGY" APPEAR IN SMALLER LETTERS BELOW THE WORD "ATOMIC" AND TO THE LEFT OF THE WORD "TABS". A SOLID BALL APPEARS AS THE "DOT" OF THE "I" IN THE WORD "ATOMIC". TWO RING CIRCLES, ONE LARGER THAN THE OTHER, INTERSECT AT THE BALL. THE SMALLER RING IS ANGLED DIAGONALLY WITH ITS TOP TO THE LEFT OF THE BALL AND THE LARGER RING IS ANGLED DIAGONALLY WITH ITS TOP TO THE RIGHT OF THE BALL.

SN 85-441,177, FILED 10-6-2011.

ALEX KEAM, EXAMINING ATTORNEY



*David J. Keam*

Director of the United States Patent and Trademark Office

# United States of America

United States Patent and Trademark Office

## ULTRA TECH

**Reg. No. 4,276,775**

PLASTIC COMPONENTS, INC. (FLORIDA CORPORATION)  
9051 NORTHWEST 97TH TERRACE  
MIAMI, FL 33178

**Registered Jan. 15, 2013**

**Int. Cl.: 17**

FOR: ACRYLIC BASED SEALANTS AND ADHESIVES, IN CLASS 17 (U.S. CLS. 1, 5, 12, 13, 35 AND 50).

**TRADEMARK**

FIRST USE 12-0-2011; IN COMMERCE 12-0-2011.

**PRINCIPAL REGISTER**

THE MARK CONSISTS OF STANDARD CHARACTERS WITHOUT CLAIM TO ANY PARTICULAR FONT, STYLE, SIZE, OR COLOR.

SN 85-441,469, FILED 10-6-2011.

NAPOLEON SHARMA, EXAMINING ATTORNEY



*David J. Kyffers*

Director of the United States Patent and Trademark Office

# United States of America

United States Patent and Trademark Office

# CLINFOWARE

**Reg. No. 4,276,776**

VSOFT INFOWARE INC. (DELAWARE CORPORATION)  
33 WOOD AVENUE SOUTH, SUITE 600  
ISELIN, NJ 08830

**Registered Jan. 15, 2013**

**Int. Cl.: 9**

FOR: COMPUTER SOFTWARE FOR THE CAPTURE AND TRANSMITTAL OF DATA, VOICE AND IMAGE INFORMATION VIA THE INTERNET, PHONE, FAX, PAPER, RADIO FREQUENCY IDENTIFICATION, AND BARCODE FOR USE IN CLINICAL TRIALS, IN CLASS 9 (U.S. CLS. 21, 23, 26, 36 AND 38).

**TRADEMARK**

**PRINCIPAL REGISTER**

FIRST USE 10-8-2011; IN COMMERCE 10-9-2011.

THE MARK CONSISTS OF STANDARD CHARACTERS WITHOUT CLAIM TO ANY PARTICULAR FONT, STYLE, SIZE, OR COLOR.

SN 85-441,843, FILED 10-7-2011.

LINDA MICKLEBURGH, EXAMINING ATTORNEY



*David J. Kyffers*

Director of the United States Patent and Trademark Office

# United States of America

United States Patent and Trademark Office



## Liberty Masonry , LLC

**Reg. No. 4,276,777**

TATE, MONTE HAROLD (UNITED STATES INDIVIDUAL)  
2905 SOUTH JOPLIN AVE  
JOPLIN, MO 64804

**Registered Jan. 15, 2013**

**Int. Cl.: 37**

FOR: MASONRY SERVICES, IN CLASS 37 (U.S. CLS. 100, 103 AND 106).

**SERVICE MARK**

FIRST USE 7-15-2012; IN COMMERCE 7-15-2012.

**PRINCIPAL REGISTER**

NO CLAIM IS MADE TO THE EXCLUSIVE RIGHT TO USE "MASONRY, LLC", APART FROM THE MARK AS SHOWN.

THE MARK CONSISTS OF THE STYLIZED TEXT "LIBERTY MASONRY, LLC" WITH AN EAGLE ABOVE THE TEXT. THE EAGLE HAS THE PATTERN OF THE AMERICAN FLAG WITHIN IT.

SN 85-441,909, FILED 10-7-2011.

DORITT L. CARROLL, EXAMINING ATTORNEY



*David J. Kyffers*

Director of the United States Patent and Trademark Office

# United States of America

United States Patent and Trademark Office



**Reg. No. 4,276,778**

**Registered Jan. 15, 2013**

**Int. Cl.: 25**

**TRADEMARK**

**PRINCIPAL REGISTER**

PEI-CHIA YAO (TAIWAN CORPORATION)  
5F., NO. 98, LN. 211, YONGKANG RD.  
FENGYUAN DIST.  
TAICHUNG CITY, TAIWAN R.O.C.

FOR: FOOTWEAR, SHOES, ATHLETIC SHOES, BEACH SHOES, LEATHER SHOES, LEISURE SHOES, RUNNING SHOES, MOUNTAINEERING BOOTS, SKI BOOTS, BOOTS, SANDALS, SLIPPERS, FOOTWEAR UPPERS, SOLES FOR FOOTWEAR, INSOLES FOR FOOTWEAR, HEELS; CLOTHING, NAMELY, SHIRTS, T-SHIRTS, SWEATSHIRTS, BLOUSES, JACKETS, COATS, PANTS, SHORTS, SWEATPANTS; HEADWEAR; GLOVES, SOCKS, BELTS, SCARVES, TIES, IN CLASS 25 (U.S. CLS. 22 AND 39).

FIRST USE 10-1-2012; IN COMMERCE 10-1-2012.

THE MARK CONSISTS OF STYLIZED WORDING "RUTER" ON THE RIGHT AND A DEVICE ON THE LEFT. THE DEVICE IS PROVIDED AT THE RIGHT THEREOF WITH A PARALLELOGRAM FORMED BY PARALLEL LINES INCLINED LEFTWARD WITH DIFFERENT WIDTH, AND AT THE LEFT WITH A TRAPEZOID FORMED BY PARALLEL LINES INCLINED RIGHTWARD WITH DIFFERENT WIDTH AND LENGTH AND EXTENDING TO THE LEFT SIDE OF THE PARALLELOGRAM IN SUCH A WAY THAT A TRIANGLE BLACK IS LEFT AT THE BOTTOM CENTER OF THE DEVICES.

SN 85-442,060, FILED 10-7-2011.

EMILY CARLSEN, EXAMINING ATTORNEY



*David J. Kybas*

Director of the United States Patent and Trademark Office



# United States of America

United States Patent and Trademark Office

# CNDestiny

**Reg. No. 4,276,779**

GRAHAM, CHANDRA N (UNITED STATES INDIVIDUAL), DBA CNDESTINY,  
5333 LIBERTY HALL CIRCLE  
WINSTON-SALEM, NC 27106

**Registered Jan. 15, 2013**

**Int. Cls.: 9 and 25**

FOR: COMPACT DISCS FEATURING MUSIC AND SPOKEN WORD IN THE FORM OF POETRY, IN CLASS 9 (U.S. CLS. 21, 23, 26, 36 AND 38).

**TRADEMARK**

FIRST USE 2-8-2012; IN COMMERCE 2-8-2012.

**PRINCIPAL REGISTER**

FOR: ATHLETIC APPAREL, NAMELY, SHIRTS, PANTS, JACKETS, FOOTWEAR, HATS AND CAPS, ATHLETIC UNIFORMS, IN CLASS 25 (U.S. CLS. 22 AND 39).

FIRST USE 2-8-2012; IN COMMERCE 2-8-2012.

THE MARK CONSISTS OF STANDARD CHARACTERS WITHOUT CLAIM TO ANY PARTICULAR FONT, STYLE, SIZE, OR COLOR.

SN 85-442,817, FILED 10-8-2011.

JACQUELINE A. LAVINE, EXAMINING ATTORNEY



*David J. Kyros*

Director of the United States Patent and Trademark Office

# United States of America

United States Patent and Trademark Office

# DATITUDE

**Reg. No. 4,276,780**

**Registered Jan. 15, 2013**

**Int. Cl.: 25**

**TRADEMARK**

**PRINCIPAL REGISTER**

PICKIN' COTTON COMMUNICATIONS, LLC (DELAWARE LIMITED LIABILITY COMPANY)  
232 IVORY STREET  
LAFAYETTE, LA 70506

FOR: A-SHIRTS; APPAREL FOR DANCERS, NAMELY, TEE SHIRTS, SWEATSHIRTS, PANTS, LEGGINGS, SHORTS AND JACKETS; ATHLETIC APPAREL, NAMELY, SHIRTS, PANTS, JACKETS, FOOTWEAR, HATS AND CAPS, ATHLETIC UNIFORMS; BODY SHIRTS; BUTTON DOWN SHIRTS; BUTTON-FRONT ALOHA SHIRTS; CAMOUFLAGE SHIRTS; CAMP SHIRTS; CLOTHING FOR ATHLETIC USE, NAMELY, PADDED SHIRTS; CLOTHING FOR BABIES, TODDLERS AND CHILDREN, TREATED WITH FIRE AND HEAT RETARDANTS, NAMELY, PAJAMAS, JACKETS, SHIRTS, PANTS, JUMPERS; CLOTHING SHIELDS, NAMELY, PADS APPLIED TO THE UNDERARMS OF SHIRTS, BLOUSES AND SWEATERS; COLLARED SHIRTS; DRESS SHIRTS, IN CLASS 25 (U.S. CLS. 22 AND 39).

FIRST USE 5-15-2012; IN COMMERCE 11-15-2012.

THE MARK CONSISTS OF STANDARD CHARACTERS WITHOUT CLAIM TO ANY PARTICULAR FONT, STYLE, SIZE, OR COLOR.

SN 85-442,896, FILED 10-9-2011.

JAY BESCH, EXAMINING ATTORNEY



*David J. Kyffers*

Director of the United States Patent and Trademark Office

# United States of America

United States Patent and Trademark Office

# MAGISTO

**Reg. No. 4,276,781**

SIGHTERA TECHNOLOGIES LIMITED (ISRAEL LIMITED COMPANY (LTD.))  
3 HAMAZMERA STREET, POB 2038

**Registered Jan. 15, 2013**

NESS-ZIONA, ISRAEL 74120

**Int. Cls.: 9 and 42**

FOR: COMPUTER SOFTWARE FOR VIDEO EDITING, VIDEO PRODUCTION AND VIDEO CREATION; DOWNLOADABLE SOFTWARE IN THE NATURE OF A MOBILE APPLICATION FOR VIDEO EDITING, VIDEO PRODUCTION AND VIDEO CREATION, IN CLASS 9 (U.S. CLS. 21, 23, 26, 36 AND 38).

**TRADEMARK**

**SERVICE MARK**

FIRST USE 7-0-2012; IN COMMERCE 7-0-2012.

**PRINCIPAL REGISTER**

FOR: PROVIDING A WEBSITE FEATURING ON-LINE NON-DOWNLOADABLE SOFTWARE THAT ENABLES USERS TO CREATE, EDIT AND PRODUCE VIDEOS, IN CLASS 42 (U.S. CLS. 100 AND 101).

FIRST USE 7-0-2012; IN COMMERCE 7-0-2012.

THE MARK CONSISTS OF STANDARD CHARACTERS WITHOUT CLAIM TO ANY PARTICULAR FONT, STYLE, SIZE, OR COLOR.

THE WORDING "MAGISTO" HAS NO MEANING IN A FOREIGN LANGUAGE.

SN 85-443,008, FILED 10-10-2011.

AMY KELLY, EXAMINING ATTORNEY



*David J. Kyros*

Director of the United States Patent and Trademark Office

# United States of America

United States Patent and Trademark Office

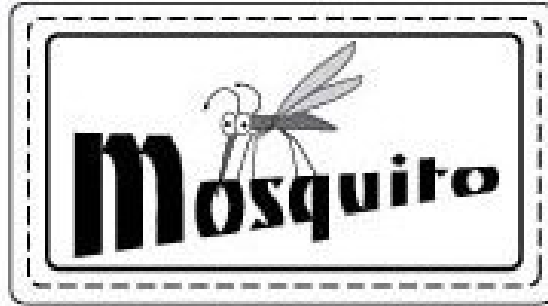

**Reg. No. 4,276,782**

**Registered Jan. 15, 2013**

**Int. Cl.: 18**

**TRADEMARK**

**PRINCIPAL REGISTER**

MELCHERS (H.K) LIMITED (HONG KONG LIMITED LIABILITY COMPANY)  
ROOM 10, 12/F SHUN TAK CENTRE WESTTOWER  
168-200 CONNAUGHT ROAD  
CENTRAL, HONG KONG

FOR: SCHOOL SATCHELS; POCKET WALLETS; SCHOOL BAGS; BAGS FOR CAMPERS AND CLIMBERS IN THE NATURE OF ALL-PURPOSE CARRYING BAGS; SUITCASES; SUITCASE HANDLES; HANDBAGS; HANDBAG FRAMES; PURSES; GARMENT BAGS FOR TRAVEL; TRAVELLING BAGS; VALISES; HAVERSACKS; TRAVELLING TRUNKS; CANVAS SHOPPING BAGS; BEACH BAGS; LUGGAGE TRUNKS; WHEELED SHOPPING BAGS; BACKPACKS, IN CLASS 18 (U.S. CLS. 1, 2, 3, 22 AND 41).

FIRST USE 6-1-2012; IN COMMERCE 8-1-2012.

THE MARK CONSISTS OF A DESIGN FEATURING A STYLIZED MOSQUITO ABOVE THE WORDING "MOSQUITO" WHICH APPEARS INSIDE A RECTANGLE OUTLINED WITH BROKEN LINES OR LINING AND ANOTHER RECTANGLE; THE LINING SHOWN IN THE DRAWING IS A FEATURE OF THE MARK.

SN 85-443,011, FILED 10-10-2011.

AMY KELLY, EXAMINING ATTORNEY



*David J. Kybas*

Director of the United States Patent and Trademark Office

# United States of America

United States Patent and Trademark Office

## IT'S . . . INTUITIVE

**Reg. No. 4,276,783**

**Registered Jan. 15, 2013**

**Int. Cl.: 42**

**SERVICE MARK**

**PRINCIPAL REGISTER**

INTUITIVE RESEARCH AND TECHNOLOGY CORPORATION (TEXAS CORPORATION)  
5030 BRADFORD DRIVE, NW  
BLDG. 2, SUITE 205  
HUNTSVILLE, AL 35805

FOR: SCIENTIFIC RESEARCH AND RELATED CONSULTING SERVICES RENDERED TO GOVERNMENT AND PRIVATE INDUSTRY IN THE AREAS OF NATIONAL SECURITY TECHNOLOGY, NATIONAL DEFENSE, DESIGN AND INTEGRATION, TEST AND EVALUATION, LOGISTICS, FACILITIES ENGINEERING, DEFENSE COMMUNICATIONS, SPACE TRANSPORTATION AND EXPLORATION, SPACE SYSTEMS ANALYSIS, SECURITY SYSTEMS AND SUPPORT, INFORMATION AND COMMUNICATIONS, SYSTEMS ENGINEERING, ENGINEERING ANALYSIS, SYSTEMS SIMULATION AND ANALYSIS, MODELING AND SIMULATION OF PHYSICAL PHENOMENA, TEST PLANNING, TEST REQUIREMENTS ANALYSIS, TEST RESULTS ANALYSIS, SYSTEMS SAFETY AND SURVIVABILITY, ENVIRONMENTAL ANALYSIS, INFORMATION SYSTEMS MANAGEMENT, SOFTWARE ENGINEERING SERVICES, SYSTEMS INTEGRATION SERVICES, DATABASE DEVELOPMENT, CUSTOM SOFTWARE DESIGN AND DEVELOPMENT, MANUFACTURING AND PRODUCTION SYSTEMS ANALYSIS AND SUPPORT, IN CLASS 42 (U.S. CLS. 100 AND 101).

FIRST USE 2-8-2012; IN COMMERCE 4-2-2012.

THE MARK CONSISTS OF STANDARD CHARACTERS WITHOUT CLAIM TO ANY PARTICULAR FONT, STYLE, SIZE, OR COLOR.

SN 85-443,135, FILED 10-10-2011.

GRETTA YAO, EXAMINING ATTORNEY



*David J. Kyjars*

Director of the United States Patent and Trademark Office

# United States of America

United States Patent and Trademark Office

# ÉGARD

**Reg. No. 4,276,784**

**Registered Jan. 15, 2013**

**Int. Cl.: 14**

**TRADEMARK**

**PRINCIPAL REGISTER**

SRULOVICZ, ILAN (UNITED STATES INDIVIDUAL)  
13603 MARINA POINTE DRIVE, APT. C302  
MARINA DEL RAY, CA 90292

FOR: WATCHES, IN CLASS 14 (U.S. CLS. 2, 27, 28 AND 50).

FIRST USE 8-0-2012; IN COMMERCE 8-0-2012.

THE MARK CONSISTS OF STANDARD CHARACTERS WITHOUT CLAIM TO ANY PARTICULAR FONT, STYLE, SIZE, OR COLOR.

THE ENGLISH TRANSLATION OF "EGARD" IN THE MARK IS RESPECT, CONSIDERATION.

SN 85-443,143, FILED 10-10-2011.

JANET LEE, EXAMINING ATTORNEY



*David J. Kyffers*

Director of the United States Patent and Trademark Office

# United States of America

United States Patent and Trademark Office

# TRUALERT

**Reg. No. 4,276,785**

**Registered Jan. 15, 2013**

**Int. Cl.: 9**

**TRADEMARK**

**PRINCIPAL REGISTER**

SANDEL AVIONICS, INC. (CALIFORNIA CORPORATION)  
2401 DOGWOOD WAY  
VISTA, CA 92083

FOR: AIRBORNE AVIONICS SYSTEM AND SOFTWARE FOR TERRAIN AWARENESS COMPRISED OF COMPUTER HARDWARE, COMPUTER SOFTWARE FOR THE ELIMINATION OF FALSE ALERTS, SENSORS, AND AVIONICS SYSTEMS INTERFACE DEVICES WHICH OPERATES BY MEANS OF A MODULAR AVIONICS ARCHITECTURE, IN CLASS 9 (U.S. CLS. 21, 23, 26, 36 AND 38).

FIRST USE 10-4-2012; IN COMMERCE 10-4-2012.

THE MARK CONSISTS OF STANDARD CHARACTERS WITHOUT CLAIM TO ANY PARTICULAR FONT, STYLE, SIZE, OR COLOR.

SN 85-443,231, FILED 10-10-2011.

MARGERY A. TIERNEY, EXAMINING ATTORNEY



*David J. Kyffers*

Director of the United States Patent and Trademark Office

# United States of America

United States Patent and Trademark Office

# WELL-KEPT.

**Reg. No. 4,276,786**

**Registered Jan. 15, 2013**

**Int. Cl.: 3**

**TRADEMARK**

**PRINCIPAL REGISTER**

WELL-KEPT, LLC (GEORGIA LIMITED LIABILITY COMPANY)  
UNIT 109  
7500 ROSWELL ROAD  
ATLANTA, GA 30350

FOR: DISPOSABLE WIPES IMPREGNATED WITH CLEANSING CHEMICALS OR COMPOUNDS FOR USE TO CLEAN PHONES AND COMPUTER SCREENS, IN CLASS 3 (U.S. CLS. 1, 4, 6, 50, 51 AND 52).

FIRST USE 11-23-2011; IN COMMERCE 11-23-2011.

THE MARK CONSISTS OF STANDARD CHARACTERS WITHOUT CLAIM TO ANY PARTICULAR FONT, STYLE, SIZE, OR COLOR.

SN 85-443,445, FILED 10-10-2011.

GEOFFREY FOSDICK, EXAMINING ATTORNEY



*David J. Kybas*

Director of the United States Patent and Trademark Office



# United States of America

United States Patent and Trademark Office

## PATENT PENDING

**Reg. No. 4,276,787**

WITCHEY, NICHOLAS J. (UNITED STATES INDIVIDUAL)  
24832 HON AVENUE  
LAGUNA HILLS, CA 92653

**Registered Jan. 15, 2013**

**Int. Cl.: 28**

FOR: CARD GAMES, IN CLASS 28 (U.S. CLS. 22, 23, 38 AND 50).

**TRADEMARK**

FIRST USE 10-9-2012; IN COMMERCE 10-9-2012.

**PRINCIPAL REGISTER**

THE MARK CONSISTS OF STANDARD CHARACTERS WITHOUT CLAIM TO ANY PARTICULAR FONT, STYLE, SIZE, OR COLOR.

SN 85-443,603, FILED 10-10-2011.

DEZMONA MIZELLE, EXAMINING ATTORNEY



*David J. Kyffers*

Director of the United States Patent and Trademark Office

# United States of America

United States Patent and Trademark Office

## JAMES NORMAN

**Reg. No. 4,276,788**

JAMES NORMAN LTD. (NEW YORK CORPORATION)  
218-A SOUTH VAN BRUNT STREET  
ENGLEWOOD, NJ 07631

**Registered Jan. 15, 2013**

**Int. Cl.: 34**

FOR: CIGARS, IN CLASS 34 (U.S. CLS. 2, 8, 9 AND 17).

**TRADEMARK**

FIRST USE 11-12-2012; IN COMMERCE 11-12-2012.

**PRINCIPAL REGISTER**

THE MARK CONSISTS OF STANDARD CHARACTERS WITHOUT CLAIM TO ANY PARTICULAR FONT, STYLE, SIZE, OR COLOR.

THE NAME(S), PORTRAIT(S), AND/OR SIGNATURE(S) SHOWN IN THE MARK DOES NOT IDENTIFY A PARTICULAR LIVING INDIVIDUAL.

SN 85-443,696, FILED 10-10-2011.

KAPIL BHANOT, EXAMINING ATTORNEY



*David J. Kyffers*

Director of the United States Patent and Trademark Office

# United States of America

United States Patent and Trademark Office

## MASTERS OF ILLUSION

**Reg. No. 4,276,789**

MASTERS OF ILLUSION, LLC (DELAWARE LIMITED LIABILITY COMPANY)  
4401 WILSHIRE BOULEVARD  
LOS ANGELES, CA 90011

**Registered Jan. 15, 2013**

**Int. Cl.: 25**

FOR: APPAREL, NAMELY, SHIRTS AND HATS, IN CLASS 25 (U.S. CLS. 22 AND 39).

**TRADEMARK**

FIRST USE 9-16-2011; IN COMMERCE 1-21-2012.

**PRINCIPAL REGISTER**

THE MARK CONSISTS OF STANDARD CHARACTERS WITHOUT CLAIM TO ANY PARTICULAR FONT, STYLE, SIZE, OR COLOR.

OWNER OF U.S. REG. NO. 4,001,900.

NO CLAIM IS MADE TO THE EXCLUSIVE RIGHT TO USE "ILLUSION", APART FROM THE MARK AS SHOWN.

SN 85-443,802, FILED 10-10-2011.

NAPOLEON SHARMA, EXAMINING ATTORNEY



*David J. Kyffers*

Director of the United States Patent and Trademark Office

# United States of America

United States Patent and Trademark Office

## SANTAL MAJUSCULE

**Reg. No. 4,276,790**

**Registered Jan. 15, 2013**

**Int. Cl.: 3**

**TRADEMARK**

**PRINCIPAL REGISTER**

SHISEIDO COMPANY, LIMITED (JAPAN CORPORATION)  
7-5-5 GINZA, CHUO-KU  
TOKYO, JAPAN 104-0061

FOR: PERFUMERIES, IN CLASS 3 (U.S. CLS. 1, 4, 6, 50, 51 AND 52).

FIRST USE 9-0-2012; IN COMMERCE 9-0-2012.

THE MARK CONSISTS OF STANDARD CHARACTERS WITHOUT CLAIM TO ANY PARTICULAR FONT, STYLE, SIZE, OR COLOR.

NO CLAIM IS MADE TO THE EXCLUSIVE RIGHT TO USE "SANTAL", APART FROM THE MARK AS SHOWN.

THE ENGLISH TRANSLATION OF "SANTAL MAJUSCULE" IN THE MARK IS SANDALWOOD CAPITAL.

SN 85-443,928, FILED 10-11-2011.

KATHRYN COWARD, EXAMINING ATTORNEY



*David J. Kybas*

Director of the United States Patent and Trademark Office

# United States of America

United States Patent and Trademark Office

## SEEDMOMMY

**Reg. No. 4,276,791**

**Registered Jan. 15, 2013**

**Int. Cl.: 35**

**SERVICE MARK**

**PRINCIPAL REGISTER**

MARKET MOMMIES, LLC (OHIO LIMITED LIABILITY COMPANY)  
1872 BERKSHIRE ROAD  
COLUMBUS, OH 43221

FOR: PROVIDING A WEBSITE FEATURING INFORMATION, NEWS, LINKS, DISCUSSION FORUM, AND ADVICE IN THE FIELD OF MOTHER OWNED BUSINESSES; ADVERTISING AND DIRECTORY SERVICES, NAMELY, PROMOTING THE SERVICES OF MOTHER OWNED BUSINESSES BY PROVIDING A WEB PAGE FEATURING ADVERTISEMENTS AND LINKS TO THE WEBSITES OF OTHERS, IN CLASS 35 (U.S. CLS. 100, 101 AND 102).

FIRST USE 1-1-2012; IN COMMERCE 1-1-2012.

THE MARK CONSISTS OF STANDARD CHARACTERS WITHOUT CLAIM TO ANY PARTICULAR FONT, STYLE, SIZE, OR COLOR.

SN 85-444,136, FILED 10-11-2011.

JAY FLOWERS, EXAMINING ATTORNEY



*David J. Kyros*

Director of the United States Patent and Trademark Office

# United States of America

United States Patent and Trademark Office

# REALTONE

**Reg. No. 4,276,792**

SDI TECHNOLOGIES INC. (DELAWARE CORPORATION)  
1299 MAIN STREET  
RAHWAY, NJ 07065

**Registered Jan. 15, 2013**

**Int. Cls.: 9 and 14**

FOR: AUDIO SPEAKERS; HEADPHONES; RADIOS INCORPORATING CLOCKS, IN CLASS 9 (U.S. CLS. 21, 23, 26, 36 AND 38).

**TRADEMARK**

FIRST USE 0-0-1957; IN COMMERCE 0-0-1957.

**PRINCIPAL REGISTER**

FOR: ALARM CLOCKS; CLOCKS INCORPORATING RADIOS, IN CLASS 14 (U.S. CLS. 2, 27, 28 AND 50).

FIRST USE 0-0-1957; IN COMMERCE 0-0-1957.

THE MARK CONSISTS OF STANDARD CHARACTERS WITHOUT CLAIM TO ANY PARTICULAR FONT, STYLE, SIZE, OR COLOR.

OWNER OF U.S. REG. NO. 673,794.

SN 85-444,146, FILED 10-11-2011.

WON TEAK OH, EXAMINING ATTORNEY



*David J. Kyfos*

Director of the United States Patent and Trademark Office

# United States of America

United States Patent and Trademark Office

**SIR APE**

**Reg. No. 4,276,793**

MILLER, CRAIG A (UNITED STATES INDIVIDUAL)  
1774 HISTORIC DECATUR RD  
SAN DIEGO, CA 92106

**Registered Jan. 15, 2013**

**Int. Cl.: 25**

FOR: BOTTOMS; FOOTWEAR; HATS; HEADWEAR; PANTS; SHIRTS; SHOES; SHORTS;  
SWEATSHIRTS; TOPS; WRISTBANDS, IN CLASS 25 (U.S. CLS. 22 AND 39).

**TRADEMARK**

FIRST USE 7-0-2012; IN COMMERCE 7-0-2012.

**PRINCIPAL REGISTER**

THE MARK CONSISTS OF THE STYLIZED WORDING "SIR APE".

SN 85-444,224, FILED 10-11-2011.

GEORGE LORENZO, EXAMINING ATTORNEY



*David J. Kyffers*

Director of the United States Patent and Trademark Office

# United States of America

United States Patent and Trademark Office

## YOU BRING IT HOME

**Reg. No. 4,276,794**

CAJUN FUNDING CORP. (DELAWARE CORPORATION)  
980 HAMMOND DRIVE, SUITE 1100  
ATLANTA, GA 30328

**Registered Jan. 15, 2013**

**Int. Cls.: 29, 30, and 43**

FOR: CHICKEN; PREPARED MEALS CONSISTING PRIMARILY OF CHICKEN, IN CLASS 29 (U.S. CL. 46).

**TRADEMARK**

FIRST USE 10-8-2012; IN COMMERCE 10-8-2012.

**SERVICE MARK**

FOR: PREPARED MEALS CONSISTING PRIMARILY OF PASTAS, RICE, AND POTATOES WITH SIDE DISHES AND BEVERAGES, IN CLASS 30 (U.S. CL. 46).

**PRINCIPAL REGISTER**

FIRST USE 10-8-2012; IN COMMERCE 10-8-2012.

FOR: RESTAURANT SERVICES, IN CLASS 43 (U.S. CLS. 100 AND 101).

FIRST USE 10-8-2012; IN COMMERCE 10-8-2012.

THE MARK CONSISTS OF STANDARD CHARACTERS WITHOUT CLAIM TO ANY PARTICULAR FONT, STYLE, SIZE, OR COLOR.

SN 85-444,301, FILED 10-11-2011.

FRED CARL, EXAMINING ATTORNEY



*David J. Kyros*

Director of the United States Patent and Trademark Office



# United States of America

United States Patent and Trademark Office

# PhytoMulti

**Reg. No. 4,276,795**

METAGENICS, INC. (DELAWARE CORPORATION)  
25 ENTERPRISE, SUITE 200  
ALISO VIEJO, CA 92656

**Registered Jan. 15, 2013**

**Int. Cl.: 5**

FOR: DIETARY SUPPLEMENTS, IN CLASS 5 (U.S. CLS. 6, 18, 44, 46, 51 AND 52).

**TRADEMARK**

FIRST USE 12-16-2011; IN COMMERCE 12-16-2011.

**PRINCIPAL REGISTER**

THE MARK CONSISTS OF STANDARD CHARACTERS WITHOUT CLAIM TO ANY PARTICULAR FONT, STYLE, SIZE, OR COLOR.

SN 85-444,361, FILED 10-11-2011.

CORY BOONE, EXAMINING ATTORNEY



*David J. Kyffers*

Director of the United States Patent and Trademark Office

# United States of America

United States Patent and Trademark Office

# BRISE

**Reg. No. 4,276,796**

**Registered Jan. 15, 2013**

**Int. Cls.: 6 and 19**

**TRADEMARK**

**PRINCIPAL REGISTER**

MASONITE INTERNATIONAL CORPORATION (CANADA CORPORATION)  
2771 RUTHERFORD ROAD  
CONCORD, ONTARIO, CANADA L4K2N6

FOR: DOOR LITES, SIDE LITES AND TRANSOM LITES IN THE NATURE OF GLASS AND PLASTIC PANELS WHICH ARE SOLD AS AN INTEGRAL COMPONENT OF METAL ENTRY DOORS AND DOOR ENTRANCEWAYS, IN CLASS 6 (U.S. CLS. 2, 12, 13, 14, 23, 25 AND 50).

FIRST USE 7-30-2012; IN COMMERCE 7-30-2012.

FOR: DOOR LITES, SIDE LITES AND TRANSOM LITES, ALL IN THE NATURE OF GLASS AND PLASTIC PANELS FOR DOORS AND DOOR ENTRANCEWAYS; DOOR LITES, SIDE LITES AND TRANSOM LITES IN THE NATURE OF GLASS AND PLASTIC PANELS WHICH ARE SOLD AS AN INTEGRAL COMPONENT OF NON-METAL ENTRY DOORS AND DOOR ENTRANCEWAYS, IN CLASS 19 (U.S. CLS. 1, 12, 33 AND 50).

FIRST USE 7-30-2012; IN COMMERCE 7-30-2012.

THE MARK CONSISTS OF STANDARD CHARACTERS WITHOUT CLAIM TO ANY PARTICULAR FONT, STYLE, SIZE, OR COLOR.

SN 85-444,390, FILED 10-11-2011.

ALLISON SCHRODY, EXAMINING ATTORNEY



*David J. Kybas*

Director of the United States Patent and Trademark Office

# United States of America

United States Patent and Trademark Office

## ATTACK OF THE 50 FT ORANGE

**Reg. No. 4,276,797**

MURPHY OIL USA, INC. (DELAWARE CORPORATION)  
200 PEACH STREET  
EL DORADO, AZ 71730

**Registered Jan. 15, 2013**

**Int. Cl.: 32**

FOR: NON-ALCOHOLIC BEVERAGES, NAMELY, CARBONATED BEVERAGES, IN CLASS 32 (U.S. CLS. 45, 46 AND 48).

**TRADEMARK**

FIRST USE 1-31-2012; IN COMMERCE 1-31-2012.

**PRINCIPAL REGISTER**

THE MARK CONSISTS OF STANDARD CHARACTERS WITHOUT CLAIM TO ANY PARTICULAR FONT, STYLE, SIZE, OR COLOR.

SN 85-444,402, FILED 10-11-2011.

ANDREA BUTLER, EXAMINING ATTORNEY



*David J. Kybas*

Director of the United States Patent and Trademark Office

# United States of America

United States Patent and Trademark Office

## CANADREAM

**Reg. No. 4,276,798**

CANADREAM CORPORATION (CANADA CORPORATION)  
2510 - 27TH STREET NE

**Registered Jan. 15, 2013**

CALGARY, ALBERTA, CANADA T1Y7G1

**Int. Cls.: 9, 12, 35, 37, 39,  
and 43**

FOR: (BASED ON USE IN COMMERCE) COMPUTER SOFTWARE FOR THE TRANSMISSION OF MAPS, DIRECTIONS AND TRAVEL RESERVATION INFORMATION TO MOBILE TELEPHONES; (BASED ON 44(E)) CALCULATORS; FRIDGE MAGNETS; MOUSEPADS, IN CLASS 9 (U.S. CLS. 21, 23, 26, 36 AND 38).

**TRADEMARK**

FIRST USE 3-10-2011; IN COMMERCE 3-10-2011.

**SERVICE MARK**

FOR: (BASED ON 44(E)) MOTOR HOMES; RECREATIONAL VEHICLES, NAMELY, CAMPERS; TRAILERS; VANS, IN CLASS 12 (U.S. CLS. 19, 21, 23, 31, 35 AND 44).

**PRINCIPAL REGISTER**

FOR: (BASED ON 44(E)) RETAIL STORE SERVICES FEATURING RECREATIONAL VEHICLES MANUFACTURED BY OTHERS, NAMELY, MOTOR HOMES, VANS, CAMPERS, TRUCK CAMPERS, IN CLASS 35 (U.S. CLS. 100, 101 AND 102).

FOR: (BASED ON 44(E)) MAINTENANCE AND/OR REPAIR OF RECREATIONAL VEHICLES MANUFACTURED BY OTHERS, NAMELY, MOTOR HOMES, VANS, CAMPERS, TRUCK CAMPERS, IN CLASS 37 (U.S. CLS. 100, 103 AND 106).

FOR: (BASED ON 44(E)) LEASING OF MOTOR VEHICLES; LEASING OF VEHICLES; RENTAL OF MOTOR HOMES; TRAVEL AGENCY SERVICES, NAMELY, MAKING RESERVATIONS AND BOOKINGS FOR TRANSPORTATION, IN CLASS 39 (U.S. CLS. 100 AND 105).

FOR: (BASED ON 44(E)) TRAVEL AGENCY SERVICES, NAMELY, MAKING RESERVATIONS AND BOOKING FOR TEMPORARY LODGING; TRAVEL AGENCY SERVICES, NAMELY, MAKING RESERVATIONS AND BOOKINGS FOR RESTAURANTS AND MEALS, IN CLASS 43 (U.S. CLS. 100 AND 101).

THE MARK CONSISTS OF STANDARD CHARACTERS WITHOUT CLAIM TO ANY PARTICULAR FONT, STYLE, SIZE, OR COLOR.

OWNER OF CANADA REG. NO. TMA655391, DATED 12-19-2005, EXPIRES 12-19-2020.



*David J. Kyros*

Director of the United States Patent and Trademark Office

**Reg. No. 4,276,798** SN 85-444,562, FILED 10-11-2011.

WON TEAK OH, EXAMINING ATTORNEY

# United States of America

United States Patent and Trademark Office

## ABSOLUTELY FAMOUS

**Reg. No. 4,276,799**

**Registered Jan. 15, 2013**

**Int. Cl.: 25**

**TRADEMARK**

**PRINCIPAL REGISTER**

TURN ON PRODUCTS INC. (NEW YORK CORPORATION)  
19TH FLOOR  
270 WEST 38TH STREET  
NEW YORK, NY 10018

FOR: CLOTHING, NAMELY, LADIES' AND GIRLS' SLACKS, PANTS, TANK TOPS, SHORTS, VESTS, JACKETS, BLAZERS, BLOUSES, T-SHIRTS, DRESSES, SKIRTS AND COATS, IN CLASS 25 (U.S. CLS. 22 AND 39).

FIRST USE 10-0-2011; IN COMMERCE 10-0-2011.

THE MARK CONSISTS OF STANDARD CHARACTERS WITHOUT CLAIM TO ANY PARTICULAR FONT, STYLE, SIZE, OR COLOR.

SN 85-444,704, FILED 10-11-2011.

TRACY CROSS, EXAMINING ATTORNEY



*David J. Kyffers*

Director of the United States Patent and Trademark Office

# United States of America

United States Patent and Trademark Office



**Reg. No. 4,276,800**

GUO, TZER-HUANG (TAIWAN INDIVIDUAL)  
NO. 57, LI JING 1ST ST., CHIDU CHIU  
KEELUNG CITY, TAIWAN

**Registered Jan. 15, 2013**

**Int. Cl.: 21**

FOR: CUPS, IN CLASS 21 (U.S. CLS. 2, 13, 23, 29, 30, 33, 40 AND 50).

**TRADEMARK**

FIRST USE 1-1-2008; IN COMMERCE 6-1-2012.

**PRINCIPAL REGISTER**

THE MARK CONSISTS OF THE WORD "SANDWICH CUP" WITH A STAR ATOP OF THE LETTER "I" AND AN UNDERLINE FROM THE LETTER "S" TO THE LETTER "U".

SN 85-444,962, FILED 10-11-2011.

CARYN GLASSER, EXAMINING ATTORNEY



*David J. Kyjars*

Director of the United States Patent and Trademark Office

# United States of America

United States Patent and Trademark Office

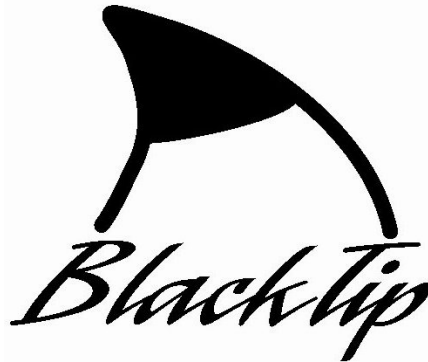

**Reg. No. 4,276,801**

**Registered Jan. 15, 2013**

**Int. Cl.: 9**

**TRADEMARK**

**PRINCIPAL REGISTER**

FITPOWDER LLC (ILLINOIS LIMITED LIABILITY COMPANY)  
26W400 CHURCHILL ROAD  
WINFIELD, IL 60190

FOR: COMPUTER DOCKING STATION, IN CLASS 9 (U.S. CLS. 21, 23, 26, 36 AND 38).

FIRST USE 3-28-2012; IN COMMERCE 3-28-2012.

THE MARK CONSISTS OF A FIN WITH A BLACK TIP AND THE WORDS "BLACKTIP" APPEARING AT THE BASE OF THE FIN.

SN 85-445,075, FILED 10-12-2011.

RAUL CORDOVA, EXAMINING ATTORNEY



*David J. Kyffers*

Director of the United States Patent and Trademark Office



**United States of America**  
United States Patent and Trademark Office

# Scummbag

**Reg. No. 4,276,802**

**Registered Jan. 15, 2013**

**Int. Cl.: 25**

**TRADEMARK**

**PRINCIPAL REGISTER**

LEBARD, MICHAEL (UNITED STATES INDIVIDUAL), DBA SCUMMBAG,  
14145 EATON HOLLOW CT.  
MOORPARK, CA 93021 AND

MORRISON, COLIN (UNITED STATES INDIVIDUAL), DBA SCUMMBAG,  
4441 CEDARGLEN CT.  
MOORPARK, CA 93021

FOR: SWEAT SHIRTS; T-SHIRTS, IN CLASS 25 (U.S. CLS. 22 AND 39).

FIRST USE 8-1-2012; IN COMMERCE 8-1-2012.

THE MARK CONSISTS OF STANDARD CHARACTERS WITHOUT CLAIM TO ANY PARTICULAR FONT, STYLE, SIZE, OR COLOR.

SN 85-445,138, FILED 10-12-2011.

TINA MAI, EXAMINING ATTORNEY



*David J. Kyros*

Director of the United States Patent and Trademark Office

# United States of America

United States Patent and Trademark Office



**Reg. No. 4,276,803**

FITPOWDER LLC (ILLINOIS LIMITED LIABILITY COMPANY)  
26W400 CHURCHILL ROAD  
WINFIELD, IL 60190

**Registered Jan. 15, 2013**

**Int. Cl.: 9**

FOR: COMPUTER DOCKING STATION, IN CLASS 9 (U.S. CLS. 21, 23, 26, 36 AND 38).

**TRADEMARK**

FIRST USE 3-28-2012; IN COMMERCE 3-28-2012.

**PRINCIPAL REGISTER**

THE MARK CONSISTS OF AN OUTLINE OF A SHARK BODY WITH THE WORDING "BLACKTIP" FORMING A PORTION OF THE BODY.

SN 85-445,194, FILED 10-12-2011.

RAUL CORDOVA, EXAMINING ATTORNEY



*David J. Kyffers*

Director of the United States Patent and Trademark Office

# United States of America

United States Patent and Trademark Office

## LABQUEST VIEWER

**Reg. No. 4,276,804**

VERNIER SOFTWARE & TECHNOLOGY, LLC (OREGON LIMITED LIABILITY COMPANY)  
13979 SW MILLIKAN WAY  
BEAVERTON, OR 970052886

**Registered Jan. 15, 2013**

**Int. Cl.: 9**

FOR: COMPUTER SOFTWARE FOR SCREEN SHARING THAT ALLOWS SIMULTANEOUS VIEWING AND REMOTE CONTROL OF INTERFACE DEVICES USED TO COLLECT AND ANALYZE DATA IN ELEMENTARY SCHOOL, JUNIOR HIGH SCHOOL, HIGH SCHOOL AND COLLEGE SCIENCE AND MATH LABORATORIES AND CLASSROOMS, IN CLASS 9 (U.S. CLS. 21, 23, 26, 36 AND 38).

**TRADEMARK**

**PRINCIPAL REGISTER**

FIRST USE 3-1-2012; IN COMMERCE 3-1-2012.

THE MARK CONSISTS OF STANDARD CHARACTERS WITHOUT CLAIM TO ANY PARTICULAR FONT, STYLE, SIZE, OR COLOR.

NO CLAIM IS MADE TO THE EXCLUSIVE RIGHT TO USE "VIEWER", APART FROM THE MARK AS SHOWN.

SN 85-445,385, FILED 10-12-2011.

LEIGH LOWRY, EXAMINING ATTORNEY



*David J. Kyfos*

Director of the United States Patent and Trademark Office

# United States of America

United States Patent and Trademark Office



**Reg. No. 4,276,805**

**Registered Jan. 15, 2013**

**Int. Cl.: 42**

**SERVICE MARK**

**PRINCIPAL REGISTER**

INTERACTIVE SCHEDULE, INC. (ILLINOIS CORPORATION)  
3639 N. HERMITAGE AVENUE  
CHICAGO, IL 60613

FOR: COMPUTER SERVICES, NAMELY, HOSTING AN INTERACTIVE WEB SITE THAT ALLOWS USERS TO PUBLISH, SHARE, ORGANIZE, ITEMIZE AND ENTER WORK, VACATION, AND PERSONAL SCHEDULES, IN CLASS 42 (U.S. CLS. 100 AND 101).

FIRST USE 5-1-2012; IN COMMERCE 9-1-2012.

NO CLAIM IS MADE TO THE EXCLUSIVE RIGHT TO USE "INTERACTIVE SCHEDULE.COM", APART FROM THE MARK AS SHOWN.

THE MARK CONSISTS OF A CALENDAR WITH A CIRCULAR ARROW NEXT TO THE WORDS "INTERACTIVE SCHEDULE.COM". THE WORDING "SCHEDULE.COM" APPEARS IN RECTANGLE DESIGN.

SN 85-445,455, FILED 10-12-2011.

DANIEL CAPSHAW, EXAMINING ATTORNEY



*David J. Kyros*

Director of the United States Patent and Trademark Office

# United States of America

United States Patent and Trademark Office

## THERE'S AN MBA FOR THAT

**Reg. No. 4,276,806**

**Registered Jan. 15, 2013**

**Int. Cl.: 41**

**SERVICE MARK**

**PRINCIPAL REGISTER**

CLEVELAND STATE UNIVERSITY (OHIO STATE UNIVERSITY)  
2121 EUCLID AVENUE  
AC 327  
CLEVELAND, OH 441152214

FOR: PROVIDING COURSES OF INSTRUCTION AT THE GRADUATE AND POST-GRADUATE LEVEL, IN CLASS 41 (U.S. CLS. 100, 101 AND 107).

FIRST USE 4-0-2012; IN COMMERCE 4-0-2012.

THE MARK CONSISTS OF STANDARD CHARACTERS WITHOUT CLAIM TO ANY PARTICULAR FONT, STYLE, SIZE, OR COLOR.

SN 85-445,594, FILED 10-12-2011.

DAVID HOFFMAN, EXAMINING ATTORNEY



*David J. Kyffers*

Director of the United States Patent and Trademark Office

# United States of America

United States Patent and Trademark Office



**Reg. No. 4,276,807**

**Registered Jan. 15, 2013**

**Int. Cls.: 11 and 43**

**TRADEMARK**

**SERVICE MARK**

**PRINCIPAL REGISTER**

THE CULT WINE GROUP, INC. (MARYLAND CORPORATION), DBA E VINO,  
SUITE 111  
11201 DOLFIELD BLVD.  
OWINGS MILLS, MD 21117

FOR: REFRIGERATED BEVERAGE DISPENSING UNITS, IN CLASS 11 (U.S. CLS. 13, 21, 23, 31 AND 34).

FIRST USE 8-30-2011; IN COMMERCE 7-17-2012.

FOR: RENTAL OF DRINK DISPENSING MACHINES, IN CLASS 43 (U.S. CLS. 100 AND 101).

FIRST USE 8-30-2011; IN COMMERCE 7-17-2012.

NO CLAIM IS MADE TO THE EXCLUSIVE RIGHT TO USE "VINO", APART FROM THE MARK AS SHOWN.

THE MARK CONSISTS OF THE LETTER "E" AND THE WORD "VINO" IN CURSIVE WRITING. A DRAWING OF A WINE GLASS IS INCORPORATED AS PART OF THE BOTTOM OF THE LETTER "E".

SN 85-445,722, FILED 10-12-2011.

DARRYL SPRUILL, EXAMINING ATTORNEY



*David J. Kybas*

Director of the United States Patent and Trademark Office

# United States of America

United States Patent and Trademark Office

# BUG GUARD

**Reg. No. 4,276,808**

AGRONO-TEC SEED CO. (UTAH CORPORATION)  
5530 MOUNTAIN VIEW DR.  
MORGAN, UT 84050

**Registered Jan. 15, 2013**

**Int. Cl.: 31**

FOR: GRASS SEED AND GRASS SOD, IN CLASS 31 (U.S. CLS. 1 AND 46).

**TRADEMARK**

FIRST USE 9-0-2011; IN COMMERCE 9-0-2011.

**PRINCIPAL REGISTER**

THE MARK CONSISTS OF STANDARD CHARACTERS WITHOUT CLAIM TO ANY PARTICULAR FONT, STYLE, SIZE, OR COLOR.

NO CLAIM IS MADE TO THE EXCLUSIVE RIGHT TO USE "BUG", APART FROM THE MARK AS SHOWN.

SN 85-445,745, FILED 10-12-2011.

CHRISTOPHER BUONGIORNO, EXAMINING ATTORNEY



*David J. Kyffers*

Director of the United States Patent and Trademark Office

United States of America  
United States Patent and Trademark Office

*InfinySim*  
LA PRÉCISION

**Reg. No. 4,276,809**

NISIMA, RODOLPHE (MARTINIQUE INDIVIDUAL)  
QUARTIER BALLEU

**Registered Jan. 15, 2013**

LE LAMENTIN, MARTINIQUE 97232

**Int. Cl.: 9**

FOR: OPHTHALMIC LENSES, IN CLASS 9 (U.S. CLS. 21, 23, 26, 36 AND 38).

**TRADEMARK**

FIRST USE 5-15-2012; IN COMMERCE 5-15-2012.

**PRINCIPAL REGISTER**

THE MARK CONSISTS OF THE STYLIZED WORDS "INFINYSIM LA PRÉCISION" WITH A HORIZONTAL CURVED LINE UNDERNEATH THE WORDS "LA PRÉCISION".

THE ENGLISH TRANSLATION OF "LA PRÉCISION" IN THE MARK IS "THE PRECISION". THE WORDING "INFINYSIM" HAS NO MEANING IN A FOREIGN LANGUAGE.

SN 85-445,880, FILED 10-12-2011.

ANDREW RHIM, EXAMINING ATTORNEY



*David J. Kybas*

Director of the United States Patent and Trademark Office



# United States of America

United States Patent and Trademark Office

## DUO FEEDER

**Reg. No. 4,276,810**

FATA HUNTER, INC. (DELAWARE CORPORATION)  
1040 IOWA AVE., STE. 100  
RIVERSIDE, CA 92507

**Registered Jan. 15, 2013**

**Int. Cl.: 7**

FOR: MACHINERY PART, NAMELY, METAL WIRE FEEDER FOR METAL CASTING MACHINES FOR REFINING GRAIN OF CAST METAL, IN CLASS 7 (U.S. CLS. 13, 19, 21, 23, 31, 34 AND 35).

**TRADEMARK**

FIRST USE 5-11-2012; IN COMMERCE 5-11-2012.

**PRINCIPAL REGISTER**

THE MARK CONSISTS OF STANDARD CHARACTERS WITHOUT CLAIM TO ANY PARTICULAR FONT, STYLE, SIZE, OR COLOR.

NO CLAIM IS MADE TO THE EXCLUSIVE RIGHT TO USE "FEEDER", APART FROM THE MARK AS SHOWN.

SN 85-446,032, FILED 10-12-2011.

JEAN IM, EXAMINING ATTORNEY



*David J. Kyfos*

Director of the United States Patent and Trademark Office

# United States of America

United States Patent and Trademark Office

## AMELIA'S FARM

**Reg. No. 4,276,811**

KNOCKEMSTIFF LLC (TEXAS LIMITED LIABILITY COMPANY)  
6032 DELOACHE AVE  
DALLAS, TX 75208

**Registered Jan. 15, 2013**

**Int. Cl.: 31**

FOR: FRESH TOMATOES; FRESH CUCUMBERS; FRESH BASIL; FRESH PEPPERS, IN CLASS 31 (U.S. CLS. 1 AND 46).

**TRADEMARK**

FIRST USE 9-29-2012; IN COMMERCE 9-29-2012.

**PRINCIPAL REGISTER**

THE MARK CONSISTS OF STANDARD CHARACTERS WITHOUT CLAIM TO ANY PARTICULAR FONT, STYLE, SIZE, OR COLOR.

NO CLAIM IS MADE TO THE EXCLUSIVE RIGHT TO USE "FARM", APART FROM THE MARK AS SHOWN.

SN 85-446,161, FILED 10-13-2011.

LESLEY LAMOTHE, EXAMINING ATTORNEY



*David J. Kybas*

Director of the United States Patent and Trademark Office

# United States of America

United States Patent and Trademark Office



**Reg. No. 4,276,812**

**Registered Jan. 15, 2013**

**Int. Cl.: 44**

**SERVICE MARK**

**PRINCIPAL REGISTER**

MEMORIAL HERMANN HOSPITAL SYSTEM (TEXAS CORPORATION)  
929 GESSNER ROAD  
SUITE 2700  
HOUSTON, TX 77024

FOR: HEALTH CARE SERVICES, IN CLASS 44 (U.S. CLS. 100 AND 101).

FIRST USE 9-11-2012; IN COMMERCE 9-11-2012.

OWNER OF U.S. REG. NOS. 2,445,784, 3,387,481, AND OTHERS.

NO CLAIM IS MADE TO THE EXCLUSIVE RIGHT TO USE "MEMORIAL" AND "PHYSICIANS. HEALTH SOLUTIONS.", APART FROM THE MARK AS SHOWN.

THE MARK CONSISTS OF THE WORD "ONE" IN LOWERCASE LETTERS, IN WHICH THE "O" IS REPRESENTED BY A SPHERE RECEIVING LIGHT ON THE UPPER LEFT HAND PORTION, TO THE LEFT OF THE WORD "MEMORIAL" STACKED UPON THE WORD "HERMANN" WHICH ALONG WITH THE "NE" FROM THE WORD "ONE" IS ABOVE THE PHRASE "CARE DELIVERY. PHYSICIANS. HEALTH SOLUTIONS.", WHICH IS ALL ABOVE AN ARC DESCENDING FROM THE SPHERE AND SWOOPING UNDER ALL THE WORDS AND PHRASES.

SN 85-446,405, FILED 10-13-2011.

ANNE FARRELL, EXAMINING ATTORNEY



*David J. Kyjars*

Director of the United States Patent and Trademark Office

# United States of America

United States Patent and Trademark Office

## LEADING THE WAY AGAINST GERMS

**Reg. No. 4,276,813**

PREVENTREX, INC. (FLORIDA CORPORATION)

**Registered Jan. 15, 2013**

6860 GULFPORT BLVD., SUITE 144  
ST. PETERSBURG, FL 33707

**Int. Cl.: 37**

FOR: SANITATION SERVICES, NAMELY, SANITIZING AND DISINFECTING SURFACES OF BUILDING STRUCTURES AND EQUIPMENT AND FIXTURES WITHIN BUILDING STRUCTURES, IN CLASS 37 (U.S. CLS. 100, 103 AND 106).

**SERVICE MARK**

FIRST USE 10-13-2011; IN COMMERCE 10-13-2011.

**PRINCIPAL REGISTER**

THE MARK CONSISTS OF STANDARD CHARACTERS WITHOUT CLAIM TO ANY PARTICULAR FONT, STYLE, SIZE, OR COLOR.

SN 85-446,418, FILED 10-13-2011.

MAYUR VAGHANI, EXAMINING ATTORNEY



*David J. Kyros*

Director of the United States Patent and Trademark Office

# United States of America

United States Patent and Trademark Office

# MICROEDGE

**Reg. No. 4,276,814**

**Registered Jan. 15, 2013**

**Int. Cl.: 11**

**TRADEMARK**

**PRINCIPAL REGISTER**

WHIRLPOOL PROPERTIES, INC. (MICHIGAN CORPORATION)  
SUITE 101  
500 RENAISSANCE DRIVE  
ST. JOSEPH, MI 49085

FOR: REFRIGERATOR FEATURE, NAMELY, SPILL CONTROL SHELVES, IN CLASS 11  
(U.S. CLS. 13, 21, 23, 31 AND 34).

FIRST USE 5-1-2012; IN COMMERCE 5-1-2012.

THE MARK CONSISTS OF STANDARD CHARACTERS WITHOUT CLAIM TO ANY PARTICULAR FONT, STYLE, SIZE, OR COLOR.

SN 85-446,481, FILED 10-13-2011.

ELLEN B. AWRICH, EXAMINING ATTORNEY



*David J. Kyffers*

Director of the United States Patent and Trademark Office

# United States of America

United States Patent and Trademark Office

# Sol Zest

**Reg. No. 4,276,815**

DNE WORLD FRUIT LLC (FLORIDA LIMITED LIABILITY COMPANY)  
1900 OLD DIXIE HIGHWAY  
FORT PIERCE, FL 34946

**Registered Jan. 15, 2013**

**Int. Cl.: 31**

FOR: FRESH FRUIT, IN CLASS 31 (U.S. CLS. 1 AND 46).

**TRADEMARK**

FIRST USE 11-5-2012; IN COMMERCE 11-5-2012.

**PRINCIPAL REGISTER**

THE MARK CONSISTS OF A STYLIZED SUN DESIGN SEPARATING THE WORDS "SOL ZEST".

THE ENGLISH TRANSLATION OF "SOL" IN THE MARK IS SUN.

SN 85-446,688, FILED 10-13-2011.

DANIEL CAPSHAW, EXAMINING ATTORNEY



*David J. Kyffers*

Director of the United States Patent and Trademark Office

# United States of America

United States Patent and Trademark Office

## GET A SHOT AT LIFE!

**Reg. No. 4,276,816**

**Registered Jan. 15, 2013**

**Int. Cl.: 44**

**SERVICE MARK**

**PRINCIPAL REGISTER**

CHRISTALENE SALDANHA (UNITED STATES INDIVIDUAL)  
2021-A EMMORTON ROAD  
SUITE 214  
BEL AIR, MD 21015

FOR: MEDICAL SERVICES AND TREATMENT FOR REHABILITATION OF DRUG AND ALCOHOL ADDICTED PATIENTS; ADMINISTERING DRUG INJECTIONS TO PREVENT CRAVINGS FOR DRUGS AND/OR ALCOHOL IN CONNECTION WITH THE TREATMENT AND RECOVERY OF DRUG AND ALCOHOL ADDICTION, IN CLASS 44 (U.S. CLS. 100 AND 101).

FIRST USE 10-4-2012; IN COMMERCE 10-4-2012.

THE MARK CONSISTS OF STANDARD CHARACTERS WITHOUT CLAIM TO ANY PARTICULAR FONT, STYLE, SIZE, OR COLOR.

SN 85-446,781, FILED 10-13-2011.

SETH A. RAPPAPORT, EXAMINING ATTORNEY



*David J. Kyros*

Director of the United States Patent and Trademark Office

# United States of America

United States Patent and Trademark Office

## INTERPRETRAVEL

**Reg. No. 4,276,817**

**Registered Jan. 15, 2013**

**Int. Cl.: 41**

**SERVICE MARK**

**PRINCIPAL REGISTER**

THE TRAVEL TEAM, INC. (NEW YORK CORPORATION)  
2495 MAIN STREET  
BUFFALO, NY 14214

FOR: LANGUAGE TRANSLATION SERVICES, IN CLASS 41 (U.S. CLS. 100, 101 AND 107).

FIRST USE 9-7-2012; IN COMMERCE 9-7-2012.

THE MARK CONSISTS OF STANDARD CHARACTERS WITHOUT CLAIM TO ANY PARTICULAR FONT, STYLE, SIZE, OR COLOR.

SN 85-446,848, FILED 10-13-2011.

NATALIE POLZER, EXAMINING ATTORNEY



*David J. Kyffers*

Director of the United States Patent and Trademark Office



# United States of America

United States Patent and Trademark Office

## PRESS IT TO UNDRRESS IT

**Reg. No. 4,276,818**

**Registered Jan. 15, 2013**

**Int. Cl.: 20**

**TRADEMARK**

**PRINCIPAL REGISTER**

SWISSRAEL, LLC (ILLINOIS LIMITED LIABILITY COMPANY)  
1600 WEST LINCOLN HWY.  
NEW LENOX, IL 60451

FOR: CLOTHES HANGERS, IN CLASS 20 (U.S. CLS. 2, 13, 22, 25, 32 AND 50).

FIRST USE 3-14-2012; IN COMMERCE 3-14-2012.

THE MARK CONSISTS OF STANDARD CHARACTERS WITHOUT CLAIM TO ANY PARTICULAR FONT, STYLE, SIZE, OR COLOR.

SN 85-447,356, FILED 10-14-2011.

KAREN K. BUSH, EXAMINING ATTORNEY



*David J. Kybas*

Director of the United States Patent and Trademark Office

# United States of America

United States Patent and Trademark Office

# Swisshanger

**Reg. No. 4,276,819**

SWISSRAEL, LLC (ILLINOIS LIMITED LIABILITY COMPANY)  
1600 WEST LINCOLN HWY.  
NEW LENOX, IL 60451

**Registered Jan. 15, 2013**

**Int. Cl.: 20**

FOR: CLOTHES HANGERS, IN CLASS 20 (U.S. CLS. 2, 13, 22, 25, 32 AND 50).

**TRADEMARK**

FIRST USE 3-14-2012; IN COMMERCE 3-14-2012.

**PRINCIPAL REGISTER**

THE MARK CONSISTS OF STANDARD CHARACTERS WITHOUT CLAIM TO ANY PARTICULAR FONT, STYLE, SIZE, OR COLOR.

SN 85-447,362, FILED 10-14-2011.

HEATHER THOMPSON, EXAMINING ATTORNEY



*David J. Kybas*

Director of the United States Patent and Trademark Office

# United States of America

United States Patent and Trademark Office

## METROGLOBAL

**Reg. No. 4,276,820**

METROPCS WIRELESS, INC. (DELAWARE CORPORATION)  
2250 LAKESIDE BOULEVARD  
RICHARDSON, TX 75082

**Registered Jan. 15, 2013**

**Int. Cl.: 38**

FOR: TELECOMMUNICATIONS SERVICES, NAMELY, WIRELESS TELEPHONY, WIRELESS BROADBAND COMMUNICATIONS SERVICES FOR THE TRANSMISSION OF VOICE, AND LONG DISTANCE TELEPHONE COMMUNICATION SERVICES, IN CLASS 38 (U.S. CLS. 100, 101 AND 104).

**SERVICE MARK**

**PRINCIPAL REGISTER**

FIRST USE 8-30-2011; IN COMMERCE 8-30-2011.

THE MARK CONSISTS OF STANDARD CHARACTERS WITHOUT CLAIM TO ANY PARTICULAR FONT, STYLE, SIZE, OR COLOR.

OWNER OF U.S. REG. NOS. 2,803,097, 3,542,846, AND OTHERS.

SN 85-447,455, FILED 10-14-2011.

INGA ERVIN, EXAMINING ATTORNEY



*David J. Kyros*

Director of the United States Patent and Trademark Office

# United States of America

United States Patent and Trademark Office

## WORLD OF MOUTH

**Reg. No. 4,276,821**

**Registered Jan. 15, 2013**

**Int. Cls.: 9 and 35**

**TRADEMARK**

**SERVICE MARK**

**PRINCIPAL REGISTER**

QUALMAN, ERIK (UNITED STATES INDIVIDUAL)  
1 LEIGHTON STREET UNIT 1206  
CAMBRIDGE, MA 02141

FOR: DOWNLOADABLE MP3 FILES, MP3 RECORDINGS, ON-LINE DISCUSSION BOARDS, WEBCASTS, WEBINARS AND PODCASTS FEATURING MUSIC, AUDIO BOOKS IN THE FIELD OF BUSINESS, AND NEWS BROADCASTS; ELECTRONIC PUBLICATIONS, NAMELY, BOOKS IN THE FIELDS OF BUSINESS, SOCIAL MEDIA, ADVERTISING, AND MARKETING RECORDED ON COMPUTER MEDIA, IN CLASS 9 (U.S. CLS. 21, 23, 26, 36 AND 38).

FIRST USE 2-7-2012; IN COMMERCE 10-1-2012.

FOR: ADVERTISING AND MARKETING SERVICES PROVIDED BY MEANS OF INDIRECT METHODS OF MARKETING COMMUNICATIONS, NAMELY, SOCIAL MEDIA, SEARCH ENGINE MARKETING, INQUIRY MARKETING, INTERNET MARKETING, MOBILE MARKETING, BLOGGING AND OTHER FORMS OF PASSIVE, SHARABLE OR VIRAL COMMUNICATIONS CHANNELS; ADVERTISING AND MARKETING SERVICES, NAMELY, PROMOTING THE GOODS AND SERVICES OF OTHERS, IN CLASS 35 (U.S. CLS. 100, 101 AND 102).

FIRST USE 2-7-2012; IN COMMERCE 10-1-2012.

THE MARK CONSISTS OF STANDARD CHARACTERS WITHOUT CLAIM TO ANY PARTICULAR FONT, STYLE, SIZE, OR COLOR.

SN 85-447,472, FILED 10-14-2011.

SIMON TENG, EXAMINING ATTORNEY



*David J. Kybas*

Director of the United States Patent and Trademark Office

# United States of America

United States Patent and Trademark Office

# CROP

**Reg. No. 4,276,822**

**Registered Jan. 15, 2013**

**Int. Cl.: 33**

**TRADEMARK**

**PRINCIPAL REGISTER**

JNJ ENTERPRISES, LLC (DELAWARE LIMITED LIABILITY COMPANY)  
69 DEFCO PARK ROAD  
NORTH HAVEN, CT 06473

FOR: ALCOHOLIC BEVERAGES EXCEPT BEERS, IN CLASS 33 (U.S. CLS. 47 AND 49).

FIRST USE 5-8-2008; IN COMMERCE 5-8-2008.

THE MARK CONSISTS OF STANDARD CHARACTERS WITHOUT CLAIM TO ANY PARTICULAR FONT, STYLE, SIZE, OR COLOR.

OWNER OF U.S. REG. NOS. 3,469,232, 3,497,325, AND 3,888,125.

SN 85-447,677, FILED 10-14-2011.

JENNY PARK, EXAMINING ATTORNEY



*David J. Kyffers*

Director of the United States Patent and Trademark Office

# United States of America

United States Patent and Trademark Office

# HairFerry

**Reg. No. 4,276,823**

**Registered Jan. 15, 2013**

**Int. Cl.: 8**

**TRADEMARK**

**PRINCIPAL REGISTER**

KIM M FERRY (UNITED STATES INDIVIDUAL)  
SUITE 497  
613 HAMPSHIRE RD  
WESTLAKE VILLAGE, CA 91361

FOR: TOOL HOLDERS, IN CLASS 8 (U.S. CLS. 23, 28 AND 44).

FIRST USE 9-1-2012; IN COMMERCE 9-1-2012.

THE MARK CONSISTS OF STANDARD CHARACTERS WITHOUT CLAIM TO ANY PARTICULAR FONT, STYLE, SIZE, OR COLOR.

SN 85-447,679, FILED 10-14-2011.

JAMES MACFARLANE, EXAMINING ATTORNEY



*David J. Kybas*

Director of the United States Patent and Trademark Office

# United States of America

United States Patent and Trademark Office

## PINDROP SECURITY

**Reg. No. 4,276,824**

**Registered Jan. 15, 2013**

**Int. Cls.: 9 and 42**

**TRADEMARK**

**SERVICE MARK**

**PRINCIPAL REGISTER**

TELINEAGE, INC. (DELAWARE CORPORATION), DBA PINDROP SECURITY,  
75 FIFTH STREET NW  
ATLANTA, GA 30308

FOR: COMPUTER SOFTWARE FOR AUTHENTICATION AND/OR FRAUD PREVENTION FOR PHONE CALLS; COMPUTER SOFTWARE FOR ENCRYPTION AND DECRYPTION; COMPUTER SOFTWARE PLATFORMS FOR AUTHENTICATION AND/OR FRAUD PREVENTION FOR PHONE CALLS; COMPUTER TELEPHONY SOFTWARE FOR AUTHENTICATION AND/OR FRAUD PREVENTION FOR PHONE CALLS; COMPUTER SOFTWARE THAT PROVIDES WEB-BASED ACCESS TO APPLICATIONS AND SERVICES THROUGH A WEB OPERATING SYSTEM OR PORTAL INTERFACE; DOWNLOADABLE COMPUTER SOFTWARE FOR USE IN AUTHENTICATION AND/OR FRAUD PREVENTION FOR PHONE CALLS, IN CLASS 9 (U.S. CLS. 21, 23, 26, 36 AND 38).

FIRST USE 3-3-2011; IN COMMERCE 3-30-2011.

FOR: CLOUD COMPUTING FEATURING SOFTWARE FOR USE IN AUTHENTICATION AND/OR FRAUD PREVENTION FOR PHONE CALLS; APPLICATION SERVICE PROVIDER FEATURING APPLICATION PROGRAMMING INTERFACE (API) SOFTWARE FOR AUTHENTICATION AND/OR FRAUD PREVENTION FOR PHONE CALLS; SOFTWARE AS A SERVICE (SAAS) SERVICES FEATURING SOFTWARE IN THE FIELD OF AUTHENTICATION AND/OR FRAUD PREVENTION FOR PHONE CALLS, IN CLASS 42 (U.S. CLS. 100 AND 101).

FIRST USE 3-3-2011; IN COMMERCE 3-30-2011.

THE MARK CONSISTS OF STANDARD CHARACTERS WITHOUT CLAIM TO ANY PARTICULAR FONT, STYLE, SIZE, OR COLOR.

NO CLAIM IS MADE TO THE EXCLUSIVE RIGHT TO USE "SECURITY", APART FROM THE MARK AS SHOWN.

SN 85-447,823, FILED 10-14-2011.

ALYSSA STEEL, EXAMINING ATTORNEY



*David J. Kyffers*

Director of the United States Patent and Trademark Office

# United States of America

United States Patent and Trademark Office

# PINDROP

**Reg. No. 4,276,825**

**Registered Jan. 15, 2013**

**Int. Cl.: 9**

**TRADEMARK**

**PRINCIPAL REGISTER**

TELINEAGE, INC. (DELAWARE CORPORATION), DBA PINDROP SECURITY,  
75 FIFTH STREET NW, SUITE 245  
ATLANTA, GA 30308

FOR: COMPUTER SOFTWARE FOR AUTHENTICATION AND/OR FRAUD PREVENTION FOR PHONE CALLS; COMPUTER SOFTWARE FOR ENCRYPTION AND DECRYPTION; COMPUTER SOFTWARE PLATFORMS FOR AUTHENTICATION AND/OR FRAUD PREVENTION FOR PHONE CALLS; COMPUTER TELEPHONY SOFTWARE FOR AUTHENTICATION AND/OR FRAUD PREVENTION FOR PHONE CALLS; COMPUTER SOFTWARE THAT PROVIDES WEB-BASED ACCESS TO APPLICATIONS AND SERVICES THROUGH A WEB OPERATING SYSTEM OR PORTAL INTERFACE; DOWNLOADABLE COMPUTER SOFTWARE FOR USE IN AUTHENTICATION AND/OR FRAUD PREVENTION FOR PHONE CALLS, IN CLASS 9 (U.S. CLS. 21, 23, 26, 36 AND 38).

FIRST USE 3-30-2011; IN COMMERCE 3-30-2011.

THE MARK CONSISTS OF STANDARD CHARACTERS WITHOUT CLAIM TO ANY PARTICULAR FONT, STYLE, SIZE, OR COLOR.

SN 85-447,840, FILED 10-14-2011.

ALYSSA STEEL, EXAMINING ATTORNEY



*David J. Kybas*

Director of the United States Patent and Trademark Office



# United States of America

United States Patent and Trademark Office

# EPRONET

**Reg. No. 4,276,826**

EPRONET CONCEPTS INC. (NEVADA CORPORATION)  
6149 S. RAINBOW BLVD.

**Registered Jan. 15, 2013**

LAS VEGAS, NV 89118

**Int. Cl.: 36**

**SERVICE MARK**

**PRINCIPAL REGISTER**

FOR: BUSINESS BROKERAGE SERVICES AND RELATED CONSULTING PERTAINING TO BUSINESS SALES, MERGERS, ACQUISITIONS AND BUSINESS VALUATIONS; CLASSIFIED REAL ESTATE LISTINGS OF APARTMENT RENTALS AND HOUSING RENTALS; COMMERCIAL AND RESIDENTIAL REAL ESTATE AGENCY SERVICES; EVALUATING REAL ESTATE TO ASSESS FEASIBILITY FOR USE AS A PROPERTY SELF-STORAGE FACILITY; ARRANGING OF LEASES AND RENTAL AGREEMENTS FOR REAL ESTATE; ASSESSMENT AND MANAGEMENT OF REAL ESTATE; LAND ACQUISITION, NAMELY, REAL ESTATE BROKERAGE; LEASING OF REAL ESTATE; MORTGAGE FORECLOSURE MITIGATION AND LOAN DEFAULT MITIGATION SERVICES, NAMELY, ACQUISITION AND LEASE-BACK OF REAL ESTATE; PROVIDING A DATABASE OF INFORMATION ABOUT RESIDENTIAL REAL ESTATE LISTINGS; PROVIDING AN INTERNET WEBSITE PORTAL OFFERING INFORMATION IN THE FIELDS OF REAL ESTATE CONCERNING THE PURCHASE AND SALE OF NEW, RESALE HOMES, AND CONDOS; PROVIDING INFORMATION IN THE FIELD OF REAL ESTATE BY MEANS OF LINKING THE WEB SITE TO OTHER WEB SITES FEATURING REAL ESTATE INFORMATION; PROVIDING REAL ESTATE LISTINGS AND REAL ESTATE INFORMATION VIA THE INTERNET; REAL ESTATE ACQUISITION SERVICES; REAL ESTATE AGENCIES; REAL ESTATE APPRAISAL AND VALUATION; REAL ESTATE BROKERAGE; REAL ESTATE BROKERAGE SERVICES SPECIALIZING IN RESTAURANTS AND OTHER FOOD SERVICE RELATED BUSINESSES; REAL ESTATE CONSULTATION; REAL ESTATE EQUITY SHARING, NAMELY, MANAGING AND ARRANGING FOR CO-OWNERSHIP OF REAL ESTATE; REAL ESTATE FINANCING SERVICES; REAL ESTATE FUNDS INVESTMENT SERVICES; REAL ESTATE INSURANCE UNDERWRITING SERVICES; REAL ESTATE INVESTMENT SERVICES; REAL ESTATE INVESTMENT SERVICES IN THE NATURE OF PURCHASING AND SELLING OF REAL ESTATE FOR OTHERS; REAL ESTATE INVESTMENT TRUST SERVICES; REAL ESTATE INVESTMENT TRUST MANAGEMENT SERVICES; REAL ESTATE INVESTMENT TRUST ADVISORY SERVICES; REAL ESTATE LENDING SERVICES; REAL ESTATE LISTING; REAL ESTATE LISTING SERVICES FOR HOUSING RENTALS AND APARTMENT RENTALS; REAL ESTATE MANAGEMENT SERVICES; REAL ESTATE MANAGEMENT CONSULTATION; REAL ESTATE MULTIPLE LISTING SERVICES; REAL ESTATE PROCUREMENT FOR OTHERS; REAL ESTATE RENTAL SERVICES, NAMELY, RENTAL OF RESIDENTIAL HOUSING, VACATION HOMES, CONDOMINIUMS, CABINS, AND VILLAS; REAL ESTATE SERVICE, NAMELY, RENTAL PROPERTY



*David J. Kyros*

Director of the United States Patent and Trademark Office

**Reg. No. 4,276,826** MANAGEMENT; REAL ESTATE SERVICES, NAMELY, RENTAL OF SHORT-TERM FURNISHED APARTMENTS; REAL ESTATE SERVICES IN THE FORM OF PROVIDING PHYSICAL ACCESS TO AVAILABLE PROPERTIES VIA A REMOTE CALL-IN LOCKING DEVICE; REAL ESTATE SERVICES TO STOP FORECLOSURE, NAMELY, MORTGAGE DEBT MANAGEMENT; REAL ESTATE SERVICES, NAMELY, PROVIDING ONLINE QUESTIONS TO HELP USERS DETERMINE THE BEST NEIGHBORHOODS AND COMMUNITIES SUITED TO THEIR INDIVIDUAL NEEDS AND PREFERENCES; REAL ESTATE SERVICES, NAMELY, LEASING AND MANAGEMENT FOR OTHERS OF CONDOMINIUMS LOCATED WITHIN HOTEL DEVELOPMENTS; REAL ESTATE SERVICES, NAMELY, VACATION HOME RENTAL MANAGEMENT SERVICES; REAL ESTATE SERVICES, NAMELY, RENTAL, BROKERAGE, LEASING AND MANAGEMENT OF COMMERCIAL PROPERTY, OFFICES AND OFFICE SPACE; REAL ESTATE SERVICES, NAMELY, PROPERTY MANAGEMENT SERVICES FOR CONDOMINIUM ASSOCIATIONS, HOMEOWNER ASSOCIATIONS AND APARTMENT BUILDINGS; REAL ESTATE SERVICES, NAMELY, CONDOMINIUM MANAGEMENT SERVICES; REAL ESTATE TRUSTEE SERVICES; REAL ESTATE VALUATION SERVICES; RESIDENTIAL REAL ESTATE AGENCY SERVICES, IN CLASS 36 (U.S. CLS. 100, 101 AND 102).

FIRST USE 11-2-2012; IN COMMERCE 11-2-2012.

THE MARK CONSISTS OF STANDARD CHARACTERS WITHOUT CLAIM TO ANY PARTICULAR FONT, STYLE, SIZE, OR COLOR.

SN 85-447,937, FILED 10-14-2011.

DAVID C. REIHNER, EXAMINING ATTORNEY

# United States of America

United States Patent and Trademark Office

# STÜCK

**Reg. No. 4,276,827**

LEIZERMAN, ERWIN JOEL (UNITED STATES INDIVIDUAL)  
717 MADISON AVE.  
TOLEDO, OH 43604

**Registered Jan. 15, 2013**

**Int. Cls.: 18 and 25**

FOR: CARRY-ALL BAGS; DUFFEL BAGS; DUFFEL BAGS FOR TRAVEL, IN CLASS 18 (U.S. CLS. 1, 2, 3, 22 AND 41).

**TRADEMARK**

FIRST USE 11-19-2011; IN COMMERCE 11-19-2012.

**PRINCIPAL REGISTER**

FOR: ATHLETIC APPAREL, NAMELY, SHIRTS, PANTS, JACKETS, FOOTWEAR, HATS AND CAPS, ATHLETIC UNIFORMS; ATHLETIC FOOTWEAR; ATHLETIC SHOES; BASEBALL CAPS AND HATS; HATS; T-SHIRTS, IN CLASS 25 (U.S. CLS. 22 AND 39).

FIRST USE 11-19-2011; IN COMMERCE 11-19-2012.

THE MARK CONSISTS OF STANDARD CHARACTERS WITHOUT CLAIM TO ANY PARTICULAR FONT, STYLE, SIZE, OR COLOR.

SN 85-448,456, FILED 10-16-2011.

WILLIAM VERHOSEK, EXAMINING ATTORNEY



*David J. Kypos*

Director of the United States Patent and Trademark Office

# United States of America

United States Patent and Trademark Office

## Creation Station

**Reg. No. 4,276,828**

SUN GRO HORTICULTURE CANADA LTD. (CANADA CORPORATION)

**Registered Jan. 15, 2013**

52130 RR 65  
SEBA BEACH, ALBERTA, CANADA T0E 2B0

**Int. Cl.: 44**

FOR: PROVIDING CONSULTATION SERVICES FOR THE MIXING AND USE OF PLANT SEEDS AND POTTING SOIL; GARDENING SERVICES, NAMELY, ARRANGING OF PLANTS AND FLOWERS AND THE REPOTTING OF PLANTS FOR OTHERS, IN CLASS 44 (U.S. CLS. 100 AND 101).

**SERVICE MARK**

**PRINCIPAL REGISTER**

FIRST USE 0-0-2008; IN COMMERCE 0-0-2008.

THE MARK CONSISTS OF STANDARD CHARACTERS WITHOUT CLAIM TO ANY PARTICULAR FONT, STYLE, SIZE, OR COLOR.

SN 85-448,557, FILED 10-17-2011.

BARBARA GAYNOR, EXAMINING ATTORNEY



*David J. Kyffers*

Director of the United States Patent and Trademark Office

# United States of America

United States Patent and Trademark Office

## METROBLOCK-IT

**Reg. No. 4,276,829**

METROPCS WIRELESS, INC. (DELAWARE CORPORATION)  
2250 LAKESIDE BOULEVARD  
RICHARDSON, TX 75082

**Registered Jan. 15, 2013**

**Int. Cl.: 38**

FOR: TELECOMMUNICATION SERVICES; TELECOMMUNICATION SERVICES, NAMELY, PROVIDING ADVANCED CALLING AND TEXTING FEATURES; TELECOMMUNICATION SERVICES, NAMELY, INBOUND CALL AND TEXT BLOCKING, IN CLASS 38 (U.S. CLS. 100, 101 AND 104).

**SERVICE MARK**

**PRINCIPAL REGISTER**

FIRST USE 2-0-2012; IN COMMERCE 2-0-2012.

THE MARK CONSISTS OF STANDARD CHARACTERS WITHOUT CLAIM TO ANY PARTICULAR FONT, STYLE, SIZE, OR COLOR.

OWNER OF U.S. REG. NOS. 2,803,097, 3,542,846, AND OTHERS.

SN 85-448,659, FILED 10-17-2011.

INGA ERVIN, EXAMINING ATTORNEY



*David J. Kyffers*

Director of the United States Patent and Trademark Office

# United States of America

United States Patent and Trademark Office

# CISTROGENE

**Reg. No. 4,276,830**

**Registered Jan. 15, 2013**

**Int. Cls.: 39 and 42**

**SERVICE MARK**

**PRINCIPAL REGISTER**

HEMATOGENIX LABORATORY SERVICES, LLC (ILLINOIS LIMITED LIABILITY COMPANY)  
18311 NORTH CREEK DR, STE A  
TINLEY PARK, IL 60477

FOR: SPECIMEN STORAGE SERVICES FOR OTHERS, NAMELY, STORAGE OF HUMAN CELLS AND HUMAN TISSUE FOR MEDICAL PURPOSES, IN CLASS 39 (U.S. CLS. 100 AND 105).

FIRST USE 5-0-2012; IN COMMERCE 5-0-2012.

FOR: SCIENTIFIC RESEARCH FOR MEDICAL PURPOSES; RESEARCH AND DEVELOPMENT IN THE FIELD OF BIOTECHNOLOGY; PROVIDING LABORATORY RESEARCH SERVICES IN THE FIELD OF GENE ANALYSIS AND BIOMARKERS; CUSTOM DEVELOPMENT OF ASSAYS; CONSULTING SERVICES AND TESTING SERVICES IN THE FIELDS OF BIOTECHNOLOGY, PHARMACEUTICAL AND CLINICAL RESEARCH AND DEVELOPMENT, LABORATORY TESTING, AND DIAGNOSTICS; PROVIDING A WEBSITE FEATURING INFORMATION ABOUT RESEARCH AND DEVELOPMENT RELATED TO BIOTECHNOLOGY, IN CLASS 42 (U.S. CLS. 100 AND 101).

FIRST USE 5-0-2012; IN COMMERCE 5-0-2012.

THE MARK CONSISTS OF STANDARD CHARACTERS WITHOUT CLAIM TO ANY PARTICULAR FONT, STYLE, SIZE, OR COLOR.

SN 85-448,872, FILED 10-17-2011.

JESSICA A. POWERS, EXAMINING ATTORNEY



*David J. Kyffers*

Director of the United States Patent and Trademark Office

# United States of America

United States Patent and Trademark Office

## THE BRENNITY

**Reg. No. 4,276,831**

**Registered Jan. 15, 2013**

**Int. Cls.: 43 and 44**

**SERVICE MARK**

**PRINCIPAL REGISTER**

TCG HOLDINGS, LP (TEXAS LIMITED PARTNERSHIP)  
1200 SUMMIT AVENUE  
FORT WORTH, TX 76102

FOR: PROVIDING ASSISTED LIVING FACILITIES, IN CLASS 43 (U.S. CLS. 100 AND 101).

FIRST USE 4-2-2012; IN COMMERCE 4-13-2012.

FOR: NURSING HOMES; HEALTH CARE SERVICES; PROVIDING LONG-TERM CARE FACILITIES, IN CLASS 44 (U.S. CLS. 100 AND 101).

FIRST USE 4-2-2012; IN COMMERCE 4-13-2012.

THE MARK CONSISTS OF STANDARD CHARACTERS WITHOUT CLAIM TO ANY PARTICULAR FONT, STYLE, SIZE, OR COLOR.

SN 85-448,921, FILED 10-17-2011.

KATHY DE JONGE, EXAMINING ATTORNEY



*David J. Kybas*

Director of the United States Patent and Trademark Office

# United States of America

United States Patent and Trademark Office

## ENTOURAGEME

**Reg. No. 4,276,832**

ENTOURAGEME LLC (DELAWARE LIMITED LIABILITY COMPANY)  
PO BOX 230061

**Registered Jan. 15, 2013**

NEW YORK, NY 10023

**Int. Cl.: 45**

FOR: INTERNET-BASED SOCIAL NETWORKING SERVICES; ON-LINE SOCIAL NETWORKING SERVICES, IN CLASS 45 (U.S. CLS. 100 AND 101).

**SERVICE MARK**

FIRST USE 2-8-2012; IN COMMERCE 11-12-2012.

**PRINCIPAL REGISTER**

THE MARK CONSISTS OF STANDARD CHARACTERS WITHOUT CLAIM TO ANY PARTICULAR FONT, STYLE, SIZE, OR COLOR.

SN 85-449,120, FILED 10-17-2011.

ALEX KEAM, EXAMINING ATTORNEY



*David J. Kybas*

Director of the United States Patent and Trademark Office



# United States of America

United States Patent and Trademark Office

## REMITCONNECT

**Reg. No. 4,276,833**

COMMERCE BANCSHARES, INC. (MISSOURI CORPORATION)  
1000 WALNUT STREET  
KANSAS CITY, MO 64106

**Registered Jan. 15, 2013**

**Int. Cls.: 36 and 42**

FOR: BANKING SERVICES DIRECTED TO THE HEALTHCARE INDUSTRY, NAMELY, EOB MEDICAL REMITTANCE RECEIPT AND PROCESSING, MEDICAL REMITTANCE PAYMENT RECEIPT AND PROCESSING, AND LOCKBOX REMITTANCE PROCESSING SERVICES, IN CLASS 36 (U.S. CLS. 100, 101 AND 102).

**SERVICE MARK**

**PRINCIPAL REGISTER**

FIRST USE 3-0-2012; IN COMMERCE 3-0-2012.

FOR: APPLICATION SERVICE PROVIDER FEATURING SOFTWARE FOR USE IN HEALTHCARE CLAIMS REMITTANCE PROCESSING, NAMELY, AUTOMATED DATA ENTRY, AUTOMATED PAYMENT POSTING, SECONDARY CLAIMS GENERATION AND SUBMISSION, DOCUMENT IMAGING, DOCUMENT AND IMAGE MANAGEMENT, IMAGE STORAGE AND MANAGEMENT, AND IMAGE ARCHIVE AND RETRIEVAL HOSTING SERVICES, IN CLASS 42 (U.S. CLS. 100 AND 101).

FIRST USE 3-0-2012; IN COMMERCE 3-0-2012.

THE MARK CONSISTS OF STANDARD CHARACTERS WITHOUT CLAIM TO ANY PARTICULAR FONT, STYLE, SIZE, OR COLOR.

OWNER OF U.S. REG. NOS. 1,206,794, 1,864,942, AND 3,743,522.

SN 85-449,162, FILED 10-17-2011.

ALLISON HOLTZ, EXAMINING ATTORNEY



*David J. Kyros*

Director of the United States Patent and Trademark Office

# United States of America

United States Patent and Trademark Office

# DARK2LIGHT

**Reg. No. 4,276,834**

COSMERICA LTD (CALIFORNIA CORPORATION)  
2468 HIGHLAND RD  
UPLAND, CA 91784

**Registered Jan. 15, 2013**

**Int. Cl.: 3**

FOR: SKIN CARE PRODUCTS, NAMELY, SKIN MOISTURIZERS, SKIN FADE CREAMS, SKIN FADE LOTIONS, SKIN LIGHTENING SERUMS, BODY CREAMS, IN CLASS 3 (U.S. CLS. 1, 4, 6, 50, 51 AND 52).

**TRADEMARK**

FIRST USE 5-15-2012; IN COMMERCE 5-15-2012.

**PRINCIPAL REGISTER**

THE MARK CONSISTS OF STANDARD CHARACTERS WITHOUT CLAIM TO ANY PARTICULAR FONT, STYLE, SIZE, OR COLOR.

SN 85-449,548, FILED 10-18-2011.

LIEF MARTIN, EXAMINING ATTORNEY



*David J. Kybas*

Director of the United States Patent and Trademark Office

# United States of America

United States Patent and Trademark Office

# GANDER.TV

**Reg. No. 4,276,835**

EYES ON THE GO, LLC (DELAWARE LIMITED LIABILITY COMPANY)

**Registered Jan. 15, 2013**

60 BROADWAY, PH-12  
NEW YORK, NY 11211

**Int. Cl.: 38**

FOR: STREAMING OF VIDEO AND AUDIOVISUAL MATERIAL ON THE INTERNET OR ON A CLOSED-CIRCUIT TELEVISION NETWORK, IN CLASS 38 (U.S. CLS. 100, 101 AND 104).

**SERVICE MARK**

FIRST USE 11-11-2011; IN COMMERCE 11-11-2011.

**PRINCIPAL REGISTER**

THE MARK CONSISTS OF STANDARD CHARACTERS WITHOUT CLAIM TO ANY PARTICULAR FONT, STYLE, SIZE, OR COLOR.

SN 85-449,719, FILED 10-18-2011.

MICHAEL TANNER, EXAMINING ATTORNEY



*David J. Kyffers*

Director of the United States Patent and Trademark Office

# United States of America

United States Patent and Trademark Office

# NIKAO

**Reg. No. 4,276,836**

**Registered Jan. 15, 2013**

**Int. Cls.: 35 and 42**

**SERVICE MARK**

**PRINCIPAL REGISTER**

NIKAO CORPORATION (KANSAS CORPORATION)  
SUITE 206  
6811 SHAWNEE MISSION PKWY  
OVERLAND PARK, KS 66202

FOR: BUSINESS DEVELOPMENT SERVICES; BUSINESS MANAGEMENT AND CONSULTATION; BUSINESS STRATEGY DEVELOPMENT SERVICES, IN CLASS 35 (U.S. CLS. 100, 101 AND 102).

FIRST USE 2-1-2012; IN COMMERCE 2-1-2012.

FOR: COMPUTER SOFTWARE CONSULTING; COMPUTER SOFTWARE DEVELOPMENT, IN CLASS 42 (U.S. CLS. 100 AND 101).

FIRST USE 2-1-2012; IN COMMERCE 2-1-2012.

THE MARK CONSISTS OF STANDARD CHARACTERS WITHOUT CLAIM TO ANY PARTICULAR FONT, STYLE, SIZE, OR COLOR.

SN 85-449,842, FILED 10-18-2011.

JOHN HWANG, EXAMINING ATTORNEY



*David J. Kyffers*

Director of the United States Patent and Trademark Office

# United States of America

United States Patent and Trademark Office



**Reg. No. 4,276,837**

UHS OF DELAWARE, INC. (DELAWARE CORPORATION)  
367 SOUTH GULPH ROAD  
KING OF PRUSSIA, PA 194060958

**Registered Jan. 15, 2013**

**Int. Cl.: 41**

FOR: EDUCATION SERVICES, NAMELY, PROVIDING SEMINARS IN THE FIELD OF WOMEN'S HEALTH, IN CLASS 41 (U.S. CLS. 100, 101 AND 107).

**SERVICE MARK**

FIRST USE 10-1-2012; IN COMMERCE 10-1-2012.

**PRINCIPAL REGISTER**

THE MARK CONSISTS OF A DEPICTION OF A FLOWER ABOVE THE WORDS "WE WOMEN ENLIGHTENED FOR BETTER HEALTH".

SN 85-449,852, FILED 10-18-2011.

JAY FLOWERS, EXAMINING ATTORNEY



*David J. Kyffers*

Director of the United States Patent and Trademark Office

# United States of America

United States Patent and Trademark Office

## OTHER PEOPLE OFTEN ENVY

**Reg. No. 4,276,838**

**Registered Jan. 15, 2013**

**Int. Cls.: 16 and 25**

**TRADEMARK**

**PRINCIPAL REGISTER**

WHITBY, LATWON (UNITED STATES INDIVIDUAL)  
3402 W. BROADWAY  
FORREST CITY, AR 72335 AND

WHITBY, EVETTA (UNITED STATES INDIVIDUAL)  
3402 W. BROADWAY  
FORREST CITY, AR 72335

FOR: BUMPER STICKERS, PAPER BANNERS, BOOK MARKERS, PENS, PENCILS, NOTE-BOOKS, AND WRITING PADS, IN CLASS 16 (U.S. CLS. 2, 5, 22, 23, 29, 37, 38 AND 50).

FIRST USE 10-29-2011; IN COMMERCE 10-29-2011.

FOR: CLOTHING, NAMELY, T-SHIRTS, SWEATSHIRTS, JACKETS, SOCKS, SHOES, HATS, HEADBANDS, WRISTBANDS, AND UNDERWEAR, IN CLASS 25 (U.S. CLS. 22 AND 39).

FIRST USE 10-29-2011; IN COMMERCE 10-29-2011.

THE MARK CONSISTS OF STANDARD CHARACTERS WITHOUT CLAIM TO ANY PARTICULAR FONT, STYLE, SIZE, OR COLOR.

SN 85-450,224, FILED 10-18-2011.

KELLY TRUSILO, EXAMINING ATTORNEY



*David J. Kybas*

Director of the United States Patent and Trademark Office

# United States of America

United States Patent and Trademark Office

# OPOE

**Reg. No. 4,276,839**

**Registered Jan. 15, 2013**

**Int. Cls.: 16 and 25**

**TRADEMARK**

**PRINCIPAL REGISTER**

WHITBY, LATWON (UNITED STATES INDIVIDUAL)  
3402 W. BROADWAY  
FORREST CITY, AR 72335 AND

WHITBY, EVETTA (UNITED STATES INDIVIDUAL)  
3402 W. BROADWAY  
FORREST CITY, AR 72335

FOR: BUMPER STICKERS, PAPER BANNERS, POSTERS, BOOK MARKERS, PENS, PENCILS, NOTEBOOKS, AND WRITING PADS, IN CLASS 16 (U.S. CLS. 2, 5, 22, 23, 29, 37, 38 AND 50).

FIRST USE 10-29-2011; IN COMMERCE 10-29-2011.

FOR: CLOTHING, NAMELY, T-SHIRTS, SWEATSHIRTS, JACKETS, SOCKS, SHOES, HATS, HEADBANDS, WRISTBANDS, AND UNDERWEAR, IN CLASS 25 (U.S. CLS. 22 AND 39).

FIRST USE 10-29-2011; IN COMMERCE 10-29-2011.

THE MARK CONSISTS OF STANDARD CHARACTERS WITHOUT CLAIM TO ANY PARTICULAR FONT, STYLE, SIZE, OR COLOR.

SN 85-450,235, FILED 10-18-2011.

KELLY TRUSILO, EXAMINING ATTORNEY



*David J. Kybas*

Director of the United States Patent and Trademark Office

# United States of America

United States Patent and Trademark Office

## The Mitten Brewing Company

**Reg. No. 4,276,840**

THE MITTEN BREWING COMPANY, LLC (MICHIGAN LIMITED LIABILITY COMPANY)  
2314 ELMER DRIVE NE  
GRAND RAPIDS, MI 49525

**Registered Jan. 15, 2013**

**Int. Cl.: 32**

FOR: BREWED MALT-BASED ALCOHOLIC BEVERAGE IN THE NATURE OF A BEER, IN CLASS 32 (U.S. CLS. 45, 46 AND 48).

**TRADEMARK**

FIRST USE 6-5-2012; IN COMMERCE 10-24-2012.

**PRINCIPAL REGISTER**

THE MARK CONSISTS OF STANDARD CHARACTERS WITHOUT CLAIM TO ANY PARTICULAR FONT, STYLE, SIZE, OR COLOR.

NO CLAIM IS MADE TO THE EXCLUSIVE RIGHT TO USE "BREWING COMPANY", APART FROM THE MARK AS SHOWN.

SN 85-450,436, FILED 10-18-2011.

STEVEN JACKSON, EXAMINING ATTORNEY



*David J. Kyffers*

Director of the United States Patent and Trademark Office



# United States of America

United States Patent and Trademark Office

# BACKBONE

**Reg. No. 4,276,841**

**Registered Jan. 15, 2013**

**Int. Cl.: 20**

**TRADEMARK**

**PRINCIPAL REGISTER**

KRUEGER INTERNATIONAL, INC. (WISCONSIN CORPORATION)  
1330 BELLEVUE STREET  
GREEN BAY, WI 54302

FOR: FURNITURE, IN CLASS 20 (U.S. CLS. 2, 13, 22, 25, 32 AND 50).

FIRST USE 7-18-2012; IN COMMERCE 7-18-2012.

THE MARK CONSISTS OF STANDARD CHARACTERS WITHOUT CLAIM TO ANY PARTICULAR FONT, STYLE, SIZE, OR COLOR.

SN 85-450,606, FILED 10-19-2011.

LINDA MICKLEBURGH, EXAMINING ATTORNEY



*David J. Kybas*

Director of the United States Patent and Trademark Office

# United States of America

United States Patent and Trademark Office

## S by Shannon Elizabeth

**Reg. No. 4,276,842**

**Registered Jan. 15, 2013**

**Int. Cl.: 3**

**TRADEMARK**

**PRINCIPAL REGISTER**

FADAL, SHANNON ELIZABETH (UNITED STATES INDIVIDUAL)  
PMB 690  
7336 SANTA MONICA BOULEVARD  
HOLLYWOOD, CA 90046

FOR: COLOGNES, PERFUMES AND COSMETICS, IN CLASS 3 (U.S. CLS. 1, 4, 6, 50, 51 AND 52).

FIRST USE 11-20-2011; IN COMMERCE 11-22-2011.

THE MARK CONSISTS OF STANDARD CHARACTERS WITHOUT CLAIM TO ANY PARTICULAR FONT, STYLE, SIZE, OR COLOR.

THE NAME(S), PORTRAIT(S), AND/OR SIGNATURE(S) SHOWN IN THE MARK IDENTIFIES SHANNON ELIZABETH FADAL, WHOSE CONSENT(S) TO REGISTER IS MADE OF RECORD.

SN 85-451,234, FILED 10-19-2011.

TARAH HARDY, EXAMINING ATTORNEY



*David J. Kybas*

Director of the United States Patent and Trademark Office

# United States of America

United States Patent and Trademark Office

## AMSU



**Reg. No. 4,276,843**

**Registered Jan. 15, 2013**

**Int. Cls.: 35, 37, and 40**

AGGREGATE AND MINING SUPPLIES DE MEXICO, S.A. DE C.V. (MEXICO CORPORATION)  
SALVATIERRA #1062  
PLAN DE GUANAJUATO  
IRAPUATO, GTO., MEXICO 36510

**SERVICE MARK**

**PRINCIPAL REGISTER**

FOR: BUSINESS ADMINISTRATION AND MANAGEMENT; COMMERCIAL INFORMATION AGENCIES; COMMERCIAL INFORMATION AND DIRECTORY AGENCY; COMMERCIAL MANAGEMENT; EXPORT AND IMPORT AGENCIES; EXPORT AND IMPORT AGENCIES IN THE FIELD OF MINING AND WELL DRILLING EQUIPMENT AND MACHINES; MARKETING SERVICES, NAMELY, PROMOTING OR ADVERTISING THE GOODS AND SERVICES OF OTHERS; ORGANIZING EXHIBITIONS FOR COMMERCIAL OR ADVERTISING PURPOSES; PROVIDING MARKETING AND PROMOTION OF SPECIAL EVENTS, IN CLASS 35 (U.S. CLS. 100, 101 AND 102).

FIRST USE 12-16-2005; IN COMMERCE 9-1-2012.

FOR: BUILDING CONSTRUCTION INFORMATION; BUILDING CONSTRUCTION SERVICES; CONCRETE POLISHING; CONSULTING IN THE FIELD OF BUILDING CONSTRUCTION; MINING EXTRACTION; PROVIDING TECHNICAL INFORMATION IN THE FIELD OF MINING EXTRACTION; RENTAL OF CONSTRUCTION AND BUILDING EQUIPMENT; REPAIR OF USED AND PARTIALLY DESTROYED WELL DRILLING AND MINING EQUIPMENT AND MACHINES; TECHNICAL CONSULTATION IN THE FIELD OF BUILDING CONSTRUCTION; WELL DRILLING, IN CLASS 37 (U.S. CLS. 100, 103 AND 106).

FIRST USE 12-16-2005; IN COMMERCE 9-1-2012.

FOR: ASSEMBLY OF PRODUCTS FOR OTHERS; CADMIUM PLATING; DECONTAMINATION OF HAZARDOUS MATERIALS; DESTRUCTION OF WASTE AND TRASH; DETOXIFICATION OF HAZARDOUS MATERIALS; ELECTRO AND METAL COATING, METAL TREATING AND CASTING, HARDENING OF METAL AND METAL PRODUCTS; ELECTROPLATING; ELECTROPLATING; ENVIRONMENTAL REMEDIATION SERVICES, NAMELY, TREATMENT OF WASTE; FIREPROOFING OF TEXTILES; FORGING OF METAL GOODS TO THE ORDER AND SPECIFICATION OF OTHERS; GALVANIZING; HAZARDOUS WASTE MANAGEMENT; HEAT TREATMENT AND COATING OF METAL; INCINERATION OF TRASH; INCINERATION OF WASTE; LAMINATING OF METAL; METAL CASTING; METAL HEAT TREATING SERVICES BY MEANS OF FURNACES AND BOILERS; METAL



*David J. Kybas*

Director of the United States Patent and Trademark Office

**Reg. No. 4,276,843** PLATING; MILL WORKING; PROVIDING MATERIAL TREATMENT INFORMATION; PROVIDING TECHNICAL INFORMATION IN THE FIELD OF CEMENT MANUFACTURING; RECYCLING OF WASTE AND TRASH; SORTING OF WASTE AND RECYCLABLE MATERIAL; TECHNICAL CONSULTING IN THE FIELD OF SOLID AND HAZARDOUS WASTE MANAGEMENT; TEMPERING OF METALS; TREATMENT OF METAL; VULCANIZATION; WASTE MANAGEMENT; WASTE PROCESSING; WASTE TREATMENT, IN CLASS 40 (U.S. CLS. 100, 103 AND 106).

FIRST USE 12-16-2005; IN COMMERCE 9-1-2012.

THE MARK CONSISTS OF THE WORD "AMSU" IN CAPITAL STYLIZED LETTERS FOLLOWED BY A CIRCLE INSIDE OF WHICH APPEARS A FORK-LIKE FIGURE.

THE WORDING "AMSU" HAS NO MEANING IN A FOREIGN LANGUAGE.

SN 85-451,395, FILED 10-19-2011.

RONALD MCMORROW, EXAMINING ATTORNEY

# United States of America

United States Patent and Trademark Office

## Humble Potato

**Reg. No. 4,276,844**

ERIC ONG (UNITED STATES INDIVIDUAL)  
8321 LINCOLN BLVD.  
LOS ANGELES, CA 90035

**Registered Jan. 15, 2013**

**Int. Cl.: 43**

FOR: RESTAURANT SERVICES, INCLUDING SIT-DOWN SERVICE OF FOOD AND TAKE-OUT RESTAURANT SERVICES, IN CLASS 43 (U.S. CLS. 100 AND 101).

**SERVICE MARK**

FIRST USE 10-26-2012; IN COMMERCE 10-26-2012.

**PRINCIPAL REGISTER**

THE MARK CONSISTS OF STANDARD CHARACTERS WITHOUT CLAIM TO ANY PARTICULAR FONT, STYLE, SIZE, OR COLOR.

SN 85-451,489, FILED 10-19-2011.

THEODORE MCBRIDE, EXAMINING ATTORNEY



*David J. Kybas*

Director of the United States Patent and Trademark Office

# United States of America

United States Patent and Trademark Office

# KARINE S

**Reg. No. 4,276,845**

SULTAN, THIERRY (UNITED STATES INDIVIDUAL)  
PO BOX 3131

**Registered Jan. 15, 2013**

SANTA MONICA, CA 90402

**Int. Cl.: 14**

FOR: JEWELRY; WATCHES; PRECIOUS METALS AND ALLOYS THEREOF; FASHION JEWELRY; COSTUME JEWELRY, IN CLASS 14 (U.S. CLS. 2, 27, 28 AND 50).

**TRADEMARK**

FIRST USE 9-1-2012; IN COMMERCE 9-1-2012.

**PRINCIPAL REGISTER**

THE MARK CONSISTS OF STANDARD CHARACTERS WITHOUT CLAIM TO ANY PARTICULAR FONT, STYLE, SIZE, OR COLOR.

SN 85-451,521, FILED 10-19-2011.

THEODORE MCBRIDE, EXAMINING ATTORNEY



*David J. Kybas*

Director of the United States Patent and Trademark Office

# United States of America

United States Patent and Trademark Office

## CARLTON HOUSE

**Reg. No. 4,276,846**

P&A MARKETING, INC. (NEW YORK CORPORATION)  
10 CRESCENT DRIVE  
SEARINGTOWN, NY 11507

**Registered Jan. 15, 2013**

**Int. Cl.: 24**

FOR: SHEETS, PILLOW CASES, BLANKETS, BLANKET THROWS, COMFORTERS, DUST RUFFLES, DUVET COVERS, BED SPREADS, AND SHAMS, IN CLASS 24 (U.S. CLS. 42 AND 50).

**TRADEMARK**

FIRST USE 4-0-2012; IN COMMERCE 4-0-2012.

**PRINCIPAL REGISTER**

THE MARK CONSISTS OF STANDARD CHARACTERS WITHOUT CLAIM TO ANY PARTICULAR FONT, STYLE, SIZE, OR COLOR.

NO CLAIM IS MADE TO THE EXCLUSIVE RIGHT TO USE "HOUSE", APART FROM THE MARK AS SHOWN.

SN 85-451,798, FILED 10-20-2011.

FLORENTINA BLANDU, EXAMINING ATTORNEY



*David J. Kybas*

Director of the United States Patent and Trademark Office

# United States of America

United States Patent and Trademark Office

## BED SMARTS

**Reg. No. 4,276,847**

BECKER, JAMES (UNITED STATES INDIVIDUAL)  
1766 MANCHESTER  
WHEATON, IL 60187

**Registered Jan. 15, 2013**

**Int. Cl.: 35**

FOR: RETAIL STORE AND ON-LINE RETAIL STORE SERVICES FEATURING FURNITURE AND SLEEP PRODUCTS, IN CLASS 35 (U.S. CLS. 100, 101 AND 102).

**SERVICE MARK**

FIRST USE 7-0-2012; IN COMMERCE 7-0-2012.

**PRINCIPAL REGISTER**

THE MARK CONSISTS OF STANDARD CHARACTERS WITHOUT CLAIM TO ANY PARTICULAR FONT, STYLE, SIZE, OR COLOR.

NO CLAIM IS MADE TO THE EXCLUSIVE RIGHT TO USE "BED", APART FROM THE MARK AS SHOWN.

SN 85-452,286, FILED 10-20-2011.

KAREN BRACEY, EXAMINING ATTORNEY



*David J. Kybas*

Director of the United States Patent and Trademark Office



# United States of America

United States Patent and Trademark Office



**Reg. No. 4,276,848**

**Registered Jan. 15, 2013**

**Int. Cl.: 33**

**TRADEMARK**

**PRINCIPAL REGISTER**

HIJOS DE ANTONIO BARCELO, S.A. (SPAIN CORPORATION)  
LA MORALEJA, 28108 ALCOBENDAS  
AV. DE EUROPA-20 PARQUE EMPRESARIAL  
MADRID, SPAIN

FOR: WINES, IN CLASS 33 (U.S. CLS. 47 AND 49).

FIRST USE 12-0-2011; IN COMMERCE 12-0-2011.

OWNER OF U.S. REG. NOS. 3,883,178 AND 3,944,598.

NO CLAIM IS MADE TO THE EXCLUSIVE RIGHT TO USE "ESTATE", APART FROM THE MARK AS SHOWN.

THE MARK CONSISTS OF TWO STORKS ON THEIR NEST ON TOP OF A TOWER STANDING ON TWO COLUMNS FORMING AN ARCH LIKE OPENING OR GATE IN THE CENTRAL PORTION OF THE TOWER. LOWER WALLS APPEAR ON BOTH SIDES OF THE TOWER. BELOW THIS DESIGN APPEARS THE WORDING "STORKS' TOWER ESTATE" IN STYLIZED CAPITAL LETTERS AND BELOW IT THE WORDING "TRÍPTICO" IN BIGGER AND MUCH MORE PROMINENT STYLIZED LETTERS.

THE ENGLISH TRANSLATION OF THE WORD "TRÍPTICO" IN THE MARK IS "TRIPTYCH".

SN 85-452,378, FILED 10-20-2011.

CAROLINE WOOD, EXAMINING ATTORNEY



*David J. Kybas*

Director of the United States Patent and Trademark Office

# United States of America

United States Patent and Trademark Office

## METTLE FITNESS

**Reg. No. 4,276,849**

**Registered Jan. 15, 2013**

**Int. Cl.: 41**

**SERVICE MARK**

**PRINCIPAL REGISTER**

CARRINGTON, KENOUS (UNITED STATES INDIVIDUAL)  
7667 CALLAGHAN ROAD / APT 1403  
SAN ANTONIO, TX 78229

FOR: PERSONAL FITNESS TRAINING SERVICES AND CONSULTANCY; FITNESS TRAINING SERVICES VIA ONE-TO-ONE IN PERSON, GROUP FITNESS SESSIONS, AND ONLINE FITNESS CONSULTATIONS; ON-LINE JOURNALS, NAMELY, BLOGS FEATURING ARTICLES AND INFORMATION REGARDING FITNESS RELATED TOPICS, IN CLASS 41 (U.S. CLS. 100, 101 AND 107).

FIRST USE 11-28-2011; IN COMMERCE 11-28-2011.

THE MARK CONSISTS OF STANDARD CHARACTERS WITHOUT CLAIM TO ANY PARTICULAR FONT, STYLE, SIZE, OR COLOR.

NO CLAIM IS MADE TO THE EXCLUSIVE RIGHT TO USE "FITNESS", APART FROM THE MARK AS SHOWN.

SN 85-452,561, FILED 10-20-2011.

APRIL HESIK, EXAMINING ATTORNEY



*David J. Kypos*

Director of the United States Patent and Trademark Office

# United States of America

United States Patent and Trademark Office



**Reg. No. 4,276,850**

**Registered Jan. 15, 2013**

**Int. Cl.: 41**

**SERVICE MARK**

**PRINCIPAL REGISTER**

CARRINGTON, KENOUS (UNITED STATES INDIVIDUAL)  
7667 CALLAGHAN ROAD / APT 1403  
SAN ANTONIO, TX 78229

FOR: PERSONAL FITNESS TRAINING SERVICES AND CONSULTANCY; FITNESS TRAINING SERVICES VIA ONE-TO-ONE IN PERSON, GROUP FITNESS SESSIONS, AND ONLINE FITNESS CONSULTATIONS; ON-LINE JOURNALS, NAMELY, BLOGS FEATURING ARTICLES AND INFORMATION REGARDING FITNESS RELATED TOPICS, IN CLASS 41 (U.S. CLS. 100, 101 AND 107).

FIRST USE 11-28-2011; IN COMMERCE 11-28-2011.

NO CLAIM IS MADE TO THE EXCLUSIVE RIGHT TO USE "FITNESS", APART FROM THE MARK AS SHOWN.

THE COLOR(S) RED, BLACK AND GRAY IS/ARE CLAIMED AS A FEATURE OF THE MARK.

THE MARK CONSISTS OF THE LITERAL ELEMENTS "M METTLE FITNESS" WHEREIN THERE IS AN IMAGE OF TWO CONCENTRIC CIRCLES WITH WORDS "M METTLE FITNESS", IN THE CENTRE OF INNER RED CIRCLE THE LETTER "M" WRITTEN IN BLACK AND GRAY COLOR AND THE WORDS "METTLE FITNESS" ARE WRITTEN IN BLACK COLOR OVER THE OUTER GRAY CIRCLE AS SHOWN IN THE MARK. TWO BOLT HEADS IN GRAY COLOR APPEAR THE OUTER GRAY CIRCLE.

SN 85-452,586, FILED 10-20-2011.

APRIL HESIK, EXAMINING ATTORNEY



*David J. Kyffers*

Director of the United States Patent and Trademark Office

# United States of America

United States Patent and Trademark Office

## CLETUS STANKTON

**Reg. No. 4,276,851**

TIMOTHY M. NEWMAN (UNITED STATES INDIVIDUAL)  
109 SUNNYBROOKE ESTATES COURT  
DARDENNE PRAIRIE, MO 63368

**Registered Jan. 15, 2013**

**Int. Cl.: 41**

FOR: ENTERTAINMENT SERVICES IN THE NATURE OF PERSONAL PERFORMANCES  
FEATURING COMEDY, IN CLASS 41 (U.S. CLS. 100, 101 AND 107).

**SERVICE MARK**

FIRST USE 11-29-2012; IN COMMERCE 11-29-2012.

**PRINCIPAL REGISTER**

THE MARK CONSISTS OF STANDARD CHARACTERS WITHOUT CLAIM TO ANY PAR-  
TICULAR FONT, STYLE, SIZE, OR COLOR.

THE NAME(S), PORTRAIT(S), AND/OR SIGNATURE(S) SHOWN IN THE MARK DOES NOT  
IDENTIFY A PARTICULAR LIVING INDIVIDUAL.

SN 85-453,315, FILED 10-21-2011.

SUSAN LESLIE DUBOIS, EXAMINING ATTORNEY



*David J. Kyffers*

Director of the United States Patent and Trademark Office

# United States of America

United States Patent and Trademark Office

## THE GARBAGE TRUCK

**Reg. No. 4,276,852**

THE GARBAGE TRUCK, LLC (CALIFORNIA LIMITED LIABILITY COMPANY)  
213 CARNELIAN ST.  
REDONDO BEACH, CA 90277

**Registered Jan. 15, 2013**

**Int. Cl.: 43**

FOR: PROVIDING OF FOOD AND DRINK VIA A MOBILE TRUCK, IN CLASS 43 (U.S. CLS. 100 AND 101).

**SERVICE MARK**

FIRST USE 12-21-2011; IN COMMERCE 12-21-2011.

**PRINCIPAL REGISTER**

THE MARK CONSISTS OF STANDARD CHARACTERS WITHOUT CLAIM TO ANY PARTICULAR FONT, STYLE, SIZE, OR COLOR.

NO CLAIM IS MADE TO THE EXCLUSIVE RIGHT TO USE "TRUCK", APART FROM THE MARK AS SHOWN.

SN 85-453,369, FILED 10-21-2011.

ANDREW LEASER, EXAMINING ATTORNEY



*David J. Kybas*

Director of the United States Patent and Trademark Office

**United States of America**  
United States Patent and Trademark Office

**TEQAVA**

**Reg. No. 4,276,853**

**Registered Jan. 15, 2013**

**Int. Cl.: 33**

**TRADEMARK**

**PRINCIPAL REGISTER**

SPARKLING TEQUILA, LLC (CALIFORNIA LIMITED LIABILITY COMPANY), DBA  
SPARKLING TEQUILA, LLC,  
# 392  
4924 BALBOA BLVD  
ENCINO, CA 91316

FOR: ALCOHOLIC BEVERAGES EXCEPT BEER, IN CLASS 33 (U.S. CLS. 47 AND 49).

FIRST USE 10-3-2012; IN COMMERCE 10-3-2012.

THE MARK CONSISTS OF STANDARD CHARACTERS WITHOUT CLAIM TO ANY PARTICULAR FONT, STYLE, SIZE, OR COLOR.

SN 85-453,661, FILED 10-21-2011.

BARBARA RUTLAND, EXAMINING ATTORNEY



*David J. Kyros*

Director of the United States Patent and Trademark Office

# United States of America

United States Patent and Trademark Office

## MESH@WORK

**Reg. No. 4,276,854**

COMPEX, INC. (CALIFORNIA CORPORATION)  
20653 LYCOMING STREET, UNIT A7  
WALNUT, CA 91789

**Registered Jan. 15, 2013**

**Int. Cl.: 9**

FOR: COMPUTER NETWORKING HARDWARE, IN CLASS 9 (U.S. CLS. 21, 23, 26, 36 AND 38).

**TRADEMARK**

FIRST USE 3-1-2011; IN COMMERCE 8-1-2011.

**PRINCIPAL REGISTER**

THE MARK CONSISTS OF STANDARD CHARACTERS WITHOUT CLAIM TO ANY PARTICULAR FONT, STYLE, SIZE, OR COLOR.

SN 85-453,681, FILED 10-21-2011.

BARBARA RUTLAND, EXAMINING ATTORNEY



*David J. Kyffers*

Director of the United States Patent and Trademark Office

# United States of America

United States Patent and Trademark Office

## GOOD CLEAN FUN

**Reg. No. 4,276,855**

**Registered Jan. 15, 2013**

**Int. Cl.: 10**

**TRADEMARK**

**PRINCIPAL REGISTER**

TANTUS, INC. (COLORADO CORPORATION)  
1095 SPICE ISLANDS DRIVE  
SPARKS, NV 89431

FOR: ADULT SEXUAL AIDS, NAMELY, DILDOS, ANAL PLUGS, PENIS RINGS, BALL GAGS, VIBRATORS AND VIBRATOR COVERS MADE OF SILICONE, IN CLASS 10 (U.S. CLS. 26, 39 AND 44).

FIRST USE 5-0-2012; IN COMMERCE 5-0-2012.

THE MARK CONSISTS OF STANDARD CHARACTERS WITHOUT CLAIM TO ANY PARTICULAR FONT, STYLE, SIZE, OR COLOR.

SN 85-453,730, FILED 10-21-2011.

FRANK LATTUCA, EXAMINING ATTORNEY



*David J. Kyffers*

Director of the United States Patent and Trademark Office



# United States of America

United States Patent and Trademark Office

# Loyal 9

**Reg. No. 4,276,856**

**Registered Jan. 15, 2013**

**Int. Cl.: 35**

**SERVICE MARK**

**PRINCIPAL REGISTER**

LOYAL 9, LLC (UTAH LIMITED LIABILITY COMPANY), DBA LOYAL 9,  
3892 NICHOLAS DR  
SANTA CLARA, UT 84765

FOR: PROVIDING A WEBSITE FEATURING INFORMATION ABOUT POLITICAL ISSUES;  
PROVIDING AN INTERNET WEBSITE FEATURING NEWS AND INFORMATION IN THE  
FIELD OF NATIONAL AND INTERNATIONAL POLITICS; PROVIDING INFORMATION  
REGARDING POLITICAL ISSUES, KNOWING HOW TO VOTE AND KNOWING HOW TO  
REGISTER TO VOTE, IN CLASS 35 (U.S. CLS. 100, 101 AND 102).

FIRST USE 5-30-2011; IN COMMERCE 6-6-2012.

THE MARK CONSISTS OF STANDARD CHARACTERS WITHOUT CLAIM TO ANY PAR-  
TICULAR FONT, STYLE, SIZE, OR COLOR.

SN 85-453,878, FILED 10-22-2011.

LINDA M. KING, EXAMINING ATTORNEY



*David J. Kyffers*

Director of the United States Patent and Trademark Office

# United States of America

United States Patent and Trademark Office

# HARVIT

**Reg. No. 4,276,857**

**Registered Jan. 15, 2013**

**Int. Cls.: 29 and 32**

**TRADEMARK**

**PRINCIPAL REGISTER**

BAK, ADAM M (UNITED STATES INDIVIDUAL), DBA ADAMBA IMPORTS INT'L, INC.,  
585 MESEROLE STREET  
BROOKLYN, NY 11379

FOR: FRUIT PRESERVES; FRUIT SPREADS; FRUIT-BASED FOOD BEVERAGE; JAMS;  
JAMS AND MARMALADES; JELLIES, JAMS; MARMALADES AND JAMS; PICKLED CU-  
CUMBERS; PICKLED FRUITS; PICKLED VEGETABLES; PICKLES, IN CLASS 29 (U.S. CL.  
46).

FIRST USE 7-1-2012; IN COMMERCE 7-1-2012.

FOR: CONCENTRATES, SYRUPS OR POWDERS USED IN THE PREPARATION OF SPORTS  
AND ENERGY DRINKS; FRUIT BEVERAGES; SYRUPS FOR MAKING FLAVOURED  
MINERAL WATERS; SYRUPS FOR MAKING FRUIT-FLAVORED DRINKS; SYRUPS FOR  
MAKING NON-ALCOHOLIC BEVERAGES; SYRUPS FOR MAKING SOFT DRINKS, IN  
CLASS 32 (U.S. CLS. 45, 46 AND 48).

FIRST USE 8-1-2012; IN COMMERCE 8-1-2012.

THE MARK CONSISTS OF STANDARD CHARACTERS WITHOUT CLAIM TO ANY PAR-  
TICULAR FONT, STYLE, SIZE, OR COLOR.

SN 85-454,078, FILED 10-24-2011.

EMILY CARLSEN, EXAMINING ATTORNEY



*David J. Kyjars*

Director of the United States Patent and Trademark Office

# United States of America

United States Patent and Trademark Office

## EXACTCOUNT

**Reg. No. 4,276,858**

RGIS, LLC (DELAWARE LIMITED LIABILITY COMPANY)  
2000 EAST TAYLOR ROAD  
AUBURN HILLS, MI 48326

**Registered Jan. 15, 2013**

**Int. Cl.: 42**

FOR: PROVIDING A WEB-BASED ONLINE PORTAL, NAMELY, HOSTING AN ONLINE WEBSITE FOR CUSTOMERS TO REMOTELY VIEW, MONITOR, TRACK, MANAGE AND MAINTAIN INVENTORY DATA, IN CLASS 42 (U.S. CLS. 100 AND 101).

**SERVICE MARK**

FIRST USE 10-0-2011; IN COMMERCE 10-0-2011.

**PRINCIPAL REGISTER**

THE MARK CONSISTS OF STANDARD CHARACTERS WITHOUT CLAIM TO ANY PARTICULAR FONT, STYLE, SIZE, OR COLOR.

SN 85-454,268, FILED 10-24-2011.

DOUGLAS LEE, EXAMINING ATTORNEY



*David J. Kyffers*

Director of the United States Patent and Trademark Office

# United States of America

United States Patent and Trademark Office

# MOLDMAN

**Reg. No. 4,276,859**

**Registered Jan. 15, 2013**

**Int. Cls.: 40 and 42**

**SERVICE MARK**

**PRINCIPAL REGISTER**

MOLDMAN CHICAGO LLC (ILLINOIS LIMITED LIABILITY COMPANY)  
1123 W. BELMONT AVE. #2  
CHICAGO, IL 60657

FOR: MOLD, MICROBIAL AND FUNGI REMOVAL AND REMEDIATION SERVICES; MOLD PREVENTION, NAMELY, TREATMENT OF HOME AND BUILDING STRUCTURE; ODOR REMOVAL SERVICES, NAMELY, HOME AND BUILDING MATERIALS SANITATION AND DEODORIZING; ODOR REMOVAL AND PREVENTION SERVICES, NAMELY, ODOR NEUTRALIZATION SERVICES; WATER DAMAGE REMOVAL, DRYING AND REMEDIATION SERVICES, IN CLASS 40 (U.S. CLS. 100, 103 AND 106).

FIRST USE 11-29-2006; IN COMMERCE 11-29-2006.

FOR: ENVIRONMENTAL TESTING AND INSPECTION OF HOUSES AND BUILDINGS FOR THE PRESENCE OF MOLD, FUNGI AND HARMFUL MICROBES; CONDUCTING ENVIRONMENTAL ASSESSMENTS, TESTING AND ANALYSIS FOR THE PRESENCE OF MOLD, FUNGI AND HARMFUL MICROBES, IN CLASS 42 (U.S. CLS. 100 AND 101).

FIRST USE 11-29-2006; IN COMMERCE 11-29-2006.

THE MARK CONSISTS OF STANDARD CHARACTERS WITHOUT CLAIM TO ANY PARTICULAR FONT, STYLE, SIZE, OR COLOR.

SN 85-454,319, FILED 10-24-2011.

JOHN KELLY, EXAMINING ATTORNEY



*David J. Kyffers*

Director of the United States Patent and Trademark Office

# United States of America

United States Patent and Trademark Office

## Seasons of Fun

**Reg. No. 4,276,860**

WEHLAGE, REEMA A. (UNITED STATES INDIVIDUAL)  
3028 AVALON COVE NW  
ROCHESTER, MN 55901

**Registered Jan. 15, 2013**

**Int. Cl.: 18**

FOR: BEACH UMBRELLAS; TOTE BAGS, IN CLASS 18 (U.S. CLS. 1, 2, 3, 22 AND 41).

**TRADEMARK**

FIRST USE 10-18-2012; IN COMMERCE 10-18-2012.

**PRINCIPAL REGISTER**

THE MARK CONSISTS OF STANDARD CHARACTERS WITHOUT CLAIM TO ANY PARTICULAR FONT, STYLE, SIZE, OR COLOR.

SN 85-454,357, FILED 10-24-2011.

VIVIAN MICZNIK FIRST, EXAMINING ATTORNEY



*David J. Kyffers*

Director of the United States Patent and Trademark Office

# United States of America

United States Patent and Trademark Office

## PRESENT LIVING HOME

**Reg. No. 4,276,861**

**Registered Jan. 15, 2013**

**Int. Cl.: 24**

**TRADEMARK**

**PRINCIPAL REGISTER**

PRESENT LIVING HOME, LLC (NEW YORK LIMITED LIABILITY COMPANY)  
261 FIFTH AVENUE, SUITE 401  
NEW YORK, NY 10016

FOR: LINEN AND TEXTILE GOODS, NAMELY, BED SHEETS, PILLOW CASES, SHAMS, PILLOW SHAMS, QUILTS, QUILT COVERS, DUVETS, DUVET COVERS, COMFORTERS, BED SPREADS, BED SKIRTS, FABRIC VALANCES AND DRAPERY, AND TEXTILE BED COVERS; THROWS; COVERS FOR CUSHIONS; DECORATIVE PILLOWS; UNFITTED FABRIC COUCH COVERS; BED BLANKETS; BATH LINEN, NAMELY, TOWELS, BEACH TOWELS, FACE TOWELS, AND HAND TOWELS; TABLE LINENS, NAMELY, TABLE CLOTHS, TABLE RUNNERS, TABLE TOPPERS, TEXTILE NAPKINS, AND TEXTILE PLACE MATS; TEXTILE OVEN MITTS AND POT HOLDERS; DISH TOWELS; TEA TOWELS; FABRIC WINDOW COVERINGS AND TREATMENTS, NAMELY, CURTAINS AND DRAPES; AND SHOWER CURTAINS, IN CLASS 24 (U.S. CLS. 42 AND 50).

FIRST USE 10-1-2012; IN COMMERCE 10-1-2012.

THE MARK CONSISTS OF STANDARD CHARACTERS WITHOUT CLAIM TO ANY PARTICULAR FONT, STYLE, SIZE, OR COLOR.

NO CLAIM IS MADE TO THE EXCLUSIVE RIGHT TO USE "HOME", APART FROM THE MARK AS SHOWN.

SN 85-454,360, FILED 10-24-2011.

VIVIAN MICZNIK FIRST, EXAMINING ATTORNEY



*David J. Kybas*

Director of the United States Patent and Trademark Office

# United States of America

United States Patent and Trademark Office

## NEST SENSE

**Reg. No. 4,276,862**

**Registered Jan. 15, 2013**

**Int. Cl.: 9**

NEST LABS, INC. (DELAWARE CORPORATION)  
900 HANSEN WAY  
NEST LABS, INC.  
PALO ALTO, CA 94304

FOR: THERMOSTATS, IN CLASS 9 (U.S. CLS. 21, 23, 26, 36 AND 38).

**TRADEMARK**

FIRST USE 10-25-2011; IN COMMERCE 10-25-2011.

**PRINCIPAL REGISTER**

THE MARK CONSISTS OF STANDARD CHARACTERS WITHOUT CLAIM TO ANY PARTICULAR FONT, STYLE, SIZE, OR COLOR.

SN 85-454,380, FILED 10-24-2011.

SUSAN LESLIE DUBOIS, EXAMINING ATTORNEY



*David J. Kybas*

Director of the United States Patent and Trademark Office

# United States of America

United States Patent and Trademark Office

# TWYXT

**Reg. No. 4,276,863**

**Registered Jan. 15, 2013**

**Int. Cl.: 9**

**TRADEMARK**

**PRINCIPAL REGISTER**

LIFE OF TWO, INC. (DELAWARE CORPORATION)  
901 MISSION STREET, SUITE 103  
SAN FRANCISCO, CA 94103

FOR: COMPUTER SOFTWARE FOR COMMUNICATION BY MEANS OF TEXT AND DIGITAL IMAGE SHARING BETWEEN PARTICIPANTS IN DEEP HUMAN RELATIONSHIPS, NAMELY, RELATIONSHIPS CHARACTERIZED BY STRONG RELATIONSHIP AND SIGNIFICANT COMMUNICATION. COMPUTER SOFTWARE FOR COORDINATION BY MEANS OF PROVIDING A REAL TIME SYNCHRONIZED TEXT AND DIGITAL IMAGE CALENDAR, TO DO LISTS, AND LOCATION SHARING FUNCTIONALITY BETWEEN PARTICIPANTS IN DEEP HUMAN RELATIONSHIPS, NAMELY, RELATIONSHIPS CHARACTERIZED BY STRONG RELATIONSHIP AND SIGNIFICANT COMMUNICATION. COMPUTER SOFTWARE FOR COUNSELING BY MEANS OF PROVIDING RECOMMENDATION FUNCTIONALITY AND SOFTWARE FUNCTIONALITY FACILITATING COUPLE RELATED ACTIVITIES SUCH AS PURCHASING, TRAVEL AND DINING ORIENTED TO PARTICIPANTS IN DEEP HUMAN RELATIONSHIPS, NAMELY, RELATIONSHIPS CHARACTERIZED BY STRONG RELATIONSHIP AND SIGNIFICANT COMMUNICATION. COMPUTER SOFTWARE FOR ARCHIVING DIGITAL INFORMATION THAT IS PLACED AND EXCHANGED ON A COMPUTER SOFTWARE PLATFORM IN A SEARCHABLE AND USABLE MANNER; COMPUTER SOFTWARE PLATFORMS FOR CONNECTING, COORDINATING, COUNSELING AND ARCHIVING DEEP HUMAN RELATIONSHIPS, NAMELY, RELATIONSHIPS CHARACTERIZED BY STRONG RELATIONSHIP AND SIGNIFICANT COMMUNICATION, IN CLASS 9 (U.S. CLS. 21, 23, 26, 36 AND 38).

FIRST USE 9-30-2012; IN COMMERCE 9-30-2012.

THE MARK CONSISTS OF STANDARD CHARACTERS WITHOUT CLAIM TO ANY PARTICULAR FONT, STYLE, SIZE, OR COLOR.

SN 85-454,418, FILED 10-24-2011.

DAVID MURRAY, EXAMINING ATTORNEY



*David J. Kyffers*

Director of the United States Patent and Trademark Office



# United States of America

United States Patent and Trademark Office

# Yolavie

**Reg. No. 4,276,864**

YOLAVIE, INC. (MARYLAND CORPORATION)  
890 BESTGATE RD., SUITE B  
ANNAPOLIS, MD 21401

**Registered Jan. 15, 2013**

**Int. Cl.: 43**

FOR: FROZEN YOGURT SHOP SERVICES IN THE NATURE OF A RESTAURANT, IN CLASS 43 (U.S. CLS. 100 AND 101).

**SERVICE MARK**

FIRST USE 4-6-2012; IN COMMERCE 4-6-2012.

**PRINCIPAL REGISTER**

THE MARK CONSISTS OF STANDARD CHARACTERS WITHOUT CLAIM TO ANY PARTICULAR FONT, STYLE, SIZE, OR COLOR.

SN 85-454,483, FILED 10-24-2011.

SUSAN RICHARDS, EXAMINING ATTORNEY



*David J. Kybas*

Director of the United States Patent and Trademark Office

# United States of America

United States Patent and Trademark Office



**Reg. No. 4,276,865**

**Registered Jan. 15, 2013**

**Int. Cl.: 29**

**TRADEMARK**

**PRINCIPAL REGISTER**

BUBBA FOODS, LLC (DELAWARE LIMITED LIABILITY COMPANY)  
4339 ROOSEVELT BLVD., SUITE 400  
JACKSONVILLE, FL 32210

FOR: FROZEN PREPARED MEATS, IN CLASS 29 (U.S. CL. 46).

FIRST USE 6-0-2012; IN COMMERCE 6-0-2012.

OWNER OF U.S. REG. NOS. 2,659,731, 2,901,596, AND 3,941,200.

NO CLAIM IS MADE TO THE EXCLUSIVE RIGHT TO USE "STEAK", APART FROM THE MARK AS SHOWN.

THE MARK CONSISTS OF TWO CONCENTRIC RECTANGLES CONTAINING THE SHADOWED WORD "BUBBA" AND THE WORD "STEAK" IN LINE WITH A BOTTOM BORDER OF THE INTERIOR RECTANGLE.

SN 85-454,594, FILED 10-24-2011.

NATALIE POLZER, EXAMINING ATTORNEY



*David J. Kyffers*

Director of the United States Patent and Trademark Office

# United States of America

United States Patent and Trademark Office

## THE NEW FINANCIAL REALITY

**Reg. No. 4,276,866**

CBTV, LLC (TENNESSEE LIMITED LIABILITY COMPANY)  
26 CENTURY BOULEVARD, SUITE 301  
NASHVILLE, TN 37214

**Registered Jan. 15, 2013**

**Int. Cls.: 16 and 41**

FOR: BOOKS IN THE FIELD OF FINANCE, IN CLASS 16 (U.S. CLS. 2, 5, 22, 23, 29, 37, 38 AND 50).

**TRADEMARK**

FIRST USE 11-21-2012; IN COMMERCE 11-21-2012.

**SERVICE MARK**

FOR: EDUCATIONAL SERVICES, NAMELY, CONDUCTING SEMINARS IN THE FIELD OF FINANCE, IN CLASS 41 (U.S. CLS. 100, 101 AND 107).

**PRINCIPAL REGISTER**

FIRST USE 11-21-2012; IN COMMERCE 11-21-2012.

THE MARK CONSISTS OF STANDARD CHARACTERS WITHOUT CLAIM TO ANY PARTICULAR FONT, STYLE, SIZE, OR COLOR.

SN 85-454,723, FILED 10-24-2011.

ANDREA K. NADELMAN, EXAMINING ATTORNEY



*David J. Kybas*

Director of the United States Patent and Trademark Office

# United States of America

United States Patent and Trademark Office

# AUTO-AWAY

**Reg. No. 4,276,867**

**Registered Jan. 15, 2013**

**Int. Cl.: 9**

NEST LABS, INC. (DELAWARE CORPORATION)  
900 HANSEN WAY  
NEST LABS, INC.  
PALO ALTO, CA 94304

FOR: THERMOSTATS, IN CLASS 9 (U.S. CLS. 21, 23, 26, 36 AND 38).

**TRADEMARK**

FIRST USE 10-25-2011; IN COMMERCE 10-25-2011.

**PRINCIPAL REGISTER**

THE MARK CONSISTS OF STANDARD CHARACTERS WITHOUT CLAIM TO ANY PARTICULAR FONT, STYLE, SIZE, OR COLOR.

SN 85-454,990, FILED 10-24-2011.

SUSAN LESLIE DUBOIS, EXAMINING ATTORNEY



*David J. Kyffers*

Director of the United States Patent and Trademark Office

# United States of America

United States Patent and Trademark Office

# NEST

**Reg. No. 4,276,868**

**Registered Jan. 15, 2013**

**Int. Cl.: 42**

**SERVICE MARK**

**PRINCIPAL REGISTER**

NEST LABS, INC. (DELAWARE CORPORATION)  
900 HANSEN WAY  
NEST LABS, INC.  
PALO ALTO, CA 94304

FOR: COMPUTER SERVICES, NAMELY, PROVIDING A WEBSITE FEATURING TECHNOLOGY THAT ALLOWS USERS TO MONITOR AND CONTROL A CLIMATE CONTROL SYSTEM AT A REMOTE LOCATION, IN CLASS 42 (U.S. CLS. 100 AND 101).

FIRST USE 10-25-2011; IN COMMERCE 10-25-2011.

THE MARK CONSISTS OF STANDARD CHARACTERS WITHOUT CLAIM TO ANY PARTICULAR FONT, STYLE, SIZE, OR COLOR.

SN 85-454,994, FILED 10-24-2011.

SUSAN LESLIE DUBOIS, EXAMINING ATTORNEY



*David J. Kyjars*

Director of the United States Patent and Trademark Office

# United States of America

United States Patent and Trademark Office

# Wintonic

**Reg. No. 4,276,869**

**Registered Jan. 15, 2013**

**Int. Cl.: 9**

**TRADEMARK**

**PRINCIPAL REGISTER**

WINTONIC BATTERY & MAGNET CO., LTD (CHINA LIMITED COMPANY (LTD.))  
NO.38 YUNFENG ROAD, XINHUA IND. PARK  
HUADU DISTRICT  
GUANGZHOU, CHINA

FOR: BATTERIES; CAMERAS; ELECTRIC METERS; ELECTRONIC DISPLAYS, NAMELY, DIGITAL SIGNAGE; ELECTROPLATING MACHINES; INDUSTRIAL AUTOMATION CONTROLS; LIGHT EMITTING DIODE (LED) DISPLAYS; MAGNETS; OPTICAL LANTERNS; SOUND TRANSMITTING APPARATUS, IN CLASS 9 (U.S. CLS. 21, 23, 26, 36 AND 38).

FIRST USE 3-18-2011; IN COMMERCE 6-15-2012.

SN 85-455,078, FILED 10-25-2011.

JUDITH HELFMAN, EXAMINING ATTORNEY



*David J. Kybas*

Director of the United States Patent and Trademark Office

# United States of America

United States Patent and Trademark Office

## VALUE ENGINEERED SOLUTIONS!

**Reg. No. 4,276,870**

SOIL SOLUTIONS LIMITED (ISLE OF MAN LIMITED COMPANY (LTD.))  
18 ATHOL STREET  
DOUGLAS, UNITED KINGDOM IM11JA

**Registered Jan. 15, 2013**

**Int. Cl.: 1**

FOR: CHEMICAL PREPARATIONS FOR STABILIZING SOIL AND DUST, IN CLASS 1 (U.S. CLS. 1, 5, 6, 10, 26 AND 46).

**TRADEMARK**

FIRST USE 9-1-2009; IN COMMERCE 6-1-2011.

**PRINCIPAL REGISTER**

THE MARK CONSISTS OF STANDARD CHARACTERS WITHOUT CLAIM TO ANY PARTICULAR FONT, STYLE, SIZE, OR COLOR.

NO CLAIM IS MADE TO THE EXCLUSIVE RIGHT TO USE "ENGINEERED SOLUTIONS!", APART FROM THE MARK AS SHOWN.

SN 85-455,080, FILED 10-25-2011.

VIVIAN MICZNIK FIRST, EXAMINING ATTORNEY



*David J. Kybas*

Director of the United States Patent and Trademark Office

# United States of America

United States Patent and Trademark Office

## COMPASSION EXCHANGE

**Reg. No. 4,276,871**

BROWN, VAUGHN DR. (UNITED STATES INDIVIDUAL)  
P.O. BOX 7277

**Registered Jan. 15, 2013**

PRINCETON, NJ 08543

**Int. Cl.: 38**

FOR: PROVIDING MULTIPLE INTERACTIVE USER ACCESS TO ONLINE NETWORKS FOR THE DISSEMINATION OF INFORMATION FOR PLACING INDIVIDUALS IN CONTACT WITH HUMANITARIAN, CHARITABLE AND PHILANTHROPIC ORGANIZATIONS AND INDIVIDUALS, IN CLASS 38 (U.S. CLS. 100, 101 AND 104).

**SERVICE MARK**

**PRINCIPAL REGISTER**

FIRST USE 10-30-2012; IN COMMERCE 10-30-2012.

THE MARK CONSISTS OF STANDARD CHARACTERS WITHOUT CLAIM TO ANY PARTICULAR FONT, STYLE, SIZE, OR COLOR.

NO CLAIM IS MADE TO THE EXCLUSIVE RIGHT TO USE "EXCHANGE", APART FROM THE MARK AS SHOWN.

SN 85-455,182, FILED 10-25-2011.

AMY KELLY, EXAMINING ATTORNEY



*David J. Kyffers*

Director of the United States Patent and Trademark Office



# United States of America

United States Patent and Trademark Office

# RATESPY

**Reg. No. 4,276,872**

MCLISTER ENTERPRISES, INC. (CANADA CORPORATION)  
6392 BAY STREET

**Registered Jan. 15, 2013**

WEST VANCOUVER, BC, CANADA V7W2G9

**Int. Cl.: 36**

FOR: FINANCIAL INFORMATION, IN CLASS 36 (U.S. CLS. 100, 101 AND 102).

**SERVICE MARK**

FIRST USE 10-2-2012; IN COMMERCE 10-2-2012.

**PRINCIPAL REGISTER**

THE MARK CONSISTS OF STANDARD CHARACTERS WITHOUT CLAIM TO ANY PARTICULAR FONT, STYLE, SIZE, OR COLOR.

SN 85-455,482, FILED 10-25-2011.

DORITT L. CARROLL, EXAMINING ATTORNEY



*David J. Kyfos*

Director of the United States Patent and Trademark Office

# United States of America

United States Patent and Trademark Office

## NATION PIZZA AND FOODS

**Reg. No. 4,276,873**

**Registered Jan. 15, 2013**

**Int. Cl.: 40**

**SERVICE MARK**

**PRINCIPAL REGISTER**

NATION PIZZA PRODUCTS, L.P. (ILLINOIS LIMITED PARTNERSHIP)  
601 EAST ALGONQUIN ROAD  
SCHAUMBURG, IL 60173

FOR: FOOD PROCESSING, IN CLASS 40 (U.S. CLS. 100, 103 AND 106).

FIRST USE 8-1-2012; IN COMMERCE 8-1-2012.

THE MARK CONSISTS OF STANDARD CHARACTERS WITHOUT CLAIM TO ANY PARTICULAR FONT, STYLE, SIZE, OR COLOR.

OWNER OF U.S. REG. NOS. 1,787,200 AND 2,401,731.

NO CLAIM IS MADE TO THE EXCLUSIVE RIGHT TO USE "PIZZA AND FOODS", APART FROM THE MARK AS SHOWN.

SN 85-455,791, FILED 10-25-2011.

SCOTT BIBB, EXAMINING ATTORNEY



*David J. Kyffers*

Director of the United States Patent and Trademark Office

# United States of America

United States Patent and Trademark Office

## Sportsideo's SportsQuest

**Reg. No. 4,276,874**

SPORTSIDE, LLC (NEW YORK LIMITED LIABILITY COMPANY)  
223 WALL STREET, #135  
HUNTINGTON, NY 11743

**Registered Jan. 15, 2013**

**Int. Cl.: 36**

FOR: PROVIDING FUNDRAISING SERVICES FOR OTHERS VIA A WEBSITE THAT FEATURES TECHNOLOGY THAT ENABLES ITS USERS TO RAISE MONEY FOR SPORTS ORGANIZATIONS, IN CLASS 36 (U.S. CLS. 100, 101 AND 102).

**SERVICE MARK**

FIRST USE 1-3-2012; IN COMMERCE 1-3-2012.

**PRINCIPAL REGISTER**

THE MARK CONSISTS OF STANDARD CHARACTERS WITHOUT CLAIM TO ANY PARTICULAR FONT, STYLE, SIZE, OR COLOR.

SN 85-455,815, FILED 10-25-2011.

DAVID MURRAY, EXAMINING ATTORNEY



*David J. Kybas*

Director of the United States Patent and Trademark Office

# United States of America

United States Patent and Trademark Office

# RE-SPRAY

**Reg. No. 4,276,875**

**Registered Jan. 15, 2013**

**Int. Cl.: 17**

**TRADEMARK**

**PRINCIPAL REGISTER**

HAMILTON MATERIALS (WASHINGTON), LLC (CALIFORNIA LIMITED LIABILITY COMPANY), DBA HAMILTON DRYWALL PRODUCTS,  
295 N. PEKIN ROAD  
WOODLAND, WA 98674

FOR: DRY PARTICLE FORMULATIONS THAT WHEN MIXED WITH WATER FORM DRYWALL FINISHING COMPOUNDS FOR THE TREATMENT OF DRYWALL, IN CLASS 17 (U.S. CLS. 1, 5, 12, 13, 35 AND 50).

FIRST USE 10-25-2011; IN COMMERCE 10-25-2011.

THE MARK CONSISTS OF STANDARD CHARACTERS WITHOUT CLAIM TO ANY PARTICULAR FONT, STYLE, SIZE, OR COLOR.

SN 85-455,822, FILED 10-25-2011.

WILLIAM P. SHANAHAN, EXAMINING ATTORNEY



*David J. Kyros*

Director of the United States Patent and Trademark Office

# United States of America

United States Patent and Trademark Office



**Reg. No. 4,276,876**

**Registered Jan. 15, 2013**

**Int. Cls.: 16, 18, 25, and 41**

**TRADEMARK**

**SERVICE MARK**

**PRINCIPAL REGISTER**

COLORADO MESA UNIVERSITY BOARD OF TRUSTEES (COLORADO STATE UNIVERSITY)  
1100 NORTH AVENUE  
GRAND JUNCTION, CO 81501

FOR: PAPER PRODUCTS, NAMELY, NOTEBOOKS, DOCUMENT PORTFOLIOS, CALENDARS, STATIONERY, NOTE CARDS, NAPKINS; BALLPOINT PENS; CHECKBOOK HOLDERS; SEALS; DECALS, IN CLASS 16 (U.S. CLS. 2, 5, 22, 23, 29, 37, 38 AND 50).

FIRST USE 10-1-2011; IN COMMERCE 10-1-2011.

FOR: BACKPACKS, BRIEFCASES, SATCHELS, BRIEFCASE-TYPE PORTFOLIOS, BILL-FOLDS, COIN PURSES, ALL PURPOSE CARRYING BAGS, NAMELY, EQUIPMENT CARRIERS, IN CLASS 18 (U.S. CLS. 1, 2, 3, 22 AND 41).

FIRST USE 10-1-2011; IN COMMERCE 10-1-2011.

FOR: CLOTHING, NAMELY, SHIRTS, T-SHIRTS, SWEATSHIRTS, SHORTS, SWEATPANTS, SWEATERS, JACKETS, SCARVES, MITTENS, SOCKS, SLIPPERS, CLOTH BIBS, AND HEADWEAR, NAMELY, CAPS, HATS, HEADBANDS AND VISORS, IN CLASS 25 (U.S. CLS. 22 AND 39).

FIRST USE 10-1-2011; IN COMMERCE 10-1-2011.

FOR: EDUCATIONAL SERVICES, NAMELY, PROVIDING COURSES OF INSTRUCTION AT THE DOCTORAL, MASTER'S, BACCALAUREATE, ASSOCIATE DEGREE, AND POST SECONDARY CERTIFICATE LEVELS; ENTERTAINMENT SERVICES, NAMELY, PROVIDING FINE ARTS EVENTS, DANCE RECITALS, LIVE MUSICAL CONCERTS AND SPORTING EVENTS, NAMELY, BASEBALL, BASKETBALL, CROSS COUNTRY, FOOTBALL, INDOOR TRACK AND FIELD, LACROSSE, OUTDOOR TRACK AND FIELD, SOCCER, SWIMMING, TENNIS, WRESTLING, GOLF, SOFTBALL, VOLLEYBALL, CHEERLEADING, CYCLING, HOCKEY, RODEO, RUGBY AND SKIING, IN CLASS 41 (U.S. CLS. 100, 101 AND 107).

FIRST USE 10-1-2011; IN COMMERCE 10-1-2011.



*David J. Kyjars*

Director of the United States Patent and Trademark Office

**Reg. No. 4,276,876** THE MARK CONSISTS OF A STYLIZED DEPICTION OF TWO MOUNTAINS (MESAS)  
WITH A FLOWING RIVER BELOW.

SN 85-455,976, FILED 10-25-2011.

JASON BLAIR, EXAMINING ATTORNEY

# United States of America

United States Patent and Trademark Office

# DAILYFIT

**Reg. No. 4,276,877**

DAILYFIT, INC. (CALIFORNIA CORPORATION)  
4500 CEDROS AVE  
SHERMAN OAK, CA 91403

**Registered Jan. 15, 2013**

**Int. Cl.: 35**

FOR: CONSULTING SERVICES, NAMELY, MARKETING AND BUSINESS OPTIMIZATION SERVICES; PROMOTING THE GOODS AND SERVICES OF OTHERS BY PROVIDING COUPONS, DISCOUNTS AND BUNDLED PACKAGES, IN CLASS 35 (U.S. CLS. 100, 101 AND 102).

**SERVICE MARK**

**PRINCIPAL REGISTER**

FIRST USE 7-1-2011; IN COMMERCE 10-1-2011.

THE MARK CONSISTS OF STANDARD CHARACTERS WITHOUT CLAIM TO ANY PARTICULAR FONT, STYLE, SIZE, OR COLOR.

SN 85-456,127, FILED 10-25-2011.

MARK SHINER, EXAMINING ATTORNEY



*David J. Kybas*

Director of the United States Patent and Trademark Office

# United States of America

United States Patent and Trademark Office

# ALLIANZ 365i

**Reg. No. 4,276,878**

**Registered Jan. 15, 2013**

**Int. Cl.: 36**

**SERVICE MARK**

**PRINCIPAL REGISTER**

ALLIANZ SE (FED REP GERMANY CORPORATION)  
KÖNIGINSTRASSE 28  
MÜNCHEN, FED REP GERMANY 80802

FOR: FINANCIAL ADVICE AND CONSULTANCY SERVICES; INSURANCE ACTUARIAL SERVICES; INSURANCE ADMINISTRATION IN THE FIELD OF ANNUITIES; INSURANCE AGENCY AND BROKERAGE; INSURANCE CLAIMS PROCESSING; INSURANCE INFORMATION AND CONSULTANCY; INSURANCE UNDERWRITING IN THE FIELD OF ANNUITIES, IN CLASS 36 (U.S. CLS. 100, 101 AND 102).

FIRST USE 1-5-2012; IN COMMERCE 1-5-2012.

THE MARK CONSISTS OF STANDARD CHARACTERS WITHOUT CLAIM TO ANY PARTICULAR FONT, STYLE, SIZE, OR COLOR.

OWNER OF U.S. REG. NOS. 2,145,557, 2,391,129, AND OTHERS.

THE ENGLISH TRANSLATION OF "ALLIANZ" IN THE MARK IS "ALLIANCE" OR "PACT" OR "AGREEMENT".

SN 85-456,392, FILED 10-26-2011.

TRICIA SONNEBORN, EXAMINING ATTORNEY



*David J. Kyffers*

Director of the United States Patent and Trademark Office



# United States of America

United States Patent and Trademark Office

## 65 INCORPORATED

**Reg. No. 4,276,879**

**Registered Jan. 15, 2013**

**Int. Cl.: 41**

**SERVICE MARK**

**PRINCIPAL REGISTER**

OMDAHL, RICHARD (UNITED STATES INDIVIDUAL)  
1009 W. GLEN OAKS LANE, SUITE 105  
MEQUON, WI 53092 AND

OMDAHL, DIANE (UNITED STATES INDIVIDUAL)  
1009 W. GLEN OAKS LANE, SUITE 105  
MEQUON, WI 53092

FOR: CONSULTING SERVICES IN THE FIELD OF CONSUMER HEALTHCARE EDUCATION,  
IN CLASS 41 (U.S. CLS. 100, 101 AND 107).

FIRST USE 4-13-2012; IN COMMERCE 4-13-2012.

THE MARK CONSISTS OF STANDARD CHARACTERS WITHOUT CLAIM TO ANY PARTICULAR FONT, STYLE, SIZE, OR COLOR.

NO CLAIM IS MADE TO THE EXCLUSIVE RIGHT TO USE "65", APART FROM THE MARK AS SHOWN.

SN 85-456,499, FILED 10-26-2011.

GINA FINK, EXAMINING ATTORNEY



*David J. Kybas*

Director of the United States Patent and Trademark Office

# United States of America

United States Patent and Trademark Office

## FIRST AMERICAN NONPROFIT FINANCE

**Reg. No. 4,276,880**

FIRST AMERICAN COMMERCIAL BANCORP, INC. (ILLINOIS CORPORATION)  
645 N. MICHIGAN AVENUE, SUITE 800  
CHICAGO, IL 60611

**Registered Jan. 15, 2013**

**Int. Cl.: 36**

FOR: LEASE-PURCHASE FINANCING, IN CLASS 36 (U.S. CLS. 100, 101 AND 102).

**SERVICE MARK**

FIRST USE 4-0-2011; IN COMMERCE 4-0-2011.

**PRINCIPAL REGISTER**

THE MARK CONSISTS OF STANDARD CHARACTERS WITHOUT CLAIM TO ANY PARTICULAR FONT, STYLE, SIZE, OR COLOR.

OWNER OF U.S. REG. NOS. 3,178,309, 4,060,685, AND OTHERS.

NO CLAIM IS MADE TO THE EXCLUSIVE RIGHT TO USE "AMERICAN NONPROFIT FINANCE", APART FROM THE MARK AS SHOWN.

SN 85-456,801, FILED 10-26-2011.

DAVID H. STINE, EXAMINING ATTORNEY



*David J. Kyros*

Director of the United States Patent and Trademark Office

# United States of America

United States Patent and Trademark Office

# AmeriCopy

**Reg. No. 4,276,881**

**Registered Jan. 15, 2013**

**Int. Cl.: 9**

**TRADEMARK**

**PRINCIPAL REGISTER**

ALL-PAC MEDIA INTERNATIONAL, INC. (CALIFORNIA CORPORATION)  
8531 LOCH LOMOND DRIVE  
PICO RIVERA, CA 90660

FOR: APPARATUS FOR RECORDING AND REPRODUCTION OF SOUND, IMAGES OR DATA; BLANK AUDIO CASSETTES; BLANK AUDIO TAPES; BLANK COMPUTER DISCS; BLANK DIGITAL STORAGE MEDIA; BLANK DISCS FOR COMPUTERS; BLANK RECORDABLE CD-RS AND DVD-RS; BLANK USB FLASH DRIVES; BLANK VIDEO CASSETTES; CD CASES; CD SLEEVES; CD-ROM DRIVES; COMPACT DISC CASES; DISC STORAGE CONTAINERS; DVD CASES; DVD DRIVES; DVD SLEEVES; JACKETS FOR VIDEO CASSETTES; RECORDABLE COMPACT DISKS AND DIGITAL VIDEO DISKS WITH PRINTABLE UPPER SURFACES ON WHICH TEXT OR GRAPHICS CAN BE DIRECTLY PRINTED, IN CLASS 9 (U.S. CLS. 21, 23, 26, 36 AND 38).

FIRST USE 7-1-2012; IN COMMERCE 11-2-2012.

THE MARK CONSISTS OF STANDARD CHARACTERS WITHOUT CLAIM TO ANY PARTICULAR FONT, STYLE, SIZE, OR COLOR.

SN 85-456,802, FILED 10-26-2011.

DAVID ELTON, EXAMINING ATTORNEY



*David J. Kypos*

Director of the United States Patent and Trademark Office

# United States of America

United States Patent and Trademark Office



**Reg. No. 4,276,882**

FIRST AMERICAN COMMERCIAL BANCORP, INC. (ILLINOIS CORPORATION)  
645 N. MICHIGAN AVENUE, SUITE 800  
CHICAGO, IL 60611

**Registered Jan. 15, 2013**

**Int. Cl.: 36**

FOR: LEASE-PURCHASE FINANCING, IN CLASS 36 (U.S. CLS. 100, 101 AND 102).

**SERVICE MARK**

FIRST USE 4-0-2011; IN COMMERCE 4-0-2011.

**PRINCIPAL REGISTER**

OWNER OF U.S. REG. NOS. 3,178,309, 4,060,685, AND OTHERS.

NO CLAIM IS MADE TO THE EXCLUSIVE RIGHT TO USE "AMERICAN NONPROFIT FINANCE", APART FROM THE MARK AS SHOWN.

THE MARK CONSISTS OF A STYLIZED SQUARE TO THE LEFT OF THE STYLIZED WORDS "FIRST AMERICAN" ALL ABOVE THE STYLIZED WORDS "NONPROFIT FINANCE".

SN 85-456,807, FILED 10-26-2011.

DAVID H. STINE, EXAMINING ATTORNEY



*David J. Kybas*

Director of the United States Patent and Trademark Office

# United States of America

United States Patent and Trademark Office

## YOUR BODY KNOWS WHAT IT WANTS

**Reg. No. 4,276,883**

LIVON LABORATORIES, INC. (NEVADA CORPORATION)  
2566 WILLIAMSBURG STREET  
HENDERSON, NV 89052

**Registered Jan. 15, 2013**

**Int. Cl.: 5**

FOR: VITAMINS, DIETARY SUPPLEMENTS, AND FOOD SUPPLEMENTS, IN CLASS 5  
(U.S. CLS. 6, 18, 44, 46, 51 AND 52).

**TRADEMARK**

FIRST USE 12-6-2011; IN COMMERCE 12-6-2011.

**PRINCIPAL REGISTER**

THE MARK CONSISTS OF STANDARD CHARACTERS WITHOUT CLAIM TO ANY PARTICULAR FONT, STYLE, SIZE, OR COLOR.

SN 85-456,962, FILED 10-26-2011.

AMY HELLA, EXAMINING ATTORNEY



*David J. Kyfos*

Director of the United States Patent and Trademark Office

# United States of America

United States Patent and Trademark Office

# MIRISK

**Reg. No. 4,276,884**

AVIR, INC. (CALIFORNIA CORPORATION)  
9805 RESEARCH DRIVE  
IRVINE, CA 92618

**Registered Jan. 15, 2013**

**Int. Cl.: 42**

FOR: MEDICAL LABORATORY SERVICES, IN CLASS 42 (U.S. CLS. 100 AND 101).

**SERVICE MARK**

FIRST USE 10-27-2011; IN COMMERCE 10-27-2011.

**PRINCIPAL REGISTER**

THE MARK CONSISTS OF STANDARD CHARACTERS WITHOUT CLAIM TO ANY PARTICULAR FONT, STYLE, SIZE, OR COLOR.

SN 85-457,061, FILED 10-26-2011.

DOMINIC J. FERRAIUOLO, EXAMINING ATTORNEY



*David J. Kyffers*

Director of the United States Patent and Trademark Office

# United States of America

United States Patent and Trademark Office

# BERKLINE

**Reg. No. 4,276,885**

**Registered Jan. 15, 2013**

**Int. Cl.: 27**

**TRADEMARK**

**PRINCIPAL REGISTER**

ASHLEY FURNITURE INDUSTRIES, INC. (WISCONSIN CORPORATION)  
ONE ASHLEY WAY  
ARCADIA, WI 54612

FOR: AREA RUGS, IN CLASS 27 (U.S. CLS. 19, 20, 37, 42 AND 50).

FIRST USE 11-1-2012; IN COMMERCE 11-1-2012.

THE MARK CONSISTS OF STANDARD CHARACTERS WITHOUT CLAIM TO ANY PARTICULAR FONT, STYLE, SIZE, OR COLOR.

OWNER OF U.S. REG. NO. 995,287.

SN 85-457,084, FILED 10-26-2011.

TEJBIR SINGH, EXAMINING ATTORNEY



*David J. Kyffers*

Director of the United States Patent and Trademark Office

# United States of America

United States Patent and Trademark Office

## FERRO-GREEN

**Reg. No. 4,276,886**

FORTA CORPORATION (PENNSYLVANIA CORPORATION)  
100 FORTA DRIVE  
GROVE CITY, PA 161276399

**Registered Jan. 15, 2013**

**Int. Cl.: 19**

FOR: SYNTHETIC FIBERS FOR REINFORCING CONCRETE, IN CLASS 19 (U.S. CLS. 1, 12, 33 AND 50).

**TRADEMARK**

FIRST USE 10-0-2012; IN COMMERCE 10-0-2012.

**PRINCIPAL REGISTER**

THE MARK CONSISTS OF STANDARD CHARACTERS WITHOUT CLAIM TO ANY PARTICULAR FONT, STYLE, SIZE, OR COLOR.

SN 85-457,542, FILED 10-27-2011.

DOMINIC J. FERRAIUOLO, EXAMINING ATTORNEY



*David J. Kybas*

Director of the United States Patent and Trademark Office



# United States of America

United States Patent and Trademark Office

## STRIDE RITE REWARDS

**Reg. No. 4,276,887**

**Registered Jan. 15, 2013**

**Int. Cl.: 35**

**SERVICE MARK**

**PRINCIPAL REGISTER**

SRL, LLC (DELAWARE LIMITED LIABILITY COMPANY)  
191 SPRING STREET  
LEXINGTON, MA 02421

FOR: ADMINISTRATION OF A CUSTOMER LOYALTY PROGRAM WHICH PROVIDES DISCOUNTS, COUPONS AND SALES NOTIFICATIONS IN THE FIELD OF SHOES AND FASHION ACCESSORIES, ADVANCE NOTIFICATIONS OF NEW STYLES AND FASHION TRENDS, EXCLUSIVE PARTICIPATION IN CONTESTS AND GAMES FOR PRIZES AND DISCOUNTS IN THE FIELD OF SHOES AND FASHION ACCESSORIES, IN CLASS 35 (U.S. CLS. 100, 101 AND 102).

FIRST USE 7-1-2012; IN COMMERCE 7-1-2012.

THE MARK CONSISTS OF STANDARD CHARACTERS WITHOUT CLAIM TO ANY PARTICULAR FONT, STYLE, SIZE, OR COLOR.

OWNER OF U.S. REG. NOS. 1,236,944, 1,273,954, AND 2,121,905.

NO CLAIM IS MADE TO THE EXCLUSIVE RIGHT TO USE "REWARDS" , APART FROM THE MARK AS SHOWN.

SN 85-457,855, FILED 10-27-2011.

CHRISTINA SOBRAL, EXAMINING ATTORNEY



*David J. Kybas*

Director of the United States Patent and Trademark Office

# United States of America

United States Patent and Trademark Office

## Thunder "Dollar" Bill

**Reg. No. 4,276,888**

KAY, B. N. (UNITED STATES INDIVIDUAL), DBA BNK,  
224 EAST 70TH STREET, #7  
NEW YORK, NY 10021

**Registered Jan. 15, 2013**

**Int. Cl.: 41**

FOR: MULTIMEDIA ENTERTAINMENT SERVICES IN THE NATURE OF DEVELOPMENT,  
PRODUCTION AND POST-PRODUCTION SERVICES IN THE FIELDS OF VIDEO AND  
FILMS, IN CLASS 41 (U.S. CLS. 100, 101 AND 107).

**SERVICE MARK**

FIRST USE 2-12-2008; IN COMMERCE 8-20-2012.

**PRINCIPAL REGISTER**

THE MARK CONSISTS OF STANDARD CHARACTERS WITHOUT CLAIM TO ANY PAR-  
TICULAR FONT, STYLE, SIZE, OR COLOR.

SN 85-458,318, FILED 10-27-2011.

SAIMA MAKHDOOM, EXAMINING ATTORNEY



*David J. Kyros*

Director of the United States Patent and Trademark Office

# United States of America

United States Patent and Trademark Office

# IN SEA

**Reg. No. 4,276,889**

MCINNIS, RYAN J (UNITED STATES INDIVIDUAL)  
6708 GREENVILLE LOOP ROAD  
WILMINGTON, NC 28409

**Registered Jan. 15, 2013**

**Int. Cls.: 16, 25, and 35**

FOR: STICKERS, IN CLASS 16 (U.S. CLS. 2, 5, 22, 23, 29, 37, 38 AND 50).

FIRST USE 1-20-2010; IN COMMERCE 1-20-2010.

**TRADEMARK**

**SERVICE MARK**

FOR: BASEBALL CAPS AND HATS; HATS; SHIRTS; SHIRTS AND SHORT-SLEEVED SHIRTS; SHORT-SLEEVED OR LONG-SLEEVED T-SHIRTS; SHORT-SLEEVED SHIRTS; T-SHIRTS; T-SHIRTS FOR ADULTS AND CHILDREN; TEE SHIRTS; WEARABLE GARMENTS AND CLOTHING, NAMELY, SHIRTS; ATHLETIC APPAREL, NAMELY, SHIRTS, HATS AND CAPS; SPORT SHIRTS; SPORTS SHIRTS; SPORTS SHIRTS WITH SHORT SLEEVES, IN CLASS 25 (U.S. CLS. 22 AND 39).

**PRINCIPAL REGISTER**

FIRST USE 1-20-2010; IN COMMERCE 1-20-2010.

FOR: ADVERTISING ON THE INTERNET FOR OTHERS; ADVERTISING SERVICES; ADVERTISING SERVICES, NAMELY, COST-PER-ACTION ON-LINE ADVERTISING; DISSEMINATION OF ADVERTISING FOR OTHERS VIA THE INTERNET; ON-LINE ADVERTISING SERVICES FOR OTHERS; ONLINE ADVERTISEMENTS; ONLINE ADVERTISING AND PROMOTIONAL SERVICES; PROMOTING THE GOODS AND SERVICES OF OTHERS BY MEANS OF DISTRIBUTING ADVERTISING ON THE INTERNET; PROMOTING, ADVERTISING AND MARKETING ON-LINE WEB SITES OF OTHERS; PROVIDING AND RENTAL OF ADVERTISING SPACE ON THE INTERNET; PROMOTING, ADVERTISING AND MARKETING OF THE BRANDS, PRODUCTS, SERVICES AND ONLINE WEBSITES OF INDIVIDUALS, BUSINESSES AND NONPROFIT ORGANIZATIONS; PROMOTING, ADVERTISING AND MARKETING THE ON-LINE DATABASES AND ELECTRONIC PUBLICATIONS OF OTHERS, IN CLASS 35 (U.S. CLS. 100, 101 AND 102).

FIRST USE 1-20-2010; IN COMMERCE 1-20-2010.

THE MARK CONSISTS OF STANDARD CHARACTERS WITHOUT CLAIM TO ANY PARTICULAR FONT, STYLE, SIZE, OR COLOR.

SN 85-458,335, FILED 10-27-2011.



*David J. Kyros*

Director of the United States Patent and Trademark Office

**Reg. No. 4,276,889** ALLISON SCHRODY, EXAMINING ATTORNEY

# United States of America

United States Patent and Trademark Office



**Reg. No. 4,276,890**

**Registered Jan. 15, 2013**

**Int. Cl.: 41**

**SERVICE MARK**

**PRINCIPAL REGISTER**

ELEVEN IP HOLDINGS LLC (DELAWARE LIMITED LIABILITY COMPANY)  
SUITE 403  
221 NORTH HOGAN STREET  
JACKSONVILLE, FL 32202

FOR: SKIING, WHITE WATER RAFTING, FISHING, MOUNTAIN, MOUNTAINEERING, BIKING, CLIMBING, HIKING AND BACK COUNTRY TREK GUIDE SERVICES; ARRANGING AND CONDUCTING LIVE SPORTING ADVENTURES FOR SKIING, WHITE WATER RAFTING, FISHING, MOUNTAIN, MOUNTAINEERING, BIKING, CLIMBING, HIKING AND BACK COUNTRY TREKKING; INSTRUCTION IN THE FIELDS OF SKIING, BACK COUNTRY SKIING, WHITE WATER RAFTING, FISHING, MOUNTAINEERING, BIKING, CLIMBING, HIKING AND BACK COUNTRY TREKKING, IN CLASS 41 (U.S. CLS. 100, 101 AND 107).

FIRST USE 11-11-2011; IN COMMERCE 11-11-2011.

THE MARK CONSISTS OF A STYLIZED DIAMOND CONTAINING MOUNTAINS AND WAVES.

SN 85-458,474, FILED 10-27-2011.

KAREN K. BUSH, EXAMINING ATTORNEY



*David J. Kybas*

Director of the United States Patent and Trademark Office

# United States of America

United States Patent and Trademark Office



**Reg. No. 4,276,891**

**Registered Jan. 15, 2013**

**Int. Cl.: 39**

**SERVICE MARK**

**PRINCIPAL REGISTER**

ELEVEN IP HOLDINGS LLC (DELAWARE LIMITED LIABILITY COMPANY)  
SUITE 403  
221 NORTH HOGAN STREET  
JACKSONVILLE, FL 32202

FOR: ARRANGING AND CONDUCTING SKIING, BACK COUNTRY SKIING, WHITE WATER RAFTING, FISHING, MOUNTAIN, MOUNTAINEERING, BIKING, CLIMBING, HIKING AND BACK COUNTRY TREK EXPEDITIONS; TRAVEL AND EXCURSION ARRANGEMENT; COORDINATING TRAVEL ARRANGEMENTS FOR INDIVIDUALS AND GROUPS, IN CLASS 39 (U.S. CLS. 100 AND 105).

FIRST USE 11-11-2011; IN COMMERCE 11-11-2011.

THE MARK CONSISTS OF A STYLIZED DIAMOND CONTAINING MOUNTAINS AND WAVES.

SN 85-458,475, FILED 10-27-2011.

KAREN K. BUSH, EXAMINING ATTORNEY



*David J. Kybas*

Director of the United States Patent and Trademark Office

# United States of America

United States Patent and Trademark Office



**Reg. No. 4,276,892**

**Registered Jan. 15, 2013**

**Int. Cl.: 9**

**TRADEMARK**

**PRINCIPAL REGISTER**

NETSOL CO., LTD. (REPUBLIC OF KOREA LIMITED COMPANY (LTD.))  
KOREA ADVANCED NANO FAB CENTER  
7TH FLOOR 906-10, IUI-DONG, YOUNGTONG-GU  
SUWON-SI, GYEONGGGI-DO, REPUBLIC OF KOREA

FOR: LARGE SCALE INTEGRATED CIRCUITS, SEMI-CONDUCTOR MEMORIES, SEMI-CONDUCTOR MEMORY UNITS, SEMI-CONDUCTOR WAFERS, SEMICONDUCTOR POWER ELEMENTS, INTEGRATED CIRCUITS, ELECTRONIC CIRCUIT BOARD, INTEGRATED CIRCUIT MODULE, COMPUTER CHIPS, CIRCUIT BOARDS, IN CLASS 9 (U.S. CLS. 21, 23, 26, 36 AND 38).

FIRST USE 10-0-2010; IN COMMERCE 2-0-2011.

THE MARK CONSISTS OF THE WORDING "NETSOL" IN BLUE WITH A STYLIZED SWIRL OVER THE WORDING IN BLUE AND GREEN.

THE COLOR(S) BLUE AND GREEN IS/ARE CLAIMED AS A FEATURE OF THE MARK.

SN 85-458,678, FILED 10-28-2011.

HANNO RITTNER, EXAMINING ATTORNEY



*David J. Kyffers*

Director of the United States Patent and Trademark Office

# United States of America

United States Patent and Trademark Office

## A TASTE OF THE EXTRAORDINARY

**Reg. No. 4,276,893**

**Registered Jan. 15, 2013**

**Int. Cl.: 33**

**TRADEMARK**

**PRINCIPAL REGISTER**

THE DRAMBUIE LIQUEUR COMPANY LIMITED (SCOTLAND CORPORATION)  
SPRINGBURN BOND  
CARLISLE STREET  
GLASGOW, UNITED KINGDOM G211EQ

FOR: ALCOHOLIC BEVERAGES, NAMELY, WINES SPIRITS AND LIQUEURS, ALCOHOLIC MIXED COCKTAILS, HARD CIDER, BEVERAGES BLENDED FROM WHISKY AND COFFEE, BEVERAGES BLENDED FROM LIQUEURS AND COFFEE, BLENDS OF COFFEE AND WHISKY LIQUEUR, IN CLASS 33 (U.S. CLS. 47 AND 49).

FIRST USE 10-3-2012; IN COMMERCE 10-3-2012.

THE MARK CONSISTS OF STANDARD CHARACTERS WITHOUT CLAIM TO ANY PARTICULAR FONT, STYLE, SIZE, OR COLOR.

PRIORITY CLAIMED UNDER SEC. 44(D) ON UNITED KINGDOM APPLICATION NO. 2596400, FILED 9-30-2011.

SN 85-458,772, FILED 10-28-2011.

KEVON CHISOLM, EXAMINING ATTORNEY



*David J. Kyffers*

Director of the United States Patent and Trademark Office



# United States of America

United States Patent and Trademark Office

# OPT4

**Reg. No. 4,276,894**

**Registered Jan. 15, 2013**

**Int. Cl.: 20**

**TRADEMARK**

**PRINCIPAL REGISTER**

KRUEGER INTERNATIONAL, INC. (WISCONSIN CORPORATION)  
1330 BELLEVUE STREET  
GREEN BAY, WI 54302

FOR: FURNITURE, IN CLASS 20 (U.S. CLS. 2, 13, 22, 25, 32 AND 50).

FIRST USE 3-14-2012; IN COMMERCE 3-14-2012.

THE MARK CONSISTS OF STANDARD CHARACTERS WITHOUT CLAIM TO ANY PARTICULAR FONT, STYLE, SIZE, OR COLOR.

SN 85-458,969, FILED 10-28-2011.

LINDA MICKLEBURGH, EXAMINING ATTORNEY



*David J. Kybas*

Director of the United States Patent and Trademark Office

# United States of America

United States Patent and Trademark Office

# OCTOFLEX

**Reg. No. 4,276,895**

PAYLESS SHOESOURCE WORLDWIDE, INC. (KANSAS CORPORATION)  
700 SW JACKSON, SUITE 202  
TOPEKA, KS 66603

**Registered Jan. 15, 2013**

**Int. Cl.: 25**

FOR: FOOTWEAR, IN CLASS 25 (U.S. CLS. 22 AND 39).

**TRADEMARK**

FIRST USE 12-0-2011; IN COMMERCE 12-0-2011.

**PRINCIPAL REGISTER**

THE MARK CONSISTS OF STANDARD CHARACTERS WITHOUT CLAIM TO ANY PARTICULAR FONT, STYLE, SIZE, OR COLOR.

SN 85-459,089, FILED 10-28-2011.

NAPOLEON SHARMA, EXAMINING ATTORNEY



*David J. Kybas*

Director of the United States Patent and Trademark Office

# United States of America

United States Patent and Trademark Office



**Reg. No. 4,276,896**

**Registered Jan. 15, 2013**

**Int. Cls.: 3 and 5**

**TRADEMARK**

**PRINCIPAL REGISTER**

W. F. YOUNG, INC. (MASSACHUSETTS CORPORATION)  
302 BENTON DRIVE  
EAST LONGMEADOW, MA 01028

FOR: NON-MEDICATED ANIMAL HEALTH PRODUCTS, NAMELY, CLEANING PREPARATIONS IN THE NATURE OF SHAMPOOS, CONDITIONERS, CONDITIONING SPRAYS, TOPICAL HAIRDRESSINGS, HAIR POLISH, MANE AND TAIL CLEANERS; NON-MEDICATED HOOF CARE PRODUCTS, NAMELY, HOOF CONDITIONERS, HOOF POLISH AND HOOF MOISTURIZING CREAM, IN CLASS 3 (U.S. CLS. 1, 4, 6, 50, 51 AND 52).

FIRST USE 12-1-2011; IN COMMERCE 12-1-2011.

FOR: VETERINARY PRODUCTS, NAMELY, ANIMAL FEED ADDITIVES FOR USE AS NUTRITIONAL DIETARY SUPPLEMENTS; HEALTH FOOD SUPPLEMENTS; LINIMENTS; MEDICATED SHAMPOOS, CREAMS AND SPRAYS; MEDICATED HOOF CARE PRODUCTS, HOOF OINTMENTS AND SPRAYS; INSECTICIDES AND INSECT REPELLENTS; ADHESIVE BANDAGES AND WRAPS, IN CLASS 5 (U.S. CLS. 6, 18, 44, 46, 51 AND 52).

FIRST USE 12-1-2011; IN COMMERCE 12-1-2011.

THE MARK CONSISTS OF A HORSE SILHOUETTE IN PROFILE RELIEF WITH STRIPING IN THE LOWER PORTION AND A FIVE STAR EMBEDDED AT CENTER.

SN 85-459,127, FILED 10-28-2011.

ROSELLE HERRERA, EXAMINING ATTORNEY



*David J. Kybas*

Director of the United States Patent and Trademark Office

# United States of America

United States Patent and Trademark Office

## Gypsy Warrior

**Reg. No. 4,276,897**

ACT GYPSY, LLC (DELAWARE LIMITED LIABILITY COMPANY)  
475 TENTH AVENUE, FLOOR 9  
NEW YORK, NY 10018

**Registered Jan. 15, 2013**

**Int. Cl.: 35**

FOR: RETAIL CLOTHING BOUTIQUES, IN CLASS 35 (U.S. CLS. 100, 101 AND 102).

**SERVICE MARK**

FIRST USE 10-20-2011; IN COMMERCE 10-20-2011.

**PRINCIPAL REGISTER**

THE MARK CONSISTS OF STANDARD CHARACTERS WITHOUT CLAIM TO ANY PARTICULAR FONT, STYLE, SIZE, OR COLOR.

SN 85-459,682, FILED 10-29-2011.

KATHERINE E. HALMEN, EXAMINING ATTORNEY



*David J. Kybas*

Director of the United States Patent and Trademark Office

# United States of America

United States Patent and Trademark Office

travel  
exchange 

**Reg. No. 4,276,898**

NATIONAL TOUR ASSOCIATION, INC. (KENTUCKY CORPORATION)  
101 PROSPEROUS PLACE, SUITE 350  
LEXINGTON, KY 40509

**Registered Jan. 15, 2013**

**Int. Cl.: 35**

FOR: PLANNING, ORGANIZING, AND CONDUCTING BUSINESS CONVENTIONS AND BUSINESS MEETINGS FOR THE GROUP TOUR AND TRAVEL INDUSTRY, IN CLASS 35 (U.S. CLS. 100, 101 AND 102).

**SERVICE MARK**

FIRST USE 12-5-2011; IN COMMERCE 12-5-2011.

**PRINCIPAL REGISTER**

OWNER OF U.S. REG. NO. 2,928,922.

NO CLAIM IS MADE TO THE EXCLUSIVE RIGHT TO USE "TRAVEL", APART FROM THE MARK AS SHOWN.

THE MARK CONSISTS OF THE WORD "TRAVEL" ABOVE THE WORD "EXCHANGE" POSITIONED TO THE LEFT OF A STYLIZED GLOBE DESIGN WITH ARROWS.

SN 85-459,989, FILED 10-31-2011.

ELISSA GARBER KON, EXAMINING ATTORNEY



*David J. Kybas*

Director of the United States Patent and Trademark Office

# United States of America

United States Patent and Trademark Office

## ALEXIAN BROTHERS ADVANCED WEIGHT SOLUTIONS

**Reg. No. 4,276,899**

**Registered Jan. 15, 2013**

**Int. Cl.: 41**

**SERVICE MARK**

**PRINCIPAL REGISTER**

ALEXIAN BROTHERS OF AMERICA, INC. (TEXAS CORPORATION)  
3040 W. SALT CREEK LANE  
ARLINGTON HEIGHTS, IL 60005

FOR: EDUCATION SERVICES, NAMELY, PROVIDING LIVE AND ON-LINE CLASSES, SEMINARS, WORKSHOPS IN THE FIELD OF HEALTH, WEIGHT AND NUTRITION , IN CLASS 41 (U.S. CLS. 100, 101 AND 107).

FIRST USE 1-31-2007; IN COMMERCE 1-31-2007.

THE MARK CONSISTS OF STANDARD CHARACTERS WITHOUT CLAIM TO ANY PARTICULAR FONT, STYLE, SIZE, OR COLOR.

OWNER OF U.S. REG. NOS. 2,724,045, 3,984,371, AND OTHERS.

NO CLAIM IS MADE TO THE EXCLUSIVE RIGHT TO USE "ADVANCED WEIGHT SOLUTIONS", APART FROM THE MARK AS SHOWN.

SN 85-460,095, FILED 10-31-2011.

LESLIE RICHARDS, EXAMINING ATTORNEY



*David J. Kyffers*

Director of the United States Patent and Trademark Office

# United States of America

United States Patent and Trademark Office

## ALEXIAN BROTHERS ADVANCED WEIGHT SOLUTIONS

**Reg. No. 4,276,900**

**Registered Jan. 15, 2013**

**Int. Cl.: 44**

**SERVICE MARK**

**PRINCIPAL REGISTER**

ALEXIAN BROTHERS OF AMERICA, INC. (TEXAS CORPORATION)  
3040 W. SALT CREEK LANE  
ARLINGTON HEIGHTS, IL 60005

FOR: CONSULTING SERVICES IN THE FIELDS OF HEALTH AND NUTRITION; COUNSELING SERVICES IN THE FIELDS OF HEALTH, NUTRITION AND LIFESTYLE WELLNESS; PROVIDING A WEBSITE FEATURING INFORMATION AND ADVICE IN THE FIELDS OF DIET, WEIGHT LOSS, DIET PLANNING AND LIFESTYLE WELLNESS; PROVIDING WEIGHT LOSS PROGRAM SERVICES, IN CLASS 44 (U.S. CLS. 100 AND 101).

FIRST USE 2-28-2012; IN COMMERCE 2-28-2012.

THE MARK CONSISTS OF STANDARD CHARACTERS WITHOUT CLAIM TO ANY PARTICULAR FONT, STYLE, SIZE, OR COLOR.

OWNER OF U.S. REG. NOS. 2,724,045, 3,984,371, AND OTHERS.

NO CLAIM IS MADE TO THE EXCLUSIVE RIGHT TO USE "ADVANCED WEIGHT SOLUTIONS", APART FROM THE MARK AS SHOWN.

SN 85-460,099, FILED 10-31-2011.

LESLIE RICHARDS, EXAMINING ATTORNEY



*David J. Kybas*

Director of the United States Patent and Trademark Office

# United States of America

United States Patent and Trademark Office

## TRESSLETTES

**Reg. No. 4,276,901**

GREENE-SHARE, CYNTHIA (UNITED STATES INDIVIDUAL)  
13 PRINCETON STREET  
PEABODY, MA 01960

**Registered Jan. 15, 2013**

**Int. Cl.: 14**

FOR: HAIR JEWELRY IN THE NATURE OF JEWELRY FOR USE IN THE HAIR, IN CLASS 14 (U.S. CLS. 2, 27, 28 AND 50).

**TRADEMARK**

FIRST USE 9-0-2012; IN COMMERCE 9-0-2012.

**PRINCIPAL REGISTER**

THE MARK CONSISTS OF STANDARD CHARACTERS WITHOUT CLAIM TO ANY PARTICULAR FONT, STYLE, SIZE, OR COLOR.

SN 85-460,170, FILED 10-31-2011.

SUSAN LESLIE DUBOIS, EXAMINING ATTORNEY



*David J. Kybas*

Director of the United States Patent and Trademark Office



# United States of America

United States Patent and Trademark Office

# KODA

**Reg. No. 4,276,902**

**Registered Jan. 15, 2013**

**Int. Cl.: 31**

**TRADEMARK**

**PRINCIPAL REGISTER**

KODA PET FOODS, INC. (CALIFORNIA CORPORATION), DBA KODA PET FOODS,  
23854 VIA FABRICANTE, STE E1  
MISSION VIEJO, CA 92691

FOR: CONSUMABLE PET CHEWS; PET FOOD; PET TREATS, IN CLASS 31 (U.S. CLS. 1  
AND 46).

FIRST USE 12-7-2011; IN COMMERCE 12-7-2011.

THE MARK CONSISTS OF STANDARD CHARACTERS WITHOUT CLAIM TO ANY PAR-  
TICULAR FONT, STYLE, SIZE, OR COLOR.

SN 85-460,337, FILED 10-31-2011.

RONALD MCMORROW, EXAMINING ATTORNEY



*David J. Kybas*

Director of the United States Patent and Trademark Office

# United States of America

United States Patent and Trademark Office

# LAGARTOS

**Reg. No. 4,276,903**

**Registered Jan. 15, 2013**

**Int. Cl.: 30**

**TRADEMARK**

**PRINCIPAL REGISTER**

GRUPO BIMBO, S.A. B. DE C.V. (MEXICO CORPORATION)  
PROLONGACION PASEO DE LA REFORMA  
NO. 1000, COL. PENA BLANCA SANTA FE  
MEXICO CITY, MEXICO 01210

FOR: CORN-BASED SNACKS, IN CLASS 30 (U.S. CL. 46).

FIRST USE 5-31-2012; IN COMMERCE 5-31-2012.

THE MARK CONSISTS OF STANDARD CHARACTERS WITHOUT CLAIM TO ANY PARTICULAR FONT, STYLE, SIZE, OR COLOR.

THE ENGLISH TRANSLATION OF THE WORD "LAGARTOS" IN THE MARK IS "LIZARDS".

SN 85-460,391, FILED 10-31-2011.

SANDRA BUJA, EXAMINING ATTORNEY



*David J. Kyffers*

Director of the United States Patent and Trademark Office

# United States of America

United States Patent and Trademark Office

## ICE MELTS. WHISKY ROCKS.

**Reg. No. 4,276,904**

TERO DESIGN HOLDINGS, LLC (DELAWARE LIMITED LIABILITY COMPANY)  
100 WASHINGTON STREET, 3RD FLOOR  
NORWALK, CT 06854

**Registered Jan. 15, 2013**

**Int. Cl.: 21**

FOR: PIECES OF MILLED ROCK USED TO ALTER THE TEMPERATURE OF BEVERAGES,  
IN CLASS 21 (U.S. CLS. 2, 13, 23, 29, 30, 33, 40 AND 50).

**TRADEMARK**

FIRST USE 4-28-2009; IN COMMERCE 4-28-2009.

**PRINCIPAL REGISTER**

THE MARK CONSISTS OF STANDARD CHARACTERS WITHOUT CLAIM TO ANY PARTICULAR FONT, STYLE, SIZE, OR COLOR.

SN 85-460,775, FILED 10-31-2011.

JENNY PARK, EXAMINING ATTORNEY



*David J. Kybas*

Director of the United States Patent and Trademark Office

# United States of America

United States Patent and Trademark Office

## PROSETTA STONE

**Reg. No. 4,276,905**

**Registered Jan. 15, 2013**

**Int. Cls.: 16 and 41**

**TRADEMARK**

**SERVICE MARK**

**PRINCIPAL REGISTER**

PROMIS HEALTH ORGANIZATION, INC. (DELAWARE NON-PROFIT CORPORATION)  
823 MONTICELLO PLACE  
EVANSTON, IL 60201

FOR: PRINTED MATERIALS IN THE FORM OF LOOK-UP TABLES FOR COMPARING AND CROSS-REFERENCING DATA FROM PATIENT-REPORTED QUESTIONNAIRES ON PHYSICAL AND MENTAL CONDITIONS, NAMELY, CONDITIONS RELATING TO DEPRESSION, ANXIETY, PAIN, FATIGUE, PHYSICAL FUNCTION AND OTHER PATIENT CONCERNS REGARDING PHYSICAL AND MENTAL FEELING AND FUNCTIONING, IN CLASS 16 (U.S. CLS. 2, 5, 22, 23, 29, 37, 38 AND 50).

FIRST USE 2-27-2012; IN COMMERCE 2-27-2012.

FOR: PROVIDING NON-DOWNLOADABLE ONLINE PUBLICATIONS IN THE FORM OF LOOK-UP TABLES FOR COMPARING AND CROSS-REFERENCING DATA FROM PATIENT-REPORTED QUESTIONNAIRES ON PHYSICAL AND MENTAL CONDITIONS, NAMELY, CONDITIONS RELATING TO DEPRESSION, ANXIETY, PAIN, FATIGUE, PHYSICAL FUNCTION AND OTHER PATIENT CONCERNS REGARDING PHYSICAL AND MENTAL FEELINGS AND FUNCTIONING; PROVIDING ONLINE INSTRUCTION ON COMPARING AND LINKING THE RESULTS FROM PATIENT-REPORTED QUESTIONNAIRES ON PHYSICAL AND MENTAL CONDITIONS, NAMELY, CONDITIONS RELATING TO DEPRESSION, ANXIETY, PAIN, FATIGUE, PHYSICAL FUNCTION AND OTHER PATIENT CONCERNS REGARDING PHYSICAL AND MENTAL FEELINGS AND FUNCTIONING, IN CLASS 41 (U.S. CLS. 100, 101 AND 107).

FIRST USE 11-26-2012; IN COMMERCE 11-26-2012.

THE MARK CONSISTS OF STANDARD CHARACTERS WITHOUT CLAIM TO ANY PARTICULAR FONT, STYLE, SIZE, OR COLOR.

SN 85-460,787, FILED 10-31-2011.

DAVID H. STINE, EXAMINING ATTORNEY



*David J. Kyros*

Director of the United States Patent and Trademark Office

# United States of America

United States Patent and Trademark Office

## FRIENDFORWARDER

**Reg. No. 4,276,906**

**Registered Jan. 15, 2013**

**Int. Cl.: 38**

**SERVICE MARK**

**PRINCIPAL REGISTER**

SONGWHALE, LLC (MINNESOTA LIMITED LIABILITY COMPANY)  
100 43RD STREET  
SUITE 115  
PITTSBURGH, PA 15201

FOR: TEXT MESSAGING SERVICES PROVIDED TO RETAILERS TO ENABLE THE CREATION OF VIRAL TEXT MESSAGING ADVERTISING AND PROMOTIONAL CAMPAIGNS, IN CLASS 38 (U.S. CLS. 100, 101 AND 104).

FIRST USE 11-6-2012; IN COMMERCE 11-6-2012.

THE MARK CONSISTS OF STANDARD CHARACTERS WITHOUT CLAIM TO ANY PARTICULAR FONT, STYLE, SIZE, OR COLOR.

SN 85-460,791, FILED 10-31-2011.

KATHERINE E. HALMEN, EXAMINING ATTORNEY



*David J. Kyffers*

Director of the United States Patent and Trademark Office

# United States of America

United States Patent and Trademark Office

# PAYWHALE

**Reg. No. 4,276,907**

SONGWHALE, LLC (MINNESOTA LIMITED LIABILITY COMPANY)  
100 43RD STREET, SUITE 115  
PITTSBURGH, PA 15201

**Registered Jan. 15, 2013**

**Int. Cl.: 36**

FOR: MOBILE DEVICE PAYMENT PROCESSING SERVICES IN THE NATURE OF FINANCIAL TRANSACTION SERVICES, NAMELY, PROVIDING SECURE COMMERCIAL TRANSACTIONS AND PAYMENT OPTIONS USING A MOBILE DEVICE AT A POINT OF SALE, IN CLASS 36 (U.S. CLS. 100, 101 AND 102).

**SERVICE MARK**

**PRINCIPAL REGISTER**

FIRST USE 11-6-2012; IN COMMERCE 11-6-2012.

THE MARK CONSISTS OF STANDARD CHARACTERS WITHOUT CLAIM TO ANY PARTICULAR FONT, STYLE, SIZE, OR COLOR.

SN 85-460,797, FILED 10-31-2011.

KATHERINE E. HALMEN, EXAMINING ATTORNEY



*David J. Kyffers*

Director of the United States Patent and Trademark Office

# United States of America

United States Patent and Trademark Office

## SIX PILLARS

**Reg. No. 4,276,908**

FLORIDA CHAMBER OF COMMERCE, INC. (FLORIDA NON-PROFIT CORPORATION)  
136 SO. BRONOUGH STREET  
TALLAHASSEE, FL 32301

**Registered Jan. 15, 2013**

**Int. Cl.: 35**

FOR: STRATEGIC PLANNING SERVICES IN THE FIELD OF BUSINESS AND ECONOMIC DEVELOPMENT, IN CLASS 35 (U.S. CLS. 100, 101 AND 102).

**SERVICE MARK**

FIRST USE 10-31-2012; IN COMMERCE 10-31-2012.

**PRINCIPAL REGISTER**

THE MARK CONSISTS OF STANDARD CHARACTERS WITHOUT CLAIM TO ANY PARTICULAR FONT, STYLE, SIZE, OR COLOR.

SN 85-461,176, FILED 11-1-2011.

JOHN GARTNER, EXAMINING ATTORNEY



*David J. Kybas*

Director of the United States Patent and Trademark Office

# United States of America

United States Patent and Trademark Office

# EBAC+

**Reg. No. 4,276,909**

**Registered Jan. 15, 2013**

**Int. Cl.: 1**

**TRADEMARK**

**PRINCIPAL REGISTER**

WESTLAKE LONGVIEW CORPORATION (DELAWARE CORPORATION)  
SUITE 600  
2801 POST OAK BLVD.  
HOUSTON, TX 77056

FOR: SYNTHETIC ETHYLENE COPOLYMER RESINS SOLD IN PELLET FORM FOR GENERAL INDUSTRIAL USE, IN CLASS 1 (U.S. CLS. 1, 5, 6, 10, 26 AND 46).

FIRST USE 9-30-1999; IN COMMERCE 9-30-1999.

THE MARK CONSISTS OF STANDARD CHARACTERS WITHOUT CLAIM TO ANY PARTICULAR FONT, STYLE, SIZE, OR COLOR.

OWNER OF U.S. REG. NO. 1,926,998.

SN 85-461,516, FILED 11-1-2011.

ERNEST SHOSHO, EXAMINING ATTORNEY



*David J. Kyffers*

Director of the United States Patent and Trademark Office



**United States of America**  
United States Patent and Trademark Office

**ENERGX**

**Reg. No. 4,276,910**

**Registered Jan. 15, 2013**

**Int. Cl.: 1**

**TRADEMARK**

**PRINCIPAL REGISTER**

WESTLAKE LONGVIEW CORPORATION (DELAWARE CORPORATION)  
SUITE 600  
2801 POST OAK BLVD.  
HOUSTON, TX 77056

FOR: POLYETHYLENE RESINS FOR USE IN THE PLASTICS INDUSTRY, IN CLASS 1 (U.S. CLS. 1, 5, 6, 10, 26 AND 46).

FIRST USE 5-4-1999; IN COMMERCE 5-4-1999.

THE MARK CONSISTS OF STANDARD CHARACTERS WITHOUT CLAIM TO ANY PARTICULAR FONT, STYLE, SIZE, OR COLOR.

OWNER OF U.S. REG. NO. 2,500,716.

SN 85-461,518, FILED 11-1-2011.

ERNEST SHOSHO, EXAMINING ATTORNEY



*David J. Kyffers*

Director of the United States Patent and Trademark Office

# United States of America

United States Patent and Trademark Office



## LAKWOOD RANCH CARDIOLOGY

**Reg. No. 4,276,911**

UHS OF DELAWARE, INC. (DELAWARE CORPORATION)  
367 SOUTH GULPH ROAD  
KING OF PRUSSIA, PA 194060958

**Registered Jan. 15, 2013**

**Int. Cl.: 44**

FOR: MEDICAL SERVICES, NAMELY, HEART CARE SERVICES, IN CLASS 44 (U.S. CLS. 100 AND 101).

**SERVICE MARK**

FIRST USE 1-0-2012; IN COMMERCE 1-0-2012.

**PRINCIPAL REGISTER**

OWNER OF U.S. REG. NOS. 2,955,306, 3,977,983, AND OTHERS.

NO CLAIM IS MADE TO THE EXCLUSIVE RIGHT TO USE "CARDIOLOGY", APART FROM THE MARK AS SHOWN.

THE MARK CONSISTS OF A HEART WITH A FERN IMAGE IN THE CENTER OF THE HEART ABOVE THE WORDS "LAKWOOD RANCH CARDIOLOGY".

SN 85-461,629, FILED 11-1-2011.

JAY FLOWERS, EXAMINING ATTORNEY



*David J. Kybas*

Director of the United States Patent and Trademark Office

# United States of America

United States Patent and Trademark Office

## SPG LIFETIME

**Reg. No. 4,276,912**

**Registered Jan. 15, 2013**

**Int. Cls.: 35 and 43**

**SERVICE MARK**

**PRINCIPAL REGISTER**

PREFERRED GUEST, INC. (DELAWARE CORPORATION)  
ONE STARPOINT  
STAMFORD, CT 06902

FOR: ADMINISTRATION OF CUSTOMER LOYALTY PROGRAMS IN THE HOTEL AND RESORT FIELDS, WHICH PROVIDE FREE OR DISCOUNTED HOTEL ROOMS, FOOD, BEVERAGE AND RECREATION CREDITS TO FREQUENT GUESTS AT PARTICIPATING HOTELS OR RESORTS THROUGH THE ISSUANCE AND PROCESSING OF LOYALTY POINTS TO FREQUENT GUESTS, IN CLASS 35 (U.S. CLS. 100, 101 AND 102).

FIRST USE 3-1-2012; IN COMMERCE 3-1-2012.

FOR: HOTEL SERVICES, IN CLASS 43 (U.S. CLS. 100 AND 101).

FIRST USE 3-1-2012; IN COMMERCE 3-1-2012.

THE MARK CONSISTS OF STANDARD CHARACTERS WITHOUT CLAIM TO ANY PARTICULAR FONT, STYLE, SIZE, OR COLOR.

OWNER OF U.S. REG. NOS. 3,195,926, 3,528,063, AND OTHERS.

NO CLAIM IS MADE TO THE EXCLUSIVE RIGHT TO USE "LIFETIME", APART FROM THE MARK AS SHOWN.

SN 85-461,725, FILED 11-1-2011.

DAVID COLLIER, EXAMINING ATTORNEY



*David J. Kypos*

Director of the United States Patent and Trademark Office

# United States of America

United States Patent and Trademark Office



walking . . Tree  
Pottery

**Reg. No. 4,276,913**

MUSGROVE, SYLVIA (UNITED STATES INDIVIDUAL)  
304 BLEVINS BOULEVARD  
BRISTOL, VA 24202

**Registered Jan. 15, 2013**

**Int. Cl.: 42**

FOR: CUSTOM DESIGN OF POTTERY BASED ON PERSONAL SELECTIONS MADE BY THE CUSTOMER, IN CLASS 42 (U.S. CLS. 100 AND 101).

**SERVICE MARK**

FIRST USE 8-1-2005; IN COMMERCE 10-1-2012.

**PRINCIPAL REGISTER**

NO CLAIM IS MADE TO THE EXCLUSIVE RIGHT TO USE "POTTERY", APART FROM THE MARK AS SHOWN.

THE MARK CONSISTS OF AN ABSTRACT DESIGN WITH THREE DOTS IN A TRIANGULAR FORM BELOW IT, THE TEXT "WALKING" ON THE LEFT, THE TEXT "TREE" ON THE RIGHT, AND THE TEXT "POTTERY" BELOW THE DOTS.

SN 85-461,815, FILED 11-1-2011.

CHRISTOPHER LAW, EXAMINING ATTORNEY



*David J. Kybas*

Director of the United States Patent and Trademark Office

# United States of America

United States Patent and Trademark Office

# TERCOO

**Reg. No. 4,276,914**

**Registered Jan. 15, 2013**

**Int. Cl.: 7**

**TRADEMARK**

**PRINCIPAL REGISTER**

TERCOO B.V. (NETHERLANDS BESLOTEN VENNOOTSCHAP (B.V.))  
ZONNEDAUW 135  
4007 VG TIEL, NETHERLANDS

FOR: MACHINE TOOLS FOR REMOVING RUST, PAINT, TAR, EPOXY, ADHESIVES AND OTHER SURFACE COATING MATERIALS FROM STEEL, IRON, CONCRETE, STONE AND OTHER MATERIALS, AND PARTS FOR THE AFORESAID TOOLS, NAMELY, ABRASIVE DISKS, CRANK SHAFTS AND SHAFT COUPLINGS; MACHINES UTILIZING ROTATIONAL MOTION FOR HIGH ENERGY SURFACE FINISHING AND MATERIAL TREATMENT; ROTARY GRINDING MACHINES, IN CLASS 7 (U.S. CLS. 13, 19, 21, 23, 31, 34 AND 35).

FIRST USE 3-27-2009; IN COMMERCE 9-22-2010.

THE MARK CONSISTS OF STANDARD CHARACTERS WITHOUT CLAIM TO ANY PARTICULAR FONT, STYLE, SIZE, OR COLOR.

SN 85-461,962, FILED 11-1-2011.

JULIE VEPPUMTHARA, EXAMINING ATTORNEY



*David J. Kyfos*

Director of the United States Patent and Trademark Office

# United States of America

United States Patent and Trademark Office

## KAMPUS KRUISERS

**Reg. No. 4,276,915**

**Registered Jan. 15, 2013**

**Int. Cl.: 28**

**TRADEMARK**

**PRINCIPAL REGISTER**

LOST INTERNATIONAL, LLC (CALIFORNIA LIMITED LIABILITY COMPANY)  
170 TECHNOLOGY DRIVE  
IRVINE, CA 92618

FOR: SKATEBOARDS, IN CLASS 28 (U.S. CLS. 22, 23, 38 AND 50).

FIRST USE 6-1-2011; IN COMMERCE 4-24-2012.

THE MARK CONSISTS OF STANDARD CHARACTERS WITHOUT CLAIM TO ANY PARTICULAR FONT, STYLE, SIZE, OR COLOR.

NO CLAIM IS MADE TO THE EXCLUSIVE RIGHT TO USE "CRUISERS", APART FROM THE MARK AS SHOWN.

SN 85-461,969, FILED 11-1-2011.

RENEE SERVANCE, EXAMINING ATTORNEY



*David J. Kyffers*

Director of the United States Patent and Trademark Office

# United States of America

United States Patent and Trademark Office

## DONKEY IN A BOTTLE

**Reg. No. 4,276,916**

DONKEY IN A BOTTLE, LLC (VIRGINIA LIMITED LIABILITY COMPANY)  
3148 DANE COURT  
KESWICK, VA 22947

**Registered Jan. 15, 2013**

**Int. Cl.: 16**

FOR: SERIES OF FICTION BOOKS, IN CLASS 16 (U.S. CLS. 2, 5, 22, 23, 29, 37, 38 AND 50).

**TRADEMARK**

FIRST USE 8-12-2010; IN COMMERCE 7-23-2012.

**PRINCIPAL REGISTER**

THE MARK CONSISTS OF STANDARD CHARACTERS WITHOUT CLAIM TO ANY PARTICULAR FONT, STYLE, SIZE, OR COLOR.

SN 85-462,175, FILED 11-2-2011.

JANICE L. MCMORROW, EXAMINING ATTORNEY



*David J. Kybas*

Director of the United States Patent and Trademark Office

# United States of America

United States Patent and Trademark Office

## Goddess Gourmet

**Reg. No. 4,276,917**

GIOVANNINA JENNIFER BELLINO (UNITED STATES INDIVIDUAL)  
9 SOUNDVIEW LANE  
SANDS POINT, NY 11050

**Registered Jan. 15, 2013**

**Int. Cl.: 29**

FOR: PREPARED FOOD KITS COMPOSED OF MEAT, POULTRY, FISH, SEAFOOD, AND/OR VEGETABLES AND ALSO INCLUDING SAUCES OR SEASONINGS, READY FOR COOKING AND ASSEMBLY AS A MEAL, IN CLASS 29 (U.S. CL. 46).

**TRADEMARK**

FIRST USE 1-31-2012; IN COMMERCE 6-8-2012.

**PRINCIPAL REGISTER**

THE MARK CONSISTS OF STANDARD CHARACTERS WITHOUT CLAIM TO ANY PARTICULAR FONT, STYLE, SIZE, OR COLOR.

NO CLAIM IS MADE TO THE EXCLUSIVE RIGHT TO USE "GOURMET", APART FROM THE MARK AS SHOWN.

SN 85-462,562, FILED 11-2-2011.

RONALD MCMORROW, EXAMINING ATTORNEY



*David J. Kyffers*

Director of the United States Patent and Trademark Office



# United States of America

United States Patent and Trademark Office

# ONCOblot

**Reg. No. 4,276,918**

MOR-NUTECH, INC. (INDIANA CORPORATION)  
1112 CHERRY LANE  
WEST LAFAYETTE, IN 47906

**Registered Jan. 15, 2013**

**Int. Cl.: 44**

FOR: PROVIDING INFORMATION IN THE FIELD OF CANCER PREVENTION, SCREENING, DIAGNOSIS AND TREATMENT, IN CLASS 44 (U.S. CLS. 100 AND 101).

**SERVICE MARK**

FIRST USE 2-23-2012; IN COMMERCE 3-9-2012.

**PRINCIPAL REGISTER**

THE MARK CONSISTS OF STANDARD CHARACTERS WITHOUT CLAIM TO ANY PARTICULAR FONT, STYLE, SIZE, OR COLOR.

SN 85-462,706, FILED 11-2-2011.

KATHLEEN M. VANSTON, EXAMINING ATTORNEY



*David J. Kybas*

Director of the United States Patent and Trademark Office

# United States of America

United States Patent and Trademark Office

## DecoCrèmes Frosting

**Reg. No. 4,276,919**

LAWRENCE FOODS, INC. (ILLINOIS CORPORATION)  
2200 LUNT AVENUE  
ELK GROVE VILLAGE, IL 60007

**Registered Jan. 15, 2013**

**Int. Cl.: 30**

FOR: ICING FOR CAKES, PIES, DONUTS AND BAKERY GOODS, IN CLASS 30 (U.S. CL. 46).

**TRADEMARK**

FIRST USE 11-2-2011; IN COMMERCE 11-2-2011.

**PRINCIPAL REGISTER**

THE MARK CONSISTS OF STANDARD CHARACTERS WITHOUT CLAIM TO ANY PARTICULAR FONT, STYLE, SIZE, OR COLOR.

NO CLAIM IS MADE TO THE EXCLUSIVE RIGHT TO USE "FROSTING", APART FROM THE MARK AS SHOWN.

THE WORDING "DECOCRÈMES" HAS NO MEANING IN A FOREIGN LANGUAGE.

SN 85-462,899, FILED 11-2-2011.

ANDREW RHIM, EXAMINING ATTORNEY



*David J. Kybas*

Director of the United States Patent and Trademark Office

# United States of America

United States Patent and Trademark Office

## SOPHY HEARING

**Reg. No. 4,276,920**

HARALDO S. ARTMANN (BRAZIL INDIVIDUAL)  
3823 BRANTLEY PLACE CIRCLE  
APOPKA, FL 32703

**Registered Jan. 15, 2013**

**Int. Cl.: 10**

FOR: HEARING AIDS, IN CLASS 10 (U.S. CLS. 26, 39 AND 44).

**TRADEMARK**

FIRST USE 9-4-2012; IN COMMERCE 9-4-2012.

**PRINCIPAL REGISTER**

THE MARK CONSISTS OF STANDARD CHARACTERS WITHOUT CLAIM TO ANY PARTICULAR FONT, STYLE, SIZE, OR COLOR.

NO CLAIM IS MADE TO THE EXCLUSIVE RIGHT TO USE "HEARING", APART FROM THE MARK AS SHOWN.

SN 85-463,335, FILED 11-3-2011.

MARK SPARACINO, EXAMINING ATTORNEY



*David J. Kyffers*

Director of the United States Patent and Trademark Office

# United States of America

United States Patent and Trademark Office

## MONARCH CAREFINDER

**Reg. No. 4,276,921**

**Registered Jan. 15, 2013**

**Int. Cl.: 9**

**TRADEMARK**

**PRINCIPAL REGISTER**

MONARCH HEALTHCARE, A MEDICAL GROUP, INC. (CALIFORNIA CORPORATION)  
7 TECHNOLOGY DRIVE  
IRVINE, CA 92618

FOR: COMPUTER APPLICATION SOFTWARE FOR MOBILE PHONES, NAMELY, SOFTWARE FOR PROVIDING INFORMATION REGARDING HEALTHCARE FACILITIES AND HEALTHCARE PROVIDERS, IN CLASS 9 (U.S. CLS. 21, 23, 26, 36 AND 38).

FIRST USE 1-25-2012; IN COMMERCE 1-25-2012.

THE MARK CONSISTS OF STANDARD CHARACTERS WITHOUT CLAIM TO ANY PARTICULAR FONT, STYLE, SIZE, OR COLOR.

OWNER OF U.S. REG. NOS. 3,089,797, 3,289,611, AND 3,496,402.

NO CLAIM IS MADE TO THE EXCLUSIVE RIGHT TO USE "CAREFINDER", APART FROM THE MARK AS SHOWN.

SN 85-463,563, FILED 11-3-2011.

ALEX KEAM, EXAMINING ATTORNEY



*David J. Kybas*

Director of the United States Patent and Trademark Office

# United States of America

United States Patent and Trademark Office

## TOXIC TAKEDOWN

**Reg. No. 4,276,922**

**Registered Jan. 15, 2013**

**Int. Cl.: 28**

**TRADEMARK**

**PRINCIPAL REGISTER**

MATTEL, INC. (DELAWARE CORPORATION)  
M1-1518  
333 CONTINENTAL BOULEVARD  
EL SEGUNDO, CA 90245

FOR: TOY ACTION FIGURES AND ACCESSORIES THEREFOR, IN CLASS 28 (U.S. CLS. 22, 23, 38 AND 50).

FIRST USE 11-7-2012; IN COMMERCE 11-7-2012.

THE MARK CONSISTS OF STANDARD CHARACTERS WITHOUT CLAIM TO ANY PARTICULAR FONT, STYLE, SIZE, OR COLOR.

SN 85-463,887, FILED 11-3-2011.

LUCY ARANT, EXAMINING ATTORNEY



*David J. Kyffers*

Director of the United States Patent and Trademark Office

# United States of America

United States Patent and Trademark Office

**turboevict** 

**Reg. No. 4,276,923**

TURBOEVICT.COM, LLC (DELAWARE LIMITED LIABILITY COMPANY)  
40 PARKER ROAD, SUITE 200  
ELIZABETH, NJ 07208

**Registered Jan. 15, 2013**

**Int. Cl.: 42**

FOR: COMPUTER SERVICES, NAMELY, PROVIDING A WEB-BASED SYSTEM AND ON-LINE PORTAL FEATURING NON-DOWNLOADABLE SOFTWARE FOR USE IN THE ADMINISTRATION AND MANAGEMENT OF EVICTION PROCEEDINGS, IN CLASS 42 (U.S. CLS. 100 AND 101).

**SERVICE MARK**

**PRINCIPAL REGISTER**

FIRST USE 10-23-2012; IN COMMERCE 10-23-2012.

THE MARK CONSISTS OF THE WORDS "TURBOEVICT" FOLLOWED BY A CIRCLE WITH THE LETTERS "T" AND "E" IN THE MIDDLE OF THE CIRCLE.

SN 85-464,290, FILED 11-4-2011.

MARY CRAWFORD, EXAMINING ATTORNEY



*David J. Kyjars*

Director of the United States Patent and Trademark Office

# United States of America

United States Patent and Trademark Office

# ACCUFRESH

**Reg. No. 4,276,924**

**Registered Jan. 15, 2013**

**Int. Cl.: 11**

**TRADEMARK**

**PRINCIPAL REGISTER**

WHIRLPOOL PROPERTIES, INC. (MICHIGAN CORPORATION)  
SUITE 101  
500 RENAISSANCE DRIVE  
ST. JOSEPH, MI 49085

FOR: REFRIGERATOR TEMPERATURE MANAGEMENT SYSTEM COMPRISING AUTOMATIC TEMPERATURE REGULATORS, TEMPERATURE SENSORS, AND THERMOSTATS, SOLD AS A COMPONENT PART OF REFRIGERATORS, IN CLASS 11 (U.S. CLS. 13, 21, 23, 31 AND 34).

FIRST USE 8-21-2012; IN COMMERCE 8-21-2012.

THE MARK CONSISTS OF STANDARD CHARACTERS WITHOUT CLAIM TO ANY PARTICULAR FONT, STYLE, SIZE, OR COLOR.

SN 85-464,304, FILED 11-4-2011.

ELLEN B. AWRICH, EXAMINING ATTORNEY



*David J. Kyffers*

Director of the United States Patent and Trademark Office

# United States of America

United States Patent and Trademark Office

# GOOD2GO

**Reg. No. 4,276,925**

**Registered Jan. 15, 2013**

**Int. Cl.: 45**

**SERVICE MARK**

**PRINCIPAL REGISTER**

U SCREEN, LLC (MICHIGAN LIMITED LIABILITY COMPANY)  
SUITE 700  
750 STEPHENSON HIGHWAY  
TROY, MI 48083

FOR: BACKGROUND INVESTIGATION AND RESEARCH SERVICES; BACKGROUND INVESTIGATION SERVICES; DRUG, ALCOHOL AND DNA SCREENING FOR SECURITY AND EMPLOYMENT PURPOSES; EMPLOYMENT BACKGROUND SCREENING, NAMELY, BACKGROUND SCREENING OF CURRENT EMPLOYEES OF OTHERS; INVESTIGATION OR SURVEILLANCE ON BACKGROUND PROFILES; PERSONAL BACKGROUND INVESTIGATIONS; PRE-EMPLOYMENT BACKGROUND INVESTIGATION SERVICES; PRE-EMPLOYMENT BACKGROUND SCREENING; PROVIDING AN INTERACTIVE WEB SITE THAT FACILITATES THE VERIFICATION OF A PERSON'S BACKGROUND CREDENTIALS, IN CLASS 45 (U.S. CLS. 100 AND 101).

FIRST USE 7-19-2012; IN COMMERCE 7-19-2012.

THE MARK CONSISTS OF STANDARD CHARACTERS WITHOUT CLAIM TO ANY PARTICULAR FONT, STYLE, SIZE, OR COLOR.

SN 85-464,714, FILED 11-4-2011.

LIEF MARTIN, EXAMINING ATTORNEY



*David J. Kybas*

Director of the United States Patent and Trademark Office



# United States of America

United States Patent and Trademark Office

# MoodON

**Reg. No. 4,276,926**

NATROL, INC. (DELAWARE CORPORATION)  
21411 PRAIRIE STREET  
CHATSWORTH, CA 91311

**Registered Jan. 15, 2013**

**Int. Cl.: 5**

FOR: DIETARY AND NUTRITIONAL SUPPLEMENTS, IN CLASS 5 (U.S. CLS. 6, 18, 44, 46, 51 AND 52).

**TRADEMARK**

FIRST USE 2-1-2012; IN COMMERCE 2-1-2012.

**PRINCIPAL REGISTER**

THE MARK CONSISTS OF STANDARD CHARACTERS WITHOUT CLAIM TO ANY PARTICULAR FONT, STYLE, SIZE, OR COLOR.

OWNER OF U.S. REG. NO. 3,596,181.

SN 85-465,412, FILED 11-5-2011.

BARBARA GAYNOR, EXAMINING ATTORNEY



*David J. Kybas*

Director of the United States Patent and Trademark Office

# United States of America

United States Patent and Trademark Office

## POSTCODE

**Reg. No. 4,276,927**

GOMEZ, MARK D (UNITED STATES INDIVIDUAL)  
4909 STAGECOACH LANE  
GARLAND, TX 75043

**Registered Jan. 15, 2013**

**Int. Cl.: 25**

FOR: SHORT-SLEEVED OR LONG-SLEEVED T-SHIRTS; T-SHIRTS; T-SHIRTS FOR WOMEN, MEN; TEE SHIRTS, IN CLASS 25 (U.S. CLS. 22 AND 39).

**TRADEMARK**

FIRST USE 10-15-2011; IN COMMERCE 10-15-2011.

**PRINCIPAL REGISTER**

THE MARK CONSISTS OF A STAMP SHAPE WITH A BIRD CARRYING A SQUARE FOLLOWED BY THE WORD "POSTCODE".

SN 85-465,428, FILED 11-5-2011.

BRENDAN MCCAULEY, EXAMINING ATTORNEY



*David J. Kyffers*

Director of the United States Patent and Trademark Office

# United States of America

United States Patent and Trademark Office

## THE BRAND COMPANY

**Reg. No. 4,276,928**

AOL INC. (DELAWARE CORPORATION)

**Registered Jan. 15, 2013**

22000 AOL WAY  
DULLES, VA 20166

**Int. Cl.: 41**

**SERVICE MARK**

**PRINCIPAL REGISTER**

FOR: PROVIDING ONLINE JOURNALS, NAMELY, BLOGS IN THE FIELDS OF EDUCATION, ENTERTAINMENT, SHOPPING, MUSIC, ARTS, CULTURE, FOOD, POLITICS, TRAVEL, TECHNOLOGY, CURRENT EVENTS, GEOGRAPHY, GAMES, SPORTS, MOVIES, EDUCATION, HISTORY, FINANCE, HEALTH, BEAUTY, NUTRITION, DIET, COMPUTERS, LIFESTYLES, FASHION, AND ONLINE SAFETY; PROVIDING INFORMATION VIA COMPUTER AND DIGITAL NETWORKS IN THE FIELDS OF ENTERTAINMENT, EDUCATION, MUSIC, SPORTS, MOVIES, AND GAMES; NEWS IN THE NATURE OF CURRENT EVENTS REPORTING; PROVIDING A WEB SITE FEATURING AN ONGOING ONLINE VIDEO SERIES IN THE FIELD OF NEWS, CURRENT EVENTS, ENTERTAINMENT, EDUCATION, MUSIC, SPORTS, POLITICS, HEALTH, FITNESS, PARENTING, LIFESTYLES, CULTURE, CHARITABLE CAUSES, TELEVISION, SCIENCE, PETS, AND COMEDY; PROVIDING COMPUTER GAMES AND VIDEO GAMES VIA COMPUTER AND DIGITAL NETWORKS; WEB SYNDICATION OF CONTENT, NAMELY, THE DISTRIBUTION OF TEXT, GRAPHICS, VIDEO, AND AUDIO FOR PUBLICATION ON MULTIPLE WEBSITES AND NETWORKS; ELECTRONIC PUBLISHING SERVICES, NAMELY, PUBLICATION OF TEXT AND GRAPHIC WORKS OF OTHERS ONLINE IN THE FIELD OF GENERAL ENCYCLOPEDIA KNOWLEDGE, IN CLASS 41 (U.S. CLS. 100, 101 AND 107).

FIRST USE 9-10-2012; IN COMMERCE 9-10-2012.

THE MARK CONSISTS OF STANDARD CHARACTERS WITHOUT CLAIM TO ANY PARTICULAR FONT, STYLE, SIZE, OR COLOR.

NO CLAIM IS MADE TO THE EXCLUSIVE RIGHT TO USE "COMPANY", APART FROM THE MARK AS SHOWN.

SN 85-466,047, FILED 11-7-2011.

KATHERINE CHANG, EXAMINING ATTORNEY



*David J. Kyjars*

Director of the United States Patent and Trademark Office

# United States of America

United States Patent and Trademark Office

# WAKE FOOL

**Reg. No. 4,276,929**

SATURN STREET, LLC (TEXAS LIMITED LIABILITY COMPANY)  
4028 SATURN STREET  
FLOWER MOUND, TX 75028

**Registered Jan. 15, 2013**

**Int. Cl.: 35**

FOR: ON-LINE RETAIL STORE SERVICES FEATURING WAKEBOARDING AND WATER-SKIING PRODUCTS, IN CLASS 35 (U.S. CLS. 100, 101 AND 102).

**SERVICE MARK**

FIRST USE 4-0-2012; IN COMMERCE 4-0-2012.

**PRINCIPAL REGISTER**

THE MARK CONSISTS OF STANDARD CHARACTERS WITHOUT CLAIM TO ANY PARTICULAR FONT, STYLE, SIZE, OR COLOR.

NO CLAIM IS MADE TO THE EXCLUSIVE RIGHT TO USE "WAKE", APART FROM THE MARK AS SHOWN.

SN 85-466,178, FILED 11-7-2011.

JOSETTE BEVERLY, EXAMINING ATTORNEY



*David J. Kybas*

Director of the United States Patent and Trademark Office

# United States of America

United States Patent and Trademark Office

## ORCHARD: AFRICA

**Reg. No. 4,276,930**

**Registered Jan. 15, 2013**

**Int. Cls.: 35 and 36**

**SERVICE MARK**

**PRINCIPAL REGISTER**

HELPING HANDS IN AFRICA (ARIZONA CORPORATION), DBA ORCHARD: AFRICA,  
SUITE 1  
456 E. RAY ROAD  
GILBERT, AZ 85296

FOR: CHARITABLE SERVICES, NAMELY, ORGANIZING AND CONDUCTING VOLUNTEER PROGRAMS AND COMMUNITY SERVICE PROJECTS AIMED AT CREATING SUSTAINABLE CHANGE IN RURAL AFRICAN VILLAGES AND DEVELOPING AND MANAGING CHARITABLE GIVING PROGRAMS OF OTHERS AND ACCEPTING AND ADMINISTERING NON-MONETARY CHARITABLE CONTRIBUTIONS, IN CLASS 35 (U.S. CLS. 100, 101 AND 102).

FIRST USE 9-1-2011; IN COMMERCE 9-1-2011.

FOR: CHARITABLE SERVICES, NAMELY, ACCEPTING AND ADMINISTERING MONETARY CHARITABLE CONTRIBUTIONS, IN CLASS 36 (U.S. CLS. 100, 101 AND 102).

FIRST USE 9-1-2011; IN COMMERCE 9-1-2011.

THE MARK CONSISTS OF STANDARD CHARACTERS WITHOUT CLAIM TO ANY PARTICULAR FONT, STYLE, SIZE, OR COLOR.

NO CLAIM IS MADE TO THE EXCLUSIVE RIGHT TO USE "AFRICA", APART FROM THE MARK AS SHOWN.

SN 85-466,459, FILED 11-7-2011.

BRIAN PINO, EXAMINING ATTORNEY



*David J. Kyffers*

Director of the United States Patent and Trademark Office

# United States of America

United States Patent and Trademark Office

## CRAFTY MULE BLEND

**Reg. No. 4,276,931**

**Registered Jan. 15, 2013**

**Int. Cl.: 30**

**TRADEMARK**

**PRINCIPAL REGISTER**

COFFEE BEAN INTERNATIONAL, INC. (OREGON CORPORATION)  
9120 NE ALDERWOOD ROAD  
PORTLAND, OR 97220

FOR: COFFEE, IN CLASS 30 (U.S. CL. 46).

FIRST USE 10-30-2012; IN COMMERCE 10-30-2012.

THE MARK CONSISTS OF STANDARD CHARACTERS WITHOUT CLAIM TO ANY PARTICULAR FONT, STYLE, SIZE, OR COLOR.

NO CLAIM IS MADE TO THE EXCLUSIVE RIGHT TO USE "BLEND", APART FROM THE MARK AS SHOWN.

SN 85-466,480, FILED 11-7-2011.

HELENE LIWINSKI, EXAMINING ATTORNEY



*David J. Kyffers*

Director of the United States Patent and Trademark Office

# United States of America

United States Patent and Trademark Office

## JAN FITNESS

**Reg. No. 4,276,932**

KARBACH, JAN (UNITED STATES INDIVIDUAL)  
3617 TIERRA BELLA  
SANTA BARBARA, CA 93105

**Registered Jan. 15, 2013**

**Int. Cls.: 25 and 41**

FOR: CLOTHING, NAMELY, CAPS, T-SHIRTS, SHORTS, IN CLASS 25 (U.S. CLS. 22 AND 39).

**TRADEMARK**

FIRST USE 2-17-2012; IN COMMERCE 5-4-2012.

**SERVICE MARK**

FOR: PERSONAL FITNESS TRAINING SERVICES AND CONSULTANCY, IN CLASS 41 (U.S. CLS. 100, 101 AND 107).

**PRINCIPAL REGISTER**

FIRST USE 2-17-2012; IN COMMERCE 5-4-2012.

THE MARK CONSISTS OF STANDARD CHARACTERS WITHOUT CLAIM TO ANY PARTICULAR FONT, STYLE, SIZE, OR COLOR.

NO CLAIM IS MADE TO THE EXCLUSIVE RIGHT TO USE "FITNESS", APART FROM THE MARK AS SHOWN.

SN 85-466,672, FILED 11-8-2011.

LIEF MARTIN, EXAMINING ATTORNEY



*David J. Kypos*

Director of the United States Patent and Trademark Office

# United States of America

United States Patent and Trademark Office

# AFSCORE

**Reg. No. 4,276,933**

**Registered Jan. 15, 2013**

**Int. Cl.: 42**

**SERVICE MARK**

**PRINCIPAL REGISTER**

WAVECREST PAYMENT SERVICES OF THE AMERICAS, INC. (FLORIDA CORPORATION)  
6700 NORTH ANDREWS AVE, SUITE 600  
FORT LAUDERDALE, FL 33309

FOR: PLATFORM AS A SERVICE (PAAS) FEATURING COMPUTER SOFTWARE PLATFORMS FOR MANAGING AND PROCESSING CHECK CASHING TRANSACTIONS, MONEY ORDERS, PREPAID CARD TRANSACTIONS, REMITTANCES, PAYMENTS AND FUND TRANSFERS, NAMELY, AN ELECTRONIC FINANCIAL PLATFORM THAT ACCOMMODATES MULTIPLE TYPES OF PAYMENT TRANSACTIONS, FOR USE PRIMARILY BY RETAILERS, BANKS AND POST OFFICES, IN CLASS 42 (U.S. CLS. 100 AND 101).

FIRST USE 8-31-2012; IN COMMERCE 8-31-2012.

THE MARK CONSISTS OF STANDARD CHARACTERS WITHOUT CLAIM TO ANY PARTICULAR FONT, STYLE, SIZE, OR COLOR.

SN 85-466,692, FILED 11-8-2011.

DAVID TAYLOR, EXAMINING ATTORNEY



*David J. Kyffers*

Director of the United States Patent and Trademark Office



# United States of America

United States Patent and Trademark Office

## CRANE BAY

**Reg. No. 4,276,934**

THE CRANE BAY, LLC (INDIANA LIMITED LIABILITY COMPANY)  
551 MERRILL STREET  
INDIANAPOLIS, IN 46225

**Registered Jan. 15, 2013**

**Int. Cl.: 41**

FOR: ENTERTAINMENT, NAMELY, LIVE MUSIC CONCERTS, IN CLASS 41 (U.S. CLS. 100, 101 AND 107).

**SERVICE MARK**

FIRST USE 2-4-2012; IN COMMERCE 2-4-2012.

**PRINCIPAL REGISTER**

THE MARK CONSISTS OF STANDARD CHARACTERS WITHOUT CLAIM TO ANY PARTICULAR FONT, STYLE, SIZE, OR COLOR.

SN 85-466,933, FILED 11-8-2011.

JAMES MACFARLANE, EXAMINING ATTORNEY



*David J. Kyffers*

Director of the United States Patent and Trademark Office

# United States of America

United States Patent and Trademark Office



**Reg. No. 4,276,935**

**Registered Jan. 15, 2013**

**Int. Cl.: 41**

**SERVICE MARK**

**PRINCIPAL REGISTER**

THE CRANE BAY, LLC (INDIANA LIMITED LIABILITY COMPANY)  
551 MERRILL STREET  
INDIANAPOLIS, IN 46225

FOR: ENTERTAINMENT, NAMELY, LIVE MUSIC CONCERTS, IN CLASS 41 (U.S. CLS. 100, 101 AND 107).

FIRST USE 2-4-2012; IN COMMERCE 2-4-2012.

NO CLAIM IS MADE TO THE EXCLUSIVE RIGHT TO USE "INDIANAPOLIS INDIANA", APART FROM THE MARK AS SHOWN.

THE MARK CONSISTS OF THE WORDING "THE CRANE BAY" IN A STYLIZED FONT AROUND THE UPPER EDGE OF A CIRCLE, WITH THE WORDING "INDIANAPOLIS INDIANA" IN A STYLIZED FONT AROUND THE LOWER EDGE OF THE CIRCLE, AND WITH TWO DOTS ON THE LEFT AND RIGHT OF THE CIRCLE SEPARATING THE UPPER AND LOWER WORDING. IN THE MIDDLE OF THE CIRCLE IS THE DESIGN OF A CRANE HOOK, THE BOTTOM PORTION OF WHICH SITS BETWEEN THE WORDS "INDIANAPOLIS" AND "INDIANA".

SN 85-466,961, FILED 11-8-2011.

JAMES MACFARLANE, EXAMINING ATTORNEY



*David J. Kybas*

Director of the United States Patent and Trademark Office

# United States of America

United States Patent and Trademark Office

## GRAM IN THE BOX

**Reg. No. 4,276,936**

GRAM IN THE MOON, LLC (FLORIDA LIMITED LIABILITY COMPANY)  
948 HEMINGWAY CIRCLE  
TAMPA, FL 33602

**Registered Jan. 15, 2013**

**Int. Cl.: 16**

FOR: PRINTED STORIES IN ILLUSTRATED FORM, NAMELY, PERSONALIZED STORIES IN PROSE OR RHYME USING INFORMATION, NAMELY, PERSONAL EXPERIENCES, HOLIDAYS, BIRTHDAYS, OCCASIONS, AND CONTAINING IMAGES, NAMELY, PICTURES AND DRAWINGS, IN CLASS 16 (U.S. CLS. 2, 5, 22, 23, 29, 37, 38 AND 50).

**TRADEMARK**

**PRINCIPAL REGISTER**

FIRST USE 8-26-2011; IN COMMERCE 10-16-2012.

THE MARK CONSISTS OF STANDARD CHARACTERS WITHOUT CLAIM TO ANY PARTICULAR FONT, STYLE, SIZE, OR COLOR.

SN 85-467,380, FILED 11-8-2011.

ERNEST SHOSHO, EXAMINING ATTORNEY



*David J. Kybas*

Director of the United States Patent and Trademark Office

# United States of America

United States Patent and Trademark Office

# P2P

**Reg. No. 4,276,937**

**Registered Jan. 15, 2013**

**Int. Cl.: 33**

**TRADEMARK**

**PRINCIPAL REGISTER**

CHAT VODKA, LLC (PENNSYLVANIA LIMITED LIABILITY COMPANY), DBA CHAT  
VODKA,  
17 WESTWOOD PLACE  
HOLLAND, PA 18966

FOR: VODKA, IN CLASS 33 (U.S. CLS. 47 AND 49).

FIRST USE 5-9-2011; IN COMMERCE 11-15-2012.

THE MARK CONSISTS OF STANDARD CHARACTERS WITHOUT CLAIM TO ANY PARTICULAR FONT, STYLE, SIZE, OR COLOR.

SN 85-467,716, FILED 11-8-2011.

MATTHEW KLINE, EXAMINING ATTORNEY



*David J. Kybas*

Director of the United States Patent and Trademark Office

# United States of America

United States Patent and Trademark Office

# SMH

**Reg. No. 4,276,938**

**Registered Jan. 15, 2013**

**Int. Cl.: 33**

**TRADEMARK**

**PRINCIPAL REGISTER**

CHAT VODKA, LLC (PENNSYLVANIA LIMITED LIABILITY COMPANY), DBA CHAT  
VODKA,  
17 WESTWOOD PLACE  
HOLLAND, PA 18966

FOR: VODKA, IN CLASS 33 (U.S. CLS. 47 AND 49).

FIRST USE 5-9-2011; IN COMMERCE 11-15-2012.

THE MARK CONSISTS OF STANDARD CHARACTERS WITHOUT CLAIM TO ANY PARTICULAR FONT, STYLE, SIZE, OR COLOR.

SN 85-467,731, FILED 11-8-2011.

MATTHEW KLINE, EXAMINING ATTORNEY



*David J. Kyffers*

Director of the United States Patent and Trademark Office

# United States of America

United States Patent and Trademark Office

*Dream Audio*

**Reg. No. 4,276,939**

**Registered Jan. 15, 2013**

**Int. Cl.: 9**

**TRADEMARK**

**PRINCIPAL REGISTER**

SUN TECHNIQUE ELECTRIC CO., LTD. (TAIWAN CORPORATION)  
NO. 93, FENGREN ROAD, FENGSHAN DIST.  
KAOHSIUNG CITY 830, TAIWAN R.O.C.

FOR: AUDIO SPEAKERS; LOUDSPEAKERS; MICROPHONES; CABINETS FOR LOUDSPEAKERS; SPEAKER CASES; MEGAPHONES; HEADPHONES; LASER DISCS, IN CLASS 9 (U.S. CLS. 21, 23, 26, 36 AND 38).

FIRST USE 11-23-2012; IN COMMERCE 11-23-2012.

NO CLAIM IS MADE TO THE EXCLUSIVE RIGHT TO USE "AUDIO", APART FROM THE MARK AS SHOWN.

THE MARK CONSISTS OF THE WORDS "DREAM AUDIO" IN STYLIZED FONT.

SN 85-467,907, FILED 11-9-2011.

KRISTIN DAHLING, EXAMINING ATTORNEY



*David J. Kybas*

Director of the United States Patent and Trademark Office

# United States of America

United States Patent and Trademark Office

## SYNCROFLOW

**Reg. No. 4,276,940**

**Registered Jan. 15, 2013**

**Int. Cl.: 9**

**TRADEMARK**

**PRINCIPAL REGISTER**

INFORM INSTITUT FUER OPERATIONS RESEARCH UND MANAGEMENT GMBH (FED  
REP GERMANY CORPORATION)  
PASCALSTRASSE 23  
AACHEN, FED REP GERMANY 52076

FOR: COMPUTER SOFTWARE THAT SYNCHRONIZES THE TRAFFIC FOR DELIVERY  
AND SHIPPING WITH A YARD'S OR PLANT'S OR SUPPLY CHAIN'S INHERENT CAPACIT-  
IES, IN CLASS 9 (U.S. CLS. 21, 23, 26, 36 AND 38).

FIRST USE 1-0-2008; IN COMMERCE 1-0-2008.

THE MARK CONSISTS OF STANDARD CHARACTERS WITHOUT CLAIM TO ANY PAR-  
TICULAR FONT, STYLE, SIZE, OR COLOR.

OWNER OF U.S. REG. NOS. 2,887,523, 2,919,744, AND 3,669,533.

SN 85-467,957, FILED 11-9-2011.

JASON BLAIR, EXAMINING ATTORNEY



*David J. Kyffers*

Director of the United States Patent and Trademark Office

# United States of America

United States Patent and Trademark Office

## REINVENT AMERICA

**Reg. No. 4,276,941**

AVP IP HOLDING CO., LLC (FLORIDA LIMITED LIABILITY COMPANY)  
101 PUGLIESE'S WAY  
DELRAY BEACH, FL 33444

**Registered Jan. 15, 2013**

**Int. Cl.: 35**

FOR: PROMOTING PUBLIC AWARENESS OF ENVIRONMENTALLY CONSCIOUS AND GREEN INNOVATIONS, SUSTAINABLE ENERGY, DEVELOPMENT AND OPPORTUNITIES FOR ENVIRONMENTALLY CONSCIOUS AND GREEN MANUFACTURING, AND JOB CREATION, IN CLASS 35 (U.S. CLS. 100, 101 AND 102).

**SERVICE MARK**

**PRINCIPAL REGISTER**

FIRST USE 5-0-2012; IN COMMERCE 5-0-2012.

THE MARK CONSISTS OF STANDARD CHARACTERS WITHOUT CLAIM TO ANY PARTICULAR FONT, STYLE, SIZE, OR COLOR.

SN 85-468,356, FILED 11-9-2011.

JUDITH HELFMAN, EXAMINING ATTORNEY



*David J. Kyffers*

Director of the United States Patent and Trademark Office



# United States of America

United States Patent and Trademark Office

# Cutter

**Reg. No. 4,276,942**

**Registered Jan. 15, 2013**

**Int. Cl.: 11**

**TRADEMARK**

**PRINCIPAL REGISTER**

UNITED INDUSTRIES CORPORATION (DELAWARE CORPORATION)  
1 RIDER TRAIL PLAZA DRIVE  
EARTH CITY, MO 63045

FOR: LANTERNS; LANTERNS THAT DISPENSE INSECT REPELLENT, IN CLASS 11 (U.S. CLS. 13, 21, 23, 31 AND 34).

FIRST USE 6-30-2012; IN COMMERCE 6-30-2012.

THE MARK CONSISTS OF STANDARD CHARACTERS WITHOUT CLAIM TO ANY PARTICULAR FONT, STYLE, SIZE, OR COLOR.

OWNER OF U.S. REG. NOS. 1,341,985, 1,757,957, AND 3,397,604.

SN 85-468,483, FILED 11-9-2011.

AMY ALFIERI, EXAMINING ATTORNEY



*David J. Kybas*

Director of the United States Patent and Trademark Office

# United States of America

United States Patent and Trademark Office

## THE PRINCESS AND THE POP STAR

**Reg. No. 4,276,943**

**Registered Jan. 15, 2013**

**Int. Cl.: 28**

**TRADEMARK**

**PRINCIPAL REGISTER**

MATTEL, INC. (DELAWARE CORPORATION)  
M1-1518  
333 CONTINENTAL BOULEVARD  
EL SEGUNDO, CA 90245

FOR: DOLLS, DOLL CLOTHING AND DOLL ACCESSORIES; DOLL PLAYSETS AND ACCESSORIES THEREFOR, IN CLASS 28 (U.S. CLS. 22, 23, 38 AND 50).

FIRST USE 10-29-2012; IN COMMERCE 10-29-2012.

THE MARK CONSISTS OF STANDARD CHARACTERS WITHOUT CLAIM TO ANY PARTICULAR FONT, STYLE, SIZE, OR COLOR.

OWNER OF U.S. REG. NO. 4,100,196.

SN 85-468,634, FILED 11-9-2011.

VIVIAN MICZNIK FIRST, EXAMINING ATTORNEY



*David J. Kybas*

Director of the United States Patent and Trademark Office

# United States of America

United States Patent and Trademark Office

## CAPTAIN PENNY

**Reg. No. 4,276,944**

**Registered Jan. 15, 2013**

**Int. Cl.: 28**

**TRADEMARK**

**PRINCIPAL REGISTER**

MATTEL, INC. (DELAWARE CORPORATION)  
333 CONTINENTAL BOULEVARD  
M1-1518  
EL SEGUNDO, CA 90245

FOR: TOY FIGURES AND ACCESSORIES THEREFOR, IN CLASS 28 (U.S. CLS. 22, 23, 38 AND 50).

FIRST USE 7-30-2012; IN COMMERCE 7-30-2012.

THE MARK CONSISTS OF STANDARD CHARACTERS WITHOUT CLAIM TO ANY PARTICULAR FONT, STYLE, SIZE, OR COLOR.

SN 85-468,649, FILED 11-9-2011.

VIVIAN MICZNIK FIRST, EXAMINING ATTORNEY



*David J. Kyffers*

Director of the United States Patent and Trademark Office

# United States of America

United States Patent and Trademark Office

## COMBAT SMASH

**Reg. No. 4,276,945**

**Registered Jan. 15, 2013**

**Int. Cl.: 28**

**TRADEMARK**

**PRINCIPAL REGISTER**

MATTEL, INC. (DELAWARE CORPORATION)  
M1-1518  
333 CONTINENTAL BOULEVARD  
EL SEGUNDO, CA 90245

FOR: TOY ACTION FIGURES AND ACCESSORIES THEREFOR, IN CLASS 28 (U.S. CLS. 22, 23, 38 AND 50).

FIRST USE 11-28-2012; IN COMMERCE 11-28-2012.

THE MARK CONSISTS OF STANDARD CHARACTERS WITHOUT CLAIM TO ANY PARTICULAR FONT, STYLE, SIZE, OR COLOR.

SN 85-468,666, FILED 11-9-2011.

SARA BENJAMIN, EXAMINING ATTORNEY



*David J. Kyffers*

Director of the United States Patent and Trademark Office

# United States of America

United States Patent and Trademark Office

# ENCOTA

**Reg. No. 4,276,946**

**Registered Jan. 15, 2013**

**Int. Cls.: 9 and 42**

**TRADEMARK**

**SERVICE MARK**

**PRINCIPAL REGISTER**

PRAXIS MANAGEMENT INTERNATIONAL, LLC (INDIANA LIMITED LIABILITY COMPANY)  
501 PENNSYLVANIA PARKWAY, SUITE 190  
INDIANAPOLIS, IN 46280

FOR: COMPUTER SEARCH ENGINE SOFTWARE, IN CLASS 9 (U.S. CLS. 21, 23, 26, 36 AND 38).

FIRST USE 6-12-2012; IN COMMERCE 6-12-2012.

FOR: PROVIDING ON-LINE, NON-DOWNLOADABLE SEARCH ENGINE SOFTWARE, IN CLASS 42 (U.S. CLS. 100 AND 101).

FIRST USE 4-22-2012; IN COMMERCE 4-22-2012.

THE MARK CONSISTS OF STANDARD CHARACTERS WITHOUT CLAIM TO ANY PARTICULAR FONT, STYLE, SIZE, OR COLOR.

THE WORDING "ENCOTA" HAS NO MEANING IN A FOREIGN LANGUAGE.

SN 85-468,694, FILED 11-9-2011.

KIM MONINGHOFF, EXAMINING ATTORNEY



*David J. Kyjars*

Director of the United States Patent and Trademark Office

# United States of America

United States Patent and Trademark Office

## LOYALTY LATTICE

**Reg. No. 4,276,947**

NOR 1, INC. (DELAWARE CORPORATION)  
440 N. WOLFE ROAD  
SUNNYVALE, CA 94085

**Registered Jan. 15, 2013**

**Int. Cl.: 35**

FOR: COMPILATION AND PROVISION OF TRADE AND BUSINESS PRICE AND STATISTICAL INFORMATION, IN CLASS 35 (U.S. CLS. 100, 101 AND 102).

**SERVICE MARK**

FIRST USE 11-9-2011; IN COMMERCE 11-9-2011.

**PRINCIPAL REGISTER**

THE MARK CONSISTS OF STANDARD CHARACTERS WITHOUT CLAIM TO ANY PARTICULAR FONT, STYLE, SIZE, OR COLOR.

SN 85-468,784, FILED 11-9-2011.

AMY KELLY, EXAMINING ATTORNEY



*David J. Kyffers*

Director of the United States Patent and Trademark Office

# United States of America

United States Patent and Trademark Office

# CHAT

**Reg. No. 4,276,948**

**Registered Jan. 15, 2013**

**Int. Cl.: 9**

**TRADEMARK**

**PRINCIPAL REGISTER**

CLEARONE (UTAH CORPORATION)  
5225 WILEY POST WAY, SUITE 500  
SALT LAKE CITY, UT 84116

FOR: HEADSETS FOR USE WITH TELEPHONES AND COMPUTERS, IN CLASS 9 (U.S. CLS. 21, 23, 26, 36 AND 38).

FIRST USE 1-9-2012; IN COMMERCE 1-9-2012.

THE MARK CONSISTS OF STANDARD CHARACTERS WITHOUT CLAIM TO ANY PARTICULAR FONT, STYLE, SIZE, OR COLOR.

OWNER OF U.S. REG. NO. 3,333,223.

SN 85-469,153, FILED 11-10-2011.

REBECCA SMITH, EXAMINING ATTORNEY



*David J. Kyffers*

Director of the United States Patent and Trademark Office

# United States of America

United States Patent and Trademark Office

## HAMPTONALITY

**Reg. No. 4,276,949**

**Registered Jan. 15, 2013**

**Int. Cl.: 43**

**SERVICE MARK**

**PRINCIPAL REGISTER**

HLT DOMESTIC IP LLC (DELAWARE LIMITED LIABILITY COMPANY)  
7930 JONES BRANCH DRIVE, SUITE 1100  
MCLEAN, VA 22102

FOR: HOTEL SERVICES, IN CLASS 43 (U.S. CLS. 100 AND 101).

FIRST USE 3-20-2012; IN COMMERCE 3-20-2012.

THE MARK CONSISTS OF STANDARD CHARACTERS WITHOUT CLAIM TO ANY PARTICULAR FONT, STYLE, SIZE, OR COLOR.

OWNER OF U.S. REG. NOS. 1,305,512, 2,482,431, AND OTHERS.

SN 85-469,240, FILED 11-10-2011.

ALAIN LAPTER, EXAMINING ATTORNEY



*David J. Kyffers*

Director of the United States Patent and Trademark Office



# United States of America

United States Patent and Trademark Office

# moyie fire

**Reg. No. 4,276,950**

**Registered Jan. 15, 2013**

**Int. Cl.: 30**

**TRADEMARK**

**PRINCIPAL REGISTER**

ROUSH, GARY (UNITED STATES INDIVIDUAL)  
2590 ROOSEVELT RD  
MOYIE SPRINGS, ID 83845

FOR: SAUCES, IN CLASS 30 (U.S. CL. 46).

FIRST USE 1-1-2012; IN COMMERCE 1-1-2012.

THE MARK CONSISTS OF STANDARD CHARACTERS WITHOUT CLAIM TO ANY PARTICULAR FONT, STYLE, SIZE, OR COLOR.

NO CLAIM IS MADE TO THE EXCLUSIVE RIGHT TO USE "MOYIE", APART FROM THE MARK AS SHOWN.

SN 85-469,922, FILED 11-10-2011.

TRACY FLETCHER, EXAMINING ATTORNEY



*David J. Kyffers*

Director of the United States Patent and Trademark Office

# United States of America

United States Patent and Trademark Office

# ENERGEMS

**Reg. No. 4,276,951**

NRG INNOVATIONS, LLC (DELAWARE LIMITED LIABILITY COMPANY)  
550 S.W. 12TH AVENUE, SUITE 550  
DEERFIELD BEACH, FL 33442

**Registered Jan. 15, 2013**

**Int. Cls.: 5 and 30**

FOR: NUTRITIONAL SUPPLEMENTS FOR BOOSTING ENERGY, IN CLASS 5 (U.S. CLS. 6, 18, 44, 46, 51 AND 52).

**TRADEMARK**

FIRST USE 9-5-2012; IN COMMERCE 10-7-2012.

**PRINCIPAL REGISTER**

FOR: CHOCOLATES AND CHOCOLATE BASED READY TO EAT CANDIES AND SNACKS, IN CLASS 30 (U.S. CL. 46).

FIRST USE 9-5-2012; IN COMMERCE 10-7-2012.

THE MARK CONSISTS OF STANDARD CHARACTERS WITHOUT CLAIM TO ANY PARTICULAR FONT, STYLE, SIZE, OR COLOR.

SN 85-470,076, FILED 11-11-2011.

JILL PRATER, EXAMINING ATTORNEY



*David J. Kybas*

Director of the United States Patent and Trademark Office

# United States of America

United States Patent and Trademark Office

## PRIMEENTERPRISE

**Reg. No. 4,276,952**

**Registered Jan. 15, 2013**

**Int. Cls.: 9 and 42**

**TRADEMARK**

**SERVICE MARK**

**PRINCIPAL REGISTER**

GREENWAY MEDICAL TECHNOLOGIES, INC. (DELAWARE CORPORATION)  
121 GREENWAY BOULEVARD  
CARROLLTON, GA 30117

FOR: SOFTWARE FOR USE IN THE MEDICAL FIELD TO COMPILE, PROCESS, HOUSE, EXCHANGE, AND ANALYZE PATIENTS' BILLING INFORMATION, SCHEDULING INFORMATION, ADMINISTRATIVE INFORMATION AND PATIENT CARE DATA, IN CLASS 9 (U.S. CLS. 21, 23, 26, 36 AND 38).

FIRST USE 5-31-2008; IN COMMERCE 5-31-2008.

FOR: SOFTWARE AS A SERVICE (SAAS) SERVICES FEATURING NONDOWNLOADABLE SOFTWARE IN THE MEDICAL FIELD TO COMPILE, PROCESS, HOUSE, EXCHANGE, AND ANALYZE PATIENTS' BILLING INFORMATION, SCHEDULING INFORMATION, ADMINISTRATIVE INFORMATION AND PATIENT CARE DATA, IN CLASS 42 (U.S. CLS. 100 AND 101).

FIRST USE 5-31-2008; IN COMMERCE 5-31-2008.

THE MARK CONSISTS OF STANDARD CHARACTERS WITHOUT CLAIM TO ANY PARTICULAR FONT, STYLE, SIZE, OR COLOR.

SN 85-470,213, FILED 11-11-2011.

NAPOLEON SHARMA, EXAMINING ATTORNEY



*David J. Kyffers*

Director of the United States Patent and Trademark Office

# United States of America

United States Patent and Trademark Office

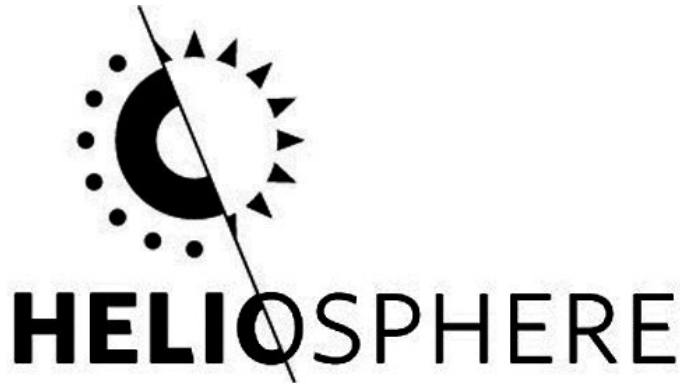

**Reg. No. 4,276,953**

**Registered Jan. 15, 2013**

**Int. Cl.: 14**

**TRADEMARK**

**PRINCIPAL REGISTER**

HELIOSPHERE DESIGNS, LLC (UTAH LIMITED LIABILITY COMPANY)  
1784 NORTH GATEWAY DRIVE  
NORTH LOGAN, UT 843412168

FOR: SUNDIALS, IN CLASS 14 (U.S. CLS. 2, 27, 28 AND 50).

FIRST USE 11-27-2012; IN COMMERCE 11-27-2012.

THE MARK CONSISTS OF THE WORD "HELIOSPHERE" UNDERNEATH A STYLIZED SUN, WITH A LINE RUNNING DIAGONALLY THROUGH THE SUN AND THE LETTER "O" IN "HELIOSPHERE". THE RAYS ON THE RIGHT-SIDE OF THE SUN ARE TRIANGLES. THE LEFT-SIDE OF THE SUN WHICH IS PARTIALLY SHADED FEATURES SEVEN SURROUNDING CIRCLES.

SN 85-470,334, FILED 11-11-2011.

SIMON TENG, EXAMINING ATTORNEY



*David J. Kybas*

Director of the United States Patent and Trademark Office

# United States of America

United States Patent and Trademark Office

## RATIONAL MIDDLE

**Reg. No. 4,276,954**

**Registered Jan. 15, 2013**

**Int. Cls.: 41 and 42**

**SERVICE MARK**

**PRINCIPAL REGISTER**

KALLENBERG, GREGORY (UNITED STATES INDIVIDUAL)  
401 MARKET STREET, SUITE 860  
SHREVEPORT, LA 71101

FOR: EDUCATIONAL AND ENTERTAINMENT SERVICES IN THE NATURE OF A DOCUMENTARY FILM SERIES AND OTHER CONTINUING PROGRAMS IN THE FIELDS OF ENERGY, ENVIRONMENT, FINANCE, BANKING, MEDICINE, GOVERNMENT, EDUCATION AND OTHER IMPORTANT POLITICAL AND EVERYDAY NEWS ISSUES AFFECTING THE LIVES AND LIFESTYLES OF THE GENERAL PUBLIC PROVIDED THROUGH TELEVISION, RADIO, SATELLITE, CABLE, VIDEO MEDIA, WEBCASTS, WIRELESS NETWORKS, INTERNET AND LIVE PERFORMANCES AND DISTRIBUTION OF PRINTABLE EDUCATIONAL MATERIALS IN CONNECTION THEREWITH; ENTERTAINMENT SERVICES, NAMELY, RECORDING, PRODUCTION AND POST-PRODUCTION SERVICES IN THE FIELDS OF VIDEO, FILMS, AND TELEVISION PROGRAMS; EDUCATIONAL SERVICES, NAMELY, CONDUCTING SEMINARS, LECTURES, WEBINARS, WORKSHOPS AND CONFERENCES IN THE FIELDS OF ENERGY, ENVIRONMENT, FINANCE, BANKING, MEDICINE, GOVERNMENT, EDUCATION AND OTHER IMPORTANT POLITICAL AND EVERYDAY NEWS ISSUES AFFECTING THE LIVES AND LIFESTYLES OF THE GENERAL PUBLIC AND DISTRIBUTION OF PRINTABLE EDUCATIONAL MATERIALS IN CONNECTION THEREWITH; PROVIDING INFORMATION, NEWS AND COMMENTARY IN THE FIELD OF CURRENT EVENTS RELATING TO ENERGY, ENVIRONMENT, FINANCE, BANKING, MEDICINE, GOVERNMENT, EDUCATION AND OTHER IMPORTANT POLITICAL AND EVERYDAY NEWS ISSUES AFFECTING THE LIVES AND LIFESTYLES OF THE GENERAL PUBLIC, VIA AN INTERACTIVE WEBSITE, IN CLASS 41 (U.S. CLS. 100, 101 AND 107).

FIRST USE 6-27-2012; IN COMMERCE 6-27-2012.

FOR: COMPUTER PROGRAMMING SERVICES, NAMELY, CREATION OF ONLINE VIRTUAL COMMUNITIES, BULLETIN BOARDS, DISCUSSION FORUMS, JOURNALS, BLOGS, CHATROOMS, MESSAGING, DIRECTORIES, OPINION POLLS, USER GENERATED CONTENT, AND CONTENT OF GENERAL INTEREST IN THE FIELDS OF ENERGY, ENVIRONMENT, FINANCE, BANKING, MEDICINE, GOVERNMENT, EDUCATION AND OTHER IMPORTANT POLITICAL AND EVERYDAY NEWS ISSUES AFFECTING THE LIVES AND LIFESTYLES OF THE GENERAL PUBLIC; COMPUTER SERVICES, NAMELY, HOSTING OF VIRTUAL COMMUNITIES, BULLETIN BOARDS, DISCUSSION FORUMS, JOURNALS, BLOGS, CHATROOMS, MESSAGING, DIRECTORIES, OPINION POLLS, USER GENERATED CONTENT, AND CONTENT OF GENERAL INTEREST IN THE FIELDS OF ENERGY, EN-



*David J. Kyffers*

Director of the United States Patent and Trademark Office

**Reg. No. 4,276,954** VIRONMENT, FINANCE, BANKING, MEDICINE, GOVERNMENT, EDUCATION AND OTHER IMPORTANT POLITICAL AND EVERYDAY NEWS ISSUES AFFECTING THE LIVES AND LIFESTYLES OF THE GENERAL PUBLIC, IN CLASS 42 (U.S. CLS. 100 AND 101).

FIRST USE 6-27-2012; IN COMMERCE 6-27-2012.

THE MARK CONSISTS OF STANDARD CHARACTERS WITHOUT CLAIM TO ANY PARTICULAR FONT, STYLE, SIZE, OR COLOR.

SN 85-470,714, FILED 11-11-2011.

FONG HSU, EXAMINING ATTORNEY

# United States of America

United States Patent and Trademark Office

# UPG

**Reg. No. 4,276,955**

**Registered Jan. 15, 2013**

**Int. Cl.: 35**

**SERVICE MARK**

**PRINCIPAL REGISTER**

UNIFIED PURCHASING GROUP, LLC (UTAH LIMITED LIABILITY COMPANY)  
901 WEST BAXTER DRIVE  
SOUTH JORDAN, UT 84095

FOR: BUSINESS SERVICES, NAMELY, COMBINED STRATEGIC GOODS OR SERVICES SOURCING AND COOPERATIVE PURCHASING FOR OTHERS; ADMINISTERING GROUP PURCHASING PROGRAMS, NAMELY, NEGOTIATING CONTRACTS WITH VENDORS AND SUPPLIERS TO ENABLE ASSOCIATION MEMBERS TO OBTAIN GROUP PURCHASING DISCOUNTS AND ROYALTIES, IN CLASS 35 (U.S. CLS. 100, 101 AND 102).

FIRST USE 1-1-2008; IN COMMERCE 1-1-2008.

THE MARK CONSISTS OF STANDARD CHARACTERS WITHOUT CLAIM TO ANY PARTICULAR FONT, STYLE, SIZE, OR COLOR.

SN 85-471,532, FILED 11-14-2011.

ALAIN LAPTER, EXAMINING ATTORNEY



*David J. Kybas*

Director of the United States Patent and Trademark Office

# United States of America

United States Patent and Trademark Office



**Reg. No. 4,276,956**

**Registered Jan. 15, 2013**

**Int. Cl.: 3**

**TRADEMARK**

**PRINCIPAL REGISTER**

LISA HOFFMAN BEAUTY, LLC (CALIFORNIA LIMITED LIABILITY COMPANY)  
SUITE 222; 11661 SAN VICENTE BLVD.  
LOS ANGELES, CA 90049

FOR: FRAGRANCED BODY CARE PRODUCTS, NAMELY, AROMATIC PERFUMED OILS,  
BODY WASH, SKIN MOISTURIZERS, AND BODY LOTION, IN CLASS 3 (U.S. CLS. 1, 4, 6,  
50, 51 AND 52).

FIRST USE 12-1-2011; IN COMMERCE 12-1-2011.

THE MARK CONSISTS OF A BRANCH SILHOUETTE FORMING ROUGHLY THE SHAPE  
OF THE LETTER S.

SN 85-472,303, FILED 11-14-2011.

EMILY CARLSEN, EXAMINING ATTORNEY



*David J. Kyffers*

Director of the United States Patent and Trademark Office



# United States of America

United States Patent and Trademark Office

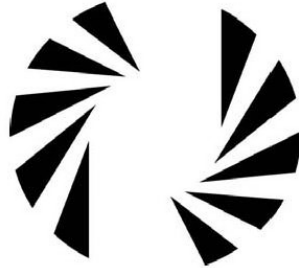

**Reg. No. 4,276,957**

**Registered Jan. 15, 2013**

**Int. Cl.: 9**

**TRADEMARK**

**PRINCIPAL REGISTER**

PHIATON CORPORATION (CALIFORNIA CORPORATION)  
18662 MACARTHUR BLVD., SUITE 405  
IRVINE, CA 92612

FOR: ADAPTERS; AUDIO-VIDEO RECEIVERS; BATTERY CHARGE DEVICES; CELLULAR PHONES; EAR PHONES; ELECTRIC CABLES; ELECTRIC CAPACITORS; ELECTRIC WIRES; GPS NAVIGATION DEVICE; HEADPHONES; HEADSETS FOR CELLULAR OR MOBILE PHONES; JUNCTION BOXES; LOUD SPEAKERS; MICROPHONES; MOBILE PHONES; MP3 PLAYERS; OPTICAL CABLES; PERSONAL DIGITAL ASSISTANTS; PORTABLE MEDIA PLAYERS; PORTABLE TELECOMMUNICATION INSTANT MESSAGING DEVICES; PORTABLE TELEPHONES; PORTABLE TELEVISIONS; POWER CABLES; REMOTE CONTROLS FOR STEREOS, RADIOS, TELEVISIONS, SATELLITE RECEIVERS, AUDIO-VIDEO RECEIVERS; SATELLITE RECEIVERS; TELECOMMUNICATION CABLES; TELEGRAPH WIRES; TELEPHONE WIRES, IN CLASS 9 (U.S. CLS. 21, 23, 26, 36 AND 38).

FIRST USE 10-0-2012; IN COMMERCE 10-0-2012.

THE MARK CONSISTS OF A PLURALITY OF TRIANGLES RADIALLY ARRANGED TO FORM AN OVERALL CIRCULAR MODE.

SN 85-473,324, FILED 11-15-2011.

ANDREW RHIM, EXAMINING ATTORNEY



*David J. Kyffers*

Director of the United States Patent and Trademark Office

# United States of America

United States Patent and Trademark Office

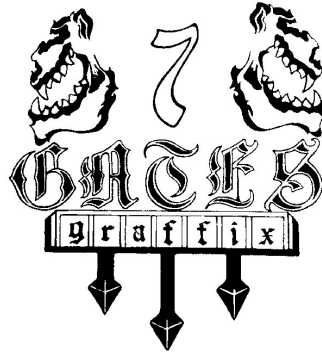

**Reg. No. 4,276,958**

GONZALES, FRANK J. (UNITED STATES INDIVIDUAL)  
726 KALISPEL AVE.  
PUEBLO, CO 81005

**Registered Jan. 15, 2013**

**Int. Cl.: 25**

FOR: CLOTHING, NAMELY, T-SHIRTS, HOODED SWEATSHIRTS, SWEATPANTS AND MECHANIC-AUTOMOTIVE WORK SHIRTS, IN CLASS 25 (U.S. CLS. 22 AND 39).

**TRADEMARK**

FIRST USE 11-29-2011; IN COMMERCE 11-29-2011.

**PRINCIPAL REGISTER**

NO CLAIM IS MADE TO THE EXCLUSIVE RIGHT TO USE "GRAPHICS", APART FROM THE MARK AS SHOWN.

THE MARK CONSISTS OF DEMON DOG HEADS FACING LEFT AND RIGHT WITH MOUTHS OPEN AND A NUMBER "7" BETWEEN THE TWO HEADS. THE STYLIZED WORDING "GATES GRAFFIX" APPEARS UNDERNEATH WITH "GRAFFIX" IN A DIVIDED RECTANGLE, BELOW WHICH THREE ARROWS POINT DOWN.

SN 85-473,335, FILED 11-15-2011.

LEIGH LOWRY, EXAMINING ATTORNEY



*David J. Kyros*

Director of the United States Patent and Trademark Office

# United States of America

United States Patent and Trademark Office



**Reg. No. 4,276,959**

**Registered Jan. 15, 2013**

**Int. Cl.: 9**

**TRADEMARK**

**PRINCIPAL REGISTER**

WILEY X, INC. (CALIFORNIA CORPORATION)  
7800 PATTERSON PASS ROAD  
LIVERMORE, CA 94550

FOR: PROTECTIVE EYEWEAR, NAMELY, SPECTACLES, SUNGLASSES AND GOGGLES; SAFETY EYEWEAR; COMPONENT PARTS FOR PROTECTIVE EYEWEAR AND SAFETY EYEWEAR; CASES FOR PROTECTIVE EYEWEAR AND SAFETY EYEWEAR, IN CLASS 9 (U.S. CLS. 21, 23, 26, 36 AND 38).

FIRST USE 2-27-2012; IN COMMERCE 2-27-2012.

THE MARK CONSISTS OF STYLIZED LETTERS "DVX" MADE TO APPEAR AS IF THEY WERE SPRAY PAINTED ON A SURFACE USING A RECTANGULAR-SHAPED STENCIL SUCH THAT THERE IS A DESIGN CONSISTING OF PAINT OVERSPRAY, SPLATTER AND DRIPS ABOUT A RECTANGULAR-SHAPED BACKGROUND AND FROM THE LOWER LEFT CORNER OF THE LETTER "D", THE LOWER LEFT PORTION OF THE LETTER "V" AND THE UPPER RIGHT PORTION OF THE LETTER "X". THE WHITE BACKGROUND IS NOT BEING USED AS COLOR IN THE MARK AND IT CONSTITUTES TRANSPARENT AREA.

SN 85-473,397, FILED 11-15-2011.

MARK SPARACINO, EXAMINING ATTORNEY



*David J. Kyjars*

Director of the United States Patent and Trademark Office

# United States of America

United States Patent and Trademark Office



**Reg. No. 4,276,960**

**Registered Jan. 15, 2013**

**Int. Cl.: 25**

**TRADEMARK**

**PRINCIPAL REGISTER**

SPOUTSHIRTS, LLC (ARIZONA LIMITED LIABILITY COMPANY)  
4101 E MINNEZONA AVE  
PHOENIX, AZ 85018

FOR: T-SHIRTS, IN CLASS 25 (U.S. CLS. 22 AND 39).

FIRST USE 7-14-2012; IN COMMERCE 7-14-2012.

THE MARK CONSISTS OF A SMILING CARTOON WHALE WITH THE LITERAL ELEMENT "SPOUTSHIRTS" ABOVE THE WHALE AND THE "T" IS REPRESENTATIVE OF THE WHALE'S SPOUT.

SN 85-474,406, FILED 11-16-2011.

TINA MAI, EXAMINING ATTORNEY



*David J. Kybas*

Director of the United States Patent and Trademark Office

# United States of America

United States Patent and Trademark Office



**Reg. No. 4,276,961**

**Registered Jan. 15, 2013**

**Int. Cls.: 6 and 20**

**TRADEMARK**

**PRINCIPAL REGISTER**

BOSHILONG NORTH AMERICA, INC. (ILLINOIS CORPORATION)  
16408 S. MAYLEON DRIVE  
PLAINFIELD, IL 60586

FOR: METAL FASTENERS, NAMELY, RIVETS; METAL SELF-ALIGNING DEMOUNTABLE SNAP FASTENERS CONSISTING OF PRESS FASTENERS AND PRESS STUDS FOR USE IN ATTACHING PANELS, HATCHES, FLOORS AND FURNITURE IN BOATS, MOTOR VEHICLES, TRAINS, AIRCRAFT AND BUILDINGS, IN CLASS 6 (U.S. CLS. 2, 12, 13, 14, 23, 25 AND 50).

FIRST USE 10-27-2011; IN COMMERCE 10-27-2011.

FOR: NON-METAL FASTENERS, NAMELY, RIVETS; NON-METAL SELF-ALIGNING DEMOUNTABLE SNAP FASTENERS CONSISTING OF PRESS FASTENERS AND PRESS STUDS FOR USE IN ATTACHING PANELS, HATCHES, FLOORS AND FURNITURE IN BOATS, MOTOR VEHICLES, TRAINS AND AIRCRAFT, IN CLASS 20 (U.S. CLS. 2, 13, 22, 25, 32 AND 50).

FIRST USE 12-5-2011; IN COMMERCE 12-5-2011.

THE MARK CONSISTS OF A BLUE GLOBE WITH BLACK STRIPES.

THE COLOR(S) BLUE AND BLACK IS/ARE CLAIMED AS A FEATURE OF THE MARK.

SN 85-474,917, FILED 11-17-2011.

WANDA KAY PRICE, EXAMINING ATTORNEY



*David J. Kybas*

Director of the United States Patent and Trademark Office

# United States of America

United States Patent and Trademark Office



**Reg. No. 4,276,962**

THE HUMMUS & PITA COMPANY LLC (NEW YORK LIMITED LIABILITY COMPANY)  
585 6TH AVENUE  
NEW YORK, NY 10011

**Registered Jan. 15, 2013**

**Int. Cl.: 43**

FOR: RESTAURANT SERVICES, IN CLASS 43 (U.S. CLS. 100 AND 101).

**SERVICE MARK**

FIRST USE 2-9-2012; IN COMMERCE 2-9-2012.

**PRINCIPAL REGISTER**

NO CLAIM IS MADE TO THE EXCLUSIVE RIGHT TO USE "HUMMUS & PITA CO.", APART FROM THE MARK AS SHOWN.

THE MARK CONSISTS OF AN OVAL BOWL WITH LIQUID INSIDE THE BOWL, THE LIQUID BEING REPRESENTED BY CONCENTRIC CIRCLES AND A REPRESENTATION OF THREE CHIPS ABOVE THE BOWL AND ONE CHIP IN THE BOWL, ALL FOLLOWED BY THE WORDS "THE HUMMUS" AMPERSAND "PITA" AND THE ABBREVIATION "CO" FOR COMPANY, WITH THE ABBREVIATION OF COMPANY DEPICTED AS THE LETTER "C" FOLLOWED BY A ZERO WITH A PERIOD BENEATH THE ZERO.

SN 85-475,420, FILED 11-17-2011.

JOHN HWANG, EXAMINING ATTORNEY



*David J. Kybas*

Director of the United States Patent and Trademark Office

# United States of America

United States Patent and Trademark Office

# JAVAGENESIS

**Reg. No. 4,276,963**

**Registered Jan. 15, 2013**

**Int. Cl.: 30**

**TRADEMARK**

**PRINCIPAL REGISTER**

JAVAGENESIS COFFEE ROASTING, LLC (GEORGIA LIMITED LIABILITY COMPANY)  
532 JOHANNAH PLACE  
LILBURN, GA 30047

FOR: COFFEE, IN CLASS 30 (U.S. CL. 46).

FIRST USE 5-1-2012; IN COMMERCE 5-3-2012.

THE MARK CONSISTS OF STANDARD CHARACTERS WITHOUT CLAIM TO ANY PARTICULAR FONT, STYLE, SIZE, OR COLOR.

SN 85-475,587, FILED 11-17-2011.

IRA J. GOODSaid, EXAMINING ATTORNEY



*David J. Kyffers*

Director of the United States Patent and Trademark Office

# United States of America

United States Patent and Trademark Office

## HAMMER DROP

**Reg. No. 4,276,964**

**Registered Jan. 15, 2013**

**Int. Cl.: 28**

**TRADEMARK**

**PRINCIPAL REGISTER**

MATTEL, INC. (DELAWARE CORPORATION)  
333 CONTINENTAL BOULEVARD  
M1-1518  
EL SEGUNDO, CA 90245

FOR: TOY VEHICLES AND ACCESSORIES THEREFOR; TOY VEHICLE TRACK SETS AND ACCESSORIES THEREFOR, IN CLASS 28 (U.S. CLS. 22, 23, 38 AND 50).

FIRST USE 11-28-2012; IN COMMERCE 11-28-2012.

THE MARK CONSISTS OF STANDARD CHARACTERS WITHOUT CLAIM TO ANY PARTICULAR FONT, STYLE, SIZE, OR COLOR.

SN 85-475,707, FILED 11-17-2011.

KATHLEEN M. VANSTON, EXAMINING ATTORNEY



*David J. Kyffers*

Director of the United States Patent and Trademark Office



# United States of America

United States Patent and Trademark Office



**Reg. No. 4,276,965**

**Registered Jan. 15, 2013**

**Int. Cl.: 35**

**SERVICE MARK**

**PRINCIPAL REGISTER**

ACE ENTERPRISES LLC (MASSACHUSETTS LIMITED LIABILITY COMPANY)  
10 WASHINGTON STREET  
WELLESLEY, MA 02481

FOR: SERVICES RELATING TO THE ANALYSIS, EVALUATION, CREATION AND BRAND ESTABLISHMENT OF TRADEMARKS, TRADE NAMES AND DOMAIN NAMES, IN CLASS 35 (U.S. CLS. 100, 101 AND 102).

FIRST USE 8-1-2012; IN COMMERCE 8-1-2012.

NO CLAIM IS MADE TO THE EXCLUSIVE RIGHT TO USE ".COM", APART FROM THE MARK AS SHOWN.

THE MARK CONSISTS OF THE STYLIZED TEXT "DOMAINESTIMATOR.COM". TO THE LEFT OF THE TEXT IS THE STYLIZED IMAGE OF TWO INTERTWINED RIBBONS. THE LETTER "S" IN THE TEXT IS A STYLIZED DOLLAR SYMBOL AND THE ".COM" PORTION OF THE TEXT RUNS VERTICALLY.

SN 85-475,859, FILED 11-17-2011.

MARTHA FROMM, EXAMINING ATTORNEY



*David J. Kybas*

Director of the United States Patent and Trademark Office

# United States of America

United States Patent and Trademark Office

## Custom Catcher

**Reg. No. 4,276,966**

BURDICK'S BAITS, LLC (FLORIDA LIMITED LIABILITY COMPANY)  
11780 GRIFFING BLVD  
BISCAYNE PARK, FL 33161

**Registered Jan. 15, 2013**

**Int. Cl.: 28**

FOR: FISHING TACKLE; FISHING TACKLE CONTAINERS, IN CLASS 28 (U.S. CLS. 22, 23, 38 AND 50).

**TRADEMARK**

FIRST USE 9-9-2011; IN COMMERCE 7-11-2012.

**PRINCIPAL REGISTER**

THE MARK CONSISTS OF STANDARD CHARACTERS WITHOUT CLAIM TO ANY PARTICULAR FONT, STYLE, SIZE, OR COLOR.

NO CLAIM IS MADE TO THE EXCLUSIVE RIGHT TO USE "CUSTOM", APART FROM THE MARK AS SHOWN.

SN 85-475,963, FILED 11-17-2011.

JOHN HWANG, EXAMINING ATTORNEY



*David J. Kyffers*

Director of the United States Patent and Trademark Office

# United States of America

United States Patent and Trademark Office

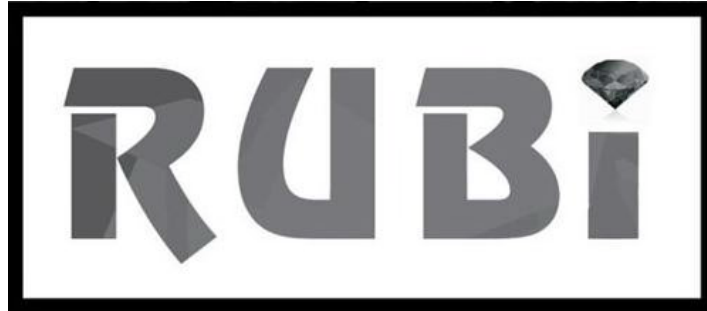

**Restoration Unified Business Integration**

**Reg. No. 4,276,967**

**Registered Jan. 15, 2013**

**Int. Cl.: 36**

**SERVICE MARK**

**PRINCIPAL REGISTER**

SPEIDEL INTERNATIONAL, INC. (WASHINGTON CORPORATION), DBA RESTORX/DKI,  
SUITE 107  
1307 WEST VALLEY HIGHWAY  
AUBURN, WA 98001

FOR: PROVIDING ELECTRONIC PROCESSING AND CLIENT DIRECTED MANAGEMENT  
OF INSURANCE CLAIMS OVER A WEB BASED COMPUTER NETWORK FOR DELIVERY  
TO MOBILE AND REMOTE DEVICES, IN CLASS 36 (U.S. CLS. 100, 101 AND 102).

FIRST USE 11-12-2012; IN COMMERCE 11-12-2012.

NO CLAIM IS MADE TO THE EXCLUSIVE RIGHT TO USE "RESTORATION UNIFIED  
BUSINESS INTEGRATION", APART FROM THE MARK AS SHOWN.

THE MARK CONSISTS OF THE WORD "RUBI" IN A RECTANGLE. THE WORDS "RESTOR-  
ATION UNIFIED BUSINESS INTEGRATION" APPEARS AT THE BOTTOM BENEATH THE  
RECTANGLE.

SN 85-476,014, FILED 11-18-2011.

WILLIAM P. SHANAHAN, EXAMINING ATTORNEY



*David J. Kyffers*

Director of the United States Patent and Trademark Office

# United States of America

United States Patent and Trademark Office

# CITY GIRLS

**Reg. No. 4,276,968**

TONNER TOYS LLC (NEW YORK LIMITED LIABILITY COMPANY)  
P.O. BOX 4410  
KINGSTON, NY 12402

**Registered Jan. 15, 2013**

**Int. Cl.: 28**

FOR: DOLLS, DOLL OUTFITS, AND DOLL ACCESSORIES, IN CLASS 28 (U.S. CLS. 22, 23, 38 AND 50).

**TRADEMARK**

FIRST USE 11-1-2012; IN COMMERCE 11-1-2012.

**PRINCIPAL REGISTER**

THE MARK CONSISTS OF STANDARD CHARACTERS WITHOUT CLAIM TO ANY PARTICULAR FONT, STYLE, SIZE, OR COLOR.

SN 85-476,178, FILED 11-18-2011.

MATTHEW EINSTEIN, EXAMINING ATTORNEY



*David J. Kyffers*

Director of the United States Patent and Trademark Office

# United States of America

United States Patent and Trademark Office

## O.F.F. OLD FART FITNESS

**Reg. No. 4,276,969**

**Registered Jan. 15, 2013**

**Int. Cls.: 25 and 41**

**TRADEMARK**

**SERVICE MARK**

**PRINCIPAL REGISTER**

CREATIVE VENTURES ON 4TH, LLC (ARIZONA LIMITED LIABILITY COMPANY)  
522 N 4TH AVENUE  
TUCSON, AZ 85705

FOR: ATHLETIC APPAREL, NAMELY, SHIRTS, PANTS, JACKETS, FOOTWEAR, HATS AND CAPS, ATHLETIC UNIFORMS; HATS; PANTS; SHIRTS; T-SHIRTS, IN CLASS 25 (U.S. CLS. 22 AND 39).

FIRST USE 1-0-2012; IN COMMERCE 1-0-2012.

FOR: PHYSICAL FITNESS INSTRUCTION, IN CLASS 41 (U.S. CLS. 100, 101 AND 107).

FIRST USE 1-0-2012; IN COMMERCE 1-0-2012.

THE MARK CONSISTS OF STANDARD CHARACTERS WITHOUT CLAIM TO ANY PARTICULAR FONT, STYLE, SIZE, OR COLOR.

NO CLAIM IS MADE TO THE EXCLUSIVE RIGHT TO USE "FITNESS", APART FROM THE MARK AS SHOWN.

SN 85-476,321, FILED 11-18-2011.

ANDREW RHIM, EXAMINING ATTORNEY



*David J. Kybas*

Director of the United States Patent and Trademark Office

# United States of America

United States Patent and Trademark Office

# PINPOINT

**Reg. No. 4,276,970**

**Registered Jan. 15, 2013**

**Int. Cl.: 10**

**TRADEMARK**

**PRINCIPAL REGISTER**

C. R. BARD, INC. (NEW JERSEY CORPORATION)  
730 CENTRAL AVENUE  
MURRAY HILL, NJ 07974

FOR: MEDICAL DEVICES AND APPARATUS IN THE NATURE OF ULTRASOUND DISPOSABLE ACCESSORIES FOR ULTRASOUND APPARATUS, NAMELY, CAPS WITH GEL USED AS AN ULTRASOUND COUPLING MEDIUM; NEEDLE GUIDES AND PROBE SHEATHS; AND PARTS AND FITTINGS THEREOF, IN CLASS 10 (U.S. CLS. 26, 39 AND 44).

FIRST USE 9-12-2012; IN COMMERCE 9-12-2012.

THE MARK CONSISTS OF THE WORD "PINPOINT" WITH A TARGET DESIGN WITHIN THE LETTER "O".

SN 85-476,393, FILED 11-18-2011.

WILLIAM JACKSON, EXAMINING ATTORNEY



*David J. Kyffers*

Director of the United States Patent and Trademark Office

# United States of America

United States Patent and Trademark Office

## LIQUID-PLUMR MAINTENANCE

**Reg. No. 4,276,971**

**Registered Jan. 15, 2013**

**Int. Cl.: 3**

**TRADEMARK**

**PRINCIPAL REGISTER**

THE CLOROX COMPANY (DELAWARE CORPORATION)  
1221 BROADWAY  
OAKLAND, CA 94612

FOR: DRAIN OPENERS, IN CLASS 3 (U.S. CLS. 1, 4, 6, 50, 51 AND 52).

FIRST USE 5-20-2012; IN COMMERCE 5-20-2012.

THE MARK CONSISTS OF STANDARD CHARACTERS WITHOUT CLAIM TO ANY PARTICULAR FONT, STYLE, SIZE, OR COLOR.

OWNER OF U.S. REG. NOS. 639,463, 2,372,109, AND 2,614,486.

NO CLAIM IS MADE TO THE EXCLUSIVE RIGHT TO USE "MAINTENANCE", APART FROM THE MARK AS SHOWN.

SN 85-476,604, FILED 11-18-2011.

FLORENTINA BLANDU, EXAMINING ATTORNEY



*David J. Kyffers*

Director of the United States Patent and Trademark Office

# United States of America

United States Patent and Trademark Office

## LIQUID-PLUMR URGENT CLEAR

**Reg. No. 4,276,972**

THE CLOROX COMPANY (DELAWARE CORPORATION)  
1221 BROADWAY  
OAKLAND, CA 94612

**Registered Jan. 15, 2013**

**Int. Cl.: 3**

FOR: DRAIN OPENERS, IN CLASS 3 (U.S. CLS. 1, 4, 6, 50, 51 AND 52).

FIRST USE 4-30-2012; IN COMMERCE 4-30-2012.

**TRADEMARK**

THE MARK CONSISTS OF STANDARD CHARACTERS WITHOUT CLAIM TO ANY PARTICULAR FONT, STYLE, SIZE, OR COLOR.

**PRINCIPAL REGISTER**

OWNER OF U.S. REG. NOS. 639,463, 2,372,109, AND 2,614,486.

NO CLAIM IS MADE TO THE EXCLUSIVE RIGHT TO USE "CLEAR", APART FROM THE MARK AS SHOWN.

SN 85-476,617, FILED 11-18-2011.

FLORENTINA BLANDU, EXAMINING ATTORNEY



*David J. Kyffers*

Director of the United States Patent and Trademark Office



# United States of America

United States Patent and Trademark Office

# geffdog

**Reg. No. 4,276,973**

**Registered Jan. 15, 2013**

**Int. Cl.: 40**

**SERVICE MARK**

**PRINCIPAL REGISTER**

MB, LLC (SOUTH DAKOTA LIMITED LIABILITY COMPANY)  
715 TAYLOR DR.  
ABERDEEN, SD 574016863

FOR: CUSTOM IMPRINTING OF COMPANY NAMES, BRANDS, AND LOGOS FOR PROMOTIONAL AND ADVERTISING PURPOSES ON THE GOODS OF OTHERS; CUSTOM MANUFACTURE OF SIGNS, BANNERS, VINYL VEHICLE AND TRAILER WRAPS AND DECALS TO THE ORDER AND SPECIFICATION OF OTHERS; EMBROIDERY SERVICES; ENGRAVING; SCREEN PRINTING, IN CLASS 40 (U.S. CLS. 100, 103 AND 106).

FIRST USE 7-0-2012; IN COMMERCE 7-0-2012.

THE MARK CONSISTS OF STANDARD CHARACTERS WITHOUT CLAIM TO ANY PARTICULAR FONT, STYLE, SIZE, OR COLOR.

SN 85-476,803, FILED 11-18-2011.

SIMON TENG, EXAMINING ATTORNEY



*David J. Kybas*

Director of the United States Patent and Trademark Office

# United States of America

United States Patent and Trademark Office



**Reg. No. 4,276,974**

**Registered Jan. 15, 2013**

**Int. Cl.: 40**

**SERVICE MARK**

**PRINCIPAL REGISTER**

MB, LLC (SOUTH DAKOTA LIMITED LIABILITY COMPANY)  
715 TAYLOR DR.  
ABERDEEN, SD 574016863

FOR: CUSTOM IMPRINTING OF COMPANY NAMES, BRANDS, AND LOGOS FOR PROMOTIONAL AND ADVERTISING PURPOSES ON THE GOODS OF OTHERS; CUSTOM MANUFACTURE OF SIGNS, BANNERS, VINYL VEHICLE AND TRAILER WRAPS AND DECALS TO THE ORDER AND SPECIFICATION OF OTHERS; EMBROIDERY SERVICES; ENGRAVING; SCREEN PRINTING, IN CLASS 40 (U.S. CLS. 100, 103 AND 106).

FIRST USE 7-0-2012; IN COMMERCE 7-0-2012.

THE MARK CONSISTS OF A STYLIZED DOG FEATURING FIVE CIRCLES OF VARIOUS SIZES ON ITS BODY.

SN 85-476,911, FILED 11-18-2011.

SIMON TENG, EXAMINING ATTORNEY



*David J. Kybas*

Director of the United States Patent and Trademark Office

# United States of America

United States Patent and Trademark Office



**Reg. No. 4,276,975**

**Registered Jan. 15, 2013**

**Int. Cl.: 9**

**TRADEMARK**

**PRINCIPAL REGISTER**

SKY TECH WORLDWIDE, INC. (CALIFORNIA CORPORATION)  
15870 EL PRADO RD., SUITE B  
CHINO, CA 91708

FOR: CELL PHONE BATTERY CHARGERS; CHARGERS FOR BATTERIES; CELL PHONE BATTERY CHARGERS FOR USE IN VEHICLES; BATTERY PACKS; EARPHONES; HEADSETS FOR CELLULAR OR MOBILE PHONES; APPARATUS FOR RECORDING, TRANSMISSION, PROCESSING AND REPRODUCTION OF SOUND, IMAGES OR DATA; APPARATUS FOR TRANSMISSION OF COMMUNICATION; ELECTRONIC COMMUNICATIONS SYSTEMS COMPRISED OF COMPUTER HARDWARE AND SOFTWARE FOR THE TRANSMISSION OF DATA BETWEEN TWO POINTS, IN CLASS 9 (U.S. CLS. 21, 23, 26, 36 AND 38).

FIRST USE 1-5-2012; IN COMMERCE 1-5-2012.

THE MARK CONSISTS OF THE LETTERS "QUBY" WITH A VEHICLE CHARGER FORMING THE DOWNSTROKE OF THE "Q" AND EARPHONES WITH A CORD FORMING THE "Y". TO THE RIGHT OF THE "Y" IS A MISCELLANEOUS RECTANGULAR DESIGN.

SN 85-478,021, FILED 11-21-2011.

LINDA MICKLEBURGH, EXAMINING ATTORNEY



*David J. Kyros*

Director of the United States Patent and Trademark Office

# United States of America

United States Patent and Trademark Office

## SILVER PENNY STORIES

**Reg. No. 4,276,976**

**Registered Jan. 15, 2013**

**Int. Cls.: 16 and 41**

**TRADEMARK**

**SERVICE MARK**

**PRINCIPAL REGISTER**

STERLING PUBLISHING CO., INC. (DELAWARE CORPORATION)  
387 PARK AVENUE SOUTH  
NEW YORK, NY 10016

FOR: SERIES OF FICTION AND NON-FICTION BOOKS ON A VARIETY OF TOPICS; SERIES OF CHILDREN'S BOOKS; CHILDREN'S ACTIVITY BOOKS AND CHILDREN'S PICTURE BOOKS, IN CLASS 16 (U.S. CLS. 2, 5, 22, 23, 29, 37, 38 AND 50).

FIRST USE 10-2-2012; IN COMMERCE 10-2-2012.

FOR: PROVIDING A WEB SITE FEATURING INFORMATION AND CONTENT ON BOOKS, AUTHORS AND THE PUBLISHING INDUSTRY, IN CLASS 41 (U.S. CLS. 100, 101 AND 107).

FIRST USE 10-2-2012; IN COMMERCE 10-2-2012.

THE MARK CONSISTS OF STANDARD CHARACTERS WITHOUT CLAIM TO ANY PARTICULAR FONT, STYLE, SIZE, OR COLOR.

NO CLAIM IS MADE TO THE EXCLUSIVE RIGHT TO USE "STORIES", APART FROM THE MARK AS SHOWN.

SN 85-478,085, FILED 11-21-2011.

ANDREW LEASER, EXAMINING ATTORNEY



*David J. Kyros*

Director of the United States Patent and Trademark Office

# United States of America

United States Patent and Trademark Office

## 2YOUNG2RETIRE

**Reg. No. 4,276,977**

PAUL G. WARD (UNITED STATES INDIVIDUAL)  
235 AGOR LANE  
MAHOPAC, NY 10541

**Registered Jan. 15, 2013**

**Int. Cl.: 41**

FOR: PROVIDING A WEBSITE FEATURING AN INTERACTIVE BLOG IN THE NATURE OF ARTICLES AND BOOK REVIEWS IN THE FIELD OF RETIREMENT ALTERNATIVES, IN CLASS 41 (U.S. CLS. 100, 101 AND 107).

**SERVICE MARK**

FIRST USE 1-1-2012; IN COMMERCE 1-1-2012.

**PRINCIPAL REGISTER**

THE MARK CONSISTS OF STANDARD CHARACTERS WITHOUT CLAIM TO ANY PARTICULAR FONT, STYLE, SIZE, OR COLOR.

SN 85-478,598, FILED 11-22-2011.

DAVID H. STINE, EXAMINING ATTORNEY



*David J. Kyfos*

Director of the United States Patent and Trademark Office

# United States of America

United States Patent and Trademark Office

## MINOMONSTERS

**Reg. No. 4,276,978**

**Registered Jan. 15, 2013**

**Int. Cl.: 9**

**TRADEMARK**

**PRINCIPAL REGISTER**

MINOMONSTERS, INC. (DELAWARE CORPORATION)  
#903  
2 MINT PLAZA  
SAN FRANCISCO, CA 94103

FOR: COMPUTER GAME SOFTWARE THAT MAY BE DOWNLOADED FROM A GLOBAL COMPUTER NETWORK, IN CLASS 9 (U.S. CLS. 21, 23, 26, 36 AND 38).

FIRST USE 12-16-2011; IN COMMERCE 12-16-2011.

THE MARK CONSISTS OF STANDARD CHARACTERS WITHOUT CLAIM TO ANY PARTICULAR FONT, STYLE, SIZE, OR COLOR.

SN 85-479,000, FILED 11-22-2011.

ELLEN B. AWRICH, EXAMINING ATTORNEY



*David J. Kyffers*

Director of the United States Patent and Trademark Office

# United States of America

United States Patent and Trademark Office

# CUISINART

**Reg. No. 4,276,979**

**Registered Jan. 15, 2013**

**Int. Cls.: 8 and 21**

**TRADEMARK**

**PRINCIPAL REGISTER**

CONAIR CORPORATION (DELAWARE CORPORATION)  
ONE CUMMINGS POINT ROAD  
STAMFORD, CT 06902

FOR: CUTTERS FOR WINE BOTTLE FOIL; MANDOLINES; MEAT TENDERIZER, NAMELY, A KITCHEN MALLET, IN CLASS 8 (U.S. CLS. 23, 28 AND 44).

FIRST USE 2-0-2012; IN COMMERCE 2-0-2012.

FOR: BOTTLE STOPPERS SPECIALLY ADAPTED FOR USE WITH WINE BOTTLES; COLANDERS; CORKSCREWS; POT LIDS; SALAD SPINNERS; WINE POURERS, IN CLASS 21 (U.S. CLS. 2, 13, 23, 29, 30, 33, 40 AND 50).

FIRST USE 4-0-2012; IN COMMERCE 4-0-2012.

THE MARK CONSISTS OF STANDARD CHARACTERS WITHOUT CLAIM TO ANY PARTICULAR FONT, STYLE, SIZE, OR COLOR.

OWNER OF U.S. REG. NOS. 1,183,520, 2,313,580, AND OTHERS.

SN 85-479,065, FILED 11-22-2011.

PAULA MAHONEY, EXAMINING ATTORNEY



*David J. Kybas*

Director of the United States Patent and Trademark Office

# United States of America

United States Patent and Trademark Office



**Reg. No. 4,276,980**

**Registered Jan. 15, 2013**

**Int. Cl.: 25**

**TRADEMARK**

**PRINCIPAL REGISTER**

VISIONS IN MOTION ENTERPRISES INC. (CALIFORNIA CORPORATION)  
501 GIBSON DRIVE #1324  
ROSEVILLE, CA 95678

FOR: ACTIVE WEAR, NAMELY, TANK TOPS, SHORT SLEEVE TOPS, STRAPPY TOPS, AND SHIRTS; ACTIVE SPORTS WEAR, NAMELY, TANK TOPS, SHORT SLEEVE TOPS, STRAPPY TOPS, AND SHIRTS; EXERCISE WEAR, NAMELY, TANK TOPS, SHORT SLEEVE TOPS, STRAPPY TOPS, AND SHIRTS; BUST SUPPORTS; COMPRESSION WEAR FOR ATHLETIC OR OTHER NON-MEDICAL USE, NAMELY, TANK TOPS, SHORT SLEEVE TOPS, STRAPPY TOPS, AND SHIRTS; YOGA WEAR, NAMELY, TANK TOPS, SHORT SLEEVE TOPS, STRAPPY TOPS, AND SHIRTS; TENNIS AND GOLF WEAR, NAMELY, TANK TOPS, SHORT SLEEVE TOPS, STRAPPY TOPS, AND SHIRTS; ATHLETIC TOPS; SUPPORT GARMENTS, OTHER THAN FOR MEDICAL USE, NAMELY, TANK TOPS, SHORT SLEEVE TOPS, STRAPPY TOPS, AND SHIRTS, IN CLASS 25 (U.S. CLS. 22 AND 39).

FIRST USE 10-6-2012; IN COMMERCE 10-6-2012.

THE MARK CONSISTS OF THE LETTER "B" IN BOLD WITH TWO OUTWARDLY EXTENDING ARMS EXTENDING WITHIN THE LOWER PORTION OF THE "B" AND A ROUND HEAD ARRANGED ABOVE THE ARMS TO SIMULATE A PERSON OR FLOWER.

SN 85-479,183, FILED 11-22-2011.

LAURIE KAUFMAN, EXAMINING ATTORNEY



*David J. Kyjars*

Director of the United States Patent and Trademark Office



# United States of America

United States Patent and Trademark Office



**Reg. No. 4,276,981**

**Registered Jan. 15, 2013**

**Int. Cl.: 25**

**TRADEMARK**

**PRINCIPAL REGISTER**

WORLDWIDE APPAREL ASSOCIATION INC. (NEW YORK CORPORATION)  
4022 COLLEGE POINT BLVD., 8N  
FLUSHING, NY 11354

FOR: MEN'S AND WOMEN'S JACKETS, COATS, TROUSERS, VESTS, IN CLASS 25 (U.S. CLS. 22 AND 39).

FIRST USE 12-1-2011; IN COMMERCE 7-1-2012.

THE MARK CONSISTS OF A STYLIZED COLLAR DESIGN COMPRISED FROM THE LETTERS "WAA" FEATURED WITH A RAISED DOT.

SN 85-479,369, FILED 11-22-2011.

AMY KELLY, EXAMINING ATTORNEY



*David J. Kybas*

Director of the United States Patent and Trademark Office

# United States of America

United States Patent and Trademark Office

MR. BROWN BY DUCKIE BROWN

**Reg. No. 4,276,982**

**Registered Jan. 15, 2013**

**Int. Cl.: 25**

**TRADEMARK**

**PRINCIPAL REGISTER**

DUCKIE BROWN, INC. (NEW YORK CORPORATION)  
321 WEST 13TH STREET  
SUITE 3A  
NEW YORK, NY 10014

FOR: MEN'S CLOTHING, NAMELY, SUITS, SPORTS JACKETS, TIES AND SHIRTS, IN CLASS 25 (U.S. CLS. 22 AND 39).

FIRST USE 2-0-2012; IN COMMERCE 11-26-2012.

THE MARK CONSISTS OF STANDARD CHARACTERS WITHOUT CLAIM TO ANY PARTICULAR FONT, STYLE, SIZE, OR COLOR.

OWNER OF U.S. REG. NO. 2,878,803.

THE NAME(S), PORTRAIT(S), AND/OR SIGNATURE(S) SHOWN IN THE MARK DOES NOT IDENTIFY A PARTICULAR LIVING INDIVIDUAL.

SN 85-479,510, FILED 11-22-2011.

COLLEEN KEARNEY, EXAMINING ATTORNEY



*David J. Kyffers*

Director of the United States Patent and Trademark Office

# United States of America

United States Patent and Trademark Office



**Reg. No. 4,276,983**

**Registered Jan. 15, 2013**

**Int. Cl.: 7**

**TRADEMARK**

**PRINCIPAL REGISTER**

TIANJIN STABLE TECHNOLOGY CO., LTD. (CHINA CORPORATION)  
ZHANGZHUANGZI INDUSTRY AREA JINGHAI DIST  
TIANJIN, CHINA 301600

FOR: CARBURETORS; FUEL INJECTORS, IN CLASS 7 (U.S. CLS. 13, 19, 21, 23, 31, 34 AND 35).

FIRST USE 9-17-2012; IN COMMERCE 9-17-2012.

NO CLAIM IS MADE TO THE EXCLUSIVE RIGHT TO USE "STABLE", APART FROM THE MARK AS SHOWN.

THE MARK CONSISTS OF THE WORDING "SDB STABLE" IN STYLIZED FONT WITH AN OVAL DESIGN.

SN 85-479,551, FILED 11-22-2011.

ESTHER BELENKER, EXAMINING ATTORNEY



*David J. Kyjars*

Director of the United States Patent and Trademark Office

# United States of America

United States Patent and Trademark Office

# MALHUNTER

**Reg. No. 4,276,984**

**Registered Jan. 15, 2013**

**Int. Cls.: 9 and 42**

**TRADEMARK**

**SERVICE MARK**

**PRINCIPAL REGISTER**

MANTECH INTERNATIONAL CORPORATION (DELAWARE CORPORATION)  
12051 LEE JACKSON HIGHWAY  
FAIRFAX, VA 22033

FOR: COMPUTER SOFTWARE, COMPUTER HARDWARE, AND COMPUTER SYSTEMS COMPOSED OF COMPUTER HARDWARE AND SOFTWARE, ALL FOR THE DETECTION AND ANALYSIS OF HARMFUL COMPUTER CODE ON A REMOTE COMPUTER, COMPUTER SYSTEM, DESKTOP COMPUTER, LAPTOP COMPUTER, PALMTOP COMPUTER, TABLET COMPUTER, CELL PHONE, SMART PHONE, BEEPER, OR ELECTRONIC MESSAGING DEVICE, IN CLASS 9 (U.S. CLS. 21, 23, 26, 36 AND 38).

FIRST USE 6-10-2011; IN COMMERCE 11-17-2011.

FOR: PROVIDING TEMPORARY USE OF NON-DOWNLOADABLE COMPUTER SOFTWARE AND SOFTWARE AS A SERVICE (SAAS) SERVICES FEATURING SOFTWARE, BOTH FOR THE DETECTION AND ANALYSIS OF HARMFUL COMPUTER CODE ON A REMOTE COMPUTER, COMPUTER SYSTEM, DESKTOP COMPUTER, LAPTOP COMPUTER, PALMTOP COMPUTER, TABLET COMPUTER, CELL PHONE, SMART PHONE, BEEPER, OR ELECTRONIC MESSAGING DEVICE; MAINTENANCE SERVICES FOR SUCH COMPUTER SOFTWARE, IN CLASS 42 (U.S. CLS. 100 AND 101).

FIRST USE 6-10-2011; IN COMMERCE 11-17-2011.

THE MARK CONSISTS OF STANDARD CHARACTERS WITHOUT CLAIM TO ANY PARTICULAR FONT, STYLE, SIZE, OR COLOR.

SN 85-479,672, FILED 11-23-2011.

ANDREA K. NADELMAN, EXAMINING ATTORNEY



*David J. Kybas*

Director of the United States Patent and Trademark Office

# United States of America

United States Patent and Trademark Office

# EVIDENTIA

**Reg. No. 4,276,985**

**Registered Jan. 15, 2013**

**Int. Cls.: 9 and 42**

**TRADEMARK**

**SERVICE MARK**

**PRINCIPAL REGISTER**

MANTECH INTERNATIONAL CORPORATION (DELAWARE CORPORATION)  
12015 LEE JACKSON HIGHWAY  
FAIRFAX, VA 22033

FOR: COMPUTER SOFTWARE, COMPUTER HARDWARE, AND COMPUTER SYSTEMS COMPOSED OF COMPUTER HARDWARE AND SOFTWARE, ALL FOR THE DETECTION AND ANALYSIS OF HARMFUL COMPUTER CODE ON A REMOTE COMPUTER, COMPUTER SYSTEM, DESKTOP COMPUTER, LAPTOP COMPUTER, PALMTOP COMPUTER, TABLET COMPUTER, CELL PHONE, SMART PHONE, BEEPER, OR ELECTRONIC MESSAGING DEVICE, IN CLASS 9 (U.S. CLS. 21, 23, 26, 36 AND 38).

FIRST USE 10-4-2011; IN COMMERCE 2-10-2012.

FOR: PROVIDING TEMPORARY USE OF NON-DOWNLOADABLE COMPUTER SOFTWARE AND SOFTWARE AS A SERVICE (SAAS) SERVICES FEATURING SOFTWARE, BOTH FOR THE DETECTION AND ANALYSIS OF HARMFUL COMPUTER CODE ON A REMOTE COMPUTER, COMPUTER SYSTEM, DESKTOP COMPUTER, LAPTOP COMPUTER, PALMTOP COMPUTER, TABLET COMPUTER, CELL PHONE, SMART PHONE, BEEPER, OR ELECTRONIC MESSAGING DEVICE; MAINTENANCE SERVICES FOR SUCH COMPUTER SOFTWARE, IN CLASS 42 (U.S. CLS. 100 AND 101).

FIRST USE 10-4-2011; IN COMMERCE 2-10-2012.

THE MARK CONSISTS OF STANDARD CHARACTERS WITHOUT CLAIM TO ANY PARTICULAR FONT, STYLE, SIZE, OR COLOR.

SN 85-479,679, FILED 11-23-2011.

ANDREA K. NADELMAN, EXAMINING ATTORNEY



*David J. Kyros*

Director of the United States Patent and Trademark Office

# United States of America

United States Patent and Trademark Office

## SMART FOUNDATION VARIABLE ANNUITY

**Reg. No. 4,276,986**

THE PENN MUTUAL LIFE INSURANCE COMPANY (PENNSYLVANIA CORPORATION)  
600 DRESHER ROAD  
HORSHAM, PA 19044

**Registered Jan. 15, 2013**

**Int. Cl.: 36**

FOR: ANNUITY UNDERWRITING, IN CLASS 36 (U.S. CLS. 100, 101 AND 102).

**SERVICE MARK**

FIRST USE 5-9-2012; IN COMMERCE 5-9-2012.

**PRINCIPAL REGISTER**

THE MARK CONSISTS OF STANDARD CHARACTERS WITHOUT CLAIM TO ANY PARTICULAR FONT, STYLE, SIZE, OR COLOR.

NO CLAIM IS MADE TO THE EXCLUSIVE RIGHT TO USE "VARIABLE ANNUITY", APART FROM THE MARK AS SHOWN.

SN 85-479,680, FILED 11-23-2011.

BRIDGETT SMITH, EXAMINING ATTORNEY



*David J. Kyffers*

Director of the United States Patent and Trademark Office

# United States of America

United States Patent and Trademark Office

## SMART FOUNDATION PLUS VARIABLE ANNUITY

**Reg. No. 4,276,987**

THE PENN MUTUAL LIFE INSURANCE COMPANY (PENNSYLVANIA CORPORATION)  
600 DRESHER ROAD  
HORSHAM, PA 19044

**Registered Jan. 15, 2013**

**Int. Cl.: 36**

FOR: ANNUITY UNDERWRITING, IN CLASS 36 (U.S. CLS. 100, 101 AND 102).

**SERVICE MARK**

FIRST USE 5-9-2012; IN COMMERCE 5-9-2012.

**PRINCIPAL REGISTER**

THE MARK CONSISTS OF STANDARD CHARACTERS WITHOUT CLAIM TO ANY PARTICULAR FONT, STYLE, SIZE, OR COLOR.

NO CLAIM IS MADE TO THE EXCLUSIVE RIGHT TO USE "VARIABLE ANNUITY", APART FROM THE MARK AS SHOWN.

SN 85-479,682, FILED 11-23-2011.

BRIDGETT SMITH, EXAMINING ATTORNEY



*David J. Kyffers*

Director of the United States Patent and Trademark Office

# United States of America

United States Patent and Trademark Office

## jelsleep technology

**Reg. No. 4,276,988**

**Registered Jan. 15, 2013**

**Int. Cls.: 20 and 24**

**TRADEMARK**

**PRINCIPAL REGISTER**

JELSLEEP LLC (ILLINOIS LIMITED LIABILITY COMPANY)  
SUITE 300  
ONE NORTHFIELD PLAZA  
NORTHFIELD, IL 60093

FOR: MATTRESSES AND PILLOWS, IN CLASS 20 (U.S. CLS. 2, 13, 22, 25, 32 AND 50).

FIRST USE 1-10-2010; IN COMMERCE 1-10-2010.

FOR: BEDDING ARTICLES, NAMELY, SHEETS, MATTRESS PADS, COMFORTERS, AND TICKING FABRIC FOR MATTRESSES, IN CLASS 24 (U.S. CLS. 42 AND 50).

FIRST USE 1-10-2010; IN COMMERCE 1-10-2010.

THE MARK CONSISTS OF STANDARD CHARACTERS WITHOUT CLAIM TO ANY PARTICULAR FONT, STYLE, SIZE, OR COLOR.

OWNER OF U.S. REG. NO. 4,013,041.

NO CLAIM IS MADE TO THE EXCLUSIVE RIGHT TO USE "TECHNOLOGY", APART FROM THE MARK AS SHOWN.

SN 85-480,468, FILED 11-23-2011.

COLLEEN KEARNEY, EXAMINING ATTORNEY



*David J. Kyros*

Director of the United States Patent and Trademark Office



# United States of America

United States Patent and Trademark Office



**Reg. No. 4,276,989**

**Registered Jan. 15, 2013**

**Int. Cl.: 1**

SODASPARKLE INTERNATIONAL LIMITED (HONG KONG LIMITED LIABILITY COMPANY)

8/F, FORD GLORY PLAZA  
37-39 WING HONG STREET, CHEUNG SHA WAN  
KOWLOON, HONG KONG

**TRADEMARK**

**PRINCIPAL REGISTER**

FOR: CARBON DIOXIDE FILLED CANISTER, CARTRIDGE, CYLINDER; MILK FERMENTS FOR THE FOOD INDUSTRY; CARBONIC ACID GAS; DISTILLED WATER; ANTIOXIDANTS USED IN THE MANUFACTURE OF BEVERAGES; FINING PREPARATION FOR CLARIFYING AND ENHANCING THE FLAVOR OF FRUIT JUICE, NAMELY, ALBUMEN; ARTIFICIAL SWEETENERS; CHEMICAL PRODUCTS FOR PRESERVING FOODSTUFFS; SACCHARIN; CHEMICAL PREPARATIONS IN THE NATURE OF FILTERING MATERIALS FOR THE BEVERAGES INDUSTRY, IN CLASS 1 (U.S. CLS. 1, 5, 6, 10, 26 AND 46).

FIRST USE 1-10-2012; IN COMMERCE 1-10-2012.

THE MARK CONSISTS OF THE STYLIZED DESIGN OF A WAVE THAT FORMS THE LETTER "S" AND THE STACKED LETTERING "ODA" AND "PARKLE".

SN 85-480,760, FILED 11-25-2011.

JENNIFER WILLISTON, EXAMINING ATTORNEY



*David J. Kyffers*

Director of the United States Patent and Trademark Office

# United States of America

United States Patent and Trademark Office

# MUMENTOS

**Reg. No. 4,276,990**

**Registered Jan. 15, 2013**

**Int. Cl.: 26**

**TRADEMARK**

**PRINCIPAL REGISTER**

HOBBY LOBBY STORES, INC. (OKLAHOMA CORPORATION)  
LEGAL DEPARTMENT  
7707 SW 44TH STREET  
OKLAHOMA CITY, OK 73179

FOR: ARTIFICIAL BOUTONNIERES; ARTIFICIAL CORSAGES; ARTIFICIAL FLOWER ARRANGEMENTS; DECORATIVE RIBBONS, IN CLASS 26 (U.S. CLS. 37, 39, 40, 42 AND 50).

FIRST USE 1-14-2012; IN COMMERCE 2-1-2012.

THE MARK CONSISTS OF STANDARD CHARACTERS WITHOUT CLAIM TO ANY PARTICULAR FONT, STYLE, SIZE, OR COLOR.

SN 85-480,783, FILED 11-25-2011.

BARBARA GAYNOR, EXAMINING ATTORNEY



*David J. Kybas*

Director of the United States Patent and Trademark Office

# United States of America

United States Patent and Trademark Office

# FVP

**Reg. No. 4,276,991**

ELLIOTT AUTO SUPPLY CO., INC. (MINNESOTA CORPORATION)  
1380 CORPORATE CENTER CURVE, SUITE 200  
EAGAN, MN 55121

**Registered Jan. 15, 2013**

**Int. Cl.: 7**

FOR: RADIATORS FOR VEHICLES, IN CLASS 7 (U.S. CLS. 13, 19, 21, 23, 31, 34 AND 35).

**TRADEMARK**

FIRST USE 4-0-2012; IN COMMERCE 4-0-2012.

**PRINCIPAL REGISTER**

THE MARK CONSISTS OF STANDARD CHARACTERS WITHOUT CLAIM TO ANY PARTICULAR FONT, STYLE, SIZE, OR COLOR.

OWNER OF U.S. REG. NOS. 3,538,633, 3,612,101, AND 3,880,992.

SN 85-481,516, FILED 11-28-2011.

JULIE WATSON, EXAMINING ATTORNEY



*David J. Kyffers*

Director of the United States Patent and Trademark Office

# United States of America

United States Patent and Trademark Office

## The Tutor Market

**Reg. No. 4,276,992**

**Registered Jan. 15, 2013**

**Int. Cl.: 41**

**SERVICE MARK**

**PRINCIPAL REGISTER**

TUTOR PLANET INC (CALIFORNIA CORPORATION)  
358 S GRAMERCY PL  
207  
LOS ANGELES, CA 90020

FOR: EDUCATION SERVICES, NAMELY, PROVIDING LIVE AND ON-LINE TUTORING  
IN THE FIELD OF K-12 EDUCATION, IN CLASS 41 (U.S. CLS. 100, 101 AND 107).

FIRST USE 7-1-2012; IN COMMERCE 9-15-2012.

THE MARK CONSISTS OF STANDARD CHARACTERS WITHOUT CLAIM TO ANY PAR-  
TICULAR FONT, STYLE, SIZE, OR COLOR.

NO CLAIM IS MADE TO THE EXCLUSIVE RIGHT TO USE "TUTOR", APART FROM THE  
MARK AS SHOWN.

SN 85-481,529, FILED 11-28-2011.

MEGHAN REINHART, EXAMINING ATTORNEY



*David J. Kyffers*

Director of the United States Patent and Trademark Office

# United States of America

United States Patent and Trademark Office

# HOPE-FR

**Reg. No. 4,276,993**

OMIKENSHI CO. LTD. (JAPAN CORPORATION)  
5-14, KAWARAMACHI 2-CHOME, CHU-KU  
OSAKA, JAPAN

**Registered Jan. 15, 2013**

**Int. Cl.: 22**

FOR: RAW TEXTILE FIBERS, NAMELY, COTTON FIBERS, HEMP FIBERS, SILK FIBERS, COARSE ANIMAL HAIRS, CHEMICAL FIBERS FOR TEXTILE USE, AND INORGANIC FIBERS FOR TEXTILE USE, COTTON WADDING FOR CLOTHES, IN CLASS 22 (U.S. CLS. 1, 2, 7, 19, 22, 42 AND 50).

**TRADEMARK**

**PRINCIPAL REGISTER**

FIRST USE 11-1-2011; IN COMMERCE 10-10-2012.

THE MARK CONSISTS OF STANDARD CHARACTERS WITHOUT CLAIM TO ANY PARTICULAR FONT, STYLE, SIZE, OR COLOR.

SN 85-481,653, FILED 11-28-2011.

HEATHER THOMPSON, EXAMINING ATTORNEY



*David J. Kyffers*

Director of the United States Patent and Trademark Office

# United States of America

United States Patent and Trademark Office

## CANNIBAL QUEEN

**Reg. No. 4,276,994**

**Registered Jan. 15, 2013**

**Int. Cl.: 41**

**SERVICE MARK**

**PRINCIPAL REGISTER**

MILE HIGH ADVERTISING, INC. (PENNSYLVANIA CORPORATION)  
5080 ANDERSON ROAD  
DOYLESTOWN, PA 18901

FOR: EDUCATIONAL AND ENTERTAINMENT SERVICES, NAMELY, A CONTINUING PROGRAM ABOUT AVIATION AND TRAVEL ACCESSIBLE BY RADIO, TELEVISION, SATELLITE, AUDIO, VIDEO AND COMPUTER NETWORKS; ENTERTAINMENT IN THE NATURE OF ON-GOING TELEVISION PROGRAMS IN THE FIELD OF AVIATION AND TRAVEL; ENTERTAINMENT SERVICES IN THE NATURE OF AN ON-GOING REALITY BASED TELEVISION PROGRAM; ENTERTAINMENT SERVICES, NAMELY, PRODUCTION AND DISTRIBUTION OF ONGOING TELEVISION PROGRAMS IN THE FIELD OF AVIATION AND TRAVEL; ENTERTAINMENT SERVICES, NAMELY, PROVIDING ON-GOING TELEVISION PROGRAMS IN THE FIELD OF AVIATION AND TRAVEL VIA A GLOBAL COMPUTER NETWORK; ENTERTAINMENT SERVICES, NAMELY, PROVIDING RECREATIONAL AVIATION RIDES IN CLASSIC AIRCRAFT, NOT FOR TRANSPORTATION PURPOSES, IN CLASS 41 (U.S. CLS. 100, 101 AND 107).

FIRST USE 10-25-2012; IN COMMERCE 10-25-2012.

THE MARK CONSISTS OF STANDARD CHARACTERS WITHOUT CLAIM TO ANY PARTICULAR FONT, STYLE, SIZE, OR COLOR.

SN 85-481,938, FILED 11-28-2011.

JENNIFER BUTTON, EXAMINING ATTORNEY



*David J. Kyffers*

Director of the United States Patent and Trademark Office

**United States of America**  
United States Patent and Trademark Office

**PLYMOUTH**

**Reg. No. 4,276,995**

GLOBUS MEDICAL, INC (DELAWARE CORPORATION)  
2560 GENERAL ARMISTEAD AVENUE  
AUDUBON, PA 19403

**Registered Jan. 15, 2013**

**Int. Cl.: 10**

FOR: SPINAL IMPLANTS MADE FROM ARTIFICIAL MATERIALS FOR USE IN SPINE SURGERY, IN CLASS 10 (U.S. CLS. 26, 39 AND 44).

**TRADEMARK**

FIRST USE 6-5-2012; IN COMMERCE 6-5-2012.

**PRINCIPAL REGISTER**

THE MARK CONSISTS OF STANDARD CHARACTERS WITHOUT CLAIM TO ANY PARTICULAR FONT, STYLE, SIZE, OR COLOR.

SN 85-482,706, FILED 11-29-2011.

CARYN GLASSER, EXAMINING ATTORNEY



*David J. Kybas*

Director of the United States Patent and Trademark Office

# United States of America

United States Patent and Trademark Office

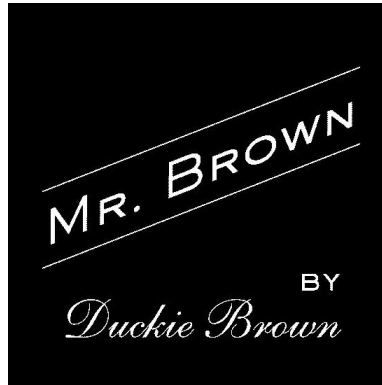

**Reg. No. 4,276,996**

**Registered Jan. 15, 2013**

**Int. Cl.: 25**

**TRADEMARK**

**PRINCIPAL REGISTER**

DUCKIE BROWN, INC. (NEW YORK CORPORATION)  
321 WEST 13TH STREET  
SUITE 3A  
NEW YORK, NY 10014

FOR: MEN'S CLOTHING, NAMELY, SUITS, SPORTS JACKETS, TIES AND SHIRTS, IN CLASS 25 (U.S. CLS. 22 AND 39).

FIRST USE 2-0-2012; IN COMMERCE 11-26-2012.

OWNER OF U.S. REG. NO. 2,878,803.

THE NAME(S), PORTRAIT(S), AND/OR SIGNATURE(S) SHOWN IN THE MARK DOES NOT IDENTIFY A PARTICULAR LIVING INDIVIDUAL.

THE MARK CONSISTS OF THE WORDS "MR. BROWN" IN A SMALL CAPS FONT, BETWEEN TWO PARALLEL LINES ANGLED UPWARD TOWARD THE RIGHT AT APPROXIMATELY 22.5 DEGREES, WITH THE WORD "BY" BELOW THE LOWER OF THE TWO UPWARDLY ANGLED PARALLEL LINES CONTAINING "MR. BROWN" BUT ABOVE THE WORDS "DUCKIE BROWN", WHICH WORDS ARE HORIZONTAL, ALL CONTAINED WITHIN A SQUARE WITH A CONTRASTING BACKGROUND SO THAT THE TEXT AND LINES ARE VISIBLE.

SN 85-483,086, FILED 11-29-2011.

COLLEEN KEARNEY, EXAMINING ATTORNEY



*David J. Kybas*

Director of the United States Patent and Trademark Office



# United States of America

United States Patent and Trademark Office



**Reg. No. 4,276,997**

**Registered Jan. 15, 2013**

**Int. Cl.: 25**

**TRADEMARK**

**PRINCIPAL REGISTER**

CARTER, NEISHA (UNITED STATES INDIVIDUAL)  
760 NW 68TH AVENUE  
PLANTATION, FL 33317

FOR: FOOTWEAR FOR WOMEN, IN CLASS 25 (U.S. CLS. 22 AND 39).

FIRST USE 8-1-2012; IN COMMERCE 8-1-2012.

THE MARK CONSISTS OF THE WORDING "ZAFFU TO" IN STYLIZED FONT WHEREIN THE LETTER "Z" IS PARTIALLY ENCIRCLED BY AN ELLIPTICAL DESIGN.

THE WORDING "ZAFFU" OR "ZAFFU TO" HAS NO MEANING IN A FOREIGN LANGUAGE.

SN 85-483,303, FILED 11-30-2011.

AMY KELLY, EXAMINING ATTORNEY



*David J. Kybas*

Director of the United States Patent and Trademark Office

# United States of America

United States Patent and Trademark Office



**Reg. No. 4,276,998**

**Registered Jan. 15, 2013**

**Int. Cl.: 18**

**TRADEMARK**

**PRINCIPAL REGISTER**

THUNDERSHIRT, LLC (NORTH CAROLINA LIMITED LIABILITY COMPANY)  
905 JACKIE ROBINSON DRIVE  
DURHAM, NC 27701

FOR: CLOTHING FOR ANIMALS; CLOTHING FOR DOMESTIC PETS; CAT APPAREL; CAT CLOTHING; GARMENTS FOR PETS; PET CLOTHING, IN CLASS 18 (U.S. CLS. 1, 2, 3, 22 AND 41).

FIRST USE 4-19-2012; IN COMMERCE 4-19-2012.

OWNER OF U.S. REG. NO. 3,689,331.

THE MARK CONSISTS OF A CAT IN A T-SHIRT, SITTING TO THE LEFT OF THE WORD "THUNDERSHIRT". THE WORD "THUNDERSHIRT" APPEARS WITHIN A RECTANGLE. THE CAT COVERS THE LEFT VERTICAL LINE OF THE RECTANGLE.

SN 85-483,342, FILED 11-30-2011.

BILL DAWE, EXAMINING ATTORNEY



*David J. Kyros*

Director of the United States Patent and Trademark Office

# United States of America

United States Patent and Trademark Office

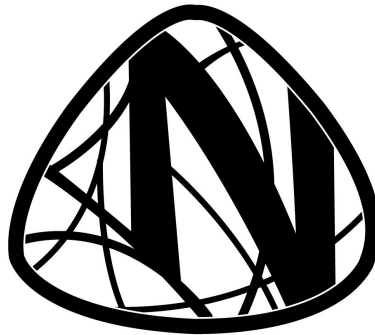

**Reg. No. 4,276,999**

**Registered Jan. 15, 2013**

**Int. Cl.: 10**

**TRADEMARK**

**PRINCIPAL REGISTER**

NELSON MEDICAL ENTERPRISES, LLC (OHIO LIMITED LIABILITY COMPANY)  
30915 LORAIN ROAD, SUITE 100  
NORTH OLMSTED, OH 44070

FOR: TRAINING DEVICES FOR USE IN VEIN THERAPY, NAMELY, DEVICES THAT INCLUDE ONE OR MORE ARTIFICIAL VEINS TO ALLOW A MEDICAL PROFESSIONAL TO PRACTICE INJECTING FLUID WITH A SYRINGE NEEDLE, IN CLASS 10 (U.S. CLS. 26, 39 AND 44).

FIRST USE 6-7-2012; IN COMMERCE 6-7-2012.

THE MARK CONSISTS OF A TRIANGLE WITH ROUNDED CORNERS AND CONTAINING THE STYLIZED LETTER "N" AND A BACKGROUND DESIGN RESEMBLING SCROLLWORK OR NETTING.

SN 85-483,592, FILED 11-30-2011.

ANDREA BUTLER, EXAMINING ATTORNEY



*David J. Kyjars*

Director of the United States Patent and Trademark Office

# United States of America

United States Patent and Trademark Office

# BioOptimized

**Reg. No. 4,277,000**

NOVUS INTERNATIONAL, INC. (DELAWARE CORPORATION)  
20 RESEARCH PARK DRIVE  
ST. CHARLES, MO 63304

**Registered Jan. 15, 2013**

**Int. Cl.: 5**

FOR: CHELATED MINERAL COMPOSITIONS FOR USE AS DIETARY MINERAL SUPPLEMENTS FOR ANIMALS, IN CLASS 5 (U.S. CLS. 6, 18, 44, 46, 51 AND 52).

**TRADEMARK**

FIRST USE 9-10-2012; IN COMMERCE 9-10-2012.

**PRINCIPAL REGISTER**

THE MARK CONSISTS OF STANDARD CHARACTERS WITHOUT CLAIM TO ANY PARTICULAR FONT, STYLE, SIZE, OR COLOR.

SN 85-483,969, FILED 11-30-2011.

ESTHER BELENKER, EXAMINING ATTORNEY



*David J. Kybas*

Director of the United States Patent and Trademark Office

# United States of America

United States Patent and Trademark Office

## GO TO ZERO

**Reg. No. 4,277,001**

HUMAN TOUCH, LLC (DELAWARE LIMITED LIABILITY COMPANY)  
3030 WALNUT AVENUE  
LONG BEACH, CA 90807

**Registered Jan. 15, 2013**

**Int. Cls.: 10 and 20**

FOR: MASSAGE CHAIRS, ELECTRIC MASSAGE CHAIRS AND MASSAGE RECLINERS,  
IN CLASS 10 (U.S. CLS. 26, 39 AND 44).

**TRADEMARK**

FIRST USE 2-1-2012; IN COMMERCE 8-1-2012.

**PRINCIPAL REGISTER**

FOR: FURNITURE, NAMELY, RECLINERS, IN CLASS 20 (U.S. CLS. 2, 13, 22, 25, 32 AND  
50).

FIRST USE 2-1-2012; IN COMMERCE 8-1-2012.

THE MARK CONSISTS OF STANDARD CHARACTERS WITHOUT CLAIM TO ANY PAR-  
TICULAR FONT, STYLE, SIZE, OR COLOR.

SN 85-484,182, FILED 11-30-2011.

REBECCA POVARCHUK, EXAMINING ATTORNEY



*David J. Kyffers*

Director of the United States Patent and Trademark Office

# United States of America

United States Patent and Trademark Office

## DO WHAT YOU DO BETTER

**Reg. No. 4,277,002**

**Registered Jan. 15, 2013**

**Int. Cls.: 10 and 20**

**TRADEMARK**

**PRINCIPAL REGISTER**

HUMAN TOUCH, LLC (DELAWARE LIMITED LIABILITY COMPANY)  
3030 WALNUT AVENUE  
LONG BEACH, CA 90807

FOR: MASSAGE CHAIRS, FOOT AND CALF MASSAGERS, HAND HELD MASSAGERS, POWERED MASSAGE APPARATUS, NAMELY, A MASSAGE BED WITH BUILT-IN HYDROTHERAPY WATER JETS, IN CLASS 10 (U.S. CLS. 26, 39 AND 44).

FIRST USE 11-1-2011; IN COMMERCE 12-1-2011.

FOR: RECLINERS AND FURNITURE, IN CLASS 20 (U.S. CLS. 2, 13, 22, 25, 32 AND 50).

FIRST USE 11-1-2011; IN COMMERCE 12-1-2011.

THE MARK CONSISTS OF STANDARD CHARACTERS WITHOUT CLAIM TO ANY PARTICULAR FONT, STYLE, SIZE, OR COLOR.

SN 85-484,188, FILED 11-30-2011.

REBECCA POVARCHUK, EXAMINING ATTORNEY



*David J. Kyros*

Director of the United States Patent and Trademark Office

# United States of America

United States Patent and Trademark Office

## ROCKLAND DIRECT

**Reg. No. 4,277,003**

**Registered Jan. 15, 2013**

**Int. Cl.: 36**

**SERVICE MARK**

**PRINCIPAL REGISTER**

ROCKLAND TRUST COMPANY (MASSACHUSETTS CORPORATION)  
288 UNION STREET  
ROCKLAND, MA 02370

FOR: ON-LINE BANKING SERVICES, IN CLASS 36 (U.S. CLS. 100, 101 AND 102).

FIRST USE 2-3-2012; IN COMMERCE 2-3-2012.

THE MARK CONSISTS OF STANDARD CHARACTERS WITHOUT CLAIM TO ANY PARTICULAR FONT, STYLE, SIZE, OR COLOR.

SEC. 2(F) AS TO "ROCKLAND".

OWNER OF U.S. REG. NOS. 3,633,895, 3,641,954, AND 3,910,066.

NO CLAIM IS MADE TO THE EXCLUSIVE RIGHT TO USE "DIRECT", APART FROM THE MARK AS SHOWN.

SN 85-485,026, FILED 12-1-2011.

CORY BOONE, EXAMINING ATTORNEY



*David J. Kyffers*

Director of the United States Patent and Trademark Office

# United States of America

United States Patent and Trademark Office

# Easycare

**Reg. No. 4,277,004**

**Registered Jan. 15, 2013**

**Int. Cl.: 3**

**TRADEMARK**

**PRINCIPAL REGISTER**

WANG, DEYOU (CHINA INDIVIDUAL)  
7100 WOODBINE AVE. SUITE 110  
MARKHAM, ONTARIO, CANADA L3R5J2

FOR: HAIR CARE PRODUCTS, NAMELY, SHAMPOO, CONDITIONER, HAIRSPRAY, HAIR STYLING GEL, HAIR MOUSSE; NON-MEDICATED SKIN PRODUCTS, NAMELY, FACIAL CREAMS, BODY LOTIONS, SKIN MOISTURIZERS, SKIN TONERS, SKIN ASTRINGENTS, SKIN CLEANSERS, FOUNDATIONS, PRESSED FACE POWERS, BLUSHES, EYE LINERS, EYEBROW PENCILS, EYE SHADOWS, MASCARAS, LIPSTICKS, LIP LINERS, FACIAL MASKS, PERFUME, LIQUID SOAPS, SHOWER AND BATH GELS, IN CLASS 3 (U.S. CLS. 1, 4, 6, 50, 51 AND 52).

FIRST USE 4-13-2012; IN COMMERCE 4-13-2012.

THE MARK CONSISTS OF STANDARD CHARACTERS WITHOUT CLAIM TO ANY PARTICULAR FONT, STYLE, SIZE, OR COLOR.

SN 85-485,064, FILED 12-1-2011.

ERIN FALK, EXAMINING ATTORNEY



*David J. Kyros*

Director of the United States Patent and Trademark Office



# United States of America

United States Patent and Trademark Office

# CryptoIVR

**Reg. No. 4,277,005**

**Registered Jan. 15, 2013**

**Int. Cls.: 9 and 36**

**TRADEMARK**

**SERVICE MARK**

**PRINCIPAL REGISTER**

DATATEL COMMUNICATIONS INC. (CANADA CORPORATION)  
1200 EGLINTON AVE E., SUITE 712  
TORONTO, CANADA M3C1H9

FOR: COMPUTER HARDWARE AND SOFTWARE USED FOR THE CONTROL OF VOICE CONTROLLED INFORMATION AND COMMUNICATION DEVICES; ELECTRONIC PAYMENT TERMINAL, IN CLASS 9 (U.S. CLS. 21, 23, 26, 36 AND 38).

FIRST USE 2-1-2011; IN COMMERCE 7-10-2012.

FOR: PROVIDING ELECTRONIC PROCESSING OF ACH AND CREDIT CARD TRANSACTIONS AND ELECTRONIC PAYMENTS VIA A GLOBAL COMPUTER NETWORK; PROVIDING ELECTRONIC PROCESSING OF ELECTRONIC FUNDS TRANSFER, ACH, CREDIT CARD, DEBIT CARD, ELECTRONIC CHECK AND ELECTRONIC PAYMENTS, IN CLASS 36 (U.S. CLS. 100, 101 AND 102).

FIRST USE 2-1-2011; IN COMMERCE 7-10-2012.

THE MARK CONSISTS OF STANDARD CHARACTERS WITHOUT CLAIM TO ANY PARTICULAR FONT, STYLE, SIZE, OR COLOR.

SN 85-486,108, FILED 12-2-2011.

GIANCARLO CASTRO, EXAMINING ATTORNEY



*David J. Kybas*

Director of the United States Patent and Trademark Office

# United States of America

United States Patent and Trademark Office

# EMAC+

**Reg. No. 4,277,006**

**Registered Jan. 15, 2013**

**Int. Cl.: 1**

**TRADEMARK**

**PRINCIPAL REGISTER**

WESTLAKE LONGVIEW CORPORATION (DELAWARE CORPORATION)  
SUITE 600  
2801 POST OAK BLVD.  
HOUSTON, TX 77056

FOR: ETHYLENE METHYL ACRYLATE COPOLYMERS FOR GENERAL INDUSTRIAL USE, IN CLASS 1 (U.S. CLS. 1, 5, 6, 10, 26 AND 46).

FIRST USE 9-30-1999; IN COMMERCE 9-30-1999.

THE MARK CONSISTS OF STANDARD CHARACTERS WITHOUT CLAIM TO ANY PARTICULAR FONT, STYLE, SIZE, OR COLOR.

OWNER OF U.S. REG. NO. 1,763,877.

SN 85-486,365, FILED 12-2-2011.

ERNEST SHOSHO, EXAMINING ATTORNEY



*David J. Kyffers*

Director of the United States Patent and Trademark Office

# United States of America

United States Patent and Trademark Office

## FIDGET TO FOCUS

**Reg. No. 4,277,007**

VARIERUSA, INC. (MASSACHUSETTS CORPORATION)  
475 HILLSIDE AVE.  
NEEDHAM, MA 02494

**Registered Jan. 15, 2013**

**Int. Cl.: 20**

FOR: CHAIRS; STOOLS, IN CLASS 20 (U.S. CLS. 2, 13, 22, 25, 32 AND 50).

**TRADEMARK**

FIRST USE 10-30-2012; IN COMMERCE 10-30-2012.

**PRINCIPAL REGISTER**

THE MARK CONSISTS OF STANDARD CHARACTERS WITHOUT CLAIM TO ANY PARTICULAR FONT, STYLE, SIZE, OR COLOR.

SN 85-486,487, FILED 12-3-2011.

EDWARD FENNESSY, EXAMINING ATTORNEY



*David J. Kyffers*

Director of the United States Patent and Trademark Office

# United States of America

United States Patent and Trademark Office

## NEVER BE COLD AGAIN

**Reg. No. 4,277,008**

SCI DIRECT, LLC (OHIO LIMITED LIABILITY COMPANY)  
7800 WHIPPLE AVENUE, N.W.  
NORTH CANTON, OH 44720

**Registered Jan. 15, 2013**

**Int. Cl.: 11**

FOR: ELECTRIC SPACE HEATERS, IN CLASS 11 (U.S. CLS. 13, 21, 23, 31 AND 34).

**TRADEMARK**

FIRST USE 8-15-2012; IN COMMERCE 8-15-2012.

**PRINCIPAL REGISTER**

THE MARK CONSISTS OF STANDARD CHARACTERS WITHOUT CLAIM TO ANY PARTICULAR FONT, STYLE, SIZE, OR COLOR.

SN 85-487,207, FILED 12-5-2011.

ANNE FARRELL, EXAMINING ATTORNEY



*David J. Kyffers*

Director of the United States Patent and Trademark Office

# United States of America

United States Patent and Trademark Office

# NARVAL

**Reg. No. 4,277,009**

**Registered Jan. 15, 2013**

**Int. Cl.: 10**

**TRADEMARK**

**PRINCIPAL REGISTER**

RESMED SAS (FRANCE CORPORATION)  
PARC TECHNOLOGIQUE DE LYON  
292 ALLEE JACQUES MONOD  
SAINT PRIEST CEDEX, FRANCE 69791

FOR: MEDICAL, DENTAL AND ORAL DEVICES FOR DIAGNOSING, TREATING AND MONITORING BRUXISM, MANDIBULAR ORTHOSIS, RESPIRATORY SLEEP DISORDERS, SLEEP APNEA AND SNORING, IN CLASS 10 (U.S. CLS. 26, 39 AND 44).

FIRST USE 10-1-2009; IN COMMERCE 10-5-2009.

THE MARK CONSISTS OF STANDARD CHARACTERS WITHOUT CLAIM TO ANY PARTICULAR FONT, STYLE, SIZE, OR COLOR.

SN 85-488,654, FILED 12-6-2011.

VIVIAN MICZNIK FIRST, EXAMINING ATTORNEY



*David J. Kyffers*

Director of the United States Patent and Trademark Office

United States of America  
United States Patent and Trademark Office

**Kiston**

基斯顿

**Reg. No. 4,277,010**

**Registered Jan. 15, 2013**

**Int. Cl.: 43**

**SERVICE MARK**

**PRINCIPAL REGISTER**

LI FURU (CHINA INDIVIDUAL)  
NO.3033, BAOAN SOUTH ROAD  
LUOHU DISTRICT, SHENZHEN  
GUANGDONG PROVINCE, CHINA 518000

FOR: BAR SERVICES; CAFE SERVICES; CANTEEN SERVICES; CRECHE SERVICES;  
HOTEL SERVICES; MAKING HOTEL RESERVATIONS FOR OTHERS; PROVIDING CON-  
FERENCE ROOMS; PROVIDING TEMPORARY HOUSING ACCOMMODATIONS; TEA  
ROOMS; TOURIST HOMES, IN CLASS 43 (U.S. CLS. 100 AND 101).

FIRST USE 1-12-2011; IN COMMERCE 1-1-2012.

THE MARK CONSISTS OF THE STYLIZED WORD "KISTON" ABOVE THE THREE CHINESE  
CHARACTERS THAT TRANSLITERATE INTO JI SI DUN.

THE NON-LATIN CHARACTERS IN THE MARK TRANSLITERATE TO JI; SI; DUN AND  
THIS MEANS "BASE; HERE; PAUSE" IN ENGLISH.

THE WORDING "KISTON" HAS NO MEANING IN A FOREIGN LANGUAGE.

SN 85-488,996, FILED 12-7-2011.

ANN E. SAPPENFIELD, EXAMINING ATTORNEY



*David J. Kybas*

Director of the United States Patent and Trademark Office

# United States of America

United States Patent and Trademark Office

## HUGS & HEALTH

**Reg. No. 4,277,011**

**Registered Jan. 15, 2013**

**Int. Cl.: 16**

**TRADEMARK**

**PRINCIPAL REGISTER**

CHANNING BETE COMPANY, INC. (MASSACHUSETTS CORPORATION)  
ONE COMMUNITY PLACE  
SOUTH DEERFIELD, MA 01373

FOR: MAGAZINES IN THE FIELDS OF HEALTH, INFANT AND YOUNG CHILD PHYSICAL AND EMOTIONAL DEVELOPMENT, PREGNANCY, MATERNAL HEALTH, CHILD SAFETY AND PARENTING, IN CLASS 16 (U.S. CLS. 2, 5, 22, 23, 29, 37, 38 AND 50).

FIRST USE 8-29-2012; IN COMMERCE 8-29-2012.

THE MARK CONSISTS OF STANDARD CHARACTERS WITHOUT CLAIM TO ANY PARTICULAR FONT, STYLE, SIZE, OR COLOR.

NO CLAIM IS MADE TO THE EXCLUSIVE RIGHT TO USE "HEALTH", APART FROM THE MARK AS SHOWN.

SN 85-489,542, FILED 12-7-2011.

CURTIS FRENCH, EXAMINING ATTORNEY



*David J. Kyffers*

Director of the United States Patent and Trademark Office

# United States of America

United States Patent and Trademark Office

## DANGEROUS SOURCE

**Reg. No. 4,277,012**

DANGEROUS MUSIC, INC. (NEW YORK CORPORATION)  
231 STEVENS ROAD  
EDMESTON, NY 13335

**Registered Jan. 15, 2013**

**Int. Cl.: 9**

FOR: AUDIO RECORDING, REPRODUCTION AND PROCESSING EQUIPMENT, NAMELY, SOURCE SELECTORS, SIGNAL ROUTERS, AUDIO SIGNAL SWITCHES, AUDIO MONITOR CONTROLLERS, AND DIGITAL TO ANALOG CONVERTERS, IN CLASS 9 (U.S. CLS. 21, 23, 26, 36 AND 38).

**TRADEMARK**

**PRINCIPAL REGISTER**

FIRST USE 1-19-2012; IN COMMERCE 1-19-2012.

THE MARK CONSISTS OF STANDARD CHARACTERS WITHOUT CLAIM TO ANY PARTICULAR FONT, STYLE, SIZE, OR COLOR.

OWNER OF U.S. REG. NOS. 3,278,866, 3,387,401, AND 3,891,136.

SN 85-490,007, FILED 12-7-2011.

DAVID ELTON, EXAMINING ATTORNEY



*David J. Kyffers*

Director of the United States Patent and Trademark Office



# United States of America

United States Patent and Trademark Office

## PROJECT EVE

**Reg. No. 4,277,013**

PROJECT EVE LLC (NEW YORK LIMITED LIABILITY COMPANY)  
188 E. 70TH #10A  
NEW YORK, NY 10021

**Registered Jan. 15, 2013**

**Int. Cls.: 41 and 45**

FOR: ARRANGING, ORGANIZING, CONDUCTING, AND HOSTING SOCIAL ENTERTAINMENT EVENTS, IN CLASS 41 (U.S. CLS. 100, 101 AND 107).

**SERVICE MARK**

FIRST USE 9-0-2012; IN COMMERCE 9-0-2012.

**PRINCIPAL REGISTER**

FOR: INTERNET-BASED SOCIAL NETWORKING SERVICES; ON-LINE SOCIAL NETWORKING SERVICES, IN CLASS 45 (U.S. CLS. 100 AND 101).

FIRST USE 6-0-2012; IN COMMERCE 6-0-2012.

THE MARK CONSISTS OF STANDARD CHARACTERS WITHOUT CLAIM TO ANY PARTICULAR FONT, STYLE, SIZE, OR COLOR.

SN 85-490,247, FILED 12-8-2011.

JOHN WILKE, EXAMINING ATTORNEY



*David J. Kybas*

Director of the United States Patent and Trademark Office

# United States of America

United States Patent and Trademark Office

# GRADUATE

**Reg. No. 4,277,014**

KENTWOOL COMPANY (PENNSYLVANIA CORPORATION)  
135 SOUTH MAIN STREET, SUITE 200  
GREENVILLE, SC 29601

**Registered Jan. 15, 2013**

**Int. Cl.: 10**

FOR: SOCKS FOR DIABETICS; COMPRESSION SOCKS FOR MEDICAL OR THERAPEUTIC USE, IN CLASS 10 (U.S. CLS. 26, 39 AND 44).

**TRADEMARK**

FIRST USE 11-7-2012; IN COMMERCE 11-7-2012.

**PRINCIPAL REGISTER**

THE MARK CONSISTS OF STANDARD CHARACTERS WITHOUT CLAIM TO ANY PARTICULAR FONT, STYLE, SIZE, OR COLOR.

SN 85-490,647, FILED 12-8-2011.

CORY BOONE, EXAMINING ATTORNEY



*David J. Kyffers*

Director of the United States Patent and Trademark Office

# United States of America

United States Patent and Trademark Office

## BRINGING TECHNOLOGY TO LIGHT

**Reg. No. 4,277,015**

LED LIGHTING SERVICES, LLC (ILLINOIS LIMITED LIABILITY COMPANY)  
3575 COMMERCIAL AVENUE  
NORTHBROOK, IL 60062

**Registered Jan. 15, 2013**

**Int. Cl.: 11**

FOR: LED T-8 RETRO-FIT KITS COMPRISED OF LED BULBS AND LIGHT FIXTURES;  
LIGHTING FIXTURES; LED LIGHTING FIXTURES FOR INDOOR AND OUTDOOR  
LIGHTING APPLICATIONS; LED LIGHTING SYSTEMS, NAMELY, LED MODULES, POWER  
SUPPLIES, AND WIRING, IN CLASS 11 (U.S. CLS. 13, 21, 23, 31 AND 34).

**TRADEMARK**

**PRINCIPAL REGISTER**

FIRST USE 3-1-2012; IN COMMERCE 3-1-2012.

THE MARK CONSISTS OF STANDARD CHARACTERS WITHOUT CLAIM TO ANY PAR-  
TICULAR FONT, STYLE, SIZE, OR COLOR.

SN 85-492,497, FILED 12-12-2011.

JENNIFER BUTTON, EXAMINING ATTORNEY



*David J. Kyffers*

Director of the United States Patent and Trademark Office

# United States of America

United States Patent and Trademark Office

## IRON BRIGADE

**Reg. No. 4,277,016**

FLEET WHOLESALE SUPPLY CO., INC. (WISCONSIN CORPORATION)  
1300 SOUTH LYNNDALE DRIVE  
APPLETON, WI 54914

**Registered Jan. 15, 2013**

**Int. Cl.: 11**

FOR: WATER TREATMENT EQUIPMENT, NAMELY, WATER SOFTENERS, IN CLASS 11  
(U.S. CLS. 13, 21, 23, 31 AND 34).

**TRADEMARK**

FIRST USE 11-2-2012; IN COMMERCE 11-2-2012.

**PRINCIPAL REGISTER**

THE MARK CONSISTS OF STANDARD CHARACTERS WITHOUT CLAIM TO ANY PARTICULAR FONT, STYLE, SIZE, OR COLOR.

OWNER OF U.S. REG. NOS. 800,296 AND 2,707,242.

SN 85-492,721, FILED 12-12-2011.

MARY ROSSMAN, EXAMINING ATTORNEY



*David J. Kyffers*

Director of the United States Patent and Trademark Office

# United States of America

United States Patent and Trademark Office

## VORTEX TECHNOLOGY

**Reg. No. 4,277,017**

BARI WOODWIND SUPPLIES, LLC (FLORIDA LIMITED LIABILITY COMPANY)  
1805 APEX ROAD  
SARASOTA, FL 34240

**Registered Jan. 15, 2013**

**Int. Cl.: 15**

FOR: MOUTHPIECES FOR MUSICAL INSTRUMENTS, IN CLASS 15 (U.S. CLS. 2, 21 AND 36).

**TRADEMARK**

FIRST USE 3-0-2012; IN COMMERCE 3-0-2012.

**PRINCIPAL REGISTER**

THE MARK CONSISTS OF STANDARD CHARACTERS WITHOUT CLAIM TO ANY PARTICULAR FONT, STYLE, SIZE, OR COLOR.

NO CLAIM IS MADE TO THE EXCLUSIVE RIGHT TO USE "TECHNOLOGY", APART FROM THE MARK AS SHOWN.

SN 85-492,723, FILED 12-12-2011.

ERNEST SHOSHO, EXAMINING ATTORNEY



*David J. Kyffers*

Director of the United States Patent and Trademark Office

# United States of America

United States Patent and Trademark Office



**Reg. No. 4,277,018**

JANICE PERKINS (UNITED STATES INDIVIDUAL)  
3154 E. CHANDLER BLVD., SUITE 110 PMB 214  
PHOENIX, AZ 850488702

**Registered Jan. 15, 2013**

**Int. Cl.: 25**

FOR: BASEBALL CAPS; HATS; SHORT-SLEEVED OR LONG-SLEEVED T-SHIRTS; T-SHIRTS, IN CLASS 25 (U.S. CLS. 22 AND 39).

**TRADEMARK**

FIRST USE 12-12-2011; IN COMMERCE 6-16-2012.

**PRINCIPAL REGISTER**

THE MARK CONSISTS OF A DESIGN THAT DEPICTS A DOG JUMPING THROUGH A RING; THE UPPER LEFT PORTION OF THE MARK CONSISTS OF THE WORDING "HEY PUP" IN STYLIZED FONT.

SN 85-492,770, FILED 12-12-2011.

ESTHER BELENKER, EXAMINING ATTORNEY



*David J. Kyffers*

Director of the United States Patent and Trademark Office

# United States of America

United States Patent and Trademark Office

## EZ-CARRIAGE CONTROL

**Reg. No. 4,277,019**

VOGEL TRAFFIC SERVICES, INC. (IOWA CORPORATION)  
1110 ALBANY PLACE SE  
ORANGE CITY, IA 51041

**Registered Jan. 15, 2013**

**Int. Cl.: 9**

FOR: ELECTRONIC POSITIONING SYSTEM FOR VEHICLES, IN CLASS 9 (U.S. CLS. 21, 23, 26, 36 AND 38).

**TRADEMARK**

FIRST USE 2-0-2012; IN COMMERCE 2-0-2012.

**PRINCIPAL REGISTER**

THE MARK CONSISTS OF STANDARD CHARACTERS WITHOUT CLAIM TO ANY PARTICULAR FONT, STYLE, SIZE, OR COLOR.

NO CLAIM IS MADE TO THE EXCLUSIVE RIGHT TO USE "CONTROL", APART FROM THE MARK AS SHOWN.

SN 85-492,784, FILED 12-12-2011.

HELENE LIWINSKI, EXAMINING ATTORNEY



*David J. Kyffers*

Director of the United States Patent and Trademark Office

# United States of America

United States Patent and Trademark Office

## CODE YELLOW

**Reg. No. 4,277,020**

PLYMOUTH DIRECT, INC. (PENNSYLVANIA CORPORATION)  
425 STUMP ROAD

**Registered Jan. 15, 2013**

MONTGOMERYVILLE, PA 18936 AND

**Int. Cl.: 3**

NATURES PILLOWS, INC. (PENNSYLVANIA CORPORATION)  
2607 INTERPLEX DRIVE  
TREVOSSE, PA 19053

**TRADEMARK**

**PRINCIPAL REGISTER**

FOR: STAIN REMOVERS; STAIN AND ODOR REMOVER KIT COMPRISED OF A STAIN AND ODOR REMOVER AND A PORTABLE BATTERY OPERATED FLUORESCENT BLACK LIGHT FOR DETECTING STAINS, IN CLASS 3 (U.S. CLS. 1, 4, 6, 50, 51 AND 52).

FIRST USE 6-13-2012; IN COMMERCE 6-13-2012.

THE MARK CONSISTS OF STANDARD CHARACTERS WITHOUT CLAIM TO ANY PARTICULAR FONT, STYLE, SIZE, OR COLOR.

SN 85-493,786, FILED 12-13-2011.

CAROLINE WOOD, EXAMINING ATTORNEY



*David J. Kyros*

Director of the United States Patent and Trademark Office



# United States of America

United States Patent and Trademark Office

## JOSTENS PROMISE

**Reg. No. 4,277,021**

JOSTENS, INC. (MINNESOTA CORPORATION)  
3601 MINNESOTA DRIVE, SUITE 400  
MINNEAPOLIS, MN 55435

**Registered Jan. 15, 2013**

**Int. Cl.: 35**

FOR: ADMINISTRATION OF A CUSTOMER LOYALTY PROGRAM WHICH PROVIDES A DISCOUNT ON CLASS RINGS FOR COLLEGE OR OTHER FURTHER SCHOOLING FOR CUSTOMERS WHO HAVE PREVIOUSLY PURCHASED A HIGH SCHOOL CLASS RING, IN CLASS 35 (U.S. CLS. 100, 101 AND 102).

**SERVICE MARK**

**PRINCIPAL REGISTER**

FIRST USE 7-31-2012; IN COMMERCE 7-31-2012.

THE MARK CONSISTS OF STANDARD CHARACTERS WITHOUT CLAIM TO ANY PARTICULAR FONT, STYLE, SIZE, OR COLOR.

OWNER OF U.S. REG. NOS. 504,577, 2,406,471, AND OTHERS.

SN 85-493,849, FILED 12-13-2011.

MATTHEW MCDOWELL, EXAMINING ATTORNEY



*David J. Kybas*

Director of the United States Patent and Trademark Office

# United States of America

United States Patent and Trademark Office

## THE ART OF CASH WELL MANAGED

**Reg. No. 4,277,022**

**Registered Jan. 15, 2013**

**Int. Cl.: 36**

**SERVICE MARK**

**PRINCIPAL REGISTER**

STATE STREET CORPORATION (MASSACHUSETTS CORPORATION)  
ONE LINCOLN STREET  
BOSTON, MA 02111

FOR: FINANCIAL ASSET MANAGEMENT; FINANCIAL INFORMATION; FINANCIAL PORTFOLIO MANAGEMENT; FUNDS INVESTMENT, IN CLASS 36 (U.S. CLS. 100, 101 AND 102).

FIRST USE 9-24-2012; IN COMMERCE 9-24-2012.

THE MARK CONSISTS OF STANDARD CHARACTERS WITHOUT CLAIM TO ANY PARTICULAR FONT, STYLE, SIZE, OR COLOR.

SN 85-493,964, FILED 12-13-2011.

PAUL E. FAHRENKOPF, EXAMINING ATTORNEY



*David J. Kyffers*

Director of the United States Patent and Trademark Office

# United States of America

United States Patent and Trademark Office



**Reg. No. 4,277,023**

DURO-LAST, INC. (MICHIGAN CORPORATION)  
525 MORLEY DR.  
SAGINAW, MI 48601

**Registered Jan. 15, 2013**

**Int. Cl.: 19**

FOR: NON-METAL ROOFING COMPONENTS AND SYSTEMS, NAMELY, FLASHINGS AND ROOFING MEMBRANES, IN CLASS 19 (U.S. CLS. 1, 12, 33 AND 50).

**TRADEMARK**

FIRST USE 2-28-2009; IN COMMERCE 2-28-2009.

**PRINCIPAL REGISTER**

NO CLAIM IS MADE TO THE EXCLUSIVE RIGHT TO USE "SOLAR-READY", APART FROM THE MARK AS SHOWN.

THE COLOR(S) BLACK, ORANGE, BLUE AND YELLOW IS/ARE CLAIMED AS A FEATURE OF THE MARK.

THE MARK CONSISTS OF THE TERM "SOLAR-READY" WITH THE "O" IN THE CONFIGURATION OF A SUN EMITTING RAYS AND HAVING THE LETTER "O" DEFINED BY AN ORANGE RING, THE REMAINDER OF THE SUN AND RAYS ARE YELLOW AND LIGHTER ORANGE THAN THE RING; THE HYPHEN INCLUDES A YELLOW PORTION NEAR THE "R" IN "SOLAR" TRANSITIONING TO ORANGE NEAR THE "R" IN "READY"; THE TERM IS UNDERScoreD BY A SERIES OF RECTANGULAR BOXES; THE BOXES ARE ORANGE AND YELLOW IN THE AREA BENEATH THE SUN AND TRANSITION TO BLACK AS THE BOXES ARE MORE REMOTE FROM THE SUN. THE WORDING AND UNDERLINING ARE OUTLINED IN BLUE.



SN 85-493,977, FILED 12-13-2011.

KEVON CHISOLM, EXAMINING ATTORNEY

*David J. Kybas*

Director of the United States Patent and Trademark Office

# United States of America

United States Patent and Trademark Office

# NUYU

**Reg. No. 4,277,024**

**Registered Jan. 15, 2013**

**Int. Cl.: 5**

**TRADEMARK**

**PRINCIPAL REGISTER**

NUSIRT SCIENCES, INC. (DELAWARE CORPORATION)  
1600 DIVISION STREET  
SUITE 230  
NASHVILLE, TN 37203

FOR: NUTRACEUTICALS FOR USE AS DIETARY AND NUTRITIONAL SUPPLEMENTS,  
IN CLASS 5 (U.S. CLS. 6, 18, 44, 46, 51 AND 52).

FIRST USE 11-1-2012; IN COMMERCE 11-1-2012.

THE MARK CONSISTS OF STANDARD CHARACTERS WITHOUT CLAIM TO ANY PAR-  
TICULAR FONT, STYLE, SIZE, OR COLOR.

SN 85-494,023, FILED 12-13-2011.

GEOFFREY FOSDICK, EXAMINING ATTORNEY



*David J. Kybas*

Director of the United States Patent and Trademark Office

# United States of America

United States Patent and Trademark Office

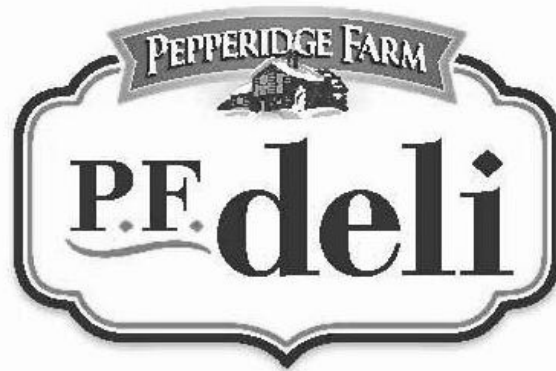

**Reg. No. 4,277,025**

**Registered Jan. 15, 2013**

**Int. Cl.: 30**

**TRADEMARK**

**PRINCIPAL REGISTER**

PEPPERIDGE FARM, INCORPORATED (CONNECTICUT CORPORATION)  
595 WESTPORT AVENUE  
NORWALK, CT 06851

FOR: ROLLS, IN CLASS 30 (U.S. CL. 46).

FIRST USE 4-9-2012; IN COMMERCE 4-9-2012.

OWNER OF U.S. REG. NOS. 360,512, 2,396,052, AND OTHERS.

NO CLAIM IS MADE TO THE EXCLUSIVE RIGHT TO USE "DELI", APART FROM THE MARK AS SHOWN.

THE MARK CONSISTS OF A MILL BENEATH A BANNER CONTAINING THE WORDS "PEPPERIDGE FARM", THE LETTERS "P" AND "F", EACH FOLLOWED BY A PERIOD, AND THE WORD "DELI", ALL ENCLOSED BY DOUBLE LINES FORMING A RECTANGULAR SHAPE ON THREE SIDES, WITH THE BANNER CONNECTING THE DOUBLE LINES AT THE TOP OF THE DESIGN.

SN 85-494,029, FILED 12-13-2011.

RONALD MCMORROW, EXAMINING ATTORNEY



*David J. Kyros*

Director of the United States Patent and Trademark Office

# United States of America

United States Patent and Trademark Office

## Programme in a Box

**Reg. No. 4,277,026**

**Registered Jan. 15, 2013**

**Int. Cl.: 35**

**SERVICE MARK**

**PRINCIPAL REGISTER**

KALFUS, MICHAEL DAVID (UNITED STATES INDIVIDUAL)  
68 HILLCREST ROAD  
BOONTON, NJ 07005

FOR: BUSINESS MANAGEMENT CONSULTING WITH RELATION TO STRATEGY, MARKETING, SALES, OPERATION, PRODUCT DESIGN PARTICULARLY SPECIALIZING IN THE USE OF ANALYTIC AND STATISTIC MODELS FOR THE UNDERSTANDING AND PREDICTING OF CONSUMERS, BUSINESSES, AND MARKET TRENDS AND ACTIONS, IN CLASS 35 (U.S. CLS. 100, 101 AND 102).

FIRST USE 8-8-2012; IN COMMERCE 8-8-2012.

THE MARK CONSISTS OF STANDARD CHARACTERS WITHOUT CLAIM TO ANY PARTICULAR FONT, STYLE, SIZE, OR COLOR.

SN 85-494,093, FILED 12-13-2011.

RONALD DELGIZZI, EXAMINING ATTORNEY



*David J. Kyffers*

Director of the United States Patent and Trademark Office

**United States of America**  
United States Patent and Trademark Office

**PASHMINA**

**Reg. No. 4,277,027**

RICHLINE GROUP, INC. (DELAWARE CORPORATION)  
1385 BROADWAY  
NEW YORK, NY 10018

**Registered Jan. 15, 2013**

**Int. Cl.: 14**

FOR: JEWELRY, IN CLASS 14 (U.S. CLS. 2, 27, 28 AND 50).

**TRADEMARK**

FIRST USE 5-30-2011; IN COMMERCE 5-30-2011.

**PRINCIPAL REGISTER**

THE MARK CONSISTS OF STANDARD CHARACTERS WITHOUT CLAIM TO ANY PARTICULAR FONT, STYLE, SIZE, OR COLOR.

SN 85-494,356, FILED 12-13-2011.

DAVID I, EXAMINING ATTORNEY



*David J. Kyfos*

Director of the United States Patent and Trademark Office

# United States of America

United States Patent and Trademark Office



**Reg. No. 4,277,028**

PROPEX OPERATING COMPANY LLC (DELAWARE LIMITED LIABILITY COMPANY)  
6025 LEE HIGHWAY, SUITE 425  
CHATTANOOGA, TN 37421

**Registered Jan. 15, 2013**

**Int. Cls.: 6, 17, 19, 22, 24,  
and 28**

FOR: CONSTRUCTION PRODUCTS IN THE NATURE OF FIBERS OF STEEL FOR USE IN IMPARTING REINFORCEMENT AND OTHER PROPERTIES TO CONCRETE, IN CLASS 6 (U.S. CLS. 2, 12, 13, 14, 23, 25 AND 50).

**TRADEMARK**

FIRST USE 3-15-2012; IN COMMERCE 3-15-2012.

**PRINCIPAL REGISTER**

FOR: PACKAGING PRODUCTS, NAMELY, HOUSE WRAP BUILDING INSULATION IN THE NATURE OF WOVEN, COATED AND LAMINATED FABRICS MADE OF MAN-MADE MATERIALS OR SHEETS OF WOVEN, COATED AND LAMINATED FABRICS MADE OF MAN-MADE MATERIALS USED AS AN INSULATING INFILTRATION BARRIER IN BUILDING CONSTRUCTION; CONCRETE CONSTRUCTION PRODUCTS IN THE NATURE OF FIBERS OF POLYPROPYLENE AND STEEL FOR USE IN IMPARTING REINFORCEMENT AND OTHER PROPERTIES TO CONCRETE, IN CLASS 17 (U.S. CLS. 1, 5, 12, 13, 35 AND 50).

FIRST USE 3-15-2012; IN COMMERCE 3-15-2012.



FOR: BUILDING PRODUCTS, NAMELY, WOVEN, COATED AND LAMINATED ROOFING FABRICS AND WOVEN, COATED AND LAMINATED FABRICS BEING SHEATHING; GEOSYNTHETIC PRODUCTS, NAMELY, WOVEN, NON-WOVEN, STITCH-BONDED, COMPOSITE, TEXTILES COMPRISING MAN-MADE AND NATURAL MATERIALS FOR USE IN SOIL STABILIZATION, SOIL SEPARATION, SOIL DRAINAGE, PAVING, SOIL REINFORCEMENT, SEDIMENT CONTROL, LANDFILL LINING SYSTEMS, EROSION CONTROL AND VEGETATIVE ESTABLISHMENT; RECREATION PRODUCTS, NAMELY, WOVEN PRODUCTS MADE OF MAN-MADE FABRICS IN THE NATURE OF FITTED SWIMMING POOL COVERS; WOVEN AND NON-WOVEN AGRICULTURAL FABRICS MADE OF MAN-MADE MATERIALS FOR USE IN VEGETATIVE CONTAINMENT, IN CLASS 19 (U.S. CLS. 1, 12, 33 AND 50).

FIRST USE 3-15-2012; IN COMMERCE 3-15-2012.

*David J. Kyffers*

Director of the United States Patent and Trademark Office

FOR: PACKAGING PRODUCTS, NAMELY, WOVEN FABRIC BAGS FOR THE TRANSPORTATION OR STORAGE OF MATERIALS IN BULK, INCLUDING THE PACKAGING OF BALED



**Reg. No. 4,277,028** COTTON; FLOORING PRODUCTS, NAMELY, WOVEN AND NON-WOVEN, COMPOSITE FIBERS FOR USE IN THE MANUFACTURE OF CARPET BACKING, CARPETS AND RUGS; RECREATION PRODUCTS, NAMELY, WOVEN PRODUCTS MADE OF MAN-MADE FABRICS IN THE NATURE OF UNFITTED SWIMMING POOL COVERS, IN CLASS 22 (U.S. CLS. 1, 2, 7, 19, 22, 42 AND 50).

FIRST USE 3-15-2012; IN COMMERCE 3-15-2012.

FOR: NON-WOVEN AND WOVEN FABRICS MADE OF MAN-MADE AND NATURAL MATERIALS FOR USE IN THE MANUFACTURE OF FILTRATION MEDIA; NON-WOVEN AND WOVEN FABRICS MADE OF MAN-MADE MATERIALS FOR USE IN THE MANUFACTURE OF AUTOMOTIVE COMPONENTS; WOVEN, COATED AND LAMINATED FABRICS MADE OF MAN-MADE MATERIALS FOR USE IN THE MANUFACTURE OF HOUSE WRAP, ROOFING AND SHEATHING; NON-WOVEN COATED AND LAMINATED FABRICS MADE OF MAN-MADE MATERIALS FOR USE IN MANUFACTURING FURNITURE AND BEDDING COMPONENTS, IN CLASS 24 (U.S. CLS. 42 AND 50).

FIRST USE 3-15-2012; IN COMMERCE 3-15-2012.

FOR: RECREATION PRODUCTS, NAMELY, WOVEN PRODUCTS MADE OF MAN-MADE FABRICS IN THE NATURE OF TRAMPOLINE COVERS, IN CLASS 28 (U.S. CLS. 22, 23, 38 AND 50).

FIRST USE 3-15-2012; IN COMMERCE 3-15-2012.

OWNER OF U.S. REG. NOS. 975,562, 2,788,557, AND 3,312,553.

THE MARK CONSISTS OF A SERIES OF CUBE DESIGNS STACKED TO FORM A 3-D REPRESENTATION OF THE LETTER "P".

SN 85-494,921, FILED 12-14-2011.

JENNIFER MARTIN, EXAMINING ATTORNEY

# United States of America

United States Patent and Trademark Office

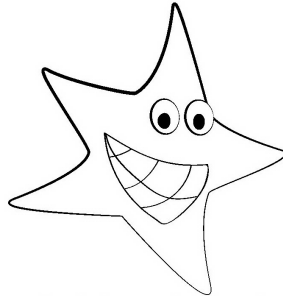

Twinkle Little Star  
Pediatric Dentistry

**Reg. No. 4,277,029**

**Registered Jan. 15, 2013**

**Int. Cl.: 44**

**SERVICE MARK**

**PRINCIPAL REGISTER**

TWINKLE LITTLE STAR PEDIATRIC DENTISTRY, LLC (NEW JERSEY LIMITED LIABILITY COMPANY)  
259 KINDERKAMACK ROAD  
WESTWOOD, NJ 07675

FOR: DENTISTRY, IN CLASS 44 (U.S. CLS. 100 AND 101).

FIRST USE 4-21-2012; IN COMMERCE 4-21-2012.

NO CLAIM IS MADE TO THE EXCLUSIVE RIGHT TO USE "PEDIATRIC DENTISTRY", APART FROM THE MARK AS SHOWN.

THE MARK CONSISTS OF A CARTOON DANCING STAR WITH BIG EYES AS WELL AS A TOOTHY, ASYMMETRIC (NARROW ON THE STAR'S RIGHT SIDE, WIDEST AT ITS LEFT SIDE) SMILE. THIS STAR IS DANCING, BALANCING ON ITS LEFT LEG. BELOW THE DANCING STAR IS THE PHRASE "TWINKLE LITTLE STAR", AND THE PHRASE "PEDIATRIC DENTISTRY" CENTERED BELOW "TWINKLE LITTLE STAR".

SN 85-495,438, FILED 12-14-2011.

ROBIN CHOSID, EXAMINING ATTORNEY



*David J. Kyffers*

Director of the United States Patent and Trademark Office

# United States of America

United States Patent and Trademark Office

## Dungeon Crawlers

**Reg. No. 4,277,030**

**Registered Jan. 15, 2013**

**Int. Cl.: 9**

**TRADEMARK**

**PRINCIPAL REGISTER**

DROWNING MONKEYS (GEORGIA LIMITED LIABILITY COMPANY), AKA DROWNING MONKEYS GAMES,  
927 COURTENAY DRIVE NE  
ATLANTA, GA 30306

FOR: VIDEO GAME PROGRAMS FOR MOBILE DEVICES, PERSONAL COMPUTERS, CONSOLES, TABLETS; DOWNLOADABLE ELECTRONIC GAME PROGRAMS; DOWNLOADABLE COMPUTER GAME PROGRAMS; COMPUTER GAME PROGRAMS; ELECTRONIC GAME SOFTWARE; INTERACTIVE GAME SOFTWARE; INTERACTIVE GAME PROGRAMS, IN CLASS 9 (U.S. CLS. 21, 23, 26, 36 AND 38).

FIRST USE 11-23-2011; IN COMMERCE 1-25-2012.

THE MARK CONSISTS OF STANDARD CHARACTERS WITHOUT CLAIM TO ANY PARTICULAR FONT, STYLE, SIZE, OR COLOR.

SN 85-495,688, FILED 12-14-2011.

JEFF DEFORD, EXAMINING ATTORNEY



*David J. Kyffers*

Director of the United States Patent and Trademark Office

# United States of America

United States Patent and Trademark Office

## SPEEDCO BICYCLES

**Reg. No. 4,277,031**

VIGOR SPORTS, INC. (CALIFORNIA CORPORATION)  
16918 EDWARDS ROAD  
CERRITOS, CA 90703

**Registered Jan. 15, 2013**

**Int. Cl.: 12**

FOR: BICYCLE FRAMES; BICYCLES, IN CLASS 12 (U.S. CLS. 19, 21, 23, 31, 35 AND 44).

FIRST USE 7-7-2012; IN COMMERCE 7-7-2012.

**TRADEMARK**

THE MARK CONSISTS OF STANDARD CHARACTERS WITHOUT CLAIM TO ANY PARTICULAR FONT, STYLE, SIZE, OR COLOR.

**PRINCIPAL REGISTER**

NO CLAIM IS MADE TO THE EXCLUSIVE RIGHT TO USE "BICYCLES", APART FROM THE MARK AS SHOWN.

SN 85-496,318, FILED 12-15-2011.

ROBIN MITTLER, EXAMINING ATTORNEY



*David J. Kyffers*

Director of the United States Patent and Trademark Office

# United States of America

United States Patent and Trademark Office

## SPEEDGUIDE

**Reg. No. 4,277,032**

STRYKER TRAUMA SA (SWITZERLAND CORPORATION)  
BOHNACKERWEG 1

**Registered Jan. 15, 2013**

SELZACH, SWITZERLAND CH-2545

**Int. Cl.: 10**

FOR: SURGICAL INSTRUMENTS FOR ORTHOPEDIC USE; SURGICAL DRILLS, DRILL GUIDES, AND DEPTH GAUGES, IN CLASS 10 (U.S. CLS. 26, 39 AND 44).

**TRADEMARK**

FIRST USE 9-24-2012; IN COMMERCE 9-24-2012.

**PRINCIPAL REGISTER**

THE MARK CONSISTS OF STANDARD CHARACTERS WITHOUT CLAIM TO ANY PARTICULAR FONT, STYLE, SIZE, OR COLOR.

SN 85-496,325, FILED 12-15-2011.

ROBERT STRUCK, EXAMINING ATTORNEY



*David J. Kyffers*

Director of the United States Patent and Trademark Office

# United States of America

United States Patent and Trademark Office

# STORQUE

**Reg. No. 4,277,033**

**Registered Jan. 15, 2013**

**Int. Cl.: 16**

**TRADEMARK**

**PRINCIPAL REGISTER**

ADE, INC. (ILLINOIS CORPORATION)  
1430 EAST 130TH STREET  
CHICAGO, IL 60633

FOR: PROTECTIVE PACKAGING COMPRISING CARDBOARD AND RESILIENT PLASTIC FILM TO SECURE AND SUPPORT A PRODUCT DURING SHIPPING OR TRANSPORT, IN CLASS 16 (U.S. CLS. 2, 5, 22, 23, 29, 37, 38 AND 50).

FIRST USE 10-30-2012; IN COMMERCE 10-30-2012.

THE MARK CONSISTS OF STANDARD CHARACTERS WITHOUT CLAIM TO ANY PARTICULAR FONT, STYLE, SIZE, OR COLOR.

SN 85-497,124, FILED 12-16-2011.

KARANENDRA S. CHHINA, EXAMINING ATTORNEY



*David J. Kyros*

Director of the United States Patent and Trademark Office

# United States of America

United States Patent and Trademark Office

# WEAR-X

**Reg. No. 4,277,034**

**Registered Jan. 15, 2013**

**Int. Cl.: 7**

**TRADEMARK**

**PRINCIPAL REGISTER**

K2 CASTINGS, INC. (DELAWARE CORPORATION)  
SUITE 125  
1 NEW HAMPSHIRE AVENUE  
PORTSMOUTH, NH 03801

FOR: MACHINES, NAMELY, CRUSHERS, IMPACT MILLS, BREAKERS, PULVERIZERS, MIXERS AND BLENDERS AND PARTS THEREFOR, FOR INDUSTRIAL AND COMMERCIAL APPLICATIONS , IN CLASS 7 (U.S. CLS. 13, 19, 21, 23, 31, 34 AND 35).

FIRST USE 10-8-2012; IN COMMERCE 11-2-2012.

THE MARK CONSISTS OF STANDARD CHARACTERS WITHOUT CLAIM TO ANY PARTICULAR FONT, STYLE, SIZE, OR COLOR.

SN 85-497,130, FILED 12-16-2011.

KARANENDRA S. CHHINA, EXAMINING ATTORNEY



*David J. Kybas*

Director of the United States Patent and Trademark Office

# United States of America

United States Patent and Trademark Office

# DANNI

**Reg. No. 4,277,035**

**Registered Jan. 15, 2013**

**Int. Cls.: 38 and 41**

**SERVICE MARK**

**PRINCIPAL REGISTER**

DANNI ASHE, INC. (CALIFORNIA CORPORATION)  
6800 BROKEN SOUND PARKWAY, SUITE 100  
BOCA RATON, FL 33487

FOR: PROVIDING ONLINE CHAT ROOMS ON THE TOPIC OF ADULT ENTERTAINMENT; PROVIDING ACCESS TO AN ONLINE COMPUTER BULLETIN BOARD DEALING WITH ADULT ENTERTAINMENT; PROVIDING ONLINE ELECTRONIC BULLETIN BOARDS FOR TRANSMISSION OF MESSAGES AMONG COMPUTER USERS CONCERNING ADULT ENTERTAINMENT; PROVIDING ONLINE FACILITIES FOR REAL TIME INTERACTION WITH OTHER COMPUTER USERS CONCERNING ADULT ENTERTAINMENT, IN CLASS 38 (U.S. CLS. 100, 101 AND 104).

FIRST USE 0-0-2001; IN COMMERCE 0-0-2001.

FOR: ENTERTAINMENT SERVICES IN THE NATURE OF PROVIDING A WEBSITE ON THE GLOBAL COMPUTER NETWORKS FEATURING INFORMATION IN THE FIELD OF ADULT ENTERTAINMENT; PROVIDING AN ONLINE WEBSITE OF INFORMATION COMPRISING ADULT MATERIAL AND VIEWING THEREOF, AND OTHER ADULT ENTERTAINMENT RELATED NEWS, FACTS, TRIVIA AND HUMOR; COMPUTER SERVICES, NAMELY, PROVIDING ON-LINE MAGAZINE AND COLUMNS IN THE FIELD OF ADULT ENTERTAINMENT, IN CLASS 41 (U.S. CLS. 100, 101 AND 107).

FIRST USE 0-0-2001; IN COMMERCE 0-0-2001.

THE MARK CONSISTS OF STANDARD CHARACTERS WITHOUT CLAIM TO ANY PARTICULAR FONT, STYLE, SIZE, OR COLOR.

OWNER OF U.S. REG. NOS. 2,698,825, 3,302,408, AND OTHERS.

SN 85-497,311, FILED 12-16-2011.

RUDY R. SINGLETON, EXAMINING ATTORNEY



*David J. Kyfos*

Director of the United States Patent and Trademark Office



# United States of America

United States Patent and Trademark Office

## WHERE DIVERSIFICATION MEETS DIRECTION

**Reg. No. 4,277,036**

JACKSON NATIONAL LIFE INSURANCE COMPANY (MICHIGAN CORPORATION)  
1 CORPORATE WAY  
LANSING, MI 48951

**Registered Jan. 15, 2013**

**Int. Cl.: 36**

FOR: ANNUITY UNDERWRITING SERVICES, IN CLASS 36 (U.S. CLS. 100, 101 AND 102).

**SERVICE MARK**

FIRST USE 3-5-2012; IN COMMERCE 3-5-2012.

**PRINCIPAL REGISTER**

THE MARK CONSISTS OF STANDARD CHARACTERS WITHOUT CLAIM TO ANY PARTICULAR FONT, STYLE, SIZE, OR COLOR.

SN 85-498,608, FILED 12-19-2011.

KYLE PEETE, EXAMINING ATTORNEY



*David J. Kyffers*

Director of the United States Patent and Trademark Office

# United States of America

United States Patent and Trademark Office

# J JET

**Reg. No. 4,277,037**

**Registered Jan. 15, 2013**

**Int. Cl.: 37**

**SERVICE MARK**

**PRINCIPAL REGISTER**

JET, INC. (OHIO CORPORATION)  
750 ALPHA DRIVE  
CLEVELAND, OH 44143

FOR: INSTALLATION, REPAIR AND MAINTENANCE OF WASTEWATER TREATMENT AND DISPOSAL PLANTS FOR RESIDENTIAL AND COMMERCIAL USE; INSTALLATION, REPAIR AND MAINTENANCE OF SUBMERGED ATTACHED GROWTH MEDIA USED FOR PROCESSING WASTEWATER, GASES, SLURRIES, AND OTHER LIQUIDS, IN CLASS 37 (U.S. CLS. 100, 103 AND 106).

FIRST USE 1-31-2012; IN COMMERCE 1-31-2012.

THE MARK CONSISTS OF STANDARD CHARACTERS WITHOUT CLAIM TO ANY PARTICULAR FONT, STYLE, SIZE, OR COLOR.

OWNER OF U.S. REG. NOS. 3,524,127 AND 3,571,704.

SN 85-498,619, FILED 12-19-2011.

ESTHER BELENKER, EXAMINING ATTORNEY



*David J. Kyros*

Director of the United States Patent and Trademark Office

# United States of America

United States Patent and Trademark Office



**Reg. No. 4,277,038**

**Registered Jan. 15, 2013**

**Int. Cl.: 35**

**SERVICE MARK**

**PRINCIPAL REGISTER**

PRO\*ACT, LLC (DELAWARE LIMITED LIABILITY COMPANY)  
24560 SILVER CLOUD CT.  
MONTEREY, CA 93940

FOR: COOPERATIVE ADVERTISING AND MARKETING AND BUSINESS CONSULTATION SERVICES ALL IN THE FIELD OF FOOD SERVICES IN THE UNITED STATES AND CANADA; PROCUREMENT, NAMELY, PURCHASING FRESH PRODUCE AND PERISHABLE GOODS IN THE UNITED STATES AND CANADA, IN CLASS 35 (U.S. CLS. 100, 101 AND 102).

FIRST USE 7-31-2011, THE MARK WAS FIRST USED ANYWHERE IN A DIFFERENT FORM OTHER THAN THAT SOUGHT TO BE REGISTERED AT LEAST AS EARLY AS 09/30/1991.; IN COMMERCE 7-31-2011, THE MARK WAS FIRST USED IN COMMERCE IN A DIFFERENT FORM OTHER THAN THAT SOUGHT TO BE REGISTERED AT LEAST AS EARLY AS 10/07/1991..

OWNER OF U.S. REG. NOS. 1,837,447 AND 2,647,953.

THE MARK CONSISTS OF AN OUTLINE OF A STYLIZED MAP OF CANADA, WITH SELECTED PROVINCE LINES THEREIN, WITH FRESH FRUITS AND VEGETABLES MAKING UP THE EASTERN, SOUTHERN AND WESTERN BORDERS OF THE MAP; AND WITH THE WORDING "PRO\*ACT" IN THE CENTER OF THE MAP.

SN 85-499,888, FILED 12-20-2011.

NELSON SNYDER, EXAMINING ATTORNEY



*David J. Kyros*

Director of the United States Patent and Trademark Office

# United States of America

United States Patent and Trademark Office

## PENNZOIL PLATINUM HE

**Reg. No. 4,277,039**

**Registered Jan. 15, 2013**

**Int. Cl.: 7**

**TRADEMARK**

**PRINCIPAL REGISTER**

PENNZOIL-QUAKER STATE COMPANY (DELAWARE CORPORATION)  
700 MILAM STREET  
HOUSTON, TX 77002

FOR: OIL FILTERS, IN CLASS 7 (U.S. CLS. 13, 19, 21, 23, 31, 34 AND 35).

FIRST USE 6-18-2012; IN COMMERCE 6-18-2012.

THE MARK CONSISTS OF STANDARD CHARACTERS WITHOUT CLAIM TO ANY PARTICULAR FONT, STYLE, SIZE, OR COLOR.

OWNER OF U.S. REG. NOS. 719,148, 3,163,560, AND OTHERS.

NO CLAIM IS MADE TO THE EXCLUSIVE RIGHT TO USE "HE", APART FROM THE MARK AS SHOWN.

SN 85-500,041, FILED 12-20-2011.

JAY BESCH, EXAMINING ATTORNEY



*David J. Kyffers*

Director of the United States Patent and Trademark Office

# United States of America

United States Patent and Trademark Office

## LEAVE WORRY BEHIND

**Reg. No. 4,277,040**

**Registered Jan. 15, 2013**

**Int. Cl.: 37**

**SERVICE MARK**

**PRINCIPAL REGISTER**

JIFFY LUBE INTERNATIONAL, INC. (DELAWARE CORPORATION)  
700 MILAM STREET  
HOUSTON, TX 77002

FOR: VEHICLE PREVENTATIVE MAINTENANCE SERVICES, NAMELY, LUBRICATING CHASSIS, CHANGING MOTOR OIL, CHANGING OIL AND AIR FILTERS, REFILLING TRANSMISSION, DIFFERENTIAL, BRAKE, POWER STEERING, RADIATOR, WINDSHIELD WASHER AND BATTERY RESERVOIRS TO PROPER FLUID LEVELS, CHANGING WINDSHIELD WIPER BLADES, INFLATING TIRES TO PROPER PRESSURE, VACUUMING INTERIORS, AND WASHING WINDOWS, IN CLASS 37 (U.S. CLS. 100, 103 AND 106).

FIRST USE 2-29-2012; IN COMMERCE 2-29-2012.

THE MARK CONSISTS OF STANDARD CHARACTERS WITHOUT CLAIM TO ANY PARTICULAR FONT, STYLE, SIZE, OR COLOR.

SN 85-500,054, FILED 12-20-2011.

TASNEEM HUSSAIN, EXAMINING ATTORNEY



*David J. Kybas*

Director of the United States Patent and Trademark Office

# United States of America

United States Patent and Trademark Office

## Partnering for your Future

**Reg. No. 4,277,041**

**Registered Jan. 15, 2013**

**Int. Cl.: 35**

**SERVICE MARK**

**PRINCIPAL REGISTER**

DRITSAS GROOM MCCORMICK, LLP (CALIFORNIA PARTNERSHIP)  
7576 N INGRAM SUITE 102  
FRESNO, CA 93711

FOR: ACCOUNT AUDITING; ACCOUNTING SERVICES; BOOKKEEPING; BUSINESS AUDITING; BUSINESS MANAGEMENT ANALYSIS; BUSINESS MANAGEMENT AND ADVICE; BUSINESS MANAGEMENT AND CONSULTATION; BUSINESS MANAGEMENT CONSULTANCY AND ADVISORY SERVICES; TAX ADVISORY SERVICES; TAX AND TAXATION PLANNING, ADVICE, INFORMATION AND CONSULTANCY SERVICES; TAX CONSULTATION; TAX FILING SERVICES; TAX PREPARATION, IN CLASS 35 (U.S. CLS. 100, 101 AND 102).

FIRST USE 6-15-2012; IN COMMERCE 6-15-2012.

THE MARK CONSISTS OF STANDARD CHARACTERS WITHOUT CLAIM TO ANY PARTICULAR FONT, STYLE, SIZE, OR COLOR.

SN 85-500,191, FILED 12-20-2011.

WANDA KAY PRICE, EXAMINING ATTORNEY



*David J. Kyffers*

Director of the United States Patent and Trademark Office

# United States of America

United States Patent and Trademark Office

## TRUST IT WITH ALL YOUR HEART

**Reg. No. 4,277,042**

**Registered Jan. 15, 2013**

**Int. Cl.: 5**

**TRADEMARK**

**PRINCIPAL REGISTER**

ILEX CONSUMER PRODUCTS GROUP, LLC (MARYLAND LIMITED LIABILITY COMPANY)  
323 WEST CAMDEN ST., SUITE 700  
BALTIMORE, MD 21201

FOR: ASPIRIN, IN CLASS 5 (U.S. CLS. 6, 18, 44, 46, 51 AND 52).

FIRST USE 5-1-2012; IN COMMERCE 5-1-2012.

THE MARK CONSISTS OF STANDARD CHARACTERS WITHOUT CLAIM TO ANY PARTICULAR FONT, STYLE, SIZE, OR COLOR.

SN 85-500,548, FILED 12-21-2011.

CURTIS FRENCH, EXAMINING ATTORNEY



*David J. Kyffers*

Director of the United States Patent and Trademark Office

# United States of America

United States Patent and Trademark Office

## THE BETTER CAUSE

**Reg. No. 4,277,043**

**Registered Jan. 15, 2013**

**Int. Cl.: 35**

**SERVICE MARK**

**PRINCIPAL REGISTER**

GOSTORK LLC (OHIO LIMITED LIABILITY COMPANY)  
4175 SPYGLASS HILL  
MASON, OH 45040

FOR: PROMOTING THE GOODS AND SERVICES OF OTHERS BY PROVIDING A WEBSITE FEATURING COUPONS, DISCOUNT OFFERS, AND SPECIAL PURCHASE OFFERS, IN CLASS 35 (U.S. CLS. 100, 101 AND 102).

FIRST USE 10-31-2012; IN COMMERCE 10-31-2012.

THE MARK CONSISTS OF STANDARD CHARACTERS WITHOUT CLAIM TO ANY PARTICULAR FONT, STYLE, SIZE, OR COLOR.

SN 85-501,084, FILED 12-21-2011.

TRACY FLETCHER, EXAMINING ATTORNEY



*David J. Kyffers*

Director of the United States Patent and Trademark Office



# United States of America

United States Patent and Trademark Office

## WEE SOCIETY

**Reg. No. 4,277,044**

**Registered Jan. 15, 2013**

**Int. Cl.: 9**

**TRADEMARK**

**PRINCIPAL REGISTER**

OFFICE: JASON SCHULTE DESIGN, INC. (CALIFORNIA CORPORATION)  
1060 CAPP STREET  
SN FRANCISCO, CA 94110

FOR: COMPUTER APPLICATION SOFTWARE FOR MOBILE PHONES AND HANDHELD COMPUTERS, NAMELY, SOFTWARE FOR CREATING BABY BOOKS, IN CLASS 9 (U.S. CLS. 21, 23, 26, 36 AND 38).

FIRST USE 8-6-2008; IN COMMERCE 8-6-2012.

THE MARK CONSISTS OF STANDARD CHARACTERS WITHOUT CLAIM TO ANY PARTICULAR FONT, STYLE, SIZE, OR COLOR.

SN 85-501,606, FILED 12-21-2011.

THEODORE MCBRIDE, EXAMINING ATTORNEY



*David J. Kyffers*

Director of the United States Patent and Trademark Office

# United States of America

United States Patent and Trademark Office

## WEE SOCIETY

**Reg. No. 4,277,045**

**Registered Jan. 15, 2013**

**Int. Cl.: 16**

**TRADEMARK**

**PRINCIPAL REGISTER**

OFFICE: JASON SCHULTE DESIGN, INC. (CALIFORNIA CORPORATION)  
1060 CAPP STREET  
SAN FRANCISCO, CA 94110

FOR: BABY BOOKS; CHILDREN'S ACTIVITY BOOKS; CHILDREN'S BOOKS; ART PICTURES, IN CLASS 16 (U.S. CLS. 2, 5, 22, 23, 29, 37, 38 AND 50).

FIRST USE 1-30-2009; IN COMMERCE 9-12-2012.

THE MARK CONSISTS OF STANDARD CHARACTERS WITHOUT CLAIM TO ANY PARTICULAR FONT, STYLE, SIZE, OR COLOR.

SN 85-501,611, FILED 12-21-2011.

THEODORE MCBRIDE, EXAMINING ATTORNEY



*David J. Kybas*

Director of the United States Patent and Trademark Office

# United States of America

United States Patent and Trademark Office

## CHATHAM CHINO

**Reg. No. 4,277,046**

PURITAN CLOTHING COMPANY OF CAPE COD, INC. (MASSACHUSETTS CORPORATION)  
408 MAIN ST.  
HYANNIS, MA 02601

**Registered Jan. 15, 2013**

**Int. Cl.: 25**

FOR: PANTS, IN CLASS 25 (U.S. CLS. 22 AND 39).

**TRADEMARK**

FIRST USE 8-17-2012; IN COMMERCE 8-17-2012.

**PRINCIPAL REGISTER**

THE MARK CONSISTS OF STANDARD CHARACTERS WITHOUT CLAIM TO ANY PARTICULAR FONT, STYLE, SIZE, OR COLOR.

NO CLAIM IS MADE TO THE EXCLUSIVE RIGHT TO USE "CHINO", APART FROM THE MARK AS SHOWN.

SN 85-501,739, FILED 12-22-2011.

NAPOLEON SHARMA, EXAMINING ATTORNEY



*David J. Kybas*

Director of the United States Patent and Trademark Office

# United States of America

United States Patent and Trademark Office

# Reel Click

**Reg. No. 4,277,047**

RIVERCOAST DISTRIBUTION COMPANY, LLC (OHIO LIMITED LIABILITY COMPANY)  
10521 STORYBOOK DR.  
CINCINNATI, OH 45242

**Registered Jan. 15, 2013**

**Int. Cl.: 35**

FOR: OPERATING ON-LINE MARKETPLACES FEATURING FILMS, IN CLASS 35 (U.S. CLS. 100, 101 AND 102).

**SERVICE MARK**

FIRST USE 10-14-2008; IN COMMERCE 4-9-2009.

**PRINCIPAL REGISTER**

THE MARK CONSISTS OF STANDARD CHARACTERS WITHOUT CLAIM TO ANY PARTICULAR FONT, STYLE, SIZE, OR COLOR.

SN 85-501,773, FILED 12-22-2011.

ANNE FARRELL, EXAMINING ATTORNEY



*David J. Kybas*

Director of the United States Patent and Trademark Office

# United States of America

United States Patent and Trademark Office

## HARVEST PICKS

**Reg. No. 4,277,048**

**Registered Jan. 15, 2013**

**Int. Cl.: 29**

**TRADEMARK**

**PRINCIPAL REGISTER**

THE DANNON COMPANY, INC. (DELAWARE CORPORATION)  
100 HILLSIDE AVENUE  
WHITE PLAINS, NY 10603

FOR: YOGURT, IN CLASS 29 (U.S. CL. 46).

FIRST USE 12-0-2011; IN COMMERCE 12-0-2011.

THE MARK CONSISTS OF STANDARD CHARACTERS WITHOUT CLAIM TO ANY PARTICULAR FONT, STYLE, SIZE, OR COLOR.

SN 85-501,882, FILED 12-22-2011.

TASNEEM HUSSAIN, EXAMINING ATTORNEY



*David J. Kybas*

Director of the United States Patent and Trademark Office

# United States of America

United States Patent and Trademark Office

# LOB CITY

**Reg. No. 4,277,049**

**Registered Jan. 15, 2013**

**Int. Cl.: 25**

**TRADEMARK**

**PRINCIPAL REGISTER**

LAC BASKETBALL CLUB, INC. (CALIFORNIA CORPORATION)  
SUITE 1100  
1111 SOUTH FIGUEROA STREET  
LOS ANGELES, CA 90015

FOR: CLOTHING, NAMELY, HOSIERY, FOOTWEAR, BASKETBALL SHOES, BASKETBALL SNEAKERS, T-SHIRTS, SHIRTS, POLO SHIRTS, SWEATSHIRTS, SWEATPANTS, PANTS, TANK TOPS, JERSEYS, SHORTS, PAJAMAS, SPORT SHIRTS, RUGBY SHIRTS, SWEATERS, BELTS, TIES, NIGHTSHIRTS, HATS, CAPS, VISORS, WARM-UP SUITS, WARM-UP PANTS, WARM-UP TOPS/SHOOTING SHIRTS, JACKETS, WIND RESISTANT JACKETS, PARKAS, COATS, BABY BIBS NOT OF PAPER, HEAD BANDS, WRIST BANDS, APRONS, UNDERGARMENTS, BOXER SHORTS, SLACKS, EAR MUFFS, GLOVES, MITTENS, SCARVES, WOVEN AND KNIT SHIRTS, JERSEY DRESSES, DRESSES, CHEERLEADING DRESSES AND UNIFORMS, SWIM WEAR, BATHING SUITS, SWIMSUITS, BIKINIS, TANKINIS, SWIM TRUNKS, BATHING TRUNKS, BOARD SHORTS, WET SUITS, BEACH COVER-UPS, BATHING SUIT COVER-UPS, BATHING SUIT WRAPS, SANDALS, BEACH SANDALS, BEACH HATS, SUN VISORS, SWIM CAPS, BATHING CAPS, NOVELTY HEADWEAR WITH ATTACHED WIGS, IN CLASS 25 (U.S. CLS. 22 AND 39).

FIRST USE 12-31-2011; IN COMMERCE 12-31-2011.

THE MARK CONSISTS OF STANDARD CHARACTERS WITHOUT CLAIM TO ANY PARTICULAR FONT, STYLE, SIZE, OR COLOR.

SN 85-501,960, FILED 12-22-2011.

DAVID TAYLOR, EXAMINING ATTORNEY



*David J. Kyffers*

Director of the United States Patent and Trademark Office

# United States of America

United States Patent and Trademark Office

## ADVANCING COMPASSION

**Reg. No. 4,277,050**

ADVANCING COMPASSION PROJECT (CALIFORNIA CORPORATION), AKA ACP,  
3525 DEL MAR HEIGHTS RD., #553  
SAN DIEGO, CA 921302122

**Registered Jan. 15, 2013**

**Int. Cl.: 35**

FOR: CHARITABLE SERVICES, NAMELY, COORDINATION OF NON-MONETARY CONTRIBUTIONS TO CHARITIES AND NON-PROFITS; CHARITABLE SERVICES, NAMELY, ORGANIZING AND CONDUCTING VOLUNTEER PROGRAMS AND COMMUNITY SERVICE PROJECTS, IN CLASS 35 (U.S. CLS. 100, 101 AND 102).

**SERVICE MARK**

**PRINCIPAL REGISTER**

FIRST USE 1-28-2012; IN COMMERCE 1-28-2012.

THE MARK CONSISTS OF STANDARD CHARACTERS WITHOUT CLAIM TO ANY PARTICULAR FONT, STYLE, SIZE, OR COLOR.

SN 85-502,743, FILED 12-22-2011.

APRIL ROACH, EXAMINING ATTORNEY



*David J. Kyffers*

Director of the United States Patent and Trademark Office

# United States of America

United States Patent and Trademark Office

## VOLUNTEERS CHANGING LIVES

**Reg. No. 4,277,051**

ADVANCING COMPASSION PROJECT (CALIFORNIA CORPORATION), AKA ACP,  
3525 DEL MAR HEIGHTS RD., #553  
SAN DIEGO, CA 921302122

**Registered Jan. 15, 2013**

**Int. Cl.: 35**

FOR: CHARITABLE SERVICES, NAMELY, COORDINATION OF NON-MONETARY CONTRIBUTIONS TO CHARITIES AND NON-PROFITS; CHARITABLE SERVICES, NAMELY, ORGANIZING AND CONDUCTING VOLUNTEER PROGRAMS AND COMMUNITY SERVICE PROJECTS, IN CLASS 35 (U.S. CLS. 100, 101 AND 102).

**SERVICE MARK**

**PRINCIPAL REGISTER**

FIRST USE 1-28-2012; IN COMMERCE 1-28-2012.

THE MARK CONSISTS OF STANDARD CHARACTERS WITHOUT CLAIM TO ANY PARTICULAR FONT, STYLE, SIZE, OR COLOR.

SN 85-502,745, FILED 12-22-2011.

APRIL ROACH, EXAMINING ATTORNEY



*David J. Kybas*

Director of the United States Patent and Trademark Office



# United States of America

United States Patent and Trademark Office

## HELP. LOVE. GROW.

**Reg. No. 4,277,052**

**Registered Jan. 15, 2013**

**Int. Cl.: 36**

**SERVICE MARK**

**PRINCIPAL REGISTER**

ADVANCING COMPASSION PROJECT (CALIFORNIA CORPORATION), AKA ACP,  
3525 DEL MAR HEIGHTS RD., #553  
SAN DIEGO, CA 921302122

FOR: ACCEPTING AND ADMINISTERING MONETARY CHARITABLE CONTRIBUTIONS;  
CHARITABLE FOUNDATION SERVICES, NAMELY, PROVIDING FINANCIAL ASSISTANCE  
FOR PROGRAMS AND SERVICES OF OTHERS; CHARITABLE FUNDRAISING SERVICES;  
CHARITABLE SERVICES, NAMELY, PROVIDING FINANCIAL SUPPORT TO PEOPLE  
FROM DISADVANTAGED COUNTRIES FOR THE PURPOSE OF FACILITATING EDUCA-  
TIONAL OPPORTUNITIES, IN CLASS 36 (U.S. CLS. 100, 101 AND 102).

FIRST USE 2-20-2012; IN COMMERCE 2-20-2012.

THE MARK CONSISTS OF STANDARD CHARACTERS WITHOUT CLAIM TO ANY PAR-  
TICULAR FONT, STYLE, SIZE, OR COLOR.

SN 85-502,757, FILED 12-22-2011.

APRIL ROACH, EXAMINING ATTORNEY



*David J. Kypos*

Director of the United States Patent and Trademark Office

# United States of America

United States Patent and Trademark Office

## COVER LOVER

**Reg. No. 4,277,053**

**Registered Jan. 15, 2013**

**Int. Cl.: 9**

**TRADEMARK**

**PRINCIPAL REGISTER**

COVER LOVER INC. (NEW YORK CORPORATION)  
P.O. BOX 785  
GOLDENS BRIDGE, NY 10526

FOR: PROTECTIVE COVERS FOR CELL PHONES, IN CLASS 9 (U.S. CLS. 21, 23, 26, 36 AND 38).

FIRST USE 6-21-2012; IN COMMERCE 6-21-2012.

THE MARK CONSISTS OF STANDARD CHARACTERS WITHOUT CLAIM TO ANY PARTICULAR FONT, STYLE, SIZE, OR COLOR.

SN 85-502,926, FILED 12-23-2011.

TASNEEM HUSSAIN, EXAMINING ATTORNEY



*David J. Kybas*

Director of the United States Patent and Trademark Office

United States of America  
United States Patent and Trademark Office

**mobilized**

**Reg. No. 4,277,054**

**Registered Jan. 15, 2013**

**Int. Cl.: 25**

**TRADEMARK**

**PRINCIPAL REGISTER**

CODY, DOUGLAS (UNITED STATES INDIVIDUAL)  
102  
1310 MINNESOTA STREET  
SAN FRANCISCO, CA 941077401

FOR: CLOTHING, NAMELY, JACKETS, PARKAS, RAIN JACKETS, TROUSERS, CARGO PANTS, SHORTS, SWEATERS, VESTS, SHIRTS, T-SHIRTS, POLO SHIRTS, UNDERGARMENTS, NECK GAITERS, SCARVES, GLOVES, SOCKS, BELTS, HEADWEAR, NAMELY, CAPS, BEANIES, AND BALACLAVAS; FOOTWEAR, IN CLASS 25 (U.S. CLS. 22 AND 39).

FIRST USE 10-1-2012; IN COMMERCE 10-1-2012.

THE MARK CONSISTS OF THE STYLIZED TEXT "MOBILIZED".

SN 85-504,472, FILED 12-27-2011.

JENNIFER MARTIN, EXAMINING ATTORNEY



*David J. Kyffers*

Director of the United States Patent and Trademark Office

# United States of America

United States Patent and Trademark Office

# Xperia

**Reg. No. 4,277,055**

**Registered Jan. 15, 2013**

**Int. Cl.: 10**

**TRADEMARK**

**PRINCIPAL REGISTER**

STARKEY LABORATORIES, INC. (MINNESOTA CORPORATION)  
ATTN: LEGAL DEPT  
6600 WASHINGTON AVENUE SOUTH  
EDEN PRAIRIE, MN 55334

FOR: BIOMEDICAL APPARATUS, NAMELY, HEARING AIDS AND PARTS THEREOF, IN CLASS 10 (U.S. CLS. 26, 39 AND 44).

FIRST USE 1-1-2012; IN COMMERCE 1-1-2012.

THE MARK CONSISTS OF STANDARD CHARACTERS WITHOUT CLAIM TO ANY PARTICULAR FONT, STYLE, SIZE, OR COLOR.

SN 85-504,679, FILED 12-28-2011.

MAYUR VAGHANI, EXAMINING ATTORNEY



*David J. Kyffers*

Director of the United States Patent and Trademark Office

# United States of America

United States Patent and Trademark Office

## SEARCHBLAST

**Reg. No. 4,277,056**

**Registered Jan. 15, 2013**

**Int. Cl.: 11**

**TRADEMARK**

**PRINCIPAL REGISTER**

CONAIR CORPORATION (DELAWARE CORPORATION)  
ONE CUMMINGS POINT ROAD  
STAMFORD, CT 06902

FOR: ELECTRIC GRILLS, IN CLASS 11 (U.S. CLS. 13, 21, 23, 31 AND 34).

FIRST USE 4-0-2012; IN COMMERCE 4-0-2012.

THE MARK CONSISTS OF STANDARD CHARACTERS WITHOUT CLAIM TO ANY PARTICULAR FONT, STYLE, SIZE, OR COLOR.

SN 85-505,881, FILED 12-29-2011.

WILLIAM JACKSON, EXAMINING ATTORNEY



*David J. Kybas*

Director of the United States Patent and Trademark Office

# United States of America

United States Patent and Trademark Office

## 7th inning stretch

**Reg. No. 4,277,057**

**Registered Jan. 15, 2013**

**Int. Cl.: 25**

**TRADEMARK**

**PRINCIPAL REGISTER**

BLOCK INDUSTRIES LLC (NEW YORK LIMITED LIABILITY COMPANY)  
8 LOMBARDI PLACE  
PLAINVIEW, NY 11803

FOR: ATHLETIC APPAREL, NAMELY, SHIRTS, PANTS, JACKETS, FOOTWEAR, HATS AND CAPS, ATHLETIC UNIFORMS; BASEBALL CAPS AND HATS; FLEECE SHORTS; GYM SHORTS; HATS; HOODED SWEAT SHIRTS; KNIT SHIRTS; LONG-SLEEVED SHIRTS; MOISTURE-WICKING SPORTS SHIRTS; PIQUE SHIRTS; POLO SHIRTS; SHIRTS; SHIRTS AND SHORT-SLEEVED SHIRTS; SHORT-SLEEVED SHIRTS; SHORTS; SPORT SHIRTS; SWEAT SHIRTS; SWEAT SHORTS; T-SHIRTS; TEE SHIRTS; WALKING SHORTS; WEARABLE GARMENTS AND CLOTHING, NAMELY, SHIRTS; WOOLLY HATS, IN CLASS 25 (U.S. CLS. 22 AND 39).

FIRST USE 5-1-2012; IN COMMERCE 7-1-2012.

THE MARK CONSISTS OF STANDARD CHARACTERS WITHOUT CLAIM TO ANY PARTICULAR FONT, STYLE, SIZE, OR COLOR.

SN 85-506,818, FILED 12-31-2011.

KYLE PEETE, EXAMINING ATTORNEY



*David J. Kypos*

Director of the United States Patent and Trademark Office

# United States of America

United States Patent and Trademark Office

## VEGGIE BABY

**Reg. No. 4,277,058**

**Registered Jan. 15, 2013**

**Int. Cls.: 2 and 16**

**TRADEMARK**

**PRINCIPAL REGISTER**

WEE CAN TOO ART SUPPLY, LLC (OREGON LIMITED LIABILITY COMPANY)  
2092 WASHINGTON ST.  
EUGENE, OR 97405

FOR: FINGER PAINTS; PAINTS; PAINTS FOR ARTS AND CRAFTS; PAINTS FOR HAND APPLICATION BY BABIES AND/OR YOUNG CHILDREN; POWDERED PAINTS; WATER-BASED PAINTS, IN CLASS 2 (U.S. CLS. 6, 11 AND 16).

FIRST USE 7-31-2010; IN COMMERCE 7-31-2010.

FOR: ARTS AND CRAFT PAINT KITS; CHALK; CHALK STICKS; CHALKS; CRAYONS; MARKING CHALK, IN CLASS 16 (U.S. CLS. 2, 5, 22, 23, 29, 37, 38 AND 50).

FIRST USE 7-31-2010; IN COMMERCE 7-31-2010.

THE MARK CONSISTS OF STANDARD CHARACTERS WITHOUT CLAIM TO ANY PARTICULAR FONT, STYLE, SIZE, OR COLOR.

NO CLAIM IS MADE TO THE EXCLUSIVE RIGHT TO USE "BABY", APART FROM THE MARK AS SHOWN.

SN 85-506,933, FILED 12-31-2011.

ERIN FALK, EXAMINING ATTORNEY



*David J. Kybas*

Director of the United States Patent and Trademark Office

# United States of America

United States Patent and Trademark Office

## ART FROM THE START

**Reg. No. 4,277,059**

**Registered Jan. 15, 2013**

**Int. Cls.: 2 and 16**

**TRADEMARK**

**PRINCIPAL REGISTER**

WEE CAN TOO ART SUPPLY, LLC (OREGON LIMITED LIABILITY COMPANY)  
2092 WASHINGTON ST.  
EUGENE, OR 97405

FOR: FINGER PAINTS; PAINTS; PAINTS FOR ARTS AND CRAFTS; PAINTS FOR HAND APPLICATION BY BABIES AND/OR YOUNG CHILDREN; POWDERED PAINTS; WATER-BASED PAINTS, IN CLASS 2 (U.S. CLS. 6, 11 AND 16).

FIRST USE 7-31-2010; IN COMMERCE 7-31-2010.

FOR: ARTS AND CRAFT PAINT KITS; CHALK; CHALK STICKS; CHALKS; CRAYONS; MARKING CHALK, IN CLASS 16 (U.S. CLS. 2, 5, 22, 23, 29, 37, 38 AND 50).

FIRST USE 7-31-2010; IN COMMERCE 7-31-2010.

THE MARK CONSISTS OF STANDARD CHARACTERS WITHOUT CLAIM TO ANY PARTICULAR FONT, STYLE, SIZE, OR COLOR.

NO CLAIM IS MADE TO THE EXCLUSIVE RIGHT TO USE "ART", APART FROM THE MARK AS SHOWN.

SN 85-506,937, FILED 12-31-2011.

ERIN FALK, EXAMINING ATTORNEY



*David J. Kybas*

Director of the United States Patent and Trademark Office



# United States of America

United States Patent and Trademark Office

# VEGGIE

**Reg. No. 4,277,060**

WEE CAN TOO ART SUPPLY, LLC (OREGON LIMITED LIABILITY COMPANY)  
2092 WASHINGTON ST.  
EUGENE, OR 97405

**Registered Jan. 15, 2013**

**Int. Cls.: 2 and 16**

FOR: FINGER PAINTS; PAINTS; PAINTS FOR ARTS AND CRAFTS; PAINTS FOR HAND APPLICATION BY BABIES AND/OR YOUNG CHILDREN; POWDERED PAINTS; WATER-BASED PAINTS, IN CLASS 2 (U.S. CLS. 6, 11 AND 16).

**TRADEMARK**

FIRST USE 7-31-2010; IN COMMERCE 7-31-2010.

**PRINCIPAL REGISTER**

FOR: ARTS AND CRAFT PAINT KITS; CHALK; CHALK STICKS; CHALKS; CRAYONS; MARKING CHALK, IN CLASS 16 (U.S. CLS. 2, 5, 22, 23, 29, 37, 38 AND 50).

FIRST USE 7-31-2010; IN COMMERCE 7-31-2010.

THE MARK CONSISTS OF STANDARD CHARACTERS WITHOUT CLAIM TO ANY PARTICULAR FONT, STYLE, SIZE, OR COLOR.

SN 85-506,949, FILED 12-31-2011.

ERIN FALK, EXAMINING ATTORNEY



*David J. Kypos*

Director of the United States Patent and Trademark Office

# United States of America

United States Patent and Trademark Office



**Reg. No. 4,277,061**

**Registered Jan. 15, 2013**

**Int. Cl.: 28**

**TRADEMARK**

**PRINCIPAL REGISTER**

PIN LINK INDUSTRY CO., LTD. (TAIWAN CORPORATION)  
NO. 66, ALLEY 71, LANE 252  
SEC. 2, JIESHOU RD.  
BADE CITY, TAOYUAN CTY, TAIWAN 33461

FOR: ACCESSORY FOR MANUALLY-OPERATED EXERCISE EQUIPMENT, NAMELY, ACCESSORY ATTACHMENT TO INCREASE MUSCLE RESISTANCE; BODY-BUILDING APPARATUS; BODY-TRAINING APPARATUS; EXERCISE BARS; EXERCISE BENCHES; EXERCISE EQUIPMENT, NAMELY, ROWING MACHINES; EXERCISE EQUIPMENT, NAMELY, ABDOMINAL BOARDS; EXERCISE EQUIPMENT, NAMELY, CHEST EXPANDERS; EXERCISE EQUIPMENT, NAMELY, CHEST PULLS; EXERCISE EQUIPMENT, NAMELY, STAIR-STEPPING MACHINES; EXERCISE EQUIPMENT, NAMELY, STATIONARY CYCLES; EXERCISE EQUIPMENT, NAMELY, EXERCISE WRIST WEIGHTS; EXERCISE MACHINES; EXERCISE PLATFORMS; EXERCISE TREADMILLS; EXERCISE WEIGHTS; EXERCISING EQUIPMENT, NAMELY, MANUALLY OPERATED JOGGING MACHINES; EXERCISING EQUIPMENT, NAMELY, POWERED TREADMILLS FOR RUNNING; EXERCISING EQUIPMENT, NAMELY, PULLEYS; EXERCISING EQUIPMENT, NAMELY, WEIGHT LIFTING MACHINES; GYMNAS TIC APPARATUS; GYMNAS TIC TRAINING STOOLS; MANUAL LEG EXERCISERS; MANUALLY-OPERATED EXERCISE EQUIPMENT; SPRING BAR TENSION SETS FOR USE IN EXERCISING; SPRING BARS FOR EXERCISING; STATIONARY EXERCISE BICYCLES AND ROLLERS THEREFOR, IN CLASS 28 (U.S. CLS. 22, 23, 38 AND 50).

FIRST USE 8-18-2012; IN COMMERCE 8-18-2012.

SN 85-507,410, FILED 1-3-2012.

MARK SPARACINO, EXAMINING ATTORNEY



*David J. Kyffers*

Director of the United States Patent and Trademark Office

# United States of America

United States Patent and Trademark Office

## SERIOUSLY SOFT

**Reg. No. 4,277,062**

**Registered Jan. 15, 2013**

**Int. Cl.: 3**

**TRADEMARK**

**PRINCIPAL REGISTER**

VICTORIA'S SECRET STORES BRAND MANAGEMENT, INC. (DELAWARE CORPORATION)  
FOUR LIMITED PARKWAY  
REYNOLDSBURG, OH 43068

FOR: BODY CREAMS, IN CLASS 3 (U.S. CLS. 1, 4, 6, 50, 51 AND 52).

FIRST USE 8-10-2012; IN COMMERCE 8-10-2012.

THE MARK CONSISTS OF STANDARD CHARACTERS WITHOUT CLAIM TO ANY PARTICULAR FONT, STYLE, SIZE, OR COLOR.

SN 85-507,449, FILED 1-3-2012.

TRACY CROSS, EXAMINING ATTORNEY



*David J. Kyffers*

Director of the United States Patent and Trademark Office

# United States of America

United States Patent and Trademark Office

## CAFÉ STACK

**Reg. No. 4,277,063**

**Registered Jan. 15, 2013**

**Int. Cl.: 21**

**TRADEMARK**

**PRINCIPAL REGISTER**

YOUCOPIA PRODUCTS, INC. (ILLINOIS CORPORATION)  
524 S. PATTON AVENUE  
ARLINGTON HEIGHTS, IL 60005

FOR: CONTAINERS FOR HOUSEHOLD OR KITCHEN USE NOT OF PRECIOUS METAL; PORTABLE CONTAINERS FOR STORING HOUSEHOLD AND KITCHEN GOODS, NAMELY, COFFEE, TEA, AND HOT CHOCOLATE, PLASTIC RACKS WITH STORAGE COMPARTMENTS FOR STORING SINGLE SERVINGS OF COFFEE, TEA AND HOT CHOCOLATE IN PLASTIC POD SHAPE, IN CLASS 21 (U.S. CLS. 2, 13, 23, 29, 30, 33, 40 AND 50).

FIRST USE 4-26-2012; IN COMMERCE 4-26-2012.

OWNER OF U.S. REG. NOS. 3,351,530 AND 4,097,154.

NO CLAIM IS MADE TO THE EXCLUSIVE RIGHT TO USE "CAFÉ", APART FROM THE MARK AS SHOWN.

THE MARK CONSISTS OF THE WORDS "CAFÉ STACK".

SN 85-508,243, FILED 1-4-2012.

DEBORAH LOBO, EXAMINING ATTORNEY



*David J. Kybas*

Director of the United States Patent and Trademark Office

# United States of America

United States Patent and Trademark Office

# Pat's Hall

**Reg. No. 4,277,064**

**Registered Jan. 15, 2013**

**Int. Cl.: 41**

**SERVICE MARK**

**PRINCIPAL REGISTER**

PAT'S HALL LLC (TEXAS LIMITED LIABILITY COMPANY)  
406 POST OAK ROAD  
FREDERICKSBURG, TX 78624

FOR: DANCE CLUB SERVICES, IN CLASS 41 (U.S. CLS. 100, 101 AND 107).

FIRST USE 10-1-2012; IN COMMERCE 10-1-2012.

THE MARK CONSISTS OF STANDARD CHARACTERS WITHOUT CLAIM TO ANY PARTICULAR FONT, STYLE, SIZE, OR COLOR.

NO CLAIM IS MADE TO THE EXCLUSIVE RIGHT TO USE "HALL", APART FROM THE MARK AS SHOWN.

SN 85-508,792, FILED 1-4-2012.

ALLISON HOLTZ, EXAMINING ATTORNEY



*David J. Kyffers*

Director of the United States Patent and Trademark Office

# United States of America

United States Patent and Trademark Office

## Agent of Change

**Reg. No. 4,277,065**

BUCHOLTZ, JEFFREY (UNITED STATES INDIVIDUAL)  
3554 GEORGIA STREET  
SAN DIEGO, CA 92103

**Registered Jan. 15, 2013**

**Int. Cl.: 41**

FOR: EDUCATION SERVICES, NAMELY, PROVIDING ON-LINE CLASSES, SEMINARS, AND WORKSHOPS IN THE FIELD OF SEXUAL VIOLENCE PREVENTION; INTERACTIVE ON-LINE TRAINING SERVICES IN THE FIELD OF SEXUAL VIOLENCE PREVENTION, IN CLASS 41 (U.S. CLS. 100, 101 AND 107).

**SERVICE MARK**

**PRINCIPAL REGISTER**

FIRST USE 10-15-2011; IN COMMERCE 11-15-2012.

THE MARK CONSISTS OF STANDARD CHARACTERS WITHOUT CLAIM TO ANY PARTICULAR FONT, STYLE, SIZE, OR COLOR.

SN 85-508,795, FILED 1-4-2012.

ALLISON HOLTZ, EXAMINING ATTORNEY



*David J. Kyffers*

Director of the United States Patent and Trademark Office

# United States of America

United States Patent and Trademark Office

## SPEAKERS TRAINING CAMP

**Reg. No. 4,277,066**

SUCCESSWORKS LLC (OREGON LIMITED LIABILITY COMPANY)  
4261 CHAMBERLIN DRIVE  
HOOD RIVER, OR 97031

**Registered Jan. 15, 2013**

**Int. Cls.: 9 and 41**

FOR: EDUCATIONAL AND TRAINING PRODUCTS, NAMELY, DVDS AND CDS, ALL FEATURING SELF-TRAINING SKILLS FOR TRAINING AND EDUCATION, ALL IN THE FIELD OF PUBLIC SPEAKING AND PRESENTATION SKILLS, IN CLASS 9 (U.S. CLS. 21, 23, 26, 36 AND 38).

**TRADEMARK**

**SERVICE MARK**

FIRST USE 0-0-1997; IN COMMERCE 0-0-1997.

**PRINCIPAL REGISTER**

FOR: TRAINING SERVICES IN THE FIELD OF PUBLIC SPEAKING AND PRESENTATION SKILLS; EDUCATIONAL SERVICES, NAMELY, PROVIDING SEMINARS IN THE FIELDS OF PUBLIC SPEAKING AND PRESENTATION SKILLS; PERSONAL COACHING SERVICES IN THE FIELD OF PUBLIC SPEAKING AND PRESENTATION SKILLS, IN CLASS 41 (U.S. CLS. 100, 101 AND 107).

FIRST USE 0-0-1997; IN COMMERCE 0-0-1997.

THE MARK CONSISTS OF STANDARD CHARACTERS WITHOUT CLAIM TO ANY PARTICULAR FONT, STYLE, SIZE, OR COLOR.

OWNER OF U.S. REG. NO. 3,380,428.

NO CLAIM IS MADE TO THE EXCLUSIVE RIGHT TO USE "SPEAKERS TRAINING", APART FROM THE MARK AS SHOWN.

SN 85-508,935, FILED 1-4-2012.

ANDREA HACK, EXAMINING ATTORNEY



*David J. Kyffers*

Director of the United States Patent and Trademark Office

# United States of America

United States Patent and Trademark Office

## CHIEF TOOLS

**Reg. No. 4,277,067**

**Registered Jan. 15, 2013**

**Int. Cl.: 16**

**TRADEMARK**

**PRINCIPAL REGISTER**

CHIEF TOOLS, LLC. (FLORIDA LIMITED LIABILITY COMPANY)  
10445 SW 109 STREET  
MIAMI, FL 33176

FOR: LIQUID PAINT FELT TIP MARKING AND COLORING APPLICATORS; PAINT APPLICATOR ROLLERS; PAINT APPLICATORS; PAINT APPLICATORS IN THE NATURE OF SPONGES; PAINT BOXES AND BRUSHES; PAINT BRUSHES; PAINT CAN LIDS SPECIALLY ADAPTED FOR HOLDING A PAINT BRUSH; PAINT PADDLES; PAINT ROLLER COVERS; PAINT ROLLER HANDLES; PAINT ROLLERS; PAINT STIRRERS; PAINT STIRRERS AND PADDLES; PAINT TRAY LINERS OF PAPER OR PLASTIC; PAINT TRAYS, IN CLASS 16 (U.S. CLS. 2, 5, 22, 23, 29, 37, 38 AND 50).

FIRST USE 5-1-2012; IN COMMERCE 5-1-2012.

THE MARK CONSISTS OF STANDARD CHARACTERS WITHOUT CLAIM TO ANY PARTICULAR FONT, STYLE, SIZE, OR COLOR.

NO CLAIM IS MADE TO THE EXCLUSIVE RIGHT TO USE "TOOLS", APART FROM THE MARK AS SHOWN.

SN 85-509,079, FILED 1-5-2012.

KATHLEEN M. VANSTON, EXAMINING ATTORNEY



*David J. Kybas*

Director of the United States Patent and Trademark Office



# United States of America

United States Patent and Trademark Office



**Reg. No. 4,277,068**

**Registered Jan. 15, 2013**

**Int. Cl.: 35**

**SERVICE MARK**

**PRINCIPAL REGISTER**

HEB GROCERY COMPANY, LP (TEXAS LIMITED PARTNERSHIP)  
CORPORATE LAW DEPARTMENT  
646 SOUTH MAIN  
SAN ANTONIO, TX 78204

FOR: RETAIL GROCERY STORE SERVICES; SUPERMARKET SERVICES; RETAIL DEPARTMENT STORE SERVICES; PROMOTING THE GOODS AND SERVICES OF OTHERS BY DISTRIBUTING ADVERTISING MATERIALS THROUGH A VARIETY OF METHODS; ADVERTISING SERVICES, NAMELY, PROMOTING THE BRANDS, GOODS AND SERVICES OF OTHERS, IN CLASS 35 (U.S. CLS. 100, 101 AND 102).

FIRST USE 4-30-2012; IN COMMERCE 4-30-2012.

OWNER OF U.S. REG. NOS. 1,840,693, 1,958,687, AND OTHERS.

THE MARK CONSISTS OF THE LETTERS "H-E-B" SUPERIMPOSED OVER AN OVAL DESIGN ABOVE THE WORD "PRIMO" WITHIN A RECTANGLE NEXT TO THE WORD "PICKS" WITHIN A RECTANGLE. THE TWO RECTANGLES ARE JOINED TOGETHER BY A CIRCLE CONTAINING A STAR.

SN 85-509,173, FILED 1-5-2012.

ANDREW LEASER, EXAMINING ATTORNEY



*David J. Kyffers*

Director of the United States Patent and Trademark Office

# United States of America

United States Patent and Trademark Office

## DOOBALLO COLLECTION

**Reg. No. 4,277,069**

**Registered Jan. 15, 2013**

**Int. Cl.: 25**

**TRADEMARK**

**PRINCIPAL REGISTER**

DOOBALLO FOOTWEAR, INC. (GEORGIA CORPORATION)  
SUITE A  
4274 SHACKLEFORD ROAD  
NORCROSS, GA 30093

FOR: FOOTWEAR, IN CLASS 25 (U.S. CLS. 22 AND 39).

FIRST USE 8-31-2012; IN COMMERCE 8-31-2012.

THE MARK CONSISTS OF STANDARD CHARACTERS WITHOUT CLAIM TO ANY PARTICULAR FONT, STYLE, SIZE, OR COLOR.

NO CLAIM IS MADE TO THE EXCLUSIVE RIGHT TO USE "COLLECTION", APART FROM THE MARK AS SHOWN.

SN 85-511,291, FILED 1-8-2012.

LESLEY LAMOTHE, EXAMINING ATTORNEY



*David J. Kyffers*

Director of the United States Patent and Trademark Office

# United States of America

United States Patent and Trademark Office

## PURE CANDLES

**Reg. No. 4,277,070**

**Registered Jan. 15, 2013**

**Int. Cl.: 4**

**TRADEMARK**

**PRINCIPAL REGISTER**

TEICHMAN, SOREN (UNITED STATES INDIVIDUAL)  
10050 SOUTH WEST BAY SHORE DRIVE  
TRAVERSE CITY, MI 49684

FOR: CANDLES, IN CLASS 4 (U.S. CLS. 1, 6 AND 15).

FIRST USE 10-18-2010; IN COMMERCE 10-18-2010.

THE MARK CONSISTS OF STANDARD CHARACTERS WITHOUT CLAIM TO ANY PARTICULAR FONT, STYLE, SIZE, OR COLOR.

NO CLAIM IS MADE TO THE EXCLUSIVE RIGHT TO USE "CANDLES", APART FROM THE MARK AS SHOWN.

SN 85-512,015, FILED 1-9-2012.

JAY BESCH, EXAMINING ATTORNEY



*David J. Kyffers*

Director of the United States Patent and Trademark Office

# United States of America

United States Patent and Trademark Office

FROM THE EARTH TO THE  
CUP...GIVE THE WORLD GREAT  
COFFEE AT A GREAT VALUE!

**Reg. No. 4,277,071**

NAPCO, INC. (ILLINOIS CORPORATION)  
1141 NORTH RADDANT ROAD  
BATTAVIA, IL 60510

**Registered Jan. 15, 2013**

**Int. Cl.: 30**

FOR: COFFEE, IN CLASS 30 (U.S. CL. 46).

**TRADEMARK**

FIRST USE 3-31-2012; IN COMMERCE 3-31-2012.

**PRINCIPAL REGISTER**

THE MARK CONSISTS OF STANDARD CHARACTERS WITHOUT CLAIM TO ANY PARTICULAR FONT, STYLE, SIZE, OR COLOR.

SN 85-513,070, FILED 1-10-2012.

RAUL CORDOVA, EXAMINING ATTORNEY



*David J. Kybas*

Director of the United States Patent and Trademark Office

# United States of America

United States Patent and Trademark Office

# SMOOTH

**Reg. No. 4,277,072**

SMOOTH SUP, LLC (CALIFORNIA LIMITED LIABILITY COMPANY)  
P. O. BOX 73505 CALLE NEGOCIO  
SAN CLEMENTE, CA 92673

**Registered Jan. 15, 2013**

**Int. Cl.: 28**

FOR: SURFBOARDS, STAND UP PADDLEBOARDS, STAND-UP SURF PADDLES,  
SKATEBOARDS AND SNOWBOARDS, IN CLASS 28 (U.S. CLS. 22, 23, 38 AND 50).

**TRADEMARK**

FIRST USE 6-28-2010; IN COMMERCE 10-20-2010.

**PRINCIPAL REGISTER**

THE MARK CONSISTS OF STANDARD CHARACTERS WITHOUT CLAIM TO ANY PAR-  
TICULAR FONT, STYLE, SIZE, OR COLOR.

SN 85-513,212, FILED 1-10-2012.

KATHRYN COWARD, EXAMINING ATTORNEY



*David J. Kybas*

Director of the United States Patent and Trademark Office

# United States of America

United States Patent and Trademark Office

## BAD TESTING

**Reg. No. 4,277,073**

SCHIFF, SHACHAR (UNITED STATES INDIVIDUAL)

**Registered Jan. 15, 2013**

9400 LATROBE  
SKOKIE, IL 60077

**Int. Cl.: 42**

FOR: COMPUTER AND TECHNOLOGICAL PROFESSIONAL SERVICES, NAMELY, SOFTWARE QUALITY ASSURANCE; WEBSITE USABILITY TESTING SERVICES; DETAILED WEBSITE ANALYSIS AND TESTING, IN CLASS 42 (U.S. CLS. 100 AND 101).

**SERVICE MARK**

FIRST USE 2-28-2012; IN COMMERCE 2-28-2012.

**PRINCIPAL REGISTER**

THE MARK CONSISTS OF STANDARD CHARACTERS WITHOUT CLAIM TO ANY PARTICULAR FONT, STYLE, SIZE, OR COLOR.

NO CLAIM IS MADE TO THE EXCLUSIVE RIGHT TO USE "TESTING", APART FROM THE MARK AS SHOWN.

SN 85-513,895, FILED 1-11-2012.

BRIDGETT SMITH, EXAMINING ATTORNEY



*David J. Kyffers*

Director of the United States Patent and Trademark Office

# United States of America

United States Patent and Trademark Office

# Soulevé Spa

**Reg. No. 4,277,074**

**Registered Jan. 15, 2013**

**Int. Cl.: 3**

**TRADEMARK**

**PRINCIPAL REGISTER**

VOLUME DISTRIBUTORS, INC. (CALIFORNIA CORPORATION)  
4199 BANDINI BOULEVARD  
VERNON, CA 90058

FOR: SHAMPOO, HAIR CONDITIONER, BODY WASH FOR HUMANS, SKIN LOTION, HAIR GEL, HAIR SPRAY, HAIR MOUSSE, FACE SCRUB, FACE WASH, AFTER-SHAVE CREAM, PRE-SHAVE CREAM, PRE-SHAVE GEL, SKIN MOISTURIZER, DEODORANT FOR BODY CARE, HAND SOAP, IN CLASS 3 (U.S. CLS. 1, 4, 6, 50, 51 AND 52).

FIRST USE 3-1-2008; IN COMMERCE 3-1-2008.

NO CLAIM IS MADE TO THE EXCLUSIVE RIGHT TO USE "SPA", APART FROM THE MARK AS SHOWN.

THE MARK CONSISTS OF THE WORDING "SOULEVÉ SPA", THE WORD "SOULEVÉ" DEPICTING A STYLIZED LETTER "O" AS A LEAF DESIGN, THE LEAF HAVING VEINS AND PETIOLE, AND THE SECOND OCCURRENCE OF THE LETTER "E" ACCENTED ABOVE WITH A STYLIZED ACUTE.

THE ENGLISH TRANSLATION OF "SOULEVE" IN THE MARK IS RAISED.

SN 85-513,904, FILED 1-11-2012.

BRIDGETT SMITH, EXAMINING ATTORNEY



*David J. Kyros*

Director of the United States Patent and Trademark Office

# United States of America

United States Patent and Trademark Office

## VILLAGE ANTIQUES

**Reg. No. 4,277,075**

**Registered Jan. 15, 2013**

**Int. Cl.: 35**

**SERVICE MARK**

**PRINCIPAL REGISTER**

VILLAGE ANTIQUES LLC (TEXAS LIMITED LIABILITY COMPANY)  
1200 BLALOCK, SUITE#350  
HOUSTON, TX 77055

FOR: RETAIL AND ONLINE RETAIL STORE SERVICES FEATURING FURNITURE AND HOME FURNISHINGS, NONE OF WHICH CONSISTS OF VINYL WALL COVERINGS, WALLPAPER, DECORATOR FABRICS OR BEDSPREADS; PROVIDING AN ON-LINE COMMERCIAL INFORMATION DIRECTORY ON THE INTERNET, PROVIDING A ON-LINE SEARCHABLE DATABASE IN THE FIELD OF BUSINESS INFORMATION AVAILABLE VIA A GLOBAL COMPUTER NETWORK AND PROVIDING DISSEMINATION OF ADVERTISING FOR OTHERS VIA AN ON-LINE ELECTRONIC COMMUNICATIONS, NONE OF WHICH INCLUDES VINYL WALL COVERINGS, WALLPAPER, DECORATOR FABRICS OR BEDSPREADS, IN CLASS 35 (U.S. CLS. 100, 101 AND 102).

FIRST USE 7-14-2011; IN COMMERCE 7-14-2011.

THE MARK CONSISTS OF STANDARD CHARACTERS WITHOUT CLAIM TO ANY PARTICULAR FONT, STYLE, SIZE, OR COLOR.

NO CLAIM IS MADE TO THE EXCLUSIVE RIGHT TO USE "ANTIQUES", APART FROM THE MARK AS SHOWN.

SN 85-514,001, FILED 1-11-2012.

DARRYL SPRUILL, EXAMINING ATTORNEY



*David J. Kyffers*

Director of the United States Patent and Trademark Office



**United States of America**  
United States Patent and Trademark Office

# SYNRIBO

**Reg. No. 4,277,076**

IVAX INTERNATIONAL GMBH (SWITZERLAND GMBH)  
ALPENSTRASSE 2

**Registered Jan. 15, 2013**

RAPPERSWIL, SWITZERLAND 8640

**Int. Cl.: 5**

FOR: PHARMACEUTICAL PREPARATIONS FOR THE TREATMENT OF LEUKEMIA, DISPENSED IN LIQUID OR VIAL FORM FOR ADMINISTRATION BY SUBCUTANEOUS INJECTION, IN CLASS 5 (U.S. CLS. 6, 18, 44, 46, 51 AND 52).

**TRADEMARK**

FIRST USE 11-12-2012; IN COMMERCE 11-12-2012.

**PRINCIPAL REGISTER**

THE MARK CONSISTS OF STANDARD CHARACTERS WITHOUT CLAIM TO ANY PARTICULAR FONT, STYLE, SIZE, OR COLOR.

SN 85-514,017, FILED 1-11-2012.

KATHERINE E. HALMEN, EXAMINING ATTORNEY



*David J. Kyros*

Director of the United States Patent and Trademark Office

# United States of America

United States Patent and Trademark Office

# MODEWALK

**Reg. No. 4,277,077**

MODEWALK, INC. (DELAWARE CORPORATION)  
38 W. 5TH AVENUE  
SAN MATEO, CA 944022004

**Registered Jan. 15, 2013**

**Int. Cl.: 35**

FOR: ONLINE RETAIL STORE SERVICES FEATURING CLOTHING, SHOES, HANDBAGS, HATS, JEWELRY, SCARVES PURSES, AND FASHION ACCESSORIES, IN CLASS 35 (U.S. CLS. 100, 101 AND 102).

**SERVICE MARK**

FIRST USE 1-0-2012; IN COMMERCE 1-0-2012.

**PRINCIPAL REGISTER**

THE MARK CONSISTS OF STANDARD CHARACTERS WITHOUT CLAIM TO ANY PARTICULAR FONT, STYLE, SIZE, OR COLOR.

SN 85-514,159, FILED 1-11-2012.

MATTHEW MCDOWELL, EXAMINING ATTORNEY



*David J. Kybas*

Director of the United States Patent and Trademark Office

# United States of America

United States Patent and Trademark Office



**Reg. No. 4,277,078**

**Registered Jan. 15, 2013**

**Int. Cl.: 31**

**TRADEMARK**

**PRINCIPAL REGISTER**

GROWMARK, INC. (DELAWARE CORPORATION)  
1701 TOWANDA AVENUE  
BLOOMINGTON, IL 61701

FOR: AGRICULTURAL SEEDS, NAMELY, SOYBEAN SEEDS, IN CLASS 31 (U.S. CLS. 1 AND 46).

FIRST USE 6-0-2012; IN COMMERCE 6-0-2012.

NO CLAIM IS MADE TO THE EXCLUSIVE RIGHT TO USE "SOYBEANS" , APART FROM THE MARK AS SHOWN.

THE MARK CONSISTS OF THE WORDING "FS" WITHIN A QUADRILATERAL AND THE WORDING "HISOY SOYBEANS" WITH A STYLIZED SOYBEAN ABOVE THE LETTER "Y" IN "HISOY", A SHADED TRIANGLE TO THE LEFT OF "SOYBEANS" AND AN INCOMPLETE CIRCLE WHICH BEGINS AFTER THE LETTER "S" IN "SOYBEANS".

SN 85-514,339, FILED 1-11-2012.

MELISSA VALLILLO, EXAMINING ATTORNEY



*David J. Kybas*

Director of the United States Patent and Trademark Office

# United States of America

United States Patent and Trademark Office

## GEMS OF FORTUNE

**Reg. No. 4,277,079**

**Registered Jan. 15, 2013**

**Int. Cls.: 9 and 28**

**TRADEMARK**

**PRINCIPAL REGISTER**

CADILLAC JACK, INC. (GEORGIA CORPORATION)  
2450 SATELLITE BOULEVARD  
DULUTH, GA 30096

FOR: ELECTRONIC GAME SOFTWARE; GAMING SOFTWARE THAT GENERATES OR DISPLAYS WAGER OUTCOMES OF GAMING MACHINES, IN CLASS 9 (U.S. CLS. 21, 23, 26, 36 AND 38).

FIRST USE 10-9-2012; IN COMMERCE 10-9-2012.

FOR: RECONFIGURABLE CASINO AND LOTTERY GAMING EQUIPMENT, NAMELY, GAMING MACHINES AND OPERATIONAL COMPUTER GAME SOFTWARE THEREFOR SOLD AS A UNIT, IN CLASS 28 (U.S. CLS. 22, 23, 38 AND 50).

FIRST USE 10-9-2012; IN COMMERCE 10-9-2012.

THE MARK CONSISTS OF STANDARD CHARACTERS WITHOUT CLAIM TO ANY PARTICULAR FONT, STYLE, SIZE, OR COLOR.

SN 85-514,454, FILED 1-11-2012.

CIMMERIAN COLEMAN, EXAMINING ATTORNEY



*David J. Kyfos*

Director of the United States Patent and Trademark Office

# United States of America

United States Patent and Trademark Office

## EPSILON ALPHA KAPPA

**Reg. No. 4,277,080**

**Registered Jan. 15, 2013**

**Int. Cl.: 41**

**SERVICE MARK**

**PRINCIPAL REGISTER**

EASTERN AMERICAN STUDIES ASSOCIATION (PENNSYLVANIA UNINCORPORATED ASSOCIATION), DBA EASA,  
PENN STATE HARRISBURG  
777 WEST HARRISBURG PIKE  
MIDDLETOWN, PA 17057

FOR: PROVIDING AN ACADEMIC HONOR SOCIETY IN WHICH STUDENTS ARE ADMITTED IN RECOGNITION OF ACADEMIC ACHIEVEMENT, IN CLASS 41 (U.S. CLS. 100, 101 AND 107).

FIRST USE 3-31-2012; IN COMMERCE 3-31-2012.

THE MARK CONSISTS OF STANDARD CHARACTERS WITHOUT CLAIM TO ANY PARTICULAR FONT, STYLE, SIZE, OR COLOR.

SN 85-515,240, FILED 1-12-2012.

TRACY FLETCHER, EXAMINING ATTORNEY



*David J. Kyffers*

Director of the United States Patent and Trademark Office

# United States of America

United States Patent and Trademark Office

# AJUMAMA

**Reg. No. 4,277,081**

SONG MI LEE LLC (OHIO LIMITED LIABILITY COMPANY)  
1698 QUARRY TRACE DRIVE  
COLUMBUS, OH 43204

**Registered Jan. 15, 2013**

**Int. Cl.: 43**

FOR: PROVIDING OF FOOD AND DRINK VIA A MOBILE TRUCK; RESTAURANT SERVICES FEATURING KOREAN CUISINE, IN CLASS 43 (U.S. CLS. 100 AND 101).

**SERVICE MARK**

FIRST USE 1-1-2012; IN COMMERCE 10-22-2012.

**PRINCIPAL REGISTER**

THE MARK CONSISTS OF STANDARD CHARACTERS WITHOUT CLAIM TO ANY PARTICULAR FONT, STYLE, SIZE, OR COLOR.

THE WORDING "AJUMAMA" HAS NO MEANING IN A FOREIGN LANGUAGE.

SN 85-516,344, FILED 1-13-2012.

JORDAN BAKER, EXAMINING ATTORNEY



*David J. Kyffers*

Director of the United States Patent and Trademark Office

# United States of America

United States Patent and Trademark Office

# NukePak

**Reg. No. 4,277,082**

SHEFFIELD, WALTER T (UNITED STATES INDIVIDUAL)  
2321 COTTONWOOD DR  
NORMAN, OK 73071

**Registered Jan. 15, 2013**

**Int. Cl.: 9**

FOR: CARRYING CASES FOR COMPUTERS; CARRYING CASES FOR ELECTRONIC EQUIPMENT, NAMELY, LAPTOP COMPUTERS, TABLET COMPUTERS, NOTEBOOK COMPUTERS, E-BOOK READERS, MP3 PLAYERS, PORTABLE MEDIA PLAYERS, DIGITAL AUDIO PLAYERS, MOBILE PHONES, DIGITAL CAMERAS, POCKET VIDEO CAMERAS, EXTERNAL HARD DRIVES, ADAPTERS, CABLES, AND CHARGERS; ROLLING CASES ESPECIALLY ADAPTED FOR HOLDING LAPTOPS AND NOTEBOOK COMPUTERS; PROTECTIVE COVERS AND CASES FOR CELL PHONES AND LAPTOPS; BATTERIES AND BATTERY CHARGERS; BATTERY CASES; CAMERA HANDLES; CAMERA HOODS; CELL PHONE BATTERY CHARGERS; COMPUTER KEYBOARDS; MOBILE TELEPHONE BATTERIES, IN CLASS 9 (U.S. CLS. 21, 23, 26, 36 AND 38).

**TRADEMARK**

**PRINCIPAL REGISTER**

FIRST USE 9-13-2012; IN COMMERCE 9-13-2012.

THE MARK CONSISTS OF STANDARD CHARACTERS WITHOUT CLAIM TO ANY PARTICULAR FONT, STYLE, SIZE, OR COLOR.

SN 85-516,422, FILED 1-13-2012.

APRIL ROACH, EXAMINING ATTORNEY



*David J. Kyfos*

Director of the United States Patent and Trademark Office

# United States of America

United States Patent and Trademark Office



**Reg. No. 4,277,083**

ULTIMATE HIGHLIGHTS FILM AND REEL, LLC (TEXAS LIMITED LIABILITY COMPANY)  
1014 MAZOURKA DR.  
ARLINGTON, TX 76001

**Registered Jan. 15, 2013**

**Int. Cl.: 9**

FOR: AUDIO AND VIDEO RECORDINGS FEATURING STUDENT ATHLETES HIGHLIGHT FILMS, IN CLASS 9 (U.S. CLS. 21, 23, 26, 36 AND 38).

**TRADEMARK**

FIRST USE 6-27-2012; IN COMMERCE 3-27-2012.

**PRINCIPAL REGISTER**

NO CLAIM IS MADE TO THE EXCLUSIVE RIGHT TO USE "HIGHLIGHTS FILM & REEL, LLC", APART FROM THE MARK AS SHOWN.

THE MARK CONSISTS OF THE WORDING "ULTIMATE HIGHLIGHTS FILM & REEL, LLC" AND THE DESIGN OF TWO ARROWS WITH CURVED SHAFTS

SN 85-516,451, FILED 1-13-2012.

FRED CARL, EXAMINING ATTORNEY



*David J. Kybas*

Director of the United States Patent and Trademark Office



# United States of America

United States Patent and Trademark Office

## NEXT CHOICE ONE DOSE

**Reg. No. 4,277,084**

**Registered Jan. 15, 2013**

**Int. Cl.: 5**

**TRADEMARK**

**PRINCIPAL REGISTER**

WATSON PHARMACEUTICALS, INC. (NEW JERSEY CORPORATION)  
MORRIS CORPORATE CENTER III  
400 INTERPACE PARKWAY  
PARSIPPANY, NJ 07054

FOR: ORAL CONTRACEPTIVES; PHARMACEUTICAL PREPARATIONS FOR THE TREATMENT AND PREVENTION OF PREGNANCY, IN CLASS 5 (U.S. CLS. 6, 18, 44, 46, 51 AND 52).

FIRST USE 7-16-2012; IN COMMERCE 7-16-2012.

THE MARK CONSISTS OF STANDARD CHARACTERS WITHOUT CLAIM TO ANY PARTICULAR FONT, STYLE, SIZE, OR COLOR.

OWNER OF U.S. REG. NO. 3,680,666.

NO CLAIM IS MADE TO THE EXCLUSIVE RIGHT TO USE "ONE DOSE", APART FROM THE MARK AS SHOWN.

SN 85-516,936, FILED 1-15-2012.

PATRICIA EVANKO, EXAMINING ATTORNEY



*David J. Kybas*

Director of the United States Patent and Trademark Office

# United States of America

United States Patent and Trademark Office



**Reg. No. 4,277,085**

**Registered Jan. 15, 2013**

**Int. Cl.: 30**

**TRADEMARK**

**PRINCIPAL REGISTER**

GENERAL MILLS MARKETING, INC. (DELAWARE CORPORATION)  
NUMBER ONE GENERAL MILLS BOULEVARD  
MINNEAPOLIS, MN 55426

FOR: FLOUR, IN CLASS 30 (U.S. CL. 46).

FIRST USE 5-31-2012; IN COMMERCE 5-31-2012.

OWNER OF U.S. REG. NOS. 13,253, 573,406, AND 766,829.

NO CLAIM IS MADE TO THE EXCLUSIVE RIGHT TO USE "GUARANTEED PREMIUM QUALITY SINCE 1880", APART FROM THE MARK AS SHOWN.

THE MARK CONSISTS OF THE SHAPE OF A WREATH. THE WREATH CONSISTS OF SEPARATE IMAGES OF WHEAT, LINES OF A ROAD, A FENCE, A BARN, A SILO, A WINDMILL, A FLOUR BAG BRANDED "GOLD MEDAL", A WHISK, MEASURING SPOONS, A STYLIZED BOWL AND SPOON, TWO LOAVES OF BREAD, WITH CURVED LINES INTERSPERSED THROUGH THE WREATH DESIGN. AT THE BOTTOM OF THE WREATH IS A MEDALLION WITH THE WORDS "GUARANTEED PREMIUM QUALITY" AND A WHEAT DESIGN AROUND THE OUTER EDGE AND "SINCE 1880 GOLD MEDAL" IN THE CENTER OF THE MEDALLION. IN THE CENTER OF THE WREATH ARE THE WORDS "THE MEASURE OF QUALITY".

SN 85-517,707, FILED 1-17-2012.

JILL PRATER, EXAMINING ATTORNEY



*David J. Kyjars*

Director of the United States Patent and Trademark Office

# United States of America

United States Patent and Trademark Office

## BASIN GLOVE

**Reg. No. 4,277,086**

NISAB LLC (FLORIDA LIMITED LIABILITY COMPANY)  
17535 NW 7TH CT.

**Registered Jan. 15, 2013**

PEMBROKE PINES, FL 33029

**Int. Cl.: 16**

FOR: GARBAGE BAGS OF PLASTIC; GENERAL PURPOSE PLASTIC BAGS; PLASTIC OR PAPER BAGS FOR HOUSEHOLD USE; PLASTIC TRASH BAGS; RUBBISH BAGS MADE OF PAPER OR PLASTIC MATERIALS; TRASH CAN LINERS, IN CLASS 16 (U.S. CLS. 2, 5, 22, 23, 29, 37, 38 AND 50).

**TRADEMARK**

**PRINCIPAL REGISTER**

FIRST USE 5-1-2012; IN COMMERCE 5-1-2012.

THE MARK CONSISTS OF STANDARD CHARACTERS WITHOUT CLAIM TO ANY PARTICULAR FONT, STYLE, SIZE, OR COLOR.

SN 85-517,902, FILED 1-17-2012.

KEVIN CORWIN, EXAMINING ATTORNEY



*David J. Kybas*

Director of the United States Patent and Trademark Office

# United States of America

United States Patent and Trademark Office

# UROIMAGE

**Reg. No. 4,277,087**

**Registered Jan. 15, 2013**

**Int. Cl.: 9**

**TRADEMARK**

**PRINCIPAL REGISTER**

GLOBAL BIOMEDICAL TECHNOLOGIES, INC. (GBTI) (CALIFORNIA CORPORATION)  
208 OTTER GLEN COURT  
ROSEVILLE, CA 95661

FOR: COMPUTER PROGRAMS FOR USE IN MEDICAL IMAGE ANALYSIS, DIAGNOSIS, AND TREATMENT, NAMELY, SOFTWARE FOR PROCESSING DIGITAL IMAGES OF THE ANATOMY FOR ANALYSIS, DIAGNOSIS AND TREATMENT, AND SOFTWARE FOR PROCESSING DIGITAL IMAGES OF THE ANATOMY TO ADD ADDITIONAL VISUAL ELEMENTS TO THE DIGITAL IMAGES FOR ENHANCED ANALYSIS, DIAGNOSIS AND TREATMENT; COMPUTER SOFTWARE FOR CREATING SEARCHABLE MEDICAL DIAGNOSIS AND TREATMENT DATABASES, IN CLASS 9 (U.S. CLS. 21, 23, 26, 36 AND 38).

FIRST USE 1-17-2012; IN COMMERCE 9-30-2012.

THE MARK CONSISTS OF STANDARD CHARACTERS WITHOUT CLAIM TO ANY PARTICULAR FONT, STYLE, SIZE, OR COLOR.

SN 85-518,660, FILED 1-17-2012.

ANGELA DUONG, EXAMINING ATTORNEY



*David J. Kyjars*

Director of the United States Patent and Trademark Office

# United States of America

United States Patent and Trademark Office

# TIDY GIRL

**Reg. No. 4,277,088**

ENVISION, INC. (KANSAS NON-PROFIT CORPORATION)  
610 N. MAIN STREET  
WICHITA, KS 67203

**Registered Jan. 15, 2013**

**Int. Cl.: 16**

FOR: PLASTIC BAGS FOR DISPOSAL OF FEMININE HYGIENE PRODUCTS, IN CLASS 16  
(U.S. CLS. 2, 5, 22, 23, 29, 37, 38 AND 50).

**TRADEMARK**

FIRST USE 1-1-2012; IN COMMERCE 1-1-2012.

**PRINCIPAL REGISTER**

THE MARK CONSISTS OF STANDARD CHARACTERS WITHOUT CLAIM TO ANY PARTICULAR FONT, STYLE, SIZE, OR COLOR.

SN 85-518,782, FILED 1-18-2012.

ALICE BENMAMAN, EXAMINING ATTORNEY



*David J. Kyfos*

Director of the United States Patent and Trademark Office

# United States of America

United States Patent and Trademark Office

# RUKUS

**Reg. No. 4,277,089**

**Registered Jan. 15, 2013**

**Int. Cl.: 9**

**TRADEMARK**

**PRINCIPAL REGISTER**

ETÓN CORPORATION (CALIFORNIA CORPORATION)  
1015 CORPORATION WAY  
PALO ALTO, CA 943034305

FOR: PORTABLE AUDIO SPEAKERS COMPATIBLE WITH WIRELESS ENABLED DEVICES;  
PORTABLE AUDIO SPEAKERS COMPATIBLE WITH WIRELESS ENABLED DEVICES  
WITH BATTERY CHARGER FOR MOBILE DEVICE CHARGING; AND SOLAR POWERED,  
PORTABLE AUDIO SPEAKERS COMPATIBLE WITH WIRELESS ENABLED DEVICES  
WITH BATTERY CHARGER FOR MOBILE DEVICE CHARGING AND USB CONNECTION,  
IN CLASS 9 (U.S. CLS. 21, 23, 26, 36 AND 38).

FIRST USE 6-11-2011; IN COMMERCE 6-11-2011.

THE MARK CONSISTS OF STANDARD CHARACTERS WITHOUT CLAIM TO ANY PARTICULAR FONT, STYLE, SIZE, OR COLOR.

SN 85-519,267, FILED 1-18-2012.

NICHOLAS COLEMAN, EXAMINING ATTORNEY



*David J. Kyros*

Director of the United States Patent and Trademark Office

# United States of America

United States Patent and Trademark Office

# iTenkara

**Reg. No. 4,277,090**

**Registered Jan. 15, 2013**

**Int. Cl.: 25**

**TRADEMARK**

**PRINCIPAL REGISTER**

ELLSWORTH, JOHN C. (UNITED STATES INDIVIDUAL), DBA TENKARA SENSEI,  
40 W. CACHE VALLEY BLVD., SUITE 9A  
LOGAN, UT 84341

FOR: BASEBALL CAPS AND HATS; COLLARED SHIRTS; FISHING SHIRTS; GOLF SHIRTS;  
HATS; HOODED SWEAT SHIRTS; LONG-SLEEVED SHIRTS; POLO SHIRTS; SHIRTS;  
SHIRTS AND SHORT-SLEEVED SHIRTS; SHORT-SLEEVED OR LONG-SLEEVED T-SHIRTS;  
SHORT-SLEEVED SHIRTS; SPORT SHIRTS; SPORTS CAPS AND HATS; SPORTS SHIRTS;  
SPORTS SHIRTS WITH SHORT SLEEVES; SWEAT SHIRTS; T-SHIRTS; TEE SHIRTS, IN  
CLASS 25 (U.S. CLS. 22 AND 39).

FIRST USE 4-15-2011; IN COMMERCE 1-12-2012.

THE MARK CONSISTS OF STANDARD CHARACTERS WITHOUT CLAIM TO ANY PAR-  
TICULAR FONT, STYLE, SIZE, OR COLOR.

THE ENGLISH TRANSLATION OF "TENKARA" IN THE MARK IS "FROM HEAVEN".

SN 85-519,617, FILED 1-18-2012.

FONG HSU, EXAMINING ATTORNEY



*David J. Kyffers*

Director of the United States Patent and Trademark Office

# United States of America

United States Patent and Trademark Office

# Get it, Girl!

**Reg. No. 4,277,091**

**Registered Jan. 15, 2013**

**Int. Cl.: 5**

**TRADEMARK**

**PRINCIPAL REGISTER**

SURVIVOR SOLUTIONS (MONTANA LIMITED LIABILITY COMPANY)  
PO BOX 720  
101 MOUNTAIN VIEW  
ST. IGNATIUS, MT 59865

FOR: DIETARY AND NUTRITIONAL SUPPLEMENTS, IN CLASS 5 (U.S. CLS. 6, 18, 44, 46, 51 AND 52).

FIRST USE 4-20-2012; IN COMMERCE 4-20-2012.

THE MARK CONSISTS OF STANDARD CHARACTERS WITHOUT CLAIM TO ANY PARTICULAR FONT, STYLE, SIZE, OR COLOR.

SN 85-519,853, FILED 1-19-2012.

DOUGLAS LEE, EXAMINING ATTORNEY



*David J. Kyffers*

Director of the United States Patent and Trademark Office



# United States of America

United States Patent and Trademark Office

## CHELSEA BRIDE

**Reg. No. 4,277,092**

**Registered Jan. 15, 2013**

**Int. Cls.: 16, 21, and 26**

**TRADEMARK**

**PRINCIPAL REGISTER**

FUTURE PROMO, INC. (NEW YORK CORPORATION)  
SUITE 204  
174 5TH AVE.  
NEW YORK, NY 10010

FOR: GUEST BOOKS AND GUEST BOOK PENS; GIFT BAGS; GIFT BOXES; PHOTO ALBUMS; STATIONERY; PRINTED INVITATIONS; INVITATION CARDS; HOLDERS SPECIALLY ADAPTED FOR HOLDING GIFT CARDS, IN CLASS 16 (U.S. CLS. 2, 5, 22, 23, 29, 37, 38 AND 50).

FIRST USE 2-0-2012; IN COMMERCE 2-0-2012.

FOR: CANDLE HOLDERS; VASES; DECORATIVE GLASS GEMS AND MARBLES FOR FILLING VASES; HAIR COMBS; FLOWER BASKETS FOR USE BY FLOWER GIRLS; TABLE PLACE CARD HOLDERS NOT OF PRECIOUS METAL, IN CLASS 21 (U.S. CLS. 2, 13, 23, 29, 30, 33, 40 AND 50).

FIRST USE 2-0-2012; IN COMMERCE 2-0-2012.

FOR: ARTIFICIAL WEDDING FLOWER GARLANDS; ARTIFICIAL FLOWERS; ARTIFICIAL FLOWER BOUQUETS; FEATHERS FOR ORNAMENTATION; ARTIFICIAL FLOWER PETALS; RIBBONS; HAIR PINS; HAIR CLIPS; ORNAMENTAL BOWS OF TEXTILE FOR DECORATION, IN CLASS 26 (U.S. CLS. 37, 39, 40, 42 AND 50).

FIRST USE 2-0-2012; IN COMMERCE 2-0-2012.

THE MARK CONSISTS OF STANDARD CHARACTERS WITHOUT CLAIM TO ANY PARTICULAR FONT, STYLE, SIZE, OR COLOR.

SN 85-520,118, FILED 1-19-2012.

WILLIAM P. SHANAHAN, EXAMINING ATTORNEY



*David J. Kyros*

Director of the United States Patent and Trademark Office

# United States of America

United States Patent and Trademark Office



**Reg. No. 4,277,093**

**Registered Jan. 15, 2013**

**Int. Cls.: 14, 16, 20, 21,  
25, and 26**

**TRADEMARK**

**PRINCIPAL REGISTER**

FUTURE PROMO, INC. (NEW YORK CORPORATION)  
SUITE 204  
174 5TH AVE.  
NEW YORK, NY 10010

FOR: TIARAS, IN CLASS 14 (U.S. CLS. 2, 27, 28 AND 50).

FIRST USE 2-0-2012; IN COMMERCE 2-0-2012.

FOR: GUEST BOOKS AND GUEST BOOK PENS; GIFT BAGS; GIFT BOXES; PHOTO ALBUMS; STATIONERY; PRINTED INVITATIONS; INVITATION CARDS; HOLDERS SPECIALLY ADAPTED FOR HOLDING GIFT CARDS, IN CLASS 16 (U.S. CLS. 2, 5, 22, 23, 29, 37, 38 AND 50).

FIRST USE 2-0-2012; IN COMMERCE 2-0-2012.

FOR: PHOTOGRAPH FRAMES; RING BEARER'S PILLOWS, IN CLASS 20 (U.S. CLS. 2, 13, 22, 25, 32 AND 50).

FIRST USE 2-0-2012; IN COMMERCE 2-0-2012.

FOR: CANDLE HOLDERS; VASES; DECORATIVE GLASS GEMS AND MARBLES FOR FILLING VASES; HAIR COMBS; FLOWER BASKETS FOR USE BY FLOWER GIRLS; TABLE PLACE CARD HOLDERS NOT OF PRECIOUS METAL, IN CLASS 21 (U.S. CLS. 2, 13, 23, 29, 30, 33, 40 AND 50).

FIRST USE 2-0-2012; IN COMMERCE 2-0-2012.

FOR: GARTERS; GLOVES; SLIPPERS; VEILS; STOLES, IN CLASS 25 (U.S. CLS. 22 AND 39).

FIRST USE 2-0-2012; IN COMMERCE 2-0-2012.

FOR: ARTIFICIAL WEDDING FLOWER GARLANDS; ARTIFICIAL FLOWERS; ARTIFICIAL FLOWER BOUQUETS; FEATHERS FOR ORNAMENTATION; ARTIFICIAL FLOWER PETALS; RIBBONS; HAIR PINS; HAIR CLIPS; ORNAMENTAL BOWS OF TEXTILE FOR DECORATION, IN CLASS 26 (U.S. CLS. 37, 39, 40, 42 AND 50).



*David J. Kybas*

Director of the United States Patent and Trademark Office

**Reg. No. 4,277,093** FIRST USE 2-0-2012; IN COMMERCE 2-0-2012.

OWNER OF U.S. REG. NO. 3,915,696.

THE MARK CONSISTS OF A STYLIZED OUTLINE OF A HOUSE WITH A DIAMOND RING IN THE HOUSE AND THE OUTLINE OF A FLOWER EXTENDING FROM THE ROOFTOP OF THE HOUSE.

SN 85-520,132, FILED 1-19-2012.

WILLIAM P. SHANAHAN, EXAMINING ATTORNEY

# United States of America

United States Patent and Trademark Office

FIRM PRO

**Reg. No. 4,277,094**

THE MEDICAL PROTECTIVE COMPANY (INDIANA CORPORATION)  
5814 REED ROAD

**Registered Jan. 15, 2013**

FORT WAYNE, IN 468353568

**Int. Cl.: 36**

FOR: INSURANCE SERVICES, NAMELY, UNDERWRITING, ISSUING AND ADMINISTRATION OF INSURANCE, NAMELY, PROFESSIONAL, MANAGEMENT, AND EMPLOYER LIABILITY INSURANCE, IN CLASS 36 (U.S. CLS. 100, 101 AND 102).

**SERVICE MARK**

FIRST USE 4-25-2012; IN COMMERCE 4-25-2012.

**PRINCIPAL REGISTER**

THE MARK CONSISTS OF THE LITERAL ELEMENT "FIRMPRO" WITH THE FANCIFUL DESIGN OF A GAVEL APPEARING ABOVE THE LETTERS "PRO".

SN 85-520,259, FILED 1-19-2012.

JASON BLAIR, EXAMINING ATTORNEY



*David J. Kybas*

Director of the United States Patent and Trademark Office

United States of America  
United States Patent and Trademark Office

# STERCID

**Reg. No. 4,277,095**

STERIMED MEDICAL WASTE SOLUTIONS, INC. (DELAWARE CORPORATION)  
23065 COMMERCE DR.

**Registered Jan. 15, 2013**

FARMINGTON HILLS, MI 48335

**Int. Cl.: 5**

FOR: DISINFECTANTS FOR MEDICAL WASTE, IN CLASS 5 (U.S. CLS. 6, 18, 44, 46, 51 AND 52).

**TRADEMARK**

FIRST USE 4-11-2012; IN COMMERCE 4-11-2012.

**PRINCIPAL REGISTER**

THE MARK CONSISTS OF STANDARD CHARACTERS WITHOUT CLAIM TO ANY PARTICULAR FONT, STYLE, SIZE, OR COLOR.

SN 85-520,310, FILED 1-19-2012.

WILLIAM BRECKENFELD, EXAMINING ATTORNEY



*David J. Kybas*

Director of the United States Patent and Trademark Office

# United States of America

United States Patent and Trademark Office

## COE F DEXTER

**Reg. No. 4,277,096**

KENDEX, LLC (CALIFORNIA LIMITED LIABILITY COMPANY)  
19311 APPLE VALLEY ROAD  
SONOMA, CA 95476

**Registered Jan. 15, 2013**

**Int. Cl.: 33**

FOR: WINE, IN CLASS 33 (U.S. CLS. 47 AND 49).

**TRADEMARK**

FIRST USE 11-13-2012; IN COMMERCE 11-13-2012.

**PRINCIPAL REGISTER**

THE MARK CONSISTS OF STANDARD CHARACTERS WITHOUT CLAIM TO ANY PARTICULAR FONT, STYLE, SIZE, OR COLOR.

THE NAME "COE F DEXTER" SHOWN IN THE MARK DOES NOT IDENTIFY A LIVING INDIVIDUAL.

SN 85-520,529, FILED 1-19-2012.

NAAKWAMA ANKRAH, EXAMINING ATTORNEY



*David J. Kyffers*

Director of the United States Patent and Trademark Office

# United States of America

United States Patent and Trademark Office

# BABU

**Reg. No. 4,277,097**

**Registered Jan. 15, 2013**

**Int. Cl.: 9**

**TRADEMARK**

**PRINCIPAL REGISTER**

CASTLE JR., WILLIAM D. (UNITED STATES INDIVIDUAL)  
156 W NEWELL AVE.  
RUTHERFORD, NJ 07070

FOR: COMPUTER SOFTWARE FOR ACCOUNTING AND BILLING UTILITY, USED FOR DATA AUDITING AND QUICK REPORTS ASSEMBLY WITH MOST DATABASE/SPREAD-SHEET FILE FORMATS ON COMPUTERS, IN CLASS 9 (U.S. CLS. 21, 23, 26, 36 AND 38).

FIRST USE 3-2-2012; IN COMMERCE 7-12-2012.

THE MARK CONSISTS OF STANDARD CHARACTERS WITHOUT CLAIM TO ANY PARTICULAR FONT, STYLE, SIZE, OR COLOR.

SN 85-521,474, FILED 1-20-2012.

LINDA POWELL, EXAMINING ATTORNEY



*David J. Kybas*

Director of the United States Patent and Trademark Office

# United States of America

United States Patent and Trademark Office



**Reg. No. 4,277,098**

**Registered Jan. 15, 2013**

**Int. Cls.: 25 and 28**

**TRADEMARK**

**PRINCIPAL REGISTER**

LIEBERMAN, JAMIE (UNITED STATES INDIVIDUAL)  
APT C  
2140 LAKE GLEN COURT  
CENTERVILLE, OH 45459

FOR: ATHLETIC APPAREL, NAMELY, SHIRTS, PANTS, JACKETS, FOOTWEAR, HATS  
AND CAPS, ATHLETIC UNIFORMS, IN CLASS 25 (U.S. CLS. 22 AND 39).

FIRST USE 4-1-2011; IN COMMERCE 4-1-2011.

FOR: GOALKEEPERS' GLOVES, IN CLASS 28 (U.S. CLS. 22, 23, 38 AND 50).

FIRST USE 4-1-2011; IN COMMERCE 4-1-2011.

THE MARK CONSISTS OF THE STYLIZED TEXT "JL" SURROUNDED BY THREE TRI-  
ANGLES. BELOW IS THE STYLIZED TEXT "PEGLIYL".

SN 85-522,408, FILED 1-23-2012.

MIDGE BUTLER, EXAMINING ATTORNEY



*David J. Kybas*

Director of the United States Patent and Trademark Office



# United States of America

United States Patent and Trademark Office

## GIVE THE GIFT OF CARE

**Reg. No. 4,277,099**

**Registered Jan. 15, 2013**

**Int. Cls.: 44 and 45**

**SERVICE MARK**

**PRINCIPAL REGISTER**

RIGHT AT HOME, INC. (NEBRASKA CORPORATION)  
SUITE 150  
OMAHA, NE 68106

FOR: HEALTH CARE SERVICES, NAMELY, HOME HEALTH CARE SERVICES IN THE NATURE OF PROVIDING ASSISTANCE WITH GENERAL MEDICAL CARE, IN CLASS 44 (U.S. CLS. 100 AND 101).

FIRST USE 4-12-2012; IN COMMERCE 4-12-2012.

FOR: PROVIDING NON-MEDICAL PERSONAL CARE ASSISTANCE WITH ACTIVITIES OF DAILY LIVING, NAMELY, MEAL PREPARATION, MEDICATION REMINDERS, LIGHT EXERCISE ASSISTANCE, CLOTHING AND BATHING ASSISTANCE, AND CLEANING ASSISTANCE, IN CLASS 45 (U.S. CLS. 100 AND 101).

FIRST USE 4-12-2012; IN COMMERCE 4-12-2012.

THE MARK CONSISTS OF STANDARD CHARACTERS WITHOUT CLAIM TO ANY PARTICULAR FONT, STYLE, SIZE, OR COLOR.

SN 85-522,514, FILED 1-23-2012.

JOSETTE BEVERLY, EXAMINING ATTORNEY



*David J. Kybas*

Director of the United States Patent and Trademark Office

# United States of America

United States Patent and Trademark Office



**Reg. No. 4,277,100**

**Registered Jan. 15, 2013**

**Int. Cl.: 45**

**SERVICE MARK**

**PRINCIPAL REGISTER**

SAFE AND SECURE HOME CARE, LLC (FLORIDA LIMITED LIABILITY COMPANY)  
2468 U.S. HWY. 441/27, SUITE 501  
FRUITLAND PARK, FL 34731

FOR: PROVIDING IN-HOME SUPPORT SERVICES TO SENIOR PERSONS, NAMELY, GERIATRIC MANAGEMENT SERVICES IN THE NATURE OF THE COORDINATION OF NECESSARY SERVICES AND PERSONAL CARE FOR OLDER INDIVIDUALS, IN CLASS 45 (U.S. CLS. 100 AND 101).

FIRST USE 3-23-2012; IN COMMERCE 3-23-2012.

NO CLAIM IS MADE TO THE EXCLUSIVE RIGHT TO USE "SAFE & SECURE HOME CARE", APART FROM THE MARK AS SHOWN.

THE MARK CONSISTS OF THE WORDS "SAFE & SECURE HOME CARE" BENEATH THE DESIGN OF A HOUSE WITH A HEART SHAPE BEHIND THE HOUSE AND A CURVED LINE RESEMBLING A HILL IN FRONT OF THE HOUSE.

SN 85-522,653, FILED 1-23-2012.

TINA L. SNAPP, EXAMINING ATTORNEY



*David J. Kyjars*

Director of the United States Patent and Trademark Office

# United States of America

United States Patent and Trademark Office

# ComforPedic

**Reg. No. 4,277,101**

**Registered Jan. 15, 2013**

**Int. Cl.: 20**

**TRADEMARK**

**PRINCIPAL REGISTER**

DREAMWELL, LTD. (NEVADA LIMITED LIABILITY COMPANY)  
SUITE 12  
2215-B RENAISSANCE DRIVE  
LAS VEGAS, NV 89119

FOR: MATTRESSES, BOX SPRINGS, MATTRESS FOUNDATIONS AND PILLOWS, IN CLASS  
20 (U.S. CLS. 2, 13, 22, 25, 32 AND 50).

FIRST USE 1-0-2012; IN COMMERCE 1-0-2012.

OWNER OF U.S. REG. NOS. 841,640, 3,189,821, AND 3,986,150.

THE MARK CONSISTS OF THE WORD "COMFORPEDIC" IN A STYLIZED FONT.

SN 85-522,784, FILED 1-23-2012.

NICHOLAS COLEMAN, EXAMINING ATTORNEY



*David J. Kyffers*

Director of the United States Patent and Trademark Office

# United States of America

United States Patent and Trademark Office

# XNY

**Reg. No. 4,277,102**

**Registered Jan. 15, 2013**

**Int. Cl.: 14**

**TRADEMARK**

**PRINCIPAL REGISTER**

SEIKO WATCH KABUSHIKI KAISHA (JAPAN CORPORATION), TA SEIKO WATCH CORPORATION,  
5-11, GINZA 4-CHOME, CHUO-KU  
TOKYO, JAPAN

FOR: WATCHES, IN CLASS 14 (U.S. CLS. 2, 27, 28 AND 50).

FIRST USE 10-26-2012; IN COMMERCE 10-26-2012.

THE MARK CONSISTS OF STANDARD CHARACTERS WITHOUT CLAIM TO ANY PARTICULAR FONT, STYLE, SIZE, OR COLOR.

SN 85-522,916, FILED 1-23-2012.

RON FAIRBANKS, EXAMINING ATTORNEY



*David J. Kybas*

Director of the United States Patent and Trademark Office

# United States of America

United States Patent and Trademark Office



**Respiratory Care  
Connection**

**Reg. No. 4,277,103**

**Registered Jan. 15, 2013**

**Int. Cl.: 16**

**TRADEMARK**

**PRINCIPAL REGISTER**

GLAXO GROUP LIMITED (UNITED KINGDOM CORPORATION)  
GLAXO WELLCOME HOUSE  
BERKELEY AVENUE  
GREENFORD, MIDDLESEX, UNITED KINGDOM UB60NN

FOR: PRINTED MATERIALS, NAMELY, BROCHURES, PAMPHLETS, LEAFLETS AND BOOKLETS FEATURING HEALTH INFORMATION ABOUT RESPIRATORY DISEASE, IN CLASS 16 (U.S. CLS. 2, 5, 22, 23, 29, 37, 38 AND 50).

FIRST USE 2-28-2011; IN COMMERCE 2-28-2011.

NO CLAIM IS MADE TO THE EXCLUSIVE RIGHT TO USE "RESPIRATORY CARE", APART FROM THE MARK AS SHOWN.

THE MARK CONSISTS OF THE WORDS "RESPIRATORY CARE" AND UNDERNEATH OF THESE WORDS IS THE WORD "CONNECTION". TO THE LEFT OF THE WORDS "RESPIRATORY CARE CONNECTION" IS A CIRCLE WITH TWO CURVED TRIANGLES WITH BRANCH-LIKE FIGURES IN THE MIDDLE FORMING AN IMAGE OF TWO LUNGS.

SN 85-523,159, FILED 1-23-2012.

ELISSA GARBER KON, EXAMINING ATTORNEY



*David J. Kyffers*

Director of the United States Patent and Trademark Office

# United States of America

United States Patent and Trademark Office

## Total Information Governance

**Reg. No. 4,277,104**

**Registered Jan. 15, 2013**

**Int. Cl.: 9**

**TRADEMARK**

**PRINCIPAL REGISTER**

ZL TECHNOLOGIES INC. (CALIFORNIA CORPORATION)  
C/O ELLE BYRAM  
2000 CONCOURSE DRIVE  
SAN JOSE, CA 95131

FOR: COMPUTER SOFTWARE FOR THE COLLECTION, EDITING, ORGANIZING, MODIFYING, BOOK MARKING, TRANSMISSION, STORAGE AND SHARING OF DATA AND INFORMATION; COMPUTER SOFTWARE FOR ARCHIVING, EDISCOVERY, COMPLIANCE AND RECORDS MANAGEMENT, IN CLASS 9 (U.S. CLS. 21, 23, 26, 36 AND 38).

FIRST USE 11-16-2012; IN COMMERCE 11-16-2012.

THE MARK CONSISTS OF STANDARD CHARACTERS WITHOUT CLAIM TO ANY PARTICULAR FONT, STYLE, SIZE, OR COLOR.

NO CLAIM IS MADE TO THE EXCLUSIVE RIGHT TO USE "INFORMATION GOVERNANCE", APART FROM THE MARK AS SHOWN.

SN 85-523,811, FILED 1-24-2012.

TARAH HARDY, EXAMINING ATTORNEY



*David J. Kyros*

Director of the United States Patent and Trademark Office

# United States of America

United States Patent and Trademark Office

## CARNIVAL OF VENICE

**Reg. No. 4,277,105**

CADILLAC JACK, INC. (GEORGIA CORPORATION)  
2450 SATELLITE BOULEVARD  
DULUTH, GA 30096

**Registered Jan. 15, 2013**

**Int. Cl.: 28**

FOR: GAMING DEVICES, NAMELY, GAMING MACHINES, SLOT MACHINES, BINGO MACHINES, WITH OR WITHOUT VIDEO OUTPUT; RECONFIGURABLE CASINO AND LOTTERY GAMING EQUIPMENT, NAMELY, GAMING MACHINES AND OPERATIONAL COMPUTER GAME SOFTWARE THEREFOR SOLD AS A UNIT, IN CLASS 28 (U.S. CLS. 22, 23, 38 AND 50).

**TRADEMARK**

**PRINCIPAL REGISTER**

FIRST USE 8-7-2012; IN COMMERCE 8-7-2012.

THE MARK CONSISTS OF STANDARD CHARACTERS WITHOUT CLAIM TO ANY PARTICULAR FONT, STYLE, SIZE, OR COLOR.

SN 85-524,392, FILED 1-24-2012.

CIMMERIAN COLEMAN, EXAMINING ATTORNEY



*David J. Kyffers*

Director of the United States Patent and Trademark Office

# United States of America

United States Patent and Trademark Office

## RENERGIE LIFT MULTI-ACTION

**Reg. No. 4,277,106**

**Registered Jan. 15, 2013**

**Int. Cl.: 3**

**TRADEMARK**

**PRINCIPAL REGISTER**

LANCOME PARFUMS ET BEAUTE & CIE (FRANCE SOCIÉTÉ EN NOM COLLECTIF (SENC))  
29 RUE DU FAUBOURG SAINT-HONORE  
PARIS, FRANCE 75008

FOR: COSMETICS, NAMELY, CREAMS FOR THE FACE, IN CLASS 3 (U.S. CLS. 1, 4, 6, 50,  
51 AND 52).

FIRST USE 8-1-2012; IN COMMERCE 8-1-2012.

OWNER OF U.S. REG. NOS. 1,739,355, 3,495,138, AND 3,834,171.

THE MARK CONSISTS OF "RENERGIE LIFT MULTI-ACTION" IN STYLIZED FORM.

SN 85-524,878, FILED 1-25-2012.

JORDAN BAKER, EXAMINING ATTORNEY



*David J. Kybas*

Director of the United States Patent and Trademark Office



# United States of America

United States Patent and Trademark Office

## OPERATION: JUST LIKE HOME

**Reg. No. 4,277,107**

RENT-A-CENTER TEXAS, L.P. (TEXAS LIMITED PARTNERSHIP)  
5501 HEADQUARTERS DRIVE  
PLANO, TX 75024

**Registered Jan. 15, 2013**

**Int. Cls.: 41 and 43**

FOR: CHARITABLE SERVICES, NAMELY, PROVIDING TELEVISIONS TO THE MILITARY, IN CLASS 41 (U.S. CLS. 100, 101 AND 107).

**SERVICE MARK**

FIRST USE 10-0-2012; IN COMMERCE 10-0-2012.

**PRINCIPAL REGISTER**

FOR: CHARITABLE SERVICES, NAMELY, PROVIDING FURNITURE AND HOME FURNISHINGS TO THE MILITARY, IN CLASS 43 (U.S. CLS. 100 AND 101).

FIRST USE 10-0-2012; IN COMMERCE 10-0-2012.

THE MARK CONSISTS OF STANDARD CHARACTERS WITHOUT CLAIM TO ANY PARTICULAR FONT, STYLE, SIZE, OR COLOR.

SN 85-525,159, FILED 1-25-2012.

ANDREA HACK, EXAMINING ATTORNEY



*David J. Kybas*

Director of the United States Patent and Trademark Office

# United States of America

United States Patent and Trademark Office



**Reg. No. 4,277,108**

SIX DIMENSIONS, INC. (FLORIDA CORPORATION)  
213 GOLF CART DRIVE  
MAYFIELD, KY 42066

**Registered Jan. 15, 2013**

**Int. Cl.: 5**

FOR: DIETARY BEVERAGE SUPPLEMENTS FOR HUMAN CONSUMPTION IN LIQUID AND DRY MIX FORM FOR THERAPEUTIC PURPOSES, ALL OF THE FOREGOING CONTAINING COFFEE OR COFFEE EXTRACTS, IN CLASS 5 (U.S. CLS. 6, 18, 44, 46, 51 AND 52).

**TRADEMARK**

**PRINCIPAL REGISTER**

FIRST USE 6-6-2010; IN COMMERCE 7-7-2011.

NO CLAIM IS MADE TO THE EXCLUSIVE RIGHT TO USE "COFFEE ANTI-AGING BLENDS", APART FROM THE MARK AS SHOWN.

THE MARK CONSISTS OF THE STYLIZED WORDING "M.D. COFFEE ANTI-AGING BLENDS" STACKED ON TOP OF EACH OTHER WITH THE LETTER "M" IN "M.D." FORMING A STYLIZED MUG WITH A HANDLE ON THE LEFT AND STEAM EMANATING FROM THE TOP.

SN 85-525,780, FILED 1-26-2012.

AMY KERTGATE, EXAMINING ATTORNEY



*David J. Kyros*

Director of the United States Patent and Trademark Office

# United States of America

United States Patent and Trademark Office

# PINUKI

**Reg. No. 4,277,109**

**Registered Jan. 15, 2013**

**Int. Cl.: 30**

**TRADEMARK**

**PRINCIPAL REGISTER**

KENOVER MARKETING CORP. (NEW YORK CORPORATION)  
9 TWENTY-NINTH STREET  
BROOKLYN, NY 11232

FOR: CANDIES; CHOCOLATE CONFECTIONS, IN CLASS 30 (U.S. CL. 46).

FIRST USE 7-25-2012; IN COMMERCE 7-25-2012.

THE MARK CONSISTS OF STANDARD CHARACTERS WITHOUT CLAIM TO ANY PARTICULAR FONT, STYLE, SIZE, OR COLOR.

THE WORDING "PINUKI" HAS NO MEANING IN A FOREIGN LANGUAGE.

SN 85-526,762, FILED 1-27-2012.

MARGARET POWER, EXAMINING ATTORNEY



*David J. Kyros*

Director of the United States Patent and Trademark Office

# United States of America

United States Patent and Trademark Office



**Reg. No. 4,277,110**

**Registered Jan. 15, 2013**

**Int. Cl.: 42**

**SERVICE MARK**

**PRINCIPAL REGISTER**

INVERT LOGISTICS, LLC (NORTH CAROLINA LIMITED LIABILITY COMPANY)  
1852 PORTERTOWN RD.  
GREENVILLE, NC 27858

FOR: PROVIDING NON-DOWNLOADABLE WEB-BASED SOFTWARE THAT ALLOWS USERS TO CREATE A PUBLICLY DISPLAYED WISH LIST OF PRODUCTS OR SERVICES THEY INTEND TO PURCHASE, IN CLASS 42 (U.S. CLS. 100 AND 101).

FIRST USE 8-26-2011; IN COMMERCE 9-1-2011.

THE STIPLING IS FOR SHADING PURPOSES ONLY.

THE MARK CONSISTS OF THE STYLIZED TEXT "GIFTBOX" IN WHICH THE LETTERS "G" AND "B" ARE CAPITALIZED. THE LETTER "T" HAS A BOW AROUND IT AND THE LETTER "O" SITS INSIDE A BOX COVERED WITH STARS. THERE ARE STARS AROUND THE BASE OF THE BOX AND RIBBONS ABOVE IT.

SN 85-528,254, FILED 1-30-2012.

DANNEAN HETZEL, EXAMINING ATTORNEY



*David J. Kybas*

Director of the United States Patent and Trademark Office

# United States of America

United States Patent and Trademark Office

The logo for TherapMedic features a stylized orange outline of a female figure on the left, followed by a period and the word "TherapMedic" in a rounded, outlined font. The entire logo is rendered in orange with a white fill.

**Reg. No. 4,277,111**

**Registered Jan. 15, 2013**

**Int. Cl.: 10**

**TRADEMARK**

**PRINCIPAL REGISTER**

THERAPMEDIC, LLC (FLORIDA LIMITED LIABILITY COMPANY), DBA THERAPMEDIC,  
SUITE 300  
1000 5TH STREET  
MIAMI BEACH, FL 33139

FOR: LASERS FOR THE COSMETIC TREATMENT OF THE FACE AND SKIN, IN CLASS  
10 (U.S. CLS. 26, 39 AND 44).

FIRST USE 6-9-2011; IN COMMERCE 6-9-2011.

THE MARK CONSISTS OF THE OUTLINED WORD "THERAPMEDIC" WITH A DESIGN  
OF A FEMALE FIGURE TO THE LEFT. THE COLOR ORANGE APPEARS IN THE DESIGN  
AND THE OUTLINE OF THE LETTERS OF THE TEXT, AND THE COLOR WHITE APPEARS  
IN THE TEXT.

THE COLOR(S) ORANGE, WHITE IS/ARE CLAIMED AS A FEATURE OF THE MARK.

SN 85-528,522, FILED 1-30-2012.

CARYN GLASSER, EXAMINING ATTORNEY



*David J. Kyros*

Director of the United States Patent and Trademark Office

# United States of America

United States Patent and Trademark Office

# ILLUMI-JET

**Reg. No. 4,277,112**

JET, INC. (OHIO CORPORATION)  
750 ALPHA DRIVE  
CLEVELAND, OH 44143

**Registered Jan. 15, 2013**

**Int. Cl.: 11**

FOR: WASTEWATER TREATMENT EQUIPMENT, NAMELY, ULTRAVIOLET DISINFECTION UNITS, IN CLASS 11 (U.S. CLS. 13, 21, 23, 31 AND 34).

**TRADEMARK**

FIRST USE 9-12-2012; IN COMMERCE 9-12-2012.

**PRINCIPAL REGISTER**

THE MARK CONSISTS OF STANDARD CHARACTERS WITHOUT CLAIM TO ANY PARTICULAR FONT, STYLE, SIZE, OR COLOR.

SN 85-528,635, FILED 1-30-2012.

ESTHER BELENKER, EXAMINING ATTORNEY



*David J. Kybas*

Director of the United States Patent and Trademark Office

# United States of America

United States Patent and Trademark Office

## ILLUMI-JET UV DISINFECTION UNIT

**Reg. No. 4,277,113**

JET, INC. (OHIO CORPORATION)  
750 ALPHA DRIVE  
CLEVELAND, OH 44143

**Registered Jan. 15, 2013**

**Int. Cl.: 11**

FOR: WASTEWATER TREATMENT EQUIPMENT, NAMELY, ULTRAVIOLET DISINFECTION UNITS, IN CLASS 11 (U.S. CLS. 13, 21, 23, 31 AND 34).

**TRADEMARK**

FIRST USE 10-8-2012; IN COMMERCE 10-8-2012.

**PRINCIPAL REGISTER**

THE MARK CONSISTS OF STANDARD CHARACTERS WITHOUT CLAIM TO ANY PARTICULAR FONT, STYLE, SIZE, OR COLOR.

NO CLAIM IS MADE TO THE EXCLUSIVE RIGHT TO USE "UV DISINFECTION UNIT", APART FROM THE MARK AS SHOWN.

SN 85-528,646, FILED 1-30-2012.

ESTHER BELENKER, EXAMINING ATTORNEY



*David J. Kybas*

Director of the United States Patent and Trademark Office

# United States of America

United States Patent and Trademark Office

## LEARNINGSPHERE

**Reg. No. 4,277,114**

**Registered Jan. 15, 2013**

**Int. Cls.: 41 and 42**

**SERVICE MARK**

**PRINCIPAL REGISTER**

KAPLAN, INC. (DELAWARE CORPORATION)  
395 HUDSON STREET  
NEW YORK, NY 10014

FOR: EDUCATIONAL SERVICES, NAMELY, PROVIDING ON-LINE COURSES OF INSTRUCTION AT THE UNDERGRADUATE, GRADUATE AND POST-GRADUATE LEVELS, IN CLASS 41 (U.S. CLS. 100, 101 AND 107).

FIRST USE 11-0-2011; IN COMMERCE 11-0-2011.

FOR: COMPUTER SERVICES, NAMELY, HOSTING AN INTERACTIVE WEB SITE THAT ALLOWS ADMINISTRATORS AND EDUCATORS TO CONDUCT COURSES OF INSTRUCTION, AND MANAGE STUDENT INFORMATION, ALL AT THE UNDERGRADUATE, GRADUATE AND POST-GRADUATE LEVELS, IN CLASS 42 (U.S. CLS. 100 AND 101).

FIRST USE 11-0-2011; IN COMMERCE 11-0-2011.

THE MARK CONSISTS OF STANDARD CHARACTERS WITHOUT CLAIM TO ANY PARTICULAR FONT, STYLE, SIZE, OR COLOR.

SN 85-529,789, FILED 1-31-2012.

IRA J. GOODSaid, EXAMINING ATTORNEY



*David J. Kypos*

Director of the United States Patent and Trademark Office



# United States of America

United States Patent and Trademark Office

# GAIN

**Reg. No. 4,277,115**

U.S. VENTURE, INC. (WISCONSIN CORPORATION)  
425 BETTER WAY  
APPLETON, WI 54915

**Registered Jan. 15, 2013**

**Int. Cls.: 4, 35, and 37**

FOR: COMPRESSED NATURAL GAS, IN CLASS 4 (U.S. CLS. 1, 6 AND 15).

FIRST USE 3-1-2012; IN COMMERCE 3-1-2012.

**TRADEMARK**

FOR: BUSINESS AND MARKETING CONSULTATION SERVICES IN THE FIELD OF COMPRESSED NATURAL GAS, IN CLASS 35 (U.S. CLS. 100, 101 AND 102).

**SERVICE MARK**

**PRINCIPAL REGISTER**

FIRST USE 3-1-2012; IN COMMERCE 3-1-2012.

FOR: VEHICLE FUELING SERVICES, NAMELY, COMPRESSED NATURAL GAS FUELING STATION SERVICES, IN CLASS 37 (U.S. CLS. 100, 103 AND 106).

FIRST USE 3-1-2012; IN COMMERCE 3-1-2012.

THE MARK CONSISTS OF STANDARD CHARACTERS WITHOUT CLAIM TO ANY PARTICULAR FONT, STYLE, SIZE, OR COLOR.

SN 85-530,179, FILED 1-31-2012.

DOMINIC FATHY, EXAMINING ATTORNEY



*David J. Kyffers*

Director of the United States Patent and Trademark Office

# United States of America

United States Patent and Trademark Office

# PROSYON

**Reg. No. 4,277,116**

THE PROSYON GROUP LLC (WYOMING LIMITED LIABILITY COMPANY)  
244 FIFTH AVENUE, #200  
NEW YORK, NY 10001

**Registered Jan. 15, 2013**

**Int. Cl.: 36**

FOR: FINANCIAL CONSULTATION IN THE FIELD OF PRIVATE EQUITY SERVICES, IN CLASS 36 (U.S. CLS. 100, 101 AND 102).

**SERVICE MARK**

FIRST USE 11-0-2011; IN COMMERCE 10-0-2012.

**PRINCIPAL REGISTER**

THE MARK CONSISTS OF STANDARD CHARACTERS WITHOUT CLAIM TO ANY PARTICULAR FONT, STYLE, SIZE, OR COLOR.

SN 85-530,243, FILED 1-31-2012.

JUSTINE D. PARKER, EXAMINING ATTORNEY



*David J. Kyffers*

Director of the United States Patent and Trademark Office

# United States of America

United States Patent and Trademark Office

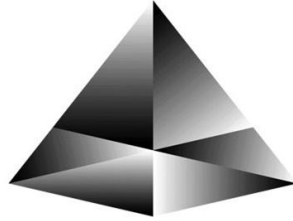

## SANDS CAPITAL

**Reg. No. 4,277,117**

SANDS CAPITAL MANAGEMENT, LP (DELAWARE LIMITED PARTNERSHIP)  
1101 WILSON BLVD, SUITE 2300  
ARLINGTON, VA 22209

**Registered Jan. 15, 2013**

**Int. Cl.: 36**

FOR: INVESTMENT SERVICES, NAMELY, MANAGEMENT OF PORTFOLIOS COMPOSED OF EQUITY SECURITIES, INCLUDING EQUITY SECURITIES OF U.S. AND GLOBAL GROWTH COMPANIES; CONSULTING IN THE FIELD OF INVESTMENTS; INVESTMENT MANAGEMENT SERVICES, IN CLASS 36 (U.S. CLS. 100, 101 AND 102).

**SERVICE MARK**

**PRINCIPAL REGISTER**

FIRST USE 9-17-2012; IN COMMERCE 9-17-2012.

OWNER OF U.S. REG. NOS. 4,055,264 AND 4,086,515.

NO CLAIM IS MADE TO THE EXCLUSIVE RIGHT TO USE "CAPITAL", APART FROM THE MARK AS SHOWN.

THE MARK CONSISTS OF THE WORDING "SANDS CAPITAL" FEATURED BENEATH A PYRAMID DESIGN.

SN 85-530,342, FILED 1-31-2012.

MARK T. MULLEN, EXAMINING ATTORNEY



*David J. Kybas*

Director of the United States Patent and Trademark Office

# United States of America

United States Patent and Trademark Office

# NUBE

**Reg. No. 4,277,118**

**Registered Jan. 15, 2013**

**Int. Cl.: 16**

**TRADEMARK**

**PRINCIPAL REGISTER**

FABRICA DE BOLSAS DE PAPEL UNIBOL S.A. (COLOMBIA CORPORATION)  
AUTOPISTA AL AEROPUERTO KM. 7  
SOLEDAD - ATLANTICO, COLOMBIA

FOR: FACE TOWELS OF PAPER; HYGIENIC PAPER; PAPER HAND-TOWELS; PAPER TOWELS; TISSUE PAPER; TOILET PAPER, IN CLASS 16 (U.S. CLS. 2, 5, 22, 23, 29, 37, 38 AND 50).

FIRST USE 12-1-2008; IN COMMERCE 12-1-2011.

THE MARK CONSISTS OF STANDARD CHARACTERS WITHOUT CLAIM TO ANY PARTICULAR FONT, STYLE, SIZE, OR COLOR.

THE ENGLISH TRANSLATION OF "NUBE" IS "CLOUD".

SN 85-530,752, FILED 2-1-2012.

MAUREEN DALL, EXAMINING ATTORNEY



*David J. Kyffers*

Director of the United States Patent and Trademark Office

# United States of America

United States Patent and Trademark Office

## DRINK NOW, THINK BETTER

**Reg. No. 4,277,119**

PATRICK SCALLAN (UNITED STATES INDIVIDUAL)  
8032 SUMMA AV. SU. D  
BATON ROUGE, LA 70809

**Registered Jan. 15, 2013**

**Int. Cl.: 5**

FOR: DIETARY AND NUTRITIONAL SUPPLEMENTS, IN CLASS 5 (U.S. CLS. 6, 18, 44, 46, 51 AND 52).

**TRADEMARK**

FIRST USE 3-28-2012; IN COMMERCE 3-28-2012.

**PRINCIPAL REGISTER**

THE MARK CONSISTS OF STANDARD CHARACTERS WITHOUT CLAIM TO ANY PARTICULAR FONT, STYLE, SIZE, OR COLOR.

SN 85-531,440, FILED 2-1-2012.

DAVID COLLIER, EXAMINING ATTORNEY



*David J. Kyffers*

Director of the United States Patent and Trademark Office

# United States of America

United States Patent and Trademark Office

# SERCA

**Reg. No. 4,277,120**

**Registered Jan. 15, 2013**

**Int. Cl.: 33**

**TRADEMARK**

**PRINCIPAL REGISTER**

SERCA WINES, LLC. (TEXAS LIMITED LIABILITY COMPANY)  
14103 CAROLCREST CIRCLE  
HOUSTON, TX 77079

FOR: RED WINE; RED WINES; WINE; WINES, IN CLASS 33 (U.S. CLS. 47 AND 49).

FIRST USE 10-1-2012; IN COMMERCE 10-1-2012.

THE MARK CONSISTS OF STANDARD CHARACTERS WITHOUT CLAIM TO ANY PARTICULAR FONT, STYLE, SIZE, OR COLOR.

THE ENGLISH TRANSLATION OF THE WORD "SERCA" IN THE MARK IS "HEART".

SN 85-531,917, FILED 2-2-2012.

AHSEN KHAN, EXAMINING ATTORNEY



*David J. Kyffers*

Director of the United States Patent and Trademark Office

# United States of America

United States Patent and Trademark Office

## COMPETE WITH CONFIDENCE

**Reg. No. 4,277,121**

**Registered Jan. 15, 2013**

**Int. Cls.: 25 and 35**

**TRADEMARK**

**SERVICE MARK**

**PRINCIPAL REGISTER**

PERFORM GROUP, LLC (DELAWARE LIMITED LIABILITY COMPANY)  
333 E. SEVENTH AVE.  
YORK, PA 17404

FOR: BODY SUITS; BRIEFS; JACKETS; LEOTARDS; PANTS; PULLOVERS; SHOES; SHORTS; SLEEVELESS JERSEYS; TEE SHIRTS; TIGHTS; TRUNKS; WARM-UP SUITS , IN CLASS 25 (U.S. CLS. 22 AND 39).

FIRST USE 5-0-2012; IN COMMERCE 5-0-2012.

FOR: COMPUTERIZED ON-LINE RETAIL STORE SERVICES IN THE FIELD OF APPAREL FOR GYMNASTS; MAIL ORDER CATALOG SERVICES FEATURING APPAREL FOR GYMNASTS, IN CLASS 35 (U.S. CLS. 100, 101 AND 102).

FIRST USE 5-0-2012; IN COMMERCE 5-0-2012.

THE MARK CONSISTS OF STANDARD CHARACTERS WITHOUT CLAIM TO ANY PARTICULAR FONT, STYLE, SIZE, OR COLOR.

SN 85-532,481, FILED 2-2-2012.

EMILY CARLSEN, EXAMINING ATTORNEY



*David J. Kybas*

Director of the United States Patent and Trademark Office

# United States of America

United States Patent and Trademark Office

# I LOVE ME

**Reg. No. 4,277,122**

**Registered Jan. 15, 2013**

**Int. Cl.: 14**

**TRADEMARK**

**PRINCIPAL REGISTER**

AU-79 LLC (CALIFORNIA LIMITED LIABILITY COMPANY)  
7065 LEXINGTON AVENUE  
WEST HOLLYWOOD, CA 90038

FOR: JEWELRY, IN CLASS 14 (U.S. CLS. 2, 27, 28 AND 50).

FIRST USE 2-1-2012; IN COMMERCE 10-1-2012.

THE MARK CONSISTS OF STANDARD CHARACTERS WITHOUT CLAIM TO ANY PARTICULAR FONT, STYLE, SIZE, OR COLOR.

SN 85-533,168, FILED 2-3-2012.

MICHELE SWAIN, EXAMINING ATTORNEY



*David J. Kybas*

Director of the United States Patent and Trademark Office



# United States of America

United States Patent and Trademark Office

*Sister*

**Reg. No. 4,277,123**

ZOJE AMERICA, INC. (FLORIDA CORPORATION)  
20817 SW 121 AVE  
MIAMI, FL 33177

**Registered Jan. 15, 2013**

**Int. Cl.: 7**

FOR: SEWING MACHINES, IN CLASS 7 (U.S. CLS. 13, 19, 21, 23, 31, 34 AND 35).

**TRADEMARK**

FIRST USE 4-12-2012; IN COMMERCE 4-12-2012.

**PRINCIPAL REGISTER**

THE MARK CONSISTS OF THE WORD "SISTER" IN ITALIC MONOTYPE CORSIVA FONT, SURROUNDED BY AN OVAL.

SN 85-535,432, FILED 2-6-2012.

JORDAN BAKER, EXAMINING ATTORNEY



*David J. Kyffers*

Director of the United States Patent and Trademark Office

# United States of America

United States Patent and Trademark Office



**Reg. No. 4,277,124**

BREAUD, ALEC (UNITED STATES INDIVIDUAL)  
207 LAC PENCHANT DRIVE  
LULING, LA 70070

**Registered Jan. 15, 2013**

**Int. Cl.: 25**

FOR: FISHING SHIRTS, FISHING HATS, IN CLASS 25 (U.S. CLS. 22 AND 39).

**TRADEMARK**

FIRST USE 8-1-2011; IN COMMERCE 5-15-2012.

**PRINCIPAL REGISTER**

THE MARK CONSISTS OF THE STYLIZED TEXT "REDICULOUS" SET IN A STYLIZED OUTLINE OF A RED DRUM FISH.

SN 85-537,592, FILED 2-8-2012.

BARBARA BROWN, EXAMINING ATTORNEY



*David J. Kybas*

Director of the United States Patent and Trademark Office

# United States of America

United States Patent and Trademark Office

FRÜTSTIX  
Paleta De Fruta!

**Reg. No. 4,277,125**

**Registered Jan. 15, 2013**

**Int. Cl.: 30**

**TRADEMARK**

**PRINCIPAL REGISTER**

TLC TRADEMARK COMPANY (CALIFORNIA CORPORATION)  
C/O THE LAFAYETTE COMPANY  
1525 STATE ST., SUITE 203  
SANTA BARBARA, CA 93101

FOR: FROZEN FRUIT CONFECTIONS, IN CLASS 30 (U.S. CL. 46).

FIRST USE 8-0-2009; IN COMMERCE 8-0-2009.

OWNER OF U.S. REG. NOS. 1,670,410 AND 2,745,924.

NO CLAIM IS MADE TO THE EXCLUSIVE RIGHT TO USE "PALETA DE FRUTA", APART FROM THE MARK AS SHOWN.

THE MARK CONSISTS OF THE TERM "FRÜTSTIX" IN STYLIZED FORM. BELOW "FRÜTSTIX" ARE THE TERMS "PALETA DE FRUTA!" IN STYLIZED FORM.

THE ENGLISH TRANSLATION OF "PALETA DE FRUTA" IS "ICE POP OF FRUIT".

SN 85-537,691, FILED 2-8-2012.

VIVIAN MICZNIK FIRST, EXAMINING ATTORNEY



*David J. Kyros*

Director of the United States Patent and Trademark Office

# United States of America

United States Patent and Trademark Office



**Reg. No. 4,277,126**

**Registered Jan. 15, 2013**

**Int. Cl.: 1**

**TRADEMARK**

**PRINCIPAL REGISTER**

THE PROCTER & GAMBLE COMPANY (OHIO CORPORATION)  
ONE PROCTER & GAMBLE PLAZA  
CINCINNATI, OH 45202

FOR: CHEMICAL PREPARATIONS FOR USE IN THE CLARIFICATION AND PURIFICATION OF WATER; CHEMICAL PREPARATIONS FOR REMOVING DIRT, CYSTS, AND POLLUTANTS FROM WATER; CHEMICAL PREPARATIONS FOR USE IN KILLING VIRUSES AND BACTERIA IN WATER, IN CLASS 1 (U.S. CLS. 1, 5, 6, 10, 26 AND 46).

FIRST USE 7-31-2012; IN COMMERCE 7-31-2012.

NO CLAIM IS MADE TO THE EXCLUSIVE RIGHT TO USE "PURIFIER OF WATER", APART FROM THE MARK AS SHOWN.

THE MARK CONSISTS OF THE WORDS "P&G" ON THE FIRST LINE, "PURIFIER OF" ON THE SECOND LINE, AND "WATER" ON THE THIRD LINE WITH A TEARDROP SHAPED OBJECT APPEARING TO THE RIGHT OF THE "P&G".

SN 85-537,812, FILED 2-9-2012.

AMY ALFIERI, EXAMINING ATTORNEY



*David J. Kybas*

Director of the United States Patent and Trademark Office

# United States of America

United States Patent and Trademark Office



**Reg. No. 4,277,127**

BROOKS, DARNELL (UNITED STATES INDIVIDUAL)  
2023 E 10 MILE ROAD  
ROYAL OAK, MI 48067

**Registered Jan. 15, 2013**

**Int. Cl.: 18**

FOR: DOG COLLARS, IN CLASS 18 (U.S. CLS. 1, 2, 3, 22 AND 41).

**TRADEMARK**

FIRST USE 1-1-2009; IN COMMERCE 1-1-2009.

**PRINCIPAL REGISTER**

NO CLAIM IS MADE TO THE EXCLUSIVE RIGHT TO USE "COLLARS MADE IN U.S.A.", APART FROM THE MARK AS SHOWN.

THE MARK CONSISTS OF A LARGE CROWN WITH 3 STARS SITTING ON TOP OF THE CURVED WORDS "RUGGIT COLLARS MADE IN U.S.A.".

SN 85-537,934, FILED 2-9-2012.

KEVON CHISOLM, EXAMINING ATTORNEY



*David J. Kyffers*

Director of the United States Patent and Trademark Office

# United States of America

United States Patent and Trademark Office

# VUELITE

**Reg. No. 4,277,128**

COOK MEDICAL TECHNOLOGIES LLC (INDIANA LIMITED LIABILITY COMPANY)  
750 DANIELS WAY, P.O. BOX 2269  
BLOOMINGTON, IN 47402

**Registered Jan. 15, 2013**

**Int. Cl.: 10**

FOR: MEDICAL DEVICES, NAMELY, PORTABLE LIGHT SOURCES FOR USE WITH FLEXIBLE AND RIGID ENDOSCOPES, IN CLASS 10 (U.S. CLS. 26, 39 AND 44).

**TRADEMARK**

FIRST USE 9-0-2012; IN COMMERCE 9-0-2012.

**PRINCIPAL REGISTER**

THE MARK CONSISTS OF STANDARD CHARACTERS WITHOUT CLAIM TO ANY PARTICULAR FONT, STYLE, SIZE, OR COLOR.

SN 85-538,316, FILED 2-9-2012.

ANGELA M. MICHELI, EXAMINING ATTORNEY



*David J. Kybas*

Director of the United States Patent and Trademark Office

# United States of America

United States Patent and Trademark Office

# FUN STRAPS

**Reg. No. 4,277,129**

SOLOMON, KIMBERLY (UNITED STATES INDIVIDUAL)  
10320 OVERBROOK RD.  
LEAWOOD, KS 66202

**Registered Jan. 15, 2013**

**Int. Cl.: 25**

FOR: SHOE STRAPS, IN CLASS 25 (U.S. CLS. 22 AND 39).

**TRADEMARK**

FIRST USE 4-0-2012; IN COMMERCE 4-0-2012.

**PRINCIPAL REGISTER**

THE MARK CONSISTS OF STANDARD CHARACTERS WITHOUT CLAIM TO ANY PARTICULAR FONT, STYLE, SIZE, OR COLOR.

NO CLAIM IS MADE TO THE EXCLUSIVE RIGHT TO USE "STRAPS", APART FROM THE MARK AS SHOWN.

SN 85-539,086, FILED 2-10-2012.

MICHAEL SOUDERS, EXAMINING ATTORNEY



*David J. Kyffers*

Director of the United States Patent and Trademark Office

# United States of America

United States Patent and Trademark Office

## WORD RAIDER

**Reg. No. 4,277,130**

**Registered Jan. 15, 2013**

**Int. Cl.: 41**

**SERVICE MARK**

**PRINCIPAL REGISTER**

EDUCATIONAL IDEAS, INC. (CALIFORNIA CORPORATION), DBA BALLARD & TIGHE,  
471 ATLAS STREET  
BREA, CA 92821

FOR: PROVIDING A WEBSITE AT WHICH AN ONLINE GAME IS PLAYED BY STUDENTS  
WISHING TO LEARN ENGLISH AND ENGLISH VOCABULARY, IN CLASS 41 (U.S. CLS.  
100, 101 AND 107).

FIRST USE 10-0-2012; IN COMMERCE 10-0-2012.

THE MARK CONSISTS OF STANDARD CHARACTERS WITHOUT CLAIM TO ANY PAR-  
TICULAR FONT, STYLE, SIZE, OR COLOR.

NO CLAIM IS MADE TO THE EXCLUSIVE RIGHT TO USE "WORD", APART FROM THE  
MARK AS SHOWN.

SN 85-539,472, FILED 2-10-2012.

ALEX KEAM, EXAMINING ATTORNEY



*David J. Keppas*

Director of the United States Patent and Trademark Office



# United States of America

United States Patent and Trademark Office



**Reg. No. 4,277,131**

PICTOMETRY INTERNATIONAL CORP. (DELAWARE CORPORATION)  
100 TOWN CENTRE DRIVE, SUITE A  
ROCHESTER, NY 146234260

**Registered Jan. 15, 2013**

**Int. Cl.: 41**

FOR: DIGITAL IMAGING SERVICES; AERIAL IMAGERY SERVICES; EDUCATIONAL SERVICES, NAMELY, CONDUCTING CONFERENCES AND WORKSHOPS IN THE FIELD OF GEO-REFERENCED, ORTHOGONAL, AND OBLIQUE AERIAL IMAGING, IN CLASS 41 (U.S. CLS. 100, 101 AND 107).

**SERVICE MARK**

**PRINCIPAL REGISTER**

FIRST USE 9-20-2011; IN COMMERCE 9-20-2011.

THE MARK CONSISTS OF THE LETTER "P" AND FOUR TRAPEZOIDS. THE FOUR TRAPEZOIDS ARE POSITIONED TO THE LEFT OF THE LETTER "P". THE TRAPEZOIDS ARE DISPLAYED IN A LAYERED MANNER.

SN 85-539,685, FILED 2-10-2012.

HENRY S. ZAK, EXAMINING ATTORNEY



*David J. Kyffers*

Director of the United States Patent and Trademark Office

# United States of America

United States Patent and Trademark Office

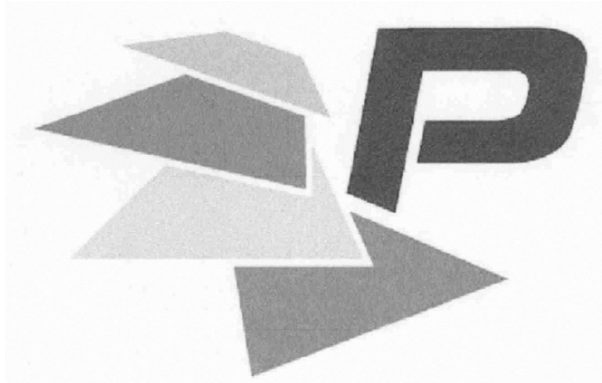

**Reg. No. 4,277,132**

**Registered Jan. 15, 2013**

**Int. Cl.: 42**

**SERVICE MARK**

**PRINCIPAL REGISTER**

PICTOMETRY INTERNATIONAL CORP. (DELAWARE CORPORATION)  
100 TOWN CENTRE DRIVE, SUITE A  
ROCHESTER, NY 146234260

FOR: PROVIDING COMPUTER MODELING SERVICES IN THE FIELD OF GEO-REFERENCED IMAGING, NAMELY, COMPUTER REPRESENTATIONS OF GEOGRAPHIC LOCATIONS CREATED FROM OBLIQUE AND NADIR AERIAL IMAGERY; PROVIDING TEMPORARY USE OF ON-LINE NON-DOWNLOADABLE SOFTWARE FOR PHOTOGRAMMETRIC ANALYSIS, IN CLASS 42 (U.S. CLS. 100 AND 101).

FIRST USE 9-20-2011; IN COMMERCE 9-20-2011.

THE MARK CONSISTS OF THE LETTER "P" AND FOUR TRAPEZOIDS. THE FOUR TRAPEZOIDS ARE POSITIONED TO THE LEFT OF THE LETTER "P". THE TRAPEZOIDS ARE DISPLAYED IN A LAYERED MANNER.

SN 85-539,780, FILED 2-10-2012.

HENRY S. ZAK, EXAMINING ATTORNEY



*David J. Kyffers*

Director of the United States Patent and Trademark Office

# United States of America

United States Patent and Trademark Office

# Ghost Juice

**Reg. No. 4,277,133**

MEIJER, INC. (MICHIGAN CORPORATION)  
2929 WALKER AVE., N.W.  
GRAND RAPIDS, MI 49544

**Registered Jan. 15, 2013**

**Int. Cl.: 32**

FOR: NON-ALCOHOLIC CIDER; NON-ALCOHOLIZED WINES; PUNCH, IN CLASS 32 (U.S. CLS. 45, 46 AND 48).

**TRADEMARK**

FIRST USE 9-8-2012; IN COMMERCE 9-8-2012.

**PRINCIPAL REGISTER**

THE MARK CONSISTS OF STANDARD CHARACTERS WITHOUT CLAIM TO ANY PARTICULAR FONT, STYLE, SIZE, OR COLOR.

OWNER OF U.S. REG. NO. 3,924,265.

NO CLAIM IS MADE TO THE EXCLUSIVE RIGHT TO USE "JUICE", APART FROM THE MARK AS SHOWN.

SN 85-539,791, FILED 2-10-2012.

AHSEN KHAN, EXAMINING ATTORNEY



*David J. Kyros*

Director of the United States Patent and Trademark Office

# United States of America

United States Patent and Trademark Office

# PneuTrain

**Reg. No. 4,277,134**

FLYNN, PATRICK J. (UNITED STATES INDIVIDUAL), DBA PNEUTECH LLC,  
236 SOUTHERN ROSE DR.  
JACKSONVILLE, FL 32225

**Registered Jan. 15, 2013**

**Int. Cl.: 12**

FOR: PNEUMATIC MASS TRANSPORTATION SYSTEM, NAMELY, TRAINS AND  
STRUCTURAL PARTS THEREOF, IN CLASS 12 (U.S. CLS. 19, 21, 23, 31, 35 AND 44).

**TRADEMARK**

FIRST USE 10-1-2009; IN COMMERCE 10-1-2009.

**PRINCIPAL REGISTER**

THE MARK CONSISTS OF STANDARD CHARACTERS WITHOUT CLAIM TO ANY PAR-  
TICULAR FONT, STYLE, SIZE, OR COLOR.

SN 85-540,060, FILED 2-10-2012.

KAPIL BHANOT, EXAMINING ATTORNEY



*David J. Kybas*

Director of the United States Patent and Trademark Office

# United States of America

United States Patent and Trademark Office

# DEADHEAD

**Reg. No. 4,277,135**

**Registered Jan. 15, 2013**

**Int. Cl.: 33**

**TRADEMARK**

**PRINCIPAL REGISTER**

BRANDI, GRACE KIM (UNITED STATES INDIVIDUAL)  
STE. 210-345  
7426 CHERRY AVENUE,  
FONTANA, CA 92336

FOR: ALCOHOLIC BEVERAGES EXCEPT BEERS; RUM, IN CLASS 33 (U.S. CLS. 47 AND 49).

FIRST USE 11-1-2011; IN COMMERCE 2-1-2012.

THE MARK CONSISTS OF STANDARD CHARACTERS WITHOUT CLAIM TO ANY PARTICULAR FONT, STYLE, SIZE, OR COLOR.

SN 85-540,198, FILED 2-11-2012.

GIANCARLO CASTRO, EXAMINING ATTORNEY



*David J. Kyffers*

Director of the United States Patent and Trademark Office

# United States of America

United States Patent and Trademark Office

# VIZPUR

**Reg. No. 4,277,136**

**Registered Jan. 15, 2013**

**Int. Cl.: 40**

**SERVICE MARK**

**PRINCIPAL REGISTER**

AQUEOUS MANAGEMENT GROUP (UTAH LIMITED LIABILITY COMPANY)  
9815 S. MONROE STREET  
SUITE 500  
SANDY, UT 84070

FOR: TREATMENT OF MATERIALS, NAMELY, CONVERTING OIL BASED PRODUCTS TO WATER SOLUBLE PRODUCTS, IN CLASS 40 (U.S. CLS. 100, 103 AND 106).

FIRST USE 3-12-2012; IN COMMERCE 3-12-2012.

THE MARK CONSISTS OF STANDARD CHARACTERS WITHOUT CLAIM TO ANY PARTICULAR FONT, STYLE, SIZE, OR COLOR.

SN 85-540,941, FILED 2-13-2012.

LINDSEY RUBIN, EXAMINING ATTORNEY



*David J. Kyros*

Director of the United States Patent and Trademark Office

# United States of America

United States Patent and Trademark Office

Community  
A Walgreens PHARMACY

**Reg. No. 4,277,137**

WALGREEN CO. (ILLINOIS CORPORATION)  
200 WILMOT ROAD  
DEERFIELD, IL 60015

**Registered Jan. 15, 2013**

**Int. Cl.: 35**

FOR: RETAIL DRUGSTORE SERVICES, IN CLASS 35 (U.S. CLS. 100, 101 AND 102).

**SERVICE MARK**

FIRST USE 11-17-2008; IN COMMERCE 11-17-2008.

**PRINCIPAL REGISTER**

OWNER OF U.S. REG. NOS. 1,057,249, 3,340,596, AND OTHERS.

NO CLAIM IS MADE TO THE EXCLUSIVE RIGHT TO USE "PHARMACY", APART FROM THE MARK AS SHOWN.

THE MARK CONSISTS OF THE WORD "COMMUNITY" ABOVE THE WORDS "A WALGREENS PHARMACY" IN A STYLIZED FORMAT. THE LETTERS "C" AND "Y" IN "COMMUNITY" ARE IN A LARGER FONT THAN THE OTHER LETTERS IN "COMMUNITY" AND FRAME THE WORDS "A WALGREENS PHARMACY" WHICH APPEAR IN A SMALLER FONT.

SN 85-541,120, FILED 2-13-2012.

MARTHA FROMM, EXAMINING ATTORNEY



David J. Kyfos

Director of the United States Patent and Trademark Office

# United States of America

United States Patent and Trademark Office

# Vanwolff

**Reg. No. 4,277,138**

PHAM, ANDREW M. (CANADA INDIVIDUAL), DBA VANWOLFF,  
1836 GRACE AVE.

**Registered Jan. 15, 2013**

LOS ANGELES, CA 90028

**Int. Cl.: 25**

FOR: SWIMWEAR; T-SHIRTS; TANK TOPS; UNDERWEAR, IN CLASS 25 (U.S. CLS. 22 AND 39).

**TRADEMARK**

FIRST USE 1-25-2012; IN COMMERCE 8-15-2012.

**PRINCIPAL REGISTER**

THE MARK CONSISTS OF STANDARD CHARACTERS WITHOUT CLAIM TO ANY PARTICULAR FONT, STYLE, SIZE, OR COLOR.

SN 85-541,686, FILED 2-14-2012.

SUE LAWRENCE, EXAMINING ATTORNEY



*David J. Kyros*

Director of the United States Patent and Trademark Office



# United States of America

United States Patent and Trademark Office

## DAVID CLINTON

**Reg. No. 4,277,139**

**Registered Jan. 15, 2013**

**Int. Cl.: 33**

**TRADEMARK**

**PRINCIPAL REGISTER**

H TWO WINES, LLC (CALIFORNIA LIMITED LIABILITY COMPANY)  
P.O. BOX 2164  
NAPA, CA 94558

FOR: ALCOHOLIC BEVERAGES EXCEPT BEERS, IN CLASS 33 (U.S. CLS. 47 AND 49).

FIRST USE 11-11-2012; IN COMMERCE 11-11-2012.

THE MARK CONSISTS OF STANDARD CHARACTERS WITHOUT CLAIM TO ANY PARTICULAR FONT, STYLE, SIZE, OR COLOR.

THE NAME(S), PORTRAIT(S), AND/OR SIGNATURE(S) SHOWN IN THE MARK DOES NOT IDENTIFY A PARTICULAR LIVING INDIVIDUAL.

SN 85-542,633, FILED 2-14-2012.

SETH A. RAPPAPORT, EXAMINING ATTORNEY



*David J. Kybas*

Director of the United States Patent and Trademark Office

# United States of America

United States Patent and Trademark Office



**EMERGENT**  
HEALTH PARTNERS

**Reg. No. 4,277,140**

EMERGENT HEALTH PARTNERS (MICHIGAN NON-PROFIT CORPORATION)  
1200 STATE CIRCLE  
ANN ARBOR, MI 48108

**Registered Jan. 15, 2013**

**Int. Cl.: 39**

FOR: AMBULANCE TRANSPORT SERVICES, IN CLASS 39 (U.S. CLS. 100 AND 105).

**SERVICE MARK**

FIRST USE 7-1-2012; IN COMMERCE 7-1-2012.

**PRINCIPAL REGISTER**

NO CLAIM IS MADE TO THE EXCLUSIVE RIGHT TO USE "EMERGENT HEALTH PARTNERS", APART FROM THE MARK AS SHOWN.

THE COLOR(S) LIGHT BLUE, DARK BLUE, RED AND BLACK IS/ARE CLAIMED AS A FEATURE OF THE MARK.

THE MARK CONSISTS OF A RECTANGLE IN LIGHT BLUE CROSSING A RECTANGLE IN DARK BLUE CROSSING A RECTANGLE IN RED NEXT TO THE WORDS "EMERGENT" IN BLACK OVER THE WORDS "HEALTH PARTNERS" IN BLACK.

SN 85-542,955, FILED 2-15-2012.

MATTHEW MCDOWELL, EXAMINING ATTORNEY



*David J. Kyffers*

Director of the United States Patent and Trademark Office

# United States of America

United States Patent and Trademark Office

# FIRST FRESH

**Reg. No. 4,277,141**

**Registered Jan. 15, 2013**

**Int. Cl.: 29**

**TRADEMARK**

**PRINCIPAL REGISTER**

SANDERS & CO, LLC (KENTUCKY LIMITED LIABILITY COMPANY)  
473 SOUTH SHAWNEE DRIVE  
MAYSVILLE, KY 41056

FOR: OLIVE OIL, IN CLASS 29 (U.S. CL. 46).

FIRST USE 3-0-2012; IN COMMERCE 3-0-2012.

THE MARK CONSISTS OF STANDARD CHARACTERS WITHOUT CLAIM TO ANY PARTICULAR FONT, STYLE, SIZE, OR COLOR.

NO CLAIM IS MADE TO THE EXCLUSIVE RIGHT TO USE "FRESH", APART FROM THE MARK AS SHOWN.

SN 85-543,375, FILED 2-15-2012.

DARRYL SPRUILL, EXAMINING ATTORNEY



*David J. Kyffers*

Director of the United States Patent and Trademark Office

# United States of America

United States Patent and Trademark Office

# TRAP EZE

**Reg. No. 4,277,142**

SPARTAN TOOL, L.L.C. (DELAWARE LIMITED LIABILITY COMPANY)  
1506 WEST DIVISION STREET  
MENDOTA, IL 61342

**Registered Jan. 15, 2013**

**Int. Cl.: 9**

FOR: CAMERAS FOR USE IN SEWER SYSTEMS, IN CLASS 9 (U.S. CLS. 21, 23, 26, 36 AND 38).

**TRADEMARK**

FIRST USE 2-28-2012; IN COMMERCE 2-28-2012.

**PRINCIPAL REGISTER**

THE MARK CONSISTS OF STANDARD CHARACTERS WITHOUT CLAIM TO ANY PARTICULAR FONT, STYLE, SIZE, OR COLOR.

SN 85-543,529, FILED 2-15-2012.

DAVID ELTON, EXAMINING ATTORNEY



*David J. Kyfos*

Director of the United States Patent and Trademark Office

# United States of America

United States Patent and Trademark Office

## Hook N Sculpt

**Reg. No. 4,277,143**

**Registered Jan. 15, 2013**

**Int. Cl.: 28**

**TRADEMARK**

**PRINCIPAL REGISTER**

PURLAND, JOHN (UNITED STATES INDIVIDUAL)  
2234 N. FEDERAL HWY, 349  
BOCA RATON, FL 33431 AND

WOLIN, LORI (UNITED STATES INDIVIDUAL)  
2234 N. FEDERAL HWY 349  
BOCA RATON, FL 33431

FOR: ACCESSORY FOR MANUALLY-OPERATED EXERCISE EQUIPMENT, NAMELY, ACCESSORY ATTACHMENT TO INCREASE MUSCLE RESISTANCE; EXERCISE DOORWAY GYM BARS; EXERCISE EQUIPMENT, NAMELY, CHEST PULLS; EXERCISE EQUIPMENT, NAMELY, STRAPS THAT ARE AFFIXED TO DOORS FOR PERFORMANCE OF VARIOUS EXERCISES USING BODY WEIGHT RESISTANCE; EXERCISE EQUIPMENT, NAMELY, LARGE MUSCLE WORKOUT APPARATUS; EXERCISE MACHINES; MANUAL LEG EXERCISERS; MANUALLY-OPERATED EXERCISE EQUIPMENT; MANUALLY-OPERATED EXERCISE EQUIPMENT FOR PHYSICAL FITNESS PURPOSES; PHYSICAL FITNESS EQUIPMENT, NAMELY, LARGE MUSCLE WORKOUT APPARATUS, IN CLASS 28 (U.S. CLS. 22, 23, 38 AND 50).

FIRST USE 6-1-2012; IN COMMERCE 8-1-2012.

THE MARK CONSISTS OF STANDARD CHARACTERS WITHOUT CLAIM TO ANY PARTICULAR FONT, STYLE, SIZE, OR COLOR.

NO CLAIM IS MADE TO THE EXCLUSIVE RIGHT TO USE "HOOK N SCULPT", APART FROM THE MARK AS SHOWN.

SN 85-543,620, FILED 2-15-2012.

ARETHA SOMERVILLE, EXAMINING ATTORNEY



*David J. Kyros*

Director of the United States Patent and Trademark Office

# United States of America

United States Patent and Trademark Office

## Defeat The Heat

**Reg. No. 4,277,144**

MISSION PRODUCT HOLDINGS, INC. (DELAWARE CORPORATION)  
185 MADISON AVENUE 12TH FLOOR  
NEW YORK, NY 10016

**Registered Jan. 15, 2013**

**Int. Cls.: 3 and 24**

FOR: NON-MEDICATED SUNCARE PREPARATIONS, IN CLASS 3 (U.S. CLS. 1, 4, 6, 50, 51 AND 52).

**TRADEMARK**

FIRST USE 5-1-2012; IN COMMERCE 5-1-2012.

**PRINCIPAL REGISTER**

FOR: TOWELS, IN CLASS 24 (U.S. CLS. 42 AND 50).

FIRST USE 5-1-2012; IN COMMERCE 5-1-2012.

THE MARK CONSISTS OF STANDARD CHARACTERS WITHOUT CLAIM TO ANY PARTICULAR FONT, STYLE, SIZE, OR COLOR.

SN 85-544,144, FILED 2-16-2012.

MELISSA VALLILLO, EXAMINING ATTORNEY



*David J. Kyros*

Director of the United States Patent and Trademark Office

# United States of America

United States Patent and Trademark Office

## Bravo México

**Reg. No. 4,277,145**

BRAVO MEXICO BEVERAGE, LLC. (FLORIDA LIMITED LIABILITY COMPANY)  
240 WEST 24 STREET  
HIALEAH, FL 33135

**Registered Jan. 15, 2013**

**Int. Cl.: 32**

FOR: ENERGY DRINKS, IN CLASS 32 (U.S. CLS. 45, 46 AND 48).

**TRADEMARK**

FIRST USE 6-15-2012; IN COMMERCE 6-15-2012.

**PRINCIPAL REGISTER**

THE MARK CONSISTS OF STANDARD CHARACTERS WITHOUT CLAIM TO ANY PARTICULAR FONT, STYLE, SIZE, OR COLOR.

SN 85-544,620, FILED 2-16-2012.

TASHIA BUNCH, EXAMINING ATTORNEY



*David J. Kybas*

Director of the United States Patent and Trademark Office

# United States of America

United States Patent and Trademark Office

# KAIR

**Reg. No. 4,277,146**

KAIR LLC (OREGON LIMITED LIABILITY COMPANY)  
14694 NW JEWELL LANE  
PORTLAND, OR 97229

**Registered Jan. 15, 2013**

**Int. Cl.: 20**

FOR: PLASTIC SHIELD FOR USE WHEN SHAMPOOING TO PROTECT FACE, EYES AND EARS FROM WATER AND SHAMPOO, IN CLASS 20 (U.S. CLS. 2, 13, 22, 25, 32 AND 50).

**TRADEMARK**

FIRST USE 11-8-2012; IN COMMERCE 11-8-2012.

**PRINCIPAL REGISTER**

THE MARK CONSISTS OF STANDARD CHARACTERS WITHOUT CLAIM TO ANY PARTICULAR FONT, STYLE, SIZE, OR COLOR.

SN 85-544,733, FILED 2-16-2012.

KERI CANTONE, EXAMINING ATTORNEY



*David J. Kybas*

Director of the United States Patent and Trademark Office



# United States of America

United States Patent and Trademark Office



**Reg. No. 4,277,147**

HANY INC. (CONNECTICUT CORPORATION)  
8 RIVER STREET  
ROCKVILLE, CT 06066

**Registered Jan. 15, 2013**

**Int. Cl.: 37**

FOR: INSTALLATION AND REPLACEMENT SERVICE FOR WATER HEATERS; INSTALLATION AND REPAIR OF GAS, PROPANE, ELECTRIC AND OIL WATER HEATING PRODUCTS, IN CLASS 37 (U.S. CLS. 100, 103 AND 106).

**SERVICE MARK**

FIRST USE 4-0-2012; IN COMMERCE 4-0-2012.

**PRINCIPAL REGISTER**

NO CLAIM IS MADE TO THE EXCLUSIVE RIGHT TO USE "WATER HEATER", APART FROM THE MARK AS SHOWN.

THE MARK CONSISTS OF THE WORDING "WATER HEATER MEDIC" IN A STYLIZED FONT. BELOW THAT IS A STRIPE. BELOW THAT IS THE WORDING "FIRST AID IN HOT WATER" IN A STYLIZED FONT WITH A CROSS TO THE LEFT OF THE WORDING. TO THE LEFT IS THE IMAGE OF A FACE OF MAN. THE MAN HAS HAIR, GLASSES, AND ON THE TOP OF HIS HEAD ARE TWO CIRCULAR IMAGES, ONE CIRCLE WITHIN THE OTHER.

SN 85-544,818, FILED 2-16-2012.

JESSICA A. POWERS, EXAMINING ATTORNEY



*David J. Kyffers*

Director of the United States Patent and Trademark Office

# United States of America

United States Patent and Trademark Office

## CROSS COUNTRY

**Reg. No. 4,277,148**

**Registered Jan. 15, 2013**

**Int. Cl.: 33**

**TRADEMARK**

**PRINCIPAL REGISTER**

CHOLAME VINEYARD LLC (ALASKA LIMITED LIABILITY COMPANY)  
10686 MEADS AVENUE  
ORANGE, CA 92869

FOR: WINES, IN CLASS 33 (U.S. CLS. 47 AND 49).

FIRST USE 10-4-2012; IN COMMERCE 10-4-2012.

THE MARK CONSISTS OF STANDARD CHARACTERS WITHOUT CLAIM TO ANY PARTICULAR FONT, STYLE, SIZE, OR COLOR.

SN 85-545,318, FILED 2-16-2012.

ROBERT C. CLARK JR., EXAMINING ATTORNEY



*David J. Kyffers*

Director of the United States Patent and Trademark Office

# United States of America

United States Patent and Trademark Office

# BULL PEN

**Reg. No. 4,277,149**

**Registered Jan. 15, 2013**

**Int. Cl.: 33**

**TRADEMARK**

**PRINCIPAL REGISTER**

CHOLAME VINEYARD LLC (ALASKA LIMITED LIABILITY COMPANY)  
10686 MEADS AVENUE  
ORANGE, CA 92869

FOR: WINES, IN CLASS 33 (U.S. CLS. 47 AND 49).

FIRST USE 10-4-2012; IN COMMERCE 10-4-2012.

THE MARK CONSISTS OF STANDARD CHARACTERS WITHOUT CLAIM TO ANY PARTICULAR FONT, STYLE, SIZE, OR COLOR.

SN 85-545,321, FILED 2-16-2012.

ROBERT C. CLARK JR., EXAMINING ATTORNEY



*David J. Kyffers*

Director of the United States Patent and Trademark Office

# United States of America

United States Patent and Trademark Office



**Reg. No. 4,277,150**

**Registered Jan. 15, 2013**

**Int. Cl.: 32**

**TRADEMARK**

**PRINCIPAL REGISTER**

TOMAHAWK ENERGY DRINK, LLC (OKLAHOMA LIMITED LIABILITY COMPANY), DBA  
BLACK STEEL BEVERAGE COMPANY,  
211 N. BROADWAY  
EDMOND, OK 73034

FOR: ENERGY DRINKS, IN CLASS 32 (U.S. CLS. 45, 46 AND 48).

FIRST USE 2-17-2012; IN COMMERCE 2-17-2012.

THE MARK CONSISTS OF A STYLIZED BLACK TOMAHAWK WITH THE WORDS "BLACK STEEL" DIRECTLY UNDERNEATH AND CONNECTED TO THE LITERAL ELEMENTS.

SN 85-545,496, FILED 2-17-2012.

GEOFFREY FOSDICK, EXAMINING ATTORNEY



*David J. Kybas*

Director of the United States Patent and Trademark Office

# United States of America

United States Patent and Trademark Office

## BLACK STEEL ARCTIC EDGE

**Reg. No. 4,277,151**

**Registered Jan. 15, 2013**

**Int. Cl.: 32**

**TRADEMARK**

**PRINCIPAL REGISTER**

TOMAHAWK ENERGY DRINK, LLC (OKLAHOMA LIMITED LIABILITY COMPANY), DBA  
BLACK STEEL BEVERAGE COMPANY,  
211 N. BROADWAY  
EDMOND, OK 73034

FOR: ENERGY DRINKS, IN CLASS 32 (U.S. CLS. 45, 46 AND 48).

FIRST USE 2-17-2012; IN COMMERCE 2-17-2012.

THE MARK CONSISTS OF STANDARD CHARACTERS WITHOUT CLAIM TO ANY PARTICULAR FONT, STYLE, SIZE, OR COLOR.

SN 85-545,501, FILED 2-17-2012.

GEOFFREY FOSDICK, EXAMINING ATTORNEY



*David J. Kyffers*

Director of the United States Patent and Trademark Office

# United States of America

United States Patent and Trademark Office

## BLACK STEEL AXECCELERATOR

**Reg. No. 4,277,152**

**Registered Jan. 15, 2013**

**Int. Cl.: 32**

**TRADEMARK**

**PRINCIPAL REGISTER**

TOMAHAWK ENERGY DRINK, LLC (OKLAHOMA LIMITED LIABILITY COMPANY), DBA  
BLACK STEEL BEVERAGE COMPANY,  
211 N. BROADWAY  
EDMOND, OK 73034

FOR: ENERGY DRINKS, IN CLASS 32 (U.S. CLS. 45, 46 AND 48).

FIRST USE 2-17-2012; IN COMMERCE 2-17-2012.

THE MARK CONSISTS OF STANDARD CHARACTERS WITHOUT CLAIM TO ANY PARTICULAR FONT, STYLE, SIZE, OR COLOR.

SN 85-545,509, FILED 2-17-2012.

GEOFFREY FOSDICK, EXAMINING ATTORNEY



*David J. Kybas*

Director of the United States Patent and Trademark Office

# United States of America

United States Patent and Trademark Office

# EZ FLEX

**Reg. No. 4,277,153**

NISSAN NORTH AMERICA, INC. (CALIFORNIA CORPORATION)  
P.O. BOX 685001  
FRANKLIN, TN 370685001

**Registered Jan. 15, 2013**

**Int. Cl.: 12**

FOR: MOTOR VEHICLE SEATING AND PARTS AND ACCESSORIES THEREFOR, ALL SOLD AS AN INTEGRAL PART OF A MOTOR VEHICLE, IN CLASS 12 (U.S. CLS. 19, 21, 23, 31, 35 AND 44).

**TRADEMARK**

FIRST USE 10-26-2012; IN COMMERCE 10-26-2012.

**PRINCIPAL REGISTER**

THE MARK CONSISTS OF STANDARD CHARACTERS WITHOUT CLAIM TO ANY PARTICULAR FONT, STYLE, SIZE, OR COLOR.

SN 85-545,695, FILED 2-17-2012.

LINDA POWELL, EXAMINING ATTORNEY



*David J. Kyjars*

Director of the United States Patent and Trademark Office

# United States of America

United States Patent and Trademark Office



**Reg. No. 4,277,154**

CHUMS, INC. (UTAH CORPORATION)  
2424 SOUTH 2570 WEST  
SALT LAKE CITY, UT 84119

**Registered Jan. 15, 2013**

**Int. Cl.: 25**

FOR: SPORTSWEAR, NAMELY, JACKETS, SWEATSHIRTS, SHIRTS, T-SHIRTS, PANTS, SHORTS, HATS AND SWEATPANTS, IN CLASS 25 (U.S. CLS. 22 AND 39).

**TRADEMARK**

FIRST USE 1-5-1999; IN COMMERCE 1-5-1999.

**PRINCIPAL REGISTER**

OWNER OF U.S. REG. NOS. 4,094,383, 4,094,394, AND OTHERS.

THE MARK CONSISTS OF A BOOBY BIRD WITH A "CHUMS" SIGN ON THE RIGHT.

SN 85-545,737, FILED 2-17-2012.

LINDSEY RUBIN, EXAMINING ATTORNEY



*David J. Kybas*

Director of the United States Patent and Trademark Office



# United States of America

United States Patent and Trademark Office

# SODA CAPS

**Reg. No. 4,277,155**

**Registered Jan. 15, 2013**

**Int. Cl.: 32**

**TRADEMARK**

**PRINCIPAL REGISTER**

SODA-CLUB (CO2) ATLANTIC GMBH (SWITZERLAND GESELLSCHAFT MIT  
BESCHRÄNKTER HAFTUNG (GMBH))  
C/O TAX EXPERT INTERNATIONAL AG  
BAARERSTRASSE 20  
ZUG, SWITZERLAND 6300

FOR: SYRUPS FOR MAKING BEVERAGES; PREPARATIONS FOR MAKING BEVERAGES,  
NAMELY, CONCENTRATES USED IN THE PREPARATION OF SOFT DRINKS AND FRUIT  
DRINKS; SYRUP PODS, NAMELY, DISPOSABLE CAPSULES CONTAINING SYRUPS FOR  
MAKING BEVERAGES, IN CLASS 32 (U.S. CLS. 45, 46 AND 48).

FIRST USE 8-0-2012; IN COMMERCE 10-0-2012.

THE MARK CONSISTS OF STANDARD CHARACTERS WITHOUT CLAIM TO ANY PAR-  
TICULAR FONT, STYLE, SIZE, OR COLOR.

NO CLAIM IS MADE TO THE EXCLUSIVE RIGHT TO USE "SODA", APART FROM THE  
MARK AS SHOWN.

SN 85-547,020, FILED 2-20-2012.

JOHN GARTNER, EXAMINING ATTORNEY



*David J. Kyffers*

Director of the United States Patent and Trademark Office

# United States of America

United States Patent and Trademark Office



**Reg. No. 4,277,156**

**Registered Jan. 15, 2013**

**Int. Cl.: 44**

**SERVICE MARK**

**PRINCIPAL REGISTER**

ADAMS LAND & CATTLE CO. (NEBRASKA CORPORATION)  
P. O. BOX 485  
BROKEN BOW, NE 68822

FOR: OPERATING A LIVESTOCK FEED YARD WHEREBY LIGHTER WEIGHT FEEDER CATTLE ARE PUT IN A SPECIALIZED FEEDING FACILITY TO BE PREPARED FOR SLAUGHTER, IN CLASS 44 (U.S. CLS. 100 AND 101).

FIRST USE 2-16-2012; IN COMMERCE 2-16-2012.

OWNER OF U.S. REG. NOS. 1,763,447 AND 2,552,363.

THE MARK CONSISTS OF A STYLIZED LETTER "A" WHICH HAS BEEN FORMED BY FOUR IRREGULARLY SHAPED TRIANGLES FORMING TWO OVERLAPPING GEOMETRIC SHAPES WITH ROUNDED EDGES.

SN 85-547,361, FILED 2-20-2012.

EDWARD NELSON, EXAMINING ATTORNEY



*David J. Kybas*

Director of the United States Patent and Trademark Office

# United States of America

United States Patent and Trademark Office

# NEURX-TF

**Reg. No. 4,277,157**

CLINICAL THERAPEUTIC SOLUTIONS (NEW JERSEY LIMITED LIABILITY COMPANY)  
1720 HIGHWAY 34  
WALL, NJ 07719

**Registered Jan. 15, 2013**

**Int. Cl.: 5**

FOR: VITAMIN SUPPLEMENTS DESIGNED TO SUPPORT HEALTHY NERVE FUNCTION,  
IN CLASS 5 (U.S. CLS. 6, 18, 44, 46, 51 AND 52).

**TRADEMARK**

FIRST USE 3-15-2012; IN COMMERCE 3-15-2012.

**PRINCIPAL REGISTER**

THE MARK CONSISTS OF STANDARD CHARACTERS WITHOUT CLAIM TO ANY PAR-  
TICULAR FONT, STYLE, SIZE, OR COLOR.

SN 85-547,818, FILED 2-21-2012.

LINDA E. BLOHM, EXAMINING ATTORNEY



*David J. Kybas*

Director of the United States Patent and Trademark Office

# United States of America

United States Patent and Trademark Office

## GROOVE GLIDER

**Reg. No. 4,277,158**

**Registered Jan. 15, 2013**

**Int. Cl.: 12**

**TRADEMARK**

**PRINCIPAL REGISTER**

RADIO FLYER, INC. (ILLINOIS CORPORATION)  
6515 WEST GRAND AVENUE  
CHICAGO, IL 60707

FOR: KICK SCOOTERS, IN CLASS 12 (U.S. CLS. 19, 21, 23, 31, 35 AND 44).

FIRST USE 8-0-2012; IN COMMERCE 8-0-2012.

THE MARK CONSISTS OF STANDARD CHARACTERS WITHOUT CLAIM TO ANY PARTICULAR FONT, STYLE, SIZE, OR COLOR.

SN 85-547,890, FILED 2-21-2012.

DAVID COLLIER, EXAMINING ATTORNEY



*David J. Kyffers*

Director of the United States Patent and Trademark Office

# United States of America

United States Patent and Trademark Office

# UNCENSORED

**Reg. No. 4,277,159**

**Registered Jan. 15, 2013**

**Int. Cl.: 33**

**TRADEMARK**

**PRINCIPAL REGISTER**

ACCOLADE WINES NORTH AMERICA, INC. (CALIFORNIA CORPORATION)  
3356 BRITTANY CIRCLE  
NAPA, CA 94558

FOR: WINE, IN CLASS 33 (U.S. CLS. 47 AND 49).

FIRST USE 7-31-2012; IN COMMERCE 7-31-2012.

THE MARK CONSISTS OF STANDARD CHARACTERS WITHOUT CLAIM TO ANY PARTICULAR FONT, STYLE, SIZE, OR COLOR.

SN 85-548,496, FILED 2-21-2012.

ZACHARY CROMER, EXAMINING ATTORNEY



*David J. Kyffers*

Director of the United States Patent and Trademark Office

# United States of America

United States Patent and Trademark Office

# DR OK

**Reg. No. 4,277,160**

**Registered Jan. 15, 2013**

**Int. Cl.: 1**

**TRADEMARK**

**PRINCIPAL REGISTER**

KATHERINE WIJAYA (INDONESIA INDIVIDUAL)  
317 112TH AVE NE, APT # 507  
BELLEVUE, WA 98004

FOR: ANTI-FREEZE; CHEMICAL ADDITIVES FOR ENHANCING THE PERFORMANCE OF LUBRICATING OILS, GREASES AND INTERNAL COMBUSTION ENGINE FUELS; CHEMICAL ADDITIVES FOR OILS; CHEMICAL ENGINE TREATMENTS AND ADDITIVES FOR ENGINE OILS, GASOLINE AND DIESEL FUELS, TRANSMISSION FLUIDS AND COOLING SYSTEMS; CHEMICAL MOTOR OIL ADDITIVES; CHEMICAL PREPARATIONS FOR USE IN THE MANUFACTURE OF ANTI-TARNISHING PREPARATIONS FOR SURFACES INCLUDING WINDOWS; CHEMICAL PRESERVATIVES FOR USE AS CORROSION INHIBITORS ON AUTOMOBILE EXHAUST SYSTEMS; CHEMICAL PRESERVATIVES FOR USE IN MANUFACTURE OF SOAP AND VEGETABLE OILS; DETERGENT ADDITIVE FOR USE WITH MOTOR OIL; OIL DISPERSANTS , IN CLASS 1 (U.S. CLS. 1, 5, 6, 10, 26 AND 46).

FIRST USE 3-12-2012; IN COMMERCE 3-12-2012.

THE MARK CONSISTS OF STANDARD CHARACTERS WITHOUT CLAIM TO ANY PARTICULAR FONT, STYLE, SIZE, OR COLOR.

SN 85-548,804, FILED 2-21-2012.

TARAH HARDY, EXAMINING ATTORNEY



*David J. Kypos*

Director of the United States Patent and Trademark Office

# United States of America

United States Patent and Trademark Office

energyearth

**Reg. No. 4,277,161**

ENERGY EARTH, LLC (TENNESSEE LIMITED LIABILITY COMPANY)

**Registered Jan. 15, 2013**

P.O. BOX 4183  
CHATTANOOGA, TN 37405

**Int. Cl.: 35**

FOR: RETAIL STORE SERVICES PROVIDED FROM AN ON-LINE, WEB-BASED VIRTUAL STOREFRONT, FEATURING A WIDE VARIETY OF ENERGY EFFICIENT, ENVIRONMENTALLY FRIENDLY, AND RENEWABLE ENERGY-RELATED CONSUMER AND HOUSEHOLD PRODUCTS AND APPLIANCES, IN CLASS 35 (U.S. CLS. 100, 101 AND 102).

**SERVICE MARK**

**PRINCIPAL REGISTER**

FIRST USE 5-1-2012; IN COMMERCE 5-1-2012.

THE MARK CONSISTS OF THE CONJOINED TERMS "ENERGY" IN THE COLOR ORANGE AND "EARTH" IN THE COLOR BLUE. THE FIRST LETTER "E" IN "ENERGY" IS IN THE COLOR ORANGE AND YELLOW AND EXHIBITS INCANDESCENCE. THE LETTER "E" IN "EARTH" CONTAINS CONTINENTS OF THE WESTERN HEMISPHERE IN THE COLOR GREEN.

THE COLOR(S) GREEN, BLUE, ORANGE, AND YELLOW IS/ARE CLAIMED AS A FEATURE OF THE MARK.

SN 85-550,023, FILED 2-22-2012.

B. PARADEWELAI, EXAMINING ATTORNEY



*David J. Kyffers*

Director of the United States Patent and Trademark Office

# United States of America

United States Patent and Trademark Office

**energyearth.com**

**Reg. No. 4,277,162**

ENERGY EARTH, LLC (TENNESSEE LIMITED LIABILITY COMPANY)  
P.O. BOX 4183  
CHATTANOOGA, TN 37405

**Registered Jan. 15, 2013**

**Int. Cl.: 35**

FOR: RETAIL STORE SERVICES PROVIDED FROM AN ON-LINE, WEB-BASED VIRTUAL STOREFRONT, FEATURING A WIDE VARIETY OF ENERGY EFFICIENT, ENVIRONMENTALLY FRIENDLY, AND RENEWABLE ENERGY-RELATED CONSUMER AND HOUSEHOLD PRODUCTS AND APPLIANCES, IN CLASS 35 (U.S. CLS. 100, 101 AND 102).

**SERVICE MARK**

**PRINCIPAL REGISTER**

FIRST USE 5-1-2012; IN COMMERCE 5-1-2012.

THE MARK CONSISTS OF THE CONJOINED TERMS "ENERGY" IN THE COLOR ORANGE AND "EARTH.COM" IN THE COLOR BLUE. THE FIRST LETTER "E" IN "ENERGY" IS IN THE COLOR ORANGE AND YELLOW AND EXHIBITS INCANDESCENCE. THE LETTER "E" IN "EARTH" CONTAINS CONTINENTS OF THE WESTERN HEMISPHERE IN THE COLOR GREEN.

THE COLOR(S) BLUE, GREEN, ORANGE, AND YELLOW IS/ARE CLAIMED AS A FEATURE OF THE MARK.

SN 85-550,058, FILED 2-22-2012.

B. PARADEWELAI, EXAMINING ATTORNEY



*David J. Kyffers*

Director of the United States Patent and Trademark Office



# United States of America

United States Patent and Trademark Office



**Reg. No. 4,277,163**

**Registered Jan. 15, 2013**

**Int. Cl.: 35**

**SERVICE MARK**

**PRINCIPAL REGISTER**

ENERGY EARTH, LLC (TENNESSEE LIMITED LIABILITY COMPANY)  
P.O. BOX 4183  
CHATTANOOGA, TN 37405

FOR: RETAIL STORE SERVICES PROVIDED FROM AN ON-LINE, WEB-BASED VIRTUAL STOREFRONT, FEATURING A WIDE VARIETY OF ENERGY EFFICIENT, ENVIRONMENTALLY FRIENDLY, AND RENEWABLE ENERGY-RELATED CONSUMER AND HOUSEHOLD PRODUCTS AND APPLIANCES, IN CLASS 35 (U.S. CLS. 100, 101 AND 102).

FIRST USE 5-1-2012; IN COMMERCE 5-1-2012.

THE MARK CONSISTS OF A LOWER-CASE LETTER "E" IN THE COLOR BLUE WITH A DESIGN OF CONTINENTS IN THE COLOR GREEN.

THE COLOR(S) BLUE AND GREEN IS/ARE CLAIMED AS A FEATURE OF THE MARK.

SN 85-550,551, FILED 2-23-2012.

B. PARADEWELAI, EXAMINING ATTORNEY



*David J. Kyffers*

Director of the United States Patent and Trademark Office

# United States of America

United States Patent and Trademark Office

## MOLECULE GLASS

**Reg. No. 4,277,164**

**Registered Jan. 15, 2013**

**Int. Cls.: 25 and 34**

**TRADEMARK**

**PRINCIPAL REGISTER**

MELOGRANO, RICHARD P. (UNITED STATES INDIVIDUAL)  
P.O. BOX 5316  
GARDENA, CA 90249

FOR: CLOTHING, NAMELY, CAPS, HATS, SHIRTS, T-SHIRTS, JACKETS, SHORTS, SLACKS, SWEATSHIRTS, SWEATPANTS, BOXER SHORTS AND SWEATERS, IN CLASS 25 (U.S. CLS. 22 AND 39).

FIRST USE 3-26-2012; IN COMMERCE 3-26-2012.

FOR: SMOKERS' ARTICLES, NAMELY, CIGAR STORAGE TUBES; NON-METALLIC ASHTRAYS; TOBACCO PIPE BOWL STIRRING RODS; HOOKAHS; PIPE TOBACCO; ROLLING TOBACCO; LIGHTERS FOR SMOKERS; MATCHES; CIGARETTE ROLLING PAPERS; GLASS STORAGE CONTAINERS FOR TOBACCO PRODUCTS; GLASS STOPPERS FOR TOBACCO PIPES; GLASS STIRRING RODS FOR TOBACCO PIPES; GLASS PLUGS FOR TOBACCO PIPES, IN CLASS 34 (U.S. CLS. 2, 8, 9 AND 17).

FIRST USE 3-26-2012; IN COMMERCE 3-26-2012.

THE MARK CONSISTS OF STANDARD CHARACTERS WITHOUT CLAIM TO ANY PARTICULAR FONT, STYLE, SIZE, OR COLOR.

NO CLAIM IS MADE TO THE EXCLUSIVE RIGHT TO USE "GLASS" IN INTERNATIONAL CLASS 34, APART FROM THE MARK AS SHOWN.

SN 85-550,607, FILED 2-23-2012.

APRIL ROACH, EXAMINING ATTORNEY



*David J. Kypos*

Director of the United States Patent and Trademark Office

# United States of America

United States Patent and Trademark Office

# NOSMUDGE

**Reg. No. 4,277,165**

BURKEY, JEFFREY (UNITED STATES INDIVIDUAL)  
273 CARA PLACE  
WINTERSVILLE, OH 43953

**Registered Jan. 15, 2013**

**Int. Cl.: 21**

FOR: MAKE-UP APPLICATION ACCESSORY, NAMELY, AN ACCESSORY THAT ACTS AS A SHIELD TO PREVENT EXCESS MASCARA FROM SPREADING TO ONE'S EYELIDS WHEN APPLYING IT, IN CLASS 21 (U.S. CLS. 2, 13, 23, 29, 30, 33, 40 AND 50).

**TRADEMARK**

FIRST USE 11-1-2012; IN COMMERCE 11-1-2012.

**PRINCIPAL REGISTER**

THE MARK CONSISTS OF STANDARD CHARACTERS WITHOUT CLAIM TO ANY PARTICULAR FONT, STYLE, SIZE, OR COLOR.

SN 85-550,664, FILED 2-23-2012.

TIMOTHY O. SCHIMPF, EXAMINING ATTORNEY



*David J. Kybas*

Director of the United States Patent and Trademark Office

# United States of America

United States Patent and Trademark Office

## HQ MILITARY SURPLUS

**Reg. No. 4,277,166**

**Registered Jan. 15, 2013**

**Int. Cl.: 35**

**SERVICE MARK**

**PRINCIPAL REGISTER**

THE SPORTSMAN'S GUIDE, INC. (MINNESOTA CORPORATION)  
411 FARWELL AVENUE  
SOUTH ST. PAUL, MN 55075

FOR: MAIL ORDER CATALOG SERVICES FEATURING GOVERNMENT MILITARY SURPLUS PRODUCTS, NAMELY, CLOTHING, FOOTWEAR AND ACCESSORIES, HUNTING AND SHOOTING ACCESSORIES, CAMPING AND OUTDOOR RECREATION PRODUCTS, OPTICS, KNIVES AND CUTLERY, FIREARMS AND AMMUNITION, DOMESTICS, NOVELTIES AND COLLECTIBLES, WATCHES, COOKWARE, FOOD PRODUCTS, WATER CANS AND BAGS; ON-LINE RETAIL STORE SERVICES FEATURING GOVERNMENT MILITARY SURPLUS PRODUCTS, NAMELY, CLOTHING, FOOTWEAR AND ACCESSORIES, HUNTING AND SHOOTING ACCESSORIES, CAMPING AND OUTDOOR RECREATION PRODUCTS, OPTICS, KNIVES AND CUTLERY, FIREARMS AND AMMUNITION, DOMESTICS, NOVELTIES AND COLLECTIBLES, WATCHES, COOKWARE, FOOD PRODUCTS, WATER CANS AND BAGS, IN CLASS 35 (U.S. CLS. 100, 101 AND 102).

FIRST USE 4-0-2012; IN COMMERCE 4-0-2012.

THE MARK CONSISTS OF STANDARD CHARACTERS WITHOUT CLAIM TO ANY PARTICULAR FONT, STYLE, SIZE, OR COLOR.

OWNER OF U.S. REG. NOS. 4,090,473 AND 4,142,793.

NO CLAIM IS MADE TO THE EXCLUSIVE RIGHT TO USE "MILITARY SURPLUS", APART FROM THE MARK AS SHOWN.

SN 85-551,013, FILED 2-23-2012.

ROBIN MITTLER, EXAMINING ATTORNEY



*David J. Kybas*

Director of the United States Patent and Trademark Office

# United States of America

United States Patent and Trademark Office



**Reg. No. 4,277,167**

MOOSEHEAD BREWERIES LIMITED (CANADA CORPORATION)  
89 MAIN STREET WEST  
ST. JOHN NEW BRUNSWICK, CANADA E2M3H2

**Registered Jan. 15, 2013**

**Int. Cl.: 32**

FOR: BREWED ALCOHOLIC BEVERAGES, NAMELY, BEER AND ALE, IN CLASS 32 (U.S. CLS. 45, 46 AND 48).

**TRADEMARK**

FIRST USE 9-5-2012; IN COMMERCE 9-5-2012.

**PRINCIPAL REGISTER**

NO CLAIM IS MADE TO THE EXCLUSIVE RIGHT TO USE "BREWING CO.", APART FROM THE MARK AS SHOWN.

THE MARK CONSISTS OF A PARTIALLY SHADED POLYGON CONTAINING THE WORDS "HOP CITY BREWING CO."

SN 85-551,112, FILED 2-23-2012.

CAROLINE WOOD, EXAMINING ATTORNEY



*David J. Kybas*

Director of the United States Patent and Trademark Office

# United States of America

United States Patent and Trademark Office



**Reg. No. 4,277,168**

MOOSEHEAD BREWERIES LIMITED (CANADA CORPORATION)  
89 MAIN STREET WEST

**Registered Jan. 15, 2013**

ST JOHN NEW BRUNSWICK, CANADA E2M3H2

**Int. Cl.: 32**

FOR: BREWED ALCOHOLIC BEVERAGES, NAMELY, BEER AND ALE, IN CLASS 32 (U.S. CLS. 45, 46 AND 48).

**TRADEMARK**

FIRST USE 9-5-2012; IN COMMERCE 9-5-2012.

**PRINCIPAL REGISTER**

NO CLAIM IS MADE TO THE EXCLUSIVE RIGHT TO USE "LAGER", APART FROM THE MARK AS SHOWN.

THE MARK CONSISTS OF THE WORDS "BARKING SQUIRREL LAGER" WRITTEN IN SCRIPT ABOVE A PICTURE OF A "SQUIRREL" HOLDING AN ACORN.

SN 85-551,692, FILED 2-24-2012.

CAROLINE WOOD, EXAMINING ATTORNEY



*David J. Kybas*

Director of the United States Patent and Trademark Office

# United States of America

United States Patent and Trademark Office

# LUCKBRIDGE

**Reg. No. 4,277,169**

**Registered Jan. 15, 2013**

**Int. Cl.: 41**

**SERVICE MARK**

**PRINCIPAL REGISTER**

LUCKBRIDGE SPORTS, LLC (MASSACHUSETTS LIMITED LIABILITY COMPANY)  
139 BELLECLAIRE AVENUE  
LONGMEADOW, MA 01106

FOR: COACHING IN THE FIELD OF SPORTS, IN CLASS 41 (U.S. CLS. 100, 101 AND 107).

FIRST USE 10-6-2011; IN COMMERCE 10-6-2011.

THE MARK CONSISTS OF STANDARD CHARACTERS WITHOUT CLAIM TO ANY PARTICULAR FONT, STYLE, SIZE, OR COLOR.

SN 85-551,813, FILED 2-24-2012.

CHERYL CLAYTON, EXAMINING ATTORNEY



*David J. Kyffers*

Director of the United States Patent and Trademark Office

United States of America  
United States Patent and Trademark Office

# APRICATO

**Reg. No. 4,277,170**

CHOPRA, MANOJ (UNITED STATES INDIVIDUAL)  
6764 KRISTI LYNNE LN  
TOLEDO, OH 43617

**Registered Jan. 15, 2013**

**Int. Cl.: 35**

FOR: SELF-SERVE FROZEN YOGURT SHOP SERVICES; PASTRY AND DESSERT SHOPS,  
IN CLASS 35 (U.S. CLS. 100, 101 AND 102).

**SERVICE MARK**

FIRST USE 4-1-2012; IN COMMERCE 5-1-2012.

**PRINCIPAL REGISTER**

THE MARK CONSISTS OF STANDARD CHARACTERS WITHOUT CLAIM TO ANY PAR-  
TICULAR FONT, STYLE, SIZE, OR COLOR.

THE WORDING "APRICOTO" HAS NO MEANING IN A FOREIGN LANGUAGE.

SN 85-551,944, FILED 2-24-2012.

AHSEN KHAN, EXAMINING ATTORNEY



*David J. Kybas*

Director of the United States Patent and Trademark Office



# United States of America

United States Patent and Trademark Office



**Reg. No. 4,277,171**

**Registered Jan. 15, 2013**

**Int. Cl.: 30**

**TRADEMARK**

**PRINCIPAL REGISTER**

MOM BRANDS COMPANY (MINNESOTA CORPORATION)  
2700 IDS CENTER 80 S. 8TH STREET  
MINNEAPOLIS, MN 55402

FOR: BREAKFAST CEREAL, IN CLASS 30 (U.S. CL. 46).

FIRST USE 8-6-2012; IN COMMERCE 8-6-2012.

OWNER OF U.S. REG. NOS. 3,971,870 AND 4,132,284.

THE COLOR(S) DARK BLUE, BLUE, GREEN AND WHITE IS/ARE CLAIMED AS A FEATURE OF THE MARK.

THE MARK CONSISTS OF A DARK BLUE SQUARE WITH THE WORDS "BAG THE BOX" IN WHITE; THE LETTER "O" HAS A SMILEY EARTH FACE WITH EYELASHES THAT IS GREEN AND BLUE; THE WORDS "BAGTHEBOX.COM" ARE IN THE COLOR BLUE AND ARE LOCATED VERTICALLY NEXT TO THE DARK BLUE SQUARE.

SN 85-552,383, FILED 2-24-2012.

BARBARA RUTLAND, EXAMINING ATTORNEY



*David J. Kyffers*

Director of the United States Patent and Trademark Office

# United States of America

United States Patent and Trademark Office



**Reg. No. 4,277,172**

**Registered Jan. 15, 2013**

**Int. Cl.: 41**

**SERVICE MARK**

**PRINCIPAL REGISTER**

WATT, STACEY (UNITED STATES INDIVIDUAL)  
2600 WHITEHAVEN ROAD  
GRAND ISLAND, NY 14072

FOR: EDUCATIONAL AND ENTERTAINMENT SERVICES, NAMELY, PROVIDING MOTIVATIONAL SPEAKING SERVICES IN THE FIELD OF PROFESSIONAL GROWTH AND DEVELOPMENT, IN CLASS 41 (U.S. CLS. 100, 101 AND 107).

FIRST USE 10-9-2012; IN COMMERCE 10-9-2012.

THE MARK CONSISTS OF THE STYLIZED PURPLE WORDS "THE SWING THEORY". THERE ARE TWO PURPLE CHILDREN WITH YELLOW HIGHLIGHTS ON A PURPLE SWING SUSPENDED BY A PURPLE TREE POSITIONED IN FRONT OF A SUNRISE SCENE WITH ORANGE ON THE TOP FADING TO YELLOW ON THE BOTTOM, WITH A YELLOW SUN BEHIND THE CHILDREN. THE PURPLE LETTERING "THE SWING THEORY" IS ACROSS THE FRONT. THE WHITE IN THE MARK IS BACKGROUND AREA WHICH IS NOT A PART OF THE MARK.

THE COLOR(S) YELLOW, ORANGE, AND PURPLE IS/ARE CLAIMED AS A FEATURE OF THE MARK.

SN 85-552,986, FILED 2-26-2012.

REBECCA GILBERT, EXAMINING ATTORNEY



*David J. Kyjars*

Director of the United States Patent and Trademark Office

United States of America  
United States Patent and Trademark Office

PANTECH .sf  
SWIFT

**Reg. No. 4,277,173**

**Registered Jan. 15, 2013**

**Int. Cl.: 9**

**TRADEMARK**

**PRINCIPAL REGISTER**

PANTECH CO., LTD. (REPUBLIC OF KOREA CORPORATION)  
PANTECH R&D CENTER, I-2, DMC, SANGAMDONG  
MAPO-GU, SEOUL, REPUBLIC OF KOREA

FOR: AUDIO-RECEIVERS AND VIDEO-RECEIVERS; BATTERIES; BATTERY CHARGERS; CELLULAR TELEPHONES; COMPUTER OPERATING RECORDED PROGRAMS; COMPUTER PROGRAMS FOR USE IN DATA COMMUNICATION BETWEEN MOBILE TELEPHONES AND COMPUTERS; EARPHONES; HEADPHONES; MOBILE TELEPHONE BATTERIES; MOBILE TELEPHONES; MP3 PLAYERS; NAVIGATION APPARATUS FOR VEHICLES IN THE NATURE OF ON-BOARD COMPUTERS; NOTEBOOK AND LAPTOP COMPUTERS; PERSONAL DIGITAL ASSISTANTS; RECHARGEABLE ELECTRIC BATTERIES; SATELLITE NAVIGATIONAL SYSTEM, NAMELY, A GLOBAL POSITIONING SYSTEM (GPS); SMARTPHONES; TABLET COMPUTERS; TELECOMMUNICATIONS CABLES; TELEPHONE RECEIVERS; TELEPHONE TRANSMITTERS; TELEPHONES; USB (UNIVERSAL SERIAL BUS) HARDWARE; USB CABLES; VIDEO CAMERAS; VIDEO TELEPHONES; WIRELESS CELLULAR PHONE HEADSETS; WIRELESS TELEPHONES; PORTABLE MULTIMEDIA PLAYERS (PMP), IN CLASS 9 (U.S. CLS. 21, 23, 26, 36 AND 38).

FIRST USE 6-10-2012; IN COMMERCE 6-10-2012.

THE MARK CONSISTS OF THE STYLIZED WORDING OF "PANTECH SWIFT".

SN 85-553,059, FILED 2-26-2012.

LUCY ARANT, EXAMINING ATTORNEY



*David J. Kyros*

Director of the United States Patent and Trademark Office

# United States of America

United States Patent and Trademark Office

# BANKINGBAD

**Reg. No. 4,277,174**

**Registered Jan. 15, 2013**

**Int. Cls.: 25 and 41**

**TRADEMARK**

**SERVICE MARK**

**PRINCIPAL REGISTER**

ENDI ENTERTAINMENT LLC (CALIFORNIA LIMITED LIABILITY COMPANY)  
#N345  
7919 EL CAJON BLVD.  
LA MESA, CA 91942

FOR: CLOTHING, NAMELY, T SHIRTS, HATS, JACKETS, HOODED SWEATSHIRTS AND SWEATSHIRTS, IN CLASS 25 (U.S. CLS. 22 AND 39).

FIRST USE 3-14-2012; IN COMMERCE 7-25-2012.

FOR: ENTERTAINMENT, NAMELY, A CONTINUING COMEDY AND DOCUMENTARY SHOW BROADCAST OVER THE INTERNET, TELEVISION, AND VIDEO MEDIA; MULTI-MEDIA ENTERTAINMENT SERVICES IN THE NATURE OF RECORDING, PRODUCTION AND POST-PRODUCTION SERVICES IN THE FIELDS OF VIDEO AND FILMS, IN CLASS 41 (U.S. CLS. 100, 101 AND 107).

FIRST USE 3-14-2012; IN COMMERCE 7-25-2012.

THE MARK CONSISTS OF STANDARD CHARACTERS WITHOUT CLAIM TO ANY PARTICULAR FONT, STYLE, SIZE, OR COLOR.

SN 85-554,048, FILED 2-27-2012.

LESLEY LAMOTHE, EXAMINING ATTORNEY



*David J. Kyffers*

Director of the United States Patent and Trademark Office

# United States of America

United States Patent and Trademark Office



Therapeutic Guitar

**Reg. No. 4,277,175**

**Registered Jan. 15, 2013**

**Int. Cl.: 41**

**SERVICE MARK**

**PRINCIPAL REGISTER**

KROUT, ROBERT E. (UNITED STATES INDIVIDUAL)  
5074 MATILDA ST. #224  
DALLAS, TX 75206

FOR: INSTRUCTION IN THE FIELD OF PLAYING GUITAR, IN CLASS 41 (U.S. CLS. 100, 101 AND 107).

FIRST USE 7-0-2012; IN COMMERCE 7-0-2012.

NO CLAIM IS MADE TO THE EXCLUSIVE RIGHT TO USE "GUITAR", APART FROM THE MARK AS SHOWN.

THE MARK CONSISTS OF THE WORDS "THERAPEUTIC GUITAR". ABOVE THE WORDS "THERAPEUTIC GUITAR" THERE IS A SQUARE PRESENTED WITHIN A SQUARE AND WITHIN THE SMALLER SQUARE IS THE IMAGE OF A HAND AND MUSIC NOTE.

SN 85-554,354, FILED 2-28-2012.

ASMAT KHAN, EXAMINING ATTORNEY



*David J. Kyffers*

Director of the United States Patent and Trademark Office

# United States of America

United States Patent and Trademark Office

# FLEX19

**Reg. No. 4,277,176**

NATURMED, INC. (INDIANA CORPORATION)  
PO BOX 3840  
CAMP VERDE, AZ 86322

**Registered Jan. 15, 2013**

**Int. Cl.: 5**

FOR: DIETARY AND NUTRITIONAL SUPPLEMENTS, IN CLASS 5 (U.S. CLS. 6, 18, 44, 46, 51 AND 52).

**TRADEMARK**

FIRST USE 2-24-2012; IN COMMERCE 2-24-2012.

**PRINCIPAL REGISTER**

THE MARK CONSISTS OF STANDARD CHARACTERS WITHOUT CLAIM TO ANY PARTICULAR FONT, STYLE, SIZE, OR COLOR.

SN 85-554,990, FILED 2-28-2012.

MAYUR VAGHANI, EXAMINING ATTORNEY



*David J. Kybas*

Director of the United States Patent and Trademark Office

# United States of America

United States Patent and Trademark Office

# VSHAKE

**Reg. No. 4,277,177**

NATURMED, INC. (INDIANA CORPORATION)  
PO BOX 3840  
CAMP VERDE, AZ 86322

**Registered Jan. 15, 2013**

**Int. Cl.: 5**

FOR: DIETARY AND NUTRITIONAL SUPPLEMENTS, IN CLASS 5 (U.S. CLS. 6, 18, 44, 46, 51 AND 52).

**TRADEMARK**

FIRST USE 4-23-2012; IN COMMERCE 4-23-2012.

**PRINCIPAL REGISTER**

THE MARK CONSISTS OF STANDARD CHARACTERS WITHOUT CLAIM TO ANY PARTICULAR FONT, STYLE, SIZE, OR COLOR.

SN 85-555,169, FILED 2-28-2012.

MAYUR VAGHANI, EXAMINING ATTORNEY



*David J. Kybas*

Director of the United States Patent and Trademark Office

# United States of America

United States Patent and Trademark Office

## sounds dangerous

**Reg. No. 4,277,178**

**Registered Jan. 15, 2013**

**Int. Cls.: 9, 41, and 45**

**TRADEMARK**

**SERVICE MARK**

**PRINCIPAL REGISTER**

SOUNDS DANGEROUS LLC (CALIFORNIA LIMITED LIABILITY COMPANY)  
APARTMENT 2  
3944 KENTUCKY DRIVE  
LOS ANGELES, CA 90068

FOR: MUSICAL RECORDINGS; MUSICAL SOUND RECORDINGS; MUSICAL VIDEO RECORDINGS; PRERECORDED AUDIO TAPES FEATURING MUSIC; PRERECORDED VIDEO CASSETTES FEATURING MUSIC; PRERECORDED VIDEO TAPES FEATURING MUSIC, IN CLASS 9 (U.S. CLS. 21, 23, 26, 36 AND 38).

FIRST USE 10-7-2009; IN COMMERCE 2-1-2011.

FOR: MUSIC COMPOSITION AND TRANSCRIPTION FOR OTHERS; MUSIC COMPOSITION FOR OTHERS; MUSIC COMPOSITION SERVICES; MUSIC PRODUCTION SERVICES; MUSIC PUBLISHING SERVICES; MUSIC SELECTION SERVICES FOR USE IN TELEVISION, FILM, RADIO AND VIDEO GAMES; MUSIC TRANSCRIPTION FOR OTHERS; PRODUCTION AND DISTRIBUTION OF RADIO PROGRAMMES; PRODUCTION OF AUDIO RECORDING; PRODUCTION OF MUSICAL SOUND RECORDING; PRODUCTION OF MUSICAL VIDEOS; PRODUCTION OF RADIO AND TELEVISION PROGRAMMES; PRODUCTION OF RADIO AND TELEVISION PROGRAMS; PRODUCTION OF RADIO OR TELEVISION PROGRAMS; PRODUCTION OF SOUND AND MUSIC VIDEO RECORDINGS; PROVIDING A WEBSITE FOR ENTERTAINMENT PURPOSES WHERE USERS CAN VIEW AND POST MUSIC FEATURING MUSIC; PROVIDING AN INTERNET WEBSITE PORTAL IN THE FIELD OF MUSIC; PUBLISHING OF BOOKS, E-BOOKS, AUDIO BOOKS, MUSIC AND ILLUSTRATIONS; RECORD MASTER PRODUCTION; RECORD MASTERING; RECORD PRODUCTION; RECORDING STUDIO SERVICES; RECORDING STUDIOS, IN CLASS 41 (U.S. CLS. 100, 101 AND 107).

FIRST USE 9-28-2009; IN COMMERCE 9-28-2009.

FOR: LICENSING OF INTELLECTUAL PROPERTY, IN CLASS 45 (U.S. CLS. 100 AND 101).

FIRST USE 10-7-2009; IN COMMERCE 10-7-2009.

THE MARK CONSISTS OF STANDARD CHARACTERS WITHOUT CLAIM TO ANY PARTICULAR FONT, STYLE, SIZE, OR COLOR.



*David J. Kyffers*

Director of the United States Patent and Trademark Office



**Reg. No. 4,277,178** SN 85-555,302, FILED 2-28-2012.

JOHN WILKE, EXAMINING ATTORNEY

# United States of America

United States Patent and Trademark Office



**Reg. No. 4,277,179**

**Registered Jan. 15, 2013**

**Int. Cl.: 9**

**TRADEMARK**

**PRINCIPAL REGISTER**

MOVING OFF CAMPUS, LLC (MISSOURI LIMITED LIABILITY COMPANY)  
SUITE 205  
5257 SHAW BLVD.  
ST. LOUIS, MO 63110

FOR: COMPUTER SOFTWARE FOR WEB-ENABLED DEVICES USED FOR SOCIAL NETWORKING, SHARING A USER'S LOCATION WITH OTHER USERS, AND LOCATING OTHER USERS, IN CLASS 9 (U.S. CLS. 21, 23, 26, 36 AND 38).

FIRST USE 3-0-2012; IN COMMERCE 3-0-2012.

THE MARK CONSISTS OF A STYLIZED LETTER "B" THAT INCORPORATES A STYLIZED FLAMING MATCHSTICK.

SN 85-555,620, FILED 2-28-2012.

SUNG IN, EXAMINING ATTORNEY



*David J. Kyffers*

Director of the United States Patent and Trademark Office

# United States of America

United States Patent and Trademark Office

# SMOKE THIS

**Reg. No. 4,277,180**

**Registered Jan. 15, 2013**

**Int. Cl.: 34**

**TRADEMARK**

**PRINCIPAL REGISTER**

DR DISTRIBUTORS, LLC (ILLINOIS LIMITED LIABILITY COMPANY)  
1634 GREENMOUNT STREET  
ROCKFORD, IL 61107

FOR: ELECTRONIC CIGARETTES, IN CLASS 34 (U.S. CLS. 2, 8, 9 AND 17).

FIRST USE 8-1-2012; IN COMMERCE 8-1-2012.

THE MARK CONSISTS OF STANDARD CHARACTERS WITHOUT CLAIM TO ANY PARTICULAR FONT, STYLE, SIZE, OR COLOR.

SN 85-556,459, FILED 2-29-2012.

DAVID MURRAY, EXAMINING ATTORNEY



*David J. Kyffers*

Director of the United States Patent and Trademark Office

# United States of America

United States Patent and Trademark Office

## LOCKTON HEALTH RISK SOLUTIONS

**Reg. No. 4,277,181**

LOCKTON, INC. (MISSOURI CORPORATION)  
444 WEST 47TH STREET, SUITE 900  
KANSAS CITY, MO 64112

**Registered Jan. 15, 2013**

**Int. Cl.: 36**

FOR: FINANCIAL RISK MANAGEMENT CONSULTING SERVICES REGARDING EMPLOYEE HEALTH CARE BENEFITS, IN CLASS 36 (U.S. CLS. 100, 101 AND 102).

**SERVICE MARK**

FIRST USE 3-0-2012; IN COMMERCE 3-0-2012.

**PRINCIPAL REGISTER**

THE MARK CONSISTS OF STANDARD CHARACTERS WITHOUT CLAIM TO ANY PARTICULAR FONT, STYLE, SIZE, OR COLOR.

OWNER OF U.S. REG. NOS. 2,624,149, 3,753,000, AND OTHERS.

NO CLAIM IS MADE TO THE EXCLUSIVE RIGHT TO USE "HEALTH RISK SOLUTIONS", APART FROM THE MARK AS SHOWN.

SN 85-556,729, FILED 2-29-2012.

LAURA KOVALSKY, EXAMINING ATTORNEY



*David J. Kybas*

Director of the United States Patent and Trademark Office

# United States of America

United States Patent and Trademark Office

## TRU HSV 1 AND 2 IGG

**Reg. No. 4,277,182**

MERIDIAN BIOSCIENCE, INC. (OHIO CORPORATION)  
3471 RIVER HILLS DRIVE  
CINCINNATI, OH 45245

**Registered Jan. 15, 2013**

**Int. Cl.: 5**

FOR: DIAGNOSTIC TESTS FOR QUALITATIVE DIAGNOSIS IN THE MEDICAL OR CLINICAL LABORATORY FOR THE DETECTION OF ANTI-HERPES SIMPLEX-1 IGG ANTIBODIES AND ANTI-HERPES SIMPLEX-2 IGG ANTIBODIES, IN CLASS 5 (U.S. CLS. 6, 18, 44, 46, 51 AND 52).

**TRADEMARK**

**PRINCIPAL REGISTER**

FIRST USE 9-27-2012; IN COMMERCE 9-27-2012.

THE MARK CONSISTS OF STANDARD CHARACTERS WITHOUT CLAIM TO ANY PARTICULAR FONT, STYLE, SIZE, OR COLOR.

OWNER OF U.S. REG. NOS. 3,407,185, 3,407,186, AND 3,877,361.

NO CLAIM IS MADE TO THE EXCLUSIVE RIGHT TO USE "HSV 1 AND 2 IGG", APART FROM THE MARK AS SHOWN.

SN 85-557,220, FILED 3-1-2012.

WILLIAM BRECKENFELD, EXAMINING ATTORNEY



*David J. Kyros*

Director of the United States Patent and Trademark Office

# United States of America

United States Patent and Trademark Office

## Pavement Princess

**Reg. No. 4,277,183**

BOURDON, LISA (UNITED STATES INDIVIDUAL)  
811 SHORE DRIVE  
EDGEWATER, MD 21037

**Registered Jan. 15, 2013**

**Int. Cl.: 25**

FOR: CLOTHING, NAMELY, SHIRTS, JACKETS, SHORTS, SWEATSHIRTS, T-SHIRTS, SWEATPANTS, SOCKS, HATS, SCARVES, GLOVES, IN CLASS 25 (U.S. CLS. 22 AND 39).

**TRADEMARK**

FIRST USE 8-6-2012; IN COMMERCE 8-14-2012.

**PRINCIPAL REGISTER**

THE MARK CONSISTS OF STANDARD CHARACTERS WITHOUT CLAIM TO ANY PARTICULAR FONT, STYLE, SIZE, OR COLOR.

SN 85-557,222, FILED 3-1-2012.

HAI-LY LAM, EXAMINING ATTORNEY



*David J. Kybas*

Director of the United States Patent and Trademark Office

# United States of America

United States Patent and Trademark Office



**Reg. No. 4,277,184**

**Registered Jan. 15, 2013**

**Int. Cl.: 35**

**SERVICE MARK**

**PRINCIPAL REGISTER**

PRIMESOURCE BUILDING PRODUCTS, INC. (DELAWARE CORPORATION)  
1321 GREENWAY DRIVE  
IRVING, TX 75038

FOR: DISTRIBUTORSHIP SERVICES IN THE FIELD OF BUILDING AND CONSTRUCTION PRODUCTS, IN CLASS 35 (U.S. CLS. 100, 101 AND 102).

FIRST USE 8-15-2012; IN COMMERCE 8-15-2012.

OWNER OF U.S. REG. NOS. 2,953,644, 3,595,792, AND 3,603,895.

THE MARK CONSISTS OF THE WORDS "GRIP RITE" INSIDE A QUADRILATERAL.

SN 85-558,341, FILED 3-2-2012.

MAYUR VAGHANI, EXAMINING ATTORNEY



*David J. Kybas*

Director of the United States Patent and Trademark Office

# United States of America

United States Patent and Trademark Office

## DORMA APPROACH

**Reg. No. 4,277,185**

**Registered Jan. 15, 2013**

**Int. Cls.: 9, 42, and 45**

**TRADEMARK**

**SERVICE MARK**

**PRINCIPAL REGISTER**

DORMA DOOR CONTROLS, INC. (PENNSYLVANIA CORPORATION)  
DORMA DRIVE  
REAMSTOWN, PA 17567

FOR: DEVICES AND INSTALLATIONS FOR THE IDENTIFICATION OF PERSONS, NAMELY, KEYPADS FOR THE ENTERING OF PASS CODES AND ASSOCIATED COMPUTERS, VOICEPRINT DETECTORS AND ASSOCIATED COMPUTERS, FACE RECOGNITION CAMERAS AND ASSOCIATED COMPUTERS, FINGERPRINT SCANNERS AND ASSOCIATED COMPUTERS, RETINAL SCANNERS AND ASSOCIATED COMPUTERS, SECURITY CARD READERS AND ASSOCIATED COMPUTERS, SECURITY CAMERAS AND ASSOCIATED COMPUTERS, AND MOTION DETECTORS AND ASSOCIATED COMPUTERS, AND COMPUTER PROGRAMS FOR THE OPERATION OF THE AFOREMENTIONED COMPUTERS; SECURITY ALARM SYSTEMS; FIRE ALARM SYSTEMS; ELECTRONIC CIRCUITS, NAMELY, DATA TRANSFORMATION, STORAGE AND CONTROL CIRCUITRY; COMPUTER CHIPS; COMPUTER PROGRAMS IN MACHINE-READABLE MEDIA, NAMELY, COMPUTER PROGRAMS TO STORE, READ, AND COMMUNICATE IDENTIFICATION DATA; COMPUTER HARDWARE IN MACHINE-READABLE MEDIA, NAMELY, IDENTIFICATION CARDS WITH COMPUTER CHIPS; VIDEO-MONITORING SYSTEM CONSISTING PRIMARILY OF VIDEO CAMERAS WHICH TRANSMIT PICTURES ON CONTROL-SYSTEMS WITH OR WITHOUT WIRE TO CONTROL MONITORS; TRANSMITTERS AND RECEIVERS FOR THE TRANSMISSION OF DATA; ELECTRICAL JUNCTION BOXES AND SOCKETS; INTERCOMS; AND ELECTRONIC CONTROLS FOR LOCKS, WINDOWS AND DOORS; COMPUTER SOFTWARE AND COMPUTER HARDWARE FOR PROVIDING REMOTE ACCESS TO ELECTRONICALLY MONITORED ENCLOSURES, IN CLASS 9 (U.S. CLS. 21, 23, 26, 36 AND 38).

FIRST USE 3-23-2012; IN COMMERCE 3-23-2012.

FOR: COMPUTER SERVICES, NAMELY, PROVIDING THE TEMPORARY USE OF ON-LINE NON-DOWNLOADABLE SOFTWARE FOR PROVIDING REMOTE ACCESS TO ELECTRONICALLY MONITORED ENCLOSURES; ON-LINE SYSTEM MANAGEMENT SERVICES THAT ALLOW USERS TO REMOTELY VIEW, MONITOR, PROGRAM, OPERATE AND CONTROL POWER OPERATED SYSTEMS AND SECURITY SYSTEMS IN HOMES, OFFICES AND VEHICLES, IN CLASS 42 (U.S. CLS. 100 AND 101).

FIRST USE 3-23-2012; IN COMMERCE 3-23-2012.



*David J. Kyffers*

Director of the United States Patent and Trademark Office



**Reg. No. 4,277,185** FOR: MONITORING OF SECURITY SYSTEMS, NAMELY, PROVIDING ELECTRONIC MONITORING OF AND REMOTE ACCESS FOR SECURED ENCLOSURES, IN CLASS 45 (U.S. CLS. 100 AND 101).

FIRST USE 3-23-2012; IN COMMERCE 3-23-2012.

THE MARK CONSISTS OF STANDARD CHARACTERS WITHOUT CLAIM TO ANY PARTICULAR FONT, STYLE, SIZE, OR COLOR.

OWNER OF U.S. REG. NOS. 1,557,624, 2,655,540, AND OTHERS.

SN 85-558,486, FILED 3-2-2012.

BARBARA BROWN, EXAMINING ATTORNEY

# United States of America

United States Patent and Trademark Office



**Reg. No. 4,277,186**

MUTIARA FOOD & DRINKS (M) SDN. BHD. (MALAYSIA LIMITED LIABILITY COMPANY)  
NO. 77 JALAN GERODA 1

**Registered Jan. 15, 2013**

LARKIN, JB, JOHOR, MALAYSIA

**Int. Cl.: 25**

FOR: CLOTHING, NAMELY, CLOTHING OF LEATHER, CLOTHING OF IMITATION OF LEATHER, WATERPROOF CLOTHING, NAMELY, COATS, OVERALLS, OVERCOATS, TEE-SHIRTS, TIGHTS, VESTS, JACKETS, UNIFORMS, SHORTS, PANTS; NECKTIES; HEAD WEAR, NAMELY, CAPS AND HATS, IN CLASS 25 (U.S. CLS. 22 AND 39).

**TRADEMARK**

**PRINCIPAL REGISTER**

FIRST USE 6-30-2011; IN COMMERCE 12-31-2011.

THE MARK CONSISTS OF THE WORDING "DRIVE" IN STYLIZED HOLLOW FONT ON THE TOP LINE AND ON THE SECOND LINE THE WORDING "M7" IN STYLIZED AND HOLLOW FONT WITHIN A BLACK SQUARE BLOCK. GOING ACROSS THE SECOND LINE IS A BLACK WITH A WHITE LINE GOING ACROSS IT ABOUT A QUARTER OF THE WAY DOWN THE BAR AND THE WORDING "ENERGY DRINK" IS WRITTEN INSIDE THE BLACK BAR TO THE RIGHT OF THE SQUARE BLOCK.

SN 85-558,716, FILED 3-2-2012.

SANDRA BUJA, EXAMINING ATTORNEY



*David J. Kyros*

Director of the United States Patent and Trademark Office

# United States of America

United States Patent and Trademark Office

# SNAPSTIK

**Reg. No. 4,277,187**

GRIPNAIL CORPORATION (RHODE ISLAND CORPORATION)  
97 DEXTER RD.

**Registered Jan. 15, 2013**

EAST PROVIDENCE, RI 029142045

**Int. Cl.: 6**

FOR: METAL FASTENERS FOR SECURING INSULATION COMPRISING A BASE PLATE FOR ADHESION TO A SURFACE, A SPINDLE, AND A SELF-LOCKING WASHER , IN CLASS 6 (U.S. CLS. 2, 12, 13, 14, 23, 25 AND 50).

**TRADEMARK**

FIRST USE 2-13-2012; IN COMMERCE 2-13-2012.

**PRINCIPAL REGISTER**

THE MARK CONSISTS OF STANDARD CHARACTERS WITHOUT CLAIM TO ANY PARTICULAR FONT, STYLE, SIZE, OR COLOR.

SN 85-558,773, FILED 3-2-2012.

TAMARA FRAZIER, EXAMINING ATTORNEY



*David J. Kyffers*

Director of the United States Patent and Trademark Office

# United States of America

United States Patent and Trademark Office

## FASHION STAR BOUTIQUE

**Reg. No. 4,277,188**

**Registered Jan. 15, 2013**

**Int. Cl.: 9**

**TRADEMARK**

**PRINCIPAL REGISTER**

XMG STUDIO INC. (CANADA CORPORATION)  
67 YONGE STREET, SUITE 1600  
TORONTO, ONTARIO, CANADA M5E1J8

FOR: COMPUTER GAME SOFTWARE, IN CLASS 9 (U.S. CLS. 21, 23, 26, 36 AND 38).

FIRST USE 5-23-2012; IN COMMERCE 5-23-2012.

THE MARK CONSISTS OF STANDARD CHARACTERS WITHOUT CLAIM TO ANY PARTICULAR FONT, STYLE, SIZE, OR COLOR.

NO CLAIM IS MADE TO THE EXCLUSIVE RIGHT TO USE "FASHION" AND "BOUTIQUE", APART FROM THE MARK AS SHOWN.

SN 85-559,074, FILED 3-2-2012.

KHANH LE, EXAMINING ATTORNEY



*David J. Kybas*

Director of the United States Patent and Trademark Office

# United States of America

United States Patent and Trademark Office

## CareOutcomes

**Reg. No. 4,277,189**

**Registered Jan. 15, 2013**

**Int. Cl.: 35**

**SERVICE MARK**

**PRINCIPAL REGISTER**

KAREMETRIX LLC (MINNESOTA LIMITED LIABILITY COMPANY), DBA  
KAREOUTCOMES,  
800 ASPEN CIRCLE  
LITTLE CANADA, MN 55109

FOR: ADVICE ON THE ANALYSIS OF CONSUMER BUYING HABITS AND NEEDS PROVIDED WITH THE HELP OF SENSORY, QUALITY AND QUANTITY-RELATED DATA; BUSINESS AND MANAGEMENT CONSULTING FOR HEALTHCARE PROVIDERS AND RELATED BUSINESSES; BUSINESS ASSISTANCE SERVICES, NAMELY, ASSISTING HEALTH CARE FACILITIES AND OTHER COMPANIES WITH CUSTOMER FOLLOW-UP TO IMPROVE CUSTOMER OUTCOMES AND SATISFACTION THROUGH THE USE OF TELECOMMUNICATION DEVICES AND COMPUTER NETWORKS WITH AUTOMATED INTERACTION AND DATA FEEDBACK, MONITORING AND COMPILATION CAPACITY; BUSINESS SERVICES PROVIDED TO THE HEALTHCARE INDUSTRY, NAMELY, THE COLLECTION, REPORTING, AND ANALYSIS OF HEALTHCARE QUALITY DATA FOR BUSINESS PURPOSES; COLLECTING AND ANALYZING CLAIMS DATA FROM HEALTHCARE ORGANIZATIONS FOR BUSINESS PURPOSES; CONDUCTING EMPLOYEE INCENTIVE AWARD PROGRAMS TO PROMOTE QUALITY; CONDUCTING QUALITY ASSURANCE SURVEYS IN HOSPITALS TO DETERMINE SERVICE QUALITY; CONSULTING IN THE FIELDS OF HEALTHCARE OPERATIONS MANAGEMENT AND HOSPITAL OPERATIONS MANAGEMENT; ELECTRONIC DATA COLLECTION AND DATA SUBMISSION SERVICES FOR BUSINESS PURPOSES IN THE FIELDS OF MEDICINE AND HEALTHCARE; HEALTHCARE MANAGEMENT SERVICE ORGANIZATION (MSO) SERVICES, NAMELY, PROVIDING PRACTICE ORGANIZATION, MANAGEMENT AND ADMINISTRATIVE SUPPORT SERVICES TO INDIVIDUAL PHYSICIANS OR SMALL GROUP PRACTICES; PROMOTING COLLABORATION WITHIN THE SCIENTIFIC, RESEARCH AND MEDICAL COMMUNITIES TO ACHIEVE ADVANCES IN THE FIELD OF HEALTHCARE; PROMOTING COLLABORATION WITHIN THE SCIENTIFIC, RESEARCH AND PROVIDER COMMUNITIES TO ACHIEVE ADVANCES IN THE FIELD OF HEALTHCARE; PROMOTING THE EXCHANGE OF INFORMATION AND RESOURCES WITHIN THE SCIENTIFIC RESEARCH AND MEDICAL COMMUNITIES TO ACHIEVE ADVANCES IN THE FIELD OF HEALTHCARE; PROVIDING REIMBURSEMENT BENCHMARKING INFORMATION AND OTHER MARKET INTELLIGENCE TO HEALTHCARE ORGANIZATIONS; RATING THE ENVIRONMENTAL QUALITIES AND IMPACT OF CONSUMER PRODUCTS OF OTHERS FOR THE PURPOSE OF MAKING PURCHASING DECISIONS; TOTAL QUALITY MANAGEMENT SERVICES, NAMELY, BUSINESS MANAGEMENT SERVICES FOR ESTABLISHING BUSINESS QUALITY POLICY AND DETERMINING BUSINESS MEANS FOR



*David J. Kyjars*

Director of the United States Patent and Trademark Office

**Reg. No. 4,277,189** IMPLEMENTING THOSE POLICIES TO IMPROVE CUSTOMER SATISFACTION, IN CLASS 35 (U.S. CLS. 100, 101 AND 102).

FIRST USE 2-1-2012; IN COMMERCE 9-1-2012.

THE MARK CONSISTS OF STANDARD CHARACTERS WITHOUT CLAIM TO ANY PARTICULAR FONT, STYLE, SIZE, OR COLOR.

SN 85-559,335, FILED 3-2-2012.

MATTHEW GALAN, EXAMINING ATTORNEY

# United States of America

United States Patent and Trademark Office

## Boomers Surf Co.

**Reg. No. 4,277,190**

**Registered Jan. 15, 2013**

**Int. Cl.: 25**

**TRADEMARK**

**PRINCIPAL REGISTER**

KNUDTEN, GREGG A. (UNITED STATES INDIVIDUAL)  
8912 E. PINNACLE PEAK RD. SUITE F9-147  
SCOTTSDALE, AZ 85255 AND

KNUDTEN, DEBORAH (UNITED STATES INDIVIDUAL)  
8912 E. PINNACLE PEAK RD. SUITE F9-147  
SCOTTSDALE, AZ 85255

FOR: SHIRTS; SHORT-SLEEVED SHIRTS; SPORT SHIRTS; SPORTS SHIRTS; SPORTS SHIRTS WITH SHORT SLEEVES; T-SHIRTS, IN CLASS 25 (U.S. CLS. 22 AND 39).

FIRST USE 11-15-2012; IN COMMERCE 11-15-2012.

THE MARK CONSISTS OF STANDARD CHARACTERS WITHOUT CLAIM TO ANY PARTICULAR FONT, STYLE, SIZE, OR COLOR.

OWNER OF U.S. REG. NO. 3,607,467.

NO CLAIM IS MADE TO THE EXCLUSIVE RIGHT TO USE "SURF CO.", APART FROM THE MARK AS SHOWN.

SN 85-560,373, FILED 3-5-2012.

BARNEY CHARLON, EXAMINING ATTORNEY



*David J. Kyffers*

Director of the United States Patent and Trademark Office

# United States of America

United States Patent and Trademark Office



**Reg. No. 4,277,191**

**Registered Jan. 15, 2013**

**Int. Cl.: 25**

**TRADEMARK**

**PRINCIPAL REGISTER**

UNIF, LLC (CALIFORNIA LIMITED LIABILITY COMPANY)  
360 W. AVE 26., #231  
LOS ANGELES, CA 90031

FOR: HOODED SWEAT SHIRTS; JACKETS; PANTS; SHIRTS; SHOES; SHORT-SLEEVED OR LONG-SLEEVED T-SHIRTS; SHORTS; SWEAT SHIRTS; SWEATERS; TOPS; WOMEN'S CLOTHING, NAMELY, SHIRTS, DRESSES, SKIRTS, BLOUSES, IN CLASS 25 (U.S. CLS. 22 AND 39).

FIRST USE 1-0-2010; IN COMMERCE 1-0-2010.

OWNER OF U.S. REG. NO. 3,417,856.

THE MARK CONSISTS OF THE WORD "UNIF" IN BLOCK LETTERS, UNDERNEATH A TRIANGLE DESIGN WITH INTERNAL LINES CREATING SMALLER TRIANGLES AT EACH OF THE THREE POINTS OF THE LARGER TRIANGLE, WITH STYLIZED LETTERS "U", "N" AND "F" WITHIN THE SMALLER TRIANGLES AND AN STYLIZED EYE DESIGN IN THE CENTER OF THE LARGER TRIANGLE.

SN 85-561,028, FILED 3-6-2012.

PAUL E. FAHRENKOPF, EXAMINING ATTORNEY



*David J. Kyffers*

Director of the United States Patent and Trademark Office



# United States of America

United States Patent and Trademark Office

# secodish

**Reg. No. 4,277,192**

DSRS INNOVATIONS, LLC (NEW YORK LIMITED LIABILITY COMPANY)  
4940 MERRICK RD. #302  
MASSAPEQUA PARK, NY 11762

**Registered Jan. 15, 2013**

**Int. Cl.: 9**

FOR: CONTACT LENS CASE TRAY, NAMELY, A STORAGE TRAY SPECIALLY ADAPTED FOR HOLDING A CONTACT LENS CASE, IN CLASS 9 (U.S. CLS. 21, 23, 26, 36 AND 38).

**TRADEMARK**

FIRST USE 4-23-2012; IN COMMERCE 4-23-2012.

**PRINCIPAL REGISTER**

THE MARK CONSISTS OF STANDARD CHARACTERS WITHOUT CLAIM TO ANY PARTICULAR FONT, STYLE, SIZE, OR COLOR.

SN 85-561,126, FILED 3-6-2012.

THOMAS MANOR, EXAMINING ATTORNEY



*David J. Kyros*

Director of the United States Patent and Trademark Office

# United States of America

United States Patent and Trademark Office

# Aerozign

**Reg. No. 4,277,193**

GODWIN, JOHN (UNITED STATES INDIVIDUAL)  
5801 E 410 RD

**Registered Jan. 15, 2013**

OOLOGAH, OK 74053

**Int. Cl.: 42**

FOR: DEVELOPMENT OF TECHNOLOGIES FOR THE FABRICATION OF CIRCUITS FOR WIRELESS COMMUNICATION, ELECTRONIC DATA PROCESSING, CONSUMER ELECTRONIC, AUTOMOTIVE ELECTRONICS; STRUCTURAL ENGINEERING DESIGN SERVICES; TESTING, ANALYSIS AND EVALUATION OF METAL TOOLS, MACHINERY AND FABRICATION EQUIPMENT, IN CLASS 42 (U.S. CLS. 100 AND 101).

**SERVICE MARK**

**PRINCIPAL REGISTER**

FIRST USE 3-6-2012; IN COMMERCE 3-10-2012.

THE MARK CONSISTS OF STANDARD CHARACTERS WITHOUT CLAIM TO ANY PARTICULAR FONT, STYLE, SIZE, OR COLOR.

SN 85-561,327, FILED 3-6-2012.

ROBIN MITTLER, EXAMINING ATTORNEY



*David J. Kybas*

Director of the United States Patent and Trademark Office

# United States of America

United States Patent and Trademark Office

## SKOOL TAGZ

**Reg. No. 4,277,194**

SO-MINE, LLC (GEORGIA LIMITED LIABILITY COMPANY)  
2650 HOLCOMB BRIDGE ROAD, SUITE 620  
ALPHARETTA, GA 30022

**Registered Jan. 15, 2013**

**Int. Cl.: 18**

FOR: BACK PACK ACCESSORIES WHICH FEATURE A FABRIC WRAP AROUND THAT FITS AROUND EXISTING BACKPACK STRAPS AND PVC HOOK AND LOOP PATCHES, NAMELY, BAGGAGE TAGS, IN CLASS 18 (U.S. CLS. 1, 2, 3, 22 AND 41).

**TRADEMARK**

FIRST USE 3-15-2012; IN COMMERCE 3-15-2012.

**PRINCIPAL REGISTER**

THE MARK CONSISTS OF STANDARD CHARACTERS WITHOUT CLAIM TO ANY PARTICULAR FONT, STYLE, SIZE, OR COLOR.

NO CLAIM IS MADE TO THE EXCLUSIVE RIGHT TO USE "TAGS", APART FROM THE MARK AS SHOWN.

SN 85-561,546, FILED 3-6-2012.

SANI KHOURI, EXAMINING ATTORNEY



*David J. Kyffers*

Director of the United States Patent and Trademark Office

# United States of America

United States Patent and Trademark Office

# ENDOHEROES

**Reg. No. 4,277,195**

**Registered Jan. 15, 2013**

**Int. Cl.: 41**

**SERVICE MARK**

**PRINCIPAL REGISTER**

ENDOCHOICE, INC. (DELAWARE CORPORATION)  
11810 WILLS RD., SUITE 100  
ALPHARETTA, GA 30009

FOR: PROVIDING RECOGNITION AND INCENTIVES BY THE WAY OF AWARDS FOR THE EXTRAORDINARY EFFORTS OF PROFESSIONALS IN GASTROINTESTINAL ENDOSCOPY AND THEIR CONTRIBUTIONS TO MANKIND; ORGANIZING AND CONDUCTING RECOGNITION AWARDS PROGRAMS TO HONOR PROFESSIONALS IN GASTROINTESTINAL ENDOSCOPY AND THEIR CONTRIBUTIONS TO MANKIND, IN CLASS 41 (U.S. CLS. 100, 101 AND 107).

FIRST USE 3-1-2012; IN COMMERCE 3-1-2012.

THE MARK CONSISTS OF STANDARD CHARACTERS WITHOUT CLAIM TO ANY PARTICULAR FONT, STYLE, SIZE, OR COLOR.

SN 85-563,799, FILED 3-8-2012.

KIMBERLY PERRY, EXAMINING ATTORNEY



*David J. Kyffers*

Director of the United States Patent and Trademark Office

# United States of America

United States Patent and Trademark Office

# NMI

**Reg. No. 4,277,196**

**Registered Jan. 15, 2013**

**Int. Cl.: 10**

**TRADEMARK**

**PRINCIPAL REGISTER**

NEW MEDICAL IMAGING CO., LTD. (TAIWAN CORPORATION)  
3F., NO. 32, SEC. 2, ZHONGYANG S. RD.  
BEITOU DIST., TAIPEI, TAIWAN 112

FOR: MEDICAL APPARATUS AND INSTRUMENT FOR DIAGNOSTIC USE, NAMELY, APPARATUS FOR MEDICAL DIAGNOSTIC TESTING IN THE FIELDS OF CANCER OR OTHER TISSUE-BASED DIAGNOSTIC TESTING, CYTOLOGY AND CELL-BASED TESTING; DIAGNOSTIC APPARATUS FOR THE DETECTION OF PERIODONTAL DISEASE; DIAGNOSTIC APPARATUS FOR THE DETECTION OF CANCER; MEDICAL APPARATUS AND INSTRUMENT FOR DIAGNOSTIC USE, NAMELY, APPARATUS FOR MEDICAL DIAGNOSTIC TESTING IN THE FIELDS OF CANCER OR OTHER TISSUE-BASED DIAGNOSTIC TESTING, CYTOLOGY AND CELL-BASED TESTING; MEDICAL DIAGNOSTIC APPARATUS, ANALYTICAL APPARATUS FOR MEDICAL PURPOSES AND BLOOD PRESSURE MEASURING APPARATUS; MEDICAL DIAGNOSTIC APPARATUS FOR DETECTING CANCER; ORGANOLEPTIC DIAGNOSTIC TESTING APPARATUS FOR MEDICAL, DENTAL OR COSMETIC USE; ORTHOPEDIC APPARATUS AND INSTRUMENTS FOR DIAGNOSTIC AND THERAPEUTIC USE; ULTRASONIC MEDICAL DIAGNOSTIC APPARATUS; ULTRASOUND DIAGNOSTIC APPARATUS; X-RAY DIAGNOSTIC APPARATUS; MEDICAL X-RAY APPARATUS; X-RAY APPARATUS FOR MEDICAL USE; X-RAY APPARATUS FOR VETERINARY USE; X-RAY APPARATUS FOR DENTAL IMAGING; X-RAY APPLIANCES FOR DENTAL AND MEDICAL USE; X-RAY DIAGNOSTIC APPARATUS; X-RAY PHOTOGRAPHS FOR MEDICAL PURPOSES; X-RAY TUBES FOR MEDICAL PURPOSES; RADIOTHERAPY APPARATUS, IN CLASS 10 (U.S. CLS. 26, 39 AND 44).

FIRST USE 2-16-2012; IN COMMERCE 5-12-2012.

THE MARK CONSISTS OF STANDARD CHARACTERS WITHOUT CLAIM TO ANY PARTICULAR FONT, STYLE, SIZE, OR COLOR.

SN 85-564,038, FILED 3-8-2012.

TINA MAI, EXAMINING ATTORNEY



*David J. Kyros*

Director of the United States Patent and Trademark Office

# United States of America

United States Patent and Trademark Office

# INTERRUPT

**Reg. No. 4,277,197**

AG SPECTRUM COMPANY (IOWA CORPORATION)  
428 E. 11TH STREET  
DEWITT, IA 52742

**Registered Jan. 15, 2013**

**Int. Cl.: 1**

FOR: LIQUID FERTILIZER AND SOIL CONDITIONER FOR AGRICULTURAL USE, IN CLASS 1 (U.S. CLS. 1, 5, 6, 10, 26 AND 46).

**TRADEMARK**

FIRST USE 3-6-2012; IN COMMERCE 3-6-2012.

**PRINCIPAL REGISTER**

THE MARK CONSISTS OF STANDARD CHARACTERS WITHOUT CLAIM TO ANY PARTICULAR FONT, STYLE, SIZE, OR COLOR.

SN 85-564,256, FILED 3-8-2012.

CURTIS FRENCH, EXAMINING ATTORNEY



*David J. Kybas*

Director of the United States Patent and Trademark Office

# United States of America

United States Patent and Trademark Office

# SAFEFLARE

**Reg. No. 4,277,198**

**Registered Jan. 15, 2013**

**Int. Cl.: 11**

**TRADEMARK**

**PRINCIPAL REGISTER**

SAFEFLARE DEVELOPMENT INC. (FLORIDA CORPORATION)  
SUITE 212  
2500 LEGACY DRIVE  
FRISCO, TX 75034

FOR: HAND HELD LED STROBE LIGHT APPARATUS, IN CLASS 11 (U.S. CLS. 13, 21, 23, 31 AND 34).

FIRST USE 6-6-2012; IN COMMERCE 6-6-2012.

THE MARK CONSISTS OF STANDARD CHARACTERS WITHOUT CLAIM TO ANY PARTICULAR FONT, STYLE, SIZE, OR COLOR.

SN 85-564,305, FILED 3-8-2012.

ROSELLE HERRERA, EXAMINING ATTORNEY



*David J. Kyffers*

Director of the United States Patent and Trademark Office

# United States of America

United States Patent and Trademark Office

# GEL-ESCENT

**Reg. No. 4,277,199**

**Registered Jan. 15, 2013**

**Int. Cl.: 16**

**TRADEMARK**

**PRINCIPAL REGISTER**

LIQUI-MARK CORP. (NEW YORK CORPORATION)  
30 DAVIDS DRIVE  
HAUPPAUGE, NY 11788

FOR: HIGHLIGHTING MARKERS, IN CLASS 16 (U.S. CLS. 2, 5, 22, 23, 29, 37, 38 AND 50).

FIRST USE 6-14-2012; IN COMMERCE 6-14-2012.

THE MARK CONSISTS OF STANDARD CHARACTERS WITHOUT CLAIM TO ANY PARTICULAR FONT, STYLE, SIZE, OR COLOR.

SN 85-564,346, FILED 3-8-2012.

JERI J. FICKES, EXAMINING ATTORNEY



*David J. Kyffers*

Director of the United States Patent and Trademark Office



# United States of America

United States Patent and Trademark Office

## HAUNTING POTION

**Reg. No. 4,277,200**

PURE & NATURAL COMPANY (ARIZONA CORPORATION)  
MS 01.45

**Registered Jan. 15, 2013**

19001 NORTH SCOTTSDALE ROAD  
SCOTTSDALE, AZ 85255

**Int. Cl.: 3**

FOR: AIR FRAGRANCING PREPARATIONS, IN CLASS 3 (U.S. CLS. 1, 4, 6, 50, 51 AND 52).

**TRADEMARK**

FIRST USE 9-11-2012; IN COMMERCE 9-11-2012.

**PRINCIPAL REGISTER**

THE MARK CONSISTS OF STANDARD CHARACTERS WITHOUT CLAIM TO ANY PARTICULAR FONT, STYLE, SIZE, OR COLOR.

SN 85-564,376, FILED 3-8-2012.

JUHI KAVEESHVAR, EXAMINING ATTORNEY



*David J. Kybas*

Director of the United States Patent and Trademark Office

# United States of America

United States Patent and Trademark Office



**Reg. No. 4,277,201**

**Registered Jan. 15, 2013**

**Int. Cl.: 35**

**SERVICE MARK**

**PRINCIPAL REGISTER**

SERVICE KINGS, INC. (ARIZONA CORPORATION)  
G1  
5150 SUNRISE BLVD  
FAIR OAKS, CA 96268

FOR: FRANCHISING, NAMELY, OFFERING BUSINESS MANAGEMENT ASSISTANCE IN THE ESTABLISHMENT AND/OR OPERATION OF CLEANING, RESTORATION AND BUILDING REPAIR, IN CLASS 35 (U.S. CLS. 100, 101 AND 102).

FIRST USE 10-12-2012; IN COMMERCE 10-12-2012.

NO CLAIM IS MADE TO THE EXCLUSIVE RIGHT TO USE "INC.", APART FROM THE MARK AS SHOWN.

THE COLOR(S) BLACK, RED, WHITE, GOLD IS/ARE CLAIMED AS A FEATURE OF THE MARK.

THE MARK CONSISTS OF A WHITE OVAL WHICH IS OUTLINED WITH THE COLORS GOLD AND RED. AT THE TOP OF THE OVAL IS A GOLD CROWN THAT OPENS AT THE TOP AND THREE RED JEWELS EMBEDDED IN THE OPEN CROWN. THE LETTERING "S", "K" SERVICE KINGS INC." APPEARS IN BLACK BELOW THE CROWN.

SN 85-565,272, FILED 3-9-2012.

KAPIL BHANOT, EXAMINING ATTORNEY



*David J. Kybas*

Director of the United States Patent and Trademark Office

# United States of America

United States Patent and Trademark Office

# Service Kings

**Reg. No. 4,277,202**

**Registered Jan. 15, 2013**

**Int. Cl.: 35**

**SERVICE MARK**

**PRINCIPAL REGISTER**

SERVICE KINGS, INC. (ARIZONA CORPORATION)  
G1  
5150 SUNRISE BLVD  
FAIR OAKS, CA 95628

FOR: FRANCHISING, NAMELY, OFFERING BUSINESS MANAGEMENT ASSISTANCE IN THE ESTABLISHMENT AND/OR OPERATION OF BUILDING CLEANING, RESTORATION AND REPAIR BUSINESSES, IN CLASS 35 (U.S. CLS. 100, 101 AND 102).

FIRST USE 10-12-2012; IN COMMERCE 10-12-2012.

THE MARK CONSISTS OF STANDARD CHARACTERS WITHOUT CLAIM TO ANY PARTICULAR FONT, STYLE, SIZE, OR COLOR.

SN 85-565,308, FILED 3-9-2012.

KAPIL BHANOT, EXAMINING ATTORNEY



*David J. Kyffers*

Director of the United States Patent and Trademark Office

# United States of America

United States Patent and Trademark Office

# IPSA

**Reg. No. 4,277,203**

**Registered Jan. 15, 2013**

**Int. Cl.: 45**

**SERVICE MARK**

**PRINCIPAL REGISTER**

IPSA LLC (NEW YORK LIMITED LIABILITY COMPANY)  
187 HICKS STREET, APT. 1D  
BROOKLYN, NY 10003

FOR: ON-LINE SOCIAL NETWORKING SERVICES; ONLINE SOCIAL NETWORKING SERVICES PROVIDED THROUGH A COMMUNITY WEBSITE; ONLINE SOCIAL NETWORKING SERVICES IN THE FIELD OF LAW; ONLINE SOCIAL NETWORKING SERVICES IN THE FIELD OF LAW PROVIDED VIA A WEBSITE; PROVIDING ON-LINE COMPUTER DATABASES AND ON-LINE SEARCHABLE DATABASES IN THE FIELD OF SOCIAL NETWORKING; SOCIAL NETWORKING SERVICES IN THE FIELD OF LAW PROVIDED VIA A WEBSITE, IN CLASS 45 (U.S. CLS. 100 AND 101).

FIRST USE 5-15-2012; IN COMMERCE 5-15-2012.

THE MARK CONSISTS OF STANDARD CHARACTERS WITHOUT CLAIM TO ANY PARTICULAR FONT, STYLE, SIZE, OR COLOR.

SN 85-565,552, FILED 3-9-2012.

MAYUR VAGHANI, EXAMINING ATTORNEY



*David J. Kyros*

Director of the United States Patent and Trademark Office

# United States of America

United States Patent and Trademark Office

# POIES

**Reg. No. 4,277,204**

**Registered Jan. 15, 2013**

**Int. Cl.: 16**

**TRADEMARK**

**PRINCIPAL REGISTER**

SEWELL JR, JOSEPH, L (UNITED STATES INDIVIDUAL), DBA WORTHINGTON, PAUL,  
205 WESTBRIAR LN  
GRAND PRAIRIE, TX 750523543

FOR: SERIES OF FICTION WORKS, NAMELY, NOVELS AND BOOKS, IN CLASS 16 (U.S.  
CLS. 2, 5, 22, 23, 29, 37, 38 AND 50).

FIRST USE 3-9-2012; IN COMMERCE 3-9-2012.

THE MARK CONSISTS OF STANDARD CHARACTERS WITHOUT CLAIM TO ANY PAR-  
TICULAR FONT, STYLE, SIZE, OR COLOR.

SN 85-565,734, FILED 3-9-2012.

LAURIE KAUFMAN, EXAMINING ATTORNEY



*David J. Kyffers*

Director of the United States Patent and Trademark Office

# United States of America

United States Patent and Trademark Office

# PCSWorks

**Reg. No. 4,277,205**

FINITIV CORPORATION (CALIFORNIA CORPORATION)  
1730 S. EL CAMINO REAL, SUITE 480  
SAN MATEO, CA 94402

**Registered Jan. 15, 2013**

**Int. Cls.: 38, 41, and 42**

FOR: CONSULTING IN THE FIELD OF TELECOMMUNICATION SERVICES, NAMELY, TRANSMISSION OF VOICE, DATA, AND DOCUMENTS VIA TELECOMMUNICATIONS NETWORKS; ELECTRONIC TRANSMISSION AND STREAMING OF DIGITAL MEDIA CONTENT FOR OTHERS VIA GLOBAL AND LOCAL COMPUTER NETWORKS; INFORMATION TRANSMISSION SERVICES VIA DIGITAL NETWORKS; TRANSMISSION OF DIGITAL FILES, IN CLASS 38 (U.S. CLS. 100, 101 AND 104).

**SERVICE MARK**

**PRINCIPAL REGISTER**

FIRST USE 3-1-2012; IN COMMERCE 3-1-2012.

FOR: DIGITAL VIDEO, AUDIO, AND MULTIMEDIA PUBLISHING SERVICES; MULTIMEDIA PUBLISHING OF BOOKS, MAGAZINES, JOURNALS, SOFTWARE, GAMES, MUSIC, AND ELECTRONIC PUBLICATIONS; ONLINE ELECTRONIC PUBLISHING OF BOOKS AND PERIODICALS; PUBLISHING OF ELECTRONIC PUBLICATIONS, IN CLASS 41 (U.S. CLS. 100, 101 AND 107).

FIRST USE 3-1-2012; IN COMMERCE 3-1-2012.

FOR: CLOUD COMPUTING FEATURING SOFTWARE FOR USE HOSTING, MANAGEMENT, PRODUCTION, AND DELIVERY IN THE FIELD OF DIGITAL MEDIA PUBLISHING; COMPUTER SERVICES, NAMELY, ELECTRONIC DIGITIZING OF WRITINGS, BOOKS, PERIODICALS, MAGAZINES, AND JOURNALS; COMPUTER SERVICES, NAMELY, ELECTRONIC IMAGING OF WRITINGS, BOOKS, PERIODICALS, MAGAZINES, AND JOURNALS; CONSULTING SERVICES IN THE FIELD OF CLOUD COMPUTING; CONVERSION OF DATA OR DOCUMENTS FROM PHYSICAL TO ELECTRONIC MEDIA; HOSTING OF DIGITAL CONTENT ON THE INTERNET; TECHNOLOGICAL PLANNING AND CONSULTING SERVICES IN THE FIELD OF DIGITAL AND MULTIMEDIA PUBLISHING, IN CLASS 42 (U.S. CLS. 100 AND 101).

FIRST USE 3-1-2012; IN COMMERCE 3-1-2012.

THE MARK CONSISTS OF STANDARD CHARACTERS WITHOUT CLAIM TO ANY PARTICULAR FONT, STYLE, SIZE, OR COLOR.



*David J. Kybas*

Director of the United States Patent and Trademark Office

**Reg. No. 4,277,205** SN 85-565,853, FILED 3-9-2012.

CHRISTINA SOBRAL, EXAMINING ATTORNEY

# United States of America

United States Patent and Trademark Office

# PCSBeacon

**Reg. No. 4,277,206**

FINITIV CORPORATION (CALIFORNIA CORPORATION)  
1730 S. EL CAMINO REAL, SUITE 480  
SAN MATEO, CA 94402

**Registered Jan. 15, 2013**

**Int. Cls.: 38, 41, and 42**

FOR: CONSULTING IN THE FIELD OF TELECOMMUNICATION SERVICES, NAMELY, TRANSMISSION OF VOICE, DATA, AND DOCUMENTS VIA TELECOMMUNICATIONS NETWORKS; ELECTRONIC TRANSMISSION AND STREAMING OF DIGITAL MEDIA CONTENT FOR OTHERS VIA GLOBAL AND LOCAL COMPUTER NETWORKS; INFORMATION TRANSMISSION SERVICES VIA DIGITAL NETWORKS; TRANSMISSION OF DIGITAL FILES, IN CLASS 38 (U.S. CLS. 100, 101 AND 104).

**SERVICE MARK**

**PRINCIPAL REGISTER**

FIRST USE 3-1-2012; IN COMMERCE 3-1-2012.

FOR: DIGITAL VIDEO, AUDIO, AND MULTIMEDIA PUBLISHING SERVICES; MULTIMEDIA PUBLISHING OF BOOKS, MAGAZINES, JOURNALS, SOFTWARE, GAMES, MUSIC, AND ELECTRONIC PUBLICATIONS; ONLINE ELECTRONIC PUBLISHING OF BOOKS AND PERIODICALS; PUBLISHING OF ELECTRONIC PUBLICATIONS, IN CLASS 41 (U.S. CLS. 100, 101 AND 107).

FIRST USE 3-1-2012; IN COMMERCE 3-1-2012.

FOR: CLOUD COMPUTING FEATURING SOFTWARE FOR USE IN HOSTING, MANAGEMENT, PRODUCTION, AND DELIVERY IN THE FIELD OF DIGITAL MEDIA PUBLISHING; COMPUTER SERVICES, NAMELY, ELECTRONIC DIGITIZING OF WRITINGS, BOOKS, PERIODICALS, MAGAZINES, AND JOURNALS; COMPUTER SERVICES, NAMELY, ELECTRONIC IMAGING OF WRITINGS, BOOKS, PERIODICALS, MAGAZINES, AND JOURNALS; CONSULTING SERVICES IN THE FIELD OF CLOUD COMPUTING; CONVERSION OF DATA OR DOCUMENTS FROM PHYSICAL TO ELECTRONIC MEDIA; HOSTING OF DIGITAL CONTENT ON THE INTERNET; TECHNOLOGICAL PLANNING AND CONSULTING SERVICES IN THE FIELD OF DIGITAL AND MULTIMEDIA PUBLISHING, IN CLASS 42 (U.S. CLS. 100 AND 101).

FIRST USE 3-1-2012; IN COMMERCE 3-1-2012.

THE MARK CONSISTS OF STANDARD CHARACTERS WITHOUT CLAIM TO ANY PARTICULAR FONT, STYLE, SIZE, OR COLOR.



*David J. Kyros*

Director of the United States Patent and Trademark Office



**Reg. No. 4,277,206** SN 85-565,890, FILED 3-9-2012.

CHRISTINA SOBRAL, EXAMINING ATTORNEY

# United States of America

United States Patent and Trademark Office



**Reg. No. 4,277,207**

TOMORROW PARTNERS, LLC (CALIFORNIA LIMITED LIABILITY COMPANY)  
2332 FIFTH STREET  
BERKELEY, CA 94710

**Registered Jan. 15, 2013**

**Int. Cl.: 42**

FOR: PROVIDING TEMPORARY USE OF ONLINE NON-DOWNLOADABLE SOFTWARE USED TO AGGREGATE, COMPARE, VISUALIZE, AND PUBLISH PERSONAL AND OPEN DATA SETS AND STORIES, IN CLASS 42 (U.S. CLS. 100 AND 101).

**SERVICE MARK**

FIRST USE 3-30-2012; IN COMMERCE 4-17-2012.

**PRINCIPAL REGISTER**

THE MARK CONSISTS OF A STYLIZED IMAGE OF A BIRD NEXT TO THE TEXT "SPARKWISE".

SN 85-567,376, FILED 3-12-2012.

MARK SPARACINO, EXAMINING ATTORNEY



*David J. Kybas*

Director of the United States Patent and Trademark Office

# United States of America

United States Patent and Trademark Office



**Reg. No. 4,277,208**

**Registered Jan. 15, 2013**

**Int. Cl.: 25**

**TRADEMARK**

**PRINCIPAL REGISTER**

SAMUEL, MELVIN (UNITED STATES INDIVIDUAL), DBA WEH I FRUM APPAREL,  
618 LISA PLACE  
APT. 618  
NORTH BRUNSWICK, NJ 08902

FOR: BASEBALL CAPS AND HATS; SHORT-SLEEVED OR LONG-SLEEVED T-SHIRTS;  
T-SHIRTS; T-SHIRTS FOR BABIES, ADULTS, CHILDREN, WOMEN, MEN , IN CLASS 25  
(U.S. CLS. 22 AND 39).

FIRST USE 8-20-2012; IN COMMERCE 9-3-2012.

THE MARK CONSISTS OF AN OBLONG DESIGN COMPRISING THE STYLISTIC ELEMENTS  
OF A SCARAB, UPON WHICH IS SUPERIMPOSED AN ANKH, AND EACH OF AN INVERTED  
AND UNINVERTED IMAGE OF THE EYE OF RA, SHEN AND MAAT SYMBOLS, AND THE  
CONTINENT AFRICA, COMBINING TO FORM THE OVERALL APPEARANCE OF A FACE.

SN 85-567,924, FILED 3-13-2012.

HANNO RITTNER, EXAMINING ATTORNEY



*David J. Kyffers*

Director of the United States Patent and Trademark Office

# United States of America

United States Patent and Trademark Office



**Reg. No. 4,277,209**

**Registered Jan. 15, 2013**

**Int. Cl.: 42**

**SERVICE MARK**

**PRINCIPAL REGISTER**

FOUNDATION SUPPORTWORKS, INC. (NEBRASKA CORPORATION)  
12330 CARY CIRCLE  
OMAHA, NE 68128

FOR: PROVIDING ONLINE, NON-DOWNLOADABLE FOUNDATION DESIGN SOFTWARE FOR USE IN BUILDING CONSTRUCTION AND ENGINEERING FOR DESIGNING BUILDING FOUNDATIONS THAT UTILIZE HELICAL PILES, IN CLASS 42 (U.S. CLS. 100 AND 101).

FIRST USE 8-15-2012; IN COMMERCE 8-15-2012.

NO CLAIM IS MADE TO THE EXCLUSIVE RIGHT TO USE "HELICAL FOUNDATION DESIGN SOFTWARE FOR PROFESSIONALS", APART FROM THE MARK AS SHOWN.

THE COLOR(S) GRAY, BLACK AND RED IS/ARE CLAIMED AS A FEATURE OF THE MARK.

THE MARK CONSISTS OF THE WORD "HELIXPRO" IN GRAY WITH BLACK OUTLINING ABOVE THE WORDS "HELICAL FOUNDATION DESIGN SOFTWARE FOR PROFESSIONALS" IN BLACK, ABOVE A RED HORIZONTAL LINE WITH GRAY SHADING. THE FIRST PORTION OF THE "H" IN "HELIXPRO" EXTENDS BEYOND THE RED LINE, AND INCLUDES TWO STYLIZED HELIXES THAT ARE GRAY WITH BLACK OUTLINING.

SN 85-568,197, FILED 3-13-2012.

LINDA LAVACHE, EXAMINING ATTORNEY



*David J. Kyjars*

Director of the United States Patent and Trademark Office

**United States of America**  
United States Patent and Trademark Office

# HELIXPRO

**Reg. No. 4,277,210**

FOUNDATION SUPPORTWORKS, INC. (NEBRASKA CORPORATION)  
12330 CARY CIRCLE  
OMAHA, NE 68128

**Registered Jan. 15, 2013**

**Int. Cl.: 42**

FOR: PROVIDING ONLINE, NON-DOWNLOADABLE FOUNDATION DESIGN SOFTWARE FOR USE IN BUILDING CONSTRUCTION AND ENGINEERING FOR DESIGNING BUILDING FOUNDATIONS THAT UTILIZE HELICAL PILES , IN CLASS 42 (U.S. CLS. 100 AND 101).

**SERVICE MARK**

FIRST USE 8-15-2012; IN COMMERCE 8-15-2012.

**PRINCIPAL REGISTER**

THE MARK CONSISTS OF STANDARD CHARACTERS WITHOUT CLAIM TO ANY PARTICULAR FONT, STYLE, SIZE, OR COLOR.

SN 85-568,237, FILED 3-13-2012.

LINDA LAVACHE, EXAMINING ATTORNEY



*David J. Kyffers*

Director of the United States Patent and Trademark Office

# United States of America

United States Patent and Trademark Office

## RESHAPE YOUR WORLD

**Reg. No. 4,277,211**

NUSIRT SCIENCES, INC. (DELAWARE CORPORATION)  
1600 DIVISION STREET, SUITE 230  
NASHVILLE, TN 37203

**Registered Jan. 15, 2013**

**Int. Cl.: 5**

FOR: NUTRACEUTICALS, NAMELY, DIETARY AND NUTRITIONAL SUPPLEMENTS, IN CLASS 5 (U.S. CLS. 6, 18, 44, 46, 51 AND 52).

**TRADEMARK**

FIRST USE 10-16-2012; IN COMMERCE 10-16-2012.

**PRINCIPAL REGISTER**

THE MARK CONSISTS OF STANDARD CHARACTERS WITHOUT CLAIM TO ANY PARTICULAR FONT, STYLE, SIZE, OR COLOR.

SN 85-568,448, FILED 3-13-2012.

REBECCA EISINGER, EXAMINING ATTORNEY



*David J. Kybas*

Director of the United States Patent and Trademark Office

United States of America  
United States Patent and Trademark Office

**Price**  
**Piston**

**Reg. No. 4,277,212**

TAYLOR, CHRISTOPHER (UNITED STATES INDIVIDUAL)  
80 BAY STATE AVE #1  
SOMERVILLE, MA 02144

**Registered Jan. 15, 2013**

**Int. Cl.: 35**

FOR: PROVIDING PRICE COMPARISON SERVICES IN THE FIELD OF CAR AND AUTO-MOBILE REPAIR VIA THE INTERNET, IN CLASS 35 (U.S. CLS. 100, 101 AND 102).

**SERVICE MARK**

FIRST USE 11-5-2011; IN COMMERCE 12-15-2011.

**PRINCIPAL REGISTER**

THE MARK CONSISTS OF THE STYLIZED WORD "PRICE" IN DARK BLUE AND BELOW IT TO THE RIGHT THE STYLIZED WORD "PISTON" IN LIGHT BLUE WITH THE LETTER "P" IN BOTH WORDS REPRESENTED WITH PISTONS.

THE COLOR(S) BLUE IS/ARE CLAIMED AS A FEATURE OF THE MARK.

SN 85-568,703, FILED 3-13-2012.

JORDAN BAKER, EXAMINING ATTORNEY



*David J. Kyffers*

Director of the United States Patent and Trademark Office

# United States of America

United States Patent and Trademark Office

# FLOORMATE

**Reg. No. 4,277,213**

SHURTAPE TECHNOLOGIES, LLC (NORTH CAROLINA LIMITED LIABILITY COMPANY)  
1712 EIGHTH STREET DRIVE, SE  
HICKORY, NC 28602

**Registered Jan. 15, 2013**

**Int. Cl.: 17**

FOR: ADHESIVE TAPE FOR COMMERCIAL OR INDUSTRIAL USE ON FLOORS, IN CLASS  
17 (U.S. CLS. 1, 5, 12, 13, 35 AND 50).

**TRADEMARK**

FIRST USE 6-0-2012; IN COMMERCE 6-0-2012.

**PRINCIPAL REGISTER**

THE MARK CONSISTS OF STANDARD CHARACTERS WITHOUT CLAIM TO ANY PAR-  
TICULAR FONT, STYLE, SIZE, OR COLOR.

SN 85-568,839, FILED 3-14-2012.

DAVID COLLIER, EXAMINING ATTORNEY



*David J. Kybas*

Director of the United States Patent and Trademark Office



# United States of America

United States Patent and Trademark Office

# PEP

**Reg. No. 4,277,214**

SONIC INNOVATIONS, INC. (DELAWARE CORPORATION)  
2501 COTTONTAIL LANE  
SOMERSET, NJ 08873

**Registered Jan. 15, 2013**

**Int. Cl.: 10**

FOR: HEARING AIDS, IN CLASS 10 (U.S. CLS. 26, 39 AND 44).

**TRADEMARK**

FIRST USE 7-9-2012; IN COMMERCE 7-9-2012.

**PRINCIPAL REGISTER**

THE MARK CONSISTS OF STANDARD CHARACTERS WITHOUT CLAIM TO ANY PARTICULAR FONT, STYLE, SIZE, OR COLOR.

SN 85-569,518, FILED 3-14-2012.

ALYSSA STEEL, EXAMINING ATTORNEY



*David J. Kybas*

Director of the United States Patent and Trademark Office

# United States of America

United States Patent and Trademark Office

# CLIX

**Reg. No. 4,277,215**

**Registered Jan. 15, 2013**

**Int. Cl.: 26**

**TRADEMARK**

**PRINCIPAL REGISTER**

IDEA VAULT, LLC (WYOMING LIMITED LIABILITY COMPANY)  
P.O. BOX 2869  
60 EAST SIMPSON AVENUE  
JACKSON, WY 83001

FOR: ROTATING CLIP-BUTTONS USED FOR SOCIAL EXPRESSION IN THE NATURE OF ORNAMENTAL NOVELTY BUTTONS, IN CLASS 26 (U.S. CLS. 37, 39, 40, 42 AND 50).

FIRST USE 7-1-2012; IN COMMERCE 7-1-2012.

THE MARK CONSISTS OF STANDARD CHARACTERS WITHOUT CLAIM TO ANY PARTICULAR FONT, STYLE, SIZE, OR COLOR.

SN 85-569,523, FILED 3-14-2012.

MATTHEW MCDOWELL, EXAMINING ATTORNEY



*David J. Kyffers*

Director of the United States Patent and Trademark Office

# United States of America

United States Patent and Trademark Office

# APIS HORN

**Reg. No. 4,277,216**

C6 EYEWEAR INTERNATIONAL LLC (FLORIDA LIMITED LIABILITY COMPANY)  
15471 S.W. 27TH STREET  
MIAMI, FL 33185

**Registered Jan. 15, 2013**

**Int. Cl.: 9**

FOR: EYEGLASSES, SUNGLASSES AND OTHER EYEWEAR, IN CLASS 9 (U.S. CLS. 21, 23, 26, 36 AND 38).

**TRADEMARK**

FIRST USE 3-1-2012; IN COMMERCE 3-1-2012.

**PRINCIPAL REGISTER**

THE MARK CONSISTS OF STANDARD CHARACTERS WITHOUT CLAIM TO ANY PARTICULAR FONT, STYLE, SIZE, OR COLOR.

SN 85-573,514, FILED 3-19-2012.

JOHN GARTNER, EXAMINING ATTORNEY



*David J. Kyffers*

Director of the United States Patent and Trademark Office

# United States of America

United States Patent and Trademark Office

## CONTOURTIONIST

**Reg. No. 4,277,217**

**Registered Jan. 15, 2013**

**Int. Cl.: 21**

**TRADEMARK**

**PRINCIPAL REGISTER**

TARTE, INC. (NEW YORK CORPORATION)  
SUITE 902  
53 WEST 36TH STREET  
NEW YORK, NY 10018

FOR: COSMETIC BRUSHES, IN CLASS 21 (U.S. CLS. 2, 13, 23, 29, 30, 33, 40 AND 50).

FIRST USE 7-20-2012; IN COMMERCE 7-20-2012.

THE MARK CONSISTS OF STANDARD CHARACTERS WITHOUT CLAIM TO ANY PARTICULAR FONT, STYLE, SIZE, OR COLOR.

SN 85-575,970, FILED 3-21-2012.

CHRISTOPHER LAW, EXAMINING ATTORNEY



*David J. Kyffers*

Director of the United States Patent and Trademark Office

# United States of America

United States Patent and Trademark Office

## BLUSHING BEAUTY

**Reg. No. 4,277,218**

**Registered Jan. 15, 2013**

**Int. Cl.: 21**

**TRADEMARK**

**PRINCIPAL REGISTER**

TARTE, INC. (NEW YORK CORPORATION)  
SUITE 902  
53 WEST 36TH STREET  
NEW YORK, NY 10018

FOR: COSMETIC BRUSHES, IN CLASS 21 (U.S. CLS. 2, 13, 23, 29, 30, 33, 40 AND 50).

FIRST USE 7-20-2012; IN COMMERCE 7-20-2012.

THE MARK CONSISTS OF STANDARD CHARACTERS WITHOUT CLAIM TO ANY PARTICULAR FONT, STYLE, SIZE, OR COLOR.

SN 85-576,043, FILED 3-21-2012.

CHRISTOPHER LAW, EXAMINING ATTORNEY



*David J. Kybas*

Director of the United States Patent and Trademark Office

# United States of America

United States Patent and Trademark Office

## UNDERCOVER LOVER

**Reg. No. 4,277,219**

**Registered Jan. 15, 2013**

**Int. Cl.: 21**

**TRADEMARK**

**PRINCIPAL REGISTER**

TARTE, INC. (NEW YORK CORPORATION)  
SUITE 902  
53 WEST 36TH STREET  
NEW YORK, NY 10018

FOR: COSMETIC BRUSHES, IN CLASS 21 (U.S. CLS. 2, 13, 23, 29, 30, 33, 40 AND 50).

FIRST USE 7-20-2012; IN COMMERCE 7-20-2012.

THE MARK CONSISTS OF STANDARD CHARACTERS WITHOUT CLAIM TO ANY PARTICULAR FONT, STYLE, SIZE, OR COLOR.

SN 85-576,075, FILED 3-21-2012.

CHRISTOPHER LAW, EXAMINING ATTORNEY



*David J. Kyffers*

Director of the United States Patent and Trademark Office

**United States of America**  
United States Patent and Trademark Office

**BUFFY**

**Reg. No. 4,277,220**

**Registered Jan. 15, 2013**

**Int. Cl.: 21**

**TRADEMARK**

**PRINCIPAL REGISTER**

TARTE, INC. (NEW YORK CORPORATION)  
SUITE 902  
53 WEST 36TH STREET  
NEW YORK, NY 10018

FOR: COSMETIC BRUSHES, IN CLASS 21 (U.S. CLS. 2, 13, 23, 29, 30, 33, 40 AND 50).

FIRST USE 7-20-2012; IN COMMERCE 7-20-2012.

THE MARK CONSISTS OF STANDARD CHARACTERS WITHOUT CLAIM TO ANY PARTICULAR FONT, STYLE, SIZE, OR COLOR.

SN 85-576,105, FILED 3-21-2012.

CHRISTOPHER LAW, EXAMINING ATTORNEY



*David J. Kybas*

Director of the United States Patent and Trademark Office

**United States of America**  
United States Patent and Trademark Office

**FANATIC**

**Reg. No. 4,277,221**

**Registered Jan. 15, 2013**

**Int. Cl.: 21**

**TRADEMARK**

**PRINCIPAL REGISTER**

TARTE, INC. (NEW YORK CORPORATION)  
SUITE 902  
53 WEST 36TH STREET  
NEW YORK, NY 10018

FOR: COSMETIC BRUSHES, IN CLASS 21 (U.S. CLS. 2, 13, 23, 29, 30, 33, 40 AND 50).

FIRST USE 7-20-2012; IN COMMERCE 7-20-2012.

THE MARK CONSISTS OF STANDARD CHARACTERS WITHOUT CLAIM TO ANY PARTICULAR FONT, STYLE, SIZE, OR COLOR.

SN 85-576,132, FILED 3-21-2012.

CHRISTOPHER LAW, EXAMINING ATTORNEY



*David J. Kybas*

Director of the United States Patent and Trademark Office



# United States of America

United States Patent and Trademark Office

## GOLDEN GAL

**Reg. No. 4,277,222**

**Registered Jan. 15, 2013**

**Int. Cl.: 21**

**TRADEMARK**

**PRINCIPAL REGISTER**

TARTE, INC. (NEW YORK CORPORATION)  
SUITE 902  
53 WEST 36TH STREET  
NEW YORK, NY 10018

FOR: COSMETIC BRUSHES, IN CLASS 21 (U.S. CLS. 2, 13, 23, 29, 30, 33, 40 AND 50).

FIRST USE 7-20-2012; IN COMMERCE 7-20-2012.

THE MARK CONSISTS OF STANDARD CHARACTERS WITHOUT CLAIM TO ANY PARTICULAR FONT, STYLE, SIZE, OR COLOR.

SN 85-576,140, FILED 3-21-2012.

CHRISTOPHER LAW, EXAMINING ATTORNEY



*David J. Kybas*

Director of the United States Patent and Trademark Office

# United States of America

United States Patent and Trademark Office

# RETOUCHER

**Reg. No. 4,277,223**

**Registered Jan. 15, 2013**

**Int. Cl.: 21**

**TRADEMARK**

**PRINCIPAL REGISTER**

TARTE, INC. (NEW YORK CORPORATION)  
SUITE 902  
53 WEST 36TH STREET  
NEW YORK, NY 10018

FOR: COSMETIC BRUSHES, IN CLASS 21 (U.S. CLS. 2, 13, 23, 29, 30, 33, 40 AND 50).

FIRST USE 7-20-2012; IN COMMERCE 7-20-2012.

THE MARK CONSISTS OF STANDARD CHARACTERS WITHOUT CLAIM TO ANY PARTICULAR FONT, STYLE, SIZE, OR COLOR.

SN 85-576,152, FILED 3-21-2012.

CHRISTOPHER LAW, EXAMINING ATTORNEY



*David J. Kybas*

Director of the United States Patent and Trademark Office

# United States of America

United States Patent and Trademark Office

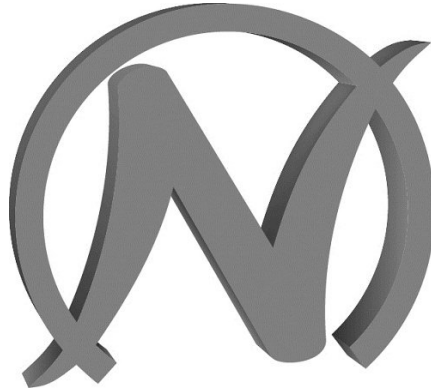

**Reg. No. 4,277,224**

**Registered Jan. 15, 2013**

**Int. Cl.: 5**

**TRADEMARK**

**PRINCIPAL REGISTER**

NUTRATEK HEALTH INNOVATIONS, INC. (CANADA CORPORATION)  
PO BOX 919  
RAYMOND, ALBERTA, CANADA T0K2S0

FOR: NUTRITIONAL SUPPLEMENTS, IN CLASS 5 (U.S. CLS. 6, 18, 44, 46, 51 AND 52).

FIRST USE 9-12-2012; IN COMMERCE 9-12-2012.

THE MARK CONSISTS OF A STYLIZED LETTER "N" INSIDE A HORSESHOE DESIGN.

SN 85-577,121, FILED 3-22-2012.

LINDA ESTRADA, EXAMINING ATTORNEY



*David J. Kyffers*

Director of the United States Patent and Trademark Office

# United States of America

United States Patent and Trademark Office

## Scents of Pride

**Reg. No. 4,277,225**

**Registered Jan. 15, 2013**

**Int. Cl.: 3**

**TRADEMARK**

**PRINCIPAL REGISTER**

BLCW ENTERPRISES (NORTH CAROLINA LIMITED LIABILITY COMPANY)  
405 CELTIC ASH STREET  
SNEADS FERRY, NC, NC 28460

FOR: AIR FRAGRANCING PREPARATIONS, IN CLASS 3 (U.S. CLS. 1, 4, 6, 50, 51 AND 52).

FIRST USE 7-1-2012; IN COMMERCE 7-1-2012.

THE MARK CONSISTS OF STANDARD CHARACTERS WITHOUT CLAIM TO ANY PARTICULAR FONT, STYLE, SIZE, OR COLOR.

SN 85-577,313, FILED 3-22-2012.

EMILY CARLSEN, EXAMINING ATTORNEY



*David J. Kyffers*

Director of the United States Patent and Trademark Office

# United States of America

United States Patent and Trademark Office

## ARTISANS APPAREL THE ART OF APPAREL

**Reg. No. 4,277,226**

ARTISANS, INC. (WISCONSIN CORPORATION)

**Registered Jan. 15, 2013**

P.O. BOX 278  
GLEN FLORA, WI 54526

**Int. Cls.: 25, 35, and 40**

FOR: CLOTHING, NAMELY, PANTS, CAPRIS, SHIRTS, T-SHIRTS, SWEATSHIRTS, SWEATERS, DRESSES, VESTS, MITTENS, LOUNGEWEAR, CAPS, SHORTS AND SCARVES, IN CLASS 25 (U.S. CLS. 22 AND 39).

**TRADEMARK**

FIRST USE 2-1-2012; IN COMMERCE 2-1-2012.

**SERVICE MARK**

FOR: ELECTRONIC CATALOG SERVICES FEATURING APPAREL; MAIL ORDER CATALOG SERVICES FEATURING APPAREL, IN CLASS 35 (U.S. CLS. 100, 101 AND 102).

**PRINCIPAL REGISTER**

FIRST USE 2-1-2012; IN COMMERCE 2-1-2012.

FOR: CUSTOM IMPRINTING OF CLOTHING WITH DECORATIVE DESIGNS, IN CLASS 40 (U.S. CLS. 100, 103 AND 106).

FIRST USE 2-1-2012; IN COMMERCE 2-1-2012.

THE MARK CONSISTS OF STANDARD CHARACTERS WITHOUT CLAIM TO ANY PARTICULAR FONT, STYLE, SIZE, OR COLOR.

OWNER OF U.S. REG. NOS. 1,681,570, 1,687,942, AND 2,723,632.

NO CLAIM IS MADE TO THE EXCLUSIVE RIGHT TO USE "APPAREL", APART FROM THE MARK AS SHOWN.

SN 85-577,429, FILED 3-22-2012.

LINDA ORNDORFF, EXAMINING ATTORNEY



*David J. Kypos*

Director of the United States Patent and Trademark Office

# United States of America

United States Patent and Trademark Office

# TEES OF EYDY

**Reg. No. 4,277,227**

**Registered Jan. 15, 2013**

**Int. Cl.: 25**

**TRADEMARK**

**PRINCIPAL REGISTER**

JUNO FASHION INTERNATIONAL CO., LTD. (CHINA LIMITED COMPANY (LTD.))  
2F, BLDG 60, NO. 2 JINGYUAN NORTH STREET  
E&T DEVELOPMENT ZONE, DAXING DISTRICT  
BEIJING, CHINA

FOR: BOOTS; DOWN JACKETS; GLOVES; HATS; LEATHER BELTS; LEATHER COATS;  
SHOES; SOCKS; WIND COATS; WOMEN'S CLOTHING, NAMELY, SHIRTS, DRESSES,  
SKIRTS, BLOUSES, IN CLASS 25 (U.S. CLS. 22 AND 39).

FIRST USE 3-1-2012; IN COMMERCE 9-1-2012.

THE MARK CONSISTS OF STYLIZED WORDING "TEESOF EYDY", WITH THE OBLIQUE  
LETTER "F" IN THE MIDDLE OF THE MARK.

THE WORDING "TEESOF EYDY" HAS NO MEANING IN A FOREIGN LANGUAGE.

SN 85-579,237, FILED 3-25-2012.

SHAILA SETTLES, EXAMINING ATTORNEY



*David J. Kyros*

Director of the United States Patent and Trademark Office

# United States of America

United States Patent and Trademark Office

## AllCare Health Plan

**Reg. No. 4,277,228**

**Registered Jan. 15, 2013**

**Int. Cl.: 44**

**SERVICE MARK**

**PRINCIPAL REGISTER**

MID ROGUE HEALTH PLAN, INC. (OREGON CORPORATION)  
740 SE 7TH STREET  
GRANTS PASS, OR 97526

FOR: MANAGED HEALTH CARE SERVICES, IN CLASS 44 (U.S. CLS. 100 AND 101).

FIRST USE 4-20-2012; IN COMMERCE 8-1-2012.

THE MARK CONSISTS OF STANDARD CHARACTERS WITHOUT CLAIM TO ANY PARTICULAR FONT, STYLE, SIZE, OR COLOR.

NO CLAIM IS MADE TO THE EXCLUSIVE RIGHT TO USE "HEALTH PLAN", APART FROM THE MARK AS SHOWN.

SN 85-579,986, FILED 3-26-2012.

VIVIAN MICZNIK FIRST, EXAMINING ATTORNEY



*David J. Kyffers*

Director of the United States Patent and Trademark Office

# United States of America

United States Patent and Trademark Office

# REVIVER

**Reg. No. 4,277,229**

KUSIN & KUSIN, LTD (TEXAS LIMITED PARTNERSHIP)  
4717 WILDWOOD  
DALLAS, TX 75209

**Registered Jan. 15, 2013**

**Int. Cl.: 5**

FOR: A REUSABLE HAND MITT IMPREGNATED WITH DEODORIZING FRAGRANCES FOR NEUTRALIZING ODORS ON CLOTHING, IN CLASS 5 (U.S. CLS. 6, 18, 44, 46, 51 AND 52).

**TRADEMARK**

FIRST USE 10-1-2012; IN COMMERCE 10-1-2012.

**PRINCIPAL REGISTER**

THE MARK CONSISTS OF STANDARD CHARACTERS WITHOUT CLAIM TO ANY PARTICULAR FONT, STYLE, SIZE, OR COLOR.

SN 85-580,263, FILED 3-26-2012.

ANDREW LEASER, EXAMINING ATTORNEY



*David J. Kybas*

Director of the United States Patent and Trademark Office



# United States of America

United States Patent and Trademark Office

## It's The IRS Notices You Don't Get That Make The Difference!

**Reg. No. 4,277,230**

**Registered Jan. 15, 2013**

**Int. Cl.: 35**

**SERVICE MARK**

**PRINCIPAL REGISTER**

PENN, SCOTT M. (UNITED STATES INDIVIDUAL)  
STE. B  
15545 BEAR VALLEY RD  
HESPERIA, CA 92345

FOR: TAX AND TAXATION PLANNING, ADVICE, INFORMATION AND CONSULTANCY SERVICES; TAX PREPARATION, IN CLASS 35 (U.S. CLS. 100, 101 AND 102).

FIRST USE 1-15-2010; IN COMMERCE 1-15-2010.

THE MARK CONSISTS OF STANDARD CHARACTERS WITHOUT CLAIM TO ANY PARTICULAR FONT, STYLE, SIZE, OR COLOR.

SN 85-581,490, FILED 3-27-2012.

SANI KHOURI, EXAMINING ATTORNEY



*David J. Kybas*

Director of the United States Patent and Trademark Office

# United States of America

United States Patent and Trademark Office

## JINGLE BELL STATION

**Reg. No. 4,277,231**

BUELING'S INC. (FLORIDA CORPORATION)  
10604 DEERBERRY DRIVE  
LAND O'LAKES, FL 34638

**Registered Jan. 15, 2013**

**Int. Cl.: 36**

FOR: CHARITABLE FUNDRAISING SERVICES BY MEANS OF A HOLIDAY SHOP, IN CLASS 36 (U.S. CLS. 100, 101 AND 102).

**SERVICE MARK**

FIRST USE 3-1-2012; IN COMMERCE 3-1-2012.

**PRINCIPAL REGISTER**

THE MARK CONSISTS OF STANDARD CHARACTERS WITHOUT CLAIM TO ANY PARTICULAR FONT, STYLE, SIZE, OR COLOR.

SN 85-581,985, FILED 3-28-2012.

ALLISON HOLTZ, EXAMINING ATTORNEY



*David J. Kyffers*

Director of the United States Patent and Trademark Office

# United States of America

United States Patent and Trademark Office

## SWEETEST BUZZ

**Reg. No. 4,277,232**

THE SWEETEST BUZZ, INC. (CALIFORNIA CORPORATION)  
1340 WEST PENNSYLVANIA AVENUE  
SAN DIEGO, CA 92103

**Registered Jan. 15, 2013**

**Int. Cls.: 35 and 43**

FOR: RETAIL BAKERY SHOPS, IN CLASS 35 (U.S. CLS. 100, 101 AND 102).

**SERVICE MARK**

FIRST USE 6-14-2012; IN COMMERCE 6-14-2012.

**PRINCIPAL REGISTER**

FOR: COFFEE SHOPS , IN CLASS 43 (U.S. CLS. 100 AND 101).

FIRST USE 6-14-2012; IN COMMERCE 6-14-2012.

THE MARK CONSISTS OF STANDARD CHARACTERS WITHOUT CLAIM TO ANY PARTICULAR FONT, STYLE, SIZE, OR COLOR.

SN 85-582,016, FILED 3-28-2012.

JAY FLOWERS, EXAMINING ATTORNEY



*David J. Kybas*

Director of the United States Patent and Trademark Office

# United States of America

United States Patent and Trademark Office

# SOCIALVILLE

**Reg. No. 4,277,233**

**Registered Jan. 15, 2013**

**Int. Cl.: 42**

**SERVICE MARK**

**PRINCIPAL REGISTER**

CHEATERTVILLE, INC. (DELAWARE CORPORATION)  
SUITE 110-234  
10620 SOUTHERN HIGHLANDS PARKWAY  
LAS VEGAS, NV 89141

FOR: COMPUTER SERVICES, NAMELY, CREATING AN ON-LINE COMMUNITY FOR REGISTERED USERS TO PARTICIPATE IN DISCUSSIONS, GET FEEDBACK FROM THEIR PEERS, FORM VIRTUAL COMMUNITIES, AND ENGAGE IN SOCIAL NETWORKING; ALL OF THE AFOREMENTIONED SERVICES EXCLUDING COMPUTER AND ELECTRONIC GAMES PROVIDED ONLINE OR ON WIRELESS DEVICES AND ON ANY OTHER TECHNOLOGICAL DEVICE, PLATFORM OR MEDIUM, IN CLASS 42 (U.S. CLS. 100 AND 101).

FIRST USE 11-14-2012; IN COMMERCE 11-14-2012.

THE MARK CONSISTS OF STANDARD CHARACTERS WITHOUT CLAIM TO ANY PARTICULAR FONT, STYLE, SIZE, OR COLOR.

SN 85-582,604, FILED 3-28-2012.

KARANENDRA S. CHHINA, EXAMINING ATTORNEY



*David J. Kyros*

Director of the United States Patent and Trademark Office

# United States of America

United States Patent and Trademark Office

## BIG SHOULDERS COFFEE

**Reg. No. 4,277,234**

BIG SHOULDERS COFFEE WORKS, LLC (ILLINOIS LIMITED LIABILITY COMPANY)  
1105 W. CHICAGO AVE.  
CHICAGO, IL 60642

**Registered Jan. 15, 2013**

**Int. Cl.: 30**

FOR: COFFEE BEANS, IN CLASS 30 (U.S. CL. 46).

**TRADEMARK**

FIRST USE 1-31-2012; IN COMMERCE 1-31-2012.

**PRINCIPAL REGISTER**

THE MARK CONSISTS OF STANDARD CHARACTERS WITHOUT CLAIM TO ANY PARTICULAR FONT, STYLE, SIZE, OR COLOR.

NO CLAIM IS MADE TO THE EXCLUSIVE RIGHT TO USE "COFFEE", APART FROM THE MARK AS SHOWN.

SN 85-582,634, FILED 3-28-2012.

WILLIAM VERHOSEK, EXAMINING ATTORNEY



*David J. Kybas*

Director of the United States Patent and Trademark Office

# United States of America

United States Patent and Trademark Office

## EVENMORE CLASSIC LEAF

**Reg. No. 4,277,235**

FUSION 360, INC. (CALIFORNIA CORPORATION)  
2425 INDUSTRIAL ROWE  
TURLOCK, CA 95380

**Registered Jan. 15, 2013**

**Int. Cl.: 1**

FOR: FERTILIZERS; PLANT FOODS; CHEMICALS FOR USE IN AGRICULTURE AND INDUSTRY, NAMELY, MICROBIAL NUTRIENT COMPOSITIONS, MICROBIAL COMPOSITIONS, BIOREMEDIATION COMPOSITIONS, MINERAL FERTILIZING PREPARATIONS, AND PLANT NUTRIENT COMPOSITIONS, IN CLASS 1 (U.S. CLS. 1, 5, 6, 10, 26 AND 46).

**TRADEMARK**

**PRINCIPAL REGISTER**

FIRST USE 11-14-2012; IN COMMERCE 11-14-2012.

THE MARK CONSISTS OF STANDARD CHARACTERS WITHOUT CLAIM TO ANY PARTICULAR FONT, STYLE, SIZE, OR COLOR.

NO CLAIM IS MADE TO THE EXCLUSIVE RIGHT TO USE "LEAF", APART FROM THE MARK AS SHOWN.

SN 85-582,692, FILED 3-28-2012.

ROBERT C. CLARK JR., EXAMINING ATTORNEY



*David J. Kyfos*

Director of the United States Patent and Trademark Office

# United States of America

United States Patent and Trademark Office

## EVENMORE CLASSIC SOIL

**Reg. No. 4,277,236**

FUSION 360, INC. (CALIFORNIA CORPORATION)  
2425 INDUSTRIAL ROWE  
TURLOCK, CA 95380

**Registered Jan. 15, 2013**

**Int. Cl.: 1**

FOR: FERTILIZERS; PLANT FOODS; CHEMICALS FOR USE IN AGRICULTURE AND INDUSTRY, NAMELY, MICROBIAL NUTRIENT COMPOSITIONS, MICROBIAL COMPOSITIONS, BIOREMEDIATION COMPOSITIONS, MINERAL FERTILIZING PREPARATIONS, AND PLANT NUTRIENT COMPOSITIONS, IN CLASS 1 (U.S. CLS. 1, 5, 6, 10, 26 AND 46).

**TRADEMARK**

**PRINCIPAL REGISTER**

FIRST USE 11-14-2012; IN COMMERCE 11-14-2012.

THE MARK CONSISTS OF STANDARD CHARACTERS WITHOUT CLAIM TO ANY PARTICULAR FONT, STYLE, SIZE, OR COLOR.

NO CLAIM IS MADE TO THE EXCLUSIVE RIGHT TO USE "SOIL", APART FROM THE MARK AS SHOWN.

SN 85-582,697, FILED 3-28-2012.

ROBERT C. CLARK JR., EXAMINING ATTORNEY



*David J. Kyfos*

Director of the United States Patent and Trademark Office

**United States of America**  
United States Patent and Trademark Office

# TREMOLO

**Reg. No. 4,277,237**

**Registered Jan. 15, 2013**

**Int. Cl.: 27**

**TRADEMARK**

**PRINCIPAL REGISTER**

THE MAYA ROMANOFF CORPORATION (ILLINOIS CORPORATION)  
3435 MADISON STREET  
SKOKIE, IL 60076

FOR: NON-TEXTILE WALL COVERINGS, IN CLASS 27 (U.S. CLS. 19, 20, 37, 42 AND 50).

FIRST USE 8-8-2012; IN COMMERCE 8-8-2012.

THE MARK CONSISTS OF STANDARD CHARACTERS WITHOUT CLAIM TO ANY PARTICULAR FONT, STYLE, SIZE, OR COLOR.

SN 85-582,877, FILED 3-28-2012.

WON TEAK OH, EXAMINING ATTORNEY



*David J. Kyffers*

Director of the United States Patent and Trademark Office



# United States of America

United States Patent and Trademark Office

# GILORE'

**Reg. No. 4,277,238**

**Registered Jan. 15, 2013**

**Int. Cl.: 3**

**TRADEMARK**

**PRINCIPAL REGISTER**

OREN-LICHTMAN, GALI (ISRAEL INDIVIDUAL)  
69 ANDERSON AVENUE  
BERGENFIELD, NJ 07621

FOR: COSMETICS, IN CLASS 3 (U.S. CLS. 1, 4, 6, 50, 51 AND 52).

FIRST USE 12-1-2011; IN COMMERCE 12-1-2011.

THE MARK CONSISTS OF STANDARD CHARACTERS WITHOUT CLAIM TO ANY PARTICULAR FONT, STYLE, SIZE, OR COLOR.

THE WORDING "GILORE" HAS NO MEANING IN A FOREIGN LANGUAGE.

SN 85-582,902, FILED 3-28-2012.

GINA FINK, EXAMINING ATTORNEY



*David J. Kyffers*

Director of the United States Patent and Trademark Office

# United States of America

United States Patent and Trademark Office



**Reg. No. 4,277,239**

VICKERY, SHADD (UNITED STATES INDIVIDUAL)  
7570 S FEDERAL HWY  
LANTANA, FL 33462

**Registered Jan. 15, 2013**

**Int. Cl.: 34**

FOR: ELECTRONIC CIGARETTES; CIGARETTES CONTAINING TOBACCO SUBSTITUTES  
NOT FOR MEDICAL PURPOSES, IN CLASS 34 (U.S. CLS. 2, 8, 9 AND 17).

**TRADEMARK**

FIRST USE 4-16-2012; IN COMMERCE 4-16-2012.

**PRINCIPAL REGISTER**

NO CLAIM IS MADE TO THE EXCLUSIVE RIGHT TO USE "CIGGIES" AND "THE ORIGINAL  
E-CIG BIZ", APART FROM THE MARK AS SHOWN.

THE MARK CONSISTS OF THE LITERAL ELEMENTS "CIGGIES THE ORIGINAL E-CIG  
BIZ" WRITTEN IN STYLIZED FORM WHEREIN THE WORDS "THE ORIGINAL E-CIG BIZ"  
ARE WRITTEN BENEATH THE RIGHT CORNER OF THE WORD "CIGGIES" AND THREE  
WAVY LINES ARE DRAWN IN BACKGROUND OF THE WORD "CIGGIES" AS SHOWN  
IN THE MARK.

SN 85-583,034, FILED 3-29-2012.

NAAKWAMA ANKRAH, EXAMINING ATTORNEY



*David J. Kyffers*

Director of the United States Patent and Trademark Office

# United States of America

United States Patent and Trademark Office

# DASHLOCKER

**Reg. No. 4,277,240**

HAM NY LAUNDRY, LLC (NEW YORK LIMITED LIABILITY COMPANY)  
2090 LINDON BLVD  
BROOKLYN, NY 11207

**Registered Jan. 15, 2013**

**Int. Cls.: 37 and 39**

FOR: DRY CLEANING; LAUNDRY SERVICES; SHOE SHINING, IN CLASS 37 (U.S. CLS. 100, 103 AND 106).

**SERVICE MARK**

FIRST USE 6-1-2012; IN COMMERCE 6-1-2012.

**PRINCIPAL REGISTER**

FOR: TRANSPORT AND STORAGE OF GOODS, IN CLASS 39 (U.S. CLS. 100 AND 105).

FIRST USE 6-1-2012; IN COMMERCE 6-1-2012.

THE MARK CONSISTS OF STANDARD CHARACTERS WITHOUT CLAIM TO ANY PARTICULAR FONT, STYLE, SIZE, OR COLOR.

SN 85-583,310, FILED 3-29-2012.

JULIE WATSON, EXAMINING ATTORNEY



*David J. Kyffers*

Director of the United States Patent and Trademark Office

# United States of America

United States Patent and Trademark Office

# SWIRL

**Reg. No. 4,277,241**

**Registered Jan. 15, 2013**

**Int. Cl.: 45**

**SERVICE MARK**

**PRINCIPAL REGISTER**

SWIRL NETWORKS, INC. (DELAWARE CORPORATION)  
420 BOYLSTON ST., 3RD FLOOR  
BOSTON, MA 02116

FOR: ONLINE SOCIAL NETWORKING SERVICES IN THE FIELD OF SHOPPING PROVIDED VIA A WEBSITE OR MOBILE APPLICATION, IN CLASS 45 (U.S. CLS. 100 AND 101).

FIRST USE 8-2-2012; IN COMMERCE 8-2-2012.

THE MARK CONSISTS OF STANDARD CHARACTERS WITHOUT CLAIM TO ANY PARTICULAR FONT, STYLE, SIZE, OR COLOR.

SN 85-583,385, FILED 3-29-2012.

CURTIS FRENCH, EXAMINING ATTORNEY



*David J. Kybas*

Director of the United States Patent and Trademark Office

# United States of America

United States Patent and Trademark Office

## OPTIMUS NUTRACEUTICALS

**Reg. No. 4,277,242**

NUTRATEK HEALTH INNOVATIONS, INC. (CANADA CORPORATION)  
PO BOX 919

**Registered Jan. 15, 2013**

RAYMOND, ALBERTA, CANADA T0K2S0

**Int. Cl.: 5**

FOR: NUTRITIONAL SUPPLEMENTS FOR HUMAN CONSUMPTION, IN CLASS 5 (U.S. CLS. 6, 18, 44, 46, 51 AND 52).

**TRADEMARK**

FIRST USE 9-12-2012; IN COMMERCE 9-12-2012.

**PRINCIPAL REGISTER**

THE MARK CONSISTS OF STANDARD CHARACTERS WITHOUT CLAIM TO ANY PARTICULAR FONT, STYLE, SIZE, OR COLOR.

NO CLAIM IS MADE TO THE EXCLUSIVE RIGHT TO USE "NUTRACEUTICALS", APART FROM THE MARK AS SHOWN.

SN 85-583,779, FILED 3-29-2012.

LINDA ESTRADA, EXAMINING ATTORNEY



*David J. Kybas*

Director of the United States Patent and Trademark Office

# United States of America

United States Patent and Trademark Office

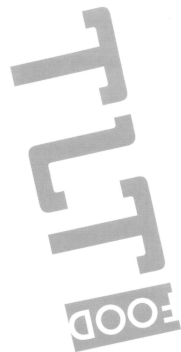

**Reg. No. 4,277,243**

**Registered Jan. 15, 2013**

**Int. Cl.: 43**

**SERVICE MARK**

**PRINCIPAL REGISTER**

TLT, LLC (CALIFORNIA LIMITED LIABILITY COMPANY)  
SUITE 204  
17000 VENTURA BOULEVARD  
ENCINO, CA 91316

FOR: RESTAURANT SERVICES, INCLUDING SIT-DOWN SERVICE OF FOOD AND TAKE-OUT RESTAURANT SERVICES, IN CLASS 43 (U.S. CLS. 100 AND 101).

FIRST USE 10-29-2012; IN COMMERCE 10-29-2012.

NO CLAIM IS MADE TO THE EXCLUSIVE RIGHT TO USE "FOOD", APART FROM THE MARK AS SHOWN.

THE MARK CONSISTS OF THE UPPER CASE LETTERS "T L T" IN A LOWER TO HIGHER, LEFT TO RIGHT, DIAGONAL DIRECTION, AND THE WORD "FOOD", ALSO IN UPPER CASE LETTERS IN A PARALLEL AND OPPOSING TOP TO BOTTOM DIAGONAL DIRECTION.

SN 85-584,175, FILED 3-29-2012.

MATTHEW EINSTEIN, EXAMINING ATTORNEY



*David J. Kybas*

Director of the United States Patent and Trademark Office

# United States of America

United States Patent and Trademark Office



**Reg. No. 4,277,244**

**Registered Jan. 15, 2013**

**Int. Cl.: 36**

**SERVICE MARK**

**PRINCIPAL REGISTER**

OHIO CREDIT UNION LEAGUE (OHIO CORPORATION)  
10 W. BROAD STREET  
SUITE 1100  
COLUMBUS, OH 43215

FOR: CREDIT UNION SERVICES, IN CLASS 36 (U.S. CLS. 100, 101 AND 102).

FIRST USE 5-15-2012; IN COMMERCE 5-15-2012.

THE MARK CONSISTS OF FOUR FILLED CIRCLES SPACED AROUND 2 LARGER UN-FILLED, BROKEN CIRCLES WITH AN "H" IN THE CENTER.

SN 85-584,435, FILED 3-30-2012.

ANNE FARRELL, EXAMINING ATTORNEY



*David J. Kyffers*

Director of the United States Patent and Trademark Office

# United States of America

United States Patent and Trademark Office



**Reg. No. 4,277,245**

**Registered Jan. 15, 2013**

**Int. Cl.: 36**

**SERVICE MARK**

**PRINCIPAL REGISTER**

OHIO CREDIT UNION LEAGUE (OHIO CORPORATION)  
10 W. BROAD STREET  
SUITE 1100  
COLUMBUS, OH 43215

FOR: CREDIT UNION SERVICES, IN CLASS 36 (U.S. CLS. 100, 101 AND 102).

FIRST USE 5-15-2012; IN COMMERCE 5-15-2012.

THE MARK CONSISTS OF FOUR FILLED CIRCLES SPACED AROUND 2 LARGER UN-FILLED, INCOMPLETE CIRCLES WITH "HAYNECIRCLE" WORDING COMING OUT OF THE CENTER OF THE CIRCLE AND THE WORDS "COMMITTED TO OHIO'S SMALL CREDIT UNIONS" UNDERNEATH.

SN 85-584,442, FILED 3-30-2012.

ANNE FARRELL, EXAMINING ATTORNEY



*David J. Kybas*

Director of the United States Patent and Trademark Office



# United States of America

United States Patent and Trademark Office

# Caretrio

**Reg. No. 4,277,246**

**Registered Jan. 15, 2013**

**Int. Cl.: 9**

**TRADEMARK**

**PRINCIPAL REGISTER**

FAMILYCARESOF, INC. (WASHINGTON CORPORATION)  
34823 RHODODENDRON DR SE  
SNOQUALMIE, WA 98065

FOR: COMPUTER SOFTWARE FOR PROVIDING WEB-BASED ACCESS TO APPLICATIONS AND SERVICES THROUGH A WEB OPERATING SYSTEM OR PORTAL INTERFACE, IN CLASS 9 (U.S. CLS. 21, 23, 26, 36 AND 38).

FIRST USE 3-1-2012; IN COMMERCE 3-1-2012.

THE MARK CONSISTS OF STANDARD CHARACTERS WITHOUT CLAIM TO ANY PARTICULAR FONT, STYLE, SIZE, OR COLOR.

SN 85-584,551, FILED 3-30-2012.

MICHELE SWAIN, EXAMINING ATTORNEY



*David J. Kyffers*

Director of the United States Patent and Trademark Office

# United States of America

United States Patent and Trademark Office

# RESMED

**Reg. No. 4,277,247**

**Registered Jan. 15, 2013**

**Int. Cl.: 10**

**TRADEMARK**

**PRINCIPAL REGISTER**

RESMED LIMITED (AUSTRALIA CORPORATION)  
1 ELIZABETH MACARTHUR DRIVE  
BELLA VISTA, NSW, AUSTRALIA 2153

FOR: MEDICAL, DENTAL AND ORAL DEVICES FOR DIAGNOSING, TREATING AND MONITORING BRUXISM, MANDIBULAR ORTHOSIS, RESPIRATORY SLEEP DISORDERS, SLEEP APNEA AND SNORING, IN CLASS 10 (U.S. CLS. 26, 39 AND 44).

FIRST USE 2-9-2011; IN COMMERCE 2-9-2011.

THE MARK CONSISTS OF STANDARD CHARACTERS WITHOUT CLAIM TO ANY PARTICULAR FONT, STYLE, SIZE, OR COLOR.

OWNER OF U.S. REG. NOS. 2,722,982 AND 3,891,826.

SN 85-584,745, FILED 3-30-2012.

KEVEN MITTLER, EXAMINING ATTORNEY



*David J. Kyffers*

Director of the United States Patent and Trademark Office

# United States of America

United States Patent and Trademark Office

## NICE PAIRING

**Reg. No. 4,277,248**

**Registered Jan. 15, 2013**

**Int. Cl.: 33**

**TRADEMARK**

**PRINCIPAL REGISTER**

TERRAVANT WINE COMPANY, LLC (CALIFORNIA LIMITED LIABILITY COMPANY),  
DBA NICE PAIRING WINES,  
920 GARDEN STREET  
C/O KOENIG & ASSOCIATES  
SANTA BARBARA, CA 93101

FOR: WINE; WINES, IN CLASS 33 (U.S. CLS. 47 AND 49).

FIRST USE 6-19-2012; IN COMMERCE 6-19-2012.

THE MARK CONSISTS OF STANDARD CHARACTERS WITHOUT CLAIM TO ANY PARTICULAR FONT, STYLE, SIZE, OR COLOR.

OWNER OF U.S. REG. NO. 4,147,754.

SN 85-585,198, FILED 3-30-2012.

ELLEN B. AWRICH, EXAMINING ATTORNEY



*David J. Kyffers*

Director of the United States Patent and Trademark Office

# United States of America

United States Patent and Trademark Office

## LIVE FOR NOW

**Reg. No. 4,277,249**

**Registered Jan. 15, 2013**

**Int. Cl.: 32**

**TRADEMARK**

**PRINCIPAL REGISTER**

PEPSICO, INC. (NORTH CAROLINA CORPORATION)  
700 ANDERSON HILL ROAD  
PURCHASE, NY 10577

FOR: SOFT DRINKS, IN CLASS 32 (U.S. CLS. 45, 46 AND 48).

FIRST USE 5-0-2012; IN COMMERCE 5-0-2012.

THE MARK CONSISTS OF STANDARD CHARACTERS WITHOUT CLAIM TO ANY PARTICULAR FONT, STYLE, SIZE, OR COLOR.

PRIORITY CLAIMED UNDER SEC. 44(D) ON MAURITIUS APPLICATION NO. MU/M/12/1469, FILED 2-15-2012.

SN 85-585,315, FILED 3-30-2012.

JUDITH HELFMAN, EXAMINING ATTORNEY



*David J. Kyffers*

Director of the United States Patent and Trademark Office

# United States of America

United States Patent and Trademark Office

## NUTRIBULLET VITALITY SUPERBOOST

**Reg. No. 4,277,250**

HOMELAND HOUSEWARES, LLC (CALIFORNIA LIMITED LIABILITY COMPANY)  
11755 WILSHIRE BLVD, SUITE 1200  
LOS ANGELES, CA 90025

**Registered Jan. 15, 2013**

**Int. Cl.: 5**

FOR: FOOD AND NUTRITIONAL SUPPLEMENTS FOR HUMAN CONSUMPTION, IN CLASS  
5 (U.S. CLS. 6, 18, 44, 46, 51 AND 52).

**TRADEMARK**

FIRST USE 3-31-2012; IN COMMERCE 3-31-2012.

**PRINCIPAL REGISTER**

THE MARK CONSISTS OF STANDARD CHARACTERS WITHOUT CLAIM TO ANY PAR-  
TICULAR FONT, STYLE, SIZE, OR COLOR.

OWNER OF U.S. REG. NOS. 7,658,475, 8,526,792, AND OTHERS.

SN 85-586,383, FILED 4-2-2012.

ROBERT C. CLARK JR., EXAMINING ATTORNEY



*David J. Kyffers*

Director of the United States Patent and Trademark Office

# United States of America

United States Patent and Trademark Office

## FIN FIGHTER

**Reg. No. 4,277,251**

GENERAL SPORTS CORPORATION (MINNESOTA CORPORATION)  
5025 FRANCE AVENUE SO.  
MINNEAPOLIS, MN 55410

**Registered Jan. 15, 2013**

**Int. Cl.: 25**

FOR: CLOTHING, NAMELY, SHIRTS, CAPS AND JACKETS, IN CLASS 25 (U.S. CLS. 22 AND 39).

**TRADEMARK**

FIRST USE 5-14-2012; IN COMMERCE 5-14-2012.

**PRINCIPAL REGISTER**

THE MARK CONSISTS OF STANDARD CHARACTERS WITHOUT CLAIM TO ANY PARTICULAR FONT, STYLE, SIZE, OR COLOR.

SN 85-586,833, FILED 4-2-2012.

JAMES GRIFFIN, EXAMINING ATTORNEY



*David J. Kyffers*

Director of the United States Patent and Trademark Office

# United States of America

United States Patent and Trademark Office



**RenoBob.com**

**Reg. No. 4,277,252**

PROMOTIONS RENOBOb.COM INC. (CANADA CORPORATION)  
5879 HENRI-BOURASSA, SUITE 304

**Registered Jan. 15, 2013**

MONTREAL, QUEBEC, CANADA H1G2V1

**Int. Cl.: 35**

FOR: PROVIDING A SEARCHABLE ONLINE ADVERTISING WEBSITE AND INFORMATIONAL GUIDE FEATURING THE GOODS AND SERVICES OF OTHER VENDORS VIA THE INTERNET IN THE FIELD OF HOME RENOVATION AND CONSTRUCTION, IN CLASS 35 (U.S. CLS. 100, 101 AND 102).

**SERVICE MARK**

**PRINCIPAL REGISTER**

FIRST USE 4-20-2012; IN COMMERCE 4-20-2012.

THE MARK CONSISTS OF A CONSTRUCTION WORKER IN A BLACK AND WHITE UNIFORM, WITH A WHITE HARD HAT AND A WHITE TOOL BELT. THE CONSTRUCTION WORKER APPEARS ON A CIRCULAR ORANGE BACKGROUND WITH A WHITE RIM INSIDE A BLACK RIM. THE WORDS "RENOBOB.COM" ARE TRANSCRIBED ON THE RIGHT SIDE OF THE CONSTRUCTION WORKER IN THE CIRCULAR BACKGROUND WITH "RENO" IN BLACK, "BOB" IN ORANGE AND ".COM" IN BLACK. THE COLOR GRAY REPRESENTS SHADING OF THE CIRCLE AND IS NOT PART OF THE MARK. THE MARK APPEARS ON A TRANSPARENT BACKGROUND, AND NO OTHER COLOR IS CLAIMED AS A FEATURE OF THE MARK.

THE COLOR(S) ORANGE, BLACK AND WHITE IS/ARE CLAIMED AS A FEATURE OF THE MARK.

SN 85-586,915, FILED 4-2-2012.

CATHERINE ROEHL, EXAMINING ATTORNEY



*David J. Kyffers*

Director of the United States Patent and Trademark Office

# United States of America

United States Patent and Trademark Office

# STUBSTATS

**Reg. No. 4,277,253**

**Registered Jan. 15, 2013**

**Int. Cl.: 42**

**SERVICE MARK**

**PRINCIPAL REGISTER**

KRONENGOLD, ADAM (UNITED STATES INDIVIDUAL)  
29 KRISTI DRIVE  
JERICHO, NY 11753

FOR: PROVIDING A WEB SITE FEATURING TEMPORARY USE OF NON-DOWNLOADABLE SOFTWARE FOR TRACKING, MONITORING, AND GENERATING REPORTS ON INFORMATION AND STATISTICS ABOUT SPORTS, MUSIC, AND ENTERTAINMENT EVENTS THAT USERS HAVE ATTENDED; PROVIDING A WEB SITE FEATURING TEMPORARY USE OF NON-DOWNLOADABLE SOFTWARE FOR USERS TO "CHECK IN" AT SPORTS, MUSIC, AND ENTERTAINMENT EVENTS; COMPUTER SERVICES, NAMELY, CREATING AN ON-LINE COMMUNITY FOR REGISTERED USERS TO PARTICIPATE IN DISCUSSIONS, GET FEEDBACK FROM THEIR PEERS, FORM VIRTUAL COMMUNITIES, AND ENGAGE IN SOCIAL NETWORKING SERVICES IN THE FIELD OF SPORTS, MUSIC, AND ENTERTAINMENT, IN CLASS 42 (U.S. CLS. 100 AND 101).

FIRST USE 3-1-2011; IN COMMERCE 6-1-2011.

THE MARK CONSISTS OF STANDARD CHARACTERS WITHOUT CLAIM TO ANY PARTICULAR FONT, STYLE, SIZE, OR COLOR.

SN 85-586,991, FILED 4-2-2012.

SANI KHOURI, EXAMINING ATTORNEY



*David J. Kybas*

Director of the United States Patent and Trademark Office



# United States of America

United States Patent and Trademark Office

# CUORi

**Reg. No. 4,277,254**

**Registered Jan. 15, 2013**

**Int. Cl.: 11**

**TRADEMARK**

**PRINCIPAL REGISTER**

CUORI ELECTRICAL APPLIANCES (GROUP) CO., LTD (CHINA LIMITED COMPANY (LTD.))  
NO.48, DEVELOPING ROAD, ZHOUXIANG TOWN  
CIXI CITY, ZHEJIANG, CHINA

FOR: ELECTRIC RADIANT HEATERS, IN CLASS 11 (U.S. CLS. 13, 21, 23, 31 AND 34).

FIRST USE 6-4-2010; IN COMMERCE 8-6-2012.

THE MARK CONSISTS OF STANDARD CHARACTERS WITHOUT CLAIM TO ANY PARTICULAR FONT, STYLE, SIZE, OR COLOR.

OWNER OF U.S. REG. NO. 3,063,878.

THE WORDING "CUORI" HAS NO MEANING IN A FOREIGN LANGUAGE.

SN 85-587,204, FILED 4-3-2012.

ESTHER A. BORSUK, EXAMINING ATTORNEY



*David J. Kybas*

Director of the United States Patent and Trademark Office

# United States of America

United States Patent and Trademark Office

## REEL CASH CRITTERS

**Reg. No. 4,277,255**

LYCOS, INC. (VIRGINIA CORPORATION)  
100 FIFTH AVENUE  
WALTHAM, MA 02451

**Registered Jan. 15, 2013**

**Int. Cl.: 41**

FOR: ENTERTAINMENT SERVICES, NAMELY, PROVIDING AN ON-LINE COMPUTER GAME, IN CLASS 41 (U.S. CLS. 100, 101 AND 107).

**SERVICE MARK**

FIRST USE 7-31-2012; IN COMMERCE 7-31-2012.

**PRINCIPAL REGISTER**

THE MARK CONSISTS OF STANDARD CHARACTERS WITHOUT CLAIM TO ANY PARTICULAR FONT, STYLE, SIZE, OR COLOR.

SN 85-587,406, FILED 4-3-2012.

LIEF MARTIN, EXAMINING ATTORNEY



*David J. Kybas*

Director of the United States Patent and Trademark Office

# United States of America

United States Patent and Trademark Office

## SHOPRAISING MALL

**Reg. No. 4,277,256**

**Registered Jan. 15, 2013**

**Int. Cls.: 35 and 36**

**SERVICE MARK**

**PRINCIPAL REGISTER**

AFFINION LOYALTY GROUP, INC. (DELAWARE CORPORATION)  
7814 CAROUSEL LANE  
RICHMOND, VA 23294

FOR: PROMOTING THE GOODS AND SERVICES OF OTHERS, AND PROMOTING CHARITABLE CONTRIBUTIONS, BY CONDUCTING A CHARITABLE DONOR GIFT CARD PROGRAM, INCENTIVE AWARDS PROGRAM, CUSTOMER LOYALTY PROGRAM AND DISCOUNT PROGRAM WHEREBY PARTICIPANTS UTILIZE GIFT CARDS TO PURCHASE GOODS AND SERVICES OF OTHERS, WHICH PURCHASES GENERATE CHARITABLE DONATIONS, IN CLASS 35 (U.S. CLS. 100, 101 AND 102).

FIRST USE 5-4-2012; IN COMMERCE 5-4-2012.

FOR: CHARITABLE FUNDRAISING SERVICES FOR ORGANIZATIONS FROM SALES GENERATED BY USE OF GIFT CARDS TO PURCHASE GOODS AND SERVICES OF OTHERS, IN CLASS 36 (U.S. CLS. 100, 101 AND 102).

FIRST USE 5-4-2012; IN COMMERCE 5-4-2012.

THE MARK CONSISTS OF STANDARD CHARACTERS WITHOUT CLAIM TO ANY PARTICULAR FONT, STYLE, SIZE, OR COLOR.

SN 85-587,728, FILED 4-3-2012.

LINDA MICKLEBURGH, EXAMINING ATTORNEY



*David J. Kyffers*

Director of the United States Patent and Trademark Office

# United States of America

United States Patent and Trademark Office

## ESCALASH MASCARA

**Reg. No. 4,277,257**

JAFRA COSMETICS INTERNATIONAL, INC. (DELAWARE CORPORATION)  
2451 TOWNSGATE ROAD  
WESTLAKE VILLAGE, CA 91361

**Registered Jan. 15, 2013**

**Int. Cl.: 3**

FOR: MASCARA, IN CLASS 3 (U.S. CLS. 1, 4, 6, 50, 51 AND 52).

**TRADEMARK**

FIRST USE 8-1-2012; IN COMMERCE 8-1-2012.

**PRINCIPAL REGISTER**

THE MARK CONSISTS OF STANDARD CHARACTERS WITHOUT CLAIM TO ANY PARTICULAR FONT, STYLE, SIZE, OR COLOR.

NO CLAIM IS MADE TO THE EXCLUSIVE RIGHT TO USE "MASCARA", APART FROM THE MARK AS SHOWN.

SN 85-588,058, FILED 4-3-2012.

ALICE BENMAMAN, EXAMINING ATTORNEY



*David J. Kybas*

Director of the United States Patent and Trademark Office

# United States of America

United States Patent and Trademark Office

## FOOD HATCH

**Reg. No. 4,277,258**

FOOD NEW MEDIA GROUP, INC. (NEW YORK CORPORATION)  
3845 BECK BLVD, SUITE 805  
NAPLES, FL 34114

**Registered Jan. 15, 2013**

**Int. Cl.: 35**

FOR: BUSINESS CONSULTING SERVICES IN THE FIELD OF FOOD; BUSINESS CONSULTING SERVICES, NAMELY, PROVIDING ASSISTANCE IN DEVELOPMENT OF BUSINESS STRATEGIES AND CREATIVE IDEATION; BUSINESS DEVELOPMENT CONSULTING SERVICES; BUSINESS DEVELOPMENT SERVICES; BUSINESS DEVELOPMENT SERVICES, NAMELY, PROVIDING START-UP SUPPORT FOR BUSINESSES OF OTHERS; BUSINESS STRATEGY DEVELOPMENT SERVICES, IN CLASS 35 (U.S. CLS. 100, 101 AND 102).

**SERVICE MARK**

**PRINCIPAL REGISTER**

FIRST USE 8-1-2012; IN COMMERCE 8-1-2012.

THE MARK CONSISTS OF STANDARD CHARACTERS WITHOUT CLAIM TO ANY PARTICULAR FONT, STYLE, SIZE, OR COLOR.

NO CLAIM IS MADE TO THE EXCLUSIVE RIGHT TO USE "FOOD", APART FROM THE MARK AS SHOWN.

SN 85-589,485, FILED 4-4-2012.

TEJBIR SINGH, EXAMINING ATTORNEY



*David J. Kyros*

Director of the United States Patent and Trademark Office

# United States of America

United States Patent and Trademark Office

## ADVENTUR-CATION

**Reg. No. 4,277,259**

MIND ADVENTURES LLC (FLORIDA LIMITED LIABILITY COMPANY)  
5633 STRAND BLVD. SUITE 309  
NAPLES, FL 34110

**Registered Jan. 15, 2013**

**Int. Cl.: 42**

FOR: PROVIDING AN INTERACTIVE WEBSITE FEATURING TECHNOLOGY THAT ALLOWS USERS TO ENGAGE IN AN INTERACTIVE ONLINE LEARNING SYSTEM TO LEARN PEOPLE, PLACES, AND THINGS RELATED TO US HISTORY INCLUDING WEB-BASED ASSESSMENTS TO MEASURE THE USER'S KNOWLEDGE, IN CLASS 42 (U.S. CLS. 100 AND 101).

**SERVICE MARK**

**PRINCIPAL REGISTER**

FIRST USE 7-16-2003; IN COMMERCE 8-27-2010.

THE MARK CONSISTS OF STANDARD CHARACTERS WITHOUT CLAIM TO ANY PARTICULAR FONT, STYLE, SIZE, OR COLOR.

SN 85-590,014, FILED 4-5-2012.

WANDA KAY PRICE, EXAMINING ATTORNEY



*David J. Kyffers*

Director of the United States Patent and Trademark Office

# United States of America

United States Patent and Trademark Office

## PIRATES VOYAGE KID'S CLUB

**Reg. No. 4,277,260**

WORLD CHOICE INVESTMENTS, LLC (TENNESSEE LIMITED LIABILITY COMPANY)  
P.O. BOX 58

**Registered Jan. 15, 2013**

PIGEON FORGE, TN 378680058

**Int. Cl.: 35**

FOR: MEMBERSHIP CLUB SERVICES, NAMELY, PROVIDING DISCOUNTS TO AND PROMOTING DINING AND ENTERTAINMENT SERVICES, AND DISSEMINATING RELATED MATERIALS AND MERCHANDISE IN CONNECTION THEREWITH TO CHILDREN, IN CLASS 35 (U.S. CLS. 100, 101 AND 102).

**SERVICE MARK**

**PRINCIPAL REGISTER**

FIRST USE 6-30-2012; IN COMMERCE 6-30-2012.

THE MARK CONSISTS OF STANDARD CHARACTERS WITHOUT CLAIM TO ANY PARTICULAR FONT, STYLE, SIZE, OR COLOR.

OWNER OF U.S. REG. NOS. 4,046,677, 4,046,678, AND 4,046,679.

NO CLAIM IS MADE TO THE EXCLUSIVE RIGHT TO USE "KID'S CLUB", APART FROM THE MARK AS SHOWN.

SN 85-590,190, FILED 4-5-2012.

REBECCA EISINGER, EXAMINING ATTORNEY



*David J. Kybas*

Director of the United States Patent and Trademark Office

# United States of America

United States Patent and Trademark Office



**Reg. No. 4,277,261**

**Registered Jan. 15, 2013**

**Int. Cl.: 35**

**SERVICE MARK**

**PRINCIPAL REGISTER**

WORLD CHOICE INVESTMENTS, LLC (TENNESSEE LIMITED LIABILITY COMPANY)  
P.O. BOX 58  
PIGEON FORGE, TN 378680058

FOR: MEMBERSHIP CLUB SERVICES, NAMELY, PROVIDING DISCOUNTS TO AND PROMOTING DINING AND ENTERTAINMENT SERVICES, AND DISSEMINATING RELATED MATERIALS AND MERCHANDISE IN CONNECTION THEREWITH TO CHILDREN, IN CLASS 35 (U.S. CLS. 100, 101 AND 102).

FIRST USE 6-30-2012; IN COMMERCE 6-30-2012.

OWNER OF U.S. REG. NOS. 4,046,677, 4,046,679, AND OTHERS.

NO CLAIM IS MADE TO THE EXCLUSIVE RIGHT TO USE "KID'S CLUB", APART FROM THE MARK AS SHOWN.

THE MARK CONSISTS OF A SEA LION IN A PIRATE COSTUME LYING IN A PUDDLE OF WATER WITH DROPS OF WATER AROUND HIS TAIL INCLUDING THE WORDS "PIRATES VOYAGE KID'S CLUB" ABOVE AND AROUND THE SEA LION.

SN 85-590,229, FILED 4-5-2012.

REBECCA EISINGER, EXAMINING ATTORNEY



*David J. Kybas*

Director of the United States Patent and Trademark Office



# United States of America

United States Patent and Trademark Office

## CAROLINA DREAMIN'

**Reg. No. 4,277,262**

SIERRA NEVADA BREWING CO. (CALIFORNIA CORPORATION)  
1075 EAST 20TH STREET  
CHICO, CA 95928

**Registered Jan. 15, 2013**

**Int. Cl.: 32**

FOR: BEER, ALE AND LAGER, IN CLASS 32 (U.S. CLS. 45, 46 AND 48).

**TRADEMARK**

FIRST USE 10-26-2012; IN COMMERCE 10-26-2012.

**PRINCIPAL REGISTER**

THE MARK CONSISTS OF STANDARD CHARACTERS WITHOUT CLAIM TO ANY PARTICULAR FONT, STYLE, SIZE, OR COLOR.

SN 85-590,388, FILED 4-5-2012.

PAUL E. FAHRENKOPF, EXAMINING ATTORNEY



*David J. Kyffers*

Director of the United States Patent and Trademark Office

# United States of America

United States Patent and Trademark Office

## The Grow Scene

**Reg. No. 4,277,263**

**Registered Jan. 15, 2013**

**Int. Cl.: 9**

**TRADEMARK**

**PRINCIPAL REGISTER**

IP HOLDINGS, LLC (WASHINGTON LIMITED LIABILITY COMPANY)  
5408 NE 88TH ST. #A-101  
VANCOUVER, WA 98665

FOR: DOWNLOADABLE ELECTRONIC PUBLICATIONS IN THE NATURE OF A MONTHLY NEWSLETTER IN THE FIELD OF INDOOR GARDENING, IN CLASS 9 (U.S. CLS. 21, 23, 26, 36 AND 38).

FIRST USE 5-17-2012; IN COMMERCE 5-17-2012.

THE MARK CONSISTS OF STANDARD CHARACTERS WITHOUT CLAIM TO ANY PARTICULAR FONT, STYLE, SIZE, OR COLOR.

SN 85-590,432, FILED 4-5-2012.

PAUL E. FAHRENKOPF, EXAMINING ATTORNEY



*David J. Kyffers*

Director of the United States Patent and Trademark Office

# United States of America

United States Patent and Trademark Office

# Wordgenuity

**Reg. No. 4,277,264**

**Registered Jan. 15, 2013**

**Int. Cl.: 9**

**TRADEMARK**

**PRINCIPAL REGISTER**

SEALES, JOSHUA (UNITED STATES INDIVIDUAL)  
839 ROSEWOOD TERRACE  
ENDWELL, NY 13760

FOR: COMPUTER APPLICATION SOFTWARE FOR MOBILE PHONES, NAMELY, SOFTWARE FOR USE IN PLAYING WORD GAMES; VIDEO GAME SOFTWARE, IN CLASS 9 (U.S. CLS. 21, 23, 26, 36 AND 38).

FIRST USE 4-29-2012; IN COMMERCE 4-29-2012.

THE MARK CONSISTS OF STANDARD CHARACTERS WITHOUT CLAIM TO ANY PARTICULAR FONT, STYLE, SIZE, OR COLOR.

SN 85-590,616, FILED 4-5-2012.

MARGERIE A. TIERNEY, EXAMINING ATTORNEY



*David J. Kybas*

Director of the United States Patent and Trademark Office

# United States of America

United States Patent and Trademark Office

## Superfan Experience

**Reg. No. 4,277,265**

OSTROWSKI, GARY R. (UNITED STATES INDIVIDUAL)  
5142 SISSON DRIVE  
HUNTINGTON BEACH, CA 92649

**Registered Jan. 15, 2013**

**Int. Cl.: 41**

FOR: ENTERTAINMENT SERVICES, NAMELY, PARTICIPATION IN SPORTS CAR RACING EVENTS, IN CLASS 41 (U.S. CLS. 100, 101 AND 107).

**SERVICE MARK**

FIRST USE 4-12-2012; IN COMMERCE 4-12-2012.

**PRINCIPAL REGISTER**

THE MARK CONSISTS OF STANDARD CHARACTERS WITHOUT CLAIM TO ANY PARTICULAR FONT, STYLE, SIZE, OR COLOR.

SN 85-590,917, FILED 4-6-2012.

ROBERT STRUCK, EXAMINING ATTORNEY



*David J. Kybas*

Director of the United States Patent and Trademark Office

# United States of America

United States Patent and Trademark Office

# ECOCABLE

**Reg. No. 4,277,266**

**Registered Jan. 15, 2013**

**Int. Cl.: 9**

**TRADEMARK**

**PRINCIPAL REGISTER**

BELDEN INC. (DELAWARE CORPORATION)  
SUITE 800  
7733 FORSYTH BOULEVARD  
ST. LOUIS, MO 63105

FOR: ELECTRONIC WIRES AND CABLES, IN CLASS 9 (U.S. CLS. 21, 23, 26, 36 AND 38).

FIRST USE 10-0-2012; IN COMMERCE 10-0-2012.

THE MARK CONSISTS OF STANDARD CHARACTERS WITHOUT CLAIM TO ANY PARTICULAR FONT, STYLE, SIZE, OR COLOR.

SN 85-591,071, FILED 4-6-2012.

JEFFERY COWARD, EXAMINING ATTORNEY



*David J. Kybas*

Director of the United States Patent and Trademark Office

# United States of America

United States Patent and Trademark Office

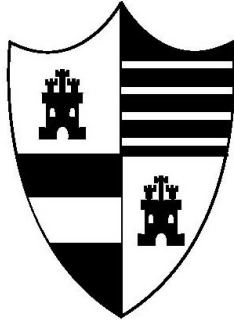

**Reg. No. 4,277,267**

**Registered Jan. 15, 2013**

**Int. Cl.: 19**

**TRADEMARK**

**PRINCIPAL REGISTER**

B&M NOBLE CO. (CALIFORNIA CORPORATION)  
1501 FRONT STREET  
SAN DIEGO, CA 92101

FOR: HARDWOOD FLOORING, IN CLASS 19 (U.S. CLS. 1, 12, 33 AND 50).

FIRST USE 6-1-2007; IN COMMERCE 6-1-2007.

THE MARK CONSISTS OF A SHIELD DIVIDED INTO 4 QUADRANTS; A BLOCK CASTLE IS LOCATED IN THE CENTER OF THE TOP LEFT AND BOTTOM RIGHT QUADRANT; NINE ALTERNATE HORIZONTAL BARS FILL THE TOP RIGHT QUADRANT; 3 ALTERNATE HORIZONTAL BARS FILL THE BOTTOM LEFT QUADRANT.

SN 85-591,684, FILED 4-6-2012.

ERIN FALK, EXAMINING ATTORNEY



*David J. Kybas*

Director of the United States Patent and Trademark Office

# United States of America

United States Patent and Trademark Office

# REEF-SPEC

**Reg. No. 4,277,268**

RED SEA FISH PHARM LTD (ISRAEL CORPORATION)  
POST OFFICE BOX 3187  
HERZLIA PITUACH, ISRAEL 46101

**Registered Jan. 15, 2013**

**Int. Cl.: 11**

FOR: AQUARIUM LIGHTS, IN CLASS 11 (U.S. CLS. 13, 21, 23, 31 AND 34).

**TRADEMARK**

FIRST USE 5-31-2012; IN COMMERCE 8-31-2012.

**PRINCIPAL REGISTER**

THE MARK CONSISTS OF STANDARD CHARACTERS WITHOUT CLAIM TO ANY PARTICULAR FONT, STYLE, SIZE, OR COLOR.

SN 85-592,299, FILED 4-9-2012.

COLLEEN MULCRONE, EXAMINING ATTORNEY



*David J. Kybas*

Director of the United States Patent and Trademark Office

# United States of America

United States Patent and Trademark Office

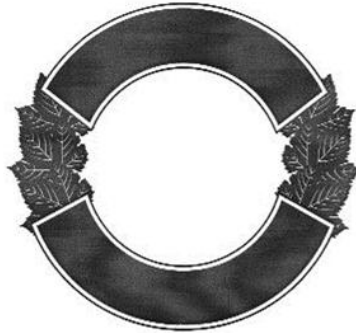

**Reg. No. 4,277,269**

**Registered Jan. 15, 2013**

**Int. Cl.: 31**

**TRADEMARK**

**PRINCIPAL REGISTER**

PANDOL BROS., INC. (CALIFORNIA CORPORATION)  
401 ROAD 192  
DELANO, CA 93215

FOR: FRESH GRAPES, IN CLASS 31 (U.S. CLS. 1 AND 46).

FIRST USE 8-14-2012; IN COMMERCE 8-14-2012.

THE MARK CONSISTS OF A BROKEN CIRCLE AND LEAF DESIGN.

SN 85-592,398, FILED 4-9-2012.

WILLIAM VERHOSEK, EXAMINING ATTORNEY



*David J. Kybas*

Director of the United States Patent and Trademark Office



# United States of America

United States Patent and Trademark Office

# E6000

**Reg. No. 4,277,270**

**Registered Jan. 15, 2013**

**Int. Cls.: 1 and 17**

**TRADEMARK**

**PRINCIPAL REGISTER**

ECLECTIC PRODUCTS, INC. (OREGON CORPORATION)  
1075 ARROWSMITH STREET  
EUGENE, OR 97402

FOR: GENERAL PURPOSE INDUSTRIAL AND CONSTRUCTION ADHESIVES, IN CLASS 1 (U.S. CLS. 1, 5, 6, 10, 26 AND 46).

FIRST USE 6-30-2012; IN COMMERCE 6-30-2012.

FOR: ADHESIVE SEALANTS FOR GENERAL PURPOSE USE AND CAULKS, IN CLASS 17 (U.S. CLS. 1, 5, 12, 13, 35 AND 50).

FIRST USE 6-30-2012; IN COMMERCE 6-30-2012.

THE MARK CONSISTS OF STANDARD CHARACTERS WITHOUT CLAIM TO ANY PARTICULAR FONT, STYLE, SIZE, OR COLOR.

OWNER OF U.S. REG. NOS. 1,688,612 AND 2,374,147.

SN 85-592,456, FILED 4-9-2012.

AMEEN IMAM, EXAMINING ATTORNEY



*David J. Kyros*

Director of the United States Patent and Trademark Office

# United States of America

United States Patent and Trademark Office

# StoryPals

**Reg. No. 4,277,271**

**Registered Jan. 15, 2013**

**Int. Cl.: 9**

**TRADEMARK**

**PRINCIPAL REGISTER**

ERIC SAILERS LLC (CALIFORNIA LIMITED LIABILITY COMPANY)  
10015 CANYONTOP ST.  
SPRING VALLEY, CA 91977

FOR: COMPUTER APPLICATION SOFTWARE FOR PC TABLETS, TABLET COMPUTERS, MOBILE PHONES AND MOBILE DEVICES, NAMELY, SOFTWARE FOR STORY AND READING COMPREHENSION FOR CHILDREN; DOWNLOADABLE SOFTWARE IN THE NATURE OF A MOBILE APPLICATION FOR STORY AND READING COMPREHENSION FOR CHILDREN, IN CLASS 9 (U.S. CLS. 21, 23, 26, 36 AND 38).

FIRST USE 1-1-2012; IN COMMERCE 7-3-2012.

THE MARK CONSISTS OF STANDARD CHARACTERS WITHOUT CLAIM TO ANY PARTICULAR FONT, STYLE, SIZE, OR COLOR.

SN 85-592,503, FILED 4-9-2012.

BARBARA A. GOLD, EXAMINING ATTORNEY



*David J. Kybas*

Director of the United States Patent and Trademark Office

# United States of America

United States Patent and Trademark Office

# PEXIOUS

**Reg. No. 4,277,272**

**Registered Jan. 15, 2013**

**Int. Cl.: 44**

**SERVICE MARK**

**PRINCIPAL REGISTER**

CELGENE CORPORATION (DELAWARE CORPORATION)  
86 MORRIS AVENUE  
SUMMIT, NJ 07901

FOR: PROGRAMS IN THE NATURE OF PROVIDING MEDICAL COUNSELING AND MEDICAL INFORMATION IN THE FIELD OF PHARMACEUTICALS AND SAFETY ISSUES PERTAINING TO PHARMACEUTICALS, AND PROVIDING MEDICAL INFORMATION IN THE AFOREMENTIONED FIELDS BY DISTRIBUTING WRITTEN MATERIALS IN CONNECTION THEREWITH; PROGRAMS IN THE NATURE OF PROVIDING MEDICAL COUNSELING AND MEDICAL INFORMATION IN THE FIELD OF POMALIDOMIDE AND SAFETY ISSUES PERTAINING TO POMALIDOMIDE AND PROVIDING MEDICAL INFORMATION IN THE AFOREMENTIONED FIELDS BY DISTRIBUTING WRITTEN MATERIALS IN CONNECTION THEREWITH, IN CLASS 44 (U.S. CLS. 100 AND 101).

FIRST USE 6-29-2012; IN COMMERCE 8-1-2012.

THE MARK CONSISTS OF STANDARD CHARACTERS WITHOUT CLAIM TO ANY PARTICULAR FONT, STYLE, SIZE, OR COLOR.

SN 85-592,625, FILED 4-9-2012.

TEJBIR SINGH, EXAMINING ATTORNEY



*David J. Kybas*

Director of the United States Patent and Trademark Office

# United States of America

United States Patent and Trademark Office

# LA PLAYA

**Reg. No. 4,277,273**

**Registered Jan. 15, 2013**

**Int. Cl.: 18**

**TRADEMARK**

**PRINCIPAL REGISTER**

MADE IN THE SHADE, INC. (CALIFORNIA CORPORATION)  
UNIT K  
201 NORTH RICE AVENUE  
OXNARD, CA 93030

FOR: MARKET UMBRELLAS AND PATIO UMBRELLAS, IN CLASS 18 (U.S. CLS. 1, 2, 3, 22 AND 41).

FIRST USE 6-22-2012; IN COMMERCE 6-22-2012.

THE MARK CONSISTS OF STANDARD CHARACTERS WITHOUT CLAIM TO ANY PARTICULAR FONT, STYLE, SIZE, OR COLOR.

THE ENGLISH TRANSLATION OF "LA PLAYA" IN THE MARK IS THE BEACH.

SN 85-592,657, FILED 4-9-2012.

TARAH HARDY, EXAMINING ATTORNEY



*David J. Kybas*

Director of the United States Patent and Trademark Office

# United States of America

United States Patent and Trademark Office

# Add a Scoop

**Reg. No. 4,277,274**

JUICE BAR SOLUTIONS INC. (CALIFORNIA CORPORATION)  
38 MAYBECK STREET  
NOVATO, CA 94949

**Registered Jan. 15, 2013**

**Int. Cl.: 5**

FOR: NUTRITIONAL SUPPLEMENTS TO BE ADDED TO BEVERAGES, IN CLASS 5 (U.S. CLS. 6, 18, 44, 46, 51 AND 52).

**TRADEMARK**

FIRST USE 9-27-2012; IN COMMERCE 9-27-2012.

**PRINCIPAL REGISTER**

THE MARK CONSISTS OF THE WORDS "ADD A SCOOP" IN A STYLIZED FORMAT.

SN 85-592,817, FILED 4-9-2012.

TOBY BULLOFF, EXAMINING ATTORNEY



*David J. Kyfos*

Director of the United States Patent and Trademark Office

# United States of America

United States Patent and Trademark Office

# iSelfCare

**Reg. No. 4,277,275**

HEALTHMATE INTERNATIONAL, LLC (MISSOURI LIMITED LIABILITY COMPANY)  
709 EAST 97TH STREET  
KANSAS CITY, MO 64131

**Registered Jan. 15, 2013**

**Int. Cl.: 10**

FOR: ELECTRIC MASSAGE APPARATUS FOR HOUSEHOLD USE; ELECTRIC MASSAGE APPLIANCES, NAMELY, ELECTRIC VIBRATING MASSAGER; MASSAGE APPARATUS; MASSAGE APPARATUS AND INSTRUMENTS; MASSAGING APPARATUS FOR PERSONAL USE, IN CLASS 10 (U.S. CLS. 26, 39 AND 44).

**TRADEMARK**

**PRINCIPAL REGISTER**

FIRST USE 10-1-2012; IN COMMERCE 10-1-2012.

THE MARK CONSISTS OF STANDARD CHARACTERS WITHOUT CLAIM TO ANY PARTICULAR FONT, STYLE, SIZE, OR COLOR.

SN 85-593,033, FILED 4-9-2012.

TARAH HARDY, EXAMINING ATTORNEY



*David J. Kybas*

Director of the United States Patent and Trademark Office

# United States of America

United States Patent and Trademark Office

# ULTRALIGHT

**Reg. No. 4,277,276**

ULTRA POI, LLC (TEXAS LIMITED LIABILITY COMPANY)  
15502 MISTY HOLLOW DR  
HOUSTON, TX 77068

**Registered Jan. 15, 2013**

**Int. Cl.: 11**

FOR: BATTERY-POWERED LIGHT STICK FOR PLAY, PERFORMANCES, AND ENTERTAINMENT, IN CLASS 11 (U.S. CLS. 13, 21, 23, 31 AND 34).

**TRADEMARK**

FIRST USE 4-23-2012; IN COMMERCE 4-23-2012.

**PRINCIPAL REGISTER**

THE MARK CONSISTS OF STANDARD CHARACTERS WITHOUT CLAIM TO ANY PARTICULAR FONT, STYLE, SIZE, OR COLOR.

SN 85-593,112, FILED 4-10-2012.

STEVEN R. FINE, EXAMINING ATTORNEY



*David J. Kybas*

Director of the United States Patent and Trademark Office

# United States of America

United States Patent and Trademark Office

## THE STAR OF PIZZA NIGHT

**Reg. No. 4,277,277**

**Registered Jan. 15, 2013**

**Int. Cl.: 29**

**TRADEMARK**

**PRINCIPAL REGISTER**

JONMOR INVESTMENTS, INC. (DELAWARE CORPORATION)  
BAYNARD BUILDING, SUITE 103  
3411 SILVERSIDE ROAD  
WILMINGTON, DE 19810

FOR: PEPPERONI, IN CLASS 29 (U.S. CL. 46).

FIRST USE 9-30-2010; IN COMMERCE 9-30-2010.

THE MARK CONSISTS OF STANDARD CHARACTERS WITHOUT CLAIM TO ANY PARTICULAR FONT, STYLE, SIZE, OR COLOR.

SN 85-594,256, FILED 4-11-2012.

ELLEN B. AWRICH, EXAMINING ATTORNEY



*David J. Kybas*

Director of the United States Patent and Trademark Office



# United States of America

United States Patent and Trademark Office

## UNITED BRIDGE PARTNERS

**Reg. No. 4,277,278**

**Registered Jan. 15, 2013**

**Int. Cls.: 35 and 37**

**SERVICE MARK**

**PRINCIPAL REGISTER**

UNITED BRIDGE PARTNERS, L.P. (DELAWARE LIMITED PARTNERSHIP)  
950 TOWER LANE, SUITE 800  
FOSTER CITY, CA 94404

FOR: OPERATION OF TOLL BRIDGES AND TOLL ROADS FOR OTHERS, IN CLASS 35 (U.S. CLS. 100, 101 AND 102).

FIRST USE 3-0-2012; IN COMMERCE 3-0-2012.

FOR: CONSTRUCTION OF TOLL BRIDGES AND TOLL ROADS; CONSULTING SERVICES FOR THE CONSTRUCTION OF TOLL BRIDGES AND TOLL ROADS, IN CLASS 37 (U.S. CLS. 100, 103 AND 106).

FIRST USE 3-0-2012; IN COMMERCE 3-0-2012.

THE MARK CONSISTS OF STANDARD CHARACTERS WITHOUT CLAIM TO ANY PARTICULAR FONT, STYLE, SIZE, OR COLOR.

NO CLAIM IS MADE TO THE EXCLUSIVE RIGHT TO USE "BRIDGE PARTNERS", APART FROM THE MARK AS SHOWN.

SN 85-594,483, FILED 4-11-2012.

BARBARA GAYNOR, EXAMINING ATTORNEY



*David J. Kybas*

Director of the United States Patent and Trademark Office

# United States of America

United States Patent and Trademark Office

## UNITED BRIDGE

**Reg. No. 4,277,279**

UNITED BRIDGE PARTNERS, L.P. (DELAWARE LIMITED PARTNERSHIP)  
950 TOWER LANE, SUITE 800  
FOSTER CITY, CA 94404

**Registered Jan. 15, 2013**

**Int. Cls.: 35 and 37**

FOR: OPERATION OF TOLL BRIDGES AND TOLL ROADS FOR OTHERS, IN CLASS 35 (U.S. CLS. 100, 101 AND 102).

**SERVICE MARK**

FIRST USE 3-0-2012; IN COMMERCE 3-0-2012.

**PRINCIPAL REGISTER**

FOR: CONSTRUCTION OF TOLL BRIDGES AND TOLL ROADS; CONSULTING SERVICES FOR THE CONSTRUCTION OF TOLL BRIDGES AND TOLL ROADS, IN CLASS 37 (U.S. CLS. 100, 103 AND 106).

FIRST USE 3-0-2012; IN COMMERCE 3-0-2012.

THE MARK CONSISTS OF STANDARD CHARACTERS WITHOUT CLAIM TO ANY PARTICULAR FONT, STYLE, SIZE, OR COLOR.

NO CLAIM IS MADE TO THE EXCLUSIVE RIGHT TO USE "BRIDGE", APART FROM THE MARK AS SHOWN.

SN 85-594,485, FILED 4-11-2012.

BARBARA GAYNOR, EXAMINING ATTORNEY



*David J. Kyjars*

Director of the United States Patent and Trademark Office

# United States of America

United States Patent and Trademark Office

# CUBICITI

**Reg. No. 4,277,280**

WIDJAJA, ADDY (INDONESIA INDIVIDUAL)  
1363 PROSPECT CIR NE  
PALM BAY, FL 32907

**Registered Jan. 15, 2013**

**Int. Cl.: 28**

FOR: TOY BUILDING BLOCKS, IN CLASS 28 (U.S. CLS. 22, 23, 38 AND 50).

**TRADEMARK**

FIRST USE 2-1-2012; IN COMMERCE 8-1-2012.

**PRINCIPAL REGISTER**

THE MARK CONSISTS OF THE STYLIZED TEXT CUBICITI.

SN 85-594,509, FILED 4-11-2012.

TRACY FLETCHER, EXAMINING ATTORNEY



*David J. Kybas*

Director of the United States Patent and Trademark Office

# United States of America

United States Patent and Trademark Office

# SLOPE-IT

**Reg. No. 4,277,281**

MYERS INDUSTRIES, INC. (OHIO CORPORATION)  
1293 SOUTH MAIN STREET  
AKRON, OH 44301

**Registered Jan. 15, 2013**

**Int. Cl.: 20**

FOR: PLASTIC BIN INSERTS MADE OF PLASTIC FOR CREATING A SLOPE, IN CLASS 20 (U.S. CLS. 2, 13, 22, 25, 32 AND 50).

**TRADEMARK**

FIRST USE 3-26-2012; IN COMMERCE 3-26-2012.

**PRINCIPAL REGISTER**

THE MARK CONSISTS OF STANDARD CHARACTERS WITHOUT CLAIM TO ANY PARTICULAR FONT, STYLE, SIZE, OR COLOR.

SN 85-594,547, FILED 4-11-2012.

MAYUR VAGHANI, EXAMINING ATTORNEY



*David J. Kybas*

Director of the United States Patent and Trademark Office

# United States of America

United States Patent and Trademark Office



**Reg. No. 4,277,282**

CARMA LABORATORIES, INC. (WISCONSIN CORPORATION)  
5801 WEST AIRWAYS AVENUE  
FRANKLIN, WI 53132

**Registered Jan. 15, 2013**

**Int. Cl.: 3**

FOR: LIP BALM, LOTION, AND CREAM, IN CLASS 3 (U.S. CLS. 1, 4, 6, 50, 51 AND 52).

**TRADEMARK**

FIRST USE 2-20-2012; IN COMMERCE 6-0-2012.

**PRINCIPAL REGISTER**

OWNER OF U.S. REG. NOS. 2,093,176, 3,877,494, AND OTHERS.

THE COLOR(S) RED AND WHITE IS/ARE CLAIMED AS A FEATURE OF THE MARK.

THE MARK CONSISTS OF A RED RECTANGLE ON AN ANGLE WITH THE WORD "CARMEX" IN WHITE.

SN 85-594,561, FILED 4-11-2012.

MATTHEW GALAN, EXAMINING ATTORNEY



*David J. Kyffers*

Director of the United States Patent and Trademark Office

# United States of America

United States Patent and Trademark Office

## Tastes like a Cookie, Eats like a Chip

**Reg. No. 4,277,283**

**Registered Jan. 15, 2013**

**Int. Cl.: 30**

**TRADEMARK**

**PRINCIPAL REGISTER**

HANNAHMAX BAKING, INC. (CALIFORNIA CORPORATION)  
14601 S. MAIN STREET  
GARDENA, CA 90248

FOR: COOKIES, IN CLASS 30 (U.S. CL. 46).

FIRST USE 6-7-2012; IN COMMERCE 6-7-2012.

THE MARK CONSISTS OF STANDARD CHARACTERS WITHOUT CLAIM TO ANY PARTICULAR FONT, STYLE, SIZE, OR COLOR.

SN 85-594,727, FILED 4-11-2012.

PRISCILLA MILTON, EXAMINING ATTORNEY



*David J. Kyffers*

Director of the United States Patent and Trademark Office

# United States of America

United States Patent and Trademark Office

## WHISPERING BLUFFS

**Reg. No. 4,277,284**

**Registered Jan. 15, 2013**

**Int. Cl.: 43**

**SERVICE MARK**

**PRINCIPAL REGISTER**

WHISPERING BLUFFS VINEYARD AND WINERY LTD. (WISCONSIN CORPORATION)  
8102 LEMONT ROAD, SUITE 1100  
WOODRIDGE, IL 60517

FOR: WINE BARS, IN CLASS 43 (U.S. CLS. 100 AND 101).

FIRST USE 5-26-2012; IN COMMERCE 5-26-2012.

THE MARK CONSISTS OF STANDARD CHARACTERS WITHOUT CLAIM TO ANY PARTICULAR FONT, STYLE, SIZE, OR COLOR.

SN 85-594,813, FILED 4-11-2012.

ZACHARY CROMER, EXAMINING ATTORNEY



*David J. Kybas*

Director of the United States Patent and Trademark Office

# United States of America

United States Patent and Trademark Office

## WHISPERING BLUFFS

**Reg. No. 4,277,285**

**Registered Jan. 15, 2013**

**Int. Cl.: 33**

**TRADEMARK**

**PRINCIPAL REGISTER**

WHISPERING BLUFFS VINEYARD AND WINERY LTD. (WISCONSIN CORPORATION)  
8102 LEMONT ROAD., SUITE 1100  
WOODRIDGE, IL 60517

FOR: WINE, IN CLASS 33 (U.S. CLS. 47 AND 49).

FIRST USE 6-30-2012; IN COMMERCE 6-30-2012.

THE MARK CONSISTS OF STANDARD CHARACTERS WITHOUT CLAIM TO ANY PARTICULAR FONT, STYLE, SIZE, OR COLOR.

SN 85-594,840, FILED 4-11-2012.

ZACHARY CROMER, EXAMINING ATTORNEY



*David J. Kybas*

Director of the United States Patent and Trademark Office



# United States of America

United States Patent and Trademark Office

## CU EXCEL CENTER

**Reg. No. 4,277,286**

ST. LOUIS COMMUNITY CREDIT UNION (MISSOURI CREDIT UNION)  
3651 FOREST PARK AVE.  
ST. LOUIS, MO 63108

**Registered Jan. 15, 2013**

**Int. Cl.: 41**

FOR: EDUCATIONAL SERVICES, NAMELY, DEVELOPING AND CONDUCTING WORKSHOPS AND CLASSES DESIGNED TO HELP INDIVIDUALS ACHIEVE FINANCIAL EMPOWERMENT, FINANCIAL INDEPENDENCE, AND FINANCIAL LITERACY, IN CLASS 41 (U.S. CLS. 100, 101 AND 107).

**SERVICE MARK**

**PRINCIPAL REGISTER**

FIRST USE 6-0-2012; IN COMMERCE 6-0-2012.

THE MARK CONSISTS OF STANDARD CHARACTERS WITHOUT CLAIM TO ANY PARTICULAR FONT, STYLE, SIZE, OR COLOR.

OWNER OF U.S. REG. NO. 3,680,969.

NO CLAIM IS MADE TO THE EXCLUSIVE RIGHT TO USE "CENTER", APART FROM THE MARK AS SHOWN.

SN 85-594,896, FILED 4-11-2012.

INGRID C. EULIN, EXAMINING ATTORNEY



*David J. Kybas*

Director of the United States Patent and Trademark Office

# United States of America

United States Patent and Trademark Office

# UNISONO

**Reg. No. 4,277,287**

**Registered Jan. 15, 2013**

**Int. Cl.: 33**

**TRADEMARK**

**PRINCIPAL REGISTER**

S.A. ANGULO AGROPECUARIA E INMOBILIARIA (ARGENTINA CORPORATION)  
BELGRANO 1415, 30 PISO  
5500 MENDOZA, ARGENTINA

FOR: WINES AND SPARKLING WINES, IN CLASS 33 (U.S. CLS. 47 AND 49).

FIRST USE 10-31-2012; IN COMMERCE 10-31-2012.

THE MARK CONSISTS OF STANDARD CHARACTERS WITHOUT CLAIM TO ANY PARTICULAR FONT, STYLE, SIZE, OR COLOR.

THE ENGLISH TRANSLATION OF "UNISONO" IN THE MARK IS "UNISONOUS".

SN 85-595,209, FILED 4-11-2012.

DAVID MURRAY, EXAMINING ATTORNEY



*David J. Kyffers*

Director of the United States Patent and Trademark Office

**United States of America**  
United States Patent and Trademark Office

# PowerWISE

**Reg. No. 4,277,288**

**Registered Jan. 15, 2013**

**Int. Cl.: 9**

**TRADEMARK**

**PRINCIPAL REGISTER**

PHYBRIDGE INC. (CANADA CORPORATION)  
2115 SOUTH SERVICE ROAD WEST  
OAKVILLE, CANADA L6L5W2

FOR: HYBRID AC/DC POWER SUPPLY MODULE WITH POWER AND LOAD SHARING FOR NETWORK SWITCHES; HYBRID AC/DC POWER SUPPLY MODULE WITH POWER AND LOAD SHARING SOLD AS AN INTEGRAL COMPONENT OF NETWORK SWITCHES, IN CLASS 9 (U.S. CLS. 21, 23, 26, 36 AND 38).

FIRST USE 3-1-2012; IN COMMERCE 7-1-2012.

THE MARK CONSISTS OF STANDARD CHARACTERS WITHOUT CLAIM TO ANY PARTICULAR FONT, STYLE, SIZE, OR COLOR.

SN 85-595,337, FILED 4-11-2012.

KIM MONINGHOFF, EXAMINING ATTORNEY



*David J. Kyfos*

Director of the United States Patent and Trademark Office

# United States of America

United States Patent and Trademark Office

# Hammerguard

**Reg. No. 4,277,289**

**Registered Jan. 15, 2013**

**Int. Cl.: 9**

**TRADEMARK**

**PRINCIPAL REGISTER**

KING, MARTIN ANTHONY (UNITED STATES INDIVIDUAL)  
KINGCALROCK@AOL.COM  
2121 SILVER LAKE AVE.  
LOS ANGELES, CA 90039

FOR: GLOVES FOR PROTECTION AGAINST ACCIDENTS; PROTECTIVE GLOVES FOR INDUSTRIAL USE; PROTECTIVE WORK GLOVES, IN CLASS 9 (U.S. CLS. 21, 23, 26, 36 AND 38).

FIRST USE 5-10-2011; IN COMMERCE 5-10-2011.

THE MARK CONSISTS OF STANDARD CHARACTERS WITHOUT CLAIM TO ANY PARTICULAR FONT, STYLE, SIZE, OR COLOR.

SN 85-595,422, FILED 4-11-2012.

WARREN L. OLANDRIA, EXAMINING ATTORNEY



*David J. Kyffers*

Director of the United States Patent and Trademark Office

# United States of America

United States Patent and Trademark Office

*Sachet*

**Reg. No. 4,277,290**

**Registered Jan. 15, 2013**

**Int. Cl.: 33**

**TRADEMARK**

**PRINCIPAL REGISTER**

VIATUS (CALIFORNIA CORPORATION)  
640 RIVER OAKS DRIVE  
PASO ROBLES, CA 93446

FOR: WINE, IN CLASS 33 (U.S. CLS. 47 AND 49).

FIRST USE 2-17-2011; IN COMMERCE 6-1-2012.

THE MARK CONSISTS OF THE WORD "SACHET" IN A STYLIZED CURSIVE FONT.

SN 85-596,641, FILED 4-12-2012.

DAVID H. STINE, EXAMINING ATTORNEY



*David J. Kyffers*

Director of the United States Patent and Trademark Office

# United States of America

United States Patent and Trademark Office

## HEALTHCARE ABOVE ALL

**Reg. No. 4,277,291**

**Registered Jan. 15, 2013**

**Int. Cl.: 42**

**SERVICE MARK**

**PRINCIPAL REGISTER**

EDGEMED HEALTHCARE SOLUTIONS, INC. (FLORIDA CORPORATION)  
4800 T-REX AVENUE  
200  
BOCA RATON, FL 33431

FOR: APPLICATION SERVICE PROVIDER, NAMELY, HOSTING, MANAGING, DEVELOPING, ANALYZING, AND MAINTAINING APPLICATIONS, SOFTWARE, AND WEB SITES, OF OTHERS IN THE FIELDS OF HEALTHCARE, BENEFITS PROGRAMS, EMPLOYEE PRODUCTIVITY, RISK MANAGEMENT; PROVIDING ON-LINE, NON-DOWNLOADABLE, INTERNET-BASED SOFTWARE APPLICATION FOR MEDICAL BILLING FOR PHYSICIANS AND HEALTH CARE INSTITUTIONS, IN CLASS 42 (U.S. CLS. 100 AND 101).

FIRST USE 10-15-2012; IN COMMERCE 10-15-2012.

THE MARK CONSISTS OF STANDARD CHARACTERS WITHOUT CLAIM TO ANY PARTICULAR FONT, STYLE, SIZE, OR COLOR.

NO CLAIM IS MADE TO THE EXCLUSIVE RIGHT TO USE "HEALTHCARE", APART FROM THE MARK AS SHOWN.

SN 85-597,036, FILED 4-13-2012.

MICHAEL WIENER, EXAMINING ATTORNEY



*David J. Kyros*

Director of the United States Patent and Trademark Office

**United States of America**  
United States Patent and Trademark Office

**ARMOURFX**

**Reg. No. 4,277,292**

ARMOURCOAT SURFACE FINISHES INC. (NEVADA CORPORATION)  
4330 PRODUCTION COURT  
LAS VEGAS, NV 89115

**Registered Jan. 15, 2013**

**Int. Cl.: 19**

FOR: WALL PANELS NOT OF METAL; BUILDING PANELS NOT OF METAL, IN CLASS 19 (U.S. CLS. 1, 12, 33 AND 50).

**TRADEMARK**

FIRST USE 5-1-2012; IN COMMERCE 5-1-2012.

**PRINCIPAL REGISTER**

THE MARK CONSISTS OF STANDARD CHARACTERS WITHOUT CLAIM TO ANY PARTICULAR FONT, STYLE, SIZE, OR COLOR.

SN 85-597,214, FILED 4-13-2012.

SHANNON TWOHIG, EXAMINING ATTORNEY



*David J. Kyffers*

Director of the United States Patent and Trademark Office

# United States of America

United States Patent and Trademark Office

## WINGSCAPES AUTOFEEDER

**Reg. No. 4,277,293**

**Registered Jan. 15, 2013**

**Int. Cl.: 7**

**TRADEMARK**

**PRINCIPAL REGISTER**

EBSCO INDUSTRIES, INC. (DELAWARE CORPORATION)  
LEGAL SERVICES  
5724 HIGHWAY 280 E  
BIRMINGHAM, AL 35242

FOR: MECHANIZED FEEDERS FOR WILDLIFE, IN CLASS 7 (U.S. CLS. 13, 19, 21, 23, 31, 34 AND 35).

FIRST USE 9-25-2012; IN COMMERCE 9-25-2012.

THE MARK CONSISTS OF STANDARD CHARACTERS WITHOUT CLAIM TO ANY PARTICULAR FONT, STYLE, SIZE, OR COLOR.

OWNER OF U.S. REG. NO. 3,369,908.

NO CLAIM IS MADE TO THE EXCLUSIVE RIGHT TO USE "AUTOFEEDER", APART FROM THE MARK AS SHOWN.

SN 85-597,226, FILED 4-13-2012.

COLLEEN DOMBROW, EXAMINING ATTORNEY



*David J. Kyffers*

Director of the United States Patent and Trademark Office



# United States of America

United States Patent and Trademark Office

## POINT BLANK

**Reg. No. 4,277,294**

**Registered Jan. 15, 2013**

**Int. Cl.: 41**

**SERVICE MARK**

**PRINCIPAL REGISTER**

GREEN, DAWN (UNITED STATES INDIVIDUAL)  
3 TRAILBRIDGE DRIVE  
CINCINNATI, OH 45241

FOR: GUN FIRING RANGES, IN CLASS 41 (U.S. CLS. 100, 101 AND 107).

FIRST USE 7-0-2012; IN COMMERCE 11-16-2012.

THE MARK CONSISTS OF STANDARD CHARACTERS WITHOUT CLAIM TO ANY PARTICULAR FONT, STYLE, SIZE, OR COLOR.

SN 85-598,371, FILED 4-16-2012.

WILLIAM VERHOSEK, EXAMINING ATTORNEY



*David J. Kybas*

Director of the United States Patent and Trademark Office

# United States of America

United States Patent and Trademark Office

WHEN I SHOOT... I SHOOT POINT  
BLANK

**Reg. No. 4,277,295**

GREEN, DAWN (UNITED STATES INDIVIDUAL)  
3 TRAILBRIDGE DR.  
CINCINNATI, OH 45241

**Registered Jan. 15, 2013**

**Int. Cl.: 41**

FOR: GUN FIRING RANGES, IN CLASS 41 (U.S. CLS. 100, 101 AND 107).

**SERVICE MARK**

FIRST USE 11-15-2012; IN COMMERCE 11-16-2012.

**PRINCIPAL REGISTER**

THE MARK CONSISTS OF STANDARD CHARACTERS WITHOUT CLAIM TO ANY PARTICULAR FONT, STYLE, SIZE, OR COLOR.

SN 85-598,375, FILED 4-16-2012.

WILLIAM VERHOSEK, EXAMINING ATTORNEY



*David J. Kybas*

Director of the United States Patent and Trademark Office

# United States of America

United States Patent and Trademark Office

## TIME TO SET THE RECORD STRAIGHT

**Reg. No. 4,277,296**

T-MOBILE USA, INC. (DELAWARE CORPORATION)  
12920 S.E. 38TH STREET  
BELLEVUE, WA 98006

**Registered Jan. 15, 2013**

**Int. Cl.: 38**

FOR: TELECOMMUNICATIONS SERVICES, NAMELY, TRANSMISSION OF VOICE AND DATA BY MEANS OF WIRELESS COMMUNICATION NETWORK; ELECTRONIC TRANSMISSION OF MAIL AND MESSAGES AND TEXT AND NUMERIC WIRELESS DIGITAL MESSAGING SERVICES BY MEANS OF WIRELESS COMMUNICATIONS NETWORKS; AND PROVIDING MULTIPLE-USER ACCESS TO A GLOBAL COMPUTER INFORMATION NETWORK, IN CLASS 38 (U.S. CLS. 100, 101 AND 104).

**SERVICE MARK**

**PRINCIPAL REGISTER**

FIRST USE 4-17-2012; IN COMMERCE 4-17-2012.

THE MARK CONSISTS OF STANDARD CHARACTERS WITHOUT CLAIM TO ANY PARTICULAR FONT, STYLE, SIZE, OR COLOR.

SN 85-598,672, FILED 4-16-2012.

CATHERINE ROEHL, EXAMINING ATTORNEY



*David J. Kybas*

Director of the United States Patent and Trademark Office

# United States of America

United States Patent and Trademark Office

## MUSIC ROCKS

**Reg. No. 4,277,297**

LYRIC JEANS, INC. (CALIFORNIA CORPORATION)  
1000 COREY AVENUE  
WEST HOLLYWOOD, CA 90069

**Registered Jan. 15, 2013**

**Int. Cl.: 14**

FOR: JEWELRY, INCLUDING EARRINGS, RINGS, NECKLACES, BRACELETS, AND CUFF LINKS, IN CLASS 14 (U.S. CLS. 2, 27, 28 AND 50).

**TRADEMARK**

FIRST USE 8-10-2012; IN COMMERCE 8-10-2012.

**PRINCIPAL REGISTER**

THE MARK CONSISTS OF STANDARD CHARACTERS WITHOUT CLAIM TO ANY PARTICULAR FONT, STYLE, SIZE, OR COLOR.

SN 85-598,809, FILED 4-16-2012.

MARK SHINER, EXAMINING ATTORNEY



*David J. Kybas*

Director of the United States Patent and Trademark Office

# United States of America

United States Patent and Trademark Office

## war bird technologies

**Reg. No. 4,277,298**

SCHOTT, JEFF (UNITED STATES INDIVIDUAL)  
4656 BUCKHORN RDG  
FAIRFAX, VA 22030

**Registered Jan. 15, 2013**

**Int. Cl.: 42**

FOR: COMPUTER SOFTWARE DEVELOPMENT, IN CLASS 42 (U.S. CLS. 100 AND 101).

**SERVICE MARK**

FIRST USE 11-18-2012; IN COMMERCE 11-18-2012.

**PRINCIPAL REGISTER**

THE MARK CONSISTS OF STANDARD CHARACTERS WITHOUT CLAIM TO ANY PARTICULAR FONT, STYLE, SIZE, OR COLOR.

NO CLAIM IS MADE TO THE EXCLUSIVE RIGHT TO USE "TECHNOLOGIES", APART FROM THE MARK AS SHOWN.

SN 85-598,862, FILED 4-16-2012.

MARK T. MULLEN, EXAMINING ATTORNEY



*David J. Kyffers*

Director of the United States Patent and Trademark Office

# United States of America

United States Patent and Trademark Office

## Counter Punch

**Reg. No. 4,277,299**

**Registered Jan. 15, 2013**

**Int. Cl.: 33**

**TRADEMARK**

**PRINCIPAL REGISTER**

STEPHEN HARE (UNITED STATES INDIVIDUAL), DBA COUNTER PUNCH WINES,  
3636 DARTMOUTH DR.  
NAPA, CA 94558

FOR: WINE, IN CLASS 33 (U.S. CLS. 47 AND 49).

FIRST USE 7-26-2012; IN COMMERCE 7-26-2012.

THE MARK CONSISTS OF STANDARD CHARACTERS WITHOUT CLAIM TO ANY PARTICULAR FONT, STYLE, SIZE, OR COLOR.

SN 85-598,973, FILED 4-16-2012.

JEAN IM, EXAMINING ATTORNEY



*David J. Kyfos*

Director of the United States Patent and Trademark Office

# United States of America

United States Patent and Trademark Office

# KJP

**Reg. No. 4,277,300**

**Registered Jan. 15, 2013**

**Int. Cl.: 18**

**TRADEMARK**

**PRINCIPAL REGISTER**

KIEL JAMES PATRICK LLC (RHODE ISLAND LIMITED LIABILITY COMPANY)  
133 CARDINAL ROAD  
CRANSTON, RI 02921

FOR: HANDBAGS, IN CLASS 18 (U.S. CLS. 1, 2, 3, 22 AND 41).

FIRST USE 8-3-2012; IN COMMERCE 8-3-2012.

THE MARK CONSISTS OF STANDARD CHARACTERS WITHOUT CLAIM TO ANY PARTICULAR FONT, STYLE, SIZE, OR COLOR.

SN 85-599,471, FILED 4-17-2012.

MICHELE SWAIN, EXAMINING ATTORNEY



*David J. Kyffers*

Director of the United States Patent and Trademark Office

# United States of America

United States Patent and Trademark Office

# SUNTECH

**Reg. No. 4,277,301**

**Registered Jan. 15, 2013**

**Int. Cl.: 9**

**TRADEMARK**

**PRINCIPAL REGISTER**

WUXI SUNTECH POWER CO., LTD. (CHINA CORPORATION)  
9 XINHUA ROAD, NEW DISTRICT  
WUXI, JIANGSU PROVINCE, CHINA 214028

FOR: PHOTOVOLTAIC SOLAR MODULES FOR COMMERCIAL, RESIDENTIAL, AND UTILITY-SCALE ELECTRICITY PRODUCTION APPLICATIONS; BUILDING-INTEGRATED PHOTOVOLTAIC SOLAR MODULES FOR INTEGRATION INTO BUILDING WALLS, ROOFS AND GLAZING FOR ELECTRICITY PRODUCTION; PHOTOVOLTAIC SOLAR PANELS FOR ELECTRICITY PRODUCTION; SOLAR CELLS; SOLAR JUNCTION BOXES; POWER INVERTERS; TRANSFORMERS; ELECTRICAL STORAGE BATTERIES, IN CLASS 9 (U.S. CLS. 21, 23, 26, 36 AND 38).

FIRST USE 9-30-2007; IN COMMERCE 11-26-2007.

OWNER OF U.S. REG. NOS. 3,111,705, 3,991,215, AND OTHERS.

THE MARK CONSISTS OF A STYLIZED LETTER "S" WITHIN A SQUARE DEVICE AND THE WORD "SUNTECH".

SN 85-599,777, FILED 4-17-2012.

VIVIAN MICZNIK FIRST, EXAMINING ATTORNEY



*David J. Kypos*

Director of the United States Patent and Trademark Office



# United States of America

United States Patent and Trademark Office



MEDIA  
COMPETITION  
RESEARCH  
GROUP

**Reg. No. 4,277,302**

DIMMICK, JOHN W. (UNITED STATES INDIVIDUAL)  
2664 LYNNMORE DR  
COLUMBUS, OH 43235

**Registered Jan. 15, 2013**

**Int. Cl.: 35**

FOR: MARKET ANALYSIS AND RESEARCH SERVICES, IN CLASS 35 (U.S. CLS. 100, 101 AND 102).

**SERVICE MARK**

FIRST USE 8-8-2012; IN COMMERCE 8-8-2012.

**PRINCIPAL REGISTER**

NO CLAIM IS MADE TO THE EXCLUSIVE RIGHT TO USE "MEDIA COMPETITION RESEARCH GROUP", APART FROM THE MARK AS SHOWN.

THE MARK CONSISTS OF THE WORDS "MEDIA" "COMPETITION" AND "RESEARCH" STACKED AND LEFT-ALIGNED, WITH THE FIRST LETTER OF EACH WORD ("M", "C", AND "R") LARGER THAN THE FOLLOWING LETTERS; THE WORD "GROUP" APPEARS BELOW THESE AND RIGHT-ALIGNED IN SMALLER TEXT; THE WORDING APPEARS TO THE RIGHT OF A STYLIZED COLUMN, CONSISTING OF THREE PARALLEL VERTICAL LINES, WITH THE BASE AND CAP CONSISTING OF TWO SHORTER PARALLEL HORIZONTAL LINES EACH.

SN 85-600,436, FILED 4-17-2012.

VERNA BETH RIRIE, EXAMINING ATTORNEY



*David J. Kybas*

Director of the United States Patent and Trademark Office

# United States of America

United States Patent and Trademark Office

## Not Just A Project..... A Relationship

**Reg. No. 4,277,303**

**Registered Jan. 15, 2013**

**Int. Cl.: 37**

**SERVICE MARK**

**PRINCIPAL REGISTER**

PINNACLE CONSTRUCTION SUPPORT GROUP INC (FLORIDA CORPORATION)  
528 E PARK AVENUE  
TALLAHASSEE, FL 32301

FOR: BUILDING CONSTRUCTION; BUILDING CONSTRUCTION AND REPAIR; BUILDING CONSTRUCTION INFORMATION; BUILDING CONSTRUCTION OBSERVATION, NAMELY, STATIC INSPECTION, FUNCTIONAL VERIFICATION INSPECTION, PERFORMANCE VERIFICATION INSPECTION; BUILDING CONSTRUCTION SERVICES; BUILDING CONSTRUCTION SUPERVISION; BUILDING CONSTRUCTION, REMODELING AND REPAIR; CONSTRUCTION AND CONSTRUCTION MANAGEMENT OF TUNNELS AND UNDERGROUND STRUCTURES; CONSTRUCTION AND INSTALLATION OF MASONRY WALLS AND STRUCTURES; CONSTRUCTION AND RENOVATION OF BUILDINGS; CONSTRUCTION AND REPAIR OF BUILDINGS; CONSTRUCTION AND REPAIR OF MOVIE AND THEATRICAL SETS AND SCENERY; CONSTRUCTION CONSULTANCY; CONSTRUCTION CONSULTATION; CONSTRUCTION OF AIRPORTS; CONSTRUCTION OF BUILDINGS; CONSTRUCTION OF MEDICAL ESTABLISHMENTS; CONSTRUCTION PLANNING; CONSTRUCTION PROJECT MANAGEMENT SERVICES; CONSTRUCTION SERVICES, NAMELY, PLANNING, LAYING OUT AND CUSTOM CONSTRUCTION OF COMMERCIAL BUILDINGS; CONSTRUCTION SERVICES, NAMELY, PLANNING, LAYING OUT AND CUSTOM CONSTRUCTION OF RESIDENTIAL AND COMMERCIAL COMMUNITIES; CONSTRUCTION SUPERVISION; CONSULTATION IN BUILDING CONSTRUCTION SUPERVISION; CONSULTATION SERVICES IN THE FIELD OF CONSTRUCTION OF ENVIRONMENTALLY-CONSCIOUS BUILDINGS; CONSULTING IN THE FIELD OF BUILDING CONSTRUCTION; CONSULTING IN THE FIELD OF HOSPITAL CONSTRUCTION; FACTORY CONSTRUCTION; GENERAL CONSTRUCTION CONTRACTING; REAL ESTATE DEVELOPMENT AND CONSTRUCTION OF COMMERCIAL, RESIDENTIAL AND HOTEL PROPERTY; RESIDENTIAL AND COMMERCIAL BUILDING CONSTRUCTION; TECHNICAL CONSULTATION IN THE FIELD OF BUILDING CONSTRUCTION, IN CLASS 37 (U.S. CLS. 100, 103 AND 106).



FIRST USE 1-1-2012; IN COMMERCE 4-1-2012.

THE MARK CONSISTS OF STANDARD CHARACTERS WITHOUT CLAIM TO ANY PARTICULAR FONT, STYLE, SIZE, OR COLOR.

SN 85-600,677, FILED 4-17-2012.

*David J. Kyffers*

Director of the United States Patent and Trademark Office

**Reg. No. 4,277,303** LINDA POWELL, EXAMINING ATTORNEY

# United States of America

United States Patent and Trademark Office



ONLINE ACCESS | BILL PAY | MOBILE

**Reg. No. 4,277,304**

OHIO VALLEY COMMUNITY CREDIT UNION (OHIO CORPORATION)  
52775 BOSTON HILL ROAD  
CLARINGTON, OH 43915

**Registered Jan. 15, 2013**

**Int. Cl.: 36**

FOR: BANKING SERVICES, NAMELY, PROVIDING ONLINE BANKING SERVICES, IN CLASS 36 (U.S. CLS. 100, 101 AND 102).

**SERVICE MARK**

FIRST USE 8-7-2012; IN COMMERCE 8-7-2012.

**PRINCIPAL REGISTER**

NO CLAIM IS MADE TO THE EXCLUSIVE RIGHT TO USE "ONLINE ACCESS", "BILL PAY", AND "MOBILE", APART FROM THE MARK AS SHOWN.

THE MARK CONSISTS OF THE WORD "CURCU" WITH TWO SWOOSHES ATTACHED TO THE LEFT SIDE OF THE FIRST "C" AND TWO SWOOSHES ATTACHED TO THE RIGHT SIDE OF THE CAPITAL "U", WITH THE LOWERCASE "R" OVERLAPPING THE SECOND CAPITAL "C", AND THE WORDS "ONLINE ACCESS", "BILL PAY", AND "MOBILE" SEPARATED BY VERTICAL SLASH MARKS BELOW THE WORD "CURCU".

SN 85-600,770, FILED 4-18-2012.

MICHAEL SOUDERS, EXAMINING ATTORNEY



*David J. Kyffers*

Director of the United States Patent and Trademark Office

# United States of America

United States Patent and Trademark Office

# Right Tasty

**Reg. No. 4,277,305**

**Registered Jan. 15, 2013**

**Int. Cl.: 30**

**TRADEMARK**

**PRINCIPAL REGISTER**

RIGHT TASTY (NEW YORK LIMITED LIABILITY COMPANY)  
112 DIAMOND ST. #3R  
BROOKLYN, NY 11222

FOR: SALAD DRESSINGS; SAUCES; VINAIGRETTES, IN CLASS 30 (U.S. CL. 46).

FIRST USE 8-15-2011; IN COMMERCE 5-5-2012.

THE MARK CONSISTS OF STANDARD CHARACTERS WITHOUT CLAIM TO ANY PARTICULAR FONT, STYLE, SIZE, OR COLOR.

NO CLAIM IS MADE TO THE EXCLUSIVE RIGHT TO USE "TASTY", APART FROM THE MARK AS SHOWN.

SN 85-600,893, FILED 4-18-2012.

NICHOLAS COLEMAN, EXAMINING ATTORNEY



*David J. Kyffers*

Director of the United States Patent and Trademark Office

# United States of America

United States Patent and Trademark Office

# ERMAX

**Reg. No. 4,277,306**

**Registered Jan. 15, 2013**

**Int. Cl.: 25**

**TRADEMARK**

**PRINCIPAL REGISTER**

ASTER SHOES, INC. (FLORIDA CORPORATION)  
310 NW 26TH STREET  
MIAMI, FL 33127

FOR: FOOTWEAR, IN CLASS 25 (U.S. CLS. 22 AND 39).

FIRST USE 5-30-2012; IN COMMERCE 7-31-2012.

THE MARK CONSISTS OF STANDARD CHARACTERS WITHOUT CLAIM TO ANY PARTICULAR FONT, STYLE, SIZE, OR COLOR.

SN 85-601,004, FILED 4-18-2012.

SETH A. RAPPAPORT, EXAMINING ATTORNEY



*David J. Kybas*

Director of the United States Patent and Trademark Office

# United States of America

United States Patent and Trademark Office

# Airase

**Reg. No. 4,277,307**

**Registered Jan. 15, 2013**

**Int. Cl.: 1**

**TRADEMARK**

**PRINCIPAL REGISTER**

AIR PRODUCTS AND CHEMICALS, INC. (DELAWARE CORPORATION)  
7201 HAMILTON BLVD.  
ALLENTOWN, PA 18195

FOR: CHEMICAL AGENTS, COMPOSITIONS OR PRODUCTS FOR USE AS WATER OR SOLVENT BASED DEAERATORS OR DEFOAMERS IN COATINGS, INKS, ADHESIVES, METAL WORKING FLUIDS, AGROCHEMICALS, CONCRETE COATINGS AND FORMULATIONS, PULP AND PAPER PROCESSING AND WATER TREATMENTS; SILICONE OR MODIFIED POLYETHER SILICONE CONTAINING CHEMICAL AGENTS, COMPOSITIONS OR PRODUCTS USED AS DEAERATORS OR DEFOAMERS IN THE MANUFACTURE AND APPLICATION OF INDUSTRIAL SYSTEMS, NAMELY, WATER OR SOLVENT BASED COATINGS, INKS, ADHESIVES, METAL WORKING FLUIDS, AGROCHEMICALS, CONCRETE COATINGS AND FORMULATIONS, PULP AND PAPER PROCESSING AND WATER TREATMENTS; MOLECULE-BASED AND ORGANIC BASED DEFOAMERS FOR USE AS CHEMICAL AGENTS, COMPOSITIONS OR PRODUCTS IN THE MANUFACTURE AND APPLICATION OF INDUSTRIAL SYSTEMS, NAMELY, WATER OR SOLVENT BASED COATINGS, INKS, ADHESIVES, METAL WORKING FLUIDS, AGROCHEMICALS, CONCRETE COATINGS AND FORMULATIONS, PULP AND PAPER PROCESSING AND WATER TREATMENTS, IN CLASS 1 (U.S. CLS. 1, 5, 6, 10, 26 AND 46).

FIRST USE 4-19-2012; IN COMMERCE 5-4-2012.

THE MARK CONSISTS OF STANDARD CHARACTERS WITHOUT CLAIM TO ANY PARTICULAR FONT, STYLE, SIZE, OR COLOR.

SN 85-601,089, FILED 4-18-2012.

MICHELLE DUBOIS, EXAMINING ATTORNEY



*David J. Kyros*

Director of the United States Patent and Trademark Office

# United States of America

United States Patent and Trademark Office

## LOVE IN A CUP

**Reg. No. 4,277,308**

TEAS AND JAVAS, LLC (RHODE ISLAND LIMITED LIABILITY COMPANY)  
2000 CHAPEL VIEW BLVD, STE 360  
CRANSTON, RI 02920

**Registered Jan. 15, 2013**

**Int. Cl.: 43**

FOR: RESTAURANT AND CAFE SERVICES, IN CLASS 43 (U.S. CLS. 100 AND 101).

**SERVICE MARK**

FIRST USE 7-9-2012; IN COMMERCE 7-9-2012.

**PRINCIPAL REGISTER**

THE MARK CONSISTS OF STANDARD CHARACTERS WITHOUT CLAIM TO ANY PARTICULAR FONT, STYLE, SIZE, OR COLOR.

SN 85-601,316, FILED 4-18-2012.

KELLEY WELLS, EXAMINING ATTORNEY



*David J. Kybas*

Director of the United States Patent and Trademark Office



# United States of America

United States Patent and Trademark Office

## CLEAR RAYZ

**Reg. No. 4,277,309**

QUASAR BIO-TECH INC. (FLORIDA CORPORATION)  
1431 TALLEVAST ROAD  
SARASOTA, FL 34243

**Registered Jan. 15, 2013**

**Int. Cl.: 10**

FOR: ELECTRONIC LIGHT THERAPY APPARATUS FOR THE SKIN, IN CLASS 10 (U.S. CLS. 26, 39 AND 44).

**TRADEMARK**

FIRST USE 10-5-2012; IN COMMERCE 10-5-2012.

**PRINCIPAL REGISTER**

THE MARK CONSISTS OF STANDARD CHARACTERS WITHOUT CLAIM TO ANY PARTICULAR FONT, STYLE, SIZE, OR COLOR.

SN 85-601,421, FILED 4-18-2012.

ELISSA GARBER KON, EXAMINING ATTORNEY



*David J. Kybas*

Director of the United States Patent and Trademark Office

# United States of America

United States Patent and Trademark Office

# Binmaxx

**Reg. No. 4,277,310**

**Registered Jan. 15, 2013**

**Int. Cl.: 9**

**TRADEMARK**

**PRINCIPAL REGISTER**

HI-TECH TRANSPORT ELECTRONICS, INC (OREGON CORPORATION)  
1730 WILLOW CREEK CIRCLE  
EUGENE, OR 974020437

FOR: ELECTRONIC COMMUNICATIONS SYSTEMS COMPRISED OF COMPUTER HARDWARE AND SOFTWARE FOR THE TRANSMISSION OF DATA BETWEEN TWO POINTS , IN CLASS 9 (U.S. CLS. 21, 23, 26, 36 AND 38).

FIRST USE 10-1-2012; IN COMMERCE 10-1-2012.

THE MARK CONSISTS OF STANDARD CHARACTERS WITHOUT CLAIM TO ANY PARTICULAR FONT, STYLE, SIZE, OR COLOR.

SN 85-602,674, FILED 4-19-2012.

ROBIN CHOSID, EXAMINING ATTORNEY



*David J. Kyffers*

Director of the United States Patent and Trademark Office

# United States of America

United States Patent and Trademark Office

# YUZEN

**Reg. No. 4,277,311**

YUZEN, LLC (COLORADO LIMITED LIABILITY COMPANY)  
2855 ROCK CREEK CIRCLE, #146  
SUPERIOR, CO 80027

**Registered Jan. 15, 2013**

**Int. Cl.: 35**

FOR: PROMOTION AND ADVERTISING OF GOODS AND SERVICES OF OTHERS THROUGH OFFERING PRODUCT SAMPLES, DEALS, COUPONS, VOUCHERS TO SUBSCRIBERS IN THE FIELD OF GREEN AND SUSTAINABLE BUSINESS ALL PROVIDED VIA AN ONLINE SUBSCRIPTION SERVICE, IN CLASS 35 (U.S. CLS. 100, 101 AND 102).

**SERVICE MARK**

**PRINCIPAL REGISTER**

FIRST USE 6-6-2012; IN COMMERCE 6-6-2012.

THE MARK CONSISTS OF STANDARD CHARACTERS WITHOUT CLAIM TO ANY PARTICULAR FONT, STYLE, SIZE, OR COLOR.

THE ENGLISH TRANSLATION OF "YUZEN" IN THE MARK IS A JAPANESE DYEING TECHNIQUE OR A TYPE OF PAPER.

SN 85-602,942, FILED 4-19-2012.

CHRISTOPHER LAW, EXAMINING ATTORNEY



*David J. Kyfos*

Director of the United States Patent and Trademark Office

# United States of America

United States Patent and Trademark Office

## INTEL COFLUENT

**Reg. No. 4,277,312**

**Registered Jan. 15, 2013**

**Int. Cl.: 9**

**TRADEMARK**

**PRINCIPAL REGISTER**

INTEL CORPORATION (DELAWARE CORPORATION)  
2200 MISSION COLLEGE BOULEVARD  
SANTA CLARA, CA 950528119

FOR: COMPUTER SOFTWARE TOOLS FOR SIMULATION, MODELING, ANALYZING, VALIDATING, AND DESIGN OF COMPUTER SYSTEMS AND SYSTEM ARCHITECTURE, IN CLASS 9 (U.S. CLS. 21, 23, 26, 36 AND 38).

FIRST USE 6-2-2012; IN COMMERCE 6-2-2012.

THE MARK CONSISTS OF STANDARD CHARACTERS WITHOUT CLAIM TO ANY PARTICULAR FONT, STYLE, SIZE, OR COLOR.

OWNER OF U.S. REG. NOS. 3,017,448, 4,010,734, AND OTHERS.

SN 85-603,213, FILED 4-19-2012.

JENNIFER MARTIN, EXAMINING ATTORNEY



*David J. Kyffers*

Director of the United States Patent and Trademark Office

**United States of America**  
United States Patent and Trademark Office

# ECOWELD

**Reg. No. 4,277,313**

TANDY LEATHER FACTORY, INC. (DELAWARE CORPORATION)  
1900 SOUTH EAST LOOP 820  
FT. WORTH, TX 76140

**Registered Jan. 15, 2013**

**Int. Cl.: 1**

FOR: ADHESIVE CEMENT FOR HOBBYISTS, IN CLASS 1 (U.S. CLS. 1, 5, 6, 10, 26 AND 46).

**TRADEMARK**

FIRST USE 9-1-2012; IN COMMERCE 9-1-2012.

**PRINCIPAL REGISTER**

THE MARK CONSISTS OF STANDARD CHARACTERS WITHOUT CLAIM TO ANY PARTICULAR FONT, STYLE, SIZE, OR COLOR.

SN 85-603,808, FILED 4-20-2012.

CARYN GLASSER, EXAMINING ATTORNEY



*David J. Kyffers*

Director of the United States Patent and Trademark Office

# United States of America

United States Patent and Trademark Office

# BELLAGENIX

**Reg. No. 4,277,314**

**Registered Jan. 15, 2013**

**Int. Cl.: 3**

**TRADEMARK**

**PRINCIPAL REGISTER**

NATURAL HEALTH NETWORK, LLC (CALIFORNIA LIMITED LIABILITY COMPANY)  
SUITE 201-273  
2500 E. IMPERIAL HIGHWAY  
BREA, CA 92821

FOR: ANTI-WRINKLE CREAM; ANTI-WRINKLE CREAMS; BEAUTY CREAMS; COSMETIC CREAMS; COSMETIC CREAMS FOR SKIN CARE; COSMETIC PREPARATIONS; COSMETIC PREPARATIONS FOR SKIN RENEWAL; FACE CREAMS; FACE CREAMS FOR COSMETIC USE; FACIAL CREAM; FACIAL CREAMS; MOISTURIZING CREAMS; NON-MEDICATED SKIN CARE PREPARATIONS, NAMELY, CREAMS, LOTIONS, GELS, TONERS, CLEANERS AND PEELS; NON-MEDICATED SKIN CREAMS, IN CLASS 3 (U.S. CLS. 1, 4, 6, 50, 51 AND 52).

FIRST USE 8-8-2012; IN COMMERCE 8-8-2012.

THE MARK CONSISTS OF STANDARD CHARACTERS WITHOUT CLAIM TO ANY PARTICULAR FONT, STYLE, SIZE, OR COLOR.

SN 85-604,579, FILED 4-21-2012.

JORDAN BAKER, EXAMINING ATTORNEY



*David J. Kyffers*

Director of the United States Patent and Trademark Office

# United States of America

United States Patent and Trademark Office

## Ten Tiny Toes

**Reg. No. 4,277,315**

MOORE, MAURICE (UNITED STATES INDIVIDUAL)  
N. WOODRIDGE CT  
WICHITA, KS 67226

**Registered Jan. 15, 2013**

**Int. Cl.: 25**

FOR: FOOTWEAR, IN CLASS 25 (U.S. CLS. 22 AND 39).

**TRADEMARK**

FIRST USE 8-21-2012; IN COMMERCE 8-21-2012.

**PRINCIPAL REGISTER**

THE MARK CONSISTS OF STANDARD CHARACTERS WITHOUT CLAIM TO ANY PARTICULAR FONT, STYLE, SIZE, OR COLOR.

SN 85-604,702, FILED 4-22-2012.

BILL DAWE, EXAMINING ATTORNEY



*David J. Kybas*

Director of the United States Patent and Trademark Office

# United States of America

United States Patent and Trademark Office

## Sketch Guess

**Reg. No. 4,277,316**

**Registered Jan. 15, 2013**

**Int. Cls.: 9 and 41**

**TRADEMARK**

**SERVICE MARK**

**PRINCIPAL REGISTER**

AFTERISK INC. (CALIFORNIA CORPORATION)  
618 EAST CHESTER RD  
COVINA, CA 91723

FOR: DOWNLOADABLE COMPUTER GAME SOFTWARE FOR USE ON WIRELESS DEVICES AND COMPUTERS, IN CLASS 9 (U.S. CLS. 21, 23, 26, 36 AND 38).

FIRST USE 7-24-2012; IN COMMERCE 7-24-2012.

FOR: ENTERTAINMENT SERVICES, NAMELY, PROVIDING ON-LINE COMPUTER GAMES, IN CLASS 41 (U.S. CLS. 100, 101 AND 107).

FIRST USE 7-24-2012; IN COMMERCE 7-24-2012.

THE MARK CONSISTS OF STANDARD CHARACTERS WITHOUT CLAIM TO ANY PARTICULAR FONT, STYLE, SIZE, OR COLOR.

SN 85-604,778, FILED 4-22-2012.

ALYSSA STEEL, EXAMINING ATTORNEY



*David J. Kyros*

Director of the United States Patent and Trademark Office



# United States of America

United States Patent and Trademark Office

# BlueVera

**Reg. No. 4,277,317**

**Registered Jan. 15, 2013**

**Int. Cl.: 5**

**TRADEMARK**

**PRINCIPAL REGISTER**

NAC MARKETING COMPANY, LLC (NEW YORK LIMITED LIABILITY COMPANY)  
260 SMITH STREET  
FARMINGDALE, NY 11735

FOR: NUTRITIONAL SUPPLEMENTS, IN CLASS 5 (U.S. CLS. 6, 18, 44, 46, 51 AND 52).

FIRST USE 11-7-2012; IN COMMERCE 11-7-2012.

THE MARK CONSISTS OF STANDARD CHARACTERS WITHOUT CLAIM TO ANY PARTICULAR FONT, STYLE, SIZE, OR COLOR.

SN 85-605,925, FILED 4-23-2012.

ROBIN CHOSID, EXAMINING ATTORNEY



*David J. Kyffers*

Director of the United States Patent and Trademark Office

# United States of America

United States Patent and Trademark Office

# FROTH PRO

**Reg. No. 4,277,318**

**Registered Jan. 15, 2013**

**Int. Cl.: 1**

**TRADEMARK**

**PRINCIPAL REGISTER**

CORSICANA TECHNOLOGIES, INC. (TEXAS CORPORATION), DBA CORSITECH,  
SUITE 2700  
3200 SOUTHWEST FREEWAY  
HOUSTON, TX 77027

FOR: CHEMICALS, NAMELY, FROTHING AGENTS USED IN THE MINING INDUSTRY,  
IN CLASS 1 (U.S. CLS. 1, 5, 6, 10, 26 AND 46).

FIRST USE 6-8-2012; IN COMMERCE 6-8-2012.

THE MARK CONSISTS OF STANDARD CHARACTERS WITHOUT CLAIM TO ANY PAR-  
TICULAR FONT, STYLE, SIZE, OR COLOR.

NO CLAIM IS MADE TO THE EXCLUSIVE RIGHT TO USE "FROTH", APART FROM THE  
MARK AS SHOWN.

SN 85-606,890, FILED 4-24-2012.

JULIE VEPPUMTHARA, EXAMINING ATTORNEY



*David J. Kybas*

Director of the United States Patent and Trademark Office

# United States of America

United States Patent and Trademark Office

**LEAF BLOWERS  
DIRECT.**

**Reg. No. 4,277,319**

POWER EQUIPMENT DIRECT, INC. (DELAWARE CORPORATION)  
1325 RODEO DRIVE  
BOLLINGBROOK, IL 60490

**Registered Jan. 15, 2013**

**Int. Cl.: 35**

FOR: ONLINE RETAIL STORE SERVICES FEATURING POWER EQUIPMENT, IN CLASS 35 (U.S. CLS. 100, 101 AND 102).

**SERVICE MARK**

FIRST USE 5-6-2012; IN COMMERCE 5-6-2012.

**PRINCIPAL REGISTER**

OWNER OF U.S. REG. NOS. 3,425,585, 3,425,587, AND OTHERS.

NO CLAIM IS MADE TO THE EXCLUSIVE RIGHT TO USE "LEAF BLOWERS DIRECT", APART FROM THE MARK AS SHOWN.

THE MARK CONSISTS OF THE STYLIZED WORDING "LEAF BLOWERS DIRECT", WHERE THE WORDING "LEAF BLOWERS" IS ABOVE THE WORDING "DIRECT", AND THE LETTER "D" IN THE WORDING "DIRECT" IS FORMED WITH THE DESIGN OF AN INSET ARROW.

SN 85-608,289, FILED 4-25-2012.

RENEE MCCRAY, EXAMINING ATTORNEY



*David J. Kyros*

Director of the United States Patent and Trademark Office

# United States of America

United States Patent and Trademark Office

# IPLEAT

**Reg. No. 4,277,320**

IFIL USA, LLC (MISSOURI LIMITED LIABILITY COMPANY)  
1801 VINE STREET  
HARRISONVILLE, MO 64701

**Registered Jan. 15, 2013**

**Int. Cl.: 11**

FOR: FILTER CARTRIDGES FOR INDUSTRIAL DUST COLLECTION SYSTEMS FOR USE  
IN PULSE-JET CLEANING, IN CLASS 11 (U.S. CLS. 13, 21, 23, 31 AND 34).

**TRADEMARK**

FIRST USE 5-8-2012; IN COMMERCE 5-8-2012.

**PRINCIPAL REGISTER**

THE MARK CONSISTS OF STANDARD CHARACTERS WITHOUT CLAIM TO ANY PAR-  
TICULAR FONT, STYLE, SIZE, OR COLOR.

SN 85-609,578, FILED 4-26-2012.

CHRISTINA SOBRAL, EXAMINING ATTORNEY



*David J. Kyffers*

Director of the United States Patent and Trademark Office

# United States of America

United States Patent and Trademark Office

# CASH BASH

**Reg. No. 4,277,321**

GATEWAY GAMING, LLC (SOUTH CAROLINA LIMITED LIABILITY COMPANY)  
135 KIOWA LANE  
PIEDMONT, SC 29673

**Registered Jan. 15, 2013**

**Int. Cl.: 28**

FOR: GAMING EQUIPMENT, NAMELY, GAMING MACHINES BEING CONFIGURED TO OFFER ELECTRONIC SLOT GAMES, ELECTRONIC BINGO GAMES, ELECTRONIC CASINO GAMES, AND ELECTRONIC SWEEPSTAKES GAMES, IN CLASS 28 (U.S. CLS. 22, 23, 38 AND 50).

**TRADEMARK**

**PRINCIPAL REGISTER**

FIRST USE 5-31-2012; IN COMMERCE 5-31-2012.

THE MARK CONSISTS OF STANDARD CHARACTERS WITHOUT CLAIM TO ANY PARTICULAR FONT, STYLE, SIZE, OR COLOR.

SN 85-610,454, FILED 4-27-2012.

KATHERINE E. HALMEN, EXAMINING ATTORNEY



*David J. Kyros*

Director of the United States Patent and Trademark Office

# United States of America

United States Patent and Trademark Office

# Eyelixr

**Reg. No. 4,277,322**

**Registered Jan. 15, 2013**

**Int. Cl.: 9**

**TRADEMARK**

**PRINCIPAL REGISTER**

NBTV MEDIA (MICHIGAN CORPORATION)  
209 PARK STREET  
TROY, MI 48083

FOR: EYEGLASSES; OPTICAL MAGNIFIERS, NAMELY, MAGNIFYING GLASSES AND LENSES, IN CLASS 9 (U.S. CLS. 21, 23, 26, 36 AND 38).

FIRST USE 8-0-2012; IN COMMERCE 8-0-2012.

THE MARK CONSISTS OF STANDARD CHARACTERS WITHOUT CLAIM TO ANY PARTICULAR FONT, STYLE, SIZE, OR COLOR.

SN 85-611,355, FILED 4-29-2012.

NICHOLAS COLEMAN, EXAMINING ATTORNEY



*David J. Kybas*

Director of the United States Patent and Trademark Office

# United States of America

United States Patent and Trademark Office

## JUICE FOR A DAY

**Reg. No. 4,277,323**

JUICE GENERATION, INC. (NEW YORK CORPORATION)  
520 47TH ROAD

**Registered Jan. 15, 2013**

LONG ISLAND CITY, NY 11101

**Int. Cl.: 39**

FOR: DISTRIBUTION SERVICES, NAMELY, DELIVERY OF JUICE, IN CLASS 39 (U.S. CLS. 100 AND 105).

**SERVICE MARK**

FIRST USE 10-22-2012; IN COMMERCE 10-22-2012.

**PRINCIPAL REGISTER**

THE MARK CONSISTS OF STANDARD CHARACTERS WITHOUT CLAIM TO ANY PARTICULAR FONT, STYLE, SIZE, OR COLOR.

SN 85-612,012, FILED 4-30-2012.

ZACHARY BELLO, EXAMINING ATTORNEY



*David J. Kybas*

Director of the United States Patent and Trademark Office

# United States of America

United States Patent and Trademark Office

# EXP

**Reg. No. 4,277,324**

EXP613, LLC (FLORIDA LIMITED LIABILITY COMPANY)  
1835 NE MIAMI GARDENS DRIVE, SUITE 250  
MIAMI, FL 33179

**Registered Jan. 15, 2013**

**Int. Cl.: 35**

FOR: HOTEL MANAGEMENT FOR OTHERS, IN CLASS 35 (U.S. CLS. 100, 101 AND 102).

**SERVICE MARK**

FIRST USE 3-0-2011; IN COMMERCE 3-0-2011.

**PRINCIPAL REGISTER**

THE MARK CONSISTS OF STANDARD CHARACTERS WITHOUT CLAIM TO ANY PARTICULAR FONT, STYLE, SIZE, OR COLOR.

OWNER OF U.S. REG. NOS. 3,551,264, 4,053,310, AND OTHERS.

SN 85-613,877, FILED 5-1-2012.

FRANK LATTUCA, EXAMINING ATTORNEY



*David J. Kyffers*

Director of the United States Patent and Trademark Office



# United States of America

United States Patent and Trademark Office

## NORMALEYES

**Reg. No. 4,277,325**

PARAGON VISION SCIENCES, INC. (ARIZONA CORPORATION)  
947 EAST IMPALA AVENUE  
MESA, AZ 85204

**Registered Jan. 15, 2013**

**Int. Cl.: 9**

FOR: CONTACT LENSES AND CONTACT LENS BLANKS AND BUTTONS, IN CLASS 9  
(U.S. CLS. 21, 23, 26, 36 AND 38).

**TRADEMARK**

FIRST USE 6-29-2012; IN COMMERCE 6-29-2012.

**PRINCIPAL REGISTER**

THE MARK CONSISTS OF STANDARD CHARACTERS WITHOUT CLAIM TO ANY PARTICULAR FONT, STYLE, SIZE, OR COLOR.

SN 85-615,672, FILED 5-3-2012.

SHAUNIA CARLYLE, EXAMINING ATTORNEY



*David J. Kyffers*

Director of the United States Patent and Trademark Office

# United States of America

United States Patent and Trademark Office

# ePrime

**Reg. No. 4,277,326**

**Registered Jan. 15, 2013**

**Int. Cl.: 9**

**TRADEMARK**

**PRINCIPAL REGISTER**

SPIRE METERING TECHNOLOGY, LLC (MASSACHUSETTS LIMITED LIABILITY COMPANY)  
14B CRAIG ROAD  
ACTON, MA 01720

FOR: ELECTRIC METERS, IN CLASS 9 (U.S. CLS. 21, 23, 26, 36 AND 38).

FIRST USE 5-3-2012; IN COMMERCE 6-2-2012.

THE MARK CONSISTS OF STANDARD CHARACTERS WITHOUT CLAIM TO ANY PARTICULAR FONT, STYLE, SIZE, OR COLOR.

THE WORDING "EPRIME" HAS NO MEANING IN A FOREIGN LANGUAGE.

SN 85-615,808, FILED 5-3-2012.

SUNG IN, EXAMINING ATTORNEY



*David J. Kyfos*

Director of the United States Patent and Trademark Office

# United States of America

United States Patent and Trademark Office

# Sharp X

**Reg. No. 4,277,327**

ELMER'S PRODUCTS, INC. (DELAWARE CORPORATION)  
460 POLARIS PARKWAY, SUITE 500  
WESTERVILLE, OH 43082

**Registered Jan. 15, 2013**

**Int. Cl.: 16**

FOR: ELECTRIC PENCIL SHARPENERS, IN CLASS 16 (U.S. CLS. 2, 5, 22, 23, 29, 37, 38 AND 50).

**TRADEMARK**

FIRST USE 9-1-2012; IN COMMERCE 9-1-2012.

**PRINCIPAL REGISTER**

THE MARK CONSISTS OF STANDARD CHARACTERS WITHOUT CLAIM TO ANY PARTICULAR FONT, STYLE, SIZE, OR COLOR.

SN 85-617,062, FILED 5-4-2012.

GINA HAYES, EXAMINING ATTORNEY



*David J. Kyffers*

Director of the United States Patent and Trademark Office

# United States of America

United States Patent and Trademark Office

## Vintner's Brush

**Reg. No. 4,277,328**

DELICATO VINEYARDS (CALIFORNIA CORPORATION)  
12001 S HIGHWAY 99  
MANTECA, CA 95336

**Registered Jan. 15, 2013**

**Int. Cl.: 33**

FOR: APERITIF WINES; APERITIFS WITH A WINE BASE; COOKING WINE; FORTIFIED WINES; FRUIT WINE; GRAPE WINE; HONEY WINE; KITS FOR MAKING WINE; KOREAN TRADITIONAL RICE WINE; NATURAL SPARKLING WINES; PORT WINES; PREPARED WINE COCKTAILS; RED WINE; RED WINES; ROSE WINE; SPARKLING FRUIT WINE; SPARKLING GRAPE WINE; SPARKLING WINES; STILL WINES; STRAWBERRY WINE; SWEET WINES; TABLE WINES; TONIC SWEET GRAPE WINE CONTAINING EXTRACTS FROM GINSENG AND CONCHONA BARK (NINJIN-KINATETSU WINE); WHITE WINE; WINE; WINE COOLERS; WINE PUNCH; WINE PUNCHES; WINE-BASED BEVERAGE, NAMELY, PIQUETTE; WINE-BASED DRINKS; WINES; WINES AND FORTIFIED WINES; WINES AND LIQUEURS; WINES AND SPARKLING WINES; WINES DERIVED FROM GRAPES GROWN IN CALIFORNIA, LABELED AND ADVERTISED IN COMPLIANCE WITH CALIFORNIA LAWS FOR WINES, IN CLASS 33 (U.S. CLS. 47 AND 49).

**TRADEMARK**

**PRINCIPAL REGISTER**

FIRST USE 6-5-2012; IN COMMERCE 11-6-2012.

THE MARK CONSISTS OF STANDARD CHARACTERS WITHOUT CLAIM TO ANY PARTICULAR FONT, STYLE, SIZE, OR COLOR.

NO CLAIM IS MADE TO THE EXCLUSIVE RIGHT TO USE "VINTNER'S", APART FROM THE MARK AS SHOWN.

SN 85-617,444, FILED 5-4-2012.

RONALD DELGIZZI, EXAMINING ATTORNEY



*David J. Kyffers*

Director of the United States Patent and Trademark Office

# United States of America

United States Patent and Trademark Office

## THE SHOPPER IS ALWAYS ON

**Reg. No. 4,277,329**

D.L. RYAN COMPANIES, LLC (DELAWARE LIMITED LIABILITY COMPANY)  
50 DANBURY ROAD  
WILTON, CT 06897

**Registered Jan. 15, 2013**

**Int. Cl.: 35**

FOR: ADVERTISING, MARKETING AND PROMOTION SERVICES, IN CLASS 35 (U.S. CLS. 100, 101 AND 102).

**SERVICE MARK**

FIRST USE 8-22-2012; IN COMMERCE 8-22-2012.

**PRINCIPAL REGISTER**

THE MARK CONSISTS OF STANDARD CHARACTERS WITHOUT CLAIM TO ANY PARTICULAR FONT, STYLE, SIZE, OR COLOR.

SN 85-620,982, FILED 5-9-2012.

IRA J. GOODSaid, EXAMINING ATTORNEY



*David J. Kyffers*

Director of the United States Patent and Trademark Office

# United States of America

United States Patent and Trademark Office

# GRIP-RITE

**Reg. No. 4,277,330**

PRIMESOURCE BUILDING PRODUCTS, INC. (DELAWARE CORPORATION)  
1321 GREENWAY DRIVE  
IRVING, TX 75038

**Registered Jan. 15, 2013**

**Int. Cl.: 8**

FOR: HAND TOOLS, NAMELY, CHALK LINE REELS AND CHALK FOR CHALK LINE REELS, IN CLASS 8 (U.S. CLS. 23, 28 AND 44).

**TRADEMARK**

FIRST USE 9-0-2012; IN COMMERCE 9-0-2012.

**PRINCIPAL REGISTER**

THE MARK CONSISTS OF STANDARD CHARACTERS WITHOUT CLAIM TO ANY PARTICULAR FONT, STYLE, SIZE, OR COLOR.

OWNER OF U.S. REG. NOS. 1,917,594, 3,680,836, AND OTHERS.

SN 85-625,302, FILED 5-15-2012.

MAYUR VAGHANI, EXAMINING ATTORNEY



*David J. Kybas*

Director of the United States Patent and Trademark Office

# United States of America

United States Patent and Trademark Office

## WHAT THE HDL?

**Reg. No. 4,277,331**

VERIA INTERNATIONAL LIMITED (BERMUDA CORPORATION)  
CANON'S COURT, 22 VICTORIA STREET  
HAMILTON HM 12, BERMUDA

**Registered Jan. 15, 2013**

**Int. Cl.: 5**

FOR: DIETARY AND NUTRITIONAL SUPPLEMENTS; HERBAL SUPPLEMENTS, IN CLASS  
5 (U.S. CLS. 6, 18, 44, 46, 51 AND 52).

**TRADEMARK**

FIRST USE 8-31-2012; IN COMMERCE 8-31-2012.

**PRINCIPAL REGISTER**

THE MARK CONSISTS OF STANDARD CHARACTERS WITHOUT CLAIM TO ANY PAR-  
TICULAR FONT, STYLE, SIZE, OR COLOR.

SN 85-625,733, FILED 5-15-2012.

SETH A. RAPPAPORT, EXAMINING ATTORNEY



*David J. Kybas*

Director of the United States Patent and Trademark Office

# United States of America

United States Patent and Trademark Office

## SWEET & STEADY

**Reg. No. 4,277,332**

VERIA INTERNATIONAL LIMITED (BERMUDA CORPORATION)  
CANON'S COURT, 22 VICTORIA STREET  
HAMILTON HM 12, BERMUDA

**Registered Jan. 15, 2013**

**Int. Cl.: 5**

FOR: DIETARY AND NUTRITIONAL SUPPLEMENTS; HERBAL SUPPLEMENTS, IN CLASS  
5 (U.S. CLS. 6, 18, 44, 46, 51 AND 52).

**TRADEMARK**

FIRST USE 8-31-2012; IN COMMERCE 8-31-2012.

**PRINCIPAL REGISTER**

THE MARK CONSISTS OF STANDARD CHARACTERS WITHOUT CLAIM TO ANY PAR-  
TICULAR FONT, STYLE, SIZE, OR COLOR.

SN 85-625,757, FILED 5-15-2012.

SETH A. RAPPAPORT, EXAMINING ATTORNEY



*David J. Kybas*

Director of the United States Patent and Trademark Office



# United States of America

United States Patent and Trademark Office

## LIVER LET LIVE

**Reg. No. 4,277,333**

VERIA INTERNATIONAL LIMITED (BERMUDA CORPORATION)  
CANON'S COURT, 22 VICTORIA STREET  
HAMILTON HM 12, BERMUDA

**Registered Jan. 15, 2013**

**Int. Cl.: 5**

FOR: DIETARY AND NUTRITIONAL SUPPLEMENTS; HERBAL SUPPLEMENTS, IN CLASS  
5 (U.S. CLS. 6, 18, 44, 46, 51 AND 52).

**TRADEMARK**

FIRST USE 8-31-2012; IN COMMERCE 8-31-2012.

**PRINCIPAL REGISTER**

THE MARK CONSISTS OF STANDARD CHARACTERS WITHOUT CLAIM TO ANY PAR-  
TICULAR FONT, STYLE, SIZE, OR COLOR.

SN 85-625,773, FILED 5-15-2012.

SETH A. RAPPAPORT, EXAMINING ATTORNEY



*David J. Kybas*

Director of the United States Patent and Trademark Office

# United States of America

United States Patent and Trademark Office

## EXPRESS YOURSELF

**Reg. No. 4,277,334**

**Registered Jan. 15, 2013**

**Int. Cl.: 16**

**TRADEMARK**

**PRINCIPAL REGISTER**

ELMER'S PRODUCTS, INC. (DELAWARE CORPORATION)  
460 POLARIS PARKWAY, SUITE 500  
WESTERVILLE, OH 43082

FOR: OPAQUE PAINT MARKERS, IN CLASS 16 (U.S. CLS. 2, 5, 22, 23, 29, 37, 38 AND 50).

FIRST USE 9-20-2012; IN COMMERCE 9-20-2012.

THE MARK CONSISTS OF STANDARD CHARACTERS WITHOUT CLAIM TO ANY PARTICULAR FONT, STYLE, SIZE, OR COLOR.

SN 85-626,085, FILED 5-15-2012.

GINA HAYES, EXAMINING ATTORNEY



*David J. Kybas*

Director of the United States Patent and Trademark Office

# United States of America

United States Patent and Trademark Office



**Reg. No. 4,277,335**

**Registered Jan. 15, 2013**

**Int. Cl.: 36**

**SERVICE MARK**

**PRINCIPAL REGISTER**

MAZDA MOTOR OF AMERICA, INC. (CALIFORNIA CORPORATION)  
7755 IRVINE CENTER DRIVE  
IRVINE, CA 92618

FOR: EXTENDED WARRANTY SERVICES, NAMELY, SERVICE CONTRACTS; PROVIDING EXTENDED WARRANTIES ON AUTOMOBILES, IN CLASS 36 (U.S. CLS. 100, 101 AND 102).

FIRST USE 5-0-2012; IN COMMERCE 5-0-2012.

OWNER OF U.S. REG. NOS. 2,697,170, 3,981,297, AND OTHERS.

NO CLAIM IS MADE TO THE EXCLUSIVE RIGHT TO USE "EXTENDED", APART FROM THE MARK AS SHOWN.

THE MARK CONSISTS OF THE WORD "MAZDA" BENEATH A FLATTENED OVAL SHAPE CONTAINING A DESIGN SUGGESTING A PAIR OF WINGS, ALL TO THE LEFT OF THE WORDS "MAZDA EXTENDED CONFIDENCE", WITH A HORIZONTAL LINE BETWEEN "MAZDA EXTENDED" AND "CONFIDENCE", AND A SERIES OF SIX SLANTED LINES SHOWN AFTER "CONFIDENCE".

SN 85-637,425, FILED 5-29-2012.

KELLY TRUSILO, EXAMINING ATTORNEY



*David J. Kyffers*

Director of the United States Patent and Trademark Office

# United States of America

United States Patent and Trademark Office

# ORAJEL

**Reg. No. 4,277,336**

**Registered Jan. 15, 2013**

**Int. Cl.: 10**

**TRADEMARK**

**PRINCIPAL REGISTER**

CHURCH & DWIGHT CO., INC. (DELAWARE CORPORATION)  
469 NORTH HARRISON STREET  
PRINCETON, NJ 085435297

FOR: TEETHING RINGS, IN CLASS 10 (U.S. CLS. 26, 39 AND 44).

FIRST USE 1-0-2012; IN COMMERCE 1-0-2012.

THE MARK CONSISTS OF STANDARD CHARACTERS WITHOUT CLAIM TO ANY PARTICULAR FONT, STYLE, SIZE, OR COLOR.

OWNER OF U.S. REG. NOS. 1,166,935, 3,647,521, AND 3,950,958.

SN 85-639,732, FILED 5-31-2012.

JOHN HWANG, EXAMINING ATTORNEY



*David J. Kybas*

Director of the United States Patent and Trademark Office

# United States of America

United States Patent and Trademark Office

# Orajel

**Reg. No. 4,277,337**

**Registered Jan. 15, 2013**

**Int. Cl.: 10**

**TRADEMARK**

**PRINCIPAL REGISTER**

CHURCH & DWIGHT CO., INC. (DELAWARE CORPORATION)  
469 NORTH HARRISON STREET  
PRINCETON, NJ 085435297

FOR: TEETHING RINGS, IN CLASS 10 (U.S. CLS. 26, 39 AND 44).

FIRST USE 1-0-2012; IN COMMERCE 1-0-2012.

OWNER OF U.S. REG. NO. 3,647,531.

THE MARK CONSISTS OF THE WORD "ORAJEL" IN QUADRILATERAL.

SN 85-639,740, FILED 5-31-2012.

JOHN HWANG, EXAMINING ATTORNEY



*David J. Kybas*

Director of the United States Patent and Trademark Office

# United States of America

United States Patent and Trademark Office

## GROOVETUNES

**Reg. No. 4,277,338**

DPI, INC. (MISSOURI CORPORATION)  
900 N. 23RD STREET  
ST. LOUIS, MO 63106

**Registered Jan. 15, 2013**

**Int. Cl.: 9**

FOR: AUDIO SPEAKERS, IN CLASS 9 (U.S. CLS. 21, 23, 26, 36 AND 38).

**TRADEMARK**

FIRST USE 8-12-2012; IN COMMERCE 8-12-2012.

**PRINCIPAL REGISTER**

THE MARK CONSISTS OF STANDARD CHARACTERS WITHOUT CLAIM TO ANY PARTICULAR FONT, STYLE, SIZE, OR COLOR.

SN 85-642,656, FILED 6-4-2012.

PATRICIA EVANKO, EXAMINING ATTORNEY



*David J. Kybas*

Director of the United States Patent and Trademark Office

# United States of America

United States Patent and Trademark Office

TAKE THE INTERNET WHERE  
LIFE TAKES YOU

**Reg. No. 4,277,339**

T-MOBILE USA, INC. (DELAWARE CORPORATION)  
12920 S.E. 38TH STREET  
BELLEVUE, WA 98006

**Registered Jan. 15, 2013**

**Int. Cl.: 38**

FOR: TELECOMMUNICATIONS SERVICES, NAMELY, WIRELESS DATA TRANSMISSION, WIRELESS TRANSMISSION OF EMAIL AND TEXT BETWEEN WIRELESS TELECOMMUNICATIONS TERMINALS AND COMPUTERS, AND PROVIDING MULTIPLE-USER ACCESS TO A GLOBAL COMPUTER NETWORK, IN CLASS 38 (U.S. CLS. 100, 101 AND 104).

**SERVICE MARK**

**PRINCIPAL REGISTER**

FIRST USE 3-28-2012; IN COMMERCE 3-28-2012.

THE MARK CONSISTS OF STANDARD CHARACTERS WITHOUT CLAIM TO ANY PARTICULAR FONT, STYLE, SIZE, OR COLOR.

SN 85-643,660, FILED 6-5-2012.

CATHERINE ROEHL, EXAMINING ATTORNEY



*David J. Kybas*

Director of the United States Patent and Trademark Office

# United States of America

United States Patent and Trademark Office

## PROTEIN PLUS

**Reg. No. 4,277,340**

**Registered Jan. 15, 2013**

**Int. Cls.: 30 and 32**

**TRADEMARK**

**PRINCIPAL REGISTER**

BOLTHOUSE JUICE PRODUCTS, LLC (DELAWARE LIMITED LIABILITY COMPANY)  
7200 EAST BRUNDAGE LANE  
BAKERSFIELD, CA 93307

FOR: COFFEE AND ESPRESSO BASED BEVERAGES IN A VARIETY OF FLAVORS CONTAINING PROTEIN, IN CLASS 30 (U.S. CL. 46).

FIRST USE 3-0-2012; IN COMMERCE 3-0-2012.

FOR: SOY OR WHEY PROTEIN BASED BEVERAGES IN A VARIETY OF FLAVORS NOT USED AS A MILK SUBSTITUTE; FRUIT AND VEGETABLE JUICES CONTAINING PROTEIN; BLENDED FRUIT AND VEGETABLE JUICES IN A VARIETY OF FLAVORS CONTAINING PROTEIN AND IN THE NATURE OF SMOOTHIES CONTAINING PROTEIN, IN CLASS 32 (U.S. CLS. 45, 46 AND 48).

FIRST USE 7-0-2010; IN COMMERCE 7-0-2010.

THE MARK CONSISTS OF STANDARD CHARACTERS WITHOUT CLAIM TO ANY PARTICULAR FONT, STYLE, SIZE, OR COLOR.

OWNER OF U.S. REG. NOS. 3,130,549 AND 3,287,016.

NO CLAIM IS MADE TO THE EXCLUSIVE RIGHT TO USE "PROTEIN", APART FROM THE MARK AS SHOWN.

SN 85-645,932, FILED 6-7-2012.

ROBIN MITTLER, EXAMINING ATTORNEY



*David J. Kypos*

Director of the United States Patent and Trademark Office



# United States of America

United States Patent and Trademark Office

## THUNDER MUNROE

**Reg. No. 4,277,341**

JO ANNE GAYLE YAMAMOTO (UNITED STATES INDIVIDUAL)  
540 21ST STREET

**Registered Jan. 15, 2013**

MANHATTAN BEACH, CA 90266

**Int. Cl.: 25**

FOR: CLOTHING FOR INFANTS AND CHILDREN, NAMELY, ONE-PIECE ROMPERS, SHORTS, T-SHIRTS, KNIT TOPS, SWIMWEAR, IN CLASS 25 (U.S. CLS. 22 AND 39).

**TRADEMARK**

FIRST USE 4-11-2012; IN COMMERCE 4-11-2012.

**PRINCIPAL REGISTER**

THE MARK CONSISTS OF STANDARD CHARACTERS WITHOUT CLAIM TO ANY PARTICULAR FONT, STYLE, SIZE, OR COLOR.

THE NAME(S), PORTRAIT(S), AND/OR SIGNATURE(S) SHOWN IN THE MARK DOES NOT IDENTIFY A PARTICULAR LIVING INDIVIDUAL.

SN 85-650,055, FILED 6-12-2012.

KATHERINE CHANG, EXAMINING ATTORNEY



*David J. Kybas*

Director of the United States Patent and Trademark Office

# United States of America

United States Patent and Trademark Office

## SIT STRAIGHT FEEL GREAT

**Reg. No. 4,277,342**

COHEN, MICHAEL (UNITED STATES INDIVIDUAL)  
336 HILLHURST BLVD  
TORONTO, CANADA

**Registered Jan. 15, 2013**

**Int. Cl.: 10**

FOR: MASSAGE APPARATUS, NAMELY, A HEATED, CYLINDER SHAPED SELF-MASSAGE APPARATUS WITH A CENTRAL GROOVE FOR USER'S VERTEBRAE WHICH AIDS IN ATTAINING AN UPRIGHT SEATED POSTURE , IN CLASS 10 (U.S. CLS. 26, 39 AND 44).

**TRADEMARK**

FIRST USE 1-21-2012; IN COMMERCE 2-20-2012.

**PRINCIPAL REGISTER**

THE MARK CONSISTS OF STANDARD CHARACTERS WITHOUT CLAIM TO ANY PARTICULAR FONT, STYLE, SIZE, OR COLOR.

SN 85-656,149, FILED 6-19-2012.

NATALIE POLZER, EXAMINING ATTORNEY



*David J. Kybas*

Director of the United States Patent and Trademark Office

# United States of America

United States Patent and Trademark Office

# ANSER

**Reg. No. 4,277,343**

**Registered Jan. 15, 2013**

**Int. Cl.: 9**

**TRADEMARK**

**PRINCIPAL REGISTER**

WINEGARD COMPANY (IOWA CORPORATION)  
3000 KIRKWOOD STREET  
BURLINGTON, IA 52601

FOR: ANTENNAS, IN CLASS 9 (U.S. CLS. 21, 23, 26, 36 AND 38).

FIRST USE 9-17-2012; IN COMMERCE 9-17-2012.

THE MARK CONSISTS OF STANDARD CHARACTERS WITHOUT CLAIM TO ANY PARTICULAR FONT, STYLE, SIZE, OR COLOR.

SN 85-658,367, FILED 6-21-2012.

ROBERT STRUCK, EXAMINING ATTORNEY



*David J. Kyffers*

Director of the United States Patent and Trademark Office

# United States of America

United States Patent and Trademark Office

## GET BACK TO HUMAN

**Reg. No. 4,277,344**

BROWN, JORDAN (UNITED STATES INDIVIDUAL)  
10 WEST 15TH STREET, APT. 817  
NEW YORK, NY 10011

**Registered Jan. 15, 2013**

**Int. Cl.: 29**

FOR: NUT BUTTERS; NUT BUTTERS, NAMELY, CASHEW BUTTER, ALMOND BUTTER AND SUNFLOWER SEED BUTTER; NUT SNACK BARS, NUT AND SEED-BASED SNACK BARS; NUT, DRIED FRUIT AND SEED-BASED SNACK BARS; NUTS, NAMELY, PREPARED NUTS, PROCESSED NUTS, ROASTED NUTS; SEASONED NUTS, SHELLED NUTS AND FLAVORED NUTS, IN CLASS 29 (U.S. CL. 46).

**TRADEMARK**

**PRINCIPAL REGISTER**

FIRST USE 9-13-2012; IN COMMERCE 9-13-2012.

THE MARK CONSISTS OF STANDARD CHARACTERS WITHOUT CLAIM TO ANY PARTICULAR FONT, STYLE, SIZE, OR COLOR.

SN 85-659,047, FILED 6-22-2012.

MARK SHINER, EXAMINING ATTORNEY



*David J. Kybas*

Director of the United States Patent and Trademark Office

# United States of America

United States Patent and Trademark Office



**Reg. No. 4,277,345**

**Registered Jan. 15, 2013**

**Int. Cl.: 33**

**TRADEMARK**

**PRINCIPAL REGISTER**

BERNIKO, LLC (FLORIDA LIMITED LIABILITY COMPANY)  
900 NORTH FEDERAL HIGHWAY, SUITE 306  
HALLANDALE BEACH, FL 33009

FOR: BOURBON; BOURBON WHISKY; GIN; LIQUEURS; LIQUOR; RUM; TEQUILA; VODKA;  
WHISKEY, IN CLASS 33 (U.S. CLS. 47 AND 49).

FIRST USE 9-11-2012; IN COMMERCE 9-11-2012.

THE MARK CONSISTS OF A BLACK, OLIVE GREEN, ARMY GREEN AND BEIGE CAMOUFLAGE PATTERN APPLIED ON BOTTLE-SHAPED PACKAGING, THE MATTER DEPICTED IN BROKEN LINES IS NOT CLAIMED AS A FEATURE OF THE MARK AND SERVES ONLY TO SHOW THE POSITION OR PLACEMENT OF THE MARK.

THE COLOR(S) BLACK, OLIVE GREEN, ARMY GREEN AND BEIGE IS/ARE CLAIMED AS A FEATURE OF THE MARK.

SN 85-674,161, FILED 7-11-2012.

RONALD MCMORROW, EXAMINING ATTORNEY



*David J. Kybas*

Director of the United States Patent and Trademark Office

# United States of America

United States Patent and Trademark Office



**Reg. No. 4,277,346**

**Registered Jan. 15, 2013**

**Int. Cl.: 25**

**TRADEMARK**

**PRINCIPAL REGISTER**

ASCHE, ALEXANDER (UNITED STATES INDIVIDUAL)  
186 MARSH ISLAND DRIVE  
KIAWAH ISLAND, SC 29455

FOR: CLOTHING, NAMELY, FOOTWEAR, HEADWEAR, HATS, TOPS, BOTTOMS, SHIRTS, T-SHIRTS, AND PANTS, IN CLASS 25 (U.S. CLS. 22 AND 39).

FIRST USE 10-12-2012; IN COMMERCE 10-28-2012.

THE MARK CONSISTS OF THE WORDING "OCEAN OAKS" IN GREEN COLOR WRITTEN IN STYLIZED FORM BELOW AN IMAGE OF A TREE WITH GREEN LEAVES AND BROWN BARK AND BRANCHES. BLUE OCEAN WAVES COVER THE BOTTOM OF THE TREE.

THE COLOR(S) GREEN, BROWN AND BLUE IS/ARE CLAIMED AS A FEATURE OF THE MARK.

SN 85-682,301, FILED 7-20-2012.

INGRID C. EULIN, EXAMINING ATTORNEY



*David J. Kybas*

Director of the United States Patent and Trademark Office

# United States of America

United States Patent and Trademark Office

## DESIGNED BY DENTAL PROFESSIONALS FOR HEALTHIER INDIVIDUALS

**Reg. No. 4,277,347**

DENTIST RX, LLC (DELAWARE LIMITED LIABILITY COMPANY)  
14787 NE 95TH STREET  
REDMOND, WA 98052

**Registered Jan. 15, 2013**

**Int. Cl.: 21**

FOR: TOOTH BRUSHES; ELECTRONIC TOOTH BRUSHES; SONIC TOOTH BRUSHES;  
TOOTH BRUSH HOLDERS; TOOTH BRUSH HOLDERS WITH SANITIZERS; REPLACEMENT  
BRUSH HEADS FOR TOOTH BRUSHES, ELECTRONIC TOOTH BRUSHES, AND SONIC  
TOOTH BRUSHES, IN CLASS 21 (U.S. CLS. 2, 13, 23, 29, 30, 33, 40 AND 50).

**TRADEMARK**

**PRINCIPAL REGISTER**

FIRST USE 10-1-2010; IN COMMERCE 10-1-2010.

THE MARK CONSISTS OF STANDARD CHARACTERS WITHOUT CLAIM TO ANY PAR-  
TICULAR FONT, STYLE, SIZE, OR COLOR.

SN 85-975,665, FILED 8-11-2010.

LINDA M. KING, EXAMINING ATTORNEY



*David J. Kybas*

Director of the United States Patent and Trademark Office

# United States of America

United States Patent and Trademark Office



**Reg. No. 4,277,348**

**Registered Jan. 15, 2013**

**Int. Cl.: 35**

**SERVICE MARK**

**PRINCIPAL REGISTER**

NEVER SATISFIED, LLC (TEXAS LIMITED LIABILITY COMPANY)  
12806 MIDWAY RD  
APT 1029  
DALLAS, TX 75244

FOR: ADVERTISING, MARKETING AND PROMOTION SERVICES; PROMOTING THE SALES OF GOODS AND SERVICES OF OTHERS IN THE FIELD OF MUSIC THROUGH THE DISTRIBUTION OF PRINTED, PROMOTIONAL MATERIALS; ADVERTISING SERVICES, NAMELY, PROMOTING AND MARKETING THE GOODS AND SERVICES OF OTHERS IN THE FIELD OF MUSIC VIA PRINT AND ELECTRONIC MEDIA; ADVERTISING AND PROMOTION SERVICES IN THE FIELD OF MUSIC; PROMOTING THE CONCERTS OF OTHERS; PROMOTING ENTERTAINMENT EVENTS OF OTHERS, IN CLASS 35 (U.S. CLS. 100, 101 AND 102).

FIRST USE 9-7-2012; IN COMMERCE 9-7-2012.

THE MARK CONSISTS OF A 3-D LETTER "N" WITH GRADIENT ON ITS FRONT FACE AND BLACK SIDES. ANGULARLY ADJACENT TO THE LETTER "N" ARE THE LETTERS "EVER". BELOW THE LETTERS "EVER" IS A LETTER "S" WHICH IN TURN IS ADJACENT TO THE LETTERS "ATISFIED".

SN 85-975,849, FILED 12-23-2010.

JUSTINE D. PARKER, EXAMINING ATTORNEY



*David J. Kyffers*

Director of the United States Patent and Trademark Office



# United States of America

United States Patent and Trademark Office

## VALOR GAMES

**Reg. No. 4,277,349**

WORLD SPORT CHICAGO (ILLINOIS NON-PROFIT CORPORATION)  
200 E. RANDOLPH ST., 20TH FLOOR  
CHICAGO, IL 60601

**Registered Jan. 15, 2013**

**Int. Cls.: 35 and 41**

FOR: PROMOTION OF SPORTS EVENTS, ATHLETIC CONTESTS, ATHLETIC GAMES AND ATHLETIC ACTIVITIES, IN CLASS 35 (U.S. CLS. 100, 101 AND 102).

**SERVICE MARK**

FIRST USE 5-15-2011; IN COMMERCE 5-15-2011.

**PRINCIPAL REGISTER**

FOR: ARRANGING, ORGANIZING, OPERATING AND CONDUCTING ATHLETIC COMPETITIONS AND SPORTING EVENTS; ATHLETIC TRAINING SERVICES; ENCOURAGING AMATEUR SPORTS AND PHYSICAL EDUCATION BY ORGANIZING, SANCTIONING, CONDUCTING, AND REGULATING AMATEUR ATHLETIC PROGRAMS AND ACTIVITIES, IN CLASS 41 (U.S. CLS. 100, 101 AND 107).

FIRST USE 5-15-2011; IN COMMERCE 5-15-2011.

THE MARK CONSISTS OF STANDARD CHARACTERS WITHOUT CLAIM TO ANY PARTICULAR FONT, STYLE, SIZE, OR COLOR.

NO CLAIM IS MADE TO THE EXCLUSIVE RIGHT TO USE "GAMES", APART FROM THE MARK AS SHOWN.

SN 85-976,932, FILED 7-1-2011.

EDWARD NELSON, EXAMINING ATTORNEY



*David J. Kyros*

Director of the United States Patent and Trademark Office

# United States of America

United States Patent and Trademark Office

# 47

**Reg. No. 4,277,350**

**Registered Jan. 15, 2013**

**Int. Cl.: 25**

**TRADEMARK**

**PRINCIPAL REGISTER**

TWINS ENTERPRISE, INC. (MASSACHUSETTS CORPORATION)  
15 SOUTHWEST PARK  
WESTWOOD, MA 02090

FOR: ATHLETIC UNIFORMS; BABY BIBS NOT OF PAPER; BASEBALL CAPS AND HATS; BOTTOMS; CAPS; CARDIGANS; EAR BANDS; EAR MUFFS; GLOVES; HATS; HEADWEAR; JACKETS; JEANS; JERSEYS; MITTENS; PANTS; PULLOVERS; SHIRTS; SHORTS; SOCKS; SWEATERS; SWEATPANTS; SWEATSHIRTS; TANK TOPS; TOPS; TRACK JACKETS; TRACK PANTS; UNDERWEAR, IN CLASS 25 (U.S. CLS. 22 AND 39).

FIRST USE 7-31-2008; IN COMMERCE 7-31-2008.

THE MARK CONSISTS OF STANDARD CHARACTERS WITHOUT CLAIM TO ANY PARTICULAR FONT, STYLE, SIZE, OR COLOR.

SN 85-977,294, FILED 12-22-2010.

CHRISTOPHER BUONGIORNO, EXAMINING ATTORNEY



*David J. Kybas*

Director of the United States Patent and Trademark Office

# United States of America

United States Patent and Trademark Office

## WORLD FOOTBALL CHALLENGE

**Reg. No. 4,277,351**

WORLD FOOTBALL CHALLENGE LLC (CALIFORNIA LIMITED LIABILITY COMPANY)  
2000 AVENUE OF THE STARS  
LOS ANGELES, CA 90067

**Registered Jan. 15, 2013**

**Int. Cl.: 25**

FOR: CLOTHING, NAMELY, T-SHIRTS, SHIRTS, IN CLASS 25 (U.S. CLS. 22 AND 39).

FIRST USE 7-19-2009; IN COMMERCE 7-19-2009.

**TRADEMARK**

THE MARK CONSISTS OF STANDARD CHARACTERS WITHOUT CLAIM TO ANY PARTICULAR FONT, STYLE, SIZE, OR COLOR.

**PRINCIPAL REGISTER**

NO CLAIM IS MADE TO THE EXCLUSIVE RIGHT TO USE "WORLD FOOTBALL", APART FROM THE MARK AS SHOWN.

SN 85-977,353, FILED 2-14-2011.

FLORENTINA BLANDU, EXAMINING ATTORNEY



*David J. Kyffers*

Director of the United States Patent and Trademark Office

# United States of America

United States Patent and Trademark Office

## KENMORE CONNECT

**Reg. No. 4,277,352**

**Registered Jan. 15, 2013**

**Int. Cls.: 7, 11, and 42**

**TRADEMARK**

**SERVICE MARK**

**PRINCIPAL REGISTER**

KCD IP, LLC (DELAWARE LIMITED LIABILITY COMPANY)  
3333 BEVERLY ROAD  
HOFFMAN ESTATES, IL 60179

FOR: COMPONENT FEATURE SOLD AS AN INTEGRAL PART OF CLOTHES WASHING MACHINES, NAMELY, ONBOARD CIRCUITRY, NAMELY, COMPUTER HARDWARE AND ELECTRONIC TRANSMITTERS WHICH PROVIDE INFORMATION AND DATA TO A CUSTOMER SERVICE FACILITY OR NETWORK VIA TELEPHONE, INTERNET OR OTHER TELECOMMUNICATION MEANS TO ENABLE THE PROVISION OF DIAGNOSTIC INFORMATION AND OTHER INFORMATION OR RECOMMENDATIONS TO APPLIANCE OWNERS, IN CLASS 7 (U.S. CLS. 13, 19, 21, 23, 31, 34 AND 35).

FIRST USE 7-0-2010; IN COMMERCE 7-0-2010.

FOR: COMPONENT FEATURE SOLD AS AN INTEGRAL PART OF CLOTHES DRYERS, REFRIGERATORS, NAMELY, ONBOARD CIRCUITRY, NAMELY, COMPUTER HARDWARE AND ELECTRONIC TRANSMITTERS WHICH PROVIDE INFORMATION AND DATA TO A CUSTOMER SERVICE FACILITY OR NETWORK VIA TELEPHONE, INTERNET OR OTHER TELECOMMUNICATION MEANS TO ENABLE THE PROVISION OF DIAGNOSTIC INFORMATION AND OTHER INFORMATION OR RECOMMENDATIONS TO APPLIANCE OWNERS, IN CLASS 11 (U.S. CLS. 13, 21, 23, 31 AND 34).

FIRST USE 7-0-2010; IN COMMERCE 7-0-2010.

FOR: DIAGNOSTIC SERVICES IN THE FIELD OF HOUSEHOLD APPLIANCES, NAMELY, PROVIDING DIAGNOSTIC INFORMATION AND INFORMATION OR RECOMMENDATIONS REGARDING THE OPERATION, MAINTENANCE OR REPAIR OF SUCH APPLIANCES VIA TELEPHONE, INTERNET OR OTHER TELECOMMUNICATION MEANS BASED ON INFORMATION AND DATA RECEIVED FROM CUSTOMER-OWNED APPLIANCE UNITS, IN CLASS 42 (U.S. CLS. 100 AND 101).

FIRST USE 7-0-2010; IN COMMERCE 7-0-2010.

THE MARK CONSISTS OF STANDARD CHARACTERS WITHOUT CLAIM TO ANY PARTICULAR FONT, STYLE, SIZE, OR COLOR.

OWNER OF U.S. REG. NOS. 2,893,535, 2,941,746, AND OTHERS.



*David J. Kyffers*

Director of the United States Patent and Trademark Office

**Reg. No. 4,277,352** NO CLAIM IS MADE TO THE EXCLUSIVE RIGHT TO USE "CONNECT", APART FROM THE MARK AS SHOWN.

SN 85-977,403, FILED 6-10-2010.

LESLEY LAMOTHE, EXAMINING ATTORNEY

# United States of America

United States Patent and Trademark Office

## BEYOND WORDS

**Reg. No. 4,277,353**

UNIEK, INC. (WISCONSIN CORPORATION)  
805 UNIEK DRIVE  
WAUNAKEE, WI 53597

**Registered Jan. 15, 2013**

**Int. Cls.: 16, 19, 20, and 21**

FOR: ART PICTURES; FRAMED ART PICTURES; ART PRINTS; FRAMED ART PRINTS; ART PRINTS ON CANVAS, IN CLASS 16 (U.S. CLS. 2, 5, 22, 23, 29, 37, 38 AND 50).

FIRST USE 4-1-2012; IN COMMERCE 4-1-2012.

**TRADEMARK**

**PRINCIPAL REGISTER**

FOR: WORKS OF ART MADE OF MEDIUM-DENSITY FIBREBOARD; WORKS OF ART IN MIXED MEDIA COMPOSED PRIMARILY OF MEDIUM-DENSITY FIBREBOARD, IN CLASS 19 (U.S. CLS. 1, 12, 33 AND 50).

FIRST USE 4-1-2012; IN COMMERCE 4-1-2012.

FOR: PICTURE AND PHOTOGRAPH FRAMES; WORKS OF ART MADE OF WOOD; WORKS OF ART MADE OF PLASTIC; WORKS OF ART IN MIXED MEDIA COMPOSED PRIMARILY OF PLASTIC; WORKS OF ART IN MIXED MEDIA COMPOSED PRIMARILY OF WOOD, IN CLASS 20 (U.S. CLS. 2, 13, 22, 25, 32 AND 50).

FIRST USE 4-1-2012; IN COMMERCE 4-1-2012.

FOR: WORKS OF ART MADE OF GLASS; WORKS OF ART IN MIXED MEDIA COMPOSED PRIMARILY OF GLASS; ART PRINTS AND DESIGNS ON GLASS, IN CLASS 21 (U.S. CLS. 2, 13, 23, 29, 30, 33, 40 AND 50).

FIRST USE 3-1-2012; IN COMMERCE 3-1-2012.

THE MARK CONSISTS OF STANDARD CHARACTERS WITHOUT CLAIM TO ANY PARTICULAR FONT, STYLE, SIZE, OR COLOR.

SN 85-977,749, FILED 6-30-2011.

DOMINIC FATHY, EXAMINING ATTORNEY



*David J. Kyros*

Director of the United States Patent and Trademark Office

# United States of America

United States Patent and Trademark Office

# TAITTINGER

**Reg. No. 4,277,354**

**Registered Jan. 15, 2013**

**Int. Cls.: 14, 16, 18, 21,  
25, and 41**

**TRADEMARK**

**SERVICE MARK**

**PRINCIPAL REGISTER**

TAITTINGER COMPAGNIE COMMERCIALE ET VITICOLE CHAMPENOISE (FRANCE  
SOCIÉTÉ PAR ACTIONS SIMPLIFIÉE (SAS))  
9 PLACE SAINT-NICAISE  
REIMS, FRANCE 51100

FOR: GOODS MADE OF PRECIOUS METALS, THEIR ALLOYS OR PLATED THEREWITH,  
NAMELY, JEWELRY, FASHION JEWELRY AND COSTUME JEWELRY, NAMELY, CUFF  
LINKS, KEY RINGS, TIMEPIECES AND CHRONOMETRIC INSTRUMENTS, NAMELY,  
WATCHES, WRISTWATCHES, IN CLASS 14 (U.S. CLS. 2, 27, 28 AND 50).

FIRST USE 10-0-2009; IN COMMERCE 3-20-2012.

FOR: PUBLICATIONS, NAMELY, BROCHURES, LEAFLETS, CATALOGUES, IN THE FIELD  
OF ALCOHOLIC AND NON-ALCOHOLIC BEVERAGES; POSTERS, POSTCARDS, GREETING  
CARDS, PENS, NOTE CARDS, IN CLASS 16 (U.S. CLS. 2, 5, 22, 23, 29, 37, 38 AND 50).

FIRST USE 12-4-2010; IN COMMERCE 12-4-2010.

FOR: LEATHER AND IMITATION OF LEATHER SOLD IN BULK, GOODS MADE OF  
LEATHER AND IMITATION OF LEATHER, NAMELY, BILLFOLDS, WALLETS, KEY CASES,  
UMBRELLAS, IN CLASS 18 (U.S. CLS. 1, 2, 3, 22 AND 41).

FIRST USE 4-0-2009; IN COMMERCE 9-0-2011.

FOR: DECORATED BOTTLES SOLD EMPTY, INCLUDING SCREEN-PRINTED BOTTLES,  
IN CLASS 21 (U.S. CLS. 2, 13, 23, 29, 30, 33, 40 AND 50).

FIRST USE 12-31-1983; IN COMMERCE 12-31-1983.

FOR: CLOTHING, NAMELY, TEE-SHIRTS, POLO SHIRTS, SHIRTS, CLOTHING ACCESSOR-  
IES, NAMELY, SCARVES, SHAWLS, TIES, APRONS, IN CLASS 25 (U.S. CLS. 22 AND 39).

FIRST USE 12-0-1999; IN COMMERCE 12-0-2007.

FOR: ORGANIZATION OF EXHIBITIONS FOR CULTURAL OR EDUCATIONAL PURPOSES,  
BOOK AND MAGAZINES PUBLISHING, IN CLASS 41 (U.S. CLS. 100, 101 AND 107).



*David J. Kyffers*

Director of the United States Patent and Trademark Office

**Reg. No. 4,277,354** FIRST USE 0-0-1967; IN COMMERCE 1-27-2008.

THE MARK CONSISTS OF STANDARD CHARACTERS WITHOUT CLAIM TO ANY PARTICULAR FONT, STYLE, SIZE, OR COLOR.

OWNER OF U.S. REG. NOS. 559,450, 1,420,365, AND 1,420,366.

SN 85-977,810, FILED 10-12-2010.

LIEF MARTIN, EXAMINING ATTORNEY



# United States of America

United States Patent and Trademark Office

## DOMESTIC BLISS DÉCOR

**Reg. No. 4,277,355**

DCWV ACQUISITION CORPORATION (DELAWARE CORPORATION)  
2250 NORTH UNIVERSITY PARKWAY  
PROVO, UT 84604

**Registered Jan. 15, 2013**

**Int. Cls.: 16, 19, and 20**

FOR: ADHESIVE-BACKED MATERIALS, NAMELY, 3D ADHESIVE-BACKED WALL ORNAMENTS COMPRISING PAPER, IN CLASS 16 (U.S. CLS. 2, 5, 22, 23, 29, 37, 38 AND 50).

**TRADEMARK**

FIRST USE 10-29-2012; IN COMMERCE 10-29-2012.

**PRINCIPAL REGISTER**

FOR: FIBERBOARD; DECORATIVE FIBERBOARD; WALL ART IN THE NATURE OF FIBERBOARD; APPLIQUÉS IN THE NATURE OF FIBERBOARD, IN CLASS 19 (U.S. CLS. 1, 12, 33 AND 50).

FIRST USE 10-29-2012; IN COMMERCE 10-29-2012.

FOR: WALL ART, NAMELY, SOFT SCULPTURE WALL DECORATIONS, IN CLASS 20 (U.S. CLS. 2, 13, 22, 25, 32 AND 50).

FIRST USE 10-29-2012; IN COMMERCE 10-29-2012.

THE MARK CONSISTS OF STANDARD CHARACTERS WITHOUT CLAIM TO ANY PARTICULAR FONT, STYLE, SIZE, OR COLOR.

NO CLAIM IS MADE TO THE EXCLUSIVE RIGHT TO USE "DÉCOR", APART FROM THE MARK AS SHOWN.

SN 85-977,814, FILED 7-11-2011.

MARK SHINER, EXAMINING ATTORNEY



*David J. Kyros*

Director of the United States Patent and Trademark Office

# United States of America

United States Patent and Trademark Office

# SWINGLINE

**Reg. No. 4,277,356**

**Registered Jan. 15, 2013**

**Int. Cl.: 16**

**TRADEMARK**

**PRINCIPAL REGISTER**

ACCO BRANDS CORPORATION (DELAWARE CORPORATION)  
300 TOWER PARKWAY  
LINCOLNSHIRE, IL 60069

FOR: PAPER SHREDDERS AND ACCESSORIES, NAMELY, PLASTIC SHREDDER BAGS, PAPER SHREDDER BAGS, SHREDDER BIN, IN CLASS 16 (U.S. CLS. 2, 5, 22, 23, 29, 37, 38 AND 50).

FIRST USE 10-31-2010; IN COMMERCE 10-31-2010.

THE MARK CONSISTS OF STANDARD CHARACTERS WITHOUT CLAIM TO ANY PARTICULAR FONT, STYLE, SIZE, OR COLOR.

OWNER OF U.S. REG. NOS. 1,782,570, 3,529,140, AND OTHERS.

SN 85-977,866, FILED 6-17-2010.

DAVID TOOLEY, EXAMINING ATTORNEY



*David J. Kyffers*

Director of the United States Patent and Trademark Office

# United States of America

United States Patent and Trademark Office

## YOUR TRUSTED SOURCE FOR TIRE INFORMATION

**Reg. No. 4,277,357**

**Registered Jan. 15, 2013**

**Int. Cl.: 35**

**SERVICE MARK**

**PRINCIPAL REGISTER**

TIRE INTELLIGENCE, LLC (NORTH CAROLINA LIMITED LIABILITY COMPANY)  
1910 SOUTH BLVD., SUITE200  
CHARLOTTE, NC 28203

FOR: BUSINESS INFORMATION SERVICES, NAMELY, PROVIDING ONLINE COMPILATION OF MARKET AND PRODUCT DATA FOR THE TIRE INDUSTRY; PROVIDING A WEB SITE FEATURING INFORMATION ON PRICING, PERFORMANCE, AND SPECIFICATIONS FOR CONSUMER VEHICLE TIRES TO ASSIST IN THE SELECTION OF CONSUMER VEHICLE TIRES, IN CLASS 35 (U.S. CLS. 100, 101 AND 102).

FIRST USE 9-18-2012; IN COMMERCE 9-18-2012.

THE MARK CONSISTS OF STANDARD CHARACTERS WITHOUT CLAIM TO ANY PARTICULAR FONT, STYLE, SIZE, OR COLOR.

SN 85-977,868, FILED 11-9-2011.

EMILY CARLSEN, EXAMINING ATTORNEY



*David J. Kyffers*

Director of the United States Patent and Trademark Office

# United States of America

United States Patent and Trademark Office

# ZEONET

**Reg. No. 4,277,358**

**Registered Jan. 15, 2013**

**Int. Cl.: 42**

**SERVICE MARK**

**PRINCIPAL REGISTER**

ZEObIT, LLC (CALIFORNIA LIMITED LIABILITY COMPANY)  
440 N. WOLFE RD  
SUNNYVALE, CA 94085

FOR: PROVIDING ONLINE NON-DOWNLOADABLE SOFTWARE USED TO STORE, UPLOAD, DOWNLOAD, BACK UP, ORGANIZE, EDIT, RECOVER, MIGRATE, REPLICATE, SYNCHRONIZE, ACCESS, MANAGE, TRANSFER AND SHARE DATA, DOCUMENTS, FILES, TEXT, IMAGES, AUDIO, VIDEO AND MULTIMEDIA CONTENT VIA GLOBAL COMPUTER, MOBILE AND OTHER COMMUNICATIONS NETWORKS; FILE SHARING SERVICES, NAMELY, PROVIDING A WEBSITE FEATURING TECHNOLOGY ENABLING USERS TO STORE, UPLOAD, DOWNLOAD, BACK UP, ORGANIZE, EDIT, RECOVER, MIGRATE, REPLICATE, SYNCHRONIZE, ACCESS, MANAGE, TRANSFER AND SHARE DATA, DOCUMENTS, FILES, TEXT, IMAGES, AUDIO, VIDEO AND MULTIMEDIA CONTENT; PROVIDING ONLINE NON-DOWNLOADABLE SOFTWARE FOR ORGANIZATION AND MANAGEMENT OF DATA IN DISTRIBUTED COMPUTER STORAGE SYSTEMS; PROVIDING ONLINE NON-DOWNLOADABLE SOFTWARE FOR CREATING AND MAINTAINING A VIRTUAL FILE SERVER DISTRIBUTED OVER A NETWORK; PROVIDING ONLINE NON-DOWNLOADABLE COMPUTER SOFTWARE FOR MIGRATING SOFTWARE APPLICATIONS TO AND FOR USE IN A CLOUD COMPUTING ENVIRONMENT; PROVIDING ONLINE NON-DOWNLOADABLE COMPUTER SOFTWARE FOR ACCESSING INFORMATION AND SITES ON A GLOBAL COMPUTER NETWORK, IN CLASS 42 (U.S. CLS. 100 AND 101).

FIRST USE 10-4-2012; IN COMMERCE 10-4-2012.

THE MARK CONSISTS OF STANDARD CHARACTERS WITHOUT CLAIM TO ANY PARTICULAR FONT, STYLE, SIZE, OR COLOR.

SN 85-977,906, FILED 9-2-2011.

C. DIONNE CLYBURN, EXAMINING ATTORNEY



*David J. Kyros*

Director of the United States Patent and Trademark Office

# United States of America

United States Patent and Trademark Office

# WANNADO

**Reg. No. 4,277,359**

WANNADO INC. (TENNESSEE CORPORATION)  
3212 WEST END AVENUE  
NASHVILLE, TN 37203

**Registered Jan. 15, 2013**

**Int. Cl.: 35**

FOR: PROMOTING OTHERS' ACTIVITIES, EVENTS, VOLUNTEER OPPORTUNITIES, AND SERVICES THROUGH THE DISSEMINATION OF ADVERTISING MATTER VIA MOBILE PHONE NETWORKS, IN CLASS 35 (U.S. CLS. 100, 101 AND 102).

**SERVICE MARK**

FIRST USE 1-15-2012; IN COMMERCE 1-15-2012.

**PRINCIPAL REGISTER**

THE MARK CONSISTS OF STANDARD CHARACTERS WITHOUT CLAIM TO ANY PARTICULAR FONT, STYLE, SIZE, OR COLOR.

SN 85-977,913, FILED 12-21-2011.

SHAILA SETTLES, EXAMINING ATTORNEY



*David J. Kyffers*

Director of the United States Patent and Trademark Office

# United States of America

United States Patent and Trademark Office

## THE STATE OF WORLD TRADE

**Reg. No. 4,277,360**

CHAMBER OF COMMERCE OF THE UNITED STATES OF AMERICA (D.C. CORPORATION)  
1615 H STREET, NW  
WASHINGTON, DC 20062

**Registered Jan. 15, 2013**

**Int. Cl.: 41**

FOR: EDUCATION SERVICES, NAMELY, PROVIDING PRESENTATIONS IN THE FIELDS OF BUSINESS, IN CLASS 41 (U.S. CLS. 100, 101 AND 107).

**SERVICE MARK**

FIRST USE 5-14-2010; IN COMMERCE 5-14-2010.

**PRINCIPAL REGISTER**

THE MARK CONSISTS OF STANDARD CHARACTERS WITHOUT CLAIM TO ANY PARTICULAR FONT, STYLE, SIZE, OR COLOR.

NO CLAIM IS MADE TO THE EXCLUSIVE RIGHT TO USE "WORLD TRADE", APART FROM THE MARK AS SHOWN.

SN 85-977,920, FILED 11-9-2010.

LINDA MICKLEBURGH, EXAMINING ATTORNEY



*David J. Kybas*

Director of the United States Patent and Trademark Office

# United States of America

United States Patent and Trademark Office

# LIKA

**Reg. No. 4,277,361**

MAYZING FOODS, INC. (CALIFORNIA CORPORATION)  
P.O. BOX 1547  
CAPITOLA, CA 95076

**Registered Jan. 15, 2013**

**Int. Cl.: 29**

FOR: MEAT SUBSTITUTES; WHEAT-BASED PROTEIN FOR USE AS A PROTEIN EXTENDER, IN CLASS 29 (U.S. CL. 46).

**TRADEMARK**

FIRST USE 7-0-2012; IN COMMERCE 7-0-2012.

**PRINCIPAL REGISTER**

THE MARK CONSISTS OF STANDARD CHARACTERS WITHOUT CLAIM TO ANY PARTICULAR FONT, STYLE, SIZE, OR COLOR.

SN 85-977,923, FILED 7-25-2011.

MARC LEIPZIG, EXAMINING ATTORNEY



*David J. Kybas*

Director of the United States Patent and Trademark Office

# United States of America

United States Patent and Trademark Office

# LOANWATCH

**Reg. No. 4,277,362**

**Registered Jan. 15, 2013**

**Int. Cls.: 36 and 42**

**SERVICE MARK**

**PRINCIPAL REGISTER**

COREVISION STRATEGIES, LLC (FLORIDA LIMITED LIABILITY COMPANY)  
5255 NORTH FEDERAL HIGHWAY, 3RD FLOOR  
BOCA RATON, FL 33487

FOR: FINANCIAL ANALYSIS AND CONSULTATION SERVICES, NAMELY, REVIEWING, MONITORING AND ANALYZING ACCOUNTS RECEIVABLES, COLLATERAL, SECURITY INTEREST AND ASSETS, IN CLASS 36 (U.S. CLS. 100, 101 AND 102).

FIRST USE 10-2-2003; IN COMMERCE 10-2-2003.

FOR: PROVIDING A WEBSITE FEATURING NON-DOWNLOADABLE SOFTWARE FOR REVIEWING, MONITORING AND ANALYZING ACCOUNTS RECEIVABLES, COLLATERAL, SECURITY INTEREST AND ASSETS, IN CLASS 42 (U.S. CLS. 100 AND 101).

FIRST USE 1-31-2012; IN COMMERCE 1-31-2012.

THE MARK CONSISTS OF STANDARD CHARACTERS WITHOUT CLAIM TO ANY PARTICULAR FONT, STYLE, SIZE, OR COLOR.

SN 85-977,933, FILED 9-23-2011.

KEVON CHISOLM, EXAMINING ATTORNEY



*David J. Kyfos*

Director of the United States Patent and Trademark Office



# United States of America

United States Patent and Trademark Office

# FingerJet

**Reg. No. 4,277,363**

**Registered Jan. 15, 2013**

**Int. Cl.: 9**

**TRADEMARK**

**PRINCIPAL REGISTER**

DIGITALPERSONA, INC. (CALIFORNIA CORPORATION)  
720 BAY ROAD  
REDWOOD CITY, CA 94063

FOR: COMPUTER SOFTWARE FOR ELECTRONIC IDENTIFICATION AND AUTHENTICATION OF BIOMETRIC DATA; COMPUTER SOFTWARE FOR CREATING AND CROSS-MATCHING BIOMETRIC TEMPLATES THAT ARE DERIVED FROM FINGERPRINT IMAGES FOR PURPOSES OF ELECTRONIC IDENTIFICATION, VERIFICATION AND AUTHENTICATION, IN CLASS 9 (U.S. CLS. 21, 23, 26, 36 AND 38).

FIRST USE 11-15-2011; IN COMMERCE 11-15-2011.

THE MARK CONSISTS OF STANDARD CHARACTERS WITHOUT CLAIM TO ANY PARTICULAR FONT, STYLE, SIZE, OR COLOR.

SN 85-977,959, FILED 9-23-2011.

LAURIE KAUFMAN, EXAMINING ATTORNEY



*David J. Kyffers*

Director of the United States Patent and Trademark Office

# United States of America

United States Patent and Trademark Office

# COBO

**Reg. No. 4,277,364**

**Registered Jan. 15, 2013**

**Int. Cl.: 12**

**TRADEMARK**

**PRINCIPAL REGISTER**

GLOBAL PARTNERS MANAGEMENT, LLC (MISSOURI LIMITED LIABILITY COMPANY)  
4301 EARTH CITY EXPRESSWAY  
EARTH CITY, MO 63045

FOR: BICYCLES, IN CLASS 12 (U.S. CLS. 19, 21, 23, 31, 35 AND 44).

FIRST USE 2-28-2011; IN COMMERCE 2-28-2011.

THE MARK CONSISTS OF STANDARD CHARACTERS WITHOUT CLAIM TO ANY PARTICULAR FONT, STYLE, SIZE, OR COLOR.

SN 85-977,967, FILED 9-15-2010.

KIM SAITO, EXAMINING ATTORNEY



*David J. Kybas*

Director of the United States Patent and Trademark Office

# United States of America

United States Patent and Trademark Office

## GET YOUR BUZZ ON

**Reg. No. 4,277,365**

CUTTING EDGE BEVERAGES, LLC (DELAWARE LIMITED LIABILITY COMPANY)  
2424 NORTH FEDERAL HIGHWAY, SUITE 411  
BOCA RATON, FL 33431

**Registered Jan. 15, 2013**

**Int. Cl.: 32**

FOR: ENERGY DRINKS, IN CLASS 32 (U.S. CLS. 45, 46 AND 48).

**TRADEMARK**

FIRST USE 3-1-2009; IN COMMERCE 1-10-2010.

**PRINCIPAL REGISTER**

THE MARK CONSISTS OF STANDARD CHARACTERS WITHOUT CLAIM TO ANY PARTICULAR FONT, STYLE, SIZE, OR COLOR.

SN 85-977,975, FILED 12-1-2011.

ESTHER BELENKER, EXAMINING ATTORNEY



*David J. Kybas*

Director of the United States Patent and Trademark Office

# United States of America

United States Patent and Trademark Office



**Reg. No. 4,277,366**

**Registered Jan. 15, 2013**

**Int. Cl.: 2**

**TRADEMARK**

**PRINCIPAL REGISTER**

COLART AMERICAS, INC. (NEW JERSEY CORPORATION)  
11 CONSTITUTION AVENUE  
P.O. BOX 1396  
PISCATAWAY, NJ 088551396

FOR: VARNISHES OTHER THAN INSULATING VARNISH, COLORING MATTERS IN THE NATURE OF ACRYLIC PAINTS, ARTISTS' VARNISHES, IN CLASS 2 (U.S. CLS. 6, 11 AND 16).

FIRST USE 2-27-2012; IN COMMERCE 2-27-2012.

OWNER OF U.S. REG. NOS. 834,250, 1,206,993, AND OTHERS.

NO CLAIM IS MADE TO THE EXCLUSIVE RIGHT TO USE "PROFESSIONAL", APART FROM THE MARK AS SHOWN.

THE MARK CONSISTS OF A RECTANGLE WITH THE WORD "LIQUITEX" IN STYLIZED WORDING; THERE IS A HORIZONTAL LINE BETWEEN THE TWO "I"'S IN "LIQUITEX" AND ANOTHER HORIZONTAL LINE UNDER "UITEX"; BELOW THE WORD "LIQUITEX" IS THE WORD "PROFESSIONAL".

SN 85-977,981, FILED 6-2-2011.

MAYUR VAGHANI, EXAMINING ATTORNEY



*David J. Kybas*

Director of the United States Patent and Trademark Office

# United States of America

United States Patent and Trademark Office



**Reg. No. 4,277,367**

**Registered Jan. 15, 2013**

**Int. Cl.: 3**

**TRADEMARK**

**PRINCIPAL REGISTER**

LISA HOFFMAN BEAUTY, LLC (CALIFORNIA LIMITED LIABILITY COMPANY)  
SUITE 222  
11661 SAN VICENTE BLVD.  
LOS ANGELES, CA 90049

FOR: FRAGRANCED BODY CARE PRODUCTS, NAMELY, AROMATIC PERFUMED OILS,  
IN CLASS 3 (U.S. CLS. 1, 4, 6, 50, 51 AND 52).

FIRST USE 12-1-2011; IN COMMERCE 12-1-2011.

THE MARK CONSISTS OF A CITRUS BLOSSOM SILHOUETTE FORMING ROUGHLY THE  
SHAPE OF THE LETTER O.

SN 85-977,984, FILED 11-14-2011.

EMILY CARLSEN, EXAMINING ATTORNEY



*David J. Kyffers*

Director of the United States Patent and Trademark Office

# United States of America

United States Patent and Trademark Office



**Reg. No. 4,277,368**

LISA HOFFMAN BEAUTY, LLC (CALIFORNIA LIMITED LIABILITY COMPANY)  
11661 SAN VICENTE BLVD, SUITE 222  
LOS ANGELES, CA 90049

**Registered Jan. 15, 2013**

**Int. Cl.: 3**

FOR: FRAGRANCED BODY CARE PRODUCTS, NAMELY, AROMATIC PERFUMED OILS,  
IN CLASS 3 (U.S. CLS. 1, 4, 6, 50, 51 AND 52).

**TRADEMARK**

FIRST USE 12-1-2011; IN COMMERCE 12-1-2011.

**PRINCIPAL REGISTER**

THE MARK CONSISTS OF A SAGE BRANCH SILHOUETTE FORMING ROUGHLY THE  
SHAPE OF THE LETTER Y.

SN 85-977,985, FILED 11-14-2011.

EMILY CARLSEN, EXAMINING ATTORNEY



*David J. Kyffers*

Director of the United States Patent and Trademark Office

# United States of America

United States Patent and Trademark Office

# TWIST

**Reg. No. 4,277,369**

**Registered Jan. 15, 2013**

**Int. Cl.: 38**

**SERVICE MARK**

**PRINCIPAL REGISTER**

TWIST AND SHOUT, INC. (DELAWARE CORPORATION)  
3RD FLOOR  
650 MISSION STREET  
SAN FRANCISCO, CA 94105

FOR: COMMUNICATION SERVICES, NAMELY, THE ELECTRONIC TRANSMISSION OF DATA COMPRISING ATTENDEE ARRIVAL TIMES AMONG USERS OF COMPUTERIZED DEVICES FOR COORDINATING IN-PERSON MEETINGS, IN CLASS 38 (U.S. CLS. 100, 101 AND 104).

FIRST USE 7-18-2012; IN COMMERCE 7-18-2012.

THE MARK CONSISTS OF STANDARD CHARACTERS WITHOUT CLAIM TO ANY PARTICULAR FONT, STYLE, SIZE, OR COLOR.

SN 85-978,002, FILED 8-12-2011.

LAURA KOVALSKY, EXAMINING ATTORNEY



*David J. Kyffers*

Director of the United States Patent and Trademark Office

# United States of America

United States Patent and Trademark Office

I V A N K A  T R U M P

**Reg. No. 4,277,370**

IVANKA TRUMP MARKS LLC (DELAWARE LIMITED LIABILITY COMPANY)  
502 PARK AVENUE  
NEW YORK, NY 10022

**Registered Jan. 15, 2013**

**Int. Cl.: 25**

FOR: CLOTHING, NAMELY, SUITS, SUIT SEPARATES, PANTS, SHORTS, VESTS, SHIRTS, SWEATERS, DRESSES, SKIRTS, UNDERGARMENTS, AND BELTS, IN CLASS 25 (U.S. CLS. 22 AND 39).

**TRADEMARK**

FIRST USE 2-0-2012; IN COMMERCE 2-0-2012.

**PRINCIPAL REGISTER**

OWNER OF U.S. REG. NOS. 3,589,236, 3,945,446, AND OTHERS.

THE COLOR(S) RED AND BLACK IS/ARE CLAIMED AS A FEATURE OF THE MARK.

THE NAME "IVANKA TRUMP" IDENTIFIES A LIVING INDIVIDUAL WHOSE CONSENT IS OF RECORD.

THE MARK CONSISTS OF THE WORDS "IVANKA" AND "TRUMP" IN STYLIZED BLACK LETTERS SEPARATED BY THE LETTERS "IT" IN BLACK APPEARING IN AN OVAL WITH A RED INNER OUTLINE AND A BLACK OUTER BORDER. THE INNER AREA OF THE OVAL IS TRANSPARENT.

SN 85-978,013, FILED 4-27-2011.

LINDA POWELL, EXAMINING ATTORNEY



*David J. Kyjars*

Director of the United States Patent and Trademark Office



United States of America  
United States Patent and Trademark Office

TEK STAR

**Reg. No. 4,277,371**

PCS WIRELESS LLC (NEW JERSEY LIMITED LIABILITY COMPANY)  
11 VREELAND ROAD  
FLORHAM PARK, NJ 07932

**Registered Jan. 15, 2013**

**Int. Cl.: 9**

FOR: BATTERY CHARGERS; CELL PHONE CASES; CELL PHONE COVERS; DEVICES FOR WIRELESS RADIO TRANSMISSION; EAR BUDS; HANDS FREE DEVICES FOR MOBILE-PHONES; HEADSETS FOR CELLULAR OR MOBILE PHONES; MOBILE TELEPHONE ACCESSORIES, NAMELY, BELT CLIPS; POWER ADAPTERS; PROTECTIVE COVERS AND CASES FOR CELL PHONES, LAPTOPS AND PORTABLE MEDIA PLAYERS, IN CLASS 9 (U.S. CLS. 21, 23, 26, 36 AND 38).

**TRADEMARK**

**PRINCIPAL REGISTER**

FIRST USE 5-31-2011; IN COMMERCE 5-31-2011.

THE MARK CONSISTS OF STANDARD CHARACTERS WITHOUT CLAIM TO ANY PARTICULAR FONT, STYLE, SIZE, OR COLOR.

NO CLAIM IS MADE TO THE EXCLUSIVE RIGHT TO USE "TECH", APART FROM THE MARK AS SHOWN.

SN 85-978,032, FILED 2-16-2011.

ALEX KEAM, EXAMINING ATTORNEY



*David J. Kybas*

Director of the United States Patent and Trademark Office

# United States of America

United States Patent and Trademark Office

# T-MAG.COM

**Reg. No. 4,277,372**

**Registered Jan. 15, 2013**

**Int. Cl.: 41**

**SERVICE MARK**

**PRINCIPAL REGISTER**

TESTOSTERONE PUBLISHING LLC (COLORADO LIMITED LIABILITY COMPANY)  
1850 RELIABLE CIRCLE  
COLORADO SPRINGS, CO 80906

FOR: COMPUTER SERVICES, NAMELY, PROVIDING ON-LINE MAGAZINE IN THE FIELD OF A WIDE VARIETY OF INFORMATION REGARDING MEN'S HEALTH IN THE AREAS OF NUTRITION AND NON-PRESCRIPTION NUTRITIONAL SUPPLEMENTS, ALTERNATIVE HEALTH AND HEALTHY LIFESTYLES, FITNESS, PERSONAL RELATIONSHIPS AND GENERAL INTEREST MAGAZINE, IN CLASS 41 (U.S. CLS. 100, 101 AND 107).

FIRST USE 11-1-2012; IN COMMERCE 11-1-2012.

THE MARK CONSISTS OF STANDARD CHARACTERS WITHOUT CLAIM TO ANY PARTICULAR FONT, STYLE, SIZE, OR COLOR.

OWNER OF U.S. REG. NOS. 2,592,361 AND 2,636,179.

SN 85-978,036, FILED 6-30-2010.

DOMINICK J. SALEMI, EXAMINING ATTORNEY



*David J. Kypos*

Director of the United States Patent and Trademark Office

# United States of America

United States Patent and Trademark Office

## GILLIGAN'S ISLAND

**Reg. No. 4,277,373**

**Registered Jan. 15, 2013**

**Int. Cl.: 25**

**TRADEMARK**

**PRINCIPAL REGISTER**

TURNER ENTERTAINMENT CO. (DELAWARE CORPORATION)  
BLDG 156 RM 5078  
4000 WARNER BLVD.  
BURBANK, CA 91522

FOR: MASQUERADE AND HALLOWEEN COSTUMES AND MASKS SOLD IN CONNECTION THEREWITH, IN CLASS 25 (U.S. CLS. 22 AND 39).

FIRST USE 9-10-2012; IN COMMERCE 9-10-2012.

THE MARK CONSISTS OF STANDARD CHARACTERS WITHOUT CLAIM TO ANY PARTICULAR FONT, STYLE, SIZE, OR COLOR.

OWNER OF U.S. REG. NO. 3,823,373.

SN 85-978,043, FILED 7-21-2011.

MICHAEL WIENER, EXAMINING ATTORNEY



*David J. Kybas*

Director of the United States Patent and Trademark Office

# United States of America

United States Patent and Trademark Office



**Reg. No. 4,277,374**

DRL ENTERPRISES, INC. (DELAWARE CORPORATION)  
2301 RAVINE WAY  
GLENVIEW, IL 60025

**Registered Jan. 15, 2013**

**Int. Cl.: 34**

FOR: CIGARETTE FILTERS, IN CLASS 34 (U.S. CLS. 2, 8, 9 AND 17).

**TRADEMARK**

FIRST USE 8-3-2010; IN COMMERCE 8-3-2010.

**PRINCIPAL REGISTER**

THE MARK CONSISTS OF A STYLIZED IMAGE OF A FACE WITH THE RIGHT HALF BEING DARK AND THE LEFT HALF BEING LIGHT WITH A TONGUE HANGING OUT AT THE BOTTOM.

SN 85-978,045, FILED 5-4-2011.

TRICIA SONNEBORN, EXAMINING ATTORNEY



*David J. Kybas*

Director of the United States Patent and Trademark Office

# United States of America

United States Patent and Trademark Office

# 1ST DAY

**Reg. No. 4,277,375**

**Registered Jan. 15, 2013**

**Int. Cls.: 9 and 42**

**TRADEMARK**

**SERVICE MARK**

**PRINCIPAL REGISTER**

ELMER'S PRODUCTS, INC. (DELAWARE CORPORATION)  
460 POLARIS PARKWAY, SUITE 500  
WESTERVILLE, OH 43082

FOR: DOWNLOADABLE SOFTWARE IN THE NATURE OF A MOBILE APPLICATION FOR CAPTURING, EDITING, STORING AND SHARING PHOTOGRAPHS, IN CLASS 9 (U.S. CLS. 21, 23, 26, 36 AND 38).

FIRST USE 7-6-2012; IN COMMERCE 7-6-2012.

FOR: PROVIDING A WEBSITE THAT GIVES COMPUTER USERS THE ABILITY TO CAPTURE, EDIT, STORE AND SHARE PHOTOGRAPHS, IN CLASS 42 (U.S. CLS. 100 AND 101).

FIRST USE 7-6-2012; IN COMMERCE 7-6-2012.

THE MARK CONSISTS OF STANDARD CHARACTERS WITHOUT CLAIM TO ANY PARTICULAR FONT, STYLE, SIZE, OR COLOR.

SN 85-978,049, FILED 5-4-2012.

GINA HAYES, EXAMINING ATTORNEY



*David J. Kybas*

Director of the United States Patent and Trademark Office

# United States of America

United States Patent and Trademark Office

## GEOFFREY BEENE GIVES BACK

**Reg. No. 4,277,376**

**Registered Jan. 15, 2013**

**Int. Cls.: 9 and 25**

**TRADEMARK**

**PRINCIPAL REGISTER**

GEOFFREY BEENE, LLC (NEW YORK CORPORATION)  
37 WEST 57TH STREET  
NEW YORK, NY 10019

FOR: COMPUTER BAGS, IN CLASS 9 (U.S. CLS. 21, 23, 26, 36 AND 38).

FIRST USE 2-28-2008; IN COMMERCE 2-28-2008.

FOR: NECKWEAR; SCARVES; TIES , IN CLASS 25 (U.S. CLS. 22 AND 39).

FIRST USE 2-28-2008; IN COMMERCE 2-28-2008.

THE MARK CONSISTS OF STANDARD CHARACTERS WITHOUT CLAIM TO ANY PARTICULAR FONT, STYLE, SIZE, OR COLOR.

OWNER OF U.S. REG. NOS. 3,488,149, 4,031,838, AND OTHERS.

THE NAME(S), PORTRAIT(S), AND/OR SIGNATURE(S) SHOWN IN THE MARK DOES NOT IDENTIFY A PARTICULAR LIVING INDIVIDUAL.

SN 85-978,070, FILED 8-31-2011.

BARBARA A. GOLD, EXAMINING ATTORNEY



*David J. Kyjars*

Director of the United States Patent and Trademark Office

# United States of America

United States Patent and Trademark Office

# ANZU

**Reg. No. 4,277,377**

**Registered Jan. 15, 2013**

**Int. Cls.: 35 and 38**

**SERVICE MARK**

**PRINCIPAL REGISTER**

ART RESEARCH AND TECHNOLOGY, L.L.C. (ARIZONA LIMITED LIABILITY COMPANY)  
2777 EAST CAMELBACK ROAD, #140  
PHOENIX, AZ 85016

FOR: PROMOTING THE GOODS AND SERVICES OF OTHERS VIA A COMPUTER NETWORK; PROVIDING AN ON-LINE SEARCHABLE DATABASE FEATURING DIGITAL FILES, NAMELY, USER-GENERATED CONTENT AND OTHER DIGITAL FILES IN THE FIELD OF BUSINESS, IN CLASS 35 (U.S. CLS. 100, 101 AND 102).

FIRST USE 3-20-2012; IN COMMERCE 3-20-2012.

FOR: PROVIDING MULTIPLE-USER ACCESS TO A COMPUTER NETWORK, IN CLASS 38 (U.S. CLS. 100, 101 AND 104).

FIRST USE 3-20-2012; IN COMMERCE 3-20-2012.

THE MARK CONSISTS OF STANDARD CHARACTERS WITHOUT CLAIM TO ANY PARTICULAR FONT, STYLE, SIZE, OR COLOR.

THE ENGLISH TRANSLATION OF "ANZU" IN THE MARK IS "APRICOT".

SN 85-978,073, FILED 10-7-2011.

RONALD MCMORROW, EXAMINING ATTORNEY



*David J. Kybas*

Director of the United States Patent and Trademark Office

United States of America  
United States Patent and Trademark Office

SYSTEM

**Reg. No. 4,277,378**

**Registered Jan. 15, 2013**

**Int. Cl.: 9**

**TRADEMARK**

**PRINCIPAL REGISTER**

INCASE DESIGNS CORP. (CALIFORNIA CORPORATION)  
14351 PIPELINE AVENUE  
CHINO, CA 91710

FOR: CARRYING CASES DESIGNED FOR STORAGE AND TRANSPORTATION OF CONSUMER ELECTRONICS, NAMELY, PORTABLE COMPUTERS, AUDIO, VIDEO AND ENTERTAINMENT PLAYERS, ELECTRONIC TABLETS, MOBILE TELEPHONES AND PERSONAL DIGITAL ASSISTANTS, IN CLASS 9 (U.S. CLS. 21, 23, 26, 36 AND 38).

FIRST USE 7-30-2012; IN COMMERCE 7-30-2012.

THE MARK CONSISTS OF STANDARD CHARACTERS WITHOUT CLAIM TO ANY PARTICULAR FONT, STYLE, SIZE, OR COLOR.

SN 85-978,076, FILED 11-19-2011.

WILLIAM JACKSON, EXAMINING ATTORNEY



*David J. Kyffers*

Director of the United States Patent and Trademark Office



# United States of America

United States Patent and Trademark Office

## DISNEY JUNIOR

**Reg. No. 4,277,379**

DISNEY ENTERPRISES, INC. (DELAWARE CORPORATION)  
500 SOUTH BUENA VISTA STREET  
BURBANK, CA 91521

**Registered Jan. 15, 2013**

**Int. Cl.: 24**

FOR: BED LINEN; BED SHEETS; COMFORTERS; CURTAINS; PILLOW CASES, IN CLASS 24 (U.S. CLS. 42 AND 50).

**TRADEMARK**

FIRST USE 10-10-2012; IN COMMERCE 10-10-2012.

**PRINCIPAL REGISTER**

THE MARK CONSISTS OF STANDARD CHARACTERS WITHOUT CLAIM TO ANY PARTICULAR FONT, STYLE, SIZE, OR COLOR.

OWNER OF U.S. REG. NOS. 826,419, 3,678,843, AND OTHERS.

SN 85-978,101, FILED 10-18-2010.

ELLEN B. AWRICH, EXAMINING ATTORNEY



*David J. Kybas*

Director of the United States Patent and Trademark Office

# United States of America

United States Patent and Trademark Office

## DISNEY JUNIOR

**Reg. No. 4,277,380**

**Registered Jan. 15, 2013**

**Int. Cl.: 25**

**TRADEMARK**

**PRINCIPAL REGISTER**

DISNEY ENTERPRISES, INC. (DELAWARE CORPORATION)  
500 SOUTH BUENA VISTA STREET  
BURBANK, CA 91521

FOR: COSTUMES FOR USE IN ROLE-PLAYING GAMES; FOOTWEAR; HALLOWEEN COSTUMES; HEADWEAR; SHIRTS; SLEEPWEAR; TOPS; UNDERWEAR; WRIST BANDS, IN CLASS 25 (U.S. CLS. 22 AND 39).

FIRST USE 10-5-2012; IN COMMERCE 10-5-2012.

THE MARK CONSISTS OF STANDARD CHARACTERS WITHOUT CLAIM TO ANY PARTICULAR FONT, STYLE, SIZE, OR COLOR.

OWNER OF U.S. REG. NOS. 826,419, 3,678,843, AND OTHERS.

NO CLAIM IS MADE TO THE EXCLUSIVE RIGHT TO USE "JUNIOR", APART FROM THE MARK AS SHOWN.

SN 85-978,102, FILED 10-18-2010.

ELLEN B. AWRICH, EXAMINING ATTORNEY



*David J. Kyffers*

Director of the United States Patent and Trademark Office

# United States of America

United States Patent and Trademark Office

## DISNEY JUNIOR

**Reg. No. 4,277,381**

**Registered Jan. 15, 2013**

**Int. Cl.: 28**

**TRADEMARK**

**PRINCIPAL REGISTER**

DISNEY ENTERPRISES, INC. (DELAWARE CORPORATION)  
500 SOUTH BUENA VISTA STREET  
BURBANK, CA 91521

FOR: TOYS, GAMES AND PLAYTHINGS, NAMELY, ACTION FIGURES AND ACCESSORIES THEREFORE, BOARD GAMES, CHILDREN'S MULTIPLE ACTIVITY TOYS, BATH TOYS, BUBBLE MAKING WANDS AND SOLUTION SETS, DISC TOSS TOYS, DOLLS, DOLL CLOTHING, DOLL ACCESSORIES, DOLL PLAYSETS, JIGSAW PUZZLES, MUSICAL TOYS, PARLOR GAMES, PARTY FAVORS IN THE NATURE OF SMALL TOYS, PLUSH TOYS, SQUEEZE TOYS, STUFFED TOYS, TALKING TOYS, TOY ACTION FIGURES AND ACCESSORIES THEREFOR, TOY MODEL HOBBYCRAFT KITS, TOY FIGURES, TOY VEHICLES, TOY TRUCKS, TOY WEAPONS, IN CLASS 28 (U.S. CLS. 22, 23, 38 AND 50).

FIRST USE 10-5-2012; IN COMMERCE 10-5-2012.

THE MARK CONSISTS OF STANDARD CHARACTERS WITHOUT CLAIM TO ANY PARTICULAR FONT, STYLE, SIZE, OR COLOR.

OWNER OF U.S. REG. NOS. 826,419, 3,678,843, AND OTHERS.

SN 85-978,103, FILED 10-18-2010.

ELLEN B. AWRICH, EXAMINING ATTORNEY



*David J. Kyros*

Director of the United States Patent and Trademark Office

# United States of America

United States Patent and Trademark Office



**SupraFruta**  
**RED SANGRIA**

**Reg. No. 4,277,382**

**Registered Jan. 15, 2013**

**Int. Cl.: 33**

**TRADEMARK**

**PRINCIPAL REGISTER**

PROJECT O, LLC (FLORIDA LIMITED LIABILITY COMPANY)  
11 ISLAND AVE., #2012  
MIAMI BEACH, FL 33139

FOR: WINE-BASED DRINKS, IN CLASS 33 (U.S. CLS. 47 AND 49).

FIRST USE 7-14-2011; IN COMMERCE 7-14-2011.

NO CLAIM IS MADE TO THE EXCLUSIVE RIGHT TO USE "RED SANGRIA" , APART FROM THE MARK AS SHOWN.

THE MARK CONSISTS OF THE WORDS "EPPA SUPRAFRUTA RED SANGRIA" AND A DESIGN CONSISTING OF TWO SMALL CIRCLES, TWO HALF CIRCLES AND A SPIRAL CONNECTING TO THE FIRST "P" IN "EPPA" TO THE HALF CIRCLES.

THE WORDING "EPPA" AND "SUPRAFRUTA" HAS NO MEANING IN A FOREIGN LANGUAGE.

SN 85-978,109, FILED 1-7-2011.

MAYUR VAGHANI, EXAMINING ATTORNEY



*David J. Kyros*

Director of the United States Patent and Trademark Office

# United States of America

United States Patent and Trademark Office

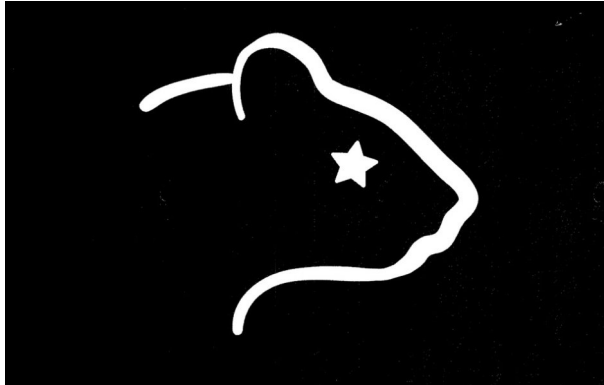

**Reg. No. 4,277,383**

**Registered Jan. 15, 2013**

**Int. Cls.: 25 and 28**

**TRADEMARK**

**PRINCIPAL REGISTER**

KIA MOTORS AMERICA, INC. (CALIFORNIA CORPORATION)  
111 PETERS CANYON ROAD  
IRVINE, CA 92606

FOR: CLOTHING, NAMELY, SHIRTS AND HATS, IN CLASS 25 (U.S. CLS. 22 AND 39).

FIRST USE 6-21-2010; IN COMMERCE 6-21-2010.

FOR: TOYS, NAMELY, STUFFED PLUSH ANIMALS, IN CLASS 28 (U.S. CLS. 22, 23, 38 AND 50).

FIRST USE 6-21-2010; IN COMMERCE 6-21-2010.

THE MARK CONSISTS OF PROFILE OF A HAMSTER WITH A STAR DESIGN FOR THE EYE.

SN 85-978,136, FILED 4-27-2010.

LINDA ORNDORFF, EXAMINING ATTORNEY



*David J. Kybas*

Director of the United States Patent and Trademark Office

# United States of America

United States Patent and Trademark Office

## EVERCREME SULFATE-FREE MOISTURE SYSTEM

**Reg. No. 4,277,384**

L'OREAL (FRANCE SOCIÉTÉ ANONYME (SA))  
14 RUE ROYALE  
PARIS, FRANCE 75008

**Registered Jan. 15, 2013**

**Int. Cl.: 3**

FOR: HAIR CARE AND NON-MEDICATED HAIR TREATMENT PREPARATIONS, IN CLASS  
3 (U.S. CLS. 1, 4, 6, 50, 51 AND 52).

**TRADEMARK**

FIRST USE 1-1-2012; IN COMMERCE 1-1-2012.

**PRINCIPAL REGISTER**

THE MARK CONSISTS OF STANDARD CHARACTERS WITHOUT CLAIM TO ANY PAR-  
TICULAR FONT, STYLE, SIZE, OR COLOR.

NO CLAIM IS MADE TO THE EXCLUSIVE RIGHT TO USE "SULFATE-FREE MOISTURE  
SYSTEM", APART FROM THE MARK AS SHOWN.

SN 85-978,137, FILED 5-27-2011.

HEATHER THOMPSON, EXAMINING ATTORNEY



*David J. Kyjars*

Director of the United States Patent and Trademark Office

# United States of America

United States Patent and Trademark Office



**Reg. No. 4,277,385**

**Registered Jan. 15, 2013**

**Int. Cls.: 18 and 25**

**TRADEMARK**

**PRINCIPAL REGISTER**

THUNDERSHIRT, LLC (NORTH CAROLINA LIMITED LIABILITY COMPANY)  
905 JACKIE ROBINSON DRIVE  
DURHAM, NC 27701

FOR: CLOTHING FOR ANIMALS; CLOTHING FOR DOMESTIC PETS; DOG APPAREL;  
DOG CLOTHING; GARMENTS FOR PETS; PET CLOTHING; HEADWEAR FOR PETS , IN  
CLASS 18 (U.S. CLS. 1, 2, 3, 22 AND 41).

FIRST USE 1-15-2009; IN COMMERCE 1-31-2009.

FOR: T-SHIRTS; HATS, IN CLASS 25 (U.S. CLS. 22 AND 39).

FIRST USE 6-1-2011; IN COMMERCE 6-1-2011.

OWNER OF U.S. REG. NO. 3,689,331.

THE MARK CONSISTS OF A SPOTTED DOG IN A T-SHIRT, SITTING TO THE LEFT OF  
THE WORD "THUNDERSHIRT". THE WORD "THUNDERSHIRT" APPEARS WITHIN A  
RECTANGLE. THE SPOTTED DOG COVERS THE LEFT VERTICAL LINE OF THE RECT-  
ANGLE.

SN 85-978,148, FILED 11-30-2011.

BILL DAWE, EXAMINING ATTORNEY



*David J. Kybas*

Director of the United States Patent and Trademark Office

# United States of America

United States Patent and Trademark Office



**Reg. No. 4,277,386**

**Registered Jan. 15, 2013**

**Int. Cls.: 16 and 35**

**TRADEMARK**

**SERVICE MARK**

**PRINCIPAL REGISTER**

QUAVERMUSIC.COM, LLC (TENNESSEE LIMITED LIABILITY COMPANY)  
1706 GRAND AVENUE  
NASHVILLE, TN 37212

FOR: GIFT CARDS, NAMELY, PRINTED CERTIFICATES THAT MAY BE REDEEMED BY MEMBERS OF AN ONLINE COMMUNITY IN CONNECTION WITH A DESIGNATED WEBSITE; EDUCATIONAL PUBLICATIONS, NAMELY, EDUCATIONAL LEARNING CARDS, WORKBOOKS, TEXTBOOKS, ACTIVITY BOOKS, STORY BOOKS, TEACHER GUIDES, MANUALS, POSTERS AND EDUCATIONAL BOOKLETS IN THE FIELD OF MUSIC; EDUCATIONAL BOOKS FEATURING MUSIC; EDUCATIONAL KITS SOLD AS A UNIT CONSISTING PRIMARILY OF EDUCATIONAL BOOKS, WORKSHEETS, AND EDUCATIONAL DVDS IN THE FIELD OF MUSIC, IN CLASS 16 (U.S. CLS. 2, 5, 22, 23, 29, 37, 38 AND 50).

FIRST USE 1-27-2011; IN COMMERCE 1-27-2011.

FOR: COMPUTERIZED ONLINE RETAIL STORE SERVICES FEATURING T-SHIRTS, JACKETS, PANTS, PONCHOS, SHIRTS, SHORTS, HATS, CAPS, BOOKS, TOYS, GAMES, DVDS, COMPACT DISCS AND COMPUTER GAMES; COMPUTERIZED ONLINE RETAIL STORE SERVICES FEATURING DOWNLOADABLE SOUND, MUSIC, IMAGE, VIDEO AND GAME FILES; COMPUTERIZED ONLINE RETAIL STORE SERVICES FEATURING VIRTUAL MERCHANDISE FOR USE BY MEMBERS OF AN ONLINE COMMUNITY IN CONNECTION WITH A DESIGNATED WEBSITE FEATURING FICTIONAL CHARACTERS, IN CLASS 35 (U.S. CLS. 100, 101 AND 102).

FIRST USE 2-2-2011; IN COMMERCE 2-2-2011.

NO CLAIM IS MADE TO THE EXCLUSIVE RIGHT TO USE "MUSIC", APART FROM THE MARK AS SHOWN.

THE MARK CONSISTS OF THE WORDS "QUAVER'S MARVELOUS WORLD OF MUSIC" OVER THE DESIGN OF A PIANO KEYBOARD.

SN 85-978,154, FILED 4-2-2011.

JOHN E. MICHOS, EXAMINING ATTORNEY



*David J. Kyfos*

Director of the United States Patent and Trademark Office



# United States of America

United States Patent and Trademark Office

# Aquarius

**Reg. No. 4,277,387**

LA CORUÑA, INC. (PUERTO RICO CORPORATION)  
P.O. BOX 50202

**Registered Jan. 15, 2013**

TOA BAJA, PUERTO RICO 00950

**Int. Cl.: 29**

FOR: FROZEN PRE-PACKAGED AND PROCESSED FISH, IN CLASS 29 (U.S. CL. 46).

FIRST USE 10-26-2011; IN COMMERCE 10-26-2011.

**TRADEMARK**

THE MARK CONSISTS OF THE WORD "AQUARIUS" IN BLUE COLOR AND STYLIZED LETTER FORMAT WITH MULTIPLE WAVES (AND / OR CURVED LINES), ONE JUST ABOVE THE OTHER. THESE MULTIPLE WAVES MERGE WITH THE LETTER "S" IN THE WORD "AQUARIUS" AT THE END OF THE LOGO.

**PRINCIPAL REGISTER**

THE COLOR(S) BLUE IS/ARE CLAIMED AS A FEATURE OF THE MARK.

SN 85-978,157, FILED 10-24-2011.

JENNIFER WILLISTON, EXAMINING ATTORNEY



*David J. Kyros*

Director of the United States Patent and Trademark Office

# United States of America

United States Patent and Trademark Office

## A+E NETWORKS INTERNATIONAL

**Reg. No. 4,277,388**

A+E TELEVISION NETWORKS, LLC (DELAWARE LIMITED LIABILITY COMPANY)  
235 EAST 45TH STREET  
NEW YORK, NY 10017

**Registered Jan. 15, 2013**

**Int. Cls.: 35 and 38**

FOR: MARKETING AND PROMOTION OF TELEVISION PROGRAMMING AND MOTION PICTURES, IN CLASS 35 (U.S. CLS. 100, 101 AND 102).

**SERVICE MARK**

FIRST USE 5-31-2012; IN COMMERCE 5-31-2012.

**PRINCIPAL REGISTER**

FOR: TELEVISION BROADCASTING SERVICES; CABLE TELEVISION BROADCASTING SERVICES; VIDEO BROADCASTING, SUBSCRIPTION TELEVISION BROADCASTING, IN CLASS 38 (U.S. CLS. 100, 101 AND 104).

FIRST USE 5-31-2012; IN COMMERCE 5-31-2012.

THE MARK CONSISTS OF STANDARD CHARACTERS WITHOUT CLAIM TO ANY PARTICULAR FONT, STYLE, SIZE, OR COLOR.

NO CLAIM IS MADE TO THE EXCLUSIVE RIGHT TO USE "NETWORKS INTERNATIONAL", APART FROM THE MARK AS SHOWN.

SN 85-978,178, FILED 12-13-2011.

GINA HAYES, EXAMINING ATTORNEY



*David J. Kybas*

Director of the United States Patent and Trademark Office

# United States of America

United States Patent and Trademark Office

# HUNT 365

**Reg. No. 4,277,389**

**Registered Jan. 15, 2013**

**Int. Cls.: 28 and 31**

**TRADEMARK**

**PRINCIPAL REGISTER**

WILDGAME INNOVATIONS, LLC (LOUISIANA LIMITED LIABILITY COMPANY)  
101 CASON ROAD, 1ST FLOOR  
BROUSSARD, LA 70518

FOR: DEER ATTRACTANTS IN POWDER FORM, LIQUID FORM OR SOLID BLOCK FORM,  
IN CLASS 28 (U.S. CLS. 22, 23, 38 AND 50).

FIRST USE 5-23-2012; IN COMMERCE 5-23-2012.

FOR: DEER FEED IN POWDER FORM, LIQUID FORM OR SOLID BLOCK FORM, IN CLASS  
31 (U.S. CLS. 1 AND 46).

FIRST USE 5-23-2012; IN COMMERCE 5-23-2012.

THE MARK CONSISTS OF STANDARD CHARACTERS WITHOUT CLAIM TO ANY PAR-  
TICULAR FONT, STYLE, SIZE, OR COLOR.

NO CLAIM IS MADE TO THE EXCLUSIVE RIGHT TO USE "HUNT", APART FROM THE  
MARK AS SHOWN.

SN 85-978,181, FILED 3-30-2011.

RUDY R. SINGLETON, EXAMINING ATTORNEY



*David J. Kyros*

Director of the United States Patent and Trademark Office

# United States of America

United States Patent and Trademark Office

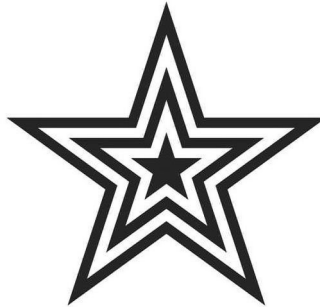

**Reg. No. 4,277,390**

**Registered Jan. 15, 2013**

**Int. Cls.: 3 and 25**

**TRADEMARK**

**PRINCIPAL REGISTER**

PD & PD, LLC (RHODE ISLAND LIMITED LIABILITY COMPANY)  
7 AUBURN AVENUE  
JOHNSTON, RI 02919

FOR: PERFUME AND COLOGNE, IN CLASS 3 (U.S. CLS. 1, 4, 6, 50, 51 AND 52).

FIRST USE 3-20-2009; IN COMMERCE 3-20-2009.

FOR: CLOTHING, NAMELY, T-SHIRTS, HOODED SWEAT SHIRTS, THERMAL SHIRTS, TANK TOPS, DRESSES, BASEBALL HATS, CAPS AND BANDANAS; CLOTHING, NAMELY, SWEATSHIRTS, SWIM WEAR, IN CLASS 25 (U.S. CLS. 22 AND 39).

FIRST USE 2-1-2010; IN COMMERCE 2-1-2010.

THE MARK CONSISTS OF THREE FIVE-POINTED STARS, IN WHICH THE FIRST STAR IS OUTLINED BY A SECOND STAR, WHICH SECOND STAR IS OUTLINED BY A THIRD STAR.

SN 85-978,182, FILED 3-31-2011.

BARBARA GAYNOR, EXAMINING ATTORNEY



*David J. Kyffers*

Director of the United States Patent and Trademark Office

# United States of America

United States Patent and Trademark Office

## VERA WANG LOVE

**Reg. No. 4,277,391**

V.E.W., LTD. (DELAWARE CORPORATION)  
15 EAST 26TH STREET, 4TH AND 5TH FLOORS  
NEW YORK, NY 10010

**Registered Jan. 15, 2013**

**Int. Cl.: 14**

FOR: DIAMOND SOLITAIRE RINGS, ENGAGEMENT RINGS, WEDDING RINGS, WEDDING BANDS, EARRINGS, NECKLACES, PENDANTS, IN CLASS 14 (U.S. CLS. 2, 27, 28 AND 50).

**TRADEMARK**

FIRST USE 10-0-2011; IN COMMERCE 10-0-2011.

**PRINCIPAL REGISTER**

THE MARK CONSISTS OF STANDARD CHARACTERS WITHOUT CLAIM TO ANY PARTICULAR FONT, STYLE, SIZE, OR COLOR.

OWNER OF U.S. REG. NOS. 2,504,826, 3,411,896, AND OTHERS.

THE NAME "VERA WANG" IDENTIFIES A LIVING INDIVIDUAL WHOSE CONSENT IS OF RECORD.

SN 85-978,192, FILED 5-26-2011.

WILLIAM VERHOSEK, EXAMINING ATTORNEY



*David J. Kyros*

Director of the United States Patent and Trademark Office

# United States of America

United States Patent and Trademark Office

## MONSTER HIGH

**Reg. No. 4,277,392**

**Registered Jan. 15, 2013**

**Int. Cl.: 28**

**TRADEMARK**

**PRINCIPAL REGISTER**

MATTEL, INC. (DELAWARE CORPORATION)  
M1-1518  
333 CONTINENTAL BOULEVARD  
EL SEGUNDO, CA 90245

FOR: SKETCHING TOYS WITH LIGHTS, IN CLASS 28 (U.S. CLS. 22, 23, 38 AND 50).

FIRST USE 11-27-2012; IN COMMERCE 11-27-2012.

THE MARK CONSISTS OF STANDARD CHARACTERS WITHOUT CLAIM TO ANY PARTICULAR FONT, STYLE, SIZE, OR COLOR.

OWNER OF U.S. REG. NOS. 3,828,721, 3,877,972, AND OTHERS.

SN 85-978,213, FILED 5-24-2011.

WENDY GOODMAN, EXAMINING ATTORNEY



*David J. Kybas*

Director of the United States Patent and Trademark Office

# United States of America

United States Patent and Trademark Office

# PEAK LIFE

**Reg. No. 4,277,393**

**Registered Jan. 15, 2013**

**Int. Cl.: 5**

**TRADEMARK**

**PRINCIPAL REGISTER**

HUNGRY FISH MEDIA LLC (DELAWARE LIMITED LIABILITY COMPANY)  
24 SCHOOL STREET  
SUITE 301  
BOSTON, MA 021085139

FOR: HERBAL SUPPLEMENTS, IN CLASS 5 (U.S. CLS. 6, 18, 44, 46, 51 AND 52).

FIRST USE 9-0-2010; IN COMMERCE 9-0-2010.

THE MARK CONSISTS OF STANDARD CHARACTERS WITHOUT CLAIM TO ANY PARTICULAR FONT, STYLE, SIZE, OR COLOR.

SN 85-978,224, FILED 5-27-2010.

KRISTIN DAHLING, EXAMINING ATTORNEY



*David J. Kybas*

Director of the United States Patent and Trademark Office

# United States of America

United States Patent and Trademark Office

# INTENT IQ

**Reg. No. 4,277,394**

INTENT IQ, LLC (DELAWARE LIMITED LIABILITY COMPANY)  
600 LEXINGTON AVE., 23RD FLOOR  
NEW YORK, NY 10022

**Registered Jan. 15, 2013**

**Int. Cl.: 35**

FOR: PLACEMENT AND MEASUREMENT OF ONLINE ADVERTISEMENTS; CONSUMER AND COMMERCIAL DATA COLLECTION FOR THE PURPOSE OF DELIVERING AND MEASURING ONLINE ADVERTISEMENTS IN THE FIELD OF ADVERTISING, IN CLASS 35 (U.S. CLS. 100, 101 AND 102).

**SERVICE MARK**

**PRINCIPAL REGISTER**

FIRST USE 7-31-2012; IN COMMERCE 7-31-2012.

THE MARK CONSISTS OF STANDARD CHARACTERS WITHOUT CLAIM TO ANY PARTICULAR FONT, STYLE, SIZE, OR COLOR.

SN 85-978,226, FILED 11-1-2011.

GINA FINK, EXAMINING ATTORNEY



*David J. Kyffers*

Director of the United States Patent and Trademark Office



# United States of America

United States Patent and Trademark Office

## MELT BY NEST FRAGRANCES

**Reg. No. 4,277,395**

NEST FRAGRANCES LLC (NEW YORK LIMITED LIABILITY COMPANY)  
601 WEST 26TH STREET NO. 1500  
NEW YORK, NY 10001

**Registered Jan. 15, 2013**

**Int. Cl.: 4**

FOR: CANDLES AND SCENTED CANDLES, IN CLASS 4 (U.S. CLS. 1, 6 AND 15).

**TRADEMARK**

FIRST USE 8-31-2012; IN COMMERCE 8-31-2012.

**PRINCIPAL REGISTER**

THE MARK CONSISTS OF STANDARD CHARACTERS WITHOUT CLAIM TO ANY PARTICULAR FONT, STYLE, SIZE, OR COLOR.

NO CLAIM IS MADE TO THE EXCLUSIVE RIGHT TO USE "FRAGRANCES", APART FROM THE MARK AS SHOWN.

SN 85-978,242, FILED 12-13-2011.

KIMBERLY PERRY, EXAMINING ATTORNEY



*David J. Kyffers*

Director of the United States Patent and Trademark Office

# United States of America

United States Patent and Trademark Office

## PREGNANCY, THE MOST BEAUTIFUL DAYS OF YOUR LIFE

**Reg. No. 4,277,396**

CLARINS S.A. (FRANCE SOCIÉTÉ ANONYME (SA))  
4, RUE BERTEAUX DUMAS  
NEUILLY-SUR-SEINE, FRANCE 92200

**Registered Jan. 15, 2013**

**Int. Cl.: 16**

FOR: PRINTED MATTER, NAMELY, PAMPHLETS, PROSPECTUSES, SIGNBOARDS OF PAPER AND CARDBOARD IN THE FIELD OF COSMETICS; PACKAGING BAGS MADE OF CARDBOARD AND PLASTIC MATERIALS, IN CLASS 16 (U.S. CLS. 2, 5, 22, 23, 29, 37, 38 AND 50).

**TRADEMARK**

**PRINCIPAL REGISTER**

FIRST USE 6-1-2012; IN COMMERCE 6-1-2012.

THE MARK CONSISTS OF STANDARD CHARACTERS WITHOUT CLAIM TO ANY PARTICULAR FONT, STYLE, SIZE, OR COLOR.

NO CLAIM IS MADE TO THE EXCLUSIVE RIGHT TO USE "PREGNANCY", APART FROM THE MARK AS SHOWN.

SN 85-978,249, FILED 5-27-2011.

B. PARADEWELAI, EXAMINING ATTORNEY



*David J. Kybas*

Director of the United States Patent and Trademark Office

# United States of America

United States Patent and Trademark Office



**Reg. No. 4,277,397**

GENX INTERNATIONAL, INC. (CONNECTICUT CORPORATION)  
393 SOUNDVIEW ROAD  
GUILFORD, CT 06437

**Registered Jan. 15, 2013**

**Int. Cl.: 11**

FOR: FILTRATION SYSTEMS FOR REMOVING PARTICULATES, ENVIRONMENTAL CONTAMINANTS AND ORGANIC COMPOUNDS FROM THE AIRSTREAM OF A LABORATORY ENVIRONMENT, IN CLASS 11 (U.S. CLS. 13, 21, 23, 31 AND 34).

**TRADEMARK**

FIRST USE 6-15-1997; IN COMMERCE 6-15-1997.

**SUPPLEMENTAL REGISTER**

NO CLAIM IS MADE TO THE EXCLUSIVE RIGHT TO USE "4 STAGE FILTER SYSTEM", APART FROM THE MARK AS SHOWN.

SER. NO. 76-710,231, FILED P.R. 1-10-2012; AM. S.R. 1-10-2012.

KATHLEEN KOLACZ, EXAMINING ATTORNEY



*David J. Kybas*

Director of the United States Patent and Trademark Office

# United States of America

United States Patent and Trademark Office

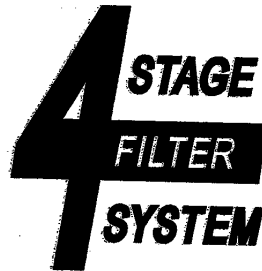

**Reg. No. 4,277,398**

GENX INTERNATIONAL, INC. (CONNECTICUT CORPORATION)  
393 SOUNDVIEW ROAD  
GUILFORD, CT 06437

**Registered Jan. 15, 2013**

**Int. Cl.: 9**

FOR: LABORATORY EQUIPMENT FOR CLINICAL AND SCIENTIFIC PURPOSES, NAMELY, AIR FILTRATION APPARATUS FOR REMOVING PARTICULATES AND VOLATILE ORGANIC COMPOUNDS FROM THE AIR STREAM OF A LABORATORY ENVIRONMENT, IN CLASS 9 (U.S. CLS. 21, 23, 26, 36 AND 38).

**TRADEMARK**

**SUPPLEMENTAL REGISTER** FIRST USE 6-15-1997; IN COMMERCE 6-15-1997.

NO CLAIM IS MADE TO THE EXCLUSIVE RIGHT TO USE "4 STAGE FILTER SYSTEM", APART FROM THE MARK AS SHOWN.

SER. NO. 76-710,232, FILED P.R. 1-10-2012; AM. S.R. 1-10-2012.

KATHLEEN KOLACZ, EXAMINING ATTORNEY



*David J. Kyffers*

Director of the United States Patent and Trademark Office

# United States of America

United States Patent and Trademark Office

## COOKING SKIRT

**Reg. No. 4,277,399**

**Registered Jan. 15, 2013**

**Int. Cl.: 25**

**TRADEMARK**

**SUPPLEMENTAL REGISTER**

BEST BRANDS CONSUMER PRODUCTS, INC. (NEW JERSEY CORPORATION)  
20 WEST 33RD STREET  
NEW YORK, NY 10001

FOR: KITCHEN APRONS, IN CLASS 25 (U.S. CLS. 22 AND 39).

FIRST USE 9-21-2012; IN COMMERCE 9-21-2012.

THE MARK CONSISTS OF STANDARD CHARACTERS WITHOUT CLAIM TO ANY PARTICULAR FONT, STYLE, SIZE, OR COLOR.

NO CLAIM IS MADE TO THE EXCLUSIVE RIGHT TO USE "SKIRT", APART FROM THE MARK AS SHOWN.

SER. NO. 76-712,664, FILED P.R. 10-19-2012; AM. S.R. 11-20-2012.

EVIN L. KOZAK, EXAMINING ATTORNEY



*David J. Kyffers*

Director of the United States Patent and Trademark Office

# United States of America

United States Patent and Trademark Office

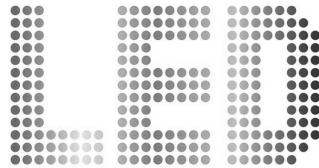

**2,000,000:1**  
Contrast Ratio

**Reg. No. 4,277,400**

LG ELECTRONICS INC. (REPUBLIC OF KOREA CORPORATION)  
20, YOIDO-DONG, YONGDUNGPO-GU  
SEOUL, REPUBLIC OF KOREA

**Registered Jan. 15, 2013**

**Int. Cl.: 9**

FOR: TELEVISION RECEIVERS, IN CLASS 9 (U.S. CLS. 21, 23, 26, 36 AND 38).

**TRADEMARK**

FIRST USE 3-11-2009; IN COMMERCE 3-11-2009.

**SUPPLEMENTAL REGISTER**

PRIORITY CLAIMED UNDER SEC. 44(D) ON REPUBLIC OF KOREA APPLICATION NO.  
40-2009-0011, FILED 3-11-2009.

SER. NO. 77-705,550, FILED P.R. 4-2-2009; AM. S.R. 12-4-2012.

JANICE L. MCMORROW, EXAMINING ATTORNEY



*David J. Kybas*

Director of the United States Patent and Trademark Office

# United States of America

United States Patent and Trademark Office



**Reg. No. 4,277,401**

IGA, INC. (DELAWARE CORPORATION)  
8745 W. HIGGINS ROAD SUITE 350  
CHICAGO, IL 60631

**Registered Jan. 15, 2013**

**Int. Cls.: 3, 4, 6, 8, 16, 29,  
30, 31, and 32**

FOR: ALL-PURPOSE DETERGENT FOR HOUSEHOLD USE; FABRIC SOFTENER SHEETS; CLEANING PREPARATIONS, NAMELY, LAUNDRY SOAPS AND DETERGENTS, LIQUID FABRIC SOFTENER, ALL-PURPOSE HOUSEHOLD CLEANERS, DISHWASHING LIQUID DETERGENTS, AUTOMATIC DISHWASHING DETERGENT, LIQUID WINDOW CLEANING SOLUTIONS AND GLASS CLEANERS, LAUNDRY BLEACH, GENERAL PURPOSE CLEANING, DISH DETERGENT; ANTIBACTERIAL SOAP; BABY WIPES, IN CLASS 3 (U.S. CLS. 1, 4, 6, 50, 51 AND 52).

**TRADEMARK**

**SUPPLEMENTAL REGISTER**

FIRST USE 3-1-2011; IN COMMERCE 3-1-2011.

FOR: CHARCOAL LIGHTER FLUID, IN CLASS 4 (U.S. CLS. 1, 6 AND 15).

FIRST USE 3-1-2011; IN COMMERCE 3-1-2011.

FOR: ALUMINUM FOIL, IN CLASS 6 (U.S. CLS. 2, 12, 13, 14, 23, 25 AND 50).

FIRST USE 3-1-2011; IN COMMERCE 3-1-2011.

FOR: PLASTIC FORKS AND PLASTIC SPOONS, IN CLASS 8 (U.S. CLS. 23, 28 AND 44).

FIRST USE 3-1-2011; IN COMMERCE 3-1-2011.

FOR: PLASTIC WRAP, PAPER TOWELS, PAPER NAPKINS, PAPER FILTERS FOR COFFEE MAKERS; LUNCH BAGS; TRASH, GARBAGE AND KITCHEN TRASH BAGS; LAWN AND LEAF DISPOSAL BAGS; SANDWICH AND FREEZER BAGS; FOOD STORAGE BAGS; BATHROOM AND FACIAL TISSUE; MAGAZINES IN THE FIELD OF GROCERIES PUBLISHED PERIODICALLY, IN CLASS 16 (U.S. CLS. 2, 5, 22, 23, 29, 37, 38 AND 50).

FIRST USE 3-1-2011; IN COMMERCE 3-1-2011.

FOR: BLANCHED, SHELLLED, ROASTED AND PROCESSED NUTS; RAISINS; FROZEN, CUT, PROCESSED, PRESERVED, DRIED, CANNED, AND COOKED FRUITS AND VEGETABLES; ONION RINGS; CRANBERRY SAUCE; PICKLES; FRUIT SALAD; PEANUT BUTTER;



*David J. Kyros*

Director of the United States Patent and Trademark Office

**Reg. No. 4,277,401** JELLIES, JAMS AND FRUIT PRESERVES; APPLESAUCE; BOLOGNA; BOUILLON; SOUPS, SOUP MIXES, BROTHS, SOUP BROTHS; SAUERKRAUT; BREAKFAST SAUSAGE LINKS, SAUSAGES AND BRATWURST; BACON AND BACON BITS; BUTTER; MARGARINE; VEGETABLE BASED SPREADS; CHILI WITH AND WITHOUT BEANS; FLAKED COCONUT; COOKING OIL, COOKING OIL SPRAY; VEGETABLE AND ANIMAL SHORTENING; EDIBLE OIL; VEGETABLE OIL; OLIVE OIL; COTTAGE CHEESE; SOUR CREAM; EGGS; TOMATO PASTE AND PUREE; NON DAIRY CREAMER; DIPS AND SNACK DIPS; FRUIT-BASED SNACK FOOD; PROCESSED EDIBLE SEEDS; FRUIT BASED FILLINGS FOR PIES AND CAKES; MILK AND DAIRY PRODUCTS EXCLUDING ICE CREAM, ICE MILK AND FROZEN YOGURT; EVAPORATED AND CONDENSED MILK; MILK POWDER; YOGURT; CHEESE; CHEESE FOOD; CREAM CHEESE; CHEESE SPREAD; POTATO CHIPS; WHIPPED CREAM; WHIPPED TOPPING; MEAT; LUNCHEON MEATS; HAM; BEEF, BEEF STEW; CORNED BEEF AND CORNED BEEF HASH; CHICKEN AND POULTRY; CORN DOGS; FISH, FISH FILLETS, FRANKFURTERS; CANNED PORK AND BEANS; INSTANT POTATOES, FRIED POTATOES, FRENCH FRIED POTATOES; SALADS EXCEPT MACARONI, RICE AND PASTA SALAD; PREPARED CHICKEN SALAD, PREPARED POTATO SALAD, AND COLE SLAW; SEAFOOD; TUNA FISH; CANNED GOODS, NAMELY, FRUITS, BERRIES, VEGETABLES, FOWL, MEATS; FROZEN GOODS, NAMELY, FRUIT, BERRIES, VEGETABLES, VEGETABLE JUICES FOR COOKING, MEAT, FOWL, SOUPS, FRUIT-BASED FILLING FOR PIES; SALTED, SMOKED AND SPICED GOODS, NAMELY, FISH, CHICKEN AND MEATS; PREPARED DEVILLED MEAT AND SAUSAGE; CONDIMENTS, NAMELY, PICKLES, PROCESSED OLIVES AND PROCESSED PIMENTOS; CHEESE; EVAPORATED MILK; PRESERVES AND MARMALADES; SALAD OIL; BAKED BEANS, IN CLASS 29 (U.S. CL. 46).

FIRST USE 3-1-2011; IN COMMERCE 3-1-2011.

FOR: STARCH, NAMELY, SALT, CANDY; CARMELS, CANDY MINTS, BUBBLE GUM; BAGELS, BREAD, ROLLS AND BUNS; ENGLISH MUFFINS; BREAD CRUMBS AND BREAD DOUGH; BREADSTICKS; GARLIC BREAD, BREADSTICKS AND TOAST; BISCUITS AND BUTTER BISCUITS; PASTRIES; CONFECTIONERY BAKING CHIPS FOR BAKING; MIXES FOR BAKERY GOODS; CAKE MIXES; EDIBLE CAKE DECORATIONS; FROSTINGS BAKING SODA; BAKING POWDER; ICE CREAM; ICE CREAM BARS, ICE CREAM SANDWICHES AND FUDGE BARS; SHERBET; FROZEN YOGURT; CONES FOR ICE CREAM; FLAVORED AND SWEETENED GELATINS; BREAKFAST CEREALS; OATMEAL; PROCESSED OATS; SPICES, CHILI POWDER, CINNAMON, CINNAMON POWDER; GARLIC POWDER AND SALT; SALT; PEPPER; SEASONINGS, SEASONING MIXES; SLOPPY JOE SEASONING MIX; VANILLA EXTRACT; COFFEE, TEA, ICED TEA, TEA BAGS, SUGAR, RICE, PASTA, NOODLES, FLOUR; FLOUR MIXES; CORN MEAL; SUGAR SUBSTITUTE; COOKIES; WAFERS; CRACKERS; CHEESE FLAVORED SNACKS, NAMELY, CHEESE CURLS AND CHEESE PUFFS; CHEESE FLAVORED PUFFED CORN SNACKS; GRAIN-BASED FOOD BARS ALSO CONTAINING FRUIT; GRANOLA BASED SNACK BARS; SALAD DRESSINGS; GRAVIES AND GRAVY MIXES; SAUCES; SAUCE MIXES; CHEESE SAUCE; MARINADES; GRITS AND HOMINY GRITS; HOMINY; HONEY; MUSTARD; KETCHUP; MAYONNAISE; VINEGAR; SALAD DRESSINGS; SALSA; MACARONI AND CHEESE; MARSHMALLOWS; PANCAKES AND PANCAKE MIXES; WAFFLES; WAFFLE MIXES; PIE CRUST; PUDDINGS AND PUDDING MIXES; TOPPING SYRUP; CHOCOLATE SYRUP; CORN SYRUP; MAPLE SYRUP; TACO SHELLS; FROZEN, MIXES FOR MAKING COMBINED NOODLE OR RICE AND SAUCE DISHES; PIZZA, PREPARED PIZZAS AND BITE-SIZED PIZZA APPETIZERS; MICROWAVE POPCORN, RICE-BASED SNACK FOODS; STUFFING MIXES CONTAINING BREAD; FOOD FLAVORING EXTRACTS; CORNMEAL; CHOCOLATE POWDER FOR MAKING HOT CHOCOLATE; SAUCES; CONDIMENTS, NAMELY, PICKLE RELISHES; UNPOPPED POPCORN, IN CLASS 30 (U.S. CL. 46).

FIRST USE 3-1-2011; IN COMMERCE 3-1-2011.

FOR: PET FOOD, CAT LITTER; FRESH FRUITS AND VEGETABLES, IN CLASS 31 (U.S. CLS. 1 AND 46).



**Reg. No. 4,277,401** FIRST USE 3-1-2011; IN COMMERCE 3-1-2011.

FOR: GINGER ALE, SOFT DRINKS AND CARBONATED WATERS; CANNED, BOTTLED AND FROZEN GOODS, NAMELY, POWDERED SOFT DRINKS, FRUIT JUICES AS COCKTAIL MIXES, VEGETABLE JUICE, IN CLASS 32 (U.S. CLS. 45, 46 AND 48).

FIRST USE 3-1-2011; IN COMMERCE 3-1-2011.

THE MARK CONSISTS OF A REPEATING PATTERN OF ALTERNATING RED AND DARK RED VERTICAL STRIPES. EACH STRIPE GRADUALLY DARKENS IN COLOR FROM BOTTOM TO TOP. THE BROKEN LINES ARE NOT A PART OF THE MARK AND ARE MERELY INTENDED TO SHOW THAT THERE IS NO BORDER TO THE STRIPES DESIGN AND NO LIMIT TO THE LENGTH OR NUMBER OF STRIPES IN THE PATTERN.

THE COLOR(S) RED AND DARK RED IS/ARE CLAIMED AS A FEATURE OF THE MARK.

SER. NO. 77-746,006, FILED P.R. 5-27-2009; AM. S.R. 11-5-2012.

MATTHEW MCDOWELL, EXAMINING ATTORNEY

# United States of America

United States Patent and Trademark Office

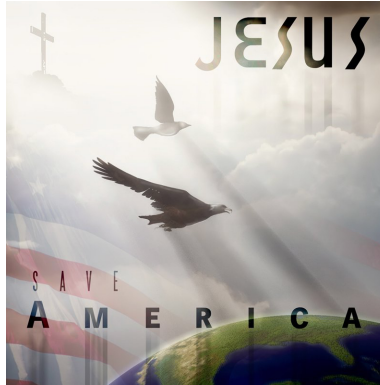

**Reg. No. 4,277,402**

**Registered Jan. 15, 2013**

**Int. Cls.: 16 and 25**

**TRADEMARK**

**SUPPLEMENTAL REGISTER**

ROYAL, DENNIS (UNITED STATES INDIVIDUAL)  
255 EASTWOOD AVENUE  
FAYETTEVILLE, NC 28301

FOR: BUMPER STICKERS, CALENDARS, DECALS, POSTERS, MEMO PADS, MOUNTED AND UNMOUNTED PHOTOGRAPHS, PRESSURE SENSITIVE GRAPHICS FOR APPLICATION TO AUTOMOBILES, PRINTED PAPER SIGNS, BOOKS, CUPS, MUGS, PLATES, BOWLS, AND TO BOTTLES, IN CLASS 16 (U.S. CLS. 2, 5, 22, 23, 29, 37, 38 AND 50).

FIRST USE 9-6-2011; IN COMMERCE 9-6-2011.

FOR: CLOTHING AND HEADWEAR, NAMELY, SHIRTS, KNIT SHIRTS, SLEEVELESS BLOUSES, T-SHIRTS, PULLOVERS, HATS, SCARVES, CAPS, TRACKSUITS, SWEAT SHIRTS, SWEAT PANTS, AND JACKETS, IN CLASS 25 (U.S. CLS. 22 AND 39).

FIRST USE 10-12-2011; IN COMMERCE 10-12-2011.

THE MARK CONSISTS OF A DEPICTION OF A PICTURE WITH A GRAY CROSS HIGH ON A MOUNTAIN ON THE LEFT UPPER CORNER; WITH THE WORD "JESUS" IN BLACK CAPITAL LETTERS ON THE RIGHT UPPER CORNER ABOVE GRAY AND WHITE CLOUDS; WITH A WHITE DOVE AND A BLACK AND WHITE EAGLE FLYING IN THE CENTER OF THE PICTURE; WITH A RED, WHITE, AND BLUE AMERICAN FLAG AS BACKGROUND; WITH THE WORD "SAVE" ON THE LEFT LOWER CORNER IN BLACK CAPITAL LETTERS BELOW THE EAGLE AND ACROSS THE FLAG; WITH THE WORD "AMERICA" IN BLACK CAPITAL LETTERS (BELOW THE WORD "SAVE") ACROSS THE FLAG AND ABOVE THE EARTH (DEPICTING LAND IN GREEN AND TAN AND DEPICTING WATER IN BLUE) WHICH IS MID-CENTER AND EXTENDS TO THE RIGHT LOWER CORNER OF THE PICTURE; WITH THE SUN STREAMING THROUGH OVERALL.

THE COLOR(S) BLACK, WHITE, RED, BLUE, GREEN, GRAY, AND TAN IS/ARE CLAIMED AS A FEATURE OF THE MARK.

SER. NO. 77-845,590, FILED P.R. 10-9-2009; AM. S.R. 12-6-2012.

Laurie Mayes, Examining Attorney



*David J. Kyros*

Director of the United States Patent and Trademark Office

# United States of America

United States Patent and Trademark Office

## CHAMBERPAK

**Reg. No. 4,277,403**

PREGIS INNOVATIVE PACKAGING INC. (DELAWARE CORPORATION)  
1650 LAKE COOK ROAD, SUITE 400  
DEERFIELD, IL 60015

**Registered Jan. 15, 2013**

**Int. Cl.: 16**

FOR: INFLATABLE PLASTIC CUSHIONS FOR PACKING OR WRAPPING, IN CLASS 16  
(U.S. CLS. 2, 5, 22, 23, 29, 37, 38 AND 50).

**TRADEMARK**

FIRST USE 9-29-2010; IN COMMERCE 9-29-2010.

**SUPPLEMENTAL REGISTER**

THE MARK CONSISTS OF STANDARD CHARACTERS WITHOUT CLAIM TO ANY PARTICULAR FONT, STYLE, SIZE, OR COLOR.

SER. NO. 77-957,840, FILED P.R. 3-12-2010; AM. S.R. 10-14-2011.

BRENDAN MCCAULEY, EXAMINING ATTORNEY



*David J. Kyros*

Director of the United States Patent and Trademark Office

# United States of America

United States Patent and Trademark Office

## REPAIR ASSURANCE

**Reg. No. 4,277,404**

**Registered Jan. 15, 2013**

**Int. Cls.: 35 and 36**

**SERVICE MARK**

**SUPPLEMENTAL REGISTER**

VISION MARKETING GROUP & ASSOCIATES (MINNESOTA LIMITED LIABILITY COMPANY)  
1994 SOUTH ROBERT ST  
WEST ST. PAUL, MN 55118

FOR: PERSONAL SERVICES FOR AUTOMOBILE OWNERS, NAMELY, COMMERCIAL INFORMATION AND ADVICE FOR CONSUMERS IN THE AUTOMOTIVE SERVICE AND WARRANTY INDUSTRY FIELDS; AND PERSONAL SERVICES FOR AUTOMOBILE OWNERS, NAMELY, PROVIDING RECOMMENDATIONS OF SERVICE PROVIDERS TO CONSUMERS FOR COMMERCIAL PURPOSES, IN CLASS 35 (U.S. CLS. 100, 101 AND 102).

FIRST USE 7-1-2010; IN COMMERCE 7-1-2010.

FOR: PERSONAL SERVICES FOR AUTOMOBILE OWNERS, NAMELY, AUTOMOTIVE REPAIR COST EVALUATION; AND PERSONAL SERVICES FOR AUTOMOBILE OWNERS, NAMELY, PROVIDING A COMPUTER DATABASE FOR THE PURPOSE OF APPRAISING REPAIRS TO DAMAGED AUTOMOBILES; AND PERSONAL SERVICES FOR AUTOMOBILE OWNERS, NAMELY, PROVIDING INFORMATION REGARDING WARRANTY CLAIMS IN THE FIELD OF AUTOMOBILES, IN CLASS 36 (U.S. CLS. 100, 101 AND 102).

FIRST USE 7-1-2010; IN COMMERCE 7-1-2010.

THE MARK CONSISTS OF STANDARD CHARACTERS WITHOUT CLAIM TO ANY PARTICULAR FONT, STYLE, SIZE, OR COLOR.

SER. NO. 85-013,105, FILED P.R. 4-13-2010; AM. S.R. 4-19-2012.

BARBARA RUTLAND, EXAMINING ATTORNEY



*David J. Kyffers*

Director of the United States Patent and Trademark Office

# United States of America

United States Patent and Trademark Office

# Immunity

**Reg. No. 4,277,405**

**Registered Jan. 15, 2013**

**Int. Cl.: 5**

**TRADEMARK**

**SUPPLEMENTAL REGISTER**

ORGANIC INDIA USA, LLC (COLORADO LIMITED LIABILITY COMPANY)  
SUITE T  
5311 WESTERN AVE  
BOULDER, CO 80301

FOR: DIETARY AND NUTRITIONAL SUPPLEMENTS, IN CLASS 5 (U.S. CLS. 6, 18, 44, 46, 51 AND 52).

FIRST USE 6-1-2000; IN COMMERCE 5-22-2002.

THE MARK CONSISTS OF STANDARD CHARACTERS WITHOUT CLAIM TO ANY PARTICULAR FONT, STYLE, SIZE, OR COLOR.

SER. NO. 85-062,130, FILED P.R. 6-14-2010; AM. S.R. 11-23-2010.

LOURDES AYALA, EXAMINING ATTORNEY



*David J. Kyffers*

Director of the United States Patent and Trademark Office

# United States of America

United States Patent and Trademark Office

# Argument Lab

**Reg. No. 4,277,406**

ARGUMENT LAB, LLC (DELAWARE LIMITED LIABILITY COMPANY)

**Registered Jan. 15, 2013**

401 WEST 22ND ST, #6J  
NEW YORK, NY 10011

**Int. Cl.: 35**

FOR: BUSINESS CONSULTING AND BUSINESS INFORMATION SERVICES, INCLUDING IN THE FIELD OF ARGUMENT; MARKET RESEARCH AND BUSINESS ANALYSIS; BUSINESS DEVELOPMENT CONSULTING SERVICES; BUSINESS RESEARCH USING FOCUS GROUPS, INTERVIEWS, AND SURVEYS IN THE FIELD OF ARGUMENT, IN CLASS 35 (U.S. CLS. 100, 101 AND 102).

**SERVICE MARK**

**SUPPLEMENTAL REGISTER**

FIRST USE 10-10-2011; IN COMMERCE 10-10-2011.

THE MARK CONSISTS OF STANDARD CHARACTERS WITHOUT CLAIM TO ANY PARTICULAR FONT, STYLE, SIZE, OR COLOR.

NO CLAIM IS MADE TO THE EXCLUSIVE RIGHT TO USE "LAB", APART FROM THE MARK AS SHOWN.

SER. NO. 85-073,791, FILED P.R. 6-29-2010; AM. S.R. 12-12-2012.

ZHALEH DELANEY, EXAMINING ATTORNEY



*David J. Kybas*

Director of the United States Patent and Trademark Office

# United States of America

United States Patent and Trademark Office

# Ortiz

**GAMING**

**Reg. No. 4,277,407**

**Registered Jan. 15, 2013**

**Int. Cls.: 9 and 28**

**TRADEMARK**

**SUPPLEMENTAL REGISTER**

ORTIZ GAMING S.L. (SPAIN CORPORATION)  
CALLE CHILE N° 4, EDIFICIO 1  
OFICINA 7, LAS ROZAS  
MADRID, SPAIN E-28290

FOR: (BASED ON USE IN COMMERCE) (BASED ON 44(E)) STAND ALONE VIDEO-GAME MACHINES AND APPARATUS; PARTS AND FITTINGS THEREFOR, IN CLASS 9 (U.S. CLS. 21, 23, 26, 36 AND 38).

FIRST USE 10-2-2012; IN COMMERCE 10-2-2012.

FOR: (BASED ON 44(E)) BINGO GAME PLAYING EQUIPMENT, IN CLASS 28 (U.S. CLS. 22, 23, 38 AND 50).

PRIORITY CLAIMED UNDER SEC. 44(D) ON ERPN CMNTY TM OFC APPLICATION NO. 009079931, FILED 5-5-2010, REG. NO. 009079931, DATED 10-12-2010, EXPIRES 5-5-2020.

THE COLOR(S) VIOLET AND BLACK IS/ARE CLAIMED AS A FEATURE OF THE MARK.

NO CLAIM IS MADE TO THE EXCLUSIVE RIGHT TO USE "GAMING", APART FROM THE MARK AS SHOWN.

THE MARK CONSISTS OF THE WORD "ORTIZ" IN VIOLET, OUTLINED IN BLACK ABOVE THE WORD "GAMING" IN BLACK.

SER. NO. 85-137,548, FILED P.R. 9-24-2010; AM. S.R. 12-6-2012.

ESTHER A. BORSUK, EXAMINING ATTORNEY



*David J. Kybas*

Director of the United States Patent and Trademark Office

# United States of America

United States Patent and Trademark Office

# CAMOZIP

**Reg. No. 4,277,408**

IDEAL FASTENER CORPORATION (DELAWARE CORPORATION)  
603 WEST INDUSTRY DRIVE  
OXFORD, NC 27565

**Registered Jan. 15, 2013**

**Int. Cl.: 26**

FOR: SLIDE FASTENERS; SLIDE FASTENERS AND PARTS THEREOF; ZIPPER FASTENERS;  
ZIPPERS, IN CLASS 26 (U.S. CLS. 37, 39, 40, 42 AND 50).

**TRADEMARK**

FIRST USE 10-1-2010; IN COMMERCE 7-1-2011.

**SUPPLEMENTAL REGISTER**

THE MARK CONSISTS OF STANDARD CHARACTERS WITHOUT CLAIM TO ANY PARTICULAR FONT, STYLE, SIZE, OR COLOR.

SER. NO. 85-146,983, FILED P.R. 10-7-2010; AM. S.R. 11-6-2012.

MICHELLE DUBOIS, EXAMINING ATTORNEY



*David J. Kybas*

Director of the United States Patent and Trademark Office



# United States of America

United States Patent and Trademark Office

# SPLIT FLOW

**Reg. No. 4,277,409**

**Registered Jan. 15, 2013**

**Int. Cl.: 7**

**TRADEMARK**

**SUPPLEMENTAL REGISTER**

FLOWSERVE MANAGEMENT COMPANY (DELAWARE BUSINESS TRUST)  
SUITE 2300  
5215 N. O'CONNOR BLVD.  
IRVING, TX 75039

FOR: CENTRIFUGAL PUMPS, IN CLASS 7 (U.S. CLS. 13, 19, 21, 23, 31, 34 AND 35).

FIRST USE 5-0-2012; IN COMMERCE 5-0-2012.

THE MARK CONSISTS OF STANDARD CHARACTERS WITHOUT CLAIM TO ANY PARTICULAR FONT, STYLE, SIZE, OR COLOR.

SER. NO. 85-147,576, FILED P.R. 10-7-2010; AM. S.R. 3-19-2012.

MARK T. MULLEN, EXAMINING ATTORNEY



*David J. Kyffers*

Director of the United States Patent and Trademark Office

# United States of America

United States Patent and Trademark Office

## DIABETES ADVOCACY ALLIANCE

**Reg. No. 4,277,410**

NOVO NORDISK A/S (DENMARK CORPORATION)

**Registered Jan. 15, 2013**

NOVO ALLÉ  
DK-2880 BAGSVAERD, DENMARK

**Int. Cl.: 35**

FOR: LOBBYING SERVICES, NAMELY, PROMOTING THE INTERESTS OF FOR-PROFIT AND NON-PROFIT ORGANIZATIONS TO IMPROVE DIABETES PREVENTION, DETECTION, AND TREATMENT, IN CLASS 35 (U.S. CLS. 100, 101 AND 102).

**SERVICE MARK**

FIRST USE 6-10-2010; IN COMMERCE 6-10-2010.

**SUPPLEMENTAL REGISTER**

THE MARK CONSISTS OF STANDARD CHARACTERS WITHOUT CLAIM TO ANY PARTICULAR FONT, STYLE, SIZE, OR COLOR.

NO CLAIM IS MADE TO THE EXCLUSIVE RIGHT TO USE "DIABETES ADVOCACY", APART FROM THE MARK AS SHOWN.

SER. NO. 85-152,294, FILED P.R. 10-14-2010; AM. S.R. 1-20-2012.

JAMES MACFARLANE, EXAMINING ATTORNEY



*David J. Kybas*

Director of the United States Patent and Trademark Office

# United States of America

United States Patent and Trademark Office

## NOVEL AGENT CONSULTING

**Reg. No. 4,277,411**

BARRY H. DAVIS (UNITED STATES INDIVIDUAL)  
1435 JOEL DRIVE  
AMBLER, PA 19002

**Registered Jan. 15, 2013**

**Int. Cl.: 35**

FOR: MARKETING RESEARCH AND CONSULTING, IN THE FIELD OF PHARMACEUTICALS AND HEALTHCARE, IN CLASS 35 (U.S. CLS. 100, 101 AND 102).

**SERVICE MARK**

FIRST USE 9-1-2010; IN COMMERCE 9-1-2010.

**SUPPLEMENTAL REGISTER**

THE MARK CONSISTS OF STANDARD CHARACTERS WITHOUT CLAIM TO ANY PARTICULAR FONT, STYLE, SIZE, OR COLOR.

NO CLAIM IS MADE TO THE EXCLUSIVE RIGHT TO USE "CONSULTING", APART FROM THE MARK AS SHOWN.

SER. NO. 85-171,040, FILED P.R. 11-7-2010; AM. S.R. 12-6-2012.

RICHARD WHITE, EXAMINING ATTORNEY



*David J. Kybas*

Director of the United States Patent and Trademark Office

# United States of America

United States Patent and Trademark Office

Milliken

**Reg. No. 4,277,412**

MILLIKEN & COMPANY (DELAWARE CORPORATION)  
920 MILLIKEN ROAD, M495  
SPARTANBURG, SC 29303

**Registered Jan. 15, 2013**

**Int. Cl.: 22**

FOR: SYNTHETIC FIBERS; NON-WOVEN POLYMERIC FIBERS FOR CONVERSION INTO A VARIETY OF INDUSTRIAL AND CONSUMER GOODS, IN CLASS 22 (U.S. CLS. 1, 2, 7, 19, 22, 42 AND 50).

**TRADEMARK**

FIRST USE 11-0-2011; IN COMMERCE 11-0-2011.

**SUPPLEMENTAL REGISTER**

OWNER OF U.S. REG. NOS. 896,986, 2,281,638, AND OTHERS.

THE MARK CONSISTS OF "MILLIKEN" IN CURSIVE WRITING.

SER. NO. 85-172,233, FILED P.R. 11-9-2010; AM. S.R. 11-5-2012.

LINDA ESTRADA, EXAMINING ATTORNEY



David J. Kyjars

Director of the United States Patent and Trademark Office

# United States of America

United States Patent and Trademark Office

# RF GLASS

**Reg. No. 4,277,413**

HRL LABORATORIES, LLC (DELAWARE LIMITED LIABILITY COMPANY)  
3011 MALIBU CANYON ROAD  
MALIBU, CA 90265

**Registered Jan. 15, 2013**

**Int. Cl.: 9**

FOR: ELECTRONIC COMPONENTS, NAMELY, MICROELECTRONIC CIRCUITRY, NAMELY, PATTERNED TRANSPARENT CONDUCTORS, SWITCHES CAPACITORS AND INDUCTORS, AND ANTENNAS FOR SENSING, AMPLIFYING AND SENDING ELECTROMAGNETIC ENERGY SIGNALS, WHICH CAN BE EMBEDDED IN PLASTIC OR GLASS, IN CLASS 9 (U.S. CLS. 21, 23, 26, 36 AND 38).

**TRADEMARK**

**SUPPLEMENTAL REGISTER**

FIRST USE 10-3-2012; IN COMMERCE 10-3-2012.

THE MARK CONSISTS OF STANDARD CHARACTERS WITHOUT CLAIM TO ANY PARTICULAR FONT, STYLE, SIZE, OR COLOR.

SER. NO. 85-190,579, FILED P.R. 12-3-2010; AM. S.R. 10-23-2012.

SUSAN RICHARDS, EXAMINING ATTORNEY



*David J. Kyfos*

Director of the United States Patent and Trademark Office

# United States of America

United States Patent and Trademark Office

## US FREESKIING

**Reg. No. 4,277,414**

**Registered Jan. 15, 2013**

**Int. Cls.: 35, 36, and 41**

**SERVICE MARK**

**SUPPLEMENTAL REGISTER**

UNITED STATES SKI ASSOCIATION (UTAH CORPORATION), DBA UNITED STATES SKI & SNOWBOARD ASSOCIATION,  
1 VICTORY LANE, P.O. BOX 100  
PARK CITY, UT 84060

FOR: ASSOCIATION SERVICES IN THE FIELD OF FREESKIING, NAMELY, PROMOTING THE INTERESTS AND ACTIVITIES OF COMPETITIVE FREESKIERS; PROMOTING FREESKIING EVENTS OF OTHERS; RETAIL AND ONLINE RETAIL STORE SERVICES FEATURING FREESKIING CLOTHING, EQUIPMENT, ACCESSORIES AND TRAINING MATERIALS; PROMOTING THE GOODS AND SERVICES OF OTHERS BY ARRANGING FOR SPONSORS TO AFFILIATE THEIR GOODS AND SERVICES WITH FREESKIING EVENTS; SPONSORSHIP SEARCH FOR CORPORATE AND COMPANY SPONSORSHIPS TO SUPPORT FREESKIING ACTIVITIES AND TO DEFRAY EXPENSES OF FREESKIERS, IN CLASS 35 (U.S. CLS. 100, 101 AND 102).

FIRST USE 4-30-2011; IN COMMERCE 4-30-2011.

FOR: FUNDRAISING ACTIVITIES FOR OTHERS TO SUPPORT FREESKIING ACTIVITIES AND TO DEFRAY EXPENSES OF FREESKIERS; MONEY RAISING ACTIVITIES TO SUPPORT AMATEUR FREESKIING ACTIVITIES AND TO DEFRAY EXPENSES OF AMATEUR FREESKIERS, IN CLASS 36 (U.S. CLS. 100, 101 AND 102).

FIRST USE 4-30-2011; IN COMMERCE 4-30-2011.

FOR: ARRANGING AND CONDUCTING REGIONAL, NATIONAL AND INTERNATIONAL FREESKIING COMPETITIONS, RACES AND EVENTS; PRODUCTION AND DISTRIBUTION OF TELEVISION PROGRAMS AND FILMS FOR OTHERS IN THE FIELD OF FREESKIING EVENTS; EDUCATIONAL SERVICES, NAMELY, CLASSES, WORKSHOPS, COACHING, ONLINE TRAINING, AND PROVIDING PRINTED INSTRUCTIONAL MATERIALS THEREWITH; RENTAL OF TRAINING VIDEOS AND COMPACT DISKS IN THE FIELD OF FREESKIING, IN CLASS 41 (U.S. CLS. 100, 101 AND 107).

FIRST USE 4-30-2011; IN COMMERCE 4-30-2011.

THE MARK CONSISTS OF STANDARD CHARACTERS WITHOUT CLAIM TO ANY PARTICULAR FONT, STYLE, SIZE, OR COLOR.



*David J. Kyros*

Director of the United States Patent and Trademark Office

**Reg. No. 4,277,414** OWNER OF U.S. REG. NOS. 2,706,114, 2,715,026, AND 3,637,298.

SER. NO. 85-201,067, FILED P.R. 12-17-2010; AM. S.R. 10-12-2012.

KAREN SEVERSON, EXAMINING ATTORNEY

# United States of America

United States Patent and Trademark Office

## PROFESSIONAL GOLF TRAVEL

**Reg. No. 4,277,415**

AMBASSADOR SOUTHWEST, LLC (ARIZONA LIMITED LIABILITY COMPANY)  
6920 EAST SHEA BOULEVARD, SUITE 103  
SCOTTSDALE, AZ 85254

**Registered Jan. 15, 2013**

**Int. Cls.: 39, 41, and 43**

FOR: ARRANGING AND COORDINATING TRAVEL ARRANGEMENTS FOR INDIVIDUALS AND GROUPS; MAKING RESERVATIONS FOR TRANSPORTATION; ORGANIZING AND ARRANGING TRAVEL ACTIVITIES, NAMELY, ORGANIZING RESERVATIONS FOR TOURS; ORGANIZATION OF TRAVEL; PROVIDING A WEBSITE AND WEBSITE LINKS TO TRAVEL INFORMATION, INCLUDING GEOGRAPHIC INFORMATION, MAPS, MAP IMAGES AND TRIP ROUTING; PROVIDING A WEBSITE FOR RESERVING VEHICLE RENTALS; PROVIDING AN ON-LINE SEARCHABLE COMPUTER DATABASE FEATURING INFORMATION ON TRAVEL; PROVIDING INFORMATION ABOUT GOLF-RELATED TRAVEL VIA THE INTERNET; PROVIDING INFORMATION AND REVIEWS CONCERNING AIRLINES AND RENTAL CAR COMPANIES FOR USE BY TRAVELERS; PROVIDING INFORMATION VIA A WEBSITE IN THE FIELD OF TRAVEL; PROVIDING INFORMATION, NEWS AND REVIEWS CONCERNING TRAVEL BY MEANS OF A TELEPHONE, FACSIMILE, THE MAIL, COURIER AND OVER ELECTRONIC COMMUNICATION NETWORKS; PROVIDING RECOMMENDATIONS TO TRAVELERS, TOURISTS, AND GOLF COURSE PLAYERS ON AIRPLANE FLIGHTS AND RENTAL CARS; PROVIDING INFORMATION VIA COMPUTER NETWORKS, GLOBAL INFORMATION NETWORKS AND WIRELESS NETWORKS IN THE FIELD OF TRAVEL AND TRAVEL DESTINATIONS; RESERVATION AND BOOKING OF SEATS FOR TRAVEL; TRAVEL AGENCY SERVICES, NAMELY, MAKING RESERVATIONS AND BOOKINGS FOR TRANSPORTATION; TRAVEL AND TOUR INFORMATION SERVICE; TRAVEL AND TOUR TICKET RESERVATION SERVICE; TRAVEL BOOKING AGENCIES; TRAVEL GUIDE AND TRAVEL INFORMATION SERVICES, IN CLASS 39 (U.S. CLS. 100 AND 105).

**SERVICE MARK**

**SUPPLEMENTAL REGISTER**



FIRST USE 12-11-2008; IN COMMERCE 12-11-2008.

FOR: INTERNET SERVICES WEBSITE, NAMELY, PROVIDING A WEBSITE FEATURING TEE TIMES AND GOLF-RELATED INFORMATION; PROVIDING A WEB SITE THROUGH WHICH GOLFERS LOCATE INFORMATION ABOUT GOLF COURSES AND GOLF TOURNAMENTS; PROVIDING A WEB SITE THROUGH WHICH GOLFERS RESERVE TEE TIMES AT GOLF COURSES; PROVIDING INFORMATION ABOUT GOLF VIA THE INTERNET; PROVIDING INFORMATION AND REVIEWS CONCERNING GOLF COURSES FOR USE BY TRAVELERS; PROVIDING NEWS AND INFORMATION ON THE SPORT OF GOLF; PROVIDING ON-LINE PUBLICATIONS, NAMELY, NEWSLETTERS IN THE FIELD OF

*David J. Kybas*

Director of the United States Patent and Trademark Office



**Reg. No. 4,277,415** TRAVEL AND TRAVEL ACCOMMODATIONS; PROVIDING RECOMMENDATIONS TO TRAVELERS, TOURISTS, AND PLAYERS ON GOLF COURSES; RESERVING TIMES FOR THE PUBLIC TO PLAY GOLF AT VARIOUS GOLF COURSES; SCHEDULING SERVICES, NAMELY, MAKING RESERVATIONS FOR OTHERS TO PLAY GOLF; ORGANIZING AND ARRANGING RESERVATIONS FOR EVENTS, ATTRACTIONS, AND VENUES, NAMELY, GOLF EVENTS, GOLF TOURNAMENTS, GOLF COURSES, AND GOLF RESORTS, IN CLASS 41 (U.S. CLS. 100, 101 AND 107).

FIRST USE 12-11-2008; IN COMMERCE 12-11-2008.

FOR: HOTEL ACCOMMODATION SERVICES, NAMELY, PROVIDING AND RELAYING INFORMATION AND SECURING PAYMENT IN CONNECTION WITH RESERVATIONS AND BOOKINGS FOR TEMPORARY LODGING; PROVIDING INFORMATION AND REVIEWS CONCERNING HOTEL ACCOMMODATIONS FOR USE BY TRAVELERS; PROVIDING ACCOMMODATION INFORMATION, NAMELY, RATINGS OF ACCOMMODATIONS IN THE NATURE OF TEMPORARY LODGING FOR USE BY TRAVELERS; PROVIDING TRAVEL LODGING INFORMATION SERVICES FOR TEMPORARY LODGINGS, AND TRAVEL LODGING BOOKING AGENCY SERVICES FOR TEMPORARY LODGING FOR TRAVELERS; TRAVEL AGENCY SERVICES, NAMELY, MAKING RESERVATIONS AND BOOKING FOR TEMPORARY LODGING; TRAVEL LODGING AND ACCOMMODATION INFORMATION SERVICES, NAMELY, PROVIDING TRAVEL ACCOMMODATION INFORMATION FOR TEMPORARY LODGINGS FOR USE IN PLANNING CORPORATE TRAVEL, IN CLASS 43 (U.S. CLS. 100 AND 101).

FIRST USE 12-11-2008; IN COMMERCE 12-11-2008.

THE MARK CONSISTS OF STANDARD CHARACTERS WITHOUT CLAIM TO ANY PARTICULAR FONT, STYLE, SIZE, OR COLOR.

NO CLAIM IS MADE TO THE EXCLUSIVE RIGHT TO USE "GOLF TRAVEL", APART FROM THE MARK AS SHOWN.

SER. NO. 85-203,330, FILED P.R. 12-21-2010; AM. S.R. 9-27-2011.

NANCY CLARKE, EXAMINING ATTORNEY

# United States of America

United States Patent and Trademark Office

# MXSurfing.com

**Reg. No. 4,277,416**

KRETZER, CHRISTOPHER J (UNITED STATES INDIVIDUAL)  
14 POMONA DR.

**Registered Jan. 15, 2013**

BARNEGAT, NJ 08005

**Int. Cl.: 41**

FOR: ENTERTAINMENT SERVICES IN THE NATURE OF ORGANIZING AND CONDUCTING MOTOCROSS AND SURFING COMPETITIONS, IN CLASS 41 (U.S. CLS. 100, 101 AND 107).

**SERVICE MARK**

FIRST USE 5-1-2010; IN COMMERCE 5-1-2010.

**SUPPLEMENTAL REGISTER**

THE MARK CONSISTS OF STANDARD CHARACTERS WITHOUT CLAIM TO ANY PARTICULAR FONT, STYLE, SIZE, OR COLOR.

SER. NO. 85-251,939, FILED P.R. 2-25-2011; AM. S.R. 11-26-2012.

JERI J. FICKES, EXAMINING ATTORNEY



*David J. Kyffers*

Director of the United States Patent and Trademark Office

# United States of America

United States Patent and Trademark Office

## ENERGY SAVINGS SUPERSTORE

**Reg. No. 4,277,417**

ENERGY EARTH, LLC (TENNESSEE LIMITED LIABILITY COMPANY)

**Registered Jan. 15, 2013**

P. O. BOX 4303  
CHATTANOOGA, TN 37405

**Int. Cl.: 35**

FOR: RETAIL STORE SERVICES PROVIDED FROM AN ON-LINE, WEB-BASED VIRTUAL STOREFRONT, FEATURING A WIDE VARIETY OF ENERGY EFFICIENT, ENVIRONMENTALLY FRIENDLY, AND RENEWABLE ENERGY-RELATED CONSUMER AND HOUSEHOLD PRODUCTS AND APPLIANCES, IN CLASS 35 (U.S. CLS. 100, 101 AND 102).

**SERVICE MARK**

**SUPPLEMENTAL REGISTER** FIRST USE 11-14-2012; IN COMMERCE 11-14-2012.

THE MARK CONSISTS OF STANDARD CHARACTERS WITHOUT CLAIM TO ANY PARTICULAR FONT, STYLE, SIZE, OR COLOR.

NO CLAIM IS MADE TO THE EXCLUSIVE RIGHT TO USE "SUPERSTORE", APART FROM THE MARK AS SHOWN.

SER. NO. 85-257,772, FILED P.R. 3-4-2011; AM. S.R. 6-4-2012.

JOHN E. MICHOS, EXAMINING ATTORNEY



*David J. Kyfos*

Director of the United States Patent and Trademark Office

# United States of America

United States Patent and Trademark Office

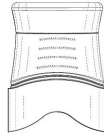

**Reg. No. 4,277,418**

**Registered Jan. 15, 2013**

**Int. Cl.: 5**

**TRADEMARK**

**SUPPLEMENTAL REGISTER**

ACRUX DDS PTY LTD (AUSTRALIA PROPRIETARY LIMITED COMPANY (P/L OR PTY. LTD.))  
103-113 STANLEY STREET  
WEST MELBOURNE VIC, AUSTRALIA 3003

FOR: PHARMACEUTICAL PREPARATIONS AND MEDICATED COMPOSITIONS FOR TOPICAL AND TRANSDERMAL APPLICATIONS IN THE FORM OF SOLUTIONS, LOTIONS, GELS, SPRAYS AND OINTMENTS FOR THE TREATMENT OF TESTOSTERONE DEFICIENCY; TOPICAL AND TRANSDERMAL MEDICATED SKIN PREPARATIONS AND PHARMACEUTICAL COMPOSITIONS FOR SPRAY APPLICATION TO THE SKIN IN THE FORM OF SOLUTIONS, LOTIONS, GELS, SPRAYS AND OINTMENTS FOR THE TREATMENT OF TESTOSTERONE DEFICIENCY; PHARMACEUTICAL PREPARATIONS FOR TRANSDERMAL DELIVERY IN THE FORM OF SOLUTIONS, LOTIONS, GELS, SPRAYS AND OINTMENTS FOR THE TREATMENT OF TESTOSTERONE DEFICIENCY, IN CLASS 5 (U.S. CLS. 6, 18, 44, 46, 51 AND 52).

FIRST USE 4-0-2011; IN COMMERCE 4-0-2011.

THE MARK CONSISTS OF A TWO-DIMENSIONAL CONFIGURATION OF AN APPLICATOR PORTION COMPRISING A TOP PORTION WITH A CONICAL RIDGED TUBE BELOW THE TOP PORTION. THE BROKEN LINES DEPICTING CURVED RIDGES INDICATE LOCATION OF THE RIDGES AND ARE NOT PART OF THIS MARK.

SER. NO. 85-259,532, FILED P.R. 3-7-2011; AM. S.R. 12-6-2012.

KAPIL BHANOT, EXAMINING ATTORNEY



*David J. Kybas*

Director of the United States Patent and Trademark Office

# United States of America

United States Patent and Trademark Office

# Pro Players

**Reg. No. 4,277,419**

**Registered Jan. 15, 2013**

**Int. Cl.: 41**

**SERVICE MARK**

**SUPPLEMENTAL REGISTER**

PIERCE, STEPHEN N. (UNITED STATES INDIVIDUAL), DBA PRO PLAYERS,  
121 BROADWAY, SUITE 220  
121 BROADWAY  
SAN DIEGO, CA 92101

FOR: ENTERTAINMENT, NAMELY, MULTIMEDIA ENTERTAINMENT SERVICES IN THE NATURE OF DEVELOPMENT, PRODUCTION, AND POST-PRODUCTION SERVICES IN THE FIELD OF MUSIC, VIDEO, TELEVISION, AND FILMS; PLANNING AND CONDUCTING SPECIAL EVENTS FOR SOCIAL ENTERTAINMENT PURPOSES; AND OPERATING OF SPORTS CAMPS, IN CLASS 41 (U.S. CLS. 100, 101 AND 107).

FIRST USE 1-1-2008; IN COMMERCE 1-1-2008.

THE MARK CONSISTS OF STANDARD CHARACTERS WITHOUT CLAIM TO ANY PARTICULAR FONT, STYLE, SIZE, OR COLOR.

SER. NO. 85-293,554, FILED P.R. 4-13-2011; AM. S.R. 11-28-2012.

CHRISTINA SOBRAL, EXAMINING ATTORNEY



*David J. Kyffers*

Director of the United States Patent and Trademark Office

# United States of America

United States Patent and Trademark Office

## DISC REVITALIZATION THERAPY

**Reg. No. 4,277,420**

VITAL LINK CHIROPRACTIC, PC (PENNSYLVANIA PROFESSIONAL CORPORATION)  
1186 CHURCH STREET  
MOSCOW, PA 18444

**Registered Jan. 15, 2013**

**Int. Cls.: 10, 41, and 44**

FOR: MEDICAL INSTRUMENT FOR TREATING FACIAL RESTRICTIONS AND SCAR TISSUE, NAMELY, AN INSTRUMENT SPECIFICALLY SHAPED, AND OF DISTINCT CONSTITUTION, USED TO REMODEL AND REVITALIZE SOFT-TISSUE, BY DISSIPATING FACIAL RESTRICTIONS AND SCAR TISSUE; MEDICAL APPARATUS AND INSTRUMENTS FOR TREATING INTERVERTEBRAL DISC-MEDIATED LOW BACK AND NECK PAIN, IN CLASS 10 (U.S. CLS. 26, 39 AND 44).

**TRADEMARK**

**SERVICE MARK**

**SUPPLEMENTAL REGISTER**

FIRST USE 1-1-2012; IN COMMERCE 1-1-2012.

FOR: EDUCATIONAL AND ENTERTAINMENT SERVICES, NAMELY, CONDUCTING CLASSES, SEMINARS AND WORKSHOPS IN THE FIELD OF MEDICINE, CHIROPRACTIC MEDICINE, TREATMENT PROTOCOLS AND SYSTEM RELATING TO NEW CHIROPRACTIC AND MEDICAL THERAPIES AND TECHNIQUES AND DISTRIBUTION OF COURSE MATERIALS IN CONNECTION THEREWITH; AND EDUCATION CONSULTING RELATED THERETO, IN CLASS 41 (U.S. CLS. 100, 101 AND 107).

FIRST USE 1-1-2012; IN COMMERCE 1-1-2012.

FOR: CONSULTATION SERVICES IN THE FIELD OF MEDICINE, CHIROPRACTIC MEDICINE, TREATMENT PROTOCOLS AND SYSTEM RELATING TO NEW CHIROPRACTIC AND MEDICAL THERAPIES AND TECHNIQUES; CHIROPRACTIC SERVICES; INTERVERTEBRAL DISC-MEDIATED NECK AND LOW BACK PAIN AND DISABILITY THERAPY BY MEANS OF A COMBINATION OF MANUAL THERAPY, THERAPEUTIC EXERCISE, PHYSIOTHERAPY, NUTRITIONAL SUPPLEMENTATION, DISC DECOMPRESSION AND CLASS IV LASER THERAPY, IN CLASS 44 (U.S. CLS. 100 AND 101).

FIRST USE 1-1-2012; IN COMMERCE 1-1-2012.

THE MARK CONSISTS OF STANDARD CHARACTERS WITHOUT CLAIM TO ANY PARTICULAR FONT, STYLE, SIZE, OR COLOR.

NO CLAIM IS MADE TO THE EXCLUSIVE RIGHT TO USE "THERAPY", APART FROM THE MARK AS SHOWN.



*David J. Kybas*

Director of the United States Patent and Trademark Office

**Reg. No. 4,277,420** SER. NO. 85-305,470, FILED P.R. 4-26-2011; AM. S.R. 9-20-2012.

DARRYL SPRUILL, EXAMINING ATTORNEY

# United States of America

United States Patent and Trademark Office

# MOLLYWOOD

**Reg. No. 4,277,421**

**Registered Jan. 15, 2013**

**Int. Cl.: 25**

**TRADEMARK**

**SUPPLEMENTAL REGISTER**

PALM, MICHAEL (UNITED STATES INDIVIDUAL)  
#446V  
1555 VINE STREET  
LOS ANGELES, CA 90028

FOR: APPARELS, NAMELY, T-SHIRTS, TANK TOPS, BALL CAPS, AND HEADWEAR, IN CLASS 25 (U.S. CLS. 22 AND 39).

FIRST USE 6-6-2011; IN COMMERCE 6-6-2011.

THE MARK CONSISTS OF STANDARD CHARACTERS WITHOUT CLAIM TO ANY PARTICULAR FONT, STYLE, SIZE, OR COLOR.

SER. NO. 85-338,540, FILED P.R. 6-6-2011; AM. S.R. 11-26-2012.

MICHAEL ENGEL, EXAMINING ATTORNEY



*David J. Kyffers*

Director of the United States Patent and Trademark Office



# United States of America

United States Patent and Trademark Office

## Wheels of Italy

**Reg. No. 4,277,422**

WHEELS OF THE WORLD, LLC (MINNESOTA LIMITED LIABILITY COMPANY)  
15620 24TH AVENUE NORTH  
MINNEAPOLIS, MN 55447

**Registered Jan. 15, 2013**

**Int. Cl.: 35**

FOR: ASSOCIATION SERVICES, NAMELY, PROMOTING THE INTERESTS OF ITALIAN VEHICLE ENTHUSIASTS; ONLINE ADVERTISING SERVICES FOR OTHERS; ADVERTISING IN THE NATURE OF E-MAIL BLAST CAMPAIGN FOR OTHERS; CONDUCTING TRADE SHOWS IN THE FIELD OF AUTOMOBILES FEATURING ITALIAN VEHICLES AND MOTORCYLES AND RELATED PRODUCTS AND ACCESSORIES, IN CLASS 35 (U.S. CLS. 100, 101 AND 102).

**SERVICE MARK**

**SUPPLEMENTAL REGISTER**

FIRST USE 1-5-2003; IN COMMERCE 1-5-2003.

THE MARK CONSISTS OF STANDARD CHARACTERS WITHOUT CLAIM TO ANY PARTICULAR FONT, STYLE, SIZE, OR COLOR.

SER. NO. 85-340,026, FILED P.R. 6-7-2011; AM. S.R. 10-22-2012.

CHARLES L. JENKINS, EXAMINING ATTORNEY



*David J. Kyfos*

Director of the United States Patent and Trademark Office

# United States of America

United States Patent and Trademark Office

## MAKE ELECTRO NOT WAR

**Reg. No. 4,277,423**

**Registered Jan. 15, 2013**

**Int. Cl.: 25**

**TRADEMARK**

**SUPPLEMENTAL REGISTER**

PALM, MICHAEL (UNITED STATES INDIVIDUAL)  
#446V  
1555 VINE STREET  
LOS ANGELES, CA 90028

FOR: APPARELS, NAMELY, T-SHIRTS, TANK TOPS, BALL CAPS, AND HEADWEAR, IN CLASS 25 (U.S. CLS. 22 AND 39).

FIRST USE 5-22-2012; IN COMMERCE 5-22-2012.

THE MARK CONSISTS OF STANDARD CHARACTERS WITHOUT CLAIM TO ANY PARTICULAR FONT, STYLE, SIZE, OR COLOR.

SER. NO. 85-340,261, FILED P.R. 6-7-2011; AM. S.R. 11-20-2012.

MICHAEL ENGEL, EXAMINING ATTORNEY



*David J. Kybas*

Director of the United States Patent and Trademark Office

# United States of America

United States Patent and Trademark Office

## CYTOKINE CIRCUIT SOLUTIONS

**Reg. No. 4,277,424**

**Registered Jan. 15, 2013**

**Int. Cl.: 5**

**TRADEMARK**

**SUPPLEMENTAL REGISTER**

RADENTZ, LESLIE MARIE (UNITED STATES INDIVIDUAL), DBA LESLIE RADENTZ, MD,  
SUITE A-140  
39755 MURRIETA HOT SPRINGS RD.  
MURRIETA, CA 92563

FOR: MEDICINAL HERBAL PREPARATION TO SOOTHE THE MANIFEST APPEARANCE  
OF INFLAMMATORY CYTOKINES OF THE SKIN , IN CLASS 5 (U.S. CLS. 6, 18, 44, 46, 51  
AND 52).

FIRST USE 9-5-2012; IN COMMERCE 9-5-2012.

THE MARK CONSISTS OF STANDARD CHARACTERS WITHOUT CLAIM TO ANY PAR-  
TICULAR FONT, STYLE, SIZE, OR COLOR.

NO CLAIM IS MADE TO THE EXCLUSIVE RIGHT TO USE "SOLUTIONS", APART FROM  
THE MARK AS SHOWN.

SER. NO. 85-345,178, FILED P.R. 6-14-2011; AM. S.R. 11-28-2012.

BRIAN NEVILLE, EXAMINING ATTORNEY



*David J. Kyffers*

Director of the United States Patent and Trademark Office

# United States of America

United States Patent and Trademark Office

# Dual Play

**Reg. No. 4,277,425**

LG ELECTRONICS INC. (REPUBLIC OF KOREA CORPORATION)  
20 YEUIDO-DONG YOUNGDEUNGPO-GU  
SEOUL 150-721, REPUBLIC OF KOREA

**Registered Jan. 15, 2013**

**Int. Cl.: 9**

FOR: TELEVISION RECEIVERS, IN CLASS 9 (U.S. CLS. 21, 23, 26, 36 AND 38).

**TRADEMARK**

THE MARK CONSISTS OF STANDARD CHARACTERS WITHOUT CLAIM TO ANY PARTICULAR FONT, STYLE, SIZE, OR COLOR.

**SUPPLEMENTAL REGISTER**

OWNER OF REPUBLIC OF KOREA REG. NO. 5450632, DATED 11-11-2011, EXPIRES 11-11-2021.

SER. NO. 85-349,416, FILED P.R. 6-17-2011; AM. S.R. 4-19-2012.

BARBARA BROWN, EXAMINING ATTORNEY



*David J. Kyffers*

Director of the United States Patent and Trademark Office

# United States of America

United States Patent and Trademark Office

## TRYTOSETTLE.COM

**Reg. No. 4,277,426**

RICHARDS-STOWER, NANCY A. (UNITED STATES INDIVIDUAL)  
40 WHITTIER DRIVE  
SCITUATE, MA 02066

**Registered Jan. 15, 2013**

**Int. Cl.: 45**

FOR: ALTERNATIVE DISPUTE RESOLUTION SERVICES, IN CLASS 45 (U.S. CLS. 100 AND 101).

**SERVICE MARK**

FIRST USE 11-6-2012; IN COMMERCE 11-6-2012.

**SUPPLEMENTAL REGISTER**

THE MARK CONSISTS OF STANDARD CHARACTERS WITHOUT CLAIM TO ANY PARTICULAR FONT, STYLE, SIZE, OR COLOR.

SER. NO. 85-352,257, FILED P.R. 6-21-2011; AM. S.R. 11-7-2012.

AMY KERTGATE, EXAMINING ATTORNEY



*David J. Kybas*

Director of the United States Patent and Trademark Office

# United States of America

United States Patent and Trademark Office

## BEST US TECH

**Reg. No. 4,277,427**

RTM PRODUCTIONS, INC. (TENNESSEE CORPORATION)  
130 SOUTHEAST PARKWAY COURT  
FRANKLIN, TN 37064

**Registered Jan. 15, 2013**

**Int. Cl.: 41**

FOR: WEBSITE CONTAINING INFORMATION ABOUT SCHOOLS THAT PROVIDE VOCATIONAL TRAINING IN THE FIELD OF AUTOMOTIVE, DIESEL, AVIATION, AND GREEN TECHNOLOGIES, COLLISION REPAIR, HVAC INSTALLATION AND REPAIR, AND WELDING, IN CLASS 41 (U.S. CLS. 100, 101 AND 107).

**SERVICE MARK**

**SUPPLEMENTAL REGISTER** FIRST USE 8-31-2011; IN COMMERCE 8-31-2011.

THE MARK CONSISTS OF STANDARD CHARACTERS WITHOUT CLAIM TO ANY PARTICULAR FONT, STYLE, SIZE, OR COLOR.

SER. NO. 85-357,128, FILED P.R. 6-27-2011; AM. S.R. 11-20-2012.

MARILYN IZZI, EXAMINING ATTORNEY



*David J. Kyffers*

Director of the United States Patent and Trademark Office

# United States of America

United States Patent and Trademark Office

## FORUM ON INNOVATION IN HEALTHCARE

**Reg. No. 4,277,428**

MGMA-ACMPE (COLORADO NON-PROFIT CORPORATION)  
104 INVERNESS TERRACE EAST  
ENGLEWOOD, CO 80112

**Registered Jan. 15, 2013**

**Int. Cl.: 41**

FOR: EDUCATIONAL SERVICES, NAMELY, CONDUCTING CONFERENCES IN THE FIELD OF HEALTHCARE DELIVERY SYSTEM AND MEDICAL MANAGEMENT, OPERATIONS AND PAYMENT SYSTEMS AND DISTRIBUTION OF COURSE MATERIAL IN CONNECTION THEREWITH, IN CLASS 41 (U.S. CLS. 100, 101 AND 107).

**SERVICE MARK**

**SUPPLEMENTAL REGISTER** FIRST USE 10-5-2011; IN COMMERCE 10-5-2011.

THE MARK CONSISTS OF STANDARD CHARACTERS WITHOUT CLAIM TO ANY PARTICULAR FONT, STYLE, SIZE, OR COLOR.

NO CLAIM IS MADE TO THE EXCLUSIVE RIGHT TO USE "FORUM", APART FROM THE MARK AS SHOWN.

SER. NO. 85-357,499, FILED P.R. 6-27-2011; AM. S.R. 10-30-2012.

DAVID YONTEF, EXAMINING ATTORNEY



*David J. Kyffers*

Director of the United States Patent and Trademark Office

# United States of America

United States Patent and Trademark Office

## WORLD PEACE RUN

**Reg. No. 4,277,429**

**Registered Jan. 15, 2013**

**Int. Cl.: 36**

**SERVICE MARK**

**SUPPLEMENTAL REGISTER**

WORLD PEACE RUN, INC. (HAWAII CORPORATION)  
73-4552 MAMALAHOA HIGHWAY  
KAILUA KONA, HI 96740

FOR: CHARITABLE FUNDRAISING; CHARITABLE FUNDRAISING SERVICES BY MEANS OF ORGANIZING AND CONDUCTING SPECIAL EVENTS; CHARITABLE FUNDRAISING SERVICES BY MEANS OF RUNNING AND WALKING EVENTS; CHARITABLE FUNDRAISING SERVICES BY MEANS OF LONG DISTANCE RUNNING EVENTS ON MULTIPLE CONTINENTS, IN CLASS 36 (U.S. CLS. 100, 101 AND 102).

FIRST USE 1-1-2012; IN COMMERCE 1-1-2012.

THE MARK CONSISTS OF STANDARD CHARACTERS WITHOUT CLAIM TO ANY PARTICULAR FONT, STYLE, SIZE, OR COLOR.

NO CLAIM IS MADE TO THE EXCLUSIVE RIGHT TO USE "RUN", APART FROM THE MARK AS SHOWN.

SER. NO. 85-362,685, FILED P.R. 7-4-2011; AM. S.R. 11-11-2012.

MARK T. MULLEN, EXAMINING ATTORNEY



*David J. Kyfos*

Director of the United States Patent and Trademark Office



# United States of America

United States Patent and Trademark Office

## PVPI UREA BOLUS

**Reg. No. 4,277,430**

NICH MARKETERS, INC. (FLORIDA CORPORATION)  
1333 COLLEGE PARKWAY, #137  
GULF BREEZE, FL 32563

**Registered Jan. 15, 2013**

**Int. Cl.: 5**

FOR: ANIMAL WOUND CLEANER, IN CLASS 5 (U.S. CLS. 6, 18, 44, 46, 51 AND 52).

**TRADEMARK**

FIRST USE 6-12-2011; IN COMMERCE 6-12-2011.

**SUPPLEMENTAL REGISTER**

THE MARK CONSISTS OF STANDARD CHARACTERS WITHOUT CLAIM TO ANY PARTICULAR FONT, STYLE, SIZE, OR COLOR.

SER. NO. 85-365,898, FILED P.R. 7-7-2011; AM. S.R. 11-20-2012.

DAVID MURRAY, EXAMINING ATTORNEY



*David J. Kyfos*

Director of the United States Patent and Trademark Office

# United States of America

United States Patent and Trademark Office

## SHACKLETON'S WHISKY

**Reg. No. 4,277,431**

**Registered Jan. 15, 2013**

**Int. Cl.: 33**

**TRADEMARK**

**SUPPLEMENTAL REGISTER**

WHYTE AND MACKAY LIMITED (UNITED KINGDOM LIMITED COMPANY (LTD.))  
DALMORE HOUSE, 310 ST VINCENT STREET  
GLASGOW, UNITED KINGDOM G25RG

FOR: WHISKY, AND WHISKY BASED LIQUEURS, IN CLASS 33 (U.S. CLS. 47 AND 49).

FIRST USE 11-0-2011; IN COMMERCE 11-0-2011.

THE MARK CONSISTS OF STANDARD CHARACTERS WITHOUT CLAIM TO ANY PARTICULAR FONT, STYLE, SIZE, OR COLOR.

NO CLAIM IS MADE TO THE EXCLUSIVE RIGHT TO USE "WHISKY", APART FROM THE MARK AS SHOWN.

SER. NO. 85-366,669, FILED P.R. 7-8-2011; AM. S.R. 11-14-2012.

BRENDAN MCCAULEY, EXAMINING ATTORNEY



*David J. Kybas*

Director of the United States Patent and Trademark Office

# United States of America

United States Patent and Trademark Office

## Import Direct

**Reg. No. 4,277,432**

**Registered Jan. 15, 2013**

**Int. Cls.: 7 and 9**

**TRADEMARK**

**SUPPLEMENTAL REGISTER**

O'REILLY AUTOMOTIVE STORES, INC. (MISSOURI CORPORATION), DBA O'REILLY  
AUTO PARTS,  
233 SOUTH PATTERSON  
SPRINGFIELD, MO 65802

FOR: IGNITION PARTS FOR LAND VEHICLES, NAMELY, COILS, DISTRIBUTOR CAPS,  
REGULATORS AND SOLENOIDS IN THE NATURE OF ENGINE VALVES AND AUTOMOTIVE  
STARTER MOTORS; AND WATER PUMPS FOR LAND VEHICLE, IN CLASS 7 (U.S.  
CLS. 13, 19, 21, 23, 31, 34 AND 35).

FIRST USE 10-1-2011; IN COMMERCE 10-1-2011.

FOR: ELECTRONIC CONTROL MODULES FOR LAND VEHICLE IGNITION; ELECTRO-  
MAGNETIC SOLENOIDS IN THE NATURE OF ENGINE VALVES AND AUTOMOTIVE  
STARTER MOTORS, IN CLASS 9 (U.S. CLS. 21, 23, 26, 36 AND 38).

FIRST USE 10-1-2011; IN COMMERCE 10-1-2011.

THE MARK CONSISTS OF STANDARD CHARACTERS WITHOUT CLAIM TO ANY PAR-  
TICULAR FONT, STYLE, SIZE, OR COLOR.

OWNER OF U.S. REG. NO. 3,846,720.

SER. NO. 85-369,921, FILED P.R. 7-13-2011; AM. S.R. 11-19-2012.

B. PARADEWELAI, EXAMINING ATTORNEY



*David J. Kyffers*

Director of the United States Patent and Trademark Office

# United States of America

United States Patent and Trademark Office

## Import Direct

**Reg. No. 4,277,433**

**Registered Jan. 15, 2013**

**Int. Cl.: 7**

**TRADEMARK**

**SUPPLEMENTAL REGISTER**

O'REILLY AUTOMOTIVE STORES, INC. (MISSOURI CORPORATION), DBA O'REILLY  
AUTO PARTS,  
233 SOUTH PATTERSON  
SPRINGFIELD, MO 65802

FOR: ELECTRONIC IGNITIONS FOR VEHICLES; IGNITION WIRE SETS COMPRISED OF CONDUCTOR CORES, CONDUCTOR INSULATION JACKETS, DISTRIBUTOR BOOTS AND CONNECTORS, AND SPARK PLUG BOOTS AND CONNECTORS; AND AUTOMOTIVE IGNITION COMPONENT PRODUCTS, NAMELY, POINTS AND CONDENSERS, DISTRIBUTOR CAPS, ROTORS, IGNITION COILS, MODULES AND CONTROL ASSEMBLIES, AND BRUSH SETS, IN CLASS 7 (U.S. CLS. 13, 19, 21, 23, 31, 34 AND 35).

FIRST USE 10-15-2012; IN COMMERCE 10-15-2012.

THE MARK CONSISTS OF STANDARD CHARACTERS WITHOUT CLAIM TO ANY PARTICULAR FONT, STYLE, SIZE, OR COLOR.

OWNER OF U.S. REG. NO. 3,846,720.

SER. NO. 85-369,986, FILED P.R. 7-13-2011; AM. S.R. 11-19-2012.

B. PARADEWELAI, EXAMINING ATTORNEY



*David J. Kyffers*

Director of the United States Patent and Trademark Office

# United States of America

United States Patent and Trademark Office

## PREMIER NEW CAR REPLACEMENT

**Reg. No. 4,277,434**

THE TRAVELERS INDEMNITY COMPANY (CONNECTICUT CORPORATION)  
ONE TOWER SQUARE  
HARTFORD, CT 06183

**Registered Jan. 15, 2013**

**Int. Cl.: 36**

FOR: INSURANCE SERVICES, NAMELY, PROPERTY AND CASUALTY INSURANCE UNDERWRITING SERVICES, IN CLASS 36 (U.S. CLS. 100, 101 AND 102).

**SERVICE MARK**

FIRST USE 11-18-2012; IN COMMERCE 11-18-2012.

**SUPPLEMENTAL REGISTER**

THE MARK CONSISTS OF STANDARD CHARACTERS WITHOUT CLAIM TO ANY PARTICULAR FONT, STYLE, SIZE, OR COLOR.

NO CLAIM IS MADE TO THE EXCLUSIVE RIGHT TO USE "NEW CAR REPLACEMENT", APART FROM THE MARK AS SHOWN.

SER. NO. 85-371,315, FILED P.R. 7-14-2011; AM. S.R. 5-3-2012.

ANDREW LEASER, EXAMINING ATTORNEY



*David J. Kyffers*

Director of the United States Patent and Trademark Office

# United States of America

United States Patent and Trademark Office

## Accredited Snow Contractors Association

**Reg. No. 4,277,435**

**Registered Jan. 15, 2013**

**Int. Cls.: 35 and 41**

**SERVICE MARK**

**SUPPLEMENTAL REGISTER**

GIE MEDIA HOLDINGS, LLC (OHIO LIMITED LIABILITY COMPANY)  
SUITE 201  
4020 KINROSS LAKES PARKWAY  
RICHFIELD, OH 44286

FOR: ASSOCIATION SERVICES FOR THE PURPOSE OF ADVANCING THE PROFESSIONAL SNOW AND ICE MANAGEMENT INDUSTRY AND TO PROMOTE ITS ROLE IN PERFORMING HIGH-RISK SERVICES TO SOCIETY; CONDUCTING BUSINESS MEETINGS DESIGNED TO PROMOTE THE EXCHANGE OF IDEAS AMONG MEMBERS AND TO FACILITATE THE CONDUCT OF THEIR BUSINESS; BUSINESS INFORMATION SERVICES IN THE NATURE OF COLLECTING AND DISSEMINATING INFORMATION PERTAINING TO THE SNOW AND ICE MANAGEMENT INDUSTRY, INCLUDING STATISTICAL DATA AND OTHER STATISTICAL RESEARCH; ASSOCIATION SERVICES, NAMELY, PROMOTING THE INTEREST OF THE SNOW AND ICE MANAGEMENT INDUSTRY TO LOCAL, STATE/PROVINCIAL, AND FEDERAL GOVERNMENTAL BODIES AND TO INSURANCE COMPANIES AND ALLIED ASSOCIATIONS, IN CLASS 35 (U.S. CLS. 100, 101 AND 102).

FIRST USE 9-0-2011; IN COMMERCE 9-0-2011.

FOR: PROVIDING EDUCATIONAL PROGRAMS, NAMELY, SEMINARS AND CONFERENCES IN THE FIELDS OF SNOW AND ICE MANAGEMENT, FINANCE, BUSINESS MANAGEMENT AND MARKETING AND PROVIDING PUBLICATIONS IN CONNECTION THEREWITH, IN CLASS 41 (U.S. CLS. 100, 101 AND 107).

FIRST USE 9-0-2011; IN COMMERCE 9-0-2011.

THE MARK CONSISTS OF STANDARD CHARACTERS WITHOUT CLAIM TO ANY PARTICULAR FONT, STYLE, SIZE, OR COLOR.

NO CLAIM IS MADE TO THE EXCLUSIVE RIGHT TO USE "ASSOCIATION", APART FROM THE MARK AS SHOWN.

SER. NO. 85-373,944, FILED P.R. 7-18-2011; AM. S.R. 11-26-2012.

JOHN DALIER, EXAMINING ATTORNEY



*David J. Kyffers*

Director of the United States Patent and Trademark Office

# United States of America

United States Patent and Trademark Office

## HERRINGBONE CROSSHATCH

**Reg. No. 4,277,436**

LUVATA FRANKLIN, INC. (DELAWARE CORPORATION)  
4720 BOWLING GREEN ROAD  
FRANKLIN, KY 42134

**Registered Jan. 15, 2013**

**Int. Cl.: 6**

FOR: METAL TUBES, IN CLASS 6 (U.S. CLS. 2, 12, 13, 14, 23, 25 AND 50).

**TRADEMARK**

FIRST USE 1-0-2010; IN COMMERCE 1-0-2010.

**SUPPLEMENTAL REGISTER**

THE MARK CONSISTS OF STANDARD CHARACTERS WITHOUT CLAIM TO ANY PARTICULAR FONT, STYLE, SIZE, OR COLOR.

SER. NO. 85-378,249, FILED P.R. 7-22-2011; AM. S.R. 11-21-2012.

SAIMA MAKHDOOM, EXAMINING ATTORNEY



*David J. Kyffers*

Director of the United States Patent and Trademark Office

# United States of America

United States Patent and Trademark Office

## BLUEBERRY SWIRL BITES

**Reg. No. 4,277,437**

NASH FINCH COMPANY (DELAWARE CORPORATION)  
7600 FRANCE AVENUE SOUTH  
EDINA, MN 55435

**Registered Jan. 15, 2013**

**Int. Cl.: 30**

FOR: BREAKFAST CEREAL, IN CLASS 30 (U.S. CL. 46).

**TRADEMARK**

FIRST USE 1-0-2010; IN COMMERCE 1-0-2010.

**SUPPLEMENTAL REGISTER**

THE MARK CONSISTS OF STANDARD CHARACTERS WITHOUT CLAIM TO ANY PARTICULAR FONT, STYLE, SIZE, OR COLOR.

OWNER OF U.S. REG. NOS. 3,662,147, 3,745,528, AND 3,834,139.

SER. NO. 85-383,559, FILED P.R. 7-28-2011; AM. S.R. 5-22-2012.

KATHERINE CHANG, EXAMINING ATTORNEY



*David J. Kyffers*

Director of the United States Patent and Trademark Office



United States of America  
United States Patent and Trademark Office

PURAFI

**Reg. No. 4,277,438**

SORIN GROUP ITALIA S.R.L. (ITALY LIMITED LIABILITY COMPANY)  
VIA STATALE 12 NORD, 86  
41037 MIRANDOLA MO, ITALY

**Registered Jan. 15, 2013**

**Int. Cl.: 10**

FOR: MEDICAL DEVICES, NAMELY, ARTERIAL FILTERS FOR OXYGENATORS, IN CLASS 10 (U.S. CLS. 26, 39 AND 44).

**TRADEMARK**

FIRST USE 12-2-2011; IN COMMERCE 12-2-2011.

**SUPPLEMENTAL REGISTER**

THE MARK CONSISTS OF "PURAFI" IN A STYLIZED FONT, WITH "AF" APPEARING LARGER IN SIZE THAN THE OTHER LETTERS.

SER. NO. 85-391,064, FILED P.R. 8-5-2011; AM. S.R. 11-13-2012.

STEVEN PEREZ, EXAMINING ATTORNEY



*David J. Kybas*

Director of the United States Patent and Trademark Office

# United States of America

United States Patent and Trademark Office

## ANGIOGENESIS

**Reg. No. 4,277,439**

GENESIS MEDICAL PRODUCTS (LOUISIANA CORPORATION)  
8032 SUMMA AV  
BATON ROUGE, LA 70809

**Registered Jan. 15, 2013**

**Int. Cl.: 32**

FOR: DIETARY SUPPLEMENTAL DRINKS IN THE NATURE OF VITAMIN AND MINERAL BEVERAGES, IN CLASS 32 (U.S. CLS. 45, 46 AND 48).

**TRADEMARK**

FIRST USE 3-28-2012; IN COMMERCE 3-28-2012.

**SUPPLEMENTAL REGISTER**

THE MARK CONSISTS OF STANDARD CHARACTERS WITHOUT CLAIM TO ANY PARTICULAR FONT, STYLE, SIZE, OR COLOR.

SER. NO. 85-391,185, FILED P.R. 8-5-2011; AM. S.R. 11-21-2012.

DORITT L. CARROLL, EXAMINING ATTORNEY



*David J. Kyros*

Director of the United States Patent and Trademark Office

# United States of America

United States Patent and Trademark Office



**Reg. No. 4,277,440**

MARINE SALES OF PICKWICK, LLC (TENNESSEE LIMITED LIABILITY COMPANY)  
7370 HIGHWAY 57  
COUNCE, TN 38326

**Registered Jan. 15, 2013**

**Int. Cl.: 35**

FOR: BOAT DEALERSHIPS, IN CLASS 35 (U.S. CLS. 100, 101 AND 102).

**SERVICE MARK**

FIRST USE 8-6-2007; IN COMMERCE 8-6-2007.

**SUPPLEMENTAL REGISTER**

NO CLAIM IS MADE TO THE EXCLUSIVE RIGHT TO USE "MARINE SALES", APART FROM THE MARK AS SHOWN.

THE MARK CONSISTS OF THE TERM "SALES" SUPERIMPOSED IN A RECTANGLE TO THE RIGHT OF THE TERM "MARINE", ALL OF WHICH IS SUPERIMPOSED ABOVE THE STYLIZED PHRASE "OF PICKWICK".

SER. NO. 85-391,472, FILED P.R. 8-6-2011; AM. S.R. 4-25-2012.

COLLEEN KEARNEY, EXAMINING ATTORNEY



*David J. Kyros*

Director of the United States Patent and Trademark Office

# United States of America

United States Patent and Trademark Office

## ONLINE ADVERTISING SURVEY & INSIGHTS SERVICE

**Reg. No. 4,277,441**

IN-STORE MARKETING INSTITUTE, INC. (ILLINOIS CORPORATION)  
7400 SKOKIE BLVD.  
SKOKIE, IL 60077

**Registered Jan. 15, 2013**

**Int. Cl.: 35**

FOR: PROVIDING AN ON-LINE COMPUTER DATABASE FEATURING TRADE INFORMATION IN THE FIELD OF DIGITAL RETAIL POINT OF PURCHASE ADVERTISING AND PRODUCT PROMOTION , IN CLASS 35 (U.S. CLS. 100, 101 AND 102).

**SERVICE MARK**

FIRST USE 4-17-2012; IN COMMERCE 4-17-2012.

**SUPPLEMENTAL REGISTER**

THE MARK CONSISTS OF STANDARD CHARACTERS WITHOUT CLAIM TO ANY PARTICULAR FONT, STYLE, SIZE, OR COLOR.

NO CLAIM IS MADE TO THE EXCLUSIVE RIGHT TO USE "SERVICE", APART FROM THE MARK AS SHOWN.

SER. NO. 85-393,635, FILED P.R. 8-9-2011; AM. S.R. 9-7-2012.

ROBERT STRUCK, EXAMINING ATTORNEY



*David J. Kyffers*

Director of the United States Patent and Trademark Office

# United States of America

United States Patent and Trademark Office

# EGG WIPES

**Reg. No. 4,277,442**

ORGANIC SALES & MARKETING, INC. (DELAWARE CORPORATION)  
114 BROADWAY

**Registered Jan. 15, 2013**

RAYNHAM, MA 02767

**Int. Cl.: 3**

FOR: BIODEGRADABLE DISPOSABLE WIPES IMPREGNATED WITH A NATURAL CLEANING SOLUTION FOR CLEANING EGGS FROM THE COOP, IN CLASS 3 (U.S. CLS. 1, 4, 6, 50, 51 AND 52).

**TRADEMARK**

FIRST USE 10-20-2010; IN COMMERCE 11-22-2010.

**SUPPLEMENTAL REGISTER**

THE MARK CONSISTS OF STANDARD CHARACTERS WITHOUT CLAIM TO ANY PARTICULAR FONT, STYLE, SIZE, OR COLOR.

SER. NO. 85-396,387, FILED 8-12-2011.

NAKIA HENRY, EXAMINING ATTORNEY



*David J. Kyffers*

Director of the United States Patent and Trademark Office

# United States of America

United States Patent and Trademark Office

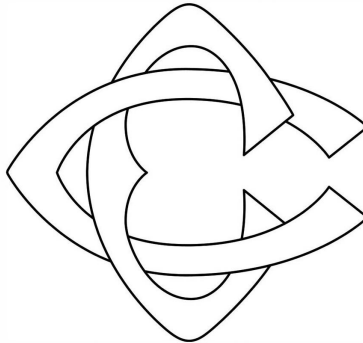

**Reg. No. 4,277,443**

**Registered Jan. 15, 2013**

**Int. Cl.: 25**

**TRADEMARK**

**SUPPLEMENTAL REGISTER**

COLLEGE OF CHARLESTON (SOUTH CAROLINA STATE UNIVERSITY)  
66 GEORGE STREET  
CHARLESTON, SC 29424

FOR: SCARVES; TIES, IN CLASS 25 (U.S. CLS. 22 AND 39).

FIRST USE 12-12-2011; IN COMMERCE 12-12-2011.

THE MARK CONSISTS OF TWO INTERLOCKING STYLIZED CAPITAL "C" LETTERS.

SER. NO. 85-424,828, FILED P.R. 9-16-2011; AM. S.R. 11-26-2012.

JAMES LOVELACE, EXAMINING ATTORNEY



*David J. Kyffers*

Director of the United States Patent and Trademark Office

# United States of America

United States Patent and Trademark Office

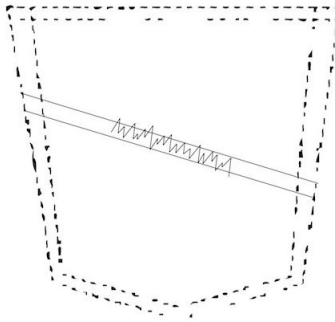

**Reg. No. 4,277,444**

**Registered Jan. 15, 2013**

**Int. Cl.: 25**

**TRADEMARK**

**SUPPLEMENTAL REGISTER**

BRIDGE & BORO APPAREL LLC (NEW YORK LIMITED LIABILITY COMPANY)  
54 CHASE ROAD  
MANHASSET, NY 11030

FOR: JEANS, IN CLASS 25 (U.S. CLS. 22 AND 39).

FIRST USE 5-27-2011; IN COMMERCE 6-14-2011.

THE MARK CONSISTS OF A GEOMETRIC POCKET STITCHING DESIGN CONSISTING OF TWO PARALLEL LINES OF STITCHING RUNNING DIAGONALLY ACROSS THE POCKET AND SLOPING DOWNWARD FROM LEFT TO RIGHT; BETWEEN THE TWO LINES OF STITCHING APPEARS STITCHING IN A RANDOM UPWARD AND DOWNWARD ZIGZAG PATTERN SLOPING DOWNWARD FROM LEFT TO RIGHT. THE DOTTED LINES SURROUNDING THE STITCHING DESIGN REPRESENT THE SHAPE OF THE POCKET AND ARE NOT CLAIMED AS A FEATURE OF THE MARK.

SER. NO. 85-425,356, FILED P.R. 9-17-2011; AM. S.R. 11-16-2012.

JIM RINGLE, EXAMINING ATTORNEY



*David J. Kyffers*

Director of the United States Patent and Trademark Office

# United States of America

United States Patent and Trademark Office

## ENDURANCE COMPANY

**Reg. No. 4,277,445**

ENDURANCE COMPANY, LLC (MISSOURI LIMITED LIABILITY COMPANY)  
203 TRACY DRIVE

**Registered Jan. 15, 2013**

COLUMBIA, MO 65203

**Int. Cl.: 41**

FOR: ATHLETIC TRAINING SERVICES; PERSONAL FITNESS TRAINING SERVICES AND CONSULTANCY; PERSONAL TRAINING SERVICES, NAMELY, STRENGTH AND CONDITIONING TRAINING; SPORTS TRAINING SERVICES, IN CLASS 41 (U.S. CLS. 100, 101 AND 107).

**SERVICE MARK**

**SUPPLEMENTAL REGISTER** FIRST USE 12-16-2010; IN COMMERCE 12-16-2010.

THE MARK CONSISTS OF STANDARD CHARACTERS WITHOUT CLAIM TO ANY PARTICULAR FONT, STYLE, SIZE, OR COLOR.

SER. NO. 85-426,198, FILED P.R. 9-19-2011; AM. S.R. 10-9-2012.

NAAKWAMA ANKRAH, EXAMINING ATTORNEY



*David J. Kyffers*

Director of the United States Patent and Trademark Office



# United States of America

United States Patent and Trademark Office

**SCATTER  
POKER**

**Reg. No. 4,277,446**

BLUE CUBE MICROWORKS LLC (NEVADA LIMITED LIABILITY COMPANY)  
7390 W. SAHARA AVE., STE 280  
LAS VEGAS, NV 89117

**Registered Jan. 15, 2013**

**Int. Cl.: 9**

FOR: COMPUTER GAME SOFTWARE FOR GAMING MACHINES INCLUDING SLOT MACHINES OR VIDEO LOTTERY TERMINALS, IN CLASS 9 (U.S. CLS. 21, 23, 26, 36 AND 38).

**TRADEMARK**

FIRST USE 1-4-2012; IN COMMERCE 5-9-2012.

**SUPPLEMENTAL REGISTER**

NO CLAIM IS MADE TO THE EXCLUSIVE RIGHT TO USE "POKER", APART FROM THE MARK AS SHOWN.

THE COLOR(S) RED, GOLD, AND BLUE IS/ARE CLAIMED AS A FEATURE OF THE MARK.

THE MARK CONSISTS OF A STYLIZED IMAGE OF THE WORDS "SCATTER POKER". THE WORD "SCATTER" IS IN GOLD LETTERS WITH A RED OUTLINE. THE WORD "POKER" IS IN GOLD LETTERS WITH A BLUE OUTLINE.

SER. NO. 85-429,680, FILED 9-22-2011.

AHSEN KHAN, EXAMINING ATTORNEY



*David J. Kybas*

Director of the United States Patent and Trademark Office

# United States of America

United States Patent and Trademark Office

## SEED AND FERTILIZER IN ONE

**Reg. No. 4,277,447**

INFINITY FERTILIZERS, INC. (IOWA CORPORATION)  
P.O. BOX 1160  
MILAN, IL 61264

**Registered Jan. 15, 2013**

**Int. Cls.: 1 and 31**

FOR: FERTILIZERS, IN CLASS 1 (U.S. CLS. 1, 5, 6, 10, 26 AND 46).

**TRADEMARK**

FIRST USE 2-1-2012; IN COMMERCE 2-1-2012.

**SUPPLEMENTAL REGISTER**

FOR: PLANT SEEDS; AGRICULTURAL SEEDS FOR PLANTING , IN CLASS 31 (U.S. CLS. 1 AND 46).

FIRST USE 2-1-2012; IN COMMERCE 2-1-2012.

THE MARK CONSISTS OF STANDARD CHARACTERS WITHOUT CLAIM TO ANY PARTICULAR FONT, STYLE, SIZE, OR COLOR.

NO CLAIM IS MADE TO THE EXCLUSIVE RIGHT TO USE "SEED AND FERTILIZER", APART FROM THE MARK AS SHOWN.

SER. NO. 85-436,014, FILED P.R. 9-30-2011; AM. S.R. 11-21-2012.

JIM RINGLE, EXAMINING ATTORNEY



*David J. Kybas*

Director of the United States Patent and Trademark Office

# United States of America

United States Patent and Trademark Office

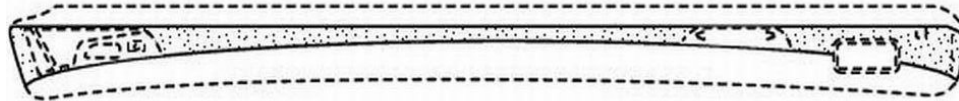

**Reg. No. 4,277,448**

SONY MOBILE COMMUNICATIONS AB (SWEDEN CORPORATION)  
NYA VATTENTORNET  
LUND, SWEDEN SE-22188

**Registered Jan. 15, 2013**

**Int. Cl.: 9**

FOR: HANDHELD COMPUTING DEVICES WITH COMMUNICATION CAPABILITY, NAMELY, APPARATUS FOR RECORDING, TRANSMISSION, PROCESSING, AND REPRODUCTION OF SOUND, IMAGES, OR DATA; MOBILE PHONES, IN CLASS 9 (U.S. CLS. 21, 23, 26, 36 AND 38).

**TRADEMARK**

**SUPPLEMENTAL REGISTER** FIRST USE 7-5-2011; IN COMMERCE 7-5-2011.

THE MARK CONSISTS OF A THREE-DIMENSIONAL DESIGN OF A PORTION OF THE GOODS, WHICH IS GENERALLY A BAND RUNNING ALONG THE SIDE OF THE GOODS AND WHICH BAND HAS ONE STRAIGHT EDGE AND ONE CONCAVE EDGE LENGTHWISE, CONSISTING OF THE AREA REPRESENTED BY THE SOLID LINES AND THE AREA CONTAINED THEREIN, WHICH IS REPRESENTED BY THE ARTIST'S STIPPLING. THE ARTIST'S STIPPLING IS NOT PART OF THE MARK. THE BROKEN LINES ARE FOR CONTEXT ONLY AND SHOW WHERE THE CLAIMED TRADE DRESS APPEARS ON THE GOODS; THE BROKEN LINES ARE NOT CLAIMED AS A FEATURE OF THE MARK. COLOR IS NOT CLAIMED AS A FEATURE OF THE MARK.

SER. NO. 85-442,260, FILED P.R. 10-7-2011; AM. S.R. 6-29-2012.

LEIGH LOWRY, EXAMINING ATTORNEY



*David J. Kyffers*

Director of the United States Patent and Trademark Office

# United States of America

United States Patent and Trademark Office

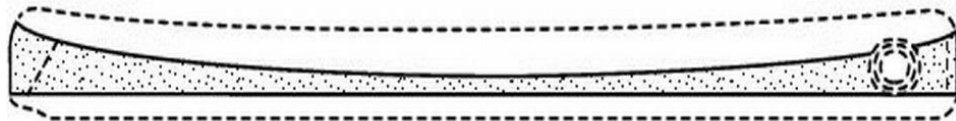

**Reg. No. 4,277,449**

SONY MOBILE COMMUNICATIONS AB (SWEDEN CORPORATION)  
NYA VATTENTORNET

**Registered Jan. 15, 2013**

LUND, SWEDEN SE-22188

**Int. Cl.: 9**

FOR: HANDHELD COMPUTING DEVICES WITH COMMUNICATION CAPABILITY, NAMELY, APPARATUS FOR RECORDING, TRANSMISSION, PROCESSING, AND REPRODUCTION OF SOUND, IMAGES, OR DATA; MOBILE PHONES, IN CLASS 9 (U.S. CLS. 21, 23, 26, 36 AND 38).

**TRADEMARK**

**SUPPLEMENTAL REGISTER** FIRST USE 7-5-2011; IN COMMERCE 7-5-2011.

THE MARK CONSISTS OF A THREE-DIMENSIONAL DESIGN OF A PORTION OF THE GOODS, WHICH IS GENERALLY A BAND RUNNING ALONG THE SIDE OF THE GOODS AND WHICH BAND HAS ONE STRAIGHT EDGE AND ONE CONCAVE EDGE LENGTHWISE, CONSISTING OF THE AREA REPRESENTED BY THE SOLID LINES AND THE AREA CONTAINED THEREIN, WHICH IS REPRESENTED BY THE ARTIST'S STIPPLING. THE ARTIST'S STIPPLING IS NOT PART OF THE MARK. THE BROKEN LINES ARE FOR CONTEXT ONLY AND SHOW WHERE THE CLAIMED TRADE DRESS APPEARS ON THE GOODS; THE BROKEN LINES ARE NOT CLAIMED AS A FEATURE OF THE MARK. COLOR IS NOT CLAIMED AS A FEATURE OF THE MARK.

SER. NO. 85-442,276, FILED P.R. 10-7-2011; AM. S.R. 6-29-2012.

LEIGH LOWRY, EXAMINING ATTORNEY



*David J. Kyros*

Director of the United States Patent and Trademark Office

# United States of America

United States Patent and Trademark Office

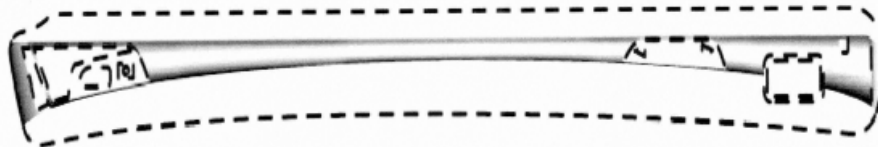

**Reg. No. 4,277,450**

SONY MOBILE COMMUNICATIONS AB (SWEDEN CORPORATION)  
NYA VATTENTORNET

**Registered Jan. 15, 2013**

LUND, SWEDEN SE-22188

**Int. Cl.: 9**

FOR: HANDHELD COMPUTING DEVICES WITH COMMUNICATION CAPABILITY, NAMELY, APPARATUS FOR RECORDING, TRANSMISSION, PROCESSING, AND REPRODUCTION OF SOUND, IMAGES, OR DATA; MOBILE PHONES, IN CLASS 9 (U.S. CLS. 21, 23, 26, 36 AND 38).

**TRADEMARK**

**SUPPLEMENTAL REGISTER** FIRST USE 7-5-2011; IN COMMERCE 7-5-2011.

THE MARK CONSISTS OF A THREE-DIMENSIONAL DESIGN OF A PORTION OF THE GOODS APPEARING IN THE COLOR SILVER, WHICH IS GENERALLY A BAND RUNNING ALONG THE SIDE OF THE GOODS AND WHICH BAND HAS ONE STRAIGHT EDGE AND ONE CONCAVE EDGE LENGTHWISE. THE BROKEN LINES ARE FOR CONTEXT ONLY AND SHOW WHERE THE CLAIMED TRADE DRESS APPEARS ON THE GOODS; THE BROKEN LINES ARE NOT CLAIMED AS A FEATURE OF THE MARK.

THE COLOR(S) SILVER IS/ARE CLAIMED AS A FEATURE OF THE MARK.

SER. NO. 85-442,300, FILED P.R. 10-7-2011; AM. S.R. 6-29-2012.

LEIGH LOWRY, EXAMINING ATTORNEY



*David J. Kypos*

Director of the United States Patent and Trademark Office

# United States of America

United States Patent and Trademark Office

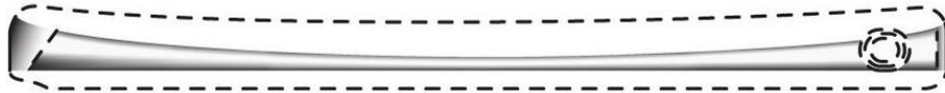

**Reg. No. 4,277,451**

SONY MOBILE COMMUNICATIONS AB (SWEDEN CORPORATION)  
NYA VATTENTORNET  
LUND, SWEDEN SE-22188

**Registered Jan. 15, 2013**

**Int. Cl.: 9**

FOR: HANDHELD COMPUTING DEVICES WITH COMMUNICATION CAPABILITY, NAMELY, APPARATUS FOR RECORDING, TRANSMISSION, PROCESSING, AND REPRODUCTION OF SOUND, IMAGES, OR DATA; MOBILE PHONES, IN CLASS 9 (U.S. CLS. 21, 23, 26, 36 AND 38).

**TRADEMARK**

**SUPPLEMENTAL REGISTER** FIRST USE 7-5-2011; IN COMMERCE 7-5-2011.

THE MARK CONSISTS OF A THREE-DIMENSIONAL DESIGN OF A PORTION OF THE GOODS APPEARING IN THE COLOR SILVER, WHICH IS GENERALLY A BAND RUNNING ALONG THE SIDE OF THE GOODS AND WHICH BAND HAS ONE STRAIGHT EDGE AND ONE CONCAVE EDGE LENGTHWISE. THE BROKEN LINES ARE FOR CONTEXT ONLY AND SHOW WHERE THE CLAIMED TRADE DRESS APPEARS ON THE GOODS; THE BROKEN LINES ARE NOT CLAIMED AS A FEATURE OF THE MARK.

THE COLOR(S) SILVER IS/ARE CLAIMED AS A FEATURE OF THE MARK.

SER. NO. 85-442,317, FILED P.R. 10-7-2011; AM. S.R. 6-29-2012.

LEIGH LOWRY, EXAMINING ATTORNEY



*David J. Kybas*

Director of the United States Patent and Trademark Office

# United States of America

United States Patent and Trademark Office

## MY JOB CHART

**Reg. No. 4,277,452**

MY JOB CHART, INC. (ARIZONA CORPORATION)  
22700 S 194TH PL  
QUEEN CREEK, AZ 85142

**Registered Jan. 15, 2013**

**Int. Cl.: 41**

FOR: INTERACTIVE ONLINE EDUCATIONAL WEBSITE FOR CHILDREN AND FAMILIES FEATURING A CUSTOMIZED, USER-GENERATED REWARDS SYSTEM ENABLING USERS TO INPUT INFORMATION ABOUT TASKS TO BE ACCOMPLISHED AND TO MONITOR AND RECORD ACCOMPLISHMENT OF TASKS AS WELL AS REWARD POINTS EARNED, SAVED, DONATED OR USED TO PURCHASE GOODS AND SERVICES OF OTHERS, IN CLASS 41 (U.S. CLS. 100, 101 AND 107).

**SERVICE MARK**

**SUPPLEMENTAL REGISTER**

FIRST USE 2-0-2009; IN COMMERCE 2-0-2009.

THE MARK CONSISTS OF STANDARD CHARACTERS WITHOUT CLAIM TO ANY PARTICULAR FONT, STYLE, SIZE, OR COLOR.

NO CLAIM IS MADE TO THE EXCLUSIVE RIGHT TO USE "JOB CHART", APART FROM THE MARK AS SHOWN.

SER. NO. 85-444,622, FILED P.R. 10-11-2011; AM. S.R. 11-14-2012.

SUSAN STIGLITZ, EXAMINING ATTORNEY



*David J. Kyffers*

Director of the United States Patent and Trademark Office

# United States of America

United States Patent and Trademark Office

## THE CHEMICAL EOR ALLIANCE

**Reg. No. 4,277,453**

RHODIA OPERATIONS (FRANCE CORPORATION)  
40 RUE DE LA HAIE-COQ  
93306 AUBERVILLIERS, FRANCE AND

**Registered Jan. 15, 2013**

**Int. Cl.: 42**

IFP ENERGIES NOUVELLES (FRANCE CORPORATION)  
1 ET 4, AVENUE DE BOIS PRÉAU  
92852 RUEIL-MALMAISON, FRANCE AND

**SERVICE MARK**

BEICIP FRANLAB (FRANCE CORPORATION)  
232 AVENUE NAPOLEON BONAPARTE  
92502 RUEIL-MALMAISON, FRANCE

**SUPPLEMENTAL REGISTER**

FOR: EVALUATIONS, ASSESSMENTS AND RESEARCH IN THE FIELDS OF SCIENCE AND TECHNOLOGY PROVIDED BY ENGINEERS; DESIGN AND DEVELOPMENT OF COMPUTERS AND SOFTWARE; RESEARCH AND DEVELOPMENT OF NEW PRODUCTS FOR THIRD PARTIES; TECHNICAL PROJECT RESEARCH, DESIGN, DEVELOPMENT, INSTALLATION, MAINTENANCE, UPDATING AND RENTAL OF SOFTWARE; COMPUTER PROGRAMMING; COMPUTER CONSULTING, NAMELY, COMPUTER HARDWARE AND SOFTWARE CONSULTING; DATA CONVERSION OF COMPUTER PROGRAMS AND DATA, NOT PHYSICAL CONVERSION; CONVERSION OF DOCUMENTS FROM A PHYSICAL TO AN ELECTRONIC MEDIUM, IN CLASS 42 (U.S. CLS. 100 AND 101).

THE MARK CONSISTS OF STANDARD CHARACTERS WITHOUT CLAIM TO ANY PARTICULAR FONT, STYLE, SIZE, OR COLOR.

PRIORITY CLAIMED UNDER SEC. 44(D) ON FRANCE APPLICATION NO. 11/3863555, FILED 10-3-2011, REG. NO. 11/3863555, DATED 10-3-2011, EXPIRES 10-3-2021.

NO CLAIM IS MADE TO THE EXCLUSIVE RIGHT TO USE "CHEMICAL EOR", APART FROM THE MARK AS SHOWN.

SER. NO. 85-445,052, FILED P.R. 10-12-2011; AM. S.R. 12-10-2012.

HEATHER BIDDULPH, EXAMINING ATTORNEY



*David J. Kyros*

Director of the United States Patent and Trademark Office



# United States of America

United States Patent and Trademark Office

## AUTOECORATING

**Reg. No. 4,277,454**

**Registered Jan. 15, 2013**

**Int. Cl.: 35**

AUTOMOTIVE ENVIRONMENTAL STRATEGIES, LLC (MICHIGAN LIMITED LIABILITY COMPANY)

C/O SUSAN M. KORNFIELD  
201 S. DIVISION, SUITE 400  
ANN ARBOR, MI 48104

**SERVICE MARK**

**SUPPLEMENTAL REGISTER**

FOR: ADVICE AND INFORMATION FOR CONSUMERS CONCERNING THE ENVIRONMENTAL IMPACT, PRICES, SPECIFICATIONS, AND OPTIONS OF MOTORIZED VEHICLES MANUFACTURED BY OTHERS; PROVIDING CONSUMER PRODUCT INFORMATION, NAMELY, A WEB SITE FEATURING ENVIRONMENTAL IMPACT RATINGS OF THE VEHICLES OF OTHERS, IN CLASS 35 (U.S. CLS. 100, 101 AND 102).

FIRST USE 10-27-2010; IN COMMERCE 10-27-2010.

THE MARK CONSISTS OF STANDARD CHARACTERS WITHOUT CLAIM TO ANY PARTICULAR FONT, STYLE, SIZE, OR COLOR.

SER. NO. 85-449,622, FILED P.R. 10-18-2011; AM. S.R. 8-14-2012.

MICHELE SWAIN, EXAMINING ATTORNEY



*David J. Kyffers*

Director of the United States Patent and Trademark Office

# United States of America

United States Patent and Trademark Office

## BEER FOR BIRDIES

**Reg. No. 4,277,455**

FRY'S ELECTRONICS, INC. (CALIFORNIA CORPORATION)  
600 E. BROKAW ROAD  
SAN JOSE, CA 95112

**Registered Jan. 15, 2013**

**Int. Cls.: 41 and 43**

FOR: ARRANGING OF CONTESTS, IN CLASS 41 (U.S. CLS. 100, 101 AND 107).

**SERVICE MARK**

FIRST USE 10-21-2009; IN COMMERCE 10-21-2009.

**SUPPLEMENTAL REGISTER**

FOR: BAR SERVICES , IN CLASS 43 (U.S. CLS. 100 AND 101).

FIRST USE 10-6-2011; IN COMMERCE 10-6-2011.

THE MARK CONSISTS OF STANDARD CHARACTERS WITHOUT CLAIM TO ANY PARTICULAR FONT, STYLE, SIZE, OR COLOR.

SER. NO. 85-451,015, FILED P.R. 10-19-2011; AM. S.R. 5-22-2012.

WON TEAK OH, EXAMINING ATTORNEY



*David J. Kyfos*

Director of the United States Patent and Trademark Office

# United States of America

United States Patent and Trademark Office



**Reg. No. 4,277,456**

CARL FORESIDE (UNITED STATES INDIVIDUAL)  
1926 SOUTH 11TH AVENUE  
MAYWOOD, IL 60153

**Registered Jan. 15, 2013**

**Int. Cl.: 25**

FOR: ATHLETIC APPAREL, NAMELY, SHIRTS, PANTS, JACKETS, FOOTWEAR, HATS AND CAPS, ATHLETIC UNIFORMS, IN CLASS 25 (U.S. CLS. 22 AND 39).

**TRADEMARK**

FIRST USE 12-15-2004; IN COMMERCE 3-18-2012.

**SUPPLEMENTAL REGISTER**

THE MARK CONSISTS OF THE WORDS "LAST GLADIATOR" ABOVE THE DESIGN OF A GLADIATOR HELMET, SWORD, AND SPIKED Mallet INSIDE OF AN INCOMPLETE OVAL. THE LINING AND STIPPLING ON THE HELMET ARE FOR SHADING PURPOSES.

SER. NO. 85-457,267, FILED P.R. 10-26-2011; AM. S.R. 12-13-2012.

AMY HELLA, EXAMINING ATTORNEY



*David J. Kyffers*

Director of the United States Patent and Trademark Office

# United States of America

United States Patent and Trademark Office



**Reg. No. 4,277,457**

**Registered Jan. 15, 2013**

**Int. Cls.: 9, 12, and 22**

**TRADEMARK**

**SUPPLEMENTAL REGISTER**

GARRIDO, GABRIEL A. (VENEZUELA INDIVIDUAL)  
SUITE 7  
5055 N.W. 74TH AVE.  
MIAMI, FL 33166

FOR: CABLE CONNECTORS; ELECTRIC CABLES; ELECTRIC CABLES AND WIRES; ELECTRIC CABLES, WIRES, CONDUCTORS AND CONNECTION FITTINGS THEREFOR; ELECTRIC WIRES AND CABLES; ELECTRICAL CABLES; ELECTRICAL CABLES AND CORDSETS; FIBER OPTIC CABLES; OPTICAL CABLES; TELECOMMUNICATION CABLES, IN CLASS 9 (U.S. CLS. 21, 23, 26, 36 AND 38).

FIRST USE 11-12-2012; IN COMMERCE 11-12-2012.

FOR: BRAKE AIR VALVES FOR LAND VEHICLES; BRAKE HARDWARE FOR VEHICLES; BRAKE LINES FOR VEHICLES; BRAKE LININGS FOR LAND VEHICLES; BRAKE SHOES FOR LAND VEHICLES; BRAKE SHOES FOR MOTOR CARS; BRAKE SYSTEMS FOR VEHICLES; FUEL LINE HOSES FOR VEHICLES; TRUCK AIR BRAKE HOSES; VEHICLE PARTS, NAMELY, POWER STEERING HOSES, IN CLASS 12 (U.S. CLS. 19, 21, 23, 31, 35 AND 44).

FIRST USE 11-12-2012; IN COMMERCE 11-12-2012.

FOR: ALL-PURPOSE STRAPS; ALL-PURPOSE STRAPS FEATURING HOOK AND LOOP FASTENERS; CABLE TIES AND STRAPS FOR FASTENING AND SECURING OBJECTS SUCH AS BUNDLES OF WIRE TOGETHER; CARGO AND CARRIER EQUIPMENT FOR VEHICLES, NAMELY, TOW ROPES, TOW STRAPS, RATCHET TIE-DOWN STRAPS, QUICK RELEASE TIE DOWN STRAPS, LASHING STRAPS, AND TARP STRAPS; NON-METAL TIE DOWN STRAPS; STRAPS, NOT OF METAL, FOR HANDLING LOADS, IN CLASS 22 (U.S. CLS. 1, 2, 7, 19, 22, 42 AND 50).

FIRST USE 10-1-2011; IN COMMERCE 10-1-2011.

NO CLAIM IS MADE TO THE EXCLUSIVE RIGHT TO USE "GERMAN TECHNOLOGY", APART FROM THE MARK AS SHOWN.

THE MARK CONSISTS OF THE WORDS "STÄRKEN GERMAN TECHNOLOGY" WITHIN AN OVAL.



*David J. Kyffers*

Director of the United States Patent and Trademark Office

**Reg. No. 4,277,457** THE ENGLISH TRANSLATION OF THE WORD "STÄRKEN" IN THE MARK IS "STRONG".

SER. NO. 85-482,628, FILED P.R. 11-29-2011; AM. S.R. 11-14-2012.

DEBORAH LOBO, EXAMINING ATTORNEY

# United States of America

United States Patent and Trademark Office

## WINDY CITY SUNGLASSES

**Reg. No. 4,277,458**

LEE, JEFFREY (UNITED STATES INDIVIDUAL)  
2680 BLAZE TRAIL  
DIAMOND BAR, CA 91765

**Registered Jan. 15, 2013**

**Int. Cl.: 9**

FOR: SUNGLASSES, IN CLASS 9 (U.S. CLS. 21, 23, 26, 36 AND 38).

**TRADEMARK**

FIRST USE 12-20-2011; IN COMMERCE 2-28-2012.

**SUPPLEMENTAL REGISTER**

THE MARK CONSISTS OF STANDARD CHARACTERS WITHOUT CLAIM TO ANY PARTICULAR FONT, STYLE, SIZE, OR COLOR.

NO CLAIM IS MADE TO THE EXCLUSIVE RIGHT TO USE "SUNGLASSES", APART FROM THE MARK AS SHOWN.

SER. NO. 85-482,679, FILED P.R. 11-29-2011; AM. S.R. 4-16-2012.

ZACHARY BELLO, EXAMINING ATTORNEY



*David J. Kyffers*

Director of the United States Patent and Trademark Office

# United States of America

United States Patent and Trademark Office

## One Week Marketing Plan

**Reg. No. 4,277,459**

SATTERFIELD, MARK (UNITED STATES INDIVIDUAL)  
2007 WESTBOURNE WAY  
ALPHARETTA, GA 30022

**Registered Jan. 15, 2013**

**Int. Cl.: 41**

FOR: TRAINING SERVICES IN THE FIELD OF SALES, IN CLASS 41 (U.S. CLS. 100, 101 AND 107).

**SERVICE MARK**

FIRST USE 2-0-2012; IN COMMERCE 2-0-2012.

**SUPPLEMENTAL REGISTER**

THE MARK CONSISTS OF STANDARD CHARACTERS WITHOUT CLAIM TO ANY PARTICULAR FONT, STYLE, SIZE, OR COLOR.

SER. NO. 85-484,263, FILED P.R. 11-30-2011; AM. S.R. 11-6-2012.

INGA ERVIN, EXAMINING ATTORNEY



*David J. Kybas*

Director of the United States Patent and Trademark Office

# United States of America

United States Patent and Trademark Office

## CENTRALLY GROWN

**Reg. No. 4,277,460**

CENTRALLY GROWN, INC. (DELAWARE CORPORATION)

**Registered Jan. 15, 2013**

2811 EAST ANA STREET, SUITE C  
RANCHO DOMINGUEZ, CA 90221

**Int. Cl.: 35**

FOR: RETAIL STORE SERVICES FEATURING PACKAGED FOOD AND DRINK, IN CLASS 35 (U.S. CLS. 100, 101 AND 102).

**SERVICE MARK**

FIRST USE 6-10-2010; IN COMMERCE 4-23-2012.

**SUPPLEMENTAL REGISTER**

THE MARK CONSISTS OF STANDARD CHARACTERS WITHOUT CLAIM TO ANY PARTICULAR FONT, STYLE, SIZE, OR COLOR.

SER. NO. 85-484,407, FILED P.R. 11-30-2011; AM. S.R. 11-16-2012.

KIM MONINGHOFF, EXAMINING ATTORNEY



*David J. Kybas*

Director of the United States Patent and Trademark Office



# United States of America

United States Patent and Trademark Office

# Text2Bid

**Reg. No. 4,277,461**

MAESTROSOFT.COM, INC. (WASHINGTON CORPORATION)  
1750 112TH AVE. NE, #A200  
BELLEVUE, WA 98004

**Registered Jan. 15, 2013**

**Int. Cl.: 9**

FOR: COMPUTER SOFTWARE FOR ELECTRONIC AUCTION BIDDING AND ACCEPTING MONETARY CHARITABLE CONTRIBUTIONS BY ELECTRONIC MEANS, NAMELY, THE INTERNET VIA MOBILE PHONES , IN CLASS 9 (U.S. CLS. 21, 23, 26, 36 AND 38).

**TRADEMARK**

FIRST USE 7-11-2011; IN COMMERCE 9-21-2011.

**SUPPLEMENTAL REGISTER**

THE MARK CONSISTS OF STANDARD CHARACTERS WITHOUT CLAIM TO ANY PARTICULAR FONT, STYLE, SIZE, OR COLOR.

SER. NO. 85-484,728, FILED P.R. 12-1-2011; AM. S.R. 11-5-2012.

KATHERINE CHANG, EXAMINING ATTORNEY



*David J. Kyffers*

Director of the United States Patent and Trademark Office

# United States of America

United States Patent and Trademark Office

## ADVANCED INTERNATIONAL PROTOCOL COURSE

**Reg. No. 4,277,462**

**Registered Jan. 15, 2013**

**Int. Cl.: 41**

**SERVICE MARK**

**SUPPLEMENTAL REGISTER**

THE PROTOCOL INSTITUTE, INC. (OHIO CORPORATION), DBA THE PROTOCOL SCHOOL  
OF WASHINGTON,  
P.O. BOX 676  
COLUMBIA, SC 29202

FOR: EDUCATIONAL SERVICES, NAMELY, CONDUCTING SEMINARS AND TRAINING  
PROGRAMS ON THE SUBJECT OF INTERNATIONAL PROTOCOL, BUSINESS ETIQUETTE  
AND CROSS-CULTURAL COMMUNICATIONS, IN CLASS 41 (U.S. CLS. 100, 101 AND 107).

FIRST USE 8-15-2011; IN COMMERCE 8-15-2011.

THE MARK CONSISTS OF STANDARD CHARACTERS WITHOUT CLAIM TO ANY PAR-  
TICULAR FONT, STYLE, SIZE, OR COLOR.

NO CLAIM IS MADE TO THE EXCLUSIVE RIGHT TO USE "PROTOCOL COURSE", APART  
FROM THE MARK AS SHOWN.

SER. NO. 85-489,523, FILED P.R. 12-7-2011; AM. S.R. 10-1-2012.

MICHELE SWAIN, EXAMINING ATTORNEY



*David J. Kyffers*

Director of the United States Patent and Trademark Office

# United States of America

United States Patent and Trademark Office

## ULTRA LIGHT

**Reg. No. 4,277,463**

BETT-A-WAY BEVERAGE DISTRIBUTORS, INC. (NEW JERSEY CORPORATION)  
110 SYLVANIA PLACE  
SOUTH PLAINFIELD, NJ 07080

**Registered Jan. 15, 2013**

**Int. Cl.: 39**

FOR: TRUCKING SERVICES, NAMELY, HAULING OF CONSUMER GOODS, RAW MATERIALS, AND PALLETS OF OTHERS, IN CLASS 39 (U.S. CLS. 100 AND 105).

**SERVICE MARK**

FIRST USE 5-0-2005; IN COMMERCE 5-0-2005.

**SUPPLEMENTAL REGISTER**

THE MARK CONSISTS OF STANDARD CHARACTERS WITHOUT CLAIM TO ANY PARTICULAR FONT, STYLE, SIZE, OR COLOR.

SER. NO. 85-491,888, FILED P.R. 12-9-2011; AM. S.R. 11-20-2012.

APRIL ROACH, EXAMINING ATTORNEY



*David J. Kyfos*

Director of the United States Patent and Trademark Office

# United States of America

## United States Patent and Trademark Office

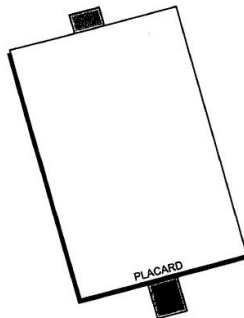

**Reg. No. 4,277,464**

**Registered Jan. 15, 2013**

**Int. Cl.: 16**

**TRADEMARK**

**SUPPLEMENTAL REGISTER**

SZMURLO, DONALD (UNITED STATES INDIVIDUAL)  
3963 LAKEWOOD ROAD  
HARSHAW, WI 54529 AND

SZMURLO, ARLENE (UNITED STATES INDIVIDUAL)  
3963 LAKEWOOD ROAD  
HARSHAW, WI 54529

FOR: BLANK OR PARTIALLY PRINTED ITEMS, NAMELY, POSTCARDS, STICKERS, PAPER LABELS, MAILING INSERTS, WRITING PAPER, MEMO PADS, NOTE PAPER, GREETING CARDS, IN CLASS 16 (U.S. CLS. 2, 5, 22, 23, 29, 37, 38 AND 50).

FIRST USE 4-14-2010; IN COMMERCE 4-14-2010.

NO CLAIM IS MADE TO THE EXCLUSIVE RIGHT TO USE "PLACARD", APART FROM THE MARK AS SHOWN.

THE MARK CONSISTS OF A STYLIZED RECTANGULAR PICKET SIGN TILTED TO THE LEFT FEATURING THE TERM "PLACARD" AT ITS BASE.

SER. NO. 85-496,702, FILED P.R. 12-15-2011; AM. S.R. 11-29-2012.

ZHALEH DELANEY, EXAMINING ATTORNEY



*David J. Kybas*

Director of the United States Patent and Trademark Office

# United States of America

## United States Patent and Trademark Office

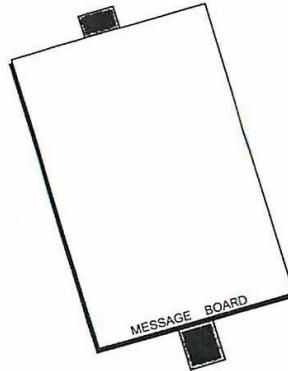

**Reg. No. 4,277,465**

**Registered Jan. 15, 2013**

**Int. Cl.: 16**

**TRADEMARK**

**SUPPLEMENTAL REGISTER**

SZMURLO, DONALD (UNITED STATES INDIVIDUAL)  
3963 LAKEWOOD ROAD  
HARSHAW, WI 54529 AND

SZMURLO, ARLENE (UNITED STATES INDIVIDUAL)  
3963 LAKEWOOD ROAD  
HARSHAW, WI 54529

FOR: BLANK OR PARTIALLY PRINTED ITEMS, NAMELY, POSTCARDS, STICKERS, PAPER LABELS, MAILING INSERTS, WRITING PAPER, MEMO PADS, NOTE PAPER, GREETING CARDS, IN CLASS 16 (U.S. CLS. 2, 5, 22, 23, 29, 37, 38 AND 50).

FIRST USE 4-14-2010; IN COMMERCE 4-14-2010.

NO CLAIM IS MADE TO THE EXCLUSIVE RIGHT TO USE "MESSAGE BOARD", APART FROM THE MARK AS SHOWN.

THE MARK CONSISTS OF A STYLIZED RECTANGULAR PICKET SIGN TILTED TO THE LEFT FEATURING THE TERM "MESSAGE BOARD" AT ITS BASE.

SER. NO. 85-496,720, FILED P.R. 12-15-2011; AM. S.R. 11-29-2012.

ZHALEH DELANEY, EXAMINING ATTORNEY



*David J. Kybas*

Director of the United States Patent and Trademark Office

# United States of America

## United States Patent and Trademark Office

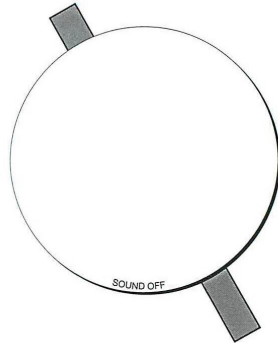

**Reg. No. 4,277,466**

**Registered Jan. 15, 2013**

**Int. Cl.: 16**

**TRADEMARK**

**SUPPLEMENTAL REGISTER**

SZMURLO, DONALD (UNITED STATES INDIVIDUAL)  
3963 LAKEWOOD ROAD  
HARSHAW, WI 54529 AND

SZMURLO, ARLENE (UNITED STATES INDIVIDUAL)  
3963 LAKEWOOD ROAD  
HARSHAW, WI 54529

FOR: BLANK OR PARTIALLY PRINTED ITEMS, NAMELY, POSTCARDS, STICKERS, PAPER LABELS, MAILING INSERTS, WRITING PAPER, MEMO PADS, NOTE PAPER, GREETING CARDS, IN CLASS 16 (U.S. CLS. 2, 5, 22, 23, 29, 37, 38 AND 50).

FIRST USE 4-14-2010; IN COMMERCE 4-14-2010.

NO CLAIM IS MADE TO THE EXCLUSIVE RIGHT TO USE "SOUND OFF", APART FROM THE MARK AS SHOWN.

THE MARK CONSISTS OF A STYLIZED BUBBLE-LIKE PICKET SIGN TILTED TO THE LEFT FEATURING THE TERMS "SOUND OFF" AT ITS BASE.

SER. NO. 85-496,758, FILED P.R. 12-15-2011; AM. S.R. 11-29-2012.

ZHALEH DELANEY, EXAMINING ATTORNEY



*David J. Kybas*

Director of the United States Patent and Trademark Office

# United States of America

## United States Patent and Trademark Office

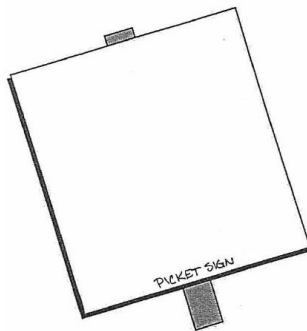

**Reg. No. 4,277,467**

**Registered Jan. 15, 2013**

**Int. Cl.: 16**

**TRADEMARK**

**SUPPLEMENTAL REGISTER**

SZMURLO, DONALD (UNITED STATES INDIVIDUAL)  
3963 LAKEWOOD ROAD  
HARSHAW, WI 54529 AND

SZMURLO, ARLENE (UNITED STATES INDIVIDUAL)  
3963 LAKEWOOD ROAD  
HARSHAW, WI 54529

FOR: BLANK OR PARTIALLY PRINTED ITEMS, NAMELY, POSTCARDS, STICKERS, PAPER LABELS, MAILING INSERTS, WRITING PAPER, MEMO PADS, NOTE PAPER, GREETING CARDS, IN CLASS 16 (U.S. CLS. 2, 5, 22, 23, 29, 37, 38 AND 50).

FIRST USE 4-14-2010; IN COMMERCE 4-14-2010.

NO CLAIM IS MADE TO THE EXCLUSIVE RIGHT TO USE "PICKET SIGN", APART FROM THE MARK AS SHOWN.

THE MARK CONSISTS OF A STYLIZED SQUARE PICKET SIGN TILTED TO THE LEFT FEATURING THE TERM "PICKET SIGN" AT ITS BASE.

SER. NO. 85-496,782, FILED P.R. 12-15-2011; AM. S.R. 11-29-2012.

ZHALEH DELANEY, EXAMINING ATTORNEY



*David J. Kybas*

Director of the United States Patent and Trademark Office

# United States of America

United States Patent and Trademark Office

## RAPID MUSCLE RESPONSE

**Reg. No. 4,277,468**

CARDIO CORE, LLC (NEW YORK LIMITED LIABILITY COMPANY)  
38-61 11TH STREET

**Registered Jan. 15, 2013**

LONG ISLAND CITY, NY 11101

**Int. Cl.: 41**

FOR: PHYSICAL FITNESS INSTRUCTION AND CONSULTATION; CONDUCTING PHYSICAL FITNESS PROGRAMS AND CLASSES, IN CLASS 41 (U.S. CLS. 100, 101 AND 107).

**SERVICE MARK**

FIRST USE 1-0-2012; IN COMMERCE 1-0-2012.

**SUPPLEMENTAL REGISTER**

THE MARK CONSISTS OF STANDARD CHARACTERS WITHOUT CLAIM TO ANY PARTICULAR FONT, STYLE, SIZE, OR COLOR.

SER. NO. 85-501,505, FILED P.R. 12-21-2011; AM. S.R. 10-31-2012.

CAROLINE WOOD, EXAMINING ATTORNEY



*David J. Kyffers*

Director of the United States Patent and Trademark Office



# United States of America

United States Patent and Trademark Office

## MICRO FOAM

**Reg. No. 4,277,469**

HAIRMARKER LLC (DELAWARE LIMITED LIABILITY COMPANY)  
620 CAMINO RANCHEROS  
SANTA FE, NM 67505

**Registered Jan. 15, 2013**

**Int. Cl.: 3**

FOR: HAIR COLORING PREPARATIONS SOLD AS AN INTEGRAL COMPONENT IN HAIR SHAMPOOS AND CONDITIONERS FOR USE AS A DELIVERY AGENT, IN CLASS 3 (U.S. CLS. 1, 4, 6, 50, 51 AND 52).

**TRADEMARK**

FIRST USE 7-31-2011; IN COMMERCE 7-31-2011.

**SUPPLEMENTAL REGISTER**

THE MARK CONSISTS OF STANDARD CHARACTERS WITHOUT CLAIM TO ANY PARTICULAR FONT, STYLE, SIZE, OR COLOR.

NO CLAIM IS MADE TO THE EXCLUSIVE RIGHT TO USE "FOAM", APART FROM THE MARK AS SHOWN.

SER. NO. 85-502,357, FILED P.R. 12-22-2011; AM. S.R. 9-18-2012.

SUZANNE BLANE, EXAMINING ATTORNEY



*David J. Kyffers*

Director of the United States Patent and Trademark Office

# United States of America

United States Patent and Trademark Office

## Horse Diversity

**Reg. No. 4,277,470**

**Registered Jan. 15, 2013**

**Int. Cl.: 45**

**SERVICE MARK**

**SUPPLEMENTAL REGISTER**

KAWAMURA, HIROSHI (JAPAN INDIVIDUAL)  
22413 OCEAN AVE  
#58  
TORRANCE, CA 90505

FOR: PROVIDING A SOCIAL NETWORKING WEBSITE FOR ENTERTAINMENT PURPOSES,  
IN CLASS 45 (U.S. CLS. 100 AND 101).

FIRST USE 5-18-2012; IN COMMERCE 5-18-2012.

THE MARK CONSISTS OF STANDARD CHARACTERS WITHOUT CLAIM TO ANY PAR-  
TICULAR FONT, STYLE, SIZE, OR COLOR.

SER. NO. 85-502,722, FILED P.R. 12-22-2011; AM. S.R. 11-21-2012.

GILBERT SWIFT, EXAMINING ATTORNEY



*David J. Kyffers*

Director of the United States Patent and Trademark Office

# United States of America

United States Patent and Trademark Office

## Certified Medical Tourism Specialist

**Reg. No. 4,277,471**

STEPHANO, RENEE-MARIE (UNITED STATES INDIVIDUAL)  
10130 NORTHLAKE BLVD, SUITE 214-289  
WEST PALM BEACH, FL 33412

**Registered Jan. 15, 2013**

**Int. Cl.: 42**

FOR: ACCREDITATION SERVICES, NAMELY, DEVELOPING AND ADMINISTERING STANDARDS AND PROCEDURES FOR CERTIFYING PROFESSIONALS IN THE FIELD OF MEDICAL TOURISM, IN CLASS 42 (U.S. CLS. 100 AND 101).

**SERVICE MARK**

FIRST USE 12-1-2011; IN COMMERCE 12-20-2011.

**SUPPLEMENTAL REGISTER**

THE MARK CONSISTS OF STANDARD CHARACTERS WITHOUT CLAIM TO ANY PARTICULAR FONT, STYLE, SIZE, OR COLOR.

OWNER OF U.S. REG. NOS. 3,637,095 AND 3,791,670.

NO CLAIM IS MADE TO THE EXCLUSIVE RIGHT TO USE "CERTIFIED", APART FROM THE MARK AS SHOWN.

SER. NO. 85-503,523, FILED P.R. 12-23-2011; AM. S.R. 11-17-2012.

TRACY CROSS, EXAMINING ATTORNEY



*David J. Kypos*

Director of the United States Patent and Trademark Office

# United States of America

United States Patent and Trademark Office

## SOLAR SYSTEMS USA

**Reg. No. 4,277,472**

SOLAR SYSTEMS USA, INC (GEORGIA CORPORATION)  
8725 ROSWELL RD BLDG O STE 209  
SANDY SPRINGS, GA 30350

**Registered Jan. 15, 2013**

**Int. Cl.: 35**

FOR: ONLINE RETAIL STORE SERVICES FEATURING SOLAR PRODUCTS, IN CLASS 35  
(U.S. CLS. 100, 101 AND 102).

**SERVICE MARK**

FIRST USE 8-27-2010; IN COMMERCE 10-1-2010.

**SUPPLEMENTAL REGISTER**

THE MARK CONSISTS OF STANDARD CHARACTERS WITHOUT CLAIM TO ANY PARTICULAR FONT, STYLE, SIZE, OR COLOR.

NO CLAIM IS MADE TO THE EXCLUSIVE RIGHT TO USE "SOLAR SYSTEMS", APART FROM THE MARK AS SHOWN.

SER. NO. 85-503,569, FILED P.R. 12-24-2011; AM. S.R. 10-17-2012.

STEPHANIE ALI, EXAMINING ATTORNEY



*David J. Kyros*

Director of the United States Patent and Trademark Office

# United States of America

United States Patent and Trademark Office

## GREEN MUSIC GROUP

**Reg. No. 4,277,473**

**Registered Jan. 15, 2013**

**Int. Cl.: 40**

**SERVICE MARK**

**SUPPLEMENTAL REGISTER**

REVERB, INC. (NEW YORK NON-PROFIT CORPORATION)  
386 FORE STREET  
#202  
PORTLAND, ME 04101

FOR: PROVIDING RECYCLING INFORMATION AT FESTIVALS AND CONCERTS, IN CLASS 40 (U.S. CLS. 100, 103 AND 106).

FIRST USE 1-1-2010; IN COMMERCE 1-1-2010.

THE MARK CONSISTS OF STANDARD CHARACTERS WITHOUT CLAIM TO ANY PARTICULAR FONT, STYLE, SIZE, OR COLOR.

NO CLAIM IS MADE TO THE EXCLUSIVE RIGHT TO USE "GROUP", APART FROM THE MARK AS SHOWN.

SER. NO. 85-518,993, FILED P.R. 1-18-2012; AM. S.R. 11-2-2012.

EMILY CARLSEN, EXAMINING ATTORNEY



*David J. Kybas*

Director of the United States Patent and Trademark Office

# United States of America

United States Patent and Trademark Office

## CHECK ADVANCE

**Reg. No. 4,277,474**

AARC, LLC (DELAWARE LIMITED LIABILITY COMPANY)  
2711 CENTERVILLE ROAD SUITE 400  
WILMINGTON, DE 19808

**Registered Jan. 15, 2013**

**Int. Cl.: 36**

FOR: CONSUMER LENDING SERVICES; FINANCIAL SERVICES IN THE NATURE OF MONEY LENDING, CHECK CASHING, DEFERRED DEPOSITS, FINANCIAL OVERDRAFT PROTECTION, AND SHORT-TERM CONSUMER LOANS, IN CLASS 36 (U.S. CLS. 100, 101 AND 102).

**SERVICE MARK**

**SUPPLEMENTAL REGISTER** FIRST USE 5-31-2011; IN COMMERCE 5-31-2011.

THE MARK CONSISTS OF STANDARD CHARACTERS WITHOUT CLAIM TO ANY PARTICULAR FONT, STYLE, SIZE, OR COLOR.

SER. NO. 85-519,319, FILED P.R. 1-18-2012; AM. S.R. 11-5-2012.

EMILY CARLSEN, EXAMINING ATTORNEY



*David J. Kyffers*

Director of the United States Patent and Trademark Office

# United States of America

United States Patent and Trademark Office

## QUESO ARROCERO

**Reg. No. 4,277,475**

QUESOS LA RICURA, LTD. (NEW YORK CORPORATION)  
225 PARK AVENUE  
HICKSVILLE, NY 11801

**Registered Jan. 15, 2013**

**Int. Cl.: 29**

FOR: CHEESE, IN CLASS 29 (U.S. CL. 46).

**TRADEMARK**

FIRST USE 5-8-2009; IN COMMERCE 5-8-2009.

**SUPPLEMENTAL REGISTER**

THE MARK CONSISTS OF STANDARD CHARACTERS WITHOUT CLAIM TO ANY PARTICULAR FONT, STYLE, SIZE, OR COLOR.

NO CLAIM IS MADE TO THE EXCLUSIVE RIGHT TO USE "QUESO", APART FROM THE MARK AS SHOWN.

THE ENGLISH TRANSLATION OF "QUESO ARROCERO" IN THE MARK IS "CHEESE FOR RICE" OR "CHEESE FOR RICE GROWERS".

SER. NO. 85-520,729, FILED P.R. 1-19-2012; AM. S.R. 11-27-2012.

ANDREA K. NADELMAN, EXAMINING ATTORNEY



*David J. Kyffers*

Director of the United States Patent and Trademark Office

# United States of America

United States Patent and Trademark Office

## SOLAR BACKUP DIRECT

**Reg. No. 4,277,476**

**Registered Jan. 15, 2013**

**Int. Cls.: 35 and 40**

**SERVICE MARK**

**SUPPLEMENTAL REGISTER**

SOLUTIONS FROM SCIENCE, INC. (ILLINOIS CORPORATION)  
PO BOX 518  
815 W. MAIN STREET  
THOMSON, IL 61285

FOR: ONLINE RETAIL STORE SERVICES FEATURING SOLAR ENERGY PRODUCTS, SURVIVAL GEAR, SEEDS AND FERTILIZER, BOOKS, DVDS AND VIDEOS, GIFT CARDS, AND FOOD AND SUPPLIES, NAMELY, PORTABLE COOKING STOVES, FOOD DEHYDRATORS, UTILITY BLANKETS, EMERGENCY SHELTERS, CAMPING LANTERNS, FIRST-AID KITS, WATER PURIFICATION TABLETS AND WATER PURIFIERS, BUTANE LIGHTERS, WATERPROOF MATCHES, TOOL KITS, AND LED LIGHT BULBS, IN CLASS 35 (U.S. CLS. 100, 101 AND 102).

FIRST USE 10-0-2010; IN COMMERCE 10-0-2010.

FOR: PROVIDING ONLINE INFORMATION ABOUT THE BENEFITS OF EMERGENCY PREPAREDNESS AND ABOUT SOLAR ENERGY PRODUCTS FOR USE IN EMERGENCY SITUATIONS, NAMELY, SOLAR GENERATORS, SOLAR PANELS FOR THE PRODUCTION OF ELECTRICITY, AND RELATED DISASTER-PREPAREDNESS SUPPLIES, IN CLASS 40 (U.S. CLS. 100, 103 AND 106).

FIRST USE 10-0-2010; IN COMMERCE 10-0-2010.

THE MARK CONSISTS OF STANDARD CHARACTERS WITHOUT CLAIM TO ANY PARTICULAR FONT, STYLE, SIZE, OR COLOR.

NO CLAIM IS MADE TO THE EXCLUSIVE RIGHT TO USE "SOLAR BACKUP", APART FROM THE MARK AS SHOWN.

SER. NO. 85-522,341, FILED P.R. 1-23-2012; AM. S.R. 10-29-2012.

EDWARD NELSON, EXAMINING ATTORNEY



*David J. Kypos*

Director of the United States Patent and Trademark Office



# United States of America

United States Patent and Trademark Office

# ECONNECT

**Reg. No. 4,277,477**

CHATSWORTH PRODUCTS, INC. (DELAWARE CORPORATION)  
31425 AGOURA ROAD  
WESTLAKE VILLAGE, CA 913614614

**Registered Jan. 15, 2013**

**Int. Cl.: 9**

FOR: ELECTRICAL POWER DISTRIBUTION UNIT FOR SUPPLYING ELECTRICAL POWER TO COMPUTER RACKS AND CABINETS IN COMPUTER DATA CENTERS AND EQUIPMENT ROOMS , IN CLASS 9 (U.S. CLS. 21, 23, 26, 36 AND 38).

**TRADEMARK**

FIRST USE 10-0-2012; IN COMMERCE 10-0-2012.

**SUPPLEMENTAL REGISTER**

THE MARK CONSISTS OF STANDARD CHARACTERS WITHOUT CLAIM TO ANY PARTICULAR FONT, STYLE, SIZE, OR COLOR.

SER. NO. 85-522,627, FILED P.R. 1-23-2012; AM. S.R. 11-8-2012.

MICHELE SWAIN, EXAMINING ATTORNEY



*David J. Kyffers*

Director of the United States Patent and Trademark Office

# United States of America

United States Patent and Trademark Office

## THE PRESENTATION ACADEMY

**Reg. No. 4,277,478**

**Registered Jan. 15, 2013**

**Int. Cl.: 41**

**SERVICE MARK**

**SUPPLEMENTAL REGISTER**

KOEGEL, TIMOTHY J. (UNITED STATES INDIVIDUAL), DBA THE KOEGEL GROUP,  
44 EAST LAKE DRIVE  
ANNAPOLIS, MD 21403

FOR: EDUCATIONAL SERVICES, NAMELY, PROVIDING SEMINARS, WORKSHOPS, AND WEBINARS ON THE SUBJECT OF PUBLIC SPEAKING, MEDIA RELATIONS, COMMUNICATION SKILLS, NEGOTIATION SKILLS, GOAL SETTING, SELLING SKILLS, LISTENING SKILLS, AND TEAM BUILDING SKILLS, AND DISTRIBUTION OF EDUCATIONAL MATERIALS IN CONNECTION THEREWITH; PROVIDING A WEBSITE FEATURING EDUCATIONAL INFORMATION AND NON-DOWNLOADABLE INSTRUCTIONAL AUDIO AND VIDEO FILES IN THE FIELD OF PUBLIC SPEAKING, MEDIA RELATIONS, AND COMMUNICATION SKILLS, IN CLASS 41 (U.S. CLS. 100, 101 AND 107).

FIRST USE 12-31-2002; IN COMMERCE 12-31-2002.

THE MARK CONSISTS OF STANDARD CHARACTERS WITHOUT CLAIM TO ANY PARTICULAR FONT, STYLE, SIZE, OR COLOR.

SER. NO. 85-524,029, FILED P.R. 1-24-2012; AM. S.R. 11-5-2012.

LESLEY LAMOTHE, EXAMINING ATTORNEY



*David J. Kyros*

Director of the United States Patent and Trademark Office

# United States of America

United States Patent and Trademark Office

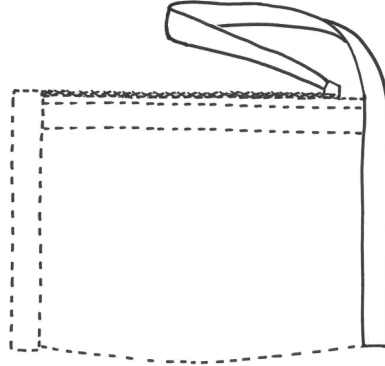

**Reg. No. 4,277,479**

**Registered Jan. 15, 2013**

**Int. Cl.: 18**

**TRADEMARK**

**SUPPLEMENTAL REGISTER**

FLANABAGS LLC (MASSACHUSETTS LIMITED LIABILITY COMPANY)  
20 BULKLEY ROAD  
SUDBURY, MA 01776

FOR: ALL PURPOSE SPORT BAGS; ALL-PURPOSE ATHLETIC BAGS; ALL-PURPOSE CARRYING BAGS; ALL-PURPOSE REUSABLE CARRYING BAGS; AMENITY BAGS SOLD EMPTY; BAGS FOR CARRYING BABIES' ACCESSORIES; BAGS FOR SPORTS; BEACH BAGS; CARRY-ALL BAGS; CARRY-ON BAGS; CLUTCH BAGS; COSMETIC BAGS SOLD EMPTY; DIAPER BAGS; FLIGHT BAGS; GROOMING ORGANIZERS FOR TRAVEL; GYM BAGS; JEWELRY ORGANIZERS FOR TRAVEL; PET ACCESSORIES, NAMELY, CANVAS, VINYL AND LEATHER POUCHES FOR HOLDING DISPOSABLE BAGS TO PLACE PET WASTE IN; SCHOOL BAGS; SHOE BAGS FOR TRAVEL; SMALL BAGS FOR MEN; SPORT BAGS; SPORTS BAGS; TOILETRY BAGS SOLD EMPTY; TOTE BAGS; TRAVEL BAGS; TRAVEL CASES; TRAVELING BAGS; WRISTLET BAGS, IN CLASS 18 (U.S. CLS. 1, 2, 3, 22 AND 41).

FIRST USE 12-25-2010; IN COMMERCE 1-21-2011.

THE MARK CONSISTS OF THE THREE-DIMENSIONAL BAG WITH A ZIPPER CLOSURE ON TOP, THE SIDES OF WHICH ARE TRIMMED WITH FABRIC STRIPS, WHERE ONE CONTINUOUS SIDE FABRIC STRIP PERMANENTLY ATTACHES TO THE ZIPPER PULL TO FORM A WRIST STRAP WHEN THE ZIPPER IS CLOSED. THE DOTTED LINES IN THE MARK INDICATE THE SHAPE OF THE GOODS AND ARE USED TO INDICATE THE PLACEMENT OF THE MARK ON THE GOODS AND ARE NOT CLAIMED AS A FEATURE OF THE MARK.



SER. NO. 85-527,892, FILED 1-28-2012.

TASNEEM HUSSAIN, EXAMINING ATTORNEY

*David J. Kyros*

Director of the United States Patent and Trademark Office

# United States of America

United States Patent and Trademark Office

## INTERNATIONAL ACADEMY OF AUTOMATION ENGINEERING

**Reg. No. 4,277,480**

HORIZON CONTROLS GROUP INC. (DELAWARE CORPORATION)  
699 WEST GERMANTOWN PIKE  
PLYMOUTH MEETING, PA 19462

**Registered Jan. 15, 2013**

**Int. Cl.: 41**

FOR: EDUCATIONAL SERVICES, NAMELY, CONDUCTING CLASSES, SEMINARS, CONFERENCES, AND WORKSHOPS IN THE FIELD OF AUTOMATION ENGINEERING AND DISTRIBUTION OF TRAINING MATERIAL IN CONNECTION THEREWITH, IN CLASS 41 (U.S. CLS. 100, 101 AND 107).

**SERVICE MARK**

**SUPPLEMENTAL REGISTER** FIRST USE 5-31-2012; IN COMMERCE 8-10-2012.

THE MARK CONSISTS OF STANDARD CHARACTERS WITHOUT CLAIM TO ANY PARTICULAR FONT, STYLE, SIZE, OR COLOR.

NO CLAIM IS MADE TO THE EXCLUSIVE RIGHT TO USE "ACADEMY" AND "AUTOMATION ENGINEERING", APART FROM THE MARK AS SHOWN.

SER. NO. 85-528,695, FILED P.R. 1-30-2012; AM. S.R. 11-19-2012.

RONALD AIKENS, EXAMINING ATTORNEY



*David J. Kyffers*

Director of the United States Patent and Trademark Office

# United States of America

United States Patent and Trademark Office

## AMERICAN JOURNAL OF BONE HEALTH EDUCATORS

**Reg. No. 4,277,481**

**Registered Jan. 15, 2013**

**Int. Cl.: 16**

**TRADEMARK**

**SUPPLEMENTAL REGISTER**

COALITION OF BONE HEALTH EDUCATORS, LLC (DELAWARE LIMITED LIABILITY COMPANY)  
241 FORSGATE DRIVE, SUITE 205A  
MONROE TOWNSHIP, NJ 08831

FOR: PRINTED PUBLICATIONS, NAMELY, PEER-REVIEWED MAGAZINES, JOURNALS, NEWSLETTERS, FEATURE REPORTS, AND MONOGRAPHS IN THE FIELDS OF OSTEOPATHY, BONE DISEASE, OSTEOPOROSIS, BONE DENSITY, PHARMACY, NURSING AND MEDICINE, IN CLASS 16 (U.S. CLS. 2, 5, 22, 23, 29, 37, 38 AND 50).

FIRST USE 8-1-2009; IN COMMERCE 10-25-2009.

THE MARK CONSISTS OF STANDARD CHARACTERS WITHOUT CLAIM TO ANY PARTICULAR FONT, STYLE, SIZE, OR COLOR.

SER. NO. 85-529,317, FILED P.R. 1-31-2012; AM. S.R. 11-15-2012.

LINDA LAVACHE, EXAMINING ATTORNEY



*David J. Kyjars*

Director of the United States Patent and Trademark Office

# United States of America

United States Patent and Trademark Office

# Chasuna Mall

**Reg. No. 4,277,482**

THE CHASUNA MALL INC. (NEW YORK CORPORATION)  
774 BEDFORD AVE  
BROOKLYN, NY 11205

**Registered Jan. 15, 2013**

**Int. Cl.: 35**

FOR: RETAIL FURNITURE STORES; RETAIL JEWELRY STORES, IN CLASS 35 (U.S. CLS. 100, 101 AND 102).

**SERVICE MARK**

FIRST USE 12-23-2011; IN COMMERCE 12-27-2011.

**SUPPLEMENTAL REGISTER**

THE MARK CONSISTS OF STANDARD CHARACTERS WITHOUT CLAIM TO ANY PARTICULAR FONT, STYLE, SIZE, OR COLOR.

NO CLAIM IS MADE TO THE EXCLUSIVE RIGHT TO USE "MALL", APART FROM THE MARK AS SHOWN.

THE ENGLISH TRANSLATION OF "CHASUNA" IN THE MARK IS "WEDDING".

SER. NO. 85-529,402, FILED P.R. 1-31-2012; AM. S.R. 11-13-2012.

AMY HELLA, EXAMINING ATTORNEY



*David J. Kyffers*

Director of the United States Patent and Trademark Office

# United States of America

United States Patent and Trademark Office

# home design

**Reg. No. 4,277,483**

**Registered Jan. 15, 2013**

**Int. Cls.: 16, 35, and 41**

**TRADEMARK**

**SERVICE MARK**

**SUPPLEMENTAL REGISTER**

RHODE ISLAND MONTHLY COMMUNICATIONS, INC. (RHODE ISLAND CORPORATION),  
FORMERLY ETR MEDIA GROUP, INC.,  
717 ALLENS AVENUE, STE 105  
PROVIDENCE, RI 02905

FOR: PRINTED MATERIALS, NAMELY, JOURNALS FEATURING LOCAL ARCHITECTS,  
CONTRACTORS, AND MATERIAL SUPPLIERS, IN CLASS 16 (U.S. CLS. 2, 5, 22, 23, 29, 37,  
38 AND 50).

FIRST USE 11-15-2010; IN COMMERCE 11-15-2010.

FOR: PROMOTING THE GOODS AND SERVICES OF OTHERS BY PROVIDING A WEBSITE  
FEATURING LOCAL ARCHITECTS, CONTRACTORS, AND MATERIALS SUPPLIERS, IN  
CLASS 35 (U.S. CLS. 100, 101 AND 102).

FIRST USE 11-15-2010; IN COMMERCE 11-15-2010.

FOR: PROVIDING A WEBSITE FEATURING NON-DOWNLOADABLE PUBLICATIONS IN  
THE NATURE OF JOURNALS IN THE FIELD OF ARCHITECTURE AND RESIDENTIAL  
CONSTRUCTION, IN CLASS 41 (U.S. CLS. 100, 101 AND 107).

FIRST USE 11-15-2010; IN COMMERCE 11-15-2010.

THE MARK CONSISTS OF STANDARD CHARACTERS WITHOUT CLAIM TO ANY PAR-  
TICULAR FONT, STYLE, SIZE, OR COLOR.

SER. NO. 85-529,434, FILED P.R. 1-31-2012; AM. S.R. 11-6-2012.

ESTHER A. BORSUK, EXAMINING ATTORNEY



*David J. Kyros*

Director of the United States Patent and Trademark Office

# United States of America

United States Patent and Trademark Office

# **LOWGI**

**PERFORMANCE DRINK**

**Reg. No. 4,277,484**

NTH DEGREE INNOVATIONS, INC. (NEW JERSEY CORPORATION)  
120 FIELDCREST AVE.  
EDISON, NJ 08837

**Registered Jan. 15, 2013**

**Int. Cl.: 32**

FOR: ENERGY DRINKS; SPORTS DRINKS; ALL OF THE FOREGOING HAVING A GLYCEMIC INDEX VALUE OF 55 OR LESS, IN CLASS 32 (U.S. CLS. 45, 46 AND 48).

**TRADEMARK**

FIRST USE 5-4-2012; IN COMMERCE 5-4-2012.

**SUPPLEMENTAL REGISTER**

NO CLAIM IS MADE TO THE EXCLUSIVE RIGHT TO USE "PERFORMANCE DRINK", APART FROM THE MARK AS SHOWN.

THE MARK CONSISTS OF THE STYLIZED TERM "LOWGI" ABOVE THE STYLIZED PHRASE "PERFORMANCE DRINK" WHEREIN THE CENTER OF THE LETTER "G" IS COMPRISED OF AN ARROW.

SER. NO. 85-530,581, FILED P.R. 2-1-2012; AM. S.R. 11-8-2012.

KIMBERLY FRYE, EXAMINING ATTORNEY



*David J. Kyros*

Director of the United States Patent and Trademark Office



# United States of America

United States Patent and Trademark Office

## THE FILM MUSIC MARKETPLACE

**Reg. No. 4,277,485**

**Registered Jan. 15, 2013**

**Int. Cl.: 41**

**SERVICE MARK**

**SUPPLEMENTAL REGISTER**

SCORE REVOLUTION, LLC (CALIFORNIA LIMITED LIABILITY COMPANY)  
SUITE 500  
1680 N. VINE STREET  
HOLLYWOOD, CA 90028

FOR: ENTERTAINMENT SERVICES, NAMELY, PROVIDING NON-DOWNLOADABLE PLAYBACK OF MUSIC VIA AN INTERNET WEBSITE; MUSIC PUBLISHING SERVICES; MUSIC SELECTION SERVICES FOR USE IN VISUAL MEDIA; PROVIDING A WEBSITE FEATURING INFORMATION IN THE FIELD OF MUSIC AVAILABLE FOR USE IN VISUAL MEDIA; PROVIDING AN INTERNET WEBSITE PORTAL IN THE FIELD OF MUSIC; PROVISION OF INFORMATION RELATING TO MUSIC, IN CLASS 41 (U.S. CLS. 100, 101 AND 107).

FIRST USE 10-22-2012; IN COMMERCE 10-22-2012.

THE MARK CONSISTS OF STANDARD CHARACTERS WITHOUT CLAIM TO ANY PARTICULAR FONT, STYLE, SIZE, OR COLOR.

SER. NO. 85-532,186, FILED P.R. 2-2-2012; AM. S.R. 11-2-2012.

DANIEL CAPSHAW, EXAMINING ATTORNEY



*David J. Kyros*

Director of the United States Patent and Trademark Office

# United States of America

United States Patent and Trademark Office

## THE FILM MUSIC MARKETPLACE

**Reg. No. 4,277,486**

**Registered Jan. 15, 2013**

**Int. Cl.: 42**

**SERVICE MARK**

**SUPPLEMENTAL REGISTER**

SCORE REVOLUTION, LLC (CALIFORNIA LIMITED LIABILITY COMPANY)  
SUITE 500  
1680 N. VINE STREET  
HOLLYWOOD, CA 90028

FOR: COMPUTER SERVICES, NAMELY, UPLOADING MUSIC TO THE INTERNET FOR OTHERS; PROVIDING A WEBSITE ALLOWING USERS TO UPLOAD AND DOWNLOAD MUSIC; PROVIDING A WEBSITE THAT GIVES USERS THE ABILITY TO PURCHASE DOWNLOADABLE MUSIC; PROVIDING AN ONLINE NON-DOWNLOADABLE INTERNET-BASED SYSTEM APPLICATION FEATURING TECHNOLOGY ENABLING USERS TO SELECT MUSIC BY PARTICULAR CHARACTERISTICS FOR USE WITH VISUAL MEDIA, IN CLASS 42 (U.S. CLS. 100 AND 101).

FIRST USE 10-22-2012; IN COMMERCE 10-22-2012.

THE MARK CONSISTS OF STANDARD CHARACTERS WITHOUT CLAIM TO ANY PARTICULAR FONT, STYLE, SIZE, OR COLOR.

SER. NO. 85-532,209, FILED P.R. 2-2-2012; AM. S.R. 11-2-2012.

DANIEL CAPSHAW, EXAMINING ATTORNEY



*David J. Kyffers*

Director of the United States Patent and Trademark Office

# United States of America

United States Patent and Trademark Office

# THERMATIC

**Reg. No. 4,277,487**

DAIMLER AG (FED REP GERMANY CORPORATION)  
MERCEDSSTRASSE 137

**Registered Jan. 15, 2013**

STUTTGART, FED REP GERMANY 70327

**Int. Cls.: 11 and 12**

FOR: HEATING AND COOLING DEVICES FOR AUTOMOBILES, NAMELY, A CLIMATE CONTROL UNIT FOR HEATING, COOLING AND VENTILATING AUTOMOBILES , IN CLASS 11 (U.S. CLS. 13, 21, 23, 31 AND 34).

**TRADEMARK**

FOR: AUTOMOBILES AND THEIR STRUCTURAL PARTS, IN CLASS 12 (U.S. CLS. 19, 21, 23, 31, 35 AND 44).

**SUPPLEMENTAL REGISTER**

THE MARK CONSISTS OF STANDARD CHARACTERS WITHOUT CLAIM TO ANY PARTICULAR FONT, STYLE, SIZE, OR COLOR.

OWNER OF FED REP GERMANY REG. NO. 30004640, DATED 2-24-2000, EXPIRES 1-31-2020.

OWNER OF U.S. REG. NO. 3,058,289.

SER. NO. 85-533,567, FILED P.R. 2-3-2012; AM. S.R. 10-26-2012.

LESLEY LAMOTHE, EXAMINING ATTORNEY



*David J. Kybas*

Director of the United States Patent and Trademark Office

# United States of America

United States Patent and Trademark Office

## 4GYellowPages.com

**Reg. No. 4,277,488**

**Registered Jan. 15, 2013**

**Int. Cl.: 35**

**SERVICE MARK**

**SUPPLEMENTAL REGISTER**

GFMIATV (NEVADA LIMITED LIABILITY COMPANY)  
SUITE 205  
11700 SW 2ND ST.  
PEMBROKE PINES, FL 33025

FOR: ADVERTISING AND PROMOTIONAL SERVICES, IN CLASS 35 (U.S. CLS. 100, 101 AND 102).

FIRST USE 4-16-2012; IN COMMERCE 4-16-2012.

THE MARK CONSISTS OF STANDARD CHARACTERS WITHOUT CLAIM TO ANY PARTICULAR FONT, STYLE, SIZE, OR COLOR.

SER. NO. 85-533,851, FILED P.R. 2-3-2012; AM. S.R. 11-13-2012.

CURTIS FRENCH, EXAMINING ATTORNEY



*David J. Kyfos*

Director of the United States Patent and Trademark Office

# United States of America

United States Patent and Trademark Office

## FoodOrderNetwork.com

**Reg. No. 4,277,489**

JUSTSERVICE.NET, LLC (ILLINOIS LIMITED LIABILITY COMPANY)  
2940 N. CLARK STREET  
CHICAGO, IL 60657

**Registered Jan. 15, 2013**

**Int. Cls.: 35 and 43**

FOR: ON-LINE ORDERING SERVICES IN THE FIELD OF RESTAURANT TAKE-OUT AND DELIVERY; AND ADVERTISING AND DIRECTORY SERVICES, NAMELY, PROMOTING THE SERVICES OF OTHERS BY PROVIDING A WEB PAGE FEATURING MENUS AND LINKS TO THE WEBSITES OF OTHERS, IN CLASS 35 (U.S. CLS. 100, 101 AND 102).

**SERVICE MARK**

**SUPPLEMENTAL REGISTER** FIRST USE 1-5-2012; IN COMMERCE 1-5-2012.

FOR: ONLINE RESTAURANT RESERVATION SERVICES AND ON LINE BOOKING OF CATERING SERVICES FOR OTHERS, IN CLASS 43 (U.S. CLS. 100 AND 101).

FIRST USE 1-5-2012; IN COMMERCE 1-5-2012.

THE MARK CONSISTS OF STANDARD CHARACTERS WITHOUT CLAIM TO ANY PARTICULAR FONT, STYLE, SIZE, OR COLOR.

SER. NO. 85-533,883, FILED P.R. 2-3-2012; AM. S.R. 11-21-2012.

PATRICIA EVANKO, EXAMINING ATTORNEY



*David J. Kybas*

Director of the United States Patent and Trademark Office

# United States of America

United States Patent and Trademark Office

## MLS SOURCE

**Reg. No. 4,277,490**

**Registered Jan. 15, 2013**

**Int. Cl.: 9**

**TRADEMARK**

**SUPPLEMENTAL REGISTER**

MLSLISTINGS INC. (CALIFORNIA NON-PROFIT MUTUAL BENEFIT CORPORATION)  
350 OAKMEAD PARKWAY, 2ND FLOOR  
SUNNYVALE, CA 94085

FOR: DOWNLOADABLE ELECTRONIC PUBLICATIONS, NAMELY, TRAINING MANUALS, INSTRUCTION MANUALS, USER GUIDES, TRAINING AND INSTRUCTIONAL VIDEOS IN THE FIELDS OF COMPUTER SOFTWARE AND REAL ESTATE INFORMATION AND DATA FOR ACCESSING INFORMATION DIRECTORIES THAT MAY BE DOWNLOADED FROM THE GLOBAL COMPUTER NETWORK; COMPUTER SOFTWARE FOR USE IN CREATING, ACCESSING, SECURING, MODIFYING, RETRIEVING, MANIPULATING, ADVERTISING, AND REVISING MULTIPLE REAL ESTATE LISTINGS WHICH INCLUDE DATA, PHOTOGRAPHS, VIDEO, AUDIO AND GRAPHICAL DATA, IMAGES AND TEXT, MAPS, AND DRIVING DIRECTIONS, IN CLASS 9 (U.S. CLS. 21, 23, 26, 36 AND 38).

FIRST USE 12-13-2011; IN COMMERCE 12-13-2011.

THE MARK CONSISTS OF STANDARD CHARACTERS WITHOUT CLAIM TO ANY PARTICULAR FONT, STYLE, SIZE, OR COLOR.

SER. NO. 85-533,956, FILED P.R. 2-3-2012; AM. S.R. 11-16-2012.

GRETTA YAO, EXAMINING ATTORNEY



*David J. Kybas*

Director of the United States Patent and Trademark Office

# United States of America

United States Patent and Trademark Office

## MLS SOURCE

**Reg. No. 4,277,491**

**Registered Jan. 15, 2013**

**Int. Cl.: 42**

**SERVICE MARK**

**SUPPLEMENTAL REGISTER**

MLSLISTINGS INC. (CALIFORNIA NON-PROFIT MUTUAL BENEFIT CORPORATION)  
350 OAKMEAD PARKWAY, 2ND FLOOR  
SUNNYVALE, CA 94085

FOR: COMPUTER SERVICES, NAMELY, ACTING AS A SOFTWARE-AS-A-SERVICE PROVIDER (SAAS) IN THE FIELD OF REAL ESTATE INFORMATION TO HOST SOFTWARE THAT COLLECTS, EDITS, ORGANIZES, MODIFIES, BOOKMARKS, TRANSMITS, STORES AND SHARES DATA AND INFORMATION, THAT CREATES SEARCHABLE AND EXTRACTABLE DATABASES OF INFORMATION AND DATA AND THAT PERMITS ACCESS TO INFORMATION DIRECTORIES THAT MAY BE DOWNLOADED FROM THE GLOBAL COMPUTER NETWORK; APPLICATION SERVICE PROVIDER (ASP) SERVICES, NAMELY, HOSTING, MANAGING AND MAINTAINING APPLICATIONS IN THE FIELDS OF COMPUTER SOFTWARE FOR CREATING SEARCHABLE DATABASES OF INFORMATION AND DATA AND FOR COLLECTION, EDITING, ORGANIZING, MODIFYING, BOOKMARKING, TRANSMISSION, STORAGE AND SHARING OF DATA AND INFORMATION AND FOR ACCESSING INFORMATION FOR DIRECTORIES THAT MAY BE DOWNLOADED FROM THE GLOBAL COMPUTER NETWORK, IN CLASS 42 (U.S. CLS. 100 AND 101).

FIRST USE 12-13-2011; IN COMMERCE 12-13-2011.

THE MARK CONSISTS OF STANDARD CHARACTERS WITHOUT CLAIM TO ANY PARTICULAR FONT, STYLE, SIZE, OR COLOR.

SER. NO. 85-533,967, FILED P.R. 2-3-2012; AM. S.R. 11-13-2012.

GRETТА YAO, EXAMINING ATTORNEY



*David J. Kybas*

Director of the United States Patent and Trademark Office

# United States of America

United States Patent and Trademark Office

## BRONX HEROES

**Reg. No. 4,277,492**

**Registered Jan. 15, 2013**

**Int. Cls.: 16 and 41**

REIANLDO T. FELIX (NEW YORK SOLE PROPRIETORSHIP), DBA BX HEROES COMIC CONVENTIONS,

2N  
3130 GRAND CONCOURSE  
BRONX, NY 10458

**TRADEMARK**

FOR: COMIC BOOKS, IN CLASS 16 (U.S. CLS. 2, 5, 22, 23, 29, 37, 38 AND 50).

FIRST USE 7-1-2008; IN COMMERCE 3-15-2009.

**SERVICE MARK**

FOR: PROVIDING ONLINE NON-DOWNLOADABLE COMIC BOOKS AND GRAPHIC NOVELS, IN CLASS 41 (U.S. CLS. 100, 101 AND 107).

**SUPPLEMENTAL REGISTER**

FIRST USE 6-1-2011; IN COMMERCE 6-1-2011.

THE MARK CONSISTS OF STANDARD CHARACTERS WITHOUT CLAIM TO ANY PARTICULAR FONT, STYLE, SIZE, OR COLOR.

SER. NO. 85-534,241, FILED P.R. 2-5-2012; AM. S.R. 11-16-2012.

JAMES A. RAUEN, EXAMINING ATTORNEY



*David J. Kyffers*

Director of the United States Patent and Trademark Office



# United States of America

United States Patent and Trademark Office

## Every 30 Seconds

**Reg. No. 4,277,493**

FERNWOOD ENTERPRISES, INC. (FLORIDA CORPORATION)  
1140 EAGLE POINT DRIVE  
ST. AUGUSTINE, FL 32092

**Registered Jan. 15, 2013**

**Int. Cl.: 44**

FOR: MEDICAL ASSISTANCE SERVICES PROVIDED VIA TELECOMMUNICATION AND GLOBAL COMPUTER NETWORKS FOR INDIVIDUALS WITH HEALTH PROBLEMS THROUGH THE USE OF WEARABLE MEDICAL DEVICES WITH AUTOMATED ALERT AND MONITORING CAPACITY, IN CLASS 44 (U.S. CLS. 100 AND 101).

**SERVICE MARK**

**SUPPLEMENTAL REGISTER** FIRST USE 2-1-2012; IN COMMERCE 2-1-2012.

THE MARK CONSISTS OF STANDARD CHARACTERS WITHOUT CLAIM TO ANY PARTICULAR FONT, STYLE, SIZE, OR COLOR.

SER. NO. 85-534,835, FILED P.R. 2-6-2012; AM. S.R. 10-29-2012.

JAY BESCH, EXAMINING ATTORNEY



*David J. Kyffers*

Director of the United States Patent and Trademark Office

# United States of America

United States Patent and Trademark Office

## AGRIFINANCE ADVISORS

**Reg. No. 4,277,494**

AGRIFINANCE ADVISORS, INC. (IOWA CORPORATION)  
6913 VISTA DRIVE  
WEST DES MOINES, IA 50266

**Registered Jan. 15, 2013**

**Int. Cl.: 36**

FOR: INSURANCE SERVICES, COMMODITY MARKETING ADVICE AND BROKERAGE SERVICES, REAL ESTATE INVESTMENT SERVICES AND REAL ESTATE BROKERAGE SERVICES, RISK MANAGEMENT SERVICES IN THE AREA OF FINANCIAL ANALYSIS, CROP INSURANCE AND COMMODITY MARKETING ANALYSIS, IN CLASS 36 (U.S. CLS. 100, 101 AND 102).

**SERVICE MARK**

**SUPPLEMENTAL REGISTER**

FIRST USE 10-20-2011; IN COMMERCE 10-20-2011.

THE MARK CONSISTS OF STANDARD CHARACTERS WITHOUT CLAIM TO ANY PARTICULAR FONT, STYLE, SIZE, OR COLOR.

SER. NO. 85-535,101, FILED P.R. 2-6-2012; AM. S.R. 11-20-2012.

WILLIAM BRECKENFELD, EXAMINING ATTORNEY



*David J. Kyffers*

Director of the United States Patent and Trademark Office

# United States of America

United States Patent and Trademark Office

## PARMA VALLEY BUTTER

**Reg. No. 4,277,495**

SORELLA USA, L.L.C. (NEW JERSEY LIMITED LIABILITY COMPANY)  
18 SPIELMAN ROAD  
FAIRFIELD, NJ 07004

**Registered Jan. 15, 2013**

**Int. Cl.: 29**

FOR: BUTTER, IN CLASS 29 (U.S. CL. 46).

FIRST USE 5-24-2012; IN COMMERCE 5-24-2012.

**TRADEMARK**

THE MARK CONSISTS OF STANDARD CHARACTERS WITHOUT CLAIM TO ANY PARTICULAR FONT, STYLE, SIZE, OR COLOR.

**SUPPLEMENTAL REGISTER**

NO CLAIM IS MADE TO THE EXCLUSIVE RIGHT TO USE "BUTTER", APART FROM THE MARK AS SHOWN.

SER. NO. 85-537,549, FILED P.R. 2-8-2012; AM. S.R. 11-20-2012.

WILLIAM BRECKENFELD, EXAMINING ATTORNEY



*David J. Kybas*

Director of the United States Patent and Trademark Office

# United States of America

United States Patent and Trademark Office



**Reg. No. 4,277,496**

**Registered Jan. 15, 2013**

**Int. Cl.: 35**

**SERVICE MARK**

**SUPPLEMENTAL REGISTER**

MEADOWBROOK FARMS, LLC (NEBRASKA LIMITED LIABILITY COMPANY)  
102 LINCOLN STREET  
WATERLOO, NE 68069

FOR: FARMERS MARKETS FEATURING FRESH FRUITS AND VEGETABLES; RETAIL STORE SERVICES FEATURING FRESH FRUITS AND VEGETABLES, IN CLASS 35 (U.S. CLS. 100, 101 AND 102).

FIRST USE 6-19-2012; IN COMMERCE 6-19-2012.

THE MARK CONSISTS OF TRADE DRESS COMPRISING THE DESIGN OF A FRESH PRODUCE STAND CONSISTING OF A SIX-SIDED STRUCTURE WITH SIX COUNTERS AND A MULTI-SIDED AWNING SUPPORTED BY SIX VERTICAL POLES.

SER. NO. 85-538,304, FILED P.R. 2-9-2012; AM. S.R. 11-21-2012.

JIM RINGLE, EXAMINING ATTORNEY



*David J. Kyffers*

Director of the United States Patent and Trademark Office

# United States of America

United States Patent and Trademark Office

## Advanced Therapeutic Solutions

**Reg. No. 4,277,497**

**Registered Jan. 15, 2013**

**Int. Cl.: 5**

**TRADEMARK**

**SUPPLEMENTAL REGISTER**

JOSEPH, MARY E (INDIA INDIVIDUAL)  
17 GREENWOOD ROAD  
17 GREENWOOD ROAD  
HOPKINTON, MA 01748

FOR: PHARMACEUTICAL PREPARATIONS AND SUBSTANCES FOR THE TREATMENT OF VIRAL, METABOLIC, ENDOCRINE, MUSCULOSKELETAL, CARDIOVASCULAR, CARDIOPULMONARY, GENITOURINARY, SEXUAL DYSFUNCTION, ONCOLOGICAL, HEPATOLOGICAL, OPHTHALMIC, RESPIRATORY, NEUROLOGICAL, GASTROINTESTINAL, HORMONAL, DERMATOLOGICAL, PSYCHIATRIC AND IMMUNE SYSTEM RELATED DISEASES AND DISORDERS, IN CLASS 5 (U.S. CLS. 6, 18, 44, 46, 51 AND 52).

FIRST USE 8-1-2012; IN COMMERCE 8-1-2012.

THE MARK CONSISTS OF STANDARD CHARACTERS WITHOUT CLAIM TO ANY PARTICULAR FONT, STYLE, SIZE, OR COLOR.

SER. NO. 85-538,513, FILED P.R. 2-9-2012; AM. S.R. 11-20-2012.

JORDAN BAKER, EXAMINING ATTORNEY



*David J. Kyffers*

Director of the United States Patent and Trademark Office

# United States of America

United States Patent and Trademark Office

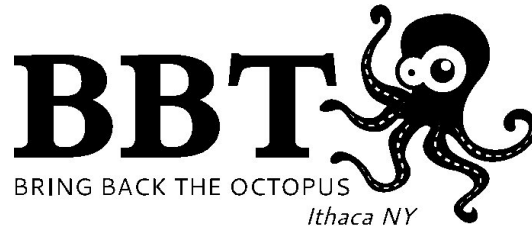

**Reg. No. 4,277,498**

**Registered Jan. 15, 2013**

**Int. Cl.: 25**

**TRADEMARK**

**SUPPLEMENTAL REGISTER**

VITALITY BUSINESS SOLUTIONS LLC (NEW YORK LIMITED LIABILITY COMPANY)  
PO BOX 493  
CORTLAND, NY 13045

FOR: T-SHIRTS, IN CLASS 25 (U.S. CLS. 22 AND 39).

FIRST USE 11-11-2011; IN COMMERCE 11-11-2011.

NO CLAIM IS MADE TO THE EXCLUSIVE RIGHT TO USE "ITHACA, NY" , APART FROM THE MARK AS SHOWN.

THE MARK CONSISTS OF THE STYLIZED LETTERS AND WORDS "BBTO BRING BACK THE OCTOPUS ITHACA NY". THE LETTER "O" IS IN THE FORM OF AN OCTOPUS.

SER. NO. 85-541,187, FILED P.R. 2-13-2012; AM. S.R. 11-28-2012.

MATTHEW KLINE, EXAMINING ATTORNEY



*David J. Kybas*

Director of the United States Patent and Trademark Office

# United States of America

United States Patent and Trademark Office

## World Musical Chairs Federation

**Reg. No. 4,277,499**

SMITHFEST EVENTS, INC. (MASSACHUSETTS CORPORATION)  
38 WILLOWDALE RD.

**Registered Jan. 15, 2013**

TYNGSBORO, MA 01879

**Int. Cl.: 41**

FOR: INSTITUTING, REGULATING AND AWARDED AMATEUR ATHLETIC CHAMPIONSHIPS; SPORTS REFEREEING AND OFFICIATING, IN CLASS 41 (U.S. CLS. 100, 101 AND 107).

**SERVICE MARK**

FIRST USE 2-21-2012; IN COMMERCE 3-25-2012.

**SUPPLEMENTAL REGISTER**

THE MARK CONSISTS OF STANDARD CHARACTERS WITHOUT CLAIM TO ANY PARTICULAR FONT, STYLE, SIZE, OR COLOR.

NO CLAIM IS MADE TO THE EXCLUSIVE RIGHT TO USE "FEDERATION", APART FROM THE MARK AS SHOWN.

SER. NO. 85-543,040, FILED P.R. 2-15-2012; AM. S.R. 12-4-2012.

RONALD DELGIZZI, EXAMINING ATTORNEY



*David J. Kyffers*

Director of the United States Patent and Trademark Office

# United States of America

United States Patent and Trademark Office

## WE FIX LEAKY CHIMNEYS

**Reg. No. 4,277,500**

MEREDITH, JOHN (UNITED STATES INDIVIDUAL)  
800 SOUTH 7TH STREET  
RICHMOND, IN 47374

**Registered Jan. 15, 2013**

**Int. Cl.: 37**

FOR: WATERPROOFING OF CHIMNEYS AND INSTALLATION AND APPLICATION OF CHIMNEY WATERPROOFING PRODUCTS, IN CLASS 37 (U.S. CLS. 100, 103 AND 106).

**SERVICE MARK**

FIRST USE 2-15-2012; IN COMMERCE 2-15-2012.

**SUPPLEMENTAL REGISTER**

THE MARK CONSISTS OF STANDARD CHARACTERS WITHOUT CLAIM TO ANY PARTICULAR FONT, STYLE, SIZE, OR COLOR.

SER. NO. 85-544,478, FILED P.R. 2-16-2012; AM. S.R. 11-30-2012.

TINA MAI, EXAMINING ATTORNEY



*David J. Kyffers*

Director of the United States Patent and Trademark Office



# United States of America

United States Patent and Trademark Office

# Best **P** LANT

**Reg. No. 4,277,501**

FLUOR ENTERPRISES, INC. (DELAWARE CORPORATION)  
6700 LAS COLINAS BLVD.  
IRVING, TX 75039

**Registered Jan. 15, 2013**

**Int. Cls.: 35, 37, and 42**

FOR: BUSINESS CONSULTATION SERVICES IN THE FIELD OF PLANT AND FACILITY PERFORMANCE OPTIMIZATION, NAMELY, BUSINESS PROCESS IMPROVEMENT AND COST ASSESSMENT, IN CLASS 35 (U.S. CLS. 100, 101 AND 102).

**SERVICE MARK**

FIRST USE 12-31-2002; IN COMMERCE 12-31-2002.

**SUPPLEMENTAL REGISTER**

FOR: CONSULTATION SERVICES IN THE FIELD OF PLANT AND FACILITY MAINTENANCE, IN CLASS 37 (U.S. CLS. 100, 103 AND 106).

FIRST USE 12-31-2002; IN COMMERCE 12-31-2002.

FOR: CONSULTATION SERVICES IN THE FIELD OF PLANT AND FACILITY PERFORMANCE OPTIMIZATION, NAMELY, MAINTENANCE ASSESSMENT OF THE PERFORMANCE AND RELIABILITY OF PLANT AND FACILITY PERFORMANCE, IN CLASS 42 (U.S. CLS. 100 AND 101).

FIRST USE 12-31-2002; IN COMMERCE 12-31-2002.

THE MARK CONSISTS OF "BEST PLANT" AND THE HORIZONTAL LINE OF THE "P" IN BLUE; THE CURVED TOP PORTION OF THE "P" APPEARS IN RED.

THE COLOR(S) BLUE AND RED IS/ARE CLAIMED AS A FEATURE OF THE MARK.

SER. NO. 85-544,936, FILED 2-16-2012.

CHRISIE B. KING, EXAMINING ATTORNEY



*David J. Kyjars*

Director of the United States Patent and Trademark Office

# United States of America

United States Patent and Trademark Office

# BESTPLANT

**Reg. No. 4,277,502**

FLUOR ENTERPRISES, INC. (DELAWARE CORPORATION)  
6700 LAS COLINAS BLVD.  
IRVING, TX 75039

**Registered Jan. 15, 2013**

**Int. Cls.: 35, 37, and 42**

FOR: BUSINESS CONSULTATION SERVICES IN THE FIELD OF PLANT AND FACILITY PERFORMANCE OPTIMIZATION, NAMELY, BUSINESS PROCESS IMPROVEMENT AND COST ASSESSMENT, IN CLASS 35 (U.S. CLS. 100, 101 AND 102).

**SERVICE MARK**

FIRST USE 12-31-2002; IN COMMERCE 12-31-2002.

**SUPPLEMENTAL REGISTER**

FOR: CONSULTATION SERVICES IN THE FIELD OF PLANT AND FACILITY MAINTENANCE, IN CLASS 37 (U.S. CLS. 100, 103 AND 106).

FIRST USE 12-31-2002; IN COMMERCE 12-31-2002.

FOR: CONSULTATION SERVICES IN THE FIELD OF PLANT AND FACILITY PERFORMANCE OPTIMIZATION, NAMELY, MAINTENANCE ASSESSMENT OF THE PERFORMANCE AND RELIABILITY OF PLANT AND FACILITY PERFORMANCE, IN CLASS 42 (U.S. CLS. 100 AND 101).

FIRST USE 12-31-2002; IN COMMERCE 12-31-2002.

THE MARK CONSISTS OF STANDARD CHARACTERS WITHOUT CLAIM TO ANY PARTICULAR FONT, STYLE, SIZE, OR COLOR.

SER. NO. 85-544,943, FILED 2-16-2012.

CHRISIE B. KING, EXAMINING ATTORNEY



*David J. Kyros*

Director of the United States Patent and Trademark Office

# United States of America

United States Patent and Trademark Office

## AT HOME WEALTH SYSTEM

**Reg. No. 4,277,503**

DYNAMIC PROSPERITY INC. (CANADA CORPORATION)

**Registered Jan. 15, 2013**

17-2595 MAIN STREET  
WINNIPEG, CANADA R2V1M5

**Int. Cl.: 41**

FOR: EDUCATION SERVICES, NAMELY, MENTORING IN THE FIELD OF INTERNET MARKETING AND DIRECT SALES; EDUCATION SERVICES, NAMELY, PROVIDING NON-DOWNLOADABLE LIVE AND ON-LINE WEBINARS, TELESEMINARS, SELF-EDUCATION PROGRAMS AND TRAININGS IN THE FIELD OF INTERNET MARKETING AND DIRECT SALES; EDUCATION SERVICES, NAMELY, PROVIDING LIVE CLASSES AND SEMINARS ALONG WITH ONLINE PROGRAMS AND TRAINING COURSES IN THE FIELD OF INTERNET MARKETING AND DIRECT SALES; EDUCATION SERVICES, NAMELY, PROVIDING HOME STUDY COURSES OF INSTRUCTION IN THE FIELD OF INTERNET MARKETING AND DIRECT SALES OFFERED THROUGH ONLINE, NON-DOWNLOADABLE VIDEOS AND INSTRUCTOR ASSISTANCE, IN CLASS 41 (U.S. CLS. 100, 101 AND 107).

**SERVICE MARK**

**SUPPLEMENTAL REGISTER**

FIRST USE 1-20-2011; IN COMMERCE 9-12-2011.

THE MARK CONSISTS OF STANDARD CHARACTERS WITHOUT CLAIM TO ANY PARTICULAR FONT, STYLE, SIZE, OR COLOR.

NO CLAIM IS MADE TO THE EXCLUSIVE RIGHT TO USE "SYSTEM", APART FROM THE MARK AS SHOWN.

SER. NO. 85-545,444, FILED P.R. 2-17-2012; AM. S.R. 11-19-2012.

LINDA ORNDORFF, EXAMINING ATTORNEY



*David J. Kyffers*

Director of the United States Patent and Trademark Office

# United States of America

United States Patent and Trademark Office

## RESPONSIBLE REFINING

**Reg. No. 4,277,504**

**Registered Jan. 15, 2013**

**Int. Cl.: 40**

**SERVICE MARK**

**SUPPLEMENTAL REGISTER**

METALOR TECHNOLOGIES USA CORPORATION (DELAWARE CORPORATION)  
P.O. BOX 255  
255 JOHN DIETSCH BOULEVARD  
NORTH ATTLEBOROUGH, MA 02761

FOR: METAL REFINING SERVICES, NAMELY, REFINING, PROCESSING, CASTING, SMELTING, MELTING AND PROCESSING OF PRECIOUS METALS, GOLD, SILVER, PLATINUM, AND PALLADIUM REFINING; RECOVERY OF PRECIOUS METALS FROM SCRAP MATERIALS FOR RECYCLING PURPOSES; RECYCLING OF PRECIOUS METALS, IN CLASS 40 (U.S. CLS. 100, 103 AND 106).

FIRST USE 5-31-2012; IN COMMERCE 5-31-2012.

THE MARK CONSISTS OF STANDARD CHARACTERS WITHOUT CLAIM TO ANY PARTICULAR FONT, STYLE, SIZE, OR COLOR.

NO CLAIM IS MADE TO THE EXCLUSIVE RIGHT TO USE "REFINING", APART FROM THE MARK AS SHOWN.

SER. NO. 85-545,482, FILED P.R. 2-17-2012; AM. S.R. 12-4-2012.

STEVEN JACKSON, EXAMINING ATTORNEY



*David J. Kyfos*

Director of the United States Patent and Trademark Office

# United States of America

United States Patent and Trademark Office

## Economic Value Proposition Matrix

**Reg. No. 4,277,505**

THE RAPID RESPONSE INSTITUTE LLC (WYOMING LIMITED LIABILITY COMPANY)  
20715 PARK PINE DR.  
KATY, TX 77450

**Registered Jan. 15, 2013**

**Int. Cl.: 35**

FOR: ADVICE RELATING TO THE ORGANISATION AND MANAGEMENT OF BUSINESS,  
IN CLASS 35 (U.S. CLS. 100, 101 AND 102).

**SERVICE MARK**

FIRST USE 1-1-2011; IN COMMERCE 1-1-2011.

**SUPPLEMENTAL REGISTER**

THE MARK CONSISTS OF STANDARD CHARACTERS WITHOUT CLAIM TO ANY PARTICULAR FONT, STYLE, SIZE, OR COLOR.

SER. NO. 85-547,521, FILED P.R. 2-20-2012; AM. S.R. 12-11-2012.

BRENDAN MCCAULEY, EXAMINING ATTORNEY



*David J. Kybas*

Director of the United States Patent and Trademark Office

# United States of America

United States Patent and Trademark Office

## MIAMI FOOD WEEK

**Reg. No. 4,277,506**

**Registered Jan. 15, 2013**

**Int. Cl.: 41**

**SERVICE MARK**

**SUPPLEMENTAL REGISTER**

ALBELO, ANTHONY (UNITED STATES INDIVIDUAL)  
SUITE 11  
2550 S BAYSHORE DRIVE  
MIAMI, FL 33133

FOR: CONDUCTING ENTERTAINMENT EXHIBITIONS IN THE NATURE OF BEER, FOOD AND WINE FESTIVALS, IN CLASS 41 (U.S. CLS. 100, 101 AND 107).

FIRST USE 9-0-2011; IN COMMERCE 9-0-2011.

THE MARK CONSISTS OF STANDARD CHARACTERS WITHOUT CLAIM TO ANY PARTICULAR FONT, STYLE, SIZE, OR COLOR.

NO CLAIM IS MADE TO THE EXCLUSIVE RIGHT TO USE "FOOD", APART FROM THE MARK AS SHOWN.

SER. NO. 85-547,944, FILED P.R. 2-21-2012; AM. S.R. 11-20-2012.

MARTHA FROMM, EXAMINING ATTORNEY



*David J. Kyffers*

Director of the United States Patent and Trademark Office

# United States of America

United States Patent and Trademark Office

## Hillbilly Stemware

**Reg. No. 4,277,507**

MOORE, DONNA (UNITED STATES JOINT APPLICANTS)  
5218 LIVERING LANE  
SAN DIEGO, CA 92117 AND

**Registered Jan. 15, 2013**

**Int. Cl.: 35**

CAVE, LIZABETH (UNITED STATES JOINT APPLICANTS)  
5218 LIVERING LANE  
SAN DIEGO, CA 92117

**SERVICE MARK**

**SUPPLEMENTAL REGISTER**

FOR: ON-LINE RETAIL STORE SERVICES FEATURING DRINK GLASSES, WINE, CHAMPANGE, MARTINI, SHOT GLASS; RETAIL STORE SERVICES FEATURING DRINK GLASSES, WINE, CHAMPANGE, MARTINI, SHOT GLASS, IN CLASS 35 (U.S. CLS. 100, 101 AND 102).

FIRST USE 10-0-2011; IN COMMERCE 10-0-2011.

THE MARK CONSISTS OF STANDARD CHARACTERS WITHOUT CLAIM TO ANY PARTICULAR FONT, STYLE, SIZE, OR COLOR.

SER. NO. 85-549,337, FILED P.R. 2-22-2012; AM. S.R. 12-3-2012.

CHRIS WELLS, EXAMINING ATTORNEY



*David J. Kyfos*

Director of the United States Patent and Trademark Office

# United States of America

United States Patent and Trademark Office

## solutions for wireless ecosystems

**Reg. No. 4,277,508**

SQUAN CONSTRUCTION SERVICES, LLC (NEW JERSEY LIMITED LIABILITY COMPANY)  
329 HAROLD AVE  
ENGLEWOOD, NJ 07631

**Registered Jan. 15, 2013**

**Int. Cls.: 9, 36, and 37**

FOR: TELECOMMUNICATION TOWERS, IN CLASS 9 (U.S. CLS. 21, 23, 26, 36 AND 38).

**TRADEMARK**

FIRST USE 1-16-2012; IN COMMERCE 1-16-2012.

**SERVICE MARK**

FOR: LAND ACQUISITION SERVICES, IN CLASS 36 (U.S. CLS. 100, 101 AND 102).

**SUPPLEMENTAL REGISTER**

FIRST USE 1-16-2012; IN COMMERCE 1-16-2012.

FOR: CONSTRUCTION OF TELECOMMUNICATION TOWERS; CONSULTING IN THE FIELD OF MAINTENANCE AND REPAIR OF TELECOMMUNICATIONS NETWORK HARDWARE, APPARATUS, AND INSTRUMENTS; MAINTENANCE AND REPAIR OF TELECOMMUNICATIONS NETWORKING HARDWARE, APPARATUS, AND INSTRUMENTS; REPAIR OF TELECOMMUNICATION MACHINES AND APPARATUS; REPAIR OR MAINTENANCE OF TELECOMMUNICATION MACHINES AND APPARATUS, IN CLASS 37 (U.S. CLS. 100, 103 AND 106).

FIRST USE 1-16-2012; IN COMMERCE 1-16-2012.

THE MARK CONSISTS OF STANDARD CHARACTERS WITHOUT CLAIM TO ANY PARTICULAR FONT, STYLE, SIZE, OR COLOR.

SER. NO. 85-549,821, FILED P.R. 2-22-2012; AM. S.R. 11-20-2012.

ZACHARY BELLO, EXAMINING ATTORNEY



*David J. Kyffers*

Director of the United States Patent and Trademark Office



# United States of America

United States Patent and Trademark Office

# Refill Bar

**Reg. No. 4,277,509**

**Registered Jan. 15, 2013**

**Int. Cl.: 20**

**TRADEMARK**

**SUPPLEMENTAL REGISTER**

USE ME, LLC (MAINE LIMITED LIABILITY COMPANY)  
C/O ROBERT EDMOND MITTEL  
PO 427  
PORTLAND, ME 04112

FOR: FURNITURE, INCLUDING SHELVING, HOLDING CONTAINERS FROM WHICH HAIR SALON CUSTOMERS CAN ADD HAIR CARE PRODUCTS TO CONTAINERS ALREADY OWNED BY THE CUSTOMERS, IN CLASS 20 (U.S. CLS. 2, 13, 22, 25, 32 AND 50).

FIRST USE 4-30-2012; IN COMMERCE 4-30-2012.

THE MARK CONSISTS OF STANDARD CHARACTERS WITHOUT CLAIM TO ANY PARTICULAR FONT, STYLE, SIZE, OR COLOR.

SER. NO. 85-549,987, FILED P.R. 2-22-2012; AM. S.R. 11-17-2012.

ODESSA BIBBINS, EXAMINING ATTORNEY



*David J. Kyffers*

Director of the United States Patent and Trademark Office

# United States of America

United States Patent and Trademark Office

## SUSTAINABLE WATER WORKS

**Reg. No. 4,277,510**

JAMES L. RICHARDSON (UNITED STATES INDIVIDUAL)  
440 BURROUGHS ST. SUITE 106  
DETROIT, MI 48202

**Registered Jan. 15, 2013**

**Int. Cls.: 35, 41, and 42**

FOR: PUBLIC POLICY CONSULTANCY SERVICES; PROJECT MANAGEMENT SERVICES FOR OTHERS IN THE FIELD OF WATER MANAGEMENT, IN CLASS 35 (U.S. CLS. 100, 101 AND 102).

**SERVICE MARK**

FIRST USE 11-0-2009; IN COMMERCE 11-0-2009.

**SUPPLEMENTAL REGISTER**

FOR: PROVIDING EDUCATION THROUGH SEMINARS AND CLASSES IN THE FIELD OF WATER MANAGEMENT, IN CLASS 41 (U.S. CLS. 100, 101 AND 107).

FIRST USE 6-27-2012; IN COMMERCE 6-27-2012.

FOR: PRODUCT DEVELOPMENT AND TECHNOLOGY CONSULTING IN THE FIELD OF WATER MANAGEMENT; ENGINEERING SERVICES, NAMELY, TECHNICAL PROJECT PLANNING FOR WATER MANAGEMENT PROJECTS, IN CLASS 42 (U.S. CLS. 100 AND 101).

FIRST USE 11-0-2009; IN COMMERCE 11-0-2009.

THE MARK CONSISTS OF STANDARD CHARACTERS WITHOUT CLAIM TO ANY PARTICULAR FONT, STYLE, SIZE, OR COLOR.

SER. NO. 85-550,553, FILED P.R. 2-23-2012; AM. S.R. 11-16-2012.

ZACHARY BELLO, EXAMINING ATTORNEY



*David J. Kybas*

Director of the United States Patent and Trademark Office

# United States of America

United States Patent and Trademark Office

## NEXT DAY ASSESSMENT

**Reg. No. 4,277,511**

WADING RIVER HOLDINGS, LLC (DELAWARE LIMITED LIABILITY COMPANY)  
P. O. BOX 519  
NEW GRETNA, NJ 08224

**Registered Jan. 15, 2013**

**Int. Cl.: 45**

FOR: DETECTIVE AGENCY SERVICES, NAMELY, PROVIDING INVESTIGATION AND SURVEILLANCE SERVICES FOR INDIVIDUALS AND BUSINESSES, IN CLASS 45 (U.S. CLS. 100 AND 101).

**SERVICE MARK**

FIRST USE 2-13-2012; IN COMMERCE 2-13-2012.

**SUPPLEMENTAL REGISTER**

THE MARK CONSISTS OF STANDARD CHARACTERS WITHOUT CLAIM TO ANY PARTICULAR FONT, STYLE, SIZE, OR COLOR.

OWNER OF U.S. REG. NO. 2,948,992.

NO CLAIM IS MADE TO THE EXCLUSIVE RIGHT TO USE "ASSESSMENT", APART FROM THE MARK AS SHOWN.

SER. NO. 85-552,467, FILED P.R. 2-24-2012; AM. S.R. 11-26-2012.

COURTNEY ALVAREZ, EXAMINING ATTORNEY



*David J. Kybas*

Director of the United States Patent and Trademark Office

# United States of America

United States Patent and Trademark Office

## The Bull Riding Hall Of Fame

**Reg. No. 4,277,512**

**Registered Jan. 15, 2013**

**Int. Cl.: 41**

**SERVICE MARK**

**SUPPLEMENTAL REGISTER**

BT ENTERPRISES (TEXAS PARTNERSHIP)  
1701 SPRINGLAKE DR.  
DRIPPING SPRINGS, TX 78620

FOR: EDUCATIONAL SERVICES, NAMELY, PROVIDING ONLINE MUSEUM DISPLAYS AND EXHIBITS IN THE FIELD OF BULL RIDING; MUSEUM SERVICES, IN CLASS 41 (U.S. CLS. 100, 101 AND 107).

FIRST USE 4-1-2012; IN COMMERCE 4-1-2012.

THE MARK CONSISTS OF STANDARD CHARACTERS WITHOUT CLAIM TO ANY PARTICULAR FONT, STYLE, SIZE, OR COLOR.

NO CLAIM IS MADE TO THE EXCLUSIVE RIGHT TO USE "HALL OF FAME", APART FROM THE MARK AS SHOWN.

SER. NO. 85-557,878, FILED P.R. 3-1-2012; AM. S.R. 12-4-2012.

IRA J. GOODSaid, EXAMINING ATTORNEY



*David J. Kyffers*

Director of the United States Patent and Trademark Office

# United States of America

United States Patent and Trademark Office

## NATURAL HEALINGS MORINGA

**Reg. No. 4,277,513**

KOITA, AHMED,T (UNITED STATES INDIVIDUAL)  
2100 TIEBOUT AVE  
BRONX, NY 10457

**Registered Jan. 15, 2013**

**Int. Cl.: 5**

FOR: HERB TEAS FOR MEDICINAL PURPOSES; HERBS FOR MEDICINAL PURPOSES;  
MEDICINAL HERB EXTRACTS, IN CLASS 5 (U.S. CLS. 6, 18, 44, 46, 51 AND 52).

**TRADEMARK**

FIRST USE 11-1-2010; IN COMMERCE 11-1-2010.

**SUPPLEMENTAL REGISTER**

THE MARK CONSISTS OF STANDARD CHARACTERS WITHOUT CLAIM TO ANY PARTICULAR FONT, STYLE, SIZE, OR COLOR.

SER. NO. 85-559,363, FILED P.R. 3-3-2012; AM. S.R. 12-3-2012.

LINDA MICKLEBURGH, EXAMINING ATTORNEY



*David J. Kyffers*

Director of the United States Patent and Trademark Office

# United States of America

United States Patent and Trademark Office

# Courtwall

**Reg. No. 4,277,514**

**Registered Jan. 15, 2013**

**Int. Cl.: 19**

**TRADEMARK**

**SUPPLEMENTAL REGISTER**

COURT WALL INTERNATIONAL HOLDING AG (SWITZERLAND COMPANY)  
BAHNHOFSTRASSE 52  
ZURICH, SWITZERLAND 8001

FOR: NON-METAL BUILDING MATERIALS FOR CONSTRUCTING SQUASH AND RACQUETBALL COURTS, NAMELY, GLASS WALLS, A WALL SYSTEM CONSISTING OF REINFORCED, DRY-STACKED, ENGINEERED CONCRETE BLOCK WITH INSULATING CORE AND COATED WITH SURFACE BOND CEMENT, PLASTIC AND SOUND DEADENING GYPSUM WALL BOARDS, HARDWOOD AND PARQUET WOOD FLOORING, IN CLASS 19 (U.S. CLS. 1, 12, 33 AND 50).

FIRST USE 6-1-2012; IN COMMERCE 6-1-2012.

THE MARK CONSISTS OF STANDARD CHARACTERS WITHOUT CLAIM TO ANY PARTICULAR FONT, STYLE, SIZE, OR COLOR.

SER. NO. 85-563,122, FILED P.R. 3-7-2012; AM. S.R. 11-18-2012.

ANTHONY RINKER, EXAMINING ATTORNEY



*David J. Kyffers*

Director of the United States Patent and Trademark Office

# United States of America

United States Patent and Trademark Office

## Public Health Watchdog

**Reg. No. 4,277,515**

PARKER WAICHMAN LLP (NEW YORK LIMITED PARTNERSHIP)  
6 HARBOR PARK DRIVE  
PORT WASHINGTON, NY 11050

**Registered Jan. 15, 2013**

**Int. Cl.: 45**

FOR: LEGAL SERVICES; NEWS REPORTING AND EXPERT LEGAL COMMENTARY SERVICES IN THE FIELD OF LEGAL NEWS; ONLINE NEWS REPORTING AND EXPERT LEGAL COMMENTARY SERVICES IN THE FIELD OF LEGAL NEWS, IN CLASS 45 (U.S. CLS. 100 AND 101).

**SERVICE MARK**

**SUPPLEMENTAL REGISTER** FIRST USE 2-29-2012; IN COMMERCE 2-29-2012.

THE MARK CONSISTS OF STANDARD CHARACTERS WITHOUT CLAIM TO ANY PARTICULAR FONT, STYLE, SIZE, OR COLOR.

SER. NO. 85-565,311, FILED P.R. 3-9-2012; AM. S.R. 11-26-2012.

JESSICA A. POWERS, EXAMINING ATTORNEY



*David J. Kyjars*

Director of the United States Patent and Trademark Office

# United States of America

United States Patent and Trademark Office

## Career Choice

**Reg. No. 4,277,516**

**Registered Jan. 15, 2013**

**Int. Cl.: 41**

**SERVICE MARK**

**SUPPLEMENTAL REGISTER**

PURSuing A DREAM CORPORATION (MARYLAND CORPORATION), DBA PURSUING  
A DREAM CORPORATION,  
13013 MARQUETTE LANE  
BOWIE, MD 20715

FOR: EDUCATION SERVICES, NAMELY, MENTORING IN THE FIELD OF SCIENCE,  
TECHNOLOGY, ENGINEERING AND MATH; EDUCATION SERVICES, NAMELY,  
PROVIDING LIVE AND ON-LINE PANEL DISCUSSIONS IN THE FIELD OF SCIENCE,  
TECHNOLOGY, ENGINEERING AND MATH; EDUCATION SERVICES, NAMELY,  
PROVIDING PANEL DISCUSSIONS IN THE FIELD OF SCIENCE, TECHNOLOGY, ENGIN-  
EERING AND MATH, IN CLASS 41 (U.S. CLS. 100, 101 AND 107).

FIRST USE 5-29-2010; IN COMMERCE 5-29-2010.

THE MARK CONSISTS OF STANDARD CHARACTERS WITHOUT CLAIM TO ANY PAR-  
TICULAR FONT, STYLE, SIZE, OR COLOR.

SER. NO. 85-567,509, FILED 3-13-2012.

JOSETTE BEVERLY, EXAMINING ATTORNEY



*David J. Kyffers*

Director of the United States Patent and Trademark Office



# United States of America

United States Patent and Trademark Office

## DÉCOR SERIES

**Reg. No. 4,277,517**

TOPSEAT INTERNATIONAL, INC. (TEXAS CORPORATION)  
6913 K AVENUE, SUITE 311  
PLANO, TX 75074

**Registered Jan. 15, 2013**

**Int. Cl.: 11**

FOR: TOILET SEATS; TOILETS, IN CLASS 11 (U.S. CLS. 13, 21, 23, 31 AND 34).

**TRADEMARK**

FIRST USE 2-29-2012; IN COMMERCE 2-29-2012.

**SUPPLEMENTAL REGISTER**

THE MARK CONSISTS OF STANDARD CHARACTERS WITHOUT CLAIM TO ANY PARTICULAR FONT, STYLE, SIZE, OR COLOR.

SER. NO. 85-568,074, FILED P.R. 3-13-2012; AM. S.R. 11-20-2012.

JILL PRATER, EXAMINING ATTORNEY



*David J. Kyffers*

Director of the United States Patent and Trademark Office

# United States of America

United States Patent and Trademark Office

**got I.F.?**

**Reg. No. 4,277,518**

DANIEL MECCA (UNITED STATES INDIVIDUAL)  
9721 CYPRESS POND AVE.  
TAMPA, FL 33647

**Registered Jan. 15, 2013**

**Int. Cls.: 14 and 25**

FOR: RUBBER OR SILICON WRISTBANDS IN THE NATURE OF A BRACELET, IN CLASS 14 (U.S. CLS. 2, 27, 28 AND 50).

**TRADEMARK**

FIRST USE 4-12-2012; IN COMMERCE 4-12-2012.

**SUPPLEMENTAL REGISTER**

FOR: SPORTS CAPS AND HATS; T-SHIRTS, IN CLASS 25 (U.S. CLS. 22 AND 39).

FIRST USE 4-12-2012; IN COMMERCE 4-12-2012.

THE MARK CONSISTS OF THE WORDING "GOT I.F.?".

SER. NO. 85-568,824, FILED P.R. 3-14-2012; AM. S.R. 11-14-2012.

LAURA KOVALSKY, EXAMINING ATTORNEY



*David J. Kybas*

Director of the United States Patent and Trademark Office

# United States of America

United States Patent and Trademark Office

## VINTAGE MODERN

**Reg. No. 4,277,519**

GLOBAL DESIGN PARTNERS LLC (DELAWARE LIMITED LIABILITY COMPANY)  
270 LAFAYETTE STREET, SUITE 1400  
NEW YORK, NY 10012

**Registered Jan. 15, 2013**

**Int. Cls.: 35 and 41**

FOR: WHOLESALE AND RETAIL STORE SERVICES FEATURING ANTIQUES, FURNITURE, LIGHTING, COLLECTIBLES, TEXTILE, ART, JEWELRY AND PHOTOGRAPHY; ON-LINE MARKETPLACES FEATURING ANTIQUES, FURNITURE, LIGHTING, COLLECTIBLES, TEXTILE, ART, JEWELRY AND PHOTOGRAPHY, IN CLASS 35 (U.S. CLS. 100, 101 AND 102).

**SERVICE MARK**

**SUPPLEMENTAL REGISTER**

FIRST USE 4-6-2012; IN COMMERCE 4-6-2012.

FOR: PROVIDING A WEBSITE FEATURING BLOGS AND NON-DOWNLOADABLE PUBLICATIONS IN THE NATURE OF ARTICLES IN THE FIELDS OF CULTURAL EVENTS, ANTIQUES, FURNITURE, LIGHTING, COLLECTIBLES, TEXTILE, ART, JEWELRY, PHOTOGRAPHY AND CUSTOM DESIGN PRODUCTS, IN CLASS 41 (U.S. CLS. 100, 101 AND 107).

FIRST USE 4-6-2012; IN COMMERCE 4-6-2012.

THE MARK CONSISTS OF STANDARD CHARACTERS WITHOUT CLAIM TO ANY PARTICULAR FONT, STYLE, SIZE, OR COLOR.

OWNER OF U.S. REG. NO. 4,020,878.

SER. NO. 85-569,012, FILED P.R. 3-14-2012; AM. S.R. 11-20-2012.

LOURDES AYALA, EXAMINING ATTORNEY



*David J. Kyros*

Director of the United States Patent and Trademark Office

# United States of America

United States Patent and Trademark Office

# GTE

**Reg. No. 4,277,520**

**Registered Jan. 15, 2013**

**Int. Cl.: 42**

**SERVICE MARK**

**SUPPLEMENTAL REGISTER**

THE RED FLAG GROUP LIMITED (HONG KONG CORPORATION)  
SUOTE 2204-2206, BONHAM TRADE CENTRE  
50 BONHAM STRAND  
SHEUNG WAN, HONG KONG 00001

FOR: SOFTWARE AS A SERVICE (SAAS) SERVICES FEATURING SOFTWARE FOR ANTI-CORRUPTION COMPLIANCE MANAGEMENT, IN CLASS 42 (U.S. CLS. 100 AND 101).

FIRST USE 7-1-2009; IN COMMERCE 7-1-2009.

THE MARK CONSISTS OF STANDARD CHARACTERS WITHOUT CLAIM TO ANY PARTICULAR FONT, STYLE, SIZE, OR COLOR.

SER. NO. 85-573,638, FILED P.R. 3-19-2012; AM. S.R. 10-27-2012.

RUDY R. SINGLETON, EXAMINING ATTORNEY



*David J. Kybas*

Director of the United States Patent and Trademark Office

# United States of America

United States Patent and Trademark Office

## THE BEST VALUE IN CONTRACT-FREE WIRELESS

**Reg. No. 4,277,521**

**Registered Jan. 15, 2013**

**Int. Cl.: 38**

**SERVICE MARK**

**SUPPLEMENTAL REGISTER**

RED POCKET INC. (DELAWARE CORPORATION)  
2060D AVENIDA DE LOS ARBOLES, SUITE 288  
THOUSAND OAKS, CA 91362

FOR: COMMUNICATION SERVICES, NAMELY, TRANSMISSION OF VOICE, AUDIO, VISUAL IMAGES AND DATA BY TELECOMMUNICATIONS NETWORKS, WIRELESS COMMUNICATION NETWORKS, THE INTERNET, INFORMATION SERVICES NETWORKS AND DATA NETWORKS; TELECOMMUNICATION SERVICES, NAMELY, LOCAL AND LONG DISTANCE TRANSMISSION OF VOICE, DATA, GRAPHICS AND VIDEO BY MEANS OF BROADBAND OPTICAL OR WIRELESS NETWORKS; TELECOMMUNICATION SERVICES, NAMELY, LOCAL AND LONG DISTANCE TRANSMISSION OF VOICE, DATA, GRAPHICS AND VIDEO BY MEANS OF BROADBAND, COPPER AND OPTICAL OR WIRELESS NETWORKS; TELECOMMUNICATION SERVICES, NAMELY, PROVIDING INTERNET ACCESS VIA BROADBAND OPTICAL OR WIRELESS NETWORKS; TELECOMMUNICATION SERVICES, NAMELY, TRANSMISSION OF VOICE, DATA, GRAPHICS, IMAGES, AUDIO AND VIDEO BY MEANS OF TELECOMMUNICATIONS NETWORKS, WIRELESS COMMUNICATION NETWORKS, AND THE INTERNET; TELECOMMUNICATION SERVICES, NAMELY, TRANSMISSION OF VOICE, DATA, GRAPHICS, SOUND AND VIDEO BY MEANS OF BROADBAND POWER LINE OR WIRELESS NETWORKS; TELECOMMUNICATION SERVICES, NAMELY, WIRELESS TELEPHONE SERVICES; TELECOMMUNICATIONS SERVICES, NAMELY, WIRELESS TELEPHONY AND WIRELESS BROADBAND COMMUNICATIONS SERVICES FOR THE TRANSMISSION OF VOICE AND DATA; WIRELESS DIGITAL MESSAGING SERVICES; WIRELESS TELEPHONE TELECOMMUNICATIONS SERVICES, NAMELY, WIRELESS MOBILE TELEPHONE CALLING PLANS; WIRELESS VOICE MAIL SERVICES, IN CLASS 38 (U.S. CLS. 100, 101 AND 104).



FIRST USE 1-15-2011; IN COMMERCE 1-15-2011.

THE MARK CONSISTS OF STANDARD CHARACTERS WITHOUT CLAIM TO ANY PARTICULAR FONT, STYLE, SIZE, OR COLOR.

SER. NO. 85-580,002, FILED P.R. 3-26-2012; AM. S.R. 11-15-2012.

KEVIN DINALLO, EXAMINING ATTORNEY

*David J. Kyffers*

Director of the United States Patent and Trademark Office

# United States of America

United States Patent and Trademark Office

## COLOR CONCEPT

**Reg. No. 4,277,522**

**Registered Jan. 15, 2013**

**Int. Cl.: 9**

**TRADEMARK**

**SUPPLEMENTAL REGISTER**

AKZO NOBEL COATINGS INTERNATIONAL B.V. (NETHERLANDS LIMITED LIABILITY COMPANY)  
VELPERWEG 76  
ARNHEM, NETHERLANDS 6824BM

FOR: COMPUTER APPLICATION SOFTWARE FOR MOBILE DEVICES FOR CREATING AND SHARING ARCHITECTURAL AND DESIGN CONCEPT BOARDS, IN CLASS 9 (U.S. CLS. 21, 23, 26, 36 AND 38).

FIRST USE 4-12-2012; IN COMMERCE 4-12-2012.

THE MARK CONSISTS OF STANDARD CHARACTERS WITHOUT CLAIM TO ANY PARTICULAR FONT, STYLE, SIZE, OR COLOR.

SER. NO. 85-580,801, FILED P.R. 3-27-2012; AM. S.R. 11-7-2012.

AISHA SALEM, EXAMINING ATTORNEY



*David J. Kyjars*

Director of the United States Patent and Trademark Office

# United States of America

United States Patent and Trademark Office

# Nica Puro

**Reg. No. 4,277,523**

FAIRMONT HOLDINGS, INC. (FLORIDA CORPORATION)  
3400 S.W. 26TH TERRACE, #A-1  
DANIA, FL 33312

**Registered Jan. 15, 2013**

**Int. Cl.: 34**

FOR: CIGAR BOXES; CIGAR CUTTERS; CIGAR TUBES; CIGARS; TOBACCO, IN CLASS 34 (U.S. CLS. 2, 8, 9 AND 17).

**TRADEMARK**

FIRST USE 10-1-2012; IN COMMERCE 10-1-2012.

**SUPPLEMENTAL REGISTER**

THE MARK CONSISTS OF STANDARD CHARACTERS WITHOUT CLAIM TO ANY PARTICULAR FONT, STYLE, SIZE, OR COLOR.

NO CLAIM IS MADE TO THE EXCLUSIVE RIGHT TO USE "PURO", APART FROM THE MARK AS SHOWN.

THE ENGLISH TRANSLATION OF "PURO" IN THE MARK IS "PURE".

SER. NO. 85-581,921, FILED P.R. 3-28-2012; AM. S.R. 10-30-2012.

ODESSA BIBBINS, EXAMINING ATTORNEY



*David J. Kyffers*

Director of the United States Patent and Trademark Office

# United States of America

United States Patent and Trademark Office

## Global Quality Awareness

**Reg. No. 4,277,524**

**Registered Jan. 15, 2013**

**Int. Cl.: 35**

**SERVICE MARK**

**SUPPLEMENTAL REGISTER**

SUBIR AND MALINI CHOWDHURY FOUNDATION (MICHIGAN NON-PROFIT CORPORATION)  
1881 HERON RIDGE DRIVE  
BLOOMFIELD HILLS, MI 48302

FOR: PROMOTING QUALITY SELF-IMPROVEMENT PRACTICES IN PERSONAL ACTIVITIES, IN CLASS 35 (U.S. CLS. 100, 101 AND 102).

FIRST USE 4-15-2011; IN COMMERCE 4-15-2011.

THE MARK CONSISTS OF STANDARD CHARACTERS WITHOUT CLAIM TO ANY PARTICULAR FONT, STYLE, SIZE, OR COLOR.

SER. NO. 85-583,255, FILED P.R. 3-29-2012; AM. S.R. 11-8-2012.

BRIAN PINO, EXAMINING ATTORNEY



*David J. Kyffers*

Director of the United States Patent and Trademark Office



# United States of America

United States Patent and Trademark Office

## Real Money Magazine

**Reg. No. 4,277,525**

**Registered Jan. 15, 2013**

**Int. Cl.: 16**

**TRADEMARK**

**SUPPLEMENTAL REGISTER**

CERTIFIED GOLD EXCHANGE, INC. (CALIFORNIA CORPORATION)  
SUITE 1  
1060 ASHFORD AVENUE  
SAN JUAN, PUERTO RICO 00907

FOR: MAGAZINES IN THE FIELD OF GOLD, SILVER, AND THE PRECIOUS METALS INDUSTRY, IN CLASS 16 (U.S. CLS. 2, 5, 22, 23, 29, 37, 38 AND 50).

FIRST USE 9-1-2011; IN COMMERCE 9-1-2011.

THE MARK CONSISTS OF STANDARD CHARACTERS WITHOUT CLAIM TO ANY PARTICULAR FONT, STYLE, SIZE, OR COLOR.

NO CLAIM IS MADE TO THE EXCLUSIVE RIGHT TO USE "MAGAZINE", APART FROM THE MARK AS SHOWN.

SER. NO. 85-586,453, FILED P.R. 4-2-2012; AM. S.R. 12-6-2012.

RONALD DELGIZZI, EXAMINING ATTORNEY



*David J. Kyros*

Director of the United States Patent and Trademark Office

# United States of America

United States Patent and Trademark Office

## Lawyer Xchange

Since 2011

**Reg. No. 4,277,526**

SETH A. STRADER (UNITED STATES INDIVIDUAL)  
3349 CAHUENGA BLVD. SUITE 2  
LOS ANGELES, CA 90068

**Registered Jan. 15, 2013**

**Int. Cl.: 45**

FOR: ATTORNEY SERVICES, IN CLASS 45 (U.S. CLS. 100 AND 101).

FIRST USE 11-15-2011; IN COMMERCE 11-15-2011.

**SERVICE MARK**

NO CLAIM IS MADE TO THE EXCLUSIVE RIGHT TO USE "LAWYER" , APART FROM THE MARK AS SHOWN.

**SUPPLEMENTAL REGISTER**

THE MARK CONSISTS OF THE WORDS "LAWYER XCHANGE" ON THE FIRST LINE. ON THE SECOND LINE ARE THE WORDS "SINCE 2011".

SER. NO. 85-587,380, FILED P.R. 4-3-2012; AM. S.R. 10-5-2012.

LEE-ANNE BERNS, EXAMINING ATTORNEY



*David J. Kybas*

Director of the United States Patent and Trademark Office

# United States of America

United States Patent and Trademark Office

## PARK ANNAPOLIS

**Reg. No. 4,277,527**

TOWNE HOLDINGS, INC. (MARYLAND CORPORATION)  
ONE PARK PLACE, SUITE 200  
ANNAPOLIS, MD 21401

**Registered Jan. 15, 2013**

**Int. Cls.: 35 and 39**

FOR: BUSINESS ADMINISTRATION, MANAGEMENT, AND OPERATION OF PARKING GARAGES AND PARKING LOTS FOR OTHERS, IN CLASS 35 (U.S. CLS. 100, 101 AND 102).

**SERVICE MARK**

FIRST USE 3-1-2012; IN COMMERCE 3-1-2012.

**SUPPLEMENTAL REGISTER**

FOR: PARKING SERVICES FOR PARKING GARAGES AND PARKING LOTS; PARKING GARAGE SERVICES; PARKING LOT SERVICES; PARKING SPACE RENTAL; VALET PARKING SERVICES; VEHICLE PARKING SERVICES, IN CLASS 39 (U.S. CLS. 100 AND 105).

FIRST USE 3-1-2012; IN COMMERCE 3-1-2012.

THE MARK CONSISTS OF STANDARD CHARACTERS WITHOUT CLAIM TO ANY PARTICULAR FONT, STYLE, SIZE, OR COLOR.

NO CLAIM IS MADE TO THE EXCLUSIVE RIGHT TO USE "PARK" , APART FROM THE MARK AS SHOWN.

SER. NO. 85-587,604, FILED P.R. 4-3-2012; AM. S.R. 11-19-2012.

ANN E. SAPPENFIELD, EXAMINING ATTORNEY



*David J. Kybas*

Director of the United States Patent and Trademark Office

# United States of America

United States Patent and Trademark Office

## KANSAS WRITING INSTRUCTION AND EVALUATION TOOL

**Reg. No. 4,277,528**

THE UNIVERSITY OF KANSAS (KANSAS STATE EDUCATIONAL INSTITUTION)  
245 STRONG HALL, 1450 JAYHAWK BOULEVARD  
LAWRENCE, KS 66045

**Registered Jan. 15, 2013**

**Int. Cl.: 41**

FOR: EDUCATIONAL SERVICES, NAMELY, PROVIDING WEB-BASED TEACHING AND ASSESSMENT INFORMATION AND STRATEGIES; EDUCATIONAL ASSESSMENT SERVICES, IN CLASS 41 (U.S. CLS. 100, 101 AND 107).

**SERVICE MARK**

FIRST USE 9-22-2010; IN COMMERCE 9-22-2010.

**SUPPLEMENTAL REGISTER**

THE MARK CONSISTS OF STANDARD CHARACTERS WITHOUT CLAIM TO ANY PARTICULAR FONT, STYLE, SIZE, OR COLOR.

SER. NO. 85-600,946, FILED P.R. 4-18-2012; AM. S.R. 11-5-2012.

CHERYL CLAYTON, EXAMINING ATTORNEY



*David J. Kyjars*

Director of the United States Patent and Trademark Office

# United States of America

United States Patent and Trademark Office

## CREMA FINA

**Reg. No. 4,277,529**

CREMA FINA INC (FLORIDA CORPORATION)  
10144 CEDAR DUNE DR  
TAMPA, FL 33624

**Registered Jan. 15, 2013**

**Int. Cl.: 33**

FOR: WINES AND LIQUEURS, IN CLASS 33 (U.S. CLS. 47 AND 49).

**TRADEMARK**

FIRST USE 12-1-2011; IN COMMERCE 12-1-2011.

**SUPPLEMENTAL REGISTER**

THE MARK CONSISTS OF STANDARD CHARACTERS WITHOUT CLAIM TO ANY PARTICULAR FONT, STYLE, SIZE, OR COLOR.

NO CLAIM IS MADE TO THE EXCLUSIVE RIGHT TO USE "CREMA", APART FROM THE MARK AS SHOWN.

THE ENGLISH TRANSLATION OF "CREMA FINA" IN THE MARK IS "FINE CREAM".

SER. NO. 85-605,390, FILED P.R. 4-23-2012; AM. S.R. 11-19-2012.

RICHARD WHITE, EXAMINING ATTORNEY



*David J. Kyffers*

Director of the United States Patent and Trademark Office

# United States of America

United States Patent and Trademark Office

# GLOW EFX

**Reg. No. 4,277,530**

R TAPE CORP. (DELAWARE CORPORATION)  
6 INGERSOLL ROAD  
SOUTH PLAINFIELD, NJ 07080

**Registered Jan. 15, 2013**

**Int. Cl.: 17**

FOR: PHOTO-LUMINESCENT POLYVINYL CHLORIDE FILMS FOR INDUSTRIAL, COMMERCIAL, RESIDENTIAL, THEATRICAL AND ARTISTIC USE, AND FOR USE IN FURTHER MANUFACTURE, IN CLASS 17 (U.S. CLS. 1, 5, 12, 13, 35 AND 50).

**TRADEMARK**

FIRST USE 4-5-2012; IN COMMERCE 4-5-2012.

**SUPPLEMENTAL REGISTER**

THE MARK CONSISTS OF STANDARD CHARACTERS WITHOUT CLAIM TO ANY PARTICULAR FONT, STYLE, SIZE, OR COLOR.

SER. NO. 85-606,130, FILED P.R. 4-24-2012; AM. S.R. 11-14-2012.

DAVID C. REIHNER, EXAMINING ATTORNEY



*David J. Kybas*

Director of the United States Patent and Trademark Office

# United States of America

United States Patent and Trademark Office

## IS IT A COLD OR ALLERGIES?

**Reg. No. 4,277,531**

KAGEN, STEVEN L. (UNITED STATES INDIVIDUAL)  
1712 SOUTH MASON STREET  
APPLETON, WI 54914

**Registered Jan. 15, 2013**

**Int. Cl.: 44**

FOR: MEDICAL SERVICES AND INFORMATION, WITH A FOCUS IN THE FIELDS OF ALLERGIES AND ASTHMA, IN CLASS 44 (U.S. CLS. 100 AND 101).

**SERVICE MARK**

FIRST USE 4-0-2012; IN COMMERCE 4-0-2012.

**SUPPLEMENTAL REGISTER**

THE MARK CONSISTS OF STANDARD CHARACTERS WITHOUT CLAIM TO ANY PARTICULAR FONT, STYLE, SIZE, OR COLOR.

SER. NO. 85-612,391, FILED P.R. 4-30-2012; AM. S.R. 11-21-2012.

JACQUELINE A. LAVINE, EXAMINING ATTORNEY



*David J. Kappas*

Director of the United States Patent and Trademark Office

# United States of America

United States Patent and Trademark Office

## POWERCHOKES

**Reg. No. 4,277,532**

EXPRO AMERICAS, LLC (DELAWARE LIMITED LIABILITY COMPANY)  
738 HIGHWAY 6 SOUTH, SUITE 1036  
HOUSTON, TX 77079

**Registered Jan. 15, 2013**

**Int. Cl.: 37**

FOR: LEASING, INSTALLATION, REPAIR AND MAINTENANCE OF OIL FIELD EQUIPMENT, NAMELY, HYDRAULIC ACTUATED DRILLING AND SNUBBING CHOKES, AUTOMATIC CONTROLS, RELIEF VALVES, SEALS, LINERS, WEAR SLEEVES, HYDRAULIC ACTUATORS AND EQUIPMENT MANIPULATORS, IN CLASS 37 (U.S. CLS. 100, 103 AND 106).

**SERVICE MARK**

**SUPPLEMENTAL REGISTER**

FIRST USE 11-1-2012; IN COMMERCE 11-1-2012.

THE MARK CONSISTS OF STANDARD CHARACTERS WITHOUT CLAIM TO ANY PARTICULAR FONT, STYLE, SIZE, OR COLOR.

OWNER OF U.S. REG. NOS. 2,444,250 AND 2,926,053.

SER. NO. 85-615,550, FILED P.R. 5-3-2012; AM. S.R. 11-15-2012.

MICHAEL TANNER, EXAMINING ATTORNEY



*David J. Kybas*

Director of the United States Patent and Trademark Office



# United States of America

United States Patent and Trademark Office

## CASHBALANCEQUALIFIER

**Reg. No. 4,277,533**

DALLAS ACTUARIES, INC. (TEXAS CORPORATION)  
6828 HYDE PARK DRIVE  
DALLAS, TX 75231

**Registered Jan. 15, 2013**

**Int. Cl.: 42**

FOR: PROVIDING A WEBSITE FEATURING ON-LINE NON-DOWNLOADABLE SOFTWARE TOOLS FOR CALCULATING EMPLOYEE PENSION AND PROFIT SHARING PLAN INFORMATION, IN CLASS 42 (U.S. CLS. 100 AND 101).

**SERVICE MARK**

FIRST USE 4-23-2012; IN COMMERCE 4-23-2012.

**SUPPLEMENTAL REGISTER**

THE MARK CONSISTS OF STANDARD CHARACTERS WITHOUT CLAIM TO ANY PARTICULAR FONT, STYLE, SIZE, OR COLOR.

SER. NO. 85-616,285, FILED P.R. 5-3-2012; AM. S.R. 11-26-2012.

WILLIAM P. SHANAHAN, EXAMINING ATTORNEY



*David J. Kybas*

Director of the United States Patent and Trademark Office

# United States of America

United States Patent and Trademark Office

## SELECT ROOFING

**Reg. No. 4,277,534**

SELECT CONTRACTORS (TEXAS LIMITED LIABILITY COMPANY)  
24523 GOSLING RD. STE G-6  
SPRING, TX 77389

**Registered Jan. 15, 2013**

**Int. Cl.: 37**

FOR: COMPREHENSIVE PREVENTATIVE MAINTENANCE SERVICE FOR ROOFING SYSTEMS; INSTALLATION OF DOORS AND WINDOWS; INSTALLATION OF INSULATING MATERIALS; INSTALLATION OF GUTTERS AND GARAGE DOORS; INSTALLING FENCING; INSTALLING SIDING; PAINTING AND APPLYING COATINGS TO BUILDING INTERIORS AND BUILDING EXTERIORS; ROOFING CONSULTATION; ROOFING CONTRACTING; ROOFING INSTALLATION; ROOFING REPAIR; ROOFING SERVICES, IN CLASS 37 (U.S. CLS. 100, 103 AND 106).

**SERVICE MARK**

**SUPPLEMENTAL REGISTER**

FIRST USE 4-26-2010; IN COMMERCE 5-1-2010.

THE MARK CONSISTS OF STANDARD CHARACTERS WITHOUT CLAIM TO ANY PARTICULAR FONT, STYLE, SIZE, OR COLOR.

NO CLAIM IS MADE TO THE EXCLUSIVE RIGHT TO USE "ROOFING" , APART FROM THE MARK AS SHOWN.

SER. NO. 85-618,954, FILED P.R. 5-7-2012; AM. S.R. 11-21-2012.

FLORENTINA BLANDU, EXAMINING ATTORNEY



*David J. Kyffers*

Director of the United States Patent and Trademark Office

# United States of America

United States Patent and Trademark Office



**Reg. No. 4,277,535**

WHITTAKER, RODERICK L (UNITED STATES INDIVIDUAL)  
P. O. BOX 623  
UNION CITY, GA 30291

**Registered Jan. 15, 2013**

**Int. Cl.: 41**

FOR: MOTION PICTURE FILM PRODUCTION, IN CLASS 41 (U.S. CLS. 100, 101 AND 107).

**SERVICE MARK**

FIRST USE 10-9-2012; IN COMMERCE 10-9-2012.

**SUPPLEMENTAL REGISTER**

THE MARK CONSISTS OF THE WORD "THE", POSITIONED OVER THE "S" OF THE WORD "SHOW", WHICH IS IN A LARGER TYPE. A MICROPHONE IS POSITIONED OVER THE WORD "SHOW", AND TO THE RIGHT OF THE WORD "THE".

SER. NO. 85-625,632, FILED 5-15-2012.

HEATHER SAPP, EXAMINING ATTORNEY



*David J. Kyffers*

Director of the United States Patent and Trademark Office

# United States of America

United States Patent and Trademark Office

## WEATHERED RUSTIC

**Reg. No. 4,277,536**

WESTERN STATES DECKING, INC. (ARIZONA CORPORATION)  
901 W. WATKINS ST.  
PHEONIX, AZ 85007

**Registered Jan. 15, 2013**

**Int. Cl.: 6**

FOR: METAL ROOFING; METAL ROOFING PANELS; METAL ROOFING TILES; METAL TILES FOR WALLS, FLOORS OR CEILINGS; STEEL IN THE FORM OF SHEETS, PLATES, FOILS AND COILS , IN CLASS 6 (U.S. CLS. 2, 12, 13, 14, 23, 25 AND 50).

**TRADEMARK**

FIRST USE 8-1-2010; IN COMMERCE 8-1-2010.

**SUPPLEMENTAL REGISTER**

THE MARK CONSISTS OF STANDARD CHARACTERS WITHOUT CLAIM TO ANY PARTICULAR FONT, STYLE, SIZE, OR COLOR.

SER. NO. 85-634,221, FILED P.R. 5-24-2012; AM. S.R. 11-2-2012.

MARGARET POWER, EXAMINING ATTORNEY



*David J. Kybas*

Director of the United States Patent and Trademark Office

# United States of America

United States Patent and Trademark Office

## ANTIQUE RUSTIC

**Reg. No. 4,277,537**

WESTERN STATES DECKING, INC. (ARIZONA CORPORATION)  
901 W. WATKINS ST.  
PHEONIX, AZ 85007

**Registered Jan. 15, 2013**

**Int. Cl.: 6**

FOR: METAL ROOFING; METAL ROOFING PANELS; METAL ROOFING TILES; METAL TILES FOR WALLS, FLOORS OR CEILINGS; STEEL IN THE FORM OF SHEETS, PLATES, FOILS AND COILS , IN CLASS 6 (U.S. CLS. 2, 12, 13, 14, 23, 25 AND 50).

**TRADEMARK**

FIRST USE 8-1-2010; IN COMMERCE 8-1-2010.

**SUPPLEMENTAL REGISTER**

THE MARK CONSISTS OF STANDARD CHARACTERS WITHOUT CLAIM TO ANY PARTICULAR FONT, STYLE, SIZE, OR COLOR.

SER. NO. 85-634,255, FILED P.R. 5-24-2012; AM. S.R. 11-2-2012.

MARGARET POWER, EXAMINING ATTORNEY



*David J. Kyfos*

Director of the United States Patent and Trademark Office

# United States of America

United States Patent and Trademark Office

## WEATHERED METALLIC

**Reg. No. 4,277,538**

WESTERN STATES DECKING, INC. (ARIZONA CORPORATION)  
901 W. WATKINS ST.  
PHEONIX, AZ 85007

**Registered Jan. 15, 2013**

**Int. Cl.: 6**

FOR: METAL ROOFING; METAL ROOFING PANELS; METAL ROOFING TILES; METAL TILES FOR WALLS, FLOORS OR CEILINGS; STEEL IN THE FORM OF SHEETS, PLATES, FOILS AND COILS , IN CLASS 6 (U.S. CLS. 2, 12, 13, 14, 23, 25 AND 50).

**TRADEMARK**

FIRST USE 8-1-2010; IN COMMERCE 8-1-2010.

**SUPPLEMENTAL REGISTER**

THE MARK CONSISTS OF STANDARD CHARACTERS WITHOUT CLAIM TO ANY PARTICULAR FONT, STYLE, SIZE, OR COLOR.

NO CLAIM IS MADE TO THE EXCLUSIVE RIGHT TO USE "METALLIC", APART FROM THE MARK AS SHOWN.

SER. NO. 85-634,267, FILED P.R. 5-24-2012; AM. S.R. 11-2-2012.

MARGARET POWER, EXAMINING ATTORNEY



*David J. Kyros*

Director of the United States Patent and Trademark Office

# United States of America

United States Patent and Trademark Office

# Athlete Guild

**Reg. No. 4,277,539**

WOOD, ROBERT SCOTT (UNITED STATES INDIVIDUAL), DBA ATHLETE GUILD LLC,  
365 HIDDEN POINTE  
NEW BRAUNFELS, TX 78132

**Registered Jan. 15, 2013**

**Int. Cl.: 35**

FOR: PROMOTING SPORTS COMPETITIONS AND EVENTS OF OTHERS, IN CLASS 35  
(U.S. CLS. 100, 101 AND 102).

**SERVICE MARK**

FIRST USE 4-1-2010; IN COMMERCE 4-1-2010.

**SUPPLEMENTAL REGISTER**

THE MARK CONSISTS OF STANDARD CHARACTERS WITHOUT CLAIM TO ANY PARTICULAR FONT, STYLE, SIZE, OR COLOR.

SER. NO. 85-635,916, FILED 5-25-2012.

CHRISTOPHER LAW, EXAMINING ATTORNEY



*David J. Kybas*

Director of the United States Patent and Trademark Office

# United States of America

United States Patent and Trademark Office

# SCUFFHAM

**Reg. No. 4,277,540**

**Registered Jan. 15, 2013**

**Int. Cl.: 9**

**TRADEMARK**

**SUPPLEMENTAL REGISTER**

SCUFFHAM AMPS OÜ (ESTONIA PRIVATE LIMITED COMPANY)  
PÄRNU MNT 10 EE-10148  
TALLINN, ESTONIA

FOR: COMPUTER SOFTWARE PROGRAMS, COMPUTER APPLICATIONS AND SOFTWARE PLUG-INS, AND DOWNLOADABLE COMPUTER SOFTWARE, PROGRAMS, DOWNLOADABLE COMPUTER APPLICATIONS, AND SOFTWARE PLUGS-INS FOR EMULATING, SIMULATING AND MODELING THE SOUNDS OF GUITAR AMPLIFIERS, BASS AMPLIFIERS, MUSICAL INSTRUMENTS AND MICROPHONES FEATURING DIGITAL AUDIO EFFECTS MODELING, EMULATION AND SIMULATION, SPEAKER AND CABINET CONVOLUTION, SIMULATION AND EMULATION, IMPULSE RESPONSE PLAYING AND PROCESSING AND CONTROL, STORAGE AND WIRED AND WIRELESS NETWORKING OF DIGITAL AUDIO DATA FOR USE WITH DESKTOP COMPUTERS, PORTABLE COMPUTERS, TABLET COMPUTERS, MOBILE COMPUTERS, SMART PHONES AND PORTABLE HANDHELD ELECTRONIC COMPUTERS, AND INSTRUCTIONAL MANUALS, SOLD AS A UNIT, IN CLASS 9 (U.S. CLS. 21, 23, 26, 36 AND 38).

FIRST USE 5-31-2011; IN COMMERCE 5-31-2011.

THE MARK CONSISTS OF STANDARD CHARACTERS WITHOUT CLAIM TO ANY PARTICULAR FONT, STYLE, SIZE, OR COLOR.

SER. NO. 85-640,582, FILED 6-1-2012.

ANDREA HACK, EXAMINING ATTORNEY



*David J. Kyros*

Director of the United States Patent and Trademark Office



# United States of America

United States Patent and Trademark Office

## Housewife How To's

**Reg. No. 4,277,541**

KATHERINE BERRY (UNITED STATES INDIVIDUAL)  
1029 WELLINGTON DR.

**Registered Jan. 15, 2013**

LEAVENWORTH, KS 66048

**Int. Cl.: 41**

FOR: INTERACTIVE ONLINE WEB JOURNALS FEATURING TIPS FOR HOMEMAKERS,  
IN CLASS 41 (U.S. CLS. 100, 101 AND 107).

**SERVICE MARK**

FIRST USE 5-10-2011; IN COMMERCE 8-19-2011.

**SUPPLEMENTAL REGISTER**

THE MARK CONSISTS OF STANDARD CHARACTERS WITHOUT CLAIM TO ANY PARTICULAR FONT, STYLE, SIZE, OR COLOR.

NO CLAIM IS MADE TO THE EXCLUSIVE RIGHT TO USE "HOW TO'S", APART FROM THE MARK AS SHOWN.

SER. NO. 85-642,446, FILED P.R. 6-4-2012; AM. S.R. 12-1-2012.

LIEF MARTIN, EXAMINING ATTORNEY



*David J. Kybas*

Director of the United States Patent and Trademark Office

# United States of America

United States Patent and Trademark Office

## GLOBAL BUSINESS TRAVEL

**Reg. No. 4,277,542**

**Registered Jan. 15, 2013**

**Int. Cl.: 16**

**TRADEMARK**

**SUPPLEMENTAL REGISTER**

NATIONAL BUSINESS TRAVEL ASSOCIATION, INC. (NEW YORK CORPORATION)  
4TH FLOOR  
110 NORTH ROYAL STREET  
ALEXANDRIA, VA 22314

FOR: MAGAZINES IN THE FIELD OF BUSINESS TRAVEL MANAGEMENT AND THE  
BUSINESS TRAVEL INDUSTRY , IN CLASS 16 (U.S. CLS. 2, 5, 22, 23, 29, 37, 38 AND 50).

FIRST USE 7-25-2012; IN COMMERCE 7-25-2012.

THE MARK CONSISTS OF STANDARD CHARACTERS WITHOUT CLAIM TO ANY PAR-  
TICULAR FONT, STYLE, SIZE, OR COLOR.

SER. NO. 85-645,800, FILED P.R. 6-7-2012; AM. S.R. 11-7-2012.

JENNIFER RICHARDSON, EXAMINING ATTORNEY



*David J. Kyfos*

Director of the United States Patent and Trademark Office

# United States of America

United States Patent and Trademark Office

## NATIONWIDE MEDICAL LICENSING

**Reg. No. 4,277,543**

NATIONWIDE MEDICAL LICENSING, LLC (FLORIDA LIMITED LIABILITY COMPANY)  
1800 PENN ST. STE 6A  
MELBOURNE, FL 32901

**Registered Jan. 15, 2013**

**Int. Cl.: 35**

FOR: BUSINESS SERVICES, NAMELY, ASSISTING OTHERS IN OBTAINING MEDICAL LICENSES BY VERIFYING AND MONITORING THE CREDENTIALS OF DOCTORS, OTHER MEDICAL PROFESSIONALS, AND HOSPITALS, MAINTAINING CREDENTIALS FOR ALL MEDICAL PROFESSIONALS, DOCUMENT COMPLETION AND COMPLETION OF INSURANCE APPLICATION FORMS, IN CLASS 35 (U.S. CLS. 100, 101 AND 102).

**SERVICE MARK**

**SUPPLEMENTAL REGISTER**

FIRST USE 5-16-2007; IN COMMERCE 5-16-2007.

THE MARK CONSISTS OF STANDARD CHARACTERS WITHOUT CLAIM TO ANY PARTICULAR FONT, STYLE, SIZE, OR COLOR.

NO CLAIM IS MADE TO THE EXCLUSIVE RIGHT TO USE "MEDICAL LICENSING", APART FROM THE MARK AS SHOWN.

SER. NO. 85-646,622, FILED P.R. 6-8-2012; AM. S.R. 10-10-2012.

MARGARET POWER, EXAMINING ATTORNEY



*David J. Kypos*

Director of the United States Patent and Trademark Office

# United States of America

United States Patent and Trademark Office



**Reg. No. 4,277,544**

**Registered Jan. 15, 2013**

**Int. Cl.: 25**

**TRADEMARK**

**SUPPLEMENTAL REGISTER**

MAHONEY, CHRISTINE L. (UNITED STATES INDIVIDUAL), DBA CHICKENFISH PRODUCTIONS,  
60 ESSEX STREET  
QUINCY, MA 02171

FOR: SHORT-SLEEVED OR LONG-SLEEVED T-SHIRTS, IN CLASS 25 (U.S. CLS. 22 AND 39).

FIRST USE 6-8-2012; IN COMMERCE 6-8-2012.

THE MARK CONSISTS OF THE STYLIZED WORDING "CHICKENFISH" APPEARING BELOW THE DEPICTION OF A PAIR OF EYES DEPICTED AS TWO STYLIZED FISH THAT ARE TOUCHING WHICH APPEARS BELOW THE DEPICTION OF A HEART. THE COLOR RED APPEARS IN THE WORDING "CHICKENFISH" AS WELL AS THE DEPICTION OF THE HEART. THE COLOR BLACK APPEARS IN THE TAIL AND BODY OF THE TWO FISH. THE COLOR BLUE APPEARS AROUND THE COLOR BLACK IN THE BODY OF THE FISH. THE COLOR PURPLE APPEARS IN THE UPPER AND LOWER FINS OF THE FISH. THE COLOR GREEN APPEARS ON THE HEAD THE FISH. THE COLOR WHITE APPEARS AS HIGHLIGHTING ON THE FISH.

THE COLOR(S) RED, BLUE, WHITE, GREEN, BLACK AND PURPLE IS/ARE CLAIMED AS A FEATURE OF THE MARK.

SER. NO. 85-647,812, FILED 6-9-2012.

MICHAEL TANNER, EXAMINING ATTORNEY



*David J. Kybas*

Director of the United States Patent and Trademark Office

# United States of America

United States Patent and Trademark Office

[www.FOODTRUCKFRANCHISE.com](http://www.FOODTRUCKFRANCHISE.com)

**Reg. No. 4,277,545**

**Registered Jan. 15, 2013**

**Int. Cl.: 35**

**SERVICE MARK**

**SUPPLEMENTAL REGISTER**

KATZ, SAM (UNITED STATES INDIVIDUAL)  
990 MT. VERNON ESTATES DR.  
990 MOUNT VERNON ESTATES DRIVE  
ATLANTA, GA 30338

FOR: ADVICE IN THE RUNNING OF ESTABLISHMENTS AS FRANCHISES, IN CLASS 35  
(U.S. CLS. 100, 101 AND 102).

FIRST USE 1-2-2012; IN COMMERCE 1-2-2012.

THE MARK CONSISTS OF STANDARD CHARACTERS WITHOUT CLAIM TO ANY PARTICULAR FONT, STYLE, SIZE, OR COLOR.

SER. NO. 85-649,278, FILED P.R. 6-12-2012; AM. S.R. 12-11-2012.

BARBARA RUTLAND, EXAMINING ATTORNEY



*David J. Kyffers*

Director of the United States Patent and Trademark Office

# United States of America

United States Patent and Trademark Office

## CANINE COMPANY

**Reg. No. 4,277,546**

THE CANINE COMPANIES, INC. (CONNECTICUT CORPORATION)  
493 DANBURY ROAD  
WILTON, CT 06897

**Registered Jan. 15, 2013**

**Int. Cls.: 35, 37, and 41**

FOR: ONLINE RETAIL STORE SERVICES IN THE FIELD OF PET PRODUCTS; DISTRIBUTORSHIP SERVICES IN THE FIELD OF ELECTRONIC PET CONTAINMENT, NAMELY, ELECTRICALLY CHARGED BOUNDARIES FOR USE AS FENCES FOR ENCLOSING PETS, IN CLASS 35 (U.S. CLS. 100, 101 AND 102).

**SERVICE MARK**

**SUPPLEMENTAL REGISTER**

FIRST USE 10-0-2011; IN COMMERCE 10-0-2011.

FOR: INSTALLATION AND MAINTENANCE OF PET CONTAINMENT AND PET ACCESS PRODUCTS, NAMELY, PET DOORS AND ELECTRICALLY CHARGED BOUNDARIES FOR USE AS FENCES AND AREA DETERRENCE, IN CLASS 37 (U.S. CLS. 100, 103 AND 106).

FIRST USE 10-0-2011; IN COMMERCE 10-0-2011.

FOR: BEHAVIORAL TRAINING OF DOMESTIC ANIMALS; TRAINING IN THE USE, OPERATION, SERVICING, MAINTENANCE AND REPAIR OF ELECTRICALLY CHARGED BOUNDARIES FOR USE AS FENCES FOR ENCLOSING PETS; PET OBEDIENCE TRAINING SERVICES, IN CLASS 41 (U.S. CLS. 100, 101 AND 107).

FIRST USE 10-0-2011; IN COMMERCE 10-0-2011.

THE MARK CONSISTS OF STANDARD CHARACTERS WITHOUT CLAIM TO ANY PARTICULAR FONT, STYLE, SIZE, OR COLOR.

OWNER OF U.S. REG. NOS. 1,556,352 AND 2,627,569.

NO CLAIM IS MADE TO THE EXCLUSIVE RIGHT TO USE "COMPANY", APART FROM THE MARK AS SHOWN.

SER. NO. 85-654,445, FILED P.R. 6-18-2012; AM. S.R. 11-6-2012.

STEVEN JACKSON, EXAMINING ATTORNEY



*David J. Kyros*

Director of the United States Patent and Trademark Office

# United States of America

United States Patent and Trademark Office

## FLAVORSWEET

**Reg. No. 4,277,547**

FIRST CREATIVE INGREDIENTS, INC. (ILLINOIS CORPORATION)  
ON770 PARTRIDGE DRIVE  
WHEATON, IL 60187

**Registered Jan. 15, 2013**

**Int. Cl.: 30**

FOR: FOOD FLAVORINGS, IN CLASS 30 (U.S. CL. 46).

**TRADEMARK**

FIRST USE 5-0-2011; IN COMMERCE 6-0-2011.

**SUPPLEMENTAL REGISTER**

THE MARK CONSISTS OF STANDARD CHARACTERS WITHOUT CLAIM TO ANY PARTICULAR FONT, STYLE, SIZE, OR COLOR.

SER. NO. 85-658,317, FILED P.R. 6-21-2012; AM. S.R. 11-12-2012.

DOUGLAS LEE, EXAMINING ATTORNEY



*David J. Kyffers*

Director of the United States Patent and Trademark Office

# United States of America

United States Patent and Trademark Office

## ESG KeyMetrics

**Reg. No. 4,277,548**

**Registered Jan. 15, 2013**

**Int. Cl.: 35**

**SERVICE MARK**

**SUPPLEMENTAL REGISTER**

GOVERNANCE HOLDINGS CO. (DELAWARE CORPORATION), DBA GMI RATINGS,  
56 NORTHPORT DRIVE  
PORTLAND, ME 04103

FOR: BUSINESS SERVICES, NAMELY, PREPARING BUSINESS REPORTS EVALUATING THE BUSINESS RISK RATING OF PUBLIC COMPANIES BY USING A PROPRIETARY SET OF CALCULATED RATIOS AND ASSESSMENTS OF SPECIFIC BUSINESS FACTORS, INCLUDING ENVIRONMENTAL, SOCIAL AND CORPORATE GOVERNANCE RISK, IN CLASS 35 (U.S. CLS. 100, 101 AND 102).

FIRST USE 12-0-2010; IN COMMERCE 12-0-2010.

THE MARK CONSISTS OF STANDARD CHARACTERS WITHOUT CLAIM TO ANY PARTICULAR FONT, STYLE, SIZE, OR COLOR.

SER. NO. 85-661,088, FILED P.R. 6-25-2012; AM. S.R. 11-19-2012.

JIM RINGLE, EXAMINING ATTORNEY



*David J. Kybas*

Director of the United States Patent and Trademark Office



# United States of America

United States Patent and Trademark Office

## Social Surveys

**Reg. No. 4,277,549**

KEA ADVERTISING (NEW YORK CORPORATION)  
217 ROUTE 303

**Registered Jan. 15, 2013**

VALLEY COTTAGE, NY 10989

**Int. Cl.: 42**

**SERVICE MARK**

**SUPPLEMENTAL REGISTER**

FOR: SOFTWARE AS A SERVICE (SAAS) SERVICES FEATURING SOFTWARE FOR BUSINESSES TO SOLICIT REVIEWS FROM CUSTOMERS FOR THIRD PARTY WEBSITES AND INTERNAL USE; SOFTWARE AS A SERVICE (SAAS) SERVICES FEATURING SOFTWARE FOR BUSINESSES IN DESIGNING, CUSTOMIZING, CONDUCTING, MANAGING AND ANALYZING CUSTOMER REVIEWS, NAMELY, ONLINE OR E-MAIL SURVEYS, POLLS AND OTHER DATA COLLECTION METHODS; SOFTWARE AS A SERVICE (SAAS) SERVICES FEATURING SOFTWARE FOR BUSINESSES TO COLLECT, ORGANIZE AND POPULATE CUSTOMER REVIEW DATA INTO USABLE FORMATS, NAMELY DATABASES AND SPREADSHEETS; SOFTWARE AS A SERVICE (SAAS) SERVICES FEATURING SOFTWARE FOR BUSINESSES TO PREDICT TYPE AND QUALITY OF CUSTOMER REVIEWS; SOFTWARE AS A SERVICE (SAAS) SERVICES FEATURING SOFTWARE FOR BUSINESSES OFFERING SMART INFORMATION TECHNOLOGY TO PREDICT AND SORT POSITIVE REVIEWS FROM NEGATIVE REVIEWS; SOFTWARE AS A SERVICE (SAAS) SERVICES FEATURING SOFTWARE FOR BUSINESSES OFFERING SMART INFORMATION TECHNOLOGY TO INCREASE POSITIVE CUSTOMER REVIEWS AND DECREASE NEGATIVE CUSTOMER REVIEWS, IN CLASS 42 (U.S. CLS. 100 AND 101).

FIRST USE 1-1-2012; IN COMMERCE 1-1-2012.



THE MARK CONSISTS OF STANDARD CHARACTERS WITHOUT CLAIM TO ANY PARTICULAR FONT, STYLE, SIZE, OR COLOR.

NO CLAIM IS MADE TO THE EXCLUSIVE RIGHT TO USE "SURVEYS", APART FROM THE MARK AS SHOWN.

SER. NO. 85-667,022, FILED P.R. 7-2-2012; AM. S.R. 11-20-2012.

STEVEN JACKSON, EXAMINING ATTORNEY

*David J. Kybas*

Director of the United States Patent and Trademark Office

# United States of America

United States Patent and Trademark Office

## TROPHY TAGS

**Reg. No. 4,277,550**

ABBOUD, MARK (UNITED STATES INDIVIDUAL)  
680 COMMERCE DR, STE 240  
WOODBURY, MN 55125

**Registered Jan. 15, 2013**

**Int. Cl.: 20**

FOR: PLASTIC HANG TAGS; PLASTIC KEY TAGS; PLASTIC KEY CHAIN TAGS; PLASTIC ORNAMENTS AND DECORATIVE TAGS, IN CLASS 20 (U.S. CLS. 2, 13, 22, 25, 32 AND 50).

**TRADEMARK**

FIRST USE 3-1-2008; IN COMMERCE 4-4-2008.

**SUPPLEMENTAL REGISTER**

THE MARK CONSISTS OF STANDARD CHARACTERS WITHOUT CLAIM TO ANY PARTICULAR FONT, STYLE, SIZE, OR COLOR.

NO CLAIM IS MADE TO THE EXCLUSIVE RIGHT TO USE "TAGS", APART FROM THE MARK AS SHOWN.

SER. NO. 85-668,833, FILED P.R. 7-4-2012; AM. S.R. 12-6-2012.

TINA BROWN, EXAMINING ATTORNEY



*David J. Kybas*

Director of the United States Patent and Trademark Office

# United States of America

United States Patent and Trademark Office



**Reg. No. 4,277,551**

JOSEPH, LESTER S (UNITED STATES INDIVIDUAL)  
633 VINCENT  
BRONX, NY 10465

**Registered Jan. 15, 2013**

**Int. Cl.: 25**

FOR: BOTTOMS; FOOTWEAR; HATS; HEADWEAR; JACKETS; PANTS; SHIRTS; SOCKS;  
TOPS; UNDERWEAR, IN CLASS 25 (U.S. CLS. 22 AND 39).

**TRADEMARK**

FIRST USE 7-6-2012; IN COMMERCE 7-6-2012.

**SUPPLEMENTAL REGISTER**

THE NAME "GILL BULLION" DOES NOT IDENTIFY A LIVING INDIVIDUAL.

THE COLOR(S) BLACK, GREEN, BROWN, GOLD, WHITE, AND GRAY IS/ARE CLAIMED  
AS A FEATURE OF THE MARK.

THE MARK CONSISTS OF A STYLIZED DESIGN OF AN ANGEL BABY WITH A BOW AND  
ARROW IN THE COLOR BLACK AND A DEVIL BABY PLAYING A MUSICAL INSTRUMENT  
IN THE COLOR BLACK, ALL OVER THE WORDING "GILL BULLION" IN STYLIZED FONT  
WITH "GILL" WRITTEN IN GREEN AND "BULLION" WRITTEN IN BROWN, THE WORDING  
BEING TO THE LEFT OF A STYLIZED DESIGN OF A STACK OF GOLD BRICKS WITH  
BLACK SHADING AND WHITE HIGHLIGHTING. THE MARK APPEARS ON A WHITE  
BACKGROUND THAT FADES TO GRAY AT THE EDGES OF THE MARK.

SER. NO. 85-672,078, FILED P.R. 7-9-2012; AM. S.R. 11-2-2012.

JASON LOTT, EXAMINING ATTORNEY



*David J. Kyffers*

Director of the United States Patent and Trademark Office

# United States of America

United States Patent and Trademark Office

## Strategic Syndicated Research

**Reg. No. 4,277,552**

**Registered Jan. 15, 2013**

**Int. Cl.: 41**

**SERVICE MARK**

**SUPPLEMENTAL REGISTER**

HRA, LLC (NEW JERSEY LIMITED LIABILITY COMPANY)  
400 LANIDEX PLAZA  
PARSIPPANY, NJ 07054

FOR: NON-DOWNLOADABLE ELECTRONIC REPORTS REGARDING FORECASTS AND ANALYSIS OF TECHNOLOGIES, THEIR APPLICATIONS AND MARKETS; NON-DOWNLOADABLE ELECTRONIC REPORTS REGARDING VARIOUS PRODUCTS FOR MARKETS, INDUSTRIES AND TECHNOLOGIES RELATED TO MEDICAL DISORDERS; NON-DOWNLOADABLE ELECTRONIC REPORTS AND DATABASES FOR RESEARCH, DEVELOPMENT, MARKETING AND PLANNING IN THE PHARMACEUTICAL INDUSTRY, IN CLASS 41 (U.S. CLS. 100, 101 AND 107).

FIRST USE 3-1-2011; IN COMMERCE 3-1-2011.

THE MARK CONSISTS OF STANDARD CHARACTERS WITHOUT CLAIM TO ANY PARTICULAR FONT, STYLE, SIZE, OR COLOR.

NO CLAIM IS MADE TO THE EXCLUSIVE RIGHT TO USE "SYNDICATED RESEARCH", APART FROM THE MARK AS SHOWN.

SER. NO. 85-674,311, FILED P.R. 7-11-2012; AM. S.R. 11-12-2012.

KATHERINE M. DUBRAY, EXAMINING ATTORNEY



*David J. Kyjars*

Director of the United States Patent and Trademark Office

# United States of America

United States Patent and Trademark Office

## ON THE WATER IN MAINE

**Reg. No. 4,277,553**

ON THE WATER IN MAINE INC. (MAINE CORPORATION)

**Registered Jan. 15, 2013**

PO BOX 100  
ROCKPORT, ME 04856

**Int. Cl.: 36**

FOR: REAL ESTATE SERVICES, NAMELY, RENTAL OF VACATION HOMES AND PROPERTIES; REAL ESTATE SERVICE, NAMELY, RENTAL PROPERTY MANAGEMENT, IN CLASS 36 (U.S. CLS. 100, 101 AND 102).

**SERVICE MARK**

FIRST USE 6-19-2006; IN COMMERCE 6-19-2006.

**SUPPLEMENTAL REGISTER**

THE MARK CONSISTS OF STANDARD CHARACTERS WITHOUT CLAIM TO ANY PARTICULAR FONT, STYLE, SIZE, OR COLOR.

SER. NO. 85-674,619, FILED P.R. 7-11-2012; AM. S.R. 11-19-2012.

EMILY CHUO, EXAMINING ATTORNEY



*David J. Kybas*

Director of the United States Patent and Trademark Office

# United States of America

United States Patent and Trademark Office

## P.V.B. LOCK BOX

**Reg. No. 4,277,554**

J.A.J.C MFG LLC (MICHIGAN LIMITED LIABILITY COMPANY)  
20412 LORNE AVE  
TAYLOR, MI 48180

**Registered Jan. 15, 2013**

**Int. Cl.: 6**

FOR: METAL THEFT PREVENTION CAGE FOR BACK FLOW PRESSURE VACUUM BREAKER AND OTHER EXTERIOR OR EXPOSED PLUMBING INSTALLATIONS, IN CLASS 6 (U.S. CLS. 2, 12, 13, 14, 23, 25 AND 50).

**TRADEMARK**

FIRST USE 6-1-2012; IN COMMERCE 6-1-2012.

**SUPPLEMENTAL REGISTER**

THE MARK CONSISTS OF STANDARD CHARACTERS WITHOUT CLAIM TO ANY PARTICULAR FONT, STYLE, SIZE, OR COLOR.

SER. NO. 85-677,343, FILED P.R. 7-15-2012; AM. S.R. 11-26-2012.

ANTHONY RINKER, EXAMINING ATTORNEY



*David J. Kyffers*

Director of the United States Patent and Trademark Office

# United States of America

United States Patent and Trademark Office

## Museum of Osteology

**Reg. No. 4,277,555**

**Registered Jan. 15, 2013**

**Int. Cl.: 41**

**SERVICE MARK**

**SUPPLEMENTAL REGISTER**

MUSEUM OF OSTEOLOGY, INC. (OKLAHOMA NON-PROFIT CORPORATION), AKA  
WORLD OF NATURE MUSEUM OF OSTEOLOGY, INC.,  
10301 SOUTH SUNNYLANE ROAD  
OKLAHOMA CITY, OK 73160

FOR: MUSEUM SERVICES, NAMELY, EXHIBITING TO THE PUBLIC A HISTORICAL SITE;  
MUSEUMS, IN CLASS 41 (U.S. CLS. 100, 101 AND 107).

FIRST USE 6-10-2005; IN COMMERCE 8-1-2010.

THE MARK CONSISTS OF STANDARD CHARACTERS WITHOUT CLAIM TO ANY PAR-  
TICULAR FONT, STYLE, SIZE, OR COLOR.

NO CLAIM IS MADE TO THE EXCLUSIVE RIGHT TO USE "MUSEUM", APART FROM  
THE MARK AS SHOWN.

SER. NO. 85-677,915, FILED P.R. 7-16-2012; AM. S.R. 11-21-2012.

JORDAN BAKER, EXAMINING ATTORNEY



*David J. Kyffers*

Director of the United States Patent and Trademark Office

# United States of America

United States Patent and Trademark Office

WORLD'S LARGEST SELECTION  
OF ELECTRONIC COMPONENTS  
AVAILABLE FOR IMMEDIATE  
SHIPMENT!

**Reg. No. 4,277,556**

DIGI-KEY CORPORATION (MINNESOTA CORPORATION)

**Registered Jan. 15, 2013**

701 BROOKS AVENUE SOUTH  
THIEF RIVER FALLS, MN 56701

**Int. Cl.: 35**

FOR: DISTRIBUTORSHIP SERVICES IN THE FIELD OF ELECTRONIC COMPONENTS AND HARDWARE; ELECTRONIC CATALOG SERVICES FEATURING ELECTRONIC COMPONENTS AND HARDWARE; ON-LINE ORDERING SERVICES FEATURING ELECTRONIC COMPONENTS AND HARDWARE; OPERATING AN ON-LINE SHOPPING SITE IN THE FIELD OF ELECTRONIC COMPONENTS AND HARDWARE; WEB-BASED CATALOG SERVICES FEATURING ELECTRONIC COMPONENTS AND HARDWARE, IN CLASS 35 (U.S. CLS. 100, 101 AND 102).

**SERVICE MARK**

**SUPPLEMENTAL REGISTER**

FIRST USE 2-6-2012; IN COMMERCE 2-6-2012.

THE MARK CONSISTS OF STANDARD CHARACTERS WITHOUT CLAIM TO ANY PARTICULAR FONT, STYLE, SIZE, OR COLOR.

SER. NO. 85-679,403, FILED P.R. 7-17-2012; AM. S.R. 11-16-2012.

NAAKWAMA ANKRAH, EXAMINING ATTORNEY



*David J. Kyffers*

Director of the United States Patent and Trademark Office



# United States of America

United States Patent and Trademark Office

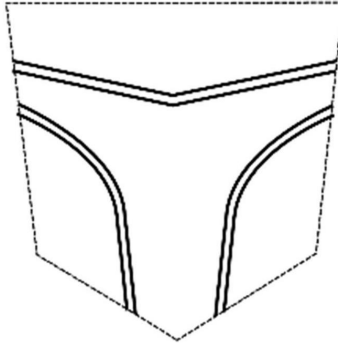

**Reg. No. 4,277,557**

**Registered Jan. 15, 2013**

**Int. Cl.: 25**

**TRADEMARK**

**SUPPLEMENTAL REGISTER**

RHEW, SI O. (UNITED STATES INDIVIDUAL)  
3008 S. SAN PEDRO ST.  
LOS ANGELES, CA 90011

FOR: PANTS, IN CLASS 25 (U.S. CLS. 22 AND 39).

FIRST USE 6-15-2012; IN COMMERCE 6-15-2012.

THE MARK CONSISTS OF A WIDE V ACROSS THE TOP OF THE POCKET WITH TWO LINES THAT CURVE DOWN TO THE BOTTOM. THE BROKEN LINES IN THE SHAPE OF A POCKET IN THE DRAWING ARE USED TO INDICATE THE POSITION OF THE MARK ON THE GOODS AND ARE NOT A FEATURE OF THE MARK.

SER. NO. 85-679,500, FILED P.R. 7-17-2012; AM. S.R. 11-26-2012.

DANIEL CAPSHAW, EXAMINING ATTORNEY



*David J. Kyffers*

Director of the United States Patent and Trademark Office

United States of America  
United States Patent and Trademark Office

# RESERFACE

**Reg. No. 4,277,558**

DERMPHARMA, INC. (CALIFORNIA CORPORATION)  
1849 W. REDLANDS BLVD., SUITE 102  
REDLANDS, CA 92373

**Registered Jan. 15, 2013**

**Int. Cls.: 3 and 5**

FOR: COSMETIC PREPARATIONS FOR SKIN CARE, IN CLASS 3 (U.S. CLS. 1, 4, 6, 50, 51 AND 52).

**TRADEMARK**

FIRST USE 7-16-2012; IN COMMERCE 7-16-2012.

**SUPPLEMENTAL REGISTER**

FOR: MEDICATED SKIN CARE PREPARATIONS, IN CLASS 5 (U.S. CLS. 6, 18, 44, 46, 51 AND 52).

FIRST USE 7-16-2012; IN COMMERCE 7-16-2012.

THE MARK CONSISTS OF STANDARD CHARACTERS WITHOUT CLAIM TO ANY PARTICULAR FONT, STYLE, SIZE, OR COLOR.

SER. NO. 85-679,820, FILED P.R. 7-18-2012; AM. S.R. 11-26-2012.

RUSS HERMAN, EXAMINING ATTORNEY



*David J. Kyfos*

Director of the United States Patent and Trademark Office

# United States of America

United States Patent and Trademark Office

## JERSEY SHORE SWEET POTATO FRY COMPANY

**Reg. No. 4,277,559**

ILVENTO J ROBERT (UNITED STATES INDIVIDUAL)  
269 RAYMOND ROAD  
PRINCETON, NJ 08540

**Registered Jan. 15, 2013**

**Int. Cl.: 29**

FOR: FRIED POTATOES, IN CLASS 29 (U.S. CL. 46).

**TRADEMARK**

FIRST USE 9-15-2010; IN COMMERCE 4-1-2012.

**SUPPLEMENTAL REGISTER**

THE MARK CONSISTS OF STANDARD CHARACTERS WITHOUT CLAIM TO ANY PARTICULAR FONT, STYLE, SIZE, OR COLOR.

OWNER OF U.S. REG. NO. 3,795,330.

NO CLAIM IS MADE TO THE EXCLUSIVE RIGHT TO USE "SWEET POTATO FRY COMPANY", APART FROM THE MARK AS SHOWN.

SER. NO. 85-681,475, FILED P.R. 7-19-2012; AM. S.R. 11-16-2012.

YAT SYE, LEE, EXAMINING ATTORNEY



*David J. Kyffers*

Director of the United States Patent and Trademark Office

# United States of America

United States Patent and Trademark Office

**THE** *Social* **NETWORK**  
*show*

**Reg. No. 4,277,560**

MONOSON-NICO, TERRY (UNITED STATES INDIVIDUAL)  
4931 BLACK BEAR ROAD, UNIT 104  
LAS VEGAS, NV 89149

**Registered Jan. 15, 2013**

**Int. Cl.: 41**

FOR: ENTERTAINMENT SERVICES, NAMELY, PROVIDING ON-GOING TELEVISION PROGRAMS IN THE FIELD OF SOCIAL NETWORKING AND SOCIAL MEDIA VIA A GLOBAL COMPUTER NETWORK; ENTERTAINMENT SERVICES, NAMELY, PROVIDING ON-GOING RADIO PROGRAMS IN THE FIELD OF SOCIAL NETWORKING AND SOCIAL MEDIA VIA A GLOBAL COMPUTER NETWORK; ENTERTAINMENT SERVICES, NAMELY, PROVIDING PODCASTS IN THE FIELD OF SOCIAL NETWORKING AND SOCIAL MEDIA, IN CLASS 41 (U.S. CLS. 100, 101 AND 107).

**SERVICE MARK**

**SUPPLEMENTAL REGISTER**

FIRST USE 5-0-2012; IN COMMERCE 5-0-2012.

NO CLAIM IS MADE TO THE EXCLUSIVE RIGHT TO USE "SHOW", APART FROM THE MARK AS SHOWN.

THE COLOR(S) BLACK AND BROWN IS/ARE CLAIMED AS A FEATURE OF THE MARK.

THE MARK CONSISTS OF THE STYLIZED WORDS "THE SOCIAL NETWORK SHOW" WITH THE WORDS "THE" AND "NETWORK" APPEARING IN BLACK AND THE WORDS "SOCIAL" AND "SHOW" APPEARING IN BROWN.

SER. NO. 85-681,577, FILED P.R. 7-19-2012; AM. S.R. 11-23-2012.

STEVEN JACKSON, EXAMINING ATTORNEY



*David J. Kyffers*

Director of the United States Patent and Trademark Office

# United States of America

United States Patent and Trademark Office

## Skin Spa New York

**Reg. No. 4,277,561**

**Registered Jan. 15, 2013**

**Int. Cl.: 44**

**SERVICE MARK**

**SUPPLEMENTAL REGISTER**

ELZNER, THOMAS (UNITED STATES INDIVIDUAL)  
4TH FLOOR  
55 WEST 21ST STREET  
NEW YORK, NY 10011

FOR: HEALTH SPA SERVICES, NAMELY, COSMETIC BODY CARE SERVICES, IN CLASS 44 (U.S. CLS. 100 AND 101).

FIRST USE 8-31-2003, THE MARK WAS FIRST USED ANYWHERE IN A DIFFERENT FORM OTHER THAN THAT SOUGHT TO BE REGISTERED AT LEAST AS EARLY AS 08/31/2003; IN COMMERCE 4-30-2004, THE MARK WAS FIRST USED IN COMMERCE IN A DIFFERENT FORM OTHER THAN THAT SOUGHT TO BE REGISTERED AT LEAST AS EARLY AS 04/30/2004.

THE MARK CONSISTS OF STANDARD CHARACTERS WITHOUT CLAIM TO ANY PARTICULAR FONT, STYLE, SIZE, OR COLOR.

NO CLAIM IS MADE TO THE EXCLUSIVE RIGHT TO USE "SKIN SPA", APART FROM THE MARK AS SHOWN.

SER. NO. 85-681,938, FILED 7-19-2012.

WILLIAM VERHOSEK, EXAMINING ATTORNEY



*David J. Kyros*

Director of the United States Patent and Trademark Office

# United States of America

United States Patent and Trademark Office

# Fold Flat

**Reg. No. 4,277,562**

3G CARDIO, LLC (ARIZONA LIMITED LIABILITY COMPANY)  
14647 SO. 50TH STREET SUITE 110  
PHOENIX, AZ 85044

**Registered Jan. 15, 2013**

**Int. Cl.: 28**

FOR: EXERCISING EQUIPMENT, NAMELY, POWERED TREADMILLS FOR RUNNING, IN CLASS 28 (U.S. CLS. 22, 23, 38 AND 50).

**TRADEMARK**

FIRST USE 7-2-2012; IN COMMERCE 7-2-2012.

**SUPPLEMENTAL REGISTER**

THE MARK CONSISTS OF STANDARD CHARACTERS WITHOUT CLAIM TO ANY PARTICULAR FONT, STYLE, SIZE, OR COLOR.

SER. NO. 85-683,535, FILED P.R. 7-21-2012; AM. S.R. 11-19-2012.

CATHERINE ROEHL, EXAMINING ATTORNEY



*David J. Kybas*

Director of the United States Patent and Trademark Office

# United States of America

United States Patent and Trademark Office

# magMaker

**Reg. No. 4,277,563**

F2F 6SIXTY DIGITAL INC. (DELAWARE CORPORATION)  
660 STUYVESANT AVE.  
IRVINGTON, NJ 07111

**Registered Jan. 15, 2013**

**Int. Cl.: 9**

FOR: COMPUTER APPLICATION SOFTWARE FOR AUTOMATING THE CREATION OF MOBILE, WEB AND DESKTOP APPLICATIONS, NAMELY, SOFTWARE FOR USE IN MOBILE, WEB AND DESKTOP ENVIRONMENTS; COMPUTER HARDWARE AND COMPUTER SOFTWARE PROGRAMS FOR THE INTEGRATION OF TEXT, AUDIO, GRAPHICS, STILL IMAGES AND MOVING PICTURES INTO AN INTERACTIVE DELIVERY FOR MULTIMEDIA APPLICATIONS; COMPUTER SOFTWARE DEVELOPMENT TOOLS, IN CLASS 9 (U.S. CLS. 21, 23, 26, 36 AND 38).

**TRADEMARK**

**SUPPLEMENTAL REGISTER**

FIRST USE 11-0-2011; IN COMMERCE 6-20-2012.

THE MARK CONSISTS OF STANDARD CHARACTERS WITHOUT CLAIM TO ANY PARTICULAR FONT, STYLE, SIZE, OR COLOR.

SER. NO. 85-683,750, FILED P.R. 7-22-2012; AM. S.R. 11-24-2012.

LEIGH CAROLINE CASE, EXAMINING ATTORNEY



*David J. Kyfos*

Director of the United States Patent and Trademark Office

# United States of America

United States Patent and Trademark Office

## SCRUB MOBILE

**Reg. No. 4,277,564**

**Registered Jan. 15, 2013**

**Int. Cl.: 35**

**SERVICE MARK**

**SUPPLEMENTAL REGISTER**

NORTH HILLS MEDICAL SUPPLY INC (PENNSYLVANIA CORPORATION), DBA SCRUB MOBILE,  
11566 PERRY HWY, SUITE 2  
WEXFORD, PA 15090

FOR: RETAIL STORE SERVICES PROVIDED ON LAND VEHICLES AND FEATURING OFF-THE-RACK UNIFORMS FOR MEDICAL STAFF AND SHOES AND MEDICAL EQUIPMENT FOR NURSING STAFF, IN CLASS 35 (U.S. CLS. 100, 101 AND 102).

FIRST USE 5-15-2012; IN COMMERCE 5-15-2012.

THE MARK CONSISTS OF STANDARD CHARACTERS WITHOUT CLAIM TO ANY PARTICULAR FONT, STYLE, SIZE, OR COLOR.

SER. NO. 85-684,362, FILED P.R. 7-23-2012; AM. S.R. 11-21-2012.

MEGHAN REINHART, EXAMINING ATTORNEY



*David J. Kybas*

Director of the United States Patent and Trademark Office



# United States of America

United States Patent and Trademark Office

## THE LOGOS QUIZ

**Reg. No. 4,277,565**

**Registered Jan. 15, 2013**

**Int. Cl.: 9**

**TRADEMARK**

**SUPPLEMENTAL REGISTER**

FOSTER RICHARD (UNITED STATES INDIVIDUAL), DBA EDGEWAY SOFTWARE,  
11 HARRIS HILL ROAD  
SHAVERTOWN, PA 18708

FOR: COMPUTER GAME PROGRAMMES DOWNLOADABLE VIA THE INTERNET; COMPUTER GAME PROGRAMS; COMPUTER GAME SOFTWARE FOR PERSONAL COMPUTERS AND HOME VIDEO GAME CONSOLES; COMPUTER GAME SOFTWARE FOR USE ON MOBILE AND CELLULAR PHONES, IN CLASS 9 (U.S. CLS. 21, 23, 26, 36 AND 38).

FIRST USE 5-23-2012; IN COMMERCE 5-23-2012.

THE MARK CONSISTS OF STANDARD CHARACTERS WITHOUT CLAIM TO ANY PARTICULAR FONT, STYLE, SIZE, OR COLOR.

NO CLAIM IS MADE TO THE EXCLUSIVE RIGHT TO USE "QUIZ", APART FROM THE MARK AS SHOWN.

SER. NO. 85-684,988, FILED P.R. 7-24-2012; AM. S.R. 11-21-2012.

JENNIFER RICHARDSON, EXAMINING ATTORNEY



*David J. Kybas*

Director of the United States Patent and Trademark Office

# United States of America

United States Patent and Trademark Office

# ACL TUBE

**Reg. No. 4,277,566**

TOPICAL GEAR LLC (TEXAS LIMITED LIABILITY COMPANY)  
613 ROBIN DALE DR  
AUSTIN, TX 78734

**Registered Jan. 15, 2013**

**Int. Cl.: 28**

FOR: ATHLETIC EQUIPMENT, NAMELY, TRAINING DEVICES TO BE WORN ON THE BODY FOR SUPPORT; BODY LIMB COMPRESSION SLEEVES FOR USE IN SOCCER AND OTHER SPORTS; PHYSICAL FITNESS EQUIPMENT, NAMELY, ANTERIOR CRUCIATE LIGAMENT SUPPORTS, SLEEVES, AND BUTTRESSES FOR EXERCISE TO IMPROVE AND ENHANCE NEUROMUSCULAR STABILIZATION, PROPRICEPTION, BALANCE, GAIT AND STRENGTH; SPORTING GOODS, NAMELY, A SPORTS TRAINING DEVICE TO IMPROVE STRENGTH, TONING, CONDITIONING, BALANCE, AND PROPRICEPTION, IN CLASS 28 (U.S. CLS. 22, 23, 38 AND 50).

**TRADEMARK**

**SUPPLEMENTAL REGISTER**

FIRST USE 3-20-2012; IN COMMERCE 3-20-2012.

THE MARK CONSISTS OF STANDARD CHARACTERS WITHOUT CLAIM TO ANY PARTICULAR FONT, STYLE, SIZE, OR COLOR.

SER. NO. 85-685,730, FILED P.R. 7-24-2012; AM. S.R. 11-21-2012.

EMILY CHUO, EXAMINING ATTORNEY



*David J. Kyros*

Director of the United States Patent and Trademark Office

# United States of America

United States Patent and Trademark Office

# ECO SOLAR

**Reg. No. 4,277,567**

ECO SOLAR LLC (TEXAS LIMITED LIABILITY COMPANY)  
630 COPPER CANYON ROAD  
ARGYLE, TX 76226

**Registered Jan. 15, 2013**

**Int. Cl.: 9**

FOR: MOBILE ELECTRONIC DEVICE ACCESSORIES, NAMELY, BATTERY CHARGERS, POWER ADAPTORS, BATTERY PACKS, PROTECTIVE CASES, HOLDERS AND STANDS SPECIALLY ADAPTED FOR USE WITH THE AFORESAID GOODS, IN CLASS 9 (U.S. CLS. 21, 23, 26, 36 AND 38).

**TRADEMARK**

**SUPPLEMENTAL REGISTER** FIRST USE 6-29-2012; IN COMMERCE 6-29-2012.

THE MARK CONSISTS OF STANDARD CHARACTERS WITHOUT CLAIM TO ANY PARTICULAR FONT, STYLE, SIZE, OR COLOR.

SER. NO. 85-685,788, FILED P.R. 7-24-2012; AM. S.R. 11-25-2012.

EMILY CHUO, EXAMINING ATTORNEY



*David J. Kyffers*

Director of the United States Patent and Trademark Office

# United States of America

United States Patent and Trademark Office

## ULTIMATE HYGIENE PROGRAM

**Reg. No. 4,277,568**

OSTREICHER, DAVID (UNITED STATES INDIVIDUAL)  
93 DIVISION AVE  
LEVITTOWN, NY 11756

**Registered Jan. 15, 2013**

**Int. Cl.: 41**

FOR: EDUCATION SERVICES, NAMELY, PROVIDING CONDUCTING CLASSES, SEMINARS AND WORKSHOPS IN THE FIELD OF ORAL HYGIENE EDUCATION AND DISEASE PREVENTION AND DISTRIBUTING COURSE MATERIALS IN CONNECTION, IN CLASS 41 (U.S. CLS. 100, 101 AND 107).

**SERVICE MARK**

**SUPPLEMENTAL REGISTER** FIRST USE 5-1-2010; IN COMMERCE 5-1-2010.

THE MARK CONSISTS OF STANDARD CHARACTERS WITHOUT CLAIM TO ANY PARTICULAR FONT, STYLE, SIZE, OR COLOR.

NO CLAIM IS MADE TO THE EXCLUSIVE RIGHT TO USE "HYGIENE PROGRAM", APART FROM THE MARK AS SHOWN.

SER. NO. 85-686,632, FILED P.R. 7-25-2012; AM. S.R. 11-26-2012.

COLLEEN MULCRONE, EXAMINING ATTORNEY



*David J. Kybas*

Director of the United States Patent and Trademark Office

# United States of America

United States Patent and Trademark Office

## FAMILY GUIDANCE & WELLNESS NETWORK

**Reg. No. 4,277,569**

**Registered Jan. 15, 2013**

**Int. Cl.: 44**

**SERVICE MARK**

**SUPPLEMENTAL REGISTER**

SIS SOLUTIONS, LLC (NEVADA LIMITED LIABILITY COMPANY), DBA FAMILY GUIDANCE AND WELLNESS NETWORK,  
730 N. EASTERN AVE. #120  
LAS VEGAS, NV 89101

FOR: MEDICAL SERVICES, IN CLASS 44 (U.S. CLS. 100 AND 101).

FIRST USE 3-18-2009; IN COMMERCE 3-18-2009.

THE MARK CONSISTS OF STANDARD CHARACTERS WITHOUT CLAIM TO ANY PARTICULAR FONT, STYLE, SIZE, OR COLOR.

NO CLAIM IS MADE TO THE EXCLUSIVE RIGHT TO USE "NETWORK", APART FROM THE MARK AS SHOWN.

SER. NO. 85-687,028, FILED P.R. 7-25-2012; AM. S.R. 11-20-2012.

CATHERINE ROEHL, EXAMINING ATTORNEY



*David J. Kybas*

Director of the United States Patent and Trademark Office

# United States of America

United States Patent and Trademark Office

## Hiking Research

**Reg. No. 4,277,570**

ELLISON, MARK (UNITED STATES INDIVIDUAL)  
780 COURTNEY STREET  
CONCORD, NC 28025

**Registered Jan. 15, 2013**

**Int. Cl.: 41**

FOR: EDUCATIONAL CLASSES AND PROGRAMS, SEMINARS, EXPERIENTIAL LEARNING PROGRAMS, AND COACHING, INCLUDING CLASSES, PROGRAMS, SEMINARS, EXPERIENTIAL LEARNING PROGRAMS, AND COACHING BASED ON RESEARCH, ALL IN THE FIELDS OF HIKING AND UTILIZING NATURE FOR IMPROVED HEALTH, STRESS REDUCTION AND INCREASED PERFORMANCE IN WORK AND PERSONAL LIFE, IN CLASS 41 (U.S. CLS. 100, 101 AND 107).

**SERVICE MARK**

**SUPPLEMENTAL REGISTER**

FIRST USE 4-15-2010; IN COMMERCE 4-15-2010.

THE MARK CONSISTS OF STANDARD CHARACTERS WITHOUT CLAIM TO ANY PARTICULAR FONT, STYLE, SIZE, OR COLOR.

SER. NO. 85-688,521, FILED P.R. 7-27-2012; AM. S.R. 11-27-2012.

JEAN IM, EXAMINING ATTORNEY



*David J. Kyffers*

Director of the United States Patent and Trademark Office

# United States of America

United States Patent and Trademark Office

# Pipe Stent

**Reg. No. 4,277,571**

GILLECE SERVICES, L.P. (PENNSYLVANIA LIMITED PARTNERSHIP)  
3000 WASHINGTON PIKE  
BRIDGEVILLE, PA 15017

**Registered Jan. 15, 2013**

**Int. Cl.: 37**

FOR: REPAIR OF DRAIN PIPE, IN CLASS 37 (U.S. CLS. 100, 103 AND 106).

**SERVICE MARK**

FIRST USE 7-25-2012; IN COMMERCE 7-25-2012.

**SUPPLEMENTAL REGISTER**

THE MARK CONSISTS OF STANDARD CHARACTERS WITHOUT CLAIM TO ANY PARTICULAR FONT, STYLE, SIZE, OR COLOR.

NO CLAIM IS MADE TO THE EXCLUSIVE RIGHT TO USE "PIPE", APART FROM THE MARK AS SHOWN.

SER. NO. 85-690,058, FILED P.R. 7-30-2012; AM. S.R. 11-27-2012.

ELLEN B. AWRICH, EXAMINING ATTORNEY



*David J. Kyffers*

Director of the United States Patent and Trademark Office

# United States of America

United States Patent and Trademark Office

## EVERYTHING IN ONE PLACE

**Reg. No. 4,277,572**

MANILLA, LLC (DELAWARE LIMITED LIABILITY COMPANY)  
300 WEST 57TH STREET  
NEW YORK, NY 10019

**Registered Jan. 15, 2013**

**Int. Cl.: 42**

FOR: PROVIDING A WEB SITE FEATURING TECHNOLOGY THAT ENABLES USERS TO ORGANIZE AND MANAGE PERSONAL ACCOUNT DATA, INCLUDING HOUEHOLD BILLS, FINANCES, TRAVEL REWARDS PROGRAMS AND SUBSCRIPTIONS, IN CLASS 42 (U.S. CLS. 100 AND 101).

**SERVICE MARK**

**SUPPLEMENTAL REGISTER** FIRST USE 8-1-2012; IN COMMERCE 8-1-2012.

THE MARK CONSISTS OF STANDARD CHARACTERS WITHOUT CLAIM TO ANY PARTICULAR FONT, STYLE, SIZE, OR COLOR.

SER. NO. 85-693,404, FILED 8-2-2012.

RUDY R. SINGLETON, EXAMINING ATTORNEY



*David J. Kyfos*

Director of the United States Patent and Trademark Office



# United States of America

United States Patent and Trademark Office

## METABOLIC TRIAD

**Reg. No. 4,277,573**

**Registered Jan. 15, 2013**

**Int. Cls.: 41 and 44**

**SERVICE MARK**

**SUPPLEMENTAL REGISTER**

LAVALLE ACADEMY, LLC (OHIO LIMITED LIABILITY COMPANY), DBA LAVALLE INSTITUTE FOR EDUCATION,  
5400 KENNEDY AVE.  
CINCINNATI, OH 45213

FOR: EDUCATIONAL SERVICES, NAMELY, PROVIDING ON-LINE CLASSES, SEMINARS AND WORKSHOPS IN THE FIELD OF HEALTH, WELLNESS AND MEDICINE; EDUCATIONAL SERVICES, NAMELY, PROVIDING CLASSES, SEMINARS AND WORKSHOPS IN THE FIELDS OF HEALTH, WELLNESS AND MEDICINE; PROVIDING CONTINUING MEDICAL EDUCATION COURSES, IN CLASS 41 (U.S. CLS. 100, 101 AND 107).

FIRST USE 8-31-2008; IN COMMERCE 8-31-2008.

FOR: HEALTH ASSESSMENT SERVICES; HEALTH CARE SERVICES, NAMELY, WELLNESS PROGRAMS; MEDICAL INFORMATION SERVICES, NAMELY, REPORTING OF CONSUMER AUTHORIZED CLINICAL TESTING RESULTS DIRECTLY TO THE PATIENT; HEALTH ASSESSMENT SERVICES, NAMELY, PROVIDING HEALTH ASSESSMENT PROTOCOLS AND PROFILES TO PATIENTS TO ASSIST THEM IN REACHING HEALTH AND WELLNESS-RELATED GOALS; HEALTH ASSESSMENT SERVICES, NAMELY, PROVIDING HEALTH ASSESSMENT SYSTEMS, PROTOCOLS AND PROFILES, OBTAINED THROUGH AN INTERDISCIPLINARY APPROACH UTILIZING A COMBINATION OF SUBJECTIVE AND OBJECTIVE DATA, PRODUCTS, NUTRITION, AND HEALTH COACHING, DIRECTLY TO CONSUMERS AS WELL AS DIRECTLY TO HEALTH CARE PROVIDERS, NAMELY, PHYSICIANS, PHARMACISTS, DIETICIANS, AND NUTRITIONAL EXPERTS, TO PROVIDE THE HEALTH ASSESSMENT SYSTEMS, PROTOCOLS AND PROFILES TO PATIENTS TO ASSIST THEM IN REACHING THEIR HEALTH AND WELLNESS-RELATED GOALS, IN CLASS 44 (U.S. CLS. 100 AND 101).

FIRST USE 8-31-2008; IN COMMERCE 8-31-2008.

THE MARK CONSISTS OF STANDARD CHARACTERS WITHOUT CLAIM TO ANY PARTICULAR FONT, STYLE, SIZE, OR COLOR.

SER. NO. 85-694,606, FILED 8-3-2012.

JOHN DWYER, EXAMINING ATTORNEY



*David J. Kyffers*

Director of the United States Patent and Trademark Office

# United States of America

United States Patent and Trademark Office

# MORAIS

**Reg. No. 4,277,574**

THE POINT CAFE LLC (FLORIDA LIMITED LIABILITY COMPANY), DBA MORAISS,  
21382 MARINA COVE CIRCLE UNIT 17-D  
AVENTURA, FL 33180

**Registered Jan. 15, 2013**

**Int. Cl.: 35**

FOR: ART GALLERIES; ART GALLERY SERVICES; COMMISSIONING OF WORKS OF  
ART; ON-LINE ART GALLERIES; PROMOTING THE GRAPHIC ARTS DESIGN SERVICES  
OF OTHERS BY MEANS OF A WEBSITE FEATURING GRAPHIC ARTWORK SUBMITTED  
BY GRAPHIC ART DESIGNERS, IN CLASS 35 (U.S. CLS. 100, 101 AND 102).

**SERVICE MARK**

**SUPPLEMENTAL REGISTER** FIRST USE 7-6-2012; IN COMMERCE 7-6-2012.

THE MARK CONSISTS OF STANDARD CHARACTERS WITHOUT CLAIM TO ANY PAR-  
TICULAR FONT, STYLE, SIZE, OR COLOR.

SER. NO. 85-695,803, FILED P.R. 8-6-2012; AM. S.R. 12-6-2012.

REBECCA GILBERT, EXAMINING ATTORNEY



*David J. Kyffers*

Director of the United States Patent and Trademark Office

# United States of America

United States Patent and Trademark Office

## Money Solutions Coach

**Reg. No. 4,277,575**

CHRIS RAUP FINANCIAL SERVICES (TEXAS SOLE PROPRIETORSHIP)  
200 WEST HWY 6, STE 330  
WACO, TX 76712

**Registered Jan. 15, 2013**

**Int. Cl.: 36**

FOR: FINANCIAL CONSULTING SERVICES, NAMELY, DEBT COUNSELING, SAVINGS AND RETIREMENT PLANNING, AND ANNUITY, FINAL EXPENSE, AND LIFE INSURANCE PLANNING, IN CLASS 36 (U.S. CLS. 100, 101 AND 102).

**SERVICE MARK**

FIRST USE 8-7-2012; IN COMMERCE 8-7-2012.

**SUPPLEMENTAL REGISTER**

THE MARK CONSISTS OF STANDARD CHARACTERS WITHOUT CLAIM TO ANY PARTICULAR FONT, STYLE, SIZE, OR COLOR.

SER. NO. 85-697,365, FILED P.R. 8-7-2012; AM. S.R. 12-6-2012.

ELISSA GARBER KON, EXAMINING ATTORNEY



*David J. Kybas*

Director of the United States Patent and Trademark Office

# United States of America

United States Patent and Trademark Office

## campus calzones

**Reg. No. 4,277,576**

ROSE LYNN HOLDINGS (WEST VIRGINIA LIMITED LIABILITY COMPANY)  
115 SHIRLANE AVE

**Registered Jan. 15, 2013**

FAIRMONT, WV 26554

**Int. Cl.: 43**

FOR: FOOD PREPARATION SERVICES; RESTAURANT SERVICES; RESTAURANT SERVICES, INCLUDING SIT-DOWN SERVICE OF FOOD AND TAKE-OUT RESTAURANT SERVICES; RESTAURANTS FEATURING HOME DELIVERY, IN CLASS 43 (U.S. CLS. 100 AND 101).

**SERVICE MARK**

**SUPPLEMENTAL REGISTER** FIRST USE 4-15-2012; IN COMMERCE 8-2-2012.

THE MARK CONSISTS OF STANDARD CHARACTERS WITHOUT CLAIM TO ANY PARTICULAR FONT, STYLE, SIZE, OR COLOR.

SER. NO. 85-697,963, FILED P.R. 8-8-2012; AM. S.R. 8-8-2012.

ANDREA BUTLER, EXAMINING ATTORNEY



*David J. Kyffers*

Director of the United States Patent and Trademark Office

# United States of America

United States Patent and Trademark Office

# POWERLIFT

**Reg. No. 4,277,577**

REEHCRAFT, INC. (NORTH DAKOTA CORPORATION)  
474 45TH STREET SOUTH  
FARGO, ND 58108

**Registered Jan. 15, 2013**

**Int. Cl.: 7**

FOR: PERSONNEL LIFTS, NAMELY, ELEVATING WORK PLATFORMS, IN CLASS 7 (U.S. CLS. 13, 19, 21, 23, 31, 34 AND 35).

**TRADEMARK**

FIRST USE 11-1-2011; IN COMMERCE 11-1-2011.

**SUPPLEMENTAL REGISTER**

THE MARK CONSISTS OF STANDARD CHARACTERS WITHOUT CLAIM TO ANY PARTICULAR FONT, STYLE, SIZE, OR COLOR.

SER. NO. 85-698,650, FILED 8-8-2012.

KIMBERLY FRYE, EXAMINING ATTORNEY



*David J. Kyffers*

Director of the United States Patent and Trademark Office

# United States of America

United States Patent and Trademark Office

## PROFESSIONAL COURT REPORTERS OF IOWA, LLC

**Reg. No. 4,277,578**

**Registered Jan. 15, 2013**

**Int. Cl.: 45**

**SERVICE MARK**

**SUPPLEMENTAL REGISTER**

PROFESSIONAL COURT REPORTERS OF IOWA, L.L.C. (IOWA LIMITED LIABILITY COMPANY), AKA PROFESSIONAL COURT REPORTERS,  
428 NW 70TH PL  
ANKENY, IA 50023

FOR: COURT REPORTING SERVICES, IN CLASS 45 (U.S. CLS. 100 AND 101).

FIRST USE 1-8-2009; IN COMMERCE 1-8-2009.

THE MARK CONSISTS OF STANDARD CHARACTERS WITHOUT CLAIM TO ANY PARTICULAR FONT, STYLE, SIZE, OR COLOR.

NO CLAIM IS MADE TO THE EXCLUSIVE RIGHT TO USE "COURT REPORTERS", APART FROM THE MARK AS SHOWN.

SER. NO. 85-701,822, FILED P.R. 8-13-2012; AM. S.R. 12-10-2012.

TEJBIR SINGH, EXAMINING ATTORNEY



*David J. Kybas*

Director of the United States Patent and Trademark Office

# United States of America

United States Patent and Trademark Office

## HEALTH INSPECTORS

**Reg. No. 4,277,579**

TELEVISION FOOD NETWORK, G.P. (DELAWARE PARTNERSHIP)  
1180 AVENUE OF THE AMERICAS  
NEW YORK, NY 10036

**Registered Jan. 15, 2013**

**Int. Cl.: 41**

FOR: EDUCATIONAL AND ENTERTAINMENT SERVICES, NAMELY, A CONTINUING PROGRAM ABOUT FOOD AND COOKING, TRAVEL, AND RESTAURANTS ACCESSIBLE BY RADIO, TELEVISION, CABLE TELEVISION, THE INTERNET, WIRELESS NETWORKS, SATELLITE, AUDIO, VIDEO, AND COMPUTER NETWORKS, IN CLASS 41 (U.S. CLS. 100, 101 AND 107).

**SERVICE MARK**

**SUPPLEMENTAL REGISTER**

FIRST USE 6-20-2012; IN COMMERCE 6-20-2012.

THE MARK CONSISTS OF STANDARD CHARACTERS WITHOUT CLAIM TO ANY PARTICULAR FONT, STYLE, SIZE, OR COLOR.

SER. NO. 85-739,954, FILED P.R. 9-27-2012; AM. S.R. 11-27-2012.

IRA J. GOODSaid, EXAMINING ATTORNEY



*David J. Kyros*

Director of the United States Patent and Trademark Office

# United States of America

United States Patent and Trademark Office

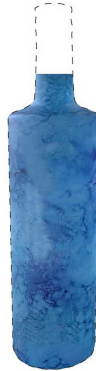

**Reg. No. 4,277,580**

**Registered Jan. 15, 2013**

**Int. Cl.: 33**

**TRADEMARK**

**SUPPLEMENTAL REGISTER**

UN SOGNO, LLC (CALIFORNIA LIMITED LIABILITY COMPANY)  
19 PIXLEY AVENUE #2  
COTE MADERA, CA 94925

FOR: DISTILLED SPIRITS, IN CLASS 33 (U.S. CLS. 47 AND 49).

FIRST USE 10-13-2008; IN COMMERCE 10-13-2008.

THE MARK CONSISTS OF THE COLOR BLUE WITH SWIRLS TO CREATE A MARBLE EFFECT AND A FROSTED EFFECT. THE DOTTED LINES ARE INTENDED TO SHOW THE POSITION OF THE MARK AND ARE NOT PART OF THE MARK AS SHOWN.

THE COLOR(S) BLUE IS/ARE CLAIMED AS A FEATURE OF THE MARK.

SER. NO. 85-741,460, FILED P.R. 9-28-2012; AM. S.R. 11-19-2012.

WILLIAM VERHOSEK, EXAMINING ATTORNEY



*David J. Kybas*

Director of the United States Patent and Trademark Office



# United States of America

United States Patent and Trademark Office

## NATURAL LENGTHENING CREME

**Reg. No. 4,277,581**

PROFESSIONAL PRODUCTS UNLIMITED, INC. (GEORGIA CORPORATION)  
116 BETHEA ROAD, SUITE 420  
FAYETTEVILLE, GA 30214

**Registered Jan. 15, 2013**

**Int. Cl.: 3**

FOR: HAIR CARE PRODUCTS, NAMELY, HAIR CREAMS; HAIR STYLING PREPARATIONS;  
HAIR CARE PREPARATIONS; HAIR NOURISHERS, IN CLASS 3 (U.S. CLS. 1, 4, 6, 50, 51  
AND 52).

**TRADEMARK**

FIRST USE 3-26-2012; IN COMMERCE 3-26-2012.

**SUPPLEMENTAL REGISTER**

THE MARK CONSISTS OF STANDARD CHARACTERS WITHOUT CLAIM TO ANY PAR-  
TICULAR FONT, STYLE, SIZE, OR COLOR.

NO CLAIM IS MADE TO THE EXCLUSIVE RIGHT TO USE "CREME", APART FROM THE  
MARK AS SHOWN.

SER. NO. 85-749,617, FILED P.R. 10-9-2012; AM. S.R. 12-3-2012.

ESTHER BELENKER, EXAMINING ATTORNEY



*David J. Kyffers*

Director of the United States Patent and Trademark Office

# United States of America

United States Patent and Trademark Office

## HEALTHY LIFESTYLE COOKING SYSTEM

**Reg. No. 4,277,582**

INNOVATIVE PRODUCT DEVELOPMENT, LLC (FLORIDA LIMITED LIABILITY COMPANY)  
4446 HENDRICKS AVE., SUITE 382  
JACKSONVILLE, FL 32207

**Registered Jan. 15, 2013**

**Int. Cl.: 11**

FOR: ELECTRIC FOOD STEAMER; ELECTRIC SKILLETS, IN CLASS 11 (U.S. CLS. 13, 21, 23, 31 AND 34).

**TRADEMARK**

FIRST USE 10-15-2012; IN COMMERCE 10-15-2012.

**SUPPLEMENTAL REGISTER**

THE MARK CONSISTS OF STANDARD CHARACTERS WITHOUT CLAIM TO ANY PARTICULAR FONT, STYLE, SIZE, OR COLOR.

NO CLAIM IS MADE TO THE EXCLUSIVE RIGHT TO USE "COOKING SYSTEM", APART FROM THE MARK AS SHOWN.

SER. NO. 85-977,990, FILED P.R. 4-12-2012; AM. S.R. 12-3-2012.

CORY BOONE, EXAMINING ATTORNEY



*David J. Kyffers*

Director of the United States Patent and Trademark Office