

BEAM DYNAMICS IN ERL FOR NON-MAGNETIZED E-COOLER

Dmitry Kayran , Xiangyun Chang

Machine Advisory Committee
January 2006

E-cooler: 2 passes ERL

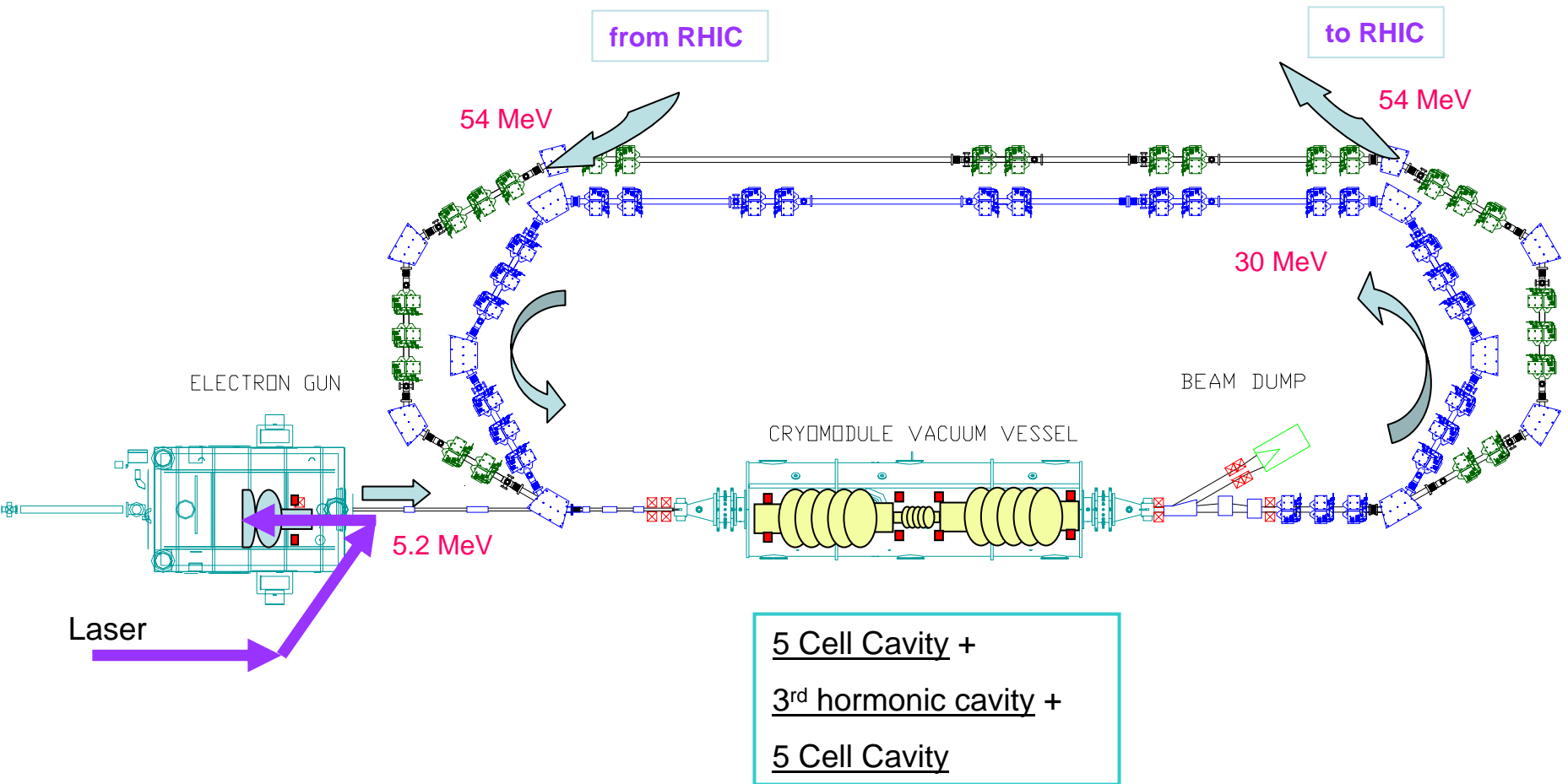

Loop lattice functions (MAD8 output)

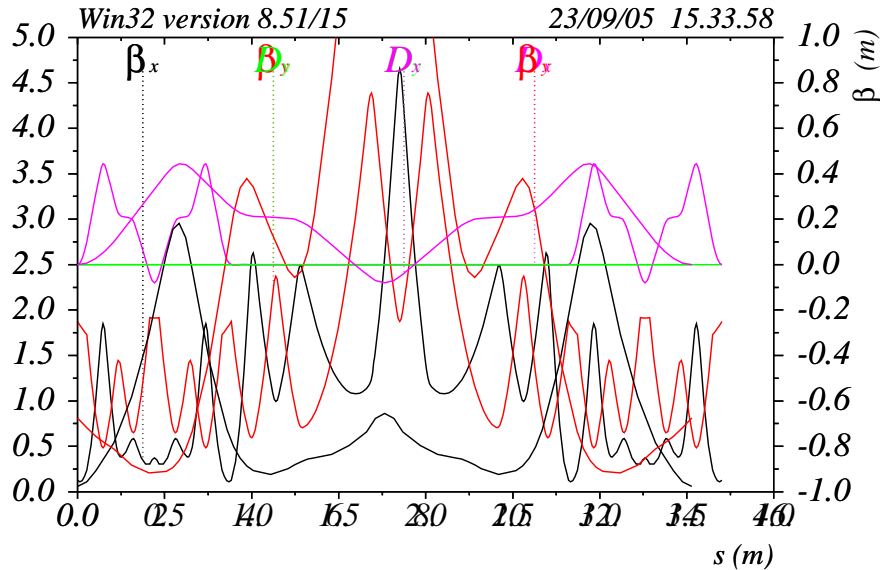
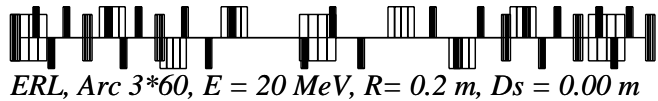

First pass

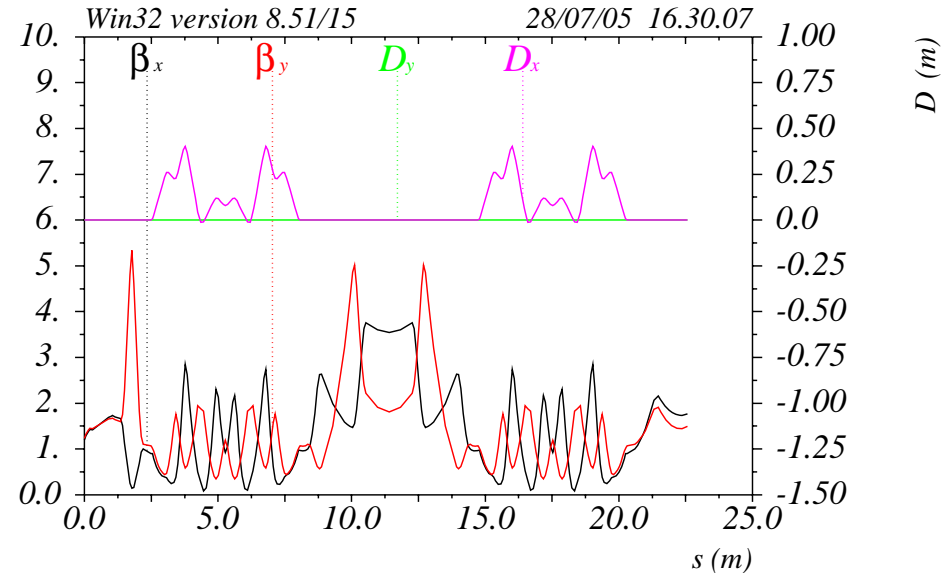
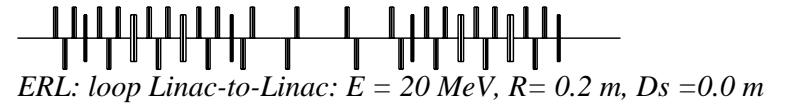

Second pass

E-cooling ERL: fitted at 12 o'clock IP

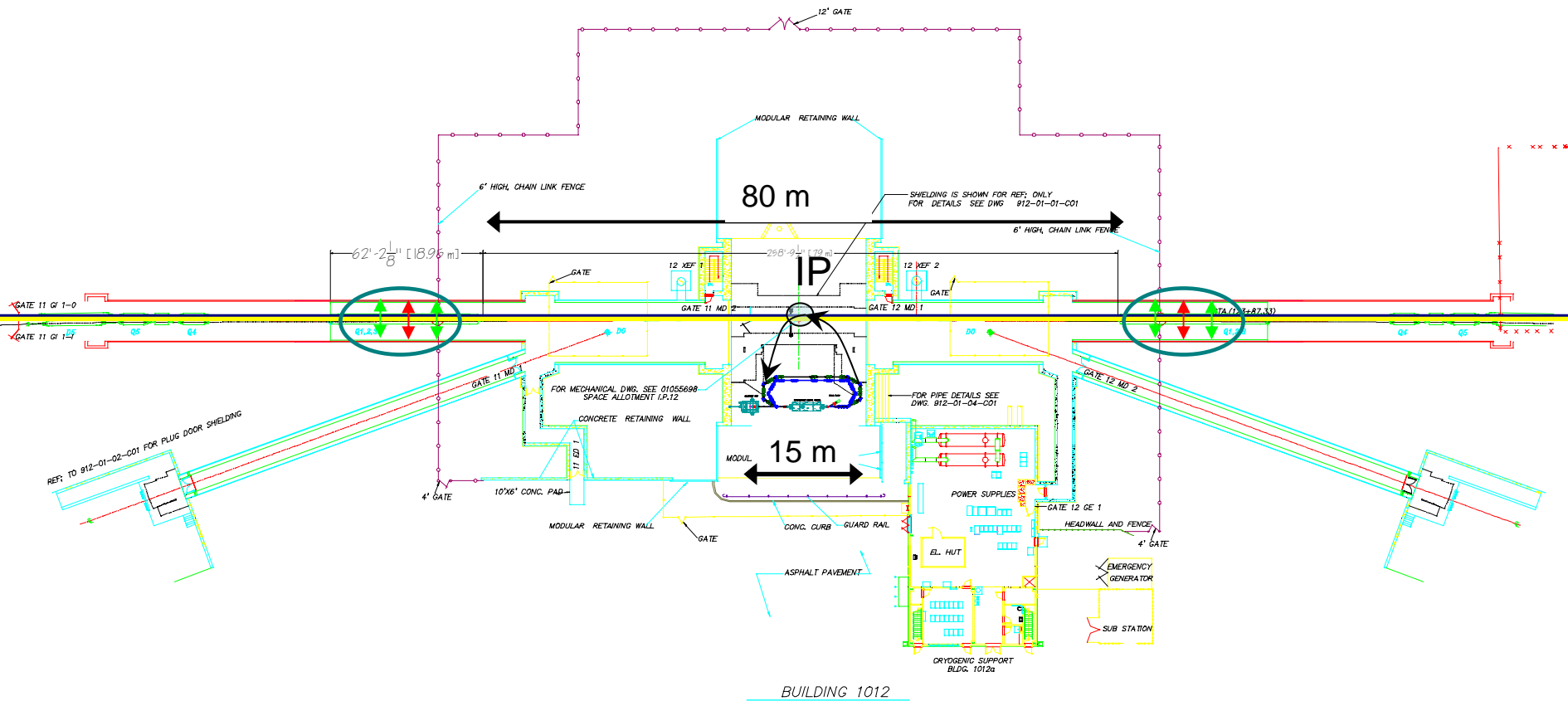

Evolution of horizontal and vertical normalized emittances in the four systems: the axially symmetric system, the Zigzag, the chicane and the Dog-leg.

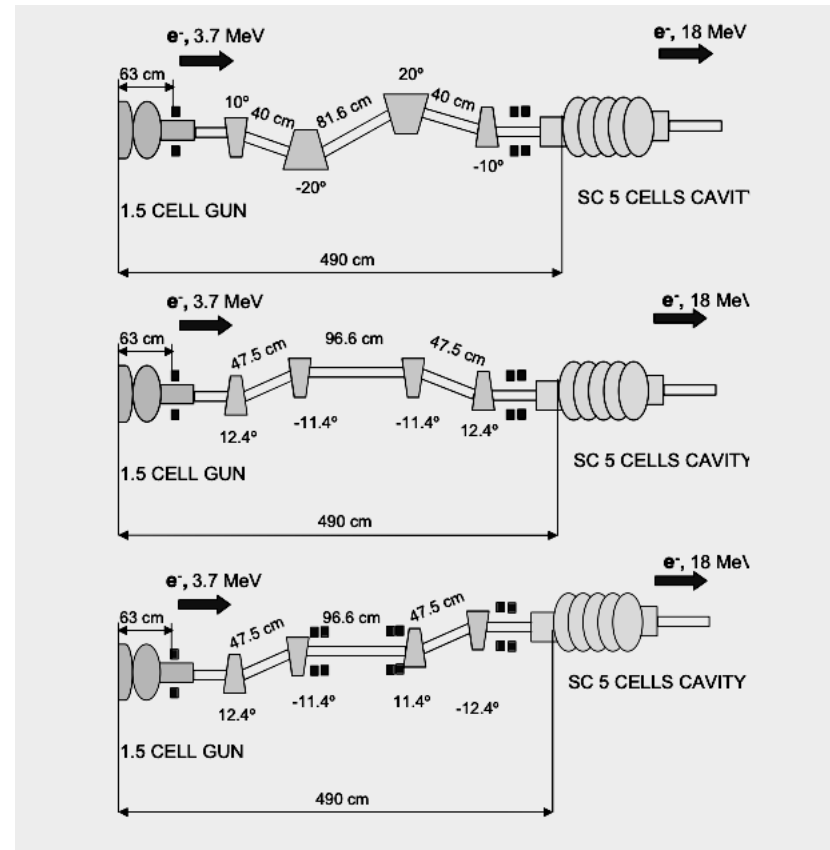
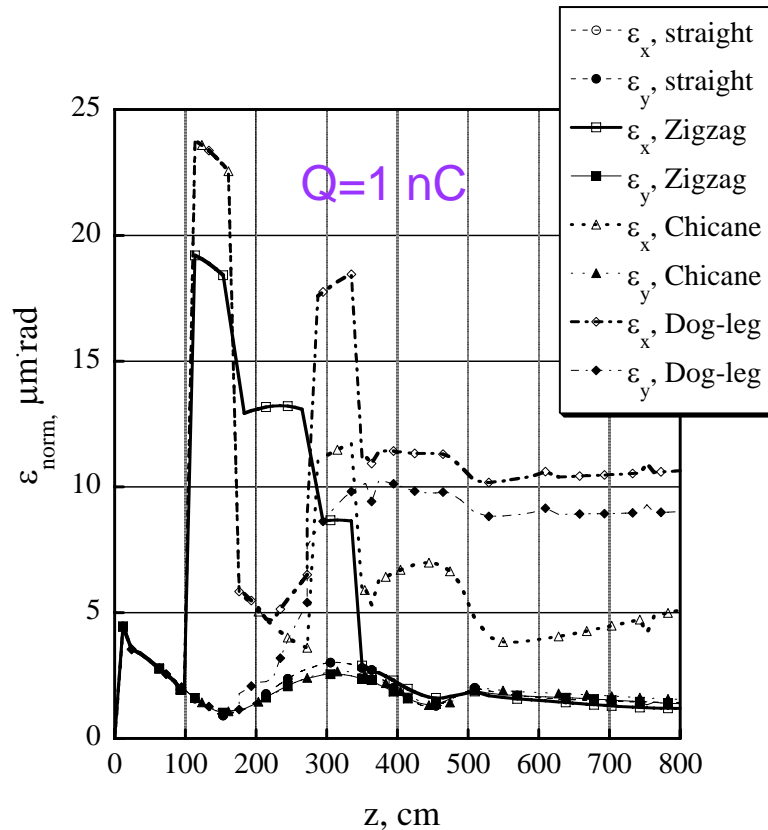

[*] D.Kayran, V.N.Litvinenko, Novel Method of Emittance Preservation in ERL Merging System in Presence of Strong Space Charge Forces, In Proceedings of 2005 Particle Accelerator Conference, May 16-20, 2005, Knoxville. TN, USA

Gun-merging-linac

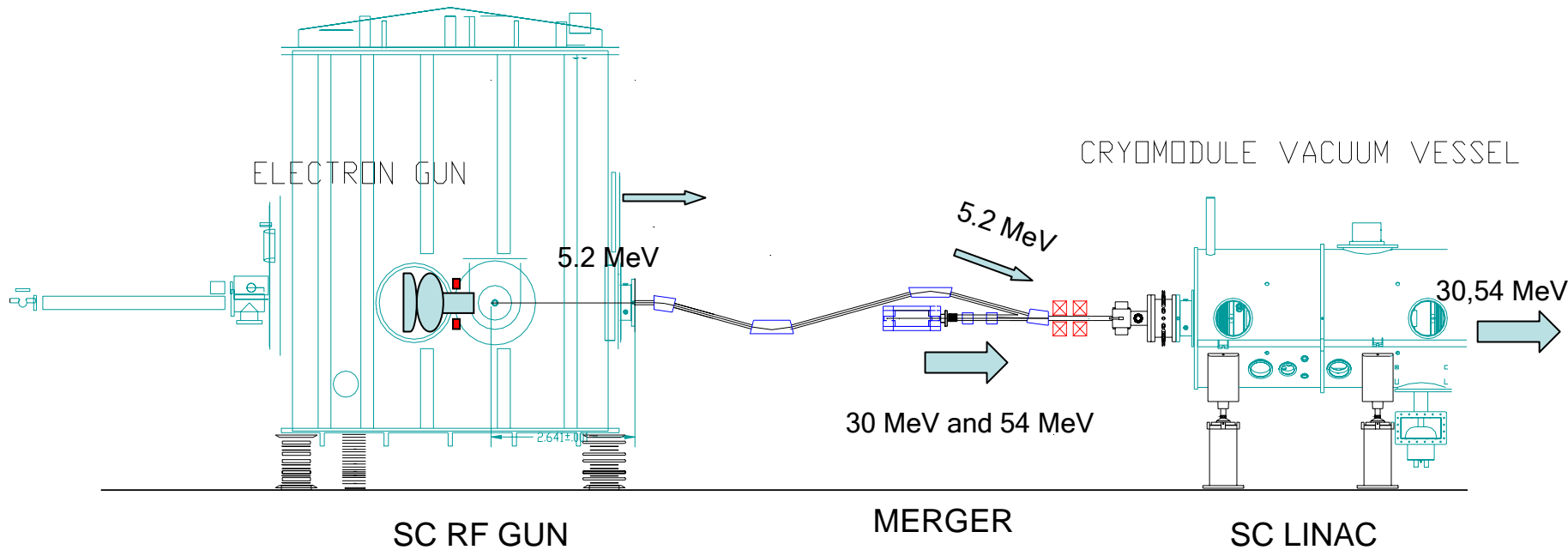

Transverse Beam Break Up studies of two loops ERL

From Eduard Pozdeyev (Jefferson Lab) studies of the two loops ERL with two 5 Cell cavities :

The threshold average current is always more than **1.5 A.**

Which is sufficiently for e-cooling operation: average current **0.05 A.**

E-cooling ERL: matching in the RHIC at 12 o'clock

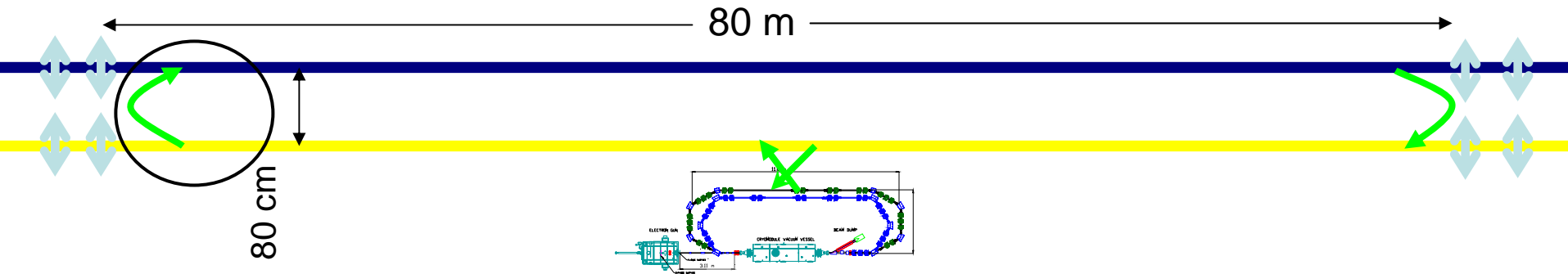

Matching two rings

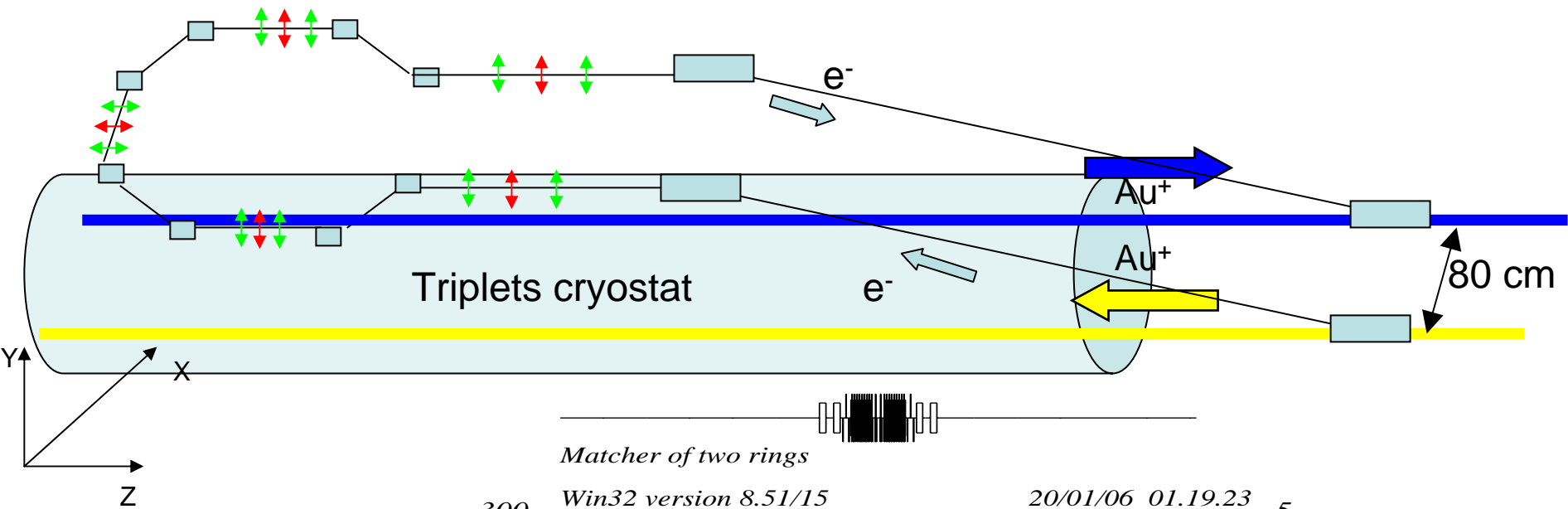

Matcher of two rings

Win32 version 8.51/15

20/01/06 01.19.23

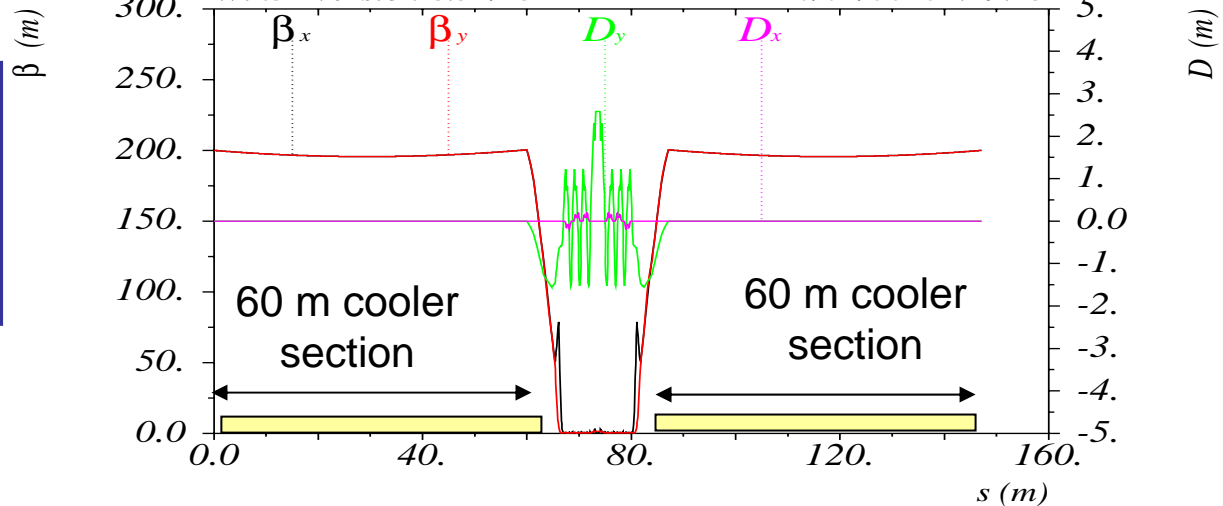

In cooling section

$$\beta_x = \beta_y = 200 \text{ m}$$

$$D_x = D_y = 0$$

MAC'06, 23-24 January, 2006

Summary

	Required for cooling	Parmela simulation results ^{*)}	
		Elliptical	Flat-top
Charge per bunch, nC	5	5	5
Energy, MeV	54	54	54
Threshold average current, mA	>50	1500	1500
Transverse emittances, $\varepsilon_x/\varepsilon_y$ mm*mrad	<5	3.0/2.4	4.7/3.8
Energy spread, $\delta E/E$	10^{-3}	2×10^{-4}	6×10^{-4}

^{*)} More details of beam dynamics simulation from the cathode to 54 MeV will be discussed in next talk

Things to do

- The detailed layout of merger to RHIC
- Start to end simulation included ions-electrons interaction
- The real magnetic field profiles should be taken to account
- More R&D should be done

20 MeV High Current High Brightness R&D ERL : layout in 912

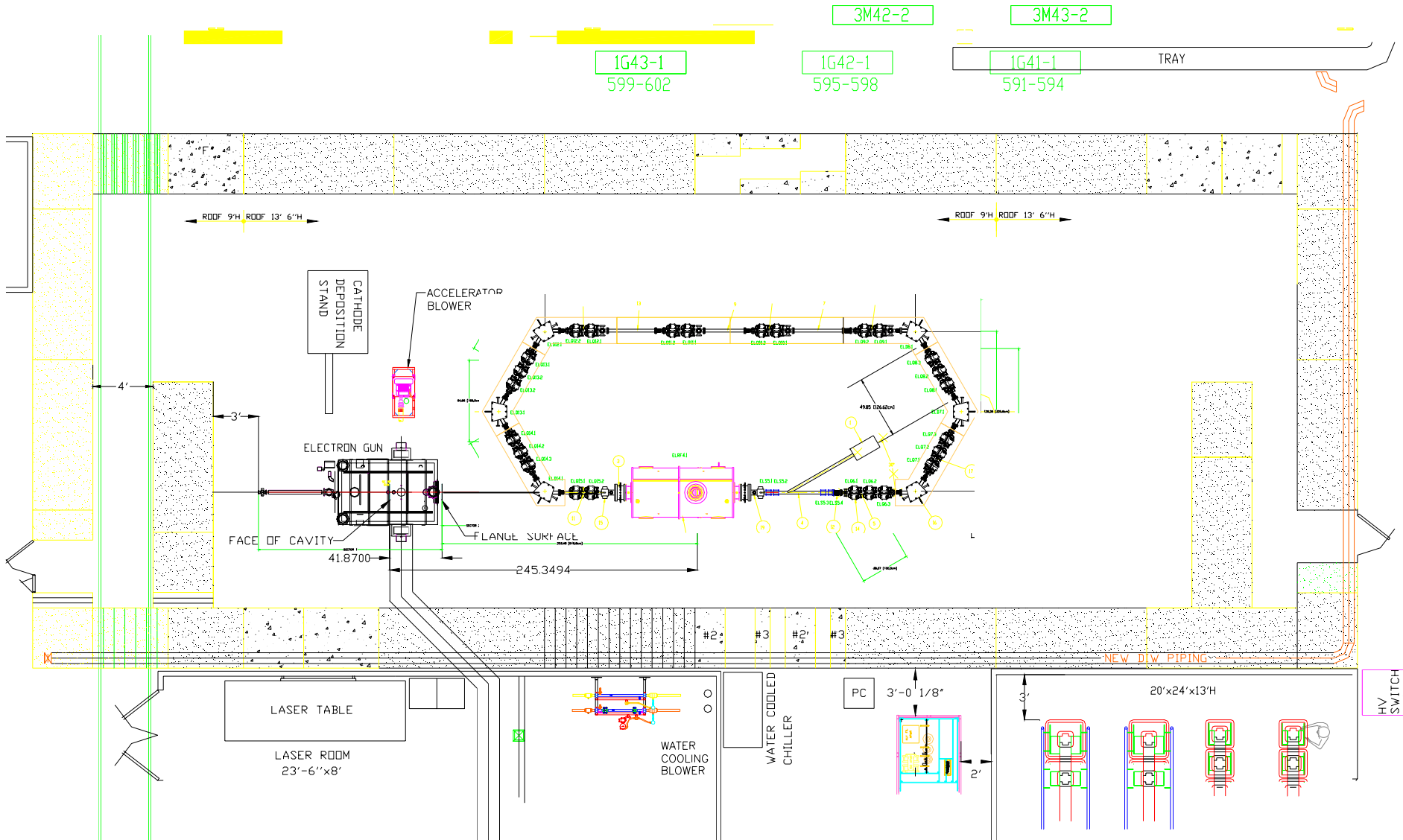

R&D ERL and E-Cooler beam parameters

	R&D prototype ERL		Required for cooling
	High average current	High charge per bunch	
Charge per bunch, nC	1.4	5	5
Numbers of passes	1	1	2
Energy maximum/injection, MeV	20/2.5	20/3.0	54/5.2
Average current, mA	500	50	50
Injected/ejected beam power, MW	1.0	0.15	0.26
Transverse emittances, mm*mrad	<5	<10	<5
Energy spread, $\delta E/E$	3×10^{-3}	5×10^{-3}	10^{-3}

- The prototype ERL will demonstrate the main parameters of the e-beam required for e-cooling
- The prototype will also serve as a test bed for studying issues relevant for very high current ERLs