

Instruction Manual

Mars Express

Scale Model 1:40



MARS EXPRESS

A European Orbiter and Lander Mission to the Red Planet

Mapping the surface and the atmosphere Cartographier la surface et l'atmosphère

Searching for water and life A la recherche d'eau et de traces de vie

<http://sci.esa.int/marsexpress>

thorsten.siwitza@esa.int

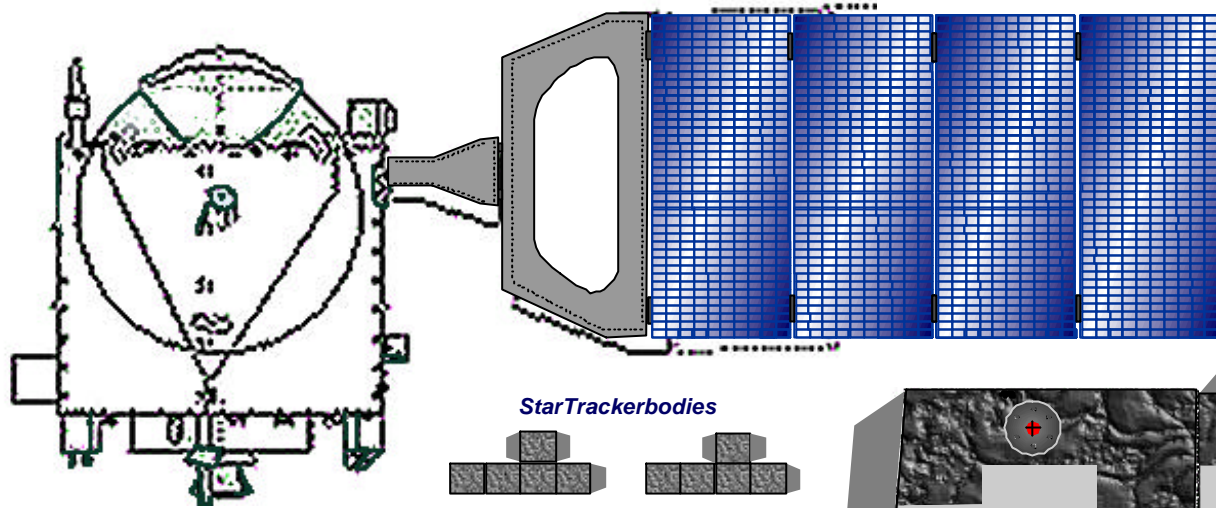

SolarArray

StarTrackerbodies

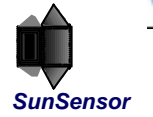
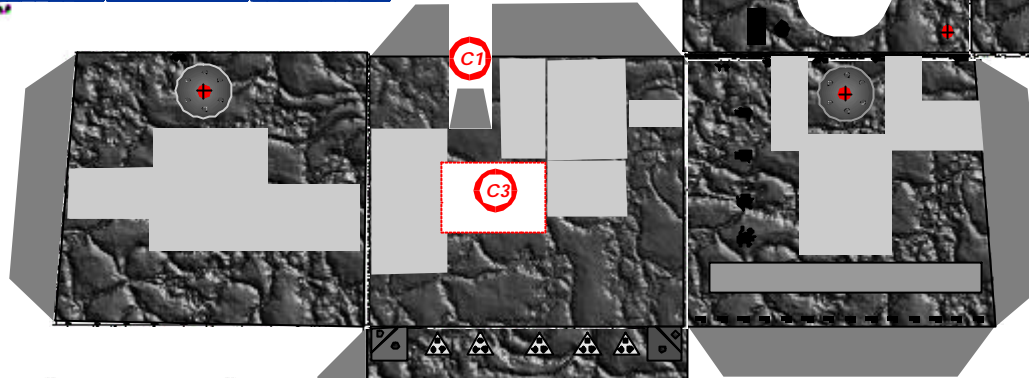

SunSensor

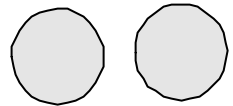

PatchAntennas



ASPERA

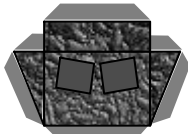

StarTracker Platform

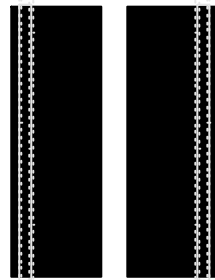
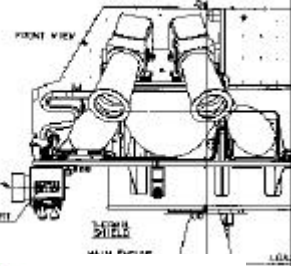

StarTrackerFunnel

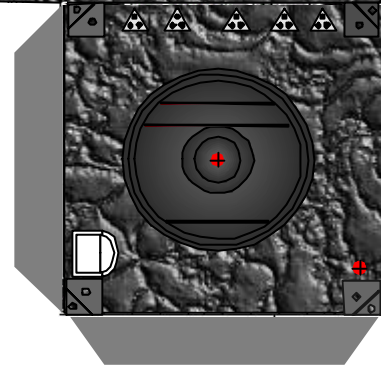

SpacecraftBody

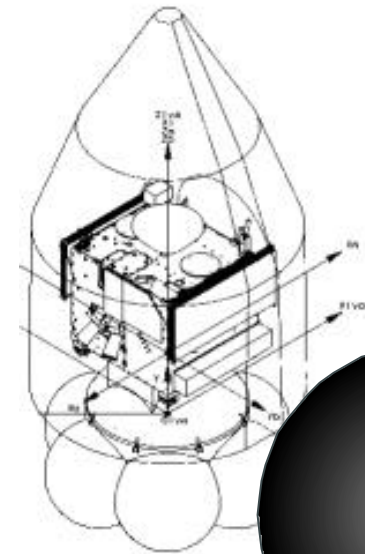

HighGainAntenna

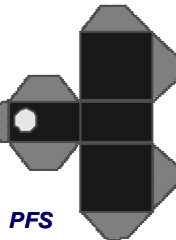
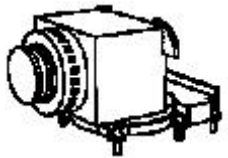

PFS

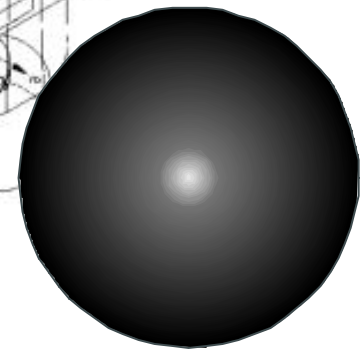
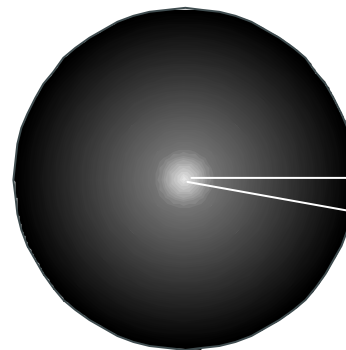

Thorsten.Iwizka@esa.int

sheet: 1



MARS EXPRESS

A European Orbiter and Lander Mission to the Red Planet





MARS EXPRESS

A European Orbiter and Lander Mission to the Red Planet

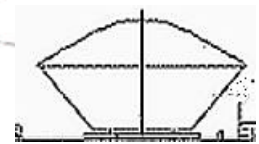
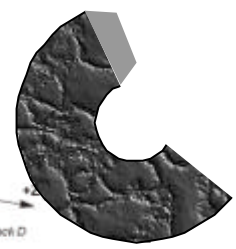
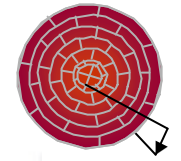
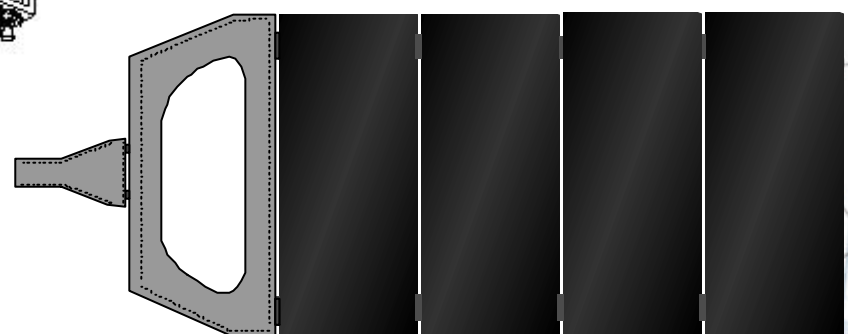
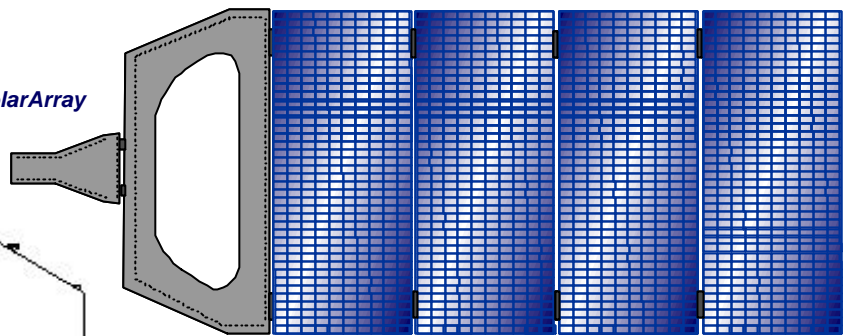
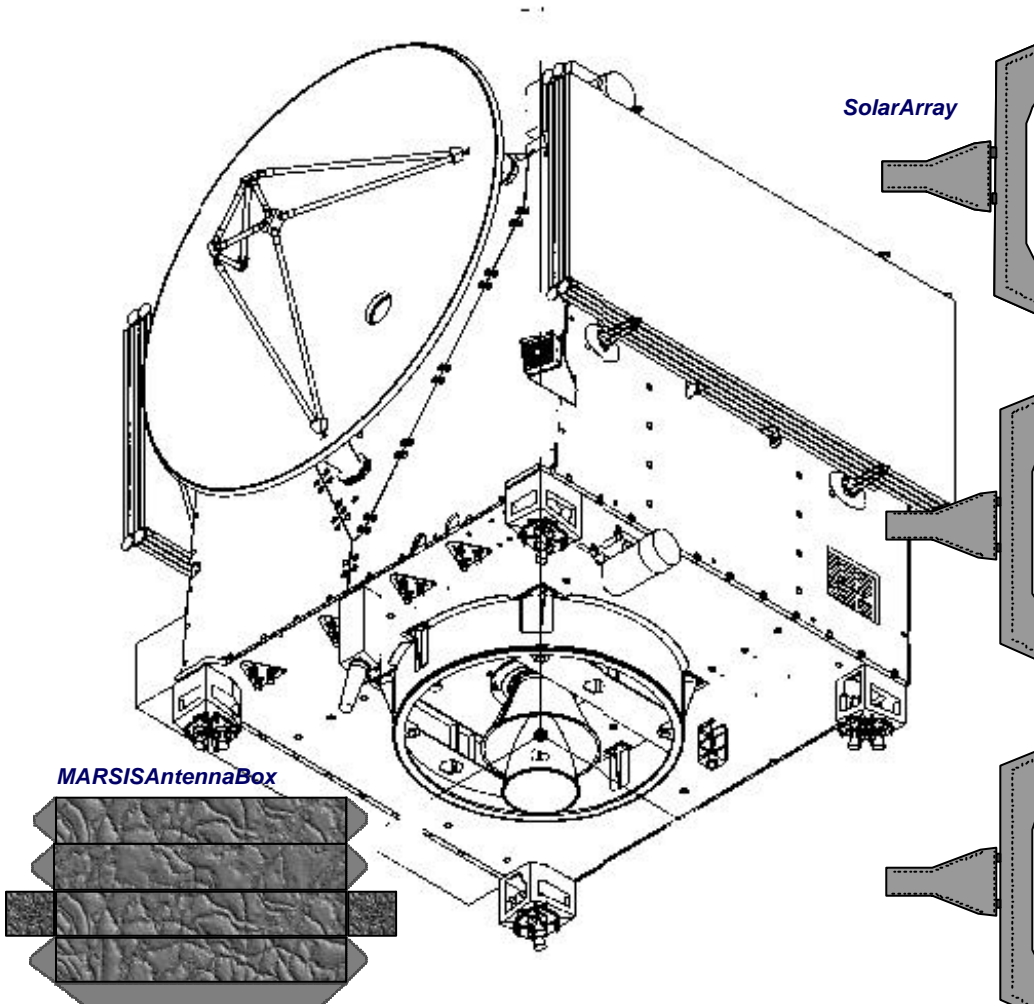

Solar Panels; top: frontside, lower two: backside

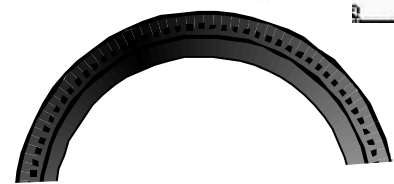
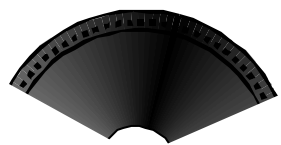
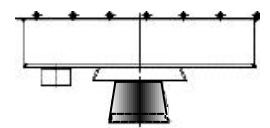

This is the instruction Manual for the scale model of the *ESA Mars Express* spacecraft. It is a step by step manual and it will probably take you a good evening to complete it. Words in *Italic* are names of actual spacecraft units and instruments. These are listed in alphabetic order in the appendix to this manual together with an explanation of their function.

But let's get started. What is needed?

- Cardboard
- Glue
- Scissors, small and standard
- Ruler
- Knife
- Needles
- Toothpicks
- Barbecue sticks
- Aluminium Foil
- Thread



Take the first sheet with the two dark circles on it - they will become the *High Gain Antenna* - and find the main body of the spacecraft.

It is grey, and if you look carefully you can count the six surfaces, the so-called panels of the spacecraft.

Then find the six small red dots on the body. Pierce them all with a needle. Locate the two in the centres of the grey circles - they will become the *Solar Array Drive Mechanisms* - and pierce them first with toothpicks, then with barbecue sticks. Roll the sticks between your fingertips while making the holes to avoid tearing the edges.

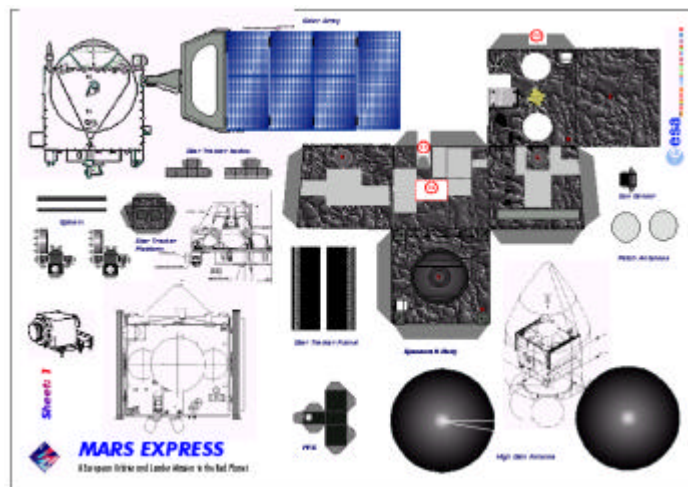

You have now finished the preparation.

Read the instructions of the next two paragraphs carefully before cutting out the spacecraft's main body.

Note the cut-outs that have been made on the top and one side panel of the spacecraft body and one in its rear panel. They are marked (C1) to (C4). The cut-outs (C1) and (C4) will be used for one of the scientific instruments, *PFS*. The one in the centre of the rear panel (C3) will be used for the *Star Tracker*. The cut-out marked (C1) is tricky. Cut along the red lines and remove the white part only. The remaining grey flap will be used as a connecting strip and will be folded and glued. Do not cut it off. All grey side flaps are for gluing different parts together.

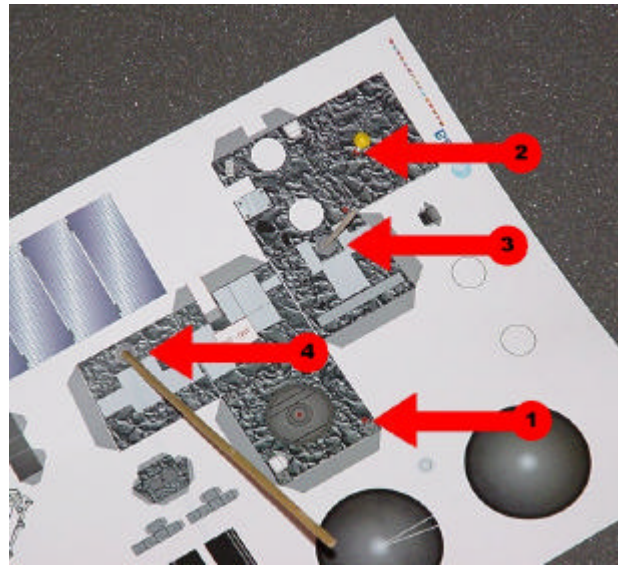

When you have cut out the shape, take a ruler and a knife and prepare the folding edges as follows: lay the ruler along an edge and run the blunt edge of the knife along it, but do not cut. This makes folding easier. Now fold against the edge of the ruler to get a nice sharp crease.

With a little imagination you will see how the parts fit together, but it is not yet time to glue the body.

On the bottom of Sheet 1 you will find a little black piece to be cut out and folded into a flat half-cube. It belongs to the science instrument *PFS*. Fold it so that the inside is black. The two flaps either side of the white circle must be glued to the back of the two large squares.



The PFS sub-assembly

This is how the finished part looks like. Keep this first sub-assembly apart for later integration.

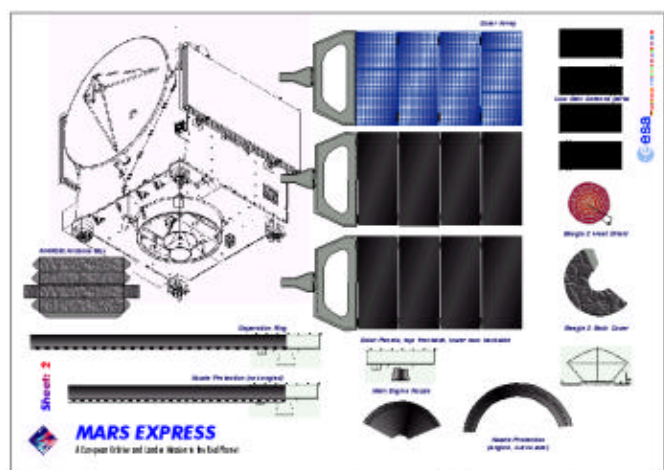

Sheet 2

Now cut out the three elements shown on the right, remembering to prepare the folds with a knife first. The larger part is the indentation on the back of the spacecraft that holds the two *Star Trackers*. This indentation element later fits into the cut-out (C3) in the main body.

Star Tracker platform and cubes as on Sheet 1

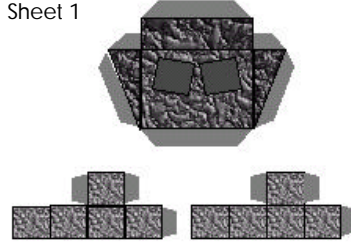

Star Tracker platform

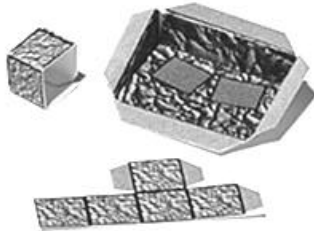

Star Tracker body, below one as on Sheet 1 and the top one assembled to a cube

Fold and glue the three elements to produce two boxes and a ramp. The inside of the ramp will become the mounting platform for the two *Star Trackers*.

Take one of the two black strips that has white lines down one side and roll it around a toothpick so that it becomes a little tube. Repeat for the other black strip. The tubes will eventually be glued into the cubes, which are then mounted onto the grey fields marked on the mounting platform. **Do not glue yet!**



Star tracker mounted on the platform

becomes a little tube. Repeat for the other black strip. The tubes will eventually be glued into the cubes, which are then mounted onto the grey fields marked on the mounting platform. **Do not glue yet!** The completed second sub-assembly should look like this:

Again, keep the three parts together for the later integration.



Aluminium foil fitted as coolers on the panels

Take the aluminium foil and cut little pieces the same size as the grey areas on the spacecraft's main body. These are the *Coolers*. This is a tedious job, but the reflective surface makes the finished model look really good.

Now cut out and pre-fold the main body of the spacecraft.

Turn it over and glue the two sub-assemblies from the inside. The Star Tracker platform has the shorter end at the top of the spacecraft or, as shown below, towards the other sub-assembly.

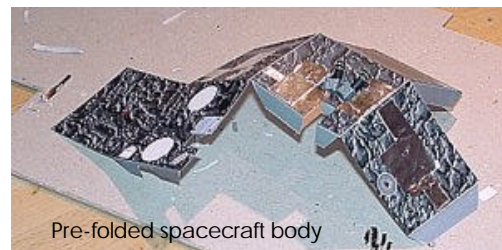

Pre-folded spacecraft body



The inside of the spacecraft's back panel: left is PFS sub-assembly fitted in the cut-out (C1), right the star tracker platform mounted in the cut-out (C2)

When the glue has set pre-fit, but do not yet glue the sides of the spacecraft body together to form a cube.

It will not of course be an exact cube, since the *High Gain Antenna* panel is slightly inclined.

Mount the pre-assembled *Star Tracker* cubes onto a toothpick via the open end of the tube. Use the toothpick to support and locate the *Star Tracker*.

Mount the pre-assembled tracker onto a toothpick via the open end of the tube. Use the toothpick to support and locate the *Star Tracker*. Apply glue to the underside of the *Star Tracker* body, i.e. one side of the small cube, and mount it in the assigned position. Repeat for the other *Star Tracker*. When you have finished, the tubes of the *Star Tracker* funnels should point down and sideways.

Careful pre-fitting is advised.

While the side panels of the spacecraft body are being closed and glued one at a time you might want to get started on some smaller equipment.

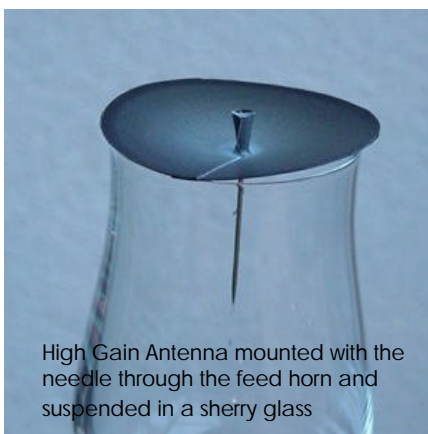
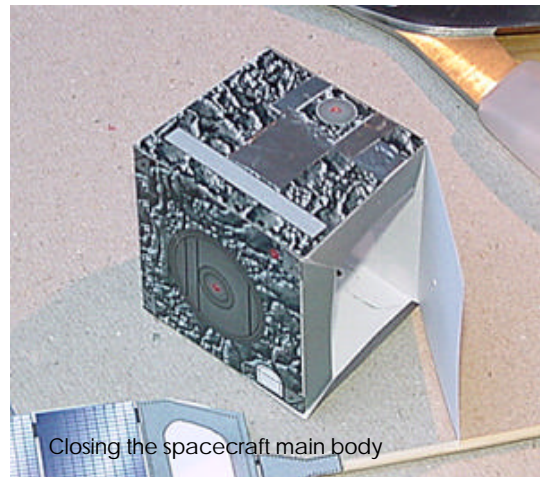

High Gain Antenna mounted with the needle through the feed horn and suspended in a sherry glass

The two large black discs are the front and back of the *High Gain Antenna*. Cut them out and glue them back to back. If any white paper is still visible fill it in with a black pen. Try to avoid a shiny finish; pencil or ink might be the best choice. Now cut along one of the white lines and slide the edges over each other. Apply glue to fix the shape of the parabola antenna permanently. Roll one of the little black strips around a toothpick to form a cylinder. This forms the feed horn of the antenna. When the *horn* has been glued and the dish has dried too, pour a drop of glue into the horn. Use a needle to pierce through

the axis of the feed horn and then through the centre of the dish. Pull the needle through the back of the antenna until the horn is in the right position. Leave the assembly suspended in a small glass to harden.

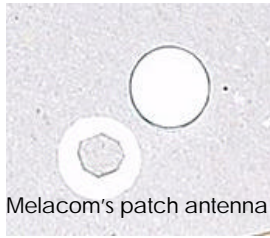

Melacom's patch antenna

The two small circles will be *patch antennas* for *Melacom* on top of the spacecraft, which communicate with the Mars Lander. Since they are a little elevated, glue small pieces of card underneath them.

The *Marsis radar booms* are stowed away in a container on the side of the spacecraft. The assembly is straightforward. The mounting position is shown as a grey stripe on the spacecraft body.



Antenna box of Marsis radar booms as on Sheet 2

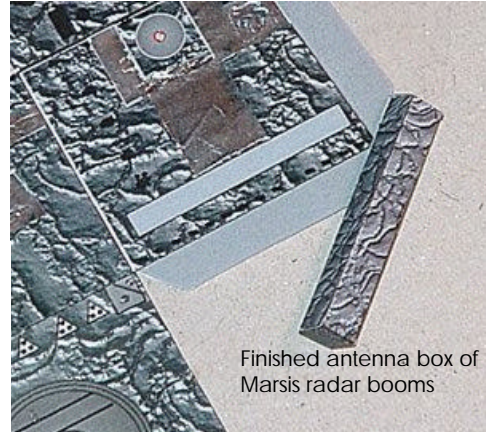

Finished antenna box of Marsis radar booms

Next comes the *Beagle 2 Lander*. Cut out the heat shield from Sheet 2 and use the same trick you used earlier on the antenna to shape the shield. The rear cover is a round conical mount and has to fit under the hat of the heat shield.



Beagle 2 heat shield



Beagle 2 back-cover



Beagle 2 back-cover and heat shield. Thread already mounted into the heat shield

Instead of a needle, fix a thread into the heat shield, so that it can be used later to suspend the model for instance from the ceiling.



Beagle 2 being glued together

Apply plenty of glue into the back cover, then turn it over and mate it with the heat shield.

The spacecraft's main body should look like the illustration below. On the left you can see a ring. This will be glued to the circle on the underside of the spacecraft body, which is facing you in the photograph. It will be the *Separation Ring* to

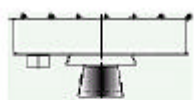

Above: The main engine with separation and protection ring.

Below: shape of the main engine nozzle on sheet 2



Spacecraft main body, bottom up, with the nozzle of the main engine, the separation ring and the nozzle protection on the left

the *Soyuz Fregat upper stage*. At the centre of the circle is one of the little red dots that you pierced earlier. Cut out the dark circle segment, which will be the nozzle on the spacecraft's *main engine*. When the glue has set, enlarge the hole in the main body so that the nozzle's sharp end fits into it and can be mounted. Now mount the *nozzle protection ring*. Cut it to size to fit the footprint around the nozzle. Note that the shape must be angled. The largest footprint belongs to the *Separation Ring*. Cut it out, glue the ring together, give it the right shape and mount it on the body. On the bottom of the previous page and below are the three elements from Sheet 2

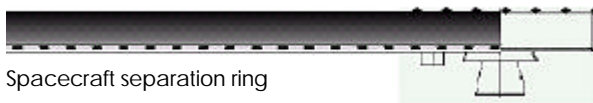

Spacecraft separation ring



Nozzle protection ring

Now you are getting more experienced, you might want to start building the external scientific instruments and antennas. In this model there are two external units that make up the experiment called *Aspera*, identical and mounted at the top and bottom of the spacecraft and the *Sun Sensor* and the *Low Gain Antennas*. Starting with *Aspera*, cut it out and prepare the folds. The stripe above the instrument cut-out can be rolled on the tip of a toothpick and glued to make a tight, short roll. This will be mounted onto the grey, circular front of the instrument to form the detector. When assembled mount the two instruments at the assigned locations on the top and bottom panels. Look for the instrument's grey footprint.

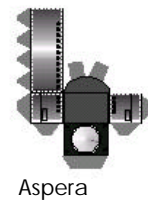

Aspera



Making of Low Gain Antennas

Next come the antennas. At the right of Sheet 2 you will find four black strips. Make them into two tight rolls. Use the short edge as the roll axis. Roll the other two over the tip of a toothpick to make sharp, pointed cones. After gluing them together like this, cut the cylinders to about 10 mm long and cut the cones to the same length, but at a 45-degree angle. Assemble the two antenna parts and leave them to harden. With a pair of pliers cut the head off a needle and insert it, coated in glue,

into the antenna stem. A short piece of the pointed end of the needle should be visible. When the composite has hardened, apply glue to the needle and to the bottom of the antenna, then insert it into the pre-pierced red hole on the top left of the spacecraft. The needle gives it some additional support.

The small *Sun Sensor* is easy to pre-assemble and should be mounted onto the top panel.

Now you can mount the two *patch antennas* and the *Beagle 2 Lander* onto the top of the spacecraft. These operations are a little tricky as you have already mounted the main engine, and the spacecraft can only lie on its side. To solve

this, support the body upright on a small glass, similar to *the High Gain Antenna* assembly method used earlier. Alternatively, you could use some card to build yourself an integration stand, i.e. a short tube. Beagle 2 is to be fixed on the yellow circle on the top panel of the spacecraft between the *patch antennas*.

Now it's time to take the *High Gain Antenna* from the glass and mount it. Important note: the small glass now used as integration stand for the antenna becomes available again and it should be used to celebrate the near completion of your spacecraft model! Push a needle through the small hole you made earlier on the front panel and glue the *High Gain Antenna* in place. Take care that the antenna stays in the correct position until the glue has set.

Last but not least - the *Solar Panels*.

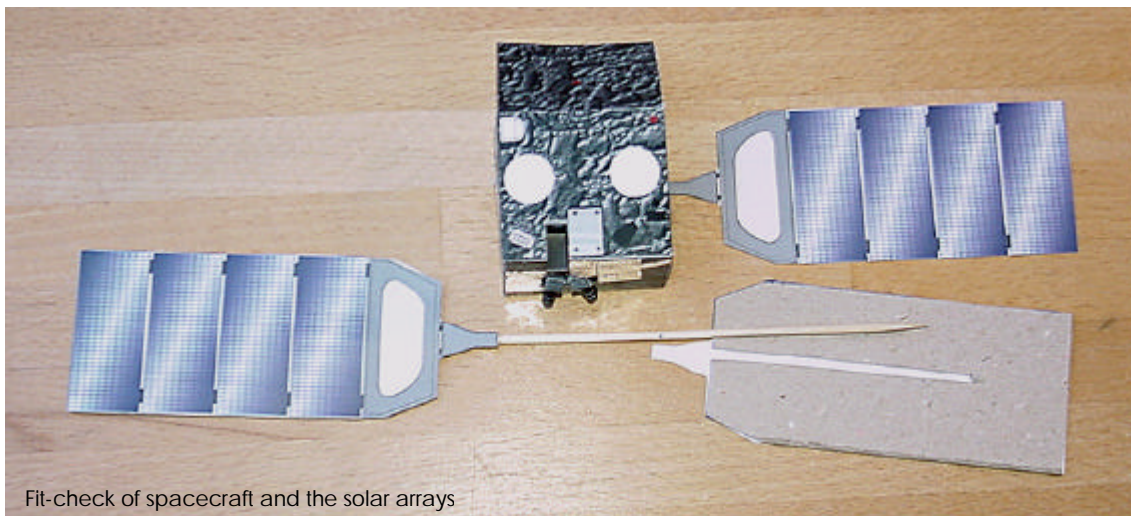

Fit-check of spacecraft and the solar arrays

Cut out two pieces of card the size and shape of the *Solar Panels*. Cut slots to take the barbecue stick. Check the correct assembly: Only one long stick is used. It has to go through the spacecraft body, it has to cover the distance of the short grey arms and, finally, enter the card of the *Solar Panel* on each side. Mark the sticks accordingly. Verify with the tips of the stick the size of the openings in the spacecraft body and enlarge them if necessary, so that the barbecue stick will fit through it with only little resistance. Do not force the stick, turn it instead.

As shown in the photograph, the blunt end of the barbecue stick is used in the first panel assembly. Glue the black back panels onto the card, glue the barbecue stick into the slot and cover with the front panel like a sandwich. At that stage your first Solar Array sandwich mounted with the long barbecue stick should look like in the picture above. When the glue of this assembly set, use the point of the stick to pierce carefully through the spacecraft body. Repeat the sandwiching procedure for the second *Solar Panel*. This is when you will realise that you need an extra pair of hands to hold the body, glue the elements together and hold them in place until they harden...

Get help!

Congratulations, you have now successfully built your first spacecraft. The Mars Express model, when suspended, should look like this:

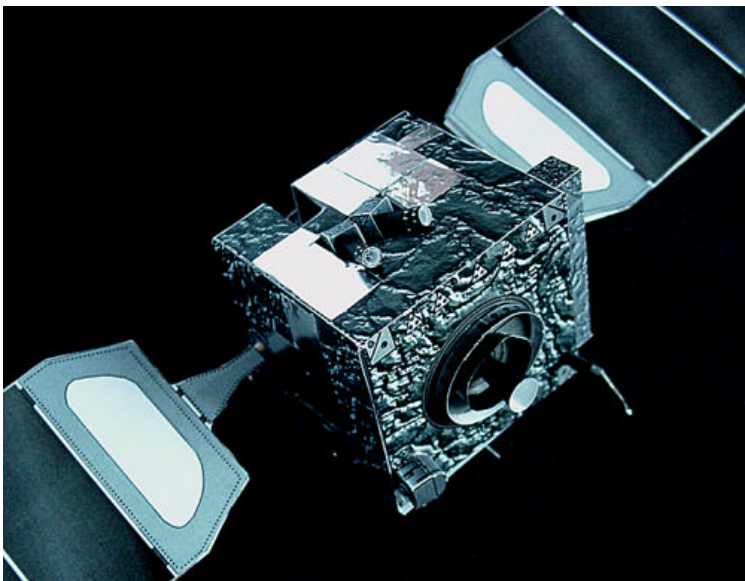
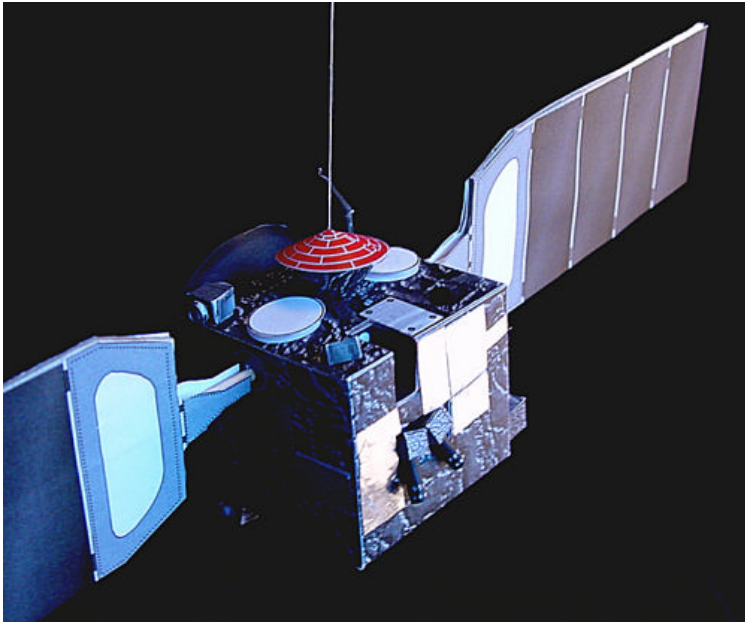
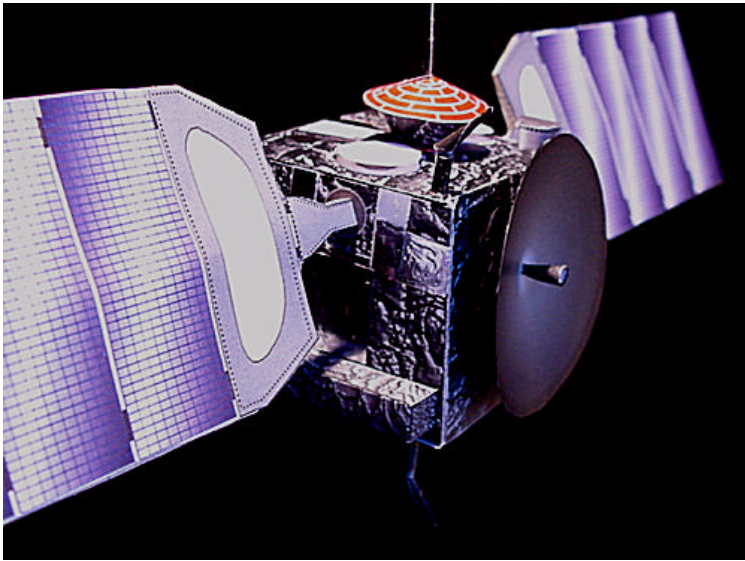

Appendix :

The Glossary

Aspera Energetic Neutral Atoms Analyser; Aspera, as one of the scientific instruments on board of MarsExpress is an imager of energetic neutral atoms and analyzer of space plasmas. It will allow determining the plasma induced atmospheric escape, as well as interaction of the solar wind with the ionosphere of Mars. Neutral particle imager and electron and ion spectrometer are mounted on a scanning platform.

Beagle 2 Beagle 2 is the name of the British led Lander of the Mars Express mission. The Lander is one of the scientific experiments provided by universities and scientific institutes of the ESA memberstates and in principal funded by the respective national governments.

Coolers Contrary to our experience on Earth where air or water transports heat from one place to the other to achieve an even distribution of temperature, conditions in space are more extreme. Due to the lack of any medium that could convey heat in open space, temperatures depend on whether a part of the spacecraft is illuminated by the sun (and gets quite hot) or is cast in shadow (and thus condemned to freeze). Since the spacecraft, its units and scientific instruments are limited to certain temperature ranges they can operate in, the temperature of the spacecraft has to be managed actively. This is done with the help of electric heaters and coolers. Note on the model that the coolers are all perpendicular oriented to the *Solar Arrays* or can be shadowed by the spacecraft body itself. This way they can radiate heat generated by units or instruments of the spacecraft most efficiently to open space.

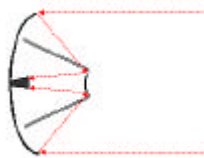

Feed Horn The Feed Horn is the collector and distributor of radiofrequency (RF) signals for the communication of the spacecraft with Earth. It is connected to the RF transmitter and receiver of the spacecraft and is mounted at the focus of the High Gain Antenna Reflector, the dish.

RF signals from the spacecraft transmitters are radiated from the Feed Horn on to a small reflector mounted on a tripod above the main dish (not part of the model) and from there back on to the reflective dish surface of the High Gain Antenna, which redirects the signal to the Earth.

Similarly, RF signals from the Earth are collected by the Reflector and focussed into the Feed Horn where they are sent

to the spacecraft receivers.

High Gain Antenna	<p>The High Gain Antenna (HGA) can transmit and receive large amounts of data, but it has to be pointed to Earth. It is the main communication mean between Ground Control and the spacecraft. Information transmitted to the spacecraft are commands for the operation of the science payload and the housekeeping of the satellite. Housekeeping of a spacecraft is the maintenance of power, temperature, orbit and attitude. Information transmitted from the spacecraft are scientific data and the housekeeping status of the spacecraft.</p> <p>The High Gain Antenna comprises two main components – a reflector and a feed horn.</p>
Marsis	<p>Marsis (Mars Advanced Radar for Subsurface and Ionospheric Sounding) is the abbreviation for the name of a scientific experiment consisting of three radar booms that are stowed in the box on the side of the spacecraft. Once deployed in Martian orbit they will send radar signals down to and below the surface of Mars. By comparing the transmitted and reflected signals scientists will be able to detect frozen water more than one kilometre below the Martian surface.</p>
Melacom	<p>Melacom is an abbreviation for the Mars Express Lander Communication unit. This internal unit, which is not shown in the model, is responsible to handle telecommands and data received from or sent to the ground station and from/to the <i>Beagle 2</i> lander. It will transmit the relevant information to the <i>High Gain Antenna</i> for communication with Earth or to the <i>Patch Antenna</i> for the communication with the lander.</p>
Nozzle	<p>The nozzle is the conical shaped exhaust of a rocket engine. It is a complicated device, since the exhaust temperatures are extreme and have to maintain their specific shape for an optimal use of the available rocket fuel.</p>
Patch Antenna	<p>These two small antennas are mounted like flat patches on the surface of the spacecraft. Their function is the communication between the orbiting spacecraft and the <i>Beagle 2</i> lander on the Martian surface.</p>
PFS	<p>Atmospheric Fourier Spectrometer. PFS is one of MarsExpress' scientific instrument. It is a Fourier infrared spectrometer optimized for atmospheric studies. It provides 3D temperature field measurements of the lower atmosphere, traces water and carbondioxide in the atmosphere, which allow to study the global atmospheric circulation. The instrument also provides data on the thermal environment of the surface.</p>
Protection Ring	<p>Around the main engine of the spacecraft is a ring shaped sheet is protecting instruments and spacecraft units on the exterior from the high temperatures of a main engine burn.</p>

Separation Ring	The separation ring is connecting a spacecraft from the launcher. It is a very important and thus highly reliable manufactured mechanism.
Solar Array	The task of the Solar Arrays are to convert the energy of the sun light to electric energy for operating the spacecraft. The Solar Arrays feed the batteries with power to operate the spacecraft. With the <i>Solar Array Drive Mechanism</i> the Array can be turned and oriented to catch a maximum of sunlight available at any given orientation. However there are operation phases when the spacecraft flies through the shadow of Mars (eclipse) and the Solar Arrays are not illuminated. During these periods the operation of the spacecraft is done on battery power.
Solar Array Drive Mechanism	The <i>Solar Array Drive Mechanism</i> is an electrical motor at the foot of each Solar Array that can orientate the Array to catch a maximum of sunlight available at any given orientation
Soyuz	The Soyuz is the name of the Russian built launcher that carries Mars Express. The Soyuz is the oldest still operating launch vehicle. Earlier versions of the same rocket carried already Yuri Gagarin to space. Today a French/Russian consortium sells the launch service on the world market.
Soyuz Fregat	The Fregat is the newest <i>upper stage</i> of the Soyuz.
Star Tracker	The Star Tracker operates as the primary compass of a spacecraft. It compares the image of stars in its field of view with an internal map of the sky. As a result the spacecraft navigation system receives information on the orientation and attitude of the spacecraft in space. For this critical function two Star Trackers, looking at different parts of the sky, are commonly used for redundancy reasons.
Sun Sensor	The Sun Sensor is similar to the Star Tracker a device to determine the orientation of the spacecraft. However the Sun Sensor is cruder and thus more robust. It will only find a major light source, such as the sun, but also the reflecting light of a closeby planetary body (Earth, Moon, Mars). Sun Sensors play an important role in spacecraft emergency cases. If for instance for unknown reasons the normal operation pattern is interrupted and the spacecraft does not report back to ground as it routinely should, the spacecraft on board computer will declare an emergency. The spacecraft shuts down all but the essential systems and is put into a slow spin. During the spin the Sun Sensor is looking for the Sun, and as a first measure orientates the Solar Arrays towards the Sun to charge the batteries. One by one other manoeuvres are called up, such as the Star Tracker operation and the Antenna being pointed towards Earth. Then the spacecraft will transmit its status and awaits assessment and new instructions from the Ground Control Operators at the European Space Agency's Operation Centre (ESOC).

Upper Stage

Launchers are composed from various stages, each of them being discharged, when burned out. The upper stage is defacto a small spacecraft connected to the real passenger spacecraft. It carries basically only a large rocket engine, fuel tanks and a navigation and communication system. Its purpose is to give the payload spacecraft this extra kick required to get away from Earth's gravity field and onto the right flightpath to the final destination.

