

Developments in Weather Responsive Traffic Management Strategies

Final Report — June 30, 2011
FHWA-JPO-11-086

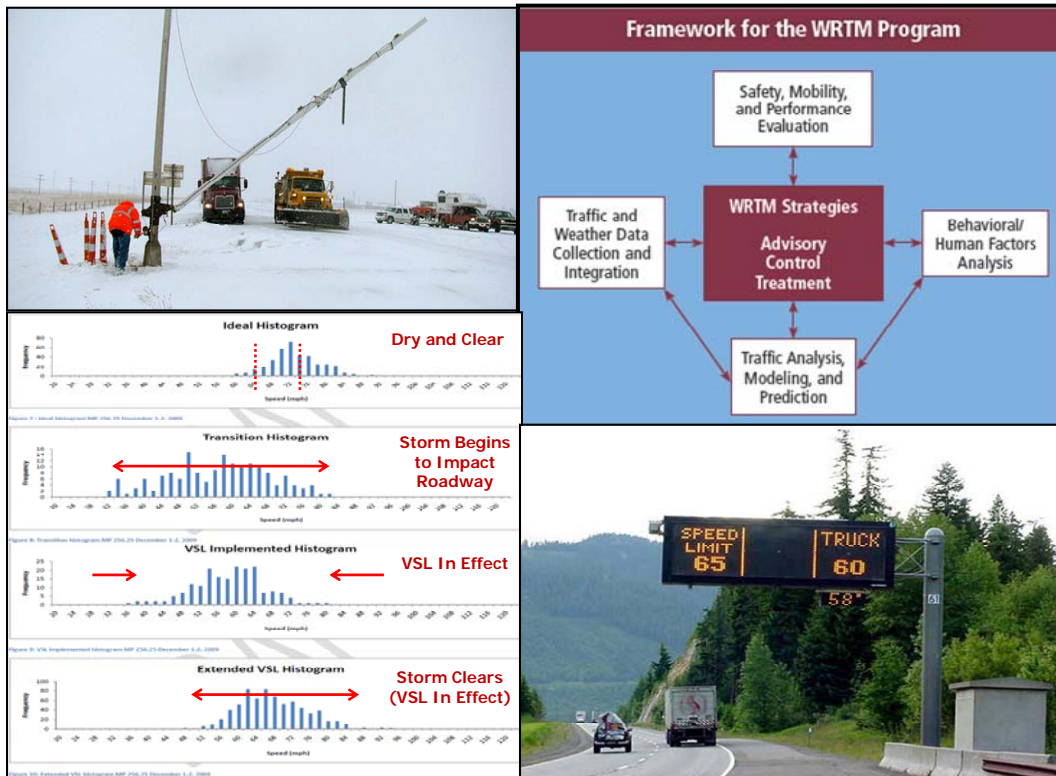

Sources for Cover Page pictures:

Top left – Wyoming DOT

Top right – FHWA Road Weather Management Program

Bottom left – Wyoming DOT

Bottom right – Washington DOT

Produced by Federal Highway Administration Road Weather Management Program for

ITS Joint Program Office

Research and Innovative Technology Administration

U.S. Department of Transportation

Notice

This document is disseminated under the sponsorship of the Department of Transportation in the interest of information exchange. The United States Government assumes no liability for its contents or use thereof.

Preface/ Acknowledgements

This report provides a comprehensive overview of weather-responsive traffic management (WRTM) practices. The content of this report focuses on what WRTM strategies exist, where they have been used, the benefits realized, what improvements are needed, and how to implement and evaluate them as part of their operations. The project also provides concepts of operations and high-level requirements that a Transportation Management Center (TMC) can use as input to system design.

The members of the consultant team and authors of this report would like to acknowledge and thank the many individuals in the Road Weather Management Program and in many TMCs around the country who have enthusiastically supported this study with their time, effort, and ideas for improving WRTM. While many individuals deserve recognition, we want to particularly acknowledge our expert panel members for supporting this project and being generous with their time and expertise.

- Dave Kinnecom – Utah Department of Transportation (UDOT)
- Brian Fariello – Texas DOT (San Antonio)
- Vince Garcia – Wyoming DOT
- Tina Greenfield Huitt – Iowa DOT
- Gene Donaldson – Delaware DOT
- Jack Stickel – Alaska DOT
- Sheldon Drobot – National Center for Atmospheric Research
- Rob Helt – City of Colorado Springs
- Peter Koonce – City of Portland

Finally, Roemer Alfelor and David Yang of the Road Weather Management Program have provided their on-going support of this effort with a clear guiding vision of WRTM and improvements.

Report Documentation Page

Form Approved
OMB No. 0704-0188

The public reporting burden for this collection of information is estimated to average 1 hour per response, including the time for reviewing instructions, searching existing data sources, gathering and maintaining the data needed, and completing and reviewing the collection of information. Send comments regarding this burden estimate or any other aspect of this collection of information, including suggestions for reducing the burden, to Department of Defense, Washington Headquarters Services, Directorate for Information Operations and Reports (0704-0188), 1215 Jefferson Davis Highway, Suite 1204, Arlington, VA 22202-4302. Respondents should be aware that notwithstanding any other provision of law, no person shall be subject to any penalty for failing to comply with a collection of information if it does not display a currently valid OMB control number. **PLEASE DO NOT RETURN YOUR FORM TO THE ABOVE ADDRESS.**

1. REPORT DATE (DD MM YYYY) June 30, 2011		2. REPORT TYPE Technical		3. DATES COVERED April 2009 –June 2011		
4. TITLE AND SUBTITLE Developments in Weather Responsive Traffic Management Strategies				5a. CONTRACT NUMBER DTFH61-06-D-00007/ORDER 07-T-09017		
6. AUTHOR(S) Deepak Gopalakrishna and Chris Cluett (Battelle), Fred Kitchener (McFarland Management, LLC), and Kevin Balke (TTI)				5b. GRANT NUMBER NA		
				5c. PROGRAM ELEMENT NUMBER NA		
				5d. PROJECT NUMBER NA		
				5e. TASK NUMBER BA07-062		
				5f. WORK UNIT NUMBER NA		
7. PERFORMING ORGANIZATION NAME(S) AND ADDRESS(ES) Battelle 100 M Street SE, Suite 250 Washington, DC 20003				8. PERFORMING ORGANIZATION REPORT NUMBER		
9. SPONSORING/MONITORING AGENCY NAME(S) AND ADDRESS(ES) United States Department of Transportation Federal Highway Administration, Office of Operations 1200 New Jersey Ave., SE Washington, DC 20590				10. SPONSORING/MONITOR'S ACRONYM(S) HOIT		
				11. SPONSORING/MONITOR'S REPORT NUMBER(S) FHWA-JPO-11-086		
12a. DISTRIBUTION/AVAILABILITY STATEMENT This document is available to the public through the National Technical Information Service, Springfield, Virginia 22161.				12b. DISTRIBUTION CODE		
13. SUPPLEMENTARY NOTES Roemer Alfelro (COTM), David Yang (COTM), Barry Zimmer (COTR)						
14. ABSTRACT (Maximum 200 words) This report provides a comprehensive overview of weather-responsive traffic management practices. It focuses on what WRTM strategies exist, where they have been used, the benefits realized, what improvements are needed, and how to implement and evaluate them as part of transportation operations. The report also contains concepts of operations and high-level requirements that an agency can use to design and develop advanced WRTM strategies. Guidance was also developed to assist in evaluating the benefits and performance of several WRTM strategies.						
15. SUBJECT TERMS Road Weather Management, Weather Responsive Traffic Management, Transportation Management Center (TMC), Concepts of Operation, System Requirements, Evaluation						
16. SECURITY CLASSIFICATION OF Unclassified			17. LIMITATION OF ABSTRACT None	18. NUMBER OF PAGES 254	19a. NAME OF RESPONSIBLE PERSON Roemer Alfelro	
a. REPORT Unclassified	b. ABSTRACT Unclassified	c. THIS PAGE Unclassified			19b. TELEPHONE NUMBER (202)-366-9242	

Table of Contents

Executive Summary	1
Chapter 1 Introduction and Background	13
1.1 PURPOSE	13
1.2 BACKGROUND AND RELATIONSHIP TO OVERALL RWMP PROGRAM.....	14
1.3 PROJECT APPROACH.....	15
1.3.1 State of the Practice Review.....	15
1.3.2 Identification of Improvements through Expert Panel Discussions.....	16
1.3.3 Concepts of Operations Development.....	17
1.3.4 Evaluation Procedures.....	17
1.4 STRUCTURE OF FINAL REPORT.....	17
Chapter 2 Review of Existing WRTM Strategies	18
2.1 STATE OF THE PRACTICE REVIEW	18
2.2 STRATEGY DETAILS	22
2.2.1 Motorist Advisory, Alert and Warning Systems	22
2.2.2 Speed Management Strategies	27
2.2.3 Vehicle Restrictions Strategies	31
2.2.4 Road Restriction Strategies	33
2.2.5 Traffic Signal Control Strategies.....	36
2.2.6 Traffic Incident Management.....	41
2.2.7 Personnel/Asset Management	43
2.2.8 Agency Coordination and Integration.....	44
2.3 CHALLENGES FOR WRTM.....	45
Chapter 3 Improvements to WRTM Strategies	47
3.1 EMERGING TRENDS.....	47
3.1.1 Connectivity	47
3.2.2 Improved Weather Forecasting and Modeling	48
3.2.3 Active Transportation and Demand Management.....	48
3.2.4 Modeling of Weather Impacts	49

3.3	RECOMMENDED IMPROVEMENTS FOR WRTM STRATEGIES	49
3.3.1	General Improvements	50
3.3.2	Strategy-specific Improvements	51
Chapter 4	WRTM Concepts of Operations and System Requirements	56
4.1	APPROACH AND USE	56
4.2	STRUCTURE OF THE CONOPS	59
Chapter 5	Evaluation Approaches and Procedures to Assess the Benefits of WRTM.....	61
5.1	PURPOSE	61
5.2	OVERALL EVALUATION PLAN, APPROACH AND STRUCTURE.....	63
5.2.1	Prepare a Plan to Conduct the Evaluation	63
5.2.2	Collect the Data.....	70
5.2.3	Conduct the Analysis.....	71
5.2.4	Prepare the Evaluation Report.....	71
5.3	EVALUATION GUIDANCE FOR SELECTED WRTM STRATEGIES	72
5.3.1	WRTM Strategy – Active Warning Systems	75
5.3.2	WRTM Strategy – Pre-Trip and En-Route Weather and Pavement Information Systems.....	78
5.3.3	WRTM Strategy – Speed Advisories and Enforceable Variable Speed Limit Systems	81
5.3.4	WRTM Strategy – Vehicle Size, Height and Profile Restriction Systems	84
5.3.5	WRTM Strategy – Seasonal Load Restriction Systems.....	86
5.3.6	WRTM Strategy – Road and Lane Use Restriction Systems	89
5.3.7	WRTM Strategy – Traffic Signal Control Systems.....	92
5.3.8	WRTM Strategy – Service and Courtesy Patrol Systems.....	96
5.3.9	WRTM Strategy – Agency Coordination and Integration Policies	100
Chapter 6	Conclusions and Recommendations	103
6.1	CONCLUSIONS	103
6.2	RECOMMENDATIONS	103

6.2.1 Recommendation #1 – Create and Maintain an Engaged Stakeholder Community for WRTM.....	104
6.2.2. Recommendation #2 – Incorporate WRTM Pilots as part of State-led efforts on Active Traffic Management and Integrated Corridor Management	105
6.2.3. Recommendation #3 – Facilitate the Deployment and Testing of Weather-Responsive Signal Timing Strategies as a Viable Traffic Management Strategy.....	106
6.2.4. Recommendation #4 – Continue the Development and Testing of Seasonal Weight Restrictions.....	107
6.2.5 Recommendation #5 – Continue and Expand Research on Impact Prediction, Simulation and Decision-support	107
6.2.6 Recommendation #6 – Identify and Document the Benefits of WRTM Strategies	109
6.2.7 Recommendation #7 – Identify Intra- and Inter-agency Communication Barriers and Methods of Overcoming Institutional Issues.....	110

References 112

APPENDIX A. List of Acronyms	117
APPENDIX B. Metric/English Conversion Factors	119
APPENDIX C. Expert Panel Survey Responses.....	120
APPENDIX D. Concept of Operations for Selected WRTM Strategies	129

List of Tables

Table ES-1. Summary of WRTM Strategies	1
Table ES-2. List of Improvements for WRTM Strategies	7
Table 1. Summary of WRTM Strategies	18
Table 2. Suggested Speed Limit for Maine's VSLs Based on Surface Conditions	28
Table 3. Suggested Speed Limits for Maine's VSLs Based on Snowfall Intensity Rates	29
Table 4. WRTM Strategies Discussed in Each Concept of Operations Document.....	57
Table 5. Selected WRTM Strategies.....	63
Table 6. Transportation Goals and Related Evaluation MOEs.....	65
Table 7. Evaluation Challenges and Mitigation Approaches	68
Table 8. Evaluation Guidance for an Active Warning System	76
Table 9. Evaluation Guidance for Pre-Trip and En-Route Weather and Pavement Information Systems	79
Table 10. Evaluation Guidance for Speed Advisories and Enforceable Variable Speed Limit Systems	82
Table 11. Evaluation Guidance for Vehicle Size, Height and Profile Restriction Systems	86
Table 12. Evaluation Guidance for Seasonal Load Restriction Systems	88
Table 13. Evaluation Guidance for Road and Lane Use Restriction Systems	91
Table 14. Evaluation Guidance for Traffic Signal Control Systems.....	94
Table 15. Evaluation Guidance for Service and Courtesy Patrol Systems	98
Table 16. Evaluation Guidance for Agency Coordination and Integration Systems	101
Table 17. SO&M Issues with Respect to Capability Maturity	110

List of Figures

Figure 1. Framework for the WRTM Program (Source: FHWA)	15
Figure 2. Example of Variable Speed Advisory Sign (Source: Maine DOT)	28
Figure 3. Variable Speed Limit Sign over Steven’s Pass on US -2 in Washington State (Source: Washington DOT)	30
Figure 4. Example of a Gate Arm Used to Control Access to Sections of Highways in Wyoming (Source: Wyoming DOT)	35
Figure 5. Minimum Required Amber/All-Red Intervals (Source: [38]).....	39
Figure 6. ATDM Vision (Source: FHWA, ATDM Informational Brief, January 2010)	49
Figure 7. Example WRTM Strategy Pathway.....	73
Figure 8. Changes in Speed Distribution due to VSL (Source: Wyoming DOT)	84
Figure 9. Growing Uncertainty along the Linkage between Weather Conditions and Traffic Impacts	108
Figure C-1 – Weighted Rankings for Motorist Advisories, Alert and Warning Systems.....	120
Figure C-2. Weighted Rankings for Sped Management Strategies.....	122
Figure C-3. Weighted Rankings for Vehicle Restriction Strategies.....	123
Figure C-4. Weighted Rankings for Route Restriction Strategies.....	124
Figure C-5. Weighted Rankings for Traffic Signal Control Strategies	125
Figure C-6. Weighted Rankings for Traffic Incident Management Strategies	126
Figure C-7. Weighted Rankings for Personal/Asset Management	127
Figure C-8. Weighted Rankings for New Strategies Identified As Part of Web-Meeting.....	128

Executive Summary

The Federal Highway Administration (FHWA) Road Weather Management Program (RWMP) has championed the cause of improving traffic operations and safety during weather events. The program’s current emphasis is to encourage agencies to be more proactive in the way they manage traffic operations during weather events. Weather Responsive Traffic Management (WRTM) is the central component of the program’s efforts. WRTM involves the implementation of traffic advisory, control, and treatment strategies in direct response to, or in anticipation of, developing roadway and visibility issues that result from deteriorating or forecasted weather conditions. WRTM also includes using weather forecasting to provide proactive advisories as well as control strategies based on forecasts of weather conditions prior to the impacts of those conditions on traffic. WRTM also brings together into a logical framework the various other activities (such as weather information integration, *Clarus*, traffic analysis, performance measurement, etc.) that the RWMP has been supporting. WRTM is not a single strategy per se but a combination of techniques, tools, and systems that transportation authorities can use for mitigating the impacts of weather on their operations.

This project focused on the core component of WRTM investigating what strategies exist, where they have been used, the benefits realized, and how to improve, implement, and evaluate them as part of transportation operations. To provide guidance on system design and development, five different WRTM strategy concepts of operations and high-level requirements were created. Guidance was also developed to assist in evaluating the benefits and performance of several WRTM strategies

As part of the state-of-the-practice review, eight different categories of WRTM strategies were identified and over 20 different strategies described (Table ES-1). An electronic database was also created to enable searchable access to the strategy in a standard format.

Table ES-1. Summary of WRTM Strategies

Definition	Applicable Weather Events	Delivery/Communication Mechanisms to Travelers
Motorist Advisories, Alert and Warning Systems		
<p>Passive Warning Systems</p> <p>This strategy involves the installation of static informational and/or warning signs to alert travelers that potentially hazardous driving conditions MAY exist downstream or at a specific location. Information is displayed regardless of whether or not the condition is present. This strategy includes the static warning signs contained in the MUTCD.</p>	<p>Icy conditions, Wind Warning, Fog, Blowing Snow, Floods</p>	<ul style="list-style-type: none"> • Static signs

Definition	Applicable Weather Events	Delivery/Communication Mechanisms to Travelers
<p>Active Warning Systems</p> <p>This strategy involves supplementing the passive warning signs with flashing beacons to alert travelers that the conditions specified on the static sign is currently in effect. The flashing beacons may be activated either manually by operators in a traffic management center or by field personnel based on observed conditions, or automatically if tied to a road weather monitoring system (such as a flood detection stream gauge or a high wind detection system).</p>	<p>Icy conditions, Wind Warning, Fog, Blowing Snow, Floods</p>	<ul style="list-style-type: none"> • Static Signs with Flashing beacons
<p>Pre-Trip Road Condition Information and Forecast Systems</p> <p>This strategy involves disseminating information about current and forecasted weather and pavement conditions to travelers before they initiate their trip, in an attempt to influence their choice of travel mode, departure time, or route.</p>	<p>Snow and Rain Accumulations, High Winds, Flooding, Limited Visibility, Tornados, Black Ice, Snow Accumulations, Flooding</p>	<ul style="list-style-type: none"> • 511 • Agency and private websites • Media Outlets • Text Messages • Social Networks (Twitter®)
<p>En-Route Weather Alerts and Pavement Condition Information</p> <p>This strategy involves providing traveler with real-time information and alerts about specific weather and pavement conditions currently existing or developing ahead of them while they are en-route. The content of the messages changes dynamically to reflect current or forecasted conditions. These systems can be used for disseminate information about different types of weather events and pavement conditions.</p>	<p>Snow and Rain Accumulations, High Winds, Flooding, Limited Visibility, Tornados, Black Ice, Snow Accumulations, Ponding, Flooding</p>	<ul style="list-style-type: none"> • Dynamic Message Signs (DMS) • Highway Advisory Radio (HAR) • 511 • FM/AM Radio • Text Message Alerts • In-vehicle Displays
<p>Speed Management Strategies</p>		
<p>Speed Advisories</p> <p>This strategy involves issuing special speed advisories in response to deteriorating weather conditions. The speed advisories are intended to achieve voluntary compliance with a recommended safe travel speed for the prevailing conditions. The speed advisory messages would not be considered enforceable by law enforcement personnel.</p>	<p>Falling Snow and Rain, Wind conditions, Limited Visibility</p>	<ul style="list-style-type: none"> • Dynamic Message Signs (DMS), Variable Speed Advisory Signs
<p>Enforceable Speed Limits/Variable Speed Limits</p> <p>This strategy involves establishing new speed limits or implementing speed restrictions in direct response to weather conditions. Speed limits would be considered enforceable by law enforcement personnel.</p>	<p>Falling Snow and Rain, Wind conditions, Limited Visibility, Ice and Snow Accumulations</p>	<ul style="list-style-type: none"> • Dynamic Message Signs (DMS) Variable Speed Advisory Signs

Definition	Applicable Weather Events	Delivery/Communication Mechanisms to Travelers
Vehicle Restriction Strategies		
<p>Size/Height/Weight/Profile Restrictions</p> <p>This strategy involves restricting specific types of vehicles from using the roadways during specific weather conditions. Vehicles may be restricted by size, height, weight, or profile based on weather conditions.</p>	<p>High wind conditions, Snow and Ice Accumulations</p>	<ul style="list-style-type: none"> • Dynamic message signs (DMS), • Static signs with variable message inserts • Highway Advisory Radio • Agency Websites
<p>Tire Chains/Alternate Traction Devices</p> <p>This strategy involves requiring vehicles to use special devices for improving traction between the vehicle and pavement. Using of traction control devices may be restricted to specific vehicles or may be required of all vehicles.</p>	<p>Ice and Snow Accumulations</p>	<ul style="list-style-type: none"> • Dynamic message signs (DMS) Static signs with variable message inserts • Highway Advisory Radio • Agency Websites
Road Restriction Strategies		
<p>Lane-Use Restrictions</p> <p>This strategy involves requiring specific types of vehicle to use specific lanes during specific weather events (e.g., trucks use right lane). This strategy may also include restricting the use of special lanes by certain types of vehicle or to all vehicles (e.g., right lane closed ahead).</p>	<p>Ice and Snow Accumulations, Rain, Flooding</p>	<ul style="list-style-type: none"> • Dynamic message signs (DMS), Static signs with variable message inserts • Highway Advisory Radio • Agency Websites
<p>Parking Restrictions</p> <p>This strategy involves implementing special parking restrictions or requirements in response to developing or forecasted weather conditions. This strategy may include a total ban of on-street parking, restricting parking to a certain side of the street, or establishing designated parking areas for specific types of vehicles.</p>	<p>Snow Accumulations, Flooding</p>	<ul style="list-style-type: none"> • Static signs with variable message inserts • Agency Websites
<p>Access Control and Facility Closures</p> <p>This strategy involves implementing controls that limit vehicle access to specific sections of roadway. Access could be restricted to specific structures (such as bridges, or causeways), passes, or entire sections of roadway.</p>	<p>Snow and Ice Accumulation, Flooding, Limited Visibility, High winds</p>	<ul style="list-style-type: none"> • Dynamic message signs (DMS), Highway Advisory Radio, • Access control gates • Agency Websites • Barricades • On-Scene Personnel
<p>Contraflow/Reversible Lane Operations</p> <p>This strategy involves operating particular sections of highway a contraflow or reversible lane facility. With this strategy, traffic is directed to travel in the direction opposite of the normal flow. This strategy is generally reserved for large scale evacuation, and where large volume of traffic needs to be cleared for an area in a short time period.</p>	<p>Hurricane, flooding, developing major snow storms</p>	<ul style="list-style-type: none"> • Dynamic message signs (DMS), Static signs, • Highway Advisory Radio, • Access control gates/ barricades, Traffic Signals, • On-scene personnel

Definition	Applicable Weather Events	Delivery/Communication Mechanisms to Travelers
Traffic Signal Control Strategies		
<p>Vehicle Detector Configuration</p> <p>This strategy involves reconfiguring detector settings or implementing special detector schemes/layouts to ensure detection of vehicles at traffic signals. This strategy might involve overlapping detector layouts or changing detector settings based on prevailing weather and pavement conditions.</p>	<p>Snow and Ice Accumulations, Heavy Rainfall, Limited Visibility</p>	<p>Not Applicable</p>
<p>Vehicle Clearance Intervals</p> <p>This strategy involves altering the time duration of vehicle and pedestrian clearance intervals (i.e., yellow change interval, all-red interval, and pedestrian clearance interval) to account for lost pavement friction and slow traffic speed approaching signalized intersections.</p>	<p>Rain and snow accumulation, heavy rainfall, ice, limited visibility</p>	<ul style="list-style-type: none"> • Signal Timing Changes • Yellow clearance interval, • All-red intervals • Pedestrian WALK/ DON'T WALK intervals
<p>Interval and Phase Duration Settings</p> <p>This strategy involves altering the time duration and/or sequencing of traffic signal phases during inclement weather conditions to account for increases in start-up lost time, reduced travel speeds, and reduced pavement traction. This strategy might include altering minimum green intervals, maximum green intervals, gap out settings, phase sequences, etc.</p>	<p>Rain and snow accumulation, heavy rainfall, ice, limited visibility</p>	<ul style="list-style-type: none"> • Signal Timing Changes • Longer minimum green intervals • Longer phase durations • Longer gap settings
<p>Traffic Signal Coordination Plans</p> <p>This strategy involves implementing new signal timing coordination plans designed to improve progression and account for reductions in travel speeds during inclement weather conditions. Timing plans could be implemented through operators in a control center or automatically based on field measurements of weather conditions.</p>	<p>Rain and snow accumulation, heavy rainfall, ice, limited visibility</p>	<ul style="list-style-type: none"> • Signal Timing Changes • Weather responsive signal timing plans
<p>Ramp Control Signals/Ramp Metering</p> <p>This strategy involves implementing special timing plans to account for lost freeway capacity, slow travel speeds, and increased start-up time at ramp control signals. Strategies could include limiting traffic flow entering the freeway or strategies to increase ramp capacities during inclement weather.</p>	<p>Rain and snow accumulation, heavy rainfall, ice, limited visibility</p>	<ul style="list-style-type: none"> • Signal Timing Changes • Longer/shorter green times, • Longer/shorter cycle lengths.

Definition	Applicable Weather Events	Delivery/Communication Mechanisms to Travelers
Traffic Incident Management		
<p>Full Function Service Patrols/Courtesy Patrols</p> <p>This strategy involves increasing the presence of full function courtesy /service patrols on freeways during inclement weather conditions. This might include increasing the number of patrols, shortening service routes, or pre-positioning patrols in known trouble spots.</p>	<p>Rain and snow accumulation, heavy rainfall, ice, limited visibility</p>	<ul style="list-style-type: none"> • Static Signs with Patrol Information
<p>Wrecker Response Contracts</p> <p>This strategy involves developing institutional arrangements and deploying techniques to reduce response times of wrecker and recovery vehicles to incident scenes during inclement weather. This would include implementing response time criteria, wrecker rotations, prepositions of recovery vehicles, etc.</p>	<p>Rain and snow accumulation, heavy rainfall, ice, limited visibility, flooding</p>	<p>Not Applicable</p>
<p>Quick Clearance Policies</p> <p>This strategy involve deploying quick clearance policies and procedures to insure that stalled, stranded, or abandoned vehicle are removed promptly during inclement weather events.</p>	<p>Rain and snow accumulation, heavy rainfall, ice, limited visibility, flooding</p>	<ul style="list-style-type: none"> • Static Signs • Dynamic Message Signs (reminding travelers of quick clearance, move over laws)
Personnel/Asset Management		
<p>This strategy involves developing tools and systems to help better manage agency assets and personnel during inclement weather events. This might include decision support tools, staffing plans, automated inventory control systems, etc.</p>	<p>Rain and snow accumulation, heavy rainfall, ice, limited visibility, flooding</p>	<p>Not Applicable</p>
Agency Coordination and Integration		
<p>This strategy involves developing policies, processes, procedures, and systems designed to promote better inter-agency and intra-agency coordination during inclement weather events. These strategies would be similar in nature to those used to develop multi-agency incident response plans.</p>	<p>Rain and snow accumulation, heavy rainfall, ice, limited visibility, flooding</p>	<p>Not Applicable</p>

The review revealed several key findings for WRTM suggestive of next steps for the Road Weather Management program:

- While specific applications of WRTM strategies may vary by location, the review identified most, if not all, of the actions that transportation managers take during weather events around the United States.
- WRTM strategies currently tend to be localized. Numerous applications exist to deal with certain specific problem locations/road segments. WRTM strategies that address regional

travel impacts due to weather are rare and primarily exist in the motorist advisory arena through the provision of such information on websites and 511 phone systems. Moving beyond a problem-specific WRTM approach to a regional management of a weather event is still a challenge. Regional management of weather events might also benefit from the availability of multi-jurisdictional, multi-State data platforms like *Clarus*.

- To truly move toward a proactive regional approach where agencies are responding based on anticipated impacts, the development of travel impact estimation and prediction models is critical.
- Most deployed WRTM strategies seem to work with current weather condition data. Very few strategies use forecast data in their process. Some examples that use forecast data primarily fall in the vehicle and route restrictions category.
- Strategies directly intended to address weather impacts are reported widely but it is much harder to find examples where general traffic management strategies have been modified specifically to deal with weather events. An often referenced but still rarely used application is weather-responsive traffic signal timing. Conceptually, significant opportunities exist for transportation operators to anticipate weather impacts and adjust their traffic management strategies. Modifications of strategies such as proactive ramp metering, active traffic management, and incident management based on forecast conditions hold great promise and should be explored by more thorough analysis of agency operations manuals and guidelines.

Subsequent to the review, an expert panel was convened to identify improvements to WRTM strategies. A web-based survey (results are presented in Appendix C) was used to identify areas of discussion among the various WRTM strategies. The list of improvements is identified in Table ES-2 below:

Table ES-2. List of Improvements for WRTM Strategies

List of General Improvements	List of Specific Improvements
<ul style="list-style-type: none"> • Improved linkages between weather conditions and traffic operational impacts. • Improved guidance on where and when to use active warning systems. • Improved impact prediction and decisions support capabilities. • Enhanced weather information integration at TMCs. • Improved techniques and tools to facilitate intra-and inter-agency coordination during weather events. • Improved coordination between transit service providers and traffic management agencies. 	<ul style="list-style-type: none"> • Improved communications systems to remote sensor locations. • Guidance on human factors issues related to providing predicted road condition information. • Use of consistent/common messaging across jurisdictional/State boundaries. • Use of social media and Smartphone applications to disseminate weather impact information to travelers. • Use of Active Traffic Management (ATM) techniques (such as variable speed limits, queue warning system, etc.) for active weather management. • Integration of weather information and transit service information. • Automated activation of weather responsive traffic signal coordination plans. • Signal timing strategies for improving transit performance during weather events. • Use of vehicle restrictions for critical transit lines during weather emergencies. • Use of full function service patrols to facilitate road clearance during weather emergencies. • Improved sensor testing and diagnostics. • Use of configurable detection systems for traffic signal operations. • Use of dynamic traffic signal clearance interval technologies.

Based on the review and the list of improvements, five strategy areas were prioritized for high-level Concept of Operations development. The Concepts of Operations were developed using a standard format for the following strategies:

1. Weather Responsive Active Traffic Management – includes vehicle, facility and route restrictions
2. Weather Responsive Traffic Signal Management
3. Weather Responsive Traveler Information – includes both pre-trip and en-route traveler information
4. Seasonal Weight Restrictions
5. Intra- and Inter-agency Coordination

Appendix D contains Concepts of Operations for all five strategies. These concepts of operations are generic and intended to be starting points for agencies exploring WRTM strategy design and implementation. However, they would need to be customized for each particular agency and location.

It was clear from the various tasks in the project that existing documented benefits of the WRTM strategies are few and far between. Strategies involving technology deployment are often

accompanied by evaluations but very few benefits are identified for the more widely deployed techniques, such as vehicle restrictions and route restrictions. Agencies are often too busy managing the impacts of the weather event to focus on collecting good data to assess the benefits of different strategies. Agencies are also hesitant to deploy new strategies for fear of liability. Issues of data availability, inconsistent deployments, and inadequacy of tools all hinder the ability of agencies to produce meaningful and applicable benefits data. Agencies desire more pilot studies with rigorous evaluations that clearly demonstrate the benefits of different types of WRTM strategies. Agencies also desire better visualization tools and information packaging that will help them communicate benefits to decision makers.

To support the broader adoption of WRTM, good evaluation studies documenting the benefits of such strategies are essential. Comprehensive guidance is provided in this project for nine WRTM strategies offering State and local agencies a practical and defensible approach to measuring the benefits of WRTM. The guidance is general in nature in order to address the numerous possible scenarios that an agency might use to implement a WRTM strategy. The guidance also includes how to structure an evaluation plan, what potential challenges exist, potential evaluation design and methods to consider, and data collection approaches. Also included are evaluation examples that demonstrate how an agency has implemented a certain WRTM strategy and their measurement of the benefits.

Specific recommendations that define a roadmap (next steps) to continue the efforts of the RWMP to promote and enhance the level of WRTM in the country include (and are described below):

1. Developing and maintaining a engaged stakeholder community for WRTM
2. Incorporating WRTM Pilots as part of State-led efforts on Active Traffic Management and Integrated Corridor Operations
3. Facilitate the deployment and testing of weather-responsive signal timing strategies as a viable traffic management strategy
4. Continue the development and testing of seasonal weight restrictions
5. Continuing research on impact prediction, simulation and decision-support
6. Identifying and documenting evidence of WRTM Strategy Benefits
7. Identifying intra- and inter-agency communication barriers and methods of overcoming institutional issues for WRTM

Recommendation #1 - Create and maintain an engaged stakeholder community for WRTM

WRTM involves a large stakeholder community including traffic managers, maintenance staff, weather data/product providers, universities, transit agencies, emergency personnel, and private sector system developers and integrators. As understanding of the potential of WRTM evolves, there is a need to have a community that is active in supporting WRTM and championing the cause of proactive management of traffic during adverse weather. Both potential implementers of WRTM strategies and those who may be able to support such implementations are not well aware of the range of strategies and their potential benefits. Stakeholder outreach to a broad group of potential implementers of WRTM strategies is needed to educate and better market the benefits.

The RWMP has been a strong proponent of stakeholder outreach and participation as evidenced by the strong community that has been created for *Clarus* and MDSS. The RWMP has already begun the process of creating a WRTM-specific community by planning a WRTM workshop in the fall of

2011. This effort needs to be sustained and maintained over the next couple of years similar to the *Clarus*/MDSS communities.

Recommendation #2 - Incorporate WRTM pilots as part of state-led efforts on Active Traffic Management and Integrated Corridor Management

Real-world applications of WRTM tend to be spot-specific and not well integrated into the larger notion of traffic management. Model applications of WRTM can provide the community with success stories and real-world results. A dedicated WRTM pilot may be difficult to justify; however, incorporation of WRTM into new and emerging approaches being considered by States and localities is a highly promising approach. The RWMP needs to consider the opportunities to test WRTM in two major initiatives supported by USDOT – Integrated Corridor Management (ICM) and Active Traffic Management (ATM). Both these initiatives are in stages where new deployments are being planned around the country. The RWMP should work with other groups within DOT to ensure that these deployments consider weather as part of their system deployment in a more comprehensive manner.

Currently, deployments already consider operations during weather as critical part of their system. The activities under this recommendation address more formally recognizing the role of weather in planned deployments for ICM and ATM around the country. These could include working with federal and State partners to develop and implement a weather-responsive scenario for ATM using the Concept of Operations developed in this project or looking at intra- and inter-agency collaboration during weather events in an integrated corridor deployment. The RWMP could provide additional support to test and evaluate new WRTM strategies and techniques as part of these systems.

Recommendation #3 - Facilitate the deployment and testing of weather-responsive signal timing strategies as a viable traffic management strategy

The state-of-the practice review showed that weather-responsive traffic signal timing strategies are still in their infancy. Only a few states have deployed and routinely used weather-responsive signal timing plans, even though weather events can have significant impacts on traffic signal operations. Traffic signal timings are often developed assuming ideal weather conditions. Weather events, such as heavy rain, thunderstorms, slush, ice and even snow can significantly affect the basic parameters used to develop traffic signal timings. These events can affect visibility of traffic signal indications; increase start-up loss times, stopping distances, and vehicle headways; and reduce travel speeds and saturation flow rates. Significant accumulations can also obscure pavement markings which may cause drivers to travel outside the normal travel paths where vehicle detectors have been placed. All consequences of weather could potentially lead to reductions in safety and efficiencies at signalized intersections. Agencies need assistance in determining how to develop and implement weather-responsive traffic signal timings. Many institutional, legal, technical, and operational issues still need to be resolved before agencies will accept widespread deployment of weather responsive signal timing strategies.

In order to achieve widespread acceptance of weather-responsive traffic signal timing plans, agencies need guidance and assistance in determine when and where these strategies are needed to maintain and improve operations during significant weather events. FHWA can provide this assistance by

providing research and funding to support more detailed system design and testing of weather-responsive signal timings.

Recommendation #4 - Continue the development and testing of seasonal weight restrictions

Recently, FHWA supported a project to develop a tool for forecast when and where seasonal weight restrictions would be needed to limit damage to pavement and subgrade conditions during spring thaw events as part of the *Clarus* Multi-State Regional Demonstration. The tool uses current road and weather observations as well as forecast information to predict future subsurface temperature to support better decision making for placing load restrictions on certain section of roadway. The tool is currently being tested in North Dakota and Montana.

The Concept of Operations developed in this research describes methods for enhancing the utilization of this tool, with the intent of increasing uniformity of when and where seasonal weight restrictions should be applied. Better uniformity of where and when these restrictions were implemented would permit commercial freight haulers and others to better plan routes and loads for reaching their destinations. Having a better idea as to when and where travel by heavy vehicles is restricted across multiple states could have significant revenue impacts for commercial fleet operators.

Recommendation #5 – Continue and expand research on impact prediction, simulation and decision-support

It was made clear by the expert panel recruited for this study that the linkage between weather conditions and traffic impacts is still unclear. This confusion results in a lack of confidence in WRTM strategy implementation. The panel also noted that there is a paucity of trusted tools and techniques to assess the impacts of weather on traffic conditions especially with and without the use of WRTM.

In response to the need for such tools, the RWMP is working with researchers and universities in the US and abroad to collect and analyze data and develop models and tools to improve the analysis, modeling and prediction of traffic flow in all types of weather conditions. The goal of such studies is to inform model development and decision support tools that allow a user to translate current and forecast conditions to traffic impacts. Currently, weather is often assumed to be ideal in models used for traffic analysis.

These tools will continue to be enhanced but admittedly, the biggest stumbling block with research in this area has been the lack of data available to create, validate and calibrate models. In turn, this has resulted in a dearth of decision-support tools for traffic managers during weather.

The RWMP should continue its efforts to develop weather-related parameters for micro-simulation models and should conduct tests of WRTM strategies with those models. After an initial set of tests the models could be installed in several TMCs and simulations conducted in parallel with actual TMC operations. A subsequent step would be to use the simulation results and test actual strategies implemented by transportation operating agencies. Concurrently, the RWMP should pursue the use of TrEPs as part of real-time or near real-time decision support systems used for traffic operations. Such decision-support engines are being developed as part of the ICM initiative in San Diego and Dallas and may offer opportunities to test the weather-related aspects of decision-support.

Recommendation #6 - Identify and document the benefits of WRTM strategies

The literature search conducted for this project has revealed very limited measurable benefits of weather responsive traffic management applications. The strongest potential benefits are documented in Chapter 2 and Chapter 5 of this report. Still, the documented benefits only hint to the range of benefits that are needed to fully promote WRTM strategies to a broad audience. The RWMP needs a comprehensive set of quantifiable benefits of WRTM strategies that can be shared with prospective traffic managers across the country who are interested in WRTM applications.

In combination with recommendation #1 which will identify a group of traffic managers across the county who are interested in implementing WRTM strategies, this recommendation involves the activities to collect documented benefits (a report and database) which will encourage others to consider deploying WRTM strategies throughout the country.

Recommendation #7 - Identify intra- and inter-agency communication barriers and methods of overcoming institutional issues

The main barrier to WRTM is often institutional rather than technological. The broad nature of WRTM and the disparate roles and responsibilities of the various stakeholders involved create barriers to effectively implement an integrated approach to managing traffic during adverse weather. As the FHWA TMC integration project clearly illustrated, there are immediate and low-cost benefits to institutional coordination but currently, most intra and inter-agency communications during inclement weather rely on informal and personal communications. This is not unique to WRTM but rather a problem with Systems Operation and Management (SO&M) as a whole. AASHTO [1] developed a capability maturity model, adapted from the world of Information Technology, to help agencies improve their SO&M approach in an evolutionary manner. A similar evolutionary approach to WRTM, allowing agencies to self-assess the current and desired levels of capability for WRTM is much needed. By tailoring and applying this AASHTO guidance to WRTM, a clear approach to institutional collaboration can be established for WRTM.

Chapter 1 Introduction and Background

1.1 Purpose

The impacts of weather on traffic operations are well-documented in the literature. Over the past decade, Federal Highway Administration's (FHWA) Road Weather Management Program (RWMP) has championed the cause of improving traffic operations and safety during weather events. The program's current emphasis is to encourage agencies to be more proactive in the way that they manage traffic operations during weather events. Weather Responsive Traffic Management (WRTM) is the central component of the program's efforts. WRTM involves the implementation of traffic advisory, control, and treatment strategies in direct response to or in anticipation of developing roadway and visibility issues that result from deteriorating or forecasted weather conditions. WRTM also includes using weather forecasting to provide proactive advisories and potentially control strategies based on forecasts of weather conditions, and not just the results of those conditions. WRTM also brings together into a logical framework the various other activities (such as weather information integration, *Clarus*, traffic analysis, performance measurement, etc.) that the RWMP has been supporting. WRTM is not a single strategy per se but a combination of techniques, tools, and systems that transportation authorities can use for mitigating the impacts of weather on their operations.

Over the past 10 years, State and local agencies have implemented various strategies to mitigate impacts of adverse weather on their operations. These strategies range the gamut from simple flashing signs to coordinated traffic control strategies and regional traveler information. Over the past decade, the RWMP has collected and compiled information on WRTM strategies in different forms. In 2003, the RWMP developed a "best practices" document that identified the state of the art in terms of how transportation operators respond to weather-events.

Since 2003 however, various new approaches, technologies, and strategies have emerged that hold great potential for WRTM. Active Traffic Management (ATM) and Integrated Corridor Management (ICM) are just two such emerging areas with opportunities for the traffic operator to improve WRTM. New weather sources, decision-support tools have emerged. For example, access to quality-checked *Clarus* data and supporting applications (use-cases) can open new avenues for WRTM. There are new formats for advisories beyond dynamic message signs, highway advisory radio, websites and 511. Improvements to WRTM strategies, based on the aforementioned trends can take on many forms. Improvements could include:

- Moving from general zone-specific data to route-specific data.
- Using new models of weather and road weather forecasting.
- Expanding coverage, quality, and capabilities of sensors.
- Making new modes of communication available to travelers (both pre-trip and en-route).
- Changing organizational roles and responsibilities.

- Creating new procedures.
- Improving decision-making and interpretation capabilities.
- Improving intra-and inter-agency communications and coordination.

These improvements can have a wide variety of impacts on driver behavior. Improvements in WRTM strategies could result in more confidence leading to increased traveler behavior changes as well as beneficial system impacts (e.g., mobility and safety improvements due to more drivers making better decisions as a result of access to improved strategies that provide more timely and trustworthy information). Drivers may value traveler information (awareness reduces stress) but not necessarily alter their decisions or driving behaviors. Driver behavior and system impacts vary greatly based on the strategy and the type of improvement.

The purpose of this final report is to summarize the results of recently completed tasks performed as part of the *Developments in Weather Responsive Traffic Management (WRTM) Strategies* project. The project took a comprehensive look at existing WRTM, identified improvements, developed sample Concepts of Operations and evaluation procedures resulting in an up-to-date and forward-looking approach to WRTM.

1.2 Background and Relationship to Overall RWMP Program

Recognizing the unacceptably high safety and mobility impacts of severe weather on the transportation system, the RWMP established a roadmap of programmatic initiatives in an effort to help State DOTs and affiliated agencies mitigate the adverse effects of weather. The RWMP created a framework for its Weather Responsive Traffic Management (WRTM) program that illustrates how weather information integration dovetails with the other key elements in the program (Figure 1).

WRTM at the core includes a set of actionable strategies that a transportation operator can implement, covering advisory, control and treatment. Supporting the ability to implement these strategies are various important elements of WRTM. These elements include:

- Traffic and Weather Data Collection and Integration – focusing on the integration of appropriate weather and traffic information to enable an agency to make decisions in a more proactive manner.
- Traffic Analysis, Modeling and Simulation – providing the modeling and simulation capabilities to assess impacts of weather events on traffic operations, and the tools necessary for a traffic manager to make informed decisions, including information from the other elements.
- Human Factors – addressing the appropriateness of the strategies for message dissemination as well as as issues relating to driver behavior in various weather conditions (such as lane changing, gap acceptance and car following).
- Performance Evaluation – determining the benefits of implementing WRTM strategies.

While each of these areas in the Figure is not new to a transportation agency, the umbrella framework of WRTM brings together all these interlinked pieces to achieve coordinated, proactive, and effective responses to weather events.

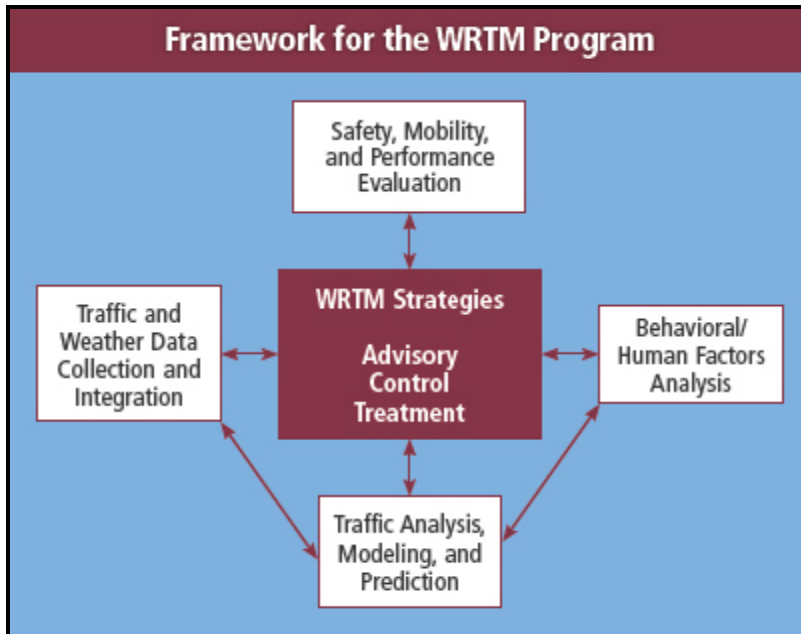

Figure 1. Framework for the WRTM Program (Source: FHWA)

Consistent with the above framework, the RWMP has initiated and completed several activities that research, document and develop tools for WRTM. The RWMP has developed several guidance documents, tools, and research reports that agencies can use to better integrate weather information in their traffic operations, analyze the relationships between weather conditions (e.g. precipitation, visibility and wind speed) and traffic parameters (e.g. volume, speed, density, driver behavior including lane changing, car-following and gap acceptance), and evaluate the effectiveness of road weather advisory and information messages.

This project focused on the core (the middle box in Figure 1) of WRTM documenting information on what WRTM strategies exist, where they have been used, the benefits realized, and how to implement and evaluate them as part of their operations. The project also provides concepts of operations and high-level requirements that a transportation agency can use as input to system design.

1.3 Project Approach

The project was conducted using the following phased sequence of activities:

1.3.1 State of the Practice Review

The objective of the review was to obtain a comprehensive picture of WRTM in the country and clearly identify the entire range of actions that traffic management operators are using to manage traffic during and in anticipation of inclement weather conditions. An in-depth literature review was conducted which included reviewing FHWA's Road Weather Resource Identification database, national and international conference publications and presentations, research reports from the RWMP website, traffic management center operating manuals, and an online key-word search. The literature review also focused on identifying as many benefits reported for these strategies as possible.

A supporting electronic database was created in Microsoft Access 2007 that lists the various WRTM strategies in a standard taxonomy developed for the project. The taxonomy identifies specific details about each strategy including applicable weather events, operating concepts, data requirements, reported benefits (where available), and contact information for a traffic operator involved in the strategy.

A detailed summary of the state of the practice is provided in Chapter 2. It is important to note that the focus of the review is from a traffic management operator viewpoint, and typical maintenance actions (snow removal, anti-icing etc) which are mostly conducted by maintenance personnel are not discussed in the review. It should also be noted, however, that in many traffic management organizations operations and maintenance personnel work closely together to implement several of the strategies identified in this report. The review is not intended to be an exhaustive listing of all the various applications of a strategy by different agencies nor is it an explicit identification of best practices.

1.3.2 Identification of Improvements through Expert Panel Discussions

The review itself identified some key ideas for improvements. In addition to the literature review, convening of an expert panel was an opportunity to obtain feedback from a variety of stakeholder groups to identify and refine specific improvements. The following individuals were contacted and agreed to participate in the panel for this task:

- Dave Kinnecom – Utah Department of Transportation (UDOT)
- Brian Fariello – Texas DOT (San Antonio)
- Vince Garcia – Wyoming DOT
- Tina Greenfield Huitt – Iowa DOT
- Gene Donaldson – Delaware DOT
- Jack Stickel – Alaska DOT
- Sheldon Drobot – National Center for Atmospheric Research
- Rob Helt – City of Colorado Springs
- Peter Koonce – City of Portland

The panel was convened over three web-meetings in June and July 2010. All the panelists were provided with the State-of-the-practice report as well as a tabular summary of strategies prior to the meetings. The first meeting, held on June 17th, focused on discussing WRTM in general and reviewing the findings in the State of the practice report. A survey was also distributed to the panel to prioritize candidate strategies for discussion at the end of first meeting. The survey responses are compiled and presented in Appendix C. The second meeting, held on July 8th, discussed several individual WRTM strategies prioritized by the panel and identified potential improvements. The third and final meeting was held on July 22nd, and focused on improving the evaluation of WRTM strategies. The improvements identified by the panel and the project team are described in Chapter 3.

1.3.3 Concepts of Operations Development

Based on the improvements suggested by the panel and with guidance from FHWA, five concepts of operations were developed. The approach to develop these documents is described in Chapter 4 and the concept of operations documents themselves are provided in Appendix D.

1.3.4 Evaluation Procedures

A current challenge to WRTM adoption is the lack of documented benefits needed in order to present a strong business case for the State DOTs to invest time and resources to purchase and deploy system components and implement weather responsive strategies. Guidance to agencies regarding evaluation approaches was developed for one or more of the WRTM strategies they may be considering or are in the process of implementing. Details of this guidance are provided in Chapter 5 in this report.

1.4 Structure of Final Report

This report discusses the activities conducted as part of *Developments in Weather Responsive Traffic Management (WRTM) Strategies* study. The following chapters are covered:

- Chapter 2 – Review of existing WRTM strategies and a description of the state of the practice
- Chapter 3 - Identification of emerging trends as well as new and improved strategies
- Chapter 4 – WRTM Concepts of Operations and System Requirements
- Chapter 5 –Evaluation approach and procedures to assess the benefits of WRTM
- Chapter 6 – Conclusions and recommendations

References and Appendices are also included.

Chapter 2 Review of Existing WRTM Strategies

2.1 State of the Practice Review

The current universe of transportation management operator actions during weather events can be grouped into the following eight categories of strategies:

1. Motorist Advisory, Alert and Warning Systems
2. Speed Management Strategies
3. Vehicle Restrictions Strategies
4. Route restrictions Strategies
5. Traffic Signal Control Strategies
6. Traffic Incident Management
7. Personnel/Asset Management
8. Agency Coordination

Table 1 provides a summary listing of the WRTM strategies. Each of the eight categories is described in detail in the following sub-sections. Under each category, specific WRTM strategies identified in the literature are described, examples provided, and (where available) documented benefits identified.

Table 1. Summary of WRTM Strategies

Definition	Applicable Weather Events	Delivery/Communication Mechanisms to Travelers
Motorist Advisories, Alert and Warning Systems		
<p>Passive Warning Systems</p> <p>This strategy involves the installation of static informational and/or warning signs to alert travelers that potentially hazardous driving conditions MAY exist downstream or at a specific location. Information is displayed regardless of whether or not the condition is present. This strategy includes the static warning signs contained in the MUTCD.</p>	<p>Icy conditions, Wind Warning, Fog, Blowing Snow, Floods</p>	<ul style="list-style-type: none"> • Static signs

Definition	Applicable Weather Events	Delivery/Communication Mechanisms to Travelers
<p>Active Warning Systems</p> <p>This strategy involves supplementing the passive warning signs with flashing beacons to alert travelers that the conditions specified on the static sign is currently in effect. The flashing beacons may be activated either manually by operators in a traffic management center or by field personnel based on observed conditions, or automatically if tied to a road weather monitoring system (such as a flood detection stream gauge or a high wind detection system).</p>	<p>Icy conditions, Wind Warning, Fog, Blowing Snow, Floods</p>	<ul style="list-style-type: none"> • Static Signs with Flashing beacons
<p>Pre-Trip Road Condition Information and Forecast Systems</p> <p>This strategy involves disseminating information about current and forecasted weather and pavement conditions to travelers before they initiate their trip, in an attempt to influence their choice of travel mode, departure time, or route.</p>	<p>Snow and Rain Accumulations, High Winds, Flooding, Limited Visibility, Tornados, Black Ice, Snow Accumulations, Flooding</p>	<ul style="list-style-type: none"> • 511 • Agency and private websites • Media Outlets • Text Messages • Social Networks (Twitter®)
<p>En-Route Weather Alerts and Pavement Condition Information</p> <p>This strategy involves providing traveler with real-time information and alerts about specific weather and pavement conditions currently existing or developing ahead of them while they are en-route. The content of the messages changes dynamically to reflect current or forecasted conditions. These systems can be used for disseminate information about different types of weather events and pavement conditions.</p>	<p>Snow and Rain Accumulations, High Winds, Flooding, Limited Visibility, Tornados, Black Ice, Snow Accumulations, Ponding, Flooding</p>	<ul style="list-style-type: none"> • Dynamic Message Signs (DMS) • Highway Advisory Radio (HAR) • 511 • FM/AM Radio • Text Message Alerts • In-vehicle Displays
<p>Speed Management Strategies</p>		
<p>Speed Advisories</p> <p>This strategy involves issuing special speed advisories in response to deteriorating weather conditions. The speed advisories are intended to achieve voluntary compliance with a recommended safe travel speed for the prevailing conditions. The speed advisory messages would not be considered enforceable by law enforcement personnel.</p>	<p>Falling Snow and Rain, Wind conditions, Limited Visibility</p>	<ul style="list-style-type: none"> • Dynamic Message Signs (DMS), Variable Speed Advisory Signs
<p>Enforceable Speed Limits/Variable Speed Limits</p> <p>This strategy involves establishing new speed limits or implementing speed restrictions in direct response to weather conditions. Speed limits would be considered enforceable by law enforcement personnel.</p>	<p>Falling Snow and Rain, Wind conditions, Limited Visibility, Ice and Snow Accumulations</p>	<ul style="list-style-type: none"> • Dynamic Message Signs (DMS) Variable Speed Advisory Signs

Definition	Applicable Weather Events	Delivery/Communication Mechanisms to Travelers
Vehicle Restriction Strategies		
<p>Size/Height/Weight/Profile Restrictions</p> <p>This strategy involves restricting specific types of vehicles from using the roadways during specific weather conditions. Vehicles may be restricted by size, height, weight, or profile based on weather conditions.</p>	<p>High wind conditions, Snow and Ice Accumulations</p>	<ul style="list-style-type: none"> • Dynamic message signs (DMS), • Static signs with variable message inserts • Highway Advisory Radio • Agency Websites
<p>Tire Chains/Alternate Traction Devices</p> <p>This strategy involves requiring vehicles to use special devices for improving traction between the vehicle and pavement. Using of traction control devices may be restricted to specific vehicles or may be required of all vehicles.</p>	<p>Ice and Snow Accumulations</p>	<ul style="list-style-type: none"> • Dynamic message signs (DMS) Static signs with variable message inserts • Highway Advisory Radio • Agency Websites
Road Restriction Strategies		
<p>Lane-Use Restrictions</p> <p>This strategy involves requiring specific types of vehicle to use specific lanes during specific weather events (e.g., trucks use right lane). This strategy may also include restricting the use of special lanes by certain types of vehicle or to all vehicles (e.g., right lane closed ahead).</p>	<p>Ice and Snow Accumulations, Rain, Flooding</p>	<ul style="list-style-type: none"> • Dynamic message signs (DMS), Static signs with variable message inserts • Highway Advisory Radio • Agency Websites
<p>Parking Restrictions</p> <p>This strategy involves implementing special parking restrictions or requirements in response to developing or forecasted weather conditions. This strategy may include a total ban of on-street parking, restricting parking to a certain side of the street, or establishing designated parking areas for specific types of vehicles.</p>	<p>Snow Accumulations, Flooding</p>	<ul style="list-style-type: none"> • Static signs with variable message inserts • Agency Websites
<p>Access Control and Facility Closures</p> <p>This strategy involves implementing controls that limit vehicle access to specific sections of roadway. Access could be restricted to specific structures (such as bridges, or causeways), passes, or entire sections of roadway.</p>	<p>Snow and Ice Accumulation, Flooding, Limited Visibility, High winds</p>	<ul style="list-style-type: none"> • Dynamic message signs (DMS), Highway Advisory Radio, • Access control gates • Agency Websites • Barricades • On-Scene Personnel
<p>Contraflow/Reversible Lane Operations</p> <p>This strategy involves operating particular sections of highway a contraflow or reversible lane facility. With this strategy, traffic is directed to travel in the direction opposite of the normal flow. This strategy is generally reserved for large scale evacuation, and where large volume of traffic needs to be cleared for an area in a short time period.</p>	<p>Hurricane, flooding, developing major snow storms</p>	<ul style="list-style-type: none"> • Dynamic message signs (DMS), Static signs, • Highway Advisory Radio, • Access control gates/ barricades, Traffic Signals, • On-scene personnel

Definition	Applicable Weather Events	Delivery/Communication Mechanisms to Travelers
Traffic Signal Control Strategies		
<p>Vehicle Detector Configuration</p> <p>This strategy involves reconfiguring detector settings or implementing special detector schemes/layouts to ensure detection of vehicles at traffic signals. This strategy might involve overlapping detector layouts or changing detector settings based on prevailing weather and pavement conditions.</p>	<p>Snow and Ice Accumulations, Heavy Rainfall, Limited Visibility</p>	<p>Not Applicable</p>
<p>Vehicle Clearance Intervals</p> <p>This strategy involves altering the time duration of vehicle and pedestrian clearance intervals (i.e., yellow change interval, all-red interval, and pedestrian clearance interval) to account for lost pavement friction and slow traffic speed approaching signalized intersections.</p>	<p>Rain and snow accumulation, heavy rainfall, ice, limited visibility</p>	<ul style="list-style-type: none"> • Signal Timing Changes • Yellow clearance interval, • All-red intervals • Pedestrian WALK/ DON'T WALK intervals
<p>Interval and Phase Duration Settings</p> <p>This strategy involves altering the time duration and/or sequencing of traffic signal phases during inclement weather conditions to account for increases in start-up lost time, reduced travel speeds, and reduced pavement traction. This strategy might include altering minimum green intervals, maximum green intervals, gap out settings, phase sequences, etc.</p>	<p>Rain and snow accumulation, heavy rainfall, ice, limited visibility</p>	<ul style="list-style-type: none"> • Signal Timing Changes • Longer minimum green intervals • Longer phase durations • Longer gap settings
<p>Traffic Signal Coordination Plans</p> <p>This strategy involves implementing new signal timing coordination plans designed to improve progression and account for reductions in travel speeds during inclement weather conditions. Timing plans could be implemented through operators in a control center or automatically based on field measurements of weather conditions.</p>	<p>Rain and snow accumulation, heavy rainfall, ice, limited visibility</p>	<ul style="list-style-type: none"> • Signal Timing Changes • Weather responsive signal timing plans
<p>Ramp Control Signals/Ramp Metering</p> <p>This strategy involves implementing special timing plans to account for lost freeway capacity, slow travel speeds, and increased start-up time at ramp control signals. Strategies could include limiting traffic flow entering the freeway or strategies to increase ramp capacities during inclement weather.</p>	<p>Rain and snow accumulation, heavy rainfall, ice, limited visibility</p>	<ul style="list-style-type: none"> • Signal Timing Changes • Longer/shorter green times, • Longer/shorter cycle lengths.
Traffic Incident Management		
<p>Full Function Service Patrols/Courtesy Patrols</p> <p>This strategy involves increasing the presence of full function courtesy /service patrols on freeways during inclement weather conditions. This might include increasing the number of patrols, shortening service routes, or pre-positioning patrols in known trouble spots.</p>	<p>Rain and snow accumulation, heavy rainfall, ice, limited visibility</p>	<ul style="list-style-type: none"> • Static Signs with Patrol Information

Definition	Applicable Weather Events	Delivery/Communication Mechanisms to Travelers
<p>Wrecker Response Contracts</p> <p>This strategy involves developing institutional arrangements and deploying techniques to reduce response times of wrecker and recovery vehicles to incident scenes during inclement weather. This would include implementing response time criteria, wrecker rotations, prepositions of recovery vehicles, etc.</p>	Rain and snow accumulation, heavy rainfall, ice, limited visibility, flooding	Not Applicable
<p>Quick Clearance Policies</p> <p>This strategy involve deploying quick clearance policies and procedures to insure that stalled, stranded, or abandoned vehicle are removed promptly during inclement weather events.</p>	Rain and snow accumulation, heavy rainfall, ice, limited visibility, flooding	<ul style="list-style-type: none"> • Static Signs • Dynamic Message Signs (reminding travelers of quick clearance, move over laws)
Personnel/Asset Management		
<p>This strategy involves developing tools and systems to help better manage agency assets and personnel during inclement weather events. This might include decision support tools, staffing plans, automated inventory control systems, etc.</p>	Rain and snow accumulation, heavy rainfall, ice, limited visibility, flooding	Not Applicable
Agency Coordination and Integration		
<p>This strategy involves developing policies, processes, procedures, and systems designed to promote better inter-agency and intra-agency coordination during inclement weather events. These strategies would be similar in nature to those used to develop multi-agency incident response plans.</p>	Rain and snow accumulation, heavy rainfall, ice, limited visibility, flooding	Not Applicable

2.2 Strategy Details

2.2.1 Motorist Advisory, Alert and Warning Systems

The first general category includes strategies designed to provide travelers with advisories, alerts, and warnings before and during their travel. The operational objective of the strategies in this area is to increase the awareness of the traveler to current and impending weather and pavement conditions. Generally these strategies can be grouped into the following four subcategories:

1. Passive warning systems
2. Active warning systems
3. Pre-Trip Road condition information and forecast systems
4. En-Route weather alerts and pavement condition information

Passive Warning Systems

The recent addition of the National Manual on Uniform Traffic Control Devices (MUTCD) [2] lists four weather-related warning signs:

- The ROAD MAY FLOOD (W8-18) sign may be used to warn users that a section of roadway is subject to frequent flooding.
- A Depth Gauge (W8-19) sign can also be used in conjunction with ROAD MAY FLOOD sign to indicate the depth of the water at the deepest point on the roadway.
- The GUSTY WINDS AREA (W8-22) sign may be used to warn road users that wind gusts frequently occur along a section of highway that are strong enough to impact the stability of trucks, recreational vehicles, and other vehicles with high center of gravity.
- The FOG AREA (W8-22) sign may be used to warn road users that foggy conditions frequently reduce visibility along a section of highway.
- BRIDGE ICES BEFORE ROAD (W8-13) is a commonly employed sign all over the U.S.

While these are the only signs included in the MUTCD that relate to weather conditions, many agencies have developed their own series of passive warning signs that they use to alert road users of potential hazardous conditions.

Evaluation/Measured Benefits

The research team was unable to locate any study that documented the use, or measured the benefits and utility of this strategy during inclement weather conditions. Warning signs are not necessarily *responsive*, as they present travelers with the same level of information whether or not that information is applicable to the current conditions. Because these signs are displayed regardless of whether the actual condition exists, these signs are often ignored by travelers. It is important to realize, however, that these signs are part of the overall weather traffic management toolbox and should be considered in a systematic approach to developing new weather-responsive traffic management strategies.

Active Warning Systems

These systems are designed to warn drivers of unsafe travel conditions through a particular section of roadway, often deployed in remote or isolated locations. Installing and implementing these systems involve integrating a weather condition detection system with standard warning or regulatory signals augmented with flashing beacons. These systems often also include speed management techniques such as speed restrictions and speed advisories.

Some examples from the Oregon DOT below illustrate the range of applicable weather events/conditions for these systems:

- The Oregon DOT installed a flood warning system on Highway 101 near Seaside [3]. The system is composed of a level sensor at the low point in the road connected to a series of static warning signs with beacons mounted on the top of the sign. The flashing beacons are activated when flood conditions are imminent. The system also transmits water level data to ODOT district offices so that maintenance personnel will be able to respond when conditions warrant.

- The Oregon DOT has also installed an ice detection and warning system on OR 140 near Butte Creek [4]. The system was deployed in November 2005 to actively warn motorists of potentially icy driving conditions along a corridor of OR140. The system consists of a road weather information system (located at milepost 35) linked to two static signs with flashing beacons (located at mileposts 41.7 and 21.7) warning travelers of icy conditions. When the threshold conditions (a combination of pavement temperature, humidity and moisture) are met, the flashing beacons will automatically turn on.
- The Oregon DOT has also used similar systems in two locations to provide high wind warning: on US Route 101 between Port Orford and Gold Beach and on the Yaquina Bay Bridge [5]. With the US 101 system, a local wind gauge is used to monitor wind speeds near Humburg Mountain. A controller continuously monitors wind speeds and activates flashing beacons attached to static warning signs located at either end of the corridor. The signs read “CAUTION HIGH WINDS NEXT 27 MILES WHEN FLASHING.” The Yaquina Bay Bridge system uses a similar architecture to activate flashers on static signs that read “Caution High Winds on Bridge When Flashing.” Wyoming and Nevada also have implemented high-wind warning systems.

Evaluation/Measured Benefits

An evaluation of the Oregon DOT High Wind Warning Signs showed B/C ratios of 4.13 and 22.80 for the US 101 and Yaquina Bay Bridge systems, respectively. Benefits were derived from personnel savings and delay reductions from not closing the roadway. Surveys also found that these systems were viewed favorably by motorists in the corridor. Crash reductions and reductions in speed and speed variance have also been reported by evaluation studies in Tennessee, London and Finland [6].

Pre-Trip Road Condition Information and Forecast Systems

A commonly deployed strategy; however, the quality of information and the types of information provided vary extensively by regions and can range from simply providing links to National Weather Service alerts and advisories to detailed pavement conditions. Good examples of pavement-conditions information website can be found in several mid-western States [7]. Improvements through *Clarus Multi-State Regional Demonstrations* are looking at providing pavement conditions forecasts which would greatly increase the timeliness and relevance of the information.

A number of locations (such as the Texas Department of Transportation [8], the Kentucky Transportation Cabinet [9], and the DC Department of Transportation [10]) are beginning to use social networking technologies (such as Facebook®, Twitter®, text messaging, etc.) to disseminate pavement conditions information and forecasts to travelers. These outlets tend to be good approaches for disseminating general information about existing or forecasted road weather conditions. Users “subscribe” to these services to receive updated information about travel conditions. Unfortunately, these sites are frequently used by agencies to disseminate more than just road weather information, which may limit their effectiveness as a tool for disseminating information widely.

Evaluation/Measured Benefits

The ITS-Benefit Cost database [6] reported the following benefit summaries under this area:

- In Idaho, 80 percent of motorists surveyed who used Road Weather Integrated Data System information as a traveler information resource indicated that the information they received made them better prepared for adverse weather [11].

- In a mountainous area of Spokane, Washington, 94 percent of travelers surveyed indicated that a road weather information website made them better prepared to travel; 56 percent agreed the information helped them avoid travel delays [12].

Anecdotal evidence from various providers and hosts of such services indicate significant usage and value reported by the travelers of emerging outlets like Twitter®. For example, DC DOT posted close to 100 updates on its Twitter® account to inform residents about the latest weather forecasts, deployment plans, snow emergency regulations and other key information. DC DOT also added approximated 250 Twitter® followers during the storm and hit the 1,000 mark during a blizzard in December 2009 [10].

En-Route Weather Alerts and Pavement Condition Information

Many States have deployed these types of systems to address a number of operational and weather situations. Currently, they tend to be standalone applications and installed for a specific set of weather situations on specific routes. These systems tend to involve coupling a road weather information system (a low visibility sensor, an environmental sensing station, or an anemometer) to measure weather conditions with a typical information dissemination system. Examples of this type of system include the following:

- In the Stockton-Manteca area of San Joaquin County, the California Department of Transportation (CalTrans) has implemented a weather information warning system for traffic traveling southbound on I-5 and westbound on State Route 120 [13]. These particular stretches of highways frequently experience low visibility situations (due to dust and fog) and high winds, as well as traffic congestion. The system consists of 36 vehicle detection sites and nine environmental sensor stations (ESS) deployed along the freeway. Caltrans uses these sensors to determine when vehicle speeds, visibility distance, and wind speeds reach pre-established thresholds. Proprietary control software automatically selects and displays warning messages on dynamic message signs (DMS) in the corridor. Examples of typical messages displayed on these signs included the following:
 - “SLOW TRAFFIC AHEAD” when average speeds are between 11 and 35 mph
 - “STOPPED TRAFFIC AHEAD” when average speeds are less than 11 mph
 - “FOGGY CONDITIONS AHEAD” when visibility distance is between 200 and 500 feet
 - “DENSE FOG AHEAD” when visibility distance is less than 200 feet
 - “HIGH WIND WARNING” when wind speed is greater than 35 mph
- The Tennessee Department of Transportation has installed a low visibility warning system on I-75 in southern Tennessee that uses this architecture [14]. The system collects field data from 2 environmental sensor station, 8 forward-scatter visibility sensors, and 44 vehicle detectors. Motorists are notified of prevailing conditions via flashing beacons atop six static signs, two highway advisory radio systems, and ten dynamic message signs. Examples of the types of messages displayed on the dynamic message signs include the following:
 - “CAUTION” alternating with “SLOW TRAFFIC AHEAD”
 - “CAUTION” alternating with “FOG AHEAD TURN ON LOW BEAM”
 - “FOG AHEAD” alternating with “ADVISORY RADIO TUNE TO XXXX AM”
 - “FOG AHEAD” alternating with “REDUCE SPEED TURN ON LOW BEAMS”
 - “DETOUR AHEAD” alternating with “REDUCED SPEED MERGE RIGHT”
 - “I-75 CLOSED AHEAD” alternating with “DETOUR”

- The Idaho Department of Transportation installed a motorist warning system on I-84 in southeast Idaho and northwest Utah. The system was installed to reduce crash frequencies during blowing snow and reduced visibility events. The system utilizes environmental sensor stations to detect pavement conditions, wind speed and direction, precipitation type and rate, air temperature, and relative humidity. Forward-scatter detection technology measures visibility distances. A central computer records sensor readings every 5 minutes. When field sensor data indicate that visibility has fallen below a predetermined threshold or that driving conditions are deteriorating, the central system alerts traffic managers in a control center. The traffic manager then enters appropriate warning messages on dynamic message signs.
- Applications also focus on coupling pavement sensing technologies and existing information dissemination technologies to warn travelers of en-route pavement conditions that might cause hazardous driving conditions. An example of this type of system includes the following:
- The Florida Department of Transportation installed a system of pavement sensors at the Florida Turnpike/I-595 interchange to address the unusually high number of wet weather crashes occurring at the interchange. The system used a sensor embedded in the road surface to monitor pavement conditions (i.e., dry or wet). A microwave vehicle detector was installed to record traffic volumes and vehicle speed. When the pavement sensor detected moisture, the system activated a flashing beacon emphasizing the posted speed limit (35 mph) [15].
- There are some private providers (Baron and Inrix) that are starting to provide en-route weather condition information through in-vehicle devices.

Evaluation/Measured Benefits

A “before and after” evaluation was conducted on the Idaho system using data from 1993 and 2000. The evaluation compared traffic speed with advisories to speeds without advisories. This evaluation found the following:

- Average speed variance was reduced and average vehicle speeds decreased by 23 percent when traffic managers displayed condition data during high winds (i.e., wind speeds over 20 mph).
- Average speeds were 12 percent lower when the system was activated during high wind events occurring simultaneously with moderate to heavy precipitation.
- Average speeds declined by 35 percent when warnings were displayed on the signs when the pavement was snow-covered and wind speeds were high.

Similar results are reported in the ITS Benefit Cost database:

- In Salt Lake City, Utah the ADVISE fog warning system tested on a two-mile section of I-215 promoted more uniform traffic flow, reducing vehicle speed variability by 22 percent while speeds increased 11 percent.
- A study of travelers on Snoqualmie Pass, WA found that DMS can decrease mean driving speeds and reduce accident severity.
- The ITS Benefit-Cost database also documented a wet pavement detection system in North Carolina reducing crash rate by 39%.
- Before and after field studies of the Florida system described above revealed the following results:

- In light rain condition, the 85th percentile speed decreased by 8 percent and speed variance was reduced from 6.7 mph to 5.7 mph.
- During heavy rain, the 85th percentile decreased by 20 percent and speed variance was reduced from 6.1 to 5.6 mph.

2.2.2 Speed Management Strategies

These strategies involve deploying systems and technologies designed specifically to manage speed during inclement weather events. This would include using both advisory and regulatory speed management techniques to influence vehicle speeds during inclement weather conditions. The operational objective of these strategies is to reduce the speeds and the speed variance of the traffic stream during inclement weather conditions.

Speed Advisories

Issuing speed advisories in response to different weather events is a common operational strategy used by many agencies. This strategy usually involves posting an advisory travel speed that is deemed safe by the operating agency for the current travel conditions on a dynamic message sign or a variable speed message sign, or activating flashers on a static speed advisory sign. Speed advisories have been used in association with limited visibility and high wind situations or when pavement friction conditions are significantly reduced (i.e., snow and/or ice events).

The Maine Department of Transportation recently completed an upgrade to their variable speed limit signs system [16]. This upgrade consisted of replacing the “old flashing 45 mph” signs with new variable speed limit signs (VSLs) like those shown in Figure 2. With the new sign system, revised operating criteria are now established for activating and deactivating the signs. These proposed new criteria for posting speed limits are based on roadway surface conditions and snowfall rate. Roadways surface conditions were assumed to affect braking friction factors, while snowfall intensity rates were assumed to impact visibility (and thus perception of reaction times). Brake friction values for various surface conditions were taken from the *Society of Accident Reconstructionist*.

Table 2 shows the suggested speeds for posting on Maine’s VSLs for varying roadway conditions, while Table 3 shows that suggested speeds for various snowfall intensity rates.



Figure 2. Example of Variable Speed Advisory Sign (Source: Maine DOT)

Table 2. Suggested Speed Limit for Maine’s VSLS Based on Surface Conditions

Surface Condition	Suggested Speed Limit to be Posted on VSLS
Dry Asphalt	65 mph
Partial Frost	60 mph
Frost	55 mph
Heavy Frost	45 mph
Tracked Snow	45 mph
Untracked Snow	45 mph
Snow & Ice	40 mph
Black Ice	40 mph
Sunny Ice	35 mph
Wet Ice	35 mph
Glare Ice	35 mph

Table 3. Suggested Speed Limits for Maine's VSLS Based on Snowfall Intensity Rates

Snowfall Intensity Rates	Suggested Speed Limit to be Posted on VSLS
Light Snowfall (≤ 0.2 in/hr liquid)	55 mph
Moderate snowfall (around 0.4 in/hr)	45 mph
Heavy snowfall (≥ 0.5 in/hr)	35 mph

Following a fatal accident, the Tennessee Department of Transportation (TDOT) implemented a fog detection and warning system on an 8-mile stretch of I-75 near Calhoun, Tennessee that uses speed advisories [14]. The system was designed to warn motorists of hazardous driving conditions and provide speed advisory conditions through a series of Dynamic Message Signs (DMS) and highway advisory radios (HARs) deployed in the corridor. The system provides two levels of speed advisories based upon the measures of visibility (when visibility is < 1320 ft, speed advisory = 50 mph; when visibility is < 480 ft, speed advisory = 35 mph).

Evaluation/Measured Benefits

The ITS Benefit-Cost Database lists various studies which quantified benefits in this area. Low-visibility warning systems such as the TDOT system reported reductions of 70-100% from pre-deployment crash rates and a reduction of speed variability by 22%.

Belz and Gårder [16] conducted an evaluation of the general speed advisory system operated by Maine DOT during the 2006-2007 and 2007-2008 winter seasons. Using a radar gun, spot speed measurements were collected in the vicinity of the VSLS during several inclement weather conditions (i.e., snowfall events) of varying intensity in two hour intervals. Roadway surface conditions were collected during each event. Average and 85th percentile speeds were compared to the recommended speed posted on the VSLS. The finding showed that the VSLS had little, if any, influence on travel speeds.

Enforceable Speed Limits/Speed Restriction/Variable Speed Limits

Variable speed limits are speed limits that change based on road, traffic, and weather conditions [17]. With appropriate legislation, variable speed limits are enforceable in many situations. While much of the available literature focuses on applications of variable speed limits for traffic management and work zone speed management applications, a few examples exist related to weather responsive traffic management applications.

- Nevada implemented an experimental regulatory and enforceable variable speed limit system on I-80 [17]. The system set speed limits based on the 85th percentile speed, visibility, and pavement conditions. Speed limits were computed using a logic tree based on the 85th percentile speed, visibility (based on stopping sight distance), and pavement conditions (based on frost, ice, rain or dry conditions). The signs were limited to 10 mph change increments. Pavement and visibility measures were provided using visibility detectors and an RWIS system. It is not clear whether this system is still operational.
- The New Jersey Turnpike Authority uses variable speed limit (VSL) signs and speed warning signs, which display a "REDUCE SPEED AHEAD" message and the reason for the speed reductions (i.e., "FOG", "SNOW", or "ICE") on a total of 120 VSL sign assemblies [18]. These sign assemblies are positioned along the freeway at two-mile intervals. When reductions are warranted, sign assemblies

are manually activated to decrease speed limits in five mph increments from 50, 55, or 65 mph to 30 mph, depending on prevailing conditions. State police officers enforce the lower speed limits by issuing summons to drivers exceeding the posted speed limit.

- Washington State DOT (WSDOT) has installed variable speed limits signs in two passes: US-2 at Stevens Pass (shown below in Figure 3) and I-90 at Snoqualmie Pass. The Snoqualmie Pass system consists of radar detection, six weather stations, nine variable message signs (VMS), and radio and microwave transmission systems. Speed limits are changed in 10 mph increments. If traction tires are advised, the speed limit is reduced to 55 mph; if traction tires are required, the speed limit is reduced to 45 mph; and if chains are required, the speed limit is reduced to 35 mph. The Steven's Pass system operates using similar concepts [19].
- More recently, the Wyoming Department of Transportation has implemented a variable speed limit system on I-80 in the Elk Mountain Corridor. Around Elk Mountain, there are “invisible” hazards (high winds, snow, fog and ice). This system replaced traditional regulatory speed limit signs with variable speed limits. Operational guidelines and decision-support systems link roadway variables such as speed, surface conditions, wind speed, wind direction and the difference between wind speed and wind gust speed to variable speed limit signs. An evaluation study of the I-80 Elk Mountain Corridor system is currently available [20].



Figure 3. Variable Speed Limit Sign over Steven's Pass on US -2 in Washington State (Source: Washington DOT)

Evaluation/Measured Benefits

The University of Washington conducted a study to evaluate the effectiveness of the Snoqualmie Pass variable speed limit system on I-90 [21]. The study examined both accident histories and speed data over the pass. User acceptance surveys were also performed. The following is a summary of the findings of this analysis:

- A before and after comparison of crash frequencies were not possible because of a failure of the State's accident database during the evaluation period.

- The system reduced average speed by up to 13 percent [22].
- The reduction in mean speed and increase in speed variance were significantly greater at VSL sites than at non-VSL sites, indicating the effects of the VSLs was to reduce mean speed and increase speed deviation.

2.2.3 Vehicle Restrictions Strategies

Another set of WRTM strategies involve placing restrictions on the types and nature of vehicles using a facility during inclement weather events. These strategies might include placing restrictions on the type of vehicles that are permitted to use facilities, and requiring vehicles to employ special equipment to improve traction. Examples of these strategies are discussed in more detail below. The operational objective of these strategies is to minimize exposure of high-risk vehicles to hazardous conditions.

Size/Height/Weight/Profile Restrictions

Many States use an operational strategy to restrict high-profile vehicles from specific highway segments. This strategy is often employed in mountain passes, valleys/canyons, and bridges/causeways (such as over ship channels) where unexpected high winds or wind gusts can overturn high profile vehicles (e.g., tractor-trailer rigs, recreational vehicles, etc.); however, this strategy could also be implemented in response to snow and ice events. This operational strategy is often coupled with motorist information systems that also disseminate weather advisories. Most deployments of this strategy are at sites experiencing a high frequency of overturned vehicles.

Examples of deployment of this type of operational strategy include the following:

- The Montana Department of Transportation uses vehicle restrictions during high wind events on a 27-mile stretch of I-90 in the Bozeman/Livingston area. Four Dynamic Message Signs are used to issue both wind advisories and vehicle restrictions. The system automatically generates advisories when average wind speeds exceed 20mph. High-profile vehicle restrictions are implemented when average wind speeds exceed 39 mph [23].
- The Nevada Department of Transportation implements high-profile vehicle restrictions during high winds on a seven-mile section of US Route 395, in the Washoe Valley between Carson City and Reno. High-profile vehicles are restricted from using this stretch of US Route 395 when average wind speeds exceed 30 mph or when maximum wind gust exceed 40 mph [24].
- The concept of operation for deploying this strategy is similar in most deployments. A computer installed in the field cabinet in the corridor monitors wind measurements (such as wind speeds, directions, and/or wind gusts) from sensors deployed within the section of roadway. When average wind speeds and/or maximum wind gust speeds exceed established thresholds, either advisory messages and/or vehicle restriction messages are posted on dynamic messages signs, depending upon the severity of the wind conditions.
- In a study for the Wyoming Department of Transportation, Young and Liesmen [25] proposed deploying a system that employs different levels of operational strategies to reduce overturning of high profile vehicles. The different strategies would be implemented based on current observations of wind speed, difference between wind speed and wind gust speed, roadway surface conditions, and the combination of a vehicle's weight and profile characteristics. Roadway weigh-in-motion and vehicle height monitoring technologies would be used to obtain a vehicle's weight and profile characteristics. The proposed levels of operational strategies are as follows:

- Level 1 – Implement advisories when measured wind and surface condition thresholds are met. (This would be equivalent to WYDOT’s current operating practice.)
- Level 2 – Restrict roadway use by all vehicles when measured wind and surface conditions thresholds are exceeded. (This would be equivalent to implementing a total road closure based on wind and pavement surface conditions.)
- Level 3 – Restrict roadway use by all high-profile vehicles based on measured wind, surface, and vehicle profile conditions.
- Level 4 – Restrict roadway use by all high-profile, light weight vehicles based on measured wind, surface, and vehicle profile conditions.

Evaluation/Measured Benefits

Based on the literature review, only one system could be identified where the benefits of vehicle restrictions were quantified for automated wind warning systems.

An evaluation of the Oregon system indicated that between 90 and 92 percent of travelers will slow down after seeing the messages [26]. Accounting for motorist delay reduction benefits as well as other benefits such as improved safety for motorists (and maintenance personnel) during high wind events, the benefit-to-cost ratios for two systems in Oregon (South Coast system and Yaquina Bay Bridge system) were 4.13:1 and 22.80:1, respectively.

Tire Chains/Alternative Traction Devices

This widely-deployed strategy is used when snow and ice accumulation cause pavement friction to be lost on specific sections of the road network during winter. The strategy is intended to address extremely slick road conditions which are not safe for vehicles with ordinary tires. In these situations, the use of tire chains is required for specific roadways.

Most northern States have “Chain-up” laws which dictate under what conditions different types of vehicles are required to chain tires. In most cases, these requirements generally apply only to commercial vehicles (i.e., vehicles with a gross vehicle weight of over 10,000 pounds), although many States recommend that passenger vehicles and light duty trucks use chains as well during certain conditions. Many States have multiple levels of chain requirements for different classes of vehicles and pavement surface conditions. For example, California has three levels of chaining requirements for vehicles [27]:

- Requirement One (R1): Chains, traction devices or snow tires are required on the drive axle of all vehicles except four wheel/all wheel drive vehicles.
- Requirement Two (R2): Chains or traction devices are required on all vehicles except four wheel/all wheel drive vehicles with snow-tread tires on all four wheels.
- Requirement Three (R3): Chains or traction devices are required on all vehicles, no exception.

A State-by-State summary can be found at <http://www.tirechainsrequired.com/laws.html>. Drivers are notified via electronic message signs, 511 traveler information, websites, and media outlets as to which vehicles are required to deploy chains and what section of roadways are under the restrictions.

Departments of Transportation and/or State police determine when to require and enforce the use of tire chains. When chains are required, typically online highway conditions website as well as its toll-free hotline is updated. Signs are posted next to the roadway to notify drivers if chains must be carried or attached to tires.

Enforcement is through the DOT and Highway Patrol. For example, CalTrans and the California Highway Patrol (CHP) designate a pull-over space alongside any road that has a chain requirement so that vehicles can safely install their chains. In some areas, traffic is metered, and CHP will only allow a certain number of vehicles through over a designated period of time.

Evaluation/Measured Benefits

Quantitative benefits are hard to identify in the literature. Recent efforts have focused on identifying the trade-offs of studded tires and contrasting the presumed increases in traction (consequently safety) with potential damage to the facility. Similar studies for tire chains are not available. However, some media and accident reports indicate some concern with instances of crashes due to truckers stopping in unsafe locations to chain-up [28].

2.2.4 Road Restriction Strategies

Road restriction strategies refer to those categories of techniques commonly deployed by agencies that restrict the use of a facility during inclement weather. The operational objective of these strategies is to help travelers avoid sections of roadway that are dangerous and would cause substantial delay. A secondary objective is to increase the efficiency and productivity of the agency in restoring the facility back to normal conditions. Examples of the types of strategies in this category include:

- Lane use restrictions,
- Parking restrictions,
- Access control and facility closures, and
- Contraflow/reversible lane operations.

Lane Use Restrictions

The most common type of weather-related lane assignment/lane restriction is requiring trucks to use a specific lane (usually the right lane) during inclement weather conditions.

Both the Alabama DOT [29] and South Carolina [30] limited visibility systems use lane assignments to separate heavy trucks from passenger cars as part of their low visibility warning system. In both these systems, dynamic message signs are activated instructing trucks to keep to the outside (or right) lane when visibility distances are reduced below 600 feet. The rationale for separating passenger vehicles and heavy trucks into separate lanes is to reduce the potential for catastrophic injuries in case of collision during these limited visibility conditions.

Parking Restrictions

The most common type of parking restrictions related to weather conditions are those associated with heavy snowfall effects. Frequently, special parking rules are implemented during significant snow events that restrict when and where on-street parking is permitted. For example, the City of Minneapolis implements special parking rules on days when a snow emergency has been declared by the City's Office of Emergency Management [31]. In implementing parking restriction, the City has established a network of "Snow Emergency Routes." These routes tend to be higher functional class roadways (such as major collectors and above) and

have been designated by the City to be cleared first during a major snow event. Snow Emergency Routes are identified by special static signs.

Emergencies can be declared based on current conditions or predicted conditions. Furthermore, emergencies are not necessarily restricted to just snow events, but could possibly include other types of weather events (e.g., flash flooding, tornados, violent electrical storms, etc.) For example, in the City of Norfolk, Nebraska, the mayor (or his or her designated representative) can implement the use of the City's emergency route system "based on falling snow, sleet, or freezing rain, or on the basis of an official forecast by the U.S. Weather Bureau, of snow, sleet, or freezing rain, or that other weather conditions, such as tornado or violent electrical storms will make it necessary that motor vehicle traffic be expedited..."

To implement the parking restrictions, an elected government official (i.e. a Mayor or County Judge) or a high ranking city official (e.g., City Manager, Director of Public Works, Director of Office of Emergency Management, etc.) must first declare that an emergency event is in progress (based on current conditions) or about to occur (based on predicted conditions). Once implemented, residents must then be notified that a weather emergency event is in effect and that vehicles must be removed from the designated roadways. This notification generally occurs through traditional notification processes (i.e., local media contacts).

Evaluation/Measured Benefits

Quantitative data on the benefits and the MOEs were not available for this strategy; however, intuitively, if there are no cars on snow emergency routes, streets can be cleared sooner—restoring full capacity of the roadway sooner and maintaining throughput. The designation of snow routes may also help with transit planning and the use of these routes for transit buses.

Access control and facility closures

All States have the authority to declare an emergency and close a roadway for public safety purposes, but it was not until the 1980s and 1990s that several Midwestern States began adopting policies and procedures for the systematic closure of roads due to snow and ice. South Dakota adopted policies for roadway closures and began erecting gates to physically close roads. Iowa and Minnesota adopted similar policies and erected gates on the entrances to specific freeway routes to prevent motorists from becoming stranded or operating vehicles on unsafe, slippery roads in locations where it was difficult to render assistance. Wyoming has a closure system on parts of I-80 in their State primarily to ensure that travelers are not stranded in remote areas without appropriate access to emergency services.

Whenever a road is closed, it must be physically blocked and detour signs need to be posted to help travelers circumvent it. The announcements of road closures are made on the department of transportation website, traveler information hotlines and phone services, and through media outlets. Travelers on roads with annual closures are more likely to be aware of a road closure than a road that is closed due to sudden flooding or another weather event. Examples of this strategy include the following:

- Wyoming (and other States) use swing gates or gate arms (like that shown in Figure 4 below) positioned at the outskirts of most cities to close the highway. These gates, when prone, physically block the roadway, closing the roadway to through travel. Generally, DOT personnel manually close gates when downstream travel conditions are deemed too hazardous for conditions, and open the gates after significant weather events have passed. In many States, it is illegal to bypass these gates when down and carries significant fines for failure to comply with the gate.

- The Minnesota Department of Transportation (MnDOT) has installed gates along I-90 and I-94 to guide traffic off the freeway and prohibit access during weather events that are considered life-threatening [32].
- As part of their low visibility warning system, Tennessee uses gate arms to close ramps entering I-75 during fog events [14]. Highway patrol troopers activate the gates to close the interstate and detour traffic to a nearby alternate facility.



Figure 4. Example of a Gate Arm Used to Control Access to Sections of Highways in Wyoming (Source: Wyoming DOT)

Evaluation/Measured Benefits

The MnDOT system was evaluated using a “with and without” case study approach on similar roadways [33]. A severe snowstorm that struck District 7 in November, 1998 provided a good case study to compare costs for clearing a section of I-90 (closed with gates) and US Highway 75 (without gates). Based on Mn/DOT’s Operations Management System Reports from the day that both roadways were cleared to bare pavement (95% clear), a number of comparisons were made as follows:

- Plows made 4 passes before I-90 was 95% clear and opened, while 10 passes were made on Highway 75 before it was 95% clear.
- For I-90, approximately \$20 in labor and materials was expended per lane mile, while approximately \$24 was expended per lane mile for Highway 75.
- I-90 was cleared to bare pavement (95% clear) approximately 4 hours sooner than Highway 75 was cleared to bare pavement (95% clear).

A conclusive benefit cost study on the impact of large-scale road closures was not found. A recent Midwest Transportation Consortium Study [34] found that with adequate communication, delays on alternate routes are minimal, even on the first day of a closure. The study also found that reductions in volume following winter storms range from 7 to 56 percent, depending on the severity of the storm.

Contraflow/Reversible Lane Operations

Several States have incorporated contraflow operations into their evacuation planning especially for hurricanes. Traffic studies post Hurricane Katrina show that in a two-day stretch last August, some 450,000 vehicles, carrying an estimated 1 million people were evacuated by reversal of about 100 miles of interstate freeway across two States, restricted access to nearly 100 additional miles of freeway, while coordinating the transportation assets on a region-wide basis. Similarly, in South Carolina, for Hurricane Floyd, DOT managers worked closely with Highway Patrol personnel during evacuation and reentry operations [30]. Traffic and emergency managers also coordinated with other local, State, and federal agencies. Before traffic flow on westbound lanes could be reversed for reentry (i.e., contraflowed from Columbia to Charleston), DOT and DPS personnel were mobilized and equipment was repositioned.

Managers utilized storm tracking, wind speed, and precipitation forecast data in combination with population density and topographic information to identify areas threatened by storm surge and inland flooding. Emergency managers consulted various information sources including the National Weather Service, the National Hurricane Center, the Federal Emergency Management Agency, as well as decision support applications such as HURREVAC (www.hurrevac.com) and HurrTrak (www.weathergraphics.com). Traffic managers monitored traffic flow with two permanent vehicle detection sites along the highway and portable detection equipment on other road facilities.

During reentry operations, portable Dynamic Message Signs (DMS) and Highway Advisory Radio (HAR) transmitters were positioned along the interstate to alert drivers of contraflow operations.

Evaluation/Measured Benefits

The most common measure of effectiveness for reversible lane systems has been traffic volume, primarily on 15-min, hourly or peak-period bases. As noted above, over 450,000 cars and ~1 million people were evacuated during Hurricane Katrina in about 36 hours [35]. Other important criteria included travel time, travel speed, overall segment level of service and crashes. During the evacuation in South Carolina, contraflow operations were not used and 1,445 vehicles was the maximum per lane volume. On the return trip, with contraflow operations, 2,085 vehicles was the maximum per lane volume, a 44 percent increase over travel without contraflow operations.

2.2.5 Traffic Signal Control Strategies

This category of strategies involves making modifications or influencing the way traffic signals operate during inclement weather. Strategies deployed by agencies could potentially include the following:

- Changing the way the detection systems interact with the traffic signal control systems during weather events,
- Modifying vehicle clearance intervals separating opposing traffic phases,
- Modifying the way that individual phases or approaches operate,
- Changing signal timing coordination plans, and
- Deploying weather-responsive ramp metering timing parameters.

Examples of these strategies are discussed below. Some of these strategies are in conceptual stages and/or being researched by universities and might not yet be deployed.

Vehicle Detector Configuration

Significant snow and ice accumulation not only impact vehicle operating characteristics but can greatly alter vehicle placement on the roadway. During normal weather conditions, these detection zones follow a traditional configuration – detection zones located within each lane on each approach. However, when snow accumulates on the pavement such that the lane lines are no longer discernable, drivers have a tendency to migrate to the center of their respective travel pathways, often with one of the wheel paths straddling the lane lines. This tendency renders the normal phase detection zones ineffective. One strategy that agencies can use to combat this situation is to overlap detection zones to ensure that the entire approach (not just the center of the lanes) is covered by the detection system.

Some vehicle detection systems are particularly susceptible to specific types of weather events. For example, the performance of video detection systems can be reduced significantly during limited visibility events, such as fog and blowing snow. Wet pavements can also cause headlight blooming in video detection systems. Fog, haze, rain, and snow can cause scattering and absorption effects in infrared detectors. Snow and ice accumulation impact the performance of the technology itself. For example, the City of Colorado Springs, which uses video detection almost exclusively at their traffic signals, has reported that they frequently experience snow and ice accumulation on some of their video detection cameras during ice storms that come from a particular direction with significant wind chill events (even though their cameras are equipped with heaters) [36]. When these weather conditions are anticipated, operators will activate a controller setting that causes the signal to automatically cycle to those approaches irrespective of vehicle demand (i.e., places the approach in a “Recall” mode). While this strategy may generate inefficiencies in the signal operations at the intersection (especially in the case when there is little or no demand on the approach), it keeps the approach from being skipped and causing drivers to disregard the signal indications.

This strategy would involve dynamically altering the physical detection zone in response to changing weather conditions. This strategy might involve either adjusting detector settings automatically in response to deteriorating visibility or pavement friction conditions. This strategy is currently available in many video-based detection systems during limited visibility conditions. An RWIS system would need to be installed to determine visibility and pavement conditions. Data would also be needed to correlate measured approach speeds with weather during different conditions. These different approach speeds could then be potentially used to dynamically adjust detector settings that correlate with observed weather conditions.

This strategy might also involve expanding or altering detection zones during deteriorating pavement conditions. For example, when snow accumulation begins to obliterate lane lines, operators in the control centers can dynamically adjust or implement a special detector scheme that would cover a wider range of wheel paths for a particular movement. Another potential strategy might be for operators to deactivate particular detection zones (thereby causing the signal to revert to a pre-timed operations) when lane lines become obliterated because of snow accumulation.

Evaluation/Measured Benefits

No studies were found in the literature review that quantified the effectiveness of changing vehicle detector configuration in response to weather conditions.

Vehicle Clearance Intervals

The vehicle clearance interval is the yellow and all-red interval that separates conflicting traffic movements at a signalized intersection. The duration of this interval is impacted by the speed of approaching traffic, the width of

the intersection, and the deceleration rate that drivers use to stop their vehicle. Numerous studies have shown that while deceleration rates are reduced (because of reduced pavement friction), approach speeds are also reduced during inclement weather, thereby reducing the need to dramatically increase vehicle clearance intervals. In fact, Perrin et al. [37] suggested that there is only a need for a 10 to 15 percent increase in the vehicle clearance interval at most intersections. This equates to an increase of between 0.5 and 1.0 seconds at most intersections. Perrin, et al. suggest that these changes would have little effect on signal operating efficiencies, yet could have a substantial reduction in vehicle crashes at some intersections. Furthermore, Perrin, et al. recommend increasing the all-red portion of the vehicle clearance interval by 1 second to account for slower clearing of intersection “sneakers” (i.e., vehicles which enter the intersection during the yellow interval to avoid having to wait through another cycle before clearing the intersection).

Al-Kaisy and Freedman [38] investigated how the vehicle clearance interval (i.e., amber/all-red interval) changes as a result of both decreasing vehicle approach speeds and reduced pavement-tire traction consistent with weather conditions. Figure 5 summarizes the recommended minimum clearance intervals for an intersection typical of suburban areas (i.e., a design speed of 80 km/hr). Similar results were found for urban roadways (i.e. 50 km/hr design speed). Using an analytical formula to compute the recommended minimum clearance interval, they concluded the following:

- The recommended minimum all-red interval did not change significantly with reductions in approach speed as long as the coefficient of friction did not drop below the standard design value (0.3 for wet pavement).
- Once the coefficient of friction drops below the design value, the recommended minimum amber/all-red interval exceeds the design interval regardless of the approach speed.
- The influence of friction between the tire and the pavement on the recommended minimum amber/all-red interval is more significant than the influence of the reduction in approach speed.

These results suggest that agencies should only consider changing vehicle clearance intervals when pavement friction factors are severely degraded (lower than 0.3).

Evaluation/Measured Benefits

The research team was unable to locate any field studies that directly measured the benefits of this strategy.

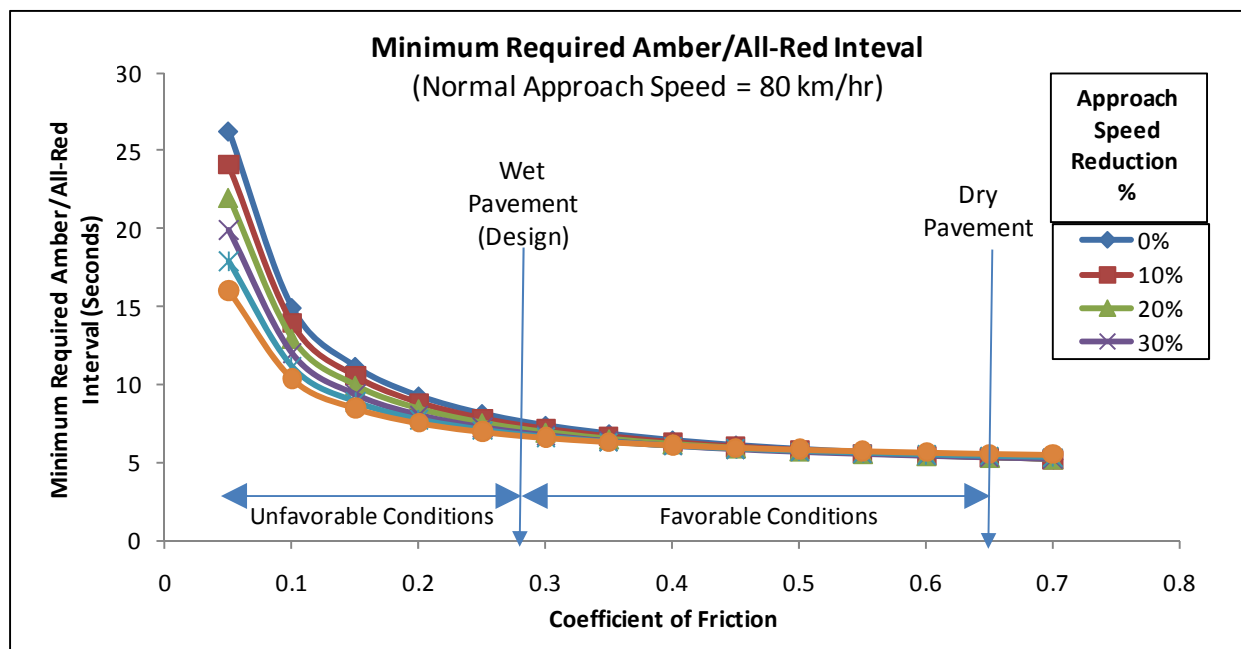

Figure 5. Minimum Required Amber/All-Red Intervals (Source: [38])

Interval and Phase Duration Settings

Past research has shown that inclement weather – particularly snow, slush, and ice – can significantly affect startup lost time and discharge headway (i.e., the distance between vehicles moving through an intersection). Both of these factors may influence duration of green intervals and other controller settings. With longer startup time, operators may need to provide additional time to allow stopped vehicles the opportunity to begin moving at the beginning of a phase. Longer discharge headways may require operators to implement longer green intervals to allow stored vehicles to clear the intersection. Also, longer discharge headways may require the gap setting on actuated controllers to be lengthened to prevent phases from terminating early. One study found that when snow began to accumulate on the pavement, saturation flow rates were reduced by as much as 16 percent [39].

Few agencies have reported adjusting their signal phase setting in response to changing traffic conditions. The City of Anchorage, Alaska indicated they increase the length of the minimum green intervals on intersection approaches located on upgrades when the pavement is snow packed [40].

Evaluation/Measured Benefits

The research team was unable to locate any field studies that directly measured the benefits of this strategy. There are several studies that use simulation studies to derive benefits; however, the team did not find any field studies that directly measure the impacts of changing interval and phase durations.

Traffic Signal Coordination Plans

Generally, agencies have multiple coordination timing plans designed to handle different traffic demands for different times of day (e.g., an A.M. Peak coordination plan, a P.M. Peak coordination plan, etc.). These timing

plans are designed to achieve a certain level of performance and to ensure a certain level of progression speed through a series of intersections. Inclement weather conditions, particular snow and ice, have been shown to dramatically impact travel speed and vehicle operating characteristics – to the point where some agencies have developed special signal coordination plans designed specifically for inclement weather, as follows:

- The Connecticut Department of Transportation operates one signal system (about 30 signals) where they implement a special timing plan in response to poor weather conditions [41]. The snow plan adjusts offsets and increases cycle lengths to accommodate slow travel speeds on the primary arterial. Operators implement the timing plan based on visual observations of snow fall rate and traffic conditions.
- The Delaware Department of Transportation implements signal timing plan changes for snow events. Operators in the control center monitor congestion levels via CCTV and increase cycle lengths when they observe increases in congestion levels [42].
- The Utah Department of Transportation has developed a set of special timing/coordination plans that they implement on select routes during snow events [43]. These timing plans were created to 1) account for slower operating speeds during significant snow events, and 2) assist with snow plowing operations on select thoroughfares. Different timing plans were developed to provide different progression strategies based on what weather conditions were like during different periods of day.

In the Utah deployment, an on-staff meteorologist examines current weather conditions and makes recommendations about when and where to implement a special signal timing plan during a snow event. Operators in the TMC are responsible for implementing pre-established coordination plans which are designed to account for lower arterial travel speeds and increased loss times because of snow on the roadway. The snow timing plans are implemented on these select thoroughfares when the following conditions are satisfied:

- A request has been made by a maintenance shed supervisor and/or a recommendation made by the TMC staff meteorologist.
- Significant reductions in travel speeds (30% or greater) have occurred.
- Signals are normally operating in a coordinated mode based on time-of-day (e.g., during late night hours, the signals are operating in a non-coordinated mode anyway).
- Delay-causing weather conditions are expected to last more than 20 minutes.
- Traffic congestion is present on the roadway.

The new timing plans are implemented by operators in the TMC using UDOT's central software system. Once implemented, these coordination plans remain in effect until one of the following conditions has been met:

- Snowplowing operations are complete;
- The next time-of-day step in a plan strategy is reached;
- The weather is no longer affecting traffic operations; or
- A request is made by [maintenance] shed operator to the TOC meteorologist to disable the plan.

Several locations (including the City of Clearwater, Florida [44]; the City of Minneapolis [45], and the City of Charlotte, North Carolina [46]) all had systems at one point in time that implemented timing plan strategies in response for different weather conditions, but have subsequently discontinued the practice because of system upgrades, changes in intersection geometries, or staff reductions.

Evaluation/Measured Benefits

The research team was unable to locate any study that measured the benefits of this strategy during weather events. Through simulation, Al-Kaisy and Freedman found that the greatest benefits of weather-responsive signal control can potentially be realized at coordinated signals in high-density town and city centers [38]. They found travel times savings ranging from 16.5 to 21.5 percent when signal systems were optimized with weather responsive timing plans.

Ramp Control Signals/Ramp Metering

Ramp control signal /ramp metering is a common traffic management strategy used to manage demand at freeway entrance ramps. Ramp meters are commonly installed to achieve three operational objectives:

1. To control the number of vehicle entering the freeway,
2. To reduce freeway demand, and
3. To break up platoons of vehicles released from upstream traffic signals.

Common strategies for operating ramp metering systems include pre-timed, traffic-responsive, isolated and system-wide ramp metering.

As with regular intersection traffic signal operations, most ramp metering control timing plans are designed assuming ideal travel conditions. During inclement weather conditions, freeway and ramp speeds could be significantly reduced, and reduced pavement friction can impact stopping distance and vehicle acceleration capabilities - all important factors in determining appropriate ramp metering timing parameters. Furthermore, inclement weather could significantly impact traffic demand patterns for particular freeways. No specific examples were found where weather-responsive ramp metering is being considered.

Evaluation/Measured Benefits

The research team was unable to locate any study that documented the use, or measured the benefits, of this strategy during weather events.

2.2.6 Traffic Incident Management

Traffic Incident Management (TIM) is a common operational strategy that is deployed by many agencies to provide the rapid detection, response, and removal of traffic incidents from highways. TIM involves the planning and coordination by many public agencies including law enforcement, fire and rescue, transportation agencies, etc. Many of the strategies that are used to clear incidents from travel lanes can be employed (or expanded) to assist with proactively managing traffic during weather events.

Full-Function Service Patrols/Courtesy Patrols

During weather events, full-function service patrols (sometimes called courtesy patrols or motorist assistance patrols) can be a valuable tool in getting stalled or disabled vehicles out of the roadways and restoring the roadway to full operating capacity quickly. These patrols provide drivers of passenger and other smaller vehicles with free roadside assistance for services such as flat tires, fuel or water transfer, jump starts, short-distance towing, accident scene protection, and minor mechanical assistance.

Full-function service patrols have been used by many agencies to assist in large-scale evacuations. Georgia DOT and Texas DOT all report using service patrols to assist in keeping roadways open during evacuation events. During bad weather events, additional patrols can be added to routine service routes that are severely impacted by weather events. If additional patrols cannot be added due to budgetary or personnel constraints, agencies could also restrict routine service routes to cover only those portions of roadways that are severely impacted by weather events (such as mountain passes, etc.). Extra diligence is needed to ensure that the safety of patrol operators as well as stranded travelers is maximized.

During inclement weather events, full-function service patrols can perform the following functions [47]:

- Perform their normal services along an evacuation route.
- Assist motorists with fuel, water, and minor repairs also along an evacuation route.
- Add vehicles to facilitate traffic control.
- Assist highway patrols and public safety.
- Implement alternate routes and emergency detour plans.
- Assist with contraflow traffic operations.
- Block roadway entrance and exit ramps.
- Assist with equipment support and equipment routing.
- Manually operate traffic signals.

Evaluation/Measured Benefits

Numerous evaluation studies have been performed documenting the benefits of motorist assistance patrols/courtesy patrols on traffic operations; however, the review was not able to locate any that assessed the benefits of operating or increasing motorist assistance patrols directly during weather events. However, it is known that increasing motorist assistance/courtesy patrols is a commonly deployed strategy to assist with hurricane evacuations.

Wrecker Response Contracts

To promote the rapid removal of stranded or stalled vehicles, many States and local agencies maintain on-call towing and recovery contracts. In most cases, these contracts dictate requirement response times or require contractor to preposition response vehicle at pre-established locations so as to promote rapid removal of incidents. These contracts can be for light vehicle or heavy vehicles.

The Colorado Department of Transportation operates a heavy tow program that is designed specifically to clear trucks from the highway during winter conditions. The program uses a private contractor to remove stalled heavy vehicles. Under the contract, the contractor is required to provide standby heavy wreckers at strategic locations along I-70 during the winter months. This allows disabled commercial vehicles to be moved quickly from traffic lanes to safe locations during weekends, holidays and adverse weather [48].

Evaluation/Measured Benefits

No formal evaluation of this strategy was identified specifically for weather events. However, Colorado DOT reported that the emergency wrecker and heavy-tow contracts were very successful in reducing the amount of time to clear a large truck from two hours to within thirty minutes.¹

Quick Clearance Policies

Quick clearance is the practice of rapidly and safely removing temporary obstructions from the roadway. Generally, quick clearance legislation authorizes the removal of driver-attended disabled or wrecked vehicles from travel lanes in addition to the authorized towing of such vehicles without regard to the drivers' being present. Quick clearance policies generally relate to the removal of disabled or wrecked vehicles, debris, and spilled cargo.

Agencies would need to ensure that quick clearance policies are enhanced prior to an event occurring. Agencies that already have quick clearance policies in place would need to investigate if they could be applied to weather-related situations.

Evaluation/Measured Benefits

Specific benefits of quick clearance during weather events were not found, but overall benefits of quick clearance policies in incident response are available. For example, Washington DOT in partnership with WSP implemented an Instant Tow Program in August 2006 to expedite response and removal of blocking disabled vehicles in Seattle and Tacoma. This program dispatches a tow and a trooper at the same time, eliminating the verification process and saving an average of 15 minutes of lane blocking congestion each time it is used. WSDOT traffic engineers have calculated the societal cost savings for each Instant Tow deployment to be approximately \$20,000 to \$35,000, depending on the location and traffic conditions. Eliminating verification inevitably results in "Dry Runs" for tow companies which can negatively affect participation. To resolve this issue, WSDOT began paying a fee of \$25 for dry runs in April 2007. To date we have been paying under \$100 a month in "dry run" fees. On July 15, 2007, the program was expanded to cover all State and interstate highways in King County (Seattle). Future expansion is also being considered in Pierce County (Tacoma), and Spokane [49].

2.2.7 Personnel/Asset Management

This might include developing standard operating procedures for staffing and supporting traffic management centers during inclement weather events. It might also include developing staffing plans and establishing reporting times for key support and maintenance personnel in advance of impending weather events. Another example might be the identification of off-site rally points for work crews after a weather emergency. Many of the techniques that are used to develop good incident management response plans could be applied to developing weather responsive traffic management plans.

The research team was unable to locate any study that measured the benefits of this strategy during weather events.

¹ "This was a successful program in its first year and we want to build on that success this year," says CDOT Regional Transportation Director Tony DeVito. "Removing a large truck from the highway used to take about two hours. By having Heavy Tow in place, we were able to clear the highway, in most cases, within 30 minutes last season."

2.2.8 Agency Coordination and Integration

These strategies would be similar in nature to those used to develop multi-agency incident response plans. Examples of techniques that might be pursued by agencies in this strategy include the following:

- Convene inter-jurisdictional taskforce to examine weather impacts of traffic operations and develop standard response plans for those emergencies.
- Develop standard operating procedures outlining the roles, responsibilities, and actions to be taken by operating agencies during inclement weather events.
- Develop multi-jurisdictional routing plans that can be implemented during inclement weather events.
- Develop systems and technologies that allow the sharing of information during emergency conditions.

Many agencies are reaching out to the National Weather Service and are getting them involved in coordination activities. The Baseline Conditions Report: *Integration of Emergency and Weather Elements into Transportation Management Centers* [50] provides several examples of agency coordination especially the use of traffic operations data by maintenance staff and weather forecasters to confirm conditions and improve responses.

The primary traffic operations data observed to be of value to maintenance and weather forecasters were CCTV images (to confirm weather and traffic conditions) and severe traffic speed reductions due to an incident or heavy congestion (possible notification of a weather related problem or a situation requiring maintenance action).

Maintenance personnel play an extremely important role in traffic safety and mobility. They pre-treat before winter storms, plow or apply abrasives to improve traction, remove roadway debris, and implement traffic control during a major incident. The report noted that cases where maintenance dispatchers were integrated with traffic operations and information was easily shared, the TMC improved operations. In these integrated cases, data collected and assembled by traffic operations staff (including weather forecasts, road conditions, and CCTV images) were made available to maintenance dispatchers for their use in determining the best course of action. In every case the maintenance dispatchers were colocated in the TMC, although technically it is certainly feasible to provide the necessary data to another location for maintenance dispatch use.

In Salt Lake City, the weather operations group (colocated in the TMC) used CCTV images and road condition reports from traffic operations to confirm weather conditions and refine forecasts provided to Statewide maintenance dispatchers (also located in the TMC). In Los Angeles, major traffic incidents identified and tracked by traffic operations personnel were provided to colocated maintenance dispatchers who deployed incident response teams to the problem to help ensure safety of other travelers and clear the traffic back-up. In Minneapolis, maintenance monitors the traffic system during traffic management off-hours using the CCTV and other ATMS tools as weather information sources. In Maryland, maintenance is nearby the control room and, when they are not present in the room, they are regularly apprised of the effects seen on the roadways due to weather. In New Jersey, the entire TMC system shifts and the ATMS tools present in the control room (CCTV) become some of the key sources of weather information.

Evaluation/Measured Benefits

The integration study [50] identified the following benefits due to enhanced integration and intra and inter-agency cooperation:

- Improved response time.

- Improved response approach that affects efficiency and safety of the transportation network.
- Improved traction on the roadway during winter weather conditions that enhance safety of travel.
- Lower overall impact on operations due to weather.

The availability of traffic operations data to weather forecasters and maintenance staff has the following costs and obstacles:

- Potential institutional obstacle of data sharing and/or collocation of weather forecasters (contracted service or in-house) and maintenance staff with traffic operations.
- Enough TMC resources (space and equipment) to facilitate collocated integration or other form of data sharing.
- Costs associated with procuring and maintaining systems with needed information.

A benefit cost study of the intra-agency cooperation and collocation of meteorologists at the TMC in Salt Lake City, Utah reported reducing costs for snow and ice control activities, and yielding a benefit-to-cost ratio of 10:1

2.3 Challenges for WRTM

The review identified a gamut of activities undertaken by State and local agencies to mitigate the impacts of weather on mobility and safety of their travelers. However, several challenges still exist that need to be overcome for WRTM to be a mainstay of traffic operations. The following is a summary of the challenges often cited:

- Oftentimes, weather forecasts lack the needed accuracy. Sometimes, agencies will put out a message warning travelers of the potential effects of a forecasted weather event only to have the weather conditions not develop as predicted. This makes it hard for transportation agencies to be proactive in planning and implementing strategies prior to a weather event happening.
- In managing a response to a weather event, most transportation agencies are trying to manage human and vehicle resources to ensure that they are deployed where needed. Some of the challenges associated with doing this are institutional. For example, some groups within an agency may be hesitant to perform an action based on forecasted information.
- For some weather events, some agencies have a need to get information about developing weather and roadway conditions to travelers outside their own State. In these situations, interagency coordination and cooperation is critical.
- The duration of some weather events can place a real strain on agency resources, especially personnel resources. Agencies need better forecasts about how long weather events will last so they can make appropriate personnel decisions to ensure that they are adequately staffed to manage traffic during these events.
- While many agencies find it relatively easy to secure funds to deploy weather monitoring and traffic management technology, developing a comprehensive Operations and Maintenance (O&M) program to keep devices operating at peak performance levels is often a challenge. Many agencies find it difficult to keep some systems operating at the same level throughout an entire region or for a long period of time.

- Sometimes, information coming out of DOTs and weather services are in conflict. Agencies need to better coordinate the dissemination of weather information with weather information service providers (such as NWS, local media, etc.) DOTs need to tailor information as the impacts of weather on roads and traffic change.
- Transportation agencies often do not know what to do in response to predicted weather conditions. It is difficult for them to translate predicted weather conditions into roadway impacts and implementable actions.
- In many locations, information sharing often tends to be informal, and prompted by local initiatives. Agencies need to have better information about the potential benefits of using weather responsive traffic management strategies.

Chapter 3 Improvements to WRTM Strategies

Moving from the state-of-the-practice to state-of-the-art in WRTM requires an understanding of emerging trends in technology, traffic management, weather information processing and distribution as well as identification of specific strategy improvements that are still required. This chapter discusses the trends and improvements for WRTM identified during the course of this project.

3.1 Emerging Trends

3.1.1 Connectivity

The world of traffic management has changed in response primarily to the explosion of the scope and the capability of communication technologies enabling a previously unimaginable level of connectivity. Broadly, ITS-JPO has defined connectivity as an important theme in their strategic plan for 2010-2014 [51]. ITS-JPO states:

“It’s a concept that is rapidly changing our daily habits: real-time information gives us the power to make decisions and act on opportunities, provides us with details needed to understand our fast-paced world, and brings us an awareness of how our systems work. The start of the 21st century introduced advanced wireless technologies to our lives, and already they are having a dramatic impact on our connections to family, friends, and the social and entertainment worlds. These technologies are proliferating throughout the business, political, and educational arenas, changing our relationship to information and creating an awareness of situations that previously would have gone unnoticed. These technologies are redefining how we access knowledge; for the realm of transportation, this means unprecedented awareness about what is happening to and throughout our transportation system at all times.”

Further, with increasing connectivity to travelers, weather condition information is often highly desired and valued by travelers. In response to a survey reported in the ITS-JPO Strategic Plan, weather conditions ranked second to traffic conditions among the information elements of interests along a route.

Transportation agencies need to find new ways of obtaining and communicating weather-related traffic and travel information to travelers, with the goal of reaching those travelers before the weather reaches an impacted area. Social networking tools (like Facebook®, Twitter®, etc.) have the potential to reach large target audiences quickly and efficiently and allow social interaction among subscribers.

Many agencies are developing social media sites and other Smartphone applications for disseminating traffic condition information. Agencies need to explore the potential of this technology for developing route-specific travel condition information, which could include information about weather on particular routes. Travelers could subscribe to sites that would allow customized information about travel conditions on specific routes. Agencies need to deploy a system that allows them to determine potential hazardous locations created by weather conditions.

One potential strategy for reducing the need to expand sensor deployments is to use social media to obtain information about travel conditions in specific corridors. Smartphone applications could also be developed that would allow travelers to enter information about travel speeds and conditions, and report accidents and other hazards created by inclement weather conditions to agencies. These sites would allow travelers to alert other subscribers of potential hazardous travel conditions (such as icy spots on roadways, flooded intersections, etc.) This strategy has been tried successfully in the City of Colorado Springs, where a social media site has been developed to allow citizens to report hazardous road conditions to the State or the city DOT. During a recent snowstorm, travelers used the site to alert other travelers of deteriorating road conditions. The DOT was able to identify developing road and travel hazards by monitoring the dialogs among subscribers. In general, agencies are reluctant to respond directly to a single post because of concerns related to the reliability of a single source; however, many agencies have found that this information can be reliable if they receive multiple posts of similar conditions.

3.2.2 Improved Weather Forecasting and Modeling

Currently, transportation agencies often find information provided by weather forecasters to be too generic and too wide-scale to be useful in making control and advisory decisions. Transportation agencies need accurate and timely information about current and future travel conditions that is specific to a particular location. Weather forecasters are working on developing new tools that will provide location-based, high resolution information about current and predicted weather and road surface condition information. This will allow transportation agencies to customize the type of weather information to specific locations.

In addition to forecast data, even with observations, there are often large gaps in coverage between weather monitoring stations. Weather and road condition information can vary tremendously between monitoring stations. Through the anticipated increase in the use of mobile observing sensors, weather forecasters will have the opportunity to obtain and fuse detailed weather and roadway condition observation data from multiple mobile sources. Currently, ongoing research is developing new tools and forecast models that will incorporate information from mobile sources in conjunction with existing sources of weather information to improve weather forecasting ability and specificity.

3.2.3 Active Transportation and Demand Management

Active Transportation and Demand Management (ATDM) is an emerging integrated approach to dynamically managing travel demand and traffic demand and available capacity of transportation facilities. It complements traditional travel demand and traffic management strategies, which tend to be static and/or reactive measures, with one or a combination of operational strategies that are tailored to real-time or predictive conditions (e.g. regional events and other demand drivers, traffic conditions, weather, conditions, incidents, etc. ATDM works to support numerous transportation policy objectives, such as:

- Providing safer and more reliable travel,
- Delaying breakdown in traffic flow,
- Providing greater choice,
- Promoting environmental sustainability,
- Meeting customer expectations for responsive service, and
- Being accountable for performance.

A real Active Management philosophy dictates that the full range of available operational strategies be considered; including the various ways these strategies can be integrated together and among existing infrastructure, to actively manage the transportation system so as to achieve system performance goals. These typically range from a lane-level management of traffic via speed, vehicle and facility control, to traditional travel demand management tools such as carpooling, vanpooling, etc.

From a weather related standpoint, ATDM promises to bring a new level of traffic and travel demand management to system operations. Consistent with the WRTM philosophy, ATDM moves systems operations towards a proactive and consumer-centric approach (Figure 6).

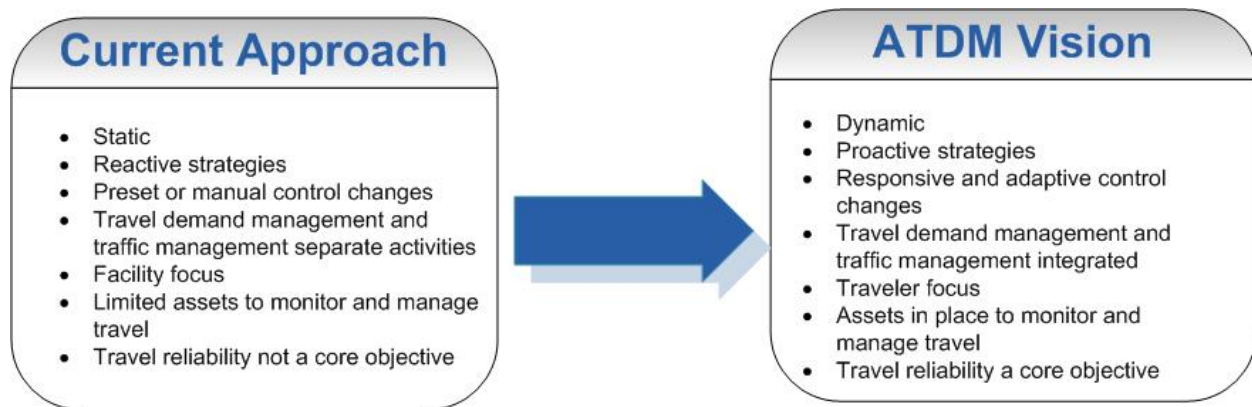

Figure 6. ATDM Vision (Source: FHWA, ATDM Informational Brief, January 2010)

3.2.4 Modeling of Weather Impacts

Transportation agencies are beginning to understand better the linkage between weather conditions and traffic operations. Many agencies as well as the FHWA Road Weather Management program are beginning to correlate weather condition information with traffic flow data to better understand the effects that weather has on highway system performance. Agencies are working with traffic sensor and archived weather data to develop correlations between weather and traffic performance. These correlations can be used by agencies to proactively and precisely impact the effects that forecast weather will have on traffic operations. This will allow agencies to better match response and management resources to impending weather events.

3.3 Recommended Improvements for WRTM Strategies

A variety of improvements were identified including improvements in communications & field infrastructure, operations & maintenance, dissemination methods, guidance, and research needs for the strategies identified in the review and are categorized into two types - general improvements and strategy-specific improvements. General improvements represent improvements that could be applied to all WRTM strategies. The strategy-specific improvements represent opportunities to improve individual strategies identified in the state-of-the-practice review.

3.3.1 General Improvements

In many ways, the following improvements are essential to achieve optimal performance for many of the WRTM strategies.

Improved Communications to Remote Locations

There are many technological options for measuring and sensing weather-related conditions (both atmospheric and pavement conditions). Many of these existing systems use radio and/or cellular technologies as the communication media for transmitting weather and roadway surface conditions back to a central location (such as a traffic management center or maintenance facility). These communications media are usually adequate for populated corridors or areas where there is substantial demand to justify the expense of installing a communications infrastructure; however, oftentimes the greatest needs for monitoring and sensing locations are in isolated or remote areas away from population centers where there are large distances between communications access points. For example, avalanche detection is critical on highways located in remote areas. Because these places are often located in wilderness areas, there is no viable means of providing communications to these locations.

One recommended improvement is to develop a network that would support communications to remote locations. This might include a low wattage satellite communications system or a government-owned CDMA (Code Division Multiple Access, a telecommunications standard for the wireless transmission of data through radio signals) cellular telephone network. This would allow agencies to transmit information to and from remote locations where traditional communications media are not available. The communications media would need to be able to support the transmission of weather data back to a central monitoring station such as a Traffic Management Center (TMC) or maintenance facility as well as support the dissemination of traveler information far in advance of problem locations. These communications networks could also be used to support the dissemination of weather-related traffic information back to motorists who are in remote areas.

Improved Linkage between Weather Conditions and Traffic Signal Operations

Traffic signal timings are usually developed assuming ideal weather conditions (i.e., dry pavements, etc.) Before agencies can implement more weather adaptive traffic signal timings, they need to have a better understanding of how weather conditions impact the capacity of the transportation system, especially the arterial street network. For example, weather conditions can be dramatically different on different parts of the network. Agencies need to have a better understanding of how different types of weather events impact basic traffic signal timing parameters, such as loss time, saturation flow rates, headways, speeds, stopping distances, gap acceptance, etc.

Once agencies have a better understanding of how weather impacts traffic signal timing parameters, agencies need assistance in determining when and where to implement changes to signal timing parameters. Because weather can impact different parts of the network differently, changes in signal timing parameters cannot be made on a system-wide basis. Instead, systems need to be established that will allow agencies to adjust signal timing parameters intersection-by-intersection. Decisions to alter signal timing parameters need to be done on a case-by-case (signal-by-signal) basis and agencies need expert systems that can help them determine when and where signal timing parameters need to be changed. Ongoing FHWA traffic modeling and analysis research is expected to provide some guidance in this area [52].

Enhanced Weather Information Integration at the TMC

TMCs are increasingly becoming aware and motivated to increase the amount and quality of weather information being used for operations. From the high-end integration with an in-house meteorologist to the low-end of active communications with regional NWS staff, TMCs are increasingly using weather information to influence their decisions. However, a lot more remains to be done in this area to move a majority of TMCs from simply monitoring the weather to making decisions in advance of deteriorating roadway and traffic conditions.

Improved Impact Prediction and Decision-Support Capabilities during Weather for Traffic Operations

Fundamentally, TMC managers are hesitant to make weather-related control decisions, because they are unsure of the impacts of their strategies on driver behavior, performance and safety. Inherently risk-averse in terms of liability, the lack of impact prediction and decision-support capabilities at the TMC makes TMC managers hesitant to implement WRTM. Decision-support, mainly the capability to run “what-if” analysis, even as an off-line tool (not-real time), is a critical need during weather events. Maintenance field personnel have benefited from decision-support systems for both their strategic (pre-event) and tactical (during event) responses to weather but the role of decision-support has lagged behind in the area of traffic operations. Ongoing FHWA traffic estimation and prediction research is expected to provide some guidance in this area [53].

Improved Intra- and Inter-Agency Coordination

Perhaps the most significant way that agencies can improve operations during weather events is by improving the level of intra- and inter-agency coordination. In many locations, improving the lines of communications within and between agencies can help improve coordination. Maintaining good lines of communications is critical to knowing who is doing what and when. It is essential that these lines of communications extend beyond jurisdictional boundaries. Transportation agencies need to identify and form working relationships with key contacts in other organizations. In some cases, providing weather information across State and national jurisdictional boundaries is critical to improving operations.

A subset of broader agency coordination pertains to interactions with transit service providers. Weather can also have severe impacts on transit operations. During weather events, traffic congestion and poor operating conditions can severely degrade schedule adherence and operational performance. Agencies need to know where transit operations are having trouble maintaining system performance and be able to dispatch maintenance forces to assist them (e.g., plowing routes impacted by snow and ice). Tools are needed to allow them to disseminate the effects of weather conditions on transit schedules and performance to transit customers. Agencies need to have the ability to accurately track and monitor transit performance to determine when and where service is disrupted because of weather conditions. Transit agencies also need to be able to accurately measure transit demands so that modifications to service can be made in real-time. With this information, they can add new services to replace vehicles that have been disabled due to severe weather, add new vehicles to routes to account for increased service demand, and provide transit users with accurate information about the impacts of weather on their service.

3.3.2 Strategy-specific Improvements

The following describes improvements on specific WRTM strategies that have been identified in the expert panel meetings.

Improved Guidance on the Use of Active Warning Systems

More agencies are installing active weather monitoring and warning systems for many different types of weather situations (flash flooding, limited visibility, excessive speeds, high winds, etc.). These systems are generally installed at isolated locations where weather-related problems frequently occur. However, they lack guidance on when and where to use them. Currently, maintenance personnel drive the decision where to install most of the weather monitoring devices (especially pavement sensors) and active warning systems. In many cases, installation is based on anecdotal information rather than on hard data and needs analysis.

One solution is to develop guidelines, criteria and analysis procedures to help them determine when and where to install weather monitoring systems and active warning systems. The guidelines would need to include processes and procedures for how agencies determine where to install active monitoring and warning systems based on actual weather data and operational needs. The procedures would need to include guidance on how operating agencies can analyze historical road weather data to determine what type and where devices should be located similar to the ESS siting guidelines created by FHWA.

Improved Sensor Testing and Diagnostics

Challenges exist with the technologies that have been deployed on many active warning systems. Solar powered devices and wireless technologies present considerable maintenance issues to many of these systems. Agencies do not always know if the system is operational, especially if the system is automated. As a result, many agencies deploy automated systems that have full (hardwired) power and communication capabilities. There is a need to provide better internal system monitoring and self-diagnosis and reporting capabilities to transportation agencies. One proposed improvement is to develop automated self-diagnosis and fault detection technologies that can be incorporated into existing active warning systems. Similar to a conflict monitor in traffic signal cabinet, these systems will constantly monitor the health of the detection and communication systems and report back to the central location when failure of critical system components is imminent. Scripts can be developed that automatically determine the health of the sensors and communications devices to a site and issue alarms to operators when the site is not functioning properly.

Guidance on Human Factors Issues Related to Predicted Road Condition Information

Related to messaging and content delivery, an emerging challenge are the human factors issues related to providing travelers information on forecast road conditions. Recently, FHWA completed a project on *Human Factors Analysis of Road Weather Advisory and Control Information* [54]. As part of this project, FHWA examined traveler requirements for weather information, reviewed current practices for disseminating road weather advisory and control information, and developed preliminary guidelines for disseminating road weather information through various dissemination technologies. While this effort provides such guidance to State DOTs, questions such as ‘what are the right types of messages (considering liability, accuracy, and timeliness, and latency) for predicted information’ remain to be answered.

Use of Consistent/Common Messaging across Jurisdictional/State boundaries

One of the big challenges in providing weather information to travelers is the wide variety of messaging that is used by various State and local agencies to convey weather and road-weather related observations and forecasts. Depending on the website or the phone system, the content, iconography, user-interface, and the granularity of data vary significantly. As travelers move from one jurisdiction/system to another, their unfamiliarity with systems is often a hindrance especially for long-distance travel. This problem is more

profound for truckers and commercial operators who have to navigate through various systems to obtain information needed for their multi-State operations. The need for standardized message-sets, icons and user-interfaces affects all traveler information systems in general but weather-related information is often more ad-hoc than, say, congestion-related information on these systems. Recent guidance on these topics has been published from FHWA but implementation efforts are still in early phases.

Improved Operations and Safety during Weather Events

Variable speed limits have been deployed in many locations with varying results. One improvement identified by the agencies is the need to develop guidelines that would permit agencies to assess where this strategy is most applicable. The guidelines would assist agencies in determining under what weather conditions, and in what locations variable speed limits would be appropriate. The guidelines would also provide direction on how to determine what speed limit was appropriate under different situations. This would include guidelines on how agencies should correlate driver speeds with specific road weather conditions. The guidelines would also provide specific criteria indicating how the system should be designed to be most effective. Common issues related to enforcement and adjudication should also be addressed in the guidelines. The design guidance should also address the level of coverage from pavement and weather sensors that are accurate enough to make variable speed limits a viable and enforceable strategy.

Configurable Detection Systems for Traffic Signal Operations

Weather can also impact detection systems at intersections. Snow accumulations can obliterate lane markings impacting vehicle trajectories through an intersection, limiting the effectiveness of lane-based traffic detectors to measure traffic demands at intersections. Ice, rain, and limited visibility conditions can also limit the effectiveness of video detection systems. As most signals rely on traffic detection systems to assist with determining when to change traffic signal indications, system efficiency and performance can be dramatically affected when agencies have problems with detection systems during weather events. Agencies need a way to dynamically adjust detector configurations to ensure that detection capabilities are maintained as weather and pavement conditions deteriorate. This might include combining detectors to account for drivers not traveling in designated lanes, placing certain approaches and phases on recall to account for loss of detection capabilities, etc.

Dynamic Traffic Signal Clearance Intervals

Because of liability issues, many transportation agencies are hesitant to alter clearance intervals (the yellow plus all-red interval used to clear the intersection of vehicles before transitioning to a conflicting movement). Most of the agencies represented in the panel feel that drivers develop expectations about clearance interval durations and are hesitant to alter them for fear that changing clearance interval durations may cause some drivers to drive more aggressively through intersections during severe weather. One strategy for addressing this issue could be to develop systems that would dynamically alter clearance intervals based on measuring speed and pavement conditions. Sensors could be installed that would measure the approach speed of vehicles and predict their stopping distance. This type of technology has already been developed for providing dynamic dilemma zone protection. Pavement sensors could also be established that could potentially measure weather factors that might influence stopping abilities (i.e., precipitation on the pavement). By adding pavement sensor data, clearance intervals could be dynamically altered to account for reduced pavement friction.

Automated Activation of Weather-Responsive Traffic Signal Timing Plans

Several agencies have developed traffic signal timing plans that they implement during weather events. The new signal timing plans are designed to account for slow travel speeds and increased stopping distances during inclement weather. Currently, these systems are implemented manually by operators. By integrating weather sensors at intersection (or by potentially deploying Connected Vehicle technologies), the selection of timing plans could be automated. This would reduce the amount of time needed to deploy new timing plans as weather conditions deteriorated. Weather observational data could be incorporated into the traffic signal control algorithms that would compare observed weather conditions to pre-established thresholds. When observed weather conditions crossed the thresholds, new traffic control strategies could be implemented directly by the traffic signal system.

Signal Strategies for Improving Transit Performance during Weather Events

Many of the systems that are traditionally deployed to promote transit operations (e.g., transit priority, queue jumping) become even more critical during weather events. These strategies are intended to help transit vehicles maintain their schedule adherence and service reliability, and become more critical during inclement weather. To improve their effectiveness during inclement weather, transit agencies may need to work with transportation agencies to develop special timing patterns, lengthen phase durations, or remove service restrictions so these strategies can be provided at greater frequencies during inclement weather.

Vehicle Restrictions for Critical Transit Lines during Weather Emergencies

One potential strategy for improving transit service during inclement weather is to implement vehicle restrictions on critical service lines during weather conditions. These restrictions may take the form of turning restrictions for vehicles crossing critical transit lines or limiting roadway use to just transit vehicles during severe weather. This strategy has been deployed in the City of Portland in transit corridors crossing their light rail lines. During heavy snow storms, the City implements temporary turn restrictions intended to prevent vehicles from crossing major transit corridors. As weather and pavement conditions deteriorate, left-turning vehicles are unable to make turns at the same speed as they do when the pavement condition is good. Lower left-turning speeds increase the potential for conflicts between light-rail vehicles and turning traffic. Reducing this potential for conflicts allows transit operators to maintain their speed, thereby improving vehicle travel times and service reliability.

Integration of Weather and Transit Service Information

Another potential strategy for improving transit service during weather events is to develop traveler information dissemination systems that provide travelers with current information about transit services and performance. The information could be disseminated to travelers through traditional information sources (such as 511 and/or website) as well as social media, such as Twitter® and Facebook®. These systems rely heavily on transit managers being able to locate their vehicle on the transportation network accurately. Systems would need to be developed that would integrate weather information with transit service performance to provide predictions of travel impacts. Transit operators could also use the information to help them plan the types of service changes that might need to occur during inclement weather conditions.

Better Use of Full Function Service Patrols to Facilitate Road Clearance

Full function service patrols are a common strategy used by many agencies to assist with detecting and clearing incidents from freeways and arterial streets. These patrols circulate through the traffic stream and provide emergency assistance to stalled or disabled vehicles, and help clear the roadway of minor collisions. During weather events, they play a critical role ensuring that disabled vehicles and minor collisions are removed as quickly as possible from the travel lanes and that lost capacity is restored. One way to improve the effectiveness of this strategy is to increase the number of service patrol vehicles in advance of developing severe weather conditions. Agencies can use forecast conditions to predict when travel conditions are likely to deteriorate. Using this information, agencies can bring in additional personnel to staff service patrol vehicles in advance of deteriorating weather conditions. They can also adjust schedules of crews to ensure that a full complement of service patrol vehicles are available to assist stranded or disabled vehicles. By looking at historical data and through knowledge of operators, agencies can add patrols at critical locations (such as steep hills, long bridges, etc.) where weather routinely creates operational problems, or create special contracts with tow and wrecker companies to quickly respond to incidents during the winter months. Examples of such contracts are found in Pennsylvania and Colorado along major interstates (PA Turnpike and CO I-70).

Chapter 4 WRTM Concepts of Operations and System Requirements

A Concept of Operations (ConOps) is a user-oriented document that describes the characteristics, functions, and features of a proposed system from a user's viewpoint. It is used to communicate to users and system developers the functions of the system and not its physical design and implementation. According to FHWA's System Engineering Guidebook for ITS, the ConOps defines and refines the vision, goals, and objectives of the system, explores various concepts for active the needs identified by users, uses operational scenarios to illustrate how the system is intended to function under different situations, and leads to high-level system requirements. The primary functions of the Con Ops are listed below.

- To identify existing operational environment and operations.
- To identify where the system could enhance existing operations.
- To illustrate the future environment with the system.
- To establish a list of operational requirements.
- To begin the traceability of the Systems Engineering Process. (The operational requirements will set benchmarks for system testing.)

The purpose of this section is to document the approach used and the structure of the concept of operations developed to describe how the agencies could potentially integrate and use the WRTM strategies to improve mobility, safety, efficiency, productivity, and customer satisfaction.

4.1 Approach and Use

Using the results of the state-of-the-practice review and the subject matter expert panel's input, the research team identified eleven different weather-responsive advisory, control, and treatment strategies that could be enhanced to improve mobility, safety, efficiency, productivity and customer satisfaction. These strategies were then grouped and presented in five different concepts of operations. Table 4 identifies which strategies are included in each of the concept of operations documents.

Table 4. WRTM Strategies Discussed in Each Concept of Operations Document

Weather Responsive Traffic Management (WRTM) Strategy	Concept of Operations				
	Weather Responsive Active Traffic Management	Weather Responsive Traffic Signal Management	Seasonal Weight Restrictions	Weather Responsive Traveler Information	Weather Responsive Intra- and Inter-Agency Integration
Active Warning Systems	✓				
Variable Speed Limits/Speed Harmonization	✓			✓	
Vehicle Restrictions	✓		✓		
Lane Closure/Restrictions	✓				
Configurable Detection Systems		✓			
Dynamic Traffic Signal Clearance Intervals		✓			
Weather-Responsive Traffic Signal Timing Plans		✓			
En-Route Traveler Information		✓		✓	
Pre-Trip Traveler Information				✓	
Intra- and Inter-agency coordination					✓
Better Use of Full Function Service Patrols					✓

As noted in the table, five different ConOps were developed as part of this research effort. A summary of the five ConOps is provided below. The details of each ConOps are contained in Appendix D.

- Weather Responsive Active Traffic Management** - Various active traffic management (ATM) strategies can be used to counter the effects of lost capacity and reduced operating speeds during inclement weather. Strategies like speed harmonization can be used to reduce the maximum posted speed limits based on snow, ice, wind, or other weather conditions. Dynamic message signs can be used to implement truck prohibitions or restrict trucks to specific lanes on a freeway to separate slow moving vehicles from vehicles not impacted by the weather conditions. Lane control signals can also be deployed to provide travelers with end of queue warnings and lane closure information. Generally these strategies are implemented at the request of police, emergency management, or maintenance personnel.

This ConOps describes how these different types of ATM strategies can be used during weather events.

- **Weather Responsive Traffic Signal Management** – The purpose of this ConOps is to describe a weather-responsive traffic signal timing strategy. The strategy would take information about roadway surface and weather conditions in real-time, and determine the changes to traffic signal timing and intersection detector settings to improve traffic flow and safety during inclement weather conditions. These new settings would be sensitive to the changes in vehicle operating characteristics caused by adverse weather. The vision is to use these strategies to better match signal timing plans and parameters to the prevailing travel conditions to promote more efficient traffic operations and reduce the potential for weather-related vehicle crashes.
- **Seasonal Weight Restrictions** – A Seasonal Weight Restriction (SWR) strategy is intended to provide decision-support to State DOT roadways subject to freeze/thaw conditions. The decision-support capability uses atmospheric weather information, road surface information and any sub-surface information as inputs into a forecasting model to predict thaw, freeze depth, and resiliency of the pavement. The goals of the strategy are to: (1) allow State decision makers to more effectively determine when to place and remove load restrictions, preserving both the pavement integrity and commercial vehicle operator productivity, (2) increase the level of confidence in restriction decision-making process, (3) improve coordination and consistency between jurisdictions during load restriction season, and (4) Improve communications and notifications to commercial operators about restriction placement and removal.
- **Weather Responsive Traveler Information** – This strategy takes both real-time and forecasted road weather conditions in a region to predict roadway travel conditions. Information about predicted travel conditions would be used to provide travelers with estimates of what travel conditions would be like at a future time. The goal is to use this information to influence both pre-trip and en route mode, route, and departure time decisions.
- **Weather Responsive Intra- and Inter-Agency Coordination** – This strategy takes into account that the success of WRTM rests on an integrated approach to operations bringing together groups within and outside the traffic management center to influence travel behavior. This strategy focuses on integrated corridor or regional operations allowing in-network mode and route shifts in response to weather, better incident response and management, and better data sharing among the various agencies involved in WRTM.

As discussed earlier, the purpose of a ConOps is to document and refine the vision, goals, objectives, and operating scenarios for how different traffic management strategies can be deployed during weather events. Developers and transportation agencies can use these ConOps as a starting point for developing and designing their own weather-responsive traffic management systems for their own unique deployment. Agencies can take the parts of the ConOps for a particular strategy that they like and integrate those parts into their existing traffic management systems. Agencies can also revise these ConOps to meet their particular circumstances and situations. Once adapted to their particular situations and circumstances, agencies can also use these ConOps to develop validation plans that define how deployed systems can be assessed to ensure that their weather responsive traffic management needs are met through their deployed systems.

4.2 Structure of the ConOps

To the extent possible, each ConOps follows the format and provides the content specified in the *IEEE Guide for Information Technology—System Definition—Concept of Operations (ConOps) Document*. The major sections contained in each ConOps are as follows:

- **Scope** – This section provides an overview of both the content of the ConOps document as well as the system itself. This section of the ConOps summarizes the purposes and motivations for the ConOps document, and identifies the intended audience for the document. Where needed, this section also describes any security or privacy considerations associated with use of the ConOps.
- **Referenced Documents** – This section of the ConOps lists the document number, title, revision and date of all documents referenced or used in the preparation of the concept of operation.
- **Current System or Situation** – This section provides an overview of current system or situation, including, as applicable, background, mission, objectives, and scope. It provides a description of the current manner in which the strategy is used to respond to weather events. It will include, where appropriate, the following: the operational environment and its characteristics; major system components and interconnections; interfaces to external systems or procedures; capabilities, functions, and features of the current systems; etc. Where possible, one or more graphical representation (such as sequence or activity charts, functional flow block diagrams, data flow diagram, etc.) will be used assist in describing the current system.
- **Justification for and Nature of Changes** – This section provides a brief summary of the reasons why a change to the strategy is needed. It summarizes the deficiencies and limitations of the current strategy or situation and a brief description of the desired changes. These may be changes in capabilities, functions, processes, interfaces, personnel, etc. The section also highlights the institutional, procedural, and technical changes that may need to occur. This section will highlight changes that are essential, desirable, or optional.
- **Concepts for the Proposed System** – This section describes the proposed improvement to the strategy that results from the desired changes specified in this section. It describes the proposed strategy in a high-level manner, indicating the operational features that are provided without specifying design details. This section provides a brief overview of the new or modified strategy, including, as applicable, background, mission, objectives, and scope. It also provides a brief summary of the motivations for the strategy. Any operational policies and constraints that apply to the proposed strategy are identified in this section. Operational policies are predetermined management decisions regarding the operation of the new or modified strategy (also called institutional constraints). Operational constraints are limitations placed on the operations of the proposed strategy. The section also provides a description of the proposed strategy, including the following, as appropriate: the operational environment and its characteristics; major system components and the interconnections among components, interfaces to external systems or procedures; capabilities or functions of the proposed strategy; charts and accompanying descriptions depicting inputs, outputs, data flow, and manual and automated processes, etc.
- **Operational Scenarios** – This section presents the operational scenarios envisioned for deploying the proposed WRTM strategies. A scenario is a step-by-step description of how the proposed strategy should operate and interact with its users and external interfaces under a

given set of circumstances. Scenarios are described in a manner that allows the reader to walk through time and gain an understanding of how all the various parts of the proposed strategy will function and interact. The scenarios are weather-based – describing how the strategy will operate during different types of weather.

- **High-level System Design and Functional Requirements** – This section contains a high-level system design that could be used to implement the strategy. The high-level design could include high level system requirements, as well as discussion of institutional, technical, procedural and physical integration that need to occur as part of deploying the strategy.
- **Suggested Performance Measures** – This section briefly discusses some of the potential performance measures that could be used to evaluate the effectiveness of the proposed improvements to the strategy.

Chapter 5 Evaluation Approaches and Procedures to Assess the Benefits of WRTM

5.1 Purpose

This chapter offers guidance to agencies regarding evaluation approaches for the WRTM strategies they may be considering or are in the process of implementing. Evaluations offer supportable evidence of the performance and benefits of WRTM strategies and systems.

A current challenge to WRTM adoption is the lack of documented benefits needed in order to present a strong business case for the State DOTs to invest time and resources to purchase and deploy WRTM system components. As State DOTs seek to apportion their scarce resources, they need assurance that the benefits outweigh the costs for implementing a particular strategy. Evaluations that meet the needs of State DOTs and address national transportation goals are essential for WRTM to become a vital part of system operations. They should address both pre- and post-implementation needs of the State DOTs. A well executed evaluation of a WRTM strategy can:

1. **Provide information to prioritize resources and justify future investments.** State DOT discretionary monies are often limited and subject to intense competition among various project alternatives. The expert panel convened for this study clearly stated that making a business case for WRTM is essential. Increasingly, even the existing funding streams require documentation of benefits or performance. The role of evaluations and documented benefits become more critical when projects have to be approved by other State entities (such as Information Technology) or technical advisory committees. Of the various benefit areas, strategies that address safety and show quantifiable improvements in safety indicators are viewed most favorably. While the panel indicated a level of comfort in using studies and evaluations from other deployments, there was a concern that sufficient information may not be currently available, and thus each agency has to come up with its own justifications. The panel also noted that in many cases, decision-making is heavily shaped by public complaints, political pressures, and other non-documented rationale. Consequently, working with independent groups to evaluate and package results for public legislators is crucial to ensure support at State levels.
2. **Provide hard evidence of performance and benefit.** The guidance offered here is intended to help State DOTs conduct evaluations that generate evidence of benefits and impacts to support implementation of the strategy and provide measures of the performance of their systems. Positive evaluation results not only support selection of future project deployments, but also provide agencies with additional support for their entire program. Some agencies justify WRTM as an integral part of their system effectiveness and do not measure individual strategy performance, while others conduct specific evaluations and research into the effectiveness of particular strategies. Reliable performance results can be very helpful to agencies in selecting the most appropriate, effective strategies for their needs and situation.

By also having these performance measures identified, States can begin on a program of continuous improvement of their strategies and programs.

- 3. Establish a WRTM benefits database and encourage wider deployment of WRTM strategies serving national transportation goals.** FHWA's Road Weather Management Program strives to maintain a national database of documented benefits of each of the WRTM strategies. As shown in the literature review conducted at the beginning of this project, very little evidence of the benefits exists at this time. As States collect data and assess the performance of their deployed systems, benefits can be added to the database that will serve as a national repository of information about WRTM strategies. This chapter offers guidance that can help focus on the important outputs and outcomes of these systems, along with a shared understanding of the links between cause and effect, and the application of robust assessment methods. This way, the information added to the benefits database will be comparable across different physical and institutional settings. It is an important objective of the RWMP to encourage widespread use of WRTM, given evidence of the adverse affects of weather on pavements and traffic safety and mobility. The various WRTM strategies offer State DOTs the tools to address and prevent these adverse impacts. In order to make the case for WRTM adoption, it is essential to be able to demonstrate, through carefully conducted evaluations, that these strategies enhance travel safety during adverse road weather conditions and offer a range of tools that allow traffic operators to perform their jobs more effectively.

The evaluation guidance provided in this chapter is general in nature in order to address the numerous possible scenarios that an agency might use to implement a WRTM strategy. The guidance is not intended to be prescriptive, describing to the State DOT implementers exactly how to conduct evaluations; rather, the chapter provides guidelines of possible effective evaluation approaches and suggests potential performance measures that could be used to determine the benefits of selected WRTM strategies.

Nine WRTM strategies are the focus of specific evaluation guidance in this chapter (see Table 5). The following input guided the determination of these nine strategies among the universe of WRTM strategies identified in this study:

- Potential of the strategy to provide significant benefits to the traffic management community.
- Availability of benefit information (or lack thereof).
- Logical groupings of strategies that would have similar evaluation approaches.
- Recommended priorities from the Expert Panel convened during this study.

Table 5. Selected WRTM Strategies

WRTM Strategy	Comments/Rationale
Active Warning Systems	Passive warning systems could be reflected in results of an evaluation of Active Warning Systems.
Pre-trip and En-route Road Weather Information Systems	Combined two strategies to encompass both types of traveler information systems.
Speed Advisories and Enforceable Variable Speed Limit Systems	Combined two strategies to encompass various types of speed advisories and speed limit systems.
Vehicle size, height, and profile restriction systems	Separated a strategy to focus on restriction systems other than seasonal load restrictions.
Seasonal Load Restriction Systems	The other portion of the above strategy to focus on load restrictions due to seasonal road conditions.
Road and Lane Use Restriction Systems	Combined two strategies related to road closure and/or lane restriction systems.
Traffic Signal Control Systems	Combined five strategies (entire category) to address related evaluation approaches of traffic signal control systems.
Service and Courtesy Patrol Systems	High benefit potential.
Agency Coordination and Integration	High benefit potential.

This chapter provides evaluation guidance to agencies interested in deploying (and evaluating) WRTM strategies and outlines an overall approach and structure to an evaluation of any strategy. It includes how to structure an evaluation plan, what potential challenges exist, potential evaluation design and methods to consider, and data collection approaches. This chapter also provides an agency with specific evaluation guidance for the selected WRTM strategies identified above, including the inputs, outputs, outcomes, and data requirements to be considered. Also included are evaluation examples that describe how agencies have implemented and evaluated specific WRTM strategies.

5.2 Overall Evaluation Plan, Approach and Structure

5.2.1 Prepare a Plan to Conduct the Evaluation

As the first step in an evaluation, an agency is encouraged to prepare an Evaluation Plan to measure the results of a WRTM strategy implementation before system development/deployment details are finalized. This advanced planning helps to guide the evaluation process in an efficient way. Because planning prompts a disciplined examination of the entire project, it often facilitates the identification of adjustments in the system design. Plans will vary for different strategy deployments, but the basic elements of an Evaluation Plan should include:

Introduction and Background

- Description of the WRTM strategy being evaluated (including information on the location and context that may be relevant to the evaluation).

- A statement of the objectives and scope of the evaluation (determine what will be included; specify outcome objectives and links to national ITS goals; assure buy-in by all stakeholders; identify audiences for the evaluation; assure independence and objectivity).
- The questions to be addressed by the evaluation (hypotheses to be tested).
- Evaluation design and methodological procedures.
- The data that will be collected to help answer the questions (determine the measures of effectiveness; identify data requirements, sources and availability to support the analysis; specify sampling requirements for data collection).
- Evaluation logistics (roles and responsibilities for conducting the evaluation, analyzing data and reporting on results).
- Identification of challenges, constraints and limitations (be prepared to mitigate these; include limitations related to interpretation and ability to generalize results).
- A schedule for conducting the evaluation (timeframe for when data collection will begin and end; planned completion date of the evaluation when a report of results will be available).
- Budget (identify resources required to support the evaluation; assure adequacy of funding for the evaluation in advance).

Selected elements of the Evaluation Plan outline are discussed in more detail below.

Objectives and Scope

As part of the statement of the evaluation objectives and scope, it will be helpful to focus on the national and state-level goals for the transportation system and how the MOEs relate to those goals. This is a critical step to orient the evaluation of a particular strategy in a larger context of State and national transportation goals. Table 6 below identifies several common goals and the MOEs that can be used in the strategy evaluations. These MOEs should be identified in the Evaluation Plan, and tied directly with the identification of data requirements to support the evaluation. The set of tables that follow in this chapter provide additional suggestions for an appropriate set of MOEs and associated data requirements.

Table 6. Transportation Goals and Related Evaluation MOEs

Selected Goals	Example Evaluation Measures of Effectiveness (MOEs)
Safety	Reduced number of crashes, injuries and fatalities.
Efficiency	Rapid return to Level of Service (LOS).
Mobility	Rapid recovery to normal travel times and throughput.
Productivity	Reduced maintenance, costs of labor and materials.
Goods Movement	Reduced restrictions placed on commercial truck traffic.
Environmental Protection	Reduced fuel use and emissions (by travelers and maintenance).
Customer Satisfaction	Increased traveler, operator and/or maintenance staff satisfaction.
Infrastructure Preservation	Improved pavement quality or reduced pavement damage due to weather-related conditions.

Hypothesis Specification

As a step in preparing the Evaluation Plan, the evaluator and the WRTM strategy project manager will need to determine not only the objectives of the evaluation but also the hypotheses that will be tested (guided by the use of the MOEs) using the data. A hypothesis is a statement of a relationship that can be tested. While hypotheses can never be proven true, the objective is to support the stated relationship in the hypothesis using the data collected and analyzed. The level of confidence in the conclusions depends on the amount of support for the hypothesis that is provided by the data. Selected example hypotheses are suggested for each of the WRTM strategies, and the evaluator is encouraged to consider other hypotheses for inclusion in the Evaluation Plan.

Design and Methods

Evaluation design and methods will vary by strategy. The design determines how and when the data will be collected and the structure of the evaluation that can help control for the potential confounding effects of exogenous factors. It is important to seek to control such effects in order to be able to say that the WRTM strategy itself was responsible, or at least primarily responsible, for the identified outcomes. This is referred to as “the attribution challenge” in that the evaluator is trying to show that the outputs and outcomes can properly be attributed to the effectiveness of the strategy and not to other factors that may also be related to the occurrence of those outcomes. Thus, a proper evaluation design is intended to control for those other effects, which may include such factors as large variability in weather across different locations, variation in road and pavement structure in different locations that affect vehicle safety, or changes over time in driver awareness due to factors other than the strategy. A few of the designs that may be most appropriate include:

Before – After: Compare data under baseline conditions before deployment and use of the WRTM strategy with post-deployment conditions for same locations under similar weather events.

This is likely to be the most appropriate evaluation design. It requires the collection of baseline data for a period of time before strategy deployment and the comparison of those data with post deployment data. A challenge for this design is to show that the implementation and use of the WRTM strategy

were responsible for the observed changes between pre- and post-deployment periods, given a variety of other factors that may also be responsible for the changes observed.

The before – after evaluation is most useful for demonstrating effects over a relatively short time period because the more time that passes, the greater the likelihood that other factors can obscure the effects of the strategy itself. However, advantages of longer time periods include the ability to track the relatively infrequent occurrence of key indicators, such as crashes, and the likelihood that a range of weather events will occur in both the pre- and post- deployment periods. This design reduces a key disadvantage of the ‘with-without’ design, as discussed below, of presenting a liability risk to the agency. However, a disadvantage of this design is that conditions independent of the strategy, such as weather, may be different in the baseline and post-deployment periods. One way to address this problem is to evaluate by weather events and compare results between the two time periods (before and after) for similar weather events in similar locations under similar conditions. The evaluator will need to identify and track other factors that could impact outcomes across the pre and post periods, in addition to both the strategy and weather, such as other government projects that are implemented after deployment that would be expected to cause changes in safety or mobility outcomes, such as road improvements or other safety measures.

Another potential disadvantage is that critical data may not be available for the baseline period or at least not in the desirable format or level of detail needed to support the evaluation. For the post-deployment period, the evaluator can specify the data requirements and institute procedures to assure that the needed data are recorded and obtained for the evaluation. But in the baseline period, the evaluation is limited to data already collected and archived. It is possible to supplement baseline data with information as recalled or reconstructed by knowledgeable individuals, but those data tend to be much less reliable.

With – Without: Compare experimental and control sites that are similar except the experimental site uses the WRTM strategy and the control site does not.

An advantage of the with-without design is the ability to effectively control for variability in weather conditions and other exogenous factors that would more or less equally affect two different locations, one of which would experience the WRTM strategy and the other would not. Then the differences in outcomes could be observed between these two selected sites, and those differences could be attributed to the effect of the strategy. The disadvantage is that the decision to withhold the benefits of the WRTM strategy from the control site could create liability issues for the implementing agency. For example, if a warning system were implemented in one location (‘with’ site) and not in the comparison location (‘without’ site) and crash rates were higher in the site that didn’t have the warning system, the implementing agency could potentially be liable for failure to implement the safety (warning) system uniformly throughout their jurisdiction.

This particular research design therefore needs to be selected with great care, especially for those WRTM strategies for which safety is a key anticipated outcome. One approach for which this evaluation design works well is to consider a limited deployment of a strategy, given the budgetary constraints of the agency, as a way to pilot test whether a more extensive deployment would be justified. For example, some cities are currently pilot testing traffic signal control systems along a set of limited routes and intersections. If they prove to be a cost effective way to enhance traffic flow during inclement weather, then more widespread deployment can be considered. In fact, State DOTs may not be willing to approve the deployment of the more costly WRTM strategies without first pilot testing them in their area and conducting an evaluation of their effectiveness.

For both the before-after and the with-without designs, qualitative interview data obtained by the evaluator from key informants (knowledgeable individuals who understand the range of events and factors that are likely to affect observed outcomes) are useful in supplementing the quantitative data normally collected during the evaluation period and aiding in interpreting evaluation results.

Case Study: A descriptive and more qualitative approach to evaluating a particular strategy implementation, a case study evaluation seeks to identify what worked well and what did not and derive lessons from the experience.

An advantage to the case study approach to evaluating WRTM strategies is that it is tightly focused on a (or several) particular implementation of the strategy and can track the cause-effect relationships as the use of the strategy yields desired outcomes. The data are primarily derived from readily available sources and interviews with key actors. This design might be particularly useful for a pilot test deployment to assess the value of a more widespread deployment under consideration. A disadvantage is that a case study is unique, and it may not be easy to generalize results to other implementations of the strategy, either in different locations or at different times. One way to address this issue is to target what are believed to be representative deployments of the strategy for case study analysis. Another approach is to conduct several case studies and assess the results cumulatively. Finally, the case study evaluation can offer insights that are useful for designing a more comprehensive evaluation following one of the other designs.

Of particular interest for evaluation design are the safety benefits assessment analysis techniques. Assessing safety benefits is obviously the hardest but also often primary motivation for evaluations. Traditional methods of comparing accident information before and after the treatment often prove inconclusive. A good primer on statistical analysis for safety can be found in Appendix D of the NCHRP 295 [55] which lists the various pitfalls that are possible when trying to assess safety effectiveness.

An Empirical Bayesian (EB) approach based on safety performance function is probably the best bet to provide a clear, justifiable estimate for safety benefits for WRTM. The EB method is the state-of-the-art FHWA-recommended approach to conduct safety evaluations of highway improvements as documented in by Hauer (2002) [56]. The EB approach seeks to overcome the difficulties associated with conventional before-after comparisons. Specifically, the proposed analysis would:

- Properly account for regression-to-the-mean.
- Overcome the difficulties of using crash rates in normalizing for volume differences between the before and after periods.
- Reduce the level of uncertainty in the estimates of the safety effects.

The EB analysis approach is comprised of three basic steps.

STEP 1: Estimate the number of accidents in the “before” period by taking a weighted average of the observed accident count and the predicted accident frequency calculated from a safety performance function (SPF) to estimate the EB-adjusted expected accident frequency in the before period.

STEP 2: Estimate the expected number of accidents in the “after” period had the improvement not been made. This estimate is obtained by adjusting the EB-adjusted expected accident frequency from the before period (as calculated in Step 1) for the difference between before and after ADTs and between ‘before and after’ number of years.

STEP 3: Estimate the effectiveness of the treatment by comparing the **observed** number of accidents after the treatment is implemented to the **expected** number of accidents in the after period, had the treatment not been implemented.

The result of Step 3 is the estimate of the safety benefit or the number of accidents avoided by the WRTM strategy. Obviously, application of the EB method requires SPFs for a reference group of sites similar to the improved sites. Typically, States have developed SPFs for their facilities (by functional class mostly) and these can be used. If they are not available, existing SPFs from available AASHTO guidance and software (such as the first edition of the *Highway Safety Manual* (HSM) or *SafetyAnalyst software*) can be calibrated for this purpose using local data.

Potential Challenges

Evaluating WRTM strategies and clearly identifying the pathway to benefits present various challenges. Methodological and institutional issues may be present that lead State DOTs to distrust or not conduct the required evaluations. While most of the challenges are common to all monitoring and evaluation activities, some of them are specific to weather-related evaluations. These challenges should be considered during evaluation planning and during the execution of the evaluation to ensure that the expected outcomes can be appropriately measured. Table 7 lists a number of evaluation challenges and suggested mitigation approaches.

Table 7. Evaluation Challenges and Mitigation Approaches

WRTM Evaluation Challenges	Mitigation Approaches
<p>Seasonality issues – comparing results across winters or seasons given the unpredictability and differences of the weather.</p>	<p>When using a before-after design, compare data for similar weather events in the two time periods. Collect event-specific data not only on strategy performance but also on the actual weather conditions experienced. Identify desired performance targets appropriate for different weather conditions and measure against those standards.</p>
<p>Insufficient road weather information – agencies lack the comprehensive road weather information in the location being considered for WRTM strategy deployment/evaluation, leading to an inability to assess and attribute strategy performance.</p>	<p>It is critical for a successful evaluation that the necessary road weather information is available prior to strategy implementation. The evaluation plan needs to identify all road weather information necessary to support the research design. If additional weather sensing or weather information sources are needed, these elements should be included in the strategy implementation.</p>

WRTM Evaluation Challenges	Mitigation Approaches
<p>Novelty effect and long-term changes may require a lengthy evaluation – travelers may respond differently immediately after implementation, but the behavior may revert back to pre-implementation responses after the novelty wears off. Also, some WRTM strategies may not have immediate impacts on traveler outcomes and may require long-term monitoring of performance to assess effectiveness.</p>	<p>Provide sufficient lag time after project deployment for users to become familiar and comfortable with the new strategies before commencing the evaluation. Include a “shake-down” period in the evaluation – time for everyone to get comfortable with the strategy and using it regularly. Design the evaluation period to adequately account for the time it is expected to take for the effects of the WRTM strategy to manifest and result in the anticipated outcomes. This is especially true for strategies involving changes in agency operations. The evaluation needs to include time for an agency to test and become comfortable with new systems and practices.</p>
<p>Pathway to benefits is often unclear, especially for traveler behavior and response – the linkage to final outcomes as experienced by the traveler is difficult to establish given confounding factors.</p>	<p>Consider conducting focus groups with representative travelers to help understand how they are likely to be impacted by the improvements, and their attitudes toward the new WRTM strategy, and use these insights to design the evaluation data collection.</p>
<p>Weak link between attitudes and behavior – how travelers say they will react and how they actually behave are often very different.</p>	<p>Include in the evaluation data both “stated preference” questions for travelers and “revealed preference” measures based on their actual use of the relevant elements of the strategy.</p>
<p>Lack of good baseline information – good data on traffic conditions and safety during weather events are rare and difficult to obtain.</p>	<p>Before the evaluation, gain a clear understanding of historical data availability, specifically as linked to weather events. It may be necessary to use expert interviews to help fill some gaps in recorded quantitative data sources.</p>
<p>Interviewing or surveying travelers – it is often difficult to find travelers who have experienced the systems being evaluated and having them agree to be surveyed.</p>	<p>Candidate subjects need to be pre-screened to assure they have the appropriate experience. Alternatively, subjects can be recruited and exposed to specific elements of the strategy. For other self-selected samples, include questions that help classify respondents appropriately in terms of their experience with and use of the strategy elements.</p>
<p>Confounding and exogenous factors – the many factors that can affect strategy outcomes are difficult to isolate and control.</p>	<p>Control for such factors as variation in weather, context, changing economic conditions, etc. can be accomplished by choosing an appropriate evaluation design and by applying analysis methods that account for such factors specifically measured in the evaluation.</p>
<p>Data collection/quality – collecting the needed data stresses an already fully committed agency staff.</p>	<p>In the planning process it is important to engage all the key stakeholders, to be sure everyone understands what will be required, and to identify all the resources needed to support the evaluation.</p>
<p>Time to adapt to deployments – a technology may not work as planned or may require a long time to work out the bugs and gain user acceptance and adaptation, thus affecting the appropriate timing of evaluation.</p>	<p>Comprehensive evaluation planning is the best approach to assuring a successful schedule. To avoid this issue, evaluations should not be rushed immediately upon deployment.</p>

WRTM Evaluation Challenges	Mitigation Approaches
Liability issues (for with-without studies) – agencies are justifiably concerned about strategies and evaluation techniques that may create safety risks.	This issue is discussed in the section on evaluation designs. Example: Agencies may agree to a with-without study with the caveat that they can deviate from the strictures of the design whenever they feel that traveler safety is at risk.
Evaluations tend to be underfunded – leading to a lack of performance documentation.	This is a fact of life in the current tight economic climate. Careful planning and identification of each of the evaluation cost elements may result in some acceptable compromises and an evaluation approach that is worth pursuing.

5.2.2 Collect the Data

After preparing an Evaluation Plan, the real evaluation work begins with the collection of the data required to test the hypotheses. Depending on the research design, historical data may need to be assembled to adequately characterize the baseline period, and new data are likely needed to be collected, either from existing records and sources or through the application of surveys, interviews or focus groups.

There are several steps in the process of assembling the data needed to support an evaluation, and this may be the most challenging phase of the evaluation because it involves balancing the needs of the evaluation with the need to successfully focus on implementing the WRTM strategy. The evaluator will have to balance data needs that would best support the evaluation's MOEs and tests of the hypotheses with the costs/time to obtain the data and availability/accessibility of the sources. One of the best ways to help assure that the data collection phase goes smoothly is to identify in the Evaluation Plan both the data and the data sources needed, and then to include in the planning process the stakeholders who will be responsible for providing the data. Everyone needs to be in agreement about the data requirements and understand exactly what data will be required and what will be available, including the costs to obtain the data, and the potential institutional barriers to gaining access to the needed data.

The evaluation is intimately intertwined with the deployment and use of the WRTM strategies and depends on the timely operation of the strategy. A delayed or partial deployment process will impact the scheduling and eventual success of the evaluation, in large measure because the data may not fully reflect the elements of the project that the evaluation is designed to assess. Weather responsive strategies are obviously tied to the occurrence of the weather events, and therefore the data collected to support the evaluation are typically linked to the occurrence of certain types of weather. Thus, the data will likely need to include information that characterizes the weather and pavement conditions, along with data that describe the deployment and usage of the WRTM strategy. However, it is precisely at those times when transportation operations and maintenance staff are trying to address the consequences of weather and implement the WRTM strategies that are intended to help them that personnel are least available to focus on the needs of the evaluation to consistently record or acquire the needed data. There is also an important timing issue in that the optimal time for data collection is not just after deployment of the strategy, but also after the strategy and its associated elements have been in use long enough that the data collected will reflect regular, routine application and use of the strategy. Data collected when strategies are very recently deployed and usage is tenuous and partial will not provide a full test of the ability of the strategy to yield the desired outcomes specified in the

Evaluation Plan. These are some of the challenges that must be fully addressed in the Evaluation Plan and managed during the data collection phase.

The Evaluation Plan will address questions of data formats, data cleaning (addressing questions of outliers and validity of the data), data storage, and data fusion that all relate to the management of the data collection and the transformations of the data that may be required to achieve comparability across different data sources, organization of the data in useful time series, and preparation of the data for analysis and interpretation. Data recorded in logs, on survey forms, through interview records, or through other manual means will need to be entered for electronic processing. The structure and organization of the data in a database will be guided by the kinds of analyses that will be conducted, as specified in the Evaluation Plan, and the software tools that will be used to process the data. Furthermore, the management of the databases that support the evaluation must adhere to proper standards of confidentiality and quality to assure that evaluation results are fully supportable and that they protect the sources of the data.

5.2.3 Conduct the Analysis

The analysis of the data begins with a focus on the evaluation goals and objectives specified in the Evaluation Plan, the data are analyzed with an eye to testing the hypotheses. The analysis is likely to initially focus on descriptive statistics that examine frequency distributions in the data. In a before-after design, data can be compared between the baseline and the post-deployment period to see what changes may have occurred that are related to the key outputs and outcomes of interest. Further guidance on outputs and outcomes associated with the WRTM strategies is presented later in this Chapter.

The analysis of WRTM strategies should keep the likely audience in mind and avoid an overly obscure, scientific presentation of the analysis. Important causal relationships in the data can be addressed and represented where possible in graphical form to enhance the communication and understanding of the findings. The analysis should be more practical than academic but still conducted with appropriate attention to quality and rigor. The results of the analysis are most likely to be viewed with regard to their policy-relevance. For example, benefit-cost evaluation analyses of WRTM strategies are expected to be of particular interest to State DOT management who are faced with serious resource limitations and want to know that a strategy being considered for purchase and deployment will be truly cost effective and highly likely to yield the benefits offered.

Data analysis calls for interpretation of results within the context of the evaluation's objectives. While the evaluator will want to be responsive to expectations for program outcomes, the analysis and interpretation must be conducted objectively, allowing the data and results to "speak" for the evaluation and avoiding the chance that subtle biases may be introduced.

5.2.4 Prepare the Evaluation Report

The final step in the evaluation is to prepare and present the results in a report. Most evaluation reports will contain a common set of sections, including a brief description of the strategy implementation, the evaluation objectives, research design and analytic methods used, and a listing of the findings, interpretations, conclusions and recommendations. The actual structure and content of the evaluation report will need to be tailored to the intended audience and its needs. Managers, decision makers and policy makers may be interested in the lessons learned, both positive and negative, about the strategy deployment and its potential utility. A discussion related to ways to enhance the benefits of strategy deployment, based on the evaluation findings, will be helpful to

include in the report. And finally, the authors of the report can offer recommendations for future research and evaluation in order to gain additional insight, based on their experience with the current evaluation and project implementation.

5.3 Evaluation Guidance for Selected WRTM Strategies

This section presents an approach to evaluating the selected WRTM Strategies identified in Section 5.1. These strategies are broadly defined and can represent many different types of site-specific implementations in order to achieve the desired outcomes and goals. Figure 7 illustrates how the implementation of a particular strategy flows through to the outcomes and achievement of the national ITS goals. Figure 7 uses the example of an Active Warning System to illustrate the kind of evaluation guidance offered in this chapter.

An operating agency decides to implement a WRTM strategy in order to achieve desired outcomes or benefits. The detailed system implementation of the strategy will depend on many site-specific factors.

The evaluation guidelines provided in this chapter focus on identifying measures of effectiveness and data requirements to evaluate the key system outputs and outcomes. If the system outputs are not successfully achieved, then the outcomes are unlikely to be achieved. Furthermore, it is important to identify the intermediate outputs in order to support a finding that the observed outcomes are actually due to the effects of the system implementation.

In the example shown in Figure 7, the national ITS goal areas addressed by the implementation of an active warning system are expected to be improved safety and driver satisfaction. It would not be possible to claim that the outcomes of reduced vehicle speeds and reduced crashes are attributable to the implementation of this WRTM strategy without being able to show that warnings were provided to the public that were both accurate and timely. Hence, it will be important to measure the outputs as well as the outcomes associated with the implementation of each of these WRTM strategies.

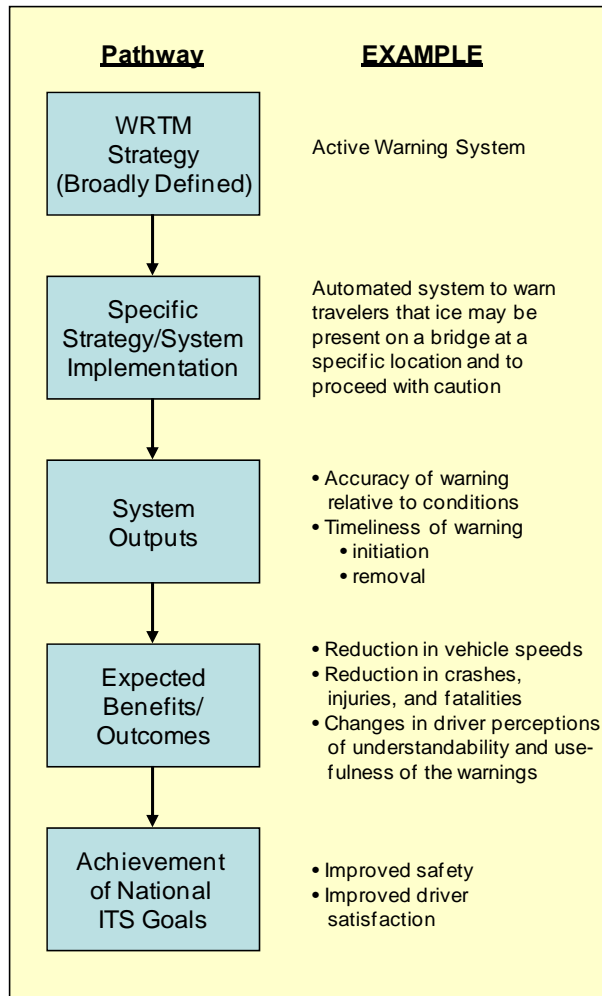

Figure 7. Example WRTM Strategy Pathway

The following key assumptions are important to consider when using the evaluation guidance provided in this chapter:

- WRTM strategies are broadly defined and can represent many different types of implementations to achieve the particular strategy.
- Two or more strategies can be combined to achieve the goals of an implementing agency.
- Implementation of strategies will vary and therefore the evaluation guidance provided will be at a high level in an attempt to represent any type of implementation.
- The key output and outcome MOEs identified represent any strategy implementation; however, depending on the specific details, not all the output and outcome MOEs may apply in some implementations.
- The evaluation guidance assumes that the system developed to achieve the benefits of a particular strategy performs as designed; the evaluation will not focus on the system performance, but rather on the evaluation of system outputs and outcomes.

- The appropriate weather information needed to achieve the outcomes of a particular WRTM strategy is assumed to be an input to the implemented system.
- The results of a meaningful evaluation will need to show the outputs and outcomes of a strategy implementation in relation to the weather conditions present and specific location(s) being addressed by system deployment.

The intent of this approach is to offer easy-to-understand, practical guidance for any agency that may want to evaluate the performance of one or more strategies. The evaluation guidance is primarily provided in tabular form. In addition to the evaluation guidance contained in the tables for each strategy, supportive text will elaborate additional specific guidance and provide an evaluation example of one or more specific implementations.

The table for each WRTM strategy contains the following information:

- A short summary description of the strategy.
- Specific examples of applications of the strategy, including implementations and conditions for which the strategy could apply.
- The key inputs needed for the strategy evaluation, such as assumptions about context, conditions, actions and data.
- The key output measures that show activities and immediate results of strategy implementation that are essential to the success of the strategy and enable the achievement of the outcome benefits. Examples include timeliness and accuracy of information, and the number of activities conducted.
- The key outcome measures that show the effects, impacts and benefits of the deployment and use of the strategy, including attainment of the national ITS goals. Examples include a decrease in the number and severity of crashes, changes in driver behaviors and satisfaction, increased throughput and reduced traffic delay, and reduced environmental impacts.
- Data requirements needed to measure the output and outcome indicators, including sources for these data.
- Additional contextual data requirements that would include essential time stamped data related to road weather conditions, used to describe the conditions under which the outputs and outcomes are produced by the strategy.

The data sources needed to support each of the selected MOEs identified in the table could include (will vary by WRTM strategy and evaluation approach):

- System records – extracted from agency archives, computerized system logs, or logs kept by operators.
- Reports from the field or traveler – collected through interviews of key field personnel who may be monitoring the system, or from travelers who experienced the system during inclement weather.
- Traffic information – from available traffic recording sensors/devices at or near the location.
- Crashes, injuries, and fatalities – from State DOT crash records and/or public safety or health departments.
- Road weather condition information – it is assumed that either road weather data are available at the location of the new system or the required road weather information is being

made available as part of the implemented project. In either case, it is critically important that the road weather condition information be available to conduct the evaluation during the weather events that the system is being put in place to address.

The following paragraphs and tables provide evaluation guidance for each of the nine selected WRTM strategies.

5.3.1 WRTM Strategy – Active Warning Systems

Active warning systems provide automated or operator activated alerts to motorists of pending dangerous driving conditions.

Evaluation Design

Table 8 provides guidance to those interested in evaluating an active warning system that includes the elements presented in Figure 7. The recommended approach to evaluate active warning systems is to utilize a before-after research design. Using this approach, a direct comparison in the specific location of the deployment can be made for each of the MOEs (e.g., number of crashes during inclement weather conditions) before the system was implemented compared with the warning system in place. The customer satisfaction MOEs would have to be measured with data after the system is in place by asking operators and/or travelers how they believe it works compared to before the system was present.

The outcome MOEs can be phrased in terms of hypotheses to be tested, such as:

- Drivers recognize and understand the warnings and respond appropriately with changes to their driving behavior (e.g., slowing down, reducing lane changes, diverting off the facility, etc.).
- Road segments with weather hazards have a better safety record (reduced crash rates and severity) when active warning systems are in place than those without such systems.
- Traffic disruptions due to weather-related traffic incidents are reduced or avoided and as a result mobility is maintained.
- Operators, maintenance and the traveling public recognize the benefits of, and appropriately respond to, active weather warnings.
- Drivers are satisfied with the warning systems and value having them.

Data Requirements and Analysis

Data requirements to support output and outcome MOEs are provided in Table 8. It is also important to consider the location of a deployment and weather conditions present during the data collection periods (baseline and post-system deployment). Analysis examples that the evaluation may want to consider include:

- Active warning system messages generated at the system deployment location during periods when the road weather conditions exceeded the established threshold (just before, during, and just after the threshold was exceeded).

- Comparison of vehicle speeds and speed differentials before and after the active warning system implementation during periods when the road weather conditions exceeded the established threshold (just before, during, and just after the threshold was exceeded).
- Comparison of number of crashes/injuries/fatalities before and after the active warning system implementation during periods when the road weather conditions exceeded the established threshold (just before, during, and just after the threshold was exceeded). A baseline should be established with crash data for at least the prior 3 years before the implementation of the active warning system.
- Comparison of vehicle through-put in the area of the warning systems before and after system activation. Examine the effect of crashes and crash reduction on mobility due to the active warning system.

Table 8. Evaluation Guidance for an Active Warning System

Active Warning Systems	
<p>Description: Active warning systems could supplement passive warning signs with flashing beacons to alert travelers that the conditions specified on the static sign are currently in effect. Additionally, an active warning system could include a changeable message sign activated automatically or manually from an operations center. The flashing beacons may be activated either manually by operators in a traffic management center or by field personnel based on observed conditions, or automatically if tied to a road weather monitoring system (such as a flood detection stream gauge or a high wind detection system).</p> <p>Key Inputs:</p> <ul style="list-style-type: none"> • Operational procedures that guide manual operation of the system • Operator training • Sensors that measure and report on road weather conditions or automatically trigger a message sign • Time stamped archived road weather condition information (appropriate to site locations, and before, during and after warning time periods) • Traffic condition information <p>Key Output MOEs:</p> <ul style="list-style-type: none"> • Timeliness of issuance of warning • Timeliness of removal of warning • Accuracy of warning relative to conditions • Time lag between when weather condition threshold exceeded and operator action taken <p>Key Outcome MOEs:</p> <ul style="list-style-type: none"> • Reduction in vehicle speeds in area of warning • Reduction in number of crashes, injuries and fatalities (in proximity to warning system) • Reduction in mobility impairments (throughput, speeds maintained) • Changes in driver perceptions of understandability and usefulness of warning 	<p>Examples of Strategy Applications:</p> <ul style="list-style-type: none"> • Ice on a bridge • High winds in a defined location • Static sign with flashers warning about a specific condition in a specific location • CMS with specific weather-related messages • Manual or automated system implementation <p>Data Requirements:</p> <ul style="list-style-type: none"> • System record (or operator log) of all warnings issued in a defined period (message content) • System record (or operator log) of dates and times warnings were issued • System record (or operator log) of dates and times warnings were removed • Reports from field, or traveler surveys/interviews, of warning appropriateness for conditions • System record of date and time of first receipt of condition indication that triggered the warning <p>Data Requirements:</p> <ul style="list-style-type: none"> • Traffic information at warning site (type, speed, flow, etc.) from field sensors or reports • State records of crashes, injuries, fatalities, in area of warning, under defined weather conditions • Traveler survey/interviews that measure whether warning was properly interpreted and understood, and how useful drivers found the warning

Evaluation Example

The Oregon DOT evaluated wind warning systems at two locations on US 101. The warning systems were aimed at general travelers, recreational vehicles, and commercial vehicle operators to improve safety at these locations. The locations included:

1. Between Port Orford and Gold Beach, Oregon on US Route 101 between mileposts 300.10 and 327.51 (“South Coast System”).
2. On the Yaquina Bay Bridge (also US Route 101), Oregon, between mileposts 141.27 (SB) and 142.08 (NB).

Both of these systems automatically activate static warning signs and flasher beacons. The messages indicate that the conditions (high winds) only exist when flashers are on. They are activated when wind speeds exceed 35 mph. Maintenance crews are notified to close the roads when wind speeds exceed 80 mph. When wind speeds fall below 25 mph for over two minutes, the flashers are turned off.

Evaluation Outcomes

The evaluation of the Oregon DOT wind warning systems focused on one of the outcome MOEs in Table 8: “Changes in driver perceptions of understandability and usefulness of warning.” Additionally, the evaluation assessed benefit/cost ratios for the systems in these two locations.

Evaluation Approach

Two separate approaches were used to determine evaluation results for the MOEs identified above. A motorists survey was conducted that focused on traveler awareness and traveler perception of the usefulness of the system. The mail-in surveys were conducted with commercial vehicle operators because of their sensitivity to high wind conditions. The benefit-cost analysis compared the savings associated with labor and equipment with the cost of implementing and maintaining the new systems. The cost savings were primarily derived from not having personnel and equipment on-site during wind events.

Results

The evaluation was conducted by the Western Transportation Institute, at Montana State University. Their report [26] identified the benefits of both of the Oregon wind warning systems. Specific findings included the following:

- Eighty-four (84) percent of the respondents for the South Coast system and 86 percent of the respondents for the Yaquina Bay system who have driven through the location during high cross winds have seen the beacons flashing.
- The response to the statement, “This system would provide me with useful information” received the highest average rating (4.26 and 4.18 for South Coast and Yaquina Bay Bridge systems, respectively) on an ordinal scale of 1 to 5, with 5 being strong agreement.
- Eighty-four (84) percent of the respondents for the South Coast system and 80 percent of respondents for Yaquina Bay system either “strongly agree” or “agree” that the system will provide them accurate information on high winds.

- An evaluation of the Oregon DOT High Wind Warning Signs showed B/C ratios of 4.13 and 22.80 for the US 101 and Yaquina Bay Bridge systems, respectively. Benefits were derived both from personnel savings and from delay reductions due to not closing the roadway.

Crash data analysis was not performed because the system was evaluated for less than one year, and some form of warning for high winds has been in place for an extended period of time.

5.3.2 WRTM Strategy – Pre-Trip and En-Route Weather and Pavement Information Systems

Pre-trip and en-route weather and pavement information systems provide various levels of traveler information to motorists regarding delays, closures due to pending weather and pavement conditions.

Evaluation Design

Table 9 provides guidance to those interested in evaluating pre-trip and en-route weather and pavement information systems. Although a system of this type may be focused on a specific location, more often it is focused on providing traveler information (about road weather conditions) across a region or large area (unlike the previous strategy, Active Warning Systems, that is very site-specific).

The recommended approach to evaluate pre-trip and en-route weather and pavement information systems is to utilize a before-after research design. However, this strategy could also lend itself well to a with-without or case study evaluation design. The choice of evaluation design would depend on the agency's objectives, expectation of data availability, and level of detail desired for evaluation results. Refer to Chapter 2 to help determine which method would be best for the particular aspect of the strategy being implemented. Additionally, refer to Table 9 to determine which MOEs will be selected for the evaluation – the more detailed the MOEs chosen (and corresponding data requirements), the more likely a 'before-after' evaluation design should be selected.

The outcome MOEs can be phrased in terms of hypotheses to be tested, such as:

- Drivers are aware of, recognize, and understand the traveler information provided and respond with appropriate trip decisions/modifications.
- Areas with severe weather have a better safety record when pre-trip and en-route weather and pavement condition information are provided to motorists than those without such information.
- Travel time and travel delays are reduced with pre-trip and en-route weather and pavement condition information.
- Drivers are satisfied with their trip, feel they are better prepared for the forecast weather conditions, and find the information provided useful and actionable.

Data Requirements and Analysis

Data requirements to support output and outcome MOEs are provided in Table 9. It is also important to consider the weather conditions present during the data collection periods (baseline and post-system deployment). Analysis examples that the evaluation may want to consider include:

- Weather and pavement condition information messages posted in the area during periods when the road weather conditions were severe.

- Comparison of motorist’s decisions/modifications/trip satisfaction/travel times for those trips with pre-trip and en-route weather and road condition information to those without the information before and after the information systems were implemented.
- Comparison of travel times and delays before and after the pre-trip and en-route weather and pavement condition information system implementation.
- Comparison of number of crashes/injuries/fatalities before and after the pre-trip and en-route weather and pavement information system implementation. A baseline should be established with crash data for at least the prior 3 years before the implementation of the WRTM strategy.

Table 9. Evaluation Guidance for Pre-Trip and En-Route Weather and Pavement Information Systems

Pre-Trip and En-Route Weather and Pavement Information Systems	
<p>Description: This strategy addresses weather-related traveler information provided at different points in time, both before and during the trip. It includes disseminating information about current and forecasted weather and pavement conditions to travelers. Objectives include enhancing traveler preparedness and offering information that can support traveler choices and behaviors, such as travel mode, departure time, or route selection. The strategy offers travelers real-time information and alerts about specific weather and pavement conditions both prior to their trip and as developing ahead of them while they are en-route. The content of the messages changes dynamically to reflect current or forecasted conditions. These systems can be used to disseminate information about different types of weather events and pavement conditions.</p> <p>Key Inputs:</p> <ul style="list-style-type: none"> • Weather and pavement conditions from road sensors, cameras, weather services, field personnel, time stamped and archived by site locations (before, during and after information is provided) • Forecasts from weather services • Translation of weather forecasts to road conditions and travel impacts • Meteorological interpretation and conversion to deployable messages and information <p>Key Output MOEs:</p> <ul style="list-style-type: none"> • Improved timeliness of message posting and removal • Improved accuracy of information <p>Key Outcome MOEs:</p> <ul style="list-style-type: none"> • Understandability of messages • Appropriate trip and driver behavior modifications (trip timing; route selection; mode selection; cancel or postpone trip) • Enhanced trip success (on time; safe arrival; satisfied traveler; preparedness) • Improved mobility (travel time reliability, planning time index; reduced travel delays, reduced speed variability) • Increased driver satisfaction and perceptions of usefulness of information • Reduction in number of crashes, injuries and fatalities 	<p>Examples of Strategy Applications:</p> <ul style="list-style-type: none"> • Websites • Phone systems (such as 511) • DMS/HAR messages • Camera images • In-vehicle systems • Social media • Weather types covered may include: <ul style="list-style-type: none"> • Rain/snow storms • High winds • Visibility (blowing snow, fog) • Pavement conditions (temperature, friction) • Current conditions and forecasts <p>Data Requirements:</p> <ul style="list-style-type: none"> • System archive of messages posted (time posted; time removed; message content) • Reports from field, or traveler survey/interviews, of message appropriateness for conditions <p>Data Requirements:</p> <ul style="list-style-type: none"> • Traveler surveys or interviews that measure driver decisions and behavior changes in response to messages provided • Traveler perceptions of influence of messages on trip outcomes and satisfaction with information understandability and usefulness. • Trip logs maintained by drivers, license plate reader data, travel speed radar data, or probe vehicle data to measure travel times • State records of crashes, injuries, and fatalities in areas and along routes for which the traveler information has been provided

Evaluation Example

These systems tend to involve coupling a road weather information system (either a low visibility sensor, an environmental sensing station, or an anemometer) to measure weather conditions with an information dissemination system. The Idaho Department of Transportation installed a motorist warning system on I-84 in southeast Idaho and northwest Utah. The system was installed to reduce crash frequencies during blowing snow and reduced visibility events. The system utilizes environmental sensor stations to detect pavement conditions, visibility, wind speed and direction, precipitation type and rate, air temperature, and relative humidity. Forward-scatter detection technology measures visibility distances. A central computer records sensor readings every 5 minutes. When field sensor data indicate that visibility has fallen below, or wind speed had increased above, a pre-determined threshold or that driving conditions are deteriorating, the central system alerts traffic managers in a control center. The traffic manager then enters appropriate warning messages on variable message signs visible to motorists driving into the area experiencing the dangerous conditions (en-route messaging).

Evaluation Outcomes

The Idaho Storm Warning System evaluation [57] focused on the following main outcome MOE listed in Table 9: “Appropriate trip and driver behavior modifications.”

Evaluation Approach

Vehicle speed data were collected over several years during good weather conditions, high winds, low visibility, and snow covered roadways. The data were analyzed to determine the effectiveness of nearby variable message signs that posted warnings on the effect of dangerous driving conditions on driver behavior in terms of vehicle speed. The analysis compared vehicle speeds during the following conditions: high winds alone, high winds with snow covered roadways, extreme low visibility, and extreme low visibility with snow covered roadways. The variable message signs were not always operational, so some of the results focused on driver behavior during these various road weather events. The results indicate findings related to changes in driver behavior when drivers are presented with warning messages on properly working signs.

Results

The “before and after” evaluation of the Idaho Storm Warning System using data from 1993 and 2000 compared traffic speed with advisories to speeds without advisories. This evaluation found the following:

- Average vehicle speeds decreased by 23 percent when traffic managers displayed condition data during high winds (i.e., wind speeds over 20 mph).
- Average speeds were 12 percent lower when the system was activated during high wind events occurring simultaneously with moderate to heavy precipitation.
- Average speeds declined by 35 percent when warnings were displayed on the signs when the pavement was snow-covered and wind speeds were high.

5.3.3 WRTM Strategy – Speed Advisories and Enforceable Variable Speed Limit Systems

Speed advisories and enforceable variable speed limit systems provide recommended reductions in speed to motorists (advisories and/or enforceable limits) in a specific location or corridor during severe road weather conditions. These advisories or limits are posted on changeable message signs controlled either automatically at the location or from an operations center.

Evaluation Design

Table 10 provides guidance to those interested in evaluating speed advisories and enforceable variable speed limit systems. The recommended approach to evaluate speed advisories and enforceable variable speed limit systems is to utilize either a before-after or with-without research design. The choice of design will depend on the system being deployed, the expected outcomes of the system, and the stage of deployment. Using the before-after design, a direct comparison in the specific location of the deployment can be made for each of the MOEs (e.g., vehicle speed, speed variability, and number of crashes during inclement weather conditions) before the system was implemented with the speed advisories/limits provided by the system, once deployed. A with-without design can compare a deployed system with another location or corridor that experiences similar road weather conditions.

The Wyoming DOT has recently deployed a variable speed limit system on an especially dangerous stretch of I-80 that experiences extreme winter weather conditions. A before-after evaluation is being conducted by the University of Wyoming. Early results show that the system is effective at both slowing vehicles and narrowing the speed variability gaps.

The outcome MOEs can be phrased in terms of hypotheses to be tested, such as:

- Drivers respond appropriately to posted speed advisories or enforceable limits during severe weather and pavement conditions.
- Areas with severe weather have a better safety record when speed advisories and enforceable limits are provided to motorists than those without such advisories.

Data Requirements and Analysis

Data requirements to support output and outcome MOEs are provided in Table 10. It is also important to consider the weather conditions present during the data collection periods (baseline and post-system deployment). Analysis examples that the evaluation may consider include:

- Speed advisories and/or enforceable speed limits posted at appropriate times given the weather conditions and when designated thresholds (e.g., wind speeds, significant snow fall, visibility, or pavement conditions) are exceeded (just before, during, and just after the threshold was exceeded).
- Comparison of vehicle speeds and variability before and after the speed advisory system implementation during periods when the road weather conditions exceeded the established threshold (just before, during, and just after the threshold was exceeded).
- Comparison of number of crashes/injuries/fatalities before and after the speed advisory and enforceable variable speed limit system implementation during periods when the road weather conditions exceeded the established threshold (just before, during, and just after the

threshold was exceeded). A baseline should be established with crash data for at least the prior 3 years before the implementation of the WRTM strategy.

These comparisons could also be made between two locations or corridors that experience similar weather conditions – one with a speed advisory/limit system and one without to measure the performance or benefits of one over another.

Table 10. Evaluation Guidance for Speed Advisories and Enforceable Variable Speed Limit Systems

Speed Advisories and Enforceable Variable Speed Limit Systems	
<p>Description: This set of strategies involves issuing customized speed advisories in response to deteriorating weather conditions. The speed advisories are intended to achieve compliance with a recommended safe travel speed for the prevailing conditions. In certain locations or under specified conditions, the speed advisory messages could be considered either voluntary or enforceable by law enforcement personnel. These strategies involve establishing new speed limits or implementing speed restrictions in direct response to weather conditions.</p>	<p>Examples of Strategy Applications:</p> <ul style="list-style-type: none"> • Speed messages displayed on DMS • Weather types covered may include: <ul style="list-style-type: none"> • Snow accumulating on pavement • Blowing snow • High winds • Impaired visibility (blowing snow, fog) • Permanent capabilities along high risk road segments
<p>Key Inputs:</p> <ul style="list-style-type: none"> • Weather and pavement conditions from road sensors, cameras, weather services, field personnel, time stamped and archived (by site locations, and before, during and after advisory time periods) • Forecasts from weather services • Traffic conditions and vehicle response to conditions 	
<p>Key Output MOEs:</p> <ul style="list-style-type: none"> • Improved timeliness of advisory posting and removal • Appropriateness of speed posted for conditions 	<p>Data Requirements:</p> <ul style="list-style-type: none"> • System archive of speeds posted (time posted; time removed; speed advised) • Reports from field, or traveler survey/interviews, of message appropriateness for conditions
<p>Key Outcome MOEs:</p> <ul style="list-style-type: none"> • Reduction in travel speed in response to guidance provided • Reduction in speed variability during adverse weather • Reduction in number of crashes, injuries and fatalities in segments covered by advisories/limits • Ability to maintain mobility and throughput on designated roadways 	<p>Data Requirements:</p> <ul style="list-style-type: none"> • Records of vehicle speeds before, during, after advisories/limits posted • State records of crashes, injuries, and fatalities along route segments for which the speed advisory or limits have been posted • Number of vehicles and trucks per hour traveling through designated roadways

Evaluation Example

The State of Wyoming recently deployed a variable speed limit (enforceable) system on I-80 between Laramie and Rawlins, Wyoming (approximately 100 miles; project corridor is 52 miles in length). This interstate corridor experiences severe road weather conditions in the form of high winds, heavy snow, blowing snow, and dangerous pavement conditions (snow and ice) that causes frequent road closures during the year (especially in the winter time).

The WYDOT variable speed limit system includes extensive sensor systems and speed limit signs to assist traffic managers in posting enforceable reduced speed limits during severe weather. The

equipment installed in the corridor to support system operation and evaluation includes 2 Dynamic Message Signs (one at each end of the corridor), 10 speed detection devices, 5 Road Weather Information Systems, 12 CCTV cameras, and 28 variable speed limit signs. Speed limits are posted by traffic managers. They reduce the speeds during severe weather from 75 mph in 10 mph increments depending on the conditions.

Evaluation Outcomes

The evaluation of the Wyoming Variable Speed Limit System was performed by the University of Wyoming (Laramie, WY). The evaluation focused on the three main outcome MOEs listed in Table 10:

- Reduction in travel speed in response to guidance provided.
- Reduction in speed variability during adverse weather.
- Reduction in number of crashes, injuries and fatalities in segments covered by advisories/limits.

Evaluation Approach

Vehicle speed data were collected during “ideal” (good weather, normal speed limits), “transition” (poor weather, no reductions in speed limits), “initial” (first on-set of reduced speed limits), and “extended” (continued use of VSL system with reduced speed limits). The data were analyzed to determine the effectiveness of reduced speed limits on driver behavior (in terms of speed changes and overall speed variability). Crash data were also collected for the past 10 years and 1 year of system operation – initial analyses were conducted to compare crash rates.

Results

The University of Wyoming published a report of the findings after a year of system operation. This report [58] presents the following initial evaluation results:

- During periods of ideal weather (clear and dry), vehicle speeds did not reduce, even when the posted enforceable speed limit was reduced to 65 mph (from 75 mph).
- During storm events where the VSL system posted reduced speeds, vehicle speeds were impacted by the use of the system. The project observed a reduction in vehicle speeds of 5.9 to 8.6 mph for every 10 mph of speed limit reduction posted. These speed reduction observations were in addition to the natural speed reductions due to weather conditions.
- During this initial period, the overall analysis did not show statistically significant differences in speed variability between normal conditions and storm events which used the VSL system. However, one location in the corridor (MP256.25) indicated that the VSL system favorably impacted speed variability as illustrated in Figure 8.
- Ten years of historical crash data were collected in the project corridor. Only 1 year of crash data were collected to date with the variable speed limit system in place, which is not enough for a statistically valid analysis. However, during the first year of system operation the crash rates were the lowest in the past decade.

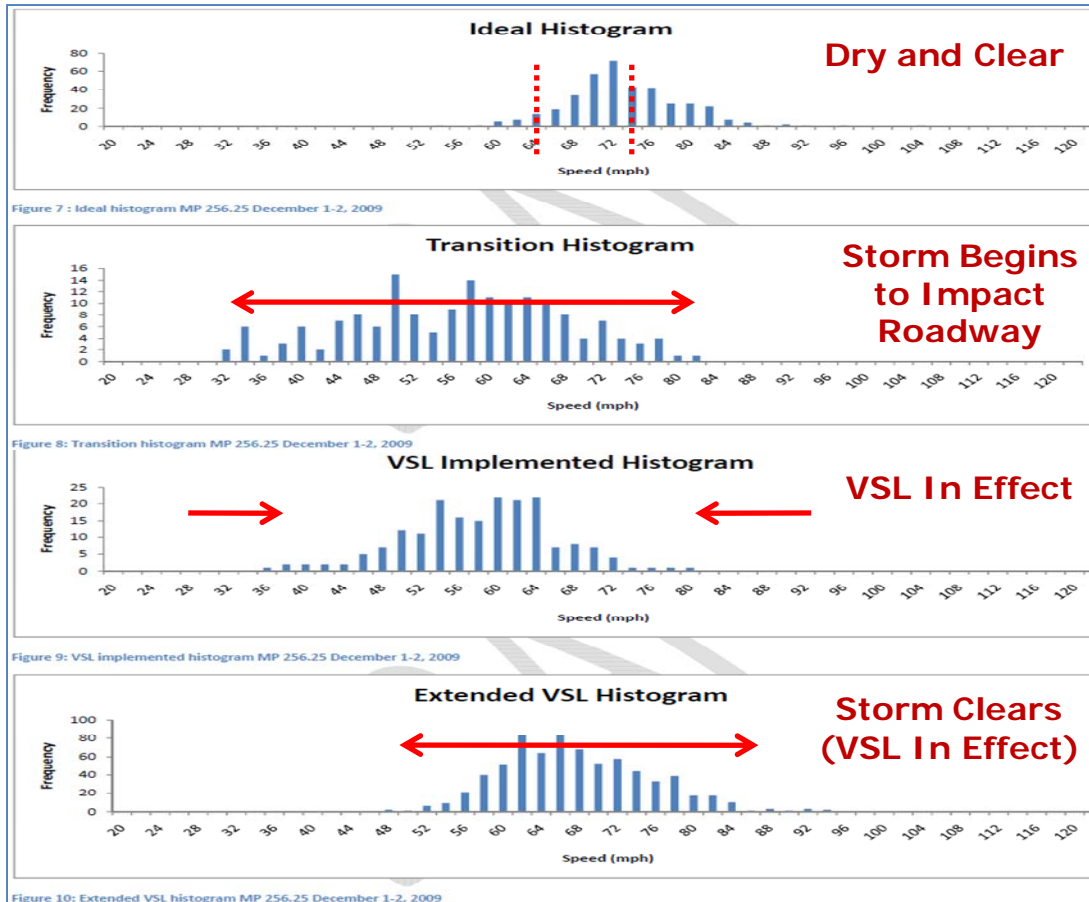

Figure 8. Changes in Speed Distribution due to VSL (Source: Wyoming DOT)

5.3.4 WRTM Strategy – Vehicle Size, Height and Profile Restriction Systems

Vehicle size, height and profile restriction systems provide roadway restrictions for trucks or high profile vehicles during severe road weather conditions. These restrictions could be posted on highway message signs and/or traveler information systems, and enforced by law enforcement officers. The restrictions are typically initiated by an operations center.

Evaluation Design

Table 11 provides guidance to those interested in evaluating vehicle size, height and profile restriction systems. The recommended approach to evaluate vehicle size, height and profile restriction systems is to utilize a ‘before-after’ research design. However, this strategy could also lend itself well to a ‘with-without’ or case study evaluation design. The choice of evaluation design would depend on the agency’s objectives, expectation of data availability, and level of detail desired for evaluation results. Refer to Section 5.2 to help determine which method would be best for the particular aspect of the strategy being implemented. Additionally, refer to Table 11 to determine which MOEs will be selected for the evaluation; the more detailed the MOEs chosen (and corresponding data requirements), the more likely a before-after evaluation design should be selected.

The outcome MOEs can be phrased in terms of hypotheses to be tested, such as:

- Targeted drivers recognize and understand the travel restrictions during severe road weather conditions and respond with appropriate action.
- Areas with restrictions in place have a better safety record during severe road weather conditions.

Data Requirements and Analysis

Data requirements to support output and outcome MOEs are provided in Table 11. It is also important to consider the weather conditions present during the data collection periods (baseline and post-system deployment). Analysis examples that the evaluation may consider include:

- Vehicle size, height and profile restrictions are posted at appropriate times given the weather conditions and when designated thresholds (e.g., wind speeds, significant snow fall, visibility, or pavement conditions) are exceeded (just before, during, and just after the threshold was exceeded).
- Determine the percent of targeted drivers/vehicles that comply with the restrictions imposed.
- Comparison of number of crashes/injuries/fatalities before and after the vehicle size, height and profile restriction systems implementation during periods when the road weather conditions exceeded the established threshold (just before, during, and just after the threshold was exceeded). A baseline should be established with crash data for at least the prior 3 years before the implementation of the WRTM strategy.

Table 11. Evaluation Guidance for Vehicle Size, Height and Profile Restriction Systems

Vehicle Size, Height and Profile Restriction Systems	
<p>Description: This strategy involves restricting certain types of vehicles from using the roadways during specific weather conditions. Vehicles may be restricted by size, height, or profile based on weather conditions. The restrictions prevent affected vehicles from proceeding along the restricted roadway (speed restrictions are covered elsewhere).</p>	<p>Examples of Strategy Applications:</p> <ul style="list-style-type: none"> • Truck restrictions on roadways experiencing heavy snow or ice conditions • Strong winds presenting roll-over risks to large or high profile vehicles (tractor trailer trucks, vans, campers, etc.)
<p>Key Inputs:</p> <ul style="list-style-type: none"> • Weather and pavement conditions from road sensors, cameras, weather services, field personnel, time stamped and archived (by site locations, and before, during and after restriction periods) • Road weather forecasts from weather services • Operational procedures and operator training to support decisions to impose restrictions • Real-time traffic condition information 	
<p>Key Output MOEs:</p> <ul style="list-style-type: none"> • Improvement in the timeliness of restriction posting and removal • Operator/traveler perceptions of appropriateness of restriction posted to actual conditions 	<p>Data Requirements:</p> <ul style="list-style-type: none"> • System archives of restrictions posted (time posted; time removed; detail of restriction message; how restriction notice was disseminated) • Reports from field, or surveys/interviews with affected travelers, of restriction awareness, appropriateness of decision for the road-weather conditions
<p>Key Outcome MOEs:</p> <ul style="list-style-type: none"> • Percent of targeted drivers/vehicles complying with restrictions • Reduction in number of crashes, injuries and fatalities, both for restricted vehicle types and collateral impacts to other vehicles • Enhanced mobility due removal of vehicles slowed by weather • Enhanced safety due to removal of vehicles slowed by weather 	<p>Data Requirements:</p> <ul style="list-style-type: none"> • Number of citations for non-compliance with restrictions • Surveys/interviews of CVOs with fleet travel in posted areas to assess number of truck trips affected or altered by restrictions • Traffic speed data; vehicle probe data measuring travel times • State records of crashes, injuries, and fatalities along route segments for which restrictions have been posted, segmented by affected vehicle types and all other vehicles

Evaluation Example

There are only a few examples of this strategy around the country and all of them focus on restrictions of vehicles (especially high-profile vehicles) during periods of high winds. No system evaluations have been conducted but several of the outcomes in this strategy are represented in evaluations of other warning systems.

5.3.5 WRTM Strategy – Seasonal Load Restriction Systems

Seasonal Load Restriction systems are specific to commercial vehicles using certain roadway that are experiencing spring thaw conditions which make them susceptible to damage. These restrictions are typically provided directly to trucking companies via fax or email and are frequently updated as conditions change. The restrictions are typically initiated by a DOT or another transportation management entity responsible for sections of roadway throughout a State. Many northern States experience these risks to their infrastructure and issue weight restrictions.

Evaluation Design

Table 12 provides guidance to those interested in Seasonal Load Restriction systems. The recommended approach to evaluate Seasonal Load Restriction systems is to utilize a before-after research design. However, this strategy could also lend itself well to a with-without evaluation design. The choice of evaluation design would depend on the agency's objectives, expectation of data availability, and level of detail desired for evaluation results. A before-after evaluation could measure damage to roadways before the restrictions were in place compared with after the restrictions were enforced. Additionally, two similar locations could show the differences in roadway damage with and without the restrictions being used. The ability to detect pavement damage from heavy vehicle traffic after one winter varies depending on the construction of the roadbed, the condition of the roadway at the beginning of the winter season, the traffic impacting the road, and the effects of the thaw cycle. As a result, it may take several years before serious damage can be detected, and this must be taken into account when planning the evaluation.

The outcome MOEs can be phrased in terms of hypotheses to be tested, such as:

- Pavement damage due to heavy vehicles is reduced when a Seasonal Load Restriction system implemented.
- Adverse economic consequences (to CVOs and the State economy) of restrictions are minimized.
- CVO companies and DOTs alike are satisfied with the implementation of a Seasonal Load Restriction system.

Data Requirements and Analysis

Data requirements to support output and outcome MOEs are provided in Table 12. It is also important to consider the road weather conditions present during the data collection periods (baseline and post-system deployment). Analysis examples that the evaluation may want to consider include:

- Seasonal weight restrictions are effective at appropriate times given the weather and pavement conditions and when designated thresholds (e.g., subsurface temperature and moisture content, pavement conditions) are exceeded (just before, during, and just after the threshold was exceeded).
- Determination of the percent of targeted drivers/vehicles that comply with the restrictions imposed.
- Determination of pavement damage due to heavy vehicles over time in locations where a Seasonal Load Restriction system was implemented and when road conditions were such that the risk of roadway damage was probable. This could also be examined for two locations—one with a restriction system in place and one without.

Table 12. Evaluation Guidance for Seasonal Load Restriction Systems

Seasonal Load Restriction Systems	
<p>Description: This strategy involves restricting commercial vehicles (trucks) by weight class when using selected roadways during spring thaw conditions, with the objective of assuring preservation of pavement integrity and reducing road maintenance requirements for roads damaged by heavy vehicles. The restrictions prevent vehicles that exceed seasonal weight limits from proceeding along a restricted roadway, unless special permits are offered on a case-by-case basis. Different road segments are assigned different weight restrictions, usually dependent on road bed construction and resistance to truck damage. Interstates are never restricted.</p>	<p>Examples of Strategy Applications:</p> <ul style="list-style-type: none"> • Truck load restrictions on vulnerable roadways are placed in the early spring as subsurface structures begin to thaw. • The restrictions are removed in the late spring as subsurface structures become firm enough to support the truck weights. • Restrictions vary across State jurisdictions and can be adjusted by amount of weight restricted and road segment. • CVOs are notified in advance of placement and removal of restrictions to facilitate planning.
<p>Key Inputs:</p> <ul style="list-style-type: none"> • Pavement conditions from road sensors, subsurface probes (rare, but typically collocated with RWIS/ESS), weather services, field personnel inspections of pavement conditions, and falling weight deflectometer readings • Road weather current conditions and forecasts from weather services • Time stamped archived road weather condition data, including subsurface probe data if available (appropriate to site locations, and before, during and after restriction periods) • Operational procedures to support management decisions to place and remove restrictions 	<p>Data Requirements:</p> <ul style="list-style-type: none"> • System archives of restriction posting, changes, and removal (time posted; time removed; notification timing; how restriction notice was disseminated; restriction adjustments) • Reports from field engineers, or surveys/interviews with affected CVOs, of appropriateness of restriction decision for the road-weather conditions • Interviews with decision-makers to describe decision process and coordination policies
<p>Key Output MOEs:</p> <ul style="list-style-type: none"> • Timeliness of restriction posting and removal (minimize length of time restrictions need to be in place) • Appropriateness of restriction posted to actual conditions (amount and duration) • Coordination of restriction decisions for contiguous roadways across jurisdictions and States 	<p>Data Requirements:</p> <ul style="list-style-type: none"> • Number of citations for non-compliance with restrictions • Surveys/interviews of CVOs with fleet travel in State where restrictions are posted to assess number of truck trips affected by restrictions, CVO response to restrictions, and economic consequences to the State. • State records of pavement conditions before and after restriction placement
<p>Key Outcome MOEs:</p> <ul style="list-style-type: none"> • Percent of CVOs complying with restrictions • Reduction in pavement damage due to over-weight vehicles • Reduction in adverse economic consequences of restrictions to CVOs and State economy • State DOT and CVO satisfaction with restriction decisions 	

Evaluation Example

A Seasonal Load Restriction tool was tested and is currently being evaluated in North Dakota, Montana and South Dakota as part of the *Clarus* Multi-State Regional Demonstrations. The tool couples a pavement and subsurface temperature prediction model with a long-range atmospheric model to forecast thermal profiles of subsurface conditions up to 2 meters depth and 10 days into the future, and incorporate restriction decision policies to provide decision support to State DOT personnel. The demonstration made this tool available to State DOT decision makers in the early spring period of 2011 when the weather warms to help forecast the critical thaw period in order to avoid the potential pavement damage that can be caused by heavy truck traffic when pavements are most vulnerable. The tool will be deployed and examined in parallel with traditional methods used by the selected States, such as visual observations of water seeping to the road surface, Falling Weight

Deflectometer (FWD) readings, and monitoring of subsurface temperature probes. The tool will also be available to support decisions to remove the load restrictions in late spring and early summer as the subsurface firms sufficiently to support the heavier vehicle traffic. It is intended that this new tool offer a scientific and accurate basis for supporting restriction placement and removal with the objective of minimizing the duration of restricted travel while adequately protecting the pavement integrity from heavy vehicle damage.

Evaluation Outcomes

The key MOEs from the table included in the evaluation are:

- Timeliness of restriction posting and removal (minimize length of time restrictions need to be in place).
- Appropriateness of restriction posted to actual conditions (extent and duration).
- Coordination of restriction decisions for contiguous roadways across jurisdictions and States.
- State DOT and CVO satisfaction with restriction decisions.

The evaluation did not look into whether the costs that are incurred by industry as a result of load restrictions during the thaw period are comparable to the additional maintenance costs that would be incurred for the road network if the load restrictions were lifted which relate to the pavement damage and economic consequences.

Evaluation Approach

The evaluation approach [59] compares the process of decision-making retroactively using data from RWIS, FWD, and the forecasts provided by the tool. State maintenance chiefs were also interviewed pre and post decision-making to assess the satisfaction with the tool and the timing of restriction placement.

Results

While the final evaluation results have not been published yet, preliminary evaluation results show that there is great potential in moving from ad-hoc implementation of load restrictions to a more scientific approach enabling better placement and notification of spring restrictions. Early results indicate:

- Early notification of thaw levels allowing for placement of restrictions before pavement damage occurs.
- Possible increase in days of advance notification to truckers allowing them to increase their efficiency.
- Early notification of return of pavement strength allowing rapid removal of restrictions.
- Increased satisfaction and comfort level with decision making practices.

5.3.6 WRTM Strategy – Road and Lane Use Restriction Systems

Road and land use restriction systems limit the use of roadways (lanes or entire road closures) during severe road weather conditions. These restrictions could be posted on highway message signs and/or

traveler information systems. The restrictions are typically initiated by an operations center. Numerous States have deployed this strategy to close roads due to severe road weather conditions.

Evaluation Design

Table 13 provides guidance to those interested in evaluating road and land use restriction systems. The recommended approach to evaluate road and land use restriction systems is to utilize a before-after research design. This strategy would not lend itself to a with-without evaluation design because restrictions of this type are not typically optional and would have to be in place if the conditions warranted it. Using this approach, a direct comparison in the specific location of the deployment can be made for each of the MOEs before the system was implemented compared with the restrictions implemented.

The outcome MOEs can be phrased in terms of hypotheses to be tested, such as:

- Drivers and CVOs recognize and understand the restrictions and respond appropriately.
- Road segments with conditions that require restrictions have a better safety record when road and land use restriction systems are in place than those without such systems.
- Operators, maintenance and the traveling public recognize the benefits of, and appropriately respond to, road restrictions.
- Maintenance forces are able to bring lanes/roads back to an acceptable level-of-service (LOS) with a road and land use restriction systems in place, versus no system.

Data Requirements and Analysis

Data requirements to support output and outcome MOEs are provided in Table 13. It is also important to consider the weather conditions present during the data collection periods (baseline and post-system deployment). Analysis examples that the evaluation may consider include:

- Lane and road restrictions are issued/posted at appropriate times given the weather conditions and when designated thresholds are exceeded (just before, during, and just after the threshold was exceeded).
- Determine the percent of targeted drivers/vehicles that comply with the restrictions imposed.
- Comparison of maintenance effort required to bring lanes/roads back to LOS for a given location before and after a road and land use restriction system was implemented.
- Comparison of number of crashes/injuries/fatalities before and after the road and land use restriction systems implementation during periods when the road weather conditions exceeded the established threshold (just before, during, and just after the threshold was exceeded). A baseline should be established with crash data for at least the prior 3 years before the implementation of the WRTM strategy.

Table 13. Evaluation Guidance for Road and Lane Use Restriction Systems

Road and Lane Use Restriction Systems	
<p>Description: These strategies involve either requiring specific types of vehicles to use selected lanes during certain weather events (e.g., trucks use right lane), or controlling access to an entire roadway. This may include restricting the use of special lanes by certain types of vehicle or to all vehicles (e.g., right lane closed ahead). It also involves implementing controls that limit vehicle access to specific sections of roadway. Access could be restricted to specific structures (such as bridges, or causeways), passes, or entire sections of roadway. Under certain weather conditions a road may be closed entirely for a period of time until conditions improve.</p> <p>Key Inputs:</p> <ul style="list-style-type: none"> • Weather and pavement conditions from road sensors, cameras, weather services, field personnel (including lane conditions for multi-lane roadways), time stamped and archived (by site locations, and before, during and after restriction periods) • Road weather forecasts from weather services • Operational procedures and operator training to support decisions to impose restrictions or closures, including coordination with all agencies involved in closure decisions • Real-time traffic condition information <p>Key Output MOEs:</p> <ul style="list-style-type: none"> • Timeliness of restriction and/or closure posting and removal • Appropriateness of restriction and/or closure to actual conditions • Coordination of restriction decisions for contiguous roadways across jurisdictions and States <p>Key Outcome MOEs:</p> <ul style="list-style-type: none"> • Reduction in number of crashes, injuries and fatalities, both for restricted vehicle types and collateral impacts to other vehicles • Increased efficiency and reduced time with which maintenance is able to bring lanes/roads back to LOS • Improved throughput, travel times and reliability, and reduced speed variability for general traffic on restricted roadways 	<p>Examples of Strategy Applications:</p> <ul style="list-style-type: none"> • Roads or lanes closed due to weather conditions • Heavy or blowing snow, ice • High winds • Low visibility • Flooding • Specified vehicle types restricted (roads or lanes) due to weather conditions <p>Data Requirements:</p> <ul style="list-style-type: none"> • System archives of restriction and/or closure posting, changes, and removal (time posted; time removed; notification timing; how restriction notice was disseminated; restriction adjustments) • Reports from field engineers, or surveys/interviews with affected CVOs, of appropriateness of restriction and/or closure decision for the road-weather conditions • Interviews with decision-makers to describe decision process <p>Data Requirements:</p> <ul style="list-style-type: none"> • State records of crashes, injuries, and fatalities along route segments for which restrictions and/or closures have been posted • Trip logs maintained by drivers, license plate reader data, travel speed radar data, or probe vehicle data to measure travel times • System records of time when lanes and/or roads are returned to LOS (compared with estimate of time it would have taken in the absence of restrictions and/or closures, based on historical records, engineering judgment, or the experience with similar lanes/roads that were not restricted)

Evaluation Example

Most of the evaluation experience with this strategy is related to road closures due to severe weather conditions. Many States have systems that close roads (either manually or automatically) to protect the traveling public from dangerous conditions. Typical weather conditions that may require a section of road to be closed include dense fog, strong winds, flooding, heavy or blowing snow, and icy pavement conditions.

The literature identified the States of North and South Dakota, Iowa, Wyoming, and Minnesota among the most proactive in the implementation of this WRTM strategy. In the case of Minnesota DOT, they have installed gates along I-90 and I-94 to guide traffic off the freeway and prohibit access during

weather events that are considered life-threatening [32]. The I-90 gate operation involves automated gate closure devices that are designed to operate in all climates and are FHWA approved for crashworthiness, safety, and operability. The existing gate arms are used in conjunction with an automatic electronic actuator to raise and lower the gates using a wireless signaling device. The automated gates are designed to be controlled from the Mn/DOT District 7 Office in Windom, Minnesota through wireless communication with Internet access and back-up landline.

Evaluation Outcomes

The evaluation of the MNDOT automated gate closure system was focused on the following outcome MOEs listed in Table 13: Increased efficiency and reduced time with which maintenance is able to bring lanes/roads back to LOS.

Evaluation Approach

The MnDOT system was evaluated using a “with and without” case study approach on similar roadways [33]. A severe snowstorm that struck District 7 in November, 1998 provided a good case study to compare effort, time, and corresponding costs for clearing a section of I-90 (closed with gates) and US Highway 75 (remained open to traffic). This evaluation example is a good illustration of implementing this WRTM strategy using automated closure gates on ramps and Interstate mainlines.

Results

Based on Mn/DOT’s Operations Management System Reports from the day that both roadways were cleared to bare pavement (95% clear), the following evaluation results were documented:

- Plows made 4 passes before I-90 was 95% clear and opened, while 10 passes were made on Highway 75 before it was 95% clear. This resulted in I-90 being cleared to bare pavement (95% clear) 4 hours sooner than Highway 75. The report indicated that most of this difference was caused by the fact that I-90 experienced very little compaction attributed to vehicles on the roadway while Highway 75 experienced greater compaction because it was open to travel.
- Approximately \$20 in labor and materials was expended per lane mile on I-90, while approximately \$24 was expended per lane mile for Highway 75.

5.3.7 WRTM Strategy – Traffic Signal Control Systems

Weather responsive traffic signal control systems include strategies that attempt to alter or implement new signal timing to improve safety at intersections and increase vehicle throughput in a corridor or grid during road weather conditions that impact travel. The road weather conditions that would be addressed by this strategy include ice and snow on the pavement that severely impact traction (both stopping and starting up a vehicle). The weather responsive traffic signal timing plans would be developed and implemented by the traffic management center. This is a relatively new concept, and applications of such systems are very few.

Evaluation Design

Table 14 provides guidance to those interested in evaluating weather responsive traffic signal control systems. The recommended approach utilizes a before-after research design. A with-without design

also could be used to during limited area proof of concept evaluation to determine if the signal timing plans produce the expected results and if they should be considered for implementation in other areas of the transportation network. This is being taken by Colorado Springs, CO. Initial weather responsive signal timing plans are being tested in one of the sixteen grids in the city's transportation system. Depending on the results of the evaluation, decisions will be made regarding refinement of timing plans and expansion of deployment. Finally, an "on-off" design could be used to evaluate an installed system, in which the operators could turn off selected intersection weather responsive timing plans and compare performance of intersections with different active timing plans. The evaluation approaches presented in Table 14 reflect the recent experiences with signal control systems in Colorado Springs and elsewhere.

The outcome MOEs can be phrased in terms of hypotheses to be tested, such as:

- Locations utilizing weather responsive traffic signal timing plans have a better safety record when severe winter weather exists than those using traditional signal timing plans.
- Throughput and travel times are improved using weather responsive traffic signal timing plans over using traditional signal timing plans.

Data Requirements and Analysis

Data requirements to support output and outcome MOEs are provided in Table 14. It is also important to consider the weather conditions present during the data collection periods (baseline and post-system deployment). Examples that the evaluation may want to consider include:

- Comparison of vehicle throughput during severe winter weather (ice and snow) before and after implementation of the weather responsive traffic control systems.
- Comparison of travel times through an arterial corridor during severe winter weather (ice and snow) before and after implementation of the weather responsive traffic control systems.
- Comparison of number of crashes/injuries/fatalities before and after the weather responsive traffic control systems are implemented during adverse weather conditions. A baseline should be established using crash data from at least 3 years before the implementation of the WRTM strategy.

Table 14. Evaluation Guidance for Traffic Signal Control Systems

Traffic Signal Control Systems	
<p>Description: These strategies involve the following elements:</p> <ul style="list-style-type: none"> Reconfiguring detector settings or implementing special detector schemes/layouts to ensure detection of vehicles at traffic signals. This might involve overlapping detector layouts or changing detector settings based on prevailing weather and pavement conditions. Altering the time duration of vehicle and pedestrian clearance intervals (i.e., yellow change interval, all-red interval, and pedestrian clearance interval) to account for lost pavement friction and slow traffic speed approaching signalized intersections. Altering the time duration and/or sequencing of traffic signal phases during inclement weather conditions to account for increases in start-up lost time, reduced travel speeds, and reduced pavement traction. This might include altering minimum green intervals, maximum green intervals, gap out settings, phase sequences, etc. Implementing new signal timing coordination plans designed to improve progression and account for reductions in travel speeds during inclement weather conditions. Timing plans could be implemented through operators in a control center or automatically based on field measurements of weather conditions. Implementing special timing plans to account for lost freeway capacity, slow travel speeds, and increased start-up time at ramp control signals. Strategies could include limiting flow entering the freeway or strategies to increase ramp capacities during inclement weather. 	<p>Examples of Strategy Applications:</p> <ul style="list-style-type: none"> Reconfigure detectors to assure detection of vehicles at traffic signals under various weather conditions, such as compacted snow covering detectors and lane markings Adjust vehicle and pedestrian clearance intervals at intersections to be responsive to various weather conditions Adjust signal timing (duration and sequencing) Adjust signal timing coordination in a corridor to manage traffic speeds and throughput Adjust ramp meter timing strategies to account for the effects of weather on traffic
<p>Key Inputs:</p> <ul style="list-style-type: none"> Weather and pavement conditions from road sensors, subsurface probes, cameras, weather services, field personnel (especially conditions in the vicinity of signalized intersections, and on freeways and associated metered freeway ramps), before, during and after implementation of signal controls Signal and ramp meter detection and timing plans and procedures in place (under both normal and adverse weather conditions) Road weather forecasts from weather services Operational procedures and operator training to support decisions to adjust signal and ramp meter timing, including centralized capability to control signal timing and settings Real-time traffic condition and flow information Coordination with transportation and law enforcement agencies that operate on affected signalized corridors 	
<p>Key Output MOEs:</p> <ul style="list-style-type: none"> Timeliness of initiation and removal of signal and ramp meter timing plans Appropriateness of timing plans/changes to actual conditions 	<p>Data Requirements:</p> <ul style="list-style-type: none"> System archives of timing plan initiation, status, changes, and removal (time activated; time removed; timing adjustments) Reports from field engineers, or surveys/interviews with affected drivers (including transit), of effectiveness of timing adjustments
<p>Key Outcome MOEs:</p> <ul style="list-style-type: none"> Reduction in number of crashes, injuries and fatalities at or near signalized intersections Travel times and/or delays through affected signalized corridors, and on mainlines that included affected metered ramps 	<p>Data Requirements:</p> <ul style="list-style-type: none"> State records of crashes, injuries, and fatalities along affected signalized corridors System records of travel times through affected signalized corridors, and on mainlines that include affected metered ramps (number of vehicles per hour; travel time in the corridor, and average traffic speeds at selected locations)

Evaluation Example

No examples of evaluations of weather responsive traffic signal or ramp metering control systems have been identified because applications of these systems to address adverse weather are very recent, and only a few agencies have begun to explore installing such systems. However, evaluations of intersection signal control systems and ramp metering systems that address issues under normal travel conditions have been conducted and they offer some insight into evaluation strategies that could be extended to such systems employed under adverse weather.

An adaptive traffic control system was installed in Park City, Utah, to improve traffic performance at its network of signalized intersections, and an evaluation report on the system's performance was published in 2009 [60]. The Minnesota Department of Transportation (Mn/DOT) commissioned an evaluation of their ramp metering system, and a report was published in 2002 [61]. These two evaluation studies are briefly summarized, and their potential applicability to similar systems under adverse weather is discussed.

Evaluation Outcomes

Each of the evaluation studies cited above addresses the two outcome MOEs listed in Table 14:

- Reduction in number of crashes, injuries and fatalities at or near signalized intersections or on mainlines served by metered ramps.
- Travel times and/or delays through affected signalized corridors, and on mainlines that include affected metered ramps.

Evaluation Approach

Time-of-day signal timings for eight intersections in Park City, UT were collected, employing both "before-after" and "on-off" timing plans. To measure responses to the signal timing adjustments, vehicle probe data were collected that documented travel times and number of stops. Observers at intersections collected data on stops and delays, using 16-second sampling intervals in a series of five-minute studies, to assess average stop-delay and the influence of the new signal timing system. The "on-off" design was preferred in order to control for changes in road conditions, such as intersection geometry, traffic demand and distribution on the network, speed limits, parking, signal phasing, and signal controller settings. Changes over time in these parameters can compromise a before-after evaluation design.

In the fall of 2000 Mn/DOT evaluated the effectiveness of the system performance, public acceptance, and benefit-cost tradeoffs of their ramp metering system in the Twin Cities Metropolitan Region. Data were collected on selected freeway segments and a parallel arterial. A market research study was also conducted using a telephone survey of travelers. Freeway and ramp loop detectors automatically monitored traffic flow, and TMC operators collected observations of ramp meter violation rates, spillover frequency, and traffic conflicts associated with the ramps. Ramp volume data and ramp meter turn-on times were recorded by the TMC system. The Department of Public Safety incident database was used to assess safety impacts at selected corridors and on-ramps.

Results

Analysis of the new signal timing system in Park City showed two or more seconds less delay on both the main and side roads under the new system. Average travel times and number of stops showed

small but measurable improvements under the new system. While an objective of this evaluation study was to determine whether the “on-off” methodology produced better results than the “before-after” approach, which it did, the general evaluation approach should apply equally well under adverse weather conditions as a way to assess system benefits.

Similarly, the Mn/DOT evaluation of the performance of their ramp meter system should also be applicable under adverse weather. Their study showed:

- An average 9% traffic volume reduction on freeways, no change on arterials, and an average 14% decline in freeway throughput under the “without meters” condition.
- Annual system wide savings of 25,121 hours of travel time with ramp meters.
- Without ramp metering, freeway travel time is almost twice as unpredictable as with metering. Ramp meters produce an annual reduction of 2.6 million hours of unexpected delay.
- Ramp metering results in annual savings of 1,041 crashes (about four per day).
- Metering results in emissions reductions but an increase in fuel consumption.
- Metering results in a net benefit of \$32 to \$37 million per year. Benefits are about five times the cost of the entire congestion management system and over 15 times the cost of the ramp metering system alone.

5.3.8 WRTM Strategy – Service and Courtesy Patrol Systems

Service and courtesy patrol systems provide increased service on selected roadways during inclement weather.

Evaluation Design

Table 15 provides guidance to those interested in evaluating service and courtesy patrol systems. Although a system of this type may be focused on a specific location, more typically it is focused on providing these services across a region or large area (a network of freeways, highways or major arterials).

The recommended approach to evaluate service and courtesy patrol systems is to utilize either a ‘before-after’ or ‘with-without’ comparison. The approach will depend on the extent of the services being deployed, the expected outcomes of the system, and the stage of deployment. Using the before-after method, a direct comparison can be made of MOE’s before and after the system was implemented in the specific location or larger region. A with-without approach can compare a deployed system with another location or corridor that experiences similar road weather conditions to measure the performance and benefits of this strategy.

The outcome MOEs can be expressed in terms of hypotheses to be tested, such as:

- Weather responsive service and courtesy patrols are more effective at clearing the roadway and assisting stranded motorists than traditional services in which a motorist calls for a tow truck or a contract service such as the American Automobile Association.
- Stranded motorists recognize the benefit of the enhanced services during inclement weather.

Data Requirements and Analysis

Data requirements to support output and outcome MOEs are provided in Table 15. It is also important to consider the weather conditions present during the data collection periods (baseline and post-system deployment). Analysis examples that the evaluation may consider include:

- Comparison of vehicle throughput during severe winter weather in areas where service patrols have been enhanced versus standard service (note: potential throughput increases would be due to aiding/removing stranded vehicles causing traffic delays).
- Comparison of travel time through a given corridor during severe winter weather in areas where service patrols have been enhanced versus areas where they are not provided (note: potential travel time decreases would be due to aiding/removing stranded vehicles that cause traffic delays).
- Percent of travelers interviewed that indicated a high level of satisfaction with the service provided (at enhanced levels) during inclement weather versus standard service levels.

Table 15. Evaluation Guidance for Service and Courtesy Patrol Systems**Service and Courtesy Patrol Systems**

Description: These strategies involve increasing the presence of full function courtesy or service patrols on freeways, and selected arterials, during inclement weather conditions. This might include increasing the number of patrols, shortening service routes, or repositioning patrols in known trouble spots.

Examples of Strategy Applications:

- Patrols that are proactively assigned to specific locations where past weather-related safety problems have been concentrated or where road weather forecasts are predicting dangerous conditions, including (for example):
 - Snow, ice
 - High winds
 - Low visibility (fog, blowing snow, smoke)
 - Flooding
- Patrols that are able to provide real time feedback to operations and maintenance to affect improved traveler notification and maintenance response to conditions

Key Inputs:

- Weather and pavement conditions and forecasts, and reports from field personnel of locations posing a driving hazard due to adverse weather
- Time stamped archived road weather condition data, including subsurface probe data if available (appropriate to site locations where patrols were assigned, and before, during and after assignment periods)
- Road weather forecasts from weather services (especially those targeted to specific areas)
- Availability of service patrols with experienced driver operators
- Real-time traffic condition information and/or information on traffic problems due to weather

Key Output MOEs:

- Timeliness of patrol assignments
- Appropriateness of patrol assignments relative to actual road weather conditions (the efficiency of assigned patrols)
- Real time field reports from patrols regarding conditions where they are assigned

Data Requirements:

- Logs of times when patrols were assigned, location of assignment, length of period of time on assigned location, and individual assigned (driver name, for follow-up information)
- Reports from the assigned patrols that include a description of road weather and traffic conditions encountered, effects on traffic, resultant accidents/crashes, number of vehicles serviced, and perception of suitability of assignment
- Interviews with decision-makers to describe the patrol assignment decision process
- Interviews with patrol drivers on actions taken and information provided to enhance operations and maintenance

Key Outcome MOEs:

- Effectiveness in aiding stranded vehicles, moving them off the active roadway, facilitating mobility
- Travel time and delays due to weather-related incidents or motorists stranded due to weather
- Customer satisfaction

Data Requirements:

- Time to assist and clear vehicles off roadway and/or get vehicles moving again, total number of vehicles assisted, and estimate of total number of vehicles delayed by each incident
- Estimate of congestion avoided per incident serviced
- Ratio of number of vehicles serviced to total number of vehicles that could have been serviced (coverage of patrols)
- Surveys/interviews with travelers who were aided to assess perceived benefits of the service

Evaluation Example

A benefits evaluation of a pilot test of courtesy patrol on Denver, CO area freeways was conducted by the University of Colorado at Denver in 1995 [62]. The evaluation sought to assess the performance of these patrols in meeting the objectives of enhanced incident management during rush hours and in reducing congestion.

The Michigan Department of Transportation operates a freeway courtesy patrol, primarily in response to vehicle breakdowns and crashes on freeways. In 2008 the Southeast Michigan Council of Governments initiated an evaluation to assess its effect on congestion relief and safety [63]. Since its

inception in 1994 until 2008 the patrol assisted 230,149 stranded motorists, made 108,440 unoccupied vehicle stops, and stopped to clear debris 12,460 times.

While these evaluations did not directly seek to address the effects of adverse weather on incident occurrence and clearance times, it seems reasonable to assume that the kinds of data collected and analyses conducted in these two studies could be applied to weather-related incidents to show both response time and safety benefits.

Evaluation Outcomes

Both the Colorado and Michigan evaluations evaluated the effectiveness of their courtesy patrols in assisting stranded motorists, clearing the roadway, reducing congestion, and enhancing overall traveler safety. Performance goals included reducing time for incident detection, verification, response, and clearance, and in addition providing effective scene management and timely information to motorists.

Evaluation Approach

The Denver evaluation examined the four phases of the time from the occurrence of an incident that causes congestion to the return to normal traffic flow: 1) the detection phase from when an incident occurs to the time a responder is aware of it, 2) the response phase which is the time it takes a responder to arrive on the scene, 3) the service phase from responder arrival to clearance, and 4) the queue dissipation phase or normal traffic restoration time. They collected details on these phase times, incident type details, and effects on traffic. Focusing on response and service times they assessed performance with and without patrols.

Michigan patrol operators fill out a service call card at each vehicle stop, and then the data are entered into a database at the dispatch center. These data are used to make operational adjustments and monitor cost effectiveness of the service.

Results

In the Denver evaluation, for incidents that did not block a lane, average incident duration time decreased by 8.6 minutes with service patrols. This resulted in an average saving of 98 vehicle hours of delay for a cleared morning incident and 75 hours saving for an afternoon clearance. The evaluation estimated this program saved between \$1.75 and \$2.03 million by reducing motorist delays, with a cost of operating the patrols of between \$120 and \$168 thousand. Thus, the program returned \$10.50 to \$16.90 for every \$1.00 spent.

The Michigan evaluation reported a similar benefit of their patrols of \$15.20 for every dollar spent in 2008. They also estimated the program saved commuters 11.5 million hours of delay in that year, resulting in significant reductions in air pollution.

Safety benefits from both these programs were not measured directly, but were assumed to follow from the effectiveness with which incidents were identified and cleared through the use of courtesy patrols, particularly reducing the risk of secondary accidents.

The data and analysis in this example covered all types of incidents encountered. In order to apply this to weather-related incidents, the evaluation would need to clearly identify the subset of incidents that were caused partially or entirely by weather, and apply a similar data collection and analysis

approach to those incidents. The appropriate baseline condition against which to measure the effectiveness of the courtesy patrol would be the mobility and throughput under the given weather condition that existed when the incident occurred. Ultimately, the ability to evaluate this strategy depends on the availability of weather information in response logs maintained by the courtesy patrol.

5.3.9 WRTM Strategy – Agency Coordination and Integration Policies

Agency coordination and integration involves establishing policies and procedures encouraging increased levels of intra- and inter-agency coordination during inclement weather. These increased levels of coordination and integration are intended to facilitate better event planning, knowledge sharing, effective decision making, and efficient response. Experience indicates that implementing this strategy by agencies that respond to major weather events can have dramatic positive impacts on improving their operations. Examples of such policies range from sharing of weather and pavement condition information between TMCs and maintenance centers/personnel to facilitate more timely traveler notification and better informed maintenance decisions, to co-location of highway patrol and emergency response agencies collocated in a TMC to enhance communications and mutual awareness of impending adverse weather conditions, or tabletop exercises include local TMC operators, State DOT personnel, emergency responders, road maintenance, and meteorologists to plan for weather condition responses and decision making strategies. They may also include multi-jurisdictional sharing of control strategies (regional traffic signal programs, coordination of ramp meters and adjacent signal systems, regional 511), regional data sharing.

Evaluation Design

Table 16 provides guidance to those interested in evaluating agency coordination and integration systems. Typically, these types of policies impact the entire area for which cooperating agencies are responsible. The recommended approach to evaluate agency coordination and integration systems is to utilize a before-after research design. Using the before-after design, a direct comparison can be made for each of the MOEs before the policy was implemented (current level of coordination and integration) compared with the full implementation of the policy (enhanced coordination and integration).

The outcome MOEs can be expressed in terms of hypotheses to be tested, such as:

- Road weather management decisions are more effective and efficient (using standard performance measurement standards of the agencies) with enhanced agency coordination and integration systems implemented than before such systems existed.
- Safety (in terms of crashes, injuries, and fatalities) and mobility (in terms of increased throughput and decreased travel delays) are improved with enhanced agency coordination and integration systems implemented than before such systems existed.
- Agency staff perceives improvements in agency coordination and integration with the new systems implemented.

Data Requirements and Analysis

Data requirements to support output and outcome MOEs are provided in Table 16. It is also important to consider the weather conditions present during the data collection periods (baseline and post-system deployment). The analysis of this strategy will include both quantitative and qualitative measurement and collection of data. While it will be important for all the participating agencies to

assess qualitatively the benefits of more coordination through information sharing, joint decision making, and shared activities, it also will be important to seek to identify good quantitative measures of the benefits of greater coordination. This could include data not only on the number of new policies, procedures, and training sessions related to coordination, but also improvements in response to weather-related traffic impacts due to joint agency decision making, or information sharing that leads to faster, more effective emergency response under conditions of adverse weather.

Table 16. Evaluation Guidance for Agency Coordination and Integration Systems

Agency Coordination and Integration Systems	
<p>Description: This strategy involves developing policies, processes, procedures, and systems designed to promote better interagency and intra-agency coordination during inclement weather events. These strategies are similar in nature to those used to develop multi-agency incident response plans.</p>	<p>Examples of Strategy Applications:</p> <ul style="list-style-type: none"> • TMC operations and maintenance share weather and pavement condition information to facilitate more timely traveler notification and better informed maintenance decisions • Highway patrol and emergency response agencies collocated in a TMC to enhance communications and mutual awareness of impending adverse weather conditions • Tabletop exercises include local TMC operators, State DOT personnel, emergency responders, road maintenance, and meteorologists to plan for weather condition responses and decision making strategies • Revised or newly created policies and procedures to ensure appropriate inter- and intra-agency coordination during adverse weather conditions
<p>Key Inputs:</p> <ul style="list-style-type: none"> • Weather experts (meteorologists) working closely with operations and maintenance decision makers, providing weather forecasts, interpreting weather data, and support for road weather policy development • Road weather forecasts from weather services • Historical and current road weather condition information • Institutional support for active integration and coordination across key agencies during weather events 	<p>Data Requirements:</p> <ul style="list-style-type: none"> • Records of agency meetings held and representation of the agencies expected to attend • Records of policies created that reflect coordinated approach to road weather management • Records of training conducted to support intra and inter-agency coordination with regard to adverse weather
<p>Key Output MOEs:</p> <ul style="list-style-type: none"> • Number of meetings among key agency representatives per month • Number of policies, procedures, and systems developed to support coordinated decision making and actions during adverse weather • Number of training sessions (focused on enhanced coordination) for key related to adverse road weather conditions 	<p>Data Requirements:</p> <ul style="list-style-type: none"> • State-wide records of crashes, injuries, and fatalities during adverse weather (before and after implementation of coordinated, integrated approach to decision making) • State-wide system records of mobility and throughput (before and after implementation of coordinated, integrated approach to decision making) • Surveys/interviews of involved agency staff regarding perceptions of outcome attainment
<p>Key Outcome MOEs:</p> <ul style="list-style-type: none"> • Efficiency and effectiveness of road weather management decisions • Improvements in transportation system performance, in terms of mobility and safety, during adverse weather • Improvements in agency staff perceptions of coordination during adverse weather 	<p>Data Requirements:</p> <ul style="list-style-type: none"> • State-wide records of crashes, injuries, and fatalities during adverse weather (before and after implementation of coordinated, integrated approach to decision making) • State-wide system records of mobility and throughput (before and after implementation of coordinated, integrated approach to decision making) • Surveys/interviews of involved agency staff regarding perceptions of outcome attainment

Evaluation Example

An evaluation was conducted for the Utah Department of Transportation (UDOT) to examine the business case for their weather operations and assess the effectiveness and benefits particularly to the UDOT maintenance and construction functions [64]. The evaluation examined the value and ease of use of the information, its effect on users' behaviors, and the benefits of the weather service to winter maintenance personnel. The evaluation sheds light on the value of collocating meteorologists in the UDOT TMC and of enhanced collaboration between operations, maintenance and related functions. Four meteorologists provide year-round support to activities including operations, winter maintenance, road construction, planning, training and incident management.

Evaluation Outcomes

The evaluation report assesses and demonstrates the value to operations and system performance of a proactive approach facilitated by improved weather information coming into the DOT, being interpreted by professional meteorologists, shared and coordinated with key stakeholders, and yielding measurable benefits that exceed costs, primarily to winter maintenance. The MOE for this strategy most directly supported by this evaluation study is: "Improvements in agency staff perceptions of coordination during adverse weather," and more specifically the perceived value of close interaction between meteorologists and the operations, maintenance, and construction functions of a DOT/TMC.

Evaluation Approach

The evaluation included both a quantitative component that involved benefit-cost modeling and a qualitative component based on interviews with the user community. The modeled component sought to predict labor and material costs of road maintenance using a set of factors that included use and perceived value of UDOT's weather services by maintenance sheds, level of anti-icing practices, vehicle miles traveled, and winter severity index. Eighty UDOT maintenance personnel were surveyed and asked about their use of UDOT's weather services to support their decision making, their perceived usefulness of those services, methods by which this information was shared with them, frequency of the uses of this information, and their perceptions of the overall reliability/quality of the information and their satisfaction with it.

Results

- 76% of respondents said that UDOT's weather forecasts were more reliable than other services, and 85% said they were more usable.
- 90% said the program provided a better level of service compared with other services.
- 80% of maintenance personnel said they changed their approach to winter maintenance by using these services.
- UDOT's program is estimated to save UDOT maintenance \$2.2 million per year in labor and material costs for winter maintenance, yielding a benefit-cost ratio of 10:1.
- Respondents said they particularly desired increased personal communications between maintenance employees and the meteorologists.

Chapter 6 Conclusions and Recommendations

This chapter provides the overall conclusions and recommendations for the project.

6.1 Conclusions

The project was able to take a comprehensive look at the State of the practice in WRTM and identify improvements required to enhance the ability of transportation system operators to manage traffic during adverse weather.

WRTM is not a single strategy but rather a broad-based set of techniques, tools and systems that transportation agencies use to mitigate the impacts of weather. As of today, WRTM exists mostly as individual systems designed to address spot-specific issues. While such systems will continue to be important and essential to the safety and mobility of motorists, the next evolution of WRTM needs to be more regional in nature with agencies viewing WRTM as a set of progressive actions that they can implement in advance of, during, and after weather events in a regional or corridor-specific manner.

To this end, WRTM needs to be an essential part of traffic management fitting into existing systems and approaches used by agencies. Emerging areas such as Active Traffic Management and Integrated Corridor Management strive to provide new capabilities. It is important that weather and WRTM be an integral part of these deployments.

The major challenge of WRTM is the need for further research to be conducted to understand the linkages between weather, road conditions, WRTM strategies, and predicted impacts. The uncertainty in these linkages results in a lack of confidence among State DOTs for implementing proactive WRTM strategies. The lack of validated and calibrated decision support systems and demonstration/documentation of their benefits are barriers that need to be overcome. Recent research and program initiatives from the RWMP have started to address these issues.

The following section provides the recommendations building on the conclusions of the study.

6.2 Recommendations

This section identifies specific recommendations that define a roadmap (next steps) to continue the efforts of the RWMP to promote and enhance the deployment of WRTM in the country. Specific recommendations include:

1. Create and maintain an engaged stakeholder community for WRTM.
2. Incorporate WRTM Pilots as part of State-led efforts on Active Traffic Management and Integrated Corridor Management.
3. Facilitate the Deployment and Testing of Weather-Responsive Signal Timing Strategies as a Viable Traffic Management Strategy

4. Continue the Development and Testing of Seasonal Weight Restrictions
5. Continue and expand research on impact prediction, simulation, and decision-support.
6. Identify and document benefits of WRTM strategies.
7. Identify intra- and inter-agency communication barriers and methods of overcoming institutional issues.

Each recommendation describes the objective, rationale, approach, and outcome – providing the details to understand its importance and significance to increase the awareness and application of WRTM. Identified within each recommendation is a set of activities or tasks necessary to achieve the overall objective of the recommendation. Although the recommendations are not in a priority order, there is high degree of interaction among them. Outcomes of a particular recommendation can be used to inform or support other recommendations.

6.2.1 Recommendation #1 – Create and Maintain an Engaged Stakeholder Community for WRTM

Objective: To develop an engaged stakeholder group focused on WRTM bringing sustained attention and emphasis on regional and proactive management of weather.

Rationale: WRTM involves a large stakeholder community including traffic managers, maintenance staff, weather data/product providers, universities, transit agencies, emergency personnel, and private sector system developers and integrators. As understanding of the potential of WRTM evolves, there is a need to have a community that is active in supporting WRTM and championing the cause of proactive management of traffic during adverse weather. Both potential implementers of WRTM strategies and those who may be able to support such implementations are not well aware of the range of strategies and their potential benefits. Stakeholder outreach to a broad group of potential implementers of WRTM strategies is needed to educate and better market the benefits.

Approach: The RWMP has been a strong proponent of stakeholder outreach and participation as evidenced by the strong community that has been created for *Clarus* and MDSS. While these communities are essential for WRTM, they are comprised primarily of two groups, the maintenance community and the weather/meteorological community. These two groups are essential for WRTM; but the broader role of WRTM implies a larger stakeholder group including:

- Traffic engineers, planners and analysts.
- System operators – These are the people who work in control centers including both traffic and transit control centers. These operators manage resources for implementing advisory and control strategies.
- Researchers – The linkages between weather and traffic impacts are still being established. A vibrant research community is essential for the success of WRTM, working on the current and forecasted impacts of weather on system operations and developing models and analytical tools to improve decision-making.
- Private sector system developers/integrators – It is important that WRTM decisions are integrated into the traffic management systems and software used by agencies. More so, as evidenced by the ConOps for WRTM, the need for weather-related decision support to be linked with traffic management control software is essential.

The RWMP has already begun the process of creating such a community by planning a WRTM workshop in the fall of 2011. This effort needs to be sustained and maintained over the next couple of years similar to the *Clarus*/MDSS communities. The primary goal of this recommendation is to share existing and emerging concepts, information, and developments to as many potential implementers of WRTM strategies as possible and encourage traffic managers to implement these practical and cost-effective strategies. Specific activities recommended include:

- Conduct a national workshop for State DOTs, traffic managers, and other supporting groups to educate stakeholders and promote the WRTM strategies described in this report.
- Publicize and distribute this report to FHWA regional offices, traffic management centers, other interested government agencies, potential vendors of related equipment and software, and organizations that may be interested in the information, such as the TMC Pooled Fund Program, the TRB, the Institute of Transportation Engineers (ITE), and the American Association of State Highway and Transportation Officials (AASHTO) and their committees and subcommittees that focus on operations and maintenance, and specific FHWA programs such as the Active Transportation Demand Management (ATDM), Integrated Corridor Management (ICM), and the Connected Vehicle initiative.
- Develop an outreach plan that focuses promotion efforts on the groups and organizations listed above and executes that plan. The plan may contain items such as the development of presentation(s) defining and promoting WRTM strategies, presenting that information at key conferences and group meetings, actively contacting traffic managers in the country and discussing the potential of WRTM strategy implementation.
- Develop and deliver training on WRTM, such as a web-based, on-line training course that would describe the WRTM program, the strategies that are included in WRTM, how they can be implemented to address weather issues and needs, the tools available, evaluation strategies, and best practice guidance.

Outcomes: The outcome of this recommendation would be a knowledgeable and equipped community of potential WRTM strategy implementers.

6.2.2. Recommendation #2 – Incorporate WRTM Pilots as part of State-led efforts on Active Traffic Management and Integrated Corridor Management

Objective: Create real-world implementation examples of WRTM by leveraging existing cutting-edge efforts in certain States and cities.

Rationale: Real-world applications of WRTM tend to be spot-specific and not well integrated into the larger notion of traffic management. Model applications of WRTM can provide the community with success stories and real-world results. A dedicated WRTM pilot may be difficult to justify; however, incorporation of WRTM into new and emerging approaches being considered by States and localities is a highly promising approach. The RWMP needs to consider the opportunities to test WRTM in two major initiatives supported by USDOT – Integrated Corridor Management (ICM) and Active Traffic Management (ATM). Both these initiatives are in stages where new deployments are being planned around the country. The RWMP should work with other groups within DOT to ensure that these deployments consider weather as part of their system deployment in a more comprehensive manner.

Approach: Currently, deployments already consider operations during weather as critical part of their system. The activities under this recommendation address more formally recognizing the role of weather in planned deployments for ICM and ATM around the country. These could include working

with federal and State partners to develop and implement a weather-responsive scenario for ATM using the Concept of Operations developed in this project or looking at intra- and inter-agency collaboration during weather events in an integrated corridor deployment. The RWMP could provide additional support to test and evaluate new WRTM strategies and techniques as part of these systems.

Outcomes: Real-world implementation of WRTM as part of ICM and ATM deployments with evaluation results.

6.2.3. Recommendation #3 – Facilitate the Deployment and Testing of Weather-Responsive Signal Timing Strategies as a Viable Traffic Management Strategy

Objective: To facilitate pilot deployments of weather-responsive traffic signal timing strategy to improve safety and efficiency during significant weather events.

Rationale: The state-of-the practice review showed weather-responsive traffic signal timing strategies to be still in their infancy. Only a few states have deployed and routinely use weather-responsive signal timing plans, even though weather events can have significant impacts on traffic signal operations. Traffic signal timings are often developed assuming ideal weather conditions. Weather events, such as heavy rain, thunderstorms, slush, ice and even snow can significantly affect the basic parameters used to develop traffic signal timings. These events can significantly affect visibility of traffic signal indications; increase start-up loss times, stopping distances, and vehicle headways; and reduce travel speeds and saturation flow rates. Significant accumulations can also obscure pavement markings which may cause drivers to travel outside the normal travel paths where vehicle detectors have been placed. All of the consequences of weather could potentially lead to losses in safety and efficiencies at signalized intersections. Agencies need assistance in determining how to develop and implement weather-responsive traffic signal timings. Many institutional, legal, technical, and operations issues still need to be resolved before agencies will accept widespread deployment of weather responsive signal timing strategies.

Approach: In order to achieve widespread acceptance of weather-responsive traffic signal timing plans, agencies need guidance and assistance to determine when and where these strategies are needed to maintain and improve operations during significant weather events. FHWA can provide this assistance to support more detailed system design and testing of weather-responsive signal timings. Specific actions to be taken include the following:

- Conduct a synthesis scan to determine institutional, legal, technical, and operational barriers to deploying weather-responsive traffic signal timing strategies.
- Coordinate the development of traffic signal control algorithms that can adapt timing settings and parameters based on weather conditions.
- Facilitate pilot deployments of weather-responsive signal timing strategies at key locations throughout the United States that to quantify and illustrate benefits.
- Consideration of inclusion of weather-related vehicle information and recommendations in *Signal Phasing and Timing (SPaT)* elements in the ITS Connected Vehicles Program.
- Facilitate the development of guidelines and techniques for developing and deploying weather-responsive signal timing.

Outcomes: The outcome of this recommendation would be a pilot test of weather-responsive signal timing strategy in one or more locations.

6.2.4. Recommendation #4 – Continue the Development and Testing of Seasonal Weight Restrictions

Objective: To increase the uniformity in which seasonal weight restrictions are applied and removed in states where freeze/thaw cycle significantly damage pavement conditions.

Rationale: Recently, FHWA supported a project to develop a tool for forecasting when and where seasonal weight restrictions would be needed to limit damage to pavement and subgrade conditions during spring thaw events as part of the *Clarus* Multi-State Regional Demonstration. The tool uses current road weather observations as well as forecast information to predict future subsurface temperature to support better decision making for placing load restrictions on certain section of roadway. The tool is currently being tested in North Dakota and Montana.

The Concept of Operations developed in this research effort examined methods for enhancing the utilization of this tool, with the intent of increasing uniformity of when and where seasonal weight restrictions should be applied to permit commercial freight haulers and others to better plan routes and loads for reaching their destinations. Having a better idea as to when and where travel by heavy vehicles is restricted across multiple states could have significant revenue impacts for commercial fleet operators.

Approach: In order to achieve widespread and consistent utilization of this tool, the research team recommends the following action items to be performed by FHWA:

- Refine and continue to test the seasonal weight restriction decision support tool developed as part of the *Clarus* multi-state regional demonstration.
- Develop guidelines and recommendations that states can follow to improve coordination with maintenance and enforcement personnel on the effects of imposing seasonal weight restrictions.
- Assist states in developing advanced notification procedures to disseminate where and when seasonal weight restrictions are applied and when and where they are removed.
- Inform and educate the trucking industry regarding the reasons why weight restrictions are needed, as well as their importance.

Outcomes: The outcome of this recommendation would be the consistent and justifiable application of seasonal weight restrictions across district and state boundaries.

6.2.5 Recommendation #5 – Continue and Expand Research on Impact Prediction, Simulation and Decision-support

Objective: Develop capability to predict impacts of adverse weather on traffic operations, enabling valuable decision-support systems as part of WRTM.

Rationale: Fundamentally, it was made clear by the expert panel recruited for this study that the linkage between weather conditions and traffic impacts is still unclear. Figure 9 illustrates the growing uncertainty across linkages that the expert panel felt was still an unknown. This confusion results in a lack of confidence in WRTM strategy implementation. The panel also noted that there is a paucity of

trusted tools and techniques to assess the impacts of weather on traffic conditions especially with and without the use of WRTM.

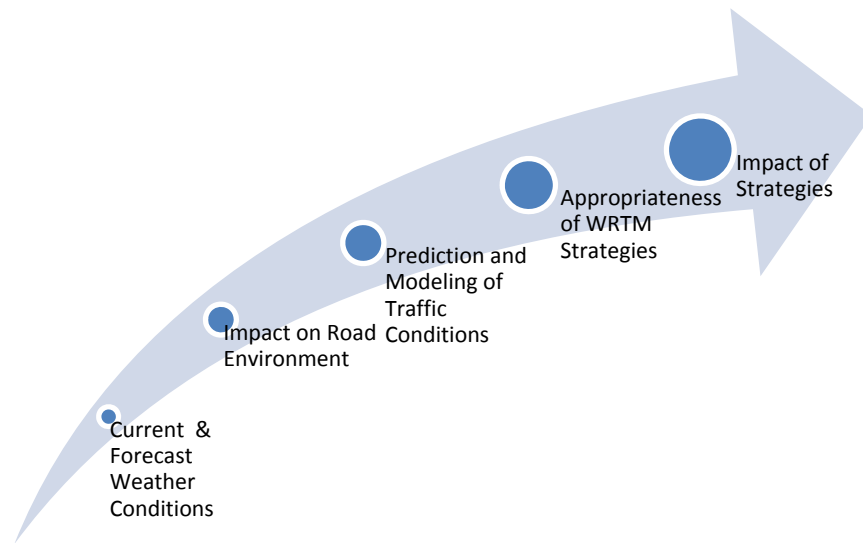

Figure 9. Growing Uncertainty along the Linkage between Weather Conditions and Traffic Impacts

In response to the need for such tools, the RWMP is working with researchers and universities in the US and abroad to collect and analyze data and develop models and tools to improve the analysis, modeling and prediction of traffic flow in all types of weather conditions. Moving from macro to micro analysis, the RWMP is looking at individual driver responses to weather conditions, such as changing lanes, merging onto a freeway, making a left turn across traffic at an intersection, or adjusting the distance behind a lead vehicle. Using video-taped data from intersections in Virginia and test tracks in Japan, the RWMP documented changes in gap-acceptance (how drivers perceive and accept gaps in traffic streams) that could be vital in changing traffic signal plans.

The goal of such studies is to inform model development and decision support tools that allow a user to translate current and forecast conditions to traffic impacts. Currently, weather is often assumed to be ideal in models used for traffic analysis. The RWMP modified two TrEPS prototypes—DYNASMART-P, a system for transportation planning, and DYNASMART-X, a real-time system for predicting traffic conditions and patterns—to account for weather impacts, improving their traffic estimation and prediction capabilities and overall utility. These weather-sensitive TrEPS models are currently being calibrated and tested in four cities around the US.

Approach: These tools will continue to be enhanced but admittedly, the biggest stumbling block with research in this area has been the lack of data available to create, validate and calibrate models. In turn, this has resulted in a dearth of decision-support tools for traffic managers during weather. Specific activities as part of this recommendation include:

- Work with state and local agencies to develop data sets linking traffic parameters to weather conditions as part of freeway and arterial monitoring systems.
- Work with ongoing research in the area of Connected Vehicles, specifically the real-time data capture and management track to develop data sets for WRTM research. Real-Time Data Capture and Management is the creation and expansion of access to high-quality, real-time and archived, multi-modal transportation data that is captured from connected vehicles

(automobiles, buses, trucks, fleet), mobile devices, and infrastructure resulting in data environments which promise to provide a wealth of data required for WRTM analysis. The RWMP has already initiated research with NCAR translating data derived from connected vehicles into useful data sets for weather-related research.

- RWMP should continue its efforts to develop weather-related parameters for micro-simulation models and should conduct tests of WRTM strategies with those models. After an initial set of tests the models could be installed in several agencies and simulations conducted in parallel with actual operations. A subsequent step would be to use the simulation results and test actual strategies implemented by transportation operating agencies.
- Collaborate with emerging “Dynamic Mobility Applications” track to look at weather-related applications especially in the area of multi-modal decision support systems.
- RWMP should pursue the actual testing and validation of TrEPs in the context of a regional planning and/or traffic operations agency. Currently, while the default values are set in the model, only through implementation and testing can these parameters be verified.
- Related to the above recommendation, the RWMP should pursue the use of TrEPs as part of real-time or near real-time decision support systems used for traffic operations. Such decision-support engines are being developed as part of the ICM initiative in San Diego and Dallas and may offer opportunities to test the weather-related aspects of decision-support.

Outcomes: Published and tested research on models and simulation approaches for supporting WRTM-related decision support.

6.2.6 Recommendation #6 – Identify and Document the Benefits of WRTM Strategies

Objective: In order to successfully promote WRTM strategies and encourage the traffic management community to consider their implementation to improve their operations, these practitioners need to better understand the potential benefits of WRTM strategies.

Rationale: The literature search conducted for this project has revealed very limited measurable benefits of weather responsive traffic management applications. The strongest potential benefits are documented in Chapter 3 and Chapter 5 of this report. Still, the documented benefits only hint to the range of benefits that are needed to fully promote WRTM strategies to a broad audience. The RWMP needs a comprehensive set of quantifiable benefits of WRTM strategies that can be shared with prospective traffic managers across the country who are interested in WRTM applications. Documented evidence of WRTM benefits can motivate them to investigate, and hopefully implement, WRTM in their agencies.

Approach: In combination with recommendation #1 which will identify a group of traffic managers across the county who are interested in implementing WRTM strategies, this recommendation involves the following activities:

- Contact a subset of interested traffic managers who are enhancing, or planning to enhance, their weather responsive traffic management capabilities. Those contacted will include agencies that served as the basis of the State-of-the-practice in WRTM capabilities. A short list of those believed to have recently expanded their WRTM capabilities or planning to do so in the near future would be developed.

- Assist the above short list of interested traffic managers to complete an evaluation plan and then carry out an evaluation of their WRTM strategy implementation. The evaluations to be conducted would be selected based on the desire for benefit information for the proposed strategy implementation, and as assessment of the likelihood of strategy implementation success and completing the evaluation. It is recommended that the RWMP support evaluations of at least three locations implementing a variety of WRTM strategies.
- Summarize the benefits realized by conducting a selected group of proposed evaluations into a report and database that can be used by the RWMP and others to promote the expanded utilization of WRTM strategies.

Outcome: The outcome of this recommendation will be a collection of documented benefits (a report and database) which will encourage others to consider deploying WRTM strategies throughout the country.

6.2.7 Recommendation #7 – Identify Intra- and Inter-agency Communication Barriers and Methods of Overcoming Institutional Issues

Objective: Improve the institutional capacity to implement WRTM around the country.

Rationale: The main barrier to WRTM is often institutional rather than technological. The broad nature of WRTM and the disparate roles and responsibilities of the various stakeholders involved create barriers to effectively implement an integrated approach to managing traffic during adverse weather. As the FHWA TMC integration project clearly illustrated, there are immediate and low-cost benefits to institutional coordination but currently, most intra and inter-agency communications during inclement weather rely on informal and personal communications. This is not unique to WRTM but rather a problem with Systems Operation and Management (SO&M) as a whole. AASHTO in their guidance [1] stated the fundamental problem with SO&M which also completely applies to WRTM (Table 17).

Table 17. SO&M Issues with Respect to Capability Maturity

“It is not yet a “mature” program by comparison with the traditional mainstreamed programs of transportation agencies—construction project development and maintenance. While many agencies are applying the basic SO&M strategies—some with great effect—SO&M generally faces several challenges to broad implementation:

- It is often not well understood throughout agency civil engineering culture
- Well defined and documented processes and recognized performance measures are lacking
- Consolidated organizational structure and accountability to top management may not be established
- It frequently lacks sustainable, predictable resources
- Essential collaborative relationships are usually informal and often unaligned”

To address these institutional barriers, AASHTO has developed a capability maturity model, adapted from the world of Information Technology, to help agencies improve their SO&M approach in an evolutionary manner. A similar evolutionary approach to WRTM, allowing agencies to self-assess the current and desired levels of capability for WRTM, is much needed.

Approach: The RWMP has created a self-evaluation tool for TMCs as part of the TMC weather integration project that provides an evolutionary path for agencies to improve their weather integration. While a separate tool for WRTM is not necessary, this recommendation suggests developing a simple approach to assess where agencies stand in terms of the six dimensions of the AASHTO capability maturity model with respect to weather. These six dimensions are [1]:

1. Business processes including formal scoping planning, programming and budgeting.
2. Systems and technology including use of systems engineering, systems architecture standards, interoperability, and standardization.
3. Performance measurement including definition of measures, data acquisition, and utilization.
4. Culture including technical understanding, leadership, outreach, and program legal authority.
5. Organization and workforce including programmatic status, organizational structure, staff development, and recruitment and retention.
6. Collaboration including relationships with public safety agencies, local governments, MPOs and the private sector.

Similar to the TMC weather integration, AASHTO also defines four levels of capability maturity:

- Level 1 – Activities and relationships; largely ad hoc, informal and champion-driven, substantially outside the mainstream of other DOT activities.
- Level 2 – Basic strategy applications understood; key processes support requirements identified and key technology and core capacities under development, but limited internal accountability and uneven alignment with external partners.
- Level 3 – Standardized strategy applications implemented in priority contexts and managed for performance; SO&M technical and business processes developed, documented, and integrated into DOT; partnerships aligned.
- Level 4 – SO&M as full, sustainable core DOT program priority, established on the basis of continuous improvement with top level management status and formal partnerships.

By tailoring and applying this guidance to WRTM, a clear approach to institutional collaboration can be established for WRTM.

Outcomes: A clear approach to improving institutional coordination for WRTM.

References

Website addresses available as of June 24, 2011.

1. AASHTO. (2011). Systems Operation and Management Guidance, retrieved from <http://aashtosomguidance.org/about/>.
2. Manual on Uniform Traffic Control Devices. 2009 Edition. U.S. Department of Transportation, Federal Highway Administration. Available at http://mutcd.fhwa.dot.gov/hdm/2009/html_index.htm.
3. Seaside Flood Warning System. Oregon Department of Transportation. Available at http://www.oregon.gov/ODOT/HWY/ITS/project_FWDS.shtml.
4. Butte Creek Ice Warning System. Oregon Department of Transportation. Available at http://www.oregon.gov/ODOT/HWY/ITS/project_buttetecreek.shtml.
5. Kumar, M. and C. Strong. Comparative Evaluation of Automated Wind Warning Systems. Western Transportation Institute. Available at http://www.westerntransportationinstitute.org/documents/reports/426705_Final_Report.pdf.
6. USDOT, ITS-JPO, ITS Benefit-Cost Database, <http://www.itsbenefits.its.dot.gov/its/benecost.nsf/SingleTax?OpenForm&Query=Road+Weather+Management>.
7. See for example, road condition information from Safe Travel USA for the State of Montana (<http://www.safetravelusa.com/mt/>).
8. <http://twitter.com/txdot>.
9. <http://twitter.com/KYTC>.
10. Media Release. DDOT's Twitter use keeps department ahead of blizzard cleanup. Federal News Radio 1500 AM. <http://www.federalnewsradio.com/?nid=19&sid=1847276>.
11. Final Evaluation Report: Evaluation of the Idaho Transportation Department Integrated Road-Weather Information System. US Department of Transportation, Federal Highway Administration. February 2006. Available at http://ntl.bts.gov/lib/jpodocs/repts_te/14267.htm.
12. Evaluation of Rural ITS Information Systems along US 395, Spokane, Washington. US Department of Transportation, Federal Highway Administration, January 2004. Available at http://ntl.bts.gov/lib/jpodocs/repts_te/13955.html.
13. Goodwin, L.C. "California DOT Motorist Warning System." in Best Practices for Road Weather Management, Version 2.0. U.S. Department of Transportation, Federal Highway Administration, May 2003. Available at http://ntl.bts.gov/lib/jpodocs/repts_te/13828.html#_Toc36447165.
14. Goodwin, L.C. "Tennessee Low Visibility Warning System." In Best Practices for Road Weather Management. Version 2.0. U.S. Department of Transportation, Federal Highway Administration, May 2003. Available at http://ntl.bts.gov/lib/jpodocs/repts_te/13828.html#_Toc36447185.

15. Goodwin, L.C. "Florida DOT Motorist Warning System." In Best Practices for Road Weather Management. Version 2.0. U.S. Department of Transportation, Federal Highway Administration, May 2003. Available at http://ntl.bts.gov/lib/jpodocs/repts_te/13828.html#_Toc36447168.
16. Belz, Nathan P. and Per E. Gårder. Maine Statewide Deployment and Integration of Advanced Traveler Information Systems. Presented at the 88th Annual meeting of the Transportation Research Board, Washington DC, January 2009.
17. FHWA Safety Website. Examples of Variable Speed Limit Application. Speed Management Workshop, TRB January 9, 2000. Available at <http://safety.fhwa.dot.gov/speedmgt/vslimits>.
18. Goodwin L. "New Jersey Turnpike Authority Speed Management." in Best Practices for Road Weather Management, Version 2.0. U.S. Department of Transportation, Federal Highway Administration, May 2003. Available at http://ntl.bts.gov/lib/jpodocs/repts_te/13828.html#_Toc36447179.
19. US 2 – W Side of Stevens Pass – Electronic Signage – Complete July 2009. Washington Department of Transportation. <http://www.wsdot.wa.gov/projects/us2/wstevenssignage/>.
20. University of Wyoming, Department of Civil and Architectural Engineering (2010, October). "Variable Speed Limit System for Elk Mountain Corridor, Final Report." Wyoming DOT and USDOT. Report No. FHWA—SY-10/04F.
21. <http://www.wsdot.wa.gov/research/reports/fullreports/511.2.pdf>.
22. Goodwin L. "Washington State DOT Speed Management." in Best Practices for Road Weather Management, Version 2.0. U.S. Department of Transportation, Federal Highway Administration, May 2003. Available at http://ntl.bts.gov/lib/jpodocs/repts_te/13828.html#_Toc36447192.
23. Road Weather Information System. Montana Department of Transportation. Available at <http://www.mdt.mt.gov/travinfo/weather/rwis.shtml>.
24. Goodwin, L.C. "Nevada DOT High Wind Warning System" in Best Practices for Road Weather Management. Version 2.0. U.S. Department of Transportation, Federal Highway Administration, May 2003. Available at http://ntl.bts.gov/lib/jpodocs/repts_te/13828.html#_Toc36447178.
25. Young, R.K and J. Liesman. Use of ITS for Operation of Roadway Segments in High Wind Conditions. Presented at the 86th Annual Meeting of the Transportation Research Board, Washington, DC, January 2007.
26. Kumar, Manjunathan, PE, and Christopher Strong, Comparative Evaluation of Automated Wind Warning Systems, Western Transportation Institute, College of Engineering, Montana State of University, Prepared for the U.S. DOT Research and Innovative Technology Administration in cooperation with the California DOT and Oregon DOT, February 2006.
27. <http://www.dot.ca.gov/hq/roadinfo/chcontrl.htm>.
28. I-90 accident claims two lives; truck driver loses life while chaining up, <http://www.kmvt.com/news/local/79457052.html>.
29. Goodwin, L.C. "Alabama DOT Low Visibility Warning System" in Best Practices for Road Weather Management. Version 2.0. U.S. Department of Transportation, Federal Highway Administration, May 2003. Available at http://ntl.bts.gov/lib/jpodocs/repts_te/13828.html#_Toc36447164.

30. Goodwin, L.C. "South Carolina DOT Low Visibility Warning System." In Best Practices for Road Weather Management. Version 2.0. U.S. Department of Transportation, Federal Highway Administration, May 2003. Available at http://ops.fhwa.dot.gov/weather/best_practices/CaseStudiesFINALv2-RPT.pdf .
31. <http://www.ci.minneapolis.mn.us/snow/parking-info.asp>.
32. Automated Gate Operational Test, Minnesota Department of Transportation. Available at <http://onlinepubs.trb.org/onlinepubs/circulars/ec052.pdf>.
33. Documentation and Assessment of Mn/DOT Gate Operations, Office of Advanced Transportation Systems, Minnesota Department of Transportation, October, 1999, available at http://www.dot.statestate.mn.us/guidestar/1996_2000/i90_i94_gate_closure/gatereport.pdf.
34. Thomas H. Maze, Michael R. Crum, and Garrett Burchett, An Investigation of User Costs and Benefits of Winter Road Closures, Midwest Transportation Consortium, for U.S. Department of Transportation Research and Special Programs Administration, Washington, DC: June 2005. Available at http://www.intrans.iastate.edu/reports/maze_road_closure_2003.pdf.
35. The Evacuation of New Orleans for Hurricane Katrina: A Synthesis of the Available Data, Ezra Boyd, PhD Candidate: LSU Geography & Anthropology, Presentation for the National Evacuation Conference, February 5, 2010. Accessed at http://www.nationalevacuationconference.org/files/presentations/day2/Boyd_Ezra.pdf.
36. Personal contact with Rob Helt, Principle Traffic Engineer, City of Colorado Springs, Colorado.
37. Perrin, Jr., J., P. Martin, and B. Hansen. Modifying Signal Timing During Inclement Weather. Presented at the 80th Annual Meeting of the Transportation Research Board. Washington, DC, January 2001.
38. Al-Kaisy, A., and Z. Freedman. Weather –Responsive Signal timing: Practical Guidelines. Presented at the 85th Annual Meeting of the Transportation Research Board, Washington, DC, January 2006.
39. Agbolosu-Arnison, S.J., A.W. Sadek, and W. ElDessouki. Inclement Weather and Traffic Flow at Signalized Intersections: Case Study from Northern New England. In Transportation Research Record No. 1867. Transportation Research Board of the National Academies. Washington, DC, 2005. pp. 163-171.
40. Personal contact with Eric Armigost, Traffic Department, Municipality of Anchorage, Alaska.
41. Personal contact with Hal Decker, TMC Manager, Connecticut Department of Transportation.
42. Personal contact with Jim Clecher, TMC Manager, Delaware Department of Transportation.
43. Personal contact with Mark Taylor, Signal Engineer, Utah Department of Transportation.
44. Personal contact with Cory Martens, Signal System, City of Clearwater, Florida.
45. Personal contact with Scott Tashney, Traffic Engineer, City of Minneapolis, Minnesota.
46. Personal contact with Charles Abel, Signal Systems Section Manager, City of Charlotte, North Carolina.

47. Houston, Nancy, et. al. *Service Patrol Handbook*. Report No. FHWA-HOP-08-031. U.S. Department of Transportation, Federal Highway Administration. Washington, DC, November 2008. Available at http://ops.fhwa.dot.gov/publications/fhwahop08031/ffsp_handbook.pdf
48. <http://www.coloradodot.info/news/2011news/06-2011/successful-season-for-i-70-west-winter-programs>.
49. Washington State DOT. Incident Response Strategic Initiatives. Revised November 19, 2007.
50. Battelle, Baseline Conditions Report: Integration of Emergency and Weather Elements into Transportation Management Centers, Prepared for the FHWA Road Weather Management Program, May 2005.
51. ITS-JPO (2010), ITS Strategic Plan, 2010-2014: Transforming transportation through connectivity, retrieved from http://www.its.dot.gov/strategic_plan2010_2014/index.htm.
52. Rakha, H., et. al. Microscopic Analysis of Traffic Flow in Inclement Weather. Report No. FHWA-JPO-09-066, EDL # 14498. US Department of Transportation, Federal Highway Administration. Washington, DC, November 2009. Available at http://ntl.bts.gov/lib/32000/32500/32539/tfiw_final.pdf.
53. Mahmassani, H.S., et. al. Incorporating Weather Impacts in Traffic Estimation and Prediction Systems. Report No. FHWA-JPO-09-065, EDL#14497. US Department of Transportation, Federal Highway Administration, Washington, DC. September 2009. Available at <http://ntl.bts.gov/lib/31000/31400/31419/14497.htm>.
54. Richard, Christian M., et. al. Human Factors Analysis of Road Weather Advisory and Control Information: Final Report. Report No. FHWA-JPO-10-053. US Department of Transportation, Federal Highway Administration. Washington, DC. March 2010. Available at http://ntl.bts.gov/lib/33000/33000/33047/rev_final_hf_analysis_road_weather.pdf.
55. NCHRP Synthesis 295 (2001), Statistical Methods in Highway Safety Analysis, A synthesis of highway practice, TRB, National Academy Press.
56. Hauer et al., (2002), Estimating Safety by the Empirical Bayes Method: A Tutorial, available at http://www.ctre.iaState.edu/educweb/CE552/docs/Bayes_tutor_hauer.pdf.
57. Kyte, Michael, et al (March 2001). Idaho Storm Warning System Operational Test - Final Report, Published By: Idaho Transportation Department.
58. University of Wyoming, Department of Civil and Architectural Engineering (Oct 2010). Variable Speed Limit System for Elk Mountain Corridor, Final Report. (Report No. FHWA-SY-10/04F). Wyoming DOT and USDOT.
59. Battelle (2011), *Clarus* Multi-State Regional Demonstration: Independent Evaluation Results, FHWA, Pending.
60. Kergaye, C., Stevanovic, A., and Martin, P. (2009). Comparison of Before–After Versus Off–On Adaptive Traffic Control Evaluations: Park City, Utah, Case Study. Transportation Research Record: Journal of the Transportation Research Board. Issue No. 2128. Transportation Research Board: Washington, DC.
61. Cambridge Systematics, Inc. (2002). Mn/DOT Ramp Meter Evaluation: Phase II Evaluation Report. Prepared for Minnesota Department of Transportation. Oakland, CA.
62. Cuciti, P. and Janson, B. (1995). Incident Management via Courtesy Patrol: Evaluation of a Pilot Program in Colorado. Transportation Research Record No. 1494. Washington, DC: Transportation Research Board. Available at: <http://pubsindex.trb.org/view.aspx?id=452640>.

63. Southeast Michigan Council of Governments. (2009). MDOT Freeway Courtesy Patrol in Southeast Michigan: FY 2008 Evaluation Report. Available at: http://library.semcog.org/InmagicGenie/DocumentFolder/FreewayCourtesyPatrol_FY2008.pdf.
64. Shi, X., O'Keefe, K., Wang, S., and Strong, C. (2007). Evaluation of Utah Department of Transportation's Weather Operations/RWIS Program: Phase I. Report prepared for UDOT by the Western Transportation Institute, Bozeman, MT.

APPENDIX A. List of Acronyms

AASHTO	American Association of State Highway and Transportation Officials
ADVISE	Adverse Visibility Information System Evaluation
ATDM	Active Transportation and Demand Management
ATM	Active Traffic Management
ATMS	Advanced Traffic Management System
CalTrans	California Department of Transportation
CCTV	Closed Circuit Television
CHP	California Highway Patrol
CMS	Changeable Message Sign
CONOP	Concept of Operations
CVISN	Commercial Vehicle Information Systems
CVO	Commercial Vehicle Operations
DMS	Dynamic Message Signs
DOT	Department of Transportation
DPS	Department of Public Safety
EB	Empirical Bayes
ESS	Environmental Sensor Stations
FHWA	Federal Highway Administration
FWD	Falling Weight Deflectometer
HAR	Highway Advisory Radio
HSM	Highway Safety Manual
HURREVAC	Hurricane Evacuation
ICM	Integrated Corridor Management
ITE	Institute of Transportation Engineers
ITS-JPO	Intelligent Transportation Systems Joint Program Office
KYTC	Kentucky Transportation Cabinet
LLC	Limited Liability Company
LOS	Level of Service
MDSS	Maintenance Decision Support System
MNDOT	Minnesota Department of Transportation

MOE	Measure of Effectiveness
MUTCD	Manual on Uniform Traffic Control Devices
NCAR	National Council for Atmospheric Research
NWS	National Weather Service
OMB	Office of Management and Budget
PA	Pennsylvania
RWIS	Road Weather Information System
RWMP	Road Weather Management Program
SO&M	Systems Operation and Management
SPF	Safety Performance Function
SWR	Seasonal Weight Restriction
TDOT	Tennessee Department of Transportation
TIM	Traffic Incident Management
TMC	Transportation Management Center
TOC	Traffic Operations Center
TRB	Transportation Research Board
UDOT	Utah Department of Transportation
USDOT	United States Department of Transportation
VMS	Variable Message Signs
VSL	Variable Speed Limit
VSLs	Variable Speed Limit Sign
WA	Washington
WRTM	Weather Responsive Traffic Management
WSDOT	Washington State Department of Transportation
WYDOT	Wyoming Department of Transportation

APPENDIX B. Metric/English Conversion Factors

ENGLISH TO METRIC	METRIC TO ENGLISH
<p>LENGTH (APPROXIMATE)</p> <p>1 inch (in) = 2.5 centimeters (cm) 1 foot (ft) = 30 centimeters (cm) 1 yard (yd) = 0.9 meter (m) 1 mile (mi) = 1.6 kilometers (km)</p>	<p>LENGTH (APPROXIMATE)</p> <p>1 millimeter (mm) = 0.04 inch (in) 1 centimeter (cm) = 0.4 inch (in) 1 meter (m) = 3.3 feet (ft) 1 meter (m) = 1.1 yards (yd) 1 kilometer (km) = 0.6 mile (mi)</p>
<p>AREA (APPROXIMATE)</p> <p>1 square inch (sq in, in²) = 6.5 square centimeters (cm²) 1 square foot (sq ft, ft²) = 0.09 square meter (m²) 1 square yard (sq yd, yd²) = 0.8 square meter (m²) 1 square mile (sq mi, mi²) = 2.6 square kilometers (km²) 1 acre = 0.4 hectare (he) = 4,000 square meters (m²)</p>	<p>AREA (APPROXIMATE)</p> <p>1 square centimeter (cm²) = 0.16 square inch (sq in, in²) 1 square meter (m²) = 1.2 square yards (sq yd, yd²) 1 square kilometer (km²) = 0.4 square mile (sq mi, mi²) 10,000 square meters (m²) = 1 hectare (ha) = 2.5 acres</p>
<p>MASS - WEIGHT (APPROXIMATE)</p> <p>1 ounce (oz) = 28 grams (gm) 1 pound (lb) = 0.45 kilogram (kg) 1 short ton = 2,000 pounds = 0.9 tonne (t) (lb)</p>	<p>MASS - WEIGHT (APPROXIMATE)</p> <p>1 gram (gm) = 0.036 ounce (oz) 1 kilogram (kg) = 2.2 pounds (lb) 1 tonne (t) = 1,000 kilograms (kg) = 1.1 short tons</p>
<p>VOLUME (APPROXIMATE)</p> <p>1 teaspoon (tsp) = 5 milliliters (ml) 1 tablespoon (tbsp) = 15 milliliters (ml) 1 fluid ounce (fl oz) = 30 milliliters (ml) 1 cup (c) = 0.24 liter (l) 1 pint (pt) = 0.47 liter (l) 1 quart (qt) = 0.96 liter (l) 1 gallon (gal) = 3.8 liters (l) 1 cubic foot (cu ft, ft³) = 0.03 cubic meter (m³) 1 cubic yard (cu yd, yd³) = 0.76 cubic meter (m³)</p>	<p>VOLUME (APPROXIMATE)</p> <p>1 milliliter (ml) = 0.03 fluid ounce (fl oz) 1 liter (l) = 2.1 pints (pt) 1 liter (l) = 1.06 quarts (qt) 1 liter (l) = 0.26 gallon (gal) 1 cubic meter (m³) = 36 cubic feet (cu ft, ft³) 1 cubic meter (m³) = 1.3 cubic yards (cu yd, yd³)</p>
<p>TEMPERATURE (EXACT)</p> <p>$[(x-32)(5/9)] \text{ } ^\circ\text{F} = y \text{ } ^\circ\text{C}$</p>	<p>TEMPERATURE (EXACT)</p> <p>$[(9/5)y + 32] \text{ } ^\circ\text{C} = x \text{ } ^\circ\text{F}$</p>

QUICK INCH - CENTIMETER LENGTH CONVERSION

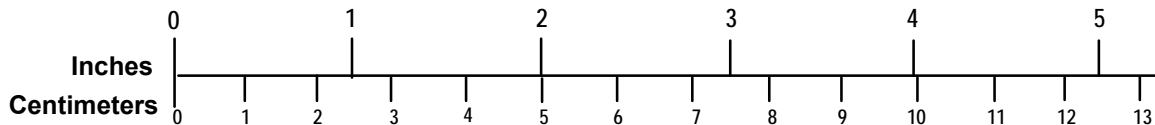

QUICK FAHRENHEIT - CELSIUS TEMPERATURE CONVERSION

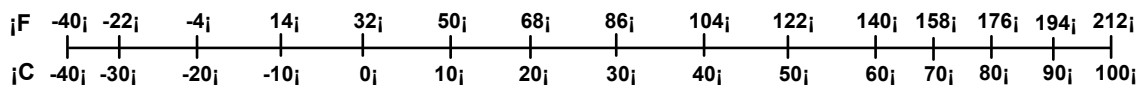

For more exact and or other conversion factors, see NIST Miscellaneous Publication 286, Units of Weights and Measures. Price \$2.50 SD Catalog No. C13 10286

APPENDIX C. Expert Panel Survey Responses

Introduction

The following sections present the rankings and the comments of the expert panel on the WRTM strategies identified in the State of the practice review. Panelists were asked to rank the strategy in terms of its potential to improve highway performance as well as the potential to improve the State of the practice of the strategy. The information was collected using an online survey.

Rankings are from 1 (low) to 5 (high). Strategies which are ranked high in both categories (improve highway performance, improve State-of-the-practice) are of critical interest as these represent cases where significant progress should be made in terms of identifying improvements.

1. Motorist Advisories, Alert and Warning Systems

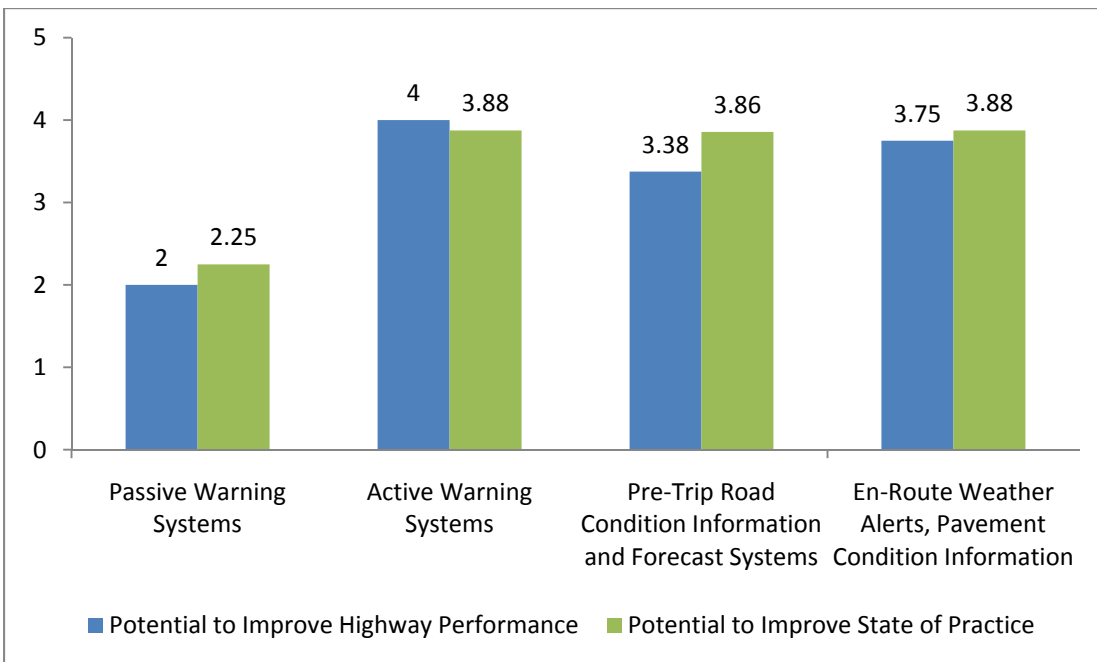

Figure C-1 – Weighted Rankings for Motorist Advisories, Alert and Warning Systems

Panel Comments

1. Intelligent Transportation System (ITS)-like information really could make a big difference, but it is still pretty immature. The other concepts can and should play a supporting role.
2. Passive warning systems can be ignored by drivers. Active roadway systems catch drivers' attention. Pre-trip information is important, and since bad weather conditions are forecast days in advance, people are checking for this. En-route weather alerts-potentially helpful if done correctly.
3. Pre-trip road condition systems could benefit from standardization definitions of reported conditions across State boundaries. En-route systems must not contribute to driver distraction.
4. A few general comments:
 - I think that most of the emphasis needs to be on winter weather snow and ice. We may see 100 crashes in a day in our metropolitan area during a snow storm. Crashes and impacts to mobility due to high winds, fog, and wet pavements do occur, but are relatively few in comparison.
 - I would also distinguish strategies between long-distance interstate travel and commuter travel. Commuters can look out their window in the morning to see the weather; long distance travelers need forecasts of what the weather and road conditions may be hundreds of miles away hours or even days in advance.
 - I also think that the emphasis needs to be on preventing crashes, rather than on mobility. Crashes are often the root cause of congestion during bad weather, so if the emphasis is on preventing crashes, it serves to improve mobility as well.
 - I think that en-route traveler information has the biggest potential for improvement. Pre-trip information technology is more mature - information can be delivered by web sites, 511, and commercial media. The consumer can also take a little time to do some research. En-route information does not have a well-established delivery mechanism. DMS's are very expensive and few and far between; HAR is an outdated and inefficient technology with legal restrictions; 511 is awkward (and possibly dangerous) to use while you are driving.
5. The biggest potential for improvement lies in a combination of active warning systems (accurate real-time sensing of road conditions) with information delivered directly to the driver via new on-board technology- satellite radio, mobile devices, or smart phone wireless data.
6. Motorist seems narrowly focused. I would include transit users as well.
7. This also seems focused on freeway work, what about arterials and signal timing strategies?
8. Avalanche advisories to travelers and stakeholders. Bridge flooding. Earthquakes.

2. Speed Management Strategies

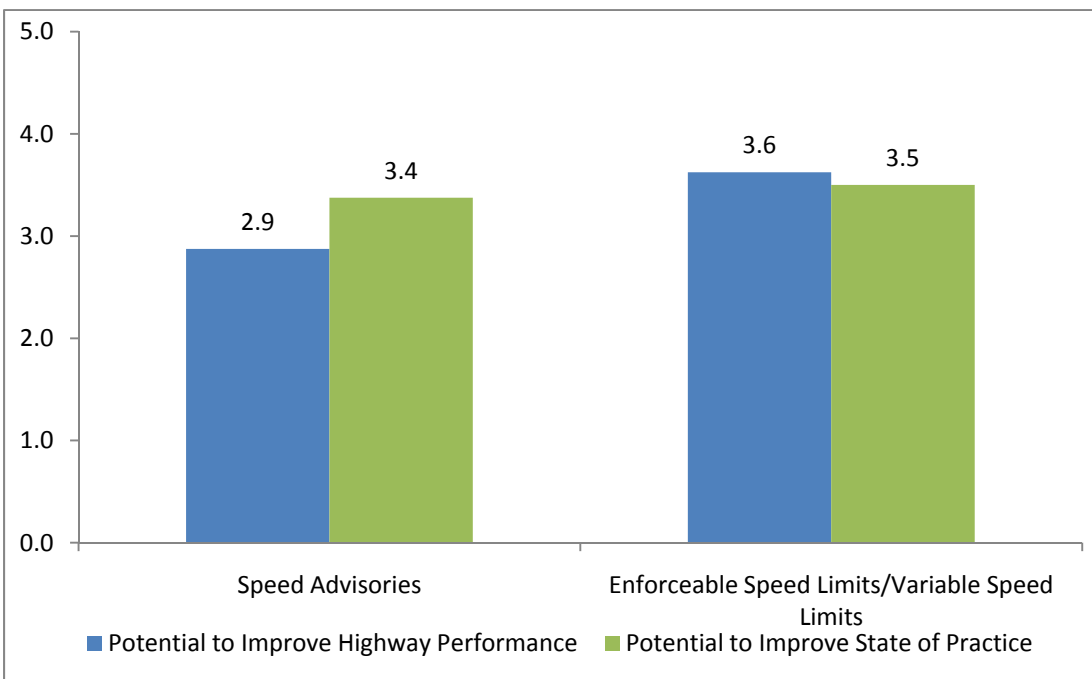

Figure C-2. Weighted Rankings for Speed Management Strategies

Panel Comments

1. Variable speed limits are not legal in Texas; however police departments can issue tickets for 'failure to control speed, under the limit' which means that a ticket can be issued for someone traveling under the speed limit if it creates an unsafe condition, such as speeding on ice covered roads.
2. My sense is that this is underutilized, but there seems to be resistance to it from some law enforcement and DOTs. Is there good research that shows the benefits in terms of crash reduction? If so, it would make it easier to justify it.
3. Expanded use and more automation. Variable speed limits also can be used for other than weather events to include construction, incidents, special events, and etc.
4. Variable speed limits are a key element of State's Strategic Highway Safety Plan (perhaps there should be more on the SHSP in our deliberations). Has not been deployed widely but gaining more acceptance.
 - Speed advisories have application to a wide stakeholder base: law enforcement, commercial vehicles, safety agencies, travel time for travelers.

3. Vehicle Restriction Strategies

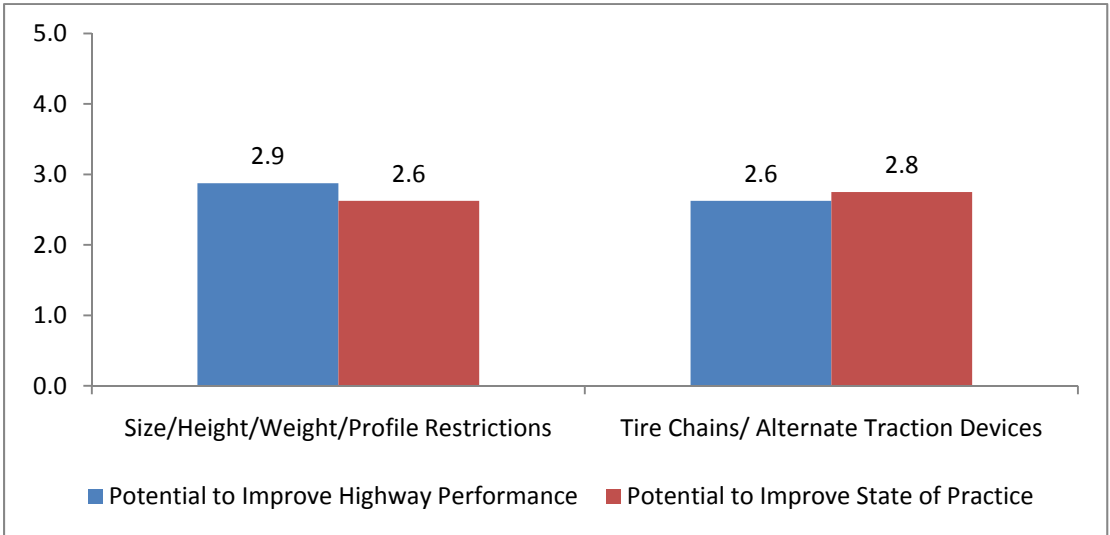

Figure C-3. Weighted Rankings for Vehicle Restriction Strategies

Panel Comments

1. Height detection systems are mature, but the practice could benefit from increased deployment.
2. Add temperature data probes for seasonal weight restrictions.

4. Route Restriction Strategies

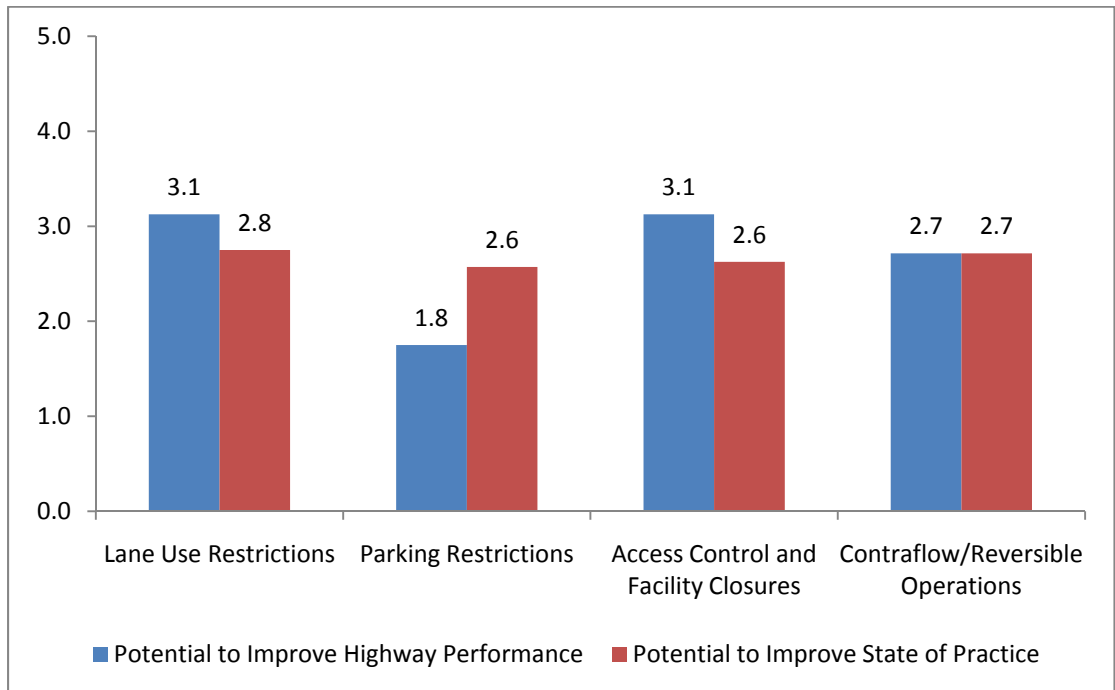

Figure C-4. Weighted Rankings for Route Restriction Strategies

Panel Comments

1. Restrictions of 18-wheelers in the left lane are fairly common, and have had positive results. I am not familiar with lane use restrictions due to weather, aside from general closures due to ice and flooding.
2. Great opportunity to examine the relationship between highway speed, travel time, and changing road condition. Iowa mentioned a current study they have. There are others. Should be pursued.
3. Alternative routes to take during congestion an inclement road conditions is not widely done, but has some opportunities.

5. Traffic Signal Coordination Strategies

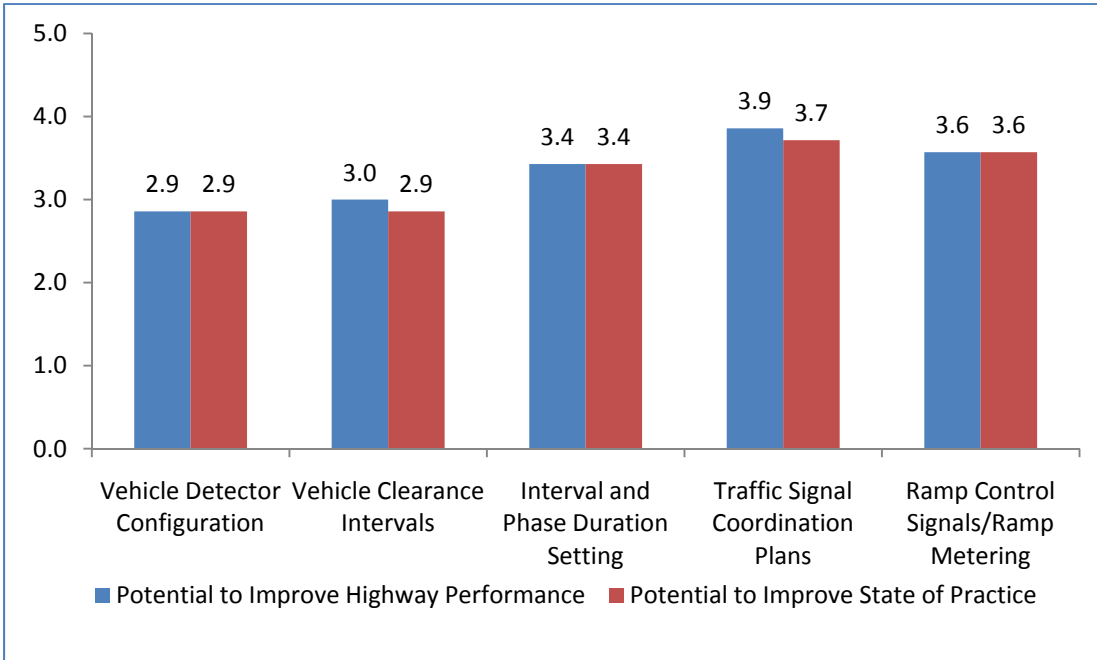

Figure C-5. Weighted Rankings for Traffic Signal Control Strategies

Panel Comments

1. Dynamic signal timing on arterials can be an effective strategy during weather-related freeway closures.
2. A few general comments: I think that detection should be designed to work in snow if it is a common occurrence. If an agency is having trouble with video detection in snow, it was probably was the wrong design choice in the first place. It also seems to be a substantial task to revise detector configurations at hundreds or thousands of signals.
3. Vehicle Clearance, Extensions, Phase Duration, and Traffic Signal Coordination (cycle, split offset). In some of the newer controllers, it is possible to change all of these by timing plan. UDOT changes some coordination patterns (offsets only) to reflect lower speeds when the roads are snow covered. We do this only on some suburban arterials, not in the downtown grid.
4. We don't change the other timing parameters, but I can see the potential benefits for doing so. Until recently, technology did not permit this, but now it does.
5. These items are not within my area of expertise.
6. It's hard to judge these because the description is not very helpful. Does the configuration change because of the weather, do you use them differently?
7. Opportunity to look at signal control base on road weather conditions.
8. Not much has been done on interval setting.
9. CVISN has mature, but may be other areas to explore.

6. Traffic Incident Management Strategies

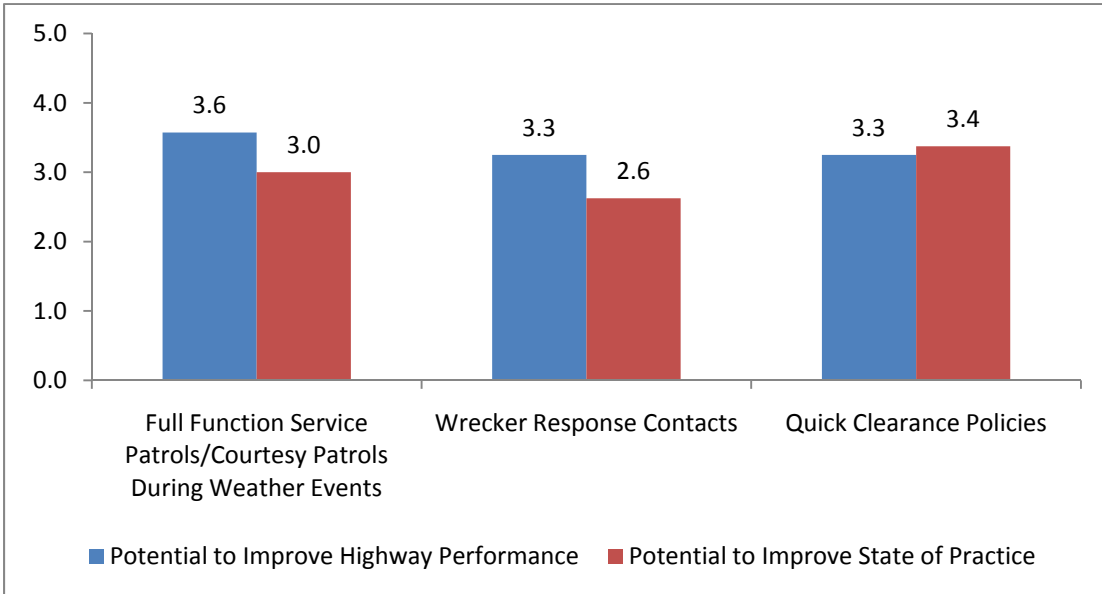

Figure C-6. Weighted Rankings for Traffic Incident Management Strategies

Panel Comments

1. All strategies to clear lanes through means other than emergency responders are a huge help during a severe weather event, but allowing emergency responders to concentrate on major accidents. Wrecker contracts and quick clearance policies can involve local and statewide political issues in order to be implemented.
2. These are all good practices independent of weather. One problem that occurs in bad weather is that resources get spread thin. Maintenance crews are not available to help service patrols deal with incidents because they are busy plowing snow. Highway patrol cannot provide the level of support necessary to deal with incidents because they are often dealing with multiple crashes. One improvement that could be considered: Supplement service patrols with extra stand-by private resources when snow is anticipated.
3. Need tie to emergency services, operations center for extraordinary weather events, DOT, military, etc. This includes flood events, earthquakes, avalanches, etc.

7. Personnel and Asset Management Strategies

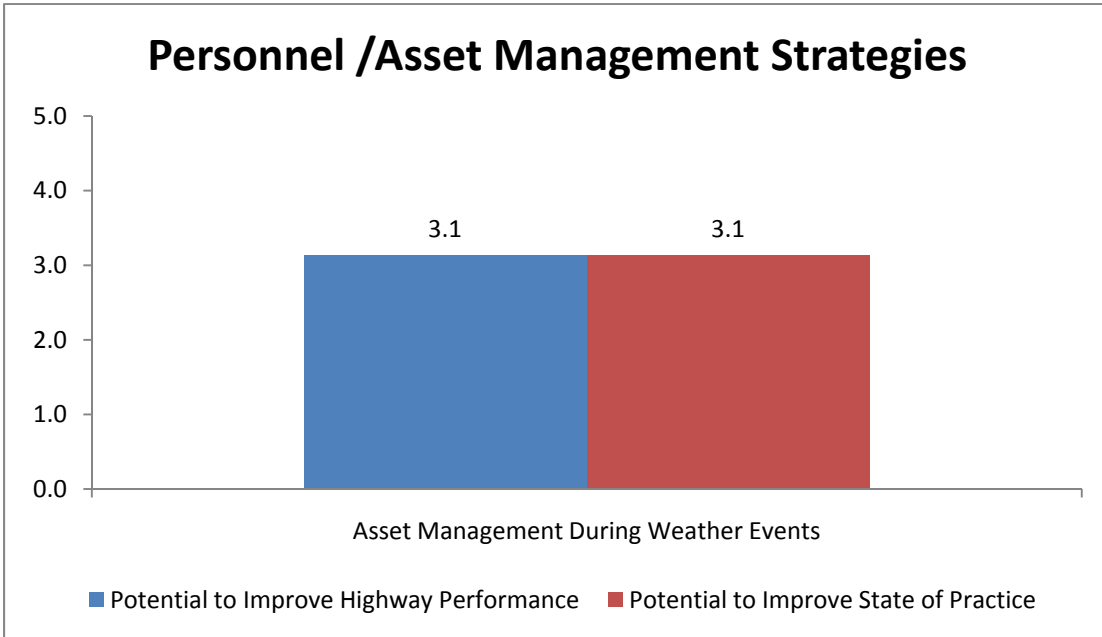

Figure C-7. Weighted Rankings for Personal/Asset Management

Panel Comments

1. Improve the ability to focus maintenance efforts where crash potential is highest. Maintenance managers allocate resources as effectively as possible, but perhaps there can be more research in this area.
2. It is unclear what Asset Management means during weather events but my response assumes it could include automated vehicle location.
3. I am not sure what this means... and I guess it can mean different things for various weather events. Flooding is much different than snow.
4. Many States have real-time systems, but others still have a long way to go.

8. Intra and Inter-agency Cooperation

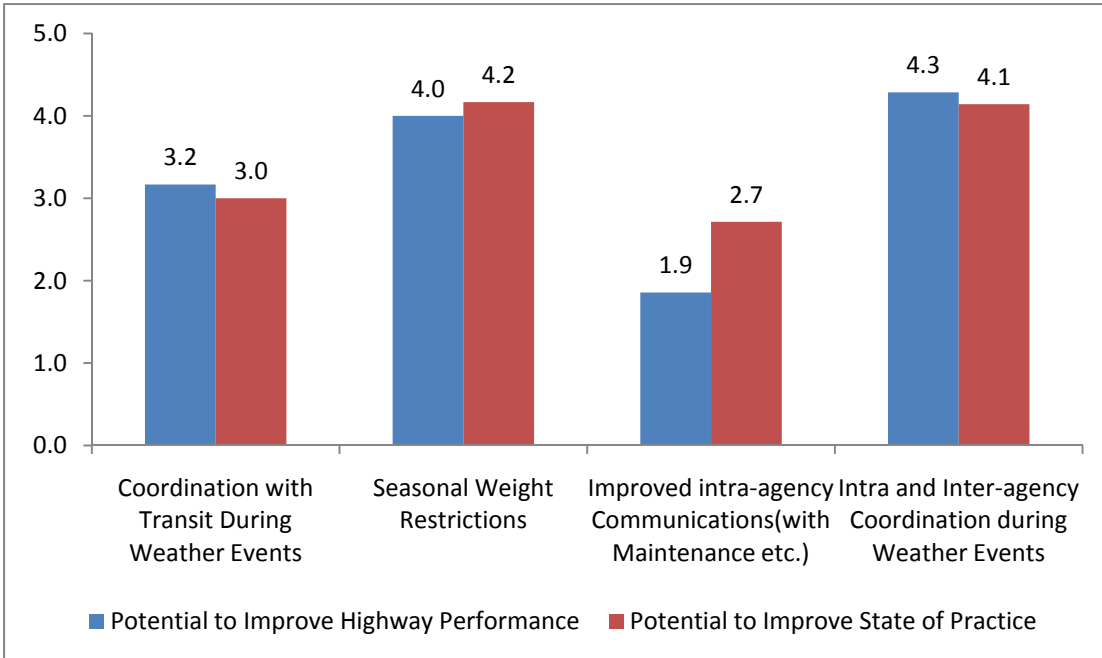

Figure C-8. Weighted Rankings for New Strategies Identified As Part of Web-Meeting

Panel Comments

1. This seems to be getting much better recently.
2. This is an important step. Adopting the Unified Command Structure and sharing video and data between agencies, and establishing good inter-agency communications is especially critical during major weather events.
3. Same as previous comment.
4. Also, more communication among DOTs, commercial media, and National Weather Service to deliver a coordinated message.
5. Working with transit during weather events is a big help. This area is not impacted by seasonal weight restrictions. Our interagency communications are already in very good shape, and have been for a long time.
6. Transit coordination to improve highway performance is low, but transit to improve system operations would be high!

APPENDIX D.

Concept of Operations for Selected WRTM Strategies

Table of Contents

D-1	Active Traffic Management (ATM) During Weather Events.....	133
	1.1 SCOPE.....	133
	1.2 REFERENCED DOCUMENTS.....	135
	1.3 CURRENT SYSTEM OR SITUATION.....	135
	1.4 NATURE AND JUSTIFICATION OF CHANGES.....	139
	1.5 CONCEPTS FOR THE PROPOSED STRATEGY.....	140
	1.6 OPERATIONAL SCENARIOS.....	144
	1.7 HIGH-LEVEL SYSTEM DESIGN.....	152
	1.8 ANALYSIS OF THE PROPOSED SYSTEM.....	157
D-2	Weather Responsive Traffic Signal Management.....	158
	2.1 SCOPE.....	158
	2.2 REFERENCED DOCUMENTS.....	159
	2.3 CURRENT SYSTEM OR SITUATION.....	159
	2.4 NATURE AND JUSTIFICATION OF CHANGES.....	161
	2.5 CONCEPTS FOR THE PROPOSED STRATEGY.....	161
	2.6 OPERATIONAL SCENARIOS.....	168
	2.7 HIGH-LEVEL SYSTEM DESIGN.....	171
	2.8 ANALYSIS OF THE PROPOSED SYSTEM.....	176
D-3	Regional Traveler Information for Weather Events.....	178
	3.1 SCOPE.....	178
	3.2 REFERENCED DOCUMENTS.....	178
	3.3 CURRENT SYSTEM OR SITUATION.....	179
	3.4 NATURE AND JUSTIFICATION OF CHANGES.....	181
	3.5 CONCEPTS FOR THE PROPOSED STRATEGY.....	181
	3.6 OPERATIONAL SCENARIOS.....	185
	3.7 HIGH-LEVEL SYSTEM DESIGN.....	187
	3.8 ANALYSIS OF THE PROPOSED SYSTEM.....	193

D-4	Seasonal Weight Restrictions	194
	4.1 SCOPE.....	194
	4.2 REFERENCED DOCUMENTS.....	195
	4.3 CURRENT SYSTEM OR SITUATION.....	196
	4.4 NATURE AND JUSTIFICATION OF CHANGES	196
	4.5 CONCEPTS FOR THE PROPOSED STRATEGY.....	196
	4.6 OPERATIONAL SCENARIOS	202
	4.7 HIGH-LEVEL SYSTEM DESIGN.....	204
	4.8 ANALYSIS OF THE PROPOSED SYSTEM.....	206
D-5	Intra-Agency and Inter-agency Coordination	207
	5.1 SCOPE.....	207
	5.2 REFERENCED DOCUMENTS.....	208
	5.3 CURRENT SYSTEM OR SITUATION.....	208
	5.4 NATURE AND JUSTIFICATION OF CHANGES	209
	5.5 CONCEPTS FOR THE PROPOSED STRATEGY.....	210
	5.6 OPERATIONAL SCENARIOS	221
	5.7 FUNCTIONAL REQUIREMENTS FOR INTRA- AND INTER-AGENCY COORDINATION	223
	5.8 ANALYSIS OF THE PROPOSED STRATEGY	242

List of Tables

Table D-1. System Requirements for Deploying Weather Responsive ATM Strategy	153
Table D-2. Potential Performance Measures for Assessing the Effectiveness of Using ATM Strategies during Weather Events.....	157
Table D-4. System Requirements for Deploying Weather Responsive Regional Traveler Information Strategy.....	189
Table D-5. System Requirements for Deploying SWR Strategy	205
Table D-6. Performance Measures for SWR	206
Table D-7. Key Systems for Weather-Related Intra- and Inter-agency Coordination	210
Table D-8. Systems included in Intra and Inter-Agency Coordination Services	215
Table D-9. System Interconnections for Inter- and Intra-agency Communications	218
Table D-10. Applicable Standards for WRTM Strategy.....	220
Table D-11. High-Level Functional Requirements for Intra- and Inter-agency Coordination	224

List of Figures

Figure D-1. Configuration of ATM Sign Gantries during Normal Travel Condition (No ATDM Strategy Deployed; Source: Texas Transportation Institute)	137
Figure D-2. Use of ATM Technologies to Implement Variable Speed Limits (Source: Texas Transportation Institute).....	137
Figure D-3. Use of ATM Technologies to Implement a Lane Closure Strategy (Source: Texas Transportation Institute).....	138
Figure D-4. High-level, Functional Components of ATM System (Source: Texas Transportation Institute).....	139
Figure D-5. Components of Weather-Responsive ATM System (Source: Texas Transportation Institute).....	141
Figure D-6. Potential Implementation of a Weather-Responsive Variable Speed Limit Using ATM Technologies (Source: Texas Transportation Institute)	145
Figure D-7. Potential Implementation of a Weather-Responsive Reduced Speed Limit for High-Profile Vehicles Using ATM Technologies (Source: Texas Transportation Institute).....	147

Figure D-8. Potential Implementation of Weather-Responsive Truck Use Prohibitions Using ATM Technologies (Source: Texas Transportation Institute) 149

Figure D-9. Potential Implementation of a Weather-Responsive Vehicle Use Restriction for High-Profile Vehicles Using ATM Technologies (Source: Texas Transportation Institute)..... 150

Figure D-10. Potential Implementation of Weather-Responsive Moving Lane Closure to Assist with Snow Removal Using ATM Technologies (Source: Texas Transportation Institute)..... 151

Figure D-11. Components of Weather-Responsive Traffic Signal Management Strategy (Source: Texas Transportation Institute) 164

Figure D-12. Concept of Weather-Responsive Traffic Signal Management Deployment with Operator as Decision Maker (Source: Texas Transportation Institute) 166

Figure D-13. Concept of a Fully Automated Weather Responsive Traffic Signal Management Deployment (Source: Texas Transportation Institute) 167

Figure D-14. Concept of Weather-Responsive Traffic Signal Timing Deployment in a Connected Vehicle Environment (Source: Texas Transportation Institute) 168

Figure D-15. Map of South Dakota Showing Forecast Road Conditions (Source: Meridian Environmental Technologies) 180

Figure D-16. Precipitation and Road Condition Forecast for April 2, 2010 (Source: Meridian Environmental Technologies) 181

Figure D-17. Functional Components of a Regional Road Weather Travel Impact Prediction System (Source: Texas Transportation Institute)..... 182

Figure D-18. High-Level Concept Diagram for Seasonal Weight Restriction (Source: Created by Authors) 198

Figure D-19. Example Temperature Profile (Source: Meridian, Clarus Multi-state Regional Demonstration, Use-Case #2 Website) 199

Figure D-20. Example Resilience Profile (Source: Meridian, Clarus Multi-state Regional Demonstration, Use-Case #2 Website) 200

Figure D-21. NDOT Load Restrictions Chart (Source: NDOT Website, <http://www.dot.nd.gov/roadreport/loadlimit/spring-load-restrictions-chart.asp>)..... 202

D-1 Active Traffic Management (ATM) During Weather Events

1.1 Scope

Traffic management is rapidly expanding to include technology, communication, and control systems that provide a more proactive approach to managing demand and supply in complex travel situations. A concept called Active Traffic Management (ATM) consists of a suite of traffic management/control strategies and advanced technologies designed to improve the operational efficiency of highway systems. These technologies and systems are used to dynamically manage traffic flow and enhance capacity through the dissemination of control and advisory information to the users of the system. The operational goals and objectives of most ATM deployments are as follows:

- To maximize both safety and traffic flow during periods of congestion;
- To reduce the potential of collisions caused by rapid and severe speed differentials due to queuing during congested periods;
- To optimize the use of existing infrastructure during recurrent and non-recurrent congestion with minimum operator intervention;
- To improve trip reliability by limiting the effects of abrupt speed and lane changes by motorists approaching the end of a queue; and
- To provide additional capacity during periods of congestion and/or incidents.

Fundamentally, ATM requires moving to a dynamic, proactive set of strategies looking at travel reliability as a core objective. Common traffic management strategies deployed in freeway applications as part of an ATM system include the following:

- **Speed Harmonization/Lane Control:** Dynamically adjust speed limits on a freeway corridor based on the level of congestion to reduce the risk of accidents and optimize the flow of vehicles through the corridor.
- **Queue Warning:** Display information about downstream traffic backups to the motorists using Variable Message Signs (VMS) to inform motorists of downstream queuing and lane closures, allowing motorists to select alternate routes or lanes and reduce queue buildup.
- **Dynamic Re-routing:** Provide information and guidance to motorists regarding diversions and alternate routes when there is downstream congestion.
- **Dynamic Vehicle Restrictions:** Restrict specific classes of vehicles, in particular large trucks, from all or a portion of the freeway. It can also consist of placing different types of restrictions on different types or classes of vehicles. Chain requirements for heavy vehicles or specific truck speed limits during limited visibility events are examples of dynamic vehicle restrictions imposed during adverse weather conditions.
- **Dynamic Lane Restrictions:** Place restrictions on the types of movements that are permitted in a lane. For freeway applications, this could mean restricting use of the lane by all or specific classes of vehicles.
- **Hard Shoulder Running:** Allow motorists to use the freeway shoulder during congested periods to reduce congestion during peak periods. For this strategy the shoulders should be upgraded to full

depth pavements, and monitored vehicle refuge areas should be constructed for disabled or stopped vehicles.

Managing traffic during adverse weather fits in the ATM framework. A concept of operations for Weather Responsive Traffic Management needs to include many if not all of the strategies identified for ATM. For example, during severe weather events, it is not uncommon for transportation and law enforcement personnel to want to implement speed, lane-use, and vehicle-use restrictions in response to deteriorating weather and pavement conditions. These restrictions are intended to improve safety by matching the operating characteristics of the traffic stream to the physical conditions that exist on the roadway. Transportation and law enforcement personnel may implement speed restrictions because of deteriorating pavement friction or limited sight distance. Speed harmonization techniques might be implemented during inclement weather to reduce and limit the effects of speed differentials in the traffic stream, which might lead to increased collisions. Similarly, transportation agencies may want to separate vehicles in the traffic stream – restricting trucks and high-profile vehicles to specific lanes. Likewise, in some situations, the appropriate response to deteriorating roadway and travel condition might be to restrict particular vehicles (such as trucks and other high-profile vehicles) from using the roadway until travel conditions have improved. Critical to all these strategies is the need to warn motorists of impending restrictions and disseminate to them the reasons for the actions.

1.1.1 Document Overview

The purpose of this document is to provide a concept of operations for using ATM strategies to better manage traffic during weather events. This concept of operations show how strategies like variable speed limits/speed harmonization, vehicle type restrictions, vehicle lane restrictions, and traveler information systems can be implemented in an holistic manner to assist in managing traffic operations during inclement weather.

- **Section 1.2:** Indicates the documents referenced in the development of this concept of operations.
- **Section 1.3:** Provides an overview of what ATM is and how it currently operates in the United States.
- **Section 1.4:** Provides a justification of the changes to the current situation.
- **Section 1.5:** Provides a discussion of the proposed changes to the system so as to allow agencies to provide weather-responsive ATM.
- **Section 1.6:** Provides several operational scenarios that illustrate how ATM strategies and technologies might be used to provide weather-responsive traffic management advisories and controls on freeways.
- **Section 1.7:** Provides the high-level user needs and system requirements.
- **Section 1.8:** Discusses the analysis and the potential performance metrics that can be used to measure system effectiveness.

1.1.2 Concept Overview

Various strategies can be used to counter the effects of lost capacity and reduced operating speeds during inclement weather. Strategies like speed harmonization can be used to reduce the maximum posted speed limits based on snow, ice, wind, or other weather conditions. Dynamic message signs can be used to implement truck prohibitions or restrict trucks to specific lanes on a freeway to separate slow moving vehicles from vehicles not impacted by the weather conditions. Lane control signals can also be deployed to provide travelers with end of queue warnings and lane closure information. Generally these strategies are

implemented at the request of police, emergency management, or maintenance personnel. Once implemented, strategies need to be updated continuously as weather conditions change over time.

1.2 Referenced Documents

The following documents were used in the development of this concept of operations document:

- *Active Traffic Management Concept of Operations*. Washington State Department of Transportation, December 2008.
- *Active Traffic Management Standard Operating Procedures I-5, SR-520, I-90*. Washington Department of Transportation, July 29, 2010.
- *Active Traffic Management: The Next Step in Congestion Management*. Report No. FHWA-PL-07-012. FHWA, U.S. Department of Transportation. July 2007.
- *Synthesis of Active Traffic Management Experiences in Europe and the United States*. Report No. FHWA-HOP-10-031. FHWA, U.S. Department of Transportation. March 2010.

1.3 Current System or Situation

Although widely used in Germany, the Netherlands, and the United Kingdom, the concept of Active Traffic Management (ATM) has only been gaining traction in the United States since 2006. With ATM, agencies try to dynamically manage capacity and demand in real-time, based on prevailing traffic and roadway conditions. The concept relies heavily on agencies having the ability to measure prevailing travel conditions in real-time, to identify root sources and specific locations of congestion, and using advance traveler information systems and technologies to implement actions and strategies to affect travel behavior in a corridor. ATM focuses on trip reliability – ensuring a level of consistency in service from the facility while at the same time reducing the amount of inconsistency (or variability) in operating conditions.

ATM deployments in Europe and the United States use combinations of symbols and words displayed on dynamic message signs (DMS) mounted on sign gantries that span over all the freeway lanes in a particular direction. These gantries are spaced at regular intervals (e.g., every ½ mile). Each gantry contains a number of different system DMS's installed over each lane or mounted to the side of the freeway. As the driver passes through sections of freeway, the messages on the signs are used to convey the specific regulatory and driving conditions that are in effect until the next sign gantry.

Key to the system is the over-the-lane DMS (ODMS). The ODMS are small in nature (e.g. 42 pixels by 42 pixels, 6 characters per line, 4 lines of 9-inch characters) and have the capability of displaying both text, and colored graphics to display vehicle and truck speed limits, truck restrictions, and lane use symbols. These ODMS are used to convey conditions to drivers driving in each lane. Side-mounted DMS (SDMS) signs mounted on the side of each lane are then used to provide drivers with information about a specific condition.

The SDMS are larger than the ODMS but still not as large as a conventional DMS. These signs are full matrix signs and are capable of displaying messages in color. The messages displayed on each sign are limited to short message (no more than three lines of eight characters each). Both SDMS on each sign gantry would display the same message (unless overridden by the operator). Each SDMS would be used to display speed limit messages, reduced speed warning messages (in conjunction with reduced speed limits on the ODMS), lane closure/ lane restriction information, and vehicle restriction messages.

On every second or third sign gantry (depending on need, geometric conditions, and sign conspicuity), the two SDMS would be replaced with a single conventional DMS located over the right shoulder. This sign would be the typical DMS sign used in most freeway management applications (3 lines of 12 to 21 – 18” characters per line). Typical messages displayed on this DMS might include safety and congestion alerts, incident messages, amber alerts, emergency restrictions, roadway or lane closures, public service announcements, etc. However, during adverse weather conditions, these signs would be used to provide travelers with weather information associated with a weather traffic management response (e.g., “ICE ON ROAD”, “FOG AHEAD”, “HIGH WINDS”, etc.).

While the discussion below is not exhaustive of the capabilities and situations in which ATM systems and technologies might be used, it is intended to illustrate some of the potential uses and capabilities of the ATM technologies deployed on a freeway.

Figure D-1 shows a typical sign configuration during normal driving conditions. In this particular situation, the ODMS are blank (or black-out). The SDMS may be used to display the speed limit of the roadway under normal driving conditions or may also be blank, while the large DMS could be blank or display normal traveler information messages.

One application of the system is to implement speed harmonization/queue warning through the use of dynamic speed limits. Sensors in the roadway constantly monitor lane-by-lane travel speeds. When congestion forms, the speed on the freeway begins to drop. The ATM control logic senses that speeds are dropping and activates the ODMSs upstream of the congested section, slowing down traffic approaching the congestion. The SDMS are also activated indicating that a reduced speed limit is in effect and/or drivers should be aware that they are approaching slow traffic ahead. This strategy is intended to reduce the speed differential between traffic regimes (i.e., congested and uncongested regimes); thereby reducing the potential for drivers to be surprised when they encounter the congested region. Figure D-2 shows how the sign gantries would be used to implement a variable speed limit ATM strategy. Speed limits can vary lane-by-lane and can be adjusted dynamically as travel conditions warrant.

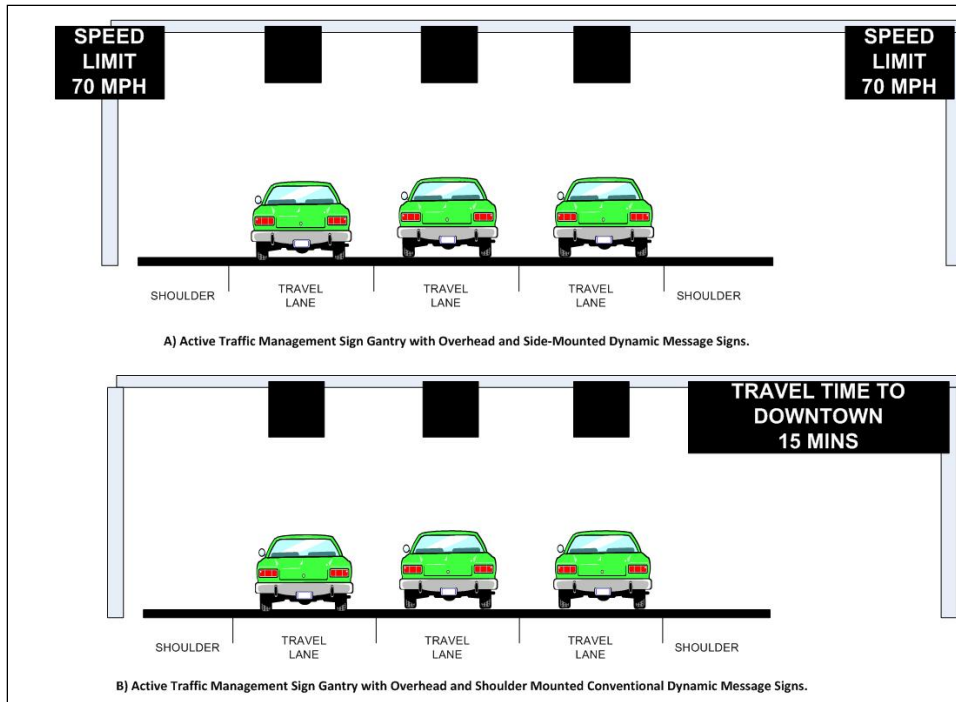

Figure D-1. Configuration of ATM Sign Gantries during Normal Travel Condition (No ATDM Strategy Deployed; Source: Texas Transportation Institute)

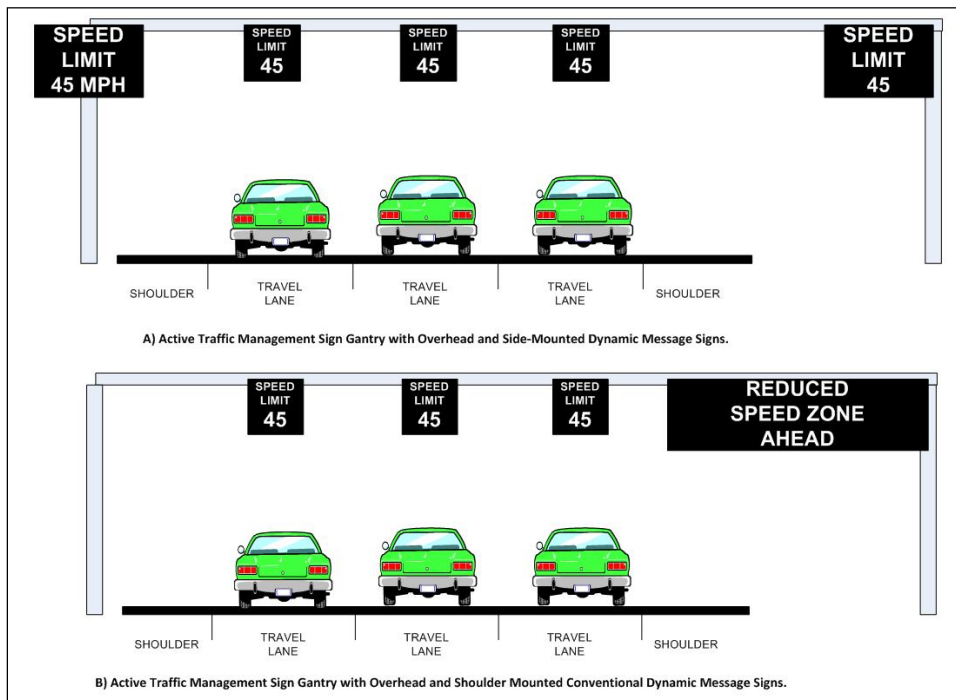

Figure D-2. Use of ATM Technologies to Implement Variable Speed Limits (Source: Texas Transportation Institute)

Another common application of the ATM technology is to provide advance warning of lane closures due to incidents or work zones. In this particular application, the ODMS can also function as lane-use control signals. (Figure D-3) shows how the ATDM system might be used to implement a notification of a lane closure strategy. A red "X" would be used to indicate that a lane is closed or blocked because of an incident or maintenance activity. A yellow "X" is used to warn travelers of an impending blockage and inform them that they should begin vacating the lane. A green downward point arrow is used to tell motorists that the lane is open and available for use. By sequencing messages upstream of the closure, the intent of this signing strategy is to provide information to approaching motorists in advance of the lane closure in an attempt to encourage drivers to vacate closed lanes further upstream of the point of closure.

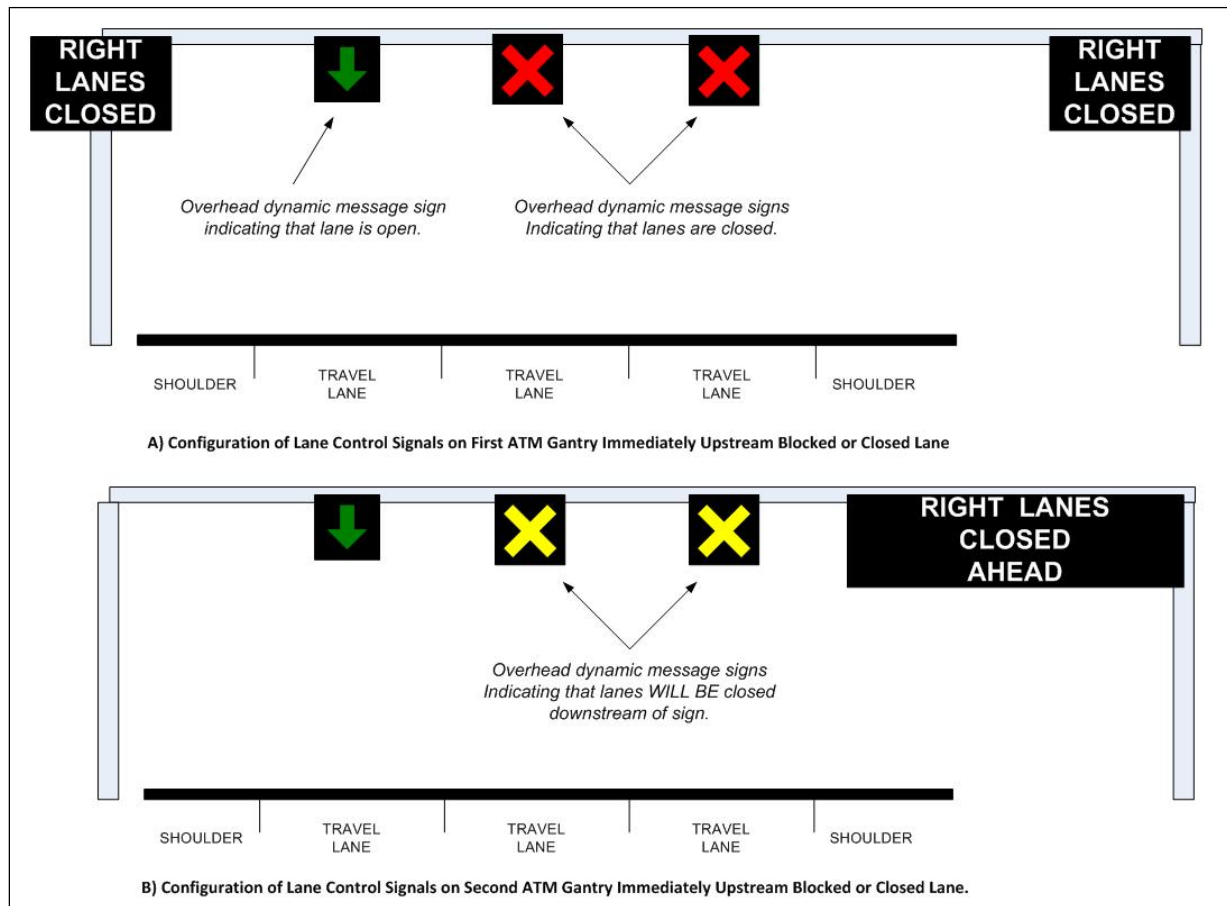

Figure D-3. Use of ATM Technologies to Implement a Lane Closure Strategy (Source: Texas Transportation Institute)

Figure D-4 shows a high-level, functional architecture of a current implementation of ATM in the United States. In both Seattle and Minneapolis, the ATM is deployed as part of a much larger freeway management system. This figure only shows the high-level, functional components needed to provide the ATM capabilities.

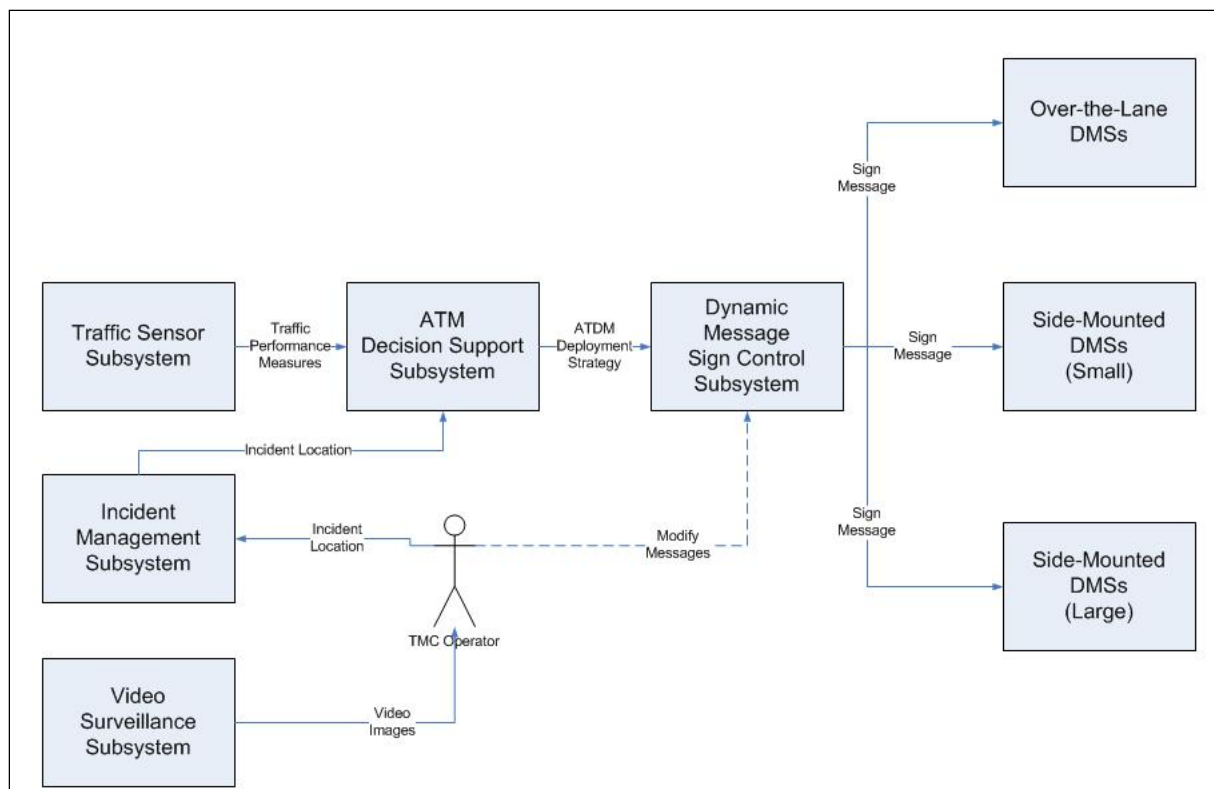

Figure D-4. High-level, Functional Components of ATM System (Source: Texas Transportation Institute)

Most ATM deployments are envisioned to operate with little or no operator involvement in the decision-making process. Traffic operating conditions are measured in real-time, and strategy selection and implementation are designed to occur automatically. The systems are designed this way so that they can be more responsive to changing traffic conditions than traditional freeway management systems.

1.4 Nature and Justification of Changes

Past research and experience have shown that adverse weather can significantly reduce not only capacity but also operating speeds on freeways. According to the 2000 Highway Capacity Manual, adverse weather can have the following impacts on traffic flow, operating speeds, and capacity.

- While light rain does not have much effect on operating speeds, heavy rains that affect visibility can have a noticeable impact on traffic flow and operating speeds.
- Similarly, light snows have a minimal effect on freeway traffic flows and operating speeds, but heavy snow can significantly influence the speed-flow curve.
- If not removed from the roadway, snow accumulation on highways cause drivers to not only increase their headways, but to also increase their lateral clearance, causing three-lane segments of freeway to operate as two widely separated lanes.

As such, the greatest benefits of ATM type strategies may be during periods of inclement weather. Coupling weather information integration into the ATM framework will enable strategies that can be used to counter the effects of lost capacity and reduced operating speeds during inclement weather.

1.5 Concepts for the Proposed Strategy

This concept of operations focuses on the systems and technologies that agencies need to deploy the following weather-responsive ATM strategies:

- To implement weather-related variable speed limits/speed harmonization.
- To implement truck speed restrictions in response to changing weather conditions.
- To prohibit trucks and other classes of vehicle from using a facility during weather events.
- To restrict trucks and high-profile vehicles from using certain lanes during weather events.
- To provide traveler information in support of weather-responsive maintenance operations.

The following section discusses some of the operational policies and constraints and the functional components of ATM strategies that are needed to implement these weather-responsive strategies.

1.5.1 Description of the Proposed Strategy

During adverse weather conditions, the ATM system could be used to provide various types of weather responsive traffic management responses, including variable speed limits (or speed harmonization), truck restrictions, truck speed limits, or lane-use control. Weather responsive ATM strategies could be implemented either automatically (with or without operator approval) or manually. Figure D-5 shows the basic architecture of the system. The pink shaded boxes with bold typeface represent new components being added to the system to accomplish the functions listed above.

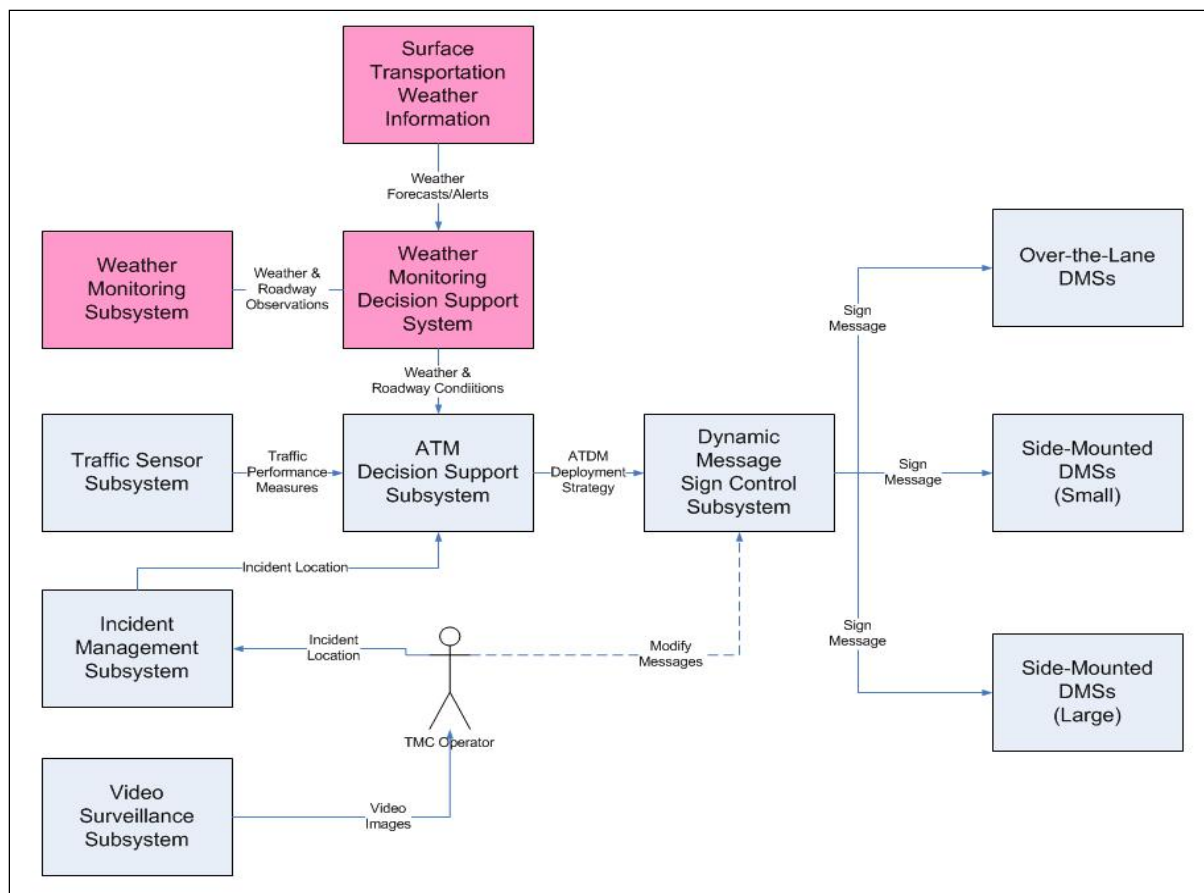

Figure D-5. Components of Weather-Responsive ATM System (Source: Texas Transportation Institute)

Weather Monitoring Subsystem

The weather monitoring component is responsible for obtaining all the road surface and weather information needed to assist in determining when and where to implement different types of weather ATM strategies. Through sensors located in the field communicating back to the weather monitoring system, the ATM decision support system would be provided with updates of weather conditions, particularly visibility, surface conditions and/or precipitation accumulations. These sensors could be agency-owned or information can be provided by a private weather information provider. The types of data needed from the weather monitoring component would include the following:

- The current wind speed and direction,
- The current ambient air temperature,
- The presence of precipitation,
- The rate at which precipitation is currently falling and the start and stop time of the latest recorded precipitation,
- The current visibility distance,

- The current temperature of the pavement surface and an indication of the presence of any moisture on the surface,
- The current depth of snow and packed snow on the traveled way,
- Expected time of snow fall or rain storm, and the probability of snow and rain, and
- The current thickness of ice on the traveled way.

The weather monitoring system may also provide situation assessments of weather conditions, such as the following:

- An assessment of the current wind condition (e.g., calm, light breeze, gale, gusty, etc.);
- An assessment of the type and intensity of the current precipitation (e.g., no precipitation, moderate snow, heavy rain, etc.);
- An assessment of the visibility (e.g., clear, foggy, smoke, sun glare, etc.); and
- An assessment of the pavement state (e.g., dry, standing water, flowing water, packed snow, etc.)

Surface Transportation Weather Information Subsystem

This represents the providers of value-added sector specific meteorological services. These providers utilize National Weather Service data and predictions (including the qualified environmental data from the *Clarus* system), road condition information and local environmental data provided by the traffic management or maintenance organizations, and their own models to provide surface transportation related weather observations and forecasts including pavement temperature and conditions. Such information could also include services like *Clarus*-enabled quality-checked ESS information or other value-added surface transportation weather forecasts at hourly frequencies (and when thresholds have been exceeded for weather/road weather parameters). This subsystem includes ongoing interaction with meteorologists for weather impact prediction and location-specific forecasts. Information from this subsystem may be directly integrated and overlaid with Traffic Management Center (TMC) management software and the ATM decision-support system.

Weather Monitoring Decision Support System (WMDSS)

The WMDSS is a subsystem component is responsible for collecting, processing, integrating, and synthesizing weather information from different sources, and assessing and predicting its impact on traffic operations in a corridor. The purpose of this assessment is to identify for transportation management agencies when, where, and for how long traffic operations in the network will be affected by weather conditions. This subsystem might use real-time or off-line micro- or mesoscopic simulation or other similar forecasting tools to model the effects of weather operations and determine where operational problems are likely to develop. This model would also illustrate how operational problems or impacts are likely to grow and expand as weather conditions continue to deteriorate.

ATM Decision Support Subsystem

The decision support subsystem is responsible for making the decisions about when and what kind of ATM strategy to implement. This component would contain the rules and criteria for when and where to implement the various active signal management strategies. Measured weather, roadway surface, and traffic conditions

would be compared to agency criteria established for each of the traffic signal management strategies approved by the agency. The output of this component would be the recommended ATM strategy. This component is responsible for performing the following functions:

- Retrieving and processing traffic and travel condition information from the roadway and weather monitoring subsystems,
- Comparing actual traffic, pavement, and weather conditions to established thresholds and criteria,
- Assessing and recommending the appropriate active traffic management strategies to deploy based on the prevailing traffic and travel conditions
- Implementing the accepted/approved active traffic management strategy on the sign gantries, and
- Updating implemented active traffic management strategies as conditions change.

DMS Control Subsystem

This component of the system is responsible for controlling the ATM technologies that have been deployed on the roadway (i.e., the dynamic message signs located on the sign gantries). This component interfaces with the decision support system and is responsible for formatting the messages to be displayed on the sign gantries and for communicating those messages to the various dynamic message signs in the system. This subsystem would also monitor the status of the various dynamic message signs and be responsible for managing the messages that are displayed on the system. This subsystem would also need to prioritize message and strategies to be deployed. As the system is likely to be used to display strategies for purposes other than just weather (such as incidents, etc.), agencies would need to develop a hierarchy of conditions for displaying different types of ATDM treatments.

TMC Operator

The goal of most ATM systems is to operate autonomously, with little or no intervention from an operator; however, a TMC operator remains a vital component of the system. The TMC operator would be responsible for developing the initial responses that needed to be implemented by the decision support system. The operator would also be responsible for identifying rules and procedures for implementing ATM strategies for different operating scenarios, and for establishing criteria and thresholds needed to implement a response. System operators would also have general oversight authority of the decision support system to fine-tune responses after they are implemented or to address issues, improvements and situations not identified during the development of the implementation rules and scenarios.

1.5.2 Operational Policies and Constraints

A number of operational constraints exist when deploying weather-responsive ATM strategies. First, ATM requires that agencies have staff and technologies that can support real-time decision-making and the dissemination of traffic and travel information to the traveling public. Generally, this means agencies have a traffic management center and an infrastructure that can support real-time traffic management. Agencies must also have the resources and capabilities to install, operate, and maintain not only the traffic detectors and the dynamic message signs, but also the weather sensing equipment.

Second, deploying weather-responsive ATM strategies requires a high density of both traffic detectors for measuring traffic conditions, and weather sensors for measuring prevailing roadway surface and visibility conditions. Roadway traffic data needs to be measured on a lane-by-lane basis and spaced at regular intervals

to ensure that changes in traffic operating conditions can be measured quickly and accurately. Weather sensors need to be installed at regular intervals (every three to five sign gantries) next to the freeway to ensure that changes in weather conditions are also detected rapidly. Roadway sensors and weather information both need to be constantly updated in real-time. Robust and redundant communications systems are needed to ensure that both roadway and weather information reach the control center.

Finally, the ATM strategies are only effective if they can be enforced by local law enforcement agencies. State and local agencies may need to enact new laws and ordinances that will allow different operating strategies (such as variable speed limits or vehicle lane-use restrictions) to be implemented. Some agencies may also have to implement changes to their Manual on Uniform Traffic Control Devices (MUTCD) to permit the use of certain signs to be displayed through dynamic message signs.

1.6 Operational Scenarios

This section describes several operational scenarios that illustrate how an Active Traffic Management (ATM) system can be used to manage traffic during adverse weather conditions. The ATM techniques that are discussed are as follows:

1.6.1 Variable Speed Limits

In an automated mode, the decision support system would monitor both weather information from the ESS and traffic flow information from the agency's traffic surveillance system. When pavement conditions or precipitation rates begin to impede traffic flow, the decision support system would recommend to the operator to activate the appropriate weather-responsive actions. These plans could be stored in a library of responses or generated by the decision support system based on the criteria established by the operations. TMC operators should work with weather forecasters, police and emergency management personnel, and maintenance personnel to identify the appropriate speed limits for a variety of pavement and visibility conditions and how these conditions should be monitored and evaluated by the decision support system.

Weather responsive variable speed limits could also be implemented based on requests by police or emergency response personnel, maintenance personnel, and/or DOT operations personnel. In these situations, system operators would implement the variable speed limits manually. Operators could manually input appropriate responses or select an appropriate response plan from a library of stored response plans. All manual overrides should be approved by the appropriate engineer-in-charge in the TMC.

Figure D-6 shows an example of how weather responsive variable speed limits could be implemented using ATM technologies. ODMS would be used to display the appropriate speed limit for each section of freeway. All speeds shown on the ODMS would be regulatory speed limits. The speeds shown on the sign would be in effect until either another set of signs show a different speed or the driver leaves the ATM zone. The SDMS would be used to alert drivers that they are in an area of reduced speeds. Large DMSs in the affected area could also be used to provide drivers information about why the reduced speed limits are in effect (e.g. ICE ON ROAD).

The decision support system and/or system operators would first need to identify the section of freeway impacted by adverse weather conditions. Using pavement and visibility information provided by the road weather information system, the decision-support system would then determine what speed limit is appropriate for the prevailing conditions. Multiple sign gantries upstream of the affected area would be used to step down the speed to the appropriate limit according to agency policies. Similarly, the transition from the reduced speed limit to the normal speed limit would be spread over multiple sign gantries according to agency policy. If a full

reduction step is not required, the sign group closest to the impact area should show the full step reduction while the sign groups upstream of the full speed reduction would show a partial speed reduction.

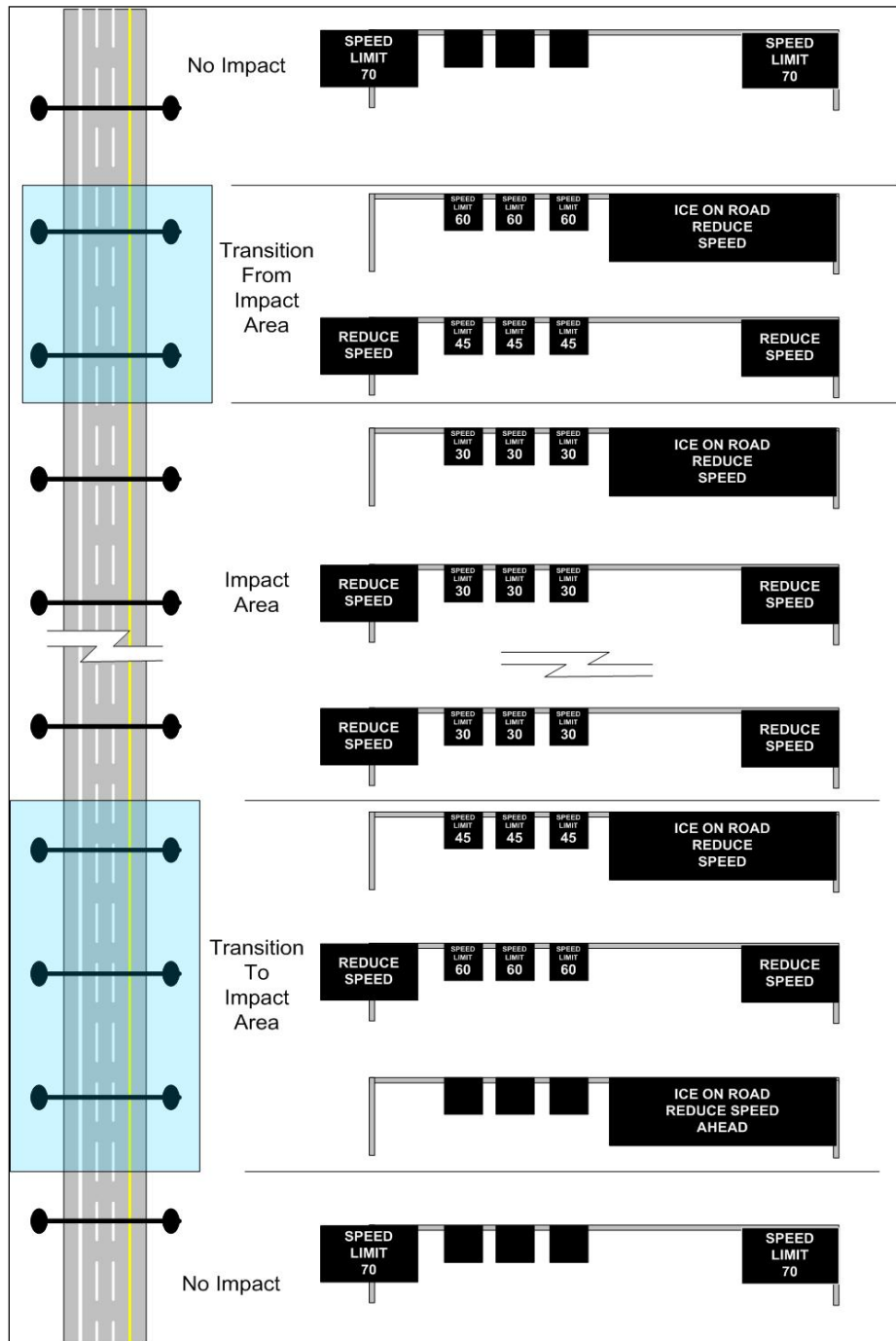

Figure D-6. Potential Implementation of a Weather-Responsive Variable Speed Limit Using ATM Technologies (Source: Texas Transportation Institute)

1.6.2 Truck Speed Restrictions

During some adverse weather events (such as high winds or icy conditions), it may be beneficial to restrict the speed at which trucks and other high-profile vehicles travel. High winds may be associated with another weather event (such as a severe thunderstorm or winter weather event) or may be a sole phenomenon not associated with another weather event. High winds are commonly associated with downdrafts from severe thunderstorms, tall bridges, or severe roadway cuts that tend to create a wind tunnel effect. Reducing the speed of trucks and other high-profile vehicles is a common strategy deployed in high wind situations to limit the potential of these vehicles overturning due to significant wind force.

Wind speed and direction information from a RWIS station, installed adjacent to the freeway, would continuously measure wind speed and direction. This information would be fed continuously to the WMDSS, where the system would compute the wind speed vector normal to the direction of travel (crosswind speed). The WMDSS would then compare the computed crosswind speed to an established threshold to determine the potential for high winds to overturn high profile vehicles. If the potential is severe enough, the WMDSS could then determine the appropriate speed limit for the prevailing crosswind conditions.

After determining what the appropriate speed limit should be for the prevailing crosswind conditions, the WMDSS would communicate this speed to the ATM system, which would then implement the reduced speed traffic plan on the sign gantries. The ODMS would be used to display an appropriate speed limit to commercial vehicle operators. The SDMS signs would be used to warn all travelers that truck speed restrictions are in effect while the conventional DMS signs would be used to convey appropriate weather-related messages to commercial fleet operators. Figure D-7 shows an example of how a reduced speed limit for high profile vehicle might be implemented on the ATM system.

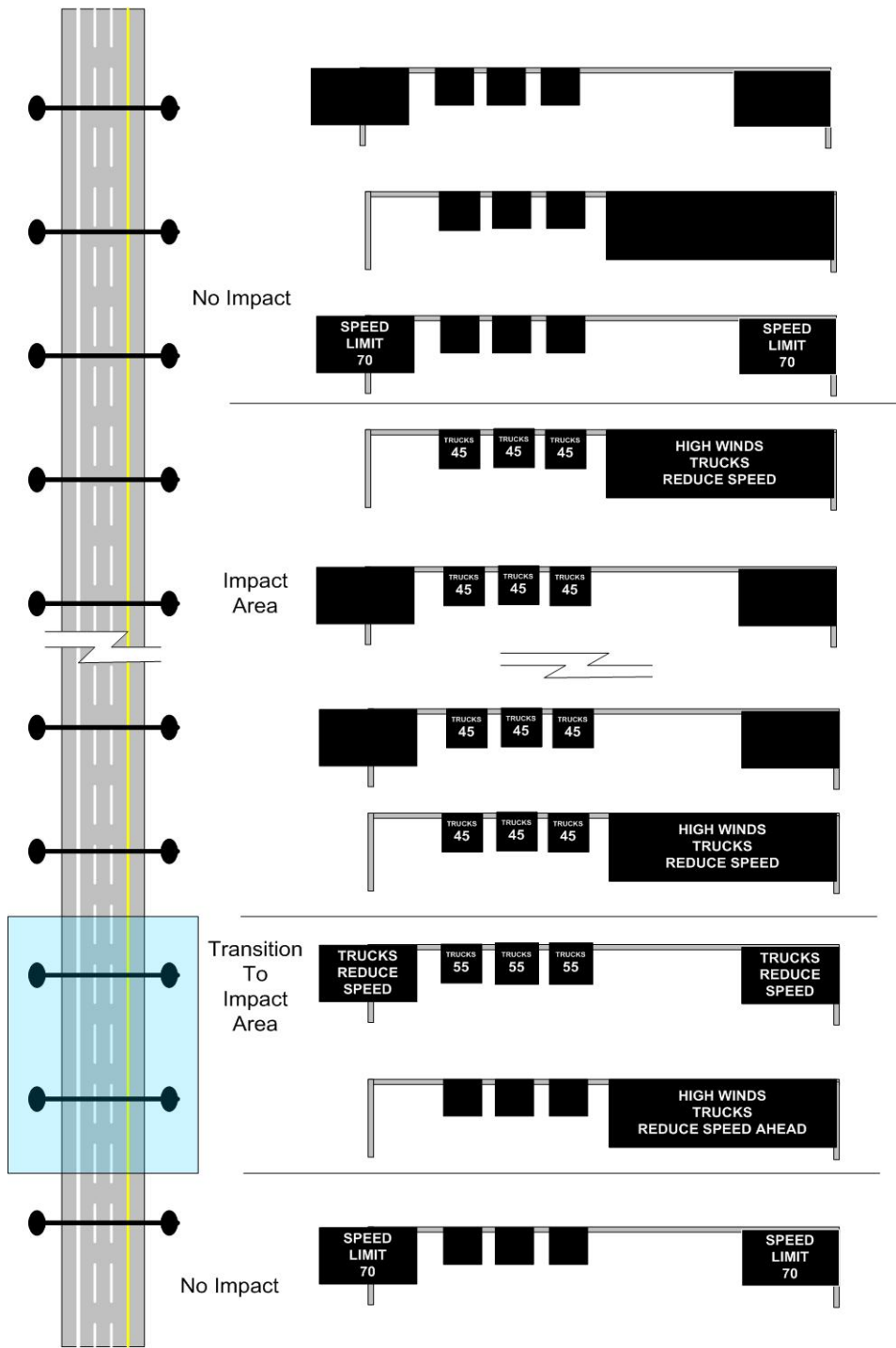

Figure D-7. Potential Implementation of a Weather-Responsive Reduced Speed Limit for High-Profile Vehicles Using ATM Technologies (Source: Texas Transportation Institute)

1.6.3 Truck Use Prohibitions

In some weather situations, agencies may want to use the ATDM system to restrict the use of certain sections of a facility by particular classes of vehicles. An example of this might be restricting high-profile trucks from using a particular section of freeway during high-wind events. For this particular weather-responsive ATDM strategy, the ODMS would be configured to display a vehicle restriction message, such as NO TRUCKS. The SDMS would then be used to provide travelers with information about why the restrictions were in place. Vehicle use restrictions could be implemented in concert with variable speed limits depending upon the weather conditions. Figure D-8 shows an example of how this strategy might be implemented in an ATDM system.

1.6.4 Vehicle Lane Use Restrictions

In other weather situations, agencies may want to use the ATDM system to restrict classes of vehicles to specific lanes. For example, during fog events, agencies may want to require trucks to use only the right lane of travel. Separate trucks from other vehicles in the traffic stream may reduce the potential for severe multi-vehicle collisions during limited visibility conditions. For this particular weather-responsive ATDM strategy, the ODMS would be configured to display a lane use restriction message, such as NO TRUCKS. The SDMS would then be used to provide travelers with information about why the restrictions were in place. Lane use restrictions could also be implemented in concert with variable speed limits depending upon the weather conditions. Figure D-9 shows an example of how this strategy might be implemented in an ATDM system.

1.6.5 Lane Closure

Figure D-10 shows how the system might be used to warn motorists of weather-related lane blockage. The figure shows the right two lanes being blocked because of a snow removal operation. To provide warning to motorists that the lanes are blocked by the plowing operation, a red "X" would be displayed on the ODMS over the closed lanes immediately upstream of the snow plow's location. The red "X" is used to indicate to drivers that the lanes immediately downstream are closed (or blocked) by the snow plows. A green arrow would be displayed on the ODMS over the lanes not closed by the snow removal operations. On the second sign gantries immediately upstream of the plow's location, a yellow "X" is displayed on the ODMS over the blocked lanes. This is intended to warn drivers that a downstream lane will be blocked, and that drivers should begin the process of vacating the lanes. The SDMS and the large DMSs would be used to provide motorists with traditional "lane blocked" or "lane closed" messages. Operators in the control center would need to continuously monitor the snow removal operations, and update the sign gantries as the operation continued downstream. Signs downstream of the moving operations could display reduced speed limits implemented by the WMDSS prior to the snow removal operations beginning on the roadway.

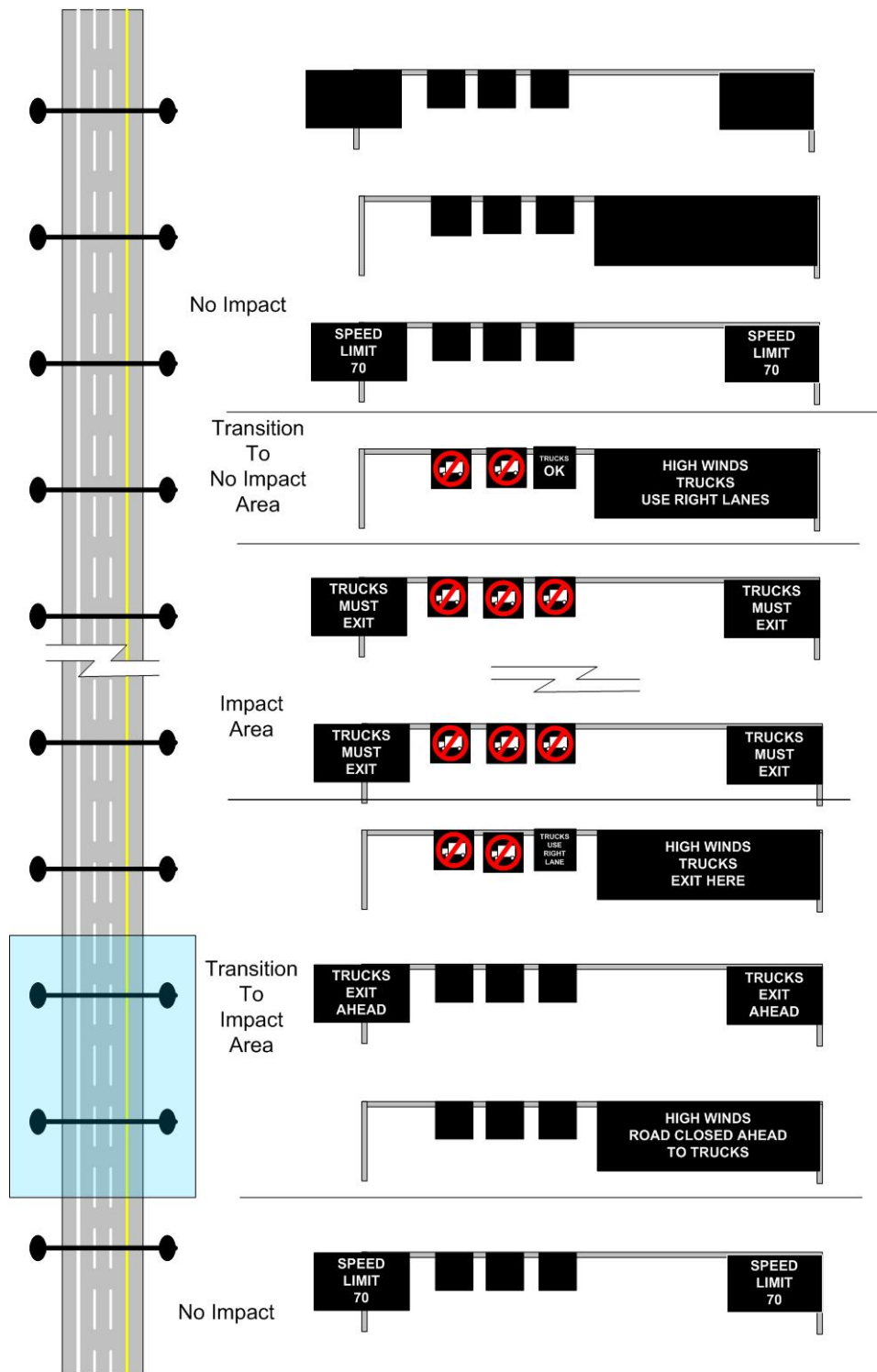

Figure D-8. Potential Implementation of Weather-Responsive Truck Use Prohibitions Using ATM Technologies (Source: Texas Transportation Institute)

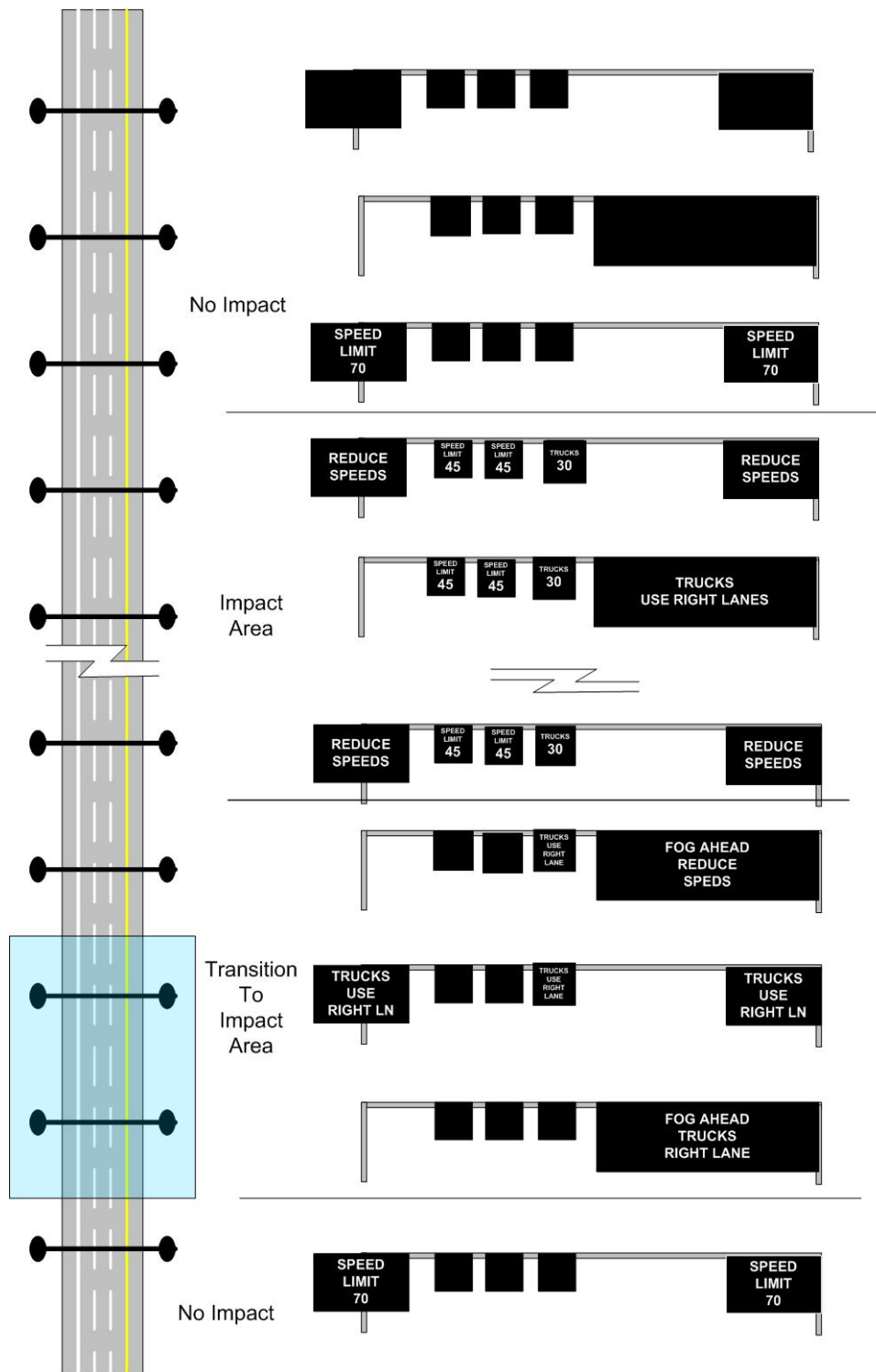

Figure D-9. Potential Implementation of a Weather-Responsive Vehicle Use Restriction for High-Profile Vehicles Using ATM Technologies (Source: Texas Transportation Institute)

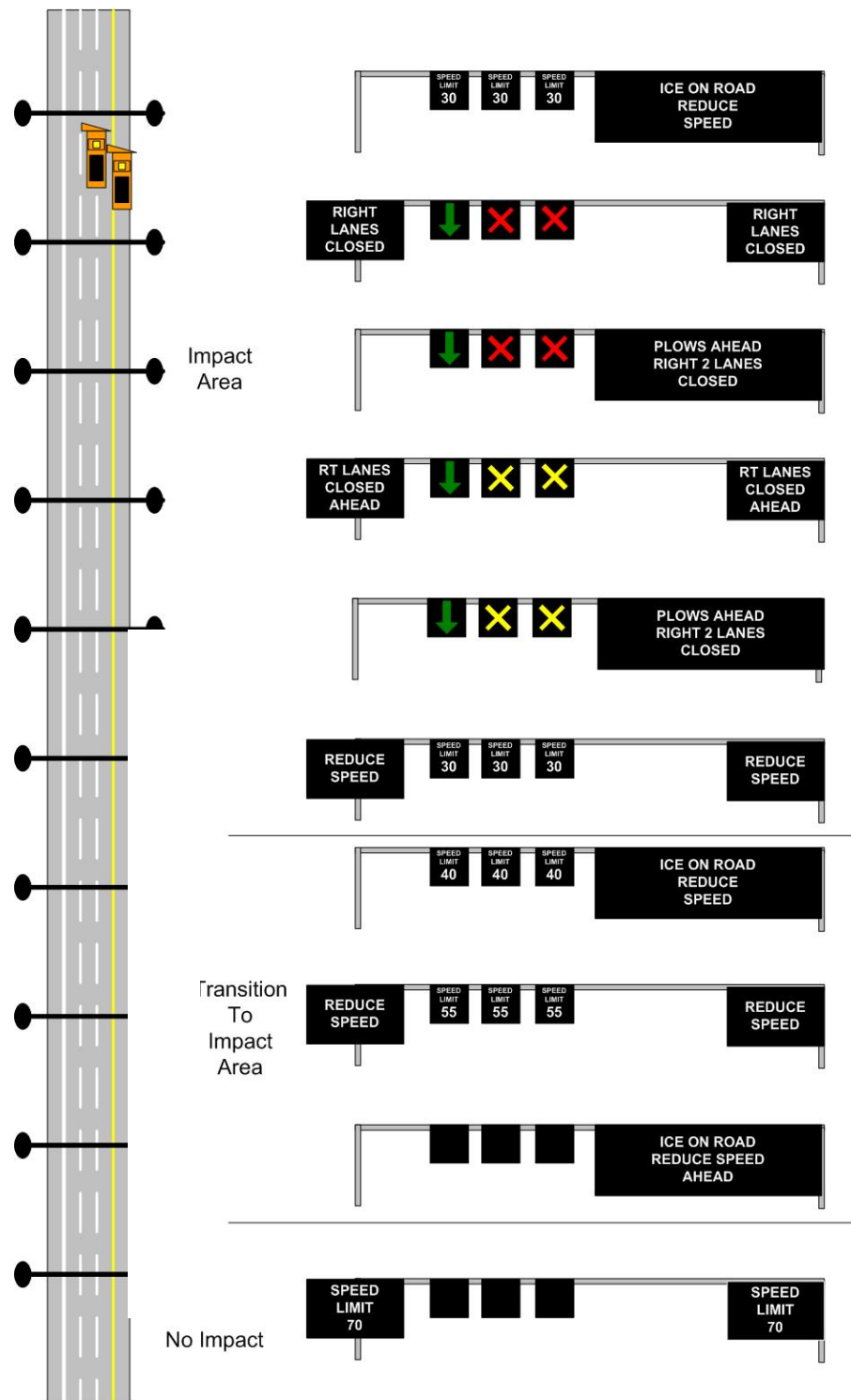

Figure D-10. Potential Implementation of Weather-Responsive Moving Lane Closure to Assist with Snow Removal Using ATM Technologies (Source: Texas Transportation Institute)

1.7 High-Level System Design

1.7.1 User Needs

Following is a list of the high-level user needs of transportation agencies that must be satisfied by ATM deployment during adverse conditions. These user needs are not in any particular order, and their order does not imply priority level.

1. Accurately measure prevailing road weather and traffic conditions occurring on the freeways in their jurisdiction.
2. Assess and predict the extent to which weather and traffic conditions will impact freeways.
3. Rapidly deploy and alter speed, lane-use, and vehicle restriction and other active traffic management strategies.
4. Monitor deployed active traffic management strategies.
5. Adjust deployed ATM strategies in real-time.

1.7.2 High-Level System Requirements

The following table shows the high-level system requirements needed to fulfill the identified user needs associated with deploying the weather responsive ATM strategy.

Table D-1. System Requirements for Deploying Weather Responsive ATM Strategy

User Need ID	User Need	Functional Requirement ID	Functional Requirement
1.	Accurately measure prevailing road weather and traffic conditions occurring on the freeways in their jurisdiction.	1.0	The system shall obtain real-time measurements of weather and roadway surface conditions from sensors at or near sections of freeway where ATM technologies have been deployed.
		1.1	The system shall be able to obtain road weather information from multiple sources.
		1.1.1	The system shall obtain real-time road weather information from environmental sensor stations (ESS) deployed in the freeway corridor.
		1.1.2	The system shall obtain route-specific road weather information from weather information service providers in real-time.
		1.2	The system shall obtain current weather information likely to impact traffic flow and operations.
		1.2.1	The system shall obtain current wind speed and direction.
		1.2.2	The system shall obtain the current ambient air temperature.
		1.2.3	The system shall obtain the precipitation data.
		1.2.4	The system shall obtain the rate at which precipitation is falling.
		1.2.5	The system shall obtain the start time of the latest recorded precipitation.
		1.2.6	The system shall obtain the stop time of the latest recorded precipitation.
		1.2.7	The system shall obtain the current visibility.
		1.3	The system shall obtain current road weather information likely to impact traffic flow and operations.
		1.3.1	The system shall obtain the current temperature of the pavement.
		1.3.2	The system shall obtain an indication of the presence of moisture of the pavement surface.
		1.3.3	The system shall obtain the current depth of snow.
		1.3.4	The system shall obtain the current thickness of ice.
		1.4	The system shall obtain real-time measurements of traffic conditions.
		1.4.1	The system shall integrate with an agency's traffic monitoring system.
		1.4.2	The system shall obtain volume measures.
1.4.3	The system shall obtain measures of prevailing travel speeds.		
1.4.4	Traffic system data shall be updated at least every minute.		

User Need ID	User Need	Functional Requirement ID	Functional Requirement
2.	Assess and predict the extent to which weather and traffic conditions will impact freeways.	2.0	The system shall have the ability to assess the degree to which the measured weather and roadway surface conditions will impact traffic operations.
		2.1	The system shall determine the degree to which the measured weather and roadway surface conditions will impact travel speeds.
		2.2	The system shall determine the degree to which the measured weather and roadway surface conditions will impact stopping distance.
		2.3	The system shall determine the degree to which the measured weather and roadway surface conditions will impact visibility.
		2.4	The system shall determine the degree to which the measured weather and roadway surface conditions will impact the speed differential between classes of vehicles.
		2.5	The system shall determine the degree to which the measured weather and roadway surface conditions will impact vehicle throughput.
		2.6	The system shall determine the degree to which the measured weather and roadway surface conditions will impact travel time reliability.
3.	Rapidly deploy and alter speed, lane-use, and vehicle restriction and other active traffic management strategies in responses to adverse weather conditions.	2.7	The system shall determine the degree to which the measured weather and roadway surface conditions will impact the need for emergency maintenance/road clearing activities.
		3.0	The system shall use real-time measurements of traffic operating conditions and weather and roadway surface conditions to determine which ATM strategy to implement for a given set of conditions.
		3.1	The system shall use real-time measurements to implement variable speed limits on the ATM system.
		3.1.1	The system shall automatically determine the appropriate speed limit for the prevailing traffic operating, weather, and roadway surface conditions using the real-time measurements.
		3.1.1.1	The system shall establish speed limits on a lane-by-lane basis.
		3.1.1.2	The system shall configure the DMS to produce a speed limit display that is consistent with the MUTCD and state and local guidelines.
		3.1.2	The system shall automatically determine the appropriate sequencing of speeds to be displayed on the DMSs to ensure proper transitions in speeds are displayed according to agency policy.
		3.1.3	The system shall have the capability to automatically configure the ODMSs to display the appropriate speed limit for each lane.
		3.1.4	The system shall have the capability to automatically configure the SDMSs to display the appropriate speed warning messages.
		3.2	The system shall use real-time measurements to implement truck speed limits on the ATM system.

User Need ID	User Need	Functional Requirement ID	Functional Requirement
		3.2.1	The system shall automatically determine the appropriate speed limit by vehicle class type for the prevailing traffic operating, weather, and roadway surface conditions using the real-time measurements.
		3.2.2	The system shall establish speed limits by vehicle class.
		3.2.2.1	The system shall configure the DMS to produce a truck speed limit display that is consistent with the MUTCD and state and local policy.
		3.2.3	The system shall automatically determine the appropriate sequencing of truck speeds to be displayed on the DMSs to ensure a proper transition in speeds is displayed according to agency policy.
		3.2.4	The system shall have the capability to automatically configure the ODMSs to display the appropriate truck speed limit for each lane.
		3.2.5	The system shall have the capability to automatically configure the SDMSs to display the appropriate truck speed warning messages.
		3.3	The system shall use real-time measurements to implement truck prohibitions on the ATM system.
		3.3.1	The system shall automatically determine when it is appropriate to prohibit trucks on the freeway based the prevailing traffic operating, weather, and roadway surface conditions using the real-time measurements.
		3.3.2	The system shall configure the DMS to produce a truck prohibition display that is consistent with the MUTCD and state and local policy.
		3.3.3	The system shall automatically determine the appropriate sequencing for displaying truck prohibitions according to agency policy.
		3.3.4	The system shall have the capability to automatically configure the SDMSs to display the appropriate warning messages associated with implementing truck prohibitions based on weather and roadway conditions and agency criteria.
		3.4	The system shall use real-time measurements to implement lane use restriction by vehicle class on the ATM system.
		3.4.1	The system shall automatically determine when it is appropriate to implement lane use restrictions by certain vehicle classes on the freeway based the prevailing traffic operating, weather, and roadway surface conditions using the real-time measurements.
		3.4.2	The system shall configure the DMS to produce a lane use restriction display that is consistent with the MUTCD and state and local policy.
		3.4.3	The system shall automatically determine the appropriate sequencing for displaying lane use restrictions according to agency policy.
		3.4.4	The system shall have the capability to automatically configure the SDMSs to display the appropriate warning messages associated with implementing lane use restrictions based on weather and roadway conditions and agency criteria.

User Need ID	User Need	Functional Requirement ID	Functional Requirement
4.	Monitor deployed active traffic management strategies.	4.0	The system shall monitor the impacts of implementing the weather-responsive ATM strategies on sections of freeway.
		4.1	The system shall obtain the traffic performance data from the traffic monitoring subsystem.
		4.2	The system shall generate traffic performance measures from the measured traffic data.
		4.2.1	The system shall generate performance measures related to the improved safety.
		4.2.2	The system shall generate performance measures related to the improved operational efficiency.
		4.2.3	The system shall generate performance measures related to the reduced level of congestion.
		4.2.4	The system shall generate performance measures related to the improved trip reliability.
		4.2.5	The system shall generate speed differential performance related to improved customer satisfaction.
		4.3	The system shall generate composite or aggregate performance measures during adverse weather conditions
		4.3.1	The summary reports shall be based on measured traffic, weather, and roadway condition data.
		4.3.2	The system shall produce summary reports by weather event.
		4.3.3	The system shall produce summary reports by sections of roadway.
		4.3.4	The system shall be able to produce summary reports that are configurable by the agency.
		4.3.5	The system shall provide real-time measures of system performance and effectiveness that are simple and easy-to-understand and communicate.
		5.	Adjust deployed ATM strategies in real-time
5.2	The system shall automatically update ATM strategies based on real-time measurements of traffic operating, weather, and roadway surface conditions.		
5.3	The system shall also allow implemented ATM strategies to be altered by an operator.		
5.4	The system shall notify the operator when changes to a deployed ATM strategy have occurred.		
5.5	The system shall automatically record when changes to a deployed ATM strategy have occurred.		
5.6	The system shall automatically return the DMSs to their previous state after the weather event is complete.		

1.8 Analysis of the Proposed System

Weather-responsive ATM is one of the tools that agencies can use to improve safety and operating efficiencies during adverse weather events. Table D-2 contains a list of potential performance measures that could be used to assess the effectiveness of deploying weather-related ATM strategies on freeways.

Table D-2. Potential Performance Measures for Assessing the Effectiveness of Using ATM Strategies during Weather Events

Performance Category	Performance Measure
Operational Efficiency	<ul style="list-style-type: none"> • Increase in # of lane-miles with weather-related ATM deployment • Change in time lag between weather-event start and activation of ATM deployment • Ratio of time per month of weather-related ATM activation to other ATM activation • Change in time to return to level of service post weather event
Safety	<ul style="list-style-type: none"> • Reduction in # of stranded motorists or abandoned vehicles • Reduction in # of severe weather rescues • Number of collisions (Property Damage only, injury, fatal) pre and post ATM deployment • Ratio of weather-related collisions to all collisions • Change in crashes per lane-mile affected by weather event • Change in commercial vehicle crash rate
Congestion	<ul style="list-style-type: none"> • Change in median and 85-percentile travel time (or median travel speed) during weather • Increase in maximum facility throughput • Increase in weather event VMT • Reduction in weather-related delay • Reduction in delay per lane-mile affected by weather event • Change in lane-miles and freeway miles "closed" by adverse weather
Reliability	<ul style="list-style-type: none"> • Change in percent of trips with inclement weather-related travel time greater than twice average travel time
Customer Satisfaction	<ul style="list-style-type: none"> • # of compliments/complaints received during weather event • # of positive & negative news articles related to agency performance during weather events

D-2 Weather Responsive Traffic Signal Management

2.1 Scope

2.1.1 Document Overview

Most traffic signal timing strategies are designed assuming ideal weather conditions. Traffic detection systems, vehicle clearance intervals, and coordination timing plans are all designed assuming ideal travel speeds (i.e., speeds at or above the posted speed limit); however, adverse weather conditions, particularly snow and ice, can cause traffic to perform differently than expected. Heavy snows and rainfall can cause vehicle travel speeds to be substantially less than those used to develop traffic signal timing plans as drivers compensate for poor driving conditions. Because of losses in pavement friction, vehicle stopping distances can be greater and vehicle start-up lost times can be longer. Fog, driving rain, and blowing snow can also affect visibility to traffic signal heads, making it more difficult for drivers to see signal indications.

The purpose of this document is to provide a description of a concept of operations for a weather-responsive traffic signal timing strategy. This strategy would take information about roadway surface and weather conditions in real-time, and determine the changes to traffic signal timing and intersection detector settings to improve traffic flow and safety during inclement weather conditions. These new settings would be sensitive to the changes in vehicle operating characteristics caused by adverse weather. The vision is to use these strategies to better match signal timing plans and parameters to the prevailing travel conditions to promote more efficient traffic operations and reduce the potential of some weather-related vehicle crashes.

2.1.2 System Overview

At its highest level, sensors would be deployed in or around a corridor that would monitor atmospheric and pavement conditions. These sensors could be owned and operated by a public entity, or public entities could obtain this information from a private provider. The sensors would measure atmospheric and road surface conditions that might affect traffic operations on roadways with traffic signals. Examples of the type of information that these sensors would collect include the following:

- Presence and type of precipitation (snow, ice, rainfall, etc.)
- Rates of precipitation and projected accumulations,
- Current accumulations,
- Roadway surface temperatures,
- Visibility, and
- Air temperature, relative humidity and wind speed (for determining the likelihood of fog formation).

Weather and roadway surface condition information could then be integrated with traffic data and fed into the decision support system designed to assist the traffic signal system operator in: (1) assessing the potential impacts and effects of current (and projected) weather and roadway surface conditions on operations, and (2) determining the most appropriate type of traffic signal strategy to deploy in response to deteriorating conditions. Potential traffic signal timing strategies might include the following:

- Altering traffic detector configurations and settings to account for obscured lane markings, or reduced travel speeds.

- Lengthening all-red clearance intervals between conflicting movements to account for increased stopping distances and reduced visibility.
- Altering phase patterns or phase splits to reduce the potential of stopping vehicles at locations where roadway surface conditions have diminished (i.e., at a crest of up-slopes where reduced pavement friction might make it difficult to accelerate from a stop or at the bottom of down-slopes where reduced pavement friction may cause drivers to slide through intersection during clearance intervals, etc.).
- Implementing new coordination plans designed to provide progressions for increased traffic demands at slower speeds prior to or during a severe weather event.

The complexity of the decision support system could vary substantially depending upon the level of sophistication of the agency and its field equipment, and the type and frequency of weather events impacting traffic operations.

The decisions support system would then feed the recommended signal timing strategy to the traffic signal management system. Many locations currently use a traffic signal management system that allows them to remotely alter and update traffic signal timing plans and parameters. The traffic signal management system and the decision support system could be integrated together to allow weather-responsive traffic signal timing strategies to be implemented automatically, with or without operator intervention.

2.2 Referenced Documents

The following documents were used in the development of this concept of operations document.

- *National Transportation Communications for ITS Protocol: Environmental Sensor Station (ESS) Interface Protocol*. NTCIP 1204 version v03. October 2009.
- *NTCIP 1202 - NTCIP Object Definitions for Actuated Traffic Signal Controller Units - version 02*. November 2005.

2.3 Current System or Situation

Generally, agencies have multiple signal coordination/timing plans designed to handle different traffic demands for different times of day (e.g., an A.M. peak coordination plan, a P.M. peak coordination plan, etc.). These timing plans are designed to achieve a certain level of performance and to ensure a certain level of progression speed through a series of intersections. Inclement weather conditions, particularly snow and ice, have been shown to dramatically impact travel speed and vehicle operating characteristics – to the point where some agencies have developed special signal coordination plans designed specifically for inclement weather. Examples include:

- Connecticut Department of Transportation: Operates one signal system (about 30 signals) where they implement a special timing plan in response to poor weather conditions.¹ The snow plan adjusts offsets and increases cycle lengths to accommodate slow travel speeds on the primary arterial. Operators implement the timing plan based on visual observations of snow fall rate and traffic conditions.

¹ Personal contact with Hal Decker, TMC Manager, Connecticut Department of Transportation.

- Delaware Department of Transportation: Implements signal timing plan changes for snow events. Operators in the control center monitor congestion levels via CCTV and increase cycle lengths when they observe increases in congestion levels.²
- Utah Department of Transportation (UDOT): Developed a set of special timing/coordination plans that they implement on select routes during snow events.³ These timing plans were created to 1) account for slower operating speeds during significant snow events, and 2) assist with snow plowing operations on select thoroughfares. Different timing plans were developed to provide different progression strategies based on what weather conditions are like during different periods of day.

In the Utah deployment, an on-staff meteorologist examines current weather conditions and makes recommendations about when and where to implement a snow timing plan during a snow event. Operators in the TMC are responsible for implementing pre-established coordination plans which are designed to account for lower arterial travel speeds and increased loss times because of snow on the roadway. The snow timing plans are implemented on these select thoroughfares when the following conditions are satisfied:

- A request has been made by a maintenance shed supervisor and/or a recommendation made by the Traffic Operations Center (TOC) staff meteorologist.
- Significant reductions in travel speeds (30% or greater) have occurred.
- Signals are currently operating in a coordinated mode based on time-of-day (e.g., during late night hours, the signals are operating in a non-coordinated mode anyway).
- Delay-causing weather conditions are expected to last more than 20 minutes.
- Traffic congestion is present on the roadway.

The new timing plans are implemented by operators in the TOC using UDOT's central software system. Once implemented, these coordination plans remain in effect until one of the following conditions has been met:

- Snowplowing operations are complete;
- The next time-of-day step in a plan strategy is reached;
- The weather is no longer affecting traffic operations; or
- A request is made by [maintenance] shed operator to the TOC meteorologist to disable the plan.

Several locations (including the City of Clearwater, Florida⁴; the City of Minneapolis⁵, and the City of Charlotte, North Carolina⁶) all had systems at one point in time that implemented timing plan strategies in response for different weather conditions, but have subsequently discontinued the practice because of system upgrades, changes in intersection geometries, or staff reductions.

² Personal contact with Jim Clecher, TMC Manager, Delaware Department of Transportation.

³ Personal contact with Mark Taylor, Signal Engineer, Utah Department of Transportation.

⁴ Personal contact with Cory Martens, Signal System, City of Clearwater, Florida.

⁵ Personal contact with Scott Tashney, Traffic Engineer, City of Minneapolis, Minnesota.

⁶ Personal contact with Charles Abel, Signal Systems Section Manager, City of Charlotte, North Carolina.

2.4 Nature and Justification of Changes

During severe weather events like heavy snow fall or heavy fog or icy conditions, drivers experience harsh operating conditions. These conditions include slower travel time between intersections, longer distance required to stop at traffic signals, slower startups from a vehicle stopped at signal, poorer visibility of vehicles, lane markings, stop bars, traffic signs, and traffic signal indications. When designing typical signal timings, normal vehicle speeds are used for developing offsets. Detectors and traffic control signs are placed at appropriate locations based on normal speeds and normal deceleration rates. If signal timings are not revised, drivers experience significantly inefficient operations. Progression along a corridor is disrupted as motorists travel at slower speeds and can reach traffic signals after the termination of green. Detectors which are installed for efficient and safe operations based on normal speeds are unable to provide that service as motorists travel at different speeds and use different deceleration rates. Traffic signs and pavement markings may not provide the critical information to the motorists in a timely manner.

Alternative signal timings that consider the slower speeds observed in the design of the offsets can significantly improve progression along the arterial corridor. Motorists will experience fewer stops along an arterial. Modified detector passage times at individual intersections using slower speeds and lower deceleration rates can provide additional safety to motorists. Under severe driving conditions, safety has a much higher priority than efficiency.

Severe weather events can also have an impact on traffic patterns. The impact on traffic patterns depends on the type of weather event. Rain and snow events cause an increase in travel times, a decrease in deceleration characteristics impacting stopping distance, and a reduction in visibility of signal indications increasing driver-perception reaction time. Motorists after an ice storm on the other hand may have excellent visibility. However the pavement condition may not be conducive to normal driving conditions. Foggy conditions on the other hand may not deteriorate roadway conditions, but significantly impact visibility. Thus each type of weather event can impact the motorists and vehicle operating characteristics in a unique manner.

The type of weather event can also have an impact on the traffic volumes that the weather response strategy has to address. Usually at the onset of a severe snow fall, traffic volumes pick up significantly as motorists expect driving conditions to worsen and stay like that for a significantly long period of time. Snow fall can deteriorate road conditions with the accumulation of snow which can be on the roadway for quite a while. These higher volumes cause significant congestion during a peak period or can create a peak demand during the off-peak period. Current signal timings cannot accommodate such a demand even under normal driving conditions. The onset of a rain storm however results in a different type of traffic pattern. Usually a severe rain storm does not have as long of a duration as a snow storm and does not usually cause road conditions to worsen to the extent that a snow storm does. Motorists tend to postpone their trip during a heavy rain storm and travel when the severity of the storm reduces. This causes some lower traffic volumes during a severe rain storm. The combination of travel patterns and traffic characteristics is an important input into the development of alternative signal timing plans for weather related events.

2.5 Concepts for the Proposed Strategy

The goals of the weather-responsive traffic signal management strategy are as follows:

- Improve traffic flow during severe weather events by rapidly deploying traffic signal timing plans that are consistent with reduced operating characteristics (slow speeds and deteriorating roadway surface and visibility) and increased traffic demands.
- Improve traffic safety and level of service during inclement weather by:

- Reducing the potential for signal-related collisions (rear-end and right-angle collisions),
- Reducing the potential for increased instances of red-light running.
- Improve system operating efficiencies by limiting stops at locations where geometrics are severely impacted by weather (uphill or downhill approaches).

The strategy is intended to be an additional operating mode over existing traffic signal timing strategies. It is intended to be implemented only when adverse weather conditions cause traffic flow conditions to deteriorate. Under normal weather conditions, the system would operate in a standby or monitoring mode. In this mode, the system would monitor weather and roadway surface conditions continuously, either from road weather information systems and environmental sensing systems installed in or near the corridor or from private weather information service providers. Pavement sensors would monitor pavement surface temperatures and/or roadway surface conditions to determine when road friction was significantly reduced by presence and/or accumulation of ice, snow, or other precipitation. Weather monitoring stations would provide measures of atmospheric conditions, such as precipitation type and rate, air temperature, etc. Visibility sensors can be used to determine when fog, driving raining, blowing snow, etc. might be impacting a driver's ability to see traffic signal indications. Operators in the control center can also use video surveillance cameras, media reports, social media alerts, and reports from maintenance and law enforcement personnel to pinpoint problem locations where roadway surface conditions have deteriorated. This information could be integrated with information from traffic system detectors that measure quality of progression and/or travel speeds to determine when weather conditions are having an impact on traffic operating conditions.

The operator (and the system itself) would continue to monitor weather and traffic operations to determine effectiveness of timing plans or when to deactivate response. Reasons for deactivating the weather-responsive traffic signal timing plan might include the following:

- Visual inspection confirms that weather conditions are no longer impacting traffic operations in the corridor.
- Operators are notified by maintenance personnel that roadway has been "treated" (e.g., plowed and sanded) and that travel conditions are no longer hazardous.
- Operators are notified by emergency management or law enforcement personnel that roadway conditions have improved.
- Operators are notified by emergency management or law enforcement personnel that roadway has been closed (in which case they may want to go to flash signal operation).
- Additional thresholds and criteria in the decision support system could be used to determine when to deactivate the weather-responsive traffic signal timing plans.

Prior to removing the weather-responsive traffic signal timing strategy, the operator may want to verify that operating conditions are returning to normal operations using video surveillance, if available. To deactivate the timing plan, the operator can use the traffic signal system management software to return the signal back to normal operations for current time-of-day. The operator (and/or the system) should log when traffic signal returned to normal operation.

2.5.1 Operational Policies and Constraints

Agencies must first address a number of operational policies and constraints before deploying this weather responsive traffic signal management strategy. First, agencies must establish implementation policies and/or standard operating procedures as to when and where to implement weather responsive traffic signal management strategies. Standard operating procedures should define under what conditions the weather

responsive traffic signal timing plans should be implemented, the steps used to implement the timing plans, the process for monitoring their implementations, and any notifications that should occur after the timing plans are implemented. The standard operating procedures should also include the conditions and criteria used to deactivate the timing plans, notifications that should occur after deactivating the system as well as any record-keeping that needs to be performed.

Implementation of the strategy also requires agency personnel to have a high level of knowledge of the conditions and nuances of when weather impacts traffic operations. Agencies also need personnel that have a good level of expertise on traffic signal timing and operations and must have the resources ready to develop and monitor traffic signal performance during adverse weather conditions.

This strategy requires that operators in a control center have access to weather and roadway conditions information. This weather information needs to be specific to identified corridors (sub-regional weather monitoring). Direct measurements of weather conditions at strategy locations are needed for automated systems. A decision support system would be needed to have an automated system. The decision support system would need to be integrated with traffic signal management software so that weather-related timing plans could be implemented automatically.

The strategy also requires good lines of communications with maintenance crews and law enforcement personnel who are responsible for maintaining safe operating conditions. These groups can provide onsite reports of driving conditions and can instruct operators when road conditions deteriorate to a point where the WRTM timing plans might be beneficial and (perhaps equally important) when roadway conditions have improved to the point where the weather-responsive traffic signal coordination plans are no longer needed.

2.5.2 Functional Components

As shown in

Figure D-11, there are four main components associated with implementing a traffic signal management strategy:

- Road weather monitoring system component,
- Decisions support system component,
- Traffic signal management system component, and
- Traffic management center (TMC) operator.

Each of these four components is discussed in detail below. While not shown in the figure, traffic condition information is an essential part of the strategy.

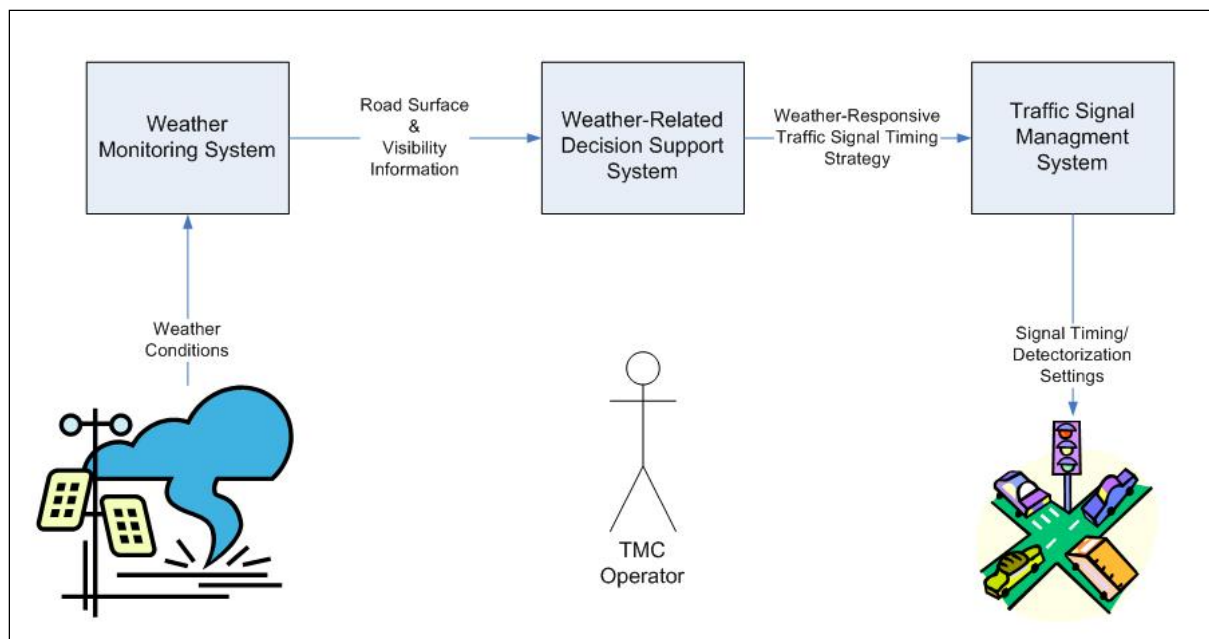

Figure D-11. Components of Weather-Responsive Traffic Signal Management Strategy (Source: Texas Transportation Institute)

Road Weather Monitoring Subsystem

The weather monitoring component is responsible for obtaining all the road surface and weather information needed to assist in determining when and where to implement a weather-responsive traffic signal management strategy. It is through this component that the system operator obtains updates of road weather conditions, particularly visibility, surface conditions and/or precipitation accumulations, through sensors located in the field communicating back to the weather monitoring system. These sensors could be agency- owned, or the information can be provided by a private weather information provider. The types of data needed from the road weather monitoring component would include the following:

- Current wind speed and direction,
- Current ambient air temperature,
- Presence of precipitation,
- Rate at which precipitation is currently falling and the start and stop times of the latest recorded precipitation,
- Current visibility distance,
- Current temperature of the pavement surface and an indication of the presence of any moisture on the surface,
- Current depth of snow and packed snow on the traveled way,
- Expected time of snow fall or rain storm, and the probability of snow and rain, and
- Current thickness of ice on the traveled way.

Weather Responsive Decision Support Subsystem

The decision support subsystem is responsible for making the decisions about when and what type of traffic signal management strategy to implement. This component would contain the rules and criteria for when and where to implement the various traffic signal management strategies. Measured weather, roadway surface, and traffic conditions would be compared with agency criteria established for each traffic signal management strategy approved by the agency. The output of this component would be the recommended signal timing strategy. The subsystem could be designed such that the recommended timing plan could be sent to the traffic management system component with or without operator approval.

Traffic Signal Management Subsystem

The traffic signal management component is responsible for implementing the selected timing strategy on the traffic signal controller. This component is the traffic signal management software system used by many agencies to remotely control and operate their traffic signal system. The decision support system would interface with this software to select timing plans from stored library, alter signal timing parameters (such as yellow and all-red duration), change detector settings (place recalls on critical phase, place phase omits, etc.), or change phase duration (minimum greens, maximum greens, split times, etc.). Generally, these systems are directly connected to traffic signal controllers in the field via a communications system. This allows the TMC operator to remotely control the traffic signal controllers and implement a new timing plan without going to the field. The subsystem also collects and monitors traffic condition information through roadside detection along all approaches.

TMC Operator

The TMC operator would remain a vital component of the system. Depending upon the implementation, recommended timing plans would need to be approved by the TMC operator; however, the primary function of the TMC operator would be to monitor and evaluate the strategy once it is deployed to determine whether or not traffic operations were actually improved by the strategy. The TMC operator would be responsible for overriding the decision support system component as well as fine-tuning the strategy once deployed. The TMC operator would also be responsible for evaluating the strategy once deployed.

Potential Deployment Scenarios

A number of ways exist by which the weather-responsive traffic signal management strategies can be implemented. Figure D-12 shows one potential deployment scenario where the operator serves as the decision maker. In this deployment scenario, roadway surface, visibility, and precipitation information would be collected from either sensors in the field or through private weather information providers. The weather-responsive decision support system would process this information and provide recommended signal timing strategies (e.g., increased clearance intervals, changes in coordination timing plans, changes in phase splits, etc.). The system would allow the operator to approve the recommended timing plan changes prior to implementing them in the field. The operator would have the ability to implement the recommended signal timing changes as is, make modification to the timing plans, or reject the timing plan changes outright. After approval, the system would send the approved signal timing plan changes through the traffic signal management system.

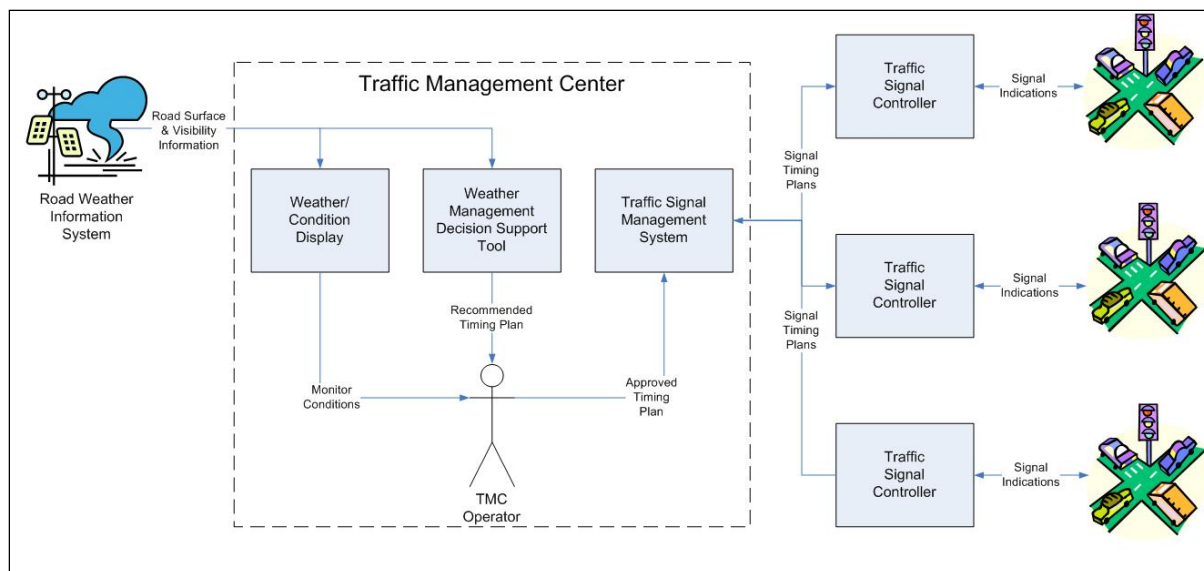

Figure D-12. Concept of Weather-Responsive Traffic Signal Management Deployment with Operator as Decision Maker (Source: Texas Transportation Institute)

This strategy could also be implemented automatically, wherein the weather responsive decision support system would be tied directly to the traffic signal management system. Using information obtained directly from field sensors or weather information service providers, the decision support system would be responsible for determining when and where signal timing changes will be implemented. The weather-responsive decision support system would then communicate the signal timing plan changes directly to the traffic signal management system, which would be responsible for implementing the traffic signal timing plan changes in the controller(s). Under this deployment scenario, the operator's role would be to serve as a supervisor of the decision-making process and override or fine-tune decisions made by the system. Figure D-13 provides a logical representation of this type of deployment scenario.

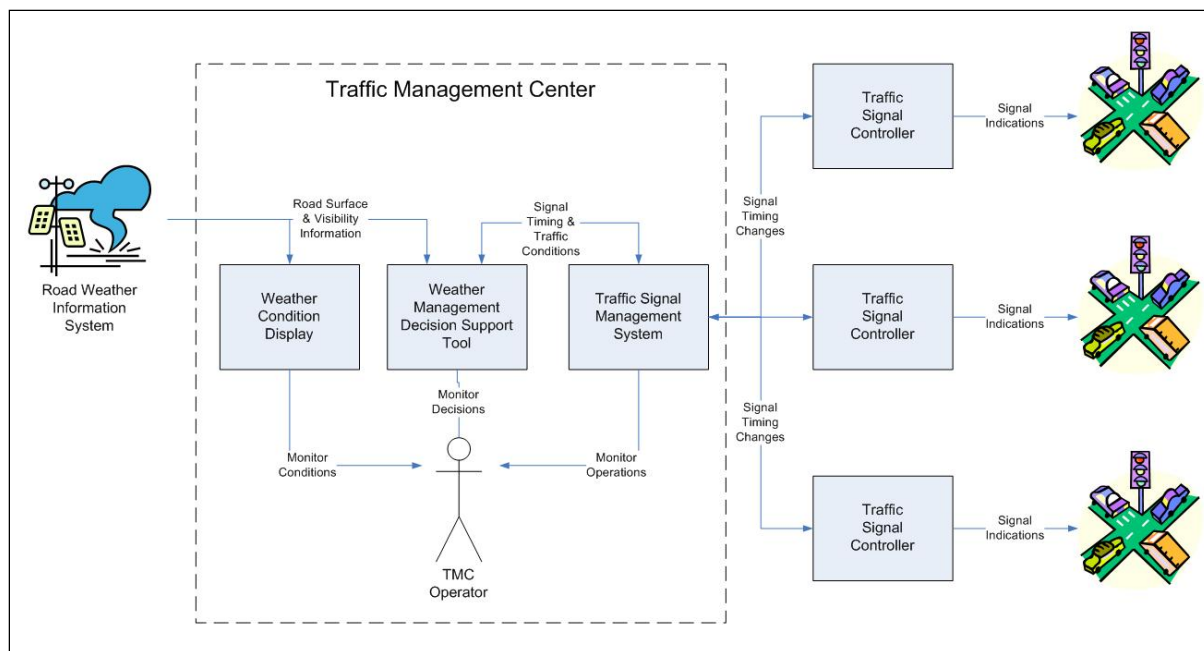

Figure D-13. Concept of a Fully Automated Weather Responsive Traffic Signal Management Deployment (Source: Texas Transportation Institute)

Figure D-14 shows a potential deployment of this strategy in a Connected Vehicles environment. In this deployment, the weather-responsive decision support system could be moved to the field, and decisions about traffic signal timing plan changes could be made at the intersection level (as opposed to the system level.) With connected vehicle technologies, on-board equipment (OBE) sensors on the vehicle can determine when individual vehicles are beginning to lose traction due to ice or snow accumulation on the pavements. This information can be communicated directly from the vehicle to the traffic signal controller through a dedicated short-range communication (DSRC) device or similar wireless communications link. The weather-responsive decision support system would collect and fuse information from multiple connected vehicles approach the intersection and determine the most appropriate weather-responsive signal strategy to implement at that particular intersection. In this deployment, the weather-responsive decision support system can be implemented as an external process to the traffic signal controller or fully integrated into the traffic signal controller. An alarm message would be sent by the traffic signal controller to the TMC alerting operators that the intersection is operating in a weather-responsive mode. Adjacent traffic signal controllers could be “alerted” to changes in traffic signal timing parameters at one intersection either through a peer-to-peer or centralized communications architecture.

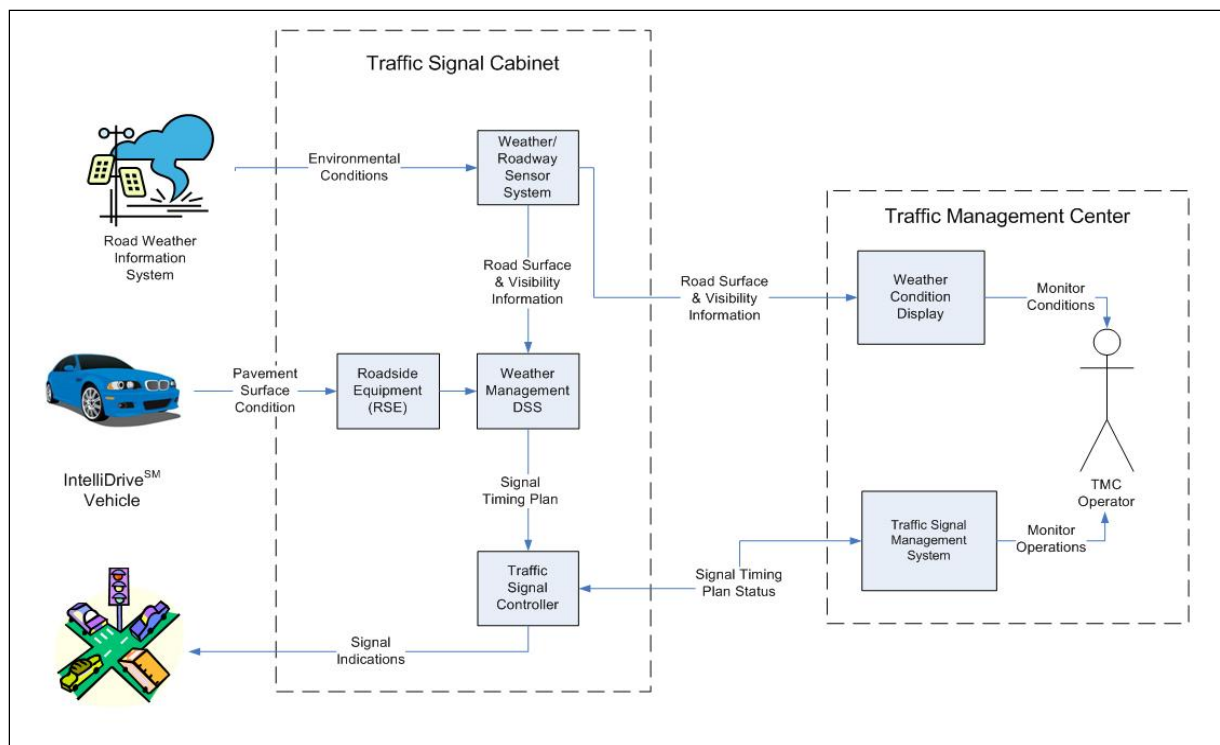

Figure D-14. Concept of Weather-Responsive Traffic Signal Timing Deployment in a Connected Vehicle Environment (Source: Texas Transportation Institute)

2.6 Operational Scenarios

Following are four operating scenarios that represent weather-responsive signal timing changes.

2.6.1 Normal Conditions

When weather is not a factor, traffic signals generally operate in two modes: pre-timed or actuated. In an actuated mode, the timing and sequencing of the signal indications are based upon the traffic demands at the intersection. In a pre-timed mode, phase timings and sequencing follow a routine, predictable pattern. Traffic signal may also operate in isolation or as part of a coordinated system. Each individual agency is responsible for establishing the timing plan and operating parameters of those signals based on local policies and traffic management objectives. When weather is not a factor, the traffic signals would continue to operate according to the timing plans and policies of the local agencies.

Under normal operating conditions, the weather decision support system has little impact on the operations of the traffic signals – the traffic signals would operate in accordance to the traffic management plans designed and installed by the agencies. The weather conditions would be monitored by the weather monitoring system, but operations of the traffic signals would not be changed until the weather-responsive decision support system determines that conditions had deteriorated (or likely to deteriorate) to a point where safety and operational efficiency are impacted.

2.6.2 Altering Detection Zone and Detection Parameters

The following operational scenario is intended to illustrate how the system might be used to alter detection zones and detection parameters that could potentially improve safety and traffic operations at signalized intersections during weather events.

In the predawn hours in the morning, an unexpected snow storm begins to traverse a city. During the last hour, the snow storm has dumped a significant amount of heavy, wet snow throughout the city. Because the pavement surface temperature is below freezing, enough snow has accumulated on the pavement surface to begin covering the lane lines to the point that they are no longer visible to drivers. Also, because the snow event was unexpected and occurred early in the morning, snow removal crews are unable to keep roadways clear of significant accumulation. As it is the natural tendency of drivers during periods of inclement weather to increase both the lateral and longitudinal separation between vehicles (to limit the likelihood of collisions), drivers often create their own travel paths when the pavement markings become covered. These travel paths do not necessarily conform to the pavement markings on the roadway. As the traffic detectors are designed, installed, and operated assuming that drivers' paths through intersections are governed by the lanes lines, they have become ineffective as drivers begin creating their own pathways through the intersection.

Weather monitoring stations installed at strategic locations in the corridor would monitor pavement surface conditions and snow fall rates. This information would be fed to the weather decisions support system that would determine the effects and impacts of the weather conditions on traffic operations. The weather decision support system would also be used to determine rate, duration, and extent of the snow fall. Because the pavement surface temperature and the snow accumulation rates are predicted to be substantial, the weather decision support system alerts the operator that a potential exists for snow accumulations to begin obliterating lane markings. If available, the operator might use a video surveillance system to confirm this prediction and to assess the extent to which the falling snow has covered the existing lane markers. If the lane markings are obscured, the operator could also use the traffic signal management system to dynamically reconfigure the detector and controller settings to improve operations of the detection system. Examples of strategies that could be implemented by operators include the following:

- Utilizing special detection features (such as call delays and/or call extensions) to prevent detector calls to specific phases from being dropped by the controller.
- Combining detectors and/or detection zones to extend the area of detection on each approach.
- Placing constant calls on detectors to ensure that phases are not skipped because of missed detections.
- Changing the phase initial and extension interval settings to accommodate for slow vehicle start-ups and travel speeds.

These settings would remain in effect until the weather conditions improved and vehicle travel paths are controlled by the lane markings again. At this time, the operator would use the traffic signal management system to reset the detection system to its normal operating condition.

2.6.3 Lengthening Red Clearance Interval

Another change to signal operations that could be made during weather events might be lengthening the red clearance intervals in response to weather conditions. The following operational scenario describes one possibility of how this might occur.

According to FHWA's *Traffic Signal Timing Manual*, the red clearance interval (also known as the all-red clearance interval) is the "interval at the end of the yellow change interval during which the phase has a red-

signal display before the display of green for the following phase.” The purpose of this interval is to allow time for vehicles that entered the intersection during the yellow-change interval to clear the intersection prior to the activating of a conflicting vehicle movement phase. During inclement weather, such as rain, snow, ice, or fog, pavement friction may deteriorate increasing stopping distances at intersections. Because clearance intervals are generally timed assuming good pavement friction, agencies may find their current red clearance intervals to be insufficient to allow vehicles to stop before the signal turns red during inclement weather. To reduce the potential for right-angle collisions from occurring at these intersections, transportation agencies may want to provide a little extra time to separate conflicting traffic streams.

Under this scenario, the weather decision support system would monitor weather and pavement conditions in the corridor. If pavement conditions that might lead to longer stopping distances are detected, the weather decisions support system could automatically implement new timing plans, through the traffic signal management system, that increases the duration of the red clearance interval. The weather decision support system would also notify the operator that a change in the signal timing plan was implemented. As pavement conditions improve, the decision support system would then implement a request to return the traffic signal system to normal operations.

2.6.4 New Traffic Signal Coordination Timing Plans

Another change to signal operations that could be made during weather events might be to automatically implement new traffic signal coordination timing plans in a group of intersections to account for slower travel speeds caused by weather.

Coordination is a traffic signal timing strategy whereby the traffic signal indications at multiple intersections turn green just prior to the arrival of a platoon of vehicles. Generally, coordinating traffic signal operations provides increased vehicle throughput through a corridor and reduces driver frustration. The process of determining when to turn the signal indication green at each subsequent intersection depends on a number of factors, one of which is speed. Speed is used to determine how much time is needed to offset the beginning of the coordinated phase at downstream intersections. Therefore, weather conditions (such as snow, rain, ice, fog, etc.) that impact speed could cause a series of intersections to lose efficiency. To account for lower travel speeds, agencies may want to implement coordination timing plans that are designed specifically for poor weather conditions.

Under this strategy, the weather decision support system would merge measurements from both the weather monitoring system and the traffic detection system to determine if weather conditions were having an impact on travel speeds in the corridor. As weather conditions worsen and pavement surface conditions deteriorate, travel speeds on arterials are likely to decline. The weather decision support system would correlate the drop in travel speeds with weather conditions and determine if a new timing plan designed for specific weather conditions might be implemented. The weather decision support system would then request that the traffic signal management software implement the appropriate weather-responsive plan. The traffic signal management system would be responsible for communicating the timing plan request directly to the traffic signal controllers. The weather responsive timing plan would remain in effect until 1) weather and roadway conditions improved enough to cause travel speeds to return to their normal level, 2) the next time-of-day schedule plan changes, or 3) the operator implemented a new timing plan.

2.7 High-Level System Design

2.7.1 User Needs

The following is a list of high-level user needs a TMC operator must satisfy in order to deploy this strategy. These user needs are not in any particular order, and their order is not intended to imply any level of priority.

1. Monitor weather and roadway surface conditions in the vicinity of the desired intersection.
2. Assess the degree to which the measured roadway surface and weather conditions are likely to impact traffic performance and efficiency at or near a signalized intersection.
3. Determine the most appropriate traffic signal timing plan changes to observed roadway surface and weather conditions.
4. Implement changes in traffic signal timing plans from remote location.
5. Monitor traffic signal operations in order to verify that timing plan changes are helping (not hindering) operational efficiency and safety at intersections.
6. Deactivate weather-responsive traffic signal timing plan and parameter settings and return traffic signal controllers to normal operations once roadway surface and weather conditions have improved.

2.7.2 High-Level System Requirements

The following table shows the high-level functional system requirements needed to fulfill the identified user needs associated with deploying the weather responsive traffic signal strategy.

Table D-3. System Requirements for Deploying Weather Responsive Traffic Signal Strategy

User Need ID	User Need	Functional Requirement ID	Functional Requirement
1.	Monitor weather and traffic conditions in the vicinity of the desired intersection(s).	1.0	The system shall obtain weather and roadway surface conditions from sensors in the vicinity of the desired intersection(s).
		1.1	The system shall be able to obtain road weather information from multiple sources.
		1.1.1	The system shall obtain road weather information from environmental sensor stations (ESS).
		1.1.2	The system shall obtain route or intersection specific road weather information from private weather information service provider.
		1.2	The system shall determine the location of the nearest ESS station in the vicinity of the desired intersection or group of intersections.
		1.2.1	The system shall allow the operator to define which ESS stations to associate with a desired intersection or group of intersections.
		1.3	The system shall obtain current road weather information likely to impact traffic flow and traffic signal operations at the vicinity of the desired intersection or group of intersections.
		1.3.1	The system shall obtain the current wind speed and direction.
		1.3.2	The system shall obtain the current ambient air temperature.
		1.3.3	The system shall obtain the presence of precipitation.
		1.3.4	The system shall obtain the rate at which precipitation is falling.
		1.3.5	The system shall obtain the start time of the latest recorded precipitation.
		1.3.6	The system shall obtain the stop time of the latest recorded precipitation.
		1.3.7	The system shall obtain the current visibility distance.
		1.4	The system shall obtain current roadway surface information likely to impact traffic flow and traffic signal operations.
		1.4.1	The system shall obtain the current temperature of the pavement surface.
		1.4.2	The system shall obtain an indication of the presence of moisture of the pavement surface.
		1.4.3	The system shall obtain the current depth of snow.
		1.4.4	The system shall obtain the current thickness of ice.
		1.5	The system shall continue to receive and incorporate standard traffic sensor inputs.

User Need ID	User Need	Functional Requirement ID	Functional Requirement		
2.	Assess the degree to which the measured road weather conditions combined with existing traffic volumes are likely to impact traffic performance and efficiency at or near a signalized intersection.	2.0	The system shall have the ability to assess the degree to which the measured weather and roadway surface conditions will impact traffic operations.		
		2.1	The system shall determine the degree to which the measured weather and roadway surface conditions will impact travel speeds at main street approaches (i.e., the coordinated phases).		
		2.2	The system shall determine the degree to which the measured weather and roadway surface conditions will impact stopping distance.		
		2.3	The system shall determine the degree to which the measured weather and roadway surface conditions will impact start-up lost time.		
		2.4	The system shall determine the degree to which the measured weather and roadway surface conditions will impact saturation flow rate.		
		2.5	The system shall determine the degree to which the measured weather and roadway surface conditions will impact vehicle placement over traffic system detectors.		
		2.6	The system shall determine the degree to which the measured weather and roadway surface conditions will impact vehicle gaps.		
		3.	Determine the most appropriate traffic signal timing plan changes to observed roadway surface and weather conditions.	3.0	The system shall recommend to the operator the most appropriate traffic signal timing plan changes.
				3.1	The system shall allow the operator to set the types of traffic signal timing plan changes to be considered.
3.2	The system shall obtain the current operating mode (e.g., free, or in coordination) of the desired intersections.				
3.3	The system shall recommend to the operator changes that can be made to the vehicle detector settings.				
3.3.1	The system shall recommend to the operator changes that can be made to the vehicle detector phase call.				
3.3.2	The system shall recommend to the operator changes that can be made to the vehicle detector extend parameter.				
3.4	The system shall recommend to the operator changes that can be made to the phase vehicle clearance.				
3.4.1	The system shall recommend to the operator changes that can be made to the phase yellow change intervals.				
3.4.2	The system shall recommend to the operator changes that can be made to the phase red clear intervals.				
3.5	The system shall recommend to the operator changes that can be made to the phase intervals settings.				
3.5.1	The system shall recommend to the operator changes that can be made to the phase minimum green interval duration.				

User Need ID	User Need	Functional Requirement ID	Functional Requirement
		3.5.2	The system shall recommend to the operator changes that can be made to the phase maximum green interval duration.
		3.5.3	The system shall recommend to the operator changes that can be made to the phase passage duration.
		3.6	The system shall recommend to the operator changes that can be made to the coordination timing settings.
		3.6.1	The system shall recommend to the operator a coordination plan.
		3.6.2	The system shall allow the operator to adjust the coordination settings (cycle lengths, splits, and offsets) to fine-tune the timing plan to the current conditions.
		3.7	The system shall recommend to the operator changes that can be made to omit phases.
		3.8	The system shall recommend to the operator changes to the phase.
4.	Implement changes in traffic signal timing plans from remote location	4.0	The system shall allow the operator to implement recommended changes to the current signal timing plans.
		4.1	The system shall implement the recommended signal timing plan changes through an agency's existing traffic signal management system.
		4.2	The system shall display the recommended timing plan changes to the operator.
		4.3	The system shall receive confirmation from the operator before recommended timing plans are implemented.
		4.4	The system shall permit the operator to amend the recommended traffic signal controller settings prior to implementation in the field.
		4.5	The system shall generate a properly formatted request to implement the approved signal timing plan changes.
		4.6	The system shall send a properly formatted request to the traffic signal management system requesting the approved changes in the current traffic signal timing plan.
		4.7	The system shall notify the operator when changes to the current traffic signal timing setting have been implemented by the traffic signal management system.

User Need ID	User Need	Functional Requirement ID	Functional Requirement
5.	Monitor traffic signal operations in order to verify that timing plan changes are helping (not hindering) operational efficiency and safety at intersections during adverse weather conditions.	5.0	The system shall monitor the impacts of implementing the weather-responsive traffic signal timing plan changes on intersection operations and performance.
		5.1	The system shall obtain the traffic performance data from the traffic signal management system to allow the operator to assess the impact of the implemented signal timing plan changes.
		5.2	The system shall generate traffic performance measures from the measured traffic data.
		5.2.1	The system shall generate quality of progression performance measures.
		5.2.2	The system shall generate phase utilization performance measures.
		5.2.3	The system shall generate number of stops performance measures.
		5.2.4	The system shall generate speed differential performance measures
		5.3	The system shall display the traffic performance measures to the operator for verification of effectiveness.
6.	Deactivate the weather-responsive signal timing plan when conditions no longer warrant using it.	6.0	The system shall notify the operator when the weather-responsive traffic signal timing parameters no longer needed.
		6.1	The system shall retrieve non-weather responsive (normal) traffic signal timing parameters.
		6.2	The system shall rest the non-time sensitive signal control parameters (phase min green, yellow change interval, red clear interval, etc.) back to normal conditions using the traffic signal management system.
		6.3	The system shall cause the traffic signal management system to implement the coordination timing plan appropriate for the time-of-day.
		6.4	The system shall notify the operator when the traffic signal control settings have been returned to "normal" operations.

2.8 Analysis of the Proposed System

This section describes some the operation-oriented and safety-oriented performance measures which can be used to assess the effectiveness of different weather-responsive traffic signal timing strategies.

2.8.1 Operation-Oriented Performance Measures

Quality of Progression

Quality of progression is a measure used to assess the effectiveness of coordinated traffic signal operations. It is measured by observing the proportion of vehicles arriving during the green phase of the coordinated movements (e.g., the main street movements). As weather impacts travel speeds on the roadway, the quality of progression is reduced.

Number of Stops

Many agencies also use stops as a measure of effectiveness for their traffic signal systems. Measuring the number of stops is important for the following reasons: 1) stops have a higher impact on emissions than delay because an accelerating vehicle emits more pollutants and uses more fuel than an idling vehicle and 2) motorists are often frustrated when they have to make multiple stops. During weather events, minimizing stops can be an important objective in evaluating a weather-responsive traffic signal timing plan. Stops are often also used as a measure of progression quality as an increased number of stops is often equated qualitatively to the perception of the effectiveness of a signal timing plan along an arterial street or network.

Travel Time and Travel Speed

Travel time and travel speed are two popular measures commonly used by agencies to assess traffic signal performance on an arterial. Travel speeds account for both the delay at intersections as well as the time to travel between intersections. The 2000 Highway Capacity Model bases arterial level of service (LOS) on travel speed. This speed includes the running time between intersections and the control delay to through vehicles at each signalized intersection. Travel time and travel speed is often expected to decrease during weather events.

2.8.2 Safety-Oriented Performance Measures

Collisions

Signal timing is only one contributing factor to crashes at signalized intersections. Evaluating crash frequency, crash patterns, and crash severity remain an important part of a safety analysis; however, crashes have a tendency to fluctuate up and down over time. In assessing whether weather-responsive traffic signal timing changes had an impact of the number, type, and severity of crashes, an analyst will need to attempt to isolate weather related crashes for other contributing factors. The analyst should also examine those types of crashes most impacted by the weather-responsive traffic signal timing improvement. For example, an analyst might want to examine the frequency and severity of right-angle and rear-end related collisions when implementing traffic signal timing improvements that affect the clearance intervals. Similarly, right-angle and rear-end collisions can be associated with poor quality of progression.

Violations

Violations, particularly red-light running violations, can also be used as a potential safety measure related to weather responsive traffic signal timing. As weather can impact pavement friction, drivers may find it more difficult to stop during the signal clearance intervals. Agencies may want to compare the number and rate of red-light running violations during weather events to assess the effectiveness of particular weather-responsive traffic signal timing strategies.

D-3 Regional Traveler Information for Weather Events

3.1 Scope

3.1.1 Document Overview

The purpose of this document is to describe a concept of operations for an enhanced regional traveler information system for disseminating road weather information and its associated impacts. Real-time regional traveler information is fast gaining in availability, capability and usage around the country. This document focuses on providing relevant, timely and actionable weather related information as part of advanced traveler information systems. This concept of operations shows how enhanced road weather conditions can be disseminated through pre-trip and en route traveler information systems during inclement weather.

- **Section 3.2:** Indicates the documents referenced in the development of this concept of operations.
- **Section 3.3:** Provides an overview of the current uses of weather information in traveler information systems.
- **Section 3.4:** Includes justification of the changes in existing procedures.
- **Section 3.5:** Discusses the proposed changes to the system to enhance road weather information dissemination.
- **Section 3.6:** Describes several operational scenarios to illustrate how enhanced road weather information can be used by travelers to make pre-trip and en route decisions.
- **Section 3.7:** Identifies high-level user needs and system requirements.
- **Section 3.8:** Discusses the evaluation procedures and the potential performance metrics that can be used to measure system effectiveness.

3.1.2 System Overview

This strategy takes both real-time and forecasted road weather conditions in a region to predict travel conditions on specific sections of roadway in the region. Information about predicted roadway and atmospheric conditions would be used to provide travelers with information about current and predicted travel conditions. The goal is to use this information to influence both pre-trip and en route mode, route, and departure time decisions.

3.2 Referenced Documents

The following documents were used in the development of this concept of operations document.

- *National Transportation Communications for ITS Protocol: Environmental Sensor Station (ESS) Interface Protocol*. NTCIP 1204 version v03. October 2009.
- Meridian Environmental Technology, Inc. *Clarus Multi-State Regional Demonstration: High level Requirements – Use Case 5*. Prepared for U.S. Department of Transportation, Federal Highway Administration. (April 30), 2009.

- Hani S. Mahmassani, Jing Dong, Jiwon Kim, Roger B. Chen and Byungkyu (Brian) Park, September 2009, *Incorporating Weather Impacts in Traffic Estimation and Prediction Systems*, FHWA-JPO-09-065, EDL# 14497, available at <http://ntl.bts.gov/lib/31000/31400/31419/14497.htm>.

3.3 Current System or Situation

Many States routinely provide travelers with information on atmospheric weather conditions that may impact travel. Travelers can typically access this information prior to beginning a trip on their State DOT's website. Travelers can also receive en-route weather information through their car radio, Highway Advisory Radio (HAR), Dynamic Message Signs (DMS), or "511" system. In many cases, road weather information is compiled from Road Weather Information System (RWIS) and field reports from maintenance personnel. These systems provide transportation operations and maintenance personnel with information about road conditions. Many agencies also provide this information to travelers through websites or use the information to provide travel condition alerts.

Many State DOTs continue to be challenged on how to convert atmospheric and sensor data to meaningful road advisories. Atmospheric information alone lacks the relevancy and usefulness of road weather information from a traveler perspective. Travelers often have to make their own interpretation on how atmospheric information might impact travel on a particular roadway. Furthermore, drivers need information about not only what the current conditions are, but also what travel conditions are likely to be when they reach a particular section of highway at some time in the future (e.g., 2 or 3 hours from now). While travelers can obtain forecasts of weather conditions from both public and private weather providers, those services often do not offer recommendations on travel routes, nor do they forecast roadway conditions. Road condition data offers travelers with information more pertinent to their travel, such as pavement conditions, ice formation, and snow accumulation, but often suffers from latency and accuracy issues related to delays and non-scientific field reported information.

As part of the *Clarus* Multi-State Regional Demonstration Program, FHWA recently demonstrated a prototype tool for disseminating road weather information to travelers: *Enhanced Road Weather Travel Advisories*. The tool uses a complex model that takes into account atmospheric conditions close to the road surface, information from quality-checked ESS in the *Clarus* database regarding pavement surface conditions, State agency road condition reports, and *Clarus*-enhanced weather and road condition forecasts to predict road travel conditions up to 12 hours in advance. The tool provides enhanced road weather forecast information for interstate highways on websites and through the 511 systems. By providing current and forecasted road conditions, the tool decreases the latency and improves the usefulness of road condition information systems. A prototype of this tool was recently demonstrated in five States: Montana, North Dakota, South Dakota, Idaho and Minnesota.

As illustrated in Figure D-15, the prototype tool provides a visual representation of the forecasted road condition information. This information can be disseminated to travelers through a website and a 511 telephone system.

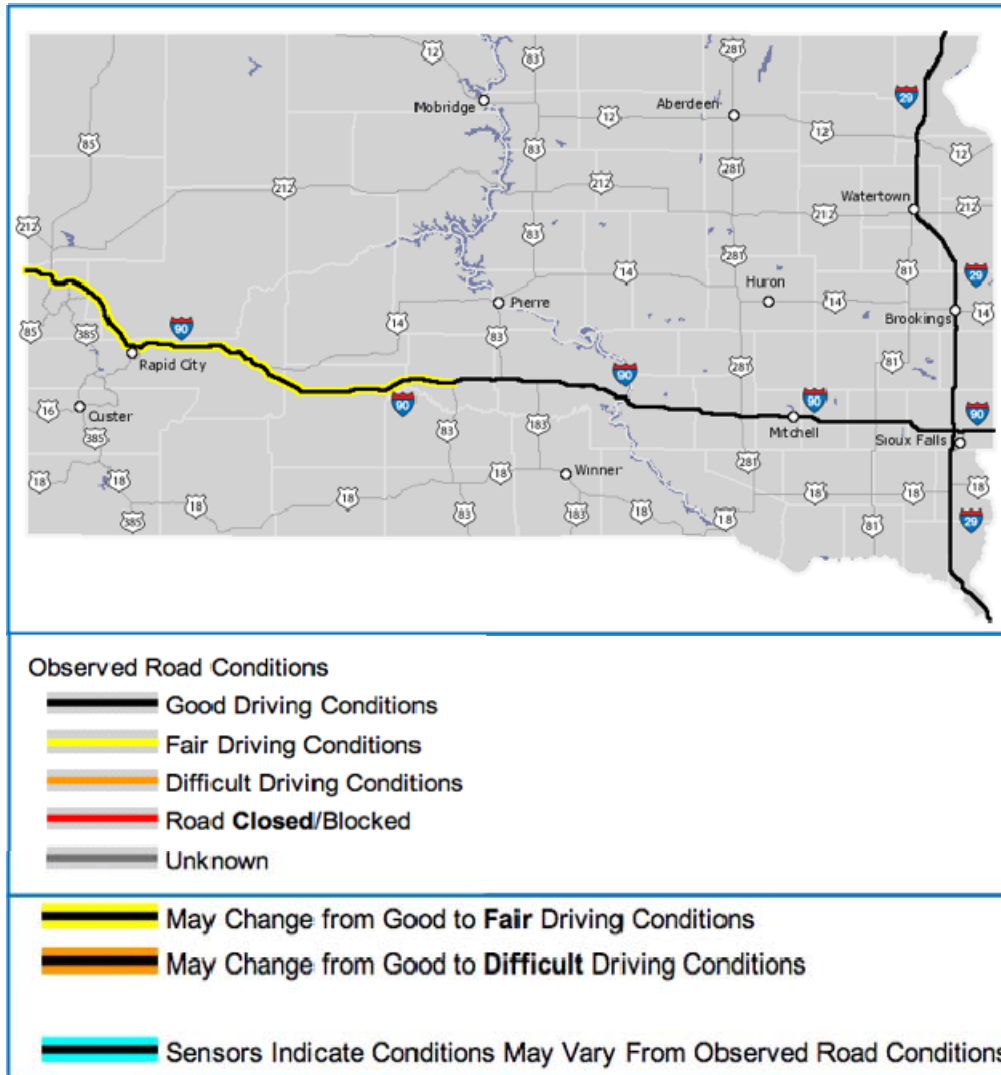

Figure D-15. Map of South Dakota Showing Forecast Road Conditions (Source: Meridian Environmental Technologies)

The tool also provides a continuous loop forecast of anticipated precipitation and road conditions. A snapshot from this loop for a past weather event is shown in Figure D-16. The loop depicts the path of a rain and snow weather system as it moves across a five State region. What is unique about the tool is its depiction of the changing road conditions as the weather event passes through the region. A user of the website can observe how various segments of the interstate are forecast to change over a 12-hour period based on the current and forecast road weather conditions.

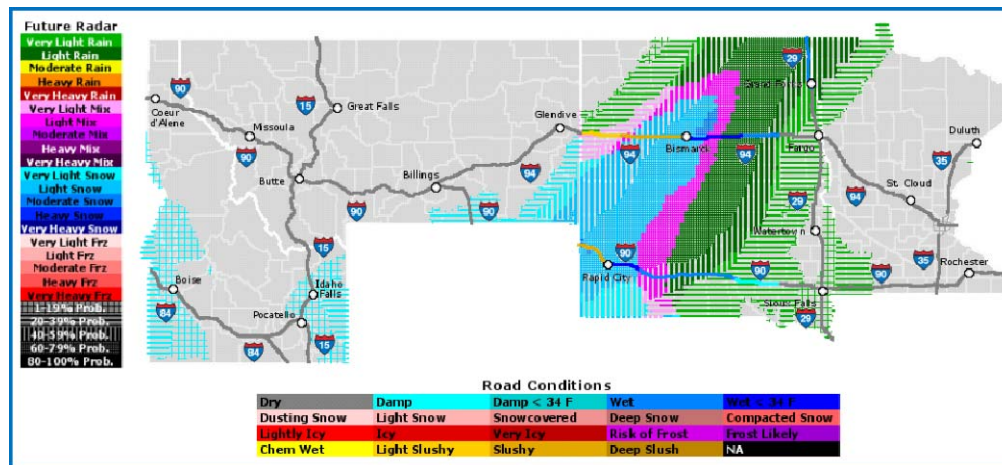

Figure D-16. Precipitation and Road Condition Forecast for April 2, 2010 (Source: Meridian Environmental Technologies)

3.4 Nature and Justification of Changes

Most of the existing systems for disseminating road weather information focus on current conditions. However, when planning a trip, travelers not only need information about current road weather conditions but also want information about what travel conditions will be like on specific sections of roadway in the future. Information about future road weather conditions will have a significant impact on travelers' departure time, route and potential mode choice decisions. Furthermore, while en route, travelers (particularly long-distance travelers) need information about current and predicted road weather conditions in making route change decisions. Roadway weather information needs to be specific to a particular section and needs to be based on forecasted weather conditions. As different vehicle types are impacted differently by weather conditions, road weather information needs to be tailored to specific user groups or vehicle types as well.

3.5 Concepts for the Proposed Strategy

This concept expands upon the *Clarus* demonstration of *Enhanced Road Weather Travel Advisories* to include predictions of road weather conditions and impacts. Under this module, not only does the system provide agencies with route-specific forecasts of road weather conditions, but it also provides a prediction of the degree to which the forecasted weather event will impact traffic flow in the network. Transportation agencies would be able to use such a tool to predict when and where congestion and operational problems are likely to occur based on the severity and intensity of the weather conditions in the near-term future. Transportation agencies need near-term predictions (e.g., up to 12-hours in advance) so that they can take steps to mitigate the effects of weather on traffic operations.

In order to provide these near-term predictions of road conditions, the system needs to be developed to perform the following functions:

- Collect, aggregate, and synthesize weather information from a number of different sources, including (but not limited to) Road Weather Information/Environment Sensing Stations, *Clarus*, and both public and private weather information service providers.
- Provide route-specific road weather condition forecasts up to 12-hours in the future.

- Using the forecasted weather conditions as well as current and historical traffic conditions, predict the impacts of weather conditions on traffic operations in a regional network, specifically identifying when and where weather events will create operational deficiencies in the network.
- Generate appropriate route-specific road weather and traffic forecast messages to be distributed through regional pre-trip traveler information dissemination systems, such as websites, traveler kiosks, etc.
- Generate appropriate route-specific road weather and traffic forecast messages to be distributed through regional en-route traveler information dissemination systems, such as dynamic message signs (DMS), highway advisory radio (HAR), 511 and others.
- Generate appropriate route-specific road weather and traffic forecast messages to be distributed through regional non-traditional traveler information dissemination systems, such as social networking systems, text alerts, and others.

3.5.1 Functional Components

Figure D-17 shows the functional components for developing and integrating predicted road weather travel conditions into a regional traveler information system. The pink shaded boxes with bold typeface represent new components being added to the system to accomplish the functions listed above. The following provides a high-level description of the functional components envisioned for this system.

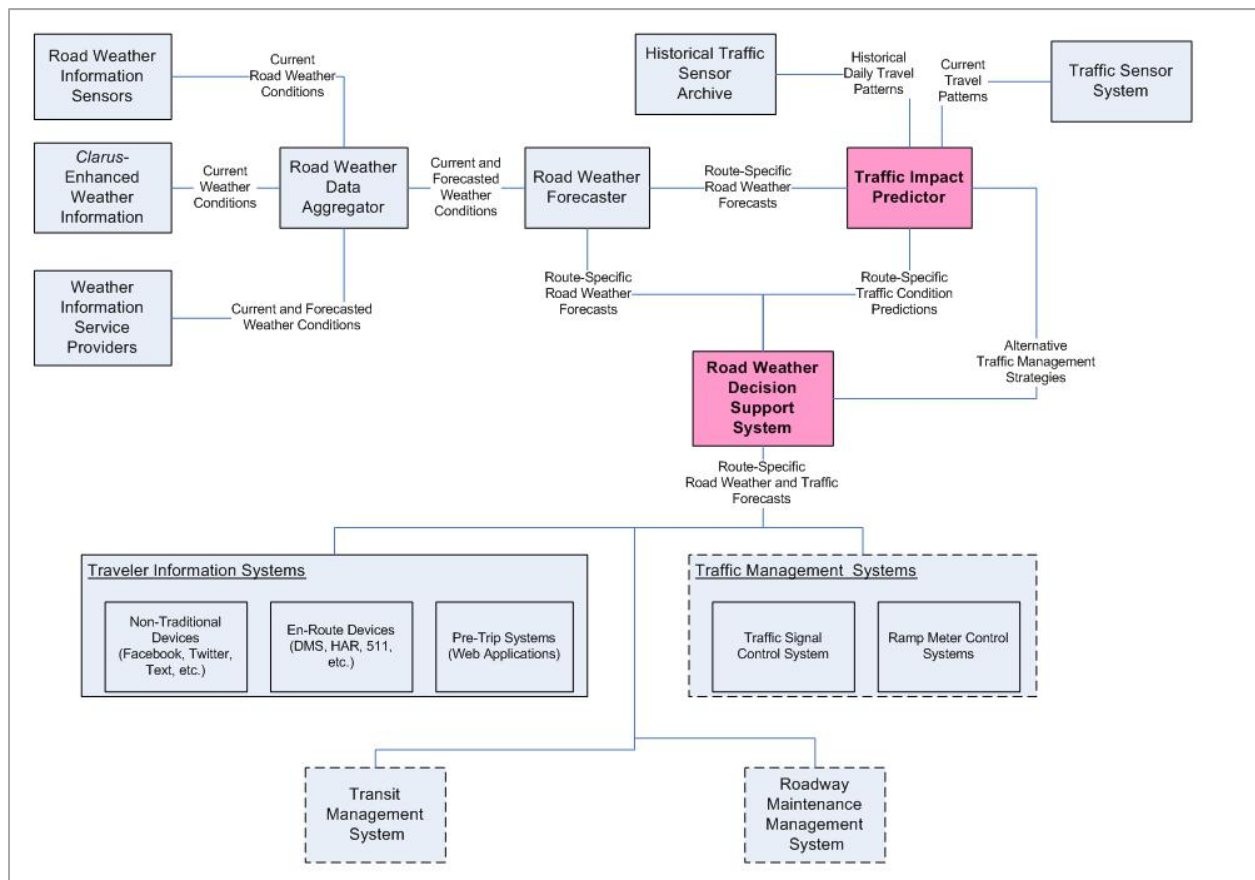

Figure D-17. Functional Components of a Regional Road Weather Travel Impact Prediction System (Source: Texas Transportation Institute)

3.5.2 Weather Monitoring Subsystem

The weather monitoring component is responsible for obtaining all the road weather information needed to assist in determining when and where travel conditions are likely to deteriorate. It is through this component that system operators obtain updates of weather conditions, particularly visibility, surface conditions and/or precipitation accumulations, through sensors located in the field communicating back to the weather monitoring system.

Road Weather Information Sensors

These sensors could be agency-owned or information can be provided by private weather information providers. The types of data needed from the weather monitoring component would include the following:

- Current wind speed and direction,
- Current ambient air temperature,
- Presence of precipitation,
- Rate at which precipitation is currently falling and the start and stop time of the latest recorded precipitation,
- Current visibility distance,
- Current temperature of the pavement surface and an indication of the presence of any moisture on the surface,
- Current depth of snow and packed snow on the traveled way,
- Expected time of snow fall or rain storm, and the probability of snow and rain, and
- Current thickness of ice on the traveled way.

The weather monitoring system may also provide situation assessments of weather conditions, such as the following:

- An assessment of the current wind condition (e.g., calm, light breeze, gale, gusty, etc.),
- An assessment of the type and intensity of the current precipitation (e.g., no precipitation, moderate snow, heavy rain, etc.)
- An assessment of the visibility (e.g., clear, foggy, smoke, sun glare, etc.), and
- An assessment of the pavement state (e.g., dry, standing water, flowing water, packed snow, etc.)

Clarus-Enhanced Weather Information

Among other things, *Clarus* is a national network for sharing, quality checking, and exchanging surface environmental data and relevant transportation conditions. As currently implemented, *Clarus* provides the following:

- A one-stop location portal for all surface transportation environmental observations;
- Data provided with and without post-processing, ready to be incorporated into value-added products including weather and traffic models as well as decision support systems;
- Continuous quality checking of data with feedback to operators of the originating sensor stations;

- Data transferred in one common protocol with full metadata;
- Management of users' rights to input or extract specific data components;
- Data retrieval tools; and
- Support for the inclusion of new technologies such as vehicle-based sensors, surface visibility information from cameras, and remote sensing technologies.

In this application, *Clarus* data may supplement or even be the primary source of weather observational data for agencies. The type of data that would be expected to be provided by the *Clarus* data is similar to that provided by individual weather monitoring stations.

Weather Information Service Provider

Agencies can use both public and private weather information service providers to obtain atmospheric weather conditions and long-term forecasts of weather conditions. For example, transportation agencies can obtain information about weather alerts, watches and warnings from direct feeds from the National Weather Service. Many agencies also subscribe to private weather information providers to obtain area or roadway specific forecasts and alerts. Transportation agencies may use this information to determine when, where, and how long weather events may impact traffic operations.

Road Weather Data Aggregator

This module would be responsible for obtaining the road weather data from the various sources available in the region. This module would extract the information from the sources and place the data in the proper format required by the road weather forecaster. The Road Weather Data Aggregator would also be responsible for performing quality checks on the data and eliminating any anomalies in the weather monitoring data.

Road Weather Forecaster

The road weather forecaster is responsible for producing route-specific forecasts of weather and roadway surface travel conditions. Specifically, the road weather forecaster would predict when and where travelers on specific routes will encounter operational deficiencies due to weather events. The road weather forecaster would also be responsible for providing agencies with estimated durations of traffic operation impacts and interruptions. Examples of the type of predictions that would be made through the road weather forecaster include the following:

- Specific bridges or overpasses that have a high probability of experiencing icing;
- Specific times and sections of roadways expected to experience flooding or significant snow accumulations;
- Particular sections of highway or bridges that are likely to experience winds of sufficient velocity to overturn high profile vehicles;
- Specific times and sections of roadway where fog conditions will limit visibility; and
- Specific time and locations where severe thunderstorms and tornado are likely to cross certain sections of highway.

The output of this module would be the time, duration, and extent of weather conditions impacting traffic operations. This information would need to be updated at least once every 15 minutes.

Traffic Impact Predictor

This component of the system would be responsible for providing near-term predictions (e.g., 15- to 60-minutes in the future) of the impacts of impending weather events on traffic operations. This component is likely to be a traffic simulation model capable of providing short-term traffic predictions, such as dynamic traffic assignment models or Traffic Estimation and Prediction Systems (TrEPS). While, traditional analysis tools do not have the capability to predict the impacts of weather, recent FHWA research has developed weather-sensitive traffic prediction and estimation models and incorporated them in TrEPS tools intended for online operation in TMCs as well as for offline evaluation of contemplated measures. This tool would be responsible for identifying when and where traffic operational problems are likely to occur in the transportation network because of an impending weather event. This tool should not only be capable of modeling the driver behavior in response to traffic control strategies, but also need to model how drivers might behave in response to both pre-trip and en route traveler information.

3.5.3 Road Weather Decision Support System

This component of the system would be responsible for taking output from the traffic impact predictor (e.g., when and where traffic operational problems are likely to occur in the network) and identifying potential traffic operational strategies for addressing these problems. The road weather decision support system might also be responsible for determining what type of traffic management control, advisory, and treatment strategies might be appropriate for a specific route or location given the predicted weather and traffic conditions. The road weather decision support system could feed this information back to the traffic impact predictor to determine if the recommended strategies had a positive effect on correcting the operational deficiency. Once an appropriate strategy had been determined, the road weather decision support system would then be responsible for implementing the recommended strategy on the appropriate devices. These devices are likely to consist of a number of different traffic management responses including traveler information systems, traffic management systems, transit management systems, and roadway maintenance management systems.

3.5.4 Traveler Information Systems

This functional component is responsible for disseminating both pre-trip and en route information directly to the driver. This functional component includes one or more of the following traveler information dissemination mechanisms:

- In-vehicle devices (such as integrated navigation devices),
- Personal communication devices (such as smart phones, personal digital assistance devices, personal computers, etc.),
- Private communication media (such as television, radio, third-party information service providers, etc.), and
- Agency-owned communication devices (such as dynamic message signs, highway advisory radio systems, websites, etc.).

3.6 Operational Scenarios

This section contains two operational scenarios that illustrate the need for a system that provides near-term predictions of roadway travel conditions based on weather forecasts building upon the suggested approaches in Section 5. This section shows how information produced by this system can be used by travelers making pre-trip and en route travel decisions – especially departure time and route choice decisions. The operational

scenarios attempt to show how this information can be disseminated using several different types of traveler information dissemination technologies. These scenarios, developed based on the experiences of real travelers during a winter storm, highlight the types of decisions facing long-distance travelers and their information needs. The scenarios also illustrate the need for communicating and sharing forecasts of road weather information and predictions of the impacts of weather on traffic operations between local and regional transportation management centers.

3.6.1 Pre-Trip

The Smith family, on vacation, has stopped for the night and is at least 8 hours drive time from their ultimate destination two States away. While watching the local weather forecast that night, they learn they are going to have to pass through an area where the National Weather Service has just posted Severe Winter Storm Warnings. Snow is expected along their planned route, but the Smith family does not know where or when driving conditions are likely to deteriorate. They go to a weather forecasting website and learn that it will begin snowing on their planned route mid-morning, but it is not expected to become heavy until early afternoon. The Smith family is faced with a number of critical decisions to be made that night that impact their travel plans the following day:

- Given that the worst part of the storm is not expected to arrive until mid-afternoon, should they get up early and try to arrive at their destination before the weather gets too bad or should they wait out the storm at their current location? If they wait out the storm in their current location, are they likely to get caught in their current location for more than one night? If they try to beat the storm, what time are roadway conditions likely to deteriorate given the timing of the storm?
- How long is the weather event likely to impact their travel options? If they try to beat the storm, what time are roadway conditions likely to deteriorate given the timing of the storm? If they wait out the storm, how long are they going to have to wait until travel conditions have improved?
- Given that several alternate routes exist to reach their destination, which one should they take? Would it be better to use the Interstate (which is likely to receive the brunt of the storm but at the same time more likely to be better maintained) or use an alternate route (which may be impacted less by the storm but is also less traveled)? Where along each route are they likely to encounter difficult driving conditions? What are their available options for shelter, places to stop, etc. along each route?

Luckily, the Smith family remembers hearing about a website where they can get forecasts of road weather information. The Smith family accesses this website from the DOT website of the State where their destination is located. This website uses hour-by-hour forecasts of weather information along with real-time pavement surface condition information to obtain hourly forecasts of the anticipated roadway travel conditions along the routes that they will be potentially traveling. From this website, they can determine what sections along each roadway are likely to be more difficult to travel at different times into the future. By knowing what the weather and roadway conditions are predicted to be as the storm tracks its way through the areas they will be traveling, the Smith family can determine when they should leave their hotel to avoid the worst travel conditions. Because they know when travel on particular sections is likely to deteriorate or become congested, they can also pre-plan locations where they will stop, check for updates on travel and weather conditions, and determine points along their way where alternate route decisions can be made. From this website, they can also sign up for alerts to be sent to their smart phone that are specific to their routes and estimated travel times through those areas. These decision points are tied to the GPS in their smart phone. The Smith family downloads the application directly to their smart phone.

3.6.2 En Route

Before leaving the hotel in the morning, the Smith family checks the travel condition website they found last night for any last minute changes in weather and travel predictions. After reaffirming the decisions they made the night before, they begin on their trip. While they are en route, the weather takes an unexpected turn for the worse and the travel conditions on the route they are traveling is expected to turn worse much sooner than predicted. The smart phone application searches their alternate routes and provides them with expected travel conditions on each route at their estimated time of arrival on that route, given the predicted travel conditions. Matching their current positions from the GPS in their smart phone to the route planned in their trip planning application, the Smiths receive updates about weather and travel conditions at key decision points as they are traveling en route. These weather alerts provide them not only with information about the current travel conditions, but also the predicted travel conditions for when they are estimated to be arriving in each section of roadway. The application also provides them with estimates as to how long travel is likely to be disrupted in the different sections along their route. The application can also provide them with information about status and availability of emergency shelters, hotels, and other travel amenities along their route.

As they continue their trip, they continue to receive updated roadway status information from their downloaded applications as well as dynamic message signs along the roadway. As the travel conditions worsen, they begin to get more nervous about the road travel conditions ahead. They call 511 and are connected with an operator that can provide them with travel condition reports and predictions along several alternate routes. The operator reports to them the current and predicted travel conditions along several of the alternate routes available to the Smiths, from their current location. Using this information, the Smiths elect to change routes further to the west where the storm has already traveled and the roadway conditions are improving.

3.7 High-level System Design

3.7.1 User Needs

Following is a list of high-level user needs that State and local transportation agencies must satisfy in order to successfully deploy this strategy. The user needs are not listed in any particular order, nor is their order intended to imply any level of priority.

1. Collect and synthesize weather and roadway surface condition data from multiple sources, both public and private, including RWIS and private weather information providers, to provide a comprehensive picture.
2. Using information about current and future weather and roadway surface conditions, predict near-term impacts (15- to 60-minutes into the future) of weather conditions on traffic operations in the transportation network (including automobile and transit operations) and identify when and where congestion is likely to form as a result of impending weather conditions.
3. Using predictions of roadway and traffic operations, evaluate alternative traffic management and traveler information dissemination strategies for addressing and identifying congestion locations and selecting the strategies that best improve safety and operations within the network.
4. Disseminate the predicted impact of weather on traffic operations to travelers both before they initiate their trip and while en route.
5. Coordinate and share information about their responses to predicted congestion and travel impacts due to an impending weather event.

3.7.2 High-Level Functional Requirements

The following table shows the high-level system requirements needed to fulfill the identified user needs associated with deploying the weather responsive regional traveler information.

Table D-4. System Requirements for Deploying Weather Responsive Regional Traveler Information Strategy

User Need ID	State and Local Transportation Agency User Need	Functional Requirement ID	Functional Requirement
1.	Synthesize road weather condition data from multiple sources.	1.1	The system shall integrate road weather information from multiple sources.
		1.1.1	That system shall include road weather information and forecasts from public sources.
		1.1.1.1	The system shall include road weather information and forecasts from agency operated RWIS and ESS.
		1.1.1.2	The system shall include enhanced road weather information and forecasts from <i>Clarus</i> .
		1.1.2	The system shall have the capabilities of incorporating road weather condition information and forecasts from private sources.
		1.2	The system shall include current weather observations.
		1.2.1	The system shall include observations of the current wind speed and direction.
		1.2.2	The system shall include observations of current ambient air temperature.
		1.2.3	The system shall include observations of the current presence of precipitation.
		1.2.4	The system shall include observations of the rate of precipitation.
		1.2.5	The system shall include observations of the current visibility distance.
		1.2.6	The system shall include observations of the pavement surface temperature.
		1.2.7	The system shall include observations of current depth of snow and packed snow on the traveled way.
		1.2.8	The system shall include observations of the current thickness of ice on the traveled way.
		1.3	That system shall include forecast road weather information.
		1.3.1	Forecasted weather information shall be provided up to 12 hours in advance.
		1.3.2	Forecasted weather information shall be on a subarea basis.
		1.3.3	Forecasted weather information shall be in 15-minute intervals.
		1.3.4	Weather forecasts shall be updated every 15 minutes.
1.3.5	Forecasted weather conditions shall include prediction of wind speed and direction.		
1.3.6	Forecasted weather conditions shall include predictions of prediction rates and accumulations.		
1.3.7	Forecasted weather conditions shall include predictions of types of precipitation.		
1.3.8	Forecasted weather conditions shall include predictions of visibility distances.		

User Need ID	State and Local Transportation Agency User Need	Functional Requirement ID	Functional Requirement
2.	Predict near-term road weather conditions based on current weather observations.	2.0	The system shall include predictions weather conditions on roadway operations.
		2.1	Road weather predictions shall be based on current and forecasted weather conditions.
		2.2	Road weather predictions shall be provided up to 12 hours in advance.
		2.3	Road weather predictions shall be provided in 15 minute intervals.
		2.4	Road weather predictions shall be provided for individual roadway segments.
		2.4.1	Road weather predictions shall include predictions of the status of the surface conditions (wet, dry, icy, etc.).
		2.4.2	Road-weather predictions shall include predictions of the pavement surface temperature.
		2.4.3	Road weather prediction shall include predictions of depth of precipitation accumulation.
		2.4.4	Road weather prediction shall include predictions of pavement friction.
		2.4.5	Road weather predictions shall include predictions of the presences of conditions affecting visibility (blowing snow, fog, etc.).
3.	Evaluate alternative traffic management and traveler information dissemination strategies for addressing identify congestion locations and select the strategies that best improve safety and operations within the network.	2.4.6	Road weather predictions shall include predictions of visibility distance.
		3.0	The system shall provide predicted travel conditions based on the estimated arrival times of travelers on specific road segments.
		3.1	The system shall predict the effects of predicted roadway weather conditions on operational effectiveness (capacity).
		3.1.1	The system shall assess the effects of predicted roadway weather conditions on freeway speeds/travel times.
		3.1.2	The system shall assess the effects of predicted roadway weather conditions on arterial travel speeds/travel times.
		3.1.3	The system shall assess the effects of weather on arterial coordination.
		3.2	The system shall predict the effects of different roadway conditions on operating demand.
		3.2.1	The system shall predict the effects of forecast roadway weather conditions on freeway demands.
		3.2.2	The system shall predict the effects of forecast roadway weather conditions on arterial demands.
		3.2.3	The system shall predict the effects of forecast roadway weather conditions on transit demands.
3.3	The system shall allow agencies to assess the effectiveness of different active traffic management strategies to overcome the predicted operational deficiencies caused by predicted roadway events.		

User Need ID	State and Local Transportation Agency User Need	Functional Requirement ID	Functional Requirement
		3.3.1	The system shall allow agencies to assess effectiveness of different traffic signal coordination strategies.
		3.3.2	The system shall allow agencies to assess the effectiveness of different traffic signal timing settings.
		3.3.3	The system shall allow agencies to assess the effectiveness of different types of vehicles restrictions.
		3.3.4	The system shall allow agencies to assess the effectiveness of different types of lane restrictions.
4.	Disseminate the predicted impact of weather on traffic operations to travelers both before they initiate their trip and while en route on their trip.	4.0	The system shall disseminate current and forecasted road weather conditions.
		4.1	The system shall support the dissemination of current and forecasted road weather condition information affecting pre-trip decision making.
		4.1.1	The system shall provide current and predicted road weather information for each roadway segment.
		4.1.2	The system shall display the predicted travel conditions for the time period selected by the user.
		4.1.3	The system shall display the predicted travel conditions for the time the user is expected to enter each segment, based on predicted travel times.
		4.1.4	The system shall allow the user to assess multiple routes based on current and predicted travel conditions.
		4.1.5	The system shall allow the user to assess different departure times.
		4.1.6	The system shall support the dissemination of pre-trip information through multiple devices, including Smart Phones, websites, and 511.
		4.2	The system shall support the dissemination of current and forecasted road weather condition information affecting en route decision making.
		4.2.1	The system shall provide updates of current and predicted road weather information for each roadway segment every 15-minutes.
		4.2.2	The system shall disseminate en route predicted road weather conditions through traditional information dissemination technologies (DMS, HAR, 511, etc.).
		4.2.3	The system shall disseminate predicted road weather conditions from 30 mins to 1 hour in the future.
		4.2.4	The system shall be used to assist travelers to make route choice decisions.
		4.2.5	The systems shall be used by operators to encourage drivers to alter through routes, or to seek shelter for deteriorating weather conditions.

User Need ID	State and Local Transportation Agency User Need	Functional Requirement ID	Functional Requirement
5.	Coordinate and share information about their responses predicted congestion and travel impacts due to an impending weather event.	5.0	The system shall support data sharing of current and predicted impacts of weather on roadway operations with other agencies.
		5.1	The system shall support data sharing of current and predicted road weather information with transportation management personnel.
		5.2	The system shall support data sharing of current and predicted road weather information with emergency management personnel.
		5.3	The system shall support data sharing of current and predicted road weather information with roadway maintenance personnel.

3.8 Analysis of the Proposed System

The effects of traveler information on driver route, departure time, and mode choice decisions are difficult to capture through direct field measurements. Instead, studies have generally relied upon user-stated preference studies and interviews to determine the degree to which travelers' and agency decisions are impacted by improved traveler information. Examples of the types of information that are used to assess the effectiveness of improved pre-trip and en route traveler information include the following:

- Does having access to current road weather information change your trip-making decisions? Did it cause you to alter your departure time, route, or travel mode decisions? If so, how?
- Does having access to predicted road weather information change your trip-making decisions? Did it cause you to alter your departure time, route, or travel mode decisions? If so, how?
- How often do you change your 1) route, 2) mode, and 3) departure time decisions based on having access to current and predicted road weather information?
- Did you find the 1) current and 2) predicted road weather information to be 1) accurate, 2) timely, and 3) useful in your trip decision making process?

D-4 Seasonal Weight Restrictions

4.1 Scope

4.1.1 Concept Overview

This section presents a Concept of Operations for Seasonal Weight Restrictions (SWR) that are imposed by transportation agencies to prevent pavement damage on specific roads by heavy loads due to subsurface freeze/thaw actions during the spring season. The Concept of Operations (ConOps) is intended to improve the techniques used to forecast the need for truck weight restrictions on specific roads and the processes for implementing and communicating the restriction decision. The following are the intended audiences for the ConOps:

- State Departments of Transportation (DOT) – The SWR ConOps enables a robust and scientifically based decision-making process for seasonal weight restrictions, minimizing pavement damage while allowing for optimum goods movement across the state. Typical groups who might benefit from the ConOps within the State DOT include:
 - District Maintenance Chiefs
 - Motor Carrier Divisions
 - Public Information Staff (who will be able to provide advance notification to the commercial vehicle community)
- System Developers and Integrators -- The SWR ConOps helps create a context for the development of a SWR tool which can be used by state DOTs.

4.1.2 Strategy Overview

A Seasonal Weight Restriction (SWR) strategy is intended to provide decision-support to state DOTs that deal with freeze/thaw conditions. The decision-support capability uses atmospheric weather, road surface and sub-surface information as inputs to a forecasting model to predict thaw occurrence, freeze depth, and resiliency of the pavement. The basic premise behind the concept is that advanced weather and road weather information sources, combined with modeling of sub-surface conditions, will result in earlier notification of sub-surface thaw to the transportation system managers who can then take more timely decisions to prevent pavement damage while providing better and advanced notification to the impacted truckers/haulers. Similarly, once the pavement has regained its strength, restrictions can be speedily removed minimizing the impact to the commercial vehicle traffic.

As **such**, the vision for the SWR strategy is to provide a more reliable, scientifically-based decision support process to guide placement of weight restrictions balancing the interests of the commercial trucking community and the structural integrity of the transportation system. The goals of the strategy are four-fold:

1. Allow State decision makers to more effectively determine when to place and remove load restrictions, preserving both the pavement integrity and commercial vehicle operator productivity.
2. Increase the level of confidence in the SWR decision-making process.
3. Improve coordination and consistency between jurisdictions during load restriction season.

4. Improve communications and notifications to commercial operators about restriction placement and removal.

SWR involves primarily State DOTs as implementers of the strategy. Various groups within the State DOTs that are involved in the decision-making process include:

- **Maintenance Districts** – Typically, the decision to impose restrictions comes from the maintenance districts. The district chiefs, in collaboration with their field staff, determine the location and the dates of restriction placement and removal. They will be the primary users of a SWR Strategy ConOps.
- **Motor Carrier Divisions** – Once the decision to place restrictions has been made, it has to go through an administrative process that can take several days before restrictions are actually posted. This involves coordination with the motor carrier division for issuing advisories and email alerts to the commercial vehicle operator community.
- **Public Information** – The groups responsible for public information including signage on roadways and traveler information systems are critical stakeholders in SWR.
- **Headquarters or Central Offices** – As maintainers of Road Weather Information Systems and Pavement Management systems in most agencies, they provide important inputs to the decision-making process.

The second primary stakeholder group is the Commercial Vehicle Operator community representing the entities that operate commercial vehicles in the state including long-haul truckers, heavy equipment movers, and farming-related operators.

Some of the assumptions made were:

1. Roles and responsibilities between the maintenance districts and central offices within the DOT. The relationship between the various groups within state DOTs may vary significantly depending on the institutional framework of the DOT.
2. Availability of quality-checked ESS information was presumed.
3. The concept does not assume the wide-spread availability of frost-probes or direct sub-surface measurements.

4.2 Referenced Documents

The following documents were used in the development of this ConOps document.

- *Development and Deployment of Clarus-Enabled Services, Clarus Multi-State Regional Demonstration: Concept of Operations* (Version 1.0), Submitted to the Federal Highway Administration, February 27, 2009.
- *Development and Deployment of Clarus-Enabled Services, Clarus Multi-State Regional Demonstration: High Level Requirements – Use Case 2*, Submitted to the U.S. Department of Transportation, Federal Highway Administration, April 30, 2009.

4.3 Current System or Situation

4.3.1 Background, Objectives, and Scope

In cold weather States in the U.S, thawing periods result in pavement damage during late winter and early spring leading to the formation of potholes and cracks. This is primarily due to the presence of water in the sub-grade resulting in a loss of pavement strength. To prevent such damage from occurring, state DOTs impose SWR for truck traffic on specific sections of the roadway during the thaw period. The primary objective of the SWR is to prevent pavement damage while still providing access and mobility to the freight traffic.

4.3.2 Description of the Current System or Situation

Load restrictions vary by State and region. Typically, they are based on the pavement conditions like surface thickness and type of sub-grade, local knowledge of weather and pavement conditions, expected truck traffic volumes, and field observations related to observed moisture and pavement distress.

In placing restrictions, decision makers currently rely on a variety of information that seeks to inform them about the conditions under the pavement. This information includes visual observations of moisture weeping through surface cracks, atmospheric temperature trends, environmental sensor station (ESS) readings of subsurface temperatures in limited locations, historical restriction patterns, and conditions and decisions in neighboring districts. Some States have heuristic guidelines based on atmospheric condition trends (number of freezing days as an indication of frozen depth, and number of melting days as an indication of thaw). Very few to no agencies have extensive sub-surface probes to use direct measures of temperatures.

When the time to remove restrictions approaches in the late spring or early summer, DOTs use a combination of decision strategies, such as falling weight deflectometer (FWD) readings, field observations of soil conditions, plus ESS and atmospheric temperature readings to estimate the appropriate time to remove restrictions. Typically DOTs are inclined to leave restrictions posted longer than may actually be necessary to protect the pavement. Normally, when the subgrade reaches about 80% of full strength, DOTs are comfortable removing weight restrictions.

4.4 Nature and Justification of Changes

Currently, when a DOT decides to place restrictions based on observed pavement conditions at the onset of warming spring conditions, it is likely to be too late to fully protect the pavement from vehicle damage, as subsurface thawing is likely to have occurred several days prior to observed evidence at the surface. Furthermore, State DOTs may have in place an administrative process that can take several days before restrictions are actually posted after the decision to restrict has been made, adding further delay and potential risk to the pavement. New advances in availability of weather information such as quality-checked *Clarus* data, coupled with enhanced sub-surface modeling techniques, can provide DOTs with thermal and strength profiles of their pavements. This information can be forecast for several weeks allowing an agency an unprecedented window of opportunity to better schedule their SWR and beat the thaw. In addition, various city and county jurisdictions follow the lead of State DOTs in setting and removing restrictions and are impacted by delays and administrative lags in restriction placement or removal times.

4.5 Concepts for the Proposed Strategy

The following sections describe the proposed improvements to the SWR strategy based on desired changes specified in Section 4 above.

4.5.1 Description of Proposed Strategy

The process starts with a decision-support system which provides forecasted sub-surface information to supplement typical existing sources of ESS data and field observations. These data combined with State policies and guidelines form the basis of the restriction placement decision by the maintenance chief. This information is then communicated to the central office where various administrative processes are initiated for the official placement and notification of decisions. These processes may include sharing the impending placement decisions with pre-registered commercial vehicle operator lists, creating and distributing maps of restricted and unrestricted roadways, providing alerts and advisories via traveler information systems such as 511 or websites, and sharing restriction information with enforcement personnel. The process is repeated for removal of restrictions. Figure D-18 shows the high-level concept diagram depicting the strategy and the environment in which it operates. Each element of the figure is described here.

Weight Restriction Decision-Support Subsystem

This is the heart of the strategy, coupling a pavement and subsurface temperature prediction model with a long-range atmospheric model to forecast thermal profiles of subsurface conditions up to two (2) meters depth and 10 days into the future. The decision-support tool provides the state DOTs with a forecast of impending sub-surface conditions (such as temperatures, resilient modulus, percent water, pore pressures) to enable a more proactive placement of restrictions.

The *Clarus* Multi-State Regional Demonstration developed a detailed Concept of Operations and systems requirements for such a decision-support tool. Figure D-19 provides a screen shot of a detailed subsurface temperature profile with time out to 10 days from the user selected start date shown on the x-axis and depth in inches from the surface down to four feet shown on the y-axis. This information is for a particular location in the state. Figure D-20 provides a screen shot of the resilience profile with all other conditions set the same as in Figure D-19. These two examples are from April 30, 2010, and they illustrate how a drop in atmospheric temperature occurred during a longer warming trend. As the warming continued and began raising the temperatures in the sub-base, the resilient modulus began to drop (from 1.0 to 0.6), indicating increased vulnerability of the pavement to potential truck damage.

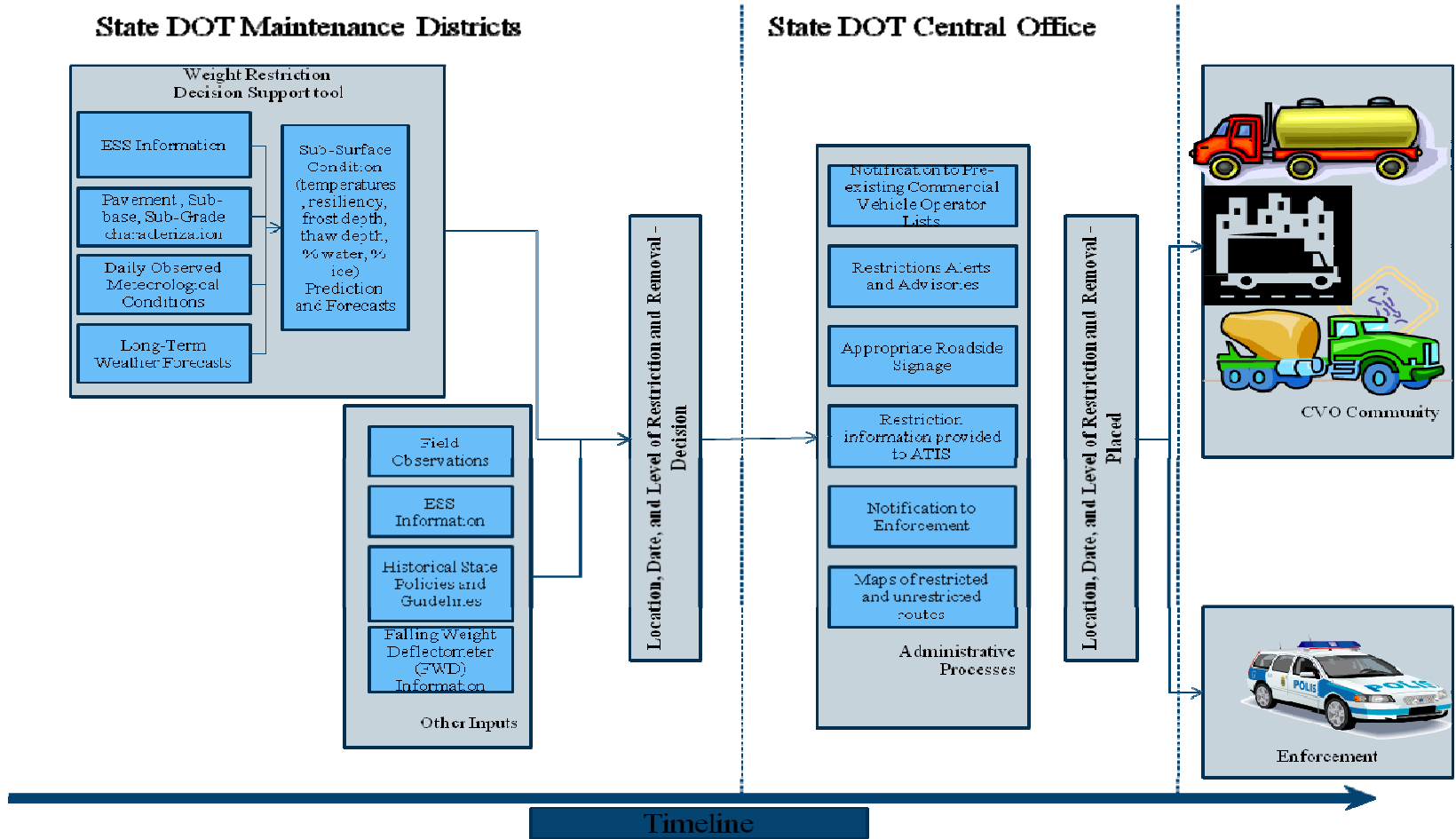

Figure D-18. High-Level Concept Diagram for Seasonal Weight Restriction (Source: Created by Authors)

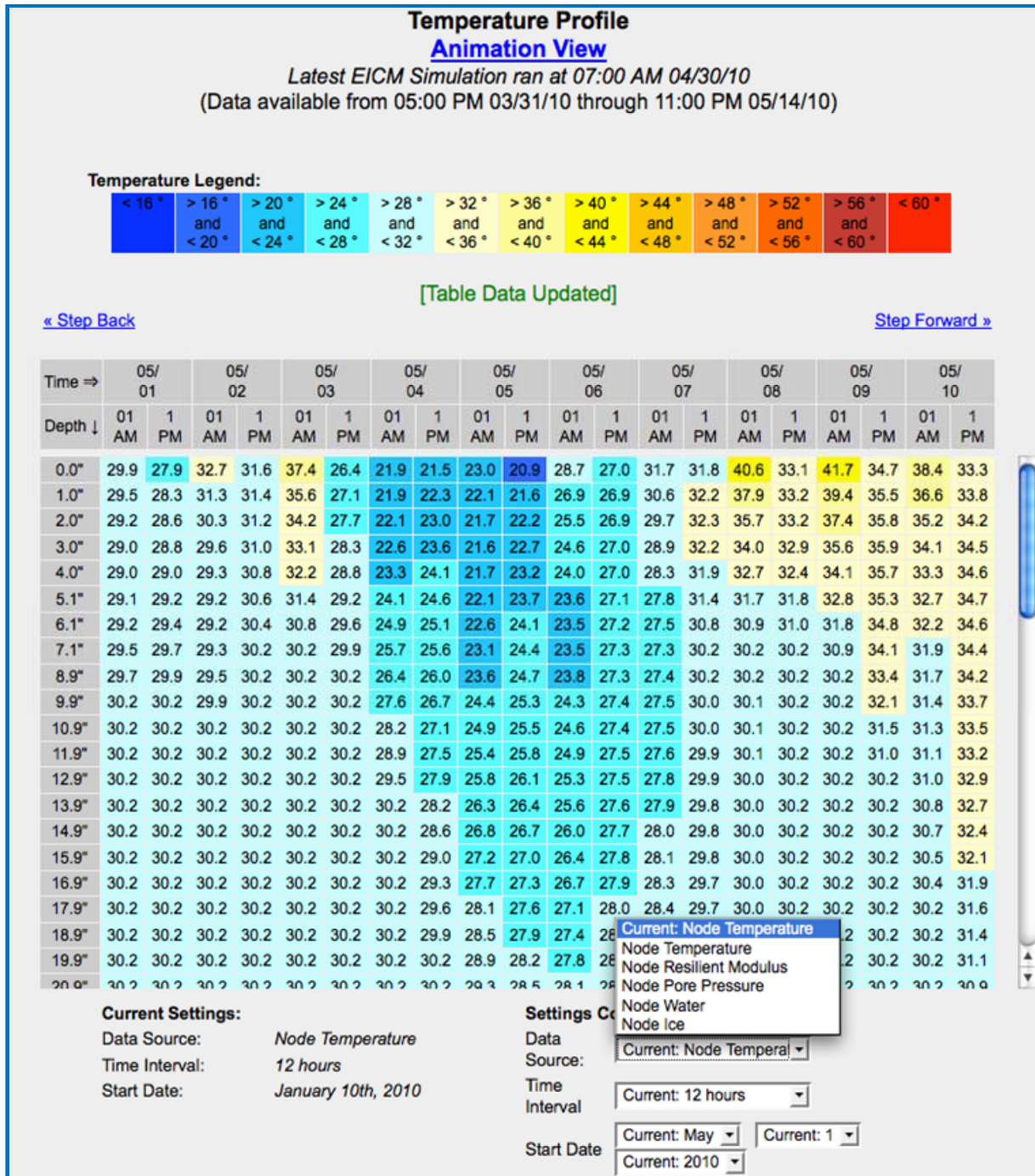

Figure D-19. Example Temperature Profile (Source: Meridian, Clarus Multi-state Regional Demonstration, Use-Case #2 Website)

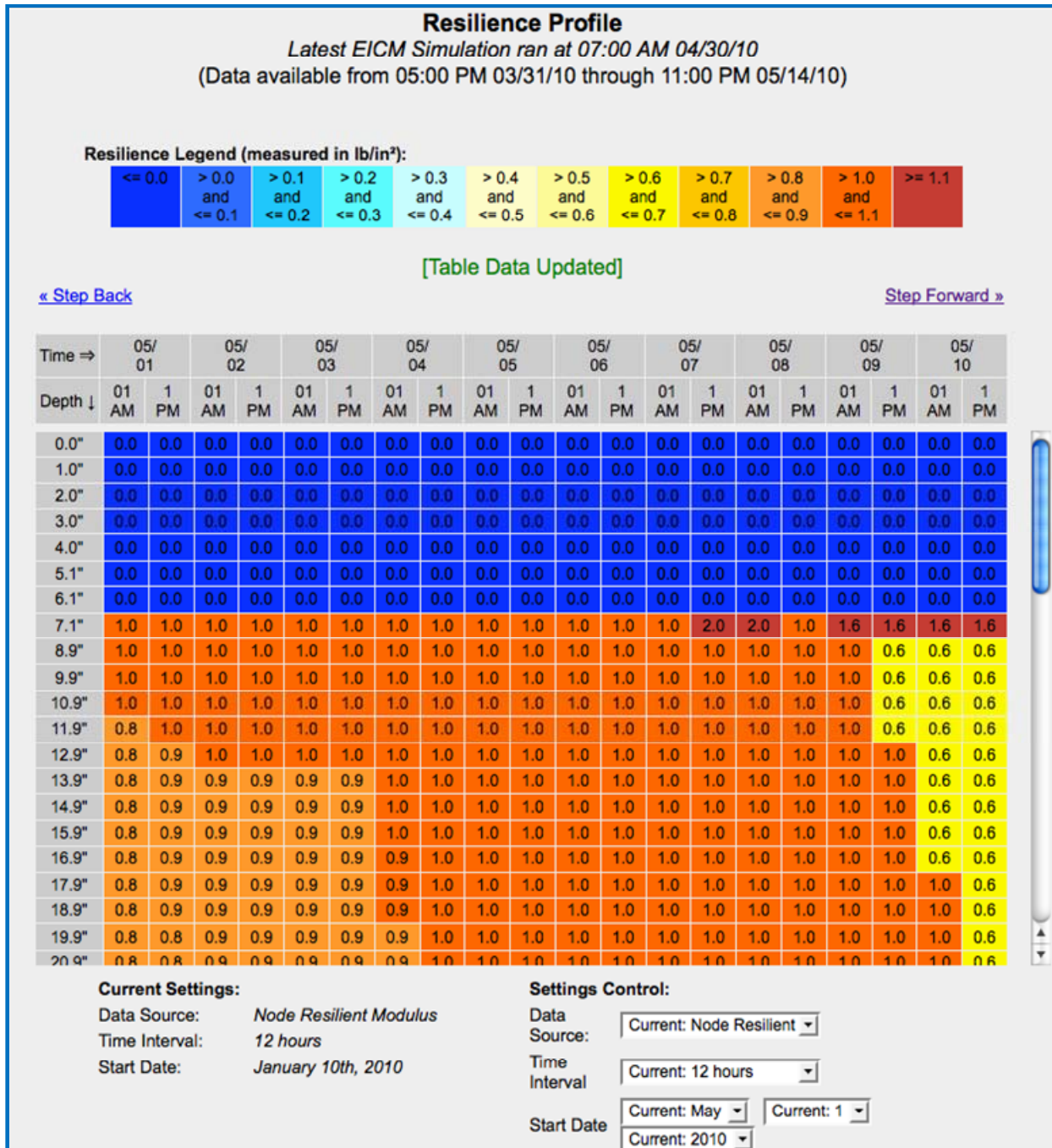

Figure D-20. Example Resilience Profile (Source: Meridian, *Clarus* Multi-state Regional Demonstration, Use-Case #2 Website)

Other Inputs

The decision-support system is only a tool in the tool box for maintenance chiefs as they consider restriction placement or removal. In addition to the weight restriction decision support system, other inputs for the SWR decision-making include field observations, ESS observations, FWD measurements, and historical restriction experience. Each of these inputs is explained below:

- **ESS Information** – ESS pavement and sub-surface temperature information is vital in verifying decision-support tool outputs as well as providing direct sub-surface measures (if sub-surface probes are part of the ESS). Ideally, these probes will be located at a depth of most concern to the DOT.
- **Field Observations** – Maintenance personnel look for visible signs of thaw such as moisture seeping through the cracks. As noted earlier, while waiting for visible signs may be too late for placement of restrictions, field observations will continue to be vital in deciding how restrictions occur.
- **FWD Information** – A direct measure of pavement carrying capacity, the Modulus (stiffness) can be determined using portable FWDs during the spring thaw. However, typical FWD programs are based on a sampling design and are part of larger pavement management programs and may not be available for the desired roads at the desired times. Where available, they play an important role in restriction removal as they can provide a direct measurement of the pavement strength. Typically, when FWD readings indicate 70-80% of pre-thaw strengths, the restrictions are removed.
- **Historical Restriction Information** - Historical restriction information plays a critical role in determining seasonal weight restriction. Agencies start paying attention to pavement conditions typically after a certain date when they have historically considered appropriate for restrictions for their area. Restrictions are also typically placed on the same sections of roadways based on historical trends of pavement distress and trucking patterns

4.5.2 Administrative Processes

Administration processes include notification of Commercial Vehicle Operators (CVOs), notification of enforcement, roadside signage, mapping, and website updates. Information about seasonal weight restrictions can be conveyed through maps and information on agency websites. Information about restrictions can be shared through email lists of commercial vehicle operators including advanced notification of impending restrictions. Typical administrative processes also include the nature of the restrictions in the State.

Figure D-21 from the North Dakota website lists the different classifications of road restrictions that they use. Depending on pavement conditions, a road may be classified into one of the described classes of restrictions.

ND Load Restrictions Chart				
Class	Single Axle	Tandem Axle	3 or more Axle Groupings	Gross Vehicle Weight
Restricted by Legal Weights	20,000 lbs.	34,000 lbs.	17,000 lbs. per axle not to exceed 48,000 lbs. gross weight on divisible loads	105,500 lbs.
8-TON	16,000 lbs.	32,000 lbs.	14,000 lbs. per axle not to exceed 42,000 lbs. gross weight on divisible loads	105,500 lbs.
7-TON	14,000 lbs.	28,000 lbs.	12,000 lbs. per axle not to exceed 36,000 lbs. gross weight on divisible loads	105,000 lbs.
6-TON	12,000 lbs.	24,000 lbs.	10,000 lbs. per axle not to exceed 30,000 lbs. gross weight on divisible loads	80,000 lbs.
5-TON	10,000 lbs.	20,000 lbs.	10,000 lbs. per axle not to exceed 30,000 lbs. gross weight on divisible loads	80,000 lbs.

Figure D-21. NDOT Load Restrictions Chart (Source: NDOT Website, <http://www.dot.nd.gov/roadreport/loadlimit/spring-load-restrictions-chart.asp>)

4.5.3 Operational Policies and Constraints

Operational Policies

Policy and guideline information that each State currently uses for implementation of seasonal weight restrictions will continue to be used. Any exemptions to the weight restrictions will continue to hold as before.

Operational Constraints

No new operational constraints are envisioned due to the implementation of the concept. Existing approaches to mitigating mobility impacts of commercial vehicle operations will continue to be in effect.

4.6 Operational Scenarios

This section describes two operational scenarios that illustrate load restriction placement and removal using a SWR decision support tool and other inputs as defined in Section 5.

4.6.1 Weight Restriction Placement

Mr. Smith is in charge of a maintenance district in north-central Montana. The roadway network in the maintenance district is characterized mostly by 2-lane rural roads typically used by local haulers (mostly wood and farm products) and local traffic. Recently however, there has been an increase in heavy truck traffic due to mineral and oil deposits found in Alberta, Canada. The roads in Mr. Smiths' district are viable options for truckers hauling heavy equipment to the mining areas across the border.

Mr. Smith has traditionally placed restrictions on his roadways using an ad-hoc approach relying on the two ESS stations in his district and reports from his field personnel. He recognizes that often times, by the time the restriction decision is made and actually placed, the thaw has already occurred and the restrictions too late to prevent pavement damage.

This winter, Mr. Smith started working with a SWR decision-support tool to see if the timing of the restrictions can be improved using forecast information. After being trained on the tool, Mr. Smith began monitoring the tool on a daily basis, starting in mid-February, a time when the weather in Montana would start turning warm. Each day, not only was he able to look at the current temperatures and the pavement strengths (in terms of resilient modulus; a term he is familiar with because of the FWD program in his state), he was able to look at the forecasts 10 days in advance.

In early March, he noticed that the decision-support tool indicated a long period of warm temperatures with sub-grade thaw occurring up to 24 inches. He knew that this was the critical time for the SWR. On March 7th, he communicated to the central office in Montana that he intends to place restrictions on the 16th. On the same day, the central office sent out a pre-notification to the e-mail list that they maintain indicating that restrictions are imminent as soon as they heard from Mr. Smith. By March 10th, an official notification was sent out and the restriction went into place on the 16th.

Mr. Smith realized that using this approach allowed him to proactively place restrictions and provide better and advance notification to the trucker community while significantly reducing pavement damage.

4.6.2 Weight Restriction Removal

For the first time in many years, Mr. Smith has not received any complaints from the truckers on the timing of the restriction placement. However, he knows that restriction placement is only one part of the equation and truckers are often more impacted by the timing of the restriction removal in early summer. He knows that as soon as he lifts the restrictions he will be bombarded with requests for oversize and overweight permits for heavy equipment movement in his district.

Traditionally, it has been difficult to ascertain an exact timeframe for restriction removal. With spring rains, and unseasonal snowfall (not uncommon in April in Montana), it is often difficult to determine if the pavement strength is back to the pre-thaw days. In recent years, as part of the pavement management system, the state DOT began conducting a survey using a portable FWD. While this is very useful, the sampling design has the portable FWD in his district only once a month.

Mr. Smith notices that the SWR decision support tool has an indicator of pavement strengths available. He starts monitoring the tool at the beginning of April and carefully noting the return of pavement strengths.

During the first week of April, his district experiences some glorious summer days with temperatures in the high 60s and early 70s. He starts getting calls from truckers asking him why the restrictions are still in place. He is able to use the screenshots from the tool to show them that the pavement strengths haven't returned and that heavy rain is expected in the next couple of weeks.

By mid-April, he starts seeing long-term warming trends, and decides to lift the restrictions at the end of April. Similar to the placement, he is able to let the Central Office know in advance, who in turn are able to provide notification to truckers.

In both the removal and restriction case, Mr. Smith reflects that having forecast information of subsurface conditions was vital and he would continue using this approach for future restrictions.

4.7 High-level System Design

4.7.1 User Needs

Following is a list of the high-level user needs of transportation agencies for SWR placement and removal. These user needs are not in any particular order, and their order does not imply priority level.

- Need current and forecast sub-surface condition information at select locations of interest across the state.
- Need decision-support on timing of restriction placement and removal information.

4.7.2 High-Level Functional Requirements

Much of the SWR strategy depends on the operational policies and practices in the state. However, the crux of the strategy lies in the decision support tool. The following table shows the high-level functional requirements needed to fulfill the identified user needs associated with deploying a decision-support system to assist with the SWR strategy.

Table D-5. System Requirements for Deploying SWR Strategy

User Need ID	User Need	Functional Requirement ID	Functional Requirement		
1.	Need current and forecast sub-surface condition information at select locations of interest across the state.	1.0	The SWR system shall generate current and 10-day forecasts of subsurface conditions at pre-determined locations.		
		1.1	The SWR system shall ingest weather and road weather data to support 10-day forecasts.		
		1.1.1	The SWR system shall acquire surface transportation weather analysis and forecast products from available models.		
		1.1.2	The system shall obtain real-time road weather information from environmental sensor stations (ESS) deployed.		
		1.2	The SWR system shall acquire roadway information.		
		1.2.1	The SWR system shall acquire available pavement information (depth, type of pavement) data from State DOTs.		
		1.2.2	The SWR system shall acquire sub-surface information (depth, type of material) from State DOTs.		
		1.3	The SWR system shall generate sub-surface conditions information based on ingested data twice a day.		
		1.3.1	The SWR system shall generate sub-surface temperatures up to specified depth.		
		1.3.2	The SWR system shall generate sub-surface resilient modulus up to a specified depth.		
		1.4	The SWR system shall display observed ESS conditions.		
		2.	Need decision-support on timing of restriction placement and removal information.	2..0	The SWR system shall generate seasonal weight restriction guidance.
				2.1	The SWR system will generate an alert when forecast sub-surface profile conditions reach thresholds.
				2.1.1	The SWR system will allow setting of different thresholds for sub-surface conditions.
2.1.1.1	The SWR system will allow setting of temperature thresholds at specific depths.				
2.1.1.2	The SWR system will allow setting of resilient modulus thresholds at specific depths.				
2.1.2	The System shall have the capability to publish alerts to users as e-mails.				

4.8 Analysis of the Proposed System

The objective of the analysis and evaluation is to assess how DOTs use and benefit from this ConOps to make their SWR placement and removal decisions. It seeks to understand the perspectives of decision makers on the benefits of the tool and its ability to offer a more reliable, scientifically-based decision making process. Whether following the tool's guidance results in changes in the duration of restrictions, compared to durations that would be obtained using traditional decision making approaches, is also of interest in the evaluation. Table D-6 contains a list of potential performance measures that could be used to assess the effectiveness of deploying a SWR strategy.

Table D-6. Performance Measures for SWR

Category	Performance Measures
Mobility, Efficiency, Productivity	1. Increase in number of days between placement of restrictions and <u>visual observations of thawing on the pavement</u>
	2. Increase in the number of days of advance notification provided to truckers/haulers
	3. Short-Term and long-term pavement distress indicators (rutting, cracking) on seasonally restricted roads
Customer Satisfaction (State DOTs)	4. Perceptions and satisfaction of state DOT personnel involved in SWR decision-making
Customer Satisfaction (Commercial Operators)	5. Number of complaints about the timing and duration of SWR
	6. Perception and satisfaction of the Commercial Vehicle Operator community with SWR in the state

D-5 Intra-Agency and Inter-agency Coordination

5.1 Scope

Effective management of traffic during adverse weather typically rests on institutional cooperation and arrangements both within and outside the agency. Weather responsive traffic management (WRTM) depends on sharing information and resources between transportation management centers, maintenance units, law enforcement centers, media and information service providers and transit operators (where appropriate), as the weather event unfolds. In recent years, the need for intra-agency and inter-agency cooperation has been clearly recognized and efforts to improve information sharing and control strategies are beginning to bear fruit. Typically, there are multiple personnel, management centers, field devices and systems involved in responding to inclement weather. This concept of operations clearly articulates an integrated multimodal approach to establish a foundation to implement many of the advisory, control, and treatment strategies for WRTM. It is important to note that unlike the other ConOps described in this Appendix, this ConOps does not recommend developing a particular system but rather focuses on the interfaces and linkages between the various stakeholders and the systems they use. Relying on the interfaces and data flows specified in the National ITS Architecture (Version 6.1), this document provides a high-level summary of the services and functional requirements for intra- and inter- agency coordination for WRTM.

5.1.1 Document Overview

- **Section 5.2:** Lists the documents referenced in the development of this concept of operations.
- **Section 5.3:** Provides an overview of current systems and level of agency coordination during weather events in the United States.
- **Section 5.4:** Provides a justification of the changes required in current coordination approaches
- **Section 5.5:** Provides a discussion of the proposed changes to the systems/centers.
- **Section 5.6:** Provides several operational scenarios that illustrate the new approaches to intra- and inter-agency coordination.
- **Section 5.7:** Provides the high-level user needs and requirements for the various centers and field equipment involved in intra- and inter-agency coordination.
- **Section 5.8:** Discusses the analysis and the potential performance metrics that can be used to measure system effectiveness.

5.1.2 Concept Overview

The agency coordination strategies would be similar in nature to those used to develop multi-agency incident response plans. Examples of techniques that might be pursued by agencies in this strategy include the following:

- Convene inter-jurisdictional taskforce to examine weather impacts of traffic operations and develop standard response plans for those emergencies.
- Develop standard operating procedures outlining the roles, responsibilities, and actions to be taken by operating agencies during inclement weather events.
- Develop multi-jurisdictional routing plans that can be implemented during inclement weather events.

- Develop systems and technologies that allow the sharing of information during emergency conditions.

These increased levels of coordination and integration are intended to facilitate better event planning, knowledge sharing, effective decision making, and efficient response. Experience indicates that implementing these strategies to major weather events can have dramatic positive impacts on improving their operations. Tools to achieve increased coordination include improved data sharing, integration of weather information, decision-support systems

5.1.3 Stakeholders

The following are the key stakeholders for agency coordination for WRTM:

- City and Local Departments of Transportation - this includes the public work departments within the city governments.
- City and Local Police and Fire Departments
- Local Media
- Private Traveler Information Service Providers
- State Department of Transportation
- State Police and Public Safety
- Transit Agencies
- Weather Service Providers - this includes both the private sector (value-added meteorological service providers) and public sector (National Weather Service)

Each of the stakeholders operates centers, systems, and field equipment which will need to exchange information during weather response.

5.2 Referenced Documents

- FHWA, *National ITS Architecture*, Version 6.1, www.iteris.com/itsarch, as of May 2011.
- Battelle, *Baseline Conditions Report: Integration of Emergency and Weather Elements into Transportation Management Centers*, Prepared for the FHWA Road Weather Management Program, May 2005.

5.3 Current System or Situation

The need for better agency coordination for weather is well-recognized and indeed, new approaches and strategies are starting to be used in the transportation community. However, coordination during weather has still not reached its full potential. Intra and Inter-agency coordination during weather is at an intermediate level of sophistication as of today. There is basic understanding of strategies and applications, key systems and processes are being developed, and both internal and external capacity is being enhanced in regions around the country.

However, the bulk of the coordination during weather relies on informal communications based on personal relationships, and conducted in an ad-hoc manner. Even in existing systems intended to share information such as CAD integration systems or regional event management systems, weather and road weather

conditions are not often fully incorporated. Recent initiatives like the Integrated Corridor Management and regional Traffic Incident Management focus on regional, multi-jurisdictional approaches for operations linking traffic, maintenance, safety, and weather stakeholders and systems.

The primary challenge in improving intra and inter-agency coordination is the availability of actionable, timely information from the various stakeholders (and their systems) involved in the response. By their nature, weather events are stressful situations for the agencies. Each agency primarily focuses on mitigation approaches starting with their jurisdictions with coordination over a region or corridor often taking a back seat to triage actions. While there are good practices across the nation, especially for the larger weather events, routine coordination still remains a challenge. Even within agencies, sharing of information is often secondary.

Over the past ten years, many transportation agencies have been reaching out to the National Weather Service and are getting them involved in coordination activities. The *Baseline Conditions Report: Integration of Emergency and Weather Elements into Transportation Management Centers*⁷ provides several examples of agency coordination especially the use of traffic operations data by maintenance staff and weather forecasters to confirm conditions and improve responses. The primary traffic operations data observed to be of value to maintenance and weather forecasters were CCTV images (to confirm weather and traffic conditions) and severe traffic speed reductions due to an incident or heavy congestion (possible notification of a weather related problem or a situation requiring maintenance action).

Maintenance personnel play an extremely important role in traffic safety and mobility. They pre-treat before winter storms, plow or apply abrasives to improve traction, remove roadway debris, and implement traffic control during a major incident. The report noted that cases where maintenance dispatchers were integrated with traffic operations and information was easily shared, the TMC improved operations. In these integrated cases, data collected and assembled by traffic operations staff (including weather forecasts, road conditions, and CCTV images) were made available to maintenance dispatchers for their use in determining the best course of action. In every case the maintenance dispatchers were collocated in the TMC, although technically it is certainly feasible to provide the necessary data to another location for maintenance dispatch use.

For example, in Salt Lake City, the weather operations group (collocated in the TMC) used CCTV images and road condition reports from traffic operations to confirm weather conditions and refine forecasts provided to Statewide maintenance dispatchers (also located in the TMC). In Los Angeles, major traffic incidents identified and tracked by traffic operations personnel were provided to collocated maintenance dispatchers who deployed incident response teams to the problem to help ensure safety of other travelers and clear the traffic back-up. In Minneapolis, maintenance monitors the traffic system during traffic management off-hours using the CCTV and other ATMS tools as weather information sources. In Maryland, maintenance is nearby the control room and, when they are not present in the room, they are regularly apprised of the effects seen on the roadways due to weather. In New Jersey, the entire TMC system shifts and the ATMS tools present in the control room (CCTV) become some of the key sources of weather information.

5.4 Nature and Justification of Changes

Improved intra- and inter-agency coordination can result in specific and desirable outcomes to travelers:

- Improved response time to incidents by traffic management personnel.
- Improved clearance time for incidents that affect efficiency and safety of the transportation network.

⁷ Battelle, *Baseline Conditions Report: Integration of Emergency and Weather Elements into Transportation Management Centers*, Prepared for the FHWA Road Weather Management Program, May 2005

- Increased throughput for travelers during weather events.
- Improved trip travel times and reliability for travelers in the region.
- Improved traction on the roadway during winter weather conditions to enhance safety of travel.
- Lower overall impact on operations due to weather.

By improving the situational awareness of the operators in the region, overall response and control actions can be coordinated to a high-degree of efficiency. For example, a traffic management agency may coordinate freeway ramp metering with weather-responsive traffic signal plans on the adjacent arterials. Similarly, a traffic management center may provide updated road condition information for transit agencies to make service changes (route, time) during winter.

5.5 Concepts for the Proposed Strategy

5.5.1 Overview

The following concepts are derived from the terminology and definitions used in the National ITS Architecture (Version 6.1). The concepts describe the key systems (inventory), the services necessary for agency coordination, and the overall operating constraints. This section represents the bulk of the regional architecture necessary for effective communications and coordination during weather events.

5.5.2 Key Systems

Table D-7 identifies the key systems for intra- and inter-agency coordination. As the table indicates, WRTM agency coordination involves a wide variety of systems (center, field and vehicles).

Table D-7. Key Systems for Weather-Related Intra- and Inter-agency Coordination

System Name	Description
City and Local Maintenance Vehicles	Maintenance vehicles owned and operated by city and local jurisdictions. These include snow plows, and other maintenance and construction vehicles which may play a role in responding to weather events. Typically, these vehicles include radio communications to the dispatch centers with potentially a vehicle-location and equipment monitoring system. Primarily responsible for roadway conditions on arterials and other city streets including snow removal, debris, construction, and lane control.
City and Local Police and Fire Vehicles	Emergency vehicles (police and fire) owned and operated by city and local jurisdictions. These vehicles generally include radio communications to the centers but also may include vehicle location, mobile data communications. Some of these vehicles may be equipped for traffic signal preemption. Typically, the first responders to incidents but also play vital roles in traffic control and operations during weather conditions.
City and Local Police Dispatch Centers	Dispatch centers for city and local police and fire departments. May include Public Safety Access Points, 911 Centers. Responsible for receiving and responding to ongoing weather impacts. May be integrated via system to system connection with traffic management (CAD integration) or may be co-located with traffic management.

System Name	Description
City and Local Public Works Centers	Dispatch and monitoring centers responsible for public works and street operations within cities. Typically, these centers house the maintenance chiefs and superintendents who direct response to weather conditions.
City and Local TOC Operator	Operator responsible for overseeing traffic at a city and local level at the Traffic Operations Center (TOC)
City and Local Traffic Operations Centers	City and local traffic operations centers (TOC) responsible for traffic operations (including signal control) on city streets. These centers include traffic signal operations, CCTV monitoring and roadside infrastructure for traffic monitoring as well as traveler advisories (portable DMS etc)
City and Local Traffic Roadside Equipment	Roadside equipment operated by cities including Environmental Sensing Stations, DMS, HAR, vehicle detection stations and CCTV cameras.
State DOT TMC Operator	Operator responsible for overseeing traffic at a state level at the Traffic Management Center (TMC).
Media outlets	Media outlets including TV and radio stations in the region are a key system to interface with often serving as the primary source of weather and road condition information in the region.
State DOT Maintenance and Construction	The group within the State DOT responsible for maintenance and construction. Typically, this group is responsible for both winter and non-winter activities on interstates and state highways.
State DOT Maintenance and Construction Vehicles	Similar to the city and local vehicles, these represent the maintenance vehicles owned and operated by the State DOT.
State DOT Roadside Infrastructure	Data gathering systems such as the RWIS network, the pavement sensors, the vehicle detection systems, CCTV camera network and roadside data dissemination equipment (Highway Advisory Radio, DMS, beacons, closure systems) are all included as the state DOT roadside infrastructure.
State DOT Traffic Management Centers	Often the nerve center for the traffic management and response during the weather events, the Traffic Management Center provides a central coordination role communicating information to different systems in the region by a variety of methods.
State Police Dispatch Centers	Dispatch center for the state highway police. Similar to the city and local police department centers, these centers represent emergency center functionality on state-owned facilities.
State Police Vehicles	State Police vehicles who are often first responders on the state owned facilities.
Statewide 511 and Traveler Information Services	State-owned and operated systems for traveler information including 511 telephone and websites, road condition information systems, and other alert systems.
Statewide and Regional Emergency Operations Centers (EOCs)	Emergency Operations Centers which are either permanent or get activated when certain criteria are met. These include both state-level EOCs and regional EOCs which bring together staff from different agencies before, during and in the aftermath of an event.

System Name	Description
Surface Transportation Weather Information	This system represents both the public and private meteorological sources of information available in the region. Could range from NWS information to value-added private services.
Transit Management Centers	Regional transit management centers operating bus, rail systems in the region. Weather poses unique challenges to transit management centers resulting in schedule disruptions, cancellations or rerouting.
Transit Operations Personnel	Personnel with the transit management responsible for transit operations
Transit Traveler Information	Traveler information provided by transit systems. May include kiosks, websites, phone systems, and in-station equipment
Transit Vehicles	Transit vehicles including buses and light rail. Often includes communication capabilities to the centers via radio but more and more equipped with vehicle location and mobile data computers.
Traveler Information Services	Other privately owned traveler information services available in the region.

5.5.3 Services

Together, the systems in Table D-7 work together to provide specific regional services during weather events in the region. This section describes the various services that can be offered during weather events utilizing data from different agencies and systems. Service descriptions are tailored from the National Architecture to increase the focus on weather-related communication and coordination. A summary of the systems involved in each services are summarized in Table D-8 in the section below.

Broadcast Traveler Information during Weather: This service collects traffic conditions, advisories, general public transportation, incident information, roadway maintenance and construction information, air quality and weather information, and broadcasts the information to travelers using technologies such as FM subcarrier, satellite radio, cellular data broadcasts, and Internet web casts. The information may be provided directly to travelers or provided to merchants and other traveler service providers so that they can better inform their customers of travel conditions. Successful deployment of this service relies on availability of real-time traveler information from roadway instrumentation, probe vehicles or other sources.

Interactive Traveler Information: This service provides tailored information in response to a traveler request. Both real-time interactive request/response systems and information systems that "push" a tailored stream of information to the traveler based on a submitted profile are supported. The traveler can obtain current information regarding traffic conditions, detours, and road conditions information.

Although the Internet is the predominant network used for traveler information dissemination, a range of two-way wide-area wireless and fixed-point to fixed-point communications systems may be used to support the required data communications between the traveler and Information Service Provider. A variety of interactive devices may be used by the traveler to access information prior to a trip or en route including phone via a 511-like portal and web pages via kiosk, personal digital assistant, personal computer, and a variety of in-vehicle devices.

This service also allows value-added resellers to collect transportation information that can be aggregated and made available to their personal devices or remote traveler systems to better inform their customers of transportation conditions. Successful deployment of this service relies on availability of real-time transportation data from roadway instrumentation, transit, probe vehicles or other means.

Transportation Operations Data Sharing for Weather: This service makes real-time transportation operations data available to transportation system operators. Various systems collect, process, and store current information on traffic and travel conditions and other information about the current state of the transportation network, and make this information available to transportation system operators, facilitating the exchange of qualified, real-time information between agencies. Using the provided information, transportation system operators can manage their individual systems based on an overall view of the regional transportation system.

Consistent with approaches in Integrated Corridor Management, the regional transportation operations data resource may be implemented as a web application that provides a web-based access to system operators, an enterprise database that provides a network interface to remote center applications, or any implementation that supports regional sharing of real-time transportation operations data including weather.

Traffic Decision Support and Demand Management: This service recommends courses of action to traffic operations personnel based on an assessment of current and forecast road network performance. Recommendations may include predefined incident response plans and regional surface street and freeway control strategies that correct network imbalances. All recommendations are based on historical evaluation, real-time assessment, and forecast of the roadway network performance based on predicted travel demand patterns. Traffic data is collected from sensors and surveillance equipment, other traffic management centers. During weather events, this service provides the capability to influence pre-trip and en-route mode, destination, route and time choices.

Emergency Call-Taking and Dispatch: This service provides basic public safety call-taking and dispatch services. It includes emergency vehicle equipment, equipment used to receive and route emergency calls, and wireless communications that enable safe and rapid deployment of appropriate resources to an emergency. Coordination between Emergency Management Subsystems supports emergency notification between agencies. Wide area wireless communications between the Emergency Management Subsystem and an Emergency Vehicle supports dispatch and provision of information to responding personnel. Systems include:

Wide-Area Alert: This service uses driver and traveler information systems to alert the public of severe weather events. The alert includes information and instructions for transportation system operators and the traveling public, improving public safety and enlisting the public's help in some scenarios. When an emergency situation is reported and verified and the terms and conditions for system activation are satisfied, a designated agency broadcasts emergency information to traffic agencies, transit agencies, information service providers, toll operators, and others that operate ITS systems. The systems, in turn, provide the alert information to transportation system operators and the traveling public using ITS technologies such as dynamic message signs, highway advisory radios, in-vehicle displays, transit displays, 511 traveler information systems, and traveler information web sites. Systems include;

Disaster Response and Recovery: This service enhances the ability of the surface transportation system to respond to and recover from disasters. It addresses the most severe incidents that require an extraordinary response from outside the local community. All types of disasters are addressed including natural disasters (hurricanes, earthquakes, floods, winter storms, tsunamis, etc.).

The service supports coordination of emergency response plans, including general plans developed before a disaster as well as specific tactical plans with short time horizon that are developed as part of a disaster

response. The service provides enhanced access to the scene for response personnel and resources, provides better information about the transportation system in the vicinity of the disaster, and maintains situation awareness regarding the disaster itself. In addition, this service tracks and coordinates the transportation resources - the transportation professionals, equipment, and materials - that constitute a portion of the disaster response.

Maintenance and Construction Vehicle and Equipment Tracking: This service will track the location of maintenance and construction vehicles and other equipment to ascertain the progress of their activities. These activities can include ensuring the correct roads are being plowed and work activity is being performed at the correct locations.

Road Weather Data Collection: This service collects current road and weather conditions using data collected from environmental sensors placed on and near the roadway (or guideway in the case of transit rail systems). In addition to fixed sensor stations at the roadside, sensing of the roadway environment can also occur from sensor systems located on maintenance and construction vehicles. The collected environmental data is used by the Weather Information Processing and Distribution service (see next service description) to process the information and make operational decisions. The collected environmental data may be aggregated, combined with data attributes and sent to meteorological systems for data qualification and further data consolidation.

Weather Information Processing and Distribution: This service processes and distributes the environmental information collected from the Road Weather Data Collection service. This service uses the environmental data to detect road weather hazards such as icy road conditions, high winds, dense fog, etc. in order that system operators and decision support systems can recommend and make appropriate decisions. The continuing updates of road condition information including current temperatures can be used by system operators to more effectively deploy road maintenance resources, issue general traveler advisories and issue location specific warnings to drivers.

Roadway Automated Treatment: This service automatically treats a roadway section based on environmental or atmospheric conditions. Treatments include fog dispersion, anti-icing chemicals, etc. The service includes the environmental sensors that detect adverse conditions, the automated treatment system itself, and driver information systems (e.g., dynamic message signs) that warn drivers when the treatment system is activated.

Winter Maintenance: This service supports winter road maintenance including snow plow operations, roadway treatments (e.g., salt spraying and other anti-icing material applications), and other snow and ice control activities. This service monitors environmental conditions and weather forecasts and uses the information to schedule winter maintenance activities, determine the appropriate snow and ice control response, and track and manage response operations.

Roadway Maintenance and Construction: This service supports numerous services for scheduled and unscheduled maintenance and construction on a roadway system or right-of-way. Maintenance services would include landscape maintenance, hazard removal (roadway debris, dead animals), routine maintenance activities (roadway cleaning, grass cutting), and repair and maintenance of both ITS and non-ITS equipment on the roadway (e.g., signs, traffic controllers, traffic detectors, dynamic message signs, traffic signals, CCTV, etc.). Environmental conditions information is also received from various weather sources to aid in scheduling maintenance and construction activities.

Systems involved in the above services are summarized in Table D-8 below.

Table D-8. Systems included in Intra and Inter-Agency Coordination Services

Systems	Broad-cast Traveler Info	Inter-active Traveler Info	Tranps. Ops Data Sharing	Traffic Decision Support & Demand Manage- ment	Emerg. Call- Taking & Dispatch	Wide Area Alert	Disaster Response & Recovery	Main and Constr. Vehicle & Equip Tracking	Road Weather Data Coll.	Weather Info Process & Distribu- tion	Roadway Auto- mated Treat- ment	Winter Main.	Roadway Main and Constr.
City and Local Maintenance Vehicles								X	X			X	X
City and Local Police and Fire Vehicles					X								
City and Local Police Dispatch Centers			X		X		X					X	
City and Local Public Works Centers			X				X	X	X	X	X	X	X
City and Local TOC Operator			X	X		X	X						
City and Local Traffic Operations Centers	X		X	X		X	X		X	X		X	X
City and Local Traffic Roadside Equipment				X		X			X		X		X
State DOT TMC Operator			X	X		X	X						
Media outlets	X		X							X		X	

Systems	Broad-cast Traveler Info	Inter-active Traveler Info	Tranps. Ops Data Sharing	Traffic Decision Support & Demand Management	Emerg. Call-Taking & Dispatch	Wide Area Alert	Disaster Response & Recovery	Main and Constr. Vehicle & Equip Tracking	Road Weather Data Coll.	Weather Info Process & Distribution	Roadway Automated Treatment	Winter Main.	Roadway Main and Constr.
State DOT Maintenance and Construction			X				X	X	X	X	X	X	X
State DOT Maintenance and Construction Vehicles								X	X			X	X
State DOT Roadside Infrastructure				X		X			X		X		X
State DOT Traffic Management Centers	X		X	X	X	X	X		X	X			X
State Police Dispatch Centers					X								
State Police Vehicles					X								
Statewide 511 and Traveler Information Services	X	X	X	X		X				X			X
Statewide and Regional Emergency Operations Centers (EOCs)			X		X	X	X			X			

Systems	Broad-cast Traveler Info	Inter-active Traveler Info	Tranps. Ops Data Sharing	Traffic Decision Support & Demand Management	Emerg. Call-Taking & Dispatch	Wide Area Alert	Disaster Response & Recovery	Main and Constr. Vehicle & Equip Tracking	Road Weather Data Coll.	Weather Info Process & Distribution	Roadway Automated Treatment	Winter Main.	Roadway Main and Constr.
Surface Transportation Weather Information			X			X			X	X			X
Transit Management Centers	X		X	X		X	X						
Transit Operations Personnel						X	X						
Transit Traveler Information		X		X		X							
Transit Vehicles													
Traveler Information Services	X	X				X							

5.5.4 System Interconnections

Table D-9 represents the interconnections between the various systems required to provide the services listed in Section 5.2. While no communications method is specified for each interconnection, the nature of the communication method (wired or wireless) will be driven by the data being exchanged between the systems. Connections listed in the table are bi-directional and include all the data flows between the two systems.

Table D-9. System Interconnections for Inter- and Intra-agency Communications

System 1 is	Connected to
City and Local Maintenance Vehicles	City and Local Public Works State DOT Maintenance and Construction
City and Local Police and Fire Vehicles	City and Local Police Dispatch Centers Statewide and Regional Emergency Operations Centers (EOCs)
City and Local Police Dispatch Centers	City and Local Public Works City and Local Traffic Operations Centers State DOT Traffic Management Centers State Police Dispatch Centers Statewide and Regional Emergency Operations Centers (EOCs) Surface Transportation Weather Information Transit Management Centers
City and Local Public Works	City and Local Traffic Operations Centers City and Local Traffic Roadside Equipment Media outlets State DOT Maintenance and Construction Surface Transportation Weather Information Transit Management Centers
City and Local TOC Operator	City and Local Traffic Operations Centers
City and Local Traffic Operations Centers	City and Local Traffic Roadside Equipment State DOT Maintenance and Construction State DOT Traffic Management Centers State Police Dispatch Centers Statewide and Regional Emergency Operations Centers (EOCs) Surface Transportation Weather Information Transit Management Centers

System 1 is	Connected to
DOT TMC Operator	State DOT Traffic Management Centers
Media outlets	State DOT Maintenance and Construction Statewide 511 and Traveler Information Services Transit Traveler Information
State DOT Maintenance and Construction	State DOT Maintenance and Construction Vehicles State DOT Roadside Infrastructure State DOT Traffic Management Centers State Police Dispatch Centers Statewide 511 and Traveler Information Services Statewide and Regional Emergency Operations Centers (EOCs) Surface Transportation Weather Information Transit Management Centers
State DOT Maintenance and Construction Vehicles	State DOT Roadside Infrastructure
State DOT Roadside Infrastructure	State DOT Traffic Management Centers Surface Transportation Weather Information
State DOT Traffic Management Centers	State Police Dispatch Centers Statewide 511 and Traveler Information Services Statewide and Regional Emergency Operations Centers (EOCs) Surface Transportation Weather Information Transit Management Centers
State Police Dispatch Centers	State Police Vehicles Statewide 511 and Traveler Information Services Statewide and Regional Emergency Operations Centers (EOCs) Surface Transportation Weather Information Transit Management Centers
State Police Vehicles	Statewide and Regional Emergency Operations Centers (EOCs)
Statewide 511 and Traveler Information Services	Statewide and Regional Emergency Operations Centers (EOCs) Surface Transportation Weather Information Transit Management Centers Transit Traveler Information Traveler Information Services

System 1 is	Connected to
Statewide and Regional Emergency Operations Centers (EOCs)	Surface Transportation Weather Information Transit Management Centers
Surface Transportation Weather Information	Transit Management Centers
Transit Management Centers	Transit Operations Personnel Transit Traveler Information Transit Vehicles Traveler Information Services

5.5.5 Operational Policies and Constraints

Standards

The following standards are especially important to services and systems included in this strategy (see Table D-10). These standards will need to be revisited as the data flows are defined during the design phase.

Table D-10. Applicable Standards for WRTM Strategy

Standards Development Organization	Standard Title	Standard Type
AASHTO/ITE	Traffic Management Data Dictionary (TMDD) and Message Sets for External Traffic Management Center Communications (MS/ETMCC)	Message/Data
AASHTO/ITE/NEMA	Data Element Definitions for Transportation Sensor Systems (TSS)	Message/Data
AASHTO/ITE/NEMA	Global Object Definitions	Message/Data
AASHTO/ITE/NEMA	NTCIP Center-to-Center Standards Group	Group
AASHTO/ITE/NEMA	NTCIP Center-to-Field Standards Group	Group
AASHTO/ITE/NEMA	Object Definitions for Dynamic Message Signs (DMS)	Message/Data
AASHTO/ITE/NEMA	Object Definitions for Environmental Sensor Stations (ESS)	Message/Data
AASHTO/ITE/NEMA	Object Definitions for Signal Control and Prioritization (SCP)	Message/Data
APTA	Standard for Transit Communications Interface Profiles	Message/Data
ASTM/IEEE/SAE	Dedicated Short Range Communication at 5.9 GHz Standards Group	Group
IEEE	Incident Management Standards Group	Group
SAE	Advanced Traveler Information Systems (ATIS) General Use Standards Group	Group

Agreements

Various agreements are necessary to support this strategy. The exact nature of the agreements will vary by region and agency but the following broad categories of agreements are typically necessary for effective coordination:

- Standard Operating Procedures for weather data coordination within DOT maintenance and traffic management
- Data sharing agreements between TMCs and traveler information service providers and media
- Agreements between city, local jurisdictions and state DOT for regional data sharing and control (including shared device control)
- Agency agreements and sign-off on coordinated response plans and strategy in the region for weather events
- Agreements on resource sharing and institutional arrangements during weather events
- Vendor and private sector provider agreements

5.6 Operational Scenarios

This section describes several operational scenarios that illustrate how an integrated intra- and inter-agency approach can be used to manage traffic during adverse weather conditions. With the base of services provided, various operational scenarios are possible. The following three scenarios are illustrative of the range of applications under this strategy.

5.6.1 Transit Service Coordination during Weather Events

Transit is often overlooked during weather events as both a partner as well as an impacted party in weather response. As a partner, transit service can provide vital mobility during severe weather events, provide opportunity for mode shifts, and relieve congestion on key corridors. As an impacted party, transit capacity and service quality are severely compromised during weather events.

Intra and inter-agency coordination can provide new opportunities to coordinate transit and traffic operations during weather. This scenario may include:

- Priority for transit-intensive service lines for snow removal activities
- Provision of comparative travel times for transit and traffic during weather events
- Real-time road condition information sharing with transit management centers
- Temporary addition of transit capacity to relieve traffic congestion and delays during weather
- Cooperative agreements for winter maintenance activities between local and city jurisdictions and transit authorities for focused management of transit roadside infrastructure (bus stops, sidewalks etc)
- Interactive and broadcast traveler information for temporary schedule and route changes during weather
- Traffic signal priority during weather events for transit
- Removal of parking restrictions/fees during weather events to promote en-route mode shifts

Services which are primarily applicable to this scenario include:

- Transportation Operations Demand Management
- Traffic Decision Support and Demand Management
- Broadcast and Interactive Traveler Information

Other services like winter maintenance and road weather data collection also support this scenario.

5.6.2 Route Diversions and Restrictions during Weather Events

This scenario focuses on the managing high-demand situations safely and effectively during weather events. Frequently, agencies need to close roads, restrict vehicles and divert traffic due to unsafe driving conditions. Often, these restrictions are made in isolation based on the jurisdiction they occur in. This often results in traffic being diverted to routes and jurisdictions which are not prepared for the influx.

Inter and intra-agency coordination creates a framework to provide proactive information to all affected parties before, during, and after the imposition of the restriction or diversion. This scenario includes:

- Use of common incident and event management systems across the region
- Agreements and standard operating procedures for vehicle and route restrictions in the region
- Coordination of impacted signal systems due to diversions
- Provision of arterial and diverted route travel times via broadcast and interactive traveler information
- Improved route guidance signage and portable dynamic signs to inform travelers across jurisdictions
- Prediction of impacts and sharing of traffic impacts with regional stakeholders
- Joint control of advisory and control devices such as cameras, CCTVs
- Identification of pre-determined response strategies and diversion points

Services which are primarily applicable to this scenario include:

- Transportation Operations Demand Management
- Traffic Decision Support and Demand Management
- Broadcast and Interactive Traveler Information

Other services like winter maintenance, road weather data collection also support this scenario.

5.6.3 Regional Incident and Emergency Management

Unique to Traffic Incident Management programs, the benefits of managing incidents better do not result from the actions of a single agency, but rather the collective actions of personnel in law enforcement, fire and rescue operations, emergency medical services (EMS), transportation, and towing and recovery. Individually, each of these TIM participants has a designated role at the incident scene. Collectively, the performance of these respective activities directly influences overall incident duration and subsequent system-wide impacts to safety and mobility.

Especially in weather related situations, this problem becomes exacerbated by the chaotic nature of weather events and the fragmented approach to maintenance and incident management. Intra/inter-agency coordination can create new multi-disciplinary and multi-jurisdictional approaches. This scenario may include:

- Use of unified command structure for incident response during weather
- Creation and activation of multi-disciplinary teams during weather events
- Pre-staging of incident management resources based on traffic management coordination
- Development of joint agency/jurisdictional protocols, and implementation of joint facilities
- Developing regional agreements for coordinated TIM operations, including cost-share and resource-sharing agreements.
- Supporting enhanced resource allocation based on efficient and effective TIM resource management.
- Identifying operational gaps in coordinated TIM operations.
- Allocating financial resources aimed at improving coordinated TIM operations.
- Multidisciplinary TIM training exercises.
- Disseminating best practices among TIM agencies.

Services which are primarily applicable to this scenario include:

- Emergency call-taking
- Transportation Operations Demand Management
- Wide area alert
- Disaster response and recovery
- Winter maintenance

5.7 Functional Requirements for Intra- and Inter-agency Coordination

Following is a list (Table D-11) of the high-level functional requirements that need to be satisfied for intra- and inter-agency coordination. These requirements are organized by the systems specified in Section 5.2. The requirements were generated based on the functional requirements specified in the National ITS Architecture (Version 6.1) and customized for weather-related functions. The set of requirements for each system represents the set of functionality that is required from each system to enable effective inter- and intra-agency coordination.

Table D-11. High-Level Functional Requirements for Intra- and Inter-agency Coordination

System Name	Functional Requirement
City and Local Maintenance Vehicles	<ul style="list-style-type: none"> • Collect environmental data from on-board sensors, including air temperature, wind speed, surface temperature, traction conditions, etc. • Transmit environmental sensor data to the traffic management/operation center. The sensor data includes location and timestamp information. • Provide environmental sensor equipment operational status to the center. • Collect environmental data from sensors located at the roadway but are monitored inside the vehicle. • Monitor materials information including remaining quantity and current application rate of materials on the vehicle. • Respond to dispatch information from the center, presented to the vehicle operator for acknowledgement and returning status. • Track current location. • Send the time stamped vehicle location to the controlling center. • Track the location and status of safety systems on-board the vehicle. • Monitor materials information including remaining quantity and current application rate of materials on the vehicle. • Respond to dispatch information from the center, presented to the vehicle operator for acknowledgement and returning status. • Send operational data to the center including the operational state of the maintenance equipment (e.g., blade up/down, spreader pattern), types and quantities of materials used for construction and maintenance activities, and a record of the actual work performed.
City and Local Police and Fire Vehicles	<ul style="list-style-type: none"> • Track current location. • Send the vehicle's location and operational data to the center for emergency management and dispatch. • Receive incident details and a suggested route when dispatched to a scene. • Send the current en route status (including estimated time of arrival) and requests for emergency dispatch updates. • Provide the personnel on-board with dispatch information, including incident type and location, and forward an acknowledgment from personnel to the center that the vehicle is on its way to the incident scene.

System Name	Functional Requirement
City and Local Police Dispatch Centers	<ul style="list-style-type: none"> • Support the interface to the Emergency Telecommunications System (e.g. 911 or 7-digit call routing) to receive emergency notification information and provide it to the emergency system operator. • Receive emergency call information from 911 services and present the possible incident information to the emergency system operator. • Receive emergency call information from motorist call-boxes and present the possible incident information to the emergency system operator. • Receive emergency call information from mayday service providers and present the possible incident information to the emergency system operator. • Receive emergency notification information from other public safety agencies and present the possible incident information to the emergency system operator. • Receive emergency notification information from public transit systems and present the possible incident information to the emergency system operator. • Coordinate, correlate, and verify all emergency inputs, including those identified based on external calls and internal analysis of security sensor and surveillance data, and assign each a level of confidence. • Send a request for remote control of CCTV systems from a traffic management center in order to verify the reported incident. • Forward the verified emergency information to the responding agency based on the location and nature of the emergency. • Update the incident information log once the emergency system operator has verified the incident. • Provide the capability for digitized map data to act as the background to the emergency information presented to the emergency system operator. • Dispatch emergency vehicles to respond to verified emergencies under center personnel control. • Store the current status of all emergency vehicles available for dispatch and those that have been dispatched. • Relay location and incident details to the responding vehicles. • Track the location and status of emergency vehicles responding to an emergency based on information from the emergency vehicle. • Store and maintain the emergency service responses in an action log. • Provide the capability for digitized map data to act as the background to the information presented to the emergency system operator. • Receive traffic images to support dispatch of emergency vehicles. • Provide the capability to request remote control of traffic surveillance devices • Coordinate response to incidents with other Emergency Management centers to ensure appropriate resources are dispatched and utilized.

System Name	Functional Requirement
	<ul style="list-style-type: none"> • Develop, coordinate with other agencies, and store emergency response plans. • Track the availability of resources and coordinate resource sharing with allied agency centers including traffic, maintenance, or other emergency centers. • Allocate the appropriate emergency services, resources, and vehicle (s) to respond to incidents, and shall provide the capability to override the current allocation to suit the special needs of a current incident. • Support remote control of field equipment normally under control of the traffic management center including traffic signals, dynamic message signs, gates, and barriers. • Provide the capability to remotely control and monitor CCTV systems normally operated by a traffic management center. • Provide the capability to identify neighborhoods and businesses that should be informed of an emergency situation based on information collected about incidents including their severity, impacted locations, and recovery schedule. • Collect real-time information on the state of the regional transportation system including current traffic and road conditions, weather conditions, special event and incident information. • Provide tactical decision support, resource coordination, and communications integration for Incident Commands that are established by first responders to support local management of an incident. • Provide incident command communications with public safety, emergency management, transportation, and other allied response agency centers. • Track and maintain resource information and action plans pertaining to the incident command. • Share incident command information with other public safety agencies including resource deployment status, hazardous material information, rail incident information, evacuation advice as well as traffic, road, and weather conditions.
City and Local Public Works	<ul style="list-style-type: none"> • Remotely control automated roadway treatment systems. Treatments can be in the form of fog dispersion, anti-icing chemicals, etc. • Remotely control the environmental sensors that, upon detecting changes in environmental or atmospheric conditions, automatically activate roadway treatment systems. • Collect automated roadway treatment system and associated environmental sensor operational status. • Collect automated roadway treatment system and associated environmental sensor fault data and request repair. • Accept requests for automated roadway treatment system activation from center personnel. • Remotely control environmental sensors that measure road surface temperature, moisture, icing, salinity, and other measures. • Remotely control environmental sensors that measure weather conditions including temperature, wind, humidity, precipitation, and visibility.

System Name	Functional Requirement
	<ul style="list-style-type: none"> • Remotely control environmental sensors on-board maintenance and construction vehicles that measure road and weather conditions including air and surface temperatures, wind speed, humidity, precipitation, visibility and other measures. • Collect environmental probe data (air temperature, exterior light status, wiper status, traction control status, etc.) from short-range communications equipment that communicates with appropriately equipped probe vehicles. • Assimilate current and forecast road conditions and surface weather information using a combination of weather service provider information (such as the National Weather Service and value-added sector specific meteorological services), data from traffic and traveler information providers, and environmental data collected from sensors deployed on and about the roadway as well as the fleet of maintenance and construction vehicles and the broader population of vehicle probes. • Provide weather and road condition information to weather service providers and center personnel. • Respond to control data from center personnel regarding environmental sensor control and weather data collection and processing. • Collect operational status for the roadside and vehicle-based environmental sensor equipment. • Assimilate current and forecast road conditions and surface weather information using a combination of weather service provider information (such as the National Weather Service and value-added sector specific meteorological services) and local environmental sensor data. • Use the various data inputs of environmental sensors and road weather data to develop a view of current and predicted road weather and road conditions. • Disseminate current and forecasted road weather and road condition information to weather service providers (such as the National Weather Service and value-added sector specific meteorological services) as well as other agencies including traffic, emergency, and transit management, traveler information providers, rail operations centers, media, and other maintenance management centers. • Provide value-added sector specific meteorological services with information on basic road facility and treatment information that supports forecasts for road conditions. • Receive inputs from the Alerting and Advisory System concerning the possibility or occurrence of severe weather, terrorist activity, or other major emergency, including information provided by the Emergency Alert System. • Exchange alert information and status with emergency management centers. The information includes notification of a major emergency such as a natural or man-made disaster, civil emergency, or child abduction. The information may include the alert originator, the nature of the emergency, the geographic area affected by the emergency, the effective time period, etc. • Exchange incident and threat information with emergency management centers as well as traffic management centers; including notification of existence of incident and expected severity, location, time and nature of incident.

System Name	Functional Requirement
	<ul style="list-style-type: none"> • Coordinate planning for incidents with emergency management centers - including pre-planning activities for disaster response, evacuation, and recovery operations. • Respond to requests from emergency management to provide maintenance and construction resources to implement response plans, assist in clean up, verify an incident, etc. This may also involve coordination with traffic management centers and other maintenance centers. • Exchange road network status assessment information with emergency management and traffic management centers including an assessment of damage sustained by the road network including location and extent of the damage, estimate of remaining capacity, required closures, alternate routes, necessary restrictions, and time frame for repair and recovery. • Receive information indicating the damage sustained by transportation assets, derived from aerial surveillance, field reports, inspections, tests, and analyses to support incident management. • Provide the center personnel with tailored external information, including weather or road condition observations, forecasted weather information or road conditions, current usage of treatments and materials, available resources, equipment and vehicle availability, road network information, and source reliability information. • Tailor the decision support information to include filtering (selection from a large amount of external information), error reduction ('smoothing' the information), fusion (combination of disparate information to match the decision needs), and analysis (creating the decision). • Provide dispatch information to maintenance and construction vehicles based on the outputs of the decision support system, including recommended roadway treatment actions. • Respond to requests from emergency management and traffic management centers for hazard removal, field equipment repair, and other roadway maintenance. • Provide emergency management and traffic management centers with information about scheduled maintenance and construction work activities including anticipated closures and impact to the roadway, alternate routes, anticipated delays, closure times, and durations. • Collect the status and fault data from roadside equipment, such as traffic, infrastructure, and environmental sensors, highway advisory radio and dynamic message signs, automated roadway treatment systems, barrier and safeguard systems, cameras, traffic signals and override equipment, ramp meters, short range communications equipment, security sensors and surveillance equipment, etc., and provide a cohesive view of equipment repair needs. • Collect current and forecast traffic and weather information from traffic management centers and weather service providers (such as the National Weather Service and value-added sector specific meteorological services). • Collect real-time information on the state of the regional transportation system including current traffic and road conditions, weather conditions, special event and incident information.

System Name	Functional Requirement
	<ul style="list-style-type: none"> • Monitor the locations of all maintenance and construction vehicles and other equipment under its jurisdiction. • Present location data to center personnel for the fleet of maintenance and construction vehicles and other equipment. • Respond to requests from emergency management and traffic management centers for hazard removal, field equipment repair, and other winter roadway maintenance. • Provide status information about scheduled winter maintenance activities including anticipated closures and impact to the roadway, alternate routes, anticipated delays, closure times, and durations. The information is provided to other management centers such as traffic, emergency, transit, traveler information providers, other maintenance centers, and the media. • Collect real-time information on the state of the regional transportation system from other centers including current traffic and road conditions, weather conditions, special event and incident information and use the collected information to support winter maintenance operations. • Dispatch and route winter maintenance vehicle drivers and support them with route- specific environmental, incident, advisory, threat, alert, and traffic congestion information. • Determine the need for roadway treatment based on current and forecasted weather information, current usage of treatments and materials, available resources, requests for action from other agencies, and recommendations from the Maintenance Decision Support system, specifically under winter conditions. This supports winter maintenance such as plowing, treating, anti-icing, etc. • Provide dispatch instructions for vehicle operators based on input parameters from center personnel, specifically for winter conditions. This could include a treatment route, treatment application rates, start and end times, and other treatment instructions. • Assess the current status of all winter maintenance activities, including actual work activities performed, current locations and operational conditions of vehicles, materials and equipment inventories, field equipment status, environmental information, etc.
City and Local Traffic Operations Centers	<ul style="list-style-type: none"> • Send requests to transit management centers to change the current transit services - schedules or fares of the transit services including park-and-ride lots. • Remotely control environmental sensors that measure road surface temperature, moisture, icing, salinity, and other measures. • Assimilate current and forecast road conditions and surface weather information using a combination of weather service provider information (such as the National Weather Service and value-added sector specific meteorological services), data from roadway maintenance operations, and environmental data collected from sensors deployed on and about the roadway. • Provide weather and road condition information to weather service providers and center personnel.

System Name	Functional Requirement
	<ul style="list-style-type: none"> • Coordinate planning for incidents with emergency management centers - including pre-planning activities for disaster response, evacuation, and recovery operations. • Exchange incident information with emergency management centers, maintenance and construction centers, transit centers, information service providers, and the media including description, location, traffic impact, status, expected duration, and response information. • Share resources with allied agency centers to implement special traffic control measures, assist in clean up, verify an incident, etc. This may also involve coordination with maintenance centers. • Exchange road network status assessment information with emergency management and maintenance centers including an assessment of damage sustained by the road network including location and extent of the damage, estimate of remaining capacity, required closures, alternate routes, necessary restrictions, and time frame for repair and recovery. • Remotely control dynamic messages signs for dissemination of traffic and other information to drivers. • Remotely control driver information systems that communicate directly from a center to the vehicle radio (such as Highway Advisory Radios) for dissemination of traffic and other information to drivers. • Collect operational status for the driver information systems equipment (DMS, HAR, etc.). • Retrieve locally stored traffic information, including current and forecasted traffic information, road and weather conditions, traffic incident information, information on diversions and alternate routes, closures, and special traffic restrictions (lane/shoulder use, weight restrictions, width restrictions, HOV requirements), and the definition of the road network itself. • Distribute traffic data to maintenance and construction centers, transit centers, emergency management centers, and traveler information providers. • Provide center personnel with an integrated regional view of current and forecast road and traffic conditions including traffic incidents, special events, maintenance activities and other events or conditions that impact capacity or demand. • Compare the impact of potential courses of action and make recommendations to the operator. • The recommended actions shall include predefined incident response plans, signal timing plan changes, DMS/HAR messages, and freeway control strategies including ramp metering, interchange control, and lane controls. • Collect real-time information on the state of the regional transportation system including current traffic and road conditions, weather conditions, special event and incident information. • Support the capability for the system operator to monitor and control the information collection service. • Collect and store CCTV surveillance system (traffic, pedestrian) operational status. • Collect environmental sensor operational status.

System Name	Functional Requirement
City and Local Traffic Roadside Equipment	<ul style="list-style-type: none"> • Activate automated roadway treatment systems based on environmental or atmospheric conditions. Treatments can be in the form of fog dispersion, anti-icing chemicals, etc. • Activate automated roadway treatment systems under center control. Treatments can be in the form of fog dispersion, anti-icing chemicals, etc. • Include surface and sub-surface environmental sensors that measure road surface temperature, moisture, icing, salinity, and other measures. • Include environmental sensors that measure weather conditions including temperature, wind, humidity, precipitation, and visibility. • Environmental sensors shall be remotely controlled by a maintenance center. • Environmental sensors shall be remotely controlled by a traffic management center. • Environmental sensors shall be remotely controlled by weather service providers such as the National Weather Service or value-added sector specific meteorological services. • Provide weather and road surface condition data to centers. • Include dynamic messages signs for dissemination of traffic and other information to drivers, under center control; the DMS may be either those that display variable text messages, or those that have fixed format display(s) (e.g. vehicle restrictions, or lane open/close). • Include driver information systems that communicate directly from a center to the vehicle radio (such as Highway Advisory Radios) for dissemination of traffic and other information to drivers, under center control. • Provide operational status for the driver information systems equipment (DMS, HAR, etc.) to the center. • Provide fault data for the driver information systems equipment (DMS, HAR, etc.) to the center for repair.
State DOT Maintenance and Construction	<ul style="list-style-type: none"> • Remotely control automated roadway treatment systems. Treatments can be in the form of fog dispersion, anti-icing chemicals, etc. • Remotely control the environmental sensors that, upon detecting changes in environmental or atmospheric conditions automatically activate roadway treatment systems. • Collect automated roadway treatment system and associated environmental sensor operational status. • Accept requests for automated roadway treatment system activation from center personnel. • Remotely control environmental sensors that measure road surface temperature, moisture, icing, salinity, and other measures. • Remotely control environmental sensors that measure weather conditions including temperature, wind, humidity, precipitation, and visibility. • Remotely control environmental sensors on-board maintenance and construction vehicles that measure road and weather conditions including air and surface temperatures, wind speed, humidity, precipitation, visibility and other measures.

System Name	Functional Requirement
	<ul style="list-style-type: none"> • Assimilate current and forecast road conditions and surface weather information using a combination of weather service provider information (such as the National Weather Service and value-added sector specific meteorological services), data from traffic and traveler information providers, and environmental data collected from sensors deployed on and about the roadway as well as the fleet of maintenance and construction vehicles and the broader population of vehicle probes. • Provide weather and road condition information to weather service providers and center personnel. • Respond to control data from center personnel regarding environmental sensor control and weather data collection and processing. • Assimilate current and forecast road conditions and surface weather information using a combination of weather service provider information (such as the National Weather Service and value-added sector specific meteorological services) and local environmental sensor data. • Use the various data inputs of environmental sensors and road weather data to develop a view of current and predicted road weather and road conditions. • Disseminate current and forecasted road weather and road condition information to weather service providers (such as the National Weather Service and value-added sector specific meteorological services) as well as other agencies including traffic, emergency, and transit management, traveler information providers, rail operations centers, media, and other maintenance management centers. • Receive inputs from the Alerting and Advisory System concerning the possibility or occurrence of severe weather, terrorist activity, or other major emergency, including information provided by the Emergency Alert System. • Coordinate planning for incidents with emergency management centers - including pre-planning activities for disaster response, evacuation, and recovery operations. • Respond to requests from emergency management to provide maintenance and construction resources to implement response plans, assist in clean up, verify an incident, etc. This may also involve coordination with traffic management centers and other maintenance centers. • Exchange road network status assessment information with emergency management and traffic management centers including an assessment of damage sustained by the road network including location and extent of the damage, estimate of remaining capacity, required closures, alternate routes, necessary restrictions, and time frame for repair and recovery. • Provide the center personnel with tailored external information, including weather or road condition observations, forecasted weather information or road conditions, current usage of treatments and materials, available resources, equipment and vehicle availability, road network information, and source reliability information. • Tailor the decision support information to include filtering (selection from a large amount of external information), error reduction ('smoothing' the information), fusion (combination of disparate information to match the decision needs), and analysis (creating the decision).

System Name	Functional Requirement
	<ul style="list-style-type: none"> • Provide an interface to the center personnel to input control parameters for the decision support process and receive decisions or information presentation. • Provide dispatch information to maintenance and construction vehicles based on the outputs of the decision support system, including recommended roadway treatment actions. • Collect current and forecast traffic and weather information from traffic management centers and weather service providers (such as the National Weather Service and value-added sector specific meteorological services). • Collect real-time information on the state of the regional transportation system including current traffic and road conditions, weather conditions, special event and incident information. • Monitor the locations of all maintenance and construction vehicles and other equipment under its jurisdiction. • Respond to requests from emergency management and traffic management centers for hazard removal, field equipment repair, and other winter roadway maintenance. • Exchange information with administrative systems to support the planning and scheduling of winter maintenance activities. This information includes: equipment and consumables resupply purchase request status, personnel qualifications including training and special certifications, environmental regulations and rules that may impact maintenance activities, and requests and project requirements from contract administration.
State DOT Maintenance and Construction Vehicles	<ul style="list-style-type: none"> • Collect environmental data from on-board sensors, including air temperature, wind speed, surface temperature, traction conditions, etc. • Transmit environmental sensor data to the center. The sensor data includes location and timestamp information. • Track the location and status of safety systems on-board the vehicle. • Monitor materials information including remaining quantity and current application rate of materials on the vehicle. • Respond to dispatch information from the center, presented to the vehicle operator for acknowledgement and returning status. • Track current location. • Send the time stamped vehicle location to the controlling center. • Monitor materials information including remaining quantity and current application rate of materials on the vehicle. • Respond to dispatch information from the center, presented to the vehicle operator for acknowledgement and returning status.

System Name	Functional Requirement
State DOT Roadside Infrastructure	<ul style="list-style-type: none"> • Activate automated roadway treatment systems based on environmental or atmospheric conditions. Treatments can be in the form of fog dispersion, anti-icing chemicals, etc. • Activate automated roadway treatment systems under center control. Treatments can be in the form of fog dispersion, anti-icing chemicals, etc. • Return automated roadway treatment system and associated environmental sensor operational status to the maintenance center. • Include surface and sub-surface environmental sensors that measure road surface temperature, moisture, icing, salinity, and other measures. • Include environmental sensors that measure weather conditions including temperature, wind, humidity, precipitation, and visibility. • Environmental sensors shall be remotely controlled by a maintenance center. • Environmental sensors shall be remotely controlled by a traffic management center. • Provide weather and road surface condition data to centers. • Send operational status of connected field equipment to the maintenance center. • Include dynamic messages signs for dissemination of traffic and other information to drivers, under center control; the DMS may be either those that display variable text messages, or those that have fixed format display(s) (e.g. vehicle restrictions, or lane open/close). • Include driver information systems that communicate directly from a center to the vehicle radio (such as Highway Advisory Radios) for dissemination of traffic and other information to drivers, under center control. • Provide operational status for the driver information systems equipment (DMS, HAR, etc.) to the center. • Provide fault data for the driver information systems equipment (DMS, HAR, etc.) to the center for repair.
State DOT Traffic Management Centers	<ul style="list-style-type: none"> • Collect and store toll pricing data from toll administration centers, including the price for each road segment to which a toll applies, with the time and date for when it applies. • Send requests to transit management centers to change the current transit services - schedules or fares of the transit services including park-and-ride lots. • Remotely control environmental sensors that measure road surface temperature, moisture, icing, salinity, and other measures. • Remotely control environmental sensors that measure weather conditions including temperature, wind, humidity, precipitation, and visibility. • Assimilate current and forecast road conditions and surface weather information using a combination of weather service provider information (such as the National Weather Service and value-added sector specific meteorological services), data from roadway maintenance operations, and environmental data collected from sensors deployed on and about the roadway.

System Name	Functional Requirement
	<ul style="list-style-type: none"> • Provide weather and road condition information to weather service providers and center personnel. • Respond to control data from center personnel regarding environmental sensor control and weather data collection and processing. • Coordinate planning for incidents with emergency management centers - including pre-planning activities for disaster response, evacuation, and recovery operations. • Exchange incident information with emergency management centers, maintenance and construction centers, transit centers, information service providers, and the media including description, location, traffic impact, status, expected duration, and response information. • Share resources with allied agency centers to implement special traffic control measures, assist in clean up, verify an incident, etc. This may also involve coordination with maintenance centers. • Provide road network conditions and traffic images to emergency management centers, maintenance and construction centers, and traveler information service providers. • Monitor incident response performance and calculate incident response and clearance times. • Exchange road network status assessment information with emergency management and maintenance centers including an assessment of damage sustained by the road network including location and extent of the damage, estimate of remaining capacity, required closures, alternate routes, necessary restrictions, and time frame for repair and recovery. • Coordinate information and controls with other traffic management centers. • Remotely control dynamic messages signs for dissemination of traffic and other information to drivers. • Collect operational status for the driver information systems equipment (DMS, HAR, etc.). • Collect fault data for the driver information systems equipment (DMS, HAR, etc.) for repair. • Retrieve locally stored traffic information, including current and forecasted traffic information, road and weather conditions, traffic incident information, information on diversions and alternate routes, closures, and special traffic restrictions (lane/shoulder use, weight restrictions, width restrictions, HOV requirements), and the definition of the road network itself. • Distribute traffic data to maintenance and construction centers, transit centers, emergency management centers, and traveler information providers. • Distribute traffic data to the media; the capability to provide the information in both data stream and graphical display shall be supported. • Provide center personnel with an integrated regional view of current and forecast road and traffic conditions including traffic incidents, special events, maintenance activities and other events or conditions that impact capacity or demand. • Identify network imbalances and potential courses of action. • Compare the impact of potential courses of action and make recommendations to the operator.

System Name	Functional Requirement
	<ul style="list-style-type: none"> • The recommended actions shall include predefined incident response plans, signal timing plan changes, DMS/HAR messages, and freeway control strategies including ramp metering, interchange control, and lane controls. • The recommended actions shall include multimodal strategies that include suggested transit strategies and suggested route and mode choices for travelers. • Provide an interface to center personnel to input control parameters for the decision support process and receive recommended actions and supporting information presentation. • Use the collected information to measure overall current and forecast network performance and predict travel demand patterns. • Collect real-time information on the state of the regional transportation system including current traffic and road conditions, weather conditions, special event and incident information.
State Police Dispatch Centers	<ul style="list-style-type: none"> • Support the interface to the Emergency Telecommunications System (e.g. 911 or 7-digit call routing) to receive emergency notification information and provide it to the emergency system operator. • Receive emergency call information from 911 services and present the possible incident information to the emergency system operator. • Receive emergency call information from motorist call-boxes and present the possible incident information to the emergency system operator. • Receive emergency notification information from other public safety agencies and present the possible incident information to the emergency system operator. • Coordinate, correlate, and verify all emergency inputs, including those identified based on external calls and internal analysis of security sensor and surveillance data, and assign each a level of confidence. • Send a request for remote control of CCTV systems from a traffic management center in order to verify the reported incident. • Forward the verified emergency information to the responding agency based on the location and nature of the emergency. • Update the incident information log once the emergency system operator has verified the incident. • Dispatch emergency vehicles to respond to verified emergencies under center personnel control. • Store the current status of all emergency vehicles available for dispatch and those that have been dispatched. • Relay location and incident details to the responding vehicles. • Track the location and status of emergency vehicles responding to an emergency based on information from the emergency vehicle. • Store and maintain the emergency service responses in an action log. • Receive traffic images to support dispatch of emergency vehicles.

System Name	Functional Requirement
	<ul style="list-style-type: none"> Coordinate response to incidents with other Emergency Management centers to ensure appropriate resources are dispatched and utilized.
State Police Vehicles	<ul style="list-style-type: none"> Track current location. Send the vehicle's location and operational data to the center for emergency management and dispatch. Receive incident details and a suggested route when dispatched to a scene. Send the current en route status (including estimated time of arrival) and requests for emergency dispatch updates. Provide the personnel on-board with dispatch information, including incident type and location, and forward an acknowledgment from personnel to the center that the vehicle is on its way to the incident scene.
Statewide 511 and Traveler Information Services	<ul style="list-style-type: none"> Disseminate traffic and highway condition information to travelers, including incident information, detours and road closures, event information, recommended routes, and current speeds on specific routes. Disseminate weather information to travelers. Provide the capability to support requests from the media for traffic and incident data. Provide the capability for a system operator to control the type and update frequency of broadcast traveler information. Disseminate customized traffic and highway condition information to travelers, including incident information, detours and road closures, recommended routes, and current speeds on specific routes upon request. Disseminate customized weather information to travelers upon request. Provide all traveler information based on the traveler's current location or a specific location identified by the traveler, and filter or customize the provided information accordingly. Accept traveler profiles for determining the type of personalized data to send to the traveler. Disseminate emergency evacuation information to the traveler interface systems, including evacuation zones, shelter information, available transportation modes, road closures and detours, changes to transit services, and traffic and road conditions at the origin, destination, and along the evacuation routes. Disseminate wide-area alert information to the traveler interface systems, including major emergencies such as a natural or man-made disaster, civil emergency, child abductions, severe weather watches and warnings, military activities, and law enforcement warnings. Select real-time information on the state of the regional transportation system including current traffic and road conditions, weather conditions, transit information, parking information, special event and incident information. Distribute real-time transportation operations data to centers in the region. The data may be broadcast or customized based on the receiving center's specified requests or subscriptions.

System Name	Functional Requirement
	<ul style="list-style-type: none"> • Provide a web site that provides real-time transportation data to transportation system operators in the region. • Collect, process, and store traffic and highway condition information, including incident information, detours and road closures, event information, recommended routes, and current speeds on specific routes. • Accept traveler profiles that define alert thresholds that establish the severity and types of alerts that are provided to each traveler. • Disseminate personalized road weather alerts reporting adverse road and weather conditions. • Provide the capability to process voice-formatted requests for traveler information from a traveler telephone information system, and return the information in the requested format. • Provide information on traffic conditions in the requested voice format and for the requested location. • Provide roadway environment conditions information in the requested voice format and for the requested location. • Provide weather and event information in the requested voice format and for the requested location. • Receive and forward region-specific wide-area alert and advisory information to the traveler telephone information system, including major emergencies such as a natural or man-made disaster, civil emergency, child abductions, severe weather watches and warnings, military activities, and law enforcement warnings.
Statewide and Regional Emergency Operations Centers (EOCs)	<ul style="list-style-type: none"> • Coordinate, correlate, and verify all emergency inputs, including those identified based on external calls and internal analysis of security sensor and surveillance data, and assign each a level of confidence. • Send a request for remote control of CCTV systems from a traffic management center in order to verify the reported incident. • Dispatch emergency vehicles to respond to verified emergencies under center personnel control. • Store the current status of all emergency vehicles available for dispatch and those that have been dispatched. • Store and maintain the emergency service responses in an action log. • Receive traffic images to support dispatch of emergency vehicles. • Provide the capability to request remote control of traffic surveillance devices. • Response to incidents with other Emergency Management centers to ensure appropriate resources are dispatched and utilized. • Provide the capability to correlate alerts and advisories, incident information, and security sensor and surveillance data.

System Name	Functional Requirement
	<ul style="list-style-type: none"> • Broadcast wide-area alerts and advisories to traffic management centers for emergency situations such as severe weather events, civil emergencies, child abduction (AMBER alert system), military activities, and other situations that pose a threat to life and property. • Broadcast wide-area alerts and advisories to transit management centers for emergency situations such as severe weather events, civil emergencies, child abduction (AMBER alert system), military activities, and other situations that pose a threat to life and property. • Broadcast wide-area alerts and advisories to traveler information service providers for emergency situations such as severe weather events, civil emergencies, child abduction (AMBER alert system), military activities, and other situations that pose a threat to life and property. • Broadcast wide-area alerts and advisories to maintenance centers for emergency situations such as severe weather events, civil emergencies, child abduction (AMBER alert system), military activities, and other situations that pose a threat to life and property. • Broadcast wide-area alerts and advisories to other emergency management centers for emergency situations such as severe weather events, civil emergencies, child abduction (AMBER alert system), military activities, and other situations that pose a threat to life and property. • Broadcast wide-area alerts and advisories to commercial vehicle administration centers and roadside check facilities for emergency situations such as severe weather events, civil emergencies, child abduction (AMBER alert system), military activities, and other situations that pose a threat to life and property. • Coordinate the broadcast of wide-area alerts and advisories with other emergency management centers. • Collect current and forecast road and weather information from weather service providers (such as the National Weather Service and value-added sector specific meteorological services). • Collect current road and weather information from roadway maintenance operations. • Assimilate current and forecast road conditions and surface weather information to support incident management. • Present the current and forecast road and weather information to the emergency system operator. • Provide strategic emergency response capabilities provided by an Emergency Operations Center for large-scale incidents and disasters. • Manage coordinated inter-agency responses to and recovery from large-scale emergencies. Such agencies include traffic management, transit, maintenance and construction management, rail operations, and other emergency management agencies. • Provide the capability to implement response plans and track progress through the incident by exchanging incident information and response status with allied agencies. • Develop, coordinate with other agencies, and store emergency response plans. • Track the availability of resources and coordinate resource sharing with allied agency centers including

System Name	Functional Requirement
	<p>traffic, maintenance, or other emergency centers.</p> <ul style="list-style-type: none"> • Support remote control of field equipment normally under control of the traffic management center including traffic signals, dynamic message signs, gates, and barriers. • Provide the capability to remotely control and monitor CCTV systems normally operated by a traffic management center. • Assimilate the damage assessment of the transit, traffic, rail, maintenance, and other emergency center services and systems to create an overall transportation system status, and disseminate to each of these centers and the traveling public via traveler information providers. • Provide the capability for center personnel to provide inputs to the management of incidents, disasters and evacuations. • Collect information about the status of the recovery efforts for the infrastructure during disasters. • Provide the overall status of infrastructure recovery efforts to traveler information providers and media. • Provide the capability to communicate information about emergency situations to local population through the Emergency Telecommunications System. • Provide the capability to identify neighborhoods and businesses that should be informed of an emergency situation based on information collected about incidents including their severity, impacted locations, and recovery schedule. • Collect real-time information on the state of the regional transportation system including current traffic and road conditions, weather conditions, special event and incident information. • Share incident command information with other public safety agencies including resource deployment status, hazardous material information, rail incident information, evacuation advice as well as traffic, road, and weather conditions.
Transit Management Centers	<ul style="list-style-type: none"> • Broadcast transit advisory data, including alerts and advisories pertaining to major emergencies, or man-made disasters. • Coordinate schedules and services between transit agencies, traffic management, maintenance and construction operations, parking management, and other surface or air transportation modes. • Provide transit operations personnel with the capability to control and monitor transit service coordination activities. • Receive information pertaining to a wide-area alert such as weather alerts, disaster situations, or child abductions. This information may come from Emergency Management or from other Alerting and Advisory Systems. • Send wide-area alert information to travelers (on-board transit vehicles or at stations/stops) and transit vehicle operators. • Collect real-time information on the state of the regional transportation system including current traffic and road conditions, weather conditions, special event and incident information.

System Name	Functional Requirement
Transit Traveler Information	<ul style="list-style-type: none"> • Disseminate customized traffic and highway condition information to travelers, including incident information, detours and road closures, recommended routes, and current speeds on specific routes upon request. • Disseminate customized weather information to travelers upon request. • Provide all traveler information based on the traveler's current location or a specific location identified by the traveler, and filter or customize the provided information accordingly. • Provide the capability for a system operator to control the type and update frequency of traveler information. • Disseminate emergency evacuation information to the traveler interface systems, including evacuation zones, shelter information, available transportation modes, road closures and detours, changes to transit services, and traffic and road conditions at the origin, destination, and along the evacuation routes. • Disseminate wide-area alert information to the traveler interface systems, including major emergencies such as a natural or man-made disaster, civil emergency, child abductions, severe weather watches and warnings, military activities, and law enforcement warnings. • Provide the capability for a system operator to control the type and update frequency of emergency and wide-area alert information distributed to travelers. • Collect, process, and store traffic and highway condition information, including incident information, detours and road closures, event information, recommended routes, and current speeds on specific routes. • Accept traveler profiles that define alert thresholds that establish the severity and types of alerts that are provided to each traveler. • Disseminate personalized road weather alerts reporting adverse road and weather conditions. • Provide the capability to process voice-formatted requests for traveler information from a traveler telephone information system, and return the information in the requested format. • Provide the capability to process dual-tone multi-frequency (DTMF)-based requests (touch-tone) for traveler information from a traveler telephone information system. • Provide information on traffic conditions in the requested voice format and for the requested location. • Provide roadway environment conditions information in the requested voice format and for the requested location. • Provide weather and event information in the requested voice format and for the requested location.

5.8 Analysis of the Proposed Strategy

Weather-responsive coordination is one of the tools that agencies can use to improve safety and operating efficiencies during adverse weather events. Following are the key output measures for intra and inter-agency coordination.

- Change in percent of weather-related incident notifications received within X minutes (across modes, routes in the corridor) before and after improving coordination
- Change in incident and routine data feeds available to each individual agency before and after improving coordination
- Change in number of agencies using common incident reporting system during weather events
- Change in incident response and clearance time during weather events
- Change in time required to implement proposed response strategies and dispose system resources for the corridor/region during weather events
- Change in perceptions of improved capability to monitor and report effectively on the system resources in the corridor during weather events
- Change in perceived improvements in system data quality to assist operators in making decisions
- Change in perceived usefulness of predicted and real-time information provided to operators for interpretation and decision making
- Change in level of satisfaction with inter-organizational coordination measures based on operator feedback
- Change in perceived effectiveness of coordinated response plans implemented
- Change in time to notification of incidents, other capacity reductions, other disruptions and return to normal operations to traveler information providers (including 3rd Party ISPs, Media, agency websites and 511)
- Changes in the nature and the number of unique DMS messages executed in response to incidents and other conditions in the corridor/region during weather events
- Change in number of media updates made for distribution to the traveling public during weather events
- Change in number and nature of instances of weather-related information on DMS, HAR, 511, and other ATIS

In addition to the above output measures, the following outcome measures are valuable for this strategy.

Mobility:

- Vehicle and Person Travel times on facilities during weather events
- Trip Reliability measures during weather events
- Incident and non-incident delay during weather events
- Time to return to pre-event level of service

Safety:

- Reduction in number of injuries/close calls for first responders
- Change in the number of accidents/incidents
- Change in the number of secondary crashes/accidents/incidents
- Change in the geographic clustering of incidents/accidents.
- Change in the severity of accidents (rating)
- Change in the percent of responders citing improvements in safety
- Change in the percent of travelers citing improvements in safety

U.S. Department of Transportation
ITS Joint Program Office-HOIT
1200 New Jersey Avenue, SE
Washington, DC 20590

Toll-Free "Help Line" 866-367-7487
www.its.dot.gov

ITS-JPO-11-086



U.S. Department of Transportation
**Research and Innovative Technology
Administration**