

APPENDIX P

CENTER OF BALANCE (CB) DETERMINATION – FINDING CB

A. DETERMINATION

The CB of cargo must be determined to accurately compute the weight and balance condition of a loaded aircraft. The agency offering cargo for air shipment is responsible for marking each item with the correct gross weight and a CB point. This includes any item measuring 10 feet or longer and/or any item having a balance point other than its center. All vehicle type cargo will have axle weights marked above each axle, on both sides of vehicle, with weather resistant material. Vehicle-type cargo with a load-carrying capability will be marked indicating an empty or loaded CB. Items not properly marked as outlined herein will not be accepted for airlift since unknown weight and CB represents an unsafe condition relative to aircraft weight and balance.

NOTE: Trailers and associated prime movers must be individually marked, even if they are connected on the aircraft. This precludes delays when vehicles must be disconnected or shipped on separate aircraft.

B. METHOD

To correctly load plan an airlift and segregate loads for individual aircraft, the correct weight and CB of cargo units must be determined. There are two main divisions--vehicles and general cargo.

1. Determine weight and CB of a vehicle after all secondary cargo is secured for airlift. Secondary loads are items of baggage or cargo transported in truck beds and trailers, and must be included in the total weight of the vehicle. Adding to or removing cargo from a weighed and marked vehicle will necessitate reweighing and recomputing the CB.
2. The following terms are used to calculate CB of a vehicle, see [Figure P-1](#):
 - a. Reference Datum Line (RDL) (also called reference line). Predetermined point from which all measurements are taken. Normally, the RDL is established at the forward front edge.
 - b. Front Overhang (FOH). Distance in inches from front bumper to center of front axle.
 - c. Wheel Base (WB). Distance in inches from center of front axle to center of rear axle or center of tandem axles.
 - d. Gross Weight (GWT) (pounds).
 - e. Rear Overhang (ROH). Distance from rear or center of tandem axles to rear bumper.
 - f. Front Axle Weight (FAW) (pounds).
 - g. Intermediate Axle Weight (IAW) (pounds).
 - h. Rear Axle Weight (RAW) (pounds).
 - i. Front Forward Edge (FFE).

- j. **Moment.** The product obtained by multiplying the weight by the distance (in inches) from the RDL.

C. COMPUTATIONAL FORMULA

The computation formula illustrated on the following pages shows examples of different types of vehicles and possible loads. Prior to beginning the process, the unit movement officer must ensure the scales are calibrated.

1. Use the following formula to compute the CB location of vehicles. Multiply weight by distance of each axle from the reference line (in inches), and then divide the total results by the vehicle gross weight. The resulting figure is the number of inches to be measured aft from the reference line to the CB of the vehicle.

Center of Balance Formula

W1 -- Front axle weight.
W2 -- Rear axle weight.
D1 -- Distance from RDL to front axle or center of articulated tandem axle
D2 -- Distance from RDL to rear axle or center of articulated tandem axle.

2. The vehicle CB is computed to the nearest whole inch. Any answer with a fraction of .5 or higher is increased to next higher number. If .4 or less, drop the number.
3. After computing the CB of a vehicle, mark its location and gross weight on both sides using weather resistant masking tape and grease pencil/magic marker, forming the letter “T”, [Figure P-2](#).

(NOTE: Masking tape will not be used to mark CB location on aerospace ground equipment with permanently mounted CB markings in accordance with Technical Order 35-1-3, Corrosion Prevention, Painting and Marking of USAF Support Equipment).

The horizontal portion of the “T” will contain the gross weight information, and the vertical portion of the “T” will contain the letters “CB,” to indicate the exact position of the vehicle’s CB. Also indicate number of inches from the RDL of the CB location and mark axle weights above each axle. The RDL measurements will be taken from the FFE of the vehicle.

4. The following illustrations show examples of methods used to determine weight and CB location of typical cargo units. These cargo units include general cargo, large or skid-mounted cargo, track-type vehicles, and single-and multiple-axle vehicles.

EXAMPLE 1 – Determine CB of Vehicles.

Step 1. Weigh all axles individually.

Step 2. Mark weight above each individual axle.

Step 3. Establish the RDL at the forward edge of the vehicle.

Step 4. Measure all distances from RDL to center of each individual axle.

Step 5. Distance multiplied by weight equals a moment.

Example of basic formula for determining the CB.
 $(D1 \times W1) + (D2 \times W2)$
 GROSS WEIGHT = CB from RDL

EXAMPLE ONE

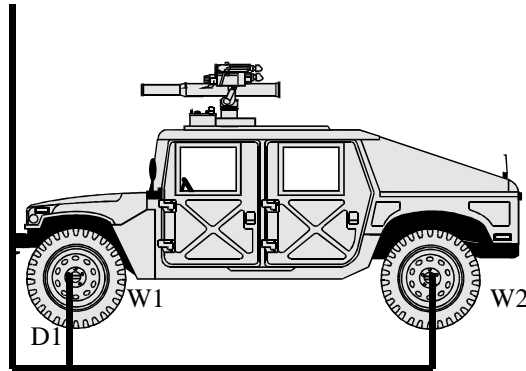

RDL

D I from RDL (from forward edge) to center of front axle = 20"
 W1 front axle weight = 2,870 lbs
 D2 from RDL (from forward edge) to center of rear axle - 150"
 W2 rear axle weight = 2,550 lbs

20" x 2,870	=	57,400 moment
150" x 2,550	=	<u>382,500</u> moment
		439,900 total moment

W1 (2,870 lbs) + W2 (2550 lbs) = Gross Weight (5,420 lbs)
 Total Moment (439,900) divided by Gross Weight = CB (81" from RDL)
 $[(D1 (20") \times W1 (2,870 \text{ lbs})) + (D2 (150" \times W2 (2,550 \text{ lbs}))]$
 Gross Weight (5,420 lbs) = CB (81" from RDL)

EXAMPLE TWO

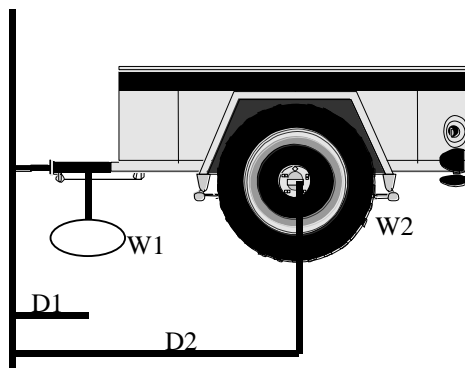

RDL

$[D1 (15") \times W1 (250 \text{ lbs})] + [D2 (102") \times W2 (2,250 \text{ lbs})]$
 W1 (250 lbs) + W2 (2,250 lbs) = Gross Weight (2,500 lbs) = CB (93" from RDL)

EXAMPLE THREE

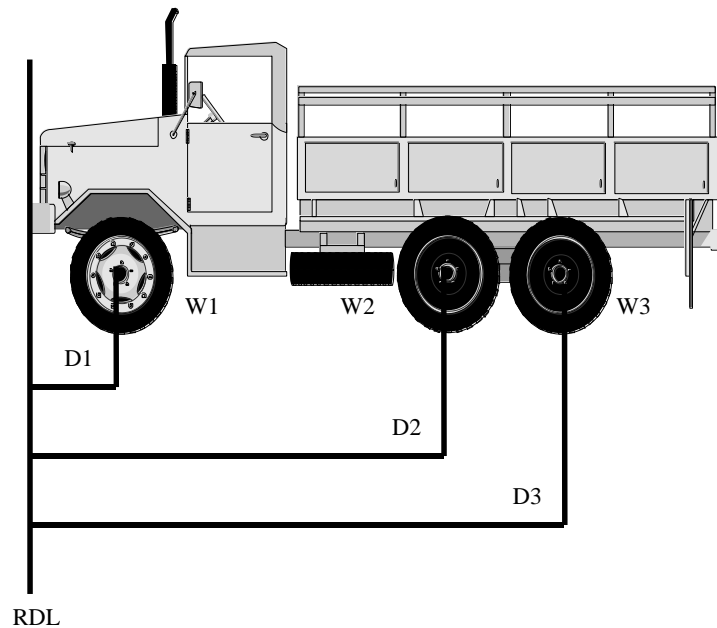

$$[D1 (70") \times W1 (12,500 \text{ lbs})] + [D2 (222") \times W2 (12,900 \text{ lbs})] + [D3 (276") \times W3 (12,700 \text{ lbs})]$$
$$W1 (12,500 \text{ lbs}) + W2 (12,900 \text{ lbs}) + W3 (12,700 \text{ lbs}) = \text{Gross weight (38,100 lbs)} = \text{CB (190" from RDL)}$$

EXAMPLE FOUR

Determine CB of Tracked Vehicles.

Step 1. To determine weight, drive the vehicle onto a platform scale (truck scale or coal yard scale) large enough to accommodate the entire vehicle. Record weight.

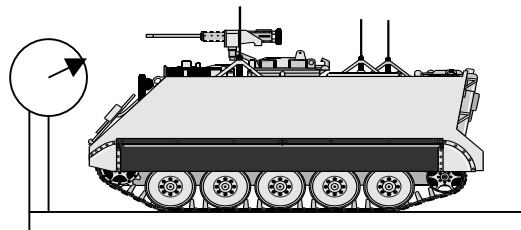

Step 2. To determine CB, drive the vehicle onto a wooden beam or pole until it tilts forward. Mark the side of the vehicle at the point of tilt.

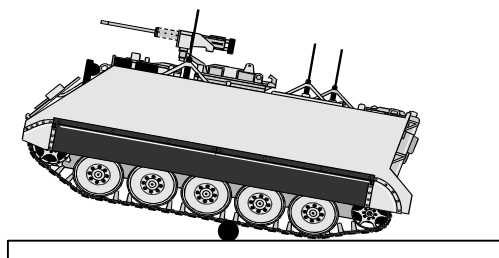

Step 3. Mark the CB and gross weight of the vehicle.

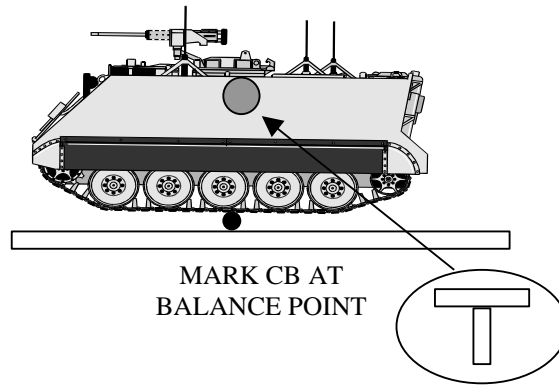

EXAMPLE FIVE

Determine CB of Skid-Mounted Cargo.

Step One. If the skid-mounted cargo will fit on the scale, weigh the whole load to use as weight figure.

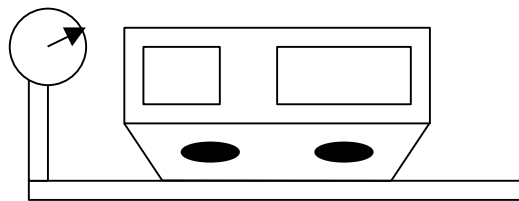

Step Two. Determine the CB by placing the load onto a pipe and centering the cargo until it balances, then mark CB.

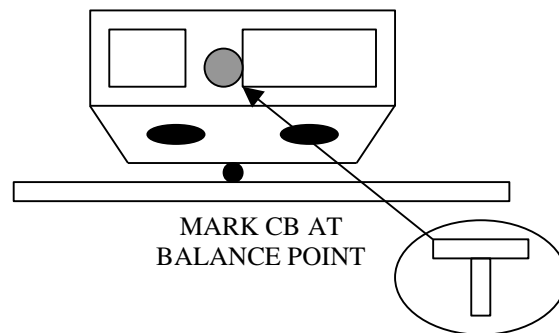

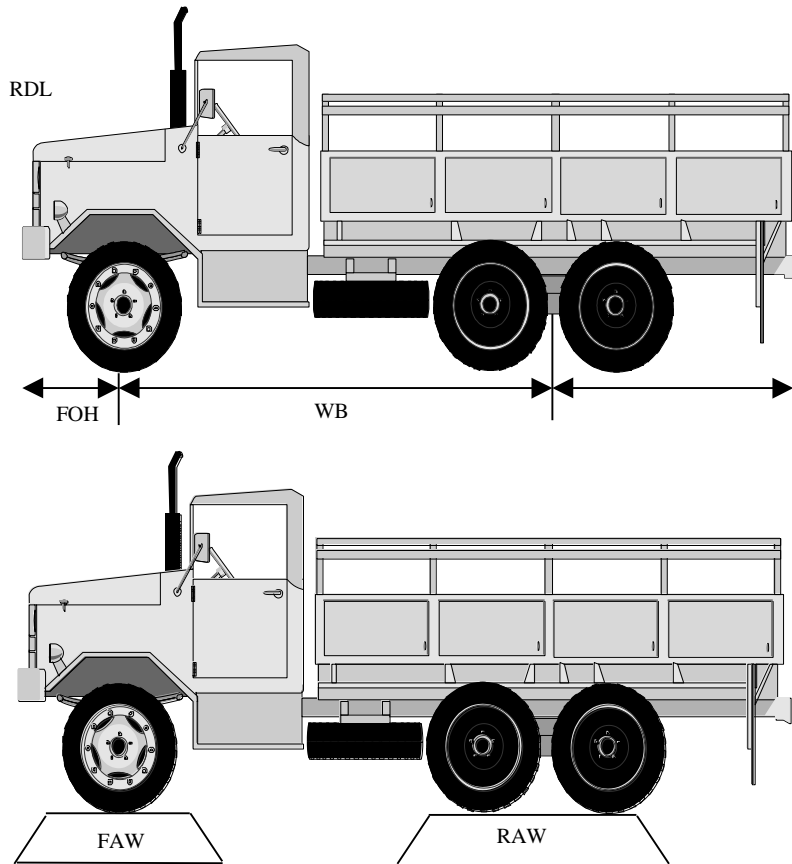

Figure P-1. Vehicle Measurement Points

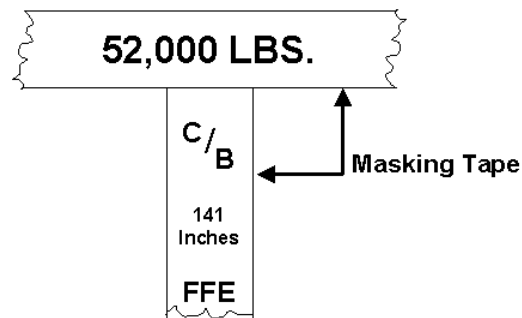

Figure P-2. Center of Balance Marker