

156 VICTORIA

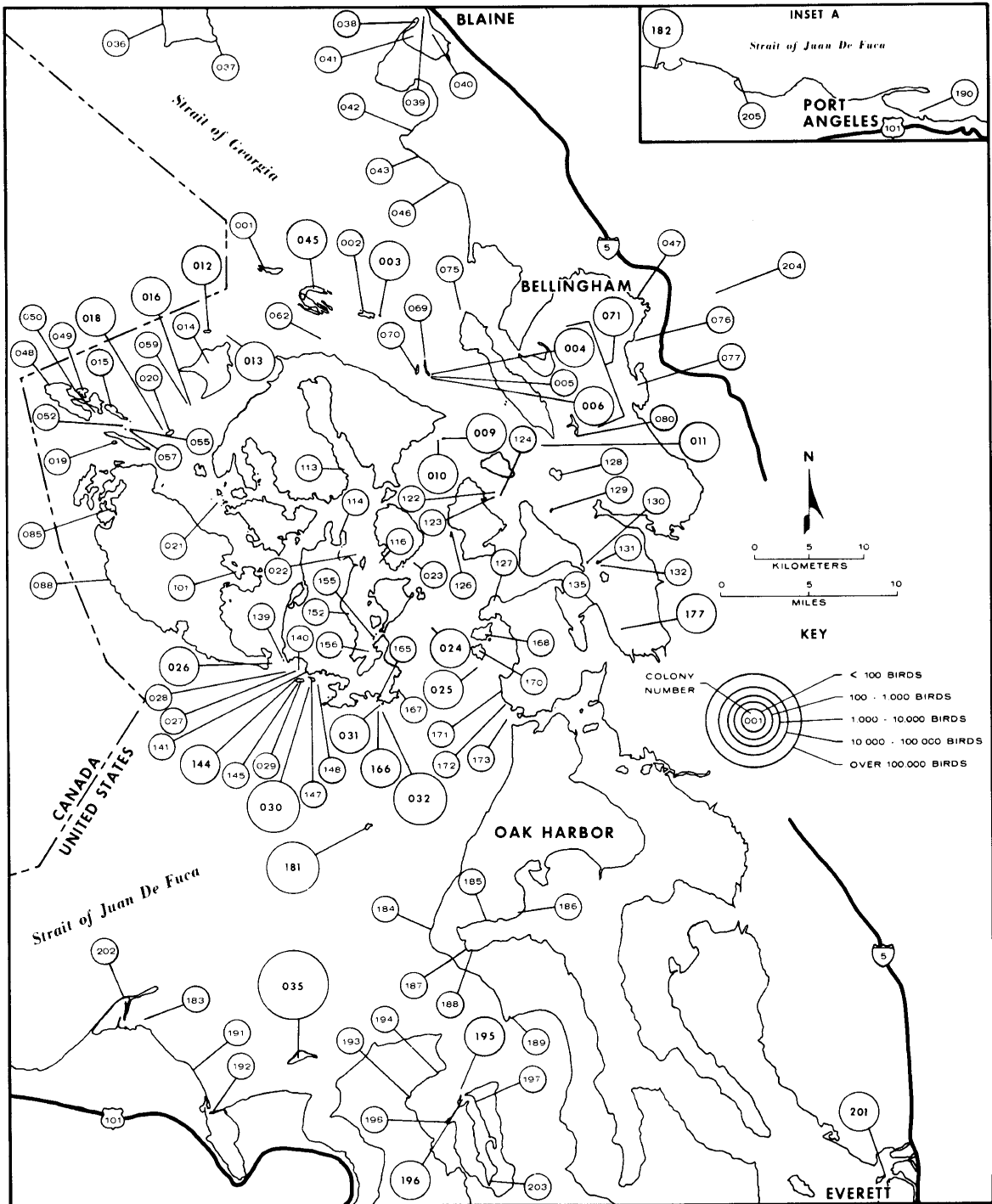

Relative distribution for Pigeon Guillemots in map area 156, Victoria.

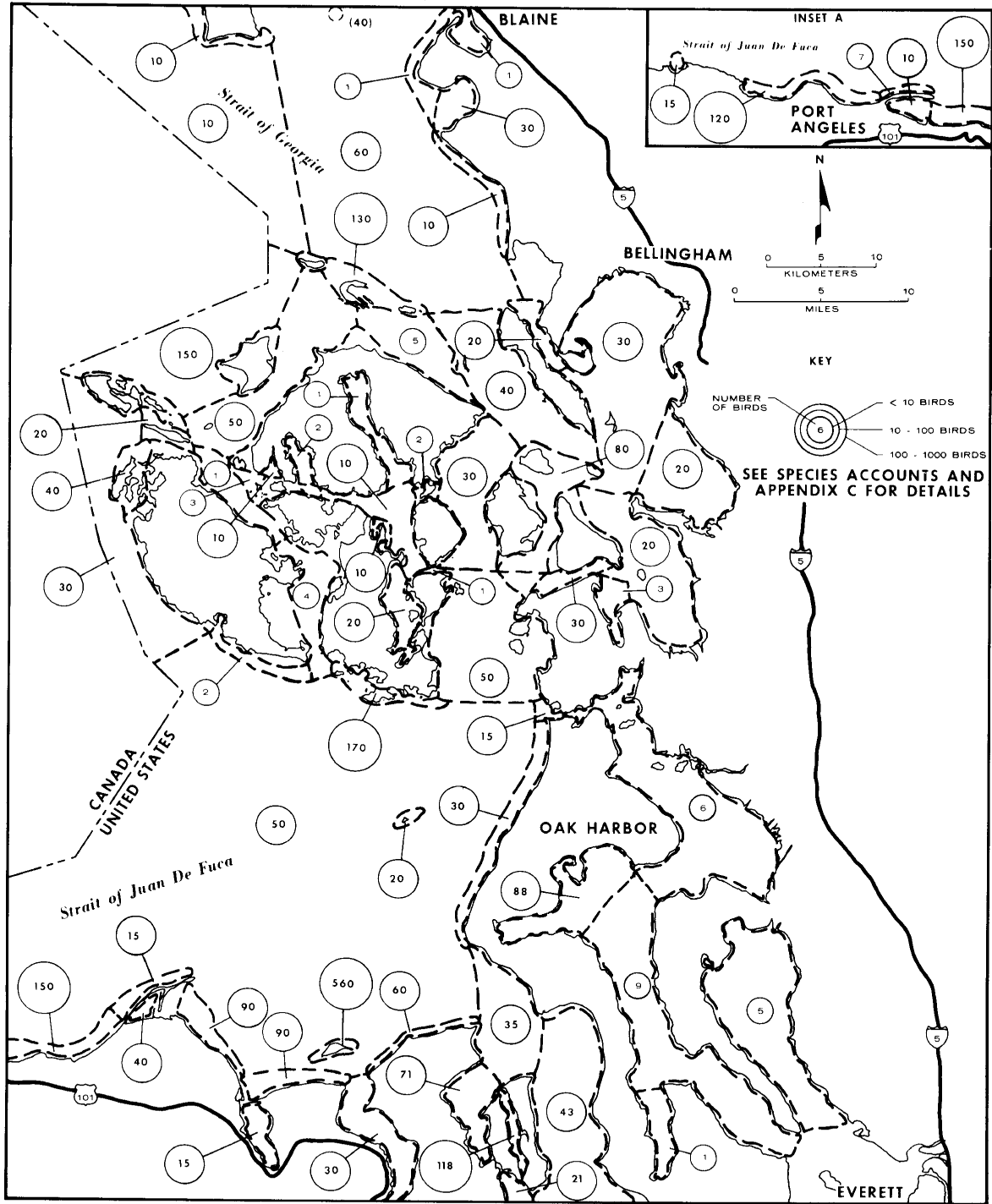

Relative distribution for Marbled Murrelets in map area 156, Victoria.

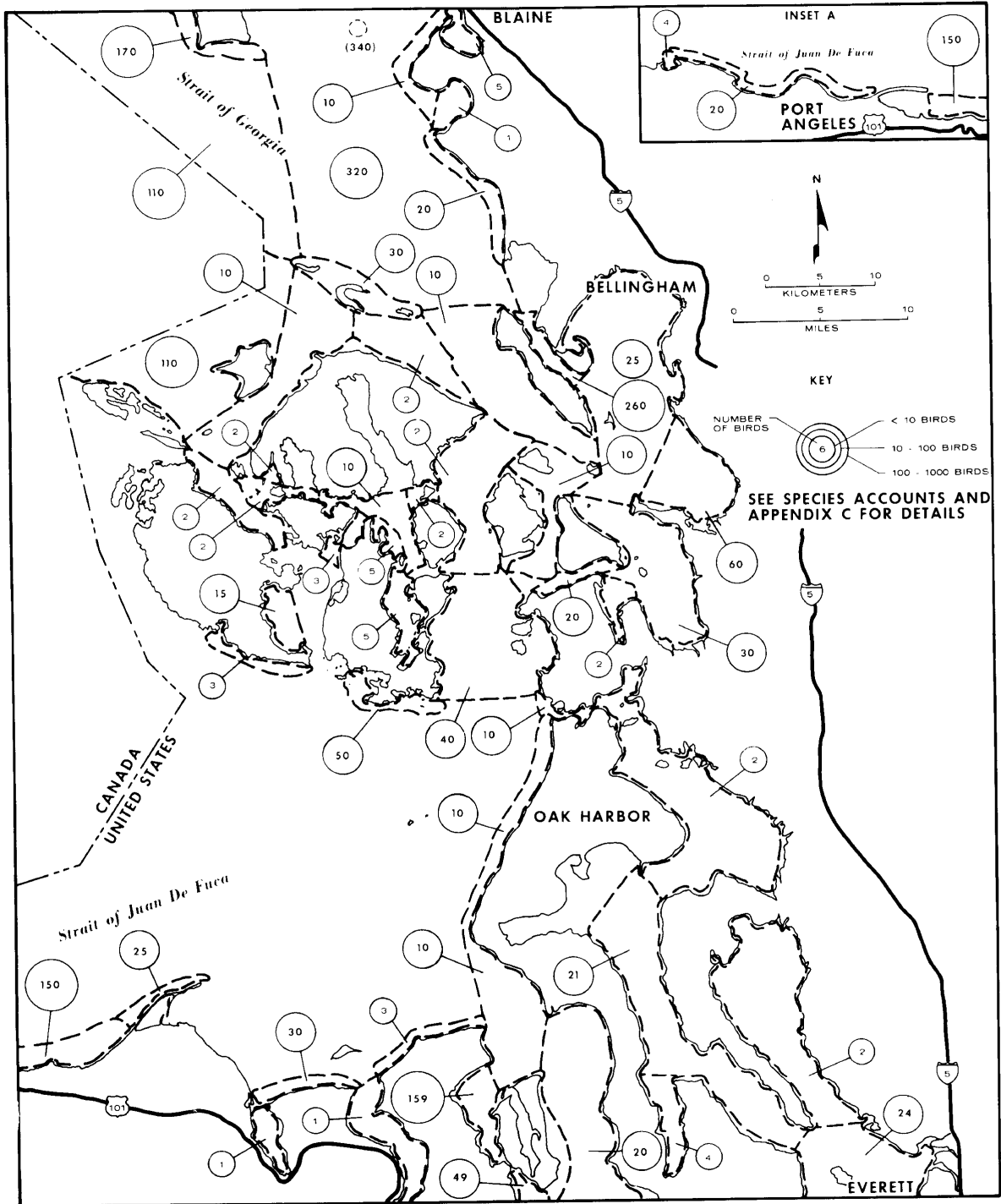

AREA 156, Victoria (cont'd.)

| SITE NUMBER | COLONY NAME | LAT.-LONG. | | | | |
|------------------|--------------------------|-----------------------------|----------------|----------------|---------------------------|--|
| 191 | PORT WILLIAMS | 48° 07' 00", 123° 03' 00" W | | | | |
| PIGEON GUILLEMOT | 34 | SPEICH | 05/23/79 | B III | 255 | |
| PIGEON GUILLEMOT | 33 | SPEICH | 05/26/78 | B III | 255 | |
| SPECIES NAME | NUMBER BREEDING BIRDS | SOURCE | SURVEY DATE | SURVEY TYPE | REFERENCE DATA QUALITY | |

Box gives the most recent or the best estimates available.

001 Patos Island 48°47'05"N, 122°57'10"W

| | | | | | |
|----------------------|----|---------------|----------|-------|---------|
| Glaucous-winged Gull | 40 | Speich & Wahl | 06/05/78 | B III | 257 |
| Pigeon Guillemot | 9 | Paulson; Wahl | 06/07/79 | A III | 207;269 |
| Total | 49 | | | | |

| | | | | | |
|----------------------|-----|---------------|------------|-------|-----|
| Glaucous-winged Gull | 40 | Manuwal 1973 | 05/27/73 | L II | 186 |
| Pigeon Guillemot | 2 | Forbush | 06/11/1888 | S - | 106 |
| Pigeon Guillemot | 1 | Jewett | 07/08/48 | S - | 157 |
| Pigeon Guillemot | 100 | Manuwal 1973 | 05/27/73 | L III | 186 |
| Pigeon Guillemot | X | Speich & Wahl | 06/05/78 | B III | 257 |

002 Matia Island 48°44'50"N, 122°50'00"W

| | | | | | |
|----------------------|-----|---------------|------------|-------|---------|
| Pigeon Guillemot | 9 | Paulson; Wahl | 06/07/79 | A III | 207;269 |
| Black Oystercatcher | 2 | Forbush | 06/09/1888 | S - | 106 |
| Black Oystercatcher | 2 | Forbush | 06/29/1888 | S - | 106 |
| Brandt's Cormorant | X | Jewett | 07/06/40 | L III | 154 |
| Brandt's Cormorant | P | Jewett | pre-1953 | ? ? | 155 |
| Pelagic Cormorant | P | Jewett 1937 | 05/23/37 | L ? | 156 |
| Glaucous-winged Gull | X | Jewett 1937 | 05/23/37 | L ? | 156 |
| Pigeon Guillemot | X | Jewett 1937 | 05/23/37 | L ? | 156 |
| Pigeon Guillemot | 40 | Jewett | 07/06/40 | L III | 154 |
| Pigeon Guillemot | X | Jewett 1937 | 07/07/40 | ? ? | 155 |
| Pigeon Guillemot | 100 | Nisqually NWR | 06/08/63 | L III | 202 |
| Pigeon Guillemot | 100 | Marshall | ?/ ?/63 | ? ? | 191 |
| Pigeon Guillemot | 25 | Nisqually NWR | 06/20/67 | L III | 154 |

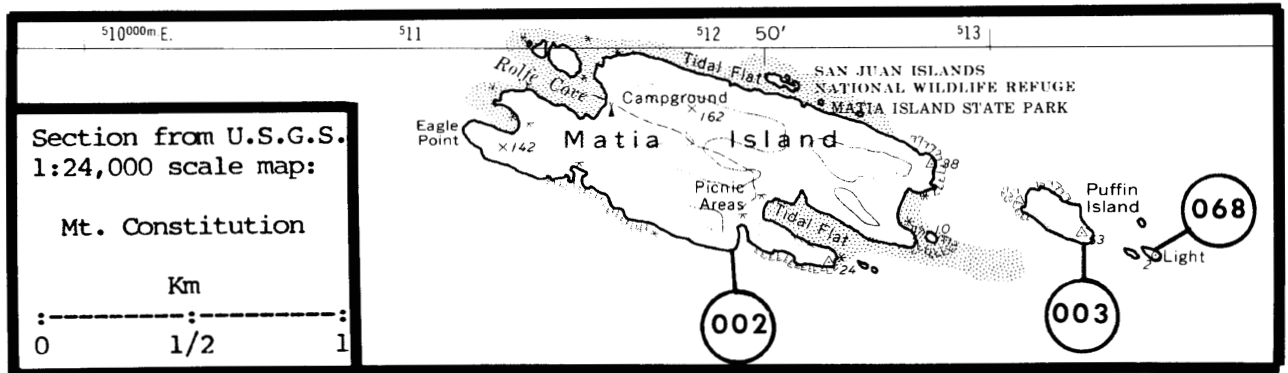
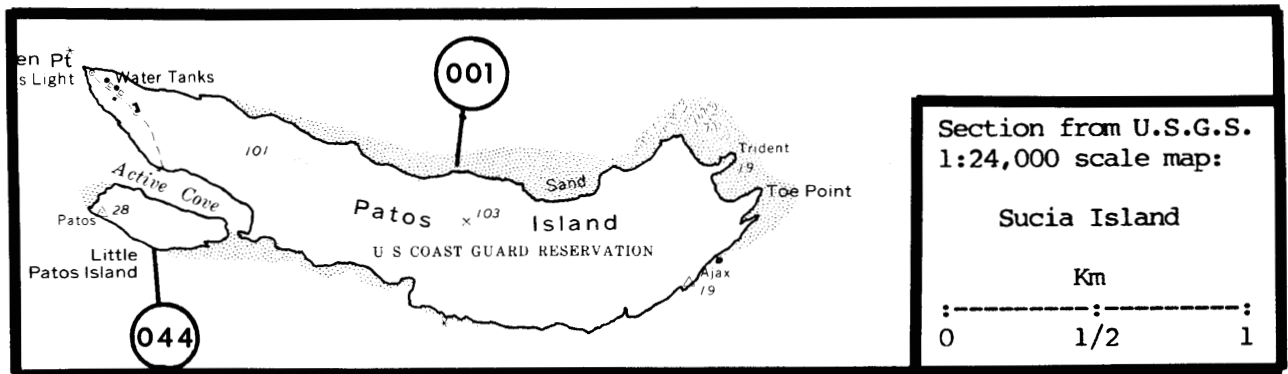

Patos Island (156001) US Coast Guard

AREA 156, Victoria (cont'd.)

| | | | | |
|------------------|-----|------------------------|-------------|-------------------|
| Pigeon Guillemot | 10 | Nisqually NWR | 08/21-23/67 | L III 202 |
| Pigeon Guillemot | 25 | Nisqually NWR | 07/13-16/68 | L III 202 |
| Pigeon Guillemot | P | Manuwal 1973 | 05/26-27/73 | L III 186 |
| Pigeon Guillemot | 8 | Wahl; Harrington-Tweit | 05/24/78 | A III 269; 124 |
| Pigeon Guillemot | 100 | Speich & Wahl | 06/05/78 | B III 257 |

003

Puffin Island 48°44'42"N, 122°49'12"W

| | | | | |
|----------------------|-----|---------------|----------|-----------|
| Black Oystercatcher | 2 | Speich & Wahl | 06/05/78 | B III 257 |
| Glaucous-winged Gull | 700 | Speich & Wahl | 06/05/78 | B III 257 |
| Pigeon Guillemot | 280 | Speich & Wahl | 06/05/78 | B III 257 |
| Total | 982 | | | |

| | | | | |
|--------------------------|---------|-----------------------|-------------|---------------|
| Cormorant sp. | 200 | Nisqually NWR | 06/06/62 | B ? 202 |
| Double-crested Cormorant | 16 | Eddy | 06/01/57 | L I 95 |
| Pelagic Cormorant | 12+ | Eddy | 06/01/57 | L III 95 |
| Pelagic Cormorant | 80 | Nisqually NWR | 06/18/63 | L III 202 |
| Pelagic Cormorant | 30 | Hauser & Monson 1963 | 07/16-17/63 | B ? 145 |
| Black Oystercatcher | 2 | Nisqually NWR | 06/18/63 | L III 202 |
| Black Oystercatcher | 2 | Hauser & Monson 1963 | 07/16-17/63 | B ? 145 |
| Black Oystercatcher | 2P | Manuwal 1973 | 05/26/73 | L III 186 |
| Black Oystercatcher | 2 | Eddy | 06/09/74 | L I 95 |
| Glaucous-winged Gull | X | Jewett 1937 | 05/23/37 | L ? 156 |
| Glaucous-winged Gull | 2 | Ray | 06/21/38 | E - 224 |
| Glaucous-winged Gull | X | Jewett | 07/06/40 | L III 154 |
| Glaucous-winged Gull | 80B | Schultz | ?/ ?/49 | L III 245 |
| Glaucous-winged Gull | 800+ | Eddy | 06/01/57 | L III 95 |
| Glaucous-winged Gull | 1200 | Nisqually NWR | 06/06/62 | B ? 202 |
| Glaucous-winged Gull | 2000 | Nisqually NWR | 06/18/63 | L III 202 |
| Glaucous-winged Gull | 600 | Hauser & Monson 1963 | 07/16-17/63 | B ? 145 |
| Glaucous-winged Gull | 600-700 | Manuwal 1973; Manuwal | 05/26/73 | L III 186;188 |
| Glaucous-winged Gull | 310 | Eddy | 06/09/74 | L II 95 |
| Glaucous-winged Gull | -250 | Wahl | 07/19/82 | A III 269 |
| Pigeon Guillemot | 8+ | Eddy | 06/01/57 | L III 95 |
| Pigeon Guillemot | 25 | Nisqually NWR | 06/18/63 | L III 202 |
| Pigeon Guillemot | 50 | Hauser & Monson 1963 | 07/16-17/63 | B III 145 |
| Pigeon Guillemot | 30 | Manuwal 1973 | 05/26/73 | L III 186 |
| Pigeon Guillemot | 36 | Nisqually NWR | 08/06/80 | B III 202 |
| Tufted Puffin | 2 | Ray | 06/21/38 | E - 224 |
| Tufted Puffin | 4 | Richardson | 06/01/57 | L III 229 |
| Tufted Puffin | 8+ | Eddy | 06/01/57 | L III 95 |
| Tufted Puffin | 2 | Nisqually NWR | 06/18/63 | L III 202 |
| Tufted Puffin | 7 | Hauser & Monson 1963 | 07/16-17/63 | B ? 145 |

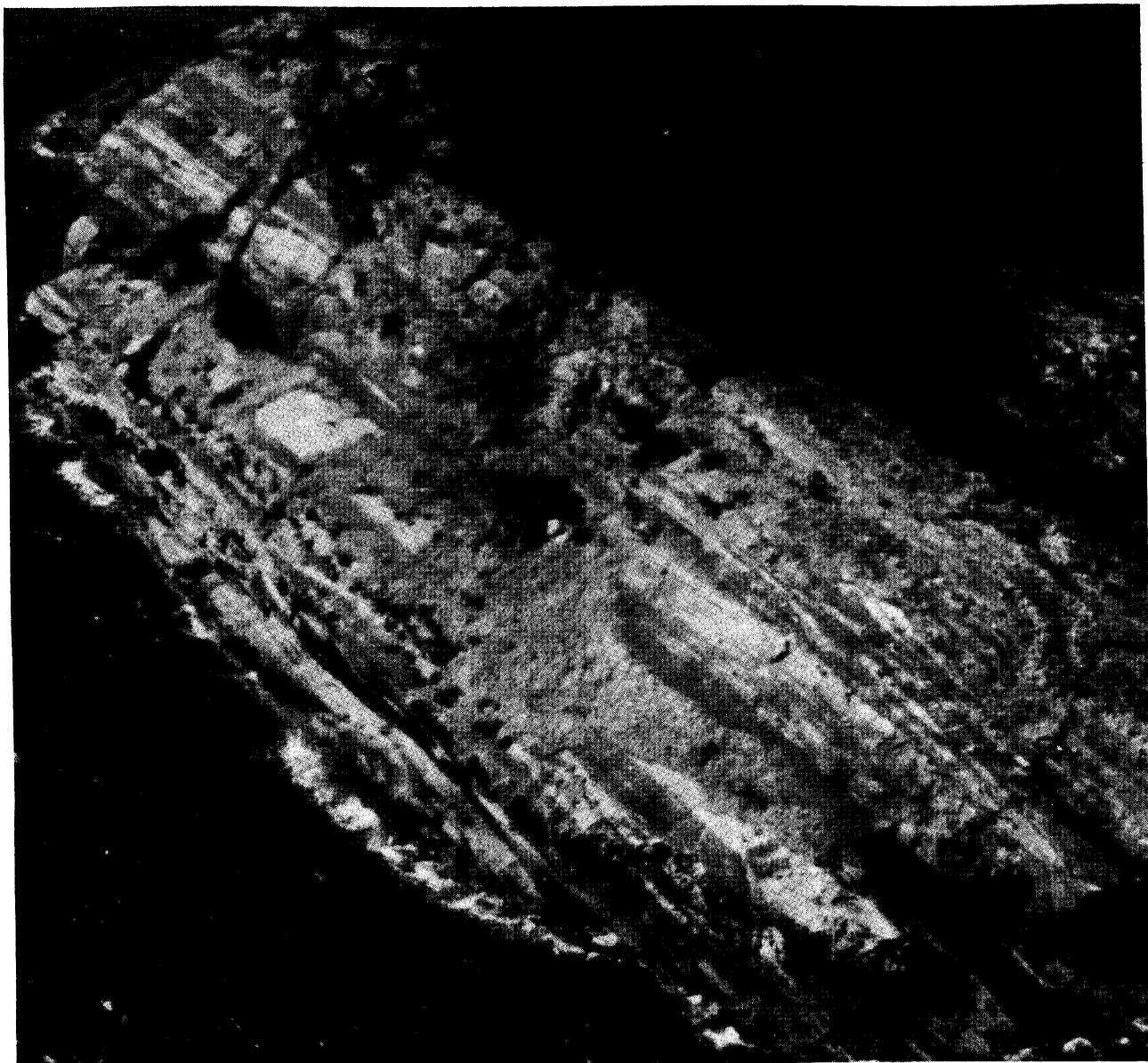
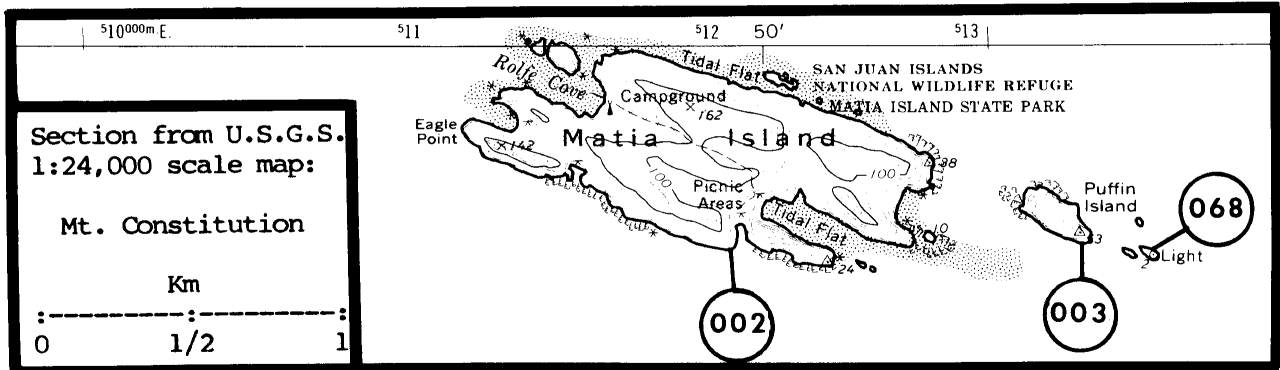

Puffin Island (156003) 19 July 1982 T.R. Wahl

AREA 156; Victoria (cont'd.)

004

Lone Tree Island (Sister Island, north) 48°41'41"N, 122°45'22"W

| | | | | |
|----------------------|-----|---------------|----------|-----------|
| Black Oystercatcher | 4 | Speich & Wahl | 06/05/78 | B III 257 |
| Glaucous-winged Gull | 820 | Speich & Wahl | 06/05/78 | B III 257 |
| Pigeon Guillemot | 6 | Speich & Wahl | 06/05/78 | B III 257 |
| Total | 830 | | | |

| | | | | |
|----------------------|-----|------------|----------|-----------|
| Pelagic Cormorant | 26+ | Eddy | 06/01/57 | L III 95 |
| Black Oystercatcher | 2 | Eddy | 06/01/57 | L I 95 |
| Black Oystercatcher | 2 | Richardson | 06/02/57 | L I 229 |
| Black Oystercatcher | 2 | Eddy 1975 | 06/13/75 | L I 94 |
| Black Oystercatcher | 2-4 | Nysewander | 06/13/75 | L III 205 |
| Glaucous-winged Gull | 584 | Eddy | 06/01/57 | L II 95 |
| Glaucous-winged Gull | 824 | Eddy 1975 | 06/13/75 | L II 94 |
| Pigeon Guillemot | 15+ | Eddy | 06/01/57 | L III 95 |
| Pigeon Guillemot | 12 | Eddy 1975 | 06/13/75 | L II 94 |

005

Sister Island, middle 48°41'33"N, 122°45'28"W

| | | | | |
|----------------------|----|---------------|----------|-----------|
| Black Oystercatcher | 2 | Speich & Wahl | 06/05/78 | B III 257 |
| Glaucous-winged Gull | 40 | Speich & Wahl | 06/05/78 | B III 257 |
| Total | 42 | | | |

| | | | | |
|----------------------|----|-----------------------|----------|------------|
| Black Oystercatcher | 2? | Eddy | 06/01/57 | L III 95 |
| Black Oystercatcher | 2 | Eddy 1975; Nysewander | 06/13/75 | L I 94;205 |
| Glaucous-winged Gull | X | Jewett 1937 | 05/26/37 | L III 156 |
| Glaucous-winged Gull | 36 | Eddy | 06/01/57 | L II 95 |
| Glaucous-winged Gull | 44 | Eddy 1975 | 06/13/75 | L II 94 |
| Pigeon Guillemot | 50 | Jewett 1937 | 05/26/37 | L III 156 |
| Pigeon Guillemot | ? | Eddy | 06/01/57 | L III 95 |

006

Sister, Little (Sister Island, south) 48°41'23"N, 122°45'30"W

| | | | | |
|--------------------------|-----|---------------|----------|-----------|
| Double-crested Cormorant | 4 | Speich & Wahl | 06/05/78 | B I 257 |
| Pelagic Cormorant | 22 | Speich & Wahl | 06/05/78 | B I 257 |
| Black Oystercatcher | 2 | Speich & Wahl | 06/05/78 | B III 257 |
| Glaucous-winged Gull | 260 | Speich & Wahl | 06/05/78 | B III 257 |
| Total | 288 | | | |

| | | | | |
|--------------------------|-----|-----------------------|----------|------------|
| Double-crested Cormorant | 4 | Eddy 1975 | 06/13/75 | L I 94 |
| Pelagic Cormorant | 18 | Eddy | 06/01/57 | L I 95 |
| Black Oystercatcher | 2 | Eddy | 06/01/57 | L III 95 |
| Black Oystercatcher | 2 | Eddy 1975; Nysewander | 06/13/75 | L I 94;205 |
| Glaucous-winged Gull | X | Jewett 1937 | 05/26/37 | B III 156 |
| Glaucous-winged Gull | 94 | Eddy | 06/01/57 | L II 95 |
| Glaucous-winged Gull | 262 | Eddy 1975 | 06/13/75 | L II 94 |

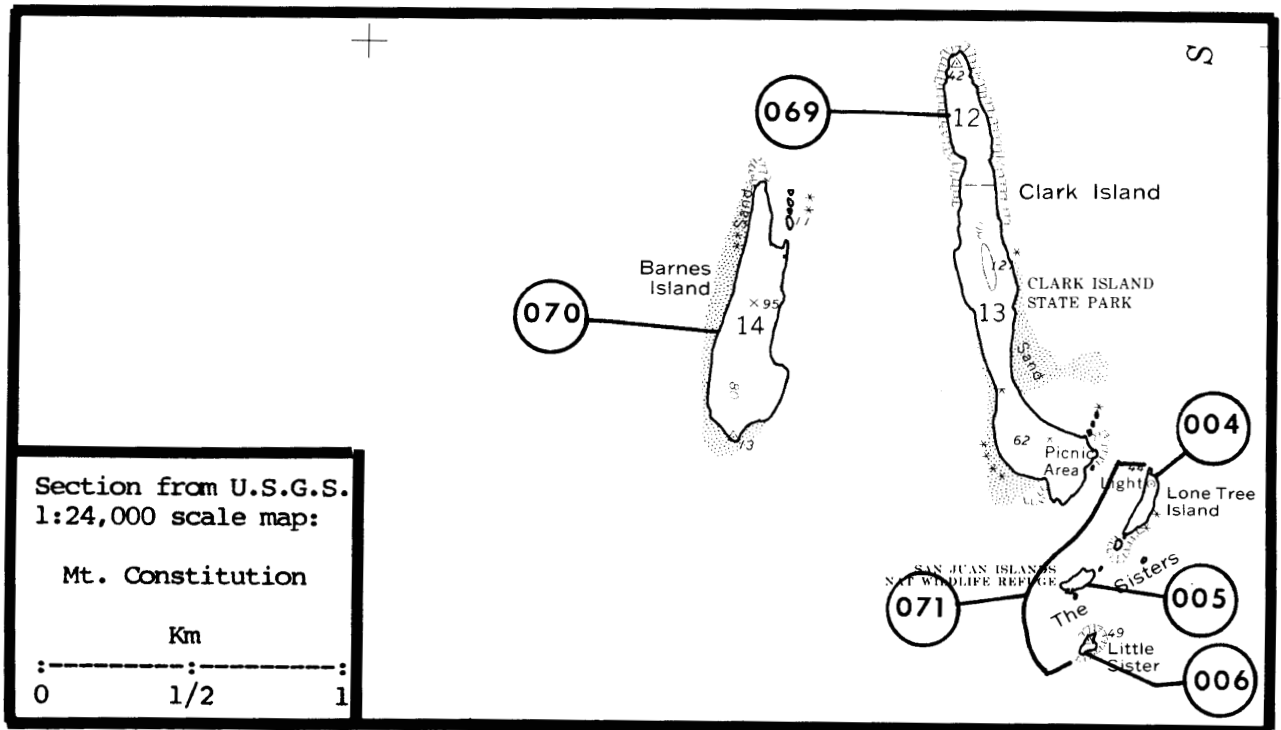

Sister, Little (156006)(right) Lone Tree Island (156004)(left) Sister Island, Middle (156005) USF&WS

AREA 156, Victoria (cont'd.)

007 Lummi Rocks 48°40'15"N, 122°40'00"W

| | | | | |
|----------------------|----|---------------|-----------|-----------|
| No Nesting Observed | 0 | Wahl | 07/19/82 | A III 269 |
| No Nesting Observed | 0 | Cassidy | Summer/79 | B III 56 |
| No Nesting Observed | 0 | Garlick | 05/21/81 | ? ? 113 |
| Glaucous-winged Gull | 12 | Eddy 1975 | 06/13/75 | L I 94 |
| Glaucous-winged Gull | 20 | Speich & Wahl | 06/05/78 | B III 257 |
| Pigeon Guillemot | 1 | Speich & Wahl | 06/05/78 | B III 257 |

008 Eliza Island 48°39'54"N, 122°35'00"W

| | | | | |
|----------------------|----|---------------|------------|-----------|
| No Nesting Observed | 0 | Speich & Wahl | 06/05/78 | B III 257 |
| Pelagic Cormorant | 2 | Salter | 05/06/48 | S - 239 |
| Pelagic Cormorant | 1 | Hudson | 06/24/49 | S - 149 |
| Glaucous-winged Gull | 1 | Salter | 07/25/48 | S - 239 |
| Glaucous-winged Gull | 6 | Manuwal 1977 | ?/ ?/73-75 | L I 187 |
| Glaucous-winged Gull | 6P | Eddy 1975 | 06/13/75 | B III 94 |
| Pigeon Guillemot | 1 | Hoffman | 06/30/49 | S - 136 |
| Pigeon Guillemot | 1 | Hudson | 07/25/49 | S - 149 |
| Pigeon Guillemot | 2 | Manuwal 1977 | ?/ ?/73-75 | L III 187 |

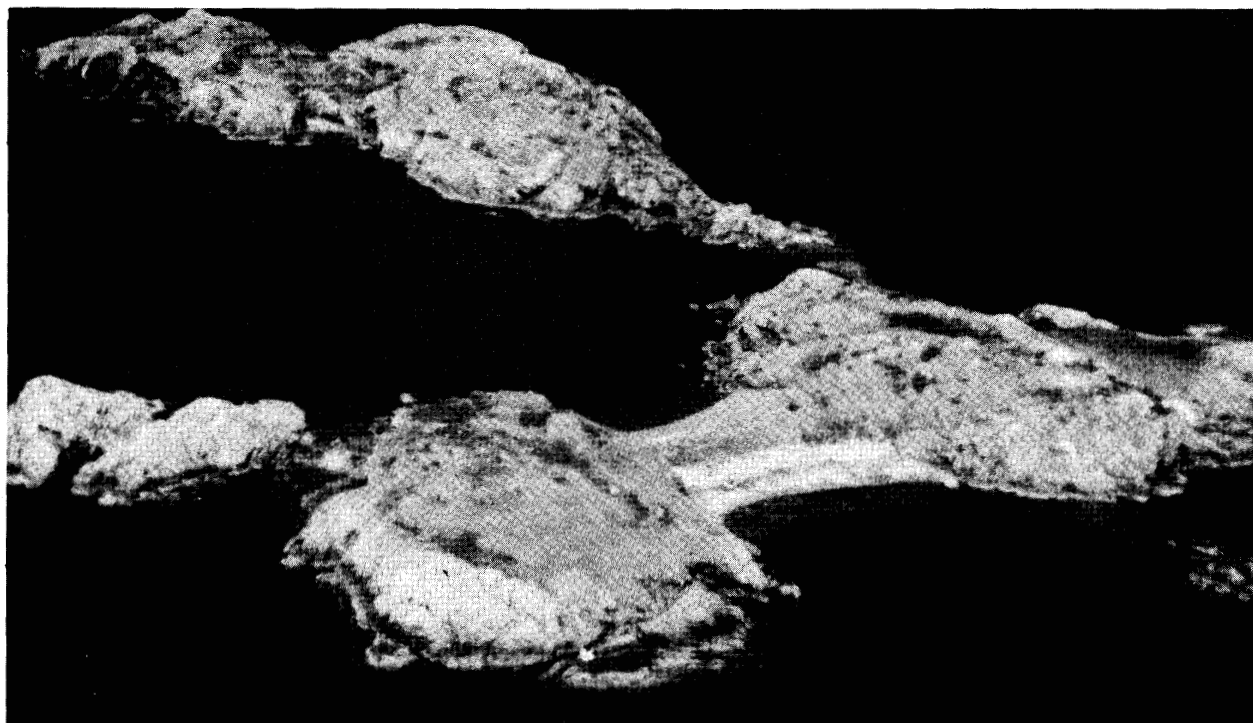

Lummi Rocks (156007) 19 July 1982 T.R. Wahl

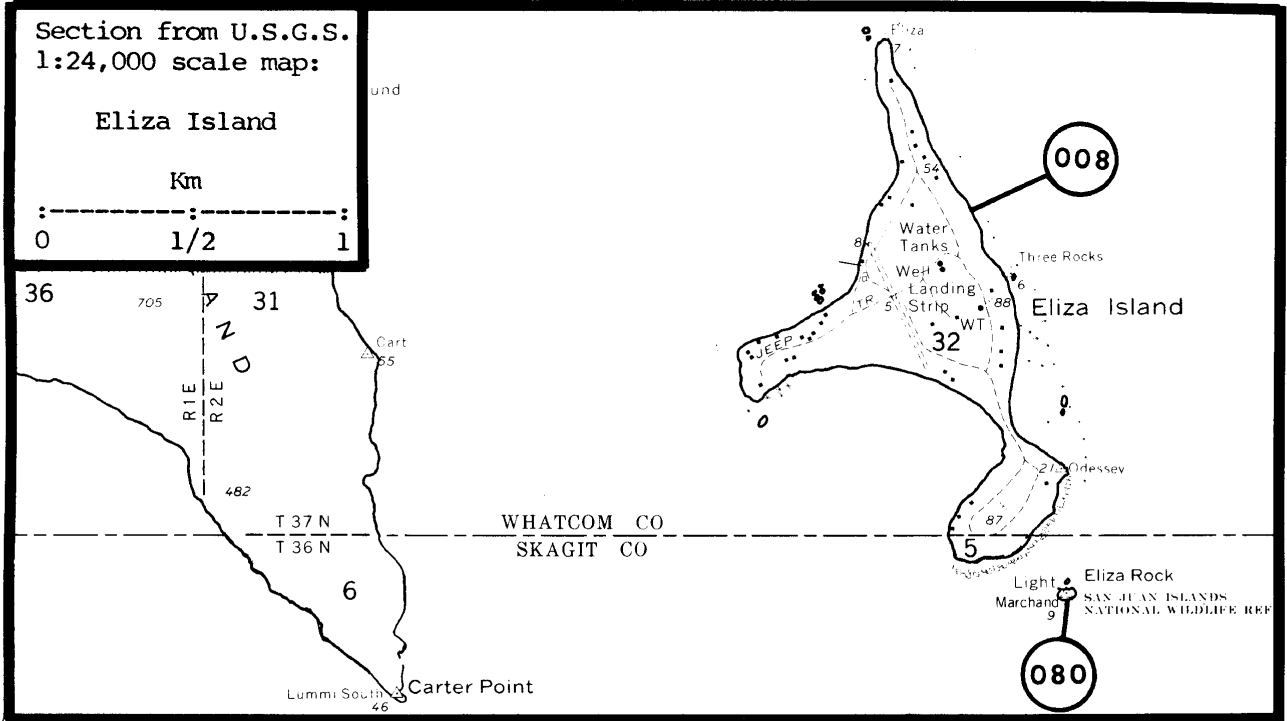
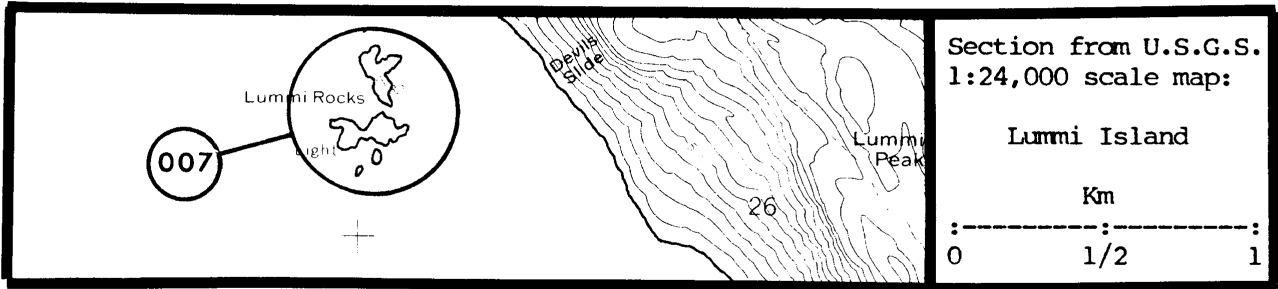

AREA 156, Victoria (cont'd.)

009

Peapod, North (North Peapod) 48°38'32"N, 122°44'37"W

| | | | | |
|----------------------|-----|--------|----------|-----------|
| Black Oystercatcher | 2 | Pitman | 06/21/78 | B III 217 |
| Glaucous-winged Gull | 211 | Wahl | 06/15/79 | B III 269 |
| Pigeon Guillemot | 5 | Wahl | 06/15/79 | B III 269 |
| Total | 218 | | | |

| | | | | |
|----------------------|------|-----------------------|----------------|---------------|
| No Nesting Observed | 0 | Jewett 1937 | 05/25/37 | B ? 156 |
| Pelagic Cormorant | 12 | Eddy | 06/02/57 | L I 95 |
| Black Oystercatcher | 4 | Nisqually NWR | 06/20/63 | B III 202 |
| Black Oystercatcher | X | Washington Dept. Game | ?/ ?/70 | ? ? 203 |
| Black Oystercatcher | 2 | Manuwal 1977 | ?/ ?/73-75 | L I 187 |
| Black Oystercatcher | 4 | Eddy | 06/07/74 | L I 95 |
| Black Oystercatcher | 2 | Nysewander | 06/13/75 | L I 205 |
| Glaucous-winged Gull | X | Hudson | 06/18-07/01/49 | ? III 148 |
| Glaucous-winged Gull | 280 | Eddy | 06/02/57 | L II 95 |
| Glaucous-winged Gull | 400 | Nisqually NWR | 06/20/63 | B III 202 |
| Glaucous-winged Gull | 440 | Manuwal 1977 | ?/ ?/73-75 | L III 187 |
| Glaucous-winged Gull | 540 | Eddy | 06/07/74 | L III 95 |
| Glaucous-winged Gull | 200 | Pitman | 06/21/78 | B III 217 |
| Glaucous-winged Gull | <250 | Wahl | 07/19/82 | A III 269 |
| Pigeon Guillemot | X | Hudson | 06/18-07/01/49 | ? III 148 |
| Pigeon Guillemot | 10+ | Eddy | 06/02/57 | L III 95 |
| Pigeon Guillemot | 4 | Nisqually NWR | 06/20/63 | B III 202 |
| Pigeon Guillemot | 4 | Manuwal | ?/ ?/73-75 | L III 187 |
| Pigeon Guillemot | 4 | Eddy | 06/07/74 | L III 95 |
| Pigeon Guillemot | 6 | Pitman | 06/21/78 | B III 217 |
| Pigeon Guillemot | 1 | Wahl; Paulson | 07/06/78 | A III 269;207 |
| Tufted Puffin | ? | Hudson | 06/18-07/01/49 | ? III 148 |

010

Peapod, South (South Peapod) 48°38'03"N, 122°45'27"W

| | | | | |
|----------------------|-----|------|----------|-----------|
| Glaucous-winged Gull | 261 | Wahl | 06/15/79 | B III 269 |
| Pigeon Guillemot | 15 | Wahl | 06/15/79 | B III 269 |
| Total | 276 | | | |

| | | | | |
|----------------------|-----|---------------|----------------|-----------|
| Cormorant sp. | P | Jewett 1937 | 05/25/37 | L III 156 |
| Pelagic Cormorant | X | Hudson | 06/18-07/01/49 | ? III 148 |
| Black Oystercatcher | 3? | Hudson | 06/18-07/01/49 | ? III 148 |
| Black Oystercatcher | 2 | Schultz | 06/02/57 | L I 244 |
| Black Oystercatcher | 2 | Nisqually NWR | 06/20/63 | B ? 202 |
| Black Oystercatcher | 2 | Manuwal 1977 | ?/ ?/73-75 | L I 187 |
| Black Oystercatcher | 2 | Eddy | 06/07/74 | L I 95 |
| Black Oystercatcher | 2 | Nysewander | 06/13/75 | L III 205 |
| Glaucous-winged Gull | 300 | Jewett 1937 | 05/25/37 | L III 156 |
| Glaucous-winged Gull | X | Hudson | 06/18-07/01/49 | ? III 148 |
| Glaucous-winged Gull | 320 | Eddy | 06/02/57 | L II 95 |
| Glaucous-winged Gull | 400 | Nisqually NWR | 06/20/63 | B ? 202 |
| Glaucous-winged Gull | 150 | Manuwal 1977 | ?/ ?/73-75 | L II 187 |

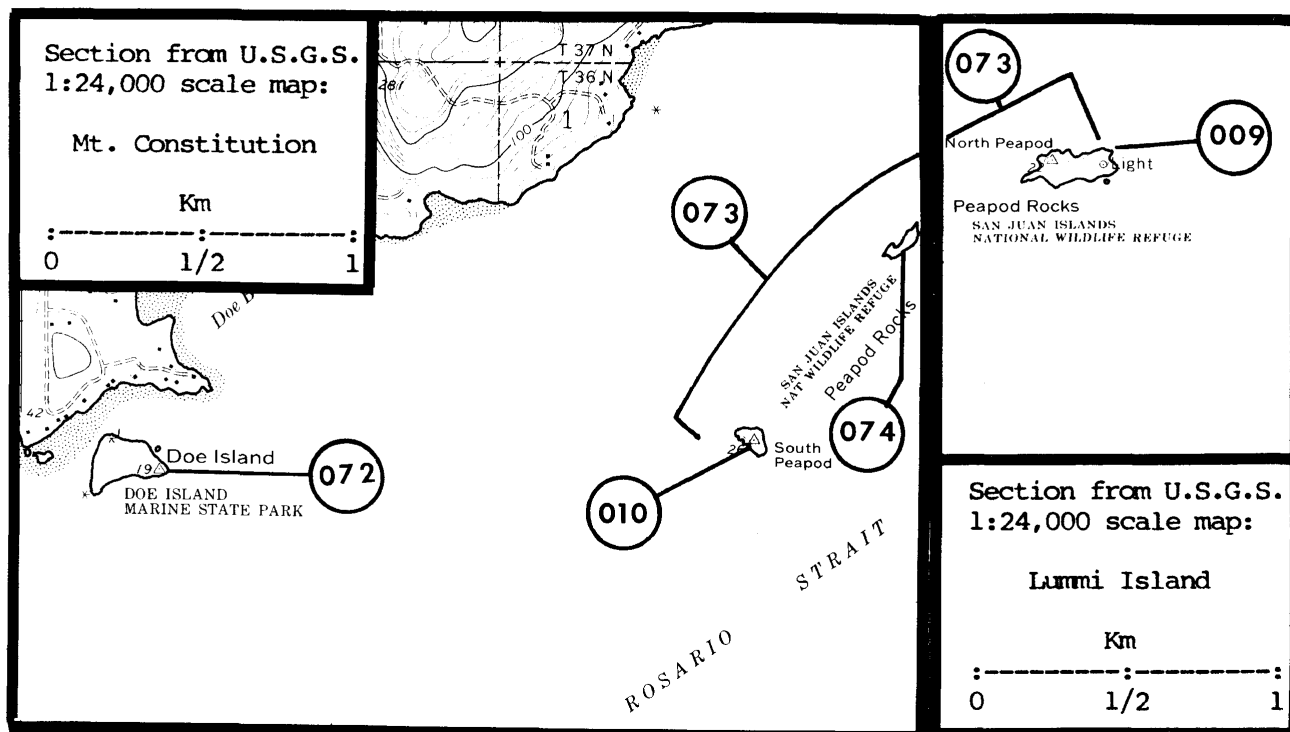

| | | | | | |
|----------------------|------|---------------|----------------|-------|-----|
| Glaucous-winged Gull | 390 | Eddy | 06/07/74 | L II | 95 |
| Glaucous-winged Gull | 170 | Pitman | 06/21/78 | B III | 217 |
| Glaucous-winged Gull | <200 | Wahl | 07/19/82 | A III | 269 |
| Pigeon Guillemot | P | Jewett 1937 | 05/25/37 | L III | 156 |
| Pigeon Guillemot | X | Hudson | 06/18-07/01/49 | ? III | 148 |
| Pigeon Guillemot | 20+ | Eddy | 06/02/57 | L III | 95 |
| Pigeon Guillemot | 2 | Nisqually NWR | 06/20/63 | B ? | 202 |
| Pigeon Guillemot | 4 | Eddy | 06/07/74 | L III | 95 |
| Pigeon Guillemot | 4 | Manuwal 1977 | ?/ ?/73-75 | L III | 187 |
| Pigeon Guillemot | 2 | Pitman | 06/21/78 | B III | 217 |
| Tufted Puffin | X | Hudson | 06/18-07/01/49 | ? III | 148 |

AREA 156, Victoria (cont'd.)

(011)

Viti Rocks 48°38'00"N, 122°37'17"W

| | | | | |
|----------------------|-----|------|----------|-----------|
| Glaucous-winged Gull | 280 | Wahl | 06/15/79 | B III 269 |
| Pigeon Guillemot | 22 | Wahl | 06/15/79 | B III 269 |
| Total | 302 | | | |

| | | | | |
|--------------------------|-------|-----------------------|-------------------------|---------------|
| Double-crested Cormorant | 4 | Hudson | 06/20/49 | E - 149 |
| Double-crested Cormorant | 40-50 | Hudson | 06/21/49 | L III 148 |
| Double-crested Cormorant | 2 | Hudson | 06/26/49 | S - 149 |
| Double-crested Cormorant | 58 | Eddy 1975 | 06/13/75 | L I 94 |
| Pelagic Cormorant | 1 | Booth | 06/26/27 | S - 34 |
| Pelagic Cormorant | 1 | Booth | 06/26/27 | S - 35 |
| Pelagic Cormorant | 2 | Booth | 06/26/27 | E - 34 |
| Pelagic Cormorant | 2 | Booth | 06/21/31 | E - 38 |
| Pelagic Cormorant | X | Hudson | 06/21/49 | L III 148 |
| Pelagic Cormorant | 2 | Hudson | 06/23/49 | E - 149 |
| Pelagic Cormorant | 1 | Hudson | 06/25/49 | S - 149 |
| Pelagic Cormorant | 160 | Eddy 1975 | 06/13/75 | L II 94 |
| Pelagic Cormorant | 22 | Speich & Wahl | 06/05/78 | B I 257 |
| Pelagic Cormorant | ? | Wahl | 07/19/82 | A III 269 |
| Black Oystercatcher | 1 | Hudson | 06/21/49 | L III 148 |
| Black Oystercatcher | 1 | Hudson | 06/25/49 | S - 149 |
| Black Oystercatcher | 2 | Wick 1958 | ?/ ?/58 | ? ? 279 |
| Black Oystercatcher | 5 | Eddy 1975; Nysewander | 06/13/75 | L II 94;205 |
| Black Oystercatcher | 2 | Speich & Wahl | 06/05/78 | B III 257 |
| Black Oystercatcher | 0 | Garlick | 05/21/81 | B III 113 |
| Glaucous-winged Gull | 2 | Booth | 06/19/27 | E - 36 |
| Glaucous-winged Gull | 6 | Booth | 06/19/27 | E - 38 |
| Glaucous-winged Gull | 16 | Booth | 06/19/27 | E - 34 |
| Glaucous-winged Gull | 12 | Booth | 06/15/30 | E - 38 |
| Glaucous-winged Gull | 16 | Booth | 06/21/31 | E - 38 |
| Glaucous-winged Gull | 1 | Hudson | 06/20/49 | E - 149 |
| Glaucous-winged Gull | X | Hudson | 06/20/49 | L III 148 |
| Glaucous-winged Gull | 530B | Schultz | ?/ ?/53 | L III 245 |
| Glaucous-winged Gull | 2B | Schultz | 07/18/61 | L III 245 |
| Glaucous-winged Gull | 2B | Schultz | 07/17/63 | L III 245 |
| Glaucous-winged Gull | 774 | Eddy 1975 | 06/13/75 | L II 94 |
| Glaucous-winged Gull | 400 | Speich & Wahl | 06/05/78 | B III 257 |
| Glaucous-winged Gull | 560 | Wahl | 06/15/78 | B III 269 |
| Glaucous-winged Gull | 100's | Wahl | 07/19/82 | A III 269 |
| Pigeon Guillemot | 2 | Booth | 06/26/27 | E - 34 |
| Pigeon Guillemot | 2 | Booth | 06/15/30 | E - 38 |
| Pigeon Guillemot | X | Hudson | 06/20/49 | L III 148 |
| Pigeon Guillemot | 2 | Hudson | 06/23/49 | E - 149 |
| Pigeon Guillemot | 2 | Eddy 1975 | 06/13/75 | L III 94 |
| Pigeon Guillemot | 2 | Speich & Wahl | 06/05/78 | B III 257 |
| Pigeon Guillemot | 22 | Wahl | 06/15/78 | B III 269 |
| Pigeon Guillemot | 1 | Wahl; Paulson | 07/06/78 | A III 269;207 |
| Tufted Puffin | 1 | [Booth] | 06/26/27 | S - 35 |
| Tufted Puffin | 4? | Hudson | 06/20/49 | L III 148 |
| Tufted Puffin | 0 | Eddy 1975 | 06/13/75 | |
| | | | (Pre-1975) | L III 94 |
| | | | Four old burrows found. | |

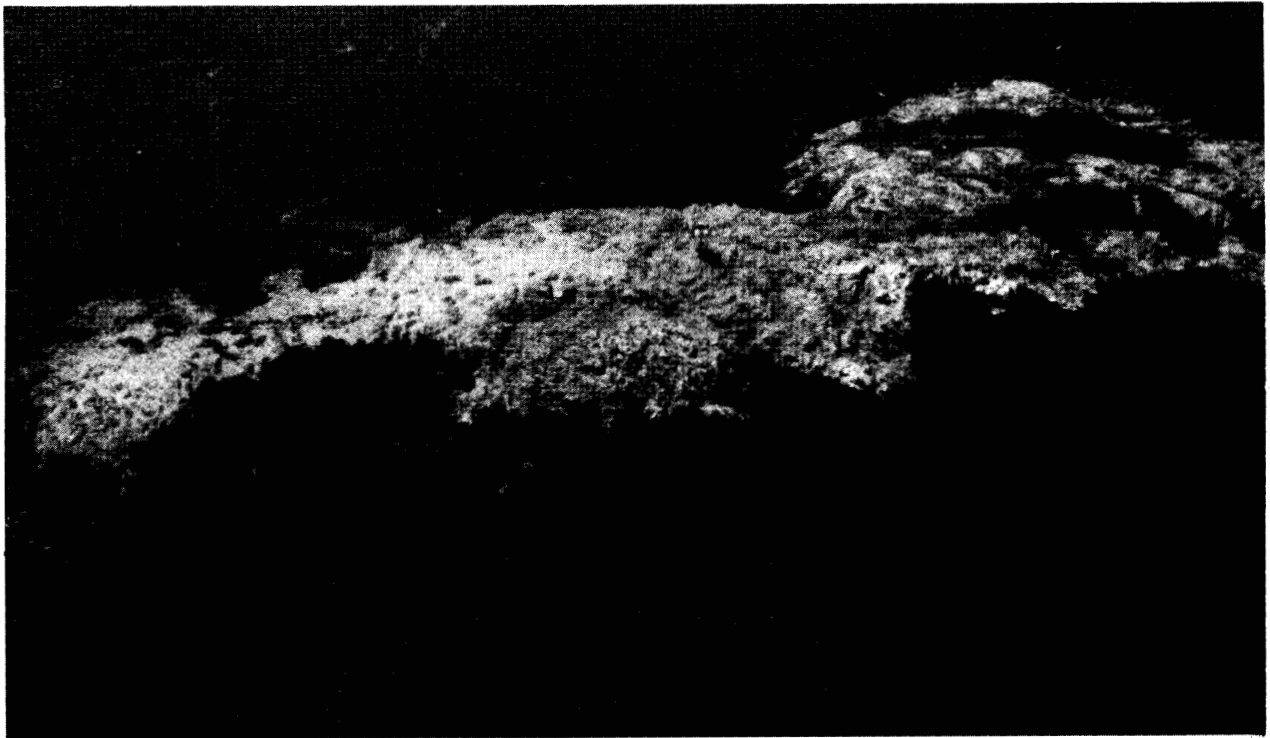
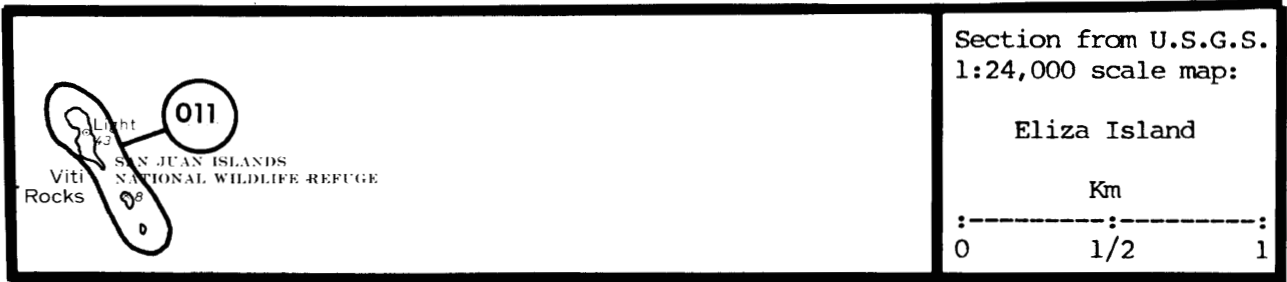

Viti Rocks (156011) 19 July 1982 T.R. Wahl

AREA 156, Victoria (cont'd.)

012

Skipjack Island 48°43'56"N, 123°02'00"W

| | | | | |
|----------------------|-----|---------------|----------|---------------|
| Pelagic Cormorant | 112 | Wahl | 07/19/82 | A I 269 |
| Glaucous-winged Gull | 55 | Paulson; Wahl | 06/07/79 | A III 207;269 |
| Pigeon Guillemot | 14 | Paulson; Wahl | 06/07/79 | A III 207;269 |
| Total | 181 | | | |

| | | | | |
|----------------------|-------|--------------------|-------------|---------------|
| Cormorant sp. | P | Edson 1929 | 06/22/05 | L III 98 |
| Pelagic Cormorant | 1 | Forbush | 06/29/1888 | S - 106 |
| Pelagic Cormorant | P | Lumley 1934 | ?/ ?/33 | |
| | | (pre-1933) | | L? ? 184 |
| Pelagic Cormorant | 0 | Lumley 1934 | ?/ ?/34 | ? ? 184 |
| Pelagic Cormorant | 20 | Eddy | 08/11/62 | B I 95 |
| Glaucous-winged Gull | 60-80 | Edson 1929 | 06/22/05 | L III 98 |
| Glaucous-winged Gull | X | Lumley 1934 | ?/ ?/33 | L? ? 184 |
| Glaucous-winged gull | X | Lumley 1934 | ?/ ?/34 | ? ? 184 |
| Glaucous-winged Gull | 200 | Jewett 1937 | 05/26/37 | L III 156 |
| Glaucous-winged Gull | 64B | Schultz | ?/ ?/47 | L III 245 |
| Glaucous-winged Gull | 1 | Schultz | 08/06/47 | S - 246 |
| Glaucous-winged Gull | X | Schultz 1951 | 06/16/48 | L III 240 |
| Glaucous-winged Gull | 55B | Schultz | ?/ ?/49 | L III 245 |
| Glaucous-winged Gull | 4 | Schultz | 08/06/49 | S - 246 |
| Glaucous-winged Gull | X | Eddy | 05/31/57 | B III 95 |
| Glaucous-winged Gull | X | Eddy | 08/11/62 | B III 95 |
| Glaucous-winged Gull | 150 | Manuwal 1977 | ?/ ?/73-75 | L III 187 |
| Glaucous-winged Gull | 202 | Eddy | 06/09/74 | L II 95 |
| Glaucous-winged Gull | 150 | Speich & Wahl | 06/05/78 | B III 257 |
| Pigeon Guillemot | 1 | Colt | 04/26/1894 | S - 61 |
| Pigeon Guillemot | P | Edson 1929 | 06/22/05 | L III 98 |
| Pigeon Guillemot | X | Bakus 1965 | 07/05-12/59 | ? ? 18 |
| Pigeon Guillemot | 125 | Eddy | 08/11/62 | B III 95 |
| Pigeon Guillemot | 40 | Manuwal 1977 | ?/ ?/73-75 | L III 187 |
| Pigeon Guillemot | 40 | Eddy | 06/09/74 | L III 95 |
| Pigeon Guillemot | 40 | Speich & Wahl | 06/05/78 | B III 257 |
| Pigeon Guillemot | 24 | Wahl; Paulson | 07/06/78 | A III 269;207 |
| Tufted Puffin | P | Edson 1929 | 06/22/05 | L III 98 |
| Tufted Puffin | X | Miller et al. 1935 | ?/ ?/33-35 | ? ? 199 |

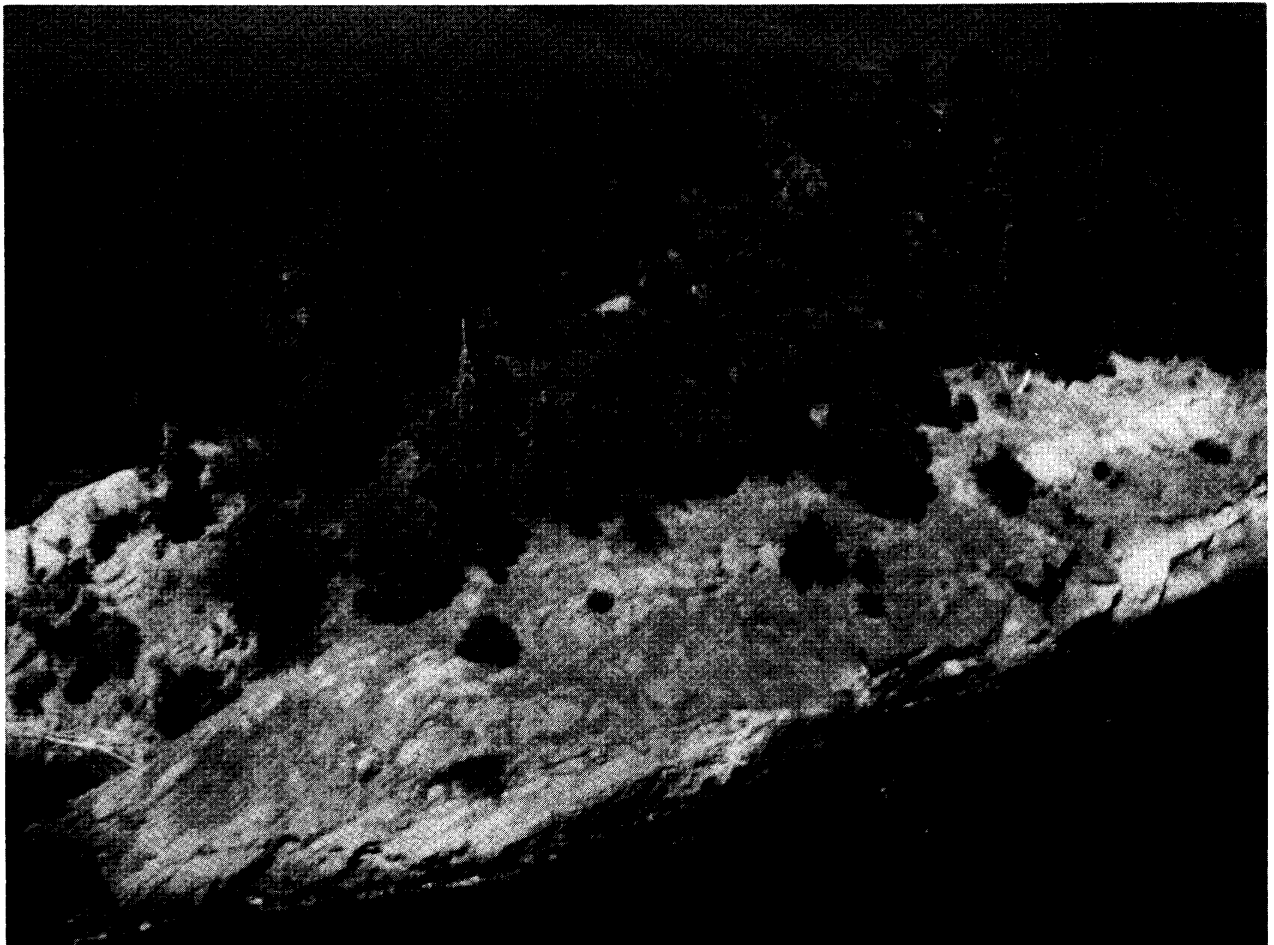
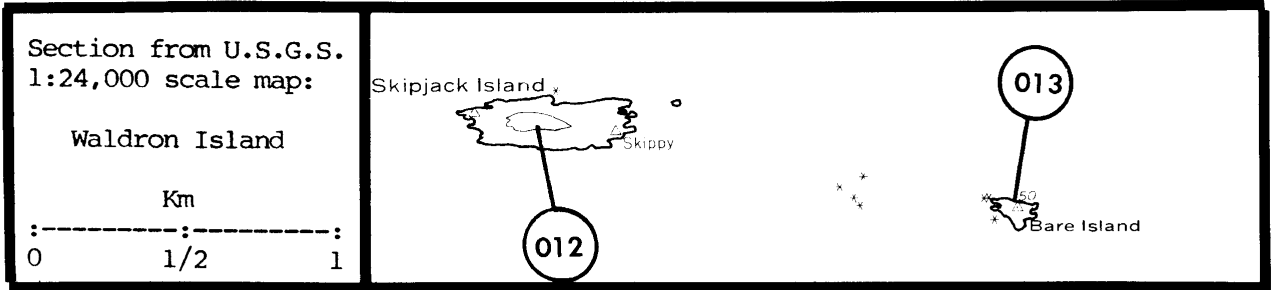

Skipjack Island (156012) 19 July 1982 T.R. Wahl

AREA 156, Victoria (cont'd.)

013

Bare Island 48°43'48"N, 123°00'47"W

| | | | | |
|----------------------|-----|---------------|----------|-----------|
| Pelagic Cormorant | 100 | Speich & Wahl | 06/05/78 | B III 257 |
| Black Oystercatcher | 2 | Speich & Wahl | 06/05/78 | B III 257 |
| Glaucous-winged Gull | 240 | Speich & Wahl | 06/05/78 | B II 257 |
| Tufted Puffin | 4 | Speich & Wahl | 06/05/78 | B II 257 |
| Total | 346 | | | |

| | | | | |
|--------------------------|-------|----------------------|-------------|-----------|
| Cormorant sp. | 20 | Nisqually NWR | 06/06/62 | B ? 202 |
| Cormorant sp. | 5P | Nisqually NWR | 05/05/67 | B ? 202 |
| Cormorant sp. | 200P | Nisqually NWR | 07/13-16/68 | B ? 202 |
| Double-crested Cormorant | N | Hudson | 07/08/49 | L III 148 |
| Double-crested Cormorant | 10 | Manuwal 1973 | 05/27/73 | L I 186 |
| Pelagic Cormorant | 50P | Edson 1929 | 06/27/05 | L III 98 |
| Pelagic Cormorant | 1 | McMannama | 08/12/48 | S - 193 |
| Pelagic Cormorant | 1 | McMannama | 08/19/48 | S - 193 |
| Pelagic Cormorant | X | Hudson | 07/08/49 | L III 148 |
| Pelagic Cormorant | 30-40 | Bakus 1965 | 07/12&17/59 | L III 18 |
| Pelagic Cormorant | 22 | Eddy | 08/11/62 | B I 95 |
| Pelagic Cormorant | 40 | Nisqually NWR | 06/20/63 | L III 202 |
| Pelagic Cormorant | 9 | Hauser & Monson 1963 | 07/16-17/63 | B ? 145 |
| Pelagic Cormorant | 14 | Nisqually NWR | 08/21-23/67 | L II 202 |
| Pelagic Cormorant | 100 | Manuwal 1977 | ?/ ?/73-75 | L III 187 |
| Pelagic Cormorant | 48 | Manuwal | 05/27/73 | L I 188 |
| Pelagic Cormorant | 75 | Manuwal 1973 | 05/27/73 | L I 186 |
| Pelagic Cormorant | 100 | Eddy | 06/10/74 | L III 95 |
| Pelagic Cormorant | 26+ | Wahl | 07/19/82 | A III 269 |
| Black Oystercatcher | 2 | Nisqually NWR | 06/06/62 | L III 202 |
| Black Oystercatcher | 3 | Hauser & Monson 1963 | 07/16-17/63 | B ? 145 |
| Black Oystercatcher | 2 | Manuwal 1977 | ?/ ?/73-75 | L I 187 |
| Black Oystercatcher | 1 | Manuwal | 05/27/73 | L III 188 |
| Black Oystercatcher | 2 | Manuwal 1973 | 05/27/73 | L I 186 |
| Black Oystercatcher | 2 | Eddy | 06/10/74 | L II 95 |
| Black Oystercatcher | 2 | Nysewander | 06/14/75 | L I 205 |
| Glaucous-winged Gull | 16 | Edson 1929 | 06/27/05 | L I 98 |
| Glaucous-winged Gull | X | Miller et al. 1935 | 07/13/35 | L ? 199 |
| Glaucous-winged Gull | >200 | Jewett 1937 | 05/26/37 | L III 156 |
| Glaucous-winged Gull | X | Schultz 1951 | 06/15/48 | L III 240 |
| Glaucous-winged Gull | 30B | Schultz | ?/ ?/48 | L ? 245 |
| Glaucous-winged Gull | 2 | Goodge | 08/12/48 | S - 116 |
| Glaucous-winged Gull | 2 | McMannama | 08/12/48 | S - 193 |
| Glaucous-winged Gull | 240B | Schultz | ?/ ?/49 | L ? 245 |
| Glaucous-winged Gull | 100's | Hudson | 07/08/49 | L III 148 |
| Glaucous-winged Gull | 10+ | Richardson | 08/11/56 | ? ? 229 |
| Glaucous-winged Gull | X | Dickerman 1960 | 07/12/59 | L ? 88 |
| Glaucous-winged Gull | 600 | Nisqually NWR | 06/06/62 | L III 202 |
| Glaucous-winged Gull | 400 | Eddy | 08/11/62 | B III 95 |
| Glaucous-winged Gull | 400 | Nisqually NWR | 06/20/63 | L III 202 |
| Glaucous-winged Gull | 300 | Hauser & Monson 1963 | 07/16-17/63 | B ? 145 |
| Glaucous-winged Gull | X | Wahl | 08/11/66 | ? ? 269 |
| Glaucous-winged Gull | 300 | Nisqually NWR | 05/05/67 | B ? 202 |

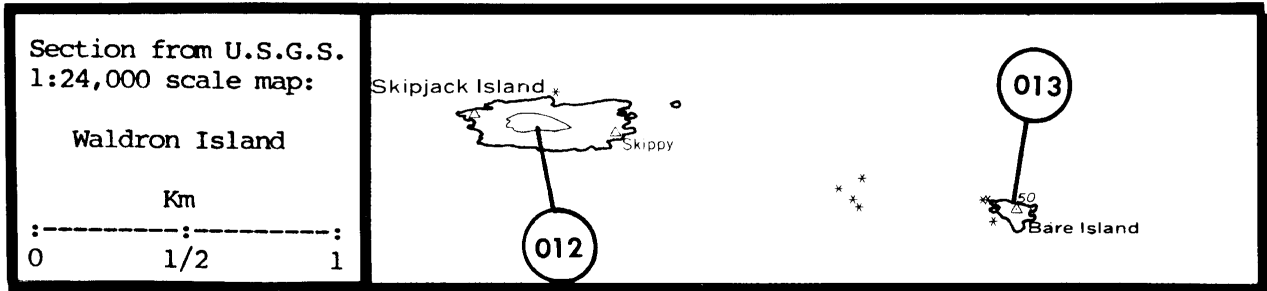

| | | | | |
|----------------------|------|-----------------------|-------------|--------------|
| Glaucous-winged Gull | 800 | Nisqually NWR | 08/21-23/67 | L III 202 |
| Glaucous-winged Gull | 800 | Nisqually NWR | 07/13-16/68 | L III 202 |
| Glaucous-winged Gull | 240 | Manuwal 1977 | ?/ ?/73-75 | L II 187 |
| Glaucous-winged Gull | 220 | Manuwal 1973; Manuwal | 05/27/73 | L II 186;188 |
| Glaucous-winged Gull | 314 | Eddy | 06/10/74 | L II 95 |
| Glaucous-winged Gull | 250± | Wahl | 07/19/82 | A III 269 |
| Pigeon Guillemot | X | Hudson | 07/08/49 | L III 148 |
| Pigeon Guillemot | 10 | Nisqually NWR | 06/06/62 | L III 202 |
| Pigeon Guillemot | 6 | Eddy | 08/11/62 | B III 95 |
| Pigeon Guillemot | 4 | Nisqually NWR | 06/20/63 | L III 202 |
| Pigeon Guillemot | 2 | Hauser & Monson 1963 | 07/16-17/63 | B ? 145 |
| Pigeon Guillemot | 10 | Nisqually NWR | 08/21-23/67 | L III 202 |
| Pigeon Guillemot | P | Manuwal 1977 | ?/ ?/73-75 | L III 187 |
| Pigeon Guillemot | 40 | Manuwal 1973 | 05/27/73 | L II 186 |
| Pigeon Guillemot | X | Eddy | 06/10/74 | L III 95 |
| Tufted Puffin | 2 | Edson | 06/27/03 | E - 100 |
| Tufted Puffin | 40 | Edson 1929 | 06/27/05 | L I 98 |
| Tufted Puffin | X | Miller et al. 1935 | ?/ ?/33-35 | L ? 199 |
| Tufted Puffin | 100 | Jewett 1937 | 05/26/37 | L III 156 |
| Tufted Puffin | 16 | Hudson | 07/08/49 | L III 148 |
| Tufted Puffin | P | Eddy | 05/31/57 | B III 95 |
| Tufted Puffin | X | Bakus 1965 | 07/12-17/59 | L III 18 |
| Tufted Puffin | <40 | Dickerman 1960 | 07/12/59 | L ? 88 |
| Tufted Puffin | 20 | Nisqually NWR | 06/06/62 | L III 202 |
| Tufted Puffin | 14 | Eddy | 08/11/62 | B III 95 |
| Tufted Puffin | 2 | Nisqually NWR | 06/20/63 | L III 202 |
| Tufted Puffin | 1 | Hauser & Monson 1963 | 07/16-17/63 | B ? 145 |
| Tufted Puffin | 4 | Manuwal 1977 | ?/ ?/73-75 | L II 187 |
| Tufted Puffin | 18 | Manuwal 1973; Manuwal | 05/27/73 | L II 186;188 |
| Tufted Puffin | 3 | Eddy | 06/10/74 | L III 95 |
| Tufted Puffin | P | Games | 07/ ?/76 | ? ? 112 |

AREA 156, Victoria (cont'd.)

014 Waldron Island¹ 48°42'05"N, 123°01'48"W

| | | | | |
|--------------------------|-------|----------------------------|------------|---------------|
| Pigeon Guillemot | 23 | Wahl; Paulson | 06/07/79 | A III 269;207 |
| No Nesting Observed | 0 | Eddy 1975 | 06/14/75 | B III 94 |
| Double-crested Cormorant | 12-16 | Schultz | ?/ ?/47 | B III 243 |
| Double-crested Cormorant | 12-16 | Schultz | ?/ ?/48 | B III 243 |
| Double-crested Cormorant | 12-16 | Schultz | ?/ ?/49 | B III 243 |
| Double-crested Cormorant | X | Hudson | 07/08/49 | ? III 148 |
| Double-crested Cormorant | >32 | Eddy & Richardson; Eddy | 05/31/57 | ? ? 97;95 |
| Double-crested Cormorant | 10P | Eddy | 08/11/62 | B III 95 |
| Pelagic Cormorant | X | Lumley 1934 | ?/ ?/33 | ? ? 184 |
| Pelagic Cormorant | 38 | Lumley 1934 | 07/04/34 | L ? 184 |
| Pelagic Cormorant | X | Hudson | 07/08/49 | ? III 148 |
| Pelagic Cormorant | 100+ | Eddy | 05/31/57 | B III 95 |
| Pelagic Cormorant | 2? | Eddy | 08/11/62 | B III 95 |
| Black Oystercatcher | X | Edson 1929 | 06/24/05 | L ? 98 |
| Glaucous-winged Gull | X | Edson 1929 | 06/20/05 | L ? 98 |
| Glaucous-winged Gull | X | Lumley 1934 | ?/ ?/33 | ? ? 184 |
| Glaucous-winged Gull | X | Lumley 1934 | 07/04/34 | L ? 184 |
| Glaucous-winged Gull | 100's | Hudson | 07/08/49 | ? III 148 |
| Glaucous-winged Gull | X | Eddy | 05/31/57 | B III 95 |
| Pigeon Guillemot | X | Hudson | 07/08/49 | ? III 148 |
| Pigeon Guillemot | 8 | Eddy | 08/11/62 | B III 95 |
| Pigeon Guillemot | 4 | Manuwal 1977 | ?/ ?/73-75 | L II 187 |
| Pigeon Guillemot | 4 | Speich & Wahl | 06/05/78 | B III 257 |
| Pigeon Guillemot | 16 | Wahl; Paulson | 07/06/78 | A III 269;207 |
| Tufted Puffin | 1 | Edson | 06/20/1895 | S - 101 |
| Tufted Puffin | 2 | Hudson | 07/08/49 | S - 149 |

¹Most records refer to Point Disney.

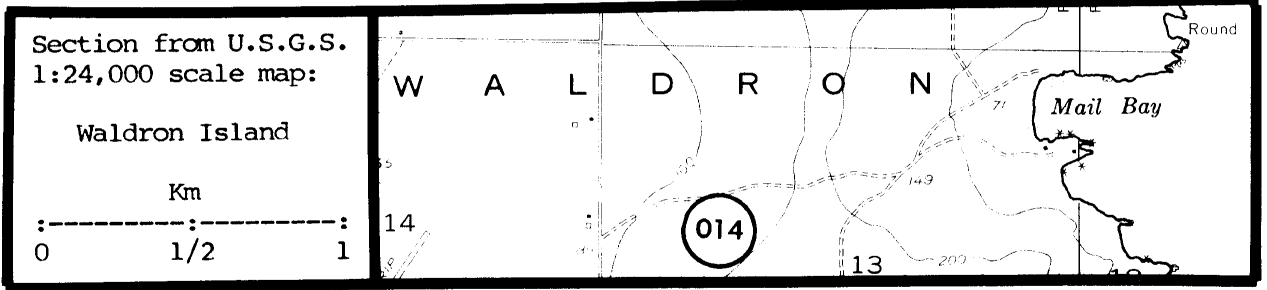

Bare Island (156013) USF&WS

AREA 156, Victoria (cont'd.)

015 Johns Island 48°40'00"N, 123°09'00"W

| | | | | |
|---------------------|---|-----------------------|----------|--------------|
| Black Oystercatcher | 1 | Frazer 1973 | 07/16/73 | B III 108 |
| Black Oystercatcher | 2 | Eddy 1975; Nysewander | 06/14/75 | B III 94;205 |

016 White Rock 48°40'04"N, 123°04'14"W

| | | | | |
|--------------------------|-----|------------|----------|-----------|
| Double-crested Cormorant | X | Richardson | ?/ ?/78 | ? ? 228 |
| Glaucous-winged Gull | 311 | Wahl | 06/14/79 | B III 269 |
| Pigeon Guillemot | 10 | Wahl | 06/14/79 | B III 269 |
| Total | 321 | | | |

| | | | | |
|--------------------------|-------|----------------------|-------------|---------------|
| Double-crested Cormorant | 150P | Jewett 1937 | 05/26/37 | L ? 156 |
| Double-crested Cormorant | 10 | Nisqually NWR | 06/20/63 | B ? 202 |
| Double-crested Cormorant | 4P | Hauser & Monson 1963 | 07/16-17/63 | B ? 145 |
| Double-crested Cormorant | 100 | Nisqually NWR | 08/21-23/67 | B ? 202 |
| Double-crested Cormorant | X | Richardson | ?/ ?/76 | ? ? 228 |
| Pelagic Cormorant | X | Eddy | 05/31/57 | B III 95 |
| Pelagic Cormorant | 112 | Eddy | 08/11/62 | B II 95 |
| Pelagic Cormorant | 15 | Nisqually NWR | 06/20/63 | B ? 202 |
| Pelagic Cormorant | 24P | Hauser & Monson 1963 | 07/16-17/63 | B ? 145 |
| Pelagic Cormorant | 40 | Nisqually NWR | 07/13-16/68 | L III 202 |
| Black Oystercatcher | 2 | Eddy | 05/31/57 | B III 95 |
| Black Oystercatcher | 6 | Nisqually NWR | 06/20/63 | B ? 202 |
| Black Oystercatcher | 2 | Hauser & Monson 1963 | 07/16-17/63 | B ? 145 |
| Black Oystercatcher | 10 | Nisqually NWR | 08/21-23/67 | B III 202 |
| Black Oystercatcher | P | Manuwal 1977 | ?/ ?/73-75 | L III 187 |
| Glaucous-winged Gull | >2 | Graves et al. | 06/20/19 | E III 118 |
| Glaucous-winged Gull | X | Jewett 1937 | 05/26/37 | L III 156 |
| Glaucous-winged Gull | 275B | Schultz | ?/ ?/47 | L III 245 |
| Glaucous-winged Gull | 130B | Schultz | ?/ ?/48 | L III 245 |
| Glaucous-winged Gull | 100's | Hudson | 07/08/49 | ? III 148 |
| Glaucous-winged Gull | 200 | Eddy | 05/31/57 | B III 95 |
| Glaucous-winged Gull | 550P | Hauser & Monson 1963 | 07/16-17/63 | B ? 145 |
| Glaucous-winged Gull | 1200P | Nisqually NWR | 08/21-23/67 | B ? 202 |
| Glaucous-winged Gull | 1000 | Nisqually NWR | 07/13-16/68 | L III 202 |
| Glaucous-winged Gull | X | Nisqually NWR | 07/27/70 | B III 202 |
| Glaucous-winged Gull | 250 | Manuwal 1977 | ?/ ?/73-75 | L III 187 |
| Glaucous-winged Gull | 388 | Eddy | 06/09/74 | L II 95 |
| Glaucous-winged Gull | 250± | Wahl | 07/19/82 | A III 269 |
| Glaucous-winged Gull | 130 | Pitman | 06/22/78 | B III 217 |
| Pigeon Guillemot | X | Hudson | 07/08/49 | ? III 148 |
| Pigeon Guillemot | 10± | Eddy | 05/31/57 | B III 95 |
| Pigeon Guillemot | 8 | Nisqually NWR | 06/20/63 | B ? 202 |
| Pigeon Guillemot | 10 | Nisqually NWR | 07/13-16/68 | L III 202 |
| Pigeon Guillemot | 26 | Manuwal 1977 | ?/ ?/73-75 | L II 187 |
| Pigeon Guillemot | 26 | Eddy | 06/09/74 | L III 95 |
| Pigeon Guillemot | 50 | Pitman | 06/22/78 | B III 217 |
| Pigeon Guillemot | 15 | Wahl; Paulson | 06/07/79 | A III 269;207 |

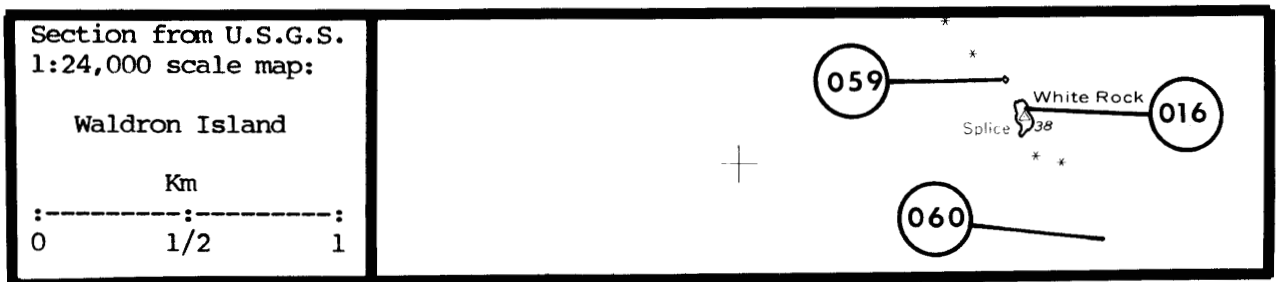
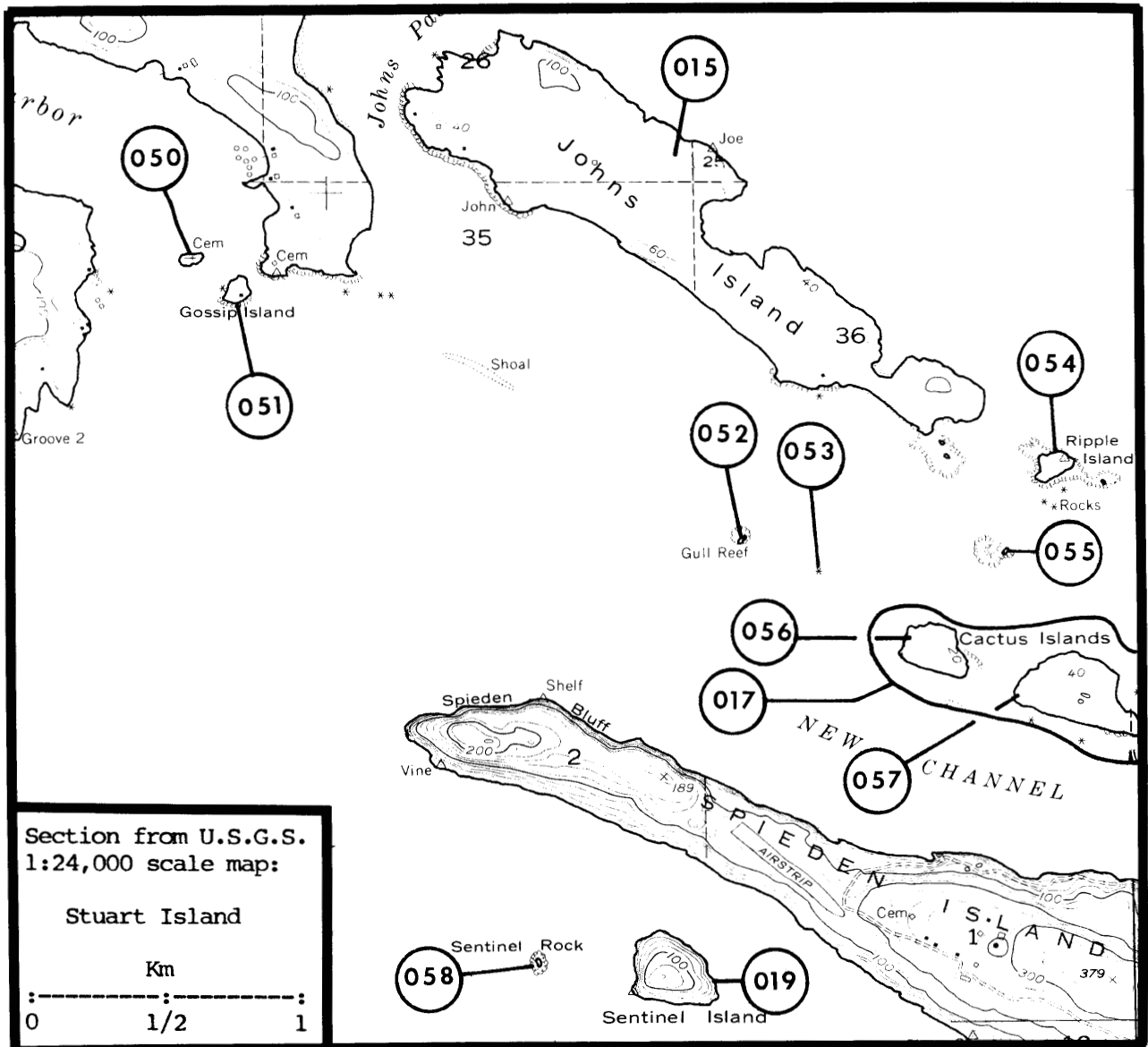

AREA 156, Victoria (cont'd.)

017

Cactus Islands¹ 48°39'00"N, 123°07'50"W

Black Oystercatcher

0

Nysewander

06/14/75

L III 205

¹The Cactus Islands were previously assigned this catalog number. The individual islands are here recognized, and data are assigned to them, (Cactus Island, west) 156056 and (Cactus Island, east) 156057, as appropriate.



White Rock (156016) 19 July 1982 T.R. Wahl

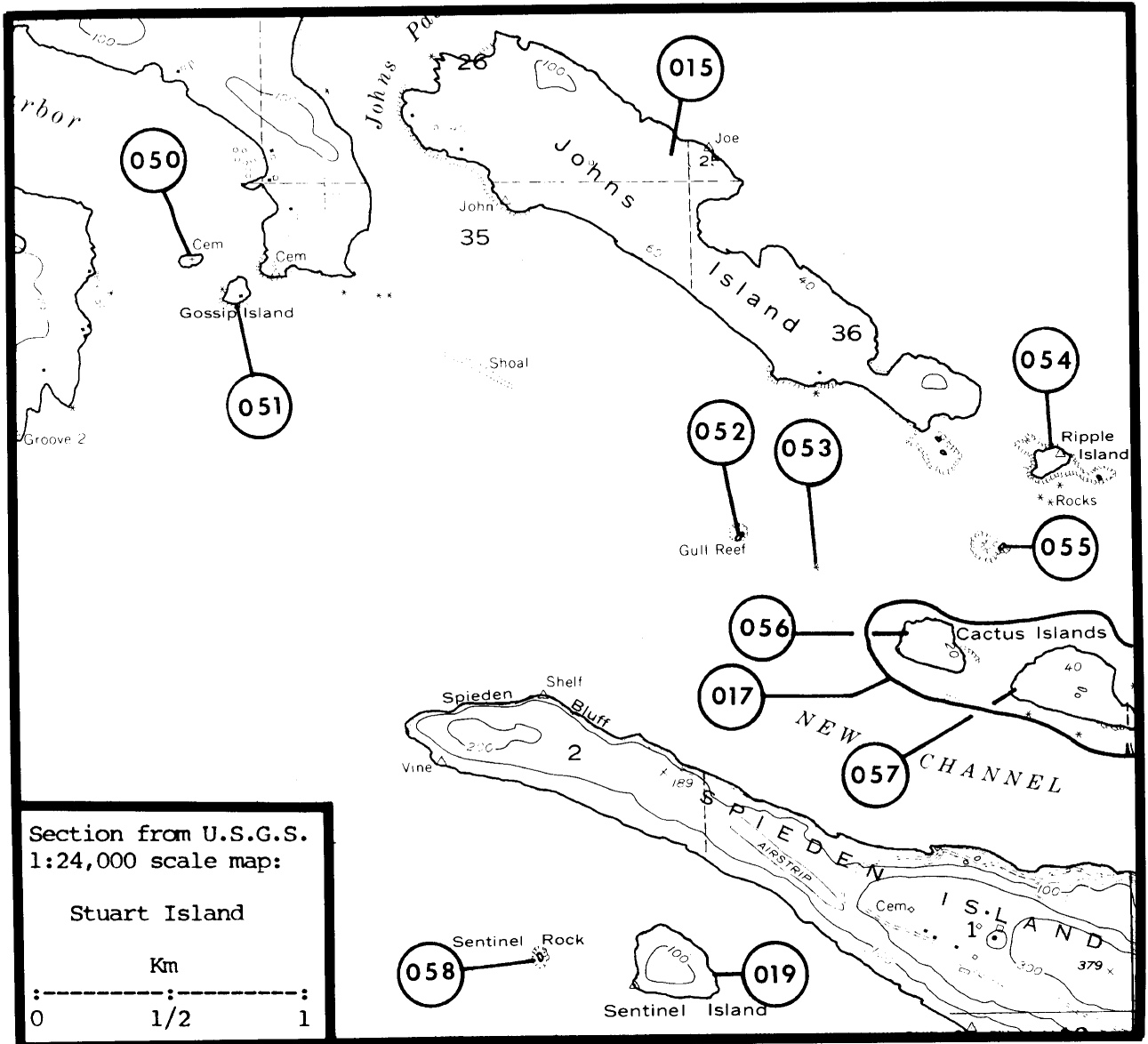

AREA 156, Victoria (cont'd.)

(018)

Gull Rock 48°39'04"N, 123°05'18"W

| | | | | |
|--------------------------|-----|------------|----------|-----------|
| Double-crested Cormorant | X | Richardson | ?/ ?/78 | ? ? 228 |
| Pelagic Cormorant | 15? | Wahl | 07/19/82 | A III 269 |
| Glaucous-winged Gull | 170 | Wahl | 06/14/79 | B III 269 |
| Pigeon Guillemot | 1 | Wahl | 06/14/79 | B III 269 |
| Total | 186 | | | |

| | | | | |
|--------------------------|------|-----------------------|-------------|---------------|
| Double-crested Cormorant | X | Richardson | ?/ ?/76 | ? ? 228 |
| Pelagic Cormorant | 4P | Nisqually NWR | 06/20/63 | B ? 202 |
| Pelagic Cormorant | 27P | Hauser & Monson 1963 | 07/16-17/63 | B ? 145 |
| Pelagic Cormorant | 75 | Nisqually NWR | 07/13-16/68 | L III 202 |
| Black Oystercatcher | 2P | Eddy | 05/31/57 | L III 95 |
| Black Oystercatcher | 2 | Bakus 1965 | 07/05/59 | L II 240 |
| Black Oystercatcher | 2P | Nisqually NWR | 06/20/63 | B ? 202 |
| Black Oystercatcher | X | Manuwal 1977 | ?/ ?/73-75 | L I 187 |
| Black Oystercatcher | 2 | Manuwal | 06/23/76 | L I 188 |
| Glaucous-winged Gull | 2 | Warburton | 06/25/27 | E - 275 |
| Glaucous-winged Gull | 15 | Edson 1929 | 06/26/05 | L II 98 |
| Glaucous-winged Gull | X | Finley | 07/29/24 | L III 104 |
| Glaucous-winged Gull | >4 | Warburton | 06/25/27 | E - 273 |
| Glaucous-winged Gull | 90+ | Rathbun | 06/11/28 | L III 223 |
| Glaucous-winged Gull | 200B | Schultz | ?/ ?/47 | L III 245 |
| Glaucous-winged Gull | 3 | Goodge | 07/14/48 | S - 116 |
| Glaucous-winged Gull | X | Schultz 1951 | ?/ ?/48 | L III 240 |
| Glaucous-winged Gull | 300B | Schultz | ?/ ?/48 | L III 245 |
| Glaucous-winged Gull | 330B | Schultz | ?/ ?/49 | L III 245 |
| Glaucous-winged Gull | 2 | Hudson | 07/08/49 | S - 149 |
| Glaucous-winged Gull | X | Hudson | 07/08/49 | L III 148 |
| Glaucous-winged Gull | 418 | Eddy | 05/31/57 | L II 95 |
| Glaucous-winged Gull | X | Bakus 1965 | 07/05/59 | L III 240 |
| Glaucous-winged Gull | 150B | Schultz | ?/ ?/60 | L III 245 |
| Glaucous-winged Gull | 400+ | Eddy | 08/11/62 | B III 95 |
| Glaucous-winged Gull | 500P | Nisqually NWR | 06/20/63 | B ? 202 |
| Glaucous-winged Gull | 500P | Hauser & Monson 1963 | 07/16-17/63 | B ? 145 |
| Glaucous-winged Gull | 300 | Nisqually NWR | 07/13-16/68 | L III 202 |
| Glaucous-winged Gull | X | Nisqually NWR | 07/27/70 | L III 202 |
| Glaucous-winged Gull | 250 | Manuwal 1977 | ?/ ?/73-75 | L II 187 |
| Glaucous-winged Gull | 392 | Manuwal 1973; Manuwal | 05/27/73 | L II 186;188 |
| Glaucous-winged Gull | 376 | Eddy | 06/08/74 | L II 95 |
| Glaucous-winged Gull | X | Manuwal | 06/23/76 | L III 188 |
| Glaucous-winged Gull | 200 | Pitman | 06/22/78 | B III 217 |
| Glaucous-winged Gull | 30 | Wahl | 07/19/82 | A III 269 |
| Pigeon Guillemot | 0 | Edson 1924 | 06/26/05 | L III 98 |
| Pigeon Guillemot | 2 | Warburton | 06/25/27 | E - 273 |
| Pigeon Guillemot | X | Hudson | 07/08/49 | L III 148 |
| Pigeon Guillemot | 12+ | Eddy | 05/31/57 | L III 95 |
| Pigeon Guillemot | X | Bakus 1965 | 07/05/59 | L III 240 |
| Pigeon Guillemot | 10 | Eddy | 08/11/62 | B III 95 |
| Pigeon Guillemot | 14 | Manuwal 1977 | ?/ ?/73-75 | L III 187 |
| Pigeon Guillemot | 2P | Manuwal 1973; Manuwal | 05/27/73 | L III 186;188 |
| Pigeon Guillemot | 15 | Eddy | 06/08/74 | L III 95 |
| Tufted Puffin | 1? | Hudson | 07/08/49 | L III 148 |

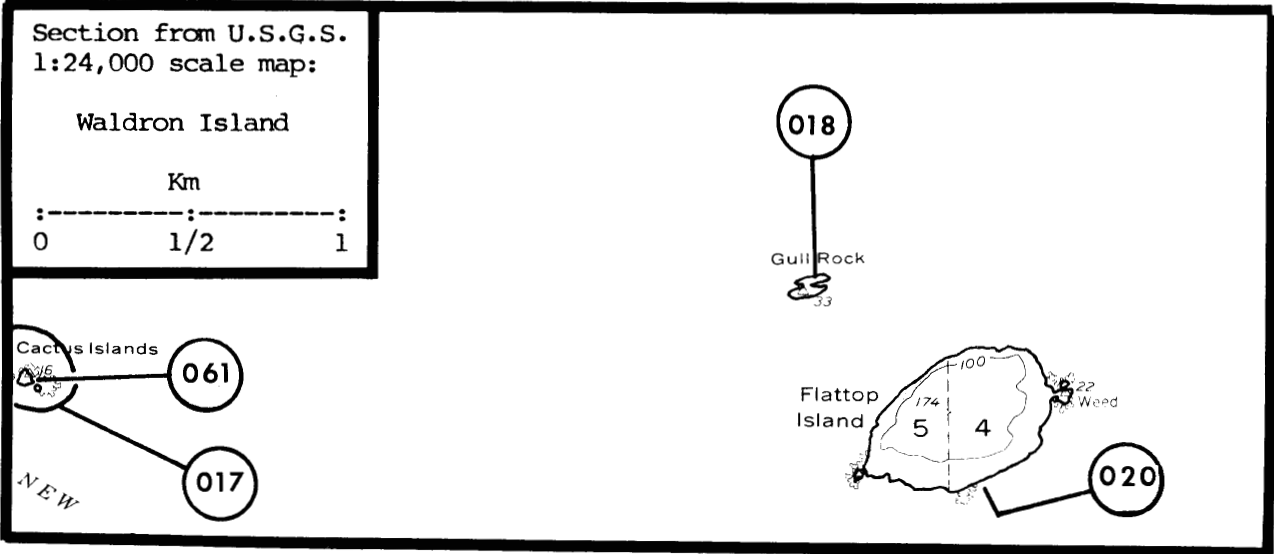

Gull Rock (156018) 19 July 1982 T.R. Wahl

AREA 156, Victoria (cont'd.)

019

Sentinel Island 48°38'24"N, 123°08'57"W

| | | | | |
|---------------------|----|-------------|----------------|-----------|
| Pigeon Guillemot | 13 | Wahl | 06/14/79 | B III 269 |
| No Nesting Observed | 0 | Eddy | 05/31-06/02/57 | B III 95 |
| Black Oystercatcher | 2 | Eddy 1975 | 06/14/75 | L II 94 |
| Black Oystercatcher | 3 | Nysewander | 06/14/75 | L II 205 |
| Pigeon Guillemot | 20 | Frazer 1973 | 07/16/73 | B III 108 |
| Pigeon Guillemot | 40 | Pitman | 06/22/78 | B III 217 |

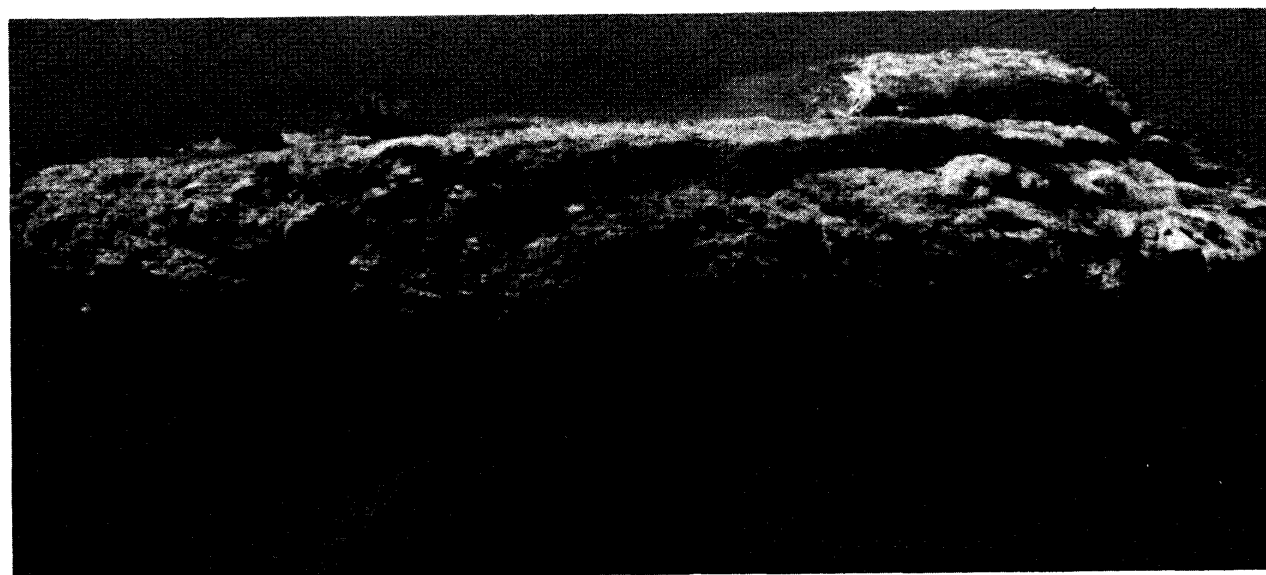

Flower Island (156022) 19 July 1982 T.R. Wahl

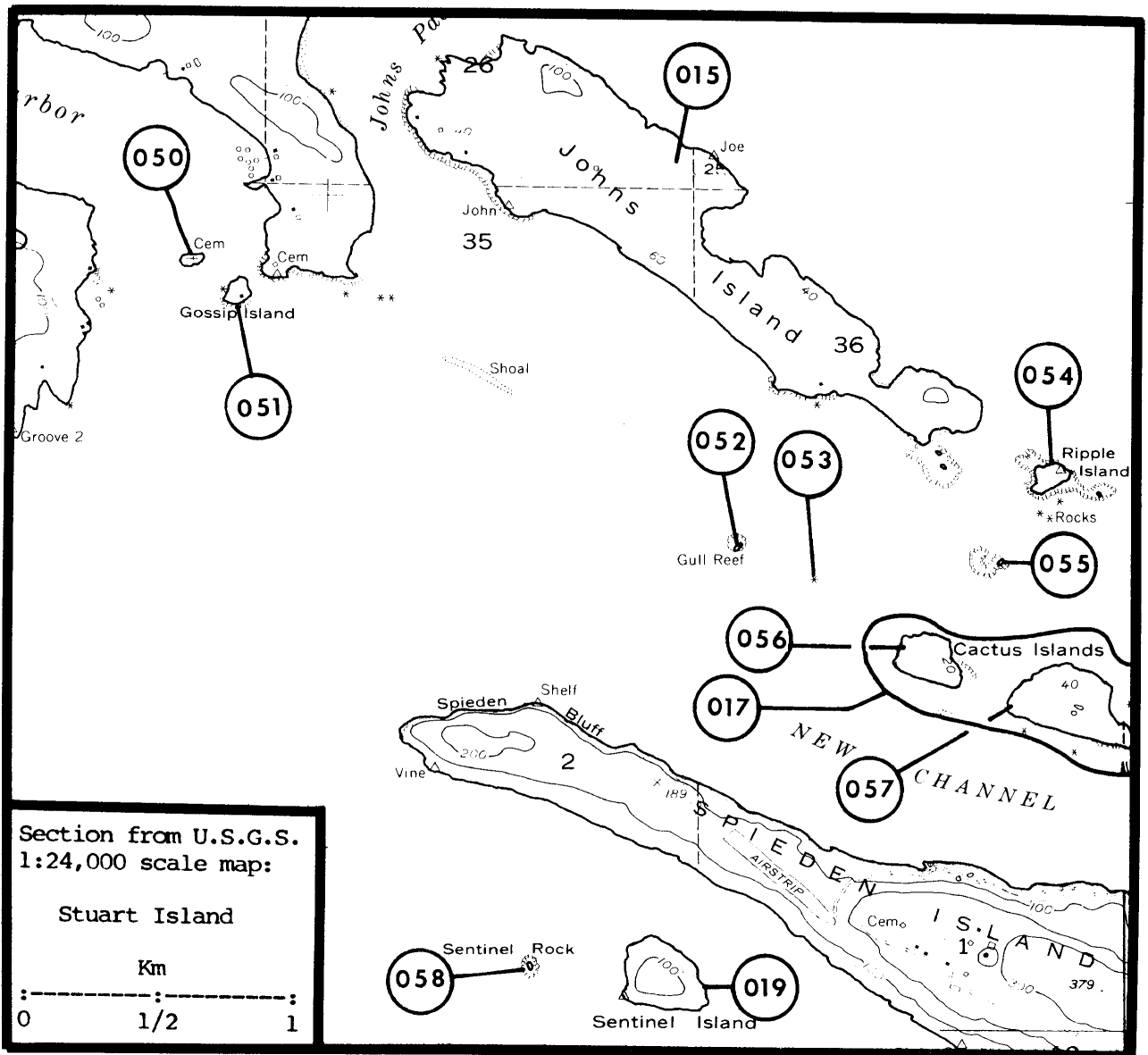

AREA 156, Victoria (cont'd.)

020

Flattop Island 48°38'51"N, 123°04'52"W

| | | | | | |
|---------------------|----|----------------------|------------|-------|-----|
| Black Oystercatcher | 2 | Washington Dep. Game | ? / ? / 79 | ? ? | 203 |
| Pigeon Guillemot | 40 | Pitman | 06/22/78 | B III | 217 |
| Total | 42 | | | | |

| | | | | | |
|--------------------------|-------|-----------------------|---------------|-------|----------|
| Double-crested Cormorant | N | Hudson | 07/08/49 | ? III | 148 |
| Double-crested Cormorant | 56 | Nisqually NWR | 07/27/70 | L II | 202 |
| Brandt's Cormorant | X | Rathbun | 06/12/28 | B III | 223 |
| Pelagic Cormorant | 32-36 | Edson 1929 | 06/20&24/05 | L II | 98 |
| Pelagic Cormorant | X | Lumley 1934 | ? / ? / 33 | ? ? | 184 |
| Pelagic Cormorant | X | Lumley 1934 | ? / ? / 34 | ? ? | 184 |
| Pelagic Cormorant | X | Hudson | 07/08/49 | ? III | 148 |
| Pelagic Cormorant | 2 | Eddy | 05/31/57 | B I | 95 |
| Pelagic Cormorant | 82 | Nisqually NWR | 07/27/70 | L II | 202 |
| Black Oystercatcher | 2 | Eddy | 05/31/57 | B III | 95 |
| Black Oystercatcher | P | Nisqually NWR | 07/27/70 | L III | 202 |
| Black Oystercatcher | 2 | Nysewander 1977; Eddy | 06/09/74 | L I | 204; 205 |
| Black Oystercatcher | 2 | Pitman | 06/22/78 | B I | 217 |
| Glaucous-winged Gull | 4 | Dennison | 06/12/1898 | E - | 86 |
| Glaucous-winged Gull | 2 | MacKay | 06/22/04 | S - | 185 |
| Glaucous-winged Gull | X | Edson 1929 | 06/20/05 | L III | 98 |
| Glaucous-winged Gull | 30-40 | Edson 1929 | 06/24/05 | L III | 98 |
| Glaucous-winged Gull | 2 | Decker | 06/18/19 | E - | 81 |
| Glaucous-winged Gull | 2 | Decker | 06/18/19 | E - | 82 |
| Glaucous-winged Gull | 80± | Decker | 06/18/19 | L III | 80 |
| Glaucous-winged Gull | X | Rathbun | 06/11-12/28 | L III | 223 |
| Glaucous-winged Gull | X | Lumley 1934 | ? / ? / 33 | ? ? | 184 |
| Glaucous-winged Gull | X | Lumley 1934 | ? / ? / 34 | ? ? | 184 |
| Glaucous-winged Gull | 95B | Schultz | ? / ? / 47 | L III | 245 |
| Glaucous-winged Gull | 30B | Schultz | ? / ? / 48 | L III | 245 |
| Glaucous-winged Gull | 30B | Schultz | ? / ? / 49 | L III | 245 |
| Glaucous-winged Gull | 100's | Hudson | 07/08/49 | ? III | 148 |
| Glaucous-winged Gull | 200+ | Eddy | 05/31/57 | B III | 95 |
| Glaucous-winged Gull | X | Bakus 1965 | 07/03-12/59 | ? ? | 240 |
| Glaucous-winged Gull | 350 | Nisqually NWR | 07/27/70 | L III | 202 |
| Glaucous-winged Gull | 15P | Frazer | 07/16/73 | B III | 108 |
| Glaucous-winged Gull | 18 | Eddy | 06/09/74 | L III | 95 |
| Pigeon Guillemot | 3 | MacKay | 06/22/04 | S - | 185 |
| Pigeon Guillemot | P | Edson 1929 | 06/20/05 | L III | 98 |
| Pigeon Guillemot | 2 | Edson 1929 | 06/24/05 | L II | 98 |
| Pigeon Guillemot | >2 | Kitchin | 06/14/34 | E - | 169 |
| Pigeon Guillemot | X | Hudson | 07/08/49 | ? III | 148 |
| Pigeon Guillemot | 20 | Eddy | 05/31/57 | B III | 95 |
| Pigeon Guillemot | >38 | Nisqually NWR | 07/27/70 | L III | 202 |
| Pigeon Guillemot | P | Manuwal 1977 | ? / ? / 73-75 | L III | 187 |
| Pigeon Guillemot | 4+ | Eddy | 06/09/74 | L III | 95 |
| Tufted Puffin | 1 | MacKay | 06/22/04 | S - | 185 |
| Tufted Puffin | 4-6 | Edson 1929 | 06/20/05 | L II | 98 |
| Tufted Puffin | 2 | Edson 1929 | 06/24/05 | L II | 98 |
| Tufted Puffin | 1 | Hudson | 07/08/49 | S - | 149 |

Section from U.S.G.S.
1:24,000 scale map:

Waldron Island

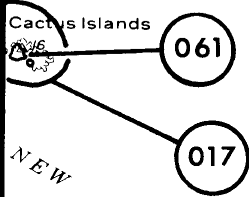
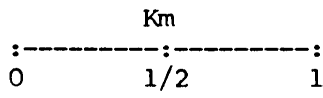

018

Gull Rock
33

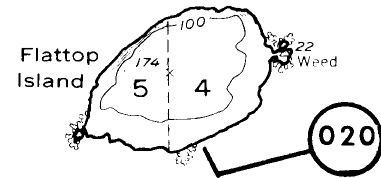

Pointer Island (156023) 19 July 1982 T.R. Wahl

AREA 156, Victoria (cont'd.)

021

Low Island 48°35'22"N, 123°01'27"W

| | | | | |
|----------------------|-----|-----------------------|-------------|---------------|
| Pigeon Guillemot | 4P | Pitman | 06/24/78 | B III 217 |
| No Nesting Observed | 0 | Eddy 1975 | 06/14/75 | B III 94 |
| Black Oystercatcher | 2 | Manuwal 1977 | ?/ ?/73-75 | L I 187 |
| Black Oystercatcher | 2P | Manuwal 1973 | 05/26/73 | L III 186 |
| Black Oystercatcher | 2 | Nysewander | 06/ ?/73 | L I 205 |
| Glaucous-winged Gull | X | Schultz 1952 | ?/?/51? | L III 241 |
| Glaucous-winged Gull | 1 | Schultz | 06/30/53 | S - 246 |
| Glaucous-winged Gull | X | Bakus 1965 | 07/03-12/59 | ? ? 240 |
| Glaucous-winged Gull | 20B | Schultz | ?/ ?/60 | L III 245 |
| Glaucous-winged Gull | 125 | Hauser & Monson 1963 | 07/16-17/63 | B III 145 |
| Glaucous-winged Gull | 150 | Manuwal 1977 | ?/ ?/73-75 | L II 187 |
| Glaucous-winged Gull | 136 | Manuwal 1973; Manuwal | 05/26/73 | L I 186;188 |
| Glaucous-winged Gull | 54+ | Manuwal | 06/23/76 | L III 188 |
| Pigeon Guillemot | 34 | Manuwal 1977 | ?/ ?/73-75 | L III 187 |
| Pigeon Guillemot | 35 | Manuwal 1973; Manuwal | 05/26/73 | L III 186;188 |
| Pigeon Guillemot | 13 | Manuwal | 06/23/76 | L III 188 |

022

Flower Island 48°32'43"N, 122°51'12"W

| | | | | |
|----------------------|----|--------|----------|-----------|
| Glaucous-winged Gull | 66 | Pitman | 06/21/78 | B III 217 |
| Pigeon Guillemot | 20 | Pitman | 06/21/78 | B III 217 |
| Total | 86 | | | |

| | | | | |
|----------------------|------|-----------------------------|-------------|-------------|
| Pelagic Cormorant | 8 | Thoresen & Galusha 1971 | 06/07/63 | L I 264 |
| Pelagic Cormorant | 4 | Thoresen & Galusha 1971 | 06-07/ ?/70 | L I 264 |
| Pelagic Cormorant | 34 | Manuwal 1977 | ?/ ?/73-75 | L I 187 |
| Pelagic Cormorant | 35 | Frazer 1973 | 07/17/73 | L I 108 |
| Pelagic Cormorant | 12 | Eddy | 06/07/74 | L I 95 |
| Black Oystercatcher | 2 | Eddy | 06/07/74 | L I 95 |
| Black Oystercatcher | 2 | Nysewander 1977; Nysewander | 06/ ?/75 | L I 204;205 |
| Black Oystercatcher | 2 | Eddy 1975 | 06/15/75 | L I 94 |
| Glaucous-winged Gull | 175B | Schultz | ?/ ?/48 | L III 245 |
| Glaucous-winged Gull | 170B | Schultz | ?/ ?/49 | L III 245 |
| Glaucous-winged Gull | X | Schultz 1951 | 06/21/50 | L III 240 |
| Glaucous-winged Gull | 1 | Schultz | 05/21/51 | S - 246 |
| Glaucous-winged Gull | 4 | Schultz | 06/05/54 | S - 246 |
| Glaucous-winged Gull | 1 | Schultz | 08/07/54 | S - 246 |
| Glaucous-winged Gull | 110B | Schultz | ?/ ?/55 | L III 245 |
| Glaucous-winged Gull | 20B | Schultz | ?/ ?/57 | L III 245 |
| Glaucous-winged Gull | 350 | Thoresen & Galusha 1971 | 06-07/ ?/63 | L III 264 |
| Glaucous-winged Gull | 270 | Thoresen & Galusha 1971 | 06-07/ ?/70 | L III 264 |
| Glaucous-winged Gull | 180 | Manuwal 1977 | ?/ ?/73-75 | L III 187 |
| Glaucous-winged Gull | 180 | Frazer 1973 | 07/17/73 | L III 108 |

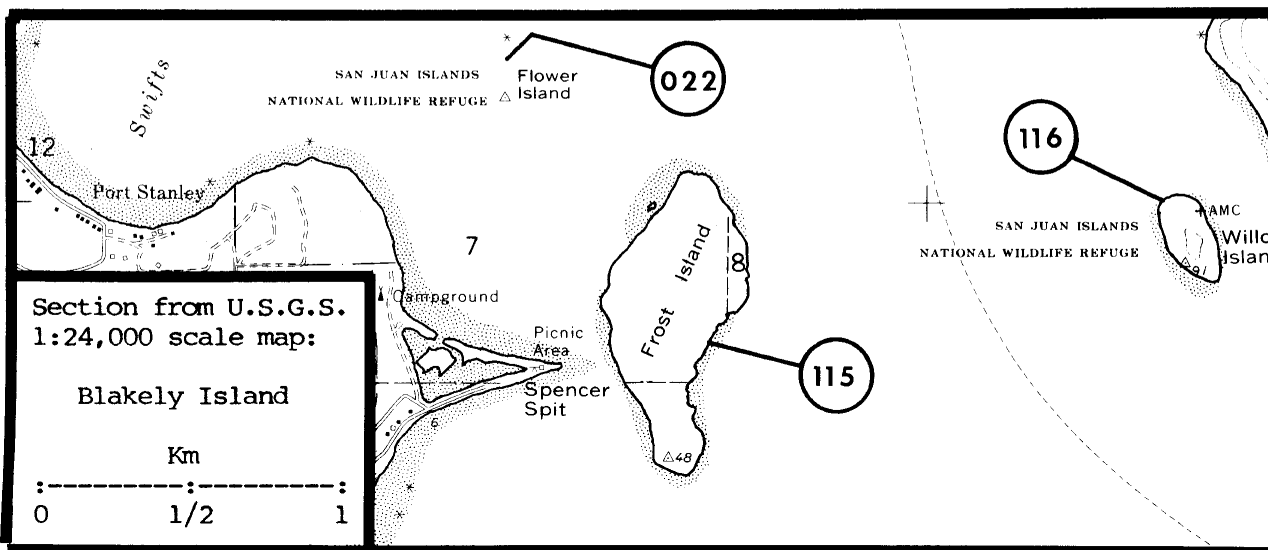
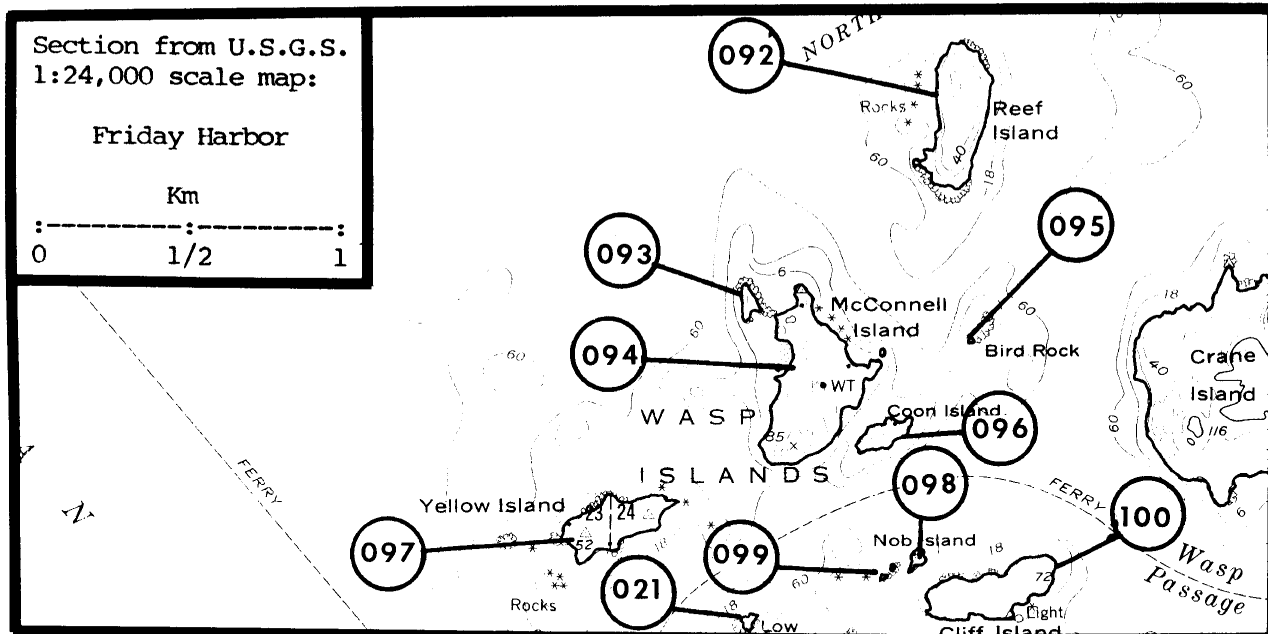

| | | | | | |
|----------------------|------|-------------------------|-------------|-------|-----|
| Glaucous-winged Gull | 180 | Eddy | 06/07/74 | L III | 95 |
| Glaucous-winged Gull | 160 | Eddy 1975 | 06/15/75 | L II | 94 |
| Glaucous-winged Gull | <200 | Wahl | 07/19/82 | A III | 269 |
| Pigeon Guillemot | 12 | Thoresen & Galusha 1971 | 06-07/ ?/63 | L III | 264 |
| Pigeon Guillemot | 16 | Thoresen & Galusha 1971 | 06-07/ ?/70 | L III | 264 |
| Pigeon Guillemot | 8 | Frazer 1973 | 07/17/73 | L III | 108 |
| Pigeon Guillemot | 41 | Eddy 1975 | 06/15/75 | L III | 94 |

AREA 156, Victoria (cont'd.)

(023)

Pointer Island 48°32'20"N, 122°46'50"W

| | | | | |
|----------------------|----|--------|----------|-----------|
| Black Oystercatcher | 2 | Pitman | 06/21/78 | B III 217 |
| Glaucous-winged Gull | 80 | Wahl | 06/15/79 | B II 269 |
| Pigeon Guillemot | 8 | Wahl | 05/15/79 | B II 269 |
| Total | 90 | | | |

| | | | | |
|----------------------|------|----------------------------|-------------|-----------|
| Black Oystercatcher | 2 | Thoresen & Galusha 1971 | 06-07/ ?/63 | L I 264 |
| Black Oystercatcher | 2 | Nisqually NWR | 06/20/63 | B II 202 |
| Black Oystercatcher | 2 | Thoresen & Galusha 1971 | 06-07/ ?/70 | L I 264 |
| Black Oystercatcher | 2-4 | Nysewander | 06/ ?/75 | L III 205 |
| Glaucous-winged Gull | 136 | Thoresen & Galusha 1971 | 06-07/ ?/63 | L II 264 |
| Glaucous-winged Gull | 100 | Nisqually NWR | 06/20/63 | B II 202 |
| Glaucous-winged Gull | 64 | Thoresen & Galusha 1971 | 06-07/ ?/70 | L II 264 |
| Glaucous-winged Gull | 116 | Eddy 1975 | 06/15/75 | L II 94 |
| Glaucous-winged Gull | 40 | Pitman | 06/21/78 | B II 217 |
| Glaucous-winged Gull | <100 | Wahl | 07/19/82 | A III 269 |
| Pigeon Guillemot | 4 | Thoresen & Galusha 1971 | 06-07/ ?/63 | L III 264 |
| Pigeon Guillemot | 4 | Nisqually NWR | 06/20/63 | B III 202 |
| Pigeon Guillemot | 4 | Thoresen & Galusha 1971 | 06-07/ ?/70 | L III 264 |
| Pigeon Guillemot | 5 | Eddy 1975 | 06/15/75 | L III 94 |
| Pigeon Guillemot | 7 | Pitman | 06/21/78 | B III 217 |

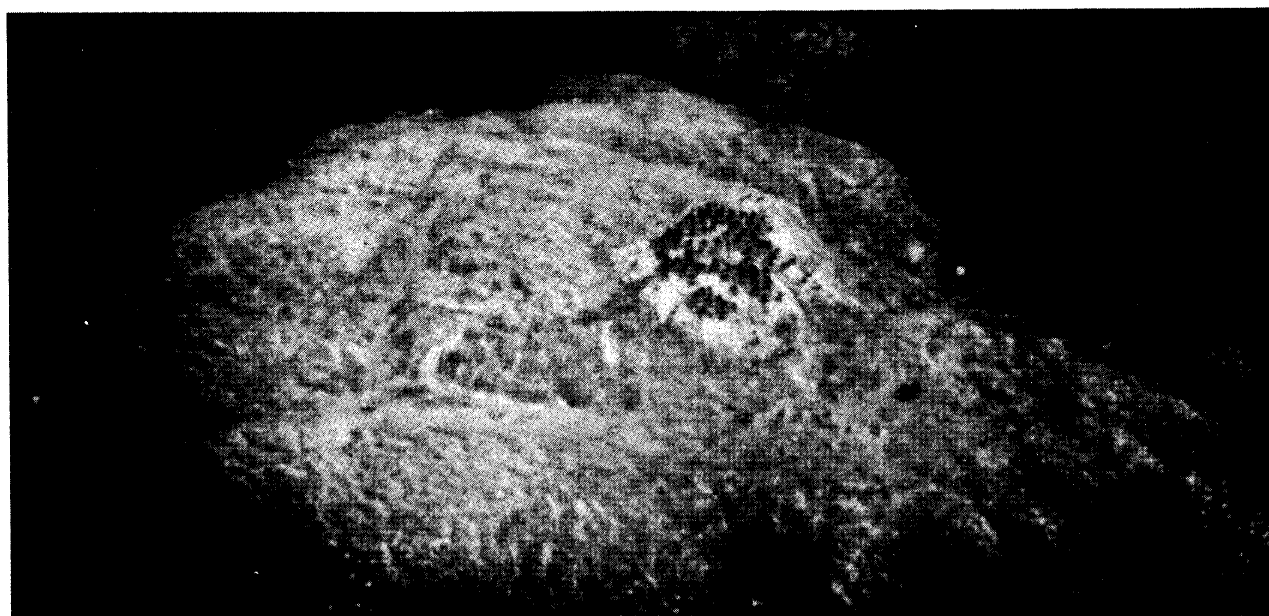

Bird Rocks (156024) 19 July 1982 T.R. Wahl

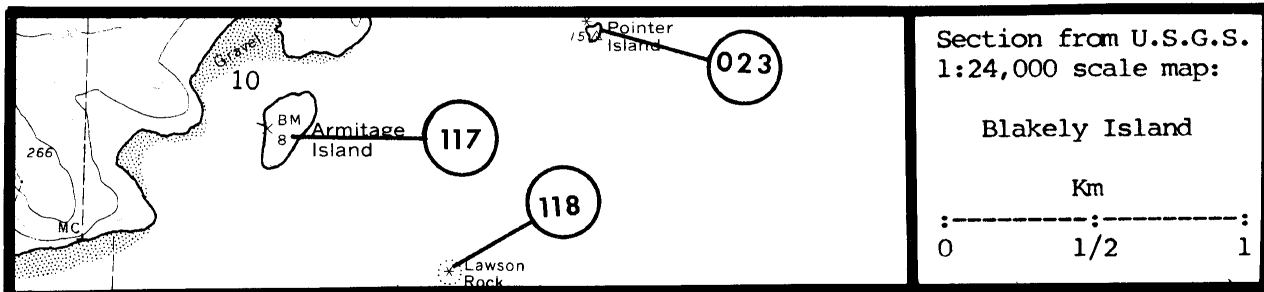

Bird Rocks (156024) USF&WS

AREA 156, Victoria (cont'd.)

024

Bird Rocks 48°29'08"N, 122°45'43"W

| | | | | | |
|--------------------------|-----|------|----------|-------|-----|
| Double-crested Cormorant | 190 | Wahl | 06/15/79 | B II | 269 |
| Pelagic Cormorant | 30 | Wahl | 06/15/79 | B II | 269 |
| Black Oystercatcher | 2 | Wahl | 06/15/79 | B III | 269 |
| Glaucous-winged Gull | 500 | Wahl | 06/15/79 | B III | 269 |
| Pigeon Guillemot | 15 | Wahl | 06/15/79 | B III | 269 |
| Total | 737 | | | | |

| | | | | | |
|--------------------------|---------|-------------------------|-------------|-------|-----|
| Double-crested Cormorant | 75 | Jewett 1937 | 05/25/37 | B II | 156 |
| Double-crested Cormorant | 0 | Thoresen & Galusha 1971 | 06-07/ ?/63 | L III | 264 |
| Double-crested Cormorant | 10 | Nisqually NWR | 08/21-23/67 | B ? | 202 |
| Double-crested Cormorant | 16 | Thoresen & Galusha 1971 | 06-07/ ?/70 | L I | 264 |
| Double-crested Cormorant | 60 | Frazer 1973 | 07/17/73 | B II | 108 |
| Double-crested Cormorant | 120-200 | Eddy 1975 | 06/15/75 | B III | 94 |
| Double-crested Cormorant | X | Manuwal | 06/26/76 | L III | 188 |
| Double-crested Cormorant | 182 | Pitman | 06/21/78 | B III | 217 |
| Double-crested Cormorant | 150 | Nisqually NWR | ?/ ?/80 | L II | 202 |
| Double-crested Cormorant | 212 | Wahl | 07/19/82 | A II | 269 |
| Pelagic Cormorant | 8-10 | Eddy | 06/02/57 | B III | 95 |
| Pelagic Cormorant | 38 | Eddy 1975 | 06/15/75 | B I | 94 |
| Pelagic Cormorant | 60 | Pitman | 06/21/78 | B I | 217 |
| Black Oystercatcher | 2 | Edson 1929 | 06/15-16/05 | L II | 98 |
| Black Oystercatcher | X | Brown | ?/ ?/18 | ? ? | 42 |
| Black Oystercatcher | 1 | Brown | 06/20/19 | S - | 43 |
| Black Oystercatcher | 1 | Eddy | 06/02/57 | B III | 95 |
| Black Oystercatcher | 2 | Thoreson & Galusha 1971 | 06-07/ ?/63 | L I | 264 |
| Black Oystercatcher | P | Nisqually NWR | 08/21-23/67 | B ? | 202 |
| Black Oystercatcher | 0 | Thoresen & Galusha 1971 | 06-07/ ?/70 | L III | 264 |
| Black Oystercatcher | 1 | Eddy 1975 | 06/15/75 | B III | 94 |
| Black Oystercatcher | 2 | Nysewander | 06/ ?/75 | B III | 205 |
| Black Oystercatcher | 2 | Manuwal | 06/26/76 | L I | 188 |
| Black Oystercatcher | 2 | Pitman | 06/21/78 | B III | 217 |
| Glaucous-winged Gull | 19 | Edson 1929 | 06/15-16/05 | L I | 98 |
| Glaucous-winged Gull | 2 | Decker | 06/20/19 | E - | 82 |
| Glaucous-winged Gull | 4 | Graves et al. | 06/20/19 | E - | 118 |
| Glaucous-winged Gull | 2 | Warburton | 06/20/19 | E - | 274 |
| Glaucous-winged Gull | 2 | Warburton | 06/20/19 | E - | 273 |
| Glaucous-winged Gull | 2 | Brown et al. | 06/20/19 | E - | 48 |
| Glaucous-winged Gull | 2 | Brown et al. | 06/20/19 | E - | 46 |
| Glaucous-winged Gull | 2 | Brown et al. | 06/20/19 | E - | 47 |
| Glaucous-winged Gull | 2 | Booth | 06/10/28 | E - | 33 |
| Glaucous-winged Gull | 400-500 | Jewett 1937 | 05/25/37 | B III | 156 |
| Glaucous-winged Gull | 300+ | Eddy | 06/02/57 | B III | 95 |
| Glaucous-winged Gull | 600 | Nisqually NWR | 06/05-06/62 | L III | 202 |
| Glaucous-winged Gull | 788 | Thoresen & Galusha 1971 | 06-07/ ?/63 | L II | 264 |
| Glaucous-winged Gull | 800 | Nisqually NWR | 06/20/63 | B III | 202 |
| Glaucous-winged Gull | 500 | Hauser & Monson 1963 | 07/16-17/63 | B III | 145 |
| Glaucous-winged Gull | X | Nisqually NWR | 08/21-23/67 | B III | 202 |
| Glaucous-winged Gull | X | Nisqually NWR | 07/13-16/68 | L III | 202 |

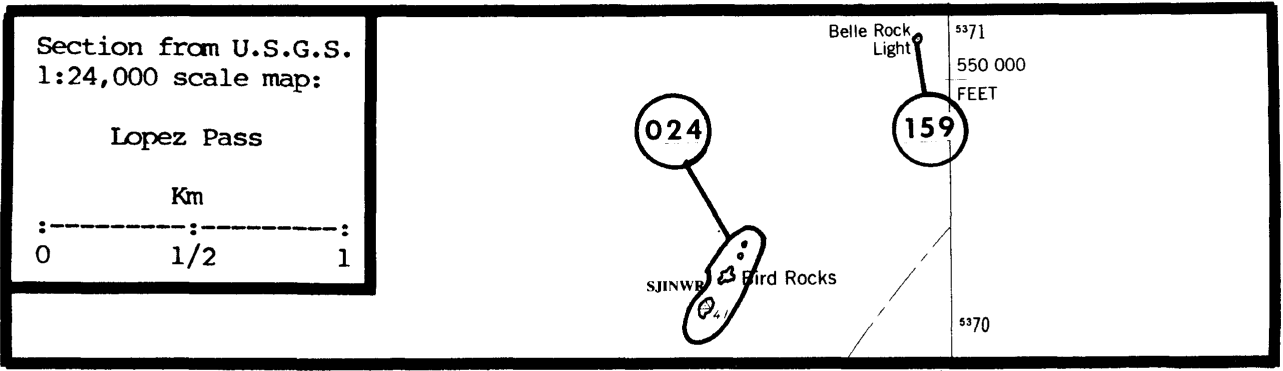

| | | | | | |
|----------------------|------|-------------------------|-------------|-------|-----|
| Glaucous-winged Gull | 1150 | Thoresen & Galusha 1971 | 06-07/ ?/70 | L III | 264 |
| Glaucous-winged Gull | 640 | Frazer 1973 | 07/17/73 | B III | 108 |
| Glaucous-winged Gull | 288 | Manuwal | 06/26/76 | L II | 188 |
| Glaucous-winged Gull | 490 | Pitman | 06/21/78 | B III | 217 |
| Glaucous-winged Gull | X | Wahl | 03/14/79 | B III | 269 |
| Glaucous-winged Gull | X | Nisqually NWR | ?/ ?/80 | L III | 202 |
| Glaucous-winged Gull | X | Wahl | 07/19/82 | A III | 269 |
| Pigeon Guillemot | 4 | Edson 1929 | 06/15-16/05 | L III | 98 |
| Pigeon Guillemot | 1 | Eddy | 06/02/57 | B III | 95 |
| Pigeon Guillemot | 4 | Galusha 1970 | ?/ ?/63 | L III | 110 |
| Pigeon Guillemot | 6 | Hauser & Monson 1963 | 07/16-17/63 | B III | 145 |
| Pigeon Guillemot | P | Nisqually NWR | 07/13-16/68 | L III | 202 |
| Pigeon Guillemot | 4 | Galusha 1970 | ?/ ?/70 | L III | 110 |
| Pigeon Guillemot | 5P | Frazer 1973 | 07/17/73 | B III | 108 |
| Pigeon Guillemot | 10 | Manuwal | 06/26/76 | L III | 188 |
| Pigeon Guillemot | 1 | Pitman | 06/21/78 | B III | 217 |
| Pigeon Guillemot | P | Wahl | 03/14/79 | B III | 269 |
| Tufted Puffin | 6 | Edson 1929 | 06/15-16/05 | L I | 98 |
| Tufted Puffin | 2 | Jewett 1937 | 05/25/37 | B II | 156 |
| Tufted Puffin | 1 | Bushnell | 08/16/42 | E - | 50 |

AREA 156, Victoria (cont'd.)

025

Williamson Rocks 48°27'03"N, 122°42'17"W

| | | | | | |
|--------------------------|-----|------|----------|-------|-----|
| Double-crested Cormorant | 146 | Wahl | 06/14/79 | B I | 269 |
| Pelagic Cormorant | 62 | Wahl | 06/14/79 | B I | 269 |
| Glaucous-winged Gull | 230 | Wahl | 06/14/79 | B III | 269 |
| Pigeon Guillemot | 26 | Wahl | 06/14/79 | B III | 269 |
| Total | 464 | | | | |

| | | | | | |
|--------------------------|-------|-------------------------|----------------|-------|--------|
| Double-crested Cormorant | 200? | Nisqually NWR | 06/05-06/62 | B ? | 202 |
| Double-crested Cormorant | 4P | Hauser & Monson 1963 | 07/16-17/63 | B III | 145 |
| Double-crested Cormorant | 20P | Nisqually NWR | 08/21-23/67 | L III | 202 |
| Double-crested Cormorant | 20 | Pitman | 06/21/78 | B I | 217 |
| Double-crested Cormorant | 262 | Wahl | 07/19/82 | A II | 269 |
| Pelagic Cormorant | 2 | Howsley | 06/19/37 | E - | 147 |
| Pelagic Cormorant | 12 | Thoresen & Booth 1958 | 06-09/ ?/57 | L I | 263 |
| Pelagic Cormorant | 6? | Nisqually NWR | 07/13-16/68 | B ? | 202 |
| Pelagic Cormorant | 134 | Eddy 1975 | 06/15/75 | L I | 94 |
| Pelagic Cormorant | 51 | Manuwal | 06/26/76 | L III | 188 |
| Pelagic Cormorant | 126 | Pitman | 06/21/78 | B I | 217 |
| Black Oystercatcher | 2 | Edson 1929 | 06/14-15/05 | L I | 98 |
| Black Oystercatcher | 2 | Thoresen & Booth 1958 | 06-09/ ?/57 | L I | 263 |
| Black Oystercatcher | 2 | Thoresen & Galusha 1971 | 06-07/ ?/63 | L I | 264 |
| Black Oystercatcher | 4P | Nisqually NWR | 07/13-16/68 | B ? | 202 |
| Black Oystercatcher | 0 | Thoresen & Galusha 1971 | 06-07/ ?/70 | L III | 264 |
| Black Oystercatcher | 2 | Eddy 1975; Nysewander | 06/15/75 | L I | 94;205 |
| Glaucous-winged Gull | 88 | Edson 1929 | 06/14-15/05 | L I | 98 |
| Glaucous-winged Gull | 240 | Dawson | 06/14-22/05 | L III | 76 |
| Glaucous-winged Gull | X | Dawson | 07/12/05 | L III | 76 |
| Glaucous-winged Gull | 2 | Hepburn | 05/31/12 | E - | 131 |
| Glaucous-winged Gull | 2 | Hepburn | [05/31/12] | E - | 131 |
| Glaucous-winged Gull | 2 | Booth | 05/30/30 | E - | 38 |
| Glaucous-winged Gull | 10 | Booth | 06/08/30 | E - | 38 |
| Glaucous-winged Gull | 10 | Howsley | 06/19/37 | E - | 147 |
| Glaucous-winged Gull | X | Schultz | ?/ ?/54 | L III | 245 |
| Glaucous-winged Gull | X | Booth | 08/ ?/54 | L III | 39 |
| Glaucous-winged Gull | 100's | Thoresen & Booth 1958 | 06-09/ ?/57 | L III | 263 |
| Glaucous-winged Gull | 800P | Nisqually NWR | 06/05-06/62 | B III | 202 |
| Glaucous-winged Gull | 500 | Thoresen & Galusha 1971 | 06-07/ ?/63 | L III | 264 |
| Glaucous-winged Gull | 450 | Hauser & Monson 1963 | 07/16-17/63 | B III | 145 |
| Glaucous-winged Gull | X | Nisqually NWR | 08/21-23/67 | L III | 202 |
| Glaucous-winged Gull | 700 | Nisqually NWR | 07/13-16/68 | B ? | 202 |
| Glaucous-winged Gull | 602 | Thoresen & Galusha 1971 | 06-07/ ?/70 | L II | 264 |
| Glaucous-winged Gull | 692 | Eddy 1975 | 06/15/75 | L II | 94 |
| Glaucous-winged Gull | >60 | Manuwal | 06/26/76 | L III | 188 |
| Glaucous-winged Gull | P | Thoresen 1980 | 06/23-08/03/77 | B III | 261 |
| Glaucous-winged Gull | 120+P | Harrington-Tweit | 04/02/78 | M III | 124 |
| Glaucous-winged Gull | 400 | Pitman | 06/21/78 | B III | 217 |
| Glaucous-winged Gull | X | Wahl | 03/13/79 | B III | 269 |
| Glaucous-winged Gull | X | Wahl | 07/19/82 | A III | 269 |
| Pigeon Guillemot | 2 | Edson | 06/15/03 | E - | 100 |
| Pigeon Guillemot | 12 | Edson 1929 | 06/14-15/05 | L III | 98 |

| | |
|--|--|
| <p>Section from U.S.G.S. 1:24,000 scale map:</p> <p>Deception Pass</p> <p>Km</p> <p>-----</p> <p>0 1/2 1</p> | <div data-bbox="1128 241 1218 325" style="text-align: center;"> <p>025</p> </div> <div data-bbox="1177 378 1258 462" style="text-align: center;">  </div> <p style="text-align: center;">SAN JUAN ISLANDS NATIONAL WILDLIFE REFUGE</p> <p style="text-align: right;">Williamson Rocks</p> |
|--|--|

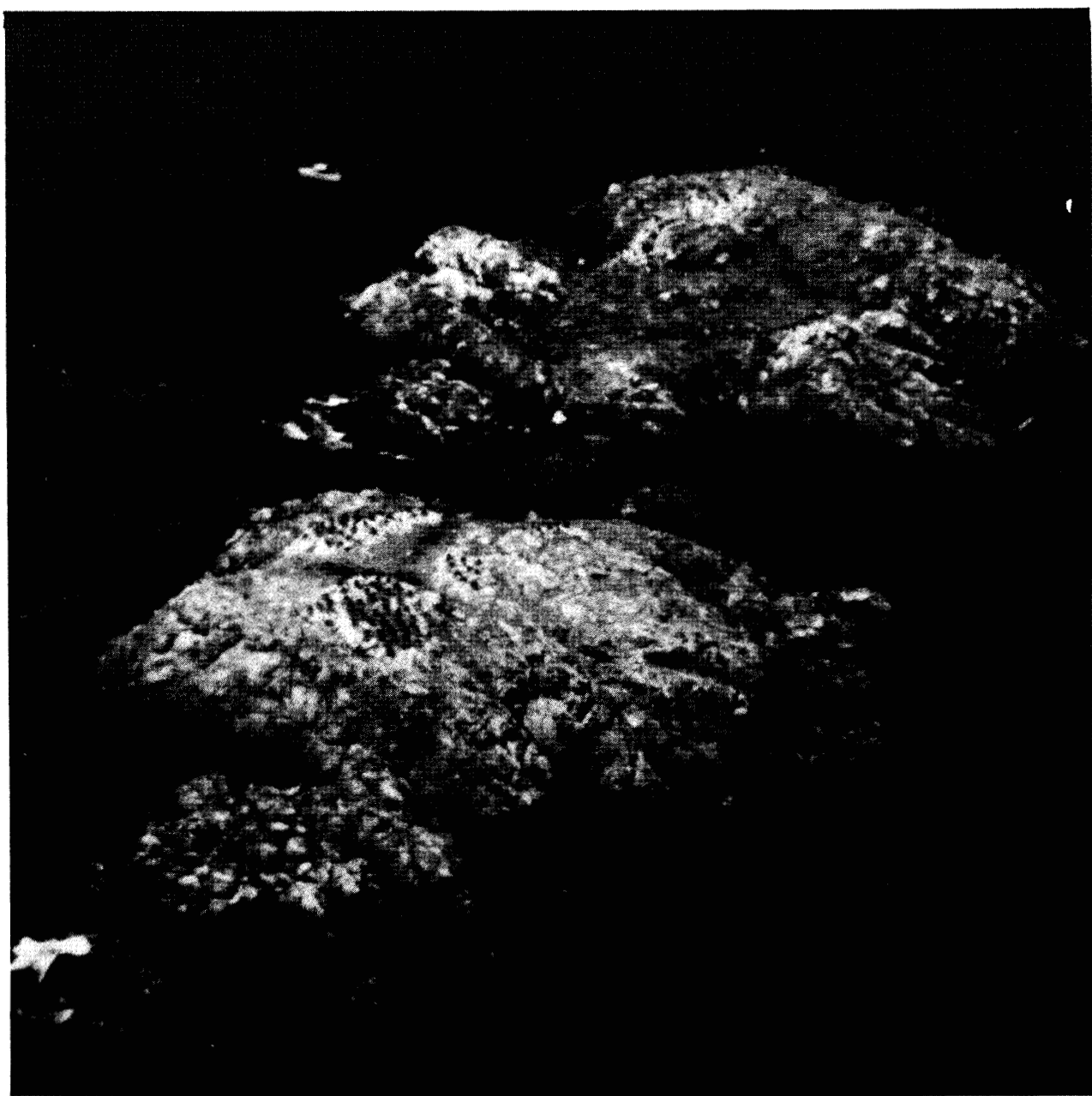

Williamson Rocks (156025) 19 July 1982 T.R. Wahl

AREA 156, Victoria (cont'd.)

| | | | | | |
|-------------------|---------|-------------------------|----------------|-------|-----|
| Pigeon Guillemot | 4 | Howsley | 06/19/37 | E - | 147 |
| Pigeon Guillemot | X | Thoresen & Booth 1958 | 06-09/ ?/57 | L III | 263 |
| Pigeon Guillemot | 20P | Nisqually NWR | 06/05-06/62 | B III | 202 |
| Pigeon Guillemot | 8 | Thoresen & Galusha 1971 | 06-07/ ?/63 | L II | 264 |
| Pigeon Guillemot | 37 | Hauser & Monson 1963 | 07/16-17/63 | B III | 145 |
| Pigeon Guillemot | 25 | Nisqually NWR | 06/21/67 | ? III | 202 |
| Pigeon Guillemot | 15 | Nisqually NWR | 08/21-23/67 | L III | 202 |
| Pigeon Guillemot | 50 | Nisqually NWR | 07/13-16/68 | B ? | 202 |
| Pigeon Guillemot | 0 | Thoresen & Galusha 1971 | 06-07/ ?/70 | L III | 264 |
| Pigeon Guillemot | 4 | Eddy 1975 | 06/15/75 | L II | 94 |
| Pigeon Guillemot | 12 | Manuwal | 06/26/76 | L III | 188 |
| Pigeon Guillemot | P | Thoresen 1980 | 06/23-08/03/77 | B III | 261 |
| Pigeon Guillemot | 50 | Pitman | 06/21/78 | B III | 217 |
| Rhinoceros Auklet | 1? | Thoresen 1980 | 06/23-08/03/77 | B III | 261 |
| Tufted Puffin | 12 | Edson 1929 | 06/14-15/05 | L II | 98 |
| Tufted Puffin | 4 | Booth | 06/10/28 | E - | 38 |
| Tufted Puffin | Several | Booth | 06/10/28 | L III | 32 |
| Tufted Puffin | 2 | Booth | 06/08/30 | E - | 38 |
| Tufted Puffin | Several | Booth | 06/08/30 | L III | 32 |
| Tufted Puffin | 16 | Thoresen & Booth 1958 | 06-09/ ?/57 | L II | 263 |
| Tufted Puffin | X | Thoresen 1981 | ?/ ?/57 | ? III | 262 |
| Tufted Puffin | X | Thoresen 1981 | ?/ ?/58 | ? III | 262 |
| Tufted Puffin | X | Thoresen 1981 | ?/ ?/59 | ? III | 262 |
| Tufted Puffin | X | Thoresen 1981 | ?/ ?/60 | ? III | 262 |
| Tufted Puffin | X | Thoresen 1981 | ?/ ?/61 | ? III | 262 |
| Tufted Puffin | X | Thoresen 1981 | ?/ ?/62 | ? III | 262 |
| Tufted Puffin | X | Thoresen 1981 | ?/ ?/63 | ? III | 262 |
| Tufted Puffin | 8 | Thoresen & Galusha 1971 | 06-07/ ?/63 | L I | 264 |
| Tufted Puffin | 1 | Hauser & Monson 1963 | 07/16-17/63 | B II | 145 |
| Tufted Puffin | X | Thoresen 1981 | ?/ ?/64 | ? III | 262 |
| Tufted Puffin | X | Thoresen 1981 | ?/ ?/65 | ? III | 262 |
| Tufted Puffin | X | Thoresen 1981 | ?/ ?/66 | ? III | 262 |
| Tufted Puffin | X | Thoresen 1981 | ?/ ?/67 | ? III | 262 |
| Tufted Puffin | 5P | Nisqually NWR | 06/21/67 | ? III | 202 |
| Tufted Puffin | X | Thoresen 1981 | ?/ ?/68 | ? III | 262 |
| Tufted Puffin | X | Thoresen 1981 | ?/ ?/69 | ? III | 262 |
| Tufted Puffin | X | Thoresen 1981 | ?/ ?/70 | ? III | 262 |
| Tufted Puffin | 0 | Thoresen & Galusha 1971 | 06-07/ ?/70 | B III | 264 |
| Tufted Puffin | X | Thoresen 1981 | ?/ ?/71 | ? III | 262 |
| Tufted Puffin | X | Thoresen 1981 | ?/ ?/72 | ? III | 262 |
| Tufted Puffin | X | Thoresen 1981 | ?/ ?/73 | ? III | 262 |
| Tufted Puffin | X | Thoresen 1981 | ?/ ?/74 | ? III | 262 |
| Tufted Puffin | X | Thoresen 1981 | ?/ ?/75 | ? III | 262 |
| Tufted Puffin | X | Thoresen 1981 | ?/ ?/76 | ? III | 262 |
| Tufted Puffin | 6+ | Thoresen 1981 | 07/24/77 | ? III | 262 |
| Tufted Puffin | P | Thoresen 1980 | 06/23-08/03/77 | B III | 261 |
| Tufted Puffin | 1 | Eddy 1975 | 06/15/75 | L III | 94 |

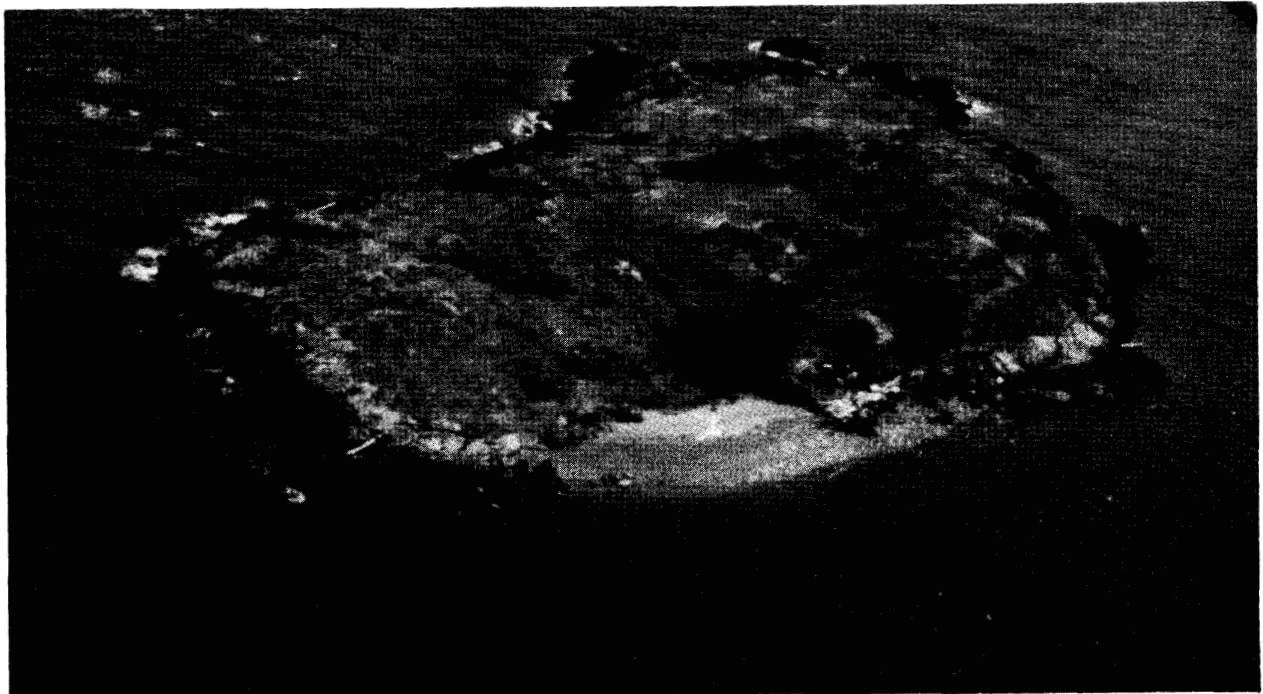
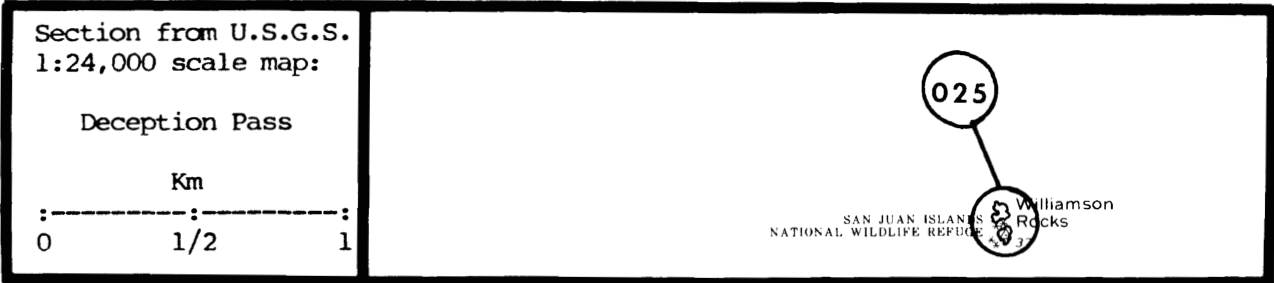

Goose Island (156026) 19 July 1982 T.R. Wahl

AREA 156, Victoria (cont'd.)

026

Goose Island 48°27'30"N, 122°57'18"W

| | | | | |
|----------------------|-----|------------|----------|---------|
| Black Oystercatcher | 4 | Eaton 1980 | 06/ ?/78 | L I 93 |
| Glaucous-winged Gull | 102 | Eaton 1980 | 06/ ?/78 | L II 93 |
| Total | 106 | | | |

| | | | | |
|----------------------|------|-------------|-------------|-----------|
| No Nesting Observed | 0 | Jewett 1937 | 05/27/37 | B III 156 |
| Black Oystercatcher | 1 | Richardson | 08/15/57 | S - 230 |
| Black Oystercatcher | 4 | Eddy | 06/08/74 | L I 95 |
| Black Oystercatcher | 4 | Eaton 1980 | ?/ ?/74 | L I 93 |
| Black Oystercatcher | 4 | Eaton 1980 | 06-07/ ?/77 | L I 93 |
| Glaucous-winged Gull | 120 | Frazer 1973 | 07/17/73 | B III 108 |
| Glaucous-winged Gull | 108 | Eddy | 06/08/74 | L I 95 |
| Glaucous-winged Gull | 66 | Eaton 1980 | 06-07/ ?/77 | L I 93 |
| Glaucous-winged Gull | <100 | Wahl | 07/19/82 | A III 269 |

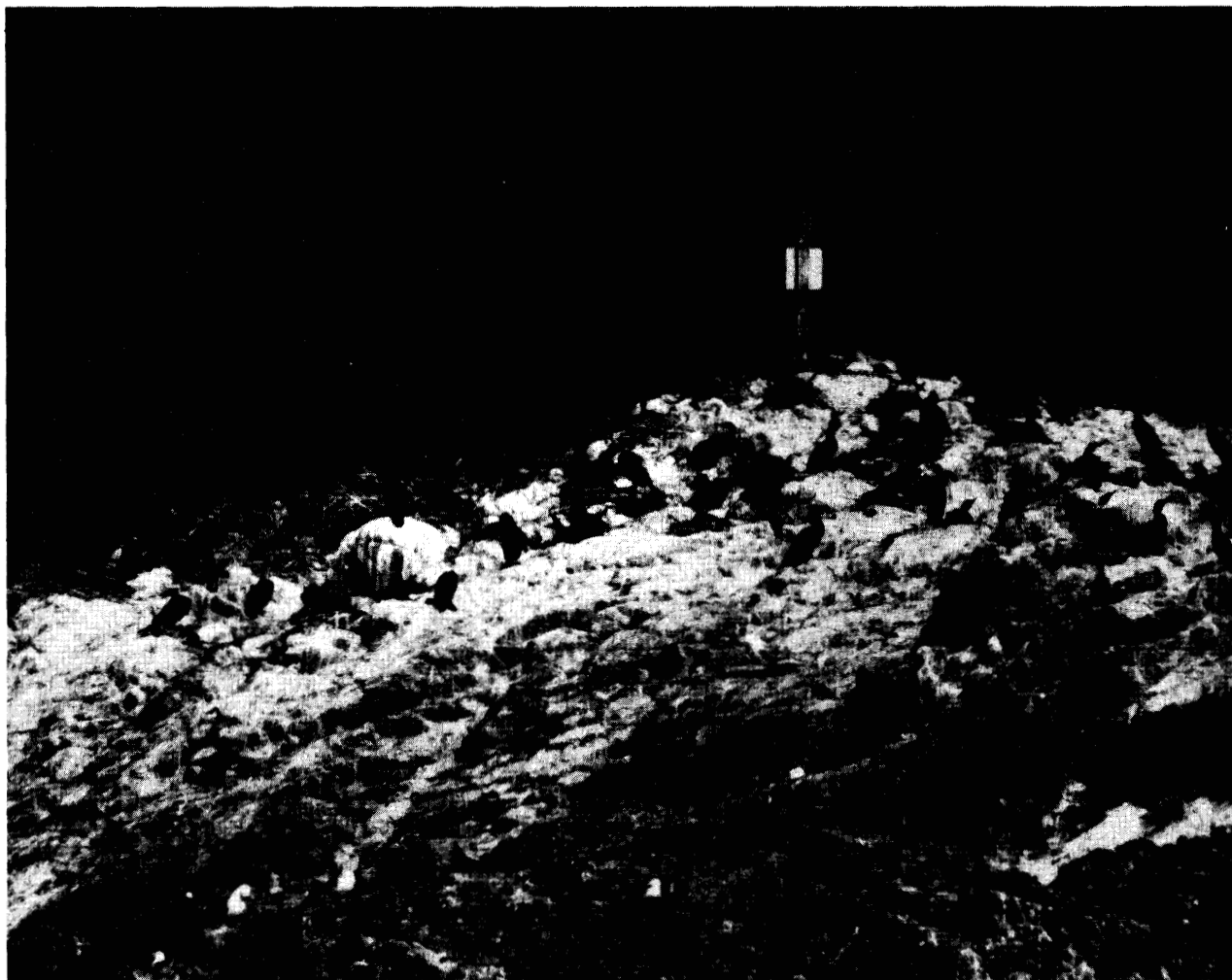

Bird Rocks, south (156024) 21 June 1978, R.L. Pitman Double-crested Cormorants

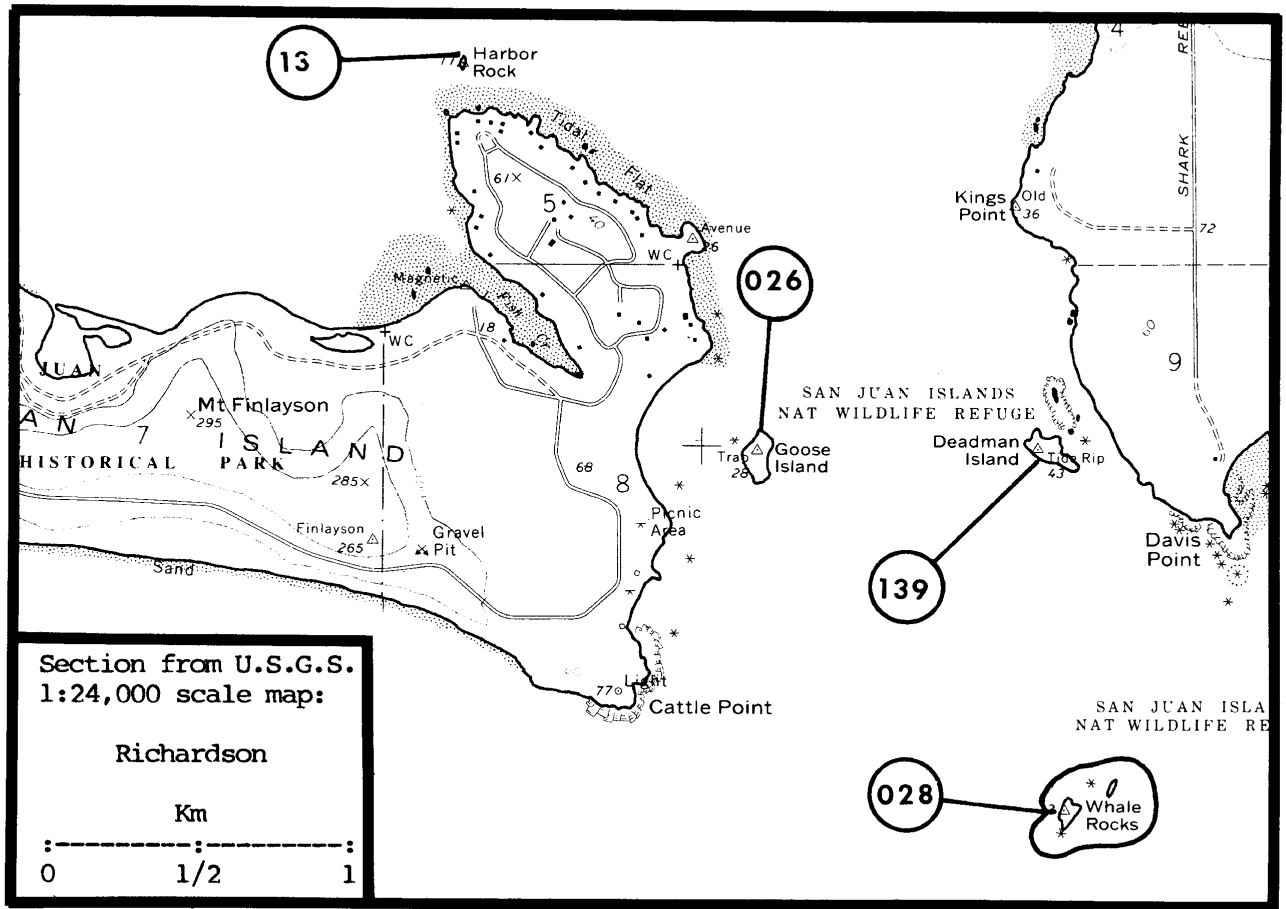

AREA 156, Victoria (cont'd.)

027 Mummy Rocks 48°26'54"N, 122°55'40"W

| | | | | |
|----------------------|-----------|--------|----------|-----------|
| Black Oystercatcher | 1 | Pitman | 06/20/78 | B III 217 |
| Glaucous-winged Gull | 50 | Pitman | 06/20/78 | B III 217 |
| Total | <u>51</u> | | | |

| | | | | |
|----------------------|------|----------------------|-------------|-----------|
| Black Oystercatcher | 5 | Eddy | 07/03/61 | B III 95 |
| Black Oystercatcher | 2 | Hauser & Monson 1963 | 07/16-17/63 | B III 145 |
| Glaucous-winged Gull | 100+ | Eddy | 07/03/61 | B III 95 |
| Glaucous-winged Gull | 60 | Hauser & Monson 1963 | 07/16-17/63 | B III 145 |
| Glaucous-winged Gull | 110 | Frazer 1973 | 07/17/73 | B III 108 |
| Glaucous-winged Gull | 35? | Wahl | 07/19/82 | A III 269 |

028 Whale Rocks 48°26'51"N, 122°56'26"W

| | | | | |
|----------------------|----------|--------|----------|----------|
| Black Oystercatcher | 2 | Pitman | 06/20/78 | B II 217 |
| Glaucous-winged Gull | 5 | Pitman | 06/20/78 | B II 217 |
| Total | <u>7</u> | | | |

| | | | | |
|----------------------|-----|---------------|-------------|-----------|
| Black Oystercatcher | 2 | Manuwal 1977 | ?/ ?/73-75 | L I 187 |
| Black Oystercatcher | 2 | Nysewander | 06-07/ ?/73 | B III 205 |
| Glaucous-winged Gull | 25? | Nisqually NWR | 06/20/63 | B ? 202 |
| Glaucous-winged Gull | 89 | Frazer 1973 | 07/17/73 | B III 108 |

029 Long Island 48°26'32"N, 122°55'20"W

| | | | | |
|----------------------|-----------|--------|----------|----------|
| Black Oystercatcher | 2 | Pitman | 06/20/78 | B II 217 |
| Glaucous-winged Gull | 20 | Pitman | 06/20/78 | B II 217 |
| Total | <u>22</u> | | | |

| | | | | |
|----------------------|-----|-------------|-------------|-----------|
| Black Oystercatcher | 9 | Frazer 1973 | 07/17/73 | B II 108 |
| Black Oystercatcher | 10 | Nysewander | 06-07/ ?/73 | B III 205 |
| Black Oystercatcher | 12? | Nysewander | 03/22/74 | B III 205 |
| Black Oystercatcher | 8 | Eddy | 06/08/74 | L II 95 |
| Glaucous-winged Gull | 125 | Frazer 1973 | 07/17/73 | B III 108 |
| Glaucous-winged Gull | 274 | Eddy | 06/08/74 | L II 95 |
| Pigeon Guillemot | 1 | Wahl | 05/19/78 | B III 269 |

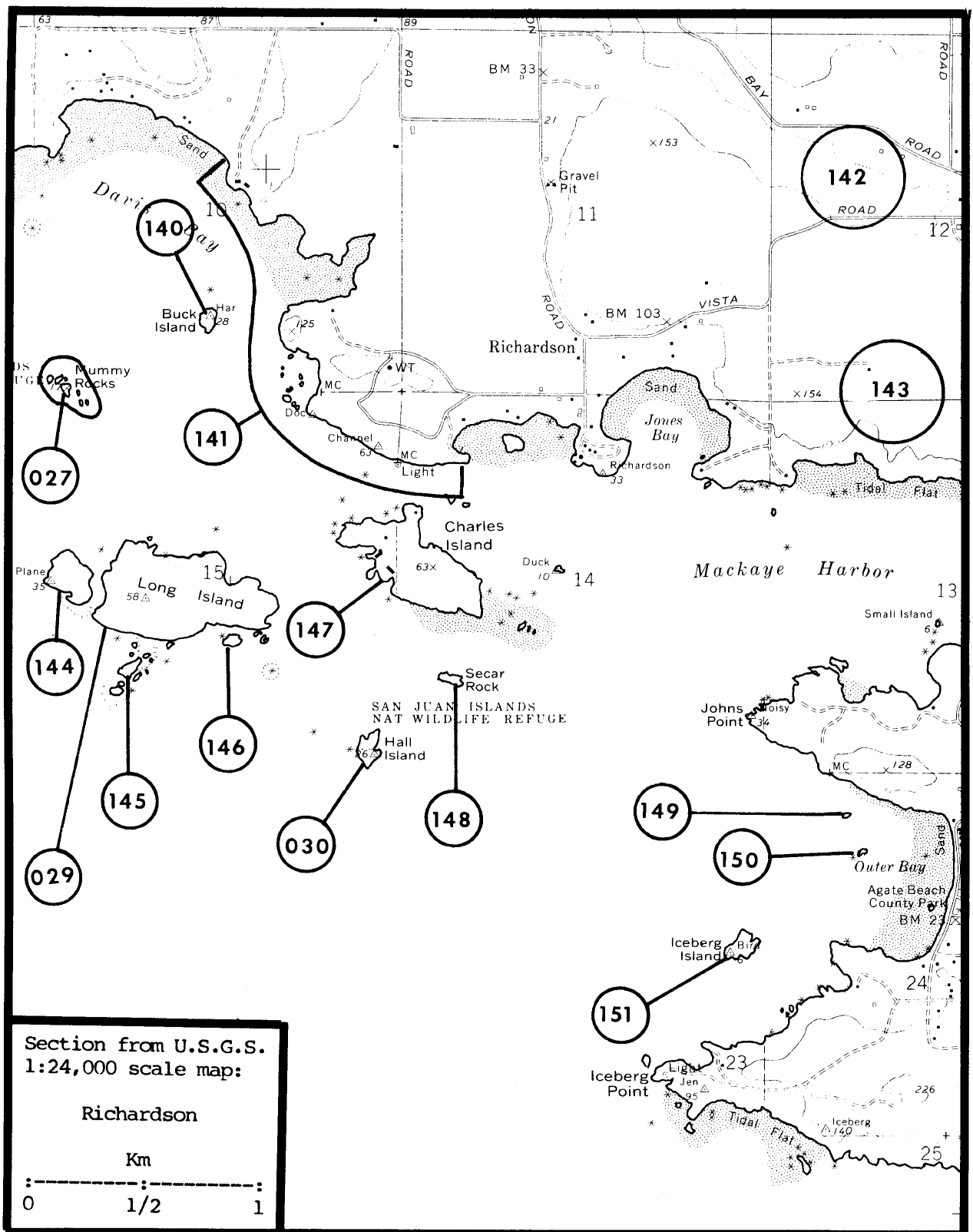

AREA 156, Victoria (cont'd.)

030 Hall Island 48°26'06"N, 122°54'37"W

| | | | | | |
|----------------------|-----|--------|----------|-------|-----|
| Pelagic Cormorant | 24 | Pitman | 06/20/78 | B I | 217 |
| Black Oystercatcher | 1 | Pitman | 06/20/78 | B III | 217 |
| Glaucous-winged Gull | 500 | Pitman | 06/20/78 | B III | 217 |
| Pigeon Guillemot | 6 | Pitman | 06/20/78 | B II | 217 |
| Total | 531 | | | | |

| | | | | | |
|--------------------------|-------|----------------------|--------------|-------|-----|
| Cormorant sp. | 100? | Devan | 04/28/71 | ? III | 87 |
| Double-crested Cormorant | X | Stopps | 07/16-17/66 | ? III | 258 |
| Pelagic Cormorant | 10P | Nisqually NWR | 06/20/63 | B ? | 202 |
| Pelagic Cormorant | 18 | Hauser & Monson | 07/16-17/63 | B II | 145 |
| Pelagic Cormorant | X | Stopps | 07/16-17 66 | ? III | 258 |
| Pelagic Cormorant | 25 | Nisqually NWR | 06/13-16/68 | L II | 202 |
| Pelagic Cormorant | 30N | Frazer 1973 | 07/17/73 | B ? | 108 |
| Black Oystercatcher | 2 | Eddy | 07/03/61 | L I | 95 |
| Black Oystercatcher | 8P | Schultz | 07/18/64 | L III | 242 |
| Black Oystercatcher | 2P | Nysewander 1977 | ?/ ?/73-74 | L III | 204 |
| Black Oystercatcher | 2 | Nysewander | 06/ ?/73 | L I | 205 |
| Black Oystercatcher | 2 | Manuwal | 06/26/76 | L I | 188 |
| Glaucous-winged Gull | X | Schultz 1952 | 07/21/48-51? | L III | 241 |
| Glaucous-winged Gull | 400B | Schultz | ?/ ?/48 | L III | 245 |
| Glaucous-winged Gull | 400B | Schultz | ?/ ?/49 | L III | 245 |
| Glaucous-winged Gull | X | Schultz 1952 | ?/ ?/51? | L III | 241 |
| Glaucous-winged Gull | 310B | Schultz | ?/ ?/55 | L III | 245 |
| Glaucous-winged Gull | 325B | Schultz | ?/ ?/60 | L III | 245 |
| Glaucous-winged Gull | 100's | Eddy | 07/03/61 | L III | 95 |
| Glaucous-winged Gull | 260B | Schultz | ?/ ?/63 | L III | 245 |
| Glaucous-winged Gull | 1000 | Nisqually NWR | 06/20/63 | B III | 202 |
| Glaucous-winged Gull | 600 | Hauser & Monson 1963 | 07/16-17/63 | B III | 145 |
| Glaucous-winged Gull | X | Schultz | 07/18/64 | L III | 242 |
| Glaucous-winged Gull | X | Schultz | ?/ ?/65 | L III | 245 |
| Glaucous-winged Gull | 1000 | Nisqually NWR | 07/13-16/68 | L III | 202 |
| Glaucous-winged Gull | 750 | Devan | 04/28/71 | ? III | 87 |
| Glaucous-winged Gull | 530B | Wahl | 07/10/71 | L III | 269 |
| Glaucous-winged Gull | 340B | Wahl | 07/09/72 | L III | 269 |
| Glaucous-winged Gull | 410B | Wahl | 07/08/73 | L III | 269 |
| Glaucous-winged Gull | 480 | Frazer 1973 | 07/17/73 | B ? | 108 |
| Glaucous-winged Gull | X | Manuwal | 06/26/76 | L III | 188 |
| Glaucous-winged Gull | X | Wahl | 03/13/79 | B III | 269 |
| Glaucous-winged Gull | 700 | Wahl | 06/14/79 | B III | 145 |
| Glaucous-winged Gull | <1000 | Wahl | 07/19/82 | A III | 269 |
| Pigeon Guillemot | 2 | Hauser & Monson | 07/16-17/63 | B III | 145 |
| Pigeon Guillemot | P | Nisqually NWR | 07/13-16/68 | L III | 202 |
| Pigeon Guillemot | 5P | Frazer 1973 | 07/17/73 | L III | 108 |
| Pigeon Guillemot | 2 | Manuwal | 06/26/76 | L III | 188 |
| Pigeon Guillemot | 6 | Wahl | 05/19/78 | B III | 269 |

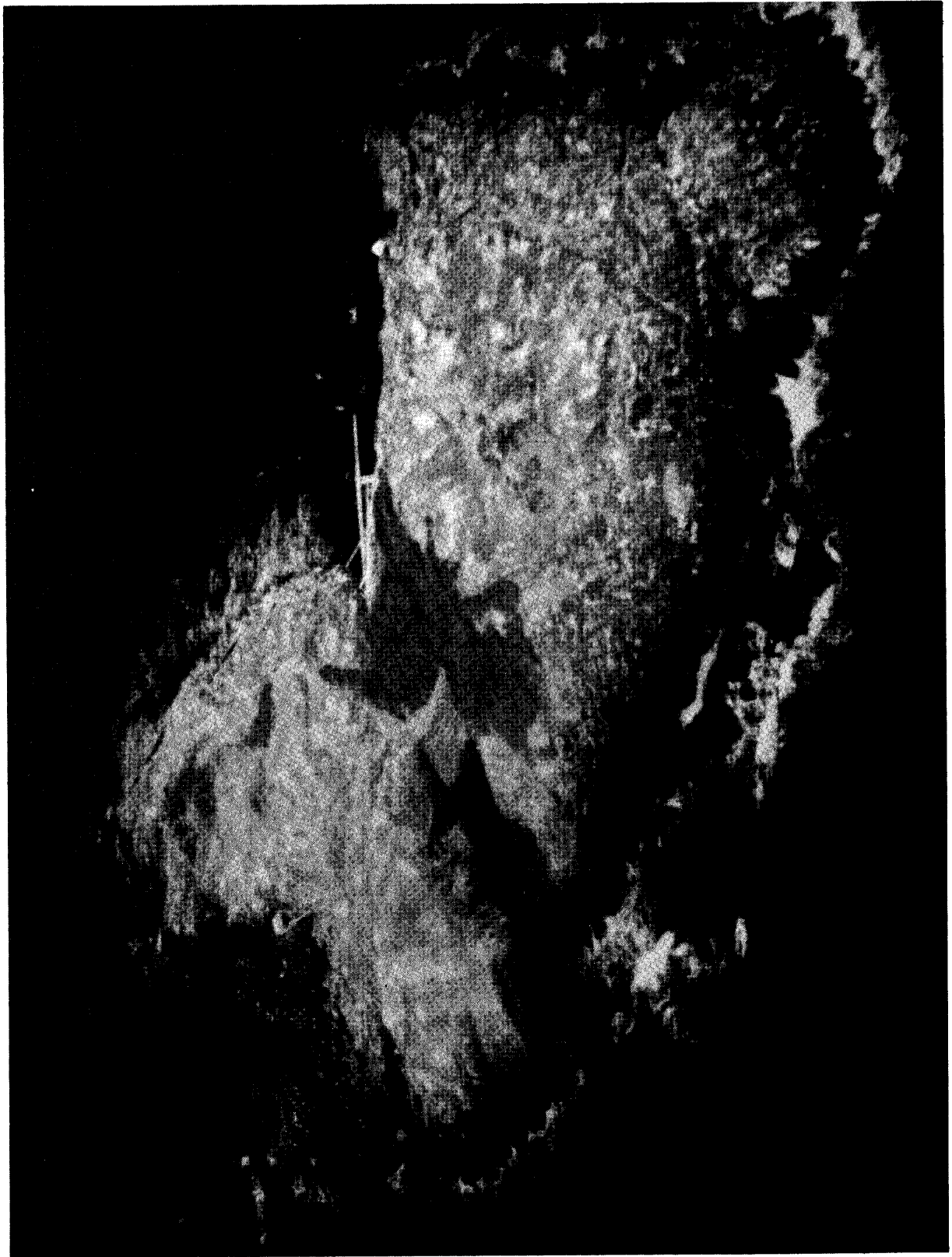

Hall Island (156030) 19 July 1982 T.R. Wahl

AREA 156, Victoria (cont'd.)

(031) Castle Island 48°25'20"N, 122°49'13"W

| | | | | |
|-------------------|-----|------|----------|-----------|
| Pelagic Cormorant | 190 | Wahl | 07/19/82 | A II 269 |
| Pigeon Guillemot | 130 | Wahl | 06/14/79 | B III 269 |
| Total | 320 | | | |

| | | | | |
|--------------------------|---------|-------------|----------|-----------|
| No Nesting Observed | 0 | Eddy | 07/03/61 | B III 95 |
| Cormorant sp. | X | Jewett 1937 | 05/25/37 | B III 156 |
| Double-crested Cormorant | 28 | Frazer 1973 | 07/17/73 | B I 108 |
| Pelagic Cormorant | 100-200 | Wahl | 06/09/74 | B II 269 |
| Glaucous-winged Gull | 0 | Wahl | 07/19/82 | A III 269 |
| Pigeon Guillemot | 200± | Rathbun | 06/11/28 | B III 223 |
| Pigeon Guillemot | X | Jewett 1937 | 05/25/37 | B III 156 |
| Pigeon Guillemot | 45 | Frazer 1973 | 07/17/73 | B III 108 |
| Pigeon Guillemot | 8+ | Manuwal | 06/26/76 | B III 188 |
| Pigeon Guillemot | 167 | Wahl | 05/19/78 | B III 269 |
| Pigeon Guillemot | 60 | Pitman | 06/20/78 | B III 217 |



Castle Island (156031) 9 June 1974 T.R. Wahl

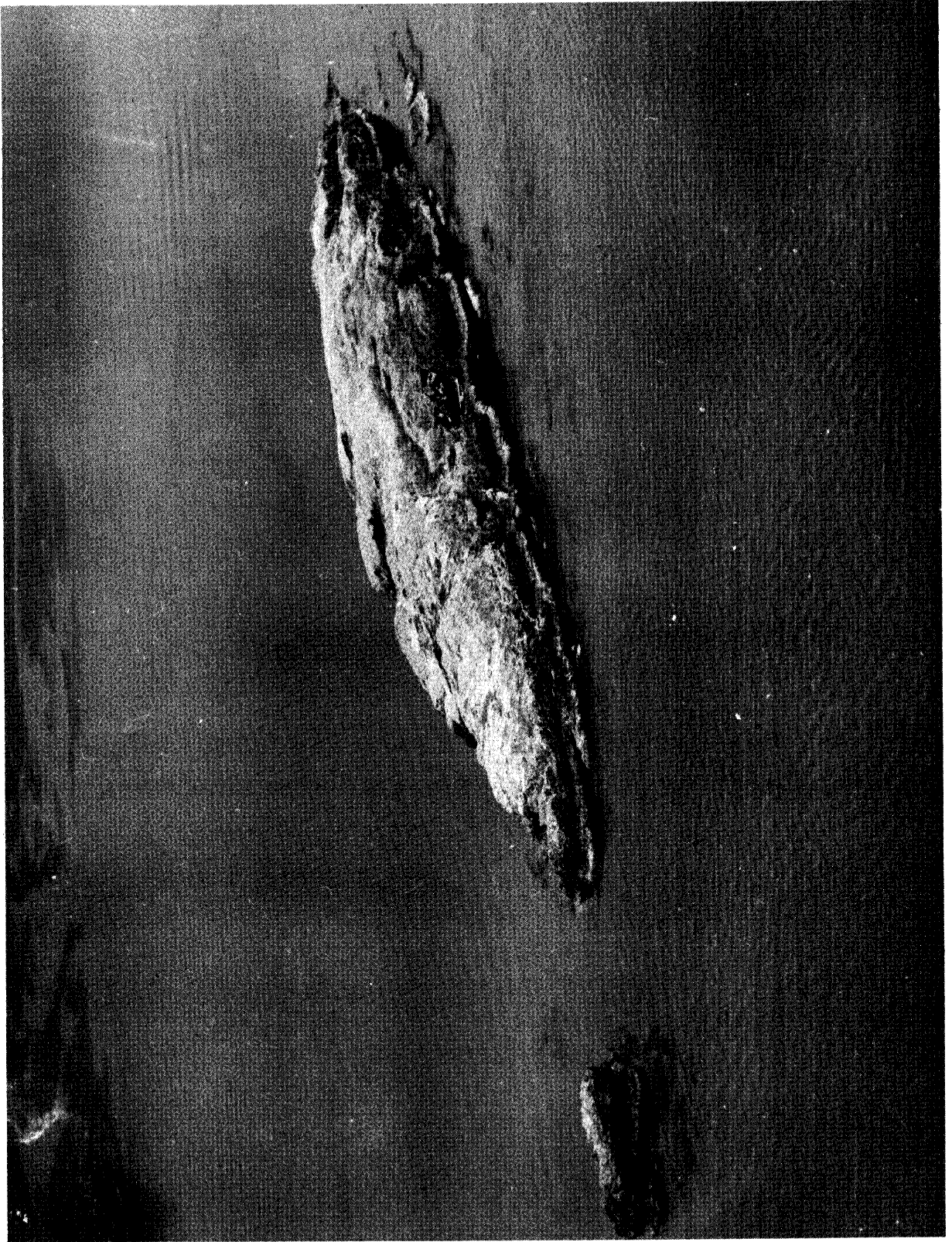

Colville Island (156032)(right) Unnamed Rock ("Colville Annex")(156166) USF&WS

AREA 156, Victoria (cont'd.)

032

Colville Island 48°24'58"N, 122°49'17"W

| | | | | |
|--------------------------|-----------|--------|----------|-----------|
| Double-crested Cormorant | 62 | Wahl | 06/14/79 | B II 269 |
| Pelagic Cormorant | 230 | Wahl | 06/14/79 | B II 269 |
| Black Oystercatcher | 2 | Pitman | 06/20/78 | B III 217 |
| Glaucous-winged Gull | 1000-2000 | Wahl | 07/19/82 | A III 269 |
| Pigeon Guillemot | 22 | Wahl | 06/14/79 | B III 269 |
| Tufted Puffin | 5P | Wahl | 06/14/79 | B III 269 |
| Total | | | | 1321-2321 |

| | | | | |
|--------------------------|---------|-------------------------|----------------|-----------|
| No nesting observed | 0 | Edson 1929 | 06/17/05 | L III 98 |
| Cormorant sp. | 50 | Nisqually NWR | 06/05-06/62 | B III 202 |
| Cormorant sp. | P | Nisqually NWR | 06/20/63 | B III 202 |
| Cormorant sp. | 175 | Devan | 04/28/71 | ? III 87 |
| Double-crested Cormorant | 0 | Drent & Guiguet 1961 | pre-1905 | - - 89 |
| Double-crested Cormorant | 100-140 | Schultz | pre-1948 | L ? 243 |
| Double-crested Cormorant | 400 | Goodge 1950 | pre-1948 | ? ? 115 |
| Double-crested Cormorant | 0 | Schultz | ?/ ?/ 48 | L III 243 |
| Double-crested Cormorant | 0 | Goodge 1950 | ?/ ?/ 48 | ? III 115 |
| Double-crested Cormorant | 50-100 | Schultz | ?/ ?/ 57 | L III 243 |
| Double-crested Cormorant | 52+ | Eddy & Richardson; | | |
| | | Eddy | 08/04/57 | ? ? 97;95 |
| Double-crested Cormorant | 34 | Eddy | 07/03/61 | L I 95 |
| Double-crested Cormorant | 28 | Thoresen & Galusha 1971 | 06-07/ ?/63 | L I 264 |
| Double-crested Cormorant | 22 | Hauser & Monson 1963 | 07/16-17/63 | B II 145 |
| Double-crested Cormorant | 0 | Schultz | 07/19/64 | L III 242 |
| Double-crested Cormorant | X | Stopps | 07/16-17/66 | L III 258 |
| Double-crested Cormorant | X | Wahl | 07/13-14/68 | L III 269 |
| Double-crested Cormorant | 24 | Thoresen & Galusha 1971 | 06-07/ ?/70 | L I 264 |
| Double-crested Cormorant | 49 | Richardson | ?/ ?/73 | ? ? 228 |
| Double-crested Cormorant | 0 | Wahl | ?/ ?/74 | L III 270 |
| Double-crested Cormorant | 92 | Pitman | 06/20/78 | B I 217 |
| Double-crested Cormorant | 534 | Wahl | 07/19/82 | A II 269 |
| Brandt's Cormorant | 18 | Eddy | 08/04/57 | B II 95 |
| Pelagic Cormorant | X | Jewett 1937 | 05/25/37 | B III 156 |
| Pelagic Cormorant | 160 | Eddy | 08/04/57 | B II 95 |
| Pelagic Cormorant | 60 | Eddy | 07/03/61 | L I 95 |
| Pelagic Cormorant | 100 | Thoresen & Galusha 1971 | 06-07/ ?/63 | L I 264 |
| Pelagic Cormorant | 2 | Schultz | 07/19/64 | L ? 242 |
| Pelagic Cormorant | X | Wahl | 07/17/65 | L III 269 |
| Pelagic Cormorant | X | Stopps | 07/16-17/66 | ? III 258 |
| Pelagic Cormorant | 40P | Nisqually NWR | 06/21/67 | ? III 202 |
| Pelagic Cormorant | X | Wahl | 07/13-14/68 | L III 269 |
| Pelagic Cormorant | 88 | Thoresen & Galusha 1971 | 06-07/ ?/70 | L I 264 |
| Pelagic Cormorant | X | Wahl | 07/09/72 | L III 269 |
| Pelagic Cormorant | 69 | Frazer 1973 | 07/17/73 | B III 108 |
| Pelagic Cormorant | 180 | Wahl | 06/02/74 | L II 269 |
| Pelagic Cormorant | X | Hayward et al. 1975 | 06/15&08/15/74 | ? III 128 |

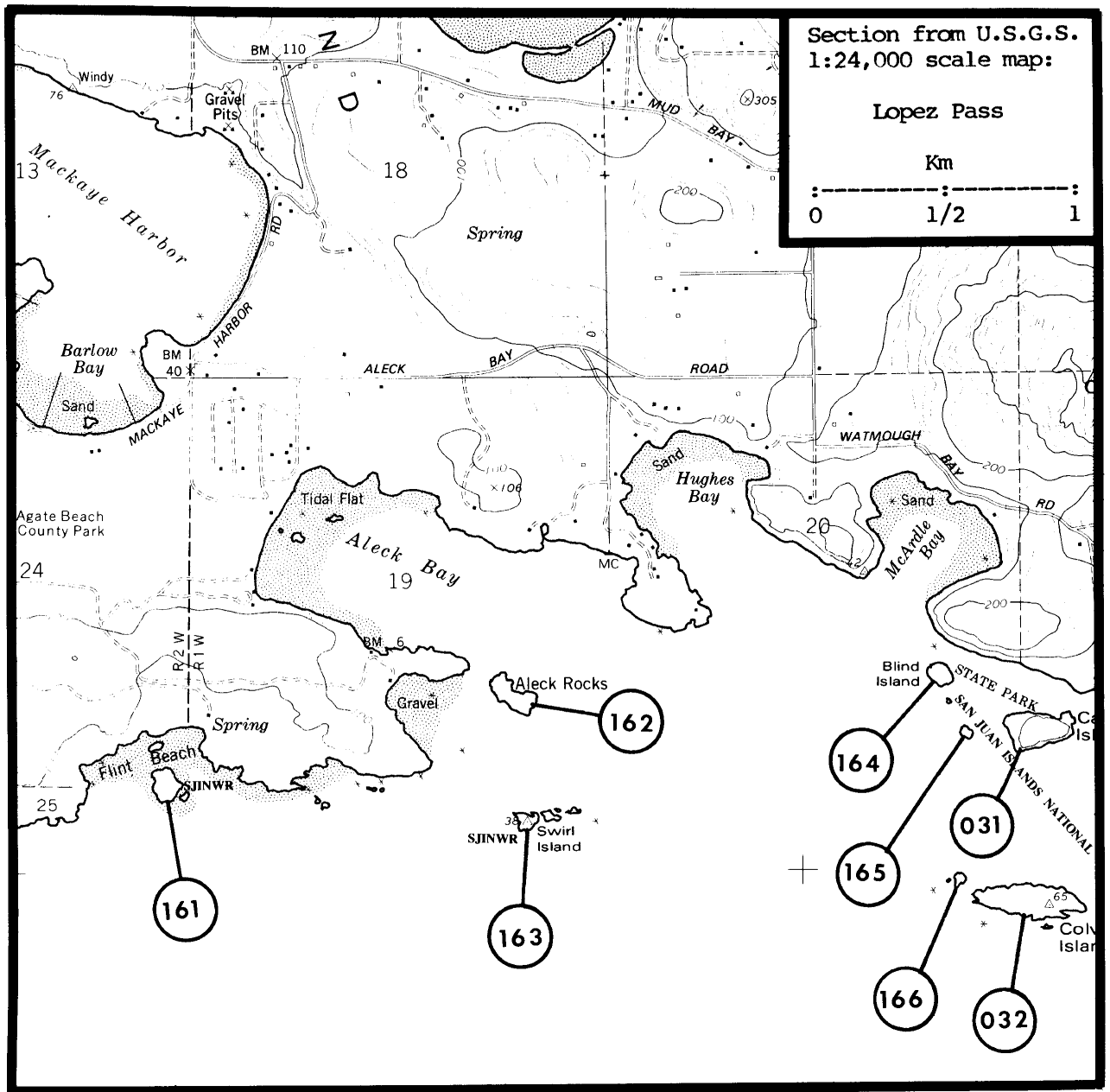

AREA 156, Victoria (cont'd.)

| | | | | |
|----------------------|-------|-------------------------|----------------|-----------|
| Pelagic Cormorant | 100 | Manuwal | 06/23/76 | L III 188 |
| Pelagic Cormorant | 92 | Pitman | 06/20/78 | B I 217 |
| Pelagic Cormorant | X | Wahl | 07/19/82 | A III 269 |
| Black Oystercatcher | 2 | Eddy | 07/03/61 | L I 95 |
| Black Oystercatcher | 4 | Nisqually NWR | 06/05/62 | B III 202 |
| Black Oystercatcher | 4 | Thoresen & Galusha 1971 | 06-07/ ?/63 | L I 264 |
| Black Oystercatcher | 1 | Nisqually NWR | 06/20/63 | B III 202 |
| Black Oystercatcher | 2 | Hansen & Monson 1963 | 07/16-17/63 | B III 145 |
| Black Oystercatcher | X | Wahl | 07/17/65 | L III 269 |
| Black Oystercatcher | X | Wahl | 07/09/67 | L III 269 |
| Black Oystercatcher | X | Wahl | 07/13-14/68 | L III 269 |
| Black Oystercatcher | 2 | Thoresen & Galusha 1971 | 06-07/ ?/70 | L I 264 |
| Black Oystercatcher | 2 | Wahl | 07/11-12/70 | L I 269 |
| Black Oystercatcher | X | Wahl | 07/09/72 | L III 269 |
| Black Oystercatcher | 2 | Nysewander | 06 ?/73 | B III 205 |
| Black Oystercatcher | 1 | Frazer 1973 | 07/17/73 | B III 108 |
| Black Oystercatcher | 4 | Wahl | 06/02/74 | L II 269 |
| Black Oystercatcher | X | Hayward et al. 1975 | 06/15&08/15/74 | ? III 128 |
| Black Oystercatcher | 4-6 | Manuwal | 06/23/76 | L III 188 |
| Glaucous-winged Gull | 400+ | Rathbun | 06/11/28 | L III 223 |
| Glaucous-winged Gull | 3,000 | Jewett 1937 | 05/25/37 | B III 156 |
| Glaucous-winged Gull | 30 | Howsley | 06/20/37 | E - 147 |
| Glaucous-winged Gull | XB | Schultz | ?/ ?/40 | L III 245 |
| Glaucous-winged Gull | 1 | Goodge | 07/28/49 | S - 116 |
| Glaucous-winged Gull | 530B | Schultz | ?/ ?/48 | L III 245 |
| Glaucous-winged Gull | 1 | McMannama | 07/28/48 | S - 193 |
| Glaucous-winged Gull | 630B | Schultz | ?/ ?/49 | L III 245 |
| Glaucous-winged Gull | 2 | McMannama | 07/09/49 | S - 193 |
| Glaucous-winged Gull | X | Schultz 1951 | 06/14-19/51 | L III 240 |
| Glaucous-winged Gull | 4 | Schultz | 06/16/51 | S - 246 |
| Glaucous-winged Gull | 740B | Schultz | ?/ ?/55 | L III 245 |
| Glaucous-winged Gull | 3 | Schultz | 07/27/55 | S - 246 |
| Glaucous-winged Gull | 840B | Schultz | ?/ ?/57 | L III 245 |
| Glaucous-winged Gull | 100's | Eddy | 08/04/57 | B III 95 |
| Glaucous-winged Gull | 1400B | Schultz | ?/ ?/58 | L III 245 |
| Glaucous-winged Gull | 1020B | Schultz | ?/ ?/61 | L III 245 |
| Glaucous-winged Gull | 500+ | Eddy | 07/03/61 | L III 95 |
| Glaucous-winged Gull | 1420B | Schultz | ?/ ?/62 | L III 245 |
| Glaucous-winged Gull | X | Nisqually NWR | 06/05/62 | B III 202 |
| Glaucous-winged Gull | 670B | Schultz | ?/ ?/63 | L III 245 |
| Glaucous-winged Gull | 2454 | Thoresen & Galusha 1971 | 06-07/ ?/63 | L II 264 |
| Glaucous-winged Gull | 2000 | Nisqually NWR | 06/20/63 | B III 202 |
| Glaucous-winged Gull | 3000 | Hansen & Monson 1963 | 07/16-17/63 | B III 145 |
| Glaucous-winged Gull | 170B | Schultz | ?/ ?/64 | L III 245 |
| Glaucous-winged Gull | 1980B | Wahl | 07/17/65 | L III 269 |
| Glaucous-winged Gull | 2470B | Wahl | 07/17/66 | L III 269 |
| Glaucous-winged Gull | 1000 | Nisqually NWR | 06/21/67 | ? III 202 |
| Glaucous-winged Gull | 800B | Wahl | 07/09/67 | L III 269 |
| Glaucous-winged Gull | 1200 | Nisqually NWR | 08/21-23/67 | L III 202 |
| Glaucous-winged Gull | X | Wahl | 07/13-14/68 | L III 269 |
| Glaucous-winged Gull | 5000 | Nisqually NWR | 07/13-16/68 | L III 202 |
| Glaucous-winged Gull | 1640B | Wahl | 07/13/68 | L III 269 |
| Glaucous-winged Gull | 2854 | Thoresen & Galusha 1971 | 06-07/ ?/70 | L III 264 |
| Glaucous-winged Gull | 1880B | Wahl | 07/11-12/70 | L III 269 |

| | | | | | |
|----------------------|-----------|-------------------------|----------------|-------|-----|
| Glaucous-winged Gull | 2500 | Devan | 04/28/71 | ? III | 87 |
| Glaucous-winged Gull | 1250B | Wahl | 07/11/71 | L III | 269 |
| Glaucous-winged Gull | 670B | Wahl | 07/09/72 | L III | 269 |
| Glaucous-winged Gull | 1330B | Wahl | 07/08/73 | L III | 269 |
| Glaucous-winged Gull | 1300 | Frazer 1973 | 07/17/73 | B III | 108 |
| Glaucous-winged Gull | 3000 | Hayward et al. 1975 | 06/15&08/15/74 | ? III | 128 |
| Glaucous-winged Gull | 2970 | Amlaner et al. 1977 | 07/ ?/74 | L II | 10 |
| Glaucous-winged Gull | 3616 | Amlaner et al. 1977 | 06/ ?/75 | L II | 10 |
| Glaucous-winged Gull | 100+ | Manuwal | 06/23/76 | L III | 188 |
| Glaucous-winged Gull | 1000-2000 | Pitman | 06/20/78 | B III | 217 |
| Glaucous-winged Gull | X | Wahl | 03/13/79 | B III | 269 |
| Glaucous-winged Gull | 800 | Wahl | 06/14/79 | B III | 269 |
| Pigeon Guillemot | X | Jewett 1937 | 05/25/37 | B III | 156 |
| Pigeon Guillemot | 4 | Eddy | 07/03/61 | L III | 95 |
| Pigeon Guillemot | 6 | Thoresen & Galusha 1971 | 06-07/ ?/63 | L II | 264 |
| Pigeon Guillemot | 9 | Hansen & Monson 1963 | 07/16-17/63 | B III | 145 |
| Pigeon Guillemot | X | Wahl | 07/17/65 | L III | 269 |
| Pigeon Guillemot | 25 | Nisqually NWR | 06/21/67 | ? III | 202 |
| Pigeon Guillemot | X | Wahl | 07/19/67 | L III | 269 |
| Pigeon Guillemot | X | Wahl | 07/13-14/68 | L III | 269 |
| Pigeon Guillemot | 50P | Nisqually NWR | 07/13-16/68 | L III | 202 |
| Pigeon Guillemot | 0 | Thoresen & Galusha 1971 | 06-07/ ?/70 | L III | 264 |
| Pigeon Guillemot | P | Devan | 04/28/71 | ? ? | 87 |
| Pigeon Guillemot | X | Wahl | 07/11/71 | L I | 269 |
| Pigeon Guillemot | X | Wahl | 07/09/72 | L I | 269 |
| Pigeon Guillemot | X | Hayward et al. 1975 | 06/15&08/15/74 | ? III | 128 |
| Pigeon Guillemot | 22 | Manuwal | 06/23/76 | L III | 188 |
| Pigeon Guillemot | 25 | Wahl | 05/19/78 | B III | 269 |
| Pigeon Guillemot | 60 | Pitman | 06/20/78 | B II | 217 |
| Pigeon Guillemot | 50 | Wahl | 03/13/79 | B III | 269 |
| Tufted Puffin | 6+ | Eddy | 08/04/57 | B III | 95 |
| Tufted Puffin | 2 | Eddy | 07/03/61 | L III | 95 |
| Tufted Puffin | 6 | Nisqually NWR | 06/05/62 | B III | 202 |
| Tufted Puffin | 0 | Wahl | 07/09/67 | L III | 269 |
| Tufted Puffin | X | Wahl | 07/13-14/68 | L I | 269 |
| Tufted Puffin | 0 | Wahl | 07/11-12/70 | L III | 269 |
| Tufted Puffin | 20-30X | Pitman | 06/20/78 | B II | 269 |

AREA 156, Victoria (cont'd.)

033 Minor Island 48°19'28"N, 122°49'06"W

| | | | | |
|-----------------------|-------|---------------|-------------|-----------|
| Glaucaous-winged Gull | X | Wahl | 07/19/82 | A III 269 |
| Glaucaous-winged Gull | 80± | Eddy | 08/28/55 | L III 95 |
| Glaucaous-winged Gull | 200 | Nisqually NWR | 08/21-23/67 | L III 202 |
| Glaucaous-winged Gull | 1000± | Newby | 07/20/72 | ? III 201 |
| Glaucaous-winged Gull | 278 | Manuwal | 05/27/73 | L II 188 |
| Glaucaous-winged Gull | 175 | Manuwal 1973 | 05/27/73 | L II 186 |

034 Smith Island¹ 48°19'08"N, 122°50'32"W

¹Observations for Smith Island (156034) are contained in the accounts of Smith and Minor islands (156181). The data are such that it is usually not possible to separate the observations made on Smith Island and Minor Island.

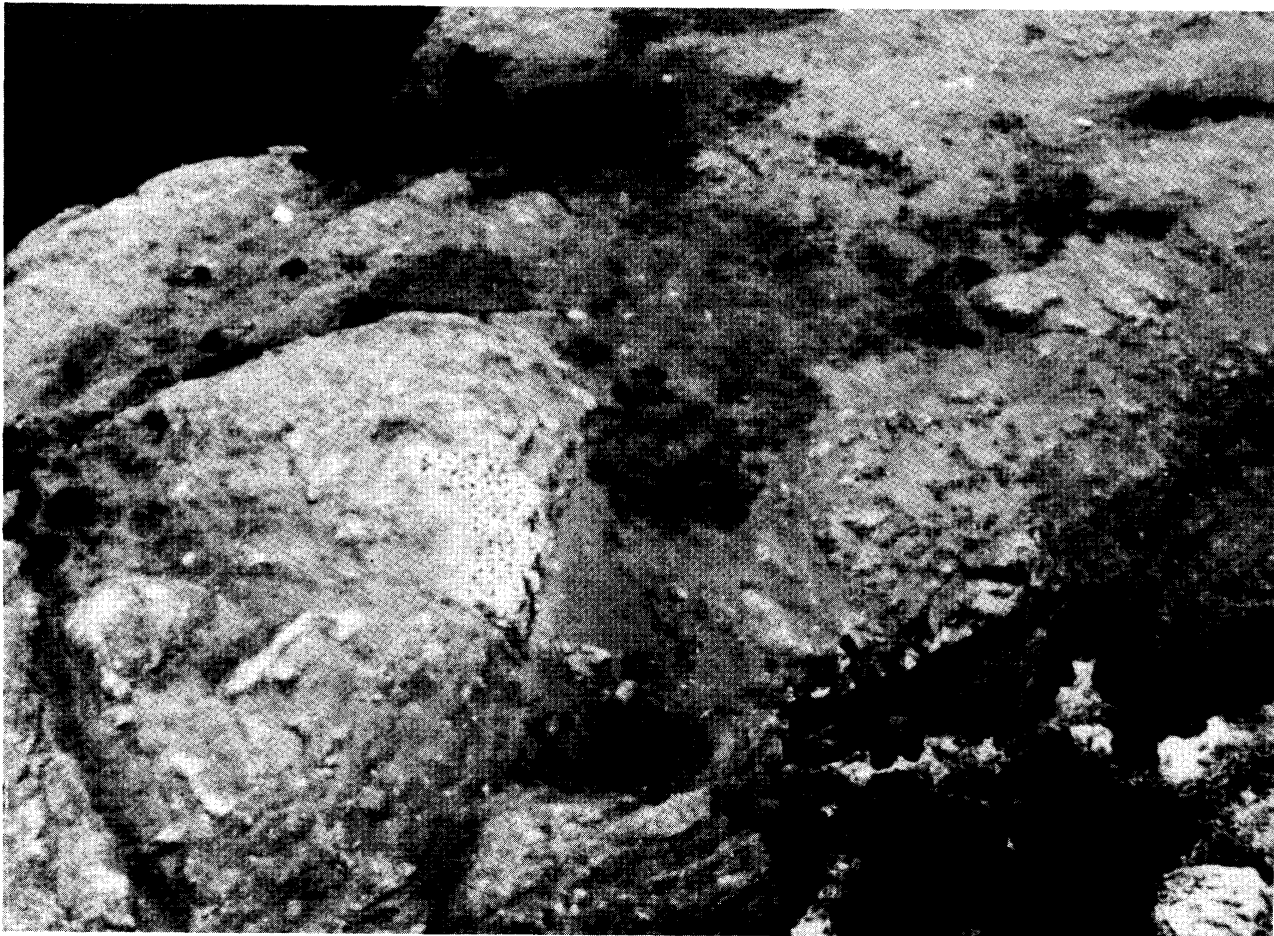

Colville Island (156032) 19 July 1982 T.R. Wahl Double-crested Cormorants

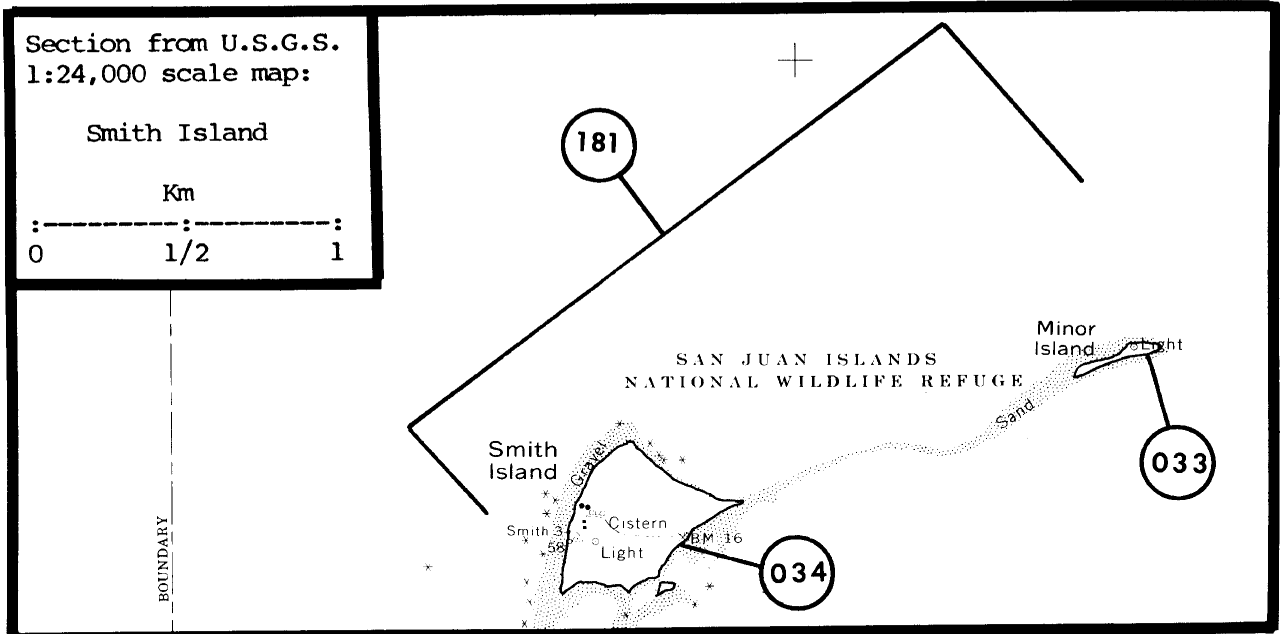

Protection Island, west spit (156035) 19 July 1982 T.R. Wahl

AREA 156, Victoria (cont'd.)

035

Protection Island 48°07'40"N, 122°55'50"W

| | | | | |
|----------------------|--------------------|--------------|-----------|-----------|
| Pelagic Cormorant | 860 | Galusha 1982 | Summer/82 | L I 111 |
| Black Oystercatcher | 20 | Galusha 1982 | Summer/82 | L I 111 |
| Glaucous-winged Gull | 11100 | Galusha 1982 | Summer/82 | L III 111 |
| Pigeon Guillemot | 1300 | Galusha 1982 | Summer/82 | L III 111 |
| Tufted Puffin | 45 | Galusha 1982 | Summer/82 | L II 111 |
| Rhinoceros Auklet | 34000 ¹ | Hirsch 1981 | Summer/80 | L III 133 |
| Total | 47325 | | | |

| | | | | |
|--------------------------|-------|-------------------|----------------|-----------|
| Double-crested Cormorant | ? | Wick 1958 | ?/ ?/39-42 | L III 279 |
| Double-crested Cormorant | 0 | Richardson & Eddy | ?/ ?/56 | ? III 231 |
| Double-crested Cormorant | 0 | Richardson & Eddy | ?/ ?/57 | ? III 231 |
| Double-crested Cormorant | 0 | Richardson & Eddy | ?/ ?/58 | ? III 231 |
| Double-crested Cormorant | 6-8 | Richardson & Eddy | ?/ ?/59 | ? II 231 |
| Double-crested Cormorant | 24 | Richardson & Eddy | ?/ ?/60 | ? II 231 |
| Double-crested Cormorant | ? | Wahl | 07/10/66 | L II 269 |
| Double-crested Cormorant | 6 | Frazer 1973 | 06/16&07/11/73 | L I 108 |
| Double-crested Cormorant | 0 | Wilson 1977 | Summer/75 | L III 285 |
| Double-crested Cormorant | 0 | Wilson 1977 | Summer/76 | L III 285 |
| Double-crested Cormorant | 0 | Pitman | 06/13/78 | L III 217 |
| Double-crested Cormorant | 0 | Speich | 08/07/79 | B III 255 |
| Double-crested Cormorant | 16 | Hirsch 1981 | Summer/80 | L I 133 |
| Pelagic Cormorant | X | Wick 1958 | ?/ ?/39-42 | L III 279 |
| Pelagic Cormorant | 140 | Eddy | 06/09-10/55 | L II 95 |
| Pelagic Cormorant | 200 | Richardson | 09/08/56 | L III 229 |
| Pelagic Cormorant | P | Wahl | 07/11/65 | L III 269 |
| Pelagic Cormorant | P | Wahl | 07/10/66 | L III 269 |
| Pelagic Cormorant | 218 | Frazer 1973 | 06/16&07/11/73 | L I 108 |
| Pelagic Cormorant | 388 | Wilson 1977 | Summer/75 | L II 285 |
| Pelagic Cormorant | 388 | Wilson 1977 | Summer/76 | L II 285 |
| Pelagic Cormorant | >100 | Harrington-Tweit | 05/25/78 | ? III 124 |
| Pelagic Cormorant | 590 | Pitman | 06/13/78 | L I 217 |
| Pelagic Cormorant | 400+ | Ragan | 06/24/79 | ? III 220 |
| Pelagic Cormorant | 584 | Speich | 08/07/79 | B I 255 |
| Pelagic Cormorant | 590 | Hirsch 1981 | Summer/80 | L I 133 |
| Pelagic Cormorant | 664 | Galusha 1982 | Summer/80 | L I 111 |
| Black Oystercatcher | 4 | Wahl | 07/11/65 | L III 269 |
| Black Oystercatcher | 0? | Wahl | 07/21/68 | L III 269 |
| Black Oystercatcher | P | Wahl | 07/18/71 | L III 269 |
| Black Oystercatcher | 2 | Wahl | 07/25/71 | L III 269 |
| Black Oystercatcher | 2 | Frazer 1973 | 06/16&07/11/73 | L III 108 |
| Black Oystercatcher | 12 | Wilson 1977 | Summer/75 | L III 285 |
| Black Oystercatcher | 12 | Wilson 1977 | Summer/76 | L III 285 |
| Black Oystercatcher | 4-8 | Pitman | 06/13/78 | L III 217 |
| Black Oystercatcher | 21 | Ragan | 06/24/79 | ? III 220 |
| Black Oystercatcher | 2 | Speich | 08/07/79 | B III 255 |
| Black Oystercatcher | 26 | Hirsch 1981 | Summer/80 | L I 133 |
| Black Oystercatcher | 35 | Galusha 1982 | Summer/80 | L III 111 |
| Glaucous-winged Gull | X | Wick 1958 | ?/ ?/39-42 | L III 279 |
| Glaucous-winged Gull | 1200+ | Eddy | 06/05/55 | L III 95 |

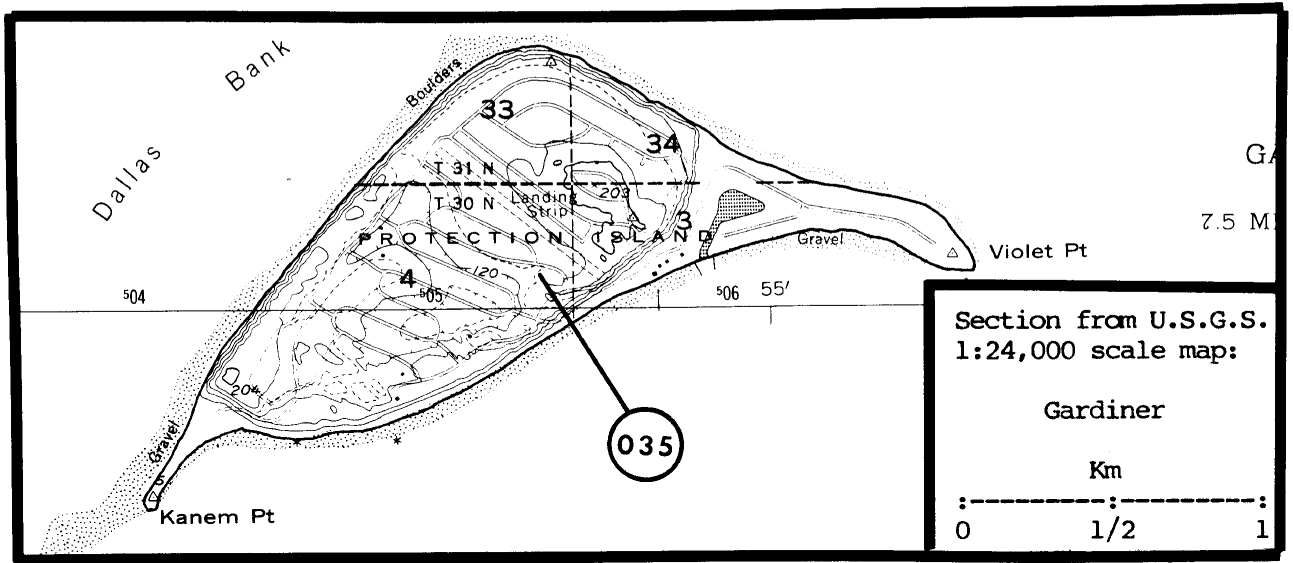

Protection Island, east spit (156035) 19 November 1979 S.M. Speich

AREA 156, Victoria (cont'd.)

| | | | | | |
|----------------------|-----------|-------------------------|----------------|-------|------------|
| Glaucous-winged Gull | 1500+ | Eddy | 06/09-10/55 | L III | 95 |
| Glaucous-winged Gull | 2 | Eddy | 07/10/55 | S - | 96 |
| Glaucous-winged Gull | X | Richardson 1961 | Summer/56 | L III | 227 |
| Glaucous-winged Gull | X | Richardson 1961 | Summer/57 | L III | 227 |
| Glaucous-winged Gull | 100's | Richardson | 05/19/57 | L III | 229 |
| Glaucous-winged Gull | 1180B | Schultz; B.B.L. | 07/ ?/57 | L III | 245;28 |
| Glaucous-winged Gull | X | Richardson 1961 | Summer/58 | L III | 227 |
| Glaucous-winged Gull | 1 | Schultz | 05/04/58 | S - | 246 |
| Glaucous-winged Gull | 120B | Schultz; B.B.L. | 07/ ?/58 | L III | 245;28 |
| Glaucous-winged Gull | X | Richardson 1961 | Summer/59 | L III | 227 |
| Glaucous-winged Gull | 1520B | Schultz; B.B.L. | 07/ ?/60 | L III | 245;28 |
| Glaucous-winged Gull | X | Schultz | ?/ ?/61 | ? ? | 245 |
| Glaucous-winged Gull | 2 | Anderson | 05/17/63 | E - | 12 |
| Glaucous-winged Gull | 100's | Anderson | 05/17/63 | L III | 11 |
| Glaucous-winged Gull | 1430B | B.B.L.; Schultz | 07/ ?/64 | L III | 28;245 |
| Glaucous-winged Gull | 2090B | B.B.L.; Schultz | 07/11/65 | L III | 28;269;245 |
| Glaucous-winged Gull | 2450B | B.B.L.; Wahl; Schultz | 07/10/66 | L III | 28;269;245 |
| Glaucous-winged Gull | 1870B | B.B.L.; Wahl | 07/16/67 | L III | 28;269 |
| Glaucous-winged Gull | 3030B | B.B.L.; Wahl | 07/21/68 | L III | 28;269 |
| Glaucous-winged Gull | 4060B | B.B.L.; Wahl | 07/20&27/69 | L III | 28;269 |
| Glaucous-winged Gull | 4070B | B.B.L.; Wahl | 07/19&26/70 | L III | 28;269 |
| Glaucous-winged Gull | 3690B | B.B.L.; Wahl | 07/18&25/71 | L III | 28;269 |
| Glaucous-winged Gull | 2360B | B.B.L.; Wahl | 07/15/72 | L III | 28;269 |
| Glaucous-winged Gull | 3300 | Frazer 1973 | 06/16&07/11/73 | L III | 108 |
| Glaucous-winged Gull | 1570B | B.B.L.; Wahl | 07/ ?/73 | L III | 28;269 |
| Glaucous-winged Gull | 1600B | B.B.L.; Wahl | 07/14/74 | L III | 28;269 |
| Glaucous-winged Gull | 8600 | Wilson 1977 | Summer/75 | L III | 285 |
| Glaucous-winged Gull | 1830B | B.B.L.; Wahl | 07/13/75 | L III | 28;269 |
| Glaucous-winged Gull | 8600 | Wilson 1977 | Summer/76 | L III | 285 |
| Glaucous-winged Gull | 2060B | B.B.L.; Wahl | 07/11/76 | L III | 28;269 |
| Glaucous-winged Gull | 2600-3000 | Pitman | 06/13/78 | L III | 217 |
| Glaucous-winged Gull | 1210B | B.B.L.; Wahl | 07/07/78 | L III | 28;269 |
| Glaucous-winged Gull | >1880 | Speich | 08/07/79 | B III | 255 |
| Glaucous-winged Gull | 1860B | Wahl | 07/13/80 | L III | 269 |
| Glaucous-winged Gull | 9488 | Hirsch 1981 | Summer/80 | L III | 133 |
| Glaucous-winged Gull | 9960 | Galusha 1982 | Summer/80 | L III | 111 |
| Glaucous-winged Gull | 1600B | Wahl | 07/12/81 | L III | 269 |
| Pigeon Guillemot | X | Suckley | Summer/1854 | ? III | 260 |
| Pigeon Guillemot | 60-70 | Pennington | 06/16/23 | L III | 215 |
| Pigeon Guillemot | P | Wick 1958 | ?/ ?/39-42 | L III | 279 |
| Pigeon Guillemot | 200± | Eddy | 06/09-10/55 | L III | 95 |
| Pigeon Guillemot | X | Richardson 1961 | Summer 56-59 | L III | 227 |
| Pigeon Guillemot | 2 | Pemberton | 06/16/56 | E - | 210 |
| Pigeon Guillemot | 2B | B.B.L. | 07/ ?/60 | L III | 28 |
| Pigeon Guillemot | X | Wahl | 07/11/65 | L III | 269 |
| Pigeon Guillemot | X | Wahl | 07/10/66 | L III | 269 |
| Pigeon Guillemot | X | Wahl | 07/21/68 | L III | 269 |
| Pigeon Guillemot | 2B | B.B.L. | 06/ ?/72 | L III | 28 |
| Pigeon Guillemot | 50-60 | Frazer 1973 | 06/16&07/11/73 | L III | 108 |
| Pigeon Guillemot | 360 | Wilson 1977 | Summer 75-76 | L III | 285 |
| Pigeon Guillemot | 526 | Harrington-Tweit; Hills | 05/25/78 | A III | 124;132 |
| Pigeon Guillemot | 285 | Pitman | 06/13/78 | L III | 217 |

| | | | | | |
|-------------------|-----------|-----------------|----------------|-------|-----|
| Pigeon Guillemot | 605 | Speich | 05/23/79 | B III | 255 |
| Pigeon Guillemot | 162 | Speich & Wahl | 06/25/79 | A III | 257 |
| Pigeon Guillemot | 652 | Speich | 08/07/79 | B III | 255 |
| Pigeon Guillemot | 608 | Hirsch 1981 | Summer/80 | L III | 133 |
| Pigeon Guillemot | 635 | Galusha 1982 | Summer/80 | L III | 111 |
| Rhinoceros Auklet | X | Suckley | Summer/1854 | ? III | 260 |
| Rhinoceros Auklet | X | Pennington | 06/16/23 | L III | 215 |
| Rhinoceros Auklet | X | Wick 1958 | ?/ ?/39-42 | L III | 279 |
| Rhinoceros Auklet | 2000+ | Eddy | 06/09-10/55 | L III | 95 |
| Rhinoceros Auklet | 1 | Hudson | 06/17/56 | S - | 149 |
| Rhinoceros Auklet | 4 | Goodge | 07/09/55 | S - | 116 |
| Rhinoceros Auklet | 2 | [Eddy] | 07/10/55 | S - | 96 |
| Rhinoceros Auklet | 6000-8000 | Richardson 1961 | Summer/56-59 | L III | 227 |
| Rhinoceros Auklet | 2 | Richardson | 04/01/56 | S - | 230 |
| Rhinoceros Auklet | 2 | Miller | 06/17/56 | S - | 197 |
| Rhinoceros Auklet | XB | B.B.L. | 04-08/ ?/57 | L III | 28 |
| Rhinoceros Auklet | XB | B.B.L. | 04-08/ ?/58 | L III | 28 |
| Rhinoceros Auklet | 1 | [Eddy] | 05/04/58 | S - | 96 |
| Rhinoceros Auklet | XB | B.B.L. | 07/ ?/59 | L III | 28 |
| Rhinoceros Auklet | 10 | Griffiee | 05/17/63 | E - | 121 |
| Rhinoceros Auklet | 2 | Anderson | 05/17/63 | E - | 12 |
| Rhinoceros Auklet | XB | B.B.L. | 06/ ?/63 | L III | 28 |
| Rhinoceros Auklet | 2 | Bédard | 06/29/65 | S - | 23 |
| Rhinoceros Auklet | X | Wahl | 07/11/65 | L III | 269 |
| Rhinoceros Auklet | X | Wahl | 07/10/66 | L III | 269 |
| Rhinoceros Auklet | X | Wahl | 07/16/67 | L III | 269 |
| Rhinoceros Auklet | X | Wahl | 07/21/68 | L III | 269 |
| Rhinoceros Auklet | XB | B.B.L. | 06-07/ ?/72 | L III | 28 |
| Rhinoceros Auklet | XB | B.B.L. | 08/ ?/73 | L III | 28 |
| Rhinoceros Auklet | 18400 | Frazer 1973 | 06/16&07/11/73 | L III | 108 |
| Rhinoceros Auklet | 25000 | Robel 1973 | 07/01-07/73 | L III | 234 |
| Rhinoceros Auklet | 2 | Robel | 07/05/73 | E - | 235 |
| Rhinoceros Auklet | XB | B.B.L. | 06-08/ ?/75 | L III | 28 |
| Rhinoceros Auklet | 34216 | Wilson 1977 | Summer/76 | L III | 285 |
| Rhinoceros Auklet | XB | B.B.L. | 08/ ?/76 | L III | 28 |
| Rhinoceros Auklet | 1000's | Pitman | 06/13/78 | L III | 217 |
| Rhinoceros Auklet | XB | B.B.L. | 07/ ?/78 | L III | 28 |
| Rhinoceros Auklet | 12 | Alcorn | 07/14/81 | E - | 8 |
| Tufted Puffin | 80-100 | Pennington | 06/16/23 | L III | 215 |
| Tufted Puffin | 140 | Eddy | 06/09-10/55 | L III | 95 |
| Tufted Puffin | X | Richardson 1961 | Summer/56-59 | L III | 227 |
| Tufted Puffin | X | Wahl | 07/10/66 | L III | 269 |
| Tufted Puffin | X | Wahl | 07/16/67 | L III | 269 |
| Tufted Puffin | X | Wahl | 07/21/68 | L III | 269 |
| Tufted Puffin | 0 | Wahl | 07/25/71 | L III | 269 |
| Tufted Puffin | 60-70 | Frazer 1973 | 06/16-07/11/73 | L III | 108 |
| Tufted Puffin | 66 | Wilson 1977 | Summer/75-76 | L III | 285 |
| Tufted Puffin | 70-100 | Pitman | 06/13/78 | L III | 217 |
| Tufted Puffin | 40 | Speich | 08/07/79 | B III | 255 |
| Tufted Puffin | 76 | Hirsch 1981 | Summer/80 | L I | 133 |
| Tufted Puffin | 32 | Galusha 1982 | Summer/80 | L I | 111 |

¹Numbers from Wilson 1977.

AREA 156, Victoria (cont'd.)

036 Point Roberts, west 48°59'02"N, 123°05'04"W

| | | | | |
|------------------|---|------|----------|-----------|
| Pigeon Guillemot | 2 | Wahl | 06/04/79 | L III 269 |
| Pigeon Guillemot | 1 | Wahl | 06/12/78 | L III 269 |

037 Point Roberts, southeast 48°58'30"N, 123°01'30"W

| | | | | |
|------------------|---|------|----------|-----------|
| Pigeon Guillemot | 1 | Wahl | 06/04/79 | L III 269 |
| Pigeon Guillemot | 4 | Wahl | 05/30/78 | L III 269 |

038 Semiahmoo Spit 48°59'27"N, 122°46'08"W

| | | | | |
|----------------------|---|-------|----------------|-----------|
| Pigeon Guillemot | 2 | Wahl | 04/19/80 | L III 269 |
| Glaucous-winged Gull | 2 | Kline | 06/31-07/10/64 | L I 170 |
| Pigeon Guillemot | 1 | Wahl | 06/01/79 | L III 269 |

039 Blaine 48°59'18"N, 122°45'19"W

| | | | | |
|----------------------|---|------|----------|---------|
| Glaucous-winged Gull | 2 | Wahl | 06/13/67 | M I 269 |
|----------------------|---|------|----------|---------|

040 Drayton Harbor, northeast 48°59'45"N, 122°45'36"W

| | | | | |
|----------------------|---|------|----------|----------|
| Glaucous-winged Gull | 2 | Wahl | 07/16/82 | M II 269 |
|----------------------|---|------|----------|----------|

041 Drayton Harbor, southwest 48°58'50"N, 122°46'25"W

| | | | | |
|--------------------------|-----|------|-----------|-----------|
| Double-crested Cormorant | 6-8 | Wahl | 07/16/82 | M I 269 |
| Double-crested Cormorant | 0 | Wahl | Summer/78 | M III 269 |
| Double-crested Cormorant | 0 | Wahl | Summer/79 | M III 269 |

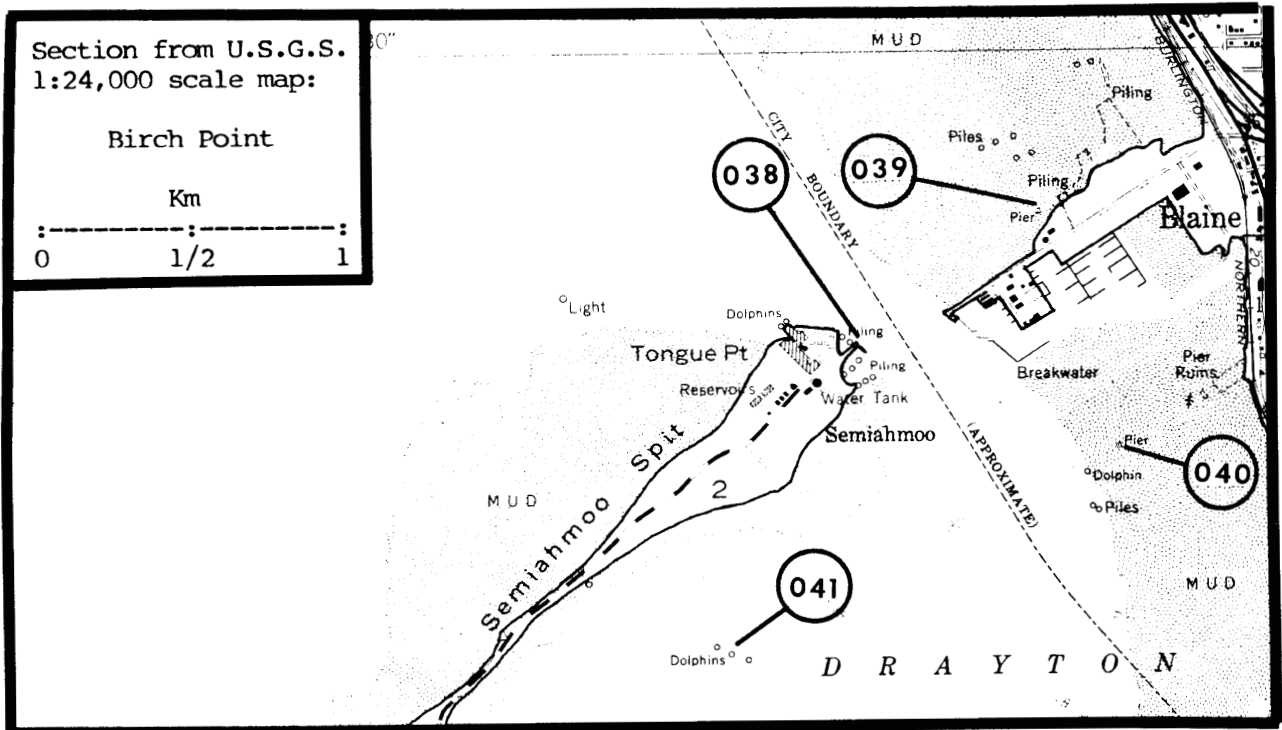
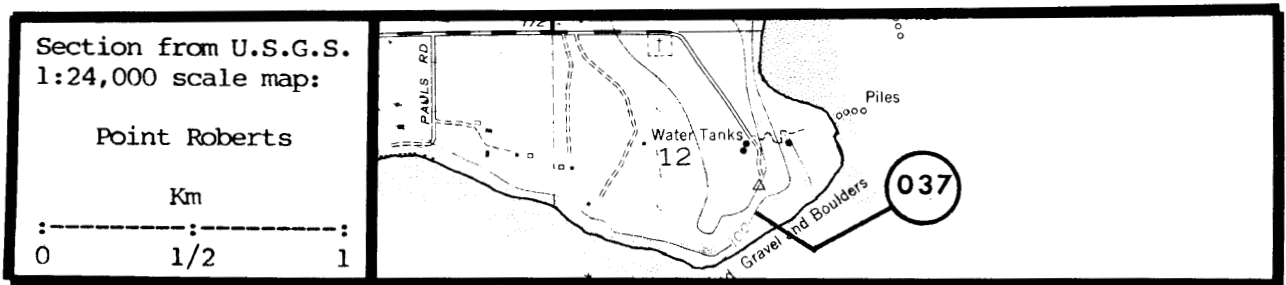
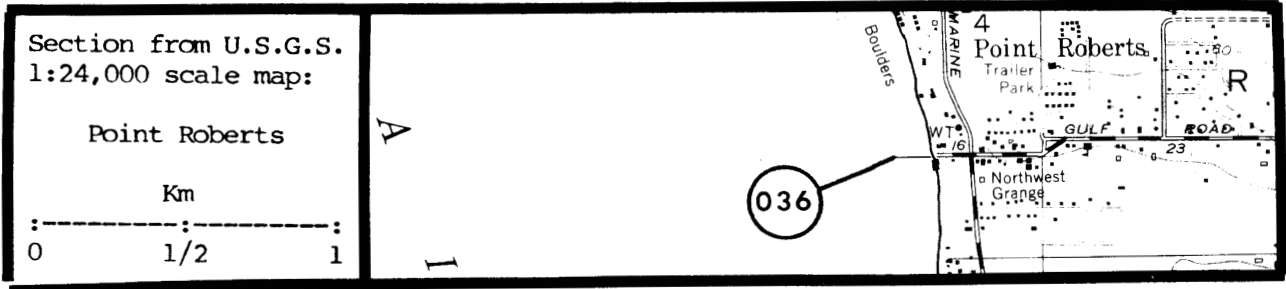

AREA 156, Victoria (cont'd.)

④042 Point Whitehorn, north 48°53'40"N, 122°47'00"W

| | | | | |
|------------------|----|------|----------|-----------|
| Pigeon Guillemot | 4 | Wahl | 04/19/80 | M III 269 |
| Pigeon Guillemot | 16 | Wahl | 06/01/79 | M III 269 |

④043 Point Whitehorn, south 48°53'00"N, 122°46'30"W

| | | | | |
|------------------|---|------|----------|-----------|
| Pigeon Guillemot | 1 | Wahl | 06/08/78 | L III 269 |
|------------------|---|------|----------|-----------|

④044 Patos Island, Little 48°47'06"N, 122°58'00"W

| | | | | |
|---------------------|---|---------------|----------|-----------|
| No Nesting Observed | 0 | Speich & Wahl | 06/05/78 | B III 257 |
|---------------------|---|---------------|----------|-----------|

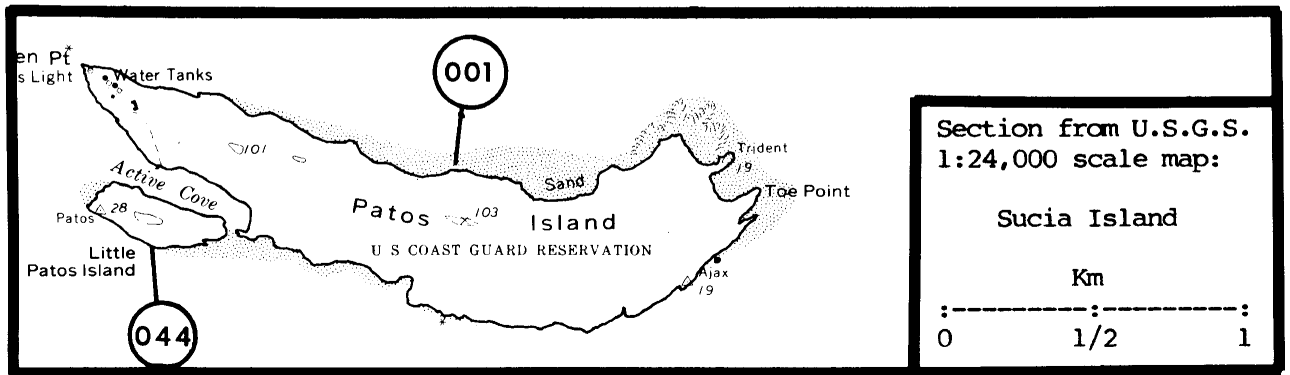
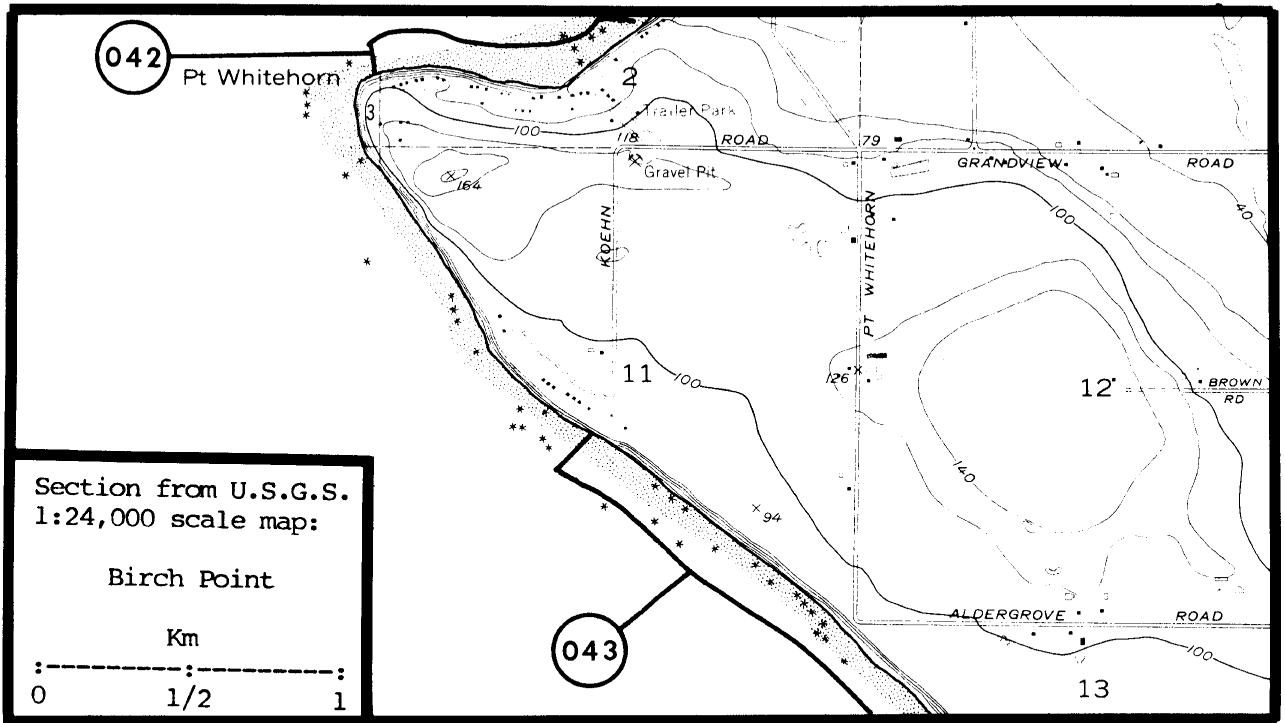

AREA 156, Victoria (cont'd.)

045

Sucia Island, complex 48°45'30"N, 122°54'00"W

| | | | | |
|----------------------|-----|---------------|-----------------------|-----------|
| Pigeon Guillemot | 620 | Speich & Wahl | 06/05/78 ¹ | B III 257 |
| Black Oystercatcher | 4 | Randolph | 06/08/1886 | E - 222 |
| Glaucous-winged Gull | 2 | Randolph | 06/08/1886 | E - 222 |
| Tufted Puffin | 2 | Randolph | 06/08/1886 | E - 222 |
| Tufted Puffin | 2 | Johnson | 06/08/1886 | E - 160 |

¹Total shoreline and nearshore survey of Sucia Island complex.



Protection Island (156035) 19 November 1979 S.M. Speich

Section from U.S.G.S.
1:24,000 scale map:

Sucia Island

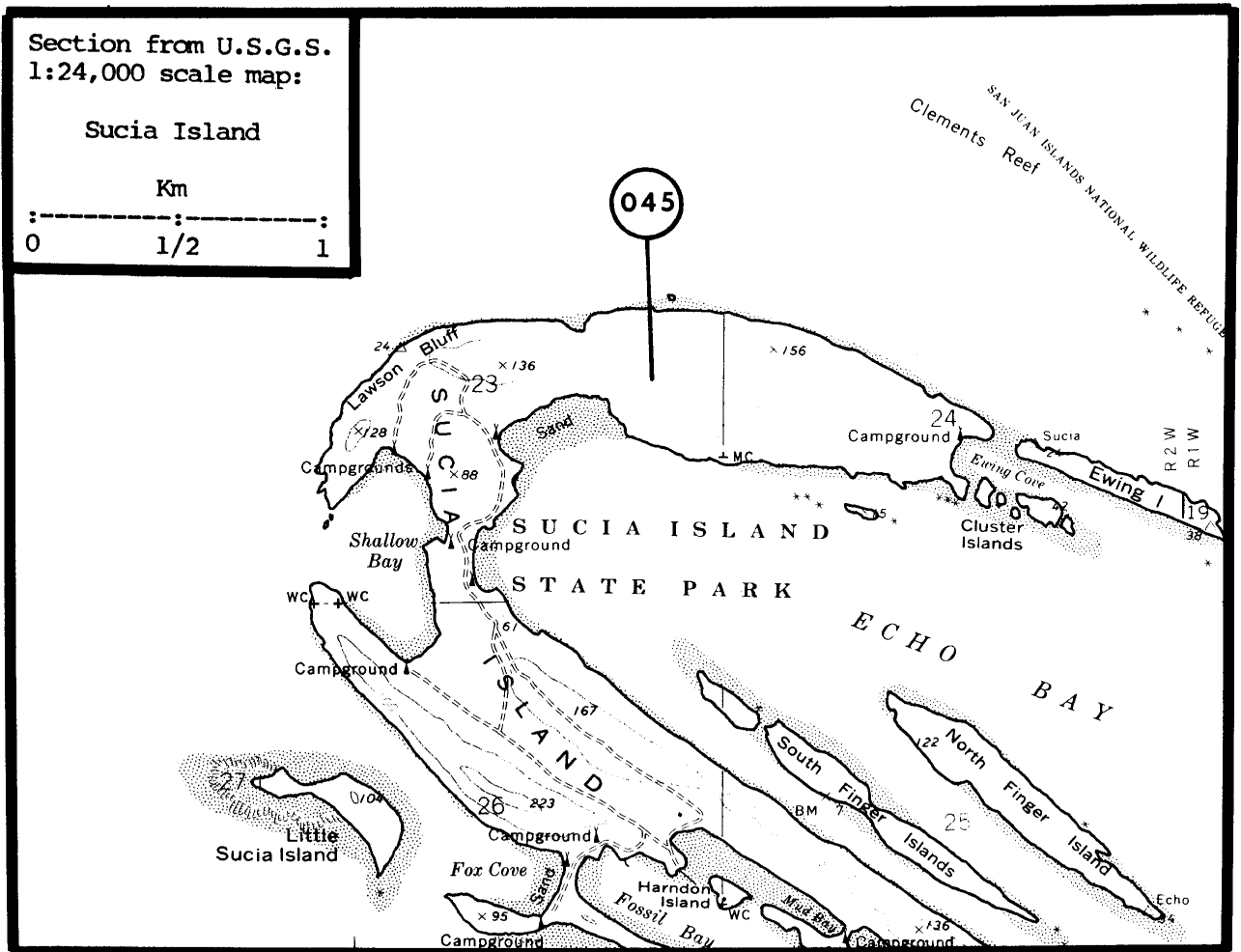
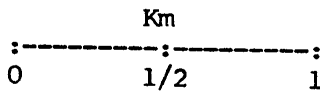

AREA 156, Victoria (cont'd.)

046

Cherry Point 48°51'24"N, 122°43'53"W

| | | | | |
|------------------|---|------|----------|-----------|
| Pigeon Guillemot | 4 | Wahl | 04/19/80 | L II 269 |
| Pigeon Guillemot | 1 | Wahl | 06/01/79 | L III 269 |

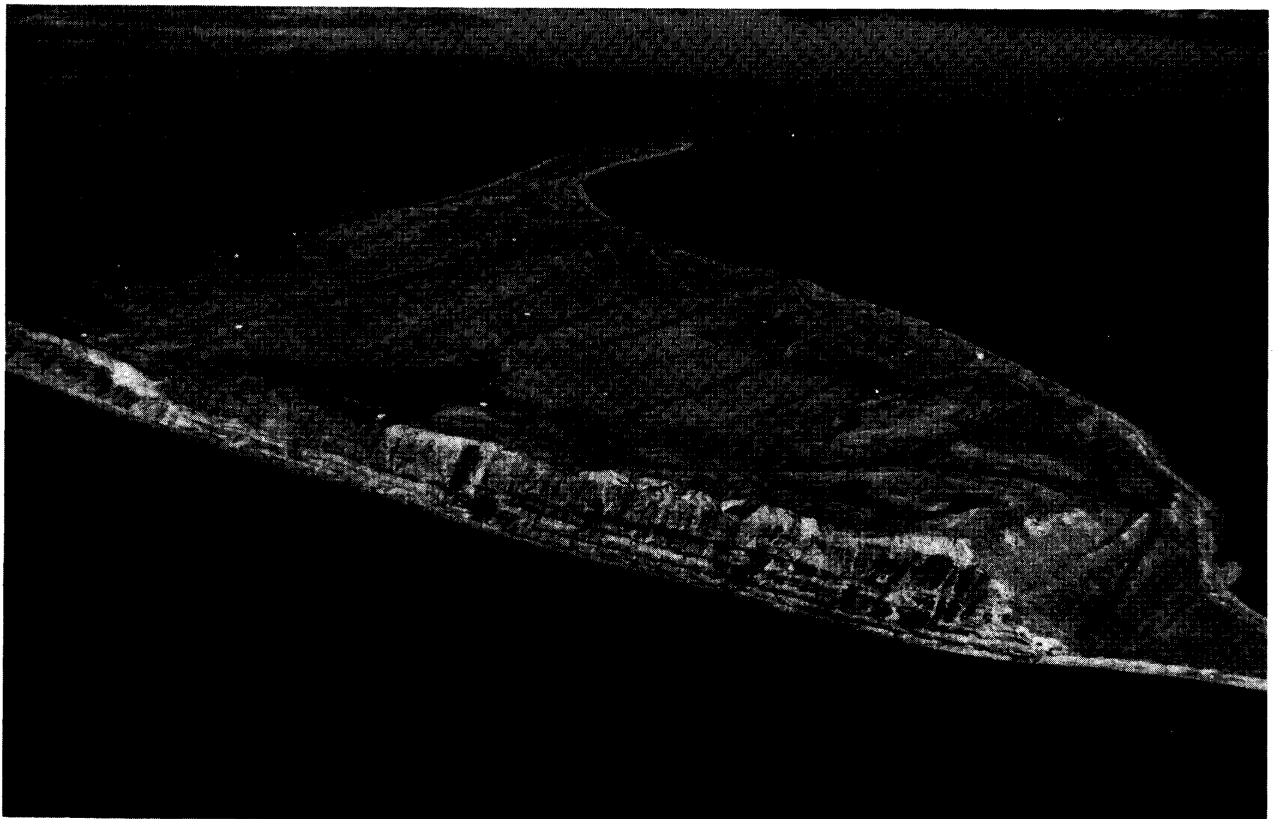

Protection Island (156035) 19 November 1979 S.M. Speich

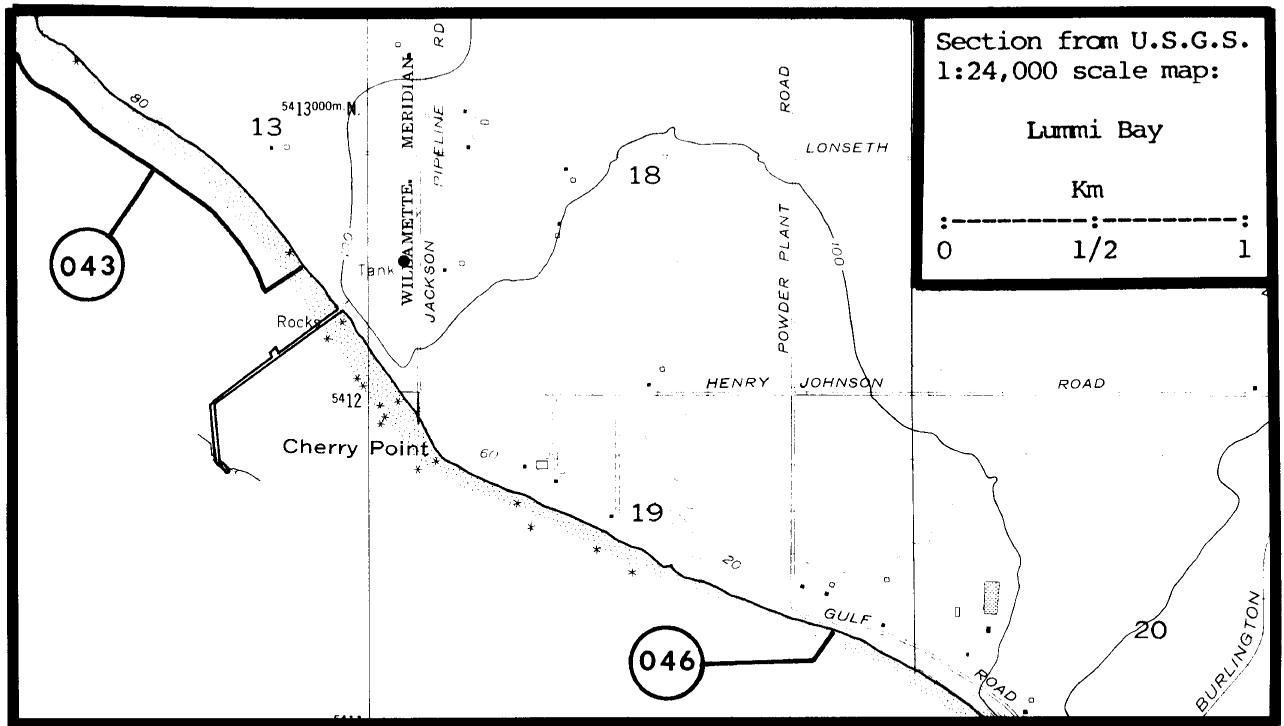

AREA 156, Victoria (cont'd.)

047

Bellingham Bay, waterfront north 48°45'20"N, 122°30'00"W

| | | | | |
|----------------------|---------|--------------------|----------|---------------|
| Glaucous-winged Gull | 34+ | Walker; Wahl | 07/16/82 | L III 272;269 |
| Glaucous-winged Gull | 2 | Wahl | 07/05/65 | L III 269 |
| Glaucous-winged Gull | X | Wahl | 07/21/71 | L III 269 |
| Glaucous-winged Gull | 100-150 | Wahl | 07/26/72 | L III 269 |
| Pigeon Guillemot | 2 | Booth ¹ | 06/14/22 | E - 36 |

¹Exact location unknown.



Protection Island (156035) 19 November 1979 S.M. Speich

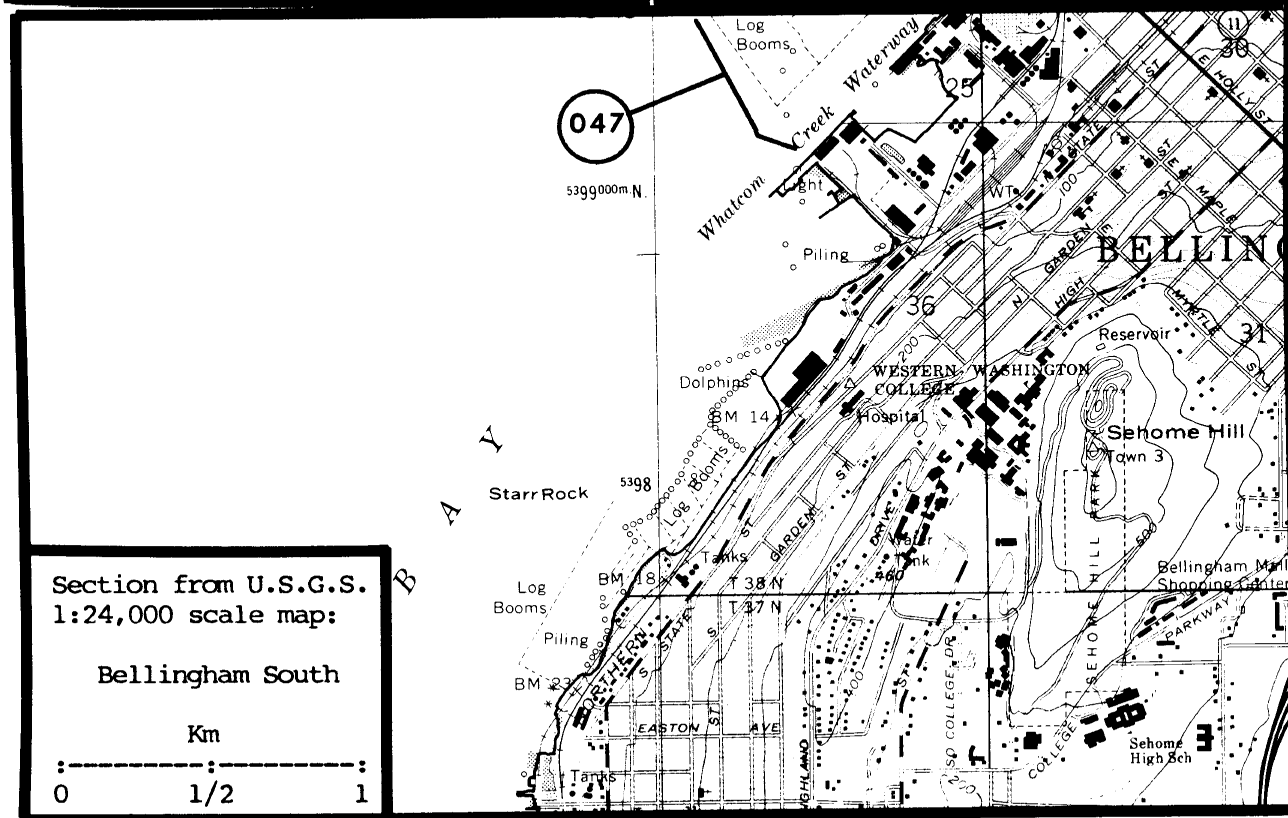
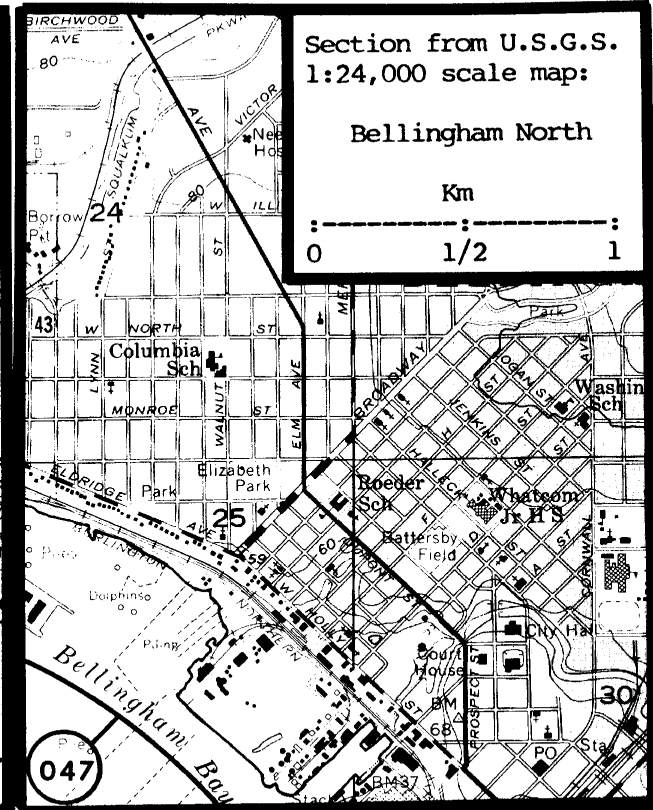
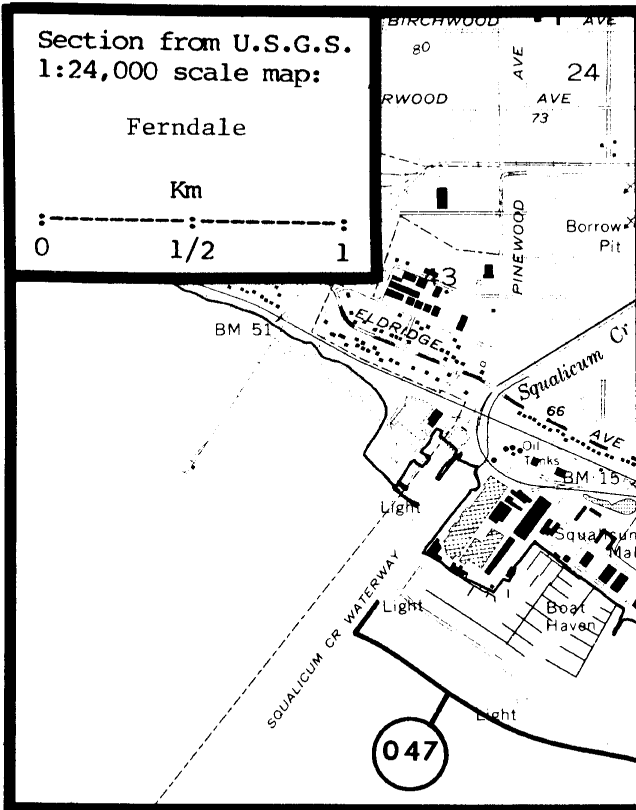

AREA 156, Victoria (cont'd.)

④48 Stuart Island, Turn Point 48°41'20"N, 123°14'18"W

| | | | | |
|----------------------|------|--------|----------|-----------|
| Black Oystercatcher | 1 | Pitman | 06/22/78 | B III 217 |
| Pelagic Cormorant | 8-12 | Drent | 08/27/60 | B III 92 |
| Glaucous-winged Gull | 2-12 | Drent | 08/27/60 | B III 92 |
| Pigeon Guillemot | 25 | Drent | 05/07/60 | B III 92 |
| Pigeon Guillemot | 50 | Drent | 08/27/60 | B III 92 |

④49 Satellite Island 48°41'00"N, 123°11'20"W

| | | | | |
|------------------|---|--------|----------|-----------|
| Pigeon Guillemot | 4 | Pitman | 06/22/78 | B III 217 |
|------------------|---|--------|----------|-----------|

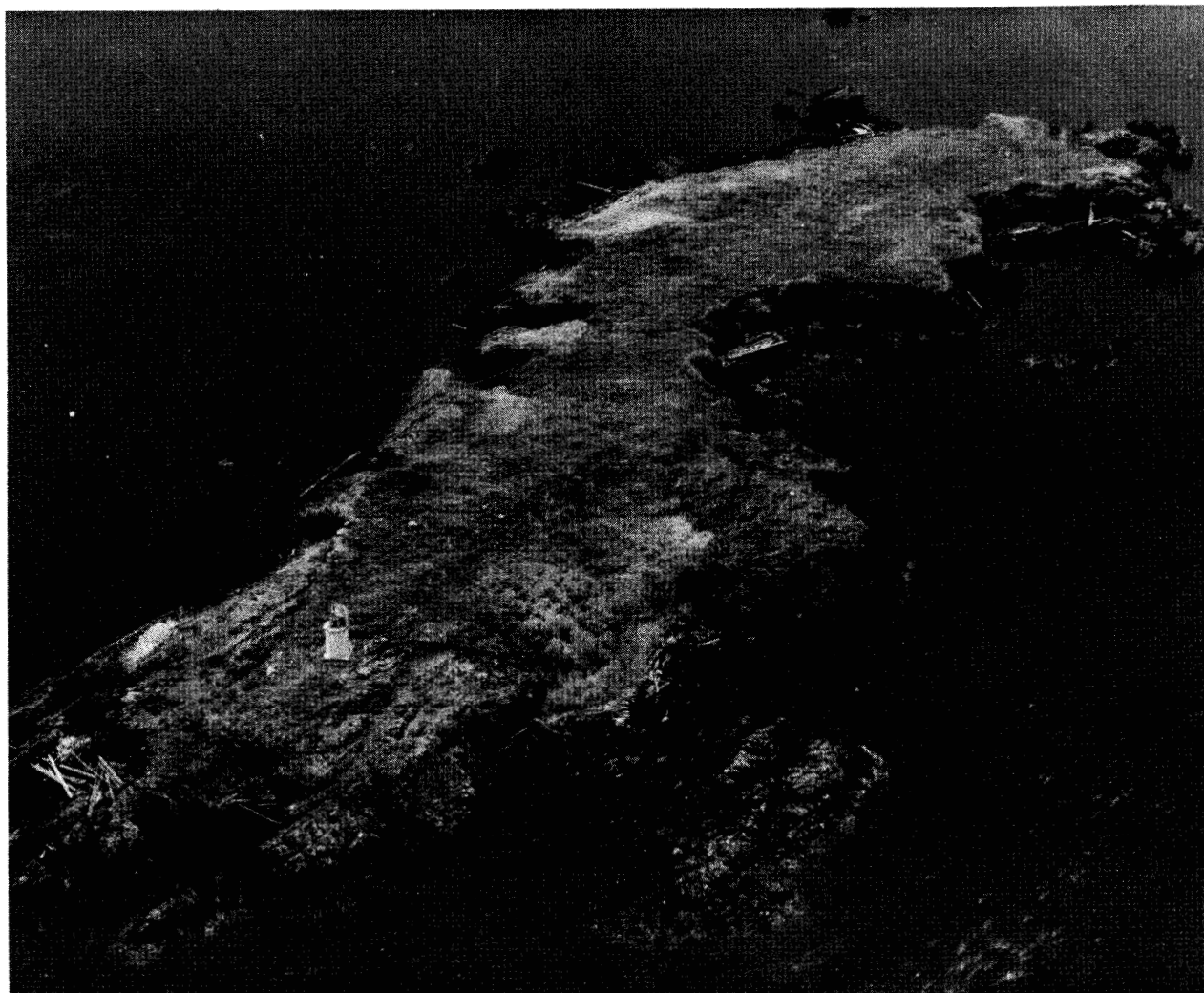

Peapod, North (156009) USF&WS

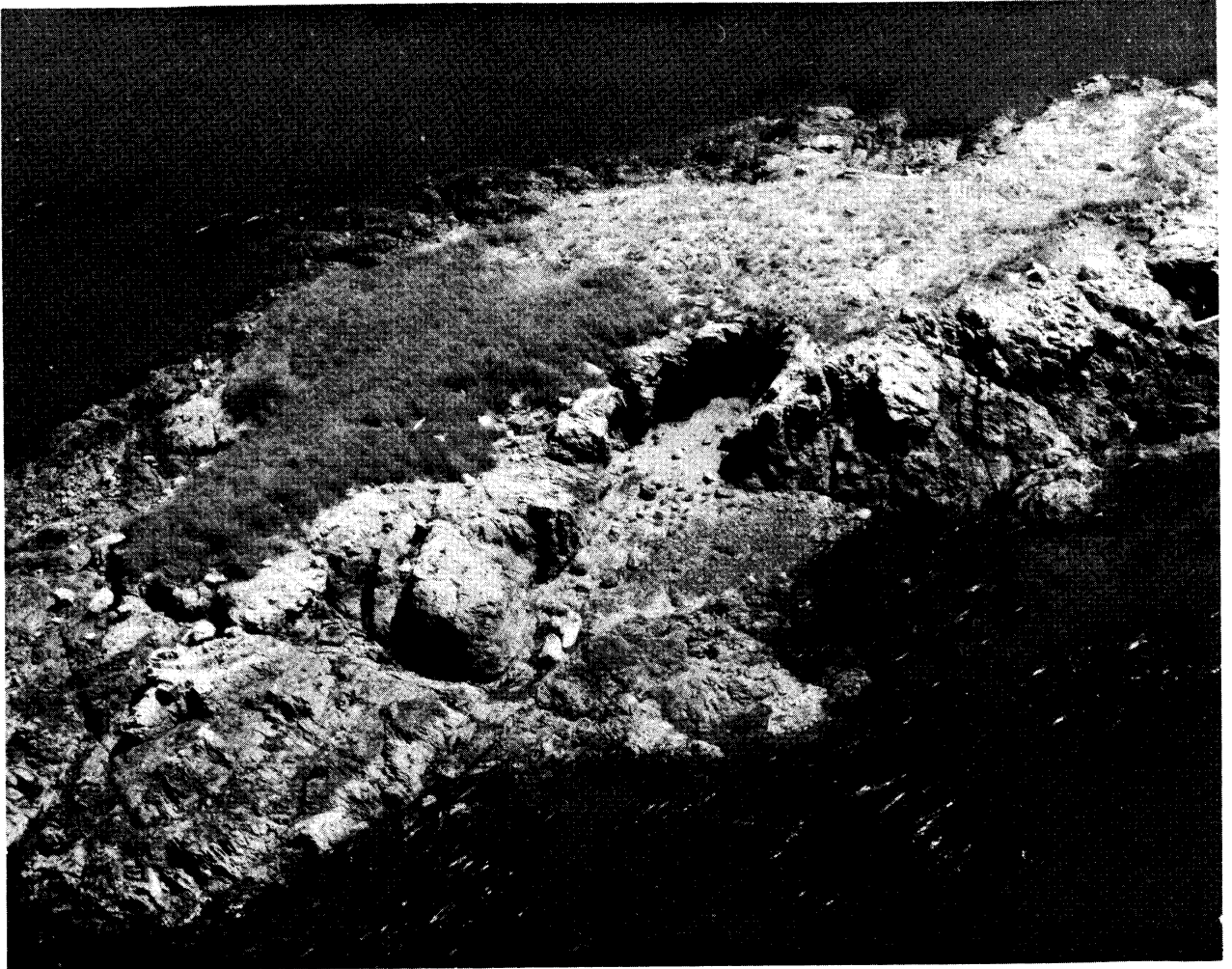
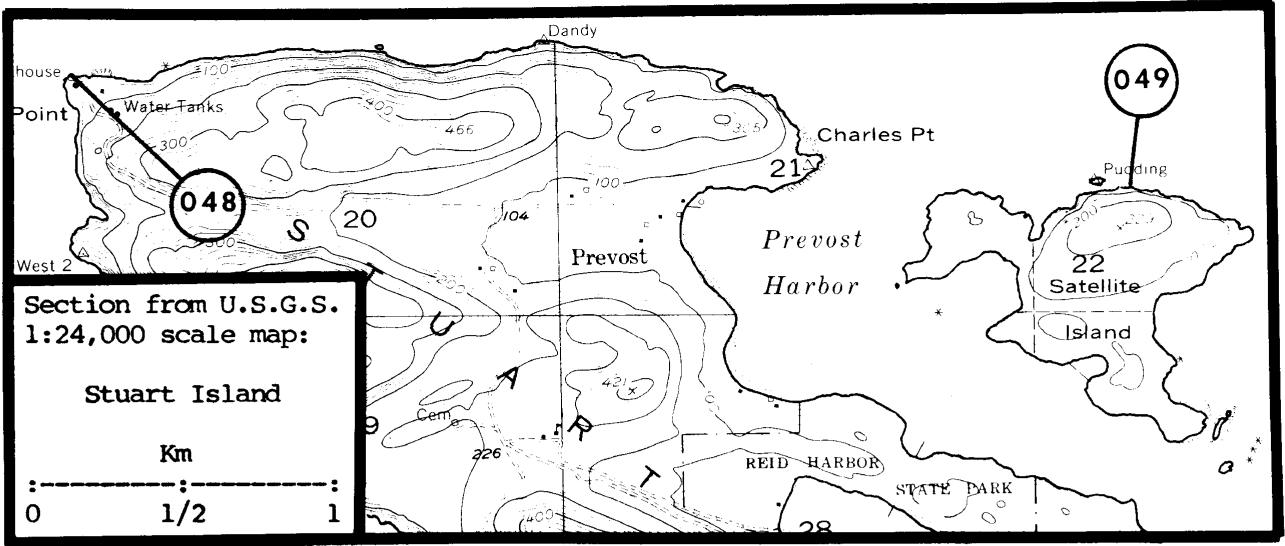

Peapod, South (156010) USFWS

AREA 156, Victoria (cont'd.)

(050) "Unnamed Rock" 48°39'54"N, 123°10'24"W

| | | | | |
|---------------------|---|--------|----------|-----------|
| Black Oystercatcher | 2 | Pitman | 06/22/78 | B III 217 |
| Pigeon Guillemot | 5 | Pitman | 06/22/78 | B III 217 |
| Total | 7 | | | |

(051) Gossip Island 48°39'47"N, 123°10'17"W

| | | | | |
|---------------------|---|--------|----------|-----------|
| No Nesting Observed | 0 | Pitman | 06/22/78 | B III 217 |
|---------------------|---|--------|----------|-----------|

(052) Gull Reef, west 48°39'17"N, 123°08'44"W

| | | | | |
|---------------------|---|--------------|------------|-----------|
| Black Oystercatcher | 2 | Pitman | 06/22/78 | B III 217 |
| No Nesting Observed | 0 | Manuwal 1977 | ?/ ?/73-75 | B III 187 |

(053) "Unnamed Rock" 48°39'13"N, 123°08'31"W

| | | | | |
|---------------------|---|--------|----------|-----------|
| No Nesting Observed | 0 | Pitman | 06/22/78 | B III 217 |
|---------------------|---|--------|----------|-----------|

(054) Ripple Island 48°39'26"N, 123°07'47"W

| | | | | |
|---------------------|---|------------|----------|-----------|
| No Nesting Observed | 0 | Pitman | 06/22/78 | B III 217 |
| Black Oystercatcher | 1 | Eddy 1975 | 06/14/75 | L III 94 |
| Black Oystercatcher | N | Nysewander | 06/14/75 | L III 205 |

(055) "Unnamed Rock" 48°39'15"N, 123°07'55"W

| | | | | |
|---------------------|---|--------|----------|-----------|
| Black Oystercatcher | 2 | Pitman | 06/22/78 | B III 217 |
|---------------------|---|--------|----------|-----------|

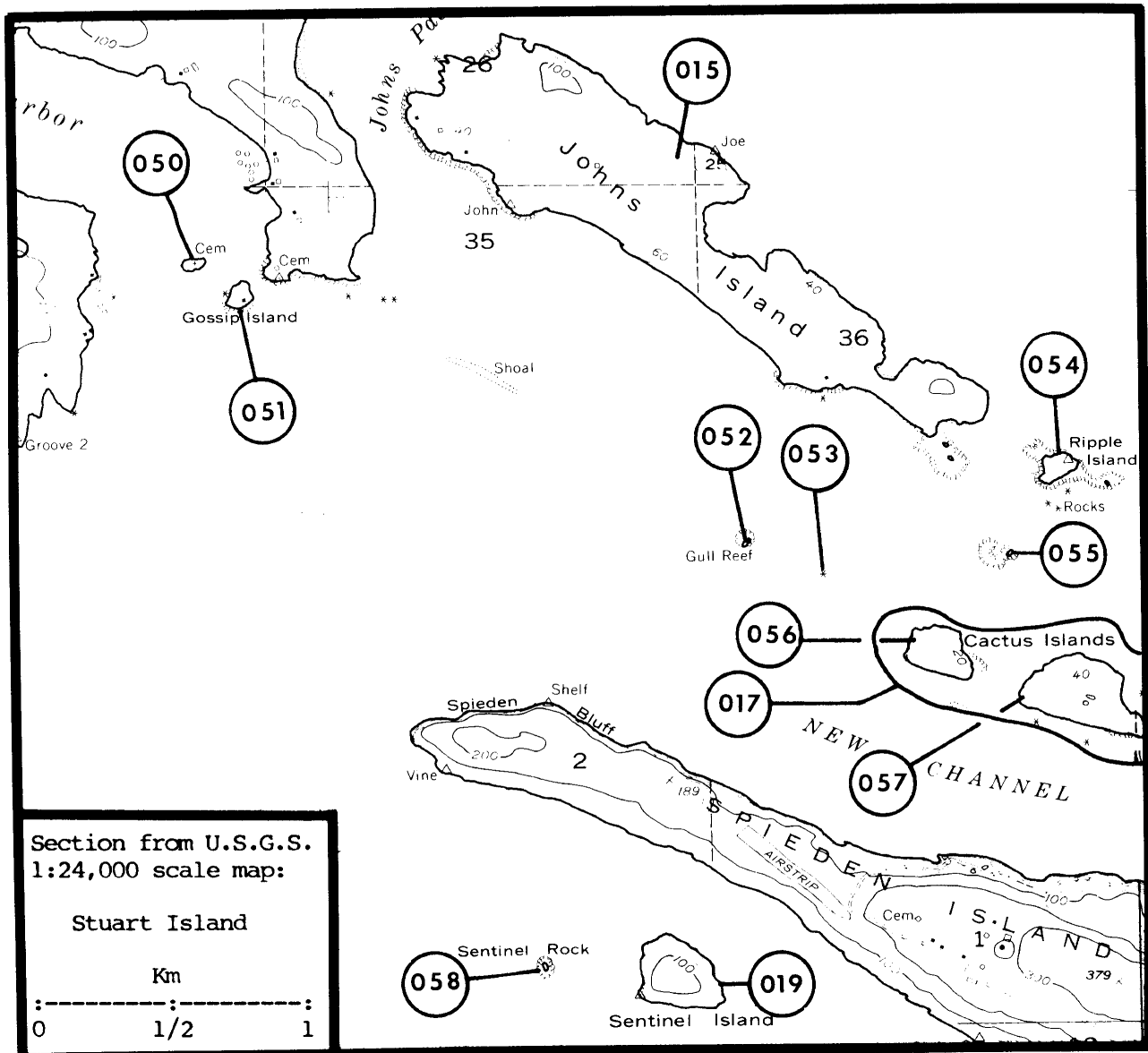

AREA 156, Victoria (cont'd.)

(056) Cactus Island, west 48°39'04"N, 123°08'10"W

| | | | | |
|---------------------|---|------------------------|----------|---------------|
| No Nesting Observed | 0 | Pitman | 06/22/78 | B III 217 |
| Pigeon Guillemot | 3 | Wahl; Harrington-Tweit | 05/24/78 | A III 269;124 |

(057) Cactus Island, east 48°39'07"N, 123°07'43"W

| | | | | |
|---------------------|-----|-------------|----------|-----------|
| Pigeon Guillemot | 30 | Pitman | 06/22/78 | B III 217 |
| Black Oystercatcher | 1 | Frazer 1973 | 07/16/73 | B III 108 |
| Pigeon Guillemot | 15P | Frazer 1973 | 07/16/73 | B III 108 |
| No Nesting Observed | 0 | Eddy 1975 | 06/14/75 | B III 94 |

(058) Sentinel Rock 48°38'25"N, 123°09'22"W

| | | | | |
|---------------------|---|--------|----------|-----------|
| No Nesting Observed | 0 | Pitman | 06/22/78 | B III 217 |
|---------------------|---|--------|----------|-----------|

(059) "Unnamed Rock" 48°40'10"N, 123°04'15"W

| | | | | |
|----------------------|----|--------|----------|-----------|
| Glaucous-winged Gull | 20 | Pitman | 06/22/78 | B III 217 |
|----------------------|----|--------|----------|-----------|

(060) Danger Rocks¹ 48°39'51"N, 123°04'00"W

| | | | | |
|----------------------|-----|-----------------------|----------|---------------|
| Glaucous-winged Gull | X | Nisqually NWR | 06/27/70 | B III 202 |
| Black Oystercatcher | P | Edson 1929 | 06/20/05 | L III 98 |
| Black Oystercatcher | 2 | Edson 1929 | 06/24/05 | L III 98 |
| Black Oystercatcher | 2 | Edson 1929 | 06/26/05 | L III 98 |
| Glaucous-winged Gull | 4 | Edson 1929 | 06/24/05 | L III 98 |
| Glaucous-winged Gull | 250 | Manuwal 1973; Manuwal | 05/27/73 | B III 186;188 |
| Pigeon Guillemot | X | Edson 1929 | 06/24/05 | L III 98 |
| Pigeon Guillemot | 14 | Manuwal 1973; Manuwal | 05/27/73 | B III 186;188 |
| Tufted Puffin | ? | Edson 1929 | 06/24/05 | L III 98 |

¹This site regularly goes under water with high tide. It appears there has been some confusion regarding this site.

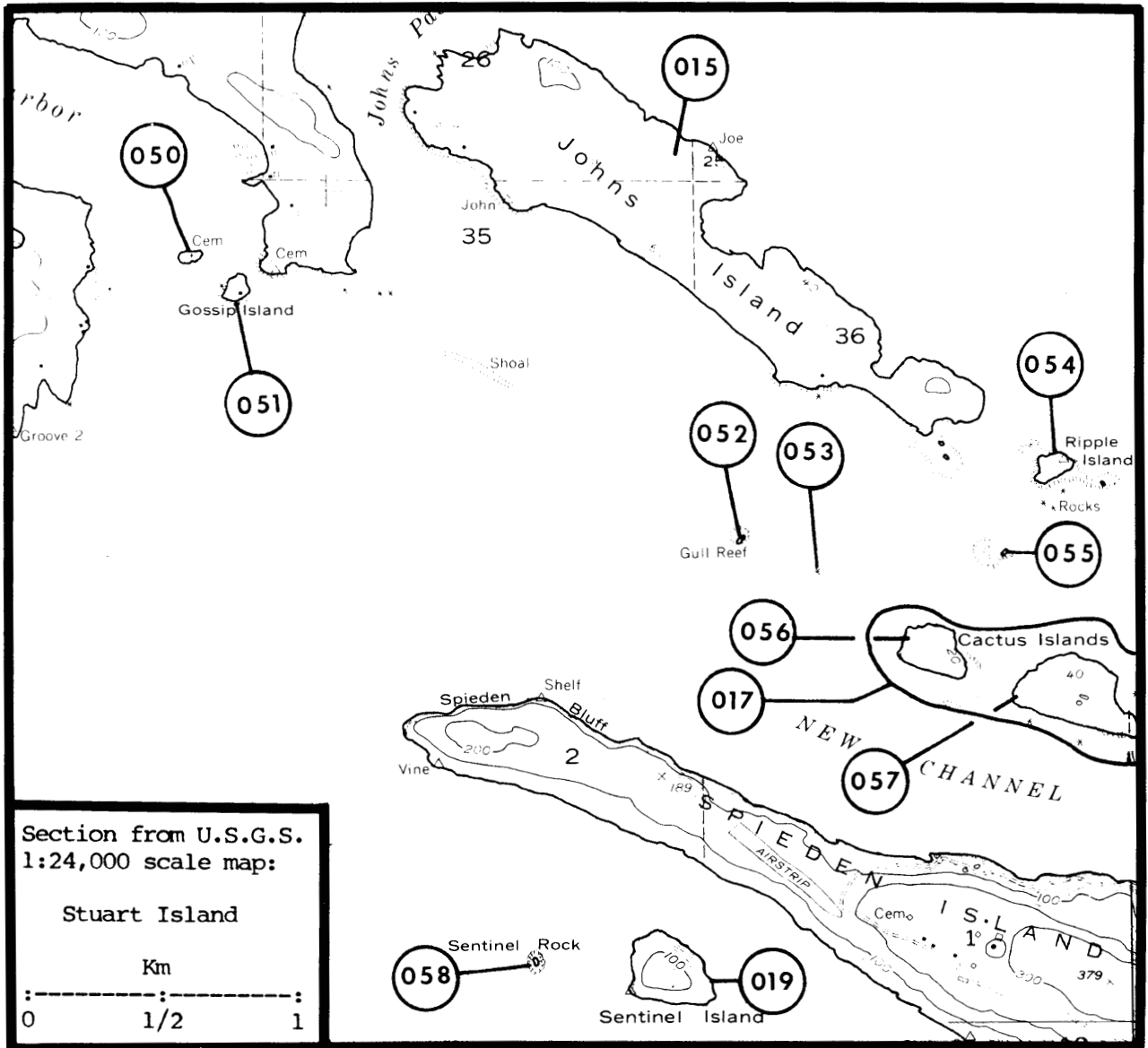

Section from U.S.G.S.
1:24,000 scale map:

Stuart Island

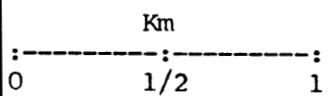

Section from U.S.G.S.
1:24,000 scale map:

Waldron Island

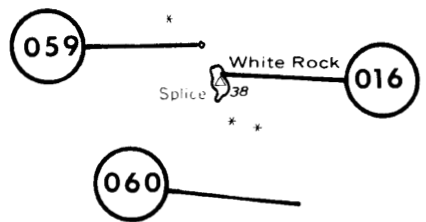
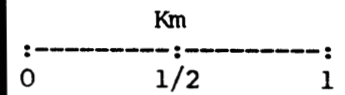

AREA 156, Victoria (cont'd.)

(061) "Unnamed Rock" 48°38'52"N, 123°07'34"W
No Nesting Observed 0 Wahl; Paulson 06/06/79 A III 269;207

(062) Parker Reef¹ 48°43'40"N, 122°53'42"W
Black Oystercatcher 2? Nisqually NWR 08/06/80 B III 202

¹This site regularly goes under water with high tide. Nesting is questionable.

(063) Freeman Island 48°41'55"N, 122°57'00"W
No Nesting Observed 0 Wahl; Paulson 06/06/79 A III 269;207

(064) "Unnamed Rock" 48°41'40"N, 122°54'23"W
No Nesting Observed 0 Wahl 06/02/79 M III 269

Section from U.S.G.S.
1:24,000 scale map:

Waldron Island

Km

0 1/2 1

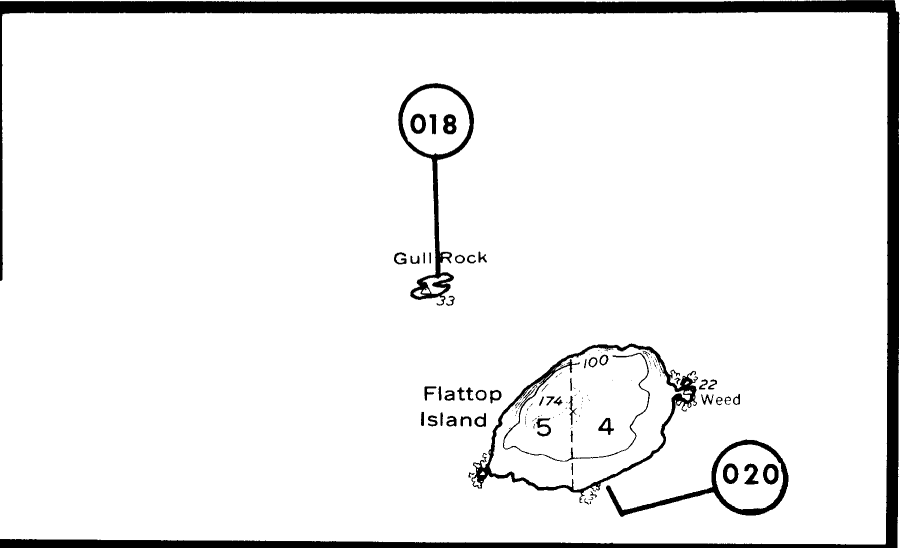
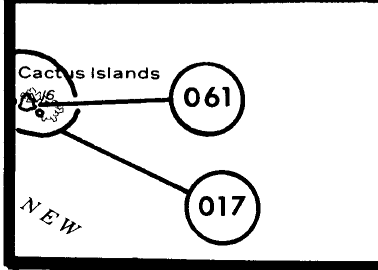

Section from U.S.G.S.
1:24,000 scale map:

Eastsound

Km

0 1/2 1

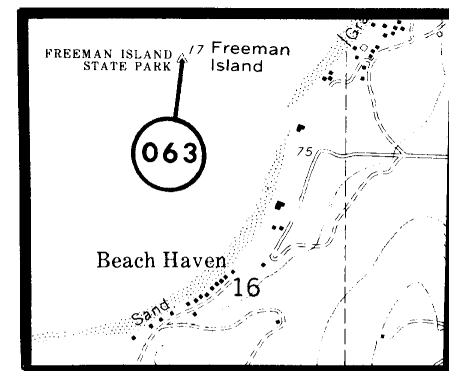
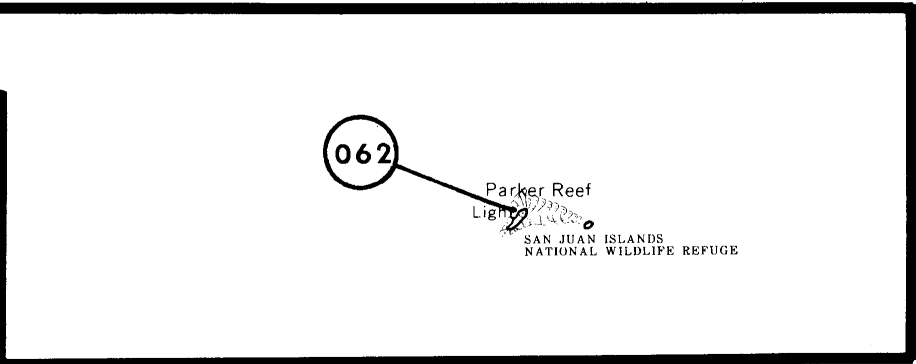

Section from U.S.G.S.
1:24,000 scale map:

Eastsound

Km

0 1/2 1

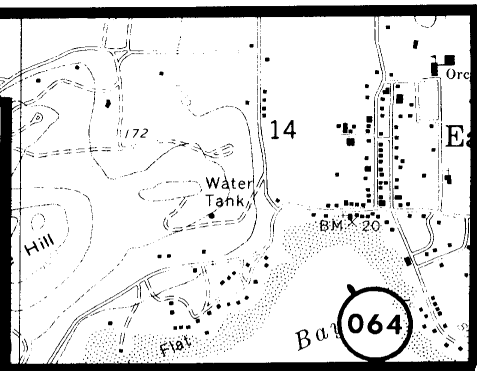

AREA 156, Victoria (cont'd.)

| | | | | | |
|---------------------|----------------|-------------------------|----------|---------------|--|
| 065 | Skull Island | 48°38'22"N, 122°59'07"W | | | |
| No Nesting Observed | 0 | Pitman | 06/24/78 | B III 217 | |
| 066 | "Unnamed Rock" | 48°38'02"N, 122°59'28"W | | | |
| No Nesting Observed | 0 | Wahl | 06/02/79 | M III 269 | |
| 067 | Sheep Island | 48°37'19"N, 122°57'25"W | | | |
| No Nesting Observed | 0 | Pitman | 06/24/78 | B III 217 | |
| 068 | "Unnamed Rock" | 48°44'36"N, 122°48'53"W | | | |
| No Nesting Observed | 0 | Wahl; Paulson | 06/06/79 | A III 269;207 | |

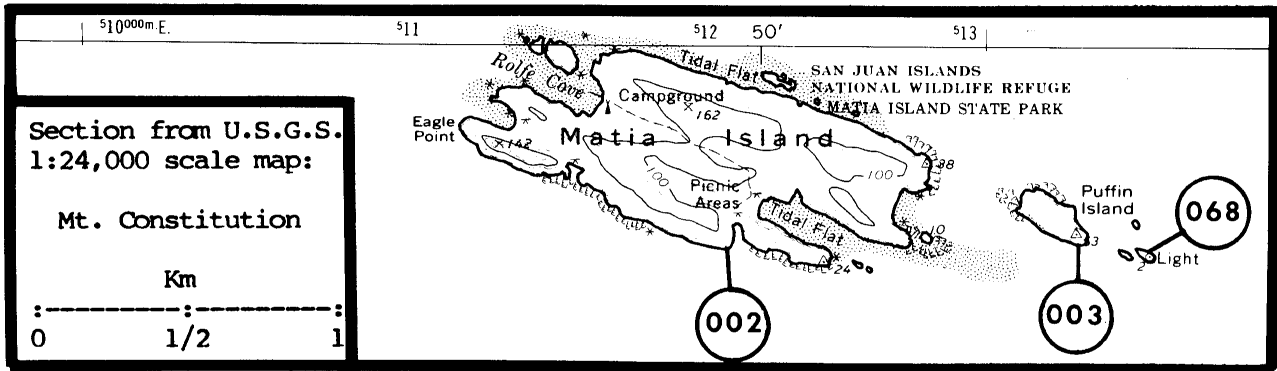
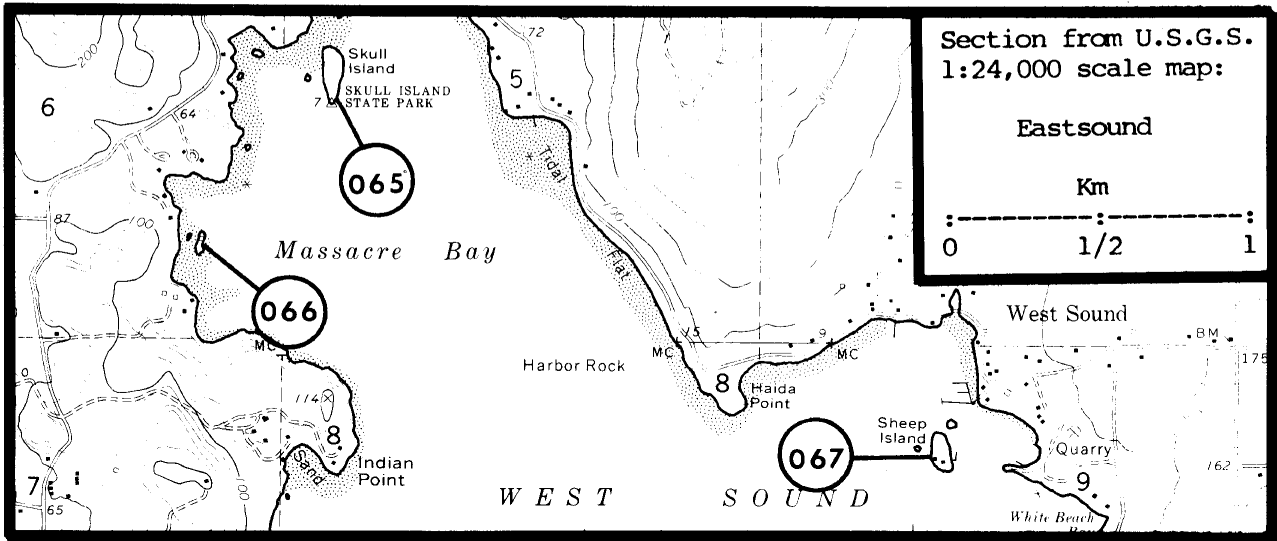

AREA 156, Victoria (cont'd.)

(069) Clark Island 48°42'08"N, 122°45'48"W

Pigeon Guillemot 13 Wahl; Paulson 07/06/78 A III 269;207

(070) Barnes Island 48°42'00"N, 122°46'24"W

Pigeon Guillemot 14 Wahl; Paulson 07/06/78 A III 269;207

(071) Sisters, The 48°41'02"N, 122°45'30"W

| | | | | |
|----------------------|---|---------------|----------|---------------|
| Black Oystercatcher | 2 | Nisqually NWR | 08/06/80 | B III 202 |
| Glaucous-winged Gull | X | Wahl | 03/14/79 | B III 269 |
| Pigeon Guillemot | 3 | Wahl; Paulson | 07/06/78 | A III 269;207 |
| Total | 5 | | | |

| | | | | |
|----------------------|------|----------------------|-------------|-----------|
| Pelagic Cormorant | 4 | Nisqually NWR | 06/20/63 | B II 202 |
| Pelagic Cormorant | 19P | Hauser & Monson 1963 | 07/16-17/63 | B III 145 |
| Pelagic Cormorant | 4 | Washington Dep. Game | ?/ ?/63 | ? ? 203 |
| Black Oystercatcher | 2 | Nisqually NWR | 06/20/63 | B III 202 |
| Black Oystercatcher | 3 | Hauser & Monson 1963 | 07/16-17/63 | B III 145 |
| Glaucous-winged Gull | 300 | Jewett 1937 | 05/26/37 | B III 156 |
| Glaucous-winged Gull | 800 | Nisqually NWR | 06/20/63 | B III 202 |
| Glaucous-winged Gull | 1600 | Hauser & Monson 1963 | 07/16-17/63 | B III 145 |
| Pigeon Guillemot | 60 | Jewett 1937 | 05/26/37 | B III 156 |
| Pigeon Guillemot | 2 | Richardson | 06/02/57 | L III 229 |
| Pigeon Guillemot | 4 | Nisqually NWR | 06/20/63 | B III 202 |
| Pigeon Guillemot | 14 | Hauser & Monson 1963 | 07/16-17/63 | B III 145 |
| Tufted Puffin | 2 | Hauser & Monson 1963 | 07/16-17/63 | B III 145 |

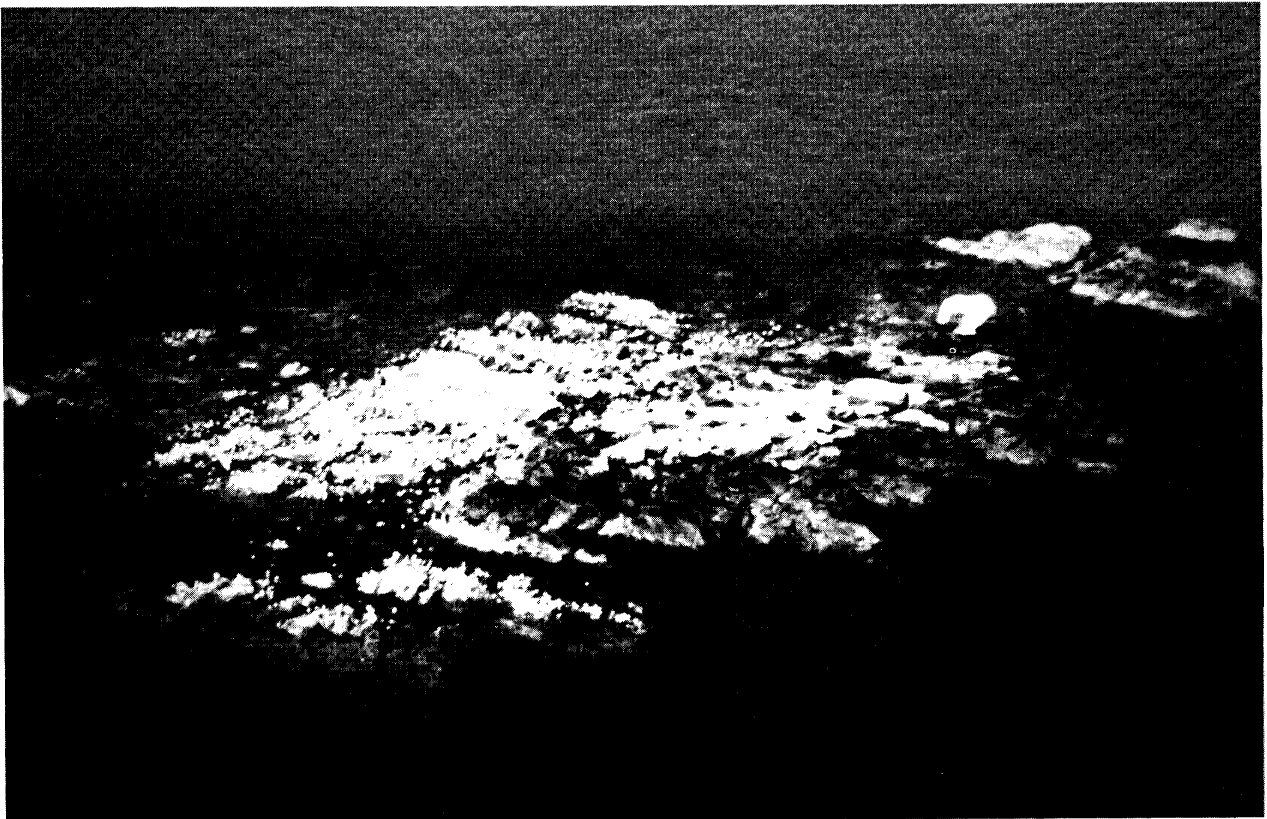
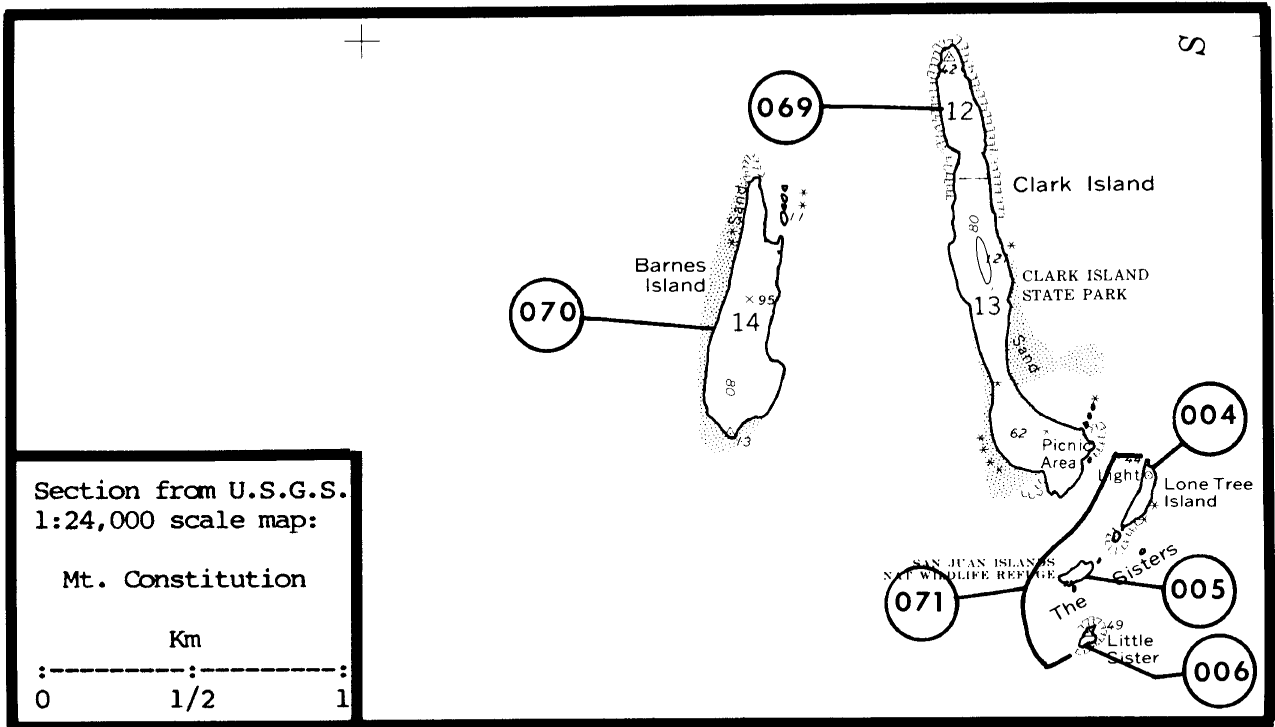

Peapod, Middle (156074) 19 July 1982 T.R. Wahl

AREA 156, Victoria (cont'd.)

(072) Doe Island 48°38'00"N, 122°47'12"W

No Nesting Observed 0 Pitman 06/21/78 B III 217

(073) Peapod Rocks¹ 48°38'21"N, 122°45'00"W

| | | | | |
|----------------------|-----|----------------------|-------------|-----------|
| Glaucous-winged Gull | X | Wahl | 03/14/79 | B III 269 |
| Black Oystercatcher | 6 | Hauser & Monson 1963 | 07/16-17/63 | B III 145 |
| Black Oystercatcher | 4 | Nysewander | 06/13/75 | B III 205 |
| Glaucous-winged Gull | 2 | Booth | 06/21/24 | E - 37 |
| Glaucous-winged Gull | 2 | Booth | 06/17/23 | E - 38 |
| Glaucous-winged Gull | 700 | Hauser & Monson 1963 | 07/16-17/63 | B III 145 |

¹Insufficient data to determine exact location. For additional records see Peapod, Middle (156074), Peapod, North (156009), and Peapod, South (156010).

(074) Peapod, Middle¹ 48°38'24"N, 122°45'01"W

| | | | | |
|---------------------|---|-------------|----------|-----------|
| No Nesting Observed | 0 | Wahl | 07/19/82 | A III 269 |
| No Nesting Observed | 0 | Jewett 1937 | 05/25/37 | B III 156 |
| No Nesting Observed | 0 | Pitman | 06/21/78 | B III 217 |
| No Nesting Observed | 0 | Wahl | 06/15/79 | B III 269 |

¹Rock awash at high tide stages.

(075) "Migley Rocks" 48°44'54"N, 122°43'00"W

Pigeon Guillemot 1 Speich & Wahl 06/05/78 B III 257

(076) Bellingham Bay, waterfront south 48°43'40"N, 122°30'40"W

| | | | | |
|------------------|---|-----------|----------|-----------|
| Pigeon Guillemot | 3 | Batchelor | 07/13/79 | L III 22 |
| Pigeon Guillemot | 3 | Wahl | 05/31/78 | L III 269 |
| Pigeon Guillemot | 5 | Hemphill | 06/27/78 | L III 129 |
| Pigeon Guillemot | 5 | Wahl | 05/23/79 | L III 269 |

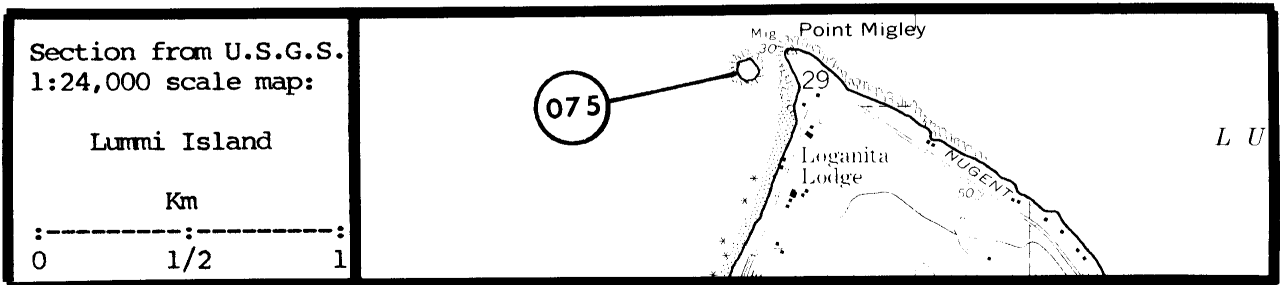
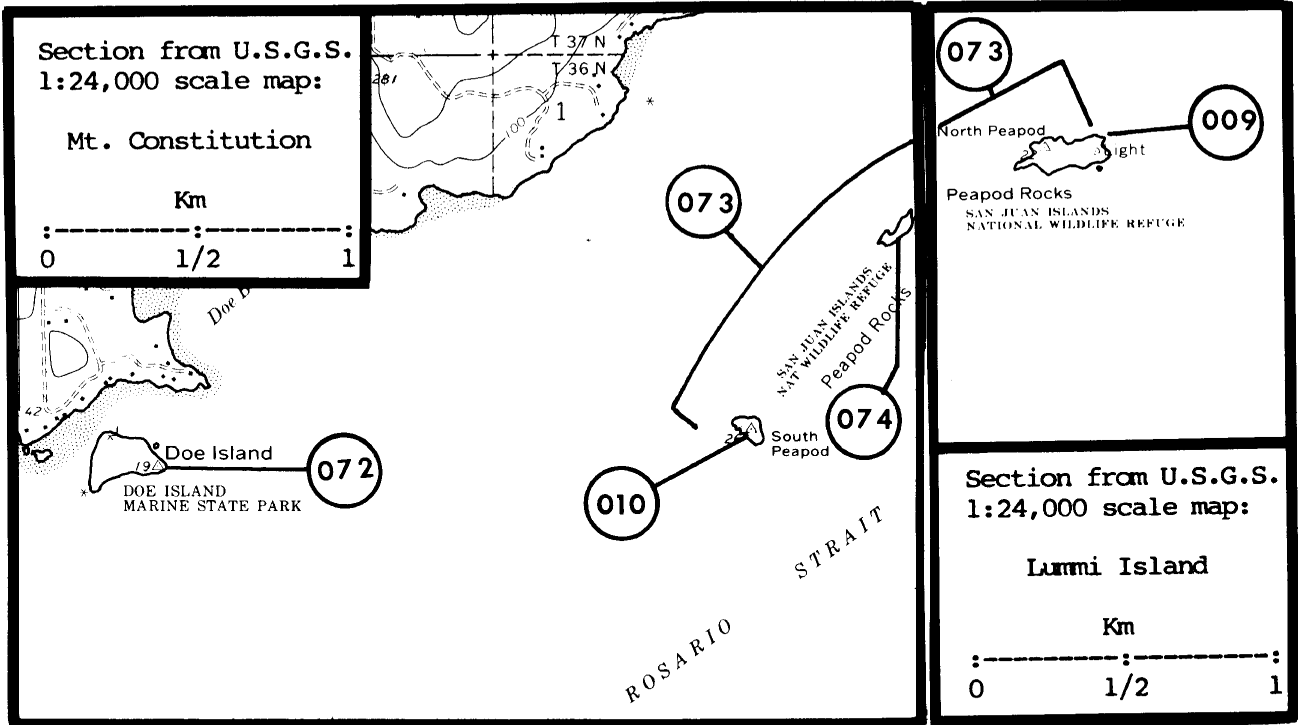

AREA 156, Victoria (cont'd.)

(077) Chuckanut Rock 48°41'05"N, 122°30'05"W

| | | | | |
|----------------------|-----------|----------|----------|---------|
| Black Oystercatcher | 2 | Benedict | 06/25/82 | B II 26 |
| Glaucous-winged Gull | 40 | Benedict | 06/25/82 | B II 26 |
| Pigeon Guillemot | 20 | Benedict | 06/25/82 | B II 26 |
| Total | <u>62</u> | | | |

| | | | | |
|----------------------|----|------------|------------|-----------|
| Black Oystercatcher | 2 | Garlick | 06/ ?/81 | B II 113 |
| Black Oystercatcher | 2 | Garlick | 06/29/82 | L I 113 |
| Glaucous-winged Gull | X | Garlick | 06/ ?/81 | B III 113 |
| Pigeon Guillemot | 1 | Edson | 06/20/1893 | S - 101 |
| Pigeon Guillemot | 10 | Edson 1929 | 06/13/05 | L III 98 |
| Pigeon Guillemot | 37 | Garlick | 07/28/78 | L III 113 |
| Pigeon Guillemot | 18 | Garlick | 06/25/79 | B III 113 |

(078) Chuckanut Island 48°40'38"N, 122°30'05"W

| | | | | |
|---------------------|---|---------|----------|-----------|
| No Nesting Observed | 0 | Garlick | 06/25/79 | B III 113 |
|---------------------|---|---------|----------|-----------|

| | | | | |
|---------------------|---|---------|----------|-----------|
| No Nesting Observed | 0 | Garlick | 07/28/78 | B III 113 |
|---------------------|---|---------|----------|-----------|

(079) Whiskey Rock 48°39'38"N, 122°30'08"W

| | | | | |
|---------------------|---|---------|-----------|-----------|
| No Nesting Observed | 0 | Garlick | Summer/79 | B III 113 |
|---------------------|---|---------|-----------|-----------|

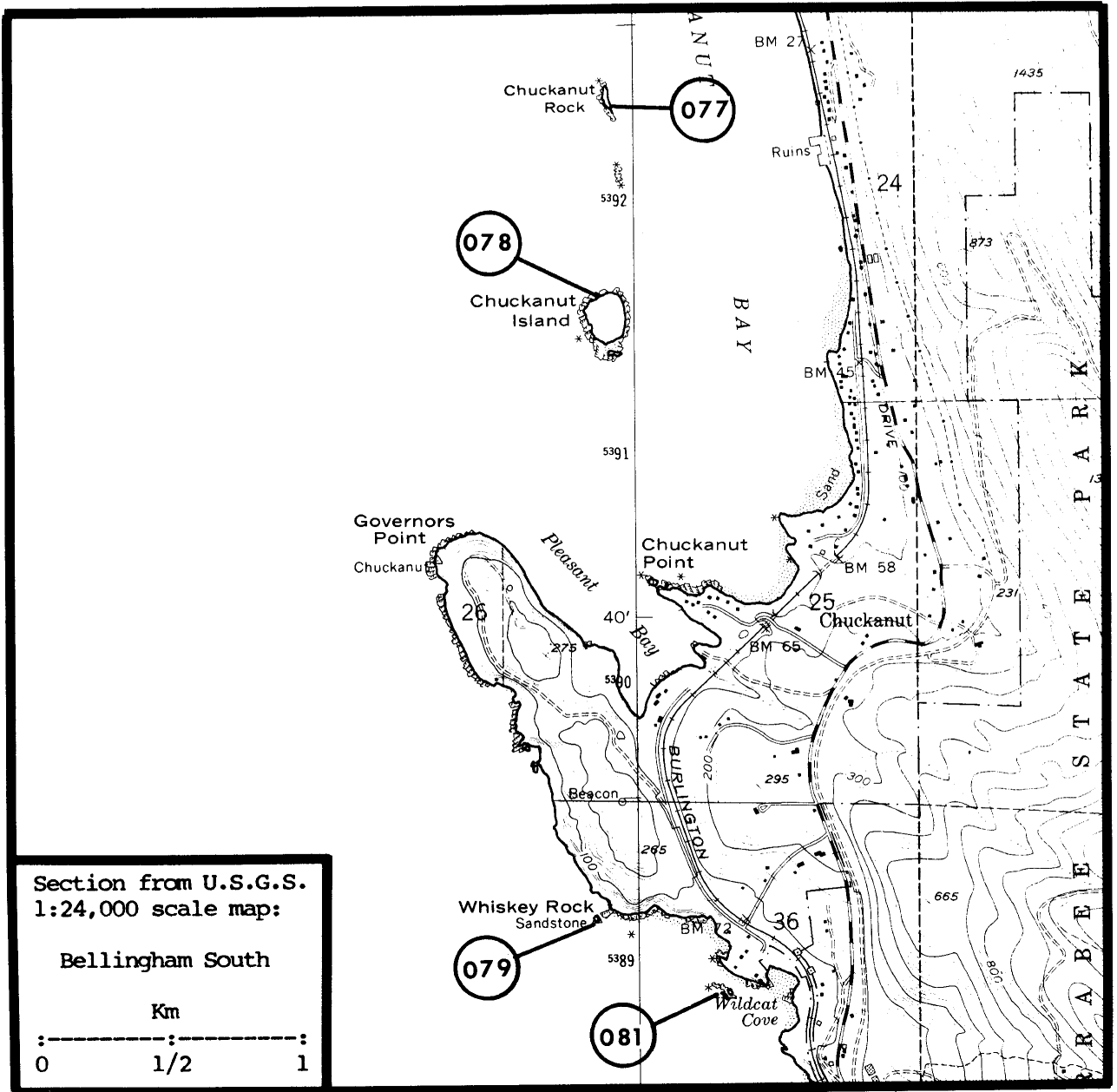

AREA 156, Victoria (cont'd.)

080 Eliza Rock 48°38'23"N, 122°34'35"W

| | | | | |
|---------------------|---|---------------|----------|-----------|
| Black Oystercatcher | 6 | Speich & Wahl | 06/05/78 | B III 257 |
| Pigeon Guillemot | 2 | Speich & Wahl | 06/05/78 | B III 257 |
| Total | 8 | | | |

| | | | | |
|----------------------|---|--------------|----------------|-----------|
| No Nesting Observed | 0 | Eddy 1975 | 06/13/75 | B III 94 |
| Glaucous-winged Gull | 2 | Manuwal 1977 | ?/ ?/73-75 | L I 187 |
| Pigeon Guillemot | X | Hudson | 06/18-07/01/49 | ? III 148 |

081 "Gargoyle Rock" 48°39'12"N, 122°29'43"W

| | | | | |
|---------------------|---|---------|-----------|-----------|
| No Nesting Observed | 0 | Garlick | Summer/79 | B III 113 |
|---------------------|---|---------|-----------|-----------|

082 Battleship Island 48°37'30"N, 123°11'03"W

| | | | | |
|---------------------|---|--------|----------|-----------|
| No Nesting Observed | 0 | Pitman | 06/22/78 | B III 217 |
|---------------------|---|--------|----------|-----------|

| | | | | |
|---------------------|---|---------------|----------------|---------------|
| No Nesting Observed | 0 | Eddy | 05/31-06/02/57 | B III 95 |
| No Nesting Observed | 0 | Frazer 1973 | 07/16/73 | B III 108 |
| No Nesting Observed | 0 | Eddy 1975 | 06/14/75 | B III 94 |
| Pigeon Guillemot | 3 | Wahl; Paulson | 07/06/78 | A III 269;207 |

083 Posey Island 48°37'07"N, 123°10'00"W

| | | | | |
|---------------------|---|--------|----------|-----------|
| No Nesting Observed | 0 | Pitman | 06/22/78 | B III 217 |
|---------------------|---|--------|----------|-----------|

| | | | | |
|------------------|----|---------------|----------|-----------|
| Pigeon Guillemot | 1? | Speich & Wahl | 05/19/78 | B III 257 |
|------------------|----|---------------|----------|-----------|

084 Barren Island 48°37'22"N, 123°09'34"W

| | | | | |
|---------------------|---|------|----------|-----------|
| No Nesting Observed | 0 | Wahl | 06/14/79 | B III 269 |
|---------------------|---|------|----------|-----------|

| | | | | |
|---------------------|---|-------------|----------------|-----------|
| No Nesting Observed | 0 | Eddy | 05/31-06/02/57 | B III 95 |
| No Nesting Observed | 0 | Frazer 1973 | 07/16/73 | B III 108 |
| No Nesting Observed | 0 | Eddy 1975 | 06/14/75 | B III 94 |
| No Nesting Observed | 0 | Pitman | 06/22/78 | B III 217 |

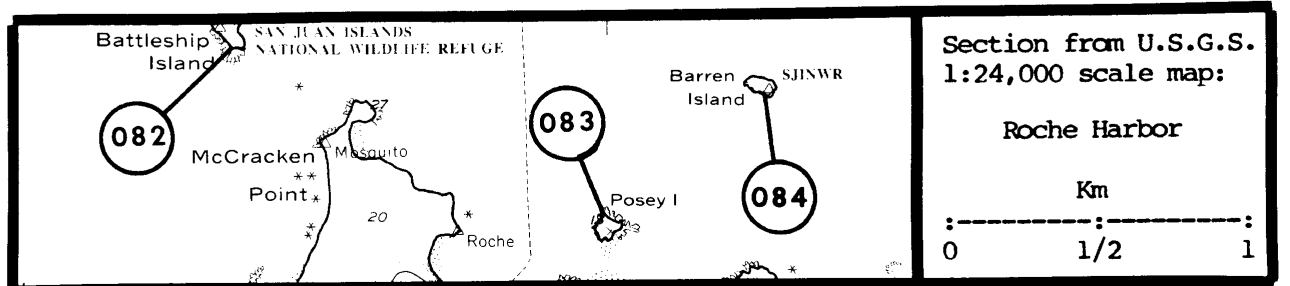
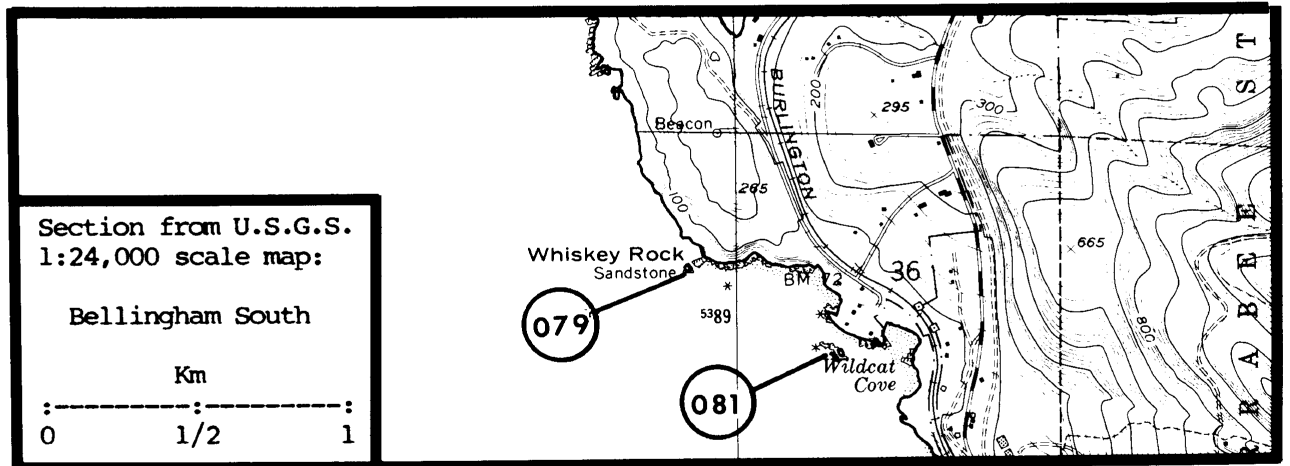
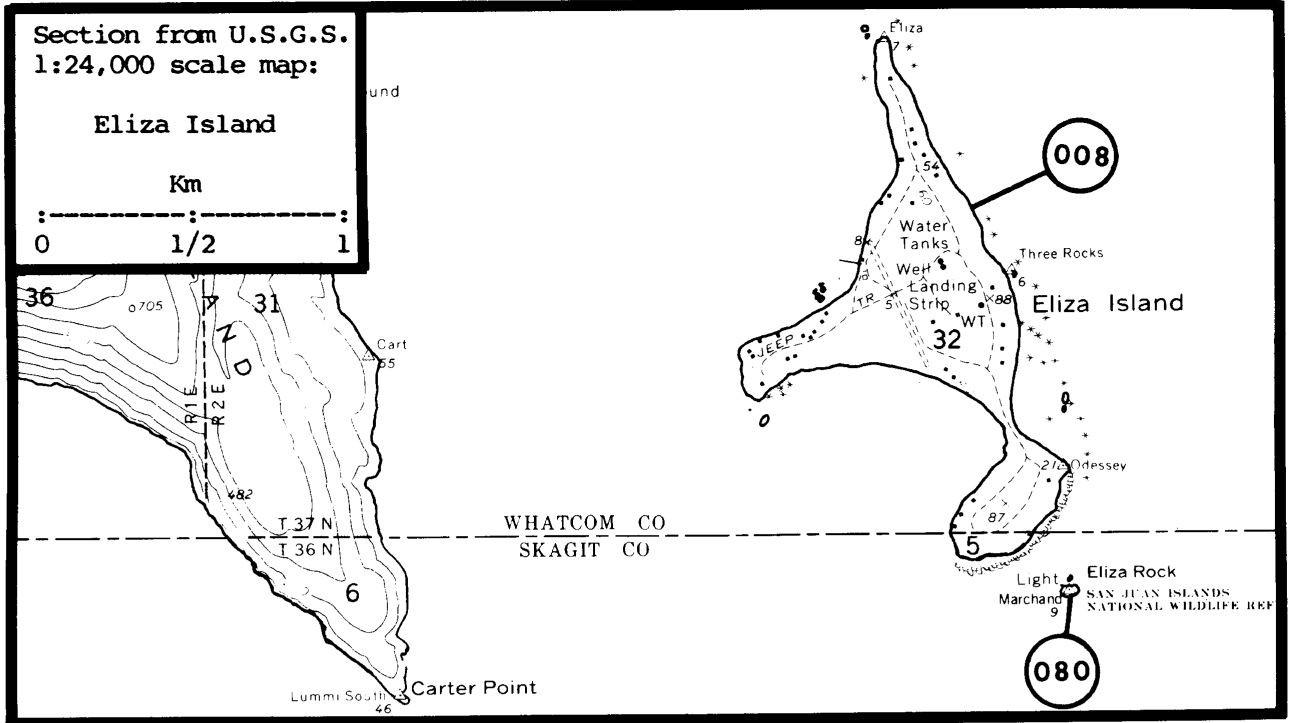

AREA 156, Victoria (cont'd.)

| | | | | |
|---------------------|---------------|-------------------------|------------|---------------|
| (085) | Pole Island | 48°36'04"N, 123°10'00"W | | |
| No Nesting Observed | 0 | Wahl | 06/13/79 | B III 269 |
| (086) | Guss Island | 48°35'04"N, 123°09'11"W | | |
| Pigeon Guillemot | 7 | Wahl | 06/14/79 | B III 269 |
| (087) | Low Island | 48°32'37"N, 123°09'47"W | | |
| No Nesting Observed | 0 | Wahl; Paulson | 06/07/79 | A III 269;207 |
| No Nesting Observed | 0 | Wahl | 05/24/78 | A III 269 |
| (088) | Lime Kiln Bay | 48°31'12"N, 123°09'03"W | | |
| Pigeon Guillemot | 5 | Wahl | 06/18/79 | L III 269 |
| (089) | O'Neal Island | 48°36'14"N, 123°05'28"W | | |
| No Nesting Observed | 0 | Pitman | 06/24/78 | B III 217 |
| No Nesting Observed | 0 | Manuwal 1977 | ?/ ?/73-75 | B III 187 |

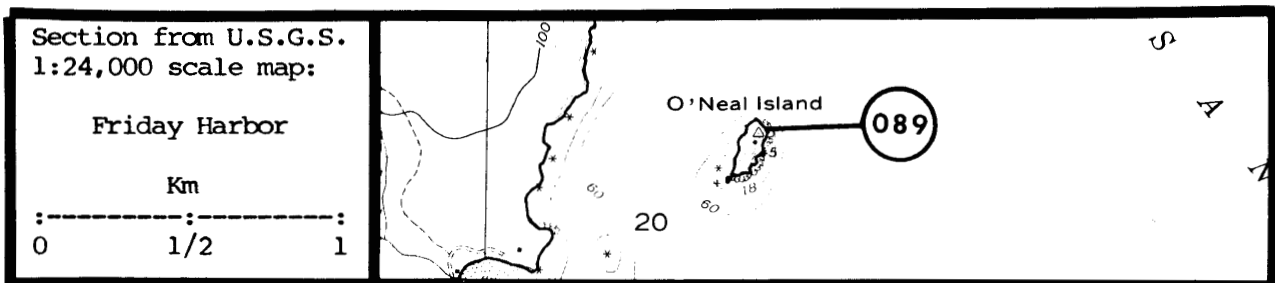
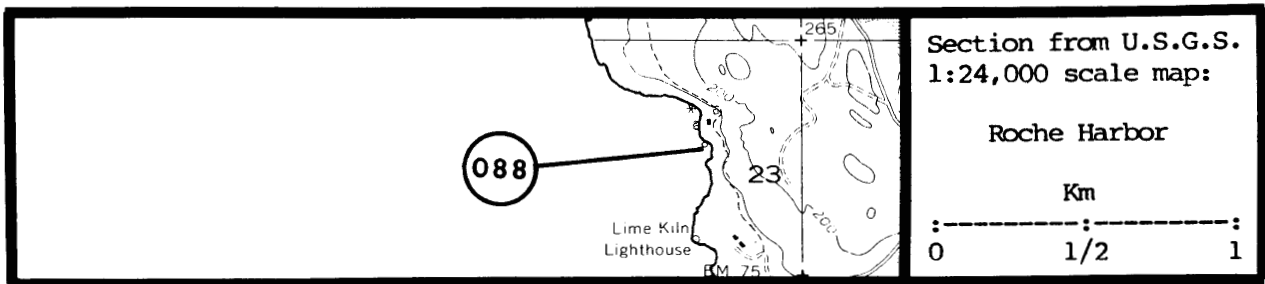
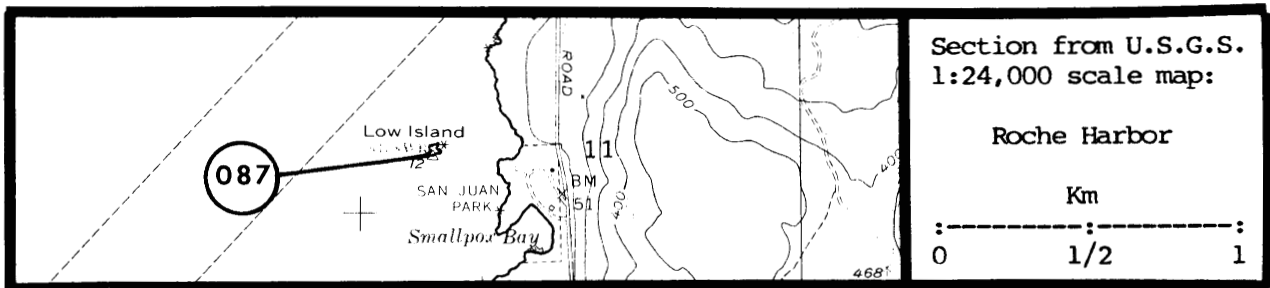
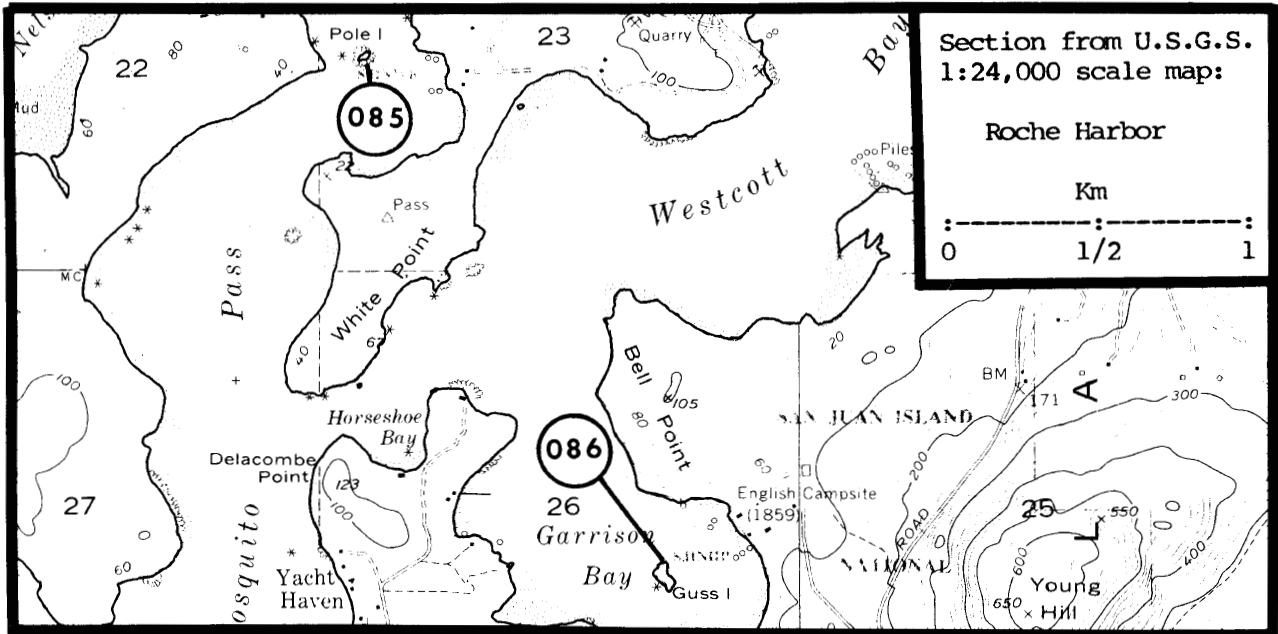

AREA 156, Victoria (cont'd.)

| | | | | |
|---|---|---------------|-------------|-----------|
| <p>(090) Jones Island 48°36'53"N, 123°02'42"W</p> | | | | |
| No Nesting Observed | 0 | Pitman | 06/24/78 | B III 217 |
| Pigeon Guillemot | ? | Jewett | 05/23-24/37 | L III 156 |
| Pigeon Guillemot | ? | Nisqually NWR | 06/20/67 | B III 202 |
| <p>(091) Fawn Island 48°36'50"N, 123°00'20"W</p> | | | | |
| No Nesting Observed | 0 | Pitman | 06/24/78 | B III 217 |
| <p>(092) Reef Island 48°36'18"N, 123°00'52"W</p> | | | | |
| No Nesting Observed | 0 | Pitman | 06/24/78 | B III 217 |
| <p>(093) "Unnamed Island" 48°35'57"N, 123°01'27"W</p> | | | | |
| No Nesting Observed | 0 | Wahl | 06/13/79 | B III 269 |
| <p>(094) McConnell Island 48°35'46"N, 123°01'17"W</p> | | | | |
| No Nesting Observed | 0 | Pitman | 06/24/78 | B III 217 |
| <p>(095) Bird Rock 48°35'54"N, 123°00'49"W</p> | | | | |
| No Nesting Observed | 0 | Wahl | 06/13/79 | B III 269 |
| <p>(096) Coon Island 48°35'43"N, 123°01'04"W</p> | | | | |
| No Nesting Observed | 0 | Pitman | 06/24/78 | B III 217 |

AREA 156, Victoria (cont'd.)

| | | | | |
|---------------------|----------------|-------------------------|------------|---------------|
| (097) | Yellow Island | 48°35'33"N, 123°01'50"W | | |
| No Nesting Observed | 0 | Pitman | 06/24/78 | B III 217 |
| Black Oystercatcher | ? | Manuwal 1973; Manuwal | 05/26/73 | B III 186;188 |
| (098) | Nob Island | 48°35'28"N, 123°01'00"W | | |
| No Nesting Observed | 0 | Pitman | 06/24/78 | B III 217 |
| (099) | "Unnamed Rock" | 48°35'27"N, 123°01'05"W | | |
| No Nesting Observed | 0 | Pitman | 06/24/78 | B III 217 |
| (100) | Cliff Island | 48°35'24"N, 123°00'13"W | | |
| No Nesting Observed | 0 | Pitman | 06/24/78 | B III 217 |
| (101) | Friday Harbor | 48°32'00"N, 123°00'20"W | | |
| Pigeon Guillemot | 2 | Miller et al. 1935 | ?/ ?/33-35 | L III 199 |
| (102) | Dinner Island | 48°30'26"N, 123°00'30"W | | |
| No Nesting Observed | 0 | Pitman | 06/22/78 | M III 217 |

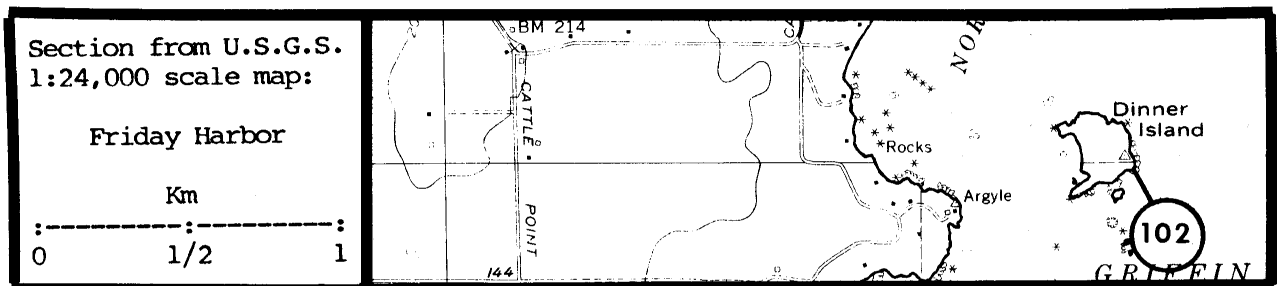
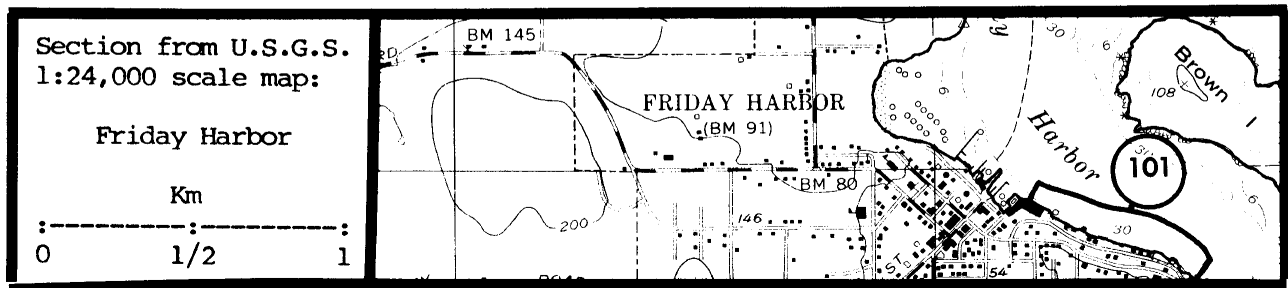
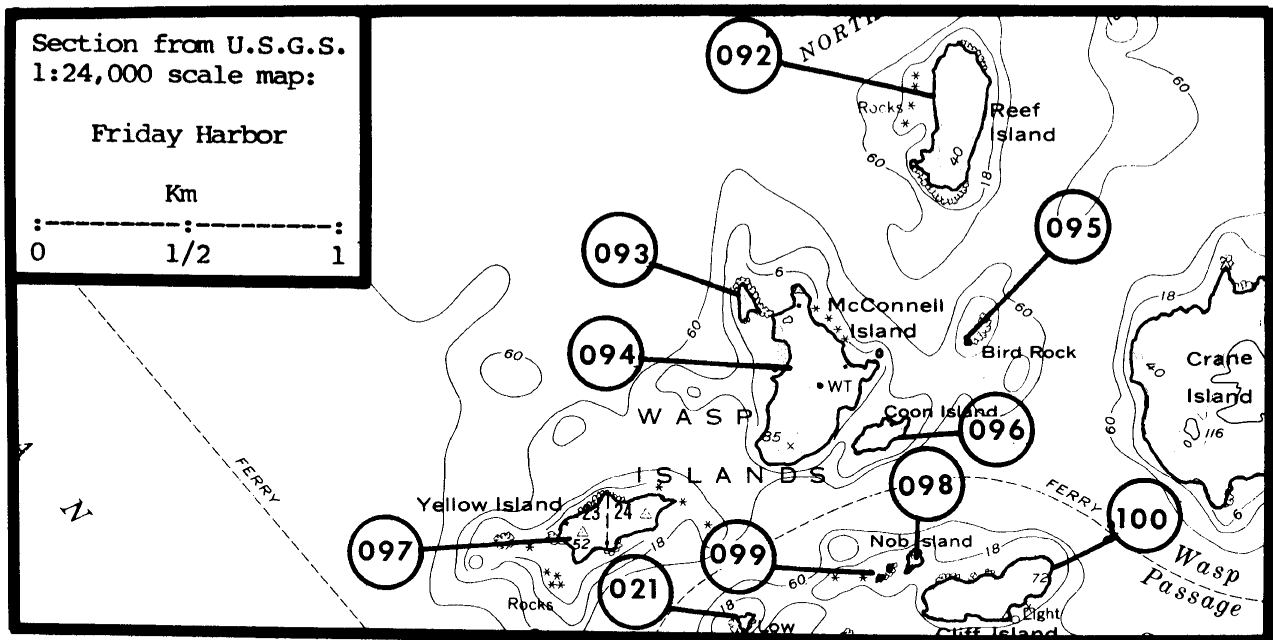

AREA 156, Victoria (cont'd.)

| | | | | | |
|---------------------|----------------------|-------------------------|----------|-------|-----|
| (103) | Victum Island | 48°36'48"N, 122°58'24"W | | | |
| No Nesting Observed | 0 | Pitman | 06/24/78 | B III | 217 |
| (104) | Double Island, north | 48°36'24"N, 122°58'21"W | | | |
| No Nesting Observed | 0 | Pitman | 06/24/78 | B III | 217 |
| (105) | Double Island, south | 48°36'16"N, 122°58'21"W | | | |
| No Nesting Observed | 0 | Pitman | 06/24/78 | B III | 217 |
| (106) | Oak Island | 48°36'22"N, 122°57'09"W | | | |
| No Nesting Observed | 0 | Pitman | 06/24/78 | B III | 217 |
| (107) | Bell Island | 48°35'46"N, 122°58'46"W | | | |
| No Nesting Observed | 0 | Pitman | 06/24/78 | B III | 217 |
| (108) | Blind Island | 48°35'06"N, 122°56'15"W | | | |
| No Nesting Observed | 0 | Pitman | 06/24/78 | B III | 217 |
| (109) | Tift Rocks/Egg Rock | 48°34'42"N, 122°59'10"W | | | |
| No Nesting Observed | 0 | Wahl | 06/17/79 | B III | 269 |

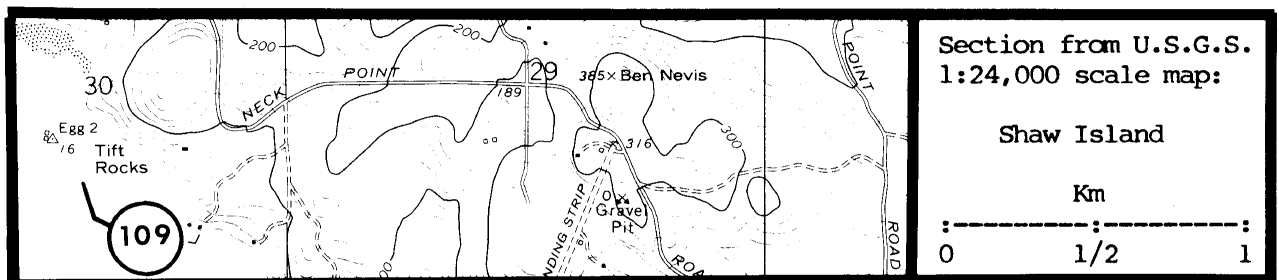
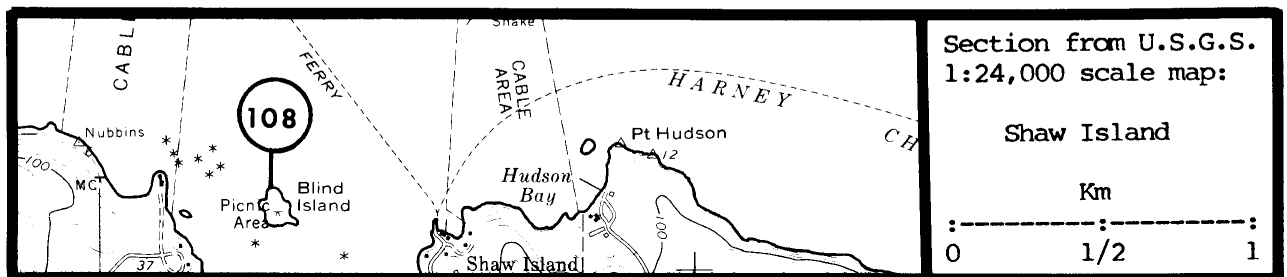
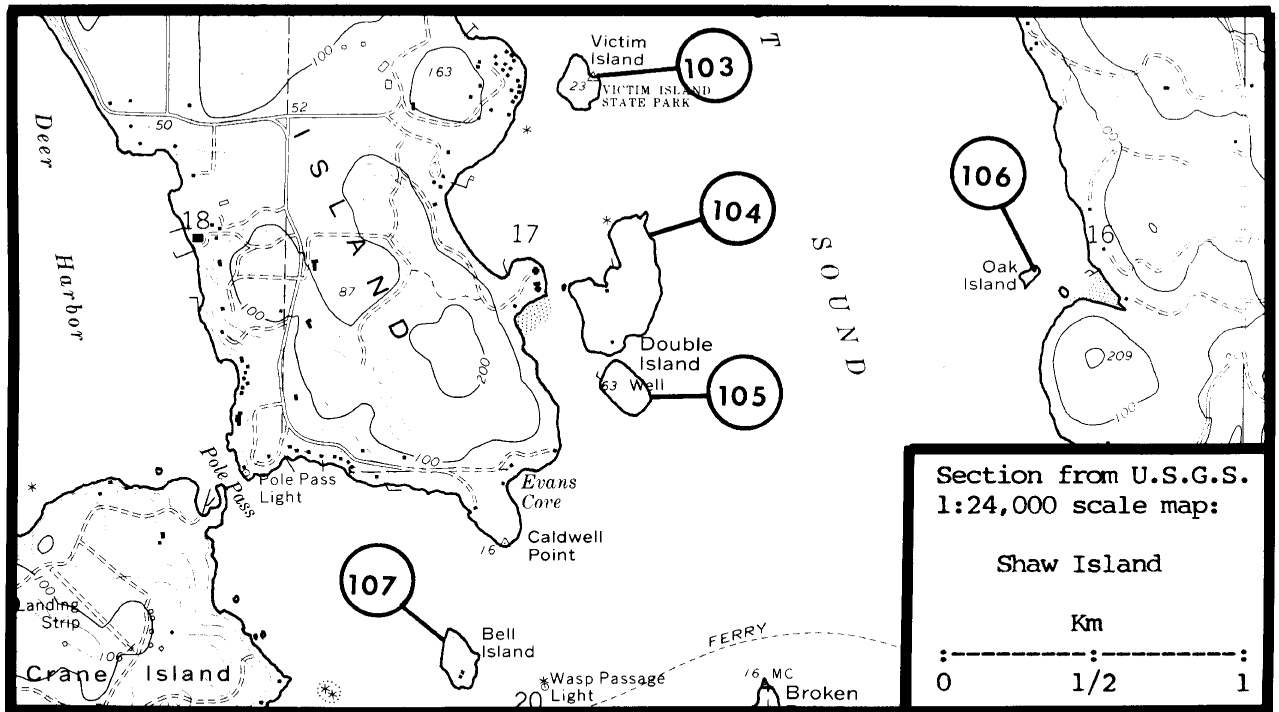

AREA 156, Victoria (cont'd.)

(110) "Unnamed Rock" 48°33'45"N, 122°55'16"W
 No Nesting Observed 0 Wahl 06/17/79 B III 269

(111) Turn Island 48°32'00"N, 122°58'12"W

| | | | | |
|---------------------|---|------|----------|-----------|
| No Nesting Observed | 0 | Wahl | 06/14/79 | B III 269 |
|---------------------|---|------|----------|-----------|

 Pigeon Guillemot 1 Wahl 05/19/78 B III 269
 Tufted Puffin 1 Anonymous 07/24/39 S - 15

(112) "Unnamed Rock" 48°31'42"N, 122°58'10"W
 No Nesting Observed 0 Wahl 06/13/79 B III 269

(113) Twin Rocks 48°36'57"N, 122°51'50"W
 Glaucous-winged Gull 2 Wahl 06/15/79 B III 269

(114) Humphrey Head 48°33'45"N, 122°52'14"W
 Pigeon Guillemot 6 Wahl 06/17/79 B II 269

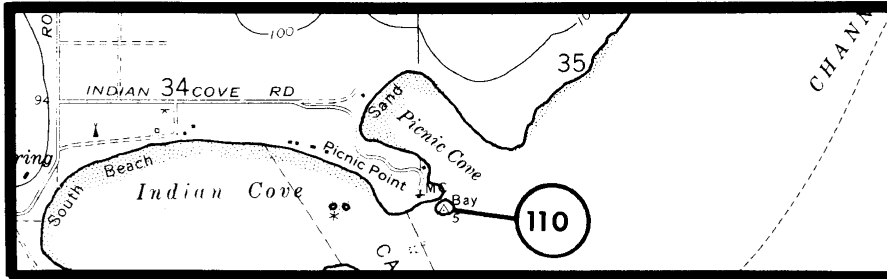

Section from U.S.G.S.
1:24,000 scale map:

Shaw Island

Km

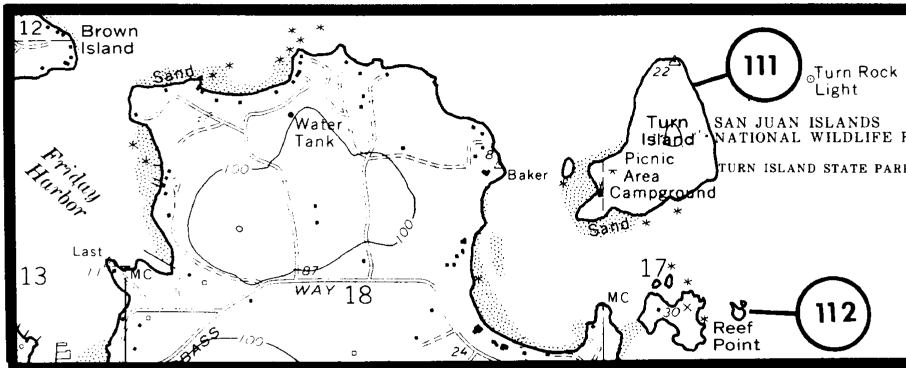
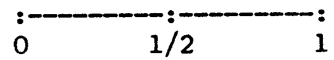

Section from U.S.G.S.
1:24,000 scale map:

Shaw Island

Km

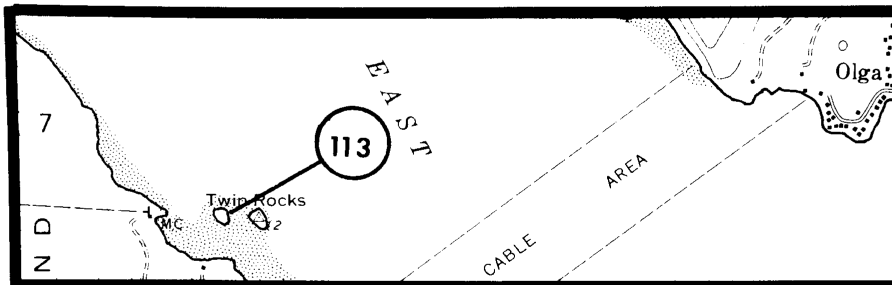
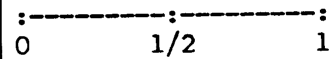

Section from U.S.G.S.
1:24,000 scale map:

Blakely Island

Km

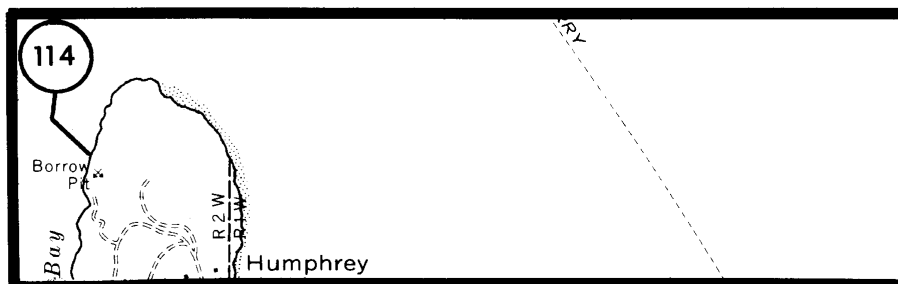
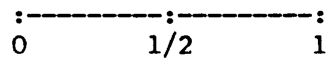

Section from U.S.G.S.
1:24,000 scale map:

Blakely Island

Km

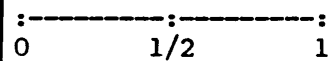

AREA 156, Victoria (cont'd.)

(115) Frost Island 48°32'18"N, 122°50'42"W

No Nesting Observed 0 Pitman 06/21/78 B III 217

(116) Willow Island 48°32'26"N, 122°49'20"W

| | | | | |
|------------------|----|--------|----------|-----------|
| Pigeon Guillemot | 7 | Wahl | 06/17/79 | B III 269 |
| Pigeon Guillemot | 10 | Wahl | 05/28/78 | B III 269 |
| Pigeon Guillemot | 8 | Pitman | 06/21/78 | B III 217 |
| Pigeon Guillemot | 5 | Wahl | 06/15/79 | B III 269 |

(117) Armitage Island 48°32'09"N, 122°47'42"W

| | | | | |
|----------------------|------|----------------------|-------------|-----------|
| No Nesting Observed | 0 | Pitman | 06/21/78 | B III 217 |
| Glaucous-winged Gull | 150? | Hauser & Monson 1963 | 07/16-17/63 | B III 145 |

(118) Lawson Rock¹ 48°31'50"N, 122°47'15"W

Black Oystercatcher 2? Nisqually NWR 08/03/80 B III 202

¹This rock regularly goes under water with high tide.

(119) James Island 48°30'45"N, 122°46'26"W

No Nesting Observed 0 Pitman 06/21/78 B III 217

(120) Trump Island 48°30'16"N, 122°50'09"W

No Nesting Observed 0 Pitman 06/21/78 B III 217

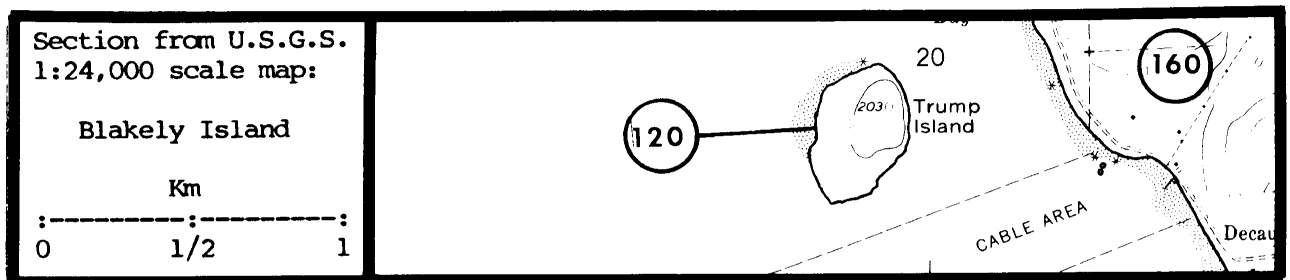
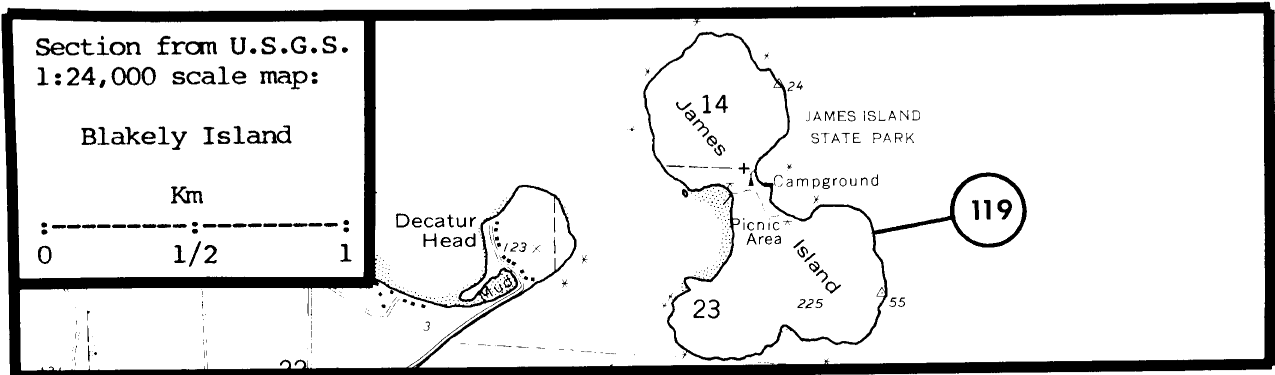
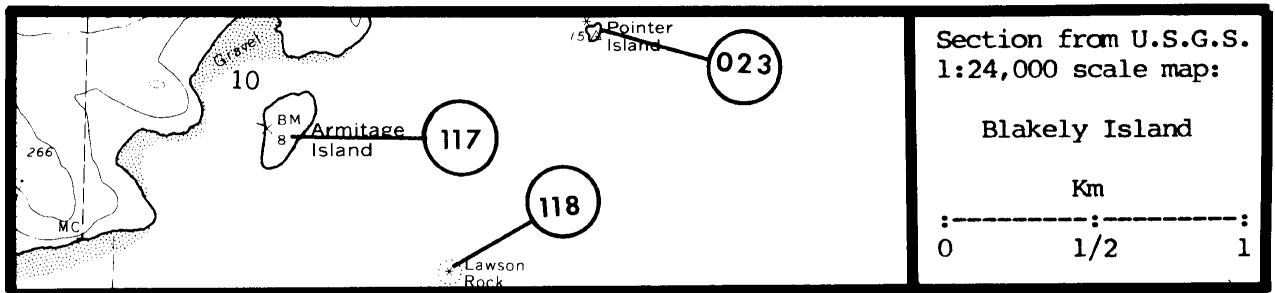
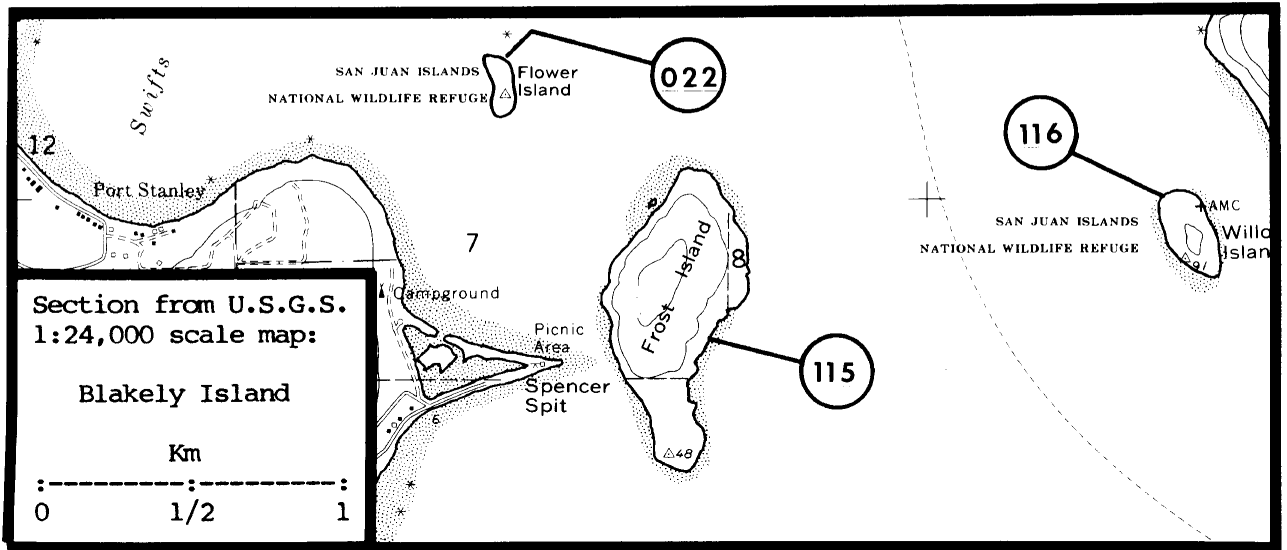

AREA 156, Victoria (cont'd.)

(121) Towhead Island 48°36'48"N, 122°42'43"W

No Nesting Observed 0 Pitman 06/21/78 B III 217

(122) Cone Island, north 48°35'40"N, 122°40'56"W

| | | | | |
|------------------|---|---------------|----------|---------------|
| Pigeon Guillemot | 3 | Wahl; Paulson | 07/06/78 | A III 269;207 |
|------------------|---|---------------|----------|---------------|

Pigeon Guillemot 3? Pitman 06/21/78 B III 217

(123) Cone Island, south 48°35'35"N, 122°40'56"W

| | | | | |
|------------------|---|---------------|----------|---------------|
| Pigeon Guillemot | 4 | Wahl; Paulson | 07/06/78 | A III 269;207 |
|------------------|---|---------------|----------|---------------|

No Nesting Observed 0 Pitman 06/21/78 B III 217

(124) Cone Island, east 48°35'31"N, 122°40'22"W

| | | | | |
|------------------|---|---------------|----------|---------------|
| Pigeon Guillemot | 2 | Wahl; Paulson | 06/07/79 | A III 269;207 |
|------------------|---|---------------|----------|---------------|

Pigeon Guillemot 4 Pitman 06/21/78 B III 217

Pigeon Guillemot 2 Wahl; Paulson 07/06/78 A III 269;207

(125) Cypress Island¹ 48°34'20"N, 122°42'30"W

Pigeon Guillemot 15 Manuwal 1973 05/25-26/73 L III 186

¹Insufficient data to show exact location.

(126) Strawberry Island 48°33'42"N, 122°44'03"W

| | | | | |
|------------------|---|---------------|----------|---------------|
| Pigeon Guillemot | 6 | Wahl; Paulson | 06/07/79 | A III 269;207 |
|------------------|---|---------------|----------|---------------|

Pigeon Guillemot 4 Pitman 06/21/78 B III 217

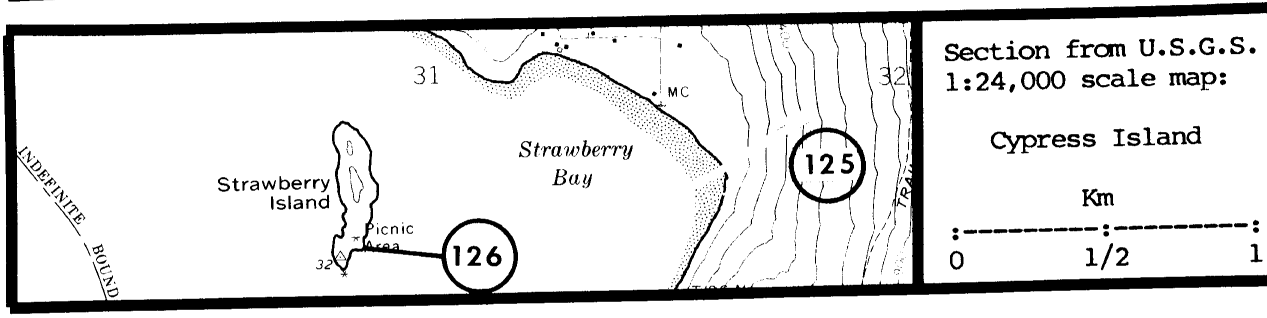
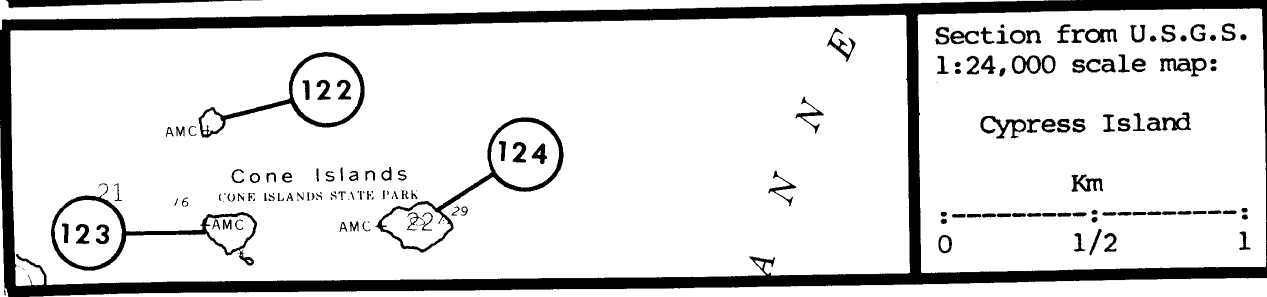
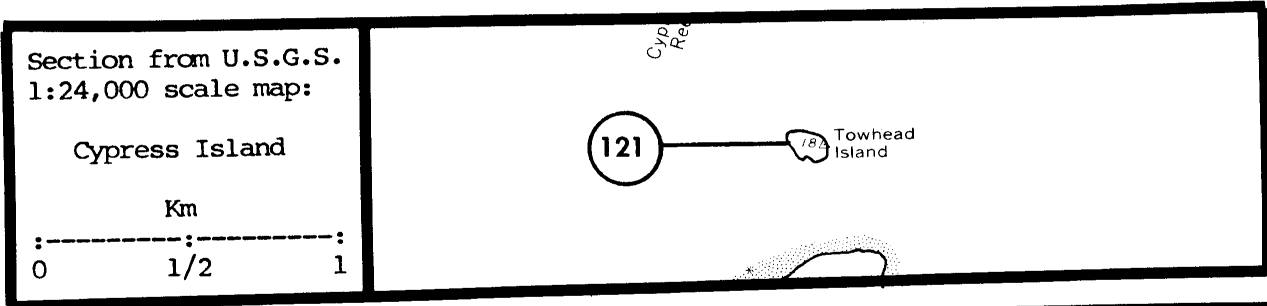

AREA 156, Victoria (cont'd.)

(127) Shannon Point 48°30'30"N, 122°41'15"W

Pigeon Guillemot X Thoresen & Booth 1958 06-09/ ?/57 L III 263

(128) Vendovi Island 48°36'37"N, 122°36'22"W

| | | | | |
|------------------|----|---------------|----------|---------------|
| Pigeon Guillemot | 12 | Wahl; Paulson | 06/07/79 | A III 269;207 |
|------------------|----|---------------|----------|---------------|

| | | | | |
|------------------|---|---------------|----------|---------------|
| Pigeon Guillemot | 8 | Wahl; Paulson | 07/06/78 | A III 269;207 |
|------------------|---|---------------|----------|---------------|

(129) Jack Island 48°34'52"N, 122°36'48"W

Pigeon Guillemot 1 Pitman 06/21/78 B III 217

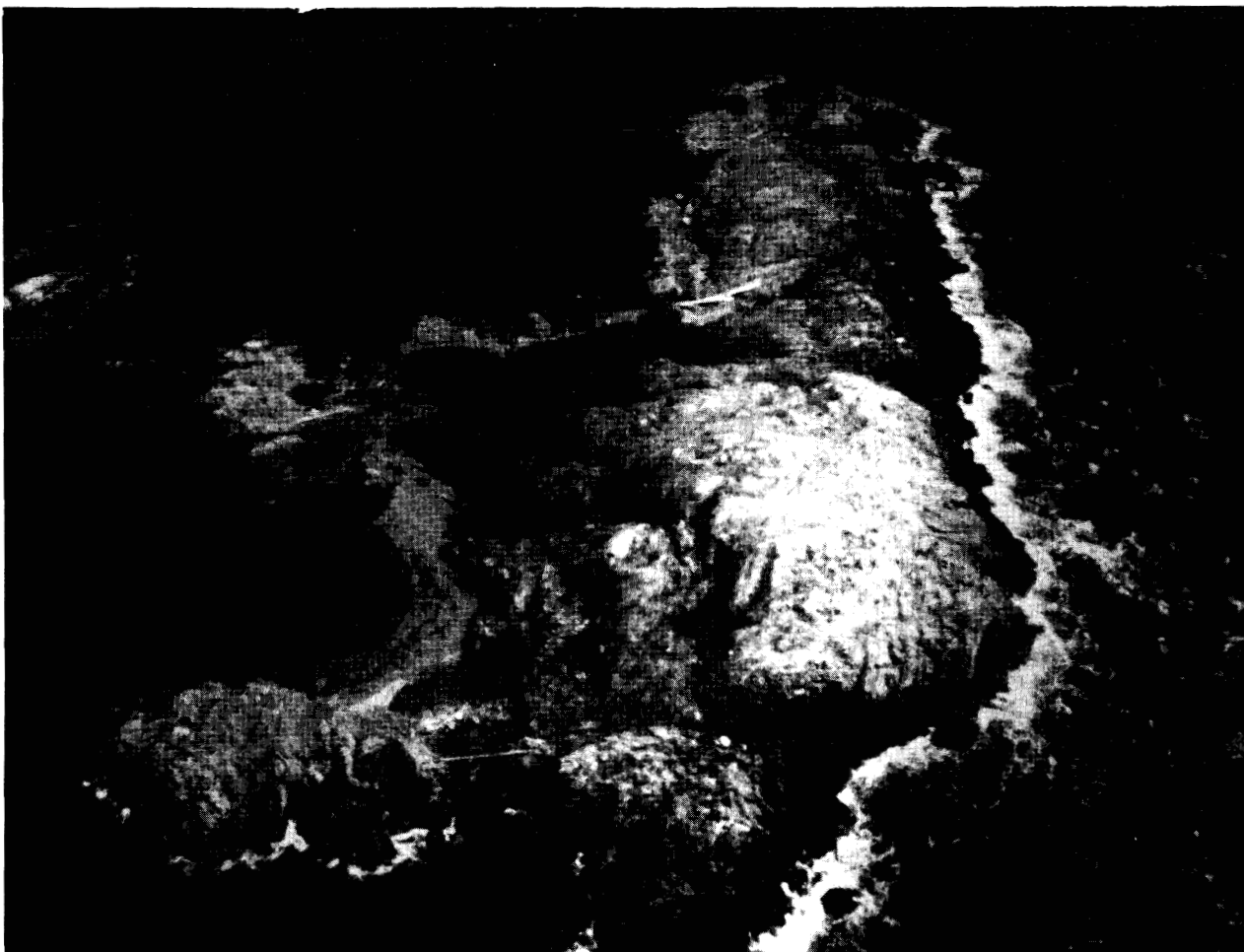

Deadman Island (156139) 19 July 1982 T.R. Wahl

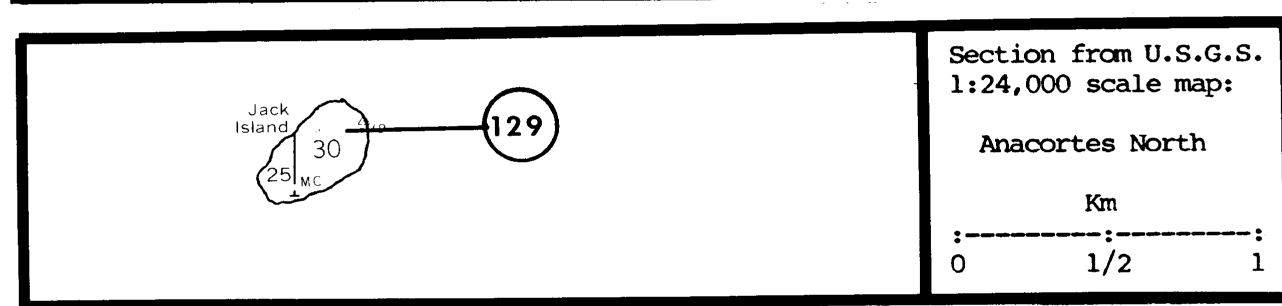
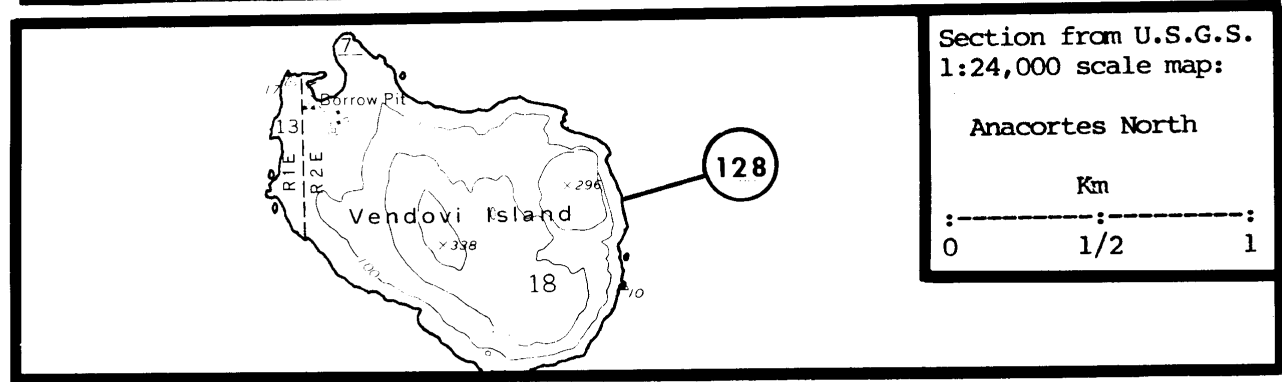
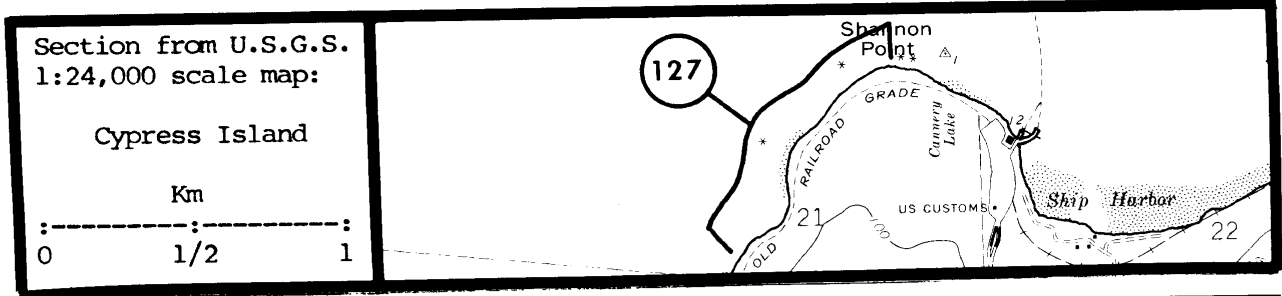

AREA 156, Victoria (cont'd.)

(130) Huckleberry Island 48°32'10"N, 122°34'06"W

| | | | | |
|---------------------|---|-----------|----------|-----------|
| Pigeon Guillemot | 1 | Pitman | 06/21/78 | B III 217 |
| No Nesting Observed | 0 | Eddy 1975 | 06/13/75 | B III 94 |
| Pigeon Guillemot | 6 | Eddy | 06/13/75 | B III 95 |

(131) Saddlebag Island 48°32'09"N, 122°33'21"W

| | | | | |
|---------------------|---|-----------|----------|-----------|
| Pigeon Guillemot | 4 | Pitman | 06/21/78 | B III 217 |
| No Nesting Observed | 0 | Eddy 1975 | 06/13/75 | B III 94 |

(132) Dot Island 48°31'58"N, 122°33'06"W

| | | | | |
|---------------------|----|-----------|----------|-----------|
| Pigeon Guillemot | 7 | Pitman | 06/21/78 | B III 217 |
| Black Oystercatcher | 1? | Wahl | 06/27/74 | ? ? 269 |
| No Nesting Observed | 0 | Eddy 1975 | 06/13/75 | B III 94 |

(133) Hat Island 48°31'28"N, 122°32'48"W

| | | | | |
|---------------------|---|-----------|----------|----------|
| No Nesting Observed | 0 | Eddy 1975 | 06/13/75 | B III 94 |
|---------------------|---|-----------|----------|----------|

(134) Anacortes, waterfront 48°31'24"N, 122°36'20"W

| | | | | |
|------------------|----|------|----------|-----------|
| Pigeon Guillemot | 6? | Wahl | 06/14/79 | B III 269 |
|------------------|----|------|----------|-----------|

(135) March Point, piers 48°30'32"N, 122°34'21"W

| | | | | |
|------------------|----|------|----------|-----------|
| Pigeon Guillemot | 15 | Wahl | 06/27/79 | L III 269 |
| Pigeon Guillemot | 1 | Wahl | 05/24/79 | L III 269 |
| Pigeon Guillemot | 4 | Wahl | 06/08/79 | L III 269 |

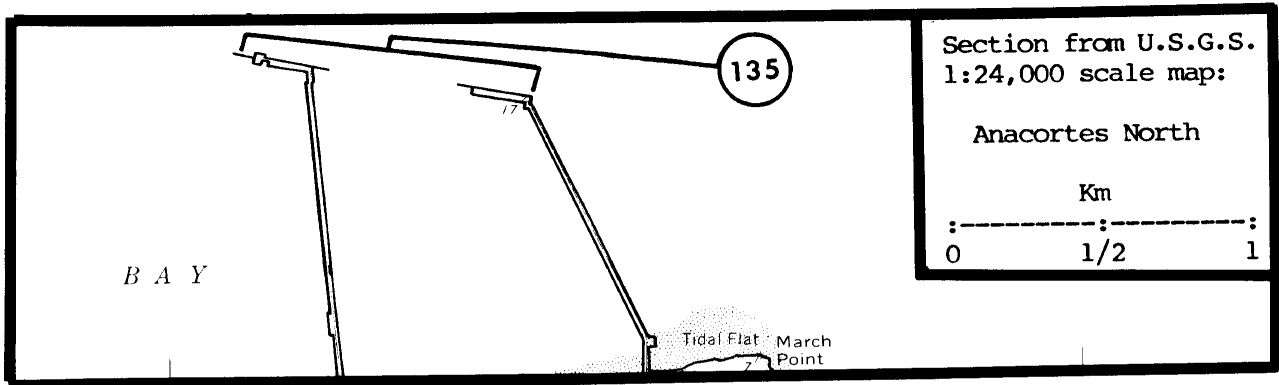
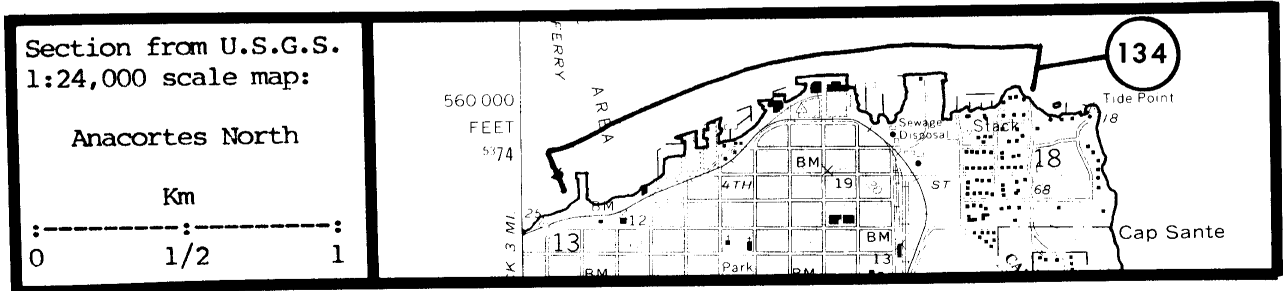
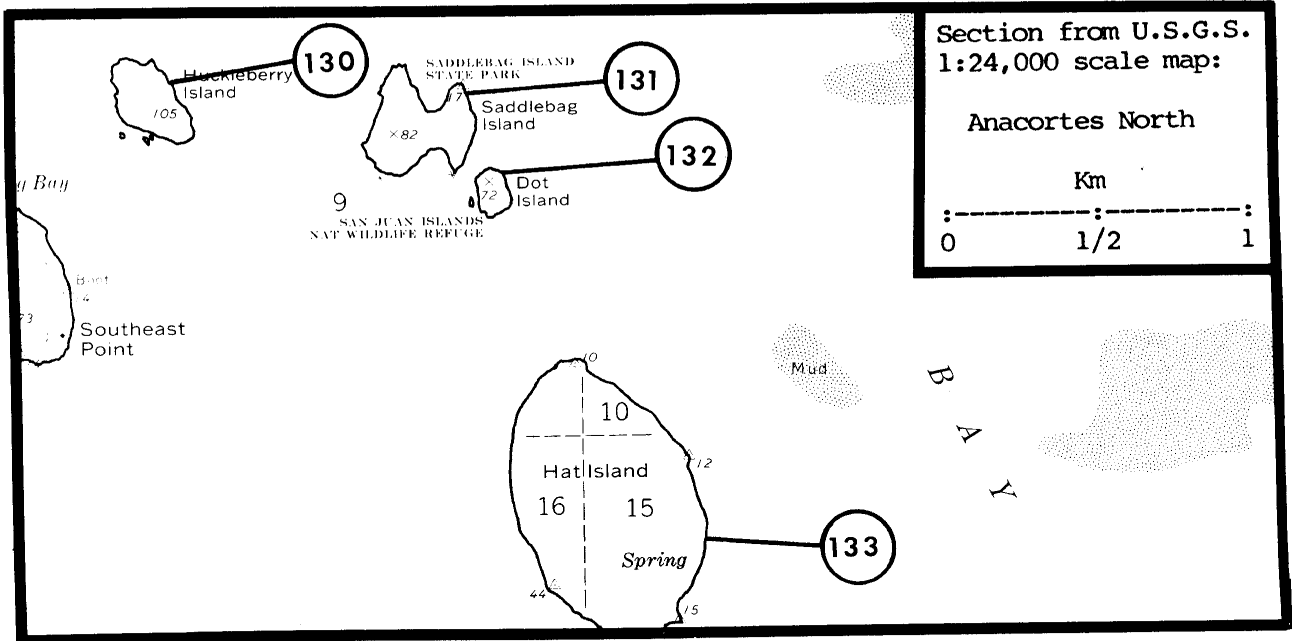

AREA 156, Victoria (cont'd.)

(136) "Unnamed Rock" 48°29'24"N, 123°06'30"W

No Nesting Observed 0 Wahl; Paulson 06/06/79 A III 269;207

(137) "Unnamed Rock" 48°28'58"N, 123°05'00"W

No Nesting Observed 0 Wahl; Paulson 06/06/79 A III 269;207

(138) Harbor Rock 48°28'13"N, 122°58'12"W

| | | | | |
|---------------------|---|---------------|----------|-----------|
| No Nesting Observed | 0 | Wahl & Speich | 06/14/79 | B III 271 |
|---------------------|---|---------------|----------|-----------|

No Nesting Observed 0 Manuwal 1977 ?/ ?/73-75 B III 187

Glaucous-winged Gull 2? Wahl & Speich 05/19/78 B III 271

(139) Deadman Island 48°27'30"N, 122°56'36"W

| | | | | |
|---------------------|---|--------|----------|-----------|
| No Nesting Observed | 0 | Pitman | 06/20/78 | B III 217 |
|---------------------|---|--------|----------|-----------|

Black Oystercatcher 2 Eaton 1980 ?/ ?/76 L I 93

Black Oystercatcher 2 Eaton 1980 ?/ ?/77 L I 93

Black Oystercatcher 0 Eaton 1980 ?/ ?/78 L III 93

Glaucous-winged Gull P Eaton 1980 ?/ ?/77 L III 93

Glaucous-winged Gull 4 Eaton 1980 ?/ ?/78 L I 93

Glaucous-winged Gull 35±? Wahl 07/19/82 A III 269

Section from U.S.G.S.
1:24,000 scale map:

False Bay

Km

0 1/2 1

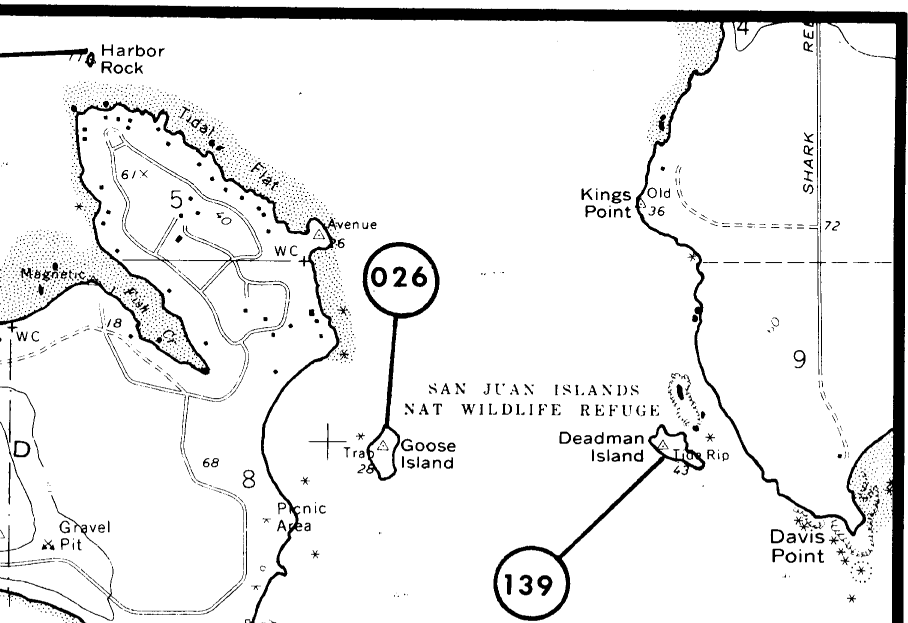
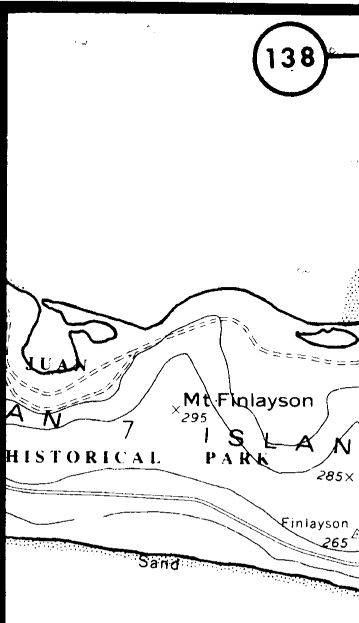
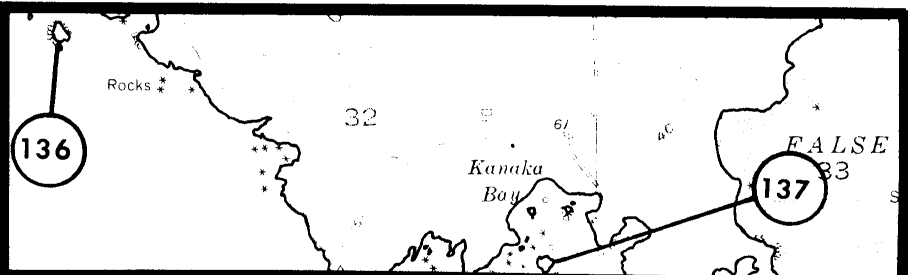

Section from U.S.G.S.
1:24,000 scale map:

Richardson

Km

0 1/2 1

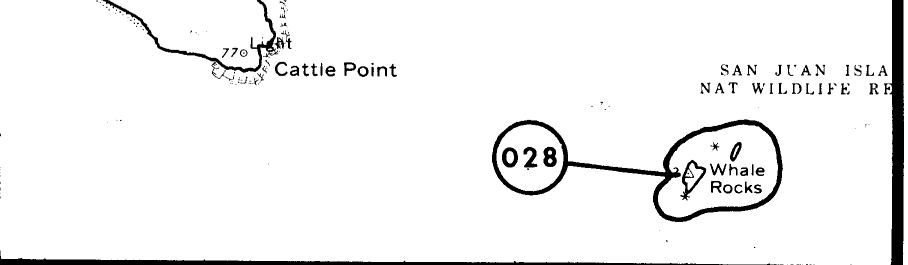

AREA 156, Victoria (cont'd.)

(140) Buck Island 48°27'09"N, 122°55'15"W

| | | | | |
|----------------------|------|----------------------|-------------|-----------|
| Black Oystercatcher | 2 | Pitman | 06/20/78 | B III 217 |
| Pelagic Cormorant | 15? | Nisqually NWR | 08/21-23/67 | B III 202 |
| Black Oystercatcher | 2 | Nisqually NWR | 06/20/63 | B II 202 |
| Black Oystercatcher | 2 | Nisqually NWR | 07/13-16/68 | L III 202 |
| Glaucous-winged Gull | 160B | Schultz | ?/ ?/47 | L III 245 |
| Glaucous-winged Gull | 160B | Schultz | ?/ ?/49 | L III 245 |
| Glaucous-winged Gull | 270 | Schultz 1951 | 06-08/ ?/49 | L II 240 |
| Glaucous-winged Gull | 1 | Schultz | 06/17/49 | S - 246 |
| Glaucous-winged Gull | X | Schultz 1952 | 07/07-08/51 | L III 241 |
| Glaucous-winged Gull | 75B | Schultz | ?/ ?/55 | L III 245 |
| Glaucous-winged Gull | 2 | Schultz | 07/23/55 | S - 246 |
| Glaucous-winged Gull | 3 | Schultz | 09/04-06/55 | S - 246 |
| Glaucous-winged Gull | 2 | Schultz | 10/06/55 | S - 246 |
| Glaucous-winged Gull | 85B | Schultz | ?/ ?/60 | L III 245 |
| Glaucous-winged Gull | 40+ | Eddy | 07/03/61 | B III 95 |
| Glaucous-winged Gull | 200 | Nisqually NWR | 06/20/63 | B III 202 |
| Glaucous-winged Gull | 200 | Hauser & Monson 1963 | 07/16-17/63 | B III 145 |
| Glaucous-winged Gull | 100 | Nisqually NWR | 08/21-23/67 | L III 202 |
| Glaucous-winged Gull | 300 | Nisqually NWR | 07/13-16/68 | L III 202 |
| Glaucous-winged Gull | 15±? | Wahl | 07/19/82 | A III 269 |
| Pigeon Guillemot | 2 | Nisqually NWR | 06/20/63 | B III 202 |
| Pigeon Guillemot | 13 | Hauser & Monson 1963 | 07/16-17/63 | B III 145 |
| Pigeon Guillemot | 25 | Nisqually NWR | 07/13-16/68 | L III 202 |

(141) Davis Bay, cliffs 48°27'10"N, 122°55'00"W

| | | | | |
|-------------------|-----|------------|----------|-----------|
| Pigeon Guillemot | 10 | Pitman | 06/20/78 | B III 217 |
| Pelagic Cormorant | 200 | Edson 1929 | 06/17/05 | M III 98 |
| Pelagic Cormorant | 80+ | Eddy | 07/03/61 | B III 95 |

(142) Lopez Island¹ 48°28'30"N, 122°53'00"W

| | | | | |
|--------------------|---|-----------|----------|----------|
| Brandt's Cormorant | X | Cantwell | pre-1953 | ? III 52 |
| Tufted Puffin | 1 | Anonymous | 06/28/55 | ? III 15 |

¹Insufficient data to show exact map location.

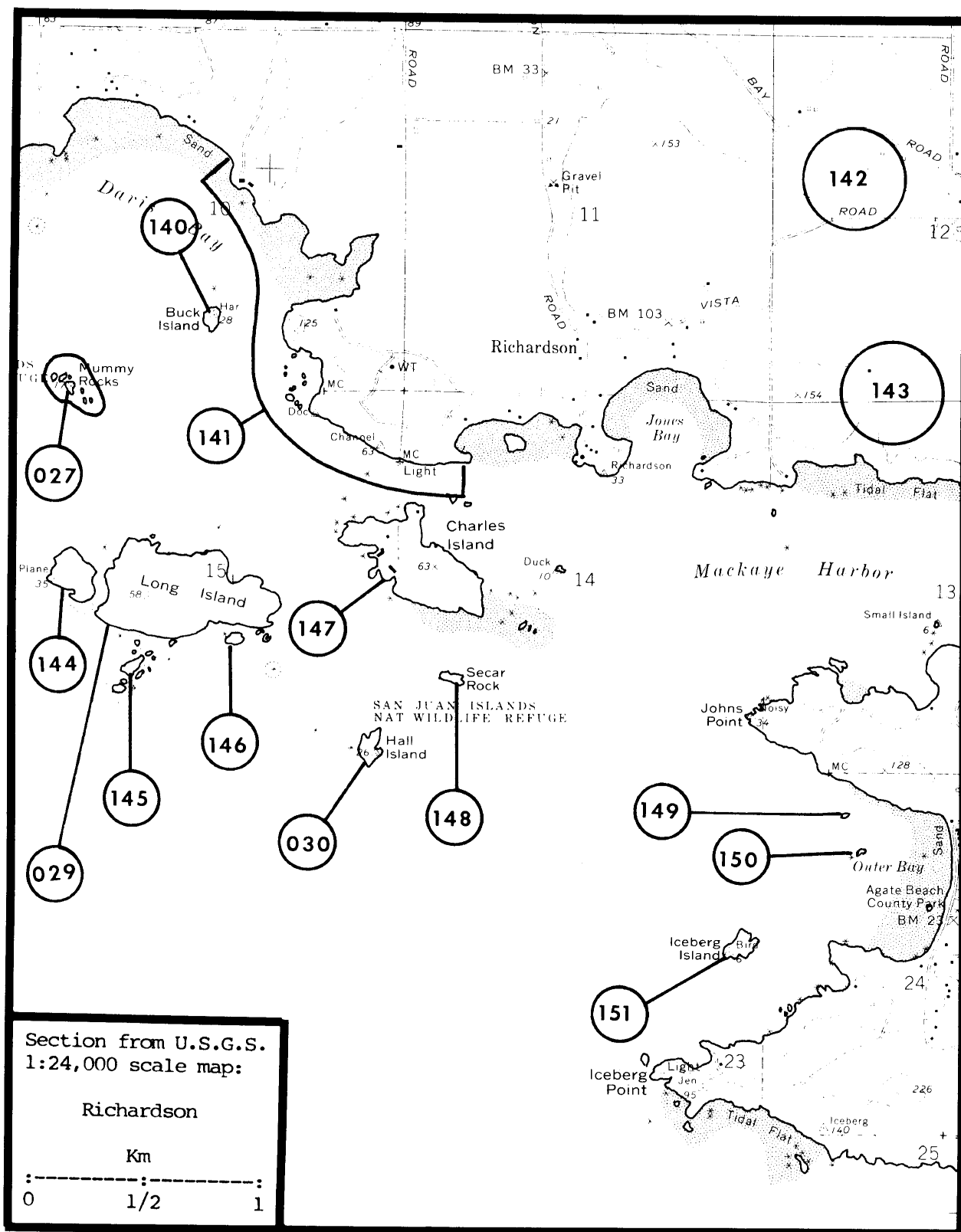

AREA 156, Victoria (cont'd.)

①④③ Lopez Island, south shore¹ 48°26'00"N, 122°52'30"W

| | | | | |
|----------------------|----|--------------------------------|-------------|---------------|
| Pelagic Cormorant | 1 | Edson | 06/09/05 | S - 271 |
| Pelagic Cormorant | X | Edson 1929 | 06/17/05 | L III 98 |
| Pelagic Cormorant | 3 | McMannama | 06/24/49 | S - 193 |
| Black Oystercatcher | 2 | Nysewander 1977; Nysewander | 06/ ?/73 | B III 204;205 |
| Glaucous-winged Gull | 52 | Galusha 1970 | ?/ ?/63 | L II 110 |
| Glaucous-winged Gull | 4 | Thoresen & Galusha 1971 | 06-07/ ?/70 | L I 264 |
| Pigeon Guillemot | 1 | McMannama | 08/03/49 | S - 193 |
| Pigeon Guillemot | 6 | Galusha 1970 | ?/ ?/63 | L II 110 |
| Pigeon Guillemot | 0 | Thoresen & Galusha 1971 | 06-07/ ?/70 | L II 264 |

¹Insufficient data to show exact map location.

①④④ "Unnamed Island" 48°26'32"N, 122°55'45"W

| | | | | |
|----------------------|-----|--------|----------|-----------|
| Glaucous-winged Gull | 200 | Pitman | 06/20/78 | B III 217 |
|----------------------|-----|--------|----------|-----------|

①④⑤ "Unnamed Rock" 48°26'18"N, 122°55'30"W

| | | | | |
|----------------------|----|--------|----------|-----------|
| Black Oystercatcher | 1 | Pitman | 06/20/78 | B III 217 |
| Glaucous-winged Gull | 40 | Pitman | 06/20/78 | B III 217 |
| Total | 41 | | | |

①④⑥ "Unnamed Rock" 48°26'22"N, 122°55'07"W

| | | | | |
|---------------------|---|------|----------|-----------|
| No Nesting Observed | 0 | Wahl | 06/13/79 | B III 269 |
|---------------------|---|------|----------|-----------|

①④⑦ Charles Island 48°26'30"N, 122°54'30"W

| | | | | |
|---------------------|---|------------|----------|-----------|
| No Nesting Observed | 0 | Pitman | 06/20/78 | B III 217 |
| Black Oystercatcher | 1 | Nysewander | 06/ ?/73 | B III 205 |

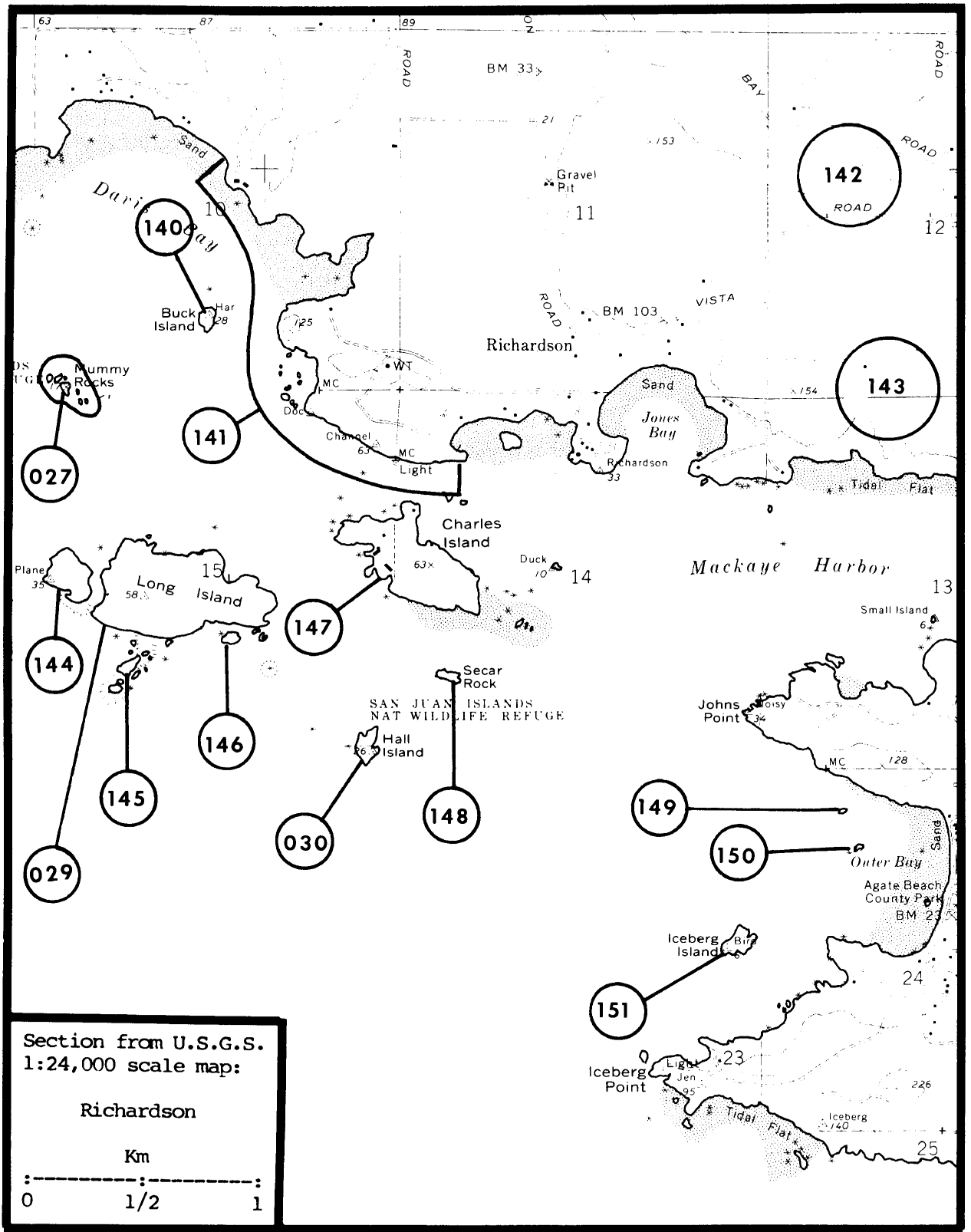

AREA 156, Victoria (cont'd.)

(148) Secar Rock 48°26'17"N, 122°54'22"W

| | | | | |
|---------------------|----|----------------------|-------------|-----------|
| No Nesting Observed | 0 | Wahl | 07/19/82 | A III 269 |
| Black Oystercatcher | 2 | Nisqually NWR | 06/20/63 | B III 202 |
| Black Oystercatcher | 1 | Hauser & Monson 1963 | 07/16-17/63 | B III 145 |
| Black Oystercatcher | 6 | Nisqually NWR | 07/13-16/68 | L II 202 |
| Black Oystercatcher | 1? | Pitman | 06/20/78 | B III 217 |

(149) "Unnamed Rock" 48°25'57"N, 122°52'58"W

| | | | | |
|---------------------|---|--------|----------|-----------|
| No Nesting Observed | 0 | Pitman | 06/20/78 | B III 217 |
|---------------------|---|--------|----------|-----------|

(150) "Unnamed Rock" 48°25'52"N, 122°52'51"W

| | | | | |
|---------------------|---|--------|----------|-----------|
| No Nesting Observed | 0 | Pitman | 06/20/78 | B III 217 |
|---------------------|---|--------|----------|-----------|

(151) Iceberg Island 48°25'37"N, 122°53'18"W

| | | | | |
|---------------------|----|---------------|----------|-----------|
| No Nesting Observed | 0 | Wahl | 07/19/82 | A III 269 |
| No Nesting Observed | 0 | Eddy | 07/03/61 | B III 95 |
| No Nesting Observed | 0 | Nisqually NWR | 06/20/63 | B III 202 |
| No Nesting Observed | 0 | Frazer 1973 | 07/17/73 | B III 108 |
| Black Oystercatcher | 1? | Pitman | 06/20/78 | B III 217 |

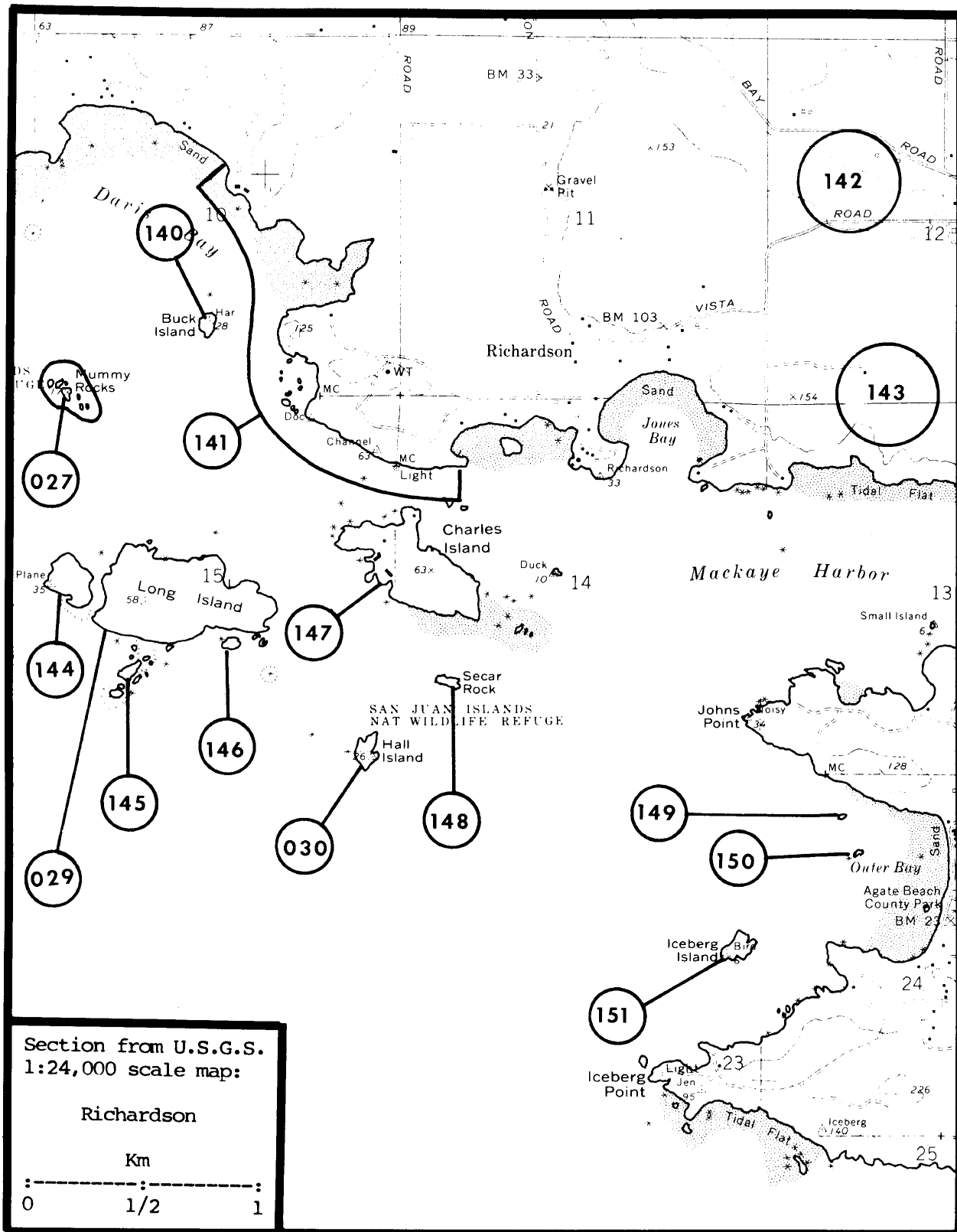

AREA 156, Victoria (cont'd.)

(152) Small Island 48°29'44"N, 122°51'42"W

| | | | | |
|----------------------|----|------|----------|-----------|
| Glaucous-winged Gull | 41 | Wahl | 06/15/79 | B III 269 |
| Pigeon Guillemot | 1 | Wahl | 06/15/79 | B III 269 |
| Total | 42 | | | |

| | | | | |
|----------------------|----|--------|----------|-----------|
| Glaucous-winged Gull | 70 | Pitman | 06/21/78 | B III 217 |
| Glaucous-winged Gull | X | Wahl | 07/19/82 | A III 269 |

(153) Rim Island 48°28'55"N, 122°49'35"W

| | | | | |
|---------------------|---|--------|----------|-----------|
| No Nesting Observed | 0 | Pitman | 06/21/78 | B III 217 |
|---------------------|---|--------|----------|-----------|

(154) Rum Island 48°28'48"N, 122°49'41"W

| | | | | |
|---------------------|---|--------|----------|-----------|
| No Nesting Observed | 0 | Pitman | 06/21/78 | B III 217 |
|---------------------|---|--------|----------|-----------|

(155) Ram Island 48°28'35"N, 122°49'50"W

| | | | | |
|------------------|-----|--------|----------|-----------|
| Pigeon Guillemot | 20P | Pitman | 06/21/78 | B III 217 |
| Total | 20P | | | |

| | | | | |
|------------------|----|-------------------------|-------------|-----------|
| Pigeon Guillemot | 52 | Thoresen & Galusha 1971 | 06-07/ ?/63 | B III 264 |
| Pigeon Guillemot | 0 | Thoresen & Galusha 1971 | 06-07/ ?/70 | B III 264 |

(156) Fortress Island 48°27'56"N, 122°50'13"W

| | | | | |
|---------------------|---|--------|----------|-----------|
| No Nesting Observed | 0 | Pitman | 06/21/78 | B III 217 |
|---------------------|---|--------|----------|-----------|

| | | | | |
|----------------------|-------|-------------------------|-------------|-----------|
| Glaucous-winged Gull | 30-60 | Eddy | 08/04/57 | L III 95 |
| Glaucous-winged Gull | 54 | Thoresen & Galusha 1971 | 06-07/ ?/63 | L I 264 |
| Glaucous-winged Gull | 4 | Galusha 1970 | ?/ ?/70 | L I 110 |
| Pigeon Guillemot | 6 | Thoresen & Galusha 1971 | 06-07/ ?/63 | L III 264 |
| Pigeon Guillemot | 0 | Galusha 1970 | ?/ ?/70 | L III 110 |

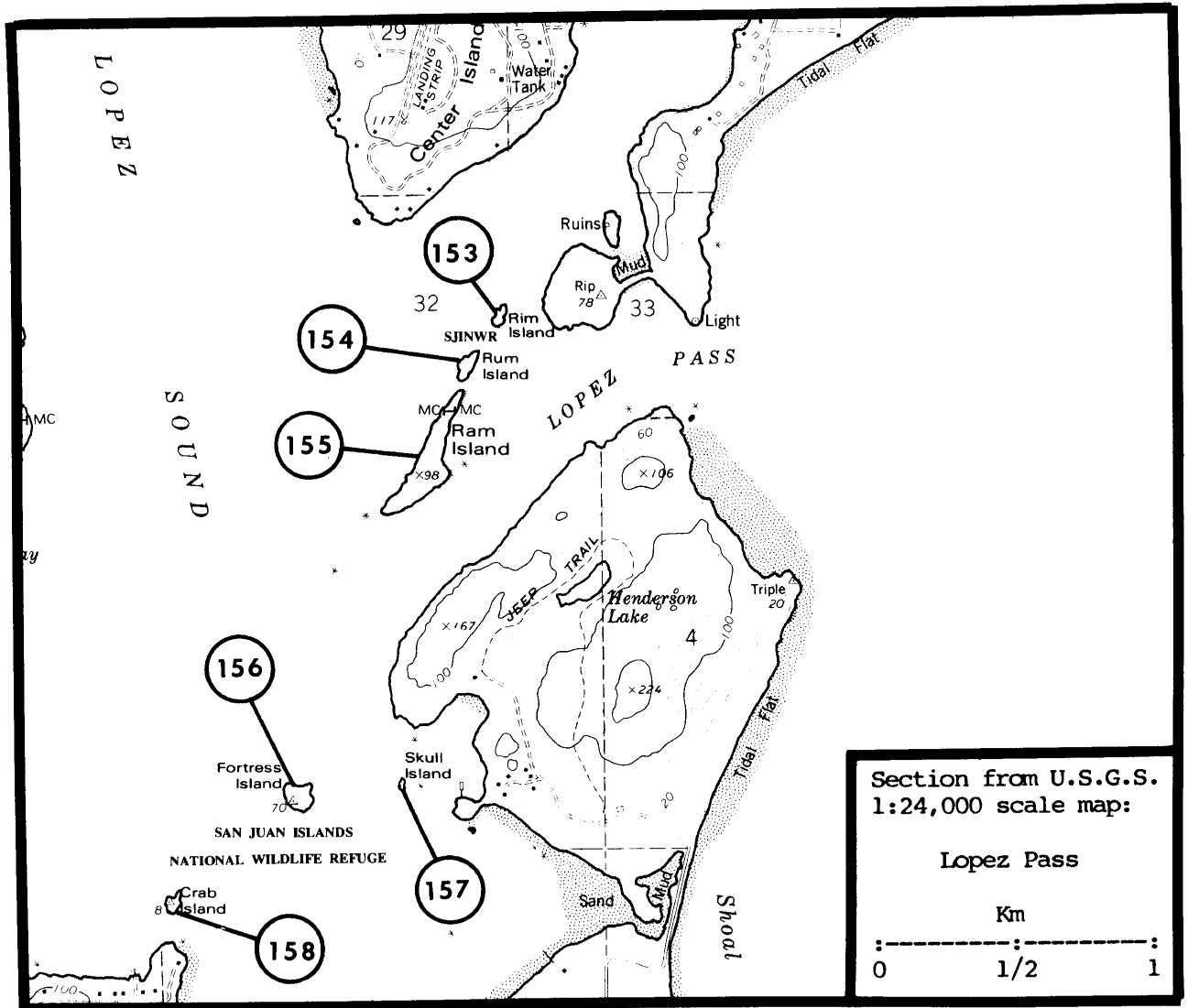
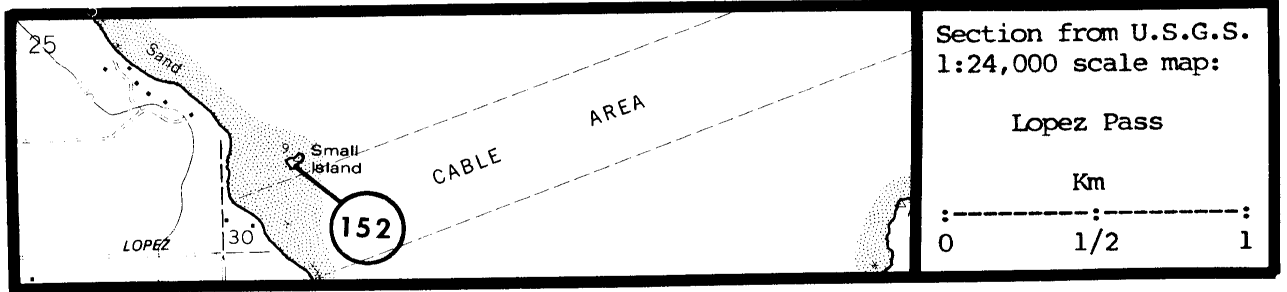

AREA 156, Victoria (cont'd.)

| | | | | | |
|------------------------------|--------------------------|-------------------------|--------------|-------|-----|
| (157) | Skull Island | 48°27'57"N, 122°49'55"W | | | |
| No Nesting Observed | 0 | Pitman | 06/21/78 | B III | 217 |
| (158) | Crab Island | 48°27'44"N, 122°50'36"W | | | |
| No Nesting Observed | 0 | Pitman | 06/21/78 | B III | 217 |
| (159) | Belle Rocks ¹ | 48°29'35"N, 122°45'12"W | | | |
| Unknown Species ² | P | Einarsen 1925 | early 1920's | ? ? | 103 |

¹At present these rocks are submerged during most tide stages.

²Reported as used for nesting by unspecified species of marine birds.

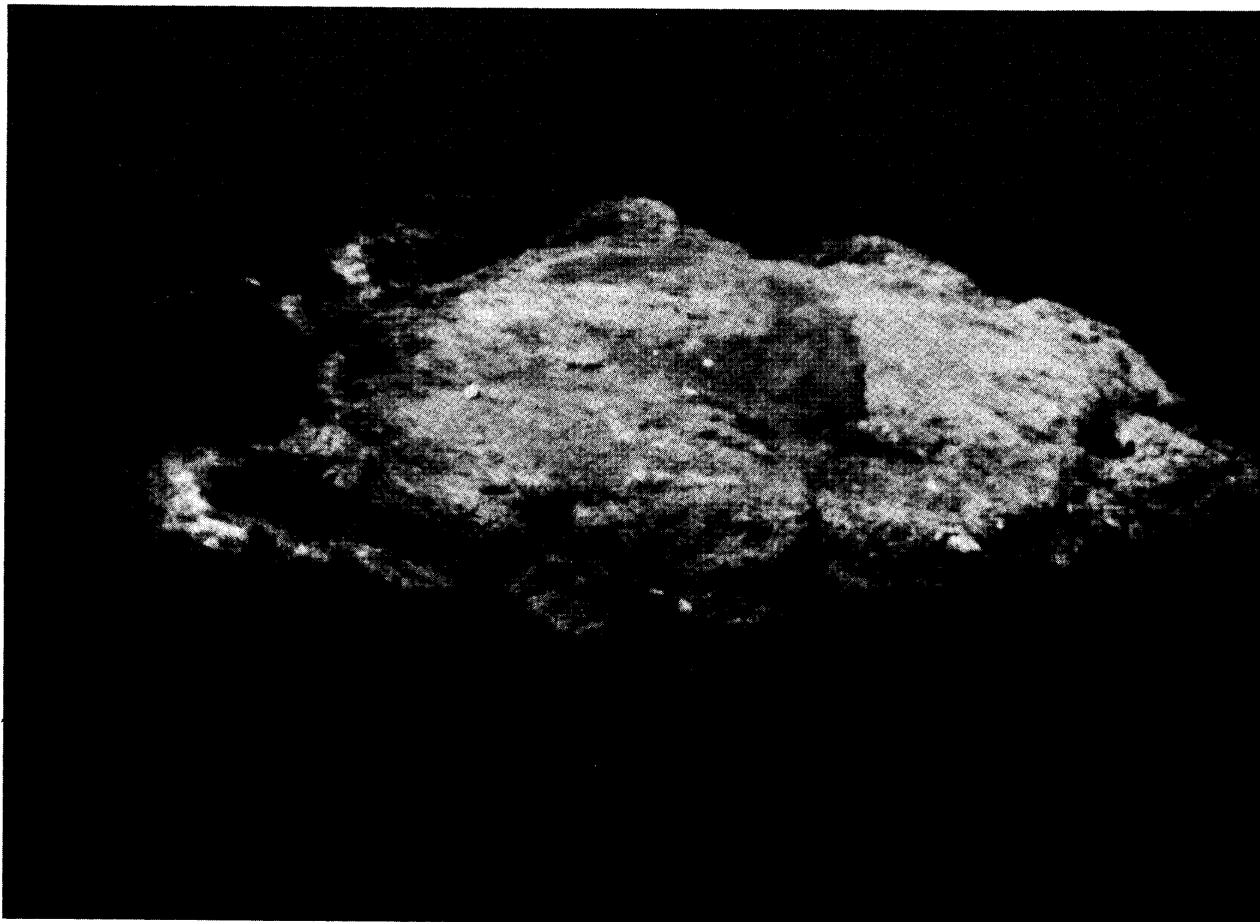

Buck Island (156140) 19 July 1982 T.R. Wahl

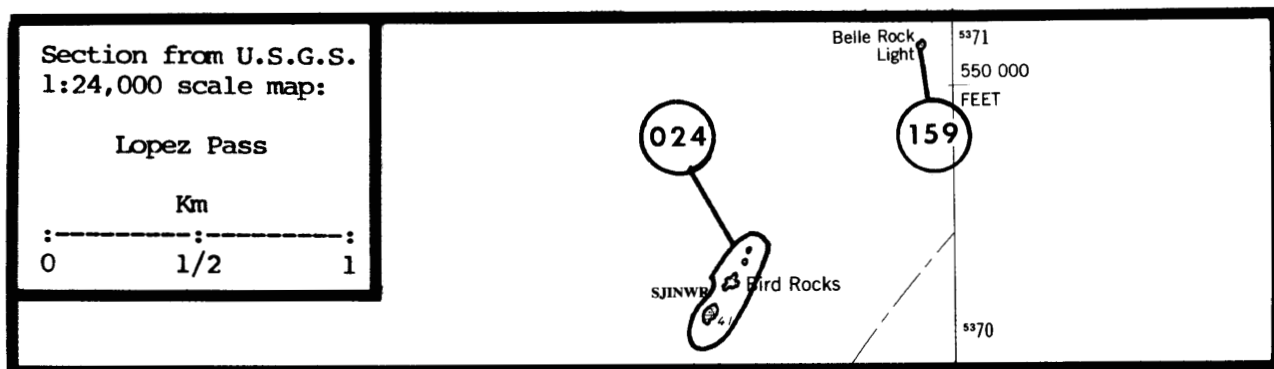
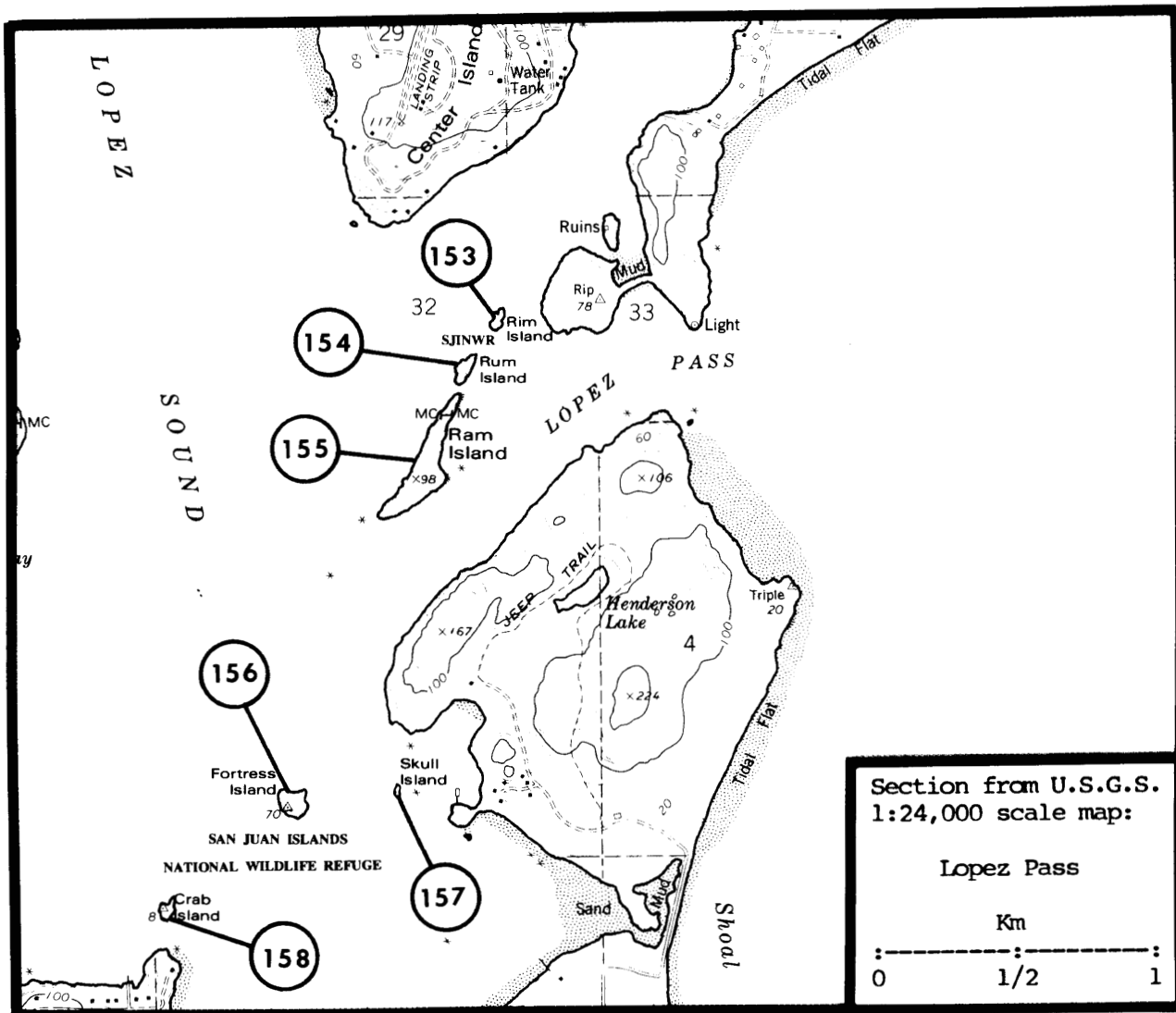

AREA 156, Victoria (cont'd.)

(160) Decatur Island¹ 48°30'35"N, 122°48'30"W

No Nesting Observed 0 Frazer 1973 07/17/73 B III 108

¹Insufficient data to show exact map location.

(161) "Flint Beach Island" 48°25'12"N, 122°52'00"W

| | | | | |
|---------------------|---|--------|----------|-----------|
| No Nesting Observed | 0 | Pitman | 06/20/78 | B III 217 |
|---------------------|---|--------|----------|-----------|

| | | | | |
|---------------------|---|------|----------|----------|
| No Nesting Observed | 0 | Eddy | 06/03/61 | B III 95 |
|---------------------|---|------|----------|----------|

(162) Aleck Rocks 48°25'23"N, 122°50'48"W

| | | | | |
|---------------------|---|--------|----------|-----------|
| No Nesting Observed | 0 | Pitman | 06/20/78 | B III 217 |
|---------------------|---|--------|----------|-----------|

| | | | | |
|---------------------|---|------|----------|----------|
| No Nesting Observed | 0 | Eddy | 06/03/61 | B III 95 |
|---------------------|---|------|----------|----------|

(163) Swirl Island 48°25'07"N, 122°50'51"W

| | | | | |
|---------------------|---|------|----------|-----------|
| No Nesting Observed | 0 | Wahl | 07/19/82 | A III 269 |
|---------------------|---|------|----------|-----------|

| | | | | |
|---------------------|---|------|----------|----------|
| No Nesting Observed | 0 | Eddy | 06/03/61 | B III 95 |
|---------------------|---|------|----------|----------|

| | | | | |
|---------------------|---|--------|----------|-----------|
| No Nesting Observed | 0 | Pitman | 06/20/78 | B III 217 |
|---------------------|---|--------|----------|-----------|

(164) Blind Island 48°25'27"N, 122°49'34"W

| | | | | |
|---------------------|---|--------|----------|-----------|
| No Nesting Observed | 0 | Pitman | 06/26/78 | B III 217 |
|---------------------|---|--------|----------|-----------|

| | | | | |
|---------------------|---|------|----------|----------|
| No Nesting Observed | 0 | Eddy | 06/03/61 | B III 95 |
|---------------------|---|------|----------|----------|

Section from U.S.G.S.
1:24,000 scale map:

Blakely Island

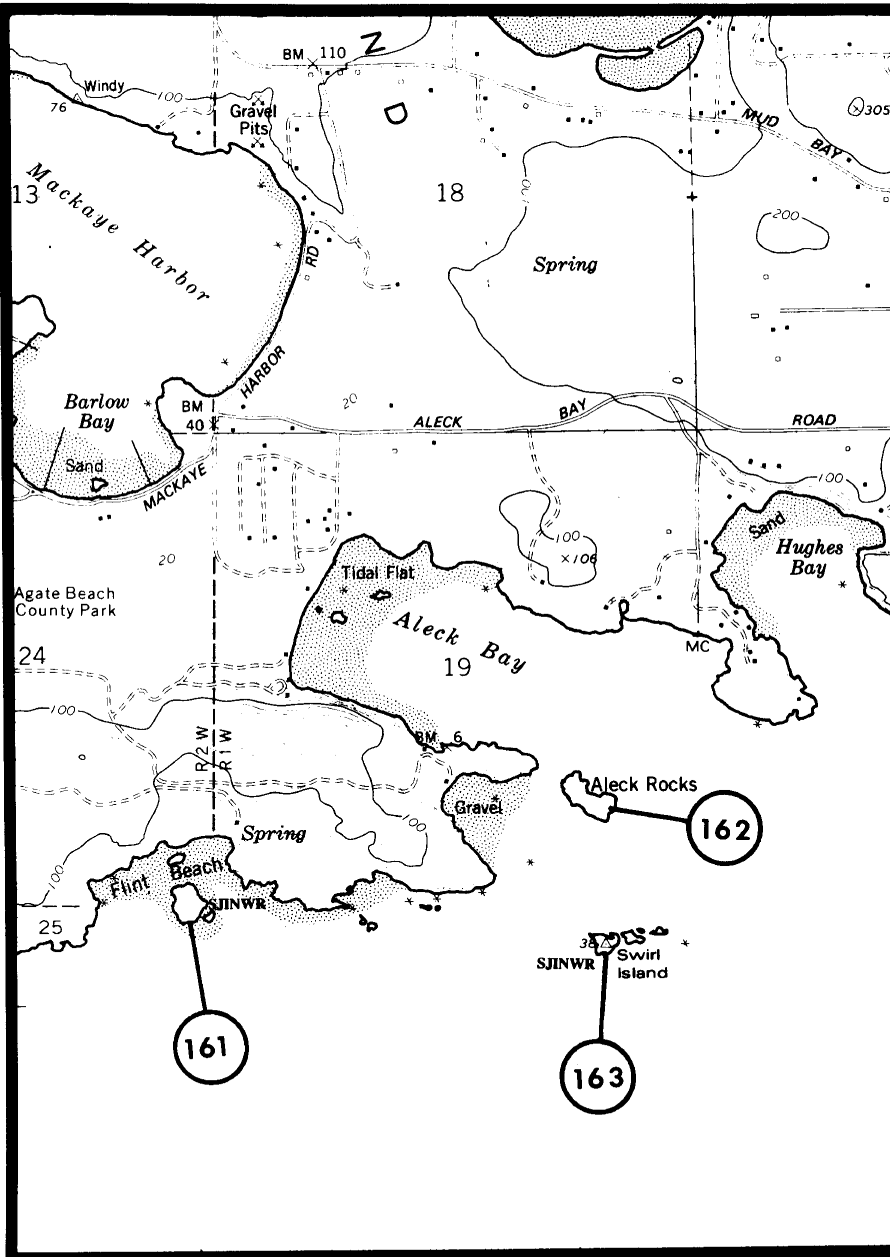
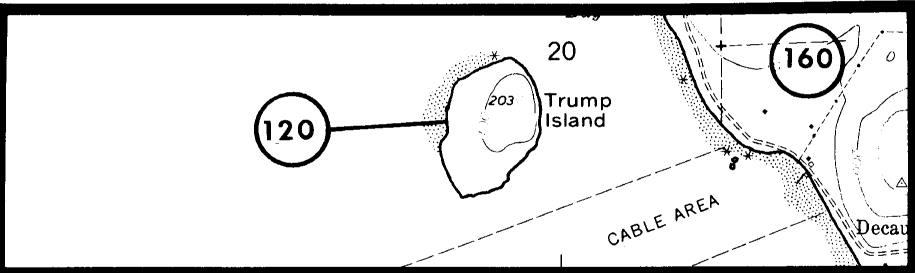
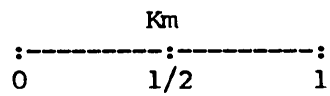

Section from U.S.G.S.
1:24,000 scale map:

Lopez Pass

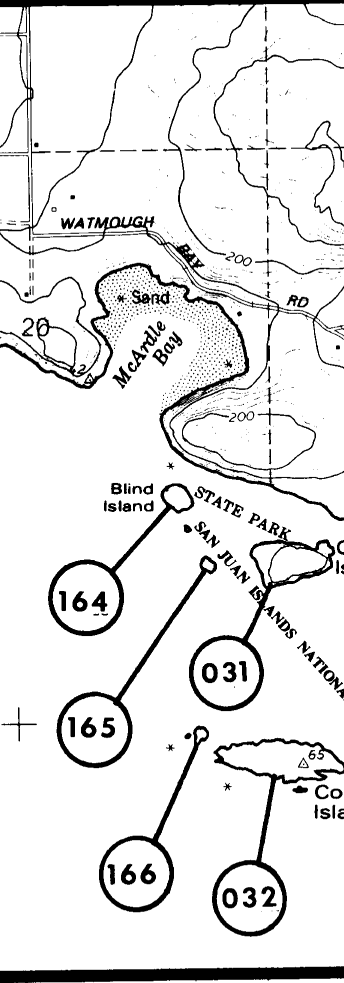
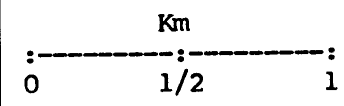

AREA 156, Victoria (cont'd.)

(165) "Unnamed Rock" 48°25'18"N, 122°49'29"W

| | | | | |
|----------------------|-----|--------|----------|-----------|
| No Nesting Observed | 0 | Pitman | 06/20/78 | B III 217 |
| Glaucous-winged Gull | 12+ | Eddy | 07/03/61 | B III 95 |

(166) "Unnamed Rock" (Colville Annex) 48°25'00"N, 122°49'32"W

| | | | | |
|--------------------------|-----|--------|----------|-----------|
| Double-crested Cormorant | 60 | Wahl | 07/19/82 | A II 269 |
| Glaucous-winged Gull | 150 | Wahl | 07/19/82 | A III 269 |
| Pigeon Guillemot | 2 | Pitman | 06/20/78 | B III 217 |
| Total | 212 | | | |

| | | | | |
|----------------------|-----|-------------------------|-------------|----------|
| Glaucous-winged Gull | 52 | Thoresen & Galusha 1971 | 06-07/ ?/63 | L I 264 |
| Glaucous-winged Gull | 118 | Thoresen & Galusha 1971 | 06-07/ ?/70 | L I 264 |
| Glaucous-winged Gull | 80 | Pitman | 06/20/78 | B II 217 |

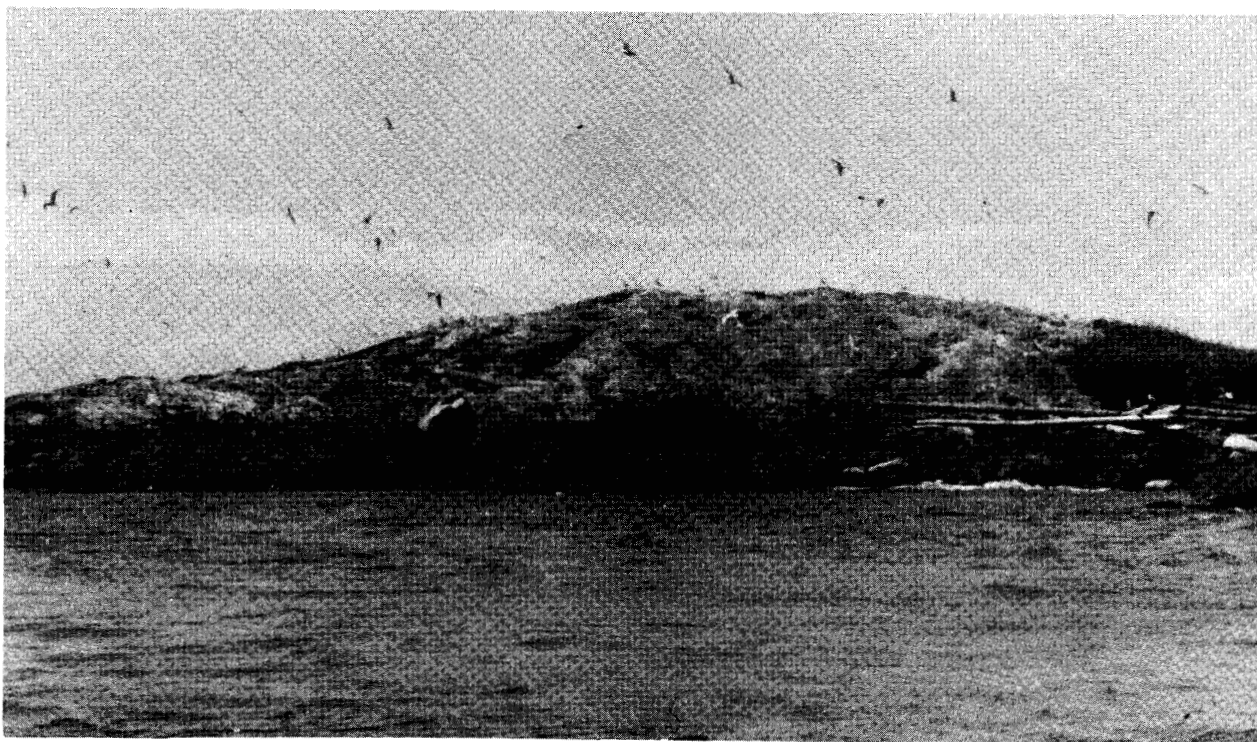

Secar Rock (156148) USF&WS

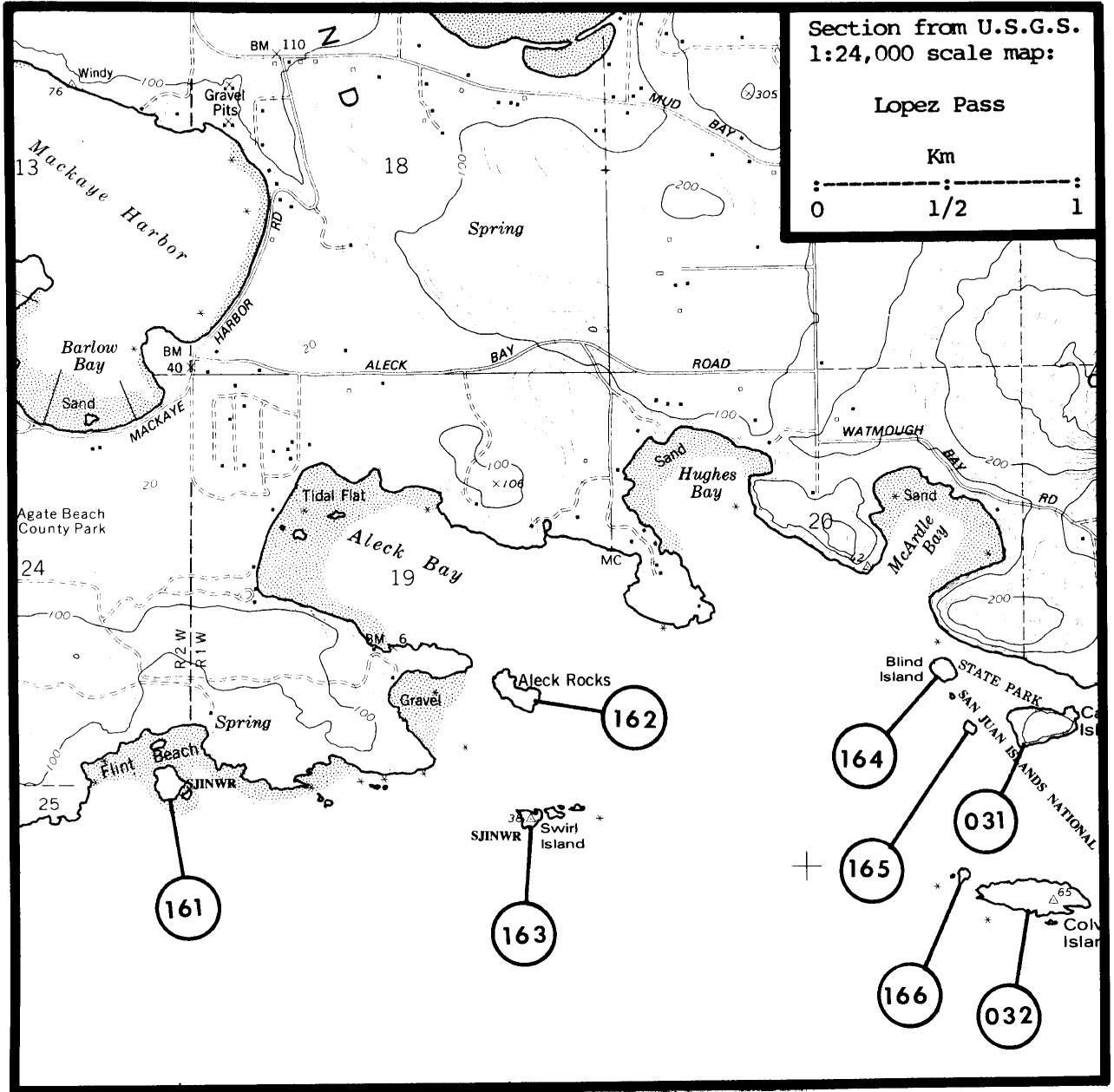

AREA 156, Victoria (cont'd.)

167 Boulder Island 48°25'58"N, 122°48'02"W

| | | | | |
|----------------------|----|--------|----------|-----------|
| Pigeon Guillemot | 2 | Wahl | 04/30/79 | B III 269 |
| No Nesting Observed | 0 | Pitman | 06/20/78 | B III 217 |
| No Nesting Observed | 0 | Wahl | 07/19/82 | A III 269 |
| Glaucous-winged Gull | 4P | Eddy | 07/03/61 | L III 95 |
| Pigeon Guillemot | 11 | Wahl | 05/19/78 | B III 269 |

168 Burrows Island 48°28'48"N, 122°42'06"W

| | | | | |
|------------------|----|------|----------|-----------|
| Pigeon Guillemot | 12 | Wahl | 06/14/79 | B III 269 |
| Pigeon Guillemot | 3 | Wahl | 05/19/78 | B III 269 |

169 Young Island 48°28'32"N, 122°41'22"W

| | | | | |
|---------------------|---|-----------|----------|-----------|
| No Nesting Observed | 0 | Pitman | 06/21/78 | B III 217 |
| No Nesting Observed | 0 | Eddy 1975 | 06/15/75 | B III 94 |

170 Allan Island 48°27'55"N, 122°42'12"W

| | | | | |
|------------------|---|------------|----------|-----------|
| Pigeon Guillemot | 2 | Wahl | 06/14/79 | B III 269 |
| Pigeon Guillemot | 1 | Edson 1929 | 06/13/05 | L III 98 |
| Pigeon Guillemot | 4 | Wahl | 05/19/78 | B III 269 |

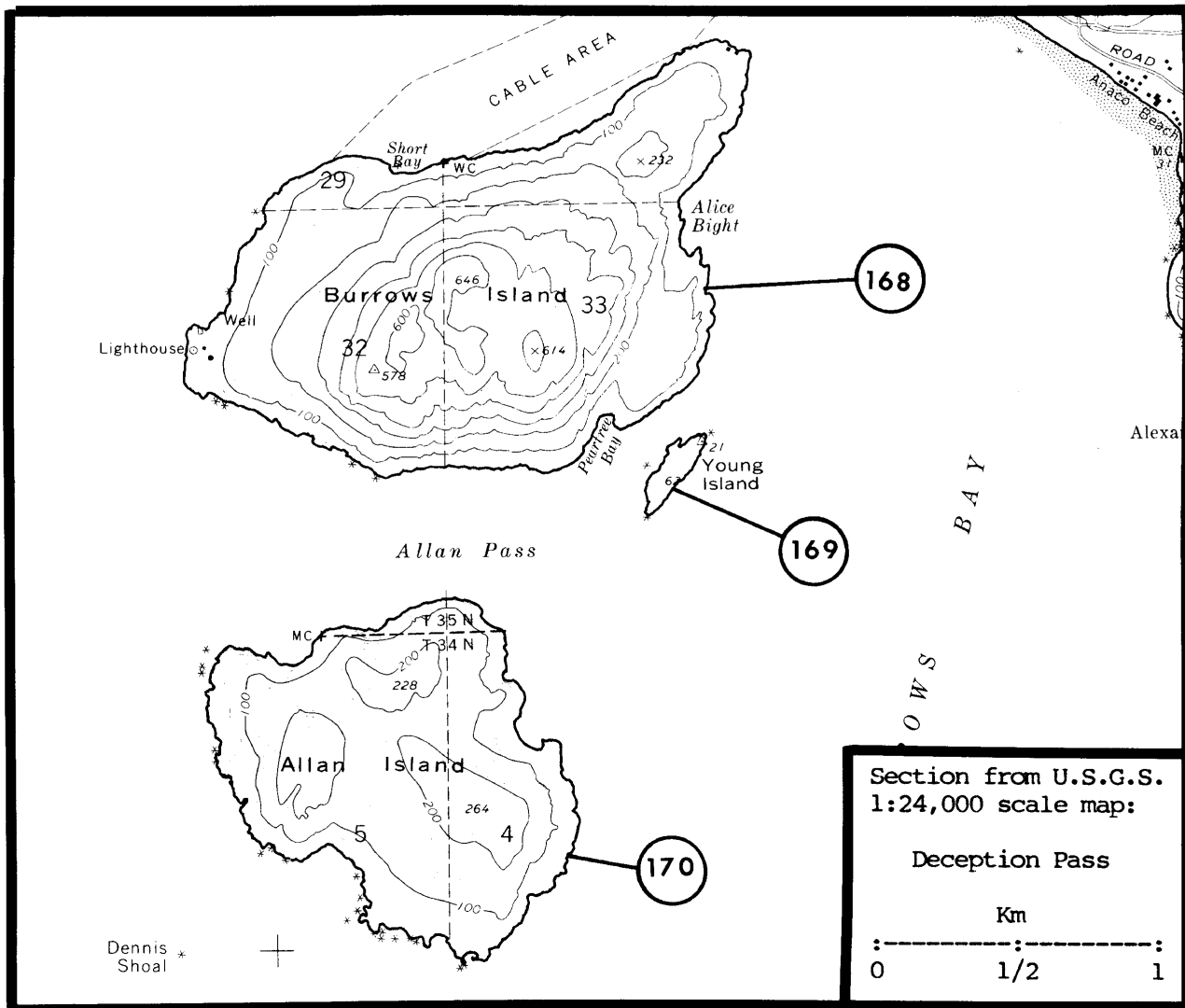
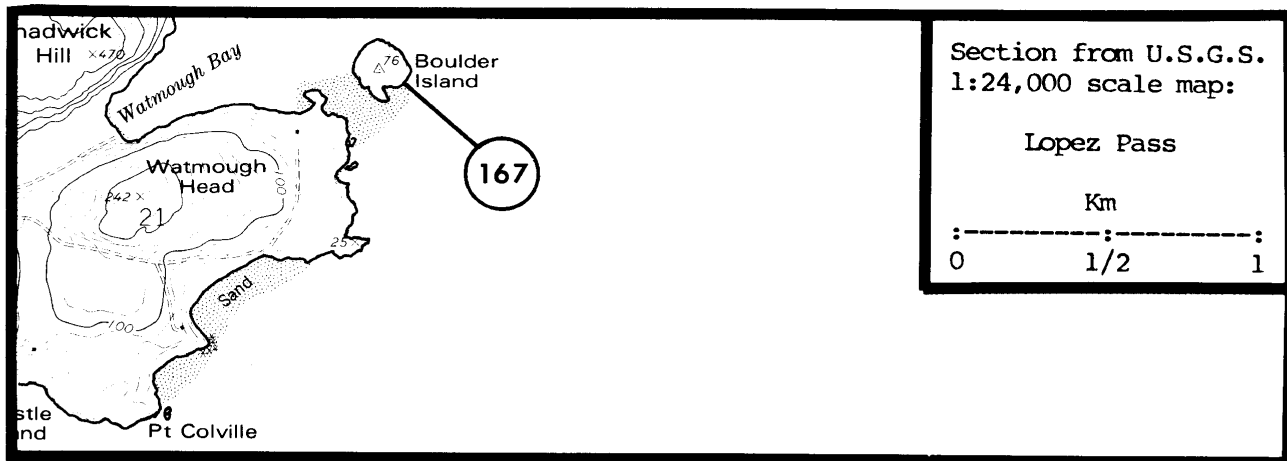

AREA 156, Victoria (cont'd.)

(171) Sares Head 48°26'00"N, 122°40'30"W

Pigeon Guillemot X Thoresen & Booth 1958 06-09/ ?/57 L III 263

(172) Northwest Island 48°25'09"N, 122°40'06"W

| | | | | |
|-------------------|----|------|----------|----------|
| Pelagic Cormorant | 10 | Wahl | 05/17/79 | B II 269 |
|-------------------|----|------|----------|----------|

Pigeon Guillemot 2 Thoresen & Booth 1958 06-09/ ?/57 L I 263

(173) Deception Island 48°24'27"N, 122°40'05"W

Pigeon Guillemot 36 Thoresen & Booth 1958 06-09/ ?/57 L II 263

(174) Pass Island 48°24'25"N, 122°38'33"W

| | | | | |
|---------------------|---|------|----------|-----------|
| No Nesting Observed | 0 | Wahl | 06/14/79 | B III 269 |
|---------------------|---|------|----------|-----------|

| | | | | |
|---------------------|---|------|-----------|-----------|
| No Nesting Observed | 0 | Wahl | Summer/78 | B III 269 |
|---------------------|---|------|-----------|-----------|

(175) Strawberry Island 48°24'26"N, 122°37'50"W

| | | | | |
|---------------------|---|------|----------|-----------|
| No Nesting Observed | 0 | Wahl | 06/07/79 | A III 269 |
|---------------------|---|------|----------|-----------|

No Nesting Observed 0 Wahl 05/24/78 A III 269

No Nesting Observed 0 Wahl 06/07/78 A III 269

(176) Ben-Ure Island 48°24'12"N, 122°37'43"W

No Nesting Observed 0 Speich & Wahl 07/06/82 A III 257

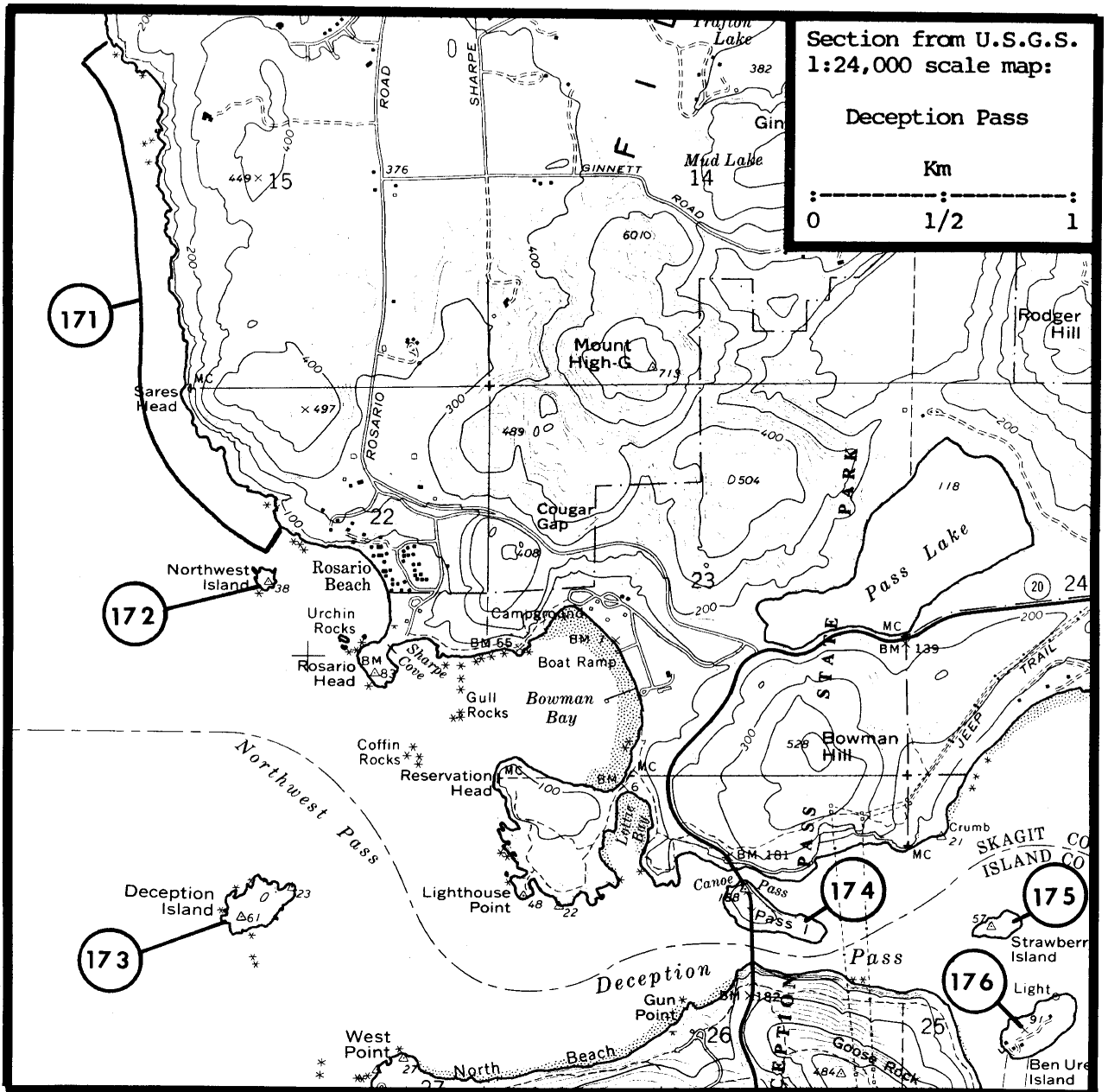

AREA 156, Victoria (cont'd.)

(177)

Swinomish Islands, west 48°28'15"N, 122°31'27"W

| | | | | |
|----------------------|-------|------------------|-----------|-----------|
| Glaucous-winged Gull | ~400 | Speich & Wahl | 07/06/82 | A III 257 |
| Glaucous-winged Gull | 270B | Wahl | 07/19/69 | L III 269 |
| Glaucous-winged Gull | 360B | Wahl | 07/18/70 | L III 269 |
| Glaucous-winged Gull | 500B | Wahl | 07/17/71 | L III 269 |
| Glaucous-winged Gull | 1000B | Wahl | 07/10/73 | L III 269 |
| Glaucous-winged Gull | 520B | Wahl | 07/06/74 | L III 269 |
| Glaucous-winged Gull | 560B | Wahl | 07/09/75 | L III 269 |
| Glaucous-winged Gull | 1070B | Wahl | 07/09/76 | L III 269 |
| Glaucous-winged Gull | 1286 | Wahl | 06/06/77 | L II 269 |
| Glaucous-winged Gull | 600B | Wahl | 07/12/77 | L III 269 |
| Glaucous-winged Gull | X | Harrington-Tweit | 03/04/78 | M III 124 |
| Glaucous-winged Gull | 410B | Wahl | 07/13/78 | L III 269 |
| Glaucous-winged Gull | X | Speich & Wahl | Summer/79 | M III 257 |
| Glaucous-winged Gull | X | Speich & Wahl | Summer/80 | M III 257 |
| Glaucous-winged Gull | X | Wahl | 07/03/81 | M III 269 |

(178)

Swinomish Islands, east 48°27'40"N, 122°30'38"W

| | | | | |
|---------------------|---|---------------|-----------|-----------|
| No Nesting Observed | 0 | Speich & Wahl | 07/06/82 | A III 257 |
| No Nesting Observed | 0 | Wahl | 07/19/69 | M III 269 |
| No Nesting Observed | 0 | Wahl | 07/18/70 | M III 269 |
| No Nesting Observed | 0 | Wahl | 07/17/71 | M III 269 |
| No Nesting Observed | 0 | Wahl | 07/10/73 | M III 269 |
| No Nesting Observed | 0 | Wahl | 07/06/74 | M III 269 |
| No Nesting Observed | 0 | Wahl | 07/09/75 | M III 269 |
| No Nesting Observed | 0 | Wahl | 07/09/76 | M III 269 |
| No Nesting Observed | 0 | Wahl | 06/06/77 | M III 269 |
| No Nesting Observed | 0 | Wahl | 07/12/77 | M III 269 |
| No Nesting Observed | 0 | Wahl | 07/13/78 | M III 269 |
| No Nesting Observed | 0 | Speich & Wahl | Summer/79 | M III 257 |
| No Nesting Observed | 0 | Speich & Wahl | Summer/80 | M III 257 |
| No Nesting Observed | 0 | Wahl | 07/03/81 | M III 269 |

(179)

Skagit Island 48°24'48"N, 122°34'42"W

| | | | | |
|---------------------|---|---------------|----------|-----------|
| No Nesting Observed | 0 | Speich & Wahl | 07/06/82 | A III 257 |
|---------------------|---|---------------|----------|-----------|

(180)

Hope Island 48°23'54"N, 122°34'06"W

| | | | | |
|---------------------|---|---------------|----------|-----------|
| No Nesting Observed | 0 | Speich & Wahl | 07/06/82 | A III 257 |
|---------------------|---|---------------|----------|-----------|

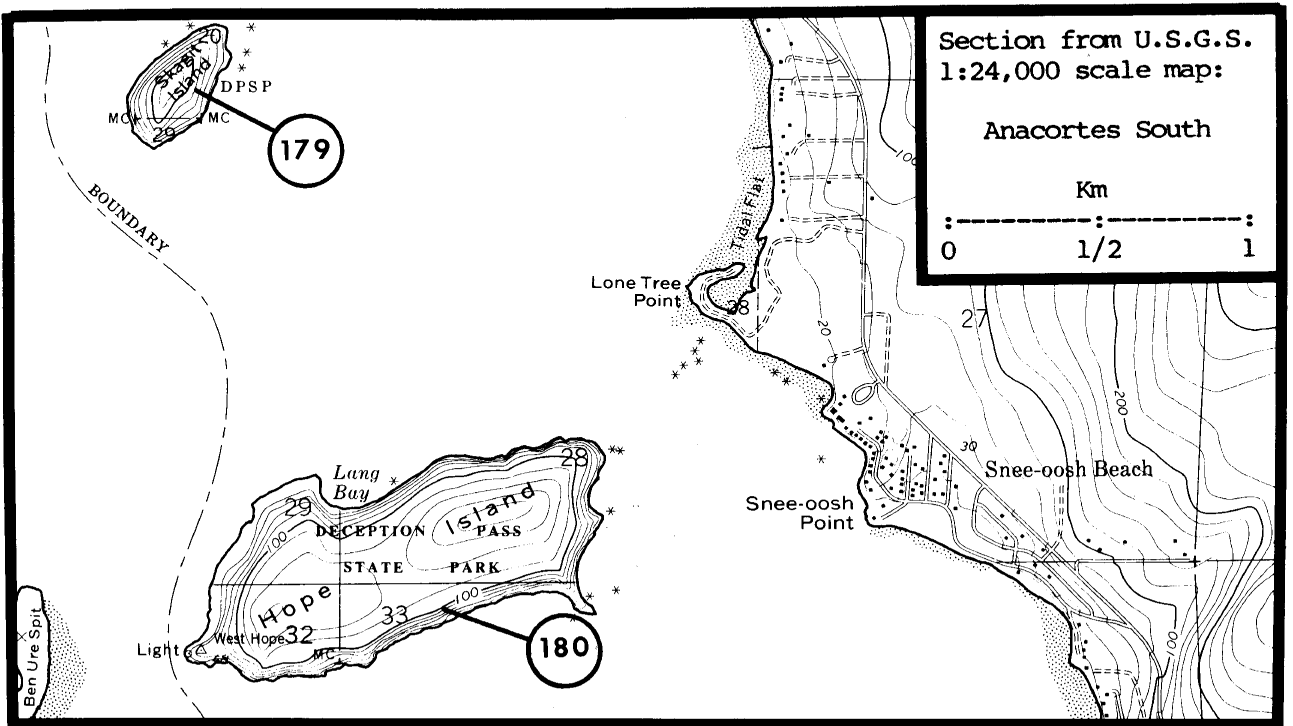
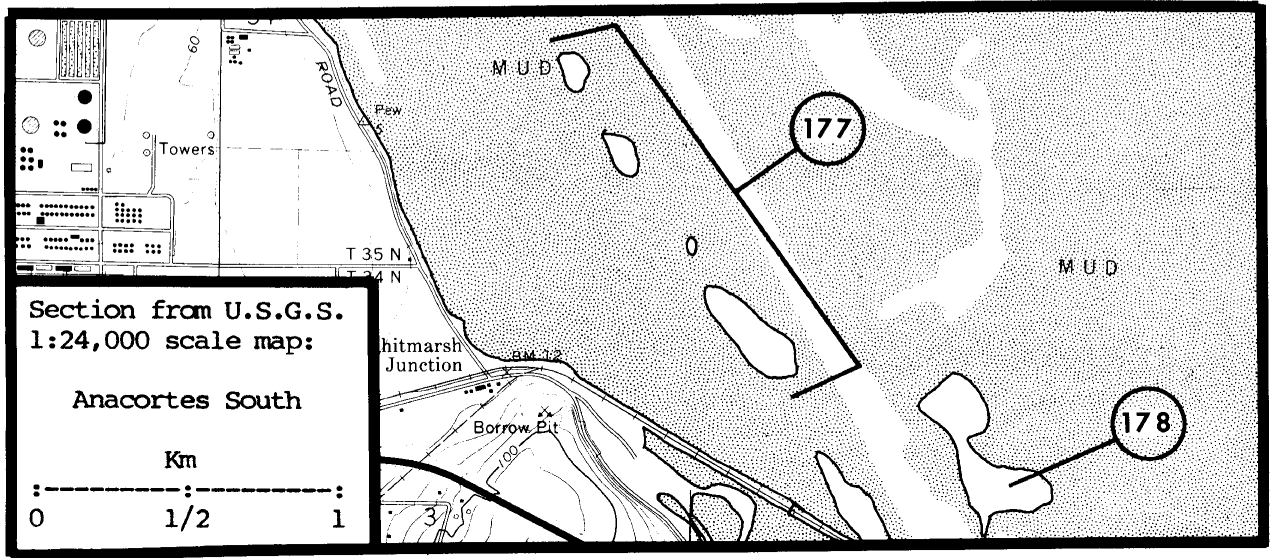

AREA 156, Victoria (cont'd.)

181

Smith and Minor Islands 48°19'16"N, 122°49'47"W

| | | | | |
|--------------------------------|------|---------------|-------------|-----------|
| Pelagic Cormorant ¹ | 440 | Nisqually NWR | 06/15-17/82 | L II 202 |
| Black Oystercatcher | 40 | Nisqually NWR | 06/15-17/82 | L II 202 |
| Glaucous-winged Gull | 1060 | Nisqually NWR | 06/15-17/82 | L III 202 |
| Pigeon Guillemot | 102 | Nisqually NWR | 06/15-17/82 | L II 202 |
| Rhinoceros Auklet ¹ | 2588 | Nisqually NWR | 06/15-17/82 | L III 202 |
| Tufted Puffin ¹ | 8 | Nisqually NWR | 06/15-17/82 | L I 202 |
| Total | 4238 | | | |

| | | | | |
|---------------------------------------|-----------|-----------------------|------------------|---------------|
| Double-crested Cormorant ¹ | 20? | Newby | 07/20/72 | L III 201 |
| Pelagic Cormorant ¹ | 70 | Hauser & Monson 1963 | 07/16-17/63 | B III 145 |
| Pelagic Cormorant ¹ | 14 | Newby | 07/20/72 | L I 201 |
| Pelagic Cormorant ¹ | 28 | Manuwal 1973; Manuwal | 05/27-28/73 | L I 202;188 |
| Pelagic Cormorant ¹ | 282 | Nisqually NWR | 06/25/79 | L I 202 |
| Black Oystercatcher | several X | Menzies 1792 | 06/06/1792 | ? ? 195 |
| Black Oystercatcher | 6 | Nisqually NWR | 08/21-23/67 | L II 202 |
| Black Oystercatcher | 12 | Manuwal 1973; Manuwal | 05/27-28/73 | L I 186;188 |
| Black Oystercatcher | 24 | Nisqually NWR | 06/25/79 | L III 202 |
| Glaucous-winged Gull | 300 | Hauser & Monson 1963 | 07/16-17/63 | B III 145 |
| Glaucous-winged Gull | 500 | Nisqually NWR | 08/21-23/67 | L III 202 |
| Glaucous-winged Gull | 10 | Manuwal 1973; Manuwal | 05/27-28/73 | L III 186;188 |
| Glaucous-winged Gull | 220 | Nisqually NWR | 06/25/79 | L II 202 |
| Glaucous-winged Gull | X | Wahl | 07/19/82 | A III 269 |
| Pigeon Guillemot | 2 | Dennison | 04/21/1894 | E - 84 |
| Pigeon Guillemot | 2 | Jewett et al. 1953 | 05/09/1894 | E - 158 |
| Pigeon Guillemot | 2 | Dennison | 05/09/1894 | E - 85 |
| Pigeon Guillemot | 2 | Dennison | 04/29/1895 | E - 84 |
| Pigeon Guillemot | 100 | Cantwell | 09/14/14 | L III 51 |
| Pigeon Guillemot | X | Cantwell | 06/ ?/16 | ? ? 52 |
| Pigeon Guillemot | 200 | Cantwell | 06/06-08/16 | L III 51 |
| Pigeon Guillemot | 50 | Cantwell | 04/17-21/17 | L III 51 |
| Pigeon Guillemot | 10 | Hauser & Monson 1963 | 07/16-17/63 | B III 145 |
| Pigeon Guillemot | 100+ | Manuwal 1973; Manuwal | 05/27-28/73 | L III 186;188 |
| Pigeon Guillemot | 8 | Wahl; Paulson | 07/05/78 | A III 269;207 |
| Pigeon Guillemot | 117 | Nisqually NWR | 06/25/79 | L III 202 |
| Pigeon Guillemot | 18 | Wahl & Speich | 06/25/79 | A III 271 |
| Rhinoceros Auklet ¹ | X | Hepburn | pre-1884 | ? III 130 |
| Rhinoceros Auklet ¹ | 2 | Dennison | 05/10/1894 | E - 83 |
| Rhinoceros Auklet ¹ | 6 | Dennison | 04/21/1895 | E - 85 |
| Rhinoceros Auklet ¹ | 2 | Dennison | 04/23/1895 | E - 85 |
| Rhinoceros Auklet ¹ | 2 | Dennison | 04/21,22&24/1895 | E - 83 |
| Rhinoceros Auklet ¹ | 2 | Dennison | 04/29/1895 | E - 86 |
| Rhinoceros Auklet ¹ | 2 | Dennison | 04/25/1899 | E - 86 |
| Rhinoceros Auklet ¹ | 2 | Dennison | 04/26/1899 | E - 86 |
| Rhinoceros Auklet ¹ | 2 | Dennison | 04/29/1899 | E - 86 |
| Rhinoceros Auklet ¹ | 2 | Dennison | 05/08/1899 | E - 86 |
| Rhinoceros Auklet ¹ | 2 | Dennison | 06/03/1899 | E - 86 |
| Rhinoceros Auklet ¹ | X | Nisqually NWR | 08/21-23/67 | L III 202 |
| Rhinoceros Auklet ¹ | 742 | Manuwal 1973; Manuwal | 05/27-28/73 | L III 186;188 |

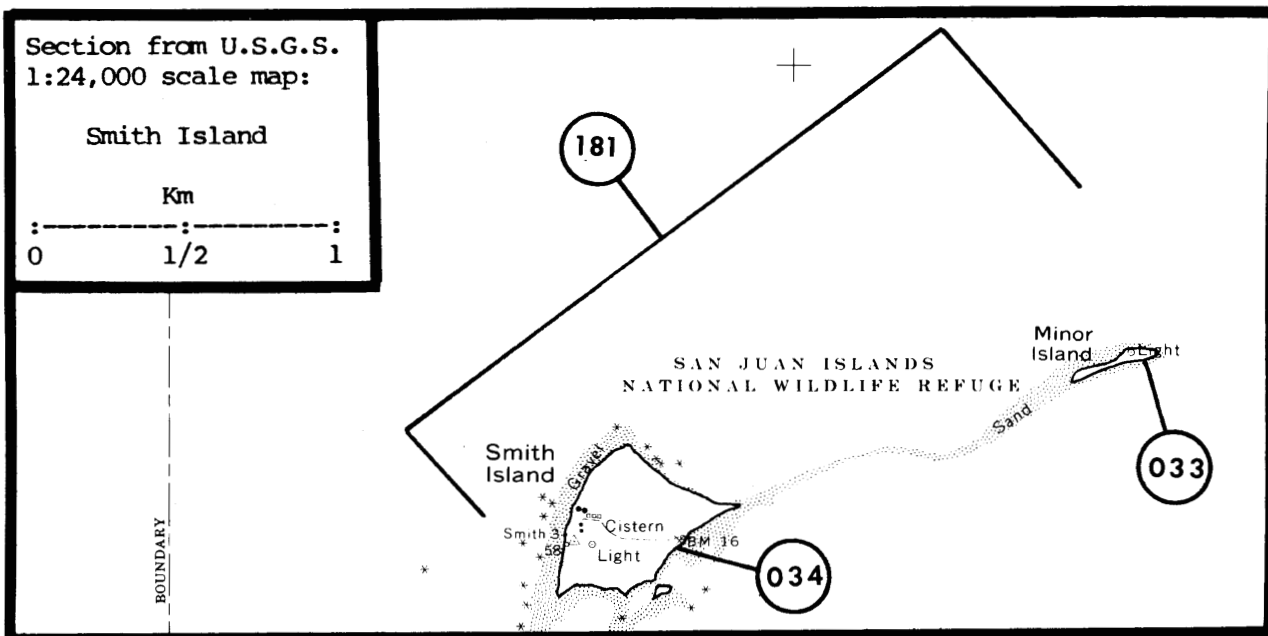

| | | | | |
|--------------------------------|------|-----------------------|-------------|---------------|
| Rhinoceros Auklet ¹ | 1200 | Manuwal 1977 | 05-06/ ?/74 | L III 187 |
| Rhinoceros Auklet ¹ | 2388 | Nisqually NWR | 06/25/79 | L III 202 |
| Tufted Puffin ¹ | X | Cantwell | 09/06/14 | L III 51 |
| Tufted Puffin ¹ | 500 | Cantwell | 09/14/14 | L III 51 |
| Tufted Puffin ¹ | ~150 | Cantwell | Summer/15? | L III 51 |
| Tufted Puffin ¹ | 150 | Cantwell | 06/06-08/16 | L III 51 |
| Tufted Puffin ¹ | 150? | Cantwell | Summer/17? | L III 51 |
| Tufted Puffin ¹ | 1P | Manuwal 1973; Manuwal | 05/27-28/73 | L III 186;188 |
| Tufted Puffin ¹ | 44 | Nisqually NWR | 06/25/79 | L III 202 |

¹Nesting on Smith Island only.

AREA 156, Victoria (cont'd.)

182

Agate Bay 48°09'30"N, 123°44'00"W

Pigeon Guillemot

117 Speich

05/31/78

M III 255



Iceburg Island (156151) 19 July 1982 T.R. Wahl

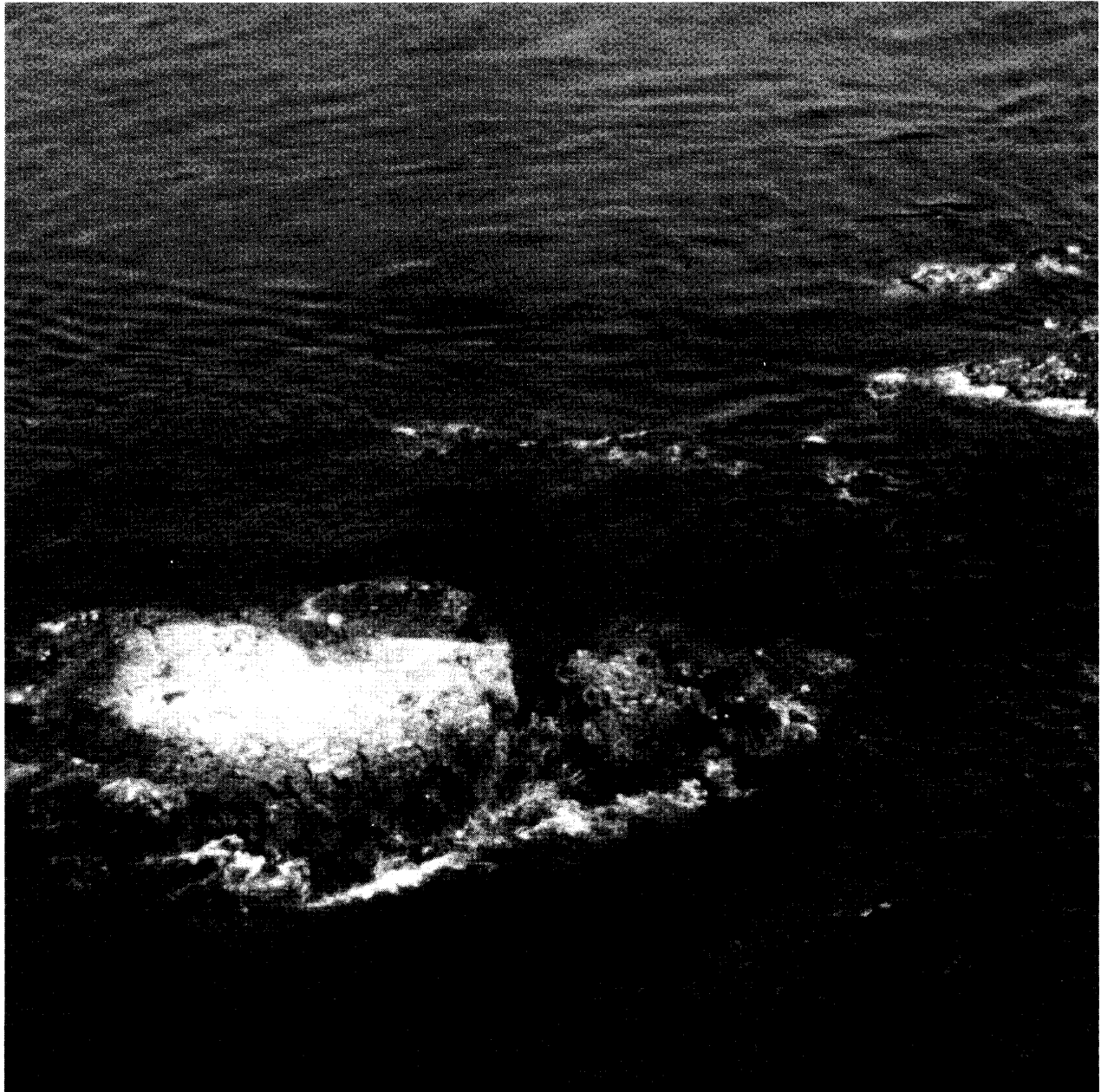
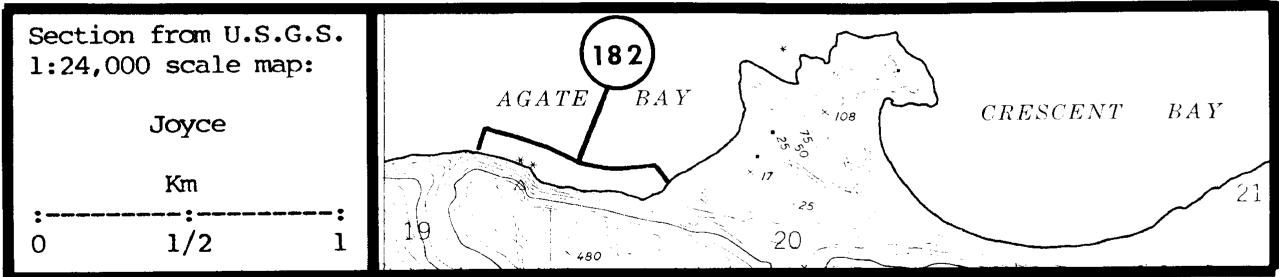

Unnamed Rock ("Colville Annex")(156166) 19 July 1982 T.R. Wahl

AREA 156, Victoria (cont'd.)

| | | | | | |
|----------------------|------------------|-------------------------|----------|---|--------|
| (183) | Dungeness, wharf | 48°09'30"N, 123°06'54"W | | | |
| Pelagic Cormorant | 44 | Speich | 08/07/79 | B | II 255 |
| Glaucous-winged Gull | 20 | Speich | 08/07/79 | B | II 255 |
| Total | <u>64</u> | | | | |



Pass Island (156174)(bridge) Northwest Island (156172) (upper right) Deception Island (156173)(left) 1978 S.G. Herman

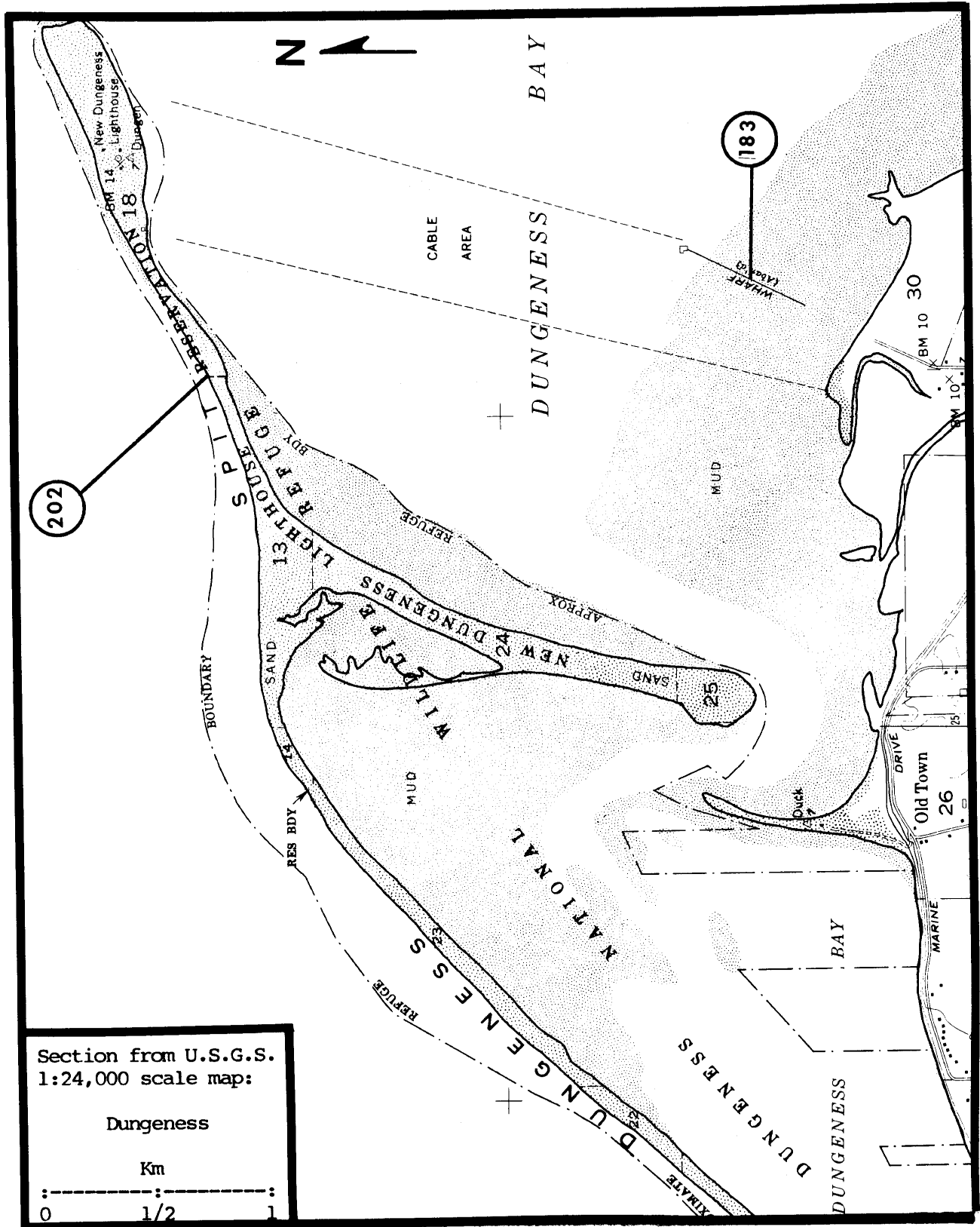

Section from U.S.G.S.
1:24,000 scale map:

Dungeness

Km

0 1/2 1

AREA 156, Victoria (cont'd.)

①84 Point Partridge 48°13'51"N, 122°46'00"W

| | | | | |
|------------------|----|------|----------|-----------|
| Pigeon Guillemot | 20 | Wahl | 07/17/82 | L III 269 |
|------------------|----|------|----------|-----------|

| | | | | |
|------------------|---|------|----------|-----------|
| Pigeon Guillemot | 6 | Wahl | 06/13/79 | L III 269 |
|------------------|---|------|----------|-----------|

①85 Penn Cove, north shore 48°14'22"N, 122°41'45"W

| | | | | |
|------------------|----|------|----------|-----------|
| Pigeon Guillemot | 50 | Wahl | 07/12/82 | L III 259 |
|------------------|----|------|----------|-----------|

①86 Blowers Bluff 48°14'30"N, 122°39'40"W

| | | | | |
|------------------|----|------|----------|-----------|
| Pigeon Guillemot | 11 | Wahl | 07/12/78 | L III 269 |
|------------------|----|------|----------|-----------|

①87 Penn Cove, southwest shore 48°13'00"N, 122°43'25"W

| | | | | |
|------------------|----|------|----------|-----------|
| Pigeon Guillemot | 16 | Wahl | 07/12/78 | L III 269 |
|------------------|----|------|----------|-----------|

①88 Penn Cove, south shore 48°12'52"N, 122°43'00"W

| | | | | |
|------------------|---|------|----------|-----------|
| Pigeon Guillemot | 5 | Wahl | 07/12/78 | L III 269 |
|------------------|---|------|----------|-----------|

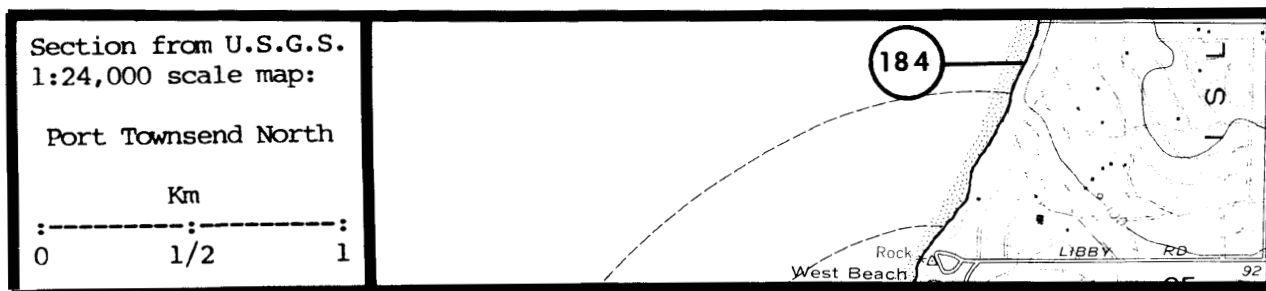

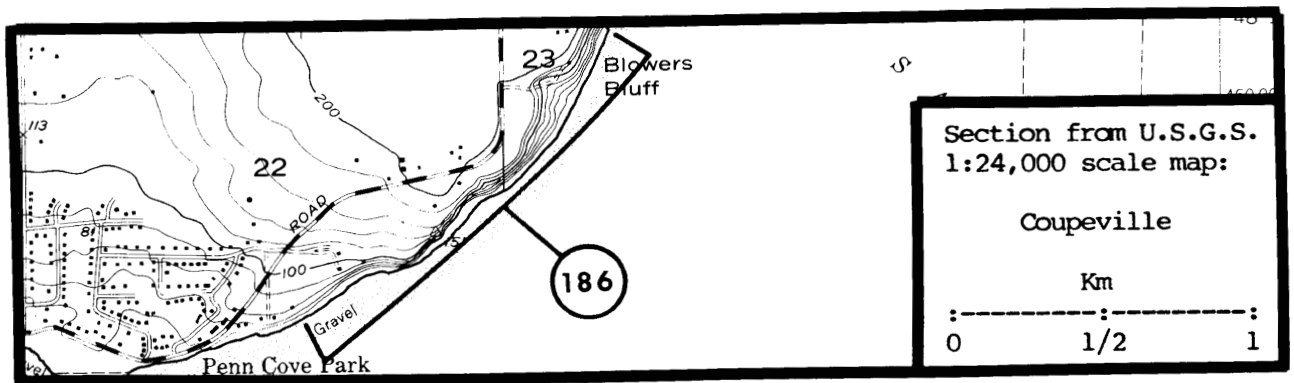
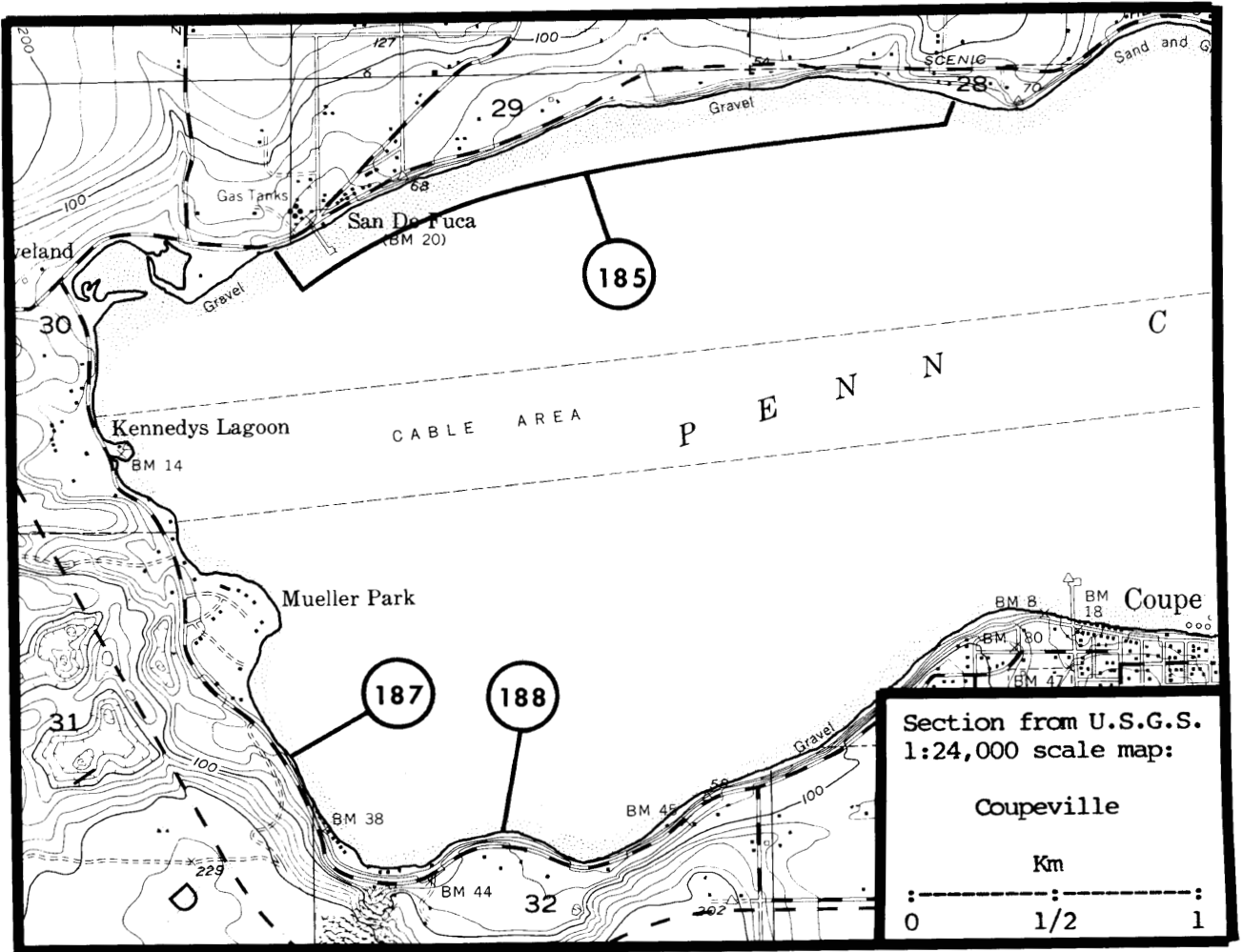

AREA 156, Victoria (cont'd.)

(189) Keystone, wharf 48°09'28"N, 122°40'09"W

Pigeon Guillemot 6 Wahl 07/17/82 L III 269

(190) Port Angeles 48°07'02"N, 123°24'38"W

| | | | | |
|-------------------|----|------------------|----------|-----------|
| Pelagic Cormorant | 58 | Harrington-Tweit | 08/15/78 | M I 124 |
| Pigeon Guillemot | P | Harrington-Tweit | 08/15/78 | L III 124 |
| Total | 58 | | | |

| | | | | |
|-------------------|----|------------------|----------|-----------|
| Pelagic Cormorant | 30 | Harrington-Tweit | 04/08/78 | M I 124 |
| Pelagic Cormorant | 62 | Harrington-Tweit | 05/05/78 | M I 124 |
| Pelagic Cormorant | 76 | Speich | 05/31/78 | M I 255 |
| Pelagic Cormorant | X | Speich | 08/22/78 | M III 255 |

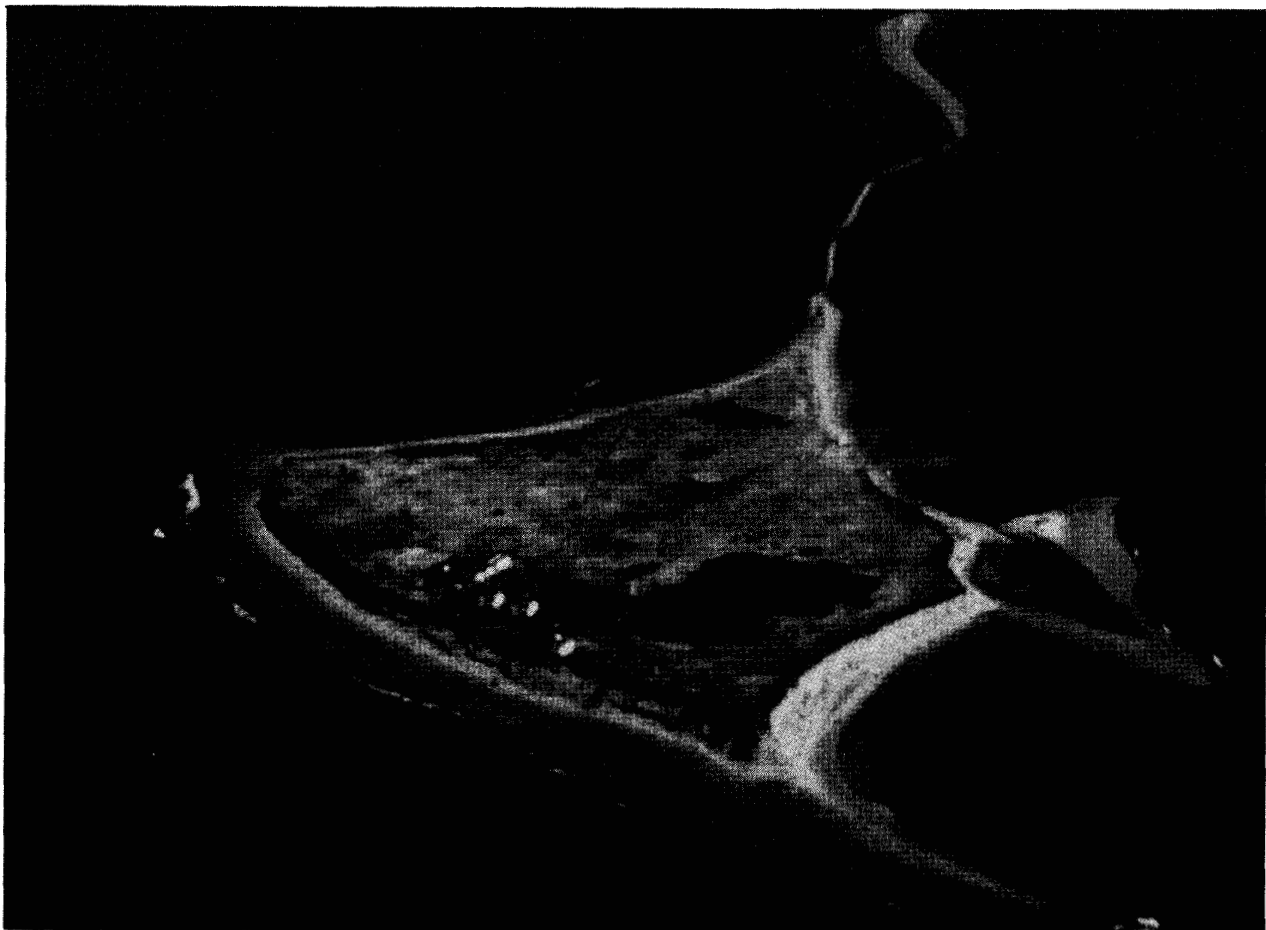

Smith and Minor Islands (156181) USF&WS

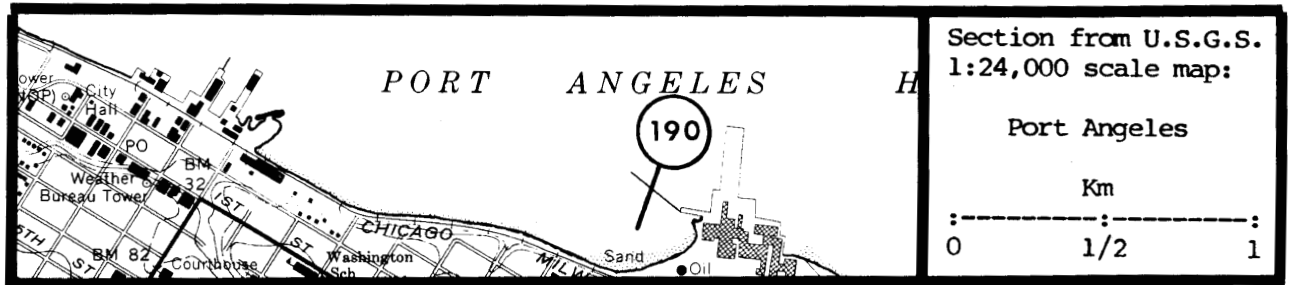
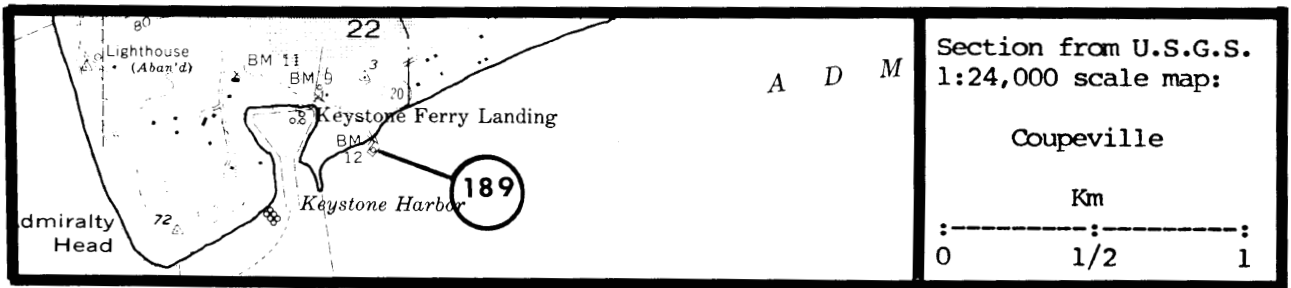

Dungeness, wharf (156183) 1979 S.M. Speich Pelagic Cormorants and Glaucous-winged Gulls

AREA 156, Victoria (cont'd.)

①91 Port Williams 48°07'00"N, 123°03'00"W

| | | | | |
|------------------|----|--------|----------|-----------|
| Pigeon Guillemot | 34 | Speich | 05/23/79 | B III 255 |
| Pigeon Guillemot | 33 | Speich | 05/26/78 | B III 255 |

①92 Travis Spit 48°04'50"N, 123°02'00"W

| | | | | |
|------------------|----|--------|----------|-----------|
| Pigeon Guillemot | 22 | Speich | 05/23/79 | B III 255 |
| Pigeon Guillemot | P | Speich | 03/21/78 | B III 255 |
| Pigeon Guillemot | 16 | Speich | 04/28/78 | B III 255 |

①93 Port Townsend, mill dock 48°05'34"N, 122°47'28"W

| | | | | |
|------------------|---|---------------|----------|-----------|
| Pigeon Guillemot | 4 | Speich & Wahl | 06/29/82 | B III 257 |
|------------------|---|---------------|----------|-----------|



Port Angeles (156190) 1979 S.M. Speich Pelagic Cormorants

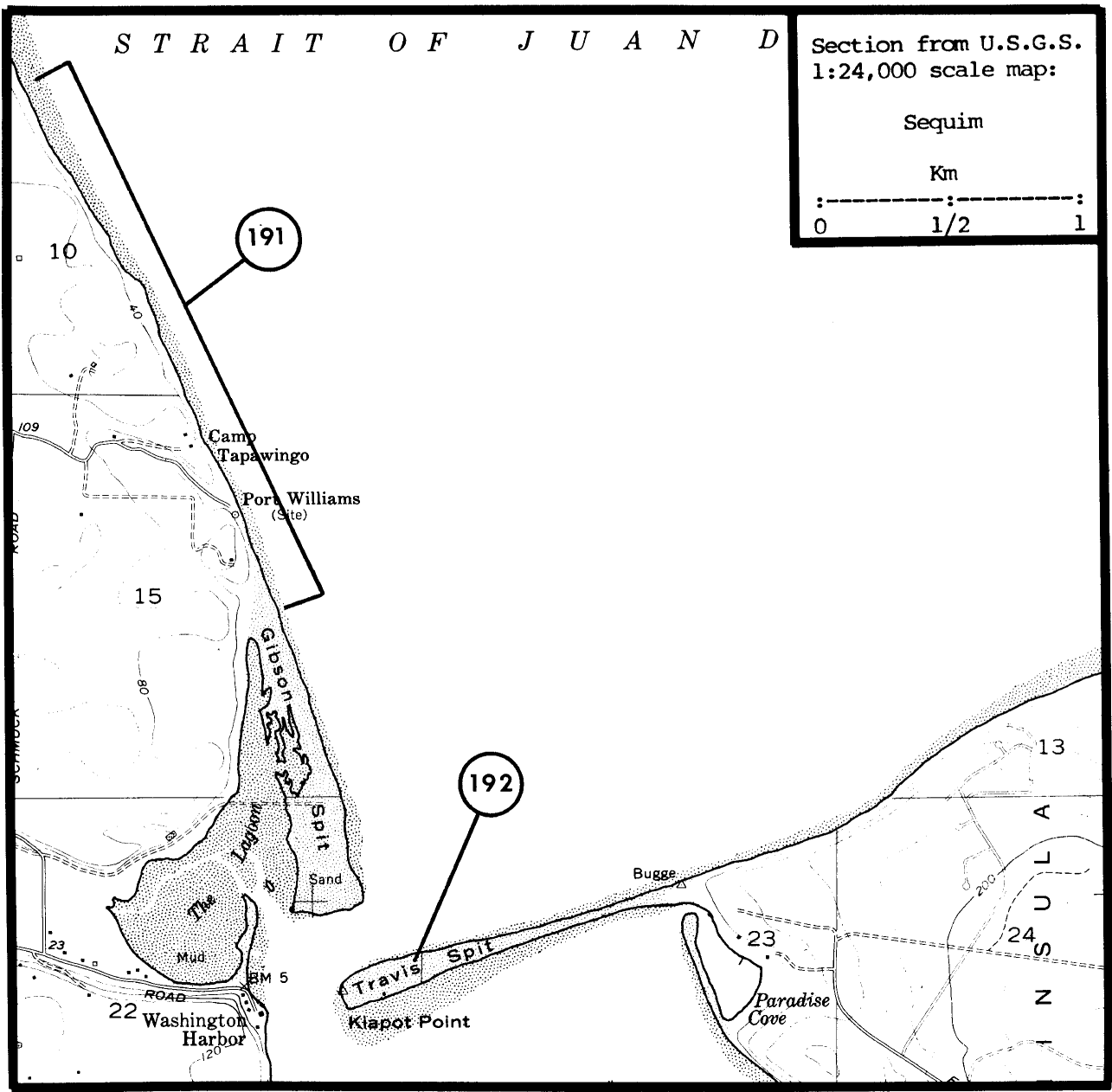

S T R A I T O F J U A N D

Section from U.S.G.S.
1:24,000 scale map:

Sequim

Km

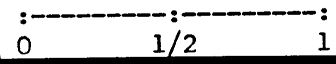

191

192

193

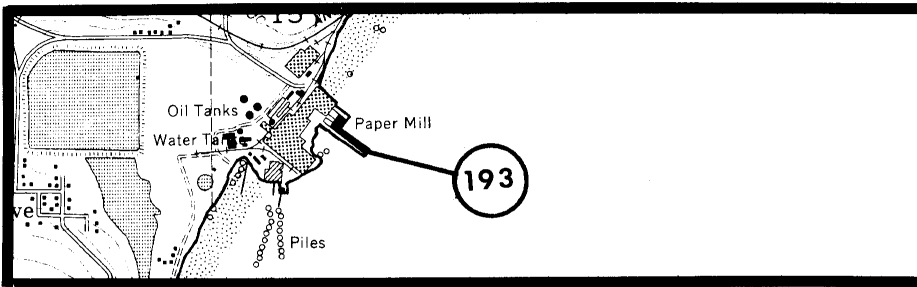

Section from U.S.G.S.
1:24,000 scale map:

Port Townsend South

Km

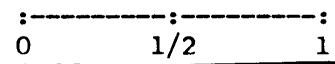

AREA 156, Victoria (cont'd.)

(194) Port Townsend, bluffs 48°06'38"N, 122°45'46"W

| | | | | |
|------------------|----|---------------|-----------|-----------|
| Pigeon Guillemot | 10 | Speich & Wahl | 06/29/82 | B III 257 |
| Pigeon Guillemot | X | Speich | Summer/78 | L III 255 |
| Pigeon Guillemot | X | Speich | Summer/79 | L III 255 |

(195) Port Townsend, tower 48°05'36"N, 122°44'00"W

| | | | | |
|-------------------|---------|---------------|----------|-----------|
| Pelagic Cormorant | 130± | Wahl | 07/19/82 | A II 269 |
| Pelagic Cormorant | 100± | Eddy | 08/28/55 | B III 95 |
| Pelagic Cormorant | 60 | Speich | 07/11/79 | B II 255 |
| Pelagic Cormorant | 80+ | Speich & Wahl | 06/29/82 | B III 257 |
| Pelagic Cormorant | 110-120 | Speich & Wahl | 07/06/82 | A II 269 |

(196) Indian Island, bar 48°05'23"N, 122°44'00"W

| | | | | |
|----------------------|------------|---------------|----------|-----------|
| Black Oystercatcher | 3 | Speich & Wahl | 06/29/82 | L III 257 |
| Glaucous-winged Gull | 100 | Speich & Wahl | 06/29/82 | L III 257 |
| Total | <u>103</u> | | | |

Glaucous-winged Gull 0 Eddy 08/26-28/55 B III 95

(197) Killisut Harbor, north bluff 48°05'36"N, 122°43'20"W

Pigeon Guillemot 33 Speich & Wahl 06/29/82 B III 257

(198) Indian Island, navy dock 48°03'05"N, 122°44'30"W

Pigeon Guillemot 9 Speich & Wahl 06/29/82 B III 257

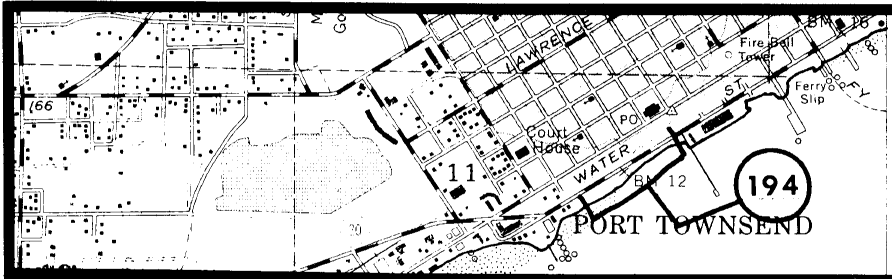

Section from U.S.G.S.
1:24,000 scale map:

Port Townsend South

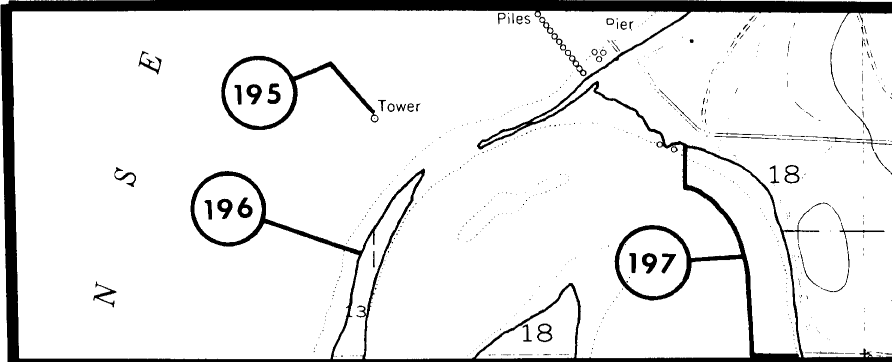
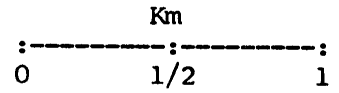

Section from U.S.G.S.
1:24,000 scale map:

Nordland

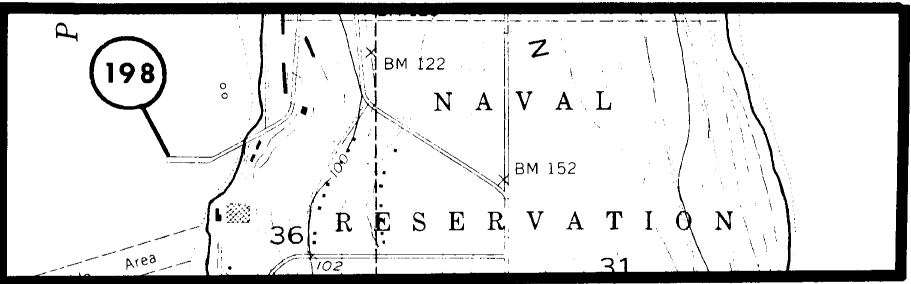
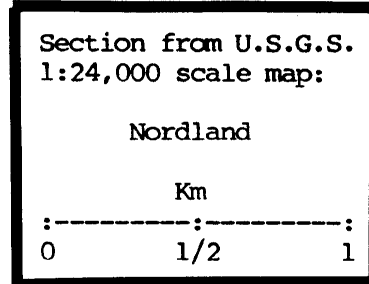
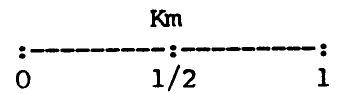

AREA 156, Victoria (cont'd.)

(199) Whidbey Island¹ 48°10'00"N, 122°40'00"W

| | | | | | |
|-------------------|---|----------|-------------------|-----|----|
| Pigeon Guillemot | 2 | Booth | 05/12/17 | E - | 38 |
| Pigeon Guillemot | 8 | Booth | 06/12/27 | E - | 34 |
| Pigeon Guillemot | 2 | Booth | 06/10/28 | E - | 34 |
| Pigeon Guillemot | 4 | Booth | 06/07/31 | E - | 38 |
| Rhinoceros Auklet | X | Dennison | 04/22,24,&25/1895 | E - | 83 |
| Rhinoceros Auklet | 2 | Dennison | 04/22/1895 | E - | 85 |
| Rhinoceros Auklet | 4 | Dennison | 04/24/1895 | E - | 85 |
| Rhinoceros Auklet | 6 | Dennison | 04/25/1895 | E - | 85 |

¹Insufficient data to show exact map location.

(200) Oak Harbor¹ 48°16'30"N, 122°39'00"W

| | | | | | |
|------------------|----|-------|----------|-----|----|
| Pigeon Guillemot | 12 | Booth | 06/09/30 | E - | 38 |
|------------------|----|-------|----------|-----|----|

¹Insufficient data to show exact map location.

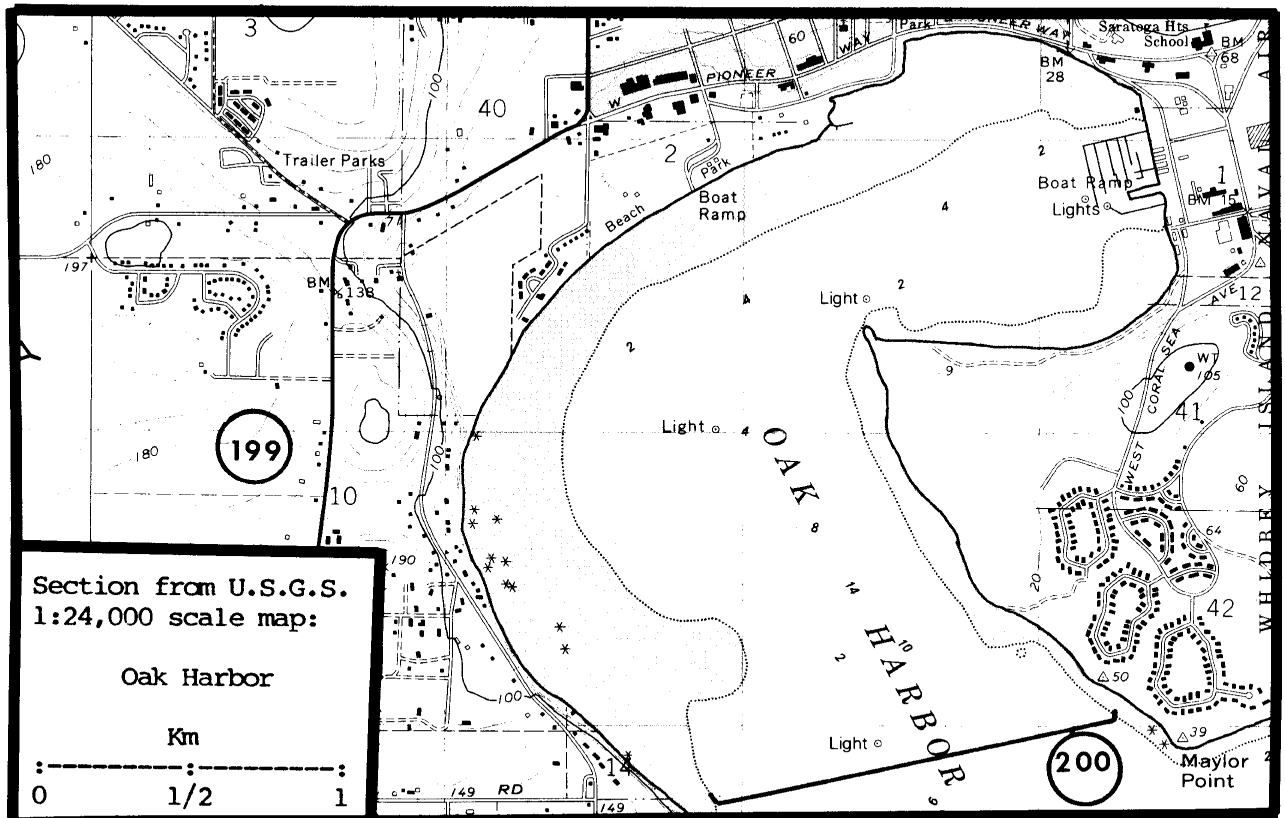

AREA 156, Victoria (cont'd.)

(201)

Jetty Island 48°00'35"N, 122°13'37"W

| | | | | |
|----------------------|-------------|---------|----------|-----------|
| Glaucous-winged Gull | 120+ | Wahl | 07/19/82 | A III 269 |
| Arctic Tern | 0 | Richter | 06/19/82 | L III 232 |
| Total | <u>120+</u> | | | |

| | | | | |
|----------------------|------|---------------------|----------------|-----------|
| Glaucous-winged Gull | 200± | Manuwal et al. 1979 | 06/09-08/30/77 | L III 190 |
| Glaucous-winged Gull | 120+ | Speich | 05/17/78 | L III 255 |
| Glaucous-winged Gull | 200± | Manuwal et al. 1979 | 05/27-07/15/78 | L III 216 |
| Glaucous-winged Gull | X | Richter | 04/21/79 | L III 232 |
| Glaucous-winged Gull | X | Richter | 06/08/80 | L III 232 |
| Glaucous-winged Gull | X | Richter | 05/17/81 | L III 232 |
| Glaucous-winged Gull | X | Richter | 06/19/82 | L III 232 |
| Arctic Tern | 14± | Manuwal et al. 1979 | 06/09/77 | L III 190 |
| Arctic Tern | 14± | Manuwal et al. 1979 | 07/21/77 | L III 190 |
| Arctic Tern | 14± | Manuwal et al. 1979 | 08/30/77 | L III 190 |
| Arctic Tern | 8 | Speich | 05/17/78 | L III 255 |
| Arctic Tern | 20± | Manuwal et al. 1979 | 05/27/78 | L III 190 |
| Arctic Tern | 20± | Manuwal et al. 1979 | 06/10/78 | L III 190 |
| Arctic Tern | 4 | Richter | 06/21/78 | L III 232 |
| Arctic Tern | 8 | Richter | 06/24/78 | L III 232 |
| Arctic Tern | 20± | Manuwal et al. 1979 | 06/28/78 | L III 190 |
| Arctic Tern | 20± | Manuwal et al. 1979 | 07/03/78 | L III 190 |
| Arctic Tern | 20± | Manuwal et al. 1979 | 07/07/78 | L III 190 |
| Arctic Tern | 20± | Manuwal et al. 1979 | 07/13/78 | L III 190 |
| Arctic Tern | X | Richter | 07/15/78 | L III 232 |
| Arctic Tern | 20± | Manuwal et al. 1979 | 07/15/78 | L III 190 |
| Arctic Tern | 0 | Richter | 04/21/79 | L III 232 |
| Arctic Tern | 0 | Richter | 06/08/80 | L III 232 |
| Arctic Tern | 0 | Richter | 05/17/81 | L III 232 |

Section from U.S.G.S.
1:24,000 scale map:

Marysville

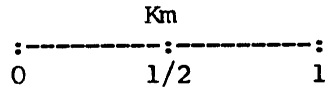

370 000
FEET

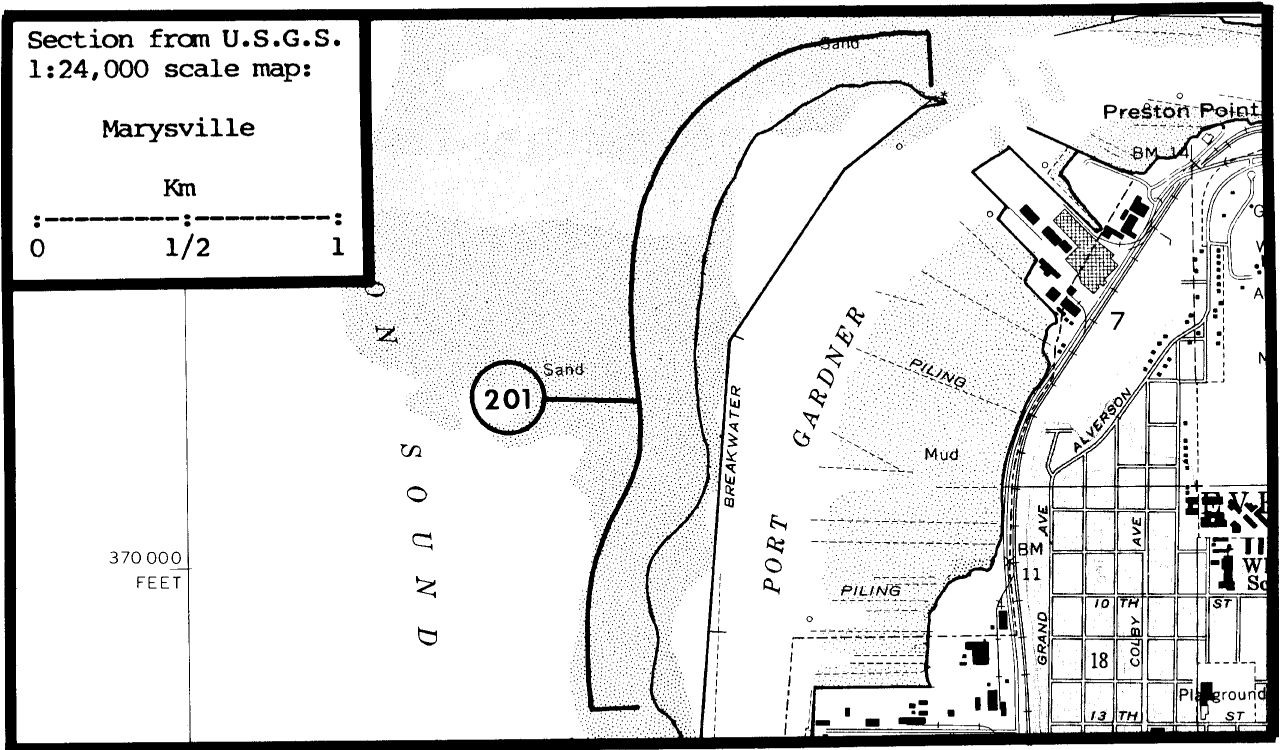

AREA 156, Victoria (cont'd.)

202

Dungeness Spit 48°10'00"N, 123°09'00"W

| | | | | |
|---------------------|----|---------|----------|-----------|
| Black Oystercatcher | 3 | Krause | 07/06/80 | L II 173 |
| Pigeon Guillemot | 45 | Greubel | 07/01/80 | L III 120 |
| Total | 48 | | | |

| | | | | |
|---------------------|----|-----------------|----------|---------------|
| Black Oystercatcher | 4 | Greubel | 06/ ?/77 | L III 120 |
| Black Oystercatcher | 3 | Greubel | 05/01/79 | L III 120 |
| Black Oystercatcher | 7 | Greubel | 07/01/79 | L III 120 |
| Black Oystercatcher | 5 | Greubel | 05/02/80 | L III 120 |
| Black Oystercatcher | 8 | Greubel | 07/01/80 | L III 120 |
| Pigeon Guillemot | 6 | Smith | 07/05/76 | L III 250 |
| Pigeon Guillemot | 43 | Speich; Manuwal | 05/26/78 | B III 255;188 |
| Pigeon Guillemot | 64 | Smith | 06/22/78 | M III 251 |
| Pigeon Guillemot | 47 | Greubel | 05/01/79 | L III 120 |
| Pigeon Guillemot | 36 | Miller | 06/29/79 | M III 198 |
| Pigeon Guillemot | 57 | Greubel | 06/02/80 | L III 120 |

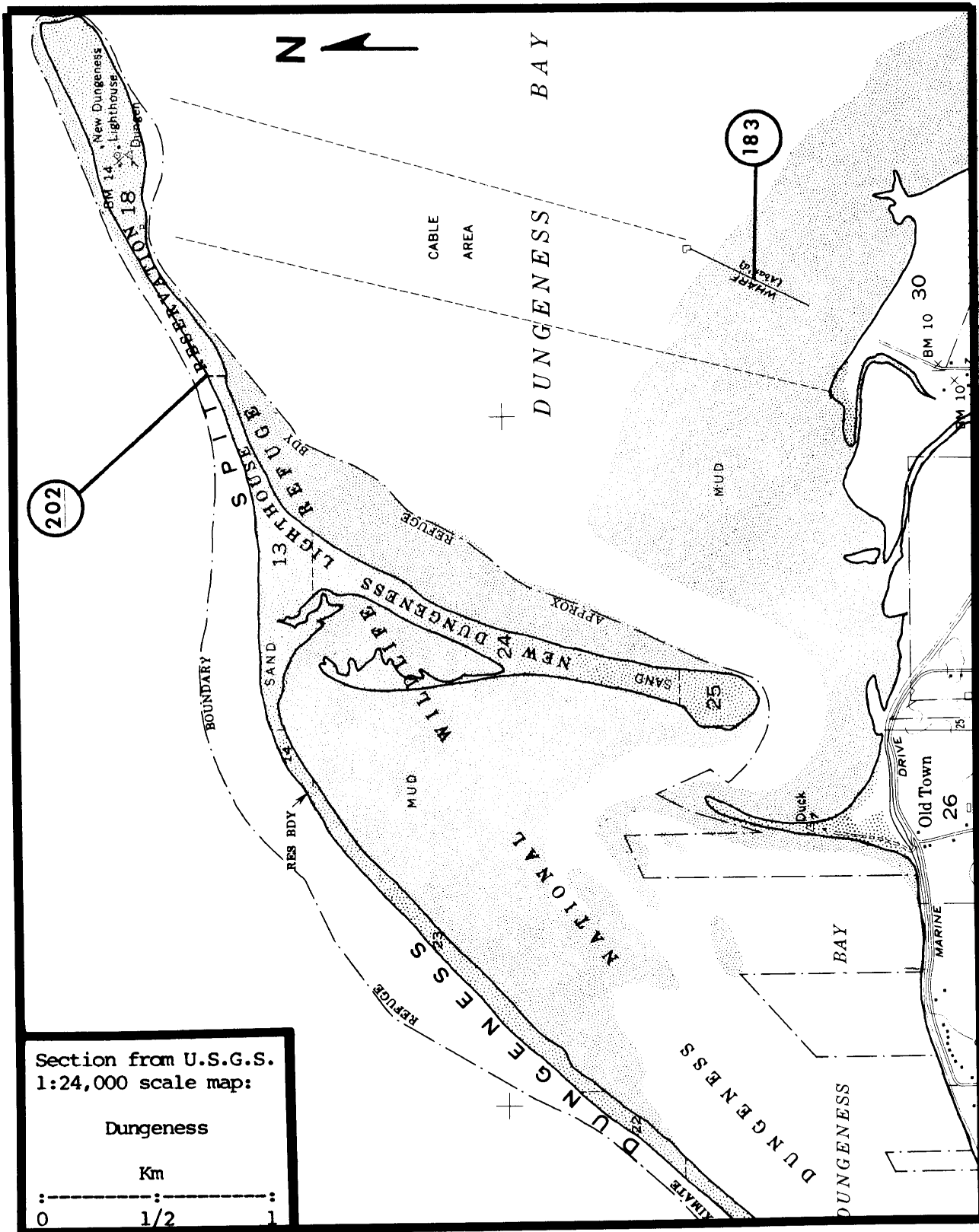

AREA 156, Victoria (cont'd.)

203

Scow Bay 48°01'52"N, 122°41'48"W

| | | | | |
|------------------|----|---------------|----------|-----------|
| Pigeon Guillemot | 29 | Speich & Wahl | 06/29/82 | B III 257 |
| Pigeon Guillemot | 4 | Meyer | 05/30/31 | E - 196 |



Port Angeles (156190) 1979 S.M. Speich Pelagic Cormorants

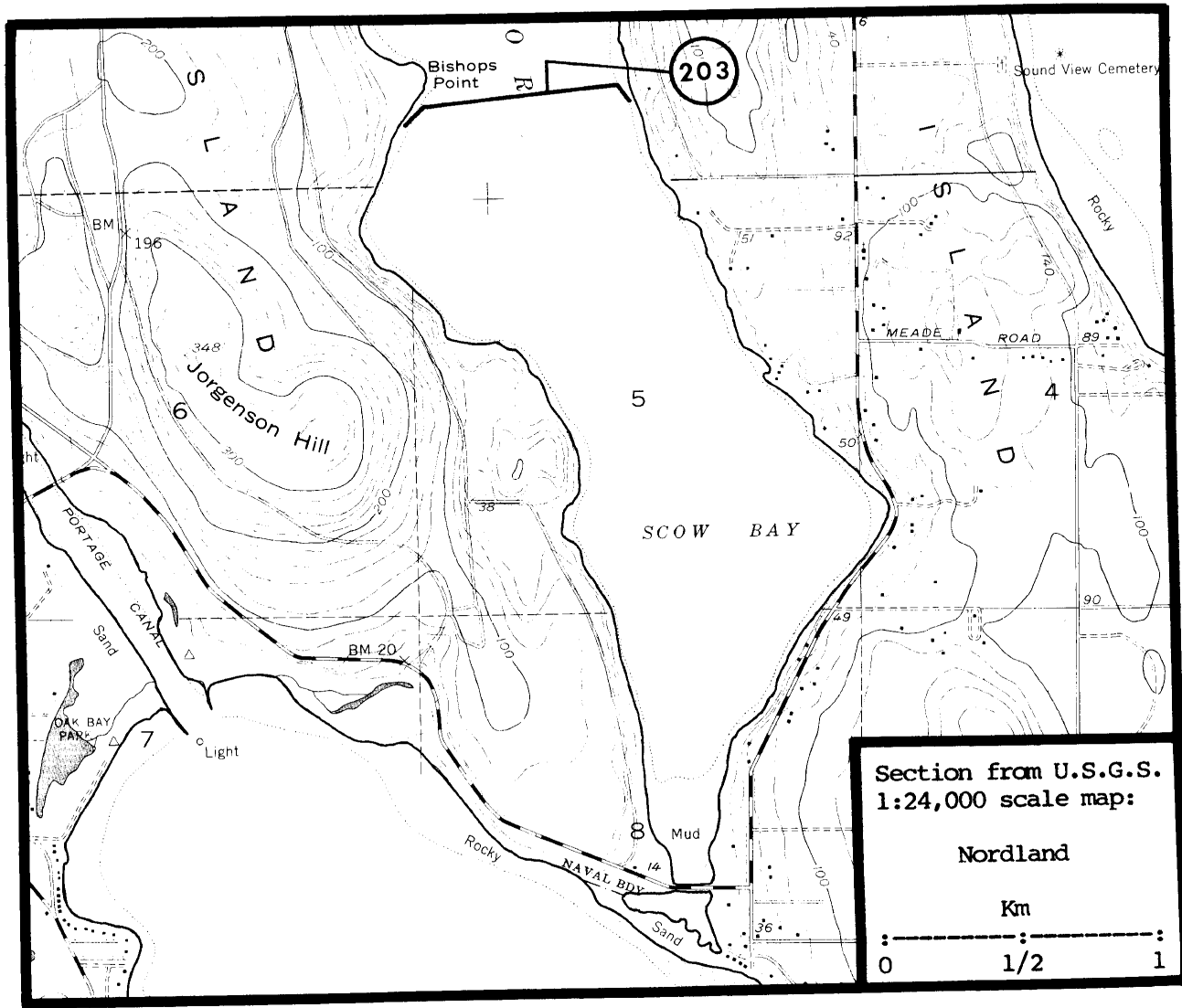

AREA 156, Victoria (cont'd.)

(204) Lake Whatcom 48°45'40"N, 122°24'00"W

| | | | | |
|----------------------|---|------|-----------|-----------|
| No Nesting Observed | 0 | Wahl | Summer/80 | M III 269 |
| No Nesting Observed | 0 | Wahl | Summer/72 | M III 268 |
| No Nesting Observed | 0 | Wahl | Summer/80 | M III 269 |
| Glaucous-winged Gull | 2 | Wahl | 08/11/71 | M I 268 |

(205) Observatory Point 48°09'02"N, 123°38'18"W

| | | | | |
|------------------|---|------------|----------|-----------|
| Pigeon Guillemot | 2 | McAllister | 06/ ?/82 | L III 192 |
|------------------|---|------------|----------|-----------|

(206) Tongue Point 48°10'00"N, 123°42'05"W

| | | | | |
|---------------------|----|------------|----------|-----------|
| Pigeon Guillemot | 2 | McAllister | 06/ ?/82 | L III 192 |
| Black Oystercatcher | 4 | Ramsey | 05/13/78 | L III 221 |
| Black Oystercatcher | 8 | Speich | 06/13/79 | L III 255 |
| Pigeon Guillemot | 6 | Ramsey | 05/13/78 | L III 221 |
| Pigeon Guillemot | 11 | Speich | 06/13/79 | L III 255 |
| Pigeon Guillemot | 2 | McNutt | 07/03/81 | L III 194 |

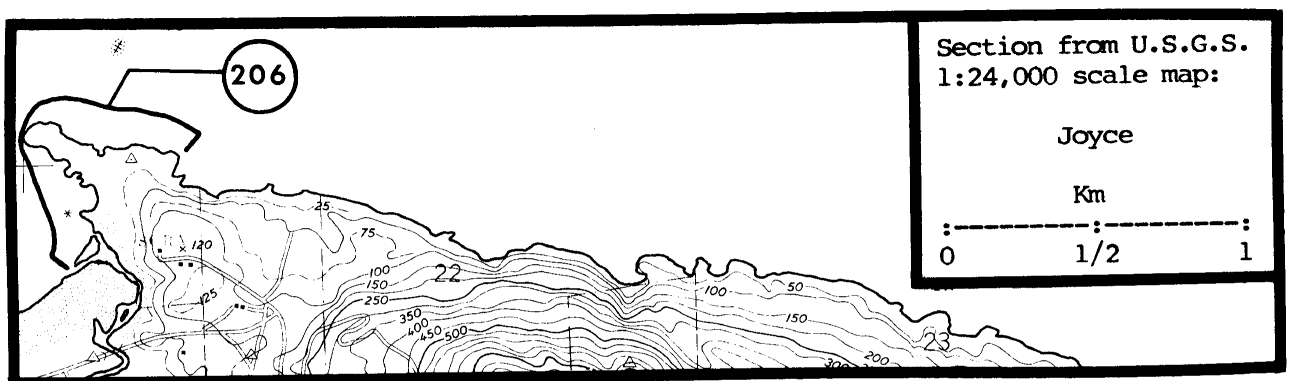
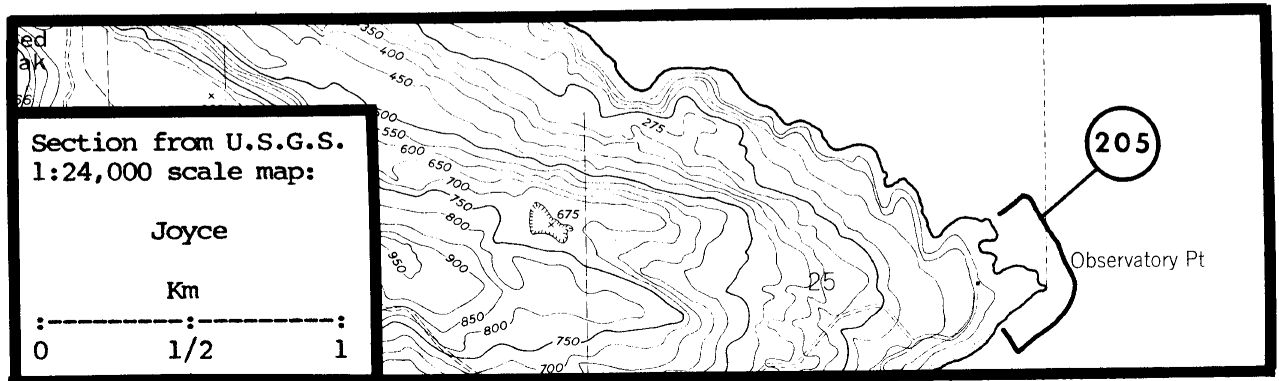
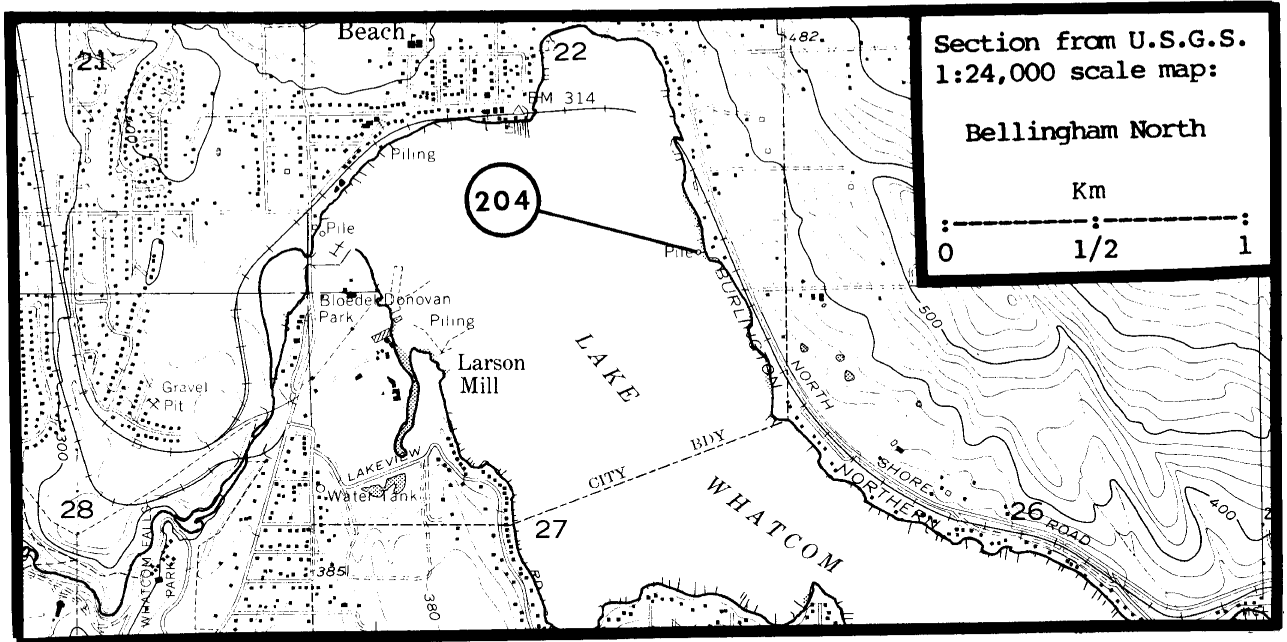

AREA 156, Victoria (cont'd.)



Dungeness Spit (156202) US Coast Guard

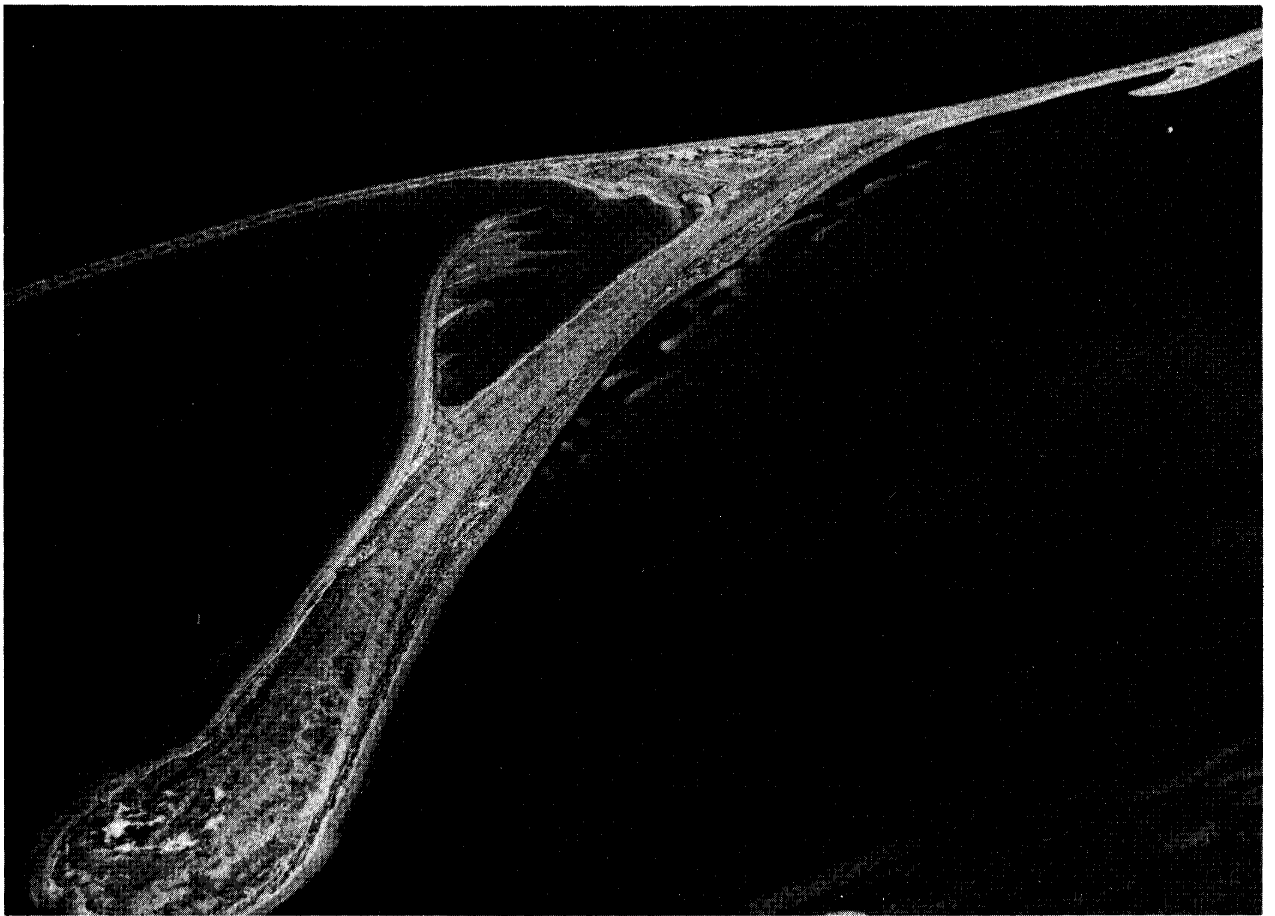

Dungeness Spit (Graveyard Spit) (156202) 26 February 1962 R.M. Glahn