

# Meteorological Techniques

***This tech note is a  
compilation of various  
techniques in forecasting***

- ***Surface Weather Elements***
- ***Fight Weather Elements***
- ***Convective Weather***

***Authors:***

***Mr. Mark R. Mireles  
Capt Kirth L. Pederson  
MSgt Charles H. Elford***

**APPROVED FOR PUBLIC RELEASE; DISTRIBUTION IS UNLIMITED**

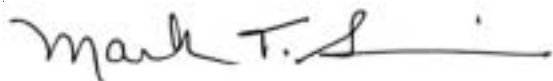


***Air Force Weather Agency/DNT  
106 Peacekeeper Dr, STE 2N3  
Offutt Air Force Base, Nebraska 68113-4039***

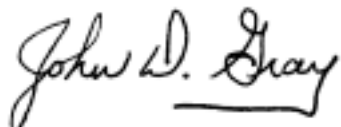


## REVIEW AND APPROVAL PAGE

AFWA/TN-98/002, *Meteorological Techniques*, 13 June 2003, has been reviewed and is approved for public release. There is no objection to unlimited distribution of this document to the public at large, or by the Defense Technical Information Center (DTIC) to the National Technical Information Service (NTIS).



MARK T. SURMEIER, GS-14, DAF  
Acting Director, Air and Space Science



JOHN D. GRAY, GS-13, DAF  
Scientific and Technical Information  
Program Manager

## REPORT DOCUMENTATION PAGE

2. Report Date: 13 June 2003
3. Report Type: Technical Note
4. Title: *Meteorological Techniques*
6. Authors: Mark R. Mireles, Capt Kirth L. Pederson, MSgt Charles H. Elford.
7. Performing Organization Names and Address: Air Force Weather Agency (AFWA), Offutt AFB NE 68113-4039
8. Performing Organization Report Number: AFWA/TN-98/002 Revised
12. Distribution/Availability Statement: Approved for Public Release; Distribution is Unlimited.
13. Abstract: Contains weather forecasting techniques of interest to military meteorologists, in three chapters: surface weather elements, flight weather elements, and convective weather. Includes both general specific rules of thumb, results of research, lessons learned from experience, etc, gathered from military and other sources. Updates and supersedes earlier AFWA/TN-98/002, *Meteorological Techniques*.
14. Subject Terms: ATMOSPHERIC PRESSURE, ATMOSPHERIC STABILITY, CLIMATOLOGY, CLOUDS, CONTRAILS, D-VALUES, DEW POINT, ELECTROOPTICS, ICING, PRECIPITATION, RELATIVE HUMIDITY, SEVERE WEATHER, SKY COVER, SOLAR WEATHER, TEMPERATURE, THUNDERSTORMS, TORNADOES, TURBULENCE, VISIBILITY, WEATHER, WINDS
15. Number of Pages: 233
17. Security Classification of Report: UNCLASSIFIED
18. Security Classification of this Page: UNCLASSIFIED
19. Security Classification of Abstract: UNCLASSIFIED
20. Limitation of Abstract: UL

**Standard Form 298**

# TABLE OF CONTENTS

## CHAPTER 1 — SURFACE WEATHER ELEMENTS

I. VISIBILITY .....	1-1
A. Dry Obstructions (Lithometeors) .....	1-1
B. Moist Obstructions (Hydrometeors).....	1-1
C. Visibility Forecasting Rules of Thumb .....	1-3
D. Visibility Forecasting Aids/Techniques .....	1-10
II. PRECIPITATION .....	1-14
A. Precipitation General Guidance .....	1-14
B. Model Guidance .....	1-18
C. Determining Precipitation Type .....	1-18
D. Forecasting Rainfall Amounts .....	1-22
E. Snowfall .....	1-23
III. SURFACE WINDS .....	1-35
A. Wind Basics .....	1-35
B. General Tools for Forecasting Surface Winds .....	1-36
C. Specialized Airfield Operations Topics .....	1-46
IV. TEMPERATURE .....	1-50
A. General Temperature Forecast Tools .....	1-50
B. Forecasting Max Temperatures .....	1-52
C. Minimum Temperature Forecasts .....	1-54
D. Some Additional Rules of Thumb .....	1-54
E. Temperature Indices .....	1-55
V. PRESSURE .....	1-61
A. General Guidance.....	1-61
B. Pressure-Related Parameters .....	1-62

## CHAPTER 2 — FLIGHT WEATHER ELEMENTS

I. CLOUDS. ....	2-1
A. Cloud Types/States of the Sky.....	2-1
B. General Forecasting Tools.....	2-5
C. Cloud Forecasting Techniques. ....	2-9
II. TURBULENCE.....	2-14
A. Levels of Intensity. ....	2-14
B. Aircraft Turbulence Sensitivities.....	2-15
C. Causes of Turbulence. ....	2-16
D. Clear Air Turbulence (CAT).....	2-18
E. Mountain Wave (MW) Turbulence. ....	2-26
F. Wake Turbulence. ....	2-29
G. Gravity Waves and Stratospheric Turbulence.....	2-30
H. Forecasting Aids. ....	2-32
III. AIRCRAFT ICING .....	2-39
A. Icing Formation Processes and Classification.....	2-39
B. Meteorological Considerations. ....	2-45
C. Products and Procedures. ....	2-49

D. Standard System Applications. ....	2-51
E. Methods and Rules of Thumb for the “Negative 8 Times D” (-8D) Procedure. ....	2-54
F. Summary. ....	2-55
<b>IV. MISCELLANEOUS WEATHER ELEMENTS. ....</b>	<b>2-56</b>
A. Flight Level and Climb Winds. ....	2-56
B. Temperature. ....	2-57
C. Thunderstorms. ....	2-58
D. Contrails. ....	2-58
E. JAAWIN and Contrails. ....	2-58
F. Forecasting In-flight Visibility for Air-refueling Mission Execution Forecasts (MEFs). ....	2-62
G. Cirrus Forecasting. ....	2-63
H. Ditch Headings and Wave Height. ....	2-64
I. Sea Surface Temperatures. ....	2-64
J. Space Weather. ....	2-65
K. Electrooptics. ....	2-77
L. Clutter or TAWS Scene Complexity. ....	2-83
M. Chemical Downwind Messages ....	2-89
N. Nuclear Fallout Bulletins ....	2-89
O. Volcanic Ash ....	2-89

**CHAPTER 3. — CONVECTIVE WEATHER**

<b>I. THUNDERSTORMS. ....</b>	<b>3-1</b>
A. Thunderstorm Types ....	3-1
<b>II. SYNOPTIC PATTERNS. ....</b>	<b>3-5</b>
A. Classic Synoptic Convective Weather Patterns. ....	3-6
B. Additional Squall Line Information ....	3-12
<b>III. CONVECTIVE WEATHER TOOLS. ....</b>	<b>3-13</b>
A. Stability Indices. ....	3-13
B. Evaluation and Techniques. ....	3-21

<b>BIBLIOGRAPHY .....</b>	<b>B-1</b>
---------------------------	------------

<b>ABBREVIATIONS AND ACRONYMS .....</b>	<b>A-1</b>
---	------------

<b>GLOSSARY .....</b>	<b>G-1</b>
-----------------------	------------

<b>SUBJECT INDEX .....</b>	<b>I-1</b>
----------------------------	------------

## LIST OF FIGURES

Figure 1-1	Whiteout Conditions -----	1-2
Figure 1-2	Ice Fog (Dissipating) -----	1-3
Figure 1-3	Pre-Frontal Fog Associated with Warm Fronts -----	1-9
Figure 1-4	Post-Frontal Fog Associated with Slow-Moving Cold Fronts -----	1-9
Figure 1-5	Graphical Method of Forecasting Fog -----	1-10
Figure 1-6.	Thermal Ribbon Spacing -----	1-15
Figure 1-7	The 500-mb Product -----	1-16
Figure 1-8	Widespread Precipitation Scenario -----	1-16
Figure 1-9	Overrunning Associated with a Typical Cyclone -----	1-17
Figure 1-10	Equal Probability of Liquid or Frozen Precipitation -----	1-19
Figure 1-11	Probability of Precipitation Being Frozen Versus Liquid -----	1-19
Figure 1-12	Method 2 -----	1-20
Figure 1-13	Snow Index (200-mb) Example -----	1-24
Figure 1-14	Centrifugal and Centripetal Forces -----	1-35
Figure 1-15	Geostrophic Wind -----	1-36
Figure 1-16	Isallobaric Flow -----	1-36
Figure 1-17	Pressure Gradient Method for Determining Surface Winds -----	1-38
Figure 1-18a-f	Variation of Isallobaric Winds by Latitude -----	1-39
Figure 1-19	Open-Cell Cumulous Shapes -----	1-42
Figure 1-20	Low-level Wind Shear Decision Tree -----	1-47
Figure 1-21	Temperature Forecasting Checklist Sample -----	1-52
Figure 1-22	Computation of Maximum Temperature -----	1-53
Figure 1-23	Heat Index -----	1-56
Figure 1-24	Fighter Index of Thermal Stress (FITS) Chart -----	1-57
Figure 1-25	Wind Chill Temperature (WCT) Index Chart with 33-Foot Garrison Anemometer Height (degrees Celsius and knots) -----	1-58
Figure 1-26	Wind Chill Temperature (WCT) Index Chart with 15-Foot Garrison Anemometer Height (degrees Celsius and knots) -----	1-58
Figure 1-27	Wind Chill Temperature (WCT) Index Chart with 5-Foot (handheld) Anemometer Height (degrees Celsius and knots) -----	1-59
Figure 1-28	Wind Chill Temperature (WCT) Index Chart with 5-Foot (handheld) Anemometer Height (degrees Fahrenheit and MPH) -----	1-59
Figure 1-29	Wind Chill Temperature (WCT) Index Chart with 33-Foot Garrison Anemometer Height (degrees Fahrenheit and MPH) -----	1-60
Figure 1-30	Wind Chill Temperature (WCT) Index Chart with 33-Foot Garrison Anemometer Height (degrees Fahrenheit and MPH) -----	1-60
Figure 1-31	Pressure Conversion Chart -----	1-64
Figure 1-32	Density Altitude Computation Chart -----	1-65
Figure 1-33	D-Value Computation Chart -----	1-66
Figure 2-1	Fair Weather Cumulus (L1) -----	2-1
Figure 2-2	Towering Cumulus (TCU) (L2) -----	2-1
Figure 2-3	Stratocumulus from Cumulus (L4) -----	2-2
Figure 2-4	Stratocumulus not from Cumulus (L5) -----	2-2

Figure 2-5a	Cumulonimbus Mammatus (L9)-----	2-2
Figure 2-5b	Cumulonimbus Mammatus (L9)-----	2-2
Figure 2-6	Cumulonimbus (L3)-----	2-3
Figure 2-7	Cumulonimbus (L9)-----	2-3
Figure 2-8	Altostratus (M1)-----	2-3
Figure 2-9	Nimbostratus (M2)-----	2-3
Figure 2-10	Altostratus (M3)-----	2-4
Figure 2-11	Altostratus (M5)-----	2-4
Figure 2-12	Altostratus Castellanus (M8)-----	2-4
Figure 2-13	Cirrus (H1)-----	2-4
Figure 2-14	Cirrus (H4) Progressively Invading the Sky-----	2-4
Figure 2-15	Cirrostratus (H6) with Cirrus-----	2-5
Figure 2-16	Cirrostratus (H7) Covering the Complete Sky-----	2-5
Figure 2-17	Cirrocumulus (H9) Alone and with Cirrus-----	2-5
Figure 2-18	Nephelometry Example-----	2-18
Figure 2-19	VAD Wind Profile (VWP) Product-----	2-8
Figure 2-20	Base Reflectivity Product-----	2-9
Figure 2-21	Reflectivity Cross-Section Product-----	2-9
Figure 2-22	Echo Tops Product-----	2-9
Figure 2-23	MCL Calculations-----	2-10
Figure 2-24	Parcel Method-----	2-10
Figure 2-25	RH and OVV Graph-----	2-11
Figure 2-26	Dissipation of Stratus Using Mixing Ratio and Temperature-----	2-12
Figure 2-27	Tropopause Method of Forecasting Cirrus-----	2-13
Figure 2-28a	CAT and Surface Cyclogenesis-----	2-18
Figure 2-28b	CAT and Surface Cyclogenesis North of the Main Jet-----	2-19
Figure 2-29a-d	CAT and Upper-Level Lows-----	2-19
Figure 2-30	CAT and the Shear Line Associated with an Upper-Level Low-----	2-20
Figure 2-31	United Air Lines Jet Stream Turbulence Model-----	2-20
Figure 2-32	CAT and Diffluent Wind Patterns-----	2-21
Figure 2-33	CAT and Strong Winds-----	2-21
Figure 2-34	Turbulence with Confluent Jets-----	2-21
Figure 2-35	Two Basic Cold-Air Advection Patterns Conducive to CAT-----	2-22
Figure 2-36	Common Open-Isotherm CAT-----	2-22
Figure 2-37	CAT in Thermal Troughs-----	2-23
Figure 2-38	CAT in Thermal Troughs-----	2-23
Figure 2-39	Closed Isotherm CAT-----	2-23
Figure 2-40	CAT and Shearing Troughs-----	2-24
Figure 2-41	CAT Associated with Strong Wind Maximum to the Rear of the Upper Trough-----	2-24
Figure 2-42	CAT in a Deep 500-mb Pressure Trough-----	2-24
Figure 2-43	Double Trough Configuration-----	2-25
Figure 2-44	CAT and Upper-Air Ridges-----	2-26
Figure 2-45	Mountain-Wave Clouds-----	2-26
Figure 2-46	Mountain-Wave Clouds-----	2-27
Figure 2-47	Mountain Wave Nomogram-----	2-28

Figure 2-48	Mountain Wave Cloud Structure-----	2-28
Figure 2-49	Graph of Mountain Wave Turbulence Potential -----	2-29
Figure 2-50a	Satellite Depiction of a Gravity Wave-----	2-31
Figure 2-50b	Satellite Depiction of a Gravity Wave-----	2-31
Figure 2-51	Forecasting Checklist for Low-Level Turbulence -----	2-32
Figure 2-52	Turbulence Forecasting from Skew-T -----	2-33
Figure 2-53	Low-Level Turbulence Nomogram—Temperature Gradient and Surface Winds -----	2-34
Figure 2-54	CAT in a Deformation Zone -----	2-35
Figure 2-55	Example of Tansverse Waves -----	2-35
Figure 2-56	Example of Billow Clouds -----	2-36
Figure 2-57	Example of Mountain Wave-----	2-36
Figure 2-58	Spectrum Width Product -----	2-37
Figure 2-59	Base Velocity Product -----	2-38
Figure 2-60	Vertically Integrated Liquid (VIL) Product -----	2-38
Figure 2-61	Icing Type Based on Temperature -----	2-43
Figure 2-62	Frequency of Freezing Precipitation -----	2-45
Figure 2-63	Cumuliform Cloud Icing Locations -----	2-46
Figure 2-64	Icing with a Warm Front -----	2-47
Figure 2-65	Icing with a Cold Front -----	2-47
Figure 2-66	Intake Icing -----	2-48
Figure 2-67	Carburetor Icing -----	2-48
Figure 2-68	Icing Flowchart -----	2-51
Figure 2-69	Typical Icing Areas in a Mature Cyclone -----	2-51
Figure 2-70	Bright Band Identification Using the WSR-88D. -----	2-52
Figure 2-71	Example of Visible Satellite Picture. -----	2-53
Figure 2-72	Example of a Colorized IR Satellite Picture -----	2-53
Figure 2-73	Example of a Meteosat satellite over the Balkans -----	2-54
Figure 2-74	Example of -8D Method -----	2-54
Figure 2-75	Increasing Wind Speed Pattern-----	2-56
Figure 2-76	Decreasing Wind Speed Pattern -----	2-56
Figure 2-77	Example Contrails Chart-----	2-59
Figure 2-78	Jet Contrail Curves on a Skew-T -----	2-61
Figure 2-79	Space Environment Global Situational Awareness Product -----	2-66
Figure 2-80	Ionospheric Conditions Impacting UHF SATCOM Chart-----	2-68
Figure 2-81	Ionospheric Conditions Impacting HF Propagation Communications and other HF Operations Chart -----	2-69
Figure 2-82	UHF SATCOM Scintillation Nowcast and Forecast Chart -----	2-70
Figure 2-83	Point-to-Point HF Radio Usable Frequency Forecast Chart -----	2-70
Figure 2-84	HF Illumination Maps Nowcast and Forecast Chart -----	2-71
Figure 2-85	Estimated Global Positioning Satellite (GPS) Single Frequency Error Map -----	2-71
Figure 2-86	Short Wave Fade Event Warning Example -----	2-72
Figure 2-87	Solar X-Ray Event Warning Example -----	2-73
Figure 2-88	Major Solar Flare Event Warning Example -----	2-73
Figure 2-89	Geomagnetic Event Warning Example -----	2-74
Figure 2-90	Energetic Particle Event Warning Example -----	2-75



Figure 2-91	Radio Event Warning Example -----	2-76
Figure 2-92	Example Solar Radio Burst Advisory -----	2-77
Figure 2-93	An Atmospheric Particle Emits Electromagnetic (EM) Energy -----	2-78
Figure 2-94	The Electromagnetic Spectrum -----	2-78
Figure 2-95	Reflection -----	2-79
Figure 2-96	Visual Contrast -----	2-80
Figure 2-97	Rayleigh Scattering -----	2-81
Figure 2-98	Mie Scattering -----	2-81
Figure 2-99	Geometric Scattering -----	2-82
Figure 2-100	Low Clutter -----	2-83
Figure 2-101	Medium Clutter -----	2-84
Figure 2-102	High Clutter -----	2-84
Figure 2-103	Apparent, Inherent, and Threshold Contrast -----	2-85
Figure 2-104	Chemical Downwind Message -----	2-89
Figure 2-105	Effective Downwind Message -----	2-89
Figure 2-106	Worldwide Depiction of Active Volcanoes -----	2-90
Figure 3-1	Single-Cell Storm Hodograph -----	3-1
Figure 3-2	Typical Multi-Cell Storm Hodograph -----	3-2
Figure 3-3	Supercell Hodograph -----	3-2
Figure 3-4	Classic Supercell -----	3-3
Figure 3-5	Typical High-Precipitation (HP) Supercell -----	3-3
Figure 3-6	Low-Precipitation (LP) Supercell -----	3-4
Figure 3-7a	Typical Dry Microburst Atmospheric Profile -----	3-4
Figure 3-7b	Typical Wet Microburst Atmospheric Profile -----	3-5
Figure 3-7c	Typical Hybrid Microburst Atmospheric Profile -----	3-5
Figure 3-8	Type “A” Tornado Producing Synoptic Pattern -----	3-6
Figure 3-9	Type “B” Tornado Producing Synoptic Pattern -----	3-8
Figure 3-10	Type “C” Tornado Producing Synoptic Pattern -----	3-9
Figure 3-11	Type “D” Tornado Producing Synoptic Pattern -----	3-10
Figure 3-12	Barotropic Low -----	3-11
Figure 3-13	Type “E” Tornado Producing Synoptic Pattern -----	3-12
Figure 3-14	Supercell Example -----	3-22
Figure 3-15	Line Echo Wave Pattern (LEWP)/Bow Echo Evolution -----	3-23
Figure 3-16a	Bow Echo -----	3-23
Figure 3-16b	Bow Echo Reflectivity Example -----	3-24
Figure 3-17	Sea Breeze Front on Reflectivity Product -----	3-25
Figure 3-18	T2 Gust Computation Chart -----	3-27
Figure 3-19	Hail Prediction Chart -----	3-29
Figure 3-20	Skew-T Chart -----	3-29
Figure 3-21	Preliminary Hail Size Nomogram -----	3-30
Figure 3-22	Final Hail Size Nomogram -----	3-30

## LIST OF TABLES

Table 1-1	Conditions favorable for the generation and advection of dust -----	1-4
Table 1-2	Visibility limits based on precipitation intensity -----	1-5
Table 1-3	Fog threat thresholds indicating the likelihood of radiation formation -----	1-11
Table 1-4	Fog stability index thresholds indicating the likelihood of radiation fog formation -----	1-12
Table 1-5	MOS visibility (VIS) categories for the continental United States and Alaska ----	1-13
Table 1-6	MOS Obstruction to Vision (OBVIS) categories for the continental United States and Alaska -----	1-13
Table 1-7	Probability of snowfall as a function of the height of the freezing level -----	1-21
Table 1-8a	Snowfall Accumulation vs Surface Visibility -----	1-23
Table 1-8b	Values added to compensate for temperature/snowflake composition -----	1-24
Table 1-9	Lake effect snowstorm checklist -----	1-27
Table 1-10	Rules of thumb for forecasting heavy non-convective snowfall -----	1-27
Table 1-11	Forecast location of heaviest snow relative to various synoptic features -----	1-29
Table 1-12	Synoptic snowstorm types -----	1-29
Table 1-13a-f	Estimating actual windspeed -----	1-40
Table 1-14	Increase of Wind Speed with Height -----	1-43
Table 1-15	Crosswind Component Table -----	1-46
Table 1-16a-g	Difference of Direction -----	1-48
Table 1-17	Temperature-Humidity Index (THI) conditions -----	1-55
Table 1-18	WBGT table -----	1-56
Table 1-19	Standard atmospheric pressure and temperatures by altitude -----	1-61
Table 1-20	Standard atmospheric pressure and temperature by level -----	1-62
Table 1-21	Types of altimeter settings -----	1-63
Table 2-1	Ceiling height forecast -----	2-7
Table 2-2	Precipitation amount forecast -----	2-7
Table 2-3	R1, R2, and R3 relative humidity values and cloud amounts -----	2-7
Table 2-4	Base of convective clouds using surface dew-point depressions -----	2-11
Table 2-5	Aircraft category type -----	2-16
Table 2-6	Turbulence intensities for different categories of aircraft (based on Table 2-5) ----	2-17
Table 2-7	Low-level mountain wave turbulence -----	2-27
Table 2-8	Layers below 9000 feet using temperature differences -----	2-34
Table 2-9	Layers above 9000 feet using temperature differences -----	2-34
Table 2-10	Wind shear critical values -----	2-34
Table 2-11	Unfavorable Atmospheric Conditions for Icing -----	2-49
Table 2-12	Favorable Atmospheric Conditions for Icing -----	2-49
Table 2-13	Engine bypass categories -----	2-60
Table 2-14	Probability of contrail formation -----	2-62
Table 2-15	Impacts and the Space Environment Global Situational Awareness Product Color Scheme -----	2-67
Table 2-16	Weather sensitivities on EO systems -----	2-87
Table 3-1	Severe thunderstorm development potential -----	3-5

Table 3-2	General thunderstorm (instability) indicators -----	3-16
Table 3-3	Severe thunderstorm indicators -----	3-17
Table 3-4	Tornado indicators -----	3-17
Table 3-5	Product analysis matrix and reasoning -----	3-18
Table 3-6	Identifying features of airmass thunderstorm development on upper-air charts ----	3-20
Table 3-7	Tornado forecasting tools -----	3-20
Table 3-8	Wet microburst potential table -----	3-24
Table 3-9	T1 convective gust potential -----	3-27
Table 3-10	VIL density versus hail size -----	3-31

## PREFACE

Much has changed since the previous *Meteorological Techniques* Technical Note, AFWA/TN-98/002, was published. Air Force Weather's reengineering is now reality. Some technology that was available in 1998 and prior is no longer being used. Newer technology exists in the Operational Weather Squadron (OWS) hubs and the Combat Weather Teams (CWTs) in base weather stations. As it was in the last *Meteorological Techniques* iteration, there are simply too many sources of data to keep track of accurately. Whether at an OWS or a CWT, the weather forecaster must use as many sources available when preparing a forecast.

This technical note is a compilation of various techniques to assist in the forecasting of Surface Weather Elements (Chapter 1), Flight Weather Elements (Chapter 2), and Convective Weather (Chapter 3). Each chapter contains sections with specific forecasting techniques. Attempt to integrate as many of these techniques as possible into the forecast process. However, keep in mind that though there are many techniques from which to choose, some may not be applicable at a particular location and/or the current regime. In time, only certain techniques may be used; others may be ignored.

Every effort has been made to ensure that the techniques in this technical note are current. Many of these techniques may appear dated, but the validity of the weather information they contain does not decline with time. To ensure relevancy of the technical note, HQ AFWA/DN will periodically review this technical note.

If you have any questions, comments, or concerns about this document, please remit to:

HQ AFWA/DN  
106 Peacekeeper Dr, Ste 2N3  
Offutt AFB NE 68113-4039  
DSN: 271-9650  
COMM: 402-294-9650

## ACKNOWLEDGMENTS

This technical note represents many hours of hard work by many people across Air Force Weather (AFW). Their dedication and effort yielded a first class document that will remain an indispensable tool for AFW forecasters around the world.

Thanks to the following professionals:

Primary Authors:

Mr. Mark R. Mireles  
Capt Kirth L. Pederson  
MSgt Charles H. Elford

Primary Reviewers:

MSgt Gary D. Mercer

Publishing and Technical Editors (AFCCC/DOPA):

Major Joe King  
Mr. Gene Newman  
TSgt Gina Vorce

And finally, we owe special thanks to the original AFWA/TN-98/002 authors, for without their hard work, this project would have been much more difficult.

Capt Maria L. Reymann  
Capt Joseph F. Piasecki  
MSgt Fizal Hosein  
MSgt Salinda A. Larabee  
TSgt Gregg T. Williams  
TSgt Mike McAleenan  
Mr. Michael A. Jimenez  
Ms. Deborah F. Chapdelaine

Lt Col Michael D. Bramhall  
HQ AFWA/DNT

**Surface Weather Elements**

**I. VISIBILITY.** The Glossary of Meteorology defines visibility as “the greatest distance in a given direction at which it is just possible to see and identify with the unaided eye, (1) in the daytime, a prominent dark object against the sky at the horizon or (2) at night, a known, preferably unfocused, moderately intense light source.” Forecasting visibility is a challenge due to the difficulty in predicting the complicated behavior of dry and “moist” (both liquid and solid) airborne particles that obstruct or reduce visibility. A description of these obstructions, some rules of thumb, and several techniques for forecasting visibility are given below.

**A. Dry Obstructions (Lithometeors).** A lithometeor is the general term for particles suspended in a dry atmosphere; these include dry haze, smoke, dust, and sand.

**1. Dry Haze.** Dry haze is an accumulation of very fine dust or salt particles in the atmosphere; it does not block light, but instead causes light rays to scatter. Dry haze particles produce a bluish color when viewed against a dark background, but look yellowish when viewed against a lighter background. This light-scattering phenomenon (called *Mie scattering*) also causes the visual ranges within a uniformly dense layer of haze to vary depending on whether the observer is looking into the sun or away from it. Typically, dry haze occurs under a stable atmospheric layer and significantly affects visibility. As a rule, industrial areas and coastal areas are most conducive to dry haze formation.

**2. Smoke.** Smoke is usually more localized than other visibility restrictions. Accurate visibility forecasts depend on detailed knowledge of the local terrain, surface wind patterns, and smoke sources (including schedules of operation of smoke generating activities).

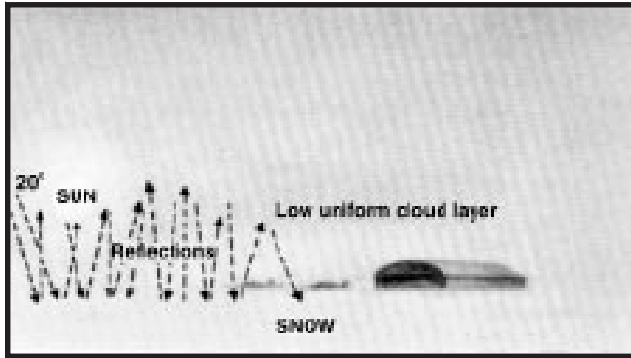
**3. Blowing Dust and Sand.** Windblown particles such as blowing dust and sand can cause serious local restrictions to visibility, often reducing visibility to near zero. The critical wind speed for lifting dust and sand varies according to vegetation, soil type, and soil moisture. Specific forecasting rules vary by station and time of year. The Local Area Forecast Program (LAFP) should document the wind speeds, directions, and surface moisture conditions in which visibility restrictions are most likely to occur.

**B. Moist Obstructions (Hydrometeors).** Condensation or sublimation of atmospheric water vapor produces a hydrometeor. It forms in the free atmosphere, or at the earth’s surface, and includes frozen water lifted by the wind. Hydrometeors which can cause a surface visibility reduction, generally fall into one of the following two categories:

**1. Precipitation.** Precipitation includes all forms of water particles, both liquid and solid, which fall from the atmosphere and reach the ground; these include: liquid precipitation (drizzle and rain), freezing precipitation (freezing drizzle and freezing rain), and solid (frozen) precipitation (ice pellets, hail, snow, snow pellets, snow grains, and ice crystals).

**2. Suspended (Liquid or Solid) Water Particles.** Liquid or solid water particles that form and remain suspended in the air (damp haze, cloud, fog, ice fog, and mist), as well as liquid or solid water particles that are lifted by the wind from the earth’s surface (drifting snow, blowing snow, blowing spray) cause restrictions to visibility. One of the more unusual causes of reduced visibility due to suspended water/ice particles is whiteout, while the most common cause is fog.

## Visibility



**Figure 1-1. Whiteout Conditions.** Occur when light reflected back and forth between snow- or ice-covered ground and low stratus clouds.

**a. Whiteout Conditions.** Whiteout is a visibility-restricting phenomenon that occurs when a uniformly overcast layer of clouds overlies a snow- or ice-covered surface. Most whiteouts occur when the cloud deck is relatively low and the sun angle is at about  $20^\circ$  above the horizon. Cloud layers break up and diffuse parallel rays from the sun so that they strike the snow surface from many angles (Figure 1-1). This diffused light reflects back and forth between the snow and clouds until the amount of light coming through the clouds equals the amount reflected off the snow, completely eliminating shadows. The result is a loss of depth perception and an inability to distinguish the boundary between the ground and the sky (i.e., there is no horizon). Low-level flights and landings in these conditions become very dangerous. Several disastrous aircraft crashes have occurred in recent years in which whiteout conditions may have been a factor.

**b. Fog.** Fog is often described as a stratus cloud resting near the ground. Fog forms when the temperature and dew point of the air approach the same value (i.e., dew-point spread is less than  $5^\circ\text{F}$ ) either through cooling of the air (producing advection, radiation, steam, or upslope fog) or by adding enough moisture to raise the dew point (frontal fog). When composed of ice crystals, it is called ice fog.

(1) **Advection Fog.** Advection fog forms due to moist air moving over a colder surface, and the resulting cooling of the near-surface air to below its dew-point temperature. Advection fog occurs over both water and land.

(2) **Radiation Fog (ground or valley fog).** Radiational cooling produces this type of fog. Under stable nighttime conditions, long-wave radiation is emitted by, and cools, the ground, forming a temperature inversion. In turn, moist air near the ground cools to its dew point. Depending on the moisture content of the ground, moisture may evaporate into the air, raising the dew point of this stable layer, accelerating radiation fog formation.

(3) **Upslope Fog (Cheyenne fog).** Upslope fog occurs when sloping terrain lifts air, cooling it adiabatically to its dew point and saturation. Upslope fog may be viewed as either a stratus cloud or fog, depending on the point of reference of the observer. Upslope fog generally forms at the higher elevations and builds downward into valleys. This fog can maintain itself at higher wind speeds because of increased lift and adiabatic cooling. Upslope winds more than 10 to 12 knots usually result in stratus rather than fog. The eastern slope of the Rocky Mountains is a prime location for this type of fog.

(4) **Steam Fog (Arctic Sea Smoke).** Steam fog is commonly seen as wisps of vapor emanating from the water's surface in the northern latitudes. Water vapor condenses and forms steam fog when water vapor is mixed with much colder air. In the middle latitudes, steam fog is most common near lakes and rivers during autumn and early winter, when waters are still warm and colder air masses prevail. A strong inversion confines the upward mixing to a relatively shallow layer within which the fog collects and assumes a uniform density. Under these conditions, the visibility is often  $3/16$  mile (300 meters) or less.

(5) Frontal Fog. Associated with frontal zones and frontal passages, this type of fog can be divided into types: warm-front pre-frontal fog; cold-front post-frontal fog; and front-passage fog. Pre- and post-frontal fogs are caused by rain falling into cold stable air and raising the dew point. Frontal-passage fog can occur in a number of situations. For example, it can occur when warm and cold air masses, each near saturation, are mixed by very light winds in the frontal zone. It can occur when relatively warm air is suddenly cooled over moist ground with the passage of a well-marked precipitation cold front. It can also occur during low-latitude summer, where evaporation of front-passage rain water cools the surface and overlying air enough to add sufficient moisture to form fog.



**Figure 1-2. Ice Fog (Dissipating).**

(6) Ice Fog (Figure 1-2). Ice fog is composed of ice crystals rather than water droplets and forms in extremely cold, arctic air ( $-29^{\circ}\text{C}$  ( $-20^{\circ}\text{F}$ ) and colder). Factors contributing to reduced visibility associated with ice fog are temperature, time of day, water vapor availability, and pollutants. Burning hydrocarbon fuels, steam vents, motor vehicle exhausts, and jet exhausts are major sources of water vapor and pollutants that help to produce ice fog. A strong low-level inversion contributes to ice fog formation by trapping and concentrating the moisture in a shallow layer. Once ice fog forms it usually persists until the temperature rises or there is an airmass change.

(7) Sublimation Fog. The American Meteorological Society Glossary of Meteorology describes sublimation as the transition from solid directly to vapor. Ice crystals sublime under low humidity in below-freezing conditions. Sublimation fog occurs when ground frost sublimates at sunrise increasing moisture in the atmosphere. This can cause a rapid onset of typically short-lived, shallow, foggy conditions reducing visibility to as low as 1/2 mile. This morning event, sometimes dubbed a “TAF Killer”, can cause problems with morning sortie generations and recoveries.

In summary, the following characteristics are important to consider when forecasting fog:

- Synoptic situation, time of year, and station climatology.
- Thermal (*static*) stability of the air, amount of air cooling and moistening expected, wind strength, and dew-point depression.
- Trajectory of the air over types of underlying surfaces (i.e., cooler surfaces, bodies of water).
- Terrain, topography, and land surface characteristics.

### **C. Visibility Forecasting Rules of Thumb.**

#### **1. Dry Obstructions - General**

*a. Dry Haze.* Dry haze layers normally restrict visibility to 3 to 6 miles, and occasionally to less than 1 mile. It usually dissipates when the atmosphere becomes thermally unstable or wind speeds increase. This can occur with heating, advection, or turbulent mixing.

*b. Duststorm Generation.* This is a function of wind speed and direction and soil moisture



**Visibility**

content. Table 1-1 lists the conditions favorable for generation and advection of dust.

After generating blowing dust upstream (in a duststorm), wind speed becomes important in advection of the dust. Dust may be advected by winds aloft when surface winds are weak or calm. Duration of the advected dust is a function of the depth of the dust and the advecting wind speeds. Synoptic situations, such as cold frontal passages, may change the wind direction and increase or decrease the probability of dust advecting into your area.

Forecasting dust generation is more difficult than forecasting the advection of observed dust into the area. Important factors to consider include location of favorable source regions, soil dryness, and agricultural practices. Areas where sound soil conservation methods are practiced are less prone to blowing dust. Plant cover protects soil from wind erosion by slowing and breaking wind flow, similar to the effects of a snow fence. Conversely, military or civilian operations may disturb the soil, destroy vegetation in an area, and increase the chance for dust generation. Tailor parameters and

conditions in Table 1-1 to better help forecast dust affecting customer’s operations. Also, do not forget pilot reports (PIREPs); they are helpful in forecasting dust.

**3. Moist Obstructions - General**

**a. Precipitation.** Use Table 1-2 as a guide to forecasting visibility based on the intensity of snow. When forecasting more than one form of precipitation at a time, or when forecasting fog to occur with the precipitation, consider forecasting a lower visibility than shown in Table 1-2.

**b. Blowing Snow.** Blowing snow due to strong surface winds can greatly reduce horizontal visibility. Visibility of less than 1/4 mile is not unusual in light or moderate snow when the winds exceed 25 knots. The composition of the snow and the effects of local terrain are as important as meteorological factors in forecasting visibility reductions caused by blowing snow. The following forecasting hints may be helpful in forecasting reduced visibility in blowing snow:

**Table 1-1. Conditions favorable for the generation and advection of dust.**

<b>Parameter or Condition</b>	<b>Favorable When</b>
Location with respect to source region	Located downstream and in close proximity
Agricultural practices	Soil left unprotected
Previous dry years	Plant cover reduced
Wind speed	≥ 30 knots
Wind direction	Southwest through northwest (dust source upstream)
Cold front	Passes though the area
Squall line	Passes though the area
Leeside trough	Deepening and increasing winds
Thunderstorm	Mature storm in local area or generates blowing dust upstream
Whirlwind	In local area
Time of day	1200 to 1900L
Surface dew point depression	≥ 10° C
<b>Potential Advection</b>	<b>Blowing dust generated upstream</b>
Wind speed	≥ 10 knots
Wind direction	Along trajectory of the generated dust
Synoptic situation	Ensures the wind trajectory continues to advect dust

**Table 1-2. Visibility limits based on precipitation intensity.**

<b>Intensity</b>	<b>Visibility Limits (statute miles)</b>
Light snow showers	> ½ mile
Moderate snow showers	> ¼ but < ½ mile
Heavy snow showers	< ¼ mile

- Moderate, dry, and fluffy snowfall with wind speeds exceeding 15 knots usually reduces visibility in blowing snow.
- Snow cover that has previously been subject to wind movement (either blowing or drifting) usually does not produce as severe a visibility restriction as new snow.
- Snow cover that fell when temperatures were near freezing does not blow except in very strong winds.
- The stronger the wind, the lower the visibility in blowing snow. The converse is also true; visibility usually improves with decreasing wind speed.
- Loose snow becomes blowing snow at wind speeds of 10 to 15 knots or greater. Although any blowing snow restricts visibility, the amount of the visibility restriction depends on such factors as terrain, wind speed, snow depth, and composition.
- Blowing snow is a greater hazard to flying operations in polar regions than in mid-latitudes because the colder snow is dry, fine and easily lifted.

Winds may raise the snow 1,000 feet above the ground, lowering visibility. A frequent and sudden increase in surface winds in polar regions may cause the visibility to drop from unlimited to near zero within a few minutes.

- Fresh snow blows or drifts at temperatures of  $-20^{\circ}\text{C}$  ( $-4^{\circ}\text{F}$ ) or less. After 3 or more days of exposure to direct sunlight, snow forms a crust and does not readily drift or blow. The crust, however, is seldom uniform across a snowfield. Terrain undulations, shadows, and vegetation often retard the formation of the crust.

- If additional snow falls onto snowpack that has already crusted, only the new snow blows or drifts.

*c. Fog.* A general summary of characteristics important to fog formation and dissipation are given here. This checklist is followed by additional forecasting guidance specific to advection, radiation, and frontal fogs.

(1) *Formation.* Fog forms by increasing moisture and/or cooling the air. Moisture in the air is increased by the following:

- Precipitation.
- Evaporation from wet surfaces.
- Moisture advection.
- Sublimation from a frozen surface.

Cooling of the air results from the following:

- Radiational cooling.
- Advection over a cold surface.

**Visibility**

---

- Advection over a cold surface.

- Upslope flow.
- Evaporation.

(2) *Dissipation.* Removing moisture and/or heating the air dissipates fog and stratus. Moisture in the air is decreased by:

- Turbulent transfer of moisture downward to the surface (e.g., to form dew or frost).
- Turbulent mixing of the fog layer with adjacent drier air.
- Advection of drier air.
- Condensation of the water vapor into clouds.
- Deposition of water vapor to ground frost.

Heating of the air results from the following:

- Turbulent transport of heat upward from air in contact with warm ground.
- Advection of warmer air.
- Transport of the air over a warmer land surface.
- Adiabatic warming of the air by subsidence or downslope motion.
- Turbulent mixing of the fog layer with adjacent warmer air aloft.
- Release of latent heat associated with the formation of clouds.

(3) *General Forecasting Guidance.* In general:

- Fog lifts to stratus when the lapse rate approaches dry adiabatic.

- Marked downslope flow prevents fog formation.

- The wetter the ground, the higher the probability of fog formation.

- Atmospheric moisture tends to sublimate on snow, making fog formation, and maintenance less likely.

- With sufficient radiational cooling (below freezing), fog can dissipate rapidly and form ground frost through the deposition process.

- Rapid formation or clearing of clouds can be decisive in fog formation. Rapid clearing at night after precipitation is especially favorable for the formation of radiation fog.

- The wind speed forecast is important because decreases may lead to the formation of radiation fog. Conversely, increases can prevent fog, dissipate radiation fog, or increase the severity of advection fog.

- A combination advection-radiation fog is common at stations near warm water surfaces.

- In areas with high concentrations of atmospheric pollutants, condensation into fog can begin before the relative humidity reaches 100 percent.

- The visibility in fog depends on the amount of water vapor available to form droplets and on the size of the droplets formed. At locations with large amounts of combustion products in the air, dense fog can occur with a relatively small water vapor content.

- After sunrise, the faster the ground temperature rises, the faster fog and stratus clouds dissipate.

- Solar insolation often lifts radiation fog into thin, multiple layers of stratus clouds.

- If solar heating persists, and no higher clouds block surface heating, radiation fog usually dissipates.

- Solar heating may lift advection fog into a single layer of stratus clouds and eventually dissipate the fog if the insolation is sufficiently strong.

(4) *Specific Forecasting Guidance.* Consider the following when faced with advection, radiation, or frontal fog situations.

(a) *Advection Fog.* Advection fog is relatively shallow and accompanied by a surface-based inversion. The depth of this fog increases with increasing wind speed (though at wind speeds above 9 knots greater turbulent mixing usually causes advection fog to lift into a low stratus cloud deck). Other favorable conditions include:

- Coastal areas where moist air is advected over water cooled by upwelling. During late afternoon, such fog banks may be advected inland by sea breezes or changing synoptic flow. These fogs usually dissipate over warmer land; if they persist through late afternoon, they can advect well inland after evening cooling and last until convection develops the following morning.

- In winter, when warm, moist air flows over colder land. This is commonly seen over the southern or central United States and the coastal areas of Korea and Europe. Because the ground often cools by radiation cooling, fog in these areas

is called advection-radiation fog, a combination of radiation and advection fogs.

- Warm, moist air that is cooled to saturation as it moves over cold water forms *sea fog*:

- If the initial dew point is less than the coldest water temperature, sea fog formation is unlikely. In poleward-moving air, or in air that has previously traversed a warm ocean current, the dew point is usually higher than the cold-water temperature.

- Sea fog dissipates if a change in wind direction carries the fog over a warmer surface.

- An increase in the wind speed can temporarily raise a surface fog into a stratus deck. Over very cold water, dense sea fog may persist even with high winds.

- The movement of sea fog onshore to warmer land leads to rapid dissipation. With heating from below, the fog lifts, forming a stratus deck. With further heating, this stratus layer changes into a stratocumulus cloud layer and eventually changes into convective clouds or dissipates entirely.

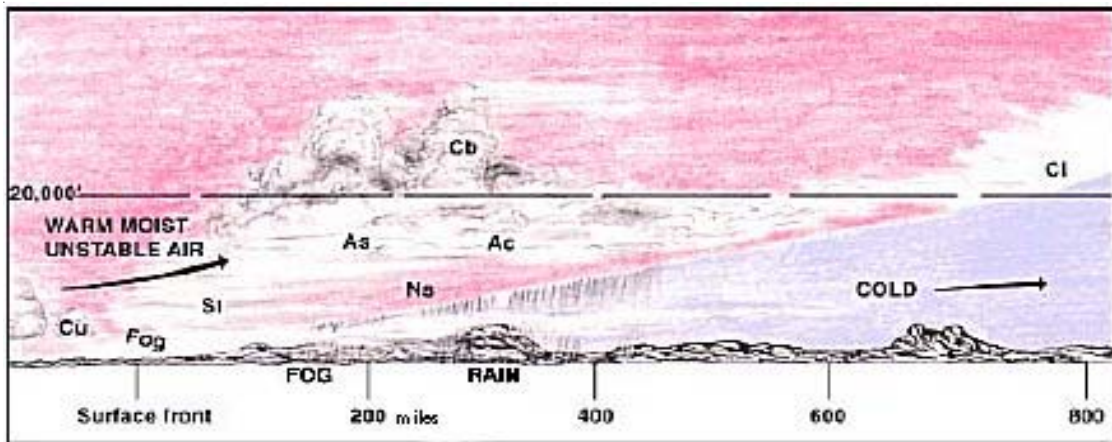
- Cooling after the heat of the day can cause sea fog to roll back in and restrict ceilings and visibility again.

(b) *Radiation Fog.* Radiation fog occurs in air with a high dew point. This condition ensures radiation cooling lowers the air temperature to the dew point. The first step in making a good radiation fog forecast is to accurately predict the nighttime minimum temperature. Additional factors include the following:

## Visibility

---

- Air near the ground becomes saturated. When the ground surface is dry in the early evening, the dew-point temperature of the air may drop slightly during the night due to condensation of some water vapor as dew or frost.
  - In calm conditions, this type of fog is limited to a shallow layer near the ground; wind speeds of 3-7 knots bring more moist air in contact with the cool surface and cause the fog layer to thicken. A stronger breeze prevents formation of radiation fog due to mixing with a dryer air aloft.
  - Constant or increasing dew points with height in the lowest 200 to 300 feet, so that slight mixing increases the humidity.
  - Stable air mass with cloud cover during the day, clear skies at night, light winds, and moist air near the surface. These conditions often occur with a stationary, high-pressure area.
  - Relatively long period of radiational cooling, e.g., long nights and short days associated with late fall and winter in humid climates of the middle latitudes.
  - In nearly saturated air, light rainfall will trigger the formation of ground fog.
  - In valleys, radiation fog formation is enhanced due to cooling from cold air drainage. This cooled air can result in very dense fog.
  - In hilly or mountainous areas, an upper-level type of radiation fog—*continental high inversion fog*—forms in the winter with moist air underlying a subsiding anticyclone:
    - Often a stratus deck forms at the base of the subsidence inversion, then lowers. Since the subsiding air above the inversion is relatively clear and dry, air at the top of the cloud deck cools by long-wave radiational cooling, which intensifies the inversion and thickens the stratus layer.
    - A persistent form of continental high inversion fog occurs in valleys affected by maritime polar air. The moist maritime air may become trapped in these valleys beneath a subsiding stagnant high-pressure cell for periods of two weeks or longer. Nocturnal long-wave radiational cooling of the maritime air in the valley causes stratus clouds to form for a few hours the first night after the air becomes trapped. These stratus clouds usually dissipate with surface heating the following day. On each successive night, the stratus cloud deck thickens and lasts longer into the next day. The presence of fallen snow adds moisture and reduces daytime warming, further intensifying the stratus and fog. In the absence of air mass changes, eventually the stratus clouds lower to the ground.
    - The first indicator of formation of persistent continental high inversion fog is the presence of a well-established, stagnant high-pressure system at the surface and 700-mb level. In addition, a strong subsidence inversion separates very humid air from a dry air mass aloft over the area of interest. The weakening or movement of the high-pressure system and the approach of a surface front dissipates this type of fog.
  - Radiation fog sometimes forms about 100 feet (30 meters) above ground and builds downward. When this happens, surface temperature rises sharply. Similarly, an unexpected rise in surface temperature can indicate impending deterioration of visibility and ceiling due to fog.
  - Finally, radiation fog dissipates from the edges toward the center. This area is not a favorable area for cumulus or thunderstorm development.
- (c) *Frontal Fog*. Frontal fog forms from the evaporation of warm precipitation as it falls into drier, colder air in a frontal system.
- *Pre-Frontal*, or warm-frontal fog (Figure 1-3) is the most common and often occurs over widespread areas ahead of warm fronts.



**Figure 1-3. Pre-Frontal Fog Associated with Warm Fronts.** This is the most common type of fog, and it often occurs over widespread areas ahead of warm fronts.

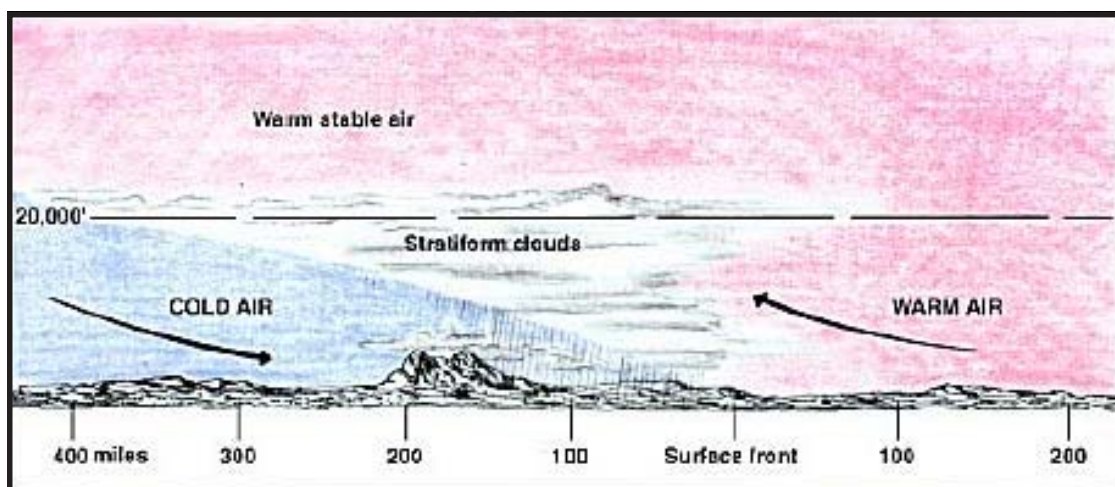
- Whenever the dew-point temperature of the overrunning warm airmass exceeds the wet-bulb temperature of the cold airmass it's replacing, fog or stratus form.

- Fog usually dissipates after frontal passage due to increasing temperatures and surface winds.

- *Post-frontal*, or cold frontal, fog occurs less frequently than warm-frontal fog.

- Slow-moving, shallow-sloped cold fronts (Figure 1-4), characterized by vertically decreasing winds through the frontal surface, produce persistent, widespread areas of fog and stratus clouds 150 to 250 miles behind the surface frontal position to at least the intersection of the frontal boundary with the 850-mb level.

- Strong turbulent mixing behind fast-moving cold fronts, characterized by vertically increasing winds through the frontal surface, often produce stratus clouds but no fog.



**Figure 1-4. Post-Frontal Fog Associated with Slow-Moving Cold Fronts.** Persistent fog may occur with this type of cold front.

## Visibility

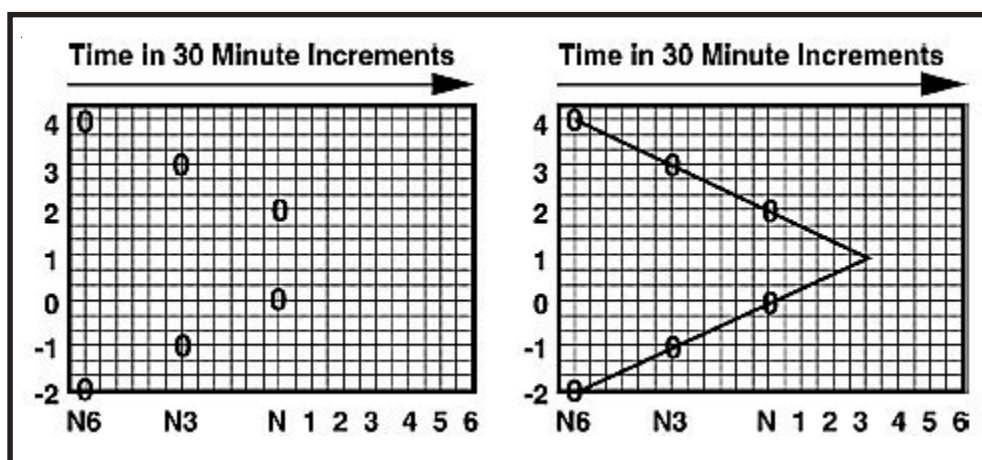
### D. Visibility Forecasting Aids/ Techniques.

**1. Using Streamlines to Forecast Visibility near the Coast.** Fog and stratus form near coastlines where moist air flows over cooling land. Surface streamlines can be used to forecast fog and stratus in those areas. To use streamlines effectively, follow three rules:

- Look at all available observations in the area.
- Consider sea surface temperatures. Visit the Navy's weather web site at: [www.fnmoc.navy.mil](http://www.fnmoc.navy.mil). You will need a login and password to enter the secure site. These can be obtained by requesting them from the site (scroll down the left side to the "Contact Us" area and request an account be opened up for your weather station). Check with your OWS to see if they already have an account with the Navy. Once inside the secure area, scroll down the left side to where it says, "Software and Manuals". After installing the appropriate software, you'll be able to view the products on the site.
- Refer to a topographical map. The scale must be large enough to show detailed terrain features. Follow the flow over terrain or across land-sea boundaries to identify the heating, cooling and lifting processes.

**2. Graphical Method for Forecasting Fog.** This method is valid for short (0 to 4 hours) periods and all times of day. The previous 3- and 6-hour temperature and dew point and graph paper are the only tools required. Use the temperature scale in effect for the period being plotted on the graph. For example, Figure 1-5 shows a Y-axis scale gradation from +4 to -2 because the 6-hour temperature was 4°C and dew point was -2°C. If the 6-hour temperature and dew point was 20°C and 15°C respectively, then use a Y-axis gradation from 20 to 15. Apply the following when using the graph:

- Plot the current temperature (T) and dew point ( $T_d$ ) on the vertical line labeled N.
- Plot the 3-hour old temperature and dew point on the vertical line labeled N-3, the 6-hour old data on the N-6 line.
- Connect the plotted temperature values with a line, extending the line to the right edge of the graph. Similarly, connect the plotted dew-point values and extend this line to the edge of the graph.
- If the lines do not intersect—stop; do not forecast fog for the following 4 hours. If the lines do intersect, from the point of intersection you can find the forecast time by proceeding vertically downward to the time scale. Add N to the forecast



**Figure 1-5. Graphical Method of Forecasting Fog.** Method uses previous 3- and 6-hour temperatures and dew points.

time to arrive at an onset time for the fog. For example, in Figure 1-5, if the current time was 0900 UTC, then forecast fog at 1200 UTC (0900 + 3 hours).

**3. Determining Fog Height.** An upper-air sounding taken when fog is present usually shows a surface inversion. If the temperature and dew point remain equal from the base to the top of the inversion, assume fog extends to the top of the inversion. If they are not equal, average the mixing ratio at the top of the inversion and the mixing ratio at the surface. The intersection of this average mixing ratio with the temperature curve is a good estimate of the top of the fog layer.

#### **4. Determining Surface Temperature Needed to:**

**a. Form Radiation Fog (Fog Point).** This value indicates the temperature (°C) at which radiation fog forms. To determine the fog point, find the pressure level of the lifted condensation level (LCL). From the dew point at this pressure level, follow the saturation mixing ratio line to the surface. The isotherm value at this point is the fog point, or the temperature at which radiation fog forms.

**Note:** The *British Quick Fog Point (BQFP)*, picked up by UK forecasters while deployed in the former Yugoslavia areas, may also prove useful. *This parameter is valid as long as there is moisture on the ground:*

$$\text{BQFP} = \text{Dew-point temperature (at max heating)} - 2$$

#### **b. Dissipate Radiation Fog.**

**Step 1.** Determine the average mixing ratio on your local upper air sounding is the lowest 50 to 100 mb of the sounding.

**Step 2.** Find where the mixing ratio line intersects the temperature curve.

**Step 3.** Descend from this intersection, dry adiabatically, to the surface pressure. The temperature of the dry adiabat at the surface is the temperature necessary.

**Note:** The temperature is approximate, since the method assumes no changes take place in the sounding from the time of observation to the time of dissipation.

**Step 4.** Modify the fog dissipation temperature to reflect changes in local and synoptic scale patterns and local effects.

**5. Fog Threat.** This value indicates the *potential* for radiation fog formation. It is calculated by subtracting the fog point from the 850-mb wet-bulb potential temperature (WBPT<sub>850</sub>). Refer to Table 1-3 to determine the likelihood of radiation fog formation.

**Table 1-3. Fog threat thresholds indicating the likelihood of radiation formation.**

Fog Threat	Likelihood of Radiation Fog
>3	Low
≥ 0 and ≤ 3	Moderate
< 0	High

$$\text{Fog Threat} = \text{WBPT}_{850} - \text{Fog Point}$$

**6. Fog Stability Index (FSI).** The Fog Stability Index (FSI) was originally developed and tested by Herr Harald Strauss and 2nd Weather Wing for use in Germany in the late 1970s. Forecasters there agreed that focusing in on the 1000- to 850-mb layer was key to making a good fog forecast. Using



**Visibility**

the representative 1200Z sounding, the FSI is designed to give you the likelihood of radiation fog formation (see Table 1-4), and is defined as:

$$FSI = 4T_{Sfc} - 2(T_{850} + Td_{Sfc}) + W_{850}$$

where,

- $T_{Sfc}$  = Surface temperature in °C.
- $T_{850}$  = 850-mb temperature in °C.
- $Td_{Sfc}$  = Surface dew point in °C.
- $W_{850}$  = 850-mb wind speed in knots.

**Table 1-4. Fog stability index thresholds indicating the likelihood of radiation fog formation.**

FSI	Likelihood of Radiation Fog
>55	Low
≥ 31 and ≤ 55	Moderate
< 31	High

- Stability from the surface to 850 mb is the main factor, and it is denoted by the temperature difference between pressure surfaces.
- Moisture availability is given by the spread between surface temperature and dew point.
- The 850-mb wind speed indicates the amount of atmospheric turbulence in the near-surface layer.

**Note:** Thresholds may require some adjustment. Test results showed that this should not be used as the sole predictor.

**8. Forecasting Visibility Using Climatology.** Climatology provides trends and averages of a variety of weather occurrences over a period of years. Consult it first to identify prevailing ceiling and visibility for the location and time of interest. Climatology can also be used to estimate diurnal variations of temperature and dew point at your station as a function of the time of year, and general

synoptic conditions. There are several sources of climatological data available from the Air Force Combat Climatology Center (AFCCC) (<http://www.afccc.mil>.)

**a. Modeled Ceiling and Visibility (MODCV).** MODCV is a software program that provides climatologically based forecasts for ceiling and visibility. (MODCV is gradually replacing the older Wind-Stratified Conditional Climatology (WSCC) tables.) Use this program as a guide to what is likely to happen based on current conditions. It is best to use MODCV after fog has formed and when conditions will improve. Adjust the display to meet current or expected weather conditions that affect visibility forecasts. These data can prevent over-forecasting an unfamiliar situation or, for the more experienced forecaster, help refine a best-guess forecast.

- MODCV output can be a very valuable tool, but do not use it blindly or indiscriminately. It is based on the month, time of day, wind direction, and the initial ceiling and the visibility category at your station—it only indirectly considers the synoptic situation. It is generally not useful in forecasting low ceilings and visibility due to smoke or duststorms.
- While the numbers in the data are important, the trends they represent are more important. Consider these trends in the light of the normal diurnal changes that take place at your station. Look at the values above and below your category—do they follow the same trends? If your wind sector is near the border of another, look at both sectors and the “all” wind category. If winds are light, look at the “calm” category. Remember to look for trends as well as numbers.

- When there are very few observations in the category (less than 10), there may be insufficient examples to make a good forecast. When six or seven cases all follow the same pattern, use this data with a fair degree of confidence. When five

cases or the fewer show no set pattern, confidence is low.

**b. Modeled Diurnal Curves (MODCURVES).**

This product provides summarized parameters including temperature, dew point, and relative humidity by hour for stations from which surface observations are available. The product provides data in monthly increments, and includes four wind sectors and two sky cover categories. Values are displayed in graphic and tabular form. These summaries resemble older temperature/dew point summaries, but are menu driven in a Windows environment.

**c. Surface Observation Climatic Summaries (SOCS).** SOCS contain the percentage frequency of occurrence of ceiling and visibility based on month, time, wind direction, and wind speed. The SOCS replaced the Revised Uniform Summary of Surface Weather Observations (RUSSWO) in July 1988. Each SOCS summarizes hourly observations (and *summary of day* data) for a given weather station in eight categories: atmospheric phenomena; precipitation, snowfall, and snow depth; surface wind; ceiling, visibility, and sky cover; temperature and relative humidity; pressure; crosswind summaries; and degree days. Each SOCS includes a Climatic Brief, described below.

**d. Operational Climatic Data Summary (OCDS).** This product is a summary of monthly and annual climatic data prepared manually when

**Table 1-5. MOS visibility (VIS) categories for the continental United States and Alaska.**

MOS VIS Category	Visibility (Miles)
1	< ½
2	½ < 1
3	1 < 3
4	3 < 5
5	>5

the creation of a standard computerized climatic brief is impractical due to lack of data. The most recent 10-year period of record is used unless more data is available. Data are supplemented from other sources such as earlier periods of record, data from contemporary and/or earlier stations, and published data from other sources.

**e. International Station Meteorological Climate Summary (ISMCS).** ISMCS is a joint USN/NOAA/USAF-produced CD-ROM that contains station climatic summaries.

**9. Forecasting Visibility Using Model Output Statistics (MOS) Guidance.** MOS is an excellent tool to help forecast visibility and vision obstructions. As always, it's important to initialize and verify the model before using MOS.

**a. Visibility (VIS).** Visibility forecasts are valid every 3 hours from 6 to 36 hours, then every 6 hours from 42 to 60 hours after 0000 and 1200 UTC. In the CONUS and Alaska, MOS visibility forecasts are grouped by categories as shown in Table 1-5.

**b. Obstruction to Vision (OBVIS).** Visibility forecasts are valid every 3 hours from 6 to 36 hours, then every 6 hours from 42 to 60 hours after 0000 and 1200 UTC. In the CONUS, MOS obstruction-to-vision forecasts are for one of the categories shown in Table 1-6 for the CONUS and Alaska.

**Table 1-6. MOS Obstruction to Vision (OBVIS) categories for the continental United States and Alaska.**

MOS VIS Category	Obstruction to Vision
F	Fog
H	Haze
B	Blowing phenomena
N	Neither fog, haze, nor blowing phenomena
X	missing data

## Precipitation

---

**10. Some Final Thoughts on Visibility Forecasting.** Experience plays an important role in forecasting visibility. Note the following:

**a. Actual Prevailing Visibility.** A drop in visibility (i.e., from 25 miles to 15 miles) could indicate a significant increase in low-level moisture that could go unnoticed in a 7+ mile report.

**b. Sector Visibility.** If sector visibility is significantly different from prevailing, it could mean something significant is occurring. For example, the lowering of sector visibility could mean a fog bank is forming or that dust is rising due to an increase in winds from a thunderstorm.

**c. Obstructions to Visibility.** Reports should include what is obstructing vision (i.e., fog, smoke, haze, etc.) as well as an estimated layer height top and/or base. For example, *visibility 10 miles in haze, top of haze layer approximately 1,500 feet*, includes haze as being the obstruction to vision and identifies the layer of haze.

**d. Tops and Bases of Haze Layers.** These are important because they may mark the bases of inversions. Tops and bases of haze layers are usually difficult to estimate, but a definite top and/or base is sometimes detectable when looking towards the horizon. Determine the height by noting the orientation to higher terrain, trees, or buildings, if available. Pilot reports of haze tops and/or bases are also useful.

**II. PRECIPITATION.** For precipitation to occur, two basic ingredients are necessary: moisture and a mechanism for lifting the air sufficiently to promote condensation. Lifting mechanisms include convection, orographic lifting, and frontal lifting. There are many techniques and methods available for forecasting precipitation.

### A. Precipitation General Guidance

**1. Extrapolation.** Extrapolation works best in short-period forecasting, especially when precipitation is occurring upstream of the station. First, outline areas of continuous, intermittent and showery precipitation on an hourly or 3-hourly surface product. Use radar and satellite data to refine the surface chart depiction. Use different types of lines, shading, or symbols to distinguish the various types of precipitation. Next, compare the present area to several hourly (or 3-hourly) past positions. If the past motion is reasonably continuous, make extrapolations for several hours. (Note: Consider local effects that may block or slow the movement of the extrapolated area.)

**2. Cloud-top Temperatures.** The thickness of the cloud layer aloft and the temperatures in the upper-levels of clouds are usually closely related to the type and intensity of precipitation observed at the surface, particularly in the mid-latitudes. Monitor METSAT imagery loops to determine if cooling cloud tops are occurring (indicating upward vertical motion). Climatology reveals the following:

- In 87 percent of the cases where drizzle was reported at the surface, the cloud-top temperatures were colder than  $-5^{\circ}\text{C}$ .
- In 95 percent of the cases during continuous rain or snow, the cloud-top temperatures were colder than  $-12^{\circ}\text{C}$ .
- In 81 percent of the cases, intermittent rain or snow fell from the clouds with cloud-top temperatures colder than  $-12^{\circ}\text{C}$ ; in 63 percent of the cases, with cloud-top temperatures colder than  $-20^{\circ}\text{C}$ .

**3. Dew-point Depression.** An upper level dew-point depression less than or equal to  $2^{\circ}\text{C}$  is a good

predictor of both overcast skies and precipitation. Dew-point spreads less than or equal to  $2^{\circ}\text{C}$  on the 850- and 700-mb forecast products are a good indication of potential precipitation, assuming there is potential for upward vertical motion.

#### 4. Frontal Placement

**a. Cold Fronts.** A cold front moving southeastward into the central and eastern United States may produce widespread, prolonged poor weather. After passage of the cold front, a band of stratiform ceilings with fog, drizzle, rain or frequent snow 200 to 500 miles wide often forms behind the front, bringing several days of bad weather.

(1) *Synoptic Pattern.* With the following sequence of events, expect widespread post-frontal weather.

- A cold front moves into the area east of the Rockies, followed by a rather shallow dome of cold, continental air.

- Figure 1-7 shows a thermal ribbon at 500 mb. Do not consider an area that is part of the ribbon when the isotherm spacing becomes greater than 150 miles.

- The 24-hour forecast position of the 500-mb trough remains west of the affected area. Any northerly flow below 500-mb tends to disrupt the necessary thermal field.

- The pre-trough air at 850 mb has a dew-point depression of  $5^{\circ}\text{C}$  or less.

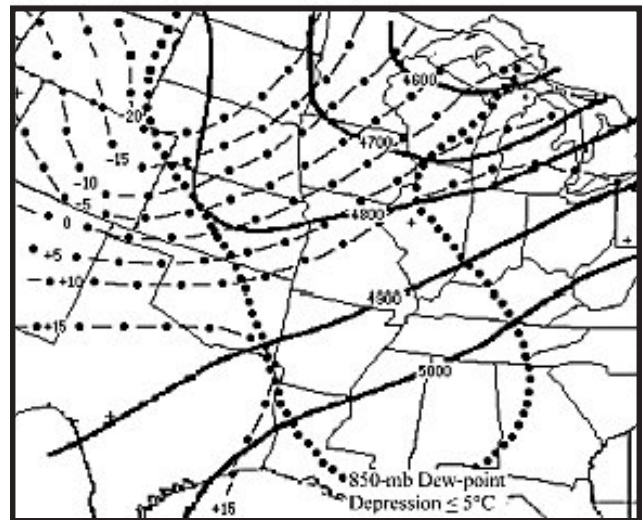
- The 500-mb system must lag behind the shortwave 850-mb trough. Weather in this post-cold frontal pattern normally includes the usual low ceilings and gusty surface winds associated with the cold front. Expect the worst conditions 25 to 75 miles behind the front where ceilings are 200 to 600 feet and visibility of 1/2 to 2 miles can occur

in rain, snow, and/or fog. From 75 to 150 miles behind the front, ceilings average 500 to 1,000 feet with rain or snow and possibly freezing rain. Beyond the 150-mile range, ceilings are above 1,000 feet with rain or snow showers. In most cases, a band of freezing rain is present in areas between the 850-mb  $0^{\circ}\text{C}$  and surface  $0^{\circ}\text{C}$  isotherms.

- The orientation of the front is also an important indicator of the nature of the post-frontal weather. Weather associated with east-west oriented cold fronts usually extends 500 miles to the rear of the front; weather associated with more northerly oriented fronts ( $050^{\circ}$  to  $230^{\circ}$ ) usually extends only 200 miles behind the front. In general, the more east-west the frontal system, the slower the weather pattern movement. Note the extent of precipitation with the east-west orientation of the surface front in Figure 1-8.

(2) *Forecasting Procedures for Widespread Post-Frontal Weather.*

**Step 1.** Determine whether a packed thermal gradient on the 850-mb chart is present.



**Figure 1-6. Thermal Ribbon Spacing.** A thermal ribbon is three or more nearly parallel isotherms in  $5^{\circ}\text{C}$  increments with spacing between isotherms about 50-150 miles.

## Precipitation

**Step 2.** Forecast the 24-hour movement of the 500-mb trough. If the forecast calls for eastward movement or the retrogression of the 500-mb trough, the flow at 850 mb behind the trough weakens and leaves the isotherm ribbon in an area of weak flow. This decay generally proceeds from south to north. If the 500-mb trough progresses normally with the 850-mb trough, the thermal ribbon moves with the surface front and widespread post-frontal weather does not form.

**Step 3.** Determine if the 850-mb pre-trough air has dew-point depressions of  $5^{\circ}\text{C}$  or less. See Figure 1-7.

**Note:** If all three of the above are present, then conditions are potentially good for widespread post-frontal weather and proceed with Steps 4 and 5.

**Step 4.** Forecast the 24- and 30-hour position of the surface cold front.

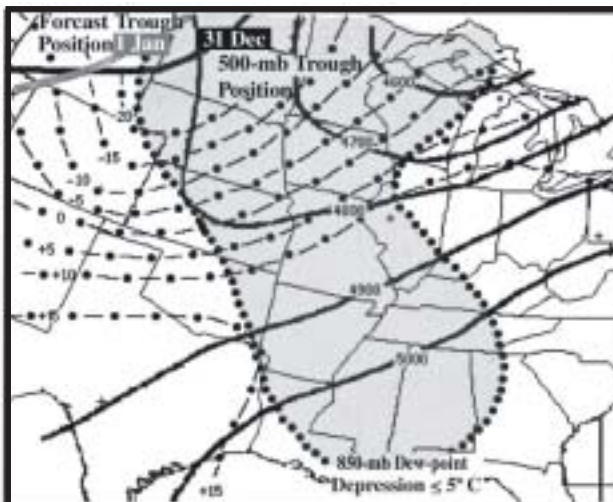
**Step 5.** Forecast the area of bad weather by using the cold front as the leading edge. If the front

is oriented more north-south than a  $050^{\circ}$  to  $230^{\circ}$  axis expect bad weather to stretch 200 miles behind the front. If the front is more east-west than a  $050^{\circ}$  to  $230^{\circ}$  axis, expand the area to 500 miles behind the front (see Figure 1-8).

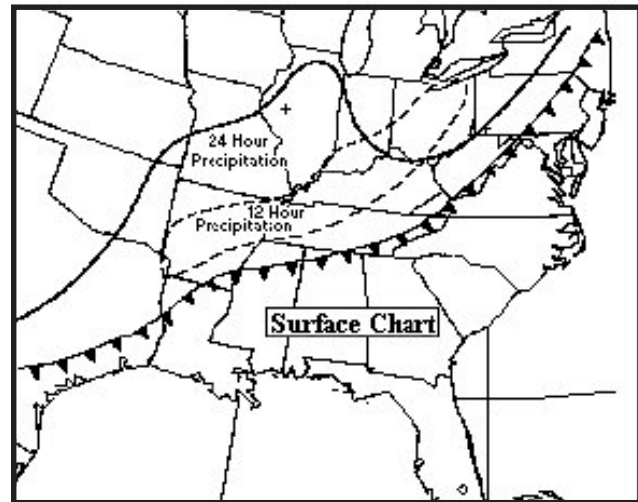
Weather persists until one of the following occurs:

- The 500-mb trough axis passes east of the area.
- Cyclogenesis takes place and associated temperature advection disturbs the pattern.
- A new cold front moves in, breaking the pattern.

**b. Warm Front—Overrunning.** Overrunning precipitation occurs in association with active warm fronts, surface cyclones passing south of your station, stationary fronts and, to a lesser degree, with slow-moving cold fronts. Stratus is a by-product and generally results from the evaporation of relatively warm precipitation into cooler air.



**Figure 1-7. The 500-mb Product.** The 500-mb trough retrogrades slightly on the northern end and moves slowly east to the southern end. Within 24 hours, the 850-mb winds over the ribbon south of the Great Lakes had fallen to almost calm.

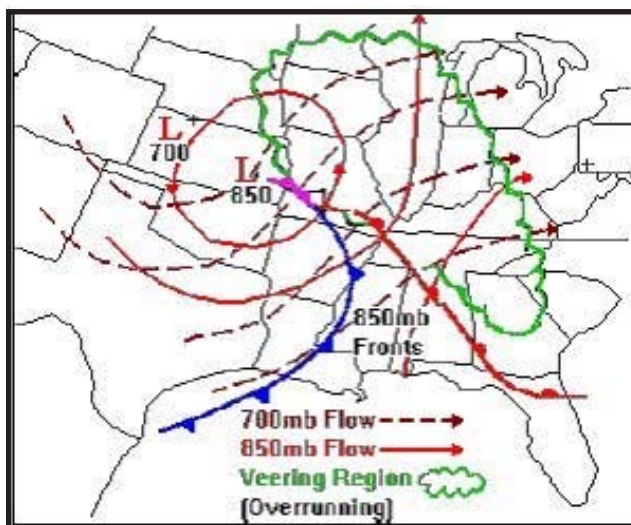


**Figure 1-8. Widespread Precipitation Scenario.** The resulting spread of precipitation 24 hours after the system shown in Figure 1-7.

Use the 925-mb or 850-mb (whichever is more applicable for your location) and 700-mb products to determine whether sufficient moisture and sufficient vertical motion are present to produce overrunning precipitation:

- The 925-mb or 850-mb product reveals if the available moisture to the south and the wind flow are favorable for the advection of this moisture into the area.
- The 700-mb product reveals if the thermal structure is adequate to produce overrunning precipitation. In general, overrunning requires warm-air advection and cyclonic curvature at 700 mb to produce significant precipitation. Therefore, the outer limits of overrunning precipitation are usually the 700-mb ridge line in advance of the system (beginning of precipitation) and behind the system where the wind changes from veering with height (warm-air advection) to backing with height (cold-air advection and the ending of precipitation).

Figure 1-9 is an idealized model of an overrunning precipitation pattern that occurs with an active warm front to the north of a surface cyclone.



**Figure 1-9. Overrunning Associated with a Typical Cyclone.** This pattern occurs with an active warm front to the north of a surface cyclone.

Forecasting the onset of overrunning precipitation associated with a stationary front is a difficult task near the surface front. The primary concern is moisture advection over the top of the cold air (consider the 925-mb or 850-mb product first). During the long time span between 850-mb products, monitor other data, especially from sites close to a moisture source. A good indicator is the increase of low-level cloudiness at the warm-sector stations upstream. Advect this moisture at the speed of the low-level winds. Dissipation of this type of overrunning takes place with one of the following two occurrences:

- When an upper-level short wave (watch upper-level analysis and vorticity forecasts) forms a low on the stationary front and the low moves through.
- When the 700-mb flow changes from cyclonic curvature to anticyclonic curvature.

**5. Drizzle Formation.** The basic requirements for significant drizzle are:

- A cloud layer or fog at least 2,000 feet deep.
- Cloud layer or fog must persist several hours to allow droplets time to form.
- Sufficient upward vertical motion to maintain the cloud layer or fog.
- A source of moisture to maintain the cloud or fog. (Light drizzle can fall from radiation and sea fog without the help of upward vertical motions).

Except for the upward motion, the requirements for drizzle can be determined by inspecting products. Vertical motion at 700 mb generally is not relevant to fog and stratus. The 850-mb Q-vectors may be useful at stations at elevations close to the 850-mb level.

## Precipitation

---

**Note:** T-TWOS #1 has detailed information on Q-vectors and their applications.

The vertical motion of concern is near the ground; identify it by drawing streamlines on surface charts to locate and track local axes of confluence. Make a reasonable estimate of whether surface confluence is stronger or weaker than usual. Drizzle onset is faster and more likely with stronger confluence.

Sometimes upslope flow and sea breeze confluence produces the gentle vertical motion needed without observations that indicate local confluence. Similarly, persistent large-scale southerly flow naturally converges as it moves northward and can provide the needed low-level gentle upward motion. Finally, the lift associated with the front supplies the needed upward motion to generate large areas of fog and stratus. In many of these instances, it is possible to observe the onset of drizzle at stations upstream and to extrapolate. Extrapolation may serve only to improve timing on arrival of conditions.

When extrapolating, remember the nature of the drizzle process. The drizzle area is likely to move or expand discontinuously since it is strongly dependent upon the lifetime of the cloud.

This has been limited to warm (above 0°C) and supercooled water clouds between -10°C and 0°C. At colder temperatures, the clouds are likely to have increasingly larger numbers of ice crystals and different physical cloud processes are occurring. Of course, when surface temperatures are equal or less than 0°C (32°F), forecast freezing drizzle.

### B. Model Guidance

**Model Output Statistics (MOS).** MOS guidance is usually a reliable tool for forecasting precipitation since it considers climatology for your station. MOS bulletins provide probability of precipitation

(POP), quantitative precipitation (QPF), probability of precipitation type (POPT), and probability of snow accumulation (POSA) forecasts. Use MOS guidance carefully during extreme weather events since climatology tends to steer MOS guidance away from forecasting rare or extreme events.

### C. Determining Precipitation Type

**1. Thickness.** Thickness is the most common predictor for precipitation type. Thickness is the vertical distance between two constant-pressure surfaces. It is a function of temperature: the warmer the air, the thicker the layer. If the thickness of the layer is known, then something is known about its mean temperature. The most used 1000-500-mb thickness value for forecasting precipitation type is the 540 (5,400 meter) threshold. Another predictor is the 0°C 850-mb isotherm. A third predictor is the 850-700-mb, 1,530-meter thickness line. Studies have shown that snow is rare when the 850-700-mb thickness is greater than 1,550 meter, or the 1000-500-mb thickness is greater than 5,440 meters.

#### a. Analyzing/Extrapolating Patterns.

**(1) Method 1.** Figure 1-10 shows the 1000-500-mb thickness associated with an equal probability of precipitation being liquid or frozen (where the number in parentheses is the number of cases used to determine the equal probability value at that station). Figure 1-11 shows the probability of precipitation being liquid or frozen as the thickness increases or decreases from the thickness values given in Figure 1-10. For example, if the expected thickness for Fort Campbell, Kentucky, is 60 meters less than the thickness value of 5,425 meters shown on Figure 1-10, then Figure 1-11 indicates the probability of precipitation being frozen is greater than 80 percent. These figures are a good starting place for determining whether precipitation is liquid or frozen. Modify these

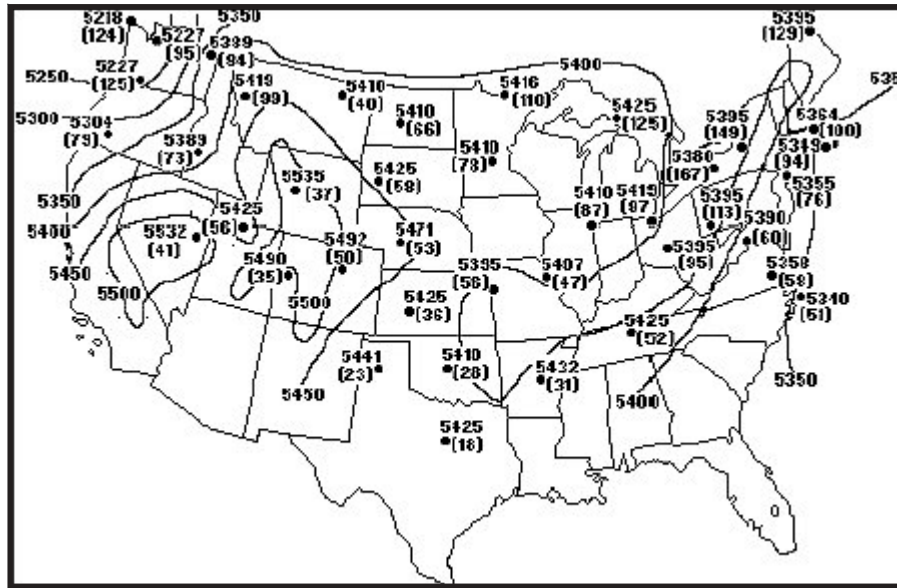


Figure 1-10. Equal Probability of Liquid or Frozen Precipitation. Based upon 1000- to 500-mb thickness (climatology).

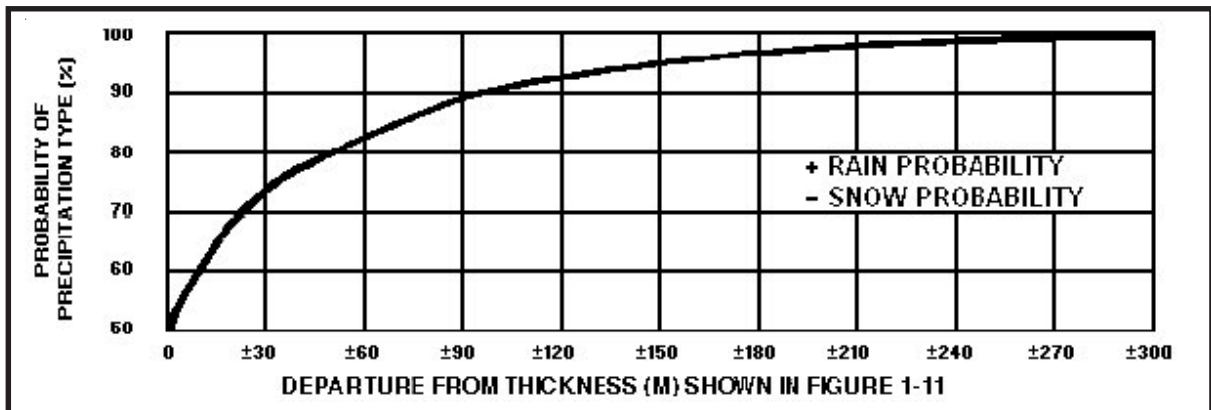


Figure 1-11. Probability of Precipitation Being Frozen Versus Liquid.



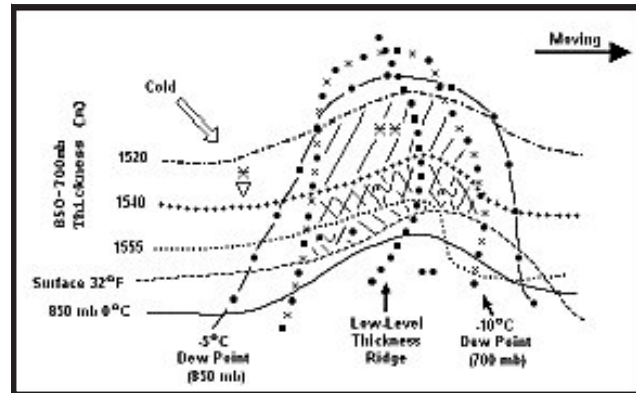
## Precipitation

whenever these thickness values are not representative; for example, for lake effect and relatively thin layers of warm or cold air.

(2) *Method 2*. This method requires that both the low- and mid-level thickness be calculated and plotted, but the precipitation analysis is rapid and straightforward. Use forecast charts by looking at the isotherms, isodrosotherms, and thickness lines. Plot the following parameters, manually or by computer, on one map.

- The mid-level thickness (700-mb height minus the 850-mb height).
- The low-level thickness (850-mb height minus the 1000-mb height), specifically the thickness ridge line.
- The 700-mb height contours.
- The 700-mb dew points.
- The 850-mb dew points.
- The surface 0°C (32°F) isotherm.
- The 850-mb 0°C (32°F) isotherm.

Analyze the mid-level thickness for the 1,520 and 1,540 meters contours and analyze for these dew points: -5°C (850 mb) and -10°C (700 mb). Forecast two or more inches of snow to occur in the area within these lines where precipitation is expected (see Figure 1-12). Analyze the mid-level thickness for the 1,555-meter line. Forecast freezing precipitation to occur in the area between this line and the 1,540-meter line and within the above dew-point lines, provided the surface temperature is below freezing. Find any areas of appropriate thickness but lacking sufficient moisture at either 850 mb or 700 mb. Be alert for any changes in the moisture pattern by advection or vertical motion. Expect only liquid precipitation



**Figure 1-12. Method 2.** Plot shows where to expect different precipitation types.

on the warm side of the 850-mb 0°C (32°F) isotherm.

(3) *Method 3*. You will need to move analyzed thickness contours to their position at the valid time of your precipitation forecast. The following are general rules for extrapolating thickness patterns:

(a) *Low-Level Thickness*. Choose several 1000- to 850-mb thickness lines that give a good estimate of the thickness pattern; e.g., the 1,300-, 1,340-, or 1,380-meter lines. Move each line in the direction of the wind at 3,000 feet with 100 percent of that wind speed. The thickness ridge moves at the speed of the associated short wave. In a strongly baroclinic situation, it moves slightly to the left of the 500-mb flow at 50 percent of the wind speed. Since thickness patterns merely depict the large-scale mass distribution, take care to adjust for rapid changes at 500 mb. Compare the thickness analysis with the surface analysis to ensure a reasonable forecast product.

(b) *Mid-Level Thickness*. Move the 1,520- to 1,540-meter band at 100 percent of the 8,000-foot wind field. Consider continuity, the latest surface analysis, and other charts when developing a new thickness forecast chart.

Snowfall begins with the approach of a low-level thickness ridge after the passage of the 700-mb ridge

line or the line of no 12-hour temperature change (the zero isallotherm) and with the approach of the low-level thickness ridge. Snowfall usually ends after the passage of the low-level thickness ridge and the 700-mb trough. Snowfall is heaviest 1 to 2 hours beforehand, and ends after the passage of the low-level thickness ridge and the 700-mb trough.

## 2. Freezing precipitation indicators

**a. Height of Freezing Level.** Forecasters often use the freezing level to determine the type of precipitation (see Table 1-7). The forecast is based on the assumption that the freezing level must be lower than 1,200 feet above the surface for most of the precipitation reaching the ground to be snow. However, forecasters must understand the complex thermodynamic changes occurring in the low-levels to correctly forecast tricky winter precipitation situations. For example, the freezing level often lowers 500 to 1,000 feet during first 1.5 hours after precipitation begins, due to evaporation or sublimation. When saturation occurs, these processes cease and freezing levels rise to their original heights within 3 hours. With strong warm-air advection, the freezing level rises as much as a few thousand feet in a 6- to 8-hour period.

The following methods use the number of freezing levels to forecast the type of precipitation expected at the surface. Each one considers the change of state of precipitation from liquid-to-solid or solid-to-liquid as it falls through the atmosphere.

(1) *Single Freezing Level.* If the freezing level equals or exceeds 1,200 feet above ground level (AGL), forecast liquid precipitation. If the freezing level is less than or equal to 600 feet AGL, forecast solid precipitation. If the freezing level is between 600 and 1,200 feet AGL, forecast mixed precipitation.

(2) *Multiple Freezing Levels.* When there are multiple freezing levels, warm layers exist where

**Table 1-7. Probability of snowfall as a function of the height of the freezing level.**

Height of freezing level above ground	Probability precipitation will fall as snow
12 mb	90%
25 mb	70%
35 mb	50%
45 mb	30%
61 mb	10%

the temperature is above freezing. The thickness of the warm and cold layers affects the precipitation type at the surface. If the warm layer is greater than 1,200 feet thick and the cold layer closest to the surface is less than or equal to 1,500 feet thick, forecast freezing rain. Conversely, if the warm layer is greater than 1,200 feet thick and the cold layer closest to the is greater than 1,500 feet thick, forecast ice pellets. Finally, if the warm layer is between 600 and 1,200 feet thick, forecast ice pellets regardless of the height of the lower freezing level.

**b. Checklist for Snow vs. Freezing Drizzle.** There are two types of atmospheric situations where freezing precipitation occurs. The most common case occurs when ice crystals melt as they fall through a sufficiently deep warm layer (temperature greater than 0°C). The water droplets hit a cold surface that has a temperature at or below freezing, and freeze on contact. The other technique is effective when the forecast decision involves the choice between snow vs. freezing drizzle. This technique is based on the precipitation nucleation process. It applies to the continental United States, Europe, and the Pacific regions. However, freezing precipitation is relatively rare in Korea. The checklist below assumes the atmosphere is below freezing through its entire depth, and the water droplets remain supercooled until surface contact.

- Does a lower-level moist layer (below 700 mb) extend upward to where temperatures are  $-15^{\circ}\text{C}$ ? If not, then freezing drizzle is possible.

## **Precipitation**

---

- Is a mid-level dry layer (800 to 500-mb) present or forecast? If yes, freezing drizzle or a mixture of snow and freezing drizzle is possible.

- Is the mid-level dry layer (dew-point depression greater than or equal to 10°C) deeper than 5,000 feet? If yes, the precipitation may change to freezing drizzle, or a prolonged period of mixed snow and freezing drizzle is possible.

- Is mid-level moisture increasing? If freezing drizzle is occurring and mid-level moisture is increasing, precipitation may change to all snow.

- Is elevated convection occurring or forecast to occur? If yes, the mid-level dry layer may be eroded, causing snow instead of freezing drizzle.

### **D. Forecasting Rainfall Amounts.**

**1. Radar Signatures Associated with Flash Floods.** Monitoring weather radar is the best way to detect the potential for heavy rains and localized flooding. Pay particular attention to the signatures below:

- Rapidly growing echoes.
- Slow moving echoes.
- Persistency (long lasting).
- Train echoes (echoes that move repeatedly over the same area).
- Hurricanes and tropical storms.
- Lines.
- Line Echo Wave Patterns (LEWPs).
- Converging echoes and lines.

**2. Satellite Signatures.** Satellite imagery is a valuable tool to use in evaluating heavy rainfall potential. Consider forecasting heavy rains with any of the signatures below:

- Quasi-stationary thunderstorm systems, those that regenerate and those that move over the same area again.

- Rapid horizontal expansion of the anvils. Infrared (IR) imagery picks this up best.

- Rapid vertical growth.

- IR tops colder than  $-62^{\circ}\text{C}$ .

- Overshooting tops.

- Merging of convective cloud lines and thunderstorms.

- Mesoscale Convective Complexes (MCCs).

- Rapid clearing to the rear of thunderstorms associated with sinking air. This is an indicator of strong vertical circulation and suggests heavy convective precipitation.

- Thunderstorm anvils that stretch out in a thin narrow band parallel to the upper-level wind flow, new thunderstorms often develop upwind.

Utilize NOAA's "SAB Areal Tropical Rainfall Potential" webpage. This is a program that takes the latest microwave Rain Rate data from the Defense Meteorological Satellite Program's Special Sensor Microwave Imager (SSM/I), the NOAA-15 Advanced Microwave Sounder Unit (AMSU), or the NASA Tropical Rainfall Measuring Mission (TRMM) and performs an extrapolation of the rain rate values based on the forecast track and speed. This forecast is taken from the official forecast bulletins issue by the NOAA National Hurricane Center and Central Pacific Hurricane Center. This

can be done for tropical depressions, storms, and hurricanes. The website is located at: [www.ssd.noaa.gov/PS/TROP/trap-img.html](http://www.ssd.noaa.gov/PS/TROP/trap-img.html).

### ***E. Snowfall.***

**1. General Guidance.** The following rules are empirical in nature:

- The average relative humidity for the layer from the surface to 500 mb must be at least 70 to 80 percent in order to have significant synoptic-scale precipitation.

- Snowfalls greater than 2 inches are associated with warm advection and positive vorticity advection, assuming adequate moisture is available (except for lake effect and orographic effects).

- Most precipitation occurs within the 65 percent (or higher) relative humidity areas on model forecast charts. Similarly, most heavy precipitation occurs within the 80 percent relative humidity area.

- The 850-mb  $-5^{\circ}\text{C}$  isotherm usually bisects the area that receives heavy snow accumulation during the subsequent 12 hours.

- Heavy snow occurs in the area north of the 850-mb  $0^{\circ}\text{C}$  isotherm and south of the 850-mb  $-5^{\circ}\text{C}$  dew-point line and the 700-mb  $-10^{\circ}\text{C}$  dew-point line.

- Beginning and ending times. Snow begins as the 700-mb ridge line passes overhead. Snow ends at the 700-mb trough line (and in some cases, at the 500-mb trough line). Heavy precipitation tends to begin as the 500-mb ridge line passes overhead and ends as the contour inflection point passes overhead.

### ***2. Estimating Rates/Accumulation***

**a. Using Weather and Visibility.** Estimates of snowfall rates can be determined from visibility measurements (see Table 1-8a and 1-8b).

- Snowfall rate is inversely proportional to prevailing visibility assuming falling snow is the predominate horizontal obscuration. Snow accumulation is dependent upon snowfall rate and storm duration. Snow falling at lower temperatures tends to compact and melt much less than snow falling near freezing. Keeping these factors in mind, the rainfall intensity and associated hourly rainfall can be roughly converted into an estimated snowfall intensity/hourly snowfall rate table. Table 1-8a was derived in part from combining rainfall intensity/rate and snowfall intensity data located in the National Weather Service (NWS) Observing Handbook No. 7.

**Table 1-8a. Snowfall Accumulation vs Surface Visibility.**

<u>Visibility (miles) and Intensity</u>	<u>Accumulation (inches/hour)</u>
> 3 -SN	< 0.1
2 - 3 -SN	< 0.2
½ -SN	< 0.3
1 ¼ -SN	0.1 - 0.4
1 -SN	0.2 - 0.6
¾ -SN	0.3 - 0.9
½ SN	0.6 - 1.4
¼ +SN	1.0 - 2.2
1/8 +SN	1.5 - 3.4
≤1/16 +SN	2.5 - 5.0+

Under most circumstances when temperatures are below freezing throughout the entire sounding, the atmosphere will not have enough moisture or instability to generate exact equivalent rain-snow rates. Table 1-8a assumes that the greater reduction of visibility is by falling snow rather than other precipitation types, fog, or blowing snow. Accumulations for each visibility category are over a temperature range from  $+1^{\circ}\text{C}$  ( $\geq 34^{\circ}\text{F}$ ) for low end rates to  $-8^{\circ}\text{C}$  ( $\leq 10^{\circ}\text{F}$ ) for high end rates.

**Precipitation**

The use of Tables 1-8a and 1-8b can be illustrated with an example. If moderate snow (1/2 mile visibility) occurred for one hour at -2°C (28°F), one would first use Table 1A to obtain the accumulation range of 0.6 to 1.4 inches per hour. Then using Table 1B, moderate snow falling at 28°F would correspond to adding 1/4 to 0.6 inches per hour (low end value for 1/2 mile visibility), resulting in 0.85 inches per hour.

**Table 1-8b. Values added to compensate for temperature/snowflake composition.**

Temperature (deg F)	R <sub>F</sub> values
≥ 31	0-
26 - 30	1/4
19 - 25	½
13 - 18	3/4
≤ 12	1+

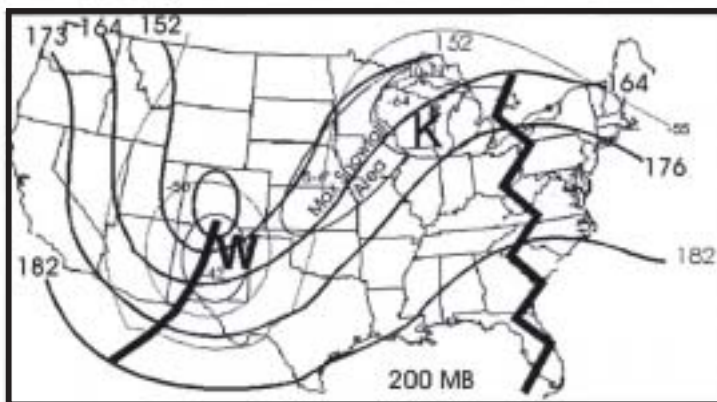
**b. Snow Index Using 200-mb Warm Advection.** This method is effective when used between 10 October and 10 March. It uses warm-air advection at 200 mb moving into an area of cold air to forecast the amount of snowfall for the next 24 hours. Warm-air advection at 200 mb is the key indicator because the 200-mb warm pocket usually coincides with the 500-mb vorticity maximum, particularly in well-developed systems. Thus, warm-air advection at 200 mb is another way to measure the strength of a weather system.

Warm air normally occurs in 200-mb troughs and cold air in the ridges. Temperatures are usually -40° to -45°C in strong troughs and are -65°C or colder in strong ridges. Generally at 200 mb, the direction of movement of the 500-mb vorticity

maximum is parallel to a line connecting the 200-mb warm and cold pockets—except in the case of large scale cyclonic flow over North America associated with rapidly moving short waves, or cutoff lows in the southwest United States that have remained nearly stationary for the previous 24 hours. If the storm is not well developed vertically (i.e., weak 200-mb temperature contrasts), heavy snow usually does not occur. If the dynamics are strong, the moisture usually advects into the storm.

- When there is warm-air advection at 700 mb into a snow threat area, the total average snow accumulation for the next 24 hours (providing the column of air is cold enough for snow) is given, in inches, by the following: determine the amount of warm-air advection at 200 mb by taking the difference (°C) between the warm core in the trough and the cold core in the ridge area; then divide by 2, ignoring the units. If the indicated warm-air advection extends less than 6° latitude (360 NM) upstream from the forecast area, the precipitation is usually of short duration. See Figure 1-13 for an example.

- If there is cold-air advection at 700 mb into the snow threat area (or it is observed within 8° of latitude (480 nm) of the forecast area at 700 mb), the total snow



**Figure 1-13. Snow Index (200-mb) Example.** Determine amount of warm-air advection (difference between K and W) 64 -42= 22°C. Divide by 2 for estimated snow amount (11 inches, in this case).

accumulation is estimated by dividing the amount of warm-air advection at 200 mb by 4.

- The maximum snowfall occurs near the coldest 200-mb temperature found downstream from the warmest 200-mb temperature.

**c. Using Precipitable Water Index (PWI, PPW on N-TFS Skew-T).** The PWI is the total atmospheric water vapor contained in a vertical column. The PWI is expressed in terms of height (inches of water) to which water would stand if completely condensed out (inches of water) and collected in a vessel (rain gauge).

- Estimate 12-hour snow amounts from the PWI by using the formula: snowfall in 12 hours equals PWI multiplied by 10.

- However, if the ground is wet and temperatures around are near freezing, use the formula: snowfall in 12 hours equals PWI multiplied by 5.

- If there is a strong influx of moisture, these techniques underestimate the snowfall.

- The highest accumulation amounts usually follow the 1,520- to 1,540-meter diffluent thickness band when it is packed between 2 degrees of latitude (approximately 120 NM).

*Example:* If the PWI is 0.75, the ground is wet, and the surface temperature is 0°C (32°F), the snowfall in 12 hours is 3.75 inches (0.75 multiplied by 5).

**3. Forecasting Snow Showers.** The technique and information discussed applies to stations that experience snow showers and have a large moisture source within 250 NM. Stations located 100 NM or more from water sources must include additional parameters (such as upslope or terrain-induced cyclonic curvature) in order for the technique to

work as well as it does for stations closer to the water source. This method may also be applicable to rain shower and thunderstorm forecasting.

The proper use of the following radar procedures requires two aids. First, streamline the Local Area Work Chart (LAWC) to depict the areas of confluence and diffluence. Next, streamline the 925- or 850-mb winds and highlight the areas of cold and warm advection. The 12-hour period between the 0000Z and 1200Z products need not be a problem if continuity of significant troughs and cold pockets is maintained. Continuity of diffluent and confluent areas help in the forecasting of clouds and icing; but alone do not indicate the onset, intensity, accumulation, or duration of the snow. For snowfall forecast, the period during which the 925- or 850-mb cold pocket begins to overrun the surface area of confluence identifies the probable period in which snow showers or squalls become identifiable on the radar.

Identify a band of snow upstream of the station on the radar; extrapolate its movement to determine whether it affects the forecast area. Synoptic-scale rain, snow, or thunderstorm bands normally move perpendicular to the band's orientation (i.e., north-south lines move east); however, snow showers or snow squall bands usually move parallel along the bands. The LAWC streamline explains the reason for the unique movement of the snow shower bands. Snow showers are a direct result of confluence at the surface, cold-air advection above, and sufficient moisture. Snow showers form, along and move with, the axis of the surface confluence. If either the band of snow showers or the confluent axis moves towards the station, forecast snow showers to begin.

Use 90 to 100 percent of the 2,000- or 3,000-foot winds to forecast snow shower movement. The reason for using such a high percentage of the low-level wind speed is that snow can precede the low-level clouds by as much as 5 minutes, depending

## **Precipitation**

---

upon the actual strength of the winds just below the cloud bases. The next step is to determine the snow shower intensity and duration, and snow amount.

It is often difficult to forecast the movement of snow shower lines and bands because they shift directions frequently. Although the directional shift usually is not greater than 15 degrees, it can make the difference between snow and no snow at a specific location. This shifting is most common when the wind core at 3,000 feet is less than 25 knots. When the wind speed core at 3,000 feet is greater than 25 knots, directional shifts are less frequent, and if they occur, they are usually less than 15 degrees.

By using the techniques and information provided above, forecast lead times can improve for snow showers. Once snows begin, use the radar to look for openings or shifts in the orientation of the bands to forecast when the snow tapers off or ends. These openings and shifts may indicate temporary breaks. If they are upstream, determine whether there is a solid band or a series of snow shower cells. A solid band does not change the observed condition, but a cellular pattern indicates an intermittent condition with periods of heavier snow and reduced visibility.

Use the LAWC to forecast when the snow ends. When a surface diffluent wind pattern arrives at the station, clearing is likely. Examine the surface wind pattern upstream for a diffluent wind pattern, and advect the pattern at the same rate the snow moved.

**4. Lake Effect Snow.** The most significant lake effect snowstorms occur during the late fall and winter when cyclonically curving cold air crosses warmer lake waters and creates localized areas of instability. Lake effect snowstorms are experienced a few hundred miles down stream in persistent weather systems. The following checklist (Table 1-9) provides a list of weighted parameters that

determine one of three possible forecast choices: snow, snow alert, or no snow.

Total the score. Greater than 40 points, forecast snow. If the score is greater than zero but less than 40, snow is possible. This indicates there is a potential for lake effect snow but conditions are marginal. Do not forecast any snow with a score of less than zero.

**5. Heavy Snow.** Generally, forecast heavy snow if all of the following conditions are met:

- 850-mb dew point in range  $-5^{\circ}$  to  $0^{\circ}\text{C}$ .
- 700-mb dew point warmer than  $-10^{\circ}$  to  $-5^{\circ}\text{C}$ .
- 500-mb temperature north of  $40^{\circ}\text{N}$  less than or equal to  $-35^{\circ}\text{C}$ ; south of  $40^{\circ}\text{N}$  less than or equal to  $-25^{\circ}\text{C}$ .

Additionally, the following more specialized guidance may help in forecasting heavy snow occurrences.

**a. Non-Convective Snowfall.** Table 1-10 lists rules of thumb for forecasting snowfall during non-convective situations.

**b. Locating Areas of Maximum 12-hour Snowfall.** Perform the following analysis to pinpoint the areas of heavy snowfall. Maximum snowfall occurs where these areas intersect the most.

- Outline the surface  $0^{\circ}\text{C}$  ( $32^{\circ}\text{F}$ ) isotherm and  $0^{\circ}\text{C}$  ( $32^{\circ}\text{F}$ ) dew points.
- At 850 mb, outline areas having dew points  $\leq 4^{\circ}\text{C}$  and moisture.
- At 700 mb, outline areas having dew points  $\leq 10^{\circ}\text{C}$  and moisture. Also, locate areas showing the greatest 12-hour cold advection.

**Table 1-9. Lake effect snowstorm checklist.** If the total is less than 0, don't forecast snow; between 0 to 40 and snow is possible; greater than 40 forecast snow.

Lake effect snow checklist/Score sheet			Score
<b>Step 1.</b>	Vorticity > 18 crossing the lake	(+20)	
<b>Step 2.</b>	If no, vorticity 12 to 18 crossing the lake	(+10)	
<b>Step 3.</b>	Vorticity maximum crosses the lake directly	(+10)	
<b>Step 4.</b>	Cyclonic curvature (surface to 500-mb)	(+5)	
<b>Step 5.</b>	If anticyclonic curvature at surface and cyclonic curvature aloft, <b>go to Step 8.</b>		
<b>Step 6.</b>	Anticyclonic curvature aloft	(-10)	
<b>Step 7.</b>	Anticyclonic curvature at the surface	(-10)	
<b>Step 8.</b>	<b>Inversions: NGM temperatures:</b>		
	T5 (830 mb-760 mb) – T3 (910 mb –870 mb) greater than 3°	(-10)	
	T5 – T3 greater than 1°	(-5)	
<b>Step 9.</b>	Temperature (water) minus temperature (850-mb) less than 10°C	(-35)	
	Temperature (water) minus temperature (850-mb) greater than 10° and less than 13°	(0)	
<b>Step 10.</b>	<b>Instability</b>		
	Conditional	(+10)	
	Moderate	(+20)	
	Extreme	(+30)	
<b>Step 11.</b>	850-mb/boundary layer wind: 0° to 210°	(-35)	
	850-mb/boundary layer wind: 340° to 020° or 220° to 230°	(0)	
	850-mb/boundary layer wind: 240° to 0°	(+20)	
<b>Total</b>			

**Table 1-10. Rules of thumb for forecasting heavy non-convective snowfall.**

850-mb and surface analysis	The 0° isotherm at the surface moves little when steady precipitation is occurring and the 850-mb level is saturated. Heaviest snowfall occurs in moist air, with dew points between -4° and 0°C, northwest of the surface low.
700 mb	The heaviest snow occurs along the track of a closed low at 700 mb. Snow ends with 700-mb trough passage. Heaviest snow also occurs in moist air with the 700-mb dew point in the range of -10° to -5°C. Heavy snow is also possible where warm anticyclonic wind flow converges with colder northwest flow. It is important to locate the center of the strongest 12-hour cooling and its movement. The area into which this center moves is also a likely area for heavy precipitation.
500 mb	When trough temperatures are -20°C or colder, heavy snow occurs approximately 400 to 800 NM downstream from the trough axis.
Precipitable Water Index (PWI)	A simple conversion for potential 12-hour snowfall is to multiply the PWI by 10.
Average relative humidity	Average relative humidity from the surface to 500-mb should be 80% or greater.
Low-level thickness	1000- to 850-mb thickness, 1300 meters or less. 850- to 700mb thickness, 1555 meters or less.



## **Precipitation**

---

- At 500 mb, locate the jet ( $-20^{\circ}\text{C}$  isotherm) and cold thermal troughs.

- Outline areas of 80 percent relative humidity (RH) from surface to 500-mb.

- Outline areas of positive vorticity advection (PVA) and 12-hour forecast position.

- Perform a low-level thickness analysis (850-700-mb thickness). A 1,520 to 1,540 meter band about 120 miles wide is a good first approximation of the heavy snowfall zone. Width is seldom greater than 200 miles and the axis of heaviest fall is 2 to 4 degrees of latitude on the cold side of the surface low.

*c. Satellite Techniques.* Two satellite imagery interpretation techniques are useful for pinpointing heavy snow areas. The first technique uses the southern edge of the coldest cloud tops in satellite imagery to approximate the southern boundary of the heavy snow band. A line drawn through the center of the coldest tops approximates the northern boundary of the most significant snowfall. The second technique focuses on the midpoint of the enhanced cloud band. Extrapolate the cloud midpoints downstream.

**Note:** The heaviest snow usually does not occur where the infrared (IR) temperatures are the coldest.)

*(1) Shear Zone Heavy Snow Events.* A common feature of snow events occurring with weaker storms is a pronounced cyclonic speed shear zone aloft. This type of situation also exhibits two other important characteristics.

- Cloud and precipitation development are usually very rapid and forecast lead-time is minimal.

- The weather associated with the shear zone often turns out to be the *main event*, although

most tend to focus most on the developing storm lifting out with the upper trough.

- The heaviest snow of the event generally occurs where the PVA and warm-air advection act together or in succession.

*(2) The Shear Zone Interpretation Technique.* The southern edge of the coldest cloud tops, often the location of the heaviest snowfall, typically develops just to the left of, and parallel to, cyclonic shear zones.

- To forecast the shear zone location, visualize a line from the vorticity maximum to just left of the downstream bulge in the dry slot. A line extended eastward or downstream through the cold cloud tops approximates the cyclonic shear zone.

- The leading edge of maximum wind speeds associated with the jet is near the furthest downstream extension of the dry slot.

- A vorticity maximum is located in the area of the greatest speed shear. Locate the vorticity maximum near the upstream edge of the enhanced clouds.

- The southern edge of the clouds and the southern edge of the attendant heavy snow band should develop about 1 degree of latitude (60 NM) left looking downstream of the shear zone.

This second method is most reliable when there is a long and narrow dry slot, which may be the result of a sharper shear zone in this area. Significant snowfall is still possible until the vorticity maximum passes. Use extrapolation of arrival of the back edge of clouds to approximate the time when the snow tapers off.

*d. Favorable Synoptic Patterns.* Analyzing the synoptic situation can help identify areas most likely to receive heavy snow. See Tables 1-11 and 1-12.

**Table 1-11. Forecast location of heaviest snow relative to various synoptic features.**

Feature	Downstream distance	Area lateral distance
500-mb vorticity maximum	700 km	250 km to the left of path
Surface low-pressure center	500 km	250 km to the left of path
500-mb low center	100 km downstream from inflection point associated trough	Along track
1000- to 500-mb thickness	Along thickness ridge	Between 5310 and 5370 meters
700-mb low center		Along track
500-mb 12-hr height fall		Left of track
Intersection of 850- and 500-mb maximum wind axis		Along track
850-mb low center	300 to 1200 km	100 to 400 km to the left of the track

**Table 1-12. Synoptic snowstorm types**

<b>Deep occluding low</b>	The track of the low is to the north-northeast and its speed slows from an initial 25 knots to only 5 to 10 knots during the occluding process. In practically all cases a closed low exists at 500-mb and captures the surface low. The area of maximum snowfall lies from the north to west of the center with rates of ½ to 1 inch per hour. The western edge of the maximum area is at the 700-mb trough or low center and all snow ends with the passage of the 500-mb trough or low center.
<b>Non-occluding low</b>	The track of the low is to the northeast or east-northeast at 25 knots or more. It is associated with a fast moving open trough (occasionally with a minor closed center) at 500 mb. The maximum area is located parallel to the warm front from north to northeast of the storm center. Duration is short (4 to 8 hours).
<b>Post-cold frontal type</b>	A sharp cold front oriented nearly north-south in a deep trough. A minor wave may form on the front and travel rapidly north along it. The troughs at 700 and 500 mb are sharp and displaced to the west of the front by 200 to 300 NM. Ample moisture is available at 850 and 700 mb. the area of maximum snowfall is located between the 850- and 700-mb troughs. The snowfall duration is 2 to 4 hours.
<b>Warm advection type</b>	Occurs infrequently. The lack of an active low near the maximum snowfall area makes it different from the others. A high-pressure ridge or wedge is situated north of a nearly stationary warm front. The area of maximum snowfall is in a band parallel to the front.
<b>Inverted trough snowstorm</b>	This consists of an inverted trough extending northward from a closed low-pressure system to the south. It may be just an inverted trough at the surface. The available moisture determines the extent of the snowfall area. Snowfall ends with the passage of the 700-mb trough. Heavy snow may occur when the flow at 500 mb is nearly parallel to the surface trough. The surface and 700-mb troughs move very slowly when this occurs.

## **Precipitation**

---

**6. Miscellaneous General Rules of Thumb (ROTs).** The rules that follow are not meant to be used by themselves. One should always use other tools before finalizing a forecast.

### **a. Drizzle.**

- Cloud layer or fog layer must be between 2,000-6,000 feet thick (drizzle is rare when thickness is greater than 10,000 feet).

- Cloud layer or fog layer must persist for several hours (allows droplets time to build).

- Cloud bases must be less than 4,000 feet (under 1,000 feet best).

- Must be sufficient upward motion to maintain cloud layer or fog.

- If drizzle occurs, there must be source of moisture to maintain the cloud or fog.

- Drizzle is most common with disorganized weather systems.

- Drizzle most often occurs on cool side (overrunning) of stationary fronts.

- Drizzle often occurs with inversion present.

- Air often saturated up through 850 mb or 800 mb.

- Temperatures at cloud top should be  $-4^{\circ}\text{C}$  or warmer.

### **b. Thickness and Precipitation.**

#### **• Freezing Precipitation.**

- 1000-500-mb thickness associated with freezing drizzle, 5330- to 5520-meter band.

- 1000-500-mb thickness associated with freezing drizzle, 5330- to 5440-meter band.

#### **• Rain and Snow.**

- 1000-500-mb thickness threshold for rain vs. snow, 5400-meter band.

- 1000-500-mb thickness associated with snow, 5360- to 5400-meter band.

### **c. Temperature.**

#### **• Rain Versus Snow Rules.**

- Surface Temperature:  $>40^{\circ}\text{F}$  - Rain,  $35^{\circ}$  to  $40^{\circ}\text{F}$  - Mixed,  $<35^{\circ}\text{F}$  - Snow.

- Surface Dew Point:  $>35^{\circ}\text{F}$  - Rain, 25 to  $35^{\circ}\text{F}$  - Mixed,  $<25^{\circ}\text{F}$  - Snow.

- 850-mb temperature:  $>5^{\circ}\text{C}$  - Rain, 1 to  $5^{\circ}\text{C}$  - Mixed,  $<1^{\circ}\text{C}$  - Snow.

- 700-mb temperature:  $>-5^{\circ}\text{C}$  - Rain, -5 to  $-9^{\circ}\text{C}$  - Mixed,  $<-9^{\circ}\text{C}$  - Snow.

- 500-mb temperature north of  $40^{\circ}\text{N}$  and Mountains:  $>-25^{\circ}\text{C}$  - Rain, -25 to  $-29^{\circ}\text{C}$  - Mixed,  $<-29^{\circ}\text{C}$  - Snow.

- 500-mb temperature south of  $40^{\circ}\text{N}$ :  $>-15^{\circ}\text{C}$  - Rain, -15 to  $-19^{\circ}\text{C}$  - Mixed,  $<-19^{\circ}\text{C}$  - Snow.

- Low levels (Surface and 850 mb) very important—if below freezing—precipitation will be:

- (1) Snow if upper levels read snow.

- (2) Freezing rain if upper levels read rain.

#### **• Freezing Precipitation.**

- Temperature range of  $0^{\circ}\text{C}$  to  $-5^{\circ}\text{C}$  best for freezing rain.

- Greater than half of freezing rain cases occur with temperatures within 1.5° C of 0° C.

- Majority of freezing drizzle cases occur between -3° C and -5° C.

- Freezing drizzle has occurred in temperatures between -5° C and -10° C.

#### **d. Heavy Snow.**

- *500 mb.*

- Begins with passage of 500-mb ridge and ends at 500-mb trough line.

- Under a 500-mb closed low, and/or slightly downstream of inflection point from where 500-mb flow changes from cyclonic to anticyclonic.

- 500-mb temperature north of 40° N < -35° C.

- 500-mb temperature south of 40° N < -25° C.

- Along and left of associated vorticity center track.

- Snowfall generally 100-200 miles wide.

- Vorticity value should be +14 or more, with largest snowstorms having values of +19 or more.

- *700 mb.*

- 700-mb dew point warmer than -10° C to -5° C

- Western edge of heavy snow is no farther west than 700-mb trough line.

- *850 mb*

- Heavy snow occurs to left of 850-mb track.

- Snow starts at zone of low-level (850 mb) convergence.

- 850-mb -5° C isotherm bisects the area in which heavy snow occurs in subsequent 6-12 hrs.

- 850-mb dew point in range -5° C to 0° C.

- In area north of the 850-mb 0° C isotherm and south of the 850-mb -5° C dew-point line and 700-mb -10° C dew-point line.

- *Surface.*

- 60-180 nm left of the track of surface low.

- Associated with strong WAA and positive vorticity advection with adequate moisture.

- In increased low-level warm advection in overrunning situations.

- *Miscellaneous.*

- 850-700-mb thickness between 1,540 and 1,520 m.

- Under 1000-500-mb thickness ridge, between 5,310 and 5,370 m thickness lines.

**7. Snowfall and the Physics Involved.** Needless to say, forecasting snow amounts during the winter is one of the most difficult tasks face by forecasters. All forecasters know that snow amount forecasting is accomplished by solving the following equation:

***snow intensity X snow duration = snow amount***

## **Precipitation**

---

When both terms on the left side of the equation are fully understood, the process of determining potential snowfall amounts becomes easier. However, even though models give us good hints regarding both terms, they do not give us the complete answer, and therein lies the job of the operational forecaster; to go beyond model guidance and further define these terms.

The goal of this section is to aid the forecaster in further defining the first term: Snow intensity. By creating additional tools to aid in forecasting this term, forecasters will be able to more accurately forecast snow amounts.

Much of this module will discuss the role of microphysics in the intensity of snowfall, based on snow crystal growth. By understanding those processes, which lead to maximized growth of snowflakes, we can better define the first term in the equation. The importance of melting layers will then be discussed, along with the role they play in determining snow versus rain forecasts.

*a. Microphysics of Snow.* The microphysics of snow plays an important role in the amount of snowfall that is possible under a particular synoptic environment. More emphasis needs to be placed on easily diagnosed microphysical processes, to differentiate those soundings where large growth of snowflakes is maximized. Classic winter precipitation events start with ice crystals forming by heterogeneous nucleation and growth through deposition. These ice crystals then may continue to grow into snowflakes by aggregation and riming. These processes will be discussed below.

*(1) Heterogeneous Nucleation.* Although most water that we see around us does not supercool appreciably, cloud droplets commonly exist in the supercooled liquid state down to temperatures as low as  $-20^{\circ}\text{C}$  and on occasion, down to  $-35^{\circ}\text{C}$ , while droplets of very pure water, only a few microns in diameter, may be supercooled down to  $-40^{\circ}\text{C}$  in the laboratory (Mason, 1962). Spontaneous

freezing occurs at  $-40^{\circ}\text{C}$ , but at higher temperatures, they can freeze if they are infected with foreign particles. Outside the laboratory, the freezing of liquid droplets is strongly dependent on a process known as heterogeneous nucleation. Heterogeneous nucleation of ice occurs in a supersaturated atmosphere when water molecules collect and freeze onto the surface of a foreign particle, such as dust and clay particles, or even a pre-existing ice crystal. For certain types of particles, heterogeneous nucleation of ice can occur at temperatures as warm as  $-5^{\circ}\text{C}$ , however it is more likely at temperatures less than  $-10^{\circ}\text{C}$ . Larger droplets tend to freeze fastest as they are more likely than smaller drops to have a freezing nuclei or ice embryo.

*(2) Growth by Deposition.* Snow crystal growth through deposition is the first process by which ice nuclei grow in size. The basic premise is that because of a gradient of saturation vapor pressures between ice nuclei and super-cooled water droplets, growth will occur as water from the water droplets is evaporated and then deposited on the ice nuclei. This process causes growth of ice nuclei at the expense of water droplets. This growth is maximized at  $-15^{\circ}\text{C}$ , where the saturation vapor pressure gradient between water and ice is greatest. Although this process plays an important role in allowing ice nuclei to grow in size, the second process, aggregation, is more important in creating large snowflakes.

*(3) Growth by Aggregation.* Snow crystal growth through aggregation is the second process that allows the larger crystals produced by deposition to continue to grow in size. The basic premise of this process is that different types of snow crystals are produced depending on the temperature of the atmosphere. Laboratory tests and observational studies have shown that the basic shape of ice crystals is highly dependent on the temperature in which it grows. Ice needles and columns tend to form at temperatures colder than

-22°C, where dendrites and plates form at warmer temperatures of -10°C to -22°C. Both types of snow crystals have significantly different terminal fall speeds, with columns and needles falling faster than dendrites and plates. This allows the columns and needles to fall into the area where dendrites and plates are residing, and through collision, aggregation of snow crystals occurs. This leads to larger and larger flakes as they continue to fall to the ground.

**(4) Growth by Riming.** Growth by riming occurs when ice crystals collide and collect liquid water drops that then freeze to the ice crystal. This process is most efficient when ice crystals fall into a saturated layer of supercooled water droplets, typically in clouds with temperatures of 0 to -10°C. Minor riming may not result in much modification to the shape of ice crystals, but excessive riming can produce snow graupel and sleet. The riming process may play a role in orographic regions where warmer upslope clouds are seeded from above by ice crystals falling from higher clouds, including wave clouds, leading to higher precipitation rates than would commonly be expected from only upslope clouds (Staudenmaier, 1999).

The “stickiness” of snow crystals increases as temperatures warm above -10°C in the sounding. Deep low-level isothermal layers near -3°C to 0°C leads to the largest flakes, due to the fact that “stickiness” is maximized at these temperatures.

**(5) Melting Layers.** Sometimes the sounding consists of a melting layer somewhere in the lower portion of the sounding. At this point, the question may be: Will the snow melt before it reaches the ground becoming rain, and/or will it refreeze close the ground and become sleet? The ultimate answer lies in the depth of the melting layer(s) and the surface conditions. Typically, the depth of warm air needed to melt snow as it falls is from about 750 feet to 1500 feet depending on the mass of flakes falling through this layer and the lapse rate (a measure of the strength of the melting layer).

When lapse rates are small, the melting layer tends to be weak, and a deeper melting layer will be required to melt the snow. When lapse rates are large, the melting layer is strong, and snow will melt within a shallower melting layer. On average, the 50% probability where flakes will reach the ground is with a melting depth of around 920 feet AGL. If the depth is greater than this, the probability is less than 50 percent that snow will continue to exist as it reaches the surface, and if the depth is less than 920 feet, the chances are greater than 50 percent that snow will reach the surface. Remember to take into consideration any wet bulb effects that may occur, especially if that melting layer is also a dry layer.

Another aspect to the melting layer is the maximum temperature found in this layer. According to research done by Stewart and King (1986), if the maximum temperature in the melting layer is only around +1°C, then snow is much more likely to reach the ground, no matter what the depth. If the maximum temperature lies between +1°C and +4°C, then sleet is most likely (depending on the size of the snowflakes), especially if temperatures cool below freezing at/very near the surface. For smaller size particles (melted drop size of less than 2 mm), freezing drizzle is more likely if the surface conditions are below freezing. If the maximum temperature in the melting layer is greater than +4°C, then flakes with a melted drop size of 4 mm and less will melt completely as they pass through this layer, with the result of rain or freezing rain, depending on the surface conditions. If flakes are greater than 4 mm in size (melted), then a mix of precipitation can be expected. Both the depth of the melting layer and the maximum temperature should be used to try to decide if snow will become sleet or rain before reaching the ground.

**b. Conclusions.** The effects of microphysical processes on snowfall production have typically not had a place in the operational forecast office. However, these processes are important in understanding not only how snow actually occurs,

**Precipitation**

---

but also, how much of it may occur. Numerical models tend to do a decent job with forecasting the “snowfall duration” portion of the equation, but they still do not do a good job with the “snowfall amount” portion. Part of this reason may be due to the oversimplification of the operational numerical models that do not take into consideration most microphysical processes. As forecasters, we need to understand these physical processes more and then apply them in our forecasts. By understanding how ice crystals form from heterogeneous nucleation, then grow through deposition, aggregation, and riming to become large enough to fall to the ground, we then can determine those days where conditions are optimal for heavier snow. Then by examining melting layers more in

depth, a more accurate forecast of precipitation type can be made.

The bottom line is to look for soundings that are nearly saturated through a deep portion of the atmosphere, consisting of saturated conditions from near 0°C at the surface to colder than -22°C, which typically is near or above 500-mb. The deeper the saturated near-freezing conditions near the surface, the larger the snowflakes will be due to “stickiness”, and if the saturated conditions continue above the -22 degree isotherm, then different types of crystals will be produced allowing aggregation to occur throughout the lower atmosphere. Finally, examine the character of the melting layer (if any) to determine if rain, sleet, or freezing rain is more likely than snow.

**III. SURFACE WINDS.** Accurate surface wind forecasting is an important task for a forecaster. Winds important for safe launch and recovery of aircraft, and are vital for successful low-level flight, ground combat operations, and base resource protection activities. An accurate wind forecast is a vital pre-requisite for accurately forecasting most other weather elements.

#### **A. Wind Basics.**

This section reviews the basic atmospheric forces responsible for atmospheric winds and describes how these forces combine. It then describes how these wind types are related to flow patterns around pressure systems.

##### **1. Atmospheric Forces.**

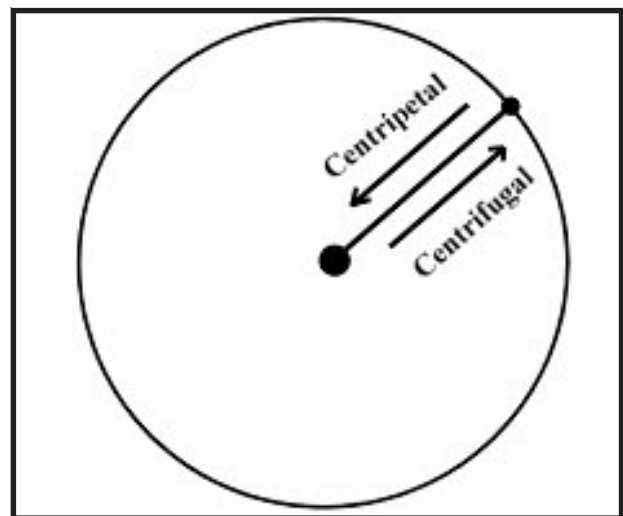
**a. Pressure Gradient Force.** This force is responsible for winds in the atmosphere. It arises from spatial differences in pressure in the atmosphere and acts to move air parcels from higher to lower pressure. The difference in the pressure between two points (over a given distance) in the atmosphere is referred to as the pressure gradient (PG). The magnitude of the PG force is directly proportional to the strength of the PG. Tightly packed isobars indicate a strong PG and are associated with strong winds. In contrast, loosely packed isobars indicate a weak PG and are associated with weak winds.

**b. Coriolis Force.** The Coriolis force is the “apparent” force that makes any mass, moving free of the Earth’s surface, to be deflected from its intended path. This force deflects winds to the right in the Northern Hemisphere and to the left in the Southern Hemisphere, due to the Earth’s rotating beneath them. The force is inversely proportional to the latitude; it is zero at the equator and increases to a maximum at the poles.

**c. Centrifugal and Centripetal Forces** (Figure 1-14). Centrifugal force throws an air

parcel outward from the center of rotation. Its strength is directionally proportional to the speed and radius of rotation. Centripetal force, equal in magnitude and opposite in direction to the centrifugal force, attempts to keep the air parcel moving around a curved path (such as around curved height contours on a constant-pressure surface).

**d. Frictional Force.** Friction directly opposes and retards the motion of one mass on contact with another. The strength of the force depends on the nature of the contact surface. The more irregular the contact surface, the greater the frictional force. Friction always acts opposite to the direction of motion. With an increase in friction, the wind velocity decreases. This force slows the wind within the boundary layer; the resulting surface wind is about 2/3 of the geostrophic or gradient wind. Friction also causes winds to flow across isobars from high to low pressure (i.e., out of highs and into lows). It may cause the wind to blow up to blow at angles up to 50° across isobars over rugged terrain and 10° across isobars over water. The effect of frictional force reaches to about 1,500 feet above ground level (AGL) over smooth terrain and as much as 6,000 feet AGL over mountainous terrain (i.e., up to the “Friction Level”, also called the geostrophic wind level and gradient wind level).



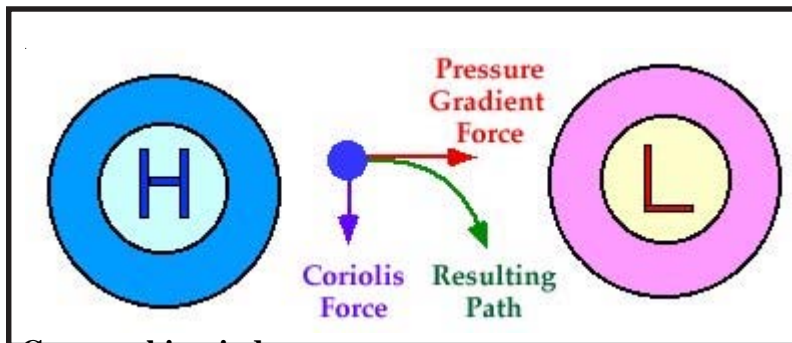
**Figure 1-14. Centrifugal and Centripetal Forces.**



## Surface Winds

### 2. Wind Types.

**a. Geostrophic Wind (Figure 1-15).** This wind results from the balance between the pressure gradient and the Coriolis Force, and blows at right angles to the pressure gradient (and parallel to isobars). The geostrophic wind gives a good approximation to the actual wind when friction and isobaric curvature is small.



**Figure 1-15. Geostrophic Wind.**

**b. Gradient Wind.** This wind results from a balance between the sum of the Coriolis and the centripetal forces. It blows parallel to curved isobars. In the middle latitudes, this wind is a better approximation of the actual wind speed than the geostrophic wind speed.

**c. Isallobaric Wind.** Isallobaric winds result from changes in pressure over time. Isallobaric winds flow perpendicular to isallobaric contours from an isallobaric high to a low as shown in Figure 1-16. Gradient and geostrophic wind speeds should be adjusted for the isallobaric flow to get a better estimate of actual winds. Although the gradient wind (adjusted for the effects of friction) is a good estimate of the actual wind when the pressure is unchanging, it is not always accurate when the pressure rapidly changes.

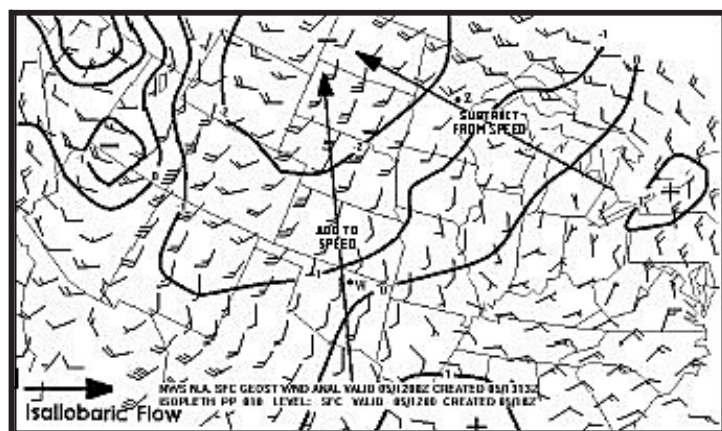
**d. Actual Wind.** The true observed wind, resulting from all the previously mentioned forces.

**3. Flow Around Pressure Systems.** Winds generally blow from higher toward lower pressure. The flow is clockwise out of highs and counterclockwise into lows in the Northern Hemisphere. The direction of the flow is opposite in the Southern Hemisphere.

Buys-Ballot's Law is useful for identifying the general location of highs and lows by observation alone: in the Northern Hemisphere, if you stand with the surface wind to your back and turn 30° clockwise, a low is to the left, and a high is to the right. In the Southern Hemisphere, with your back to the wind, turn 30° counterclockwise and the low is to the right, and the high is to the left.

### B. General Tools for Forecasting Surface Winds.

**1. Climatology.** Climatology is a useful tool in forecasting winds. It provides historic averages of wind speed and direction over a period of years. Consult it first to identify prevailing winds for the



**Figure 1-16. Isallobaric Flow.** Isallobaric winds flow perpendicular to isallobaric contours from an isallobaric high to an isallobaric low.

location and time of interest. These prevailing or climatological winds are meso- and micro-scale local phenomena such as land and sea breezes and thermal lows. Variations from the climatological winds are often the result of migratory systems such as lows, highs, and fronts. Climatological winds can be retrieved from several sources, including the following:

**a. International Station Meteorological Climate Summary (ISMCS).** This is a joint USN/NOAA/USAF summary that contains climatic summaries on CD-ROM.

**b. Surface Observation Climatic Summaries (SOCS).** Part C of the SOCS includes the percentage frequency of occurrence of peak winds based on month, time, direction, and speed.

**Note:** The tools noted above can be obtained from the Air Force Weather Technical Library, collocated with the Air Force Combat Climatology Center.

**2. Topography.** Topography can have an important effect on both the direction and speed of winds. Frictional effects due to rough terrain can slow wind speeds and change their direction. Mountains upstream may delay or block winds or trigger strong downslope winds.

- Get a detailed topographic map from a tactical product or atlas.

- Locate the station of interest.

- Note the topography around the station, such as hills, valleys, lakes, etc.

**3. Trends.** If the air mass and pressure systems affecting the area of interest are not expected to change, use persistence for short-term forecasting. This is especially true in tropical locations, where conditions remain much the same from day to day. In these locations, diurnal variations in winds

usually dominate. Trend charts are excellent tools to track and forecast these “persistent” winds.

**4. Calculating Geostrophic Winds.** Forecasters can estimate short-term surface winds by knowing the geostrophic wind (just above the friction layer) and correcting it for friction. Their sensitivity to changes in the pressure field, however, makes geostrophic winds unsuitable for long-term forecasting. Geostrophic winds also do not work well in areas of strongly curved isobars. Use geostrophic winds in a 90-minute to 2-hour window from valid time for best results.

- Obtain a value of the geostrophic wind at the location of interest. To obtain these values, use the VAD profile from Doppler radar, a representative sounding, an N-TFS or NCEP product, etc.

- Mean surface wind speed is generally about 2/3 of the geostrophic wind during the daytime period of maximum heating (due to frictional effects). The surface wind may not be representative if the geostrophic wind is less than 15 knots.

- The mean wind direction in the Northern Hemisphere deviates from the geostrophic direction by minus 10° over ocean areas and up to minus 50° over rugged terrain. Average deviation at a station should be determined locally.

- Cautions:

- Do not use geostrophic winds to forecast surface winds with nearby convection.

- Use geostrophic winds to forecast surface wind speeds after a frontal passage, but not to forecast wind shifts with frontal passage.

- Surface winds may be considerably different from the geostrophic wind under a shallow inversion.

## Surface Winds

•• Geostrophic winds may overestimate the true wind when a low-pressure center is within 200 miles of the area being evaluated.

**5. Calculating Gradient Winds.** The pressure gradient can provide a reliable estimate of the actual wind in mid-latitudes. Use following steps (Figure 1-17 is an example) to convert an existing surface pressure gradient (millibars) into a representative gradient wind (knots).

• Step 1: Create a  $6^\circ$ -latitude radius circle with the forecast location at the center.

• Step 2: Note pressure value at forecast location.

• Step 3: Note pressure value at edge of circle in direction system is coming from at right angles to isobars.

• Step 4: Find the difference in pressure (millibars) between the forecast location and the reference point.

• Step 5: Use the numerical difference (millibars) found to represent the wind speed in knots (e.g. using Figure 1-17, a 10 millibar difference = 10 knots).

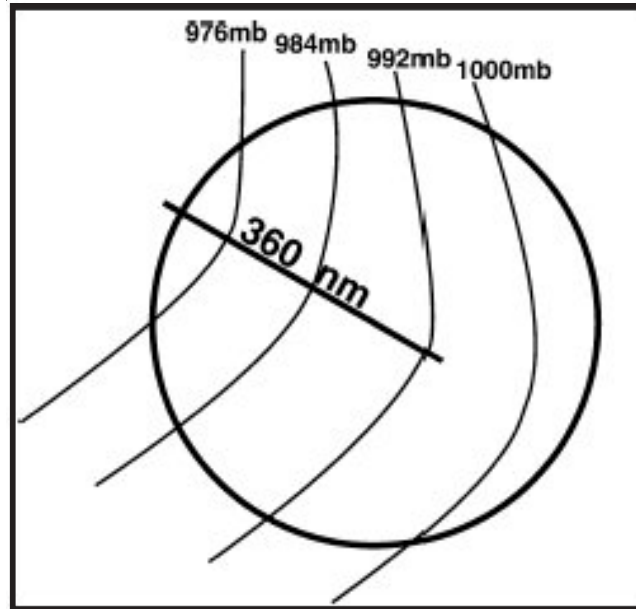
• Step 6: The gradient wind will be approximately equal to the value derived in Step 5.

Now, to figure a representative surface wind:

• Use 50% of the gradient wind as a forecast of the mean surface wind speed.

• Use 80%-100% of the gradient wind for daytime peak gusts.

• Wind direction follows isobars (adjust for friction, back about  $15^\circ$ ).



**Figure 1-17. Pressure Gradient Method for Determining Surface Winds.**

Note: The pressure gradient wind speed is inversely proportional to changes in latitude or air density (e.g., increasing latitude/air density = decreasing wind speed).

### 6. Calculating Isallobaric Winds.

- Display a geostrophic/gradient wind chart.
- Overlay contours of pressure tendency (e.g., PP in the N-TFS) using an increment of 1.0 mb.
- Locate the closed contours of pressure tendency to identify isallobaric centers for flow direction.
- Compute the distance between pressure tendency contours for your location.
- Apply the contour spacing value obtained above to the appropriate Variations of Isallobaric Wind Product (Figure 1-18, a-f) to get correction speed.

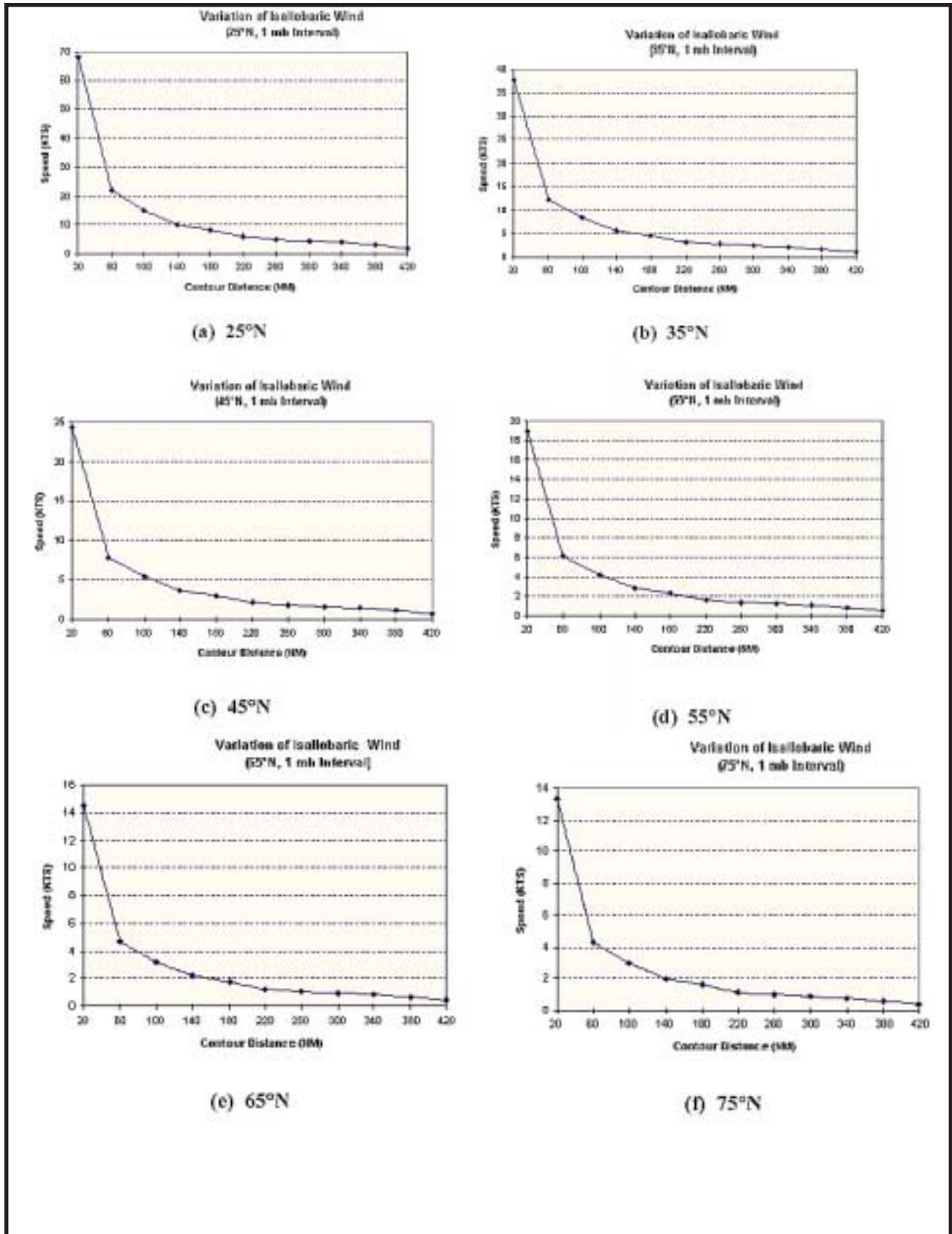


Figure 1-18a-f. Variation of Isallobaric Winds by Latitude.

**Surface Winds**

- If the isallobaric flow is opposite to the geostrophic wind direction, then subtract the value from the geostrophic speed. If the isallobaric flow is the same as the geostrophic wind direction, then add the correction value to the geostrophic speed (see example 1).

*Example 1:* In Figure 1-16, point W in northern Oklahoma is located near 36.5°N. The contour spacing is 2° latitude or ~120 NM. At 36.5°, we use Figure 1-18b (35°N) to get the variation in isallobaric wind. At 120 NM, the interpolated isallobaric wind speed is 7 knots. Since the wind

at W (15010) is in the same direction as the isallobaric flow, simply add the winds (i.e., adjusted wind speed = 10 knots + 7 knots = 17 knots).

*Example 2:* In Figure 1-16, point Z in central Minnesota is near 45°N and has a contour spacing of 1 mb per 160 NM. Figure 1-18c gives an isallobaric wind speed of 3 knots. However, since the geostrophic wind direction is about 120° different than the isallobaric, enter Table 1-13d with the geostrophic speed (13 knots) and isallobaric speed (3 knots) to estimate a wind speed of 10 knots.

**Table 1-13a-f. Estimating actual windspeed.** Knowing the difference in direction of isallobaric flow vector and geostrophic wind vector, enter appropriate table with wind speeds to estimate actual surface winds.

a) 0° to 12.5°		d) 77.6° to 102.5°										
		Speed B										
Speed A		5	10	15	20	25	30	35	40	45	50	
	5	0	5	10	15	20	25	30	35	40	45	50
	10	5	1	5	10	15	20	25	30	35	40	50
	15	10	5	1	5	10	15	20	25	30	35	50
	20	15	10	5	2	5	10	15	20	25	30	50
	25	20	15	10	5	2	5	10	15	20	25	50
	30	25	20	15	10	5	3	6	10	15	20	50
	35	30	25	20	15	10	6	3	6	10	15	50
	40	35	30	25	20	15	10	6	4	6	11	50
	45	40	35	30	25	20	15	10	6	4	7	50
	50	45	40	35	30	25	20	15	11	7	5	50

b) 12.6° to 45°		e) 102.6° to 135°										
		Speed B										
Speed A		5	10	15	20	25	30	35	40	45	50	
	5	2	6	10	15	20	25	30	35	40	45	50
	10	6	4	7	12	16	21	26	31	36	41	50
	15	10	7	7	9	13	18	23	27	32	37	50
	20	15	12	9	9	12	15	19	24	29	33	50
	25	20	16	13	12	12	14	17	21	26	30	50
	30	25	21	18	15	14	14	16	19	23	27	50
	35	30	26	23	19	17	16	17	19	22	25	50
	40	35	31	27	24	21	19	19	19	21	24	50
	45	40	36	32	29	26	23	22	21	22	24	50
	50	45	41	37	33	30	27	25	24	24	24	50

c) 45.1° to 77.5°		f) 135.1° to 167.5°										
		Speed B										
Speed A		5	10	15	20	25	30	35	40	45	50	
	5	5	8	11	18	23	27	32	37	42	47	50
	10	8	10	13	17	22	26	31	36	41	46	50
	15	13	13	15	18	22	26	30	35	40	44	50
	20	18	17	18	20	23	26	30	35	39	44	50
	25	23	22	22	23	25	28	31	35	39	43	50
	30	27	26	26	26	28	30	33	36	40	44	50
	35	32	31	30	30	31	33	35	38	41	45	50
	40	37	36	35	35	35	36	38	40	43	46	50
	45	42	41	40	39	39	40	41	43	45	48	50
	50	47	46	44	44	43	44	45	46	48	50	50

		Speed B										
Speed A		5	10	15	20	25	30	35	40	45	50	
	5	9	14	19	24	29	34	39	44	49	54	58
	10	14	19	24	29	34	39	44	49	53	58	63
	15	19	24	29	33	38	43	48	53	58	63	68
	20	24	29	33	38	43	48	53	58	63	67	72
	25	29	34	38	43	48	53	58	62	67	72	77
	30	34	39	43	48	53	58	62	67	72	77	82
	35	39	44	48	53	58	62	67	72	77	82	87
	40	44	49	53	58	63	67	72	77	82	87	92
	45	49	53	58	63	67	72	77	82	87	92	96
	50	54	58	63	68	72	77	82	87	92	96	96

Some final guidance on using isallobaric winds to forecast surface winds:

- Lows tend to move toward the center of isallobaric lows, where the air is converging horizontally and moving upward.

- Highs tend to move toward the center of isallobaric highs, where the air is subsiding and diverging horizontally.

- Isallobaric winds are normally less than 10 knots.

- Use a Skew-T to determine if a low-level surface inversion is present.

- If surface heating is not sufficient to break the inversion, forecast unchanged wind speeds.

- If winds increase above the inversion (and the inversion is below 5,000 feet), expect maximum gusts during maximum heating to be 80 percent of the 5,000 feet wind speed.

- If winds do not increase above the inversion, forecast 40 to 70 percent of the 5,000-foot wind speed to mix down to the surface.

- Caveats:

- Percentages shown above are only general estimates; actual values may differ widely due to local terrain. Determine appropriate values locally from forecast studies.

- Normally, maximum gustiness occurs at the time of maximum heating. Short periods of strong gusts may also occur just as the inversion breaks. Note that inversions may break before maximum heating.

- Other phenomena may break the nocturnal inversion. Propagating outflow boundaries from

previous days' thunderstorms may be sufficiently strong to temporarily break the inversion.

- With southwest winds, average gusts approximate 70 percent of the maximum wind observed in low-level wind data. Peak gusts may equal the highest wind speed reported in the low-level wind field during maximum heating.

- With west-northwest winds and moderate to strong cold-air advection, peak speeds can exceed the highest value observed in the low-level wind field.

- Under a strong pressure gradient, winds continue throughout the day or night with little diurnal change.

**7. Numerical Output Products.** Numerical weather prediction products such as a meteogram provide an objective tool to forecast wind speeds, directions, and other weather elements. Meteograms are produced for most locations. Since meteograms are based on weather forecast models, initialize the model before using the meteogram.

**8. Wind Profiles.** Wind profiles include data from Skew-T, Wind Profilers, meteograms, and WSR-88D Vertical Azimuth Display Wind Profile (VWP). These vertical profiles show the winds in a small cross-section of the atmosphere, but do represent the winds over a much larger horizontal area. The low-level jet can often be seen on the profiles.

- Read the winds off the display.

- Determine the temperature profile either from a current or forecast Skew-T or upper-air product.

- Follow rules above in the sections on *Geostrophic Winds and Diurnal Temperature Data*.

**9. Uniform Gridded Data Fields (UGDF).** UGDF are forecast fields displayed on N-TFS or

## Surface Winds

similar weather communications and processing equipment. These fields can be displayed vertically in a cross-section, or horizontally in a LAWC.

- Using UGDF, plot a forecast Skew-T for the time and place of interest.

- Using 1000-mb UGDF, plot a forecast LAWC for the time and place of interest.

- Refer to the section on *Gradient Winds* for use with the LAWC.

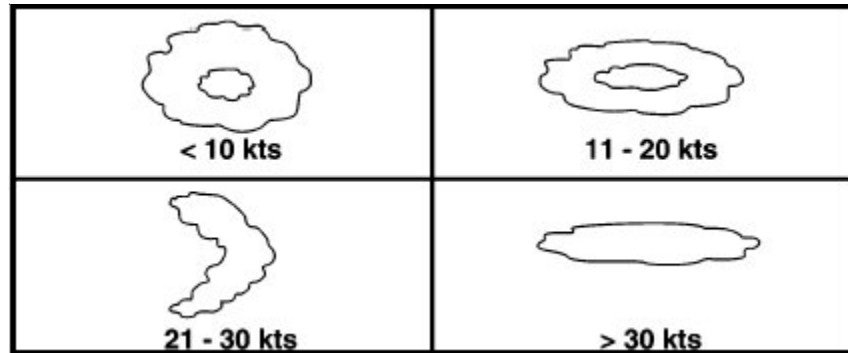
**10. Satellite-Derived Winds.** Satellite-derived low-level winds 5000 feet and below can be used to forecast surface winds. Although not as accurate as radiosonde winds, satellite-derived winds are useful in data-sparse areas. Bulletins are TWXNXX KWBC in the Northern Hemisphere and TWXSXX KWBC in the Southern Hemisphere.

- Extract low-level wind information from bulletins.

- See the *Gradient Winds* section for application rules.

**11. Satellite Imagery.** Low-level cloud patterns from satellite imagery are valuable in forecasting surface winds, especially in data-sparse oceanic areas. Best images to use are higher resolution (1 to 4 km) visible and infrared images. Keep in mind that the winds at cloud level may not be the same as the surface wind. Study the terrain of the satellite photo (using an atlas or tactical maps). Determine the type and shape of clouds, then use the following guidance:

**a. Open-Cell Cumulus.** (Refer to Figure 1-19.)



**Figure 1-19. Open-Cell Cumulus Shapes.** These formations are associated with straight-line or cyclonic flow.

- Associated with straight-line or cyclonic flow.

- Doughnut shape with a hole: less than 10 knots.

- Elongated doughnut shape: 11 to 20 knots.

- Arc shape: 21 to 30 knots.

- Solid elongated cloud: greater than 30 knots.

**b. Closed-cell Stratocumulus.**

- Associated with anticyclonic flow.

- Wind direction hard to determine by cloud alone. Use other clues.

- Wind speeds are generally less than 20 knots.

**c. Stratocumulus Lines**

- Seen off south or east coastlines or large lakes.

- Associated with cyclonic, anticyclonic, or straight-line flow.

- Wind almost parallel to cloud lines.

- The smaller the cloud elements, the stronger the winds. Visible separation between cloud elements indicates greater than 20 knots.

**d. Cumulus Lines or Streets.**

- Mainly in tropical and subtropical regions.
- Wind almost parallel to cloud lines.

**e. Smoke/Ash/Dust.**

- Seen at different levels.
- Sharp boundaries are upstream, diffuse boundaries are downstream.

**f. Leaside Clearing.** Indicates winds crossing ridgeline greater than 45°.

**g. Lakes in Summer.**

- Cumulus clouds dissipate as they move over cooler lakes.

- Cloud-free area occurs downstream over land, before clouds start developing.

**h. Lakes in Winter.**

- Colder, drier air moving over an unfrozen lake forms stratocumulus lines downstream over the lake and land.

- A cloud-free region often exists on the upstream side.

**i. Ice Packs on Large Lakes and Seas.** Persistent winds push the ice away from the upstream shore and pack it against the downstream shore.

**j. Bow Waves, Plume Clouds, and Von Karman Vortices.** Bow waves are found in front of an obstacle to the wind flow such as an island, and plume clouds and Von Karman vortices are found downstream of an obstacle in the in windflow.

**12. Elevation Effects.** A decrease of pressure and density of the air and decrease of friction with elevation, cause wind speeds on average increase about 1 to 2 knots for every 2000 feet above sea level. Table 1-14 shows the increase in wind speed

**Table 1-14. Increase of Wind Speed with Height.**

Elevation (ft)	Temperature °C (°F)	Surface Wind 35 (kts)	Surface Wind 50 (kts)
		Speed at altitude	Speed at altitude
2000	7 (44)	36	52
4000	4 (38)	37	54
6000	0 (32)	39	56
8000	-3 (26)	40	58
10000	-7 (20)	41	59
12000	-10 (14)	42	61
14000	-13 (8)	43	64



## Surface Winds

---

with elevation at specific temperatures. After making wind forecasts using other tools, adjust wind speeds for elevation using Table 1-14.

**13. Local Wind Effects.** After using the above general wind forecasting techniques, forecasters should fine-tune their wind forecasts based on local effects, many of which are described below.

**a. Drainage Winds.** This wind occurs at night with strong cooling and a very weak pressure gradient. Since cooler air is heavier than warmer air, it sinks to lower elevations in sloping terrain.

- Requires only a very shallow terrain slope and has occurred with slopes less than 200 feet.
- Speeds rarely exceed 2 to 3 knots.
- Occurs when surface ridging affects the area, so can be forecast using surface analysis or prognosis products.

**b. Mountain Breeze.** This breeze is simply a stronger case of drainage wind in a mountainous area. At night, radiation cools the mountainside air. As the cooler air becomes denser, it sinks toward the lower elevations and collects in the valleys.

- Speeds may reach 11 to 13 knots.
- The cooler air may become several hundred feet thick in the valley.
- Can be forecast using a sequence of surface analyses and prognosis products.

**c. Fall Wind.** Typically, this cold wind originates in snow-covered mountains under high pressure. The air on the snow-covered mountains is cooled enough so that it remains colder than the valley air despite adiabatic warming upon descent. Near the edges of the mountains, the cold air flows

rapidly through gaps and saddles down to the valley below. The *glacier wind*, one type of fall wind, is most noticeable during summer due to the large temperature differences. The *bora*, another type of fall wind, occurs mainly in Europe. It also occurs in North America when cold air flows down the eastern slopes of the Rockies in Alberta and Montana.

- The fall winds begin once the high pressure is in place.
- Channeled fall winds have been known to reach 100 knots for days at a time.
- Temperatures in the lower elevations may drop more than 11°C (20°F) when the breeze sets in.
- Can be forecast using a sequence of surface analyses and prognosis products.

**d. Valley Breeze.** These winds flow in the opposite direction to the mountain breeze described above. The valley breeze develops during the day as the mountain slopes rapidly become heated by the sun (more quickly than the protected valleys). Air from the valley then “slides” upward to replace the buoyant, heated air rising from the mountain slopes.

- The breeze averages about 13 knots.
- The stronger the heating, the stronger the wind. The early afternoon, therefore, is the most favorable time for the strongest winds.
- The best conditions for valley breeze development are clear skies and a weak synoptic pressure gradient.
- Can be forecast using a sequence of surface analyses and prognosis products.

**e. Foehn (Chinook) Wind.** This warm wind flows down the leeward side of mountains. The wind forms when moist air is forced to ascend on the windward side of a mountain and then descends on the leeward side. As the air rises on the windward side, it expands and cools at the relatively slow moist adiabatic cooling rate. The moisture in the air condenses into clouds (and precipitates out). As the now dry air descends on the leeward side, it is compressed and heated relatively quickly at the dry adiabatic heating rate. The result is a very strong, warm, and dry downslope wind.

- The winds start when strong winds aloft flow perpendicular to a mountain range. A leeside trough may form consequently, further forcing the air downslope.

- Look for clouds and precipitation on the windward side of the mountain range ending suddenly at or near the ridgeline in a “foehn wall”.

- Conditions associated with mountain-wave turbulence may also cause Chinooks. Lenticular clouds usually associated with mountain-wave turbulence may signal a Chinook.

- Temperatures may rise as much as 28°C (50°F) in a few minutes at the base of the mountains. Melting snow cover can cause flash flooding.

**f. Land and Sea Breezes.** Sea breezes blow onshore from sea to land during the day; land breezes blow offshore from land to sea during the night. These breezes result from the differential heating between land and water. During the day, land heats faster than water; cool air over the water flows in from the sea—as the sea breeze—to replace the warmer air rising over the land. At night, the opposite occurs: the warmer rising air over the ocean is replaced by cooler air from the land—the land breeze. In the sea and land breezes,

the return flow aloft often forms nearly closed circulation cells.

- Sea Breeze

- Occurs throughout the year in the tropics, mainly in the summer in higher latitudes.

- Begins to develop 3 to 4 hours after sunrise and peaks in the afternoon; the wind is gusty and may be variable.

- Circulation often extends 12 miles over land and water, (35 to 45 miles is not unusual).

- The depth of the circulation varies from 13,000 feet in the tropics to 3,000 feet in higher latitudes.

- Best conditions are a weak pressure gradient and clear skies, allowing strong heating.

- If the ocean temperature just offshore is unusually cold, fog or low stratus clouds may accompany the sea breeze. The fog and stratus, however, generally dissipate rapidly over the warm land.

- Horizontal convergence and convection (forming a sea-breeze front) may mark sea breezes farthest penetration inland.

- Can be forecast using a sequence of surface analyses and prognosis products.

- Land Breeze

- Much weaker than the sea breeze, with smaller horizontal and vertical dimensions.

- Normally begins shortly before midnight and peaks near sunrise.

**Surface Winds**

**C. Specialized Airfield Operations Topics.**

**1. Runway Crosswinds.** A crosswind is the wind component directed perpendicular to a runway. Winds parallel to a runway have zero crosswind component, regardless of speed, while winds perpendicular to the runway have a crosswind component equal to their actual wind speeds (use the maximum sustained wind or gust, whichever is greater). AFW weather organizations will use the maximum wind gust in the most unfavorable direction for computing the effective crosswind component. Crosswind component values can be calculated using the following technique:

- **Step 1.** Determine the absolute (positive) difference in degrees between the direction of the runway heading and the direction (magnetic) of the actual wind (e.g., runway orientation is 030°/210°; wind direction is 090°). Difference off runway is 60° (90° - 30° = 60°).

- **Step 2.** Using Table 1-15, relate this direction difference to the actual wind speed to find the crosswind component.

**2. Low-Level Wind Shear.** Wind shear is a change in wind direction, wind speed, or both, along a given direction in space (e.g., along a horizontal or vertical distance). The strongest wind shears are associated with abrupt changes in wind direction and/or speed over a short distance. The Doppler radar VAD wind profile and other velocity products combined with surface observations and rawinsonde data can help identify areas of low-level wind shear. Low-level wind shear is particularly hazardous to aviation operations: it occurs so close to the surface that pilots often do not have enough time to compensate for its effects. Wind shear is often associated with fronts, inversions, and thunderstorms. The decision table in Figure 1-20 is adapted from British Meteorological Office and Continental Airlines low-level wind shear rules. The conditions are not all inclusive and local effects (e.g., mountain waves, local terrain, etc.) are not addressed.

**Table 1-15. Crosswind Component Table.** Speed (kts) angle between wind direction and heading.

Speed (kts)	Angle between wind direction and heading (°)								
	10	20	30	40	50	60	70	80	90
5	1	2	3	3	4	4	5	5	5
10	2	3	5	6	8	9	9	10	10
15	3	5	8	10	11	13	14	15	15
20	3	7	10	13	15	17	19	20	20
25	4	9	13	16	19	22	23	25	25
30	5	10	15	19	23	26	28	30	30
35	6	12	18	22	27	30	33	34	35
40	7	14	20	26	31	35	38	39	40
45	8	15	23	29	34	39	42	44	45
50	9	17	25	32	38	43	47	49	50
55	10	19	28	35	42	48	52	54	55
60	10	21	30	39	46	52	56	59	60
65	11	22	33	42	50	56	61	64	65
70	12	24	35	45	54	61	66	69	70
75	13	26	38	48	57	65	70	74	75
80	14	27	40	51	61	69	75	79	80
85	15	29	43	55	65	74	80	84	85
90	16	31	45	58	69	78	85	89	90
95	16	32	48	61	73	82	89	94	95

**Note:** The gradient level is assumed to be 2,000 feet above the station. The vector wind difference mentioned in Figure 1-20, line 10, is obtained from Tables 1-16 a through g.

- **Step 1.** Determine the absolute angular difference between the two winds on opposite sides of a front approximately 50 NM apart (e.g., Wind A = 03011, wind B = 11019, Difference = 110 - 30 = 80°).

- **Step 2.** Select the table that corresponds to the angular difference (See Table 1-16a-g: 77.6° to 102.5°).

- **Step 3.** Enter the table and apply wind speed A and B (round to the nearest 5 knots). Vector difference is the intersection of Speed A and B (e.g., Speed A = 11 rounded to 10 knots. Speed B = 19 rounded to 20 knots. Vector difference is 22 knots).

1. Are thunderstorms forecast or observed within 10 NM?	Yes, LLWS assumed. No, go to step 2.
2. Is there a low-level jet below 2000 ft?	Yes, LLWS assumed. No, go to step 3.
3. Is the sustained surface wind speed 30 kts or greater?	Yes, forecast LLWS. No, go to step 4.
4. Is the surface wind speed 10 kts or greater?	Yes, go to step 5. No, go to step 6.
5. Is the difference between the gradient wind speed and two times the surface wind speed 20 kts or greater?	Yes, forecast LLWS. No, go to step 9.
6. Is there an inversion or isothermal layer below 2000 ft?	Yes, go to step 7. No, go to step 8.
7. Is the value of the vector difference between the gradient wind and the surface wind 30 kts or greater?	Yes, forecast LLWS. No, go to step 9.
8. Is the value of the vector difference between the gradient wind and the surface wind 35 kts or greater?	Yes, forecast LLWS. No, go to step 9.
9. Is a surface front present or forecasted to be in the area?	Yes, go to step 10. No, go to step 13.
10. Is the vector difference across the front equal to or greater than 20 kts over 50 NM (see Table 1-14)?	Yes, forecast LLWS. No, go to step 11.
11. Is the temperature gradient across the front 5°C (10°F) or more per 50 NM?	Yes, forecast LLWS. No, go to step 12.
12. Is the speed of movement of a front 30 kts or more?	Yes, forecast LLWS. No, go to step 13.
13. Located over mountainous terrain?	Yes, go to step 14. No, go to step 15.
14. Do the following conditions exist? a. Cloud bases > 8000 ft AGL. b. Surface temperatures > 27°C (80°F). c. Surface temperatures/dew point spread greater than 23°C (40°F). d. Virga/convective activity within 10 NM of runway approach.	Yes, forecast LLWS. No, go to step 15.
15. Forecast no significant low-level wind shear.	

**Figure 1-20. Low-Level Wind Shear Decision Tree.** Local effects are not addressed.

**Surface Winds**

**Table 1-16a-g. Difference of Direction.**

**(a) 0° to 12.5°**

		Speed B										
		5	10	15	20	25	30	35	40	45	50	
Speed A	5	0	5	10	15	20	25	30	35	40	45	50
	10	5	1	5	10	15	20	25	30	35	40	45
	15	10	5	1	5	10	15	20	25	30	35	40
	20	15	10	5	2	5	10	15	20	25	30	35
	25	20	15	10	5	2	5	10	15	20	25	30
	30	25	20	15	10	5	3	6	10	15	20	25
	35	30	25	20	15	10	6	3	6	10	15	20
	40	35	30	25	20	15	10	6	4	6	11	15
	45	40	35	30	25	20	15	10	6	4	7	11
	50	45	40	35	30	25	20	15	11	7	5	11

**(d) 77.6° to 102.5°**

		Speed B									
		5	10	15	20	25	30	35	40	45	50
Speed A	5	7	11	15	20	25	30	35	40	45	50
	10	11	14	18	22	26	31	36	41	46	50
	15	15	18	21	25	29	33	38	42	47	52
	20	20	22	25	28	32	36	40	44	49	53
	25	25	26	29	32	35	39	43	47	51	55
	30	30	31	33	36	39	42	46	50	54	58
	35	35	36	38	40	43	46	49	53	57	61
	40	40	41	42	44	47	50	53	56	60	64
	45	45	46	47	49	51	54	57	60	63	67
	50	50	50	52	53	55	58	61	64	67	70

**(b) 12.6° to 45°**

		Speed B									
		5	10	15	20	25	30	35	40	45	50
Speed A	5	2	6	10	15	20	25	30	35	40	45
	10	6	4	7	12	16	21	26	31	36	41
	15	10	7	7	9	13	18	23	27	32	37
	20	15	12	9	9	12	15	19	24	29	33
	25	20	16	13	12	12	14	17	21	26	30
	30	25	21	18	15	14	14	16	19	23	27
	35	30	26	23	19	17	16	17	19	22	25
	40	35	31	27	24	21	19	19	19	21	24
	45	40	36	32	29	26	23	22	21	22	24
	50	45	41	37	33	30	27	25	24	24	24

**(e) 102.6° to 135°**

		Speed B									
		5	10	15	20	25	30	35	40	45	50
Speed A	5	8	13	17	22	27	32	37	42	47	52
	10	13	17	21	26	31	35	40	45	50	55
	15	17	21	25	30	34	39	44	49	53	58
	20	22	26	30	34	38	43	47	52	57	62
	25	27	31	34	38	43	47	51	56	61	65
	30	32	35	39	43	47	51	56	60	65	69
	35	37	40	44	47	51	56	60	64	69	73
	40	42	45	49	52	56	60	64	68	73	77
	45	47	50	53	57	61	65	69	73	77	81
	50	52	55	58	62	65	69	73	77	81	86

**(c) 45.1° to 77.5°**

		Speed B									
		5	10	15	20	25	30	35	40	45	50
Speed A	5	5	8	13	18	23	27	32	37	42	47
	10	8	10	13	17	22	26	31	36	41	46
	15	13	13	15	18	22	26	30	35	40	44
	20	18	17	18	20	23	26	30	35	40	44
	25	23	22	22	23	25	28	31	35	39	43
	30	27	26	26	26	28	30	33	36	40	44
	35	32	31	30	30	31	33	35	38	41	45
	40	37	36	35	35	35	36	38	40	43	46
	45	42	41	40	39	39	40	41	43	45	48
	50	47	46	44	44	43	44	45	46	48	50

**(f) 135.1° to 167.5°**

		Speed B									
		5	10	15	20	25	30	35	40	45	50
Speed A	5	9	14	19	24	29	34	39	44	49	54
	10	14	19	24	29	34	39	44	49	53	58
	15	19	24	29	33	38	43	48	53	58	63
	20	24	29	33	38	43	48	53	58	63	68
	25	29	34	38	43	48	53	58	63	67	72
	30	34	39	43	48	53	58	62	67	72	77
	35	39	44	48	53	58	62	67	72	77	82
	40	44	49	53	58	63	67	72	77	82	87
	45	49	53	58	63	67	72	77	82	87	92
	50	54	58	63	68	72	77	82	87	92	96

**(g) 167.6° to 180°**

		Speed B									
		5	10	15	20	25	30	35	40	45	50
Speed A	5	9	14	19	24	29	34	39	44	49	54
	10	14	19	24	29	34	39	44	49	54	59
	15	19	24	29	34	39	44	49	54	59	64
	20	24	29	34	39	44	49	54	59	64	69
	25	29	34	39	44	49	54	59	64	69	74
	30	34	39	44	49	54	59	64	69	74	79
	35	39	44	49	54	59	64	69	74	79	84
	40	44	49	54	59	64	69	74	79	84	89
	45	49	54	59	64	69	74	79	84	89	94
	50	54	59	64	69	74	79	84	89	94	99

Rules of thumb for low-level wind shear associated with a variety of meteorological causes are given below:

**a. Cold Frontal Boundary.** Low-level wind shear exists below 5,000 feet for up to 2 hours

behind a fast moving front. The potential persists until the depth of the cold air reaches the gradient level.

**b. Warm Frontal Boundary.** Low-level wind shear exists below 5,000 feet for up to 6 hours ahead

of a surface front; it terminates with warm front passage. Pilot Reports (PIREPs) are invaluable for forecasting Low-level wind shear in warm front situations. Strong vertical wind shears are usually accompanied by turbulence when the shear occurs in a (thermally) stable air mass.

**c. Low-Level Inversions.** Shear occurs in these inversions with a light surface wind and a strong gradient level (2,000 feet) wind. Always look for strong winds aloft (from Skew-T) when an inversion forms or is forecast to form. This frequently occurs under stable air mass conditions; usually at night, early morning, or evening, when the isobaric gradient supports strong winds (see surface analysis or prognosis).

**d. Thunderstorm Gust Front.** A thunderstorm gust front is a cold outflow from a thunderstorm that forms a mesoscale frontal boundary at the base of the storm. Wind speeds and directions associated with the gust front are variable and hard to predict. The best way to forecast this feature is to identify it with the Doppler radar. Low angle reflectivity products can often identify the gust front and velocity products can identify the wind speeds and wind direction associated with the gust front. Crosscheck your radar information with surface observations.

**e. Low-level Jet.** Low-level jets are bands of air in the boundary layer that are flowing faster than the overall environmental wind.

- They are especially common in the United States Central Plains states in summer, mostly during night or early morning hours, and are a transport mechanism for gulf moisture.

- A low-level jet wind speed profile is typically calm to 8 knots at the surface with a speed increase to 25 to 40 knots or more at 650 to 1,500 feet above ground level. Speed then decreases with height above 1,500 feet to approach the gradient level wind speed of 15 to 30 knots.

- They occur above very stable air; the core of the jet is just above the top of the inversion layer.

- Other favored areas include:

- Desert coastal regions, especially in coastal areas with cold upwelling currents.

- Over equatorial upwelling currents.

- Border of heat troughs.

- Sharply defined zones of heavy rain (e.g., the backside of strong United States Midwest thunderstorms).

- The most extensive and intense low-level jets occur over the western Indian Ocean, southern Iraq and the Persian Gulf, during the Northern Hemisphere summer Indian monsoon.

- Extend from east of Madagascar across eastern Somalia to India.

- Speeds may exceed 60 knots at a core height of 5,000 feet.

- Low-level jets occur along west coasts of South America, south of the equator and in Namibia.

- Found between 800 feet and 5,000 feet in the tropics.

- May be 5,000 to 15,000 feet aloft in mountainous areas.

**f. Mountain-Wave Conditions.** Under certain conditions, wind flowing across mountain chains can start flowing in an up and down motion similar to waves in the ocean. These waves in the wind flow are called mountain waves. They can have high crests (amplitude) that cause strong turbulence for aircraft and deep troughs that reach the ground and cause strong winds and wind shear

## Temperature

---

at an airfield miles downwind from the mountain chain. Wind speeds experienced at the surface can be as strong as the wind speed experienced at the mountaintop. The distance away from the mountain chain where the wave reaches the surface varies according to the distance between the crests in the waves (wavelength) in the mountain wave pattern. The nature of the mountain range and many other factors influence the shape, strength, and pattern of the waves. This makes forecasting mountain waves very challenging but consider the following in your forecast.

Mountain waves are sometimes seen on satellite imagery as a series of cloud lines downwind and parallel to the mountain range. The cloud lines are perpendicular to the wind flow.

Mountains with a steep leeward and gentle windward slopes create the largest amplitude mountain waves.

Winds flowing within 30 degrees of perpendicular to the ridgeline are more favorable for generating mountain waves. Also, a wind speed at the crest of about 25 knots increasing with height is more favorable for generating mountain waves. (25 knots is a generalization. The actual wind speed needed may vary from only 14 knots up to 30 knots depending on the shape of the mountains.)

Another important factor for mountain wave formation is upstream stability. Look for upstream temperature profiles that exhibit an inversion or a layer of strong stability near mountain top height, with weaker stability at higher levels.

**IV. TEMPERATURE.** Temperature forecasts are one of the most common weather forecast requests. The temperature can have a greater influence on

ground operations and daily life than any other single element. The most commonly required temperature forecasts are for maximums and minimums, post frontal, and critical temperatures for wind chills and heat stress. Many variables influence temperature changes; e.g., insolation, radiation, mixing, advection, convection, and adiabatic processes. This chapter covers specific techniques to help forecast this important surface weather element.

### ***A. General Temperature Forecast Tools.***

**1. Climatology.** Climatology is a common method used for forecasting temperatures. In most locations, decades worth of weather data are used to derive the climatology. This climatology, or weather trends over a period, is an important ingredient to temperature forecasting. Several sources for climatological data are available from the Air Force Combat Climatology Center (AFCCC), including the following:

**a. Wind-stratified Conditional Climatology Tables (WSCC).** The tables display monthly and annual climatology data to include maximum, mean, and minimum diurnal temperatures. They also give percent frequency of occurrence of past hourly observations for specified weather categories of ceiling and visibility, stratified by surface wind direction.

**b. International Station Meteorological Climate Summary (ISMCS).** ISMCS is a jointly developed USN/NOAA/USAF CD-format climatological tool that contains station climatic summaries.

**c. Surface Observation Climatic Summaries (SOCS).** Each SOCS summarizes surface hourly observations and “summary of day” data for a given

weather station. SOCS output include observed atmospheric phenomena/precipitation: snowfall, snow depth, surface wind, ceiling, visibility, sky cover, temperature, relative humidity, pressure, crosswind summaries, and degree days. Upon request, analysts can update existing SOCS for stations with five or more years of records.

**d. Modeled Diurnal Curves (MODCURVES).** MODCURVES provide monthly summaries of temperatures, dewpoint, altimeter setting, relative humidity, and pressure altitude changes by hour for stations with representative numbers of (>20,000) surface observations. The product includes four wind sectors and two sky cover categories displayed in graphic and tabular form.

**Note:** These aids are available through the Air Force Combat Climatology Center's website.

**2. Model Output Statistics (MOS).** MOS guidance is an excellent tool to help forecast temperatures. MOS guidance derives its forecasting relationships by correlating past model output with station climatology. It is imperative to initialize and verify the model before using its MOS.

**a. Maximum/Minimum Temperatures (MX/MN).** View displayed guidance for projections of 24, 36, and 48 hours after the initial data time (0000 UTC or 1200 UTC analysis time).

**b. Hourly Temperatures (TEMP).** Time-specific, two-meter temperature forecasts are valid every 3 hours from 6 to 60 hours after 0000 and 1200 UTC. Two meters is the height of most temperature measuring instruments, so it is used in the computations.

**3. Persistence.** Persistence often works well for forecasting temperatures. Simply take high and low temperatures from the previous day and compare the current synoptic situation with that of the previous day. If there have been no changes in either the air mass or the general weather (clouds, winds, etc.), this technique works accurately from day to day until changes do occur.

**4. Extrapolation.** This technique refers to the forecasting of a weather feature based solely on past motions of that feature. To use extrapolation techniques in short-range forecasting, it is necessary to be familiar with the positions of fronts and pressure systems, their direction and speed of movement, precipitation and cloud patterns that might affect the local terminal, and the upper-level flow that affects the movement of these weather patterns.

**Step 1.** Determine the air mass that is over the region during the forecast time of interest.

**Step 2a. Maximum temperature forecasting.** Check the high temperatures in that air mass for the preceding days.

**Step 2b. Minimum temperature forecasting.** Check the low temperatures in that air mass for the preceding nights.

**Step 3.** Account for adiabatic changes. If the air is rising (upslope trajectory), subtract 1° to 3°C (1.8° to 5.4°F) (based on moist or dry adiabatic lapse rate) for every 1,000 feet of ascent to allow for adiabatic cooling of the parcel as it rises. If the flow is downslope, add 1° to 3°C (1.8° to 5.4°F) for the corresponding ascent.



**Temperature**

**Step 4.** Remember to allow for modifications of the air mass, such as expected cloud cover, winds, and precipitation.

**5. Temperature Forecasting Checklist.** As with all meteorological parameters, temperature forecasting is easier when a routine approach is employed. Figure 1-21 is an example of a typical temperature-forecasting checklist. Add other key items that work well.

**B. Forecasting Max Temperatures.**

**1. Within an Air Mass.** Use the following steps to forecast maximum temperatures:

**Step 1.** Examine the current analysis and prognosis products to determine the source of the air mass expected over the station at verification time. Select a station 24 hours upstream and use its previous day's maximum temperature as a first guess for the forecast.

**Step 2.** Modify the first estimate for adiabatic effects by determining the elevation difference between the two stations (5.3°F/1000 ft).

**Step 3.** Make a cloud cover forecast for the station, compare it to the cloud cover at the upstream station, and determine the difference in effects of insolation. Use diurnal temperature curves that consider cloud cover (such as MODCURVES) to make a final temperature forecast.

**2. Using the Skew-T, Log P Diagram.** Calculations for the maximum temperature on the Skew-T should be done using the early morning, or cool, sounding for the day. For continental United States locations, this is normally done with the 1200Z plotted on a Skew-T. Of course, many of us are not stationed in CONUS, and we have to use the available sounding that comes closest to the coolest part of the day, during the period near sunrise. In order to calculate the maximum expected temperature for the day, you must first determine if the day will be cloudy, with little solar insolation received at the surface, or sunny, with a great deal of solar insolation received at the surface.

Analysis of the current clouds and expected cloud development on the Skew-T should provide this information. If the day is expected to be mostly sunny, follow a dry adiabat from your 850-millibar temperature to the surface pressure level and read

<b>TEMPERATURE GUIDE</b>			
CLIMATOLOGY	EXTREME	MAX _____	MIN _____
	AVERAGE	MAX _____	MIN _____
YESTERDAY'S		MAX _____	MIN _____
FRONTAL PASSING		YES _____	NO _____
NWS CHART (or equivalent)		MAX _____	MIN _____
MOS BULLETIN (or equivalent)		MAX _____	MIN _____
REPRESENTATIVE SKEW-T		MAX _____ AT _____	MIN _____ AT _____
YOUR FORECAST		MAX _____ AT _____	MIN _____ AT _____

**Figure 1-21. Temperature Forecasting Checklist Sample.** Add other key items that work well.

the temperature at the intersection. For mountainous areas and high elevations, you should adjust the procedure to start at a pressure level about 5,000 feet above the surface. If the day is expected to be mostly cloudy (broken-to-overcast cloud cover), follow a moist adiabat from the 850-millibar level (or 5,000-foot AGL pressure level) to the surface pressure level and read the temperature at the intersection. See Figure 1-22 for examples of the maximum temperature computations for sunny and cloudy conditions.

In summer air mass situations, strong radiation inversions routinely develop. If your plotted morning Skew-T shows a radiation inversion with a top between 4,000 and 6,000 feet, you should use the temperature at the top of the inversion (the warmest point in the inversion) as the starting point in the computation, instead of the 850-millibar temperature.

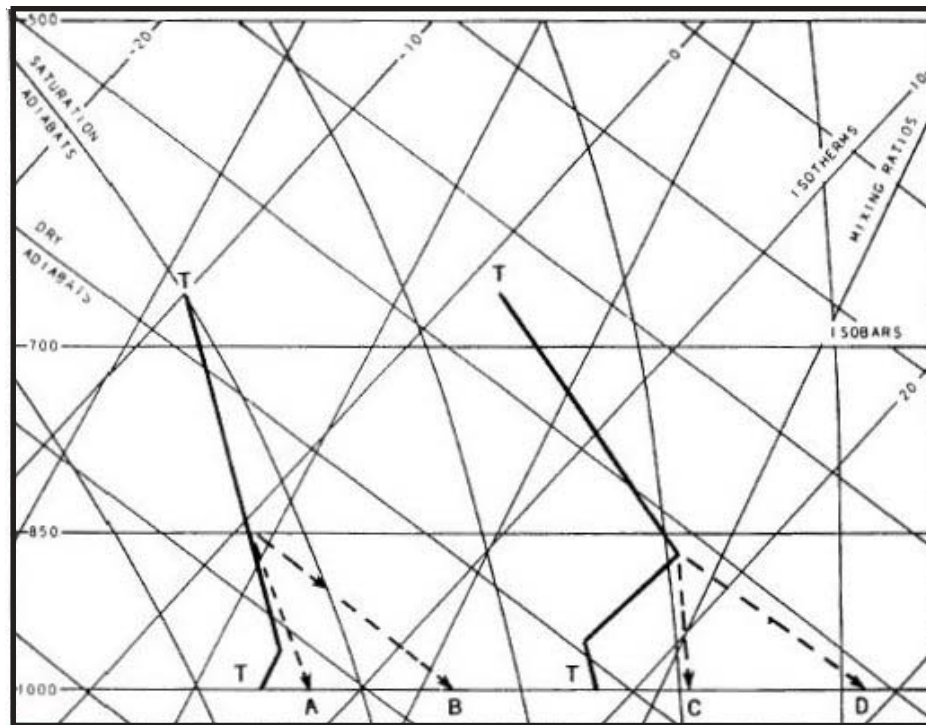
### 3. When a Warm Front Approaches.

**Step 1.** Forecast an 850-mb temperature (700-mb if local surface is above the 850-mb level), considering temperature advection at that level.

**Step 2.** Follow the dry adiabat from the 850-mb or 5,000 feet temperature down to the surface. Use 700-mb if the station elevation is above the 850-mb level.

**Step 3.** Read the temperature at the surface as a good first guess at the afternoon maximum temperature.

*d. When a Low-Level Inversion is Present.* This method is most effective under cloud-free or scattered sky conditions in late spring or early autumn.



**Figure 1-22. Computation of Maximum Temperature.** With no inversion 4,000 to 6,000 feet and (A) mostly cloudy skies (B) mostly clear skies; with an inversion between 4,000 to 6,000 feet and (C) mostly cloudy skies (D) mostly clear skies.

## Temperature

---

**Step 1.** Use the top of a nocturnal surface inversion (warmest part of the inversion).

**Step 2.** Follow the dry adiabat to the surface.

**Step 3.** Read the temperature at the surface as an estimate of the afternoon maximum temperature.

### C. Minimum Temperature Forecasts.

**1. Using the Skew-T, Log P Diagram.** One method to forecast the minimum temperature is by following the moist adiabat passing through the 850-mb dew-point temperature to the surface. This method requires an unchanging air mass from the time of the sounding to the forecast valid time. Use a forecast sounding if atmospheric changes are expected. Use 700-mb if station elevation is above the 850-mb level.

**2. Using Dew Point.** Use the dew point at the time of the maximum temperature as a forecast minimum temperature for the following night. If skies are clear and winds are calm, minimum temperatures may be 2° to 4°C (3.6° to 7.2°F) lower than the afternoon dew point from September through March at all stations located on flat terrain or valley floors. This technique does not take into account air mass changes.

**3. After Cold Frontal Passage.** Forecast the coldest minimum temperature the second morning after a cold front passes. This rule works well when the typical cold front is considered. A cold front passes during the afternoon, and cold advection starts with the shift of the wind to northwest. Cold-air advection continues through the night and into the next day. At minimum temperature time, the north wind is still blowing, but at a lower speed than earlier. Cold advection continues during the second day, but it is not as strong. By the second morning, the high is centered near or over the station. With little wind and little or no temperature advection, the minimum temperature is colder than

the morning before. During the second day, the high moves east and warm advection begins. The third morning's minimum temperature is generally warmer than the second.

### D. Some Additional Rules of Thumb.

**1. Forecasting with Limited Data.** It is possible to make an accurate temperature forecast from the information available in most weather stations.

- Combine station and area climatology with a thorough knowledge of the local terrain and its effects on weather to understand physical processes controlling local weather.

- Obtain upper-air sounding data if possible.

- T1 on the MM5 Output Bulletin is the forecasted temperature at 500 feet AGL. This temperature takes diurnal effects into consideration and is a good approximation of the surface temperature. Be sure and initialize and verify the model so that you can make needed adjustments.

- Some tips to consider if surface observations are the primary or only tool:

- Get out a piece of paper and plot hourly temperatures and dew points (time on the X-axis and temperature on the Y-axis) to establish station diurnal trend curves. It may take several days to establish a firm pattern, but this is an excellent limited-data, temperature-forecasting tool.

- Use the dew point at the time of the maximum temperature as the forecast minimum temperature for the following night if skies are primarily clear and no change in air mass is expected.

- Subtract the average diurnal variation for the month from the maximum temperature to estimate a minimum temperature when little change is expected in the cloud cover or air mass. Add it

to the minimum temperature for estimating the maximum temperature.

- The moistness or the dryness of the ground affects heating of the ground. Solar radiation evaporates moisture in or on the ground first, before heating the surface. This inhibits the daytime maximum heating. A wet soil heats up and cools down much slower than a dry soil.

- Snow cover significantly affects daytime heating of the ground and therefore the air. Expect lower temperatures if there is snow cover. Air masses advected over an area with snow cover cool if the air mass is warmer than the ground. Snow reflects solar radiation and limits surface heating.

- Light winds allow for increased heating during the day. Wind speeds of over 10 knots decrease the daily maximum temperature by 1°C (2°F) or more due to the turbulent mixing down of cooler air from aloft. For surface winds above 35 knots, the high temperature is as much as 3°C (5°F) lower.

- Moisture decreases the daily temperature range. For example, the spread between daily maximum and minimum temperatures ranges from only 3° to 5°C (5° to 10°F) in a wet-season tropical forest to over 28°C (50°F) in dry, interior deserts.

- Pressure trends help forecasters anticipate approaching fronts. Plotting hourly pressures allows diurnal pressure curves to be established.

Large variations from the norm could indicate approaching frontal systems or pressure centers.

**Note:** *AWS/FM-300/1, Single Station Analysis and Forecasting*, contains trends and typical cloud types associated with approaching fronts.

**2. High Winds and Cooling.** High winds retard cooling due to turbulent mixing. At night, due to more rapid cooling of the air in the lowest levels, the air mixed down is warmer than air near the ground surface. One rule of thumb is to add 1°C (2°F) to the low temperature forecast if the winds are to be around 15 knots. Add up to 3°C (5°F) for winds of 35 knots or greater. This technique does not consider warm- or cold-air advection.

**3. Humidity and cooling.** High relative humidity (80 percent or greater) in the low-levels may inhibit cooling, because moisture is an efficient long-wave heat trapper. A humid night may sometimes be 3°C (5°F) warmer than a drier night. This rule is especially important if situated near a large body of water.

### ***E. Temperature Indices.***

**1. Temperature-Humidity Index (THI).** To accurately express the comfort or discomfort caused by the air at various temperatures; it is necessary to take into account the amount of moisture present. The National Weather Service uses the THI to gauge the impact of the environment on humans. The formula for completing the index is:

**Table 1-17. Temperature-Humidity Index (THI) conditions.**

THI °C (°F)	Conditions
22 (72)	Slightly uncomfortable conditions
24 (75)	Discomfort becomes acute and most people would use air conditioners, if available
>26 (79)	Discomfort is general and air conditioning is highly desirable

**Note:** This table was formulated in °F and includes °C as a reference only.

**Temperature**

$$THI = 0.4(T + T_w) + 15.0$$

where: T is the dry-bulb temperature and  $T_w$  is the wet-bulb temperature. Both are in °F. Use Table 1-17 to determine THI.

**2. Heat Index.** The heat index, also known as apparent temperature, is the result of extensive bioenvironmental studies. Determine the heat index by inputting air temperature and relative humidity into Figure 1-23. Like the THI, it

considers the combined effects of high air temperatures and atmospheric moisture on human physiology.

**3. Wet-bulb Globe Temperature (WBGT) Heat Stress Index (Table 1-18).** The Wet-Bulb Globe Temperature (WBGT) was developed because the dry-bulb (free air) temperature alone does not provide a realistic guide to the effects of heat—the dry bulb does not take humidity and heat radiation into effect. The computation of the WBGT

General Heat Stress Index										
Danger Category	Apparent Temperature (°F) (Humiture)		Heat Syndrome							
IV. Extreme Danger	>130°		Heatstroke or sunstroke imminent							
III. Danger	105° - 130°		Sunstroke, heat cramps, or heat exhaustion likely. Heatstroke possible with prolonged exposure and physical activity.							
II. Extreme Caution	90° - 105°		Sunstroke, heat cramps, and heat exhaustion possible with prolonged exposure and physical activity.							
I. Caution	80° - 90°		Fatigue possible with prolonged exposure and physical activity.							
Note: Degree of heat stress may vary with age, health, and body characteristics.										
TEMPERATURE °F	Relative Humidity									
		10%	20%	30%	40%	50%	60%	70%	80%	90%
	104	98	104	110	120	>130	>130	>130	>130	>130
	102	97	101	108	117	125	>130	>130	>130	>130
	100	95	99	105	110	120	>130	>130	>130	>130
	98	93	97	101	106	110	125	>130	>130	>130
	96	91	95	98	104	108	120	128	>130	>130
	94	89	93	95	100	105	111	122	128	>130
	92	87	90	92	96	100	106	115	122	128
	90	85	88	90	92	96	100	106	114	122
	88	82	86	87	89	93	95	100	106	115
	86	80	84	85	87	90	92	96	100	109
	84	78	81	83	85	86	89	91	95	99
	82	77	79	80	81	84	86	89	91	95
	80	75	77	78	79	81	83	85	86	89
	78	72	75	77	78	79	80	81	83	85
76	70	72	75	76	77	77	77	78	79	
74	68	70	73	74	75	75	75	76	77	

**Figure 1-23. Heat Index.** Enter this temperature/humidity nomogram with observed or forecast data to predict apparent temperature and effect on people.

**Table 1-18. WBGT table.** This table was formulated in °F and includes °C as a reference only.

WBGT °C (°F)	Water intake (quarts per hour)	Work/rest cycle (minutes)
28 - 29 (82 - 84.9)	at least ½	50/10
29 - 31 (85 - 87.9)	at least 1	45/15
31 - 32 (88 - 89.9)	at least 1 ½	30/30
> 32 (> 90)	more than 2	20/40

involves 3 thermometers and is normally determined and disseminated by medical or disaster preparedness personnel and not AFW personnel. However, AFW personnel should know what is involved in computing it. The WBGT is computed by adding 70 percent of the wet-bulb temperature, 20 percent of the black globe temperature and 10 percent of the dry-bulb temperature. Army FM 34-81, *Weather Support for Army Tactical Operations*, lists WBGTs of more than 30°C (86°F) as a critical meteorological value for Army operations.

The formula is:

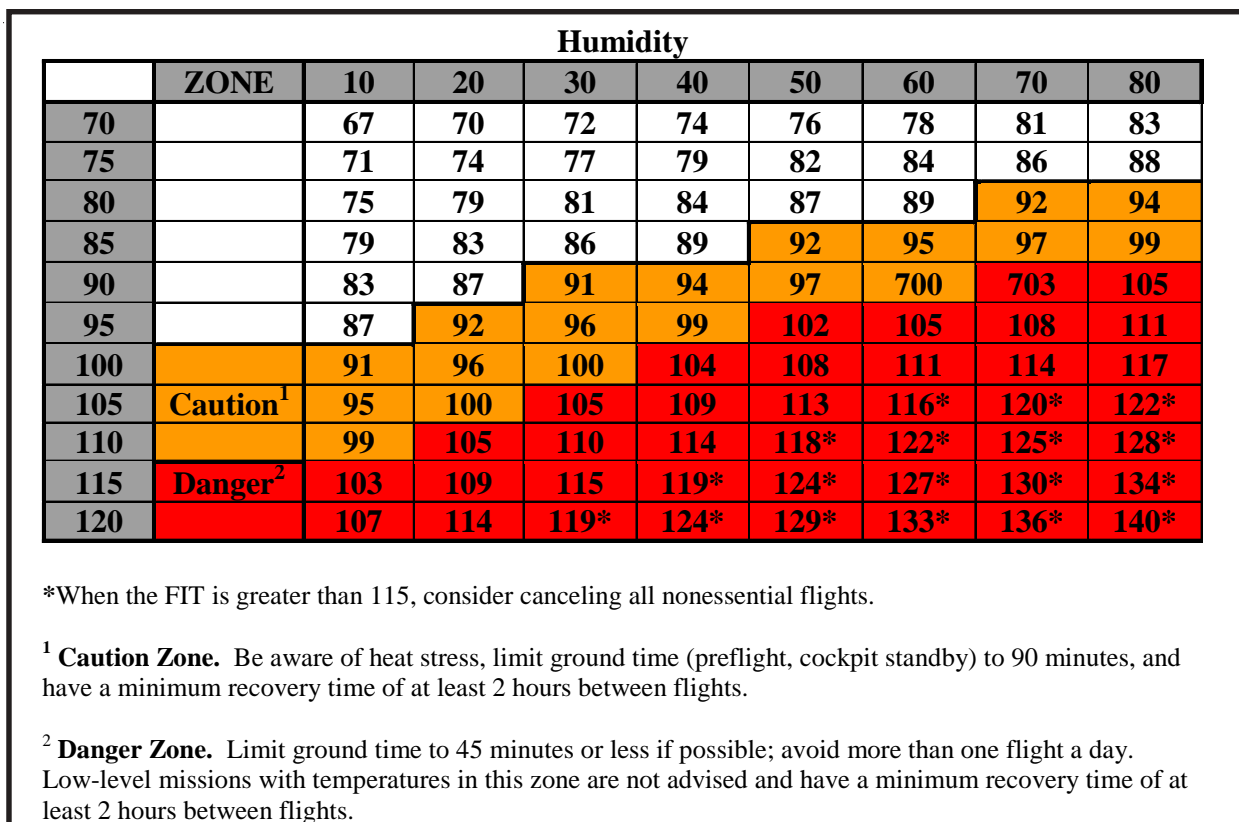
$$\text{WBGT} = 0.7 \text{ WB} + 0.2 \text{ BG} + 0.1 \text{ DB}$$

where: WB = Wet-bulb temperature in °F, BG = Black-globe temperature in °F, and DB = Dry-bulb temperature in °F.

**Note:** Wear of heavy body armor or NBC gear adds 6° C (11° F) to WBGT activity.

**4. Fighter Index of Thermal Stress (FITS).**

This index is only one of many used to support Air Force flying activities but may possibly be one of the most requested. It was developed by the former Tactical Air Command Surgeon General specifically for F-4 Phantom aircraft, and uses the Heat Index Equation. This technique is best suited for predicting the effects of heat on personnel in lightweight flight suits. (See Figure 1-24.)



**Figure 1-24. Fighter Index of Thermal Stress (FITS) Chart.** Enter the figure with the local air temperature in °F and relative humidity. At the intersection, read the FITS value and determine the zone.

**Temperature**

5. **Wind Chill.** Wind chill is one of the more frequently asked questions during the winter months. Wind-chill temperature is a temperature index that combines the effects of low air temperatures with additional heat losses caused by the wind's removal of the warm layer of air trapped

in contact with skin. The faster the wind blows, the faster the layer of warm air is carried away. To calculate the observed or forecast wind-chill temperature, simply enter the forecast temperature and the forecast wind speed(2-minute average, not gusts) into one of the charts (Figures 1-25 through 1-30).

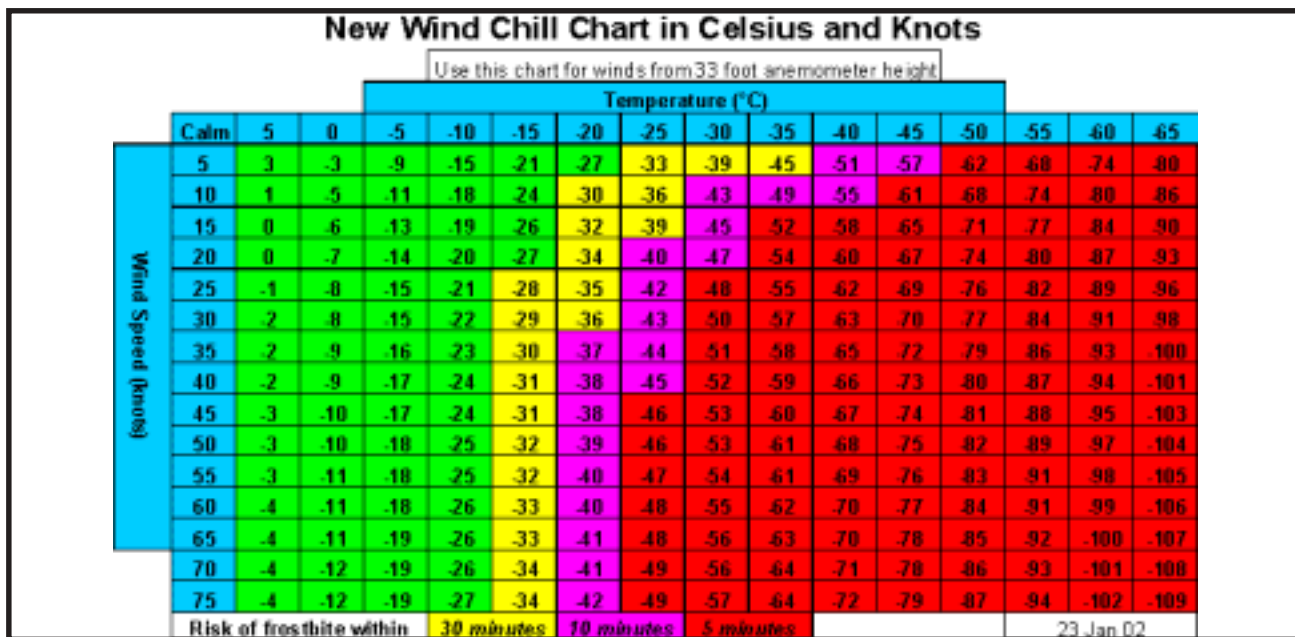


Figure 1-25. Wind Chill Temperature (WCT) Index Chart with 33-Foot Garrison—Anemometer Height (degrees Celsius and knots).

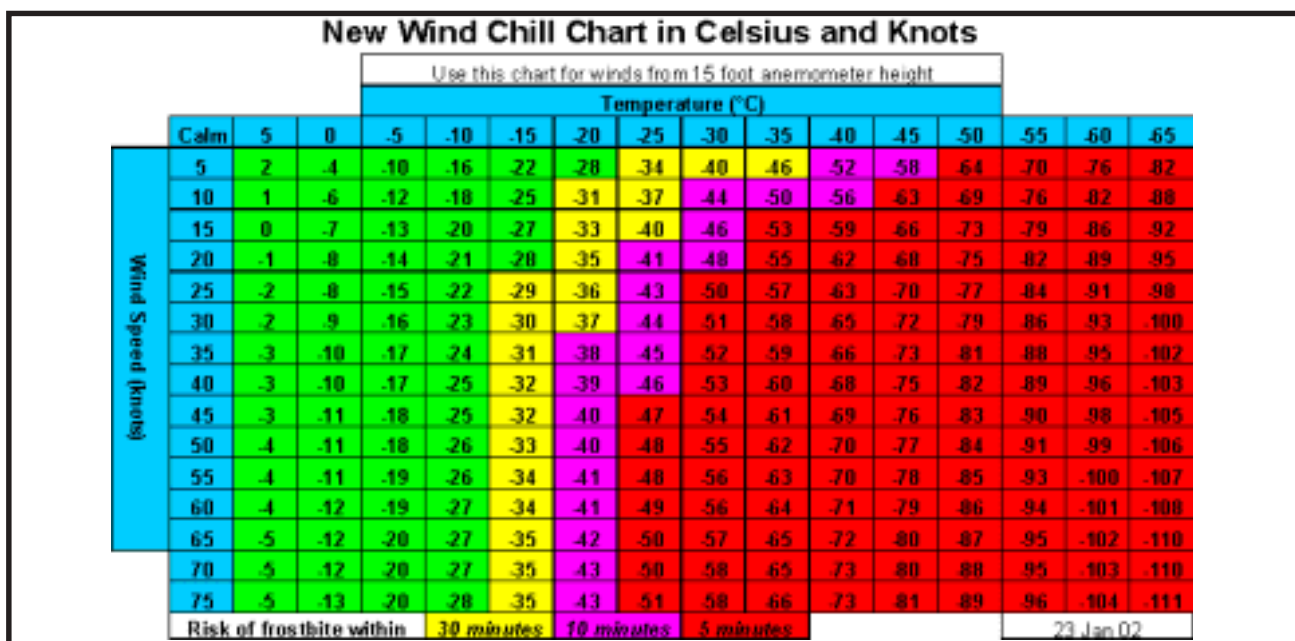


Figure 1-26. Wind Chill Temperature (WCT) Index Chart with 15-Foot Garrison—Anemometer Height (degrees Celsius and knots).

**New Wind Chill Chart in Celsius and Knots**

Use this chart for winds from 5 foot anemometer height (handheld)

		Temperature (°C)															
		Calm	5	0	-5	-10	-15	-20	-25	-30	-35	-40	-45	-50	-55	-60	-65
Wind Speed (knots)	5	2	-4	-10	-16	-23	-29	-35	-41	-47	-53	-59	-65	-72	-78	-84	
	10	0	-6	-13	-19	-26	-32	-39	-45	-52	-58	-65	-71	-77	-84	-90	
	15	-1	-8	-14	-21	-28	-34	-41	-48	-54	-61	-68	-75	-81	-88	-95	
	20	-2	-8	-15	-22	-29	-36	-43	-50	-57	-63	-70	-77	-84	-91	-98	
	25	-2	-9	-16	-23	-30	-37	-44	-51	-58	-65	-72	-79	-86	-93	-100	
	30	-3	-10	-17	-24	-31	-38	-46	-53	-60	-67	-74	-81	-88	-95	-103	
	35	-3	-11	-18	-25	-32	-39	-47	-54	-61	-68	-76	-83	-90	-97	-104	
	40	-4	-11	-18	-26	-33	-40	-48	-55	-62	-70	-77	-84	-91	-99	-106	
	45	-4	-11	-19	-26	-34	-41	-48	-56	-63	-71	-78	-85	-93	-100	-108	
	50	-4	-12	-19	-27	-34	-42	-49	-57	-64	-72	-79	-87	-94	-102	-109	
	55	-5	-12	-20	-27	-35	-42	-50	-57	-65	-73	-80	-88	-95	-103	-110	
	60	-5	-13	-20	-28	-35	-43	-51	-58	-66	-73	-81	-89	-96	-104	-111	
	65	-5	-13	-21	-28	-36	-44	-51	-59	-67	-74	-82	-90	-97	-105	-112	
	70	-6	-13	-21	-29	-36	-44	-52	-60	-67	-75	-83	-90	-98	-106	-114	
75	-6	-14	-21	-29	-37	-45	-52	-60	-68	-76	-83	-91	-99	-107	-114		
Risk of frostbite within		30 minutes				10 minutes				5 minutes							
		23 Jan 02															

Figure 1-27. Wind Chill Temperature (WCT) Index Chart with 5-Foot (handheld) Anemometer Height (degrees Celsius and knots).

**New Wind Chill Chart in Fahrenheit and MPH**

Use this chart for winds from 5 foot anemometer height (handheld)

		Temperature (°F)																			
		Calm	40	35	30	25	20	15	10	5	0	-5	-10	-15	-20	-25	-30	-35	-40	-45	-50
Wind Speed (mph)	5	35	29	23	17	11	5	-1	-8	-14	-20	-26	-32	-38	-44	-50	-56	-62	-68	-74	
	10	32	25	19	13	6	0	-7	-13	-19	-26	-32	-39	-45	-51	-58	-64	-71	-77	-83	
	15	30	23	17	10	3	-3	-10	-16	-23	-30	-36	-43	-50	-56	-63	-69	-76	-83	-89	
	20	28	22	15	8	1	-5	-12	-19	-26	-33	-39	-46	-53	-60	-67	-73	-80	-87	-94	
	25	27	20	13	7	0	-7	-14	-21	-28	-35	-42	-49	-56	-63	-70	-77	-84	-90	-97	
	30	26	19	12	5	-2	-9	-16	-23	-30	-37	-44	-51	-58	-65	-72	-79	-86	-93	-100	
	35	25	18	11	4	-3	-10	-17	-24	-32	-39	-46	-53	-60	-67	-74	-82	-89	-96	-103	
	40	25	17	10	3	-4	-11	-19	-26	-33	-40	-48	-55	-62	-69	-76	-84	-91	-98	-105	
	45	24	17	9	2	-5	-12	-20	-27	-34	-42	-49	-56	-64	-71	-78	-86	-93	-100	-107	
	50	23	16	9	1	-6	-13	-21	-28	-36	-43	-50	-58	-65	-72	-80	-87	-95	-102	-109	
	55	23	15	8	1	-7	-14	-22	-29	-37	-44	-52	-59	-66	-74	-81	-89	-96	-104	-111	
	60	22	15	7	0	-8	-15	-23	-30	-38	-45	-53	-60	-68	-75	-83	-90	-98	-105	-113	
	65	22	14	7	-1	-8	-16	-24	-31	-39	-46	-54	-61	-69	-76	-84	-92	-99	-107	-114	
	70	21	14	6	-1	-9	-17	-24	-32	-40	-47	-55	-62	-70	-78	-85	-93	-100	-108	-116	
75	21	13	6	-2	-10	-17	-25	-33	-40	-48	-56	-63	-71	-79	-86	-94	-102	-109	-117		
Risk of frostbite within		30 minutes				10 minutes				5 minutes											
		23 Jan 02																			

Figure 1-28. Wind Chill Temperature (WCT) Index Chart with 5-Foot (handheld) Anemometer Height (degrees Fahrenheit and MPH).



Temperature

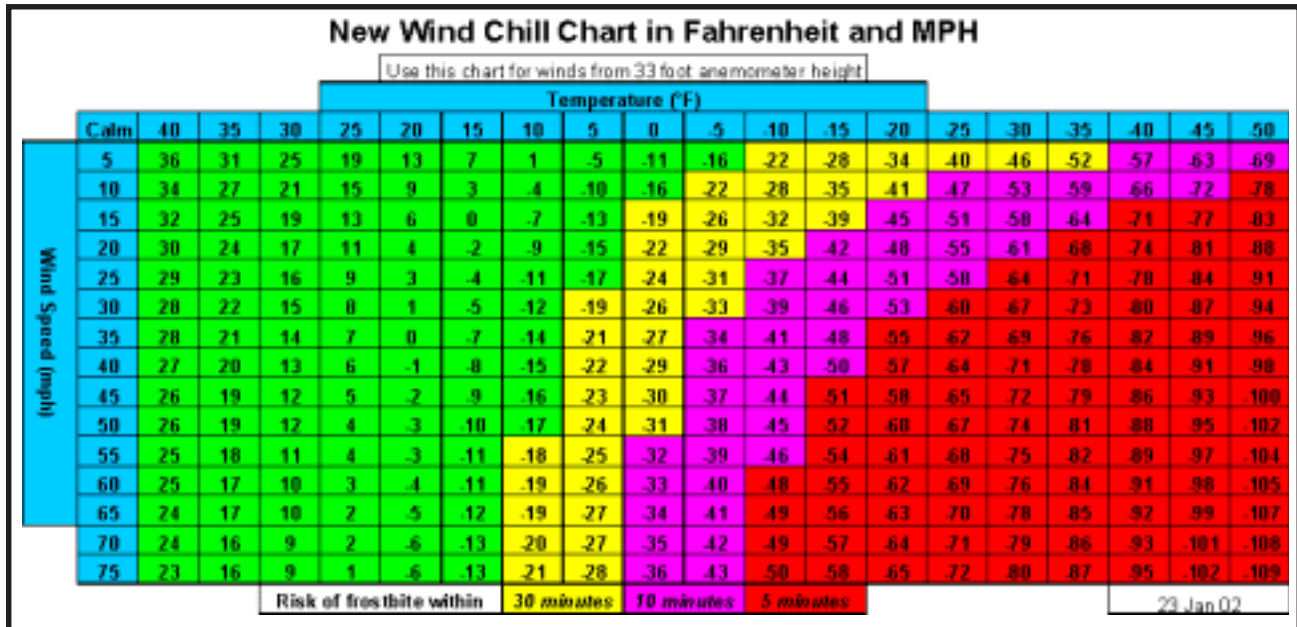


Figure 1-29. Wind Chill Temperature (WCT) Index Chart with 33-Foot Garrison Anemometer Height (degrees Fahrenheit and MPH).

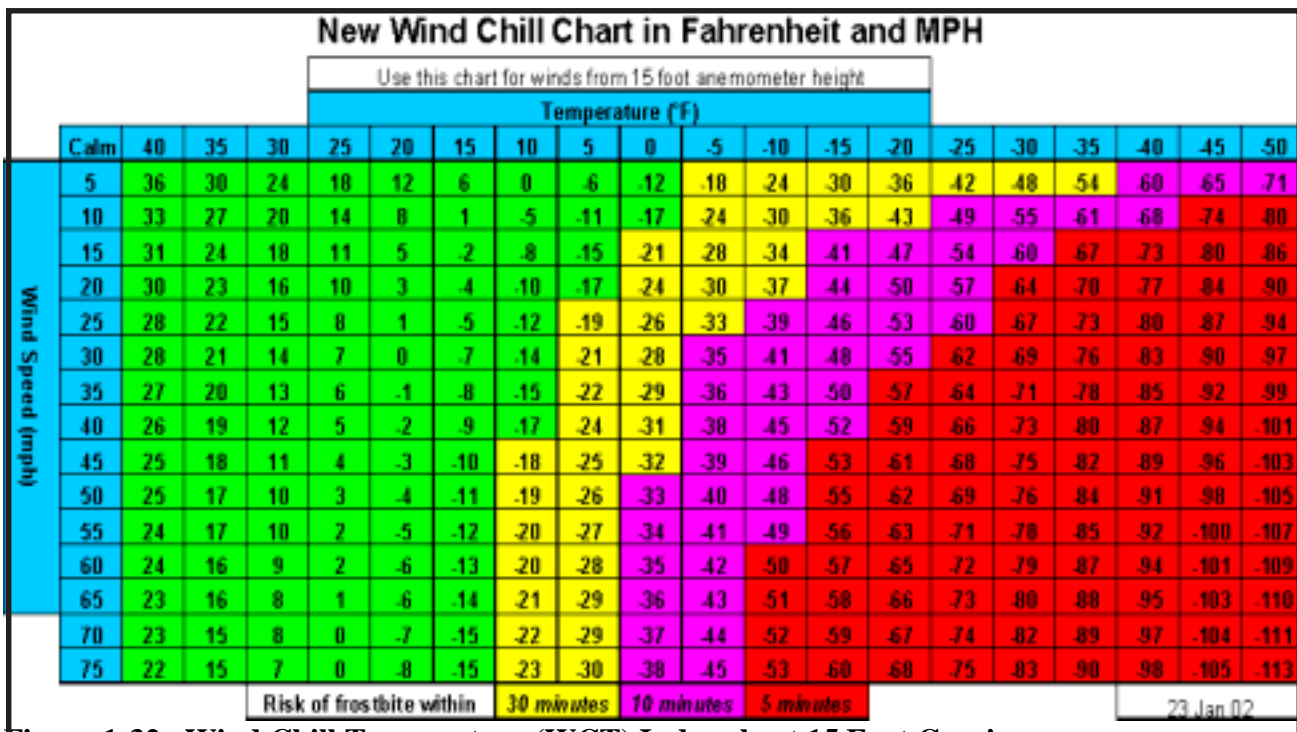


Figure 1-30. Wind Chill Temperature (WCT) Index Chart with 15-Foot Garrison Anemometer Height (degrees Fahrenheit and MPH).

**V. PRESSURE.**

**A. General Guidance.** Pilots must consider atmospheric pressure and its effect on takeoffs, landings, rate of climb, and true flight altitude. Incorrect pressure forecasts can handicap missions. This chapter begins with a general discussion of pressure, and then discusses techniques to help calculate and forecast sea-level pressure, altimeter settings, pressure altitude, density altitude, and D-values.

Atmospheric pressure is the force exerted on a surface by the weight of the air above it. Station pressure is simply the atmospheric pressure measured at the station, and is the base value from which sea-level pressure and altimeter settings are determined. Pressure changes most rapidly in the vertical, with the most rapid changes occurring near the surface, with more gradual changes with increasing height at higher altitudes. Horizontal variations in pressure are much smaller and are caused by synoptic-scale pressure centers.

**1. Air Mass Effects.** Air masses have different thermal properties; for example, a continental Polar (cP) air mass is colder and drier, hence, denser (higher pressure) than a maritime Tropical (mT) air mass. Pressure changes due to air-mass movements are best detected by extrapolating from upstream stations, analyzing model forecast products, and by looking at direct model output alphanumeric messages.

**2. Diurnal Considerations.** Daily heating and cooling, as well as

“atmospheric tides,” cause diurnal pressure changes. On the average, two maxima occur each day, at approximately 1000L and 2200L. Likewise, there are two pressure minima, at approximately 0400L and 1600L. The difference between the maxima and minima is greatest near the Equator (about 2.5-mb), decreasing to practically zero above 60° latitude.

**3. Standard Atmosphere.** The standard atmosphere is a hypothetical vertical distribution of atmospheric temperature, pressure, and density that is taken to be representative of the atmosphere. The international community agreed on the standard atmospheric values in order to ensure standardized pressure altimeter calibrations, and aircraft performance calculations. This information (reflected in the Skew-T, Log P diagram) can be useful to compare current or expected conditions with the standard. Table 1-19 lists the pressures and temperatures associated with the standard

**Table 1-19. Standard atmospheric pressure and temperatures by altitude.**

U.S. Standard Atmosphere									
Altitude (ft)	Pressure		Temperature		Altitude (ft)	Pressure		Temperature	
	Millibars (mb)	Inches Of Hg	°C	°F		Millibars (mb)	Inches Of Hg	°C	°F
0	1,013.2	29.92	15.0	59.0					
1,000	977.2	28.86	13.0	55.4	26,000	359.9	10.63	-36.5	-33.7
2,000	942.1	27.82	11.0	51.9	27,000	344.3	10.17	-38.5	-37.3
3,000	908.1	26.82	9.0	48.3	28,000	329.3	9.72	-40.5	-40.9
4,000	875.1	25.84	7.1	44.7	29,000	314.8	9.30	-42.5	-44.4
5,000	843.1	24.90	5.1	41.2	30,000	300.8	8.89	-44.4	-48.0
6,000	812.0	23.98	3.1	37.6	31,000	287.4	8.49	-46.4	-51.6
7,000	781.8	23.09	1.1	34.0	32,000	274.5	8.11	-48.4	-55.1
8,000	752.6	22.22	-0.8	30.5	33,000	262.0	7.74	-50.4	-58.7
9,000	724.3	21.39	-2.8	26.9	34,000	250.0	7.38	-52.4	-52.2
10,000	696.8	20.58	-4.8	23.3	35,000	238.4	7.04	-54.3	-65.8
11,000	670.2	19.79	-6.8	19.8	36,000	227.3	6.71	-56.3	-69.4
12,000	644.4	19.03	-8.8	16.2	37,000	216.6	6.40	-58.5	-69.7
13,000	619.4	18.29	-10.8	12.6	38,000	206.5	6.10	Constant to 65,600 Feet	
14,000	595.2	17.58	-12.7	9.1	39,000	196.8	5.81		
15,000	571.8	16.89	-14.7	5.5	40,000	187.5	5.54		
16,000	549.2	16.22	-16.7	1.9	41,000	178.7	5.28		
17,000	527.2	15.57	-18.7	-1.6	42,000	170.4	5.04		
18,000	506.0	14.94	-19.7	-5.2	43,000	162.4	4.79		
19,000	485.5	14.34	-22.6	-8.8	44,000	154.7	4.57		
20,000	465.6	13.75	-24.6	-12.3	45,000	147.5	4.35		
21,000	446.4	13.18	-26.6	-15.9	46,000	140.6	4.15		
22,000	427.9	12.64	-28.6	-19.5	47,000	134.0	3.96		
23,000	410.0	12.11	-30.6	-23.9	48,000	127.7	3.77		
24,000	392.7	11.60	-32.5	-26.6	49,000	121.7	3.59		
25,000	376.0	11.10	-34.5	-30.2	50,000	116.0	3.42		

**Pressure**

atmosphere in 1000-foot increments. Table 1-20 lists the same data by pressure level.

**Table 1-20. Standard atmospheric pressure and temperature by level.**

Pressure Level	Height Above Mean Sea-Level		Temperature
	(m)	(ft)	
(mb)	(m)	(ft)	(°C)
1000	111	364	+14.3
950	540	1773	+11.5
925	764	2520	+10
900	988	3243	+8.6
850	1457	4781	+5.5
800	1949	6394	+2.3
750	2466	8091	-1.0
700	3012	9882	-4.6
650	3591	11780	-8.3
600	4206	13801	-12.3
550	4865	15962	-16.6
500	5574	18289	-21.2
450	6344	20812	-26.2
400	7185	23574	-31.7
350	8117	26631	-37.7
300	9164	30065	-44.5
250	10363	33999	-52.3
200	11784	38662	-56.5
150	13608	44647	-56.5
100	16180	53083	-56.5

### B. Pressure-Related Parameters.

**1. Sea-Level Pressure (SLP).** SLP is the atmospheric pressure at mean sea level. It can be measured directly at sea level or determined from the observed station pressure at other locations. SLP is normally reported in millibars and the standard is 1013.25 mb (29.92 inches of Mercury (Hg)).

**a. Computing SLP.** Follow the steps below to obtain sea-level pressure.

**Step 1.** Obtain height of 1000-mb surface using the following formula (if the number is negative the 1000-mb surface is below ground level):

$$1000\text{-mb height} = (500\text{-mb height}) - (1000\text{-}500\text{-mb thickness})$$

**Step 2.** Divide 1000-mb height by 7.5-mb/meters.

**Step 3.** Add value of Step 2 to 1000 mb.

• **Example.** Using the upper air charts, the 500-mb height is 5500 meters, and the 1000-500-mb thickness is 5300 meters.

**Step 1.** 5500 meters - 5300 meters = 200 meters. The 1000-mb height is 200 meters.

**Step 2.** 200 meters divided by 7.5-mb/meters = 26.67 mb.

**Step 3.** Add 26.67 mb to 1000-mb = 1026.67 mb.

**b. Model output.** Another way to forecast SLP is to use the model output. Review meteograms and bulletins for forecast values. Be sure to initialize and verify the model before using it.

**2. Altimeter Setting.** The altimeter setting is the value of atmospheric pressure to which the scale of a pressure altimeter is set. There are three different types of altimeter settings from the Q-code system: QNE, QNH, and QFE. This code system was developed when air-to-ground communications were by wireless telegraph and many routine phrases and questions were reduced to three-letter codes. Table 1-21 explains each altimeter setting and how it affects the altimeter reading.

**a. QNH.** QNH is the altimeter setting Air Force weather forecasters work with the most. Obtain the QNH altimeter setting by measuring the surface pressure and reducing it to sea level. When QNH is set, the altimeter indicates height above mean sea level. Follow the steps below to forecast the QNH.

**Step 1.** Obtain the current QNH setting in inches of Mercury (Hg), for the desired location.

**Table 1-21. Types of altimeter settings.**

Altimeter Setting	Corresponding Pressure Altimeter reading on the ground	Corresponding Pressure Altimeter Reading in the air
QNE (29.92 inches of Hg or 1013.25 mb)	Airfield pressure altitude	Altitude of aircraft in a standard atmosphere
QNH (Station pressure reduced to sea level)	Airfield elevation above sea level	Altitude of aircraft above sea level without consideration of temperature
QFE (Actual station pressure)	Zero elevation	Altitude of aircraft above sea level without consideration of temperature

**Step 1.** Current altimeter setting is 29.98 inches.

**Step 2.** Current sea-level pressure is 1015.5 mb.

**Step 3.** Forecast sea-level pressure is 1020.5 mb.

**Step 4.**  $1020.5 - 1015.5 = 5.0$

**Step 5.**  $5.0 \times 0.03 = 0.15$

**Step 6.**  $29.98 + 0.15 = 30.14$

30.14 inches of Hg is the new altimeter setting. Consider diurnal effects, upstream observations, and the synoptic situation with every pressure forecast. Subtract 0.01 from this setting for the final value to compensate for the height of the aircraft altimeter above the ground surface.

**b. Pressure Conversion Product.** Figure 1-31 simplifies the above method for obtaining the altimeter setting. To forecast the sea-level pressure at the desired station and desired time, enter the value and read the altimeter setting. Subtract 0.01 from this setting for the final value to compensate for the height of the aircraft altimeter above the ground.

**3. Pressure Altitude (PA).** PA is the height of a given level in ICAO Standard Atmosphere above the level corresponding to a pressure of 1013.2 mb (29.92 inches). For example, if the airfield has a PA of 1000

feet, aircraft arriving or departing perform as if the elevation is at 1000 feet, no matter what the true field elevation is. Most aircrews require PA to calculate takeoff and landing data, and request this information via the Pilot-to-Metro Service (PMSV). A simple formula for calculating PA, using a given altimeter and the field elevation (FE), in feet, is:

$$PA = FE + [1000 (29.92 - QNH)]$$

Note: The manual method cannot be compared to a scientific algorithm, as the manual method will only give an approximation of the PA, and should only be used with that in mind.

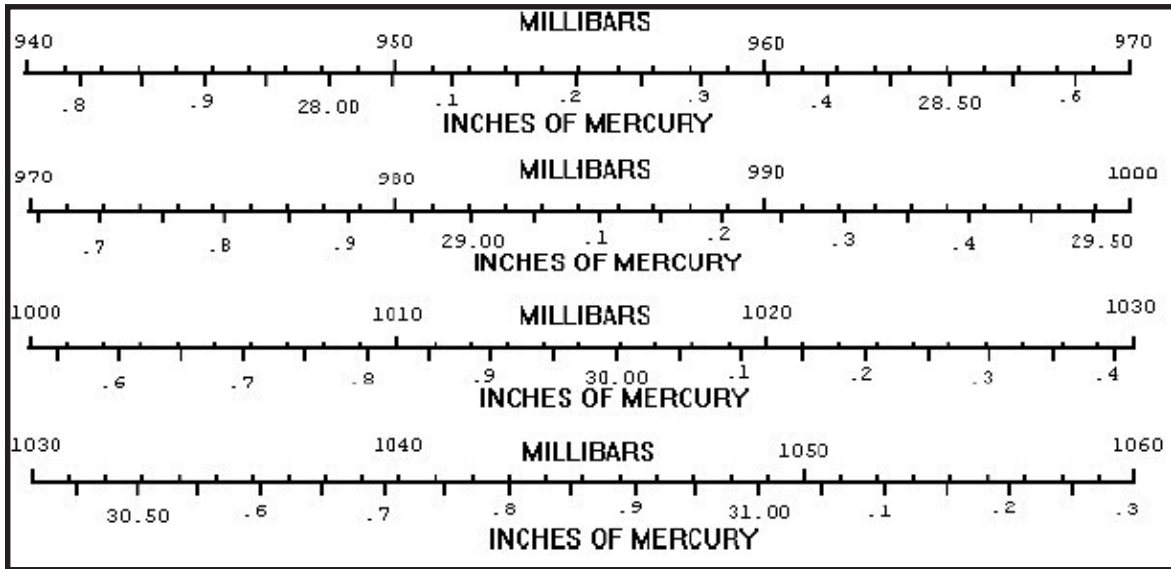
In the formula, QNH is the forecast or observed altimeter setting. The QNH in the Terminal Aerodrome Forecast (TAF) is the lowest value expected during the entire forecast period. Adjust it as necessary to forecast the actual values for the time in question. Use Figure 1-31 to convert between millibars and inches of Hg.

• **Example 1.** Field Elevation of 590 feet and QNH of 29.72 inches of Hg.

$$\begin{aligned} PA &= FE + [1000 (29.92 - QNH)] \\ &= 590 + [1000 (29.92 - 29.72)] \\ &= 590 + [1000 (0.20)] \\ &= 590 + 200 \\ &= 790 \text{ feet} \end{aligned}$$

• **Example 2.** Field Elevation of 1000 feet and QNH of 30.05 inches of Hg.

**Pressure**



**Figure 1-31. Pressure Conversion Chart.** The figure gives a graphical method for obtaining the altimeter setting (see instructions in text).

$$\begin{aligned}
 PA &= FE + [1000 (29.92 - QNH)] \\
 &= 1000 + [1000 (29.92 - 30.05)] \\
 &= 1000 + [1000 (-0.13)] \\
 &= 1000 - 130 \\
 &= 870 \text{ feet}
 \end{aligned}$$

DA can be obtained by either of the computational or graphical methods described below.

*a. Computed.* To figure a DA (value may be five percent or more too high in high temperatures and humidities), use the following formula:

$$DA = PA + (120 \times DT)$$

**4. Density Altitude (DA).** Density Altitude is pressure altitude corrected for the temperature variations from the standard atmosphere. A higher DA means less lift and thrust available to an aircraft; which affects takeoff rolls (longer), ability to climb (decreased), and payload capacity (reduced). This is especially critical on hot days, for any aircraft on a short runway that is loaded down with weapons, cargo, and fuel. Also consider helicopters flying at high altitudes on rescue, or other missions that increase weight with payloads and passengers during the mission.

The 120 in the formula represents the temperature constant and DT is the actual air temperature minus the standard atmosphere temperature at the pressure altitude. *Example.* Given a station PA of 2010 feet, actual surface temperature of 30°C, and standard atmospheric temperature (for the given PA) of 11°C (see Table 1-20 for standard atmospheric temperatures), calculate the DA.

Use the following method to compute DA.

**Note:** These methods don't account for humidity. Humid air is **less** dense than dry air. Aircraft performance is reduced in high humidity environments.

**Step 1.** 30°C - 11°C = +19°C. The temperature difference (DT) is +19°C.

**Step 2.** Apply the density altitude formula to calculate the DA.

$$\begin{aligned}
 DA &= PA + (120 \times DT) \\
 &= 2010 + 120 (30 - 11) \\
 &= 2010 + (120 \times 19)
 \end{aligned}$$

$$= 2010 + 2280$$

$$= 4290$$

The DA is +4,290 feet. Remember, this value may be five percent or more too high in high temperatures.

**b. Graphical.**

**Step 1.** Enter the base of Figure 1-32 with the temperature and proceed vertically to the inclined pressure altitude line.

**Step 2.** From the intersection of the temperature and pressure altitude lines, proceed horizontally to the left side of the product. Read the DA (in thousands of feet) from the scale on the left.

• **Example.** With a temperature of 22°C and a pressure altitude of 0 feet, calculate the density altitude.

**Step 1.** From 22°C proceed vertically to the inclined PA labeled sea level (0 feet)

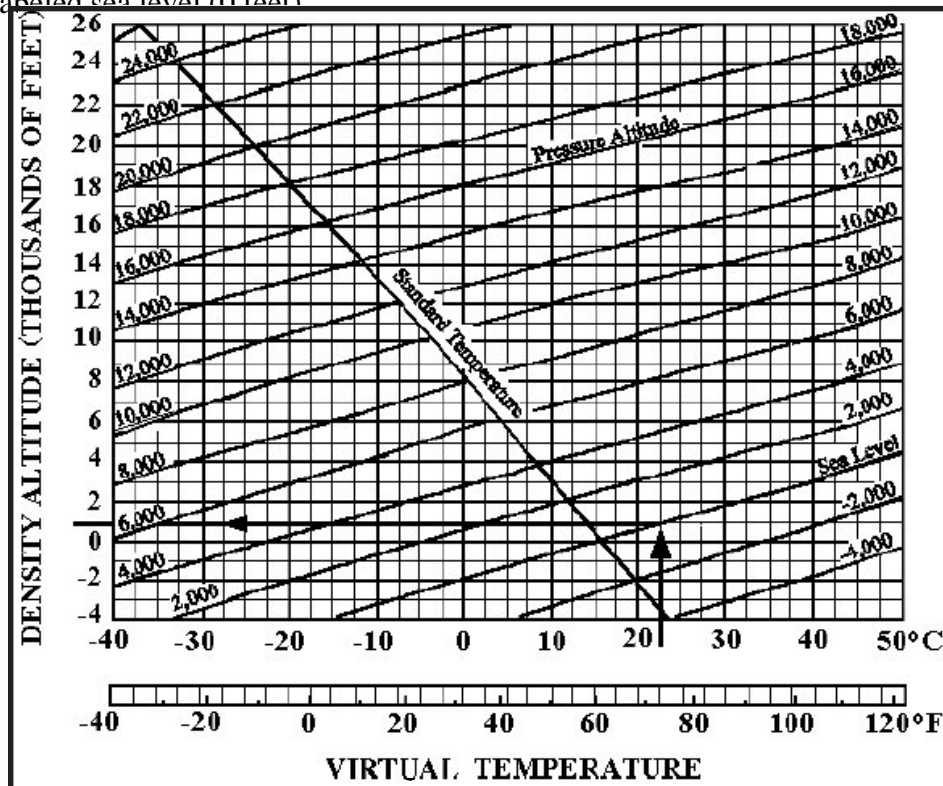
**Step 2.** From this intersection, proceed horizontally to the left edge of the product. Read the DA from the scale outside the product. The answer is 1000 feet.

**5. D-Value.** The D-value is the difference between the true altitude of a pressure surface and the standard atmosphere altitude of this pressure surface. Methods to obtain D-value are given below:

**a. Computed.** To figure D-value, use the following formula:

$$D\text{-value} = \text{True Altitude} - \text{Standard Altitude}$$

**Example.** Determine the D-value for a mission at 11,000 feet MSL. Use the appropriate constant-pressure product for the flight level, in this case, the 700-mb chart. The standard height for the 700-mb level is 9,882 feet MSL (from Table 1-19). Consulting



1-32. Density Altitude Computation Chart. See instructions above to graphically compute density altitude.

**Pressure**

---

the 700-mb analysis product (or sounding), the 700-mb level is at 9,200 feet. Thus:

$$D\text{-value} = (9200 - 9882) = -682 \text{ feet}$$

**b. Graphical.** This method uses the graph in Figure 1-33 to compute estimates of the D-value between heights of standard pressure surfaces, or between surface altimeter setting and the height of a standard surface.

**Step 1.** Determine the altitude of interest (aircraft flight level, for example).

**Step 2.** Determine the observed or forecast heights (in meters) of standard pressure levels bounding the altitude of interest (a helicopter at 7000 feet would be bound by the 700-mb and 850-mb surfaces, for example).

**Step 3.** If the altitude of interest is below the 850-mb level, determine the observed or forecast height of the 850-mb level (meters) and the observed or forecast surface (not reduced to sea-level) altimeter setting in inches of Hg.

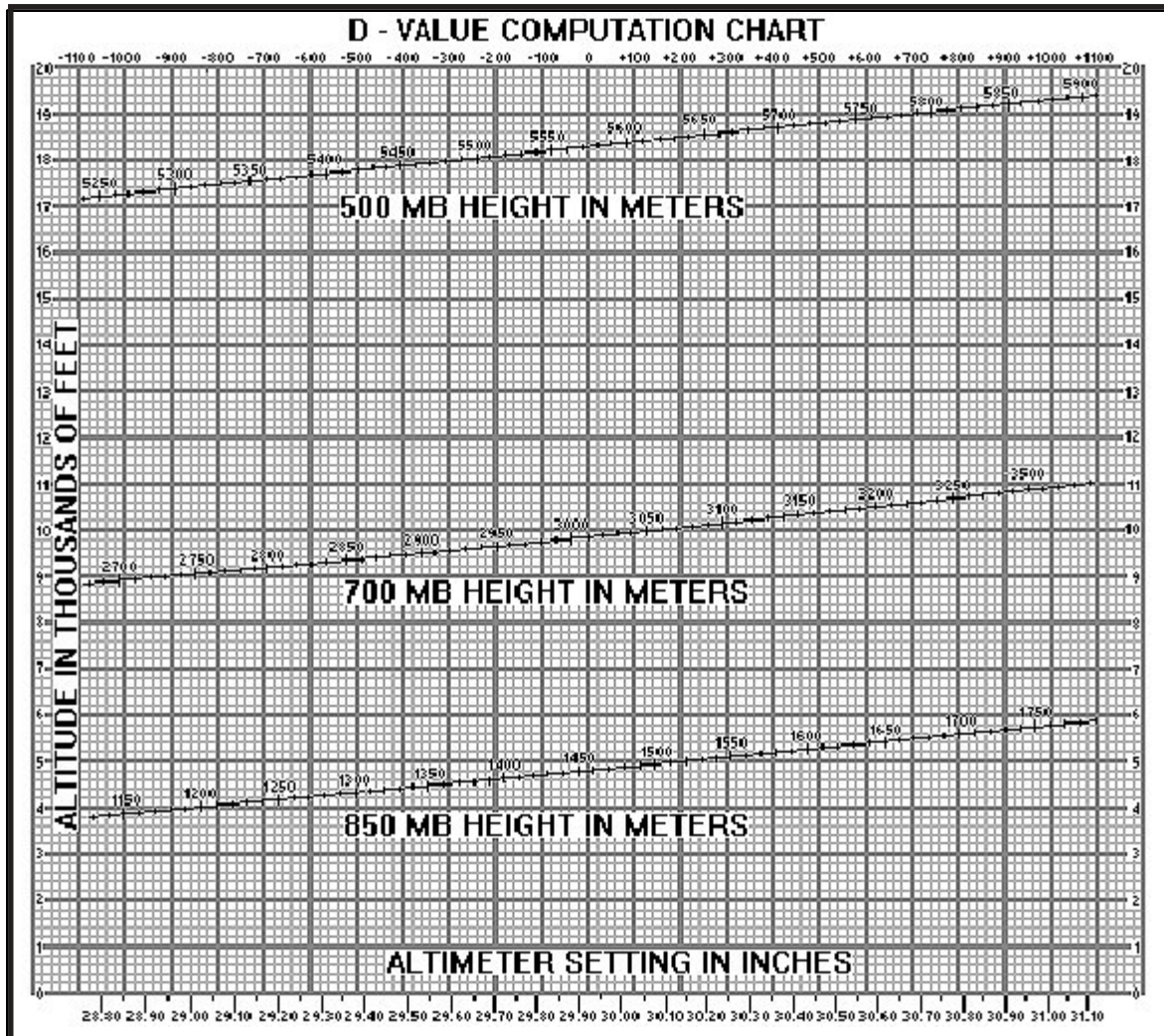
**Step 4.** Plot the heights of the pressure surfaces and/or the altimeter setting on the graph in Figure 1-33. Connect them with a straight line.

**Step 5.** Locate the point at which the line crosses the altitude of interest, then read straight up the graph to get the D-value in feet.

**Caution:** The D-value change is assumed to be linear with height: the error with this assumption should not cause the estimated D-value to be off by more than 50 feet. There are other inherent errors in forecasting pressure heights and altimeter settings that could affect the estimate.

• **Example 1.** Compute a D-value for 3000-feet, given an 850-mb pressure surface is 1640 meters, and surface altimeter is 30.15 inches of Hg. Be sure to plot the altimeter setting point on the zero altitude line, and connecting that point with the 850-mb point gives a D-value of +430 feet.

• **Example 2.** Compute a D-value for 15,000 feet, knowing the 500-mb height at the time of interest is forecast to be 5420 meters and the 700-mb height is to be 2940 meters. Solution: Plotting the 500-mb and 700-mb heights on the graph in Figure 1-33 and connecting them with a line, shows the line crossing the 15,000-foot altitude at a D-value of -410 meters.



**1-33. D-Value Computation Chart.** The figure shows standard pressure level heights in meters and altimeter settings in inches, simplifying the computation of D-values and altimeter settings at nonstandard pressure levels.



**Flight Weather Elements**

**I. CLOUDS.** Clouds form when water vapor changes to either liquid droplets (condensation) or ice crystals (deposition). This happens when air is cooled below its saturation point either directly (radiational cooling or advection) or by being raised higher in the atmosphere (adiabatic cooling). Before beginning to forecast clouds, identification of the basic cloud types and associated characteristics are important.

**A. Cloud Types/States of the Sky.** Clouds are classified by how they form: “cumuliform” clouds are produced by rising air in an unstable atmosphere, while “stratiform” clouds occur when a layer of air is cooled below its saturation point without extensive vertical motion. Although stratiform clouds produce less spectacular weather, persistent low ceilings and poor visibilities, are critical to Air Force and Army operations.

Clouds are further classified by the altitude at which their bases form: low, middle and high cloud layers. For example, “L1” refers to “low clouds, type 1,” as reported in the International Cloud Atlas. Keeping these basics in mind will help in understanding the various techniques and rules

available for forecasting clouds. The International Cloud Atlas and the UK Meteorological Office “Cloud Types for Observers” contain some information relating cloud type with other atmospheric conditions to help forecasters.

**1. Low Clouds (Near Surface to 6500 Feet above Ground Level (Agl)).**

**a. Cumulus (CU) (Figures 2-1 and 2-2).**

Cumulus clouds are cottony in appearance with an internal structure of updrafts and downdrafts. Cumulus clouds develop by moderate to strong lifting, especially convection.

- L1 – Little vertical extent, may also appear flattened or ragged; good weather.

- L2 - Moderate or strong (towering) vertical development.

**b. Stratocumulus (SC) (Figures 2-3 and 2-4).**

Formed by the spreading out of cumuliform clouds or the lifting and mixing of stratiform clouds. Precipitation from stratocumulus clouds is normally light and intermittent.



**Figure 2-1. Fair Weather Cumulus (L1).**



**Figure 2-2. Towering Cumulus (TCU) (L2).**

**Clouds**

- L4 – Formed by the spreading out of cumulus.

- L5 – Not formed by the spreading out of cumulus.

- L8 – Together with cumulus; bases at different levels.

*c. Stratus (ST).* Sheet-like in appearance with diffuse or fibrous edges. Stratus clouds usually produce light continuous or intermittent precipitation — but not showery.

- L6 – More or less a continuous layer or sheet, or in ragged sheets, or a combination of both, but no stratus fractus of bad weather.

- L7 – Stratus fractus or cumulus fractus of bad weather are present.

*d. Cumulonimbus (CB) (Figures 2-5a-b, 2-6 and 2-7).* Massive in appearance with great vertical extent, cumulonimbus clouds are responsible for the most intense weather on earth—heavy rain, hail, lightning, tornadoes, and damaging winds.

- L3 – Top lacks cirriform development; no anvil top.

- L9 – Presence of a cirriform anvil.

**2. Middle Clouds (6500 to 20,000 feet AGL).**

*a. Altostratus (AS) (Figure 2-8).* Similar in appearance to stratus but at a higher altitude, altostratus clouds are dense enough to prevent objects from casting shadows, and do not create the “halo phenomena.”



**Figure 2-3. Stratocumulus from Cumulus (L4).**



**Figure 2-5a. Cumulonimbus Mammatus (L9).**



**Figure 2-4. Stratocumulus not from Cumulus (L5).**



**2-5b. Cumulonimbus Mammatus (L9).**



**Figure 2-6. Cumulonimbus (L3).**



**Figure 2-8. Altostratus (M1).**



**Figure 2-7. Cumulonimbus (L9).**



**Figure 2-9. Nimbostratus (M2).**

- M1 – Middle range cloud with features similar to low stratus.

**b. Nimbostratus (NS) Figure 2-9).** Thicker and darker than altostratus clouds, nimbostratus clouds usually produce light to moderate precipitation. Although classified as a middle cloud by definition, its base usually builds downward into the low cloud height range.

- M2 – Darker gray or bluish gray; greater part dense enough to cover the sun/moon.

**c. Altcumulus (AC) (Figures 2-10, 2-11, and 2-12).** The appearance is similar to SC clouds but consist of smaller elements. Two important variations of AC are altcumulus castellanus (ACC) and altcumulus standing lenticular (ACSL). ACC has greater vertical extent than

regular AC, implying mid-level instability. ACSL clouds are caused by the lifting action inherent in mountain waves, and indicate turbulence.

- M3 – Greater part is semitransparent.
- M4 – In patches; almond or fish shaped.
- M5 – Semitransparent bands in one or more continuous layers.
- M6 – Spreading out of cumulus or cumulonimbus.
- M7 – Two or more layers; usually opaque.
- M8 – Small sproutings in the form of towers or battlements (ACC).

## Clouds

- M9 – Chaotic sky and occurs at several layers.

### 3. High Clouds (Bases above 20,000 Feet AGL).



Figure 2-10. Altocumulus (M3).



Figure 2-11. Altocumulus (M5).



Figure 2-12. Altocumulus Castellanus (M8).

**a. Cirrus (CI) (Figures 2-13 and 2-14).** Cirrus clouds consist entirely of ice crystals. A partial halo around the sun or moon occasionally accompanies cirrus clouds; however, the presence of a complete halo usually indicates cirrostratus instead of cirrus.

- H1 – Filaments, strands, or hooks; not progressively invading the sky.

- H2 – Dense, in patches or entangled sheaves, not the remains of an anvil.

- H3 – Remains or the upper part of a CB (anvil).

- H4 – Hooks and/or filaments; progressively invading the sky.



Figure 2-13. Cirrus (H1).



Figure 2-14. Cirrus (H4) Progressively Invading the Sky.

**b. Cirrostratus (CS) (Figures 2-15 and 2-16).**

Cirrostratus clouds appear more sheet-like than CI clouds and will produce halos if they are thin enough. CS is distinguishable from yellow-brown haze by its whiter and brighter appearance.

- H5 – Cirrus and cirrostratus bands; progressively invading but not further than 45° above the horizon.

- H6 – Same as H5, but extends to more than 45° above the horizon.

- H7 – Veil covering the entire celestial dome.



**Figure 2-15. Cirrostratus (H6) with Cirrus.**



**Figure 2-16. Cirrostratus (H7) Covering the Complete Sky.**

- H8 – no longer progressively invading the sky and does not cover the entire celestial dome.

**c. Cirrocumulus (CC) (Figure 2-17).**

Cirrocumulus clouds appear similar to AC or ACC, but with smaller individual elements. Individual cloud elements of CC can be covered by your little finger when extended at arm's length; AC and ACC cannot. The elements can be so small that they are often difficult to see by the unaided eye. Some cirrocumulus clouds may resemble fish scales and are sometimes referred to as a "mackerel sky."

- H9 – Individual elements, or small tufts/turrets; apparent width of less than 1°.



**Figure 2-17. Cirrocumulus (H9) Alone and with Cirrus.**

**B. General Forecasting Tools.**

**1. Climatology.** Climatology is a time-proven method that works well for forecasting clouds. Derived from decades of data, the sources for climatological data are:

**a. Conditional Climatology (CC).** Its information is contingent upon the initial conditions. These CC tables yield valuable prognostic information on both the persistent and changing characteristics of ceiling and visibility. They will display monthly and annual climatology

## Clouds

---

data. Factors such as cloud cover and type of precipitation associated with the clouds are included in the calculations. There are two groupings of CC:

(1) *Category-Based CC*. Portrays relationships between ceiling and/or visibility and various elements (e.g., time of day, specific weather elements, wind direction, and map type). These relationships give the most probable ceiling and visibility category when forecasting a particular element.

(2) *Time-Based CC*. Describes how a specific initial weather condition changes over time. The initial condition is usually a ceiling or visibility category, and in certain instances is stratified by wind direction, moisture, map type, or other parameters. Subsequent conditions are usually portrayed as frequency distributions of ceiling and visibility categories for each hour after the initial time.

**b. Modeled Ceiling/Visibility (MODCV).** An electronic version of the CC tables that provides climatological forecasts for ceilings and visibility. The display can be adjusted to meet current or expected weather conditions that affect cloud forecasts.

**c. International Station Meteorological Climate Summary (ISMCS).** A joint US Navy (USN)/National Oceanic and Atmospheric Administration (NOAA)/USAF summary that contains almost all non-USAF station climatic summaries.

**d. Modeled Curves (MODCURVES).** A program that uses climatology as a guide to provide the temperature baseline for the time of year and time of day. Adjust the display to reflect current or

expected weather conditions that may impact cloud forecasts (i.e., temperatures, winds, etc.).

**e. Surface Observation Climatic Summaries (SOCS).** Part D of the SOCS includes the percentage frequency of occurrence of ceiling versus visibility from hourly observations. It includes the probability of ceiling heights ranging between the surface and 20,000 feet, as well as the probability of no ceiling. A station must have 5 years of recorded observations to be included in a SOCS.

**Note:** These forecasting aids are available at most weather stations and are available on the through the Air Force Combat Climatology Center (AFCCC) website.

### 2. Model and Centralized Guidance.

**a. Model Output Statistics (MOS).** MOS guidance is an excellent tool for cloud forecasting. MOS guidance derives its forecasting relationships by correlating past model output with station climatology. Climatology is the key ingredient. If the weather is abnormal for a particular time of year, the MOS data will be biased towards climatology (average conditions), and may be as accurate as climatology during these times. As always, it's imperative to verify the model before using its MOS. Here is a brief explanation of header formats using the MOS:

- CLDS—Opaque cloud cover forecast for specified time (overcast, broken, scattered, clear).
- CIG.—Ceiling height forecast for specified time. Table 2-1 contains ceiling heights that correspond to the numerical values in this product.
- TSV<sub>xx</sub>—Thunderstorm/conditional severe thunderstorm probability for 6- and 12-hour periods.

**Table 2-1. Ceiling height forecast.**

Ceiling Height Code	Cloud Height
1	< 200 ft
2	200 - 400 ft
3	500 - 900 ft
4	1000 – 3000 ft
5	3100 – 6500 ft
6	6600 – 12,000 ft
7	> 12,000 ft

**Table 2-2. Precipitation amount forecast.**

A. Value for 6-hour period	B. Value for 12-hour period
0. No precipitation	0. No precipitation
1. 0.01 to 0.09 inches	1. 0.01 to 0.09 inches
2. 0.10 to 0.24 inches	2. 0.10 to 0.24 inches
3. 0.25 to 0.49 inches	3. 0.25 to 0.49 inches
4. 0.50 to 0.99 inches	4. 0.50 to 0.99 inches
5. Greater than 0.99 inches	5. 1.00 to 1.99 inches
	6. Greater than 1.99 inches

- QPF—Precipitation amount forecast for 6- and 12-hour periods (Table 2-2).

- OBVIS—Obstruction to vision forecast for a specified time (H - Haze, F - Fog, and N - No Haze or Fog).

**b. R1, R2, and R3 values.** The “R” numbers in the NGM and ETA numerical bulletins specify forecast relative humidity percents for layers of the atmosphere above a data point (station).

- R1 is the relative humidity of the surface to 1,000 feet layer centered near 500 feet AGL.

- R2 is the relative humidity of the 1,000 to 17,000 feet layer centered near 9,000 feet AGL.

- R3 is the relative humidity of the 17,000 to 39,000 feet layer centered near 28,000 feet AGL. Use this information (after initializing and verifying the model) and Table 2-3 to help determine cloud amounts and levels through the 48-hour point. Note that this technique will not necessarily help determine the cloud base, only that a cloud layer may exist in that layer. Remember also that these percentages are layer averages. Shallow cloud decks may be present that aren’t identified because

**Table 2-3. R1, R2, and R3 relative humidity values and cloud amounts.**

RH%	Cloud amount (eighths)
< 65	0
70	1 to 2
75	3 to 4
80	4 to 5
85	6 to 7
> 90	8

shallow layers of high RH values become “averaged out” when over the entire layer. This is especially true with the R2 and R3 layers.

**c. AFWA Trajectory Forecast Bulletins.** Trajectory forecasts from AFWA can help pinpoint the origin of air parcels moving towards the station. Knowledge of the initial position, movement, and properties of an air parcel allows you to do an accurate advection forecast over time. Note the observed flow at the initial point and at the end point. Interpolate between them and estimate the curvature and path of the parcel. Determine moisture advection for levels at 2,000 feet AGL,

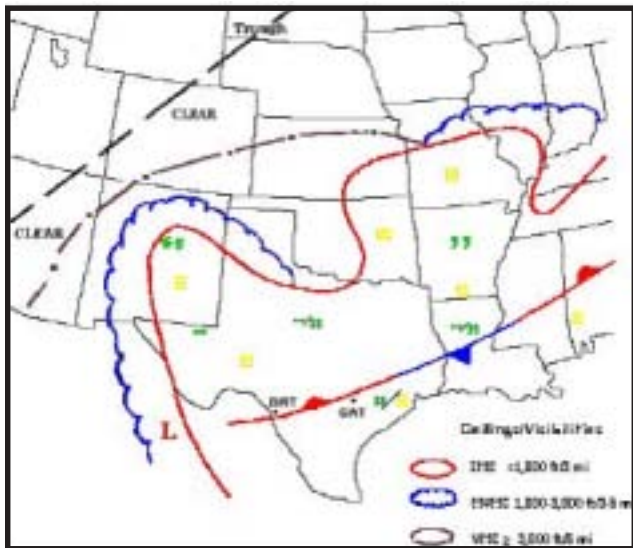
**Clouds**

850-mb, 700-mb and 500-mb. Following the “N” header, the bulletin depicts the amount of cloud cover in eighths for each standard level.

There are some disadvantages to using the trajectory bulletins. The trajectories do not include changes in temperature or moisture except for adiabatic contributions; nor do they consider cooling and moistening (by evaporation) of cool air parcels passing over warm bodies of water. Similarly, it does not take into consideration the influences of topography.

**3. Extrapolation.** This technique refers to the forecasting of a weather feature based solely on its recent past movement. To use extrapolation techniques in short-range forecasting (0 to 6 hours), determine the positions of fronts and pressure systems, their direction and speed of movement, precipitation and cloud patterns that might affect the local terminal, and the upper-level flow that affects the movement of these weather patterns.

To forecast clouds by extrapolation, simply advect them downstream. For an analysis of clouds by heights or type, using a satellite or a nephanalysis will aid tremendously, especially if the previous continuity was annotated. Figure 2-18 shows an example of a nephanalysis product.

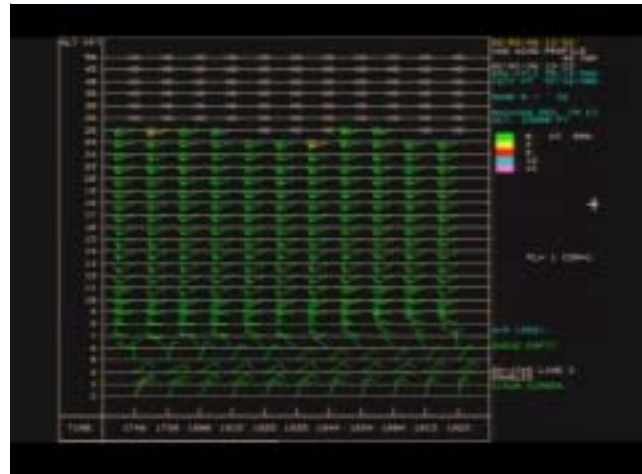


**Figure 2-18. Nephanalysis Example.**

**4. Weather radar.** Doppler weather radar can detect cloud layers by sensing large ice crystals present in middle- and high-level clouds and refractive index gradients associated with all clouds. Typical reflectivities are between -12 to +15 dBZ, but may range as high as +20 dBZ. The following products and their uses may help in identifying and advecting clouds.

Note: Remember, most radar products are not designed to be used as stand-alone products.

**a. Velocity Azimuth Display (VAD) Wind Profile (VWP) (Figure 2-19).** Look for “invading” upper-level wind barbs that signify clouds are progressively advancing towards the Radar Data Acquisition (RDA) unit.



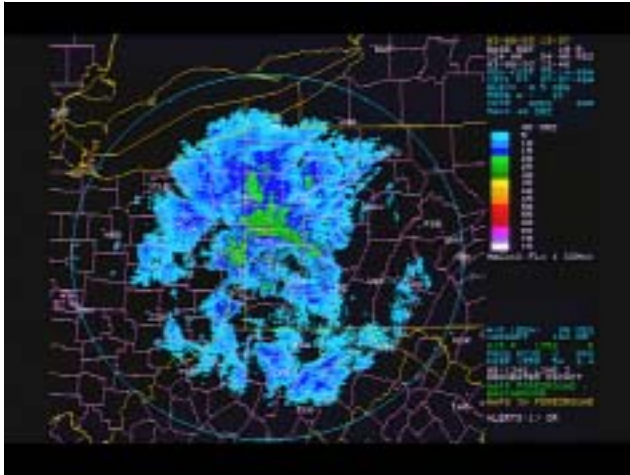
**Figure 2-19. VAD Wind Profile (VWP) Product.**

**b. Base Reflectivity (R) (Figure 2-20).** Determine the height, thickness, and location of clouds using this product.

Step 1. Determine and use the best elevation that depicts the cloud layer.

Step 2. Place the cursor on the edge of the echo closest to the RDA and note the readout of azimuth, range and elevation in Mean Sea Level (MSL) of the base of the layer.





**Figure 2-20. Base Reflectivity Product.**

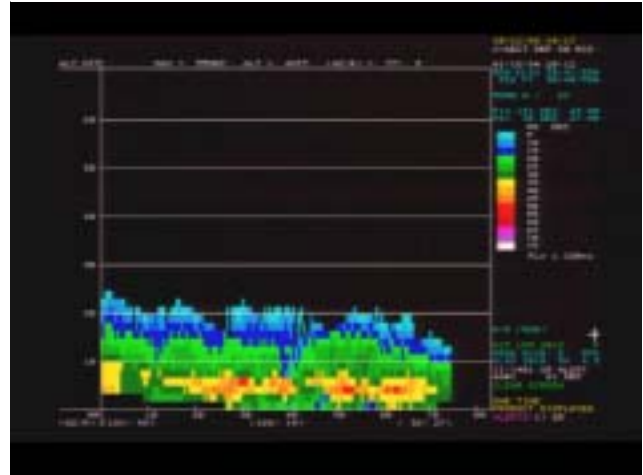
Step 3. Determine and use the highest elevation that shows the cloud layer.

Step 4. Place the cursor on the edge of the echo farthest from the RDA and note the readout of azimuth, range and elevation (MSL) of the top of the layer.

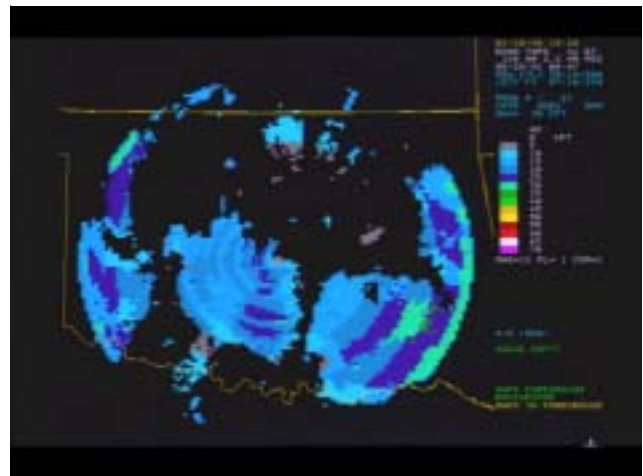
Note: If the cloud base or top is not uniform, repeat this technique several times to get average heights and thickness. Use a four-panel display of the reflectivity product for successively higher elevation scans. From the four-panel, determine information on the depth (top and bottom), as well as the structure of a layer, by using the steps above.

**c. Reflectivity Cross Section (RCS) (Figure 2-21).** This product helps to infer the top of a cloud layer and its depth, depending on the distance from the radar and the viewing angle. Keep in mind, the resolution of the base reflectivity product is better. The RCS product integrates returns from the surface to 70,000 feet and tends to over-exaggerate the cloud layers.

**d. Echo Tops (ET) (Figure 2-22).** The ET product can provide an indication of the top of a cloud layer using the threshold value of 18 dBZ. Always use the reflectivity product in conjunction with ET to determine the existence and extent of the cloud layers.



**Figure 2-21. Reflectivity Cross-Section Product.**



**Figure 2-22. Echo Tops Product.**

### **C. Cloud Forecasting Techniques.**

#### **1. Determining cloud heights.**

**a. Using Skew-T, Log P diagram.** The mixing condensation level (MCL) is the lowest height, in a layer to be mixed by wind, at which saturation occurs after the complete mixing of the layer. Use the MCL as a tool for determining the base of stratus and cold-air stratocumulus decks.

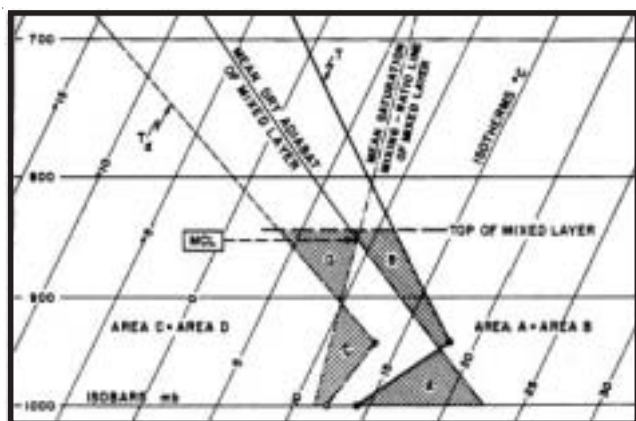
**Step 1.** Determine the top of the layer height to be mixed (a subjective estimate based on winds, terrain roughness, original sounding, etc.). Stations

## Clouds

in the cold air should have a pronounced low-level (but elevated) inversion. Use this as the top of the mixing layer.

**Step 2.** Determine an average temperature and dew point within that layer using an equal area method.

**Step 3.** Trace the average temperature up the dry adiabat and the average dew point ( $T_d$ ) up the mixing ratio line until they intersect. This level is the MCL, and provides a good approximation of stratus or stratocumulus base heights, if they form. Figure 2-23 illustrates this process.



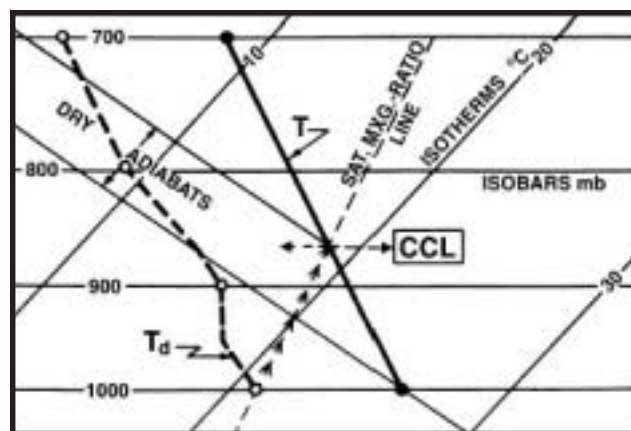
**Figure 2-23. MCL Calculations.** The MCL provides a good approximation of stratus or stratocumulus base heights.

The base of non-precipitating convective (cumuliform clouds) will be 25-mb above the convective condensation level (CCL). The CCL is the height to which a parcel of air, if heated sufficiently from below, will rise adiabatically until it is saturated and condensation begins. In the most common case, the CCL is the height of the base of cumuliform clouds produced solely from convection.

Frequently, the surface dew point is used to compute the CCL. But when there is a great deal of variation in moisture content in the layers near the surface, an average moisture value of the lower layer may be used in place of the surface-parcel

moisture value — this is known as the moist layer method. It was developed to give more accuracy in severe weather forecasting and considers the low-level moist layer of the sounding starting at the surface. The CCL is displayed in both meters (nearest 10) and millibars — all heights are MSL.

**(1) Parcel Method.** This is the easiest of the methods to compute. On a Skew-T, from the surface dew point, proceed up the chart parallel to the saturation mixing-ratio lines until it intersects the temperature curve on the sounding. This intersection point is the CCL. See Figure 2-24.



**Figure 2-24. Parcel Method.** To find the CCL, from the surface dew point, proceed up the chart parallel to the saturation mixing-ratio lines until it intersects the temperature curve on the sounding.

**(2) Moist Layer Method.** A layer is defined as “moist” if it has an RH of 65 percent or more at all levels. In practice, the moist layer does not extend past the lowest 150 mb of the sounding. After finding the depth of the moist layer (or lowest 150 mb of the sounding, whichever is smaller), find the mean mixing ratio of this layer. Follow the mean mixing ratio line of the moist layer to the point where it crosses the temperature curve of the sounding. The level of intersection is the CCL.

**b. Base of convective clouds using dew-point depressions.** Forecast the height of cumulus cloud bases by inserting current or forecast surface dew

point depression (DPD) into Table 2-4. This table is not suitable for use at stations situated in mountainous or hilly terrain and should be used only when clouds are formed by active surface convection in the vicinity of the station. Use with caution when the surface temperature is below freezing due to the difficulties in accurately determining dew points at low temperatures.

**c. Relative humidity and vertical velocity.**

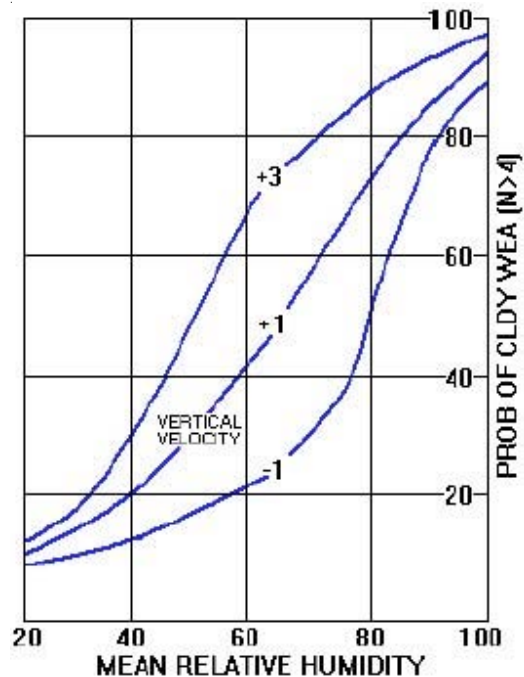
Upward motion is associated with instability and cloudiness. Downward vertical motion usually results in clearing skies. Figure 2-25 gives the probability of a ceiling for a given omega vertical velocity (OVV) and relative humidity (RH). Obtain OVV and RH values from the ETA or NGM numerical bulletins, or from a computer analysis and display program such as the N-TFS. After initialization and verification of the model output:

**Step 1.** Determine the mean RH for the forecast area.

**Step 2.** Determine the OVV for the forecast area.

**Step 3.** Using Figure 2-25, find the mean RH on the bottom axis and follow it up until it crosses the curved line whose value corresponds to the measured value for OVV.

**Step 4.** From that intersection, read the probability of cloud ceilings using the horizontal lines.



**Figure 2-25. RH and OVV Graph.** Probability of a ceiling based on RH and OVV values.

**2. Cloud amounts.**

**a. Forecasting clouds in relation to 700-mb features.** The location and coverage of mid-level clouds can be determined by the following rules of thumb:

**Table 2-4. Base of convective clouds using surface dew-point depressions.**

DPD (°C)	Estimated Cumulus Height (ft)	DPD (°C)	Estimated Cumulus Height (ft)
0.5	200	1.0	400
1.5	600	2.0	800
2.5	1,000	3.0	1,200
3.5	1,400	4.0	1,600
4.5	1,800	5.0	2,000
5.5	2,200	6.0	2,400
6.5	2,600	7.0	2,800
7.5	3,000	8.0	3,200
8.5	3,400	9.0	3,600
9.5	3,800	10.0	4,000
10.5	4,200	11.0	4,400
11.5	4,600	12.0	4,800
12.5	5,000		

## Clouds

- Height contours and isotherms:
  - Parallel to the front: extensive cloud band.
  - Perpendicular to the front: narrow cloud band.
- Streamlines:
  - Cyclonic: extensive clouds.
  - Anticyclonic: few clouds.
- 700-mb ridge passage ahead of a cold front generally coincides with low and middle cloud formation.
- 700-mb trough passage after a cold front generally coincides with low and middle cloud clearing.

**3. Formation, Advection, and Dissipation of Low Stratus.** Air cooled by contact with a colder surface may be transferred upwards by turbulent mixing caused by the wind. The height to which the cooling is diffused upwards depends on the stability of the atmosphere, the wind speed, and the roughness of the surface.

One study found the mean depth of the turbulent layer to be 60 meters (200 feet) for each knot of wind at ground level up to a surface wind speed of 16 knots. With stronger winds the depth was independent of wind speed, averaging 1066 meters (3500 feet) in the early morning, rising during the day to 1200 meters (4000 feet). When the air is cloud-free but initially stable in the lower layers, the layer where turbulent mixing takes place is a very shallow layer. Cooling is confined to very low levels, resulting in the formation of very low stratus or fog.

**a. Wind Speed.** Wind speed is usually the controlling factor in determining whether fog or

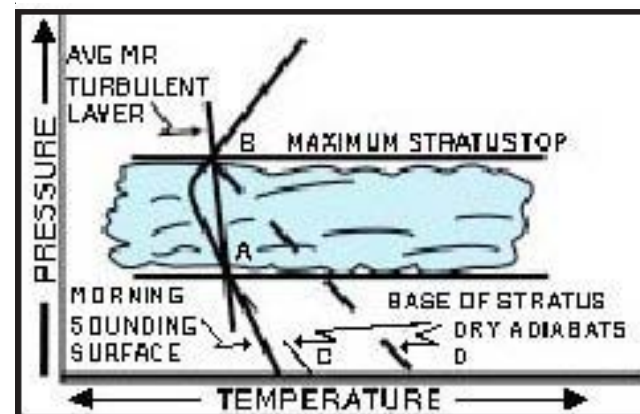
stratus will form—although there is no single critical value determining which will occur. Local topography is also an important consideration. Typically, stratus will form due to nocturnal cooling with surface wind speeds exceeding 10 to 15 knots in an inland site; 5 to 10 knots on an exposed coastal location, and over 25 knots in a deep valley.

**b. Empirical rules.** The level at which stratus forms over land bears some relation to wind speed and the influence of local orographic features, but the dependence of cloud height on temperature and humidity prevents any simple relationship between cloud height and wind speed.

- The height of stratus in meters above level ground is 20 to 25 times the surface wind speed in knots (70 to 80 times for height in feet).

- If advected stratus clears during the morning, the dissipation temperature will give the best estimate of the temperature at which the cloud will move inland again during the evening.

**c. Dissipation of Stratus Using Mixing Ratio and Temperature.** Manual analysis of the morning Skew-T is often an excellent tool to use in determining the dissipation time of stratus. Use the checklist below to determine the surface temperatures needed to begin dissipating and to completely dissipate stratus (see Figure 2-26).



**Figure 2-26. Dissipation of Stratus Using Mixing Ratio and Temperature.**

**Step 1.** Find the average mixing ratio between the surface and the base of the inversion.

**Step 2.** Find the intersections of the average mixing ratio line and the temperature curve. The approximate height of the base is at point (A) and the top of the stratus deck is at point (B).

**Step 3.** Follow the dry adiabat from (A) to the surface. Label the surface intersection point as (C). This point is the surface temperature required to start dissipation.

**Step 4.** Follow the dry adiabat from (B) to the surface. Where it intersects the surface, label the point (D). Point (D) is the surface temperature required for complete dissipation.

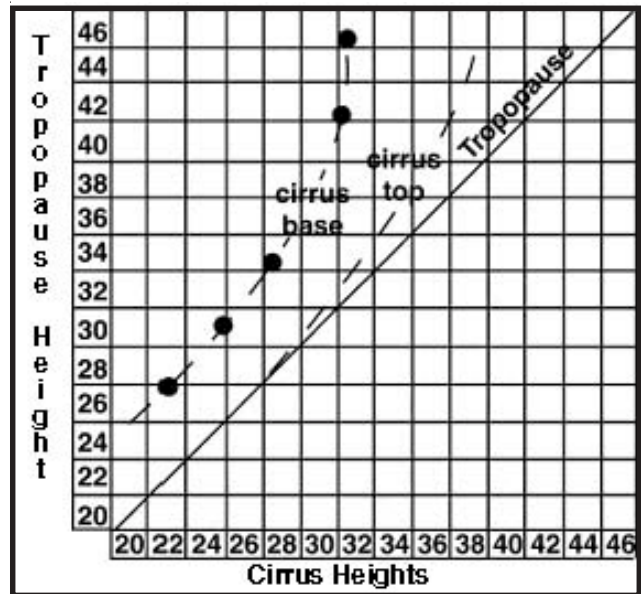
#### 4. Forecasting Cirrus Clouds.

**a. Convective cirrus.** For purely convective cirrus, both thunderstorm and frontal, the following rules of thumb apply:

- **Rule C1.** When straight-line or anticyclonic flow exists at 300-200-mb, over the area downstream from a thunderstorm area, cirrus may appear the next day and advance ahead of the ridgeline.

- **Rule C2.** Cirrus may not appear if the contours over the area downstream are cyclonically curved. It is more likely to appear, however, if the flow is weak.

**b. Tropopause Method of Forecasting Cirrus.** Many studies have shown the relationship between the tropopause and cirrus deck tops. In rare circumstances the cirrus deck will extend up into the lower stratosphere. A 4-year study concluded the base and tops of cirrus could be determined in relation to the tropopause. Figure 2-27 shows average cirrus bases and tops. To use this table, find the current tropopause height and read across to see the average cirrus base and top.



**Figure 2-27. Tropopause Method of Forecasting Cirrus.** Find the current tropopause height and read across to see the average cirrus base and top (heights in 1000s of feet on the X and Y axes).

**5. Precipitation-Induced Clouds.** Experience shows that during continuous precipitation, cloud bases lower in a discontinuous rather than continuous manner, and the lower cloud sheet appears to form rather suddenly over extensive areas.

**a. Snow.** When snow falls through a layer with a temperature greater than 0°C, the snowflakes start to melt. If the dry- and wet-bulb temperatures at ground level are initially greater than 0°C, the snow ultimately reaches the ground without melting. This is due to an isothermal layer, with a temperature near 0°C, establishing itself near the ground. The air is also cooled below its wet-bulb temperature, supersaturation occurs, and stratus clouds form with bases at or very near ground level.

**b. Rain.** Evaporation from falling rain may cause supersaturation and the formation of clouds. The base of the cloud layer will be at a height where the temperature lapse rate decreases significantly or becomes negative (a positive lapse rate exists when temperature decreases with height).

## Clouds

---

**6. Rules of Thumb.** The following rules are empirical in nature. They may need adjustment for location and the current weather regime:

- The cloud base of a layer warmer than 0°C is usually located where the dew point depression decreases to less than 2°C.

- The cloud base of a layer between 0°C and –10°C is usually located at a level where the dew point depression decreases to less than 3°C.

- The cloud base of a layer between –10°C and –20°C is usually located where the dew point depression decreases to less than 4°C.

- The cloud base of a layer less than –25°C is usually located where the dew point depression decreases to less than 6°C, but can occur with depressions as high as 15°C.

- For two adjacent layers in which the dew point depression decreases with height more sharply in the lower layer than in the upper layer, the cloud base should be identified with the base of the layer showing the sharpest decrease with height.

- The top of the cloud layer is usually indicated by an increase in dew-point depression. Once a cloud base has been determined, the cloud is assumed to extend up to the level where a significant increase in dew-point depression starts. The gradual increase in dew-point depression that usually occurs with height is not considered significant.

- 500-mb dew-point depressions of 4°C or less coincide with overcast mid-level cloudiness.

**II. TURBULENCE.** The importance of turbulence forecasting to the flying customer can't

be overstated. The impact of forecasting and classifying turbulence, however, is a challenge. The difficulty arises because factors creating turbulence in one instance may not cause turbulence in a similar situation. Complicating matters further is that while one aircraft may report “smooth sailing,” minutes later, another aircraft flying through the same airspace may report significant turbulence.

Turbulence can rip an aircraft apart in flight, damage the airframe, and cause injury. Therefore, accurate turbulence forecasts are an important part of an aviation weather brief. If forecasters understand the basics of atmospheric turbulence, they will better analyze and forecast this dangerous phenomenon.

Note: Diagrams presented may show patterns over the United States only. These patterns are applicable, however, to most areas worldwide, given the same synoptic situation.

### A. Levels of Intensity.

The levels of turbulence intensity are based on the impact to aircraft flying through an area of concern.

**1. Light Turbulence.** The aircraft experiences slight, erratic changes in attitude and/or altitude, caused by a slight variation in airspeed of 5 to 14 knots with a vertical gust velocity of 5 to 19 feet per second. Light turbulence may be found in many areas, such as:

- In mountainous areas, even with light winds.
- In and near cumulus clouds.
- Near the tropopause.
- At low altitudes in rough terrain when winds exceed 15 knots.

- At low altitudes flying over terrain that releases heat at different rates. (i.e. Flying over a grassy field followed by a concrete surface, etc.)

**2. Moderate Turbulence.** The aircraft experiences moderate changes in attitude and/or altitude, but the pilot remains in positive control at all times. There are usually small variations in airspeed of 15 to 24 knots; vertical gust velocity is 20 to 35 feet per second. Moderate turbulence may be found:

- In towering cumuliform clouds and thunderstorms.

- Within 100 NM of the jet stream on the cold-air side.

- At low altitudes in rough terrain when the surface winds exceed 25 knots.

- In mountain waves (up to 300 miles leeward of a ridge), with winds perpendicular to the ridge exceeding 50 knots.

- In mountain waves as far as 150 miles leeward of the ridge and within 2,000 to 3,000 feet of the tropopause when winds are perpendicular to the ridge is 25 to 50 knots.

**3. Severe Turbulence.** The aircraft experiences abrupt changes in attitude and/or altitude and may be out of the pilot's control for short periods. There are usually large variations in airspeed greater than or equal to 25 knots and the vertical gust velocity is 36 to 49 feet per second. Severe turbulence occurs:

- In and near mature thunderstorms.

- Near jet stream altitude and about 50 to 100 miles on the cold-air side of the jet core.

- Up to 50 miles leeward of a ridge if a mountain wave exists and winds perpendicular to the ridge are 25 to 50 knots.

- In mountain waves as far as 150 NM leeward of the ridge and within 2,000 to 3,000 feet of the tropopause when winds perpendicular to the ridge exceed 50 knots.

**4. Extreme Turbulence.** The aircraft is violently tossed about and is practically impossible to control. Structural damage may occur. Rapid fluctuations in airspeed are the same as severe turbulence (greater than or equal to 25 knots) and the vertical gust velocity is greater than or equal to 50 feet per second. Though extreme turbulence is rarely encountered, it is usually found in the strongest forms of convection and wind shear. The two most frequent locations of extreme turbulence are:

- In mountain waves in or near the rotor cloud.

- In severe thunderstorms, especially in organized squall lines.

**B. Aircraft Turbulence Sensitivities.** Different types of aircraft have different sensitivities to turbulence. Table 2-5 lists the categories for most military fixed-wing and rotary-wing aircraft at their typical flight configurations. Turbulence forecasts in Terminal Aerodrome Forecasts (TAFs) are specified for Category II aircraft. Modify the local turbulence forecast for the type of aircraft supported. An aircraft's sensitivity varies considerably with its weight (amount of fuel, cargo,

**Turbulence**

**Table 2-5. Aircraft turbulence category type.**

Military Aircraft Turbulence Categories	
Aircraft Type	Turbulence Category
OH-58 UH-1 AH-1	I
AH-64 B-52H C-130 C-141 C-20 C-12 C-5A/B C-9A/C CH-47 CT-43A E-3B E-4B F-15 F-16 KC-135 RAH-66 T-1A T-6 T-38 T-43A U-25 U-21 H-3 H-69	II
A-10 C-17A C-21A C-32A/B EA-6B F-117A F-14 (wings unswept) F-18 KC-10 RQ-1A (see note 3 below) RQ-4A T-37 UV-18A/B	III
B-1B (wings swept and unswept) B-2A F-14 (wings swept) F-22 V-22	IV
Civilian Aircraft Turbulence Categories	
Aircraft Type	Turbulence Category
A-319 A-320 A-321 A-300 A-340 (200 - 300) A-340 (500-600) B-737 (600 - 900) B-747 B-777 C-208 CRJ DHC-6	II
B-737-200 B-757 B-767 E-145 LJ-25 LJ-35 LJ-60 MD-11	III
<p>*Note 1: Turbulence categories for aircraft with auto gust alleviation systems may not be accurately depicted by the above table.</p> <p>*Note 2: An aircraft's weight, airspeed, and/or altitude may change its turbulence category from its default value.</p> <p>*Note 3: M/RQ-1 is CAT III in strong wind and mountain wave environments, but CAT I in proximity to strong wind directional shear or operating near the LCL.</p>	

munitions, etc.), air density, wing surface area, wing sweep angle, airspeed, and aircraft flight “attitude.” Since aircraft sensitivity to turbulence varies considerably, use caution when applying forecast turbulence (Category II) to a specific aircraft type, configuration, and mission profile. Table 2-6 is a guide to convert turbulence intensities for different categories of aircraft.

**1. Fixed Wing Aircraft.** Generally, the effects of turbulence for fixed-wing aircraft are increased with:

- Non-level flight.
- Increased airspeed.
- Decreased weight of the aircraft.
- Increased wing surface area.

- Decreased air density (increased altitude).
- Decreased wing sweep angle (wings more perpendicular to fuselage).

**2. Rotary Wing Aircraft.** Generally, the effects of turbulence for rotary-wing aircraft are increased with:

- Increased airspeed.
- Decreased weight of the aircraft.
- Decreased lift velocity (the faster the lift-off, the less the turbulence).
- Increased arc of the rotor blade (the longer the blade, the greater the turbulence).

**C. Causes of Turbulence.** Turbulence is caused by abrupt, irregular movements of air that create sharp, quick updrafts/downdrafts. These updrafts



**Table 2-6. Turbulence intensities for different categories of aircraft (based on Table 2-5).**

	I	II	III	IV
	N	N	N	N
	(L)	N	N	N
	L	(L)	N	N
	L-(M)	L	(L)	N
<b>Turbulence</b>	M	L-(M)	L	(L)
<b>Reported As</b>	M-(S)	M	L-(M)	L
	S	M-(S)	M	L-(M)
	S-(X)	S	M-(S)	M
	X	S-(X)	S	M-(S)
	X	X	S-(X)	S
	X	X	X	S-(X)
	X	X	X	X

N = None    ( ) = Occasional (less than 1/3 of the time)  
 L = Light    M = Moderate    S = Severe    X = Extreme

**Note:** Use caution when converting extreme turbulence reports between various aircraft types. Extreme turbulence causes a range of effects from a minimum threshold (rapid airspeed fluctuations greater than 25 knots) to a maximum threshold (structural damage). Even though the table considers this, the design is more for the sake of “completeness” rather than observational or scientific evidence.

and downdrafts occur in combinations and move aircraft unexpectedly. There are two basic atmospheric conditions that cause turbulence to occur: thermal conditions and mechanical mixing.

**1. Thermal Turbulence.** Surface heating can generate turbulent conditions. As solar radiation heats the surface, the air above it is warmed by contact. Warmer air is less dense, and “bubbles” of warm air rise upward as updrafts. Uneven surface heating, and cooling of risen air, allows for areas of downdrafts as well. These vertical motions may be restricted to the low levels, or may generate cumulus clouds that can grow to great heights as thunderstorms. The following are characteristics of thermal-induced turbulence:

- Normally confined to the lower troposphere (surface to 10,000 feet).
- The maximum occurrence is between late morning and late afternoon.

- The main impact to flight operations is during terminal approach and departure and during low-level flights.

- Moderate turbulence may occur in hot, arid regions, as the result of irregular convective currents from intense surface heating.

The strongest thermal turbulence is found in and around thunderstorms. Moderate or severe turbulence can be found anywhere within the storm, including the clear air along its outer edges. The highest probability of turbulence is found in the storm core, between 10,000 and 15,000 feet.

**2. Mechanical Turbulence.** Mechanical turbulence is caused by horizontal and vertical wind shear and is the result of pressure gradient differences, terrain obstructions, or frontal zone shear. Four types of mechanical turbulence discussed later in this chapter include the following: clear air turbulence (CAT), mountain wave (MV)

## Turbulence

turbulence, wake turbulence and gravity waves. The following are some general characteristics of mechanical turbulence:

- Most turbulence results from a combination of horizontal and vertical wind shears.
- Turbulence layers are usually 2,000 feet thick, 10 to 40 miles wide, and several times longer than wide.
- Wind shear turbulence may result from strong horizontal pressure gradients alone. It occurs when the pressure gradient causes a horizontal shear in wind direction or speed.
- Local terrain can magnify gradient winds to cause strong winds and turbulence near the surface. This creates eddy currents that can make low-level flight operations hazardous.
- Most turbulence resulting from upper frontal zone shear occurs between 10,000 feet and 30,000 feet.
- The jet stream causes most turbulence in the upper troposphere and lower stratosphere, usually occurring in patches and layers, with the stronger turbulence on the low-pressure (cold-air side) of the jet stream.
- Strong turbulence is often associated with irregular and mountainous terrain. The greater the irregularity of the terrain and the sharper the slope of mountains, the greater the intensity and vertical extent of the turbulence.

- Fronts may produce moderate or greater turbulence.

- Turbulence intensity depends on the strength and speed of the front.

- Over rough terrain, fronts produce moderate or greater low-level turbulence.

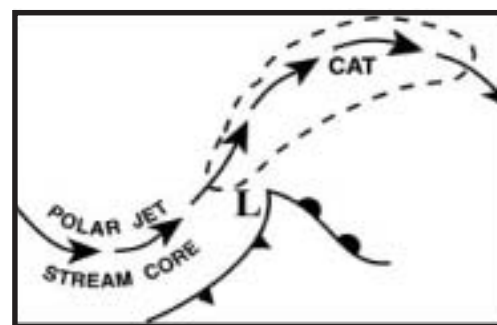
- Updrafts may reach 1,000 feet per minute in a narrow zone at low levels just ahead of the front.

- Over flat terrain, fronts moving over 30 knots produce moderate or greater low-level turbulence.

**D. Clear Air Turbulence (CAT).** CAT includes all turbulence not associated with visible convective activity. It includes high-level frontal and jet stream turbulence. It may occur in high-level, non-convective clouds. The following paragraphs describe the classic locations of CAT under specific meteorological conditions. CAT is not limited to these locations: adjustments to the forecast position may be necessary.

### 1. Surface and Upper-level Low Patterns.

**a. Surface Cyclogenesis.** When cyclogenesis occurs, forecast CAT near the jet stream core N-NE of the surface low development (Figure 2-28a). Sometimes the surface low redevelops north of the main jet, with a formation of a secondary jet (Figure 2-28b). Numerical models may not forecast this jet genesis. CAT intensity is directly related to the strength of cyclogenesis to the proximity to mountains, to the intensity of the jet core, and to the amplification and curvature of the downstream ridge. For cyclogenesis less than 1 mb/hour, expect moderate CAT. For cyclogenesis greater than or



**Figure 2-28a. CAT and Surface Cyclogenesis.** The figure shows CAT near the jet stream core northeast of the surface low development.

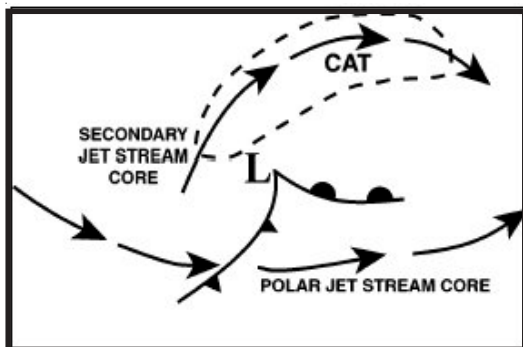
equal to 1 mb/hour, anticipate moderate to severe CAT.

the low is cut-off, CAT will diminish to light in the vicinity of the low.

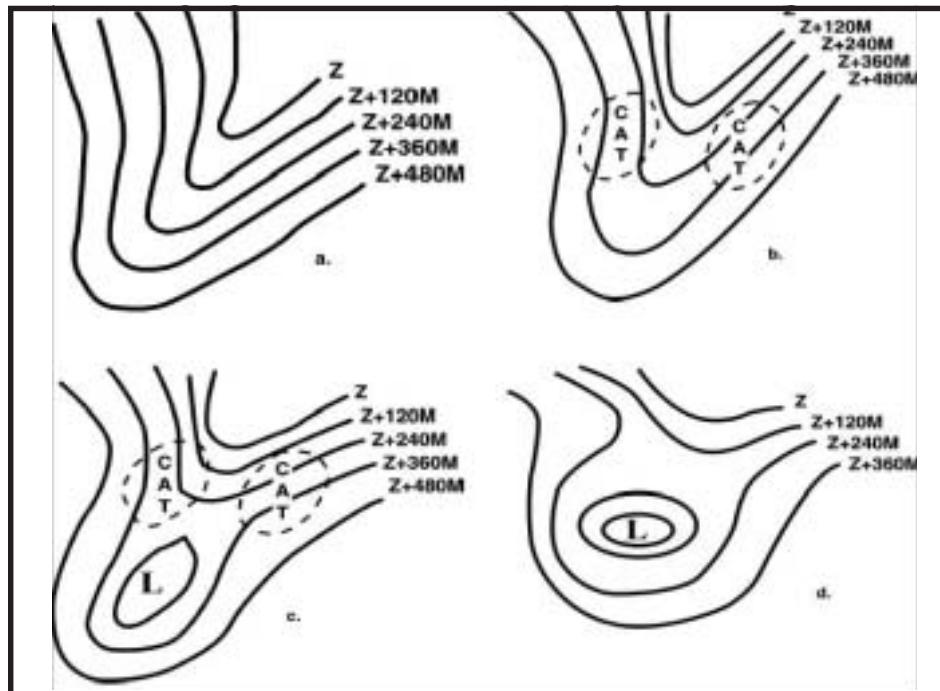
**b. Upper-level Lows.** There is a potential for moderate CAT in the development of cut-off upper-level lows. The sequence in Figure 2-29a-d shows CAT development in various stages during development of a cut off low. CAT usually forms in the areas of confluent and diffluent flow. Once

**c. 500-mb Cat Criteria.** The 500-mb product is useful for forecasting CAT. However, do not use it exclusively. Consider data at all available levels. The following patterns may signal CAT:

- Shortwave troughs near one another (double troughs).
- Well-defined thermal trough.
- A narrow band of strong winds with strong horizontal wind shears.
- Closed isotherm cold pocket moving through an open flow pattern (i.e., height field with no closed contours).
- 500-mb winds greater than 75 knots in areas with wind shifts greater than or equal to 20°, and tight thermal gradients.



**Figure 2-28b. CAT and Surface Cyclogenesis North of the Main Jet.** The figure shows CAT near a secondary jet stream core north to northeast of the surface low that developed north of the main jet.



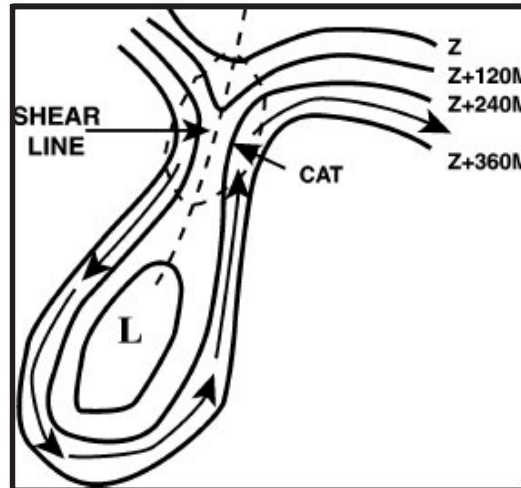
**Figure 2-29a-d. CAT and Upper-Level Lows.** Figure shows CAT development in various stages during development of a cut-off low.

**Turbulence**

- Troughs associated with a surface frontal wave (often indicated by sharply curved isotherms around the northern edge of a warm tongue).

Note: Unless otherwise indicated, Figures 2-29 through 2-33 show 500-mb level data, though text will also associate turbulence observed at other levels.

*d. Shear Lines in Upper-level Lows.* Forecast moderate CAT when: the jet stream is greater than or equal to 50 knots around a closed upper-level low, and a very narrow neck occurs, with a shear line separating the prevailing flow around the low. Forecast moderate to severe CAT if the jet reaches 115 knots. The potential for CAT is greatest between the two anticyclonically curved portions of the jet (see Figure 2-30).



**Figure 2-30. CAT and the Shear Line Associated with an Upper-Level Low.** Forecast moderate or greater turbulence when a shear line separates the prevailing winds around a low.

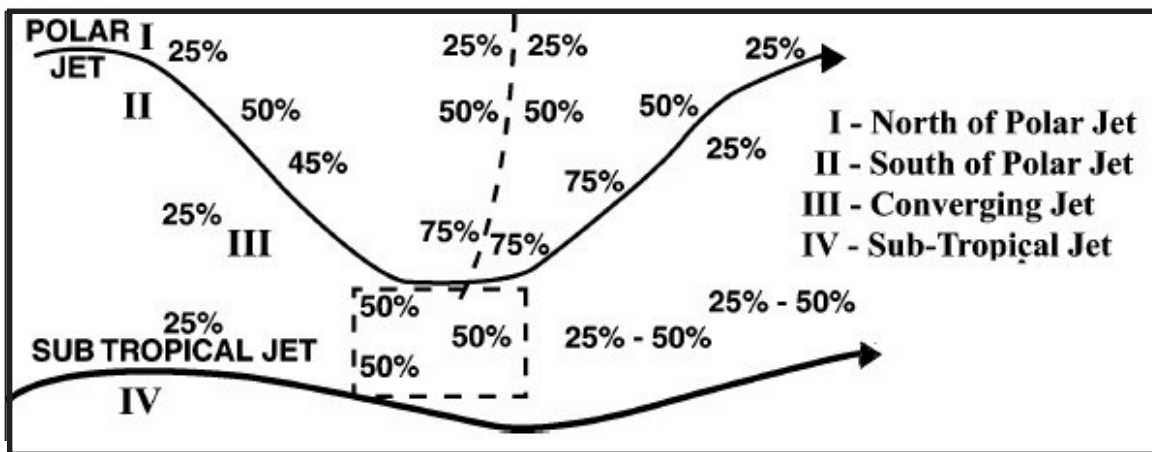
- Horizontal wind shear should be greater than 40 knots/150 NM and/or vertical wind shear should be greater than 6 knots/1,000 feet.

**2. Wind.**

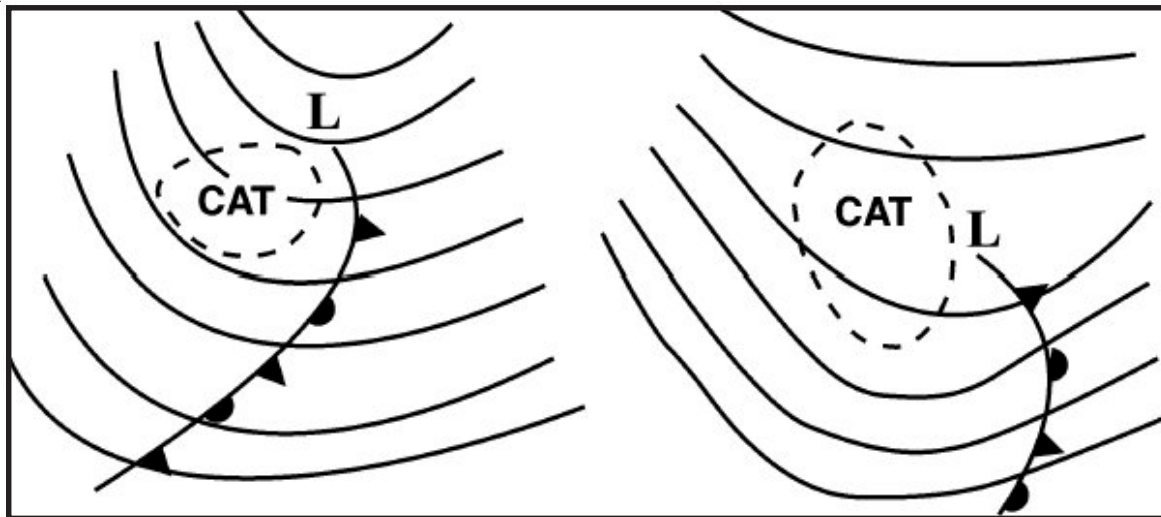
*a. Jet Stream Turbulence Model.* In the early 1960s, the Meteorology Department at United Airlines developed a basic jet stream turbulence model (Figure 2-31). The following applies to CAT occurrences in the model:

- Associated with converging polar and subtropical jets, mountain waves, and strong upper level frontal zones.

*b. Diffluent Wind Patterns.* Most CAT occurs during formation of diffluent upper-level wind patterns. Once the diffluent pattern becomes established, CAT may weaken in the diffluent zone. However, when a surface front is present (or forming), the potential for CAT increases in the areas of upper-level diffluent flow near the surface system (see Figure 2-32).



**2-31. United Air Lines Jet Stream Turbulence Model.** A flight through the box would have a 50 percent chance of encountering CAT. Probabilities are not cumulative and are estimated.

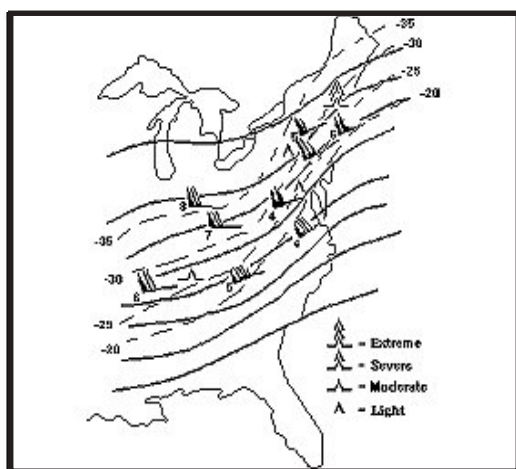


**Figure 2-32. CAT and Diffluent Wind Patterns.** The potential for CAT increases in the areas of upper-level diffluent flow near the surface system.

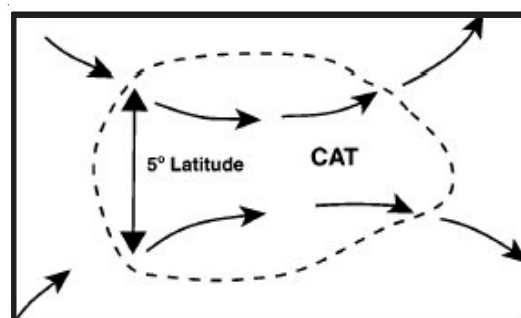
*c. Strong Winds.* CAT can exist in areas of strong winds when isotherms and height contours are nearly parallel and only minor variations exist in wind direction (about 20° per 4 degrees of latitude) with exceptionally tight thermal gradients. Figure 2-33 illustrates a situation in which 500-mb winds exceeded 100 knots in the vicinity of a very high thermal gradient. CAT was observed between 18,000 and 33,000 feet. Additionally, CAT often occurs along and above a narrow band of

strong 500-mb winds when horizontal wind shears are strong on either side of the band, especially if the winds have an ageostrophic tendency.

*d. Confluent Jets.* When two jet stream cores converge to within 250 NM, the potential for CAT increases. Figure 2-34 shows the potential CAT area where two jets come within 5° latitude of one another. Since the poleward jet is usually associated with colder temperatures and is lower than the second jet, the poleward jet will often undercut the other. This increases the static stability and produces strong vertical wind shears. The potential for CAT ends where the jets diverge to a distance of greater than 5° latitude.



**Figure 2-33. CAT and Strong Winds.** Isotherms, 500-mb height contours, and winds shown. Turbulence between 18,000 and 33,000 feet.



**Figure 2-34. Turbulence with Confluent Jets.** The CAT area occurs where two jets come within a distance of 5° latitude.

**Turbulence**

**3. Thermal patterns.** Analyze both the thermal and wind patterns to assess the potential for CAT. Appreciable cold-air advection is one significant clue to CAT potential.

**a. Temperature Gradients at/above 300 mb.**

Temperature gradients at the 300-, 250-, and 200-mb pressure levels provide key information. Expect CAT when a temperature gradient of greater than or equal to 5°C/120 NM exists or is forecast to occur and at least one of the following is observed:

- Trough movement greater than or equal to 20 knots.
- Wind shift greater than or equal to 75° in the region of cold advection.

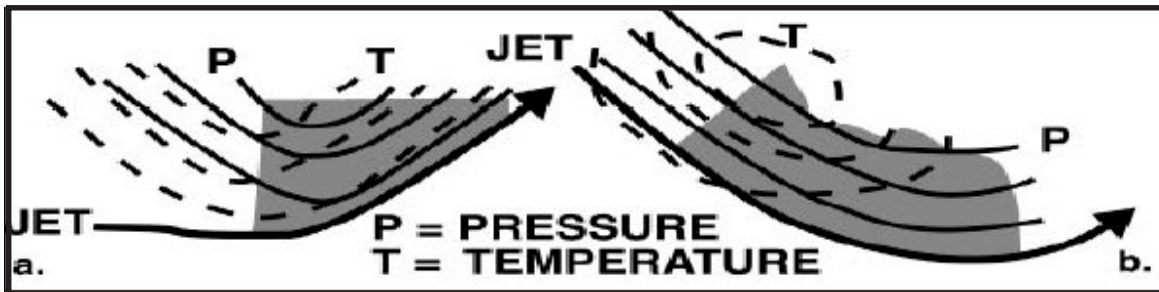
- Horizontal wind shear greater than or equal to 35 knots/110 NM (~200 km).

- Wind component normal to the cold advection is greater than or equal to 55 knots.

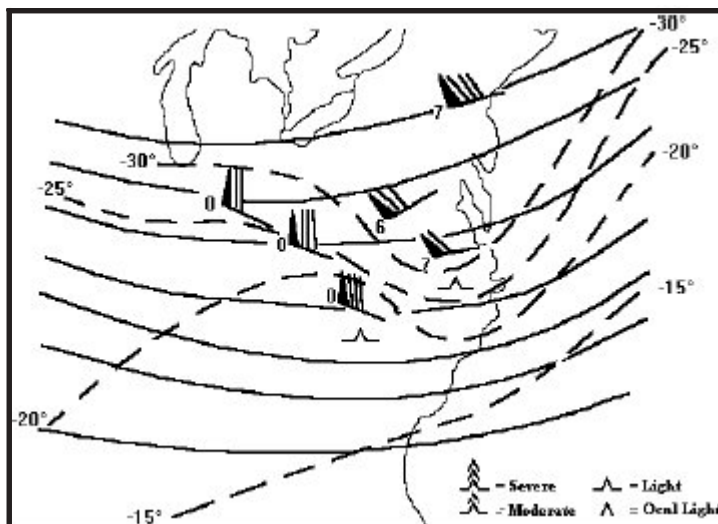
**b. Open Isotherm Troughs.**

This situation encompasses the majority of the CAT patterns. The noticeable bulging of a cold-air tongue in a relatively tight thermal gradient may occur at or near the base of the trough. In either case, the isotherms curve more sharply than the height contours (see Figures 2-35 and 2-36). In either case, moderate turbulence was reported between 25,000 and 35,000 feet.

Cold tongues commonly develop and move in from the northwest behind a pressure trough. Wind

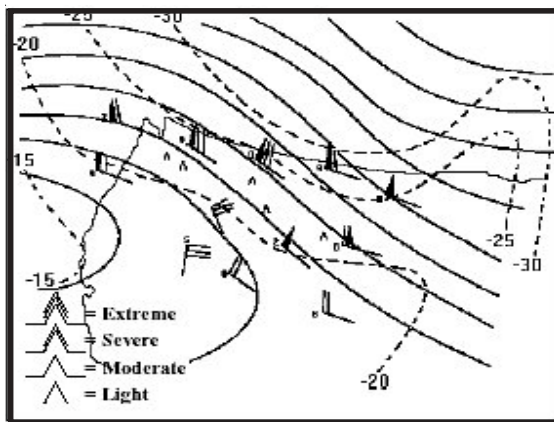


**Figure 2-35. Two Basic Cold-Air Advection Patterns Conducive to CAT.** Shaded areas highlight thermal patterns conducive to generation of CAT.



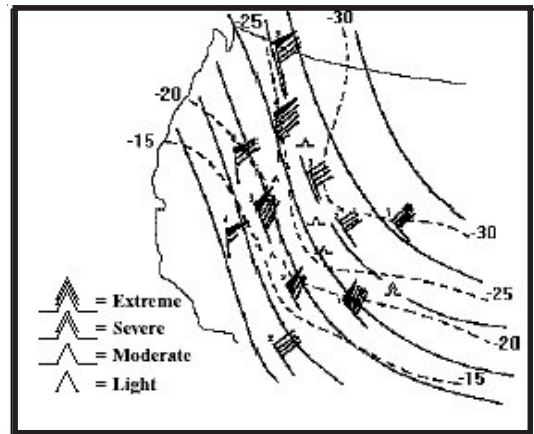
**Figure 2-36. Common Open-Isotherm CAT.** This situation encompasses the majority of the CAT patterns.

direction only changes gradually in this area. These troughs often move into the western states from the Pacific (see Figures 2-37 and 2-43). Once the thermal configuration shown becomes apparent, check for development at higher levels. In the Figure 2-37, a trough and tongue of cold air at 300 mb extended across the indicated turbulence zone on a northeast-southwest line and was instrumental in creating the turbulence. The lack of turbulence indicators in the strong CAA area in south-central Canada probably is due to a lack of PIREPS.



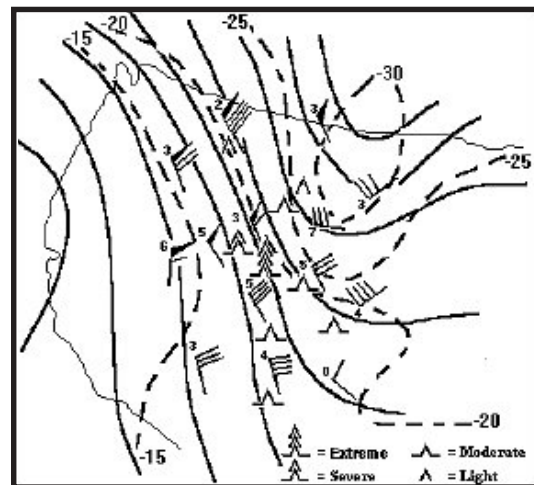
**Figure 2-37. CAT in Thermal Troughs.** CAT was reported from 28,000 to 37,000.

Figure 2-38 shows a thermal gradient in combination with a smooth, strong wind flow pattern and deep thermal trough. This pattern indicates a strong probability of CAT. The tight thermal gradient produced an average of 8 knots/1,000 feet of wind shear between 24,000 feet and 26,000 feet in northern Utah. CAT began with a tightening thermal gradient. Strong winds, an abnormally tight thermal gradient, and strong thermal troughing and ridging at 500 mb were strong indicators.



**Figure 2-38. CAT in Thermal Troughs.** CAT was reported from FL250 to FL320 except over Utah where the report was at FL390.

*c. Closed Isothermal Patterns.* CAT is often found in the development of a moving, closed cold-air isotherm at 500 mb when the height contours are not closed. CAT incidents between 24,000 and 37,000 were numerous (see Figure 2-39) in this rapidly moving pattern. The shear zone in the eastern region of the jet streak over the northern U.S. Rockies contributes to the CAT.

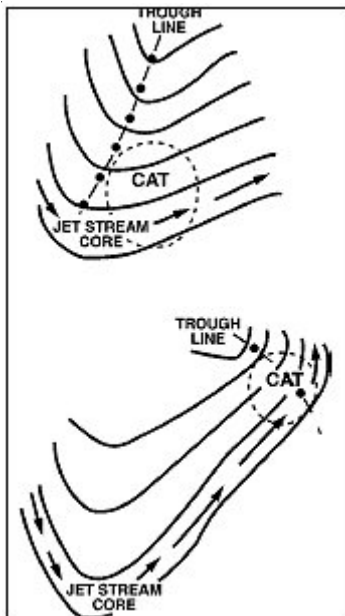


**Figure 2-39. Closed Isotherm CAT.** CAT was reported between FL240 and FL370.

**Turbulence**

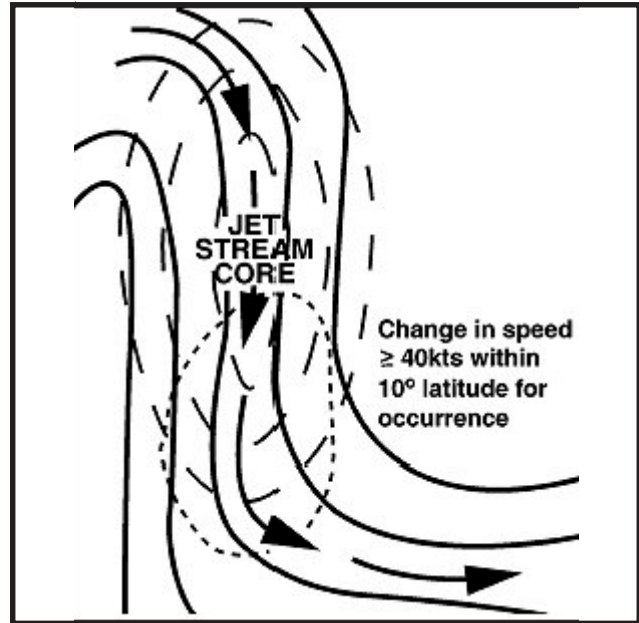
**4. Troughs and Ridges.**

*a. Shearing Troughs.* Rapidly moving troughs north of a jet may produce CAT in the confluent flow at the base of the trough (see Figure 2-40). The area of CAT is concentrated north of the jet stream core.



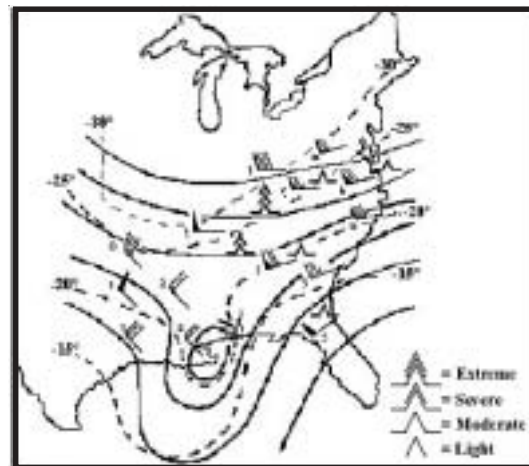
**Figure 2-40. CAT and Shearing Troughs.** The area of CAT is concentrated north of the jet stream core.

*b. Strong Wind Maximum to the Rear of the Upper Trough.* CAT potential is high when a strong north-south jet is located along the backside of an upper trough. CAT usually occurs in the area of decreasing winds between the base of the trough and the max wind upstream. The change of wind speed should be greater than or equal to 40 knots within 10° of latitude for CAT to occur. If the difference between the jet core and the minimum wind speed is greater than or equal to 60 knots, CAT is most likely to occur between the jet core and the base of the trough, centered on the warm-air side of the jet (see Figure 2-41).



**Figure 2-41. CAT Associated with Strong Wind Maximum to the Rear of the Upper Trough.** The potential is high when a strong north-south jet is located along the backside of an upper trough.

*c. 500-mb Deep Pressure Trough.* A common configuration is a relatively deep pressure trough at 500 mb. CAT is often found in a sharply anticyclonic, persistent isotherm pattern downwind of the trough. In the example shown in Figure 2-42, the isotherms are sharply curved anticyclonically through eastern Mississippi and



**Figure 2-42. CAT in a Deep 500-mb Pressure Trough.** CAT was reported between FL180 and 26,000.



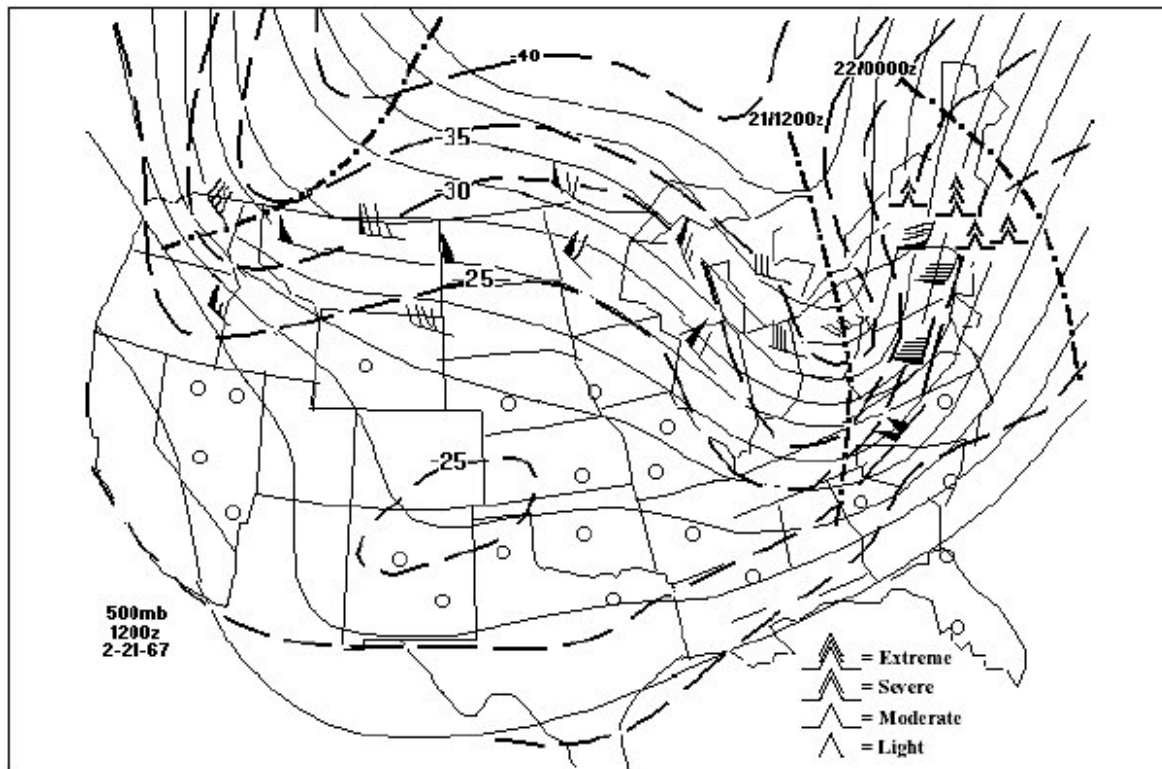
Alabama, and the amplitude of the isothermal ridge exceeds that of the height contours. CAT was found downwind from the sharp curvature in the isotherms leeward of the trough between 18,000 and 26,000.

**d. Double Trough Configuration.** Strong CAT is often associated with two troughs when they are close enough together that the trailing trough influences the airflow into the leading trough. This common pattern is often associated with a flat or flattening intervening ridge, which advects warm air into the bottom of the lead trough. Although the double trough can be detected at a number of levels, the 500-mb product is the best to use. Figure 2-43 depicts two troughs that are quite far apart. Nevertheless, the trailing trough (located over the Southwestern United States) exerts a definite influence on the airflow into the leading trough.

Moderate-to-extreme CAT was reported between 18,000 and 30,000.

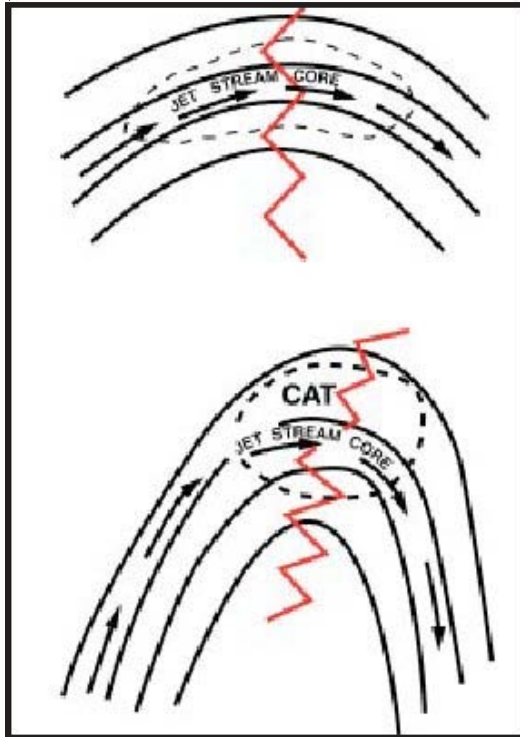
**e. Upper-Level Ridges.** Expect at least moderate CAT on both sides of the jet near the area where the jet undergoes maximum latitudinal displacement in an amplifying ridge (see Figure 2-44). Maximum CAT is located in the area of greatest anticyclonic curvature (usually within 250 NM of the ridge axis and elongated in the direction of the flow). Expect moderate or greater CAT with the following conditions:

- Strong vertical wind shear greater than or equal to 10 knots/1,000 feet.
- Winds greater than 135 knots in an area of broad anticyclonic curvature.



**Figure 2-43. Double Trough Configuration.** Moderate-to-extreme CAT was reported between 18,000 and 30,000 (MSL).

## Turbulence



**Figure 2-44. CAT and Upper-Air Ridges.** Maximum CAT is located in the area of greatest anticyclonic curvature.

### 5. Uses of Upper-air Data To Forecast CAT.

Here are some hints for using upper-air products to pick out synoptic conditions favorable for CAT, as described elsewhere:

**a. 700- And 850-mb Height and Temperature Fields.** These tools are useful in identifying regions of thermal advection, wind components normal to mountain ridges, mid- or low-level turbulence, and upper-level frontal boundaries.

**b. 500-mb Analysis of Heights, Temperature, and Vorticity.** Key on areas of thermal advection, short-wave troughs, and wind components perpendicular to mountain ridges. A 500-mb chart can also be used to approximate jet stream positions and upper-air synoptic patterns. For example, place jets near the following isotherms:

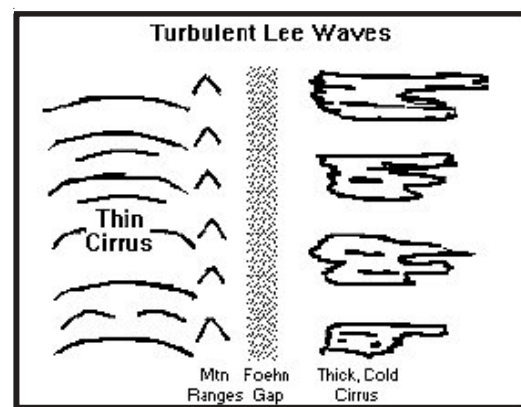
- Subtropical Jet:  $-11^{\circ}\text{C}$
- Polar Front Jet:  $-17^{\circ}\text{C}$
- Northern Branch:  $-30^{\circ}\text{C}$

**c. 250-mb Jet Stream.** Analyze closely to determine the current and future jet stream core position.

**d. 200-mb Analyzed Height and Temperature Fields.** Look for regions of strong isotherm packing in association with strong wind flow. **The 200-mb isotherms align closely with the 500-mb vorticity pattern and clearly depict short waves and developing systems.**

**E. Mountain Wave (MW) Turbulence.** The most severe type of terrain-induced turbulence is mountain wave turbulence. It most often occurs in clear air and in a stationary wave downwind of a prominent mountain range. It is caused by the mechanical disturbance of the wind by the mountain range.

The sketch in Figure 2-45 shows a foehn gap, a gap in the cloud cover, that indicates turbulent lee waves are present. The gap is located between the cirrus clouds and mountain range on the leeward side of the range. Wave intensity depends on several factors:



**Figure 2-45. Mountain-Wave Clouds.** A foehn gap indicates turbulent lee waves are present.

- Wind speed and direction. Winds flowing within 30 degrees of perpendicular to the ridgeline with little change in direction with height are more favorable for generating mountain waves. Also, a wind speed at the crest of about 25 knots increasing with height is more favorable for generating mountain waves. (25 knots is a generalization. The actual wind speed needed may vary from only 14 knots up to 30 knots depending on the shape of the mountains.)

— Rule of thumb: Mountain waves can extend as far as 300 NM leeward of the mountain range when the wind component perpendicular to mountain range exceeds 50 knots. A wave can extend as far as 150 NM when the perpendicular component exceeds 25 knots.

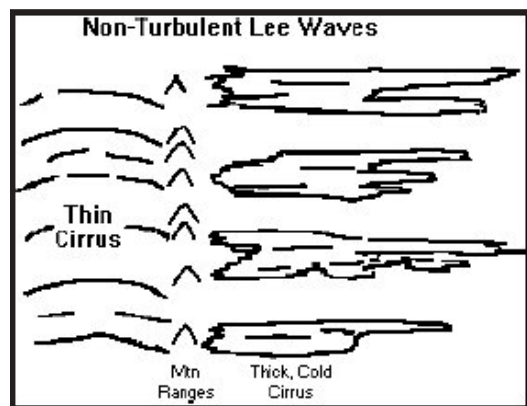
- Height and slope of the mountain (high mountains with steep leeward and gentle windward slopes produce the most intense turbulence).

- Another important factor for mountain wave formation is upstream stability. Look for upstream temperature profiles that exhibit an inversion or a layer of strong stability near mountain top height, with weaker stability at higher levels.

- An inversion capping the tropopause induces a stronger downward wave and cause wave amplification.

The most dangerous turbulence is found in the rotor and cap clouds. Downdrafts in these clouds can force a plane into a mountain. The sketch in Figure 2-46 has no foehn gap; the clouds nestle against the mountain range on the leeward side. This indicates an absence of turbulent waves.

Table 2-7 and Figure 2-47 (used together), provide guidance in forecasting mountain-wave turbulence.



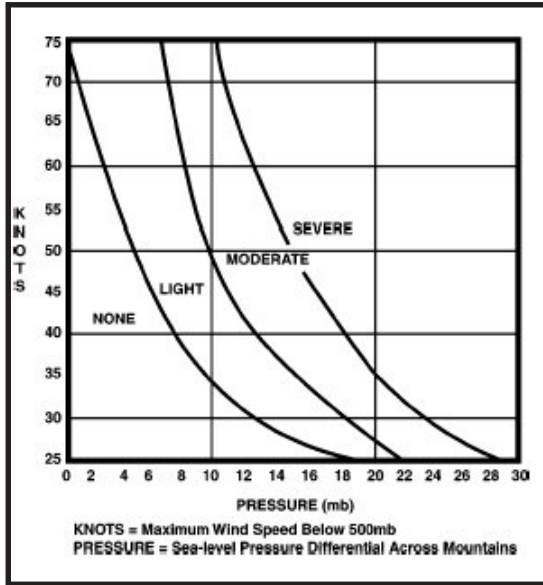
**Figure 2-46. Mountain-Wave Clouds.** The lack of a foehn gap indicates the absence of turbulent lee waves.

**Table 2-7. Low-level mountain wave turbulence.**

Low-Level Mountain-Wave Turbulence (Surface To 5,000 Ft Above Ridge Line)			
Low-Level Feature	Turbulence Intensity		
	Light	Moderate	Severe
Wind Component Normal to Mountain Range at Mountain Top and > 24 kt and			
dP Across Mountain at Surface is	See Figure 2-47	See Figure 2-47	See Figure 2-47
dT  Across Mountain at 850 mb is	< 6°C	6°C - 9°C	> 9°C
dT/dX  Along Mountain Range at 850 mb is	< 4°C/60 NM	4-6°C/60 NM	> 6°C/60 NM
Lee-Side Surface Gusts	< 25 kt	25 - 50 kt	> 50 kt
Winds Below 500 mb > 50 kt	Increase the Turbulence found by one degree of intensity (i.e., Moderate to Severe)		

- Notes:**
- (1) dP is the change in surface pressure across the range.
  - (2) |dT| is the absolute value of the 850-mb temperature difference across the range.
  - (3) |dT/dX| is the absolute value of the 850-mb temperature gradient along mountain range.
  - (4) Turbulence category forecast is the worst category obtained from each of the four parameters.

**Turbulence**



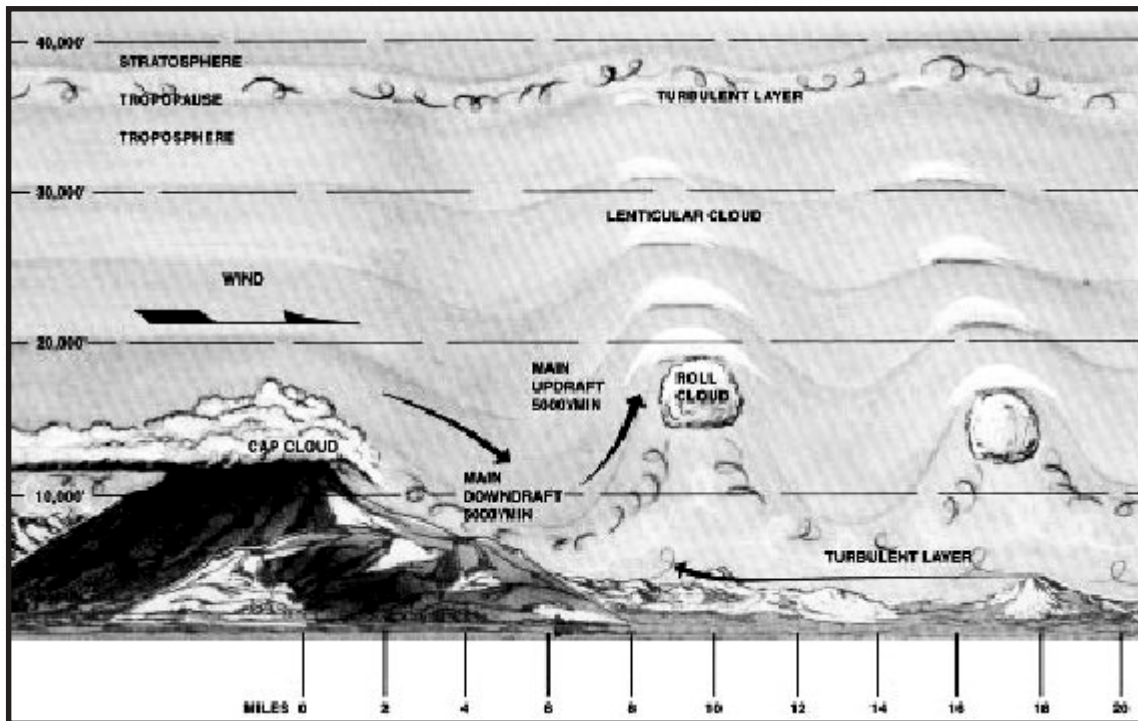
**Figure 2-47. Mountain Wave Nomogram.** Use this nomogram to predict mountain wave turbulence intensity.

*1. Associated Clouds.* There are specific clouds associated with mountain wave turbulence. These

are cap (Foehn wall), roll (rotor), and lenticular clouds. Figure 2-48 illustrates the structure of a strong mountain wave and associated cloud patterns. The lines and arrows depict wind flow.

*a. Cap Cloud.* The cap cloud hugs the tops of mountains and flows down the leeward side with the appearance of a waterfall. This cloud is dangerous because it hides the mountain and has strong downdrafts associated with it. The downdrafts can be as strong as 5,000 to 8,000 feet per minute.

*b. Roll Cloud.* The roll cloud, also called a rotor cloud, looks like a line of cumulus clouds parallel to the ridgeline. It forms on the leeside and has its base near the height of the mountain peak and top near twice the height of the peak. The roll cloud is dangerously turbulent with strong updrafts (5,000 feet per minute) on the windward side and dangerous downdrafts (5,000 feet per minute) on its leeward edge. This cloud may form



**Figure 2-48. Mountain Wave Cloud Structure.** The figure illustrates the structure of a strong mountain wave and its associated cloud patterns. The lines and arrows depict wind flow.

immediately on the lee of the mountain or it may be a distance of 10 miles downwind.

**c. Lenticular Clouds.** Lenticular clouds are relatively thin, lens-shaped clouds with bases above the roll cloud. Their tops extend to the tropopause. These clouds have a tiered or stacked look due to atmosphere stability above the mountain ridge. All lenticular clouds are associated with turbulence. In polar regions, lenticular clouds often appear high in the stratosphere around 80,000 feet. These clouds are called “mother-of-pearl” (nacreous) clouds.

## 2. Occurrence Indicators.

- Rapidly falling pressure to the lee side of mountains with significant differences on the windward side.

- Lee-side gusty surface winds at nearly right angles to the mountains.

- Observations of ACSL, rotor clouds or cap clouds.

- A lee-side cirrus trench.

- A well defined lee-side trough.

- A well defined lee-side trough.

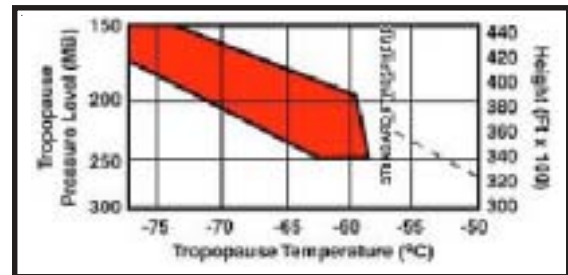
- PIREPS indicating mountain wave turbulence.

- Blowing dust picked up and carried aloft to 20,000 feet MSL or higher.

## 3. Conditions Favorable for Mountain Wave Turbulence.

- Temperature of  $-60^{\circ}\text{C}$  or colder at the tropopause (see Figure 2-49).

- Jet stream over or just north of the ridge line.



**Figure 2-49. Graph of Mountain Wave Turbulence Potential.** When the tropopause temperature and height readings fall within the shaded area, the potential for mountain wave turbulence exists when the wind speed and direction criteria are met.

- A cold front approaching or stationary to the north of the mountain range.

- Cold air advection across or along the mountain range.

**F. Wake Turbulence.** Although neither forecasted nor recorded in a TAF, wake turbulence is a problem with the increased use of heavy aircraft. You should be aware of how wake turbulence forms and be aware of its effects.

**1. Characteristics.** Every aircraft generates two counter-rotating vortices. Wake turbulence results when an aircraft encounters vortices from another aircraft. Vortex generation begins when the nose wheel lifts off the ground and ends when the nose touches back down again during landings. A vortex forms at a wingtip as air circulates outward, upward, and around the wingtip. The diameter of the vortex core varies with the size and weight of the aircraft.

These vortices can be 25 to 50 feet in diameter with a much larger area of turbulence. The vortices usually stay fairly close together (about 3/4 of the wing span) until dissipation. They sink at a rate of 400 to 500 feet per minute and stabilize about 900 feet below the flight path, where they begin to

## Turbulence

---

dissipate. Vortex size is reduced by the use of winglets, vertical fins attached to the tips of the aircraft wings.

**2. Dissipation.** Atmospheric turbulence increases the dissipation of wake turbulence while ground effect and surface winds alter the low-level vortex characteristics slightly. As the vortex sinks into the boundary layer, it begins to move laterally at about 5 knots. A crosswind will decrease the lateral movement of a vortex moving toward the wind and increase the movement of a vortex moving with the wind. This could hold one of the vortices over the runway for an extended period or allow one to drift onto a parallel runway. Vortices persist longer during inversions.

Listed below are some rules for avoiding wake turbulence (Federal Aviation Administration (FAA) Aeronautical Information Manual):

- If two aircraft fly in the same direction within 15 minutes of each other, the second should maintain an altitude equal to or higher than the first. If required to fly slightly below the first, the second aircraft should fly upwind of the first.

- Vortex generation begins with liftoff and lasts until touchdown. Therefore, aircraft should avoid flying below the flight path of a recent arrival or departure.

- Stable conditions combined with a crosswind of about 5 knots may keep the upwind vortex over the runway for periods of up to 15 minutes.

### **G Gravity Waves and Stratospheric Turbulence.**

Stratospheric CAT and tropospheric CAT are fundamentally different. Tropospheric CAT is primarily caused by deformations in the horizontal wind field and vertical wind shears. “Breaking” of gravity or buoyancy waves causes stratospheric CAT.

**1. About gravity waves.** A gravity wave is generated when an air parcel at equilibrium with its environment is rapidly displaced vertically (see Figure 2-50a-b). This can happen over mountain ranges for example. The mountain range lifts the parcel up and the suddenly it has different characteristics than its surrounding environment. While ascending the air parcel has greater pressure and expands. As the air parcel expands it cools and becomes heavier than its surrounding environment. Since the air is so heavy it falls and accelerates through the equilibrium point and becomes compressed, heats up warmer than the surrounding environment, and accelerates back up. This up and down motion as the parcel travels downstream is a gravity wave. Severe weather events, convection and jet streams also generate gravity waves.

- Gravity waves that propagate into the stratosphere, grow in amplitude due to decreasing air densities.

- Typical wavelengths are: 5 to 5000 km horizontally and .1 to 5km vertically. They can last from about 5 minutes to over a day.

- Stratospheric-breaking mountain waves on the order of 10 to 100 km wavelength typically generate turbulence felt by aircraft.

- Mountain waves generate sharp potential temperature gradients and overturn potential temperature surfaces causing rapid changes in air density resulting in mechanical turbulence for aircraft.

- Organized deep convection can also generate gravity waves that break in the stratosphere and generate turbulence.

**2. Forecasting Gravity Waves/Stratospheric Turbulence.** Gravity waves and stratospheric turbulence features are too fine scale and occur at very high altitudes. For both of these reasons, present forecast models can’t forecast stratospheric

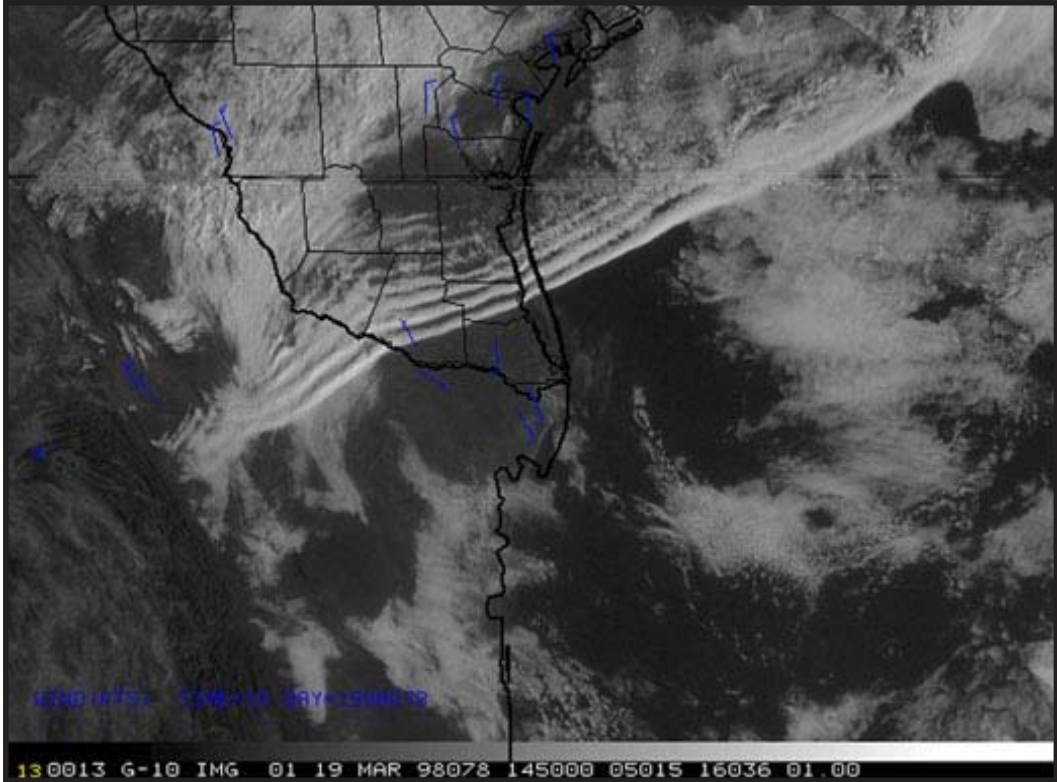


Figure 2-50a. Satellite Depiction of a Gravity Wave.

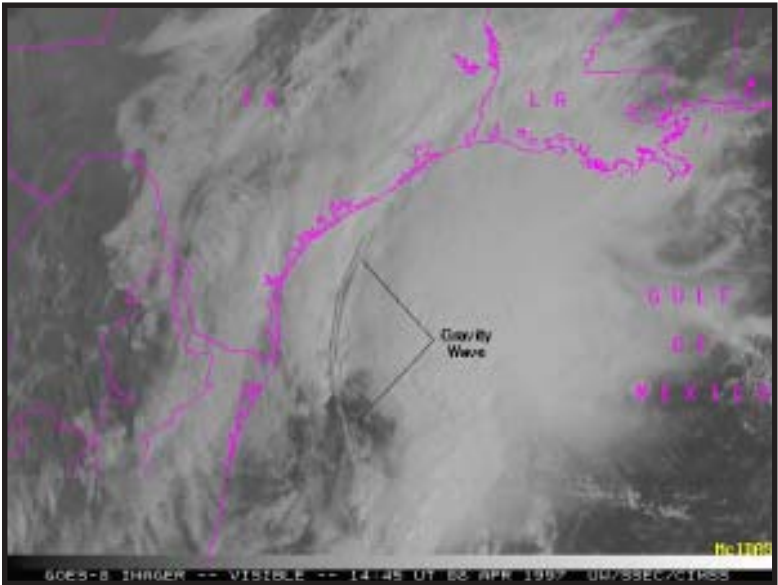


Figure 2-50b. Satellite Depiction of a Gravity Wave.

**Turbulence**

turbulence. Briefers should use centralized turbulence forecast products and the general background provided above to support customers.

**H. Forecasting Aids.** Use the following list of checklists, figures, standard system tools, and tables provided to aid you in providing accurate turbulence forecasts.

**1. Location of Turbulence Conditions.** The general location of turbulence should be anticipated in the following areas:

- Thunderstorms.
- Areas of strong thermal advection, such as:
  - Cold-air advection.
  - Warm-air advection.
  - Strong upper-level fronts.
  - Rapid surface cyclogenesis.
  - Outflow area of cold digging jet.

• Areas of large vertical shear, particularly below strong stable layers in:

- Tilted ridges.
- Sharp ridges.
- Tilted troughs.
- Confluent jet streams.

• Areas of considerable horizontal directional and/or speed shear, such as in:

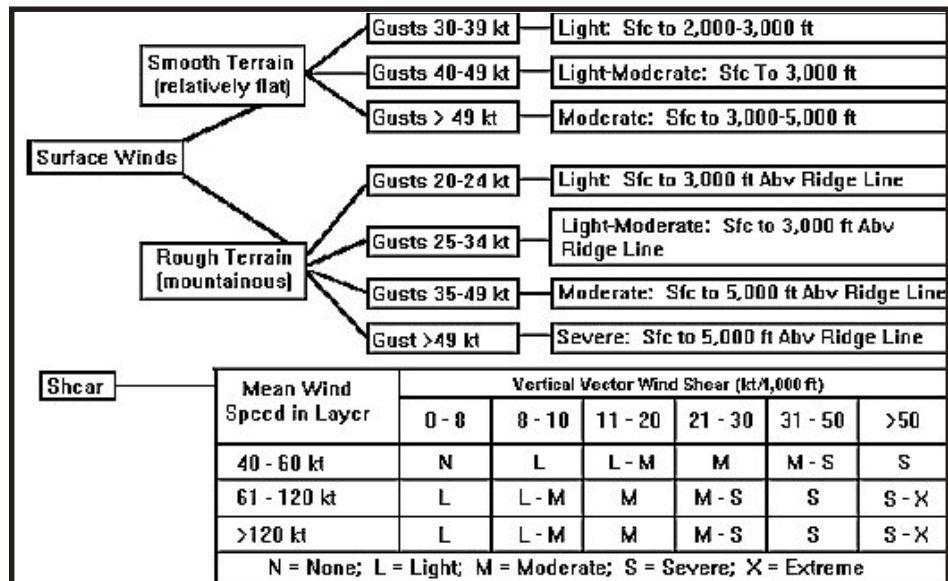
- Mountain areas.
- Diffluent upper flow.
- Developing cut-off lows.
- Sharp anticyclonic curvature.

**2. Basic Forecasting Checklist for Predicting Low-level (Surface To 10,000 Feet) Turbulence.**

Low-level turbulence can dramatically impact flight operations. Aircrews operating in high speed, low altitude training routes must be prepared to make quick corrections to avoid catastrophic accidents (see Figure 2-51).

Note: Checklist is based on category II aircraft. Adjust turbulence values for supported aircraft using Tables 2-5 and 2-6.

**3. Forecasting Turbulence in Convective Clouds.** This section describes a method for forecasting turbulence in convective clouds using a Skew-T. The method considers two layers of the atmosphere: Surface to 9,000 feet MSL and above 9,000 feet MSL (see Figure 2-52). The forecast is



**Figure 2-51. Forecasting Checklist for Low-Level Turbulence.** This checklist is designed for category II aircraft.



designed for Category II aircraft and must be modified for other types of aircraft.

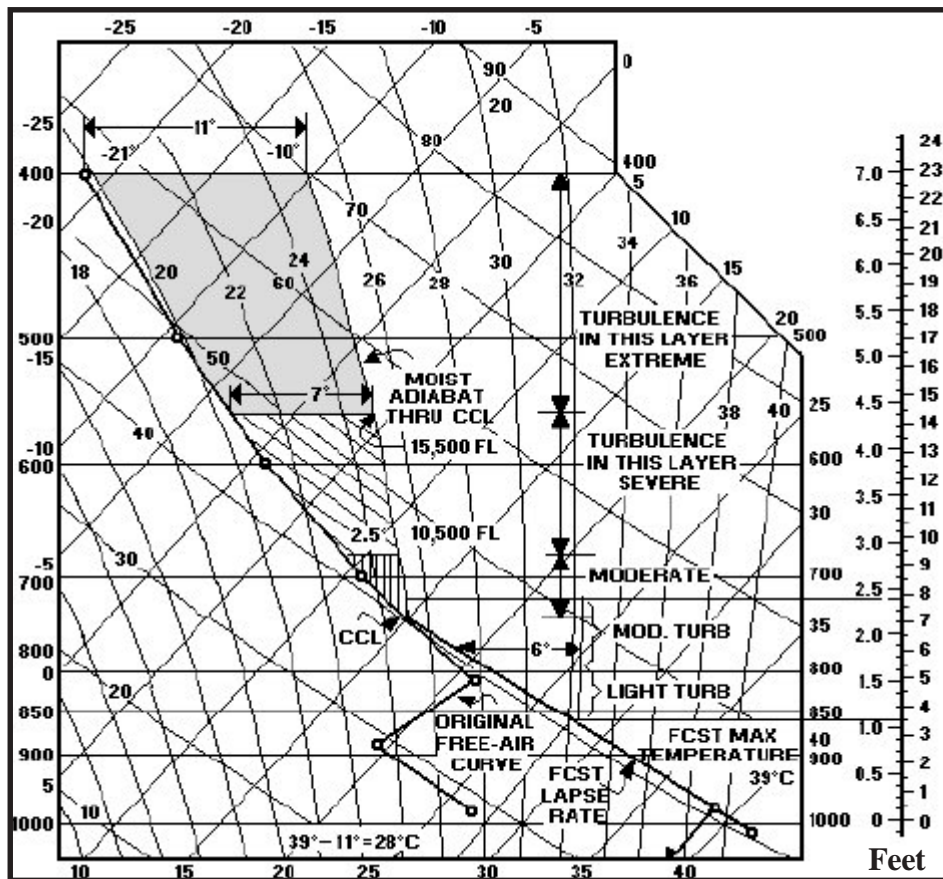
**a. Layers from Surface to 9000 feet.**

Use the steps below to estimate the buoyant potential in the lower atmosphere. Use the results obtained by this method to estimate turbulence in thunderstorms.

- Use the convective temperature to forecast the maximum surface temperature. Project a dry adiabat from the convective condensation level (CCL) to the surface. This gives the convective temperature. Adjust this temperature using temperature curves for local effects.

- Subtract 11°C from the final forecast maximum temperature. Follow this isotherm to its intersection with the dry adiabat projected upward from the forecast maximum temperature.

If the intersection is above 9,000 feet MSL, forecast no turbulence below 9,000 feet MSL. If the intersection is below 9,000 feet, draw a moist adiabat from the intersection of the isotherm and the dry adiabat upward to the 9,000 feet level. The temperature difference between this moist adiabat and the free-air temperature curve determines the severity of the turbulence as well as the limits of the layers of each degree of turbulence. Apply the temperature differences to Table 2-8.



**Figure 2-52. Turbulence Forecasting from Skew-T.** The figure depicts a method for forecasting turbulence in convective clouds using a Skew-T.

**Turbulence**

*b. Layers above 9000 Feet.* Follow the moist adiabat that passes through the CCL upward to the 400-mb level. The maximum temperature difference between this moist adiabat and the forecast free-air temperature curve is the central portion of the most turbulent area. The intensity of the turbulence is found in Table 2-9.

**Table 2-8. Layers below 9000 feet using temperature differences.**

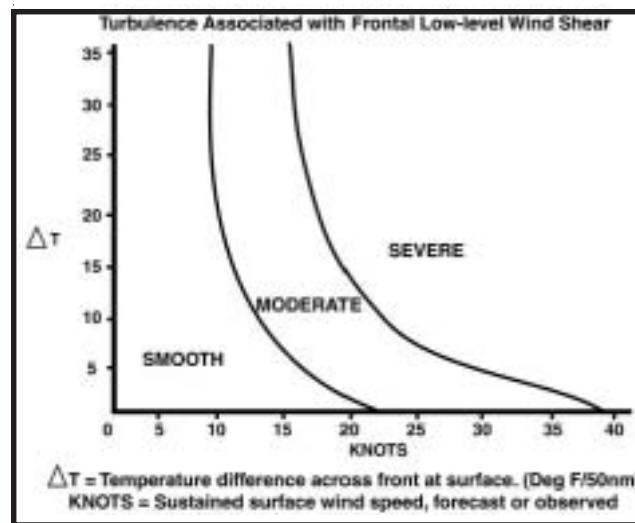
Layers where temperature difference is	Turbulence is forecast as
0° to 6°C	Light
6° to 11°C	Moderate
11°C or more	Severe

**4. Low-level Turbulence Nomogram.** The graph in Figure 2-53 can be used to predict turbulence using forecast or observed winds and the temperature differences across a surface front.

**5. Wind Shear Critical Values.** Use Table 2-10 if receiving PIREPs with turbulence for a particular area and you want to quickly confirm if the turbulence will likely continue in the area. When two of the criteria are present in the same region, forecast the higher turbulence intensity, (e.g., if moderate horizontal criteria and severe vertical criteria are present in the same region, forecast severe turbulence in this region).

**Table 2-9. Layers above 9000 feet using temperature differences.**

Layers where temperature difference is	Turbulence is forecast as
0° to 2.5°C	Moderate
2.5° to 7°C	Severe
7°C or more	Extreme



**Figure 2-53. Low-Level Turbulence Nomogram—Temperature Gradient and Surface Winds.** Use this figure to predict turbulence using forecast or observed winds and temperature differences across a surface front.

**Table 2-10. Wind shear critical values.**

	Turbulence Intensity			
	Light	Moderate	Severe	Extreme
Horizontal shear		25-49 kt/90 NM	50-89 kt/90 NM	> 90 kt/90 NM
Vertical shear	3-5 kt/1000 ft	6-9 kt/1000 ft	10-15 kt/1000 ft	> 15 kt/1000 ft

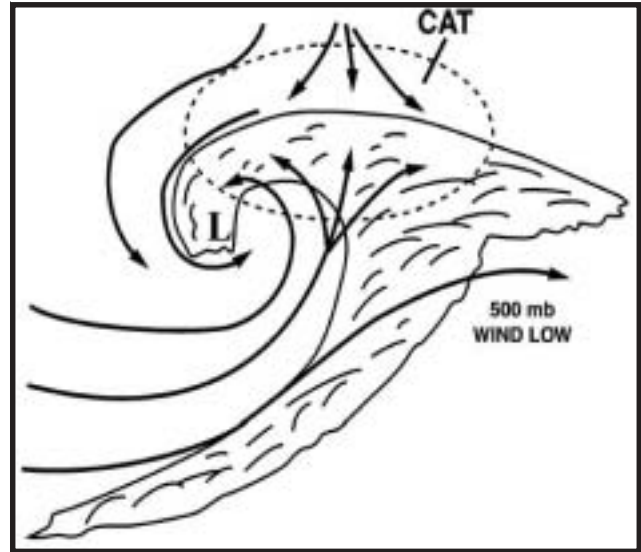
**7. Satellite Signatures and Turbulence Forecasting.** Be familiar with and recognize the following features:

**a. Deformation Zone.** A region where the atmosphere is undergoing contraction in one direction and elongation or stretching in the perpendicular direction, relative to the motion of the air stream (see Figure 2-54). A cloud border is often located near and parallel to the stretching axis. Situations where moderate to severe turbulence is most likely are as follows:

- Cyclogenesis is in progress, accompanied by a building or rapidly moving upper ridge to the east of the storm.
- The cloud system is encountering confluent (opposing) flow caused by a blocking upper-level system (a closed low or anticyclone) downstream.
- Low and associated comma-cloud system are dissipating.
- A flattening of the cloud border on the upstream side of the comma.

**b. Wave Cloud Signatures.**

(1) *Transverse Bands.* Defined as irregular, wave-like cirrus cloud patterns that form nearly perpendicular to the upper flow (Figure 2-55). They



**Figure 2-54. CAT in a Deformation Zone.** Moderate-to-severe turbulence can occur in the dashed area.

are usually associated with the low-latitude subtropical jet stream and indicate large vertical and possibly horizontal wind shears. Generally, the wider, thicker transverse bands are more likely to contain severe turbulence, possibly due to the added presence of thermal instability. In these situations, the bands often have a carrot-shaped appearance, similar to cumulonimbus anvils. Cloud bands, in general, tend to be aligned with the cloud layer shear vector. For this reason, the presence of cirrus bands that differ in orientation from the prevailing wind direction indicate directional shear with height.



**Figure 2-55. Example of Transverse Waves.**

## Turbulence

(2) *Billows*. Defined as wave cloud patterns in cirrus, or middle-level clouds, which are regularly, spaced, narrow, and oriented to the upper flow. They are most often seen when a strong jet intersects either a frontal cloud system or a line of cumulonimbus clouds at a large crossing angle. The anvil debris of convective clouds in these situations extends well downstream from its source. Although individual waves dissipate quickly (less than 30 minutes), new waves can reform nearby under favorable conditions. The longer the wavelength of the billows, the better the chance for significant turbulence. Kelvin-Helmholtz instability is often made visible in billow clouds (Figure 2-56)..



**Figure 2-56. Example of Billow Clouds.**

(3) *Water Vapor Image Darkening*. This refers to elongated bands, or in some cases, large oval-shaped gray regions that become darker in successive images. The darkening is usually accompanied by cold advection and convergence in the mid- and upper-levels of the troposphere resulting in compensating sinking through a deep layer. Vertical cross-sections through such features reveal sloping baroclinic zones (tropopause leaves or folds). This indicates stratospheric air is descending into the upper troposphere. Moderate or stronger turbulence occurs over 80 percent of the time when image darkening occurs, especially when it persists for at least 3 hours.

(4) *Mountain Waves*. Defined as stationary waves situated downwind of a prominent mountain range and caused by the disturbance of the wind by the mountain range. Usually the wave exhibits a stationary, narrow clearing zone parallel to steep mountain ranges (Figure 2-57). It may also occur in Chinook wind synoptic situations, near or just east of the upper ridge and south of the jet stream.



**Figure 2-57. Example of Mountain Wave.**

**8. Vertical Cross Sections.** Vertical cross-sections of the atmosphere can greatly increase the understanding of atmospheric structures that contribute to turbulence development. N-TFS can quickly generate and analyze Skew-Ts and Uniform Gridded Data Field (UGDF) distance-log P vertical cross-sections needed for this technique. Analyzing wind speeds (10 knot intervals) and temperature (at 5°C intervals) will reveal jet cores and strong vertical temperature gradients associated with atmospheric turbulence. Frontal boundaries and areas of wind shear that contribute to turbulence can also be found.

**9. Doppler Weather Radar.** This radar provides unique, near real-time capabilities to detect and display turbulence indicators such as frontal boundaries, low-level jets, gust fronts, and upper-level wind shear.

**a. Spectrum Width (Figure 2-58).** Though not conclusive, spectrum width values of 8-11 knots are associated with moderate turbulence (Cat II aircraft). Values 12 knots or higher may indicate severe turbulence. Use the spectrum width product to confirm suspected turbulence areas found using other products such as base velocity.

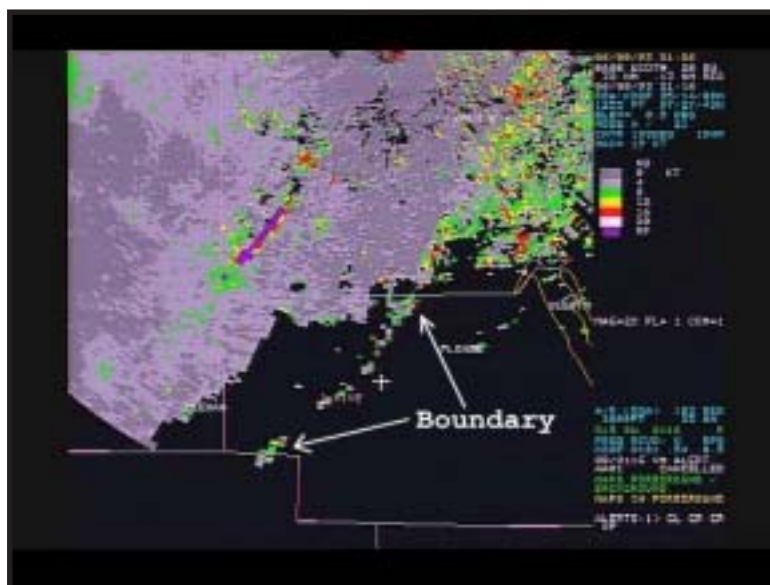
**b. Velocity Azimuth Display (VAD) Wind Profile (VWP) (see Figure 2-19).** The VWP is a graphic display of winds. This product allows you to examine the current and past vertical wind structure to help identify meteorological conditions associated with atmospheric turbulence evolving over time (e.g., inversions, wind shifts, and development of jet streams). Look for areas of sharp turning in the winds with high wind speeds to identify strong local vertical wind shear.

**c. Base Velocity (Figure 2-59).** This product displays horizontal wind velocities. Areas of

sudden speed or directional shifts are associated with wind shear and atmospheric turbulence. Intense shear regions, such as the top of the thunderstorm associated with storm top divergence, can also be located using base velocity.

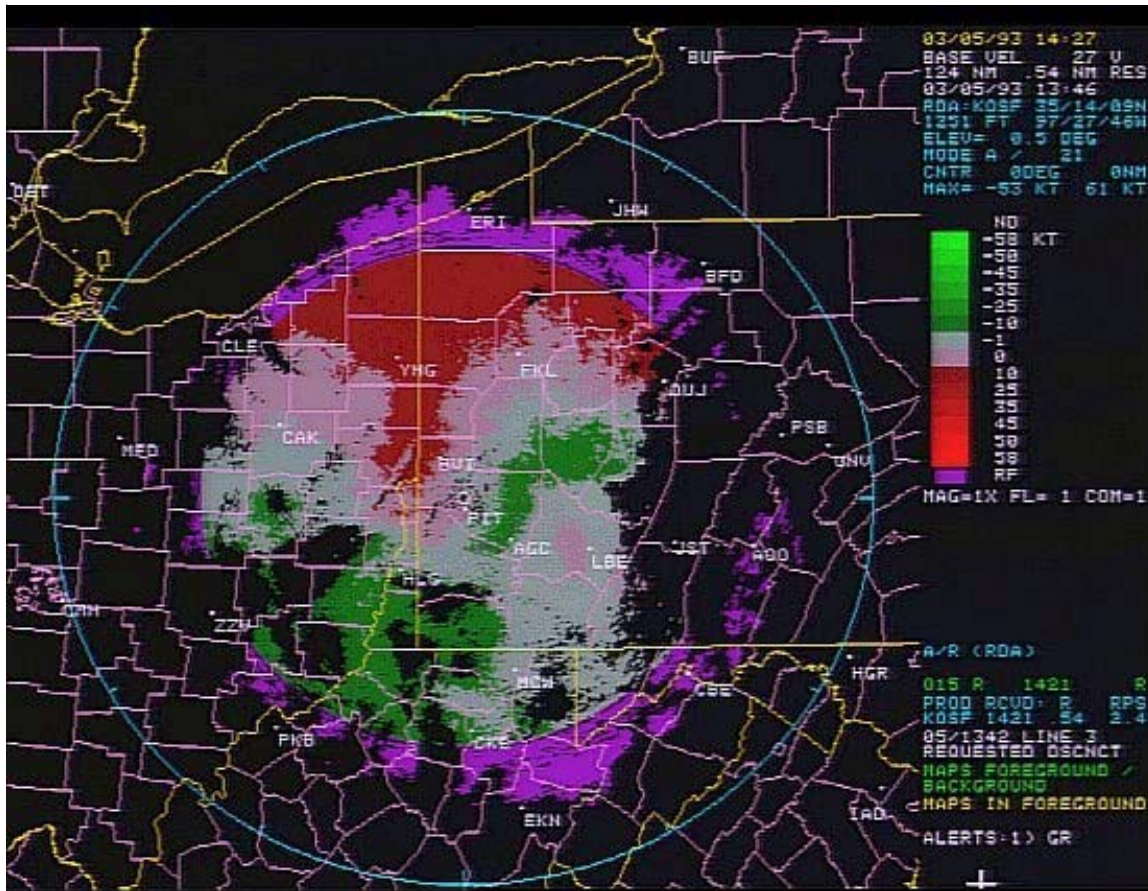
**d. Vertically Integrated Liquid (VIL) (Figure 2-60).** Higher VIL values indicate a strong potential for severe convective weather and associated wind shear and atmospheric turbulence.

**10. Forecast Weather Models.** Today's weather models provide turbulence forecasts for various flight levels using complicated algorithms. They also provide meteograms that give vertical cross-section forecasts for the atmosphere that can help in identifying turbulent areas. As always verify the model before using the products.

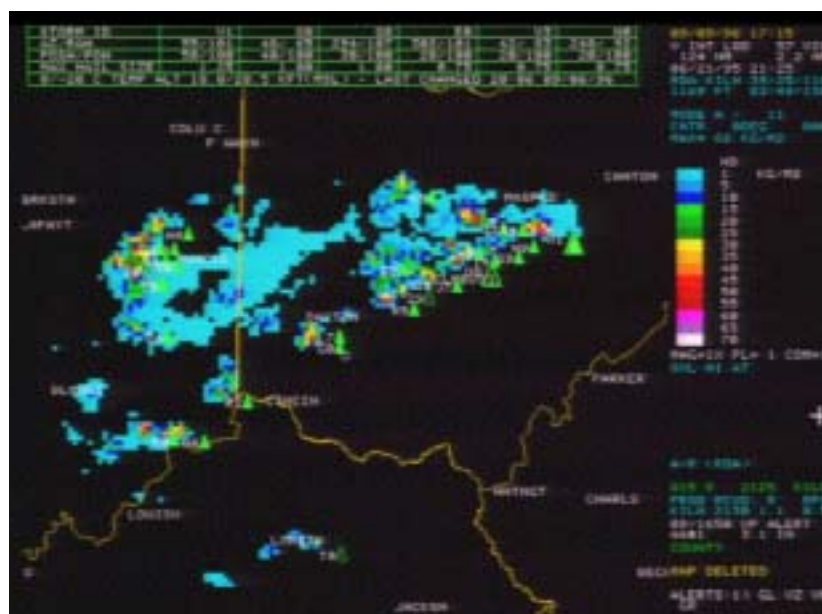


**Figure 2-58. Spectrum Width Product.**

**Turbulence**



**Figure 2-59. Base Velocity Product.**



**Figure 2-60. Vertically Integrated Liquid (VIL) Product.**

**III. AIRCRAFT ICING.** Structural icing interferes with aircraft control by increasing drag and weight while decreasing lift. Engine-system icing reduces the effective power of aircraft engines. The accuracy of the icing forecast begins with an accurate prediction of precipitation, clouds, and temperature.

Aircraft icing generally occurs between the freezing level and  $-40^{\circ}\text{C}$ . However, icing can occur at  $-42^{\circ}\text{C}$  in the upper parts of cumulonimbus clouds. The frequency of icing decreases rapidly with decreasing temperatures, becoming rare at temperatures below  $-30^{\circ}\text{C}$ . The normal atmospheric vertical temperature profile usually restricts icing to the lower 30,000 feet of the atmosphere.

Icing may occur during any season of the year. In the middle latitudes (such as in most of the United States, Northern Europe, and the Far East), icing is most frequent in the winter. Frontal activity is also more frequent in the winter, and the resulting cloud systems are more extensive, creating favorable icing conditions. In winter, however, polar regions are normally too cold to contain the concentration of moisture necessary for icing. Generally, locations found at higher latitudes (such as Canada and Alaska) have the most severe icing conditions in the spring and fall.

#### **A. Icing Formation Processes and Classification.**

**1. Processes.** We know that clouds are not water vapor but consist of water droplets and/or ice crystals that form when the atmosphere becomes saturated with respect to liquid or ice. Once saturated, the atmosphere can produce or maintain clouds through several processes. These include the following: (1) addition of water vapor, (2) Cooling and lifting by convective processes, (3) Cooling and lifting by mechanical (orographic) processes, and (4) Convergence.

**a. Terrain.** Air lifted by terrain can lead to development of a variety of clouds ranging from widespread cloudiness covering hundreds of kilometers, to relatively small cap clouds over mountain peaks.

One example of terrain effects is upslope easterly winds over the western high plains that often create widespread cloudiness as the air is forced westward over the gently rising terrain. These clouds can result in broad areas of icing conditions, which can last for days at a time. Such patterns generally occur after passage of arctic or polar fronts.

Icing hazards can also develop in orographic clouds, which tend to develop along mountaintops and ridges and can persist for days if the winds and moisture are consistent. Winds blowing perpendicular to ridgelines provide the most favorable conditions for orographic cloud development.

**b. Fronts.** Fronts act like “moving terrain” forcing one air mass up and over another. Although the lifting over a moving cold air mass can have a broad extent, the more intense lifting caused by a cold front tends to be limited to narrow bands of clouds tens of kilometers wide near the surface frontal location. Fronts in general can be areas of enhanced icing due to the presence of convection and ample moisture. The icing threat posed by a cold front varies based on the strength and extent of the associated lift and ultimately, the aircraft’s flight altitude and trajectory through the frontal cloud. A flight path perpendicular to the cloud band can reduce the icing threat, while a path parallel to the cloud band can be particularly hazardous due to the prolonged time within the cloud.

**c. Cyclones.** Cyclonic circulations generate convergence of air near the centers of low-pressure systems, and thus, large-scale (over hundreds or even thousands of kilometers) rising motion and

## Icing

---

cloud formation. Large-scale dynamic processes such as warm air advection and differential vorticity advection can also lead to broad regions of uplift and cloudiness. Areas ahead of active and stationary warm fronts and behind the surface low center are the primary areas where icing occurs. These locations all provide favorable conditions for the formation of supercooled liquid cloud and freezing precipitation. Additionally, the extensive nature, both vertically and horizontally, of a synoptic-scale cyclone can result in long exposures of aircraft to icing conditions. The synoptic aspects of icing will be treated more specifically in future training components on synoptic-scale processes.

**2. Phase Transitions.** Water is a unique substance in that, at typical tropospheric pressures and temperatures, it exists in three phases: liquid, solid, and vapor. The transitions between phases control, to a large extent, the likelihood and amount of liquid water available for icing. Phase change processes can be divided into six categories: *condensation*, *evaporation*, *freezing*, *melting*, *deposition*, and *sublimation*. Click the various transition types from the menu bar on the left to learn about the processes and their relationship to in-flight icing.

**a. Condensation.** Condensation is the transition of water vapor to liquid water. This phase transition forms liquid water clouds. Processes leading to condensation are described in the section on cloud formation. We know that clouds are typically formed in rising air that cools to its dewpoint temperature. As an air parcel rises, it expands and cools adiabatically and vapor condenses onto small airborne particles called cloud condensation nuclei (CCN). As the air continues to rise and cool, additional condensation takes place on these activated droplets and the droplets continue to grow.

**b. Evaporation.** Evaporation is the transition of liquid water to vapor. When clouds mix with surrounding dry environments, droplets evaporate

because of their exposure to sub-saturated conditions. If enough dry air is mixed in, clouds dissipate. This entrainment and mixing process is a common occurrence in both convective and stratiform clouds. Stratus can change to stratocumulus and eventually dissipate as dry air is entrained.

**c. Freezing.** Freezing is the transition of liquid water to ice. Liquid water droplets do not necessarily freeze at 0° C. Droplets may become supercooled, persisting at temperatures well below 0° C. In order for a supercooled droplet to freeze, it must come into contact with a small particle called an ice nucleus. The ability of these ice nuclei to catalyze droplet freezing is temperature dependent. At temperatures warmer than -12° C to -15° C few active nuclei exist and clouds are likely to be composed primarily of liquid droplets rather than ice crystals. If a cloud lacks a sufficient concentration of ice nuclei, widespread areas of supercooled water can exist and the icing hazard becomes very likely. When the temperature approaches -40° C, an ice nucleus is no longer needed and droplets freeze spontaneously.

**d. Melting.** Melting is the transition of ice to liquid water. This process is important in forming freezing precipitation by a “classical” warm intrusion process that is covered in detail in the *Icing in Precipitation* section. Melting can also remove accreted ice from the airframe if the pilot is able to safely descend (or in more rare cases ascend) to temperatures warmer than 0° C. Thus, knowledge of the altitude of the freezing level and depth of the above-freezing air is an important part of the icing forecast. If the freezing layer extends down to the surface, there may be no escape from icing conditions other than flight above or around the cloud or horizontally toward warmer air. These recourses are often impossible for smaller aircraft that have limited range, altitude, and ability to handle icing.



**e. Deposition.** Deposition is the transition of water vapor to ice. At a given temperature, the vapor pressure over a water surface is greater than that over an ice surface. If water droplets and ice crystals exist in the same environment (called mixed phase conditions), vapor molecules in the air will deposit on an ice crystal rather than condense onto a water droplet. Thus, the ice crystals grow at the droplets' expense. Deposition creates sub-saturation with respect to water and the droplets evaporate to maintain water saturation, leaving additional water vapor available for ice crystal growth. In mixed-phase clouds, glaciation, the transition of the cloud from supercooled liquid to ice, generally takes place rapidly. Glaciation tends to begin in the highest part of the cloud and then work downward, as ice crystals become larger and heavier and fall. Therefore, in stratiform clouds with tops generally colder than around  $-15^{\circ}\text{C}$ , we would not expect significant icing conditions to exist because at these colder temperatures, ice nuclei generally are active, forming ice and leading to glaciation of the cloud. The exception is in cumuliform (including stratocumulus) clouds with strong enough updrafts to supply both the liquid droplets and ice crystals with enough condensate for coexistence.

**f. Sublimation.** Sublimation is the transition of ice to water vapor. This process occurs in a sub-saturated environment that is below freezing where ice particles transition directly to water vapor without melting.

**3. Icing Factors.** The importance of meteorological parameters in the icing process is described in this section of the training.

The information needed to diagnose icing severity and type is not generally available operationally and much must be inferred from other data sources. Thus, some knowledge of the values for liquid water content, droplet size, temperatures, and altitudes conducive to icing will help you interpret the data on hand.

Icing severity and type depends on the properties of the aircraft as well as the atmospheric conditions. Forecasters cannot be expected to know and understand all the aircraft-specific icing influences, but rather need to focus on diagnosing the icing environment. This section describes the most important meteorological parameters to consider when forecasting icing severity and type. Special problems related to specific aircraft types are mentioned where appropriate, to increase your awareness of these factors.

The meteorological quantities most closely related to icing severity and type are, in order of importance: (1) Liquid water content (LWC), (2) Temperature (Altitude), and (3) Droplet size.

**a. Liquid Water Content.** Cloud liquid water content (LWC) plays an important role in determining the icing potential but is, perhaps, one of the more difficult parameters to quantify. The few forecast rules relating LWC, icing type, and severity are mostly rules of thumb that have not been rigorously verified. In this section findings of recent research in this area are presented in the hope of providing some insight into the role of LWC in the icing forecast problem. Few concrete rules for forecast application are available since LWC distribution is highly variable from one case to another.

**(1) Definition.** The density of liquid water in a cloud, or "liquid water content" (LWC), is expressed either as grams of water per cubic meter ( $\text{g}/\text{m}^3$ ) or per kilogram ( $\text{g}/\text{kg}$ ) of air. If the temperature is below freezing, the liquid water content is a measure of how much supercooled liquid water (SLW) is available to accrete on the aircraft. However, the quantity of liquid, the LWC or SLW, is not measured routinely, and only a few of the operational NWP models include them as output parameters and the accuracy of these model LWC forecasts have not been extensively studied at the time of this writing.

## Icing

---

**b. Temperature.** Temperature can affect both the severity and type of icing. For icing to occur, the outside air and airframe temperatures must be below 0° C. Since supercooled droplets (SLD) need an ice nucleus to freeze (and thus take themselves out of the icing picture), and since ice nucleus activity is strongly temperature dependent we expect most icing to take place at warmer temperatures (but still below 0° C). This graphic shows that most icing tends to occur at temperatures between 0° and -20° C. The only physical “cold limit” to icing is at -40° C, where liquid droplets freeze without the presence of ice nuclei.

**c. Droplet Size.** Although droplet size variation can have an influence on icing, it has not been found to be as important as LWC and temperature variations unless the droplet size is larger than those classified as cloud droplets. Cloud droplets are generally considered to be those with diameters smaller than 40 microns. Larger drops persisting in subfreezing temperatures are called supercooled large drops or SLD and can present a significant icing hazard. SLD includes freezing drizzle (diameters 40 to 200 microns) and freezing rain (diameters greater than 200 microns).

**(1) Collection Efficiency.** The size of supercooled droplets does affect icing severity and type, but to a lesser degree than LWC and temperature. Droplet size influences the collection efficiency of drops on the airframe. Small droplets have little mass and momentum. Thus, as the airplane flies through the air, these tiny drops tend to be swept around the airframe, following the airflow streamlines. If drops are to impact at all, they will likely do so near the leading edges where the air diverges to go around the airfoil. Airspeed and the shape of the airfoil are other factors that influence collection efficiency.

**d. Altitude.** There is certainly no altitude limit to the occurrence of icing; icing conditions can be present from the surface to the maximum altitudes

airplanes can fly. However, some guidance can help the forecaster focus attention on areas where icing is more likely to occur. The Schultz-Politovich PIREP study shows a peak occurrence near 10,000 ft, with 50% of values between 5,000 and 13,000 ft.

**4. Icing Types.** It is important for both forecasters and pilots to be able to distinguish the type of icing expected since different ice types present different hazards to flight. The three primary icing types are rime, clear, and mixed.

**a. Rime Icing.** Rime ice grows when droplets rapidly freeze upon striking an aircraft. The rapid freezing traps air and forms a brittle, opaque, and milky-colored ice. Rime ice grows into the air stream from the forward edges of wings and other exposed parts of the airframe.

**b. Clear Icing.** In clear ice formation, only a small portion of the drop freezes immediately while the remaining unfrozen portion flows or smears over the aircraft surface gradually freezing. Since few air bubbles are trapped during this gradual process, the end result is ice less opaque and denser than rime ice that can appear either as a thin smooth surface or as rivulets, streaks, or bumps of clear ice.

**c. Mixed Icing.** Due to small-scale (tens of kilometers or less) variations in the liquid water content (LWC), temperature, and droplet sizes, an airplane can encounter both rime and clear icing along its flight path. Known as mixed icing, this can appear as layers of relatively clear and opaque ice when examined from the side. Mixed ice is similar to clear ice in that it can spread over more of the airframe’s surface and is more difficult to remove than rime ice.

**d. Frequency and Occurrence.** Rime icing is the most frequently reported icing type. The type of icing is dependent on the temperature, liquid

water content, and other aircraft-dependent variables. In some cases, temperature can be a good indicator for diagnosing the type of icing expected. However, there are often instances where the temperature-icing type relationship is not well defined. The relationship between temperature and icing type that is typically used is outlined in Figure 2-61.

Clear	0° C to -10° C
Mixed	-10° C to -15° C
Rime	-15° C to -40° C

**Figure 2-61. Icing Type Based on Temperature.** Figure shows most common temperature ranges for various types of icing.

**5. Icing Severity.** In a given icing environment, the icing potential is dependent upon aircraft type, aircraft design, flight altitude, and airspeed as well as the meteorological factors. Commercial jet aircraft are the least vulnerable to icing due to their rapid airspeed, powerful de-icing equipment, and tendency to fly at higher altitudes where temperatures are typically colder than the range of temperatures common for icing (i.e.,  $T < -40^{\circ}\text{C}$ ). Training type aircraft are more susceptible because they typically operate at lower altitudes, where icing is more common, and at slower speeds.

**a. Pilot Definitions.** The current official definitions of icing severity were written for pilot reports of icing during flight. These definitions are currently undergoing FAA review so pilots, forecasters, and others who need to be aware of the expected degree of the icing hazard can use and understand the terminology. The current, official definitions are presented here, but may be updated after the FAA review is completed. Severity is categorized according to the rate of accumulation, the effectiveness of available de-

icing equipment, and the actions a pilot must take to avoid or combat the accumulation of ice. Four categories of icing for pilot reporting have been developed based on these considerations: trace, light, moderate, and severe.

**(1) Trace.** The trace category is used when the rate of ice accumulation is just slightly greater than the rate of loss due to sublimation. This category of icing is not hazardous. De-icing, anti-icing equipment, or an altitude change are not necessary unless this category is encountered for one hour or more.

**(2) Light.** The light icing category means that the rate of ice accumulation may create a problem if the aircraft remains in this environment for one hour or more. Occasional use of de-icing or anti-icing equipment is necessary to remove or prevent accumulation. When prolonged flight in this environment is likely, a heading or altitude change becomes necessary.

**(3) Moderate.** The icing category is classified as moderate when the rate of ice accumulation is so great that even a short encounter can become hazardous. The use of de-icing or anti-icing equipment is necessary. Often a heading or altitude change is also required especially if the aircraft remains in the moderate icing environment for more than a very short period.

**(4) Severe.** Icing is severe whenever the rate of ice accumulation is such that de-icing or anti-icing equipment cannot control or reduce the hazard. Typically an immediate heading and/or altitude change is necessary.

**6. Icing in Precipitation.** A type of clear icing that is caused by droplets larger than cloud-size (greater than 40 microns) can pose an especially hazardous icing problem. This type of clear ice is often referred to as supercooled large droplet ice. There are particular atmospheric processes and conditions that tend to cause this clear ice type. A

## Icing

---

general discussion of these conditions and processes will be presented in this section.

**a. Introduction.** Aircraft icing caused by supercooled large droplets (large droplets are defined as greater than 40 microns in diameter) can present a significant hazard to aviation. Large droplets tend to form a very lumpy textured ice similar to that illustrated in the accompanying graphic. The lumpy texture significantly disrupts airflow and the aerodynamics of the aircraft. These drops can flow along the airfoil for some distance prior to freezing. Additionally, these drops can impact the airfoil farther aft than smaller cloud-sized droplets. The net result is ice accreted on surfaces beyond the reach of de-icing equipment.

**b. Physical Mechanisms.** SLD are either formed through melting of ice and subsequent supercooling of the drops (warm layer process), or through droplet growth processes within a supercooled environment (collision-coalescence). In the first case, the presence of the ice phase is needed; in the second case, it is not. In either case the presence of freezing precipitation at the surface is a good initial indicator of SLD aloft.

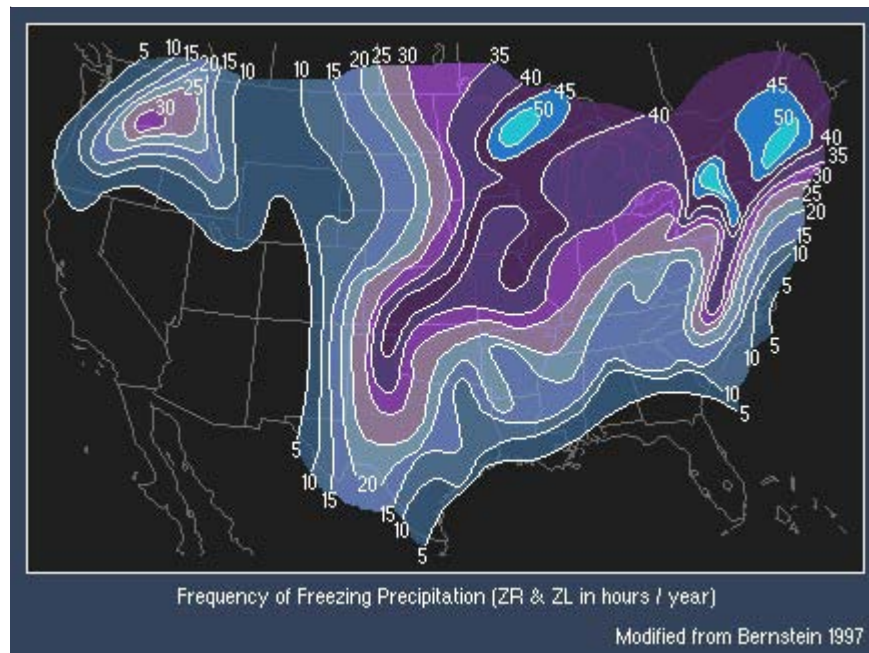
**(1) Warm-Layer Process.** Warm intrusions aloft during a precipitation event can often result in a region where conditions for the formation of SLDs are favorable and the possibility of clear ice accretion composed of these SLDs increases. The precipitation types most often associated with a warm layer process during the cold season are either freezing rain (ZR) or freezing drizzle (ZL). Freezing rain and freezing drizzle can result from snowflakes falling through and melting in a layer of warm air aloft (usually at least 2° to 3° C), then continuing to fall into a layer of subfreezing air below. The warm layer must be deep enough to melt frozen precipitation. If the low-level cold layer is too cold or too deep, the supercooled drops (ZL or ZR) can refreeze to ice pellets.

**(2) Collision-Coalescence.** ZR and ZL can also form by collision and coalescence of droplets. This does not have to involve a preliminary ice phase, as in the melting process, and no warm layer is required. Typically in a cloud, there is a distribution of drop sizes resulting in a distribution of fall speeds. If the distribution (of either) is large enough, then some of the drops will collide with one another and coalesce into larger drops. Usually, when the largest drops in a distribution are around 20 microns, this process begins. This process can rapidly convert cloud-sized droplets into larger drizzle drops (between 200 and 500 microns) or even raindrops (greater than 500 microns).

**c. Where SLD are found.** Relatively few measurements of SLD conditions in and below clouds have been made. However, since SLD conditions are often associated with freezing precipitation at the surface, it is useful to examine climatologies of freezing precipitation frequency. The accompanying graphic is a geographical distribution of ZR/ZL and IP frequency. Bernstein and Brown developed this climatology by compiling 30 years of ZR/ZL and IP observations from 207 stations across the CONUS.

Figure 2-62 illustrates the frequency of freezing precipitation in hours per year. From this data it is apparent that the most common occurrences of freezing precipitation (and conditions favorable for SLD formation) are found over the interior of the Pacific Northwest, the Great Lakes region, and along the Appalachians.

Although familiarity with this type of climatological information is useful to incorporate into an icing forecast, it is of greater importance to examine the real-time meteorological conditions and features that may enhance the production of SLD.



**Figure 2-62. Frequency of Freezing Precipitation.**

### ***B. Meteorological Considerations.***

**1. Cloud type.** The type and amount of icing varies with each type of cloud.

**a. Stratiform.** Stable air masses often produce stratiform clouds with extensive areas of relatively continuous icing potential conditions. Icing intensities in-cloud generally ranges from light to moderate, with the maximum intensity occurring in the cloud's upper portions. Both rime and mixed icing are observed in stratiform clouds. High-level stratiform clouds (e.g., cirrostratus) contain mostly ice crystals and produce little icing.

- Typically occurs in the mid- and low-level clouds in a layer between 3000 and 4000 feet thick.

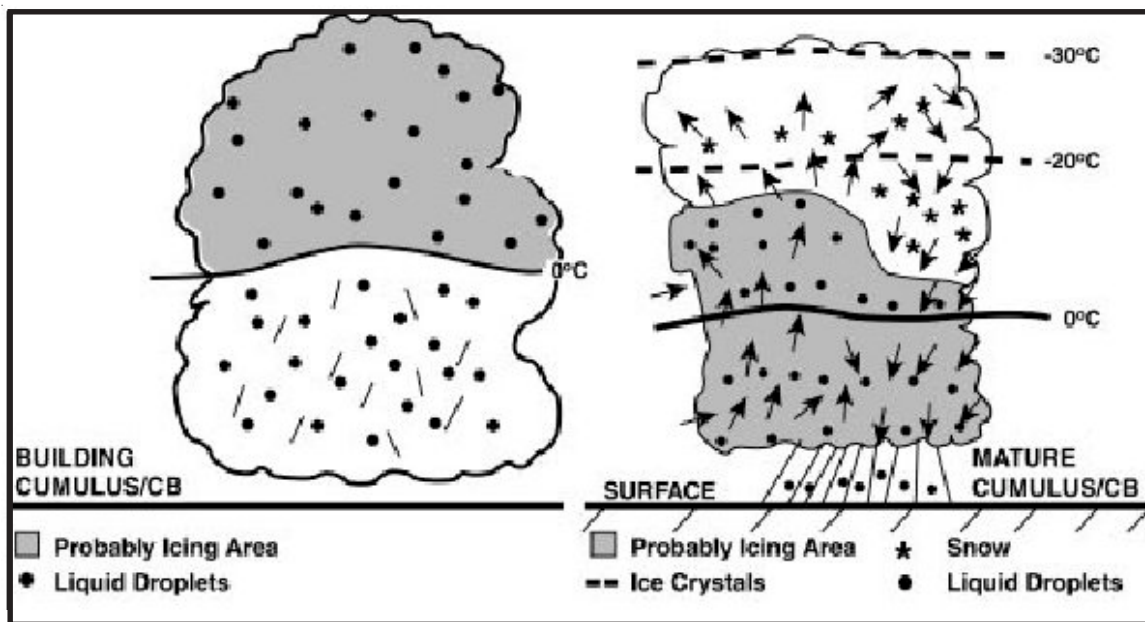
- Rarely occurs more than 5000 feet above the freezing level.

- Multiple layers of clouds may be so close together that flying between layers is impossible. In these cases, maximum depth of continuous icing conditions rarely exceeds 6000 feet.

**b. Cumuliform.** Unstable air masses produce cumuliform clouds with a limited horizontal extent of potential icing conditions. Icing generally occurs in the updraft regions in mature cumulonimbus, but is confined to a shallow layer near the freezing level in a dissipating thunderstorm (see Figure 2-63).

Icing intensities generally range from light in small cumulus to moderate or severe in towering cumulus and cumulonimbus. The most severe icing occurs in cumulus clouds just prior to entering the cumulonimbus stage. Although icing occurs at all levels above the freezing level in building cumulus, it is most intense in the upper half of the cloud.

## Icing



**Figure 2-63. Cumuliform Cloud Icing Locations.** The figure shows the location of icing in the building and mature stages of cumuliform formation and dissipation.

- The zone of icing in cumuliform clouds is smaller horizontally but greater vertically than in stratiform clouds.

- Icing (usually clear or mixed) is more variable in cumuliform clouds because many of the factors conducive to icing depend largely on the particular stage of the cloud's development.

**c. Cirriform Clouds.** Icing rarely occurs in cirrus clouds, even though some non-convective cirriform clouds do contain a small proportion of water droplets. However, moderate icing can occur in the dense cirrus and anvil tops of cumulonimbus, where updrafts may contain considerable amounts of supercooled water.

**2. Frontal Systems.** Icing can occur either above or below frontal surfaces aloft. The following general rules will help in forecasting frontal icing.

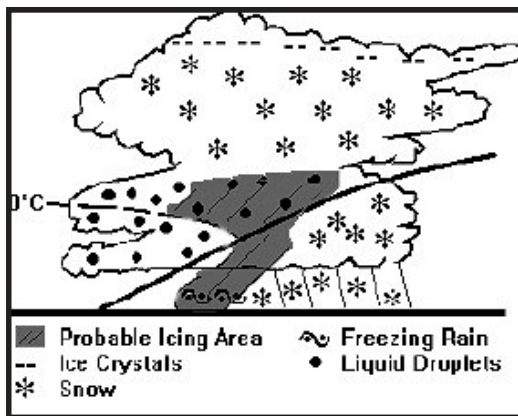
**a. Above the Frontal Surface Aloft.** For significant icing to occur above a frontal surface, lifted air must cool to temperatures below freezing, and be at or near saturation. If the warm air is unstable, icing may be sporadic; if it is stable, icing may be continuous over an extended area. While precipitation forms in the relatively warm air above the frontal surface at temperatures above freezing, icing generally occurs in regions where cloud temperatures are colder than 0°. Generally, this layer is less than 3000 feet thick.

**b. Below the Frontal Surface Aloft.** Occurs most often in freezing rain or drizzle. As it falls into the cold air below the front, the precipitation may become supercooled and freeze on impact with aircraft. Freezing drizzle and rain occur with both warm fronts and shallow cold fronts.

### c. Frontal Icing Characteristics.

#### (1) Warm fronts (Figure 2-64).

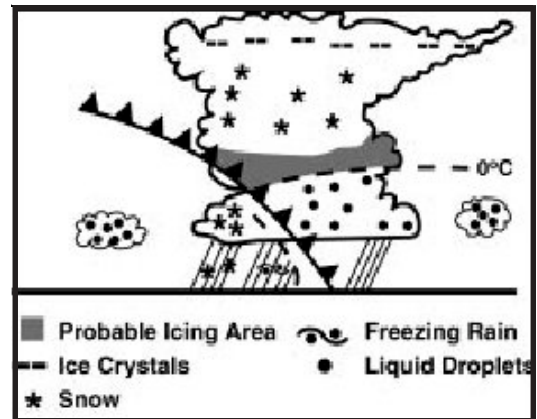
- Clear or mixed icing. Occurs 100 to 200 miles ahead of the warm frontal surface position.
- Light rime icing. Normally occurs in altostratus up to 300 miles ahead of the warm frontal surface position.



**Figure 2-64. Icing with a Warm Front.** Icing occurs up to 300 miles ahead of the warm frontal surface position.

(2) *Cold Fronts.* Icing associated with cold fronts is usually not as widespread as that with warm fronts because cold fronts typically move faster and have fewer clouds (Figure 2-65).

- Clear icing. More prevalent than rime icing in the cumuliform clouds associated with cold fronts.
- Moderate icing. Light-moderate clear icing occurs in supercooled cumuliform clouds up to 100 miles behind the cold front surface position. It occurs most readily above the frontal zone.
- Light icing. Occurs in the extensive layers of supercooled stratocumulus clouds that frequently exist behind cold fronts. Icing in the stratiform clouds of a widespread slow moving cold frontal



**Figure 2-65. Icing with a Cold Front.** Icing associated with cold fronts is usually not as widespread as icing with warm fronts.

cloud shield is similar to icing associated with warm fronts.

(3) *Stationary and Occluded Fronts.* Icing associated with occluded and stationary fronts is similar to that of warm or cold frontal icing. Moderate icing frequently occurs also with deep, cold, low-pressure areas where frontal systems are indistinct.

Note: Icing can be severe in freezing precipitation.

### 3. Other Icing Conditions.

**a. Terrain.** Icing is more likely and more severe when found in clouds over mountainous regions than over other terrain. Mountain ranges cause upward air motions on their windward side. Strong upslope flow can lift large water droplets as much as 5,000 feet into sub-freezing layers above a peak, resulting in supercooled water droplets. In addition, when a frontal system moves across a mountain range, the normal frontal lift combines with the mountain's upslope effect to create extremely hazardous icing zones.

**b. Induction Icing.** In addition to the hazards created by structural icing, an aircraft frequently is

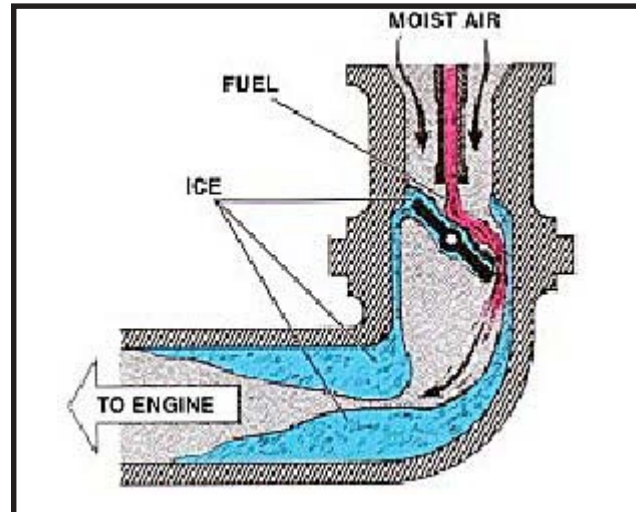
## Icing

subjected to icing of the power plant itself. Ice develops on air intakes under the same conditions favorable for structural icing. Ice formation is most common in the air induction system but may also be found in the fuel system. The main effect of induction icing is power loss due to its blocking of the air before it enters the engine. On some helicopters, a loss of manifold pressure combined with air intake screen icing may force the immediate landing of the aircraft.

(1) *Air Intake Ducts.* In flights through clouds containing supercooled water droplets, air intake duct icing is similar to wing icing. However, the ducts may ice when the skies are clear and the temperatures are above freezing. While taxiing, and during takeoff and climb, reduced pressure exists in the intake system (see Figure 2-66). This lowers temperatures to the point that condensation and/or sublimation takes place, resulting in ice formation, which decreases the radius of the duct opening and limits the air intake. Ice formed on these surfaces can later break free, causing potential foreign object damage (FOD) to internal engine components.

(2) *Carburetor Icing.* Carburetor icing is treacherous, and frequently causes complete engine failure. It may form under conditions in which structural ice could not possibly form. Carburetor

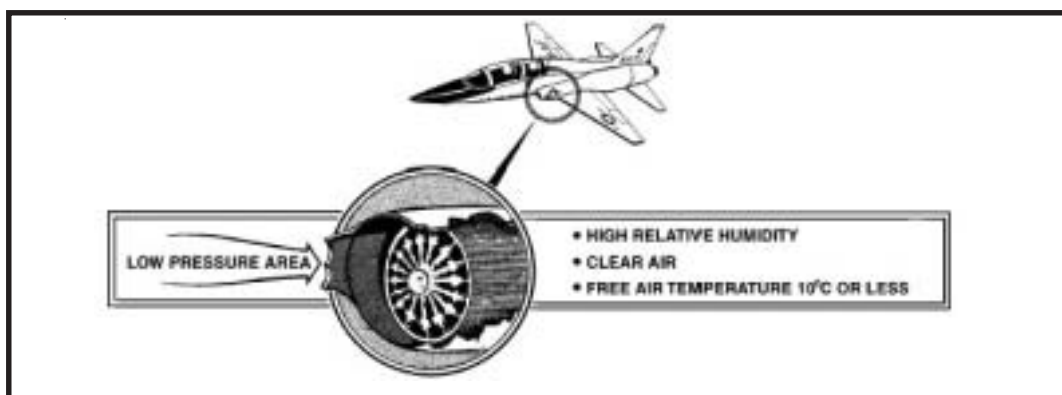
icing occurs when moist air, drawn into the carburetor, is cooled to a dew point temperature less than  $0^{\circ}\text{C}$  (frost point). Ice in the carburetor may partially or totally block the flow of the air/fuel mixture as seen in Figure 2-67.



**Figure 2-67. Carburetor Icing.**

- When the relative humidity of the outside air being drawn into the carburetor is high, ice can form inside the carburetor (even in cloudless skies) when the temperature is as high as  $22^{\circ}\text{C}$  ( $72^{\circ}\text{F}$ ) or as low as  $-10^{\circ}\text{C}$  ( $14^{\circ}\text{F}$ ).

- The fact that carburetor icing can occur in temperatures well above  $0^{\circ}\text{C}$ , may lead the pilot to potentially misdiagnose engine problems.



**2-66. Intake Icing.** Ice formed on these surfaces can later break free, causing potential foreign object damage to internal engine components.



**C. Products and Procedures.** Below is a listing of products and what to look for during the evaluation process of determining icing conditions. Later paragraphs will provide some rules of thumb and methods/procedures that expand on some of the products listed here.

**1. Centralized products.**

**a. AFWA High-level Hazard Charts.** Extrapolate and adjust AFWA-produced icing products. Use them to decide if favorable icing conditions exist.

**b. Regional OWS Icing Products .** Use these products to check for freezing precipitation that could suggest moderate (freezing drizzle) or severe (freezing rain) icing.

**c. AIRMETS and SIGMETS.** These provide information on moderate and greater areas of icing.

**2. Upper-air data and reports.**

**a. PIREPS and AIREPS.** Use these reports to verify icing forecasts, to locate icing areas that impact your area of responsibility, and to identify synoptic conditions causing icing.

Note: PIREPs/AIREPs are important data sources since they originate from aircrews—those most threatened by icing conditions. Therefore, solicit aircrews aggressively for reports so other aircrews may benefit from their reporting.

**b. Upper-Air Data.** Check upper-air soundings along a flight route for dew point spreads at flight level, and then use Tables 2-11 and 2-12 to determine icing. Also, pay close attention to the upper-level flow to identify upstream icing, which may advect into the route of flight by the time the aircraft reaches the area.

**c. Upper-Air Composites on N-TFS.** Upward vertical motion in the vicinity of a jet stream maximum, combined with adequate moisture and CAA, give a good indication of icing. When these upper-air composite features are located in the vicinity of each other, generally forecast icing. Use other information in this section to determine icing type and intensity.

**Table 2-11. Unfavorable Atmospheric Conditions for Icing.**

Temperature	Dew Point Depression	Forecast
0°C to -7°C	> 2°C	none
-8°C to -15°C	> 3°C	none
-16°C to -22°C	> 4°C	none
lower than -22°C	any spread	none

**Table 2-12. Favorable Atmospheric Conditions for Icing.**

Temperature	Dew point depression	Advection	Forecast	Probability
0°C to -7°C	≤ 2°C	Neutral/weak CAA	Trace	75%
		Strong CAA	Light	80%
-8°C to -15°C	≤ 3°C	Neutral/weak CAA	Trace	75%
		Strong CAA	Light	80%
0°C to -7°C	≤ 2°C	None	Light	90%
-8°C to -15°C	≤ 3°C	Associated areas with vigorous cumulus buildups due to surface heating		

## Icing

---

(1) *Vorticity*. Use the 500-mb product to show areas of positive and negative vorticity advection (PVA/NVA). Overlay the vertical velocity product (OVV) to show vertical motion.

(2) *Wind Speed (Jet Stream)*. Use 300- and 200-mb data to highlight locations of jet streams, with emphasis on wind speed maxima and minima.

(3) *Moisture*. Analyze the 850-, 700-, and 500-mb analysis products for moisture. Sufficient moisture, combined with cold-air advection, should alert the forecaster to the possibility of icing in that area.

(4) *Thermal Advection Patterns*. Evaluate the 1000-500-mb, 1000-700-mb, or 1000-850-mb thickness products for thermal advection patterns. Cold-air advection into an area usually increases the possibility of icing.

### *d. Other composites.*

(1) *Icing from Freezing Precipitation*. The following are instructions for creating a composite product using surface and 850-mb data.

Step 1. Analyze surface isotherms in one color and then overlay the 850-mb isotherms in another color.

Step 2. Display the 850-mb moisture (dew point depression of 2°, 3°, 4°C) using a third color.

Step 3. Look for areas on the composite chart with surface temperatures of 0°C or colder and 850-mb temperatures above freezing. Precipitation in these areas is likely to be occurring as freezing rain or freezing drizzle.

(2) *Horizontal Weather Depiction (HWD)*. Freezing level forecast products overlaid on an HWD product could be a useful tool for identifying areas and levels of icing.

*e. Vertical Cross Section*. Generate a vertical cross section to show the amount of moisture in the atmosphere and the associated temperatures and dew-point depressions at the levels of interest. Evaluate the cross section to see where the following rules of thumb might apply.

(1) *Relative Humidity (RH)*. Identifying relative humidity values in an area can also be a key to making an accurate icing forecast. Generally, values greater than 65 percent indicate broad areas of icing.

(2) *Temperature and Dew-Point Depression-Icing Occurrence*. Knowing the relationship between temperature and dew point in the atmosphere can provide a good indication of the occurrence of icing. Some rules of thumb below include the percent probability of icing for the desired locations. Use Figures 2-61, 2-63, and 2-68. Also refer to Tables 2-11 and 2-12.

(3) *Temperatures-Icing Types*. Temperatures can also indicate the type of icing to forecast. Clear ice usually occurs at temperatures just below freezing, while rime ice predominates at lower temperatures. Use the rules of thumb below as a general guide for forecasting icing types.

- Forecast rime icing when temperatures at flight altitude are colder than -15°C or when between -1° and -15°C in stable, stratiform clouds.

- Forecast clear icing when temperatures are between 0° and -8°C in cumuliform clouds or in freezing precipitation.

- Forecast mixed rime and clear icing when temperatures are between -8° and -15°C in unstable clouds.

**3. Surface Products**. Surface products can be used as a guide for potential icing conditions. This is not as reliable as using an upper-air analysis, but it can be very useful. Possible icing occurs along

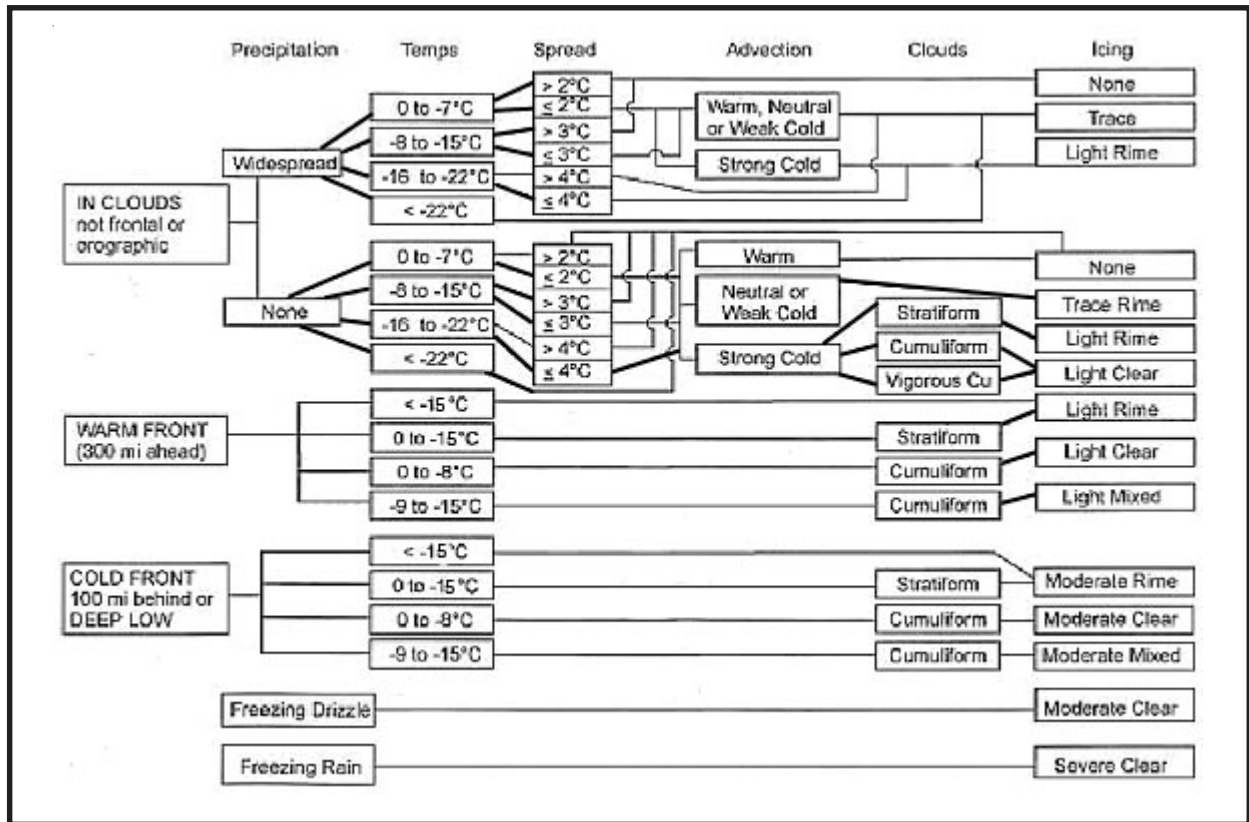


Figure 2-68. Icing Flowchart.

frontal cloud shields, low-pressure centers, and precipitation areas along the route (see Figure 2-69). General conditions for icing, in relation to the position of surface features, include the following:

- Up to 300 miles in advance of a warm front.
- Up to 100 miles behind the cold front.
- Over a deep, almost vertical low center.

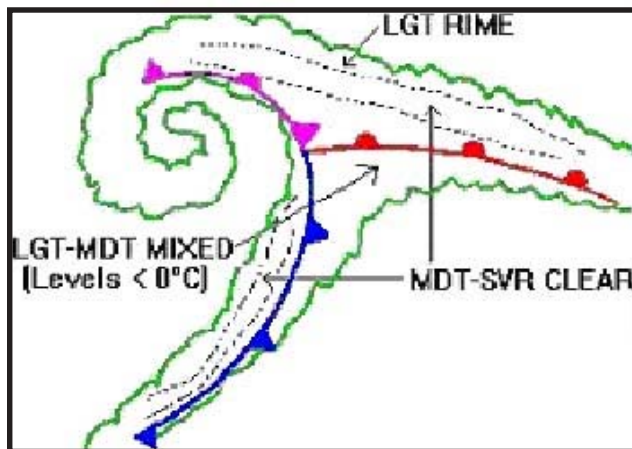


Figure 2-69. Typical Icing Areas in a Mature Cyclone. The figure shows general locations for icing, in relation to the position of surface features.

**D. Standard System Applications.**

**1. Radar.** Use the WSR-88D radar to determine potential icing areas by looking at reflectivity and velocity products. The following rules of thumb will help identify icing conditions with the WSR-88D.

**a. Cold-Air Advection (CAA).** Base Velocity (V) and the VAD Wind Profile (VWP) are helpful products for determining CAA. The Base Velocity Product indicates cold-air advection by a backward S-shaped pattern in the zero isotach. The VWP will show winds backing with height, associated with CAA (the same pattern you see on the Skew-

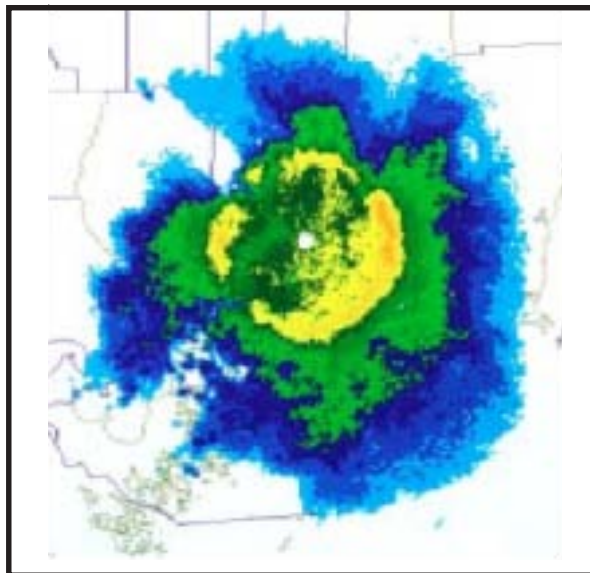
## Icing

T). Updated every volume scan, the VWP is also a valuable tool to monitor changes in the vertical profile between upper-air runs and should always be used to augment your Skew-T.

**b. Freezing Level.** The Reflectivity Cross Section (RCS) can also be used to identify and measure the height of the freezing level. To obtain an accurate measurement of the height of the freezing level, choose RCS end points on different sides of the bright band on the Base Reflectivity product.

**c. Bright Band Identification.** The Base Reflectivity (R) product will display the freezing level as a ring of enhanced reflectivity (30 to 45 dBZ) around the Radar Data Acquisition Unit (RDA). This enhanced area is called the bright band, formed when frozen precipitation melts as it falls through the freezing level (Figure 2-70). The height of the outer edge of the bright band is the

height of the freezing level ( $0^{\circ}\text{C}$ ). You can measure the height (MSL) by placing the cursor on the area of interest and reading the elevation to the right of the reflectivity panel. Although there is currently no WSR-88D product that is specifically designed to help forecast icing, inferences still can be made from locating the bright band. After determining the height of the freezing level by using the PUP cursor, the next step is to determine the approximate height of the  $-22^{\circ}\text{C}$  isotherm, which is generally accepted as the outer temperature threshold for icing. This height will have to be derived from Skew-T data or PIREPs within the local area. Use the PUP cursor to locate this elevation on your reflectivity product. Any echo return located between the freezing level and the height of the  $-22^{\circ}\text{C}$  isotherm could have the potential to produce icing. This determination should obviously be made in conjunction with other analysis and empirical rules that support the potential for icing.

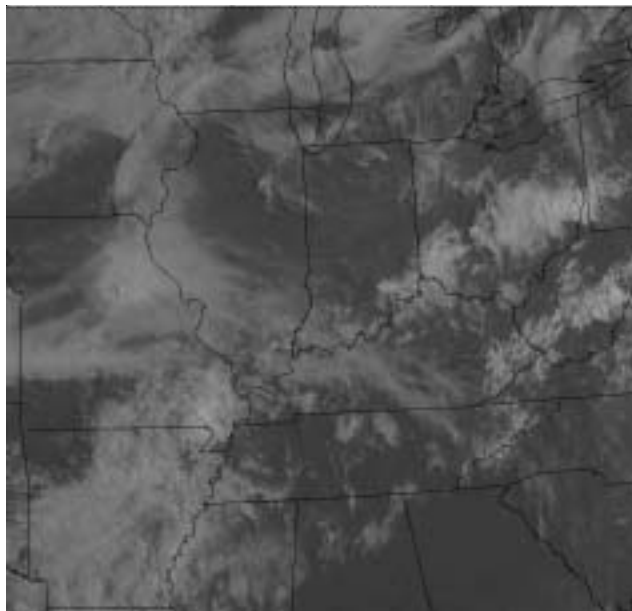


**2-70. Bright Band Identification Using the WSR-88D.** The enhanced area is called the bright band, formed when frozen precipitation melts as it falls through the freezing level.

## 2. Satellite imagery.

**a. GOES-8 and GOES-9 Imagery.** There are five spectral channels on GOES-8 and GOES-9; three of them (Channels 1, 2, and 4) can be useful in spotting potential aircraft icing areas.

(1) *Channel 1 (Visible) (Figure 2-71).* Brighter clouds on visible imagery imply greater thickness and high water content. Visible data can also assist in the identification of embedded convection.



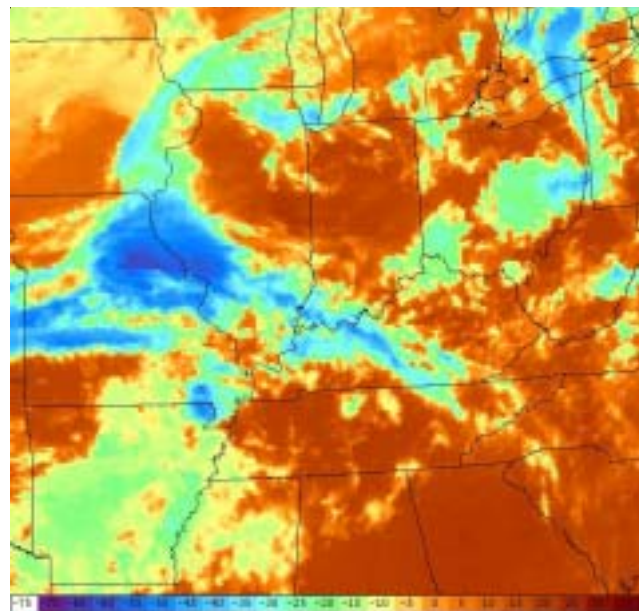
**Figure 2-71. Example of Visible Satellite Picture.**

(2) *Channel 2 (Near Infrared).* Three principles of radiation are applicable to this channel. First, small water droplets are more reflective than larger ones. Second, water clouds are more reflective than ice clouds. Finally, warm scenes radiate more than cold scenes.

- Thus during the daytime, ice clouds (relatively large ice particles, poorly reflective, and cold) will be darker than small droplet water clouds (smaller droplets, higher reflectivity, and warmer).

- Supercooled clouds, composed of small water droplets, may be very cold (down to  $-20^{\circ}\text{C}$ ) but they appear brighter during the daytime due to reflected radiation.

(3) *Channel 4 (Infrared or IR) (Figure 2-72).* Cloud-top temperatures can be found from IR imagery. If the cloud-top temperature is in the range  $0^{\circ}\text{C}$  to  $-20^{\circ}\text{C}$  and not covered by higher clouds, icing may be present. However, if cloud tops are close to  $0^{\circ}\text{C}$ , the in-cloud temperature may be above freezing and no icing will occur.

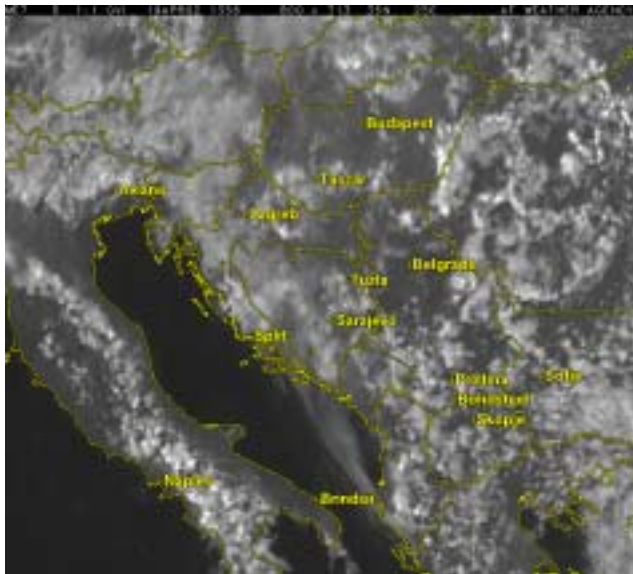


**Figure 2-72. Example of a Colorized IR Satellite Picture.**

Compare Channels 1, 2, and 4 to find supercooled clouds during daytime hours. Embedded lighter gray shades sometimes occur with heavier icing due to the large cloud droplet sizes (higher liquid water content) or slightly thicker clouds.

**b. GMS and Meteosat (Figure 2-73).** These provide basic visible and IR images only. Image enhancement (such as those available from GOES satellites) is not available. Use rules applying to GOES channels 1-4, as describe in the previous paragraphs, to detect possible areas of icing.

## Icing



**Figure 2-73.** Example of a Meteosat satellite over the Balkans.

**E. Methods and Rules of Thumb for the “Negative 8 Times D” (-8D) Procedure.** One effective way to forecast icing is by using the Skew-T to complete the -8D Method. An example of the completed method can be found in Figure 2-74.

**1. -8D Method; Procedures.**

**Step 1.** Plot the upper-air data from a sounding on a Skew-T.

**Step 2.** Plot the temperature and dew point in degrees and tenths to the left of each plotted point.

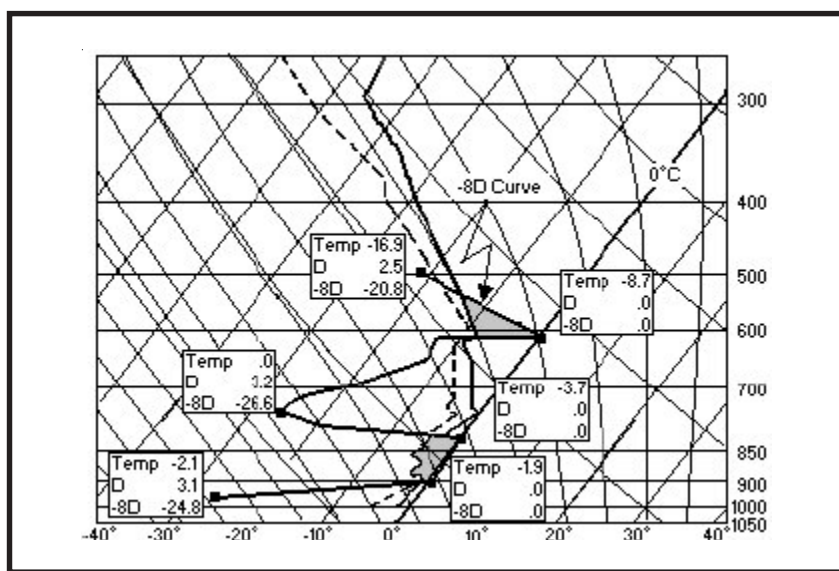
**Step 3.** Determine the dew-point depression for the significant levels. This is D and is always positive or zero.

**Step 4.** Multiply the dew-point depression (D) by -8 and plot the product (in °C) opposite the temperature at the pressure level.

**Step 5.** Repeat Step 4 for each temperature between 0°C and -22°C.

**Step 6.** Connect the points plotted by step 5 with a dashed line.

**Step 7.** Icing layers usually occur between the intersection of the temperature and the -8D curve when it is on the right of the temperature curve.



**Figure 2-74.** Example of -8D Method. The figure is a graphical presentation of the -8D method for forecasting icing.

**Step 8.** Use the cloud type, the precipitation observed at the sounding time or forecast time, as well as the temperature and dew point to forecast the type and intensity of icing.

**Note:** In this example, the air in the middle layers is supersaturated with respect to ice. Forecast icing in this layer using Figure 2-69 and the information that follows to determine type and intensity.

### **2. -8d Method; Rules of Thumb.**

- When the temperature curve lies to the right of the -8D curve in a subfreezing layer, the layer is subsaturated with respect to both ice and water surface. Icing does not usually occur in this region.

- When the dew-point depression is 0°C, the -8D curve must fall along the 0°C isotherm. Light rime icing will likely occur in a region of altostratus or nimbostratus, with moderate rime icing occurring in cumulonimbus, cumulus, and stratus cloud types.

- When the dew-point depression is greater than 0°C and the temperature curve lies to the left of the -8D curve in the subfreezing layer, the layer is supersaturated with respect to ice and probably subsaturated with respect to cloud droplets.

- If altostratus, altocumulus, or stratocumulus is expected in this layer, usually only light rime icing occurs.

- If the clouds are cirrus, cirrocumulus, or cirrostratus, usually only light frost sublimates on aircraft.

- In cloudless regions, there will be no supercooled droplets, but frost will often form on the aircraft through direct sublimation of water vapor. This is a factor to aircraft and helicopters that cannot tolerate any form of icing.

**F. Summary.** Some aircraft have limited or no deicing capability and therefore must avoid icing conditions at all times. Icing forecasting begins with a solid understanding of the physical processes responsible for icing and a thorough knowledge of the atmospheric conditions over your area of responsibility.

If icing is suspected, start with the general rules provided (tailored with local rules of thumb and techniques) and interrogate the atmosphere for location, type, and severity of icing. When icing is probable, use the techniques and tools presented to further refine your forecast.

**Miscellaneous Weather Elements**

**IV. MISCELLANEOUS WEATHER ELEMENTS.**

This section focuses mostly on flight weather elements (wind, temperature, thunderstorms, contrails, and D-values) that do not fit neatly into other sections. Some of the areas receive more in-depth explanations in other parts of this publication (i.e., thunderstorms in the severe weather section), but they're addressed here to show how they are tied into forecasting flight weather elements. Additionally, this chapter includes information on space, chemical downwind messages, electro-optics, and nuclear fallout bulletins.

**A. Flight Level and Climb Winds.**

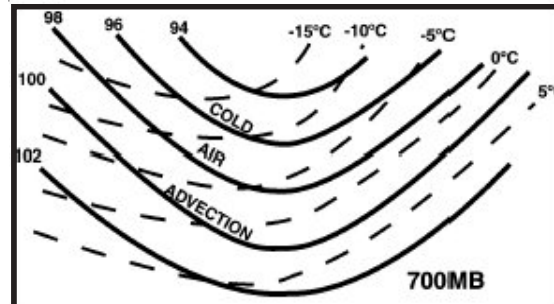
**1. Flight level winds.** Forecasting accurate flight level winds (winds aloft) helps aircrews better plan fuel requirements, resulting in safer and timelier missions. Flight weather briefers use a variety of tools and products to prepare these flight level winds. In most cases, use the following tools and products without modification; however, spot check them against other information and adjust, if necessary, when independent information is available.

**a. Constant Pressure Products.** These rules of thumb should be used when determining flight level winds from constant pressure products:

- Use the product nearest to the desired level and extrapolate upward or downward as necessary.
- Relationships between isotherm and height contours are invaluable in forecasting upper winds. If the wind direction is known, estimate the speed through the following relationship between isotherms and contours.

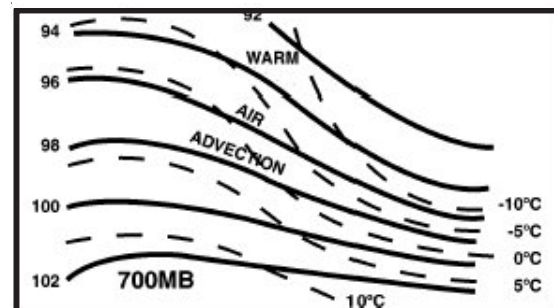
- Little change in wind speed and direction results when isotherms and contours are in phase and parallel.

- Increasing flight level winds occur with tight thermal gradients (denser packing of isotherms) associated with cold-air advection aloft (See Figure 2-75).



**2-75. Increasing Wind Speed Pattern.** Tight thermal packing associated with CAA indicates increasing wind speeds.

- Decreasing flight level wind speeds occur with loose thermal gradients (looser packing of isotherms) associated with warm-air advection aloft (See Figure 2-76).



**2-76. Decreasing Wind Speed Pattern.** Loose thermal packing associated with WAA indicates decreasing wind speeds.

**b. Satellite Imagery.** Interpret wind directions and speeds using cloud shape, size, and orientation.

**c. Vertical Cross Section Using Distance Log-P.** Distance Log-P plots and associated contours can provide a general picture of wind speeds along a cross section. Keep in mind that wind speeds are approximate values since they are interpolated between the actual station data points.



Note: This product is best used to locate synoptic features such as jet streams, jet cores, and wind patterns.

**2. Climb Winds.** Forecast climb winds using upper-level wind products displayed from standard meteorological systems, or by using rawinsonde data plotted by local computer programs. Below are specific examples of resources available to forecast climb winds:

**a. Upper-Air Products.** Locate the area of interest and read the winds directly from several upper charts. Interpolate intermediate winds. Winds interpolated from these charts will not be as accurate as winds from a Skew-T.

**b. Time Cross Section-Time Log-P winds.** Cross section plots and associated contours can provide a good look at a vertical cross section of the current, plus 3 previous, model runs for a specific station. Use this product to review wind trends at or near your station or to investigate wind behavior at another station during a specific weather event. Extrapolate the information on these plots to produce a fairly accurate short-range wind forecast.

**c. Velocity Azimuth Display (VAD) Wind Profile (VWP).** The VWP display on the Doppler radar provides representative wind direction and speed measurements compiled at several heights and distances from the radar antenna. The VAD default range is 16 NM from the antenna. Up to 11 previous profiles (one profile per volume scan) can be displayed on screen, with the most recent profile to the far right. The VWP displays wind direction and speed values in 1,000 foot increments, adjustable up to 70,000 feet mean sea level (MSL). Because of its usefulness, each station should include the VWP as part of the Routine Product Set (RPS) lists.

Not all volume scans will produce a usable VWP product (see Figure 2-19 for an example of a VWP).

If “ND” appears instead of a wind direction and speed, the winds could not be determined at that level due to a lack of scatterers or the thresholds for RMS and symmetry were exceeded. However, you may still be able to find valuable wind information by examining the VAD wind product for the levels of interest. Keep the following in mind when using VWPs:

- Precipitation creates a high concentration of scatterers; therefore, VWPs usually give good wind estimates in these conditions.

- The amount of scatterers available in the radar beam affects the radar’s ability to make good wind estimations.

- Scatterers are often scarce in clear, cold air; therefore, VWP may not be reliable in such conditions. In some cases, the radar may produce no wind information at all.

**d. Upper-Air soundings.** Locate sounding data nearest to the area of interest and read the winds and temperature directly from the standard and supplemental levels. These soundings are used to plot the Skew-T, so they give representative winds and temperatures within about an hour of the time of the sounding run.

**e. Skew-T, Log-P Diagram.** Read winds and temperatures directly from the plot. Heights are given in kilometers (km) or thousands of feet using a scale on the far right. Keep in mind that Skew-Ts do not present an instantaneous profile of the winds directly above the radiosonde site.

Note: Radiosonde balloons ascend at a rate of about 1,000 feet a minute. In a 1-hr ascent time, the balloon is carried downwind approximately 20 to 100 NM and to an altitude as high as 60,000 feet by the prevailing upper-level winds.

**B. Temperature.** Use centrally-produced forecast products to forecast temperatures aloft. If the

## Miscellaneous Weather Elements

---

temperature is in a layer between standard levels, interpolate between the base and the top of the layer. If you know only one boundary temperature, then extrapolate using an assumed lapse rate of 2°C (5.5°F) per 1,000 feet in the troposphere, and isothermal in the stratosphere.

**C. Thunderstorms.** Forecast thunderstorms for high-level flights the same as you do for low-level operations, with one main difference—do not underestimate thunderstorm tops. Pilots are usually able to better detect individual thunderstorms at high altitudes than at low altitudes when they are not imbedded in cirrus clouds. However, they may not be able to fly over them due to limitations in their aircraft's maximum ceiling. Use the following tools to find thunderstorm tops:

- Use a sequence of infrared (IR) satellite images, with Skew-T data, to get the temperature and height of the coldest convective cloud tops.
- Look at the latest FANH, FATR, or local hazardous weather products.
- Check out the latest composite radar products, convective SIGMET bulletins, and PIREPs.
- Use your radar to get tops of local thunderstorms or to dial up other RDAs for thunderstorm tops in other areas.

**D. Contrails.** Contrails, or condensation trails, are elongated tubular-shaped clouds composed of water droplets or ice crystals that form behind an aircraft when the wake becomes supersaturated with respect to water or ice. Aside from the obvious military concerns (aircraft detection), the hazard presented by contrails is the development of a cloud deck with reduced visibility at a flight level where, previously, no cloud existed.

### 1. Contrail types:

**a. Aerodynamic.** Aerodynamic contrails form by the momentary reduction of air pressure as air flows at high speeds past an airfoil. These trails usually form at the tips of the wings and propellers. They are relatively rare and occur for only short periods in an atmosphere that is nearly saturated. Aerodynamic contrails occur during extreme flight maneuvers and are virtually impossible to forecast. A small change in altitude or reduction in airspeed, however, is usually enough to stop their formation.

**b. Engine Exhaust.** This is the most common form of contrails and also the most visible. They form when water vapor within exhaust gasses mix with and saturate the air in the wake of a jet aircraft. Whether or not the wake reaches saturation depends on the ratio of water vapor to heat in the exhaust gas as well as on the pressure, temperature, and relative humidity of the air in the environment.

### E. JAAWIN and contrails.

**1. AFWA Contrail Product Overview.** The technique shown on the JAAWIN page is referred to as the “Appleman” method. Jet exhaust at some temperature with some amount of vapor pressure mixes with ambient air at some other temperature and vapor pressure. The technique mixes air from these two sources. It is assumed that the “mixed” air will exist at intermediate ranges of temperature and moisture values between the jet exhaust and the atmosphere. It is sometimes the case that intermediate temperature and moisture combinations will condense, even if the original jet exhaust and the atmosphere are not themselves saturated.

If contrails are expected, the JAAWIN contrails chart (Figure 2-77) depicts the lowest and highest altitudes in hundreds of feet. In this example,

contrails are expected between 47,800 and 65,500 feet.

- 655 (red)
- 478 (blue)

If the top is green, look for another contrail layer above by using the link for “Layer 2”. There will be another pair of numbers on that image.

**2. Definition of Bypass:** The term “Bypass” refers to how a turbine engine operates. During normal operation, the intake air is split into two parcels, which move through the engine at different speeds. One parcel is compressed and heated (and slowed in the process), then sent out of the exhaust nozzle. This is the portion that turns the fan blades. The other parcel “bypasses” both the compressor

and the combustion chamber, so is not burned. This is the portion that increases momentum, since the fan speeds up this parcel. A high-bypass engine will have a large fraction of the intake air bypass the compressor and combustion chamber. Conversely, a low-bypass engine will have a small fraction of the intake air bypass the compressor and combustion chamber. According to AFRL sources, values between 0.0 and 4.0 are classified as “low-bypass”. JAAWIN gives contrail forecasts for no-bypass, low-bypass, and high-bypass engines.

• **Aircraft and Their Probable Engine Bypass Categories.** Note: the term ‘bypass’ refers to the engine. It is possible that the engine on a specific jet may not be typical of that model of aircraft. Table 2-13 describes the typical, unmodified engine in the column “Engine Type”.

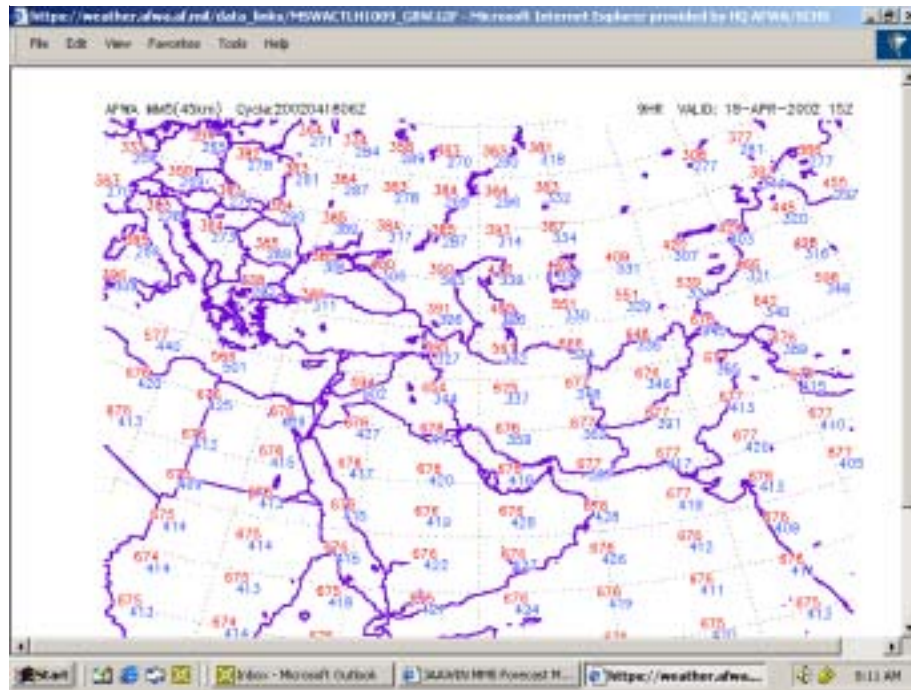


Figure 2-77. Example Contrails Chart.

**Miscellaneous Weather Elements**

**3. Manual Method for Forecasting Probability of Contrail Formation.** Critical relationships between pressure, temperature and relative humidity used to forecast contrails are shown on a plotted Skew-T in Figure 2-78. Construct a scaled overlay of Figure 2-78 for your Skew-T and use it to find the temperature and relative humidity necessary for the formation of contrails in the wake of a jet aircraft flying at a particular pressure level.

At a particular flight altitude, only the flight altitude temperatures and relative humidity values are required to make a “yes” or “no” forecast for contrails.

- If the flight altitude temperature is to the right of the 100 percent curve, forecast no contrails regardless of the relative humidity.

- If the flight altitude temperature is left of the zero percent curve, always forecast contrails no matter what the relative humidity.

- If the flight altitude temperature is between the 0 and 100 percent curves, both the relative humidity and the flight altitude temperature are needed to forecast contrails.

- Contrails form only if the actual relative humidity is equal to or greater than the value indicated at that point on the graph (called the uncertain or possible area).

- If the humidity along the route is unknown, assume a 40 percent relative humidity if there are no clouds and a 70 percent relative humidity if there are clouds.

**Table 2-13. Engine bypass categories.**

Aircraft	Engine MFR	Engine	Engine Type
T-38	General Electric	J85-GE-5	Turbojet (no bypass)
U-2	General Electric	F-118-101	Turbojet (no bypass)
KC-135A	Pratt & Whitney	J57-P-59W	No bypass
B-1B	General Electric	F-101-GE-102	Low-bypass Turbofan
B-52H	Pratt & Whitney	TF33-P-3/103	Low-bypass Turbofan
C-9A/C	Pratt & Whitney	JT8D-9	Low-bypass Turbofan
C-141A/B	Pratt & Whitney	TF33-P-7	Low-bypass Turbofan
F-15/A/B/E	Pratt & Whitney	F-100-PW-220/229	Low-bypass Turbofan
F-15/C/D	Pratt & Whitney	F-100-PW-220/229	Low-bypass Turbofan
C-21A	Garrett	TFE-731-2-2B	Low-bypass Turbofan
F-16/C/D	Pratt & Whitney	F100-PW-200/220/229	Low-bypass Turbofan
C-17A	Pratt & Whitney	F117-PW-100	Low-bypass Turbofan
F-16/C/D	General Electric	F110-GE-100/129	Low-bypass Turbofan
KC-135E	Pratt & Whitney	TF-33-PW-102	Low-bypass Turbofan
B-2	General Electric	F-118-GE-100	Low-bypass Turbofan
F-117A	General Electric	F404-F1D1	Low-bypass Turbofan
E-3A	Pratt & Whitney	TF33-PW-100A	Low-bypass Turbofan
C-5A/B	General Electric	TF39-GE-1C	High-bypass Turbofan
E-4B	General Electric	CF-6-50E2	High-bypass Turbofan
KC-10A	General Electric	CF-6-50C2	High-bypass Turbofan
KC-135R/T	CFM International (SNECMA/GE)	CFM-56	High-bypass Turbofan
A-10	General Electric	TF34-GE-100	High-bypass Turbofan
VC-25A	General Electric	CF6-80C2B1	High-bypass Turbofan

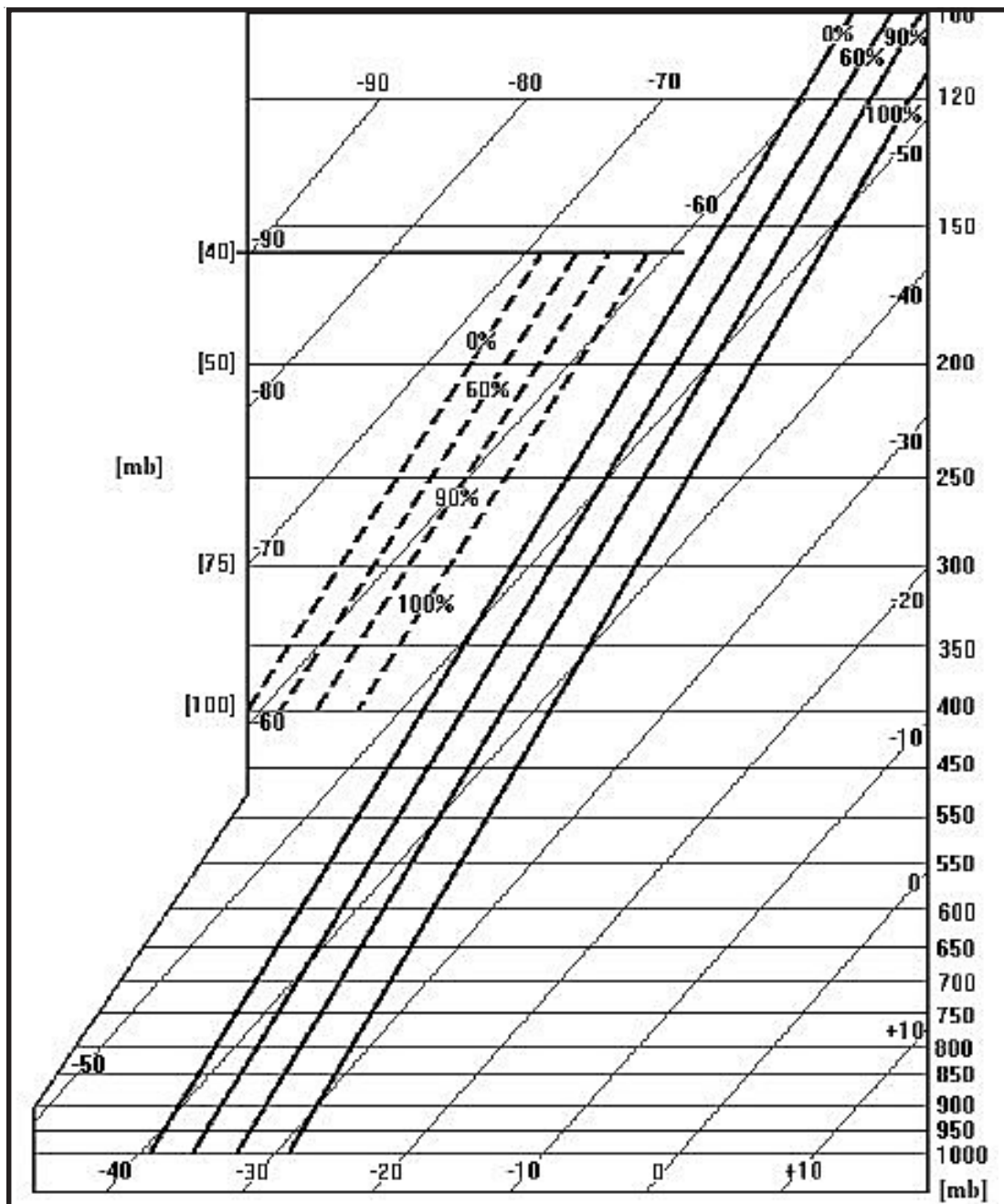
Miscellaneous Weather Elements

**Note:** Dashed lines and brackets on Figure 2-78 indicate curves in the 100- to 40-mb region.

air temperature and relative humidity data are not available.

The accuracy of contrail forecasts is degraded by uncertainties in measuring relative humidity at high altitudes. Use the empirical data in Table 2-14 to estimate contrail probabilities when accurate upper-

Apply the flight altitude and temperature at flight time in Table 2-14 to get the contrail probability. For example, at a pressure level of 250 mb and a



**Figure 2-78. Jet Contrail Curves on a Skew-T.** Critical relationships between pressure, temperature, and relative humidity used to forecast contrails are shown in the figure. Dashed lines and brackets indicate curves in the 100- to 40-mb region.

## Miscellaneous Weather Elements

**Table 2-14. Probability of contrail formation.** Enter table with temperature at pressure level of interest and read up to get probability.

Contrail Probability							
Pressure (mb)	95%	90%	75%	50%	25%	10%	5%
150	-60.5°C	-59.3°C	-57.1°C	-55.5°C	-53.6°C	-51.5°C	-50.7°C
175	-58.8°C	-57.4°C	-55.3°C	-53.6°C	-51.4°C	-49.6°C	-48.5°C
200	-58.5°C	-56.6°C	-54.8°C	-53.1°C	-51.0°C	-48.5°C	-47.0°C
250	-58.1°C	-56.3°C	-53.8°C	-52.2°C	-50.1°C	-47.1°C	-45.3°C
300	-55.5°C	-54.0°C	-52.0°C	-50.7°C	-49.1°C	-46.3°C	-44.3°C
350	N/A	-49.9°C	-49.4°C	-49.0°C	-48.0°C	-45.9°C	-43.6°C

temperature of -52°C, there is a 50 percent probability of contrail formation.

#### **F. Forecasting In-Flight Visibility for Air-Refueling Mission Execution Forecasts (MEFs).**

The most critical time during air refueling, as far as in-flight visibility is concerned, is just prior to and during hookup when hookup must be accomplished visually. Once hookup is accomplished, in-flight visibility should not interfere with the refueling operation. Aircrews base the current GO/NO GO decision for air refueling on in-flight visibility of less than one nautical mile. Aircraft involved in air refueling operations will often descend or ascend within the 5,000-foot air-refueling route (AR) window to seek better in-flight visibility. Usually aircrews conduct air-refueling operations at altitudes above 23,000 feet with an altitude of 29,000 feet considered optimum. In-flight visibility is optimal (7+ nautical miles) when the AR track is cloud free, but many ARs tend to cover several hundred miles. Most of the time in certain areas of responsibility (AOR), clouds are likely to be present along a portion of a given AR track. Exercise discretion when applying the following rules of thumb gleaned from several "old" sources.

**1. Cloud Cover.** This rule uses cloud cover amount for determining in-cloud flight visibility when the cloud deck is assumed to be greater than or equal to 2,000 feet in thickness.

Clear — 7+ nautical miles

3/8 or less — More than 3 nautical miles  
 3/8 to 5/8 — 1 to 3 nautical miles  
 6/8 to 8/8 — Less than 1 nautical mile

#### **2. In-flight Visibility Rules.**

##### **a. Temperature/Dew-point Depressions:**

Temperatures below -30°C mean in-flight visibility of 1/2 nautical mile for each degree of dew-point depression. Example: A dew-point depression of 4°C (SCT to BKN) would yield an in-flight visibility of 2 nautical miles, and 1°C (OVC) would yield 1/2 nautical mile.

**b. Cloud Thickness:** Yet another rule of thumb commonly used is based on cirriform cloud thickness. Keep in mind that the vertical visibility in thin cirrus is usually better than the horizontal visibility. So even though ground observers can see up through the cirrus or pilots can see the ground through it, the horizontal visibility in the cirrus may be limited to the following:

If the cloud deck is thin-broken to thin-overcast, forecast 1-2 nautical miles.

If the cloud deck is thicker, i.e., opaque, broken to overcast, forecast 1/2 nautical mile.

**c. Thunderstorm cirrus:** This is the most difficult to forecast in-flight visibility for, and varying in-flight visibilities are common. This cirrus is often layered and sporadic, i.e., patchy. If there is no significant cloud cover (3/8 or less) at

---

**Miscellaneous Weather Elements**

flight level, forecast at least 3 nautical miles in-flight visibility. If there is significant cloud cover (5/8 or more) but at least 2,000 feet vertical airspace with 3/8 or less clouds between layers, forecast 1 to 3 nautical miles. If there is significant cloud cover (5/8 or more) and less than 2,000 feet vertical airspace with 3/8 or less clouds between layers, forecast less than 1 nautical mile.

**G. Cirrus Forecasting.** Successfully forecasting cirrus in an AR track can help in determining in-flight visibility. The following statements concerning cirrus forecasting came from several references:

- Most cirrus layers are thin and less than 1,000 feet thick. For opaque cirrus, when the tropopause is low, i.e., around 35,000 feet, the average thickness is about 4,000 feet and when high, i.e., around 45,000 feet, the thickness is about 8,000 feet.

- Cirrus bases tended to lower and vertical thickness increased with increasing degrees of cloudiness. The average thickness of scattered cirrus over the mid-latitudes was noted as 3,700 feet with bases around 32,000 feet. The cirrus increased to 6,900 feet thick with bases lowering to 27,000 feet with overcast cirrus.

- Most cirrus tops were found to be less than 2,000 feet below the tropopause when the trop is near 35,000 feet. If the trop is near 45,000 feet, cirrus tops will normally be about 5,000 feet below.

- There is more cirrus in summer than in winter due mainly to thunderstorm activity, which supplies additional upper-level moisture for cirrus formation.

- There is no real diurnal variation in cirrus although surface observations tend to show more cirrus in the daytime. Observing nighttime cirrus is difficult, hence, the hours around sunrise and sunset showed the largest amounts of cirrus being

reported. Thunderstorm cirrus does have a marked increase over land during the afternoon while it increases over water during the late night hours.

- Thin overcast cirrus usually occurs in a layer 4,000 to 6,000 feet thick. There is usually enough visibility through the layer to allow visual air refueling hookup.

- Contrail-produced cirrus poses problems. Morning ARs that are relatively cloud-free may produce contrail cirrus that may render an AR track unusable in the afternoon. From upper air soundings, determine the probability of contrails at AR altitudes and forecast accordingly. Note: METSAT data, especially visible shots may clue forecasters to increasing cirrus from contrails.

- Tops of cirrus associated with the polar jet stream generally occur within 1,000 feet above or below the maximum wind. In a well-developed pattern, especially in the area east of the upper trough and up to the ridgeline, the tops of cirrus often slope upward from the polar to the subtropical jet stream.

- Cirrus tops generally occur below the height of the maximum wind in the subtropical jet stream. The average distance of the tops below the subtropical jet stream is 4,000 feet. The tops of cirrus that become less dense and appear as a thin overcast or broken layer, compared to the more dense lower portion of the cloud, normally attain a greater height extending up to the altitude of the jet core.

- Established cirrus sheets usually lower 650 feet per 12 hours.

- Cirrus bases occur near areas of strong vertical shear of the horizontal wind.

- Advective cirrus is most frequently observed during daytime. Advective cirrus bases are usually

## Miscellaneous Weather Elements

---

between 33,000 and 39,000 feet. Advective cirrus tops are usually between 37,000 and 43,000 feet.

- Thunderstorm cirrus usually dissipates within six hours of the dissipation of the lower part of the initial cloud system, but the cirrus frequently recurs downstream early the next day.

- Cirrus is more opaque in areas of strongest shear or maximum wind.

- Cirrus occurrence is often associated with:

- Confluent airflow

- Over a ridge extending upstream toward the trough

- An area to the south and within 300 miles of the jet stream

- Convective activity through a deep layer

- An area ahead of a surface warm front or occlusion

- Anticyclonic curvature of the 1000-500mb thickness lines

- Advection of positive vorticity (PVA)

- A dew point depression of 10°C or less at 400, 450 and 500mb

- Closed jet isotachs of over 100 knots

**H. Ditch Headings and Wave Height.** Aircrews need ditch heading and wave height information for operations conducted over water. Wind and waves pose the greatest threats to pilots facing the possibility of ditching in the ocean or in a large lake. Obviously, high winds and their associated high waves and swell systems spell the greatest danger. If the surface winds are relatively light

(typically 15 knots or less), aircrews plan their approach parallel to any swells. With winds greater than 15 knots the rule is to crab into the wind and then land as parallel as possible to the main swells. Buoy observations can be used to determine current wind speed and direction. Ship observations contain wind direction and wind speed as well as wave height information.

Visit the Navy's weather web site at: [www.fnmoc.navy.mil](http://www.fnmoc.navy.mil). You will need a login and password to enter the secure site. These can be obtained by either requesting them from the site (scroll down the left side to the "Contact Us" area and request an account be opened up for your weather station), or check with your OWS to see if they already have an account with the Navy. Once inside the secure area, scroll down the left side to where it says, "Software and Manuals". After installing the appropriate software, you'll be able to view the products on the site.

**I. Sea Surface Temperatures.** Sea surface temperatures are a factor for Air Force operations conducted over water. The temperature of the water affects the crews' ability to survive if forced to bailout or ditch. AFW forecasters provide sea surface temperature information to the aircrews for their routes so the crews can determine their survival times and what equipment they must take. It's a fact that the colder the temperature of the water, the survivability factor decreases without the proper survival gear. Your forecast determines which water survival suit they must wear. The heavier the suit the lower the crewman's agility due to the bulkiness of the suit and the likelihood of the aircrew being more uncomfortable on long flights. Buoy observations can be used to determine current temperatures and the Navy NOGAPS model provides sea surface temperature forecasts. FNMOC and MPC also have a variety of satellite-derived sea surface temperature products and other maritime products available. See section F above for more information on accessing this data from the Navy.



## **J. Space Weather.**

**1. The Space Environment.** Space weather describes the conditions in space that affect Earth and its technological systems. Space Weather is a consequence of (1) the behavior of the sun that releases electrically charged particles and electromagnetic radiation, (2) the nature of Earth's magnetic field and atmosphere, and (3) our location in the solar system. The sun emits radiation over the entire electromagnetic spectrum. The distribution of energy is such that the most intense portion of it falls in the visible part of the spectrum. Substantial amounts also lie in the Near Ultraviolet and Infrared portions. Less than 1 percent of the sun's total emitted electromagnetic radiation lies in the EUV/x-ray and radiowave wings.

Particles (primarily protons, but occasionally cosmic rays) can reach the Earth in 15 minutes to a few hours after the occurrence of a strong solar flare. The Earth is a rather small target 93 million miles from the sun, so predicting solar proton and cosmic ray events is a difficult forecast challenge. The major impact of these protons is felt over the polar caps, where the protons have ready access to low altitudes through funnel-like cusps in the Earth's magnetosphere. The impact of a proton event can last for a few hours to several days after a flare ends.

**Particle Events.** The sources of the solar charged particles (mostly protons and electrons) include the following: solar flares, disappearing filaments, eruptive prominences, and solar sector boundaries (SSBs) or high-speed streams (HSSs) in the solar wind. Except for the most energetic particle events, the charged particles tend to be guided by the interplanetary magnetic field (IMF) that lies between the sun and the Earth's magnetosphere. The intensity of a particle-induced event generally depends on the size of the solar flare, filament, or prominence, its position on the sun, and the structure of the intervening IMF.

**2. Space Weather Impacts on Operations.** Space weather events interfere with combat operations several ways. The primary concerns are disrupted UHF, HF, and satellite communications; radiation exposure to highflying jets; and navigation problems. The following products are for CWTs to use to prepare aircrew for their missions.

### **3. Space Weather Products.**

**a. The Space Environment Global Situational Product.** This product (Figure 2-79) provides information on the space environment and related impacts to operations for 6 categories. These are: (1) HF communications, (2) UHF SATCOM, (3) Satellite Ops, (4) Space Object Tracking/Satellite Drag, (5) High-Altitude Flight, and (6) Radar Interference.

**HF Communications:** This is degradation of HF communications due to changes in the ionosphere where long-range HF signals are usually reflected. Moderate or greater solar flares are considered in assessing the observed and forecast conditions. These solar flares emit x-rays, which enhance the lower levels of the ionosphere resulting in absorption of HF signals. Solar flares usually affect the lower portion of the HF spectrum, but can blackout the entire spectrum if sufficiently energetic. Also considered in assessing or forecasting HF communications is the level of geomagnetic activity. Strong geomagnetic activity often results in a decrease in the ionosphere's ability to reflect HF signals. Strong geomagnetic activity also leads to enhanced aurora in the northern and southern high latitudes that can significantly degrade HF communications.

**UHF SATCOM:** This category depicts degradation of UHF SATCOM communications due to changes in the ionosphere. UHF signals are transmitted through the ionosphere ("transionospheric") for communications to satellites. UHF scintillation occurs mainly in the equatorial region and the auroral region. In the equatorial region, the greatest

Miscellaneous Weather Elements

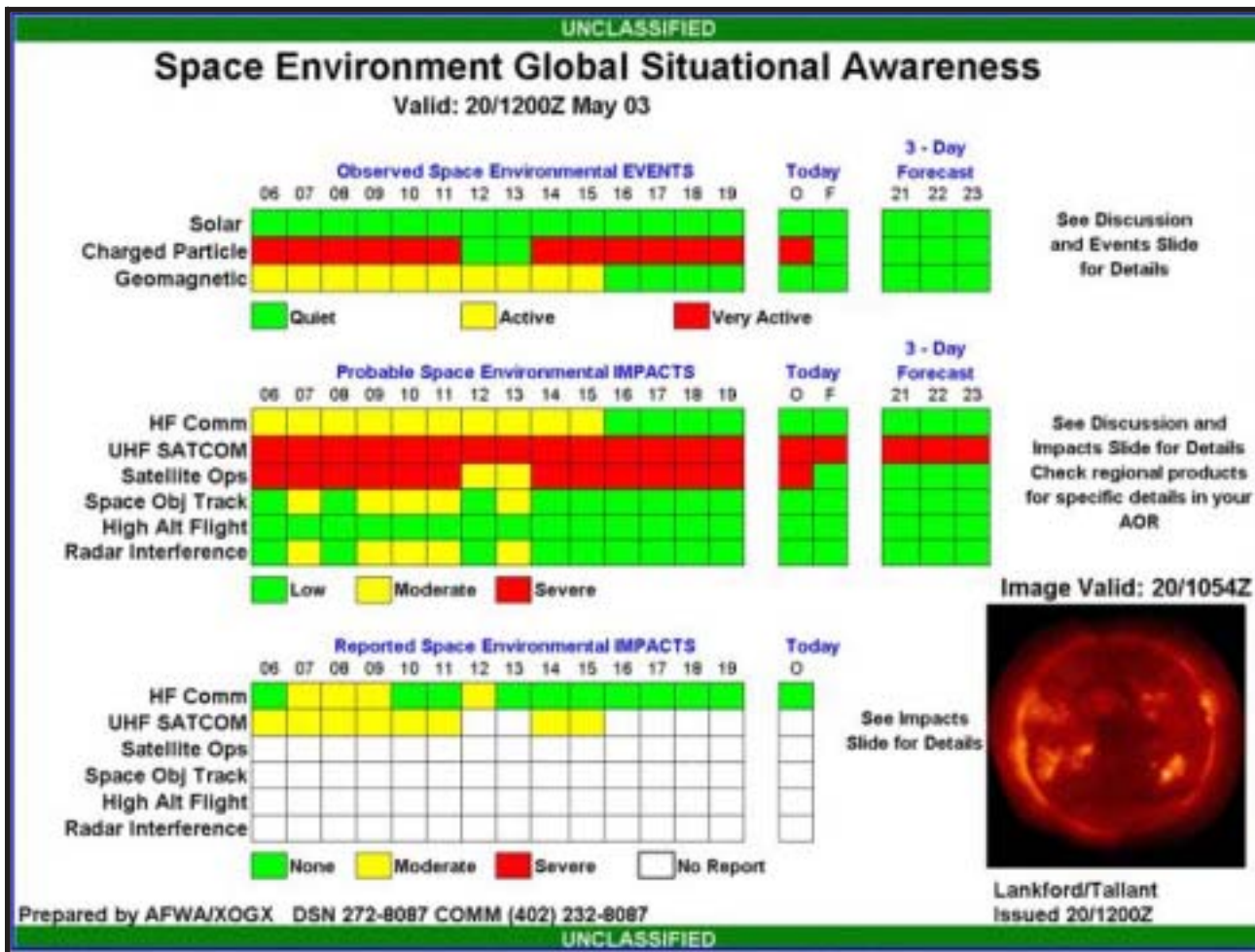


Figure 2-79. Space Environment Global Situational Awareness Product.

impacts usually occur just after local sunset to approximately 0200L and have a seasonal dependence. During quiet geomagnetic activity, the scintillation is usually stronger, with moderate to strong geomagnetic activity working to suppress the equatorial UHF scintillation. Strong geomagnetic activity also leads to enhanced aurora in the northern and southern high latitudes which can significantly degrade UHF communications.

**Satellite Operations:** This is the potential for or observed degradation or damage to satellites themselves. This damage or degradation usually results from particle interactions with the spacecraft. Particles can deposit electrical charge on or within spacecraft and cause damage through a discharge, or can damage the satellite through

collision or by overwhelming or disorienting the satellite’s sensors. Information considered in determining the state of this category are the number and energy of particles in the space environment (e.g. increased by flares, coronal mass ejection, etc), geomagnetic activity which can enhance and accelerate particles in the space environment, and reported observations of satellite anomalies thought to be the result of the satellite environment.

**Space Object Tracking:** This is the observed and forecast potential for unexpected changes in the orbits of satellites. Changes in satellite orbits result from an increase or decrease in the drag normally experienced at a satellite’s orbit. This change in drag results from the heating or cooling of the upper

**Table 2-15. Impacts and the Space Environment Global Situational Awareness Product Color Scheme.**

<b>GREEN</b>	The environment is unlikely to contribute to operational problems.
<b>YELLOW</b>	The environment will cause moderate impacts to operations.
<b>RED</b>	The environment will cause severe impacts to operations.

atmosphere due to changes in the sun’s radiation output, or due to geomagnetic activity. (Energy deposited in Earth’s upper atmosphere by EUV, x-ray, and charged particle bombardment heats the atmosphere, causing it to expand outward).

**High Altitude Flight:** This is the maximum level of radiation exposure at an altitude of 67,000 ft. It will be **YELLOW** for dose rates greater than 10 millirems/hr and **RED** for dose rates exceeding 100 millirems/hr. This radiation is a product of cosmic rays from outside the solar system as well as very high-energy protons occasionally produced by explosive events on the sun. (See Table 2-15.)

**Radar Interference:** This is observed and forecast degraded operation of the radars used to track objects in space. Radio frequency bursts from the sun can cause interference to radars when the sun is in their field of view. Additionally, anomalous returns can occur when geomagnetic activity disturbs the ionosphere.

This product uses a stoplight color scheme defined as follows.

- **GREEN**      The environment is unlikely to contribute to operational problems.
- **YELLOW**    The environment will cause moderate impacts to operations.
- **RED**         The environment will cause severe impacts to operations.

The bottom portion of this product reports the space weather event that caused the impact to operations. The events can be solar flares/ radio bursts, energetic particles, or geomagnetic storms.

**Solar Activity:** This category shows the overall activity level of the sun and its likelihood to impact systems. Criteria analyzed to determine the state of this category are the occurrence of moderate or greater X-ray flares and significant solar radio bursts.

**Geomagnetic Activity:** This category shows the overall geomagnetic activity level of the Earth’s magnetic field. A measured or forecast planetary geomagnetic activity index is used to determine the likelihood of system impacts. Changes in the geomagnetic activity are caused by streams of solar particles interacting with the planet’s magnetic field. These particles may have been increased by flares, coronal mass ejections, disappearing filaments, or coronal holes.

**Charged Particle Environment:** This category shows the observed or forecast potential for system impacts from charged particles significantly above normal background levels. Charged particle enhancements occur due to solar events or enhanced geomagnetic activity.

The product is divided from left to right. The left portion of the product represents activity and impacts observed in the last fourteen days. This portion of the slide is only updated for the 00Z product. The right portion of the slide shows the forecast for the next three days. This portion of the slide is usually updated during the 18Z forecast,

**Miscellaneous Weather Elements**

when most of the new data is available to the forecast center. The center column represents the forecasted and observed conditions for the current day. It is updated throughout the day. This column usually starts out as a forecast (00Z) and evolves into an observed category (18Z).

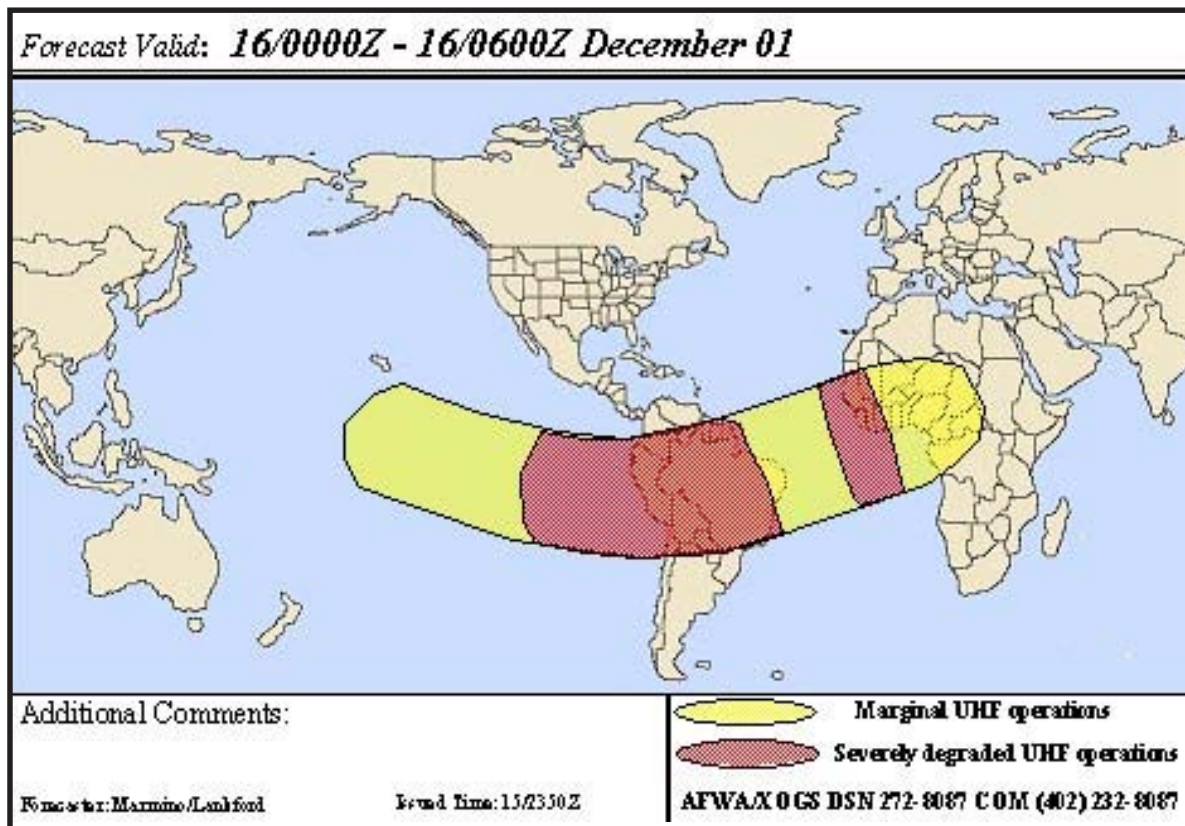
**b. 6-Hour Forecast of Ionospheric Conditions Impacting UHF SATCOM (Figure 2-80).**

**Description.** A graphical bulletin issued four times per day and valid for the following six hours, it contains information on ultra-high frequency (UHF) radio propagation conditions. Regions of forecasted marginal UHF operations highlighted in yellow (experiencing 4-10 db fade), and regions forecast to experience severely degraded (experiencing >10 db fade) UHF propagation highlighted in red. Use in tandem with UHF SATCOM Scintillation Nowcast and Forecast.

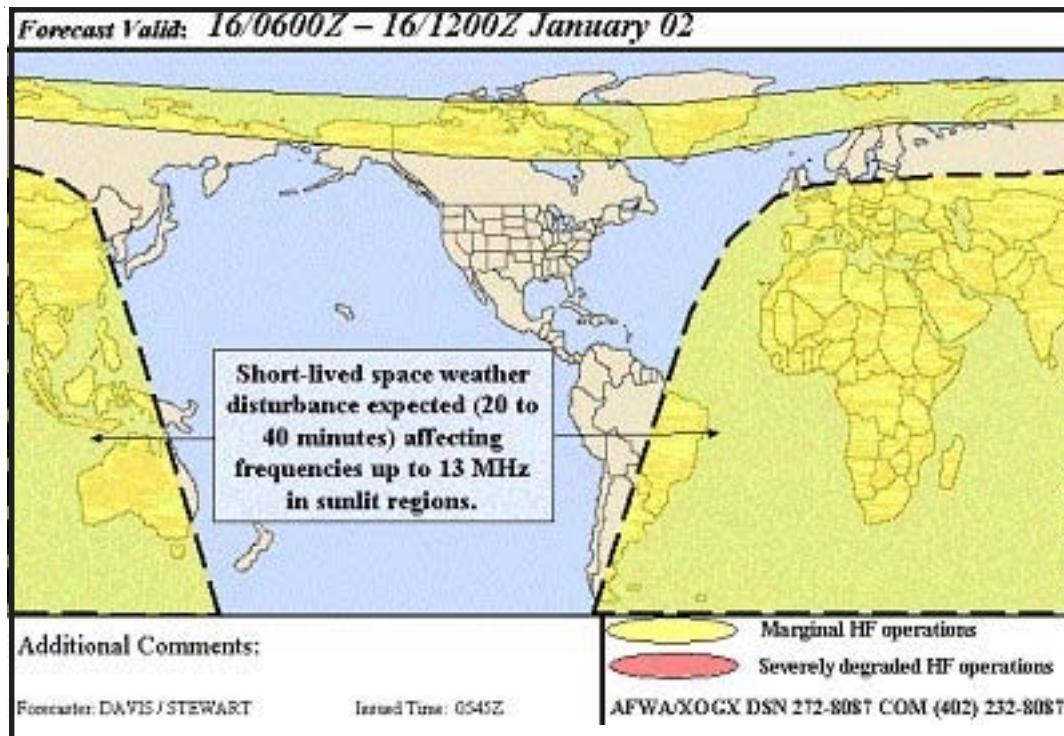
**Operational Impacts/Uses.** Customers can use this product for situational awareness and to develop planning guidance for operations using UHF and SATCOM systems. Areas specified as being impacted represent the worst-case scenario for long-haul HF communications being attempted through the contoured region.

**c. 6-Hour Forecast of Ionospheric Conditions Impacting HF Propagation (Figure 2-81).**

**Description.** Graphical bulletin issued four times per day and valid for the following six hours; contains information on high frequency (HF) radio propagation conditions and solar and terrestrial conditions that relate to or have an impact on HF communications. Regions of forecasted marginal HF operations highlighted in yellow, and regions forecast to experience severely degraded HF propagation highlighted in red. The marginal HF



**Figure 2-80. Ionospheric Conditions Impacting UHF SATCOM Chart.**



**Figure 2-81. Ionospheric Conditions Impacting HF Propagation Communications and other HF Operations Chart.**

implies impacts to frequencies up to 20 MHz, while the severely degraded HF operations implies impacts to the entire HF spectrum (up to 30 MHz).

**Operational Impacts/Uses.** Customers can use this product for situational awareness and to develop planning guidance for operations using HF systems. Areas specified as being impacted represent the worst-case scenario for long-haul HF communications being attempted through the contoured region. Amber represents areas where frequencies up to 20 MHz may suffer degradation for upwards of 40 minutes. Red areas represent degradations of frequencies above 20 MHz for over 40 minutes.

**d. UHF SATCOM Scintillation Nowcast and Forecast (Figure 2-82).**

**Description.** This product is a graphic map depicting the estimated potential amount of performance degradation (signal fading) of UHF SATCOM as a result of ionospheric scintillation. Although DoD SATCOM uses the entire UHF radio band, these UHF Scintillation maps apply only to UHF SATCOM between 225 MHz and 400 MHz (the lower portion of the UHF spectrum is impacted more than the higher end). Regions of light or weak degradation (1-4 dB) are in green, regions of moderate degradation (4-10 dB) are in yellow and regions of severe degradation (greater than 10 dB) are in red. **Use in tandem with 6-Hour Forecast of Ionospheric Conditions Impacting UHF SATCOM.**

Miscellaneous Weather Elements

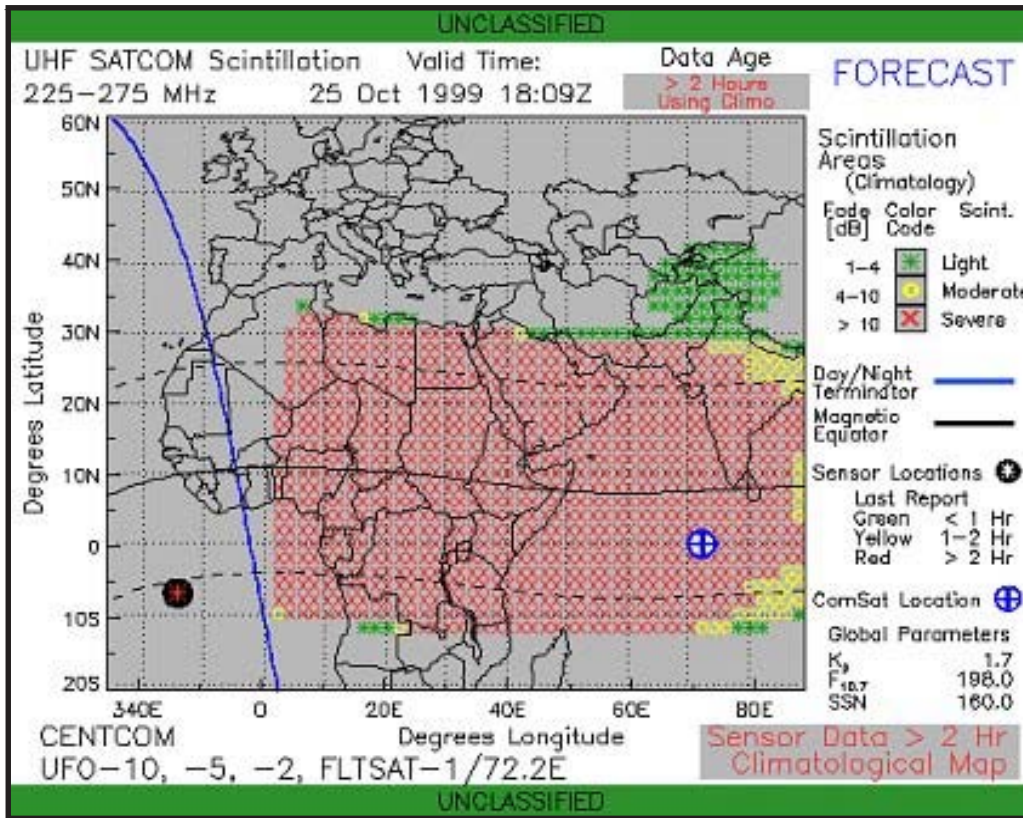


Figure 2-82. UHF SATCOM Scintillation Nowcast and Forecast Chart.

**Operational Impacts/Uses.** Customers can use this product for situational awareness and to develop planning guidance for operations using UHF and SATCOM systems.

*e. Point-to-Point HF Radio Usable Frequency Forecasts (Figure 2-83).*

**Description.** Provides predictions of HF radio propagation conditions, including Maximum Usable Frequency (MUF), Frequency of Optimum Transmission (FOT), and Lowest Usable Frequency (LUF).

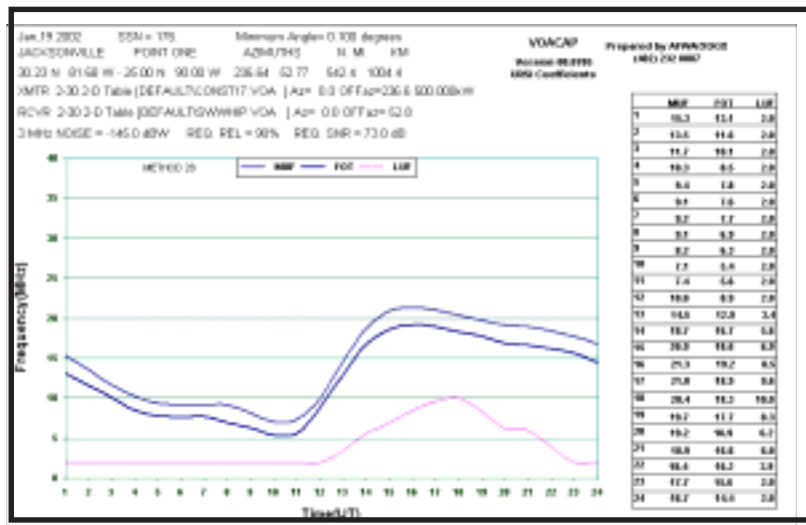


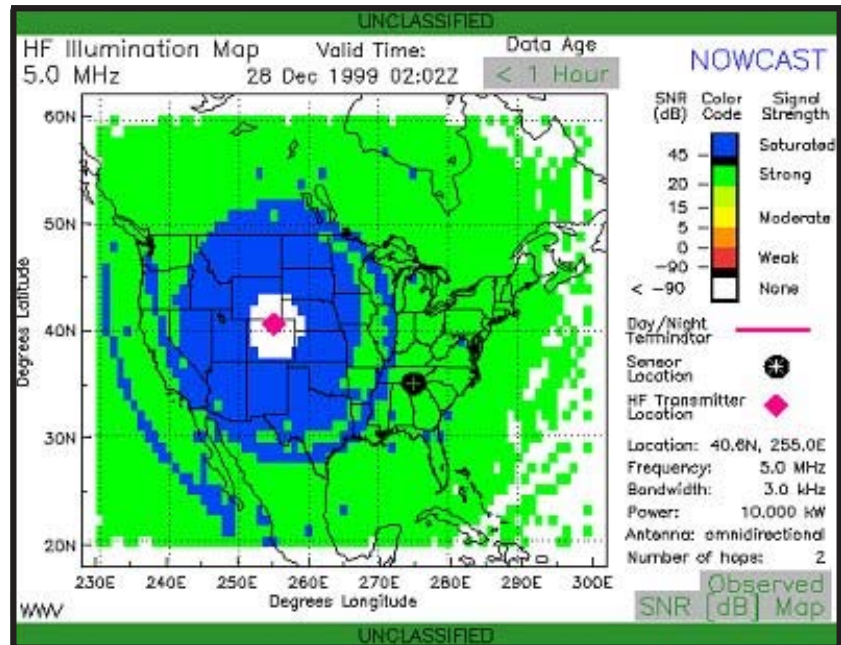
Figure 2-83. Point-to-Point HF Radio Usable Frequency Forecast Chart.

**Operational Impacts/Uses.** Customers can use this product to develop planning guidance as well as relatively precise mission-support information for operations using

long-haul HF communications. The equipment and signal paths used can be specified, allowing the user to customize this product for their particular needs.

*f. HF Illumination Maps Nowcast and Forecast (Figure 2-84).*

**Description.** This product is designed to help HF operators better understand the HF propagation environment and to better react to ionospheric conditions to improve HF communications. It is also designed to help HF communicators select an operating frequency that will provide the greatest probability of successful communications. The map displays the signal strength, noise intensity, or signal-to-noise ratio on the ground. The product is color-coded and visually displays zones of possible communications frequencies.



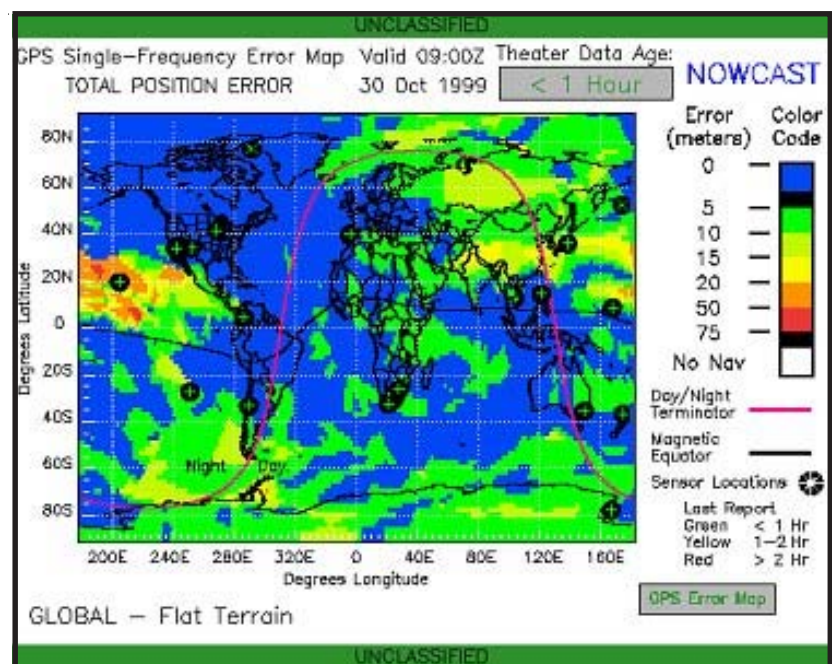
**Figure 2-84. HF Illumination Maps Nowcast and Forecast Chart.**

sitioning errors that result from inaccurate ionospheric correction for single-frequency GPS users. The product displays errors in total position (latitude, longitude, and height), horizontal position (latitude only), and altitude position (height only).

Operational Impacts and Uses. Customers can use this product for situational awareness and to develop planning guidance for operations using HF systems. The output is frequency specific, and can be applied directly to long-haul HF communications being attempted from the transmitter location.

*g. Estimated Global Positioning Satellite (GPS) Single Frequency Error Maps —1-Hour Nowcast and Forecast (Figure 2-85).*

**Description.** A graphical product that estimates near real-time po-



**Figure 2-85. Estimated Global Positioning Satellite (GPS) Single Frequency Error Map.**

## Miscellaneous Weather Elements

Product assumes a greater GPS error for hilly terrain than flat terrain. Geometric data from 4 visible GPS satellites are used to create the product. GPS errors are color-coded and are displayed in meters.

**Operational Impacts/Uses.** Customers can use this product for situational awareness and to develop planning guidance for operations using single-frequency GPS systems. It is important to note that the effects shown in this product do not apply to dual-frequency GPS systems.

### *h. Alerts and Warnings.*

#### • **Short Wave Fade Event Warning (WOXX50 KGWC) (Figure 2-86)**

**Description.** Notifies customers of short-wave fades (affecting HF communications).

**Operational Impacts/Uses.** Short wave fades cause a loss of communications on HF frequencies; instead of reflecting HF radio waves, the ionosphere absorbs them. Effects may last up to 30 minutes in a smaller event, and several hours in a large event. Frequencies affected depend on the size of an event; in large events, the entire HF spectrum is affected. High Frequency radio users may experience degradation at certain frequencies or a complete HF communication blackout. Length of time depends on location of transmitter/receiver, duration and intensity of X-ray event. Also radar systems that utilize HF or lower UHF bands may experience anomalous returns (If the radar is pointed into the sun's general direction during the time of the X-ray event).

WOXX50\_KGWC - SHORT WAVE FADE EVENT WARNING

WOXX50 KGWC 110018  
 SUBJECT: AFWA EVENT WARNING REPORT ISSUED AT 0018Z 11 MAR 2002  
 PART A. SHORT WAVE FADE EVENT: THE SHORT WAVE FADE EVENT, WHICH BEGAN AT 2254Z10 MAR 2002 IS STILL IN PROGRESS, AS SOLAR X-RAY LEVELS REMAIN HIGH.  
 PART B. HIGH FREQUENCY RADIO COMMUNICATIONS AND INTERCEPT CAPABILITY IN DAYLIT AREAS OF THE GLOBE WILL EXPERIENCE SIGNAL FADES UP TO 12 MHZ FOR AN ADDITIONAL 60 MINUTES OR MORE. EFFECTS MAY LAST SOMEWHAT LONGER AT LOWER FREQUENCIES. NO FURTHER UPDATES WILL FOLLOW UNLESS THIS EVENT EXTENDS BEYOND THE EXPECTED DURATION OR AN ADDITIONAL SHORT WAVE FADE OCCURS.  
 PART C. REMARKS: ISSUED BY THE AIR FORCE WEATHER AGENCY, OFFUTT AFB, NE. IF YOU HAVE QUESTIONS OR REQUIRE FURTHER INFORMATION, CALL THE DUTY FORECASTER AT DSN 272-8087, COMMERCIAL 402-232-8087. INFORMATION CAN ALSO BE OBTAINED AT <https://weather.afwa.af.mil> UNDER THE SPACE WEATHER LINK.

**Figure 2-86. Short Wave Fade Event Warning Example**

#### • **Solar X-ray Event Warning (WOXX55 KGWC) (Figure 2-87).**

**Description.** Messages sent when an X-ray event occurs.

**Operational Impacts/Uses.** Short-wave fades for high frequency (HF) radio communications, where radio operators in most cases, will find HF unusable. Very large X-ray events can also damage satellite components, though this is rare.



WOXX55\_KGWC - SOLAR X-RAY EVENT WARNING

WOXX55 KGWC 110817

SUBJECT: AFWA EVENT WARNING REPORT ISSUED AT 0817Z 11 DEC 2001

PART A. SOLAR X-RAY EVENT:

THE X-RAY EVENT WHICH BEGAN AT 0804Z 11 DEC 2001 REACHED A MAXIMUM OF X3 AT 0808Z 11 DEC 2001, AND FELL BELOW X1 LEVEL AT 0815Z 11 DEC 2001.

PART B. THIS EVENT AFFECTED HIGH FREQUENCY RADIO COMMUNICATIONS AND INTERCEPT CAPABILITY IN DAYLIT AREAS OF THE GLOBE.

PART C. REMARKS:

ISSUED BY THE AIR FORCE WEATHER AGENCY, OFFUTT AFB, NE. IF YOU HAVE QUESTIONS OR REQUIRE FURTHER INFORMATION, CALL THE DUTY FORECASTER AT DSN 272-8087, COMMERCIAL 402-232-8087. INFORMATION CAN ALSO BE OBTAINED AT <https://weather.afwa.af.mil> UNDER THE SPACE WEATHER LINK.

**Figure 2-87. Solar X-Ray Event Warning Example**

• **Major Solar Flare Event Warning Operational Impacts/Uses.**  
(WOXX51 KGWC) (Figure 2-88)

**Description.** Notifies customers of significant solar flares. Reports are issued when a USAF Solar Optical Observing Network site reports a flare of importance 3B or greater. If there is no optical patrol (unable to observe the sun optically), a report is issued if the X-ray flux equals or exceeds X5.

• Major solar flare, enhanced X-ray emission:

•• HF systems operating in the sunlit hemisphere may experience short wave fades up to 30 MHz. Fades generally persist for less than one hour, but may persist much longer.

WOXX51\_KGWC - MAJOR SOLAR FLARE EVENT WARNING

WOXX51 KGWC 131445

SUBJECT: AFWA EVENT WARNING REPORT ISSUED AT 1445Z 13 DEC 2001

PART A. MAJOR SOLAR FLARE EVENT: AT 1430Z 13 DEC 2001 A SOLAR FLARE EQUALED OR EXCEEDED SIZE AND IMPORTANCE OF 3B.

PART B. THIS EVENT WILL AFFECT HIGH FREQUENCY RADIO COMMUNICATIONS IN SUNLIT AREAS OF THE GLOBE. THE FLARE WILL DECLINE TO PRE-EVENT LEVELS DURING THE NEXT ONE TO TWO HOURS.

PART C. REMARKS:

ISSUED BY THE AIR FORCE WEATHER AGENCY, OFFUTT AFB, NE. IF YOU HAVE QUESTIONS OR REQUIRE FURTHER INFORMATION, CALL THE DUTY FORECASTER AT DSN 272-8087, COMMERCIAL 402-232-8087. INFORMATION CAN ALSO BE OBTAINED AT <https://weather.afwa.af.mil> UNDER THE SPACE WEATHER LINK.

**Figure 2-88. Major Solar Flare Event Warning Example**

## Miscellaneous Weather Elements

••LF and VLF systems operating through the sunlit hemisphere may experience sudden phase advances during the event.

• Major solar flare, enhanced radio frequency emission:

••VHF, UHF, and SHF systems operating in the sunlit hemisphere may experience radio frequency interference (RFI) during event. Systems pointing sunward are especially susceptible to RFI.

• **Geomagnetic Event Warning (WOXX54 KGWC)**  
*Figure 2-89.*

**Description.** Notifies customers of forecasted or observed geomagnetic disturbances.

**Operational Impacts/Uses.**

• HF systems operating in middle and auroral zones will experience Maximum Usable Frequency (MUF) depressions during the disturbance. Long east-west paths (over 3000 km) extending poleward

of  $\sim 55^{\circ}$  may experience non-great circle propagation, multipathing, and auroral zone absorption.

• Poleward-pointing HF/VHF/UHF radars, equatorward of the auroral zone, may observe enhanced clutter, interference, and false targeting.

• VHF and UHF space track radars operating through the auroral zone may experience unusual signal retardation and refraction, causing ranging and pointing errors.

• VHF, UHF and SHF satellite communication systems operating through the auroral zone may experience enhanced phase/amplitude scintillation.

• LF and VLF systems operating across the Auroral and Polar Regions may experience phase advances during the event.

• Geosynchronous and other high-altitude satellites may experience spacecraft charging, especially when in the midnight to sunrise sector.

WOXX54\_KGWC - GEOMAGNETIC EVENT WARNING

WOXX54 KGWC 222010

SUBJECT: AFWA EVENT WARNING REPORT ISSUED AT 2010Z 22 OCT 2001

PART A. GEOMAGNETIC EVENT IN PROGRESS (UPDATE):

THE GEOMAGNETIC FIELD IS AT SEVERE STORM LEVELS. THE 3-HOUR AP WAS 122 AND THE 24-HOUR AP WAS 72 AT 22/1915Z THE DISTURBANCE IS FORECAST TO CONTINUE AT SEVERE STORM LEVELS THROUGH THE NEXT 10 HOURS (BASED ON 24-HOUR AP) WHEN VALUES WILL DECREASE TO ACTIVE LEVELS. THIS PRODUCT WILL BE UPDATED EVERY 6 HOURS UNTIL THIS EVENT ENDS.

PART B.

POSSIBLE EFFECTS ARE SATELLITE DRAG ON LOW EARTH ORBIT SATELLITES, SATCOM SCINTILLATION, HF RADIO COMMUNICATION INTERFERENCE OR LAUNCH TRAJECTORY ERRORS.

PART C. REMARKS:

ISSUED BY THE AIR FORCE WEATHER AGENCY, OFFUTT AFB, NE. IF YOU HAVE QUESTIONS OR REQUIRE FURTHER INFORMATION, CALL THE DUTY FORECASTER AT DSN 272-8087, COMMERCIAL 402-232-8087. INFORMATION CAN ALSO BE OBTAINED AT <https://weather.afwa.af.mil> UNDER THE SPACE WEATHER LINK.

**Figure 2-89. Geomagnetic Event Warning Example**

Subsequent discharges may cause electrical upsets. Similar charging problems may occur on low altitude satellites with inclinations transiting auroral latitudes.

- Low altitude polar orbiting satellites may experience increased atmospheric drag due to enhanced atmospheric density. This effect will begin approximately 6 hours after the storm starts, and last until approximately 12 hours after the storm ends.

- ***Energetic Particle Event Warning (WOXX53 KGWC) Figure 2-90.***

**Description.** Notifies customers of forecast or observed enhancements of energetic particles in the near-earth environment.

### Operational Impacts/Uses.

- Satellite-borne sensors may be contaminated, damaged or destroyed by direct collision with high-energy particles.

- Geosynchronous and other high-altitude satellites (or satellites in lower orbits, but with paths through the Auroral zones) may experience problems associated with 2 different anomaly sources:

- Internal charging and discharging associated with the energetic particle environment.

- Single event upsets (SEU) associated with the cosmic ray environment.

#### WOXX53\_KGWC - ENERGETIC PARTICLE EVENT WARNING

WOXX53 KGWC 021125

SUBJECT: AFWA EVENT WARNING REPORT ISSUED AT 1125Z 02 OCT 2001

PART A. ENERGETIC PARTICLE EVENT END: THE SATELLITE-ALTITUDE ENERGETIC PARTICLE EVENT THAT BEGAN NEAR 0510Z 02 OCT 2001 HAS ENDED.

THE PEAK 5-MIN AVERAGED FLUX OBSERVED DURING THE EVENT WAS: GREATER THAN 50 MEV 25 P/CM2/SEC/STER AT 02/0845Z. GREATER THAN 10 MEV 2360 P/CM2/SEC/STER AT 02/0810Z. NO FURTHER MESSAGES WILL BE SENT FOR THIS EVENT.

PART B.

THIS EVENT MAY HAVE PRODUCED SPACECRAFT CHARGING AND SENSOR CONTAMINATION OR DAMAGE, ESPECIALLY FOR GEOSYNCHRONOUS OR HIGH INCLINATION ORBITS.

PART C. REMARKS: ISSUED BY AIR FORCE WEATHER AGENCY, OFFUTT AFB, NE. IF YOU HAVE QUESTIONS OR REQUIRE FURTHER INFORMATION, CALL THE DUTY FORECASTER AT DSN 272-8087, COMMERCIAL 402-232-8087. INFORMATION CAN ALSO BE OBTAINED AT <https://weather.afwa.af.mil> UNDER THE SPACE WEATHER LINK.

**Figure 2-90. Energetic Particle Event Warning Example**

## Miscellaneous Weather Elements

- High altitude aircraft, such as the Supersonic Transport, traversing polar latitudes may be exposed to enhanced radiation levels.

- High latitude HF communication (generally poleward of 55 degrees of latitude) will experience degraded or a complete blackout due to the increased ionization from the charged particles entering the auroral zone, termed as a Polar Cap Absorption (PCA) event.

- Spacecraft personnel, especially those engaged in extra-vehicular activity (EVA) in polar orbit, may be exposed to enhanced radiation levels.

- **Radio Event Warning (WOXX52 KGWC) (Figure 2-91).**

**Description.** Notifies customers of significant solar radio bursts. A preliminary report is issued when a solar radio burst above 5,000 SFU is detected. This report provides the start time of the event. A final report is issued when the event ends. This report provides a list of frequencies on which bursts exceeding 5,000 SFU were observed, the peak flux, and the time of the peak.

### Operational Impacts/Uses.

- Radars may experience interference, increased noise levels, and false targeting.

- Satellite communications may experience increased noise levels or loss of communications.

WOXX52\_KGWC - RADIO EVENT WARNING

WOXX52 KGWC 250908  
 SUBJECT: AFWA EVENT WARNING REPORT ISSUED AT 0908Z 25 SEP 2001  
 PART A.  
 THE SOLAR RADIO EVENT WHICH BEGAN AT 0848Z 25 SEP 2001 CAUSED BURSTS OF:  
 FREQUENCY (MHZ): 610  
 PEAK FLUX (SFU): 5800  
 TIME OBSERVED: 0852  
 PART B.  
 THIS EVENT COULD HAVE AFFECTED SPACECRAFT COMMAND AND CONTROL, CAUSED RADIO FREQUENCY INTERFERENCE, AND/OR INTERCEPT CAPABILITY.  
 PART C. REMARKS:  
 ISSUED BY THE AIR FORCE WEATHER AGENCY, OFFUTT AFB, NE. IF YOU HAVE QUESTIONS OR REQUIRE FURTHER INFORMATION, CALL THE DUTY FORECASTER AT DSN 272-8087, COMMERCIAL 402-232-8087. INFORMATION CAN ALSO BE OBTAINED AT <https://weather.afwa.af.mil> UNDER THE SPACE WEATHER LINK.

**Figure 2-91. Radio Event Warning Example**

## Miscellaneous Weather Elements

- **Solar Radio Burst Advisory (NWXX50 KGWC) (Figure 2-92).**

**Description.** Notifies customers of solar radio bursts that could cause radio frequency interference (RFI) on radar/telemetry equipment at selected locations.

**Operational Impacts/Uses.** Radar system may experience increased noise levels and false targets.

- Radar system may experience increased noise levels and false targets.

- Satellite communications may experience increased noise levels or loss of communications due to interference.

NWXX50 KGWC - SOLAR RADIO BURST ADVISORY

NWXX50 KGWC 191527

SUBJECT: AFWA ADVISORY REPORT ISSUED AT 1527Z 19 JAN 2002

PART A. A SIGNIFICANT RADIO BURST IS IN PROGRESS

THE FOLLOWING SITES MAY EXPERIENCE INTERFERENCE: ANTIGUA, ASCENSION, BUCKLEY, CAPE COD, EGLIN, FYLINGDALE, KAPAUN, AND MILLSTONE.

PART B. RADAR SYSTEMS MAY EXPERIENCE INCREASED NOISE LEVELS AND FALSE TARGETS. SATELLITE COMMUNICATIONS MAY EXPERIENCE INCREASED NOISE LEVELS OR LOSS OF COMMUNICATIONS DUE TO INTERFERENCE.

PART C. REMARKS:

ISSUED BY THE AIR FORCE WEATHER AGENCY, OFFUTT AFB, NE. IF YOU HAVE QUESTIONS OR REQUIRE FURTHER INFORMATION, CALL THE DUTY FORECASTER AT DSN 272-8087, COMMERCIAL 402-232-8087. INFORMATION CAN ALSO BE OBTAINED AT <https://weather.afwa.af.mil> UNDER THE SPACE WEATHER LINK.

**Figure 2-92. Example Solar Radio Burst Advisory.**

**K. Electrooptics.** In order to understand the use of Target Acquisition Weather Software (TAWS) you need a basic understanding of electrooptics. The sensors of Precision Guided Munitions (PGM) rely on electro-optics (EO) to operate. Terrestrial weather affects the PGM's ability to distinguish the target from the background environment. The weather sensitivities will vary depending on the particular targeting and weapon systems employed.

To understand EO you must have a basic understanding of electromagnetic energy (EM) and of the electromagnetic spectrum. EM energy is energy in the form of a sinusoidal wave that travels at the speed of light (186,000 miles per second).

EM energy originates at the Sun, but it is absorbed and retransmitted by many objects in the Earth's atmosphere. Sensing or detecting this energy is what EO is all about. One way to visualize the process of EM energy movement is to recall what occurs when a stone is dropped into a calm pool of water. See Figure 2-93. The waves or ripples that emanate outward from the point where the stone enters the water is similar to EM energy traveling through the atmosphere. EM energy propagates as coupled electric and magnetic waves, each oscillating at 90° to the direction of motion. The path that electromagnetic energy will travel through the atmosphere depends greatly on weather conditions.

Miscellaneous Weather Elements

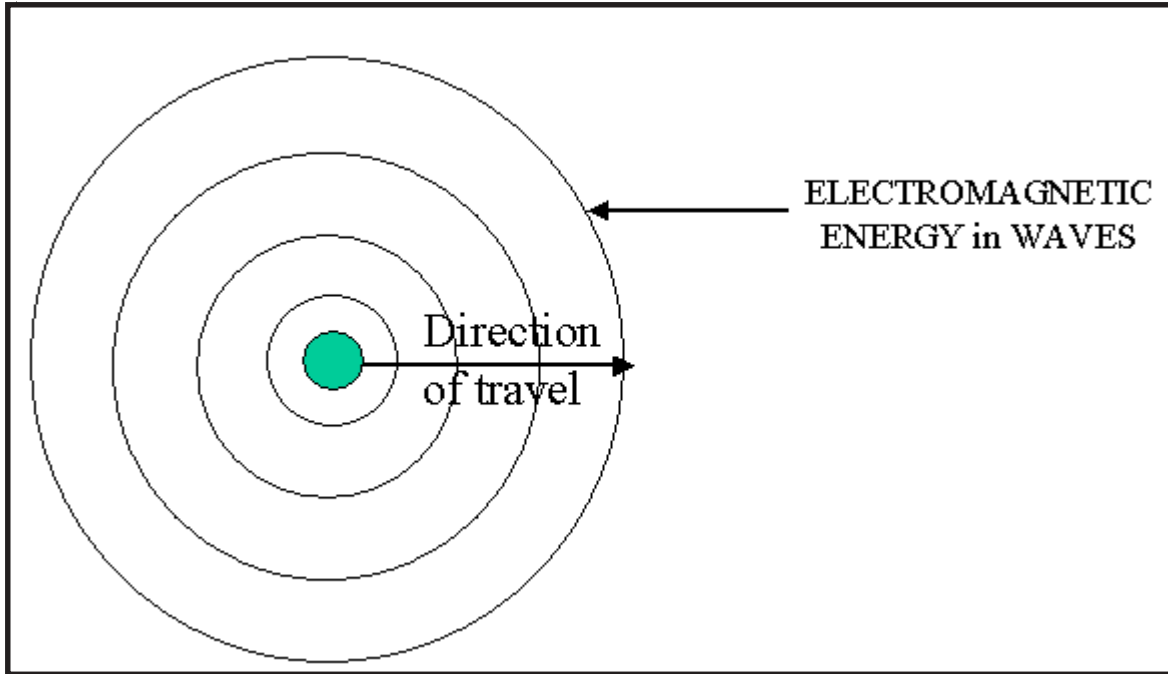


Figure 2-93. An Atmospheric Particle Emits Electromagnetic (EM) Energy.

Electromagnetic energy, as applied to EO, is broken down into five basic categories categorized by its wavelength or frequency. The wavelength is determined by measuring the distance between two successive crests of the wave. Frequency is the number of waves that pass a given point in a unit of time. This is also known as the oscillation rate and is measured in cycles/second (Hertz). Frequency and wavelength are inversely proportional. As wavelength decreases, frequency increases. As wavelength increases, frequency decreases.

**1. Categories of Electromagnetic Energy.** The five categories of electromagnetic energy are ultraviolet, visible, infrared, millimeter, and microwave. See Figure 2-94. The portion of the spectrum we are most interested in to forecast for PGM’s encompasses the 0.4-micron ( $\mu\text{m}$ ) to 100 $\mu\text{m}$  wavelengths. This portion of the spectrum includes visible and infrared energy. Visible wavelengths range from 0.4  $\mu\text{m}$  to 0.74  $\mu\text{m}$  and infrared wavelengths range from 0.74  $\mu\text{m}$  known as “near IR” to 100  $\mu\text{m}$  (.1mm) “far far IR.”

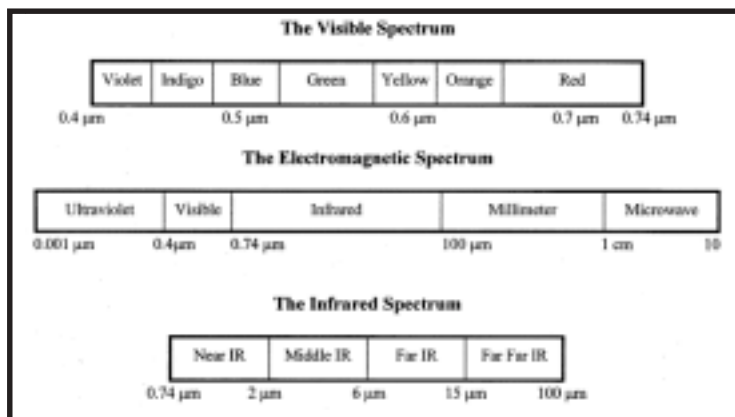


Figure 2-94. The Electromagnetic Spectrum.

Besides wavelength, frequency is the most used characteristic to classify electromagnetic energy.

**2. Atmospheric Processes Impacting EM Energy.** The degree of impacts that atmospheric particles have on EM energy depend on the wavelength and frequency of the energy, particle size and one or more atmospheric physical processes that EM energy undergoes as it passes through the earth's atmosphere. The four atmospheric processes are emission, reflection, scattering, and absorption. For these processes to occur some form of an atmospheric particle or constituent such as dust, water vapor, clouds, haze, smoke, fog or precipitation must be present. The main factor in determining which atmospheric process occurs is particle size.

**a. Emission.** Emission is the process of generation and transmission of EM energy. The two primary sources of emission that affect EO and PGM's are the Sun and the Light Amplification by Stimulated Emitted Radiation (LASER). Keep in mind that when we talk about emission we are talking on the scale of molecules. Every substance in the atmosphere emits EM energy at a particular

wavelength. An atmospheric particle generally emits EM energy at the same wavelength as it absorbed the energy.

The TAWS program predicts the performance of electrooptical (EO) weapon and navigation systems. The program's output is based on the weather. Algorithms calculate the impact of atmospheric processes on weapon performance.

**b. Reflection (Figure 2-95).** Reflection is the process by which the surface of an atmospheric particle reflects a portion of the EM energy that falls upon, or strikes a surface. Reflection occurs when the wavelength of EM energy is much smaller than the size of the particle it is striking.

Three terms associated with the reflection process are reflectance, reflectivity, and albedo. Reflectance is the ratio of the amount of energy at a specific wavelength reflected by an object, to the amount of energy incident upon it. Reflectivity is the ratio of the amount of EM energy reflected by a surface to the total amount incident upon the surface. Albedo, for our purposes, is an object's reflectivity in the visible spectrum.

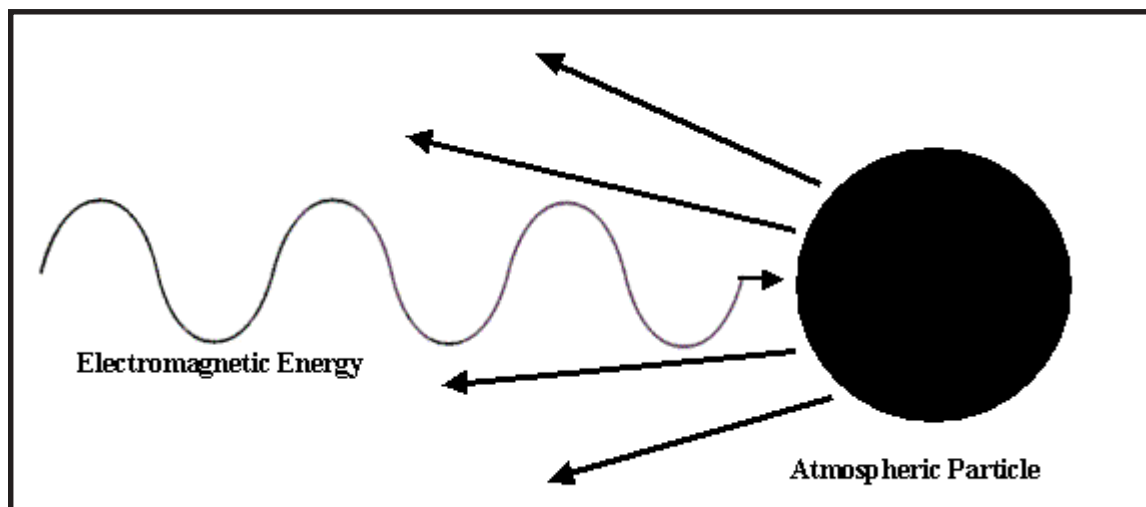


Figure 2-95. Reflection

**Miscellaneous Weather Elements**

---

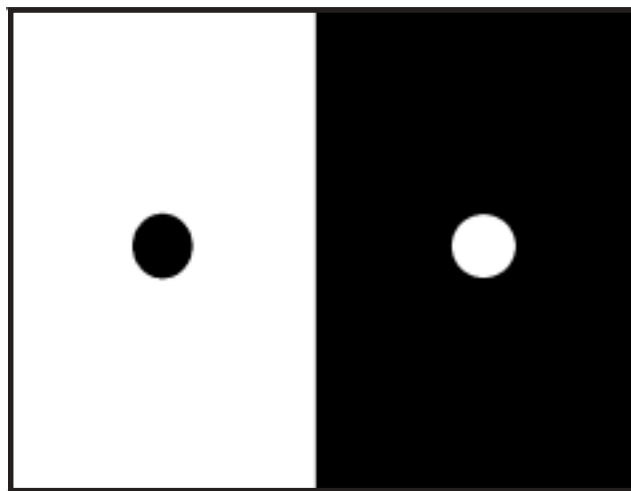
Reflection is a very important process and must be present to detect a target unless the target emits substantial amounts of EM energy at either visible or infrared wavelengths. Different targets have different reflectance values associated with them. Reflectance, in addition to variables such as surface composition and roughness, account for the difference between the target's reflected EM energy and that of the background.

- **Visual Contrast (Figure 2-96).** Visual contrast is the difference in reflectance between a target and its background. A perfect reflector reflects energy in the same direction in which it receives the energy. An example of a perfect reflector is a mirror. A diffuse reflector reflects energy in all directions. An example of a diffuse reflector is flat paint. It is much easier to detect a light target on a dark background because the detected energy comes primarily from the light target. Figure 2-96 illustrates this concept. The figure shows a black dot on a white background and a white dot on a black background. The white dot on the black background is much easier to detect especially at a farther distance. Move back from the figure and see it for yourself!

- **c. Scattering.** Scattering plays an important part in the color of the Sun, the sky, and the clouds. When sunlight passes through a clean, cloudless atmosphere, an observer on the earth's surface sees the sun as a distinct, white solar disc and the sky as deep blue. The Sun's white appearance represents all seven colors in the visible portion of the EM spectrum. The scattering of the shorter wavelengths (blue light) causes the sky's blue color by molecules in the atmosphere. The more scattering the bluer the sky appears.

When the sky is void of clouds but haze and smoke is present the sun appears blurred and the sky as bright and white. The scattering of all the visible wavelengths causes this effect by the haze and smoke particles in the atmosphere. EM energy passing through a thin layer of cloud cover with neither haze nor smoke present produces a different effect. The water droplets, which make up the cloud, scatter the visible wavelengths in approximately equal degrees making the cloud appear nearly white.

If cloud cover increases in thickness and density, as during development of a cumulus cloud, sunlight scatters more and some of it is absorbed by the



**Figure 2-96. Visual Contrast.**



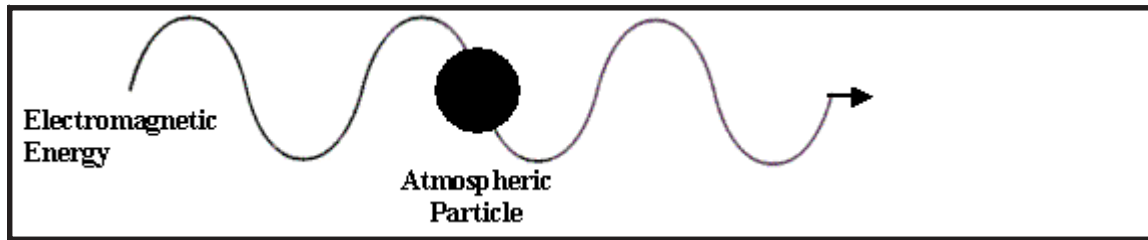


Figure 2-97. Rayleigh Scattering.

cloud droplets. Sunlight that actually reaches the observer's field of view on the earth's surface is greatly reduced and the base of the clouds appears gray.

There are three types of scattering; Rayleigh (Figure 2-97), Mie (Figure 2-98) and geometric (Figure 2-99), and all three are wavelength dependent. Rayleigh scattering occurs when the size of the atmospheric particle is smaller than the wavelength of EM energy. Rayleigh scattering occurs at shorter wavelengths and causes the sky to appear blue. Typically, oxygen, nitrogen, and water vapor cause Rayleigh scattering.

Mie scattering occurs when the size of the atmospheric particle is the same size as wavelength of EM energy. Mie scattering is caused by aerosols, particulate, and haze and occurs at all wavelengths. Mie scattering can reduce visibility to between 3 and 7 miles. Aerosols generally grow into a large enough size range for Mie scattering when the relative humidity is greater than 75 percent.

Geometric scattering occurs when the size of the atmospheric particle is larger than the wavelength of EM energy. Geometric scattering is caused by cloud droplets and precipitation, and it occurs at all wavelengths. Geometric scattering is significant when visibility is less than 3 miles and haze, mist,

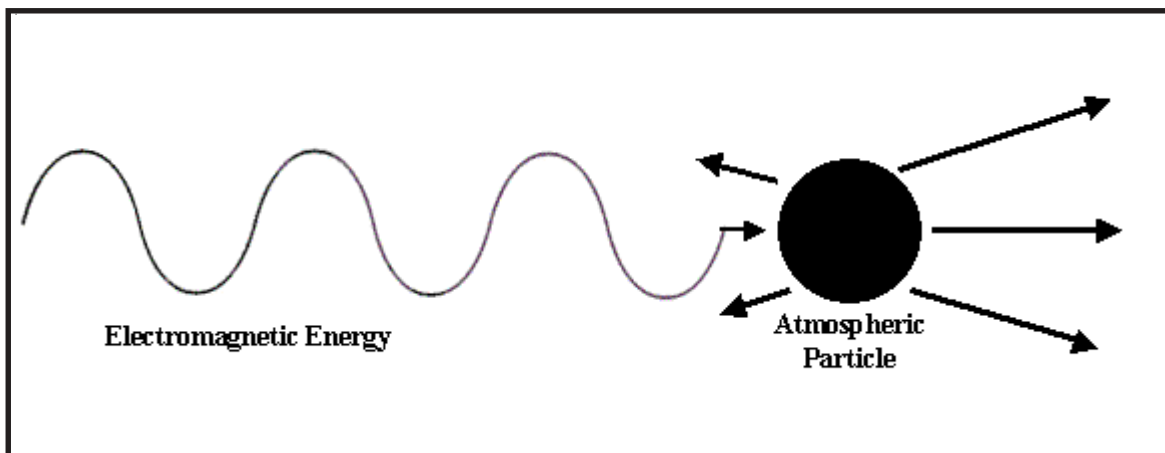


Figure 2-98. Mie Scattering.

## Miscellaneous Weather Elements

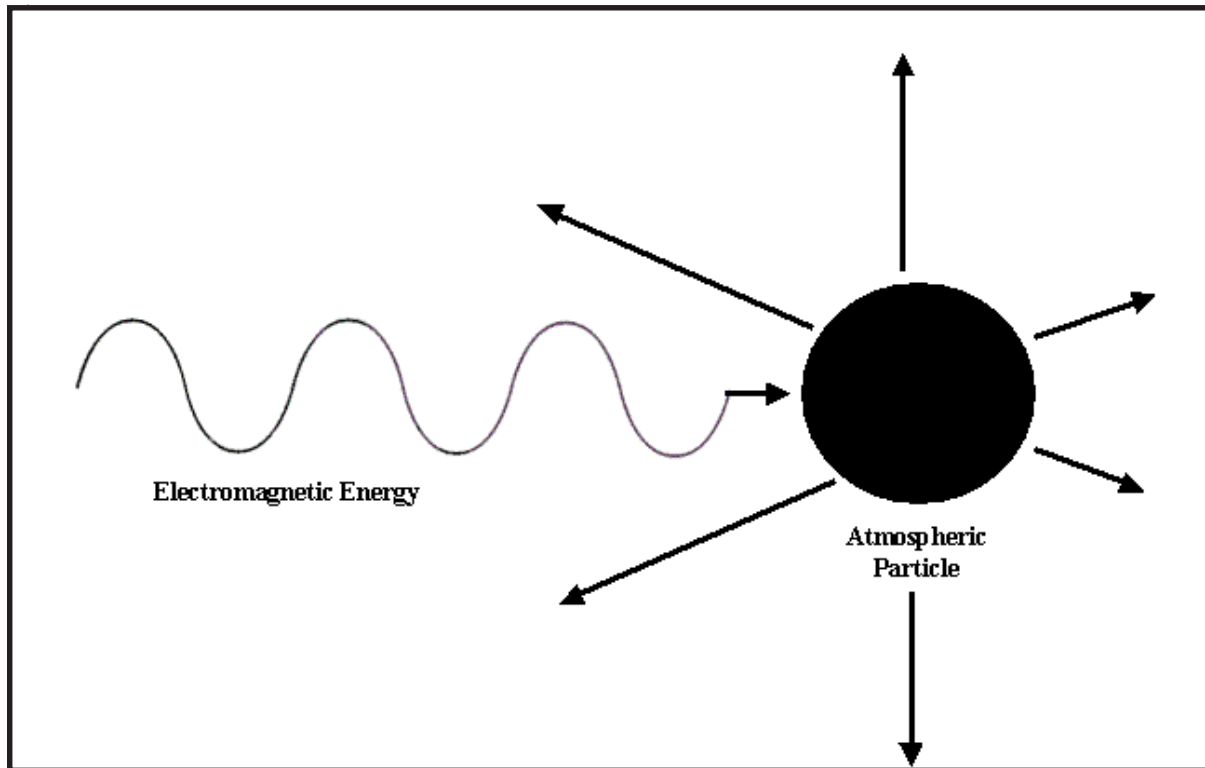


Figure 2-99. Geometric Scattering.

or fog is present. Geometric scattering causes the worst contrast between targets and their backgrounds.

**d. Absorption.** Absorption is the process by which EM energy is absorbed by substances or atmospheric particles such as water vapor, carbon dioxide, ozone, or oxygen. Absorption affects the infrared wavelengths of EM energy the most and is not a significant factor in the visible wavelengths. High absolute humidity increases absorption and partially closes the window to IR EM energy. High relative humidity (90 percent and above) is significant when combined with aerosols. Both solid and liquid particles cause absorption but the process is highly dependent on wavelength. Absorption is minimized in the 8 to 12 micron wavelength ranges. For this reason most IR sensors are designed to operate in the 8 to 12  $\mu\text{m}$  wavelength range.

Absorptivity is the measure of how much energy is absorbed by the skin of the object. Infrared sensors detect the radiative skin temperature of an object. Objects with a high level of absorptivity heat and cool faster than those with low absorptivity. Objects that have high absorptivity will have higher daytime temperatures and lower nighttime temperatures. Some materials that have high absorptivity are concrete, stone, and brick. Some materials that have low absorptivity are polished metal, sand, and calm water surfaces.

The four atmospheric processes just discussed are vitally important when working with EO and PGMs. A deterioration or loss of EM energy can result from various environmental and meteorological factors. The loss or absorption of EM energy between the emitter and receiver is called extinction.

Atmospheric processes are not the only ones affecting EM energy received by the EO sensor

from a target. Certain factors at the Earth's surface also affect EM energy. These Earth factors affect the detection of a target by EO sensors. The factors are distance, target-to-background contrast (inherent contrast), and target size.

**3. Distance and Target Size.** The greater the distance, whether horizontal, vertical or slant range, the harder it is to detect and identify a target. For example, you are driving on a highway and you see an object sitting along the side of the highway two miles ahead. At one mile, you can clearly identify the object as a car. At one-half mile, you clearly identify the car as a police cruiser. In other words, the ease of detection and identification increases as distance decreases.

The larger a target is the easier it is to detect and identify. To illustrate this let's return to our vehicle traveling on a highway. Two miles ahead there are two road signs. One sign measures 12 feet wide by 10 feet high. The other sign measures two feet by two feet. You will be able to identify the larger sign at a greater distance than you will the smaller sign. Road engineers place important information like exit information on larger signs in order that drivers have time to make decisions and change lanes if necessary.



**Figure 2-100. Low Clutter.**

**L. Clutter or TAWS Scene Complexity.** TAWS provides the user with three choices of scene complexity: low, moderate, and high.

Studies have shown that background clutter can have a pronounced effect on target detectability. Clutter consists of elements in the target scene that have similar size

and contrast to the target. In high clutter scenarios, you may need more than twice the sensor resolution that you need in low clutter scenarios.

In TAWS, clutter is treated subjectively. Below are examples of scenes ranging from low to high clutter. You must make a subjective judgment on which scene condition most closely resembles the expected scenario.

**Note:** Clutter is a very important parameter for IR and night vision goggles (NVG) sensors in TAWS. If you are unsure about the expected clutter conditions, it is best to select a clutter level of medium.

**1. Low Clutter (Figure 2-100).** A background scene is considered to have low clutter if it has relatively few objects in the immediate target vicinity that can be mistaken for the target. Moreover, those objects will typically differ in

shape from that of the target. The end result is that very little of the contrast results in confusing clutter near the immediate target location. Low-clutter scenes require minimum target resolution to allow the operator to distinguish targets from other confusing objects.

## Miscellaneous Weather Elements

### 2. *Medium Clutter* (Figure 2-101).

A background scene is considered to have medium clutter if it contains some confusing objects in the vicinity of the target, which are of comparable in size to the target. Generally, the scene will tend to have fewer non-target candidates than highly complex scenes and the confusing objects will differ more in shape from the target.

Comparably less resolution is required to distinguish targets from confusing objects with medium clutter than with high clutter.

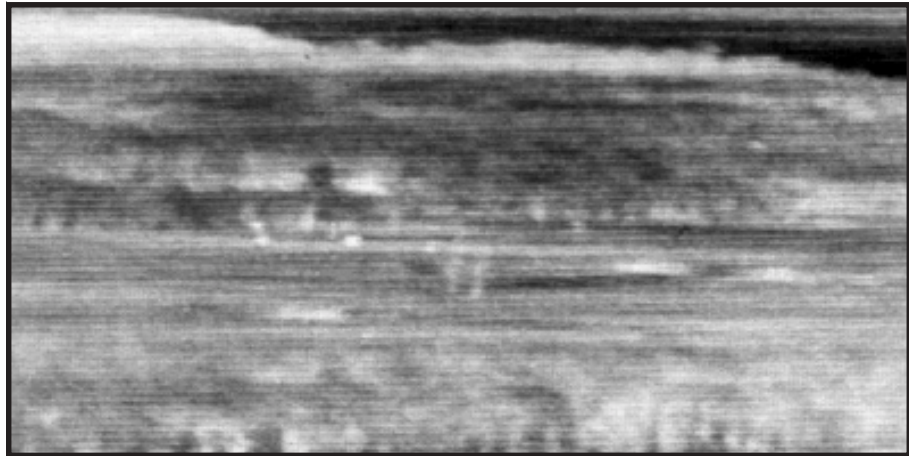


Figure 2-101. Medium Clutter.

3. *High Clutter* (Figure 2-102). A background scene is considered to have high clutter, if it contains many confusing objects or patterns that may be mistaken for targets.

Moreover, the confusing patterns must be in the immediate target vicinity, usually within a few target dimensions of the actual target location. In complex scenes, the operator must have comparatively greater resolution in order to be able to distinguish the target from competing objects.

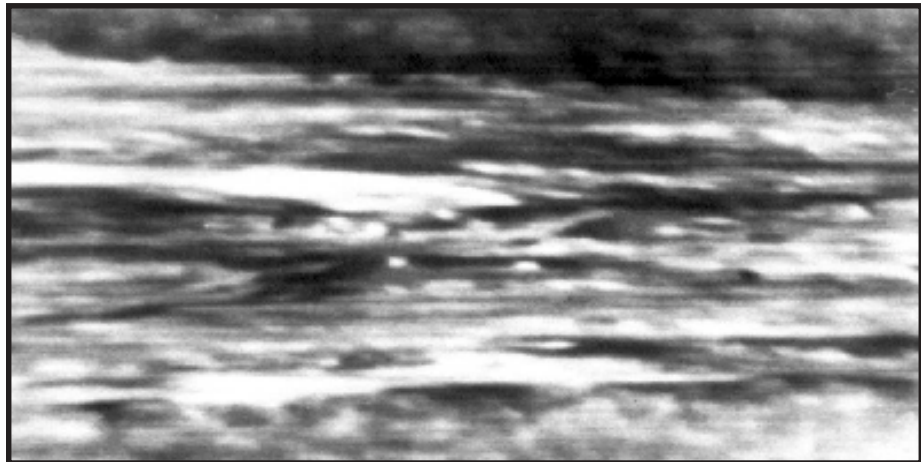


Figure 2-102. High Clutter

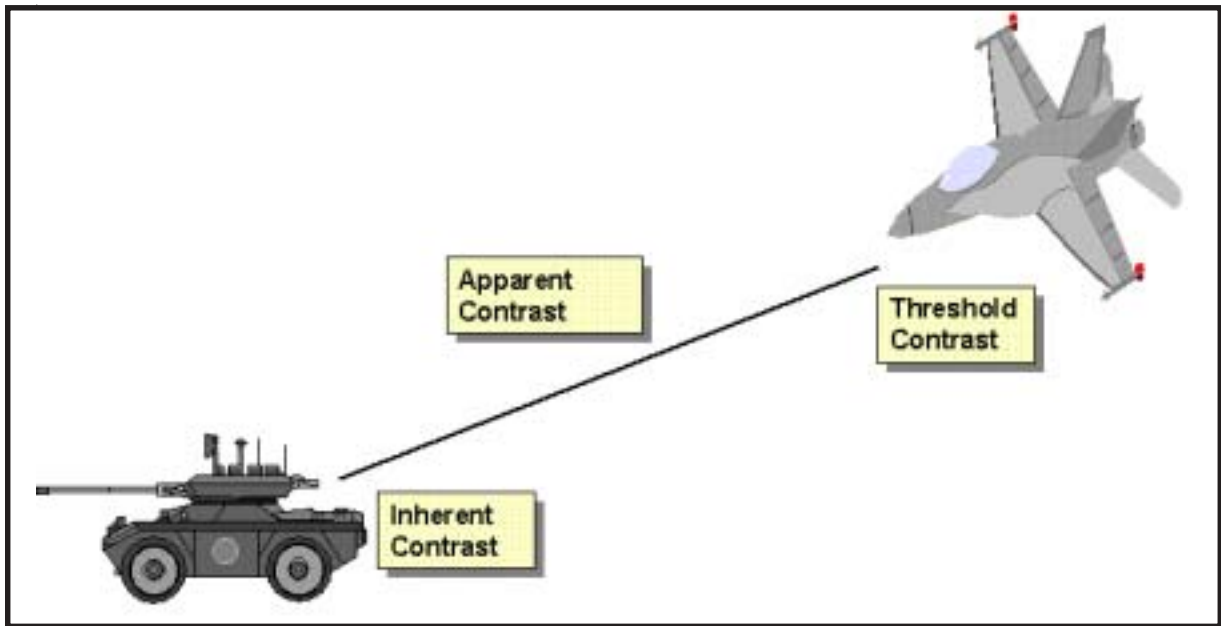
### 4. *Apparent, Threshold, and Inherent Contrast.*

Contrast between target and background is divided into three distinct types depending on distance between the sensor or viewer, and the target and its background. The types are apparent contrast, threshold contrast, and inherent contrast as depicted in Figure 2-103.

Apparent contrast is the difference between EM energy received by a sensor from the target and the EM energy received from the target's surrounding background at a considerable distance. Because of the distance and effects of any scattering and

absorption in the atmosphere, there is very little difference between EM energy received from the target and background. The target is not detectable against its background.

Threshold contrast is the point where the energy received by a sensor from the target and the EM energy received from the target's surrounding background is such that the target is first detected against the background 50 percent of the time.



**Figure 2-103. Apparent, Inherent, and Threshold Contrast.**

Inherent contrast is the difference between EM energy received by a sensor from the target and the EM energy received from the target's surrounding background. For true inherent contrast, no atmospheric processes, such as scattering or absorption, are considered to be occurring. The greater the inherent contrast the easier it is to detect and identify a target. For example, a hot tank against a cold snow covered background would provide a strong inherent contrast. A hot tank against a concrete highway during a late summer afternoon would provide a weaker inherent contrast.

Surface targets emit EM energy just like atmospheric particles. The amount of EM energy emitted by a target depends on its composition and temperature. Emissivity is how well an object releases or emits EM energy or heat. Different materials exhibit different emissivity values. For example, concrete has an emissivity of 90 percent and would appear warmer thermally than polished steel, which has an emissivity of 10 percent. Objects like polished metal and calm water have low emissivity values and will appear cold

thermally even though their physical temperature might be warm.

In recent years defense contractors have developed effective coatings for military weapon systems that lower their emissivity so they will have a cooler thermal image against their backgrounds. This makes them harder to detect.

Little or no "visible" EM energy is emitted from surface targets and backgrounds with the exception of targets like fires and focused high intensity lights. As EM energy wavelengths increase, surface targets emit more energy than they reflect. Infrared sensors at middle and far wavelengths rely on emission, not reflection to view targets and their backgrounds.

An important parameter to understand when using IR sensors is *radiative* or *brightness* temperature. Brightness temperature derives its name from the brighter image shown on most IR sensors with higher radiative temperatures. Radiative temperature is a result of physical temperature and emission of the target and the background.

## Miscellaneous Weather Elements

---

Radiative temperature helps to describe thermal contrasts between two objects that have the same physical temperature. This thermal contrast is sometimes referred to as infrared contrast. Different surfaces emit EM energy at different rates thus creating a difference that IR sensors can measure. An example would be a real tank sitting next to a wooden mockup of a tank. Both objects would possess the same temperature but the real tank would emit EM energy at a different rate than the wooden mockup.

Infrared sensors detect the radiative temperature of objects rather than their actual temperature. The radiative temperature of an object is determined by an object's emissivity.

**5. Thermal Response.** Thermal response is the measure of how fast or slow an object will heat or cool. Objects can heat and cool at different rates, so contrast between objects can vary over a 24-hour period. Heating and cooling of the material an object is composed of is dependent on four factors. These factors are absorptivity, thermal conductivity, thermal capacity, and surface area-to-mass ratio.

**6. Surface Area-to-mass.** Surface area-to-mass ratio can be used to determine how hot or cold an object will appear thermally if both objects are made of the same material. Two objects made of the same material will have the same absorptivity, conductivity, and capacity.

When considering objects of the same shape but different mass (size) the smaller object would heat and cool faster because it has the larger surface area-to-mass ratio. For objects of the same mass but different shape the object with the greater surface area will heat and cool faster.

**7. Thermal Capacity.** Thermal capacity is a measure of how much heat an object can store. It is dependent on the specific heat and mass of the object. Objects that have a high thermal capacity

have three common characteristics. They heat up in the interior but release that heat slowly through their exterior. They heat and cool more slowly than objects with a low thermal capacity. They also moderate diurnal heating and cooling effects.

Objects that have a low thermal capacity will heat and cool quickly since most of the energy remains close to the surface of the object.

**8. Thermal Conductivity.** Thermal conductivity is the measure of how rapidly heat is transferred from the surface of a material to the interior. Objects with low conductivity have four common characteristics. The heat remains close to the skin (exterior) of the object. They will have higher daytime radiative temperatures and appear brighter on an IR sensor. The skin (exterior) of these objects loses their heat quickly and will cool rapidly at night. The lower the conductivity the faster an object will heat and cool.

**9. Minimum Resolvable Temperature.** Minimum Resolvable Temperature (MRT) represents the temperature of all the facets of the target visible to the pilot from his or her viewing direction and altitude. In using MRT in target detection, the temperature and sizes of all visible facets are taken into account when the TAWS algorithms calculate thermal contrast. MRT detection range is the range at which the pilot should be able to make out the shape of the target against the background.

**10. Minimum Detectable Temperature.** Minimum Detectable Temperature (MDT) represents the hottest or coldest spot of the target that is visible to the pilot from his or her viewing direction and altitude. In using MDT in target detection the temperature and size of only the hot or cold spot of the target is taken into account when thermal contrast is calculated. All of the other visible target facets are ignored. MDT detection range is the range at which the pilot should be able to make out a hot or cold spot against the background but not the shape of the target.

Miscellaneous Weather Elements

**11. Weather Sensitivities on EO Systems.** Table 2-16 lists sensitivities of various weather parameters on three categories of EO sensors: Infrared (IR), Television (TV)/Night Vision Goggle (NVG) and Laser. The sensitivity levels are High (H), Moderate (M), or Low (L).

**Table 2-16. Weather sensitivities on EO systems.**

Weather		IR	TV/NVG	LASER
Surface Temperature				
	At Time Over Target	H	M	L
	Before Time Over Target	H	M	0
Surface Dew Point				
	At Time Over Target	H	0	0
	Before Time Over Target	L	0	0
Sea Surface Temperature				
	At Time Over Target	H	0	0
	Before Time Over Target	L	0	0
Surface Wind Direction				
	At Time Over Target	0	0	0
	Before Time Over Target	0	0	0
Surface Wind Speed				
	At Time Over Target	M	0	0
	Before Time Over Target	M	0	0
Surface Visibility				
	At Time Over Target	H	H	H
	Before Time Over Target	L	0	0
Precipitation Type				
	At Time Over Target	M	0	M
	Before Time Over Target	M	0	0
Precipitation Rate				
	At Time Over Target	H	0	H
	Before Time Over Target	H	0	0
Surface Aerosols				
	At Time Over Target	L	L	H
	Before Time Over Target	0	0	0
Battle-Induced Contaminants (BIC's)				
	At Time Over Target	H	H	H
	Before Time Over Target	0	0	0
Boundary Layer Height				

**Miscellaneous Weather Elements**

	At Time Over Target	H	H	H
	Before Time Over Target	0	0	0
High Cloud Type				
	At Time Over Target	L	M	0
	Before Time Over Target	L	0	0
High Cloud Amount				
	At Time Over Target	H	L	0
	Before Time Over Target	H	0	0
High Cloud Base Height				
	At Time Over Target	L	L	0
	Before Time Over Target	L	0	0
<b>Weather</b>		<b>IR</b>	<b>TV/NVG</b>	<b>LASER</b>
Middle Cloud Type				
	At Time Over Target	L	0	0
	Before Time Over Target	L	0	0
Middle Cloud Amount				
	At Time Over Target	H	L	0
	Before Time Over Target	H	0	0
Middle Cloud Base Height				
	At Time Over Target	L	L	0
	Before Time Over Target	L	0	0
Low Cloud Type				
	At Time Over Target	L	0	0
	Before Time Over Target	L	0	0
Low Cloud Amount				
	At Time Over Target	H	L	0
	Before Time Over Target	H	0	0
Low Cloud Base Height				
	At Time Over Target	L	L	0
	Before Time Over Target	L	0	0
Upper Layer Temperature <sup>3</sup>				
	At Time Over Target	0	0	0
	Before Time Over Target	0	0	0
Upper Layer Dew Point <sup>3</sup>				
	At Time Over Target	0	0	0
	Before Time Over Target	0	0	0
Upper Layer Visibility <sup>3</sup>				
	At Time Over Target	0	0	0
	Before Time Over Target	0	0	0
Upper Layer Aerosol				
	At Time Over Target	0	0	0
	Before Time Over Target	0	0	0



**M. Chemical Downwind Message (CDM) (Figure 2-104).** The CWT provides this information upon request. The CDM is used much like a toxic corridor forecast except that it is a forecast of wind, stability, temperature, humidity, cloud cover, and weather. Additional guidance for preparing CDMs is contained in Army Field Manual (FM) 3-3, Chemical and Biological Contamination Avoidance.

CWTs can link to this FM from the AFWA Field Support Division (AFWA/XOP) web page. Tactical Army CWTs derive the CDM from the IMETS Chemical Downwind Report application. There is also a limited number of CDMs available on the JAAWIN web site (bulletin headings usually start with an FX. Air Force Manual 15-135, Attachment 3 contains information on how to decode a CDM bulletin.

**N. Nuclear Fallout Bulletins (Figure 2-105).** Radioactive particles travel through the atmosphere after a nuclear detonation. Effective downwind message bulletins available through JAAWIN provide wind forecasts for such an event, based on the warhead size. The bulletin headings start with FU and are further split out by location. For example FUUS 43 KGWC is a bulletin covering a portion of the United States.



Figure 2-104. Chemical Downwind Message.



Figure 2-105. Effective Downwind Message.

**O. Volcanic Ash.** There has been an increase in concern about volcanic activity over the last few years. This can be attributed to anything from increasing air traffic to people populating the areas

**Miscellaneous Weather Elements**

---

around volcanoes. Figure 2-106 is a depiction of known active volcanoes across the globe. You will notice they are concentrated on the edges of continents, along island chains, or beneath the oceans.

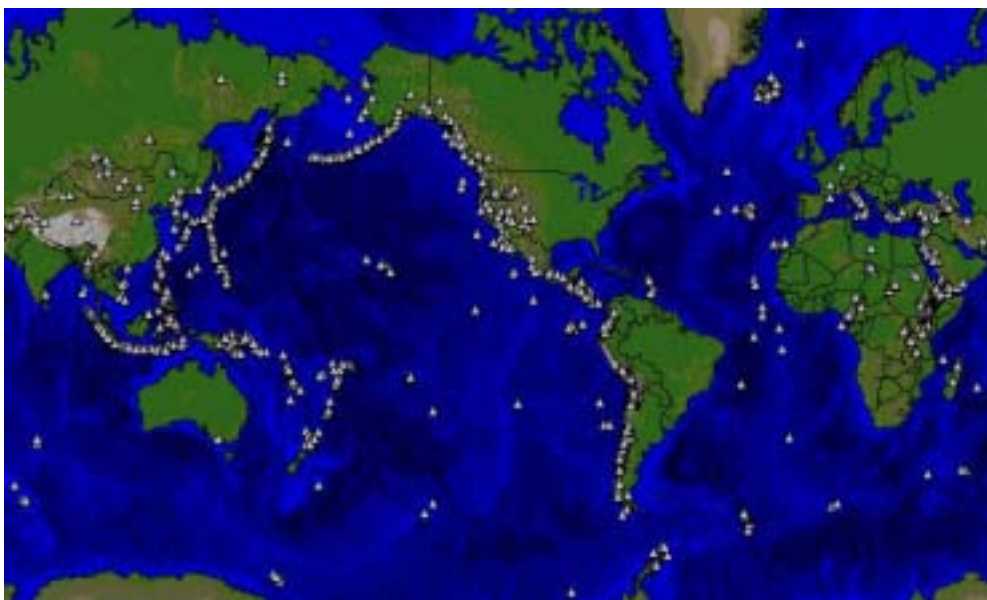
Volcanic ash, better known as tephra, is a general term for fragments of volcanic rock and lava that are blasted into the air by volcanic explosions or carried upward in the volcanic plume by hot, hazardous gases. The larger fragments usually fall close to the volcano, but the finer particles can be advected quite some distance.

We are mostly concerned with the fine ash. This ash can contain rock, minerals, and volcanic glass fragments smaller than .1 inch in diameter, or slightly larger than the size of a pinhead. Volcanic ash is not fluffy ash like that from burning wood, leaves, or paper. It is hard; it does not dissolve in water, and can be extremely small. Ash is extremely abrasive (similar to finely crushed window glass), mildly corrosive, and electrically conductive, especially when wet.

Eruption columns can grow rapidly and reach heights of more than 12 miles above a volcano in less than 30 minutes. Ash clouds can also extend miles downwind and can last for weeks.

As the ash cloud and gas move and disperse downwind, it becomes increasingly difficult for aircraft pilots to see the ash. It may begin to take on the appearance of a cloud as it is immersed into the upper level dynamics. Pilots especially have a difficult time at night trying to differentiate the ash and clouds. Even if they have on-board radar, the ash particles are too small to detect.

Ash can cause immediate and long-term damage to an aircraft. The main cause of engine failure is ash melting in the hot sections of the engine. This can cause surging and flameout. Ash is very corrosive and can easily erode engine parts, such as the compressor and turbine blades. It is also highly abrasive and can easily scratch and erode plastic, glass, and metals. Ash contaminates the air filtration system and impairs sensitive on-board equipment.



**Figure 2-106. Worldwide Depiction of Active Volcanoes.**

**Convective Weather**

**I. THUNDERSTORMS.** There are three basic storm types: single-cells, multi-cells and super-cells. This section will cover each storm type, unique characteristics of each, and associated severe weather. Thunderstorm-produced severe weather consists of a combination of tornadoes, hail, strong winds, lightning, and heavy rainfall.

While upward vertical motions and instability of an air mass determine whether thunderstorms will occur, wind shear strongly influences the type of thunderstorms to expect. Other conditions being the same (and favorable to thunderstorm formation), the greater the shear, and the more likely the convection will be sustained. Each type of storm can be identified by a distinctive hodograph pattern, which is a visual depiction of the wind shear. AWS/FM-92/002 describes hodograph construction and use, and it is available from AFWTL. Knowing expected storm type is key to predicting severe weather.

**A. Thunderstorm Types**

**1. Single Cell.** Single-cell storms are short-lived (30 to 60 minutes) cells with one updraft that rises rapidly through the troposphere. Precipitation begins at the mature stage in a single downdraft.

When the downdraft reaches the surface, it cuts off the updraft and the storm dissipates. Figure 3-1 is a typical hodograph for a single-cell storm.

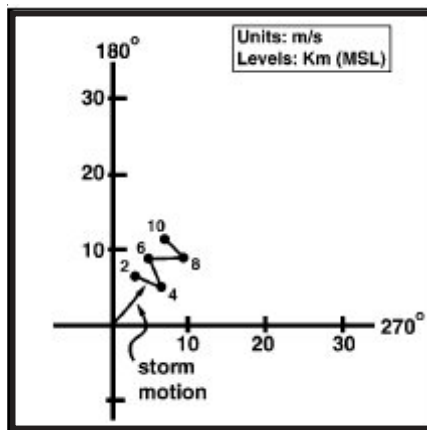
**a. Single-Cell Storm Indicators.**

- Weak vertical and horizontal wind shear.
- The shear profile on the hodograph has a random pattern.
- Storm motion is with the mean wind in the lowest 5 to 7 km.

**b. Associated Severe Weather.**

- High winds and hail are possible but short-lived.
- Tornadoes are rare.

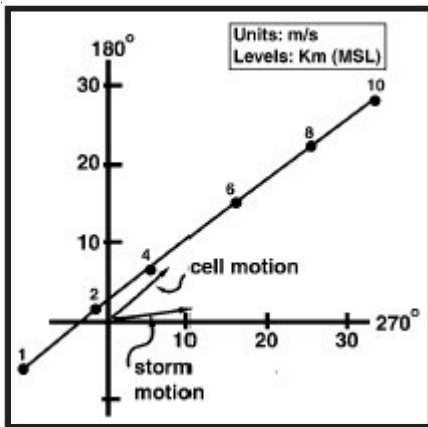
Watch developing cells using weather radar. When severe weather does occur in single-cell storms, it usually is in the stronger and longer-duration cells. Individual cells develop stronger core reflectivity at higher elevations than surrounding cells and must be closely monitored.



**Figure 3-1. Single-Cell Storm Hodograph.**

## Thunderstorms

**2. Multicellular.** Multicellular storms are clusters or short-lived single-cell storms. Each cell generates a cold outflow that can form a gust front. Convergence along this boundary causes new cells to develop every 5-15 minutes in the convergent zone. These storms are longer in duration than single-cell storms because they typically regenerate along the gust front. Figure 3-2 is a typical hodograph for a multicellular storm.



**Figure 3-2. Typical Multi-Cell Storm Hodograph.**

### a. Multicellular Storm Indicators.

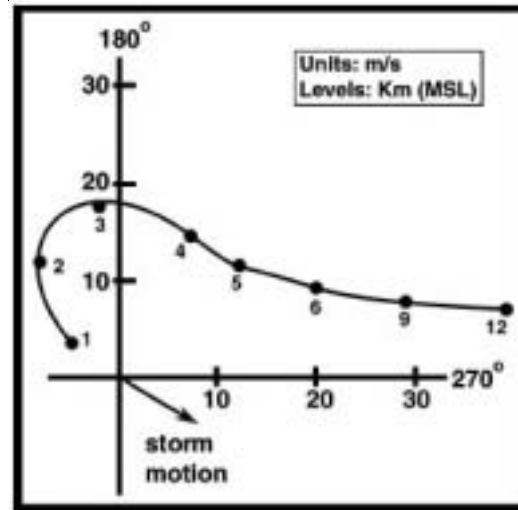
- A straight-line or unidirectional shear profile.
- Strong directional shear in the lower levels, and strong speed shear aloft.
- Individual cell motion coincides with mean wind.
- Storm clusters propagate in the direction of the gust front and to the right of the mean wind.

### b. Associated Severe Weather.

- Possible flash flooding from slow-moving cells.
- Large hail near downdraft centers.

- Short-duration tornadoes possible along gust fronts near updraft centers.

**3. Supercell.** Supercell thunderstorms consist of one rotating updraft, a forward-flanking downdraft that forms the gust front, and a rear-flanking downdraft. These storms may exist for several hours and are a frequent producer of severe weather. There are three types of supercells: classic, high precipitation (HP), and low precipitation (LP). The hodograph for a supercell is pictured in Figure 3-3. The following indicate a supercell storm:

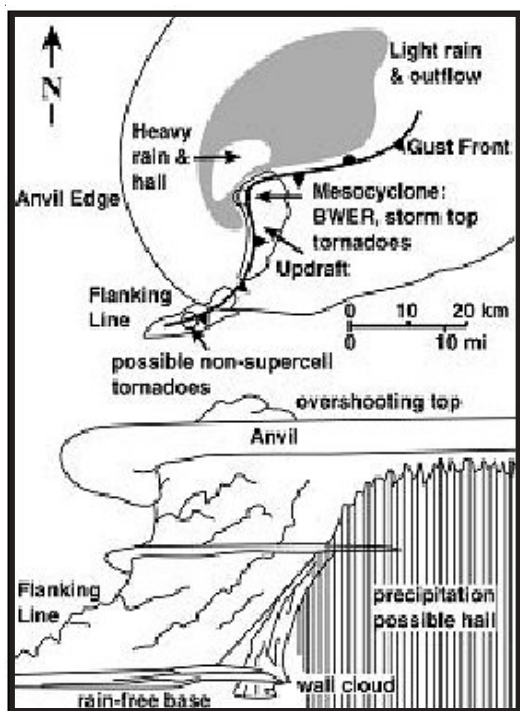


**Figure 3-3. Supercell Hodograph.** The figure shows a cyclonically curved hodograph.

- Curved shear profile in lower levels, becoming straight-line above 3 km.
- At least 70 degrees of directional shear in the first 3 km. Average amount of vertical shear for a supercell is 90 degrees.
- Shear vector veers with height in the lower levels, which can produce storm updraft rotation.
- Wind speed increases with height.
- A “cyclonically curved” hodograph, as shown in Figure 3-3, is associated with cyclonically

rotating cells that move to the right of the mean (surface to 6km) low-level wind. “Anticyclonically curved” hodographs indicate storms moving to the left of the mean wind; these storms are notorious hail producers.

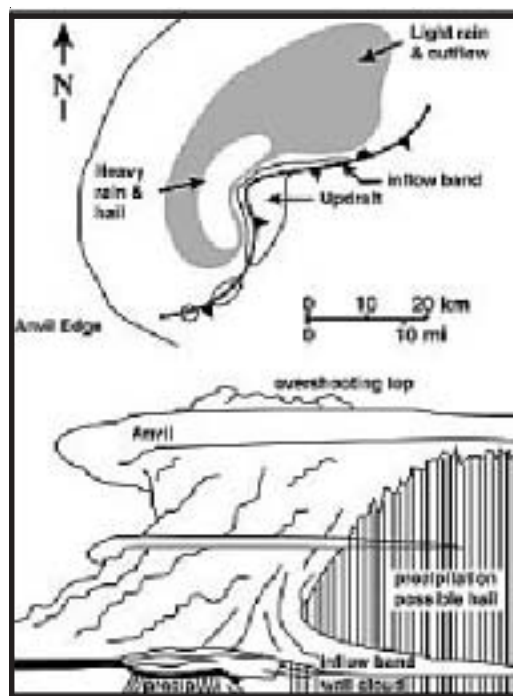
**a. Classic Supercells (Figure 3-4).** Classic supercells are usually isolated from the main thunderstorm outbreak and are identified by the classic “hook echo” in the low-level reflectivity pattern and bounded weak-echo region (BWER) aloft. These cells have the following associated severe weather:



**Figure 3-4. Classic Supercell.** These supercells are identified by a “hook echo” in the low-level reflectivity pattern.

- Golf ball size hail.
- Wind gusts in excess of 50 knots (along the gust front and from microbursts in the rear-flanking downdraft).
- Tornadoes possible.

**b. High-Precipitation (HP) Supercells (Figure 3-5).** These develop in deep, moist layers with high moisture values. They are more common the further east you go from the Plains. They produce heavier rain than classic supercells and are not as isolated as these storms. Radar patterns associated with HP storms are more varied than the classical “hook”. HP storms have the potential to evolve into bow echo configurations. Associated severe weather includes the following:



**Figure 3-5. Typical High-Precipitation (HP) Supercell.** These supercells develop in deep, moist layers with high moisture values.

- Very heavy rain.
- Tornadoes and hail possible.

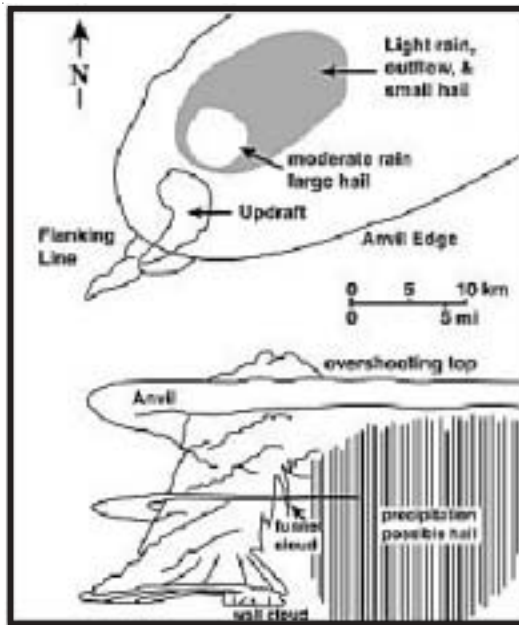
**c. Low-Precipitation (LP) Supercells (Figure 3-6).** These storms are most commonly found along the dryline of west Texas. They produce some precipitation, but have a rather “benign” appearance on radar. Although smaller in diameter than classic supercell storms, they are still capable of producing severe weather. These cells have the following associated severe weather:

**Thunderstorms**

- Large hail.
- Tornadoes.

**4. Dry, Wet, and Hybrid Microbursts.**

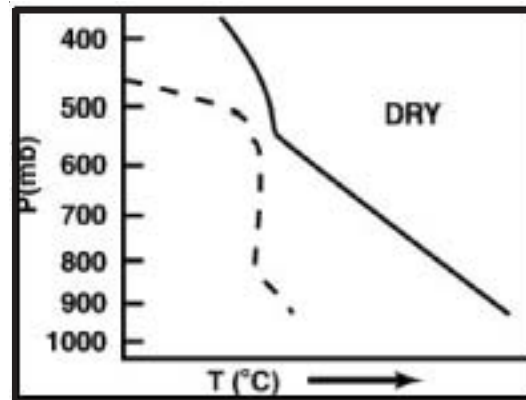
Downbursts are dynamically enhanced concentrated downdrafts from thunderstorms that result in damaging winds with gusts of 50 knots or greater at the surface. These usually occur in the rear-flanking downdraft region of supercell storms and may also be found behind the gust front. Downbursts/microbursts, however, are not restricted to large supercell storms; they can come from innocuous-looking, high-based rain clouds (dry microbursts), from single and multicellular pulse storms (wet microbursts), or from hybrid microbursts that combine dry and wet extremes. The microburst type depends on the type of environment where the formation of the storm takes place.



**Figure 3-6. Low-Precipitation (LP) Supercell.** These storms occur most often along the dryline of west Texas.

Figure 3-7a-c portrays typical atmospheric profiles for dry, wet, and hybrid microbursts. Currently, there is no method for predicting precisely when and where a microburst will occur, but if the environment is conducive to microburst occurrence, then the possibility for a microburst event can be incorporated into the forecast.

**5. Derechos.** Derechos are straight-line winds from severe convective storms. There are two types of derechos. The first are rapidly propagating segments of an extensive squall line associated with a strong, migratory low-pressure system that occurs in the late winter and spring. The second type develops in association with a relatively weak frontal system in a moisture-rich environment, showing characteristics of both squall lines and non-linear types of mesoscale convective systems (MCS), and is a late spring and summer event. They predominately occur along an axis from southern Minnesota through the Ohio River Valley, but are not limited to that region.



**Figure 3-7a. Typical Dry Microburst Atmospheric Profile.**

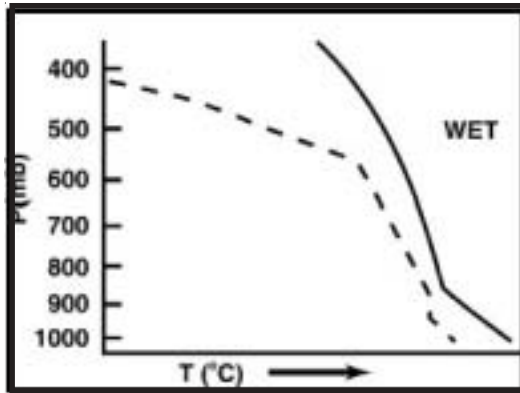
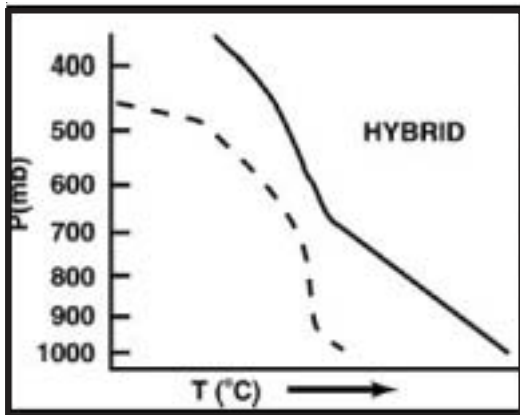


Figure 3-7b. Typical Wet Microburst Atmospheric Profile.



3-7c. Typical Hybrid Microburst Atmospheric Profile.

**II. SYNOPTIC PATTERNS.**

This section describes basic severe thunderstorm-producing synoptic weather patterns for mid-latitudes, and describes acknowledged parameters used to identify areas for thunderstorm development: mid-level jets or shears, dry-air intrusions between 850 mb and 700 mb, and low-level moisture gradients. These parameters have proven to be useful to identify severe thunderstorm triggering mechanisms, and for forecasting when and where severe thunderstorm outbreaks will occur in each of the synoptic patterns. Stability index usage for thunderstorm forecasting is covered later.

Mid-level jets can be used to determine areas of thunderstorm and tornado development. Mid-level jets are wind speed and shear maxima that occur between 10,000 and 20,000 feet, or roughly 700 mb to 500 mb. These jets should not be confused with upper-level polar front and sub-tropical jet streams. Table 3-1 shows an empirical relationship between threshold values for mid-level jet speeds and other shear parameters relative to severe thunderstorm development.

Dry-air intrusions at 700 mb are a major triggering mechanism for tornadoes and can be used to pinpoint areas of potential severe thunderstorm development. Dry-air intrusions are difficult to identify by a particular temperature/dew-point

**Table 3-1. Severe thunderstorm development potential.**

Parameters	Weak	Moderate	Strong
Jet Speed	35 kts	35 – 50 kts	> 50 kts
Horizontal shear	15 kts/90 NM	15 – 30 kts/90 NM	> 30 kts/90 NM
Winds crossing the axis of 700-mb dry intrusions and moisture boundaries	Less than 20° or not at all	20 - 40°	> 40°
Surface dew point	< 13°C	13 - 18°C	> 18°C
850-mb dew point	< 8°C	8 - 12°C	> 12°C

## Thunderstorms

spread or relative humidity, since the values vary widely from case to case. They can often be identified by looking at the intensity with which drier air is being forced into the moist air. Table 3-1 also shows an empirical relationship between the angle of the 700-mb winds and the dry-air intrusion axis, and severe thunderstorm potential.

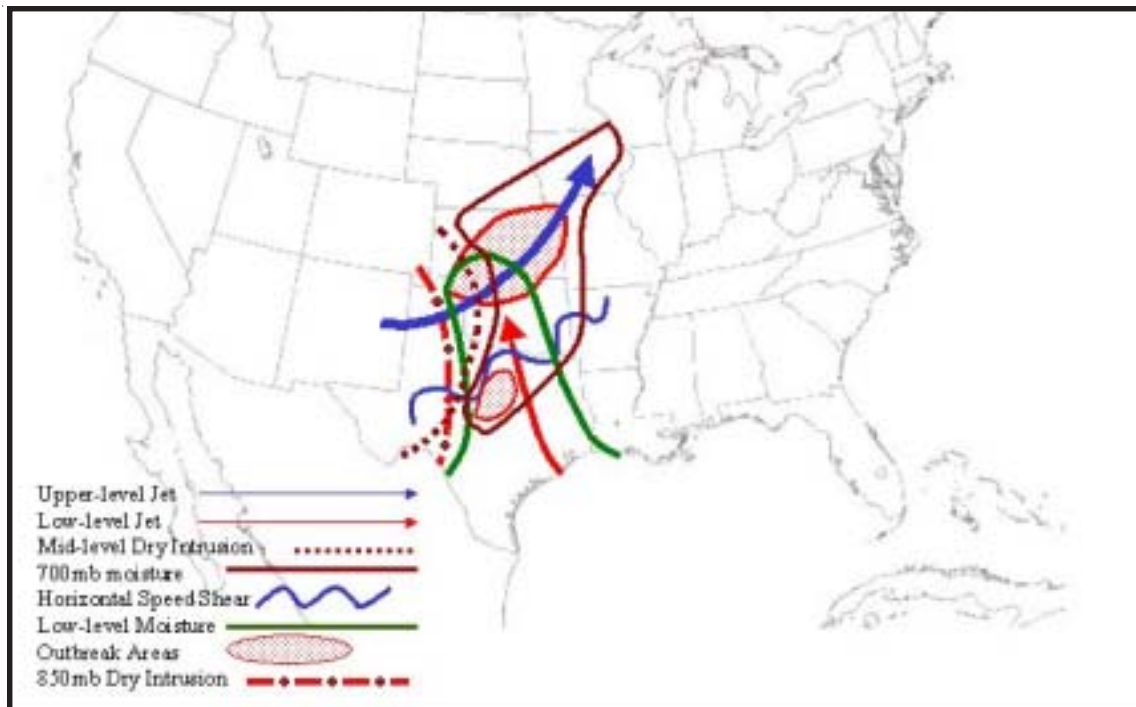
Almost all severe thunderstorm outbreaks are associated with strong low-level (below 700 mb) moisture except in the case of winds greater than or equal to 50 knots associated with dry microbursts. The moisture axes are generally located on the windward side of the outbreak area. The intensity of the storm is usually proportional to the tightness of the moisture gradient along the wind component from dry to moist air.

**Note:** When the 850-mb or 925-mb product is not representative of moisture below 700 mb, the moisture gradient can often be determined from satellite imagery and computer-generated vertical cross sections.

**A. Classic Synoptic Convective Weather Patterns.** Identifying severe synoptic patterns is essential to identifying areas of potentially severe thunderstorms. TR200 (Rev), states, “successful tornado and severe-thunderstorm forecasting is largely dependent upon the forecaster’s ability to carefully analyze, coordinate, and assess the relative values of a multitude of meteorological variables and mentally integrate and project these variables three-dimensionally in space and time.” The ability to correctly identify severe synoptic patterns saves time and allows efforts to be focused on the threat area.

**Note:** In the following severe weather patterns, the parameters are 12Z depictions, while the outbreak areas are depicted at the time of occurrence, which may not be 12Z. Hence, the advection of severe weather parameters must be taken into account.

**1. Type A Synoptic Pattern (Dryline) (Figure 3-8).** With the Type A Pattern, thunderstorms



**Figure 3-8. Type “A” Tornado Producing Synoptic Pattern.**



initially form on the edges of dry air. Storms tend to form rapidly in widespread, isolated clusters.

**a. Characteristics.** The following features that must be present for thunderstorm formation characterize by the Type A pattern:

- A well-established southwesterly 500-mb jet.
- A distinct surface to 700-mb warm dry-air intrusion from the southwest.
- Low-level confluence along the dry line.
- Low-level moisture advection from the south, ahead of the dry air.
- Convective development characterized by unusually rapid growth (15-30 minutes) from inception to maturity with almost immediate production of very large hail, damaging winds, and tornadoes (usually in groups or families).

**b. Initial Outbreak Area**

- Storms are usually confined to the edges of the dry air at 850 mb and 700 mb.
- The convergence area between the moist and dry air (area of maximum gradient from dry to moist air).
- These storms form rapidly, in isolated clusters, along the leading edge of the dry intrusion. (Sharp, well-defined squall lines are not common with this pattern.)

**c. Severe Weather Area.** Severe weather may extend up to 200 miles to the right of the 500-mb jet and from the area of maximum low-level convergence to the point where the moisture decreases to less than needed to support convection. The most violent storms usually form where the jet meets the moist/dry air convergence area.

A secondary outbreak area may be along and 150 miles to the right of the 500-mb horizontal speed shear zone. It will extend from the maximum low-level convergence area to the point where low-level moisture no longer supports severe weather.

**d. Trigger Mechanisms**

- Diurnal heating.
- Passage of an upper-level jet max.
- Low-level intrusion of warm, moist air east of the dryline.
- Mid-level dry air moving into a moist region.

**e. Timing.** Look for thunderstorms to develop at the time of maximum heating or up to 6 hours afterwards. Under normal circumstances, convection is usually capped by an inversion until the convective temperature is reached. Once convective activity has started, watch for it to continue for 6 to 8 hours or longer. The convective activity may last until the moist and dry air mixes, changing the airmass structure.

## Synoptic Patterns

**2. Type B Synoptic Pattern (Frontal) (Figure 3-9).** The Type B Pattern is characterized by prefrontal squall lines with one or more mesoscale lows. These squall lines form at the intersection of the low-level jet and the upper-level jet. The lows often form in the area of the intersection of the low-level jet and the warm front and are frequently accompanied by tornadic outbreaks.

**a. Characteristics.** The Type B Pattern is characterized by the following features:

- A well-defined 500-mb jet.
- A well-defined dry air intrusion between the surface and 700 mb.
- A strong unstable wave with associated cold and warm fronts.
- Almost always have frontal and prefrontal squall lines.
- Strong cold-air advection behind the cold front.

- Low-level jet, instrumental in transporting warm, moist air from the south.

- Cool, moist air associated with 500-mb and 700-mb trough axes. The axes will lie to the immediate west of the threat area.

- Low and mid-level confluence between low-level warm air and mid level cooler air.

**b. Severe Weather.** The severe weather with the Type “B” pattern is associated with strong cold air advection and strong cold fronts. This type of system can occur at anytime but severe weather usually occurs in the spring. As cold air moves into the threat area, it collides with warm, moist air moving up from the south. This collision of contrasting air masses leads to strong thunderstorms.

**c. Severe Weather Areas.** A number of events occur in the initial severe weather area beginning with the development of mesoscale lows at the intersection of the low-level jet and the warm front. As a result upward vertical motion in the area is



**Figure 3-9. Type “B” Tornado Producing Synoptic Pattern.**

increased. The location of severe weather depends a great deal on the speed of the cold front, coupled with the speed of the dry intrusion area. The best potential for severe weather is along and 150 miles to the right of the horizontal speed zone of the upper-level jet; however, the area of concern can extend down to the leading edge of the dry air intrusion. The threat area does not extend far into the dry air because the absence of moisture decreases the chance of thunderstorm development.

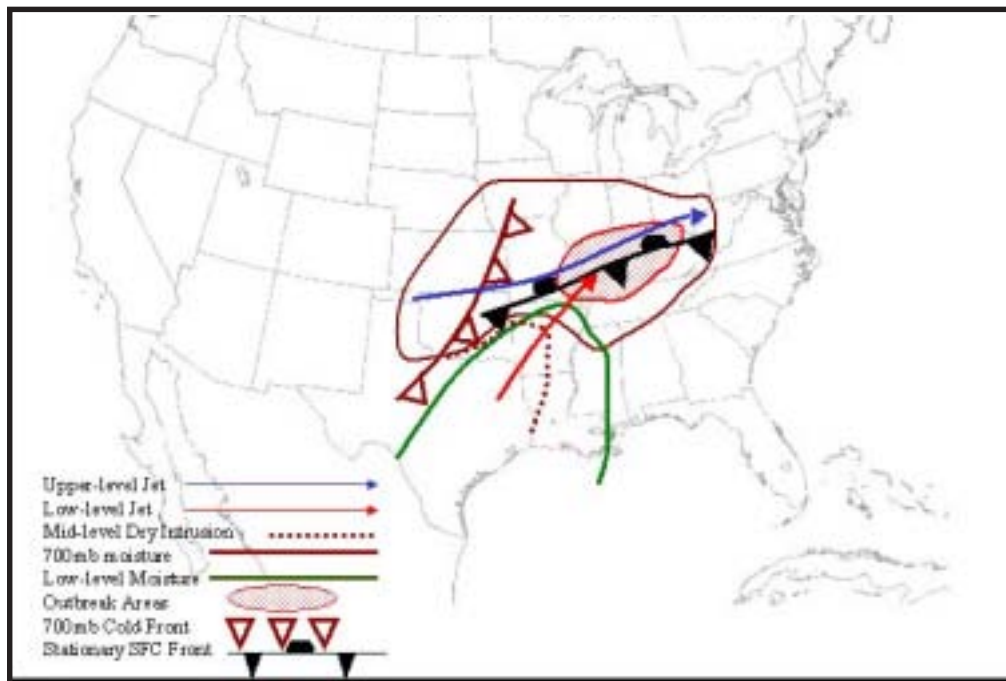
**d. Triggers.**

- An approaching cold front coupled with the dry air intrusion is the key factor. In this type, it is the cold front that provides lift and the dry air decreases stability.

- Intersecting lines of discontinuity. Watch for intersecting squall lines, intersecting upper and lower-level jet streams, and the intersection of a low-level jet and warm front.

**e. Timing.** In this pattern, thunderstorms can occur anytime and may last all day and night. These thunderstorms do not require diurnal heating, and as long as the airmass stays unstable, thunderstorms in a squall line can persist.

**3. Type C Synoptic Pattern (Overrunning)** (Figure 3-10). As a review, overrunning is warm, moist air overrunning cold, dense air below. You may think this is a stable situation; but it all depends on the stability of the warm air. If the warm air is unstable, the lift over the cold air may actually encourage the development of thunderstorms.



**Figure 3-10. Type “C” Tornado Producing Synoptic Pattern.**

## Synoptic Patterns

**a. Characteristics.** The type C pattern is characterized by the following features:

- An east to west oriented stationary front with warm, moist overrunning tropical air.
- A west-southwest to west-northwest upper-level jet or a strong 500-mb westerly horizontal wind speed shear zone.
- A 700-mb dry intrusion advecting from the southwest.

- Tornadoes may occur when surface dew points are 50°F (10°C) or higher. Fuel comes from the release of latent heat.

**b. Severe Weather.** Tornadoes, large hail, and damaging winds are all possible in the Type C Pattern. Strong overrunning and the presence of a stationary front are warning signs to the potential for severe weather.

**c. Severe Weather Areas.** Scattered thunderstorms develop on and north of the

stationary front due to overrunning (figure 3-10). In the overrunning region, a squall line may form along the leading edge of the dry air intrusion and thunderstorms may reach severe levels. The severe threat area extends from approximately 50 miles west of the axis of maximum overrunning to the eastern edge of the overrunning.

**d. Triggers.** Overrunning, maximum diurnal heating, and a dry-air intrusion where active thunderstorms already exist combine to trigger severe convective weather.

**e. Timing.** Severe thunderstorm occurrence and duration depends on the onset time of dry air intrusion and maximum heating. Severe weather continues until the dry air intrusion decreases or moves out. Activity can last 6 hours after maximum heating.

**4. Type D Synoptic Pattern (Cold Core) (Figure 3-11).** The Type D pattern is noted for hail producing storms and funnel clouds. Single tornadoes are rare but they do occur. The key to this pattern is the cold core system.

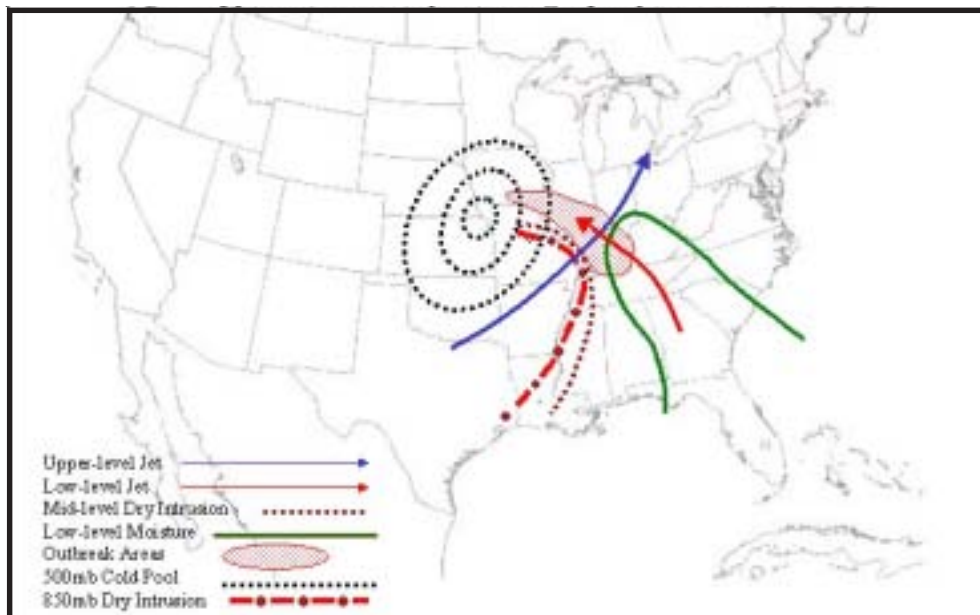


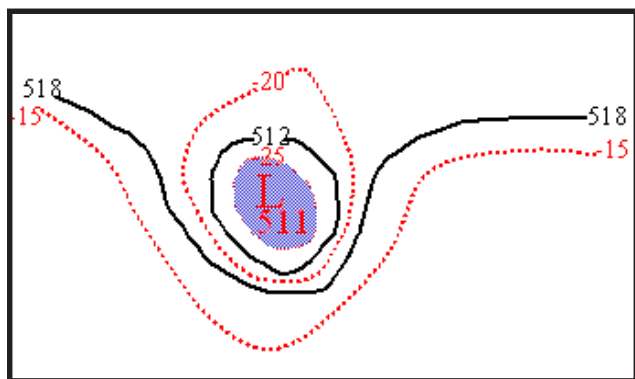
Figure 3-11. Type “D” Tornado Producing Synoptic Pattern

**a. Features:**

- A deep, southerly upper-level jet.
- A deepening surface low.
- A 500-mb cold-core low.
- Cool, dry air advection at all levels.
- A low-level jet advecting warm, moist air from the south-southeast, under the cold air aloft.

**b. Severe Weather.** Funnel clouds in the Type D Pattern are often referred to as “cold air” funnels. The reason for instability is warm air moving under cold air aloft, which is associated with a cold core low at 500 mb.

**c. Severe Weather Area.** Thunderstorms will form in the area between the upper-level jet and the closed isotherm center at 500-mb. Severe weather may occur in the area bounded by approximately 150 miles right of the upper-level jet, back to the cold core low, and to the front edge of the dry air intrusion, and to the east and northeast limit of the underrunning warm air (Figure 3-12).



**Figure 3-12. Barotropic Low.**

**d. Triggers.**

- Intense low-level confluence. Lift is generated when confluence is present in the low levels, and diffluence is occurring aloft.
- Decreasing stability due to the upper level cold air moving over warm, moist air.

**e. Timing.** Violent storms typically occur during max heating with a rapid decrease in intensity after sunset.

**5. Type E Synoptic Pattern (Squall Line) (Figure 3-13).** With the Type E Synoptic Pattern, frontal or prefrontal squall lines are usually well defined. The squall lines may be fast or slow moving. In either case, severe storms develop rapidly.

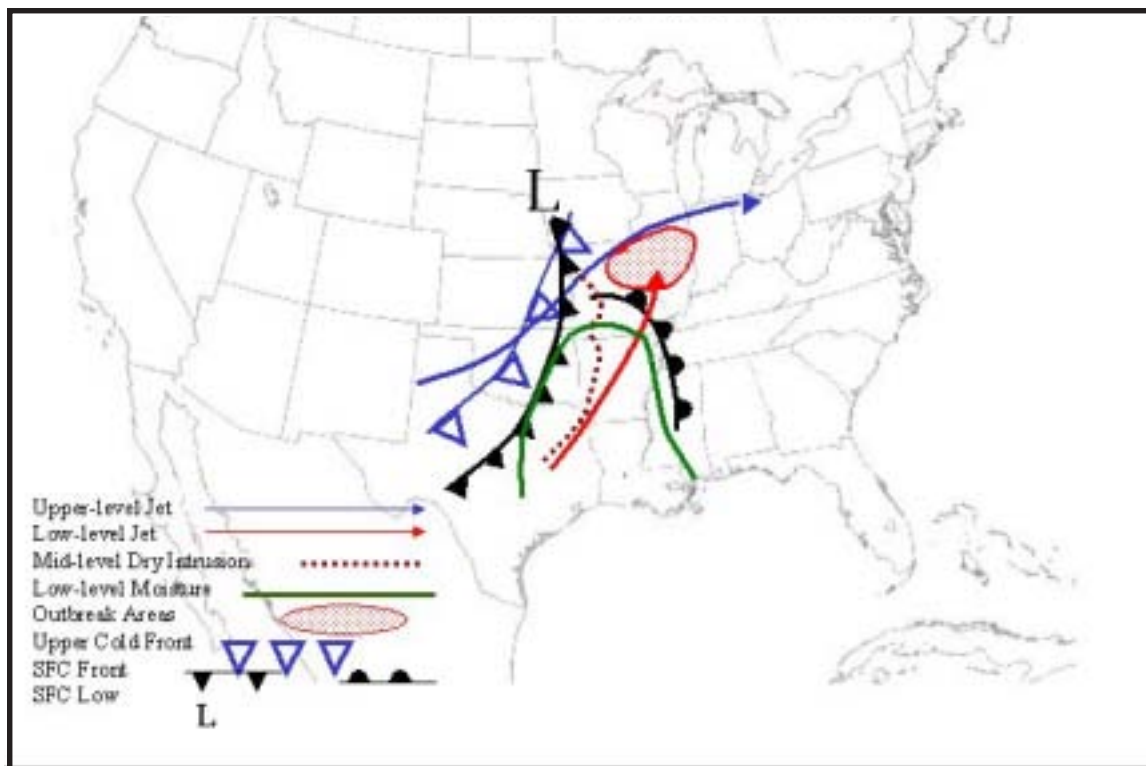
**a. Features.**

- Well defined upper-level westerly jet.
- Well-defined dry air bounded by a 700-mb warm sector.
- Low-level convergence.
- Moderate to strong southerly low-level flow advecting warm, moist air over cooler drier air.

**b. Severe Weather.** In addition to developing ahead of cold fronts, squall lines associated with the Type E pattern also develop ahead of warm and occluded fronts.

**c. Severe Weather Areas.** Severe weather may develop along and south of the upper-level jet but north of the 850-mb warm front. The west-east boundary is from the 700-mb cold front to the area of increasing stability.

Thunderstorms form in the overrunning warm air between the 850-mb warm front and the upper-level

**Synoptic Patterns**

**Figure 3-13. Type “E” Tornado Producing Synoptic Pattern.**

jet axis; where the 700-mb dry air intrusion meets the frontal lifting of the warm, moist air in the low-levels, and the strong 500-mb cold air advection.

A secondary threat area exists where the 700-mb dry air intrusion extends south of the 850-mb warm front. Thunderstorms can develop along the 500-mb horizontal speed shear zone and along transitory, active squall lines.

**d. Triggers.**

- Frontal lifting of warm, moist, unstable air.
- A 700-mb dry air intrusion.
- Diurnal heating.
- Cold air advection at 500mb.

**e. Timing.** Thunderstorms will develop with the onset of 500-mb cold air advection into the severe outbreak area. Maximum severe activity occurs from the time of maximum heating to a few hours after sunset. At times, severe storms may continue until midnight, or until the airmass becomes more stable.

**B. Additional Squall Line Information :**

- Squall lines may be triggered as a line or may organize into a line from a cluster of cells.
- For a given CAPE, the strength and longevity of an MCS increase with increasing depth and strength of the vertical wind shear.
- The characteristic squall line lifecycle is to evolve from a narrow band of intense convective cells to a broader, weaker system over time.

- The time over which this evolution takes place depends strongly on the magnitude of the low-level vertical wind shear; stronger shear leads to longer-lived systems.
- It is the component of low-level environmental shear *perpendicular* to the line orientation (line-normal shear) that is most critical for controlling squall line structure and evolution.
- In general, stronger system cold pools require a greater magnitude of vertical wind shear to produce a stronger and longer-lived system.
- In general, the higher the LFC, the more low-level shear required for the system's cold pool to continue initiating convection.

Also visit NOAA's Meteorological Education and Training website at: <http://www.meted.ucar.edu/modules.htm> for more information and training on convective systems.

### III. CONVECTIVE WEATHER TOOLS.

The thermal stability or instability of a column of air can be conveniently expressed as a single numerical value called a stability index. These indices are aids for forecasting thunderstorms and should not be used as the sole basis for making a thunderstorm forecast. Detailed procedures for calculating many of these indices can be found in AWS/TR-79/006. Also see various PC programs such as SHARP or Skew-T Pro, available from the AFWTL.

#### A. Stability indices.

**1. Convective Available Potential Energy (CAPE).** This is a measure of the convective instability of the atmosphere and thus, the potential for thunderstorms. CAPE values are not a direct indicator of severe weather. They should be used in conjunction with helicity (a measure of the rotation potential of a column of air) for forecasting

severe weather. Use values above 200 J/kg in conjunction with helicity to determine conditions for tornadic thunderstorms and severe weather. Be aware that violent thunderstorms and tornadoes are associated with a wide range of values.

**2. Bulk Richardson Number (BRN).** The BRN is a better indicator of storm type than of storm severity or storm rotation. It is useful in differentiating between weak, multi-cellular storms (non-severe) and supercell-storm (severe) types. The BRN is a measure of turbulent energy (a ratio of buoyancy to vertical wind shear) in a column of air to enhance or hinder convective activity.

- Works best when the CAPE index is 1,500 to 3,500 J/kg.

- When CAPE is less than 1,000 J/kg and accompanied by moderate wind shear, the BRN value may indicate supercells, but the lack of buoyancy is likely to inhibit severe weather occurrence.

- When CAPE is greater than 3,500 J/kg with a moderate wind shear environment, BRN values may suggest multicell storms (non-severe storms), but the buoyant energy will be sufficient to produce tornadoes and large hail.

**Note:** Using BRN might not be useful for predicting tornado development as it is for predicting multi- vs. supercell type thunderstorms. Strong tornadoes have developed in environments with BRN values ranging from 0 – 40.

**3. Cross Totals (CT).** CT is most effective for thunderstorm coverage and severity east of the Rockies and along the Gulf Coast. It measures a combination of low-level moisture and upper-level temperature. The CT value is contingent on the low-level moisture band being at 850 mb and the cold air pocket at 500 mb. If the moisture and cold air are centered slightly above or below these levels,

## Convective Weather Tools

CT values will not be a reliable indicator of thunderstorm coverage or severity.

**4. Dynamic Index.** This index is designed for airmass thunderstorms. Positive values indicate stability, and negative numbers indicate a conditionally unstable air mass. A triggering mechanism is needed for thunderstorms to occur when conditionally unstable; diurnal heating is usually enough to trigger the convection.

**5. Energy/Helicity Index (EHI).** Use this index only if strong thunderstorms are forecast. As mentioned previously, CAPE cannot be used alone to forecast severe weather. EHI is a combination of CAPE and Storm Relative Helicity (S-RH), which measures the contribution of convective instability of the atmosphere and the shear vorticity to the potential for tornado formation. Strong to violent tornadoes are associated with a wide range of CAPE values: large CAPE values combined with low wind shear, and conversely, low CAPE values combined with high wind shear are both capable of producing conditions favorable for the development of tornadoes (mesocyclogenesis).

**6. Fawbush-Miller Stability Index (FMI).** This index is similar to the Showalter Stability Index, except it emphasizes the low-level (surface) moisture rather than the 850-mb moisture. The FMI can be more representative than the Showalter Index, however, computation of the FMI is definitely more difficult (Ref: AWS/TR-79/006). Use only when the Showalter appears to be misrepresenting the low-level moisture.

**7. GSI Index.** This index was developed for use in the central Mediterranean using the following procedure:

**Step 1.** Obtain the minimum temperature/dew point spread (°C) between 650 mb and 750 mb.

**Step 2.** Obtain the average wet-bulb temperature in the lowest 100 mb by the equal area

method. From this point, follow the saturation adiabat to the 500-mb level. Subtract the temperature where the saturation adiabat crosses the 500-mb level is subtracted from the observed 500-mb temperature (°C).

**Step 3.** Add the values from Step 1 and Step 2 above to calculate GSI.

**Example:** If the saturation adiabat crosses the 500-mb level at -20°C, and the observed 500-mb temperature is -15°C, then the value would be -5.

**8. K Index (KI).** The K Index is primarily used for forecasting heavy rain and thunderstorm potential. It is not an indicator of severe weather. The K index was developed for air-mass thunderstorm forecasting. It works best in the summer east of the Rockies in maritime-tropical (mT) air masses and in any tropical region. It has limited use in overrunning situations and in mountainous regions.

**9. KO Index.** The KO index, created by the German Weather Bureau, is sensitive to moisture and works best for cool moist climates (mP), (i.e., Europe, Pacific Northwest). The KO Index's drawback is its complexity. Unlike most other indices, the standard Skew-T programs do not calculate it. The KO equation is:

$$KO = \frac{(Qe_{500} + Qe_{700})}{2} - \frac{(Qe_{850} + Qe_{1000})}{2}$$

(Where  $Qe$  is the equivalent potential temperature at a given level.)

To find  $Qe$ , first find the lifting condensation level (LCL) for the given pressure level. Continue up the moist adiabat until all moisture is removed from the parcel. This occurs at the level where the moist and dry adiabats become parallel. From there, continue up the dry adiabat to the top edge of the chart. There, read  $Qe$  directly. Do this for each of the four pressure levels in the equation and



plug into the equation. The result is the KO index. (Ref: AWS/FM-90/001)

**10. Lifted Index (LI).** The LI can be used successfully at most locations since it contains a good representation of the low-level moisture. This index counters deficiencies in the Showalter Index when low-level moisture and/or inversions are present. However, it fails to consider cold air above 500 mb. Threshold values are generally lower than the Showalter Index.

**11. Modified Lifted Index (MLI).** The MLI considers the destabilizing effects of cold air aloft, which the LI fails to take into account. It works well as a severe thunderstorm indicator in Europe, and has also been used with success in the CONUS. It gives poor results when the  $-20^{\circ}\text{C}$  level is above 500-mb (too warm) or below the LCL (too cold).

**12. S Index (S).** The German Military Geophysical Office (GMGO) developed this index as a variation of the Total Totals (TT) index. The S Index adds the moisture available at 700 mb to a variable parameter based on the Vertical Totals Index (VT). The addition of 700-mb moisture tailors this index for sections of Europe since low-level heating is usually less intense in parts of Europe than it is in the States, and 700-mb moisture is a good predictor of thunderstorm development there. The S-Index is useful from April to September. It can be computed from the equation:

$$S = TT - (700T - 700Td) - A$$

Where A is defined as follows:

$$\text{If } VT > 25 \text{ then } A = 0$$

$$\text{If } VT > 22 \text{ and } < 25 \text{ then } A = 2$$

$$\text{If } VT < 22 \text{ then } A = 6$$

**13. Severe WEather Threat Index (SWEAT).** The SWEAT index is designed to predict severe

storms and tornadoes, rather than ordinary thunderstorms. High SWEAT values do not necessarily mean that severe weather will occur since it doesn't consider triggering mechanisms. High SWEAT values based on the morning sounding do not necessarily imply severe weather will occur. If SWEAT values remain high for the forecast sounding, then severe weather potential is high.

**14. Showalter Stability Index (SSI).** This index works best in the Central US with well-developed systems. This index should only be used as a first indication of instability. It doesn't work well if a frontal surface or inversion is present between 850-mb and 500-mb. It also is not a good predictor of severe weather when low-level moisture is present below 850-mb. See Fawbush-Miller or Lifted Index.

**15. Storm-Relative Directional Shear (SRDS).** SRDS is also a SHARP-derived index, used to measure the amount of directional shear in the lowest 3 km of the atmosphere. Strong directional shear significantly contributes to storm rotation.

**16. Storm-Relative Helicity (S-RH).** Helicity has been found to correlate strongly with the development of rotating updrafts. The correlation with tornadoes is less clear. Helicity is very sensitive to the storm motion. Storms that encounter boundaries or slow down can have radically different helicities than the general environment. A high-helicity, low-shear environment is possible.

**17. Surface Cross Totals (SCT).** Use SCT to predict severe potential for areas at high elevations.

**18. Thompson Index (TI).** Use TI to determine thunderstorm severity over or near the Rockies.

**19. Total Totals (TT).** Use TT to forecast thunderstorm coverage and severity. This index is particularly good with cold air aloft. It may over-

**Convective Weather Tools**

forecast severe weather when sufficient low-level moisture is not available. The TT index is the sum of the Vertical Totals and Cross Totals.

**20. Vertical Totals (VT).** Use VT in the western U.S., the UK, and in Western Europe to predict thunderstorm potential.

**21. Wet-Bulb Zero Height (WBZ).** The WBZ is often a good indicator of hail and surface gusts 50 knots or greater when it lies between 5,000 and 12,000 feet; and of tornadoes, when it lies between 7,000 and 9,000 feet. It is not a good indicator in

deep mT air masses, which naturally have high WBZs; hail or strong surface gusts rarely occur in these air masses outside the immediate vicinity of tornadoes. Many studies indicate a strong correlation between the height of wet-bulb zero and the types of tornadoes that will occur. While it doesn't directly forecast the occurrence of tornadoes, WBZ can help predict whether tornadoes will form in families or singularly once they are forecast.

Table 3-2 lists various general thunderstorm indices and threshold values; Table 3-3 lists indices and

**Table 3-2. General thunderstorm (instability) indicators.**

Index	Region	Weak (Low)	Moderate	Strong (High)
CAPE		300 to 1000	1000 to 2500	2500 to 5300
Cross Totals(CT)	East of Rockies	< 18 No TSTMS	18 to 19	>= 20
	Gulf Coast	< 16 No TSTMS	20 to 21	
Dynamic Index	Airmass TSTMS	Positive numbers		Negative numbers
Panhandle-MtW Index		0 to -2	-2 to -6	< -6 Svr Possible
OSI Index	Mediterranean	> 2		< 2
K Index (KI)	East of Rockies	20 to 26	26 to 33	> 33
	(mT air masses), and the Tropics			
	West of Rockies	15 to 21	21 to 30	> 30
KO Index (KO)	(mT)			
	Cool, moist disturb Europe, Pacific NW	> 6	2 to 6	< 2
Lifted Index (LI)		0 to -2	-3 to -5	-5 and lower
S-Index	Europe, April-	< 39	≥ 40 and < 46	≥ 46
	September only	No thunderstorms	Thunderstorms possible	Thunderstorms likely
Showalter Stability Index (SSI)	US	> +3	+2 to -2	< -3 Svr Pbl
	Europe	> 2	< 2	
Total Totals(TT)		No thunderstorms	Thunderstorms	
	West of Rockies	43 to 51	52 to 54	> 54
	East of Rockies	44 to 45	46 to 48	> 48
Vertical Totals(VT)	Europe	> 42	> 48	> 50
	US- general			> 26
	Gulf Coast			> 23
	West of Rockies	< 28	28 to 32	> 32
		No thunderstorms		
	UK			> 23
	W. Europe			> 28

threshold values for forecasting severe weather potential. Tables 3-4 and 3-7 list various tornado indicators. Thresholds vary somewhat from site to site, so closely monitor these values to discover

the best value for local use and adjust accordingly. The best way to evaluate a threshold is to keep a continuous record of their effectiveness. Regional values are given where data are available.

**Table 3-3. Severe thunderstorm indicators.**

Index	Region	Weak (Low)	Moderate	Strong (High)
Bulk Richardson Number (BRN)		> 50		10 to 50
		Multi-cellular storms		Supercells
Cross Totals (CT)	East of Rockies	22 to 23	24 to 25	> 25
	Gulf Coast	16 to 21	22 to 25	> 25
	West of Rockies	< 22	22 to 25	> 25
Modified Lifted Index (MLI)	Europe	0 to -2	-3 to -5	-5 and lower
Surface Cross Totals (SCTI)	East of 100°W			=> 27
	High Plains			=> 25
	Foothills of Rockies			=> 22
SWEAT Index	Midwest and Plains	< 275	275 - 300	=> 300
	(unreliable at higher elevations)			
Thompson Index (TI)	Over the Rockies	20 to 29	30 to 34	=> 35
	East of Rockies	25 to 34	35 to 39	=> 40
Total-Totals (TT)	West of Rockies	55 to 57	58 to 60	=> 61
	East of Rockies	48 to 49	50 to 55	=> 56
Wet-Bulb Zero (WBZ) Height	Not for use with deep mT air masses	< 5,000 ft	5,000 to 12,000 ft	7,000 to 9,000 ft
			Large Hail	Tornado

**Table 3-4. Tornado indicators.**

Index	Value	Interpretation
Energy/Helicity Index (EHI)	0.8 to 1	Weak tornadoes.
	1 to 4	Strong tornadoes.
	> 4	Violent tornadoes.
Lifted Index (LI)	< -6	Tornadoes possible.
Mean Storm Inflow (MSI)	> 20	Mesocyclone development possible
Showalter Index (SSI)	< -6	Tornadoes possible.
Storm Relative Directional Shear (SRDS)	> 70	Mesocyclone development possible
Storm Relative Helicity (SRH)	> 400	Tornadoes possible.
SWEAT Index	≥ 400	Tornadoes possible.
Wet-Bulb Zero (WBZ) Height	7,000 to 9,000 ft (mP)	Families of tornadoes.
	≥ 11,000 ft (mT)	Single tornadoes.

## Convective Weather Tools

Table 3-5. Product analysis matrix and reasoning.

Charts	Feature to Analyze	Why (favorable/unfavorable; weak, moderate, strong chance for severe weather conditions.)
200 mb/300 mb	Identify jet maximums.	• $\leq 55$ knots <b>Weak</b>
		• 56 to 85 knots <b>Moderate</b>
		• $\geq 86$ knots <b>Strong</b>
	Streamline and identify diffluent areas.	Favorable for development.
	Shade areas of horizontal wind speed shear.	Favorable for development.
500 mb	Identify jet maximums.	• $\leq 35$ kt <b>Weak</b>
		• 36 to 49 <b>Moderate</b>
		• $\geq 50$ <b>Strong</b>
	Streamline and identify diffluent areas.	Favorable for development.
	Isopleth 12-hour height falls (Oct to Apr) or 24-hour height falls (May to Sep).	• $\leq 30$ m <b>Weak</b>
		• 31 to 60 m <b>Moderate</b>
		• $\geq 61$ m <b>Strong</b>
	Perform 2°C isotherm analysis, color cold pools, identify thermal ridges and troughs.	Severe activity suppressed near and east of thermal ridge particularly when in phase with streamline ridge.
	Identify areas of cold air advection.	The following temperatures are favorable:
		• Dec to Feb: $-16^{\circ}\text{C}$ or lower.
• Mar, Apr, Oct, Nov: $-14^{\circ}\text{C}$ or lower.		
• May, Jun: $-12^{\circ}\text{C}$ or lower. • Jul to Sep: $-10^{\circ}\text{C}$ or lower.		
Identify dew-point depressions of $6^{\circ}\text{C}$ or less, moisture analysis.	Cut-off moisture sources indicate a short wave is present.	
Identify areas of vorticity advection.	<b>NVA: Weak Or Not Favorable.</b>	
	Positive Vorticity isopleths crossing 500-mb height contours:	
	• $\leq 30^{\circ}$ <b>Moderate</b>	
	• $> 30^{\circ}$ <b>Strong</b>	
	Storms develop on the periphery of the vorticity maximum and not directly below.	
700 mb	Perform 2° isotherm analysis, identify thermal troughs and ridges.	Good stacking of cold air here and at 500 mb is favorable for severe.
	Indicate (12-hour) temperature no-change line.	Advancement of the temp. no-change line ahead of the 700-mb trough indicates the surface low will intensify.
	Draw dew-point depression lines.	Moisture fields detached from the main moisture field indicate rising motions and a possible short wave in the area.
	Mark dry line. The dry line can be placed where dew point is $\leq 0^{\circ}\text{C}$ , the dew point depression is $\geq 7^{\circ}\text{C}$ , or the RH is $\leq 50$ percent.	Weak winds across the dry line: <b>Weak</b>
		Winds 15 to 25 knots crossing between $10^{\circ}$ and $40^{\circ}$ : <b>Moderate</b>
		Winds $\geq 26$ knots crossing between $41^{\circ}$ and $90^{\circ}$ : <b>Strong</b>
Streamline and identify confluent areas.	Confluent areas are favorable for severe.	

Table 3-5 (continued). Product analysis matrix and reasoning.

Charts	Feature to Analyze	Why (favorable/unfavorable; weak, moderate, strong chance for severe weather conditions).
<b>850 mb</b>	Streamline and identify confluent zones.	The greater the angle of winds from dry to moist air, the more unstable.
	Identify wind speed maximums.	<ul style="list-style-type: none"> <li>• <math>\leq 20</math> knots      <b>Weak</b></li> <li>• 21 to 34 knots    <b>Moderate</b></li> <li>• <math>&gt; 35</math> knots      <b>Strong</b></li> </ul>
	Draw every 2°C isotherm starting with an isotherm that bisects the entire U.S. Mark thermal ridges.	Thermal ridge is often ahead of convergence zone. Cold air advection often found behind the main convergence zone, unless a dry line forms and moves out ahead of the cold advection. (Warm air is usually ahead of the main convergence zone).
	Draw isodrosotherms every 2°C starting at 6°C (43°F).	Dew point: <ul style="list-style-type: none"> <li>• <math>&lt; 8^{\circ}\text{C}</math> (46°F)      <b>Weak</b></li> <li>• 9°C to 12°C (48 to 54°F)    <b>Moderate</b></li> <li>• <math>\geq 13^{\circ}\text{C}</math> (55°F)      <b>Strong</b></li> </ul>
	Color in areas of significant moisture.	A diffuse moisture field is unfavorable for development of severe weather. Thermal ridge east of moisture axis: <b>Weak</b> Thermal ridge coincident with the moisture axis: <b>Moderate</b> Thermal ridge west of the moisture axis: <b>Strong</b>
Identify dry line.	Note the angle of winds crossing from dry to moist air, the greater the angle, the greater the instability. Where the dry line is intruding into moist areas is unstable.	
<b>Surface</b>	2-mb isobar analysis	Surface pressure patterns indicate likely areas for severe weather: <ul style="list-style-type: none"> <li>• <math>&gt; 1009</math> mb      <b>Weak</b></li> <li>• 1009 to 1005 mb    <b>Moderate</b></li> <li>• <math>&lt; 1005</math>      <b>Strong</b></li> </ul>
	Isallobaric analysis (12-hour) identify areas of falling pressure.	Squall lines often develop in narrow troughs of falling pressure. A strong pressure rise/fall couplet is favorable for severe weather. The following values indicate probability of severe weather: <ul style="list-style-type: none"> <li>• <math>\leq 1</math> mb      <b>Weak</b></li> <li>• 2 to 5 mb      <b>Moderate</b></li> <li>• <math>&gt; 6</math> mb      <b>Strong</b></li> </ul>
	Identify areas of rapid temperature and dew point change	Favorable for development of severe weather
	2° isodrosotherm analysis starting at 50°F (10°C).	Areas of horizontal moisture convergence are favorable. The following dew point temperatures indicate probability of severe weather: <ul style="list-style-type: none"> <li>• <math>\leq 50^{\circ}\text{F}</math> (10°C)      <b>Severe Unlikely</b></li> <li>• <math>&gt; 51</math> to 55°F (11 to 12°C)    <b>Weak</b></li> <li>• <math>&gt; 56</math> to 64°F (13 to 17°C)    <b>Moderate</b></li> <li>• <math>&gt; 65^{\circ}\text{F}</math> (18°C)      <b>Strong</b></li> </ul>
	Identify confluent streamline areas.	Areas of strong winds converging with weak winds is favorable.
	Identify highs, lows, fronts, squall lines, and dry lines and mark their previous locations.	Any discontinuity line is a likely place for thunderstorm development. Intersecting discontinuity lines are highly probable locations for development. Use distance between past and current locations to extrapolate onset of thunderstorms.
<b>1000/500 mb Thickness</b>	Mark thickness ridge.	Probable area for squall line.
	Mark thickness no-chance line (12-hour).	Indicates area of cold advection.

**Convective Weather Tools****Table 3-6. Identifying features of airmass thunderstorm development on upper-air charts.**

Product	Feature to Analyze	Why (favorable/unfavorable for convective weather conditions.)
200 mb/300 mb	Streamline	Areas under diffluent flow aloft are favorable for thunderstorms; convergence strongly suppresses development.
500 mb	Ridge placement	Convection forms on the confluent side of the ridge axis.
	Vorticity advection	PVA is present, severe weather is possible. NVA or neutral, severe weather unlikely
	Short-wave troughs	Severe weather possible.
850 mb/925 mb	Streamline	Confluence.
	Gradient Winds	Use to forecast steering flow if stronger than forecast sea breeze.
Surface/LAWC	Streamline: Draw convergent asymptotes	Expect convection to begin along these lines when convective temperature is reached.
Composite Workchart	Satellite depiction Radar observations LAWC: streamlines	Identify cells/lines of convection. Identify intersecting boundaries as possible areas for severe winds, heavy rain, and possible hail.
	Mark past positions of significant features.	Use the time difference and distance between related weather features to forecast their future movement, and to forecast areas of intersecting boundaries and development.

**Table 3-7. Tornado forecasting tools.**

Tool	Parameter(s) Measured	Indicator for:
Bulk Richardson Number (BRN).	Buoyancy and wind shear.	Storm type: multicell, supercell.
Convective Available Potential Energy (CAPE).	Buoyancy.	Potential updraft strength, which relates to storm intensity.
Energy/Helicity Index (EHI).	Combines CAPE and SRH.	Tornadoes.
Mean Storm Inflow (MSI).	Storm relative winds.	Mesocyclone development.
Storm Relative Directional Shear (SRDS).	Low-level vorticity (i.e., strong low-level cyclonic circulation).	Mesocyclone development.
Storm Relative Helicity (SRH).	Potential for a rotating updraft, horizontal vorticity due to wind shear.	Supercells and tornadoes.
Hodographs.	Vertical and horizontal directional and speed shear, mean wind, storm motion, storm inflow, helicity.	Storm type: single cell, multicell, and supercell.

**B. Evaluation and Techniques.** There are many data sources and tools available to the forecaster: atmospheric models and numerical analysis techniques, satellite, radar, conventional upper-air data, and a variety of software applications designed to help forecasters interpret these data. Some of these programs are available on the Internet. Deciding which tools and data to use in forecasting severe convective weather can be an overwhelming task. Using the following techniques and rules of thumb may help in organizing your thoughts as you move through the forecast process. Start by knowing the typical “seasons” for thunderstorm activity in the geographical area of interest as described in regional climatologies produced by AFCCC.

**1. Synoptic Evaluation for Potential Severe Weather.** Begin by determining if the current and/or forecast weather pattern for the area of interest is favorable for severe convective weather pattern development. After initializing available Numerical Weather Prediction (NWP) model outputs (i.e., MM5, ETA, NOGAPS, etc.), examine the graphical representations of the NWP model outputs to determine which one has the best handle on the current synoptic weather pattern.

Pay close attention to areas where favorable severe convective storm predictors stack with height. The more favorable conditions in a specific area, the greater the chance of development of severe thunderstorms.

Use composite products to help stack significant features. If the analysis is complete, when most of the predictors indicate a strong potential for severe weather, then seriously consider forecasting severe thunderstorms, tornadoes, strong winds, and/or hail. If predictors indicate weak potential, then consider forecasting non-severe thunderstorms. If indicators are mixed, consider forecasting non-severe thunderstorms with isolated or scattered severe thunderstorms. Finally, if low-level predictors are strong, weak upper-level diffluence

is often sufficient to trigger severe weather, and if low-level predictors are marginal, strong upper-level diffluence is necessary to trigger severe convective storms.

Incorporate local rules of thumb, the Military Weather Advisory, forecast discussion bulletins, and the various stability indices appropriate for the location into the decision-making process. It is seldom wise to base a forecast on a single tool when several are available.

**2. Forecast Products and Techniques.** Begin with a Skew-T of the nearest representative upper-air sounding to the location of interest. Use the techniques described here to analyze the sounding for indications of convective instability in the air mass. There are many good Skew-T software programs available to help with this analysis. Determine if the air mass is absolutely unstable or, more commonly, conditionally unstable.

Next, analyze the upper-air and surface products for the area of interest (Table 3-5). Upper-air analyses are not as useful for forecasting airmass thunderstorms as they are for forecasting the classic severe thunderstorms previously discussed, but they can often help. The LAWC will play a key role in an analysis since it can be updated hourly and the significant triggering mechanisms are often apparent on these products. Table 3-6 identifies key predictors to analyze and why they are significant.

### **3. Identifying Severe Weather Features.**

**a. Tornado Features.** The first requirement to predict tornadoes is a forecast for severe thunderstorms, and then to determine whether tornadogenesis will occur. Research has shown the strength or magnitude of various parameters derived from the low-level wind and thermodynamic fields of the atmosphere are keys to *tornadogenesis*. The elements that contribute to tornadogenesis are strong storm-relative flow,

**Convective Weather Tools**

strong vertical wind shear, strong low-level vorticity (i.e., strong low-level cyclonic circulation), potential for strong rotating updrafts and great instability or buoyancy. All of these elements are associated with supercells, which are known tornado producers. However, not all tornado-producing thunderstorms are supercells.

Several tools are available for determining whether conditions exist for tornadogenesis. These are shown in Table 3-7 with the parameters they measure, and what each tool is used to predict. The actual threshold values are listed in Tables 3-2 through 3-4.

Note that several of these tools indicate storm type rather than just tornado type or strength. Knowing the expected storm type can indicate where tornadoes are likely to form within the storm, aiding severe storm metwatch: combine storm type knowledge with the WSR-88D's meso indicator

(and other features), and track/forecast movement of potentially tornadic storms and radar signatures. Listed below are descriptions of likely locations where supercell and non-supercell tornadoes are found in a storm.

**(1) Supercell Tornadoes.** These tornadoes develop in the mesocyclone of classic and heavy precipitation supercells, and on the leading edge of the storm updraft in the vicinity of the wall cloud of low-precipitation supercells.

**(2) Non-Supercell Tornadoes.** They can occur in the flanking line of a supercell, during the growth stage in the updraft of "pulse" thunderstorms (strong, single-cell storms), along the gust front of multicellular storms, and in strong updraft centers of multicellular storms. Tornadoes in single-cell and multicellular storms are rare, and require exceptionally strong development of those storms to produce a tornado.

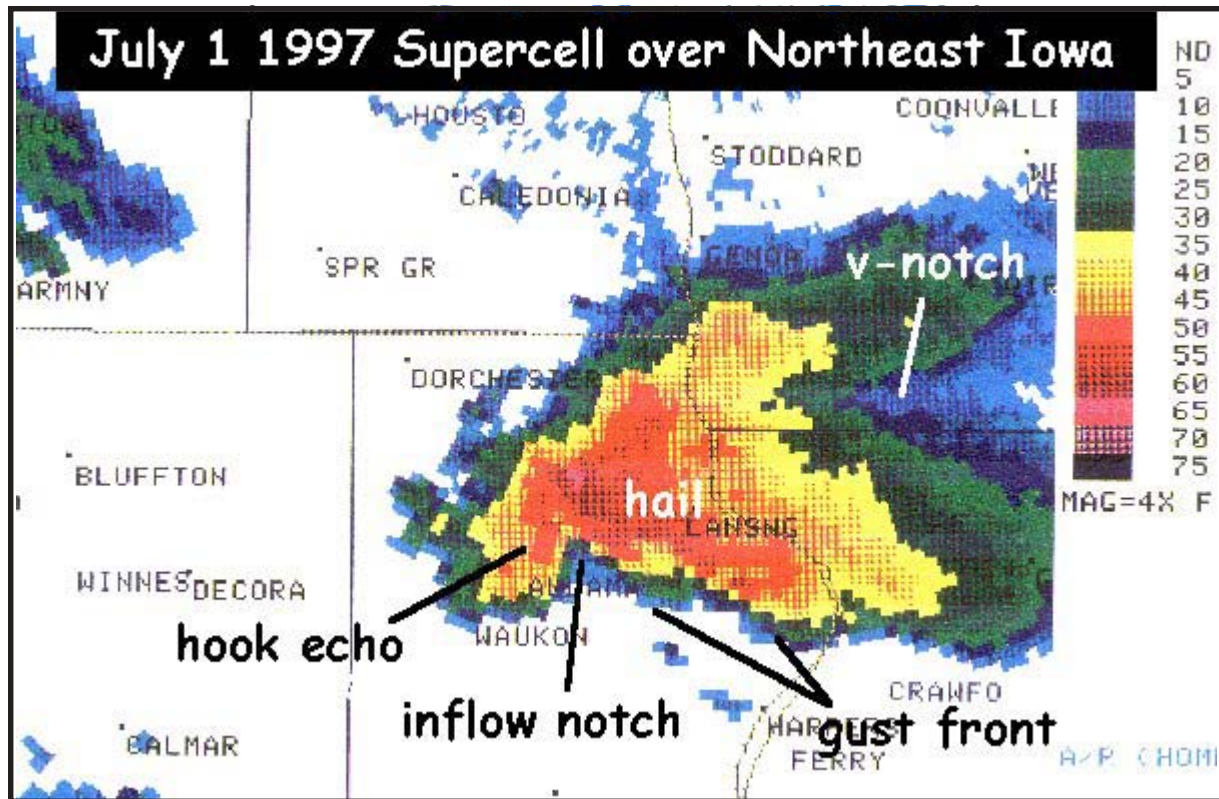


Figure 3-14. Supercell Example.

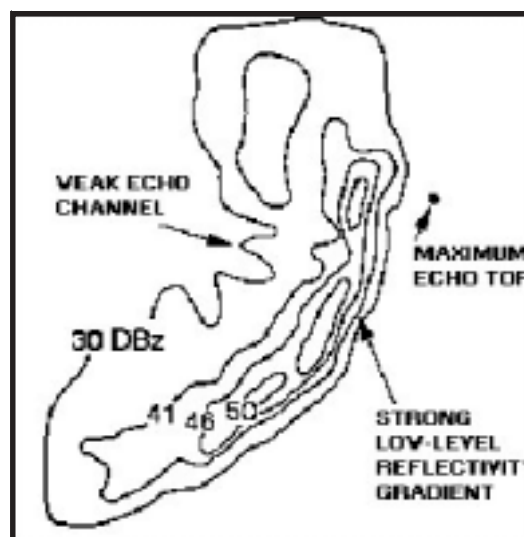


**b. Bow Echo Features.** The bow echo is a line of storms that accelerates ahead of the main line of storms. The bow echo forms from strong thunderstorms with a gust front. A strong downburst develops and the line echo wave pattern (LEWP) begins to “bow.” A well-developed bow echo or “spear head” is associated with the mature stage of the downburst. Strong winds and tornadoes are possible near the bow. Figure 3-14 shows the evolution of the bow echo in a LEWP.

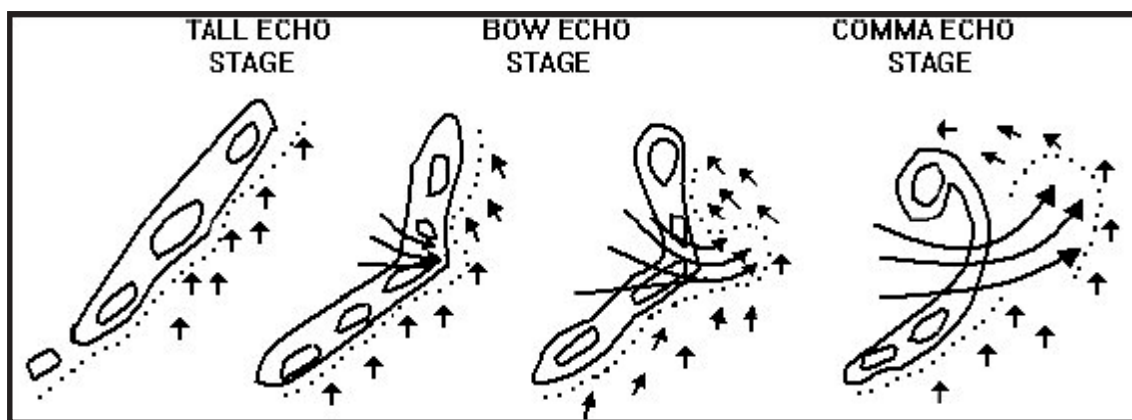
As the downburst weakens, the line forms a comma shape often with a mesocyclone developing on the north end of the comma, which will be evident by a “hook” in the radar echo. At this point, tornadoes may still occur in the area of the mesocyclone, but the winds are now decreasing. Strong to severe straight-line winds are likely to exist if four specific characteristics of the bow echo are present (See Figure 3-15 and 3-16.)

- The low-level echo configuration is concave downstream (bowed).
- Weak echo channels exist.

- A strong reflectivity gradient along the leading edge of the concave-shaped echo.
- The maximum echo top is over or ahead of the strong low-level reflectivity gradient.

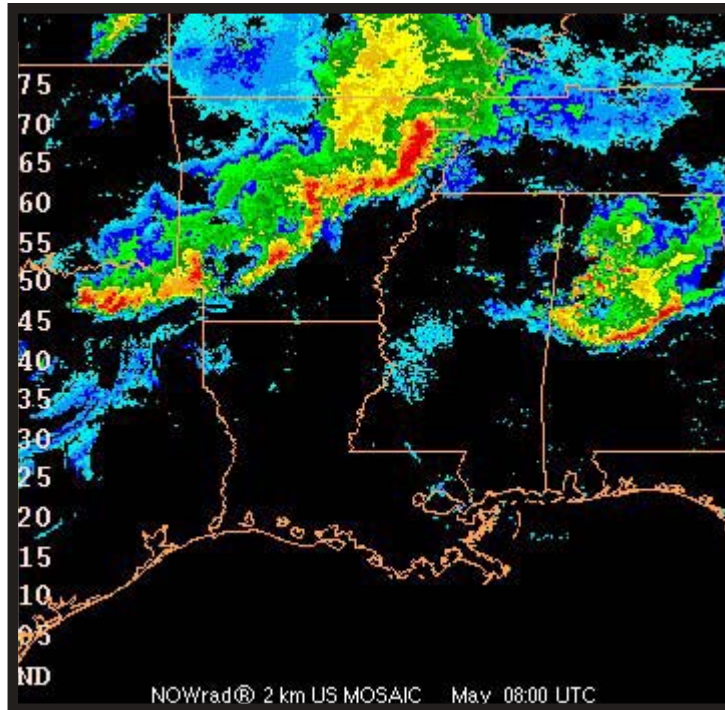


**Figure 3-16a. Bow Echo.** Strong winds and tornadoes are possible near the bow.



**Figure 3-15. Line Echo Wave Pattern (LEWP)/Bow Echo Evolution.** Strong to severe straight-line winds are likely to exist.

**Convective Weather Tools**



**Figure 3-16b. Bow Echo Reflectivity Example.**

*c. Wet Microburst Features.* Microbursts or downbursts are difficult to predict and detect due to their small spatial scale (less than 4-km diameter), shallow vertical extent and short life span. However, the following technique can provide up to 40 minutes lead time predicting maximum downburst winds from pulse-type thunderstorms (single cell thunderstorms).

The following conditions must exist:

- A source of dry (dew-point depression  $\geq 18^{\circ}\text{C}$ ), potentially cold air between 400 and 500 mb.
- Reflectivity  $\geq 55$  dBZ (sufficient moisture for entrainment of the parcel to produce negative buoyancy through evaporative cooling).

To predict the wind gust potential:

- Interrogate the suspect storm cells on the WSR-88D.
- Obtain the maximum top of the cell using Echo Tops and get the VIL.

**Table 3-8. Wet microburst potential table.** Determine VIL and maximum cell tops (100s of feet) from the WSR-88D, to read maximum downburst winds (knots) in body of the table.

		T O P S									
		250	300	350	400	450	500	550	600	650	700
V I L	35	45	42	37	31	23					
	40	49	46	42	38	30	19				
	45	53	50	47	42	36	28	14			
	50	57	55	51	46	41	34	24			
	55	60	57	54	50	45	39	31	18		
	60	63	61	57	54	50	44	37	27		
	65	66	64	61	58	53	48	42	33	21	
	70	69	67	64	61	57	53	46	39	29	
	75	72	70	67	64	60	56	50	44	35	22
80	75	72	70	67	63	59	54	48	40	29	

- Cross-reference the two values using Table 3-8, and read the maximum downburst winds, in knots, in the body of the table.

For the Southern Plains, Southeast, and Gulf Coast, add 1/3 of the mean low-level wind speed to the value in the table to predict the wind gust from the potential microburst. For the Northeast, add mean low-level wind speed to the value given in the table.

**Note:** This technique will not work when VIL values are large due to hail contamination. When thunderstorms are too close to the radar, echo top estimates are erroneously low. This technique also works poorly for thunderstorms over 125 NM away from the radar. This only works for pulse-type air-mass thunderstorms; it does not work for multicell and supercell storms.

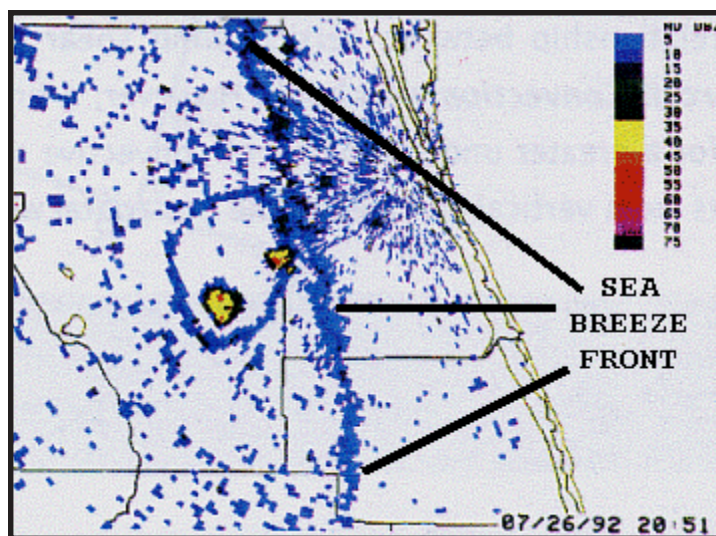
#### *d. Boundaries and Boundary Interaction Features.*

(1) *Satellite.* As diurnal heating occurs, cumulus clouds will often form into cloud streets (over land) oriented with the gradient wind flow. Look for clear areas forming in the flow; these identify sea-breeze fronts, lake breezes, and outflow boundaries. The leading edge of these boundaries

between clear areas and cloud streets is highly favorable for development. Similarly, the boundary between cloud-free areas and fog-stratus broken/overcast areas are prime for development as clouds burn off. When outflow boundaries intersect, convection is almost guaranteed if the air mass is unstable or conditionally unstable.

(2) *WSR-88D (Figure 3-17).* Sea-breeze boundaries and other discontinuities in low-level flow can usually be identified in the WSR-88D base reflectivity displays. The sea breeze will appear as a thin line of low intensity returns parallel to the coastline. These patterns can be entirely obliterated if lower intensity values are masked for clutter suppression. Convection is most likely to form on these lines when the convective temperature is reached.

(3) *Streamline Analysis/Sea Breeze Onset.* Use the latest LAWC streamline analysis combined with current satellite and radar analysis. Create a composite product (or use the LAWC) to identify locations of streamline-confluent asymptotes, sea/lake breezes, and outflow boundaries. Mark past locations of these boundaries. Determine speed and direction of movement of boundaries to project when and where these boundaries will intersect.



**Figure 3-17. Sea Breeze Front on Reflectivity Product.**

## Convective Weather Tools

---

The intersections are almost certain to result in air-mass thunderstorms. If thunderstorms are present along the boundaries already, severe weather (usually severe wind gusts) is possible. Tornadoes and hail are unlikely unless strong upper-level support is evident.

**(4) MWA Products.** These centrally produced products cover large forecast areas and periods of time. Although they are not site-specific forecasts, they are products of an extensive evaluation of observed and forecast weather conditions. They should be carefully considered in the preparation of site-specific thunderstorm forecasts. They should not be used as the sole decision aid in preparing the forecast.

### 4. Techniques.

**a. Severe Thunderstorm Checklist.** The parameters involved in producing ordinary versus severe thunderstorms are well-documented. However, no two thunderstorm situations are alike. There are varying degrees of intensity for each parameter, and the combinations of parameters produce individual storm events. This makes a foolproof, all-inclusive checklist impossible. The following checklist is an outline of the forecast reasoning process. Incorporate local rules of thumb and stability thresholds to fine-tune this for each station.

**Step 1.** Identify the current weather regime.

- Dryline.
- Frontal.
- Overrunning.
- Cold Core.
- Squall Line.
- Airmass Thunderstorm.

**Step 2.** Analyze available NWP models. Tailor the analysis.

**Step 3.** Are elements for severe weather present? Refer to Table 3-5 for features associated with severe weather elements.

**Step 4.** Analyze current and forecast Skew-Ts and calculate stability indices appropriate for the weather pattern and station. Do they indicate severe weather potential? See Tables 3-6 and 3-7.

**Step 5.** Produce and examine the current and forecast hodograph from current and forecast sounding data. What type of storms can be expected?

**Step 6.** What type of severe weather: tornadoes, convective winds, or hail? Severe weather forecasting aids follow.

**b. Forecasting Convective Wind Gusts.** This section presents four methods to forecast convective wind gusts. Each is designed to forecast winds under different conditions: Use the T1 method for scattered thunderstorms in the vicinity of the forecast location; T2 winds are designed for intense squall lines or numerous thunderstorms; the next method is for high-based thunderstorms; and the Snyder Method is for air-mass or pulse thunderstorms. Each of these methods requires a current sounding or forecast Skew-T.

**(1) T1 Gust Computation.** There are two methods of computing the T1 gust, one for when an inversion is present, the other for no inversion.

**(a) T1 Method 1.** The top of the inversion is within 150 mb to 200 mb of the surface and is not susceptible to being broken by surface heating.

- Project moist adiabat from warmest point of inversion to 600 mb.

- Calculate temperature difference (°C) between moist adiabat and dry-bulb temperature trace at 600 mb. Label as T1.

- Refer to Table 3-9. The value found for T1 is considered to be the average gust speed.

- Add 1/3 of lower 5,000 feet mean wind speed to chart value for maximum gust speed.

- Wind gust direction is determined from mean wind direction in layers between 10,000 feet and 14,000 feet above local terrain.

**Table 3-9. T1 convective gust potential.**

T1 values (°C)	Average Gust Speed (knots)	T1 values (°C)	Average Gust Speed (knots)
3	17	15	49
4	20	16	51
5	23	17	53
6	26	18	55
7	29	19	57
8	32	20	58
9	35	21	60
10	37	22	61
11	39	23	63
12	41	24	64
13	45	25	65
14	47		

**(b) T1 Method 2.** No inversion present or inversion is relatively high (more than 200-mb above surface).

- Forecast maximum surface temperature.

- Project moist adiabat from maximum temperature to 600 mb.

- Calculate the difference between moist adiabat and dry-bulb temperature trace at 600 mb and label as T1.

- Refer to Table 3-9. The value found for T1 is considered to be the average gust speed.

- Add 1/3 of lower 5,000 feet mean wind speed to chart value for maximum gust speed.

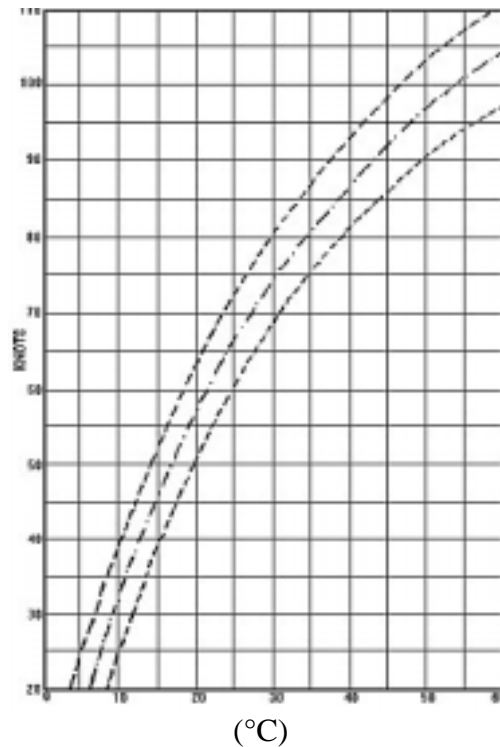
- Wind gust direction is determined from mean wind direction in layers between 10,000 and 14,000 feet above local terrain.

**Step 2.** Project the moist adiabat through wet-bulb zero to the surface.

**Step 3.** Read value of temperature (°C).

**(2) T2 Gust Computation (Figure 3-18).**

**Step 1.** Find the wet-bulb zero (where wet-bulb curve crosses the 0°C isotherm).



**Figure 3-18. T2 Gust Computation Chart.** See Step 6.

**Convective Weather Tools**

**Step 4.** Subtract the moist adiabat temperature (°C) from the surface dry-bulb (°C) (or projected maximum) temperature.

**Step 5.** Label as T2.

**Step 6.** Refer to Figure 3-18. Follow the T2 up to where it intersects the three curves. The first intersection point represents the minimum gust; the middle intersection point represents the average gust; and the upper intersection point represents the maximum gust.

**Step 7.** The mean wind direction in the layer between 10,000 and 14,000 feet has been found to closely approximate direction of maximum gusts at surface and should be used in forecasting gust direction.

**(3) Snyder Method.** A method of forecasting the average gust with airmass thunderstorms.

**Step 1.** Plot the latest rawinsonde, plot the wet-bulb curve, and locate the height of wet-bulb zero. \_\_\_\_\_

**Step 2.** Forecast maximum temperature at time of thunderstorm occurrence (°F). \_\_\_\_\_

**Step 3.** Lower the WBZ to the surface, moist adiabatically to get the “Down Rush Temperature” (°F). - \_\_\_\_\_

**Step 4.** Step 2 value - Step 3 value \_\_\_\_\_

**Step 5.** Find the average wind speed in the layer 5,000 feet above and below the WBZ. + \_\_\_\_\_

**Step 6.** Average gust associated with air-mass thunderstorms.  
Step 4 + Step 5. \_\_\_\_\_ knots

**(4) Derecho Checklist.** The derecho resembles the Line Echo Wave Pattern (LEWP) and/or a large bow echo. Storm movement can exceed 50 knots and move slightly to the right of the mean wind. They last for several hours, continually maintaining high wind speeds and gusts, and traverse hundreds of miles. The following parameters are necessary for derecho development. Without all of these elements present, derechos are unlikely.

- 500-mb flow direction from west to northwest (most frequent with wind direction 240° to 280°).
- Quasi-stationary surface frontal boundary parallel to 500-mb flow.
- Warm air advection at 850-mb and 700-mb.
- Estimated mean wind speed from 8,000 to 18,000 feet  $\geq$  25 knots.
- Surface-Based Lifted Index (SBLI)  $\leq$  -6.
- Mean relative humidity from 700 mb to 500 mb less than 70 percent.
- Maximum 500-mb 12-hour height-falls  $\geq$  60 meters.

Finally, if these parameters exist over a 250 NM (or greater) swath downstream of the MCS, then any rapidly-moving squall lines or squall line segments moving with the mean flow of 35 knots or greater are likely to develop into a derecho. If these conditions do not persist downstream for 250 NM, locally strong or severe winds are still possible in lines of downburst clusters, or bow echoes.

**c. Forecasting Hail and Hail Size.** Hail is a microscale phenomenon associated with all

thunderstorms. The key is to determine if the hail within a thunderstorm will reach the surface, and then determine the hailstone size.

**(1) Forecasting Hail (Using the Skew-T).**

The following is an objective method derived from a study of severe Midwest thunderstorms. This method determines the cloud depth ratio, and then correlates cloud depth ratio and freezing level to occurrence or non-occurrence of hail. The unit of measure is hectopascals (hPa).

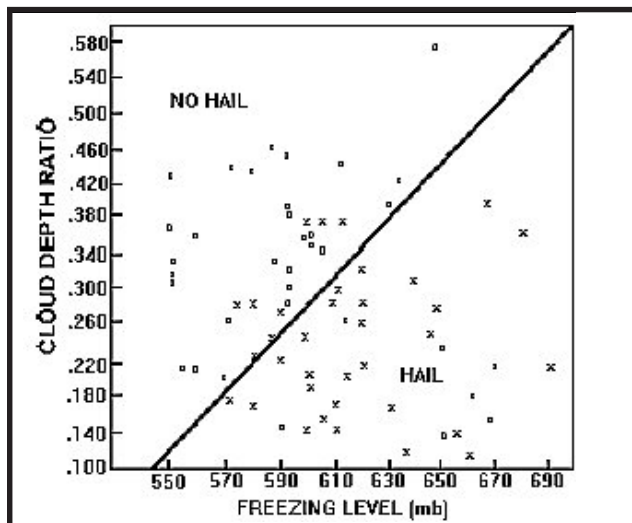
**Step 1.** From a Skew-T, calculate the Convective Condensation Level (CCL), Equilibrium Level (EL), and Freezing Level (FL).

**Step 2.** Determine cloud-depth ratio:  

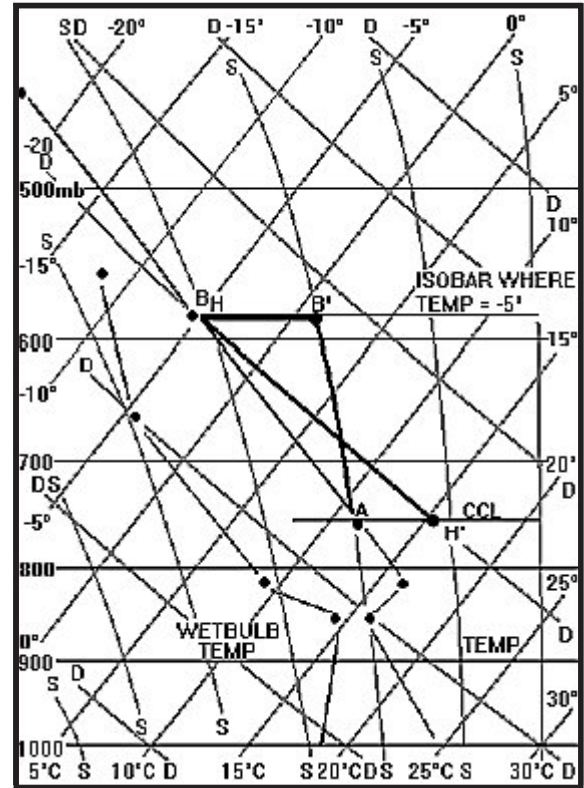
$$\frac{CCL - FL}{CCL - EL}$$

**Step 3.** Cross-reference the cloud-depth ratio (y-axis) to the freezing level (x-axis) on Figure 3-19. If the plot is below the line, forecast hail; if above the line, do not forecast hail.

**(2) Forecasting Hail Size (using Skew-T).**  
 The following technique requires a sounding plotted on a Skew-T chart. The calculations are



**Figure 3-19. Hail Prediction Chart.** See text. Also shown are the results of the original study.



**Figure 3-20. Skew-T Chart.** Curves labeled “S” are saturation adiabats; lines labeled “D” are dry adiabats. Other points are described in the text.

accomplished graphically, either on the Skew-T or on the accompanying charts (Figures 3-20 to 3-22).

**Step 1.** Determine the convective condensation level (CCL), which is found using the mean mixing ratio in the lowest 150 mb, then follow the saturation mixing-ratio line to its intersection with the temperature trace, Point A (See Figure 3-19).

**Step 2.** Point B<sub>H</sub> is at the intersection of the -5°C isotherm and the sounding.

**Step 3.** From Point A, go moist adiabatically to the pressure at B<sub>H</sub>, this is Point B'.

**Step 4.** Note the temperature difference (°C) between B<sub>H</sub> and B'. It is used with the horizontal axis in Figure 3-21.

**Convective Weather Tools**

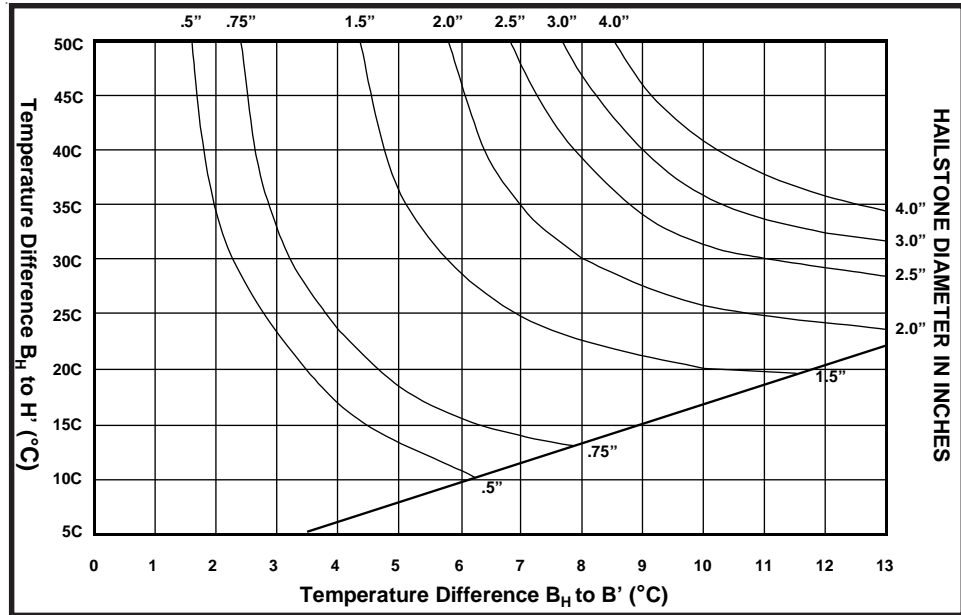
**Step 5.** Go from  $B_H$  dry adiabatically to the CCL, this is Point H'. The temperature difference between  $B_H$  and H' is used with the vertical axis in Figure 3-21.

**Step 6.** Forecast preliminary hail size from Figure 3-20. The dashed lines on Figure 3-21 represent hailstone diameter in inches.

**Step 7.** Use the following procedures to find the wet-bulb zero height.

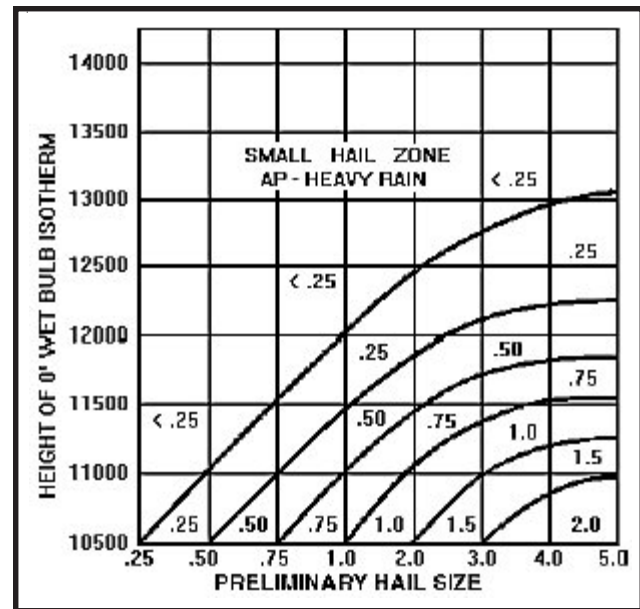
- Choose a reported level close to the freezing level. From the dew point at that level, draw a line upward parallel to a saturation mixing-ratio line.
- From the temperature at the same level, draw a line upward parallel to a dry adiabatic until it intersects the line drawn in the previous step.
- From this intersection, follow a saturation adiabat back to the original pressure. This is the wet-bulb temperature (°C).
- Repeat the above steps as necessary; connect the various wet-bulb temperatures to form a trace.
- Wet-bulb-zero height is the height at which the wet-bulb trace crosses the 0°C isotherm.

**Step 8.** If the wet-bulb-zero height is less than 10,500 feet, the preliminary hail size computed in Step 6 will be the final size. If the wet-bulb-zero height is greater than 10,500 feet, enter Figure 3-22 with the preliminary hail size and the height of the wet-bulb-zero to compute final hail size.



**Figure 3-21. Preliminary Hail Size Nomogram.**

**(3) Forecasting Hail Size Using VIL Density.** Use the WSR-88D to approximate hail size from active storms using Table 3-10.



**Figure 3-22. Final Hail Size Nomogram.** If the wet-bulb-zero height is greater than 10,500 feet, enter this figure with the preliminary hail size and height of the wet-bulb-zero to compute final hail size.



### 5. General Rules of Thumb.

**a. Onset of Typical Thunderstorms.** Predict thunderstorm onset at the time when convective temperature is forecast or maximum solar insolation is expected. Predict formation along confluent streamline asymptotes and discontinuities in the flow such as sea breezes, outflow boundaries, and lake breezes.

**b. Severe Thunderstorms.** Hail, tornadoes, and severe winds are less common with air-mass thunderstorms. For severe storms to occur, at least one of the following must be present:

**Table 3-10. VIL density versus hail size.**

VIL Density	Hail Size
$\geq 3.5 \text{ g/m}^3$	$\geq \frac{3}{4}$ inch
$\geq 4.0$	$\geq 1$ inch
$\geq 4.3$	$\geq$ Golf ball size

- Cold and/or dry air aloft.
- Shortwave troughs at 500 mb.
- Positive Vorticity Advection (PVA).
- Any other locally derived ROTs that have been developed for your location.

## BIBLIOGRAPHY

- A Compendium on Cirrus and Cirrus Forecasting*, AWS-TR 105-130, Air Weather Service, Scott AFB, Illinois, March 1957.
- Aerographer's Mate I&C*, NAVEDTRA 10362-B1, United States Government Printing Office, Washington DC, 1985.
- Air Force Global Weather Center, AFGWCP 105-1, Volume 3, Offutt AFB, Nebraska, 29 August 1986.
- Campbell, TSgt Rodger, *Forecasting Techniques*, SC2570 Meteorological Technician, Volume 3-4, Extended Course Institute, Maxwell AFB, Alabama, 17 February 1994.
- Carle, Ed, "Flash Flood Forecasting Tools," Western Region Technical Attachment 82-26, NWSFO, Salt Lake City, Utah, June 1982.
- Clear Air Turbulence Forecasting Techniques*, AFGWC/TN 79/001, Air Force Global Weather Center, Offutt AFB, Nebraska, 1979.
- Conditional Climatology (CC) Tables*, FYI #23, HQ AWS/XON, Air Weather Service, Scott AFB, Illinois, September 1993.
- Cook, Billie J., "A Snow Index Using 200-mb Warm Air Advection," *National Weather Digest*, Volume 5, May 1980.
- Crisp, MSgt Charlie A., *Training Guide for Severe Weather Forecasters*, AFGWC/TN-79/002, Air Force Global Weather Center, Offutt AFB, Nebraska, November 1979.
- Drizzle*, 3WW/FM-80/002, Third Weather Wing, Offutt AFB NE, January 1980.
- Elliot, George, *Compilation of Weather Forecasting Rules, Techniques and Procedures*. (McMaster, Greg, Air Force notes-Compilation of Weather Forecasting Rules, Techniques and Procedures-unpublished).
- Evans, Michael S., *A Method for Predicting Severe Weather Thresholds of Vertically Integrated Liquid in West Virginia*, Eastern Region Technical Attachment No. 94-5a, NWSFO, Charleston, West Virginia, May 1994.
- Forecasting of Aircraft Condensation Trails*, AWS Manual 105-100, Air Weather Service, Scott AFB, Illinois, 11 March 1960.
- Forecasters' Guide on Aircraft Icing*, AWS/TR-80/001, Air Weather Service, Scott AFB, Illinois, March 1980.
- Frazier, Mark, *The Prediction of Thunderstorm Wind Gusts Based on Vertically Integrated Water Content and Storm Echo Tops*, Eastern Region Technical Attachment No. 94-7b, NWSFO, Pittsburgh, Pennsylvania, July 1994.

*Isallobaric Wind*, T-TWOS #14, Air Weather Service, Scott AFB, Illinois, March 1993.

*Jet Stream Analysis and Turbulence Forecasting*, AFGWC TM 76-1, Air Force Global Weather Center, Offutt AFB Nebraska, 1976.

Jimenez, Michael A., “*Low-Level Wind Shear: Still Dangerous After All These Years,*” 7WW/FM-91/001, Seventh Weather Wing, Scott AFB, Illinois, 1991.

Johns, R. H., and W. D. Hirt, “*Derechos: Widespread Convectively Induced Windstorms,*” *Weather and Forecasting*, Volume 2, March 1987.

Lee, David R., and Roland B. Stull, “*Clear Air Turbulence Forecasting Techniques,*” AFGWC/TN-79/001 (REV), Air Force Global Weather Center, Offutt AFB, Nebraska, February 1984.

*Meteorological Techniques*, AWS Pamphlet 105-56, Air Weather Service, Scott AFB, Illinois, 1 August 1979.

Myers, Jane E. and Michael Fitzsimmons, *Case Study Applying the High-Wind Warning Decision Tree*, Eastern Region Technical Attachment No. 89-6, National Weather Service Eastern Region, Bohemia, New York, 16 May 1989.

*NOAA Technical Memorandum*, NWS WRTA 92-32, National Weather Service Western Region, Salt Lake City, Utah, October 1992.

*Notes on Analysis and Severe-Storm Forecasting Procedures of the Air Force Global Weather Central*, Technical Report 200 (REV), May 1972.

Nouhan, Victor J., *Measuring Snowfall, Depth, And Liquid Equivalent During And After Extreme Blizzard Events*, National Weather Service Forecast Office, Goodland, Kansas, 1998

Politovich, Marcia, *Forecasting Aviation Icing: Icing Type and Severity*, University Center for Atmospheric Research, Boulder, Colorado, 1998.

Quale, Robert, and Fred Doehring, “*Heat Stress, A Comparison of Indices,*” *Weatherwise*, June 1981.

*Q-vectors Users Manual*, T-TWOS #1, Air Weather Service, Scott AFB, Illinois, March 1992.

Rothfusz, Lans P., *The Heat Index Equation*, WRTA 90-24, National Weather Service Western Region, Salt Lake City, Utah, July 1990.

Schwerdt, Richard W., *Effect of Wind and Temperature on Humans-Revisited*, CRTA 93-04, National Weather Service Central Region, Kansas City, Missouri, February 1993.

Scott, Christopher W., *Variation in the Force of the Wind with Elevation*, CRTA 93-12, NWSFO, Cheyenne, Wyoming, 1993.

*Single Station Analysis of Surface Observations*, AWS/FM-300/001, Air Weather Service, Scott AFB, Illinois, January 1987.

Staudenmaier, Michael, Jr., *The Importance of Microphysics in Snowfall: A Practical Example*, Western Region Technical Attachment No. 99-12, National Weather Service Western Region, Salt Lake City, Utah, 22 June 1999.

“Summary of Rules for Winter Precipitation Forecasting,” 3WW/FM-80/001, Third Weather Wing, Offutt AFB, Nebraska, January 1980.

*Surface Weather Observations*, AFM 15-111, Headquarters Air Weather Service, Scott AFB, Illinois, September 1996.

Taylor, MSgt Tony D., *Weather Element Forecasting, Flight Hazards, and Limited Data*, SC01W01A Supplemental Forecaster Training, Volume 3, Extended Course Institute, Maxwell AFB, Alabama, July 1996.

Techniques for High-Level Analysis and Forecasting of Wind and Temperature Fields, WMO-106.TP.45., World Meteorological Organization, Geneva

3rd Weather Wing (3WW) Seminar 78-2, Third Weather Wing, Offutt AFB, Nebraska, 1978.

*Thunderstorm Indices*, AWS Meteorological Enhancement Team Pamphlet, Air Weather Service, Scott AFB, Illinois, 1994.

*Thunderstorms*, NWS Training Center, Hydrometeorology & Management Division, Kansas City, Missouri, September 1993.

*The Use of the Skew T, Log P Diagram in Analysis and Forecasting*, AWS/TR-79/006 Revised, Air Weather Service, Scott AFB, Illinois, December 1979.

Weber, Eugene M., “Major Snowstorm Development over the Midwest United States,” 3WW TN 79-2, Third Weather Wing, Offutt AFB, Nebraska, August 1979.

*Wet-Bulb Globe Temperature, A Global Climatology*, USAFETAC/TN-90/005, United States Air Force Environmental Applications Center, Scott AFB, Illinois, October 1990.

Woodard, MSgt Brian, “*General Knowledge And Surface Weather Observations*”, CDC 1W051C Weather Journeyman,. Vol 1, Extension Course Institute, Maxwell AFB, Alabama, 28 July 2000

## ABBREVIATIONS AND ACRONYMS

<b>AC</b>	ALTOCUMULUS
<b>ACC</b>	ALTOCUMULUS CASTELLANUS
<b>AFCCC</b>	AIR FORCE COMBAT CLIMATOLOGY CENTER
<b>ACSL</b>	ALTOCUMULUS STANDING LENTICULAR
<b>AFDIS</b>	AIR FORCE DIAL-IN SUBSYSTEMS
<b>AFH</b>	AIR FORCE HANDBOOK
<b>AFM</b>	AIR FORCE MANUAL
<b>AFWA</b>	AIR FORCE WEATHER AGENCY
<b>AIRMET</b>	AIRMAN'S METEOROLOGICAL INFORMATION
<b>AGL</b>	ABOVE GROUND LEVEL
<b>API</b>	ANTECEDENT PRECIPITATION INDEX
<b>AS</b>	ALTOSTRATUS
<b>AWC</b>	NATIONAL WEATHER SERVICE AVIATION WEATHER CENTER
<b>BKFG</b>	BAROKLINE FEUCHT - GMGO (AN NWP MODEL)
<b>BRN</b>	BULK RICHARDSON NUMBER
<b>BWER</b>	BOUNDED WEAK ECHO REGION
<b>C</b>	CELSIUS
<b>CAA</b>	COLD-AIR ADVECTION
<b>CAPE</b>	CONVECTIVE AVAILABLE POTENTIAL ENERGY
<b>CAT</b>	CLEAR AIR TURBULENCE (OR CATEGORY)
<b>CB</b>	CUMULONIMBUS
<b>CC</b>	CIRROCUMULUS OR CONDITIONAL CLIMATOLOGY
<b>CCL</b>	CONVECTIVE CONDENSATION LEVEL
<b>CI</b>	CIRRUS
<b>CIG</b>	CEILING
<b>CONTRAIL</b>	CONDENSATION TRAIL
<b>CONUS</b>	CONTINENTAL UNITED STATES
<b>CP</b>	CONTINENTAL POLAR AIR MASS
<b>CS</b>	CIRROSTRATUS
<b>CT</b>	CROSS TOTALS
<b>CU</b>	CUMULUS
<b>DA</b>	DENSITY ALTITUDE
<b>DPD</b>	DEW POINT DEPRESSION
<b>DOD</b>	DEPARTMENT OF DEFENSE
<b>EHI</b>	ENERGY/HELICITY INDEX
<b>ESI</b>	EUROPEAN SNOW INDEX
<b>EL</b>	EQUILIBRIUM LEVEL
<b>ET</b>	ECHO TOPS
<b>F</b>	FAHRENHEIT
<b>FAA</b>	FEDERAL AVIATION ADMINISTRATION
<b>FBD</b>	FORMATTED BINARY DATA
<b>FE</b>	FIELD ELEVATION
<b>FMI</b>	FAWBUSH-MILLER STABILITY INDEX
<b>FITS</b>	FIGHTER INDEX OF THERMAL STRESS
<b>FL</b>	FLIGHT LEVEL

<b>GMGO</b>	GERMAN MILITARY GEOPHYSICAL OFFICE
<b>GMS</b>	GEOSTATIONARY METEOROLOGICAL SATELLITE (FAR EAST)
<b>GOES</b>	GEOSTATIONARY OPERATIONAL ENVIRONMENTAL SATELLITE (UNITED STATES)
<b>GSI</b>	GOLLEHON STABILITY INDEX
<b>HG</b>	MERCURY
<b>IMC</b>	INSTRUMENT METEOROLOGICAL CONDITIONS
<b>IR</b>	INFRARED
<b>ISMCS</b>	INTERNATIONAL STATION METEOROLOGICAL CLIMATE SUMMARY
<b>ITS</b>	INDEX OF THERMAL STRESS
<b>KI</b>	K-INDEX
<b>KM</b>	KILOMETER
<b>KO</b>	KO INDEX
<b>KT</b>	KNOTS
<b>L</b>	LIGHT TURBULENCE
<b>LAFP</b>	LOCAL ANALYSIS AND FORECAST PROGRAM
<b>LAWC</b>	LOCAL AREA WORK CHART
<b>LC</b>	LOW CLOUD
<b>LCL</b>	LIFTED CONDENSATION LEVEL
<b>LEWP</b>	LINE ECHO WAVE PATTERN
<b>LI</b>	LIFTED INDEX
<b>LLJ</b>	LOW-LEVEL JET
<b>LLT</b>	LOW-LEVEL THICKNESS
<b>LLWS</b>	LOW-LEVEL WIND SHEAR
<b>MWA</b>	MILITARY WEATHER ADVISORY-METERS
<b>M</b>	MODERATE TURBULENCE
<b>MARWIN</b>	BRAND NAME FOR RAWINSONDE EQUIPMENT.
<b>MB</b>	MILLIBARS
<b>MCC</b>	MESOSCALE CONVECTIVE COMPLEX
<b>MCL</b>	MIXING CONDENSATION LEVEL
<b>MCS</b>	MESOSCALE CONVECTIVE SYSTEM
<b>METEOSAT</b>	METEOROLOGICAL SATELLITE (EUROPE)
<b>METTIPS</b>	METEOROLOGICAL TECHNICAL INFORMATION PROGRAM
<b>METWATCH</b>	METEOROLOGICAL WATCH
<b>MLI</b>	MODIFIED LIFTED INDEX
<b>MM5</b>	FIFTH GENERATION MESOSCALE MODEL
<b>MODCURVES</b>	MODELED CURVES
<b>MODCV</b>	MODELED CEILING AND VISIBILITY
<b>MOGR</b>	MODERATE OR GREATER
<b>MOS</b>	MODEL OUTPUT STATISTICS
<b>MP</b>	MARITIME POLAR AIR MASS.
<b>MT</b>	MARITIME TROPICAL AIR MASS
<b>MSI</b>	MEAN STORM INFLOW
<b>MSL</b>	MEAN SEA LEVEL
<b>MV</b>	MOUNTAIN WAVE TURBULENCE
<b>MVMC</b>	MARGINAL VISUAL METEOROLOGICAL CONDITIONS
<b>MWA</b>	MILITARY WEATHER ADVISORY

<b>NGM</b>	NESTED GRID MODEL
<b>NM</b>	NAUTICAL MILES
<b>NCAR</b>	NATIONAL CENTER FOR ATMOSPHERIC RESEARCH
<b>NCEP</b>	NATIONAL CENTERS FOR ENVIRONMENTAL PREDICTION
<b>NESDIS</b>	NATIONAL ENVIRONMENTAL SATELLITE DATA AND INFORMATION SERVICE
<b>NEXRAD</b>	NEXT GENERATION WEATHER RADAR
<b>NOAA</b>	NATIONAL OCEANIC AND ATMOSPHERIC ADMINISTRATION
<b>NOGAPS</b>	NAVAL OPERATIONAL GLOBAL ATMOSPHERIC PREDICTION SYSTEM
<b>NS</b>	NIMBOSTRATUS
<b>N-TFS</b>	NEW TACTICAL FORECAST SYSTEM
<b>NVA</b>	NEGATIVE VORTICITY ADVECTION
<b>NWP</b>	NUMERICAL WEATHER PREDICTION
<b>NWS</b>	NATIONAL WEATHER SERVICE
<b>OVV</b>	OMEGA VERTICAL VELOCITY
<b>PA</b>	PRESSURE ALTITUDE
<b>PGF</b>	PRESSURE GRADIENT FORCE
<b>PIREP</b>	PILOT REPORT
<b>PFJ</b>	POLAR FRONT JET
<b>PMSV</b>	PILOT TO METRO SERVICE
<b>POP</b>	PROBABILITY OF PRECIPITATION
<b>POPT</b>	PROBABILITY OF PRECIPITATION TYPE
<b>POR</b>	PERIOD OF RECORD
<b>POSA</b>	PROBABILITY OF SNOW ACCUMULATION
<b>PVA</b>	POSITIVE VORTICITY ADVECTION
<b>PWI</b>	PRECIPITABLE WATER INDEX
<b>QFE</b>	STATION PRESSURE
<b>QNE</b>	PRESSURE ALTITUDE
<b>QNH</b>	ALTIMETER SETTING
<b>QPF</b>	QUANTITATIVE PRECIPITATION FORECAST
<b>R</b>	BASE REFLECTIVITY
<b>RAOB</b>	RADIOSONDE OBSERVATION
<b>RAREP</b>	RADAR REPORT
<b>RCS</b>	REFLECTIVITY CROSS SECTION
<b>RDA</b>	RADAR DATA ACQUISITION
<b>RH</b>	RELATIVE HUMIDITY
<b>RMS</b>	ROOT MEAN SQUARE
<b>RW</b>	RAIN SHOWER
<b>S</b>	SEVERE TURBULENCE
<b>SBLI</b>	SURFACE-BASED LIFTED INDEX
<b>SC</b>	STRATOCUMULUS
<b>SCT</b>	SURFACE CROSS TOTALS
<b>SFC</b>	SURFACE
<b>SHARP</b>	SKEW-T/HODOGRAPH ANALYSIS AND RESEARCH PROGRAM
<b>SIGMET</b>	SIGNIFICANT METEOROLOGICAL INFORMATION
<b>SLD</b>	SUPER-COOLED LARGE WATER DROPLETS
<b>SLP</b>	SEA LEVEL PRESSURE

<b>SOCS</b>	SURFACE OBSERVATION CLIMATIC SUMMARIES
<b>SRDS</b>	STORM RELATIVE DIRECTIONAL SHEAR
<b>SRH OR S-RH</b>	STORM RELATIVE HELICITY
<b>SSI</b>	SHOWALTER STABILITY INDEX
<b>ST</b>	STRATUS
<b>STJ</b>	SUBTROPICAL JET
<b>SST</b>	SEA SURFACE TEMPERATURE
<b>SWEAT</b>	SEVERE WEATHER THREAT INDEX
<b>T</b>	TEMPERATURE
<b>TAF</b>	TERMINAL AERODROME FORECAST
<b>TFRN</b>	TEMPERATURE HUMIDITY INDEX
<b>T</b>	THOMPSON INDEX
<b>TRW</b>	THUNDERSTORM/RAIN SHOWER
<b>TT</b>	TOTAL TOTALS
<b>UGDF</b>	UNIFORM GRIDDED DATA FIELD
<b>UK</b>	UNITED KINGDOM
<b>USAF</b>	UNITED STATES AIR FORCE
<b>USN</b>	UNITED STATES NAVY
<b>UTC</b>	UNIVERSAL TIME COORDINATE (FORMERLY GMT)
<b>VAD</b>	VELOCITY AZIMUTH DISPLAY
<b>VCNTY OR VC</b>	VICINITY
<b>VIL</b>	VERTICALLY INTEGRATED LIQUID
<b>VIS</b>	VISIBILITY (VISIBLE SATELLITE IMAGERY)
<b>VMC</b>	VISUAL METEOROLOGICAL CONDITIONS
<b>VT</b>	VERTICAL TOTALS
<b>VWP</b>	VAD WIND PROFILE
<b>WAA</b>	WARM AIR ADVECTION
<b>WBGT</b>	WET-BULB GLOBE TEMPERATURE
<b>WBZ</b>	WET-BULB ZERO
<b>WMO</b>	WORLD METEOROLOGICAL ORGANIZATION
<b>WSR-88D</b>	WEATHER SURVEILLANCE RADAR-1988 DOPPLER
<b>WV</b>	WATER VAPOR IMAGERY
<b>X</b>	EXTREME



## GLOSSARY

**Adiabatic Process.** A thermodynamic change of state in a system in which there is no transfer of heat or mass across the boundaries of the system. An example of such a system is the concept of the air parcel. In an adiabatic process, compression always results in warming and expansion in cooling.

**Advection.** The horizontal transfer of an atmospheric property by the wind.

**Ageostrophic.** The vector difference between the observed wind and the geostrophic wind.

**Air Mass.** A large body of air that is largely homogenous both horizontally and vertically in temperature and moisture.

**Altimeter Setting.** The station pressure reduced to sea level without compensating for temperature.

**Apparent Temperature.** What the air temperature “feels like” for various combinations of temperature and relative humidity.

**Baroclinic.** A state in which a constant-pressure surface intersects a constant density surface. In upper-air products, can be seen where height lines intersect isotherms.

**Barotropic.** A state in which a constant-pressure surface is coincident with a constant density surface. In upper-air products, can be seen where height lines parallel isotherms.

**Bora.** Cold, dry, gale-force, gravity-assisted winds that blow down from mountains.

**Bounded Weak Echo Region (BWER).** (Also known as a vault.) A radar signature within a thunderstorm characterized by a nearly vertical weak echo surrounded on the sides and top by significantly stronger echoes. This feature is associated with a strong updraft and is almost always found in the inflow region of a thunderstorm. It cannot be seen visually. See WER.

**Boundary Layer.** Also called Surface Boundary Layer and Friction Layer. The layer of air immediately adjacent to the earth’s surface.

**Bow Echo.** A bow shaped line of convective cells that is often associated with swaths of damaging straight-line winds and small tornadoes.

**Convective Available Potential Energy (CAPE).** The amount of energy available to create convection, with higher values indicating the possibility for severe weather.

**Centripetal Force.** The force that tends to keep an air parcel moving in a curved path, such as isobars.

**Chinook.** A warm and dry (sometimes very strong) wind that flows down the leeward side of mountains.

**Clear Icing.** A layer or mass of ice which is relatively transparent because of its homogeneous structure and small number and size of air pockets. Clear icing is associated with freezing rain or drizzle and cumuliform cloud formations.

**Cloud Streets.** Rows of cumulus or cumulus-type clouds aligned parallel to the low-level flow. Cloud streets can sometimes be seen from the ground, but are best seen on satellite imagery.

**Coalescence.** Usually used to denote the growth of water drops by collision. The term is also used for the growth of an ice particle by collision with water drops.

**Cold-air Advection.** The horizontal transport of colder air into a region by wind. See warm-air advection.

**Cold Front.** Any nonoccluded front, or portion thereof, that moves so that the colder air replaces the warmer air; that is, the leading edge of a relatively cold air mass.

**Cold Low.** At a given level in the atmosphere, any low that is generally characterized by colder air near its center than around its periphery. A significant case of the cold low is that of a cut-off low, characterized by a completely isolated pool of cold air.

**Cold Pool.** A region of relatively cold air, represented on a weather map analysis as a relative minimum in temperature surrounded by closed isotherms. Cold pools aloft represent regions of relatively low stability, while surface-based cold pools are regions of relatively stable air.

**Comma Echo.** A thunderstorm radar echo which has a comma-like shape. It often appears during latter stages in the life cycle of a bow echo.

**Conditional Instability.** Stable unsaturated air that results in instability in the event or on the condition that the air becomes saturated.

**Condensation.** The process in which a vapor is turned into a liquid, such as water vapor into water droplets. Condensation is the opposite of evaporation.

**Confluence.** A pattern of airflow in which wind direction converges along an axis oriented parallel to the flow. The opposite of diffluence. Confluence can be, but is not necessarily, mass convergence.

**Convection.** The mass motion within a fluid, resulting in the transport and mixing of the properties of that fluid. This could be the transport of heat and/or moisture. It is often used to imply only upward vertical motion; in this sense, it is the opposite of subsidence.

**Convective Temperature.** The temperature the air near the ground must warm to in order for surface-based convection to develop. However, thunderstorms may develop well before or well after the convective temperature is reached (or may not develop at all) due to conditions other than heating. Convective temperature can be a useful parameter for forecasting the onset of convection.

**Convergence.** A contraction of a vector wind field; the opposite of divergence. Convergence in a horizontal wind field indicates that more air is entering a given area than is leaving at that level. To compensate for the resulting excess, vertical motion may result—upward forcing if convergence is at low levels or downward forcing (subsidence) if convergence is at high levels.

**Convergent Asymptote.** Any horizontal line along which horizontal convergence of the airflow is occurring. See Divergent Asymptote.

**Coriolis Force.** An apparent force due to the spinning earth that deflects an air parcel to the right of its motion in the Northern Hemisphere. The force deflects parcels to the left in the Southern Hemisphere.

**Density Altitude.** Density altitude is the pressure altitude corrected for temperature and humidity.

**Derecho.** A line of intense, fast-moving thunderstorms that moves across a great distance. They are characterized by damaging straight-line winds over hundreds of miles.

**Dew Point.** The temperature to which air must be cooled to reach saturation (at constant pressure and water vapor content). Also called dew point temperature.

**Diffluence.** A pattern of air flow where wind direction spreads apart (or “fans-out”) along an axis oriented parallel to the flow. The opposite of confluence. Diffluence is not the same as divergence. In diffluent flow, winds normally decelerate as they move through the region of diffluence, resulting in speed convergence which offsets the apparent divergence of the diffluent flow.

**Divergence.** The expansion or spreading out of a vector wind field resulting in a net outflow of air from a particular region; usually said of horizontal winds. It is the opposite of convergence. Divergence at upper levels of the atmosphere enhances upward motion, and hence the potential for thunderstorm development.

**Divergent Asymptote.** Any horizontal line along which horizontal divergence of the airflow is occurring.

**Downburst.** A strong localized downdraft resulting in an outward burst of cool air creating damaging winds at or near the surface. Sometimes the damage resembles tornadic damage. Usually associated with thunderstorms, downbursts can occur with showers too weak to produce thunder. See Microburst.

**Downdraft.** A sudden descent of cool or cold column of air towards the ground, usually with precipitation, and associated with a thunderstorm or shower. Contrast with an updraft.

**Drainage Wind.** A wind directed down the slope of an incline caused by density differences.

**Dry Line.** The boundary between a dry air mass (e.g., from the desert southwest) and a moist air mass (e.g., from the Gulf of Mexico). The passage of a dry line results in a sharp decrease in humidity, clearing skies, and a wind shift from southeasterly or south to southwesterly or west. It usually lies north-south across the central and southern Plains states during spring and summer, and its presence influences severe weather development in the Great Plains.

**Dry Microburst.** A microburst with little or no precipitation reaching the ground; most common in semiarid regions. Dry microbursts may develop in an otherwise fair-weather pattern; visible signs may include a cumulus cloud or small cumulonimbus with a high base and high-level virga, or an orphan anvil from a dying rain shower. At the ground, the only visible sign might be a dust plume or a ring of blowing dust beneath a local area of virga. Compare with Wet Microburst.

**Dry Slot.** An intrusion of dryer air into a region of moist air. Usually seen in the formation of comma clouds.

**D-Value.** The difference between the true altitude and the standard altitude of a pressure surface.

**Empirical.** Relying upon or gained from experiment or observation.

**Eta Model.** NWS forecast model. Eta is not an acronym, but a letter in the Greek alphabet.

**Evaporation.** The process in which a liquid is turned into a gas, such as liquid water turning into water vapor. Evaporation is the opposite of condensation.

**Extrapolation.** The technique of forecasting the position of a weather feature based solely upon recent past motion of that feature.

**Fall Wind.** Similar to a drainage wind, but with cold air on a much larger (and stronger) scale.

**Fetch.** Distance the wind blows over open water.

**Flanking Line.** A line of cumulus or towering cumulus clouds connected to and extending outward from the most active part of a supercell, normally on the southwest side. The line normally has a stair-step appearance, with the tallest clouds closest to the main storm, and generally coincides with the pseudo-cold front.

**Flash Flood.** A flood that rises and falls rapidly with little or no advance warning, usually because of intense rainfall over a relatively small area.

**Foehn Wind.** See Chinook Wind.

**Fog.** A hydrometeor consisting of visible water droplets suspended in the atmosphere near the earth's surface that restricts visibility below 1000 meters (0.62 miles). Fog can also be considered a cloud on the earth's surface.

**Fog Index.** An index derived from a formula that uses surface and 850-mb parameters to determine stability. The lower the index, the greater the likelihood of fog. Also called the fog stability index.

**Forward-Flank Downdraft.** The main region of downdraft in the forward, or leading, part of a supercell, where most of the heavy precipitation is. Compare with Rear-Flank Downdraft.

**Gale.** A wind with mean wind speeds of 34 to 40 knots and gusts of 43 to 51 knots.

**Geostrophic Wind.** A wind that results from the balance of the pressure gradient force and Coriolis Force. It causes winds to blow parallel to isobars.

**Gradient Wind.** The wind that results from the balance of the sum of the Coriolis Force and centripetal force and the pressure gradient force.

**Gust Front.** The leading edge of gusty surface winds from thunderstorm downdrafts; sometimes associated with a shelf cloud or roll cloud. See also Downburst, Outflow Boundary.

**Haze.** A lithometeor consisting of fine dust, salt, or pollutant particles dispersed through a portion of the atmosphere. The particles are so small they are not felt or individually seen with the naked eye.

**Heat Index.** An index that combines temperature and relative humidity to determine an apparent temperature. Heat index thresholds are used to indicate the effects of heat and humidity on the human body.

**Helicity.** A property of a moving fluid which represents the potential for helical flow (flow which follows a corkscrew pattern) to evolve. Helicity is proportional to the strength of the flow, the amount of vertical wind shear, and the amount of turning in the flow (vorticity). Atmospheric helicity is computed from the vertical wind profile in the lower part of the atmosphere (usually from the surface up to 3 km), and is measured relative to storm motion.

**High-Precipitation Supercell (HP Supercell).** A supercell thunderstorm in which heavy precipitation (often including hail) falls on the trailing side of the mesocyclone. Precipitation often totally envelops the region of rotation, making visual identification of any embedded tornadoes difficult and very dangerous. Unlike classic supercells, the region of rotation in many HP storms develops in the front-flank region of the storm. HP supercell storms often produce extreme and prolonged downburst events, serious flash flooding, and very large damaging hail events.

**Hodograph.** A polar coordinate plot of wind vectors representing the vertical distribution of horizontal winds. Hodograph interpretation can help in forecasting the potential evolution of thunderstorms (squall line vs. supercells, splitting vs. non-splitting storms, tornadic vs. non-tornadic storms, etc.). Also, a method of analyzing a wind sounding. The individual wind vectors at selected levels are plotted head-to-tail on a polar coordinate diagram.

**Hook (or Hook Echo).** A radar reflectivity pattern characterized by a hook-shaped extension of a thunderstorm echo, usually in the right-rear part of the storm (relative to its direction of motion). A hook often is associated with a mesocyclone, and indicates favorable conditions for tornado development.

**Hydrometeors.** Any substance produced by the condensation or deposition of water vapor in the air.

**Insolation.** The intensity at a specified time, or the amount in a specified period, of direct solar radiation incident on a unit of horizontal surface on or above the earth's surface.

**Inflow Notch.** A radar signature characterized by an indentation in the reflectivity pattern on the inflow side of the storm. The indentation often is V-shaped, but this term should not be confused with V-notch. Supercell thunderstorms often exhibit inflow notches, usually in the right quadrant of a classic supercell, but sometimes in the eastern part of an HP supercell storm or in the rear part of a storm (rear inflow notch).

**Instability.** The state of equilibrium in which a parcel of air when displaced has a tendency to move further away from its original position (e.g., the tendency to accelerate upward after being lifted). It is a prerequisite condition of the atmosphere for spontaneous convection and severe weather to occur. For

example, air parcels, when displaced upward, often accelerate forming cumulus clouds and possibly thunderstorms.

**Inversion.** A departure from the usual increase or decrease of an atmospheric property with altitude. It usually refers to an increase in temperature with increasing altitude, which is a departure from the usual decrease of temperature with height in the tropopause.

**Isallobar.** The line of equal change in atmospheric pressure during a certain time period. It marks the change in pressure tendency.

**Isallotherm.** A line of equal temperature change.

**Isobar.** A line connecting points of equal pressure.

**Isochrone.** A line drawn on a map in such a way as to join places at which a phenomenon is observed at the same time, i.e. lines indicating the places at which rain commences at a specified time.

**Isodrosotherm.** The line connecting points of equal dew point.

**Isogon.** Line connecting points of equal wind direction.

**Isopleth.** General term for a line connecting points of equal value of some quantity. Isobars and isotherms are examples of isopleths.

**Isotach.** A line connecting points of equal wind speed.

**Isotherm.** A line of equal temperature.

**Jet Stream.** An area of strong winds concentrated in a relatively narrow band in the middle latitudes and subtropical regions of the Northern and Southern Hemispheres. The most well-known is the polar jet stream flowing in a semi-continuous band around the globe from west to east, it is caused by the temperature gradient where cold polar air moving towards the equator meets warmer equatorial air moving poleward. It is marked by a strong temperature gradient and strong vertical wind shear. Various types of jet streams include the following: arctic, low level, polar, and subtropical jets.

**Kelvin-Helmholtz Instability.** Instability arising from a strong vertical shear of wind through a narrow atmospheric layer across which there is a sharp gradient of temperature and density; e.g., at an inversion. A wave-like perturbation may be set up which gains energy at the expense of the large-scale flow.

**Land Breeze.** A breeze that blows from land to sea at night. Part of the land/sea breeze couplet.

**Lapse Rate.** The rate of change of temperature with height.

**Lithometeor.** The general term for dry atmospheric suspensoids, including dust, haze, smoke, and sand.

**Line Echo Wave Pattern (LEWP).** A special configuration in a line of convective storms that indicates the presence of a low-pressure area and the possibility of damaging winds and tornadoes. In response to very strong outflow winds behind it, a portion of the line may bulge outward forming a bow echo.

**Loess.** Buff to yellowish brown loamy soil deposited by wind.

**Low-level Jet.** Strong winds that are concentrated in relatively narrow bands in the lower part of the atmosphere. It is often amplified at night. The strong southerly wind over the United States Plains states during spring and summer is a notable example. See Jet Stream.

**Low-Precipitation Supercell (LP Supercell).** A supercell thunderstorm characterized by a relative lack of precipitation. Visually similar to a classic supercell, except without the heavy precipitation core. LP supercell storms often exhibit a striking appearance; the main tower often is bell-shaped, with a corkscrew appearance suggesting rotation. They are capable of producing tornadoes and very large hail. Radar identification often is difficult relative to other types of supercells, so visual reports are very important. LP supercell storms usually occur on or near the dry line, and thus are sometimes referred to as dry line storms.

**Macroscale.** The meteorological scale for obtaining weather information covering an area ranging from the size of a continent to the entire globe. Systems have a horizontal size greater than 1500 NM and duration from several days to over a week; e.g., long waves and semipermanent pressure systems.

**Maritime Air Mass.** An air mass influenced by the sea. It is a secondary characteristic of an air mass classification, signified by the small “m” before the primary characteristic, which is based on source region. For example, mP is an air mass that is maritime polar in nature. Also known as a “marine air mass.”

**Mesoscale.** Systems vary in size horizontally from 1 to 500 NM and duration from tens of minutes to several hours. This includes mesoscale convective complexes, mesoscale convective storms, and squall lines. Smaller phenomena are classified as microscale, while larger are classified as synoptic-scale.

**Mesocyclone.** A storm-scale region of rotation, typically 2 to 6 miles in diameter and often found in the right rear flank of a supercell (or often on the eastern, or front, flank of an HP supercell). The region of a mesocyclone is a known area for tornadogenesis. Mesocyclone, used as a radar term, is defined as a rotation signature on Doppler radar that meets specific criteria for magnitude, vertical depth, and duration.

**Mesoscale Convective Complex (MCC).** A large, round or oval-shaped, mesoscale convective system (MCS), which is approximately 100,000 km<sup>2</sup> in size and lasts at least 6 hours. Generally forms during the afternoon and evening, during which the threat of severe weather is the greatest. It normally reaches its peak intensity at night, when heavy rainfall and flooding become the primary threats. However, severe weather may occur anytime during its life cycle.

**Mesoscale Convective System (MCS).** A large, organized convective weather system comprised of a number of individual thunderstorms. It normally persists for several hours and may be rounded or linear in shape. This term is often used to describe a cluster of thunderstorms that does not meet the criteria for a mesoscale convective complex (MCC).

**Metamorphism.** A pronounced change in internal structure due to pressure, heat, and water that results in a more compact and more highly crystalline condition, e.g., snow pack changing to ice.

**Microburst.** A severe localized wind blasting down from a thunderstorm. It covers an area less than 2.5 miles (4 km) in diameter and is of short duration, usually less than 5 minutes. See downburst.

**Microscale.** Systems have a horizontal size less than 1 NM and duration from a few seconds to a few minutes. These comprise the smallest weather systems.

**Middle Latitudes.** The latitude belt roughly between 35° and 65° North and South. Also referred to as the temperate region.

**Mie Scattering.** Scattering of energy predominantly in a forward direction from particles in the air.

**Mixed Icing.** A combination of clear and rime icing.

**Mountain Breeze.** A breeze that descends a mountain slope during the night. It is caused by surface cooling of an incline.

**Mountain Waves.** Waves formed on the leeside (lee waves) of a mountain barrier, characterized by strong turbulence.

**Nephanalysis.** The analysis of a synoptic product in terms of the types and amount of clouds and/or precipitation.

**Orographic.** Related to, or caused by, physical geography such as mountains or sloping terrain.

**Outflow Boundary.** A storm-scale or mesoscale boundary separating thunderstorm-cooled air (outflow) from the surrounding air; similar in effect to a cold front, with passage marked by a wind shift and usually a drop in temperature. Outflow boundaries may persist for 24 hours or more after the thunderstorms that generated them dissipate, and may travel hundreds of miles from their area of origin. New thunderstorms often develop along outflow boundaries, especially near the point of intersection with another boundary (cold front, dry line, another outflow boundary, etc.).

**Overrunning.** Refers to an air mass moving over a denser surface air mass, such as warm air moving over a cold air mass in a warm front. Weather generally associated with this event includes cloudiness, cool temperatures, and steady rain.

**Persistence.** The tendency for a phenomenon to occur in the future, given it occurred in the immediate past. For example, if it rained the past two hours, persistence says it will rain during the next hour.

**Pressure Altitude.** The height of a given level in the ICAO STANDARD ATMOSPHERE above the level corresponding to a pressure of 1013.2 mb.

**Pressure Gradient Force (PGF).** The primary force responsible for winds. It arises from spatial atmospheric pressure differences and acts in the direction from high to low pressure.



**Pseudo-cold Front.** A boundary between a supercell's inflow region and the rear-flank downdraft. It extends outward from the mesocyclone center, usually toward the south or southwest (but occasionally bows outward to the east or southeast in the case of an occluded mesocyclone), and is characterized by advancing of the downdraft air toward the inflow region. It is a particular form of gust front.

**Pulse Storm.** A thunderstorm within which a brief period (pulse) of strong updraft occurs, during and immediately after which the storm produces a short episode of severe weather. These storms generally are not tornado producers, but often produce large hail and/or damaging winds.

**Q-Vector.** A measure of atmospheric motion that combines temperature advection and divergence due to changes in vorticity advection with height.

**Rain-free Base.** A dark, horizontal cloud base with no visible precipitation beneath it. It typically marks the location of the thunderstorm updraft. Tornadoes may develop from wall clouds attached to the rain-free base, or from the rain-free base itself—especially when the rain-free base is on the south or southwest side of the main precipitation area.

**Rear-Flank Downdraft (RFD).** Regions of dry air subsiding on the backside of, and wrapping around, a mesocyclone. It often is visible as a clear slot wrapping around the wall cloud. Scattered large precipitation particles (rain and hail) at the interface between the clear slot and wall cloud may show up on radar as a hook or pendant; thus the presence of a hook or pendant may indicate the presence of an RFD.

**Relative Humidity.** An indicator of moisture in the air, expressed as a percentage. It is the ratio of the actual mixing ratio to the saturation mixing ratio of the air.

**Rime Icing.** Deposit of white, rough ice crystals which form when supercooled water droplets of fog come into contact with a solid object (e.g., aircraft) at a temperature below 0° C.

**Shear.** The change in wind speed (speed shear) and/or direction (directional shear) over a short distance. It can occur vertically, such as a change with height (vertical wind shear), or horizontally. The term also is used in Doppler radar to describe changes in radial velocity over short horizontal distances.

**Squall.** A sudden onset of strong winds with speeds increasing by at least 16 knots and sustained at 22 or more knots for at least one minute. The intensity and duration is longer than that of a gust.

**Squall Line.** A narrow band or line of active thunderstorms. It may form from an outflow boundary or the leading edge of a mesohigh.

**Stable/Stability.** Occurs when a rising air parcel becomes denser than the surrounding air. It then returns to its original position. When the density of the air parcel remains the same as the surrounding air after being lifted, it is also considered stable, since it does not have the tendency to rise or sink further. Contrast with unstable air and instability.

**Standard Atmosphere.** The internationally agreed upon vertical distribution of temperature, pressure, and density taken as representative of the atmosphere.

**Storm Scale.** Refers to weather systems with sizes on the order of individual thunderstorms. See Synoptic Scale, Mesoscale.

**Straight-line Winds.** Generally, any wind that is not associated with rotation, and is used mainly to differentiate from tornadic winds.

**Streamline.** Arbitrarily spaced lines whose tangent at any point in the flow is parallel to the horizontal velocity vector at a particular level at a particular instant in time.

**Subsidence.** A sinking or downward motion of air, often seen in anticyclones. It is most prevalent when there is colder, denser air aloft. It is often used to imply the opposite of atmospheric convection.

**Supercell.** A severe thunderstorm characterized by a rotating, long-lived, intense updraft. Although not very common, they produce a relatively large amount of severe weather that includes extremely large hail, damaging straight-line winds, and practically all violent tornadoes.

**Suspensoid.** A system composed of one substance dispersed throughout another substance. E.g., dust dispersed through the atmosphere.

**Synoptic Scale (or Large Scale).** Size scale referring generally to weather systems with horizontal dimensions of several hundred miles or more. Most high and low pressure areas seen on weather maps are synoptic-scale systems. Systems vary in size horizontally from 500 NM to 1,000 NM and duration from tens of hours to several days, e.g., migratory cyclones and frontal systems.

**Thermal Ribbon.** A band of closely-spaced isotherms.

**Trajectory.** The path in the atmosphere tracing the points successively occupied by an air parcel in motion.

**Tropopause.** The upper boundary of the troposphere, between the troposphere and the stratosphere, usually characterized by an abrupt change in lapse rate from positive (decreasing temperature with height) to neutral or negative (temperature constant or increasing with height).

**Unstable/Instability.** Occurs when a rising air parcel becomes less dense than the surrounding air. Since its temperature does not cool as rapidly as the surrounding environment, it continues to rise on its own.

**Updraft.** A small-scale current of rising air. If the air is sufficiently moist, then the moisture condenses to become a cumulus cloud or an individual tower of a towering cumulus or cumulonimbus.

**Valley Breeze.** A wind that ascends a mountain slope during the day.

**Virtual Temperature.** In a given air mass, the temperature of dry air having the same density and pressure as the given air mass.

**Visibility.** The greatest distance in a given direction at which it is just possible to see and identify with the unaided eye: (1) in the daytime, a prominent dark object against the sky at the horizon, (2) at night, a preferably unfocused, moderately intense light source.

**V-notch.** A radar reflectivity signature seen as a V-shaped notch in the downwind part of a thunderstorm echo. The V-notch often is seen on supercells, and is thought to be a sign of diverging flow around the main storm updraft (and hence a very strong updraft). This term should not be confused with inflow notch or with enhanced V, although the latter is believed to form by a similar process.

**Vorticity.** A measure of the local rotation in a fluid flow. It usually refers to the vertical component of rotation (rotation about a vertical axis) and is used most often in reference to synoptic scale or mesoscale weather systems. By convention, positive values indicate cyclonic rotation.

**Wall Cloud.** A localized, persistent, often abrupt lowering from a rain-free cloud base. Wall clouds can range from a fraction of a mile to nearly 5 miles in diameter, and normally are found on the south or southwest (inflow) side of the thunderstorm. When seen from within several miles, many wall clouds exhibit rapid upward motion and cyclonic rotation. However, not all wall clouds rotate. Rotating wall clouds usually develop before strong or violent tornadoes, by anywhere from a few minutes up to nearly an hour. Wall clouds should be monitored visually for signs of persistent, sustained rotation, and/or rapid vertical motion.

**Warm-air Advection.** The horizontal transport of warmer air into a region by wind.

**Warm Cloud-Top Rain.** Rain that falls from clouds whose tops do not reach the freezing level. The coalescence process initiates such rain.

**Weak Echo Region (WER).** Radar term for a region of relatively weak reflectivity at low levels on the inflow side of a thunderstorm echo, topped by stronger reflectivity in the form of an echo overhang directly above it. The WER is a sign of a strong updraft on the inflow side of a storm, within which precipitation is held aloft. When the area of low reflectivity extends upward into, and is surrounded by, the higher reflectivity aloft, it becomes a BWER.

**Wet Microburst.** A microburst accompanied by heavy precipitation at the surface. A rain foot may be a visible sign of a wet microburst. See Dry Microburst.

**Whiteout.** An atmospheric optical phenomenon of the Polar Regions in which the observer appears to be engulfed in a uniformly white glow. Shadows, horizon, or clouds are indiscernible; sense of depth and orientation is lost; only very dark, nearby objects can be seen.

# Subject Index

## A

### AIRCRAFT ICING

- Icing formation processes and classification 2-39
  - icing factors 2-41
    - liquid water content 2-41
    - temperature 2-42
    - droplet size 2-42
      - collection efficiency 2-42
    - altitude 2-42
  - icing in precipitation 2-43
    - introduction 2-44
    - physical mechanisms 2-44
      - collision-coalescence 2-44
      - warm-layer process 2-44
    - where supercooled large droplets are found 2-44
  - icing severity 2-43
    - pilot definitions 2-43
      - light 2-43
      - moderate 2-43
      - severe 2-43
      - trace 2-43
  - icing types 2-42
    - clear 2-42
    - frequency and occurrence 2-42
    - mixed 2-42
    - rime 2-42
  - phase transitions 2-40
    - condensation 2-40
    - deposition 2-41
    - evaporation 2-40
    - freezing 2-40
    - melting 2-40
    - sublimation 2-41
    - processes 2-39
    - terrain 2-39
    - fronts 2-39
    - cyclones 2-39
- Meteorological considerations 2-45
  - cloud type 2-45
    - stratiform 2-45
    - cumuliform 2-45
    - cirriform 2-46
  - frontal systems 2-46

above frontal surface aloft	2-46
below frontal surface aloft	2-46
frontal icing characteristics	2-47
cold fronts	2-47
warm fronts	2-47
stationary and occluded fronts	2-47
other icing conditions	2-47
induction icing	2-47
air intake ducts	2-48
carburetor icing	2-48
terrain	2-47
Negative 8D (-8D) method	2-54
procedures	2-54
rules of thumb	2-55
Products and procedures	2-49
centralized products	2-49
AFWA high-level hazard charts	2-49
AIRMETS and SIGMETS	2-49
regional OWS icing products	2-49
upper-air data and reports	2-49
other composites	2-50
horizontal weather depiction	2-50
icing from freezing precipitation	2-50
PIREPS and AIREPS	2-49
surface products	2-50
upper-air data	2-49
upper-air composites on N-TFS	2-49
moisture	2-50
thermal advection patterns	2-50
vorticity	2-50
wind speed (jet stream)	2-50
vertical cross section	2-50
relative humidity	2-50
temperature and dew-point depression-icing occurrence	2-50
temperature and icing types	2-50
Standard system applications	2-51
radar	2-51
bright band identification	2-52
cold-air advection	2-51
freezing level	2-52
satellite imagery	2-53
GOES-8 and GOES-9 imagery	2-53
channel 1 (visible)	2-53
channel 2 (near infrared)	2-53
channel 4 infrared	2-53
GMS and Meteosat	2-53

## C

### CLOUDS

- Cloud forecasting techniques 2-9
  - cloud amounts 2-11
    - forecasting clouds in relation to 700-mb features 2-11
  - determining cloud heights 2-9
    - base of convective clouds using dew-point depressions 2-10
    - relative humidity and vertical velocity 2-11
    - using skew-T Log P diagram 2-9
      - parcel method 2-10
      - moist layer method 2-10
  - forecasting cirrus clouds 2-13
    - convective cirrus 2-13
    - tropopause method 2-13
  - formation, advection and dissipation of low stratus 2-12
    - dissipation of stratus using mixing ratio and temperature 2-12
    - empirical rules 2-12
    - wind speed 2-12
  - precipitation induced clouds 2-13
    - rain 2-13
    - snow 2-13
  - rules of thumb 2-14
- Cloud types/states of the sky 2-1
  - low clouds 2-1
    - cumulonimbus 2-2
    - cumulus 2-1
    - stratocumulus 2-1
    - stratus 2-2
  - middle clouds 2-2
    - altocumulus 2-3
    - altostratus 2-2
    - nimbostratus 2-3
  - high clouds 2-4
    - cirrocumulus 2-5
    - cirrostratus 2-5
    - cirrus 2-4
- General forecasting tools 2-5
  - climatology 2-5
    - conditional climatology 2-5
      - category-based CC 2-6
      - time-based CC 2-6
    - international station meteorological climate summary (ISMCS) 2-6
    - modeled ceiling and visibility (MODCV) 2-6

- modeled diurnal curves (MODCURVES) 2-6
- operational climate data summary (OCDS) 2-6
- surface observation climate summaries (SOCS) 2-6
- extrapolation 2-8
- model and centralized guidance 2-6
  - AFWA trajectory forecast bulletins 2-7
  - model output statistics 2-6
  - R1, R2 and R3 values 2-7
- weather radar 2-8
  - echo tops 2-8
  - reflectivity 2-8
  - reflectivity cross section 2-8
  - velocity azimuth display wind profile 2-8

## M

### MISCELLANEOUS FLIGHT WEATHER ELEMENTS

- Contrails 2-58
  - bypass engines 2-59
  - contrail types 2-58
    - aerodynamic 2-58
    - engine exhaust 2-58
  - JAAWIN contrail chart 2-58
  - manual method for forecasting probability 2-60
- Chemical downwind message 2-89
- Cirrus forecasting 2-63
- Clutter or TAWS scene complexity 2-83
  - apparent, threshold and inherent contrast 2-84
  - high clutter 2-84
  - low clutter 2-83
  - medium clutter 2-84
  - minimum resolvable temperature 2-86
  - minimum detectable temperature 2-86
  - surface area-to-mass 2-86
  - thermal capacity 2-86
  - thermal conductivity 2-86
  - thermal response 2-86
- Ditch headings and wave height 2-64
- Electrooptics 2-77
  - atmospheric processes impacting EM energy 2-79
  - categories of electromagnetic energy 2-78
    - emission 2-79
    - reflection 2-79
    - scattering 2-80
    - absorption 2-82
  - distance and target size 2-83

- weather sensitivities on EO systems 2-87
- Flight level and climb winds 2-56
  - flight level winds 2-56
    - constant pressure products 2-56
    - satellite imagery 2-56
    - vertical cross section using distance Log-P 2-56
  - climb winds 2-57
    - skew-T Log P 2-57
    - time cross section 2-57
    - upper-air products 2-57
    - upper-air soundings 2-57
    - velocity azimuth display wind profile 2-57
- Forecasting in-flight visibility 2-62
  - cloud cover 2-62
  - in-flight visibility rules 2-62
    - cloud thickness 2-62
    - temperature/dew-point depressions 2-62
    - thunderstorm cirrus 2-62
- Nuclear fallout bulletins 2-89
- Sea surface temperatures 2-64
- Space weather 2-65
  - alerts and warnings 2-72
    - Energetic Particle Event Warning 2-75
    - Geomagnetic Event Warning 2-74
    - major solar flare event warning 2-73
    - radio event warning 2-76
    - short wave fade event warning 2-72
    - solar radio burst advisory 2-77
    - solar x-ray event warning 2-72
  - impacts on operations 2-65
  - space environment 2-65
  - products 2-65
    - estimated GPS single frequency error maps 2-71
    - HF illumination maps nowcast and forecast 2-71
    - point-to point HF radio usable frequency forecasts 2-70
    - space environment global situational product 2-65
    - UHF SATCOM scintillation nowcast and forecast 2-69
    - 6-hour forecast of ionospheric conditions impacting UHF SATCOM 2-68
    - 6-hour forecast of ionospheric conditions impacting HF propagation 2-68
- Temperature 2-57
- Thunderstorms 2-58
- Volcanic ash 2-90

## P

### PRECIPITATION



Determining precipitation type	1-18
freezing precipitation indicators	1-21
height of freezing level	1-21
checklist for snow vs. freezing drizzle	1-21
thickness	1-18
analyzing/extrapolating patterns	1-18
method 1	1-18
method 2	1-20
method 3	1-20
low-level thickness	1-20
mid-level thickness	1-20
Forecasting rainfall amounts	1-22
radar signatures associated with flash floods	1-22
satellite images	1-22
General Guidance	1-14
extrapolation	1-14
cloud-top temperatures	1-14
cold fronts	1-15
synoptic pattern	1-15
widespread post-frontal weather	
dew-point depression	1-14
drizzle formation	1-17
warm fronts	1-16
Miscellaneous general rules of thumb	1-30
drizzle	1-30
heavy snow	1-31
temperature	1-30
thickness and precipitation	1-30
Model Guidance	1-18
Snowfall	1-23
estimating rates/accumulation	1-23
snow index using 200-mb warm advection	1-24
using precipitable water index	1-25
using weather and visibility	1-23
forecasting snow showers	1-25
general guidance	1-23
heavy snow	1-26
favorable synoptic patterns	1-28
locating areas of maximum 12-hour snowfall	1-26
non-convective snowfall	1-26
satellite interpretation	1-28
shear zone heavy snow events	1-28
shear zone interpretation technique	1-28
lake effect snow	1-26
Snowfall and the physics involved	1-31

- conclusions 1-33
- microphysics of snow 1-32
  - growth by aggregation 1-32
  - growth by deposition 1-32
  - growth by riming 1-33
  - heterogeneous nucleation 1-32
  - melting layers 1-33

## PRESSURE

- General guidance 1-61
  - air mass effects 1-61
  - diurnal considerations 1-61
  - standard atmosphere 1-61
- Pressure-related parameters 1-62
  - altimeter setting 1-62
    - pressure conversion product 1-63
    - QNH 1-62
  - d-value 1-66
    - computed 1-66
    - graphical 1-66
  - density altitude 1-64
    - computed 1-64
    - graphical 1-65
  - pressure altitude 1-63
  - sea-level pressure 1-62
    - computing SLP 1-62
    - model output 1-62

## S

### SURFACE WINDS

- General tools for forecasting winds 1-36
  - calculating geostrophic winds 1-37
  - calculating gradient winds 1-38
  - calculating isallobaric winds 1-38
- climatology 1-36
  - international station meteorological climate summary (ISMCS) 1-37
  - surface observation climate summaries (SOCS) 1-37
- elevation effects 1-43
- local wind effects 1-44
  - drainage wind 1-44
  - fall wind 1-44
  - foehn 1-45
  - land and sea breeze 1-45
  - mountain breeze 1-44
  - valley breeze 1-44

- numerical output products 1-41
- satellite-derived winds 1-42
- satellite imagery 1-42
  - bow waves, plume clouds and Von Karmen vorticies 1-43
  - cumulus lines or streets 1-43
  - closed-cell cumulus 1-42
  - ice packs on large lakes and seas 1-43
  - lakes in summer 1-43
  - lakes in winter 1-43
  - leeside clearing 1-43
  - open-cell cumulus 1-42
  - smoke, ash and dust 1-43
  - stratocumulus lines 1-42
- topography 1-37
- trends 1-37
- unicorm gridded data fields 1-41
- wind profiles 1-41
- Specialized airfield operations topics 1-46
  - low-level wind shear 1-46
    - cold frontal boundary 1-48
    - warm frontal boundary 1-48
    - low-level inversions 1-49
    - thunderstorm gust front 1-49
    - mountain-wave conditions 1-49
  - runway crosswind 1-46
- Wind basics 1-35
  - flow around pressure systems 1-36
  - atmospheric forces 1-35
    - centrifugal and centripetal forces 1-35
    - coriolis force 1-35
    - frictional force 1-35
    - Pressure gradient force 1-35
  - wind types 1-36
    - actual wind 1-36
    - geostropic 1-36
    - gradient 1-36
    - isallobaric 1-36

## T

### TEMPERATURE

- Additonal rules of thumb 1-54
  - forecasting with limited data 1-54
  - high winds and cooling 1-55
  - humidity and cooling 1-55
- Forecasting maximum tempertures 1-52

- using the skew-T, Log P diagram 1-52
- when a low-level inversion is present 1-53
- when a warm front approaches 1-53
- within an air mass 1-52
- Forecasting minimum temperatures 1-54
  - after cold frontal passage 1-54
  - using dew point 1-54
  - using the skew-T, Log P diagram 1-54
- General temperature forecast tools 1-50
  - climatology 1-50
    - international station meteorological climate summary (ISMCS) 1-50
    - modeled diurnal curves (MODCURVES) 1-51
    - surface observation climate summaries (SOCS) 1-50
    - wind-stratified conditional climatology (WSCC) 1-50
  - extrapolation 1-51
  - modeled output statistics 1-51
    - maximum/minimum temperatures 1-51
    - hourly temperatures 1-51
  - persistence 1-51
  - temperature forecasting checklist 1-52
- Temperature indices 1-55
  - fighter index of thermal stress 1-57
  - heat index 1-56
  - temperature-humidity index 1-55
  - wet-bulb globe temperature heat stress index 1-56
  - wind chill 1-58

## THUNDERSTORMS

- Convective weather tools 3-13
  - evaluation and techniques 3-21
    - forecast products and techniques 3-21
    - forecasting hail and hail size 3-28
      - forecasting hail 3-29
      - forecasting hail size 3-29
  - identifying severe weather features 3-21
    - boundaries and boundary interaction features 3-25
      - MWA products 3-26
      - satellite analysis/sea breeze onset 3-25
      - WSR-88D 3-25
    - bow echo features 3-23
    - tornado features 3-21
      - supercell tornadoes 3-22
      - non-supercell tornadoes 3-22
    - wet microburst features 3-24
  - synoptic evaluation for potential severe weather 3-21
  - techniques 3-26
    - forecasting convective wind gusts 3-26

- Derecho checklist 3-28
- Snyder method 3-28
- T1 gust computation 3-26
  - T1 method 1 3-26
  - T1 method 2 3-27
  - T2 gust computation 3-27
- severe thunderstorm checklist 3-26
- stability indices 3-13
  - convective available potential energy 3-13
  - Bulk Richardson number 3-13
  - cross totals 3-13
  - dynamic index 3-14
  - energy/helicity index 3-14
  - Fawbush-Miller stability index 3-14
  - GSI index 3-14
  - K index 3-14
  - KO index 3-14
  - lifted index 3-15
  - modified lifted index 3-15
  - S index 3-15
- severe weather threat index 3-15
- Showalter stability index 3-15
- storm-relative directional shear 3-15
- storm-relative helicity 3-15
- surface cross totals 3-15
- Thompson index 3-15
- total totals 3-15
- vertical totals 3-16
- wet-bulb zero height 3-16
- Squall lines 3-12
- Synoptic patterns 3-5
  - Classic synoptic convective weather patterns 3-6
    - type a synoptic pattern (dryline) 3-6
      - characteristics 3-7
      - initial outbreak area 3-7
      - severe weather area 3-7
      - trigger mechanisms 3-7
      - timing 3-7
    - type b synoptic pattern (frontal) 3-8
      - characteristics 3-8
      - severe weather 3-8
      - severe weather areas 3-8
      - timing 3-9
      - trigger mechanisms 3-9
    - type c synoptic pattern (overrunning) 3-9
      - characteristics 3-10
      - severe weather 3-10

- severe weather areas 3-10
  - timing 3-10
  - trigger mechanisms 3-10
- type d synoptic pattern (cold core) 3-10
  - features 3-11
  - severe weather 3-11
  - severe weather areas 3-11
  - timing 3-11
  - trigger mechanisms 3-11
- type e synoptic pattern (squall line) 3-11
  - features 3-11
  - severe weather 3-11
  - severe weather areas 3-11
  - timing 3-12
  - trigger mechanisms 3-12
- Thunderstorm types 3-1
  - derechos 3-4
  - dry, wet and hybrid microbursts 3-4
  - multicellular 3-2
    - multicellular storm indicators 3-2
    - associated severe weather 3-2
  - single cell 3-1
    - single-cell storm indicators 3-1
    - associated severe weather 3-1
  - supercell 3-2
    - classic supercells 3-3
    - high-precipitation supercells 3-3
    - low-precipitation supercells 3-3

## TURBULENCE

- Aircraft turbulence sensitivities 2-15
  - fixed wing 2-16
  - rotary wing 2-16
- Causes of turbulence 2-16
  - thermal 2-17
  - mechanical 2-17
- Clear air turbulence 2-18
  - surface and upper-level patterns 2-18
    - shear lines in upper-level lows 2-20
    - surface cyclogenesis 2-18
    - upper-level lows 2-19
    - 500-mb CAT criteria 2-19
  - thermal patterns 2-22
    - closed isotherm patterns 2-23
    - open isotherm troughs 2-22
    - temperature gradients at/above 300 mb 2-22
  - troughs and ridges 2-24

- double trough configuration 2-25
- shearing troughs 2-24
- strong wind maximum to rear of upper trough 2-24
- upper-level ridges 2-25
- 500-mb deep pressure trough 2-24
- uses of upper-air data to forecast CAT 2-26
  - 700- and 850-mb height and temperature fields 2-26
  - 500-mb analysis of heights, temperature and vorticity 2-26
  - 250-mb jet stream 2-26
  - 200-mb analyzed height and temperature fields 2-26
- wind 2-20
  - confluent jets 2-21
  - diffluent wind patterns 2-20
  - jet stream turbulence model 2-20
  - strong winds 2-21
- Forecasting aids 2-32
  - checklist for predicting low-level turbulence 2-32
  - doppler weather radar 2-36
    - base velocity 2-37
    - spectrum width 2-37
    - velocity azimuth display wind profile 2-37
    - vertically integrated liquid 2-37
  - forecast weather models 2-37
  - forecasting turbulence in convective clouds 2-32
    - layers from surface to 9,000 feet 2-33
    - layers above 9,000 feet 2-34
  - location of turbulence conditions 2-32
  - low-level turbulence nomogram 2-34
  - satellite signatures and turbulence forecasting 2-35
    - deformation zone 2-35
    - wave cloud signatures 2-35
      - transverse bands 2-35
      - billows 2-35
      - water vapor image darkening 2-36
      - mountain waves 2-36
  - vertical cross sections 2-36
  - wind shear critical values 2-34
- Gravity waves and stratospheric turbulence 2-30
  - about gravity waves 2-30
  - forecasting gravity waves/stratospheric turbulence 2-30
- Levels of intensity 2-14
  - extreme 2-15
  - light 2-14
  - moderate 2-15
  - severe 2-15
- Mountain wave turbulence 2-26
  - associated clouds 2-28

- cap cloud 2-28
- roll cloud 2-28
- lenticular clouds 2-29
- conditions favorable for mountain wave turbulence 2-29
- occurrence indicators 2-29
- Wake turbulence 2-29
  - characteristics 2-29
  - dissipation 2-30

## V

### VISIBILITY

- Climatology 1-12
  - international station meteorological climate summary (ISMCS) 1-13
  - modeled ceiling and visibility (MODCV) 1-12
  - modeled diurnal curves (MODCURVES) 1-13
  - modeled output statistics 1-13
  - operational climate data summary (OCDS) 1-13
  - surface observation climate summaries (SOCS) 1-13
- Final thoughts on visibility 1-14
- Forecasting aids and techniques 1-10
  - determining fog height 1-11
  - graphical method for forecasting fog 1-10
  - fog point 1-11
  - fog stability index 1-11
  - fog threat 1-11
  - using streamlines to forecast visibility near the coast 1-10
- Forecasting rules of thumb 1-3
  - dry obstructions 1-3
    - dry haze 1-3
    - duststorm generation 1-3
  - moist obstructions 1-4
    - blowing snow 1-4
    - fog 1-5
      - dissipation 1-6
      - formation 1-5
      - general forecasting guidance 1-6
      - specific forecasting guidance 1-7
        - advection fog 1-7
        - frontal fog 1-8
        - radiation fog 1-7
    - precipitation 1-4
- Types of obstructions 1-1
  - dry obstructions 1-1
    - blowing dust and sand 1-1
    - dry haze 1-1



smoke 1-1  
moist obstructions 1-1  
fog 1-2  
    advection 1-2  
    frontal 1-3  
    ice 1-3  
    radiation 1-2  
    steam 1-2  
    sublimation 1-3  
    upslope 1-2  
precipitation 1-1  
suspended water particles 1-1  
whiteout conditions 1-2