

Expert Meeting Report: Interior Insulation Retrofit of Mass Masonry Wall Assemblies

K. Ueno and R. Van Straaten
Building Science Corporation (BSC)

February 2012

NOTICE

This report was prepared as an account of work sponsored by an agency of the United States government. Neither the United States government nor any agency thereof, nor any of their employees, makes any warranty, express or implied, or assumes any legal liability or responsibility for the accuracy, completeness, or usefulness of any information, apparatus, product, or process disclosed, or represents that its use would not infringe privately owned rights. Reference herein to any specific commercial product, process, or service by trade name, trademark, manufacturer, or otherwise does not necessarily constitute or imply its endorsement, recommendation, or favoring by the United States government or any agency thereof. The views and opinions of authors expressed herein do not necessarily state or reflect those of the United States government or any agency thereof.

Available electronically at <http://www.osti.gov/bridge>

Available for a processing fee to U.S. Department of Energy
and its contractors, in paper, from:

U.S. Department of Energy
Office of Scientific and Technical Information
P.O. Box 62
Oak Ridge, TN 37831-0062
phone: 865.576.8401
fax: 865.576.5728
email: <mailto:reports@adonis.osti.gov>

Available for sale to the public, in paper, from:

U.S. Department of Commerce
National Technical Information Service
5285 Port Royal Road
Springfield, VA 22161
phone: 800.553.6847
fax: 703.605.6900
email: orders@ntis.fedworld.gov
online ordering: <http://www.ntis.gov/ordering.htm>



Printed on paper containing at least 50% wastepaper, including 20% postconsumer waste

Expert Meeting Report: Interior Insulation Retrofit of Mass Masonry Wall Assemblies

Prepared for:
Building America
Building Technologies Program
Office of Energy Efficiency and Renewable Energy
U.S. Department of Energy

Prepared by:
K. Ueno and R. Van Straaten
Building Science Corporation
30 Forest Street
Somerville, MA 02143

Technical Monitor: Cheryn Engebrecht
Subcontract Number: KNDJ-0-40337-00
January 2012

[This page left blank]

Contents

Figures	vi
Tables	vi
Definitions	vii
Executive Summary	viii
1 Background	1
2 Meeting Information	1
3 Meeting Objectives and Agenda	3
3.1 Research Questions	3
3.2 Agenda	4
3.3 Presenter Biographies	4
4 Presentation Summaries	5
4.1 John Straube: Mass Masonry Insulation Retrofits - Fundamentals and Challenges	5
4.2 Henri Fennell: Variations on a (Mass Masonry?) Theme – With a Touch Of Foam	8
4.3 Mark Bomberg: Issues in the Interior Thermal Upgrade of Existing and Historic Masonry Walls	10
4.4 Christopher Schumacher: Assessing The Freeze-Thaw Resistance of Clay Brick for Interior Insulation Retrofit Projects	12
4.5 Kohta Ueno: Masonry Wall Interior Insulation Retrofit Embedded Beam Simulations	14
4.6 Ad Hoc Presentation: Terry Brennan - Disabled Housing Renovation, Utica NY, Circa 2008	15
4.7 Ad Hoc Presentation: Bill Rose - Building Science vs. the Historical Preservation Community .	17
4.8 Ad Hoc Presentation: Len Anastasi - A Solution to Interior Insulation Of Masonry Buildings....	18
4.9 Meeting Follow Up: Green Building Advisor Blog Post	19
5 Discussion	19
5.1 Question and Answer Discussions	19
5.2 Group Discussion to Cover Key Questions and Action Items	22
5.2.1 Details for Bulk Water Control	22
5.2.2 Thermal Issues	23
5.2.3 Interior Insulation Material Selection	23
5.2.4 Insulation Assembly Geometry Effects	24
5.2.5 Energy Savings	24
5.2.6 Durability Issues	25
5.2.7 Historic Issues	25
5.2.8 Capillary Flow and Efflorescence	25
5.2.9 Non-Specialist Analysis	27
5.2.10 Tapered Window Openings	27
5.2.11 Experiment and Monitoring Opportunity	27
References	28
Appendix A (Agenda, Objectives, Key Questions, Presenter Bios)	29

Figures

Figure 1. Photo taken during expert meeting.....	1
Figure 2. Pre- and post-retrofit temperature gradients through wall	6
Figure 3. Interior retrofit with air gap membrane and drainage detail.....	7
Figure 4. AVID installation and diagram (© 2011 by HC Fennell Consulting; reprinted with permission)	8
Figure 5. “Inside-out” approach (© 2011 by HC Fennell Consulting; reprinted with permission)	9
Figure 6. DELPIN output, non-capillary active insulation, 1999-2004 simulation (Häupl 2010).....	11
Figure 7. Mock-up of IFT insulation system: two continuous layers of insulation and air gap.....	12
Figure 8. Removal of brick sample, and dilatometry (dimensional change) measurements	13
Figure 9. Determination of S_{crit} value plotting degree of saturation against strain (dilation)	14
Figure 10. Embedded beam uninsulated case (left) and insulated case (right)	15
Figure 11. Moisture issues at windows in retrofitted building (Brennan 2011).....	16
Figure 12. Moisture issues at chapel windows (Brennan 2011).....	16
Figure 13. Hygric buffer mat and interior insulation application (Anastasi 2011).....	18
Figure 14. Hygric buffer mat product, with non-metallic friction fastener.....	18
Figure 15. Drip edges to control surface tension at parapets and sills (Straube and Burnett 2005).....	20
Figure 16. Steel angle bolted to masonry to transfer load out of beam pocket	22
Figure 17. Precast window sill drip edge detail (L); rowlock window sill (R)	23
Figure 18. Two-dimensional heat flow modeling party wall (assembly, temperatures, heat flux) ...	24
Figure 19. Hygrothermal simulations of heat flux with uninsulated, 1.5”, and 3” ccSPF walls.....	25
Figure 20. Installation of injectable liquid damp-proofing course (Aida DPC, Remmers Ltd., 2005).....	26
Figure 21. Tapered window opening jamb detail and interior view (sill left uninsulated).....	27

Unless otherwise noted, all figures were created by Building Science Corporation

Tables

Table 1. Expert Meeting Participants	2
--	---

Unless otherwise noted, all tables were created by Building Science Corporation

Definitions

ACH	Air changes per hour
ASTM	American Society for Testing and Materials
BA	Building America Program. More information about BA can be found at www.buildingamerica.gov
BSC	Building Science Corporation. More information about BSC can be found at www.buildingscience.com
ccSPF	Closed-cell Spray Polyurethane Foam
DER	Deep Energy Retrofit
DOE	U.S. Department of Energy
FT	Freeze-thaw
IAQ	Indoor air quality
NREL	National Renewable Energy Labs. More information about NREL can be found at http://www.nrel.gov/
ocSPF	Open-cell Spray Polyurethane Foam
PCF	Pounds per cubic foot
RH	Relative humidity
SPF	Spray Polyurethane Foam
WUFI	Wärme- Und Feuchtetransport Instationär (http://www.wufi.de/)
XPS	Extruded polystyrene

Executive Summary

The Building Science Corporation team held an Expert Meeting on Interior Insulation Retrofit of Mass Masonry Wall Assemblies on July 30, 2011, at the Westford Regency Hotel in Westford, MA. Featured speakers included John Straube, Christopher Schumacher and Kohta Ueno of Building Science Corporation, Henri Fennell of Building Envelope Solutions, Inc., and Mark Bomberg of Syracuse University. Some ad hoc presentations were given by practitioners in the audience as well. This was followed by a question-and-answer period and discussion.

Key results from this meeting were:

- Greater understanding of the state-of-art in assessing risks or and performing interior insulation retrofit of mass masonry wall assemblies
- Greater understanding of the uncertainties in assessments
- Definition of key research needs to investigate and potentially reduce uncertainties.

Extensive information was presented on assessment of risk factors for premature building deterioration due to interior insulation retrofits, and methods to reduce such risks.

It was found that conflicting understanding exists, such as general assessment approaches, assessments of masonry material properties, and the inclusion of air spaces between insulation and masonry units in hygrothermal analysis. Little research has been conducted on these issues, as well other major key issues such as the impact the architectural detailing has on rainwater concentration, timber beam pocket strategies, and below grade strategies.

The next steps are to define projects to address the research needs identified at the meeting. One upcoming retrofit was put forward as an opportunity to experiment with methodologies.

1 Background

There is a large stock of uninsulated mass masonry buildings across the United States. The retrofit of interior insulation is commonly implemented to improve energy performance of these buildings, while maintaining their often historic exterior appearance. There are known durability issues associated with interior insulation, such as interstitial condensation and freeze-thaw damage issues. In many cases, these issues have been or are being addressed, but there are still remaining questions that should be answered before mass implementation in a variety of climate zones.

However, leaving these buildings uninsulated is at odds with the Building America target of broad energy retrofits of existing homes to reduce residential carbon emissions 20% by 2020 and 80% by 2050.

2 Meeting Information

Building Science Corporation held an Expert Meeting on Interior Insulation Retrofit of Mass Masonry Wall Assemblies on July 30, 2011, at the Westford Regency Hotel in Westford, MA. There were 38 in attendance; two participants attended by webinar. Invited speakers gave presentations in their particular area of expertise. Three additional experts also gave brief presentations of their significant case studies and/or history with these issues. The presentations were followed by discussion with the expert audience.



Figure 1. Photo taken during expert meeting

The final agenda for the meeting is listed in Appendix A. The presentations are included in Appendix B through H. A list of attendees is included in Table 1.

Table 1. Expert Meeting Participants

Name	Organization	Email Address
Linda Wigington	Affordable Comfort	lwigington@affordablecomfort.org
Aaron Davenport	BASF	aaron.davenport@basf.com
Charlise Goodbread	BASF	charlise.goodbread@basf.com
Chris Little	BASF	chris.little@basf.com
Henri Fennell	HC Fennell Consulting	hFennell09@gmail.com
Betsy Pettit	Building Science Corporation	betsy@buildingscience.com
Chris Schumacher	Building Science Corporation	chris@buildingscience.com
Joe Lstiburek	Building Science Corporation	joe@buildingscience.com
John Straube	Building Science Corporation	john@buildingscience.com
Ken Neuhauser	Building Science Corporation	ken@buildingscience.com
Kohta Ueno	Building Science Corporation	kohta@buildingscience.com
Peter Baker	Building Science Corporation	pbaker@buildingscience.com
Randy Van Straaten	Building Science Corporation	randy@buildingscience.com
Paul Eldrenkamp	Byggmeister Design Build	paul@byggmeister.com
Terry Brennan	Camroden Associates Inc.	terry@camroden.com
Steve Marchese	CEDA	smarchese@cedaorg.net
Mac Sheldon	Demilec	mac@sheldon.com
Gary Parsons	Dow	gdparsons@dow.com
Dave Kimball	Dow Corning	dave.kimball@dowcorning.com
Len Anastasi	Exo-Tec Consulting	len@exo-tec.biz
Jan Kosny	Fraunhofer-MIT Center for Sustainable Energy Systems	jkosny@fraunhofer.org
Martin Holladay	Green Building Advisor	mholladay@taunton.com
Emerson Dahmen	Habitat for Humanity Merrimack	emerson@merrimackvalleyhabitat.org
James Comeau	Habitat for Humanity Merrimack	mjtupware@comcast.net
David DeRose	Halsall	dderose@halsall.com
Duncan Prah	IBACOS	dprahl@ibacos.com
Hartwig Künzel	Fraunhofer Institute for Building Physics	hartwig.Künzel@ibp.fraunhofer.de
Ed Reeves	Icynene	ereeves@icynene.com
Edward Haber	Illinois Home Weatherization Assistance Program	edwardhaber@hotmail.com
John Inglese	Inglese Architecture & Engineering	j.inglese@inglese-ae.com
Marie McMahon	National Grid	marie.mcmahon@us.ngrid.com
Marcus Bianchi	NREL	marcus.bianchi@nrel.gov
Manfred Kehrer	ORNL	kehrerm@ornl.gov
Achilles Karagiozis	Owens Corning	achilles.karagiozis@owenscorning.com

Name	Organization	Email Address
Bill Rose	University of Illinois	wrose@illinois.edu
Pat Huelman	University of Minnesota	phuelman@umn.edu
Mark Bomberg	University of Syracuse	mbomberg@rogers.com
Emily Vance	University of Waterloo	ervance@uwaterloo.ca
Rob LePage	University of Waterloo	rtmlepage@gmail.com

3 Meeting Objectives and Agenda

The objective of this session was to explore the current state of implementation and research on interior insulation retrofit of mass masonry wall assemblies. Discussions on this topic were applicable to existing mass masonry single- and multi-family residential buildings. The meeting consisted of presentations and discussion related to interior insulation retrofit evaluation and implementation strategies. Issues such as durability, energy performance, and detailing were discussed. Differing approaches and areas of need for research to resolve uncertainties in such approaches were sought.

3.1 Research Questions

Building Science Corporation posed the following research questions relevant to this area of study:

- What are typical details required to reduce rainwater exposure, thus balancing out reduced inward drying with reduced wetting from the exterior? Are typical existing surface drainage details (e.g., solid stone sills, window “eyebrows,” band courses) sufficient, or is it necessary to retrofit additional protection?
- What are the energy savings associated with interior insulation retrofits? Can effective thermal performance be obtained by leaving these buildings uninsulated, and relying on thermal mass effects?
- What is the current level of understanding of evaluating the in-service post-retrofit freeze-thaw resistance of a masonry enclosure, using material property testing and hygrothermal simulations? Can this process be developed further, and/or streamlined?
- What are effective solutions to address durability concerns at moisture-sensitive structural members (e.g., wood beams and joists) embedded in masonry structures, in a post-retrofit situation?
- What are some key issues that need to be addressed when interfacing with historical preservation requirements (e.g., National Park Service tax credits) and performing these retrofits?
- Are there retrofit methods to reduce capillary uptake through existing masonry structures, which are simpler (and less costly) than the retrofit of regletted capillary breaks?
- Based on hygrothermal simulations and field experience, are there widely-applicable limits to interior insulation levels (and type of insulation), based on climate zone, building exposure, and material properties that can be evaluated by non-specialists?

- Are there cases of building enclosure failures that can be traced directly to the retrofit of interior insulation, and what were the circumstances and contributing factors in the failures?
- Given that many mass masonry buildings have deep window openings with limited available space (due to window clearance issues), what is the effect of thinner (e.g., ~1”) insulation at these openings?

3.2 Agenda

- 9:00 AM Welcome and Meeting Introduction
 - Brief Building America Program Overview
- 9:15-10:00 AM John Straube: Mass Masonry Insulation Retrofits: Fundamentals and Challenges
- 10:00-10:30 AM Henri Fennell: Variations on a (Mass Masonry?) Theme – With A Touch Of Foam
- 10:30-10:45 AM Break
- 10:45-11:15 AM Mark Bomberg: Thermal Upgrade of Masonry Walls - Interior Methods
- 11:15-11:45 AM Christopher Schumacher: Assessing the Freeze-Thaw Resistance of Clay Brick for Interior Insulation Retrofit Projects
- 11:45-12:15 AM Kohta Ueno: Masonry Wall Interior Insulation Retrofit Embedded Beam Simulations
- 12:15 to 1:15 Lunch break (lunches provided)
- 1:15 to 1:45 Special Topic Discussions
 - Field experience of field practitioners not on speakers list
 - If warranted—collect photos for display and discussion over lunch break from field practitioners
 - Discussion of problematic water concentration details seen in the field
 - Discussion of retrofit details to reduce water exposure
- 1:45 to 3:00 Group discussion to cover key questions, action items, follow-up plan, and wrap-up.
- 3:00 PM Adjourn meeting

3.3 Presenter Biographies

John F. Straube (Ph.D., P.Eng.) is a principal of Building Science Corporation and a professor of building science in the Civil Engineering Department and School of Architecture at the University of Waterloo, Canada. Dr. Straube has acted as an educator, researcher, consultant and expert witness on energy efficiency, durability and IAQ. Current interests include the optimal system design of buildings, sustainable buildings, and moisture problem avoidance.

Henri Fennell (CSI/CDT) is a principal of HC Fennell Consulting, a building science consulting and education firm. He is an architect with twenty-five years of experience in energy conservation products and services, and specializes in the use of manufactured and field-installed urethane technologies. As a building envelope consultant, Henri worked with architects, designers, builders, and contractors to diagnose and solve building envelope problems. Before this position, he was president of Building Envelope Solutions, Inc. / FOAM-TECH, a spray foam contracting firm, and then Technical Research Manager at Conservation Services Group, Inc.

Mark Bomberg (Ph.D.) is a research professor at Syracuse University. He is a leader of an industry-university collaborative research center on hygrothermal performance of building enclosures. His research specialties include high performance building enclosures and thermal insulating materials. Prior to this position, he was a senior researcher at the National Research Council of Canada for 24 years.

Christopher J. Schumacher (M.A.Sc.) is a principal of Building Science Corporation. He is recognized as an expert in the field of building monitoring and building systems and enclosure testing. He has led the design, installation and analysis of monitoring systems for 15 building enclosure test facilities, 6 test building sites, 3 climate chambers and 2 sustainable building technologies demonstration projects in over a dozen states and countries as far abroad as Mongolia and New Zealand.

Kohta Ueno (M.A.Sc.) is a senior associate of Building Science Corporation. His responsibilities at Building Science Corporation include project management, liaison work with builders and industry clients, HVAC design, energy analysis of house designs, computer modeling, field testing and verification, and forensic field investigations. He has been with BSC since 1998, and completed his Master's degree with the Building Engineering Group under John Straube at the University of Waterloo in 2007.

4 Presentation Summaries

Five main presentations were given describing current approaches to interior insulation retrofit of masonry buildings. In addition, three “ad hoc” presentations were given by practitioners, regarding specific evaluation and insulation approaches as well as the relationship between the building science community and the historical preservation community.

4.1 John Straube: Mass Masonry Insulation Retrofits - Fundamentals and Challenges

In his presentation, Dr. Straube first noted that there are many different types of assemblies—solid brick or stone masonry, terra cotta backup or CMU backup wall, etc. In addition, the face brick and core brick have different properties: face brick tends to be the highest quality brick (well-fired) and core brick the worst (under- and over-fired).

Generally, the outside of building sees the same rain and similar temperatures pre- and post-retrofit. However, the biggest changes are inside the wall, where the assembly previously saw

moderated temperatures and is now experiencing colder conditions (Figure 2). Hence, the question is whether there is a potential for freeze-thaw damage deeper in the wall.

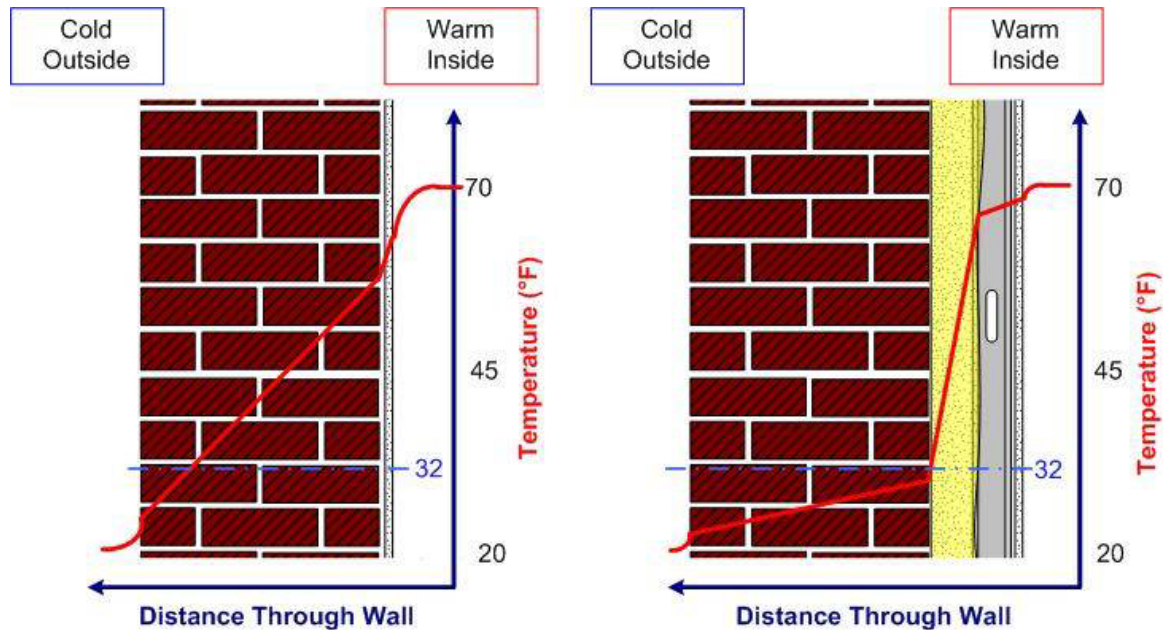

Figure 2. Pre- and post-retrofit temperature gradients through wall

Other impacts of interior insulation retrofits are that the assembly had reduced drying to the interior, and the amount of energy flow through the wall (and thus drying potential) has been minimized.

There is a condensation risk at the masonry-to-insulation interface. In early days of retrofits (1970s oil crisis), steel stud and fiberglass batt were installed and covered with polyethylene on the interior. However, air leakage could bypass imperfectly installed polyethylene vapor barriers/air barriers, resulting in condensation problems. This condensation-based wetting would occur in a spot that is at freezing temperatures, post-retrofit. Although this interface was hidden, it became a durability issue, manifested as the assembly degrading and spalling.

Another concern is rot/corrosion of embedded elements. An interesting aspect of this issue with interior insulation retrofits is that although the assembly may have higher moisture contents, it is also much colder—which slows the rate of corrosion and rot.

Embedded wood timbers are a common embedded element of durability concerns. A number of solutions are being pursued, including borate injections into the wood, metal wedges next to the member (to provide passive heat flow), active heating, or construction of a load bearing structure inside of the masonry, and cutting off the end of the beam.

When considering windows within such structures, rain and thermal continuity (avoiding thermal flanking) are paramount for good performance. There needs to be a minimum insulation value to prevent frosting and condensation. Rain penetration at the window-to-wall interface and the effect of rain concentration features need to be addressed through good detailing.

Currently, 2.0, 1.0, and 0.5 pound per cubic foot (pcf) polyurethane foams are commonly used for interior insulation. There is little guidance available to design teams on selection of these products, which may become more significant issues as additional products are brought onto the market.

Another interesting option is to use board foam products. One recommended detail is the application of a liquid-applied vapor permeable air and water barrier on the interior face of the masonry, and semi-permeable foam.

The team had opportunity to inspect a building in Regina, SK, which had 4” polyisocyanurate board foam applied to interior in 1982. There was no damage to the masonry; however, one needs to recognize that Regina is in a very dry climate zone (~14”/year precipitation).

Mass or storage walls, by their nature, do not require a separate drainage system, instead relying on safe storage of moisture in the mass of the system. However, there are cases where leakage occurs in the existing building, or thin (2-wythe) masonry provides inadequate storage. This might be addressed with an interior drainage system (Figure 3). This need can be evaluated onsite by looking for staining, rot, and from historical knowledge of facility maintenance staff. However, the interior drainage detail is difficult to implement, is high risk, and should be considered the last response. One troubling detail is drainage of the flashing connection at the floor slab interruptions. The drilling of the sloped drained hole to the outside is a high risk and particular detail.

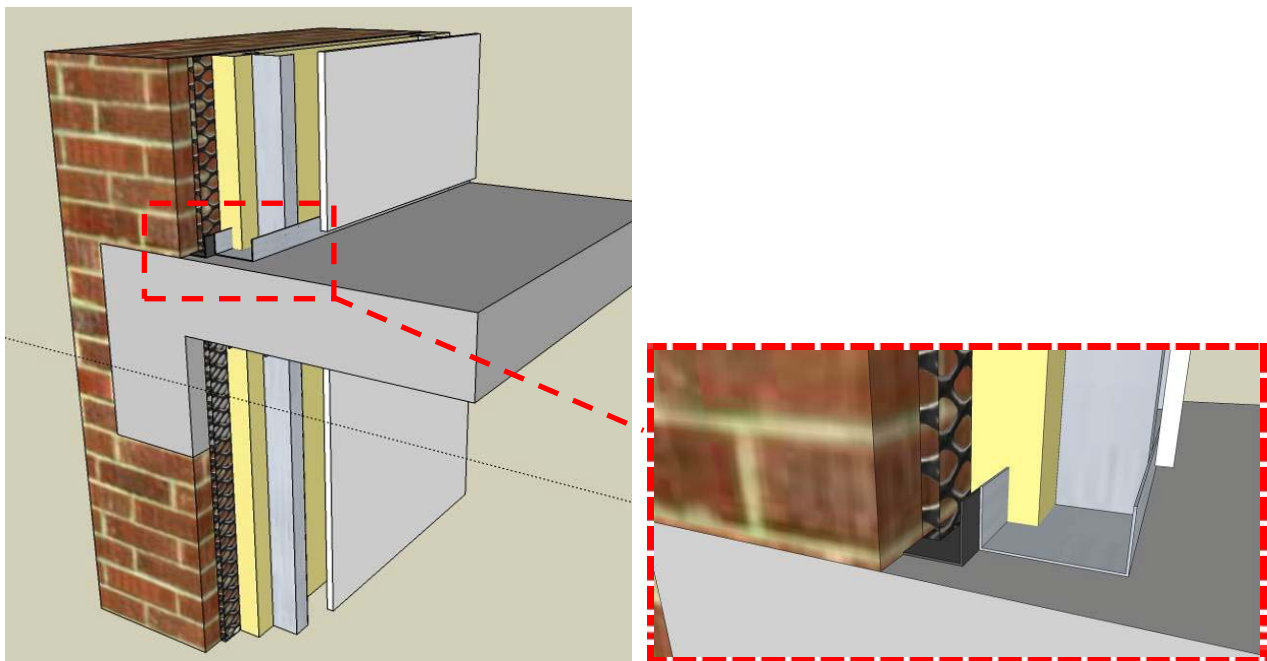

Figure 3. Interior retrofit with air gap membrane and drainage detail

A series of six recommended evaluation steps were presented: each incremental step reduces uncertainties in the evaluation. They were, in order of importance:

- Site Visit Assessment (assessment of rain leakage, poor detailing, existing freeze-thaw damage)

- Simple Tests and Modeling (dry density, liquid water uptake, saturation moisture content, and basic hygrothermal/WUFI modeling)
- Detailed Tests and Modeling (thermal conductivity, Fagerlund’s Critical Degree of Saturation or S_{crit})
- Site Load Assessment (assessment of driving rain load, run down patterns; monitoring of rain deposition with driving rain gauges is the most thorough method)
- Prototype Monitoring (retrofit of a small area of the building, and monitoring of temperature and moisture content, including comparisons to models)
- Maintenance and Repair (creating a recommended program of inspection/repair, perhaps in the form of a building owner’s manual)

Dr. Straube concluded by stating that the concept of freeze-thaw failure being a pass/fail digital test is a fundamentally wrong assumption, as discussed in more detail by Schumacher. [View Dr. Straube’s presentation.](#)

4.2 Henri Fennell: Variations on a (Mass Masonry?) Theme – With a Touch Of Foam

Mr. Fennell opened his presentation by describing the Air, Vapor, Insulation, Drainage (AVID) approach, which is an interior insulation/drainage detail applied to basements and crawl spaces (Figure 4). Interior spray foam was deemed inadequate for management of bulk water alone, without intentional drainage. The recommended AVID approach is shown in Figure 4: it involves draping polyethylene from grade to a perimeter drain, and then applying spray foam. Some specific details of this approach are to treat wood beams buried in the insulation with preservatives, and to include a “drip edge” detail at the bottom of the plastic sheet to drain the water into the gutter (to avoid water intrusion at the basement slab).

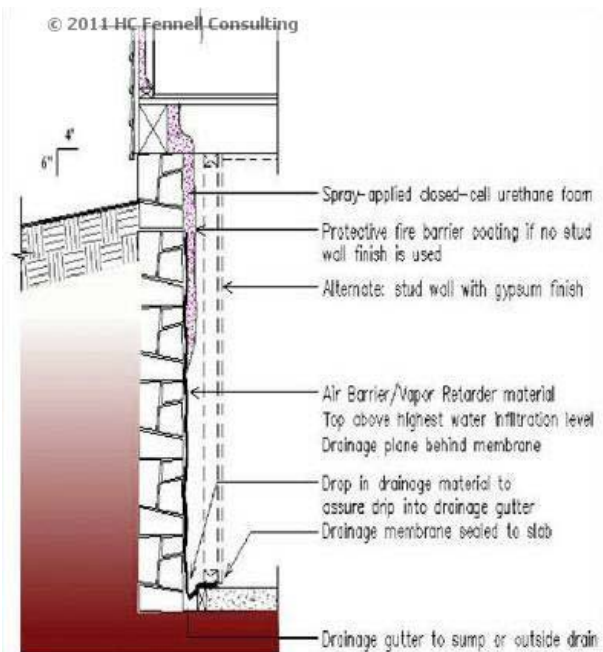
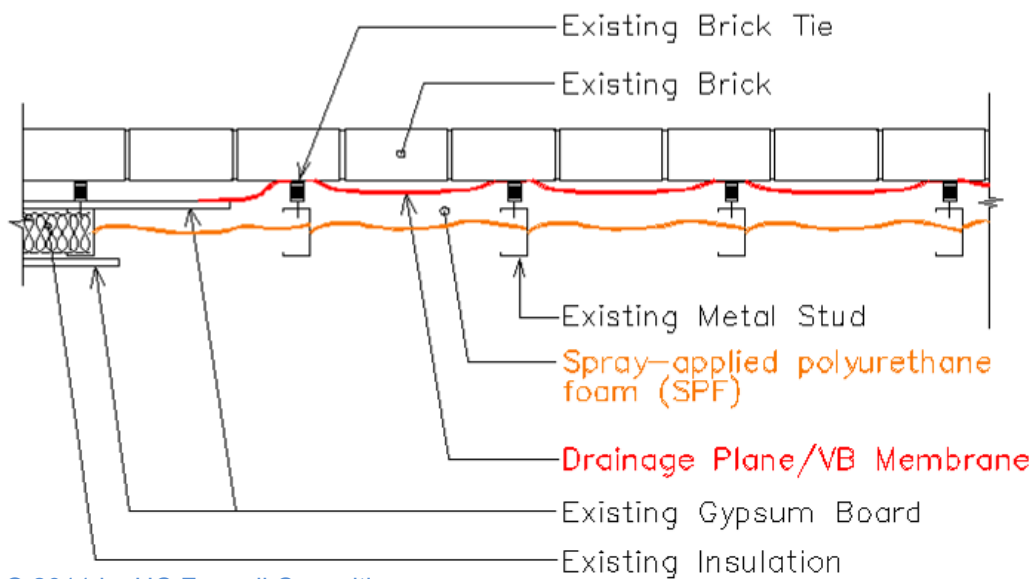

Figure 4. AVID installation and diagram (© 2011 by HC Fennell Consulting; reprinted with permission)

AVID examples included the Gilman Housing project (using Tu-Tuff reinforced polyethylene), and the Westford House/Barn (see Pettit 2008 and Lstiburek 2010a), which used self-adhered membrane. Collected data indicated that these basement insulation retrofits result in the basement/crawl space operating close to interior conditions (including dewpoint/air moisture levels).

Next, Mr. Fennell presented the “Inside-out Approach” (Figure 5), which involves using the existing masonry wall as a rainscreen. It was typically applied to failed brick veneer/steel stud backup walls, where the backup wall suffered bulk water intrusion, resulting in mold and mildew damage. One approach was to install a polyethylene drainage plane inside of the brick veneer, draining to a water management gutter at the floor level. This approach could be applied to mass masonry walls as well.



© 2011 by HC Fennell Consulting

Figure 5. “Inside-out” approach (© 2011 by HC Fennell Consulting; reprinted with permission)

One installation detail makes use of the fact that when spray foam is applied on flat polyethylene, differential cooling will draw the polyethylene inward, creating a ½” to 1-¼” air space in middle of framed elements. Alternatively, a drainage mesh (e.g., Obdyke Cedar Breather) could be used to intentionally create the air space behind the polyethylene. A potential advantage of the approach is its reversibility for historic projects. An alternate approach is to create an entire stand-alone structure (such as SIPS panels) inboard of the existing structure. Small scale reversibility at discrete locations (e.g., blocked-off basement windows) can also be achieved through use of rigid foam insulation plugs with polyethylene (as a bond break).

This was followed by review of several case studies, showing highlighted design approaches to interior masonry insulation applications and described below.

Berkshire Elderly Housing (Pittsfield, MA 2004): This project highlighted the use of closed wall cavity (plaster wall with strapping) retrofit insulation, using closed cell SPF. Many application holes (~12” o.c.) were required in order to achieve full coverage. Excess foam was trimmed flush

at the application holes; a layer of gypsum board was applied as a finish surface (as opposed to patching the plaster) for cost reasons.

Brady, Patrick Residence (Gloucester, MA 1995) was a project with stone walls and vaulted arches, which required insulation above these stone arches. The team was limited to a single application hole at each vault apex; however, infrared scans showed that good coverage was achieved.

Buster, Cami Residence (Fairlee, VT 1990) provided an interesting anecdote: it was a stone building with interior spray foam which subsequently suffered from a fire. To everyone's surprise, the ccSPF walls were not damaged; the foam apparently acted as fire blocking, eliminating paths for superheated air to travel through the assembly.

Keene State College Fiske Hall (Keene, NH 2008) was a dormitory renovation done using open cell spray foam (ocSPF). One challenge was that the stud bay cavities were completely filled, and due to expansion of the ocSPF, the trimmed excess was comparable to the amount of foam applied to the wall. This brings into question the cost savings of open cell, when excessive trimming is required.

A number of additional projects were presented. Mr. Fennell's firm initially did more closed-cavity injection projects, rather than open cavity (surface sprayed) projects. One of the reasons for the popularity of injection was that this is typical for the manufacturing field, which was his background. Almost all of his early 1980s jobs were closed cell cavity fill.

Mr. Fennell would typically assess freeze thaw risks by calling in experts (such as BSC or Mark Bomberg). In some cases, his firm sent away samples for detailed analysis. There were only a few cases where it was discovered that there was an outright problem with interior insulation. He has done many projects all over North America and has never had a call-back regarding ensuing damage. View Mr. Fennell's [presentation](#).

4.3 Mark Bomberg: Issues in the Interior Thermal Upgrade of Existing and Historic Masonry Walls

In his presentation, Dr. Bomberg first provided some basic background on interior insulation retrofits. He then asserted that any masonry building can be insulated on the interior if a “capillary active layer” (CAL) or “capillary active material” is used. Such insulation material is vapor diffusion-open and capillary active: as a result, interior moisture condenses on cold side, but the moisture is transported back to interior by capillarity. As this material is vapor-open, it does not inhibit drying to the interior. The industry has had—as Bomberg puts it—a “ridiculous fear of water” in construction. However, it is the effect of water—not the presence of water—that is critical. Designs are generally acceptable if they avoid mold growth and allow drying.

A case study was presented based on analysis done in Germany using the DELPHIN hygrothermal simulation (Figure 6); the graph gives results over five simulated years, showing moisture content through the thickness of the assembly. Low moisture contents were noted through the thickness, but with higher levels at the interior and exterior layers. Wintertime condensation was observed at the insulation-to-masonry interface when a non-capillary active insulation was used (left-hand spikes in Figure 6). In contrast, capillary active insulation reduced

interior moisture contents; however, it resulted in increased exterior moisture content levels relative to the previous (non-CAL) case.

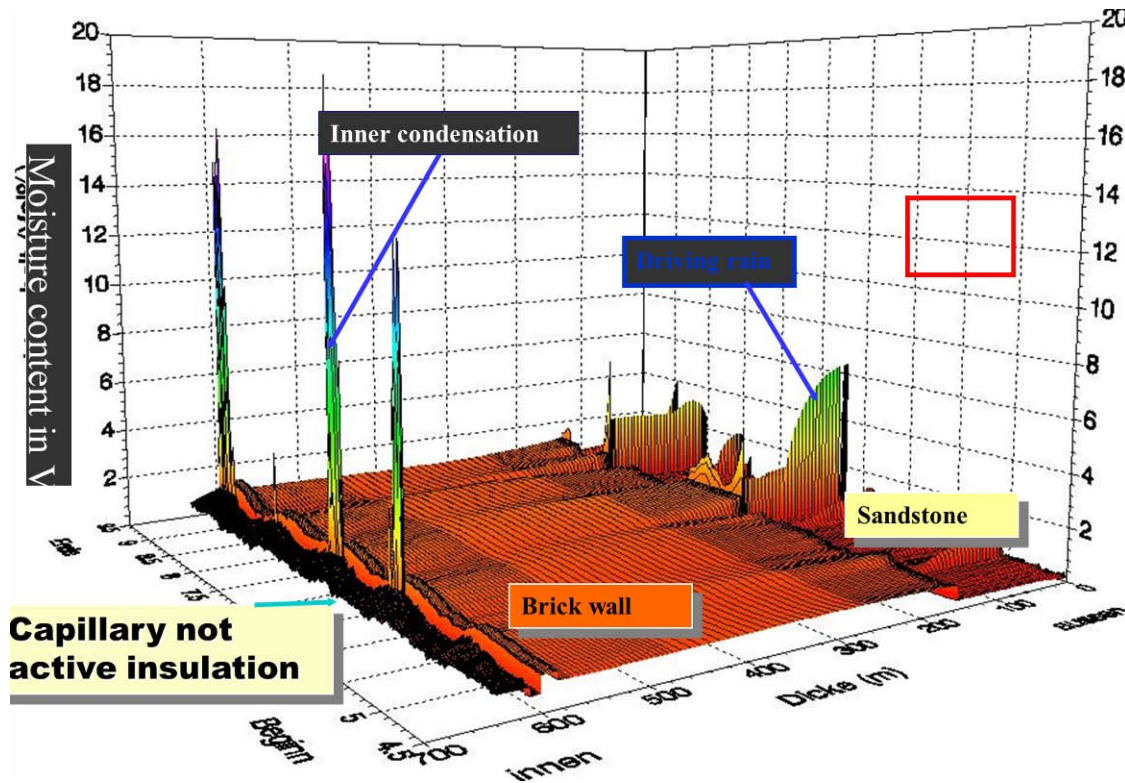

Figure 6. DELPIN output, non-capillary active insulation, 1999-2004 simulation (Häupl 2010)

These simulations indicated that the capillary active layer needs to use nano-technology, which will create pores sized at a level that directly affects water capillary (“micropores”). Material development of several calcium silicates formulations to meet these requirements was described. The actual insulation product is a solid sheet material; there are five commercial manufacturers of this material in the US, for industrial applications.

Dr. Bomberg presented a case study where such products were used in the Church of Our Lady in Dresden, Germany. A second application is presented for Rijksmuseum Amsterdam, where the architect initially proposed foam glass. Simulations showed high moisture content at the interface; these levels were lower when a capillary active layer (calcium silicate) was used (allowing inward drying).

One key to the use of the capillary active layer is to ensure capillary contact between the masonry and the insulation; various plasters were used for this purpose. A project in Sapporo, Japan, used an assembly combining clay plaster on the interior, followed by a layer of lime plaster. Monitored results are being collected and compared with simulations. German climatic plaster (high clay content, capillary active) is also used in this application, between calcium silicate and masonry.

A completely different system was subsequently presented, which was the Integrated Façade Technology (IFT) wood fiber insulation system, manufactured in France, Germany, and Japan.

Dr. Bomberg prefers this product over calcium silicate. The system consists of spray foam against masonry, a ventilated air gap, a treated wood fiberboard insulation board, and a lime plaster finish (see Figure 7). The recommended spray foam products are between 1.1 pcf and 3.5 pcf. In this application, the limit is 1.5” of closed cell, to allow for drying. Future work includes research on this moisture active thermal insulation layer, including the potential to integrate it with heating, cooling and ventilation, air conditioning systems. View Dr. Bomberg’ [presentation](#).



Figure 7. Mock-up of IFT insulation system: two continuous layers of insulation and air gap

4.4 Christopher Schumacher: Assessing The Freeze-Thaw Resistance of Clay Brick for Interior Insulation Retrofit Projects

Mr. Schumacher presented the current state of assessing the freeze-thaw resistance of clay brick; he introduced the topic by covering the basics of moisture storage and transport in porous materials (as per Straube and Burnett 2005). Then, he presented four historic and current theories of the mechanisms that cause freeze-thaw degradation at a microscopic level:

Closed Container Theory: Water expands 9% upon freezing (demonstrated to be a questionable mechanism by 1930s experimental work).

Ice Lensing Theory: Water migrates from warm water to sub-zero ice, displacing material as it travels.

Hydraulic Pressure Theory: As ice forms, liquid water is displaced and either “high pressure flow” or “dead end traps” occur.

Disequilibrium Theory: Moisture in unfrozen pores connected by capillaries to frozen pores (similar scenario to ice lensing) move by diffusion, causing damage.

He asserts that in reality, a combination of these mechanisms is likely at play, explaining anomalies seen in masonry performance.

The literature indicates that current ASTM tests used in industry (ASTM C62 and C67, and the cold soak/boil or c/b ratio) are not reliable determinants of freeze-thaw risks, resulting in both false positives and false negatives.

The frost dilatometry testing techniques (building on Fagerlund's work) developed at BSC were then presented; this work is covered in more detail by Mensinga et al. (2010), and Lstiburek (2010b). The fundamental problem with the existing freeze-thaw resistance measurements is that they are digital tests (pass/fail). In reality, there is a continuum of performance, based on the exposure of the brick. This technique measures the critical degree of saturation (or S_{crit}) of a masonry material. At water contents below S_{crit} , no freeze-thaw damage will occur regardless of number of freeze-thaw cycles, while above S_{crit} , damage is measurable after only a few cycles.

The measurement involves removal and preparation of brick samples from the building, freeze-thaw cycling them at various moisture contents, and measuring dimensional changes of the sample (see Figure 8).



Figure 8. Removal of brick sample, and dilatometry (dimensional change) measurements

S_{crit} level can be determined by plotting sample dimensions before and after thermal cycling, at various moisture contents (Figure 9). If the sample grows, then freeze thaw degradation is occurring and that sample's moisture content is above the S_{crit} threshold. This threshold can subsequently be used as a limit state in evaluating hygrothermal model outputs.

Work for the future includes refinement and documentation of the dilatometry test method, documentation practices for assessing buildings (material conditions and moisture distribution and loads), and development and documentation methods to address moisture concentrations. View Mr. Schumacher's [presentation](#).

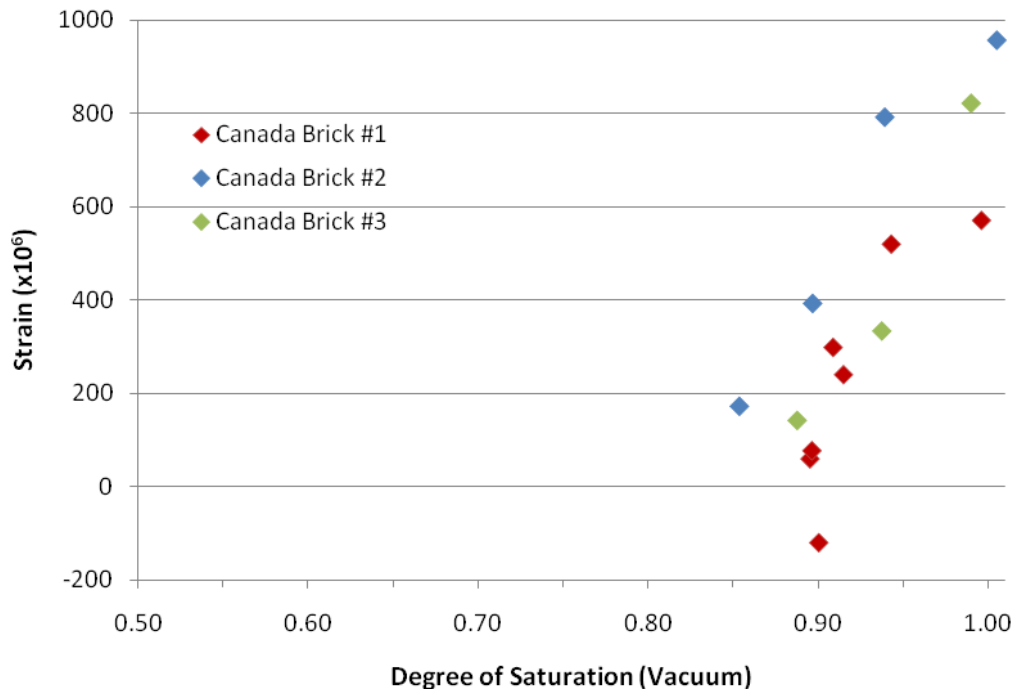

Figure 9. Determination of S_{crit} value plotting degree of saturation against strain (dilation)

4.5 Kohta Ueno: Masonry Wall Interior Insulation Retrofit Embedded Beam Simulations

Mr. Ueno first presented a literature review of research on moisture issues in wood beams embedded in masonry, which become colder (and have less available drying) after interior insulation retrofits. One researcher measured embedded joist moisture contents after interior insulation: one case remained substantially dry, while another showed elevated moisture contents after insulation. It was theorized that the latter case involved bulk water control or capillarity issues (i.e., exterior moisture loadings). Other researchers performed hygrothermal and thermal analysis, in order to predict the moisture effect of retrofit insulation and the heat loss effects of leaving a wide gap in the insulation surround the embedded member.

The first portion of the current work was a series of three-dimensional heat transfer simulations, which demonstrated a number of phenomenon, including

Insulating the entire wall lowers the temperature of embedded wood.

Installing metal “heat spreader” plates at the sides of the member (bypassing the insulation) raises the wood temperature, albeit limited by the dimensions of the embedded member.

Omitting the insulation surrounding the embedded wood effectively raises the temperature.

Applying reduced thicknesses of insulation was not effective at raising the wood temperature.

These results applied to both embedded heavy beams and smaller dimension lumber floor joists. The heat transfer analysis showed that the addition of metal plates reduced the heat loss savings (due to insulation) by 9%, and that having an uninsulated band had a 20% “giveback” effect.

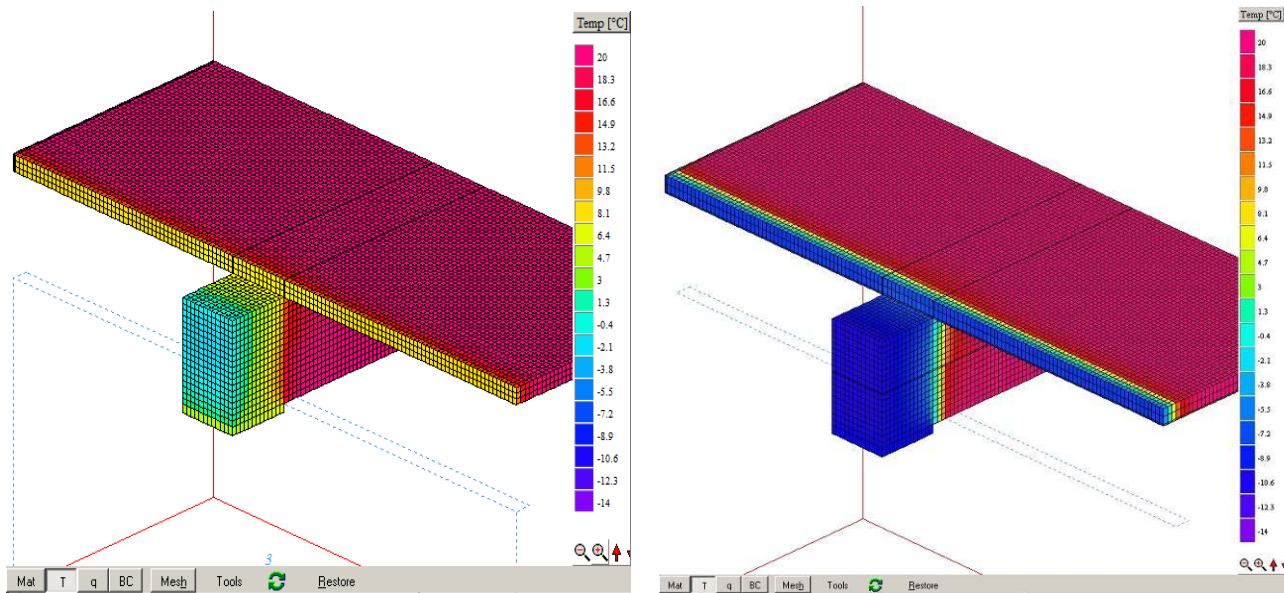

Figure 10. Embedded beam uninsulated case (left) and insulated case (right)

These results were then used as inputs to one-dimensional hygrothermal simulations. In a one-dimensional limitation, the insulated and uninsulated cases have identical geometries. Therefore, a “temperature index” approach was used, taking the three-dimensional results and modifying the thermal conductivity of the wood beam to approximate the temperature conditions. In addition, the effect of interior air leakage into the beam pocket was analyzed.

Initial simulations showed that the air gap between the beam end and the masonry needed generous ventilation to the interior to maintain tolerable moisture content levels in the wood, even in the uninsulated case. Insulation had mixed results, such as higher wintertime moisture contents, but similar summertime levels. Changing the exterior masonry material had a major impact on embedded wood member moisture contents, raising uncertainty of the results of this approach. Mr. Ueno made it clear that caution should be used in interpreting these results, as there is a high degree of uncertainty regarding the accuracy of this simulation approach, and the absence of monitored hygrothermal conditions for which to compare such models. Future work could include the use of two-dimensional hygrothermal simulations, and field monitoring of embedded wood members. View Mr. Ueno’s [presentation](#).

4.6 Ad Hoc Presentation: Terry Brennan - Disabled Housing Renovation, Utica NY, Circa 2008

Mr. Brennan presented a case study in a masonry building retrofitted with interior insulation (urethane spray foam and steel framing) that showed signs of failures.

The building owner initially reported mold issues around the window penetrations on the top floor of the building (particularly at arch-top windows), on all orientations. It was found that this was not mold, but re-emulsification of gypsum drywall compound due to bulk water penetration

(see Figure 11); the compound was sufficiently wet and plastic that it could be “ribboned” like clay.

A diagnosis of the building exterior revealed a series of details that concentrate exterior rainwater at vulnerable locations, for instance, the window pan coping deposits rainwater onto the existing stonework, where it concentrates at the grout joint (Figure 11). A preferred approach would be a metal water shedding detail that covers the entire sloping stonework, with a drip edge 1” off the face of the stonework, to shed the water from the masonry. Other poor masonry detailing was observed throughout of the building, resulting in the observation that builders did not necessarily make buildings “better in the old days”—instead, only the well-detailed buildings have survived until today.



Figure 11. Moisture issues at windows in retrofitted building (Brennan 2011)

Brennan also observed newly occurring freeze-thaw damage in the cast stone material. At the chapel section, damage was observed at some of the arch-top windows, with an interior ceiling vault, and spray foam at the exterior wall (Figure 12). Excavation at the damage site showed plaster degradation and rust of the reinforcement mesh and steel framing.



Figure 12. Moisture issues at chapel windows (Brennan 2011)

Investigation revealed that the problem windows were surrounded by wet masonry, while the non-problem windows had dry masonry (as confirmed by measurements with a electrical capacitance moisture meter). All windows that showed damage had obvious water management defects in the brickwork above. Site work showed that it is often difficult to get an honest assessment of the building from the occupants and staff.

This case study provides a valuable example of details that were sufficiently problematic to cause long-term problems. A site assessment should be used to look around the building, observe where water comes in, how it comes in, and how it can be kept out of the wall. The most important recommendation is that if rain control cannot be addressed and upgraded, interior insulation should not be implemented. View Mr. Brennan's [presentation](#).

4.7 Ad Hoc Presentation: Bill Rose - Building Science vs. the Historical Preservation Community

Mr. Rose discussed conflicts between the historical preservation community and the building science community; these are two distinct “camps,” each with their own sphere of influence and self-identified practitioners. Due to current developments, the preservation community believes that building science is seeking to assert an “undue influence” on their field.

The communication gap that exists between these two communities is exemplified, for instance, by the National Park Service/Technical Preservation Services Preservation Brief 03: Conserving Energy in Historic Buildings (circa 1978). It simply gave the guideline to “insulate historic buildings, but use a vapor barrier,” which is misguided thinking that practice has long since been surpassed. Mr. Rose was a reviewer in a recent effort to update the guide. In response to this work, he wrote a white paper which included the following generalization: “I can give you a historic building with great energy efficiency, durability measured in centuries, and exposure of historic elements... choose two out of three.” However, this statement was not well received by preservation community.

Mr. Rose discussed a few examples of how deterioration was addressed at projects where he was involved. His key messages were that insulation can have an impact, some problems are complex, and that convincing historical preservation groups to address water management (through even slight architectural modifications) can be very difficult.

The preservation community typically wants to know “how much wetter will my building get?” and “how wet is too wet?” He suggests that the building science community needs to provide whatever knowledge that it can offer on these questions: however, the answer is often only general guidance on risks, with a strong degree of uncertainty. Unfortunately, the preservationists want a high degree of certainty, as the result of failed insulation strategies that were implemented in the 1970s.

He concluded by suggesting that the focus would be better directed at ongoing building maintenance, and that interior insulation should only be allowed conditionally with an increase of the ongoing maintenance budget. This is a practical solution that property owner could use to seek appropriate budgets to resolve the most likely causes of premature water-related damage during the life of the building.

Note that no presentation materials were provided during Rose’s talk.

4.8 Ad Hoc Presentation: Len Anastasi - A Solution to Interior Insulation Of Masonry Buildings

Mr. Anastasi presented his preferred approach to interior insulation retrofits of masonry assemblies. His solution involves attaching a drainage mat covered with a polyolefin film to the interior of the masonry, and applying closed cell spraying foam inboard of that material. The point of the cavity is that bulk water in incidental locations could be drained and/or redistributed without concentrated damage to the immediate area. It allows greater drying to the masonry, compared to direct application of ccSPF to the interior surface. This application has been developed into a commercial product, marketed as a “hygric buffer mat.”



Figure 13. Hygric buffer mat and interior insulation application (Anastasi 2011)

The mat is attached to the masonry with non-metallic friction fit plastic fasteners, typically with a 2’ o.c. spacing.

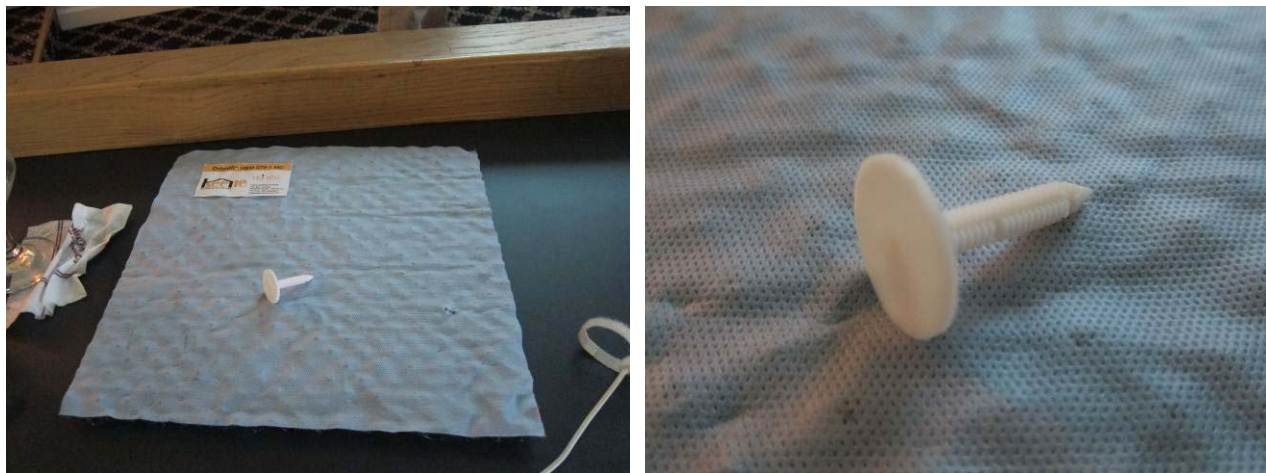

Figure 14. Hygric buffer mat product, with non-metallic friction fastener

Several application examples were given, such as the Water Works Condominiums, in Chestnut Hill, MA (2006): there have been no call backs or apparent problem. One option for this air gap assembly is that if a problem developed, a fan could be installed to pressurize the “buffer mat” cavity with interior air, to dry out any moisture issues. View Mr. Anatasi’s [presentation](#).

4.9 Meeting Follow Up: Green Building Advisor Blog Post

One of the attendees (Martin Holladay, Green Building Advisor) writes a regular column (“Musings of an Energy Nerd”) for the Green Building Advisor website, which is a collaboration between BuildingGreen.com (the publishers of Environmental Building News) and Taunton Press. His column for August 12, 2011 (“Insulating Old Brick Buildings: If you’re thinking of insulating the interior of a load-bearing brick wall, proceed with caution”) was a summary of this Expert Meeting and the post-meeting discussion. This presents another method to distribute the information presented in this Expert Meeting to the building community. Read the [blog post](#); it includes the comments/discussion on the post.

5 Discussion

The primary purpose of the discussion portion of the meeting was to identify key questions in industry regarding the evaluation and implementation of interior insulation retrofit strategies. They are presented here in a question-and-answer format.

5.1 Question and Answer Discussions

The following items were follow-up discussions from the various presentations, and topics of interest to the speakers and the audience.

Q: Is the parapet condition a good test of the suitability of interior insulation retrofit?

A: This is a reasonable test, but not a 100% answer by any means. The parapet could have been built from a different brick, have greater exposure due to poor cap flashing details, or higher exposure due to cracking at the base of the parapet from expansion and contraction. Furthermore, they are different than typical above-grade walls, due to solar exposure on both sides of the assembly.

Q: With the caveats to using software tools such as WUFI to evaluate the risk of premature freeze thaw degradation due to interior insulation retrofit, is such an analysis worthwhile?

A: WUFI analysis should be done by experts. If done well, it can provide confidence in likelihood of success of the retrofit installation.

Q: Is brick testing necessary for evaluating the risk of premature freeze thaw degradation due to interior insulation retrofit?

A: It has importance; however, it should be considered secondary to the site assessment. The loading due to bulk water concentrations (as observed during the site assessment) can far overwhelm any analysis determining limits for S_{crit} . The scope of the investigation depends on the nature of the project, and the acceptable degree of uncertainty. In the cases of historically significant or landmark buildings, a more in-depth investigation to limit uncertainty is recommended.

Q: Is there data available on impact of drip edge distances, and on the degree of water concentrations due to surface conditions in general?

A: There is definitely a dearth of research on this topic. However, there are general, simple concepts that should be observed and followed. More research in the area is needed, in order to develop unobtrusive drip edges that will meet historic requirements.

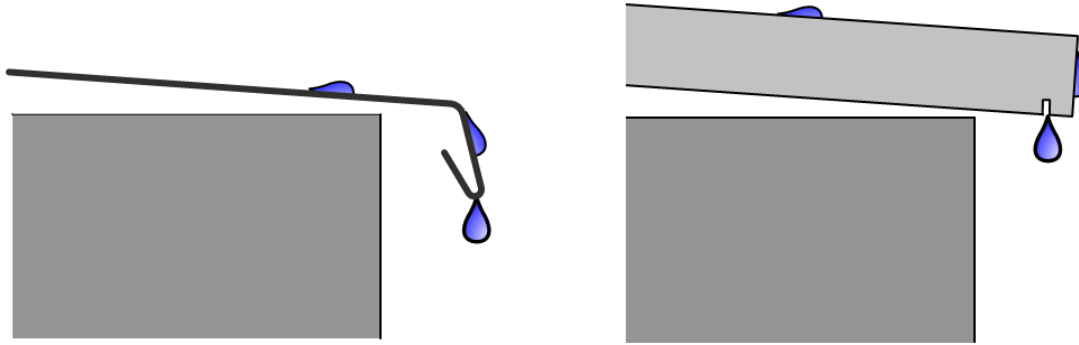

Figure 15. Drip edges to control surface tension at parapets and sills (Straube and Burnett 2005)

Q: What is the impact of having an air gap between the insulation and the masonry (as per the “hygric buffer mat” discussion above)?

A: A great degree of disagreement was evident amongst the participants and the speakers, regarding the risks and merits of such air gaps. In some cases, air gaps are intentionally added, while in others, they are specifically avoided. The risk of adding an air space is that the “buffer” space will be damp, resulting in mold growth (and IAQ problems if there is any air connection from the “buffer” space to the interior). In addition, there is a potential for air leakage from the interior to the “buffer” space, which could introduce additional moisture to the assembly. The benefit of the “buffer” space is that damp wall areas can potentially dry via air convection to less damp areas, thus minimizing localized degradation. In addition, in cases of severe loadings, dried, heated, and conditioned air could be injected into the cavity, to dry the assembly.

Q: Should we be using open or closed cell foam in these applications?

A: Open cell spray foam (ocSPF) is sufficiently vapor permeable (“vapor open”) that there is some risk of frosting or condensation at the interface between the insulation and the masonry, especially at elevated relative humidities. In addition, inward driven water vapor can be a factor with open cell foam: impermeable finishes that act as a vapor barrier (e.g., glass picture frames, mirrors mounted on exterior walls) should be eliminated, due to summertime condensation risks. Closed cell spray foam (ccSPF) does not suffer from either of these issues; however, it substantially reduces the drying of the masonry to the interior, compared to ocSPF.

Q: Are clear protective sealants (silanes and siloxanes) a good solution to accompany these retrofits?

A: There was significant disagree amongst the participants. Some practitioners have used these products on a number of projects without issues (DeRose, Halsall). Others bring up the two

decades of experience (some of it extremely negative) with sealers in the preservation industry, which has led them away from sealants. The worst issues occur when bulk water enters the masonry in macroscopic cracks (which the sealants cannot bridge), resulting in both wetting and inhibited drying. The reply was that newer formulations have been developed, which may address previous issues.

Q: Is better maintenance really the solution that is needed?

A: Significant disagreement amongst participants. Some point out that many water management problems are simple maintenance problems (clogged roof drains/scuppers/gutters, missing downspouts), while other argue that solutions typically applied by maintenance personnel can be detrimental, due to poor understanding of the building physics (application of caulking to weep holes, use of extensive caulking rather than repair of flashing, etc.)

Q: Since it is known that salinity is a critical parameter in the freeze thaw process, how can dilatometry testing capture actual thresholds similar to the field?

A: Since the samples are taken from the field in their existing condition, and they are saturated with distilled water (similar to the rain water that they will be seeing in the field), it is believed that similar salinity conditions should be achieved.

Q: Has the dilatometry approach been validated with bricks from the field that were either confirmed to be freeze-thaw resistant or freeze-thaw susceptible?

A: Anecdotal evidence suggests that the approach is sound. Further validation would be beneficial.

Q: The ventilation air changes per hour (ACH) used in Mr. Ueno's simulations seemed too high.

A: This is an item which merits further investigation, including field measurement.

Q: One retrofit option for embedded beams is to cut off the embedded beam stub, and build supports inboard of the masonry wall. If one does not cut the beams embedded in the masonry (instead simply adding the supporting columns on the interior) would the rot spread?

A: It is unlikely that the rot would come that far in. However, it might be necessary to connect the supporting structure to the masonry with metal strapping, to avoid movement.

Q: Would borate treated sticks, like those used in telephone poles, be a simple answer to embedded beam problems?

A: Perhaps. There was some concern whether borate would spread sufficiently through the body of the wood to achieve adequate protection.

Q: Could one use a steel shoe (joist hanger) to transfer the load from the beam to the masonry in the case of an embedded wood beam?

A: Yes. Another option is a pressure treated ledger board connected to the masonry and the joists.



Figure 16. Steel angle bolted to masonry to transfer load out of beam pocket

5.2 Group Discussion to Cover Key Questions and Action Items

The following discussion covered some of the key questions raised in the meeting agenda.

5.2.1 Details for Bulk Water Control

What are typical details required to reduce rainwater exposure, thus balancing out reduced inward drying with reduced wetting from the exterior? Are typical existing surface drainage details (e.g., solid stone sills, window “eyebrows,” band courses) sufficient, or is it necessary to retrofit additional protection?

Need to examine inclined vs. horizontal surface treatments as separate issues; greatest risk lies with horizontal surfaces (limited drainage).

Need to examine the “funnel” effects at joints, such as at coping stones/band courses.

Need a retrofit drip edge that can be used under window sills with a minimal visible appearance for historic buildings. One example was to use a caulk bead to create a low-visibility drip edge on the underside of a window sill.

Need to understand the effect of retrofitting kerf cuts to the underside of window sills which lack proper drip edges (one practitioner has seen water bridging this gap, during spray tests).

Also need to address the rowlock course window sill, as seen in lower cost/residential construction. One possible solution is the use of a metal sill cap, across the top of the sill. But as a cautionary note on the sill cap: one observed problem was interior air leakage condensation on underside of sill cap.

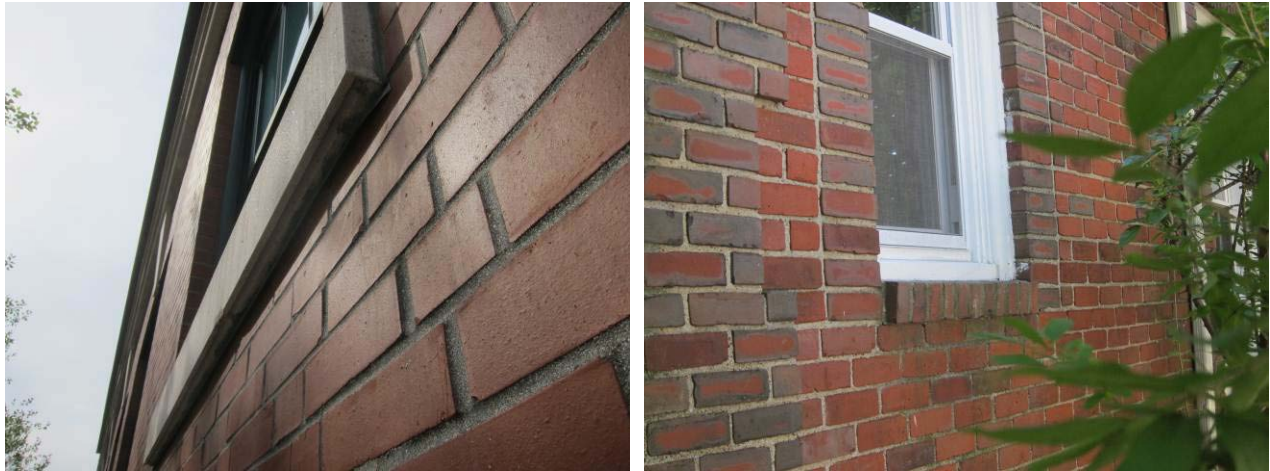

Figure 17. Precast window sill drip edge detail (L); rowlock window sill (R)

What is the treatment required for window? Generally, the windows should be removed, the opening should be waterproofed, and the window reinstalled. Rehabilitation of windows in place should be approached with caution. The use of exterior storms might reduce the wetting potential at the window opening; however, it typically does not address leakage between the frame and masonry.

One proposed water shedding detail is a gutter at the top of the window, to move water to the sides.

5.2.2 Thermal Issues

Do we want to use composite studs (e.g., extruded PVC “Eco Stud”) in lieu of steel studs in order to improve thermal performance?

Creating space between the steel stud frame wall and the masonry wall (to prevent thermal bridging) is always an uphill battle. The industry should clearly define the impact of various stud spacing levels. The minimum dimension is sufficient to avoid direct connection of the stud to the masonry. The ORNL Steel Stud (Modified Zone Method) online calculator can be used to approximate the effect of stud spacing away from the masonry wall. Additional discussions are needed on using non-metallic tiebacks from the framing to the masonry.

5.2.3 Interior Insulation Material Selection

Many of the projects presented here appear to be gut rehabilitations. There is a need for a system that insulates without requiring gutting the interior. Foam injection sounds like a sensible approach when trying to reduce the scope, and keep the renovation simple. However, there are risks of insufficient coverage, trapping moisture-sensitive materials outboard of the insulation, and blowing off interior finishes.

As an example of interior finish removal: one recent case had gypsum block (USG Pryobar) infill interior to the masonry wall. Leaving this in place, outboard of the insulation creates a durability risk; field measurements showed high moisture contents even prior to insulation. The recommendation was to remove the gypsum block before insulation. Other practitioners noted that when gypsum plaster was “trapped” outboard of the insulation in some retrofits, it re-emulsified and softened.

What are options besides using ccSPF and ocSPF spray foams? The industry has concluded that fiberglass and polyethylene is a high risk solution. However, perhaps greater success could be achieved with cellulose or mineral wool (greater airflow suppression and elimination of voids) and a variable-permeability interior vapor control layer (e.g., CertainTeed MemBrain; allows drying but controls wintertime condensation). However, the group had concerns about salt migration. One example building had sufficient moisture movement to create “salt stalactites” with a cellulose installation. It is a highly questionable solution in cases where there is the possibility of future bulk water management issues.

5.2.4 Insulation Assembly Geometry Effects

What is the impact of an air space (vented to inside, outside or unvented) for various wall thicknesses, both in terms of thermal effects and moisture redistribution? This is a research need to be addressed.

What is the effect of party demising (interior-to-interior) walls, intersecting with the exterior wall (a.k.a. “tee” walls)? Two-dimensional thermal simulations seem to indicate that roughly 12” of insulation along the interior wall is sufficient to control the majority of heat flow. A common case would be when one unit in a multi-unit residential building was being insulated, while the adjacent unit was remained uninsulated.

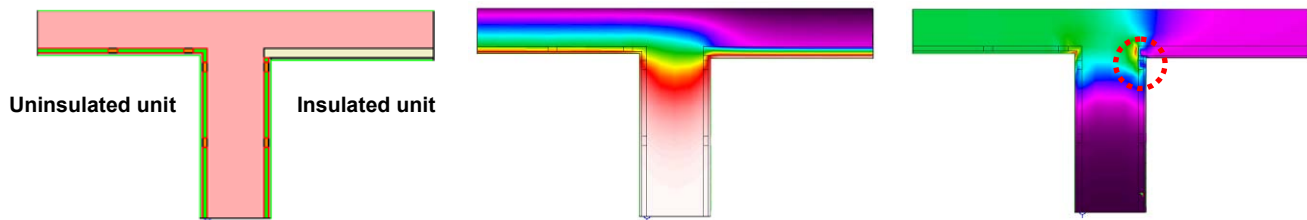
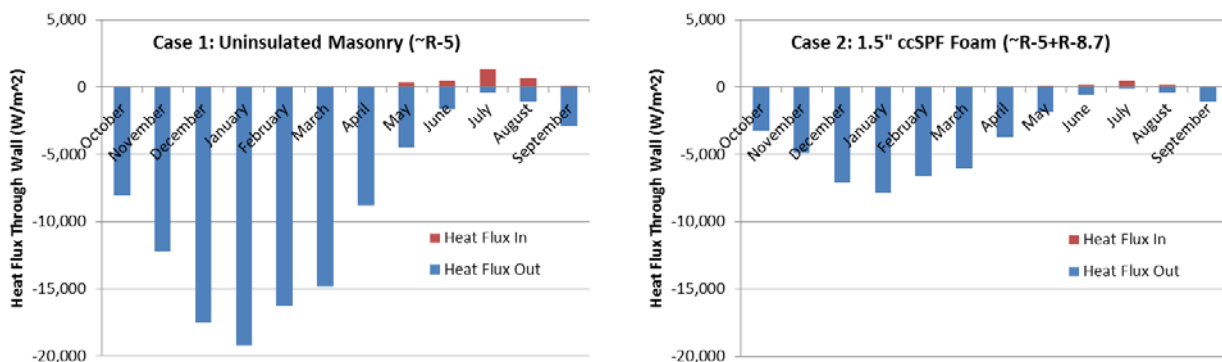
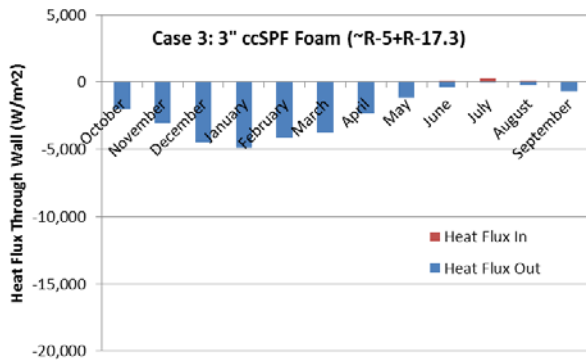

Figure 18. Two-dimensional heat flow modeling party wall (assembly, temperatures, heat flux)

5.2.5 Energy Savings

What are the energy savings associated with interior insulation retrofits? Can effective thermal performance be obtained by leaving these buildings uninsulated, and relying on thermal mass effects? Energy models suggest thermal mass is not significant to energy performance for buildings located in heating-dominated climates; it is of greater benefit in locations with high diurnal swings around the interior setpoint (see Figure 19).





Climate: Burlington, VT

Case 2 ≈ 60% reduction in heat flow through walls

Case 3 ≈ 75% reduction in heat flow through walls

Figure 19. Hygrothermal simulations of heat flux with uninsulated, 1.5”, and 3” ccSPF walls

However, there is an LBNL study that showed 39% energy saving by adding an extra layer of drywall (additional thermal mass) (Kosny). Also, thermal mass is important and valuable to allow off-peak heating and may be more important in the future with variable electricity supply. But there was agreement that leaving these buildings uninsulated is not a good choice for energy performance.

5.2.6 Durability Issues

What is the current level of understanding of evaluating the in-service post-retrofit freeze-thaw resistance of a masonry enclosure, using material property testing and hygrothermal simulations? Can this process be developed further, and/or streamlined?

What are effective solutions to address durability concerns at moisture-sensitive structural members (e.g., wood beams and joists) embedded in masonry structures, in a post-retrofit situation?

In Germany, it is estimated that in roughly 30% of cases, there are problems with inset wood (Künzel). Other than adding heat to the beam ends, there are no clear solutions. Fraunhofer has a project underway monitoring beam end moisture contents.

There was a suggestion that the beam be set in a clay plaster, but there is little actual experience with this technique.

Q: Are there cases of building enclosure failures (specifically freeze-thaw damage to the masonry) that can be traced directly to the retrofit of interior insulation, and what were the circumstances and contributing factors in the failures?

A: Actual cases with modern insulation are not known. It is easy to confuse damage due to surface water management issues.

5.2.7 Historic Issues

What are some key issues that need to be addressed when interfacing with historical preservation requirements (e.g., National Park Service tax credits) and performing these retrofits? (Left open.)

5.2.8 Capillary Flow and Efflorescence

Are there retrofit methods to reduce capillary uptake through existing masonry structures, which are simpler (and less costly) than the retrofit of regletted capillary breaks? Specifically, how do

we reduce capillary flows through foundation walls, which can result in salt efflorescence of the masonry, and/or failures of the exterior parging.

There are “damp proof cremes” available commercially in the United Kingdom, which are injected into horizontal holes in order to create a “damp proofing course” (Figure 20). Are these viable products? They are reported to work only 20%-30% of time in the field (Künzel).



Figure 20. Installation of injectable liquid damp-proofing course (Aida DPC, Remmers Ltd., 2005)

Special salt-accommodating plasters have been used for the last 30 years in Germany; they work well and are inexpensive. The plasters function by having substantial interstitial of space, where salts can crystallize without causing dimensional instability issues. Saw cut reglet damp proofing is an option, but special plasters are much less costly (Künzel).

It was noted that the rate of capillary transport is a function of temperature; it is greater in cold conditions than warm (Rose). This may be a significant phenomenon, and may be affected by addition of insulation.

Nitric salts are very hygroscopic, which also leads to substantial efflorescence in agricultural applications, and may be throwing off Rose’s observations (Künzel).

5.2.9 Non-Specialist Analysis

Based on hygrothermal simulations and field experience, are there widely-applicable limits to interior insulation levels (and type of insulation), based on climate zone, building exposure, and material properties that can be evaluated by non-specialists? (Left open.)

5.2.10 Tapered Window Openings

Given that many mass masonry buildings have deep window openings with limited available space (due to window clearance issues and historic requirements not to change window profiles), what is the effect of thinner (e.g., ~1”) insulation at these openings?

Tapered window opening and exposed window sills limit ability to add insulation. No available solutions were presented. Two- or three-dimensional thermal modeling would provide some insight into this issue.

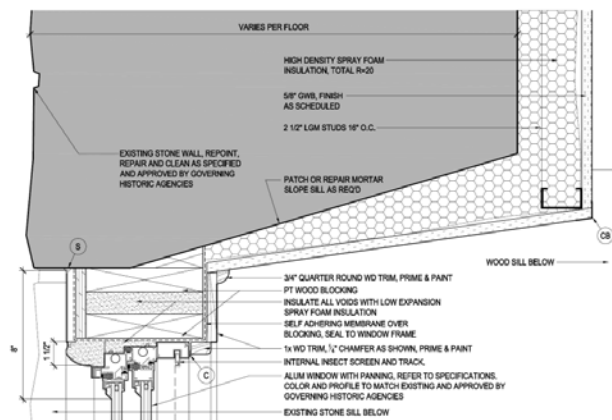

Figure 21. Tapered window opening jamb detail and interior view (sill left uninsulated)

5.2.11 Experiment and Monitoring Opportunity

Fraunhofer Center for Sustainable Energy Systems in Cambridge, MA is moving to an old masonry (brick) building, and they are open for experiment insulation methods and monitoring installations. Please contact Dr. Kosny if interested in participating in this work.

References

Lstiburek, J.W. (March 2010a). “Building Sciences: Rubble Foundations.” *ASHRAE Journal* (vol. 52); pp. 72-78. Atlanta, GA: American Society of Heating, Refrigeration, and Air-Conditioning Engineers, Inc.

Lstiburek, J.W. (May 2010b). “Building Sciences: Thick as a Brick.” *ASHRAE Journal* (vol. 52); pp. 50-56. Atlanta, GA: American Society of Heating, Refrigeration, and Air-Conditioning Engineers, Inc.

Mensinga, P., J. Straube, C. Schumacher, C., et.al. 2010. “Assessing the Freeze-Thaw Resistance of Clay Brick for Interior Insulation Retrofit Projects” *Performance of the Exterior Envelopes of Whole Buildings XI*. Atlanta, GA: American Society of Heating, Refrigeration, and Air-Conditioning Engineers, Inc. Proceedings of Building XI Conference Clearwater, FL.

Pettit, B. (April/May 2008) “Remodeling for Energy Efficiency.” *Fine Homebuilding Magazine*. Newtown, CT: Taunton Press.

Straube, J.F., and Burnett, E.F.P., (2005). *Building Science for Building Enclosure Design*, Building Science Press: Westford, MA.

Appendix A (Agenda, Objectives, Key Questions, Presenter Bios)

Building America Expert Meeting on *Interior Insulation Retrofit of Mass Masonry Wall Assemblies*

Date/Time: Saturday, July 30, 2011
9 am to 3 pm

Location: Westford Regency Hotel
219 Littleton Road Westford, MA 01886
P: (800) 543-780; (978) 692-8200

Meeting Manager: Kohta Ueno, Building Science Corporation
Kohta@buildingscience.com; (617) 863-5276

List of Presenters:

- John Straube (Building Science Corporation)
- Henri Fennel (Conservation Services Group)
- Mark Bomberg (Syracuse University)
- Christopher Schumacher (Building Science Corporation)
- Kohta Ueno (Building Science Corporation)

The objective of this session is to explore the current state of implementation and research on interior insulation retrofit of mass masonry wall assemblies. There is a large stock of uninsulated mass masonry buildings and the retrofit of interior insulation is commonly implemented to improve their energy performance, while maintaining their often historic exterior appearance. There are known durability issues associated with interior insulation, such as interstitial condensation and freeze-thaw damage issues. These issues have been or are being addressed in many cases, but there are still remaining questions that should be answered before mass implementation in a variety of climate zones. However, leaving these buildings uninsulated is at odds with the Building America target of broad energy retrofits of existing homes to reduce residential carbon emissions 20% by 2020 and 80% by 2050. Discussions on this topic will be applicable to existing mass masonry single and multi-family residential buildings. Issues such as durability, energy performance, and detailing will be examined.

Key questions regarding this meeting:

1. What are typical details required to reduce rainwater exposure, thus balancing out reduced inward drying with reduced wetting from the exterior? Are typical existing surface drainage details (e.g., solid stone sills, window “eyebrows,” band courses) sufficient, or is it necessary to retrofit additional protection?
2. What are the energy savings associated with interior insulation retrofits? Can effective thermal performance be obtained by leaving these buildings uninsulated, and relying on thermal mass effects?
3. What is the current level of understanding of evaluating the in-service post-retrofit freeze-thaw resistance of a masonry enclosure, using material property testing and hygrothermal simulations? Can this process be developed further, and/or streamlined?

4. What are effective solutions to address durability concerns at moisture-sensitive structural members (e.g., wood beams and joists) embedded in masonry structures, in a post-retrofit situation?
5. What are some key issues that need to be addressed when interfacing with historical preservation requirements (e.g., National Park Service tax credits) and performing these retrofits?
6. Are there retrofit methods to reduce capillary uptake through existing masonry structures, which are simpler (and less costly) than the retrofit of regletted capillary breaks?
7. Based on hygrothermal simulations and field experience, are there widely-applicable limits to interior insulation levels (and type of insulation), based on climate zone, building exposure, and material properties that can be evaluated by non-specialists?
8. Are there cases of building enclosure failures that can be traced directly to the retrofit of interior insulation, and what were the circumstances and contributing factors in the failures?
9. Given that many mass masonry buildings have deep window openings with limited available space (due to window clearance issues), what is the effect of thinner (e.g., ~1") insulation at these openings?

Expected Results:

As a result of this meeting, a summary report will be prepared and peer reviewed before final submission and web posting. It is expected that the information obtained, relative to the Key Questions listed above, will lend itself toward the eventual production of an important guide for best practices for interior insulation retrofit of mass masonry wall assemblies.

Invitees:

Participants will be key people working in the fields of building science, building enclosure research and consulting, residential construction, and building energy efficiency. A blend of industry, research, and government participants will be sought.

Meeting Agenda:

- 9:00 AM Welcome and Meeting Introduction: Brief Building America Program Overview
- 9:15-10:00 AM John Straube: Mass Masonry Insulation Retrofits: Fundamentals and Challenges
- 10:00-10:30 AM Henri Fennel: Variations on a (Mass Masonry?) Theme – With A Touch of Foam
- 10:30-10:45 AM Break
- 10:45-11:15 AM Mark Bomberg: Thermal Upgrade of Masonry Walls -Interior Methods
- 11:15-11:45 AM Christopher Schumacher: Assessing the Freeze-Thaw Resistance of Clay Brick for Interior Insulation Retrofit Projects

- 11:45-12:15 AM Kohta Ueno: Masonry Wall Interior Insulation Retrofit Embedded Beam Simulations
- 12:15 to 1:15 Lunch break (lunches provided)
- 1:15 to 1:45 Special Topic Discussions
 - Field experience of field practitioners not on speakers list
 - If warranted—collect photos for display and discussion over lunch break from field practitioners
 - Discussion of problematic water concentration details seen in the field
 - Discussion of retrofit details to reduce water exposure
- 1:45 to 3:00 Group discussion to cover key questions, action items, follow-up plan, and wrap-up.
- 3:00 PM Adjourn meeting

Presenter Bios

John F. Straube (Ph.D., P.Eng.) is a principal of Building Science Corporation and a professor of building science in the Civil Engineering Department and School of Architecture at the University of Waterloo, Canada. Dr. Straube has acted as an educator, researcher, consultant and expert witness on energy efficiency, durability and IAQ. Current interests include the optimal system design of buildings, sustainable buildings, and moisture problem avoidance.

Henri Fennell (CSI/CDT) is a principal of HC Fennell Consulting, a building science consulting and education firm. He is an architect with twenty-five years of experience in energy conservation products and services, and specializes in the use of manufactured and field-installed urethane technologies. As a building envelope consultant, Henri worked with architects, designers, builders, and contractors to diagnose and solve building envelope problems. Before this position, he was president of Building Envelope Solutions, Inc. / FOAM-TECH, a spray foam contracting firm, and then Technical Research Manager at Conservation Services Group, Inc.

Mark Bomberg (Ph.D.) is a research professor at Syracuse University. He is a leader of an industry-university collaborative research center on hygrothermal performance of building enclosures. His research specialties include high performance building enclosures and thermal insulating materials. Prior to this position, he was a senior researcher at the National Research Council of Canada for 24 years.

Christopher J. Schumacher (M.A.Sc.) is a principal of Building Science Corporation. He is recognized as an expert in the field of building monitoring and building systems and enclosure

testing. He has led the design, installation and analysis of monitoring systems for 15 building enclosure test facilities, six test building sites, three climate chambers and two sustainable building technologies demonstration projects in over a dozen states and countries as far abroad as Mongolia and New Zealand.

Kohta Ueno (M.A.Sc.) is a senior associate of Building Science Corporation. His responsibilities at Building Science Corporation include project management, liaison work with builders and industry clients, HVAC design, energy analysis of house designs, computer modeling, field testing and verification, and forensic field investigations. He has been with BSC since 1998, and completed his Master's degree with the Building Engineering Group under John Straube at the University of Waterloo in 2007.

EERE Information Center

1-877-EERE-INF (1-877-337-3463)

www.eere.energy.gov/informationcenter

U.S. DEPARTMENT OF
ENERGY

Energy Efficiency &
Renewable Energy

DOE/GO-102012-3475 • February 2012

Printed with a renewable-source ink on paper containing at least 50% wastepaper, including 10% post-consumer waste.