

# The U.S. Air Service in World War I

---

## Volume I

The Final Report  
and A Tactical History

Edited by  
Maurer Maurer

The Albert F. Simpson Historical Research Center  
Maxwell AFB Alabama

The Office of Air Force History  
Headquarters USAF  
Washington 1978



**Library of Congress Cataloging in Publication Data**

Main entry under title:

The U.S. Air Service in World War I.

CONTENTS: v.1. Final report of the Chief of Air Service, AEF. A tactical history of the Air Service, AEF.

1. European War, 1914-1918—Aerial operations, American.
2. United States. Army. A.E.F., 1917-1920. Air Service. I. Maurer, Maurer.

D606.U54

940.4'49'73

75-42296

---

**Advisory Committee**

Dr. I. B. Holley, Jr.  
Duke University

Lt. Gen. James R. Allen  
Superintendent, USAF Academy

Dr. Robert F. Byrnes  
Indiana University

Lt. Gen. Albert P. Clark  
USAF(ret.)

Lt. Gen. Raymond B. Furlong  
Commander, Air University

Dr. Henry F. Graff  
Columbia University

Dr. Louis Morton  
Dartmouth College

Dr. Forest C. Pogue  
Director, Dwight D. Eisenhower  
Institute for Historical Research

Mr. Jack Stempler  
General Counsel, USAF

**Office of Air Force History**

Maj. Gen. John W. Huston, Chief

Chief Historian  
Dr. Stanley L. Falk

Deputy Chief Historian  
Max Rosenberg

Chief, Histories Division  
Carl Berger

Senior Editor  
Lawrence J. Paszek





# Foreword

---

In December 1918 Maj. Gen. Mason M. Patrick, Chief of Air Service, American Expeditionary Forces (AEF), directed his newly appointed Assistant Chief of Staff, Col. Edgar S. Gorrell, to prepare a history and final report on U.S. air activities in Europe during World War I. The narratives written and compiled by Gorrell and his staff were submitted by Patrick to Gen. John J. Pershing, Commander in Chief of the AEF. They summarized Air Service activities from the arrival of the first airmen in France in the spring of 1917 until the Armistice on November 11, 1918. The "Final Report" was published by the Air Service in an *Information Circular* in 1921, and by the Army in a multivolume collection of World War I documents in 1948. Although it has been used and cited by a number of historians over the years, it deserves to be better known. The Office of Air Force History, therefore, is republishing it so as to reach a wider circle of persons interested in the Great War and the early history of military aviation.

Another important document produced under Gorrell's supervision as part of the history of the Air Service, AEF, is a "Tactical History" written by Lt. Col. William C. Sherman and a group of officers working with him in France at the end of the war. Although published in part in an *Air Service Information Circular* in 1920, Sherman's "Tactical History" has remained virtually unknown, or at least has not had extensive use. Since it provides excellent information about the conduct of combat operations, it should be of value to persons interested in aerial warfare in the First World War. It has been included, therefore, in this volume with the "Final Report."

This is one of a series of volumes of World War I documentation that the Office of Air Force History is planning to publish.

John W. Huston  
Major General, USAF  
Chief, Office of Air Force History



---

The "Final Report" published in this volume has been taken from *Air Service Information Circular (Aviation)*, Vol. II, No. 180, 15 February 1921. Substantive changes made in the Office of the Chief of Air Service when the "Final Report" was being prepared for publication in 1921 have been pointed out in notes provided by the editor.

The source for the section on corps observation in the "Tactical History" included in this volume is the *Air Service Information Circular (Heavier-than-Air)*, Vol. I, No. 75, 12 June 1920; the source for the section on army observation, pursuit, day bombardment, and observation balloons is a microfilm (T-619) copy of "Gorrell's History of the Air Service, AEF," Ser. D, Vol. I. The last four sections, which vary greatly in style, have been edited in the same general manner as the section on corps observation was edited when it was prepared for printing in 1920. The first part of the "Tactical History," a seventeen-page section entitled "The Achievement of the Air Service," has been omitted since a revised and edited version of the same material appears as Chapters I-III of the "Final Report."

Associated with the "Tactical History" and included with it in "Gorrell's History" are a "Manual for the Employment of Air Service (Tentative)" and "Notes on the Employment of the Air Service from the General Staff Point of View." Both the "Manual" and the "Notes" are scheduled for publication in another volume of this series.

The general editorial policy in preparing the "Final Report" and "Tactical History" for publication has been to copy the materials as they were found in the places indicated, and keep the editing and annotation to a minimum. Typographical and other minor errors have been corrected, but no attempt has been made to verify data and correct any inaccuracies that may exist in those materials. The editor has not tried to straighten out such inconsistencies as the numbering of units (1st or First Pursuit Group; 2d or Second Army; Third, 3d, or III Corps, etc.) or the

---

spelling of the various forms of the verb "to strafe" (strafe or straff, strafing or strafing) when there seemed to be no established usage during the First World War. Except for the previously mentioned editing done on parts of the "Tactical History," no effort has been made to establish uniformity throughout this volume in punctuation, capitalization, spelling, format, and other stylistic matters. The introduction, graphs, maps, photographs, and abbreviation list were added by the editor. Mr. Deane J. Allen and Mr. Lawrence J. Paszek of the Office of Air Force History assisted in readying the manuscript for publication by proofing the editorial changes, preparing the graphics, selecting the photographs, and maintaining a close liaison with the printers to resolve the numerous difficulties that arise in the final phases of production. Mr. John Hamilton and Mr. Jim Eschinger, Typography and Design Division of the Government Printing Office, designed the interior layout of the book.

Photographs were selected from collections held by USAF's 1361st Photo Squadron, Air Force Art Collection, and by the Audiovisual Archives Division of the National Archives.

**Maurer Maurer**  
Editor

---

<b>Foreword</b> .....	v
<b>Preface</b> .....	vii
<b>Introduction</b> .....	1
<b>Final Report of the Chief of Air Service, AEF</b>	
I. Achievement .....	17
II. The Woevre and the Marne .....	29
III. St. Mihiel and the Argonne-Meuse .....	37
IV. Early Problems and Their Solutions .....	51
V. Reorganization and Development .....	65
VI. Period of Expansion .....	71
VII. The Working Organization .....	75
VIII. Difficulties .....	81
IX. Scope of Activities and General Remarks .....	85
X. Training .....	93
XI. The Supply Section .....	117
XII. The Technical Section .....	131
XIII. The Balloon Section .....	137
XIV. The Aircraft Armament Section .....	145
XV. The Photographic Section .....	151
XVI. The Radio Section .....	157
XVII. The Medical Consultant .....	161
XVIII. Conclusion .....	163
<b>A Tactical History of the Air Service, AEF</b>	
<b>Part One: The Achievement of the Air Service, AEF</b>	
<b>Part Two: Tactical History of Corps Observation</b>	
I. Introduction .....	169
II. The First Corps Observation Group in the Toul Sector .....	171
III. The 12th Aero Squadron in the Baccarat Sector .....	185
IV. The Third Flight of the 99th Squadron in the Vosges .....	193
V. The 1st Corps Air Service at Chateau-Thierry .....	197
VI. The Third Corps Air Service on the Vesle River .....	221
VII. The Corps Air Service in the St. Mihiel Offensive .....	235
VIII. The Corps Air Service in the Argonne-Meuse Offensive .....	245

<b>Part Three: Tactical History of Army Observation</b>	
I. On the Toul Sector .....	259
II. The St. Mihiel Offensive .....	269
III. The Argonne-Meuse Offense .....	275
<b>Part Four: Tactical History of Pursuit Aviation</b>	
I. The Toul Sector .....	283
II. Chateau-Thierry .....	291
III. St. Mihiel Offensive .....	301
IV. Argonne-Meuse Offensive .....	313
V. American Pursuit Units on the British Front .....	325
VI. Second Army Pursuit .....	341
<b>Appendices to Tactical History of Pursuit Aviation</b>	
A. Sample Battle Orders, Air Service, First Army .....	343
B. Sample Operations Order, 1st Pursuit Wing .....	346
C. Sample Operations Order, 1st Pursuit Group .....	348
D. Table: Percentage of Casualties to Available Pilots .....	350
E. Chart: Enemy Aircraft Brought Down .....	351
F. Chart: Ratio of Confirmed Victories to Casualties .....	352
G. Table: Planes on Hand and Available for Service and Pilots Available...	353
<b>Part Five: Tactical History of Day Bombardment</b>	
I. From the Beginning to the St. Mihiel Offensive .....	357
II. The St. Mihiel Offensive .....	365
III. The Argonne-Meuse Offensive .....	371
<b>Part Six: Tactical History of American Observation Balloons</b>	
I. In the Toul Sector .....	379
II. At Chateau-Thierry .....	381
III. In the St. Mihiel Battle .....	383
IV. In the Argonne-Meuse Offensive .....	385
V. Miscellaneous .....	387
<b>Appendices</b>	
A. Directive for "Final Report" .....	389
B. Outline of Tactical Organization, 11 November 1918 .....	391
<b>Abbreviation List</b> .....	393
<b>Notes</b>	
To the Introduction .....	395
To the Final Report .....	397
To the Tactical History .....	403
<b>Index</b> .....	406

---

## List of Photographs

Col. Henry C. Whitehead .....	3
Col. Edgar S. Gorrell .....	4
Col. Thomas DeW. Milling .....	5
Lt. Col. William C. Sherman .....	6
Lts. Douglas Campbell and Alan Winslow .....	30
Observers leave observation balloon .....	32
A Caquot balloon .....	35
The Arizona Balloon Buster (Art by Merv Corning) .....	36
Capt. Field E. Kindley .....	45
Lt. Col. "Billy" Mitchell and Maj. Raynal C. Bolling .....	53
<i>Lafayette Escadrille</i> hangars at Ham airdrome; Officers of the 103d Aero Squadron, formerly of the <i>Escadrille</i> , receive decorations .....	56
Pilots of the <i>Lafayette Escadrille</i> with one of their pet lions; Maj. William K. Thaw .....	57
Spad VII .....	60
Repair shop at Issoudun .....	64
Parachute descent from free balloon .....	70
Brig. Gen. Benjamin Foulois with Gen. John J. Pershing .....	75
Aviators in training .....	80
A Handley-Page bomber readied for a mission on the Aisne front .....	84
Observers train in aerial gunnery; Miniature planes used for sighting with machine guns in aerial gunnery .....	96
Secretary of War, Newton D. Baker and Brig. Gen. Foulois at Issoudun; Lt. Quentin Roosevelt .....	106
Flying field at Issoudun .....	107
An RAF class in gunnery training .....	109
A British Sopwith stockroom for engines and spare parts .....	116
DH-4 aircraft of the U.S. Air Service at Romorantin .....	127
Aviation Mechanics uniform insignia of the U.S. Air Service .....	132
Observer climbs into a basket of an observation balloon; Balloon ascends; Balloon shot down by enemy fire .....	139
Observers parachute from French balloon shot down by enemy fire .....	141
Lt. Col. John Paegelow .....	143
A machine gun on a Scarff mount ready for action .....	144
Aerial observer reaches for camera prior to a reconnaissance mission .....	150
Camera on Salmson; Movie camera mounted on aircraft; Photo printing room at Tours; Composition of aerial maps and models .....	153

---

Capt. Albert W. Stevens with DeRam camera on a Salmson .....	155
Radio operators receive message from fliers .....	156
Maj. Gen. Mason M. Patrick .....	163
The Eagle of Lille (Art by Merv Corning) .....	168
A railroad gun .....	180
An aerial view of trenches taken during photo reconnaissance .....	194
Maj. Lewis H. Brereton and Col. "Billy" Mitchell .....	196
Messages received from aircraft for transmission to artillery units .....	215
Maj. Joseph T. McNarney .....	220
Maj. Harry B. Anderson and Lt. Arthur R. Christie .....	234
Field radio station .....	241
French soldiers watch an observation balloon falling in flames .....	244
Lt. George C. Kenney .....	258
Maj. John N. Reynolds .....	261
A 155-mm artillery battery .....	268
A pilot's view of a battle .....	271
Night bombardment scene .....	274
Lt. Everett R. Cook .....	277
Capt. "Eddie" Rickenbacker and Lt. Reed Chambers .....	282
Maj. Bert M. Atkinson .....	287
Graveside services for 1st Lt. Quentin Roosevelt .....	297
Fall of the Flying Fool (Art by Merv Corning) .....	300
Burning balloon shot down by an aircraft .....	310
"Balloon Buster" Frank Luke, Jr. ....	312
Capt. James A. Summersett, Jr. ....	317
Maj. Harold E. Hartney .....	320
An Attack in World War I (Art by Merv Corning) .....	327
Maj. Reed G. Landis .....	341
Breguets of the 96th Aero Squadron head for a daylight bombing assault on German territory .....	356
A Breguet 14-B2 of the 96th Aero Squadron .....	360
DH-4 aircraft of the 11th Aero Squadron conduct a bombing attack .....	364
Capt. Cecil G. Sellers .....	366
Bombs loaded for a mission .....	367
Maj. James L. Dunsworth observes bomb loading .....	370
Col. Charles Def. Chandler; Col. Frank P. Lahm; Observation balloon and winch .....	378



Maj. John H. Jouett; Caquot balloon with winch .....	382
An observer with a telephone set in a balloon basket .....	383
Partially inflated balloon—10th Balloon Company; Col. Frank P. Lahm and his staff .....	386

### List of Tables, Maps, and Charts

Combat Squadrons in AEF—Dates of Assignment and Demobilization .....	18
First Day Bombardment Group—Chart of Complete Operations .....	19
U.S. Balloon Companies in AEF—Dates of Assignment and Demobilization ..	20
1st Day Bombardment Group—Bombs Dropped During October .....	21
Squadrons, Balloon Companies, Photo Sections and Air Parks Assigned to Armies in the AEF .....	22
Air Service Units of the First American Army, Nov. 11, 1918 .....	23
Flying Time of Air Service Assigned to Armies from Beginning of Operations until July 1st, 1919 .....	24
Total Number of Airplanes Dispatched to Zone of Advance .....	25
Air Service Stations in AEF—Establishment and Demobilization .....	26
Casualties of U.S. Air Service Personnel .....	27
Air Service, AEF, Chart of Organization .....	63
Airplanes Received from All Sources—From Beginning of Operations to Dec. 31, 1918 .....	66
Monthly Arrival of Air Service Personnel in AEF .....	67
Air Service Personnel in AEF—Arrival and Departure .....	68
U.S. Air Service, AEF, Location of Air Service Centers in France .....	77
Handley Page Flow Sheet .....	86
Hours Flown in Training, AEF .....	98
Chart Showing When Instruction Commenced and Finished at all Flying Schools in AEF .....	100
U.S. Air Service, AEF, Training Centers for Co-operation with Artillery, 1917-1918 .....	102
U.S. Air Service, AEF, Training Centers in France, 1917-1918 .....	111
Air Service, AEF, General Flow of Aeronautical Material Airplanes, as of November 11, 1918 .....	118
Air Service, AEF, General Flow of Aeronautical Material Spare Parts, as of November 11, 1918 .....	120
Air Service, AEF, General Flow of Aeronautical Material General Supplies, as of November 11, 1918 .....	121

---

U.S. Air Service, AEF, Location of Sources of Supply and Distributing Stations for Zone of Advance, 1917-1918 .....	129
U.S. Air Service, AEF, Balloon Centers in France, 1917-1918 .....	136
Air Service, AEF, General Flow of Aeronautical Material Balloons and Balloon Supplies, as of 11 November 1918 .....	141
Enemy Aircraft Brought Down by 1st, 2nd, and 3rd Pursuit Compared with American Pursuit Casualties .....	351
Enemy Planes Brought Down by American Pursuit Compared with American Pursuit Casualties .....	352
Planes on Hand, Available for Duty, and Pilots Available in First, Second, and Third Pursuit Groups, AEF .....	353

# The U.S. Air Service in World War I

---

## Volume I

The Final Report  
and A Tactical History



# Introduction

---

The "Final Report" and "Tactical History" published in this volume are products of the historical program of the Air Service, American Expeditionary Forces (AEF). They are part of that monumental compilation of historical narratives and documentary materials that has come to be known as "Gorrell's History." Persons seeking source materials on U.S. military aviation in the First World War would do well to research this multi-volume collection housed in the National Archives. All who do so are forever indebted to Mason M. Patrick, Edgar S. Gorrell, Ernest L. Jones, William C. Sherman, and the many other people who had a part in documenting and preserving the history of Air Service activities in Europe in 1917 and 1918.

When the United States entered the war in April 1917, the Army had two reporting systems for obtaining historical information from some of its major components, but that was the extent of the historical program.<sup>1</sup> In February 1918, however, the War Department created a Historical Branch of the General Staff to write the history of the World War. About the same time, Gen. John J. Pershing, Commander in Chief of the AEF, set up a historical unit in AEF General Headquarters at Chaumont-en-Bassigny, France. During the weeks that followed, historical programs were established by various elements of the U.S. Army, including the AEF's Services of Supply (SOS), with headquarters at Tours, France.<sup>2</sup>

On 9 May 1918, SOS established a Section of Historical Records and directed SOS departments to appoint historians, write their histories up to the end of May, and thereafter submit monthly historical reports.<sup>3</sup> Since the Air Service, AEF was then under SOS, a copy of the directive was sent to its Chief, Brig. Gen. Benjamin D. Foulois, whose office was on the second floor of Beaumont Barracks B at Tours. One of Foulois' assistants, Col. Oliver S. Eskridge, bucked the order down the hall to the Information Section, Room 203: "Captain Jones—This is your job. Go to it."<sup>4</sup>

Ernest L. Jones, who had learned to fly in a Curtiss pusher in 1909, had edited and published the magazine *Aeronautics* in New York before the war. Commissioned a first lieutenant in June 1917, he had been assigned as intelligence officer in the Aeronautical Division of the Signal Corps in Washington. Promoted in October, he had gone to France with Foulois and had organized the unit that had become the Information Section of the Air Service, AEF. As Chief of Information, Jones was responsible for collecting and distributing aeronautical, technical, and military data. To this he now added the job of historian. Receiving the SOS directive on Saturday, 11 May, Capt. Jones penciled a

---

"Yes, Sir!" on Eskridge's note and entered a new phase in what was to be a long career as chronicler of aviation events.<sup>5</sup>

To get the SOS historical program started, the secretary of the SOS staff called a meeting of the newly-designated historians for 1000 the following Monday morning. There Jones learned that SOS wanted historical records—orders, bulletins, memoranda, other documents, statistical data, official statements by commanders, etc.—covering Air Service activities at all levels. But that was not all. In addition to "comprehensive, all-inclusive, constructive historical facts," SOS wanted "the living, the human, the American story of the Services of Supply of the American Expeditionary Forces."<sup>6</sup> At this time, however, the Air Service historical program covered only administrative, logistic, and training activities; it did not then include the Zone of Advance and units in combat.

Jones was able to do very little before the deadline of 1 June for submitting the initial history to SOS. He described the work he turned in as consisting of "a chart and explanations of the then existing organization, a map showing the location of A.S. centers, various charts indicating the organization sub-divisions, methods and progress of training, very brief accounts of certain training centers and 'stories' of several A.S. Sections which were hardly more than statements of duties assigned."<sup>7</sup>

Soon after receiving the initial histories, SOS canceled the requirement for monthly installments. Each organization was to keep its history up to date and on file subject to call. With the pressure off and so many other things requiring Jones' attention, little more was done with the history of the Air Service until after 2d Lt. Lucien H. Thayer was assigned to the Information Section on 2 September for historical work.

After Thayer took up his duties, Jones took two important steps to move the program forward. First, he obtained an extension of the program to include all Air Service activities in Europe. Second, he set up a system for obtaining historical reports from the various units of the Air Service. Each unit was to write its history, including data about its origin, movement overseas, activities in the AEF, commanders, and awards. The emphasis, however, was to be on operations. Jones wanted "picturesque accounts of notable air battles and the human story of their participants." Such accounts were needed, he believed, "to please the public who will be eager for authentic stories of the deeds of American soldiers." In preparing the material, he said, every effort "should be made to present facts of dramatic, comic, or tragic interest, tales of obstacles overcome, of discouraging conditions, of problems of personnel, equipment, supplies,

transportation or maintenance, or tests and experiments that may have historical value."<sup>8</sup>

Jones soon discovered, however, that "difficulties of gathering information in the midst of intense military effort" would make it impossible to accomplish much in the Zone of Advance so long as the fighting continued.<sup>9</sup> Furthermore, in reviewing the histories received from the various organizations, Thayer found that many were incomplete or inaccurate, or that they dealt in generalities and needed to be filled out with factual data from interviews or from research in files.

The only other important development in the program before the Armistice on 11 November 1918 apparently was the assignment of a photographic unit to take whatever pictures Jones needed for the history of the Air Service.

At the Armistice, Jones had a historical staff of 2 officers, 2 enlisted men, and 1 civilian as part of the Information Section at Tours. Foulois, who had ended up as Assistant Chief of Air Service at Tours, apparently had never given any particular attention to the historical program. Nor had Maj. Gen. Mason M. Patrick, who had succeeded Foulois as Chief of Air Service.

Patrick's attitude changed, however, as the fighting came to an end. He and some of his staff at Chaumont, which had become headquarters for the Air Service as well as for the AEF, began to show interest in documenting Air Service activities in Europe. Patrick's attitude at this stage apparently was reflected in the answer that his Chief of Staff, Col. Henry C. Whitehead, gave to a question from the Photographic Section concerning pictorial records of the war. Whitehead said that the Chief of Air Service "is not only extremely anxious but demands" that as many such records as possible be obtained. Whitehead continued: "We must do everything as thoroughly as is possible to complete all records, to obtain all information, and to profit in the interest of future progress, investigation, [and] study . . . thru aerial photography and thru all other phases of aviation."<sup>10</sup>

A week later, on 18 November, Whitehead directed Air Service organizations to finish their histories "at their earliest convenience" and send them to the Information Section. Although Whitehead's message indicated a desire to get the histories in from the units, its wording did not indicate any great urgency. Rather, it instructed the units to take enough time to make their histories "as complete and interesting as possible."<sup>11</sup> Jones, however, was asking the units to complete their histories through 11 November 1918 and send them in "at the earliest possible moment."<sup>12</sup> Afterwards the units were to keep their histories up to date so they would be ready when requested.



Col. Henry C. Whitehead.

A little later Jones asked the units to send in with their histories any original poems, verses, and cartoons they had, as well as drawings of squadron insignia and rosters of officers. Units that were slow in submitting their histories received reminders from Jones, who also took steps to see that each unit turned in its history before sailing for home.

By early December, Patrick had decided on a program for compiling a complete record of all Air Service activities in Europe. In addition to narratives covering the development of the various Air Service organizations, this record was to include sufficient facts and figures to answer any question that might be asked about the Air Service, AEF. Such a comprehensive historical record, Patrick believed, would assist in establishing military aeronautics on a sound basis in the future. To supervise and coordinate the work of compiling this record, the Chief of Air Service created a new position of Assistant Chief of Staff on 4 December 1918. The man selected for this job was Edgar S. Gorrell, who was to report directly to Patrick.<sup>13</sup>

Born in Baltimore in 1891, "Nap" Gorrell (pronounced gor'rel) had graduated from the U.S. Military Academy in 1912, learned to fly at San Diego in 1915, and served with the 1st Aero Squadron during the Mexican expedition. After earning a master's degree in aeronautical engineering at the Massachusetts Institute of Technology, he had been assigned as intelligence officer in the Aeronautical Division in Washington, where he was when the United States entered the war. He had gone to Europe in June 1917 as a member of the aeronautical commission headed by Maj. R. C. Bolling. Afterwards he had been Chief of the Technical Section and later of the Strategic Section of the Air Service, AEF, and had served as Aviation Officer in G-3 at General Headquarters, AEF. Having been commissioned a second lieutenant upon graduation from the U.S. Military Academy, Gorrell had advanced rapidly, as many other aviation officers did during the war. Henry H. Arnold, for example, rose from captain to colonel in less than six weeks in 1917 and claimed that when he pinned on his eagles he was, at age 31, the youngest colonel in the Army. But Gorrell topped that when he became a colonel on 28 October 1918 at age 27. It was this bright, young colonel who became the chief historian of the Air Service, AEF, on 4 December 1918.<sup>14</sup>



Col. Edgar S. Gorrell

One thing that apparently helped to shape the historical program of the Air Service, AEF, in the days following the Armistice was a history compiled by the Air Service of the First Army. This history (if it could be called that) had been sent to the Commanding General of the First Army, Lt. Gen. Hunter Liggett,



on 25 November 1918, with a copy evidently being sent to Patrick's headquarters about the same time. The purpose of the history, which covered operations from the time the First Army was formed on 10 August 1918 until 11 November 1918, was disclosed in the final paragraph of a two-page introductory statement signed by Lt. Col. William C. Sherman, Chief of Staff, Air Service, First Army:

In a branch which is as new as the Air Service, and about which so little was known at the beginning of the war, it was only natural that there would be a certain lack of appreciation of the difficulties under which we were working. I feel, however, that the histories and data submitted will give a comprehensive idea of what has been accomplished.<sup>15</sup>

The histories referred to by Sherman were those of the various sections of the Office of the First Army Air Service Commander and of the various service (i.e., tactical) organizations—corps air services, wings, groups, and squadrons—of the Air Service, First Army. The data mentioned by Sherman included station lists, general orders, personnel rosters, intelligence reports, operations reports, statistical summaries, and other documents pertaining to the operations of the Air Service, First Army, in its two campaigns, St. Mihiel and Argonne-Meuse. Altogether, the histories and documents constituted a comprehensive record of what the Air Service, First Army, had done.

Someone at Chaumont was sufficiently impressed to want something like it for the period before the First Army was formed. Whitehead asked Sherman's boss, Col. Thomas DeW. Milling, Chief of Air Service, First Army, for a comprehensive report on Air Service operations in the Chateau-Thierry campaign. Since Capt. Philip J. Roosevelt, then a member of Milling's staff, was familiar with these operations, Whitehead wanted Roosevelt to prepare the history. When Roosevelt submitted his narrative on pursuit aviation, it was accompanied by one that he had asked 1st Lt. Burdette S. Wright to prepare on observation operations.<sup>16</sup>

Gorrell, who by then was established in his new job as Assistant Chief of Staff, recognized that although the materials assembled by the First Army Air Service provided valuable information they did not constitute a proper history of Air Service operations in combat. Such a history was needed, and Gorrell thought that Sherman was the man to write it.

A graduate of the U.S. Military Academy in 1910, Bill Sherman had ranked third in a class of 83. He was commissioned in the Corps of Engineers but had become interested in aviation and had received his first flying lessons from a friend, Tom Milling, at College Park in 1911. Assigned to aviation duty in September



Col. Thomas DeW. Milling.

1912, Sherman was one of the original members of the 1st Aero Squadron, which was organized at Texas City in March 1913. Later that year, however, Sherman had been sent back to the Corps of Engineers, and in June 1917 he had gone to France with the 1st Division. He had served as Assistant Chief of Staff, G-2, of the 1st Division during combat operations around Montdidier and at Chateau-Thierry from April to July 1918, and had held the same position in III Corps during combat operations on the Marne and Vesle and during the Meuse-Argonne offensive. He had been assigned to aviation duty once again on 15 October 1918, when he became Chief of Staff under Col. Milling, who was succeeding Brig. Gen. William Mitchell as Chief of Air Service, First Army.<sup>17</sup> Selected by Gorrell to write the tactical history of the Air Service, Sherman set up an office and gathered a staff at Chaumont.

On 12 December, a week after Gorrell had become Assistant Chief of Staff, Patrick announced that in addition to a comprehensive historical record he wanted a "final report" on Air Service statistics in Europe to give to General Pershing. The project was assigned to Gorrell, who was to set up a staff at Paris to do the job. The idea of the report, Patrick said, "is to show what has been done . . . and why it was done." No one was to be permitted to return to the United States without first putting into writing any information of value that he had acquired while in the Air Service. Officers in key positions were to prepare statements of lessons learned from the war and send them, along with books, pamphlets, maps, photographs, and other supporting data, to Gorrell in Paris before the end of December. Directing that this work be "thoroughly done," Patrick said he wanted answers for "the questions that those in authority may investigate concerning the conduct of our Air Service." To be sure there would be no doubt as to the origin of the order, and to ensure that it reached the right people, the Chief of Air Service added: "This telegram has been sent by me personally . . . Acknowledge receipt . . . Patrick."<sup>18</sup>

The staff that Gorrell set up in Paris included 1st Lt. Charles B. Nordhoff. A native of Los Angeles, Nordhoff had served with the American Ambulance Service in France before joining the French Aviation Service in June 1917. After pilot training, he had been sent to the front for duty with Escadrille N.99. Transferring to the U.S. Air Service in February 1918, he had been attached to Escadrille N.99 until July, when he was assigned to the Executive Section of the U.S. Air Service in Paris. While serving with the French, Nordhoff had written a series of articles published in the *Atlantic Monthly*. The reputation he had thus gained as a man of letters may have been responsible for his spending the rest of the



Lt. Col. William C. Sherman, Chief of Staff, First Army AS.

---

war "removing split infinitives from military reports," as the former *chasse* pilot described his work in Paris.<sup>19</sup> It was there that Gorrell found him and made him editor-in-chief for the final report.

With the help of his staff, Gorrell drew up lists of questions for the various organizations to answer concerning their activities. To expedite work on the report, he also asked key officers to prepare resumes of the information they would like to see incorporated in the final report concerning the work of their departments.

Gorrell's assignment as chief historian had not relieved Jones of any responsibilities. Instead, Jones' historical work increased greatly. In December his staff grew to 10 officers and a large force of clerks and typists who were busy editing, copying, and assembling four copies of the historical narratives and documents received from the various organizations. Called upon to produce a history of the Air Service for use as a chapter in a book that SOS was writing about its activities in Europe, Jones assigned the task to Lt. C.I. Wheat. Jones also had to help Sherman by copying thousands of pages to replace First Army records destroyed by fire.

On 6 January 1919 Gorrell moved his staff from Paris to Tours and temporarily took control of the Information Section, which then had 13 officers, 53 enlisted men, and 2 civilians. Two days later, on 8 January, a number of important decisions were made in a conference that Gorrell had with Jones and others at Tours. The histories submitted by the various organizations no longer would be edited and made up in four copies; one copy would be enough. It would be checked to see that it was complete. If it were not, a wire would be sent to obtain the missing information. The history would be indexed, bound, and tabbed to mark pages containing information worthy of being included in the final report. The history then would be sent to Gorrell's office for use with the lessons learned and resumes submitted by the various departments in preparing the final report. At that time, on 8 January, about two-thirds of the more than 500 reports that had been requested in the three categories—histories, resumes, and lessons learned—had been received.

The necessary changes in organization and procedures were quickly made. When narrative histories and documents arrived at the office of the Assistant Chief of Staff, the adjutant sent them on to the compilation office, where they were assembled, indexed, and bound. This work was handled by Jones with a staff of 22 officers, 72 soldiers, and 3 civilians. The bound volumes were then delivered to the file room, run by Lt. W. A. MacCalmont and

---

one soldier. An editorial board of 24 officers, 5 soldiers, and 1 civilian under Maj. R. I. Mowry read the narrative histories, as well as the lessons learned, and marked the pages to be called to the attention of the editor-in-chief. Nordhoff, assisted by 1 soldier and 1 civilian, used this material to supplement the resumes, which constituted the foundation of the report being prepared for Patrick.

At the same time a photographic unit at Tours had 9 officers and 64 men copying documents and photographs for the history. At Chaumont, 8 officers and 5 men were helping Sherman write the story of combat operations. At Paris the Technical Section had 7 officers and 16 civilians compiling technical matter, and the Executive Section was preparing statistical data, for inclusion in the history. Thus, on 5 February 1919, when the activity was near its peak, more than 250 people were working on the various projects under Gorrell's direction. And this did not include the many other people throughout the Air Service, AEF, who had written historical narratives, statements of lessons learned, and resumes, or had helped to collect data, documents, and other materials for the history.

When the first chapters of the final report were finished on 5 February, copies were sent by airplane to Air Service headquarters at Chaumont and to the Air Service office in Paris for criticism. The courier service continued daily until the middle of February. By that time the "Final Report," the "Tactical History," and the Air Service chapter for the SOS history had been completed. Most of the work of assembling the historical narratives and documents had also been finished, although some materials were to be added later.

The "Final Report" had 19 chapters, with 134 single-spaced, typewritten pages of text, 36 pages of photographs, 17 pages of tables and charts, and 3 maps. With a table of contents, picture captions, index and other materials, the document had a total of 252 pages.

The 19 chapters fell into 3 major parts, the first of which consisted of 3 chapters, 28 pages, summarizing the combat record of the Air Service. The second part, 6 chapters with a total of 40 pages, was a review of organizational development and of logistical and training problems and accomplishments. The third part, 9 chapters totalling 64 pages, was concerned with training and with the work of some of the more important sections—Supply, Technical, Balloon, Aircraft Armament, Photographic, Radio, and Medical—of the Air Service. This was followed by a brief, 2-page, concluding chapter.

Only about one-fifth of the text had to do with military operations, the other four-fifths being devoted to activities in

---

preparation for, or in support of, combat. The relative amounts of space given to combat on the one hand and to preparation and support on the other probably was a fairly accurate reflection of the division of Air Service efforts between those two broad areas of activities. In a situation in which much of the necessary materiel, including aircraft, had to be procured overseas, from foreign sources, and much of the training had to be accomplished in the theater of operations, the Air Service had to expend a large part of its effort in Europe in the development of a combat force. The Armistice, however, made it unnecessary for the Air Service to realize and commit to battle the full combat potential that it had set out to develop. Thus, some of the greatest achievements of the Air Service in Europe were in preparation for combat. The way in which the contents of the "Final Report" were apportioned between development and employment tended to show the Air Service in the best light. That evidently is what Patrick wanted, and that is what he was given.

As would be expected, the "Final Report" also reflected the interests and concerns of the man charged with its preparation. Gorrell's fondness for quantitative data is seen in the use of statistics in the text and accompanying charts to depict progress and achievements of the Air Service in various programs and areas of activities. Many other examples could be cited. For example, Gorrell undoubtedly was responsible for the inclusion of a paragraph on the de Ram camera, one of his pet projects. On the other hand, there is not one word about "strategical aviation" and the contributions that Gorrell made in the development of strategic bombardment, the thing for which he is perhaps best remembered. The absence of any mention of that subject may be because his plan for strategic bombing was not put into effect during World War I, and the significance of his ideas regarding such employment of airpower was not fully appreciated until later.<sup>20</sup>

Critical reading of the report reveals repetition, poor organization, and other weaknesses, many of which obviously were the result of the speed with which the report had to be prepared. Despite its defects, however, the "Final Report" is a document of great historical interest and one of considerable value as a summary of the activities of the Air Service, AEF.

Air Service officials in the period after the war thought highly enough of the "Final Report" to publish it in an *Air Service Information Circular* in 1921.<sup>21</sup> In 1948 the Army's Historical Division included it in a multi-volume collection of documents that it published on the *United States Army in the World War, 1917-1919*.<sup>22</sup>

---

In preparing the "Final Report" for printing in 1921, the Office of the Chief of Air Service made few substantive changes in the text, and those mostly to correct statistics. But the editors, as editors so often do, made many stylistic changes (these included changing "planes" into "airplanes" and "motors" into "engines") to suit their own ideas as to what constituted good writing and editing. As seems to be inevitable in such an undertaking, not all of the editing was for the better. For instance, the abbreviation "S.O.S.", after being properly transcribed "Services of Supply" in several chapters, was changed to "Source (or Sources) of Supply" in Chapter XI, a slip that helps to confirm that various parts of the report were edited by different people.

The "Tactical History" prepared by Sherman consisted of a narrative of 141 single-spaced, typewritten pages, with 16 pages of appendices. It was divided into six major parts. The first part, "The Achievement of the Air Service," was used, with some additions, deletions, and editorial changes, for the introductory chapters of the "Final Report." The second part, which was concerned with corps observations, was published in an *Air Service Information Circular* in 1920.<sup>23</sup> The other four parts were devoted to army observation, pursuit, day bombardment, and observation balloons.

The various parts of the "Tactical History" evidently were written by different people who, unfortunately, were not identified in the document or in related materials included in "Gorrell's History." The authors obviously were experts in the areas about which they were writing. They knew their subject matter thoroughly and were able to describe in detail the way in which combat operations were organized, planned, and executed. It is this detailed descriptive information that makes the "Tactical History" particularly valuable and useful to students of aerial operations in World War I. The comments and criticisms included by the authors also are of considerable interest.

Patrick found some statements in the "Tactical History" that he would have preferred not to have seen included. He did not eliminate them, however, and did not even finish reading the history before he sent it to Brig. Gen. Fox Conner, Assistant Chief of Staff, G-3, at General Headquarters, AEF, on 14 February 1919. Patrick thought it would help to complete G-3 files and might be of value to Connor's study of the operations of the AEF.

The "History of the Air Service, AEF" which was started by Ernest Jones in May 1918 and which today is known as "Gorrell's History" consists of 280 volumes (plus 2 index volumes) in 18 series lettered A through R. The narratives and documents were arranged with the idea of bringing together in a single series all of

the materials of one kind or relating to one broad subject area. Squadron histories, for example, make up Series E, with squadron designations being used to arrange the units in numerical sequence through the first 25 volumes, with supplemental histories bound in the 2 additional volumes that complete the series. In the same fashion, the materials on balloons, including those pertaining to the Balloon Section as well as the histories of balloon companies, make up the seven volumes of Series F.

A rough idea of the general arrangement of the materials in "Gorrell's History" is shown in the following listing of the series as given in the first index volume:

Series	Subject (number of volumes) <sup>24</sup>
A	Early History and General Organization (29)
B	Foreign Relations (15)
C	Tactical Units [groups and above] (15)
D	Air Service Tactical History of the War, & Manual (2)
E	Squadron Histories (27)
F	Balloon Section, S.O.S. and Zone of Advance (7)
G	Photographic Section, S.O.S. and Z. of A. (7)
H	Mechanics Regiments, Construction Companies and Air Parks (5)
I	Paris Headquarters, and Supply Section, S.O.S. and Z. of A. (32)
J	Training Section and Schools (12)
K	Technical Section (2)
L	Personnel, Information, Radio and Cable Section, and Medical Service (14)
M	Miscellaneous [Intelligence, maps, photographs, welfare organizations, prisoners of war, poems, cartoons, newspapers, insignia, etc.] (48)
N	Duplicates of All First Army Material (25)
O	[Reports on Air Service Activities] (31)
P	[Third Army] (2)
Q	[Air Service Liquidation] (5)
R	[Investigation of Effects of Allied Bombing] (2)

The series titles, however, provide only a rough guide to the subject matter of the narratives and documents. Fortunately, a more detailed index is available. As noted earlier, the volumes were indexed as they were assembled at Tours in January and February 1919. Copies of the indexes not only were bound in the respective volumes but also were assembled in one folder as a master guide to the contents of the history, volume-by-volume, through the different series. In addition, there is in a separate volume an alphabetical index to subject matter. While these 2



indexes are of great value to researchers, they do not cover all 280 volumes of the history. They do not indicate the presence of some volumes, such as one on Recording and Accounting of Air Service Property, A-28, or the one containing a Supplementary History of the Air Service, First Army, N-24. Further, they omit reference to the last four series, O-R, which were later additions to the history.

Some 20 years after the history had been compiled, Gorrell said that an effort had been made "to include a report of every activity undertaken or accomplished in the AEF, of every battle fought, of every production problem met, of every success or failure—in fact, a complete story." He then went on to describe the objective of this effort:

It was anticipated that that history, when compiled, would later be made available to the air officers under the American flag everywhere so they could take it home to their quarters and study it, perhaps pipe in mouth and carpet-slipped feet on the desk, learning now of one event and later of another, and calmly and gradually profiting by the lessons learned and the mistakes made by those who had pioneered.<sup>25</sup>

But the history in the form in which it existed at the end of the war did not lend itself to that purpose. When it was shipped to the United States in the summer of 1919 the intention was to use the information contained in the narratives and documents to produce a history of the Air Service, AEF that could be published and made available to officers and others who wanted it to read and study. But that was not to be. Although work on a history of the Air Service, AEF was started by the Information Section of the Office of the Chief of Air Service in Washington, the project soon faltered and then collapsed as a result of reduced appropriations for the Air Service.<sup>26</sup>

Gorrell observed in 1940 that his history was "in the vaults of the War Department in Washington, some of the pages torn, some yellowing, many hard to read. But small use has been made of it," he said, "because of its inaccessibility."<sup>27</sup>

Accessibility did not improve greatly with the transfer of the history to the National Archives. In 1961, however, the history became available on microfilm made by the National Archives at the request of the U.S. Air Force Historical Division. The 58 rolls of 35-mm. film, with the 2 index volumes at the beginning of the first roll, are identified by the National Archives as Microcopy T-619.<sup>28</sup>

For his contributions to the "History of the Air Service, AEF," Ernest L. Jones was promoted to major on 20 February 1919. He returned to the United States the following April and was assigned to the Office of the Chief of Air Service in Washington



until he was discharged in 1920. He worked at various editorial and writing jobs in the field of aviation in the 1920's and 1930's and returned to uniform as an intelligence officer in the Air Corps in 1941. He served as a historical officer at Headquarters of the Army Air Forces and the U.S. Air Force in Washington from 1943 until 1948, when he retired from military services as a lieutenant colonel. He stayed with the Air Force historical program as a civilian historian, however, until 1952.

During all those years, and until his death in 1955, Ernest Jones devoted much effort to compiling a detailed chronology of U.S. military aviation from the Civil War through World War I, which he gave to the Air Force.<sup>29</sup> This remarkable, multi-volume chronology, which included additional data that Jones collected for the period to 1941, is now in the Albert F. Simpson Historical Research Center at Maxwell Air Force Base, where researchers find it a valuable guide to events in the early history of United States military aviation.

With the "Tactical History of the Air Service" as a beginning, Sherman went on to win recognition as an expert in military history and tactics. He taught at the Air Service Tactical School at Langley Field, Virginia, in the early 1920's and later at the Army's Command and General Staff School at Fort Leavenworth, Kansas. He was the author of a book on *Air Warfare*, which was published in New York in 1926. But death, which followed a long illness, cut short the career of this brilliant officer in 1927 at age 39. Like many other officers who had received temporary promotions during the war, Sherman dropped back to his permanent rank—captain—in 1920. A few weeks later, however, he received an Air Service commission as major, the rank he held until he was posthumously promoted to lieutenant colonel.<sup>30</sup>

Nordhoff was introduced in Paris to another American, James Norman Hall, who also had flown for the French before becoming a member of the U.S. Air Service, and who also had written for the *Atlantic Monthly*. The two men collaborated on the history of *The Lafayette Flying Corps* and then went on to produce such famous works as *Mutiny on the Bounty*, *Men Against the Sea*, *Falcons of France*, and *Pitcairn's Island*.<sup>31</sup>

Gorrell resigned his commission in 1920 and made his career in the world of business and industry until his death in 1945. During that period he headed the Stutz Motor Car Company, the Air Transport Association, and an investment company he organized in Washington. When war broke out again in Europe in 1939, Gorrell saw the events of an earlier day repeating themselves. The United States Air Service had not been prepared for war in 1917, and it appeared to Gorrell that the same thing was going to



---

happen again. Turning back to the history he had helped to write in France, Gorrell tried to use the experience of the First World War to show the need for preparedness, for developing the aircraft industry and building up an air force so the nation would be ready when the challenge came again. The lessons were there, he believed, if the nation would learn from the torn and yellowing pages of "Gorrell's History."<sup>32</sup>



---

# **Final Report of Chief of Air Service**

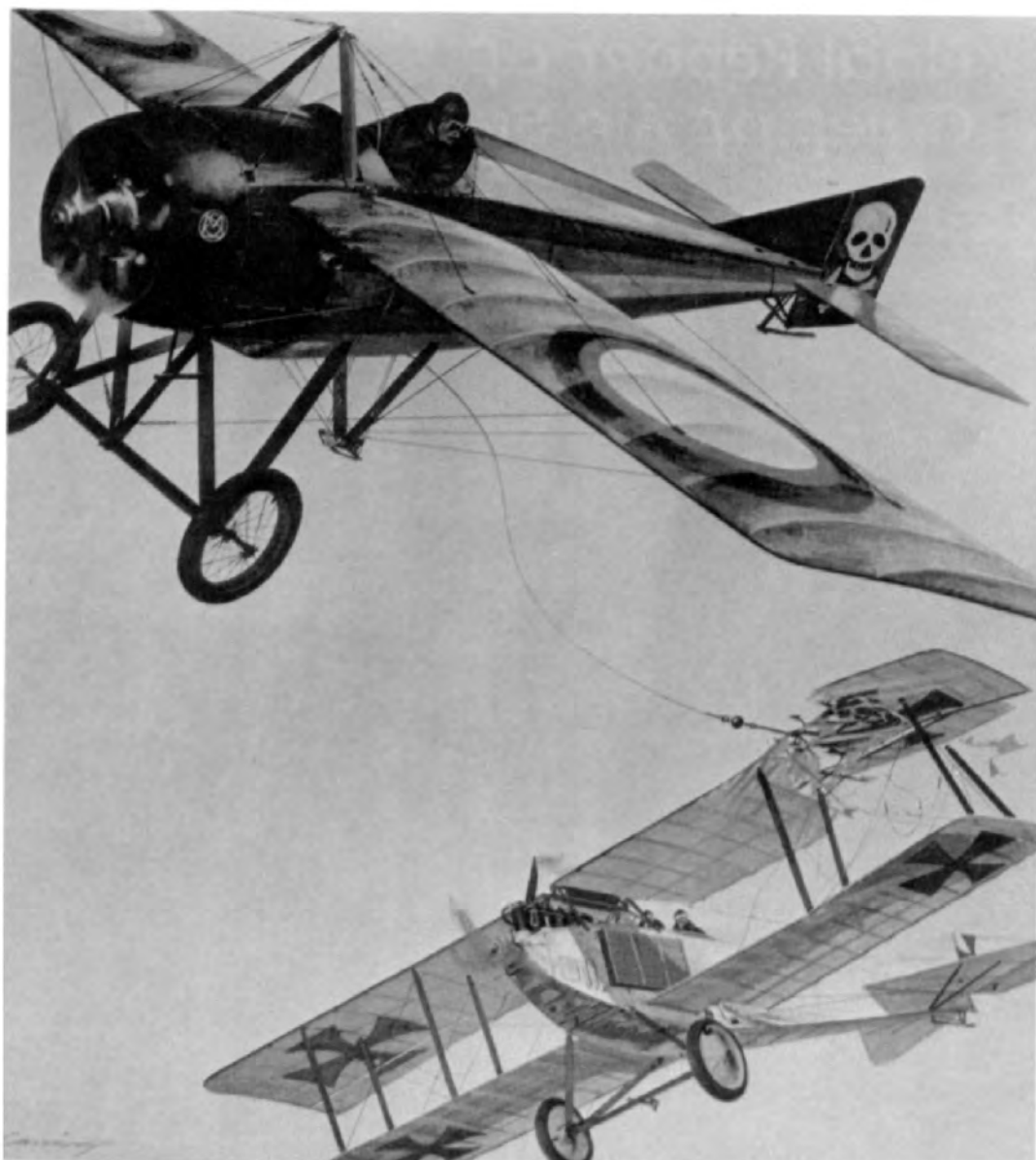

When hostilities ceased on November 11, 1918, there were actually assigned to armies 45 American squadrons and 767 pilots, 481 observers, 23 aerial gunners, and the complement of soldiers.<sup>1</sup> These squadrons were equipped with 740 airplanes, with armament of the latest type, and the flying personnel, trained in Air Service schools, was second to none in the world for aggressiveness and skill. Twelve of these squadrons were equipped with American built airplanes and Liberty engines. This engine in actual service fulfilled the highest hopes of it which had been entertained in the United States.

On the Marne, at St. Mihiel, and in the Argonne our air forces were pitted against the best which Germany could produce, and the results show that the enemy more than met his match. Our pilots shot down 731 enemy airplanes<sup>2</sup> which were officially confirmed, and many others, too far behind the lines to be confirmed by our own witnesses, but which were nevertheless undoubtedly destroyed. They also destroyed 73 (confirmed) enemy balloons.<sup>3</sup> Our total losses in air battles were 289 airplanes and 48 balloons brought down by the enemy.<sup>4</sup>

Our squadrons, in round numbers, took part in 150 bombing raids, during which they dropped over 275,000

pounds of explosives on the enemy. They flew 35,000 hours over the lines and took 18,000 photographs of enemy positions, from which 585,000 prints were made by the Photographic Sections attached to observation groups. On innumerable occasions they regulated the fire of our Artillery, flew in contact with Infantry during attacks, and from a height of only a few yards from the ground they machine-gunned and bombed enemy batteries, convoys and troops on the march.

Of the 35 balloon companies then in France, with 446 officers and 6,365 men, there were 23 companies serving with the armies at the front. This balloon personnel had also been trained in American Expeditionary Forces schools and in every test proved its worth. Our balloons at the front made 1,642 ascensions and were in the air a total of 3,111 hours. They made 316 artillery adjustments, each comprising all the shots fired at one target; they reported 12,018 shell bursts, sighted 11,856 enemy airplanes, reported enemy balloon ascensions 2,649 times, enemy batteries 400 times, enemy traffic and roads and railroads 1,113 times, explosions and destructions 597 times.

Air Service depots to supply the squadrons and balloon companies at the front were in full operation and

others were being prepared to maintain this force, which was to be increased rapidly. Needed steps had been taken to provide for the equipment of this force as it was placed at the front, and it was certain that it could be fully maintained. A production plant had been built and was in full operation, where some 10,000 men were employed in assembling airplanes and in repairing airplanes, engines, and balloons which had seen service at the front.



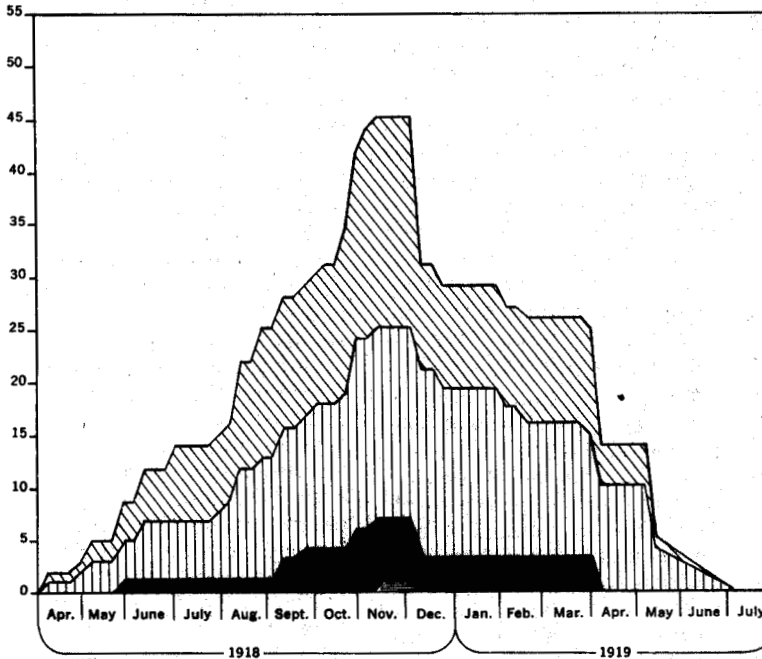

Our balloons were attacked by enemy airplanes on 89 occasions; 35 of them were burned during such attacks, 12 others were destroyed by shell fire, and 1 blown over enemy lines.<sup>5</sup> Our observers jumped from the baskets 116 times; in no case did the parachute fail to open properly. One observer lost his life because pieces of the burning balloon fell on his descending parachute.

**COMBAT SQUADRONS IN AMERICAN E. F.  
(DATE OF ASSIGNMENT AND DEMOBILIZATION)**



NO.	SQUADRON SERIAL NO.	TYPE	DATE ASSIGNED TO THE FRONT	DATE ORDERED DEMOBILIZED
1	1	Cor. Obs.	April 8, 1918	July 1, 1919
2	94	Pursuit	April 9, "	Apr. 7, 1919
3	12	Cor. Obs.	April 30, "	Apr. 7, 1919
4	95	Pursuit	May 4, "	Dec. 5, 1918
5	91	Army Obs.	May 7, "	Apr. 7, 1919
6	88	Cor. Obs.	May 24, "	May 11, 1919
7	96	D. Bomb.	May 29, "	Dec. 11, 1918
8	27	Pursuit	May 29, "	Dec. 5, 1918
9	147	Pursuit	May 29, "	Dec. 5, 1918
10	90	Cor. Obs.	June 11, "	Dec. 19, 1918
11	99	Cor. Obs.	June 12, "	Feb. 13, 1919
12	139	Pursuit	June 12, "	Dec. 11, 1918
13	13	Pursuit	June 26, "	Dec. 5, 1918
18	103	Pursuit	June 30, "	Dec. 11, 1918
15	135	Cor. Obs.	July 24, "	Feb. 5, 1919
16	104	Cor. Obs.	Aug. 7, "	Dec. 19, 1918
17	8	Cor. Obs.	Aug. 14, "	Feb. 5, 1919
18	24	Army Obs.	Aug. 14, "	July 1, 1919
19	49	Pursuit	Aug. 14, "	Dec. 5, 1918
20	50	Cor. Obs.	Aug. 14, "	Apr. 2, 1919
21	93	Pursuit	Aug. 14, "	Dec. 11, 1918
22	213	Pursuit	Aug. 14, "	Apr. 10, 1919
23	22	Pursuit	Aug. 22, "	Apr. 10, 1919
24	28	Pursuit	Aug. 22, "	Apr. 10, 1919
25	9	N. Obs.	Aug. 26, "	May 11, 1919
26	11	D. Bomb.	Sept. 5, "	Dec. 11, 1918
27	20	D. Bomb.	Sept. 5, "	Dec. 11, 1918
28	258	Cor. Obs.	Sept. 10, "	July 1, 1919
29	166	D. Bomb.	Sept. 20, "	Apr. 7, 1919
30	168	Cor. Obs.	Sept. 30, "	May 10, 1919
31	185	Pursuit	Oct. 5, "	Apr. 10, 1919
32	141	Pursuit	Oct. 18, "	May 11, 1919
33	354	Cor. Obs.	Oct. 21, "	May 11, 1919
34	25	Pursuit	Oct. 22, "	Apr. 8, 1919
36	85	Army Obs.	Oct. 25, "	May 11, 1919
36	186	Army Obs.	Oct. 25, "	July 1, 1919
37	100	D. Bomb.	Oct. 26, "	Apr. 8, 1919
38	163	D. Bomb.	Oct. 27, "	Apr. 8, 1919
39	138	Pursuit	Oct. 28, "	July 1, 1919
40	638	Pursuit	Oct. 28, "	May 11, 1919
41	41	Pursuit	Oct. 29, "	May 11, 1919
42	278	Army Obs.	Oct. 29, "	May 11, 1919
43	17	Pursuit	<sup>a</sup> Nov. 4, "	Dec. 11, 1918
44	148	Pursuit	<sup>b</sup> Nov. 4, "	Dec. 11, 1918
45	150	N. Bomb.	Nov. 9, "	Dec. 5, 1918

<sup>a</sup> Began work 7/15/18 with R.A.F. in field.  
<sup>b</sup> Began work 7/20/18 with R.A.F. in field.  
<sup>c</sup> Began work 2/18/18 with F. A.B. in field.

**LEGEND**  
 PURSUIT  
 OBSERVATION  
 DAY BOMBING  
 NIGHT BOMBING

Sept. 12, 1918. First Day of St. Mihiel offensive.  
 Sept. 26, 1918. First Day of First Argonne Meuse offensive.  
 Nov. 1, 1918. First Day of Last Argonne Meuse offensive.  
 Nov. 11, 1918. Armistice.

**FIRST DAY BOMBARDMENT GROUP  
CHART OF COMPLETE OPERATIONS**

- △ 95TH SQUADRON
- 20TH SQUADRON
- 11TH SQUADRON
- 166TH SQUADRON

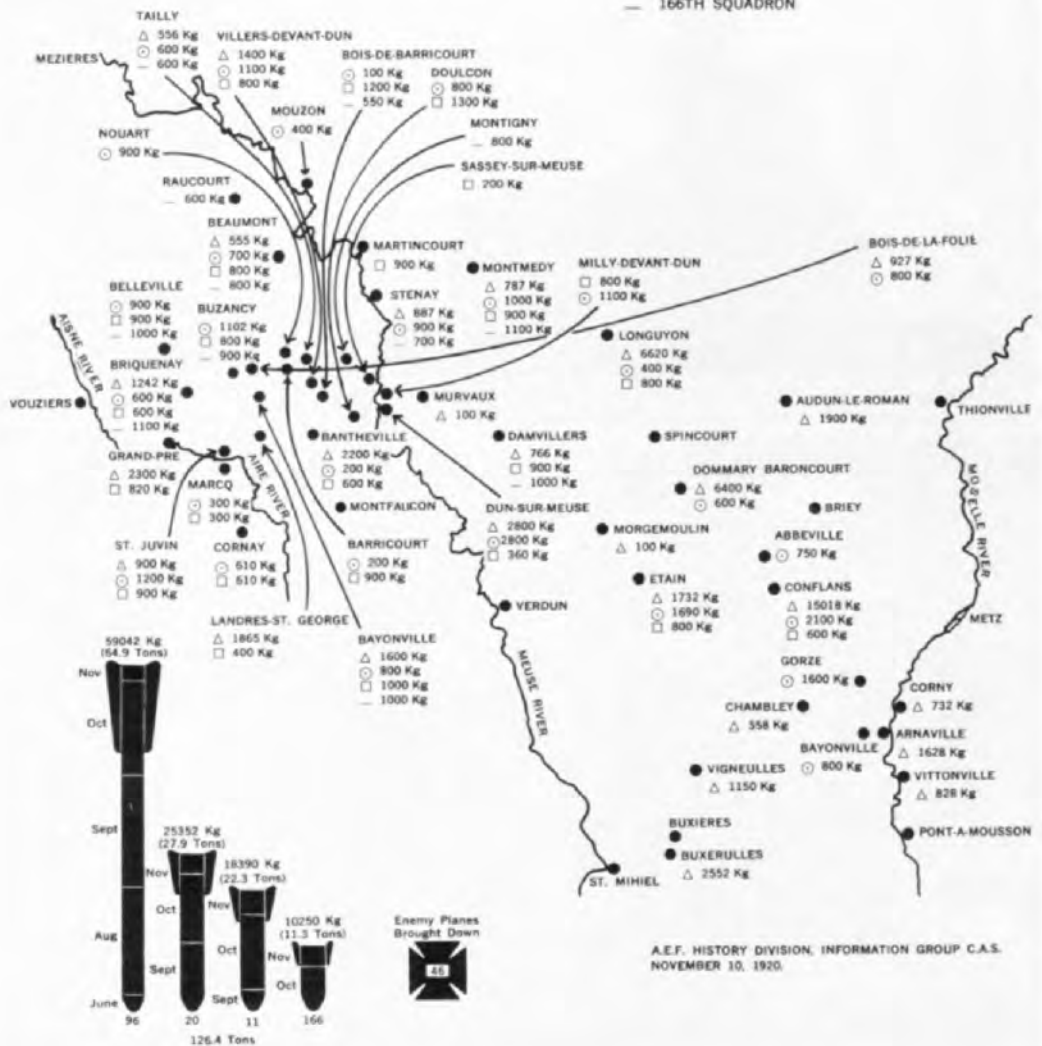

**U.S. BALLOON COMPANIES ASSIGNED TO ARMIES IN AMERICAN E. F.  
(WITH DATES OF ASSIGNMENT AND DEMOBILIZATION)**

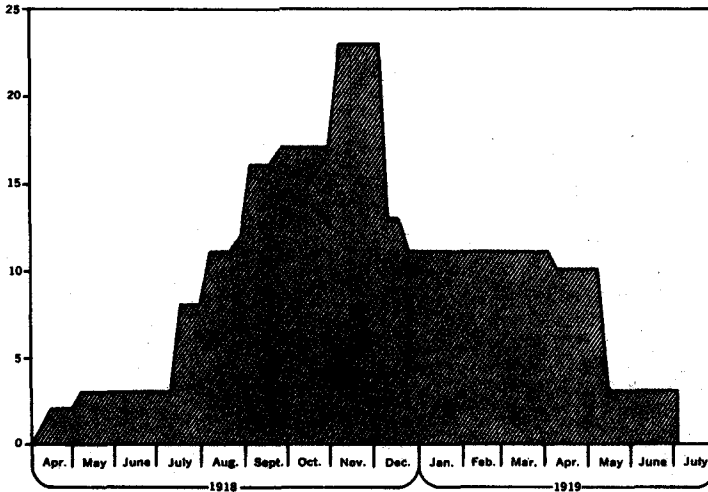

NO.	SERIAL NO.	DATE ASSIGNED TO FRONT	DATE ORDERED DEMOBILIZED
1	1	Apr. 15, 1918	April 7, 1919
2	2	Apr. 15, 1918	May 11, 1919
3	4	May 7, 1918	Dec. 11, 1919
4	3	July 16, 1918	May 11, 1919
5	5	July 16, 1918	Dec. 11, 1919
6	6	July 16, 1918	Dec. 11, 1919
7	7	July 16, 1918	Dec. 11, 1919
8	8	July 16, 1918	Dec. 11, 1919
9	9	Aug. 5, 1918	Dec. 11, 1919
10	43	Aug. 5, 1918	Dec. 11, 1919
11	69	Aug. 5, 1918	Dec. 22, 1919
12	16	Aug. 24, 1918	May 11, 1919
13	10	Aug. 29, 1918	Dec. 22, 1919
14	11	Aug. 29, 1918	Dec. 11, 1919
15	12	Aug. 29, 1918	Dec. 11, 1919
16	42	Aug. 29, 1918	Dec. 11, 1919
17	15	Sept. 23, 1918	May 11, 1919
18	13	Nov. 6, 1918	May 11, 1919
19	14	Nov. 6, 1918	July 1, 1919
20	24	Nov. 6, 1918	July 1, 1919
21	25	Nov. 6, 1918	May 11, 1919
22	26	Nov. 6, 1918	May 11, 1919
23	44	Nov. 6, 1918	July 1, 1919

SEPT. 12, 1918. FIRST DAY OF ST. MIHIEL OFFENSIVE.  
 SEPT. 26, 1918. FIRST DAY OF FIRST ARGONNE MEUSE OFFENSIVE.  
 NOV. 1, 1918. FIRST DAY OF LAST ARGONNE MEUSE OFFENSIVE.  
 NOV. 11, 1918. ARMISTICE.





**SQUADRONS, BALLOON COMPANIES, PHOTO SECTIONS AND AIR PARKS ASSIGNED TO ARMIES IN THE A. E. F.**

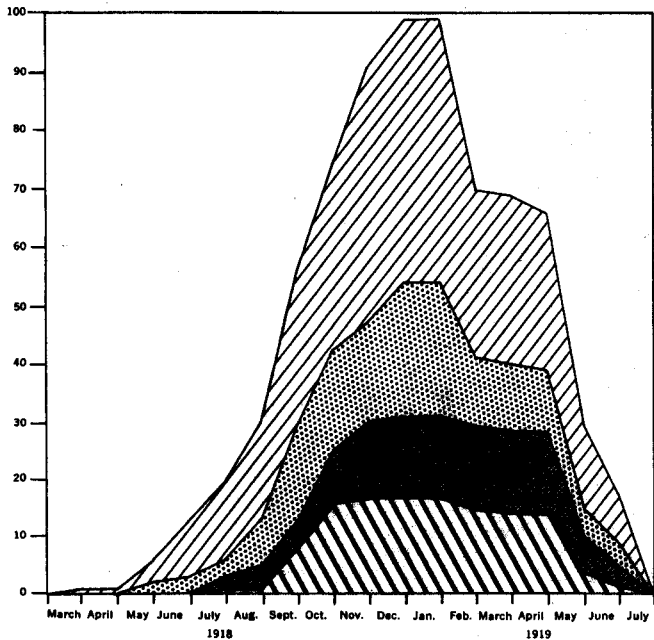

DATE	SQUADRONS	BALLOON COMPANIES	PHOTO SECTIONS	AIR PARKS
1918				
March	1			
April	4			
May	10	2		
June	14	3		
July	17	3	2	3/4 *
August	27	8	4	3/4 *
September	32	16	5	7 3/4 *
October	44	17	9	16
November	45	17	13	17
December		23	14	17
1919				
January	45	23	14	17
February	29	12	14	15
March	29	12	14	14
April	27	11	14	14
May	14	5	6	4
June	8	4	4	1
July	—	—	—	—

LEGEND

- SQUADRONS
- BALLOON COMPANIES
- PHOTO SECTION
- AIR PARKS

Two flights of 648 Squadron used as an Air Park from June 18th, 1918. Third flight assigned on September 5th, 1918.



**FLYING TIME OF AIR SERVICE ASSIGNED TO ARMIES FROM BEGINNING OF OPERATIONS UNTIL JULY 1ST, 1919**

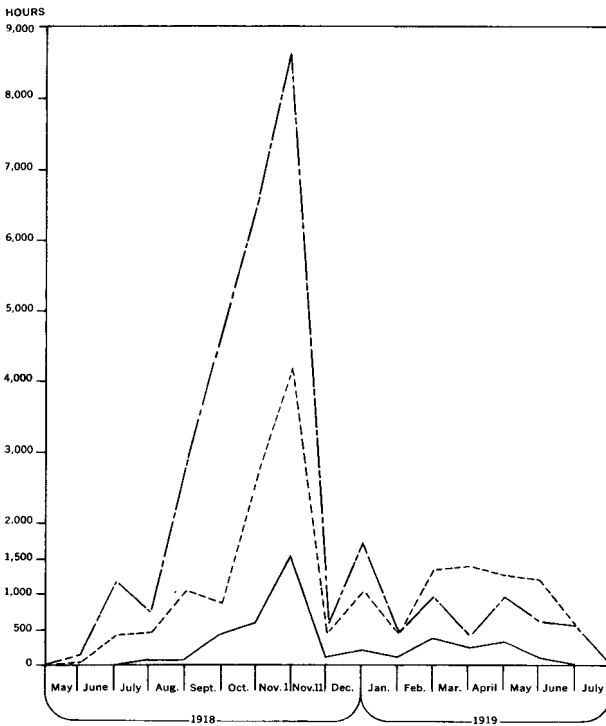

DATE	PURSUIT	OBSERVATION	BOMBARDMENT	TOTAL
<b>1918</b>				
May	138:22	32:		170:22
June	1166:25	407:49		1574:14
July	732:05	447:40	66:50	1246:35
August	2906:50	2486:32	83:45	3997:10
September	2423:51	867:33	421:41	3713:05
October	6498:02	2675:21	597:53	9771:16
November 1st	8583:40	4169:31	1526:	14279:11
November 11th	536:58	432:57	128:10	1098:05
December	1664:42	1010:17	209:45	2884:44
<b>1919</b>				
January	419:08	417:25	123:20	959:53
February	945:41	1295:58	375:50	2617:29
March	391:14	1369:20	251:55	2012:29
April	928:13	1219:29	338:50	2486:32
May	589:27	1150:21	101:06	1840:54
June	519:25	519:10	—	1038:35
July	—	—	—	—

LEGEND

- PURSUIT
- · - · - · OBSERVATION
- BOMBARDMENT

SOURCE: Operation Reports, 1st, 2nd & 3rd Army.

# TOTAL NUMBER OF AIRPLANES DISPATCHED TO ZONE OF ADVANCE

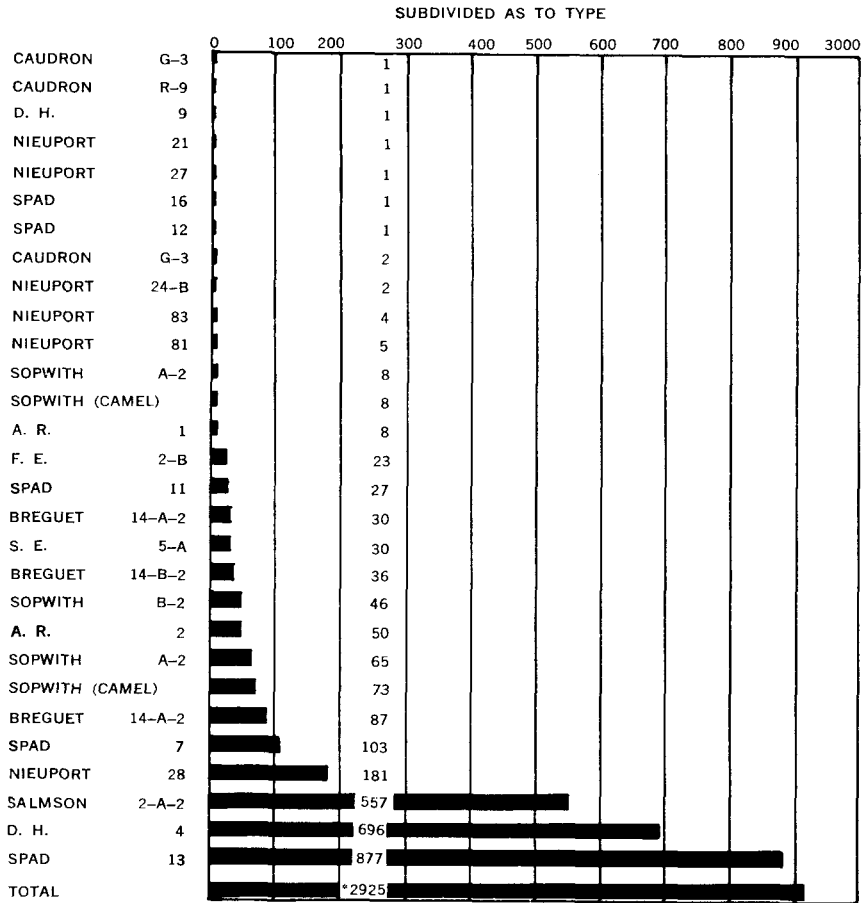

\* Includes planes dispatched, but later returned to field.

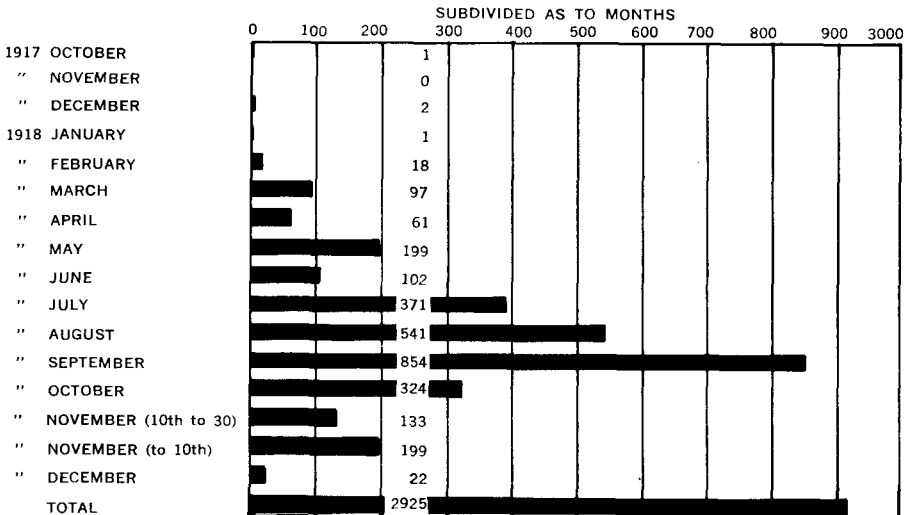

Approved: 6/18/20

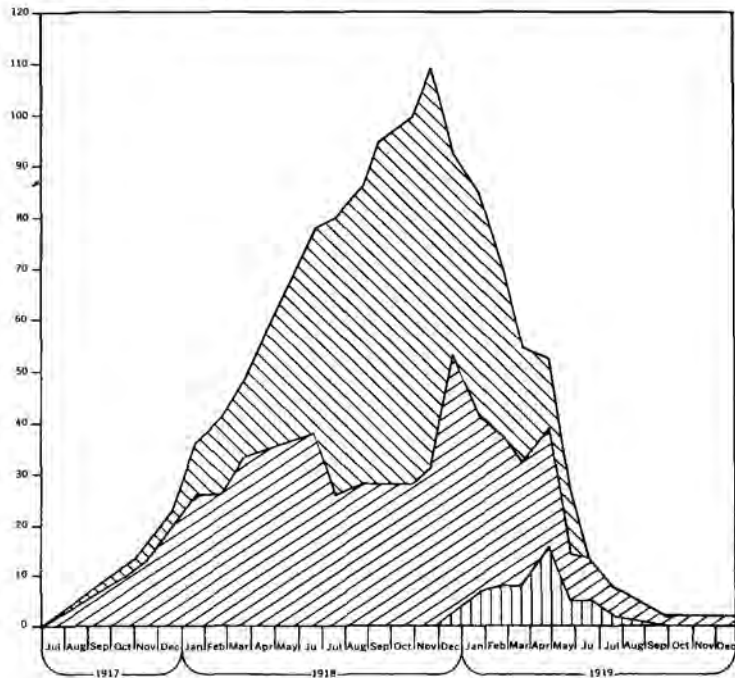
AIR SERVICE STATIONS IN AMERICAN E. F.  
(ESTABLISHMENT AND DEMOBILIZATION)

Date	Service of Supply	Zone of Advance	Germany	Total
1917				
October 31,	11	2		13
November 21,	13	3		16
December 26,	20	3		23
1918				
January 23,	26	10		36
February 27,	26	15		41
March 27,	33	15		48
June 26,	38	39		77
July 24,	26	54		80
August 28,	28	58		86
September 18,	28	66		94
October 30,	28	71		99
November 26,	31	78		109
December 25,	50	39	3	92
1919				
January 29,	34	43	7	84
February 26,	30	34	8	72
March 26,	24	22	8	54
April 30,	24	13	15	52
May 28,	9	13	5	27
June 25,	8	0	5	13
July 23,	6	0	2	3
August 18,	5	0	1	6
September 30,	2	0	0	2
October 31,	2	0	0	2
November 30,	2	0	0	2
December 31,	2	0	0	2

 Zone of Advance.  
 Service of Supply.  
 Germany.



**CASUALTIES OF U.S. AIR SERVICE PERSONNEL  
(ATTACHED TO AMERICAN, BRITISH, FRENCH AND ITALIAN ARMIES)  
TO NOVEMBER 11, 1918**

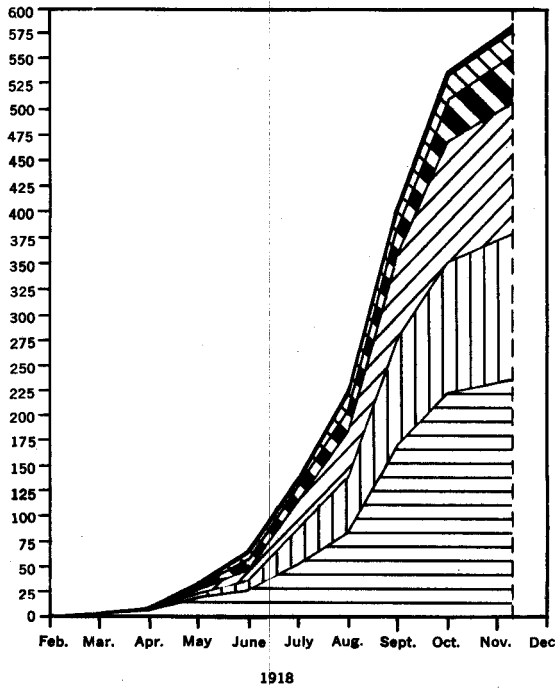

Date	Killed in Action	Prisoners	Wounded in Action	Killed by Accident	Injured by Accident	Interned	Totals
March 1918	3	—	—	1	—	—	4
April 1918	5	—	—	2	1	—	8
May 1918	18	4	4	5	2	—	33
June 1918	26	9	13	10	7	1	66
July 1918	52	37	28	12	9	1	139
Aug. 1918	84	56	46	19	13	1	219
Sept. 1918	171	105	82	27	18	3	406
Oct. 1918	222	129	118	42	23	3	537
to Nov. 11, 1918	235	145	130	45	25	3	583

Casualties of Combat Squadron only.  
Died of disease not included  
All Totals Cumulative.  
APPROVED 2/16/20.

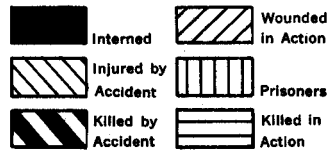





### The Toul Sector

The Air Service, American Expeditionary Forces, commenced actual operations at the front in the spring of 1918. The Toul sector was chosen as the place where American squadrons would be located and given their final practice to bridge over the gap which must always exist between training in schools and work under actual war conditions. In this locality the opposing armies were facing each other in two well-defined positions, and since the early days of the war this had been a comparatively quiet sector. Means of liaison had been developed and there existed airdromes which provided all needed facilities. In the air, as on the ground, the enemy was comparatively inactive, using this sector, as did the French, either as a rest area for tired units or as a position to be held by units which had not been so thoroughly trained. It was well recognized that these conditions imposed one serious disadvantage. They bred false ideas of what constituted real war, for, from the beginning the staff of the American Expeditionary Forces thoroughly understood that movement constitutes the essence of war. However, our state of preparedness, a situation which will always be encountered where actual preparation for war must be carried on while

the war is waged, made it seem wiser to take but one step at a time, and fortunately this particular part of the western front remained inactive until the St. Mihiel offensive on September 12, 1918.

### Corps Observation

In April, 1918, the 1st Corps Observation Group, consisting of the 1st, 12th, and 88th Squadrons, was organized. The pilots for the most part were men who had never served at the front. On the other hand, the observers had nearly all seen service with French squadrons and their experience so gained proved of great value. This group was placed under the tactical control of the French 37th Army Corps and under the administrative control of the American 1st Army Corps. Its mission was primarily to keep the command informed by visual and photographic reconnoissances of the general situation within and behind the enemy lines. To accomplish this, a routine schedule of operations was prescribed for each day, consisting of several

close-range reconnoissances of the sector, and toward dusk a reconnoissance for hostile batteries in action. In addition to this routine work, special missions were arranged, in many instances for the day following. Artillery adjustments, in particular, were carried out, and many long distance and special reconnoissances. Except in the one case of the attack on Seicheprey,<sup>1</sup> no opportunities offered for contact patrols.

### Value of Experience in the Toul Sector

From a command point of view the work of this group in the Toul sector was comparatively unimportant. There were no marked opportunities for obtaining information of value, as no active operations occurred. The instruction of the group itself in its duties during this time was carried on consistently and with great advantage. Individuals made rapid strides in learning the details of their duties and except training in actual combat they had arrived at a state of excellence by the time they were to take part in real warfare. This period was also utilized in organizing and operating the group as such, as opportunity existed for so doing without paying the ordinarily heavy price of mistakes

in war. A proper organization was evolved rapidly and the principles and methods established stood the test of time. Changing conditions made minor modifications necessary, but the essentials proved sound and were the model for succeeding groups.

### Work in Quiet Sectors

During this period one of these squadrons was detached for duty in the Baccarat sector,<sup>2</sup> where its experience was along the same lines as those followed by the other two squadrons in the Toul sector.

During the summer while American divisions were in line in the Vosges Mountains the 99th Aero Observation Squadron received its first battle training, operating over the southern end of this sector and participating in the attack on Frapelle.

### Army Observation

The 91st Squadron, our first army observation unit, commenced active operations on the front on June 6, 1918, also in this Toul sector. Its personnel, too, had much to learn of its work from its own experience. The best methods to employ in obtaining information of the enemy's rear areas were

studied and developed. Many material difficulties in doing photographic work were met and overcome. Aerial gunnery was brought to a high degree of efficiency. Formation flying was constantly practiced and when active operations began in this sector the 91st Squadron had gained confidence in itself and had acquired knowledge of long-

distance reconnaissance that proved of great value to our staff in later operations. It may be noted here that subsequently officers of the allied armies who knew the work done by this squadron stated emphatically that no better work had been done at any time during the war by any observation squadron on the western front.



*Lts. Douglas Campbell (left) and Alan Winslow, 94th Pursuit Squadron, scored the two victories in the Toul sector on April 14, 1918.*

## Day Bombardment

Day bombardment had its beginning on May 18, 1918, when the 96th Aero Squadron was established on the Amanity airdrome, also in this Toul sector. Its personnel had received some training with both French and British units. The shape of the St. Mihiel salient and the installations within and behind it offered excellent opportunities for bombing. The first raid was made on June 12, when the yards at Dommary-Baroncourt were successfully attacked. Early in July owing to overeagerness in adverse weather an entire flight of this squadron was lost, and as at this time there was also difficulty in replacing equipment, the squadron was somewhat crippled. By August equipment had been secured and 20 successful raids were made during this month. These did considerable material damage, but even more important was the moral effect produced. Bombing has a great effect upon all troops and according to French intelligence reports the enemy took to his dug-outs long before the bombers reached their objectives.

Much tactical knowledge was gained by this squadron while in the Toul sector. By trial the most satisfactory formation for encountering en-

emy pursuit was developed. The enemy methods of attack were studied closely, and the experience gained proved of value during the more serious enemy efforts which were made later.

## Pursuit

The Toul sector likewise served as a place for giving final practice to the pursuit units. The 94th Pursuit Squadron commenced operations on April 14, 1918,<sup>3</sup> and on that same day, thanks largely to the excellent liaison with the anti-aircraft defenses and to blunders of the enemy, two enemy airplanes were shot down in our lines without loss to ourselves.<sup>4</sup> The moral effect of this was great and from this very first day our pursuit squadrons showed in their work that aggressive spirit and high morale which alone can win in war.

In May, 1918, three other squadrons<sup>5</sup> were ready to be sent into battle, and the 1st Pursuit Group of four squad-

rons was formed. Fortunately, there were among the pilots some who had served with the Lafayette Escadrille and their experience in war was invaluable in teaching our new pilots, who had much to learn. The very best of school work can not give a pilot the atmosphere and feeling of the front. Not alone is this true in general, but schooling can not impress upon the students the relative importance of vision in the air, aerial gunnery, formation flying and fighting, and acrobacy. In particular, teamwork and formation flying had to be emphasized at the front. These matters were vigorously undertaken, and with marked success. For a time the enemy was neither numerous nor aggressive and combats were infrequent, but there was always the atmosphere and many of the conditions which prevailed in active warfare.

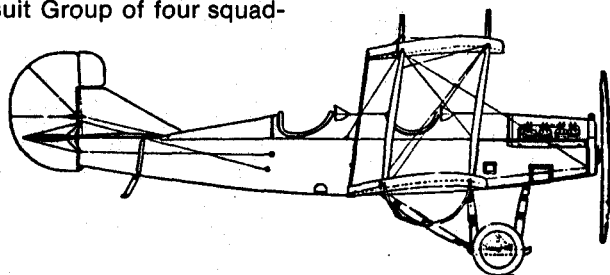

In June, 1918, advantage was taken of bombing raids carried on by the British Independent Air Force to cooperate by attacking enemy pursuit airplanes which sought to interfere with these raids, and on three occasions enemy pursuit airplanes were shot down by our pilots.

Our pursuit squadrons, like the observation squadrons, came out, after their stay in the Toul sector, while not veteran fighting organizations, yet possessed of excellent morale, and well equipped to undertake the more serious work in which they were about to be engaged.

### Balloons

This quiet sector was also chosen for the development of our balloon companies. In February, 1918, the 2d Balloon Company joined the 1st Division, which was then in line. Two other companies (one sent to this Toul sector, one to near Baccarat)<sup>6</sup> reached the front in April, relieving French companies. Specialists from French units remained with our balloon companies until

the men had become sufficiently adept, which ordinarily required but a short time. After our own companies had been thus trained they themselves undertook the training of newly arriving American balloon units. The mission of these balloon companies was to regulate artillery fire, to locate targets, to report all activity within the enemy lines by day and, when possible, by night.

### The Marne and the Vesle

The work of all of our air forces became of a much sterner type when they entered more active sectors which were the scenes of hard fighting in July and August. The operations on the Marne and the Vesle may be roughly divided into three periods—the preparation for the expected German offensive, which came on July 15; the



*Observers leave observation balloon.*

crushing of that offensive and preparations for the Allied counter offensive of July 18; and this counter offensive itself, from Soissons to Chateau Thierry, with the consequent retreat of the Germans to the line of the Vesle and later to the Aisne. Each of these periods called for a somewhat different disposition of the air forces to effect the best results.

### **Observation**

The 1st Corps Observation Group, consisting of the 1st and 12th Aero Squadrons, reached the Marne sector during the first days of July, 1918, and occupied an air-drome about 55 kilometers from the existing front line. It was assigned to duty with the 1st Army Corps, which at that time held the front extending from a short distance west of Chateau-Thierry to Courchamps, with two divisions in the front line. Although the positions of the opposing forces had somewhat stabilized after the German offensive of May 27, 1918, conditions were quite different from those existing in the Toul area. There were a number of strong points hastily organized rather than a continuous line of trenches. The enemy had also powerful artillery and by this time had massed the heavy guns that were intended to support his formidable attack of July 15. A very powerful

enemy air force had also been assembled, and our squadrons, accustomed to the lesser and not so highly trained air forces of the Toul sector, now daily encountered enemy patrols of some 7 to 20 machines of the latest Fokker type and flown by the best of German pilots, who were vigorous and aggressive and who showed a teamwork and persistency new to our experience.

On July 1, 1918, the American attack on Vaux gave an opportunity to employ contact patrols and advantage was taken of this to give all our available teams the experience which can not be gained otherwise.

The arrival of the 88th Squadron on July 6 completed this group, which operated as such from July 7. From this last date to July 15 the main purpose of operations undertaken was a thorough reconnaissance and surveillance of the enemy opposite our sector, in order to keep our command informed of his movements and dispositions. Missions were sent out for this purpose daily at dawn and dusk, while other missions were dispatched throughout the day according to the existing situation. All missions were quite definite. Great

importance was attached to photographing the enemy works. Visual reconnaissances and photographic missions were both fraught with difficulties and the enemy often endeavored to interfere with them. Nevertheless, our staff received timely and important information, the result of the work of this observation group during this period. In addition, a certain number of artillery adjustments and contact patrols were undertaken.

When the enemy attack finally came and was repulsed the corps observation worked during every hour of daylight and again brought invaluable information

### **Observation Work in the Counter-Offensive**

The allied counter offensive of July 18 changed materially the work of the observation squadrons. A war of movement had begun and there became apparent at once the greater difficulties in the way of keeping ground and air forces closely in touch with each other. Contact patrols became of far greater importance. Photography decreased in importance, while the regulation of artillery fire on hostile batteries became much more difficult. Our patrols, in spite of these obstacles, did obtain important

information and transmit it to its destination. Our corps observation did effective work, even deep photography, while enemy attempts at photography and visual reconnaissance were greatly hampered by our own pursuit. Throughout all of these operations, in spite of the larger number of enemy airplanes in this sector and their aggressiveness, our pilots maintained their fighting spirit against heavy odds.

Early in August, 1918, the American 3d Army Corps came into line on the Vesle and an observation group, consisting of the 88th American Squadron and two French squadrons, was organized for its use. The enemy had paused in his retreat and held strongly the heights north of the Vesle. The character of the observation work demanded of both of our observation groups was essentially the same as that undertaken on the Marne. Added experience made for greater efficiency, and the difficult problem of liaison with both Artillery and Infantry was attacked with energy. On the whole, it may be stated that during this, their first taste of real warfare, the observation squadrons did good service.

Though opposed by a vigorous enemy pursuit, they kept our command informed of enemy movements and of the locations of our own troops.

### Pursuit

The 1st Pursuit Group commenced operations in the Marne sector early in July, 1918, as part of the Air Service of the French VIth Army. Here conditions were decidedly different from those which had been encountered in the Toul sector, where single airplanes were comparatively safe and where formations of three to six airplanes did excellent work. In the Chateau—Thierry sector the squadron formation became the rule almost from the very beginning. At all times the enemy had a superior number of pursuit airplanes, the French Intelligence Service estimating the odds at one period to be 4 to 1.

From the beginning of the German attack on July 15 it was planned to maintain during daylight hours a double-tier barrage, one tier at medium and the other at high altitudes. For a time it was attempted to utilize a single squadron formation. This, however, proved unwieldy and the squadrons were echeloned by separate flights,

while it became the rule that no patrol should go out at medium altitudes without a covering patrol high above. Fighting at all times against heavy odds our pilots carried the war into the enemy's country and the majority of combats took place well within the enemy lines.

Close protection of observation airplanes proved costly and could be undertaken only exceptionally, where the moral support afforded justified the probable losses. Pursuit airplanes are intended primarily for offensive work. It is the role of the pursuit pilot to seek and to attack enemy airplanes. To distract the attention of the pursuit pilot from this primary duty by directing him to guard observation airplanes, requiring him to follow them and to keep track of their movements while at the same time he endeavors to watch for hostile aircraft, renders him just so much less efficient. Playing his proper role, devoting his entire attention to attacking and driving away or destroying enemy airplanes, the pursuit pilot protects the observation airplanes more effectively than when charged with this specific mission alone. It is evident, however, that thorough protection to observers can be given only when there is a sufficiently large number of pursuit airplanes to keep the enemy out of the air.

## Balloons.

Three balloon companies<sup>7</sup> took part in the Chateau Thierry counter offensive. Two of them operated south of Soissons, accompanying the 1st and 2d American Divisions when those divisions, as part of the French Xth Army, advanced to cut the Soissons-Chateau—Thierry road. The 4th Balloon Company reached the vicinity of the Chateau—Thierry salient after this counter offensive was well under way. It joined the 3d Division and took part in the advance to the Vesle. These balloon com-

panies not only did valuable work in adjusting artillery fire but also kept constant watch upon the progress of the advancing infantry, reporting to the divisional staffs new developments from hour to hour. The aggressive enemy pursuit aviation brought down 8 of our balloons and 1 more was damaged by shell fire. In all, 12 observers were forced to make parachute descents during these operations.

*A Caquot balloon.*



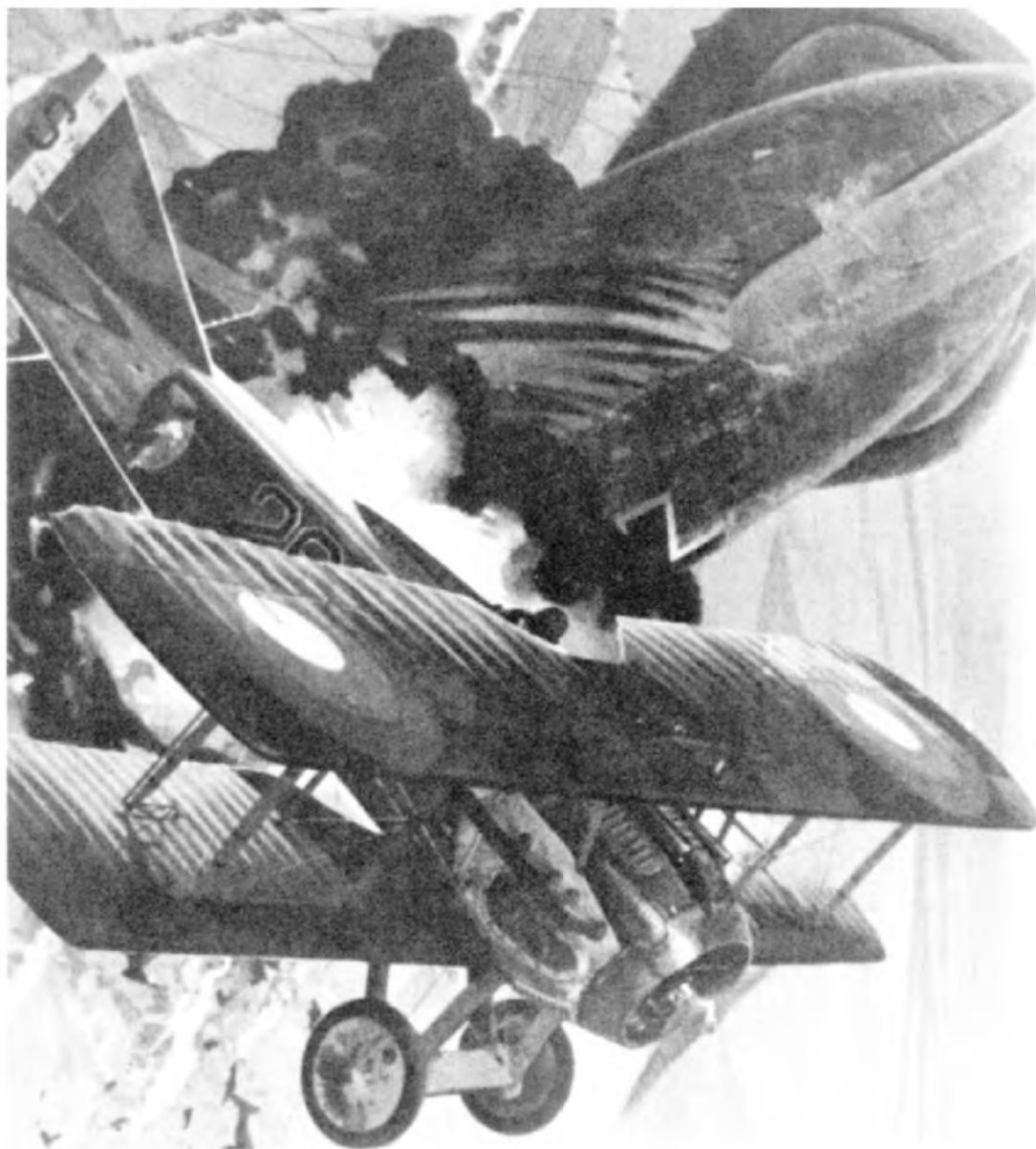



#### Organization for the St. Mihiel Battle.

On August 10, 1918, the United States 1st Army was organized. Army headquarters were located at La Ferte-sous-Jouarre but soon moved to Neufchateau, in the vicinity of the St. Mihiel salient, where plans were perfected for the attack soon to take place there.

In mid-August the American Air Service comprised 1 Army observation squadron, half a dozen corps observation squadrons, 1 of which was equipped with DH-4 airplanes and Liberty engines, 1 day bombardment squadron, and 14 pursuit squadrons. Two of the pursuit squadrons were serving with the British Expeditionary Force.<sup>1</sup>

In anticipation of the St. Mihiel offensive, the French placed at the disposal of the American Army a considerable number of their own air squadrons, which were put under the command of the Air Service commander of our own 1st Army.<sup>2</sup>

Additional American squadrons were being equipped as rapidly as possible. It was a task of no little magnitude to prepare these new squadrons for actual battle, to organize the group, corps, and wing staffs, to make dispositions for

sheltering our own units and the French units under our command, and to link up the units of the Army Air Service with each other and with the various corps, division, and artillery production centers by wire, radio, courier, and "air-plane drop-message" grounds.

On August 26 the headquarters of the 1st Army moved to Ligny-en-Barrois, and shortly thereafter these French squadrons reported for duty. An airdrome and a drop-message station were immediately prepared. The order of battle of the 1st Army placed the United States 5th Corps on the left of the line, its left flank joining the French 11d Army at Chatillon-sous-les-Cotes; on its right was the French 11d Colonial Corps, near the point of the salient, and on the south side of the salient were the United States 4th and 1st Corps, from left to right, with the right flank of the 1st Army joining the VIIIth French Army at Pont-sur-Seille.

To each corps was assigned an observation group made up of French and American squadrons. These corps Air Service units are component parts of the corps to which they are assigned and are under the direct orders of the corp commanders.

The Army observation group was formed around the 91st Aero Squadron as a nucleus by adding two new aero squadrons, the 24th and the 9th, but as these had not had actual battle experience, they did little work other than perfecting their own training. The 91st Aero Squadron, therefore, took care of all of the long-range day reconnaissances.

Four French squadrons were organized into a group for the regulation of the army artillery, which included several regiments of long-range guns capable of reaching the Metz fortifications.

A number of bombing squadrons belonging to the British Independent Air Force were also placed at the disposal of the commander in chief for the coming offensive.

This concentration of air forces placed under the orders of the Air Service commander of our 1st Army 701 pursuit airplanes, 366 observation airplanes, 323 day bombardment airplanes, 91 night bombardment airplanes, a total of 1,481 airplanes, and gave us the largest aggregation of air forces that had ever been engaged in one operation on the western front at any time during the entire progress of the war.

### Preparation for the Attack.

The concentration of forces in preparation for an attack is a difficult problem. Any marked increase of aviation activity is sure to be noted instantly and to arouse the suspicion of the enemy, as every airplane approaching the lines is tracked both by sight and by sound. During the period of our intensive preparation road circulation was abnormally heavy, new gun emplacements were being installed, and new ammunition dumps established. It was necessary to prevent enemy reconnaissance of our rear areas at all cost and this called for much activity on the part of our own air forces. There was also an immense demand by troops designated for the attack for photographs permitting a minute study of the terrain. This too caused an increase of our aerial activity, as did the registration of batteries on sensitive points in the enemy's rear areas. This was to be the first major action of the American Army, and the staff, endeavoring to make adequate preparation for it, made further demands upon the Air

Service in the way of visual and photographic reconnaissances.

All of the Air Service units assigned to this 1st Army had moved into position before September 12 and had had time to familiarize themselves with the country over which they were to operate.

### Observation at St. Mihiel

The actual operation of wiping out this St. Mihiel salient required but four days, September 12 to 15. On the first three days the weather was bad, and while it did not prevent all flying, it seriously interfered with the air program. Throughout all daylight hours whenever it was possible to fly, command airplanes, artillery surveillance airplanes, infantry contact patrols, and long-range army reconnaissance missions were undertaken.

September 14 was the only day when it was possible to dispatch photographic missions, the results of which were entirely satisfactory.

Particular credit is due the corps and army Air Service pilots and observers for their gallantry in flying in most unfavorable weather, rain, and high winds during the St. Mihiel operation. The army observation penetrated as far as 60 kilometers beyond the enemy's front line at a time when rain was falling heavily and clouds prevented flying at an altitude higher than about 1,000 meters.

### Pursuit at St. Mihiel

On September 11, the day before the battle, and on the next two days, our pursuit pilots showed the value of fast, high-powered, single-seater airplanes for missions of visual reconnaissance in unfavorable atmospheric conditions. These airplanes could fly at

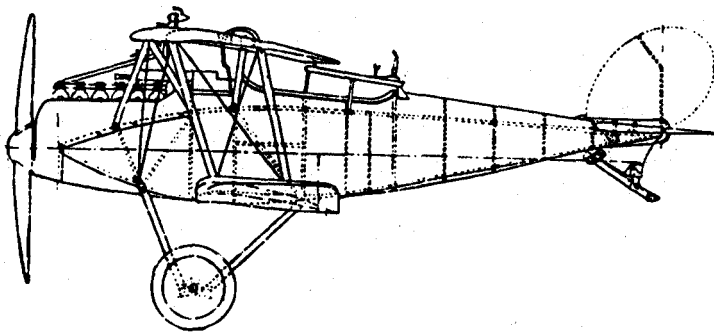

times when it was almost impossible for the biplace machines to take the air, and although the pilots had not been specially trained in observation, they brought back important information of our advancing troops.

These pursuit pilots also attacked ground objectives or engaged in "ground straffing," as this work came to be called. On September 12 American and French pursuit airplanes found the Vigneulles-St. Benoit Road filled with the enemy's retreating troops, guns, and transport. This road was a forced point of passage for such of the enemy as were endeavoring to escape from the point of the salient. All day long our pursuit airplanes harassed these troops with their machine-gun fire, throwing the enemy columns into confusion. The airplanes of the 3d Pursuit Group, which were equipped to carry small bombs, did particularly effective work in destroying a number of motor trucks on this important road.

This ground straffing was effectively continued on September 13 and 14, when good targets presented themselves on the St. Benoit-Chambley and Chambley-Mars-La Tour Roads. On September 14 the pursuit pilots devoted most of their time to the more normal work of fighting in the air, during which they inflicted many casualties on the enemy

Air Service and gained a marked aerial superiority. This was a day of good weather. Early in the morning it became evident that the enemy pursuit squadrons had been heavily reinforced. At least four new enemy organizations were positively identified. The enemy pursuit fought persistently and tenaciously in an effort to cover the German retreat, but they were heavily outnumbered and succeeded only rarely in approaching the line of battle to attack any observation airplanes. They did, however, inflict heavy casualties upon our day bombardment airplanes, French, English, and American, when the latter penetrated deep into the enemy's rear areas. Throughout the days of the attack particularly good work was done by the American 1st Pursuit Group in destroying enemy balloons. So well was this work done that it is doubtful whether the enemy received any information at all from his balloons on the western side of the salient.

### **Day Bombing at St. Mihiel.**

The weather hampered the day bombers throughout the battle. Expeditions were dispatched daily, but except on September 14 low clouds and high winds interfered with formation flying and accurate bombing. The enemy opposed this day bombing with all his might, and his use of his pursuit airplanes in this manner drew them away from the line of battle and made more easy the work of our observation airplanes on their all-important missions of keeping the higher command informed of the progress of the battle and thus assisting in its favorable development.

### **Night Bombing at St. Mihiel.**

While the daylight hours during this battle were unusually rainy and foggy, the nights were for the most part clear. The British Independent Air Force cooperating in the American attack made nightly expeditions to Longuyon, Conflans, Metz-Sablons, and other points on the railway line which the enemy was using to bring up reserves, while the French night bombardment group, containing one Italian squadron, also attacked these

points as well as enemy posts of command and concentration centers nearer to the front. The enemy bombers were also very active at night. In the absence of any night reconnaissance squadrons, airplanes of the French night bombardment group were used to keep watch over the enemy's movements at night as well as for bombing purposes, and they greatly aided the Intelligence Section of our Army Staff.

### **Balloons at St. Mihiel.**

Under our command 15 American and 6 French balloon companies took part in this battle. There were approximately 12 enemy balloons opposite the American sector. The weather conditions during the first two days prevented effective balloon observation, but the balloon companies moved forward with the advancing line and on September 14 regulated artillery fire and sent to the different army corps and divisional staffs much important information. During these September days the 21 balloon companies moved forward a total distance of 202 kilometers by straight line measurement.

### **Summary of Operations at St. Mihiel.**

Despite handicaps of weather and inexperience, the Air Service contributed all in its power to the success of this St. Mihiel operation. The staff was kept informed of developments practically hourly by clear and intelligible reports. The hostile air forces were beaten back whenever they could be attacked, the rear areas were watched, photographed, and bombed. Our airplanes participating in the battle, by the material damage and confusion which they caused, helped to increase the total prisoners.

### **The Argonne-Meuse Offensive.**

The tactical history of the Air Service prior to the Argonne-Meuse offensive is largely concerned with its training. By the end of the St. Mihiel offensive, however, it was felt at last that the American units then on the front had developed into trained combat organizations. All grades, from individual pilots or observers, had learned much from both the French and British and had had the invaluable experience of fighting, which alone completes the training for war. The American Army, having successfully and

with comparatively small loss wiped out the St. Mihiel salient, was now to undertake the much more serious task of attacking the enemy's line from the Argonne to the Meuse, a line which it was of vital importance to the enemy to hold. During the period from September 14 to 26, the bulk of the American Army had to be transferred to the new attack area. To assure the essential secrecy was a serious problem for the Air Service. The troop movements had to be screened from enemy aerial observation, yet it was desired that no great increase in our own aerial activity should give to the enemy an indication of our battle plans. The attack on St. Mihiel had drawn there a large part of the enemy's air forces, which had been operating in the Conflans-Briey area. On the other hand, while the French had placed at our disposal some 742 French airplanes for the St. Mihiel battle, nearly three-quarters of them were withdrawn before the beginning of the Argonne-Meuse offensive.

The difficulties of close cooperation with the other arms of the service being fully realized, every effort was therefore bent toward bringing about a close understanding between the aerial and ground troops.

### Corps Observation.

The corps observation units, on arrival in the new sector, became acquainted with it by using French airplanes already in that sector, thus avoiding a show of increased force.

During the entire period from September 14 to November 11, weather conditions remained on the whole unfavorable. Low clouds and fog obscured the ground almost every morning and afternoon. Photographic missions were sent out, but were instructed to cover only the most important points, while elaborate preparations were made for more extensive work whenever the weather would permit.

Pursuit machines flew over the observation airplanes which were engaged on these photographic missions, and while their prime object was to attack the enemy, they furnished protection which was of value.

Where the weather permitted the missions for Artillery surveillance were successful. Attempts to make adjustments on fugitive targets did not succeed so well. The batteries were moved frequently and communication was difficult. The radio work was far below a proper standard, and in fact nothing but dropped messages, the simplest but slowest of methods, proved successful.

Visual reconnaissance did supply much valuable information. Nothing but the heaviest rain or densest fog was permitted to stop these missions by which the corps and divisional staffs were kept informed of the enemy's movements. During many periods they were the sole source of information. Infantry contact patrols increased in their efficiency. Instruction courses were inaugurated and men from Infantry organizations were given a short but intensive course in aerial liaison, our pilots and observers were sent into the front line, Infantry officers were urged to visit airdromes and were taken up in airplanes. By these means and by the wide distribution of educational matter, there commenced to develop the mutual understanding which is the foundation of all good cooperation.

A noticeable departure from methods employed in the past was the sending out of what came to be known among our pilots as "Cavalry reconnaissance" patrols. These were observation airplanes flying at very low altitudes scouring the terrain immediately in advance of the Infantry and returning to drop messages showing the locations of machine-gun nests, strong

points, or other obstacles in the way of our advance. Although not strictly their role, such patrols frequently attacked with machine guns the enemy's infantry.

### Army Observation.

During this offensive two squadrons of the army observation group were assigned to daywork and one to night reconnaissances.<sup>3</sup> Day reconnaissances were mainly visual, missions being dispatched as frequently as necessary in order to keep the sector under constant surveillance. Airplanes penetrated deeply into the enemy's lines, and returned with much information of his rear areas. Photographs were taken of all railroad centers and important points. Of particular value were photographs taken, before and after fire on these points by the army artillery, of Montmedy, Longwy, Spincourt, Dommary-Baroncourt, and Conflans. Though these important stations were protected by concentrations of antiaircraft artillery and pursuit airplanes, they were successfully photographed, allowing our ar-

tillery to fire effectively during the attack. In addition, the group kept four command teams constantly on duty at army Air Service headquarters. These teams were called upon to perform almost every class of reconnaissance mission, frequently making flights at an altitude of not more than 100 meters. Their work proved of great value to the army staff. As the great part of enemy movements now took place at night, night reconnaissance work was of increasing importance. In order for this to be successful, however, perfect conditions of visibility and a highly trained personnel are essential. Only a few of our fliers had as yet become sufficiently experienced in night reconnaissance and weather conditions were rarely favorable. However, on the few nights suitable for observation, much information of value was obtained.

### **Pursuit.**

Our pursuit, on entering the Argonne-Meuse operation, had reached a stage at which it ranked in efficiency with the pursuit aviation of the allied armies. It now consisted of three groups of highly trained squadrons,<sup>4</sup> with pilots second to none.

The moral effect of an attack by air forces upon ground troops was fully realized.

Furthermore it was believed that the Germans would use their low-flying battle airplanes in considerable numbers, to harass our ground forces, and also that German balloons would be a peculiar menace to large concentrations of our troops. It was, therefore, decided to assign an entire group, the first, to the task of combating low-flying battle airplanes and to the destruction of balloons. This proved a wise measure. On the first day 10 enemy balloons were destroyed and the remainder were so constantly attacked that their value to the enemy was negligible. Many German battle airplanes were also destroyed, with remarkably small losses to our own forces. Conditions on both sides had now reached a stage at which it was believed that more enemy airplanes would be destroyed and a greater moral effect produced by using larger concentrations at points where a study of the enemy's methods indicated he would be present. On the first day of the offensive, September 26, 1918, a group sortie was made, and resulted in the destruction

of eight enemy airplanes; a second one the same afternoon brought down three more. Thereafter, these concentrations were made almost daily, weather permitting, the hour and place being based on the enemy's probable actions. A successful sortie at Bayonville, on October 18, succeeded in bringing 40 enemy airplanes into combat. Their formation was broken up and 9 of them destroyed, the remainder escaping to their airdromes.

### **Night Pursuit**

A study of pursuit tactics would not be complete without reference to the night pursuit. Whatever the material damage done by night bombing may have been, its moral effect was very great. This was due in no small part to the consciousness of helplessness. The Germans did little or no day bombing, but did considerable night bombing and were believed to be preparing for even more extensive efforts. Hence every effort was made to combat night bombers, and a squadron for this purpose was organized during the Argonne-Meuse offensive.<sup>5</sup> It had little time in which to operate, and was seriously handicapped by shortage both of material and of pursuit pilots experienced in night flying. Nevertheless it did succeed on two occasions in coming into contact with

enemy night bombers, and the success achieved in a limited time led to the belief that the night bomber would have been compelled in a short time either to modify his operations or to adopt an entirely different type of airplane.

### "Ground Strafing."

"Ground strafing" having proved so efficacious this was continued during the Argonne offensive, and the enemy's troops were attacked by our pursuit airplanes with machine guns and light bombs. Our intelligence reports showed that a much desired effect was obtained, for the mere sight of any of our airplanes, no matter of what type, caused much confusion among the enemy.

### Day Bombing

The Argonne-Meuse offensive saw a great improvement in the work of the day bombardment group.<sup>6</sup> The early history of day bombardment units had been one of heavy losses, not alone in our own service but in that of our allies. Several steps were taken to prevent this. The utmost stress was laid on gunnery, and constant practice soon began to have its effect. Formation flying was insisted upon, and the bombers were taught that a tight formation meant safety; an airplane that left the formation was almost certain to be lost. Objectives now began to be attacked by the whole group, instead of by a single squadron; and better cooperation was secured with pursuit. This reduced our own losses and increased those of the enemy.

Such is the demoralizing effect of bombing, that the enemy in an effort to prevent it will attack with all his available forces and at what ever cost. Our own tactics recognized this fact. As an example, on October 4, Dun-Sur-Meuse and Landres St. Georges were each hit with a ton and a half of bombs. Low clouds afforded many pockets for lurking enemy pursuit airplanes, and our bombers were attacked by a group of 30 Fokkers and Pfalz. They fell upon our 96th Squadron, which was in the lead, and which closed in and held these enemy pursuit airplanes at a distance. Two

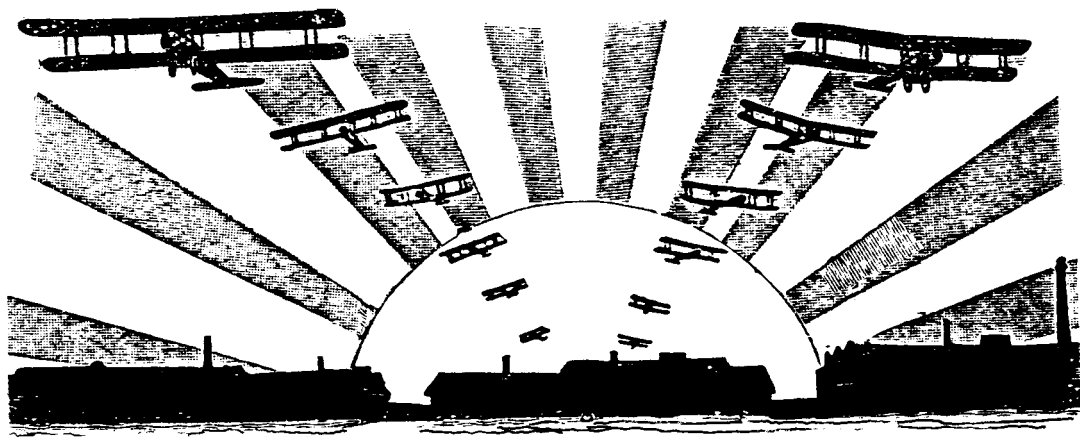

other bombing squadrons, the 20th and the 11th, following, attacked this enemy pursuit from the rear, shooting down two of them. A general fight then ensued, during which and when it was hottest, 30 Spads of the American 2d Pursuit Group, according to plan, arrived on schedule time and attacked with vigor. The enemy, thus trapped, lost 13 airplanes, while we lost only 1.

As further proof of the efficacy of these tactics, over two-thirds of all the enemy airplanes shot down during this Argonne offensive were destroyed by just such concentrations and under similar conditions.

The material effect of these bombing raids is also great. In one such attack on Bayonville, 250 enemy troops were killed and 750 wounded. Again these raids invariably drew enemy pursuit from the rest of the front, rendering it safer for our corps observation.

The most remarkable concentration of air forces during this offensive took place in the late afternoon of October 9, when something over 200 bombing airplanes, about 100 pursuit airplanes, and 53 tri-place machines, after rendezvousing in our rear area, passed over the enemy lines in two échelons. A total of 32

tons of bombs were dropped on the cantonment district between La Waville and Damvillers, in which locality a counterattack had been anticipated throughout the afternoon. This concentration was strongly attacked by the enemy, and during the engagement 12 enemy airplanes were brought down out of control, while only 1 of our own airplanes of all this large number failed to return.<sup>7</sup>

### **Balloons.**

Thirteen American balloons operated during this offensive. They were not inflated until the night of September 25, and the enemy is believed not to have been aware of their presence. Of particular note is the success that attended the maintenance of liaison. The balloon companies at all times kept pace with the general advance, one company covering a record distance of 32 kilometers in a day, over shell-torn ground. Nevertheless, telephone communication was established at each stage and information sent in to corps and divisions.

### **Americans with Royal Air Force, B. E. F.**

The tactical history of American pursuit would be incomplete without reference to American pilots and units with the Royal Air Force. Of the 216 pilots sent to the Royal Air Force in the field, some served in British squadrons, but two wholly American aero squadrons, the 17th and 148th, operated under British wings, in all respects on the same footing as British units. Still others of the pilots trained in England, who were intended to be employed in the American night bombardment program, were sent to the Independent Force, Royal Air Force, and later returned to England to act as instructors in the American Expeditionary Forces school. Confirmed casualties inflicted upon enemy aircraft by Americans serving with the British totaled 225, whereas their battle casualties were 71, or a superiority of 3 to 1.<sup>8</sup>

### **The 17th Aero Squadron.**

Organized at Kelly Field, May 13, 1917, the 17th Aero Squadron<sup>9</sup> was trained in Canada and at Fort Worth, Tex. While its future pilots, as individuals in British organizations, were completing their training with the Royal Air Force on the British front, the soldier personnel of the squadron was divided for



training into three flights which were attached to units of the Royal Air Force in the field. Finally, organized as a complete squadron, its own pilots made their first flights over the Dunkirk front on July 15, 1918. From August 18 to September 20, 1918, the 17th Aero Squadron was engaged at Auxi-le-Chateau with the 3d

Brigade, Royal Air Force, in the British drive on Cambrai. As the Cambrai front was broken and the line swung rapidly eastward, the squadron moved to an airdrome near Doullens, from which, under the 3d British Army, it carried on normal pursuit operations and developed to a high state aerial bombing by pursuit airplanes and "ground strafing." The squadron completed its work with the Royal Air Force on October 28, 1918,

and on November 1, 1918, proceeded to join the American 2d Army on the American front. The advent of an armistice prevented further service over the lines. In its operations from July 15, 1918, the American 17th Squadron destroyed 64 confirmed enemy aircraft. Twenty-four of its own members were battle casualties.<sup>10</sup> Its 2,600 hours over the lines were variously employed in all branches of pursuit aviation. Four of its flyers were decorated with the British distinguished flying cross.

### **The 148th Aero Squadron.**

The 148th Aero Squadron was likewise formed at Kelly Field, Tex., on November 11, 1917. With its complement of flyers from Fort Worth, it sailed for England in February, 1918. As with the 17th, the flying officers were sent to English flying schools and the squadron to the Royal Air Force in the field. It was on July 20 that the first flight was made by the squadron over the lines from the Cappelle airdrome near Dunkirk. The officers of the squadron were not those who had accompanied it overseas, but were other American flyers trained



*Capt. Field E. Kindley left the RAF in May 1918 and joined the 148th Aero Squadron as a flight commander. He is credited with shooting down 11 enemy aircraft.*

in England who had already been engaged in war flying with the British. After three weeks of preliminary work on the Nieuport-Ypres front, the 148th Squadron was sent to the British 4th Army operating from Albert to Roye, and shortly began its share in the drive on Cambrai. The dropping of 20-pound bombs on the retreating enemy became a daily feature of the squadron's work, as did the use of machine-gun fire against ground targets. The squadron advanced with the British and was engaged in all actions in its sector. During the bitterly contested retreat of the enemy, the 148th advanced from Albert to the Canal-du-Nord, thence to Le Cateau, and finally to Le Quesnoy. With the 17th Squadron,<sup>11</sup> it was ordered to the American front on October 28th. The two squadrons proceeded to Toul, but were not again engaged in active operations before the signing of the armistice. In the course of its work the 148th American Squadron destroyed 66 (confirmed)<sup>12</sup> enemy aircraft. In accomplishing this it suffered but 11 casualties. In all 2,100 hours were spent over the enemy lines in offensive patrols, low bombing and "strafing" raids, and attacks on balloons. Three of its members were decorated with the British distinguished flying cross and one with the distinguished service cross.

The individual pilots with British squadrons and the two American squadrons serving with the Royal Air Force were all many times commended by the officers of the Royal Air Force under whom they served directly and also by the General Officer commanding the Royal Air Force in the Field.<sup>13</sup>

### American Pilots on Italian Front.

Of the American pilots trained in Italy, 65 served gallantly with Italian squadrons on the Italian front and 17 others had been assigned to the Italian naval station at Foggia-Renatico for operations against Austrian submarine bases. They were all commended most highly by the officers under whom they served.

### Honors and Awards.

Of the Air Service officers and soldiers who took part in active operations while members of the Air Service, American Expeditionary Forces, individuals<sup>14</sup> were decorated or cited for great gallantry displayed in action against the enemy, and the total number of decorations and citations awarded was 611.<sup>15</sup> One officer received the congressional medal of honor.<sup>16</sup> The American distinguished service cross was awarded to 235 individuals, of which number 41 were also awarded the oak

leaf cluster.<sup>17</sup> Four individuals were cited in American orders. Two individuals received the British distinguished service cross and 20 the British distinguished flying cross.<sup>18</sup> Thirty-nine persons were awarded the French Legion of Honor, 5 the medaille militaire, 158 the croix de guerre (and of these 8 individuals were each cited a second time); eight individuals became entitled to wear the fourragère, and 149 Americans (4 of whom twice received this honor) were awarded French citations.<sup>19</sup> Of the Americans serving with the Italians, six received the corona d'Italia, one the medaglia d'oro al valor militare (gold medal of valor), two the medaglia d'argento al valor militare (silver medal of valor),<sup>20</sup> and 41 the croce di guerra. Thirteen Belgian decorations were bestowed upon



Legion of Honor

Air Service officers, 2 Roumanian, 1 Serbian, 2 Montenegrin, and 1 Chinese.<sup>21</sup>

### **General Remarks in the Light of Experience.**

Nothing but actual experience in battle can complete the training of any armed force. The first active operations in which such a force takes part always brings to light deficiencies from a tactical point of view. This was true in our own case, but the more largely so because of our failure to prepare for war until war was actually upon us. In addition to this greatest of all causes for our deficiencies, there were other points so clearly brought out that it seems well to mention those for which remedies exist.

### **The Air Service a Combat Arm.**

There was throughout our experience a marked tendency on the part of commanders of the larger ground units and their staffs to regard the air force as a staff service rather than as a combat arm. There was lack of knowledge of the best ways in which to use this new arm, and too little regard was paid to the local tactical situation and to the necessity for the combined employment of the air force and all other combatant arms. While the air forces assigned to tactical organizations are entirely

under the orders of the division, corps, and army commanders, in many cases this command was not fully exercised. This was due, of course, to lack of experience with this newest of all arms, and the remedy is obvious. In the future it will be essential for all commanding officers and their staffs to possess knowledge of the limitations and possibilities of their air forces just as they know what, for example, their artillery can or can not do. The Air Service may well originate and suggest employment for its units, but the final decision rests upon the commanding general of the tactical organization to which they are assigned, and to regard the air forces as separate and distinct from the other component parts of this organization is to sacrifice the cohesion and unity of effort which alone distinguish an army from a mob.

In the Air Service as well there was lack of knowledge of the capabilities of the other arms with which it was associated. This was due likewise to the newness of the air force and to the fact that there had not been time for air and

ground troops to become thoroughly acquainted with each other.

In all future training provision must be made for Air Service officers to learn the work of other arms, and particularly for aerial observers there must be a sufficient amount of General Staff training which will render of great value the reports which they must submit. Acting as the eyes of the Army and making reports upon which weighty decisions will be based, these observers must be trained so that their reports will be accurate and will contain the facts of real importance.

### **Mobility.**

Many of the conditions which existed during the period of trench warfare and fairly stabilized conditions were greatly modified or ceased to exist with the coming of a war of movement. In this latter phase mobility is of the greatest importance and the ability of the air force to move, like that of all other arms, depends upon an adequate supply of transportation. It is a fact that the efficiency of the air forces was greatly lessened by reason of the lack of sufficient transportation. This same lack existed throughout the Army, but attention is called to it here because it is believed that the

necessity for rapid movement on the part of air forces and their dependence upon transportation make it essential that sufficient should be furnished.

### Difficulties and Delays in Forming an Air Service.

Again owing to the many technical problems which had to be solved, to the many difficulties connected with the procurement of equipment which had to be overcome, and to the considerable time that it takes for training, it has been shown that it requires longer to place an efficient Air Service in the field than is the case with any other arm of the Service. In all planning for the future this fact must be given full consideration.

### Night Reconnaissance and Night Pursuit.

During the war just ended the extreme importance of night reconnaissance and of night pursuit work was little realized until the spring of 1918. In future wars these two methods will be of increasing importance and in time of peace every effort should be made for their development. All experience has shown that it has become increasingly dangerous to move ground troops during the day and that

most large movements will take place at night. Plans must be made for night reconnaissance by aircraft in order that such movements may be detected and interrupted.

### Day Bombing.

The importance of bombing operations has been mentioned. While the material damage done by such bombing raids has been questioned, and while it has been proved that in many cases such damage was not great, there is absolutely no doubt

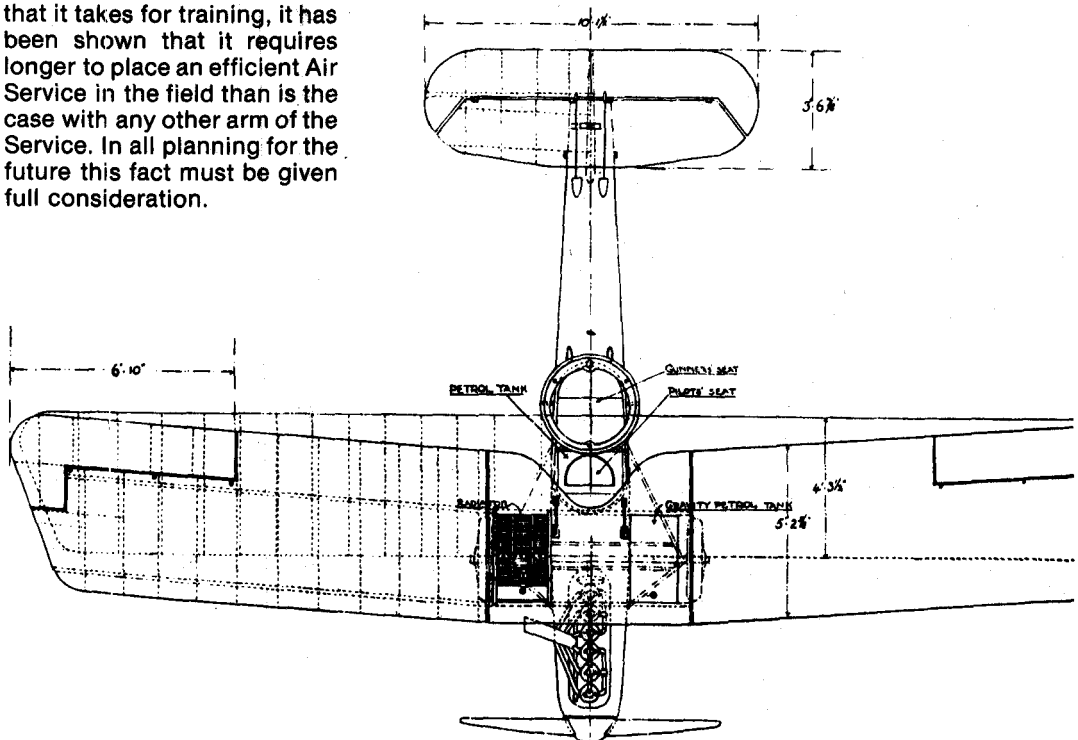

that the moral effect of these operations is most considerable, and it must be borne in mind at all times that armies are defeated not by absolutely destroying them but by the destruction of their morale.

### **"Ground Straffing."**

The attack by aircraft upon ground troops, using machine guns and small bombs, showed clearly that this has a most demoralizing effect. When properly employed, this aid from the sky in assisting during an attack by our own troops or in repelling an attack or counterattack by the enemy greatly raises the morale of our own forces and much hampers the enemy. It will be well to specialize in this branch of aviation and to provide squadrons or groups with armored airplanes provided with a number of machine guns and small bombs for just such work against ground objectives. Lacking such specially prepared airplanes, we did employ our pursuit airplanes in this way, and at times even our observation airplanes joined in such attacks upon enemy infantry. Just before hostilities ceased it had been decided by the Air Service to organize a number of such battle squadrons and sample airplanes had been equipped and armed for their use. This project should be thoroughly developed in the future.

### **Shortage of Staff Officers.**

In common with the rest of our forces the Air Service suffered from a shortage of properly qualified staff officers, and this too must be borne in mind in all plans for future development.

### **Splendid Morale of Air Service Personnel.**

There must be made some mention of the excellent morale of both flying and nonflying personnel with the Air Service. The skill of our flyers, the aggressive spirit displayed by both pilots and observers were beyond praise. These men asked only to fly and to fight. On the ground the nonflying personnel with squadrons at the front were untiring in their efforts to keep the airplanes in the air. They

worked with great spirit and marked efficiency. Back from the front, at the training centers, at the production center, at depots and other stations, officers and men gave the best that was in them, worked whole-heartedly and intelligently; no man spared himself, and all strove for the common end—to make the Air Service, American Expeditionary Forces, count for something in the struggle in which our entire Army was taking part.

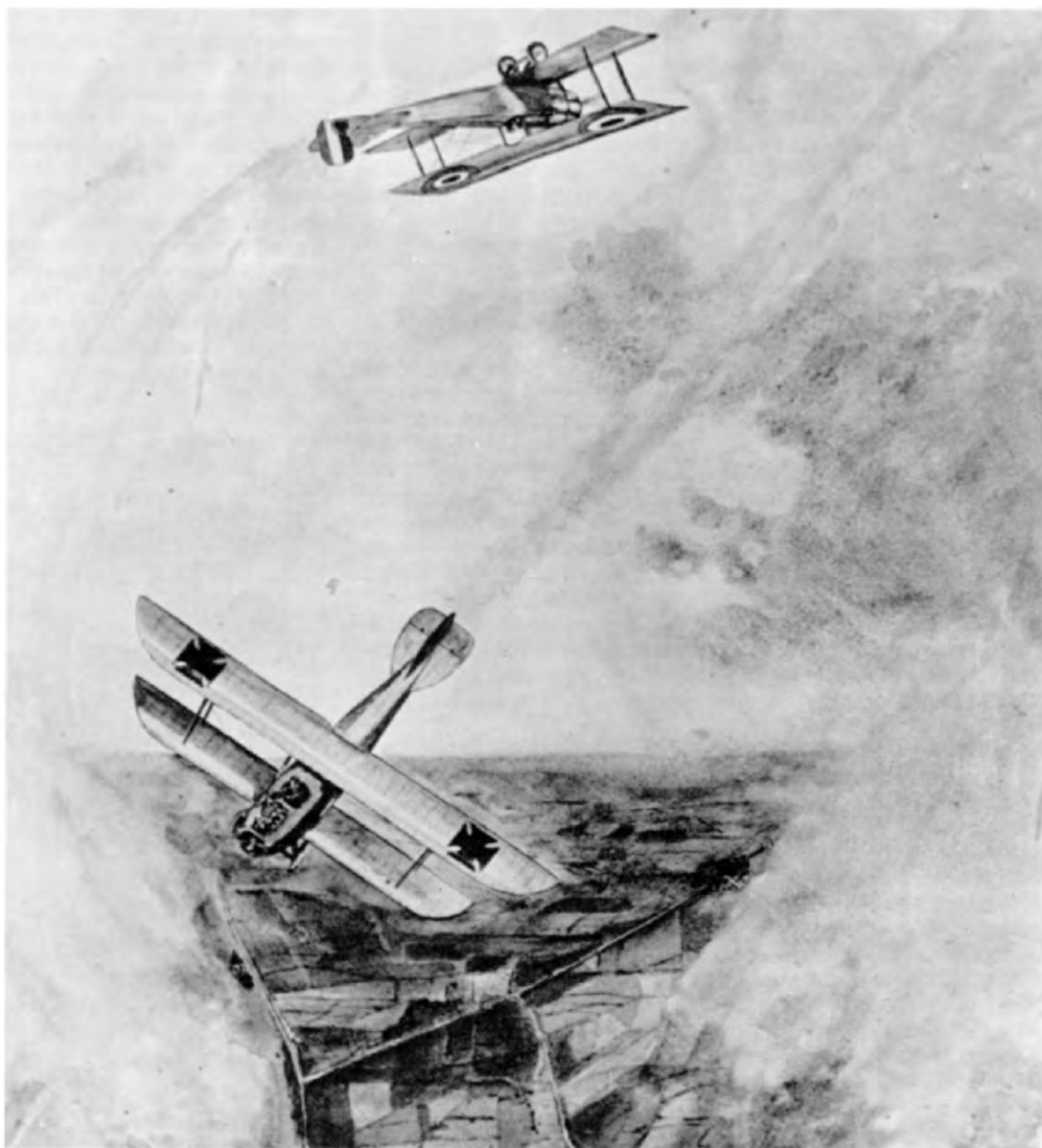

## IV. Early Problems and Their Solutions.

### Seventeen Months of Achievement.

When, in April, 1917, the United States declared war on Germany, the Air Service of the American Army, then called the Aviation Section, Signal Corps, had a strength of only 65 officers and about 1,100 men. It possessed about 200 training airplanes, but not a single one of a type considered fit for service on the actual battle fronts, nor were any airplanes of this type being manufactured in the United States. There was no existing foundation of practical experience or knowledge upon which could be based plans for the development of an overseas force and for the placing of an aerial army in the air.

Seventeen months later, on November 11, 1918, in the Air Service, American Expeditionary Forces, there were 7,738 officers<sup>1</sup> and 70,769 men, of whom 6,861 officers and 51,229 men were in France (of this number 446 officers and 6,365 men constituted the Balloon Section). Some 768 officers<sup>2</sup> and 19,307 men were training in England and the remainder training and fighting in Italy.

There were being operated 26 training schools<sup>3</sup> for pilots and observers, and in addition American officers were being trained in three schools operated by our allies. From the

training schools on November 11, 1918,<sup>4</sup> there had been graduated 1,674 fully trained pilots and 851 observers. There had been sent to the front 1,402 pilots and 769 observers. These schools were being operated with greater and greater efficiency, as evidenced by the fact that between November 11, 1918, and January 1, 1919, there were graduated 675 pilots and 357 observers.

From the balloon school there had been graduated a total of 199 officers and 623 enlisted men, specialized, who were taught the operation of balloon winches, lookout work, machine gunnery, and radio operation.

The development of the Air Service, American Expeditionary Forces, during the time we were in this war was the result of much effort during which delays and technical difficulties were being overcome. It is proposed to give a brief account of the way in which the problems were met and solved.

### Prewar Information.

Shortly before the declaration of war five officers of the Aviation Section, Signal Corps, had been sent to Eu-

rope. One was an observer, one was in the office of a military attaché, and three were flying students.<sup>5</sup> Owing to the short time they had been on this duty they had been unable to send to the United States much information of real value.

### Developments in Washington, and the First Program.

To collect data, to coordinate the interests of the United States, and to provide for the production of aviation material, the Aircraft Production Board of the Council of National Defense began its work in Washington in May, 1917, just after the arrival of military missions sent by the French and British, which brought with them certain information concerning the character of the aviation equipment needed. A cable had been received from the premier of France in which he urged the United States to form a flying force of 4,500 airplanes to be on the front during the campaign of 1918. This program, it was stated, would necessitate 5,000 pilots and 50,000 mechanics and require 2,000 airplanes and 4,000 engines to be constructed monthly in American factories. The Aviation Section of the Signal

Corps and the Aircraft Production Board adopted the program contained in this cablegram, and it was subsequently approved by the General Staff in Washington and became the basis of the whole development of American military aviation. The Joint Army and Navy Technical Aircraft Board in Washington was called upon to determine the number of airplanes which should be produced for this force. It reported that for service use on the front 12,000 airplanes and 24,000 engines would be necessary.

### **Creation of the Air Service, American Expeditionary Forces.**

Shortly after his appointment, the Commander in Chief of the American Expeditionary Forces<sup>6</sup> appointed Maj. T. F. Dodd, A. S. S. C., as aviation officer, American Expeditionary Forces, and a member of his staff.

Upon his arrival in France in June, 1917, Lieut. Col. William Mitchell, A. S. S. C., one of the five officers previously mentioned as being on duty in Europe, succeeded Maj. Dodd as aviation officer. The aviation activities were at once separated from Signal Corps control; henceforth the Air Service, American Expeditionary Forces, was consid-

ered an organization on a footing similar to that of other combat arms of the Service.

### **First Air Program, American Expeditionary Forces.**

The Commander in Chief instructed his staff to prepare at once a program for the American Expeditionary Forces. The result of this work was the general organization project, approved July 11, 1917, and intended to be merely a preliminary draft outlining the desired tactical organization of the overseas forces. This project provided for only 59 Air Service squadrons to balance the then proposed number of ground troops. Later it was learned that the United States had adopted an Air Service program as proposed by the French, 4,500 airplanes on the front during the campaign of 1918. This number was the equivalent of about 260 aero squadrons, and in order to conform to the United States plan, the additional 201 squadrons were included in what was known as "The service of the rear project," approved by the Commander in Chief, September 18, 1917. This program also included additional balloon companies in accordance with recommendations received from the French general headquarters.

### **Growing Difficulties of Liaison Between Europe and America.**

It soon became apparent in Washington that questions concerning types of equipment to be manufactured and the materials required must be studied first-hand in Europe. It was essential to secure samples of the types of aeronautic equipment to be manufactured in the United States and all necessary technical data, much of which had never been committed to paper and which could be found only among those actually engaged in such work. Serious questions arose with respect to royalties demanded by the European Governments on behalf of their citizens who were inventors or owners of special processes and devices.

Without careful study on the ground it was obviously impossible to determine just what would be the requirements of a production program, what should be built in Europe, what in America, the assistance the United States could render the Allies or receive from them, the opportunity for training American personnel in European schools, or the relative priority of the various demands made by the Allies upon the United States.





*Lt. Col. (later Brig. Gen.) William ("Billy") Mitchell.*

*Maj. Raynal C. Bolling, head of aeronautical mission.*

### **Work of the Aeronautical Mission.**

In order that all these matters might be investigated with accuracy and dispatch, the aeronautical mission of the Aircraft Production Board was sent to Europe in June, 1917, under the charge of Maj. R. C. Bolling, S. O. R. C. This mission included 2 flying officers of the Army, 2 officers of the Navy, a number of industrial experts,<sup>7</sup> and 93 skilled mechanics and factory experts whom it was intended to place in factories for the purpose of securing first-hand practical information regarding methods of manufacture which could not be readily embodied in plans and specifications.

This mission made a thorough canvass of the production situation in England, France, and Italy. The principal matters with which it dealt during the first few months were the principle of free exchange between the Allies and for the duration of the war of the rights to manufacture all classes of aeronautic material; the rapid transmission to the United States of sample airplanes, engines, and accessories, with data necessary for their production; the collection of general information needed for American producers; the choice of types of aircraft to be produced in the United States; the possibility of purchasing aviation material in Europe; the assistance the United States could give to the Air Services of the Allies including the allocation of raw materials; the possibility of sending personnel for training in Europe; and the coordination and standardization of aircraft production in all Allied countries, with the consequent elimination of obsolete types wherever manufactured.

This aeronautical mission performed invaluable work in gathering and transmitting to the United States essential

information and in bringing together more closely than had hitherto been the case the Air Services of Italy, England, and France on questions concerning the production and allotment of material.

### **Procurement of Material.**

The studies of this mission early convinced its members that no matter how optimistic were the promises of production in the United States, nothing in the way of finished and satisfactory aviation material could be expected to arrive in Europe from the United States before about July, 1918. This meant that the Air Service, American Expeditionary Forces, in order to participate in the spring campaign of 1918 must obtain elsewhere its necessary equipment.

A contract with the French, known as the agreement of August 30, 1917, was prepared and signed by the French Air Ministry and the Commander in Chief, American Expeditionary Forces. This contract provided that the French Government would deliver to the Air Service, American Expeditionary Forces, by June 1, 1918, 5,000 airplanes and 8,500 engines. On its part, the United States was to furnish by November 1, 1917, certain specified tools and materials needed for the fulfillment of the French obligation. It provided also that the airplanes

and engines to be furnished by February 1, 1918, would be supplied even though the United States should be unable to deliver on schedule time, its quota of materials and tools. It was upon the provisions of this agreement that the Air Service, American Expeditionary Forces, planned its program of training and of putting squadrons in the field.

### **Motor Mechanics Return to United States.**

Small squads of the mechanics who had accompanied this mission were sent back to the United States from time to time, carrying to the Aircraft Production Board the lessons they had learned and valuable samples of aeronautical material. Eighteen of these men were later examined and commissioned in the Air Service.

### **Development of the Organization.**

The magnitude of the problem confronting the Air Service soon made it necessary to enlarge the organization. Col. William Mitchell, still with his title of aviation officer, Ameri-

can Expeditionary Forces, was given jurisdiction and control over the Air Service in the Zone of Advance, while Maj. Bolling, on account of the knowledge he had gained concerning questions of production, was given charge of aviation in the Zone of Interior, as it was then called. At this time Maj. Bolling was active in the organization of an Interallied Aircraft Board which did important work coordinating the various air programs of the Allies and of the United States.

This organization, with one officer in charge at the front and an officer in charge at the rear, resulted in divided responsibility. General Orders No. 26, Headquarters American Expeditionary Forces, August 28, 1917, appointed Col. (later Maj. Gen.) William L. Kenly, then of the 7th Field Artillery, Chief Aviation Officer, American Expeditionary Forces. On September 3, 1917, Gen. Kenly was announced as Chief of Air Service, American Expeditionary Forces. Maj. (later Col.) Bolling remained in charge of the Air Service, Lines of Communication, with the title of Assistant Chief of Air Service, his headquarters being in Paris. Col. William Mitchell became air commander, Zone of Advance. In the early part of September, 1917, the offices of the Chief of Air Service and of the air commander, Zone of Advance, were moved to Chau-

mont, where were established the headquarters of the American Expeditionary Forces.

### **Early Work In the Zone of Advance.**

During the early autumn of 1917 the work in the Zone of Advance consisted chiefly of making plans and projects for future development. No squadrons were then available for duty at the front except the 1st Aero Squadron, which had arrived in Europe on September 1, 1917, and after a period of training at Avord had been located at Amanty, near the 1st Corps School.

The main problems at the front were therefore the preparation of organization projects, the selection of suitable sites for airdromes and supply depots, and the study of Air Service tactics and strategy. These studies were made firsthand with the French and British Air Services and in connection with the operations of their ground troops.

### **First Air Depot.**

The construction of the 1st Air Depot at Colombey-les-Belles was begun upon the arrival of the first available troops in October, 1917. It was realized that the Air Service would need such a depot as a receiving and distributing

point for personnel, material, supplies in general, and as a site for shops for engine, airplane, and motor transport repairs which were not serious enough to require shipment further to the rear. At this locality there would also be needed an airdrome to accommodate several squadrons. The buildings originally authorized covered 185,977 square feet, but this authorization was increased in September, 1918, to 587,293 square feet, of which by November 11, 1918, 357,363 square feet had been completed.

### **Problems of the Rear Schools and Training.**

The task of the Assistant Chief of Air Service Lines of Communication was the making of all preparations for placing the fighting units at the front and the providing for their training, their equipment, and their maintenance. This was a huge and complex undertaking which necessitated great foresight and much organizing ability. The fall of 1917 was occupied particularly with the establishment of schools and training centers sufficient in number and ca-



Lafayette Escadrille hangars at Ham airdrome.

Officers of the 103d Aero Squadron, formerly of the Escadrille, receive decorations.





*Pilots of the Lafayette Escadrille with one of their pet lions.*

*Maj. William K. Thaw (left) senior officer of the Escadrille, assumed command of the 103d Aero Squadron and later led the 3d Pursuit Group.*

capacity to provide for training Air Service personnel, flying and nonflying. The known lack of training machines and other essentials in America made it improbable that the United States could produce before January 1, 1918, more than 500 pilots, and these with no more than preliminary training. To meet the immediate emergency, it was necessary to take advantage of schools already established by the Allies. As early as June 26, 1917, cables were sent to the United States calling for cadets who were there waiting flying training to be sent to Europe to be trained in French, English, and Italian schools. The officers of the 1st Aero Squadron and such other flying officers as could be spared from administrative or technical duties were sent to French finishing schools. A Training Section in charge of all this instruction was organized. Three training schools were immediately started. The site at Issoudun recommended by the French military mission to the United States was accepted, and during the latter part of July, 1917, the

construction of a center for advanced flying training was begun. A French school already in operation at Tours was taken over about November 1, 1917, with the intention of using it for preliminary training. Later this developed into an important center for training army corps pilots and observers. Another small French school already in operation at Clermont-Ferrand was also taken over in November, 1917, to be used for the development of day bombardment pilots and bombardiers.

### **The Lafayette Flying Corps.**

On October 1, 1917, orders were issued creating a board of officers to examine those members of the Lafayette Flying Corps, then serving with the French, who desired to transfer to the American Air Service. This organization of American volunteers contained many experienced pilots trained in the best schools of France and serving in French squadrons on the front. Ninety of these men were eventually transferred to the Air Service, American Expeditionary Forces, and gave invaluable assistance in building up our own pursuit aviation. Three of our pursuit

groups have been commanded by former Lafayette flyers,<sup>8</sup> and this corps provided us also with a considerable number of squadron commanders, flight commanders, and experienced instructors.

### **Soldier Personnel.**

It was necessary to make provision for the instruction, classification, and assembly into squadrons of the Air Service personnel to be sent from the United States. The training of soldiers as mechanics and riggers was from the first a serious problem. Not only were such men arriving from the United States entirely unacquainted with foreign airplanes and engines, but few of them had been trade tested, and their officers were likewise inexperienced. Earnest efforts to establish a mechanic's school in France failed, owing to the impossibility of obtaining suitable buildings and material for instruction. It therefore became necessary to train these men at the flying centers, although it was known that this system would result in decreased efficiency in these centers. So great was the shortage of personnel that these enlisted men, while presumably undergoing training, had to carry on all of the work at the posts to which they were assigned and in many cases had to assist in their

construction. Two hundred mechanics were placed in seven French airplane factories near Paris, where they served until January 24, 1918. There were assigned to French aviation fields 475 soldiers, the nucleus of a much larger number which it was intended temporarily and for instruction to place in French schools in proportion to the number of American flyers being trained therein.

An important agreement was made with England on December 5, 1917, whereby a total of 15,000 mechanics were to be kept in England under instruction, and in addition a total of 6,200 laborers were to be assigned to temporary duty in that country. It was provided that these mechanics would be withdrawn for service in France when other untrained personnel was sent from the United States to take their places. It was expected that there would thus be established a constant flow of men trained in England under what was the nearest possible approach to service conditions and that such men would be ready when they reached France to take their place in our own squadrons.

### **Technical Section Organized.**

A Technical Section of the Air Service was organized.<sup>9</sup> It was to secure and compile technical information from every possible source. This section was also charged with the responsibility for recommending the types of airplanes, engines, motor cars, photographic and wireless appliances, and all other apparatus and equipment to be purchased in Europe or produced in the United States.

### **Liaison Section.**

In accordance with the orders of the Chief of Air Service that all negotiations with the air ministries of allied Governments should be carried on by the Assistant Chief of the Air Service, Lines of Communication, a Liaison Section was established in November, 1917, which sooner or later acted as an intermediary in all questions of supply from foreign sources.<sup>10</sup>

### **Search for Material.**

The European markets were canvassed and such material as would serve our purpose was ordered. This included airplanes for service and training purposes, trucks, and au-

tomobiles, hangars, and innumerable articles of equipment, instruments, and accessories.

### **Recommendation of Airplanes—DH-4.**

In order to hasten the time when materials produced in America would be available, it was necessary to gather and forward to the United States all possible information on allied Air Services and the equipment used by them and to make recommendations concerning the various types of airplanes, armament, motor-transport equipment, and accessories to be put into production in the United States for use overseas. This called for much study and the exercise of good judgment on the part of the members of the aeronautical mission. Its first recommendation was that the DH-4 airplane be built in the United States. In the spring and summer of 1917 this machine, equipped with the Eagle Rolls-Royce engine, had been tried on the British front, where its performance in speed and altitude and in climbing ability surpassed that of other airplanes then in use over the lines.<sup>11</sup>

It was believed that this airplane, with the Liberty engine, of greater horsepower and lighter than the Eagle Rolls, would be satisfactory for our use. Assurance was received from the United States that the first of these machines would be delivered in Europe by January, 1918. As a matter of fact, the first deliveries in quantity of these machines in Europe were not made until June and July, 1918, and by that time the supremacy of the DH-4 had been partially lost. This is an illustration of one of the difficulties always encountered in recommending any type of aircraft for production and for future use. If the type chosen is merely in the experimental stage it may turn out to be entirely unsuited for the purpose it was to serve; if it has passed beyond this stage and proven of value by actual use at the front, so rapid is the development that by the time it could be produced in the United States and delivered in Europe it may have been rendered obsolete by improved machines.

### **Recommendation of Pursuit Machines.**

These facts apply with marked emphasis to the second instance, the recommen-

dation that no single-seater machines should be built in the United States for service at the front. The improvement in pursuit airplanes was so rapid that few types retained their superiority for more than six months. In the summer of 1917, the Spad with the 150 Hispano-Suiza engine had been in use for nearly a year, but although it still held first place among single-seaters, its supremacy was threatened by the Spad Monocoque with the 160-horsepower Gnome Monosoupape engine. This airplane was, however, still in an experimental stage, and though it was reasonably certain that the Spad would ultimately be displaced, it was by no means sure what would supersede it. The Hispano-Suiza Co. had increased the power of their engine to 180

and even to 220 horsepower. The former did not give a sufficiently great increase in performance and the 220 horsepower was not at that time fully perfected. Of all single-seater types then being tried it seemed that the Spad Monocoque would be the machine of 1918.

To those charged with the selection of machines to be produced in the United States, it was plain that none of the pursuit type could be built in time to insure that they would not be out of date when actually placed in service on the western front.

The Allies took this same view and made urgent and persistent recommendations that the building of single-seaters be not attempted in the United States, while they promised to supply the Air



*Spad VII.*



Service, American Expeditionary Forces, with all such machines as would be needed for its program. Simultaneously the Gnome 160-horsepower engine intended for use in the Spad Monocoque seemed to be a failure.

Influenced by all of these known facts, the United States was therefore advised not to attempt the manufacture of pursuit airplanes and that its greatest service could be rendered by confining its production efforts to the larger machines, which would probably be subject to fewer modifications and improvements, and to the manufacture of engines.

Furthermore, there was some evidence that the summer of 1918 would see the development of biplace pursuit machines which would at least partially replace some of the single-seater machines on the front. The British Bristol Fighter, biplace pursuit, had given a remarkable performance during the summer of 1917. Very fast and easily maneuvered, it had the advantage of four machine guns instead of two and was able to defend itself from attack from almost every direction. If it were possible to install the Liberty engine in this airplane it was thought that it would be eminently satisfactory for our use. Accordingly the production of this Bristol Fighter with the Liberty engine was recommended.

Such were the conditions and the recommendations made in July and August, 1917, based upon the best information then available. This is what actually took place. The Spad Monocoque proved a failure; the Monosouape Gnome as first produced had not the power of the original model, nor was it sufficiently reliable for service; on the other hand, the Hispano-Suiza 220-horsepower was developed so satisfactorily that the Spad thus equipped maintained its position as the leading allied pursuit machine; the Liberty engine was not successfully adapted to the Bristol Fighter; and the deliveries of the DH-4 were so delayed that it had lost much of its effective superiority by the time it reached the western front. All of these facts are now well known but it is helpful to recall the picture as it appeared in the summer of 1917.

### **Allocation of Raw Materials**

With the arrival from the United States of raw material for the Allies, it became necessary to allocate and distribute it. It had become apparent that one of the weaknesses of foreign aviation was the total lack of standardization which

resulted in a system of unregulated private manufacture. This was notably serious in view of the shortages which existed of certain materials, such as spruce, linen, and dope. To use up such valuable materials in the manufacture of antiquated airplanes made the situation the more critical. The dictation of what airplanes should be built was at that time a matter of great delicacy.

In order to bring about standardization, the Interallied Aircraft Board was created, with Col. Bolling as the first American representative, and it did most valuable work in bringing together the French, British, and Italian Air Services on these vital questions.

### **Construction.**

The construction of schools, warehouses, depots, industrial plants, and salvage and repair shops was an evident necessity in the development of the Air Service system of supply. The great scarcity of personnel and of material made it impossible to solve this problem fully until the summer of 1918. As considerable amounts of raw

material collected at the ports in the early fall of 1917, warehouses for temporary storage purposes were needed. The training centers then under construction lacked labor and material. As airplanes from the United States were expected during the first months of 1918, plants had to be established for their assembly. Depots for salvage and repair of airplanes, while they would not be needed for some time, had to be started in order that there might be no delay after the Air Service commenced actual operations. The Air Service building program evolved called for the immediate construction of 4,749,300 square feet of floor space.

### **Creation of an Organization.**

The creation from personnel then available in Europe of an organization capable of carrying on all these projects seemed at the outset a hopeless problem. Scarcely any American personnel trained in Air Service activities was available in Europe, and the necessity of retaining in the United

States the small number of experienced men prevented assistance from that quarter. Even of clerical assistants, supply officers, and men with technical training, there was a woeful deficiency, with the result that France, England, Italy, and the entire American Expeditionary Forces were combed for needed personnel. Nearly all technical communications and most current correspondence were in a foreign language, making necessary a number of interpreters and stenographers capable of taking dictation and writing in both French and English. In spite of all these difficulties and some wasted effort dissipated in needless friction, the accomplishments during the period from June until December, 1917, were of magnitude and of the utmost importance to the Air Service of the American Expeditionary Forces.

### **Outline of the Organization.**

The organization of the entire Air Service during this time had been approved by the Commander in Chief in September, 1917.

The Chief of Air Service, American Expeditionary Forces,

was in command both in the Zone of Advance and in the Lines of Communication, responsible to the Commander in Chief for the efficiency of the entire service. The air commander, Zone of Advance, maintained a staff comprising officers charged with administration operations, information, and a materiel department. He was charged with the organization and equipment of units formed in the Zone of Advance and with the actual preparation for the employment of what were then known as the tactical and strategical air forces. The Assistant Chief of Staff, Lines of Communication, had under his control departments of administration, production, finance, transportation, and the Technical Section. The director of Air Service instruction, under the Assistant Chief of Air Service, Lines of Communication, was in charge of personnel, materiel, instruction, and the transportation assigned for his use. These subbranches of the Air Service communicated directly with each other, all matters of policy, however, being controlled by the Chief of Air Service, American Expeditionary Forces.

# AIR SERVICE A. E. F. CHART OF ORGANIZATION

AS OF NOV. 11th, 1918.

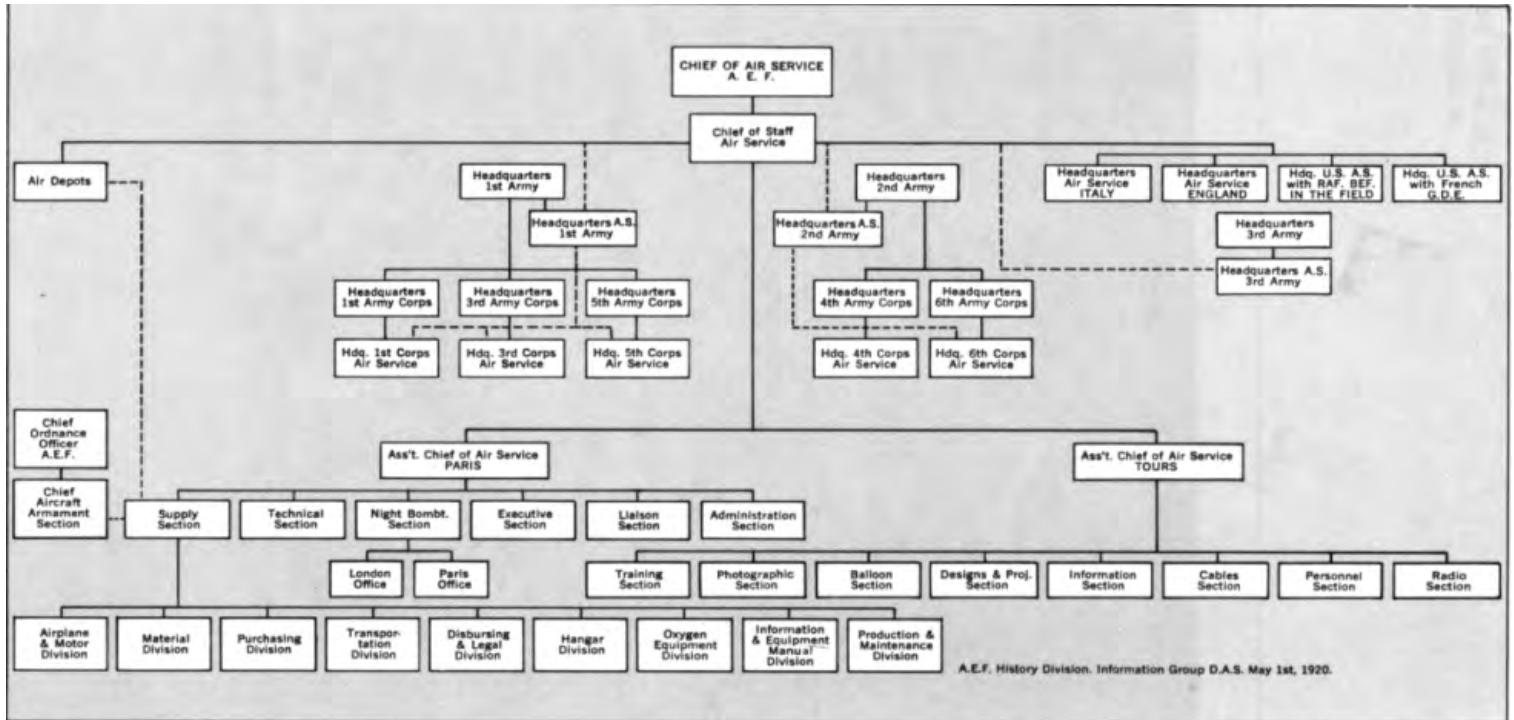

MANUAL

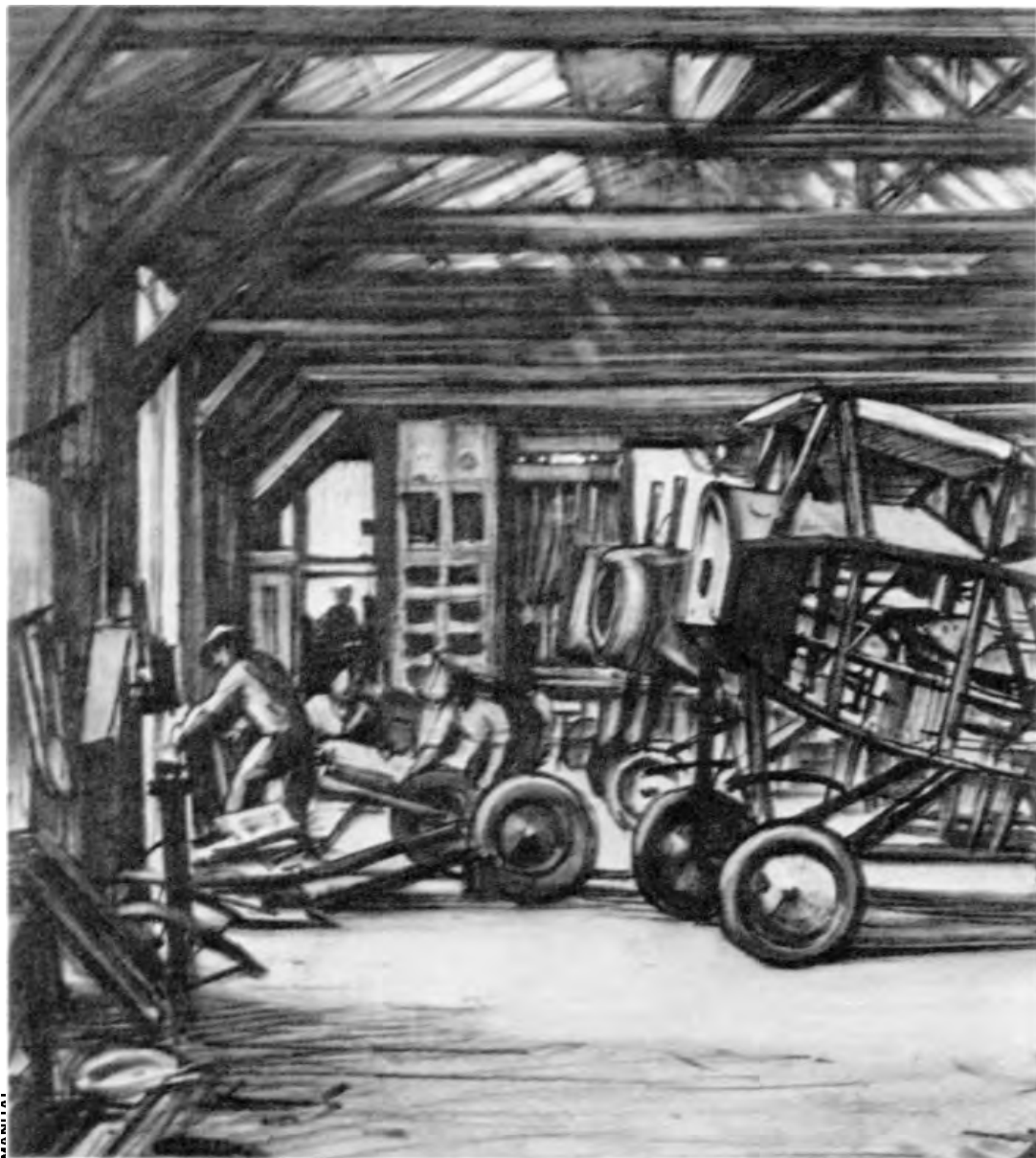

APR 1918

### Reorganization.

In November, 1917, Brig. Gen. B. D. Foulois, Air Service, arrived in France and was placed in charge of all Air Service activities in the American Expeditionary Forces on November 27, 1917. A reorganization of the Air Service, employing largely personnel which had accompanied the new Chief of Air Service from the United States, was effected. Officers were placed in charge of the following sections: Policy, Administration, Technical, Training, and Organization, Balloon, Personnel, and Supply. Col. Bolling was relieved as Assistant Chief of Air Service, Lines of Communication, to assume the position of chairman of the Joint Army and Navy Aircraft Committee, created with the approval of the War Department, in pursuance of a resolution of the Aircraft Board in Washington. Actual authority for the formation of this committee in the American Expeditionary Forces was later given by general headquarters, and the Chief of Air Service was designated as its chairman. The purpose of this committee was to coordinate industrial with military and naval activities in Europe and the United States and to constitute the proper official

channel through which should pass all communications with the European nations relative to aircraft material. During the early months of 1918, while the most strenuous development of the Air Service was being undertaken, this committee assisted largely in the coordination and allocation of raw, semifinished, and finished aircraft products.

### Shortage of Personnel and Equipment.

The shortage of men and materials still constituted the most serious difficulty in carrying out the projects already initiated and in a further development of the Air Service according to its original program. It was clearly evident that there was not time to train personnel in the United States and that no facilities for such training existed in France, and at the beginning of December, 1917, the outlook in this direction was almost hopeless. Although such a contingency had not been contemplated in the agreement with the French of August 30, 1917, the French Government later claimed that

the 5,000 airplanes which it had promised could not be produced by the personnel then available in its factories. It accordingly requested the United States to send 12,000 mechanics to assist in the French Motor Transport Service, so that an equivalent number of their own men might be withdrawn for work in airplane factories. It was promised that thus the terms of the August 30 contract could be fulfilled. This request was approved by the Commander in Chief upon the recommendation of the Air Service, American Expeditionary Forces. The Air Service in the United States undertook to organize the desired personnel. The men were concentrated, trade tested, and organized into companies on a regimental basis upon tables of organization which contemplated their use primarily for service with the French Army. The first of these motor-mechanic regiments did not arrive in France until February 24, 1918. This and the next regiment to arrive were assigned to duty with the French under an agreement made by the War Department in Washington in the early spring of 1917 at the time of the visit of Marshal Joffre's military mission.

# AIRPLANES RECEIVED FROM ALL SOURCES FROM BEGINNING OF OPERATIONS TO DEC. 31, 1918 (MONTHLY FIGURES)

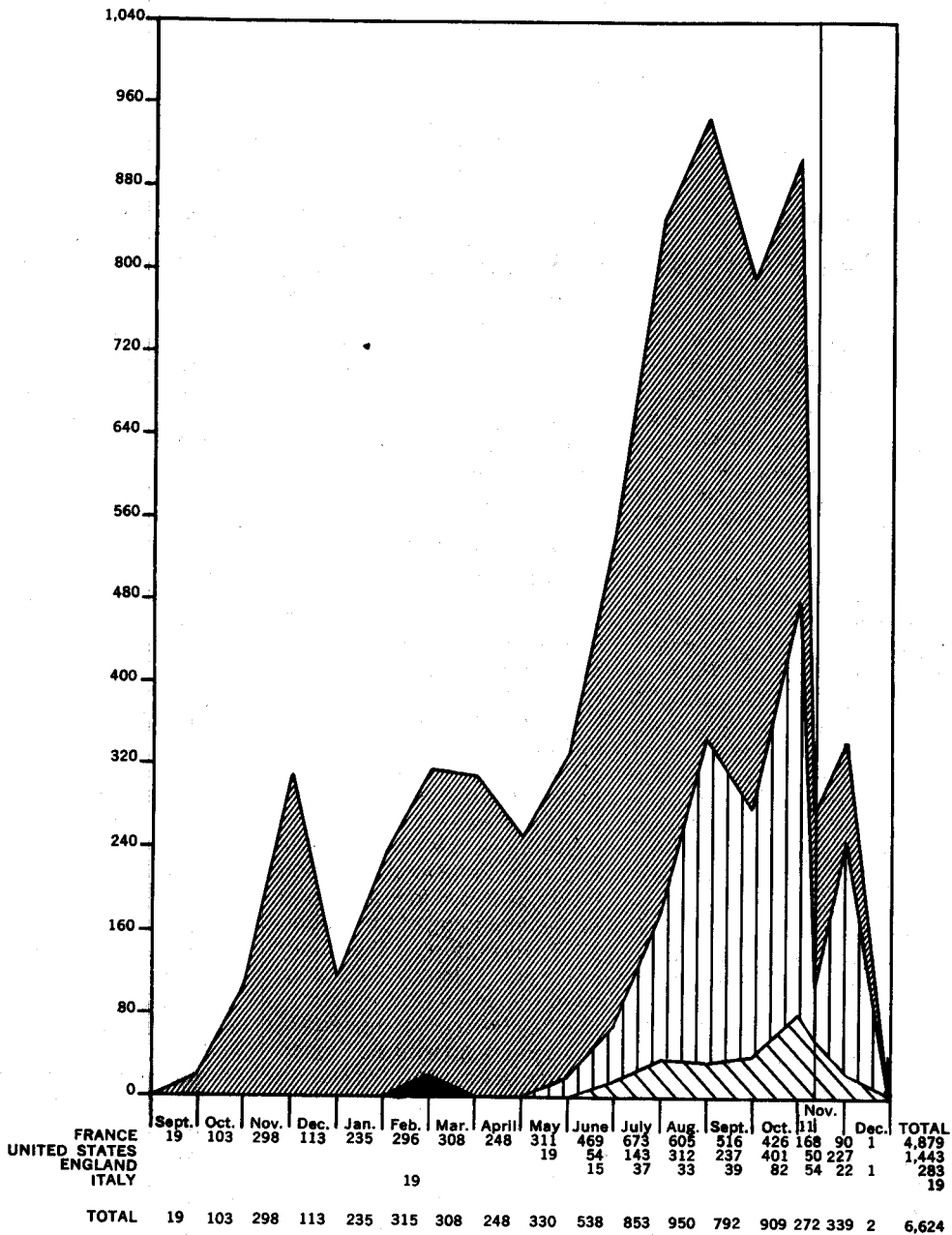

**LEGEND**

- FRANCE
- ENGLAND
- UNITED STATES
- ITALY

**MONTHLY ARRIVAL OF AIR SERVICE PERSONNEL IN AMERICAN E. F.**

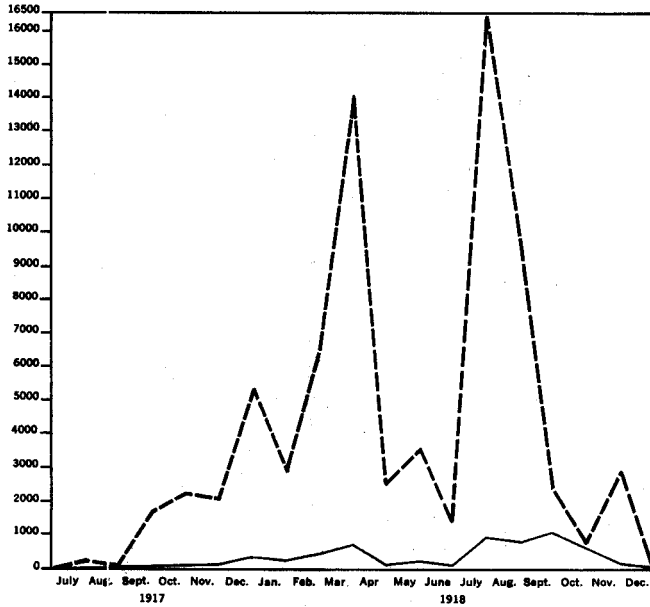

DATE	OFFICERS		ENLISTED MEN	
	MONTHLY	CUMULATIVE	MONTHLY	CUMULATIVE
<b>1917</b>				
July	8	8	207	207
August	9	17	47	254
September	45	62	1722	1976
October	61	123	2215	4191
November	105	228	2089	6280
December	301	529	5559	11719
<b>1918</b>				
January	194	723	2840	14559
February	368	1091	6470	21029
March	682	1773	13877	34906
April	94	1867	2416	37322
May	190	2057	3484	40806
June	75	2132	1116	41922
July	891	3023	16558	58480
August	794	3817	9830	68310
September	1074	4891	2422	70732
October	607	5498	709	71441
November	194	5692	2831	74272
December	15	5707	1	74273

LEGEND  
 OFFICERS ———  
 ENLISTED MEN - - -

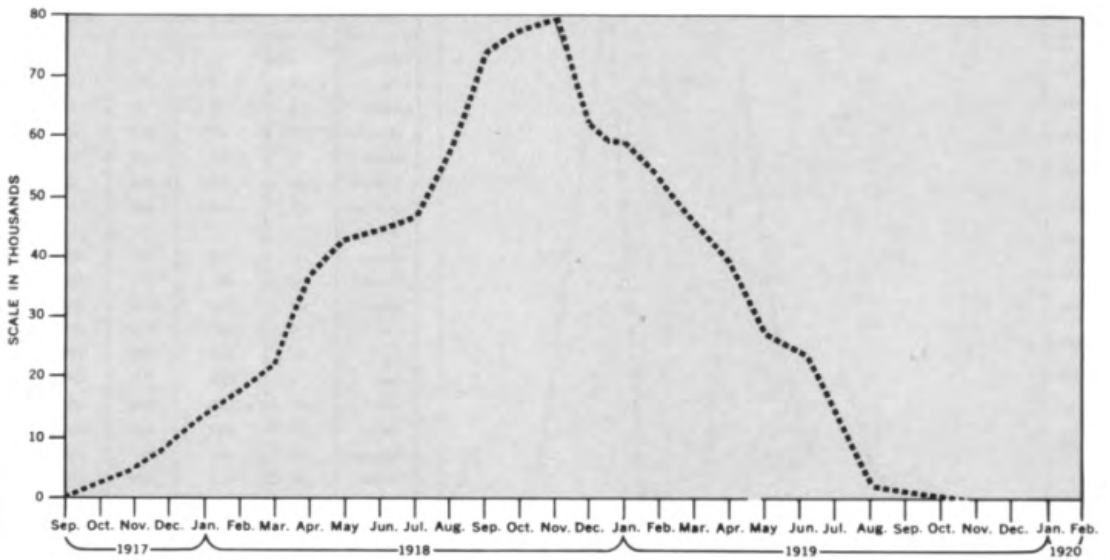
**AIR SERVICE PERSONNEL IN AMERICAN E. F.  
(SHOWING ARRIVAL AND DEPARTURE)**



---

### **Location of Air-Service Production Center at Romorantin.**

It was still foreseen that no matter what assistance in the way of material would be received from the Allies, it would be absolutely necessary to erect a plant in which material received from the United States could be assembled. This plant, known as Air-Service Production Center No. 2, was located at Romorantin, and its construction started on January 16, 1918, with a projected personnel of 19,000 men and an authorized area of buildings of 3,685,400 square feet.

### **Removal of Headquarters From Paris.**

In February, 1918, when the headquarters of the Lines of Communication were transferred to Tours the Air Service personnel which had been on duty in Paris was likewise ordered to Tours. As, however, most of the material which was to be procured in Europe would come from French factories, and as most of the factories producing such material were located in Paris or in its vicinity, as moreover the Technical Section of the

French Service was likewise in Paris, it soon became apparent that it would be absolutely necessary to return the Supply Section to Paris, where it was relocated on April 30, 1918, and continued to perform its work.

### **Dependence Upon Foreign Production.**

In the early part of 1918, it became evident that until at least the 1st of July complete reliance would have to be placed upon foreign production, especially French, for all aircraft and other material needed for our Air Service program. It was also apparent that the French would be unable to carry out the terms of the August 30, 1917, contract, as their promises had been based upon too optimistic estimates of the production possibilities of their manufacturers, and the Air Service, American Expeditionary Forces, was therefore confronted with the possibility that there would be grave lack of flying equipment for the squadrons which might be placed at the front. This prospect was made more serious by the very great enlargement of the French and British air programs for 1918, which demanded of both of these countries supreme efforts for the fulfillment of their own needs. These facts made it

important for the Air Service to conclude new contracts for the production for its use of foreign airplanes, engines, and accessories. Fully apprised of the gravity of the situation, the Commander in Chief, American Expeditionary Forces, abrogated the agreement with the French of August 30, 1917. Weeks of negotiation finally produced another contract with the French known as the agreement of May 3, 1918, by which the French engaged themselves to supply us with aviation material equal both in quality and quantity to that supplied to their own forces and in proportion to the number of our divisions in France. This, however, was largely contingent upon the receipt of raw, semifinished, and finished products from the United States. Owing to continued insistence by cable, there had been received by May 1, 1918, approximately 90 per cent of the machine tools and raw materials called for by the original agreement of August 30, 1917. The new contract of May 3, 1918, and various conferences between the headquarters of the Allied Commander in Chief and our own General Headquarters assured the Air Service of

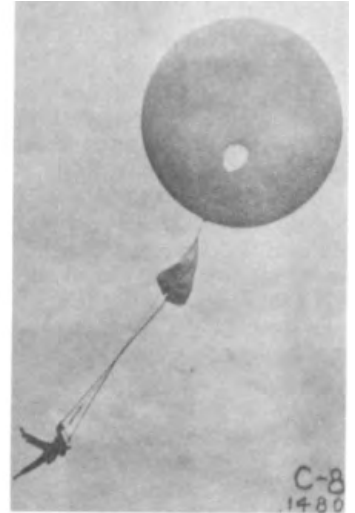
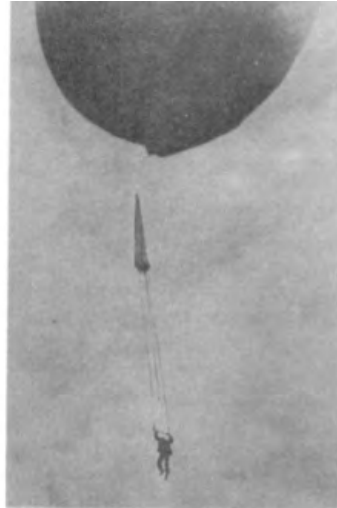

sufficient material for the enlargement it might be able to realize. The concluding of this agreement proved the turning point in the history of American aviation supply questions in France and laid the foundation of the supply for our efforts at the front.

### **Development of the Balloon Program.**

Fortunately for the Balloon Section of the Air Service,<sup>2</sup> the balloon industry in France had been well developed through the previous 10 years, and there were available industrial facilities for the production of captive balloons and the necessary accessories. Contracts were placed for such material

with the French in September, 1917, and there had also been drawn up for the Balloon Section a sound production program of material to be manufactured in the United States. The organized training and equipment for the Balloon Section therefore progressed steadily and with a minimum amount of difficulty compared with like problems in the Heavier-than-Air Service.

One of the chief difficulties of the Balloon Section was the procurement of sufficient hydrogen and gas, and it became necessary to draw upon the United States for approxi-

mately 1,500 tons of ferrosilicon and 238 tons of caustic soda. Special apparatus, such as winches and tenders, did not arrive from the United States in the quantities expected, and this compelled us to call upon the French for such equipment, although a lack of raw materials for its production caused a shortage never quite made up until hostilities ceased.

*Free balloon with parachute: parachute is attached to the balloon during ascent (left); ready to drop (center); off balloon (right).*

### New Chief of Air Service.

By General Order 81, G. H. Q., A. E. F., May 29, 1918, Brig. Gen. (later Maj. Gen.) Mason M. Patrick was announced as Chief of Air Service, American Expeditionary Forces.

### Problems.

By this date the program for the ground troops of the American Expeditionary Forces had been greatly enlarged and it became necessary to employ the small numbers of Air Service personnel in such a way as to maintain in operation the numerous Air Service establishments. The development of the production center at Romorantin was pressed to the utmost. The acceptance park which had been established at Orly near Paris was enlarged; the completion of the aviation instruction center at Issoudun was hastened, as it soon became apparent that

the expected fully trained personnel would not arrive from the United States in time and that this instruction center would be required to train large numbers of flying officers needed to meet the Air Service program. Another grave question was the procurement of sufficient aerial observers to meet the needs of the increased number of American divisions to be placed at the front.

### 202-Squadron Program

The most pressing problem at this time was the balancing of the Air Service program with the enlarged program for ground troops. The rate at which such ground troops arrived from the United States had been greatly increased by the utilization of British tonnage which had been made available after the opening of the enemy offensive in the spring of 1918, and a corresponding change in the Air Service program was imperative. Instead of being composed of one army of five corps the American Expeditionary Forces was now to be a much larger body. At the same time while the shipment of ground troops from the United States was proceeding at this increased rate the sending of

Air Service personnel was absolutely stopped for some months. A balanced Air Service program to correspond to this increase and at the same time to develop on the front an Air Service in proportion to the number of divisions, corps, and armies then contemplated was sent by the chief of staff, American Expeditionary Forces, to the Chief of Air Service on July 29, 1918. From the Air Service point of view, however, the delays already experienced in procurement of material and in the arrival of personnel made it imperative that the original Air Service program must be decreased rather than increased.

The Commander in Chief realized fully the existing conditions and that the Air Service could not carry out the enlarged program, and therefore approved a modification which covered the formation of observation squadrons to meet the requirements of the artillery and infantry and of only 60 pursuit, 14 day-bombardment, and 27 night-bombardment squadrons.

This revised program submitted by the Chief of Air Service, August 16, 1918, and



approved on August 17, 1918, became known as the "202-squadron program" and was based upon the very best estimates then obtainable of the total number of squadrons which might with great effort be placed on the front by the end of June, 1919. It was formulated after consideration of the programs which each of the Allies expected to carry out by that date. It was also based upon a very careful estimate of the material which could be secured as indicated by the production probabilities in the United States and known conditions in the factories in France and England. The opinion that the personnel to carry out this program would be available was founded upon cable advices earlier received from the United States indicating what would be available for sending overseas.

It was thoroughly realized that the Commander in Chief and the authorities in the United States wished to place on the western front the largest and the most efficient Air Service which could be equipped and maintained.

### **Continued Problem of Personnel.**

The deficiency of commissioned and enlisted personnel previously emphasized was at all times a serious matter. Priority had been granted to the Air Service for approximately 7,500 men per month from November, 1917, and cables from the United States indicated that such numbers would be sent, but this personnel did not arrive. After March 21, 1918, the date on which the enemy broke through the allied front, a practical embargo was placed upon sending from the United States of any other than Infantry and machine guns, which absolutely stopped the coming of Air Service personnel.

It was impossible to draw upon the mechanics trained in England, as this same embargo prevented the sending of untrained men to take their places. One result of this lack of much-needed men was the inability even to maintain existing Air Service establishments in operation at full capacity, while their enlargement and the undertaking of new projects was an absolute impossibility. The Air Service training centers planned and under construction would need, to operate at full capacity, not less than 11,000 enlisted men. Since these men themselves had to be trained, results of any magnitude

could not be expected until after a lapse of from five to six months from the time of commencing operations at these centers. The Air Service program at the front had contemplated active operation on a considerable scale by July 1, 1918. This meant that on January 1, 1918, there should have been available for work at the schools alone at least 10,000 men. On that date there were, however, in the whole Air Service, American Expeditionary Forces, only 5,600 enlisted men and these were nearly all entirely untrained. The imperative need of men for work in the Zone of Advance and at the supply depots continually decreased the small number of squadrons available for service at the schools. Issoudun, which should have had not less than 6,000 men in February, 1918, was in that month reduced to 2,700, and this number could not be increased beyond 3,700 until August, 1918.

The arrival of even 10,000 men in the early spring of 1918 would have advanced the Air Service program on the front by approximately four months, but it was not until the late summer that the arrival of Air Service troops in France in considerable numbers actually commenced.

### **Mobilization of Personnel-Coordination Staff.**

The distribution of these squadrons to their ultimate destinations in what was now called the Services of Supply (S. O. S.), or in the Zone of Advance needed careful regulation in order that the real necessities at each station should be met in the fullest measure possible. The mobilization of these squadrons and their distribution was first handled by the Personnel Section, Air Service, and later by what was called the Coordination Staff,<sup>1</sup> created to provide a central body to assure a thorough understanding and complete accord among all Air Service activities, excepting actual combat operations in the Zone of Advance, to balance the needs of the different sections, to provide for the proper allocation of available personnel, and as a center of information concerning all Air Service matters. This staff developed plans which were carried out up to the date when hostilities ceased. All sections of the Air Service made their requests for personnel to this staff, which secured notification of the dates of arrival in France of all Air Service units, and was responsible that the necessary orders were prepared in ad-

vance so that there might be no delay in the movement of these troops after their disembarkation.

As it was found that the arriving squadrons were unbalanced, many of their men not having been trade tested, practically all of them were sent to St. Maixent, where there had been established a concentration post for Air Service troops, and where facilities had been created for trade testing and completing the organization and equipment of all squadrons before sending them to their destinations. This staff kept itself informed daily of the progress of the work at St. Maixent and kept constant track of the movements of all Air Service personnel throughout the American Expeditionary Forces. It was also responsible for the assembly at proper times and places of all of the equipment intended for the squadrons going to the front, and for its delivery to the squadron supply officers, and in general for the regulation of the movements of all personnel and equipment so that the minimum delay would be experienced.

In addition, this staff made calculations of the personnel and material required to meet

each part of the entire Air Service program. It maintained records of Air Service development, of the capacity of Air Service establishments, and of the demands made upon them. Its Accountability Division was charged with a systematic inspection of Air Service projects under development. The Plans and Progress Division was responsible for the provision of data for proposed development. Weekly progress reports covering all Air Service activities were prepared and issued.

### **Executive Section.**

The Executive Section<sup>2</sup> succeeded to the duties of the Coordination Staff on November 4, 1918. When the process of liquidation became necessary, after November 11, 1918, the valuation of all Air Service property was done by this section.

### **Personnel Section.**

The Personnel Section<sup>3</sup> dates from July 23, 1917. Its duties, although on a smaller scale, may well be compared to those of the adjutant general of the American Expeditionary Forces. Upon it have devolved the maintenance of complete records of all personnel of the Air Service, the issuance of orders to such

personnel, and other duties necessary in the distribution of all Air Service forces. During the first months of its operation it was also charged with recruiting in Paris, examining over 500 applicants from the American Ambulance and other American activities in France. The Air Service post office was likewise at first a branch of this Personnel Section. In February, 1918, it moved to Tours, where it has been maintained ever since.

### **Cable Section.**

Of the greatest importance in the administration of the Air Service is the Cable Section.<sup>4</sup> In the early days the Assistant Chief of Air Service, Lines of Communication, sent cables covering Air Service production problems direct to Washington through the American embassy in Paris. There was a resulting initial saving of time, but an aftermath of mixed and incoherent references, and the transmission of cables to the United States without the sanction of the general staff, American Expeditionary Forces, led to a temporary lack of coordination of Air Service efforts and those of the remainder of the American Ex-

peditionary Forces. This was later corrected and the cable office was specifically charged with handling all such messages and with seeing that needed approval was secured before they were transmitted to the United States.

### **Information Section.**

The Information Section was first created at Air Service headquarters, general headquarters, in September, 1917.<sup>5</sup> Its efforts were mainly directed toward the collection of such data as would be useful in the development of the Air Service, American Expeditionary Forces.

The present Information Section is a growth of an Intelligence Section, Air Service Training Department, organized in Paris in December, 1917. During the closing months of the war it was a central collecting and distributing agency within the Air Service for technical, military, and aeronautical data. Its work was concretely expressed in comprehensive bulletins, of which 313 were issued. Secret documents of importance were circulated among the proper officers and general inquiries of all sorts were answered. Intimate relations were maintained with the French and British Air Services and with Washington by means of special officers who traveled between these cen-

ters. During the year 1918, 25,725 miscellaneous publications and 19,169 maps were distributed. Early in the year a French-English Aeronautical glossary was compiled after exhaustive research. In September, 1918, an information officer was appointed at each of the training centers. During the summer of 1918, preliminary work, which was foreseen to be necessary for the compilation of a history of the Air Service, American Expeditionary Forces, was assigned to this section. The armistice altered the situation and necessitated the rapid completion of this history. Col. E. S. Gorrell, assistant chief of staff, Air Service, was assigned to prepare an exhaustive record covering the narrative, statistical, technical, and tactical history of the Air Service.<sup>6</sup> Having been assigned to this duty at Tours on January 9, 1919, such portion of the Information Section personnel as was engaged on this historical work was transferred to his direct control, leaving the remainder of the Information Section to bring to a conclusion the other work with which it was charged.



*Brig. Gen. Benjamin Foulois (left), with Gen. John J. Pershing in France.*

### **Organization Air Service, American Expeditionary Forces, November 11, 1918.**

It seems appropriate that there should be given a statement of the organization of the Air Service, American Expeditionary Forces, at the time when hostilities ceased and when it was a cohesive working body.

### **The Chief of Air Service, American Expeditionary Forces.**

Responsible to the Commander in Chief for the organization, training, material, equipment, methods, and all other matters affecting the efficiency of the Air Service was the Chief of Air Service, American Expeditionary Forces. The official headquarters of the Air Service were at general headquarters and under the immediate supervision of the chief of staff, Air Service.<sup>1</sup>

---

### **Major Branches of Air Service, American Expeditionary Forces.**

The Chief of Air Service, American Expeditionary Forces, established all general policies. For the administration of matters not affecting policies there were two assistant chiefs of Air Service, one at headquarters, Services of Supply, and the other in Paris.<sup>2</sup> There was also an Air Service representative in London charged with the responsibility for Air Service matters in Great Britain and Ireland; and an officer in Italy with similar duties.<sup>3</sup> The Paris office maintained liaison with the Allies and with the Air Service of the United States Navy. The functions, the duties, and the authority of the heads of each of these sections were clearly defined.

#### **Assistant Chief of Air Service, Tours.**

The Assistant Chief of Air Service at headquarters, Services of Supply, was charged with keeping personnel records, with the supervision of training, with the administra-

tion of Air Service centers in the Services of Supply, and with the supervision of the Balloon Division, Air Service, which maintained schools for training and centers for equipment and repair. The most important sections of his office were those which actually conducted flying training, all balloon activities, and radio and photographic work.

#### **Assistant Chief of Air Service, Paris.**

The Assistant Chief of Air Service, Paris, was in command of all Air Service personnel in that city. His most important duties were those connected with the supply of aviation material. He was responsible for the provision of the material and equipment necessary for the carrying out of the Air Service program. Under him were divisions making and supervising contracts with the allied and neutral Governments and with individual concerns, receiving, assembling, and dispatching airplanes, engines, war material, and equipment secured from all sources, including the United States; also the Technical Section, Night Bombardment Section, Aircraft Armament Section, the latter operating directly under the Chief of Ordnance, but in close accord with the Air Service. The Technical Sec-

tion supplied advice on engineering questions, provided data and estimates for proposed developments and maintained an experimental flying field. It was likewise charged with the inspection and test of airplanes and engines and with their acceptance. The Night Bombardment Section supervised the American multiengine night bombardment program, and worked in close accord with the other Air Service sections concerned in this project, while its London office was charged with the training of flying and mechanic personnel in England, and with the assembly in British plants of Handley-Page airplanes fabricated in the United States.

#### **Air Service Construction.**

Construction of Air Service projects was under the control of the Director of Construction and Forestry.<sup>4</sup> The Air Service Designs and Projects Section was responsible for selection of sites, the preparation and approval of airplanes, the necessary surveys and drawings, and for procuring the needed sanction of headquarters for the execution of each project.



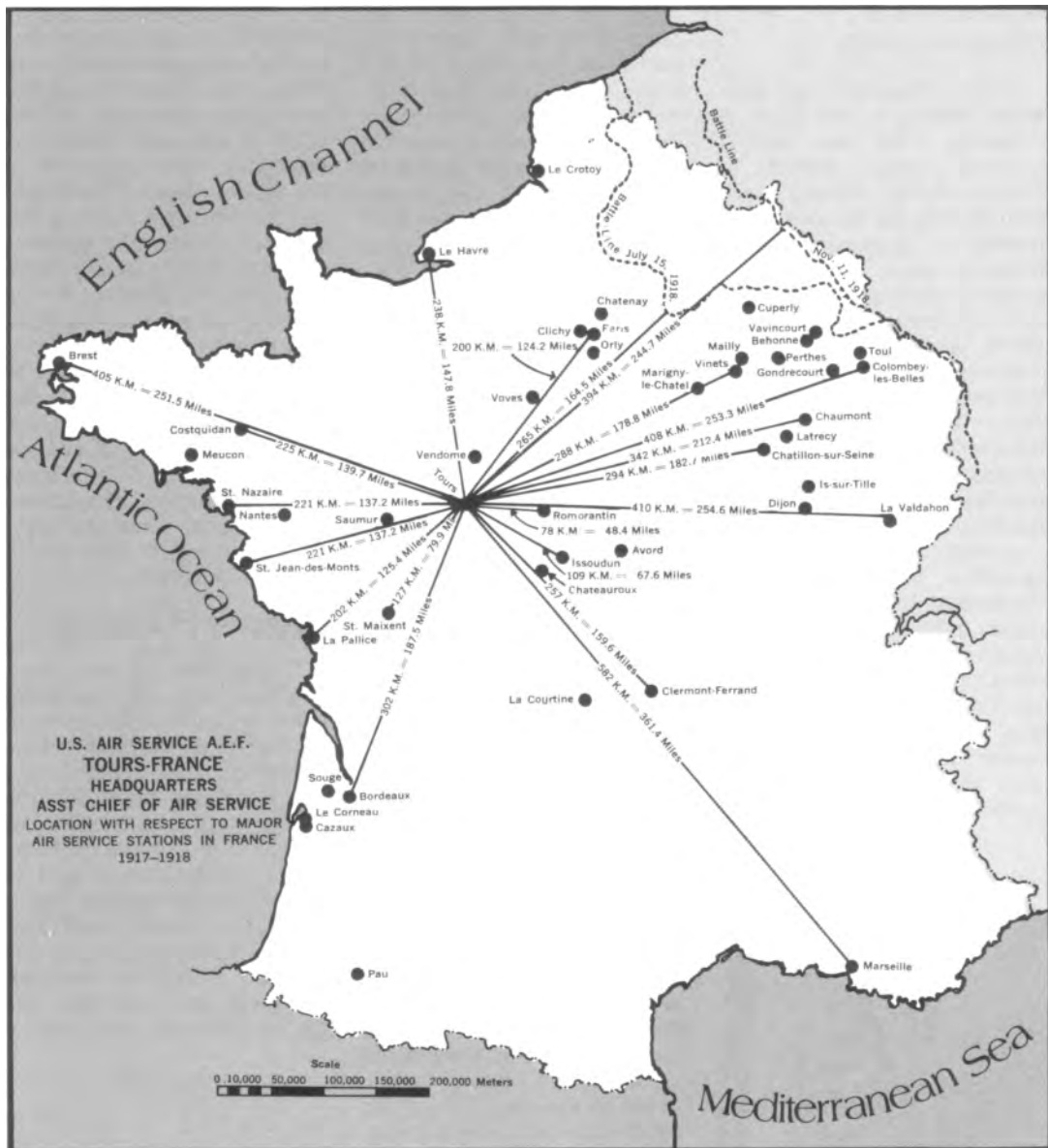

## Mobilization of Flying Personnel.

Flying personnel was supplied directly to the Zone of Advance from Air Service schools. Upon arrival in France flying officers were sent to the Air Service Concentration Barracks at St. Maixent, where they were instructed concerning the details of foreign engines and other apparatus until the Training Section gave notice that they could be received at any of the flying schools. In the preliminary schools in the United States these officers had been assigned to some particular branch of aviation—pursuit, army or corps observation, day or night bombardment. Subject to emergency calls from the Zone of Advance and to the preference of the pilot when not in conflict with immediate needs, this classification was followed in sending flyer officers to the proper advance training Air Service centers.

The 1st Air Depot in the Zone of Advance gave daily notice of the needs at the front. Based upon this information, officers ready for active service were ordered to the 1st Air Depot and from there they were sent to the armies as they were needed.

## Mobilization of Units.

All Air Service troops arriving in France likewise passed through the Air Service Concentration Barracks at St. Maixent. The individuals were trade tested and assigned to squadrons which were formed in accordance with tables of organization, ground officers being provided at this point. In case a squadron was being prepared for early assignment to the Zone of Advance, a squadron commander nominated by an army Air Service commander and approved by the Chief of Air Service was usually sent to join this command at St. Maixent. The squadron, as soon as it was in readiness, then moved to a training center, to the acceptance field at Orly, or to the production center at Romorantin, for temporary duty in order that men in specialized trades might gain some familiarity with their duties. Each squadron then proceeded to the 1st Air Depot, the date of its departure being determined by the availability of its equipment and flying person-

nel. The squadron supply officer with a detachment was sent to a supply warehouse to collect the squadron equipment and accompany it to the point of assembly. Pilots and observers were collected at the 1st Air Depot. The squadron commander, with a nucleus of officers and soldiers, preceded the remainder of the squadron to prepare for its coming and to assure himself that the airplanes and squadron equipment were in readiness. Upon its arrival in the Zone of Advance, the squadron was reported to general headquarters, G-3, for assignment to an army. Squadrons for instruction centers went directly from St. Maixent to their destinations.

## Movement of Supplies.

The supply of airplanes, engines, and other replacement equipment for units at the front was maintained by a system of dispatch from factories and base ports through Air Service depots located and designed to provide the most direct transportation and to insure the immediate fulfillment of the needs of individual units. Aviation material was secured from two sources, European and American, and the supply system was built up

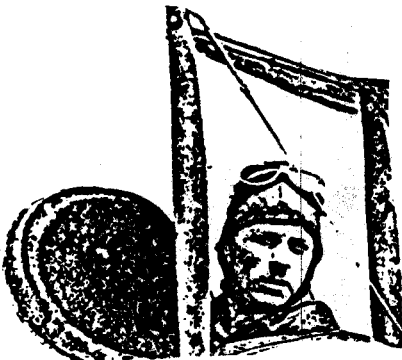

accordingly. The acceptance field at Orly received and dispatched all material from European sources. The production center at Romorantin assembled all airplanes and engines received from the United States and dispatched them to their destinations. From these two major centers and also directly from factories in France, England, Italy, and the United States, engines, spare parts and general Air Service equipment and accessories were shipped to depots by rail, by motor, and by air. The air depots supplied air parks, which in turn furnished supplies to the units actually operating at the front.

### **Interrelation of Units of Supply.**

The service squadrons<sup>6</sup> at the front were complete and self-contained, each with a machine-shop truck when these could be supplied. For material not with the squadron or for work which the squadron itself could not do, it applied to the air park, where a limited quantity of spare parts for immediate needs and where facilities for making minor repairs and for the installation of new engines were

maintained. These air parks were organized to care for from one to nine squadrons and their personnel varied in number in accordance with the work to be done. Repair work which could not be done at the air park was performed at the air depot 20 to 50 miles farther in the rear and designed to supply from 30 to 50 squadrons with engines, spare parts, ammunition, armament, radio, tools, special clothing, and general accessories. The air depots also undertook airplane salvage. Farther back in the Services of Supply were stores of supplies, including full squadron equipments and all spare parts. All major repairs, overhaul, and rebuilding of engines, was carried on at the Air Service Production Center No. 2. Much salvage work was also done at this establishment.

### **Air Service Command at the Front.**

The Air Service was organized upon the principle that at the front it is a combat, not a staff, arm and is to be employed in combination with other similar arms of the service. The units of the Air Service are organized as integral parts of larger units, divisions, army corps, armies, and the general headquarters reserve. They are therefore

commanded in the full sense of the word by the commanding generals of these larger units, whose decisions are executed by their general staffs. Responsibility for the performance of the allotted task rests upon the Air Service officer commanding the unit or units involved. The Air Service originates and suggests employment for its units but final decision is vested in the commanding general of the larger units, of which the Air Service forms a part.<sup>6</sup> Since the Air Service is a combat arm, the principles which govern its use are similar to those of other such arms:

(a) Concentration for offense and defense. This is executed by reinforcing corps and army Air Services by units from the general headquarters reserve, when such exists.

(b) Commanders of larger organizations exercise direct control over all units, including Air Service units, in their command. There is no separate chain of tactical command in the Air Service.



*Aviators constantly trained to keep abreast of changing methods and technology in aerial warfare (above). Air Service recruits learn to wire a fuselage (right).*

### **Importance of Technical Difficulties in the Air Service.**

The problems confronting the Air Service, American Expeditionary Forces, and the difficulties which arose at every stage of its development were of a peculiarly intricate and technical nature. The distance of 3,000 miles between the western battle front in Europe and the base of supplies in the United States was an obstacle of no mean proportions. When we declared war there had not been manufactured in the United States a single airplane or engine considered fit for use on the western front. The manufacturers in America had had no experience in the technical aeronautic development since 1914, nor in the production of service airplanes. The allied Governments after 2½ years of experience were continually faced with questions of engineering and procurement due to the development of new types of aircraft and engines,

to the promising performance of experimental products, and to the subsequent failure of some of them. When we entered the war there was everywhere a serious shortage of such vital things as machine tools, seasoned wood, dope, castor oil, and linen.

### **The Changing Methods of Aerial Warfare.**

One of the major problems faced by all air services was the difficulty of keeping abreast of progress in this newest arm of warfare. Specialized pursuit aviation can not be said to have been wholly developed until the fall of 1915. Systematic long-distance bombardment came somewhat later and day bombing was not fully developed until the last year of the war. Infantry liaison was early attempted and continually used, but even at the close of hostilities it had not been perfected. It was not until the spring of 1918 that night reconnaissance by aircraft became of great importance. The Allies owed mainly to night reconnaissance their foreknowledge of the coming of the final German attack on the Marne on July 15, 1918.

### **The Change in Airplane Design.**

Progress in airplane construction had been equally rapid. A machine that dominates the air one day may be totally obsolete six months later. A complex construction program involving a vast amount of technical detail can not be changed within a few days to meet each radical invention or improvement in design. The ceaseless competition between belligerents is illustrated by Germany's effort during the last year of the war to dominate the pursuit field. She placed on the front in rapid succession no less than six new types of monoplace machines—the Pfalz, the Fokker triplane, two types of Fokker biplanes, the Siemens-Schuckert, and the Junker monoplane. The experience of the French has been that 10 months must ordinarily elapse between the official acceptance of an airplane of new type and its appearance in numbers on the front. An Air Service desiring to place on the front the largest possible number of machines of best types and with the least delay is faced on the one hand with a

bewildering succession of changed or improved designs and on the other by a complexity of a modern industrial quantity production program. The result is a compromise, and we can hope for nothing better.

### **Difficulties in Allied Aviation.**

In no spirit of criticism it may be remarked that the Allies themselves from the beginning of hostilities in 1914 had met a series of difficulties and disappointments in the development of their aviation programs. In general their difficulties and failures were in many respects similar to those of the United States. A complete knowledge of the conditions and capabilities of the aeronautic factories was for a long time not available to the respective Governments. There was not adequate definite Government supervision of manufacture. Wastage inevitable in any air program occurred from time to time. When we remember our own experiences with the Bristol Fighter, the many changes necessary in the Liberty engine, the De Haviland airplane, and all other aviation equipment produced in the United States, it is not surprising to note that a number of like instances occurred during the development of allied aviation from the meager foundation existing in 1914.

### **Need for Initiative.**

An air program can be successful only by encouraging individual initiative, invention, and experimentation, following which there must be the necessary abandonment of unsuccessful types. Much wastage is inevitable. A great variety of types of airplanes and engines have been under construction in the allied countries but very few of them may be considered as entirely successful. In order to secure air supremacy, the allied nations have at all times been forced to maintain large experimental fields and other expensive organizations which play no part in actual aerial warfare. The successful development of allied airplanes, engines, and accessories has come only after lengthy, discouraging, and costly attempts. Just as the DH-4 airplane did not reach the front until much of its superiority had disappeared, many allied airplanes were built and used at the front at times when they were obsolescent, for example, the Sopwith 1A2, the Farman, and the Avion Renault.

### **Need for Comprehension Before Criticizing.**

The difficulties which we encountered in our attempt to develop night bombing are curiously parallel to those of the French, British, and Italian

Air Services. It follows that the air programs of any two nations will show a remarkable similarity until more fundamental and precise knowledge of the science of aviation is available. The mistakes made can not be considered as unusual nor as avoidable. Each disappointment, each failure of judgment, might have been, and in many instances was, duplicated in the case of every warring nation. Criticism of the mistakes made by the United States Air Service frequently indicates that those who make it fail to comprehend the subject of which they speak rashly.

### **Problem of Trained Personnel.**

As has been said over and over again, the lack of trained personnel was one of the most serious obstacles to the execution of our Air Service program. On account of the lack of training facilities in the American Expeditionary Forces it was understood that the United States would undertake the task of organizing and training the sorely needed commissioned and enlisted specialists. It was necessary, however, to establish at once in the American Expeditionary Forces training centers for all types of flying instruction, for it was soon realized that the American schools were incapable of the immediate production of a sufficient

number of pilots and observers. No small difficulty in carrying on such training was the necessity for developing standardized instruction for American personnel which would fit in properly with the scheme of instruction employed in foreign schools to which American students had also to be sent.

The supply of enlisted personnel was from the first mainly a physical problem for the American Expeditionary Forces, the procurement of a sufficient tonnage to transport the needed troops. A number of factors, however, combined to raise this to a point of supreme importance second to none in its relation to Air Service development. Facing the Air Service at all times was the newness of the aviation forces in the United States, the

practical nonexistence there of mechanical training centers, the variety of the types of foreign airplanes, airplanes, and tools with which our mechanics would have to deal, and the great amount of construction necessary in the American Expeditionary Forces.

#### **Ignorance of Equipment Needed.**

The problem of the supply of equipment and material was further complicated by the lack of knowledge in the United States of exactly what was needed for air forces at the front or how to undertake the production of such equipment. Types of airplanes for service use were not known with technical exactitude, nor were American manufacturers familiar with drawings, tolerances, or materials necessary for their production. Lack of tonnage likewise was a se-

rious hindrance to our giving aid by sending raw materials to the allies.

#### **Importance of an Efficient and Adequate Service of Supply.**

An efficient air force at the front can not be maintained without a highly efficient supply service and the maintenance of many large warehouses, depots, and other installations. The building program was necessarily a large one, and it was early realized that a large number of construction troops and a vast amount of raw material must be procured at once in order that this program might keep pace with the ever growing needs of the Air Service it was intended to place at the front.

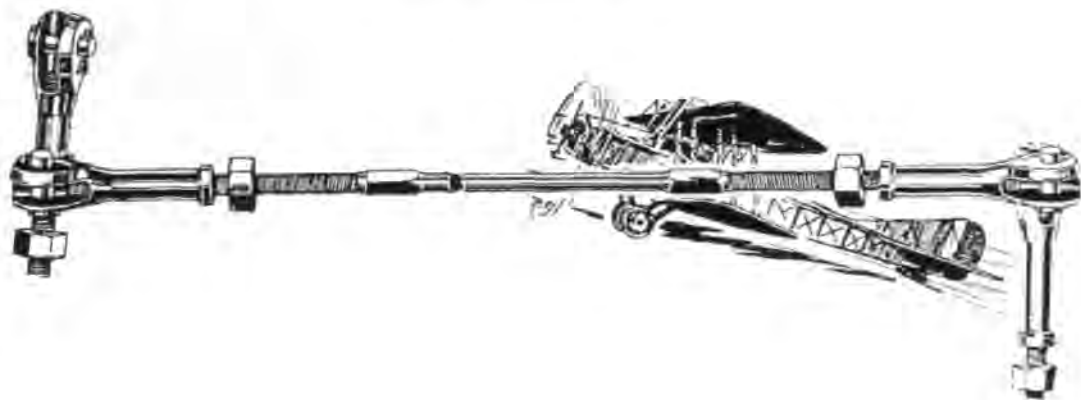

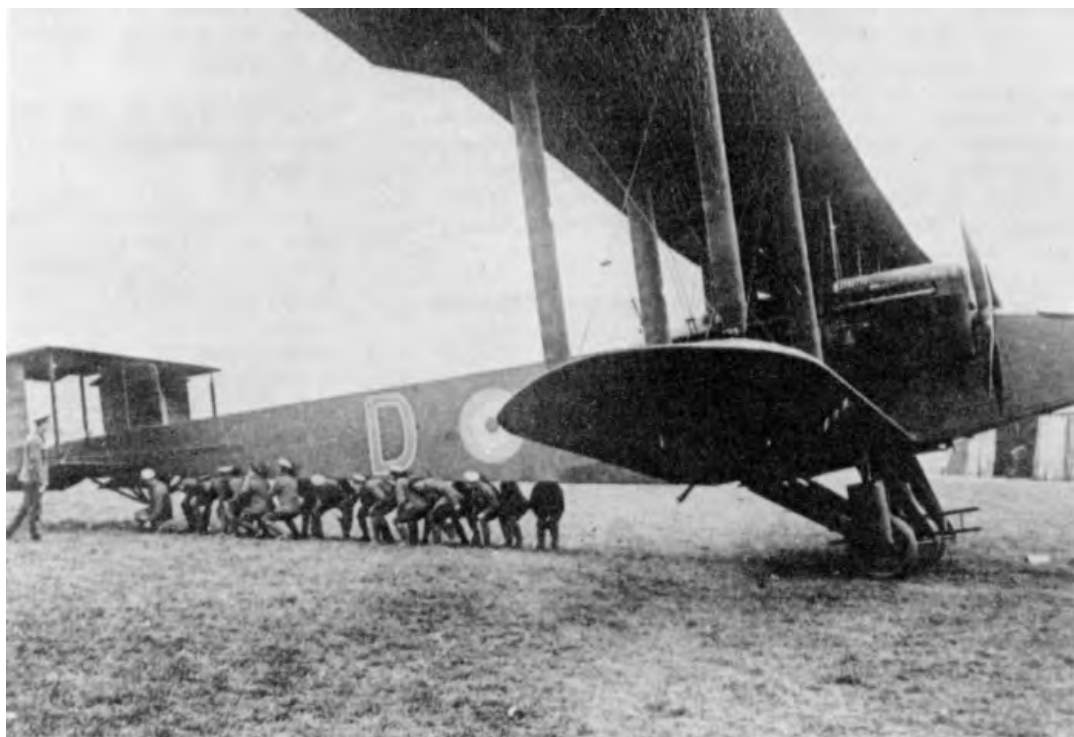

*A Handley-Page bomber readied for a mission on the Aisne front in France.*





## IX. Scope of Activities and General Remarks.

### **Air Service Activities in England.**

Although there was delay in sending untrained personnel to England to replace trained mechanics and thus permit them to be sent to France, ultimately 71 squadrons thus trained in England did reach France with our armies. In all a total of 211 squadrons and further additional large detachments of Air Service troops were at some time during 1917 and 1918 on training duty in England at the 70 or 80 airdromes which were operated jointly by American and British troops.

The first American detachment for flying training in England of 1 officer and 53 cadets arrived at Liverpool, September 2, 1917. By December 21, 1918, 203 untrained cadets and 176 officers from the Royal Air Force schools in Canada and the United States, and 80 casual officers with preliminary flying training had arrived for preliminary Air Service training in England. Of this number 216 were sent for service with the Royal Air Force in the field completely trained; 96 were sent to the American Expeditionary Forces; 20 were transferred for final training in France, and 60 were returned to the United States upon the

signing of the armistice; 83 officers sent to England for special training as instructors had been returned to France upon its completion.

From pilots trained in England on Sopwith Camel airplanes, two complete American squadrons, the 17th and 148th, with American enlisted personnel, were formed and served with the Royal Air Force in the field until November 1, 1918, at which date they were ordered to join the American 2d Army. The record of these two squadrons, as well as the records of the individual American pilots who served with British squadrons, was most brilliant. A number of the individual pilots were decorated by the British for deeds of great gallantry, and the squadrons were most highly commended by the officers under whom they served directly, as well as by the general officer commanding the Royal Air Force in the field.<sup>1</sup>

Some of the personnel for the Handley-Page program which completed its training in England was assigned to duty with the British Independent Force, Royal Air Force, and later returned to

England to act as instructors in the American school which was conducted there. This personnel also while in France rendered most efficient service and was highly complimented by the commanding general of this Independent Force.

### **Handley-Page Agreement and Night-Bombardment Section.**

In order to provide for the equipment necessary to engage in night-bombing operations, after much discussion and preliminary negotiations an agreement was concluded with the English Government January 26, 1918, by which the United States undertook to fabricate parts for Handley-Page machines, which parts were to be shipped to England and there assembled in factories by English workmen. This agreement covered also the sending to England from the United States of a certain number of laborers to be employed primarily in the construction of airdromes and acceptance parks to be utilized by night bombardment squadrons which were to be organized in the United States

and sent to England, where they would receive their final service training, the pilots, after sufficient instruction, to fly airplanes to France and the squadron personnel to be sent to France simultaneously.

The Night Bombardment Section, Air Service, on June 28, 1918, established an office in London to supervise all work under this agreement. The Paris office of this Night Bombardment Section selected six airdromes in France

and planned an air park and a depot, much of the latter of which was constructed.

This night-bombardment program covered the development of 30 Handley-Page squadrons. All of the work under this Handley-Page agreement was stopped abruptly the day after the armistice was signed. No Handley-Page night bombing squadron ever reached France, although two such squadrons had completed

their training in England, and there was available other partially trained personnel for the rapid organization of sufficient additional squadrons as the airplanes became ready for use. There was a delay in the shipment of fabricated parts from the United States, and the result of this inability to forward these parts on schedule time was the failure of the United States to put any Handley-Page night bombing squadrons at the front.

**HANDLEY PAGE FLOW SHEET**

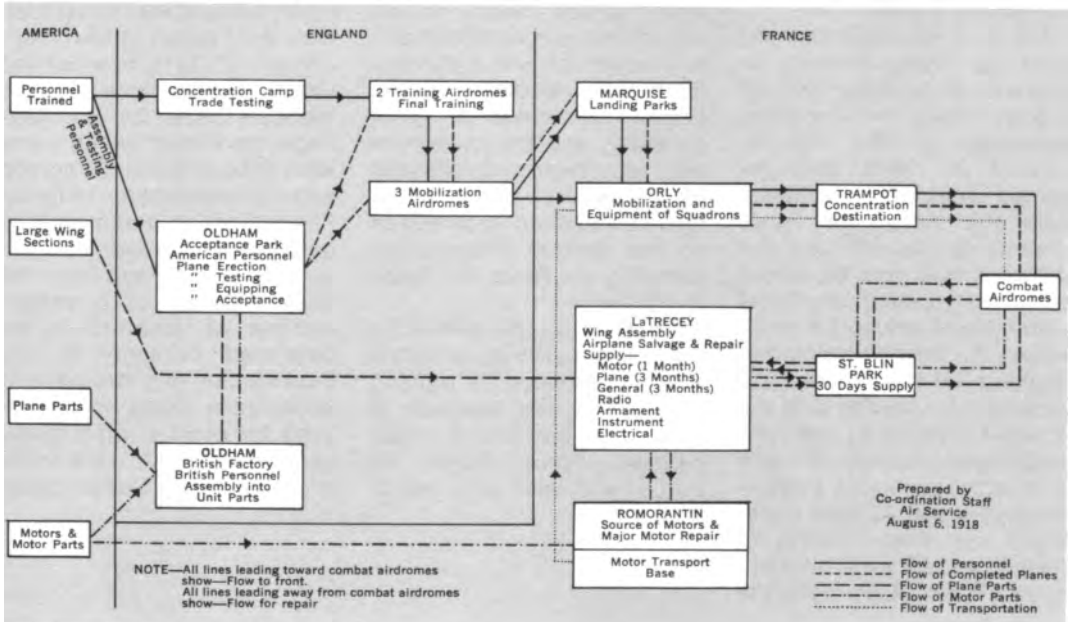

### **Air Service Activities in Italy.**

A number of flying officers were also sent to Italy for training and after having been given courses on Caproni machines, 65 of our pilots saw service with the Italian squadrons at the front. In addition 17 American pilots had been assigned to the Italian naval station at Foggia-Renatico for operations against Austrian naval bases. Two American officers were killed on the Italian front when their machine was shot down in combat. From June 20 to November 2, 1918, these American pilots flew 587 hours over the lines and took part in 65 bombardment missions. The proportion of American to Italian flying personnel on the Italian front ranged at various times between 20 and 30 per cent. All of this American flying personnel was highly commended by the commanding general of the Italian Air Service. Forty-one of them received Italian war crosses and eight received other decorations.

On his visit to Italy in July, 1917, Maj. Bolling collected valuable information from the Italian Government concern-

ing its ability to prepare aeronautical equipment for the American Air Service in France. In August, 1917, a verbal arrangement was made for the purchase of 500 S. I. A. airplanes and 200 Caproni airplanes. The 450-horsepower Caproni was at that time a successful, but slightly out-of-date type, bombing machine. The 600-horsepower Caproni was still in the experimental stage. Of the S. I. A. airplanes ordered, only 50 were ever built and these proved a disappointment. None of the Capronis were ever built for us.

Further study of the Caproni airplane and further information concerning its performance warranted the issue of instructions in the fall of 1918 to conclude a definite contract for obtaining a considerable number of such machines. There was difficulty in meeting the conditions imposed by our Air Service, but finally a favorable and practicable agreement was concluded

whereby the United States Army and Navy Air Services were to receive one-sixth of the monthly production of Caproni airplanes, beginning in October, 1918. Tentative plans were also made for securing a factory whose output would be reserved exclusively for American use.

According to the original agreement made with the Italian Government in the summer of 1917, 500 pilots were to be trained in Italy. A more definite contract was made on April 1, 1918, in which the course of training was clearly prescribed.

In connection with the training of American pilots in Italy many difficulties were encountered. The training center at Foggia was about 450 miles from the base of supplies, which were scarcely ever available in sufficient quantities, causing much loss of time and some dissatisfaction. In all, 406 Americans received preliminary flying training in Italian schools, of which 131 were given special bombing training.

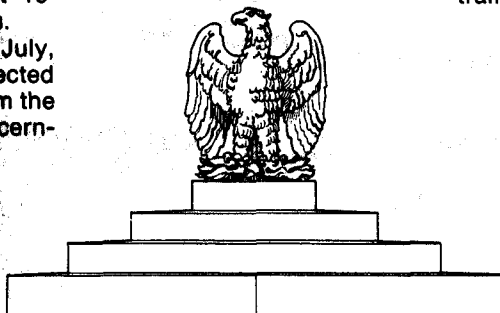

### The DH-4 Airplane and the Liberty Engine.

The first DH-4 airplanes were received from the United States in May, 1918. A number of minor changes were necessary in the first airplanes received before they were regarded as entirely fit for service at the front. While great improvements in airplanes had been made during the time which elapsed between the sending of the recommendation to the United States for the building of the DH-4 airplane, and its actual appearance in France, and while the supremacy which this airplane held in 1917 was largely a thing of the past, the Liberty engine with which the DH-4's were equipped proved equal to the highest expectations of its designers and builders. Combining great power with unus-

ual reliability and great lightness of weight it is one of the most successful aeronautical engines ever produced, and the confidence of the Allies in its performance was shown by their eagerness to secure more Liberty engines than we were able to furnish. The fact that it could be produced in great quantity and that its spares were standardized made it a most valuable asset for the American Air Service, and perhaps the greatest single material contribution of the United States to aviation.

The first use made of the DH-4 airplane fitted with the Liberty engine on the western front was on August 2, 1918,

when a patrol 18 strong of the 135th Aero Squadron in formation went from the air-drome at Ourches along the lines. The pilots and mechanics of this squadron had been trained in England.

Up to November 11, 1918, a total of 1,213 DH-4 airplanes and 2,083 Liberty engines had been received overseas, and of these 543 airplanes<sup>2</sup> had been sent to the front. Some of these American-built airplanes were used at American Expeditionary Forces flying schools in order that the pilots who were to fly them at the front might have the proper amount of training on them before they were sent into action.

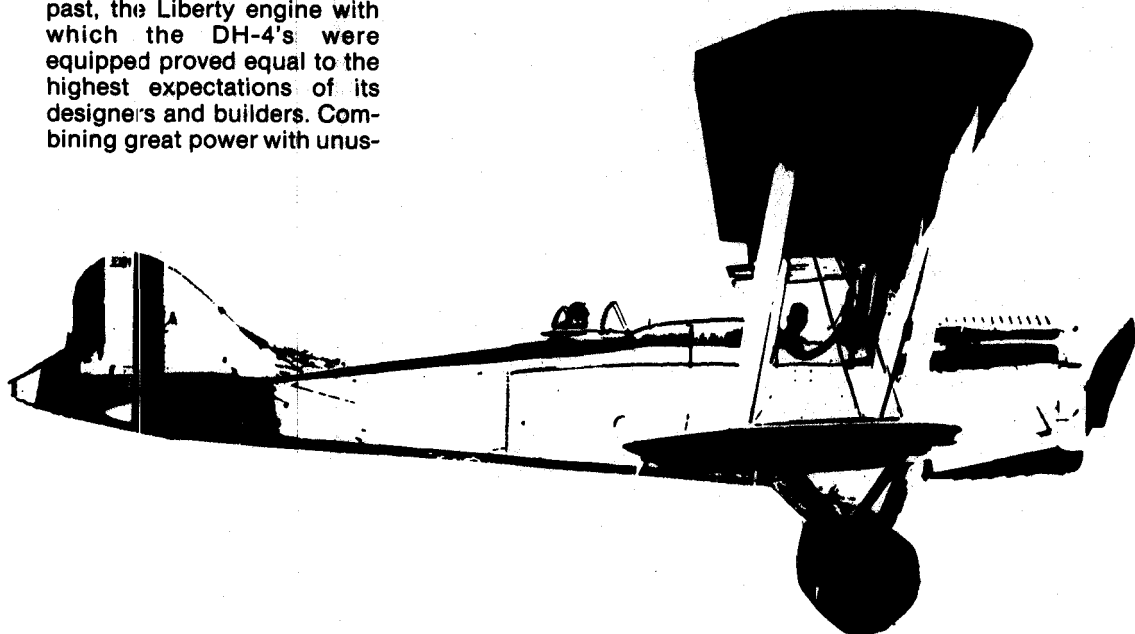

### **Inequalities in Pay of Aviators.**

Before our declaration of war with Germany and while the development of military aviation in the United States was in its infancy under peace conditions then existing, it had been considered equitable to adjust the pay of flying officers according to their ability and experience. Three ratings had therefore been established: The reserve military aviator, the junior military aviator, and the military aviator, with increases of pay of 25, 50, and 75 per cent, respectively, calculated upon the pay of their line rank. Participation in active operations changed radically the conditions which had made this adjustment of pay equitable, and furthermore, owing to the developments in flying, these arrangements no longer represented the ability of their holders to pilot machines. The Air Service, American Expeditionary Forces, therefore proposed a cable which was transmitted to the United States, October 18, 1918, recommending the abolition of these grades and the estab-

lishment of a just and equitable system of additional pay for all flying personnel engaged in regular and frequent aerial flights.

### **Temperament.**

Much has been heard during the present war of what has been called "temperament" of flying officers. The truth is that the flyer is no more temperamental than any other healthy young man and is equally anxious to live up to the best traditions of the profession of arms. It is a fact that the insignia worn by flying officers is more conspicuous and that they are more readily identified than officers of other branches of the service. This largely accounts for criticism which has been directed at flying officers as a class and for the statements sometimes made that these officers were more prone than others to commit breaches of discipline. Such statements were investigated with great care from time to time, not only by direction of the Chief of the Air Service but by the Inspector General's Department, and all reports indicated without exception that the behavior of Air Service officers was in no degree more blameworthy than that of any other officers of the American Expeditionary Forces.

### **Morale and Esprit de Corps.**

In the Air Service, as in other branches, nothing contributes more to success than the cultivation of the best possible esprit de corps. In fact, this is probably more important in the Air Service on account of the voluntary nature of the duties performed. This becomes apparent when it is remembered that it is impossible to teach a man to fly or become an observer against his will and that it is extremely difficult, even after he has been taught, to utilize his knowledge fully except with his own most hearty cooperation. While companionship and inspiration of example are never lacking in the midst of the dangers attending work done in time of war by ground troops, the flyer, on the other hand, is practically alone in the air and is often the final judge of his own conduct under fire. It is evident at once that the very highest morale is essential to the success of an

Air Service in active operations. Similarly in the case of the enlisted personnel belonging to this service, not every man can be made a good mechanic, nor can his failure to become one render him amenable to discipline or reflect upon him in any way. The work of these men is judged mainly by their ability to care for intricate mechanisms, and the relation of the members of a squadron to the officers who pilot the machines is to a great extent that of advisers and guardians to men whose lives depend upon the advice and the care given.

### **Discipline.**

It is thoroughly realized that discipline is an essential to the success of an army. The Air Service officers and men must be as well or even better disciplined in the true sense of the word than those of any other combatant arm. The nature of the duties performed by these men is mentioned in order to call attention to the necessity for bearing these facts in mind and for exercising control over this personnel intelligently.

### **Relations with Other Branches of the American Expeditionary Forces.**

The administration and development of the Air Service has been in many ways dependent upon important aid rendered by other arms. The Director of Construction and Forestry has been charged with the construction of all Air Service projects. The Aircraft Armament Section, while acting in close liaison with the Supply Section, Air Service, has been under the direct control of the Chief Ordnance Officer. The Medical Research Boards have compiled most valuable information and rendered indispensable service in a field previously undeveloped in the United States. A large portion of the radio work of the Air Service has been done in close cooperation with the Signal Corps. The Motor Transport Corps, since August, 1918, has been in charge of all transportation supplied to the Air Service. The uninterrupted supply of gasoline and lubricating oil was assured by the Quartermaster Corps. All gasoline came from the United States and castor oil was procured largely from the

French. In all, there was supplied for the Air Service, 4,825,697 gallons of aviation gasoline and 617,815 gallons of castor oil. All of these other branches lent their aid and gave hearty support to the Air Service, American Expeditionary Forces.

### **Observers.**

The procurement and training of observers for the Air Service presented many difficulties. Officers who are to act as aerial observers should have sufficient General Staff training to enable them to know what to look for, to recognize what they see, and to report accurately and intelligently the result of their observations. While it was not possible in this war to secure a considerable number of officers so trained, this fact must be borne in mind in the future and all such observers must be given this through training in order that the work done by them may be of real value.

### **Relief Organizations.**

The Air Service, American Expeditionary Forces, is deeply indebted to the relief organizations which operated at its centers and with some of its squadrons at the front. The Red Cross and the Y. M. C. A. have at all times been present and have rendered invaluable assistance at periods when the only comforts and cheer for

officers and soldiers alike were procured by the unremitting efforts of these two bodies of workers. The canteens, clubs, libraries, and messes wherever established by these organizations were of the greatest value to the Air Service at times when such facilities were sorely needed.

### **Liquidation and Retrenchment.**

When it became evident that the signing of the armistice was possible, steps were taken to prepare the way for the liquidation of Air Service property and contracts. On November 5, 1918, the French undersecretary of state for aeronautics was verbally informed that in the event of the signing of an armistice the Air Service, American Expeditionary Forces, would probably cancel all orders and cease its activities and was requested to be ready to furnish a statement showing our total liabilities to the French Government. This was followed two days later by orders to all Air Service stations and depots to prepare a complete inventory and definite records which would be of use in winding up these business affairs. The Legal and Disbursing Division was instructed to prepare at once a state-

ment of all Air Service obligations, while the Order and Acceptance Division and the Purchasing Division were instructed to place no further orders except for small amounts of material necessary for immediate use. Information as to incomplete contracts was collected. Upon the signing of the armistice, contracts with the French Government were immediately canceled and notice was served that no further deliveries would be accepted. At the same time work on all Air Service projects was discontinued and a cable was sent to the United States asking that no more Air Service supplies be floated.

Air Service representatives in England and Italy were directed to conclude all business under their supervision with the least possible delay, to cancel all obligations and to negotiate equitable settlements for the approval of the Chief of Air Service, communicating direct with him upon all questions of policy and asking instructions concerning all settlements which would involve large disbursements or considerable quantities of material.

Steps were taken to cancel all informal agreements and to stop deliveries under them in France, England, Italy, Switzerland, and Spain. An Air Service Liquidation Board was appointed and sat daily in Paris, investigating and reporting upon all questions concerning these business settlements. Commanding officers of all schools and other Air Service stations were ordered to prepare supplies and equipment for immediate shipment to Romorantin, where they were to be classified, put into stock, shipped to the United States, salvaged, or otherwise disposed of as directed by the Chief of Air Service. The supply and depot officers were directed to estimate the amount of material which would be needed for replacements for the aero squadrons which were to be kept with the armies. Ordnance supplies were disposed of as outlined in General Order No. 41, Headquarters S. O. S., September 2, 1918.

A board of officers was constituted to investigate the status of all material being produced for the Air Service in French factories, to ascertain the amount of such material and its degree of completion.

There were some 1,600 separate outstanding orders with French merchants and the

value of the undelivered material thereunder amounted to approximately 18,000,000 francs. Every one of these orders was carefully examined and adjustments were made with the creditors. In practically all cases the dealers were quite willing to settle on fair terms. Many of them accepted complete cancellation of their orders without compensation. Where material which could

be of use was actually finished deliveries were accepted, and in some cases where the material was either incomplete or would not be needed in the Air Service the settlements were made by agreeing to pay to the dealers sums which would avoid any loss on their part, the salvage value of the material being fixed with care.

The French Government expressed a desire to take over the Air Service installations at

St. Jean-de-Monts, Tours, Issoudun, Aulnat, and Orly, at a fair valuation, to assume all obligations toward landowners and to arrange for the payment by the United States of a reasonable rental covering the period of occupation. Subject to any general policy which might be adopted by the American Expeditionary Forces, this offer was accepted.

Throughout all of this period of retrenchment and liquidation every matter of an important nature received the personal attention of the Chief of Air Service.





### **The Problem on April 6, 1917.**

When the United States declared war there were in the Army 65 flying officers. Of them a few had seen active service in Mexico and the rest were either recent graduates of the school at San Diego or still under instruction. None of them had ever flown a modern service airplane, and the majority had been trained on a system of controls differing wholly from that in use on airplanes in Europe. No observers or bombers had been trained, and practically no specialized instruction, as the term is now understood, had been given. From this nucleus, an Air Service numbering thousands of trained flyers was to be developed and placed in service on the western front within the shortest possible time.

### **Necessity for Schools Overseas.**

It was evident from the first that as much as possible of the enormous training program involved would have to be carried out in the United States. Only preliminary training, however, could at first be given there, because there

were no machines in the United States suitable for advanced training and no pilots qualified to give advanced instruction. The necessity of large schools and training centers in Europe for advanced and specialized training was therefore obvious. It was also necessary to make use of allied schools to the greatest extent possible, until such time as American installations came into operation.

### **Acceptance of the Issoudun Site.**

The French had recommended the prompt construction of a large American school, at a site some 11 kilometers from the town of Issoudun, and had offered to make arrangements for the land and construct the necessary 7 miles of railway. In June, 1917, this site was examined and accepted, but owing to the necessity of building the railway and the delay in the arrival of materials, construction was not started until August 18, 1917.

### **Creation of the Training Section.**

On July 2, 1917, a Training Section<sup>1</sup> was tentatively created by order of the aviation officer, American Expeditionary Forces. The section was subsequently divided into five divisions, viz: Personnel, Records, Material, Training, and Inspection and Intelligence. Officers assigned to the section were placed in charge of pursuit instruction, bombardment instruction, aerial gunnery, and observation. A number of assistants were added from officers and cadets sent to Europe for training, and the necessary clerical personnel was recruited from civilians found in Paris. At this time there were no officers qualified by training or experience to take charge of the higher phases of aviation instruction, and the officers assigned to special instruction duty knew little or nothing of the subjects in which they were called upon to instruct. In addition to their organization work they had therefore to perfect themselves in their subjects by such training and investigation as was possible under the circumstances.

## The Cadets.

It had become apparent in the early summer of 1917 that a sufficient number of pilots with preliminary training could not be expected from the United States in time to meet the program then in contemplation, and that it would be necessary to make use to the utmost of allied schools in Europe, both for preliminary and advanced training. Based on assurances of allied Air Services that opportunities would be furnished in their schools for the training of a large number of untrained men, the United States was asked on June 26, 1917, to send overseas 100 cadets a month, beginning July 1, 1917. A number of eligible Americans, who were in France, where most of them had been serving in the Ambulance Corps, were examined by an aviation examining board and enlisted for flying training. In all, approximately 2,300 cadets, without preliminary flying training, were sent to Europe or enlisted overseas.

## Difficulties and Delays.

The preliminary training of these men did not proceed as contemplated. The assurances of the allied governments with respect to vacancies

in their schools were based on the arrival of the cadets during the summer of 1917. Some few of them arrived during August and September, but the majority did not reach Europe until October, November, and December. The loss of the favorable training weather, the increase in the allied Air Service Programs, which made it necessary for them to utilize their schools to the utmost and the then existing situation on the Italian front, all combined to defeat, in a large measure, the plan for early preliminary training, with the result that most of the cadets were thrown back on the American schools for this instruction. The only American school where primary flying could be taught was the school at Tours, which had been taken over from the French on November 1, 1917. The school at Issoudun, planned for advanced training, had no machines of the type required for preliminary training, nor could these machines be obtained. It was in fact impossible to supply a sufficient quantity of them for the school at Tours. A number of cadets awaiting training were, however, placed at Issoudun, where the enforced inaction, and the fact that from time to time they were called upon to assist in the absolutely necessary construction work, which this post was carrying on under the most difficult conditions, ow-

ing to shortage of personnel, led to great dissatisfaction. The situation on January 1, 1918, presented a more discouraging aspect; 1,060 cadets were then in Europe awaiting training, for whom no training could be provided. These men for the most part had been honor graduates of ground schools and had been sent abroad as a reward for their good work and high qualities. At the rate at which training was then proceeding it would have required 10 months to a year to place them all under instruction. Only the high caliber of the men themselves prevented a complete loss of morale under these conditions. It was necessary to withdraw from the schools all cadets who could not be placed in training and to concentrate them at the Air Service concentration camp, St. Maixent, to await their turn. This step was taken in January, 1918.

## Commissioning of Cadets.

Another unfortunate feature was that cadets who had remained in the States were now arriving as commissioned officers, having received their commission on completion of their preliminary training there. In many cases these men had entered the service

later than the men who had been sent abroad and were there awaiting training. The result was deemed so unjust that a plan was presented to the Secretary of War, on his visit to the American Expeditionary Forces, and approved by him, to commission all cadets in Europe with the rank they would have had had they been commissioned at the date of their graduation from ground school. The commissions so given were temporary, in the sense that if any of the cadets holding them did not successfully complete their flying training in Europe, the commissions would lapse and the cadet would fall again to enlisted status and be returned to the United States. This plan went into operation during February and March, and all cadets in Europe were commissioned under it.

### **The Limiting of Primary Training in American Expeditionary Forces.**

By good fortune, training proceeded somewhat more rapidly than had been anticipated, and owing to this fact, and to assistance rendered by the French and British in creating vacancies in their schools, practically every cadet in Europe was placed in training by May 15. By the middle of July, 1918, preliminary training in American

schools had been practically completed, so far as all the cadets were concerned, and the question was presented whether preliminary training could not be continued for the benefit of deserving enlisted men, many of whom had enlisted in the Air Service with the idea that they would eventually be taught to fly. It seemed desirable also to give instruction to a number of officers who were performing duties which it was thought would be better performed by them if they were practical flyers. On the other hand, it was clear that in order to meet the program the schools would be forced to the utmost to give finishing and "refresher" courses to men already trained, and that the continuance of preliminary training would seriously impede production of finished personnel. The decision was finally reached to establish the general principle that no preliminary training would be given thereafter in the American Expeditionary Forces, but to make exceptions in the cases of a number of enlisted men, whose applications had already been approved by the examining board, and in the case of officers whose training was deemed necessary for the more effective performance of their duties.

### **The Squadrons Recommend Men for Training.**

It was also decided to call on all squadrons of the American Expeditionary Forces periodically for a recommendation of one or two exceptionally qualified men per squadron, who should be given training as a reward for the excellence of their service. These calls were made during August and September, and a number of enlisted men were given training as a result of the recommendations so made. The excellent showing made by these men leads to the conclusion that it might have been advisable in the first instance to withhold from aviation students both their wings and commissions until such time as they had fully completed their training and were actually ready to go to the front. Though the wisdom of this course could hardly have been foreseen the inauguration of the system in the spring of 1917, its advantages seem to be sufficiently proved to warrant its adoption in the future.



*American and British observers on their way to train in aerial gunnery (above).*

*Miniature planes were constructed for sighting with machine guns in aerial gunnery training (right).*

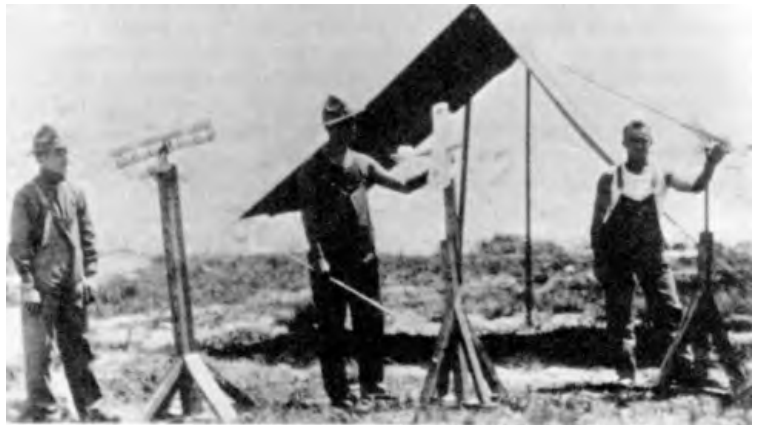

**Issoudun.**

The situation which confronted the Training Section in the beginning of the autumn of 1917, was, to say the least, disheartening. Construction of the main American center at Issoudun had been seriously delayed, owing to lack of materials and shortage of personnel. It was imperative to get this center into operation as soon as possible, and also to establish schools of observation, bombardment, and aerial gunnery. Efforts were concentrated upon Issoudun. The first French airplanes were delivered there in October and a provisional school put in operation in October 24, 1917. The situation was, however, very unsatisfactory, as the barracks and accommodations at the school were of the crudest kind, and it had been impossible to build roads before the rainy weather made the camp a sea of mud. The flying field itself was newly sown and mud thrown from the wheels of the airplanes broke propellers almost as fast as they could be put on. No

machine shops had been established and no materials for their erection were at hand, nor were there any machine tools or power available. All mechanical work had to be done in two machine-shop trucks brought from America. It was clear that a great amount of time and labor was necessary before the school could function effectively.

**Tours.**

On November 1, 1917, the French School at Tours was taken over by the American service. This school was originally intended for observation training, but the necessity of giving preliminary training to cadets required that it be devoted to this use. The school was poorly equipped and had a capacity of not over 100 students a month.

**Clermont-Ferrand.**

In November, 1917, the French School at Clermont-Ferrand was also taken over for bombardment training. This school was small and by no means ideally situated. It was, however, the only school already constructed that was available, and the shortage of men and material did not at the time permit of entering into a new construction project. Training in day bombardment commenced at this school about December 1, 1917, and was continued throughout the war.

**St. Jean de Monts.**

Numerous proposed sites for an aerial gunnery school were examined, but none found satisfactory, as all of them involved an amount of construction impossible at that time. It was thought that an aerial gunnery school required either a large expanse of water or an uninhabited stretch of country over which shooting could be done. Neither of these conditions could be found readily in locations convenient to railway transportation, or adapted to rapid completion. The problem seemed almost insurmountable until a place adapted for shooting over water was finally discovered on the west coast, near St. Jean de Monts (Vendée). The project for the construction of a school to graduate 300 pilots a month was submitted for approval on March 10, 1918. The difficulties encountered in the construction of this school were very great. The site was located some 10 miles from a railway, and all materials had to be hauled over roads by truck. The field itself was covered with trees and traversed by banks, which had to be leveled and resown, and con-

## HOURS FLOWN IN TRAINING—A.E.F. (CUMULATIVE FIGURES)

FROM BEGINNING OF OPERATIONS TO DISCONTINUANCE OF TRAINING MARCH 5TH, 1919

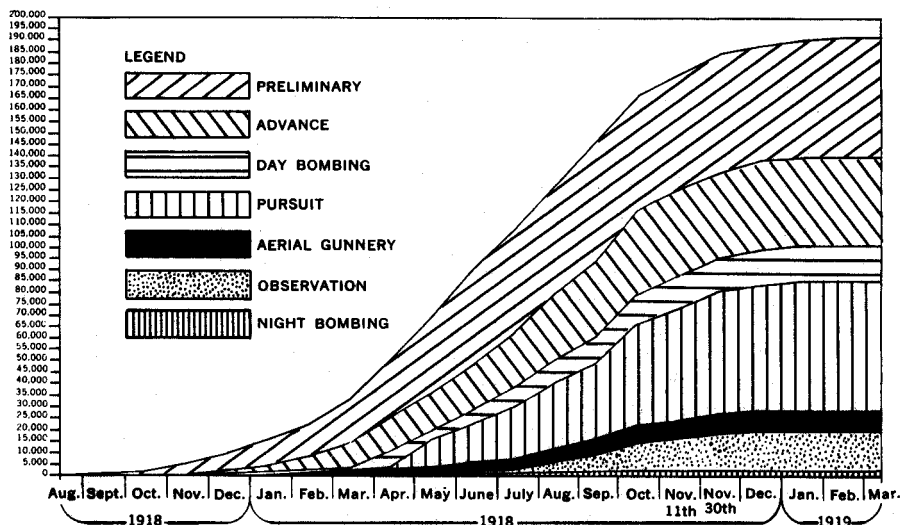

Includes all training in French, British, Italian and American Schools.

	Preliminary	Advance	Pursuit	Observation	Day Bombing	Night Bombing	Aerial Gunnery	TOTAL
August, 1917.	200:15							200:15
September	1218:37							1218:37
October	2728:24	371:						3099:24
November	5219:51	596:44			6:24			5822:59
December	7576:29	1712:19	109:		205:36			9603:24
January, 1918.	10896:27	4525:11	245:	101:40	414:10		354:05	16536:33
February	14829:46	7540:07	453:	321:25	669:55		626:21	24440:34
March	20339:07	11745:49	770:	500:38	1260:51	15:	1020:10	35651:25
April	26316:07	14895:23	5432:52	1057:30	2714:25	188:08	1719:55	52324:20
May	34080:07	17044:36	11494:54	1296:36	4433:04	449:46	2288:05	71087:08
June	41623:07	20244:50	16107:24	1813:40	6645:25	886:16	3234:50	90555:32
July	46841:42	24335:17	22266:21	2181:40	8401:20	1349:44	3842:08	109218:12
August	48783:42	29723:16	29372:37	4554:19	10081:19	1556:55	5061:32	129133:40
September	49587:39	33968:13	34055:21	7804:15	10883:16	1877:03	5892:54	144068:41
October	50706:39	38678:49	44793:54	12463:56	12667:12	2334:33	6817:53	168462:56
Nov. 11th	51217:44	38678:49	49002:13	14294:33	14336:53	2570:01	7224:07	171322:30
Nov. 30th	51552:44	38678:49	54136:13	16801:07	15645:01	2570:01	7661:36	187045:31
December	51640:49	38678:49	56468:15	17881:10	15645:01	2570:01	7875:36	190760:39
January, 1919.	52117:49	38678:49	56693:03	18846:10	15645:01	2570:01	7875:36	192229:53
February	52514:49	38678:49	57198:03	18711:10	15645:01	2570:01	7875:36	193192:50

struction was delayed by lack of men and material. The uselessness of commencing operations before the completion of shops and the means of maintaining airplanes in commission having been amply proved in the past, instruction was not started until August 9, 1918, when the school was practically completed.

### **Training of Mechanics.**

The training of mechanics presented extreme difficulties from the beginning. The handful of experienced airplane mechanics in the United States at the outbreak of the war had been retained there for the most part in order to operate the United States schools, and the enlisted personnel of squadrons sent to Europe was composed largely of men with no mechanical experience whatsoever. Even those who did have mechanical experience were wholly ignorant of the European engines, on which they were called upon to work. This condition threatened to be so serious that every effort was made to alleviate it. Five hundred mechanics, arriving in England, on September 15, 1917, were stopped at Southampton and diverted to British schools; some 200 were placed in factories in and about Paris, where they assisted in the construction of airplanes and engines,

and 207 were sent to the French Mechanician School at Bron (Rhone), for training.

### **Drawbacks in Training Mechanics in Flying Schools.**

Shortage of personnel, necessary for the construction of Issoudun, and the working of other Air Service schools, soon made these methods of instruction impracticable and the majority of the Air Service enlisted men received up to January 1, 1918, got only such training as they could pick up at schools in connection with the duties which they were called upon to perform. This system of training mechanics in flying schools proved unsatisfactory from the first. It not only reduced the efficiency of the schools but caused constant disorganization when squadrons were withdrawn from the school for service at the front.

### **Contract with British December 5, 1917.**

It was the early appreciation of this situation which led to the making of the contract with the British authorities on December 5, 1917, whereby it was agreed that a pool of 15,000 men should be kept constantly in England, work-

ing and training in British schools and factories. As additional men were added to this pool it was contemplated that the surplus over 15,000 could be organized into squadrons from such men as had received training in England and withdrawn to France for service. This scheme would have worked satisfactorily had enlisted personnel arrived from the United States as promptly as promised and had it not been necessary to curtail the number of Air Service troops sent to Europe in the first half of the year 1918. As it was it operated seriously to reduce the man power available for work in France, and this at a time when ample force was absolutely necessary to lay the foundations of the large production which the schools were expected to turn out in the following summer.

### **Training in Italy.**

The Italian Government had offered to erect a school in Italy, with a capacity of 500 students. This offer was accepted in the autumn of 1917, and a school at Foggia (a city about 360 kilometers south-east of Rome) was constructed by the Italians for the use of American flyers. Instruction in preliminary flying was started on September 28, 1917, and continued during the autumn and winter. In all, about 450 students were sent

# CHART SHOWING WHEN INSTRUCTION COMMENCED AND FINISHED AT ALL FLYING SCHOOLS IN A. E. F.

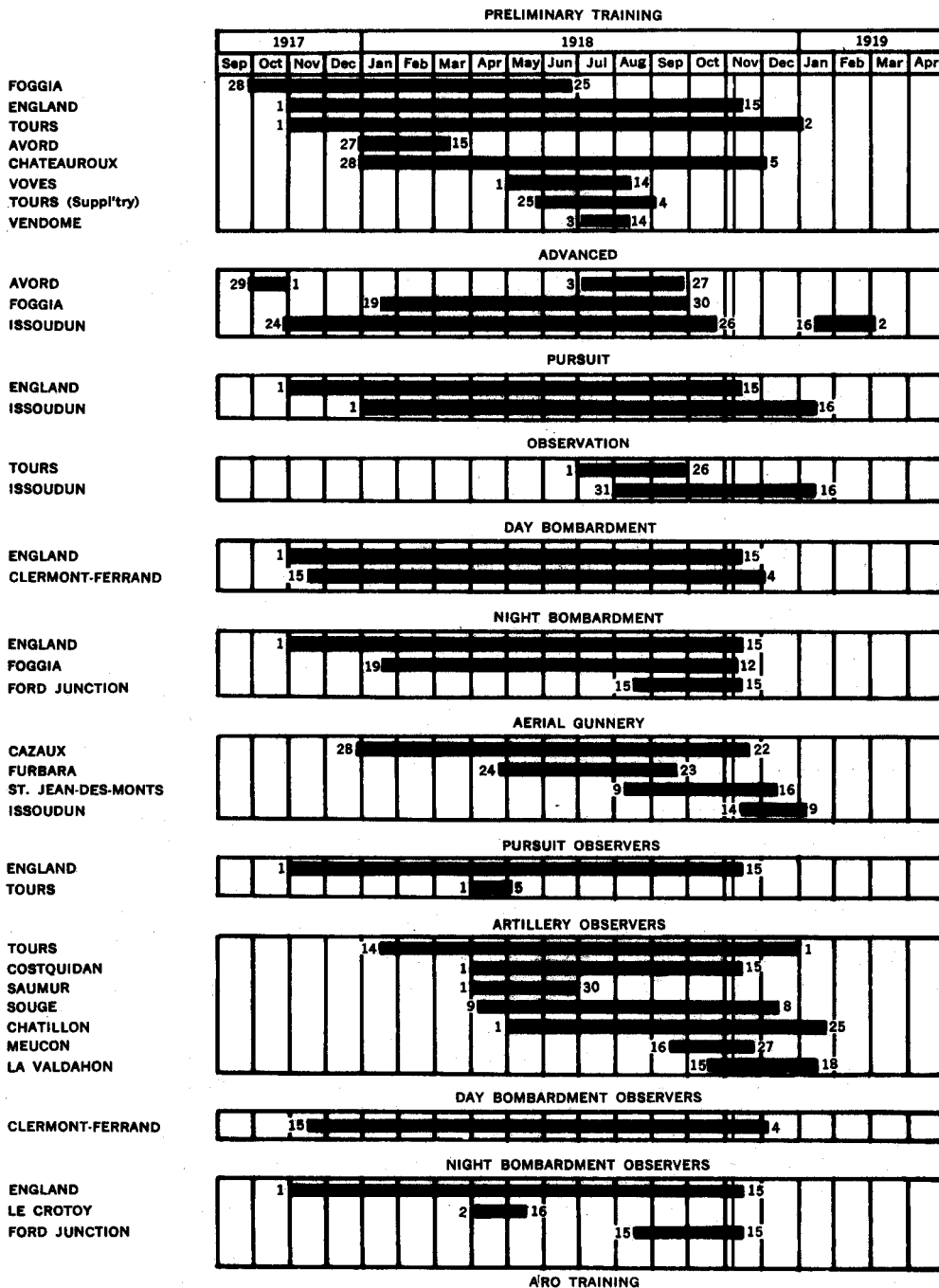



to this school for preliminary training. On January 19, 1918, an extension to the camp was opened and the school was made to include advanced training on S. I. A. biplanes, and bombardment training on the Caproni bombardment airplane. In all, 406 pilots graduated from the preliminary course, of whom 131 subsequently graduated from the bombardment course.<sup>2</sup>

### **Unsatisfactory Results at Foggia.**

Training in Italy, however, did not prove satisfactory. The preliminary training was carried out on Farman airplanes, this being the only type procurable. It developed on the return of graduates to France for advanced training that the Farman airplane differed so much from the airplanes on which they had to continue their training that almost as much difficulty was experienced in teaching them as would have been the case had they received no flying instructions. In the advanced training, the S. I. A. airplanes in use at the school, although exceedingly good as far as performance was concerned, showed certain structural

weaknesses which led to their being condemned for school purposes. The training in Caproni flying was reduced to small proportions by lack of Caproni airplanes, spare parts, and labor at the school. Nor did this training, when complete, qualify men for night bombardment according to the standards set on the western front. The 96 men who completed the course were placed with Italian squadrons, where they rendered creditable service on the Italian front.

### **Furbara.**

In the spring of 1918 an attempt was made to establish a school of aerial gunnery at Furbara, Italy, and instruction was started on April 24. Lack of machines and the distance from other training centers, which made it difficult to carry out the scheme of instruction deemed necessary, resulted in the abandonment of this project after two classes, 52 pilots, had gone through the school.

### **Training in French Schools.**

The French at all times gave as much assistance in training American pilots and observers as the equipment of their schools and the exigencies of their program permitted. In all, 444 students were graduated from preliminary training in French schools. These men

received from 25 to 30 hours instruction in Farman and Caudron airplanes, thus materially lightening the burden of preliminary training in the American Expeditionary Forces.

### **Aerial Gunnery at Cazaux.**

By far the most important contribution made by the French to the American Air Service training was the finishing course in aerial gunnery which they permitted the American Air Service to give, under their supervision and direction, at their aerial gunnery school situated at Cazaux (Gironde). This work, which commenced on December 28, 1917, in a large measure neutralized the delay in getting an American aerial gunnery school into operation, and overcame the early difficulties caused by our lack of machine guns and ammunitions. In addition to the above, 24 bombing teams were given some training at Le Cretoy; 148 pilots completed an intermediate course in Nieuport and Sopwith flying at Avord, and about 100 pilots and observers had experience in French squadrons at the front. French instructors and advisers rendered valuable service.

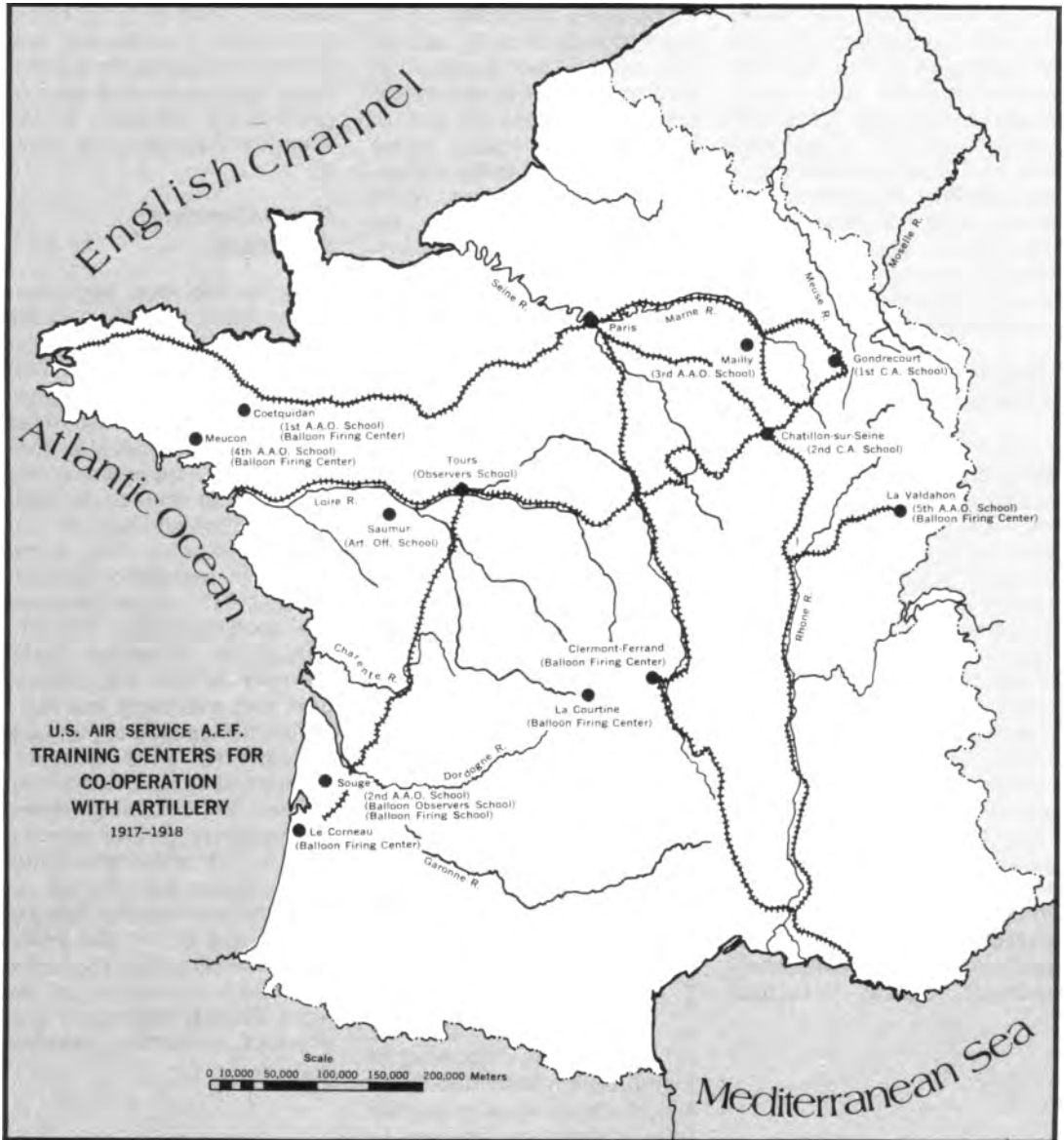

### **Training in British Schools.**

The training in British schools covered three phases—the training of cadets who had no previous flying training, the training of officers who had received preliminary flying training in the Royal Air Force schools in Canada and the United States, and the training of casual officers who had received preliminary training and included selected officers sent from France for specialized instruction in higher phases of training.

The training of cadets commenced on September 4, 1917, with the arrival of a detachment of 53 cadets and one officer, at the British School of Military Aeronautics at Oxford. In all, 204 cadets were completely trained; 176 officers, trained at the Royal Air Force schools in Canada and the United States, were also completely trained, and casual officers to the number of 162 received some training, making a total of 542 men who received training in England. This number includes 6 observers and 83 officers who were returned to stations in France, where they were used as instructors. In all, 216 pilots were sent to the Royal Air

Force in the field, and operated either with the British or in the two American pursuit squadrons (17th and 148th) which were completely trained and equipped by the Royal Air Force, and operated on the British front. Ninety-six completely trained pilots were furnished direct from British schools to the American Air Service. Twenty-three cadets were also given preliminary training at the British school at Vendome (near Tours), France.

### **Our Debt to the Royal Air Force.**

The assistance given by the Royal Air Force to the Training Section of the Air Service was invaluable. While the contribution in completely trained pilots delivered to the American Service was small, the value of the training given to instructors in methods of instruction in flying, gunnery, bombardment, navigation, and night flying can not be overestimated. The British officers, furnished to the Training Section as instructors and advisers, performed in all cases the most valuable work. The price paid to the British by the American Air Service for the training of American pilots, and the assistance rendered them through American personnel in England and their use of American pilots in active serv-

ice on their front, were by no means disproportionate to the benefits received.

### **Training in the United States.**

It became apparent during the autumn of 1917 that such school installations as could be provided in Europe would be wholly inadequate, even under the most favorable circumstances, to give full courses in advanced and specialized training to the number of pilots and observers required to meet the Army program. If the number of men necessary for this program were to be passed through the schools of the American Expeditionary Forces, all that could be accomplished with men and material available would be to give finishing and "refresher" courses, and to provide facilities for transformation to the actual machines they would use in service. In accordance with this the United States was advised by cable, dated November 23, 1917, that it would have to assume the burden of the complete training of all aviators sent abroad. This burden



was assumed by the United States in cable 645-R dated January 15, 1918, and the most strenuous efforts appear to have been made to provide the installations necessary to carry it out. It was estimated that the advanced schools of the United States would begin during June and July, 1918, to turn out pilots, fully trained or at least very far advanced in pursuit, bombardment, observation, and gunnery, as well as observers and bombers. These estimates were based upon information received from the United States by cable and otherwise during the spring and early summer of 1918, to the effect that schools for advanced and specialized training were in operation. Efforts were accordingly directed to gearing the schools in the American Expeditionary Forces to meet this situation.

The output of trained personnel from the States was, however, delayed, and up to the time of the armistice the schools in the American Expeditionary Forces were required to bear a much larger proportion of the burden than

had been contemplated. One realizes the extreme difficulty of placing a large and thoroughly trained flying personnel into service, when it is considered that in spite of unlimited efforts to train this personnel in the United States not a single American trained pursuit or observation pilot and only eight bombing pilots, who could be said to have received complete training in the United States, reached the front before November 11, 1918.

### **Observation Flying and Its Importance.<sup>3</sup>**

The progress of the war in the year 1918 has clearly demonstrated the fact that the work of the observer and observation pilot is the most important and far-reaching

which an Air Service operating with an Army is called upon to perform. This was neither the general nor public impression at the time of the entry of the United States into the war. The spectacular elements of aerial combat, the featuring of successful pursuit pilots, and the color of romance which was attached to the work of men whose only business was to fight in the air, combined to create a popular idea of the importance of pursuit duty. This idea has from the beginning proved a serious handicap to the development of other branches of the Air Service. The impression was rendered more difficult to combat by the fact that the airplanes used for pursuit work are in general more difficult to pilot than airplanes used in observation or bombardment, with the

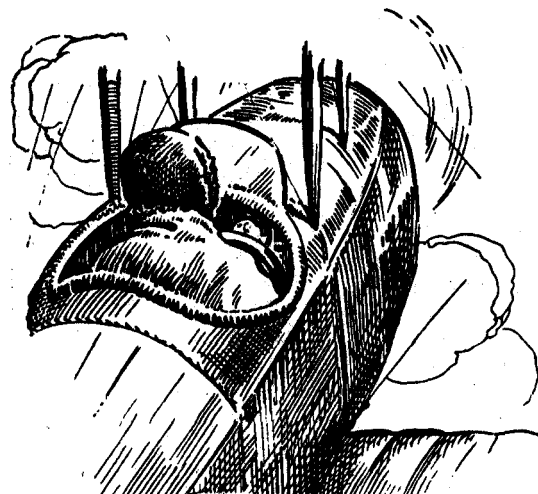

result that a tendency has existed to select the best flyer for pursuit duty. The idea that pursuit was a higher and more desirable form of aviation duty than observation permeated the entire flying personnel of the Air Service, with the inevitable result that observation pilots and observers lost caste among their fellows, and during their training periods, and before the true state of affairs was revealed to them by active service, tended to resent assignment to this duty or to regard such assignment as proof of their own lack of ability.

### **Observation Training.**

The training of observers in the American Expeditionary Forces commenced in the autumn of 1917, upon the arrival of the first brigades of artillery in France. Observers were detailed from these brigades and the first air work was given by a French squadron stationed at Le Valdahon. This training was soon supplemented by the opening of a station at Amanty, and by the sending of qualified artillery men to serve with French squadrons operating on the front. Only a very small number of observers could be trained in this way and their training was limited to the use of observation with artillery.

### **Tours.**

It had been decided to use the school at Tours as a center for training observers and observation pilots, but the pressure to give preliminary training made it impossible to use this school for training of observers until January 16, 1918. On this date the observation school was opened and the first class of 200 students commenced their training. Five other finishing schools were put in operation during the winter and spring of 1918. These were: Chatillon, Souge, Le Valdahon, Meucon, and Coetquidan. At all of these schools observers who had finished the course at Tours were given actual practice with either infantry or artillery or both. The increase in the strength of the ground army in the spring of 1918, and the consequent large increase in the number of observers and observation pilots needed, made their production during the recent summer and autumn the most pressing Air Service training problem.

### **Lack of Observer Personnel.**

Up to June the chief obstacle to the training had been lack of installations and equipment. At this time, however, it became apparent that the observer personnel which was being received by the Air Service was becoming insuffi-

cient, both in number and quality. Urgent calls were made upon the United States, but it soon became evident that sufficient personnel would not arrive from there in time to meet the requirement. Of 725 observers called for in June and July only 145 arrived in August, 86 in September, and 149 in October, or a total of 380 who could be made available for front line work before the cessation of hostilities. To meet the deficiency a large number of officers were detailed to observer schools from the Artillery during the summer and autumn of 1918; of these 825 passed the flying examination and commenced training. In all 1,250 observers commenced training in the American Expeditionary Forces and 851 graduated.\* The large percentage of the men who failed to qualify for observer work is the result of two factors—the very high standard required for the modern observer, and the fact that it is impossible to instruct a student in this extremely technical and arduous duty unless he himself desires earnestly to serve in this capacity. In the last phase of the war the work of the observer was constantly becoming more diversified, more important, and more difficult. The training of a large number of men able to do this work ef-

fectively, is to-day, and apparently will continue to be, one of the most difficult problems confronting the Air Service.

### Pursuit Training.

The school at Issoudun was primarily intended for advanced and pursuit training, and all pursuit training has been carried on there. After a thorough course in advanced flying, the student was carefully drilled in acrobatics, formation flying, and combat, with camera guns installed on machines. He was also in some cases given special training in night flying, the application of which to pursuit work was developed to a successful result by the British during the last few months of the war. After graduation from these courses the student was given a full course in shooting from the air, either at Cazaux or the American school at St. Jean-de-Monts, or (in cases where preliminary gunnery training had been received in the United States), on a shooting area recently established near the school of Issoudun itself. In all, 766 pilots were graduated as pursuit pilots with complete training, including aerial gunnery. Up to the close of hostilities 627 of these men were sent to the Zone of Advance, the balance being retained as instructors, testers, and staff pilots.



*Secretary of War, Newton D. Baker and Brig. Gen. Foulois at Issoudun (above). Lt. Quentin Roosevelt, son of ex-President Theodore Roosevelt, commanded the field in 1918.*



*Flying field at Issoudun*

### **Day Bombardment Training at Clermont- Ferrand.**

Bombardment training was started on December 1, 1917, at the school at Clermont-Ferrand (Puy-de-Dome), taken over from the French. The installation for this work was very modest, only two squadrons of enlisted personnel and 20 Breguet airplanes being available. The 17 pilots who were first to arrive had received preliminary training only and had not only to be taught to fly Breguet airplanes but also to serve as instructors to train future classes. The method of training was developed from the French and British systems, and was directed to impress on the students the possibility and need of precision bombing. The first class of students arrived in February, 1918, but training was delayed owing to the fact that 10 of the 20 Breguet machines had to be set aside for use at the front, and no other machines could at the time be obtained. It was not until September, 1918, that the school received DH-4 air-

planes, and most of these machines even then were without bomb racks. The graduates of Ellington Field, the bombing school in the United States, never arrived in sufficient number to keep the schools running to capacity, and lack of personnel hampered throughout the production of trained men. In all, the school trained up to December 1, 1918, 212 bombing pilots and 262 bombers. The average number of airplanes at the school for this purpose was 60.

### **Night-Bombardment Training.**

Owing to the small capacity of the school at Clermont-Ferrand and the location of the field, which was situated in a valley surrounded by mountains and stretches of country on which no landings could be made, night flying could not be taught at Clermont-Ferrand, and it was necessary to establish night-bombardment training in a separate school. The airplanes contemplated for use in night bombardment were Handley-Page airplanes, equipped with two Liberty engines. The parts of these machines were to be fabricated in America and shipped to England to be assembled. None of them became available before the cessation of hostilities.

During the spring and summer of 1918 approximately 20 pilots and 6 observers were selected for training as instructors in night bombardment and sent through British schools and then to the British front for further experience. These were the only officers fully trained in night bombardment. In the latter part of September, 1918, an American school in night bombardment was opened at Ford Junction in the Chichester training area, England, but the delay in receipt of airplanes prevented any effective instruction being given up to November 11, when the center was evacuated and all personnel returned to the United States.

### **Aerial Gunnery.**

To provide facilities for training in aerial gunnery constituted one of the most difficult problems encountered by the Training Section of the Air Service in France. When the United States entered the war the importance of gunnery training was only beginning to be realized, and up to this time many British pilots, and most French pilots, had been forced to take the air without having fired one shot from a synchronized machine



gun mounted on a service machine. The French Government was reluctant to permit the promiscuous firing of machine guns from the air, except in districts where inhabitants were not likely to be injured, and this made necessary the erection of a school either near a large stretch of water, or in some very sparsely inhabited area, which was most difficult to find in France. In addition to these difficulties the delay in supply of machine guns and machine-gun ammunition from the United States made even effective ground-training impossible during the early stages. The extent of the installation required many be gathered from the fact that it was necessary to give a course in aerial gunnery to all flying personnel, pilots, observers, and gunners who were sent to the front.

### **Vital Importance of Accurate Shooting.**

The correctness of the idea that a fighting airplane should be regarded mainly as a moving platform for a machine gun has been fully demonstrated, and it is hardly too much to say that the length of a pilot's life at the front is directly proportionate to his, and his observer's, ability to shoot. Up to the date of the armistice little assistance could be expected from the United States, owing to the lack of service type

machines equipped with synchronized guns available there for training. Moreover, the long delay necessarily intervening between the completion of training in the United States and the arrival of the pilot in Europe necessitated in all cases further refresher courses.

### **Gunnery Training November 11, 1918.**

At the time of cessation of hostilities training in gunnery was being carried on by the Air Service at St. Jean-de-Monts, which had a capacity of between 500 and 600 pilots and observers a month. In addition, shooting was being done from the air in the areas adjacent to the schools of Issou-

dun, Tours, Clermont-Ferrand, Chatillon, and Souge, and full courses in ground gunnery, including courses in deflection, were being carried on coincident with flying training at all principal schools. The camera gun was also extensively used in combat and other practice maneuvers, and constant shooting practice, both ground and aerial, was given to all pilots in squadrons at the front, at times when their services were not required over the lines. The gunnery training of pursuit pilots had by this time been transferred from Cazaux to Issoudin and St. Jean-de-Monts, but the French school was still instructing approximately 100 observers and gunners per month.

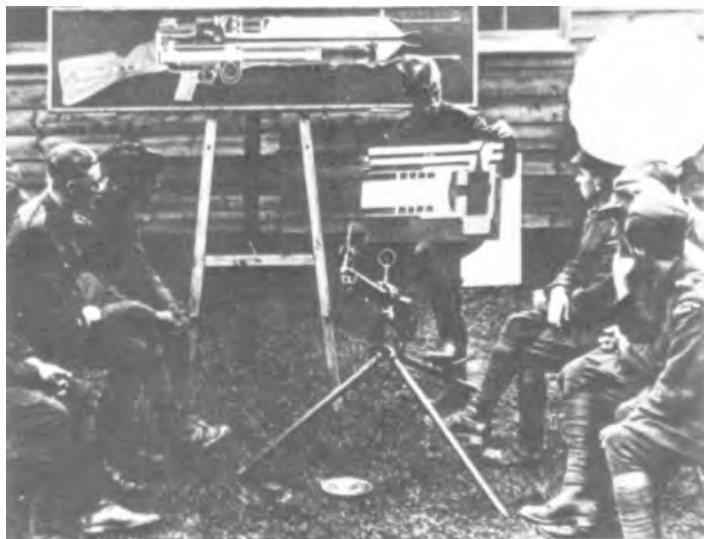

*An RAF class in gunnery training.*

### **Casualties in Training.**

On November 11, 1918, a total of 218 pilots and observers had been killed at training centers; 169 were students undergoing instruction and 49 were instructors, testers, and transfer pilots.<sup>5</sup> Of these accidents 19 deaths were due to collision in the air, and of the rest, a great many can fairly be ascribed to engine failure and lack of judgment or poor flying on the part of the pilot. The balance must be put down to "causes unknown." Classification into the particular maneuver which the machine was performing at the time of the crash, such as "stall", "vrille",<sup>6</sup> "side-slip", "dive", etc. is not very helpful, since these effects have probably in all cases resulted from the fundamental failure to maintain sufficient flying speed.

### **Greater Danger in Pursuit Training.**

Examination of the figures, however, shows that the number of fatalities increases rapidly with the use of small, fast machines. Thus, with the Avro or similar type of preliminary training airplanes, only one death for 3,000 and 4,000 hours need be anticipated,

while experience has pointed out the greatly increased risk of training on such machines as the Sopwith Camel, Dolphin, and Spad. Of course, the fact that these machines are, as a rule, used for the more advanced and dangerous work such as combat, gunnery, and acrobatics, has an important bearing on any comparative figures.

### **Hours Per Fatality.**

In the schools of the American Expeditionary Forces the hours flown per fatality vary from 2,738 for preliminary training, to 1,023 for advanced and pursuit training. The general average is 1,173 hours per fatality. It seems a safe conclusion that approximately 1 fatality per 1,000 hours is to be expected in advanced training under war conditions. The proportion of fatalities to graduation in the American Expeditionary Forces shows 1 fatality to 90 graduates in preliminary work, 1 fatality to 9.2 graduations in pursuit training, and an average of about 1 fatality to 50 graduations in observation and bombard-

ment. The total average appears to be 1 fatality for every 18 completely trained flying officers available for service.

### **The Use of Parachutes.**

No method of entirely preventing casualties in flying training has been found. It is true that parachutes were successfully used on the front by the German Air Service during the last few weeks of the war, to enable pilots and particularly observers, whose machines had been shot down or set on fire at great altitudes, to land without injury. This use of these appliances is, however, most recent, and is still in the experimental stage. The question was being studied at the close of hostilities and some examples of parachutes and their attachment to the airplane had been procured and a number ordered. While experiments indicate that the parachute will eventually prove of service in furnishing means of escape to pilots and observers whose airplane catches fire or breaks in some vital part at high altitude, their value in preventing casualties in training seems doubtful, as by far the greater proportion of accidents in training are the result of conditions which occur at altitudes so low that the use of a parachute would be impossible.



### **The Normal Method of Keeping Down Casualties.**

For the present at least it seems that proper flying rules, rigidly enforced, prompt elimination of inapt pupils, constant care in the maintenance and testing of airplanes, and careful attention to the health and morale of the flyers themselves are the only method by which training casualties can be kept down.

### **Training Accomplishments.**

In considering the results accomplished in Air Service training in the American Expeditionary Forces, it must be borne in mind that the efforts made had constantly to be directed toward production of trained personnel on an enormous scale. The delays which are always incident to large-scale production and which were so fully evidenced in the production of ordnance, ships, and airplanes during the present war, affected equally the productions of trained personnel. A school to turn out 20 pilots a month might be constructed and put in operation in three weeks. A school to turn out 800 pilots a month will take a year before it settles into running order. In

order to reach a fair judgment of the results accomplished, the figures of the trained personnel turned out must be considered in connection with the development capacity of the schools and installations at the time of the cessation of hostilities.

### **Salient Facts.**

Tables and charts annexed give full details with respect to the personnel under training in the American Expeditionary Forces. The following figures, however, deserve particular notice. By November 11, 1918, there had been graduated in the American Expeditionary Forces 1,674 fully trained pilots and 851 observers, of whom 547 were aerial observers and the remainder bombers and gunners. Of the personnel graduated 1,402 pilots and 769 observers<sup>7</sup> were sent to the Zone of Advance before the close of hostilities, the balance at that date being held on duty as instructors, testers, and transfer pilots. The training of 349 students was permanently discontinued owing to physical disability, inaptitude, and other causes. Fatalities in training totaled 219.<sup>8</sup> A total of 2,948 airplanes was furnished in the schools for training purposes, and 173,098 hours<sup>9</sup> were flown in training to November 11, 1918.

### **Final Capacity of Schools.**

As bearing on the developed capacity of the schools at the date of cessation of hostilities, it should be noted that, in addition to the above, 675 pilots and 357 observers were graduated during the period from November 11, 1918, to January 1, 1919, bringing the grand total of fully trained flying personnel, piloting and nonpiloting, to 3,557. At the close of hostilities the Air Service was operating 10 schools<sup>10</sup> overseas of which 7 were constructed by American forces. Personnel was also under training in 3 schools under the jurisdiction of allied services.

### **Morale.**

The most important element in the success of a flying school is morale. It is impossible to teach a man to fly or become an observer against his will, and in fact no really satisfactory results can be accomplished unless students, as well as the mechanics and workmen, are animated by the highest esprit de corps and most earnestly desire to succeed themselves, and to have

the service make a creditable showing. Owing to a number of causes, of which perhaps the technical nature of the service, its novelty, and the danger involved in training, are the main ones, the morale of flying schools is more sensitive and more easily effected than that of other military institutions. It is essential that the officers in charge be men of character which will command respect and inspire the highest confidence in their subordinates. It is well for them to be masters of the subjects taught and willing themselves to perform any of the exercises which they order their students to perform. In this manner only can the necessary respect and confidence be inspired.

### **Discipline.**

In order to maintain the requisite esprit de corps the elimination of undesirable and unfit students must be prompt and rigid. The discipline enforced must be of a character which will not only keep the pilot out of trouble at the school, but will fit him to assume heavy individual responsibility. It must be remembered that in action the pilot is necessarily his own master and that treatment of him as a school boy and not as a man during the course of his instruction, though it may save trouble at the time, will tend to produce an irresponsible and

worthless officer. The principle should be to give the students, especially when commissioned, such liberty as will tend to let them "find" themselves during their course of instruction and those who are not able to comport themselves properly under such conditions should be eliminated.

### **Delays in Training.**

Delays in training must be avoided as much as possible, also excessive purposeless flying. Experience indicates that most men are at their best between approximately 100 and 300 hours, and that they rapidly lose keenness after flying more than the latter amount at schools. In short, great care must be taken to do everything to encourage the highest morale obtainable, and all factors which militate against it must, wherever possible, be eliminated.

### **The Industrial Side of a Flying School.**

Flying training differs primarily from all other forms of military training, in the amount of special equipment required, its enormous cost, and the difficulty of maintaining it in a serviceable condition. A flying field, to render efficient service, must be in

effect a factory on a large scale. It must have shops with the latest high-speed machinery, and storehouses for the carrying of enormous quantities of spare parts. This aspect of a flying school is sometimes overlooked, but it becomes evident when the machine shop, construction, repair, and supply activities of a large school are considered.

### **Issoudun Cited as Typical.**

The main shops at Issoudun comprised a machine shop, a foundry, a magneto repair department, an acetylene welding room, and a room for instrument repair, where the most delicate instruments could be wholly remodeled, repaired, or rebuilt. In addition the Aero Repair Department is equipped to repair or construct any portion of an airplane, including wings, spars, struts, and even cables. At a time when this school was averaging 500 to 600 flying hours a day, the shops were called upon to turn out, after complete overhaul, 100 to 120 engines a week, and the Aero Repair Department to rebuild from the ground up, out of spares and salvaged parts,

more than 20 airplanes a week. When it is considered that the complete overhaul of the simplest aviation engine requires approximately 100 man-hours, and that 32 full working days are required for the rebuilding of an airplane, the magnitude of the above figures becomes striking. This work, moreover, did not include top overhaul and minor (in some cases even major) airplane repairs, which were made at the outlying fields of the school, each of which had its own shops.

### **The Need of Standardizing Training Planes.**

Bearing in mind the factory element in a school, and the number of highly trained mechanics required to carry it on, the necessity of reducing so far as possible the number of types of airplanes used at any one installation becomes evident. Owing to the fact that the Air Service could not secure in Europe the types of training machines which it desired, but had to take such machines as were procurable, no less than 32 types of airplanes were at various times in use at Issoudun, 17 types of Nieuports

alone being constantly in service. This resulted in the supply department of that school having to carry approximately 44,000 separate airplane parts and 20,000 different engine parts. The amount of supplies required at a school of this size is enormous. Between 50 and 100 carloads of material have been received at Issoudun in a single day. While the difficulty of conducting the factory end of this school, could, of course, be diminished under ideal conditions, it is clear that this element of the flying school must always constitute the most important part of its installation and any disregard of it or of the railroad communications which are necessary to make it possible will result in failure.

### **Training of Engineer Officers.**

The training of the engineer officers, who must conduct these factory activities, and supervise the maintenance of airplanes, in squadrons and at outlying posts, requires careful attention. It has been found that the only men competent for this work were men who, before entering the Army, had had practical mechanical experience as a part of their professions or means of livelihood. No academic course can fit men to supervise properly these activities. The mechanics used for the actual

labor are in many cases highly trained workmen, with long experience, and the result of placing them under the immediate command of officers less experienced than themselves is disastrous.

### **Fine Quality of Enlisted Personnel.**

During the past year, the work of the enlisted mechanics of the Air Service, in shops and squadrons, has been beyond praise. Drawn in many cases from highly remunerative trades, they pursued these same trades in the American Expeditionary Forces, under the dullest and most difficult conditions and for the modest remuneration of the soldier, with an enthusiasm and success deserving the highest commendation. On frequent occasions, to offset lack of man power, work was carried on in shops throughout the night so as to have the airplanes ready for use in the morning, and extra work outside of hours was more the rule than the exception.

### The Layout of a School.

In order to permit the expansion of a school to any measurable size, its activities must be divided between outlying fields. Failure to appreciate this fact leads to many expensive installations, which are neither wholly wasted, or the use of which is seriously impaired by the fact that they are concentrated at one point. The number of machines which can be used effectively, without danger of collision, on any given field, no matter how large, is limited. A considerable increase in flying can only be accomplished by placing fields at a distance of some 2 or 3 miles from the main field, in order to provide the necessary air room. These separate installations must be self-contained and able to operate independently; their only relation with the main field being reliance upon it for supply and major airplane and engine repairs. At the date of the armistice, 10 separate fields were in operation at the school of Issoudun. Of these fields, the first three, devoted to the more elementary training, were clustered about the school headquarters. The seven additional fields were wholly separate and complete installations, placed at a distance of several miles from the main camp. In addition, a landing field was

reserved for use of the acrobatics class, no installation being placed there, however. This system permitted indefinite expansion, established a high esprit de corps at the different fields, and permitted ready comparison as to the respective merits of officers and engineers in charge of the commands.

### Selection of Flying Instructors.

In Air Service training, as in all other training, the ability and character of the instructors is the most important factor making for success or failure. The greatest possible care should be given to the selection of flying instructors. Not every man who is himself a good flyer can impart his knowledge. The instructor, in addition to being an excellent flyer, must be able to analyze his pupils thoroughly, and to

impart his knowledge in the manner in which it can best be assimilated by them. It is an advantage, and of course lends great weight to the instructor's word, if in addition to his qualities he is a man who has had actual experience on the front, but the mere fact of having experience on the front by no means qualifies him as an instructor. The work done at all times by instructors and testers can not be too highly praised. They were drawn necessarily from among men of exceptional ability as pilots, who possessed, in addition, qualities of character far above the average. Their duties at schools were not only monotonous, but in some cases, as in testing and combat instruction, extremely dangerous. It presented little chance for their advancement and defeated their one great ambition to serve over the lines. The patience and uncomplaining devotion to duty of our instructors can never receive sufficient recognition.



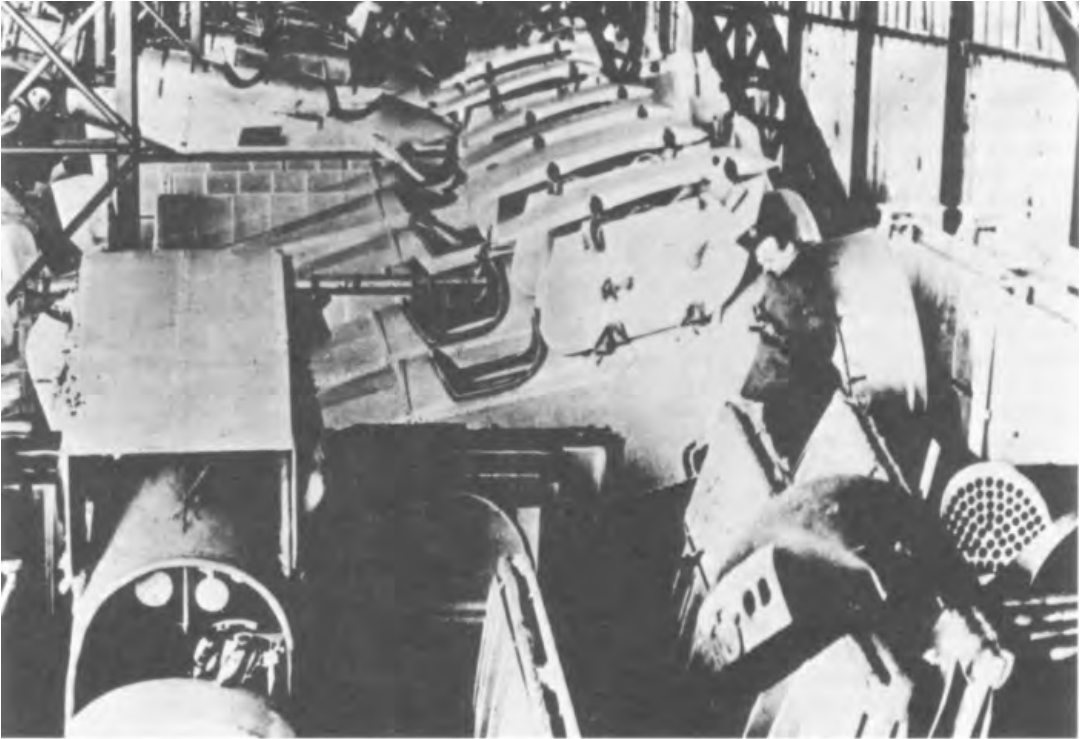

A British Sopwith stockroom for engines and spare parts.

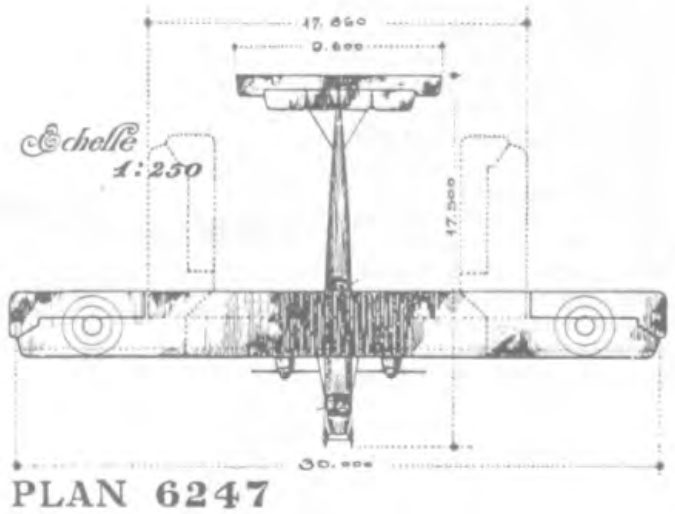



## The Fruit of a Vast Effort.

On November 11, 1918, there were 45 American squadrons working along 137 kilometers of the western front. These 45 fighting units represented the fruit of a vast and far-reaching effort in which every section of the Air Service played its part, and one of the most intricate problems involved in this effort, that of equipment and supply, was met and solved by the Supply Section.<sup>1</sup>

## Activities of the Supply Section.

The Supply Section handled all aviation material from its arrival or purchase overseas to the moment of its final distribution to training centers or to units in the Zone of Advance. At the close of hostilities, the quantity of aviation freight had reached a daily average of 500 tons. The Material Division, which had charge of incoming material at the seven base ports, had a personnel of 1,200 and handled as many as 1,700 requisitions and 1,300 manifests per month. A system of depots was established and operated by the Supply Section to store and distribute material; the principal one of these, the First Air Depot at Colombey-les-Belles, handled an average of 18 tons of a

wide variety of material per day. The most important Air Service project in France, Air Service Production Center No. 2 at Romorantin, planned, maintained, and operated by the Supply Section, was in itself a huge industrial enterprise. It was here that the DH-4 airplanes received from the United States were assembled, tested, and equipped with all accessories. From May 11, 1918, when the first American-built airplane arrived in France, to the close of hostilities, a total of 1,087 DH-4 airplanes were assembled at Romorantin, and of this number 543 were dispatched to the front. During the same period, Production Center No. 2 had also salvaged 308 airplanes and a great number of engines, reclaiming wornout or crashed material which would otherwise have been a total loss to the Service. In order to meet the 202-squadron program had the war continued, there would have been necessary at Romorantin a personnel of more than 25,000. At the close of hostilities there were 50 acres of covered floor space, 509 acres of prepared flying field, and a personnel of 12,000 officers and soldiers.

## Purchasing in Europe.

The Supply Section purchased all material which the Air Service found it necessary to procure in Europe. A total of 5,151 airplanes was secured from European sources. France alone furnishing us with 4,874. An average of spare engines in the proportion of 1 to 4 was maintained for service airplanes brought overseas, and our squadrons were furnished with quantities of spare parts 50 per cent in excess of those furnished by the French to similar units.

## Orly.

Three weeks after the site had been located on the map, the aviation acceptance park at Orly was built and in operation. This park was used for the reception of foreign-built airplanes, which were equipped with machine guns, instruments, and other accessories at Orly before being flown to the front. On November 11, 1918, there was at Orly a personnel of 323 officers and 2,283 enlisted men. The park was designed to equip 25 airplanes daily, but during active operations as many as 91 airplanes have left the field for the front in the course of a single day. Al-

AIR SERVICE, A. E. F.

### GENERAL FLOW OF AERONAUTICAL MATERIAL AIRPLANES

AS OF NOVEMBER 11, 1918

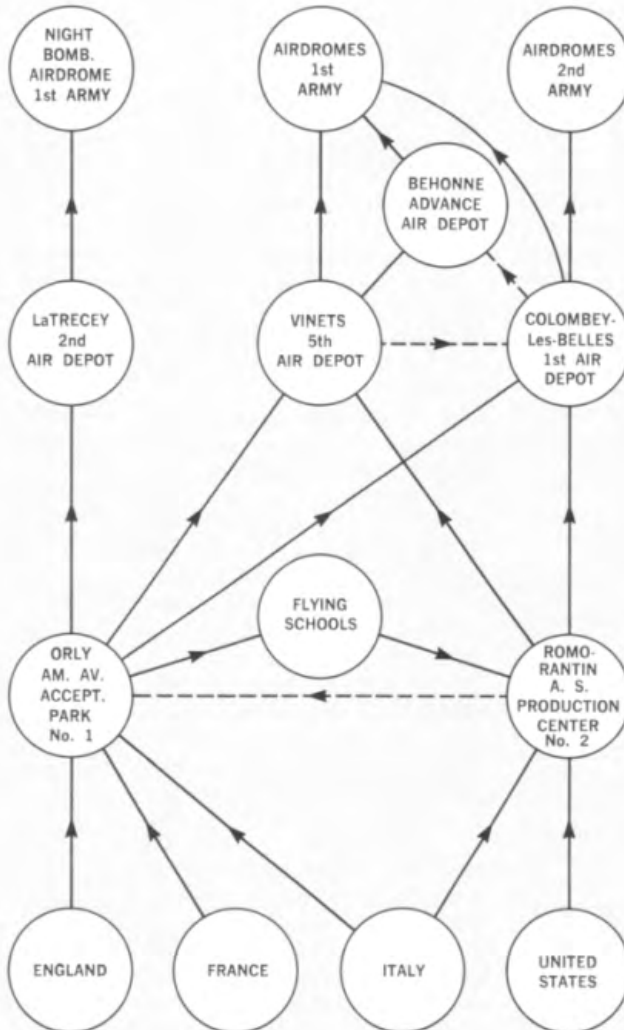

AIRPLANES MADE IN UNITED STATES SENT FROM ROMORANTIN TO ORLY FOR EQUIPMENT OR ARMAMENT IF LACKING AT ROMORANTIN.

LATRECEY, AIR DEPOT FOR MULTI-ENGINE NIGHT BOMBARDMENT, DID NOT BEGIN ACTIVE FUNCTIONING.

AIRPLANES SENT FROM COLOMBEY-LES-BELLES TO BEHONNE IN EMERGENCY. ALSO FREQUENTLY PASSED THROUGH VINETS EN-ROUTE TO COLOMBEY-LES-BELLES.

though military conditions often made it necessary to dispatch airplanes when the weather was far from perfect, only six ferry pilots lost their lives in a total of 403,084 miles of aerial travel, or an average of one life lost in a mileage equal to nearly three trips around the world. At the close of hostilities, every requisition for airplanes from the Zone of Advance had been met, and there remained on hand, in parks and depots, a surplus of 200 airplanes, fully equipped and ready for dispatch to the front.

### **Personnel.**

On November 11, 1918, there were in round numbers 3,000 officers and 20,000 soldiers engaged in the work of supplying the Air Service in France.

### **Control of Depots.**

The control of air depots, in time of war, constitutes a delicate problem. Fighting forces on the front believe that they appreciate the needs of the front better than anyone in the rear and consider that the control of air depots should be in their hands. It can not be denied that this is a reasona-

ble standpoint, but it is also true that the front can never understand the ever-changing conditions of supply and demand at the base. On the whole, in order to maintain a smooth and systematic method of furnishing material to the fighting units, it seems best in the light of experience that the air depots should be controlled by the men responsible for supply.

### **The Flow of Supply.**

There were two sources of supply for material of the Air Service in France—Europe and the United States. Supplies from America arrived at the seven base ports at each of which an officer of the Supply Section was stationed. American-built airplanes with engines installed were sent from the ports direct to the Air Service Production Center No. 2, at Romorantin, where they were assembled, equipped, and dispatched by air to air depots in the Zone of Advance. Other supplies from the United States were dispatched from the ports to depots in the Services of Supply<sup>2</sup> such as Clichy and Romorantin. From these depots material was forwarded by rail or motor truck to air depots in the Zone of Advance. Airplanes and engines purchased in Europe were received at Aircraft Acceptance Park No. 1 at Orly, equipped with armament and

accessories, and flown to air depots in the Zone of Advance. Other supplies purchased in Europe were received in the depots of the Services of Supply, and forwarded by rail or motor truck to air depots in the Zone of Advance. At the close of hostilities, Colombey-les-Belles was the air depot which provided for practically all the needs of the Air Service on the front. Aided by camouflage, its location behind the lines made it remarkably free from aerial attack, and safe from any reasonable advance of the enemy forces. It acted as a base of supply for our air parks, which were located conveniently close to the airdromes and were capable of serving from one to nine squadrons each. From the air depot at Colombey-les-Belles, supplies were forwarded to the air parks by motor transports, and airplanes held in reserve in the hangars of the air depot were flown to the squadrons when need for them arose.

AIR SERVICE, A. E. F.

GENERAL FLOW OF AERONAUTICAL MATERIAL SPARE PARTS

AS OF NOVEMBER 11, 1918

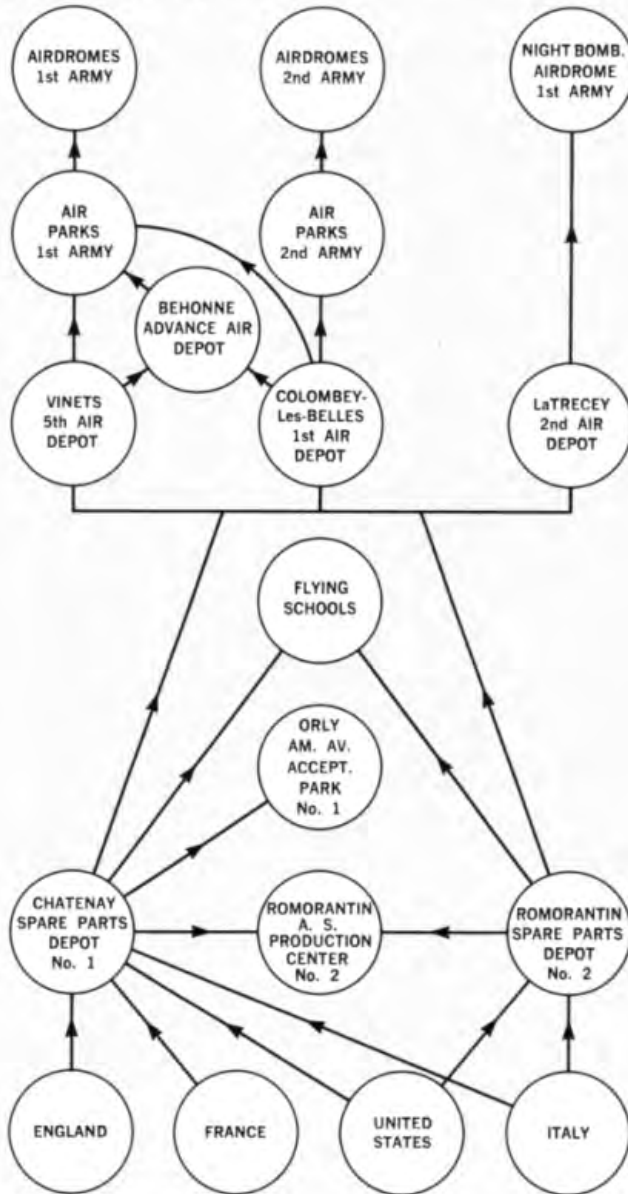

LIBERTY ENGINE SPARE PARTS ONLY FROM ROMORANTIN TO LATRECEY

AIR SERVICE, A. E. F.

GENERAL FLOW OF AERONAUTICAL MATERIAL GENERAL SUPPLIES

AS OF NOVEMBER 11, 1918

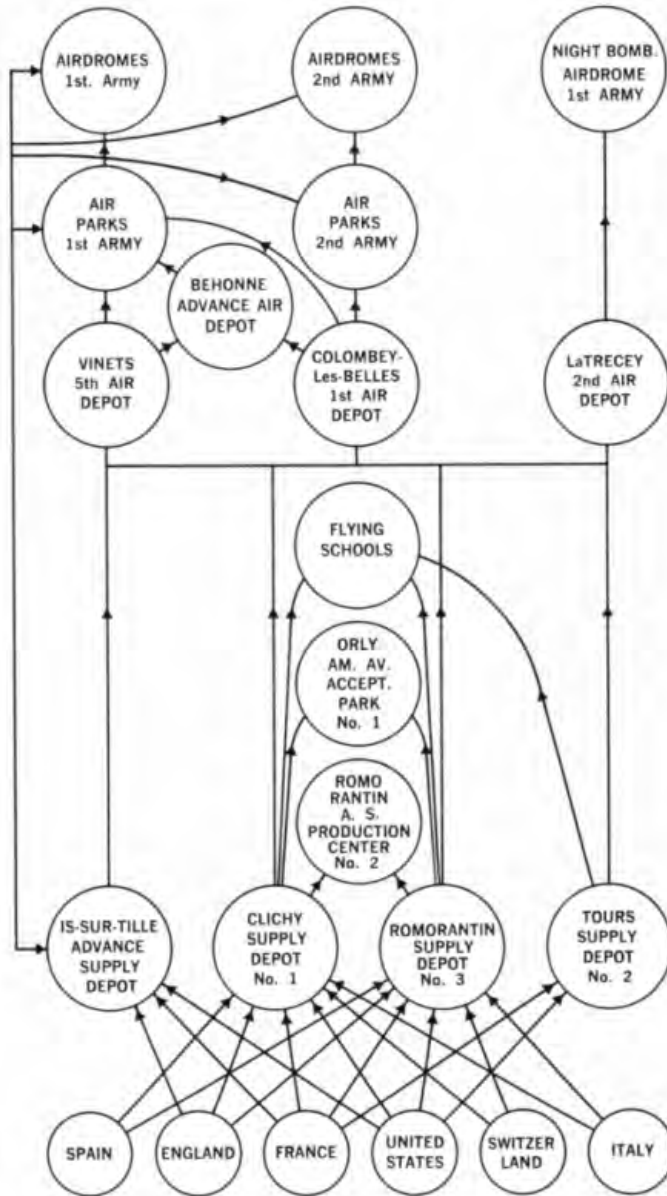

### The Airplane and Motor Division.

The Airplane and Motor Division of the Supply Section placed orders and accepted deliveries from the French of airplanes, engines, and spare parts. As the French were unable to furnish fully equipped airplanes, it was necessary to

equip and test every airplane dispatched to the schools or to the front. The acceptance park at Orly was organized under direction of this division, and when American-built airplanes began to be assembled at Romorantin, a system was organized for dispatching airplanes from that center as well. Every airplane bought in Europe was subjected to a rigid test and inspection before acceptance. Test groups, consisting of a pilot, an in-

spector, an airplane mechanic, an engine mechanic, and a clerk, went the rounds of the French fields where airplanes awaited our acceptance, and each airplane in this way received a trial flight and a careful inspection by experts. Out of all the airplanes presented by the French for acceptance, only 2,100 were accepted when first presented. After defects had been

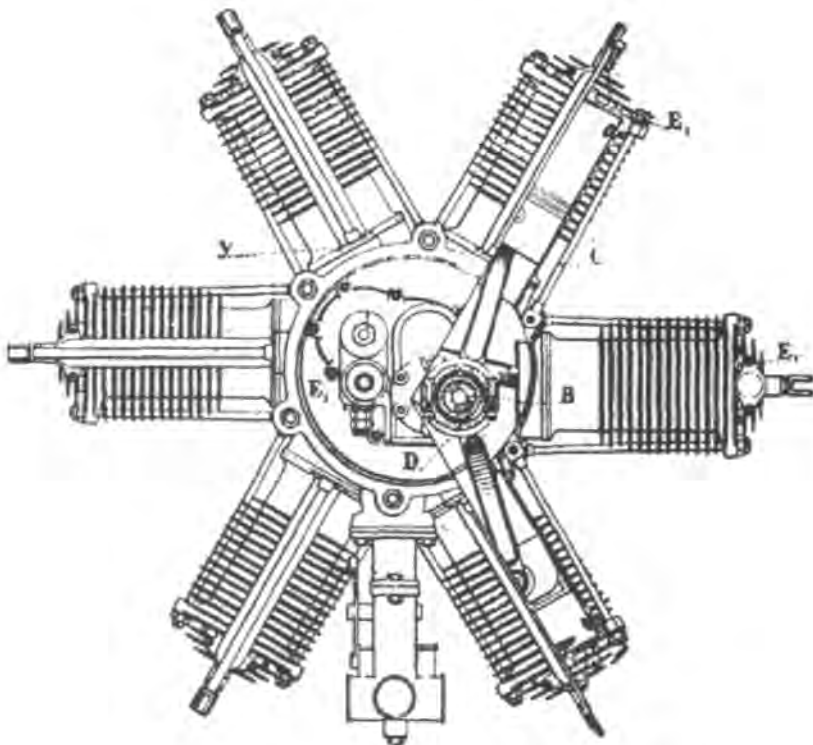

remedied, 597 airplanes were accepted after one rejection and 191 after two rejections; a few airplanes were accepted after as many as six rejections, which were necessary in order to enforce the remedy for serious defects. The majority of rejections were due to poor quality of material, but many were due to poor flying qualities developed in the trial, or to engine trouble discovered either on the ground or in flight. It was the original idea of the French Government to deliver its airplanes to us at Le Bourget, near Paris, but during March, 1918, the Germans bombed this place and destroyed several Spad airplanes already accepted by the American Air Service. The French then notified us that we would have to establish an acceptance park of our own, as they quite naturally refused to assume responsibility for American property; Orly was the result. Orly will be remembered as one of the most compact, efficient, and notable projects of the Air Service in France. On March 31, 1918, the field existed only in the minds of its founders; on April 6, the first lot of airplanes was accepted there, and at the close of hostilities there were 78 hangars, scores

of barracks and buildings, several miles of cinder road, and complete water, light, and telephone facilities. The average length of time between the arrival of an airplane and its dispatch, fully equipped and tested, to the front was two to three days. More than 97 per cent of these airplanes reached their destination safely, and 86 per cent arrived at the front without forced landings. There were dispatched from Orly to the front altogether more than 1,800 airplanes fully equipped and 332 unequipped, as well as 1,000 which were sent to the various American schools throughout France. In addition to the acceptance park at Orly, the Airplane and Motor Division operated two depots—one at Vinets, where airplanes and spare parts were stored in the Zone of Advance, and one at Chatenay, where great quantities of spare parts for airplanes and engines were concentrated, at a point readily accessible to the front, but at a reasonably safe distance from the enemy.

### **Materiel Division.**

The Materiel Division of the Supply Section maintained and operated port clearance offices and base and intermediate depots, kept stock records of all material handled by the division in France, prepared tonnage priority schedules, and maintained records of tonnage allotments, kept records of aviation production in the United States, received all accomplished requisitions for general aviation material, and prepared forecasts for general material to be purchased in Europe and statements of that to be procured from the United States. The work of this division may be judged from the fact that up to the close of hostilities it received more than 10,000 requisitions, issued more than 7,600 manifests, and made more than 4,300 purchase recommendations. Its personnel grew from 150 in December, 1917, to 1,213 on November 11, 1918. The base depots operated by the Materiel Division were located at Clichy, Tours, and Romorantin, and the intermediate depot was placed at Is-sur-Tille. The latter depot made shipments to more than 40 different units of the Air Service, exclusive of

isolated shipments to individuals, and to one-half of these consignees the depot made regular shipments at weekly intervals or oftener. More than 90 per cent of all orders received were acted upon and the material placed in the hands of the forwarding agencies within 24 hours. Aviation clearance officers were maintained at the ports of St. Nazaire, Bordeaux, Le Havre, Brest, Marseille, La Pallice, and London. The tonnage that passed through these ports was enormous, including as it did gasoline, oil, airplanes, engines, and all other aviation material received from the United States.

#### **Purchasing Division.**

The Purchasing Division of the Supply Section was organized to supply the Air Service with whatever materials and supplies it was necessary to procure in Europe, thus forming a central purchasing agency to control all buying for the Air Service, American Expeditionary Forces. A somewhat complicated procedure was necessary before the French purchasing boards and the French Government would approve our orders, and for this work a special department of the division was orga-

nized, whose function was to visit the various French bureaus each day to place our orders before the proper officials, and thus to obtain as prompt action as possible.

#### **Transportation Division.**

The function of the Transportation Division of the Supply Section was to secure transportation for the Air Service units. Owing to the shortage of transportation throughout the whole American Expeditionary Forces and the fact that on August 15, 1918, the Motor Transport Corps took over entire control of allocation of transportation in the American Expeditionary Forces, the problem was chiefly one of liaison with G-4, general headquarters, and with the Motor Transport Corps. To carry on this liaison work to the best advantage, Air Service transportation officers were attached to the 1st Army, to the 2d Army, and to

the office of the Chief of Air Service at general headquarters, American Expeditionary Forces. Routine liaison work with the Motor Transport Corps, and G-4, Services of Supply, was carried on by the Assistant Chief of Transportation in the office of the division at Tours.

#### **Disbursing and Legal Division.**

The foundation upon which the Disbursing Division of the Supply Section, first organized in August, 1917, built its structure was the clause of the aviation supply contract negotiated with the French Government on May 3, 1918, which provided that the French Government should furnish us with aviation materials of the same quality and type as those furnished its own units. There is not space in this report to enlarge on the complex and delicate work performed by the Disbursing Division, but its experience has thrown light on certain basic facts which seem worthy of mention. It has been proved that initial appropriations in time of war should be large enough to meet any possible demands, and that such appropriations should not be designed to cover a specified



period, but should cover the emergency as long as it exists. Regulations governing the method of expenditure should be made to conform to the laws of the country in which business is being done, rather than to the requirements of a set of rules made in peace times in accordance with the laws of the United States.

### **Oxygen Equipment Division.**

The task of the Oxygen Equipment Division of the Supply Section was to organize the supply, installation, and maintenance of equipment to furnish oxygen for pilots flying at high altitudes. The investigation of the Medical Board has proved the great value of oxygen under these circumstances. The division on November 11, 1918, was in a position to cover the maxi-

mum needs of the Air Service. During the summer of 1918, it was necessary to purchase a certain amount of equipment in France, but at the close of hostilities oxygen equipment was beginning to arrive from the United States.

### **Hangar Division.**

The duties of the Hangar Division of the Supply Section were purely administrative, as the personnel for handling and erecting hangars was supplied by depots and other stations of the Air Service. The problem of supplying hangars was like the airplane problem, for it was necessary to obtain simultaneously large quantities of material both from Europe and from the United States. This was not easy, as the French

had few hangars to spare, and during the German advance in the spring of 1918, the hangar situation was grave. Steel hangars did not begin to arrive from the United States until July, 1918, and in August deliveries began on hangars which had been ordered from the British. At the close of hostilities all requisitions for hangars had been filled and there was a reserve of some 200 steel hangars at Romorantin.

### **Information Division.**

The Information Division of the Supply Section was charged with compiling the Equipment Manual, which included also general infor-

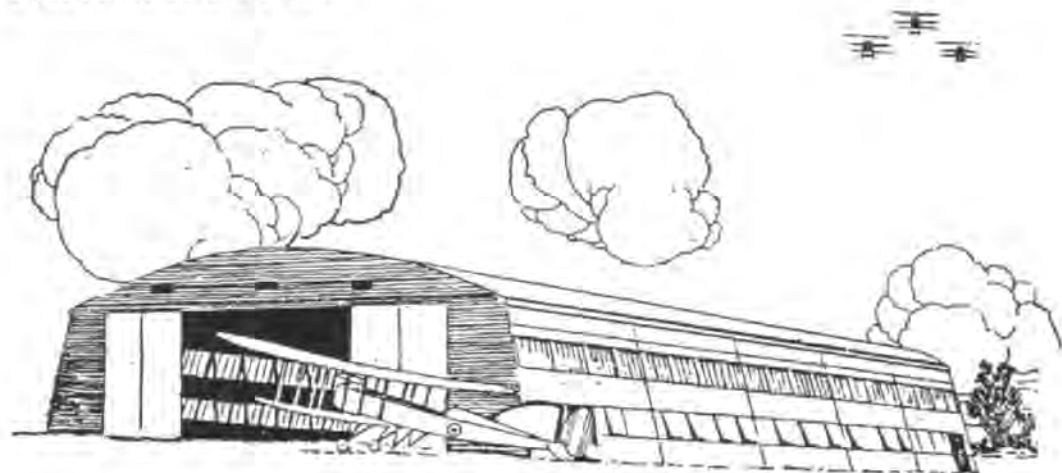

mation on aerial armament, photography, quartermaster, radio, transportation, medical, and chemical warfare equipment. The scope of this manual was broadened in order to assist future squadron commanders, who would probably be selected from among pilots on active duty and not entirely familiar with all the branches of their new work. The Information Division acted also as a central information office for the Supply Section.

### **Production and Maintenance Division.**

The Production and Maintenance Division of the Supply Section, which formed a major part of the organization of Air Service Production Center No. 2, saw the growth at Romorantin of an industrial community of 10,000 where 10 months before a pine forest stood. Airplanes and engines arriving from the United States were sent to Romorantin for assembly, equipped with armament and accessories, and dispatched to the front. Damaged airplanes and engines from all parts of the front were sent to Romorantin for salvage and repair, a valuable service

of reclamation. At the close of hostilities, Romorantin was a large manufacturing plant, complete in every detail and equipped to assemble engines and airplanes, to make tests, and to do armament and photographic work of all kinds. With its equipment and skilled personnel, this plant could produce equally well a delicate instrument or an airplane engine. There was also a supply depot for general aviation supplies and equipment, a depot for raw material, steel hangars, and construction supplies, and a large spare parts depot for American airplanes and engines. The total construction at Romorantin amounted to more than 2,800,000 square feet: 36,000 linear feet of roads had been laid; there were 55,000 feet of railroads and 425 acres of flying field. This construction was accomplished only by the utmost determination and ingenuity: at one time the shortage of lumber became so serious that it was necessary to erect a sawmill to cut up timber felled in clearing the grounds for flying fields. On another occasion, when it became impossible to obtain demountable barracks, special barracks were designed and built out of the packing cases in which DH airplanes were shipped.<sup>3</sup>

The Production and Maintenance Division opened its office at Romorantin on March 31, 1918. On April 1, the first work of preparing for airplane assembly was begun, and when the first DH-4 airplane arrived at Romorantin, on May 11, 1918, there was a crew of 35 men available to begin its assembly, testing, and dispatch to the front. On November 11, 1918, there were 1,101 men available for DH-4 assembly work. During many months, particularly while preparations were being made for the American offensives, Romorantin was kept going day and night. The record for the dispatch of airplanes to the front was established when 60 airplanes were dispatched in one day. Of all the airplanes dispatched to air depots at the front, 200 miles away, only 5½ per cent have been crashed en route, and one-quarter of these crashes were due to fog, rain, and other causes beyond control. No casualties have occurred to Air Service production center pilots on the field at Romorantin, and only two lives have been lost on ferry duty. Regarding the

work of salvage and repair, 889 DH-4 airplanes and 295 airplanes of foreign make were received in a damaged condition. Deliveries of repaired airplanes were small as compared with airplanes received, but it must be kept in mind that no airplane was sent to Romorantin if it were possible to repair it elsewhere. If major repairs of engines had been permitted at squadron airdromes and air parks at the front, the number of spare parts required to keep complete stocks at these points would have been enormous, and it, therefore, was necessary to centralize the major repairs of engines at Romorantin. In spite of the great difficulties arising from the short-

age of spare parts for foreign engines, the Engine Repair Department has acquitted itself well. Spare Parts Depot No. 2, which was located at Romorantin handled all the spare parts for Liberty engines and DH-4 airplanes used in France. Up to the close of hostilities this depot had received more than 2,600 propellers and issued more than 1,600; 2,706 Liberty engines were received and 1,199 were issued. The depot had received 1,526 wings and issued 1,038. A total of more than 3,750 tons of material was handled by this depot.

#### **The London Branch.**

In order to obtain from British sources supplies which it was becoming more and more difficult to procure in

France, the London branch of the Supply Section was established on June 18, 1918. Several airplane orders had been placed through the British Government, and this fact also made it desirable, for purposes of inspection, acceptance, and dispatch to France, to establish an office in London, where the movements of airplanes could be recorded, and to which ferry pilots could report and receive instructions. The officer in charge of this branch reported to the aviation officer, base section No. 3, Service of Supply, and also to the Chief of the Supply Section in Paris. In the beginning, the work of the London



branch was somewhat hampered by the fact that the British Air Ministry could be approached only by permission of the general purchasing agent in Great Britain. On August 21, the Chief of the Supply Section authorized the London Branch to initiate all Air Service purchases necessary in England, and the general purchasing agent of Great Britain was instructed to that effect by the general purchasing agent of the American Expeditionary Forces. The London Branch also acted as purchasing agent for the Night Bombardment Section with the British authorities or in the open market. In the beginning, British inspection was employed for all airplanes dispatched to France, but it was found later that some friction was avoided by American inspection of the SE-5 airplanes sent from England.

### **Projects and Designs Division.**

The Projects and Designs Division had charge of the selection of sites for projects, obtained the necessary approvals, prepared projects for construction, and made surveys and layouts. In the beginning, this division had charge of the actual construction, but later all con-

struction work for the Air Service was turned over to the Director of Construction and Forestry, Corps of Engineers.

### **The 1st Air Depot.**

In closing this brief account of the activities of the Supply Section, it is fitting that mention be made of the 1st Air Depot at Colombey-les-Belles. Lying 11 miles south of Toul, this site was chosen as a convenient location for an advanced supply depot, and on November 11, 1918, Colombey-les-Belles was the only large air depot in the Zone of Advance. Nearly all airplanes and supplies for squadrons operating on the front were received at Colombey-les-Belles, and a large amount of repair work on airplanes and engines of a nature which could not be done in squadrons, was done at this depot. Construction began on November 1, 1917, and 75 per cent of the original project was complete on April 5, 1918.<sup>4</sup> At the close of hostilities, 90 officers and 2,000 soldiers were engaged in carrying on the work of the depot—transportation, advance supply, quartermaster, machine shops, airplane repairs, and airplane acceptance and replacements. During the month of September, 1918, 2,595 requisitions were handled. These requisitions were from units in the Zone of Advance, and each one comprised from

40 to 50 items. At the time of the armistice, this air depot was supplying 23 headquarters groups, 18 observation squadrons, 7 bombardment squadrons, 20 pursuit squadrons, 12 park squadrons, 8 photographic sections, and 23 balloon companies. Between April 1 and November 11, 1918, it dispatched more than 206,000 gallons of transportation gasoline, nearly 280,000 gallons of aviation gasoline, more than 167,000 gallons of special fighting gasoline, more than 47,000 gallons of castor oil, and 27,000 gallons of mineral oil. It was only on the day that the armistice was signed that the Quartermaster Department took over the gasoline and oil business of the 1st Air Depot. The Airplane Repair Department received more than 175 crashed airplanes in August, 1918, and of these 52 were rebuilt and returned to service; in all, the 1st Air Depot rebuilt and returned to service 237 crashed airplanes. On the airplane acceptance and replacement field, many hundred airplanes were often in storage at one time. Since the armistice, all squadrons demobilizing for return to the United States have turned in their airplanes and Air Service equipment to this air depot.

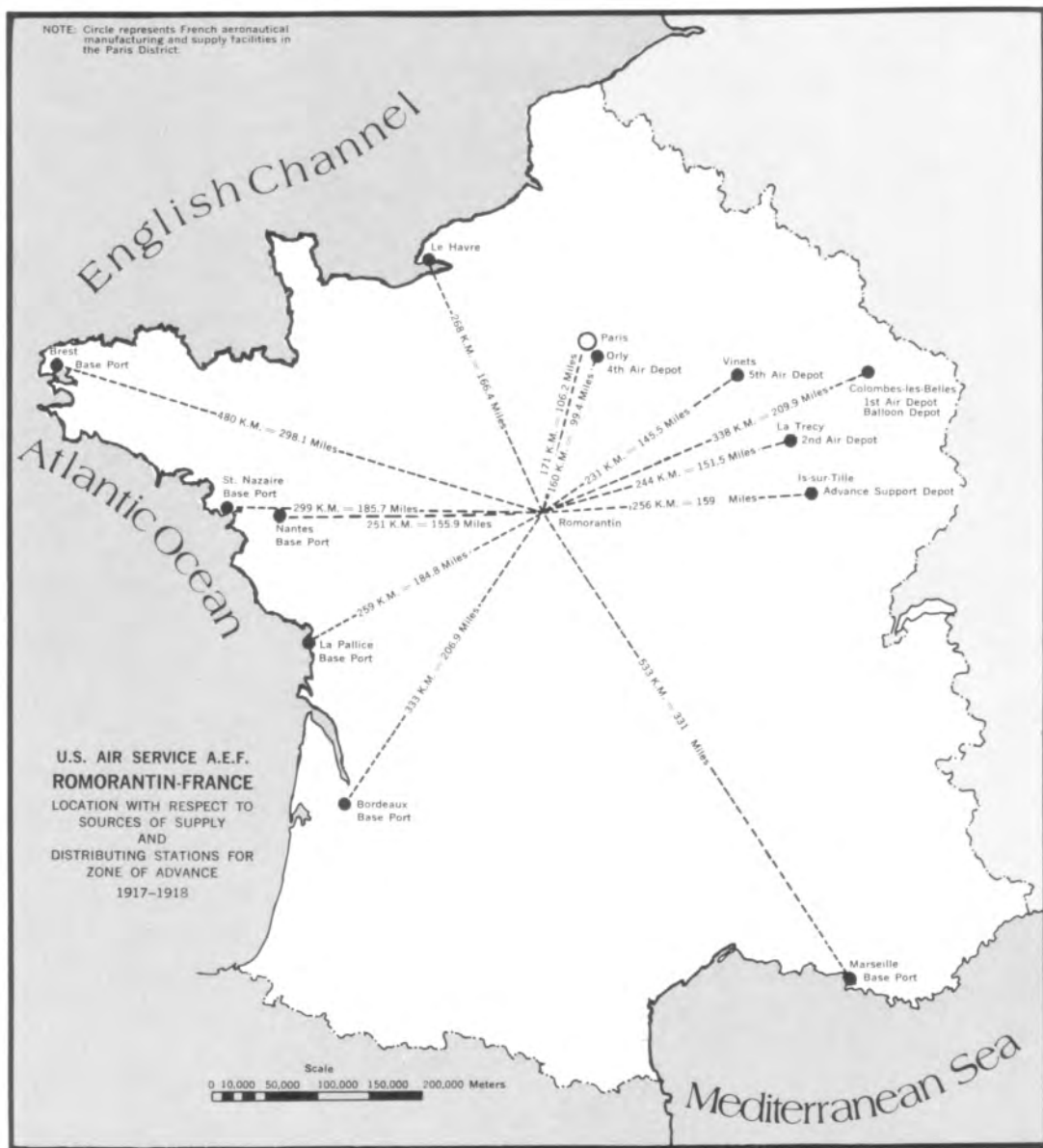

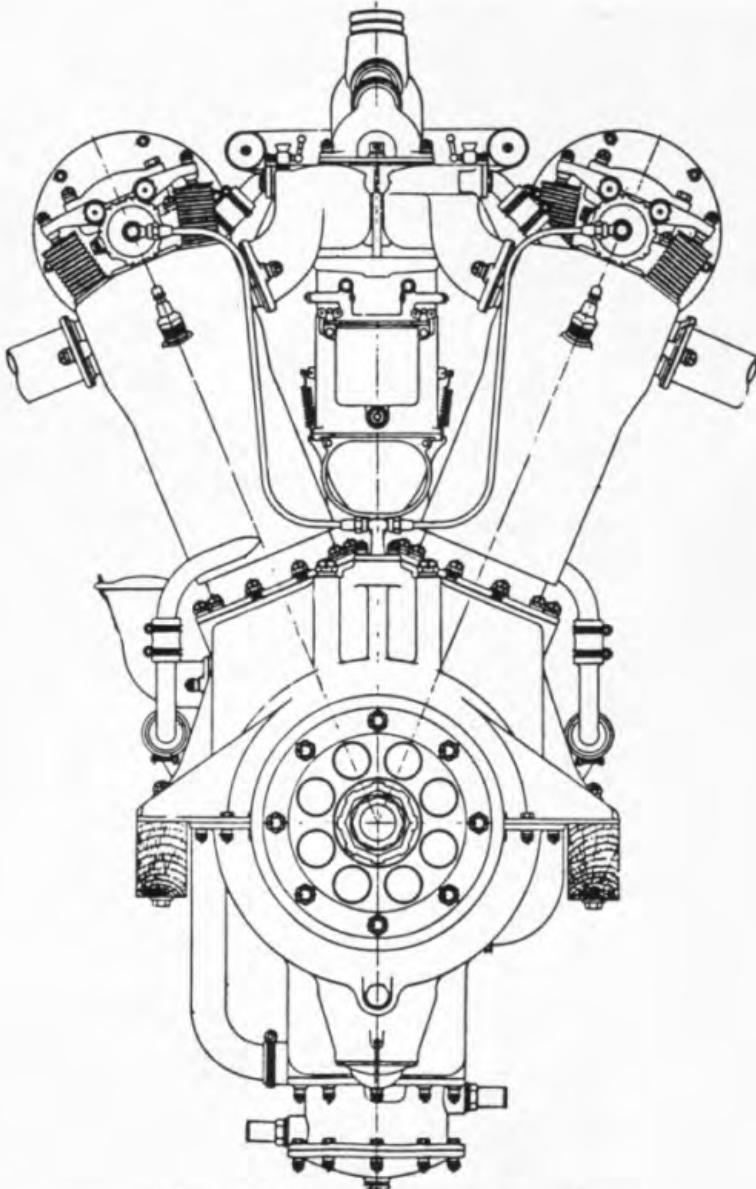

Front elevation of the Liberty Twelve

### Origin and Functions.

Technical questions pertaining to aeronautics were first handled in the American Expeditionary Forces by the aeronautical mission of the Aircraft Production Board. Upon the dissolution of this mission and the return of most of its members to the United States, an officer who had been one of its members remained in Paris, assigned to the Air Service, Line of Communications, and especially charged with the responsibility of obtaining technical information for the use of the Air Service. The organization which was gradually built up from this origin became the Technical Section, Air Service, whose function was the preparation of aeronautical data to be sent to the United States, the recommendation for the placing of orders for material to be used in the Air Service, and the selection of types of airplanes, instruments, and equipment for immediate use. The work of the section was done by divisions specializing in airplanes, engines, airplane instruments, metallurgy, order and acceptance, chemistry, technical data, history and research, and drafting. In conjunction with the duties of the section there was maintained an aviation experimental field. Of these nine divisions, seven

formed part of the initial organization. One other division, Armament, was later transferred from the province of the Technical Section.<sup>1</sup> The entire trend of the work of this section was toward the practical, rather than the theoretical. Experimental work was done only when necessary in the betterment of existing material. Work of a research nature was not developed until the fall of 1918, and then only to secure information as to the comparative value of different types of aviation material. By making recommendations and suggestions regarding the best types of materials obtainable, the Technical Section aimed toward the highest degree of efficiency in the Air Service.

### Growth.

In August, 1917, one officer was engaged in the technical work of the Air Service, American Expeditionary Forces. In November, 1917, the total personnel was 50, of whom 19 were officers. At the close of hostilities the section possessed a roster of 126 officers, 276 soldiers, and 55 civilians; a total of 457, of whom 26 officers and 193 soldiers and 1 civilian were located at the experimental field, American Aviation Acceptance Park No. 1, at Orly.

### Summary of Duties of Technical Section.

In its relations to the development and improvement of the Air Service, American Expeditionary Forces, the Technical Section was charged with a large number of most important duties and with direct responsibility for aeronautical progress. To the Chief of Air Service it gave information accompanied by recommendations on the technical problems which faced the Air Service. In view of the entire lack of standardized equipment of all kinds, the Technical Section was charged with the approval of all new designs in airplanes, engines, and accessory equipment before their official adoption and purchase. The Technical Section decided all questions of airplanes and airplane equipment, with the exception of armament, photographic, and radio material, which concerned the section only as regards problems of installation. The investigation of new equipment, as well as experimental and test work necessary in the development of aviation equipment under

production, was under control of this section. Data on the performance of all airplanes, engines, and accessories in field service and determination of their comparative values were a portion of the information which was collected and organized. When such information made it evident that changes and modifications should be made in any type of equipment, the approval of the Technical Section was called for. The preparation of specifications and orders for the procurement of aeronautical equipment in the United States or from foreign Governments was a portion of its duties, as was also the inspection for acceptance of the material received from foreign Governments. With especial regard to the collection and proper filing of information, the Technical Section prepared instructional manuals and descriptive pamphlets and bulletins concerning the operation, maintenance, adjustment, and repair of the various types of airplanes and equipment in use, and compiled for reference in this connection complete technical files and bulletins giving the results of studies and investigations with which it was concerned.

### The Airplane Division.

The most important accomplishment of the Airplane Division of the Technical Section was the improvements which it effected in the DH-4 airplane. Investigations and recommendations were made, and approval obtained, for the installation of protective gasoline tanks on the DH-4 and other types of airplanes. At the close of hostilities the first lot of these tanks which were then in production, had arrived at the 1st Air Depot. A DH-4 airplane was remodeled into a DH-9 type for the purpose of obtaining information relative to the performance of the

latter machine. In liaison with the Aircraft Armament Section, armored seats for the protection of pilots were designed, and a DH-4 airplane, equipped with eight machine guns for "ground strafing" purposes, had been dispatched to the Zone of Advance. Mud guards to prevent the breaking of DH-4 propellers by flying mud were designed and sample sets produced. Studies were made in the design of camera suspensions to apply to the DH-4 and Salmson 2A2 airplanes. The Nieuport training machine was somewhat remodeled upon recommendations of this division.

1

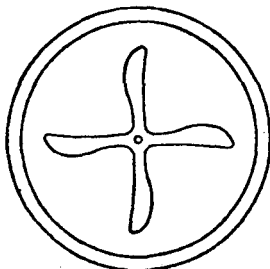

*Aviation Mechanics uniform  
insignia of the U.S. Air Service.*



### **Engine Division.**

The Engine Division, which dated from November, 1917, made like contributions with respect to engines. It had investigated the changes necessary to improve the design and fittings of the Ghome 160-horsepower engine for the Nieuport Type 28; these airplanes, as modified, were ready for delivery at the close of hostilities. In connection with the installation of protective tanks on the DH-4, the Selden pump nonpressure gasoline system was installed. Successful investigations were conducted regarding oil, spark plug, and ignition troubles, as encountered with Liberty and other engines. Experiments in carburation and various other engine tests were carried out at the experimental field for the information of squadrons at training centers and with the armies.

### **Airplane Instrument Division.**

Since October, 1917, recommendations concerning the purchase of different types of airplane instruments has been in the hands of the Airplane Instrument Division of the Technical Section. This division has assisted the Supply Section in obtaining prompt

deliveries and has superintended the installation of instruments on airplanes at the aviation acceptance park. During its existence, the Instrument Division has completed 40 separate tests of airplanes, under conditions as nearly as possible approximating those at the front. Studies were made of British and French methods of testing. Following special experiments which were made on various types of parachutes, recommendations were made as to the most efficient types. A large number of new designs of instruments were investigated and reported upon with a view to their adaptability to the material in use and their probable success.

### **Metallurgy Division.**

With respect to the comparative qualities of the metals used in airplanes, in engines, and as fittings, the Division of Metallurgy has conducted exhaustive laboratory experiments. Availing itself of the laboratory facilities generously offered by the Citroen Works, the Metallurgy Division has supervised all tests made in connection with metals used by the Air Service. It has analyzed broken parts of engines and metal fittings of airplanes and made recommendations concerning the proper specifications of metals to be used. It has likewise

maintained inspection at the plants supplying metal products, recommending as it saw fit that certain changes be made in the manufactured products.

### **Order and Acceptance Division.**

The work of the Order and Acceptance Division has been concerned solely with orders placed with foreign Governments for aeronautic material and with the inspection of this material. Since April, 1918, this division has flight-tested all foreign-built airplanes submitted for acceptance. Upon the signing of the armistice, the personnel of the division then engaged in acceptance work was transferred, by request, to the French board for the acceptance of airplanes. This placing of Americans on the French board of acceptance came as a consequence of the thorough inspection service previously maintained by the members of the Order and Acceptance Division.

### **Chemical Division.**

The Chemical Division collected information relative to the standardization of airplane dope, the methods of camouflage and the fabrics in use, and compiled chemical data of interest to the Air Service. It obtained analyses of

water, gasoline, oil, varnish, glues, and paints in order to facilitate future orders for these materials.

### **Technical Data and History and Research.**

The Divisions of Technical Data and History and Research were among the last organized. Their special functions were the collection and compilation of technical information in such forms as to make it of practical service. Particular attention was paid to obtaining the most accurate historical information available bearing upon the design, employment, and history of the different types of airplane material; this has been done with a view to having concise and accurate information after the war.<sup>2</sup>

### **The Drafting Division.**

The Drafting Division has furnished drawings and blueprints as needed by the different divisions of the Technical Section and by other sections of the Air Service. During its existence it has completed a total of 1,400 tracings and drawings and 75,000 blueprints.

### **Experimental Field.**

In connection with Aviation Acceptance Park No. 1 at Orly an experimental field was maintained, where were conducted airplane and engine tests and experimentation in equipment. The aerial testing of radio apparatus was largely the duty of this field in the early days of its inception. It also assisted in the acceptance of the Marlin synchronized machine gun for use on the DH-4 and other American airplanes. At this experimental field was performed also the work made necessary by the changes in the types of airplanes and by the adaptation of airplanes to meet the requirements imposed by service at the front.

### **Liaison.**

Through special officers detailed for this work the Technical Section maintained a close liaison with the Air Services of the Allies. At London a branch office of the Technical Section was established to devote itself exclusively to obtaining information regarding aeronautical progress in England. The section was particularly closely allied to the French Section Technique, from which much valuable information was obtained. A technical officer was also sta-

tioned in Italy. At the production center at Romorantin officers representing the section assisted in solving the technical problems which arose. Technical questions arising in the Zone of Advance were taken up and acted upon through representatives of the Technical Section, traveled between Paris, the first Air Depot, and the squadron at the front.

### **Value of Section.**

The Technical Section of the Air Service has rendered material assistance in connection with the procurement of technical equipment and supplies. It has given sound advice on important aeronautical questions. The permanent files of technical information which have been collected have been and will hereafter be of great value. It has cooperated heartily with all branches of the Air Service. In these ways the Technical Section of the Air Service has proved its worth and has demonstrated that such a body composed of experts in the different lines must be maintained as a component part of the Air Service as an aid in future development of aeronautics.

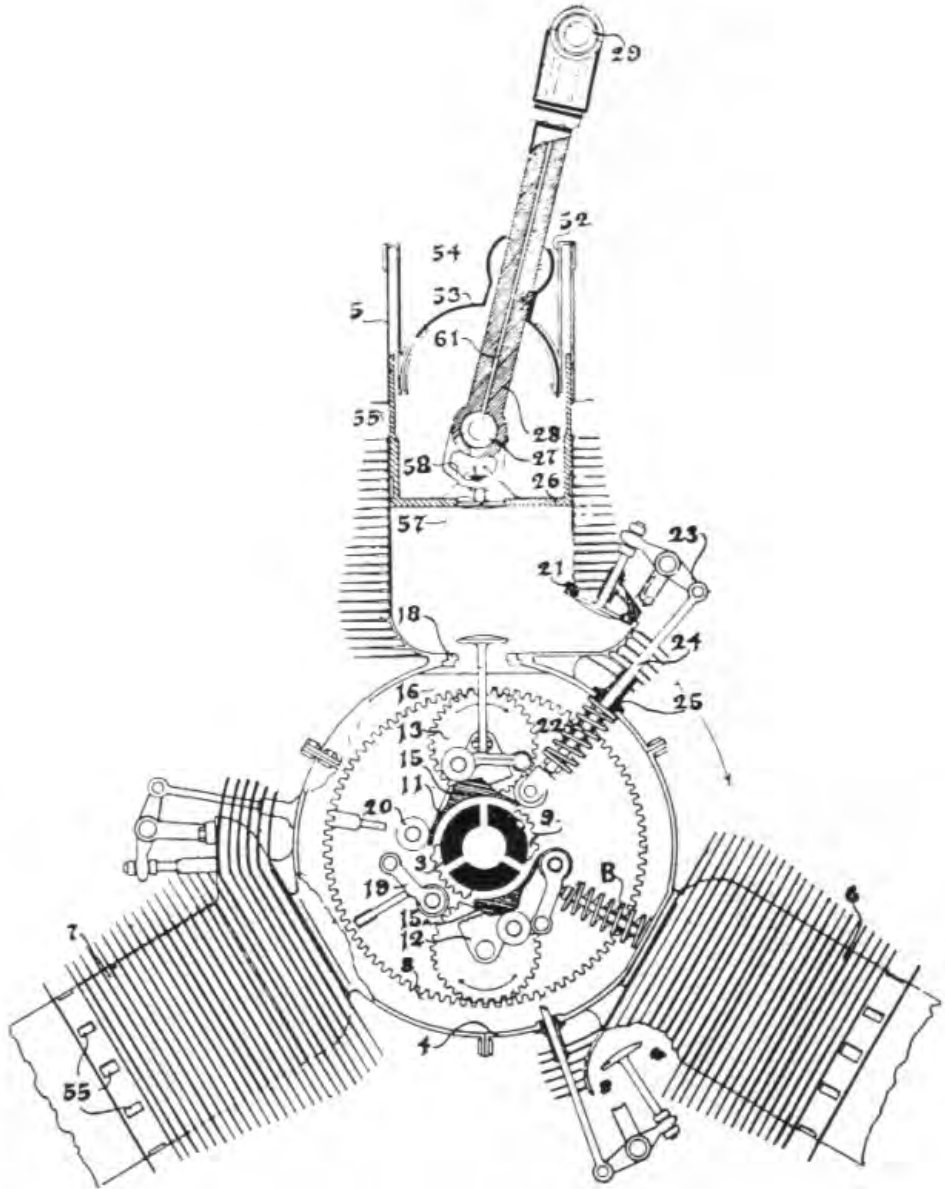

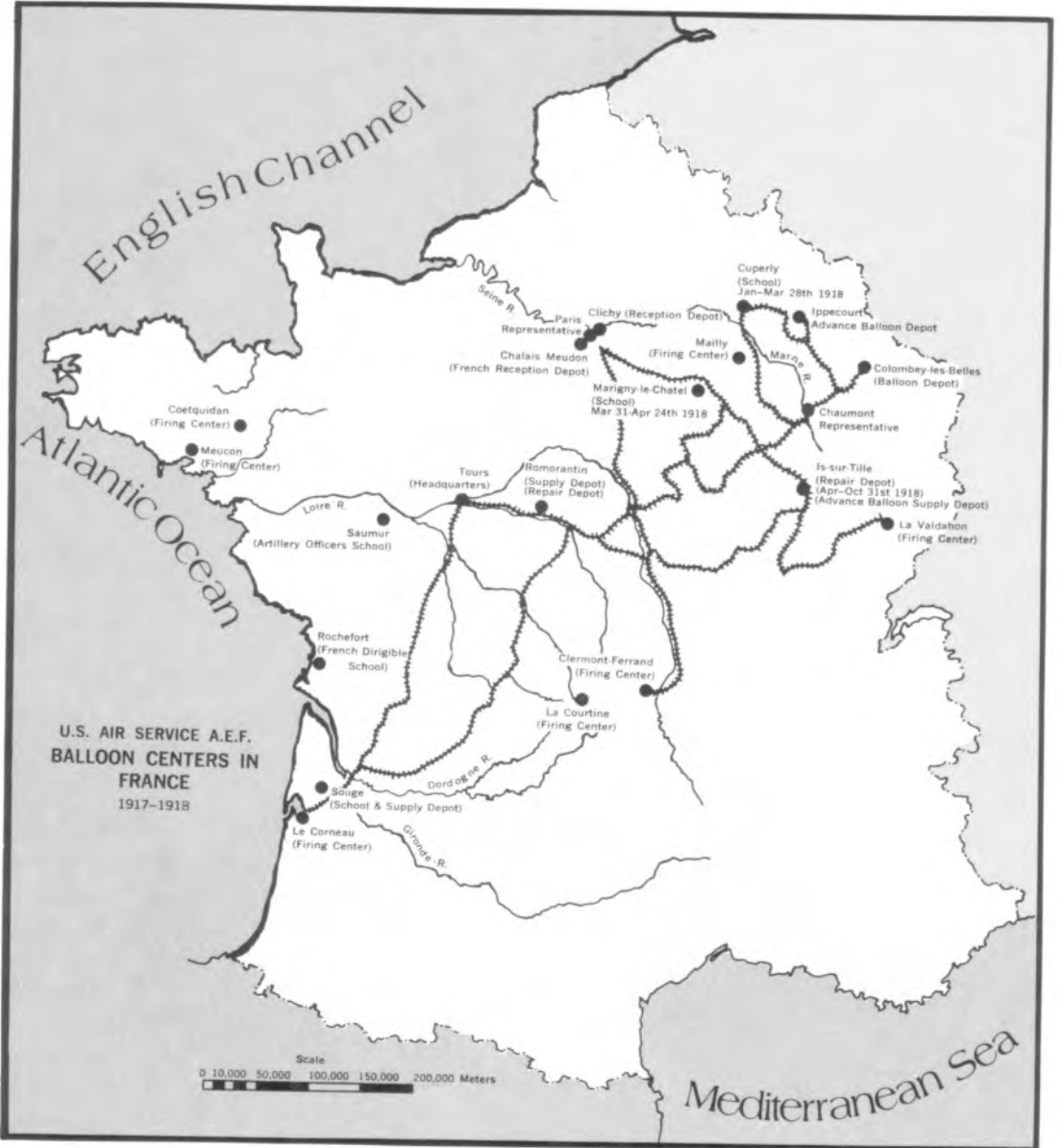

### **No Balloon Service Before the War.**

The United States Army had almost no Balloon Service previous to our declaration of war. On December 28, 1917, four companies, comprising the 2d Balloon Squadron, arrived overseas, and were assigned to Artillery training centers in the Services of Supply.

### **Size of the Balloon Section.**

The general organization project, as amended and completed by the service of the rear project, for the American Expeditionary Forces, called for 69 balloon companies, and the revised project, approved by general headquarters, American Expeditionary Forces, on August 17, 1918, provided for a total of 133 companies by June 30, 1919. According to the latter schedule, 70 balloon companies should have arrived in France by October 31, 1918. There were actually, at the cessation of hostilities, a total of 35 companies operating in France, of which two had been organized from balloon casualties in the American Expeditionary Forces. Of these, 12 were stationed at Artillery firing centers and balloon schools in the rear, 6 assigned to armies were en route to the Zone of Advance, and 17 were serving with the 1st and 2d

Armies at the front. On November 11, 1918, the personnel of the Balloon Section consisted of 446 officers and 6,365 soldiers. Of the officers, 230 were commissioned in the Air Service, and the remainder attached from other arms for duty as instructors or observers. Only 14 officers of the Balloon Section were on a nonflying status.

### **First Arrival at the Front.**

The 2d Balloon Company arrived in the Toul sector on February 23, 1918. Although many American aviators were serving with both British and French squadrons before that date, this was the first completely equipped American Air Service unit assigned to the 1st Army Corps, to which were assigned the first American units to take their places at the front.

### **Training.**

Valuable training in the regulation of Artillery fire was obtained in France by sending all Balloon Companies, as they arrived over seas, to Artillery firing centers in the Services of Supply. They remained at these stations until relieved by newly arrived companies from the United States, and were then assigned to a quiet sector

on the front for battle training. Although it was intended to give observers and maneuvering officers a full course of instruction in the United States, it was not at first possible to do so without seriously delaying the arrival overseas of balloon troops. This condition made it imperative to establish a balloon school in the American Expeditionary Forces. The school was first located at Cuperly (Marne), close to the French balloon school of Vadenay, from which valuable technical assistance was secured. The enemy advance in the latter part of March, 1918, made necessary a hasty move, and Camp Souge was chosen for the new location. The first classes at Souge began on May 5, and from that time a new class for observers and maneuvering officers was started on the 6th of each month, including December 1918, the month in which the activities of the school ended. The classes graduated a total of 199 officers and trained 623 soldier specialists, who were taught the operation of balloon winches, telephone line work, look-out work, machine

gunnery, and radio operation. It was necessary to maintain the school in France for the instruction of observers detailed from the Artillery and other arms of the American Expeditionary Forces, as well as for the instruction of Balloon Section enlisted men seeking commissions in this branch.

### Failures to Qualify.

Twenty per cent of the officers taking the observer's course, and 12 per cent of those taking the maneuvering course, failed to qualify. It was found that officers with no previous balloon experience were not qualified to follow the advanced instruction given at the balloon school unless given preliminary training of three or four weeks with a balloon company. Attached officers who were found unsuitable as observers were returned to their own arm of the service. Officers commissioned in the Air Service and found unsuitable for balloon work were assigned to supply or other administrative duties, provided that they were properly qualified; if not, they were reported for reclassification and assignment to other arms of the American Expeditionary Forces.

### Operations.

In the Services of Supply, 4,224 ascensions were made, covering 3,721 hours; in the

Zone of Advance, 1,642 ascensions were made, covering 3,111 hours; this gives a total of 5,866 ascensions, with a duration of 6,832 hours. Artillery adjustments numbered 623 in the Service of Supply and 316 in the Zone of Advance, making a total of 939 (each artillery adjustment comprising all the shots fired at one target). Balloons were attacked by enemy airplanes on 89 occasions. Thirty-five of our balloons were burned in this way, 12 were destroyed by enemy fire, and one blown over the lines.<sup>2</sup> Our observers jumped from the basket 116 times, and in no case did the parachute fail to open properly. One life was lost because pieces of the burning balloon fell on the descending parachute. Several observers were injured in rough landings, and two were captured when during a high wind the cable of their balloon broke and they were blown into the enemy lines.

### Summary of Surveillance Reports.

A summary of general surveillance reports from balloons includes the following totals: Enemy shell bursts reported, 12,018; enemy airplanes sighted, 11,856; enemy balloons reported in ascension, 2,649; enemy batteries observed firing, 400; enemy infantry seen, 22 times; enemy traffic on roads and railroads reported, 1,113 times; smokes, fires, and flares reported, 2,941 times; explosions and destructions reported, 597.

### In the Offensives.

The 1st and 2d Balloon Companies took active part in the operations north of Chateau—Thierry during the latter part of July, 1918, while serving with the 1st Army Corps. Both these companies kept up with the advance at all times, the 2d Company building six different balloon sheds within 10 days. During the St. Mihiel offensive the balloon troops with our 1st Army consisted of 15 American and 6 French companies. In the Argonne

*Ascending balloon.*

*Observer climbs into a basket of an observation balloon.*

*Balloon shot down by enemy fire.*



battle, 15 companies, including 2 French companies, operated with the 1st Army. There were four American companies with the 2d Army.

### **Shortage of Balloon Troops.**

The few companies available attempted in every possible way to make up for our serious shortage of balloon troops. The 2d Balloon Company, for example, was sent to the front in February, 1918, and from that time until the signing of the armistice, it was only once relieved from front line duty, and then for a period of only one week. From the beginning of the Second Battle of the Marne until November 11, 1918, this company was almost continually engaged in open warfare. The service of the 3d and 4th Companies was almost as strenuous. It is doubtful if the combat troops of any other arm of the service have operated so continuously at the front. Whatever measure of success has been attained by American balloon troops with the armies has been due to the determination of the personnel to overcome all obstacles and to work to the limit of human endurance in order to do their share toward defeating the enemy.

### **Equipment.**

There has been no occasion on which a Balloon Company of the American Expeditionary Forces has been unable to operate because of lack of equipment. Owing to the failure of companies to arrive as rapidly as desired there was on hand on November 11, 1918, sufficient equipment to maintain the 35 companies for one year. Balloon equipment was procured either from the French or from the United States on requisition through the established agencies of the Supply Section. The distribution of special equipment was left to the Balloon Supply Officer. It was handled with a minimum of paper work by troops in the field. The first 10 companies to arrive overseas were completely supplied with French equipment, since replaced in constantly increasing quantities by equipment arriving from the United States.

### **Balloons and Winches.**

The two principal items of equipment were balloons and winches. Twenty type "R" balloons of French manufacture were secured at first, after which American-made balloons were received in sufficient quantities and constantly improving quality. In all, 265 American balloons were received, 30 being furnished to

the French and 15 to the British upon their requests. Losses of balloons included 35 burned<sup>3</sup> by the enemy, 1 because of the cable breaking, 12 destroyed<sup>4</sup> by shell fire, and 25 condemned on account of long service. For the year ending October 1, 1918, the French requirements were 4<sup>4</sup>/<sub>7</sub> balloons per company per year. Our statements to the United States were based on an allowance of 6 balloons per company per year. The French double-engine balloon winch, known as the Caquot, was considered the most efficient developed up to this time. Fifty of these were obtained from the French. Although they were reproduced in the United States, none of American make reached France. The early adoption by the aeronautical mission of the Aircraft Production Board of the successful French type "R" balloon and Caquot winch, and their immediate reproduction in the United States, proved a wise procedure and resulted in a great saving of time.

### **Hydrogen.**

Hydrogen supply was assured by pooling all our resources, including chemicals and cylinders, with the French. Most of the gas was produced by commercial plants under contract with the



AIR SERVICE, A. E. F.

### GENERAL FLOW OF AERONAUTICAL MATERIAL BALLOONS AND BALLOON SUPPLIES

AS OF NOVEMBER 11, 1918

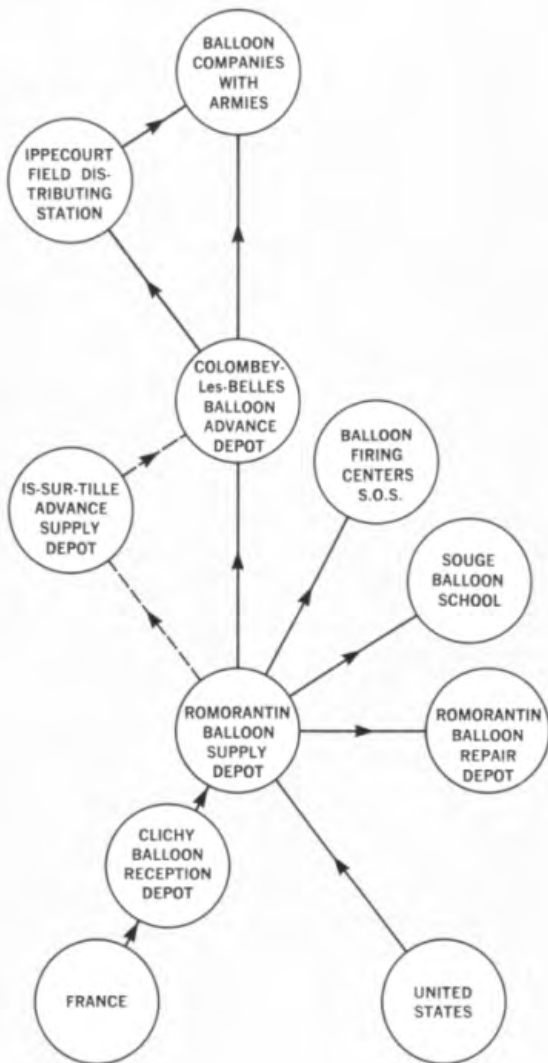

----- BALLOONS ONLY THROUGH IS-SUR-TILLE



Observers parachute from French balloon shot down by enemy fire.

French Government. The average price paid for hydrogen was practically the same as that paid to commercial plants in the United States. A total of 51,345 cylinders were received from the United States, of which 34,545 were filled when received. For the production of hydrogen 1,857 tons of ferrosilicon, sufficient to produce more than 82,500,000 cubic feet, were shipped to France. The total amount of compressed hydrogen received from the French was only a little more than 7,000,000 cubic feet, or about one-eleventh of the quantity obtainable from the ferrosilicon shipped from the United States. The average daily consumption of hydrogen for a balloon company in active operations was found to be 2,600 cubic feet. Our generous contribution of chemicals for the manufacture of hydrogen made it practicable for the French to expand their protection balloon service to an extent that would not otherwise have been possible.

### **Plans for a Large Hydrogen Plant.**

In order to prepare for the Air Service program to June, 1919, and to supply the demand for hydrogen to inflate

the small balloons for carrying propaganda into enemy countries, plans were made to construct near Paris the largest hydrogen plant in the world, with a production of one-half million cubic feet daily. This plant would have been in operation by March 1, 1919.

### **Transportation.**

The statement that equipment and supply were satisfactory refers only to Air Service equipment. Several balloon companies were at times unable to operate on account of the shortage of transportation, and the efficiency of others was greatly reduced by the same cause. On November 11, 1918, the balloon companies had only 40 per cent of the transportation allowed them by the approved Tables of Organization. The change from trench warfare to open warfare involved no particular difficulties for our balloon companies except those caused by the lack of sufficient motor transportation.

### **Balloon Barrages.**

Although the American Army did not undertake the installation of barrage balloons for the protection of cities and factories, the Balloon Section procured samples of French equipment both for the balloon school at Souge and for shipment to the United States. In addition to this a field officer was sent to the French protection balloon school, where he took the complete course of instruction and visited many of the French protective balloon installations. Sufficient information is therefore in the hands of the Balloon Section of the Air Service to provide protective service whenever necessary.

### **The Repair Depot.**

The inspection and repair of balloons, adjustment of cordage, repair of parachutes, etc., was accomplished at the repair depot first established at Is-sur-Tille, and later removed to larger and more satisfactory buildings at Romorantin. This depot inspected and adjusted 163 balloons, made complete sets of rigging for 71, and extensive repairs on 28. Seventy-four parachutes were repaired. The depot was called upon also for other varieties of fabric work, such as aerial targets for the Air Service.



### General Remarks.

The procurement of balloon observers by assignment from the Artillery only, a plan which was effective until August, 1918, was not satisfactory. When Artillery officers were detailed as balloon observers against their inclinations, the result was a waste of time and effort. The procurement of balloon equipment by the Supply Section and its distribution by the Balloon Section gave entire satisfaction. The life of our balloons can be materially lengthened when it is possible to provide hangars for their protection. Under existing circumstances company requirements should be estimated at six balloons per company per year. Experience in the field proved the value of carrier pigeons. Except for dirigible and airplane use, the basket-type parachute is preferable to the individual type, and it is suggested that all parachute fabric should be treated with fire-proof solution. The French type "R" balloon was satisfactory, but a similarly shaped balloon of the extensible type is preferable on account of greater economy of gas consumption.

*Lt. Col. John Paegelow, Commanding Officer, 1 Army Corps Balloons, later became Balloon Officer, Air Service, Group of Armies.*

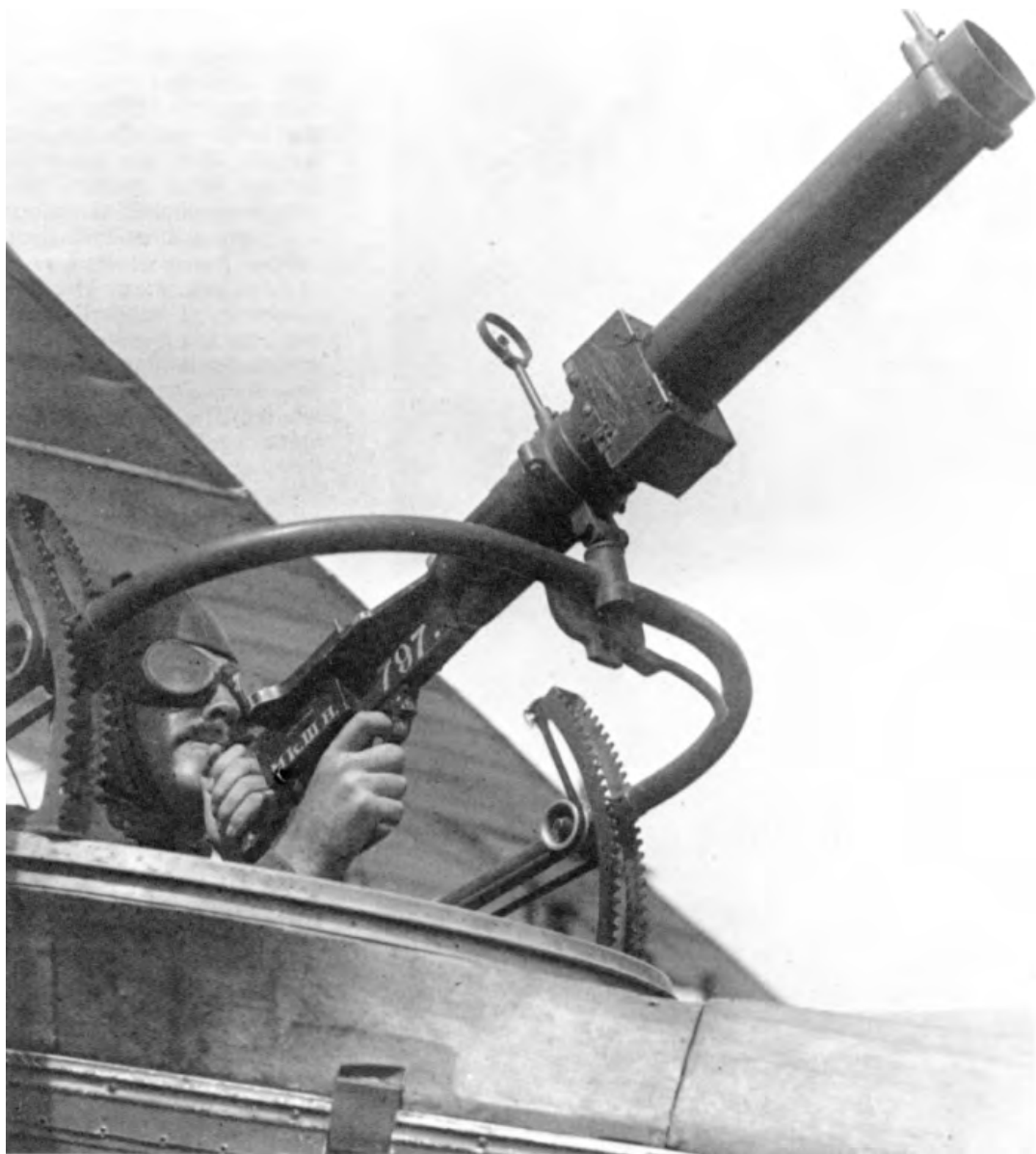

# XIV. The Aircraft Armament Section.

## Origin of the Section.

Shortly after our declaration of war, a preliminary survey of the aircraft-armament situation was made by officers of the European aircraft mission of the Aircraft Production Board. During the summer of 1917, questions pertaining to armament were handled by Air Service personnel of the Technical Section of the Air Service, and in November, 1917, four Ordnance officers were attached temporarily to the Technical Section.

## Placed Under Ordnance Control.

The Aircraft Armament Section<sup>1</sup> is now a unit of the Ordnance Department, but works in intimate liaison with the Air Service. Up to the spring of 1918, the Aircraft Armament Section acted mainly as a technical advisor to the Air Service, as all supplies of armament and ordnance material were under control of the Supply Section, Air Service. On April 15, 1918, however, an agreement was made between the Chief Ordnance Officer and the Chief of Air Service (superseding the

tentative agreement of December 13, 1917), whereby the Aircraft Armament Section took over the supply and control of all armament material. A special system of supply, under exclusive Ordnance control, was organized, and has so functioned up to the close of hostilities.

## Early Difficulties.

It was contemplated that the Air Service should procure airplanes as rapidly as possible from the allied Governments, and in planning to obtain these airplanes it was specified that they should be turned over to the American service fully equipped with armament. The allied Governments, however, proved unable to deliver the airplanes equipped as contemplated. It became necessary, therefore, to arrange for the manufacture of a variety of parts and accessories which could best be made in French factories, and it was for this reason that the Aircraft Armament Section was located in Paris, the industrial center of France. It soon proved undesirable, however, to have all of the manufacturing and installation work done in these factories, and in order to expedite matters a machine shop at Courbevoie, a suburb of Paris, was taken over from a private concern and developed until it provided a large proportion of

the manufacturing facilities demanded by the section's program.

## Installation Fields.

At Orly and at Romorantin installation fields were established for the purpose of installing armament equipment on airplanes as they were delivered to us by foreign Governments and from the United States. Up to the close of hostilities, 1,672 airplanes were equipped with armament at Orly and 1,331 at Romorantin. This section was able at all times to meet the delivery of foreign-built airplanes as well as<sup>2</sup> to meet delivery of those built in America. Facilities were provided for the modification of equipment, for "running in" and testing machine guns, and for modifying the various types of bomb-dropping apparatus which had to be adapted to the classes of bombs purchased from different sources.

## Personnel.

This section had developed from a personnel of 1 officer in August, 1917, to 5 on November 1, 1917, and to 3,216 officers and soldiers on November 19, 1918, including all the armorers working in squadrons, and 995 men in training at the armament

*A machine gun on a Scarff mount ready for action.*

school, St. Jean-de-Monts. On the date of the armistice it was handling approximately 2,600 items of armament for the Air Service of the American Expeditionary Forces.

### **Organization of the Section.**

The Aircraft Armament Section was divided into four branches: (1) Engineering, (2) Equipment, (3) Supply, and (4) General Control and Administration. These branches were all located at the Paris headquarters. The installation field at Orly was devoted to work on foreign type airplanes, while the field at Romorantin was devoted to American-built machines. This section also maintained personnel working in conjunction with the Air Service in advance, intermediate and base depots, such as Colombey-les-Belles, Behonne, Vinets, and Chatillon.

### **The Paris Depot.**

At 10 Rue Huyghens, Paris, the section had its own depot, which, in connection with those mentioned above, worked to keep the squadrons equipped with ammunition and armament material. The main machine shop at Courbevoie looked after the manufacturing of small parts, and certain other classes of work were still done in factories about Paris. At Orly, St. Jean-de-Monts, and Clermont-Ferrand experimental fields has been established, where the various classes of armament material were tested.

### **The School at St. Jean-de-Monts.**

At St. Jean-de-Monts, under the auspices of the chief ordnance office, there was a training school for ordnance personnel, including supply officers, ordnance officers, and armorers, for duty with squadrons. This school trained practically all of the 3,000 men who

were prepared for service in the field, approximately 1,000 of whom were under instruction when hostilities ceased.

### **The Engineering Branch.**

The function of the Engineering Branch of this section was to design and develop machine-gun parts, airplane cannon, gun mountings, sights, synchronizing gears, bombs, bomb gears, link fabric belts, armor plate for airplanes, etc. It became necessary to design armament material for production in France, pending its production in the United States. Problems of installation of American armament on foreign airplanes were met almost daily, and overcome only after much study and experiment. An idea of the amount of designing and drafting this made necessary may be had from the fact that at the time of the armistice there were over 3,000 blueprints in the files of the Engineering Branch. The trouble with the Marlin guns is a typical instance of the emergencies which had to be met. The first consignment of these guns arrived in February, 1918, but was not accompanied by any drawings, and it was found that the type of gun in quantity production contained no synchronizing gear connections. In order to mount it, the guns had to be rebuilt and the airplane al-

tered. Finally, in August, when a serious shortage of Vickers guns seemed possible, the French Government consented to make the necessary changes in the machines being delivered to us. The gun connections had been already designed and placed in production, and during August 1918, Marlin guns were mounted on Spads for the first time. In October, 1918, Salmson airplanes, also prepared to mount the Marlin, were delivered to us. Armament studies had been made for mounting these guns on other late-model service airplanes (including the Breguet-Liberty and LePere), though the cessation of hostilities prevented the parts from being manufactured.

### **Liaison with the Front.**

In order to anticipate the needs of the squadrons and familiarize armament officers and pilots with new devices, an experimental officer made frequent trips to the Zone of Advance. These trips put the Engineering Branch in touch with changing conditions at the front, and were the means, for example, of introducing the Marlin gun to our pilots, a few weeks before it was regularly installed on new airplanes.

### **Equipment Tables.**

The Engineering Branch has prepared detailed descriptions of the armament material in use, as well as complete equipment tables for the latest service airplanes. The files also contain armament specifications for the service airplanes used by the French and British, and studies of the armament of German airplanes are now being made.

### **Difficulties Encountered.**

There has been scarcely an item of armament material in which some changes or development were not necessary. Some of the more important difficulties encountered overseas by the Engineering Branch were: The confusion caused by the .303 and .30 caliber machine guns, remodeling the ground-type Vickers for air work, arranging the Marlin gun to fire by means of the French mechanical synchronizing gear and equipping it with a jam preventer, modifying the Lewis gun for use in the air, and designing practical machine-gun mounts, bomb racks, etc.

### **Standardization.**

In the past the matter of armament standardization has not been entirely satisfactory; practically all airplanes, for instance, have been designed

to use certain specified armament, making change of armament extremely difficult. This phase of the subject seems worthy of study for a number of years to come, or until the existing material which is satisfactory and serviceable shall have been utilized. The Vickers and the Marlin have proved satisfactory. Armament installation should be regarded with an eye to no single gun or synchronizing gear. The French airplanes, redesigned to receive the Marlin gun, had been so arranged that either the Vickers or the Browning could be installed with no great changes. This example seems worthy to be followed by the designers of aircraft-armament layouts for some time to come.

### **Bomb Unit.**

The bomb unit of the Engineering Branch was intrusted with the study and design of bombs and pyrotechnic material. The problems constantly met and solved were parallel to those encountered by the machine-gun unit. It was necessary to make a close and constant study of all the accomplishments of our Allies in this phase of modern warfare, in order to bring our bombing equipment up to the high standard attained by other services. In America,

bombs different in type and character from those of our Allies were being manufactured. In order to drop these bombs from the foreign-built airplanes with which, it was contemplated, the American Air Service was to be equipped, it was necessary to construct new types of bomb suspensions, releases, gears, sight mounts, etc. The bomb unit, both through the study of foreign practice and by actual experiments, was able to meet all demands placed upon it by the Air Service, and has now in its files material which will form a splendid basis for further development of this important weapon of war.

### Equipment Branch.

In the beginning, the Equipment and Engineering Branches of the section were conducted under one head, but with an increasing demand for the armament of airplanes, it became necessary to separate the two. The Equipment Branch provided for the production of armament material and accessories in French factories prior to the establishment of our own machine shops and continued this production in our own shops and installation fields when the demands of the Air Serv-

ice necessitated their establishment. The duties of the branch consisted in the inspection before delivery, the installation and the maintenance of armament material, up to the point at which such material was totally lost to the service, either through loss over the lines, or complete destruction. It was charged also with the salvage of material not completely destroyed, and acted as liaison agent with the squadrons in receiving weekly letters from their armament officers, who pointed out difficulties encountered, kept track of the expenditure of ammunition and reported on any inventions or experimental work done at the front. In October, 1918, the aircraft armament officer on the staff of the ordnance officer of the First Army became the liaison agent of this section. The Equipment Branch published weekly bulletins of information useful to officers and

agents of the Aircraft Armament Section in improving the service.

### .30 and .303 Calibers.

One of the chief difficulties encountered by the Equipment Branch was caused by the difference in caliber of the ammunition used by the French and American Air Services. In order to use our ammunition it was necessary to install new ammunition boxes on the airplanes, a step which appears simple, but which in reality could only be done in the factory, before the airplanes were delivered to us. After several months of effort, and in view of a shortage of Vickers guns, the French finally consented to build our airplanes with .30 caliber ammunition boxes, thereby relieving this section of a great source of trouble.





### **At Orly.**

By the end of June, 1918, a large number of airplanes had been accepted by the American Air Service and flown to Orly for their equipment. As the armament of these airplanes proceeded, it was found necessary to form an installation unit to mount the guns, sights, etc., a testing unit to test the synchronization of the guns, and an inspection unit to see that the material was perfected and the installation properly done. As the guns received from the United States were new and stiff and it was considered necessary that armament on airplanes leaving Orly should be ready to be used in combat, with the possibility of jams reduced to a minimum, a "running in" plant for machine guns was installed. The armament of foreign-built airplanes at Orly continued until the close of hostilities.

### **At Romorantin.**

The history of the Equipment Department at Romorantin is a record of the arming of the American DH-4 airplanes for active service. About May 15, 1918,<sup>3</sup> when the first shipment of these airplanes was received, it was discovered that it would be necessary to complete the armament, run in the machine guns, and make the necessary changes. A large plant

and an adequate force became necessary. Day and night shifts were worked from July 25 to November 11, at which date the armament personnel numbered 511, of whom 31 were officers.

### **The Handley-Page Question.**

The Equipment Branch of the Aircraft Armament Section followed closely the attempts of the Air Service to procure airplanes for night bombardment purposes, and had worked out problems incidental to the arming of the Handley-Page machines, which were to be assembled in England. When the signing of the armistice put an end to this activity, the materials received were reboxed and re-shipped to the United States.

### **The Supply Branch.**

The Supply Branch of the Aircraft Armament Section procured, produced, maintained, and distributed supplies of aircraft armament material. It received requisitions, placed orders, made deliveries, maintained warehouses, and kept the records involved in these transactions. The Supply Branch was authorized to draw material from the Ordnance Department, or to purchase it from foreign Gov-

ernments, this latter under a definite system of requisitioning.

### **First Depot.**

In April, 1918, an inventory of all aircraft armament material was made, and the first armament depot established. An adequate system was provided for buying from French warehouses and factories through the Purchasing Division of the Air Service. About the middle of August, the warehouses of the several depots were so well stocked that demands for double supplies of armament for a prospective drive were met with very little difficulty. About July 1, 1918, a typical layout of buildings necessary for armament supply officers at air depots was furnished to the Designs and Projects Division of the Air Service. In October, 1918, the Supply Branch formulated a table of unit equipment designed for the maintenance of supplies on the basis of the number of guns with which the unit was equipped.



### **Accomplishment of the Section.**

The Photographic Section<sup>1</sup> of the Air Service, during the short period of its existence, had placed our aerial photography on the same high level as that of the allied armies. Requirements of the Air Service for photographic supplies and personnel in the Zone of Advance have always been promptly met, but this at times was accomplished by a narrow margin and not without sacrifice elsewhere.

### **Personnel.**

Since October, 1918, the soldier personnel has been sufficient to meet all requirements, and on November 11, 1918, the photographic personnel in the American Expeditionary Forces was large enough to meet the Air Service program up to January, 1919. There existed a shortage of specialists, owing to the fact that qualified officers with the training necessary for this

work were difficult to obtain, and it was not until November 6, 1918, that this serious shortage was relieved.

### **Training in the United States.**

The Photographic Sections arriving from America were of excellent material, and their training, received at the Rochester School of Aerial Photography, was highly satisfactory.

### **Equipment.**

In the United States, at the time of our declaration of war, aerial photography was almost unknown, and it was necessary to make a study of the material used by our Allies with a view to selecting and producing in quantity for our Air Service the latest and most satisfactory equipment. Meanwhile, it was realized that the Photographic Section, to fill the immediate needs, must depend on European sources of supply. Owing to the depleted conditions of these markets, it was extremely difficult to secure the required materials in Europe, for what raw material remained available was of low grade, particularly in the case of plates and paper. Bromide paper was at one time almost unobtainable, and until the opening of a new bromide paper factory near Paris by an American photographic manufacturer,<sup>2</sup>

the skill of the Photographic Section was taxed to the limit to obtain the desired results on a less satisfactory paper. Since the arrival of American materials, the photographic work produced shows an improvement of at least 50 per cent. Up to the close of hostilities, 15 photographic section equipments had arrived from the United States. In April, 1918, the Photographic Section prepared an equipment list which was adopted as standard for the American Expeditionary Forces.

### **Lens Difficulties.**

The most serious problem on the hands of the section during the early days of its service was that of securing photographic lenses. It was only after the most persistent effort, first exerted in the summer of 1917, that this matter was finally brought to the attention of the highest French authorities, and the question placed before an interallied board. Under the direction and guidance of the French Service Geographique, the production was soon increased and the output placed on an allocation basis entirely satisfactory to our Air Service.

*Aerial observer reaches for camera prior to a reconnaissance mission.*

### **Transportation.**

With the exception of the electrical generating set the American photographic trucks and trailers proved better than the French. The American set had a capacity of only 1 kilowatt and was not of standard voltage. The standard 110-volt equipment permits the use of local current when available. At the front, the section was seriously handicapped by lack of the authorized motorcycle transportation.

### **Training in the American Expeditionary Forces.**

As there was no American personnel available for this purpose, the photographic training of pilots and observers at Air Service training centers was generally intrusted to the French, and it was not until shortly before the close of hostilities that the section was able to send its own instructors to the more

important centers. In July, 1918, the Air Service considered the establishment of a specialist course in aerial photography at one or more of the training centers, but the project could not be put into effect before the close of hostilities.

### **Cinema Training Films.**

Through the Interallied Photographic Conference arrangements had been made for the mutual exchange of motion-picture training films. The films made by the British and French for this purpose cover a considerable range of subjects, and it was intended primarily to use them for the benefit of training schools in America. At the close of hostilities the first consignment of these films had just been received from the French.

### **Operations.**

The Photographic Section developed and finished all the aerial photographs made at the various training centers, as well as at the front, and was intrusted with the production of training gun films, identification photographs of Air Service personnel, and photostat work.

### **At the Front.**

Although the normal output of the Photographic Section working with squadrons at the front might properly be considered mass production, it is true that special occasions arise when this mass production is inadequate. Early in the war, this mass production was assigned to G-2, but during the first part of the Argonne offensive it was found necessary to call on the Photographic Section of the Air Service to meet the enormous demands for photographs. In view of the success with which this impromptu work was achieved (56,000 prints being produced and distributed in four days), a project to have the Photographic Section of the Air Service take over such work in the future was submitted to the general staff, American Expeditionary Forces, in October, 1918, and approved. Within one week three base photographic laboratories were established; one with the 1st Army, one with the 2d Army, and one as a base laboratory for all armies and general headquarters. These laboratories were equipped with apparatus for making enlargements and large direct copies of assemblages and mosaics, as well as for speedy production of the enormous quantities of reprints from the aerial negatives required previous to an offensive.



*Camera mounted on a Salmson (upper left), and a movie camera operator (upper center) prior to observation flights. Printing room at the School of Aerial Photography at Tours (upper right). Photo interpreters form composites (lower left) and model aerial maps for training observers (lower center). Composite maps show the "Hindenburg System" (lower right).*

### **Output of the Section.**

In spite of the fact that our greatest quantities of photographic work were produced during periods of poor light and unfavorable weather conditions, new speed records were established. The maximum amount of work planned for a photographic section was 10,000 prints per day. Photographic Section No. 5 made a record of 11,500 prints in one day.

### **With the 1st Army Observation Group.**

The 1st Army Observation Group, which was charged particularly with long-distance reconnaissance, became a specialist photographic group, and as such produced an unusual number of valuable photographs. Although the Tables of Organization contemplated but one photographic section to each observation group, it was necessary to assign two complete sections and equipments to this group. During the few clear days which preceded the offensive of November 1, the activity was such that these sections pro-

duced 10,000 photographic prints in one day, and it is recorded that at one time this group of two squadrons had 14 cameras over the lines.

### **The De Ram Camera.**

In August, 1917, the De Ram automatic plate camera<sup>3</sup> was selected by the Air Service, American Expeditionary Forces, as the most desirable aerial camera for use during the campaign of 1918. In spite of meager facilities, the De Ram camera was successfully produced in France and it received its baptism of fire in the Argonne offensive, where it was employed by the observation groups with the 1st Army. With this camera the observer is not obliged to crouch in the fuselage, continually changing plates and making exposures, but is entirely free to use his eyes, and his machine gun when necessary. In one case two of our airplanes, engaged in a photographic mission, were attacked by seven of the enemy. They succeeded in driving off the enemy airplanes and shooting down two of them, without in any way interfering with their photographic work, which was successfully and automatically accomplished throughout the fight by the De Ram camera.

### **A Word of Praise.**

The long hours and working speeds required of the laboratory forces during periods of activity made the work very arduous, particularly the night work, in closed and stuffy dark rooms. The men fully realized the importance of their work and the necessity for speed, and their tenacity through these long periods without sleep or relaxation was admirable.

### **Relations with the Allied Services.**

The Photographic Section is especially indebted to the numerous officers of the allied photographic services with whom it has come in contact. The French mission has rendered valuable services to our aerial photography in all its branches, and the Photographic Branch of the Royal Air Force has always been most generous with any material required.

### **Work on Military History.**

As the sections were still mobilized for active service, new work was undertaken after the armistice. The classification and filing of all aerial negatives was undertaken, and every effort made to complete the photographic side of the military history of the war.

Ground photographs were made of all the important points pictured in aerial photography, so as to make the latter as intelligible as possible, both for future training purposes and for military history. Steps were taken to obtain from the French and British photographs of areas in which American units had fought in liaison with the allied forces, areas which, in many cases, had not been covered by our Air Service. In these aerial pictures will be read the history of our contribution to the great struggle, and they will depict the sum total of man's ingenuity turned to a work of devastation.



*Capt. Albert W. Stevens with a De Ram camera mounted on a Salmson of the 24th Aero Squadron.*







## Origin of the Section.

Before the formation of the Radio Section,<sup>1</sup> the Technical Section of the Air Service, which began its operations in August, 1917, handled all questions concerning Air Service radio. During this period the Technical Section, in its advisory capacity, and after extensive technical investigation of British, French, and Italian apparatus, caused an order to be placed (by the Signal Corps for the Air Service) with the French Government for about \$1,000,000 worth of Air Service radio equipment. The formation of the Radio Section of the Air Service was authorized on April 9, 1918, and the preliminary work necessary to provide an immediate supply of apparatus, and to install this apparatus on airplanes, was at once undertaken.

## Technical Development.

Throughout the operations of the American Expeditionary Forces, all technical development in the production of radio apparatus for use on airplanes was in the hands of

the Radio Development Section of the Signal Corps in the United States, and the assistance of radio experts of the Research Division of the Signal Corps, American Expeditionary Forces, was given to the Air Service in the most generous and satisfactory manner.

## Equipment.

Equipment purchased from the French Government was used to fill the needs of the Air Service as regards apparatus for radio liaison with the Artillery, and a total of 1,688 installations of this radio apparatus on airplanes, both for training purposes and for actual operations, was made in the American Expeditionary Forces up to the close of hostilities. Electrical material for the heating and lighting of airplanes, as well as apparatus for illuminating airdromes for night-flying operations, was also purchased from French sources.

## Radio Telephony for Interplane Communication.

Samples of airplane telephone apparatus received in the American Expeditionary Forces during May, 1918, were turned over to the Research Division of the Signal Corps, and flying facilities for testing this apparatus were provided at the experimental field of the

Technical Section, Air Service. It was intended, provided the apparatus fulfilled active service requirements, to commence training in voice-command flying at the 7th Aviation Instruction Center (Clermont-Ferrand) on a sufficiently large scale to permit the simultaneous operation of as many bombing squadrons as possible, using this system. Owing to various technical and mechanical defects, the details of which have already been covered in reports by the Research Division of the Signal Corps, the apparatus did not prove satisfactory. None of this apparatus was employed in operations on the front.

## Night Flying by Radio Direction.

The navigation of night-flying airplanes by radio direction, which was developed by the Royal Air Force in England during January and February, 1918, was investigated, and an extensive program for using this system in our night-bombing operations was adopted. A radio installation detachment of 60 men who had been given previous training in British radio schools was established at the Handley-Page factory in Oldham, Lancashire, in readiness for

the commencement of the American Handley-Page construction program at that point. Pending the development of apparatus in the United States, a contract was placed with the British for 550 special radio navigation sets to equip our night-bombing airplanes. A school for the instruction of flying personnel in the night navigation of airplanes by radio direction was established at the training and mobilization field of the Night Bombardment Section, Ford Junction, England. This school was opened on September 15, 1918, and 28 officers and 70 soldiers were enrolled as students, though none of this personnel completed the prescribed course before the signing of the armistice.

### **Radio Liaison with Artillery.**

In August and September, 1917, the Chief of the Technical Section,<sup>2</sup> Air Service, made a study of Air Service radio communication as regards cooperation with the Artillery, and after conferring with officers of the Italian, French,

and British Air Services, it was recommended by him that the Air Service, American Expeditionary Forces, should take immediate measures to provide its own personnel for the operation of special stations to receive airplane radio signals at batteries and higher artillery commands. The system by which such ground stations are provided and controlled by the Air Service itself had been in effect in the British Expeditionary Forces since the inception of fire control by airplane radio in December, 1914. The subject was referred to the chief signal officer, American Expeditionary Forces, and, based on his recommendations, an agreement was approved on October 10, 1917, whereby the Signal Corps was to have charge of radio stations for communication with airplanes. For this reason, no action was taken by the Air Service toward the development of a force of radio operators to conduct its liaison with the Artillery.

### **Division of Responsibility.**

The establishment by the Artillery of a separate radio organization to maintain both its interior ground liaison and its communications with airplanes had, however, been approved in the United States, and Artillery brigades arriving in France after January 1, 1918, included certain radio personnel for this service. It was found, however, that this personnel had not had a sufficient course of training before arriving in France. Under General Order 30, Section VII, paragraph 3-F, general headquarters, American Expeditionary Forces, February 15, 1918, the Signal Corps was required to supervise Artillery radio stations, both in training and operations, including stations for communication with airplanes. The personnel for maintenance of radio equipment on airplanes was included in Air Service Tables of Organization of January 15, 1918, and also in the revision of these tables as approved by general headquarters, American Expeditionary Forces, on September 8, 1918. A situation was thus created by which three separate divisions of the responsibility for radio efficiency ensued between the transmission of a message from an airplane and the delivery of the message to the artillery command concerned.

There was the responsibility of the Air Service squadron commander, charged with the correct procedure of his observers in using the radio apparatus on the airplane, and the efficiency of the radio detachment of his squadron which maintained it; the responsibility of the Signal Corps radio officer charged with supervision of ground artillery stations; and that of the Artillery radio officers and operators, who reported direct to commanders of their own batteries or other units. This division of responsibility did not make for efficiency and there were many cases of failure in liaison between artillery and aero squadrons dispatched to conduct fire-control missions.

### **Training of Squadron Personnel.**

A shortage of suitable personnel in the spring of 1918 made it impossible for the Air Service, American Expeditionary Forces, to conduct the advanced training necessary for its squadron radio officers and radio mechanics, and the radio school established in connection with the 2d Aviation Instruction Center, on May 23, 1918, was supplied with instructor personnel by the Radio Division of the Sig-

nal Corps. The school was well equipped and efficiently conducted, and up to the close of hostilities, a total of 37 Air Service radio officers and 161 radio mechanics and operators for squadron maintenance duties were given final training and "refresher" courses and assigned to squadrons in the Zone of Advance.

### **Final Agreement with Signal Corps.**

General Order 152, general headquarters, American Expeditionary Forces, September 10, 1918, charged the chief signal officer, American Expeditionary Forces, with general supervision and control of all radio operations, including those of the Artillery, Air Service, Tank Corps, and other special services. Based upon this order

and because the Signal Corps had previously provided instructor personnel for the training of aero squadron radio officers and radio mechanics, an arrangement was concluded on October 2, 1918, by which the chief signal officer assumed responsibility for the training of all personnel of the Air Service requiring radio instruction; the development and supply, through the regular channels of the Signal Corps, of all radio equipment for the Air Service, and the installation of all radio equipment on airplanes. Air Service radio personnel was also to receive technical orders and operating instructions from the supervisory radio officers of the Signal Corps, and the reserve supply of airplanes radio apparatus was transferred to the supply system of the Signal Corps. Up to the close of hostilities no changes were made in airplane radio installation or methods of operation.





### **Medical Responsibility for Flying Fitness.**

In considering the medical aspects of aviation one salient fact has been emphasized by our experience in the present war: The need of the utmost discretion in selecting flying personnel and of the most constant and skillful care of pilots and observers while in training and in active service at the front. The basic principle is a simple one—the proper medical responsibility for flying fitness—and medical officers of special knowledge and ability should be at all times attached to the Air Service and provided with the proper facilities for a study of the problems involved.

### **The Medical Research Laboratory.**

In order to arrive at a knowledge of the problems that arise in connection with flying fitness, it is necessary to investigate the general conditions which affect the efficiency of pilots, to make experiments and tests to determine the ability of pilots to fly at high altitudes, to develop by test and experiment the best means of providing oxygen for pilots flying at high altitudes, and to study and develop the tests to which candidates for flying commissions are subjected.

With such investigations in view a Medical Research Board was organized at Mineola on October 18, 1917. The officers composing this board were physicians and surgeons of the very highest quality and specialists in the various departments of medicine covered by their investigations. The work of the Medical Research Board in the United States was from the first successful; its personnel increased and it developed a complete and specialized laboratory equipment. On August 6, 1918, a group of 48 officers and soldiers, divided into four units, embarked for service in the American Expeditionary Forces. The most important of these units was assigned to the 3d Aviation Center at Issoudun, where its equipment was set up and a complete medical research laboratory established. The splendid work of this organization is recorded in detail in its report. Tests and recommendations were made in regard to the personnel then under flying instruction at Issoudun and a very interesting series of special investigations were conducted concerning the condition of successful flyers returned from the front. It is not practicable as yet to give any conclusion as to the results of this investigation for the material collected of unique value in the history of aviation must be

carefully compiled and studied before the essential facts are adduced.

### **Special Leaves and Rest for Flyers.**

An important constructive accomplishment of the Medical Consultant's office<sup>1</sup> was the acceptance by general headquarters of the proposal that aviators be put on a separate leave basis from that in force throughout the Army. The experience of both the French and English air services has demonstrated the fact that flying men should have frequent rest and change of scene. The methods in use by our Allies might be improved by controlling places of recreation, so that the flyer may have a thoroughly agreeable change, with amusements and sports, away from the centers of population. Flying fitness is so intimately dependent on personal conduct and standards that no amount of legislation alone will produce the results desired; it is only through the active cooperation of the flyers themselves that we may hope to maintain the morale and esprit de corps which make for the maximum of efficiency.





### A Tribute to Our Allies.

No account of the activities of the Air Service, American Expeditionary Forces, would be complete without paying due tribute to the assistance rendered by the Air Service of the Allies. From the time of our declaration of war they threw open to us their sources of information, cooperated with us in every possible manner, and supplied us with much of the material we lacked so sorely. In all of the relations between our Air Service and those of the other powers alongside of whom we fought, there was ever present the finest spirit of helpfulness and cordiality. France in particular, on whose ravaged soil the decisive battles of the western front have been fought, supplied us, in spite of her own vast effort and dire need, with material without which our Air Service would have found it impossible to operate. England and Italy likewise aided us to the full measure of their ability.

### A Tribute to the Air Service Personnel.

Whatever measure of success the Air Service, American Expeditionary Forces, attained was above all other things due to the splendid qualities of its officer and

soldier personnel. The squadrons actually at the front worked untiringly, the flying officers displayed great gallantry, and the ground officers and the soldiers in the squadrons worked continuously, faithfully, and intelligently to make this service count for something in the war, to keep the equipment in order, and to promote efficiency. But much of the great task of carrying on a modern war is, however, performed far from the sights and scenes of battle, unstimulated by the heat of struggle, and without hope of glory. In the offices, in the shops, in the hangars, at depots, production centers, and at schools the soldiers of the Air Service have labored tire-

lessly at duties which were often irksome and monotonous. Their contribution to our victory was a large one, it was given in full measure, and in all cases they put into their work the best that was in them.

### Conclusion.

In the course of the development of the Air Service overseas mistakes have been made and disappointments have been encountered, as was inevitable in the building up of a new and highly technical arm. As we consider these errors with a view to their avoidance in the future, one fact stands out most prominently, one common source of all of our difficulties becomes apparent; these failures were the unavoidable result of our unpreparedness and of the necessity for actually preparing for war while hostilities were in progress.

Respectfully submitted.

Mason M. Patrick,  
Major General, U.S.A.,  
Chief of Air Service, A.E.F.







---

# **Tactical History of the Air Service**



---

## **Part 2\***

# **Tactical History of Corps Observation**

\* Part 1, The Achievement of the Air Service, AEF, has been eliminated in this section, since a revised and edited version appears at the beginning (Chapters I-III) of the "Final Report of the Chief of Air Service, AEF."



*The Eagle of Lille (Art by Meru Corning).*

---

The narrative to follow will deal with tactical phases of the history of the corps observation branch of the American Air Service operating on the western front. No attempt will be made to narrate incidents or events of a purely human interest nature. Only those phases and details of the ground covered by the corps observation organization having an important bearing, either direct or indirect, on tactics will be dealt with. The narrative, in so far as possible, will be carried on according to the chronological order of developments and events. Particular stress will be laid upon the development of the Corps Air Service in its intimate relation to other branches and arms of the service.

This history will tell, campaign by campaign, in sequence:

- (a) What the Corps Air Service was; its organization.
  - (b) What its mission was under varying conditions.
  - (c) How it planned to accomplish its mission.
  - (d) The operations undertaken in accordance with the plan.
  - (e) The work actually accomplished.
  - (f) Comments and criticisms, campaign by campaign.
- A final commentary in the form of a digest will conclude the history.

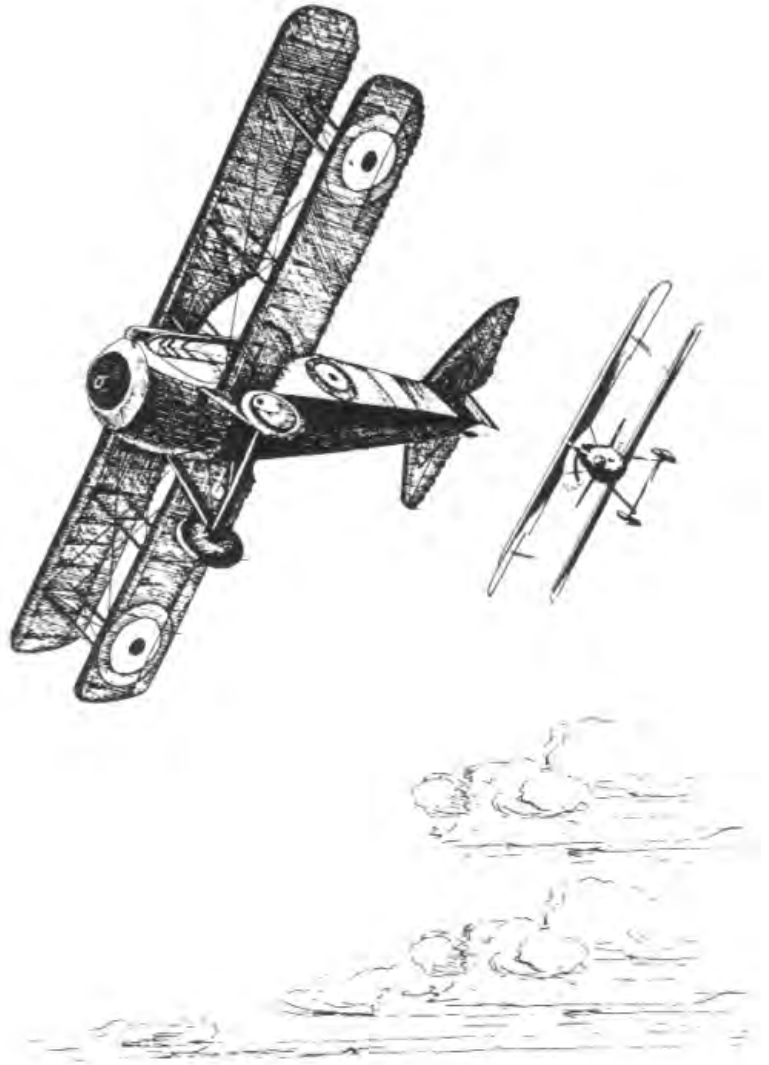

Spads

## **II. The First Corps Observation Group in the Toul Sector.**

---

### **What the Corps Air Service Was; Its Organization.**

Three squadrons composed the 1st Corps observation group, which early in April commenced active operations over the front occupied by the 26th Division, United States Army, between Flirey and Apremont on that portion of the front known as the Toul sector. The airdrome was situated at Ourches, about 30 kilometers behind the lines. The 1st, 12th, and 88th Aero Squadrons formed the group. The airplanes of the 1st Aero Squadron were of the Spad type, two-seater, 200-horsepower, Hispano-Suiza engine. Those of the 12th were of the A. R. type, two-seater, 190-horsepower, Renault engine. The 88th flew airplanes of the Sopwith type, two-seater, Rhone rotary engine, 120-horsepower.

The pilots of these three squadrons, with one or two exceptions, had never before operated on the front. The group and squadron commanders were in every case men of long experience in training work but had never flown to an appreciable extent under war conditions. The greater portion of the observers, after a course of intensive tactical and technical training in observation schools, had spent from one to two months on duty as active fliers with French squadrons at the front. These officers brought to their organizations a very considerable and exceedingly valuable practical knowledge of the work about to be undertaken.

The enlisted mechanical and special technical personnel was well trained and in most cases proved thoroughly qualified for the work in hand.

The installation and equipment of the airdrome was practically complete by the time the group of three squadrons was formed. Hangar and barrack space was ample and operations were not hindered by faulty or incomplete installation.

### **The Tactical Situation.**

The 1st Corps group was assigned for duty to the 26th Division, United States Army. The division sector extended along the front from Flirey to Apremont, a distance of 15 kilometers. No major operations were in course nor were any foreseen as an immediate contingency. Our positions were strongly organized for defense by lines of trenches and barbed-wire entanglements. Our troops were supported by the usual complement of divisional artillery organized in carefully prepared positions.

The friendly situation in the air was satisfactory. Two American pursuit squadrons with station at Toul were available for the aerial defense of the sector. These were sufficient in view of the inactive aspect of that portion of the front.

---

The situation of the enemy on the ground was essentially the same as our own. His lines were strongly organized, by means of trenches and barbed-wire systems, for defense. He was strongly supported by artillery of various calibers.

In the air the enemy was weak. Isolated observation airplanes were reported from time to time. No pursuit formations of more than five airplanes were operating, and the presence of pursuit airplanes, even in small numbers, over the sector was rare. The enemy depended for aerial defense very largely upon an unusually strong concentration of mobile antiaircraft artillery.

### **The Mission of the 1st Corps Group.**

The mission of the 1st Corps observation group was primarily to keep the friendly command informed of the general situation within the enemy lines by means of visual and photographic reconnaissances. It was called upon to effect, whenever necessary, the adjustment of our own artillery fire. It was required to be in readiness to accomplish contact patrols with our troops in case of attack. In addition, it was called upon to furnish the means of training our ground troops in the use of the aerial arm, e.g., to take part in terrain exercises with the troops of the 26th Division and to conduct panel exercises with the divisional artillery by means of radio. It was not expected at this time that the work of the 1st Corps group would produce any important tactical results or render any great assistance to the conduct of operations. It was expected, rather, that this period on a quiet sector of the front would serve to complete the schooling of pilots and observers and render them more competent to undertake intensive operations elsewhere on a larger and more complete scale.

### **Plans for Accomplishment of Mission.**

In order to fulfill its mission efficiently, to coordinate its activities, and to insure centralization of command and eliminate lost motion, the group headquarters was organized as follows:

- (a) Group commander.
- (b) Group adjutant.
- (c) Group supply officer.
- (d) Group transportation officer.
- (e) Group operations officer.
- (f) Assistant group operations officers.
- (g) Branch intelligence officer.
- (h) Group photographic officer.
- (i) Group radio officer.



---

### Functions of Group Officers.

The group commander was responsible for the accomplishment of the tactical and administrative functions of the group.

The group adjutant was responsible for all matters of routine administration pertaining to the organizations of the group. This officer was conceded no tactical functions.

The technical and routine supply of the organizations of the group was supervised by the group supply officer.

The group transportation officer was responsible for the solution and adjustment of transportation problems arising in the group.

The operations officer was responsible, under the group commander, for the successful conduct of aerial operations. It was the duty of this officer to plan the day's work in such a way as to most effectively carry out the demands of the tactical situation. It was his duty to keep in constant touch with the posts of command (P. C.'s) of combat troops; to fulfill their requirements, foresee their needs, and take such steps as appeared requisite to inform them thoroughly as to the possibilities and limitations of the Air Service in its relation to their work. He was further charged with the work of collecting, compiling, and distributing for the entire group all tactical data necessary to the proper functioning of the squadrons. He was responsible for the assignment to each squadron of its daily missions. He was charged with the preparation of the daily operations orders and operations reports of the group, and with the maintenance of an accurate file of all reports, orders, and other bulletins and data having to do with the conduct of the operations of the group.

The assistant operations officer seconded the operations officer in all his functions and replaced him in his absence.

The branch intelligence officer was assigned to the group by the G-2 section of the General Staff. This officer was responsible for the collection, compilation, and distribution of all information of the enemy pertaining, directly or indirectly, to aerial operations. He was further responsible for the collection, compilation, and transmission to all higher commands of information of the enemy gathered from Air Service sources. The assemblage, study, interpretation, and distribution of aerial photographs, functions which have to do properly with information of the enemy, was accomplished by the branch intelligence officer, assisted in each case by the observer who had carried out the photographic reconnaissance.

The group photographic officer commanded the photographic section. He was responsible for the photographic equipment of the group and was charged with the duty of supervising the installation of photographic apparatus aboard the airplanes of the squadrons. He supervised the development and printing of all photographs.

The group radio officer was responsible for the proper functioning of the radio equipment of each squadron. He commanded the group radio station. He acted as technical advisor and instructor to the entire group in all matters pertaining to radio. He was responsible for the accomplishment of the necessary liaison between the group and the radio stations of posts of command in the division. It was his duty to collect, compile, and transmit all data pertaining to the functioning of airplane and ground radio in accordance with the radio liaison plans of higher command.

### **Technical and Tactical Installations.**

By direction of the group commander and under the supervision of the group operations officer a center of tactical information and intelligence for the use of all organizations was installed at the headquarters of the group. This center was known as the operations room.

### **The Operations Room.**

In this room were conveniently displayed detailed large-scale maps of the division sector and of the enemy's defensive organization in so far as known. A bulletin board was installed, and on it appeared charts, diagrams, and tabulations of all available tactical and technical information collected by the operations and intelligence officers. Roomy worktables were provided for the use of pilots and observers.

*Rigging a post for receiving messages from airplanes.*



---

Maps and photographs for the individual use of flying officers were kept on file for distribution. A collection of technical books and pamphlets was provided for purpose of reference.

### **The Photo Section.**

A complete photographic laboratory and a shop for minor repairs of photographic apparatus was installed under the direction of the group photographic officer to supplement the photographic motor truck and trailer which formed a part of the equipment of the group.

### **The Radio Section.**

A group radio station was organized by the radio officer, using as its basis the radio equipment of one squadron. The radio station was equipped with sending and receiving apparatus of the E-3 bis type for terrestrial communication and with a receiving set of the artillery spark type for receiving airplane messages on short-wave lengths.

### **Group Security and Defense.**

In order to provide against the contingency of enemy air raids, the buildings and hangars of the group were camouflaged as carefully as the available means permitted. Camouflage nets were spread across the hangars. The roofs of huts were screened with boughs. Hangars and huts were widely separated and irregularly disposed. Refuge dugouts, from 30 to 40 feet underground, heavily shored with logs, were constructed. A post regulation, stringently enforced, required the screening of all lighted windows after sundown. Antiaircraft machine guns were scattered about the airdrome.

### **Tactical Organization of Squadrons.**

The tactical staff and personnel of each squadron of the group comprised the commanding officer; three pilots, designated as flight commanders; two observers, designated, respectively, as operations and assistant operations officers; 15 additional pilots, of whom three were designated as deputy flight commanders; and 16 additional observers. Each squadron was divided into three sections of six airplane teams each, each section known as a flight.

### **Technical Organization of Squadrons.**

Three technical sections having an important bearing upon tactical activities formed a part of each squadron.

The engineer department was headed by an expert mechanical officer (the engineer officer) and comprised the engine mechanic

---

personnel of the squadron, including the machine-shop and airplane repair units. This department was responsible for the maximum mechanical efficiency of engines and airplanes at all times.

The armament department, headed by an officer detailed from the Ordnance Department of the United States Army (the armament officer), assisted by a staff of specially trained gunsmiths, was responsible for the maintenance and repair of the machine-gun armament of the airplanes. This department was further responsible for the supply of machine-gun ammunition, star-shell pistols, and signal rockets, and for the maintenance of a stock of metal containers, with streamers attached, for use by the airplanes in communication with the ground by means of dropped messages.

The radio section, headed by an officer from the Signal Corps (the radio officer), was responsible for the installation of wireless equipment aboard the airplanes of the squadron and for its proper functioning. A staff of electrical mechanics was detailed from the enlisted personnel of each squadron to the radio sections. The squadron radio sections were under the supervision of the group radio officer and were required to lend him any necessary assistance.

### **Assignment of Tactical Duties by Squadron.**

The tactical work contemplated was assigned in the following manner:

To the 1st Aero Squadron:

- (a) Missions of a special nature requested by the command (command missions).
- (b) Long-distance photographic missions.
- (c) Adjustment of divisional heavy artillery fire.
- (d) Long-distance visual reconnaissance.

To the 12th Aero Squadron and the 88th Aero Squadron:

- (a) Short-range visual reconnaissance.
- (b) Short-range photographic missions.
- (c) Adjustment of light artillery fire.
- (d) Infantry contact patrols.

### **Assignment of Missions.**

The distribution and assignment of special missions to squadrons was effected by the group operations officer or his assistant. The assignment of pilots and observers for a particular mission was made by the squadron operations officer. The general practice in each squadron in the apportioning of the work for the following day was approximately as follows:

Upon the assignment of the work on hand to the squadrons, the squadron operations officers prepared a schedule of the following

---

day's work with the assignment by name of the pilot and observer to comprise the team which should carry out the mission contemplated. Copies of this schedule were posted upon bulletin boards in the group operations room, the squadron mess hall, and the tent for pilots and observers located at the flying field. Other copies of this schedule were distributed to the squadron radio and armament officers and to the group photographic officer for whatever preparation on the part of each might be required. In so far as conditions permitted, it was the practice to place one flight daily from each squadron on active duty basis. To the members of this flight were assigned the missions for the current day. A second flight was held upon "alert," i.e., in reserve, the members of that flight to remain available at all times during the current day for the performance of any urgent missions required. The remaining flight was off duty unless exceptional circumstances required its participation in operations. Advance schedules for each day were issued by the squadron operations officer so as to allow sufficient time for the proper preparation of missions by pilots and observers as well as for the accomplishment of necessary work on airplanes and equipment by the technical officers of squadrons and the group.

### **Communication and Liaison.**

Interior communications of the group consisted of direct telephone lines from the group to the squadron headquarters and to the pilots' and observers' tent on the field. Long-distance lines to tactical posts of command in the division and to Higher Air Service headquarters were maintained through the regional exchanges. Radio liaison between the group and all points in the divisional area was established from the group radio station. Two pigeon lofts stationed at the airdrome made possible a liaison service from advanced posts of command in the divisional sector. By means of airplane the following types of liaison were possible:

- (a) By radio from the airplane to the ground.
- (b) By visual signals from the airplane to the ground, e.g., signal rockets.
- (c) Dropped written messages from the airplane to the ground.
- (d) Visual signals from the ground to the airplane, e.g., rockets, bengal flares, and signal panels.

A courier service was maintained between the posts of command of the division and the group (motorcycle dispatch service). By means of automobile and motorcycle side-car transportation, personal liaison by the officers of the group and the squadrons was established with all posts of command in the divisional area, Higher Air Service headquarters, and the pursuit aviation forces operating in the same sector.



Arrangements for rapid calling by airplanes equipped with radio of specially designated batteries to react upon enemy sensitive points, e.g., columns on roads and batteries in action, were made by observers of the group in conference with artillery commanders and battalion radio officers. It was planned that all sector reconnaissance airplanes should be prepared at all times to call the batteries designated for this work whenever suitable targets were observed and to conduct rapid adjustments according to prearranged methods.

### **Plan for Routine Operations of Each Flying Day.**

Weather permitting, a routine schedule of operations for each day, to include the following, was prescribed:

- (a) One close-range reconnaissance of the sector at daylight.
- (b) One close-range reconnaissance of the sector between the hours of 9 and 12.
- (c) One close-range reconnaissance of the sector between 2 p.m. and 5 p.m.
- (d) One close-range reconnaissance of the sector shortly before sundown to take advantage of the semilight for distinguishing the flashes of enemy batteries in action and reporting on their location, as well as to gather information as to enemy routine night circulation which began at this hour.
- (e) One team (pilot and observer) on duty at the airdrome, with airplane in readiness for immediate departure, to answer urgent calls.

The 12th and 88th Squadrons were held responsible in turn for carrying out the plan of routine operations during succeeding weeks.

### **Types of Missions—How They Were Prepared and Accomplished.**

Special missions, such as artillery adjustments, photographic and long-distance reconnaissances, reconnaissances of particular zones or localities, contact patrols, and exercises, were accomplished by prearrangement and usually prepared under the direction of the group or squadron operations officer on the day preceding the date set for the accomplishment of the mission, the team to execute the work being designated in advance.

### **The Short-Range Reconnaissance.**

The reconnaissance mission, if short-range, required the preparation of only one airplane. The observer was first notified of his

---

assignment to the mission and instructed by the operations officer in the details of locality, type of information desired, tactical situation, liaison data, etc. The pilot was then assigned and conferred with his observer. Pilot and observer then proceeded to prepare their equipment. The observer applied to the squadron radio officer for the mounting of radio equipment and the assignment of proper wave length. He then saw to the loading and mounting of his guns by the armament section. The pilot similarly assured the loading and mounting of his gun or guns, the testing of engine, and the tune-up generally of his airplane. Both provided themselves with maps drawn from the group operations room. Before leaving on the mission they checked out at the assembly tent, signing their names and indicating the nature of the mission. Once in the air over the field, the observer carefully tested his radio and signaled to his pilot to proceed to the lines only upon receiving the panel "Understood" from the detail on duty at the group radio station. The mission was then undertaken, the observer ordinarily directing the course of the airplane by hand signals or interphone communication with the pilot. Upon return from the mission the team checked in, noting briefly the conditions encountered, any abnormal incidents, and the duration of the flight. The pilot then saw to the care of the airplane, engine, armament, and radio equipment, reporting to radio and armament officers any faults in the functioning of the equipment for which each was responsible, and to the engineer officer and mechanics assigned to his airplane, any engine or airplane trouble met with in the course of the flight. The observer proceeded without delay to the operations room of the group, where he discussed the results of his mission verbally with the operations and intelligence officers and prepared a written report. The operations and intelligence officers were then responsible for the communication of the results of the mission to the tactical authorities concerned. The observer's written report was carefully filed for record. No mission was considered accomplished until a full report had been rendered. Observers undertaking short-range reconnaissance missions of the type just outlined were under standing orders to report direct to the division post of command by wireless any abnormal aspect of the enemy's sector, and, further, if the situation warranted and the conditions permitted, to assist the artillery in reacting by means of rapid adjustment of zone fire. At this time the communication of urgent information to the division by means of dropped message was not contemplated, excepting in the case of infantry contact patrols.

### **The Long-Range Reconnaissance.**

The long-range reconnaissance differed in execution from the short-range type in that no radio was employed and that for the purpose of





---

added security the airplane undertaking the mission was accompanied by two or more protecting airplanes from the same squadron. Details of preparation, execution, and recording were essentially the same.

### **The Photographic Reconnaissance.**

The photographic mission resembled closely the long-range reconnaissance. Even for photographic missions in close proximity to the friendly lines, two protecting airplanes were usually furnished, aerial photographs being ordinarily secured at an altitude which rendered encounter with enemy pursuit patrols a possibility. The observer detailed to accomplish a photographic reconnaissance carefully measured the territory to be covered and reported on the basis of his measurements to the photographic officer the number of photographic plates and camera magazines required for the complete covering of the zone in question. The photographic officer assured the mounting of the camera and accessories in the airplane designated for the flight. The mission then proceeded in the ordinary way, the photographic airplane leading. Upon completion of the mission, airplanes and equipment were checked by the pilots flying the formation. Observers made the customary reports. The observer taking the photographs held himself in readiness to identify the plates after development and to assist in their interpretation by the intelligence officer. The mission was not considered completed until plates had been identified with respect to their location on the terrain and the interpretation completed and reported to the tactical authorities concerned. Report on interpretation was rendered in every case by the intelligence officer, not by the observer, whose report merely recounted the routine incidents of the flight.

### **The Artillery Adjustment.**

Preparation of the prearranged artillery adjustment mission was similar to that of the short-range reconnaissance. The observer, just before leaving for his mission, announced his departure by telephone to the battery with which he was about to conduct fire. Upon return the observer and pilot followed the same routine prescribed for the ordinary reconnaissance flight. In reporting, the observer was required to state, in addition to any generalizations regarding the incidents and result of the mission, the number of shots fired and the number of shots observed.

### **The Contact Patrol.**

In addition to the routine preparations prescribed for the short-range reconnaissance, the observer detailed to fly an infantry contact

---

patrol was required to provide himself, from the stock maintained by the armament officer of his squadron, with Very pistols (two, in the event of a misfire from the first pistol employed), Very cartridges of various numbers of stars, to conform with the divisional plan of liaison, and metal containers for use in dropping messages to the posts of command.

### **Operations Undertaken.**

Technical and tactical preliminary preparations having been completed, the 1st Corps group undertook actual operations. In a general way the ground covered during the two and one-half months spent by the group in the Toul sector was of limited extent. Work was light. One squadron, operating at high tension, would have been sufficient for the accomplishment of all missions required by the tactical situation.

Numerous artillery adjustments, neither very important nor very arduous, were successfully carried out by the group, and particularly by the 12th Aero Squadron. The 1st Aero Squadron effected successful photographic missions at frequent intervals. The 88th Aero Squadron, which joined the group late in May, was particularly active in effecting close-range reconnaissances of the enemy sector, although it was afforded one or two opportunities to undertake close-range photo missions, long-range reconnaissances, and light-artillery adjustments.

It is noteworthy that the work of the group was seldom hampered by the presence of enemy pursuit aircraft. Practically no experience in combat was gained. On the other hand, the enemy antiaircraft fire in the sector was exceedingly dense, active, and accurate. Pilots of the group were adept at evading antiaircraft fire after a month on the sector. During the Seichperey action infantry contact patrols were attempted. They were unsuccessful, partly because of the inexperience of the teams undertaking them, principally because of the incomplete training of the troops, who showed no panels when airplanes called for the staking of the line.

No definite training program with the troops was laid down by the division commander. By individual arrangement between artillery commanders and observers of the group panel, exercises for the instruction of the radio and panel details of artillery battalions were frequently undertaken and carried to a successful issue. Upon one occasion, during infantry maneuvers in the rear areas of the division sector, airplane cooperation was called for. The line was staked successfully upon the call of the airplane observer and messages were dropped at the division posts of command at frequent intervals. The experience was, perhaps, of some value to the troops but taught the personnel of the group nothing not thoroughly understood previously.

War conditions were conspicuously lacking. The exercise presented no difficulties and was executed on the part of the Air Service with entire ease.

### Comment.

During the stay at Ourches the 1st Corps group contributed nothing of prime importance to operations. Its presence was chiefly valuable to other arms because of the negative information it furnished the command with regard to the enemy activity. The constant watch maintained along the lines by airplanes of the group rendered any secret preparations by the enemy for attack on a large scale extremely difficult. Detection of increased enemy transport, artillery, dumps, and cantonments was virtually certain.

To the group itself the period spent on the Toul sector was invaluable. The group organization there evolved proved in the main successful and efficient and has served as a type for the formation of all succeeding corps observation groups. Minor changes have from time to time developed in meeting varying situations, but the basic principles of observation group organization were established at Ourches and have stood the test of time.

In the more arduous work of corps observation which followed during the campaigns of the summer and fall the experience in matters of routine and the confidence gained by the flying personnel at Ourches stood in good stead. No essential to a liberal flying training was lacking, with the possible exception of actual combat work against armed pursuit.

A criticism of the liaison maintained by the group with the division, to the effect that it was neither complete nor effective, might be added. It is true that liaison, as it later came to be understood, was here practically non-existent. No close personal understanding based on good general tactical principles between staff and Air Service ever existed. The activities of the Air Service were unfamiliar to the staff. The activities of the staff and the units it controlled were unfamiliar to the Air Service. As a precautionary measure, in case of increased activity, full liaison and complete tactical understanding should have been established. On the other hand, the situation at the time demanded no such intimacy between Air Service and line as later became indispensable. Lacking the incentive of urgency neither staff nor Air Service realized the gap that remained to be bridged. The later operations of the group at Chateau-Thierry were handicapped by lack of liaison experience.



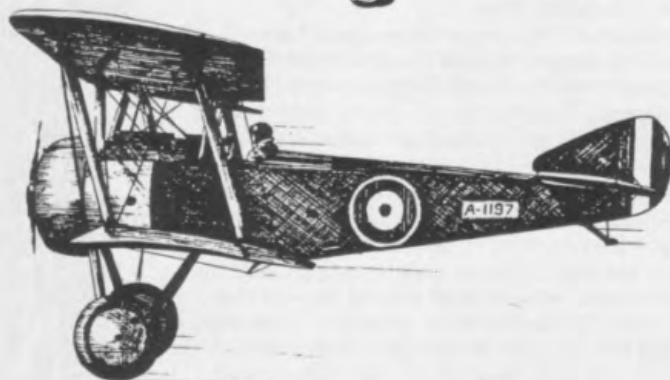

### **III. The 12th Aero Squadron in the Baccarat Sector.**

---

#### **Introduction.**

During the first week of June the 12th Aero Squadron received notice that orders would shortly issue for its movement overland to Vathemenil, in the Baccarat sector, to the southeast of Luneville. Accordingly, an advance party of several officers and a considerable detachment of men were sent forward to prepare the airdrome and buildings for the arrival of the squadron. The fact that the location assigned for the airdrome possessed little else than some newly erected hangars necessitated a great amount of labor by this advance party in the preparation of the landing field, offices, and quarters for both enlisted and commissioned personnel. A construction squadron had not been available for this work; the utilization of squadron officers and men in the advance party and in addition the necessity for utilizing a large proportion of the squadron in this work after its arrival interfered with active operations for a period of four days. However, the tactical situation in that sector at the time was not such that this delay could result seriously, the observation work during this time being carried out by the French squadron which the 12th was to relieve. On the other hand, much benefit was derived by the squadron in its earnest and strenuous endeavors to complete the airdrome installation necessary to the conduct of active operations over the front; a unit spirit of teamwork was developed which proved invaluable in the months to come.

During its first week in this sector, the squadron gave up its equipment of A. R. airplanes and received 18 Salmson two-seater observation airplanes equipped with the radial Salmson engine of 260 horsepower. This airplane proved most satisfactory in every respect; no observation airplane used upon the western front up to the conclusion of the armistice gave greater all-around satisfaction.

#### **The Tactical Situation.**

The Baccarat sector was a typical "stabilized" or "quiet" sector. The enemy was strongly entrenched in positions which had been in existence for many months. Barbed-wire entanglements and machine-gun strong points reinforced the lines of trench work. To the rear he was supported by the usual complement of field and heavy artillery.

In the air his forces were considerably more numerous than was the case in the Toul sector. A rather active observation service was supplemented by a pursuit force which carried out daily patrols of the sector. The latter, although not equipped with the latest types of enemy pursuit airplanes, was active and aggressive. Bombardment squadrons operated on practically all clear nights against various posts of command in the sector, allied airdromes, and the towns and villages

---

adjoining the lines. Farther to the rear the enemy had a considerable amount of pursuit aviation which devoted its energies to the attack of allied day bombardment squadrons which were then carrying out long-distance raids into Germany throughout that area.

The sector of the 42d Division, United States Army, to which the 12th Squadron was assigned, extended approximately from Badenviller to Blamont, some 12 kilometers. As in the Toul sector, the positions of the infantry were strongly organized by means of trench systems, barbed-wire entanglements, and machine-gun emplacements. The infantry was reinforced by the divisional artillery which consisted of two regiments of field and one regiment of heavy artillery. The division operated under the command of the 6th Corps of the 8th French Army. The command of all aviation forces in the Baccarat sector operating for the 6th Corps, 8th French Army, was vested in the "commandant of the sector aeronautique," whose headquarters were located at Luneville. This officer corresponds to the present corps chief of Air Service in the American Air Service.

In addition to the 12th Aero Squadron, the aviation forces of the sector consisted for the most part of observation squadrons operating in conjunction with the divisions to the right and left of the 42d Division, United States Army. These squadrons carried out observation work for their divisions of the same nature as that to be performed for the 42d Division, United States Army. In addition, there operated one observation squadron which did the work of the Army corps. There was no regularly assigned pursuit aviation patrolling that section of the front. As a consequence the observation airplanes there operating had to rely solely upon their own armament as a means of defense against hostile aircraft.

### **Mission of the 12th Aero Squadron.**

The mission devolving upon the 12th Aero Squadron in this sector was:

1. Reconnaissance and surveillance of the enemy.
  - (a) Visual.
  - (b) Photographic.
2. Adjustment of artillery fire.
3. Cooperation with the infantry should a situation arise requiring the dispatch of an infantry-contact patrol to locate the position of the front lines.
4. Training with the infantry and artillery.
  - (a) Terrain exercises for practice in marking out the front lines.
  - (b) Panel exercises, e.g., simulated adjustments of artillery fire.
5. Coordination and completion of training of flying and ground personnel under actual war conditions.

---

### Plans Made to Fulfill Mission.

To operate as an individual squadron all that was required in addition to the organization of the squadron, as described under that heading in the chapter on the operations in the Toul sector, was to place in active operation the squadron radio equipment, to install a photographic section, and to assign for duty at the squadron a branch intelligence officer. Under the direction of the squadron commander, the work over the lines was to be distributed by the operations officer and assistant operations officer according to a roster of the flying personnel, exceptions to be made occasionally in cases where certain pilots and observers were particularly well qualified to carry out some special mission. In general, the routine operations of the squadron were carried out in accordance with the methods prescribed in the Toul sector.



---

### Post Security and Defense.

The defense of the airdrome was organized along the same lines as those described in the chapter on the Toul sector. Carefully prepared plans for the defense and, if necessary, the withdrawal of the squadron in case of hostile attack were received from the commandant of the secteur aeronautique, 6th Corps, 8th French Army. These plans were given careful study and all necessary steps were taken to carry them into execution in case the need arose.

### Communication and Liaison.

1. *Interior communications.*—Telephone lines were constructed connecting the various offices, barracks, and hangars.
2. *Telephonic.*—Long-distance telephone lines to tactical posts of command in the division and Higher Air Service headquarters were maintained through regional switchboards.
3. *Radio.*—The squadron radio section insured, in this stabilized sector, the sending and receipt of radio messages between all points in the divisional area. In addition, it made possible the receipt and record of all messages sent by the squadron airplane in their work over the front.
4. *Airplane.*—(a) Radio, from the airplane to the ground.  
(b) Visual signals, from airplane to ground, e.g., rockets.  
(c) Dropped written messages, from airplane to ground.  
(d) Visual signals, ground to airplane, e.g., rockets, bengal flares, signal panels.
5. *Motor-cycle dispatch service.*
6. *Personal.*—Frequent visits by the commanding officer, pilots, and observers of the squadron to the posts of command of the division.

### Operations Undertaken.

In the actual fulfillment of the missions assigned to the pilots and observers of the squadron in this sector the same general methods were pursued as those described as being the routine methods for the execution of the various types of missions carried out by corps observation units in the chapter on operations in the Toul sector. For the most part, the missions performed were confined to those of artillery adjustment and visual and photographic reconnaissance. On only one occasion were infantry contact patrols attempted. That occurred during a raid the enemy carried out against the American troops at the time of the relief of the 42d Division by the 77th Division, United States Army.<sup>1</sup> The raid took place during the night, and on the following morning the 12th Aero Squadron was requested to locate the friendly front line. In attempting to carry out the request, the



observer in the first airplane dispatched returned with a serious wound caused by anti-aircraft artillery fire. The second observer, when the infantry failed repeatedly to respond to his signals calling upon them to mark out the first line by means of panels or bengal flares, flew so low that he was able to distinguish the uniforms of such men as exposed themselves to view, and was thus able to give a rough idea as to the position of the friendly infantry. Unfortunately, he was wounded by machine-gun fire from the ground before he had fully satisfied himself as to the location of our first-line troops. The third airplane dispatched encountered no better fortune than the first two in receiving a response from the infantry, but he was finally able to report briefly upon the position of the latter by means of observations made at extremely low altitude.

For the most part, aside from the visual reconnaissance missions performed at dawn and twilight of each day, and a certain number of photographic missions requested by the division and the commandant of the secteur aeronautique, practically all of the work undertaken was that solicited by the squadron commander and the observers. It being realized that the plan of operations in this sector was one of training, every effort was made to arrange and perform as many adjustments of artillery as were possible. The only limitation placed upon this type of work was that which resulted from a shortage of artillery ammunition, the artillery regiments being allotted only a fixed amount for their per diem allowance.

Great stress was laid upon the matter of exercises. Under the direction of the squadron commander, and with the advice of the commandant of the regional secteur aeronautique and that of a captain observer from one of the nearby French observation squadrons, a large number of exercises was carried out with the infantry and the artillery. The infantry exercises took the form of training the infantry in the proper use of their panels and bengal flares marking out the line at the call of the aerial observer. These exercises, for the most part, took place with reserve battalions in the second or third lines. With the artillery, exercises were arranged frequently for the practice of a method for rapid adjustment of specially designated batteries against fugitive targets located by the observer in the enemy lines and reported to the battery by means of dropped written messages. This method of adjustment was designed especially for use in a war of movement. It had been adopted by the French observation squadrons of that sector after a long and thorough study of enemy and allied methods in the major operations of the preceding spring. The "shoots" were conducted over the actual lines; the targets were chosen by the observer after taking the air. Usually they were points in enemy territory assumed to be fugitive targets. Too much value can not be given to the results of this form of exercise to both the artillery

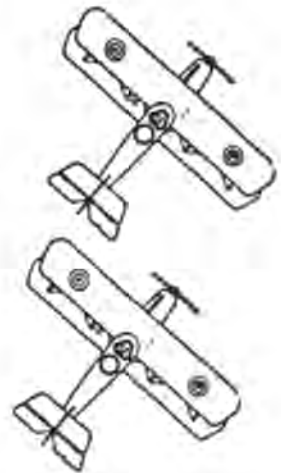

---

and the observers of the squadron. Considerable success marked the efforts of both the artillery and the observers, and the experience gained later proved of value to both.

Considerable advance was made on the part of the observers of the squadron in gaining a knowledge of the importance of close personal liaison with the officers of the divisional artillery and infantry posts of command. Various incidents arose which taught the observers that few of the American troops entering the lines for the first time would have even a working knowledge of the elements which are so necessary to bring about some measure of success in the cooperation of the observation air service with the divisional ground troops. It was brought most forcibly home to all the squadron observers that great and prolonged effort would be necessary on their part to fit the ground troops to properly fulfill their part in working with the Air Service during the execution of artillery fire adjustments or infantry contact patrols. Questions connected with the execution of artillery fire adjustments were mainly those of proper operation of the artillery radio stations and the functioning of the crews assigned to them for the operation of panel strips used to signal the airplane observer. As regards the infantry, the main difficulties may be briefly stated to have been:

- (a) To insure the proper supply and distribution to the first-line infantry of infantry signal panels and bengal flares.
- (b) To instruct the individual infantryman in their proper use.
- (c) To train the individual infantryman to respond by signal to the requests of the airplane observer for the marking out of the line as automatically and readily as a soldier responds to fire discipline.

During the three weeks operations by the 12th Aero Squadron in the Baccarat sector much valuable advice and aid were given by the corps observation air service commander—the commandant secteur aeronautique, 6th Corps, 8th French Army—and by the experienced observer whom he placed at the disposal of the squadron commander.

As the result of attacks from hostile pursuit forces during the execution of the missions assigned to them, considerable experience was gained by some three or four tours of pilots and observers of the squadron in aerial combat.

### **Comment.**

In the main the actual operations conducted by the 12th Aero Squadron in the Baccarat sector were only a continuation and development of those carried out previously in the Toul sector. The conduct of visual and photographic reconnaissance missions, prearranged artillery fire adjustments, and infantry contact patrols was similar in every way to that of like operations in the Toul sector. In a

---

few instances visual reconnaissance missions were dispatched under orders from the secteur aeronautique of the 6th French Corps to procure certain specific information in well-defined areas of the enemy positions, but on the whole reconnaissance missions covered the entire divisional sector under standing orders to observe and report upon all forms of enemy activity. In the course of the squadron's stay in the Baccarat sector it was learned that a general visual reconnaissance of the sector produced very little in the way of valuable results except when performed at dawn or just before darkness; reconnaissance missions performed during the daytime scarcely ever realized success sufficient to justify their dispatch and execution. This fact is easy of comprehension when it is remembered that the sector had long been stabilized and that no active operations were in course. Enemy and friendly activity was almost entirely confined to the hours of darkness.

Undoubtedly the most valuable lessons of the period at Baccarat were those learned concerning the scope of personal liaison in preparation of successful cooperation between the squadron and the divisional ground troops. In addition, the experience derived in the execution of the exercises with the artillery, which had as their purpose the rapid adjustment of fire of specially designated batteries upon fugitive targets in a war of movement, although not of great extent, was sufficient to acquaint the observers of the squadron with the general principles of this form of aerial work and to impress them with the importance of developing it in the future.

From the point of view of the squadron alone it had undoubtedly proved of great value for the unit to be thrown entirely upon its own resources during the period of its operations in this sector. A considerable training was acquired by the officers of the squadron while it thus operated as an isolated Air Service unit, which they would not have received operating as one squadron in a group during the same length of time. As a tactical matter, this fact proved of great value during the American Air Service operations on the Marne, for at that time the need immediately arose for a much larger number of observers trained in the principles of liaison with ground troops and the conduct of group and squadron operations than had been necessary or were available at any previous time.

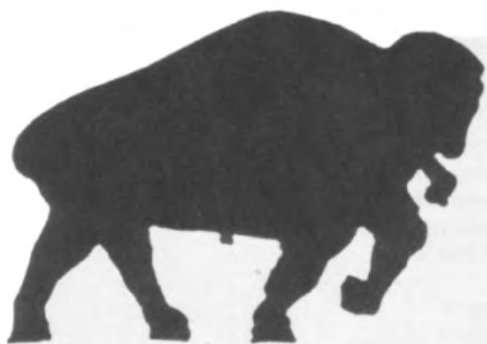

99TH AERO SQUADRON



## IV. The Third Flight of the 99th Squadron in the Vosges.

---

### Introductory.

Toward the middle of July, 1918, the 5th Division (United States), holding a sector in the Vosges Mountains to the southwest of the towns of Celles and Frapelle, was ordered to advance and capture the last-named place. To assist the 5th Division in the operation the 3d Flight of the 99th Aero Squadron was brought forward from the station of the squadron at Luxouil-les-Bains and took station on the airdrome at Dogneville near Epinal. The flight was assigned to the 33d French Corps observation group operating at Dogneville. Seven Salmson airplanes, with a corresponding number of pilots and observers and adequate mechanic personnel in charge of the flight commander, composed the flight. Armament and radio sections were attached. To all intents and purposes the flight was organized as a self-contained unit and was administered along similar lines to those obtaining in the French squadrons of the group.

### Tactical Situation.

The 5th Division occupied a mountainous, wooded sector. The defenses of the friendly sector were of the stabilized warfare type, consisting of trenches, barbed-wire entanglements, dugouts, and carefully prepared and camouflaged artillery positions. The infantry was supported by the usual complement of light and heavy artillery.

The enemy was strongly organized for defense at Frapelle. The town lay within a salient conforming to the course of a small creek which ran through a mountainous defile.

The operations in view contemplated cutting off the enemy salient and forcing the abandonment of the town of Frapelle, which constituted an important rail head and road junction.

### Mission of the Air Service.

The mission of the 3d Flight, 99th Squadron, in view of the tactical situation and plan of attack, was as follows:

- (a) To photograph the enemy defenses previous to the attack.
- (b) To insure effective surveillance of the enemy positions previous to and during the attack carefully noting and reporting any indication of counteroffensive or local reactions in preparation.
- (c) To adjust the friendly divisional artillery on sensitive points within the enemy lines.
- (d) To report the location of and adjust fire on enemy batteries in action.

- 
- (e) To maintain contact, by means of infantry contact patrols, between the command and the front line during the offensive operations.
  - (f) To photograph the friendly positions at the close of the operation contemplated.

### **Plans for Accomplishment of Mission.**

Immediately upon arriving in the sector personal liaison was established by officers of the 3d Flight with the divisional command and commanders of divisional artillery and infantry units. Means and methods of airplane cooperation with the troops were discussed and definite lines of procedure arranged by mutual agreement. Telegraphic, telephonic, radio, and courier communication was established. The commanding officer of the French group lent valuable advice and assistance in perfecting the plan of liaison and of operations.

In order to assure cooperation of the troops with the airplane during infantry contact patrols, terrain exercises were carried out with the 9th and 10th Infantry Brigades of the 5th Division.



*An aerial view of trenches taken during photo reconnaissance.*

---

## Operations.

Prior to the attack airplanes of the 3d Flight successfully carried out, by prearrangement, adjustments with the divisional artillery on enemy battery positions and strong points. Photographic missions reconnoitered enemy territory to a depth of 40 kilometers, securing photographs of considerable tactical value to the command. It is worthy of note in this connection that heretofore no corps squadron had ever photographed enemy territory in this sector deeper than 10 kilometers. Careful visual reconnaissance of enemy territory was carried out at frequent intervals and the command assured of the absence of any abnormal activity on the part of the opposing forces.

On August 17, following a heavy artillery preparation, the 9th Brigade took the offensive at daybreak. Two airplanes of the 3d Flight were over the lines when the attack began, one of these being an infantry contact airplane and the other an artillery airplane charged with the mission of detecting and reporting indications of enemy counter-attacks in preparation. These airplanes were replaced at frequent intervals during the day until the successful issue of the operation.

In spite of the terrain exercises carried out by the infantry in preparation for the attack, calls of infantry contact airplanes for the line were consistently disregarded. The line was never staked by means of panels. The approximate location of the friendly advance elements was, however, determined and reported to the command at frequent intervals, contact patrols being carried out at altitudes as low as to permit distinguishing and identifying the uniforms of troops on the ground. In the course of these missions the friendly airplanes were submitted to heavy machine-gun and rifle fire from hostile forces at close range. In many instances airplanes of the 3d Flight on infantry contact patrol took active part in the combat on the ground, attacking and silencing enemy machine guns and scattering with their fire groups of German soldiers caught in the open and on the roads. It is a matter of record that several machine-gun nests were completely put out of action in combat with corps observation airplanes of the 3d Flight.

Upon the successful issue of the attack and the establishment of a new front line of defense, the airplanes of the 3d Flight were dispatched and successfully photographed the friendly front line.

Enemy aerial activity at Frapelle was negligible, the work of the airplanes seldom being hindered by hostile pursuit.

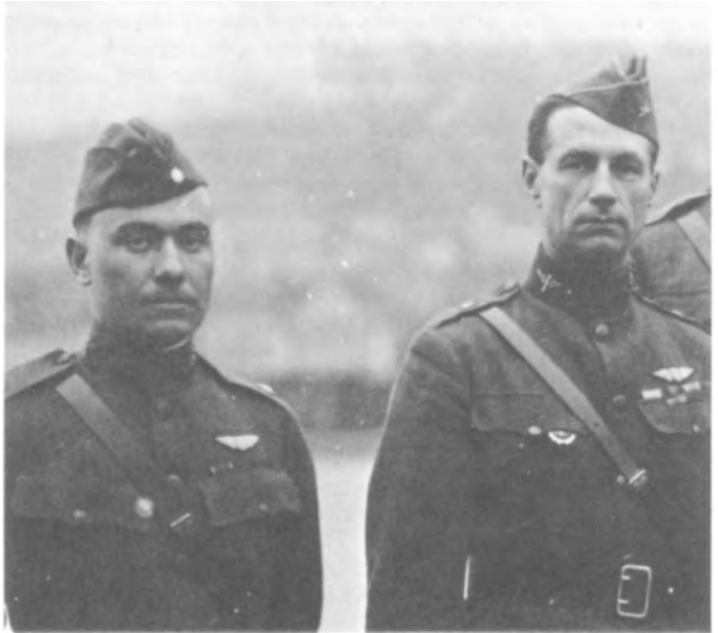

*Maj. (later Lt. Col.) Lewis H. Brereton (left) commander of the 1st Corps Observation Group, succeeded Col. (later Brig. Gen.) William ("Billy") Mitchell (right) as Chief of Air Service I Corps in June 1918.*



## V. The 1st Corps Air Service at Chateau-Thierry.

---

### Introduction.

The German offensive which began May 26 on the Aisne and carried the enemy forces as far as the Marne was virtually arrested by the first week in June. It had resulted in a huge V-shaped salient, the mouth stretching between Soissons and Rheims and the tip resting on the Marne at Chateau-Thierry. During the last week of June, plans were announced for the commencement of operations by the 1st American Army Corps on the western side of the salient, in a sector commencing at the village of Vaux, immediately to the west of Chateau-Thierry, and extending approximately as far as Courchamps. The first week of July saw the installation of the 1st Corps headquarters at La Ferte-sous-Jouarre.

The Chateau-Thierry campaign may be divided into two main actions; the first, an allied defensive; the second, an allied offensive. During the operations of the 1st American Army Corps on this front there were three phases. The first was marked by preparations of the enemy for a renewed offensive and preparations by the Allies of a defense to meet the impending attack. The second was the period of enemy offensive and successful allied resistance. The third saw the execution of a determined and successful allied offensive. Therefore the history of the Corps Air Service on the Marne can best be treated in three parts dealing with the Air Service operations during each of these three phases.

### The Corps Chief of Air Service.

During the first week of July, the office of the chief of Air Service, 1st American Army Corps, was established at La Ferte-sous-Jouarre.<sup>2</sup> Here for the first time the chief of Air Service assumed active tactical control of the units making up the Corps Air Service. These units consisted of the observation squadrons comprising the 1st Corps group, and the balloon companies operating with the corps troops.

Note.—In the tactical control of the corps balloon companies, the chief of Air Service was represented at all times by a trained balloon officer, known as the corps balloon wing commander, who assumed direct charge of all operations conducted by the balloon units. At no time were the detailed operations of the balloon units controlled from the office of the chief of Air Service. This work was performed by the corps balloon wing commander and staff, with offices located in proximity to the various balloon companies.<sup>3</sup>

## Organization and Functions of the Chief of Air Service.

The office of the chief of Air Service, as it operated on the Marne in July and August, 1918, was organized as follows:

- Corps chief of Air Service.
- Adjutant.
- Information officer.
- Operations officer.
- Liaison officer.

The duties of the corps chief of Air Service were defined in General Orders No. 81, H. A. E. F., dated May 29, 1918:

PAR. 5. The duties of the chief of Air Service of an Army Corps are as follows:

1. In each Army Corps there will be a chief of Air Service, who will command the corps aeronautical units.
2. He is the adviser of the corps commander and the Corps General Staff in all that pertains to the Air Service. He will keep the corps commander informed in regard to aeronautical matters and will make such recommendations as he considers necessary regarding aeronautical personnel, material, and methods. In accordance with the general plan of operations and in cooperation with G-3 of the corps, he prepares the general plans of action for all the air units of the corps. He insures the coordination of the aeronautical plans of divisions and supervises the employment of all air units throughout the corps in accordance with the approved plans. He prepares the detailed plans for the air units under his direct orders.
3. Under the authority of the corps commander the chief of Air Service is charged with the instruction and inspection of all air units assigned or attached to the corps, the collection, dissemination, and utilization of aeronautical information within the corps and the necessary liaison with the artillery and the Air Service of the Army and of neighboring corps.
4. He apportions the aeronautical supplies and material placed at the disposal of the corps and prepares timely requisitions for aeronautical supplies.

The units under the command of the corps chief of Air Service were:

- 1st Aero Squadron.
- 12th Aero Squadron.
- 1 French squadron, replaced July 6 by the 88th Aero Squadron.

These three squadrons comprised the 1st Corps observation group, which retained the same organization established in the Toul sector in the month of May.

The relation of the Chief of Air Service to the corps commander and staff was chiefly advisory. The Air Service being a comparatively new arm of the service, the corps chief of Air Service had to bear in mind that few of those higher in command were acquainted with its actual possibilities and limitations.

The relation of the chief of Air Service to the units of his command was both administrative and tactical. With him rested responsibility to the corps commander that all orders of the corps were properly executed. He prepared all general plans of action for the Air Service of

---

the corps in accordance with the orders of the corps commander. He supervised the maintenance of all liaison between the units of his command and the corps ground troops. He supervised the instruction of the units of his command and took all necessary steps to insure close cooperation with the line units to which the Air Service units were assigned. He provided for the replacement of material and personnel and reported to the proper authorities any lack in training of personnel.

The function of the chief of Air Service in his relation to the line units was to insure for them thorough cooperation by the units under his command and to act in an instructive and advisory capacity. It was his duty to assign the Air Service units to line units and supervise in detail the work performed. It was his function to initiate measures for the instruction of the infantry and artillery in the proper employment of and efficient cooperation with the Air Service units.

The duties of the adjutant to the chief of Air Service dealt entirely with the administration of the units which comprised the Corps Air Service.

It was the duty of the information officer to keep the chief of Air Service and Air Service units supplied with the latest tactical and technical information, including maps, photographs, tactical orders, technical air service information and general air service information. He was responsible for the Consolidated Intelligence Report of the Corps Air Service, published nightly.

The operations officer was responsible, under the direction of the chief of Air Service, for the proper coordination and execution of all operations of the Corps Air Service units. He prepared and forwarded all orders concerning operations and supervised their execution. It was his duty to prepare the daily Corps Air Service Operations Report.

It was the duty of the liaison officer to establish and constantly maintain a close personal liaison with the following:

1. Commanding officers and operations officers of—
  - (a) Observation group of the Corps Air Service.
  - (b) Individual squadrons of the group.
2. Commanding officers, G-2's and G-3's of—
  - (a) The Army Corps.
  - (b) Chief of artillery of corps.
  - (c) Corps heavy artillery.
  - (d) The divisions of the corps—
    - (1) Infantry.
    - (2) Artillery.
  - (e) Subordinate posts of command of all above line commands.

It was his duty to inform himself concerning all matters connected with the corps units necessary to the conduct of operations by the squadrons; to carefully study the information so secured and transmit same to the operations departments of the group and squadrons; to ascertain the amount of training previously acquired by the artillery and infantry units, and the methods, rules, and principles under which the training was carried out. Together with the information officer, he was responsible to insure that the group secured all maps, photographs, and other information from the corps troops necessary for operations. It was his duty to arrange with the corps chief signal officer for the establishment of all necessary telephone and radio liaison between the Chief of Air Service, observation group, corps staff, and line posts of command, and in general to supervise the



---

establishment of all other necessary forms of liaison between the Corps Air Service and other corps troops. It was his duty to supervise the work of collecting and forwarding the following information to the Chief of Air Service, the group, and squadrons:

1. Location of all posts of command.
2. Names of commanders.
3. Telephone and radio connections therewith.
4. Locations of panel and "dropped message" stations.
5. Radio calls.
6. Panel numbers, i.e., the particular panel assigned to each post of command.
7. Radio, telephone, and panel codes in use between—
  - (a) Ground stations.
  - (b) Airplane and ground.
  - (c) Ground and airplane.
8. If artillery:
  - (a) Location of guns.
  - (b) Number of guns.
  - (c) Caliber and type.
  - (d) Fields of fire.

It was his duty to arrange definite plans for:

1. War of movement artillery adjustments by means of airplane.
  - (a) Exercises looking toward proficiency in such type of adjustment.
2. Designation and use of certain batteries for fire on fugitive targets upon call from observer.
3. Exercises with the infantry looking toward proficiency in cooperation with the infantry airplane.

The plan of communications drawn up by the chief of Air Service was as follows:

Direct telephonic communication with the group and squadrons.

Telephonic communication, through the corps headquarters switchboard, with all other corps units, and through regional switchboards with Higher Air Service headquarters.

Telegraphic liaison through corps telegraph office.

Radio liaison with the group and all corps units by means of a radio station established at the Chief of Air Service headquarters.

Personal liaison through visits made by the Chief of Air Service and his staff to the group, corps headquarters, and all corps units.

Motor cycle courier service between group and Chief of Air Service, motor cycle dispatch service, to corps and divisional posts of command.

---

The 1st Corps observation group was organized technically, tactically, and for the purposes of administration and supply along the same lines that had been followed in its original organization at the Ourches airdrome.

The third American squadron to join the 1st Corps group did not arrive until July 6. July 7 saw the completion of the organization and installation of the headquarters of the Corps Air Service and the beginning of operations of the Corps Air Service entire. Previous to this date certain operations had been carried out and a digression will be made at this point to describe them.

### **Effectives and Station.**

During the last week of June orders were received for the 1st Corps observation group headquarters and the 1st and 12th Aero Squadrons to proceed from their respective stations to the Marne sector. The movement by motor truck commenced June 28. By noon of the 29th all the airplanes of both squadrons had been flown overland from the Ourches and Vathemenil airdromes to the new location at Saints, some 5 kilometers to the south of Couloumiers. Advance parties from each squadron had arrived by automobile and perfected all arrangements for the billeting of officers and men. By the night of June 29 the main body of both units had arrived and been installed on the airdrome. One French squadron temporarily assigned to the group was already installed on the airdrome.

The airdrome was situated on a large level wheat field which had but recently been harvested. The hangars had already been erected by French Air Service construction units; they were the standard type of large Bessoneaux canvas shelters; all of them were well camouflaged.

The enlisted personnel, for the most part, were billeted in a group of farm buildings which bordered the flying field, the overflow being quartered in squadron tentage. The commissioned personnel were billeted in the near-by villages of Saints and Mauperthuis.

The sector of the front to be covered extended approximately from Chateau-Thierry to Courchamps, a distance of 15 kilometers.

The distance of the front lines from the airdrome varied from 40 to 55 kilometers.

The location of the observation group at such a great distance from the front lines was a tactical necessity, considering the impending enemy offensive in the direction of Paris.

### **Tactical Situation.**

At this time there were two divisions operating under the 1st Army Corps (United States). The 2d Division was holding a sector of the

front which extended from a short distance west of Chateau-Thierry to Torcy, and the 167th French Division occupied the front from Torcy to Courchamps. The front lines consisted of shallow, hastily constructed trenches, by no means a continuous system. These were strengthened to a certain extent by barbed-wire entanglements. Machine-gun emplacements, located at all strong points, made up for the most part the immediate defenses of the first lines. These two divisions were supported by the usual complement of divisional artillery, two regiments of 75's and one of 155's. In addition, there were several reserve batteries of 75's. The corps artillery consisted of motorized regiments of 155 G.P.F. and older model French guns of the same caliber.

Until the 6th of July, the Air Service of the 1st Corps (United States) consisted of the 1st and 12th Aero Squadrons and one French squadron. Under orders of the Army Air Service commander, 6th French Army, there operated the 1st American Pursuit Group of four squadrons and several French squadrons which performed the work of night and day reconnaissance for the Army. Until the middle of July there were no allied bombardment squadrons operating in this sector.

The situation of the enemy ground troops was much similar to that of the two divisions of the 1st American Army Corps which opposed them. Their first lines consisted for the most part of a series of strong points organized for machine-gun defense. Shallow trenches, fox holes, and organized shell craters completed the lines between strong points. Behind the infantry positions was a large amount of field artillery, and farther to the rear the enemy had massed, even at this time, the formidable array of heavy artillery with which he executed the artillery preparation of his offensive of July 15. Along the entire sector the enemy had a remarkably well-organized anti-aircraft defense consisting of machine guns and artillery.

At Chateau-Thierry the enemy had a powerful aggregation of pursuit squadrons. In addition, there were many squadrons which carried out the work of observation, army day and night reconnaissance, and bombardment. Here, for the first time in the history of the observation squadrons of the 1st Corps group, it became a daily occurrence to encounter enemy pursuit patrols in numbers varying from 7 to 20 in a single patrol. These hostile pursuit forces were equipped with the latest types of fast scout airplanes, and among the squadrons there encountered by the Americans were some of the best of the German pursuit aviation.

### **Preliminary Operations.**

On June 30 the major portion of the pilots and observers of the 1st and 12th Aero Squadrons carried out flights over the front lines which



*Vietnam Cross*

---

sufficed to orient and accustom them to the new sector. On the afternoon of July 1 occurred the attack by the 2d Division (United States) against the village of Vaux. At this time airplanes from both squadrons were in the air performing the work of infantry contact. Others executed command missions of surveillance for both the infantry and artillery posts of command. All other available pilots and observers were sent out as auxiliary surveillance teams, whose function, in the main, was to assure allied domination of the air with the secondary purpose of giving these teams the benefit to be derived from a first-hand participation in the attack. The operations of this and the previous day were conducted as a matter of emergency, before comprehensive plans had been drafted assigning squadrons to specific work with the various corps units.

During the next five days the 1st and 12th Squadrons perfected their interior organization on the airdrome, established their lines of supply, received and placed in good running order a number of new airplanes and in general prepared for their work in the new sector. A considerable amount of personal liaison work was effected by the operations officers and the observers for the purpose of making specific arrangements and securing all data and information necessary to the conduct of operations. Missions of visual reconnaissance were executed at dawn and twilight daily. Numerous flights were made by the flying personnel for the purpose of becoming thoroughly oriented to the sector. Several photographic missions were performed over portions of enemy territory designated by G-2 of the corps staff. A few artillery adjustments were accomplished, but the relief of the 2d Division by the 26th Division (United States) prevented the performance of other adjustments which had been arranged.

This relief took place on the 5th of July. On the same date the group was ordered to move to the airdrome at Francheville, a small village to the northwest of Couloumiers. The move was executed without incident that day. On July 6 the French squadron of the group was relieved by the 88th Aero Squadron (United States) which had proceeded overland from the Ourches airdrome. Operations by the Corps Air Service as a complete organization began on July 7.

Aside from the relief of the 2d Division (United States) by the 26th Division (United States), the tactical situation remained the same as described above.

### **The Mission of the Corps Air Service.**

The mission of the Corps Air Service was to keep the command informed, by means of visual and photographic reconnaissance, of the situation within the enemy lines to the depth of 8 kilometers opposite



---

the corps front; to adjust the fire of the corps and divisional artillery; and to hold itself in readiness to perform corps and divisional command missions and infantry contact patrols whenever such should become necessary. If the situation permitted, it was to furnish the means of further training our ground troops in the use of the observation airplane.

### **Tactical and Technical Installation.**

The tactical and technical installation of the 1st Corps observation group at Francheville was essentially as when the group was originally organized at the Ourches airdrome.

### **Assignment of Tactical Duties by Squadron.**

The tactical work contemplated was assigned as follows:

To the 1st Aero Squadron:

- (a) Corps command missions.
- (b) Adjustment of corps heavy artillery fire.
- (c) Surveillance of hostile artillery and location of enemy batteries.
- (d) Visual reconnaissance of the corps sector.

To the 12th Aero Squadron:

All missions of the 26th Division (United States).

To the 88th Aero Squadron:

All missions of the 167th French Division.

The work of a division squadron consisted of:

- (a) Command missions.
- (b) Adjustment of divisional artillery fire.
- (c) Visual reconnaissance of divisional sector.
- (d) Divisional infantry contact patrols.

The 1st and 12th Squadrons being equipped with the Salmson, an airplane much better adapted to the work of photography in an active sector than the Sopwith, all missions of photography were equally divided between these two squadrons.

The manner of carrying on the day's routine operations in the group and squadrons remained essentially the same as that described in the chapter on the Toul sector. However, due to the intensive nature of the work to be performed, the practice of assigning flights to "duty," "alert," and "off duty" was here abandoned.

The group plan of communication and liaison remained the same as it had been in the Toul sector except that the group was not here equipped with courier pigeons.

---

### Operations Undertaken.

From July 7 to 15 the actual operations undertaken had as their main purpose a thorough reconnaissance and surveillance of the corps sector in order to keep the corps and divisional command informed constantly as to the situation and developments in the enemy territory. In addition, it was desired to regulate the fire of the artillery against sensitive points not visible from balloons and terrestrial observatories and against hostile battery positions, and to perform registrations according to the plans drawn up to cope with the impending enemy offensive. Accordingly, a thorough visual reconnaissance at the entire corps sector took place at dawn and twilight daily. Other visual reconnaissance missions were dispatched throughout the day according to the tactical situation. All such missions were much more definite in scope than had been the reconnaissance missions executed daily in the Toul sector. The attention of the observers was especially directed to the location of the enemy's battery positions, the movement on roads and railways, the location of any evidence of new works, trenches, stores, munitions, and troop concentrations.

A nightly meeting was held in the G-2 section of the Corps General Staff for the purpose of discussing the developments of the day, all new information concerning the general situation, and all new plans, or changes in existing plans. The Corps Air Service was represented at this meeting by the chief of Air Service, or a member of his staff, by the group branch intelligence officer, and as often as possible by the group and squadron commanders. At this time all photographic missions were assigned to the group by the Corps G-2 section, and instructions were given as to the particular information to be sought by the observers during the next day's visual reconnaissance missions.

On account of the great distance of the group airdrome from the front lines, it was thought expedient to establish an advance landing field at Morass farm, a few kilometers east of La Ferte-sous-Jouarre. On this field were stationed two airplanes from each of the group squadrons, which proceeded there soon after daylight on all days when the weather permitted aerial operations. Supplies for the operation of the airplanes were transported by motor truck from the Francheville airdrome. A radio station was established at this field for the purpose of communication with the group and the corps and divisional posts of command. A direct telephone line connected the field with the office of the chief of Air Service and the corps switchboard. The duty of the pilots and observers making up the crews of the airplanes stationed daily at Morass farm was to hold themselves in readiness to perform immediately any mission assigned

---

to them from the office of the chief of Air Service. These crews were equipped for the execution of all types of missions except those of photography.

With the exception of the attack on Vaux, July 1, no enemy or allied action took place before July 15 which required the execution of infantry contact patrols. A few exercises took place behind the lines for the purpose of training the infantry in the marking out of the line.

The unstable state of the sector made it imperative that frequent photographs be secured of the first-line positions and of the enemy territory farther to the rear. As often as the weather permitted, missions of this nature were dispatched from the two squadrons assigned to the work. Great difficulty was experienced in carrying out these missions, due to frequent and persistent attacks of hostile pursuit patrols. Attempts made to carry out such missions accompanied by pursuit patrols to act as protection were seldom completely successful. Such work placed the friendly pursuit airplanes at great disadvantage during enemy attacks, leaving them practically at the mercy of the hostile pursuit patrols attacking from above unless they left the formation. In the latter case, they immediately ceased to be of value as direct protection for the observation airplane occupied with the taking of photographs. Aside from the general impracticability of pursuit protection during attacks by hostile airplanes, great difficulty was encountered in effecting a rendezvous with friendly pursuit forces before proceeding to the lines. The result was a gradual adoption of a policy of sending a number of observation airplanes upon each photographic mission, the leading airplane of the formation being equipped for the photographic work contemplated and the others acting as biplace protection. However, due to the element of confidence undoubtedly induced by the presence of pursuit airplanes during a photographic mission, pursuit protection was not abandoned, and as frequently as possible arrangements were perfected to have them accompany the photographic airplane.

Fire adjustments were carried out for the artillery of the corps and the divisions. All those conducted were prearranged by the observer in liaison with the posts of command concerned. None of them attempted more than the regulation of fire upon certain points, crossroads, and positions. No destruction shoots were effected. Work with the artillery was seriously interfered with on account of the small amount of preliminary training in such work given the corps and divisional artillery before it took up active operations. The battalion radio crews possessed little if any experience in receiving and transmitting to the batteries the messages sent by wireless from the artillery airplane. The panel crews were untrained in the proper choice of locations for the display of panels and in panel manipulation, with

---

the result that the airplane observer experienced the greatest difficulty in locating and reading the ground signals necessary to the proper execution of the adjustment. In many instances battalions lacked the necessary material to place their radio stations in working order. This was true in particular of the corps artillery, the regulation of which by means of aerial observation was more imperative than in the case of the divisional artillery. Due to the great distance separating the squadrons from the artillery posts of command, intercommunication by all usual means employed in a stabilized sector was practically impossible. As a result much valuable time was lost, many failures went uncorrected, and many misunderstandings arose. The main reliance of the Air Service in attempting to improve its cooperation with the artillery came to be personal liaison. To perform liaison of this nature sufficient to meet the need of instructing the artillery in the proper use of the artillery airplane proved impossible with the group so far removed from the artillery posts of command. Again, the artillery was so constantly occupied in its routine operations, and in perfecting its preparations to defend the sector in the event of a renewed enemy offensive of large scale, that it was virtually impossible to devote sufficient attention to the details and training necessary to improve work conducted by means of aerial observation. On the part of the Air Service, certain failures in attempted artillery adjustments arose on account of persistent attacks made by hostile patrols. Others were due to inability to notify the artillery post of command in cases where it was impossible to dispatch the airplane at the prearranged hour, either as the result of failures in material or unfavorable weather. Many of the airplane replacements received were marked "Not inspected" and it was found necessary to completely overhaul such airplanes before their use in operations over the lines. Others were completely lacking in radio equipment, and much difficulty was experienced during July in keeping airplanes available to depart on missions of artillery adjustment at a fixed hour. None of the failures which occurred were due to insufficient training on the part of observer personnel. All the observers assigned to artillery missions were officers who were admirably well fitted for this work, both through training and actual experience with French squadrons in operations over the front.

During the first two weeks of operations in the Chateau-Thierry sector the need of a carefully organized personal liaison system became apparent. The operations carried out in that period gave rise to incidents which indicated that only by means of such liaison could the full measure of cooperation between the observation squadrons and the corps ground troops be realized. As the days passed, it became increasingly apparent that great effort would be required on the part of the Chief of Air Service staff and the officers of the group and squadrons to guard against failures in Air Service operations likely

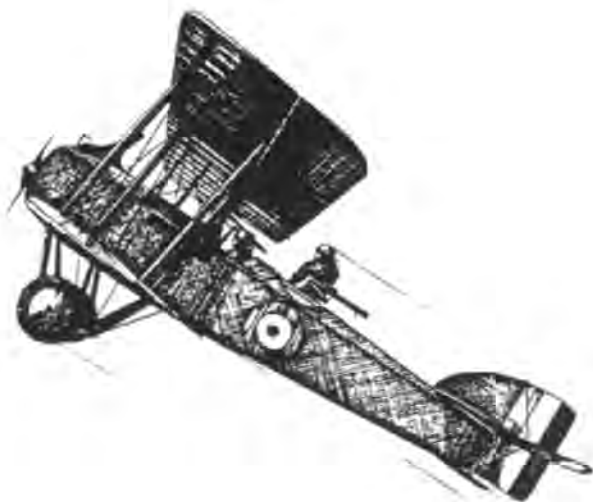

*The Breguet two-seater was used for artillery spotting.*

to result from insufficient training on the part of corps ground troops in the proper use of the Air Service arm. As a consequence, an intensive system of personal liaison was inaugurated between the office of the Chief of Air Service, the group and squadrons, and the posts of command of the corps line organizations. As an initial effort in this direction, an experienced observer was detailed from each of the divisional squadrons and arrangements were made for these officers to take station at the headquarters of the divisions to which the squadrons were assigned for operations. It was the duty of the liaison officer to investigate all matters connected with the proposed divisional operations and to forward without delay to his squadron all information, plans, and data necessary for complete Air Service

---

cooperation in such operations. In addition, the liaison officer of the Chief of Air Service made daily visits to the headquarters of the corps chief of artillery, the post of command of the corps artillery commander, and the post of command of each division, where he interviewed the officers in charge of the G-2 and G-3 sections, and, if necessary, the Chief of Staff concerning operations for the ensuing day. As it became increasingly difficult to send messages between the divisions and the group, the custom developed of sending one officer from each squadron to each division and the post of command of the corps artillery commander each day for the purpose of returning with all new information, plans, and requests for missions, and to transmit all details concerning the results obtained or difficulties encountered in the performance of the missions of the previous day.

The inauguration of the above personal liaison system did much to improve the cooperation of the Air Service with the line organizations, but it could not surmount the obstacles in the way of insufficient preliminary training on the part of the ground troops in the proper use of the Corps Observation Air Service, which constantly arose to prevent the effective conduct of aerial operations.

The main value of the operations of the 1st Corps Air Service on the Marne before the opening of the enemy offensive of July 15 was the results accomplished in the supply of information concerning the activities of the enemy by means of visual and photographic reconnaissance. The results accomplished in the regulation of the fire of artillery were of comparatively little value. On the other hand, to the Chief of Air Service and staff, the group, and the squadrons, the experience gained in the course of these operations was invaluable. It gave them a basis upon which to plan the carrying out of all future operations in this sector. During this period the 1st and 12th Squadrons had become accustomed to the use and care of the Salmson airplane. The pilots and observers of all three squadrons had become thoroughly oriented to the new sector. The frequent combats engaged in during missions over the lines had prepared the flying personnel to carry out their missions, relying in the main upon their own guns and skill for proper defense. A considerable knowledge had been gained of the steps necessary to be taken along the lines of personal liaison to insure a certain measure of success in future aerial operations. The past two weeks had shown conclusively that small reliance could be placed upon the telephone as a means of liaison under the conditions obtaining in this sector. From the point of view of the Corps Air Service the experience of the past two weeks was of great value. In the main, the Air Service was well fitted and ready to take up the difficult tasks which confronted it.

The second phase of the Marne campaign extended from July 15 to 18. During these three days the last enemy offensive was launched, spent its full force, and was completely checked by the allied defense.

Plans for meeting this proposed drive of the enemy against Paris had been prepared in detail. The plan of employment of the Corps Air Service dealt with the proposed execution of the various types of missions to cope with whatever tactical situation might arise. Complete plans for the orderly withdrawal of the group from Francheville to an airdrome, some 20 kilometers farther to the rear, were ready for execution should the need arise.

Throughout the enemy offensive corps and divisional command airplanes and surveillance airplanes operating for the infantry and artillery, were in the air during the hours of daylight. Here, again, the Corps Air Service proved of value chiefly in the results it accomplished as a source of information for the command. The execution of infantry contact patrols for the purpose of taking the line did not prove necessary in the sector of the 1st Corps. The duration of the entire enemy offensive was so short that no real developments resulted from the point of view of Corps Air Service tactics.

During the late afternoon of July 17, the plans for the allied counteroffensive which opened July 18 were received. Immediately personal liaison was effected by the Air Service with all corps and divisional posts of command. Arrangements were made to have infantry contact patrols take the line as marked out by the Infantry at stated intervals during the next day. The work of corps and divisional command airplanes was planned in such manner that there would be a continuous surveillance over the corps and divisional fronts during the hours of daylight. Arrangement was made to station a squadron liaison officer at the corps artillery headquarters. The area of fire of the corps artillery was plotted on a special map. The area was divided into zones, each zone to be covered by one group of the corps artillery in the work of neutralizing the artillery of the enemy. Copies of this map were prepared for the use of the squadron observers in the work of surveillance. This plan permitted the location of an enemy battery in action by the observer. He could then signal this information to the corps artillery group concerned which would immediately take it under fire. If, in the course of his further surveillance, the observer noted that the artillery fire was not properly directed he would then signal to the group the necessary corrections. Certain batteries of each brigade of divisional artillery had been specially designated to care for the work of firing upon fugitive targets located by observers and signaled to the battalion radio stations. Although attempts had been made daily during the course of the preceding two weeks to fix plans for the rapid adjustment of roving batteries against targets signaled from the airplane, no success had been attained. The result was that there was no real provision made to cope with a situation of mobile warfare should such result from the next day's allied counteroffensive. Cooperation by the Air Service would then have to



---

depend upon the transmission to the squadrons of information as to the new locations of the artillery and the availability of certain batteries for the work of adjusting on fugitive targets, a situation latent with possibilities of failure.

The third and last phase of the Marne campaign commenced on the morning of July 18 with the opening of the allied counteroffensive between Soissons and Chateau-Thierry. A treatment of the work of the 1st Corps Air Service from this time until August 12, when the 1st Corps was relieved by the 3d Corps (United States), and the Air Service of the 1st Corps was withdrawn from the sector, can best be made by describing the work undertaken from the point of view of each type of mission common to the operations of a Corps Air Service.

During the advance of the 1st Corps to the Vesle, the execution of frequent infantry contact patrols in order to inform the command of the location of the advancing infantry became a matter of the day's routine. There were two methods of requesting such missions. At first the division commander notified the Chief of Air Service during the previous day that he desired such patrols to be performed at certain stated hours on the following day. This custom had two serious disadvantages. In the first place, there are only certain circumstances during which an infantry contact patrol is likely to attain the desired success. Such patrols are best executed shortly after the first or later stages of an infantry attack, when the troops are momentarily resting and are free, in a measure, to devote their attention to what is going on in the air above them. At such times they will more than likely see and recognize their "infantry airplane" and note the signaled request for them to mark out the line. On the other hand, if they are in the midst of active combat conditions, they naturally have little time or inclination to give attention to the air above them, and in all likelihood the signals of the infantry airplane will go unheeded. The second disadvantage is that no division commander knows the day before what situation will obtain on the following day. As a result, when it is impossible to send notice to the Air Service that the location of the front lines is already known to the command and that there is no need for the execution of the prearranged infantry contact patrol, the infantry airplane will proceed to accomplish its task all to no purpose. The second method of requesting such missions was to send word to the squadron direct, or through the office of the Chief of Air Service, some one or two hours beforehand. From most points of view this is the ideal method, but it depends solely upon the available modes for rapidly transmitting messages to the squadron concerned. Within two days after the successful launching of the allied offensive, it became impossible to rely upon telephone, telegraph, or radio for liaison



---

between the various divisional posts of command and the Air Service. As a consequence, the hours for the execution of infantry contact patrols were necessarily fixed the day before and these, together with all information as to the probable location of the infantry at such hours, were sent to the squadron by means of the liaison officer, who daily made the trip from the office of the Chief of Air Service or the squadron to the post of command concerned.

The most serious difficulties encountered in the performance of infantry contact patrols were those which were the direct result of the lack of training of the infantry in carrying out their part in response to the signals of the airplane observer. Both the 26th and the 42d Divisions (the latter relieved the 26th Division on July 25) had been given a certain amount of training in conjunction with the Air Service. It was by no means sufficient to insure a uniform success in keeping the command informed as to the location of the infantry by means of the infantry airplane. To begin with, there arose many cases where infantry units were not equipped with the proper supply of individual panels and flares for marking out the lines. After this condition was remedied, the infantry had apparently forgotten their proper use for marking out the line at the call of the observer. The result was that in the majority of infantry contact patrols the observer was forced to descend to altitudes varying from 300 to 50 meters, face the galling machine-gun and rifle fire that invariably met him when flying at such low height, and locate the front lines of the friendly troops by distinguishing their uniforms. As time passed, the efforts of Air Service liaison officers met with some success in improvement of the results of infantry contact patrols by means of attempts to instruct the infantry in marking out the line, but at no time during the Marne offensive did such missions accomplish the results that would have been possible had the infantry been given a thorough course of training in the use of the Air Service before they took up active operations on the front.

During the first two weeks of the offensive the advance was so rapid that it became impossible to take photographs of all the territory in the line of the advance. The photographic missions undertaken were therefore directed to the work of procuring photographs of certain areas chosen by the G-2 section of the corps staff. Weather conditions frequently hampered the execution of these missions, but on the whole valuable results were obtained. At about this time the taking of oblique views at low altitudes, varying from 400 to 800 meters, became customary, for such photographs prove invaluable to the command in the planning of future operations. Until this date, all photography had been vertical.

Visual reconnaissance missions were carried out regularly at dawn and twilight of each day. Other missions of a like nature were

---

dispatched whenever the tactical situation made it necessary to secure particular information as to enemy activity. Much visual reconnaissance was carried out by artillery surveillance airplanes during periods of inactivity on the part of the enemy artillery. The routine procedure was to signal all information to the appropriate post of command by radio, later confirming it by dropped written messages.

During the opening days of the offensive, the corps artillery surveillance airplanes met with considerable success in their work of signaling reports on the activity of hostile batteries. This was done in pursuance to the plan made July 17 and described above. However, after movement on the part of the corps artillery regiments began, and as it became increasingly difficult to keep up communication between the Air Service and the front-line troops, this plan had to be abandoned, for it was impossible to keep the Air Service informed of the location of the corps artillery units. The best substitute for the plan then proved to be to signal the post of command of the corps artillery by radio and transmit all information to this one station. The corps artillery commander was then enabled to assign whatever battery he had available for the delivery of fire. The serious drawback of this method was the fact that the observer was not able to signal corrections for the fire if it proved inaccurate, for, not knowing the location of the battery firing, he could not judge the errors of fire with reference to the line battery target. His only recourse was to give corrections with reference to north, south, east, and west. This method was never satisfactorily employed by the American Air Service.

The work of surveillance carried out in a similar manner to that described in the last paragraph was, in the main, about all the divisional artillery airplanes were ever able to do during this same period. After the first day of the offensive, the divisional artillery was moved forward almost daily. The failure of all ordinary means of liaison made it impossible to carry out scheduled adjustments, for it was seldom possible to transmit to the Air Service the location of the batteries before another move occurred. Once the divisional artillery took up the advance, it likewise became impossible to have regularly assigned batteries for the conduct of fire on fugitive targets. This system is admirable in a stabilized sector, or in comparatively mobile warfare when the system of liaison permits of the speedy transmission of messages from the line units to the Air Service. But under conditions like those obtaining on the Marne from July 18 until the halt at the Vesle, with the Air Service located on airdromes from 40 to 60 kilometers behind the front of attack, and the artillery of the division changing position daily, it was obviously a complete failure. The net

---

result was that the Air Service cooperation with the artillery consisted mainly in its work as an information agent. In a few instances the observer was successful in securing the fire of a battery on a fugitive target; at such times valuable results were obtained. But for the most part it was impossible to notify the observer, before his departure, of the location of the batteries or battalions, and attempts made by the observer to locate them while in the air by means of repeated wireless calls and a prolonged search for the radio station panel were usually unavailing. In addition, the same difficulties here arose as had been prevalent before the 18th of July, viz, those due to the inexperience of the artillery radio stations, panel crews, and the general lack of knowledge on the part of the artillery units in the use of airplane observation as a means of adjustment.

In establishing for the first time the custom of detaching a trained observer from his squadron and assigning him to act as Air Service liaison officer at the posts of command of the corps artillery commander and at the headquarters of each division, the corps chief of Air Service sought to ameliorate the general unsatisfactory condition which resulted from the breakdown of all ordinary means of



*Messages received from aircraft for transmission to artillery units.*

---

liaison during the advance to the Vesle. In addition, it was hoped that by this means the artillery and infantry could be instructed somewhat in the proper use and limitations of the Air Service.

The great distance to be covered between the line organizations and the Air Service, together with the conditions which resulted through the rapid advance of the ground troops, was the cause of a complete breakdown in telephonic communication. After the 19th of July it was practically impossible to procure a connection between the divisions and the squadrons. The same state of affairs existed as to telephonic communication with the corps headquarters after it had moved forward from La Ferte-sous-Jouarre to Buire.

It was nearly always possible to send messages by means of telegraph, but pressure of business was such that the service required from two to four hours from corps headquarters to the group and squadrons, and still longer was required to send a message from the divisions to the divisional squadron.

Radio, the form of liaison which is ideal for use in war of movement, was never developed to a point where it could be relied upon. Messages were successfully interchanged between the group and the various posts of command in the corps area from time to time, but for the most part, due to insufficiently trained radio personnel and occasional shortages in material, reliance could not be placed upon this form of liaison.

It therefore became the duty of the liaison officer stationed at the posts of command of the divisions and the corps artillery, working in conjunction with other liaison officers who made daily trips from the group and squadrons to these posts of command, to supply the chief of Air Service, group, and squadrons, with all information necessary for the conduct of Air Service operations which in ordinary circumstances had been transmitted by means of the telephone, telegraph, or radio system. From the point of view of dispatch, this system had its obvious drawbacks, but resulted in a situation considerably better than that obtaining before its institution. In addition, it produced some good results in establishing a closer understanding on the part of the line organizations as to the proper use and limitations of the Air Service. Many difficulties and misunderstandings which had arisen previously on account of failures to properly distribute the various codes used in operations by the Air Service with both artillery and infantry ceased, due to the efforts of these Air Service liaison officers. Much valuable instruction in Air Service matters was given by them to the officers of the line organizations with a resulting improvement in operations later conducted.

---

At about the time of the relief of the 26th Division by the 42d Division (United States), the corps sector was narrowed to a one division front and the 167th French Division ceased operations under the 1st Army Corps (United States). These changes occurred about the 25th of July. On July 22, the 1st and 12th Aero Squadrons were moved from the airdrome at Francheville to that at Morass farm to the east of La Ferte-sous-Jouarre. On the 20th of July the Sopwith airplanes of the 88th Aero Squadron were replaced with the Salmson. The 88th Aero Squadron continued operations from Francheville until July 25, when the 167th French Division was withdrawn from the corps sector, at which time the 88th Squadron was assigned to the 3d Corps. From July 25 until August 12, all corps command missions, photography missions, and divisional work was carried out by the 1st and 12th Aero Squadrons. To a French squadron, which was at this time assigned to the 1st Corps group, was given the work of adjusting the fire of the corps artillery. Early in August the 42d Division was relieved by the 4th Division (United States).

On account of the large number of enemy pursuit squadrons operating in this sector there were numerous losses in carrying out the work of corps observation. The replacement of pilots and observers was slow and far from satisfactory. In addition great difficulty was experienced in procuring replacements in airplanes. As a result it became increasingly difficult to carry out the work at hand and it was not infrequent that a flying personnel of from six to eight pilots and observers in each squadron executed the missions scheduled for the day. This necessitated the execution of two or three missions per team per day.

On August 2 the group moved to the airdrome at Mayen-Multien (just north of the Meaux), for although the flying field was even farther from the lines than that of Morass farm the latter location was needed for the establishment of the Air Service of an Army Corps. On August 10 the group was again moved, this time to Coincy, to the southwest of Fere-en-Tardenois. On August 12 the 1st Corps Air Service was relieved from duty in the sector and was sent to Chailly-en-Brie to await orders to proceed to another sector.

## **Comment.**

In taking up active operations on the Marne the Air Service of the 1st American Army Corps was well fitted from the point of view of organization, equipment, personnel, and training to cope successfully with the work before it. While it is true that it had never engaged in operations during a war of movement, it had had a training and experience which permitted it to meet new situations and problems with every prospect of success.



At the time that it arrived in the Marne area the tactical situation was such that it was of necessity located at a considerable distance from the front lines. Shortages in airdrome equipment and available labor troops to prepare new airdromes during the advance of the ground troops proved a great handicap in the carrying out of operations when the danger of a successful enemy offensive had passed and the advance toward the Vesle had commenced.

The condition in which airplane replacements arrived necessitated a great amount of labor, which detracted from the routine preparation of material for operations over the lines. Lack of replacements in airplanes and flying personnel at certain times proved a great handicap in carrying out the work at hand.

The failure of pursuit protection as a means of safeguarding the success of missions at times when enemy pursuit aviation completely dominated the air was counteracted in a measure by the dispatch of two or three observation airplanes in formation. The availability of biplane protection during the operations in this sector would have added materially to the success of the 1st Corps Air Service.

The principal value of the work of the 1st Corps Air Service during all the operation on the Marne was in its results as an information agent for the staffs of the corps and divisions by means of the execution of visual and photographic reconnaissance command missions, infantry contact patrols, and missions of surveillance of the enemy artillery. As a factor in aiding the artillery to adjust its fire, the Corps Air Service was of comparatively small value.

The Marne campaign demonstrated beyond doubt the necessity of developing to the highest possible degree a system of liaison by radio between the various corps and divisional posts of command and the Air Service. It proved that in a rapid advance small reliance could be placed upon the telephone and telegraph. Lack of training on the part of the radio station personnel was without doubt the main reason for the failure of radio liaison between ground stations. The same was true with regard to most failures which occurred in attempted adjustments of artillery fire after an initial communication with the battalion radio station had been established. The lack of training of panel crews was equally apparent and was usually productive of as poor results in the attempted cooperation between the Air Service and the artillery.

The method of dealing with the distribution of codes and the assignment of call letters and panel numbers as established by the corps was productive of great confusion, misunderstandings, and failures during the first few weeks of the operations on the Marne. Toward the latter part of July the placing of all such matters under the jurisdiction of one staff officer did much to do away with the difficulties which had formerly arisen.



---

Probably the most valuable lesson of the entire campaign was the knowledge that neither the artillery nor the infantry of the United States divisions here engaged had a sufficient knowledge or experience in the proper use and limitations of the observation Air Service of the corps. With one exception these divisions were among the oldest in France, and this knowledge concerning their lack of proper training in the use of the Air Service arm forewarned the Corps Air Service as to what to expect in the future and to devote the major portion of its efforts to the work of instructing both infantry and artillery in the employment of aerial observation before it could hope to realize the full measure of success in operations to be undertaken in the future.

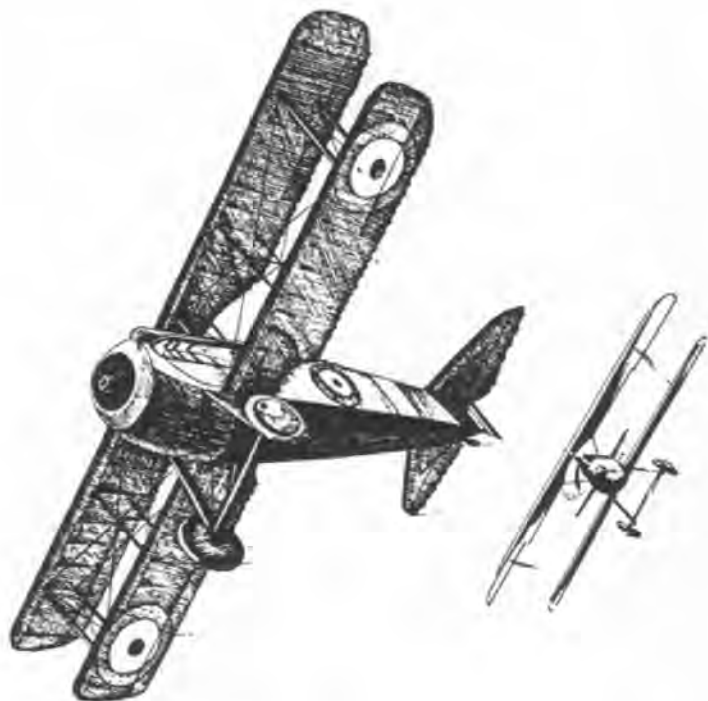



*Maj. Joseph T. McNarney, the Chief of Air Service, III Corps, in August 1918.*



## **VI. The Third Corps Air Service on the Vesle River.**

---

### **Introductory.**

By the opening of the first week in August, 1918, the 6th French Army had advanced to the River Vesle. The 3d American Army Corps, attached to the 6th French Army, held a sector along the river extending approximately from Bazoches to Courlandon. To second the operations of the 3d Corps in the accomplishment of its tactical mission, an Air Service group was placed at the disposal of the corps commander.

### **Organization of the Air Service, 3d American Army Corps.**

The Air Service assigned to the 3d Corps was composed of three squadrons operating under the immediate command of an Air Service officer designated as chief of Air Service to the corps.<sup>4</sup> No group commander or headquarters was assigned. The chief of Air Service took station, with his office and staff, at the airdrome, and there exercised the dual function of corps and group commander.

The organization of the office of the chief of Air Service was essentially as outlined in the chapter on operations of the 1st Corps Air Service at Chateau-Thierry. This organization adapted itself admirably to the routine of administration and direction of operations of the 3d Corps group. A French Aviation Officer was detailed to assist the chief of Air Service in directing the work of French units assigned to the group.

The following squadrons comprised the 3d Corps groups:  
88th Aero Squadron (United States) (Salmson biplace).  
284th French Squadron (Spad biplace).  
237th French Squadron (Breguet biplace).

### **The Airdrome Location Installation Defense.**

The airdrome of the 3d Corps group at the opening of operations on the Vesle was situated at the Ferme des Greves, on the heights overlooking the left bank of the Marne River, about 10 kilometers east from Chateau-Thierry. The front lines were roughly 30 kilometers distant. Preparation had been made for reception of the group by the technical services of the 6th Army. Hangar accommodations, for the most part of the individual tent type, were adequate for housing the 38 airplanes of the three squadrons. Huts and billets provided ample shelter for the various headquarters and for the commissioned and enlisted personnel. The airdrome had no defenses against air raids other than the regional antiaircraft artillery. Shelter from bombs existed in the form of abandoned trenches and dugouts constructed by the troops which had recently fought over the ground.

---

### **Group Supply.**

Routine supply was assured from near-by corps railheads. Technical supplies were drawn from the 4th American Mobile Air Park, situated near Couloumiers, and, in special urgent cases, from the base depots at Paris, by motor transport.

### **The Tactical Situation.**

The 3d Corps was organized for attack with two divisions in the line and one in reserve. The usual complement of artillery supported the forward divisions. In addition, the corps possessed a powerful concentration of heavy artillery, caliber 155. The mission of the corps was to seize a favorable opportunity for forcing the passages of the Vesle and to exploit success as far as the River Aisne.

In the air the friendly situation was weak. One French pursuit group was charged with patrolling the entire front of the 6th Army. The pursuit defense was inadequate. Corps on the right and left of the 3d Corps had three or more squadrons each, for the accomplishment of observation missions. The aerial observation units at the disposal of the 3d Corps were adequate. All squadrons were experienced.

Opposite the front of the 3d Corps the enemy was strongly organized for defense along the heights to the north of the Vesle. He was strongly supported by heavy concentrations of artillery and machine guns. It was presumed that he would confine his operations to those of a purely defensive nature. No immediate aggressive action on his part was foreseen.

In the air the enemy was strong. A defense concentration of pursuit squadrons opposite this sector furnished constant patrols from daylight to dark. The personnel of these squadrons was aggressive, experienced, and determined to prevent observation of enemy activity at all costs. The enemy completely dominated the air. His observation effectives were apparently inconsiderable.

### **Mission of the 3d Corps Air Service.**

The mission of the 3d Corps Air Service was as follows:

1. To establish an effective surveillance of the enemy and report to corps and division all negative and positive observations of his activity, rendering certain the detection of either a retreat or an attack in preparation.
2. To effect such photographic reconnaissance of enemy defenses opposite the front of the 3d Corps as the command might from time to time require.

- 
3. To locate, by flash, enemy batteries in action and assist reaction by our own artillery.
  4. To adjust the fire of our own artillery.
  5. To inform the command of the location of our own advance elements during aggressive action (contact patrols).
  6. To advance the training of our own troops in the use of the aerial arm during active infantry or artillery operations.

### **Plan for Effecting Mission.**

In order to carry out effectively the mission of the Air Service, as above outlined, the following assignment of squadrons was directed by the Chief of Air Service:

### **Assignment of Squadrons.**

To the 3d Corps (photographs, corps visual reconnaissance command missions), the 88th Squadron.

To the division on the right (divisional artillery, adjustments, division sector reconnaissance, contact patrols), the 88th Squadron.

To the division on the left (divisional artillery adjustments, divisions sector reconnaissance, contact patrols), the 284th Squadron.

To the corps artillery (surveillance and locating of enemy batteries in action, adjustment of corps heavy artillery), the 237th Squadron.

### **Communications.**

The usual intergroup telephone communications, connecting all units of the group through a central switchboard, were at once established.

### **Telephone.**

By special arrangement with the chief signal officer of the corps a direct copper telephone circuit was strung from the group to corps headquarters. The permanent maintenance of this very rapid and essential means of communication with the command was made possible by the comparatively stable situation which followed the arrest of the allied advance at the Vesle.

Communication with the divisions through the corps central was possible.

### **Radio.**

The radio section of the 88th Squadron assured wireless communication with the corps and divisions. Operators were kept at the receivers 24 hours daily.



### **Motor Cycle Dispatch Service.**

Motor cycle dispatch service, one run daily, was assured by the office of the Chief of Air Service between corps and army headquarters. Divisional dispatches were forwarded by the divisional courier services through the corps message center.

### **Liaison.**

Under the direction of the Chief of Air Service a very complete and effective system of personal liaison was worked out and put into immediate effect. One observer from the 88th Squadron was stationed at the corps message center. This observer was instructed to keep in touch by personal contact at frequent intervals, with the staff. It was his function to keep the group informed from time to time during the course of each day of the tactical situation and the needs of the staff and line. He acted as advisor to the commanding general and the staff, speaking for and in the absence of the Chief of Air Service. He received by telephone all requests, complaints, and information from the divisions and transmitted these to the Chief of Air Service or his representatives at the airdrome. He transmitted messages from the airdrome to the corps and divisional staffs and units.

In addition, the Chief of Air Service made daily visits to the corps and, in conference with staff and representatives of corps artillery and divisional units, worked out the solution of air service problems having a bearing on the operations in course.

By direction of the Chief of Air Service, observers of the various squadrons were designated from time to time to visit and confer with the divisional and artillery staffs and unit commanders.

It was arranged that all corps field orders, operations orders, plans of liaison, summaries of intelligence, liaison and intelligence bulletins should be forwarded by courier with the least possible delay to the office of the Chief of Air Service at the airdrome. All situation reports and maps, both artillery and infantry, were furnished by the services concerned in like manner. Codes and keys were furnished the Air Service by the G-2 sector of the corps staff. Radio plans and diagrams were furnished the group radio section by the corps radio officer.

Air Service tactical and technical orders and bulletins emanating from the Air Service of the 6th French Army were forwarded to the group daily by motor dispatch.

In this way a very complete file of tactical and technical data was secured and kept up to date. All data directly affecting the operations of the group flying and technical personnel was conveniently posted and labeled, by class, in the group operations room. Complete

---

information on the tactical situation, both friendly and enemy, was thus maintained within easy reach of officers.

### **Orders—By Whom Issued.**

After conference and by arrangement with the Chief of Air Service it was prescribed that all requests for the accomplishment of special missions for the corps should emanate from the G-2 section of the staff. Orders having their source in the divisions were communicated direct by telephone, radio, or motor cycle dispatch service from the divisional headquarters to the Chief of Air Service or his representative, who directed their execution by the squadron concerned. Prearranged missions were communicated on the day preceding their execution to the operations officer of the Chief of Air Service. These were incorporated in the operations order for the next day, issued to the group by the Chief of Air Service.

### **Tactical Reports.**

Upon the conclusion of each day's operations the operations officer of the Chief of Air Service received the reports of the operations officers of each squadron and prepared a consolidated operations report for the group. The group operations report was transmitted daily to the various higher commands concerned.

Upon the basis of individual observers' reports and the group operations report, the branch intelligence officer, assigned by G-2 to the group, prepared nightly an Air Service Intelligence Report for submission to the G-2 section of the corps and the divisions.

In addition to the usual method of reporting, elsewhere described (see History of the 1st Corps Group at Ourches), observers of the 3d Corps group returning from infantry contact and reconnaissance missions were required, by direction of the Chief of Air Service, to report by dropped message to the headquarters of the divisions concerned and to the corps the results, whether positive or negative, of their missions. Teams were instructed not to return to the airdrome at the close of a mission until messages had been dropped giving full and complete account of the observations effected.

### **Tactical Operations Undertaken.**

During the first week in August, 1918, the 3d Corps Air Service commenced active operations along the Vesle. Each day's work was carefully planned by the Chief of Air Service and his assistants on the basis of the tactical situation as communicated by corps and divisional headquarters through the various channels of liaison above outlined.

---

At no time was an attack on a large scale projected or launched by the troops of the 6th Army. The operations partook of the nature of harassing infantry and artillery assaults upon the enemy's positions with the object of weakening his morale and wearing down his strength and resources. Frequent short advances across the river into his lines were carried out, but until the opening days of September the passage of the Vesle was not permanently affected by troops of the 3d Corps.

It developed upon the Corps Air Service to maintain a constant watch upon the enemy to detect any preparations for attack or retreat upon his part. To this end morning and evening reconnaissances were established as a matter of daily routine. These reconnaissances covered the entire corps sector. The divisional sectors were, as a rule, closely reconnoitered at least once daily by the divisional squadrons. Too much stress can not be laid upon the importance to the command of the negative information regarding the enemy's activity gathered by these reconnaissances. The command was at all times assured that, unless otherwise advised by the Air Service, no untoward events were impending. Plans for the completion of our own lines of defense and orders for the undertaking of any local aggressive operations could thus be issued with a relative degree of certitude that all contingencies having to do with enemy reaction had been foreseen and guarded against upon the basis of an unchanged situation.

While realizing the importance of the communication of negative information, the Air Service spared no effort to gather as much positive data as the situation permitted. The morning and evening reconnaissances were particularly effective in locating in the half light the flashes of enemy batteries in action. No source was more fertile than the Air Service in information regarding the situation of hostile batteries. A ruse, developed in the 88th Squadron, for trapping enemy guns into exposing their locations is worth noting. The airplane seeking to locate batteries first flew boldly up to the lines and remained at close range for some little time, preserving an altitude of about 700 meters. If, as was usually the case, the enemy guns ceased fire in presence of hostile observation, and no battery flashes were observed, the airplane retreated some 10 kilometers into its own territory and dropped to an altitude of, roughly, 200 meters. After an interval it returned at this altitude to the lines. It was rare that the observer, under these conditions, failed to pick out two, three, or more batteries which had resumed fire upon noting the absence of observation.

Vertical aerial photographs secured by the group were a valuable source of positive information. During the six weeks spent by the 3d Corps group on the Vesle the entire sector opposite the corps front was photographed to a depth of 12 kilometers. This work was accomplished by formations of three or five airplanes. Numerous

---

missions failed because of the active resistance of enemy pursuit, which attacked in vastly superior numbers. The average altitude was 3,000 meters. Upon one or two occasions close pursuit protection was secured from the neighboring French pursuit group 22. Ordinarily, pursuit protection was not available owing to the insufficient effectiveness of group 22, which was responsible alone for the protection of the entire Army front. It was found also that the delays encountered in meeting protecting airplanes were responsible for the failure of missions which started during perfect weather and ran into fog or clouds before the protection could be obtained and the lines reached.

A complete assemblage of oblique views of the Vesle front was secured. These photographs, remarkable for their clearness and sharpness of detail, were taken by the group photographic officer, using a 50-centimeter camera mounted on a support of his own devising which was fixed to the observer's machine-gun turret. They



---

were of great tactical interest in familiarizing the staff and commanders of combatant units with the features of the enemy terrain immediately opposite the corps front.

Special missions were from time to time dispatched, by order of the corps commander, to reconnoiter the passages of the Vesle. Airplanes detailed for these missions flew at a low altitude along the river. The observer noted accurately the location and number of bridges and footbridges intact.

All reconnaissance missions reported upon the density and location of shell falling in our own and enemy territory.

Upon each of the several occasions when the forcing of the passages of the Vesle was attempted, airplanes of the group were dispatched to stake the line of the division fronts. These missions met with small success. Our troops appeared ignorant of the use of panels in communicating their location upon the call of the airplane. In any case panels were rarely shown and the covered nature of the terrain made the distinguishing of individual men extremely difficult, even when observations were carried out at the minimum altitude.

Adjustments with divisional and corps artillery were vigorously encouraged. A considerable proportion of these were arranged only after solicitation by the Air Service. Ordinarily, in the prearranged adjustment, the observer detailed for the mission visited the battery on the day previous to undertaking the work. In conference with the battalion radio officer and the battery commander the details of the shoot and the method of adjustment were determined in advance and thoroughly understood by all participants. Even where careful preliminary liaison of this sort was undertaken before attempting work with the artillery, failure, rather than success, was the rule. The difficulty in most cases was traced to the improper functioning of the artillery radio station. Artillery radio personnel was found to be consistently inexpert and inexperienced. Particular care was exercised by the group to assure the proper functioning of the radio equipment aboard airplanes. Observers tested their radio before leaving the field. Wherever possible the group radio section followed the calls of the airplanes after its arrival at the battery. Instances occurred where airplane wireless was charged with faulty functioning and where an accurate log of all calls sent by the airplane during an unsuccessful adjustment had been filed by the operators at the group set, proving efficient functioning of the airplane's equipment and failure on the part of the battalion station to receive effectively.

Every effort was made by the personnel of the group to clear up, by personal liaison, the difficulties encountered in radio signaling. Observers and radio officer made frequent trips to artillery units. The problem of airplane radio was discussed on the ground in a majority of



---

cases where adjustments had failed. Repeated panel exercises, executed with a view to training artillery radio personnel, were scheduled and successfully accomplished. Better results were finally obtained, although adjustments were never accomplished with that average of success which was sought.

During the closing days of August the advance of the entire allied line to the west of the 6th French Army made it evident that the enemy's position on the heights of the Vesle was threatened from the left bank and must soon become untenable. His retreat across the Aisne was considered imminent. Accordingly, the Air Service of the 3d Corps was instructed to seek and carefully report all indications of the expected withdrawal. In this connection the Air Service furnished the following information:

- (a) Noticeable increase and added aggressiveness of enemy pursuit aviation over the sector, rendering observation difficult.
- (b) Sudden decrease of enemy anti-aircraft artillery.
- (c) Sudden absence of enemy balloons opposite our front.
- (d) Increase of fires in villages along the presumed line of withdrawal.
- (e) Explosions of artillery dumps.

Observations of this nature became so frequent and convincing by September 1 that the Chief of Air Service of the corps felt warranted in stating definitely on that date that the enemy retreat was in full course. On September 3 the conclusion drawn by the Air Service was proved correct. The enemy had completely evacuated the left half of the corps sector and retreated across the Aisne. The 77th Division (United States), holding the left of the 3d Corps sector on that date, crossed the plateau between the Vesle and the Aisne without encountering resistance other than enemy harassing fire delivered from flanking artillery.

### **Move of the 88th Squadron to Advance Airdrome at Goussancourt.**

In view of the expected enemy retreat, to be followed by a corresponding advance of the 3d Corps units and headquarters, preparations were made for the forward movement of the 3d Corps Air Service. The forward movement was dictated by the necessity for close liaison. An airdrome was selected at Goussancourt and hangar accommodations for one squadron assured by the technical services of the 6th French Army. It was planned to station the 88th Squadron at Goussancourt immediately upon completion of the field, leaving the two French squadrons of the group temporarily at the Ferme des Greves. The office of the Chief of Air Service prepared to take station at Goussancourt. The use of Goussancourt as an advance airdrome

---

and gas station was not contemplated in view of the practical difficulties developed by the experience of the 1st Corps group at the Ferme Morasse. It was judged that better results could be obtained by moving a squadron of 18 airplanes entire to the advance field and thence conducting operations normally. The comparative mobility of a single squadron assured its easy retreat in case of an enemy advance which might threaten its security. In practice the experiment proved successful.

About August 25 the office of the Chief of Air Service and the 88th Squadron moved to the advance field and took permanent station. Huts, hangars, and billeting accommodations were adequate. A direct telephone circuit to the corps switchboard had been prepared, assuring communication with the corps and its units and with the field at Ferme des Greves through the corps central and thence by direct circuit. The usual lines of liaison and courier services were immediately set in operation. The move was so planned that no break in operations was involved, one half the 88th Squadron flying to the advance field early in the day, while the other half assured operations, the remaining airplanes flying to the advance field later in the day, while operations were resumed by those which had already arrived at Goussancourt.

In order to reduce liaison difficulties and to coordinate effectively the work of squadrons on separate fields, a routine scheme for the operations of the 237th and 284th French squadrons was devised and put into effect. These squadrons were made responsible for all surveillance of the corps sector and for reconnaissance of the left divisional front. No special orders or instructions were required for the accomplishment of this work, which involved a set procedure. Airplanes of the French squadrons returning from surveillance missions were required to drop reports of their missions at a prepared dropping ground established adjacent to the office of the Chief of Air Service. This obviated landing, with its attendant dangers and difficulties, and furnished at the same time a sufficient check on the work accomplished. The 88th Squadron continued to assure the accomplishment of corps missions, photographic reconnaissances, and missions for the right division. Heavy artillery adjustments were accomplished as usual by the 237th Squadron, in personal liaison with the corps artillery. The 284th Squadron similarly carried on the artillery work for the division on the left. Complete telephonic summaries of the day's work were received each evening from the French squadrons by the Chief of Air Service.

In general, the scheme of coordinating the work of the group operating from a rear and an advance field was successful. Communication was adequately provided for, useless liaison was

obviated, full control was retained by the Chief of Air Service. When the advance of the 77th Division to the Aisne Canal was followed by a forward movement of all corps elements, close-up liaison between the office of the Chief of Air Service, the corps squadron, and the elements and posts of command of the corps was already established and operations were not impeded by the change in situation.

During the second week of September the 3d Corps was relieved and proceeded overland by rail and motor transport to the Verdun area. The 88th Squadron was likewise relieved and proceeded for a period of rest to the Ferme des Greves. The 237th and 284th Squadrons assured the Air Service missions for the units relieving the 3d Corps.

On September 11 the 88th Squadron was temporarily attached to the 5th Corps (United States) and ordered to the 5th Corps group with station on the airdrome at Souilly. The move to Souilly is noteworthy in that the movement order was not received by the squadron until 9 p.m. of the 11th. The squadron moved by road and air to the Verdun area on the following day, the flight of 200 kilometers being made in the rain under low-hanging clouds. Upon arrival at Souilly no gas or oil was available for refilling the tanks of the airplanes. With the gas and oil remaining after the flight from Ferme des Greves, airplanes of the 88th Squadron operated over the lines at St. Mihiel on the afternoon of the 12th.



### **Training Operations of the 3d Corps Group on the Vesle.**

With a view to instructing the infantry in the details of contact patrol and staking of the front line by airplane, the Chief of Air Service established an infantry contact school for troops of the division in line. The duration of the course was three days for each division. Troops to the number of 200 were drawn from the rifle companies, machine-gun battalions, and headquarters detachments of each division and sent by motor transport, fully rationed and equipped for three days, to the airdrome at Ferme des Greves. Three or more officers were in charge of each detail of 200. The details brought with them sets of ground panels for use in signaling from posts of command to airplanes, signal rockets and pistols, bengal flares, and individual panels for each infantryman. The details of transport, rations, and equipment were a function of the training section of Corps G-3.

The course consisted of lectures to officers and men on the use of airplane observation generally. Particular stress was laid upon the importance to the individual soldier as well as to the command of infantry contact patrols in determining the position of advance elements during an attack or retreat. Practical terrain maneuvers, in



---

which airplanes participated, and the line was called for, by means of conventional rocket signals, and staked by the troops, using individual panels, were accomplished during each day of the course. After each terrain exercise an explanation and critique was held by observers participating. An informal discussion, in which questions of individual men were answered, followed the critique. Upon returning to their division the troops were instructed to spread the information acquired at the school throughout their units.

The school thus established produced very appreciable results. Divisions whose men had recently returned from the lectures and exercises at the airdrome could be counted upon, under almost all conditions, to cooperate with the airplanes during contact patrols. It became the rule rather than the exception to observe infantry panels after calling for the line.

### **Comment.**

The Air Service of the 3d Corps on the Vesle actively contributed to the conduct of operations. The negative and positive information furnished was very complete and exact.

As a means of liaison between the command and advancing troops, the Air Service was, on the whole, unsuccessful. Ignorance of troops in the use of signals and panels was the cause of failure in every case.

The liaison school established at the airdrome cleared up many difficulties and would have proved of great value had time been available to test its effect.

Air Service cooperation with the artillery was unsatisfactory. Poor radio liaison was the cause of failure.

The work of the 3d Corps group over the lines was carried out in face of aggressive and superior enemy aerial effectives. Protection was practically nonexistent. The entire dependence of corps observation upon pursuit barrage was here demonstrated in the most convincing manner. Mission after mission was hindered or failed completely because of enemy ascendancy in the air. Observation airplanes were forced to carry out their work at low altitudes, rarely venturing far into the enemy lines. Observation was rendered extremely arduous and difficult.



*During the St. Mihiel offensive, the Chief of Air Service, IV Corps was Maj. Harry B. Anderson (left); V Corps, Lt. Col. Arthur R. Christie (right).*

## VII. The Corps Air Service in the St. Mihiel Offensive.

---

### The Tactical Situation.

The St. Mihiel offensive of the 1st American Army may be divided into two periods:

The period of preparation, August 10 to September 11.

The period of attack, September 12 to 16.

On August 10 the situation of the front lines in the St. Mihiel sector was the same as that described when treating of the same sector in the chapter on corps observation activities from April to July, 1918. From Pont-sur-Seille to Chatillon-sous-les-Cotes the front lines remained practically the same as they had been for the past three and a half years. Commencing August 10, the American preparation for the St. Mihiel offensive began, and from then on until the first week in September the bringing up of new units and reserves, supplies and material, stores and munitions took place. The Army sector was held by four Army Corps. From left to right the line of battle included the 5th Corps (United States), the 2d Corps (French colonial corps), the 4th Corps (United States), and the 1st Corps (United States).

On August 26, 1918, the headquarters of the 1st Army Air Service commander was established at Ligny-en-Barrois.<sup>5</sup> Under his command was the French Aerial Division, which consisted of a large number of pursuit and day-bombardment squadrons. In addition, there was one other French pursuit group and three American pursuit groups—one American day-bombardment group—the 1st Army observation, and one French Army artillery group for the adjustment of long-range artillery fire. Eight night-bombardment squadrons of the British R. A. F. were to cooperate with the Air Service of the 1st Army whenever the tactical situation made such action expedient.

The Corps Air Service of each corps operating under the 1st American Army was made up of one squadron for each division and one squadron for the corps. The Air Service of the 2d Colonial Corps consisted entirely of French squadrons. The 1st Corps observation group was made up of the 1st, 12th, and 50th American Squadrons and two French squadrons. In the 4th Corps group were the 8th, 135th, and 90th American Squadrons and one French squadron. The 5th Corps group consisted of the 88th, 99th, and 104th American Squadrons.<sup>6</sup>

The situation of the enemy in the St. Mihiel sector was approximately the same as that described in the chapter on the Toul sector. The sector of the front from St. Mihiel north to Chatillon-sous-les-Cotes was organized in approximately the same manner as the Toul or St. Mihiel sector. The enemy was favored by the terrain, which offered many natural positions of great strength. These positions had been well organized for a prolonged defense. Some intimation of an impending allied offensive in this sector had reached the enemy, and

immediately preceding the attack of September 12 he commenced a redistribution of his available forces, especially with a view to echeloning them in depth. As far as was known at the time, the enemy strength in the sector remained about the same as it had been throughout the summer months.

In the air the strength of the enemy continued the same as it had been since the previous spring. A few pursuit patrols of Fokker airplanes were reported as operating in this sector, but it was quite probable that these were new airplanes received as replacements for the Albatross and Pfalz type formerly in use. Individual observation and photograph airplanes operated over the sector, but no unusual number of hostile aircraft was at any time encountered or reported before the opening of the St. Mihiel offensive.

The observation air service of each corps was organized along the same lines as those described in the foregoing chapters on the organization of the 1st and 3d Corps groups. In the 1st and 4th Corps, the officers of the corps chief of Air Service were located at corps headquarters. In the 5th Corps, due to the fact that the group had been assembled for the first time and was made up of three squadrons,

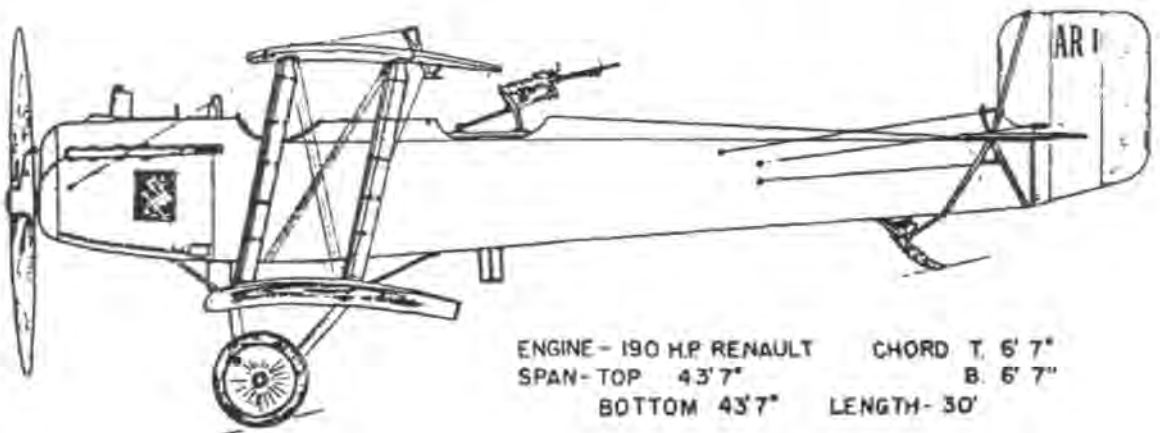



only one of which had had a considerable experience in active front-line operations, the corps chief of Air Service and staff remained at the location of the group.

The 1st Corps group was located in the vicinity of Toul on two airdromes. The 1st and 12th Squadrons were stationed at the airdrome just east of Toul, which had formerly been occupied by the 1st Pursuit Group in the spring of 1918. The 50th and 211th (French) Squadrons occupied a newly constructed airdrome at Biqueley, just south of Toul. The 4th Corps group entire occupied the airdrome at Ourches. The French squadrons of the Air Service of the 2d French Colonial Corps were located at Rumont, to the northeast of Bar-le-Duc. The 5th Corps group occupied a flying field at Souilly.

With the exception of the 5th Corps group, each Corps Air Service was established and ready for operations by the first week in September. The 5th Corps group was not completed until the day of the attack, when the 88th Squadron arrived from the Vesle.

The one new squadron of the 1st Corps group, the 50th, had but recently arrived at the front. It was equipped with airplanes of the *DH-4* type with the new Liberty engine. Two of the three American squadrons of the 4th Corps group were also equipped with the *DH-4* Liberty; the 90th Squadron had Salmson airplanes. In the 5th Corps group all squadrons were equipped with the Salmson.

### **The Corps Observation Wing Commander.**

About the 1st of September the wing commander of corps observation for the Air Service 1st Army was appointed and established his office at Toul.<sup>7</sup> As this officer and staff were a part of the Army Air Service, in outlining his functions it will suffice to quote the Army order enumerating his duties. This order read as follows:

The wing commander (under the chief of Air Service, 1st Army) is charged with the instruction and inspection of all observation squadrons or observation groups assigned to Army Corps. He coordinates their duty and exercises technical supervision over all Army Corps aviation units. This includes the method by which duty is performed; the supply and proper care of material; the supply and instruction of personnel; the location of airdromes; the handling and care of transportation; the state of the telephonic, radio, and other signaling appliances and methods; the photographic section; the operations officers; the preparation and forwarding of orders, reports, and messages; the maintenance of liaison with contiguous troops; and the reporting to the chief of Air Service of the Army any irregularities observed in methods of performing duty either tactical or technical.

The corps observation wing commander and his staff were all officers who had been through the operations on the Marne with the Air Service of the 1st Army Corps. Their experience proved of great value in preparing the various Corps Air Services, many of which were made up in large part of newly formed squadrons for the St. Mihiel offensive. Profiting by the lessons learned on the Marne, measures were taken to guard, in so far as possible, against recurrence of the



Observers insignia

---

conditions which had there hindered the work of the Corps Air Service. By means of bulletins prepared in the office of the wing commander and distributed to the Air Service of each corps, the steps necessary to be taken by the Air Service in the preparation for the coming offensive were explained with great care and detail.

### **Plans for Accomplishment of Missions.**

The plans made by each Corps Air Service in preparation for the St. Mihiel offensive were, for the most part, essentially the same as those made to meet the tactical situation on the Marne and the Vesle. The Corps Air Service commander assigned the squadrons of his group to care for the corps and divisional work. Under his supervision, and under the direct guidance of the group commander, the tactical officers of the group and squadrons and the group branch intelligence officer, working in conjunction with the staff of the corps chief of Air Service, collected and compiled the data necessary for the coming operations. Particular attention was given to the assignment of liaison officers from each group to the corps post of command and the headquarters of each division. In addition, the flying officers of the squadrons and the operations officers of the group and squadrons made daily trips to the various posts of command of the corps and divisional troops in order to insure a thorough understanding on the part of all line officers of the essential elements necessary to bring about successful cooperation between the Corps Air Service and the corps ground troops. In so far as possible, in the time at their disposal, they carried out the work of instructing the infantry and artillery in the details of infantry contact patrols and artillery fire adjustments.



---

The plan of communications between the office of the wing commander, the various corps chiefs of Air Service, the corps observation groups, and the various post of command of each corps was the same as that described in the chapter on the Marne campaign. In addition to the custom there established of assigning an experienced observer to remain at the corps artillery post of command and the headquarters of each division as an Air Service liaison officer, an officer was sent from the 1st and 5th Corps Air Service to the headquarters of the Army Corps operating on either flank of the 1st American Army, and another liaison officer was sent from the 4th Corps Air Service to establish thorough liaison with the Air Service on the 2d French Colonial Corps.

### **Operations During Period of Preparation.**

In the operations undertaken during the period of preparation the following types of missions were executed in each corps:

Visual reconnaissance.

Photographic reconnaissance.

Artillery fire adjustment.

Exercises with artillery and infantry.

Visual reconnaissance of the corps and division sectors was carried out as a routine matter at dawn and twilight of each day. A few other special visual reconnaissance missions were dispatched to secure information of a particular nature in well-defined areas. The work of visual reconnaissance was valuable only in that it kept the command informed at all times of the situation in the enemy lines opposite each corps. The information secured in this manner was for the most part of a negative nature, due to the inactivity of the enemy at this period, but it served the purpose of assuring the staff of each corps that there were no new developments in the general tactical situation.

Photographic reconnaissance, during the period of preparation, consisted for the most part of taking oblique views of the enemy territory immediately opposite the front lines of each corps. This type of photograph proved of great value in the preparation of detailed plans for the attack.

No great amount of adjustment of artillery fire took place, due to the necessity of veiling all preparations for the offensive. The shoots executed were therefore merely those necessary to register the fire of a few batteries on certain points.

Exercises were conducted as frequently as possible in each corps for the purpose of preparing the infantry and artillery to cooperate successfully with the airplane observer during the coming offensive.

All operations were greatly hindered by the unfavorable weather which prevailed during the early days of September.

---

During the four days of the American offensive which cleared the St. Mihiel salient of the enemy, weather conditions, except on September 14, were such as to greatly hinder the carrying out of aerial operations.

### **Operations During the Period of Attack.**

On the morning of the 12th of September, when the attack was launched, a heavy mist, low-lying cloud banks, and intermittent rain combined to make all aerial observation extremely difficult. Notwithstanding this fact, command airplanes for the corps and divisions, infantry contact patrols, and artillery surveillance airplanes performed their respective missions throughout the hours of daylight. The command was thus kept informed of the general progress of the battle and at periodic intervals was given the first line of our advancing troops located by observers executing the missions of infantry contact. Missions operating in cooperation with the artillery were unable, on account of atmospheric conditions, to accomplish much work of value in the regulation of artillery fire on fugitive targets, but, taking advantage of momentary gaps in the clouds and mist, they were able to observe and report upon the location of such targets from time to time and to furnish other information of considerable value to the artillery.

The work accomplished on September 13 was virtually a repetition of that of the 12th, for the same unfavorable weather conditions continued. September 14 was the one day during the offensive which was favorable for the conduct of aerial operations by the Corps Air Service. Missions of every type were dispatched, throughout the hours of daylight. Command airplanes, infantry contact patrols, and visual reconnaissance missions kept the command well informed as to the progress of the attacking troops and of the situation within the enemy lines to a depth of 8 kilometers. Photographic missions were executed and resulted in a large number of successful photographs of the enemy's front-line positions. Artillery surveillance airplanes secured much valuable information which was immediately sent by radio to the artillery posts of command and later confirmed by both dropped messages and telephonic reports upon the return of the observer to the airdrome. Some successful adjustments of the fire of designated batteries upon fugitive targets located in the enemy lines were accomplished, but, due to a variety of causes, which will be discussed hereafter, this type of work did not produce the results which the tactical situation made possible. From early morning of the 14th there was a very noticeable increase of hostile pursuit aviation. Some of the best enemy flights operated along the sector and observation airplanes were repeatedly attacked, but in the majority of cases successfully defended themselves and accomplished their

---

assigned missions. On September 15, unfavorable weather again greatly hindered aerial operations; the work done was similar to that accomplished during the first two days of the offensive.

**Comment.**

The short duration of the St. Mihiel offensive and the unfavorable weather which prevailed throughout three of the four days make it difficult to draw conclusions of value from a review of the work then done by the Air Service of the various corps engaged.

In supplying information to the various staffs of the Army the corps, and the divisions the work of the command airplanes, artillery surveillance airplanes, and infantry contact patrols was of undoubted value. During all the hours of daylight such airplanes were in the air in numbers sufficient to follow the entire situation of the friendly troops and that of the enemy whenever atmospheric conditions made movement on the ground visible. The system of communications was such that the information thus procured was speedily transmitted to all concerned, except in certain cases to the more advanced posts of command of the artillery and infantry. All such information was first sent from the airplane by radio. It was later confirmed by written messages dropped at the location of the posts of command concerned and again at the corps post of command. A later telephonic message was sent forward by the group branch intelligence officer to the G-2 section of the corps through the office of the corps Chief of Air



*Field radio stations received artillery adjustment information from observation aircraft.*

---

Service. All information of value to the Army Air Service was forwarded through the office of the corps observation wing commander from the 1st and 4th Corps groups, and direct from the group headquarters of the 2d French Colonial Corps and the 5th Corps.

On the one day that it was possible to dispatch photographic missions the results attained were entirely satisfactory.

As information agents the airplanes, operating in cooperation with the artillery of the corps and divisions, were all that could be desired. There were several causes which contributed to the lack of success in adjusting artillery fire on fugitive targets.

There was a large number of new squadrons which took part in the St. Mihiel operation. Some of these squadrons had had a considerable experience working over quiet sectors but none of them had participated before in offensive operations conducted on a large scale. A considerable number of their pilots and observers were inexperienced in operations over the front. As a consequence there were some failures by the observers to report direct to artillery posts of command the fugitive targets which they located during missions over the lines. They noted and recorded the information and sent it to the corps post of command by radio, dropped messages, and later telephonic reports; but failed to realize that their first duty was to convey it to the proper artillery post of command, where it could be given immediate attention. In a few instances when repeated radio calls to artillery posts of command failed to elicit response in the shape of answering panels, the observer then failed to drop a written message.

On the other hand, the artillery battalions, in particular those assigned to fugitive target work, failed repeatedly to respond to radio calls from the airplanes assigned to cooperate with them. The same conditions prevalent on the Marne again obtained in the St. Mihiel offensive with respect to the operation of artillery radio and panel stations. In some cases the trouble was a matter of faulty installation but in the vast majority of such failures the cause was traced to the insufficient training and experience of the crews assigned to operate radio and panel stations. It was also found that dropped written messages were often lost because of the failure of details at the panel station to be on constant lookout for airplanes seeking to communicate with the post of command.

Many other failures of the artillery to respond to radio calls from the airplane were due to changes being made in the location of the batteries and battalion radio stations without notifying the Air Service. In one instance six adjustments had been prearranged for the next day; during the night all six batteries were moved and, although the fact was well known to the artillery that an Air Service liaison officer

was on duty at division headquarters, no notice of the change in location of these units was sent to the Air Service. In some cases where it was necessary to order the forward movement of batteries which had been designated to fire on fugitive targets upon call from the airplane the assignment of other batteries to replace them during their movement was neglected. It might well be asked why the Air Service liaison officer did not prevent such occurrences. The answer is that during an offensive of the sort then in progress no one man can attend to matters of this sort and that the real solution is attention by the artillery to forwarding such information to the Air Service as is necessary for its conduct of operations. Without such cooperation on the part of the artillery little success may be expected.

One feature of this campaign may well be remarked. During all previous work on the part of the Corps Air Service few obstacles in the way of unfavorable weather had been encountered except in the taking of photographs. During the greater part of the time in which the various squadrons had operated over the front the weather had been excellent for aerial operations. In the short spells of poor weather which had occurred during the late spring and summer operations were seldom undertaken. Here for the first time missions were sent out irrespective of weather, an actual downpour or a thick fog being the only two conditions which were allowed to impede the conduct of operations. The flying personnel learned to carry out their work of reconnaissance and infantry contact at extremely low altitudes, trusting to occasional breaks in the clouds and mist to make objects on the ground momentarily visible. Furthermore, they achieved considerable success in securing general information as to the situation along the front of attack and also in locating the position of the friendly infantry lines under such conditions. The knowledge that some success could be achieved in this manner was utilized in great measure during the operations conducted from that time on. The low-flying infantry contact patrol and visual reconnaissance mission during unfavorable weather became an institution of corps observation during the St. Mihiel offensive.

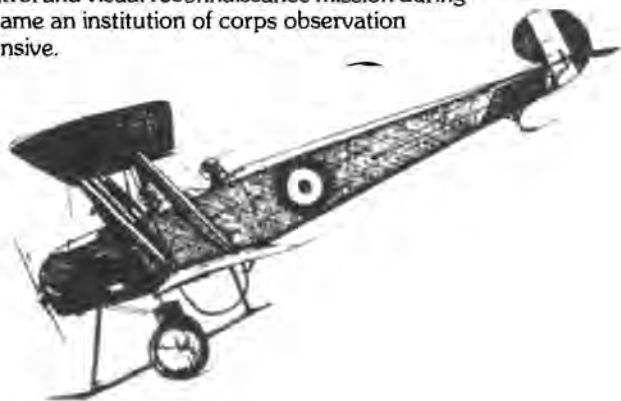

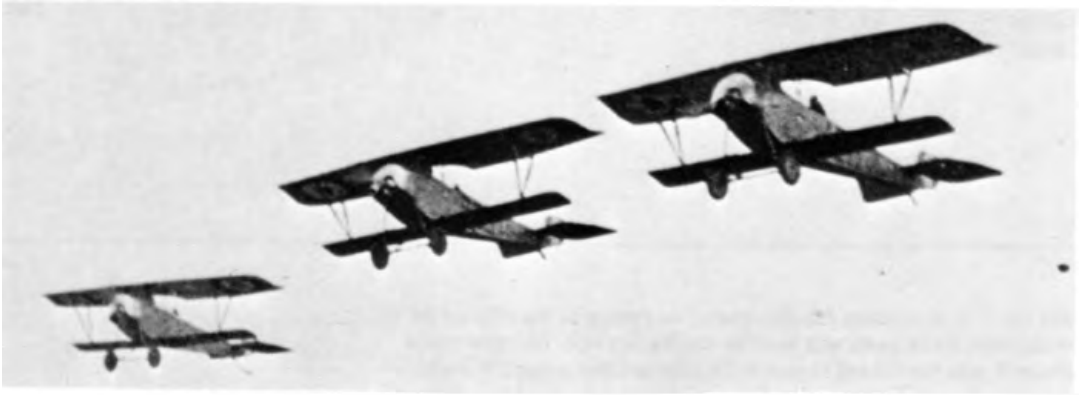

*French soldiers watch an observation balloon falling in flames.*



## VIII. The Corps Air Service in the Argonne-Meuse Offensive.

---

### Effectives and Station.

Shortly after the conclusion of the St. Mihiel offensive a certain redistribution of units took place between the various Corps Air Services in preparation for the Argonne-Meuse offensive. The three American Army Corps which were to take part in the main offensive were the 1st, 3d, and 5th. The 4th Corps was to be enlarged to include the former sector of the 1st Corps. The 4th Corps, the 2d French Colonial Corps, and the 33d French Corps were to remain in place and not take part in the main offensive. One American squadron was relieved from the Air Service of the 4th Corps, leaving the 8th and 135th American Squadrons and one French squadron in the group at Ourches. The Air Service of the 2d French Colonial Corps was composed of the same squadrons as had participated in the St. Mihiel offensive. The Air Service of the 33d French Corps was made up of French squadrons with headquarters at Beauzee.

The observation group of the Air Service, 3d Army Corps, was located on the airdromes at Souilly, Vadelaincourt, and Beauzee. The group was comprised of the 88th and 90th American Squadrons and three French squadrons.

The Air Service of the 5th Corps included the 99th and 104th American Squadrons and two French squadrons. The 5th Corps group was established on the airdrome at Foucaucourt.

The 1st Corps observation group, located at Remicourt, was made up of three American squadrons, the 1st, 12th, and 50th, and one French squadron.

### The Corps Chiefs of Air Service.

In the Argonne-Meuse operations the headquarters of the corps chief of Air Service of each corps was established at the corps headquarters. Although much can be said in favor of the plan of establishing the chief of Air Service headquarters near the group, it was thought best, in view of the conditions likely to obtain in the coming offensive, to locate each chief of Air Service at corps headquarters. The experience of the past had clearly demonstrated that the majority of difficulties encountered by the Corps Air Service were those connected in general with problems of liaison, the securing information necessary to operations, and the insufficient training possessed by the line organizations in the use and limitations of the Air Service arm. While as a matter of principle an intimate supervision by the chief of Air Service of the daily operations of the group and squadrons is much to be desired. Nevertheless, this consideration was here outweighed by the results possible to obtain by locating the chief of Air Service at corps headquarters.

---

The headquarters of the corps observation wing, 1st Army, was located at Chaumont-sur-Aire, where the 1st Pursuit Wing headquarters was also established. The headquarters of the chief of Air Service, 1st Army, was at Souilly.

The organization of the office and staff of each corps chief of Air Service and the organization of each corps observation group was the same as that described heretofore.

### The Tactical Situation.

The tactical situation faced at the opening of the Argonne-Meuse offensive was in many respects similar to that before the St. Mihiel offensive. The positions occupied by the ground troops of the three American corps which were to participate in the main attack were strongly organized by means of trench works, barbed-wire entanglements, and machine-gun emplacements. Beside the large amount of divisional and corps artillery immediately to the rear of the infantry positions, there was a formidable concentration of Army artillery located throughout the area to the west of Verdun.

With the exception of the French Aerial Division, which had been relieved, the other branches of the Air Service, 1st Army, in addition to the Air Service of each corps, remained of approximately the same strength as that described under the chapter on the St. Mihiel offensive.

The enemy occupied positions of great strength along the entire front of the 1st American Army. Intricate trench systems and well-

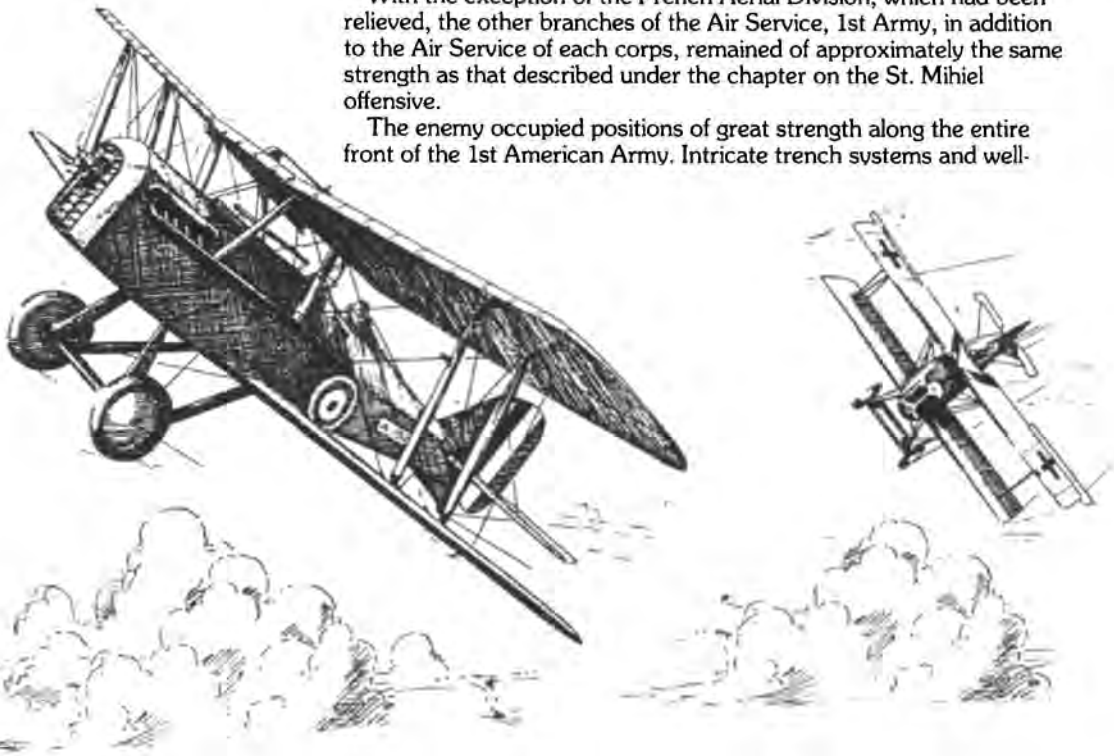

---

organized strong points, protected throughout the course of the front by barbed-wire entanglements, were occupied by the enemy infantry. Behind the lines of the latter was an artillery organization of formidable size and strength. Here, as in the St. Mihiel salient, the nature of the terrain was such that every advantage was given the enemy for a prolonged and successful resistance to attack.

Since September 14, when the comparatively negligible hostile pursuit forces of the St. Mihiel sector were augmented by the arrival of some of the best enemy squadrons, the Air Service of the enemy had been largely increased in the area opposite the Argonne-Meuse sector by the addition of many pursuit, observation, and bombardment units. The success of the allied offensives farther west had made it a matter of vital importance to the enemy that no advance be made by the allied armies in the Argonne-Meuse sector. As a consequence, a large number of his best Air Service units were sent to operate in the latter region.

### **The Mission of Corps Observation.**

The mission of the Air Service of an Army Corps during offensive operations has been described in full in previous chapters. The necessity for complete secrecy during the preparation of the Argonne-Meuse offensive prevented all operations on the part of the corps observation units, brought into the sector to participate in the attack, before the day set for the beginning of the offensive. Only the French squadrons which had been working in the sector for a considerable time past were allowed to carry out the routine work of reconnaissance, photography, and artillery adjustment.

### **Plans to Fulfill Mission.**

Detailed plans of employment of the Air Service under his command were accordingly prepared by the chief of Air Service of each corps to meet the tactical situations likely to obtain in a war of movement. Arrangements were made to allow the observers of the American squadron just arrived to fly with pilots of the French squadrons already operating on the front, so as to familiarize the observers with the new sector before the day of attack. Observers who were to act as Air Service liaison officers were sent to take station at the divisional posts of command of each corps. Other liaison officers were stationed with the corps to the right and left of the 1st Army. All measures were taken to procure in detail the information necessary to carry out each type of mission common to corps observation and to insure the future rapid transmission of such information to the Air Service of each corps

---

after the opening of the offensive. Careful plans were drawn up of the precise methods to be employed in cooperating with the corps and divisional artillery, and these plans were discussed in detail with the artillery officers concerned in personal visits made by Corps Air Service officers to artillery posts of command. Particular attention was given the subject of training the infantry in marking out the first line by panels during the execution of infantry contact patrols. Personal visits were made to all radio stations by group or squadron radio officers to make necessary arrangements for insuring success in radio liaison between the Air Service and all other posts of command in the corps. Exercises were conducted whenever possible with artillery and infantry units before they entered the lines.

Soon after the arrival of the two American squadrons of the 3d Corps group on the field at Souilly, an infantry contact school was here established to instruct detachments of infantry in the details of contact patrol and the marking out of the front line. This school was organized and operated under the same general plan as that described under "Training Operations of the 3d Corps Group on the Vesle" in a foregoing chapter. As soon as possible thereafter, other schools of the same nature were established at the airdromes of the 1st and 5th Corps groups.

The plan of liaison of each Corps Air Service was drawn up in accordance with the plan of liaison of the corps. The details of this plan were in no way essentially different from the system of communications or plan of liaison of Corps Air Service operations described in foregoing chapters. Special steps were, however, taken to guard against repeated radio failures between the airplane and the ground stations. In agreement with the chief signal officer of each corps, it was arranged that in every case where an airplane, the radio set of which had been successfully tested over the field before departure by signals received and acknowledged at the group radio station, called and failed to receive a response from the radio stations of the corps of divisional posts of command, a written memorandum noting the instance should be forwarded to the office of the corps chief signal officer for proper action to prevent a reoccurrence. To make certain of speedy telephonic liaison between the office of the chief of Air Service and the group, a direct wire was obtained. Particular care was given by the chief of Air Service of each corps to assure good telephonic liaison between his office and that of the pursuit wing commander. On account of the great distance between the corps headquarters and the airdrome of the 1st Corps group, an advance landing field was established at the location of the corps headquarters. On this field were to be stationed throughout the day a certain number of "alert" airplanes to care for missions of great urgency.

In assigning the work of each corps to the squadrons of each group the same general plan was followed as has been heretofore described. It happened that in each group there was one French squadron of the type known as the Heavy Artillery Squadron; to the squadrons of this type was assigned the work of adjusting the fire of the corps artillery and conducting missions of artillery surveillance for the corps. Other corps missions and divisional work was evenly divided among the remaining squadrons of the group.

Arrangements were made for the close protection of photographic missions by pursuit airplanes in cases where it was impracticable to furnish protection by means of observation airplanes from the group itself. The plan consisted of diverting a pursuit patrol from its routine barrage patrol at the hour desired. All detailed arrangements as to the exact time and place of rendezvous, the course to be pursued, and other matters of a like nature were left to the photographic and pursuit patrol leaders, who were to confer by telephone beforehand.

### Operations Conducted.

In treating of the operations carried out by the corps observation Air Service during the Argonne-Meuse offensive each type of mission executed will be discussed separately. No attempt will be made to describe the work of each corps in turn.

The unfavorable weather encountered during the St. Mihiel offensive continued the greater part of the time between September 26 and November 11. There were occasional ideal flying days, but for the most part atmospheric conditions were poor to impossible and proved a great handicap in carrying out aerial operations. Haze and fog obscured the ground to a great extent in the early morning and late afternoon during the last four weeks of the offensive. In considering the work performed by the Corps Air Service these weather conditions must be kept in mind as an element which affected the execution of each type of mission. In the matter of reconnaissance and infantry contact patrol work they produced some radical departures from the methods ordinarily used.

The photographic missions undertaken during the period from September 26 to November 11 were in almost every case confined to the taking of photographs of well-defined areas of particular interest to the G-2 section of the corps and Army staffs. Atmospheric conditions were so infrequently favorable to the taking of large numbers of photographs that those possible were necessarily directed to cover areas of the most immediate interest to the staff. Elaborate preparations were made in all corps air services to have airplanes ready to take off at the slightest prospect of success. All photographic missions were ordered by the G-2 section of the corps staff. They were



---

carefully prepared by the squadron observers working in conjunction with the branch intelligence officer of the group, and at the first sign of the approach of favorable atmospheric conditions the mission left the airdrome. A considerable number of missions were devoted to the securing of oblique photographs, as had been the case during the preparation of the St. Mihiel offensive. Such photographs were of value particularly with respect to the preparation of plans for the advance of the divisional infantry. At other times, it became necessary to photograph certain sensitive points in the enemy territory. Such missions, which require the greatest care, were assigned to flying teams of long experience. To attain success in them it was necessary that both pilot and observer be thoroughly familiar with the exact locality to be photographed so that no mistake would be made in securing photographs of the exact points desired. Unfavorable weather prevailed, to such an extent that it was never practical to attempt to photograph all the area of the front lines as fast as the troops advanced. The most that could be hoped for was to procure photographs of the areas most important in view of the tactical situation. At certain times during the offensive, when the need for photographs became imperative, missions of this nature were dispatched when atmospheric conditions made their failure almost certain. This was done in the hope of seizing advantage of a momentary break in the clouds or fog after reaching the lines. It is interesting to note that considerable success met efforts of this nature. At times when the weather was comparatively favorable in the vicinity of the airdromes the sky was a mass of clouds over the front lines. At other times when fog and mist made it quite difficult to "take-off" at the airdrome, missions operating over the lines to a depth of 8 kilometers into enemy territory were able to secure a considerable number of successful photographs.

In this offensive, as had been the case on the Marne, photographic missions were invariably given protection against attacking hostile pursuit airplanes. The large number of enemy pursuit flights operating in the sector made it practically certain that a photographic mission would be attacked one or more times during the course of the flight. Protection by pursuit patrols from the nearest pursuit group was utilized to a large extent by photographic missions dispatched from the 3d Corps group, and with excellent results. On the other hand, the missions of a like nature sent out from the 1st and 5th Corps groups employed for the most part biplace protection offered by airplanes from the groups themselves. This latter type of protection differed in no way, in methods employed, from those described in foregoing chapters. The pursuit protection, however, ceased to operate close in to the photographic airplane as in the Marne sector. It was found that better results could be obtained by flying a more or less erratic course

---

some 500 meters above the photographic airplane. This method allowed the pursuit airplanes to retain the advantage of their maneuverability and at the same time to assure to the photographic mission considerable protection in the event of attack. The utilization of pursuit protection or biplace protection by means of other observation airplanes resulted in either case in some losses to the protecting airplanes in warding off the attacks of the enemy from the photographic airplane, but in the great majority of cases protection of either sort sufficed to insure the safe return of the photographic airplane with a mission successfully accomplished. Toward the latter part of the offensive, considerable advantage was taken of the diversion created by the dispatch of large combined bombing and pursuit formations over the lines to afford photographic missions incidental protection. The hours for such raids being known to the Corps Air Service, photographic teams were able to time their execution of the mission so as to take advantage of the protection offered by presence of the raiding airplanes.

As in previous offensives, the most important work accomplished for the artillery of the corps and divisions was that of surveillance. Missions of this nature operated over the various corps sectors when it was at all possible to make out objects on the ground, and much valuable information was secured and sent by means of radio and dropped written messages to the various artillery posts of command. Particular attention was paid during these missions to locating and reporting the positions of hostile batteries. Considerable success in such work was obtained in following out plans similar to those described in the chapter on the Marne campaign, where special maps were prepared which allowed the observer to signal various artillery posts of command assigned to care for certain areas marked off on the map.

With regard to work with assigned fugitive target batteries, a variety of conditions was encountered which combined to nullify the efforts of the Corps Air Service in this field. Frequent radio failures marked attempts to adjust fire of batteries. Despite every effort made by the radio officers and liaison officers of the Air Service to prevent such occurrences, the battalion radio stations of the artillery repeatedly failed to respond to calls from the airplane. Dropped written messages requesting artillery fire were seldom effective in accomplishing more than the transmittal of the information concerning the location of the fugitive target. The target usually disappeared during the lapse of time necessary to place the radio station in communication with the airplane observer. During rapid advances by our troops, the movement of artillery units made it impossible to assign special batteries or battalions to fugitive target work. Information as to the location of battery positions at such times was seldom available for

---

communication to the Air Service before further movement became necessary. Every difficulty encountered on the Marne during attempts to conduct fugitive target work with specially designated batteries or battalions was here encountered anew despite the efforts of the Air Service. In addition, the generally unfavorable weather made all attempts to adjust the fire of artillery by airplane observation exceedingly difficult and uncertain of success. Conditions described above were equally true of Air Service cooperation with the artillery in the matter of prearranged fire adjustments.

Missions of corps and divisional visual reconnaissances were carried out daily at dawn and twilight. Other missions of the same nature were executed throughout the day whenever necessitated by the tactical situation. Nothing short of heavy rain or complete fog was allowed to hinder this type of work. Airplanes left the airdrome when atmospheric conditions were most unfavorable, with the hope that upon reaching the front there would be occasional moments when observations could be conducted through the clouds and mist. Every possible effort was made to secure information concerning all enemy activity and the general situation in hostile territory. Remarkable results were achieved in this work. At times the information reported by aerial observers was the sole reliance of the command in following developments along the front lines and within the enemy territory. Reconnaissance missions kept under surveillance at all times, when it was possible to fly, the front lines along the entire Army front to a distance of 8 kilometers within the hostile rear areas. Many special missions were sent out to observe and report upon enemy activity at designated points and within certain areas of particular importance defined by the corps and individual staffs.

With the establishment of infantry contact schools at the group airdrome of each Corps Air Service came a gradual betterment of the conditions which had obtained in the past in the performance of the





---

work of infantry contact patrols. While there were a large number of instances reported where the observer was forced to fly at extremely low altitudes and locate the front lines by distinguishing the uniforms of the ground troops, on the whole the cooperation of the infantry in marking out the line was far greater than it had been in any previous campaign. As increased knowledge of the necessity for such patrols became spread throughout the rank and file of the infantry by means of the group schools and the distribution of short bulletins sent out by the Air Service for this purpose, it became possible to start upon the performance of a contact patrol with some assurance that the ground troops would respond to the signals of the airplane observer by panels or flares.

Particular attention was given by the Air Service of each corps to developing a feeling of friendliness and confidence on the part of the infantry with respect to its Air Service. It was found that the enlisted personnel of many units still retained the impression that all American airplanes were to be recognized by a star painted on the bottom surface of the lower wings, an insignia which had been used on airplanes in the United States and which became widely known, whereas the concentric circle insignia actually used on American airplanes at the front was practically unknown to new divisions. The result was that many failures on the part of the infantry to respond to airplane signals were directly due to an opinion on their part that such signals were not made by airplanes working in cooperation with them. Consequently, considerable effort had to be made by the Air Service to clear up the misunderstanding. This was done by means of the distribution of printed circulars on the subject dropped from observation airplanes, the circulation through all infantry units of short bulletins on the subject of the work of the infantry contact patrol, and by temporary adoption, in many squadrons, of the divisional insignia which was painted on the airplane in conspicuous places. The result of these efforts was a marked increase in the number of successful contact patrols carried out. As an additional means of bringing about closer cooperation, between the Corps Air Service and the infantry, the custom was inaugurated of sending observers from each squadron to remain with the infantry for periods of two or three days. Personal liaison visits were of great value to both the infantry and the Air Service in promoting mutual confidence and in gaining a knowledge concerning the activities of each arm so essential to successful cooperation. During the last four weeks of the offensive it became almost a daily custom for observation airplanes to carry cigarettes and newspapers during their missions over the lines to drop to the troops on the ground whenever opportunity presented itself. All such efforts on the part of the Air Service to promote a feeling of interest and friendship on the part of the ground troops were of undoubted value in



obtaining success during the conduct of missions sent out to locate the front lines.

In all reconnaissance and infantry contact patrol work the use of radio from the airplane as a means to transmit the information gathered to the various commands concerned was almost entirely abandoned. Although the past training of the observers had contemplated the use of this means of liaison between the airplane and the ground during the conduct of such work, it was found that the numerous radio failures which occurred made the use of dropped written messages much more satisfactory.

Probably the most noticeable departure from methods employed in the past in the cooperation of the observation airplane with the infantry during attacks was the development during the Argonne-Meuse offensive of what became known as the cavalry reconnaissance patrol. Observation airplanes flying at low altitudes conducted close observation of the terrain immediately in advance of the friendly infantry, locating the position of machine-gun nests, strong points, and all other hostile defenses likely to retard the progress of the attack. All information of this nature, together with the location and strength of enemy rear guards, was then transmitted to the immediate front-line troops by means of dropped written messages. In this way the infantry was kept informed at short intervals of time of all developments in the area immediately ahead and were given information which proved of great value in aiding their advance. Although not within the scope of the Corps Observation Air Service, as a matter of principle, such cavalry reconnaissance patrols frequently used their machine guns to strafe hostile ground troops impeding the progress of the friendly infantry.

Although large numbers of hostile pursuit airplanes operated in this sector throughout the offensive, they were ineffective in hindering to any degree the operations conducted by the Corps Air Service, due in great measure to the excellent work performed by the pursuit forces of the First Army in maintaining a constant pursuit barrage at varying altitudes along the course of the Army front. However, it was but natural that many combats between observation airplanes and hostile pursuit forces should occur during the long period of intense aerial activity which characterized the Argonne-Meuse offensive. Comparatively small losses were suffered by the corps observation squadrons during such combats. Observation airplanes, by the adoption of energetic and aggressive tactics, proved their ability to successfully defend themselves while continuing the execution of their assigned missions. Losses inflicted upon attacking enemy pursuit forces were considerably larger than those suffered by the Corps Air Service. One observation pilot, who had been assisted by various observers, was officially credited with the destruction of nine enemy aircraft during the course of the offensive.<sup>8</sup>

---

Throughout the offensive, corps observation airplanes operating over enemy territory distributed quantities of propaganda leaflets supplied by the second section of the General Staff.

### **Comment.**

A review of the operations conducted by the Corps Air Service units during the Argonne-Meuse offensive shows a prevalence of conditions affecting the success of aerial operations much similar to those obtaining in the Marne and Vesle campaigns. Here, again, the greatest difficulties encountered arose through insufficient training on the part of the infantry and artillery in the use and limitations of the Air Service. Unfavorable weather throughout the greater part of the offensive proved a great hindrance in the execution of photography and artillery missions.

The establishment of infantry contact schools and other steps taken to improve the cooperation of the Air Service with the infantry realized a marked improvement in the results attained during the later stages of the offensive.

Except for the work of artillery surveillance, the results attained in cooperating with the artillery were unsatisfactory. In practically every case the cause of failures to adjust the fire of artillery was faulty radio liaison.

The work of corps and divisional reconnaissance was carried out with consistent success; at all times when aerial operations were possible the staff was kept informed by complete and accurate reports of the situation along the front of the Army.

The cavalry reconnaissance patrol as developed during this offensive rendered valuable aid to the advancing front-line ground troops. Patrols of this nature and infantry contact missions kept the command informed of the position of the first line throughout the offensive.

The marked success attained in the development of low-flying patrols during adverse weather was the outstanding feature of the Corps Air Service operations during the Argonne-Meuse offensive.

The general organization of the Corps Air Service stood the test of all demands made upon it during the offensive. No essential change was made in its organization in this period.

Under conditions bound to obtain in the rapid organization of the Air Service of four Army corps from new and largely inexperienced units, the corps observation wing headquarters as it functioned during the St. Mihiel and Argonne-Meuse offensives justified its existence. On the other hand, it is believed that under normal conditions this headquarters would be unnecessary to the successful operation of the Corps Air Service organizations of an Army.



---

## **Part 3**

# **Tactical History of Army Observation**



*Lt. George C. Kenney was associated with the 91st Aero Squadron during World War I. He became the Commanding General of the Far East Air Forces in World War II.*

---

During the inactive period on the Toul sector covering the late spring and summer of 1918 and up to the St. Mihiel offensive which commenced on September 12, army observation in the American Air Service was carried out by one unit, the 91st Aero Service Squadron. Previous to its assignment to the 1st Army on August 10, 1918, this organization worked under orders of the Chef de l'Aeronautique of the 8th French Army. The formation of the 1st Army Observation Group on September 6, 1918, with the 91st squadron as a nucleus, added to this branch of the observation service two other organizations, the 24th squadron and the 9th Night Reconnaissance Squadron, though neither of the latter did service flying previous to the St. Mihiel offensive.

The 91st Aero Squadron arrived in the Zone of Advance on December 14, 1917, being stationed on the aviation field near Amanty, Department of the Meuse, for the purpose of receiving equipment and for carrying out a program of training before taking up active service flying at the front. At this time the personnel included no flying officers.

During the first two months barracks, hangars, and other necessary buildings were erected, and the field put in condition for flying. Pilots continued to arrive and on February 24, 1918, the flying personnel consisted of twenty pilots, including the commanding officer, who took command on this date.<sup>1</sup>

The squadron at this time had not received its equipment, and the pilots were given training in observation work by piloting students of the 1st Corps Observation Training Center at Gondrecourt, Meuse. This flying was done in French Avions Renault,<sup>2</sup> which had been assigned to the First Corps Training Center.

On April 24 the permanent equipment commenced to arrive. The planes were Salmsons type 2A2, equipped with the Salmson 260 HP radial motor. The armament consisted of fixed Vickers and twin Lewis guns of French manufacture.

The pilots were trained in flying the new planes, and the mechanics were given courses of instruction in their upkeep at the Salmson motor factory.

The full complement of airplanes having been received, and the personnel considered sufficiently well trained, orders were received to proceed to the front for active service over the lines, and on May 24, 1918, the squadron moved to the airdrome at Gondreville-sur-Moselle, Department of Meurthe-et-Moselle.

The airdrome at Gondreville was, at the beginning of operations, about 26 kilometers from the line, far enough to give reasonable security, thus allowing for a semi-permanent camp, and near enough to permit long distance reconnaissance to be carried out in spite of the handicaps of high altitude flying and limited fuel carrying capacity. The field itself was located to the south of the Toul-Nancy road, the

---

southern half being reserved for the 91st Squadron. The French 41st Squadron occupied the northern portion of the field. The terrain was well suited to flying, being level and well drained. There were four hangars of the Bessonneau<sup>3</sup> type, well camouflaged. Three were used as flight hangars and the fourth to house surplus planes. Between them were located the supply, armament, photographic, and hospital tents, together with the engineering and repair shops. The enlisted men's quarters were somewhat south of the hangars, under the shelter of low hills. Squadron headquarters, observers' room, operations and intelligence offices, photographic laboratory and officers quarters and mess were located at some distance from the field on the western side of the road. From the standpoint of security, this arrangement proved very effective since great concentration was avoided, and the danger of damage from aerial bombing raids cut down. Measures were taken for the defense and security of the post against attacks from the air. Machine guns were mounted at several points, and shelter trenches dug.

The great disadvantage of the location of the airdrome was that it was located at the crossing of two main roads making it an easy target for bombers. However, though the enemy made several attempts to bomb the field during the summer, in no case did he succeed in causing any damage.

Previous to the move from Amanty three observers had reported for duty. Immediately after the move to the front, the remaining observers commenced to arrive, fifteen having reported for duty by the 11th of June. All the observers had done a certain amount of service flying with French squadrons. A few of them had worked over the Toul sector.

Service flying could not be started immediately, due principally to the inferior quality of the propellers furnished by the French air park.

Although it was unwise to attempt service flying with these propellers, patrols were carried out along the lines, commencing June 3, for the purpose of familiarizing the pilots and observers with the principal feature of the sector over which they were to work. In the course of three days every flyer had been given the opportunity to fly along the lines.

On the 5th of June the propeller difficulty was overcome by the receipt of a supply of another make. On the 6th the commanding officer reported that the squadron was ready for duty, and on the same day operations orders were received from the Chef de l'Aeronautique of the 8th French Army, through the Chief of Air Service, 1st Corps. This operations order directed that the squadron perform visual and photographic reconnaissances of the enemy's rear areas, together with adjustment of fire of the army artillery. This latter branch of the work was never actually carried out, as during the early



part of the summer army artillery was rarely used. A later order limited the activities of the squadron to pure reconnaissance. The sector assigned was that of the 8th French Army and was bounded as follows: On the west, Cotes-de-Meuse, exclusive; on the north, the railroad Etain, Conflans, Metz; on the east, the highway from Metz to Nomeny. Maps were furnished showing the routes to be covered on visual and photographic missions, the order of their importance being indicated by number. The missions for June covered five visual and nine photographic routes to be reconnoitered as frequently and completely as possible. This method of assigning routine missions for each month was continued through July and August, and until the separation of the squadron from French jurisdiction. The limits of the sector were gradually extended to the east and north. As the attack of St. Mihiel grew imminent the northern boundary was entirely removed and missions carried out to an indefinite depth.

Previous to June 6, there had been no definite study of the sector, as no definite theatre of operations had been assigned, nor had the exact nature of the work been defined. Upon receipt of the operations order of June 6, systematic study was commenced. Plans for an observers' room had been made previously and the room itself furnished. Maps of the sector on a 1/20,000 scale were placed in the room. As many photographs as possible were procured of towns and military works in the enemy's territory. Pilots and observers were instructed to study the sector carefully. For a few weeks this study



*Maj. John N. Reynolds, commander of the 91st Aero Squadron, stands beside one of the squadron's Salmsons.*

---

was carried out by each man independently, but the results were [not] entirely satisfactory. On the 21st of June a quiz was given for the purpose of determining just how much each man knew about the sector. The results of this examination showed that much more could be gained if future instruction were carried out in systematic form. A course of study was arranged, and examinations given at frequent intervals. These examinations were not for the purpose of grading the flyers, but merely to enable each man to determine wherein it was necessary that he make improvement.

Several methods of study were used, the most effective being as follows: A skeleton map, that is one having one or two railroads stenciled on it and merely serving as reference points, was furnished to each man and he was requested to fill in all the railroads, roads, towns, woods, streams and other topographical features by reference to a map. As soon as this was completed, new skeleton maps were distributed, which were then completed from memory. This method fixed the features of the sector firmly in the men's minds. In addition, each flight was requested to prepare a large scale military map, on which was shown by conventional symbols the location of enemy works, the information to be obtained from all available sources. The element of competition was brought in, and the best map turned in was placed in the observers room as the official map of the enemy works to which all new information was transferred.

Familiarity with towns, dumps and airdromes was obtained by means of a course of study of aerial photographs posted on large cards, with the names of the various places shown under each. These card photographs were studied for several days, after which the captions were removed and the town dumps or airdromes named from memory.

Another method of study was to mount maps of the sector on cards which were cut into pieces of uniform size and shape, after the fashion of a picture puzzle. The measure of the familiarity with the sector was the time taken to put the pieces together.

The effect of this instruction was very apparent, not only in the amount and character of the information brought back by the observers, but in the work of the pilots as well. Photographic routes were covered more accurately, and the pilots themselves carried out independent observations and returned with very valuable reports.

The initial visual reconnaissance over enemy territory was carried out in the late afternoon of June 7. A formation of four planes was accompanied by five pursuit planes from the 1st Pursuit Group as protection. This mission was carried out at an altitude of 3,000 meters. Very active and accurate anti-aircraft fire was encountered, practically every plane having received some damage from fragments of high

---

explosive shells. In view of this, it was decided to carry out future missions at an altitude of 5,000 meters.

Flying at this height had several advantages. First, lessened damage from anti-aircraft fire, due to the difficulty in ranging. Second, more extended visibility allowing a greater amount of territory to be reconnoitered for a given route, on both visual and photographic missions. Third, the Salmson plane at this altitude was more than a match for any enemy single seater in the matter of speed and unless surprised, would successfully give combat, due to having guns mounted both in front and in the rear.

At first visual reconnaissances were carried out between the hours of eight o'clock and sixteen o'clock. Experience soon showed that this practice was worse than remaining on the ground, for it exposed men and material to great danger, without obtaining results commensurate with the risk. As the enemy made practically all his movements under cover of darkness, it was decided to carry out visual missions only during the early and late hours of the day. The early morning reconnaissance proved to be the most valuable for it was these missions which caught the tail movements of the night work. When the weather was at all suited to flying, the atmospheric conditions at early morning were usually advantageous. The air was free from haze, and though there was always a certain amount of mist in the valley of the Moselle, the remainder of the sector was so high that visibility was very good over practically the whole area.

Formations of three and four planes were sent out at daylight, but by the time proper altitude was reached it was too late to obtain information of value. It was necessary that the planes be over enemy territory as soon as it became light. Formation flying was impossible in the dark. Single planes were henceforth used, each covering an independent route and starting an hour before daybreak. This arrangement proved very satisfactory. The single planes gained their altitude and arrived over predetermined points far back in enemy territory just as it became sufficiently light for observation. The sector would then be reconnoitered and the plane roll on its way home with the information before enemy planes could climb and give combat.

The evening reconnaissance proved to be of very little value both on account of atmospheric conditions and because the enemy did not commence his activity until well after dark. On this sector there was always at evening a thick haze, which often reached a height of four thousand meters and greatly hindered observation, especially in the direction of the sun. There was, therefore, great danger of surprise attacks by enemy pursuit planes. Conditions of visibility steadily became worse during those missions. Some movement of the enemy was picked up just as it became dark, but it was impossible to remain

---

to obtain more information for the squadron had neither the equipment for nor the personnel trained in night flying.

Occasionally special visual reconnaissances were carried out during daylight hours, and formations were employed. In such cases it was found advantageous to divide their work among the observers, the observer in the leading plane observing the railroads primarily, another the ammunition and material dumps, and a third the roads and billets. One or more observers in each formation, the number depending on the known strength and aggressiveness of the enemy, would devote all their time to the air, watching for hostile aircraft.

The operations order of June 6, 1918, gave specific instructions pertaining to the taking of aerial photographs. All photographs were to be taken with a camera of fifty two centimeters focal length, and at an altitude of fifty four hundred meters. In practice it was very seldom possible to climb to this altitude and the majority of photographic work was done at an average of five thousand meters.

Since pursuit planes were not used for protection and all the photographic work was at long distances behind the enemy lines, formations of three or four planes were employed, only the leading plane at first being equipped with a camera. The other planes acted as protection, though endeavoring to pick up whatever information they could.

This method had two disadvantages. First, if the leading plane developed motor trouble or could not accomplish its mission for any reason, the sortie was likely to be a complete failure. Second, because of the limited number of plates carried by one plane, the maximum being 48, the area photographed would be comparatively small.

The use of two cameras in the formation was then tried. This has the advantage that if one plane was forced to leave the formation, the other photographic plane could complete the mission. Although greater reliability was assured by this method, it left much to be desired, as no greater amount of territory was covered, though the chances of obtaining good photographs was greater, in case both planes succeeded in covering the course.

Later, two photographic planes flying a kilometer apart and protected by a formation above them was tried, but this loose formation proved unsuccessful, due to its vulnerability when attacked by the enemy.

A plan was finally adopted for use on long photographic reconnaissances, which proved satisfactory. Every plane in the formation was equipped with a camera, carried a maximum number of plates, and had its own individual mission outlined. The flight commander would lead the formation over the lines and carry out this mission while the other planes afforded him protection. The leader would then drop out of first place while the next plane took his

---

position and covered its particular course, the former leader flying in the rear. This maneuver was repeated until the entire mission was completed.

Although this method gave satisfaction, it was clumsy to a certain degree in that it involved a constant change in the formation, and necessitated flying under a constantly changing leadership. Also there was danger that the continuity of the photographic mosaic might be broken during the changes in flying position at the end of each section of the mission.

The method used by one flight was to equip each machine with a camera, and have the flight commander lead the formation throughout the entire course. The leading plane photographed a certain portion of the course, and just before the end of his route was reached, the observer in the next plane began to operate his camera. By this method the integrity of the formation was reserved, and the continuity of the assemblage assured, while protection was given by the planes not actually engaged in taking photographs.

These tactical methods were developed slowly as the result of painful experience. The weather interfered greatly with the work, army observation being impossible during about 60% of the time. There was no great amount of rain during the summer, and therefore the field was in such a condition that the most could be made of every clear day. Army observation required almost perfect weather conditions as a great deal of the work consisted of photography carried on at high altitude.

At the beginning of operations the enemy's aerial activity was very slight. This was probably due to the fact that the Toul sector had seen no real activity since the beginning of the war, and the great concentration of the German Air Force was then to the west in the region of Soissons.

The pursuit planes encountered were mainly Pfalz and Albatros scouts in patrols of three or four. They rarely offered to attack a formation, but contented themselves with remaining in the distance taking shots at long range or following a flight, ready to attack any plane which became separated from the formation. The immunity from attack when in close formation was surprising.

During the first three months the enemy patrolled his back areas very inadequately. Extended missions were often carried out to a considerable depth into the German back areas, without interference from, or even the presence of enemy aircraft.

During the month of August the Fokker type D VII scout plane made its appearance. The pilots of these machines showed more energy in their work than did their predecessors. They were aided in their work by anti-aircraft artillery, a system of signals having apparently been arranged upon for the purpose of indicating the

---

position of alien planes. The work of the 91st Squadron called for the reconnaissance of identical areas several times a week. The enemy evidently knew that those missions would be carried out in the vicinity of Metz or Conflans. As soon as a formation of the squadron planes crossed the lines, the fact would be signalled to the anti-aircraft batteries at the two above-mentioned places. The latter would fire a signal salvo and by the time the formation had arrived a patrol of enemy aircraft would be found waiting over the objective.

Beginning on the 1st day of September, there was a noticeable increase in the enemy's air forces in the sector. Whereas formerly combat had taken place only well in the German back areas, strong offensive patrols were now encountered when merely across the lines. Evidently the enemy suspected an attack, and was attempting to screen his preparations for defense. Observation indicated large troop movements, and a strengthening of defenses, especially the Hindenburg line, in the region of which high patrols of enemy pursuit planes constantly interfered with our observations.

On August 23, 1918, the 24th Aero Squadron, equipped with Salmson planes, moved to the northern portion of the Gondreville field, the French Squadron having vacated a few days before. The 24th Squadron had been designated for army observation. Additional hangars, tents, and barracks were erected to take care of the greater amount of equipment and increased personnel of an American squadron.

On Sept 6, 1918, the 1st Army Observation Group was formed, consisting of the 91st, 24th and 9th squadrons. The 9th Squadron was at this time stationed at Amanty, Department of the Meuse, and was equipped for night reconnaissance, using French Breguets. Neither the 24th or the 9th Squadron commenced active operations until after the 12th of September.

### **Comment.**

The greater part of the personnel of the 91st Aero Squadron had received no training or instruction in army observation work before being sent to the front.

Nine of the observers were artillery officers who had been given instruction with a French squadron on repos<sup>4</sup> behind the lines. They had received no systematic instruction, the work consisting of radio practice, one or two practice reglage<sup>5</sup> with smoke bombs, and one mission for the purpose of photographing isolated objectives. They had then been given a course in aerial machine gunnery at the school at Cazaux, where very good instruction in ground shooting, and the mechanism of the Lewis gun was given. Unfortunately weather conditions gave little and in some cases, no opportunity for shooting in

the air. This average amount of time in the air of any of these observers before being sent to the front was not over ten hours.

The remainder of the observers, with one exception had attended the 1st Corps Observation Training Center at Gondrecourt, and had received a somewhat better training than those mentioned above. One observer had been through the observation school at Fort Sill, Oklahoma.

All the observers had been first sent to the front with French squadrons. This policy was admirable in that the observers, in spite of inadequate schooling, worked under fire with experienced men who knew the flying game through and through.

In the case of the pilots they had received no training in observation flying except the small amount of staff work done with student observers of the 1st Corps Training Center. They had absolutely no knowledge of aerial gunnery, except what little they were able to pick up for themselves. Four had been sent to Cazaux, but received no instruction there.

Considerable difficulty was experienced with photographic plates, supplied by the French. Several lots received were found to have been exposed to light and a great many hazardous missions were flown without result.

The airdrome itself was well located and entirely suited to the conditions of stationary warfare existing in the Toul sector during this period. It was well located from a sanitary standpoint, being on high ground, and not too near the village. The barracks were well built and comfortable. The entire camp was lighted by electricity, which was a decided advantage, as a great deal of night work and study was necessary. Especially was this of value in the photographic laboratory where the greater part of the work had to be done at night.





*9th Aero Squadron.*



*24th Aero Squadron.*



*A 155-mm artillery battery.*



---

The St. Mihiel offensive is chiefly remarkable in that it was the first all-American large scale operation. As far as the army observation is concerned, one new problem presented itself, that of making long distance reconnaissances under extremely unfavorable weather conditions. The 91st Squadron was now to be reinforced by two other army squadrons, the 24th Squadron and the 9th Night Reconnaissance Squadron, the three operating as a group. Due to the inexperience of the flying personnel, the 24th Squadron was unable to participate to any great extent. The 9th Squadron could not function at all because of lack of equipment and training.

The order of operations issued by the Chief of Air Service, 1st Army, on September 10, made the 1st Army Observation Group responsible for the reconnaissance of the enemy's back areas opposite the entire sector of attack, keeping the General Staff supplied with information concerning the disposition and movement of enemy forces. The order also stated that the sector was to be under constant observation by planes of this group.

The Chief of Staff, 1st Army, submitted a map on which were indicated the various artillery objectives, to be photographed just before and on every day during the attack until further notice.

The method of employment of the group as formulated by the Commanding Officer was as follows:

(a) Previous to the day of attack. The artillery objectives were to be photographed and complete reconnaissance both visual and photographic of the enemy's lines of communication and billeting areas, in order to ascertain any troop movement or concentration.

(b) During the attack. A continuous barrage of observation planes was to be maintained over enemy territory throughout the entire day. On the course . . . [for an?] attack the enemy must bring up his reserves during the hours of daylight. The success or failure of an operation often hinges on the General Staff's knowledge of the number and disposition of these reserves.

Formations of three planes were scheduled to leave the airdrome at intervals of two hours, beginning at daybreak, to reconnoiter the enemy's rear areas. It was considered necessary to employ formations of at least three planes, as there was no pursuit protection available and the friendly pursuit patrols did not penetrate the enemy lines to the same depth that the army reconnaissance planes were required to go. It was certain that all these planes would be vigorously attacked by enemy aircraft.

The artillery objectives to be photographed were divided into three different groups, each group to be taken by individual photographic planes. One of these missions included Metz-Sablon and the other Conflans, both of which points were far behind the enemy lines and were points especially well guarded by enemy pursuit planes, being

Allied bombing objectives. It was considered necessary to send as many protecting planes as possible with each of these photographic planes, so that the missions could be accomplished even in spite of enemy opposition. Formations of 6 planes were scheduled to take each of these first two missions. The objectives of the third mission lying within the zone that was to be patrolled by Allied pursuit planes, was to be carried out by only three planes.

Certain planes that were unfit for service over the lines were to be kept in readiness to carry out all liaison missions between the airdrome and the 1st Army dropping ground, located near Ligny-en-Barrois.

On the evening of September 11, a memorandum was received from the Chief of Staff, notifying the group commander that the attack would commence next morning at five o'clock, preceded by a four hour artillery preparation.

When dawn of September 12 arrived, heavy banks of dark rain clouds, fanned by a strong southwest wind, were racing across the sky at an altitude of about three hundred meters, and rain was falling in showers at frequent intervals. In spite of these adverse weather conditions two planes left the airdrome shortly after daybreak, to carry out a visual reconnaissance. One plane succeeded in finding a rift in the clouds through which it descended and gathered valuable information. The other plane was less fortunate and returned to the airdrome after an unsuccessful attempt at finding an opening in the clouds and fog.

Owing to the prevailing adverse weather conditions, it was necessary to disregard the schedules that were prepared the preceding day as the low hanging clouds rendered formation flying impossible. Photography was out of the question. Single planes were dispatched whenever the weather permitted. The planes were required to fly at low altitudes, under the clouds but proved successful, in that they could climb into the clouds and to safety in case of the appearance of enemy aircraft, or when especially heavy and accurate anti-aircraft fire was encountered.



---

Flying at such a low altitude is extremely dangerous, not alone because of constant exposure to fire from machine guns, anti-aircraft artillery and attack by enemy aircraft who have the advantage in altitude, speed and maneuverability, but because of the danger of becoming lost far back of the lines, and consequent failure of the mission, especially when operating over such larger area as that assigned to an Army Reconnaissance Squadron.

Both pilot and observer must know practically every foot of their sector, when flying under these conditions over a large area, for the visibility is necessarily limited, and the speed of the plane gives little time to orient oneself. When taking advantage of the shelter afforded by clouds, observation is intermittent, and unless the terrain be perfectly familiar, no observations of value can be made.

It was for this reason that only observers and pilots who had worked over the terrain prior to the attack could be sent on missions.

During the three months preceding the St. Mihiel attack, the operations depended entirely upon the weather, but upon the opening of hostilities it was imperative that the enemy's back areas be



*A pilot's view of a battle*

---

reconnoitered in spite of disagreeable weather conditions and planes were dispatched whenever opportunities presented themselves.

During the first day the enemy territory was successfully reconnoitered to a depth of 60 kilometers. Not one mission was carried out at an altitude exceeding 1,000 meters. This was accomplished without the loss of a single plane or even a single casualty.

This success was due largely to the fact that during the three months preceding the attack, the pilots and observers had gained a thorough knowledge of the entire sector, both through actual experience and because of the extensive training given them during the earlier operations.

Because of the excellent condition of the aviation field which the group occupied, it being well drained and covered with grass, it was possible for the planes to "take off" without breaking the propeller in spite of the occasional heavy rainstorms.

Because of the rapid increase in numbers of enemy pursuit planes as the battle progressed, the successful reconnoitering of the enemy back areas became extremely difficult. However, by the determination of the pilots and observers, the group was at all times able to furnish the Staff with complete and accurate information regarding the movement and disposition of the enemy forces.

September 15 was marked by a decided change in the weather. The sky was perfectly clear and the visibility was excellent. The usual dawn reconnaissance was dispatched, although two planes were employed instead of one. Planes of the 24th Squadron accompanied several of the formation.

During the late forenoon several photographic missions were dispatched but were only partially successful, because each formation was repeatedly attacked by superior numbers of enemy pursuit planes. These planes employed entirely different methods and attacked the Allied planes with a determination and persistency that had never been encountered in this particular sector. In the course of the afternoon several photographic missions were successfully accomplished, in spite of enemy opposition.

The only enemy pursuit planes that were encountered in this sector prior to September 1, were Pfalz and Albatross scouts. At the high altitudes at which the 91st Squadron had worked, the Salmson plane had a decided advantage over these many planes, both in climbing and horizontal speed.

The reinforcing enemy pursuit was largely equipped with the Fokker D VII scouts. This plane had a considerable advantage in climbing speed over the Salmson. However, the horizontal speed of the latter plane was greater at high altitudes, thereby enabling it to break off a combat at any desirable time.

---

September 16 saw the conclusion of the attack, reconnaissances were carried out through the day, but though there was a certain degree of enemy aerial opposition, no difficulty was experienced in carrying out any of the missions.

During the next three days, missions were dispatched only for the purpose of keeping up a general light surveillance of the sector.

On September 20, orders were received directing the removal of the group, in accordance with the general plans of the transferral of the First Army to the sector west of Verdun. The new airdrome was located at Vavincourt, Meuse. The advance echelon was sent out immediately on receipt of the order to move. On September 22, the move to the new station was completed.

The effective work done and the comparatively small number of casualties suffered during the St. Mihiel offensive, gave evidence of the excellent training and experience gained during the previous three months.

The General Staff had been kept supplied at all times with information of the enemy in spite of almost impossible weather conditions. It is true that three of our planes were lost, but two of them were inexperienced teams of the 24th Squadron. As against this, the records show a total of five enemy planes destroyed by group flyers during this period.

### **Comment.**

During the entire period of operations of the army observation on the front, there was a want of liaison between this organization and all other arms. The nature of the duties that were performed by this organization were such that it could work entirely independent from all other units but it is felt that if there had been closer relations between the various units better results might have been obtained, for example: throughout the St. Mihiel Offensive, which lasted only a short time, the army observation group had very little information regarding the progress of the ground troops, or in fact anything that was taking place except the information that was brought back by observers of their own organization and these observers did not concentrate their attention on points such as the location of the front line troops, etc.

Also, the observers and pilots were in absolute ignorance as to the value of the information that they were obtaining. If lectures had been delivered to these observers and pilots at times by officers of the General Staff, it is believed that a keener interest would have been aroused and consequently greater efficiency would have been realized.



*Night bombardment scene.*

---

The move of the 91st and 24th Squadrons of the 1st Army Observation Group, from the Toul Sector to that west of Verdun, took place on the 21st and 22nd of September. The new airdrome was located at Vavincourt, Department of the Meuse. No difficulty of any kind was experienced in making this move, the main echelon moving during one night a distance of almost 100 kilometers. Two days were required for the ferrying of the planes, due to a shortage of pilots.

The group was now to operate as a whole from the same airdrome. The 9th squadron had arrived two days previously, and was equipped for night reconnaissance. Preparations were made for immediate active service flying, for it was known that an offensive by the 1st Army was imminent. The observers and pilots were given a special course of instructions on the principal features of the new sector, and patrols sent out along the lines for the purpose of familiarizing them with the terrain. Weather conditions were extremely unfortunate during this preliminary flying, and consequently very little knowledge of the sector was gained.

The airdrome at Vavincourt left much to be desired. It was located at a prominent fork of two roads, making it an easy target for night bombers, the field was uneven, and at the beginning of operations was at a distance of 45 kilometers from the front of the army sector. No adverse criticism can be made of either the field or its location, as in an operation carried out as quickly as the move to the Argonne, and with such a large air force to be provided for, ideal airdromes could not be expected. It is worthy of note that in spite of the constantly increasing distance to the lines, missions were performed without difficulty throughout the whole offensive.

The order of operations, giving the duties to be performed by the group during the coming offensive, was issued by the Chief of Air Service on September 23. The sector assigned was bounded on the east by a line through Verdun and Longbey, and on the west by a line through Vouziers and Mezieres. Missions were to be carried out to an indeterminate depth. In practice, the eastern boundary did not exist for orders were constantly received for missions in the area of the 2nd Army.

In general the order of operations made the group responsible for the reconnaissance, both by day and night, of the entire army sector.

The artillery objectives for the first part of the offensive were indicated. They were to be photographed both before and after firing.

Four planes, with pilots and observers, were to be stationed at army air service headquarters for the purpose of carrying out command missions on orders from the Chief of Air Service.

Upon receipt of the above orders, the group commander formulated his plans for carrying them out. Four teams from the 9th

---

Squadron were immediately sent to army air service headquarters on command work.

Day reconnaissance was to be mainly visual, planes to be dispatched as frequently as necessary in order to keep the sector under constant surveillance from daylight to dusk. Artillery objectives were to be photographed, as well as the principal lines of communications, railroad centers, and other important points. These latter missions were to be carried out on special orders from the second section of the General Staff.

The night reconnaissance squadron was to conduct reconnaissance from early evening until daylight. Bombs were to be carried on these night missions and used against convoys, troops and military works.

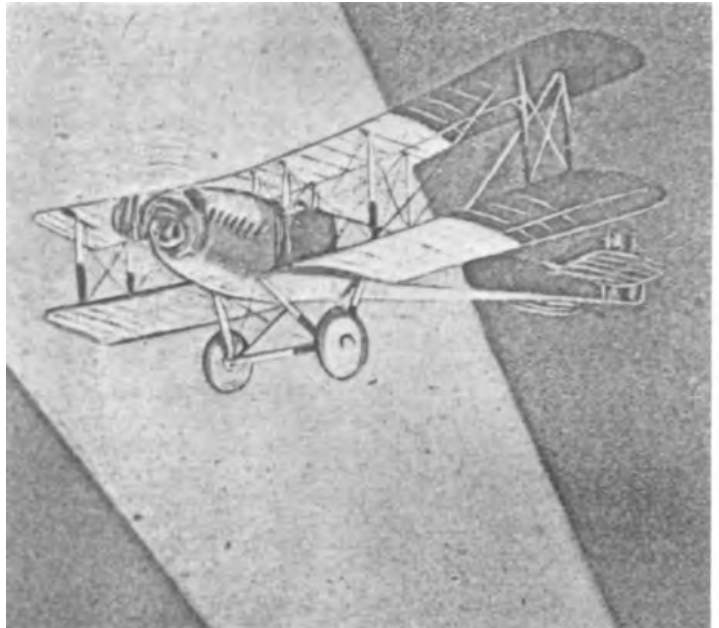



---

The attack commenced on the morning of September 26 with ideal weather conditions. On the four days previous low clouds and rain had prevented any effective work from being carried out. This had a decided effect on the first days work, due to lack of familiarity with the terrain. This fact, coupled with the activity of the hostile air forces, interfered greatly with the success of the photographing of the artillery objectives, and to some extent with the visual work.

Weather conditions throughout the whole operations were extremely bad. Only ten days out of the whole period were suitable for army observation. The most was made of the small amount of good weather, and with two day squadrons operating an immense amount of work was accomplished. The last three days of October being perfect, gave opportunity for very important work to be accomplished in preparation for the attack, which commenced on November 1st. The areas opposite the American front were reconnoitered and photographed thoroughly, but the work was done in the face of intense opposition by hostile aircraft.

One of the most valuable pieces of work carried out during the last three days of October was the photographing of the army artillery objectives at Montmedy, Longuyon, Spincourt, Dommery-Baroncourt and Conflans. The enemy had protected these points by intense anti-aircraft barrages, and high patrols of pursuit planes, but in spite of these obstacles, the objectives were photographed both before and after registration fire, allowing the artillery to fire effectively during the attack.



*Lt. Everett R. Cook, Commanding Officer of  
the 91st Aero Squadron.*

---

The command teams which had been stationed at Air Service Headquarters did very effective work. The pilots and observers were quartered at headquarters, and remained in readiness to carry out any mission during the hours of daylight. The missions assigned varied in character; from verifying reports as to the location of the front lines, to the seeking out of enemy reserves at points where counter-attacks were expected. This work was carried out by single planes flying at extremely low altitudes. The command planes sometimes penetrated hostile territory to a depth of 15 kilometers, and were constantly exposed to heavy machine gun and anti-aircraft artillery fire. They were especially liable to attack by pursuit planes which had every advantage of speed, maneuverability, and position. The strain of flying under these conditions coupled with the necessarily close confinement while awaiting orders, made it necessary that the teams be changed every ten days, and personnel from each of the squadrons in the group were sent out on this work successfully.

The history of army observation would be incomplete without reference to the work of night reconnaissance. This work promised to bring in valuable information, since most military movements of importance are made at night. In order that it may be performed successfully, perfect conditions of visibility and a highly trained personnel are necessary.

The 9th Squadron was the only night reconnaissance unit in the American Air Service. The poor weather conditions throughout the Argonne-Meuse operation gave little opportunity for the squadron to work. In addition, only a very few of the flyers had been trained for night work. In spite of these handicaps it is only fair to say that on the few nights suitable for observation, information of value was obtained, and considerable damage done to the enemy by bombing.

### **Comment.**

The army observation group was operating under difficulties throughout the entire offensive, the field being situated such a long distance from the lines and lack of liaison with the zone of operations made it difficult for the group commander to make the proper disposition of the effectives under his command. Sometimes the atmospheric condition in the vicinity of the airdromes was such that a plane could not even attempt to leave the ground and at the front, a distance of about 100 kilometers, it was perfectly clear. But because of this lack of liaison and communication these conditions were not known to the group commander.

The new French-52 centimeter automatic camera proved to be very unreliable. These cameras were first received in September and were mounted and tested, working fairly well at first but later when an

---

attempt was made to use them on missions they were continually jamming. When the plates did not jam they were either unexposed or unevenly exposed. After giving them a fair trial they were discarded.

The Chief of Staff of the 1st Army practiced the transmission of orders for the group commander through the branch of intelligence officer and the Chief of Air Service transmitted his orders direct to the group commander. Having orders come through two separate channels from different authority there was a constant confliction of orders until the group commander made complaint to higher authority when it was decided that it would be best to transmit orders through one defined channel. Orders came direct from the Chief of Air Service, 1st Army thereafter.

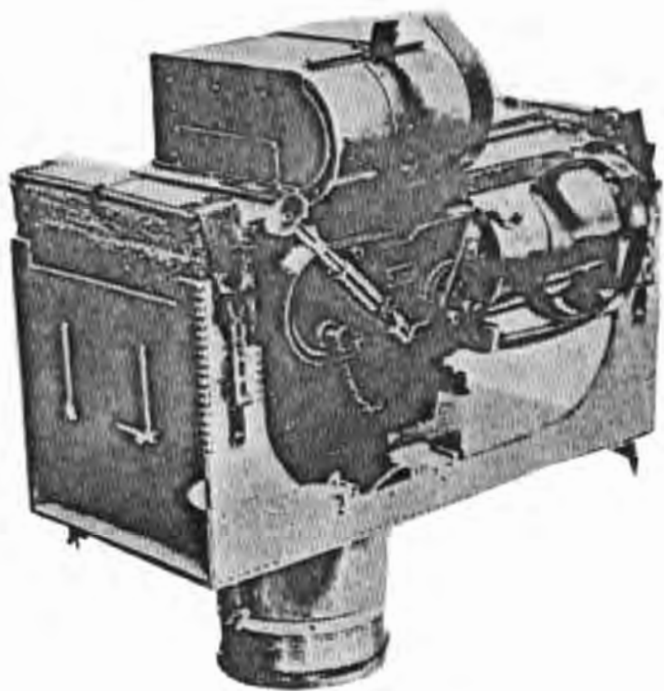



---

## **Part 4**

# **Tactical History of Pursuit Aviation**



94TH AERO SQUADRON



95TH AERO SQUADRON



27TH AERO SQUADRON



Capt. "Eddie" Rickenbacker, credited with shooting down 26 enemy aircraft in World War I, commanded the 94th Aero Squadron from September to December, 1918. Lt. Reed Chambers, a flight commander, shot down 7.

---

The First Pursuit Organization and Training Center was established at Villeneuve-les-Vertus, Marne, South of Epernay, on January 16, 1918. The 96th Aero Squadron arrived on February 18, 1918, the 94th Aero Squadron on March 4, and on March 15, American pursuit pilots, American trained and from squadrons organized with American enlisted personnel, made their first patrol of the front.

The patrols carried out by the 94th and 95th Aero Squadrons' pilots at Villeneuve-les-Vertus were composed as a rule of two or three American pilots flying Nieuport type 28 airplanes, unarmed, and one French pilot of the Escadre No. 1, which was under the command of Commandant Menard. The French pilot had a Spad.

The mission of these patrols was the maintenance of a barrage over the Marne River from Epernay to Chalons against enemy long distance photographic airplanes. These enemy machines flew singly and at extraordinary altitudes—over 5,000 meters. The fact that the American airplanes had no machine guns was due to the shortage of these guns that prevailed on the West Front at that time, but the fact that the area in which they worked was so far back of the lines as to make the danger of enemy attack negligible, coupled with the fact that the moral effect of their presence was in all probability sufficient to insure the retreat of an isolated enemy photographic airplane, rendered this experience a valuable one. Only eight patrols of this character were carried out from the Villeneuve airdrome, for on March 31 the headquarters and both the squadrons moved from Villeneuve-les-Vertus to Epiez.

This move was necessitated by the enemy attack of March 21 against the 5th British Army. Escadre No. 1 left Villeneuve on March 27 and the American squadrons had to evacuate the airdrome immediately thereafter in order to make room for French and British forces of night bombardment aviation.

Sixteen of the original pilots who had been with the 95th Aero Squadron had been sent from training schools to the front without aerial gunnery training. These officers were sent to Cazaux on March 24, so that on April 9 when the Gengoult airdrome,<sup>1</sup> four kilometers northeast of Toul, became available for American use, it was the 94th Aero Squadron that proceeded there with eighteen pilots trained in aerial gunnery. Machine guns for one squadron were procured, some from French parks in the vicinity, and some from our own supply department. However, a week was required to tune up airplanes and to get everything in condition for the start of operations. On the evening of April 13 the squadron was ready to operate and the Army Air Service Commander, 8th French Army, issued orders that evening making the American Air Service responsible for the sector from St. Mihiel on the west to Pont-a-Mousson on the east.

---

The Toul sector, as this came to be called, was in many respects an ideal one in which to break in new pilots over the front. The enemy pursuit aviation was neither aggressive, numerous, nor equipped with the best types of machines. The liaison with the front was extraordinarily good—probably better than on any other sector of the front. The terrain, however, was difficult in cases of forced landings.

A special mention is necessary of the liaison with the front in the Toul sector. The anti-aircraft artillery has as one of its main functions acting as sentinels for pursuit aviation. Its trained observers were always on the watch for enemy aircraft. They were highly expert at distinguishing the various types. The various anti-aircraft guns, sections, and batteries were connected direct by telephone to three centers of control, from west to east, Commercy, Lironville and Disulouard, each of these in turn were connected by telephone to the observation post at Mt. St. Michel, whence a direct wire led to the operations office of the 1st Pursuit Group on the Toul airdrome. Messages relative to enemy aerial activity had priority on the wires, and as an average it took less than four minutes for a report relative to activity of enemy aircraft, giving the number, type, altitude and direction of flight, to be received in the group operations office.

One of the advantages of this situation was exemplified on April 14, the first day of operations by the 94th Aero Squadron. Three pilots were off on patrol, while two others were awaiting on alert, Lieut. Douglas Campbell and Lieut. Alan F. Winslow. An alert was received from Lironville of two enemy single-seated aircraft headed south. Within four minutes after the enemy planes had first been sighted by the anti-aircraft post, Lieutenants Campbell and Winslow were in the air and in another four minutes both enemy planes had been brought down. They crashed on the airdrome. Lieutenant Campbell brought his adversary down in flames. Both enemy pilots were taken prisoners. Naturally the moral effect of such a victory on the very first day of operations was a lasting one. The factors which contributed to it were the skill and ability of our pilots, the correct disposition taken by the squadron commander, the rapid transmission of information from the front, the fact that the rotary Gnome engine of the model 28 Nieuport could be started like a flash, and the inexperience of the enemy fliers, who became lost in the lowhanging clouds and high winds which were prevailing. The fact that the enemy pilots had blundered could not, in all probability, have been turned to advantage had our liaison with the front been less perfect or had the squadron been equipped with an airplane driven by a water cooled engine.

Another advantage which resulted from direct telephonic liaison with the front was that the moral effect of our air service operations on our own ground troops was excellent. The small numbers of the enemy opposed to us made the utilization of very small formations



---

possible to us and consequently it rarely occurred that the infantry caught sight of an enemy plane without a couple of ours putting in an appearance in a few minutes.

This liaison with the front was possible because the front was a stabilized one. The line of battle had scarcely moved for three and one-half years, and throughout that time work on the telephonic communications had been progressing.

On May 4 the 95th Aero Squadron moved up to Toul from Epiez, and the 1st Pursuit Group was organized under Maj. B. M. Atkinson. From that time on until the end of June the 1st Pursuit Group gradually got broken into work over the lines. This work was greatly facilitated for the 94th and 95th Aero Squadrons by the fact that some officers of the Lafayette Escadrille, who were experienced men, were assigned to the new squadrons.<sup>2</sup> The presence of these officers who had all had experience at the front, assisted greatly in taking the other pilots across the big transition from school flying to fighting. It was found in the spring and summer of 1918, that no amount of training at the rear, even though the instructors were French pilots who had served at the front, would give the pupils the atmosphere and point of view of a fighting pilot. Four of the principal things which a pursuit pilot has to learn, are, in the order of their importance, vision of the air, aerial gunnery, formation flying and acrobacy. To an average pupil at school the order of importance appeared to have been reversed. It was extremely difficult at first, and it was always difficult, for new pilots to appreciate the vital importance and extreme difficulty of seeing enemy aircraft before being seen by them, so that advantage could be taken of the sun and altitude in making the actual attack.

The importance of formation flying and especially formation fighting was taught the American pilots after they reached the front. The first American pursuit pilots were trained under French instructors. They were trained by men of long experience at the front. There was no word spoken to them in training that would lead to any other conclusion than that the action in war flying was individual. A protective patrol was mentioned as remaining above in attack. The leader opened the attack, but from there on, the individual acted as he thought best. In consequence team work had to be learned after they joined at the front.

On May 31, 1918, the 27th Aero Squadron under Maj. H. E. Hartney and the 147th Aero Squadron<sup>3</sup> under Maj. G. H. Bonnell, both officers who had flown with the Royal Flying Corps, joined the 1st Pursuit Group and on the following day started in upon their routine work.

For breaking in new squadrons the practice was for several days to assign for their patrols the line of allied balloons as a line not to be crossed except in combat, and in addition a pilot of one of the older

---

squadrons took out the first few patrols, acting as patrol leader so that the new pilots could get accustomed to the sector. Even with these precautions it was found that a large percentage of new pilots on their first few flights at the front had a tendency to get lost. This was no doubt due in a large measure to the fact that in their cross-country flying at flying schools pupils were free to devote their entire time to watching the ground while as soon as they got near the lines they had to devote all their attention to watching the air for enemy planes.

During the month of June the 1st Pursuit Group did some work in cooperation with British day bombardment airplanes of the Independent Royal Air Force. This force was carrying out almost daily raids on Mannheim, Coblenz, or other Rhine towns. The 1st Pursuit Group operations office was informed by telephone message from the Independent R.A.F. of the probable hours, altitude, route of return, and number of airplanes. On several occasions it was found that the British bombers were being trailed homeward by enemy pursuit airplanes which lay several hundred yards in the rear of the bombing formation, shooting at long range. Our pursuit airplanes knowing the probable route of return of the bombers and their altitude generally were able to possess the advantages of superior altitude and with the sun at their backs could with excellent results dive into the midst of the rather straggling enemy pursuit formation whose attention was centered upon their efforts to attack the bombing planes.

### Comments.

Considering the fact that the American pursuit squadrons operating in the Toul area in April, May, and June were completely new to operations on the front, excellent results were achieved.

All information of the enemy was received from the 8th French Army, and it is felt that the French system of publishing a daily Air Service bulletin of intelligence is one that might well be adapted in our own service. This policy giving information as to the strength of the enemy, location of his airdromes, and the possibility of reinforcements as well as the regular army summaries of intelligence were most valuable in that they served to bring home to the pilots an appreciation of the part that they were playing in the general scheme of war. Because the Toul sector was a quiet sector, the liaison with the front was superior to that which obtained in any other sector on the whole line of battle. Frequent maps and diagrams giving the latest information of the enemy served to make the French Air Service summaries of information and the French Army summaries of intelligence more easily understood.

The airdrome on which the group was located was one that was in a position where it might easily have been attacked by enemy bombardment machines, but during the months of April, May, and

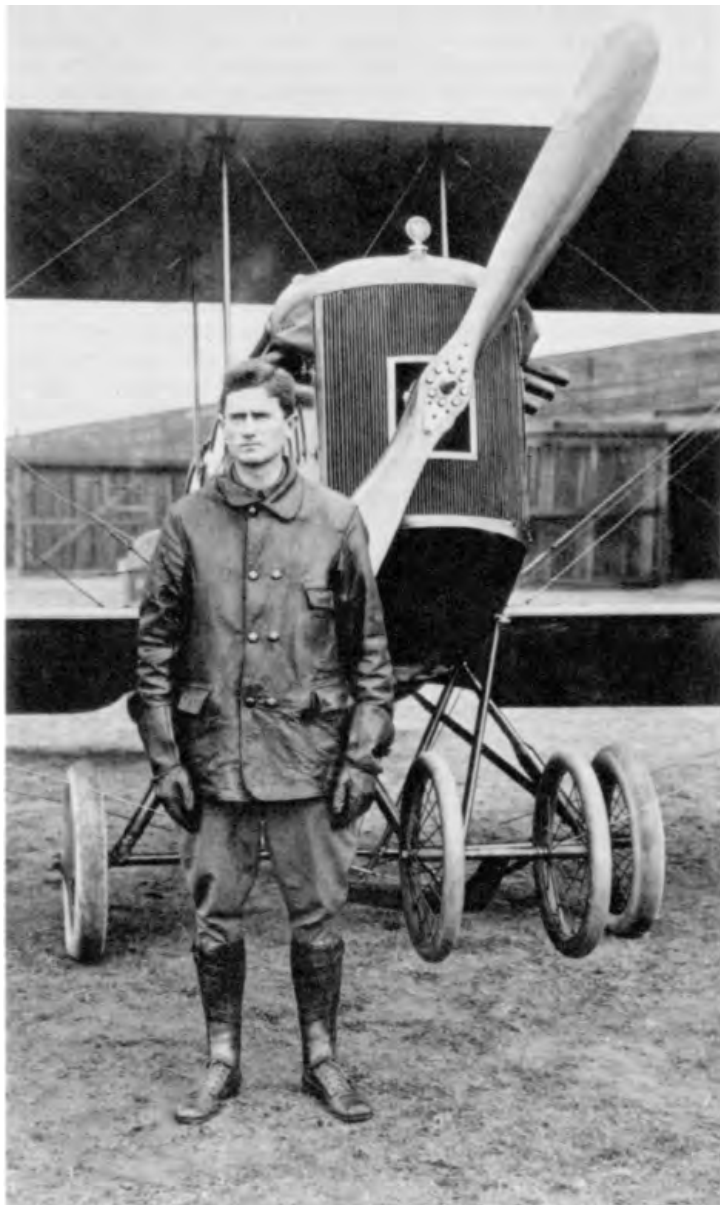

*Maj. Bert M. Atkinson assumed command of the 1st Pursuit Group in the Toul Sector.*

---

June, no enemy bombardment airplanes operated in the Toul sector. The fact that no enemy bombardment planes could be used against the group was known to the French authorities, and, therefore, the placing of the group on the Toul airdrome could not be criticized from this standpoint.

The security provided in the air by the machines themselves was one of the many elements in the art of combat which our pilots, being new to the front, had to learn while they were at Toul. It is felt that considering their inexperience, a high degree of teamwork was developed within the flights which operated from the Toul sector.

The orders which were received from the 8th French Army were general in character, and left to the group commander the responsibility and opportunity to handle his group to the best advantage. As a matter of fact, the only orders which were received from the 8th French Army were orders in which the sector for which the group was responsible was at first laid down and later extended. The altitude, strength, and method of employment of the elements was left entirely to the judgement of the group command.

The aggressive spirit, which is a keystone of pursuit aviation, was developed to a high degree in the units of the 1st Pursuit Group, which it was at the Toul sector. It is recognized that if the group had been forced to enter into active operations, such as were later encountered, at Chateau-Thierry and in the St. Mihiel battle or in the operations west of the Meuse River, numerous grave shortcomings would have appeared. The role of pursuit aviation in a war of movement was imperfectly appreciated, and the group was not prepared to face the problems of supply, transportation, or combat in an active sector. Fortunately, it did not have to face any of these problems. The fact that the group was not in a position to meet them was due to the fact of inexperience alone, and the training and practice which all ranks received while operating from the Toul airdrome rendered them fit to meet these problems when they developed later in the fight of July and the following months.

### **The 103d Aero Squadron, February 20 to July 3, 1918.**

The enlisted personnel of the 103rd Aero Squadron began to take over their duties from the French enlisted personnel of the Lafayette Escadrille (Spad 124) at the La Noblette airdrome on February 20, 1918. The Lafayette Escadrille's flying personnel was composed of Americans who originally entered the French service and were later transferred to the United States Army. At La Noblette the 103rd Aero Squadron formed a part of the 21st French Pursuit Group under the IV French Army and engaged in patrols of the sector Rheims-St.

---

Menehould. The sector was comparatively quiet and patrols of three planes were occasionally employed though the flight of five or six was more often used. In addition the squadron was sometimes called upon to answer alerts of enemy aircraft entering the defended area surrounding Paris. No enemy aircraft, however, were encountered on any of these latter missions.

About April 1, the 103rd Aero Squadron was detached from the IV French Army and proceeded to the VI French Army area, being stationed on the airdrome at Bon Maison about one kilometer south of Fismes. Throughout the month of April the 103rd Aero Squadron comprised all the pursuit aviation at the disposal of the VI French Army, and it was responsible for the sector Noyon-Rheims. The feature of work in this sector, which at the time was very quiet, was to be found in the excellent results which were obtained in answering alerts transmitted by wireless in Spad airplanes with their water-cooled Hispano-Suiza engines. Excellent liaison was maintained with the anti-aircraft artillery posts and the radiogoniometric stations by wireless, and as the airdrome was only fifteen kilometers from the line of battle, excellent results were achieved.

The Noyon-Rheims sector was considered so quiet about May 1 that the 103rd Aero Squadron was relieved from duty with the VI French Army and sent to Flanders for duty with the French Detachment des Armees du Nord which went to defend the hopeless position at Kemmel Hill, south of Ypres.

Conditions in this sector were extremely difficult as the enemy paid no attention to the sector for days at a time and then would mass formations of thirty and forty pursuit airplanes on the lines to gain temporary air superiority for a few hours. While operating from Dunkirk the 103rd Squadron put in an unusually high percentage of hours without gaining contact with the enemy while at other times the air would appear to be simply filled with enemy planes.

On July 3 the Detachment des Armees du Nord was disbanded and 103rd Aero Squadron moved to Toul to form a part of the 2nd Pursuit Group. A few weeks later when the 3rd Pursuit Group was formed at Vaucouleurs the 103rd Aero Squadron was used as the nucleus.

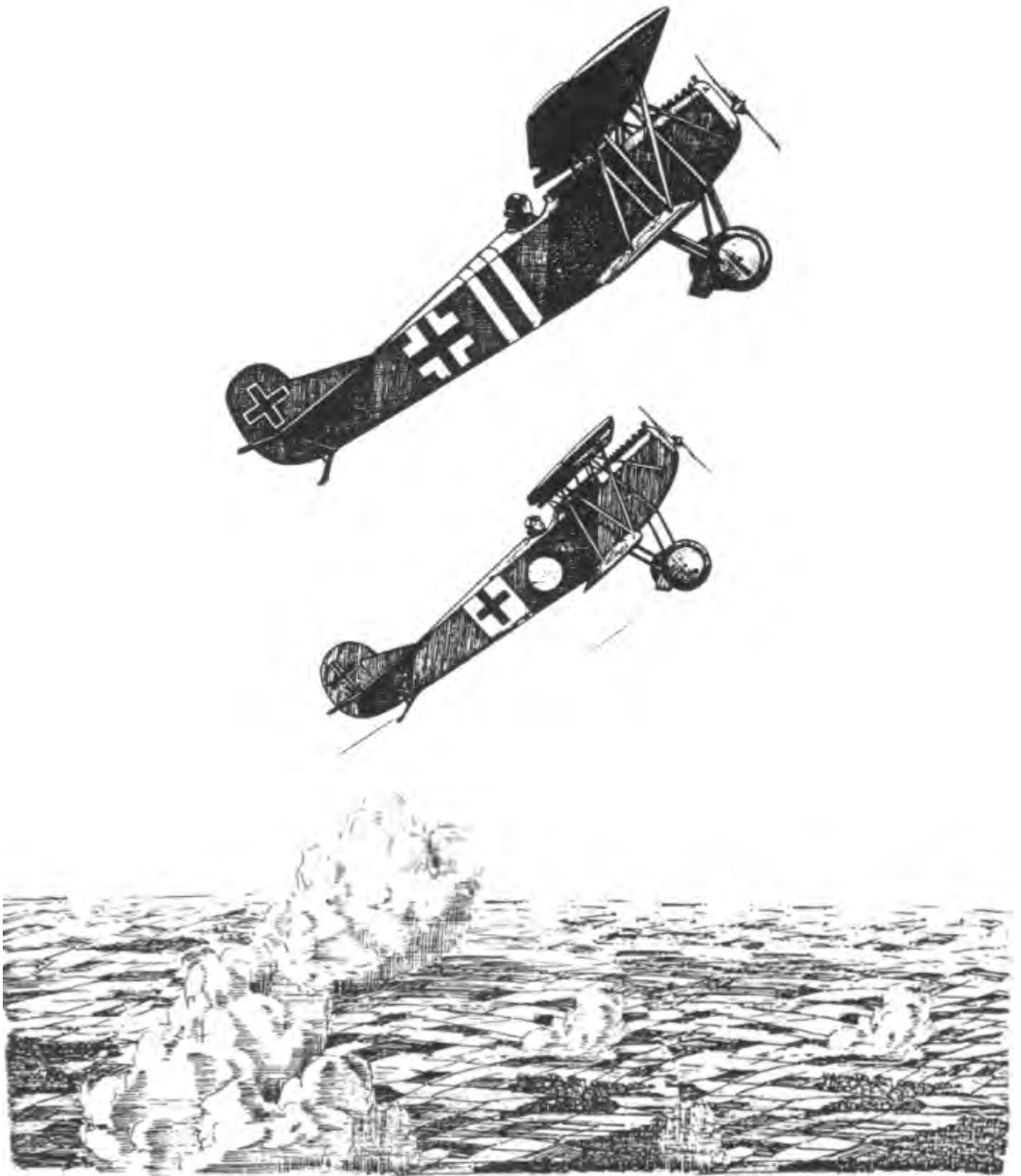

*Fokker D-7 aircraft, which Germans used in large numbers at Chateau-Thierry.*

---

The move from Toul to Chateau-Thierry area by the 1st Pursuit Group might almost be considered a model. The group commander had reconnoitered the airdrome, which was bounded by the four small villages of Ormeaux, Touquin, Pezarches and Rigny. He personally accompanied the advance party to the field. This party comprised a sufficient personnel from each squadron to care for the arriving airplanes, to install the necessary telephonic liaison and to arrange for billeting the enlisted and commissioned personnel. The alteration of conditions from those met with at Toul, where the group had been installed on what had been an airdrome before the war, and the personnel lived in compactly built stone barracks, to those met on an airdrome that had been created within two weeks by the French, from a field with growing crops, and where some of the personnel was billeted at distances of three or four kilometers from the airdrome, was extreme. Nevertheless, on June 23, fifty-four airplanes left Toul; fifty-two arrived at Ormeaux and were in condition to fly on June 29. By that time telephones had been installed, and the French 6th Army had supplied a wireless telegraph receiving station for the maintenance of liaison with the front.

The Ormeaux airdrome was in many respects an ideal terrain for an airdrome. It was large and smooth, and while standing wheat, which covered a part of it, at first interfered by damaging many propellers, the landing field was the best from which the 1st Pursuit ever operated. But it was located about 45 kilometers from the nearest point of the lines, where the Toul airdrome had been less than 20. In addition, as Ormeaux was located almost directly south of the point of the salient, the sector which the 1st Pursuit Group was called upon to cover was at some point 55 kilometers from the airdrome. This distance from the front added to the fact that the lines had not crystalized, made telephonic liaison with the front impossible, and liaison by radio imperative. At no time in this operation was wireless liaison with the front very helpful. Except for the reports of returning patrol leaders, the group commander worked practically in ignorance of what the enemy air service was doing.

In order to give a proper perspective of the situation, which compelled placing the 1st Pursuit Group 45 kilometers from the nearest point of the lines, it is necessary to understand the infantry and artillery situation as to reserves.

By July 1, the 6th French Army was beginning to expect that another German attack might occur in the salient at any time within a couple of days. At that time, very few of the American divisions, which afterwards took part in repulsing the German attack of July 15 and in the successful counter-attack of the 18th, which resulted in pinching out the salient and starting the ball rolling toward final victory, had arrived on the scene. The possibility of a further enemy advance

---

necessitated the location of our airdrome far to the rear, and this necessity was emphasized because the French armies had suffered almost crippling losses in Bessonneaux and other material during the German advances earlier in the year.

From the point of view of tactical operations over the lines, the sizes of formations employed and methods of employing them required almost as radical a change of methods by our pilots as was required by the big jump which all pilots had to make from the training schools to the front. At Toul our pilots had been opposed by two squadrons of enemy pursuit equipped with a rather inferior type of single-seated planes—Albatrosses. At Chateau-Thierry the enemy had a large concentration of Fokker D-7 airplanes, whose crews showed a tenacity, aggressiveness, teamwork, and persistency wholly new to our experience.

While at Toul our pilots had been able to achieve a remarkable success in attacks upon the enemy two-seaters, and our corps observation aviation acted practically without interference. On the other hand, at Chateau-Thierry our pursuit was engaged practically daily with formations of the enemy as large in numbers as thirty and more and averaging about fifteen. In the Toul sector a single pursuit plane with a skillful pilot, if not very effective, was at least practically safe, and formations of between three and six did excellent and effective work. At Chateau-Thierry no formations were employed, except on very rare occasions, of less than one squadron. This squadron was as a rule echeloned by flights and the preferred method of attack against enemy pursuit formations, which were usually following a single leader in one great big V, was for one flight to attack, throw the enemy formation into confusion, and leave the other two flights to attack and bring down enemy planes which became separated from the big formation.

Flights in squadron formation had been practiced at Toul. From the first day at Chateau-Thierry they became the only method of operations employed. In brief, the main objects of pursuit aviation at this period of operations were threefold, in order of importance, (a) to allow our corps observation aviation to work freely and so help the artillery and the infantry, (b) to interfere with enemy observation by airplane and balloon, and (c) to cause such other casualties and inflict such other material damage on the enemy as may be possible.

For the work of protecting our corps observation aviation it became necessary above all else to drive back the enemy pursuit whenever it was encountered. Close protection, i.e., surrounding our corps airplanes with pursuit planes, is rarely successful. It is work for which pursuit airplanes, at least of the single seated type, are unfit, for they cannot fire except to the front, and for them to turn and fight to the rear, and so make use of their superior maneuverability to attack the



---

enemy leaves the two seated airplanes alone and unprotected. In addition, the leading of a close protection patrol is extremely difficult owing to the difference of speed in the different types of airplanes—single-seaters and two-seaters. But such close protections are of great moral value. Many losses occurred in the Chateau-Thierry fighting when pursuit protection, assigned to accompany photographic airplanes working at less than 4,000 meters, were attacked by large formation of the enemy. Denied the possibility of utilizing their maneuverability, speed or guns, they were easy prey.

The attack of enemy observation airplanes in a sector where such overwhelming numbers of enemy pursuit planes are encountered, as were encountered at Chateau-Thierry, is costly, dangerous, and difficult, but it is nearly the most important function of pursuit. Operating against enemy two-seaters means operating at about 3,500 meters. This gives to hostile pursuit patrols at a greater altitude every advantage, for whichever patrol has greater altitude can select the methods and conditions of combat. Intermediate patrols of this character accomplished much in the way of results, but in carrying them out our pilots were frequently attacked from above by superior numbers of the enemy. As a consequence, the policy was adopted of covering every intermediate patrol with a protection of a flight or more, always on the watch for enemy planes at great altitude. The protection would dive and warn the leader of the large formation when danger threatened.

To the last function of pursuit aviation, the attack of ground objectives, only minor importance was attached to Chateau-Thierry. The Commandant d'Aeronautique of the 6th French Army had a sufficient background and experience to appreciate that the function of pursuit aviation was to aid the operations of the army by fighting in the air, and while on a few occasions, when particularly good objectives were certainly known to offer themselves, "ground strafing" was ordered; this work held a minor role.

On June 29 a few voluntary patrols were made and again on June 30, so that by July 1 the pilots had all become more or less oriented to the new sector, which ran from Faverolles on the west to Dormans on the east. The afternoon of July 1 saw the operations of the 2d Division against the village of Vaux.

At this time Groupe de Combat 17 was operating under the orders of the 6th French Army as well as the 1st Pursuit Group. Early in the morning our 75 batteries began to take up advance positions close to the lines, unhidden throughout the day, and in the evening, when the infantry went forward, they found themselves perfectly covered by Allied airplanes. Briefly, the steps in the ladder included infantry liaison planes, at approximately 2,500, 3,500, and 4,500 meters altitude respectively, the whole ladder leaning as it were into the German lines,

---

so that the planes at 4,500 meters altitude were working from twelve to seventeen kilometers over enemy territory. The work of the 1st Pursuit Group that date brought further written congratulations from the Chief of Air Service of the 6th French Army.

It may be stated here that despite the fact that the enemy opposite the 6th French Army had at his disposal, and used, a much larger quantity of pursuit aviation than the 6th French Army could call upon, the line of contact with the enemy pursuit, was, as a rule, from 5 to 15 kilometers inside the enemy lines. The very large majority of our casualties occurred over the enemy lines, and almost all the enemy planes that were destroyed fell in his lines. It was no rare thing for our pilots to make three full patrols of two hours duration in the course of a day, and on one occasion, when the tension was at its highest, three of our pilots made five patrols each in the course of a single day.



---

From July 1 the anticipation of an attack by the enemy became daily more and more acute, and the signs that an attack was coming became more and more evident. In this connection, it should be stated that the intelligence furnished to the 1st Pursuit Group when it was acting under order from both the 6th and 8th French Armies, left nothing to be desired. Not only were the army summaries of intelligence furnished to the group, but these summaries contained lucid studies of the military situation, weighing the various possible operations of the enemy. Such studies were of inestimable value in working up the spirit of teamwork and operation of the combined arms among men who live many kilometers away from the line of the battle, and who have little time to think about the part the other arms are playing. And not only were these army summaries of intelligence furnished by the 6th French Army, but a special aeronautic summary of intelligence covering all the latest information of the enemy air service and anti-aircraft service was published daily. This summary contained not only maps showing the location of enemy airdromes, balloons, and anti-aircraft artillery units, but also valuable information on the enemy's methods of fighting, of observing, and of protecting his ground troops by machine guns, etc.

At midnight of July 14/15 the enemy guns opened; at dawn his attack commenced. The artillery demonstrations covered the entire front of the 4th, 5th and 6th French Armies, from Faverolles—about half way between Soissons and Chateau-Thierry—on the west to the Argonne Forest on the east, but the infantry action was entirely east of Chateau-Thierry. The enemy crossed the Marne and established some bridgeheads on the south bank and on the east flank of the salient he made considerable progress towards Epernay, but on the whole the attack broke down.

In the afternoon of July 17th the 6th French Army sent the information that orders for July 18th would be late in arriving. Throughout that day and those that followed it for two weeks, our pilots set a new standard for the amount of work a pursuit group could do. The group was changing types of machines, abandoning the Nieuport Model 28, and adopting the Spad XIII. The latter, while possessing many advantages, is a far more difficult machine to keep in commission. The Hispano-Suiza motor with which it is equipped is far more difficult to make minor adjustments or major repairs upon than the 160 H.P. Gnome of the Nieuport. In addition the squadron mechanics were without experience in handling either the motor or the planes. Actually on July 14, one squadron, the 94th, was not working, because its machines were all new, none of them having been tuned up. But for every pilot who had a plane in commission, the days from July 14 on were days when they worked as pursuit pilots had rarely worked before in this war.

---

While the line receded daily, and the enemy's withdrawal gave an added spur to their energies, this fact from the standpoint of the fighting pilot was not unalloyed joy. When the enemy came to a temporary halt on the Vesle River, the 1st Pursuit Group found itself 75 kilometers from the front. Flying planes good for a patrol of but an hour and three-quarters at the most, and which could only be counted upon for an hour and one-half, most of their time was spent in monotonous formation flying up to the lines and back again to the airdrome. Early in August an advanced landing field was established at Coincy, with mechanics and gasoline. From every view point, this was unsatisfactory, as compared with a suitable airdrome. The additional number of landings entailed was responsible for a great deal of minor damage, sufficient to put machines temporarily out of commission—damage such as broken tail-skids, etc. At this time it is impossible to recall a single occasion when a patrol of a dozen planes left the airdrome at Saints, stopped at Coincy to refill with gasoline and returned to Saints without at least one airplane incurring damage of a more or less serious nature at either Saints or Coincy. The most nearly satisfactory method of handling the situation was found to be to have the formations leave Saints and go up to the lines, fly there as long as possible and then stop at Coincy to refill on the return trip.

### Comments.

When the 1st Pursuit Group arrived at the Chateau-Thierry area, it found itself operating under new and very different circumstances and conditions than those which had been met with in the Toul sector. The line of battle was not crystallized, and no telephonic liaison with the front existed. In fact, telephonic liaison throughout the entire operations at Chateau-Thierry could hardly be depended upon.

The location of the group's airdromes, first at Ormeaux, and later at Saints, was so far from the line of battle that it was in a different telephone region from that of the Headquarters of the 6th Army under which the group was operating. This resulted in difficult connections, which invariably took considerable time to secure. For the liaison with the front, the group was depending upon a wireless net whose reliability was questionable. Occasionally it was out of commission, and often when it would work the information which it brought was not sufficiently explicit to permit of the formation of definite plans of action. Personal liaison with units in the forward areas, the corps air service, and with the 6th Army headquarters, was maintained, but did not reach the perfection which experience later proved to be extremely valuable. On the other hand, the information of the enemy, which was received from the 6th Army, might well be taken as a model. Precise and explicit information of the disposition of all the enemy forces, both of his Air Service and of his ground troops, was



*Graveside services for 1st Lt. Quentin Roosevelt, pilot of the 95th Aero Squadron, shot down and killed on 14 July 1918 during the operations at Chateau-Thierry.*

---

furnished and kept up to date. Tactical studies of the opportunities which the situation presented to him were carefully studied, and the results of these studies were promptly circulated.

Despite the fact that the 1st Pursuit Group airdrome was never closer than 45 kilometers from the lines, the 6th French Army appreciated the possibilities of a further withdrawal very acutely. Hardly had the group arrived and been installed before the group commander was ordered to reconnoiter airdromes in the rear, and a site in the vicinity of Melun was picked out to retreat to in case a retreat became necessary. Having just moved from the Toul airdrome to the Chateau-Thierry area, the group was well provided with transportation, and in case of retreat had been necessary, in all probability nothing would have been lost. The airdromes which were actually occupied by the group were excellently laid out, and it is improbable that any large percentage of the material of the group could have been destroyed by enemy bombardment.

From the commencement of the German attack of July 15, the plan of employment of pursuit units of the 6th Army contemplated the maintenance of a double tier barrage, one tier at intermediate, and the other at high altitude, uninterruptedly from daylight to dark every day. The fact that for a large part of the time the 1st Pursuit Group suffered from having a large part of its machines out of commission rendered it impossible for the group to maintain both intermediate and high patrols of sufficient strength throughout the area allotted to it. The unity of flights had to be interfered with as frequently a flight did not have more than two or three planes available for duty. The mistake was, therefore, made for a short time of utilizing squadron formations not echeloned by flights. These proved to be unwieldy, easily thrown into confusion by the enemy, unable to be controlled by a single leader, and the more or less inexperienced pilots frequently became separated from them. They also had the disadvantage that they were forced to operate without top protection, and, therefore, were frequently attacked by the enemy when he possessed the advantage of numbers, altitude, and an advantageous position in relation to the sun. Later on, this mistake was corrected, the echeloning of every squadron by its separate flights was put in practice, and the rule was established that no patrol was to be sent out at intermediate altitude except when accompanied by another patrol at high altitude, which could come to its assistance if it was attacked from above. Throughout the Chateau-Thierry operations, the enemy possessed superior numbers of pursuit airplanes; in fact the 6th French Army estimated at one time that the proportion of enemy aviation was to the American as 4 to 1. The enemy was extremely persistent and aggressive in fighting, and rarely broke off a combat as long as our planes remained over the hostile lines. Nevertheless, it is a noteworthy fact that the great

---

majority of combats in the Chateau-Thierry area took place over the enemy side of the line. While it is true that several of our balloons were burned; that our ground troops were repeatedly harassed by machinegun fire, and that our corps air service suffered more severe losses than they had anticipated, it is also true that the 1st Pursuit Group carried the fighting into enemy territory; that our corps air service, despite its losses, was always able to do its work, even the work of deep photography; and that enemy attempts at photography and visual reconnaissances were seriously interfered with. The concentration of enemy troops for his attack of July 15 was watched and reported upon in all its details by the allied air services; the location of his reserves were established, and the secrecy of the mobilization for the allied counter-attack was maintained. In this connection, it may be pointed out that a determined and aggressive pilot and observer will always be able to execute an isolated reconnaissance, or a dash across our lines for the destruction of one of our balloons if he is favored by weather conditions. Such reconnaissances are seldom productive of valuable information, and the material damage of such attacks is comparatively slight. It is only reconnaissances carried out periodically and attacks on our balloons and ground troops which are constant and persistent that produce the most valuable results. It is fair to state that while our pursuit aviation was always outnumbered at Chateau-Thierry, at no time was the enemy enabled to carry out repeated reconnaissances of our rear areas, and at no time were his planes able to approach our lines without encountering the acute danger of being attacked by our pilots. Throughout the entire operation, our pilots maintained their aggressive spirit, and attacked and fought successfully superior numbers of enemy planes.





Fall of the Flying Fool. (Art by Meru Corning)



---

On August 26, 1918, the 1st Army Air Service headquarters was established at Ligny-en-Barrois. This marks the first concentration of American air forces under its own commander, and it is interesting to note conditions prevailing at this time.

The front of the 1st Army, extending from Chatillon-sous-les-Cotes to Pont-sur-Seille, insofar as aviation was concerned, had been very quiet for some time. The enemy performed his photographic reconnaissances with single machines, flying at high altitudes, and his pursuit patrols were small and infrequent. Pursuit units of the enemy continued to use in this sector Albatros and Pfalz machines, but it was observed that some of these organizations were gradually being transferred into Fokker flights. In the matter of airdromes, the enemy was better off than the 1st American Army, and possessed many small fields within access of any part of the front line. Several airdromes were unoccupied, and were in such condition that they could be utilized quickly by reinforcements, their barracks and hangars being more or less serviceable.

The 1st American Army was less favored in this respect. While the Verdun sector had been the scene of great French aerial activity in 1916, very few airdromes were available, and those on hand were not the best for pursuit aviation. Almost every available field had been taken up and they were short in hangars and billet space, so that by the time the allocation of aviation pursuit had been made to the 1st Army, the problems of locating and housing the units was a serious one. Two American pursuit groups were in process of organization for the establishment of the 1st Pursuit Wing. These were already located at Tour and Vaucouleurs.

The sector of the 1st American Army at this time, insofar as pursuit was concerned was for convenience divided into two sections, that on the east of the salient covered by the 1st and 7th American Corps, and that on the west of the Meuse, allocated to the 2nd French Colonial Corps and the 5th American Corps. Great secrecy prevailed as to the location of the units. Especially with regard to those located on the Western side of the salient where the line extended north and south, and where American units were operating for the first time. Like other arms of the service, American units in this section were moving in quietly and at night, and being concealed throughout the day in the woods and other places of cover.

All these conditions prevailed when the following allotments of pursuit aviation were made to the 1st Army:

French Air Division consisting of the 2nd French Pursuit Escadre with headquarters at Ochev, and three groups of French pursuit, forming a second escadre, with headquarters at Rancourt. The headquarters of the division itself were located at Tannois.



All of the American pursuit in existence, with the exception of the 17th and 148th Squadrons, which were operating with the British, were concentrated in the 1st Pursuit Wing, with headquarters at Toul, and the 1st Pursuit Group, with headquarters at Rembercourt. The 1st Pursuit Wing consisted of the 2nd and 3rd Pursuit Groups; the 2nd Pursuit Group composed of the 13th, 22nd, 49th and 139th U.S. squadrons, and the 3rd Pursuit Group consisted of the 28th, 93rd, 103rd, and 213th U.S. squadrons. The 1st Pursuit Group consisted of the 27th, 94th, 95th, and 147th Aero Squadrons. One French Group (G.C.16) was allocated to the 1st American Pursuit Wing commander for duty in connection with the offensive.

With these units at his disposal, and with the general conditions of the air program for the offensive in mind, the Chief of Air Service, 1st Army, made certain plans for the pursuit units for the attack. He decided to utilize the American pursuit all along the front for the purpose of protective barrage at all altitudes, with incidental duties as occasion arose, of a more combative nature, such as ground straffing, balloon destruction, and offensive patrols. Conforming with the plan of operations of the whole army, the pursuit operations consisting of four phases:

1. Preparation until the day of attack.
2. During artillery preparation.
3. During the attack as far as first combined army objective.
4. Exploitation of attack so far as 2nd combined army objective.

Certain general principles, strategical and tactical, were laid down which formed the basis of all pursuit aviation in operations. They were based on the fundamental fact that pursuit aviation has a double mission to perform, and it is well at this point to consider these. They were divided as follows:

- (a) Offensive.
- (b) Protective.

Offensive patrols cross the enemy line in sufficient strength to cruise over his rear area, search out enemy aircraft, and attack them, with the object of causing maximum casualties and inflicting the greatest possible damage to his air service, and with the further object of obtaining definite moral superiority. They work at all altitudes, but generally it is advantageous to fly as high as possible, as altitude gives one greater advantage when contact with the enemy is made. To such an extent is this true, that protection must be assured low patrols.

Protective patrols have a double mission to perform:

- (a) To place corps observation aviation in a position where it will be, and will feel that it is protected.
- (b) To protect ground troops from the results of enemy artillery adjustments, reconnaissances and photographic airplanes.

---

Protective patrols are not to be considered as defensive in character. All pursuit aviation is offensive in character, but they are distinguished from offensive patrols by the limitation in area and duties imposed upon them, in that they must insure the safe return of all reconnaissance machines which cross the lines. While, on the other hand, offensive machines attack and destroy any enemy aircraft, in the discretion of the patrol leader, wherever found. The performance of the double role of protective patrols cannot be accomplished by the maintenance of a permanent barrage of a sector. Such a procedure is fatiguing for the pilots and expensive in material in comparison with the results obtained and using up of resources in machines, rendering it impossible for us to have concentrations in force for offensive expeditions when required. Consequently, a permanent barrage will only be resorted to in times of intense action, when enemy machines must not be permitted to penetrate to the rear areas. It is to be noted that barrage patrols can only afford protection to army corps air service when acting over a limited breadth of front, which as a rule, should not exceed 15 kilometers. The size and altitude of the protective patrols will depend on the general activity of the sector, and the strength and degree of aggressiveness of enemy aviation. Two tiers at least should be established when possible, owing to the inability of machines to locate enemy planes that are more than 3,000 feet below, and when this is impossible, it is well to have a patrol during its tour of duty fly at different altitudes. The patrols need not penetrate beyond five kilometers and must religiously stick to their sector when on duty. When a rigid system of protective patrols is impractical or unnecessary, there will be substituted a system which will comprise patrols especially directed against enemy army corps aviation, plus a number of machines on alert, ready to take off for duty with any situation which may arise due to increased ground activity or preparation. The size of the alert or mobile reserve will differ daily, and will be used according to the exigencies of the moment supporting or reinforcing our aviation when necessary.

While the offensive or protective patrol, or protective barrage was to be the first function of American pursuit aviation, it was in addition to perform four types of special missions:

- (a) Close protection of corps airplanes.
- (b) Cooperation with day bombardment planes.
- (c) Attack on balloons.
- (d) Attack on ground troops with bombs and machineguns.

Close cooperation between these units when operating together should exist. Cooperation of day bombardment was to be utilized especially for the purpose of obtaining contact with enemy pursuit airplanes, but was not to afford covering protection. The bombing

---

expedition itself was to be of sufficient size to allow it to rely on its own armament.

Attacks on balloons were to be made only when specially requested, this being a very dangerous and difficult undertaking but when it was ordered, necessary protection was to be furnished, and it was intended that concentrated attacks should be made on the enemy when most favorable. Attacks on ground objectives were to be indulged in, using machine guns and bombs for the purpose of demoralizing retreating forces, strafing enemy reserves and reinforcements, and were to be carried out in force so as to produce the maximum moral effect, but neither machines nor bombs were to be used to any extent except in an active area.

Certain routine procedures were mapped out for the pursuit units and were as follows:

The 1st Pursuit Wing and the 1st Pursuit Group were each attached respectively to the 1st Army, and were to receive all their orders from the Chief of the Air Service for that Army.

The tactical unit of the aviation was to be normally a flight of five or six machines, but, at times groups of flights, were to be used. A formation of five or six machines being a tactical unit, every effort was made to bring it, during the days of preparation, to the highest tactical efficiency. Pilots of a flight were quartered and lived together on the ground as much as possible, and worked together in the air at all times. When a flight was considered too weak to carry out a given mission effectively, it was to have the support of one or several other flights, with which it was to cooperate. The flights of 5 or 6 machines being a fighting unit, the power and control of the leader was enhanced so that all pilots were subservient to his wishes. He was made responsible for the proper carrying out of all orders, and to enable him to do this, he had to insure that his flight was capable of taking off in formation, maneuvering in formation, cooperating with other similar flights, reforming quickly when dispersed, attacking at the proper time. The responsibility of the flight commander, therefore increased greatly and necessitated during these days of preparation, hard work and personal appliance to the tasks and problems which confronted him.

The limitations of the Spad airplane were fully realized, and this called for efficiency in the enlisted personnel of the squadrons. Flight commanders were responsible that methods of specialization were introduced, and that his unit was organized to produce the greatest results and imbued with the right spirit that conquers all. In the 2nd and 3rd Pursuit Groups, which were just formed, the enlisted personnel, while enthusiastic, were what might be classed as "fresh troops," and were inexperienced, and had to receive the necessary

experiences on the particular motor and machine in use in order to keep the greatest number possible in commission.

During the period preparatory to the attack, from August 29 to September 12, the 1st Pursuit Wing, working on the front between the Meuse and the Moselle Rivers, maintained patrols sufficient to prevent any reconnaissance, visual or photographic, of the area Lionville, Beuconville, Domeurs, Francheville, Becq and Gironville. The Wing commander divided the sector for this purpose into two areas, the western running from St. Mihiel to Essey, both inclusive, and the eastern, Seicheprey to Pont-sur-Seille, both inclusive, and gave orders that a double tier barrage should be maintained from daylight to dark over these sectors. The low patrol, acting at from 2,500 to 3,500 meters, and the higher patrol at from 3,500 to 5,500 meters. Each patrol overlapped by 15 minutes, and were not permitted to penetrate over the enemy lines more than five kilometers. By the 5th of September, the wing had made an area approximately 5 kilometers over the enemy's lines practically safe for corps observation machines to operate. Some close protection work was ordered to act in cooperation with the army reconnaissance squadron, and one particularly dangerous balloon near Mont Sec was attacked repeatedly.

To the west of the Meuse, the 1st Pursuit Group moved in quietly to Remercourt airdrome, and took up duties similar to those of the 1st Pursuit Wing, consistent with secrecy as to their location, and with few machines, prevented reconnaissance of the 5th Corps area, and protected the photographic machines of the 2nd French Colonial and the 5th Corps. The presence of American troops on this side of the salient was concealed very effectively. On the airdrome of the 1st Pursuit Group itself, hangars and billets were carefully concealed, and machines kept under cover as much as possible. One machine was kept over the airdrome at all times for the purpose of diverting enemy photographic missions that might attempt the location of the group, and it was interesting to note that not a single photograph was obtained of this airdrome by the enemy after the group moved in. Owing to the surface of the field, it is believed that the enemy never suspected the presence of a pursuit group of 100 machines in such a place.

This group, although it displayed a feeble front, spent most of the time preceding the attack in perfecting liaison with the anti-aircraft service, radio service, corps observation service, army observation group, balloons and the 2nd French Army to the north, that by the day of the attack, very satisfactory liaison had been established together with plans for extension of the same during the progress of the attack. Pilots of this group acquainted themselves with the new sector and

several advance landing fields were spotted as available during the operations. Replacement machines which up to this time had been almost impossible to obtain were secured and made ready for action. All new pilots were instructed in the general principles and tactics in fighting in accordance with the experience gained on the Chateau-Thierry front.

On September 10 Groupe-de-Combat 16, commanded by Captain Meni of the French Army, reported to the 1st Pursuit Wing commander for duty. This placed a total of approximately 275 pursuit airplanes at the disposal of the wing commander on the east of the Meuse, and 100 machines at the disposal of the 1st Pursuit Group commander on the west of the Meuse. Over the whole front approximately 65 percent of the machines could be kept in commission, but, owing to the nature of the motor, and in some cases the inexperience of mechanics, it was impossible to keep a larger percentage than this available for any period of time.

The atmospheric conditions on September 10, 11, and 12 were most unfavorable for aviation. High winds, low clouds, and intermittent rains prevailed at all times. Both the 1st Wing and the 1st Pursuit Group performed valuable individual machine reconnaissance as deep as Etain, Vigneulles, and Thiarcourt, determining upon orders from the army, the facts that the enemy was preparing to withdraw from the salient, but that he had not already done so. These flights made in the face of the most adverse weather conditions imaginable, and at an altitude of 400 meters or less, in spite of heavy anti-aircraft and machine gun fire, deserve special mention, not only on account of the danger entailed, but also on account of the value of the information secured.

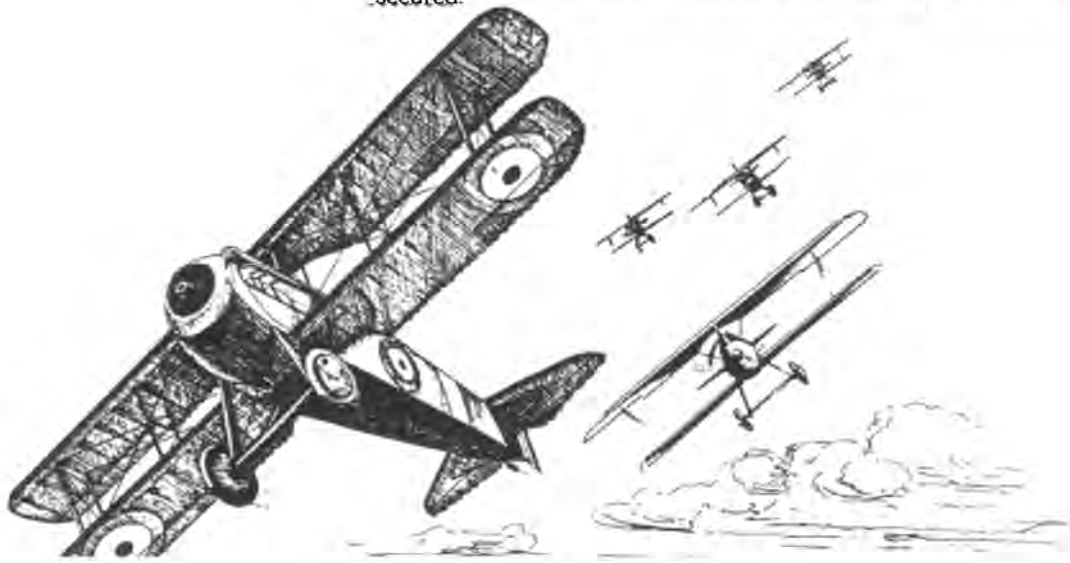

On September 12th, at 5 H 00 the 1st Army commenced the wiping out of the St. Mihiel salient. Throughout the day there were high winds, and rain fell intermittently. The usual functions of the pursuit aviation could not be performed, but the pursuit planes were used to secure valuable information and to harass by machinegun and bombs the retreating enemy. Many favorable objectives presented themselves, especially over the Vigneville-Chambley and the Vigneulles-St. Benoit roads. The 3rd Pursuit Group, equipped its machines with bombs, and on these roads, together with assistance of the machine guns of the 2nd and 1st Pursuit Groups, constantly threw into confusion the retreating German forces.

Simultaneously with our army's attack on September 12, the enemy concentrated his air service in force on our front. Before September 12, enemy pursuit patrols of more than six planes were but rarely encountered, and when encountered, they were almost invariably alert machines attacking our day bombardment airplanes deep in the enemy lines, but with this enemy concentration, large enemy formations appeared and consequently our patrols had to be increased in strength. Owing to weather conditions on the opening day, few large patrols were used, and many individual reconnaissances were made by pursuit pilots of the 1st, 2nd and 3d Group. Often single machines determined and reported the advance of our front line, actually flying down to 50 meters, and co-operating with the troops on the ground.

By September 13, shortly after midnight, infantry patrols from the south and those from the west met near Vigneulles. Still the enemy was in retreat. The Chambley, Mars-la-Tour road was jammed with his reinforcements coming up and his wagons in retreat. In one day the 3d Pursuit Group made five expeditions bombing and harassing with machine guns, protected by elements of the 2nd Pursuit Group. The 1st Pursuit Group on its sector harassed the infantry, maintaining protective patrols above at different altitudes. But, it was not until September 14, when the weather cleared, that pursuit aviation was able to operate at its normal altitude.

The coming of good weather marked the commencement of great activity in the air, especially to the east of the Meuse. Large concentrations of enemy pursuit machines of the latest type were met and bitter combats ensued. It became necessary for the 1st Pursuit Wing to increase the size of its patrols, and often more than one squadron was employed on one mission by this unit. While the activity was not so great on the front of the 1st Pursuit Group, the enemy was encountered, and many victorious combats occurred, and some balloons were shot down. Perhaps the striking feature of the days of exploitation was the utilization of the Spad machine for low flying for the purpose of combatting enemy balloons and low flying battle

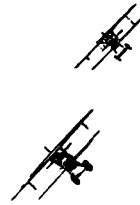

---

planes, and also for purposes of observation and reconnaissance, when weather conditions prevented its use in the normal way.

### Comments.

While the American pursuit aviation accomplished excellent results in the St. Mihiel offensive, it is well to consider whether or not the fundamental principles were adhered to, and consider what might have been the result had conditions such as weather, enemy strength, terrain, and strategical disposition of our own forces been otherwise.

From the first day of preparation, the strength of the enemy, the location of his airdromes, and the possibility of reinforcements were well known to the higher command. Facilities in the way of liaison, were established by all units in order that during the progress of the attack, touch could be kept with the enemy disposition, strength, and reinforcement. Up to the day of the attack there was no room for improvement in this respect. The French P.C.'s of anti-aircraft were not a little adverse to moving with the rapidity demanded by the progress of the attack; the result was that for some time our pursuit units in touch with them were handicapped considerably. This was not the case with American anti-aircraft batteries, who were very mobile and followed up closely the advance of the infantry. The liaison between units was very good on the west of the sector. The 1st Pursuit Group was in close touch by telephone and personal liaison with the French and American corps, and co-operated often with the Second French Army to the north. The liaison with the balloons, too, was excellent, and pilots on this sector were quite familiar with each step, and able to carry out intelligently the missions allotted to them. The liaison on the eastern side of the salient partially broke down when the attack commenced. Liaison between air service units remained excellent through out all stages of the battle.

In criticizing an operation such as this, it is well to consider as a matter of general principle whether proper provision was made for the security of our own pursuit aviation. Security embraces all these measures taken by a command to protect itself from observation, annoyance, or surprise by the enemy. In pursuit aviation, it will be well to consider first whether or not these precautions were taken with respect to the units themselves, and second whether everything possible in this respect was done by the actual machines themselves on the line. It is felt that the precautions taken by the 1st Pursuit Wing were quite adequate under the circumstances. A very large quantity of aviation, a pursuit group and three squadrons of corps observation, making a total of about 175 airplanes, were placed on the Toul airdrome. It is not without the range of possibility that the enemy on a clear night two or three days before the attack might have attacked this airdrome in force, as indeed they did on several occasions on the



---

British front in the spring and summer of 1917, when all the units on that field would have been put out of action for the day of attack. This particular field is very easy to locate at night because of the lack of camouflage, and the natural landmarks surrounding it, and it is felt that an aggressive attack at the proper time would have had disastrous results. This however was a chance taken as a result of necessity. The 3rd Pursuit Group at Vaucouleurs on the other hand was more carefully concealed from observation, annoyance, or surprise, and the hangars more scattered and less liable to damage of this nature. The 1st Pursuit Group on the west of the salient was very perfectly concealed, and well spread out over the airdrome, and not liable to be put out of action by one attack.

It is felt that the pursuit units of the 1st Army were not sufficiently protected from surprise in that they were all short of transportation. Aviation units placed so far behind the line can keep a large establishment of transportation on hand without danger of crowding roads or blocking traffic in the case of a push. In the event of an enforced retreat, millions of dollars of valuable property and material that cannot easily be replaced can be rapidly withdrawn in the back areas without inconvenience to the troops on the front. Economy in air service transportation is false and units should at no time, on general principle, be allowed to operate without their full complement of transportation. Under the heading of security, the matter of concealment should be considered. The fact that the enemy did not secure one photograph of the 1st Pursuit Group airdrome is worthy of notice. This was due not only to the camouflage and to the care of the personnel, but also the fact that one single seater machine was kept over the airdrome at all times, and on two occasions enemy photographic machines were diverted from their course as they neared this point, and the enemy were never enlightened as to the occupants, and in all probability never suspected the presence of 100 machines there, an airdrome which would under normal conditions be considered unfit for pursuit aviation.

The security provided in the air by the machines themselves was adequate for all purposes. This is inherent in the echelon formation of flights, which provides for a tactical disposition comparable to the advance body, support and reserve used by ground troops. It is felt that commanding officers saw to it in every case that good internal security was maintained by all formation. The fact that individual machines were permitted to go out on active sectors was justified first, by the extreme importance of the missions, and second, by the fact that no clouds prevented surprise.

The art of giving proper instruction and orders to troops is one of the most important features in the exercise of command. It is believed that the wing, groups and squadrons of American pursuit aviation at



the time of the St. Mihiel fight were on the whole in this respect equal to other air services, but at the same time there were shortcomings. Too much reliance was placed on the telephone, and orders were often given over the telephone that should have been transmitted by special courier. The plan of action for pursuit on the salient is considered to have been the best.

The use of American pursuit aviation for protective barrage is considered wise in that the troops on the ground soon became acquainted with the fact, and it proved to raise their morale. At times, close protection was afforded to observation machines. It is felt that this was not necessary. On the east of the salient, where this protection was indulged in, several corps observation machines were lost; on the west only one was destroyed. It would be better to advance "no man's land" of the air service five miles beyond the trenches, and leave the intervening space clear for our own machines to work.

In spite of the fact that some observation machines were lost, pursuit aviation on the whole was vigorous and offensive, as it should be, and met and coped with every situation that arose. Balloons were attacked with determination, and massed enemy troops withdrawn on September 12, 13, and 14 were harassed and repeatedly thrown into confusion. Large enemy formations when they appeared were fought gallantly even by inferior members, and every opportunity of making observations from pursuit planes was seized with eagerness. The principle of economy of forces might have been applied to great advantage during the strenuous times of bad weather. Instead of sending out many small missions, it would have been better to send out as few as possible of these and conserve the machines for concentration purposes in the intervals of good weather. It was well known that our total pursuit strength greatly exceeded that of the enemy, and when he was not using his pursuit in bad weather, our resources in pursuit should have been drained as little as possible, and diverted for purposes of observation, which is not in the line of pursuit work, on as few occasions as possible, so as to insure a predominance in the fine weather. Perhaps only one criticism can be made of the fighting of the pilots themselves, and this is due probably to the nature of the machine. The pilots never attempted to make deflection shots, and always relied on getting on the tail of the enemy and shooting him down from this position. They should make it a practice to seize every opportunity of firing deflection bursts, as it has been proved by pilots of other nations that surprising results can be obtained in this way. In this connection, it is pointed out that pilots were a little too much inclined when out-numbered, to dive away, relying on the superior

*Burning balloon shot down by an aircraft.*

---

speed of the Spad to get them out of the difficulty. The best principle is to fight it out, relying on maneuverability for defense. The development of the low flying in this offensive and the work of balloon destruction is worthy of special attention. The eyes of the enemy were literally blinded in that his balloons were all destroyed, and planes on which he had counted for flying low and harassing our troops, were in most cases destroyed. It was felt that the American air concentration here had supreme command of the air, and this undoubtedly accounts for the fact that the enemy soon brought to this front some of his best pursuit units and filled pursuit airdromes to their capacity.

Another feature worthy of particular notice is the development of the flight as a fighting unit in the action. There is no doubt that pursuit from the very nature of its work should be employed tactically by units or flights. This enhances the responsibility of the flight commander, and necessitates extreme care in the selection of those pilots. They must have had a great deal of experience and must maintain at all times, more than in any sporting team, the respect and implicit confidence of each pilot in the flight. Each flight should be a unit composed of pilots, one and all prepared to stick by their flight commander at all costs, and ready if necessary to fall rather than have their chain of responsibility in the flight broken. While there were not many opportunities, owing to the bad weather conditions, of showing the extent to which this had been perfected in the American pursuit units, it is felt that the work of the new units of the 1st Pursuit Wing in the early days of the attack is worthy of special mention in this respect. Under the circumstances, they stuck well together, and with flight commanders of slightly more experience, nothing could stand up against them.

So much depends on the type of machine in pursuit work that one cannot express an opinion on pursuit operations without considering the type of machine. The Spad machine was probably the fastest on the front, and as good as any at diving, but as all pursuit work is offensive, these two qualities should be coupled with the all important feature of maneuverability. It should be capable of zooming at high altitudes, and the pilot's visibility should not be hindered in any way. It is felt that from the standpoint of maneuverability at all altitudes, and visibility, our pilots were handicapped in this respect, and their work is all the more praiseworthy under these circumstances. The number of machines in commission is probably as important a consideration as any in the operations of our pursuit units. It was impossible for our mechanics to keep more than 65% serviceable, and pilots were not often able to do more than one mission each day, owing to the fact that the Hispano-Suiza motor, with reduction gear, was very difficult to keep in condition.

---

*"Balloon Buster" Frank Luke, Jr., pilot of the 27th Aero Squadron, shot down 14 enemy balloons and 4 aircraft between 12 and 29 September 1918. He won the Medal of Honor for his heroic action on the 29th, when he force-landed in enemy territory and fought off a score of enemy troops who surrounded him before he fell dead from a wound in his chest.*

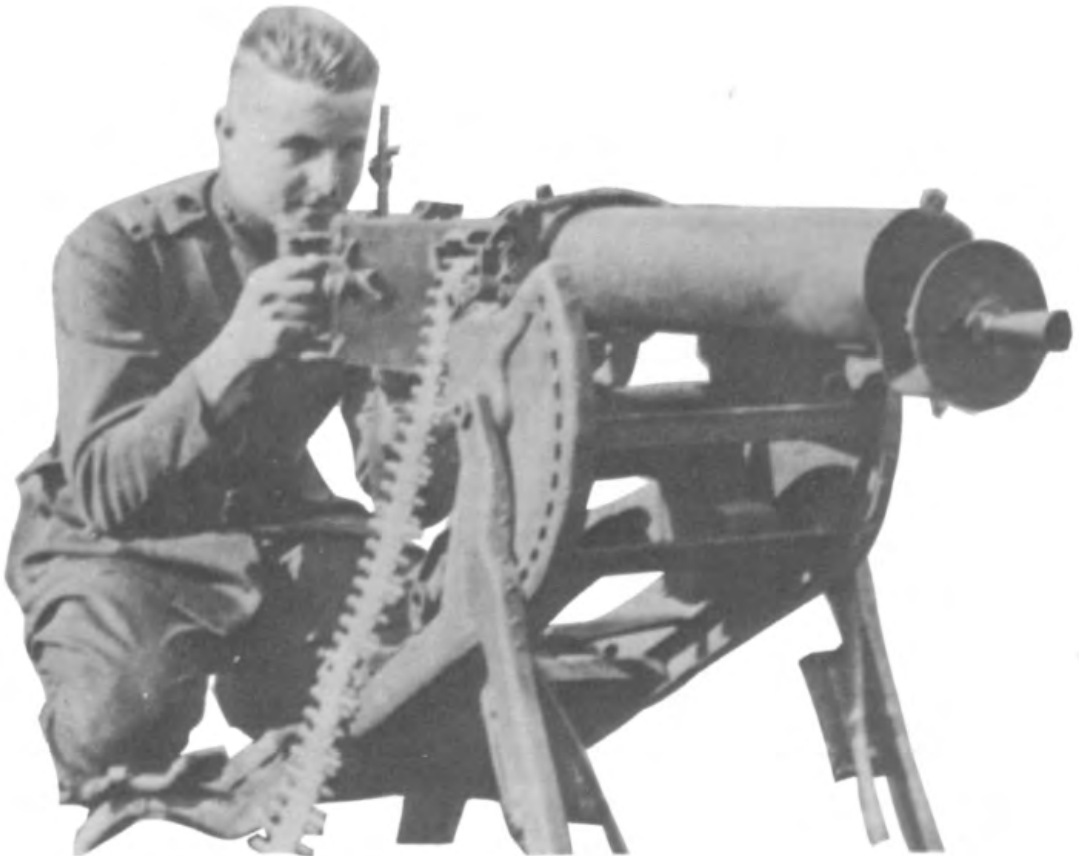

---

Between September 14 and September 26, the 1st American Army conducted one of the most important staff operations of the war in transferring the bulk of the divisions from the sector northeast of St. Mihiel to the line west of the Meuse River. The role of pursuit aviation during this preparatory period had for its object the prevention of long distance reconnaissance of the new American area. At the same time, it was important that no display of aerial strength should be shown over the new sector, as such display of strength would be an indication to the enemy of the transfer of troops that was going on. The enemy air service was largely concentrated in the Conflans-Briey area, and the period between September 14 and 25 was marked by severe and repeated combats. Between September 20 and 23, the 2nd, and 3rd Pursuit Groups of the 1st Pursuit Wing changed station, but this changing station was not allowed to interfere with operations which were still carried on over the front created by the St. Mihiel battle. The 1st Pursuit Group remained on its airdrome at Rembercourt but it too confined its operations to the sector east of the Meuse. G.C. 16 of the French Army was relieved from duty with the 1st Pursuit Wing. The wing headquarters moved from Toul to Chaumont-sur-Aire; the 2nd Pursuit Group moved from Toul airdrome to the Belrain airdrome, and the 3rd Pursuit Group moved from the Vaucouleurs airdrome to the Lisle-en-Barrois airdrome. The wing headquarters and its groups immediately perfected liaison with the corps air service, the army observation group, and the armies to the right and left of the 1st Army.

For the Argonne-Meuse offensive, the 1st Pursuit Group was allotted the rather new task of combatting enemy battle flights and of destroying balloons. In other words, all of its operations were confined to extremely low altitudes. The plans drawn up by the group commander and approved by the C.A.S. of the 1st Army were followed throughout the offensive. The following are the plans drawn up by the Commanding Officer, 1st Pursuit Group.

**"LOW FLYING IN THE OFFENSIVE"**  
(Without infantry strafing)

The 1st Pursuit has been entrusted with the important and rather unique mission shown below in the offensive, and officers and men are enjoined to cooperate with the commanding officer in making it a success.

1. **PROGRAM.**

a) *Strategical.* The 27th and the 95th squadrons will each detach and operate a flight at their respective advanced field, Verdun and Froides. Daily disposition will be made of the remainder of the group over the sector for which we are responsible, viz: Aisne to Chatillon-sous-les-Cotes.

b) *Date of Attack.* Dawn balloon attack by patrols of three on squadron sector: Dawn to 8 h 00 continuous patrol of squadron sectors and close liaison with advanced landing field, one airplane only from each patrol landing at the advanced field. 8 h 00 to 15 h 30, no schedule, planes being dispatched according to exigencies of operations. 15 h 30 to dark, continuous offensive patrol helping infantry and working close touch with them doing a certain amount of liaison work to report progress of attack. Dusk of evening, balloon attack, pilots landing by flares on own airdrome.

c) *Days of Exploitation* (2nd, 3rd and 4th days). Dawn to 8 h 00 and 15 h 30 to dusk, continuous offensive low patrols. Concentrated day and evening balloon attacks, according to requirements.

d) Detached flights will operate independently, making short, snappy, frequent sorties as the occasion demands.

## 2. METHODS OF BALLOON STRAFFING.

a) *Dawn:* The pilots on this attack having carefully checked up the balloon emplacements the night before, will be dispatched in the darkness individually, but three to each balloon, two having balloon guns, and will make one concentrated attack all along the lines at a given minute, all watches having been previously synchronized.

b) *Daylight:* Daylight balloon straffing missions will only be dispatched in the case of troublesome balloons. A pilot will attack the balloon at a given minute, and be reinforced immediately by three formations of at least four machines each on a pre-arranged balloon emplacement and no other.

c) *Dusk of Evening:* Pilots will go out in groups of three and two will do the attacking on given balloon emplacements and no other, returning and landing on the field by flares, using the same recognition signals as night bombers.

## 3. Low-flying Day Patrols:

a) These will consist of two echelons of three machines each. One echelon must patrol a given beat at a given height and at a given time, so as to be over given points at definite times, thus insuring contact with all advancing troops and lessen the likelihood of attack by large formations.

4. Field is being prepared for night flying, and parachute and Holt landing flares<sup>4</sup> will be attached to each plane.

The plan of employment drawn up by the Commanding Officer, 1st Pursuit Wing in order to get the maximum results from its pursuit aviation laid emphasis on the employment of large forces for offensive measures. While the necessity for utilization of pursuit airplanes for shock action had been constantly growing more apparent, the peculiar conditions of the St. Mihiel battle had provided its employment in this manner at an earlier date. The plan of employment of the units of the

---

1st Pursuit Wing was as follows:

***“PLAN OF EMPLOYMENT OF PURSUIT, AND DAY  
BOMBARDMENT UNITS—1ST PURSUIT WING.”***

1. The operations will cover four phases.
  - i) Preparation until day of attack.
  - ii) During artillery preparation.
  - iii) During attack, as far as first combined army objective.
  - iv) Exploitation of attack as far as second combined army objective.

While the areas and objectives will be altered from time to time, the plan of employment of pursuit aviation in the last three stages of attack will follow the same general principles.

2. (a) *Preparation until day of attack:* In order that secrecy may be obtained no airplanes from this wing will operate west of Chatillon-sous-les-Cotes until after H hour.

(b) The normal activity of the sector between Chatillon and Pont-sur-Seille will be maintained, and the groups will operate over the sector of the last operations.

3. *Pursuit Aviation after H hour:*

(a) Pursuit aviation at the disposal of the 1st Pursuit Wing comprises the 2nd and 3rd Pursuit Groups. The sector of the 1st Pursuit Wing is from Pont-sur-Seille on the east to La Harazee on the west. The sector of attack is from the Meuse River on the east to La Harazee on the west.

(b) In order to maintain a proper superiority over the enemy air service it will be necessary for our air service, not only to maintain protective patrols within the enemy's lines for the defense of our army corps air service and to attack enemy reconnaissance planes, but it will also be necessary from time to time to take the offensive with a display of dominating force, sending out powerful expeditions so as to cover intermediate and high altitudes and to sweep the air clear of enemy aviation up to a depth, 10 or 12 kilometers inside the lines.

(c) One group will protect the front, daily, from dawn to 12 h 30 and the other from 12 h 30 till dark. In the protection of the front patrols of one flight will operate over the sector, Chatillon-sous-les-Cotes, Pont-sur-Seille, patrols of two flights will be maintained throughout the period assigned over the sector Chatillon-sous-les-Cotes, -----<sup>5</sup>La Harazee.

In view of the fact that it is believed that most of the enemy aviation is concentrated in the region of Metz, especial attention will be paid to the sector between the Meuse and Chatillon.

(d) *Special Missions of Pursuit Aviation:* By requiring one group to do its barrage work in the morning, its squadrons will be available

---

for an offensive operation in the afternoon, and vice-versa. The group assigned to patrol in the afternoon will be on the alert in the morning to carry out an offensive operation, in which the entire group may be called upon to participate at medium and high altitudes, penetrating about 12 kilometers beyond our advancing lines to clean the air of enemy aviation. A similar expedition may be sent out in the afternoon from the group that has done patrolling in the morning. The hours at which these offensive missions are carried out will be constantly varied and an effort will be made to order offensive missions at hours when intelligence received from the anti-aircraft artillery indicates maximum activity. The strength and frequency of attacks on ground objectives will depend upon the strength of enemy aerial activity encountered.

In special circumstances, pursuit reconnaissance will be ordered. While it is not anticipated that such missions will be ordered, group commanders will see that their pilots are familiar with infantry ground panels.

*Close protection for Corps Observation:* Photographic missions when they are required, will be provided by the squadron assigned to barrage patrol. The Corps Observation Wing will be informed of the hours at which the different groups will be responsible for the barrage patrol the night before. When observation squadrons cannot provide their own protection, they will notify the Corps Observation Wing Commander, who is authorized to adjust this protection directly with the group that is responsible, at the hour in question, for the barrage patrol. The group operations officer will inform the patrol leader of the squadron going out on barrage patrol, that its mission has been altered from that of barrage patrol to one of close protection, and the patrol leader in question will get into immediate telephonic liaison with the pilot who is responsible for the photographic missions.

4. *Day Bombardment Aviation:* The 1st Pursuit Wing comprises the 1st Day Bombardment Group. In principle, this group will be used to attack from high altitudes, large objectives such as towns and railroad stations from which traffic is radiating.

In the first stages of attack, it will operate against enemy concentrations along the valley of the Meuse, Romagne, St. Juvin, Grandpre.

*Special Missions of Bombardment:* In emergencies when intelligence received that specially favorable targets are presenting themselves within 6 or 8 kilometers of our front lines, this group will be ordered to attack such targets at low altitude in order to cause confusion and material damage to enemy elements arriving as reinforcements or retreating.

The low work of the 1st Pursuit Group justified its introduction on the first day of the Argonne-Meuse attack, September 26. Ten enemy





*Capt. James A. Summersett, Jr., next to the insignia of the 96th Aero Squadron, which he commanded during the Argonne-Meuse Offensive.*

---

balloons were shot down in flames on that date. The constant destruction and harassing of the enemy's balloons by the group resulted in the enemy detailing a certain force at all times for their protection, and he made many ingenious attempts to trap our pilots who were attacking his balloons. This resulted in counter schemes being employed in which not only were attacks on balloons carried out, but a number of enemy airplanes were brought down by the group. While many successful balloon attacks were made in the early morning and throughout the day, the most successful attacks were those carried on in the dusk of the evening. The 1st Pursuit Group in addition to its attacks on enemy balloons and its defensive work in destroying German battle-planes, was enabled to use shock action at low altitudes by means of a concentrated patrol of all squadrons which was made about three o'clock every afternoon.

The policy employed with respect to the 1st Pursuit Wing of using large forces for shock action deep in the enemy's side of the lines, justified itself on the first day of the American attack in the Argonne-Meuse area, September 26. The first group sortie was made by the 2nd Pursuit Group at dawn of September 26 and resulted in the destruction of 8 enemy airplanes. A similar sortie by the 3rd Pursuit Group on the afternoon of September 26 resulted in the destruction of 3 more enemy planes. One of the most successful shock operations carried out by the 1st Pursuit Wing was carried out on October 18th in which two squadrons of the 2nd Pursuit Group, equipped with bombs and machineguns for the purpose of harassing group objectives flying at an extremely low altitude, two squadrons of the 3rd Pursuit Group at between 2,000 and 3,000 meters, all four squadrons of the Day Bombardment Group at 4,000 meters, and two more squadrons of the 3rd Pursuit Group, flying at 4,500 meters, met at the previously appointed rendezvous of Bayonville at 3:30 in the afternoon. The enemy appeared in force, some 30 or 40 enemy planes being seen by our pilots. Their formation was broken up, at least nine of them were destroyed, and the others forced to return to their airdromes. It is not to be forgotten that throughout the Argonne-Meuse operations both the 2nd Pursuit Group and the 3rd Pursuit Group were equipped with bombs for use in attacking ground objectives.

During the Argonne-Meuse offensive, a night pursuit squadron was added to the 1st Pursuit Group for the purpose of attacking enemy bombers. The details connected with the organization of this service presented a whole series of new and difficult problems which were satisfactorily solved. After the introduction of the night pursuit squadron, very few night bombardment attacks were undertaken by the enemy. In a few cases our night pursuit pilots were able to come within range of the enemy raiders. The night pursuit squadron combined offensive tactics with its defense against enemy bombers,

---

and on several occasions crossed the enemy lines and dropped small bombs on enemy posts of command and concentration of troops.

In addition to its offensive shock patrols, the 1st Pursuit Wing carried on the more conventional protective patrols for which provision was made in the plan of employment, and also afforded a certain amount of close protection to the army corps observation planes. The imperative necessity of extremely close liaison with the corps air services in the carrying out of these missions was emphasized, and the policy was adopted in October of having the corps observation planes which were to receive close protection from pursuit planes, land on the airdrome of the pursuit group assigned to give protection, so that the observation airplane crew and the pursuit patrol leader could come to a definite understanding of the work to be done and the methods of doing it.

### **Comments.**

At the beginning of the Argonne-Meuse offensive, American pursuit aviation had reached that stage in numbers and efficiency where it ranked with the pursuit units of the other nations. It consisted of three groups of highly organized squadrons with pilots of the very first order. Taught by the experiences of the French and the British, they had at this stage the greatest efficiency in personnel. It was known that the enemy had brought to the Conflans area his best units of pursuit, and it was known too that battle-flights, a creation of the German air strategists, would be employed by them should occasion arise. By this time the American Army was beginning to appreciate the morale effect of aviation, and it was felt that the necessity of supremacy of the air was needed more by American arms in these operations than perhaps ever before, to produce the greatest results. It needed the moral supremacy, so easily enhanced by a predominance of ground troops, of low-flying airplanes to carry Americans over the awful terrain of the Meuse under trying weather conditions. Bearing this in mind, the Chief of Air Service, 1st Army, with the acquiescence of the French advisors on aviation, decided that it would be well to utilize a portion of the pursuit, namely, the 1st Pursuit Group, under his command, for combatting enemy battle planes and for the destruction of enemy balloons. This step made the withdrawal from the higher altitudes of a large percentage of the resources in pursuit machines, but in the opinion of the Chief of Air Service, 1st Army, it was more important that enemy aviation including balloons and airplanes, low and in full sight of the advancing troops, should be destroyed at all costs. His judgment was right, the results obtained fully justifying the expenditure, and it is believed that this innovation was one that caught the Germans by surprise, and to a certain extent upset his plans. Very few German balloons were able to work, especially those on the east

---

of the Meuse, which, if allowed to operate, would have been able without doubt to direct enfilading fire so successfully that the advance of our troops would have been hampered even more than it was, and our huge concentrations in that area would have been located and probably disastrous results have followed.

No greater provision was made for the security of the operating units than in the St. Mihiel offensive. The 2nd and 3rd Pursuit Groups were without adequate transportation, and it is felt that the existence of the American pursuit units were jeopardized at all times for want of it. The airdromes at Belrain, Rembercourt, and Lisle-en-Barrois were well laid out and well concealed. The enemy knew undoubtedly that a great deal of pursuit aviation was located at Belrain, because of the fact that this was an old field, but he was never advised, and probably never was suspicious about Rembercourt or Lisle-en-Barrois. The danger of night bombing was minimized by the introduction of night pursuit so that the danger from this source was partially removed.

With regard to the security of the units in the air little comment can be made, save that formations were well kept, and plans were made for the protection of patrols. Those of the 2nd, and 3rd Pursuit Groups working at high altitudes, were properly echeloned, and worked well together. So-called scouring patrols<sup>7</sup> used by the 1st Pursuit Group where one formation acted as a pivot, with two squadrons cooperating, were very effective, and produced wonderful results besides insuring the protection of themselves.



*Maj. Harold E. Hartney, who had flown with the Royal Flying Corps and had been shot down by Richtofen, commanded the 1st Pursuit Wing from September to November 1918.*

---

The employment of large concentrations of pursuit, consisting of several formations echeloned and cooperating, developed to a great extent in the Argonne-Meuse offensive, and, thanks to the skillful disposition of same by the commanding officer of the 1st Pursuit Wing, excellent results were obtained with a minimum expenditure of machines and personnel. Concentrations of this nature are effective in that they employ the principle of economy of forces. Seldom does the weather in the months of October and November in France permit constant patrol at high altitude throughout the day. Commanders, therefore, figuratively speaking, can pile up their resources in machines and pilots until the bright intervals, when they are able to send out the whole in a well regulated and disciplined mass, and sweep the sky under the direction of a competent flight leader, and applying the general principles of aerial tactics. In this connection, it is well to develop the competitive spirit in flight leaders, as was done in the Argonne-Meuse offensive. For excellent work leaders were chosen and given command of a formation, and permitted to maneuver it as they chose, and some skillful aerial maneuvers with successful encounters were produced. It is safe to say that had the operations continued, by next spring the good patrol leader would be the most sought out pilot in pursuit work.

The security of balloon attackers, endangered as it was more than ever by machinations of the enemy, was properly looked after by the arrival of supporting formations from different directions immediately following the balloon attack. When the element of surprise cannot be utilized for day balloon attack, and when it is essential that a balloon be destroyed, even though protected by enemy aviation, this probably is the best and surest way of bringing about its destruction, and originality of this scheme can be credited to the American aviation. At first sight criticism might be directed to the fact that individual machines and small formations were allowed to operate, but this can be met by the statement that such was not the case, except when weather conditions or the nature of the work itself permitted this action. Some too, may criticize the fact that pursuit squadrons were allowed to work at low altitude in that they were not suitable from the nature of their construction, and danger from forced landing in devastated country. It is felt, however, that the use of the Spad machine for this purpose was quite justified under the circumstances, and that no violation of the principle of security of either personnel or material was affected thereby, especially when one considers the losses in machines and personnel, which were extremely low.

Little can be said with regard to the orders of the different commanders. Experience had taught the army, wing, group and squadron commanders the best principles in this regard. In every case plans were made, policies outlined, and daily orders issued in

---

accordance therewith, throughout the operations. In some cases, the orders were a little slow in forthcoming. Units should be advised of their work as long before as possible, and in this connection it might be well for higher commands to issue orders of a general nature and alter them later by telephone or special courier in accordance with the exigencies of the moment, relying in full on the judgment of the subordinates, who are on the ground and know the conditions, and need only to be told the general scheme and wishes to produce the desired results. It is necessary to note, too, that the principle of economy of forces, of husbanding resources in bad weather to use them in good. In considering the subject of orders, it is well to call attention to the fact that flight leaders kept their formations well in hand, conferences were always held before the missions, and the general scheme in detail worked out, so that actual signals from the patrol leader reduced possibility of confusion to a minimum. The principle of having squadron operations officers work in close touch with the group operations officer is good, and less confusion of orders is apt to arise when harmony prevails, as it did in all the groups during these operations.

An inspection of the pursuit work in this offensive would not be complete without considering the individual combative tactics of the pilots. In bad flying weather, such as existed during these operations, the tendency is towards smaller formation and individual effort. Commanders, in permitting pilots to go out in low-flying cloud weather, knowing the possibility of surprise by the enemy, must be careful that this is not overdone. He and his pilots should ever be alert to the possibility of the sudden return to good weather and normal pursuit activities, and sufficient reserve should be available at all times to reinforce patrols when occasion demands.<sup>8</sup> Conversely, his pilots should on the other hand be ready to make use of the fact that the enemy is inclined to work singly and seize every opportunity of meeting him in force and destroying completely. Pilots during the Argonne-Meuse offensive were a little too apt to rely on the diving qualities of their machine, rather than maneuverability. It is felt that the true pursuit machine of the future must rely on nothing but offensive action, coupled with maneuverability. In this way, one of the elementary principles of tactics, the offensive, is maintained. To dive is to run away; to maneuver is to stand up and fight. No matter what the development of aviation, it will be a very long time before a quickly maneuvering ship is easily shot down; a diving target is the easiest, and can be conquered by simply catching up and shooting dead-on. Probably the best way to convince pilots of these facts, and all general principles, is to send them up to the front line as often as opportunity affords, and let them see the general activities for themselves. It is found that commanders of pursuit groups did in practice employ this

---

principle, and pilots who were not on duty spent a great deal of time up near the front, co-operating with other units, and gaining tips for use the next day. This proved valuable, not only as a physical, but as a mental diversion and exercise, and pilots who kept themselves keen and interested with their work were found to be less subject to nervous breakdowns or temporary setbacks.

A survey of pursuit tactics in the Argonne-Meuse would not be complete without considering the work of the night pursuit introduced at this period. At first sight critics might be inclined to underestimate the value of this unit, but a careful study of their work, and their general strategical value soon emphasizes the value of this unit on the front at this time. It must be remembered that the Germans did very little day bombing, and that all indications led the higher command to believe that they intended increasing their night bombing activities during the winter months. The concentrations of large bodies of American troops between the Argonne Forest and the Meuse after the advance over the shell-torn low-lying water-filled shell areas, meant increased immobility on the part of our troops, and offered exceptional targets for the enemy. Night bombers, of their very nature, were slow and cumbersome, and no match at all for pursuit planes, and once located by the latter in the beam of a searchlight or moonlight, it was felt that night pursuit could handle the situation satisfactorily, if, indeed, not completely destroy the twin night bomber's effectiveness. The units assigned this duty, though handicapped by supplies of spare parts and even properly trained pilots, made themselves felt, and besides preventing the deep penetration by night bombers, frequently bombed on their patrols enemy concentrations, dumps, etc., and proved that American pursuit could harass the enemy night and day in good weather.

The institution of night pursuit, which is perhaps the highest development of aviation, undoubtedly gave the enemy the impression that the American Air Service was fully alive to its possibilities and to the resources at their disposal, and would, if the German aviation was to continue, have to adopt counter-measures on this as in the day work, to retain its place in the military aeronautical world. The development of night pursuit will probably in the future be considered by students of aviation one of the successes of American aviation, in that only one other nation in the war attempted this new function of pursuit, so replete with possibilities and potentialities.

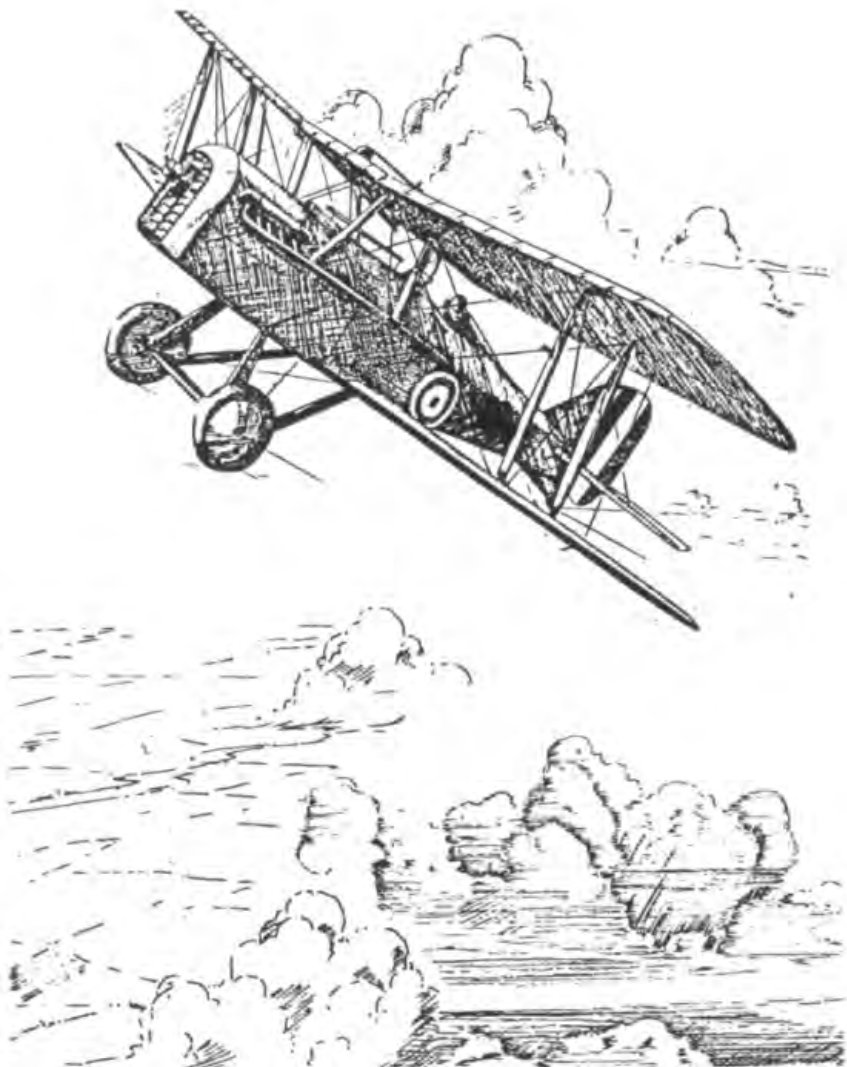



## V. American Pursuit Units on the British Front.

---

On March 17, certain American pilots were posted to British squadrons in the field. From that date to the end of the war, American pilots saw service on the front with the Royal Air Force. These pilots were placed under the command of the British squadron commanders, and possessed the same status as British pilots, and were used precisely the same as if they were British subjects. On June 20 the 17th Aero Squadron was formed, equipped with Sopwith Camel airplanes, using 9 pilots as a nucleus, who had seen about three months service in British squadrons. On July 1, the 148th Aero Squadron was formed on the same principle and with similar equipment. These two squadrons operated under British wings exactly as if they had been British squadrons. A number of American pilots remained with British squadrons. Americans participated, therefore, in all the operations explained in the following report. These operations were all directed by British command, but American pilots had a great deal to do with carrying them out. The work of Americans on the British front is so enveloped within the work of the Royal Air Force, that a tactical history of American operations on the British front can only be told by a tactical history of operations of the Royal Air Force.

On March 31, the Germans began their Picardy drive, which culminated in their establishing the line as far west as Montdidier, Villers-Bretonneux and Albert. The stopping of this advance can be attributed as much to the work of the Royal Air Force as to any other single factor.

For months previous to this drive, the British held absolute supremacy of the air. The S.E.-5 and the Sopwith Camel were so far superior to the Albatross, Pfalz, and Fokker tri-plane, that all fighting took place far over the enemy side of the lines, if there was fighting at all. The enemy was unable to fight unless he had advantage of position and numbers, but a formation of S.E.-5s or Sopwith Camels would never refuse an opportunity to attack two or more times their number.

Besides having the superior type of machines, the British had a greater number available than the enemy, which made the situation doubly hard for him to cope with. The enemy was compelled to concentrate his force during certain periods of the day, granting the British absolute air supremacy during certain hours, and contesting their supremacy during others.

During the Picardy drive, the British were pushed back into country where there were plenty of airdromes. The push was, however, so rapid, that many airdromes were taken, and machines unserviceable at the time had to be burned. Those squadrons which were in the sector of the push were forced to make several moves. In this case the mobility of the Royal Air Force was its saving factor. Each squadron possessed sufficient transportation to move its necessary supplies.

---

Moreover, there existed a reserve lorry park, which had a certain number of squadrons to provide moving facilities for. The reserve lorry parks were kept very busy. The Royal Air Force also possessed plenty of temporary hangars, which were easily set up ready for use. The supply of airdromes, therefore, depended merely upon the supply of airdrome sites.

A great many squadrons were moved back of the sector of the push, and once back of that sector, every squadron held itself in readiness for a move at a few hours notice.

The problem which confronted the Royal Air Force was to assist in the stopping of the push. The R.A.F. was, therefore, to do more than carry out artillery adjustment and do reconnaissance. Bombers had to work overtime, and pursuit machines had to be used for ground strafing as well as for patrol work.

Ground strafing was not an entirely new use for pursuit machines but more of it was done during the last week of March and the first week of April than had ever been done before. The enemy was bringing up large formations of troops, which offered splendid targets for aircraft. All pursuit machines available were used to harass these enemy reserves, and not only were pursuit machines used but two seaters, too, joined in the battle on the ground.

Ground strafing was not carried on systematically. The method of conducting a ground strafe was for squadrons to send over flights of six machines at half hour intervals, after getting about five miles over the line, the flight split up, and each pilot went independently, found a ground target, machine gunned it, bombed it, and got back the best way he could. This method was discontinued in about a week. Pilots were then sent out in twos, with 15 minute intervals between pairs. However, different wings used different methods, but none really had a successful system. The enemy did no ground strafing on our troops, their machines had a hard time even getting up to the line.

To protect our ground strafing machines and to keep all enemy machines away from the lines, the usual patrols were necessary. Patrols of our machines were of one flight or two flights of machines, very rarely of three flights. Two flights of machines were very effective because of the superiority of our types. All fighting in the air was far over the enemy's side of the line.

The enemy in the Picardy drive frequently appeared with masses of aviation as large as 50 or 75 machines, working in a large drove with no apparent formation. They were forced to use a large formation due to the inferiority of their machines. Small formations of enemy machines always working some distance behind their lines took advantage of low clouds to attack our ground strafing machines.

As a result of the work of the R.A.F. in March, development was made in ground strafing and in the patrol. Ground strafing prevented

---

reserves from reaching the line except at night without being harassed. Losses, however, were heavy, due to lack of cooperation between protecting machines and those doing ground strafing. There seemed to be no cooperation whatever. Weather conditions were not taken advantage of and in fact did not seem to affect operations in the least.

This offensive developed a large patrol. A G.H.Q. Wing was formed for the purpose of having a large mobile reserve of pursuit aviation. In it were one S.E.-5 squadron, one Clerget Camel squadron, and one Le Rhone Camel squadron.<sup>9</sup> Later the number of squadrons was increased. Patrols were to be made up of 12 Camels, with 6 S.E.-5s above, or 24 Camels with 12 S.E.-5s above. The formation of three flights, or six flights, was quite adequate to deal with enemy formations of any size that were likely to be met. The large formation had its birth in this offensive, and with it came the development of the art of patrol leading. The squadron, or three flight patrol, was not common however, until about three months later.

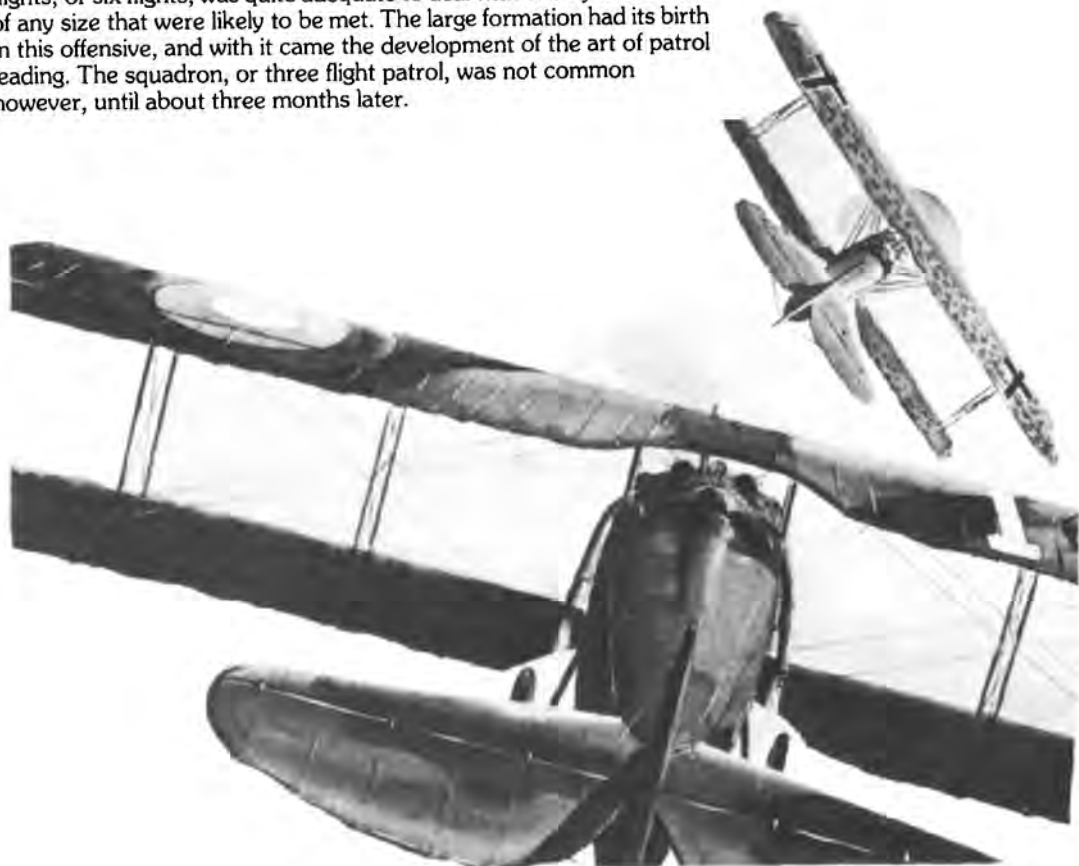

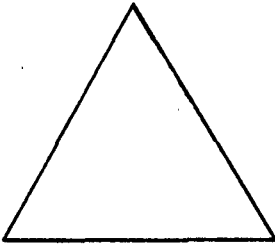

Although some machines were lost in this offensive, due to airdromes being taken by the enemy, a great deal of credit is due the British system of making squadrons mobile. It was here proved that each squadron must possess sufficient transportation to move the supplies and equipment of a squadron. The motor lorry reserve parks proved most efficient. Temporary hangars were far more useful than large permanent hangars, which took some time to construct. If British squadrons had not been on a mobile basis, the loss of supplies and machines in this push would have been immense, but as the situation was handled, the work of a squadron was not interfered with by a move. Squadrons even the day a move was carried out conducted patrols as usual.

The push was made by the Germans between Ypres and La Bassee, which began April 12, was not so important in its effect upon aviation as the Picardy drive. The push was much shorter in duration, and due to bad weather conditions, aerial activity was not extensive, except for the first two days of the offensive.

It seemed that there was very little preparation for the push in the way of putting a great many squadrons on that front. It was possible for a squadron working between Ypres and Nieuport to do patrols on the front of the push. Some other squadrons, which had been working in the push at Albert, were able to patrol the Ypres-La Bassee front without moving their airdromes. The enemy captured a few airdromes, but only one squadron lost its machines. There was no shortage in the supply of airdromes. The enemy had a great many machines on this front, but not so many as the British. Previous to the push, the British held absolute air supremacy.

During the push, ground strafing was done to some extent, but not as much as in the March drive. The need was not so great. Patrols on this front were of larger formations that had been in use previously. The General Headquarters Wing had an opportunity to try out the three and six flight patrols. On these patrols the S.E.-5s served as a protecting flight for the Camels which worked below. The combination proved a great success. The superiority of the air possessed by the British previous to this offensive was maintained. All fighting that took place was 10 to 15 miles back of the enemy's line. The enemy were unable to keep balloons up to any great extent. The enemy two-seater machines accomplished very little work. Our balloons were up in great numbers constantly, and our two-seaters worked from morning until night.

The German drive between Noyon and Montdidier began about June 7, and lasted for something like a week. Although this front was a French front, the R.A.F. practically carried on the war in the air.

About four days previous to the push, the 9th Brigade was moved to the vicinity of Beauvais. It is not known to American pilots how many

*The unit markings, triangle (above) and dumbbell (below), displayed by the 148th and 17th Squadrons from July to October, 1918, were assigned by the RAF.*

squadrons the French had on this front. It seemed that the French supplied their own planes for observation and the British supplied the machines for bombardment and pursuit.

Upon first moving to that sector, few enemy machines were seen. They scarcely made their appearance until the day of the push. They evidently had plenty available, for when the offensive began, the enemy put as many machines on the front as the Allies had there.

It was then that the Fokker bi-plane made its appearance. At first they were mixed with Fokker tri-planes, and a few days later some purely Fokker bi-plane formations made their appearance. The Fokker bi-planes, however, did not create such a sensation then as they did later. The machine was probably not as good at first, and the pilots did not seem to be able to get all that was possible out of the machines.

For three days prior to the push, bombing raids were made on all important centers from 8 to 15 miles back of the enemy lines, and three-flight patrols were carried out. When the push began, the 9th Brigade had at least half its machines on ground strafing all the time. Those squadrons which were detailed to do ground strafing carried out four missions each day for three days, bombing and machinegunning reserves. When the weather was clear, four machines would go out together—two to protect, and the other two to do ground strafing. This plan seemed to work fairly well, but it is not thought to be the proper method of conducting a ground attack. When weather was bad, two machines would go out together, both carrying bombs, and both doing ground strafing work. Protecting patrols were supposed to be out whenever low-flying was ordered.

Enemy patrols were large on this front. The enemy would concentrate on certain hours of the day, when they would put all of their two-seaters and pursuit planes in the air together. All British squadrons patrolled with three flights of machines. Fighting was always on the enemy's side of the line.

The enemy seldom tried to get balloons up on this front, while the French had their balloons up from daylight until dark, and they were seldom molested. Whenever enemy balloons were reported up, an organized balloon strafing formation was sent out.

As a result of this push, the three-flight patrol was proved most effective. Previous to this offensive, the three-flight patrol was used only by a few squadrons, but here all patrols that were sent out consisted of three or six flights. Ground strafing was not yet systematically conducted. There was no cooperation between the protecting patrols and the low-flying machines. Those doing the ground strafing practically had to depend upon themselves, not upon their protectors. Two protecting machines served as a protection only because the enemy would attack them first, and give the lower



*The more typical U.S. insignia, the Liberty Head (above) and the Snow Owl (below) were later selected by the Squadrons.*

---

machines a chance to get back. Two machines were not offensively strong enough to be of any use.

In this offensive ground strafing served a great benefit in checking the enemy's advance because so much of it was done. The liaison between French observation machines and the British pursuit machines was very poor. The plan, however, seemed to be to keep up a constant barrage of pursuit planes, permitting Allied two-seaters to work at all times. This plan did not call for the liaison between pursuit and two-seater machines that is required where two-seaters are to work only during certain hours of the day.

Subsequent to the German drives, came the Allied drives, extending from July to the end of the war. The offensives with which Americans are familiar, due to participation in them, were the drives from Montdidier and Villers-Bretonneux east in August, and the drive from Albert east through Bapaume, Cambrai, and Le Cateau in August, September, and October. At this time there were a great number of Americans working on the British front. The two American squadrons, 148th and 17th, were participating in the Allied drives in these places, and their work there was no small factor in contributing to the success of the R.A.F.

The first stage of the drive from Montdidier and Villers-Bretonneux carried the line forward to Bray, Rosiers and a point four miles west of Roye. Previous to this push, the R.A.F. held absolute air supremacy. They had operating on this front more machines than the enemy had, but at the time of the offensive, the enemy increased the number of machines. The only type of pursuit machine used by the enemy was the Fokker bi-plane, and it there proved to be the best pursuit machine in operation. There were in this sector a few of the enemy's best squadrons, but also some very poor squadrons. There were sufficient good squadrons, however, to prove the superiority of the Fokker over the S.E.-5 and the Camel. The enemy had one handicap, however, which was purely a moral one. The British had held the air supremacy for so long that the morale of the German flying corps was low, while ours was high.

The British had plenty of airdromes in this vicinity to meet the emergency, although hangars and billets were crowded. Some squadrons used advanced landing grounds in the sector of the offensive, rather than moving to that area, due to the fact that those particular squadrons would be needed in offensives on other fronts in a short time, so that a permanent move would not have been worth while. Many enemy airdromes were captured with a few machines.

In the first days of this offensive, ground strafing was carried out on an extensive scale. Not only were pursuit machines used to harass enemy reserves as far back as 5 or 8 miles, but they were used to bomb the bridges over the Somme in the vicinity of Peronne from low

---

altitude. The weather was very bad for ground strafing, due to very low clouds, which condition caused many of our machines to be shot down by ground fire. The weather conditions also prevented cooperation between machines with the mission of ground strafing and protecting machines. In fact, protecting machines could not be used. The organization of work, however, was much better than in previous drives.

Pursuit machines here took on a work which had never before been done, mainly that of working in conjunction with tanks. The airplane was to fly low over the tanks and put out of action any antitank guns, and to assist in destroying enemy machinegun nests. On the day of the push the machines of one squadron were detailed for this purpose.

Patrolling on this front was always with at least three flights of machines. The enemy often used larger patrols, but as a rule, its patrols consisted of 12 or 18 machines. On the day of the push, patrolling was taken care of by machines loaned from another brigade, which worked on an adjoining front, while the machines which operated ordinarily in the sector of the push took care of the special work such as ground strafing, low protective patrols, and work with tanks. On the days following the push, when no ground strafing was being done, the machines which ordinarily worked on the sector of the push, carried out the patrols without the machines of the other brigade. The enemy here, as usual, followed the policy of concentrating all his force at certain periods of the day, rather than trying to carry out work at all hours of the day, as the R.A.F. did.

The second stage of the drive from the line established at Bray, Rosieres and near Roye, came about August 20. The conditions existing in respect to the machines of both the Allied and the enemy were practically the same as in the first stage with the exception of possibly a small decrease in number on both sides.

The plans for the work of various squadrons were very complete in detail. The weather permitted the working out of definite systems. The day before the offensive, each squadron was informed of what its work was to be and what every other squadron on the front would be doing at the same time. Certain squadrons were detailed to work with tanks; certain others to do ground strafing; others to carry out in low protective patrols, and others from another brigade to do high patrols. The cooperation between the protecting machines and those doing ground strafing was better than it had ever been before. Those machines which were to do ground strafing were informed the day before the attack of the zone in which they were to work. Two hours after H-hour, another designated zone was to be the area of their attacks with bombs and machine guns. After a certain length of time attacks were to be directed on another designated area. In short, all squadrons had complete information on what our ground troops were

---

doing, and what they were working, thereby giving great certainty to pilots in carrying out their work. It was also a wonderful help to pilots to know just what work every other squadron on that front was to do.

Air supremacy was at all times in this push kept by the Allies. This was really the first time when definite systems in regard to ground strafing had been worked out. The results were more effective work with fewer casualties than previously.

As the offensive in this sector advanced, the situation with respect to airdromes became rather acute. The ground over which troops had advanced was riddled with shell holes, and an airdrome could not be made in a short time. It was, therefore, necessary for squadrons to patrol too far away from their own airdromes to put in their full amount of time on the line. Too much time was consumed in going to and returning from the lines, thereby lessening the strength of the R.A.F. a considerable amount.

About the 1st of September the scene of greatest activity was transferred from the Roye front to the sector immediately north of it, however, as the line advanced east from Peronne and Saint Quentin, this front remained active, though not as active as in the first days of the offensive. During the last days of August, the 148th Squadron and 17th Squadron were put on the front between Arras and Albert, and operated on that front as the line moved east until the 1st of November. A tactical history, therefore, had best be given of operations on the front where the two American squadrons were working.

About the 25th of August the British began a drive towards Bapaume. The developments in the air in this offensive were very far reaching. The drive may be divided into three parts, the first ending with the taking of Bapaume; the second with the crossing of the Canal du Nord; the third with the taking of Cambrai and Le Cateau.

For this push, the British had few squadrons available besides those which ordinarily took care of that front, but the number of machines available for the British during the first few days of the offensive was greater than the number of machines available for the enemy.

During the first two days of the push, ground strafing was carried on very extensively, and the organization of protection patrols above and the sending out of ground strafing machines was systematically conducted. Enough squadrons were detailed to ground strafe, so that about six machines were kept over the lines on that mission all the time. Incidentally, they were a protection to our corps machines. They patrolled low at about 4,000 feet.<sup>10</sup> There was also a high patrol of two or three flights of machines working practically all day. The arrangement worked splendidly for the first few days, during which time the weather was clear. During the following few days weather was bad and low clouds prevailed. Ground strafing machines were still



---

sent out but not with adequate protection, for by that time the enemy had put more squadrons on the front. Some days when clouds should have prohibited a ground strafe, machines were called upon to perform missions six and eight miles beyond the line. Protecting patrols were supposed to be above the clouds, but there was no cooperation with the low-flying machines. Occasionally, however, when weather permitted, a well organized scheme would be arranged, putting over within an hour's time all machines of two squadrons to bomb and machinegun troops. At the same time about six flights of machines would be used to protect them . . . [as well as some] two-seaters, which had work to carry out at the same time. This plan was really a departure from the British plan of not concentrating during certain periods of the day, as the enemy always did. The plan worked splendidly, but due to the shortage of squadrons, it could not be followed during many periods of the day without using up too many machines to carry on work during other periods.

As a result of the ground strafing, the enemy ceased moving transport or troops in large bodies. One could seldom see over three motor trucks or horse drawn wagons together. A space of about a quarter of a mile would usually be left between them. Movement of troops in the daytime within five miles of the line practically ceased, while on our side transport and troops packed the roads until within a short distance of the line. The low bombing in this push forced the enemy to build numerous underground passages and shelters in all places extensively occupied.

Due to the intensive activity on the ground, and the extensive operations of two-seaters and our low-flying pursuit planes, all patrolling was brought down lower than usual. Then the enemy pursuit planes most of the time flew low to combat our ground strafing machines. Few patrols were made above 14,000 feet. Most aerial activity was under 10,000 feet. Lowering patrols in this manner gave the British better use of their available squadrons for ground strafing. During the first stage of this drive the enemy patrols were as a rule small for the purpose of combatting our low strafing machines, but some large formations of 30 or more machines made their appearance occasionally.

During this stage of the push, the British held absolute air supremacy at all periods of every day. Our balloon line remained intact all the time, and our two-seaters worked from morning until night. The enemy could scarcely keep a balloon up, and their two-seaters seldom got within two miles of the line.

During the second stage of the push, the time from the taking of Bapaume until the crossing of the Canal du Nord, aerial activity was as great, if not greater, than ever before. The enemy squadrons which moved in were exceedingly good. The 2nd Bavarian Pursuit Group

---

was known to be there. The reason for the great enemy aerial activity on this front was that the Canal du Nord was a very important line for the enemy to hold. The R.A.F. was unable to put many more squadrons on this front than in the previous stage of the push, due to the fact that the Allies were carrying out an offensive on every part of their line.

The enemy seemed to have plenty of airdromes, while the airdromes of the Allies were so far behind the lines that the time a machine could spend on the line was decreased from 45 to 30 minutes. This fact amounted to a decrease in the air force of 15 or 20 percent. The country was so riddled with shell holes that there were few sites for airdromes which did not require some time to put in shape for use. The country over which our machines had to fly in approaching and returning from the lines was in such a condition that a forced landing meant a crashed machine.

During this stage of the push practically no ground strafing was carried out. The need was not so great; moreover, pursuit machines were necessary for regular patrol work to hold supremacy of the air.

Patrols used in this stage were always of a large number of machines. The enemy always flew in large formation, still using his policy of concentration on certain hours of the day. The R.A.F. always had four or six flights working under one patrol leader. Less than four flights were useless. Then working in four or six flights, the bottom flight patrolled at a height between 12,000 and 14,000 feet, which placed the top flight about 18,000 feet. Other lower patrols of a strength of two or three flights would take care of work under 10,000 feet. Occasionally, it was prescribed that the bottom flight of a six flight patrol would work at six or eight thousand feet. The British policy here was to keep two-seaters over the line at all hours of the day, and therefore, to keep pursuit patrols up at all hours of the day. The enemy policy was that of concentration.

During this stage of the push, the British kept air supremacy more than half the time, but there were times when the enemy possessed supremacy. During these hours when the enemy concentrated his forces, two-seaters got over the line; however, not without difficulty. Many times an inferior number of our machines by maneuvering, and by staying off a fight, kept enemy two-seaters back when a superior number of enemy pursuit machines were present. During other periods of the day, our two-seaters were permitted to carry on their work uninterrupted. Our two-seaters accomplished many times the work accomplished by the enemy. Enemy balloons were able to carry on more work than previously, but nothing like as much work as ours carried on. Some British balloons were brought down, due to the advantage taken by the enemy of a salient in the line, and the wind direction.

---

It was a tactical error on the part of the R.A.F. to send out a large patrol of from four to six flights and prescribe that the bottom flight work at 6,000 or 8,000 feet. To do this threw the top flight too low to make it immune from attack. The top flight, or protecting flight, must always be in a position where attack on it is impossible. It would have been a better plan, where only four or six flights were available, to take care of the front at a given time. To order the bottom two or three flights to work between 6,000 and 10,000 feet, and the top two or three flights to work between 15,000 and 18,000 feet. The distance between patrols is too great for close cooperation, but better air supremacy can be kept than by having a larger unit more compact but with the top machines too low.

The war in the air, which was fought while the battle line was at the Canal du Nord, during the latter part of the month of September, was probably the hardest that has ever been fought. The enemy made a good bid for air supremacy. He did not get it. His morale, however, did strengthen greatly during September. The Fokker bi-plane was better than any pursuit machine on the front, and to that fact can be attributed the enemy's aggressiveness. Patrol leading became the most important factor in determining air supremacy. The enemy patrol leaders showed skill and ability in handling patrols of several flights. The superiority of the British patrol leaders, however, was responsible more than any other factor for keeping air supremacy.

In that stage of the drive which extended from September 27 until the last of October, which dates include the taking of Cambrai and La Cateau, the war in the air was not on such a large scale as during the previous period. The enemy had few good squadrons of pursuit machines on the front. The British kept there practically the same number that had been there in the previous stage.

On the day of the crossing of the Canal du Nord, and for a few days following, some effective ground strafing was done. The method employed was to have certain squadrons detailed to work all day from



---

advanced landing grounds, in order to bomb and machine gun any good targets reported by observation machines. Later, when the line had advanced to Cambrai, machines were ordered to carry bombs and strafe ground targets from a low altitude, and then carry on with a patrol, patrols usually consisting of five or six flights, the bottom three to carry bombs and the top flights to serve as their escort. As a slight departure from this plan, after moving ground targets became difficult to find, low strafing was ordered to be carried out on cities used as concentration centers, as far back of the line as eight miles. However, pilots would not go low when 8 miles inland. Towns four or five miles back of the lines were bombed from 2,000 and 3,000 feet, but those 8 miles back were bombed from 6,000 to 8,000 feet.

The size of the enemy patrols remained large in this stage of the push, but the enemy did not seem to have enough machines to carry out work many hours of the day. The enemy could not keep balloons up, and two-seaters could not get near the line. Our corps machines carried on work almost without interruption from daylight until dark, and our balloon line was always thick with balloons. Whenever an enemy balloon was put up, it was forced to work under 2,000 feet. The R.A.F. possessed absolute air supremacy at all times during this stage of the push.

From a tactical standpoint, the R.A.F. squadrons were not well managed by the staff during this push in all cases. The policy of having squadrons on advanced landing grounds to do ground strafing on targets reported by other machines is good. The policy of sending out a strong patrol and requiring the bottom flights to do ground strafing is bad. The effectiveness of the patrol is ruined. If the lower machines cross the lines at a low altitude, the protecting patrol must come to the line at a low altitude. Effective ground strafing can be carried out, but the patrol is ruined. Following this plan, the patrol must get its height on the lines, which means that there will never be an enemy formation below it, or in a position to be attacked by it. The policy of directing low bombing on concentration centers deserves approval, but it is questionable whether the damage done at the time was worth wasting a strong pursuit patrol for. It seems that bombardment machines may have been used to better advantage for destruction, and the pursuit machines used to better advantage by properly arranged patrols.

In addition to tactics employed during an offensive, there are certain other tactics of aerial warfare carried on by the R.A.F. with which Americans who worked with the British are familiar. The operations may have been carried out in an offensive, but were also carried out on practically all fronts at all times. Wireless interception, balloon strafing, anti-aircraft use, and escorting of bombers deserve some mention.

---

By wireless interception is meant the interception of messages of enemy observation machines at two different stations, and thereby pin-pointing the location of the enemy two-seater. Immediately the information as to the location of the enemy machine is sent to a squadron which is operating close to the line, and two or three machines which had been standing by for the message were immediately dispatched. Machines used for this purpose were always rotary motored because of their ability to leave the ground without warming up. This practice was exceedingly successful. As a rule, the enemy machine would be found at the designated spot. If the enemy machine were not destroyed, its work would at least be broken off.

The methods of the R.A.F. employed in keeping down enemy balloons do not deserve a great amount of mention, because it was not as a rule organized effort. Enemy balloons, however, did little work. The R.A.F. held such air supremacy that the single machine was usually safe from enemy aircraft in attacking a balloon. During offensives some organized balloon straffs were carried out. A method commonly employed was to have two machines detailed to straff the balloons, both machines carrying incendiary ammunition. These two machines would have sufficient protection to make them safe from enemy aircraft. Sometimes the number of flights would be three, sometimes six, depending upon the conditions. Another method employed was to have certain machines of a low patrol carry ammunition for balloons with orders to carry on an ordinary patrol and attack balloons, if up. S.E.-5s were capable of doing better balloon strafing than any other machines on the British front because of their superior speed and zoom. One method of carrying out a balloon straff, with lessened risk from ground fire, was to have a number of machines carry bombs and drop them in the vicinity of the winch or the sources of ground fire. The ground fire was too effective by the enemy in the last part of the war, that it was very important to diminish it if possible.

Anti-aircraft batteries on the British front did not cooperate with machines in the air in an effective way. The enemy seemed to have quite a good system of signals. The answer may be given that practically all flying was on the enemy's side of the lines. This is true but the greatest effectiveness of anti-aircraft does not lie in the actual destruction of machines, but in a means of signals to airplanes. The principle was recognized by the enemy, but seemingly not by the British. British machines on patrol were most of the time in a position to be signalled to by anti-aircraft batteries, but there was practically no cooperation.

American squadrons and Americans with R.A.F. squadrons performed a great deal of work escorting bombers. Most British pursuit squadrons did not attempt to escort bombers to their destination. The pursuit machines would follow the bombers over the

---

lines about 15 miles, at 2,000 or 3,000 feet above, and leave them, and probably not see them again until the bombers arrived back at the line. The 148th and 17th Aero Squadrons, however, performed some very good escorts, going right over to the objective to be bombed, flying right with or a little above the machines they were escorting. This was made possible due to the personal relationship of the pilots of the pursuit and bombing squadrons.

The pursuit machines being used for escort were the Sopwith Camel, S.E.-5s, and, during October, the Sopwith Snipe. The Camel was a slower machine than the bombers, and did not have the gliding angle.

The difficulty in pursuit machines escorting bombers was that once in a fight, the bombers would put their noses down for home, and leave the pursuit machines to fight too far on the enemy side of the lines. If the two-seater machines would stay to fight, the situation would have been simple. The speed and gliding angle of the bombers allowed them to pull right away from a Sopwith Camel or an other machine which turned back to fight. Most pursuit pilots would, therefore, dislike to escort bombing planes to their destination.

If the speed of the pursuit machine is as great as the speed of the bombing planes and of the enemy pursuit, they may escort bombers successfully to their destination. It is necessary, however, to secure perfect cooperation between the escort and the escorted. If in a fight, both must fight. The two-seaters can protect the single-seaters from attack from above, and the single-seaters can protect the two-seaters from attack from below.

The British have been criticized in their extensive use of ground strafing with pursuit machines on the grounds that their work is merely combat work. Ground strafing came into use by necessity in the March drive, and it there proved to be worth far more than its use cost. Its effects in the enemy drive at Noyon cannot be overestimated. Reserves were broken up, and transport columns were dispersed. In allied pushes, strafing was not so necessary, but its work was equally effective. Ground strafing is important because of the actual destruction done, but is more important because of its moral effect on the enemy. Whether or not an Air Service can do ground strafing depends upon the state of air supremacy held. If absolute air supremacy is held by an air force, pursuit machines may be spared to do ground strafing, and that air supremacy still be held. However, if absolute air supremacy is not possessed, machines cannot be spared to do ground strafing because their primary purpose is to gain air supremacy.

A criticism, however, that can be made of the management of R.A.F. pursuit squadrons is on the policy of making squadrons "stand by" for patrols or ground strafes. Operations were made easier for the

Wing management by this, but it detracted from the efficiency of the pilots. Many times pilots were kept on alert for hours, and for no apparent reason. During great offensives, it may be necessary to keep squadrons standing by, but every effort should be made on the part of the command to avoid this at all times possible, and if pilots must be kept on alert, the command should be careful to relieve them from duty at the first possible moment. By this means and by others, the command should always endeavor to keep pilots in the best fighting condition.

Throughout the period in which Americans worked with the British, it will have been observed that the British always held supremacy of the air. This is due to the fact that the R.A.F. recognized the principle that an Air Force to be of assistance to ground troops must be offensive. The war in the air must be carried to the enemy's side of the line. The line of equal safety for machines of both sides should be a line that distance behind the enemy line where the corps observation machines can do their most effective work. The R.A.F. recognized this principle, and succeeded in establishing that line.

The success in establishment of this air supremacy can be attributed to a combination of many factors, but the most important factor was the early development in the R.A.F. of formation fighting. The R.A.F. first made the formation a unit as a departure from the principle of a single machine being independent. The tactical unit was recognized to be the flight, composed of five or six machines. That was considered to be the largest number of machines capable of being handled as one body under one leader. In the latter days of the war, when patrols of six flights were placed under one leader, the flight of five or six machines remained the tactical unit, and the development was one of co-operation between units.

This tactical history of the Royal Air Force is important to the American Air Service because the Americans who operated there are familiar only with the use of those tactics. The methods of the R.A.F. were the methods of the 148th squadron and the 17th squadron, and of various American pilots who did all their work in R.A.F. squadrons. The tactical history of American Air Service pursuit units on the British front is brought out by the tactical history of the Royal Air Force in operations in which American pilots and squadrons participated.







On October 12, the 2nd Army Air Service came into existence with Headquarters at Toul. It was not until October 25, however, that the first units of pursuit were developed. This consisted of the 4th Pursuit Group, located at the Toul airdrome, composed of one squadron, the 141st, which had started operations on October 23. Subsequently, three more squadrons, the 25th, 17th and 148th, joined the group, and preparations for the proposed offensive of November 10, 11 were formulated. Airplanes were very hard to get, and these units were not able to operate to their greatest efficiency as a result. Pursuit work, therefore, was confined to the activities of the 141st squadron, which carried out a number of patrols of the sector, and several patrols for the protection of photographic and reconnaissance machines. During these patrols the squadron engaged in thirteen combats, and shot down two enemy airplanes, without loss.

The 141st and 25th squadrons, carefully trained, and working with the experienced 17th and 148th from the British front, would have in all probability, under the experienced group staff, produced excellent results on the front, and the commanding officers, benefitting by the experience of the first three groups, worked hard to prepare this group for its introduction as one of the pursuit groups of the Second Army.

*Insignia of the 25th Aero Squadron (top) and of the 141st Aero Squadron (Bottom). Maj. Reed G. Landis (right), commanding the 25th, shot down 11 enemy aircraft.*





---

## Appendix A.

Headquarters, Air Service, First Army,  
American Expeditionary Forces.

September 11th, 1918.

### Battle Orders No. 1.

1. The enemy is losing ground, personnel and material at all points of the front on which the allied armies are attacking. On the front of the first Army he is holding the line Pont-sur-Seille—St. Mihiel—Fresnes-en-Woevre—Chatillon-sous-les-Cotes in his old positions. His Air Service is estimated at 150 pursuits, 120 reconnaissance and 25 battle air planes, which is being reinforced. The strength of his ground troops is estimated at about seven divisions, with from three to five divisions in reserve. The strength and morale of these divisions is reported low. There are signs that he intends to withdraw from his first lines and make his main resistance at some point further to the rear.

2. The First Army attacks on the whole front on 12 September, 1918. The hour of the attack will be 5 H, 12 September, 1918. The 1st and 4th Corps will attack at H hour. The 5th Corps will attack at H hour plus three hours. The Second French Colonial Corps will attack as follows:

The attack west of the 4th Corps at H plus one hour.

The attack south of the 5th Corps at H plus four hours. The artillery bombardment will commence as follows:

1st and 4th Corps H minus four hours. 5th Corps H minus four hours. The Second Colonial Corps will attack at H minus four hours.

3. OUR AIR SERVICE WILL TAKE THE OFFENSIVE AT ALL POINTS WITH THE OBJECT OF DESTROYING THE ENEMY'S AIR SERVICE, ATTACKING HIS TROOPS ON THE GROUND AND PROTECTING OUR OWN AIR AND GROUND TROOPS.

4. (a) The Corps Sectors of reconnaissance are as announced in Annex #3, Field Orders #9, Appendix #4, dated September 7, 1918. Particular attention is to be paid to minute reconnaissance of the enemy lines to determine whether he has been reinforced or has changed his dispositions. Important information involving immediate action obtained by Corps Air Services will be sent by telephone, radio or courier airplane to the C.A.S., 1st Army, or to the nearest brigade of the French Air Division.<sup>11</sup>

(b) The 1st Army Observation Group (Reynolds) will execute the reconnaissances and surveillance as ordered in the plan of reconnaissance, Annex #3, Field Orders #9, Appendix #4, dated September 7th, 1918. Particular attention is to be paid to minute reconnaissance of the enemy lines to determine whether he has been reinforced or has changed his dispositions. Important information involving immediate action obtained by our Air Services

will be sent by telephone, radio or courier plane to the C.A.S., 1st Army, or to the nearest brigade of the French Air Division. Three airplanes will be held ready to execute any special reconnaissance ordered.

(c) The Army Artillery Group<sup>12</sup> (Block) will execute the observation ordered for the Artillery to which it is attached. Important information involving immediate action obtained by Air Services will be sent by telephone, radio or courier airplane to the C.A.S., 1st Army or to the nearest brigade of the French Air Division.

(d) The First Pursuit Wing, (Atkinson) will cover the front Pont-sur-Seille—St. Mihiel, inclusive. An absolute barrage<sup>13</sup> will be established against enemy aviation, our own observation aviation will be protected and an attack against all balloons exposing themselves on this front will be made early in the morning. After 9:00 A.M., one pursuit group loaded with bombs will be held in reserve to be used for the purpose of attack of hostile troops or convoys on the ground, so as to be ready to leave the ground 15 minutes after the receipt of the order.

The First Bombardment Group will attack the hostile division and corps posts of command and such enemy positions as present a suitable target.

The right flank of the 1st Pursuit Wing will be protected by the First Brigade (French) Aerial Division and the Aerial defenses of the 8th French Army. Close liaison will be maintained by the 1st Pursuit Wing (Atkinson) with both of these and with the Army Corps so as to keep close track of the advance of the troops.

(e) The First Pursuit Group, (Hartney) will cover the front Chatillon sous les Cotes—St. Mihiel, inclusive. A barrage will be maintained against hostile aviation, observation aviation will be protected and hostile balloons will be attacked opposite the front of the 5th Corps.

The left flank will be protected by the aerial defenses of the 2nd French Army with which close liaison will be maintained. Close liaison will also be kept with the Corps Air Services so as to keep track of the advance of the troops.

(f) The Army Night Bombing and Reconnaissance Wing,<sup>14</sup> (Major Villome) will execute the night reconnaissance directed as provided for. Railroad Centers and airdromes will be bombed systematically as provided for in the plan of employment. Particular attention will be paid to the German Night Bombing Airdromes.

(g) The French Air Division (Vaulgremant) will take the offensive against the enemy's aviation and troops on the ground. The brigades will execute successive attacks, passing over both sides of the St. Mihiel salient. On the right (east) of the area opposite the front of the 1st and 4th Army Corps and on the left (west) opposite the front of the Fifth Army Corps and on the left of the Second Colonial Corps the meeting point of these two axes approximately the area Jonville-Hadenville-Chambley. The principle being to operate along the axes indicated so as to take the enemy aviation in reverse and force it towards our lines. Attacks will be made against the ground troops of the enemy when occasion offers.

The bombardment aviation will attack the objects on the ground which show themselves to be the most dangerous as operations develop.

Provision will be made for guarding the 1st Army's right flank against hostile air attack. Close liaison will be maintained by radio and courier planes with the Corps Air Services so as to insure the air division's cooperation in the attack.

---

5. The Equipment Section will hold itself ready to insure the supply and movement of any units required.

6. The Army Dropping Ground for messages from airplanes is a point two and one-half kilometers southeast of Ligny-en-Barrois. The Army Landing Field is Maulan, six kilometers east of Ligny-en-Barrois. The 1st Day Bombardment Group will provide a detail of four command airplanes to take station at Maulan, beginning at 7:00 A.M. September 12th.

7. Reports will reach the Chief of Air Service at Headquarters Air Service, First Army, Ligny-en-Barrois.

A liaison officer from each Corps Air Service, each Wing or independent group of the Army Air Service, and the French Aerial Division will report at the Headquarters, C.A.S., 1st Army, at 21-00H each day to receive orders.

A liaison officer for the Night Bombardment Group, (Villome) will report at the Headquarters, C.A.S., 1st Corps at 14-00H each day to receive orders.

**William Mitchell.**

Read and explained to assembled  
Corps Air Service Commanders,  
Group Commanders,  
Wing Commanders,  
Chief of Staff of the Air Division,  
Staff of the C.A.S., 1st Army at 15-30, September 11, 1918, without giving H  
hour.



---

## Appendix B.

### Headquarters 1st Pursuit Wing Operations Office

October 31st, 1918

### Operations Order

#### No. 61 for Nov. 1st, 1918.

1. *Information of the enemy:* It is reported by the Intelligence that the Pursuit Air Service of the enemy in our immediate front has been greatly increased. This is evident from the number of planes seen and encountered during the last few days. There were known to be a total of 48 flights, all branches, before this increase.

The greater portion of the enemy ground reserves for the sector, GRANDPRE-MEUSE RIVER, are reported to be bivouaced in the BOIS DE LA FOLIE, BOIS DE BARRICOURT and the BOIS D'ANDREVANNE.

2. *Plan of Operations:* The First Army will attack on the front, GRANDPRE-AINCREVILLE at H hour. Artillery preparation will begin at H-2 hour.

The line held by the First Army is as follows:

Northern edge of GRANDPRE to southern edge of BOIS DES LOGES, through CHAMPIGNEULLE, through ST. GEORGES, just south of LANDRES-ST. GEORGES, around northern edges of BOIS DE BANTHEVILLE to northern edge of AINCREVILLE, along southern edge of BOIS DE BABIEMONT, northern edge of CLERY-LE-CRAND, through CLERY-LE-PETIT.

As soon after the launching of this attack as possible, this wing will bomb the three woods mentioned in Paragraph 1, this order, with its entire strength of Day Bombers and Pursuit, less one squadron of Pursuit which will be held out for the protection of the front on the return of this mission. The First Pursuit Group will cooperate with this expedition.

3. (a) *The Second Pursuit Group:* One Squadron will be held to maintain the barrage of the front immediately after the return of the expedition ordered in the above paragraph. Three squadrons will bomb the northern edge of the BOIS DE BARRICOURT as accurately as this can be done from 3000 meters. After bombs are dropped they will meet and accompany the day bombers to the line, and then take up the patrol of the attacking front (GRANDPRE-AINCREVILLE), between 2500 and 4000 meters to the limit of their gas.

Bombs should be released at "H" hour minus ten minutes.

This Group will have the protection of the front during the morning until 11 h 45, and will be on alert after 13 h 00.

(b) *The Third Pursuit Group:* This Group will bomb and ground-straft from low altitude; squadrons will arrive at their respective areas at "H" hour.

One squadron will bomb and ground-straft the road BAYONVILLE-BARRICOURT. It is reported that there are eight occupied hangars along this road. One squadron will bomb and ground-straft the area REMONVILLE.

---

ANDREVANNE and any targets that may be presented in edge of the woods immediately north of that road. One squadron will bomb and ground-straft the area ANDEVILLE-LES-TUILERIES. All of these squadrons will return over the route IMECOURT-BEFFU-GRANDPRE.

The Group will remain on alert after return from this mission until 11 h 15 and will maintain the prescribed patrols over the sector from 11 h 15 until dark.

(c) *The First Day Bombardment Group*: Will bomb the BOIS DE LA FOLIE at "H" hour from 3000 meters.

One squadron will bomb along the road running due east from BUZANCY, from the point where that road enters the BOIS DE LA FOLIE to where this road turns sharply northeast toward NOUART.

Two squadrons will bomb the unimproved road which runs northeast through the BOIS DE LA FOLIE. This road leaves the BUZANCY-NOUART road at a point 800 meters west of the sharp bend to the northeast.

4. *The First Pursuit Group*: Will furnish protection to the Third Pursuit Group, flying at about 900 to 1000 meters over the area which the Third Group is covering.

By order of Lt. Col. Atkinson:

**John Wentworth,**  
Captain, Air Service,  
Assistant Operations Officer<sup>15</sup>

Copies by Courier to:

- 1st P. G.
- 2nd P. G.
- 3rd P. G.
- 1st Day B. G.

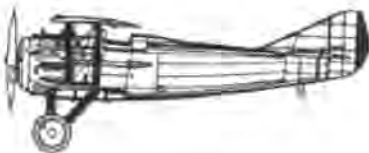

## Appendix C.

### First Pursuit Group Operations Office

October 22nd, 1918

### Operations Order Number 41.

1. The 185th squadron will stand on alert to protect our back areas against all hostile bombing planes which may cross the lines along the eastern zone or the northern zone.

Time	Squadron	On Alert
18h30 to 19h20	185th	2 planes
19h30 to 20h30	185th	2 planes
20h30 to 21h30	185th	2 planes
21h30 to 22h30	185th	2 planes
22h30 to 23h30	185th	2 planes
23h30 to 0h30	185th	2 planes
1h30 to 2h30	185th	2 planes

#### SCHEDULE "B"

1. A plane will be dispatched from the 147th Squadron to destroy the enemy balloon at MONTIGNY. This plane will arrive at the balloon location at dawn. Twenty (20) minutes before the plane leaves the ground the 147th Squadron operations will notify the power plant as to the time of departure.

Leave at 5:20

Dawn 6h00

#### SCHEDULE "C"

Time	Squadron	No. Planes	Route	To Patrol	Alt.
6h00 to 8h00	94	3	Grande Pre	Champigneulles to Beaumont	600 m
7h00 to 9h00	147	3	Brieuiliss	Bantheville to Beaumont	600 m
8h00 to 10h00	27	6	Consenveye	Beaumont to Champigneulles	600 m
9h00 to 11h00	95	3	Sommerance	Landres St. George to Briuelles	600 m
10h00 to 12h00	147	6	St. Juvin	Champigneulles to Beaumont	600 m
11h00 to 13h00	95	3	Cunel	Bantheville to Beaumont	600 m
11h00 to 13h00	27	6		ON ALERT	



Time	Squadron	No. Planes	Route	To Patrol	Alt.
12h00 to 13h00	95	6		ON ALERT	
12h00 to 14h00	94	3	Chatel-Chehery	Champigneulles to Beaumont	600 m
13h00 to 15h00	94	3	Charny	Beaumont to Bantheville	600 m
14h00 to 16h00	94	3	Apremont	St. Juvin to Landres St. George	600 m
15h30 to Dusk	94	3	Sommerance	Landres St. George St. Juvin	600 m

#### SCHEDULE "D"

1. A concentrated patrol of the 147th, 95th and 27th squadrons will be flown at 15 h 00.

(a) At 15 h 00 all available planes of the 147th Squadron will proceed to the lines by the way CORNAY and MARCQ to CUNEL, at 600 meters.

(b) At 15 h 05 all available planes of the 27th Squadron will proceed to the lines by way of CONSENVOYE AND DANNEVOUX to CUNEL at 600 meters.

(c) At 15 h 10 all available planes of the 95th Squadron will proceed to the lines direct to CUNEL at 600 meters.

2. The three squadron formations will rendezvous over CUNEL at 15 h 35 and will proceed to scour the lines from BEAUMONT to CHAMPIGNEULLES. The 95th Squadron will act as the pivot squadron. The 147th and 27th squadrons will conform with and keep in touch with the 95th Squadron.

#### SCHEDULE "E"

1. At 16 h 20 the 94th and 95th Squadrons will plan to dispatch one balloon straffer each for balloon locations which will be given later in the day.

By order of Major Hartney

**Arthur L. Cunningham**

1st Lt. A.S.U.S.A.

Group Operations Officer

Copies to: 27, 94, 95, 147.

C.A.S. 1st Army.

C.O. First Pursuit Wing.

---

**Appendix D.**

Percentage of Casualties; killed, wounded missing;  
to average number of available Pursuit  
Pilots at Front.

Month	Pilots	Casualties	Percentage
April	20	0	0
May	34	8	23.5
June	77	5	6.5
July	128	23	17.9
August	147	15	10.2
September	265	37	13.9
October	270	34	13.6
November	222	29*	13.1*

\*Prorated.

Source: Group and Squadron Operations Report, 1918.



Appendix E.

**ENEMY AIRCRAFT BROUGHT DOWN BY 1ST, 2ND, & 3RD PURSUIT COMPARED WITH AMERICAN PURSUIT CASUALTIES**

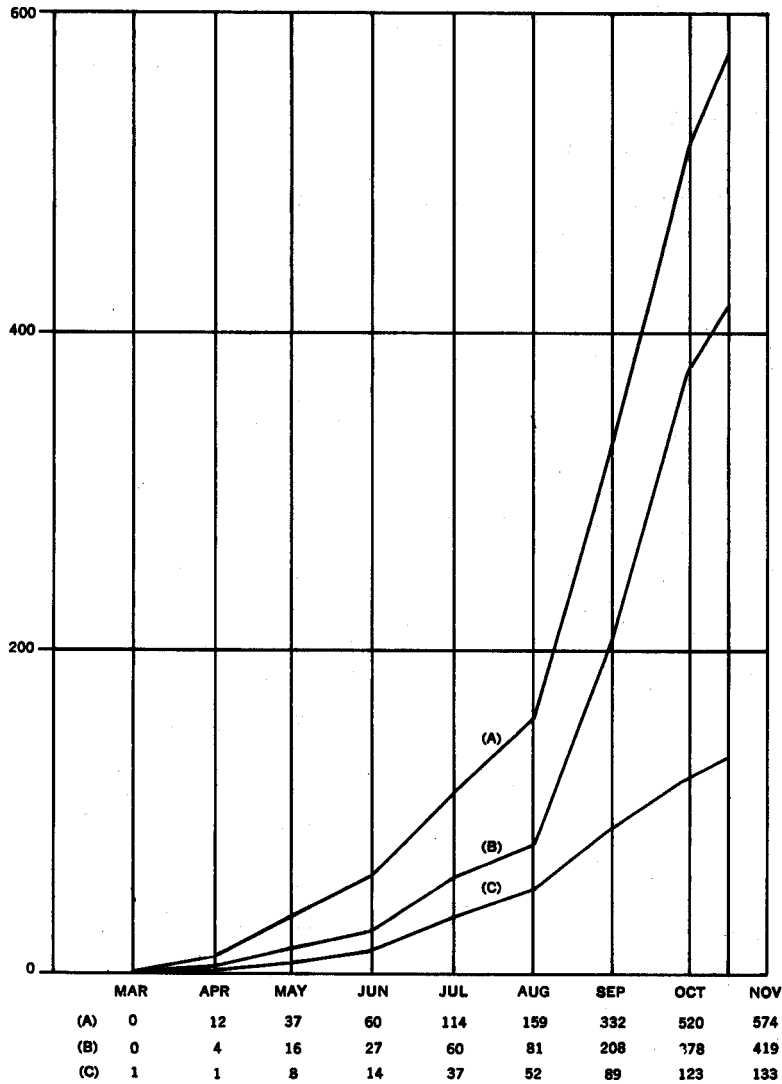

(A) Aircraft claimed. (B) Aircraft confirmed. (C) American pursuit casualties.

Appendix F.

**ENEMY PLANES BROUGHT DOWN  
BY AMERICAN PURSUIT  
COMPARED WITH AMERICAN PURSUIT CASUALTIES**

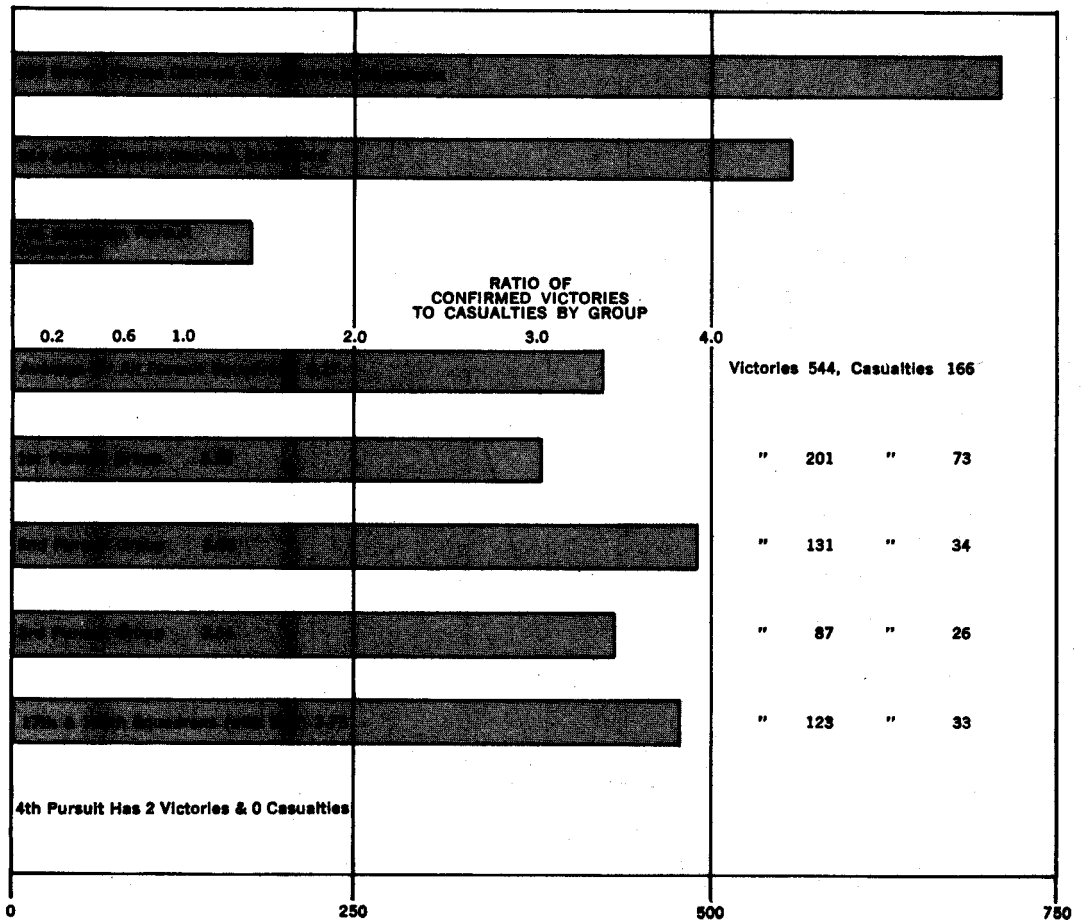

---

**Appendix G.**
**Planes on Hand, Planes Available for Duty, and  
Pilots Available, First, Second, and Third  
Pursuit Groups, A.E.F.\***

<b>Date</b>	<b>Planes on Hand</b>	<b>Servicable Planes</b>	<b>Available Pilots</b>
17/4-23/4	19	15	20
24/4-30/4	20	17	20
1/5-7/5	19	15	20
8/5-14/5	44	32	35
15/5-21/5	40	29	35
22/5-28/5	34	26	33
29/5-4/6	50	44	75
5/6-11/6	65	53	75
12/6-18/6	67	56	80
19/6-25/6	76	70	80
26/6-2/7	78	70	85
3/7-9/7	90	37	95
10/7-16/7	129	71	132
17/7-23/7	148	92	143
24/7-30/7	162	110	141
31/7-6/8	177	105	130
7/8-13/8	213	105	142
14/8-20/8	241	106	139
21/8-27/8	252	131	178
28/8-3/9	282	157	229
4/9-10/9	294	183	235
11/9-17/9	363	221	286
18/9-24/9	369	246	293
25/9-1/10	377	245	285
2/10-8/10	360	240	293
9/10-15/10	366	257	317
16/10-22/10	293	189	240
23/10-29/10	277	161	230
30/10-5/11	287	161	222
6/11-11/11	286	166	223

Source: Group Operations Reports, 1918.



---

## **Part 5**

# **Tactical History of Day Bombardment.**

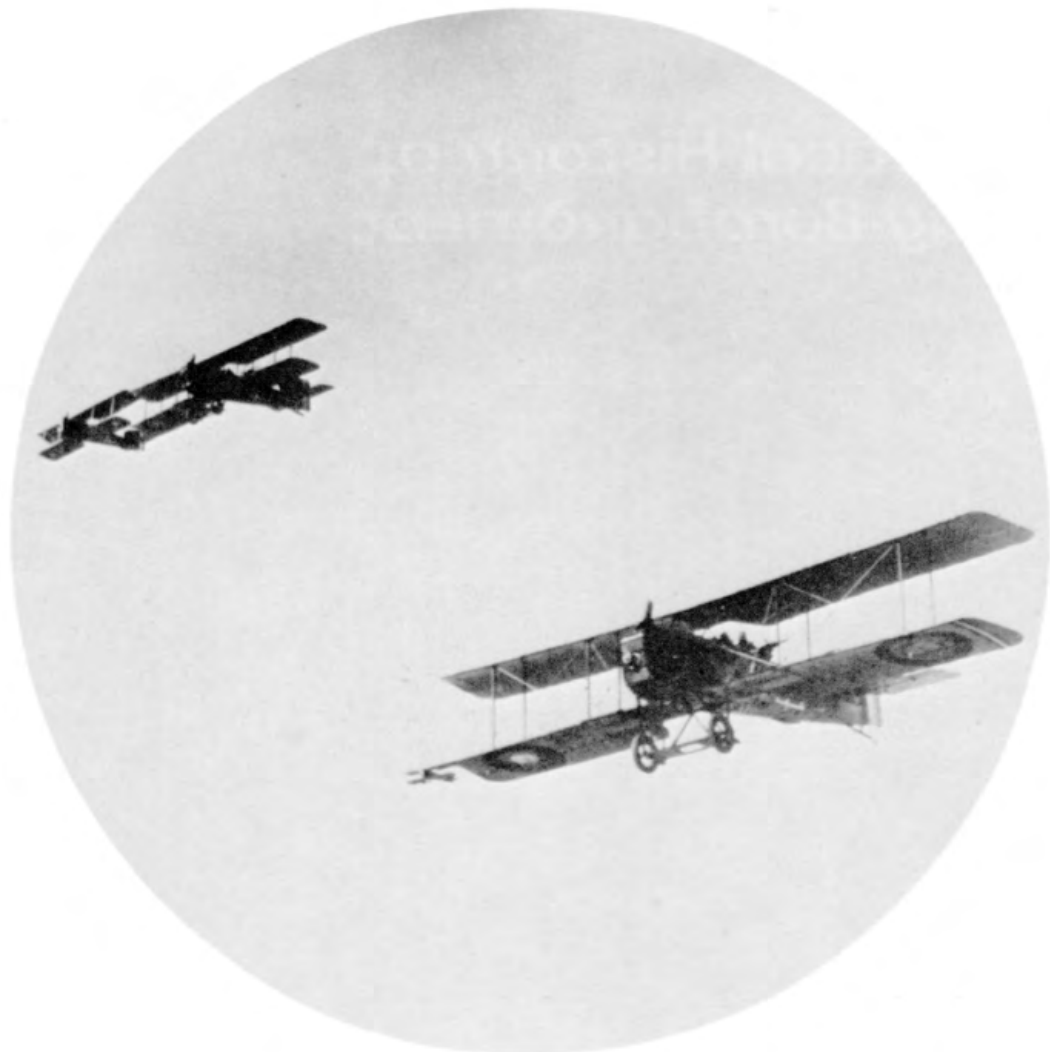

*Breguets of the 96th Aero Squadron head for a daylight bombing assault on German territory.*



# I. From the Beginning to the St. Mihiel Offensive.

---

Day bombardment had its beginning May 18, when the 96th Aero Squadron, the first unit of day bombardment was established on the Amanty airdrome to begin active operations against the enemy. The airdrome proper has an immense field which was leveled and rolled by an American construction squadron. When the field was finished eighteen to twenty planes could assemble on the ground and takeoff in formation. The surrounding country is semi-mountainous, and is notable for large tracts of forest, which afford very few fields suitable for forced landings. That portion of the front between the Meuse and the Moselle rivers, and known as the Toul sector, had been quiet for more than three years, and afforded excellent opportunities for perfecting precision bombing and training pilots and observers.

The lines of the sector had assumed the shape of a gigantic V with the point at St. Mihiel, the left arm extending north along the Meuse beyond Verdun, and the right arm crossing the Moselle at Pont-a-Mousson. The objectives chosen for attack were situated at the opening of this V. By crossing the lines at either arm of the V, depending upon the direction of the wind, and recrossing at the other arm, the minimum amount of time spent over hostile territory. The railroad centers in the heart of the V were extremely important in the enemy's network system of communication and supply. The Briey iron mines, which furnished the bulk of Germany's munition material, were situated at the opening of the V. To tap their ore supply the Germans had built a double and four track railway system with centers at Conflans, Longuyon, Dommary-Baroncourt and Audun-le-Roman. These four railroad centers were chosen as the primary objectives of the 96th squadron. Railroads, munitions depots, detraining points, command posts, and such distributing points as Thiarcourt, Vigneulles, and Mars-la-Tour were secondary objectives, to be attacked if the important targets were obscured by clouds.

When bombing operations began in the Toul sector there was very little opposition from hostile aircraft. The principal airdromes were clustered around Metz, Mars-la-Tour, Longuyon, Conflans, and Briey. The V shape of the salient, though favorable for rapid bombing raids, made it possible for enemy pursuit airplanes from either flank of the sector to join in the attack on the bombers. Pilots and observers often watched enemy airplanes leave their airdromes to engage the formation in combat. The speed and climbing ability of the Fokker and Pfalz enabled enemy pilots to wait until a raiding formation had crossed the lines before taking to the air. This advantage gave them the maximum time for combat before exhausting their fuel. Their plan was to gain altitude, attack from the sun or some favorable position, then continue to harass the bombers until the lines were recrossed.

The anti-aircraft defenses at the lines and around the principal objectives were excellent. Barely were the lines crossed without

---

running a fierce barrage of shell fire. The batteries at Conflans and Metz were the most accurate and persistent in the sector. The enemy also used his anti-aircraft batteries as a means to warn his pursuit airplanes of the presence of a raiding formation. A line of bursts pointed toward the formation of bombers would invariably call the enemy patrols to combat.

The French squadrons, operating in this sector, had reported a gap in the chain of anti-aircraft batteries before Verdun and St. Mihiel, but every attempt by the bombers to find it drew a barrage of shrapnel and high explosive.

The flying equipment of the 96th Squadron consisted of ten bombing airplanes, type Breguet 14 B 2, equipped with 300 horsepower type 12 F. E. V. Renault motors,<sup>1</sup> which had been transferred from the 7th Aviation Instruction Center. These airplanes had been used at the school for instruction purposes for seven months, and were in constant need of major repairs. It was impossible to get spare parts. The squadron mechanics, when ordered to get the Breguets ready for duty over the lines, were forced to utilize worn out farm machinery discarded by the peasants in the vicinity of the airdrome. Parts of an old harvester were used for tail posts, wagon tires were cut up to make tail skids, and pieces of an ox-cart tongue were employed to reinforce the wing spars. One of the bombers carried brace wires which had once served on the telephone line of communications. Due to the ingenuity of the mechanics the squadron was ready for operations long before spare parts became available.

The Breguet bomber can carry 500 pounds of bombs to 4,000 meters in thirty-five minutes. The bombs are attached to a bomb dropping device in the lower wings, which is operated by an oil pressure gear. The gear is adjusted, by calculating the ground speed of the airplane, to make a trail of bursts 120 meters in length. In operations against the enemy the bombs used for destruction of material were the Michelin 155 mm. and the 115 mm. long and short.<sup>2</sup>

These were fragmentation and penetration bombs, and were exploded by delayed fuses. Incendiary bombs were used against buildings. The 90 mm. personnel bombs, both steel and cast steel, exploded on contact, and were used against troops. For some objectives an assortment of sizes and types was carried on each airplane. The Michelin improved bomb sight was used for aiming at the target.<sup>3</sup> The aiming was done by the leading observer, who pulled his bomb dropping lever at the right instant, and the other pilots or observers released their bombs immediately afterward.

For armament the observer on the Breguet carried a pair of Lewis machine guns, stripped of the cooling devices, and mounted on a tourelle.<sup>4</sup> A Vickers gun, synchronized to shoot through the propeller

---

was the pilot's weapon. Later a fixed tunnel gun was mounted in the fuselage to shoot under the tail, as the enemy's favorite point of attack was the blind spot where he was screened from the observer's tourelle gun by the stabilizer.

The personnel of the 96th Squadron consisted of American trained pilots and observers, and mechanics, who had received instruction at the 7th Aviation Instruction Center, Clermont-Ferrand. Several teams, including the flight leaders and leading observers, had been sent to French bombing squadrons to acquire experience over the lines. While the squadron was waiting for equipment further instruction was given the personnel by fliers from the British 55th Squadron, Independent Air Force.

Before the St. Mihiel operations orders were received from the Chief of the Air Service, 1st Army Corps, with headquarters at Toul. Objectives were designated by the chief of the group of French armies. An operations office was established at the airdrome with full information, maps, and photographs of the sector. Telephonic liaison was effected between this office and headquarters.

In a quiet sector day bombardment has a threefold object, the destruction of material, reconnaissance, and observation of enemy tactics in combat. Except during an offensive there is but little opportunity to attack massed troops. The principal mission during such a period is to destroy the enemy's transport lines by which supplies and personnel are delivered to the front, or by which ore and other products of military importance are delivered to the rear. The most favorable targets are the railroad centers where the traffic arteries converge. The railroad yards at Conflans was an easy target to hit, and so arranged that a trail of bombs placed across the neck of the tracks would interrupt the traffic. It was observed that closing the Conflans yards even for a day would cause a congestion of cars in the railroad yards at Dommary-Baroncourt. The latter target would then be attacked, causing even further diversion of the traffic. Conflans would be again attacked with similar results. Munition depots and stores of material also offered favorable targets, but were not attacked unless for some reason the bombers could not reach a railroad center. The long distance raids proved wonderful opportunities for deep reconnaissance especially of enemy railroad movements. Any pronounced current of railroad traffic, going in one direction, or converging at one point, would be reported by every observer making that particular raid. Further confirmation was unnecessary, for the observers were obliged to submit their written raid reports without consulting each other. Photographs of the bursts often revealed troop and construction activity at the objectives, and were subject to careful interpretation. In preparing for the St. Mihiel offensive the pilots and observers watched closely the enemy tactics in combat, noting



*A Breguet 14-B2 of the 96th Aero Squadron.*

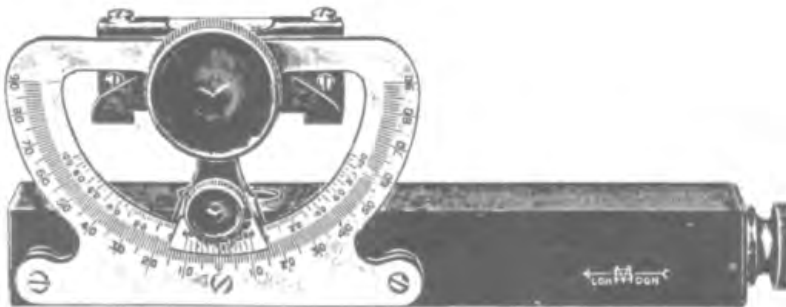

---

especially his methods of attacking formations of bi-place airplanes. The lessons learned proved of immense value in the succeeding offensives.

Many types of formations were tried before the one most suitable for the Breguet was adopted. Upon the advice of the British the V formation of six airplanes was tried. The second and third airplane flew fifty meters above and behind the leader, the last three fifty meters below. It was found, however, that the construction of the Breguet would not permit a formation of this type. The pilot has insufficient visibility to the front to hold his position in relation to the other airplanes. The French open V, stepped up from the leader, was also tried, but did not afford enough self protection unless carried out in echelons of three flights. A V formation of seven airplanes, with the seventh closing the V at the rear, was found best in consideration of the limited supply of airplanes. The formation was compact and mobile. The pilots flew at fifty meters distance from each other until preparing a bomb, when they closed in to thirty meters, and in case of attack to twenty meters.

The first bombing mission carried out by the 96th Squadron was on June 12, when railroad yards at Dommary-Baroncourt were successfully attacked by a formation of six Breguets. Nearly a ton of bombs were dropped, making a trail of explosions across the yards, and some hitting a warehouse beside the tracks. Enemy airplanes were encountered but no losses occurred. The raid required nearly four hours. Later raids to the same objective were made in two hours, showing the improvement made in the methods of reaching the objective. The difficulty of carrying out missions in adverse weather conditions was realized July 10, when a formation of six Breguets was forced to land in hostile territory. All day the weather had been extremely unfavorable, but the clouds seemed to lift late in the afternoon. The squadron was eager to carry out missions, and for that reason attempted the hazardous raid. An hour later after the formation had left the field the clouds closed down to 100 meters of the ground, and rain set in for the night. The formation was carried into Germany by a high southwest wind. After an hour of flying above the clouds the leader shook his ailerons to signify that he was lost. It was impossible to return by compass before the gasoline was exhausted. The six airplanes landed near Coblenz.<sup>5</sup>

The acute shortage of flying equipment, and the loss of a whole flight, left the squadron with only one airplane available for duty during the rest of July. The single Breguet was used for bombing practice, and shooting at the T.<sup>6</sup> By August 1 eleven new Breguets were ferried from Colombey les Belles, and operations were resumed. Replacements arrived in the flying personnel, and two flights were organized. Due to the lack of airplanes it was found inadvisable to

---

carry out a mission with two flights, and the large formation was adopted. During the fourteen flying days of August, the 96th Squadron made twenty raids, and dropped 21.1 tons of bombs on the main objectives. The average number of airplanes available was ten. Most of the raids were very gratifying in their results. In a raid on Conflans, August 20, the bombs destroyed forty German airplanes in the box cars, and killed fifty workmen and soldiers. Reports from the French intelligence bureau told of the terror spread in the enemy rear areas by the American bombers. Day bombing was feared by the enemy troops to such an extent that their dugouts would be filled long before the bombers reached the objective. If the enemy airplanes did not attack over the objective the observers would empty several drums into the barracks of the cantonments.

### Comments.

Considering the limited supply and worn out condition of its flying equipment, and the inexperience of its flying personnel in duties over the lines, the bombing operations of the 96th squadron during this period were carried out with success. As this squadron was for nearly four months the only American day bombardment unit operating against the enemy it had to establish its own precedents to meet particular situations, without advantageous conferences with other units similarly engaged.

The location, security, shelter and nature of the soil of the Amanty airdrome were all that could be desired for a day bombardment unit. The immense flying field was leveled and rolled to permit assembling in large formations on the ground. When a formation is assembled before the take-off it can proceed direct to the objective, whereas the delay resulting from assembling in the air often causes the formation to arrive at the objective too late to achieve the desired results.

The excellence of the liaison, when the sector was quiet and the lines of communication well established, was not fully appreciated until the offensive began. During this quiet period the 96th squadron received full information of the disposition and strength of the enemy's air forces. By studying the maps placed at their disposal the pilots and observers knew exactly the location of every enemy airdrome and anti-aircraft battery in the sector. This intimacy with the enemy's air defense enabled them to choose the safest routes to their objectives. Later the rapid shifting of our own and enemy units to meet the needs of the offensives made it difficult to obtain such information.

The raids made during this period were on distant objectives, and were made at the greatest altitude possible for the loaded Breguets. The high altitudes attained by the formations reduced the dangers

---

from enemy anti-aircraft batteries. There was but little hostile aircraft opposition in the sector until just before the St. Mihiel offensive. The experience gained by the squadron while in the sector proved to be of immense value when the activities of the offensive began. New squadrons should be allowed to operate in quiet sectors when possible, to prepare the pilots and observers for the exigencies of the offensives.

It is thought that insufficient responsibility is rested in the group commander as to whether or not a raid should be made. The group commander is fully acquainted with the possibilities of his command to carry out particular raids under given conditions of weather and strength in flying personnel and equipment. It is suggested that the question of departure on raids be left entirely to the discretion of the group commander.

Before a squadron is sent to the front to operate against the enemy, measures should be taken to insure adequate replacements in equipment. It was the experience of the 96th Squadron that many pilots and observers were unable to participate in flying because of the lack of airplanes and spare parts. The failure to supply replacements lowers the efficiency of any unit. The mechanics of the 96th squadron met conditions at the front which were not anticipated in their training schools. It was necessary to exercise great ingenuity to make major repairs on airplanes with bits of discarded farm machinery, and without the aid of machine shops.

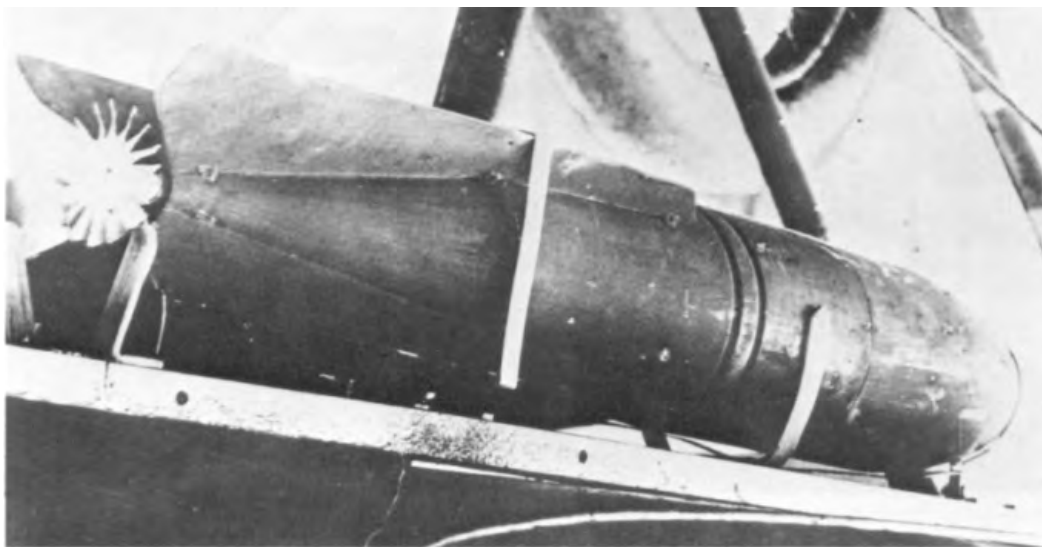



*DH-4 aircraft of the 11th Aero Squadron conduct a bombing attack.*



---

To avoid arousing the enemy's suspicions preceding the offensive, orders were issued to carry out the usual raids with the least possible exhibition of increased strength. The usual air patrols were made by the pursuit squadrons, while the air forces which were to constitute the aviation of the 1st Army were concentrated in the sector. Three groups of French day bombardment and four groups of French pursuit were moved into the sector to cooperate with the American units. The enemy also began to concentrate pursuit squadrons behind the point of expected attack.

The 1st Day Bombardment Group was formed two days before the offensive opened, and included the 11th, 20th, and 96th Squadrons. The 11th and 20th Squadrons had not completed their squadron organization. Some of their pilots and observers had seen action with the French squadrons, but most of them made their first flights over the lines during this offensive. The two new squadrons operated De Haviland 4 airplanes, with Liberty motors. The armament was the same as that of the Breguet, save that the pilot had two Marlin machine guns, synchronized to shoot through the propeller. The De Haviland 4 carried the British Wimpey bomb sight attached to the outside of the fuselage.<sup>7</sup> This sight permitted the observer to aim at the target while standing, a position which kept him in readiness to fight off an attack by hostile aircraft.

Bombing operations during the offensive were directed against hostile troops concentrations immediately behind the enemy's lines as primary objectives, and raids to railroad centers which were congested with troops and supplies as secondary objectives. To interfere with traffic of reinforcements and supplies from the sector east of the Moselle river it was found expedient to send bombing expeditions against the bridges, and bridgeheads, between Pont-a-Mousson and Metz. The main object of day bombardment during the offensive was to throw into confusion and destroy enemy troops marching into, or retreating from battle. During the days of exploitation the bombers continued to hamper as much as possible the enemy's withdrawal of personnel and material.

September 12 was marked by the worst kind of weather for flying. A terrific southwest wind made formation flying extremely hazardous, and a low ceiling of fast moving clouds reduced the visibility to two or three kilometers. The heavy rains of the previous week had made the Amanty airdrome so muddy that the propellers of fifty percent of the airplanes were broken while taking off. This constant breakage of propellers, by the mud slung from the wheels, was a primary cause of the heavy casualties. Formations of ample strength were scheduled to carry out the missions, but it was rare that half the airplanes left the ground. In spite of the terrible weather conditions, and the



*Capt. Robert S. Sorenson, commanding officer of the 20th Aero Squadron, next to one of the squadron DH-4 aircraft.*

discouraging losses in personnel, the pilots and observers of the group were ready and eager for the most hazardous missions.

For the first two days of the offensive the 11th and 20th squadrons were assigned to fly barrage patrol with the 2nd Pursuit Group. Two teams from each squadron were ordered to Army Headquarters for command work. Later both squadrons operated with the 96th Squadron in carrying out bombing missions.

Late at night, September 11, orders were received to hold the 96th Squadron on the alert early in the morning, to bomb and machine gun hostile troops in front of our advancing infantry. To carry out these orders the twelve available Breguets were divided into flights of four each. The plan was to send the flights over to attack at 30 minute intervals, and thus keep up the enemy troops under a continuous bombardment. The first order to raid was received at 10 A.M. The objective was troop concentration at Buxieres, in the town and along the roads radiating from it. Because of the strong wind and the low cloud ceiling it was considered impracticable to attempt even these small formation flights. Consequently, that the order be obeyed, the leading team of the first flight volunteered to attempt the mission alone, and to determine, if possible, the best method of conducting troop bombing under the existing unfavorable conditions. The team did not return. It was later learned that the Breguet came down in flames south of Commercy, while returning to the airdrome. The mission had been accomplished. After this first loss of the offensive it was decided to send all the airplanes on single missions, and not dissipate the strength of the squadron in small formations.

The second mission was successful. Eight Breguets bombed the enemy troops at Buxerulles. The formation passed over St. Mihiel proper at 500 meters, which is very low for a bombing formation but it did not draw a single anti-aircraft shell. The withdrawal from the point of the salient had already begun. Upon the return of this mission another formation attempted to take off, but three fourths of the propellers were broken by the mud. A fifth mission left the airdrome at 6:35 P.M. to bomb the troops at Vigneulles. Orders for the mission were received too late for the formation to reach the objective before night had fallen, in spite of which the raid was carried out successfully. The formation returned to the night flying, and though landing flares were put out four out of the five planes crashed on the field. One pilot was killed in attempting to land. During the day the 96th Squadron lost four of its flying personnel and had eight airplanes lost or put out of commission. Four and one-half tons of bombs were dropped on enemy troops, and every mission designated in orders was carried out.

Weather and field conditions prevented bombing operations in the morning of the second day. In the late afternoon orders were received to attack a congestion of retreating enemy troops in Chambley, and

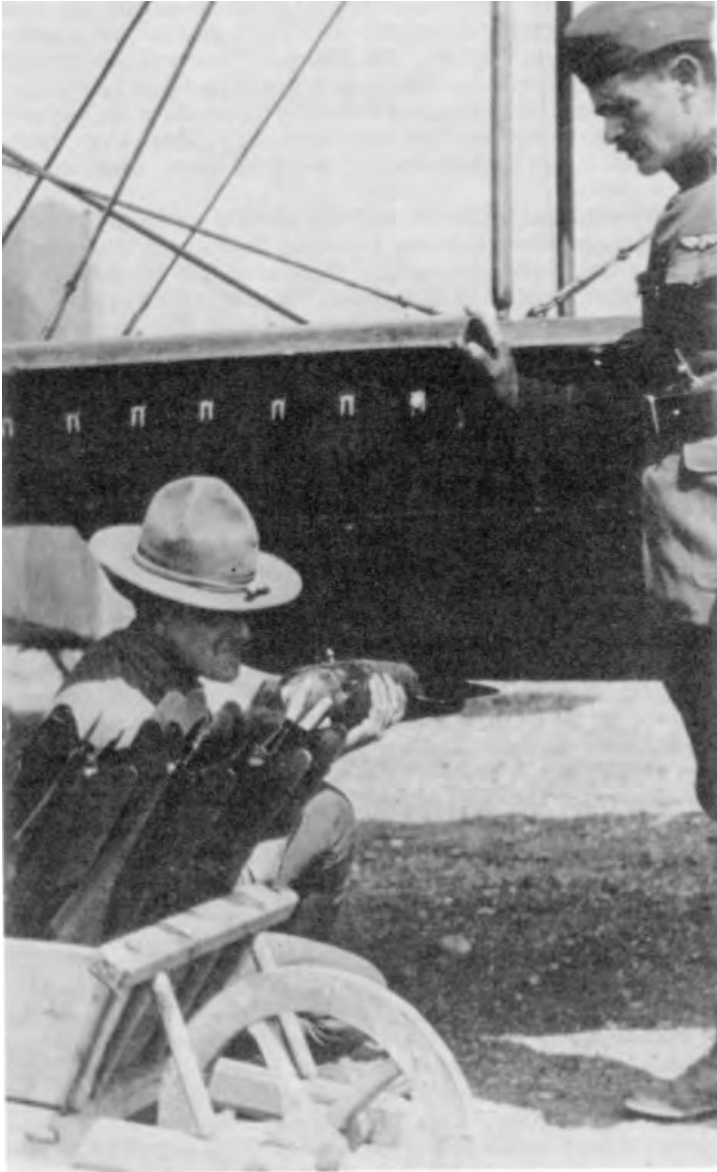

*Bomb loading.*

---

on the road leading from Chambley to Gorze. Seven Breguets were assigned to the mission, but the usual toll of broken propellers allowed only three to reach and bomb the objective. The low clouds forced the formation down to below 1,000 meters in approaching Chambley. While engaged in bombing and observing the results of the bursts the three Breguets were attacked from the clouds by fifteen enemy pursuit airplanes. Two of the bombers, and one of the enemy, were shot down in the combat.

On the third day of the offensive the whole group took part in the bombing operations. Conflans, Dommery-Baroncourt, Vittonville, Etain, and Arnaville were successfully bombed. Ten Breguets started for Conflans, on the first daylight raid, but only three crossed the lines, where they were met by twenty enemy airplanes. The thickness of the clouds made it possible for the bombers to continue the mission in spite of the overwhelming odds. By weaving in and out of the cloud layers, and skillful tactics to elude the surrounding Fokkers, the formation carried on the raid, and obtained excellent photographs of the bursts at the neck of the railroad yards. Attacks were next directed against the bridges and bridgeheads of the Moselle river. Good hits were made on all objectives. Propaganda pamphlets were dropped over hostile troops at Allemont, Harville, and Conflans. The usual raids were carried out on the important objectives, especially Conflans and Longuyon, where troop concentrations were most frequent. Four Breguets, comprising a formation raiding Conflans, disappeared entirely, and was not heard from until two survivors returned from Germany after the armistice was signed. In an unequal fight with twenty-five Fokkers three of the bombers went down in flames, and the fourth was so badly disabled that the pilot was forced to land near the objective. A similar disaster occurred to a formation of the 11th Squadron, September 18, when five out of six De Haviland 4s failed to return.

Throughout the entire offensive the weather had been extremely unfavorable for formation flying. Due to shortage of airplanes, and the muddy condition of the field, the formations which crossed the lines were too small to cope with the fierce and persistent enemy aircraft opposition. A closed V formation of fourteen or sixteen bombers is self-protected against ordinary attacks. A formation of six bi-plane airplanes has not sufficient armament to withstand the organized attack of twenty or thirty enemy airplanes.

It was a recognized fact that enemy pursuit formations would leave off combat with Allied pursuit in order to attack the bombers. The enemy pilots put forth every effort to wipe out the bombing units.

Day bombardment, by operating deep over the enemy's air defenses, keep large forces of his pursuit aviation away from the immediate front, and thus indirectly protected our army and army

---

corps observation airplanes. It was observed that when the bombers engaged large numbers of enemy pursuit airplanes well behind the battle lines the observation airplanes were able to carry out their work with much less interruption by hostile aircraft. Thus, aside from the material damage inflicted on the enemy, and the incalculable effects of the shattering his morale, day bombardment contributed greatly to a desired dispersion of the enemy's aviation strength.

The casualties of the bombers were heavy. The 96th Squadron lost sixteen pilots and observers during the first four days of the attack, which is a high percentage of loss even in a day bombardment unit. The 11th Squadron lost twelve of its flying personnel, and the 20th Squadron three. The total casualties of the group for the offensive numbered thirty-one.

### Comments.

The work done by day bombardment during the St. Mihiel offensive is worthy of praise. The terrific weather made formation flying, upon which bombing depends, almost impossible. The muddy flying field caused so many broken propellers that the formations which crossed the lines were never large enough for self-protection. The main lesson learned from this offensive was that large formations must be employed by day bombardment when the enemy aircraft opposition is strong and persistent. As it was impossible to obtain sufficient replacements in airplanes and spare parts the formations were small and the losses heavy.

It is thought inadvisable to send day bombardment to a greater depth than fifteen kilometers behind the enemy's lines during the attack. This offensive showed that the damage done on long distance raids was not commensurate with the losses sustained. Objectives during an offensive should also be chosen with careful consideration the enemy's concentrations of aircraft.

Pilots arrived at the front without having flown heavily loaded airplanes. It was found that most replacement pilots could hold formation with an airplane which had excess power and maneuver easily but were unable at first, to fly tight formation with an unwieldy bomber which used all its available power. The observers were instructed in the use of a single gun at the training school, but the double gun was always used over the lines. The result was that son

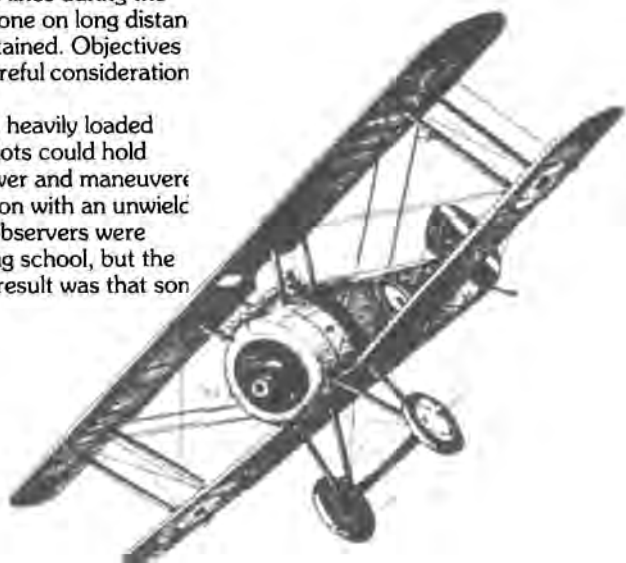



*Maj. James L. Dunsworth, commander of the 1st Day Bombardment Group, observes bomb loading (above).*

---

In preparing for the Argonne-Meuse operations the 1st Day Bombardment Group was ordered to carry out bombing expeditions to objectives east of the Moselle river. The object was to convey the impression of an impending attack on Metz, and thus avert the enemy's attention from the real point of attack. The enemy air forces were concentrated in the region around Metz, where aerial encounters were exceptionally severe and persistent. On September 23 the group was moved to the Maulan airdrome, near Ligny-en-Barrois. The flying field was situated on a narrow ridge on each side of which were deep, treacherous valleys. It was necessary for the airplanes to take off one at a time. If a strong wind was blowing at right angles to the ridge the pilots when landing had to exercise extreme caution to avoid crashing in the valley beyond the T. The airplanes left the field according to position in formation, and assembled over Ligny-en-Barrois. This necessary maneuver caused considerable delay in reaching the objectives. The hangar space was so limited that two-thirds of the airplanes had to stand out in the weather causing the wings to warp, and the braces to sag. Constant adjustment in alignment was necessary to keep the maximum numbers of airplanes available for duty.

The 166th Squadron, equipped with De Haviland 4 airplanes, was added to the group, but did not get ready to operate before the third week in October. Improvement in flying equipment included armored seats for the pilots, tunnel guns for the observers, and detachable fuel tanks for the Breguets, which were released in case of fire from enemy incendiary bullets.

The heavy casualties incurred by small formations during the St. Mihiel offensive led to a conference, of the group commander with the flight leaders, to determine the best means of insuring a maximum number of airplanes in formation when crossing the lines. The 96th Squadron had a full complement of Breguets, but lacked pilots and observers. It was decided, therefore, pending the arrival of replacements to supplement the personnel of the 96th Squadron with enough teams from the other squadrons to make one large Breguet formation. The remaining teams of the 11th and 20th squadrons made up the personnel of one large De Haviland 4 formation. In this way the group secured greater safety, and the early missions of the offensive were successfully carried out by the formations of twelve to eighteen airplanes.

The objectives were similar to those of the St. Mihiel offensive. The group was used to attack, from high altitudes where possible, such towns as Romagne, St. Juvin, Grandpre, Bantheville, and Dun-sur-Meuse, and railroad centers from which traffic was radiating. Early in the offensive missions were carried out against troop concentrations between the Meuse River and the Argonne forest. When intelligence

---

was received of favorable targets within six or eight kilometers of the lines, the group was ordered to attack such objectives at low altitude to cause the maximum amount of confusion and damage to the enemy elements as reinforcements for retreating before our infantry.

With the increase of formation strength, and improvement in skill of the bombing personnel, the group wrought telling havoc on the objectives of the Argonne-Meuse. Fires were frequently started with incendiary bombs. Due to the incessant cloudy weather most of the early raids were made at an altitude of 1,500 to 2,500 meters. The anti-aircraft fire of the enemy was so accurate that the flight leaders found it necessary to fly at least 500 meters below the background of clouds.

Dun-sur-Meuse was the objective of the first group operations September 26, the day which opened the Argonne-Meuse offensive. Four and one-half tons of bombs were dropped in the town and railroad yards. As the squadrons approached the objectives they were in turn attacked by relays of enemy pursuit airplanes, numbering as many as twenty in each. Six of the enemy were seen to go down out of control. The 20th Squadron lost five De Havillands 4s of which three went down in flames. One observer of the 96th Squadron and one of the 20th Squadron were killed in the combat. The airplanes of all three squadrons suffered severely in the day's fighting.

On September 29 two and a half tons of bombs were dropped on Grandpre and Marcq. The railroad tracks were cut, and fires started in the munition dumps. This raid was remarkable for the excellent protection afforded by fourteen pursuit airplanes which escorted the bombers all the way to the objective. Bantheville received a ton and a half of bombs on October 1. Three fires were started in the town, and great damage done to the railroad tracks and stores of material. On the following day two tons of bombs were dropped on St. Juvin, and a ton and a half on Corny, but the visibility was so bad that accurate observations of the results could not be made. These raids continued to be successful, and the losses were minimized by employing large formations, and cooperating with our pursuit.

October 4 was a very successful day for the bombers. Dun-sur-Meuse was hit with a ton and a half of bombs, and Landres St. Georges with a like amount. The combats of the day were severe. In each attack the enemy numbered about thirty Fokkers and Pfalz. The clouds were low and afforded many lurking pockets for the enemy pursuit. In the last flight the 96th Squadron was attacked by the full formation of enemy airplanes. The bombing squadron tightened up and kept the pursuers at bay until the 26th Squadron and 11th Squadron attacked the Fokkers and Pfalz in the rear. Two of the enemy were seen to go down. When the combat was the hottest thirty Spads from the 2nd Pursuit Group arrived on schedule time and joined in the general fight. The enemy was in a trap and could not



---

escape combat with all our forces. The Spads brought down eleven of the enemy, bringing the total of victories of the fight up to thirteen.

Another highly successful raid was the shock attack on Bayonville, October 18, on which the group dropped four tons of bombs. The bombs burst in the middle of the town. It was later learned that on this single raid 250 of the enemy troops were killed by our bombs and 750 wounded. According to instructions from headquarters the bombing squadrons returned by way of St. Juvin to encourage our infantry. A successful raid was made by the group on Montmedy, November 4. Numerous fires were started and great damage done to buildings and warehouses. The hottest combat of the offensive was fought on returning from this mission. Two airplanes of the 11th Squadron went down in flames. Six of the enemy were shot down, two in flames. The last mission of the offensive was a raid on Mousson, on which good hits were made. On this last raid the 20th Squadron lost three planes. Four of the enemy went down in flames or out of control.

During the Argonne-Meuse operations the 1st Day Bombardment Group was distinguished for success in precision bombing. Enemy troops were attacked, material was destroyed, and the morale of the enemy so shaken that formations of bombers became the source of constant dread. Statistics of the air service show that two thirds of the enemy airplanes brought down, during the offensive, were brought down by, or in conjunction with day bombardment.

### Comments.

The transfer of the 1st Day Bombardment Group from Amanty to Maulan, just before the opening of this offensive, gave no advantage to the group save slightly better telephonic liaison with headquarters of the Air Service, 1st Army. From the standpoint of flying field and quarters the change was for the worse. The airdrome at Maulan is bisected by a ravine through which runs a highway. Either one of the two landing fields is too small for the needs of a group. The prevailing winds in the sector made it necessary for pilots to land across wind, or



---

run the risk of crossing the highway to crash into the ravine. On many occasions excellent pilots would make a perfect landing on the ridge, but the receding slope would increase their momentum, and cause their airplanes to roll down the ravine. It might be said that this flying field has a slight advantage over the Amanty field in drainage and nature of the soil. This advantage, however, was offset by the faulty location of the hangars, and the inadequacy of shelter for both material and personnel.

A criticism might here be made of lack of definite understanding regarding the occupation of the airdrome. When the group arrived at Maulan fifty percent of the men's quarters were occupied by Italian laborers in the employ of the French. Although repeated promises were made to evacuate the Italians they remained in possession of the barracks for nearly six weeks. This necessitated the use of hangars for the shelter of our enlisted men, who were compelled to sleep on the ground in the most inclement weather. Furthermore, some of the barracks occupied by the Italians constituted the quarters allotted to the pilots and observers. It is well to state the necessity of providing not only sufficient, but comfortable quarters for the flying personnel. The pilots and observers of day bombardment fly long hours at great altitudes. The observers who stand up in the wind especially suffer from the cold, often returning from raids with frostbitten cheeks. When not in the air they spend most of their time studying maps and photographs in preparation for the next raid. There are days when they have to remain on the alert from daylight until almost dark, ready to take off at a moments notice. If their quarters are such that they are cold and miserable when leaving the ground it is impossible for them to do their best work over the lines.

From the standpoint of security it was well that this airdrome was situated at considerable distance from the lines. Transportation was so scarce that if the enemy had made a rapid advance only about one fourth of the troops material could have been moved. The four squadrons were forced to operate with transportation facilities which are usually assigned to one squadron. There were times when every motor vehicle had to be used to transport materials needed in operations, with the result that the camp had to get along without wood or water. This shortage lowered the efficiency of the group.

The group profited by the lessons learned during the St. Mihiel offensive. With the experience of the other squadrons for guidance, the 166th squadron demonstrated that a new squadron could operate over the lines without great initial losses. The formation used by all the squadrons were devolved from the types of formation found most successful in the previous offensive. Group bombing was developed so that four squadrons instead of one attacked single objectives. This

change in tactics marked the greatest progress in day bombardment not only in group protection, but in the amount of damage inflicted upon the enemy. It was found however, that the employment of airplanes of different speeds, such as the Breguet, and De Haviland 4, prevented group bombing from attaining its maximum efficiency. Cooperation between day bombardment and pursuit units was perfected during this offensive, and accounted somewhat for the reduction of losses.

This offensive also showed the necessity of placing more stress on aerial gunnery instructions in the training schools. When the observers were unskilled with their guns the enemy attacked the bombing formations at close quarters. Constant shooting practice at ground targets was given to the observers to develop precision in fire. At the end of the offensive the accuracy and concentration of the observer's fire usually kept the enemy at considerable distance from the bombing formations.

Although replacements in airplanes was all that could be desired, it was impossible to get replacements in flying personnel. Airplanes, equipped and loaded for the raids, would often remain idle at the airdrome for the want of pilots and observers. Repeated requests for pilots and observers did not bring adequate replacements until a few days before the armistice was signed.

It is thought that careful consideration should be given to the possibilities of equipping bombing airplanes with armor which will partially protect the observers from machine gun fire. The observers had no protection save that which they maintained by fire superiority. Protection, no matter how slight, gives an advantage which often decides the outcome of an aerial combat.

Many pilots and observers who had been trained at American instruction centers, and sent to the front with French and British bombing squadrons were recalled for service with American units during the Argonne-Meuse offensive. Some served as replacements in the squadrons of the 1st Day Bombardment Group; but the greater number were transferred to the squadrons which formed the nucleus of the 2nd Day Bombardment Group. This second group was ready to operate against the enemy November 6, but the rainy weather, which continued until the armistice was signed, prevented operations.





---

**Part 6**

**Tactical History  
of American  
Observation Balloons**



*Col. Charles Def. Chandler (above)  
replaced Col. Frank P. Lahm as the  
head of U.S. Air Service, AEF  
balloon activities.*

*Observation balloon and winch.*



---

On February 26, 1918; the 2nd Balloon Company moved into position near Royamieux, northwest of Toul, relieving a French Company. It was assigned to the 1st Division, 1st Corps, for work.

On April 12, 1918, the 4th Balloon Company arrived at Lahayieux, in the area of the 2nd Division. The 1st Company took station near Baccarat on April 15, and worked with the 22nd Division. All three of these companies were under the control of the Balloon Group, 1st Corps, with headquarters at Toul. These three companies were the only ones at the front until the latter part of July.

The plan of putting companies at the front at this early date was for the purpose of training in quiet sectors. They relieved French balloon companies and were assisted in their early training by French Commissioned and non-commissioned specialists. French personnel was retained until American specialists were competent to carry on the work alone, —usually a very short time. This practice was continued until sufficient American companies had become proficient at the front, to permit of their training specialists for new companies. Experienced observers and maneuvering officers were transferred from the older companies to new organizations . . . when the latter came to the front.

The mission of these balloons was to regulate artillery fire, locate targets, report all activity seen within the enemy lines by day, and to report all that could be seen at night.

Night and day flights were made at all times, weather permitting, though the number of night flights was always limited.

The Toul sector was an almost perfect sector for training, except that artillery activity was not great. Perfect telephonic liaison was easily constructed and maintained. This liaison consisted of lines to group headquarters, anti-aircraft batteries, and neighboring artillery batteries. Personal liaison was emphasized as it was at all times necessary to instruct the other branches of the service as to the use, possibilities, and limitations of the balloons.

Liaison with pursuit and observation aviation was not all that could be desired. This was never developed to any great degree of perfection during any of the operations. In the Toul sector, however, liaison with pursuit groups was established and by means of conference between pilots and balloon observers, improvements in methods of attack and defense were made.





---

When the American participation in the Chateau-Thierry offensive commenced, there were but three American Balloons at the front. These were the 1st, 2nd, and 4th Companies, the 1st near Baccarat, the 2nd and 4th north of Toul.

The 2nd Company had been at the front since the latter part of February; the 1st and 4th since the early part of April. All three of these companies were trained and in condition to face all conditions of warfare.

In the Chateau-Thierry salient the enemy was equipped with their usual high percentage of balloons and in addition they had a very large airplane concentration.

The 2nd Company received orders about the 1st of July to proceed to the Chateau-Thierry sector. This company was packed and on the road in less than six hours and made excellent move to the new sector in less than forty-eight hours. Upon its arrival in the new sector, it was assigned immediately to the 1st Division, 1st Corps, and proceeded to work with that division and with the corps artillery, 1st Corps, until the corps was relieved from that sector.

The 1st Balloon Company left Baccarat with its truck train just after the middle of July and arrived in the area of the 2nd Division about July 18, 1918.

The 4th Company left its position near Royaumieux near Toul, about the second or third of August and got into the fight before the Vesle was reached. It was assigned to the 3d Division and worked with that division until relieved in the latter part of August.

The balloons followed the front line of the advancing infantry at a distance of about five kilometers and registered artillery fire, located targets, and gave general information bearing upon the enemy retreat. The weather was generally poor, which hindered efficient work. Despite all adverse conditions, the balloons rendered valuable service which was commented upon in official reports.

As a result of operations in the Chateau-Thierry offensive, eight balloons were burned, and one damaged by enemy shell fire. Twelve descents were made in parachutes. Considering the number of balloons engaged, the number of artillery adjustments completed and the amount of information transmitted was exceptionally high.

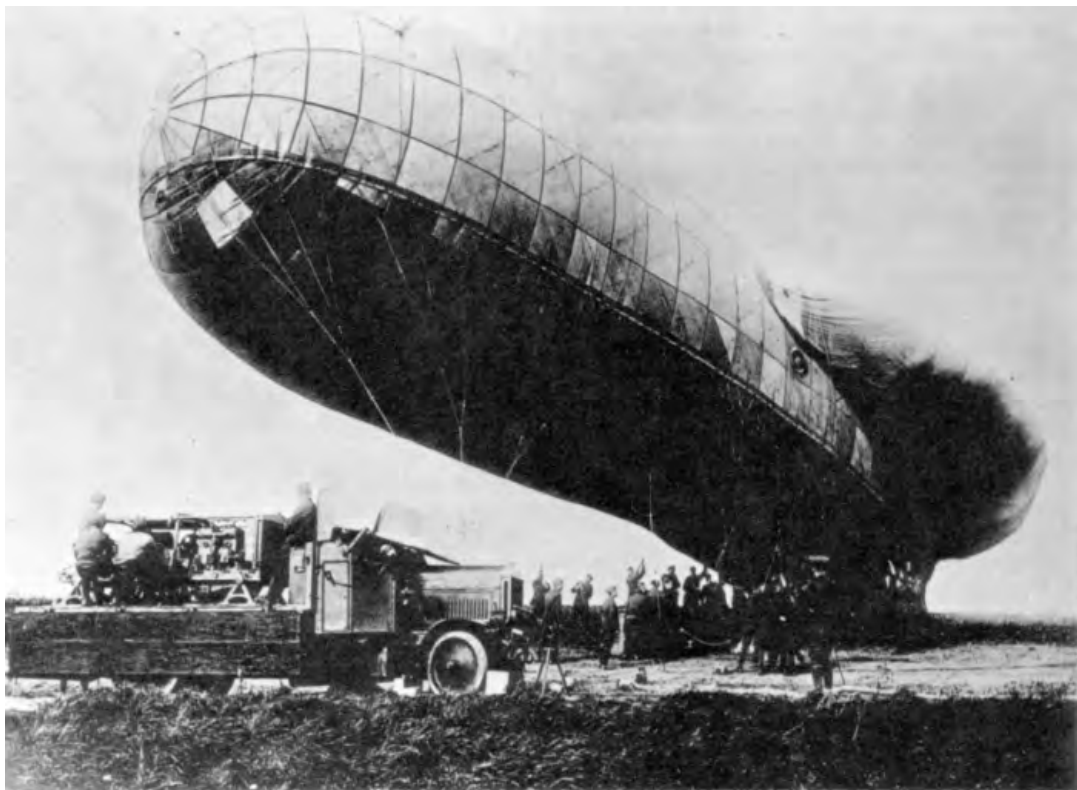

*A Caquot observation balloon with winch.*

*Maj. John H. Jouett was the Commanding Officer, IV Corps Balloons, during the St. Mihiel offensive.*



Under the American command, fifteen American balloon companies and six French companies took part in this offensive, making twenty-one balloons in all.

There were approximately twelve enemy balloons opposite the American sector.

The weather conditions of the 12th and 13th of September were such as to prevent Balloon observation. High winds caused damage to the balloons which nevertheless were in ascension.

Direct line measurement gives a total of 202 kilometers travelled by companies with inflated balloons following our attacking infantry. The actual distance travelled was much greater.

Regulation of artillery fire and infantry liaison work was carried on very successfully when weather permitted, many targets being destroyed, and front line positions being determined.

Positions of advance and retreat were thoroughly worked out before the attack started. Definite itineraries of advance were planned and the positions beyond the lines were so determined that each balloon maintained, approximately, its place in the axis of its sector.

Liaison was well established and maintained. Reports were rendered promptly and accurately.



*An observer with a telephone set in a balloon basket.*



## IV. In the Argonne-Meuse Offensive.

---

Thirteen American balloons and two French balloons were utilized by the 1st Army in its offensive operations between September 26 and November 11. The two French balloons did little or no work due to sickness of personnel.

All the American balloons, except that of the 7th Balloon Company, were not inflated until the night of September 25, 1918. Captured documents proved that the enemy was unaware of their presence. The 7th Balloon Company took over the position of a French company, and, with French cocards<sup>1</sup> on the balloon, ascended on September 24th and 25th.

All of these companies except the two French companies moved with the general advance, keeping between 5 and 6 kilometers behind the front line. They occupied successive positions, establishing telephonic liaison at each stage of the advance.

Straight line measurements show a total of advance of 425 kilometers by the American balloon companies. For many miles the balloons were maneuvered forward by hand. In one day the 8th Balloon Company maneuvered forward 32 kilometers by hand. This is believed to be a world's record.

Twenty-one balloons were lost between September 26th and November 11th, fifteen of these were burned by attacks of enemy planes, and six destroyed by shell fire. It is believed that the enemy lost fifty balloons during the same period opposite the sector of the 1st Army.

Balloon anti-aircraft defense drove off many attacks, the 6th Balloon Company bringing down two enemy planes within 24 hours.



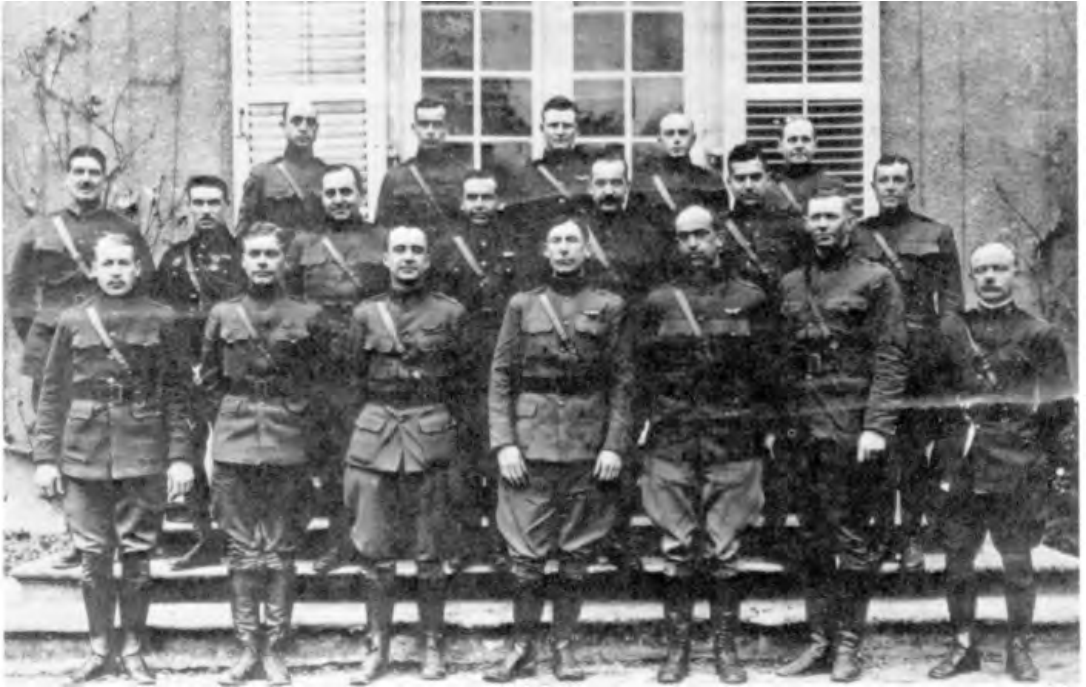

*Col. Frank P. Lahm and his Headquarters Staff, Second Army, Air Service*

*A partially inflated balloon—10th Balloon Co., near Jezainville, France (right)*



---

It has been found by experience in quiet sectors and during offensives that the balloon observers and company commanders had been thoroughly trained in the importance of maintaining liaison with the artillery. There is another phase of the observers work which has not been greatly emphasized and which developed great importance in the war of 1918, —that is, liaison with the divisions. The practice of having a corps balloon for the purpose of working with corps artillery and also for giving information to both the intelligence and operations section of the corps worked well. The work of this balloon is less important than the work of the divisional balloon in the matter of intelligence and operations. The corps headquarters is usually situated too far in the rear and the means of communication are far too uncertain for information which is sent back, either to the intelligence or operations section of the corps staff, to be of great benefit. This is especially true of reports made during the heat of action because by the time such reports get back over crowded telephone lines or by courier, it is too late to take any action upon them. The contrary, however, is true of the division. A divisional balloon, not only should work with the artillery of the division and with whatever artillery units are near it, but it should be done of the intelligence centers for the division. Its telephonic connections make it more valuable for this work, than an airplane, especially when intelligence of points immediately in advance of the line of battle is sought. Constant liaison should be maintained between every divisional balloon and the divisional G-2 and G-3.

It has been found that division staffs are always trying to get more information about what is going on at the front and every effort possible should be made to have balloon observers trained to assist them. Observers can carry on artillery adjustments at the same time that they are undertaking general surveillance of the sector, and there are always some special points which balloon observation can clear up for the staff.

As far as panel identification of the infantry front line is concerned, it is too uncertain to be counted upon. If the panels are displayed just right and if atmospheric conditions are just so, it will be successful. If, however, all conditions are not favorable then it will not be successful. If the Division staff is relying on its balloon to give information which is gotten from panel liaison, they are often very likely to be disappointed. The work can be better handled by airplanes and should normally be cared for by them.

On days of even fair visibility during action, the front line can be pretty well traced out by grenade smoke and similar signs. Enemy convoys can be picked up moving either to or from the front, explosions of various nature tell their story. In fact, there are many ways, —some of which come only once and are never repeated, —by

---

which the intelligence section and operations section of divisions can greatly profit by liaison with divisional balloons.

There should be a course of instruction for balloon group commanders and company commanders with reference to liaison work with division, and, to a certain extent, with corps.

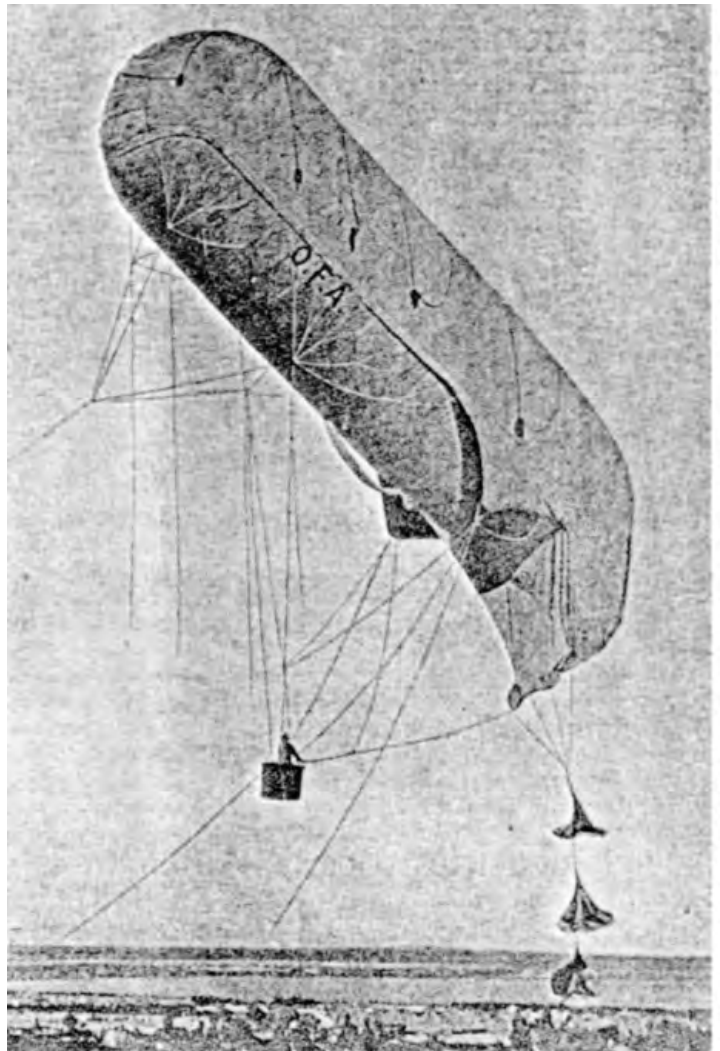



---

## Appendix A

### Directive for "Final Report"

PARIS DEC 12 1918

AIR SERVICE TOURS

NO 2534 D HAVE CREATED IN PARIS UNDER COLONEL GORRELL WHO HAS BEEN APPOINTED ASSISTANT CHIEF OF STAFF AIR SERVICE AND HAS THEREBY AUTHORITY TO GIVE ORDERS IN MY NAME FOR THE EXECUTION OF THE DESIRED WORK COMMA A STAFF DIRECTLY UNDER MY PERSONAL SUPERVISION CHARGED WITH THE RESPONSIBILITY OF FORMULATING FOR ME MY FINAL REPORT ON ALL PHASES OF AMERICAN AIR SERVICE ACTIVITIES IN EUROPE PERIOD I DESIRE THIS REPORT TO BE SUBSTANTIATED BY ALL POSSIBLE APPENDED DATA AND IT MUST COVER AIR SERVICE ACTIVITIES FROM VIEWPOINTS OF HISTORICAL COMMA STATISTICAL COMMA TECHNICAL COMMA AND TACTICAL ACCOMPLISHMENTS PERIOD FUNDAMENTAL IDEA IS TO SHOW WHAT HAS BEEN DONE AT EVERY AIR SERVICE POINT AND WHY IT WAS DONE PERIOD FINAL REPORT MUST PUT INTO WRITING THE KNOWLEDGE GAINED BY ALL OF US IN EUROPE IN ORDER THAT EXPERIENCE OF EVERY MAN MAY BE MADE AVAILABLE FOR FUTURE USE BEFORE MEN RETURN TO CIVIL LIFE PERIOD YOU WILL REPORT NO ONE UNDER YOUR ORDERS AS AVAILABLE TO BE RETURNED TO THE UNITED STATES UNTIL YOU ARE CERTAIN THAT HE HAS FURNISHED IN WRITING TO COLONEL GORRELL ANY INFORMATION OF VALUE WHICH HE POSSESS AND WHICH HE HAS ACQUIRED WHILE IN THE AMERICAN AIR SERVICE PERIOD MAKE CERTAIN THAT SO FAR AS YOU AND THE MEN UNDER YOU ARE CONCERNED THAT THIS WORK IS THOROUGHLY DONE PERIOD YOU CAN EASILY VISUALIZE THE MAIN AIR SERVICE POINTS THAT MAY HAVE BEWILDERED YOU WHEN AMERICA FIRST ENTERED THE WAR AND ALSO THE QUESTIONS THAT THOSE IN AUTHORITY MAY INVESTIGATE CONCERNING THE CONDUCT OF OUR AIR SERVICE PERIOD ANSWERS TO ALL OF THESE POINTS DESIRED PERIOD CREATE IF NECESSARY A FORCE UNDER YOU TO HANDLE THESE QUESTIONS FOR YOU PERIOD MY REPORT SHOULD BE FINISHED IN THIRTY DAYS PERIOD THEREFORE YOUR REPORT SHOULD REACH ME IN PARIS



ATTENTION COLONEL GORRELL BEFORE DECEMBER 31ST 1918 PERIOD FROM TIME TO TIME QUESTIONS WILL BE SENT YOU CONCERNING FURTHER INFORMATION THAT MAY BE DESIRED PERIOD AM DEPENDING ON YOU TO SUBMIT QUICKEST POSSIBLE REPLY IN EACH CASE PERIOD YOU SHOULD NOT AWAIT ARRIVAL OF THESE QUESTIONS BUT AUTOMATICALLY FURNISH ME WITH EVERY PIECE OF INFORMATION WHICH YOU CAN ANTICIPATE WILL HELP ME IN COMPILING THIS REPORT PERIOD AS SUPPORTING DATA TO INFORMATION YOU FURNISH ALSO WHENEVER POSSIBLE FORWARD ALL BOOKS PAMPHLETS MAPS PHOTOGRAPHS CHARTS GRAPHS FORMS ET CETERA THAT YOU ARE ABLE TO OBTAIN PERIOD YOUR EARNEST ASSISTANCE QUICKLY DESIRED WITH A VIEW TO WINDING UP ONCE AND FOR ALL THE FURNISHING TO ME OF THE INFORMATION THAT IS NECESSARY AND WHICH IN THE PAST HAS NEITHER BEEN SUCCESSFULLY RAPIDLY NOR COMPLETELY FURNISHED PERIOD WHENEVER POSSIBLE ALWAYS EMPHASIZE THE REASONS WHY THINGS WERE SO DONE PERIOD IN ADDITION COMMA I DESIRE FROM YOU PERSONALLY COMMA AND FROM YOUR SECTION CHIEFS THROUGH YOU COMMA A FRANK STATEMENT OF WHAT YOU AND YOUR PRINCIPAL ASSISTANTS REGARD AS THE MOST IMPORTANT AIR SERVICE LESSONS TO BE DRAWN FROM OUR EXPERIENCE IN PRESENT WAR PERIOD THIS TELEGRAM HAS BEEN SENT BY ME PERSONALLY PERIOD YOUR REPLIES SHOULD BE ADDRESSED TO CHIEF OF AIR SERVICE PARIS ATTENTION COLONEL GORRELL PERIOD ACKNOWLEDGE RECEIPT TELEGRAM PERIOD.

PATRICK

**Appendix B**

**AIR SERVICE, AEF  
OUTLINE OF TACTICAL ORGANIZATION**

11 November 1918

First Army Air Service

1st Pursuit Wing

2d Pursuit Group

13th Aero Squadron

22d Aero Squadron

49th Aero Squadron

139th Aero Squadron

3d Pursuit Group

28th Aero Squadron

93d Aero Squadron

103d Aero Squadron

213th Aero Squadron

1st Day Bombardment Group

11th Aero Squadron

20th Aero Squadron

96th Aero Squadron

166th Aero Squadron

155th Aero Squadron

1st Pursuit Group

27th Aero Squadron

94th Aero Squadron

95th Aero Squadron

147th Aero Squadron

185th Aero Squadron

First Army Observation Group

9th Aero Squadron

24th Aero Squadron

91st Aero Squadron

186th Aero Squadron

First Army Balloon Wing

11th Balloon Company

43d Balloon Company

Corps Observation Wing

I Corps Air Service

I Corps Observation Group

1st Aero Squadron

12th Aero Squadron

50th Aero Squadron

I Corps Balloon Group

1st Balloon Company

2d Balloon Company

5th Balloon Company

III Corps Air Service

III Corps Observation Group

88th Aero Squadron

90th Aero Squadron

III Corps Balloon Group

3d Balloon Company

4th Balloon Company

9th Balloon Company

42d Balloon Company

V Corps Air Service

V Corps Observation Group

99th Aero Squadron

104th Aero Squadron

V Corps Balloon Group

6th Balloon Company

7th Balloon Company

8th Balloon Company

12th Balloon Company

---

**Second Army Air Service****4th Pursuit Group**

17th Aero Squadron  
25th Aero Squadron  
141st Aero Squadron  
148th Aero Squadron

**5th Pursuit Group**

41st Aero Squadron  
138th Aero Squadron  
638th Aero Squadron

**2d Day Bombardment Group**

100th Aero Squadron  
163d Aero Squadron

**IV Corps Air Service****IV Corps Observation Group**

85th Aero Squadron  
135th Aero Squadron  
168th Aero Squadron  
258th Aero Squadron  
278th Aero Squadron

**IV Corps Balloon Group**

15th Balloon Company  
16th Balloon Company  
69th Balloon Company

**VI Corps Air Service****VI Corps Observation Group**



8th Aero Squadron  
354th Aero Squadron

**VI Corps Balloon Group**

10th Balloon Company

**Units ordered to front from SOS for Second Army**

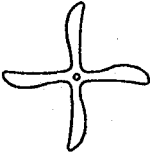
13th Balloon Company  
14th Balloon Company  
24th Balloon Company  
25th Balloon Company  
26th Balloon Company  
44th Balloon Company

AASC	Army Air Service Commander	rsch	research
ACAS	Assistant Chief of Air Service	SE-5	Royal Flying Corps scouting
AEF	American Expeditionary Force		experimental aircraft
AFSHRC	Albert F. Simpson Historical Research Center, Maxwell AFB, Alabama	sec	section
AG	Adjutant General	ser	series
AR	French aircraft built by the Avion Renault company	SIA	Italian Air Service
AS	Air Service	SORC	Signal Officers Reserve Corps
ASI	Aerospace Studies Institute, Air University, Maxwell AFB, Alabama	SOS	Services of Supply
		USAF	United States Air Force
		vol	volume
		YMCA	Young Men's Christian Association
ASSC	Air Section, Signal Corps	WDGO	War Department General Order
BEF	British Expeditionary Force	Z of A	zone of advance
CAS	Chief of Air Service		
CG	commanding general		
cm	centimeter		
CO	commanding officer		
C/S	chief of staff		
DH-4	De Haviland biplace aircraft		
DFC	distinguished flying cross		
div	division		
DSC	distinguished service cross		
E-3	German monoplane fighter built by Fokker		
FEV	French engine series designation for Vee-type engine (actually Fe Vee)		
			1
GHQAEF	General Headquarters American Expeditionary Force		
GO	general order		
GPF	high-powered ( <i>grande puissance</i> ) Filloux rifle		
HAEF	Headquarters American Expeditionary Force		
hist	history		1
hp	horsepower		
hq	headquarters		
no	number		
OCAS	Office of Chief of Air Service		
ops	operations		
para	paragraph		
RAF	Royal Air Force		

Uniform insignia of the U.S. Air Service for all enlisted men  
except aviation mechanics and enlisted aviators (above).  
The one for enlisted aviators appears below.



---

## INTRODUCTION

1. WDGO 1, 1905, and 24, 1912; Field service Regulations, para 35, 1914.

2. For the development of the Army's historical program before and during World War I, see: Elizabeth B. Drewry, *Historical Units of Agencies of the First World War*, Bulletins of the National Archives, No 4, July 1942; Joseph Mills Hanson, "The Historical Section, Army War College," *Journal of the American Military History Foundation*, Vol I, No 2 (Summer 1937), pp 70-74; Waldo G. Leland and Newton D. Mereness, *Introduction to American Official Sources for the Economic and Social History of the World War* (New Haven, 1926), pp 50-93, especially 61-69; National Archives, *Handbook of Federal World War Agencies and Their Records, 1917-1921* (Washington, 1943).

3. AG, Hq SOS, Memo for Chiefs of Staff Departments, 9 May 18, in "History of the Air Service, American Expeditionary Forces" (hereafter cited as "Gorrell's History"), Ser M, Vol 16 (hereafter cited as M-16).

4. Photocopy of Eskridge's note in the Albert F. Simpson Historical Research Center, file 106-83 (location of documents in the Center will hereafter be given as AFSHRC plus file number). The introductory paragraphs relating to the historical program of the Air Service, AEF, are based largely on materials in "Gorrell's History," especially [Capt. Ernest L. Jones,] "History of the History of the Air Service," in M-16, and [Capt. Ernest L. Jones,] "History of the Information Section," in L-4. Other sources included Ernest L. Jones, "Chronology of Aviation," sub 9 May 1918, in AFSHRC 168.6501, and miscellaneous papers in AFSHRC 106-83.

5. Ernest L. Jones, Personal Data, and related papers, in AFSHRC administrative file HO/"J."

6. Sec of Hist Records, Hq SOS, Type of Facts for Report of June 1st, 1918, in "Gorrell's History," M-16.

7. [Jones,] "History of the Information Section."

8. [Jones,] Air Service History, Outline of Type of Facts Desired, in "Gorrell's History," M-16.

9. [Jones,] "History of the Information Section."

10. Ltr, C/S, AS, AEF to Photo Sec, ca. 11 Nov 18, quoted in Photo Sec, Brief Review of Work, Sec J, in "Gorrell's History," G-5.

11. GHQ AEF, Telegram No 1252, 19 Nov 18, in "Gorrell's History," M-16.

12. Ltr, Capt. Ernest L. Jones to CO's, subj: Air Service History, 18 Nov 18, in AFSHRC 106-83.

13. OCAS, AEF, Office Memo 88, 4 Dec 18, in "Gorrell's History," A-9; OCAS, AEF, GO 6, 4 Dec 18, in "Gorrell's History," M-16.

14. TAGO, *Official Army Register, 1918* (Washington, 1918), p 692; George W. Cullum, *Biographical Register of Officers and Graduates of the United States Military Academy*, #5049; *Who's Who in America*, Vol 23 (Chicago, 1944), p 303; USAF Historical Study 98, *The United States Army Air Arm, April 1861 to April 1917* (USAF Hist Div, Air University, 1958), pp 137, 139, 150, 167-168, 170, 194. The statement concerning Arnold is from his book, *Global Mission* (New York, 1949), p 48.

15. Ltr, C/S, AS, 1st Army to CG, 1st Army, subj: Air Service, 1st Army, 25 Nov 18, in "Gorrell's History," C-3.

16. Ltr, CAS, AEF to AASC, 1st Army, subj: Historical Operations Report, 11 Dec 18, and 2d Ind, Capt. Philip J. Roosevelt to CAS, AEF, undated, in "Gorrell's History," C-1.

17. TAGO, *Official Army Register, 1918*, p 144; Cullum, *Biographical Register*, #4855; Association of Graduates of the United States Military Academy, *Sixtieth Annual Report* (1929), pp 313-315.

18. Telegram No 2534D, signed Patrick, to Air Service, Tours, 12 Dec 18, in "Gorrell's History," M-16; see Appendix A.

19. James Norman Hall, Charles Bernard Nordhoff, and Edgar G. Hamilton (eds.), *The Lafayette Flying Corps* (Boston, 1920), Vol I, p 367.

20. Col. Edgar S. Gorrell, "Early History of the Strategical Section," in "Gorrell's History," B-6; USAF Historical Study 89, *The Development of Air Doctrine in the Army Air Arm, 1917-1941* (USAF Hist Div, Air University, 1955), pp 10-12; Robert Frank Futrell, *Ideas, Concepts, Doctrine; A History of Basic Thinking in the United States Air Force, 1907-1964* (ASI, Air University, 1971), pp 22-25.

21. Vol II, No 180. 15 Feb 21.

22. (Washington, 1948), Vol 15, pp. 225-290.

23. Vol I, No 75, 12 Jun 20.

24. The figure given for the number of volumes in each series is the editor's count on 30 October 1974 rather than the one given in the index volume of "Gorrell's History."

25. Edgar S. Gorrell, *The Measure of America's World War Aeronautical Effort*, lecture at Norwich University, Vermont, 26 Nov 40, Norwich Univ Pub No 6, p v.

26. CAS, *Annual Report, 1921*, p. 22; *ibid.*, 1922, p 18.

27. Gorrell, *Measure*, p v.

28. Copies of the film may be purchased from the Publications Sales Branch (NATS), National Archives (GSA), Washington, DC 20408, the price, as of 1 November 1974, being \$12.00 a roll. For some unknown reason, the second volume in Series K was not



---

microfilmed with the other volumes, but in late 1974 the National Archives was planning to film the volume and add it to T-619.

29. Jones, Personal Data.

30. Association of Graduates, *Sixtieth Annual Report*, pp 313-315.

31. James Norman Hall, *My Island Home; An Autobiography* (Boston, 1952), pp 228-229, 232-234, 238-239. *The Lafayette Flying Corps* (2 volumes) was published in Boston in 1920.

32. Gorrell, *Measure, passim*; Gorrell, "What! No Airplanes?" address at Convention of National Association of State Aviation Officials, Louisville, 17 Oct 40, in AFSHRC 168.604-34; Gorrell, "The Counsel of Errors—World War I Twenty Years After," address at Virginia Military Institute, 13 Feb 41, in AFSHRC 168.604-35.

## FINAL REPORT

### Chapter I.

1. An "Editor's Note" prefacing the 1921 edition of the "Final Report" said, "The report is quoted verbatim with the exception of the fact that all statistics included herein have been revised to date." The figure for pilots was changed from 744 to 767, and for observers from 454 to 481.

2. Original report: 753 enemy airplanes. Changes are still being made in U.S. Air Service credits for the destruction of enemy aircraft. See Maurer Maurer, "Another Victory for Rickenbacker," *The Airpower Historian*, Apr 1960, pp 117-124. For a list of credits compiled by the U.S. Air Force's Historical Research Division in the late 1960's, see USAF Historical Study 133, *U.S. Air Service Victory Credits, World War I* (Hist Rsch Div, Air University, 1969).

3. Original report: 71 balloons.

4. Original report: 357 planes and 35 balloons.

5. Original report: "... 35 of them were burned during such attacks and 9 others were destroyed by shell fire. Our observers ...."

### Chapter II.

1. In a raid on 20 April 1918, German troops captured Seicheprey, a village east of St. Mihiel that had been garrisoned by the U.S. 26th Division. The Germans held the village about 12 hours before being driven out by American and French forces.

2. The 12th Aero Squadron.

3. The first U.S. pursuit unit to enter combat was the 103d Aero Squadron, which began operations on 18 February 1918 while attached to a French army.

---

4. These victories were credited to 2d Lt. Alan F. Winslow and 1st Lt. Douglas Campbell. For earlier victories credited to members of the U.S. Air Service, see USAF Historical Study 133, p 63.

5. The 27th, 95th, and 147th Aero Squadrons.

6. The 4th Balloon Company in the Toul Sector, and the 1st Balloon Company near Baccarat.

7. The 1st, 2d, and 4th Balloon Companies.

### Chapter III.

1. Army observation: 91st Aero Squadron; corps observation: 1st, 12th, 90th, 99th, 104th, and 135th Aero Squadrons, with the 135th being the DH-4 Liberty squadron; day bombardment: 96th Aero Squadron; pursuit: 13th, 14th, 17th, 22d, 27th, 49th, 88th, 93d, 94th, 95th, 103d, 139th, 148th, and 213th Aero Squadrons, the 17th and 148th being with the British.

2. Col. William Mitchell.

3. The 9th, 24th, and 91st Aero Squadrons, the 9th being assigned night operations.

4. The 1st Pursuit Group: 27th, 94th, 95th, and 147th Aero Squadrons; the 2d Pursuit Group: 13th, 22d, 49th, and 139th Aero Squadrons; the 3d Pursuit Group: 28th, 93d, 103d, and 213th Aero Squadrons.

5. The 185th Aero Squadron.

6. The 1st Day Bombardment Group: 11th, 20th, 96th and 166th Aero Squadrons.

7. The description of this "remarkable concentration," which was accomplished by the French rather than by the U.S. Air Service, was copied, with minor editorial changes but without substantive alteration, from Ops Rpt No 40, AS 1st Army, 9 Oct 18. Section 3(d) of the report briefly describes bombing expeditions launched by two squadrons of the Day Bombardment Group of the First Army Air Service shortly after noon. This is followed by an Annex, which begins: "Details were received at a late hour concerning a very important and remarkable bombing expedition, which was launched in the late afternoon by a great number of planes of the French Aerial Division, which were co-operating with the Air Service of the First American Army, in the Argonne Sector." The Annex continues with the details given in the "Final Report."

8. Original report: Enemy casualties, 198; American casualties, 80; superiority, 2½ to 1.

9. The date given is for the formation of a company that provided enlisted personnel for the squadron when it was organized on 16 June 1917. See Maurer Maurer (ed.), *Combat Squadrons of the Air Force, World War II* (Washington, 1969), pp 94-96.

10. Original report: 25 casualties.
11. Original report: "Finally, with the 17th . . . ."
12. Original report: 65 confirmed.
13. Maj.-Gen. John Maitland Salmond.
14. Original report: 466 individuals.
15. Original report: Total decorations and citations, 530.
16. This sentence was not in the original report. The award mentioned was made in 1919 to 2d Lt. Frank Luke, Jr. The Medal of Honor was later awarded to other members of the Air Service for actions during World War I.
17. Original report: "The American D.S.C. was awarded to 288 individuals, of which number 30 also received one Oak-leaf, 2 two, 1 three, 2 four, and 1 seven Oak-leaves, thus giving a total of 36 of the 228 individuals receiving 52 Oak-leaves."
18. Original report: One DSC and 17 DFC.
19. Original report: "Three persons were awarded the French Legion of Honor, one the Medaille Militaire, 70 the Croix de Guerre and, of these, 8 individuals became entitled to wear the Fourragère, and 149 Americans (4 of whom twice received this honor) were awarded French citations."
20. Original report: One received the silver medal.
21. This sentence was not in the original report.



Croix de Guerre

## Chapter IV.

1. Original report: 7,726 officers.
2. Original report: 756 officers.
3. Original report: 16 training schools.
4. Date was not in original report.
5. Maj. William Mitchell was the observer; Capt. Carleton G. Chapman was in London; 1st Lts. Joseph E. Carberry, Millard F. Harmon, Jr., and Davenport Johnson were the flying students.
6. Maj. Gen. John J. Pershing.
7. The Army officers were Capts. Virginius E. Clark and Edgar S. Gorrell.
8. Maj. William Thaw, 3d Pursuit Group; Maj. Charles Biddle, 4th Group; Capt. Dudley L. Hill, 5th Group.
9. This section was headed successively by Capt. Edgar S. Gorrell, Col. Halsey Dunwoody, Maj. Robert Marsh, Jr., Lt. Col. E.J. Hall, and Maj. A.D. Butterfield.
10. The chiefs of the section were Capt. R.D. Skinner and later Maj. E.L. Gros.
11. Paragraph continues in original report.

---

### **Chapter V.**

1. The Chief of Air Service also moved to Tours, where Air Service headquarters remained until October 1918.
2. The chief of the section was Col. Charles deF. Chandler.

### **Chapter VI.**

1. The chief was Lt. Col. Harry M. Toulmin.
2. The chief was Col. Warwick Greene.
3. The chiefs included Maj. Robert Glendinning, Lt. Col. Theodore A. Baldwin, Lt. Col. W.H.H. Hutton, Col. Hiram Bingham, and Maj. George W. DeArmond.
4. The chiefs were 1st Lt. Quilla C. Duke, Maj. George W. DeArmond, Maj. Robert E. O'Brien, and Maj. James E. Chaney.
5. The chief was Capt. Ernest L. Jones.
6. This statement reflects Gorrell's interpretation of Patrick's order (ACAS, AEF, Office Memo 88, 4 Dec 18) making Gorrell responsible for "the preparation and compilation of the historical, statistical, technical and tactical records of the Air Service, American Expeditionary Forces."

### **Chapter VII.**

1. Air Service headquarters were with Headquarters, AEF in Paris from mid-June 1917 until 1 September 1917 and at Chaumont-en-Bassigny from 1 September 1917 until mid-February 1918. The office of the Chief of Air Service, AEF then was situated at Tours until October 1918, when Patrick moved his office to General Headquarters, AEF at Chaumont.
2. The assistant chief at Headquarters, Services of Supply, at Tours was Brig. Gen. Benjamin D. Foulois; at Paris, Col. Halsey Dunwoody.
3. The representative in London was Col. Clarence R. Day; in Italy, Maj. Robert Glendinning.
4. A Services of Supply organization.
5. In the U.S. Air Service during World War I a "service" unit was one with a tactical, or combat, function (e.g., observation, pursuit, bombardment) rather than, as in more recent times, one that provided supporting (e.g., supply, maintenance) services for other units.
6. In the AEF, each army (e.g., First Army) and corps (e.g., IV Corps) to which Air Service units were assigned or attached for combat had an aviation officer who was both a staff officer on the staff of the commanding general and the commander of the Air Service units so assigned or attached. In his staff capacity, the aviation officer had the title Chief of Air Service; in his command

---

role his title was Army (or Corps) Air Service Commander. These titles, however, were often used interchangeably.

### Chapter IX.

1. See Chapter III, note 13.
2. Original report: 628 airplanes.



### Chapter X.

1. The chiefs of the section were Lt. Col. Joseph E. Carberry, Lt. Col. Thomas DeW. Milling, Col. Henry C. Smither, and Col. Walter G. Kilner.
2. Original report: 121 graduated.
3. In the original report, this was the beginning of a new chapter, XI, "Training (Con'td)."
4. Original report: 831 graduated.
5. Original report: 199 pilots and observers killed; 159 students; 40 instructors, testers, and transfer pilots.
6. Spin; tail spin.
7. Original report: 1,230 pilots and 749 observers.
8. Original report: 199 fatalities.
9. Original report: 2,941 airplanes and 149,889 hours.
10. Original report: 11 schools.

### Chapter XI.

1. The chiefs were Lt. Col. Townsend F. Dodd and later Col. Halsey Dunwoody.
2. In this chapter, the original "S.O.S." was transcribed "Source (or Sources) of Supply" in the 1921 edition. The present editor has corrected this to "Services of Supply."
3. The paragraph continues in the original report.
4. The original report gave the year as 1917, which obviously was wrong.

### Chapter XII.

1. See Chapter IV, note 9.
2. The Division of Technical History and Research was established on 22 October 1918, its historical function being detailed later by Gorrell.

### Chapter XIII.

1. The chief was Col. Charles deF. Chandler.
2. In the original report the sentence read: "Thirty-five of our

---

balloons were burned in this way, and nine were destroyed by shell fire."

3. Original report: 37 burned.
4. Original report: 5 destroyed.

#### **Chapter XIV.**

1. The chief was Lt. Col. Harry J. Malony.
2. The preceding eleven words (to meet the delivery of foreign-built airplanes as well as) were not in the original report.
3. Original report: May 18, 1918.

#### **Chapter XV.**

1. The section was headed by Maj. James Barnes, Lt. Col. Shelby C. Leasure, and Maj. Edward J. Steichen.
2. Eastman Kodak Company.
3. This camera had been invented by Lt. G. de Ram of the French Air Service, who had offered it to the French government and had been turned down. Gorrell heard about it while Chief of the Technical Section and had it investigated by a group of officers, after which it was adopted by the U.S. Air Service. It was a large, heavy camera which was mounted in the fuselage of an airplane. It carried 50 plates, 18 x 24 cm., and could be operated by either the pilot or observer. When the operator pressed the release, an exposure was made, after which the plate was changed and the shutter set automatically so that the camera was ready for the next exposure.

#### **Chapter XVI.**

1. The section was headed by Capt. F.N. Shumaker and Maj. John G. Thornell.
2. Capt. Edgar S. Gorrell was Chief of the Technical Section at that time.

#### **Chapter XVII.**

1. The Medical Consultant was Col. Thomas R. Boggs.

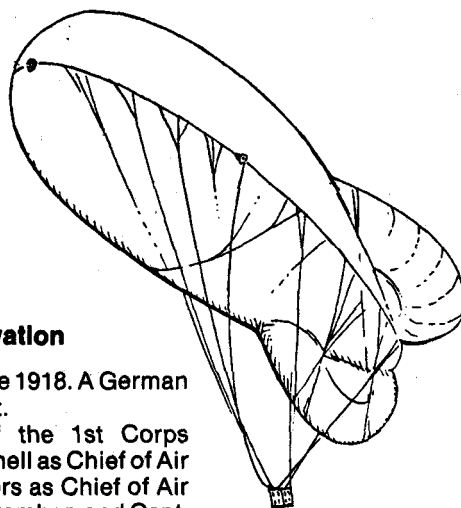

## TACTICAL HISTORY

### Part Two: Tactical History of Corps Observation

1. The 77th Division relieved the 42d on 21 June 1918. A German raid on 24 June was repulsed after a sharp fight.

2. Maj. Lewis H. Brereton, commander of the 1st Corps Observation Group, succeeded Col. William Mitchell as Chief of Air Service, I Corps in late June 1918. His successors as Chief of Air Service, I Corps were Maj. Melvin A. Hall on 2 September, and Capt. Oliver P. Echols on 1 November 1918.

3. The Corps Balloon Wing Commander was Maj. (later Lt. Col.) John A. Paegelow, who became Army Balloon Wing Commander when the First Army was formed in August 1918. With the formation of the army wing, a lettered company of the wing headquarters was assigned to each corps as the corps balloon headquarters. Later the lettered companies were replaced by corps balloon group headquarters. See Appendix B.

4. The Chief of Air Service, III Corps at the beginning of August 1918 was Maj. Joseph T. McNarney, his successors being Maj. Melvin A. Hall on 8 August, Capt. Kenneth P. Littauer (acting commander) on 31 August, Col. Joseph C. Morrow on 20 September, and Capt. Littauer on 22 October.

5. The Army Air Service Commander, First Army was Col. William Mitchell, who was succeeded in October by Col. Thomas DeW. Milling.

6. The Chief of Air Service, IV Corps was Maj. Harry B. Anderson; V Corps, Lt. Col. Arthur R. Christie until 28 October 1918; then Maj. Martin F. Scanlon.

7. The Corps Observation Wing Commander was Maj. Lewis H. Brereton until 23 October 1918, then Maj. Melvin A. Hall.

8. 1st Lt. William P. Erwin of the 1st Aero Squadron. See USAF Historical Study 133, p. 20.

### Part Three: Tactical History of Army Observation

1. The commander was Maj. John N. Reynolds.

2. The aircraft were French A.R.s, with Renault engines. A list of abbreviations compiled by the Information Section, Air Service, AEF indicated that A.R. meant Army Corps (Corps d'Armée) type aircraft with Renault engines. (Bull of Info Sec, AS, AEF, Vol V, No 205 (29 Jul 18.) It also has been said to stand for Aeronautique, referring to the builder, the French government's Section Technique de l'Aeronautique. W.M. Lamberton, comp., *Reconnais-*

---

sance & Bomber Aircraft of the 1914-1918 War (Los Angeles, 1962), p 74.

3. A French hangar made of a frame covered with canvas, with a canvas draw-curtain covering the front.

4. Rest.

5. Adjustments.

#### **Part Four: Tactical History of Pursuit Aviation**

1. This name does not appear on any of the World War I station lists, or any of the World War I or more recent maps, seen by the editor. The reference evidently is to the field commonly referred to in the Air Service, AEF, as the "Toul" airdrome, northeast of Toul on the Toul-Dieulouard road.

2. Those who had transferred from the French to the American Air Service included Maj. John Huffer, Commanding Officer of the 94th Aero Squadron; Capt. Kenneth Marr, Flight Commander and later Commanding Officer, 94th Aero Squadron; Capt. David McKelvy Peterson, Flight Commander of the 94th and later Commanding Officer of the 95th Aero Squadron; Maj. Raoul Lufbery, the famous "ace" of the Lafayette Escadrille; and 2d Lt. Alan F. Winslow, credited with the 94th Aero Squadron's first victory in aerial combat.

3. The squadron numbers, which obviously were wrong in the original copy, have been changed from 28 to 27 and from 167 to 147.

4. The Holt flare, made by the Yorkshire Steel Co. of London, was mounted on the underside of the wing of an airplane to light the ground when landing at night.

5. There is a blank, indicated by eight hyphens, in the original copy.

6. Key officers of the Air Service, AEF, and particularly those concerned with directing pursuit and bombardment operations, repeatedly stated that the ultimate objective of warfare was to destroy the enemy's will to fight, the objective of military aviation thus being the destruction of the morale of the enemy. The shock actions referred to were directed toward that end.

7. A "scouring patrol" was an offensive operation against enemy aircraft. It was carried out by a "chain" of three flights of three or more aircraft. The lead flight (pivot) flew an erratic course on a pre-designated general heading with the other two flights doing the same at a distance but with each in constant touch with the other two. Thus a trap was set for enemy planes that might observe the feeble front presented by one flight and attack, at which time the other two would join the battle.



---

### Part Five: Tactical History of Day Bombardment

1. A V-12 motor.
2. The Michelin brothers, André and Edouard, not only manufactured automobile tires and published guide books for travelers but also made bombs, bomb racks, bomb sights, and other war materiel during World War I.
3. This sight had settings for ground speed and altitude, the latter being obtained from the plane's altimeter. Ground speed was obtained just before the bomb run by timing, with a stop watch, a flight of 600 meters in the same direction as the bomb run.
4. A tourelle was a ring, or Scarff, mount, which enabled the gunner to swing his gun in different directions.
5. Maj. Harry M. Brown, the squadron's commander, was one of the 12 who became prisoners of war.
6. The "target" was the landing T, which was placed on the field to indicate the direction for takeoff and landing. One of the duties of the airdrome officer was to place the T in the proper position. So far as practicable, he was to keep it headed into the wind, but pilots were under orders to takeoff and land "with the T" regardless of the direction of the wind.
7. This high-altitude bomb sight, which was developed by Lt. Comdr. Wimperis of the Royal Naval Air Service, did not require the use of a stop watch and thus did not require holding level flight for a considerable period in which the aircraft was especially vulnerable to antiaircraft fire. With the Wimperis sight, a plane could coast down from high altitude and quickly release the bomb after only a few seconds of level flight.

### Part Six: Tactical History of American Observation Balloons.

1. French insignia.



---

## INDEX

### The U.S. Air Service in World War I, Vol. I

- Accidents in training: 27, 110-12
- Adjutants: 172-73, 199
- Administration operations and systems: 73-74, 76
- Administration Section, Air Service: 65
- Aincreville: 346
- Air Depot, 1st: 55, 78, 117, 128, 132
- Air parks: 79, 117-19. *See also* Airfields
- Air Service (*see also* Aviation Section, Signal Corps)
  - activation: 52
  - casualties: 27
  - command and control, concept of: 79
  - discipline in: 90, 113
  - expansion program: 71-74
  - first concentration under own commander: 301
  - headquarters moves: 69
  - history projects: 1-14, 74, 134, 154-55, 389-90
  - inactivation procedures: 91-92
  - insignia: 243, 393
  - Italy, representative in: 76, 91
  - London, representative in: 76, 86, 91, 124
  - morale: 49, 89-90, 94, 112-13, 185, 304-305
  - organization and reorganization: 62-63, 65, 75-80
  - Paris, representative in: 69, 76, 86
  - prewar strength: 51
  - prisoners of war: 27, 361, 368
  - roles and missions, view of: 47, 79
  - Services of Supply, representatives at: 76
  - stations in Services of Supply: 26, 73, 77
  - support by services: 90
  - 202-squadron program: 71-72, 117
  - tribute to personnel: 163
  - wartime strength, periodic: 37, 51, 72
  - Zone of Advance stations: 2-3, 62

---

Air Service Production Center No. 2. *See* Romorantin

Air supremacy, achievement: 319, 328, 330, 332-39

Air units (*see also* Groups; Squadrons; Wings)

202-squadron program: 71-72, 117

air supremacy, achievement: 319, 328, 330, 332-39

alerts, proper use: 338-39

British, attachments to and from: 32, 37, 235, 302, 325-39, 375

command and control: 36, 42, 47, 172, 186, 197-202, 225, 275, 279, 283, 288, 301, 304, 309-10, 321-22, 325, 363

enemy strength: 34, 172, 185, 203, 222, 236, 247, 292, 298, 307, 326, 329, 333, 336, 343, 346, 363, 372

escort missions: 337-38, 343-49

French, attachments to and from: 34, 37, 40-41, 198, 202-203, 217, 221, 235, 245, 249, 259-67, 283, 288-89, 301-11, 359, 365, 375

ground troops, relations with: 253-54

missions, typical: 176-81, 186-90, 193-95, 205, 222-23, 261-62, 278, 294, 302-304, 359-61

mobility: 230, 291

strength: 310

tactical reports: 225

tactics. *See* Tactics

tanks, cooperation with: 331

Aircraft

Armament. *See* Armament; also by type

armor plate protection: 375

balloons. *See* Balloons

capabilities and limitations: 38-39, 185, 263, 272, 311, 322, 325-26, 330, 357-58, 361, 375

identification, friend or foe: 253, 284

insignia on: 253

largest concentration: 37

losses. *See* Aircraft losses

maintenance and repair: 175-76, 358, 362-63, 369

number needed, estimate of: 51-52

number, prewar: 51

number received, all sources: 66, 88

number in service, periodic: 17, 25, 353, 362

number in training programs: 112

production and procurement. *See* Aircraft production and procurement

replacement program: 217-18, 306, 361-63, 368-69, 375

serviceable percentage: 311

types in use, number: 114

---

Aircraft Acceptance Park No. 1. *See* Orly

Aircraft Armament Section, Air Service: 76, 90, 145-49

**Aircraft losses**

American: 17, 31, 39, 44-46, 87, 126, 254, 273, 296, 310, 331, 351-52, 361, 366, 368, 372-73

British: 327-28, 330

enemy: 17, 31-32, 42, 44-46, 254, 273, 284, 318, 341, 351-52, 362, 368, 372-73, 385

Aircraft Production Board: 51-53, 131, 140, 145

**Aircraft production and procurement**

American production: 17, 59-61, 72, 81, 83, 108, 117, 122, 146

assembling, equipping and maintenance: 17, 49, 62, 69, 117, 122, 126-28

basis for U.S. production: 51-52

British production: 127-28

delivery system and flow: 118-19, 145, 341

design, trends and improvements in: 81-82, 132-34

French production and delivery: 53-54, 65, 69-70, 72, 76, 81-82, 85-87, 91, 97, 117, 122-24

German production and design: 81

industry, coordination of: 65

initiative, importance in: 82

inspection, testing and acceptance: 76, 78-79, 88, 122-23, 128, 131-34, 149, 208

materials, procurement and distribution: 59, 61, 65, 69, 72, 78, 81, 83, 127

problems in: 81-82

royalties on: 52, 54

salvage operations: 79, 92, 113-14, 117, 126-28

standardization programs: 54, 61, 114

surplus at Armistice: 119

**Aircraft types**

Albatros: 236, 265, 272, 292, 301, 325

A.R. (Avion Renault). *See* Renault *below*

Avro: 110

Breguet: 108, 147, 209, 221, 266, 356, 358, 360-61, 366, 368, 371, 375

Bristol: 61, 82

Caproni: 87, 101

Caudron: 101

Clerget: 327, 330

De Havilland: 37, 59-61, 82, 88, 108, 117, 126-27, 132-34, 149, 237, 364-65, 368, 371-72, 375

---

Dolphin: 110  
Farman: 82, 101  
Fokker: 33, 43, 81, 236, 265, 272, 290, 292, 301, 325, 329-30, 335,  
357, 368, 372  
Handley-Page: 76, 84-86, 108, 149, 158  
Junkers: 81  
Le Pere: 147  
Le Rhone: 327, 330  
Nieuport: 101, 114, 132-33, 283-84, 295  
Pfalz: 43, 81, 236, 265, 272, 301, 325, 357, 372  
Renault: 82, 171, 185, 236, 259  
Salmson: 132, 147, 153, 155, 185, 193, 205, 210, 217, 221, 237,  
259, 263, 266, 272  
S.E. (Scouting Experimental): 128, 325, 327-28, 330, 337-38  
S.I.A. (Italian Air Service): 87, 101  
Siemens-Schuckert: 81  
Sopwith: 82, 85, 101, 110, 116, 171, 205, 217, 324-25, 338  
Spad: 44, 60-61, 110, 123, 147, 171, 221, 283, 288-89, 295, 304,  
307, 311, 321, 372-73  
trainers: 94, 110  
types recommended: 59-61

#### Airfields

acreage required: 117  
construction and maintenance: 37, 85-86, 93, 97, 117-19, 126,  
185, 218, 334, 357, 362  
defense of. *See* Security operations and systems  
deficiencies in: 296, 301, 334, 373-74  
enemy facilities: 301, 334  
enemy seizures: 328  
equipment shortages: 218  
layout for schools: 115  
number in service: 22  
seizures from enemy: 330  
sites and their selection: 23, 55, 76, 128  
transfer to France: 92

Air-ground coordination and communication: 33-35, 40, 47, 55,  
81, 186, 188-91, 194-95, 199, 208-19, 223-33, 238-43, 253, 273,  
303-304, 307, 337, 383, 385, 387-88

Airplane Division, Technical Section: 132

Airplane Instrument Division, Technical Section: 133

Airplane and Motor Division, Supply Section: 122-23

Aisne Canal: 231

---

Aisne-Marne offensive: 17, 32-34, 81, 140, 191, 197-219, 238

Aisne River: 33, 222, 229, 313

Albert: 46, 325, 328, 330, 332

Alerts, proper use: 338-39

Allemont: 368

Amanty: 31, 55, 105, 259-60, 266, 357, 362, 365, 373-74

Ambulance Corps: 94

American Expedition Forces  
expansion program: 71-72, 105  
headquarters activated: 55

American Red Cross: 90

Ammunition

caliber differences: 148

incendiaries: 337

shortages: 189

supply and expenditure: 109, 148, 176

Anderson, Major Harry B.: 234

Andeville: 347

Andrevanne: 347

Antiaircraft defense

American: 31, 41, 175, 221, 284, 308, 385

by balloons: 385

British: 337

enemy: 172, 182, 189, 195, 203, 213, 229, 262-63, 265-66, 277,  
306, 357-58, 372

Antipersonnel bombs: 358

Apremont: 171

Argonne Forest: 295, 323, 371

Argonne - Meuse offensive. *See* Meuse - Argonne offensive

Armament

deficiencies in: 109, 146-48

depot established: 149

maintenance and repair: 176

salvage operations: 148

standardization programs: 147

- 
- supply, control and installation: 17, 117, 119, 126, 145, 148-49, 263
  - typical systems: 358-59, 365
  - Armies (*see also* Army Air Service)
    - First: 269-70, 273, 275-79, 301, 304-11, 313-23, 343-44, 346, 385
    - Second: 45, 85, 124, 137, 152, 275
  - Armistice proclaimed: 17
  - Armor plate
    - design and development: 146
    - protection by: 375
  - Armorers, training: 145-46
  - Army Air Service
    - First: 4-5, 37-38, 124, 137-38, 148, 152, 154, 235-43, 246, 301-11, 345, 365-69, 373, 391-92
    - Second: 341-44, 386
  - Army Observation Group, 1st: 154, 259, 266, 269-73, 343
  - Arnaville: 368
  - Arnold, Colonel Henry H.: 4
  - Arras: 332
  - Artillery fire adjustment: 17, 29, 32-33, 35, 37-38, 40-41, 102, 137-38, 158, 172, 176, 178, 181-82, 186, 188-91, 193-95, 201, 204-19, 223-33, 235-43, 249-55, 260-67, 379, 381, 383, 387-88
  - Artillery fire support
    - American: 171, 186, 193-94, 203, 222, 246, 270, 277, 343, 346
    - enemy: 203, 222, 247, 302
  - Atkinson, Major Bert M.: 285, 287
  - Audun-le-Roman: 357
  - Aulnat: 92
  - Austria, operations against: 46, 87
  - Automobiles. *See* Motor vehicles; Transportation
  - Auxi-le-Château: 45
  - Aviation Acceptance Park No. 1. *See* Orly
  - Aviation cadets, training: 93-95, 97, 103

---

**Aviation Instruction Centers**

2d: 159

3d: 161

7th: 157, 358-59

**Aviation medicine. See Medical Research Board****Aviation Section, Signal Corps: 51-52****Avord: 55, 100-101****Baccarat sector: 30, 32, 185-91, 379, 381****Badenviller: 186****Baker, Newton D.: 95****Balloon companies**

arrivals and departures: 137

ascensions, duration and number: 17, 138

command and control: 76

dedication of troops: 140

French attachments: 138-40

mobility: 381, 383, 385

number needed, estimate of: 52

operations by: 35, 40, 44, 138-40, 197, 379-88

organization and assignment: 137

personnel strength and shortages: 17, 51, 137, 140

pilots: 137-38

reconnaissance reports, summary of: 138

training programs: 32, 137-38, 379, 381, 387-88

1st: 138, 379, 381

2d: 137-40, 379, 381

3d: 140

4th: 35, 140, 379, 381

6th: 385

7th: 385

8th: 385

10th: 386

**Balloon Section, Air Service: 65, 70, 76, 137-43****Balloon Squadron, 2d: 137****Balloons**

antiaircraft defense by: 385

assembling and maintaining: 17

attacks against enemy aircraft: 304, 307, 310-11, 313-14, 317-18,  
321, 328-29, 337, 344, 348-49



- 
- barrages, experience with: 142
  - British uses and losses: 328-39
  - Caquoat type: 382
  - centers in France: 136
  - company requirements: 143
  - enemy attacks against: 17, 138
  - enemy losses: 17, 39, 42, 316-18, 385
  - enemy use: 40, 42, 229, 328-29, 333-34, 336, 381, 383
  - French production and equipment: 40, 70, 140
  - French uses and losses: 329, 379, 383, 385
  - inspection, maintenance and repair: 142
  - losses: 17, 35, 138-40, 299, 381, 385
  - number in service: 17, 20, 22, 137, 381-85
  - R type: 140, 143
  - supply system: 70, 140-41, 143
  - transportation facilities: 142
- Bantheville: 372
  - Bapaume: 330, 332
  - Barbed-wire obstructions: 171-72, 185-86, 193, 203, 246-47
  - Bar-le-Duc: 237
  - Barracks construction: 126
  - Base depots: 123
  - Bayonville: 42, 44, 318, 373
  - Bazoches: 221
  - Beaumont: 349
  - Beauvais: 328
  - Beauzée: 245
  - Becq: 305
  - Beffu: 347
  - Behonne: 146
  - Belrain: 313, 320
  - Bessonneaux hangars: 202, 260, 292
  - Beuconville: 305

- 
- Bicqueley: 237
- Blamont: 186
- Blueprints, production: 134, 146
- Bois d'Andrevanne: 346
- Bois de Babiemont: 346
- Bois de Bantheville: 346
- Bois de Barricourt: 346
- Bois de la Folie: 346-47
- Bois des Loges: 346
- Bolling, Colonel Raynal C.: 4, 53, 55, 61, 65, 87
- Bomb sights
- Michelin: 358
  - Wimperis: 365
- Bombardiers
- number trained: 112
  - training programs: 58, 93, 97-98, 101, 103-04, 108
- Bombardment squadrons, revised program: 71
- Bombing operations (see also Strategic air support; Tactical air support)
- British operations: 32, 39, 286, 326, 329-30, 332-33, 336
  - command and control: 76
  - enemy morale, effect on: 32, 34, 49, 307, 362, 369, 373
  - enemy operations: 40, 42, 123, 185-86, 203, 260, 288, 320
  - first missions: 31, 361
  - French operations: 39-40
  - general operations: 39, 43, 46, 48-49, 82, 85-87, 278, 303-304, 307, 316-18, 344, 346-47, 357-63, 365-69, 371-75
  - Italian operations: 39
  - missions, typical: 359-61
  - night operations: 39, 320, 323, 366
  - number of raids: 17
  - volume of drops: 17, 19, 21, 44, 362, 372-73
- Bombs
- antipersonnel: 358
  - design and development: 146-48
  - incendiaries: 358, 372
  - load capacities: 358

- 
- loading and release systems: 145-48, 358, 367, 370
  - smoke types: 266
  - varied types: 266, 358, 372
  - Bon Maison: 289
  - Bonnell, Major G. H.: 285
  - Bordeaux: 124
  - Bray: 330-31
  - Brereton, Lieutenant Colonel Lewis H.: 196
  - Brest: 124
  - Bridges and bridgeheads, strikes against: 365, 368
  - Briey: 40, 313, 357
  - Brigades, 9th and 10th: 194-95
  - British air force. *See* Royal Flying Corps
  - British Air Ministry: 128
  - British Army ( *see also* Royal Flying Corps; United Kingdom)
    - antiaircraft defenses: 337
    - staff practice: 336
    - Third Army: 45
    - Fourth Army: 46
    - Fifth Army: 283
    - 9th Brigade: 328-29
  - British Expeditionary Forces: 37, 158
  - Bron: 99
  - Buire: 216
  - Buxerulles: 366
  - Buxieres: 366
  - Buzancy: 347
  - Buzancy - Nouart road: 347
  - Cable Section, Air Service: 74
  - Cadets. *See* Aviation cadets
  - Cambrai: 45-46, 330, 335-36

---

**Cameras**

deficiencies in: 267, 278-79  
De Ram model: 9, 154-55  
French models: 278-79  
on guns: 109, 152  
mounting systems: 132, 153, 155

Camouflage operations: 119, 133, 175, 193, 202, 260

Campbell, Lieutenant Douglas: 30, 284

Canada, training in: 85, 103

Canal du Nord: 46, 332-35

Cannon, aircraft: 146

Cappelle: 45

Caquot balloon: 382

Caquot winch: 35, 140

Castor oil. *See* Petroleum, oil and lubricants

**Casualties**

Air Service: 27  
enemy, from air attack: 44  
ferry pilots: 119, 126  
hours flown per loss: 110  
observers: 110, 217, 369  
pilots: 217, 350, 366, 369, 371-72  
in training: 27, 110-12

Caustic soda: 70

Cavalry reconnaissance patrol: 254-55

Cazaux: 100-101, 106, 109, 266-67, 283

Celles: 193

Chailly-en-Brie: 217

Chalons: 283

Chambers, Lieutenant Reed: 281

Chambley: 39, 344, 366, 368

Chambley-Mars-la-Tour road

Champigneulle: 346, 349

- 
- Chandler, Colonel Charles De F.: 377
- Châteauroux: 100
- Château-Thierry counteroffensive: 5, 33-35, 138, 183, 212-19, 221, 288, 290-99, 306
- Châtenay: 123
- Châtillon-sous-les-Côtes: 37, 100, 105, 109, 146, 235, 301, 313, 315, 343-44
- Chaumont-sur-Aire: 246, 313
- Chaumont-en-Bassigny: 55
- Chemical Division, Technical Section: 133
- Chief of Air Service, AEF. *See* Patrick, Major General Mason M.
- Chief of Ordnance. *See* Ordnance Department
- China, decorations awarded by: 47
- Christie, Lieutenant Colonel Arthur R.: 234
- Citroën Works: 133
- Cities, attacks on: 336
- Clerks: 62
- Clermont-Ferrand: 58, 97, 100, 108-109, 146, 157, 359
- Cléry-le-Grand: 346
- Cléry-le-Petit: 346
- Clichy: 119, 123
- Coblentz: 286, 361
- Codes, issue and use: 216, 218, 224
- Coëtquidan: 100, 105
- Coincy: 217, 296
- Colombey-les-Belles: 55, 117, 119, 128, 146, 361
- Combat operations: 10  
  first commitments: 29-30  
  ground conditions: 285  
  mobility, trend to: 47-48  
  time engaged: 17, 24

---

**Command and control**

aerial photography: 76

Air Service concept: 79

air units: 38, 42, 47, 172, 186, 197, 198-202, 225, 275, 279, 283,  
288, 301, 304, 309-10, 321-22, 325, 363

balloon companies: 76

bombing operations: 76

radio operations: 76, 90, 158

supply depots: 119

Commercy: 284, 366

Communications operations and systems: 37, 41, 44, 62, 143, 176-  
79, 188, 190, 194-95, 200-201, 205-19, 223, 225, 230, 239-43, 248-  
55, 278, 284, 289, 291, 296, 322, 343-44, 387-88. *See also by type.*

Concentration, principle of: 38

Confians: 39-41, 261, 266, 269, 277, 313, 319, 357-59, 362, 368

Conner, Brigadier General Fox: 10

Consenvoye: 349

**Construction programs (see also Maintenance and repair)**

airfields: 37, 85-86, 93, 97, 117-19, 136, 185, 218, 334, 357, 362

barracks: 126

general: 55, 61-62, 69, 71, 76, 83, 90, 93, 97, 123, 126, 128, 149,  
259, 260

railway facilities: 93, 114, 126

roads: 97, 123, 126

Contact patrols. *See* Air-ground coordination; Tactical air support

Cook, Lieutenant Everett R.: 277

Coordination Staff, Air Service: 73

Cornay: 349, 372

Corning, Merv: 36, 300

**Corps**

I: 301, 343-44

IV: 343-44

V: 343-44

VII: 301

**Corps Air Service**

I: 29, 33, 37, 137-38, 172, 197-219, 235-43, 245-55, 345, 359

III: 34, 212-19, 221-33, 235-43, 245-55

- 
- IV: 37, 235-43, 245, 343  
V: 37, 231, 235-43, 245-55, 301, 305  
organization: 198-202, 221, 235-37, 245-46, 255  
staff systems: 199, 221, 246
- Corps Artillery, I: 381
- Corps Balloon Group, I: 379
- Corps Observation Group, I: 21, 33, 171-83, 197-219
- Corps Observation Training Center, I: 259, 267
- Côtes-de-Meuse: 261
- Couloumières: 202, 204, 222
- Courbevoie: 145
- Courchamps: 33, 197, 202-203
- Courier service: 37, 177, 194, 201, 224-25, 230, 322, 343-44
- Courlandon: 221
- Critiques: 232. *See also* Lessons learned
- Cross-training: 41
- Cunel: 349
- Cuperly: 137
- Damvillers: 44
- Dannevoux: 349
- Decorations and awards: 46
- De Ram camera: 9, 154-55
- Designs and Projects Section, Air Service: 76
- Director of Construction and Forestry: 76, 90, 128
- Disbursing and Legal Division, Supply Section: 124-25
- Disbursing requirements: 124-25
- Discipline, in Air Service: 90, 113
- Disulouard: 284
- Distinguished Service Cross awards: 46
- Distinguished Flying Cross (British) awards: 46

---

Distinguished Service Cross (British) awards: 46

Divisions

1st: 32, 35, 379, 381

2d: 35, 202-19, 293, 379, 381

3d: 35, 381

4th: 217

5th: 193-95

26th: 171-72, 204-205, 213-17

42d: 186, 213-19

77th: 188, 229

Dodd, Major Townsend F.: 52

Dogneville: 193

Domeurs: 305

Dommary-Baroncourt: 31, 41, 277, 357, 359-61, 368

Dope, standardizing: 133

Dormans: 293

Douellens: 45

Drafting Division, Technical Section: 134

Drawings, production: 134

Dunkirk: 45, 289

Dun-sur-Meuse: 43, 371-72

Dunsworth, Major James L.: 370

Economy of force, principle of: 310, 321-22

Ellington Field: 108

Engine Division, Technical Section: 132

Engineer officers, training: 114

Engineering Branch, Aircraft Armament Section, Air Service: 146,  
148

Engines

American production: 81

assembling and repairing: 17, 114, 126-28

design and improvement: 133

Gnome: 60-61, 133, 284, 295



---

Hispano-Suiza: 60-61, 171, 289, 295, 311  
inspection, testing and acceptance: 76, 78-79, 88, 131, 134  
Liberty: 17, 37, 60-61, 82, 88, 108, 127, 130, 133, 237, 365  
metals specifications: 133  
number needed and delivered: 51-52, 127  
production and procurement: 54, 76  
Renault: 171, 358  
Rhone: 171  
Rolls-Royce Eagle: 59-60  
Salmson: 185, 259  
Salvage operations: 117, 126  
standardization programs: 88  
supply system: 119

England. *See* British Army Royal Flying Corps; United Kingdom

Epernay: 283, 295

Epiez: 283, 285

Epinal: 193

Equipment Branch, Aircraft Armament Section: 148-49

Equipment tables: 147, 149, 151

Escort missions. *See* Pursuit operations

Eskridge, Colonel Oliver S.: 1

Esprit de corps. *See* Morale

Essey: 305

Etain: 261, 306, 368

Examining boards: 94

Executive Section, Air Service: 8, 73

Fabrics, standardizing: 133

Favorolles: 293, 295

Fère-en-Tardenois: 217

Ferme des Greves: 221, 229-31

Ferme Morasse: 206, 217, 230

Ferrosilicon, supply of: 70, 142

Ferry pilots: 119, 126-27

---

Fighter groups. *See* Groups

Fighter operations. *See* Pursuit operations

Fismes: 289

Flares

design and development: 147-48

tactical use: 188-89, 213, 231, 253, 366

Flash spotting: 223, 226

Flirey: 171

Fog, effect of. *See* Weather, effect on operations

Foggia-Renatico: 46, 87, 99-101

Ford Junction, England: 100, 108, 158

Formation flying: 30-31, 34, 43, 218, 263-64, 269-70, 285, 292, 296,  
298, 309, 327-28, 334-35, 339, 361, 365, 368-69, 371, 374-75

Fort Sill: 267

Foucaucourt: 245

Foulois, Brigadier General Benjamin D.: 1, 65

Fragmentation bombs: 358

France

aircraft production and delivery: 53-54, 65, 69-70, 72, 76, 81-82,  
85-87, 91, 97, 117, 122-24

airfields transfer to: 92

arrivals in: 86

attachments to and from: 34, 37, 40-41, 59, 198, 202-203, 217,  
221, 235, 245, 249, 259-67, 283, 288-89, 301-11, 359, 365, 375

balloon centers in: 136

balloons, attachments from: 138-40

balloons, production and equipment: 40, 70, 140

balloons, uses and losses: 329, 379, 383, 385

bombing operations by: 39-40

camera models: 278-79

decorations awarded by: 46

production agreements with: 54

pursuit operations by: 227

reconnaissance operations by: 247

tactics: 361

training programs by: 58-59, 85, 95, 99-101, 105, 108

tribute to: 163

- 
- Second Army: 37, 305, 308, 344  
Fourth Army: 288-89, 295  
Fifth Army: 295  
Sixth Army: 34, 203, 221-33, 289, 291-99  
Eighth Army: 37, 186-91, 259-67, 283-89, 344  
Tenth Army: 35  
II Colonial Corps: 37, 235-43, 245, 301, 305, 343-44  
VI Corps: 186-91  
XXXIII Corps: 193-95, 245  
XXXVII Corps: 29  
167th Division: 203, 205, 217  
16th Pursuit Group: 302, 306, 313  
17th Pursuit Group: 293  
21st Pursuit Group: 288-89  
22d Pursuit Group: 227  
1st Squadron: 283  
2d Squadron: 301  
41st Squadron: 260  
50th Squadron: 237-43  
211th Squadron: 237-43  
237th Squadron: 221, 223, 230-33  
284th Squadron: 221, 223, 230-33
- Francheville: 204-206, 211, 217, 305  
Frapelle: 30, 193, 195  
Fresne-en-Woevre: 343  
Froides: 313  
Fuel tanks: 132, 133, 371  
Furbara: 100-101
- Gas (balloon), supply of: 70  
Gasoline pump, Selden: 132-33  
Gasoline tanks: 132-33, 371  
General Staff, AEF: 74  
General Staff, War Department: 52  
Generators, deficiencies in: 152  
Gengoult: 283  
Germany  
    Air Service stations in: 26

- 
- aircraft production and design: 81
  - 2d Pursuit Group: 333-34
  - Gironville: 305
  - Glue, analyzing: 134
  - Gondrecourt: 259, 267
  - Gondreville-sur-Moselle: 259, 266
  - Gorrell, Colonel Edgar S.: 4-7, 9, 12-14, 74
  - Gorze: 368
  - Goussancourt: 229-31
  - Grandpré: 316, 346-47, 371-72
  - Great Britain. *See* British Army; Royal Flying Corps; United Kingdom
  - Ground-air coordination. *See* Air-ground coordination
  - Ground combat troops
    - air coordination with: 33-35, 40, 47, 55, 81, 186, 188-91, 194-95, 199, 208-19, 223-33, 238-43, 273, 303-304, 307, 337, 383, 385, 387-88
    - attacks on. *See* Tactical air support
    - enemy strength: 343
    - relations with: 253-54
    - training with: 182-83, 189-90, 195, 200, 205, 207, 210, 213, 216, 219, 223, 231-32, 239, 248
  - Ground crews, training: 171
  - Groups (*see also* Air units)
    - commanders: 172-73, 363
    - headquarters stations: 23
    - organization: 172-74, 183, 202
    - staffs and staff officers: 172-74
    - 1st Bombardment: 316-18, 344-45, 347, 365-69, 371-75
    - 1st Pursuit: 31, 34, 39, 203, 262, 284-89, 291-99, 302-11, 344, 346-49, 351-53
    - 2d Bombardment: 375
    - 2d Pursuit: 44, 289, 302-11, 313-23, 346, 351-53, 366, 372
    - 3d Pursuit: 39, 289, 302-11, 313-23, 346-47, 351-53
    - 4th Pursuit: 341-44
  - Gun mounts design and development: 146-47

---

**Gunners**

importance: 109

number in service: 17

number trained: 112

training programs: 30, 43, 93, 97-98, 101, 103-104, 106, 108-109,  
266-67, 283, 375

Hadenville: 344

Hall, James Norman: 13

Hangar Division, Supply Section: 125

**Hangars**

Bessonneaux type: 202, 260, 292

British: 326, 328

facilities: 125-26, 221, 371

use as quarters: 374

Hartney, Major Harold E.: 285, 320

Harville: 368

Hindenburg Line: 266

History projects: 1-14, 134, 154-55, 389-90

History and Research Division, Technical Section: 134

Hydrogen, supply and consumption: 70, 140-43

Identification, friend or foe: 253, 284

Ignition systems, tests of: 133

Imecourt: 347

Incendiary ammunition: 337

Incendiary bombs: 358, 372

Industry, coordination with: 65

Infantry, support of. *See* Air-ground cooperation; Tactical air  
support

Information Division, Supply Section: 125-26

Information officers: 199

Information Section, Air Service: 1-3, 7, 12, 74

---

**Insignia**

Air Service: 243, 393  
aircraft: 253  
airplane pilot: 196  
aviation mechanic: 132  
balloon pilot: 142, 393  
observer: 237  
Royal Flying Corps: 320  
1st Bombardment Group: 370  
9th Squadron: 268  
12th Squadron: 184  
17th Squadron: 328-29  
25th Squadron: 341  
88th Squadron: 227  
91st Squadron: 258  
94th Squadron: 281  
95th Squadron: 291  
96th Squadron: 291, 317  
99th Squadron: 192  
141st Squadron: 341  
148th Squadron: 328-29

Inspection Section, Air Service: 93

Inspector General's Department: 89

**Instructors**

as examples to students: 112-13  
number trained: 112  
qualifications: 115  
intraining accidents: 110  
training programs: 44, 85, 93, 103, 108, 152

**Instruments**

design and tests: 133  
production and repair: 126

Intelligence officers: 172-73, 187, 225, 238, 241, 250, 279

Intelligence operations and reports: 40, 43, 199, 218, 225, 241-42,  
255, 269, 273, 286, 295-97, 308, 316, 346, 362, 371-72

Intelligence Section, Air Service: 74, 93

Inter-Allied Aircraft Board: 55, 61

Interpreters: 62

Issoudun: 58, 65, 71-72, 92-94, 97, 99-100, 106, 109, 113-15, 161

---

Is-sur-Tille: 123, 142

**Italy**

Air Service representative in: 76, 91  
attachments to: 46, 87  
bombing operations by: 39  
decorations awarded by: 46, 87  
training programs in: 51, 58, 87, 99-101  
tribute to: 163

Jezainville: 386

Joffre, Marshal Joseph: 65

Joint Army-Navy Aircraft Committee: 65

Joint Army-Navy Technical Aircraft Board: 52, 65

Jones, Captain Ernest L.: 1-4, 7, 10, 12-13

Jonville: 344

Jouett, Major John H.: 382

Kelly Field: 44-45

Kemmel Hill: 289

Kenly, Colonel William L.: 55

Kenney, Lieutenant George C.: 258

Kindley, Captain Field E.: 45

La Bassée: 328

La Harazée: 315

La Noblette: 288

La Pallice: 124

La Ferté-sous-Jouarre: 37, 197, 206, 216-17

La Wavrille: 44

**Laboratories**

medical research: 161  
photographic: 152

Lafayette Escadrille: 31, 58, 285, 288

Lahayieux: 379

- 
- Lahm, Colonel Frank P.: 377, 386
- Landis, Major Reed G.: 341
- Landres St. Georges: 43, 346, 372
- Language barrier, overcoming: 62, 74
- Le Bourget: 123
- Le Cateau: 46, 330, 332, 335
- Le Crotoy: 100-101
- Le Havre: 124
- Le Quesnoy: 46
- Le Valclahon: 100, 105
- Legal and Disbursing Division, Air Service: 91
- Legion of Honor awards: 46
- Lenses, photographic: 151
- Les Tuileries: 347
- Lessons learned: 219, 237-38, 369, 374-75, 387-88
- Liaison
- with Allies: 52, 76, 188, 194, 221, 305, 308, 329-30
  - deficiencies in: 273, 278, 296, 331, 333
  - practices and systems: 29, 31, 34, 41, 44, 74, 124, 132, 134, 145, 147-48, 154, 177-78, 183, 190-91, 194-95, 199, 201, 204-19, 224-33, 238-43, 245-55, 270, 284-86, 289, 305, 308, 313-23, 338, 344, 359-63, 373, 375, 479, 383, 387-88
- Liaison officers: 199, 209-10, 213, 215-16, 238-39, 242-43, 247-48, 251, 345
- Liaison Section, Air Service: 59
- Liggett, Lieutenant General Hunter: 4
- Lighting facilities: 123
- Ligny-en-Barrois: 37, 235, 270, 301, 345, 371
- Lines of communication: 62, 69, 362
- Lines of communication, enemy: 357
- Link belts, design and development: 146



---

Lionville: 305

Liquidation Board: 91

Lironville: 284

Lisle-en-Barrois: 313, 320

London

Air Service representative in: 76, 86, 91, 124

Supply Section branch at: 127

Technical Section branch at: 134

Longbey: 275

Longuyon: 39, 277, 357, 368

Longwy: 41

Lubricants. *See* Petroleum, oil and lubricants

Luke, Lieutenant Frank, Jr.: 36, 312

Lumber shortage: 126

Lunéville: 185

Luxouil-les-Bains: 193

MacCalmont, Lieutenant W. A.: 7

Machine guns

American employment: 186, 203, 246, 304

Browning: 147

cameras on: 109, 152

design and development: 146

enemy employment: 185, 203, 222, 278, 295, 306

Lewis: 147, 259, 266, 324, 358

Marlin: 134, 146-47, 365

Scharf mounting: 144

shortages: 283

testing and adoption: 132, 149

tunnel guns: 371

Vickers: 147-48, 259, 358-59

Machine shops. *See* Maintenance and repair

Maintenance and repair: 55, 79, 86, 97-99, 113-14, 117, 126-27, 146. *See also* Construction programs.

aircraft: 175-76, 358, 362-63, 369

armament: 176

---

Mannheim: 286

Maps

compilation and distribution: 74, 224, 251, 261-62, 269, 286, 295,  
362

Photomaps: 153, 262, 264-65

Marcq: 349, 372

Marne battles. *See* Aisne - Marne offensive

Marne River: 221, 283, 295

Marseille: 124

Mars-la-Tour: 39, 357

Material Section, Supply Section: 93, 117

Materiel Division, Supply Section: 123-24

Maulan: 345, 371, 373

Mauperthuis: 202

Maxwell Air Force Base: 13

Mayen-Multhien: 217

McNarney, Major Joseph T.: 220

McVicker, Charles: 312

Meaux: 217

Mechanics

dedication of: 114

ingenuity: 358, 363

insignia: 132

number needed, estimate of: 61

in production force: 54, 65, 72

training programs: 58-59, 76, 85, 99, 171, 259

Medal of Honor awards: 46, 312

Medical Research Board: 90, 125, 161

Méluin: 298

Menard, Commandant (French Army): 283

Meni, Captain (French Army): 306

---

**Messages**

drops: 37, 41, 174, 177, 188-89, 214, 225, 230, 240-42, 251, 253-54, 270, 345

interception: 337

Metallurgy Division, Technical Section: 133

Metz: 37, 39, 261, 266, 269, 315, 357-58, 365, 371

Meucon: 100, 105

Meuse - Argonne offensive: 5, 17, 37-49, 138-40, 152, 154, 245-55, 275-79, 313-23, 371-75, 385

Meuse River: 288, 301, 305-07, 313, 315-16, 319-20, 323, 346, 357, 371

Mexican Punitive Expedition: 93

Mézières: 275

Michelin bombs and sights: 358

Milling, Colonel Thomas De W.: 5

**Missions**

Aeronautical: 53-54

Allied: 51, 65

**Missions, typical combat**

bombing operations: 359-61

observation: 179, 181, 188-90

photographic: 181

pursuit: 176-81, 186-90, 193-95, 205, 222-23, 261-62, 278, 294, 302-304, 359-61

Mitchell, Brigadier General William: 6, 196, 52-55, 196

Mobile Air Park, 4th: 222

**Mobility**

air units: 230, 291

balloon companies: 381, 383, 385

of Royal Flying Corps: 325-26, 328

trend of combat to: 47-48

Mont St. Michel: 284

Mont Sec: 305

Montdidier: 325, 328, 330

Montenegro, decorations awarded by: 47

---

Montigny: 348

Montmédy: 41, 277, 373

**Morale**

of Air Service personnel: 49, 89-90, 94, 112-13, 185, 304-305  
enemy fluctuations: 32, 34, 49, 307, 330, 335, 338, 362, 369, 373  
friendly forces, effect of operations on: 32, 34, 49

Morass farm. *See* Ferme Morasse

Mosaic photographs. *See* Photomaps

Moselle River: 263, 305, 357, 365, 368, 371

Motor Transport Corps: 90, 124

Motorcycle courier service: 177, 188, 201, 224-25

Motor-vehicle losses, enemy: 39

Motors. *See* Engines

Mowry, Major R. I.: 8

National Archives: 12

National Defense, Council of: 51

Navigators, training: 103

Neufchâteau: 37

Nieuport: 46, 328

Night Bombardment Section, Air Service: 76, 86

**Night operations**

bombardment: 39, 320, 323, 366  
navigation by radio: 157-58  
pursuit: 42, 48-49, 76, 82, 85-86, 191, 318-19, 321, 323  
reconnaissance: 48, 81, 203, 266, 276, 278, 314, 344, 379

Nomény: 261

Nordhoff, Lieutenant Charles B.: 6-8, 13

Nouart: 347

Noyon: 328, 338

Noyon-Rheims sector: 289

Observation. *See* Reconnaissance, aerial

- 
- Observation squadrons (*see also* Balloon units; Balloons)  
headquarters stations: 23  
number expanded: 71
- Observers (*see also* Pilots)  
casualties: 110, 217, 369  
combat experience and efficiency: 29, 242, 260, 267, 271-73, 369  
insignia: 237  
mission routine, typical: 129, 181, 188-90  
number in service: 17, 51  
number trained and assigned: 112  
replacement system: 375  
shortages: 71, 105-106  
training programs: 40, 47, 51, 58, 83, 90, 93, 97-98, 103-105, 137-38, 143, 152, 172, 191, 266-67, 272, 357, 387-88
- Ochey: 301
- Offensive, principle of: 29, 47-48, 339
- Oil. *See* Petroleum, oil and lubricants
- Oldham, England: 157
- Operations centers: 174-75
- Operations officers: 172-73, 187, 199, 322
- Order and Acceptance Division, Technical Section: 91, 133
- Orders  
issuance and transmission. *See* Command and control  
typical for mission: 343-49
- Ordnance Department: 76, 90, 145
- Ordnance officers: 146
- Organization and reorganization  
for air program: 52  
of Air Service: 62-63, 65, 75-80  
balloon companies: 137  
combat planning: 30, 37  
corps air service: 198-202, 221, 205-37, 245-46, 255  
expansion programs: 54-55  
First Army Air Service: 391-92  
groups: 172-74, 183, 202  
problems in: 48  
squadrons: 175-76, 204
- Organization Section, Air Service: 65

- 
- Orly: 71, 78-79, 92, 117-19, 122-23, 131, 134, 145-46, 149
- Ormeaux: 291, 296
- Ourches: 88, 171-83, 202, 204, 237, 245
- Oxford, England: 103
- Oxygen Equipment Division, Supply Section: 125
- Packing cases, use in construction: 126
- Paegelow, Lieutenant Colonel John A.: 143
- Paints, analyzing: 134
- Panels, tactical use: 172, 182, 186, 188-90, 195, 207, 213, 218, 228-29, 231-33, 242, 248, 253, 316, 387
- Paper, photographic: 151
- Parachutes, design and descents by: 17, 32, 35, 70, 110, 138, 141, 143, 381
- Paris  
Air Service representative in: 69, 76, 86  
enemy drive on. *See* Alsne-Marne offensive  
ordnance depot at: 148, 222
- Parks. *See* Airfields
- Patrick, Major General Mason M.: 10, 62, 75-76, 145  
Allies, tribute to: 163  
heads Air Service: 71  
history project directive: 3-4, 6, 9-10, 389-90
- Patrols, ground: 41
- Pay and allowances, pilots: 89
- Penetration bombs: 358
- Péronne: 330, 332
- Pershing, General John J.: 1, 52
- Personnel  
arrivals and departures, periodic: 67-68, 71-72  
assignment and movement: 73, 78  
shortages in: 65, 72, 82-83, 99
- Personnel Section, Air Service: 65, 73-74, 93
- Petroleum, oil and lubricants: 90, 128, 133-34

---

**Péxarches: 291**

**Photographic officers: 172-73, 181**

**Photographic Section, Air Service: 151-55**

**Photographic units: 3, 8**

**accomplishments: 151**

**assignment: 154**

**dedication of personnel: 154**

**number in service: 22**

**personnel strength and training: 151**

**transportation facilities: 152**

**Photography, aerial**

**Allied cooperation in: 154-55**

**enemy operations: 34, 236, 283, 299, 301-302, 309**

**equipment procurement and distribution: 151, 175**

**general operations: 30, 33-34, 38, 41-42, 152, 176-78, 181-82, 186-87, 189, 193-95, 204-19, 222-33, 239-43, 249-55, 260-67, 269-73, 275-79, 299, 316, 341-44, 359, 368**

**importance: 239, 250**

**interpretation: 153, 181**

**mission routine, typical: 181**

**supervision of: 76**

**tactics in: 250-51, 263-65, 269-70**

**training programs: 152**

**volume of production: 17, 154**

**Photography, historical: 3, 155**

**Photomaps: 153, 262, 264-65**

**Picardy campaign: 325-39**

**Pigeons, communication by: 143, 177**

**Pilots**

**Allies, training by: 58-59, 72, 85, 88, 95, 99-101, 103, 105, 108**

**balloon companies: 137-38**

**balloon pilot insignia: 142, 393**

**behavior, criticism of: 89**

**casualties: 217, 350, 366, 369, 371-72**

**combat experience and efficiency: 17, 29, 31-32, 34, 38, 42, 171, 237-38, 269, 271, 283, 299, 319, 359, 362, 365**

**commissioning procedures: 94-95**

**daily routine schedule: 178**

**enemy combat experience and efficiency: 33, 222, 242, 265-66, 272-73, 284-85, 288, 298-99, 304, 310, 321, 335, 369, 372**

---

from enlisted grades: 95  
ferry pilots: 119, 126-27  
ground crews, relations with: 90  
insignia: 196  
leaves and rest program: 161  
medical responsibility for: 161  
number needed, estimate of: 51  
number trained and assigned: 112  
number prewar: 93  
number in service, periodic: 17, 51, 353  
pay and allowances: 89  
procurement and assignment: 78  
qualifications needed: 285, 311, 374  
rating system: 89  
replacement system: 199, 217-18, 278, 361, 375  
romantic image of: 104-05  
test pilots: 112  
training programs: 31, 39-40, 44-46, 51, 58, 71, 76, 82-83, 85-88,  
93-95, 98-101, 103-106, 108, 112, 152, 171-72, 186, 191, 207,  
259, 261-62, 266-67, 272, 275, 278, 285-86, 306, 341, 357, 361

Plans and Progress Division, Air Service: 73

Policy Section, Air Service: 65

Pont-à-Mousson: 283, 357, 365, 373

Pont-sur-Seille: 37, 235, 301, 305, 315, 343-44

Port facilities: 119, 123-24

Postal services: 74

Prisoners of war, Air Service: 27, 361, 368

Production and Maintenance Division, Supply Section: 126-27

Projects and Designs Division, Supply Section: 128

Propaganda operations: 142, 255, 368

Propellers

damage to: 365-66, 368-69

deficiencies in: 260

number handled: 127

protection methods: 132

Publications, compilation and issue: 74, 125-26, 132, 134, 148

Purchasing Division, Supply Section: 91, 124



---

Purchasing systems: 117, 122-24

**Pursuit operations**

British actions: 326-39

effect on friendly troops: 284-85

enemy actions: 39, 43-44, 203, 207-208, 221-27, 229, 233, 240, 250, 254, 265-66, 269-70, 272-73, 277, 284, 286, 289, 298, 301, 368, 372

first action: 31

formation flying: 30-31, 34, 43, 218, 263-64, 269-70, 285, 292, 296, 298, 309, 327-28, 334-35, 339, 361, 365, 368-69, 371, 374-75

French actions: 227

general actions: 31-32, 34, 38, 41-42, 44, 207, 222, 249, 283-89, 301-11, 313-23, 343-44, 372

night actions: 42, 48, 318-19, 321, 323

protection failures in: 218, 233, 292-93

tactics: 292-93, 302-304, 309-11, 318, 321-23

tactical orders, typical: 343-49

Pursuit Organization and Training Center, 1st: 283

Pyrotechnics. *See* Flares

Quartermaster Corps: 90, 128

R type balloon: 140, 143

**Radio**

in artillery fire adjustment: 158-59, 172, 218, 228

communications by. *See* Communications systems

deficiencies in: 41, 228, 233, 242, 248, 251, 254-55

equipment development and distribution: 157, 175, 187

experiments and tests: 134

field stations: 241-42, 248, 251

interplane communication: 157

messages, interception: 337

night navigation by: 157-58

operations, supervision of: 76, 90, 158

plans and diagrams: 224

training programs: 158-59, 218

Radio officers: 172, 174, 228, 251

Radio Section, Air Service: 157-59

**Railway systems**

construction: 93, 114, 126

enemy, attacks on: 357, 359-61, 365, 368, 371-72

---

Rancourt: 301

Reconnaissance, aerial

by balloons: 379-88

British operations: 326-39

cavalry reconnaissance patrol: 254-55

enemy operations: 33-34, 38, 203, 222, 236, 265, 299, 302, 329,  
331

French operations: 247

general operations: 29-30, 33-34, 37-38, 41-42, 88, 172, 176, 178-  
82, 186, 188-91, 193-95, 203-19, 222-33, 239-43, 247-55, 259-  
67, 269-73, 275-79, 307, 310, 314-23, 341-44, 347, 359, 365,  
368-69, 379

importance: 104-105, 226, 239

night operations: 48, 81, 203, 266, 276, 278, 314, 344, 379

tactics: 250-51, 263-65, 269-70

Records Section, Air Service: 93

Records systems: 123

Recruiting programs: 74

Rembercourt: 302, 305, 313, 320

Remicourt: 245

Remonville: 346

Rental charges: 92

Repairs. See Maintenance and repair

Requisitions and manifests handled: 117, 123, 128

Reports, tactical: 225

Research projects: 131, 134, 147

Reynolds, Major John N.: 261

Rheims: 197, 288

Rhine River area: 286

Rickenbacker, Captain Edward V.: 281

Riggers, training: 58-59

Rigny: 291

Road construction: 97, 123, 126

- 
- Rochester School of Aerial Photography: 151, 153
- Rocket signals: 188, 232
- Roles and missions, Air Service view: 47, 79
- Romagne: 316, 371
- Romorantin: 69, 71, 78-79, 91, 117, 119, 122-23, 125-27, 129, 134, 142, 145-46, 149
- Roosevelt, Captain Philip J.: 5
- Roosevelt, Lieutenant Quentin: 297
- Rosières: 330-31
- Roumania, decorations awarded by: 47
- Royal Flying Corps  
aircraft losses: 327-28, 330  
attachments to and from: 32, 37, 44-46, 81, 85, 103, 108, 235, 302, 325-39, 375  
balloons, uses and losses: 328-39  
bombing operations: 32, 39, 286, 326, 329-30, 332-33, 336  
hangars: 326, 328  
insignia: 320  
mobility: 325-26, 328  
night navigation by radio: 157-58  
pursuit operations: 326-39  
reconnaissance operations: 326-39  
tactical air support: 326-39  
tactics: 326-29, 331-32, 335-36, 361  
transportation facilities: 325-26, 328  
3d Brigade: 45  
General Headquarters Wing: 327-39  
55th Squadron: 359
- Royalties on aircraft: 52, 54
- Royaumieux: 379, 381
- Roye: 46, 330-32
- Rumont: 237
- Ruses: 226, 371
- Sablons: 39, 269
- St. Benoit: 39

- 
- St. Georges: 346
- St. Jean-de-Monts: 92, 97-100, 106, 109, 146
- St. Juvin: 316, 371-73
- St. Maixent: 73, 78, 94
- St. Menehould: 288-89
- St. Mihiel: 231, 283, 305, 313, 343-44, 357-58, 366
- St. Mihiel offensive: 5, 17, 29, 31, 37-49, 138, 235-43, 245, 261, 269-73, 288, 314, 357-63, 365-69, 383
- St. Nazaire: 124
- St. Quentin: 332
- Saints: 202, 296
- Salvage operations: 79, 92, 113-14, 117, 126-28, 148
- San Diego aviation school: 93
- Saumur: 100
- School of Aerial Photography: 151, 153
- Schools system: 51, 55-58, 72, 76, 82-83, 93-94, 97, 99, 103-104, 111-12, 115, 137, 146, 158
- Seats, armored: 132, 371
- Secretary of War. *See* Baker, Newton D.
- Security operations and systems: 40, 74, 119, 175, 188, 221, 247, 250, 260, 267, 288, 299, 301, 305, 308-309, 315, 320-21, 374, 385
- Seicheprey: 29, 305
- Selden gasoline pump: 132-33
- Sellers, Captain Cecil G.: 367
- Serbia, decorations awarded by: 47
- Service Geographique: 151
- Service squadrons: 79
- Services of Supply: 1-2, 7, 10
- Air Service representatives at: 76
- flow of supplies through: 119
- stations in: 26, 73, 77

- 
- Shelling reports: 228
- Sherman, Lieutenant Colonel William C.: 5-8, 10, 13
- Sights, design and development: 146, 148
- Signal Corps  
communications supervision by: 158-59  
separation from: 52
- Signalling systems: 188, 231, 233, 322, 337
- Signalling systems, enemy: 265-66
- Simpson Historical Research Center: 13
- Smoke bombs: 266
- Soissons, battle of: 33, 35, 197, 212-19, 265
- Somme River: 330
- Souge: 100, 105, 109, 137, 142
- Souilly: 231, 237, 245-46, 248
- Southampton, England: 99
- Spain, contracts with: 91
- Spare parts (*see also* Maintenance and repair)  
flow of supply: 120, 123  
ratio: 117
- Spare Parts Depot No. 2. *See* Romorantin
- Spark plugs, tests of: 133
- Specialists. *See* Mechanics; Technicians
- Spincourt: 41, 277
- Squadrons (*see also* Air units)  
arrivals in France: 86  
assignment and movement: 78  
number needed, estimate of: 52  
number in service: 17-18, 22, 117  
headquarters stations: 23  
organization: 175-76, 204  
revised program: 71  
1st Observation: 6, 29, 33, 58, 171-83, 198-219, 235-43, 345-55  
8th Observation: 235-43, 245  
9th Observation: 37, 259-67, 269-73, 275

---

11th Bombardment: 44, 364-69, 371-75  
12th Observation: 29, 33, 171-83, 185-91, 198-219, 235-43, 245-55  
13th Pursuit: 302-11  
17th Pursuit: 44-46, 85, 103, 302, 325-39, 341-44, 352  
20th Bombardment: 44, 365-69, 371-75  
22d Pursuit: 302-11  
24th Observation: 37, 259-67, 269-73, 275-79  
25th Pursuit: 341  
27th Pursuit: 285-89, 302-11, 313-23, 349  
28th Pursuit: 302-11  
49th Pursuit: 302  
50th Observation: 235-43, 245-55  
88th Observation: 29, 33-34, 171-83, 198-219, 221-33, 235-43, 245-55  
90th Observation: 235-43, 245-55  
91st Observation: 30, 37, 259-67, 269-73, 275-79  
93rd Pursuit: 302-11  
94th Pursuit: 31, 283-89, 295, 302-11  
95th Pursuit: 285-89, 302-11, 313-23, 349  
96th Bombardment: 31, 43, 283-89, 356-63, 365-69  
99th Observation: 30, 193-95, 235-43, 245-55  
103d Pursuit: 288-89, 302-11  
104th Observation: 235-43, 245-55  
135th Observation: 88, 235-43, 245  
139th Pursuit: 302  
141st Pursuit: 341-44  
147th Pursuit: 285-89, 302-11, 348-49  
148th Pursuit: 44-46, 85, 103, 302, 325-39, 344-48, 352  
166th Bombardment: 371-75  
185th Pursuit: 348-49  
213th Pursuit: 302-11

Staffs and staff officers: 49, 62, 65, 73-80, 387. *See also* Command and control  
British practice: 336  
corps air service: 199, 221, 246  
group: 172-74  
for history project: 3, 7-8

Standardization programs  
aircraft: 54, 61, 114  
armament: 147  
engines: 88  
in training programs: 83

- 
- Stevens, Captain Albert W.: 155
- Storage facilities: 61-62, 117, 123
- Strafing. *See* Tactical air support
- Strategic air support: 344, 346-47, 357-63, 365-69, 371-75
- Summersett, Captain James A., Jr.: 317
- Supply Branch, Aircraft Armament Section: 149
- Supply depots: 17, 55, 62, 72, 76, 79, 83, 91, 113, 117, 123, 126, 128  
command and control: 119  
strikes against: 371-73
- Supply officers: 62, 146, 172-73
- Supply operations and systems: 73, 76, 77-79, 83, 91, 109, 206, 222, 345. *See also* Services of Supply  
ammunition: 109, 148, 176  
armament: 17, 117, 119, 126, 145, 148-49, 263  
balloon gas: 70  
for balloons: 70, 140-41, 143  
disbursing requirements: 124-25  
distribution system: 119-21, 129  
enemy operations: 357  
engines: 119  
flow through Services of Supply: 119  
hydrogen: 70, 140-43  
personnel strength: 117, 119  
photo equipment: 151, 175  
priority schedules: 123  
purchasing system: 117, 122-24  
records system: 123  
requisitions and manifests handled: 117, 123, 128  
shortages: 231  
space required: 117, 126  
spare parts: 120, 123  
time intervals in: 123-24  
tonnage volumes: 117, 124  
transportation in: 119
- Supply Section, Air Service: 65, 69, 90, 117-28, 145
- Support by services: 90
- Surprise, principle of: 321
- Surveillance operations. *See* Reconnaissance, aerial

---

Switzerland, contracts with: 91

Synchronizing mechanisms: 146-47

Tactical air support

British operations: 326-39

enemy actions: 299

enemy morale, effect on: 49, 338

friendly morale, effect on: 310, 319

general operations: 17, 39, 43, 46, 49, 172, 176-78, 181-83, 186,  
188-90, 194-95, 201, 203-19, 223-33, 238-43, 248, 252-54, 293-  
94, 304, 307, 310, 314, 344, 346-47, 357-63, 365-69, 371

Tactical officers: 238

Tactics: 34, 42-43

British: 326-29, 331-32, 335-36, 361

changes and trends in: 81

enemy: 318, 326, 333, 357, 354-61

formation flying: 30-31, 34, 43, 218, 263-64, 268-70, 285, 292,  
296, 298, 309, 327-28, 334-35, 339, 361, 365, 368-69, 371, 374-  
75

formation flying, enemy: 326

formulation and adoption: 55

French: 361

in photographic and reconnaissance missions: 250-51, 263-65,  
269-70

in pursuit operations: 292-93, 302-304, 309-11, 318, 321-23

Tanks, cooperation with: 331

Tannois: 301

Technical Data Division, Technical Section: 134

Technical Section, Air Service: 8, 59, 62, 65, 76, 131-34, 145, 157-  
58

Technicians, procurement and training: 62, 93, 104

Telegraph facilities and communications: 194, 201, 212, 215-16,  
218

Telephone facilities and communications: 44, 123, 177, 188, 194,  
200-201, 206, 210, 212, 216, 218, 223-25, 230, 240-41, 248-49,  
284-85, 291, 296, 308, 310, 322, 343-44, 359, 373, 379, 383, 385,  
387

Terrain exercises: 186, 195, 231-32, 239-40, 248



- 
- Test pilots: 112
- Thayer, Lieutenant Lucien H.: 2-3
- Thiacourt: 306, 357
- Tools, production and procurement: 54, 69
- Torcy: 203
- Toul sector: 29-34, 46, 171-83, 206, 235, 237, 259-67, 275, 283-89, 291-92, 296, 298, 301-302, 308, 313, 341, 357, 359, 379, 381
- Toul-Nancy road: 259
- Touquin: 291
- Tours: 58, 69, 74, 92, 94, 97, 100, 105, 109, 123-24, 153
- Training aids, lack of: 58
- Training centers: 111
- Training films production: 152
- Training manuals: 125-26. *See also* Publications
- Training programs: 17, 29, 31, 40-41, 47, 51-52, 54-58, 65, 71-72, 82-83, 93-115
- accidents and casualties in: 27, 110-12
  - accomplishments: 112
  - in aerial photography: 152
  - armorers: 145-46
  - in artillery-fire adjustments: 102, 105, 208
  - aviation cadets: 93-95, 97, 103
  - balloon companies: 32, 137-38, 379, 381, 387-88
  - bombardiers: 58, 93, 97-98, 101, 103-104, 108
  - by British: 58, 72, 85, 88, 95, 99-100, 103, 108
  - in Canada: 85, 103
  - cross-training: 41
  - deficiencies in: 218-19, 228, 242, 245, 255
  - delays and purposelessness, effect of: 113
  - by French: 58-59, 85, 95, 99-101, 105, 108
  - ground crews: 171
  - with ground troops: 182-83, 189-90, 195, 200, 205, 207, 210, 213, 216, 219, 223, 231-32, 239, 248
  - gunnery: 30, 43, 93, 97-98, 101, 103-104, 106, 108-109, 266-67, 283, 375
  - hours flown in: 98, 112
  - hours flown per fatality: 110
  - industrial aspects: 113-14

---

instructors: 44, 85, 93, 103, 108, 152  
by Italy: 51, 58, 87, 99-101  
mechanics: 58-59, 76, 85, 99, 171, 259  
navigators: 103  
observers: 40, 47, 51, 58, 83, 90, 93, 97-98, 103-105, 137-138, 143,  
152, 172, 191, 266-67, 272, 357, 387-88  
pilots: 31, 39-40, 44-46, 51, 58, 71, 76, 82-83, 85-88, 93-95, 98-  
101, 103-106, 108, 112, 152, 171-72, 186, 191, 207, 259, 261-62,  
266-67, 272, 275, 278, 285-86, 306, 341, 357, 361  
problems in: 109  
in radio communications: 158-59, 218  
riggers: 58-59  
schools, inclusive dates at: 100  
standardizing: 83  
students eliminated: 112  
undesirables, eliminating: 113  
in United States: 103-104, 109

Training Section, Air Service: 58, 65, 78, 93, 97, 108

#### Transportation

balloon companies: 142  
British facilities: 325-26, 328  
deficiencies in: 47-48, 83, 97, 309, 320, 374  
in flow of supplies: 119  
liaison by air service: 124  
photographic units: 152  
problems in: 55-58  
tactical systems: 177-78

Transportation Division, Supply Section: 124

Transportation officers: 172-73

Trench systems: 171-72, 185-86, 192-94, 203, 246

Trucks. *See* Motor vehicles; Transportation

Tunnel guns: 371

#### United Kingdom (*see also* British Army; Royal Flying Corps)

aircraft production: 127-28  
assignments to: 59  
decorations awarded by: 46, 85  
training programs by: 58, 72, 85, 88, 95, 99-100, 103, 108  
tribute to: 163

United States Navy: 76, 87

- 
- Vadelaincourt: 245
- Vadenay: 137
- Varnish, analyzing: 134
- Vathemenil: 185, 202
- Vaucouleurs: 289, 301, 309, 313
- Vaux: 33, 197, 204, 207, 293
- Vavincourt: 273, 275
- Vendome: 100, 103
- Verdun sector: 231, 246, 273, 275, 313, 357-58
- Very pistol: 182
- Vesle River: 32-35, 212-16, 218, 221-33, 237-38, 296, 381
- Vigneulles: 39, 306-307, 357, 366
- Vigneulles-St. Benoit road: 307
- Vigneville-Chambley road: 307
- Villeneuve-les-Vertus: 283
- Villers-Bretonneux: 325, 330
- Vinets: 123, 146
- Vittonville: 368
- Vosges sector: 30, 193-95
- Vouziers: 275
- Voves: 100
- Warning systems, enemy: 358
- Water analysis and supply: 123, 133-34, 374
- Weather, effect on operations: 31, 38-42, 213, 240-41, 243, 249-50, 252, 255, 263, 265-67, 269-70, 275, 277-78, 306-307, 310-11, 321-22, 328-29, 331-32, 361, 365-66, 368-69, 372, 375, 381, 383
- Welfare agencies: 90-91
- Wheat, Lieutenant C. I.: 7
- Whitehead, Colonel Henry C.: 3-5

---

Wimperis bomb sight: 365  
Wing commanders: 237-38  
Wing, 1st Pursuit: 246, 301-11, 313-23, 344, 346-47  
Wings (airplane), number delivered: 127  
Winslow, Lieutenant Alan F.: 30, 284  
Wireless communications: 223, 289, 291, 296  
Wright, Lieutenant Burdette S.: 5  
Young Men's Christian Association: 90-91  
Ypres: 46, 289, 328  
Zone of Advance: 2-3, 62  
    Air Service stations in: 26, 73  
    early work in: 55  
    in organization scheme: 62  
    personnel shortages: 72  
    pilot assignments: 78