

2. HEALTH EFFECTS

2.1 INTRODUCTION

The primary purpose of this chapter is to provide public health officials, physicians, toxicologists, and other interested individuals and groups with an overall perspective of the toxicology of mercury. It contains descriptions and evaluations of toxicological studies and epidemiological investigations and provides conclusions, where possible, on the relevance of toxicity and toxicokinetic data to public health.

A glossary and list of acronyms, abbreviations, and symbols can be found at the end of this profile.

Mercury is a metal element that occurs naturally in the environment. Metallic or elemental mercury (Hg^0) is the main form of mercury released into the air by natural processes. Mercury bound to other chemicals may have valence states of either +1 (Hg^{+1}) or +2 (Hg^{+2}). Mercury with a valence state of +1 is referred to as mercurous mercury, and mercury with a valence state of +2 is referred to as mercuric mercury. Many inorganic and organic compounds of mercury can be formed from the mercuric (divalent) cation (Hg^{+2}). For information on the physical and chemical properties of mercury, refer to Chapter 3.

There are many similarities in the toxic effects of the various forms of mercury, but there are also significant differences. In the text, tables, and figures of this profile, the metallic mercury and the inorganic salts, including mercurous chloride, mercuric chloride, mercuric acetate, and mercuric sulfide, are organized under the general heading of inorganic mercury. The organic mercury compounds including methylmercuric chloride, dimethylmercury, and phenylmercuric acetate are addressed in this document under the heading of organic mercury. In most discussion in the text, the specific effects are attributable to a particular form, and the form is specified.

The general population is most commonly exposed to mercury primarily from two sources: (1) eating fish and marine mammals (e.g., whales, seals) that may contain some methylmercury in their tissues or (2) from the release of elemental mercury from the dental amalgam used in fillings. It is not known how much of the elemental mercury released from dental amalgam is inhaled as a mercury vapor, how much is breathed out, how much is swallowed in a liquid form, or how much is converted into a mercuric salt that is either swallowed or directly absorbed into the oral mucosa. Exposure to mercury, however, does not necessarily mean that adverse health effects will result. Health effects depend upon the amount of exposure, the form

2. HEALTH EFFECTS

of mercury, and the route of exposure. Each form and route leads to different effects, and these are discussed in detail in this chapter. The levels of mercury that the general population are exposed to from either fish or dental amalgam are discussed in Chapter 5. Hazard assessments combine the information in Chapter 5 on exposure levels with the dose-response information in this chapter to develop an estimate of the potential for adverse health effects from any given exposure.

In the environment, inorganic mercury can be methylated by microorganisms to methylmercury. Methylmercury will accumulate in the tissues of organisms. The animals at the top of the food chain tend to accumulate the most methylmercury in their bodies. Any source of mercury release to the environment may, therefore, lead to increased levels of methylmercury in tissues of large fish and mammals. Occupational exposures are primarily to metallic mercury vapor. Accidental exposures to mercury are more common than accidental exposures to many hazardous substances, because liquid mercury is shiny and interesting, and because liquid mercury has been used in many electrical and mechanical devices. Accidental exposures, even to small amounts of mercury, may be harmful. Liquid mercury is poorly absorbed by the skin and from the intestines, but vapors that are released from liquid mercury are readily absorbed through the lungs and are very harmful when inhaled. The text in this chapter provides considerable detail on a number of accidental exposures to all forms of mercury. This information is intended to inform the reader and help prevent accidental exposures in the future.

The literature on the health effects of mercury is extensive. However, the human and animal data are generally limited to inhalation exposure to metallic mercury vapors and oral exposure to inorganic and organic mercury compounds. There is limited dermal exposure information on adverse effects from ointments and creams that contain inorganic mercury compounds.

Once absorbed, metallic and inorganic mercury enter an oxidation-reduction cycle. Metallic mercury is oxidized to the divalent inorganic cation in the red blood cells and lungs of humans and animals. Evidence from animal studies suggests that the liver is an additional site of oxidation. Absorbed divalent cation from exposure to mercuric compounds can, in turn, be reduced to the metallic or monovalent form and released as exhaled metallic mercury vapor. In the presence of protein sulfhydryl groups, mercurous mercury (Hg^+) disproportionates to one divalent cation (Hg^{+2}) and one molecule at the zero oxidation state (Hg^0). The conversion of methylmercury or phenylmercury into divalent inorganic mercury can probably occur soon after absorption, also feeding into the oxidation-reduction pathway.

2. HEALTH EFFECTS

This profile contains a discussion of acrodynia under Relevance to Public Health (Section 2.5). Acrodynia is an idiosyncratic hypersensitivity response from exposure to mercury and is characterized by certain cardiovascular, dermal, and neurological effects, among others. In the section on health effects by route of exposure, the relevant symptoms are discussed under the appropriate headings without reference to the syndrome. This occurs, in part, because there is some overlap between symptoms characteristic of acrodynia and those seen in persons who are not hypersensitive and, in part, because not every report of a study in which the symptoms were observed states whether the authors considered the affected person to have suffered from acrodynia.

This profile also contains a general discussion of the human exposures to mercury associated with dental amalgam. This discussion is at the end of the Relevance to Public Health Section 2.5, under the heading More on Health Effects and Dental Amalgam.

2.2 DISCUSSION OF HEALTH EFFECTS BY ROUTE OF EXPOSURE

To help public health professionals and others address the needs of persons living or working near hazardous waste sites, the information in this section is organized first by route of exposure — inhalation, oral, and dermal; and then by health effect — death, systemic, immunological, neurological, reproductive, developmental, genotoxic, and carcinogenic effects. These data are discussed in terms of three exposure periods — acute (14 days or less), intermediate (15–364 days), and chronic (365 days or more).

Levels of significant exposure (LSE) for each route and duration are presented in Tables 2-1, 2-2, and 2-3 and illustrated in Figures 2-1, 2-2, and 2-3. The points in the figures showing no-observed-adverse-effect levels (NOAELs) or lowest-observed-adverse-effect levels (LOAELs) reflect the actual doses (levels of exposure) used in the studies. LOAELs have been classified into "less serious" or "serious" effects. "Serious" effects are those that evoke failure in a biological system and can lead to morbidity or mortality (e.g., acute respiratory distress or death). "Less serious" effects are those that are not expected to cause significant dysfunction or death, or those whose significance to the organism is not entirely clear. ATSDR acknowledges that a considerable amount of judgment may be required in establishing whether an end point should be classified as a NOAEL, "less serious" LOAEL, or "serious" LOAEL, and that in some cases, there will be insufficient data to decide whether the effect is indicative of significant dysfunction. However, the Agency has established guidelines and policies that are used to classify these end-points. ATSDR believes that there is sufficient merit in this approach to warrant an attempt at distinguishing between "less

2. HEALTH EFFECTS

serious" and "serious" effects. The distinction between "less serious" effects and "serious" effects is considered to be important because it helps the users of the profiles to identify levels of exposure at which major health effects start to appear. LOAELs or NOAELs should also help in determining whether or not the effects vary with dose and/or duration, and place into perspective the possible significance of these effects to human health.

The significance of the exposure levels shown in the Level of Significant Exposure (LSE) tables and figures may differ depending on the user's perspective. Public health officials and others concerned with appropriate actions to take at hazardous waste sites may want information on levels of exposure associated with more subtle effects in humans or animals (LOAELs) or exposure levels below which no adverse effects (NOAELs) have been observed. Estimates of levels posing minimal risk to humans (Minimal Risk Levels or MRLs) may be of interest to health professionals and citizens alike.

Levels of exposure associated with carcinogenic effects (Cancer Effect Levels, CELs) of mercury are indicated in Tables 2-2 and 2-3 and Figures 2-2 and 2-3. Cancer effects could occur at lower exposure levels; however, a range for the upper bound of estimated excess risks (ranging from a risk of 1 in 10,000 to 1 in 10,000,000 [10^{-4} to 10^{-7}]) has not been developed by EPA.

Estimates of human Minimal Risk Levels (or MRLs) have been made for mercury. An MRL is defined as an estimate of daily human exposure to a substance that is likely to be without an appreciable risk of adverse effects (noncarcinogenic) over a specified duration of exposure. Although the term, MRL, may seem to imply a slight level of risk, MRLs are, in fact, considered to represent safe levels of exposure for all populations, including sensitive subgroups. MRLs are derived when reliable and sufficient data exist to identify the target organ(s) of effect or the most sensitive health effect(s) for a specific duration within a given route of exposure. MRLs are based on noncancerous health effects only and do not consider carcinogenic effects. MRLs can be derived for acute, intermediate, and chronic duration exposures for inhalation and oral routes. Appropriate methodology does not exist to develop MRLs for dermal exposure.

Although methods have been established to derive these levels (Barnes and Dourson 1988; EPA 1990a), uncertainties are associated with these techniques. Furthermore, ATSDR acknowledges additional uncertainties inherent in the application of the procedures to derive less than lifetime MRLs. As an example, acute inhalation MRLs may not be protective for health effects that are delayed in development or are acquired following repeated acute insults, such as hypersensitivity reactions, asthma, or chronic

2. HEALTH EFFECTS

bronchitis. As these kinds of health effects data become available and methods to assess levels of significant human exposure improve, these MRLs may be revised.

2.2.1 Inhalation Exposure

Most of the studies on inhalation exposure concern exposure to metallic mercury vapor. For this reason, the term “metallic mercury” will be used in this section instead of “inorganic mercury.” Other forms of inorganic mercury do not pose a risk by the inhalation pathway. Inhalation of sufficient levels of metallic mercury vapor has been associated with systemic toxicity in both humans and animals. The major target organs of metallic mercury-induced toxicity are the kidneys and the central nervous system. At high-exposure levels, respiratory, cardiovascular, and gastrointestinal effects also occur. Some metallic mercury vapor may condense (Milne et al. 1970), or in the case of vapors from dental amalgam, may dissolve in saliva and be ingested (WHO 1991). Condensed droplets are more likely to be ingested than inhaled (resulting in a lower absorbed dose than would be expected for a given concentration in air). Mercury vapor concentrations in the general work environment may also be lower than those in the micro-environment immediately surrounding workers (Bell et al. 1973; Stopford et al. 1978); therefore, estimates of air mercury values in occupational studies should be carefully evaluated for bias towards a level that may be lower than actual exposure levels.

No studies were located concerning effect levels following inhalation exposure to inorganic salts of mercury (e.g., mercuric or mercurous salts, oxides). Also, much of the information located regarding effects of metallic mercury vapors or volatile organic compounds (VOCs) comes from studies with significant limitations. Information on inhalation exposure to organic mercury compounds (e.g., alkyl mercury compounds) in humans is limited to case reports and includes only qualitative data on gastrointestinal, renal, muscular, and neurological effects. In many cases, it is difficult to determine whether effects observed in exposed persons were directly attributable to mercury exposure. In addition, a great deal of the information on effects associated with inhalation exposure to metallic mercury vapor comes from studies conducted several decades ago, when methods for determining exposure levels were less precise than current methods.

2. HEALTH EFFECTS

2.2.1.1 Death

Metallic Mercury. Several studies have reported death in humans following accidental acute-duration exposure to high, but unspecified, concentrations of metallic mercury vapor (Campbell 1948; Kanluen and Gottlieb 1991; Matthes et al. 1958; Rowens et al. 1991; Soni et al. 1992; Tauveg et al. 1992; Teng and Brennan 1959; Tennant et al. 1961). Death in all cases was attributed to respiratory failure. In all of these cases, high levels of mercury vapors were generated by volatilizing metallic mercury by heating.

Available animal data on death from exposure to metallic mercury vapors were also limited to acute-duration exposures (Ashe et al. 1953; Christensen et al. 1937; Livardjani et al. 1991b). Rats, guinea pigs, and mice died from severe pulmonary edema following a 24–48-hour exposure to an unspecified concentration of metallic mercury vapor resulting from spillage of mercury droplets on the floor of a static exposure chamber (Christensen et al. 1937). Exposure of rats to 27 mg/m³ of elemental mercury vapors for 2 hours, followed by observation for 15 days, resulted in substantial mortality (20 of 32 rats died prior to their scheduled sacrifice) (Livardjani et al. 1991b). Rabbits appeared to be less sensitive, with death occurring in 1 of 2 rabbits exposed to 28.8 mg/m³ metallic mercury for 30 hours and no deaths in rabbits exposed to the same concentration for 20 hours or less (Ashe et al. 1953).

All reliable LOAEL values for death following exposure to inorganic mercury in each species and duration category are recorded in Table 2-1 and plotted in Figure 2-1.

Organic Mercury. Case studies of occupational exposure to alkyl mercury compounds have reported deaths in humans following inhalation exposure to organic mercury vapors. The cause of death was not reported, but most subjects died after developing profound neurotoxicity (Hill 1943; Hook et al. 1954). Exposure to diethylmercury vapor (estimated exposure level = 1–1.1 mg/m³) for 4–5 months resulted in the death of 2 women (Hill 1943). The cause of death was not reported; however, the symptoms experienced by the women were consistent with mercury toxicity, and autopsies revealed pronounced gastrointestinal disorder. It is unclear whether the gastrointestinal effects were directly attributable to the mercury exposure. A 41-year-old man with 3–4 years of exposure to alkyl mercury compounds used in seed dressing died within approximately 3 months after cleaning up a spill of liquid containing alkyl mercury (Hook et al. 1954). A 57-year-old male employed for 5 years treating lumber with an alkyl mercury preparation (unspecified) died soon after developing neurological toxicity (Lundgren and Swensson 1949).

Table 2-1. Levels of Significant Exposure to Inorganic Mercury - Inhalation

Key to figure ^a	Species (strain)	Exposure/ duration/ frequency	System	NOAEL (mg/m ³)	LOAEL		Reference Chemical Form
					Less serious (mg/m ³)	Serious (mg/m ³)	
ACUTE EXPOSURE							
Death							
1	Rat (Wistar)	1 or 2 hr				27 M (20/32 died prior to scheduled sacrifice)	Livardjani et al. 1991 ELEM
Systemic							
2	Rat (Wistar)	1 or 2 hr	Resp			27 M (death by asphyxiation; lung edema; hyaline membranes, necrosis of alveolar epithelium; and fibrosis)	Livardjani et al. 1991 ELEM
3	Rabbit	1-30 hr	Resp			28.8 (marked cellular degeneration and some necrosis)	Ashe et al. 1953 ELEM
			Cardio			28.8 (marked cellular degeneration and some necrosis)	
			Gastro			28.8 (marked cellular degeneration and some necrosis)	
			Hepatic			28.8 (widespread necrosis)	
			Renal			28.8 (widespread necrosis)	
Neurological							
4	Rabbit	1-30 hr				28.8 (brain necrosis)	Ashe et al. 1953 ELEM

Table 2-1. Levels of Significant Exposure to Inorganic Mercury - Inhalation (continued)

Key to figure ^a	Species (strain)	Exposure/ duration/ frequency	System	NOAEL (mg/m3)	LOAEL		Reference Chemical Form	
					Less serious (mg/m3)	Serious (mg/m3)		
Developmental								
5	Rat (Sprague-Dawley)	8 d 1 or 3 hr/d Gd 11-14 + 17-20				1.8	(offspring hypoactive at 3 mo of age, significant retardation in spatial learning, reduced ability to adapt to new environment)	Danielsson et al. 1993 ELEM
6	Rat (Sprague-Dawley)	7d 1,4 hr/d ppd 11-17				0.05 M	(offspring hyperactive, significantly impaired spatial learning)	Fredriksson et al. 1992 ELEM
7	Rat (Sprague-Dawley)	6 d 1.5 hr/d Gd 14-19				1.8	(offspring hyperactive, significantly impaired spatial learning, deficits in adaptive behavior)	Fredriksson et al. 1996 ELEM
INTERMEDIATE EXPOSURE								
Systemic								
8	Rat	12-42 wk 5 d/wk 3 hr/d	Resp Hepatic Renal	3.0 M 3.0 M			3.0 M (dense deposits in tubular cells; lysosomal inclusions)	Kishi et al. 1978 ELEM

Table 2-1. Levels of Significant Exposure to Inorganic Mercury - Inhalation (continued)

Key to figure ^a	Species (strain)	Exposure/duration/frequency	System	NOAEL (mg/m ³)	LOAEL		Reference Chemical Form
					Less serious (mg/m ³)	Serious (mg/m ³)	
9	Rabbit	1-11 wk 5 d/wk 7 hr/d	Resp		6.0	(unspecified histopathological changes in lungs)	Ashe et al. 1953 ELEM
			Cardio		6.0	(unspecified histopathological changes in heart)	
			Gastro		6.0	(unspecified histopathological changes in colon)	
			Hepatic		6.0	(marked cellular degeneration with mild necrosis in liver)	
			Renal		6.0	(marked cellular degeneration; widespread necrosis in kidneys)	
10	Rabbit	12 wk 5 d/wk	Cardio		0.86	(unspecified histopathological changes)	Ashe et al. 1953 ELEM
			Renal		0.86	(mild to moderate unspecified histopathological changes in the kidneys)	
Immunological/Lymphoreticular							
11	Mouse (SJL/N)	10 wk 5 d/wk 0.5-19 hr/d		0.075 F	0.17 F	(serum antinucleolar antibodies)	Warfvinge et al. 1995 ELEM
Neurological							
12	Rat	12-41 wk 5 d/wk 3 hr/d				3.0 M (significant decline in conditioned avoidance response and increase in escape response latency)	Kishi et al. 1978 ELEM

Table 2-1. Levels of Significant Exposure to Inorganic Mercury - Inhalation (continued)

Key to figure ^a	Species (strain)	Exposure/ duration/ frequency	System	NOAEL (mg/m ³)	LOAEL		Reference Chemical Form	
					Less serious (mg/m ³)	Serious (mg/m ³)		
13	Rabbit	12 wk 5 d/wk 7 hr/d				0.86	(unspecified histopathological changes in the brain)	Ashe et al. 1953 ELEM
14	Rabbit	1-11 wk 5 d/wk 7 hr/d				6.0	(marked cellular degeneration with brain necrosis)	Ashe et al. 1953 ELEM
15	Rabbit	13 wk 4 d/wk 6 hr/d				4	(tremors)	Fukuda 1971 ELEM
Developmental								
16	Monkey (Squirrel)	15-17 wk 5 d/wk 4 or 7 hr/d last 2/3 gestation				0.5	(increase in duration and variability in lever-press performance, aberrant transitions)	Newland et al. 1996 ELEM
CHRONIC EXPOSURE								
Systemic								
17	Rat	72 wk 5 d/wk 7 hr/d	Renal	0.1				Ashe et al. 1953 ELEM
18	Dog	83 wk 5 d/wk 7 hr/d	Renal	0.1				Ashe et al. 1953 ELEM
19	Rabbit	83 wk 5 d/wk 7 hr/d	Renal	0.1				Ashe et al. 1953 ELEM

Table 2-1. Levels of Significant Exposure to Inorganic Mercury - Inhalation (continued)

Key to figure ^a	Species (strain)	Exposure/ duration/ frequency	System	NOAEL (mg/m ³)	LOAEL		Reference Chemical Form
					Less serious (mg/m ³)	Serious (mg/m ³)	
Neurological							
20	Human	1-5 yr			0.076 M (difficulty with heel-to-toe gait)		Ehrenberg et al. 1991 ELEM
21	Human	1-41 yr 15.3 yr mean			0.026 ^b M (increased frequency of mild intention tremors with weight load)		Fawer et al. 1983 ELEM
22	Human	0.7-24 yr			0.014 (impaired performance on neurobehavioral tests)		Ngim et al. 1992 ELEM

^aThe number corresponds to entries in Figure 2-1.

^bUsed to derive a chronic inhalation Minimal Risk Level (MRL) of 2×10^{-4} mg/m³; concentration corrected for intermittent exposure and divided by an uncertainty factor of 30 (3 for use of a minimal LOAEL and 10 for human variability).

ALT = alanine amino transferase; AST = aspartate aminotransferase; Bd Wt = body weight; Cardio = cardiovascular; CEL = cancer effect level; d = day(s); ELEM = elemental mercury; Endocr = endocrine; F = female; Gastro = gastrointestinal; Gd = gestational day; Hemato = hematological; hr = hour(s); IgA = immunoglobulin A; IgG = immunoglobulin G; IgM = immunoglobulin M; LOAEL = lowest-observed-adverse-effect level; M = male; min = minute(s); mo = month(s); NOAEL = no-observed-adverse-effect level; NS = not specified; occup = occupational; ppd = postpartum day (s); Resp = respiratory; wk = week(s); yr = year(s)

Figure 2-1. Levels of Significant Exposure to Inorganic Mercury - Inhalation

Acute (≤14 days)

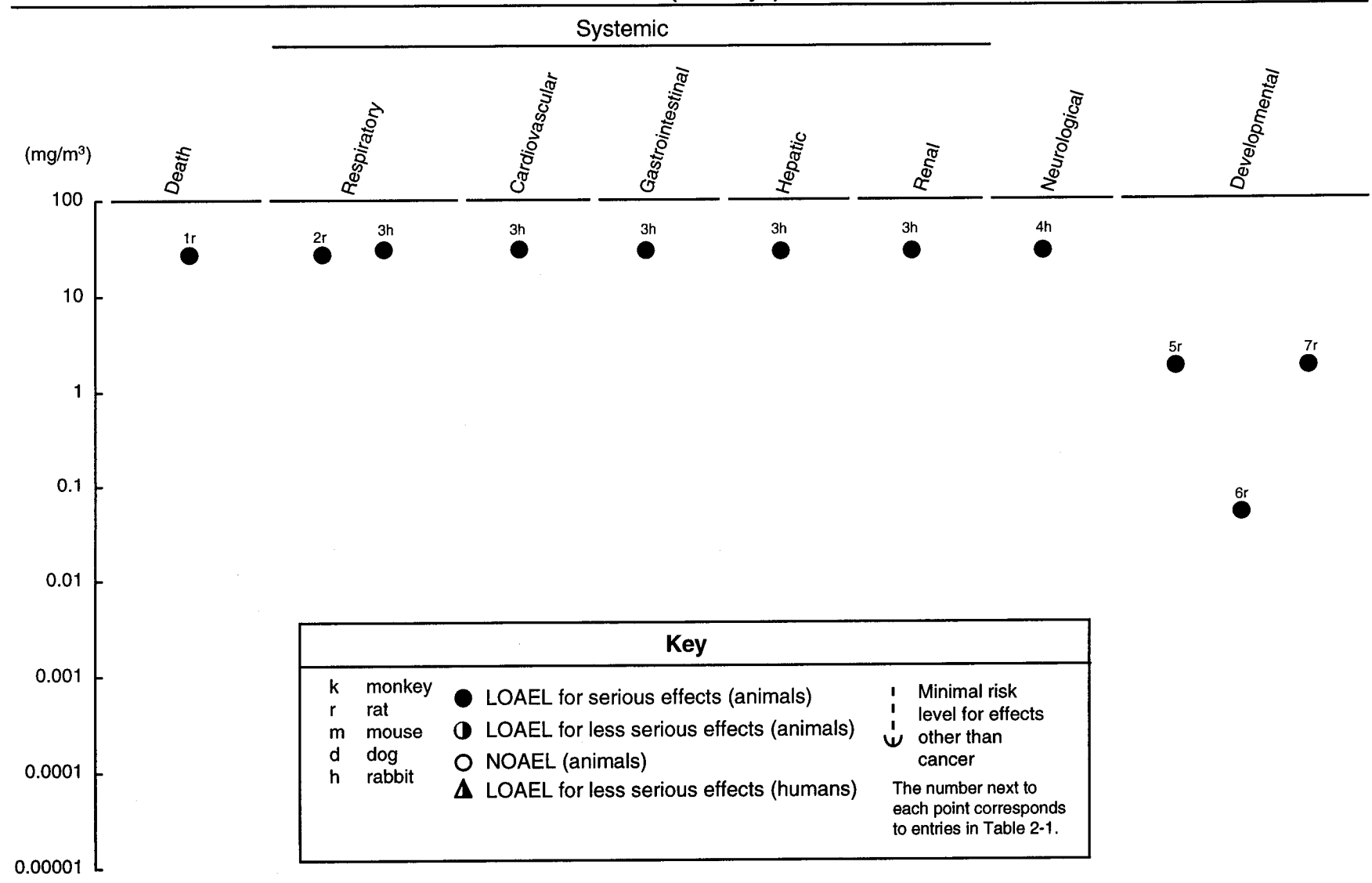

Figure 2-1. Levels of Significant Exposure to Inorganic Mercury - Inhalation (cont.)
Intermediate (15-364 days)

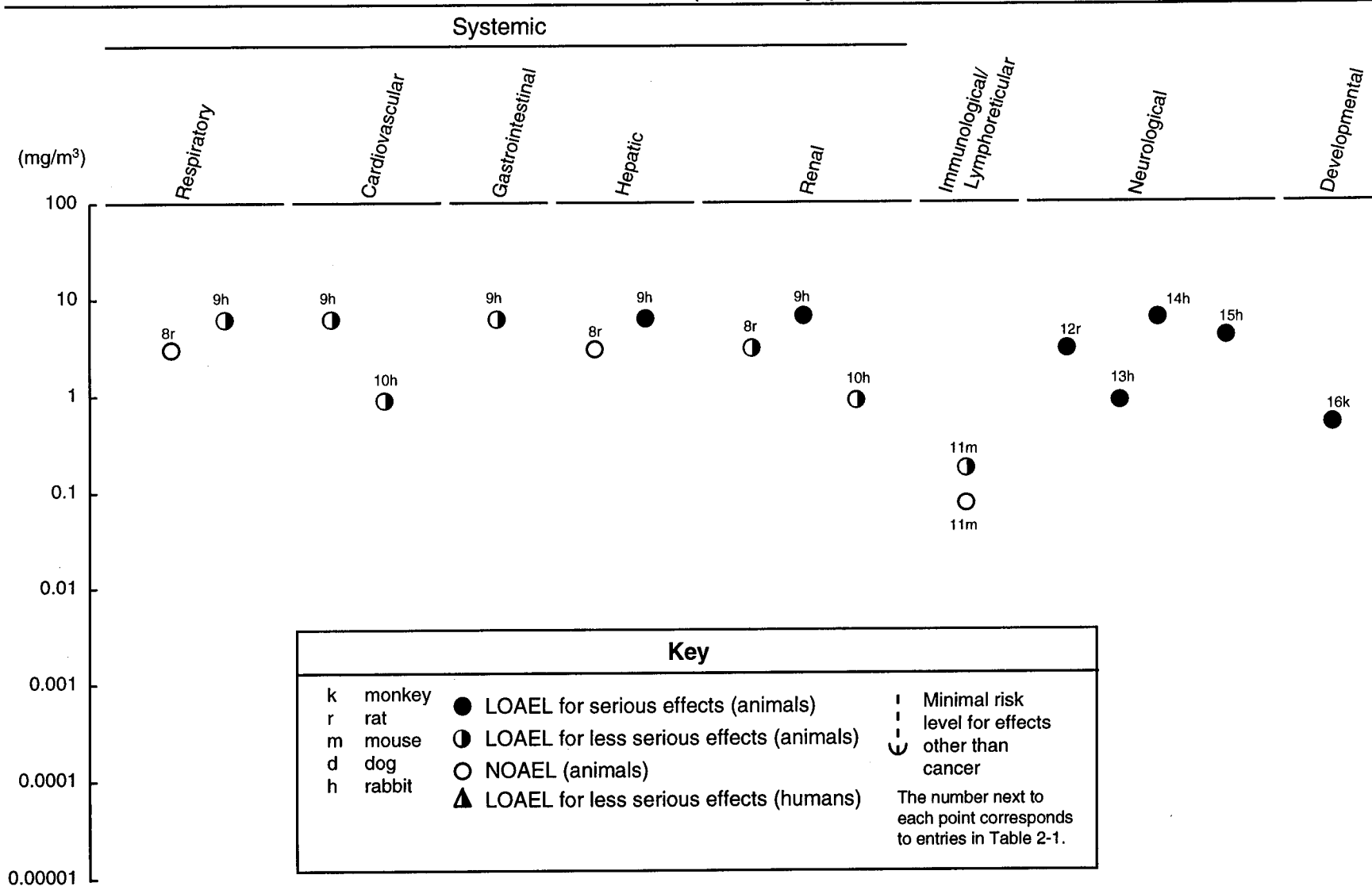
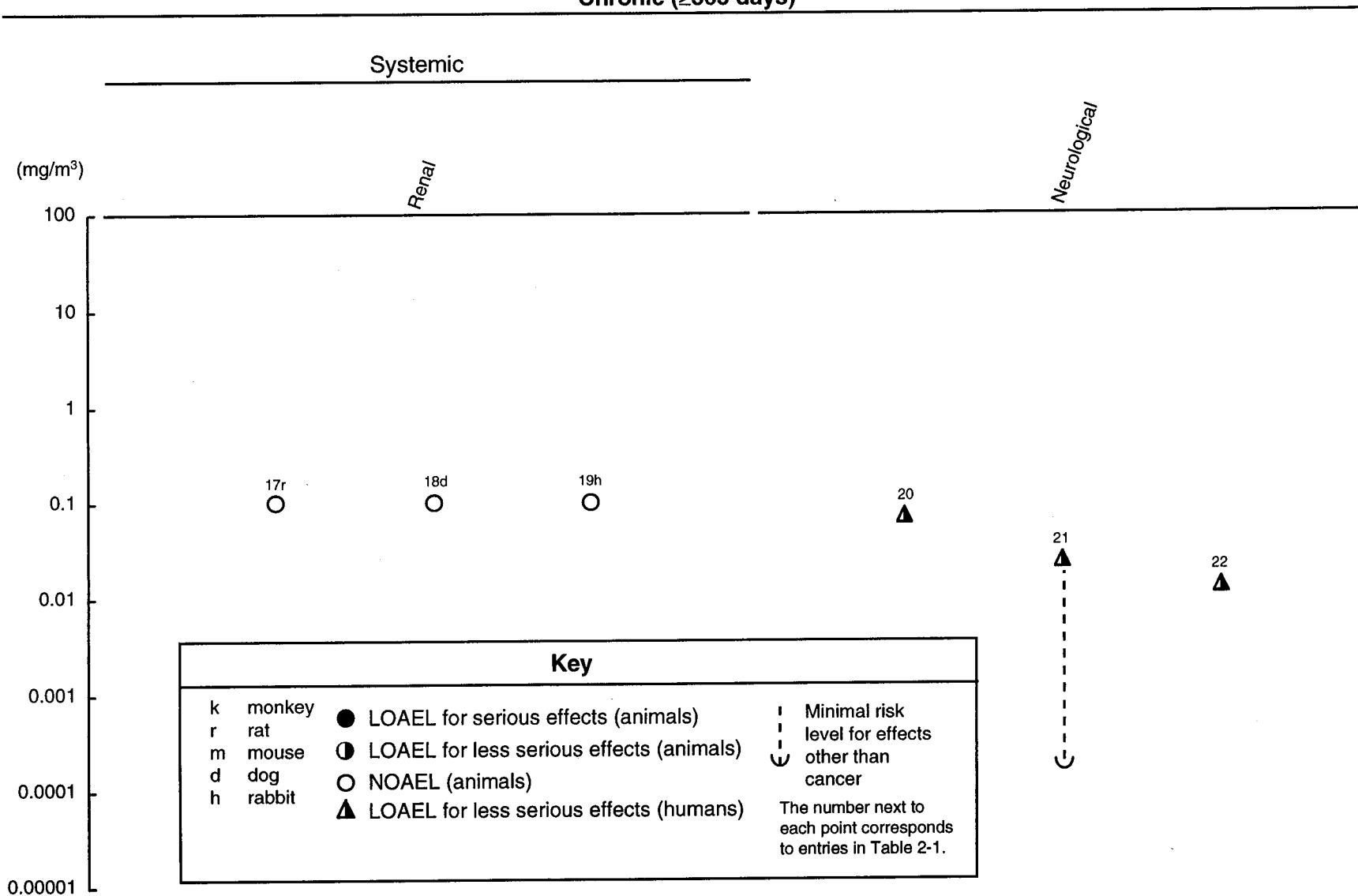

Figure 2-1. Levels of Significant Exposure to Inorganic Mercury - Inhalation (cont.)
Chronic (≥365 days)



2. HEALTH EFFECTS

A 39-year-old farmer who had treated seeds with phenylmercuric acetate for 6–7 seasons died within several months of developing severe neurological toxicity (Brown 1954).

Four rats died soon after developing severe ataxia following inhalation of unspecified concentrations of methylmercury iodide vapor for 22 days (Hunter et al. 1940).

2.2.1.2 Systemic Effects

The highest NOAEL values and all reliable LOAEL values for systemic effects in each species and duration category are recorded in Table 2-1 and plotted in Figure 2-1.

Respiratory Effects

Metallic Mercury. In humans, respiratory symptoms are a prominent effect of acute-duration high-level exposure to metallic mercury vapors. The most commonly reported symptoms include cough, dyspnea, and tightness or burning pains in the chest (Bluhm et al. 1992a; Gore and Harding 1987; Haddad and Sternberg 1963; Hallee 1969; Kanlun and Gottlieb 1991; King 1954; Lilis et al. 1985; Matthes et al. 1958; McFarland and Reigel 1978; Milne et al. 1970; Rowens et al. 1991; Snodgrass et al. 1981; Soni et al. 1992; Taueg et al. 1992; Teng and Brennan 1959; Tennant et al. 1961). X-ray analyses of the lungs have primarily shown diffuse infiltrates or pneumonitis (Bluhm et al. 1992a; Garnier et al. 1981; Gore and Harding 1987; Hallee 1969; King 1954; Soni et al. 1992; Tennant et al. 1961). Pulmonary function may also be impaired. Airway obstruction, restriction, hyperinflation (Snodgrass et al. 1981), and decreased vital capacity (Lilis et al. 1985; McFarland and Reigel 1978) have been reported. The decreased vital capacity observed by Lilis et al. (1985) persisted for 11 months after exposure. In the more severe cases, respiratory distress, pulmonary edema (alveolar and interstitial), lobar pneumonia, fibrosis, and desquamation of the bronchiolar epithelium have been observed. The ensuing bronchiolar obstruction by mucus and fluid results in alveolar dilation, emphysema, pneumothorax, and possibly death (Campbell 1948; Gore and Harding 1987; Jaffe et al. 1983; Kanlun and Gottlieb 1991; Matthes et al. 1958; Taueg et al. 1992; Teng and Brennan 1959; Tennant et al. 1961).

Little information is available regarding exposure levels resulting in the above symptoms. However, workers accidentally exposed to mercury vapors at an estimated concentration of up to 44.3 mg/m³ for 4–8 hours exhibited chest pains, dyspnea, cough, hemoptysis, impairment of pulmonary function (i.e.,

2. HEALTH EFFECTS

reduced vital capacity), diffuse pulmonary infiltrates, and evidence of interstitial pneumonitis (McFarland and Reigel 1978).

Very little information was located regarding respiratory effects associated with intermediate-duration exposures. However, two studies noted chronic coughs in subjects exposed to metallic mercury vapor for several weeks (Schwartz et al. 1992; Sexton et al. 1976). No respiratory symptoms and no abnormalities were noted upon examining chest X-rays or the results of pulmonary function tests in a group of chloralkali workers exposed for an average of >6 years to levels of mercury ranging from near 0 to 0.27 mg/m³ (85% of the group was exposed at or below 0.1 mg/m³) (Smith et al. 1970).

Respiratory effects in animals have been observed following acute inhalation exposure of metallic mercury vapors. Rats exposed to 27 mg/m³ of elemental mercury vapors for 2 hours then observed for 15 days displayed dyspnea and death due to asphyxiation (Livardjani et al. 1991b). Respiratory tract lesions included lung edema, necrosis of the alveolar epithelium and hyaline membranes, and occasional lung fibrosis.

Exposure to 28.8 mg/m³ of mercury vapor lasting from 1 to 20 hours produced effects ranging from mild to moderate pathological changes (unspecified) (Ashe et al. 1953). For exposures lasting 30 hours, marked cellular degeneration and some necrosis were observed in the lungs of 1 rabbit. Less severe respiratory changes (unspecified mild-to-moderate pathological changes) were reported in rabbits following exposure to metallic mercury vapor at 6 mg/m³ for 7 hours a day, 5 days a week for 1–11 weeks (Ashe et al. 1953). The usefulness of these results is limited because the study did not specify the pathological changes nor distinguish between primary and secondary effects (i.e., pathological changes secondary to induced shock).

Congested lungs were observed in rats exposed to 1 mg/m³ metallic mercury vapors for 100 hours continuously per week for 6 weeks (Gage 1961). In rats exposed to 3 mg/m³ mercury vapor for only 3 hours a day, 5 days a week for 12–42 weeks, pathological examination revealed no significant changes in the respiratory system (Kishi et al. 1978). The potential for oral exposure was not quantified in these studies; however, it is likely that most of the exposure was via inhalation.

Organic Mercury. Dyspnea, respiratory depression, and respirations frequently obstructed by mucus were observed in a farmer who had treated grain with phenylmercuric acetate for several seasons (Brown 1954). An autopsy revealed purulent bronchopneumonia. It is unclear whether the respiratory effects were direct

2. HEALTH EFFECTS

effects of the phenylmercuric acetate or secondary to the severe neurotoxicity also seen in this subject. A case study reported that no respiratory effects were observed in four men inhaling unspecified concentrations of methylmercury for several months (Hunter et al. 1940). Both of these studies are limited because exposure levels were unknown.

No studies were located regarding respiratory effects in animals after inhalation exposure to organic mercury.

Cardiovascular Effects

Metallic Mercury. Increases in heart rate and blood pressure have been reported following inhalation exposure to metallic mercury in humans. Acute inhalation exposure to high concentrations of metallic mercury vapor generated by heating metallic mercury resulted in increased blood pressure (Haddad and Sternberg 1963; Hallee 1969; Snodgrass et al. 1981) and heart rate/palpitations (Bluhm et al. 1992a; Haddad and Sternberg 1963; Hallee 1969; Jaffe et al. 1983; Snodgrass et al. 1981; Soni et al. 1992; Teng and Brennan 1959). In one of these cases, the increase in heart rate was characterized as a sinus tachycardia (Soni et al. 1992). Exposures of longer durations due to spills or occupational exposures have also been reported to result in increased blood pressure (Fagala and Wigg 1992; Foulds et al. 1987; Friberg et al. 1953; Karpathios et al. 1991; Tauieg et al. 1992) and increased heart rate (Fagala and Wigg 1992; Foulds et al. 1987). A single case report was located regarding cardiovascular effects resulting from inhalation of mercury vapors released from a paint that contained a high level of phenylmercuric acetate (Aronow et al. 1990). The affected child was diagnosed with acrodynia and exhibited a rapid heart beat and hypertension.

Chronic-duration occupational exposures, however, have given mixed results regarding effects on blood pressure and heart rate. Two studies of workers exposed to relatively low levels of mercury (near 0–0.27 mg/m³ in one study and an average of 0.075 mg/m³ in the other) for an average of greater than 6 or 7 years showed no effects on blood pressure or electrocardiography (Schuckmann 1979; Smith et al. 1970). In contrast, workers exposed to an estimated 0.03 mg/m³ of mercury vapor (estimate based on blood levels) for at least 5 years reported an increased incidence of palpitations, and cardiovascular reflex responses were slightly reduced compared to unexposed matched controls (Piikivi 1989). Also, workers in a thermometer plant had a high incidence of hypertension (5 of 9 workers) (Vroom and Greer 1972). A morbidity and mortality study of chloralkali workers showed an increased likelihood of death due to

2. HEALTH EFFECTS

ischemic heart and cerebrovascular disease (Barregard et al. 1990). These studies are limited, however, because exposure to other chemicals may have contributed to the effects observed, exposure levels may have been estimated from only a few actual determinations, and other risk factors were not consistently considered.

Significant increases in systolic blood pressure and diastolic blood pressure were found in volunteers with dental amalgam containing mercury when compared to a control group (matched for age and sex) that had no amalgam fillings (Siblerud 1990). However, the length of time that the individuals had the dental amalgams was not reported. Furthermore, the blood pressure levels of the amalgam group were closer than those of the nonamalgam group to "normal" blood pressure levels reported for the general population. The authors suggested that the populations from which such normal values are drawn are likely to include many people with amalgam dental fillings, but without additional data to determine which control group would best represent "normal," these results have limited use.

In animals, cardiovascular effects were noted following inhalation exposure to mercury vapor. Marked cellular degeneration with some necrosis of heart tissue was observed in rabbits following acute intermittent exposure to 28.8 mg/m³ metallic mercury vapor for periods ranging from 4 to 30 hours (Ashe et al. 1953). Mild-to-moderate pathological changes (unspecified) were seen for 1–4-hour exposures. Exposures to lower concentrations (0.86–6 mg/m³) of mercury vapor for periods ranging from 2 to 12 weeks also resulted in mild-to-moderate pathological changes (unspecified) in the hearts of rabbits. The usefulness of these results is limited because the study did not specify the pathological changes nor distinguish between primary and secondary effects (i.e., pathological changes secondary to induced shock).

Organic Mercury. Only two case histories were located regarding cardiovascular effects in persons exposed by inhalation to organic mercury compounds. No cardiovascular effects were reported in four men hospitalized for neurological symptoms after inhaling an unspecified concentration of methylmercury dust for at least several months (Hunter et al. 1940). Elevated blood pressure was reported in two men exposed occupationally to methylmercury compounds (dose not known) (Hook et al. 1954).

No studies were located regarding cardiovascular effects in animals after inhalation exposure to organic mercury.

2. HEALTH EFFECTS

Gastrointestinal Effects

Metallic Mercury. Many instances of gastrointestinal effects have been reported in humans following acute inhalation exposure to metallic mercury vapor. A classical sign of mercury intoxication is stomatitis (inflammation of the oral mucosa). Accordingly, a number of case studies have reported stomatitis after acute-duration exposure to high concentrations of metallic mercury vapors (Bluhm et al. 1992a; Garnier et al. 1981; Haddad and Sternberg 1963; Snodgrass et al. 1981; Tennant et al. 1961). Occasionally, the stomatitis was accompanied by excessive salivation (Hallee 1969; Karpathios et al. 1991) or difficulty swallowing (Campbell 1948). Other gastrointestinal effects observed after acute-duration exposure to high levels of mercury include abdominal pains (Bluhm et al. 1992a; Campbell 1948; Haddad and Sternberg 1963; Milne et al. 1970; Teng and Brennan 1959), nausea and/or vomiting (Haddad and Sternberg 1963; Hallee 1969; Kanlun and Gottlieb 1991; Lilis et al. 1985; Milne et al. 1970; Rowens et al. 1991; Snodgrass et al. 1981; Soni et al. 1992; Taueg et al. 1992), and diarrhea (Bluhm et al. 1992a; Kanlun and Gottlieb 1991; Rowens et al. 1991; Taueg et al. 1992; Teng and Brennan 1959). The autopsy of a young child who was intoxicated with mercury vapor and died of pulmonary edema revealed a grayish, necrotic mucosa of the stomach and duodenum (Campbell 1948).

Intermediate-duration exposures to mercury spills have also resulted in similar gastrointestinal effects. A case study reported that teenage girls exhibited anorexia, intermittent abdominal cramps, mild diarrhea, painful mouth, and bleeding gingiva 2 weeks after a spill of metallic mercury in their home (on carpet) resulted in the release of metallic mercury vapor (Sexton et al. 1976). Air levels in the home were measured 6 months after the initial spill and ranged from 0.02 to 1 mg Hg/m³, depending upon the degree of ventilation and proximity to the spill. Fagala and Wigg (1992) reported a case of colicky abdominal pain and diarrhea in a 12-year-old girl exposed to mercury vapors for approximately 6 months after a spill in her home.

Limited information was located regarding gastrointestinal effects in persons who are chronically exposed to elemental mercury vapors. Stomatitis was observed in 22 of 72 workers exposed to mercury vapors in the manufacture of thermometers in the 1940s (Bucknell et al. 1993). Drooling, sore gums, ulcerations of the oral mucosa, and/or diarrhea were observed in 5 of 9 workers in a thermometer-manufacturing plant (Vroom and Greer 1972). A correlation was also observed between mercury exposure levels and unspecified oropharyngeal symptoms in workers from a chloralkali plant (Smith et al. 1970).

2. HEALTH EFFECTS

Two animal studies assessed the gastrointestinal effects from mercury vapor exposure. In rabbits, effects ranging from mild pathological changes to marked cellular degeneration and some necrosis of the colon were observed following exposure to 28.8 mg/m³ mercury vapor for 4–30 hours (Ashe et al. 1953). A single exposure to 28.8 mg/m³ for 1–2 hours or multiple exposures of 6 mg/m³ for 7 hours a day, 5 days a week for up to 11 weeks resulted in either no changes or mild pathological changes. The usefulness of these results is limited because the study did not specify the pathological changes nor distinguish between primary and secondary effects (i.e., pathological changes secondary to induced shock).

Organic Mercury. Gastrointestinal effects were reported in several case studies of humans exposed to organomercurial compounds. A 39-year-old farmer who had dressed his seeds for several seasons with phenylmercuric acetate exhibited a swollen mouth, reddened and tender gums, carious teeth, a thin blue line at the gums, and an infected and swollen posterior pharyngeal wall (Brown 1954). Similarly, two women who died following 3–5 months of occupational exposure to diethylmercury vapors exhibited inflammation of the mouth and gums, excessive salivation, and unspecified gastrointestinal disorders (Hill 1943). Marked salivation was observed in one man and nausea was observed in another occupationally exposed to alkylmercury compounds used for dressing seeds (Hook et al. 1954). Gastrointestinal effects were not, however, observed in four men after inhalation of dust containing methylmercury for several months (Hunter et al. 1940).

No studies were located regarding gastrointestinal effects in animals after inhalation exposure to organic mercury.

Hematological Effects

Metallic Mercury. Initial exposure to high concentrations of elemental mercury vapors produces a syndrome similar to "metal fume fever," which is characterized by fatigue, fever, chills, and elevated leukocyte count. Evidence of moderate-to-high leukocytosis with neutrophilia was reported following acute inhalation exposure to metallic mercury vapor (Campbell 1948; Haddad and Sternberg 1963; Hallee 1969; Jaffe et al. 1983; Lilis et al. 1985; Matthes et al. 1958; Rowens et al. 1991).

Similarly, an elevated white cell count was observed in a 12-year-old girl with a 6-month exposure to mercury vapors from a spill of metallic mercury in her home (Fagala and Wigg 1992). Thrombocytopenia and frequent nosebleeds were reported in two of four family members exposed to mercury vapors in their

2. HEALTH EFFECTS

home as a result of a spill of metallic mercury (Schwartz et al. 1992). The authors considered this to be a unique reaction to the mercury exposure.

In volunteers with dental amalgam, significantly decreased hemoglobin and hematocrit and increased mean corpuscular hemoglobin concentrations were found compared to controls without dental amalgams (Siblerud 1990). δ -Aminolevulinic acid dehydratase activity in erythrocytes was decreased in workers exposed to elemental mercury in the manufacture of tungsten rods (Wada et al. 1969). The decreases correlated with increases in urinary mercury. The estimated exposure level to mercury in the plant was slightly less than 0.1 mg/m^3 . In workers exposed to $0.106\text{--}0.783 \text{ mg/m}^3$ mercury vapor, there was a significant increase in α_2 -macroglobulin and ceruloplasmin (an α -globulin protein active in the storage and transport of copper) compared to unexposed workers (Bencko et al. 1990).

No studies were located regarding hematological effects in animals after inhalation exposure to inorganic mercury.

Organic Mercury. No studies were located regarding hematological effects in humans or animals after inhalation exposure to organic mercury.

Musculoskeletal Effects

Metallic Mercury. A number of studies have reported increases in tremors, muscle fasciculations, myoclonus, or muscle pains after acute (Adams et al. 1983; Bluhm et al. 1992a; Karpathios et al. 1991; McFarland and Reigel 1978), intermediate (Aronow et al. 1990; Barber 1978; Sexton et al. 1976; Taueg et al. 1992), or chronic (Albers et al. 1982, 1988; Bidstrup et al. 1951; Chaffin et al. 1973; Chapman et al. 1990; Fawer et al. 1983; Smith et al. 1970; Verberk et al. 1986; Vroom and Greer 1972; Williamson et al. 1982) exposure to metallic mercury vapor. These effects are probably neurally mediated and are discussed more fully in Section 2.2.1.4.

No studies were located regarding musculoskeletal effects in animals after inhalation exposure to metallic mercury.

Organic Mercury. Exposure to unspecified alkyl mercury compounds has caused muscular effects (e.g., muscle fasciculations, absence of deep reflexes in arms, Babinski reflex) (Brown 1954; Hook et al. 1954;

2. HEALTH EFFECTS

Hunter et al. 1940). These effects may have been secondary to neurological changes and are discussed more fully in Section 2.2.1.4.

No studies were located regarding musculoskeletal effects in animals after inhalation exposure to organic mercury.

Hepatic Effects

Metallic Mercury. A case study described the acute poisoning of a young child who was exposed to mercury vapors that were produced from heating an unknown quantity of mercury (Jaffe et al. 1983). Hepatocellular effects were characterized by biochemical changes (e.g., elevated serum alanine aminotransferase [ALT]), ornithine carbamyl transferase, and serum bilirubin levels) and evidence of a decrease in the synthesis of hepatic coagulation factors. Similarly, hepatomegaly and central lobular vacuolation were observed in a man who died following acute-duration exposure to high levels of elemental mercury vapors (Kanlun and Gottlieb 1991; Rowens et al. 1991).

Serious liver effects have been noted in animals at high exposure concentrations. Acute inhalation exposure of rabbits to metallic mercury vapor concentrations of 28.8 mg/m³ for 6–30 hours resulted in effects ranging from moderate pathological changes (unspecified) to severe liver necrosis (Ashe et al. 1953). These effects were less severe (mild effects to degeneration) at shorter exposure durations and following exposure to 6 mg/m³ mercury vapors for 7 hours a day, 5 days a week for 1–5 weeks (Ashe et al. 1953). Effects ranging from moderate pathological changes to marked cellular degeneration and some necrosis were seen at mercury concentrations of 6 mg/m³ for 7 hours a day, 5 days a week for 6–11 weeks (Ashe et al. 1953). No hepatic changes were present in a pathological examination of the livers of rats intermittently exposed to 3 mg/m³ mercury vapor for only 3 hours a day, 5 days a week for 12–42 weeks (Kishi et al. 1978). The studies by Ashe et al. (1953) and Kishi et al. (1978) were deficient in quantitative data, and used a small number of animals. However, available human and animal data suggest that metallic mercury vapors can cause liver effects following acute exposures.

Organic Mercury. Midzonal necrosis in the liver was observed during the autopsy of a farmer who died after treating grain with phenylmercuric acetate for several seasons (Brown 1954). No conclusions can be drawn from this study, however, because other factors may have contributed to the hepatic effects in this subject.

No studies were located regarding hepatic effects in animals after inhalation exposure to organic mercury.

2. HEALTH EFFECTS

Renal Effects

Metallic Mercury. The kidney is a sensitive target organ of toxicity following inhalation exposure to metallic mercury. This sensitivity may be, in part, because of the relatively high accumulation of mercury in the kidneys. Acute high-concentration inhalation exposure in humans has resulted in effects ranging from mild transient proteinuria or s syndrome has been reported light changes in urinary acid excretion (Bluhm et al. 1992b; Soni et al. 1992); to frank proteinuria, hematuria, and/oliguria (Campbell 1948; Hallee 1969; Snodgrass et al. 1981); to acute renal failure with degeneration or necrosis of the proximal convoluted tubules (Campbell 1948; Jaffe et al. 1983; Kanluen and Gottlieb 1991; Rowens et al. 1991). Actual exposure concentrations are unknown in these cases, but urinary mercury excretion as high as 59–193 µg/hour has been reported (Bluhm et al. 1992b).

A nephrotic in two case studies of intermediate-duration exposure (Agner and Jans 1978; Friberg et al. 1953). In one report, the exposure was to a spill in the home (Agner and Jans 1978); in the other, the exposure was occupational (Friberg et al. 1953). The nephrotic syndrome was characterized by edema and proteinuria with albumin and hyaline casts in the urine. These changes usually abated within a few months following termination of exposure. Among a group of 10 patients who reported adverse effects associated with dental amalgams (the route of exposure in dental amalgams is probably a mixture of inhalation exposure to mercury vapor released from the amalgams, absorption of the vapor through the oral mucosa, and ingestion), a decrease in the ability to concentrate the urine and elevated urinary albumin were observed (Anneroth et al. 1992). Removal of one amalgam resulted in a significant decrease in urinary albumin (it is unknown whether other amalgams remained). In a study of renal function in 10 healthy volunteers having an average of 18 amalgam-filled tooth surfaces both before and after amalgam removal (Sandborgh-Englund and Nygren 1996), no signs of renal toxicity were found in conjunction with mercury released from the amalgam fillings. Although plasma mercury levels increased significantly one day after removal of the fillings (all removals were accomplished in one dental session), glomerular filtration rates were similar both before and after mercury exposure (amalgam removal). Blood, plasma, and urine mercury concentrations were significantly lower 60 days after amalgam removal.

The results from a number of studies show renal toxicity in workers chronically exposed to mercury vapor (Barregard et al. 1988; Bernard et al. 1987; Buchet et al. 1980; Cardenas et al. 1993; Danziger and

2. HEALTH EFFECTS

Possick 1973; Ehrenberg et al. 1991; Kazantzis et al. 1962; Langworth et al. 1992b; Piikivi and Ruokonen 1989; Roels et al. 1982; Stewart et al. 1977; Stonard et al. 1983; Sunderman 1978; Tubbs et al. 1982). Several of these reports have focused on workers with proteinuria (Danziger and Possick 1973; Kazantzis et al. 1962; Tubbs et al. 1982), while others have examined a variety of urinary parameters in exposed populations. Biopsies in the studies of workers with proteinuria have shown both proximal tubular and glomerular changes. In the report by Kazantzis et al. (1962), heavy albuminuria was reported to be accompanied by both proximal tubular damage and glomerulosclerosis. Examination of tissue samples from two other workers with proteinuria showed changes in the foot processes of cells associated with the glomerular basement membrane and deposition of IgG and C3 (Tubbs et al. 1982).

Comparisons of exposed populations to controls have shown a variety of changes in exposed workers, ranging from no effects (Bernard et al. 1987; Piikivi and Ruokonen 1989) to increases in urinary protein (Stewart et al. 1977), the specific gravity of the urine (Ehrenberg et al. 1991), and urinary *N*-acetyl- β -glucosaminidase (NAG) (Barregard et al. 1988; Boogaard et al. 1996; Langworth et al. 1992b). A detailed examination of markers for urinary dysfunction showed increases in urinary excretion of Tamm-Horsfall glycoprotein and tubular antigens and decreases in urinary pH and excretion of glycoaminoglycans, prostaglandin E2 and F2 α , and thromboxane B2 (Cardenas et al. 1993). Several studies have also shown correlations with some of these parameters and urinary mercury content (Buchet et al. 1980; Cardenas et al. 1993; Ehrenberg et al. 1991; Langworth et al. 1992b; Roels et al. 1982; Stonard et al. 1983). Attempts to define threshold levels for effects have produced mixed results. A no-effect level of 72 μg Hg/g creatinine was determined for urinary excretion of albumin, β_2 -microglobulin, or retinol binding protein (Bernard et al. 1987). However, other studies have shown increases in urinary albumin at urinary mercury levels >50 μg Hg/g creatinine (Buchet et al. 1980) and increases in urinary *N*-acetyl- β -glucosaminidase at urinary mercury levels of >50 or >100 μg Hg/g creatinine. Boogaard et al. (1996) reported that after exposure to mercury with urinary levels below the biological exposure index of 35 $\mu\text{g}/\text{g}$ creatinine, a transient increase in NAG was observed, but there was no correlation with duration of exposure and that this increase was not an early indicator of developing renal dysfunction. More information on correlation between urinary mercury levels and renal toxicity can be found in Section 2.5.

Serious degenerative effects have been observed in the kidneys of animals exposed to moderate-to-high levels of metallic mercury vapors following acute- and intermediate-duration exposures (Ashe et al. 1953). Effects ranging from marked cellular degeneration to tissue destruction and widespread necrosis were observed in rabbits exposed to mercury vapor at a concentration of 28.8 mg/m^3 for 2–30 hours. Moderate

2. HEALTH EFFECTS

pathological changes (unspecified) were also seen for 1-hour exposures. As the duration of exposure increased to 30 hours, extensive cell necrosis in the kidneys became evident. These results and the following results are limited as to their usefulness because the pathological changes are not described.

In an intermediate-duration study, rabbits exposed to mercury vapor concentrations of 0.86 mg/m³ for 7 hours a day, 5 days a week for 12 weeks exhibited moderate pathological kidney changes that were reversible with cessation of exposure (Ashe et al. 1953). Larger doses (6 mg/m³) administered for 7 hours a day, 5 days a week for up to 11 weeks, produced effects that ranged from mild, unspecified, pathological changes to marked cellular degeneration and widespread necrosis (Ashe et al. 1953).

In rats, slight degenerative changes (i.e., dense deposits in tubule cells and lysosomal inclusions) in the renal tubular epithelium were evident following exposure to 3 mg/m³ mercury vapor for 3 hours a day, 5 days a week for 12–42 weeks (Kishi et al. 1978).

Low-level chronic-duration inhalation exposures to 0.1 mg/m³ metallic mercury vapor for 7 hours a day, 5 days a week for 72–83 weeks in rats, rabbits, and dogs produced no microscopic evidence of kidney damage (Ashe et al. 1953). Only two dogs were tested in the study.

Organic Mercury. An autopsy of a man who died after acute high-level exposure to alkyl mercury vapor revealed necrosis of the tubule epithelium, swollen granular protoplasm, and nonstainable nuclei in the kidneys (Hook et al. 1954). No studies were available on renal effects following intermediate or chronic-duration exposure to organic mercury vapors in humans.

No studies were located regarding renal effects in animals after inhalation exposure to organic mercury.

Endocrine Effects

Metallic Mercury. A 13-year-old boy exposed to mercury vapors for 2 weeks developed a thyroid enlargement with elevated triiodothyronine, and thyroxine; and low thyroid-stimulating hormone levels (Karpathios et al. 1991). Serum-free thyroxine (T4) and the ratio of free thyroxine to free 3,5,3'-triiodothyronine (T3) were found to be slightly, but significantly, higher in workers with the highest exposure concentrations in a study of chloralkali workers exposed an average of 10 years to metallic mercury vapor (Barregard et al. 1994a, 1994b). Further, serum-free T3 was inversely associated with cumulative mercury exposure, suggesting a possible inhibitory effect of mercury on 5'-deiodinases, which is responsible for the

2. HEALTH EFFECTS

conversion of T4 to the active hormone T3. In this study, serum total testosterone (but not free testosterone) was positively correlated with cumulative mercury exposure, while prolactin, thyrotrophin, and urinary cortisol concentrations were not associated with exposure. However, two other occupational studies found no relationship between mercury exposure (unspecified concentration) and endocrine function (i.e., testicular, thyroid, and pituitary) (Erfurth et al. 1990; McGregor and Mason 1991). Biochemical indices that were measured in the occupational study by McGregor and Mason (1991) to assess endocrine effects included serum testosterone, sex-hormone binding globulin, thyroid-stimulating hormone, and prolactin. Erfurth et al. (1990) measured both basal serum concentrations of thyrotrophin, thyroxine, triiodothyronine, and cortisol, as well as the response to a thyrotrophin challenge.

No studies were located regarding endocrine effects in animals after inhalation exposure to metallic mercury.

Organic Mercury. No studies were located regarding endocrine effects in humans or animals after inhalation exposure to organic mercury.

Dermal Effects

Metallic Mercury. Inhalation exposure of individuals to elemental mercury vapors for acute and intermediate durations has resulted in erythematous and pruritic skin rashes (Aronow et al. 1990; Bluhm et al. 1992a; Foulds et al. 1987; Karpathios et al. 1991; Schwartz et al. 1992; Sexton et al. 1976). Other dermal reactions to mercury exposure include heavy perspiration (Aronow et al. 1990; Fagala and Wigg 1992; Karpathios et al. 1991; Sexton et al. 1976) and reddened and/or peeling skin on the palms of the hands and soles of the feet (Aronow et al. 1990; Fagala and Wigg 1992; Karpathios et al. 1991).

No studies were located regarding dermal effects in animals after inhalation exposure to metallic mercury.

Organic Mercury. No studies were located regarding dermal effects in humans or animals after inhalation exposure to organic mercury.

2. HEALTH EFFECTS

Ocular Effects

Metallic Mercury. Ocular effects observed following acute exposure included red, burning eyes and conjunctivitis (Bluhm et al. 1992a; Sexton et al. 1976). Workers chronically exposed to mercury have also exhibited a peculiar grayish-brown or yellow haze on the outer surface of their lenses (Atkinson 1943; Bidstrup et al. 1951; Locket and Nazroo 1952). These case studies contained insufficient quantitative data for dose-response assessment.

No studies were located regarding ocular effects in animals after inhalation exposure to metallic mercury.

Organic Mercury. No studies were located regarding ocular effects in humans or animals after inhalation exposure to organic mercury.

Other Systemic Effects

Metallic Mercury. Initial exposure to high concentrations of elemental mercury vapors produces a syndrome similar to "metal fume fever," which is characterized by fatigue, fever, chills, and an elevated leukocyte count. Accordingly, several studies have reported fever and/or chills in humans after exposure to high concentrations of elemental mercury vapors (Aronow et al. 1990; Bluhm et al. 1992a; Garnier et al. 1981; Lilis et al. 1985; McFarland and Reigel 1978; Milne et al. 1970; Schwartz et al. 1992; Snodgrass et al. 1981).

Organic Mercury. No studies were located regarding other systemic effects in humans or animals after inhalation exposure to organic mercury.

2.2.1.3 Immunological and Lymphoreticular Effects

Metallic Mercury. The immune reaction in humans to mercury exposure appears to be idiosyncratic, with either increases or decreases in immune activity depending on individual genetic predisposition (see Section 2.4). Therefore, it is not surprising that several studies of workers exposed to elemental mercury vapor have failed to show consistent or marked changes in immune function parameters in large populations. For example, no effect on serum immunoglobulins (IgA, IgG, or IgM) and no increase in autoantibody titres were observed in a group of chloralkali workers exposed for an average of 13.5 years

2. HEALTH EFFECTS

(Langworth et al. 1992b). Similarly, no increases in antilaminin antibodies were observed in workers exposed for an average of 7.9 years (Bernard et al. 1987), and no increase in antiglomerular basement membrane antibodies or IgE was seen in workers exposed for between 1.5 and 25 years (Cardenas et al. 1993). Slight decreases in IgA and IgG were observed in workers after more than 20 years of exposure to metallic mercury vapors when compared to unexposed controls (Moszczyński et al. 1990b). No significant differences in the concentrations of immunoglobulins or complement components were found in a study of 76 chloralkali workers previously exposed to mercury vapor for an average of 7.9 years (range, 1.1–36.2 years) (Ellingsen et al. 1994). No increase in the prevalence of autoantibodies was observed between the formerly exposed worker group and a control group of 53 age-matched referents. The average time elapsed since the cessation of occupational exposure was 12.3 years (range, 1–35 years).

Evidence of a human autoimmune response has been obtained in a few studies. Examination of the kidneys of two workers with proteinuria revealed granular deposition of IgG and the complement C3 in the glomeruli (Tubbs et al. 1982). Among a group of 10 patients who reported adverse effects associated with dental amalgams (the route of exposure is probably a mixture of inhalation exposure to mercury vapor released from the amalgams and dermal exposure to the amalgams), 3 had increased antiglomerular basement membrane antibodies and 2 had elevated antinuclear antibodies (Anneroth et al. 1992). After removal of one amalgam, there was a significant decrease in IgE (it is unknown whether other amalgams remained). Also, 1 of 89 workers examined by Langworth et al. (1992b) showed a weak reaction to antiglomerular basement membrane, and 8 of 44 workers examined by Cardenas et al. (1993) showed an abnormally high anti-DNA antibody titre. Only two studies have shown increases in immune parameters in exposed populations. Increases in IgA and IgM were observed in workers in a mercury producing plant (Bencko et al. 1990). The study is limited by a lack of information on daily dose levels, duration of employment and potential confounding factors (smoking, alcohol). An increase in anti-DNA antibodies was observed in workers from a chloralkali plant (Cardenas et al. 1993).

Other experimental evidence suggests that mercury can alter a number of parameters of the host's immune system and lead to increased susceptibility to infections, autoimmune diseases, and allergic manifestations. In workers exposed to mercury vapor concentrations of 0.024–0.09 mg/m³ for less than 10 and up to 31 years (Moszczyński et al. 1995), the stimulation of T-lymphocytes (as manifested by an increased number of T-cells [CD3+], T-helpers [CD4+], and T-suppressors [CD8+]) was observed in peripheral blood; however, no significant effect was seen on NK-cell (CD16+) count. A positive correlation was found between the T-helper cell count and the duration of exposure ($p < 0.05$). The combined stimulation of

2. HEALTH EFFECTS

the T-cell line and an observed decrease in the helper/suppressor ratio were suggestive of an autoimmune response.

In a mercury-producing plant, neutrophil function was found to be significantly reduced in workers with a mean exposure duration of 8 months (range, 0.5–46 months) (Perlingeiro and Queiroz 1995). In this study, both chemotactic and chemical-specific reducing activities of the neutrophils of exposed workers were found to be affected. While improved industrial hygiene practices over a 6-month period resulted in a decrease in urine mercury concentration in the workers, it did not result in the return of neutrophil migration activity to within the normal range. There was, however, no observed increase in the incidence of infections in the mercury-exposed group compared to controls. Based on their observations, Perlingeiro and Queiroz (1995) suggested that even exposures to levels of mercury considered "safe" in some industrial settings may lead to impairment of neutrophil function.

Exposure of genetically susceptible mice to mercury vapor for a period of 10 weeks resulted in an autoimmune response similar to that seen in similar mice after treatment with mercuric chloride by subcutaneous injections and in drinking water (Warfvinge et al. 1995). This response was manifested as a syndrome, which included a general stimulation of the immune system, with hyperimmunoglobulinemia, anti-nucleolar-fibrillar autoantibodies, and glomerular disease accompanied by vascular immune complex deposits. Actual inhalation exposure times for the 0.3–1 mg Hg/m³ exposure concentrations varied from 0.5 to 19 hours a day (5 days a week), but doses for individual exposure groups were also expressed in µg/kg/week units. The LOAEL for serum antinucleolar antibodies was determined to be an absorbed dose of 0.170 mg Hg/kg/week (from a 1.5-hour daily exposure to 0.5 mg/m³) and the corresponding NOAEL was a calculated absorbed dose of 0.075 mg/kg/day (from a 0.5-hour daily exposure to 0.0005 mg/m³). Higher doses were required for B-cell stimulation and for the development of immune complex deposits.

The highest NOAEL values and all reliable LOAEL values for immunological effects in each species and duration category are recorded in Table 2-1 and plotted in Figure 2-1.

Organic Mercury. No studies were located regarding immunological and lymphoreticular effects in humans or animals after inhalation exposure to organic mercury.

2. HEALTH EFFECTS

2.2.1.4 Neurological Effects

Metallic Mercury. The central nervous system is probably the most sensitive target organ for metallic mercury vapor exposure. Nervous system disorders following exposure to metallic mercury vapors are both consistent and pronounced. Acute-, intermediate-, and chronic-duration exposures elicit similar neurological effects. Symptoms intensify and may become irreversible as exposure duration and/or concentration increases. Most occupational studies discuss chronic-duration exposure to a time-weighted average (TWA) concentration or to a concentration range, thereby preventing the assessment of dose-response relationships within the populations studied. However, the average exposure levels for affected groups are similar in many of these studies.

In humans, several case studies have reported adverse neurological effects following acute inhalation of high concentrations of mercury vapor. A wide variety of cognitive, personality, sensory, and motor disturbances have been reported. The most prominent symptoms include tremors (initially affecting the hands and sometimes spreading to other parts of the body), emotional lability (characterized by irritability, excessive shyness, confidence loss, and nervousness), insomnia, memory loss, neuromuscular changes (weakness, muscle atrophy, muscle twitching), headaches, polyneuropathy (paresthesia, stocking-glove sensory loss, hyperactive tendon reflexes, slowed sensory and motor nerve conduction velocities), and performance deficits in tests of cognitive function (Adams et al. 1983; Bluhm et al. 1992a; Hallee 1969; Jaffe et al. 1983; Karpathios et al. 1991; Lilis et al. 1985; McFarland and Reigel 1978; Snodgrass et al. 1981). A few individuals have also noted hearing loss, visual disturbances (visual field defects), and/or hallucinations (Bluhm et al. 1992a; McFarland and Reigel 1978). In a case study of exposure to a calculated metallic mercury vapor level of 44 mg/m³ for <8 hours, workers experienced long-lasting feelings of irritability, lack of ambition, and lack of sexual desire (McFarland and Reigel 1978). Three and one-half months after exposure to high levels of mercury vapor during 2 days of an industrial liquid mercury salvaging operation, a 54-year-old man exhibited a syndrome resembling amyotrophic lateral sclerosis, characterized by slowed conduction velocities (suggestive of peripheral nerve damage). Urinary mercury levels were 100 µg/g creatinine at the time of the exam; after an additional 2 months (no treatment administered), levels dropped to less than 30 µg/g creatinine and symptoms disappeared (Adams et al. 1983). In contrast, chelation therapy (2.3 dimercaptosuccinic acid [DMSA] or – acetyl-D,L-penicillamine [NAP]) and lowering of urinary mercury levels did not result in improvement in depression, anxiety, phobias, psychotic-like behavior, interpersonal sensitivity, and hostility observed in another group of workers exposed to high concentrations of mercury vapor for up to 16 hours (Bluhm et al. 1992a).

2. HEALTH EFFECTS

In case reports of individuals exposed to inorganic mercury vapor for an intermediate duration, similar effects were reported (Barber 1978; Fagala and Wigg 1992; Foulds et al. 1987; Friberg et al. 1953; Sexton et al. 1976; Taueg et al. 1992). After 6 months of exposure to a spill of metallic mercury in the place where she slept, a 12-year-old girl experienced dizziness, joint pains, weakness, insomnia, numbness and tingling in her palms, decreased pinprick and vibration sensations in the lower extremities, intentional tremors, a slowing of the background rhythms on electroencephalograms, irritability, outbursts of temper, shyness, sensitivity, auditory hallucinations, and photophobia (Fagala and Wigg 1992). Similarly, a 4-year-old boy exposed for approximately 1 month to mercury vapors released from paint containing phenylmercuric acetate exhibited irritability, personality change, insomnia, headaches, weakness, and nerve dysfunction in the lower extremities (Aronow et al. 1990). This study is not discussed under organic mercury because the exposure was to metallic mercury vapors released from the paint.

Two adolescents (ages 13 and 15) who were unintentionally exposed to concentrated mercury vapors for 3 months developed a variety of more immediate- and long-term effects (Yeates and Mortensen 1994). In the 15-year-old male, the earliest symptoms included declining school performance, irritability, depression, neurobehavioral complaints, tremor, rash, hypertension, cold intolerance, diaphoresis, headaches, sleep disturbance, paresthesias, and anorexia. He was referred to a pediatric teaching hospital, where he was diagnosed with acrodynia and mercury poisoning. Before undergoing two courses of chelation therapy with 2,3-dimercaptosuccinic acid (DMSA), his average 24-hour urine mercury and blood mercury levels were 1,314 $\mu\text{g/L}$ and 23 $\mu\text{g/L}$, respectively. His 13-year-old half-sister, who was also exposed, had pretreatment average 24-hour urine mercury and blood mercury levels of 624 $\mu\text{g/L}$ and 69 $\mu\text{g/L}$, respectively; her pretreatment medical symptoms included tremor, rash, anorexia, paresthesias, and neuropsychiatric complaints (e.g., irritability, social withdrawal, and emotional lability). On hospital admission, she was diagnosed with acrodynia and underwent three courses of DMSA treatment, which were complicated by severe peripheral neuropathy, accompanied by a significant weight loss. Although the neuropathy was relatively mild at the time of initial neurological evaluation, it became progressively worse, and eventually the patient required a wheelchair and assistance eating. The neuropathy had resolved by the 1-year follow-up neuropsychological evaluation; however, despite removal from exposure, return of blood and urinary mercury to acceptable levels, and resolution of clinical signs of mercury poisoning and associated neuropsychiatric symptoms, both patients continued to show major deficits in visuoperceptual and constructional skills, nonverbal memory, and abstract reasoning.

2. HEALTH EFFECTS

A worker (age, mid-40s) exposed to mercury in a thermometer factory for approximately 3.5 years experienced acute, intermediate, chronic, and delayed neurological effects (White et al. 1993). During his employment, he performed a variety of functions, including sweeping mercury off floors with a vacuum cleaner or hose blower, repairing and cleaning machines, disassembling machines containing mercury, and operating a machine that crushed instruments so that he could then separate the mercury from other materials for reuse. From approximately the beginning of his employment at the factory, he experienced a number of symptoms, including blurred vision, ocular pain, rash, a strange taste in the mouth, weakness, memory loss, rage, and irrational behavior. The month following his release by the factory, his urine mercury concentration was measured at 690 $\mu\text{g/L}$, which confirmed a diagnosis of mercury poisoning. He was treated by chelation with penicillamine over a 2-month period; approximately 2 months after the completion of treatment, his urine mercury level was only 17 $\mu\text{g/L}$. Approximately 21 months after termination of his employment, neurological examination revealed nystagmus on upward gaze, bilateral manual tremor, diminished sensation to pain, peripheral neuropathy, and abnormalities in nerve conduction. An magnetic resonance imaging (MRI) examination revealed mild central and cortical atrophy, with punctiform foci of T2 in both frontal regions, especially underlying the precentral gyri and in the white matter (both subcortical and gyri). The MRI data were interpreted as consistent with diffuse and focal white matter disease. Neuropsychological testing conducted during the same time period revealed problems with cognitive function, fine manual motor coordination, visuospatial analysis and organization, memory for visuospatial information, affect, and personality almost 2 years after cessation of employment at the factory.

In contrast with the long-term (perhaps permanent) effects noted in the previous study, Yang et al. (1994) reported that recovery from chronic elemental mercury intoxication may be complete when patients are removed early from the exposure environment. A 29-year-old worker in a Taiwanese lampsocket-manufacturing facility, with an initial urinary mercury concentration of 610 $\mu\text{g/L}$ (in a 24-hour sample) and a blood mercury concentration of 237 $\mu\text{g/L}$ (reference range, $<10 \mu\text{g/L}$), exhibited a variety of symptoms, including blurred vision, dysarthria, prominent gingivitis, tremors (usually postural and intentional), unsteady gait, and slow mental response. The TWA concentration of mercury in the air in the room where he spent most of his working time during his 5 years on the job was 0.945 mg/m^3 . The worker also had a higher blood lead concentration of 450 $\mu\text{g/L}$ (reference range, $<20 \mu\text{g/L}$), and lead toxicity or interactions with mercury could have occurred. The man underwent an 8-week course of chelation with D-penicillamine, which resulted in a rapid improvement in gait; a complete recovery from all symptoms occurred over a 4-month period.

2. HEALTH EFFECTS

A 27-year-old female, who worked primarily in a room with a TWA mercury air concentration of 0.709 g/m^3 and who had been on the job for 1.5 years, showed a variety of symptoms, including gum pain, dizziness, poor attention, bad temper, some numbness, hypersalivation, hyperhidrosis, dizziness, and fatigue. She had initial urine and blood mercury levels of $408 \text{ }\mu\text{g/L}$ and $105 \text{ }\mu\text{g/L}$, respectively, but did not require chelation; the symptoms abated fully approximately 2 months following discontinuation of exposure (Yang et al. 1994).

Other chronic-duration exposures to metallic mercury vapor have resulted in tremors (which may be mild or severe depending on the degree of exposure), unsteady walking, irritability, poor concentration, short-term memory deficits, tremulous speech, blurred vision, performance decrements in psychomotor skills (e.g., finger tapping, reduced hand-eye coordination), paresthesias, decreased nerve conduction, and other signs of neurotoxicity (Albers et al. 1988; Bidstrup et al. 1951; Chaffin et al. 1973; Chang et al. 1995; Chapman et al. 1990; Fawer et al. 1983; Langolf et al. 1978; Piikivi et al. 1984; Smith et al. 1970; Sunderman 1978; Uzzell and Oler 1986; Vroom and Greer 1972; Williamson et al. 1982). The majority of studies suggest that motor system disturbances are reversible upon exposure cessation, while cognitive impairments, primarily memory deficits, may be permanent (Chaffin et al. 1973; Hanninen 1982; Miller et al. 1975).

Several studies have noted correlations between exposure level or duration and effects (e.g., memory deficits, psychomotor coordination, motor and sensory nerve conduction velocities, electromyographic abnormalities, evidence of polyneuropathy, tremor, emotional changes, reflex abnormalities, and electroencephalographic changes) (Albers et al. 1982; Iyer et al. 1976; Levine et al. 1982; Smith et al. 1983; Vroom and Greer 1972; Williamson et al. 1982). Early studies suggested that frank neurotoxicity (pronounced tremors, erethism, restriction of visual fields, difficulty seeing) was generally observed at $>300 \text{ }\mu\text{g}$ mercury in a 24-hour urine (Bidstrup et al. 1951) or at $>0.1 \text{ mg/m}^3$ (Smith et al. 1970). More recent studies using sensitive tests for psychomotor skills, tremor, and peripheral nerve function suggest that adverse effects may be associated with very low exposures (see below). However, conflicting information exists regarding thresholds for neurotoxic effects.

Several reports have presented essentially negative findings at low exposure levels ($0.025\text{--}0.076 \text{ mg/m}^3$). Chloralkali workers exposed to low air levels of mercury vapors for at least 5 years (group average, 14 years) reported an increase in memory disturbances, sleep disorders, anger, fatigue, confusion, and hand tremors compared to the controls (Piikivi and Hanninen 1989). However, tests of psychomotor

2. HEALTH EFFECTS

coordination and memory showed no significant deficits in the exposed group. The exposed and control groups were matched for age, sex, vocational status, education, and mean number of amalgam fillings. A group-average exposure concentration of 0.025 mg/m^3 mercury vapors was estimated from repeated analyses of blood mercury concentration (mean, 51.3 nmol/L . $10 \text{ } \mu\text{g/L}$) (see the discussion regarding these estimated exposure levels in Section 2.5). Also, no effects on tremors, bimanual coordination, color determination, or reaction time were observed in chloralkali workers with more than 7 years of exposure to low levels of mercury; ambient air levels measured for 2 years prior to testing averaged 0.076 mg/m^3 and the average blood level in the workers was $19.9 \text{ } \mu\text{g/L}$ (Schuckmann 1979). Negative findings were also noted when the results of tremor frequency spectra and psychometric tests of a group of chloralkali workers exposed for an average of 13.5 years were compared to unexposed controls (Langworth et al. 1992a). The TWA exposure level was estimated to be 0.025 mg/m^3 , based on measurements taken at the time of the study, and blood levels in the workers averaged 55 nmol/L (. $11 \text{ } \mu\text{g/L}$). Despite the negative objective findings, subjective reports of fatigue, memory disturbances, and confusion were significantly higher in the exposed workers.

Boogaard et al. (1996) evaluated the effects of exposure to elemental mercury on the nervous system and the kidneys of workers producing natural gas in the Netherlands. Early signs of alterations in renal and neurological functions were studied in three groups of workers who were exposed to different levels of mercury that were below the current ACGIH biological exposure index of $35 \text{ } \mu\text{g/g}$ creatinine. Air concentrations ranged from 10 to $1,500 \text{ } \mu\text{g/m}^3$ (median, 67) at locations where mercury exposure was anticipated; the potential 8-hour TWA exposure ranged from 33 to $781 \text{ } \mu\text{g/m}^3$ (median, 88). Air concentrations ranged from 0 to $6 \text{ } \mu\text{g/m}^3$ at locations where little mercury exposure was expected. Current mercury concentrations in urine were 23.7, 4.1, and $2.4 \text{ } \mu\text{g/g}$ in high, low, and control exposure groups, respectively; mercury concentrations in blood were 3.5, 1.5, and $2.2 \text{ } \mu\text{g/L}$, respectively. There were no differences among the three study groups with respect to either motor nerve conduction velocity or tremor frequency spectra of physiological tremors. Also, no significant correlations were found between the results of the neurological tests and any of the present or historical biological monitoring data.

In contrast to the negative findings above, several studies have shown significant effects on tremor or on cognitive skills at comparable or lower group-average exposure levels ($0.014\text{--}0.076 \text{ mg/m}^3$). Using the same paradigm as Langworth et al. (1992a), a significant difference was seen in the tremor frequency spectra in mercury-exposed workers from three industries who were exposed to low levels of mercury for an average of 15.3 years (range, 1–41 years) when compared to unexposed controls (Fawer et al. 1983).

2. HEALTH EFFECTS

The TWA mercury concentration measured in the work area at the time of the study was 0.026 mg Hg/m³ (range not reported). It was assumed that the workers were exposed to the same concentration of mercury for the duration of their employment. However, the group size was small, and the results may have been influenced by a small number of more severely affected individuals. It is also possible that the tremors may have resulted from intermittent exposure to concentrations higher than the TWA. Urinary mercury levels in these workers averaged 11.3 μmol/mol creatinine (. 20 μg/g creatinine). Tremors have also been associated with occupational exposures that produced urinary concentrations of 50–100 μg/g creatinine and blood levels of 10–20 μg/L (Roels et al. 1982). Difficulty with heel-to-toe gait was observed in thermometer-plant workers subjected to mean personal-breathing-zone air concentrations of 0.076 mg/m³ (range, 0.026–0.27 mg/m³) (Ehrenberg et al. 1991).

Decreases in performance on tests that measured intelligence (a similarities test) and memory (digit span and visual reproduction tests) were observed in chloralkali workers exposed for an average of 16.9 years to low levels of mercury when compared to an age-matched control group (Piikivi et al. 1984). Significant differences from controls were observed among workers with blood levels >75 nmol/L (. 15 μg/L) and urine levels >280 nmol/L (. 56 μg/L).

Dentists (n=98, mean age 32, range 24–49) with an average of 5.5 years of exposure to low levels of mercury showed impaired performance on several neurobehavioral tests (Ngim et al. 1992). Exposure levels measured at the time of the study ranged from 0.0007 to 0.042 mg/m³ (average, 0.014 mg/m³) and blood levels ranged from 0.6 to 57 μg/L (average, 9.8 μg/L). Controls were matched for age, fish consumption, and number of amalgam fillings. Differences in education, sex distribution, and reported use of Chinese traditional medicines that might contain mercury were adjusted for in the statistical analysis. The dentists showed significantly poorer performance on finger tapping (measures motor speed), trail making (measures visual scanning), digit symbol (measures visuomotor coordination and concentration), digit span, logical memory delayed recall (measures visual memory), and Bender-Gestalt time (measures visuomotor coordination). The dentists had a higher aggression score than the controls. Correlations were observed for exposure levels and duration. This study is limited, however, by lack of blinding and failure to report control mercury levels; the statistical procedures used for confounders (use of traditional Chinese medicines) were not reported.

In a study of the relation between cumulative exposure to mercury and chronic health impairment, 298 dentists had their mercury levels measured by an X-ray fluorescence technique. Electrodiagnostic and neuropsychological findings in the dentists with more than 20 μg/g tissue (head and wrist) mercury levels

2. HEALTH EFFECTS

were compared with those of a control group consisting of dentists with no detectable mercury levels. Twenty-three out of 298 dentists with the highest mercury levels were administered neurological tests and compared to controls. The high mercury group had slowed conduction velocities in motor (median nerve) and sensory (suralnerve) nerves, mild neuropsychological impairment (increased errors in the Bender-Gestalt test), mild visuographic dysfunction, and higher distress levels (self-reported) than the control group. Seven of the high exposure dentists showed manifestations of polyneuropathy. Exposure concentrations were not specified. No polyneuropathies were detected in the control group (Shapiro et al. 1982). Abnormal nerve conduction velocities have also been observed at a mean urine concentration of 450 $\mu\text{g/L}$ in workers from a chloralkali plant (Levine et al. 1982). These workers also experienced weakness, paresthesias, and muscle cramps. Prolongation of brainstem auditory-evoked potentials was observed in workers with urinary mercury levels of 325 $\mu\text{g/g}$ creatinine (Discalzi et al. 1993). Prolonged somatosensory-evoked potentials were found in 28 subjects exposed to 20–96 mg/m^3 of mercury (Langauer-Lewowicka and Kazibutowska 1989).

In animals, as in humans, adverse neurological and behavioral effects are prominent following inhalation exposure to high concentrations of metallic mercury vapor. However, animals appear to be less sensitive than humans. Marked cellular degeneration and widespread necrosis were observed in the brains of rabbits following exposures to metallic mercury vapor at 28.8 mg/m^3 for durations ranging from 2 to 30 hours (Ashe et al. 1953). Exposures of 1 hour produced moderate (unspecified) pathological changes.

Intermediate-duration exposure of rabbits to 6 mg/m^3 mercury vapor for periods of 1–11 weeks produced effects ranging from mild, unspecified, pathological changes to marked cellular degeneration and some necrosis in the brain (Ashe et al. 1953). The more serious degenerative changes were observed at longer exposure durations (i.e., 8 and 11 weeks). Mild-to-moderate pathological changes were revealed in the brains of rabbits exposed to a metallic mercury vapor concentration of 0.86 mg/m^3 for 12 weeks (Ashe et al. 1953). The usefulness of these results is limited because the pathological changes are not specified and no distinction is made between primary and secondary effects (i.e., pathological changes secondary to induced shock).

Two of 6 rabbits exposed to 4 mg/m^3 metallic mercury vapor for 13 weeks exhibited slight tremors and clonus and had mercury concentrations of 0.8–3.7 $\mu\text{g/g}$ wet tissue in the brain (Fukuda 1971). Following intermittent exposure to 3 mg/m^3 for 12–39 weeks, rats exhibited a decline in conditioned avoidance response; however, no histopathological changes were evident (Kishi et al. 1978). The change was

2. HEALTH EFFECTS

reversible within 12 weeks after exposure cessation and was associated with a decrease in the mercury concentration in brain tissue to below 10 µg/g wet weight (w/w). Mice exposed to an unspecified concentration of metallic mercury vapor intermittently for more than 3 weeks exhibited progressive neurological dysfunction (i.e., wobbling and unresponsiveness to light), beginning 22 days after initial exposure, and subsequently died 4 days later (Ganser and Kirschner 1985).

No studies were located regarding neurological effects in animals following chronic inhalation exposure to inorganic mercury.

Organic Mercury. Exposure to organic mercury via inhalation is extremely rare. The only reports of even its potential occurrence come from a few case histories. Case reports have described neurological effects in humans after inhalation exposure to organic mercury; however, no quantitative data were provided. Following acute inhalation exposure of dust containing methylmercury, four men had initial symptoms including numbness and tingling of limbs, unsteadiness in gait, difficulty in performing fine movements (e.g., buttoning a shirt), irritability, and constricted vision (Hunter et al. 1940). At least 2 years after these occupational exposures, the subjects had not fully recovered from their symptoms. Acute high-level exposure to an unspecified alkyl mercury compound has reportedly caused neurological symptoms (e.g., ataxia, unsteady gait, slurred speech, memory difficulties, tremors) in exposed workers (Hook et al. 1954; Lundgren and Swensson 1949).

A case study reporting neurological effects in a boy after exposure to mercury vapor released from paint containing phenylmercuric acetate (Aronow et al. 1990) was discussed under metallic mercury because the exposure was to metallic mercury vapors released from the paint.

Dimethylmercury is extremely volatile, and extremely toxic (in the 5 mg/kg body weight range). The following case history describes an accidental death due to an occupational spill of only a few drops of dimethylmercury. The primary exposure route is thought to have been dermal, but dimethylmercury is so volatile that inhalation exposure might also have occurred. Blayney et al. (1997) provided the first account of this tragic event. The case history was subsequently detailed by Nierenberg et al. (1998). The exposure occurred to a 48-year-old female chemistry professor who was admitted to the hospital 5 months (154 days) after, as best as can be determined, she inadvertently spilled several drops (estimated at 0.4–0.5 mL, about 1,500 mg) of dimethylmercury from the tip of her pipette onto the back of her disposable latex gloves. The spill was cleaned and the gloves disposed of. Hair analysis on a long strand

2. HEALTH EFFECTS

of hair revealed that after a brief lag time, mercury content rose rapidly to almost 1,100 ppm (normal level, <0.26 ppm; toxic level, >50 ppm), and then slowly declined with a half-life of 74.6 days. These results support the occurrence of one or several episodes of exposure, and are consistent with laboratory notebook accounts of a single accidental exposure. Testing of family members, laboratory coworkers, and laboratory surfaces failed to reveal any unsuspected mercury spills or other cases of toxic blood or urinary mercury levels. Permeation tests subsequently performed on disposable latex gloves similar to those the patient had worn at the time of the lone exposure revealed that dimethylmercury penetrates such gloves rapidly and completely, with penetration occurring in 15 seconds or less and perhaps instantly. Polyvinyl chloride gloves were equally permeable to dimethylmercury. Five days prior to hospital admission, the patient developed a progressive deterioration in balance, gait, and speech. During the previous 2 months, she had experienced brief episodes (spaced weeks apart) of nausea, diarrhea, and abdominal discomfort, and had lost 6.8 kg (15 lb). Medical examination revealed moderate upper-extremity dysmetria, dystaxic handwriting, a widely based gait, and “mild scanning speech.” Routine laboratory test results were normal. Computed tomography (CT) and magnetic resonance imaging (MRI) of the head were normal except for the incidental finding of a probable meningioma, 1 cm in diameter. The cerebrospinal fluid was clear, with a protein concentration of 42 mg/dL and no cells. A preliminary laboratory report indicated that the whole-blood mercury concentration was more than 1,000 µg/L (normal range, 1–8 µg/L; toxic level, >200 µg/L). Chelation therapy with oral succimer (10 mg/kg orally every 8 hours) was begun on day 168 after exposure. Whole blood concentrations rose to 4,000 µg/L after one day of chelation, and urinary mercury levels were 234 µg/L (normal range, 1–5 µg/L; toxic level, >50 µg/L). Despite the initial success of chelation therapy, administration of vitamin E, and a blood exchange transfusion, at 176 days postexposure, the patient became comatose. Further aggressive general support and chelation therapy failed, life support was removed (following the patient’s advance directive), and the patient died 298 days postexposure. Autopsy results revealed diffusely thin cortex of the cerebral hemispheres (to 3 mm), and extensive gliosis of the visual cortex around the calcarine fissure and the superior surface of the superior temporal gyri. The cerebellum showed diffuse atrophy of both vermal and hemispheric folia. Microscope evaluation revealed extensive neuronal loss and gliosis bilaterally within the primary visual and auditory cortices, with milder loss of neurons and gliosis in the motor and sensory cortices. There was widespread loss of cerebellar granular-cell neurons, Purkinje cells, and basket-cell neurons, with evidence of loss of parallel fibers in the molecular layer. Borgmann’s gliosis was well developed and widespread.

The highest NOAEL values and all reliable LOAEL values for neurological effects in each species and duration category are recorded in Table 2-1 and plotted in Figure 2-1.

2. HEALTH EFFECTS

2.2.1.5 Reproductive Effects

Metallic Mercury. No acute-duration exposure data were located regarding reproductive effects in humans after inhalation exposure to metallic mercury. However, several studies found no effect on fertility following intermediate or chronic inhalation exposure to metallic mercury in humans (Alcser et al. 1989; Cordier et al. 1991; Lauwerys et al. 1985). A retrospective cohort study reported that male workers in a U.S. Department of Energy (DOE) plant exposed for at least 4 months had urinary mercury concentrations of 2,144–8,572 µg/L (Alcser et al. 1989). This sample population showed no significant difference in fertility compared to controls (unexposed workers); however, they were never monitored for elemental mercury exposure. In a questionnaire study assessing the fertility of male workers exposed to mercury vapor from various industries (i.e., zinc-mercury amalgam, chloralkali, or electrical equipment product plants), there was no statistically significant difference in the number of children of the exposed group compared to a matched control group (Lauwerys et al. 1985). The concentration of mercury in the urine of these exposed workers ranged from 5.1 to 272.1 µg/g creatinine. No correlation was observed between prolactin, testosterone, luteinizing hormone, and follicle stimulating hormone levels and blood or urine mercury levels in male workers exposed to mercury vapors (Erfurth et al. 1990; McGregor and Mason 1991). Also, no effect on the response of these hormones to challenge with gonadotropin releasing hormone was observed (Erfurth et al. 1990).

Although no effect on fertility was observed in exposed workers, an increase in the rate of spontaneous abortions was reported in association with increased mercury concentrations in the urine of the fathers exposed to metallic mercury in chloralkali plants before the pregnancy (Cordier et al. 1991). There was a significantly increased risk of spontaneous abortion, at a rate of 18.4%, when fathers had more than 50 µg/L mercury in the urine, compared to a rate of 8.6% when fathers were unexposed. Sikorski et al. (1987) reported that women occupationally exposed to metallic mercury vapors (dentists and dental assistants) had more reproductive failures (spontaneous abortions, stillbirths, congenital malformations) and irregular, painful, or hemorrhagic menstrual disorders than a control (unexposed) group of women. The reproductive difficulties and menstrual disorders were correlated with mercury levels identified in scalp and pubic hair collected from the women. It should be noted that this study has been recently severely criticized for what Larsson (1995) calls "erroneous interpretation of results and distortion of conclusions." The Sikorski et al. (1987) paper is nonetheless presented in this toxicological profile as part of the available published data on reported human mercury exposure. Its presence here is based upon its publication in a

2. HEALTH EFFECTS

credible peer-reviewed international journal and is intended neither as endorsement nor condemnation of the data or conclusions in the 1987 paper.

Rowland et al. (1994) report that 418 women with high exposure to mercury (i.e., female dental assistants) were less fertile than unexposed controls. In this study, the probability of conception with each menstrual cycle (called "fecundability" by the authors) in women who prepared 30 or more amalgams per week and who were evaluated as having 4 or more poor mercury-hygiene practices was 63% of the fecundity of the unexposed controls. Rowland et al. (1994) noted that occupational groups with roughly the same potential for exposure often contain subjects whose actual exposures are quite different, depending on their particular work environment and their work practices within that environment. For example, 20% of the women in the final sample in this study reported preparing more than 30 amalgams per week with 4 or more poor hygiene factors. Among the women preparing the same number of amalgams, this study found differences in "fecundability," based upon each dental assistant's reported number of poor mercury-hygiene factors. One peculiar observation, however, was that women determined to have had low exposure to mercury in their dental occupation were found to be more fertile than unexposed controls. The reason(s) for the observed U-shaped dose-response curve were not known.

In animals, exposure to metallic mercury vapors causes prolongation of the estrous cycle. In a study by Baranski and Szymczyk (1973), female rats exposed via inhalation to metallic mercury (at an average of 2.5 mg/m³, 6 hours a day, 5 days a week for 21 days) experienced longer estrous cycles than unexposed animals. In addition, estrous cycles during mercury exposure were longer than normal estrous cycles in the same animals prior to exposure. Although the initial phase of the cycle was protracted, complete inhibition of the cycle did not occur. During the second and third weeks of exposure, these rats developed signs of mercury poisoning including restlessness, seizures, and trembling of the entire body. The authors speculated that the effects on the estrous cycle were caused by the action of mercury on the central nervous system (i.e., damage to the hypothalamic regions involved in the control of estrous cycling).

Organic Mercury. No studies were located regarding reproductive effects in humans or animals after inhalation exposure to organic mercury.

The highest NOAELs and all reliable LOAELs for reproductive effects in each species and duration category are recorded in Table 2-1 and plotted in Figure 2-1.

2. HEALTH EFFECTS

2.2.1.6 Developmental Effects

Metallic Mercury. No association was demonstrated between inhalation exposure of the father and increased rates of major fetal malformations or serious childhood illnesses in a retrospective cohort study of workers at a U.S. DOE plant (Alcser et al. 1989).

A case study of a woman chronically exposed to an undetermined concentration of mercury vapor reported that her first pregnancy resulted in spontaneous abortion, and her second resulted in the death of the newborn soon after birth (Derobert and Tara 1950). It is unclear whether the reproductive toxicity experienced by the woman was due to the mercury exposure. However, after recovery from overt mercury poisoning, she gave birth to a healthy child. A woman occupationally exposed to mercury vapors for 2 years prior to pregnancy and throughout pregnancy was reported to have delivered a viable infant at term (Melkonian and Baker 1988). Urinary mercury in the woman at 15 weeks of pregnancy was 0.875 mg/L (normal levels are approximately 0.004 mg/L). Also, a case report of a woman exposed to mercury vapors in her home during the first 17 weeks of pregnancy reported that the woman delivered a normal child who met all developmental milestones (although the child was not formally tested for psychological development) (Thorpe et al. 1992). Although mercury exposure was not measured, the child was born with hair levels of 3 mg/kg (3 ppm) of mercury. This hair level is comparable to that observed in populations consuming fish once a week (WHO 1990) and suggests that exposure in this case may have been relatively low.

Exposure of neonatal rats to metallic mercury vapor at 0.05 mg/m³ for 1 or 4 hours a day for 1 week during a period of rapid brain growth (postpartum days 11–17) resulted in subtle behavioral changes when the rats were tested at 4 and 6 months of age (Fredriksson et al. 1992). Offspring of rats exposed for 1 hour/day showed increases in the time necessary to finish a task in the radial arm maze (spatial learning). Offspring of rats exposed for 4 hours a day showed increases in both the time to finish the task and in the number of errors committed. When tested for locomotor activity at 2 months, an increase in rearing was observed in the 4 hour/day group, but repeat testing at 4 months showed lower locomotor, rearing, and total activity than controls. The 1-hour/day exposure group showed no difference from controls at 2 months, and increased activity and decreased rearing at 4 months when compared to controls.

Three groups of 12 pregnant Sprague-Dawley rats were exposed by inhalation to 1.8 mg/m³ metallic mercury vapor on gestation days (Gd) 11–14 and 17–20 for 1 hour ("low dose") or 3 hours ("high dose").

2. HEALTH EFFECTS

Hg/kg/day ("high dose"). At postpartum day 3, each litter was reduced to 4 male and 4 female offspring. No significant differences between the mercury-treated offspring and the controls were observed for surface righting, negative geotaxis, pinna unfolding, and tooth eruption. Tests of spontaneous motor activity (locomotion, rearing, rearing time, and total activity) showed that the mercury-treated offspring were hypoactive at 3 months of age; at 14 months, only total activity differed between exposed and control groups. In spatial learning tasks, exposed offspring showed retarded acquisition in the radial-arm maze but no differences in the circular-swim maze. A simple test of learning, habituation to a novel environment (activity chambers), indicated a reduced ability to adapt. The authors conclude that prenatal exposure to mercury vapor results in behavior changes in the offspring similar to those reported for methylmercury. On postpartum days 3–4, the mercury contents in the brain, liver, and kidneys were 0.001, 0.004, and 0.002 mg Hg/kg, respectively, for control offspring; 0.005, 0.053, and 0.033 mg Hg/kg, respectively, for animals exposed for 1 hour a day; and 0.012, 0.112, and 0.068 mg Hg/kg, respectively, for animals exposed for 3 hours a day (Danielsson et al. 1993).

Four groups of 12 pregnant Sprague-Dawley rats were exposed to methylmercury or elemental mercury alone or in combination as follows: (1) administered 2 mg/kg/day methylmercury via gavage during Gd 6–9; (2) exposed by inhalation to 1.8 mg/m³ metallic mercury (elemental mercury) vapor for 1.5 hours per day during Gd 14–19; (3) exposed to both methylmercury by gavage (2 mg/kg/day, Gd 6–9) and elemental Hg vapor by inhalation (1.8 mg/m³, Gd 14–19) (methylmercury + elemental mercury); or (4) given combined vehicle administration for each of the 2 treatments (control). The inhalation regimen corresponded to an approximate dose of 0.1 mg Hg/kg/day. At postpartum day 3, each litter was reduced to 4 male offspring. There were no differences between any of the groups in maternal body weight gain before parturition. No differences in body weight, pinna unfolding, tooth eruption, surface righting reflex, and negative geotaxis were observed in the offspring. Offspring of dams exposed to elemental Hg showed hyperactivity in the spontaneous motor activity test chambers over all three parameters: locomotion, rearing, and total activity; this effect was potentiated in the animals of the methylmercury + elemental Hg group. In the swim maze test, the methylmercury + elemental mercury and elemental mercury groups evidenced longer latencies to reach a submerged platform, which they had learned to mount the day before, compared to either the control group or the methylmercury group. In the modified enclosed radial-arm maze, both the methylmercury + elemental Hg and elemental Hg groups showed more ambulations and rearings in the activity test prior to the learning test. During the learning trial, the same groups (i.e., methylmercury + elemental Hg and elemental Hg) showed longer latencies and made more errors in

2. HEALTH EFFECTS

acquiring all eight pellets. Generally, the results indicate that prenatal exposure to elemental mercury causes alterations to both spontaneous and learned behaviors, suggesting some deficit in the adaptive functions of the rats. Co-exposure to methylmercury, which by itself did not alter these functions at the dose given in this study, served to aggravate the changes significantly. Brain mercury concentrations in offspring were 1 ng/g w/w in the controls, 4 ng/g in the methylmercury group, 5 ng/g in the elemental Hg group, and 12 ng/g in the methylmercury + elemental Hg group (Fredriksson et al. 1996).

Adult female rats were exposed to metallic mercury vapor at 2.5 mg/m³ for 3 weeks prior to fertilization and during Gd 7–20 (Baranski and Szymczyk 1973). A decrease in the number of living fetuses was observed in these dams compared to unexposed controls, and all pups born to the exposed dams died by the sixth day after birth. However, no difference in the occurrence of developmental abnormalities was observed between exposed and control groups. The cause of death of the pups in the mercury-exposed group was unknown, although an unspecified percentage of the deaths was attributed by the authors to a failure of lactation in the dams. Death of pups was also observed in another experiment in which dams were only exposed to the same dose level prior to fertilization, supporting the conclusion that high mortality in the first experiment was due, at least in part, to the poor health of the mothers. Without further information, this study must be considered inconclusive regarding developmental effects.

Newland et al. (1996) studied the offspring of pregnant squirrel monkeys exposed to 0.5 or 1 mg/m³ of mercury vapor for 4 or 7 hours per day, 5 days per week during the last two-thirds or more of the gestation period. One female and 2 male offspring came from mothers exposed to 0.5 mg/m³ mercury vapor during gestation weeks 5–19, 5–21, or 6–22 for a total of 247–510 hours, resulting in total doses of 1,304–2,900 µg (20–38 µg/day); and 3 male offspring came from mothers exposed to 1 mg/m³ mercury vapor during gestation weeks 7–21, 3–18, or 8–21 for a total of 283–402 hours, resulting in total doses of 2,901–4,305 µg (42–62 µg/day). Five male offspring born about the same time as the exposed monkeys served as controls. Lever pressing was maintained under a Concurrent Random-Interval 30 schedule of reinforcement. Time allocation on each lever was examined during behavioral transitions and in a steady state. Median maternal blood levels ranged from 0.025 to 0.09 µg/g in animals exposed to 0.5 mg/m³ and from 0.12 to 0.18 µg/g in animals exposed to 1 mg/m³. No differences in birth weight, weight gain, or body weight at time of behavioral testing were observed between exposed and control offspring. No difference in sensitivity to reinforcer ratios was identified in the steady state, but there was much more variability in the steady-state performance of exposed monkeys, as indicated by the standard deviation of the regression, than in controls. Logistic regression was used to examine the transition to new schedule

2. HEALTH EFFECTS

parameters. Exposed monkeys were found to produce smaller or slower transitions than controls. The magnitude and stability of lever-press durations for controls and exposed monkeys were indistinguishable early in the experiment, but at the end, the exposed monkeys had longer lever-press durations and the session-to-session variability was much greater. One monkey's exposure began during the third week of gestation (earlier than any of the others) and its behavior was so erratic that some of the analyses could not be accomplished. Long-term effects of prenatal mercury vapor exposure included instability in lever-press durations and steady-state performance under concurrent schedules of reinforcement as well as aberrant transitions (Newland et al. 1996).

Organic Mercury. No studies were located regarding developmental effects in humans or animals after inhalation exposure to organic mercury.

The highest NOAELs and all reliable LOAELs for developmental effects in each species and duration category are recorded in Table 2-1 and plotted in Figure 2-1.

2.2.1.7 Genotoxic Effects

There is inconclusive evidence that occupational exposure to metallic mercury and to organic and inorganic mercury compounds, primarily through inhalation, causes structural and numerical chromosome aberrations in human lymphocytes. In one study, significant increases in the frequency of acentric fragments (chromosome breaks) occurred in 4 workers exposed to high concentrations of metallic mercury and in 18 workers exposed to a mixture of mercuric chloride, methylmercuric chloride, and ethylmercuric chloride (Popescu et al. 1979). Mercury concentrations in the workplace ranged from 0.15 to 0.44 mg/m³; the urinary excretion level of mercury for both exposed groups was . 890 µg/L. The findings of this study are suspect because the control group was not matched for sex, smoking habits, or sample size.

Additionally, one of the four individuals in the metallic mercury group had a history of benzene poisoning, which was reflected in the unusually high frequency of abnormal chromosome morphology seen in this individual. No difference in the incidence of aneuploidy was found between the exposed workers and the controls. In an earlier study, an apparent association between increased chromosome aberrations and workplace exposure to mercury (as measured by urinary mercury levels) was reported (Verschaeve et al. 1976). However, the study was not well controlled (i.e., not matched for sex, smoking habits, or sample size), and the only significant increase in structural aberrations occurred in the three workers exposed to ethylmercury. Significant increases in aneuploid were also noted for the exposure groups compared to the

2. HEALTH EFFECTS

control subjects. However, these data should also be interpreted with caution since age has an influence on aneuploidy, and in this study, there was a general trend toward a higher incidence of aneuploidy in the older exposed workers (ages 36–63 years). It is noteworthy that in a subsequent study performed by these investigators (Verschaeve et al. 1979), no adverse effects on the structure or number of chromosomes were demonstrated in 28 subjects exposed to moderate levels of metallic mercury (urinary levels of 50 µg/L). The authors concluded that the results from their 1976 study, showing an association between increased chromosomal aberrations and occupational exposure to mercury, may have been affected by factors other than exposure to mercury compounds.

No increased frequency of structural aberrations was found in 22 workers exposed to mercury vapors; no information was provided on numerical aberrations (Mabille et al. 1984). The mean duration of exposure was 4 years, and the mean urinary and blood mercury levels in the exposed group were 117 µg/g creatinine and 0.031 µg/mL, respectively. More recently, peripheral lymphocytes from 26 male chloralkali workers exposed to mercury vapors (25–50 µg/m³), for a mean exposure time of 10 years, were analyzed for micronucleus induction. The results were compared to results obtained from 26 unexposed subjects (Barregard et al. 1991). Groups were matched for age (±7 years) and smoking habits; plasma, erythrocyte, and urine mercury levels were determined. Parallel lymphocyte cultures from each donor group were incubated in the presence of pokeweed mitogen, which stimulates both B- and T-lymphocytes, and phytohemagglutinin, which primarily activates T-cells. The analysis showed no significant increase in the frequency or the size of micronuclei in the exposed versus the control group. Nor was there a correlation between micronuclei induction and plasma, erythrocyte, or urinary levels of mercury. Within the exposed group, however, there was a significant correlation between micronuclei induction in phytohemagglutinin-stimulated lymphocytes and cumulative exposure (whole-blood mercury level over employment time); the response was independent of age or smoking habits. These results, suggesting a genotoxic effect on T-lymphocytes, are unusual since there is evidence that B-lymphocytes may be more sensitive indicators of chemically induced clastogenesis than T-lymphocytes (Högstedt et al. 1988). The authors stated that the evidence of a genotoxic response confined to T-lymphocytes could have been a random finding but hypothesized that long-term exposure to mercury may cause an accumulation of cytogenetic effects.

Similarly, there was no correlation between urinary mercury levels (60–245 µg/L) or the duration of exposure (11–34 years) and increased frequency of structural aberrations and micronuclei in the lymphocytes of 29 male workers exposed to mercury fulminate (Anwar and Gabal 1991). From the overall

2. HEALTH EFFECTS

results, the authors concluded that mercury in the manufacturing process may not have been the clastogen. Other genotoxicity studies are discussed in Section 2.5.

2.2.1.8 Cancer

Metallic Mercury. There is no evidence from epidemiological studies that indicates inhalation of metallic mercury produces cancer in humans (Cragle et al. 1984; Kazantzis 1981). No evidence of an association between metallic mercury exposure and cancer mortality was found in a group of workers employed in a facility utilizing the metal in a lithium isotope separation process (Cragle et al. 1984). Overall mortality in the mercury-exposed group was less than that of the standard white male population and that of a control group of men who were not exposed to mercury. Similarly, no excess of cancer of the kidneys or nervous system was found among a cohort of 674 Norwegian men exposed to mercury vapors for more than 1 year at 2 chloralkali plants (Ellingsen et al. 1993). An excess in lung cancer (type not specified) was found in Swedish chloralkali workers 10 years after the end of long-term, high-level exposure to metallic mercury (Barregard et al. 1990). However, these workers had also been exposed to asbestos. Furthermore, no data on smoking status was provided, although the study implied that the workers did not smoke much.

No studies were located regarding cancer in animals after inhalation exposure to metallic mercury.

Organic Mercury. Associations were reported between the use of mercury-containing fungicides (i.e., mercury levels in hair) and leukemia in farmers and between the use of mercury-containing seed dressings and leukemia in cattle (Janicki et al. 1987). However, the study was limited in reporting methodology used to conduct this study. Furthermore, the study did not adequately address exposure to other chemicals, or adjust for other leukemia risk factors.

No studies were located regarding cancer in animals after inhalation exposure to organic mercury.

2.2.2 Oral Exposure

The bulk of the information regarding toxicity resulting from oral exposure to inorganic mercury comes from studies of mercuric chloride. However, a few studies are also available on the effects of oral exposure to mercuric acetate, mercurous chloride (calomel), and mercuric sulfide (cinnabar). Discussion of these

2. HEALTH EFFECTS

compounds has not been separated in this section, but the specific inorganic compound responsible for any effect is noted both in the text and in Table 2-2 and Figure 2-2.

Health effects following oral exposure to organic mercury were observed in humans and animals. The majority of the studies used to derive the NOAELs and LOAELs shown in Table 2-3 and Figure 2-3 concern exposure to methylmercuric chloride; however, in several studies, exposure was to methylmercuric acetate, methylmercuric hydroxide, methylmercuric dicyanidiamide, or phenylmercuric acetate. These chemicals are discussed together in Table 2-3 and Figure 2-3. In order to facilitate a comparison of studies using different compounds of mercury (either organic or inorganic), all doses are expressed in terms of the mercury exposure (mg Hg/kg/day) rather than to the mercury compound (HgX or RHgX/kg/day) to which one is exposed. For example, a dose of 1 mg/kg (when the compound is methylmercuric chloride) refers to 1 mg/kg mercury rather than 1 mg/kg methylmercuric chloride.

2.2.2.1 Death

Inorganic Mercury. A lethal dose of mercuric chloride was estimated to be 10–42 mg Hg/kg for a 70-kg adult (Gleason et al. 1957). Death from oral exposure to inorganic mercury is usually caused by shock, cardiovascular collapse, acute renal failure, and severe gastrointestinal damage (Gleason et al. 1957; Murphy et al. 1979; Troen et al. 1951). Eighteen cases of human poisoning (suicide attempts in some cases) were reported by Troen et al. (1951); 9 patients died following oral ingestion of single doses of mercuric chloride (range, 29–>50 mg Hg/kg). The most common findings in these cases were gastrointestinal lesions (e.g., mild gastritis to severe necrotizing ulceration of the mucosa) and renal involvement (e.g., albuminuria, anuria, and uremia). Death of a 50-year-old woman due to ingestion of an unspecified amount of mercurous chloride in Chinese medicine has also been reported (Kang-Yum and Oransky 1992). The death was attributed to renal failure.

In rats, the oral LD₅₀ values (lethal dose, 50% kill) ranged from 25.9 to 77.7 mg Hg/kg as mercuric chloride (Kostial et al. 1978). The signs of acute mercury toxicity in animals were similar to those described above for humans. Male rats appeared to be slightly more sensitive to the lethal effects of mercuric chloride; 2 of 5 male rats and no female rats died when given gavage doses of 14.8 mg Hg/kg, 5 days a week for 2 weeks (Dieter et al. 1992; NTP 1993). Mice showed slightly less toxicity, with no deaths at 14.8 mg Hg/kg, death in 1 male at 29 mg Hg/kg, and deaths in 5 of 5 males and 4 of 5 females at 59 mg Hg/kg when administered by gavage over the same period (NTP 1993).

Table 2-2. Levels of Significant Exposure to Inorganic Mercury - Oral

Key to figure ^a	Species (Strain)	Exposure/duration/frequency (Specific route)	System	NOAEL (mg/kg/day)	LOAEL		Reference Chemical Form
					Less serious (mg/kg/day)	Serious (mg/kg/day)	
ACUTE EXPOSURE							
Death							
1	Rat (Fischer- 344)	14 d 5 d/wk 1 x/d (GW)				14.8 M (2/5 males died)	Dieter et al. 1992; NTP 1993 MC
2	Rat	once (G)				25.9 (LD ₅₀)	Kostial et al. 1978 MC
3	Mouse (B6C3F1)	14 d 5 d/wk 1 x/d (GW)				59 (5/5 males; 4/5 females died)	NTP 1993 MC
Systemic							
4	Human	once (C)	Gastro Renal		30 F (nausea, vomiting, abdominal cramps, diarrhea)		Afonso and deAlvarez 1960 MC
5	Rat (Long- Evans)	6 d 1 x/d (GW)	Endocr		7.4 F (increased release of iodine from thyroid)	30 F (acute renal failure, oliguria, proteinuria, hematuria)	Goldman and Blackburn 1979 MC

Table 2-2. Levels of Significant Exposure to Inorganic Mercury - Oral (continued)

Key to figure ^a	Species (Strain)	Exposure/duration/frequency (Specific route)	System	LOAEL			Reference Chemical Form
				NOAEL (mg/kg/day)	Less serious (mg/kg/day)	Serious (mg/kg/day)	
6	Rat (Sprague-Dawley)	once (G)	Hemato		7.4 F (9-10% decrease in hemoglobin, erythrocytes, hematocrit)		Lecavalier et al. 1994 MC
			Hepatic		7.4 F (decreased lactate dehydrogenase)		
			Renal		7.4 F (mild histopathological changes - protein casts, cellular casts, and interstitial sclerosis)		
			Bd Wt	9.2 F			
7	Rat (Fischer-344)	14 d 5 d/wk 1 x/d (GW)	Renal	0.93 ^b	1.9 M (increased absolute and 3.7 F relative kidney weight)	7.4 (minimal to mild acute renal necrosis)	NTP 1993; Dieter et al. 1992 MC
			Bd Wt	7.4 M	14.8 M (10% decreased body weight in males)		
8	Mouse (Bom:NMRI)	once (GW)	Renal	5 F	10 F (decreased renal selenium-dependent glutathione peroxidase activity; minor renal tubular damage)	20 (proximal tubule necrosis)	Nielson et al. 1991 MC
9	Mouse (B6C3F1)	14 d 5 d/wk 1 x/d (GW)	Renal		3.7 (increased absolute and relative kidney weight)	59 (acute renal necrosis)	NTP 1993 MC
			Gastro	29	59 (stomach inflammation and necrosis)		
			Bd Wt	59			
10	Mouse (Swiss)	10 d 1 x/d (GW)	Endocr		6 F (decreased serum triiodothyronine)		Sin et al. 1990 MS

Table 2-2. Levels of Significant Exposure to Inorganic Mercury - Oral (continued)

Key to figure ^a	Species (Strain)	Exposure/duration/frequency (Specific route)	System	LOAEL		Reference Chemical Form
				NOAEL (mg/kg/day)	Less serious (mg/kg/day)	
11	Mouse (Swiss)	10 d 1 x/d (GW)	Endocr		6 F (decreased serum thyroxine and triiodothyronine)	Sin et al. 1990 MC
Immunological/Lymphoreticular						
12	Mouse (B6C3F1)	14 d 5 x/wk 1 x/d (GW)		7.4 F	14.8 F (decreased thymus weight)	NTP 1993 MC
INTERMEDIATE EXPOSURE						
Systemic						
13	Rat (Charles Foster)	60-180 d ad lib (W)	Endocr		2.6 M (increased corticosterone levels in adrenal and plasma)	Agrawal and Chansouria 1989 MC
14	Rat (Wistar)	350 d ad lib (W)	Cardio		7M (increased blood pressure and cardiac inotropy)	Boscolo et al. 1989 MC
			Renal		7M (tubular degeneration and membranous glomerulonephritis)	
15	Rat (Sprague-Dawley)	350 d ad lib (W)	Cardio		7M (increased blood pressure and cardiac inotrophy)	Boscolo et al. 1989; Carmignani et al. 1989 MC
			Renal		7M (hydropic degeneration and desquamation of the tubular cells)	

Table 2-2. Levels of Significant Exposure to Inorganic Mercury - Oral (continued)

Key to figure ^a	Species (Strain)	Exposure/duration/frequency (Specific route)	System	NOAEL (mg/kg/day)	LOAEL		Reference Chemical Form
					Less serious (mg/kg/day)	Serious (mg/kg/day)	
16	Rat (Wistar)	180 d ad lib (W)	Cardio		28M (increased blood pressure; decreased cardiac contractility)		Carmignani et al. 1992
			Renal		28 M (mesangial proliferative glomerulonephritis; decreased acid phosphatase in lysosomes of tubular cells)		MC
17	Rat (Fischer-344)	26 wk 5 d/wk 1 x/d (GW)	Renal	0.23 ^c	0.46 (increased absolute and relative kidney weight)		Dieter et al. 1992; NTP 1993
			Bd Wt	1.9 M 0.46 F	3.7 M (10% decrease in body weight gain) 0.93 F		MC
18	Rat (Long-Evans)	40 d 1 x/d (G)	Endocr		5.3 F (increased thyroid activity; decreased triiodothyronine synthesis)		Goldman and Blackburn 1979 MC
19	Rat (Sprague-Dawley)	3 mo ad lib (F)	Resp		2.2 F (respiratory difficulties; forceful and labored breathing)		Goldman and Blackburn 1979 MC
			Endocr		2.2 F (decreased thyroidal iodine uptake, iodine release, and iodine turnover)		

Table 2-2. Levels of Significant Exposure to Inorganic Mercury - Oral (continued)

Key to figure ^a	Species (Strain)	Exposure/ duration/ frequency (Specific route)	System	LOAEL		Reference Chemical Form
				NOAEL (mg/kg/day)	Less serious (mg/kg/day)	
20	Rat (Wistar)	4 wk ad lib (F)	Hepatic	5 M 11.1 F	10 M (decreased absolute liver weight) 22.2 F	Jonker et al. 1993b MC
			Renal			5 M (nephrosis and 5.5 F proteinaceous casts, increased relative kidney weight)
			Endocr	10 M 11.1 F	20 M (increased relative adrenal weight) 22.2 F (decreased absolute adrenal weight)	
			Bd Wt	5 M 11.1 F		10 M (21% decreased body weight) 22.2 F (27% decreased body weight)
			Other		5 M (decreased food and 5.5 F water intake)	
			Renal	1 M	8 M (ketones in urine, increased relative weight of kidneys, slight histopathological changes to outer cortex basophilic tubules) 1.1 F (increased absolute and relative kidney weight)	Jonker et al. 1993b MC
			Bd Wt	8 M 8.9 F		
22	Mouse (B6C3F1)	7 wk ad lib (W)	Renal	0.6 M	2.9 M (nuclear swelling in epithelial cells)	Dieter et al. 1983 MC
			Hepatic Endocr	14.3 M	2.9 M (increased liver weight)	

Table 2-2. Levels of Significant Exposure to Inorganic Mercury - Oral (continued)

Key to figure ^a	Species (Strain)	Exposure/duration/frequency (Specific route)	System	LOAEL			Reference Chemical Form
				NOAEL (mg/kg/day)	Less serious (mg/kg/day)	Serious (mg/kg/day)	
23	Mouse (SJL/N)	10 wk ad lib (W)	Renal	0.28 F	0.56 F (increased granular IgG deposits; slight glomerular endocapillary cell hyperplasia; slight tubular atrophy, inflammation, and fibrosis)		Hultman and Enestrom 1992 MC
24	Mouse (B6C3F1)	26 wk 5 d/wk 1 x/d (GW)	Renal	1.9 M 14.8 F	3.7 M (cytoplasmic vacuolation of tubule epithelium, increased absolute weight)	14.8 M (26% decrease in body weight gain in males)	NTP 1993 MC
			Bd Wt	7.4 M 14.8 F			
25	Mouse (Swiss)	4 wk 1 x/d (GW)	Endocr		6 F (decreased serum thyroxine)		Sin and Teh 1992 MS
Immunological/Lymphoreticular							
26	Mouse (B6C3F1)	7 wk ad lib (W)		0.6 M	2.9 M (suppression of lymphoproliferative response to T-cell, concanavalin A and phytohemagglutinin)		Deiter et al. 1983 MC
Neurological							
27	Rat (Sprague-Dawley)	3 mo ad lib (F)				2.2 F (inactivity; abnormal gait)	Goldman and Blackburn 1979 MC

Table 2-2. Levels of Significant Exposure to Inorganic Mercury - Oral (continued)

Key to figure ^a	Species (Strain)	Exposure/duration/frequency (Specific route)	System	NOAEL (mg/kg/day)	LOAEL		Reference Chemical Form
					Less serious (mg/kg/day)	Serious (mg/kg/day)	
CHRONIC EXPOSURE							
Death							
28	Rat (Fischer- 344)	2 yr 5 d/wk 1 x/d (GW)				1.9 M (40/50 males died versus 24/50 control male deaths)	Dieter et al. 1992; NTP 1993 MC
Systemic							
29	Rat (Fischer- 344)	2 yr 5 d/wk 1 x/d (GW)	Resp	1.9	3.7 (increase in nasal inflammation)		NTP 1993 MC
			Gastro		1.9 M (forestomach epithelial hyperplasia; inflammation of the cecum)		
			Renal			1.9 M (marked thickening of glomerular and tubular basement membranes; degeneration and atrophy of tubule epithelium)	
			Bd Wt			1.9 (24% decrease in male body weight gain and 16% decrease in female body weight gain)	
30	Mouse (B6C3F1)	2 yr 5 d/wk 1 x/d (GW)	Renal		3.7 F (foci of proximal tubule with thickened basement membrane; basophilic cells with scant cytoplasm)		NTP 1993 MC

Table 2-2. Levels of Significant Exposure to Inorganic Mercury - Oral (continued)

Key to ^a figure	Species (Strain)	Exposure/ duration/ frequency (Specific route)	System	LOAEL		Reference Chemical Form	
				NOAEL (mg/kg/day)	Less serious (mg/kg/day)		Serious (mg/kg/day)
Cancer							
31	Rat (Fischer- 344)	2 yr 5 d/wk 1x/d (GW)				3.7 (CEL: forestomach squamous cell papillomas in males and females; thyroid follicular cell carcinomas in males)	NTP 1993 MC

^aThe number corresponds to entries in Figure 2-2.

^bUsed to derive an acute oral Minimal Risk Level (MRL) of 7×10^{-3} mg mercury/kg/day; dose corrected for 5 day/week exposure and divided by an uncertainty factor of 100 (10 for extrapolation from animals to humans and 10 for human variability).

^cUsed to derive an intermediate oral MRL of 2×10^{-3} mg mercury/kg/day; dose corrected for 5 day/week exposure and divided by an uncertainty factor of 100 (10 for extrapolation from animals to humans and 10 for human variability).

ad lib = ad libitum; Bd Wt = body weight; Cardio = cardiovascular; CEL = cancer effect level; d = day(s); Endocr = endocrine; F = female; (F) = feed; (G) = gavage; Gastro = gastrointestinal; Gd = gestational day; (GO) gavage with oil; (GW) gavage with water; Hemato = hematological; Hg = mercury; hr = hour(s); IgG = immunoglobulin G; LD₅₀ = lethal dose 50% kill; LOAEL = lowest-observed-adverse-effect level; M = male; MA = mercuric acetate; MC = mercuric chloride; MN = mercuric nitrate; MS = mercuric sulfide; min = minute(s); mo = month(s); NOAEL = no-observed-adverse-effect level; NS = not specified; ppd = postpartum day (s); Resp = respiratory; (W) = drinking water; wk = week(s); x = times; yr = year(s)

Figure 2-2. Levels of Significant Exposure to Inorganic Mercury - Oral
Acute (≤14 days)

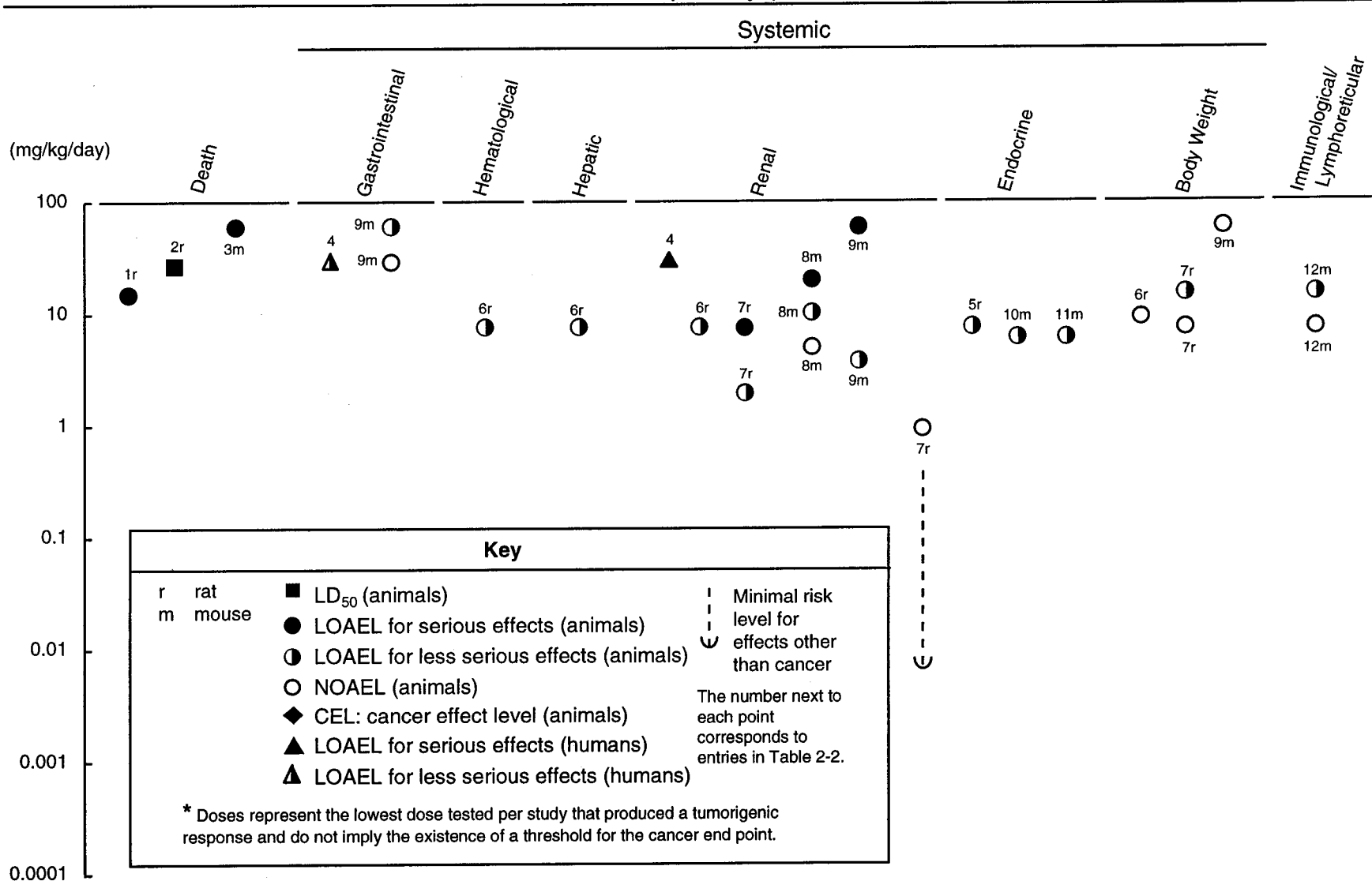

Figure 2-2. Levels of Significant Exposure to Inorganic Mercury - Oral (cont.)
Intermediate (15-364 days)

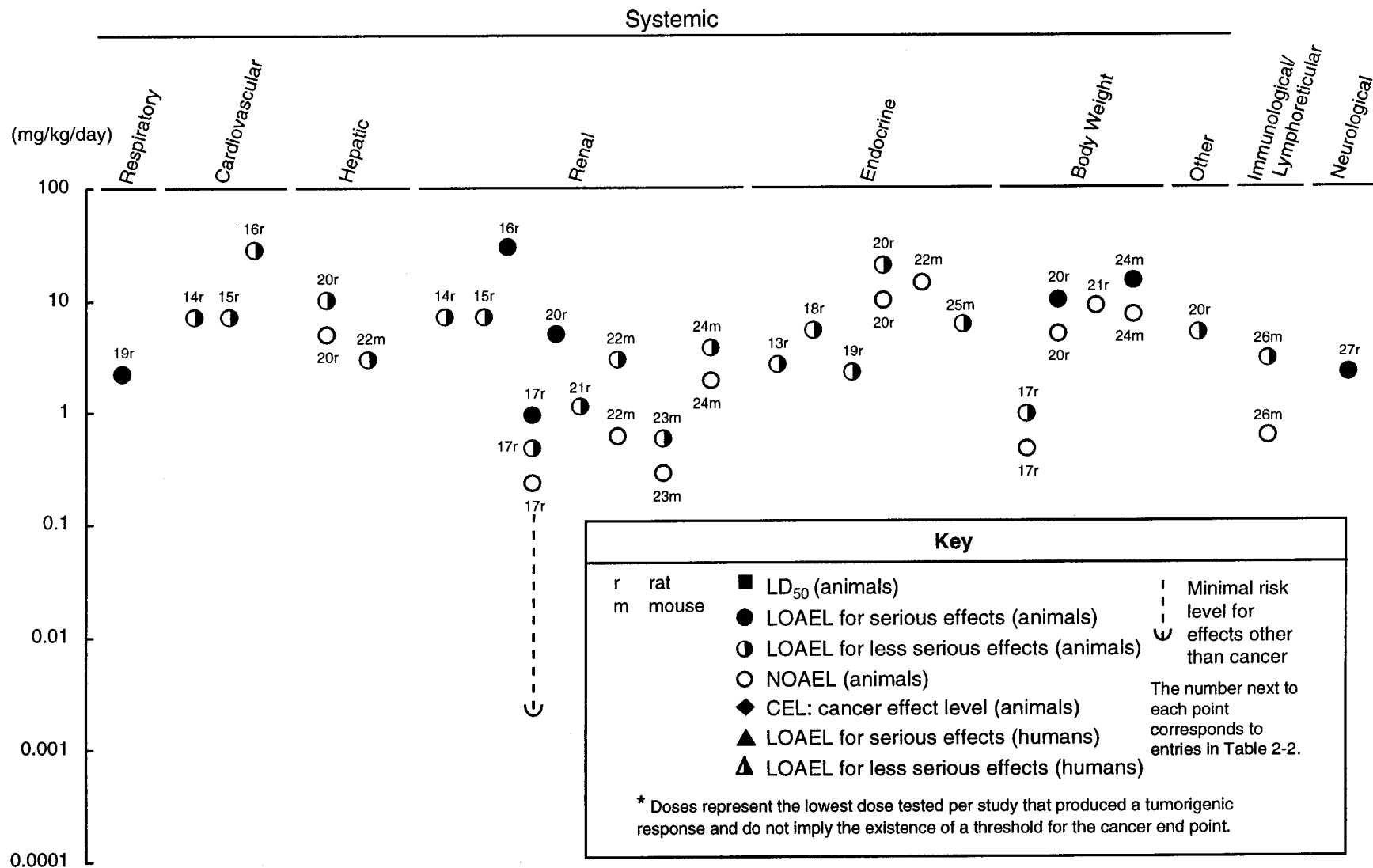

Figure 2-2. Levels of Significant Exposure to Inorganic Mercury - Oral (cont.)

Chronic (≥ 365 days)

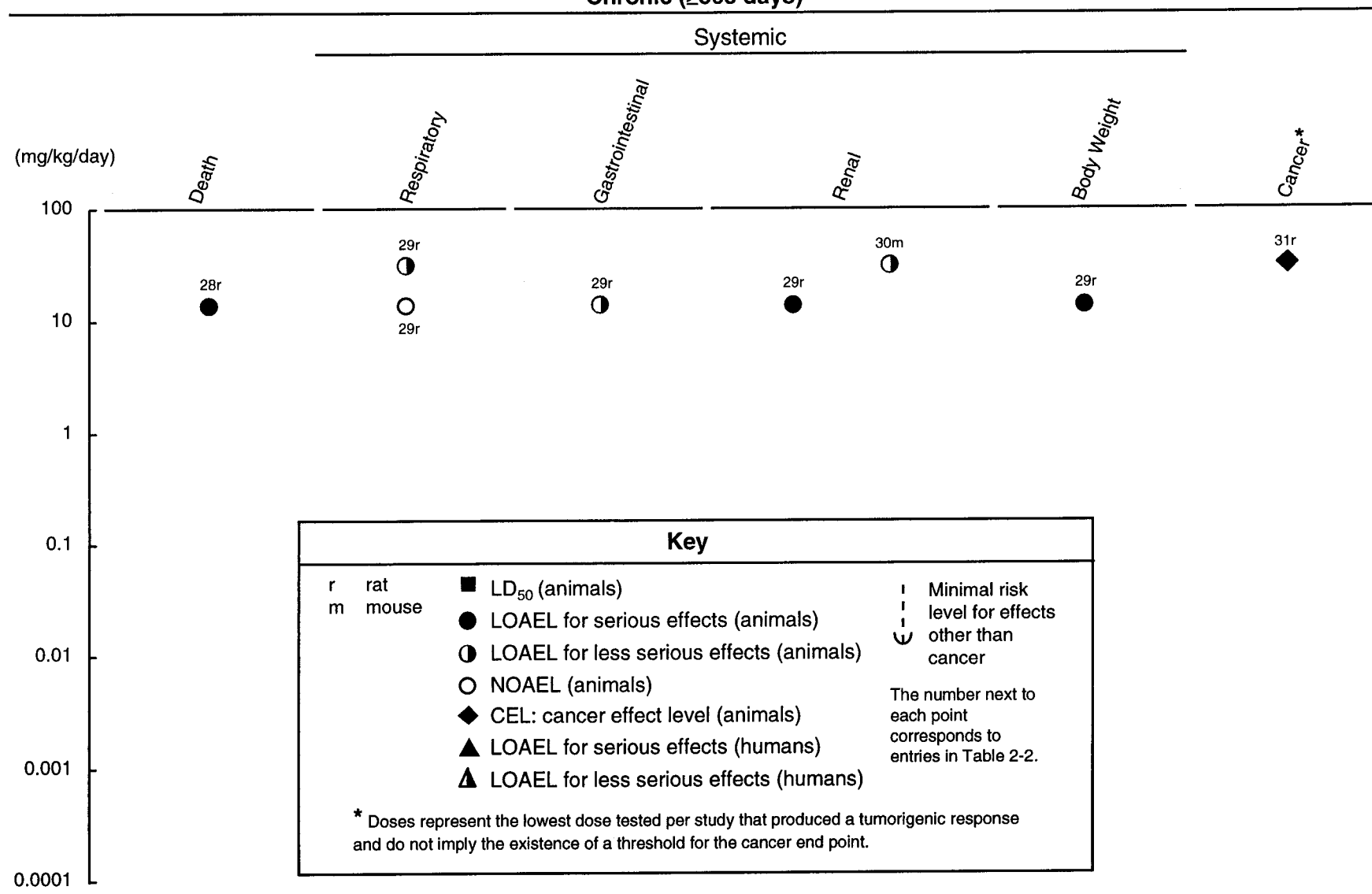

Table 2-3. Levels of Significant Exposure to Organic Mercury - Oral

Key to figure ^a	Species (Strain)	Exposure/duration/frequency (Specific route)	System	NOAEL (mg/kg/day)	LOAEL		Reference Chemical Form
					Less serious (mg/kg/day)	Serious (mg/kg/day)	
ACUTE EXPOSURE							
Death							
1	Mouse (C57BL/6N)	once (G)				16 M (4/6 died) 40 F (4/6 died)	Yasutake et al. 1991b MMC
Systemic							
2	Rat (Sprague-Dawley)	2 d 1 x/d (GW)	Cardio		12M (18% decreased heart rate)		Arito and Takahashi 1991 MMC
			Other		12M (hypothermia)		
3	Mouse (C57BL/6N)	once (G)	Renal	8 M 24 F	16 M (decreased phenolsulfon-phthalein excretion, increased serum creatinine, swollen tubular epithelial cells)		Yasutake et al. 1991b MMC
Neurological							
4	Rat (Sprague-Dawley)	2 d 1 x/d (GW)		1.32 M	4M (decreased paradoxical sleep and increased slow-wave sleep)		Arito and Takahashi 1991 MMC
5	Rat (Sprague-Dawley)	once (G)			0.80M (dye transport across blood-brain barrier)		Chang and Hartmann 1972b MMC
6	Rat (Wistar)	2 d 1 x/d (G)			10M (impaired performance in tilting plane test)	20 M (decreased nerve conduction velocity; edema and Wallerian degeneration of peripheral nerves)	Fehling et al. 1975 MMC

Table 2-3. Levels of Significant Exposure to Organic Mercury - Oral (continued)

Key to figure ^a	Species (Strain)	Exposure/duration/frequency (Specific route)	System	LOAEL			Reference Chemical Form
				NOAEL (mg/kg/day)	Less serious (mg/kg/day)	Serious (mg/kg/day)	
7	Rat (Wistar)	8 d 1 x/d Gd 7-14 (GW)		4 F		6 F (spasms; gait disturbance; hind limb crossing in dams)	Fuyuta et al. 1978 MMC
8	Rat (Wistar)	9, 13, or 21 d 1 x/d Gd 12-20, 0-12, or 0-20 (GW)		2 F		4 F (hindlimb crossing in dams)	Inouye and Murakami 1975 MMC
9	Rat (Wistar)	10 d 1 x/d (F)				6.9 M (ataxia; instability walking; peripheral nerve degeneration)	Miyakawa et al. 1974 MMS
10	Rat (Sprague-Dawley)	Once (G)		16 M		20 M (decreased activity in t-maze test)	Post et al. 1973 MMC
11	Rabbit (New Zealand)	1-4 d 1 x/d (G)				5.5 (degeneration of ganglion cells, cerebellum, and cerebral cortex)	Jacobs et al. 1977 MMA
Reproductive							
12	Rat (Wistar)	7 d 1 x/d (G)				5 M (reduced mean litter size in untreated females)	Khera 1973b MMC
13	Rat (Fischer-344)	once Gd 7 (G)				8 F (16.7% postimplantation loss, 32.3% decreased litter weight, 14.0% decrease in maternal weight gain)	Lee and Han 1995 MMC
14	Mouse (ICR)	once Gd 10 (GW)		16 F		20 F (increased resorptions; decreased fetuses per litter)	Fuyuta et al. 1979 MMC

Table 2-3. Levels of Significant Exposure to Organic Mercury - Oral (continued)

Key to figure ^a	Species (Strain)	Exposure/duration/frequency (Specific route)	System	LOAEL		Reference Chemical Form	
				NOAEL (mg/kg/day)	Less serious (mg/kg/day)		Serious (mg/kg/day)
15	Mouse (CFW)	once Gd 8 (G)		2 F		3 F (decreased number of pups per litter)	Hughes and Annau 1976 MMH
16	Mouse (Swiss-Webster)	5-7 d 1 x/d (G)		5 M			Khera 1973b MMC
17	Gn Pig (Hartley)	once Gd 21, 28, 35, 42 (GW)				11.5 F (increased abortions)	Inouye and Kajiwara 1988b MMC
18	Hamster	once Gd 8 (GW)		15.8 F		22 F (increased resorption)	Gale 1974 MA
Developmental							
19	Human	NS (F)			0.0012	(delayed walking; abnormal motor scores)	Cox et al. 1989 MMC
20	Rat (Wistar)	4 d 1 x/d Gd 6-9 (G)		0.004	0.008	(reduction in behavioral performance of offspring)	Bornhausen et al. 1980 MMC
21	Rat (Sprague-Dawley)	Once Gd 15 (GW)			6.4	(decreased glutamate receptor binding affinity and decreased avoidance latency in offspring)	Cagiano et al. 1990 MMC
22	Rat (Sprague-Dawley)	4 d 1 x/d Gd 6-9 (G)		1.6			Fredriksson et al. 1996 (MM)

Table 2-3. Levels of Significant Exposure to Organic Mercury - Oral (continued)

Key to figure ^a	Species (Strain)	Exposure/duration/frequency (Specific route)	System	LOAEL			Reference Chemical Form	
				NOAEL (mg/kg/day)	Less serious (mg/kg/day)	Serious (mg/kg/day)		
23	Rat (Wistar)	8 d 1 x/d Gd 7-14 (GW)		2		4	(decreased fetal weight; increased malformations [total]; hydrocephaly; wavy ribs)	Fuyuta et al. 1978 MMC
24	Rat (ddN)	once Gd 6, 7, 8, 9, 10 (GW)				24	(fetal deaths; edema; brain lesions; cleft palate)	Inouye and Murakami 1975 MMC
25	Rat (Wistar)	9, 13, or 21 d 1 x/d Gd 12-20, 0-12, or 0-20 (GW)				2	(fetal edema and brain lesions)	Inouye and Murakami 1975 MMC
26	Rat (Fischer-344)	once Gd 7 (G)				8	(curved backbones, 9.6% reduced fetal body length)	Lee and Han 1995 MMC
27	Rat	9 d Gd 6-14 ad lib (W)		0.2	4		(increased number of fetuses with delayed ossification or calcification)	Nolen et al. 1972 MMC
28	Rat (Wistar)	4 d Gd 6-9 (G)		0.04	0.4		(increased startle response in offspring)	Stoltenburg-Didinger and Markwort 1990 MMC
29	Rat (Sprague-Dawley)	once Gd 15 (G)				6.4	(21.3-53% decr maximum number of muscarinic receptors in brain, signif. decr avoidance latency in offspring)	Zanoli et al. 1994 MMC

Table 2-3. Levels of Significant Exposure to Organic Mercury - Oral (continued)

Key to figure ^a	Species (Strain)	Exposure/duration/frequency (Specific route)	System	LOAEL			Reference Chemical Form	
				NOAEL (mg/kg/day)	Less serious (mg/kg/day)	Serious (mg/kg/day)		
30	Mouse (C57BL/6N)	8 d 1 x/d Gd 6-13 (GW)				2	(increased malformations [total]; decreased ossification; absence of 1 or more sterebrae)	Fuyuta et al. 1978 MMC
31	Mouse (ICR)	once Gd 10 (GW)		8	(incomplete fusion of sternbrae)	12	(cleft palate; decreased fetal weight)	Fuyuta et al. 1979 MMC
32	Mouse (CFW)	once Gd 8 (G)		2	3 (decreased number of avoidances and increased escapes in offspring)			Hughes and Annau 1976 MMH
33	Mouse (C3H/HeN)	once Gd 13, 14, 15, 16 (GW)				16	(decreased survival of offspring; impaired righting response; gait and hindlimb crossing; decreased brain weight; dilated lateral ventricles; smaller caudate putamen)	Inouye et al. 1985 MMC
34	Mouse (Swiss-Webster)	12 d Gd 6-17 (GO)		1.0		5.0	(100% stillbirths; failure to litter)	Khera and Tabacova 1973 MMC
35	Mouse (ICR)	once Gd 10 or 12 (GW)		12		16	(cleft palate; dilation of renal pelvis; decreased fetal weight)	Yasuda et al. 1985 MMC
36	Gn Pig (Hartley)	once Gd 21, 28, 35, 42 (GW)				11.5	(retarded fetal brain development)	Inouye and Kajiwara 1988b MMC

Table 2-3. Levels of Significant Exposure to Organic Mercury - Oral (continued)

Key to figure ^a	Species (Strain)	Exposure/ duration/ frequency (Specific route)	System	LOAEL			Reference Chemical Form
				NOAEL (mg/kg/day)	Less serious (mg/kg/day)	Serious (mg/kg/day)	
37	Hamster	once Gd 8 (GW)		2.5	5 (decreased crown-rump length)	22 (increased resorption)	Gale 1974 MA
38	Hamster (Golden Syrian)	once Gd 10 ; or 6d 1 x/d Gd 10-15 (GW)				1.6 (degeneration of cerebellar neurons in neonates)	Reuhl et al. 1981a MMC
39	Hamster (Golden Syrian)	Once Gd 10; or 56d 1 x/d Gd 10-15 (GW)				1.6 (degeneration of cerebellar neurons in offspring 10 months postexposure)	Reuhl et al. 1981b MMC
INTERMEDIATE EXPOSURE							
Death							
40	Mouse (ICR)	26 wk ad lib (F)				3.1 (51/60 males and 59/60 females died versus 1/60 male and 1/60 female controls)	Mitsumori et al. 1981 MMC
Systemic							
41	Rat	12 wk ad lib (F)	Renal		0.08 (cytoplasmic mass in proximal tubule cells)		Fowler 1972 MMC
42	Rat (albino)	3-12 wk 5 d/wk (G)	Renal		0.84 F (fibrosis, inflammation, and large foci in renal cortex)		Magos and Butler 1972 MMD

Table 2-3. Levels of Significant Exposure to Organic Mercury - Oral (continued)

Key to figure ^a	Species (Strain)	Exposure/duration/frequency (Specific route)	System	NOAEL (mg/kg/day)	LOAEL		Reference Chemical Form
					Less serious (mg/kg/day)	Serious (mg/kg/day)	
43	Rat (Wistar)	23-28 d 7 d/wk or 1 x every 3 d for 13 d (G)	Cardio		0.4 M (increased systolic pressure)		Wakita 1987 MMC
44	Mouse (ICR)	26 wk ad lib (F)	Renal	0.15	0.6 (toxic epithelial degeneration of renal proximal tubules)		Hirano et al. 1986 MMC
45	Mouse (BALB/c)	12 wk ad lib (F)	Hepatic	0.5 F			Ilback 1991 MM
			Renal Endocr	0.5 F	0.5 F (22% decrease in thymus weight)		
Immunological/Lymphoreticular							
46	Mouse (BALB/c)	12 wk ad lib (F)			0.5 F (reduced natural killer T-cell activity; decreased thymus weight and cell number)		Ilback 1991 MM
Neurological							
47	Monkey (Macaca fascicularis)	NS 1 x/d (G)		0.043 F		0.077 F (intention tremor)	Burbacher et al. 1984 MMH
48	Monkey (Macaca fascicularis)	4 mo 1 x/d (G)		0.06 F		0.08 F (slight tremor; gross motor incoordination; blindness)	Burbacher et al. 1988 MMH
49	Monkey (Macaca fascicularis)	6 mo (in apple juice)			0.05 F (72% increased number of reactive glia)		Charleston et al. 1994 MM

Table 2-3. Levels of Significant Exposure to Organic Mercury - Oral (continued)

Key to figure ^a	Species (Strain)	Exposure/duration/frequency (Specific route)	System	LOAEL			Reference Chemical Form
				NOAEL (mg/kg/day)	Less serious (mg/kg/day)	Serious (mg/kg/day)	
50	Monkey (macaca fascicularis)	150 d 1 x/d (W)		0.04 F			Petruccioli and Turillazzi 1991 MMC
51	Rat (Holtzman)	1-6 wk 7 d/wk (G)				0.8 M (focal cytoplasmic degeneration of dorsal root ganglia and cerebellum, severe ataxia)	Chang and Hartmann 1972a MMC
52	Rat	3-12 wk 5 d/wk (G)		0.84 F		1.68 F (ataxia; edema and necrosis of cerebellum)	Magos and Butler 1972 MMD
53	Rat (Sprague-Dawley)	15 d 1 x/3d (GO)			0.8 M (decreased synthesis of dopamine neurotransmitter)		Sharma et al. 1982 MMC
54	Rat (Wistar)	50 d 7 d/wk (G)			3.20 M (decreased neurotransmitter activities in cerebellum)		Tsuzuki 1981 MMC
55	Rat	8 wk 7 d/wk (G)				1.6 M (extensive degeneration of dorsal root fiber)	Yip and Chang 1981 MMC
56	Mouse (CD-1)	60 d 7 d/wk (G)		0.25 M		1.0 M (hindleg weakness; microgliocytosis and degeneration)	Berthoud et al. 1976 MMC
57	Mouse	28 wk ad lib (W)				1.9 M (degenerative changes of Purkinje cells and granule cell loss in cerebellum)	MacDonald and Harbison 1977 MMC
58	Cat	11 mo ad lib (F)				0.015 (degeneration of cerebellum and necrosis of dorsal root ganglia)	Chang et al. 1974 MM

Table 2-3. Levels of Significant Exposure to Organic Mercury - Oral (continued)

Key to figure ^a	Species (Strain)	Exposure/duration/frequency (Specific route)	System	LOAEL			Reference Chemical Form
				NOAEL (mg/kg/day)	Less serious (mg/kg/day)	Serious (mg/kg/day)	
59	Cat	44-243 d 1 x/d (GW)				0.25 (neuronal degeneration; distorted myelination)	Khera et al. 1974 MMC
Reproductive							
60	Monkey (Macaca fascicularis)	4 mo 1 x/d (G)		0.04 F		0.06 F (abortion, stillbirth, decreased conception)	Burbacher et al. 1988 MMH
Developmental							
61	Human	NS (F)		0.0012	(delayed walking; abnormal motor scores)		Cox et al. 1989 MMC
62	Monkey	28-29 d 1 x/d ppd 1-28 or 29 (W)				0.5 (loss of dexterity, locomotor activity; ataxia; blindness; comatose; neuronal degeneration)	Willes et al. 1978 MMC
63	Rat (Wistar)	2 wk prior to mating through weaning (W)		0.08	(impaired tactile-kinesthetic function in offspring)		Elsner 1991 MMC
64	Rat	47 d prior to and during gestation (W)		0.7	1.4 (depression of membrane synthesis, monoamine oxidase, and cytochrome oxidase in fetal hepatocyte mitochondrial membranes)		Fowler and Woods 1977 MMH

Table 2-3. Levels of Significant Exposure to Organic Mercury - Oral (continued)

Key to figure ^a	Species (Strain)	Exposure/duration/frequency (Specific route)	System	NOAEL (mg/kg/day)	LOAEL		Reference Chemical Form
					Less serious (mg/kg/day)	Serious (mg/kg/day)	
65	Rat (Sprague-Dawley)	15-17 wk 11 wk, Gd 1-21, pp (F)			0.5	(decreased cell-mediated cytotoxicity, increased thymus lymphocyte activity in fetus)	Ilback et al. 1991 MM
66	Rat	approx 52 d ad lib (F)		0.05			0.25 (increased incidence of eye defects in fetuses) Khera and Tabacova 1973 MMC
67	Rat (Sprague-Dawley)	approx 25 wks; 14 wks prior to mating through ppd 50 (F)			0.195	(increased norepinephrine levels in cerebellum of offspring, increased brain weight)	Lindstrom et al. 1991 MMC
68	Rat	68 d Gd 1 to ppd 42 (G)					0.10 (decreased swimming ability and righting reflex; retarded maze learning in offspring) Olson and Boush 1975 MMH
69	Mouse (BALB/c)	15 wk ad lib (F)			5.0	(increased proliferative response of pup splenocytes)	Thuvander et al 1996 MMC
CHRONIC EXPOSURE							
Death							
70	Mouse (B6C3F1)	104 wk ad lib (F)					0.69 M (50/60 males died versus 31/60 controls) Mitsumori et al. 1990 MMC

Table 2-3. Levels of Significant Exposure to Organic Mercury - Oral (continued)

Key to figure ^a	Species (Strain)	Exposure/duration/frequency (Specific route)	System	LOAEL			Reference Chemical Form
				NOAEL (mg/kg/day)	Less serious (mg/kg/day)	Serious (mg/kg/day)	
Systemic							
71	Rat (Wistar)	2 yr ad lib (W)	Gastro	0.4 M		4.2 M (ulcerative cecitis)	Solecki et al. 1991 PMA
			Hemato	0.4 M		4.2 M (decreased hemoglobin, erythrocyte and hematocrit)	
			Renal			0.4 M (increased severity of renal nephrosis)	
			Endocr		4.2 M (significant increased adrenal absolute weight [5%])		
			Bd Wt		0.4 M (approximately 10% decrease in body weight gain)		
72	Rat (NS)	2 yr ad lib (F)	Resp	0.1			Verschuuren et al. 1976 MMC
			Cardio	0.1			
			Gastro	0.1			
			Hemato	0.1			
			Musc/skel	0.1			
			Hepatic	0.1			
			Renal	0.02	0.1 (increased kidney weight; decreased kidney enzymes)		
			Dermal	0.1			
Ocular	0.1						
73	Mouse (ICR)	104 wk ad lib (F)	Renal	0.03 M 0.11 F		0.15 M (incr chronic nephropathy) 0.6 F	Hirano et al. 1986 MMC

Table 2-3. Levels of Significant Exposure to Organic Mercury - Oral (continued)

Key to figure ^a	Species (Strain)	Exposure/ duration/ frequency (Specific route)	System	LOAEL			Reference Chemical Form
				NOAEL (mg/kg/day)	Less serious (mg/kg/day)	Serious (mg/kg/day)	
74	Mouse (B6C3F1)	104 wk ad lib (F)	Gastro Renal	0.14 M 0.6 F 0.03 M 0.13 F	0.69 M (stomach ulceration)	0.14 M (increased chronic 0.6 F nephropathy with epithelial cell degeneration; regeneration of the proximal tubules; interstitial fibrosis)	Mitsumori et al. 1990 MMC
Neurological							
75	Monkey (Macaca fascicularis)	NS 1 x/d (G)		0.043 F		0.077 F (intention tremor)	Burbacher et al. 1984 MMH
76	Monkey (Macaca fascicularis)	12 or 18 mo			0.05 F (89-152% increased number of reactive glia)		Charleston et al. 1994 MM
77	Monkey (Cynomolgus)	6.5-7 yr 7 d/wk 1 x/d (G)				0.05 (decreased fine motor performance; diminished touch and pinprick sensitivity)	Rice 1989c MMC
78	Monkey (Cynomolgus)	3-4 yr 7 d/wk 1 x/d				0.05 (spatial visual impairment)	Rice and Gilbert 1982 MMC
79	Monkey (Cynomolgus)	7 yr 1 x/d (C)			0.05 (impaired high-frequency hearing)		Rice and Gilbert 1992 MMC
80	Rat (NS)	2 yr ad lib (F)		0.1			Verschuuren et al. 1976 MMC

Table 2-3. Levels of Significant Exposure to Organic Mercury - Oral (continued)

Key to figure ^a	Species (Strain)	Exposure/duration/frequency (Specific route)	System	LOAEL			Reference Chemical Form
				NOAEL (mg/kg/day)	Less serious (mg/kg/day)	Serious (mg/kg/day)	
81	Mouse (ICR)	104 wk ad lib (F)		0.11 F		0.6 F (degeneration or fibrosis of sciatic nerve)	Hirano et al. 1986 MMC
82	Mouse (B6C3F1)	104 wk ad lib (F)		0.14 M		0.69 M (sensory neuropathy; cerebral and cerebellar neuronal necrosis; posterior paralysis)	Mitsumori et al. 1990 MMC
83	Cat	2 yr 7 d/wk (F)		0.020	0.046 (impaired hopping reaction; hypalgesia)	0.074 (degeneration of dorsal root ganglia, cerebellar granular cell degeneration)	Charbonneau et al. 1976 MMC
Reproductive							
84	Rat (NS)	2 yr ad lib (F)		0.1			Verschuuren et al. 1976 MMC
85	Mouse (ICR)	104 wk ad lib (F)		0.15 M		0.73 M (decreased spermatogenesis)	Hirano et al. 1986 MMC
86	Mouse (B6C3F1)	104 wk ad lib (F)		0.14 M		0.69 M (tubular atrophy of the testes)	Mitsumori et al. 1990 MMC
Developmental							
87	Human	NS (F)		0.00062 BMDL			Crump et al. 1998 MM
88	Human	NS (F)		0.0013 ^b			Davidson et al. 1998 MM
89	Human	NS (F)		0.0005			Myers et al. 1997 MM

Table 2-3. Levels of Significant Exposure to Organic Mercury - Oral (continued)

Key to figure ^a	Species (Strain)	Exposure/duration/frequency (Specific route)	System	LOAEL			Reference Chemical Form
				NOAEL (mg/kg/day)	Less serious (mg/kg/day)	Serious (mg/kg/day)	
90	Monkey (Macaque)	328-907 d 1 x/d (W)				0.04- 0.06	(impaired visual recognition memory in offspring) Gunderson et al. 1988 MMH
Cancer							
91	Rat (Wistar)	2 yr ad lib (W)				4.2 M	(CEL: renal cell adenoma) Solecki et al. 1991 PMA
92	Mouse (ICR)	104 wk ad lib (F)				0.73 M	(CEL: renal epithelial adenocarcinoma in males) Hirano et al. 1986 MMC
93	Mouse (ICR)	78 wk ad lib (F)				1.6 M	(CEL: renal adenomas and adenocarcinomas) Mitsumori et al. 1981 MMC
94	Mouse (B6C3F1)	104 wk ad lib (F)				0.69 M	(CEL: renal epithelial cell adenomas and carcinomas) Mitsumori et al. 1990 MMC

^aThe number corresponds to entries in Figure 2-3.

^bUsed to derive a chronic oral Minimal Risk Level (MRL) of 3×10^{-4} mg mercury/kg/day; the NOAEL dose was derived from hair levels, uncertainty factors of 1.5 for pharmacokinetic and 1.5 for pharmacodynamic variability in the relationship between mercury hair levels and mercury ingestion rates, and a modifying factor of 1.5 for domain-specific differences between the Faroe and Seychelles studies $((1.5 + 1.5) \times 1.5 = 4.5)$. No other uncertainty factor was used since the children exposed in utero represent the most sensitive population.

ad lib = ad libitum; ALT = alanine amino transferase; AMC = ammoniated mercuric chloride; approx = approximately; AST = aspartate aminotransferase; Bd Wt = body weight; BMDL = benchmark dose, lower limit (95%); Cardio = cardiovascular; CEL = cancer effect level; d = day(s); Endocr = endocrine; F = female; (F) = feed; (G) = gavage; Gastro = gastrointestinal; Gd = gestational day; Gn pig = guinea pig; (GO) gavage with oil; (GW) gavage with water; Hemato = hematological; Hg = mercury; hr = hour(s); LOAEL = lowest-observed-adverse-effect level; M = male; MM = methylmercury; MMA = methylmercuric acetate; MMC = methylmercuric chloride; MMD = methylmercuric dicyandiamide; MMH = methylmercuric hydroxide; min = minute(s); mo = month(s); NOAEL = no-observed-adverse-effect level; NS = not specified; ppd = postpartum day(s); Resp = respiratory; (W) = drinking water; wk = week(s); x = time(s); yr = year(s)

Figure 2-3. Levels of Significant Exposure to Organic Mercury - Oral
Acute (≤ 14 days)

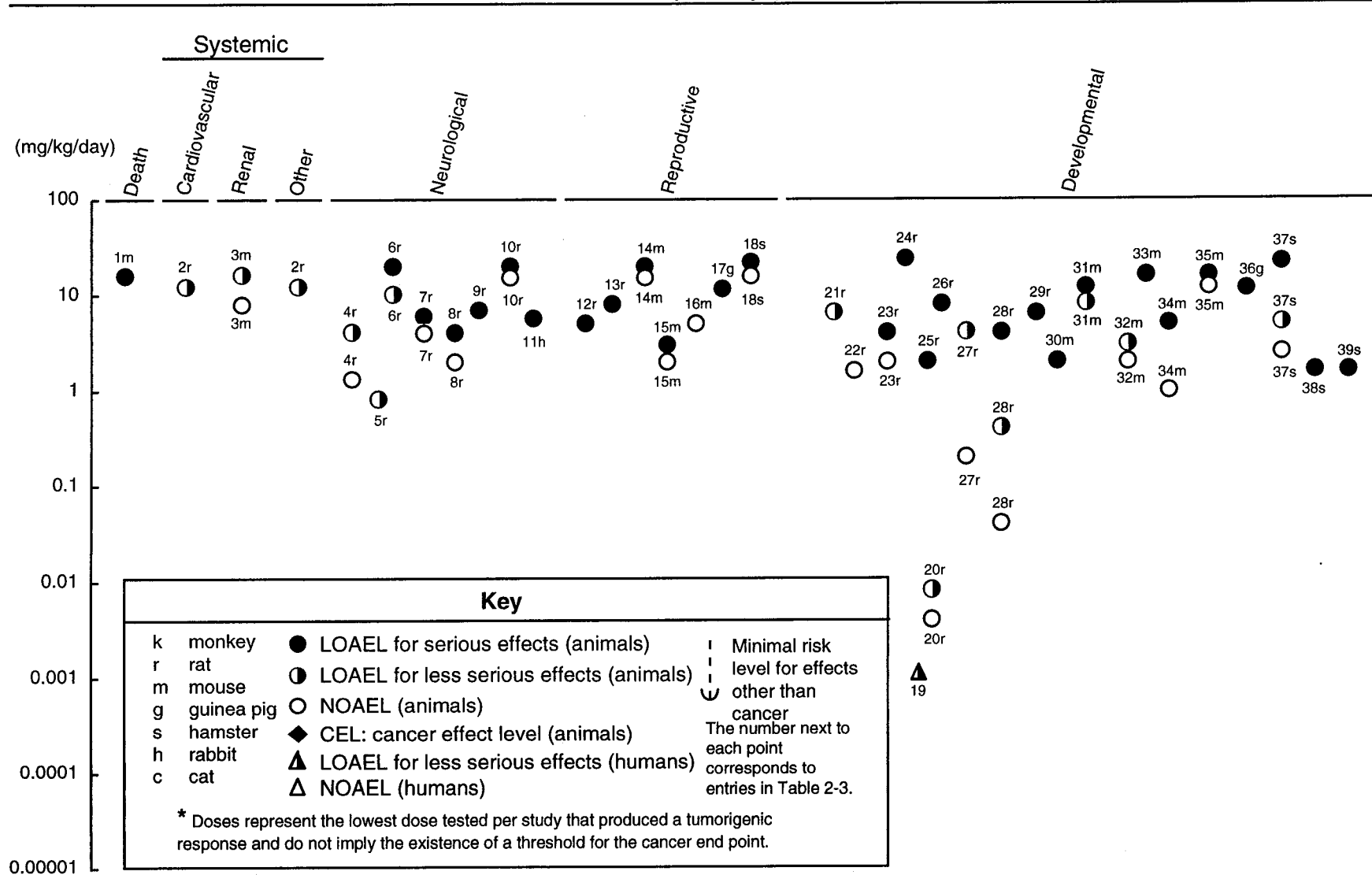
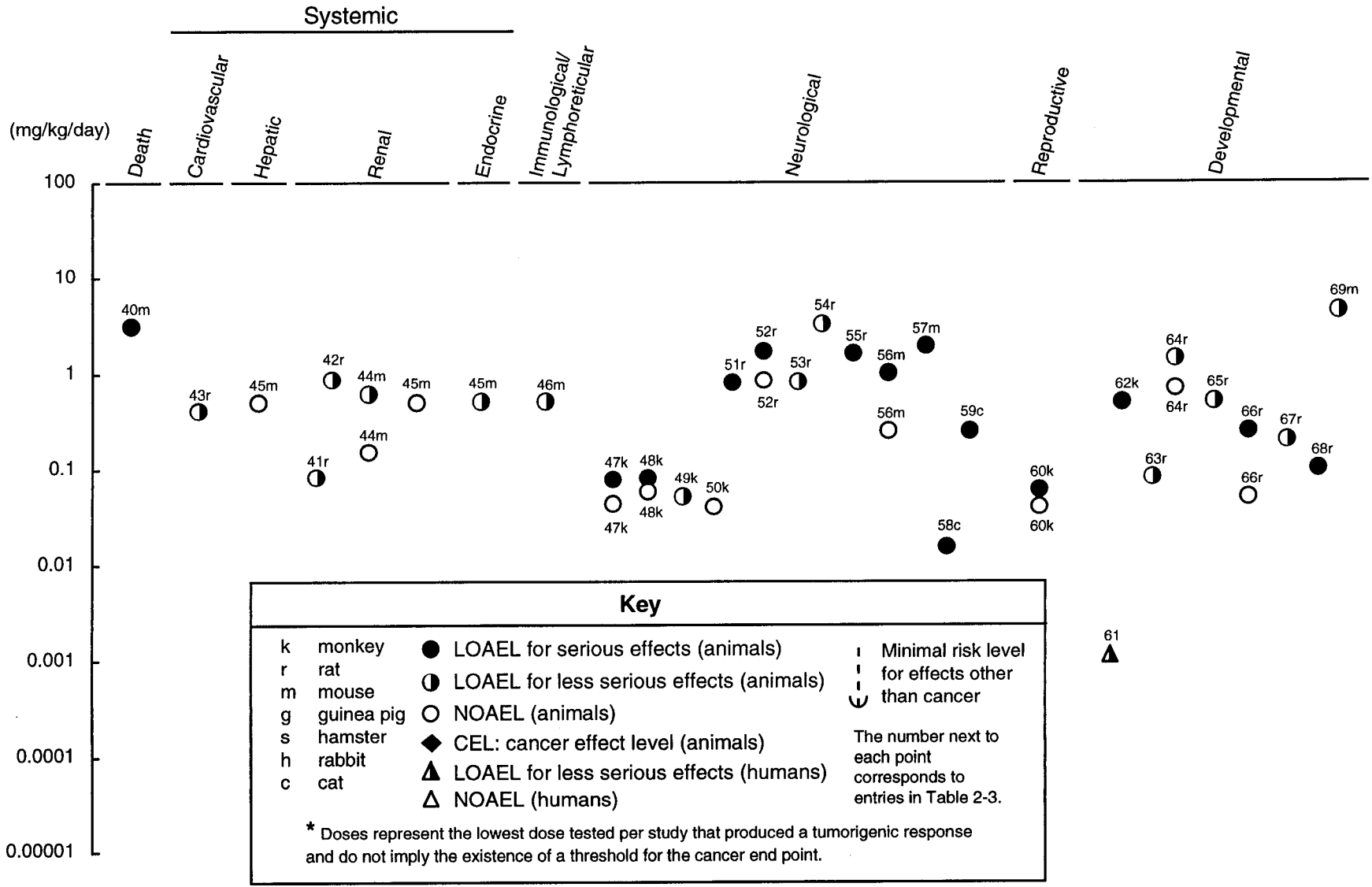
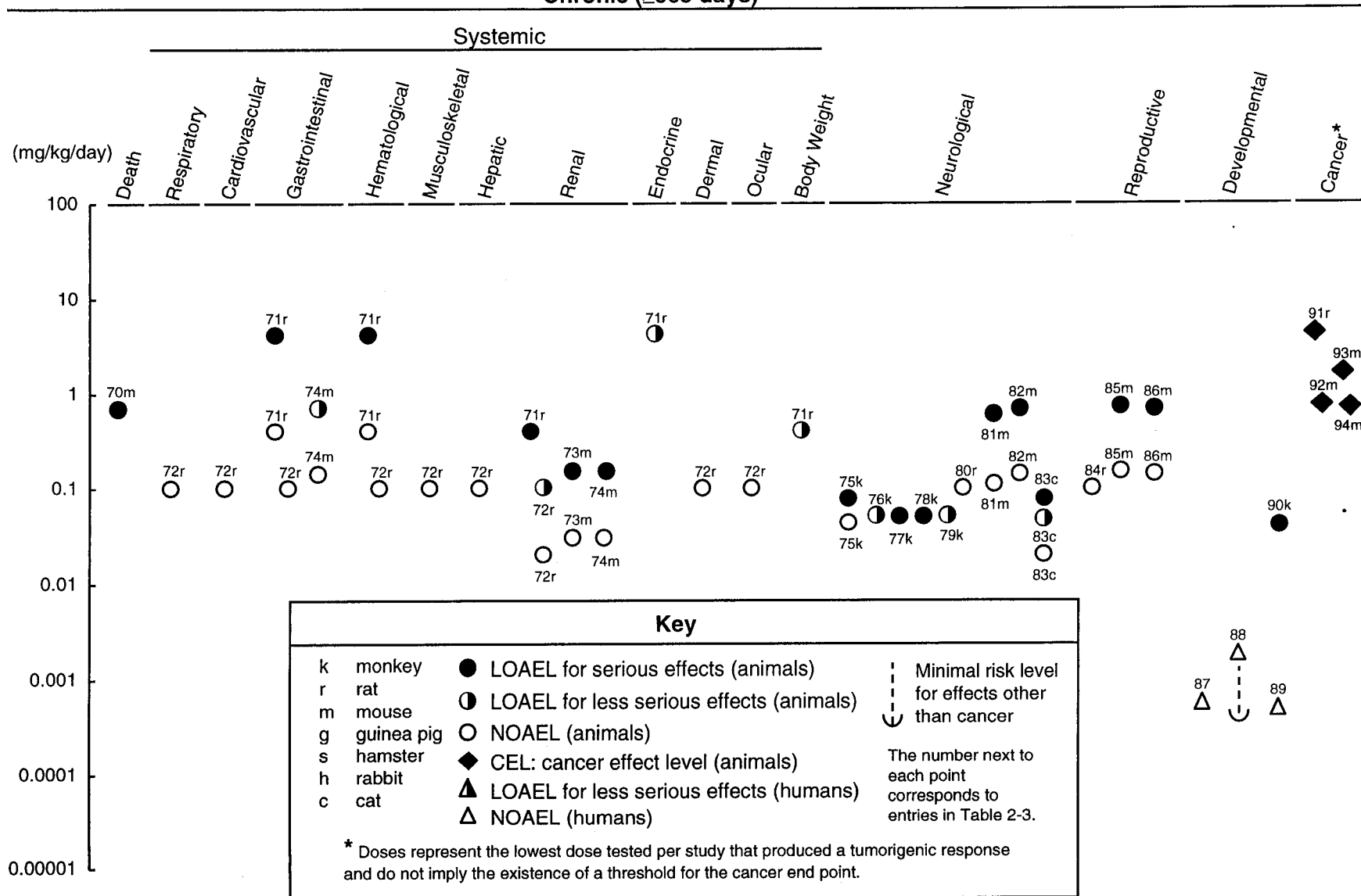

Figure 2-3. Levels of Significant Exposure to Organic Mercury - Oral (cont.)
Intermediate (15-364 days)



2. HEALTH EFFECTS

Figure 2-3. Levels of Significant Exposure to Organic Mercury - Oral (cont.)
Chronic (≥365 days)



2. HEALTH EFFECTS

2. HEALTH EFFECTS

Chronic exposure to mercuric chloride resulted in increased mortality in male rats at 1.9 mg Hg/kg/day but no increase in mortality in female rats at up to 3.7 mg Hg/kg/day or in either male or female mice at up to 7.4 mg Hg/kg/day (NTP 1993). Renal lesions in the male rats were thought to contribute to the early deaths in these animals.

The highest NOAEL values and all reliable LOAEL values for death for each species and duration category are recorded in Table 2-2 and plotted in Figure 2-2 for inorganic mercury.

Organic Mercury. The acute lethal dose of organic mercury compounds for humans is difficult to assess from the available literature. Death resulting from organic mercury ingestion has been amply documented following outbreaks of poisoning (Minamata disease) after consumption of methylmercury-contaminated fish in Minamata, Japan (Tsubaki and Takahashi 1986) and after consumption of grains contaminated with methyl- and ethylmercury in Iraq (Al-Saleem and the Clinical Committee on Mercury Poisoning 1976; Bakir et al. 1973). Death occurred in two boys who ate meat from a butchered hog that had been fed seed treated with ethylmercuric chloride (Cinca et al. 1979). However, primarily because of the delay between mercury consumption and the onset of symptoms, the amount of organic mercury ingested in these cases is difficult to determine. Fatal doses estimated from tissue concentrations range from 10 to 60 mg/kg (EPA 1985b). A case-control study examining the cause of death for patients with Minamata disease compared to the cause of death in unexposed persons showed that those patients who died prior to 1970 had significantly increased noninflammatory diseases of the nervous system; Minamata disease was reported as the underlying cause of death (Tamashiro et al. 1984). For this group, pneumonia and nonischemic heart disease were reported as prominent secondary cause of death. For those patients who died between 1970 and 1980, significant increases in Minamata disease were reported as the primary cause of death. Nonischemic heart disease correlated with the incidence of Minamata disease, and noninflammatory central nervous system disease was a prominent secondary cause of death in this group.

Methylmercury toxicity is very strain- and sex-specific in mice. A single oral dose of methylmercuric chloride at 16 mg Hg/kg resulted in the death of 4 of 6 male mice (C57BL/6N Jcl strain) but no deaths in females (Yasutake et al. 1991b). No increase in mortality was observed in female mice until 40 mg Hg/kg was administered, at which dosage 4 of 6 females died. Twenty-six weeks of dietary exposure to methylmercuric chloride resulted in increased mortality in both male and female mice (ICR strain) at 3.1 mg Hg/kg/day (Mitsumori et al. 1981). Chronic (104 weeks) dietary exposure to methylmercuric

2. HEALTH EFFECTS

chloride resulted in increased deaths in male mice (B6C3F₁ strain) at 0.69 mg Hg/kg/day but no increased mortality in females at up to 0.60 mg Hg/kg/day (Mitsumori et al. 1990).

The highest NOAEL values and all reliable LOAEL values for death for each species and duration category are recorded in Table 2-3 and plotted in Figure 2-3 for organic mercury.

2.2.2.2 Systemic Effects

Ingestion of mercury compounds has been associated with systemic toxicity in both humans and animals. As with inhalation exposure to metallic mercury vapor, the major target organs of toxicity following oral exposure to inorganic and organic mercury are the kidneys and the central nervous system, respectively. Available information is limited mainly to that concerning exposure to mercuric chloride and methylmercuric chloride. Oral exposure to mercury, especially the organic mercury form, has also been observed to result in adverse developmental effects in humans and experimental animals. A discussion of the differences in the toxicities of metallic mercury, inorganic compounds, and organic compounds of mercury is presented in Section 2.5. The systemic effects observed after oral exposure are discussed below.

The highest NOAEL values and all reliable LOAEL values for systemic effects for each species and duration category are recorded in Table 2-2 and plotted in Figure 2-2 for inorganic mercury, and recorded in Table 2-3 and plotted in Figure 2-3 for organic mercury.

Respiratory Effects

Inorganic Mercury. Extremely limited information was located regarding respiratory effects in humans after oral exposure to inorganic forms of mercury. A 35-year-old man who swallowed an unknown amount of mercuric chloride had severe pulmonary edema and required artificial ventilation (Murphy et al. 1979). Fine rales were detected in a 19-month-old boy who swallowed powdered mercuric chloride (Samuels et al. 1982). A 50-year-old female who ingested 5 tablets of a Chinese medicine that contained an unspecified amount of mercurous chloride (Kang-Yum and Oransky 1992) experienced shortness of breath.

The only study located regarding respiratory effects in animals after oral exposure to inorganic mercury described forceful and labored breathing, bleeding from the nose, and other unspecified respiratory

2. HEALTH EFFECTS

difficulties in Long-Evans rats after dietary exposure to 2.2 mg Hg/kg/day as mercuric chloride for 3 months (Goldman and Blackburn 1979).

Organic Mercury. Limited information was located regarding respiratory effects in humans after oral exposure to organic mercury. Two boys who died after eating meat from a hog that had eaten seed treated with ethylmercuric chloride developed bronchopneumonia and edematous alveolitis, and required artificial ventilation (Cinca et al. 1979). Bronchopneumonia was also identified as the cause of death in four adults and one infant who died as the result of methylmercury poisoning in Iraq during 1972 (Al-Saleem and the Clinical Committee on Mercury Poisoning 1976). It is unclear whether these respiratory effects were the result of direct effects on the respiratory system or were secondary to other effects.

The only information located regarding respiratory effects in animals after oral exposure to organic mercury comes from a study in which rats were exposed to methylmercuric chloride in the diet for 2 years (Verschuuren et al. 1976). This study showed no treatment-related histopathological lesions in the lungs of exposed rats at 0.1 mg Hg/kg/day.

Cardiovascular Effects

Inorganic Mercury. Cardiovascular toxicity has been observed following ingestion of mercuric chloride and mercurous chloride in humans. The majority of the information regarding cardiovascular effects comes from reports of children who were treated with mercurous chloride tablets for worms or mercurous chloride-containing powders for teething discomfort (Warkany and Hubbard 1953). These authors described multiple cases in which tachycardia and elevated blood pressure were observed in the affected children. The only information located regarding cardiovascular effects in humans after ingestion of mercuric chloride comes from a case study of a 22-year-old who attempted suicide by ingesting approximately 20 mg Hg/kg as mercuric chloride (Chugh et al. 1978). An electrocardiogram showed no P wave, prolongation of the QRS segment, and a high T wave. The authors suggested that these cardiovascular effects were secondary to severe hyperkalemia.

Exposure of rats to 28 mg Hg/kg/day as mercuric chloride for 180 days in drinking water resulted in an increase in blood pressure, a decrease in cardiac contractility, and no effect on heart rate (Carmignani et al. 1992). The increase in blood pressure was attributed to a vasoconstrictor effect, and the decrease in contractility was attributed to the direct toxic effect of the mercury on the cardiac muscle. Slightly

2. HEALTH EFFECTS

different results were obtained following 350-day exposure of a different strain of rats to 7 mg Hg/kg/day as mercuric chloride in drinking water (Boscolo et al. 1989; Carmignani et al. 1989). In the chronic study, positive inotropic response, increased blood pressure and cardiac contractility, and decreased baroreceptor reflex sensitivity were observed. The investigators suggested that the mechanism for the cardiac effects in the chronic study involved the release of norepinephrine from presynaptic nerve terminals. Evidence of this release was provided by the fact that mercury administration reduced the cardiovascular response to bretylium (which blocks presynaptic release of the neurotransmitter norepinephrine) but not tyramine (which releases neurotransmitter from nerve terminals).

Organic Mercury. Electrocardiography in four family members who ate meat from a hog that had consumed seed treated with ethylmercuric chloride had abnormal heart rhythms (ST segment depression and T wave inversion) (Cinca et al. 1979). Death of the two children in the family was attributed to cardiac arrest, and autopsy of these boys showed myocarditis. Cardiovascular abnormalities were also observed in severe cases of poisoning in the Iraqi epidemic of 1956, when widespread poisoning resulted from eating flour made from seed grains treated with ethylmercury *p*-toluene sulfonamide (Jalili and Abbasi 1961). These abnormalities included irregular pulse, occasionally with bradycardia, and electrocardiograms showing ventricular ectopic beats, prolongation of the Q-T interval, depression of the S-T segment, and T inversion.

A decrease in heart rate was observed in male rats given 2 gavage doses of 12 mg Hg/kg as methylmercuric chloride (Arito and Takahashi 1991). An increase in systolic blood pressure was observed in male rats after daily oral gavage doses of 0.4 mg Hg/kg/day as methylmercuric chloride for 3–4 weeks (Wakita 1987). This effect began approximately 60 days after initiation of exposure and persisted for at least 9 months. No treatment-related histopathological changes were observed in the hearts of rats exposed to 0.1 mg Hg/kg/day as methylmercuric chloride in the diet for up to 2 years (Verschuuren et al. 1976).

Gastrointestinal Effects

Inorganic Mercury. Ingestion of metallic mercury results in negligible absorption and little effect on the gastrointestinal tract. The two case histories identified are unusual in that the dose levels could be reasonably well quantified. The first case history reported ingestion of 15 mL (204 g) of metallic mercury by a 17-year-old male storekeeper who swallowed mercury from the pendulum of a clock (apparently out of curiosity rather than as a suicide attempt). On admission, and 24 hours later, he was symptom free, and

2. HEALTH EFFECTS

physical examination was normal. The patient complained of no gastrointestinal symptoms, and was treated with a mild laxative and bedrest (Wright et al. 1980).

In a second and massive incidence of ingestion, a 42-year-old man who had spent much of his life (since the age of 13) repairing instruments that contained mercury, intentionally ingested an estimated 220 mL (about 3,000 g) while repairing a sphygmomanometer (Lin and Lim 1993). Upon admission, the patient presented with significantly elevated mercury blood levels (103 $\mu\text{g/L}$, normal $<10 \mu\text{g/L}$) and urine levels (73 $\mu\text{g/L}$, normal $<20 \mu\text{g/L}$). In the previous 2 years he had developed mild hand tremors, forgetfulness, irritability, and fatigue. Only a mild abdominal discomfort and no hepatic complications were observed at admission. The neurological symptoms were attributed to the long occupational exposure to mercury and not to the recent acute exposure. The initial radiological examination showed a conglomeration of mercury globules in the fundus of the stomach and ascending colon, with fine metallic spots dispersed throughout the small intestine. Abdominal ultrasonography was normal. He was treated with immediate gastric lavage and cathartics. He also received D-penicillamine 1 g/day orally for 7 days. Seven days later, there were only spots of metallic mercury in the ascending colon. By 2 weeks, most of the mercury had been excreted in the feces and was measured at a total volume of 220 mL (this number was used to estimate the amount initially ingested). The authors reported that systemic absorption appeared low, based on the return to low levels of mercury in the urine and blood over the 10 days of monitoring following the exposure. A subsequent evaluation 6 months later revealed no further gastrointestinal involvement.

Ingestion of mercuric chloride is highly irritating to the tissues of the gastrointestinal tract. Blisters and ulcers on the lips and tongue and vomiting were observed in a 19-month-old boy who ingested an unknown amount of mercuric chloride powder (Samuels et al. 1982). Similarly ingestion of a lethal dose of mercuric chloride by a 35-year-old man resulted in vomiting, diarrhea, colicky abdominal pain, oropharyngeal pain, and ulceration and hemorrhages throughout the length of the gastrointestinal tract (Murphy et al. 1979). Ingestion by a woman of 30 mg Hg/kg as mercuric chloride resulted in severe abdominal pain, diarrhea, nausea, and vomiting (Afonso and deAlvarez 1960). Another report of an attempted suicide by a 22-year-old reported ulceration of the mouth and throat and bloody vomit after ingestion of approximately 20 mg Hg/kg (Chugh et al. 1978). Because of vomiting, the actual effective dose was unknown.

Reports of ingestion of mercurous chloride have not found similar caustic effects; however, a 50-year-old woman who ingested an unspecified amount of mercurous chloride in a Chinese medicine experienced nausea and vomiting (Kang-Yum and Oransky 1992). Several children who were treated with mercurous

2. HEALTH EFFECTS

chloride for constipation, worms, or teething discomfort had swollen red gums, excessive salivation, anorexia, diarrhea, and/or abdominal pain (Warkany and Hubbard 1953).

Inflammation and necrosis of the glandular stomach were observed in mice that were given oral doses of 59 mg Hg/kg as mercuric chloride 5 days a week for 2 weeks (NTP 1993). In a 2-year gavage study, an increased incidence of forestomach hyperplasia was observed in male rats exposed to 1.9 or 3.7 mg Hg/kg/day as mercuric chloride compared to the control group.

Organic Mercury. Case studies of individuals who were orally exposed to alkyl mercury compounds (unspecified form) reported diarrhea, tenesmus, irritation, and blisters in the upper gastrointestinal tract (Lundgren and Swensson 1949). Ingestion of meat from a hog that was fed seed treated with ethylmercuric chloride resulted in vomiting in two of the family members (Cinca et al. 1979). No quantitative data were available. Ingestion of flour made from seed grains that had been treated with ethylmercury *p*-toluene sulfonanilide also commonly resulted in abdominal pain and vomiting, diarrhea, or constipation (Jalili and Abbasi 1961).

Pfab et al. (1996) reported a case of a 44-year-old man who ingested 83 mg/kg Thiomersal in a suicide attempt (5 g/60 kg). Thiomersal is a widely used alkyl-aryl-organomercurial bactericide. The man developed gastritis, renal tubular failure, dermatitis, gingivitis, delirium, coma, polyneuropathy, and respiratory failure. Treatment was symptomatic plus gastric lavage and the oral chelation with dimercaptopropane sulfonate and dimercaptosuccinic acid. The patient's condition was at its worst on day 17; however, the patient recovered completely (after several months). Maximum mercury concentrations were: blood, 14 mg/L; serum, 1.7 mg/L; urine, 10.7 mg/L; and cerebrospinal fluid, 0.025 mg/L. Mercury concentration in blood declined with two velocities: first with a half-time of 2.2 days, then with a half-time of 40.5 days. The decline of mercury concentration in blood, urinary mercury excretion, and renal mercury clearance were not substantially influenced by chelation therapy.

Exposure of rats to phenylmercuric acetate for 2 years resulted in necrosis and ulceration of the cecum at doses as low as 4.2 mg Hg/kg/day in drinking water; no effect was observed at 1.7 mg Hg/kg/day in the feed (Fitzhugh et al. 1950; Solecki et al. 1991). Mice showed ulceration of the glandular stomach after 2 years of dietary exposure to methylmercuric chloride at 0.69 mg Hg/kg/day (Mitsumori et al. 1990). In contrast, no treatment-related histopathological lesions in the stomach or jejunum were observed in rats exposed via the diet to 0.1 mg Hg/kg/day as methylmercuric chloride (Verschuuren et al. 1976).

2. HEALTH EFFECTS

Hematological Effects

Inorganic Mercury. Information is limited regarding hematological effects in humans after ingestion of inorganic mercury. The only information located regarding hematological effects in humans was the report of anemia that developed (probably secondary to massive gastrointestinal hemorrhaging) in a 35-year-old man who ingested a lethal amount of mercuric chloride (Murphy et al. 1979). Bone marrow activity in the afflicted man was normal, but thrombocytopenia was also observed.

Groups of 10 female Sprague-Dawley rats were administered a single gavage dose of mercuric chloride at 7.4 or 9.2 mg Hg/kg in water and necropsied at 14 days postexposure. Blood samples were analyzed for hemoglobin concentration, hematocrit value, erythrocyte counts, total and differential leukocyte counts, and platelet counts. Serum was analyzed for sodium, potassium, inorganic phosphorus, total bilirubin, alkaline phosphatase, aspartate aminotransferase (AST), total protein, calcium, cholesterol, glucose, uric acid, and lactate dehydrogenase (LDH). There were no effects on body weight, and weights of other organs were not affected. Significant decreases in hemoglobin, erythrocytes, and hematocrit were also reported. There was a significant decrease in serum protein and calcium in the low-dose mercury group only. Mercury was found mainly in the kidneys (12.6 and 18.9 ppm at the low and high dose, respectively), but trace amounts were also detected in the liver, brain, and serum (Lecavalier et al. 1994).

No other studies were located regarding hematological effects in animals after oral exposure to inorganic mercury.

Organic Mercury. No studies were located regarding hematological effects in humans after oral exposure to organic mercury.

Rats that received phenylmercuric acetate in their drinking water for 2 years showed decreases in hemoglobin, hematocrit, and red blood cell counts at a dose of 4.2 mg Hg/kg/day (Solecki et al. 1991). The anemia observed in this study may have been secondary to blood loss associated with the ulcerative lesions in the large intestine seen at this dose (see Gastrointestinal Effects above). No treatment-related changes were observed in hematological parameters measured in rats (strain not specified) exposed via the diet for 2 years to 0.1 mg Hg/kg/day as methylmercuric chloride (Verschuuren et al. 1976).

2. HEALTH EFFECTS

Musculoskeletal Effects

Inorganic Mercury. A single case report was identified that found evidence of skeletal muscle degeneration (markedly elevated serum aldolase, LDH, and creatinine phosphokinase; and the presence of pigment granular casts and myoglobin in the urine) in a 22-year-old man who ingested 2 g of mercuric chloride in an attempt to commit suicide (Chugh et al. 1978). Several children who were treated with mercurous chloride for constipation, worms, or teething discomfort experienced muscle twitching or cramping in the legs and/or arms (Warkany and Hubbard 1953). The muscular effects were probably secondary to changes in electrolyte balance (i.e., potassium imbalance due to fluid loss or renal wasting).

No studies were located regarding musculoskeletal effects in animals after oral exposure to inorganic mercury.

Organic Mercury. Autopsy of one of two boys who died after eating meat from a hog that had consumed seed treated with ethylmercuric chloride showed muscle wasting (Cinca et al. 1979). This effect was probably secondary to neurotoxicity. Electromyography in the two surviving members of the family showed no abnormalities. Musculoskeletal effects observed in Iraqis poisoned by consuming flour made from grains treated with ethylmercury *p*-toluene sulfonanilide included deep skeletal pain and muscle twitching or fasciculations (Jalili and Abbasi 1961). It is likely that these effects were secondary to effects on the nervous system.

No treatment-related histopathological changes in skeletal muscle were observed in rats exposed via the diet for 2 years to 0.1 mg Hg/kg/day as methylmercuric chloride (Verschuuren et al. 1976).

Hepatic Effects

Inorganic Mercury. Limited information was located regarding hepatic effects in humans who ingested inorganic mercury. A 35-year-old man who ingested a lethal dose of mercuric chloride became jaundiced and exhibited elevated AST, alkaline phosphatase, LDH, and bilirubin (Murphy et al. 1979). An autopsy revealed an enlarged and softened liver. Hepatic enlargement was also observed in a 19-month-old boy who ingested an unknown amount of powdered mercuric chloride (Samuels et al. 1982).

Limited information was located regarding the hepatic effects of inorganic mercury in animals.

2. HEALTH EFFECTS

Groups of 10 female Sprague-Dawley rats were administered a single gavage dose of mercuric chloride at 7.4 or 9.2 mg Hg/kg in water and necropsied at 14 days postexposure. There were no effects on body or relative liver weights from mercuric chloride exposure. LDH activity was significantly decreased in animals exposed to HgCl₂ at both dose levels. Mercury was found mainly in the kidneys (12.6 and 18.9 ppm at the low and high dose, respectively), but trace amounts were also detected in the liver, brain, and serum (Lecavalier et al. 1994).

Two intermediate-duration studies in rats showed biochemical changes following ingestion of mercuric chloride (Jonker et al. 1993b; Rana and Boora 1992). Increases in hepatic lipid peroxidation and decreases in glutathione peroxidase were observed in rats orally exposed to an unspecified dose of mercuric chloride for 30 days (Rana and Boora 1992). In a 4-week range-finding study, groups of 5 rats per sex (10 per sex for controls) received diets containing mercuric chloride at 5, 10, or 20 mg Hg/kg/day in males and 5.5, 11.1, and 22.2 mg Hg/kg/day in females. Absolute liver weight decreased starting at the mid-dose group in males and in the high-dose group in females (Jonker et al. 1993b). The liver weight significantly increased in mice given 2.9 mg Hg/kg/day as mercuric chloride in the drinking water for 7 weeks; however, no histopathological changes were observed (Dieter et al. 1983). Male rats administered mercuric chloride by gavage for 2 years showed a slight increase in acute hepatic necrosis (11 of 50 versus 4 of 50 in controls); however, it is unclear whether this increase was statistically significant (NTP 1993).

Organic Mercury. Extremely limited information was also obtained regarding the hepatic effects of organic mercury exposure. An autopsy of four adults and four infants who died as the result of methylmercury poisoning in Iraq in 1972 reported fatty changes in the liver occurred in most cases (Al-Saleem and the Clinical Committee on Mercury Poisoning 1976). It is unclear whether these changes were the direct result of methylmercury on the liver or whether they were due to other causes. The prevalence of liver disease in a population from the Minamata area was not significantly increased when compared to unexposed controls (Futatsuka et al. 1992).

No treatment-related changes were observed in hepatic parameters measured in rats exposed via the diet to 0.1 mg Hg/kg/day as methylmercuric chloride (Verschuuren et al. 1976).

2. HEALTH EFFECTS

Renal Effects

Inorganic Mercury. The kidney appears to be the critical organ of toxicity for the ingestion of mercuric salts. Renal effects in humans have been observed following acute oral exposure to inorganic mercury. Acute renal failure has been observed in a number of case studies of mercuric chloride ingestion (Afonso and deAlvarez 1960; Murphy et al. 1979; Samuels et al. 1982). An autopsy of a 35-year-old man who ingested a lethal dose of mercuric chloride and exhibited acute renal failure showed pale and swollen kidneys (Murphy et al. 1979). A case study reported acute renal failure characterized by oliguria, proteinuria, hematuria, and granular casts in a woman who ingested 30 mg Hg/kg as mercuric chloride (Afonso and deAlvarez 1960). Another case study reported a dramatic increase in urinary protein secretion by a patient who ingested a single dose of 15.8 mg Hg/kg as mercuric chloride (assuming a body weight of 70 kg) (Pesce et al. 1977). The authors of the report surmised that the increased excretion of both albumin and β_2 -microglobulin was indicative of mercury-induced tubular and glomerular pathology. Acute renal failure that persisted for 10 days was also observed in a 19-month-old child who ingested an unknown amount of powdered mercuric chloride (Samuels et al. 1982). Decreased urine was observed in a 22-year-old who attempted suicide by ingesting approximately 20 mg Hg/kg (Chugh et al. 1978). Myoglobin and pigmented casts were observed in the urine, and the authors suggested that these observations, in combination with a highly elevated level of serum creatine phosphokinase, indicated that rhabdomyolysis may have contributed to the renal failure.

Ingestion of mercurous chloride has also resulted in renal toxicity in humans. Decreased urinary output and edema were observed in a 60-year-old woman who ingested an unspecified amount of mercurous chloride in a Chinese medicine (Kang-Yum and Oransky 1992). Renal failure was a contributing factor in the death of this woman. Renal failure also developed in two female patients who chronically ingested a mercurous chloride-containing laxative (Davis et al. 1974).

Renal toxicity has been observed in Fischer 344 rats and B6C3F₁ mice following acute-, intermediate-, and chronic-duration exposures to mercuric chloride (Dieter et al. 1992; NTP 1993). In the 14-day study, male and female rats were exposed by gavage to 0.93–14.8 mg Hg/kg/day as mercuric chloride for 5 days a week. There was a significant increase in the absolute and relative kidney weights of males beginning at the 1.9-mg/kg/day dose level. An increased incidence of tubular necrosis was observed in rats exposed to at least 3.7 mg/kg/day; severity progressed with increasing dose levels. Increases in urinary levels of alkaline phosphatase, AST, and LDH were also observed at 3.7 mg Hg/kg/day; at 7.4 mg Hg/kg/day,

2. HEALTH EFFECTS

increased urinary γ -glutamyltransferase activity was also observed. Mice given a single gavage dose of 10 mg/Hg/kg as mercuric chloride showed minor renal tubular damage and rapid regeneration of the tubular epithelium (Nielsen et al. 1991). At 20 mg Hg/kg/day, the mice showed necrosis of the proximal tubules. Mice given gavage doses of mercuric chloride 5 days a week for 2 weeks showed an increase in absolute and relative kidney weights at 3.7 mg Hg/kg/day and acute renal necrosis at 59 mg Hg/kg/day (NTP 1993).

Groups of 10 female Sprague-Dawley rats were administered a single gavage dose of mercuric chloride at 7.4 or 9.2 mg Hg/kg in water and necropsied at 14 days postexposure. No effects on body weight or weights of other organs were found. Mercury was found mainly in the kidneys (12.6 and 18.9 ppm at the low and high doses, respectively), but trace amounts were also detected in the liver, brain, and serum. Mild-to-moderate morphological changes, consisting of protein casts, cellular casts, and interstitial sclerosis, were noted in the kidneys of HgCl₂-treated animals in both groups (Lecavalier et al. 1994).

In a 4-week range-finding study, groups of 5 rats per sex (10 per sex for controls) received diets containing mercuric chloride at 5, 10, or 20 mg Hg/kg/day for males and 5.5, 11.1, and 22.2 mg Hg/kg/day for females. Nephrosis and proteinaceous casts in the kidneys were observed in all groups (males and females) fed mercuric chloride. An increased number of epithelial cells in the urine was observed in males exposed at the low dose; however, this effect was not observed at higher dose levels and the authors noted that the effect could not be ascribed to treatment. The minimum-nephrotoxic-effect level (MNEL) and the no-nephrotoxic-effect level (NNEL) for mercuric chloride in feed were determined to be 8 mg Hg/kg/day in males and 8.9 mg Hg/kg/day in females and 1 mg Hg/kg/day in males and 1.1 mg Hg/kg/day in females, respectively (Jonker et al. 1993b). In a follow-up 4-week study, 10-week-old Wistar rats were fed mercuric chloride at the MNEL and NNEL. In males, the MNEL resulted in the presence of ketones in urine and an increase in the relative weight of kidneys. Effects observed in females in the MNEL group included decreased density of urine and increased absolute and relative kidney weights. Increased absolute and relative kidney weights were also seen in females at the NNEL. A few histopathological changes were found in the basophilic tubules in the outer cortex of the kidneys in 5 of 5 males and 1 of 5 females exposed to the MNEL (Jonker et al. 1993b).

Similarly, male mice receiving mercuric chloride in drinking water for 7 weeks showed slight degeneration of the tubular epithelial cells (nuclear swelling) at 2.9 mg Hg/kg/day and minimal renal nephropathy

2. HEALTH EFFECTS

(dilated tubules with either flattened eosinophilic epithelial cells or large cytomegalic cells with foamy cytoplasm) at 14.3 mg Hg/kg/day (Dieter et al. 1983).

In a 6-month exposure to 0.23–3.7 mg Hg/kg/day, a significant increase in severity of nephropathy (i.e., dilated tubules with hyaline casts, foci of tubular regeneration, and thickened tubular basement membrane) was observed in Fischer 344 rats exposed to 0.93 mg/kg/day of mercuric chloride compared to the controls (NTP 1993). The absolute and relative kidney weights were increased in males at 0.46 mg/kg/day. In B6C3F₁ mice, the incidence and severity of cytoplasmic vacuolation of renal tubule epithelium increased in males exposed to at least 3.7 mg Hg/kg/day as mercuric chloride for 6 months (NTP 1993). Administration of large doses of mercuric chloride (28 mg Hg/kg/day) in the drinking water for 6 months also resulted in focal degeneration of the tubular cells with decreased acid phosphatase in the lysosomes (indicative of the release of the lysosomal contents) (Carmignani et al. 1992). Notably, at this dose, renal glomerular changes were also evident. The glomeruli showed hypercellularity, and there was deposition of amorphous material in the mesangium; thickening of the basement membrane with IgM present was also observed.

When a strain of mice (SJL/N) sensitive to the immunotoxic effects of mercury was given mercuric chloride in the drinking water at 0.56 mg Hg/kg/day for 10 weeks, slight glomerular cell hyperplasia with granular IgG deposits in the renal mesangium and glomerular blood vessels were observed (Hultman and Enestrom 1992). No tubular necrosis was observed.

In a 2-year study, male rats gavaged with 1.9 or 3.7 mg Hg/kg/day as mercuric chloride 5 days a week exhibited an incidence of marked nephropathy (described as thickening of glomerular and tubular basement membranes and degeneration and atrophy of tubular epithelium) that was significantly greater in severity than in the control group (NTP 1993). In addition, the incidence of renal tubule hyperplasia was increased in the high-dose male rats. In the same study, the incidence and severity of nephropathy were significantly greater in male and female mice gavaged with 3.7 and 7.4 mg Hg/kg/day as mercuric chloride 5 days a week than in the controls. Administration of 7 mg Hg/kg/day as mercuric chloride to rats in the drinking water resulted in hydropic degeneration and desquamation of tubule cells (Carmignani et al. 1989). Electron microscopy showed lysosomal alterations in the proximal tubules and thickening of the basal membrane of the glomeruli.

2. HEALTH EFFECTS

Organic Mercury. Data on renal toxicity associated with ingestion of methylmercury in humans come from several case studies. An outbreak of ethylmercury fungicide-induced poisoning was reported by Jalili and Abbasi (1961). Affected individuals exhibited polyuria, polydypsia, and albuminuria. Two boys who ingested meat from a hog that had consumed seed treated with ethylmercuric chloride also had increased blood urea, urinary protein, and urinary sediment (Cinca et al. 1979); an autopsy revealed nephritis. A 13-month-old boy who ate porridge made from flour treated with an alkyl mercury compound (specific mercury compound not reported) experienced albuminuria, red and white cells, and casts in the urine (Engleson and Herner 1952). In autopsies carried out to evaluate the cause of death in 4 adults and 4 infants from the Iraqi epidemic of 1972, one case exhibited tubular degeneration in the kidneys (whether an adult or child was not specified) (Al-Saleem and the Clinical Committee on Mercury Poisoning 1976).

Organic mercury-induced nephrotoxicity has been demonstrated in rodents following acute-, intermediate-, and chronic-duration exposure. The usefulness of results from subchronic studies may be limited because the pathological changes observed were often not distinguished as primary or secondary effects (i.e., pathological changes secondary to induced shock). Nonetheless, they provide some useful indication of potential effects.

Administration of methylmercuric chloride to mice in a single gavage dose of 16 mg Hg/kg resulted in decreased renal function (decreased phenolsulfonphthalein excretion), increased plasma creatinine, and swelling of tubular epithelial cells, with exfoliation of the cells into the tubular lumen (Yasutake et al. 1991b). Although no effects were observed after a single gavage dose of 8 mg Hg/kg (Yasutake et al. 1991b), 5 daily gavage doses of 8 mg Hg/kg/day as methylmercuric chloride in rats resulted in vacuolization and tubular dilation in the proximal tubules with ongoing regeneration (Magos et al. 1985). Similar effects were observed after 5 doses of 8 mg Hg/kg/day as ethylmercuric chloride (Magos et al. 1985).

In an intermediate-duration study, histopathological changes were observed in the kidneys of female rats exposed to 0.86, 1.68, or 3.36 mg Hg/kg/day as methylmercury dicyanidiamide by gavage 5 days a week for 3–12 weeks (Magos and Butler 1972). The low-dose group exhibited large foci of basophilic tubular epithelial cells, desquamation, fibrosis, and inflammation in the renal cortex; however, no control group was used in the study (Magos and Butler 1972). A 12-week diet containing 0.08 mg Hg/kg/day as methylmercury caused ultrastructural changes (cytoplasmic masses containing ribosomes and bundles of smooth endoplasmic reticulum) in kidney proximal tubule cells of female rats, despite the normal appearance of the

2. HEALTH EFFECTS

glomeruli at the light microscopic level (Fowler 1972). The author concluded that these changes could be a result of metabolism to inorganic mercury and may account for proteinuria observed in exposed humans. Administration of methylmercuric chloride in the diet of mice for 26 weeks at a dose of 0.6 mg Hg/kg/day resulted in degeneration of the proximal tubules characterized by nuclear swelling and vacuolation of the cytoplasm (Hirano et al. 1986).

Rats fed daily doses of phenylmercuric acetate for up to 2 years exhibited slight-to-moderate renal damage (e.g., tubular dilatation, atrophy, granularity, fibrosis) (Fitzhugh et al. 1950). These effects were evident at doses (beginning at 0.02 mg Hg/kg/day) that were two orders of magnitude lower than those required to induce detectable effects in the mercuric acetate-treated rats (Fitzhugh et al. 1950). A NOAEL of 0.005 mg Hg/kg/day was determined. The authors concluded that some of the histological changes were present to some degree in the control animals, suggesting that low levels of mercury apparently hasten the normal degenerative processes of the kidneys (see Inorganic Mercury above). Problems in this study limit its usefulness in determining effect levels. Increased severity of renal nephrosis was also observed in another study in which rats were given 0.4 mg Hg/kg/day as phenylmercuric acetate in the drinking water for 2 years (Solecki et al. 1991). Lower doses in this study were not tested. Mice given methylmercuric chloride in the diet at a dose of 0.13 mg Hg/kg/day showed epithelial cell degeneration and interstitial fibrosis, with ongoing regeneration of the tubules present (Mitsumori et al. 1990); no effect was observed at 0.03 mg Hg/kg/day. Similar effects were seen in mice given methylmercuric chloride in the diet for 2 years at a dose of 0.11 mg Hg/kg/day (Hirano et al. 1986). Rats given methylmercuric chloride in the diet for 2 years at a dose of 0.1 mg Hg/kg/day had increased kidney weights and decreased enzymes (alkaline phosphatase, ATPase, NADH- and NADPH-oxidoreductase, and AMPase) in the proximal convoluted tubules (Verschuuren et al. 1976). However, histopathological examination revealed no treatment-related lesions.

A 2-year study conducted with mercuric acetate in the feed of rats showed an increased severity of renal damage at doses of mercury as low as 2 mg Hg/kg/day (Fitzhugh et al. 1950). Rats initially showed hypertrophy and dilation of the proximal convoluted tubules. At this stage, eosinophilia, rounding, and granular degeneration of the epithelial cells were observed. Occasionally basophilic cytoplasm and sloughing of the cells were observed. As the lesion progressed, tubular dilation increased, and hyaline casts appeared within the tubules; fibrosis and inflammation were observed. Finally, tubules appeared as cysts, and extensive fibrosis and glomerular changes were observed. However, this study was limited because

2. HEALTH EFFECTS

group sizes were small, survival data were not reported, and a considerable number of early deaths from pneumonia were noted.

Endocrine Effects

Inorganic Mercury. No studies were located regarding endocrine effects in humans after oral exposure to inorganic mercury.

Several studies have reported effects on the thyroid after acute- or intermediate-duration exposure to mercuric chloride. An increase in iodine release from the thyroid was observed following gavage administration of 7.4 mg Hg/kg/day as mercuric chloride to rats for 6 days (Goldman and Blackburn 1979). Serum levels of thyroid hormones (triiodothyronine and/or thyroxine) in mice decreased after administration of 6 mg Hg/kg/day as mercuric chloride or mercuric sulfide for 10 days by gavage (Sin et al. 1990). Similar effects were observed after 4 weeks of dosing with mercuric sulfide (Sin and The 1992). Administration by gavage of 5.3 mg Hg/kg/day as mercuric chloride to rats for 40 days resulted in increased thyroid weight, thyroidal iodine uptake, and protein-bound iodine in the serum (Goldman and Blackburn 1979). Decreased triiodothyronine and monoiodotyrosine were also observed. Dietary exposure of rats to 2.2 mg Hg/kg/day as mercuric chloride for 3 months resulted in decreased thyroidal iodine uptake, release, and turnover (Goldman and Blackburn 1979). Adrenocortical function was evaluated in male rats exposed to 0, 9, 18, or 36 mg Hg/kg/day as mercuric chloride in drinking water for 60–180 days (Agrawal and Chansouria 1989). A significant increase in adrenal and plasma corticosterone levels in all dose groups was observed after 120 days of exposure. After 180 days of exposure, corticosterone levels had returned to control values. The relative adrenal gland weight was significantly increased for all exposed groups compared to control values.

In a 4-week range-finding study, groups of 5 rats per sex (10 per sex for controls) received diets containing mercuric chloride at 5, 10, or 20 mg Hg/kg/day in males and 5.5, 11.1, and 22.2 mg Hg/kg/day in females. The high dose resulted in an increased relative adrenal weight in males and a decreased absolute adrenal weight in females (Jonker et al. 1993b)

Organic Mercury. No studies were located regarding endocrine effects in humans or animals after oral exposure to organic mercury.

2. HEALTH EFFECTS

Dermal Effects

Inorganic Mercury. Limited information was located regarding dermal effects of inorganic mercury in humans. Several children who were treated with medications containing mercurous chloride for constipation, worms, or teething discomfort exhibited flushing of the palms of the hands and soles of the feet (Warkany and Hubbard 1953). The flushing was frequently accompanied by itching, swelling, and desquamation of these areas. Morbilliform rashes, conjunctivitis, and excessive perspiration were also frequently observed in the affected children. Patch tests conducted in several children revealed that the rashes were not allergic reactions to the mercury. Kang-Yum and Oransky (1992) reported hives in a woman who ingested a Chinese medicine containing an unspecified amount of mercurous chloride, which suggests an allergic response to the medicine.

No studies were located regarding dermal effects in animals after oral exposure to inorganic mercury.

Organic Mercury. Only a few studies were identified regarding dermal effects of organic mercury, however, the case history concerning dimethylmercury exposure is a very important alert to the hazards of this organomercurial.

Blayney et al. (1997) originally reported the fatal case of a dimethylmercury exposure after a dermal exposure to an extremely small amount of material. The case history was subsequently detailed by Nierenberg et al. (1998). The exposure occurred to a 48-year-old female chemistry professor who was admitted to the hospital 5 months (154 days) after, as best as can be determined, she inadvertently spilled several drops (estimated at 0.4–0.5 mL; about 1,500 mg) of dimethylmercury from the tip of her pipette onto the back of her disposable latex gloves. The spill was cleaned and the gloves disposed of. Hair analysis on a long strand of hair revealed that after a brief lag time, mercury content rose rapidly to almost 1,100 ppm (normal level, <0.26 ppm; toxic level, >50 ppm), and then slowly declined with a half-life of 74.6 days. These results support the occurrence of one or several episodes of exposure, and are consistent with laboratory notebook accounts of a single accidental exposure. Testing of family members, laboratory coworkers, and laboratory surfaces failed to reveal any unsuspected mercury spills or other cases of toxic blood or urinary mercury levels. Permeation tests subsequently performed on disposable latex gloves similar to those the patient had worn at the time of the lone exposure revealed that dimethylmercury penetrates such gloves rapidly and completely, with penetration occurring in 15 seconds or less and perhaps instantly. Polyvinyl chloride gloves were equally permeable to dimethylmercury. Five days prior to

2. HEALTH EFFECTS

admission, the patient developed a progressive deterioration in balance, gait, and speech. During the previous 2 months, she had experienced brief episodes (spaced weeks apart) of nausea, diarrhea, and abdominal discomfort; and had lost 6.8 kg (15 lb). Medical examination revealed moderate upper-extremity dysmetria, dystaxic handwriting, a widely based gait, and “mild scanning speech.” Routine laboratory test results were normal. Computed tomography (CT) and magnetic resonance imaging (MRI) of the head were normal except for the incidental finding of a probable meningioma, 1 cm in diameter. The cerebrospinal fluid was clear, with a protein concentration of 42 mg/dL and no cells. A preliminary laboratory report indicated that the whole-blood mercury concentration was more than 1,000 µg/L (normal range, 1–8 µg/L; toxic level, >200 µg/L). Chelation therapy with oral succimer (10 mg/kg orally every 8 hours) was begun on day 168 after exposure. Whole blood concentrations rose to 4,000 µg/L after one day of chelation, and urinary mercury levels were 234 µg/L (normal range, 1–5 µg/L; toxic level, >50 µg/L). Despite the initial success of chelation therapy, administration of vitamin E, and a blood exchange transfusion, at 176 days postexposure, the patient became comatose. Further aggressive general support and chelation therapy failed, life support was removed (following the patient’s advance directive), and the patient died 298 days post exposure. Autopsy results revealed diffusely thin cortex of the cerebral hemispheres (to 3 mm), and extensive gliosis of the visual cortex around the calcarine fissure and the superior surface of the superior temporal gyri. The cerebellum showed diffuse atrophy of both vermal and hemispheric folia. Microscope evaluation revealed extensive neuronal loss and gliosis bilaterally within the primary visual and auditory cortices, with milder loss of neurons and gliosis in the motor and sensory cortices. There was widespread loss of cerebellar granular-cell neurons, Purkinje cells, and basket-cell neurons, with evidence of loss of parallel fibers in the molecular layer. Bergmann’s gliosis was well developed and widespread.

In the only other organic mercury studies identified for dermal exposures, a study of a large group of people who consumed methylmercury-contaminated bread over a 1- to 3-month period showed a dose-related history of rashes (Al-Mufti et al. 1976). These may also have been allergic responses. A 13-month-old child who ingested porridge made from flour that had been treated with an alkyl mercury compound (specific mercury compound not reported) developed a measles-like rash, fever, and facial flushing (Engleson and Herner 1952). Also, Iraqis who consumed flour made from grain treated with ethylmercury *p*-toluene sulfonanilide exhibited skin lesions consisting of pruritus on the palms, soles, and genitalia (Jalili and Abbasi 1961). In severe cases, exfoliative dermatitis of the hands and feet was also observed.

2. HEALTH EFFECTS

The only information located regarding dermal effects in animals after oral exposure to organic mercury comes from a study in which rats were exposed to methylmercuric chloride in the diet for 2 years (Verschuuren et al. 1976). No treatment-related lesions were observed upon histopathological examination of the skin of rats exposed to 0.1 mg Hg/kg/day.

Ocular Effects

Inorganic Mercury. No information was located regarding ocular effects in humans from ingestion of inorganic mercury.

No studies were located regarding ocular effects in animals after oral exposure to inorganic mercury.

Organic Mercury. No information was located regarding ocular effects in humans from ingestion of organic mercury. While visual effects result from methylmercury exposure, they are cortical in origin (see neurotoxicity below).

The only report of ocular effects in animals after oral exposure to organic mercury comes from a study in which rats were exposed to methylmercuric chloride via the diet for 2 years (Verschuuren et al. 1976). No treatment-related lesions were observed upon histopathological examination of the eyes of rats exposed to 0.1 mg Hg/kg/day. As in humans, the visual effects resulting from methylmercury exposure in primates are considered to be centrally mediated (Rice and Gilbert 1982, 1990).

Body Weight Effects

Inorganic Mercury. No information was located regarding body weight effects in humans from ingestion of inorganic mercury.

A single dose of mercuric chloride administered to female Sprague-Dawley rats (10/group) at 7.4 or 9.2 mg Hg/kg in water resulted in no effects on body weight at 14 days postexposure (Lecavalier et al. 1994). However, a number of animal studies have reported decreases in body weight or body weight gain after ingestion of mercuric chloride (Chang and Hartmann 1972a; Dieter et al. 1992; NTP 1993). After a 4-week exposure to mercuric chloride in the food, male Wistar rats had a 21% body weight decrease at 10 mg Hg/kg/day, and female Wistar rats had a 27% decrease in body weight at 22.2 mg Hg/kg/day. No

2. HEALTH EFFECTS

significant loss was observed at the next-lower-dose groups of 5 and 11.1 mg Hg/kg/day in males and females, respectively (Jonker et al. 1993b).

Doses of 14.8 mg Hg/kg/day administered to rats 5 days a week for 2 weeks resulted in a 10% decrease in male body weight gain (NTP 1993). Much lower doses produced decreases in body weight gain when administered over longer periods. In rats, decreases in body weight gain of approximately 10% were observed with doses of 0.93 mg Hg/kg as mercuric chloride when administered by gavage 5 days a week for 6 months (NTP 1993). Mice were less sensitive, showing no effect at 7.4 mg Hg/kg/day and a 26% decrease in body weight gain at 14.8 mg Hg/kg/day in the same study (NTP 1993).

Organic Mercury. No information was located regarding body weight effects in humans from ingestion of organic mercury.

A number of animal studies have reported decreases in body weight or body weight gain after ingestion of methyl or phenyl mercury. A 20–25% decrease in body weight gain in male and female rats was observed after 5 gavage doses of 8 mg Hg/kg/day as methylmercuric chloride or ethylmercuric chloride (Magos et al. 1985). In intermediate-duration studies with methylmercury, biologically significant decreases in body weight gain have been observed in rats after exposure to doses as low as 0.8 mg Hg/kg/day for 6 weeks (Chang and Hartmann 1972a) and in mice after exposure to 1 mg Hg/kg/day for 60 days (Berthoud et al. 1976). No effect on female body weight gain was observed after dietary exposure to 0.195 mg Hg/kg/day as methylmercuric chloride for 14 weeks (Lindstrom et al. 1991). A 2-year exposure to 0.4 mg Hg/kg/day as phenylmercuric acetate in the feed resulted in a 10% decrease in body weight gain in rats (Solecki et al. 1991). Gavage administration of methylmercuric chloride to rats for 2 days at 12 mg Hg/kg/day resulted in a persistent decrease in the body temperature of the rats (Arito and Takahashi 1991).

Other Systemic Effects

Inorganic Mercury. Several children who were treated with mercurous chloride contained in powders or tablets for constipation, worms, or teething discomfort exhibited low-grade or intermittent fevers (Warkany and Hubbard 1953).

No studies were located on other systemic effects in animals after oral exposure to inorganic mercury.

2. HEALTH EFFECTS

Organic Mercury. No studies were located regarding other systemic effects in humans or animals after oral exposure to organic mercury.

2.2.2.3 Immunological and Lymphoreticular Effects

Inorganic Mercury. No studies were located regarding immunological or lymphoreticular effects in humans after oral exposure to inorganic mercury.

The immune response to mercury exposure is complex, depending in part on the dose of mercury and the genetic characteristics of the exposed population (see Section 2.4). Administration of 14.8 mg Hg/kg/day as mercuric chloride to B6C3F₁ mice 5 days a week for 2 weeks resulted in a decrease in thymus weight (NTP 1993), suggesting immune suppression. However, a 2-week exposure to 0.7 mg Hg/kg/day as mercuric chloride in the drinking water resulted in an increase in the lymphoproliferative response after stimulation with T-cell mitogens in a strain of mice particularly sensitive to the autoimmune effects of mercury (SJL/N) (Hultman and Johansson 1991). In contrast, a similar exposure of a strain of mice (DBA/2) not predisposed to the autoimmune effects of mercury showed no increase in lymphocyte proliferation.

A significant suppression of the lymphoproliferative response to T-cell mitogens, concanavalin A, and phytohemagglutinin was observed in male B6C3F₁ mice administered 2.9 or 14.3 mg Hg/kg/day as mercuric chloride in drinking water for 7 weeks (Dieter et al. 1983). A significant decrease in the weight of the thymus and spleen and a decrease in antibody response were also exhibited at 14.3 mg Hg/kg/day. An increase in B-cell-mediated lymphoproliferation was, however, observed at both 2.9 and 14.3 mg Hg/kg/day. No immunological effects were observed at the lowest dose of 0.57 mg Hg/kg/day. When SJL/N mice were administered mercuric chloride in the drinking water for 10 weeks, an increase in circulating antinucleolar antibodies was observed at 0.28 mg Hg/kg/day, and deposition of granular IgG deposits was observed in the renal mesangium and glomerular blood vessels at 0.56 mg Hg/kg/day (Hultman and Enestrom 1992).

In rats, immune deposits have been observed in the basement membrane of the intestines and kidneys following gavage exposure to 2.2 mg Hg/kg/day as mercuric chloride twice weekly for 2 months, although no functional changes were evident in these tissues (Andres 1984). The observation of these deposits suggests that autoimmunity to specific components of these tissues has developed.

2. HEALTH EFFECTS

The highest NOAEL values and all reliable LOAEL values for immunological and lymphoreticular effects in each species and duration category are recorded in Table 2-2 and plotted in Figure 2-2 for inorganic mercury.

Organic Mercury. No studies were located regarding immunological effects in humans after oral exposure to organic mercury.

In BALB/c mice administered a diet containing 0.5 mg Hg/kg/day as methylmercury for 12 weeks, the thymus weight and cell number decreased by 22 and 50%, respectively, compared to the control group (Ilback 1991). The natural killer cell activity was reduced by 44 and 75% in the spleen and blood, respectively. However, the lymphoproliferative response in the spleen increased at this dose of mercury.

The LOAEL value for immunological and lymphoreticular effects in mice for intermediate-duration oral exposure to organic mercury is recorded in Table 2-3 and plotted in Figure 2-3.

2.2.2.4 Neurological Effects

Inorganic Mercury. The oral absorption of metallic mercury is negligible, and even massive doses have not resulted in neurological effects. The two case histories identified are unusual in that the dose levels could be reasonably well quantified. The first case history reported ingestion of 15 mL (204 g) of metallic mercury by a 17-year-old male storekeeper who swallowed mercury from the pendulum of a clock (apparently out of curiosity rather than as a suicide attempt). On admission, and 24 hours later, he was symptom free, and physical examination was normal. The patient complained of no gastrointestinal symptoms, and was treated with a mild laxative and bed rest. The results of serial daily urine mercury estimates were normal (all less than 15 µg) and did not suggest significant absorption. The radiological investigation illustrated a characteristic pattern of finely divided globules of mercury in the gastrointestinal tract (Wright et al. 1980).

The second and massive incidence of ingestion involved a 42-year-old man who had spent much of his life (since the age of 13) repairing instruments that contained mercury. He intentionally ingested an estimated 220 mL (or about 3,000 g) while repairing a sphygmomanometer (Lin and Lim 1993). Upon admission, the patient presented with significantly elevated mercury blood levels (103 µg/L, normal <10 µg/L) and urine levels (73 µg/L, <20 µg/L). In the previous 2 years he had developed mild hand tremors,

2. HEALTH EFFECTS

forgetfulness, irritability, and fatigue. The occupational exposures made it difficult to determine any additional neurological effects from the acute exposure. There was no history of peripheral neuropathy, vertigo, insomnia, or muscular weakness. Neuropsychiatric and psychology evaluations indicated poor concentration and a defect in recent memory. EEG results indicated diffuse cortical dysfunction predominantly on the left hemisphere. He was treated with immediate gastric lavage and cathartics. He also received D-penicillamine 1 g/day orally for 7 days. Blood and urine mercury levels obtained 3 days after chelating therapy were 116.9 and 22.9 μ g/L, respectively. By 2 weeks postexposure, most of the mercury had been excreted in the feces and was measured at a total volume of 220 mL (this number was used to estimate the amount initially ingested). The patient was lost to follow-up, but returned to the hospital 6 months later (for glycemic control), at which time examination revealed a lessening of his hand tremors.

Most case studies of neurotoxicity in humans induced by oral exposure to inorganic mercury salts have reported neurotoxic effects as the result of ingestion of therapeutic agents that contain mercurous chloride (e.g., teething powders, ointments, and laxatives). Several children treated with tablets or powders containing mercurous chloride exhibited irritability, fretfulness, sleeplessness, weakness, photophobia, muscle twitching, hyperactive or hypoactive tendon reflexes, and/or confusion (Warkany and Hubbard 1953). A 4-year-old boy who had been given a Chinese medicine containing mercurous chloride for 3 months developed drooling, dysphagia, irregular arm movements, and impaired gait (Kang-Yum and Oransky 1992). Davis et al. (1974) reported that two women developed dementia and irritability due to chronic ingestion of a tablet laxative that contained 120 mg of USP-grade mercurous chloride (0.72 mg Hg/kg/day, assuming an average body weight of 70 kg). One woman had taken 2 tablets daily for 25 years, and the other woman took 2 tablets daily for 6 years. Both patients died from inorganic mercury poisoning, and at autopsy, low brain weight and volume and a reduced number of nerve cells in the cerebellum were seen. Light microscopic analysis revealed granules of mercury within neuronal cytoplasm. Electron microscopy revealed mercury deposits in some neurons.

In addition, neurotoxicity has been observed after ingestion of lethal doses of mercuric chloride. Blurred vision and diplopia were reported by a 35-year-old man who ingested a lethal dose of mercuric chloride (Murphy et al. 1979). Prior to death, the man experienced repeated seizures. An autopsy revealed abscesses on the occipital lobe and cerebellum.

2. HEALTH EFFECTS

Acute- and intermediate-duration studies describing neurotoxic effects in animals following exposure to inorganic mercury salts are limited. A study was conducted by Chang and Hartmann (1972b) in which mercuric chloride was administered both by gavage and subcutaneously. Evidence of disruption of the blood-brain barrier (i.e., leakage of dye into the brain tissue) was observed 12 hours after a single dose of 0.74 mg Hg/kg as mercuric chloride in rats (Chang and Hartmann 1972b). These investigators also administered 0.74 mg Hg/kg/day as mercuric chloride to rats for up to 11 weeks. Within 2 weeks, there were coagulative or lucid changes in cerebellar granule cells and fragmentation, vacuolation, and cytoplasmic lesions in the neurons of dorsal root ganglia. Neurological disturbances consisted of severe ataxia and sensory loss, with an accompanying loss in body weight. No conclusions regarding the oral neurotoxicity of mercuric chloride can be drawn from the results of this study because the discussion of the results observed in the study did not clearly differentiate whether the effects were observed as the result of oral or subcutaneous exposure. It is expected that mercuric chloride administered subcutaneously would be much more toxic than that administered orally because of the very poor absorption of inorganic forms of mercury from the gastrointestinal tract.

Dietary exposure of rats to 2.2 mg Hg/kg/day as mercuric chloride for 3 months resulted in inactivity and abnormal gait (Goldman and Blackburn 1979). However, it is unclear whether the effects observed in this study were the direct result of effects on the nervous system, or whether they may have been secondary to other toxic effects. No evidence of neurotoxicity (clinical signs of neurotoxicity and optic and peripheral nerve structure) was seen in mice administered 0.74 or 2.2 mg Hg/kg/day as mercuric chloride in the drinking water for 110 days (Ganser and Kirschner 1985). The investigators increased the dose administered to the low-dosed animals to 7.4–14.8 mg Hg/kg/day for an additional 400 days; however, still no neurotoxic effects were observed. Similarly, no histopathological evidence of brain lesions was observed in rats receiving gavage doses of mercuric chloride as high as 3.7 mg Hg/kg/day 5 days a week for up to 2 years or in mice receiving gavage doses as high as 7.4 mg Hg/kg/day 5 days a week for up to 2 years (NTP 1993).

The highest NOAEL values and all reliable LOAEL values for neurotoxic effects in each species and duration category are recorded in Table 2-2 and plotted in Figure 2-2 for inorganic mercury.

Organic Mercury. Most of the information concerning neurotoxicity in humans following oral exposure to organic mercury comes from reports describing the effects of ingesting contaminated fish or fungicide-treated grains (or meat from animals fed such grains). Information about doses at which the effects

2. HEALTH EFFECTS

occurred is frequently limited because of difficulties in retracing prior exposure and uncertainties in estimating dose levels based on assumed food intake and contamination levels.

Although isolated instances of alkyl mercury poisoning have been reported (Cinca et al. 1979; Engleson and Herner 1952), the epidemic poisonings in Japan and Iraq focused attention on the neurotoxicity of these compounds. The first reported widespread outbreak of neurological disorders associated with the ingestion of methylmercury-contaminated fish occurred in the Minamata area of Japan (Kutsuna 1968). The neurological syndrome was characterized by a long list of symptoms including prickling, tingling sensation in the extremities (paresthesia); impaired peripheral vision, hearing, taste, and smell; slurred speech; unsteadiness of gait and limbs; muscle weakness; irritability; memory loss; depression; and sleeping difficulties (Kutsuna 1968; Tsubaki and Takahashi 1986). Elevated concentrations of methylmercury were observed in the hair and brains of victims (see Section 2.5). Epidemics of similar neurological disorders were reported in Iraq in 1956 and 1960 (Bakir et al. 1973; Jalili and Abbasi 1961) as the result of eating flour made from seed grain treated with ethylmercury *p*-toluene sulfonamide. Affected individuals had an inability to walk, cerebellar ataxia, speech difficulties, paraplegia, spasticity, abnormal reflexes, restriction of visual fields or blindness, tremors, paresthesia, insomnia, confusion, hallucinations, excitement, and loss of consciousness. In the winter of 1971–1972 in Iraq, more than 6,530 patients required hospitalization and 459 deaths occurred, usually due to central nervous system damage, after the ingestion of contaminated bread prepared from wheat and other cereals treated with a methylmercury fungicide (Bakir et al. 1973).

Al-Mufti et al. (1976) attempted to correlate symptoms of the poisoning incident with an estimate of methylmercury intake based on average levels found in grain and self-reported estimates of the number of loaves ingested. A number of assumptions were made in the estimates, and there were logistical constraints in surveying the widely spread rural population in Iraq. Moreover, only a total mercury intake was derived and compared with the results of a clinical evaluation and a survey for symptoms. Nonetheless, interesting and useful results were reported based on the 2,147 people surveyed. The mean period of exposure for the Iraqi population exposed to contaminated bread was 32 days, with some people consuming the bread for as long as 3 months. A mean of 121 loaves per person was eaten; the maximum was 480 loaves. Based on the mean number of loaves, the total intake of methylmercury was estimated at between 80 mg and 250 mg. However, those who had consumed the most loaves may have ingested up to 1,000 mg of methylmercury over a 3-month period. Of those with symptoms of alkylmercury poisoning at the time of the survey (October 1972–May 1973), 80% had eaten more than 100 loaves. Of the 75 people who had reported eating more than 200 loaves, 53 (71%) presented with some evidence of poisoning. The incidence rate for

2. HEALTH EFFECTS

poisoning was estimated at 271 per 1,000; this includes a mortality of 59 per 1,000, a severe disability rate of 32 per 1,000, a rate of mild or moderate disability of 41 per 1,000; and a rate for those with only a subjective evidence of poisoning of 138 per 1,000. Based on estimates of total intake, dose-related increases were observed in the incidence and severity of paresthesia, astereognosis (loss of the ability to judge the form of an object by touch), persistent pain in the limbs, persistent headaches, difficulty walking, difficulty using the arms, and changes in speech, sight, and hearing. The most commonly observed symptom was paresthesia, most frequently involving the extremities but also on the trunk and the circumoral region. Difficulty walking and a feeling of weakness were the next most common symptoms. The total estimated intake in total milligrams associated with the four categories (no evidence of poisoning, subjective evidence, mild to moderate evidence, and severe symptoms) is as follows for all ages combined (number of persons in parentheses): 95 mg (n=59), 141 mg (n=131), 160 mg (n=35), 173 mg (n=22). This dose range is small for such dramatically different health states, and does not widen when the data are evaluated by age group. Interestingly, the total intake associated with severity of symptoms decreases on a mg/kg body weight basis with increasing age in contrast with what would be expected if children were more susceptible. For example, intakes (mg/kg over the total exposure period) associated with severe symptoms are as follows for the age groups 5–9 years, 10–14 years, and 15 years and older, respectively: 7.8 mg/kg (n=9), 4 mg/kg (n=7), and 3.6 mg/kg (n=6). Comparable numbers are for the mild/moderate symptoms and the subjective symptoms (shown): 6 mg/kg (n=19), 3.4 mg/kg (n=20), and 2.4 mg/kg (n=92). It is possible that child sensitivity may not be as large a factor when exposures reach the levels experienced in Iraq.

Neurotoxic effects seen in the Minamata (Japan) and Iraqi poisonings have been associated with neuronal degeneration and glial proliferation in the cortical and cerebellar gray matter and basal ganglia (Al-Saleem and the Clinical Committee on Mercury Poisoning 1976), and derangement of basic developmental processes such as neuronal migration (Choi et al. 1978; Matsumoto et al. 1965) and neuronal cell division (Sager et al. 1983). In the brain, Purkinje, basket, and stellate cells were severely affected. Granule cells were variably affected. Sural nerves removed from two women with neurotoxicity associated with the Minamata incident also showed evidence of peripheral nerve degeneration and regeneration (Miyakawa et al. 1976).

Similar effects have been observed in persons ingesting meat contaminated with ethylmercuric chloride (Cinca et al. 1979). Neurotoxic signs observed in two boys who ultimately died as the result of the exposure included gait disturbance, ataxia, dysarthria, dysphagia, aphonia, hyperreactive tendon reflexes,

2. HEALTH EFFECTS

hypotonia, spasticity, mydriasis, horizontal nystagmus, agitation, and coma. Electroencephalography showed decreased alpha activity and increased slow-wave activity. Autopsy showed nerve cell loss and glial proliferation in the cerebral cortex (calcarine cortex, midbrain, bulbar reticular formation), demyelination, granule cell loss in the cerebellum, and motor neuron loss in the ventral horns of the spinal cord. Neurotoxic signs in the surviving family members were generally similar (ataxia, gait impairment, spasticity, drowsiness, intentional tremor, agitation, hypoesthesia in the limbs, speech difficulties, and visual disturbances); all but the narrowing of the visual fields resolved after termination of exposure.

A New Mexico family, including a pregnant woman, a 20-year-old female, and 2 children (a 13-year-old male and an 8-year-old female) ate meat from a hog inadvertently fed seed grain treated with a fungicide containing methylmercury and experienced severe, delayed neurological effects (Davis et al. 1994). Several months after the exposures, the children developed symptoms of neurological dysfunction. The newborn child of the exposed mother showed signs of central nervous system disorder from birth. Twenty-two years after the 3-month exposure period, the people who were 20 and 13 years old at time of exposure had developed cortical blindness or constricted visual fields, diminished hand proprioception, choreoathetosis, and attention deficits. MRI examination of these two revealed residual brain damage in the calcarine cortices, parietal cortices, and cerebellum. The brain of the person who was exposed at age 8 (who died of aspiration pneumonia with a superimposed *Klebsiella* bronchopneumonia and sepsis at age 29) showed cortical atrophy, neuronal loss, and gliosis, most pronounced in the paracentral and parieto-occipital regions. Regional brain mercury levels correlated with the extent of brain damage. The youngest (*in utero* at the time of exposure) developed quadriplegia, blindness, severe mental retardation, choreoathetosis, and seizures, and died at age 21. The inorganic mercury levels in different regions of the brain of the 29-year-old patient ranged from 82 to 100% of the total mercury present. Since inorganic mercury crosses the blood-brain barrier poorly, biotransformation of the methylmercury to inorganic mercury may have occurred after the methylmercury crossed the blood-brain barrier, accounting for its observed persistence in the brain and its possible contribution to the brain damage.

LeBel et al. (1996) studied early nervous system dysfunction in Amazonian populations exposed to low levels of methylmercury. A preliminary study was undertaken in two villages on the Tapajos River, an effluent of the Amazon, situated over 200 km downstream from the methylmercury extraction areas. The study population included 29 young adults ≤ 35 years (14 women and 15 men) randomly chosen from a previous survey. Hair analyses were conducted with cold vapor atomic fluorescence spectrophotometry. Total hair Hg (THg) varied between 5.6 $\mu\text{g/g}$ and 38.4 $\mu\text{g/g}$, with MeHg levels from 72.2% to 93.3% of

2. HEALTH EFFECTS

the THg. A quantitative behavioral neurophysiological test battery, designed for use under standard conditions in an area without electricity and for persons with minimal formal education was administered to all participants. The results of visual testing showed that although all participants had good near and far visual acuity, color discrimination capacity (Lanthony D-15 desaturated panel) decreased with increasing THg ($F=4.1$; $p=0.05$); near visual contrast sensitivity profiles (Vistech 6000) and peripheral visual field profiles (Goldman Perimetry with Targets I and V) were reduced for those with the highest levels of THg. For the women, manual dexterity (Santa Ana, Helsinki version) decreased with increasing THg ($F=16.7$; $p<0.01$); this was not the case for the men. Although the women showed a tendency towards reduced grip strength, muscular fatigue did not vary with THg for either sex. The authors claim that this study demonstrates that it is possible, using a sensitive test battery, to detect alterations in nervous system functions, consistent with knowledge of Hg toxicity, at levels below the currently recognized threshold of $50 \mu\text{g/g}$ THg.

Mental retardation has not generally been reported as a neurotoxic effect of alkyl mercurial exposure in adults. However, a 9-month-old infant who received porridge made from alkyl mercury-contaminated grains for approximately 4 months lost the ability to crawl or walk and exhibited persistent mental retardation (Engleson and Herner 1952). These effects are similar to those seen in infants born to mothers who consumed methylmercury-contaminated food during pregnancy (see Section 2.2.2.6), suggesting that in addition to the prenatal period, infancy may also be a susceptible period for the development of these types of effects.

Studies in experimental animals also indicate that organic mercury is a potent neurotoxicant. Adult female monkeys (*Macaca fascicularis*) were exposed to methylmercury ($0.050 \text{ mg Hg/kg/day}$) in apple juice by mouth for 6, 12, or 18 months, or 12 months followed by 6 months without exposure (clearance group). A fifth group of monkeys was administered mercuric chloride ($0.200 \text{ mg Hg/kg/day}$) by constant-rate intravenous infusion through an in-dwelling catheter for 3 months. Controls were housed and handled with the exposed monkeys, but were not administered mercury. The number of neurons, astrocytes, reactive glia, oligodendrocytes, endothelia, and pericytes in the cortex of the calcarine sulcus was estimated by use of the optical volume fractionator stereology technique. Reactive glia showed a significant increase in number for every treatment group, increasing 72% in the 6-month, 152% in the 12-month, and 120% in the 18-month methylmercury-exposed groups, and the number of reactive glia in the clearance group remained elevated (89%). In the mercuric chloride group, there was a 165% increase in the number of reactive glia. Neurons, astrocytes, oligodendrocytes, endothelia, and pericytes showed no significant change in number in

2. HEALTH EFFECTS

any exposure group. The methylmercury-treated monkeys (all groups) appeared normal in terms of cage behavior throughout the entire exposure period, supporting the conclusion that there was no significant loss in the neuron population. Examination of tissue samples did not reveal any apparent degradation in the structure of neurons or chronic changes in the glial cells (e.g., the appearance of hypertrophic astrocytes), which are commonly observed following exposure to high levels of mercury. No apparent dilation of the perivascular spaces was observed. The average volume of the cortex of the calcarine sulcus did not differ significantly from controls for any methylmercury-treated group. The methylmercury-clearance group had low levels of methylmercury present in tissues; however, the level of inorganic mercury was also elevated. The astrocytes and microglia in the methylmercury group contained the largest deposits of inorganic mercury. Comparing the results of the methylmercury and inorganic mercury groups suggests that inorganic mercury may be responsible for the increase in reactive glia (Charleston et al. 1994).

Charleston et al. (1996) studied the effects of long-term subclinical exposure to methylmercury on the number of neurons, oligodendrocytes, astrocytes, microglia, endothelial cells and pericytes within the thalamus from the left side of the brain of the monkey *Macaca fascicularis*. These parameters were determined by use of the Optical Volume Fractionator stereological method. The accumulated burden of inorganic mercury (IHg) within these same cell types has been determined by autometallographic methods. Four groups of female monkeys (n=4-5) were exposed to 50 µg Hg/kg/day methylmercury in apple juice for 6, 12, or 18 months, or 12 months followed by 6 months without exposure (clearance group). One control animal each was sacrificed with the 6- and 12-month exposure groups, and two additional animals were sacrificed at the end of the experiment. All monkeys appeared normal—no changes in behavior or motor skills were observed. Hematological function (white blood cell count and differentiation, erythrocyte count, hemoglobin, hematocrit, and red cell indices) and blood chemistry (urea nitrogen, creatine, bilirubin, albumin, total protein, alkaline phosphatase, and electrolytes) were normal. No weight loss was observed. Neurons, oligodendrocytes, endothelia, and pericytes did not show a significant change in cell number for any exposure group. Astrocyte cell number exhibited a significant decline for both the 6-month (44.6%) and clearance exposure groups (37.2%); decreased astrocyte counts were also observed in the other exposure groups, but these were not significant. The microglia, in contrast, showed a significant increase in the 18-month (228%) and clearance exposure groups (162%). Results from mercury speciation and quantification analysis of contralateral matched samples from the thalamus of the right side of the brain from these same monkeys indicated that methylmercury concentrations plateaued at around 12 months exposure, whereas the inorganic levels, presumably derived from demethylation of methylmercury, continued to increase throughout all exposure durations. Autometallographic determination of the

2. HEALTH EFFECTS

distribution of IHg by cell type indicates that both the astrocytes and microglia contain substantially elevated IHg deposits relative to all other cell types. The data suggest that the inorganic mercury present in the brain, accumulating after long-term subclinical methylmercury exposure, may be a proximate toxic form of mercury responsible for the changes within the astrocyte and microglial populations.

Rice (1996a) evaluated delayed neurotoxicity produced by methylmercury in monkeys treated with methylmercury from birth to 7 years of age. When these monkeys reached 13 years of age, individuals began exhibiting clumsiness not present previously. Further exploration revealed that treated monkeys required more time to retrieve treats than did nonexposed monkeys and displayed abnormalities on a clinical assessment of sense of touch in hands and feet, despite the fact that clinical examinations performed routinely during the period of dosing had not yielded abnormal results. Another group of monkeys, dosed from *in utero* to 4 years of age, also took longer to retrieve treats when assessed years after cessation of exposure. These observations were pursued in both groups of monkeys by objective assessment of somatosensory function in the hands: both groups of monkeys exhibited impaired vibration sensitivity. The results suggest that a delayed neurotoxicity occurred when these monkeys reached middle age. The author notes persons with Minamata disease also have symptoms of delayed neurotoxicity. The results from a study of more than 1,100 Minamata patients over the age of 40 indicated a difficulty in performing daily activities that increased as a function of age compared to matched controls. Methylmercury may represent the only environmental toxicant for which there is good evidence for delayed neurotoxicity observable many years after cessation of exposure.

Rice (1996b) further compares the sensory and cognitive effects of developmental methylmercury exposure in monkeys to the effects in rodents. Developmental exposure to methylmercury in the Macaque monkey produced impairment of function in the visual, auditory, and somatosensory systems. In addition, delayed neurotoxicity was observed in monkeys years after cessation of dosing, manifested as overall clumsiness and slowness in reaching for objects. The effects of developmental methylmercury exposure on cognitive function in monkeys are more equivocal; both positive and negative results have been obtained, with no obvious pattern with regard to possible domains of impairment. Prenatal methylmercury exposure in rodents produced retarded development and impairment of motor function, while the evidence for cognitive impairment is less consistent. Derivation of reference doses based on these data from monkeys and rodents is remarkably congruent, and is virtually identical to values derived from evidence for developmental impairment in humans. Research needs include determination of neurotoxic effects at lower body burdens

2. HEALTH EFFECTS

in the monkey, including dose-effect data, and a more systematic exploration of the pattern of behavioral deficits in both primates and rodents.

Gilbert et al. (1996) used fixed interval/fixed ratio performance in adult monkeys to evaluate effects from exposure *in utero* to methylmercury. The fixed interval/fixed ratio (FI/FR) schedule is considered to be a sensitive indicator of neurotoxicity. In the present study, monkeys (*Macaca fascicularis*) were exposed *in utero* to methylmercury. Maternal doses of methylmercury of 0, 50, 70, or 90 µg/kg/day (in apple juice) (n=11, 9, 2, and 2, respectively) resulted in infant blood mercury levels at birth ranging from 1.04 to 2.45 ppm. Monkeys were tested on a multiple FI/FR schedule of reinforcement at 8–10 years of age. Four FI/FR cycles were run per session. Pause time and run rate were calculated for FI and FR components, as well as FI quarter-life and local FI response rates. Methylmercury treatment and sex effects were investigated by fitting a linear orthogonal polynomial regression to each monkey's profile across sessions and performing two-way ANOVAs on the resulting linear and intercept terms. Results from all treated monkeys were combined and compared to the control group. There were no treatment-related effects on either the fixed interval (FI) or fixed ratio (FR) component for pause time or run rate. Analysis of the quarter-life revealed a significant treatment by sex effect as well as a main effect for sex. Post hoc t-tests revealed a significant difference in quarter-life of treated male and female monkeys and a marginal difference between treated and control males. The FI run rate of the male monkeys was significantly greater than that of the female monkeys whereas the FR run rate of the males was marginally greater. These results indicate that there may be a differential effect of methylmercury on male and female monkeys, which could be interpreted as an effect on temporal discrimination. The authors concluded that adult monkeys exposed to *in utero* methylmercury exhibited very limited sex-related effects on the FI/FR intermittent schedule of reinforcement.

Typical neurotoxic signs observed in rats exposed to methylmercury include muscle spasms, gait disturbances, flailing, and hindlimb crossing (Fuyuta et al. 1978; Inouye and Murakami 1975; Magos et al. 1980, 1985). These effects have been observed after acute-duration gavage dosing with methylmercury concentrations at doses as low as 4 mg Hg/kg/day for 8 days (Inouye and Murakami 1975) and may not be observed until several days after cessation of dosing (Inouye and Murakami 1975; Magos et al. 1985). Histopathological examination of the nervous systems of affected rats has shown degeneration of cerebellar granule cells and dorsal root ganglia (Magos et al. 1980, 1985) and degenerative changes in peripheral nerves (Fehling et al. 1975; Miyakawa et al. 1974, 1976). Comparison of the effects of 5 doses of 8 mg Hg/kg/day as ethyl- or methylmercury showed dorsal root damage as well as flailing and hindlimb

2. HEALTH EFFECTS

crossing after exposure to both chemicals, but only methylmercury caused substantial cerebellar damage (Magos et al. 1985). Additional changes in rats exposed to methylmercury have also been observed. Rats exposed to a single gavage dose of 19.9 mg Hg/kg as methylmercuric chloride were found to have statistically significant differences in open-field tests, such as decreases in standing upright, area traversed, and activity, compared to controls. However, no accompanying histopathological changes were observed (Post et al. 1973). The exposed animals were also lethargic and ataxic initially, but symptoms disappeared within 2–3 hours. Changes in the phases of sleep were also observed in rats given 2 doses of 4 mg Hg/kg/day as methylmercuric chloride (Arito and Takahashi 1991). Paradoxical sleep was decreased and slow-wave sleep was increased. At a higher dose (12 mg Hg/kg/day for 2 days), circadian sleep patterns were also disrupted. Administration of a single dose of methylmercuric chloride (0.8 mg Hg/kg) produced blood-brain barrier dysfunction in rats (Chang and Hartmann 1972b) similar to that reported for inorganic mercury as discussed previously. In rabbits given 5.5 mg Hg/kg as methylmercuric acetate for 1–4 days, widespread neuronal degenerative changes (in cervical ganglion cells, cerebellum, and cerebral cortex) have been observed without accompanying behavioral changes (Jacobs et al. 1977).

Longer-duration studies in animals have shown qualitatively similar effects, but generally at lower daily doses with increasing durations of exposure. Rats given a dose of 10 mg Hg/kg as methylmercuric chloride once every 3 days for 15 days showed degeneration in the cerebellum with flailing and hind leg crossing (Leyshon and Morgan 1991). Rats given a TWA dose of 2.1 mg Hg/kg/day as methylmercury iodide or 2.4 mg Hg/kg/day as methylmercury nitrate by oral gavage for 29 days became weak and severely ataxic and developed paralysis of the hind legs (Hunter et al. 1940). Severe degeneration of peripheral nerves, posterior spinal roots, and trigeminal nerves were reported. Severe degenerative changes were also observed in the dorsal root fibers of rats given 1.6 mg Hg/kg/day as methylmercuric chloride for 8 weeks (Yip and Chang 1981). Similarly, ataxia (beginning the second week of exposure) and cerebellar edema and necrosis occurred in rats after 7 weeks of exposure by gavage to 1.68 mg Hg/kg as methylmercury dicyanidamide for 5 days a week (Magos and Butler 1972). When rats were administered 0.8 mg Hg/kg/day as methylmercuric chloride by gavage for up to 11 weeks, effects similar to those reported for mercuric chloride (e.g., neuronal degeneration of the cerebellum and dorsal root ganglia and neurotoxic clinical signs) were seen but with increased severity (Chang and Hartmann 1972a).

Mice have shown comparable effects at similar doses. Mice exposed to 1.9 or 9.5 mg Hg/kg/day as methylmercury in the drinking water for 28 weeks exhibited degeneration of Purkinje cells and loss of granular cells in the cerebellum (MacDonald and Harbison 1977). At the higher of these doses, hind limb

2. HEALTH EFFECTS

paralysis was observed as early as 8 days, whereas at 1.9 mg Hg/kg/day, decreases in motor activity and hind limb paralysis did not develop until 24 weeks of exposure. Interestingly, cerebellar lesions were observed at 1.9 mg Hg/kg/day as early as 8 days after the start of dosing. Neuronal degeneration and microgliosis were observed in the corpus striatum, cerebral cortex, thalamus, and hypothalamus, accompanied by hind leg weakness, in mice administered 1 or 4 mg Hg/kg/day as methylmercuric chloride by gavage for 60 days (Berthoud et al. 1976). Similarly, a marked neurotoxic disturbance (not further identified) was reported in mice that received 3.1 mg Hg/kg/day as methylmercuric chloride in the diet for 26 weeks (Mitsumori et al. 1981). No effects of this type were observed in this study at 1.6 mg Hg/kg/day, but it is unknown whether more subtle neurological effects may have been missed, as the intent of this study was not to identify neurotoxic effects of methylmercury.

Some studies suggest that cats and monkeys are more sensitive to the neurotoxic effects of organic mercury than rodents. Cats fed tuna contaminated with methylmercury at doses equivalent to 0.015 mg Hg/kg/day for 11 months, starting when the cats were kittens, displayed degenerative changes in the cerebellum and the cerebral cortex (Chang et al. 1974). However, only 3 of 16 animals exhibited incoordination and weakness. Similarly, cats given gavage doses of methylmercuric chloride as low as 0.25 mg Hg/kg/day for 44–243 days displayed degenerative lesions in the granule and Purkinje cells of the cerebral cortex and/or cerebellum and degenerative changes in the white matter, but no manifestations of neurotoxicity (ataxia, loss of righting reflex, visual and sensory impairments) were observed until 0.5 mg Hg/kg/day was given (Khera et al. 1974). Neonatal monkeys given 0.5 mg Hg/kg/day as methylmercuric chloride in infant formula for 28–29 days exhibited stumbling and falling prior to termination of exposure (Willes et al. 1978). Despite the termination of exposure, abnormalities in the several reflexes; blindness; abnormal behavior consisting of shrieking, crying, and temper tantrums; and coma developed. Histopathological analyses showed diffuse degeneration in the cerebral cortex (especially the calcarine, insular, pre-, and postcentral gyri, and occipital lobe), cerebellum, basal ganglia, thalamus, amygdala, and lateral geniculate nuclei. Macaque monkeys exposed to methylmercuric chloride in biscuits exhibited tremors and visual field impairment (Evans et al. 1977). These effects were observed in animals that were first administered 4–5 priming doses of 1 mg Hg/kg at 5-day intervals (no toxicity observed), followed by "maintenance" doses of 0.5–0.6 mg Hg/kg once a week for 87–256 days. Squirrel monkeys developed similar symptoms after receiving a single priming dose of 1 or 2 mg Hg/kg as methylmercuric chloride by gavage, followed 77 days later by maintenance doses of 0.2 mg Hg/kg once a week for 90–270 days (Evans et al. 1977). The doses were adjusted to maintain steady-state blood mercury levels in the range of 1–4 ppm. No tremors or convulsions were observed in female monkeys (*Macaca fascicularis*) during a 150-day exposure

2. HEALTH EFFECTS

to methylmercury chloride at 0.04 mg Hg/kg/day (Petruccioli and Turillazzi 1991). However, beginning at 177–395 days after exposure to methylmercuric hydroxide at 0.08 mg Hg/kg/day, 6 of 7 female monkeys (*Macaca fascicularis*) exhibited slight tremors and decreased sucking responses, followed by claw-like grasp, gross motor incoordination, and apparent blindness (Burbacher et al. 1984, 1988). These effects were also observed in one animal from each of the lower-dose groups (0.04 and 0.06 mg Hg/kg/day) (Burbacher et al. 1988).

Miyama et al. (1983) attempted to correlate electrophysiological changes with "early" neurological signs in rats during dietary exposure to methylmercuric chloride for an unspecified period of time. They observed the following sequence in the onset of electrophysiological-somatic signs: fall in compound action potential > decrease in sensory nerve conduction velocity > tail rotation > weight loss. However, varying doses of selenium were co-administered with the methylmercury, complicating the interpretation of these results.

Evidence for a neurochemical component of methylmercury-induced toxicity following intermediate-duration exposures has been reported (Concas et al. 1983; Sharma et al. 1982; Tsuzuki 1981). A depression in the synthesis of the neurotransmitter, dopamine (whole-brain levels), was observed in the absence of clinical signs of neurotoxicity in rats fed doses as low as 0.8 mg Hg/kg/day as methylmercuric chloride once every 3 days for 15 days (Sharma et al. 1982). An increased number (but not an affinity) of benzodiazepine receptor binding sites and a decreased content of cyclic guanosine monophosphate (cGMP) were observed in the cerebellar cortex of rats administered 3.92 mg Hg/kg/day as methylmercuric chloride in the drinking water for 20 days (Concas et al. 1983). Activities of several enzymes associated with central neurotransmitter metabolism in the cerebellum (e.g., acetylcholinesterase, tryptophan hydroxylase, monoamine oxidase, catechol-*o*-methyltransferase) were depressed in rats administered 3.2 mg Hg/kg/day as methylmercury by gavage for 50 days (Tsuzuki 1981). These findings suggest that an alteration in neurotransmission may be one mechanism of action for mercury-induced neurotoxicity. However, the observed effects on the neurotransmitters may be secondary to other effects on the nervous system.

The chronic neurotoxic effects of methylmercury in animals are similar to those seen after intermediate exposure. Mice administered methylmercuric chloride in the diet for 2 years at approximately 0.6 mg Hg/kg/day showed posterior paralysis and sensory neuropathy, characterized by cerebral and cerebellar necrosis, as well as degeneration of spinal dorsal nerve roots and the sciatic nerve (Hirano et al. 1986; Mitsumori et al. 1990). Cats fed contaminated fish or contaminated fish and methylmercury at doses

2. HEALTH EFFECTS

as low as 0.046 mg Hg/kg/day for 2 years exhibited neurobehavioral toxic signs, including mild impairment of motor activity and diminished sensitivity to pain (Charbonneau et al. 1976). These effects began after 60 weeks of exposure but did not progress during the remainder of the 2 years of exposure. At higher doses of 0.074 and 0.18 mg Hg/kg/day, ataxia, alterations in gait, motor incoordination, muscle weakness, changes in temperament, and convulsions were also observed. Histopathological analyses showed neuronal degeneration in the motor, sensory, auditory, and occipital cortices and cerebellar granule cell degeneration. Five monkeys fed 0.05 mg Hg/kg/day as methylmercuric chloride from birth until the age of 3–4 years displayed impaired spatial vision at that time (Rice and Gilbert 1982). Continued dosing until 6.5–7 years of age resulted in clumsiness, decreased fine motor performance, and insensitivity to touch when tested at 13 years of age (Rice 1989c). Impaired high-frequency hearing was also displayed by these monkeys when tested at 14 years of age (Rice and Gilbert 1992). It is noteworthy that a wide range of neurotoxic symptoms (motor, visual, and auditory) were observed in a species similar to humans several years after dosing had ceased. No clinical signs or histopathological evidence of neurotoxicity was observed in rats that received 0.1 mg Hg/kg/day as methylmercuric chloride in the diet for 2 years (Verschuuren et al. 1976).

Deficiencies in many of the studies make it difficult to fully evaluate the quality of the data reported. General problems include the following: (1) many details of experimental protocols were omitted, thereby prohibiting an evaluation of the study's adequacy; (2) very often, only one dose was used, so an analysis of any possible dose-response relationships was not possible, and the possibility that certain observed effects were not compound-related cannot be excluded; (3) control data often were not presented; and (4) the results were frequently described in subjective terms, and no attempt was made to quantitate the data. Despite these limitations, animal studies do provide irrefutable evidence that the central and peripheral nervous systems are target organs for organic mercury-induced toxicity.

In summary, methylmercury is neurotoxic to humans and to several species of experimental animals following acute, intermediate, and chronic oral exposure. The major effects that are seen across the studies include motor disturbances, such as ataxia and tremors, as well as signs of sensory dysfunction, such as impaired vision. The predominant neuropathological feature is degenerative changes in the cerebellum, which is likely to be the mechanism involved in many of the motor dysfunctions. In humans, disruptions of higher functions have also been noted, as evidenced by depression and irritability.

2. HEALTH EFFECTS

The highest NOAEL values and all reliable LOAEL values for neurotoxic effects in each species and duration category are listed in Table 2-3 and plotted in Figure 2-3 for organic mercury.

2.2.2.5 Reproductive Effects

Inorganic Mercury. In an attempt to terminate her pregnancy, a 31-year-old woman ingested 30 mg Hg/kg as mercuric chloride in week 10 of her pregnancy (Afonso and deAlvarez 1960). Despite gastric lavage and treatment with dicapmerol, 13 days after exposure vaginal bleeding and uterine cramps occurred, followed by spontaneous abortion of the fetus and placenta. It was inconclusive whether the abortion was directly due to the mercury exposure.

Organic Mercury. No studies were located regarding reproductive effects in humans following oral exposure to organic mercury.

Abortions and decreased mean litter size are the predominant reproductive effects in different species of animals following oral exposure to organic mercury. Groups of 30 pregnant Fischer 344 rats were orally administered 10, 20, or 30 mg/kg as methylmercuric chloride dissolved in saline on Gd 7. Controls were given saline only (n=30). Maternal body weight gain and deaths were monitored. On Gd 20, the dams were laparotomized under ether anesthesia, and the fetuses were removed. Surviving fetuses were examined for gross toxic effects, sex, and weight; half were stained for skeletal examination. Mercury levels in maternal and fetal organs were measured. The LD₅₀ of methylmercuric chloride for fetuses was calculated. Maternal body weights were decreased for 2 days in rats given 10 mg/kg, for 6 days in rats given 20 mg/kg, and were continuously decreased for rats given 30 mg/kg methylmercuric chloride. Survival rates of fetuses were 19.2, 41.4, and 91.1% less than controls for the 10, 20, and 30 mg/kg methylmercuric chloride groups, respectively. Implantation sites in the 3 groups decreased by 5.9, 13.7, and 22.5%, respectively, compared with controls. Preimplantation losses in the 3 groups were 17.2, 24.8, and 30.1%, respectively; postimplantation losses were 16.7, 34.1, and 88.9%, respectively. The reduction of litter weight was greatly enhanced with increasing methylmercuric chloride doses (32.3, 67.0, and 89.2%, respectively), presumably due to postimplantation loss, which already increased at high treatment levels. The LD₅₀ of methylmercuric chloride for fetuses was determined to be 16.5 mg/kg. Mercury content in maternal organs was highest in the kidneys, followed by blood, spleen, liver, and brain, while in fetal organs it was highest in the liver (Lee and Han 1995).

2. HEALTH EFFECTS

Pregnant hamsters that received a single oral gavage dose of mercuric acetate on Gd 8 showed an increase in the incidence of resorptions at doses as low as 22 mg Hg/kg (Gale 1974). The incidence of resorptions was 35% at 22 mg Hg/kg, and increases were observed in a dose-related manner (53% at 32 mg Hg/kg, 68% at 47 mg Hg/kg, and 99% at 63 mg Hg/kg).

In a study by Khera (1973), after 5–7 days of oral gavage doses of 1, 2.5, or 5 mg Hg/kg/day as methylmercuric chloride, male rats were mated to unexposed female rats. A dose-related reduction of mean litter size was attributed to preimplantation losses from incompatibility of sperm-to-implantation events after mercury treatment of the parent male rat. At doses of 2 mg Hg/kg/day as methylmercury by gavage during Gd 6–9, pregnant Sprague-Dawley rats showed no differences in maternal body weight gain before parturition or in the body weights of the offspring (Fredriksson et al. 1996).

In male mice, no reduction in the incidence of fertile matings was observed after administration of 5–7 oral doses of up to 5 mg Hg/kg/day as methylmercuric chloride (Khera 1973). There was a significant dose-related decrease in the number of pups born per litter in mice receiving oral doses of 3, 5, or 10 mg Hg/kg administered on Gd 8 as methylmercuric hydroxide (Hughes and Annau 1976). Effects were not observed at 2 mg Hg/kg/day. Similarly, female mice administered 20 mg Hg/kg/day as methylmercuric chloride by gavage on Gd 10 had increased resorptions, decreased live fetuses per litter, and decreased numbers of fetuses per litter (Fuyuta et al. 1978). After guinea pigs were exposed to 11.5 mg Hg/kg as methylmercuric chloride by gavage on Gd 21, 28, 35, 42, or 49, half of the litters were aborted 4–6 days after treatment (Inouye and Kajiwara 1988). An increased rate of reproductive failure due to decreased conceptions and increased early abortions and stillbirths occurred in female monkeys exposed to 0.06 or 0.08 mg Hg/kg/day as methylmercury for 4 months (Burbacher et al. 1988). The menstrual cycle length was not affected at these dose levels. Reproductive effects were not observed in monkeys exposed to 0.04 mg/kg/day for the same duration.

Testicular functions were studied in monkeys (*M. fascicularis*) exposed to 0.025 or 0.035 mg Hg/kg/day as methylmercury by gavage for 20 weeks (Mohamed et al. 1987). The mean percentage of motile spermatozoa and the mean sperm speed were significantly decreased for both treatment groups compared to controls. Morphological examination of semen smears indicated an increased incidence of tail defects (primarily bent and kinked tails) in both exposed groups. No histopathological effects were evident on the testes. The study was limited because there were only three animals in each exposure group.

2. HEALTH EFFECTS

Testicular effects were also observed after chronic-duration exposure to methylmercuric chloride. Tubular atrophy of the testes was observed in mice ingesting 0.69 mg Hg/kg/day in their feed for up to 2 years (Mitsumori et al. 1990). Decreased spermatogenesis was observed in mice receiving 0.73 mg Hg/kg/day in the diet (Hirano et al. 1986). No adverse effects on the testes were observed in these studies at 0.14–0.15 mg Hg/kg/day. Similarly, no adverse effects were observed in the testes, prostate, ovaries, or uterus of rats exposed through the diet to 0.1 mg Hg/kg/day as methylmercuric chloride for 2 years (Verschuuren et al. 1976).

The highest NOAEL values and all reliable LOAEL values for reproductive effects in each species and duration category are recorded in Table 2-3 and plotted in Figure 2-3 for organic mercury.

2.2.2.6 Developmental Effects

Inorganic Mercury. No studies were located regarding developmental effects in humans or animals following oral exposure to inorganic mercury.

Organic Mercury. When grains treated with fungicides containing mercury have been accidentally consumed or when fish with high levels of methylmercury have been eaten, epidemics of human mercury poisonings have occurred with high incidences of developmental toxicity. These episodes, as well as case reports from isolated incidences of maternal consumption of organic forms of mercury during pregnancy, have provided evidence that the developing nervous system of the fetus is highly sensitive to mercury toxicity. The first such incident was reported in Sweden in 1952 when flour from grain treated with an unspecified alkyl mercury compound ingested by a pregnant woman was associated with developmental toxicity. An apparently normal infant was born, but the infant later displayed brain damage manifested by mental retardation, incoordination, and inability to move (Engleson and Herner 1952). A 40-year-old woman, 3 months pregnant, consumed methylmercury-contaminated meat for an unspecified duration and subsequently delivered a male infant with elevated urinary mercury levels (Snyder and Seelinger 1976). At 3 months, the infant was hypotonic, irritable, and exhibited myoclonic seizures. At 6 years of age, the child displayed severe neurological impairment (e.g., blindness, myoclonic seizures, neuromuscular weakness, inability to speak) (Snyder and Seelinger 1976). In the 1955 mercury poisoning outbreak in Minamata, Japan, severe brain damage was described in 22 infants whose mothers had ingested fish contaminated with methylmercury during pregnancy (Harada 1978). The types of nervous system effects described in the Minamata outbreak included mental retardation; retention of primitive reflexes; cerebellar symptoms;

2. HEALTH EFFECTS

dysarthria; hyperkinesia; hypersalivation; atrophy and hypoplasia of the cerebral cortex, corpus callosum, and granule cell layer of the cerebellum; dysmyelination of the pyramidal tracts; and an abnormal neuronal cytoarchitecture. It has been suggested that the widespread damage involved derangement of basic developmental processes, such as neuronal migration (Choi et al. 1978; Matsumoto et al. 1965) and neuronal cell division (Sager et al. 1983).

Large-scale poisonings also occurred in Iraq in 1956 and 1960 (Bakir et al. 1973). Thirty-one pregnant women were victims of poisoning; 14 women died from ingesting wheat flour from seeds treated with ethylmercury *p*-toluene sulfonamide (Bakir et al. 1973). Infants were born with blood mercury concentrations of 250 µg/100 mL and suffered severe brain damage. Similar cases of severe brain damage resulting from prenatal exposure to methylmercury were reported in an outbreak of methylmercury poisoning in Iraq occurring in 1971–1972 (Amin-Zaki et al. 1974). Attempts to correlate symptoms with exposure levels have shown that a dose-response relationship exists between the severity of the neurological symptoms in offspring and the maternal intake of methylmercury (as determined using analysis of hair for mercury content) (Cox et al. 1989; Marsh et al. 1980, 1981, 1987). Delays in walking and talking were more often associated with lower peak hair levels during pregnancy than were mental retardation and seizures (Marsh et al. 1981, 1987). These studies showed that the most severely affected children had been exposed to methylmercury during the second trimester of pregnancy. Male offspring were more severely affected than female offspring. Neurological abnormalities have also been observed among offspring of Cree Indians in Quebec, Canada, exposed to methylmercury in fish (McKeown-Eyssen et al. 1983).

A significant correlation was observed between male offspring with abnormal muscle tone or reflexes and maternal prenatal exposure (as determined using hair levels). An analysis of peak hair mercury levels during pregnancy in mothers exposed during the 1971–1972 outbreak in Iraq has led to an estimated population threshold of 10 ppm (highest value during pregnancy, for total mercury in hair) associated with delays in the onset of walking in infants (Cox et al. 1989). However, this estimated threshold for the Iraqi population depends heavily on the assumed background frequency for abnormal onset of walking time, as well as the threshold chosen to define onset of walking as abnormal. Furthermore, most of the positive responses (i.e., reported delays in onset of walking or talking) were observed for maternal hair levels above about 60 ppm. Only 3 of 24 children with positive responses were born to mothers with hair levels below 59 ppm. The peak total mercury hair levels during pregnancy for the mothers of those 3 children were 14, 18, and 38 ppm (WHO 1990). A maternal exposure level of 0.0012 mg/kg/day, corresponding to a hair

2. HEALTH EFFECTS

level of 14 ppm, was estimated for the Iraqi women using a simple, one-compartment pharmacokinetic model (see Section 2.4).

Davidson et al. (1995b) studied the effects of prenatal methylmercury exposure from a diet high in fish on developmental milestones in children living in the Republic of Seychelles (i.e., the Seychelles Child Development Study (SCDS)). In this double blind study, children were evaluated with the Bayley Scales of Infant Development (BSID) at 19 months of age (n=738). The 19-month cohort represented 94% of the initially enrolled pairs. The cohort was evaluated again at 29 months (n=736) with the BSID and the Bayley Infant Behavior Record. Mercury exposure was determined by cold vapor atomic absorption analysis of maternal hair segments during pregnancy. The 29-month cohort represented approximately 50% of all live births in the year 1989. This particular study population was carefully selected based on the following reasons: (1) they regularly consume a high quantity and variety of ocean fish; (2) pre-study mercury concentration in maternal hair was in the appropriate range (<5 to >45 ppm) to study low-level exposure; (3) there is no local industry for pollution, and the Seychelles location is 1,000 miles from any continent or large population center; (4) the Seychellois population is highly literate, cooperative, and has minimal immigration; and (5) the Seychellois constitute a generally healthy population, with low maternal alcohol and tobacco use. The association between maternal hair mercury concentrations and neurodevelopmental outcomes at 19 and 29 months of age was examined by multiple regression analysis with adjustment for confounding variables. Testing was performed by a team of Seychellois nurses extensively trained in administration of the BSID.

Maternal hair concentrations measured in hair segments that corresponded to pregnancy ranged from 0.5 to 26.7 ppm, with a median exposure of 5.9 ppm for the entire study group. The mean BSID Mental Scale Indexes at both 19 and 29 months were comparable to the mean performance of U.S. children. The mean BSID Psychomotor Scale Indexes at 19 and 29 months were 2 standard deviation units above U.S. norms, but consistent with previous findings of motoric precocity in children reared in African countries. No effect of mercury was detected on BSID scores at either age. On the Bayley Infant Behavior Record, activity level in boys, but not girls, decreased with increasing mercury exposure. The only subjective observation correlated with prenatal mercury exposure was a slight decrease in activity level in boys (but not girls) as determined by the Bayley Infant Behavior Record.

The overall study cohort was broken down into sub-groups based upon maternal hair mercury concentration as follows: <3 ppm (n=164), 4–6 ppm (n=215), 7–9 ppm (n=161), 10–12 ppm (n=97), and

2. HEALTH EFFECTS

>12 ppm (n=99). No significant or remarkable effect on the activity of the respective groups of children was observed outside the highest concentration group (i.e., maternal hair concentrations >12 ppm). When boys were examined separately, there appeared to be a trend toward decreased activity with increasing mercury concentrations, most visible above the group median value of 5.9 ppm. The mercury effect was highly significant in males ($p=0.0004$), but it was not statistically significant ($p=0.87$) in females. The activity level scores for males decreases 1/10 point (on a 9-point scale) for every ppm of mercury in maternal hair. While the activity score for the overall cohort was comparable to the mode of 5 for U.S. children, those children born to mothers with hair mercury levels of 20 ppm, males scored >1 point below the U.S. mode value. Scores of females remained at the comparable value for U.S. children, regardless of the magnitude of maternal hair mercury level. When the subjective activity scores for male and female children are evaluated collectively, no significant/remarkable decrease in activity is apparent outside the >12 ppm maternal hair concentration group. The affect on activity level in boys is not considered an adverse effect, and the 5.9 ppm level is categorized as a NOAEL. Since the children had been exposed *in utero*, they represent the most sensitive subpopulation.

Myers et al. (1997) evaluated the population of the SCDS for developmental milestones similar to those determined in Iraq. As part of this ongoing study, cohort children were evaluated at 6.5, 19, 29, and 66 months of age. At 19 months care-givers were asked at what age the child walked (n=720 out of 738) and talked (n=680). Prenatal mercury exposure was determined by atomic absorption analysis of maternal hair segments corresponding to hair growth during the pregnancy.

The median mercury level in maternal hair for the cohort in this analysis was 5.8 ppm with a range of 0.5–26.7 ppm. The mean age (in months) at walking was 10.7 (SD=1.9) for females and 10.6 (SD=2.0) for males. The mean age for talking (in months) was 10.5 (SD=2.6) for females, and 11.0 (SD=2.9) for males. After adjusting for covariates and statistical outliers, no association was found between the age at which Seychellois children walked or talked and prenatal exposure to mercury. The ages for achievement of the developmental milestones were normal for walking and talking in the Seychellois toddlers following prenatal exposure to methylmercury from a maternal fish diet. The 5.8 ppm NOAEL of this study is thus considerably below the one derived from the dose-response analysis of the data for the Iraqi methylmercury poisonings (10 ppm).

The SCDS cohort continues to be monitored and evaluated for developmental effects. In an analysis of the latest round of outcome measures for children at age 66 months (n=708), Davidson et al. (1998) report no

2. HEALTH EFFECTS

adverse developmental effects associated with prenatal and postnatal exposure to methylmercury in fish at the levels experienced in this cohort. The actual exposure is reflected in a mean maternal hair level of 6.8 ppm for the prenatal exposure (SD=4.5, n=711, range, 0.5-26.7) and in a mean children's hair level of 6.5 ppm (SD=3.3, n=708, range, 0.9-25.8) for both the prenatal and subsequent postnatal exposure. The age-appropriate main outcome measures included: (1) the McCarthy Scales of Children's Abilities, (2) the Preschool Language Scale, (3) the Woodcock-Johnson Tests of Achievement—Letter and Word Recognition, (4) Woodcock-Johnson Tests of Achievement—Applied Problems and, (5) the Bender Gestalt test, and (6) the Child Behavior Checklist. The test results were similar to what would be expected from a healthy, well-developing U.S. population. No test indicated a deleterious effect of methylmercury from the exposure levels received in this population. Four of the six measures showed better scores in the highest MeHg groups compared with lower groups for both prenatal and postnatal exposure. The authors conclude that this result is likely due to the benefits of increased levels of fish in the diet, possibly because of increased consumption of omega-3-fatty acids. Serum from a subset of 49 of the children was sampled for polychlorinated biphenyl (PCB) levels. None of the samples had detectable levels (detection limit 0.2 ng/mL) for any of the 28 congeners assayed (from congener 28 to 206), indicating that was no concurrent (i.e, potentially confounding) exposure to PCBs in this population. The median level of total mercury for each of 25 species sampled was 0.004–0.75 ppm, with most medians in the range of 0.05–0.25 ppm, levels that are comparable to fish in the U.S. market. The authors conclude, that this most recent NOAEL of 6.8 ppm for the SCDS cohort at 66 months of age strongly supports the findings at earlier ages, and that the benefits of eating fish outweigh the small risk of adverse effects from an increased exposure to methylmercury for this exposure pathway.

Weihe et al. (1996) began a long-term evaluation of the health implications for people living in the Faroe Islands who are exposed to heavy metals and polychlorinated biphenyls (PCBs) from the consumption of fish and pilot whales. A birth cohort of 1,000 children was examined at approximately 7 years of age for neurobehavioral dysfunctions associated with prenatal exposure to mercury and PCB. Preliminary analyses of the data show that several neurobehavioral tests are associated with mercury exposure parameters. With emphasis on prenatal exposures to PCB, another cohort was generated during 1994–1995, and this cohort will be followed closely during the next years. In the Faroe Islands, marine food constitutes a considerable part of the diet. In addition to fish, both meat and blubber from pilot whales are included in the diet. Muscle tissue of pilot whales caught in the Faroe Islands contains an average mercury concentration of 3.3 µg/g (16 nmol/g), about half of which is methylmercury. In some years an evenly distributed annual catch of pilot whales would make the average dietary intake of mercury close to more than the Provisional

2. HEALTH EFFECTS

Temporary Weekly Intake of 0.3 mg recommended by WHO. In 1 of 8 consecutive births, the mercury concentration in maternal hair exceeded a limit of 10 $\mu\text{g/g}$, a level where neurobehavioral dysfunction in the child may occur. The maximum level was 39.1 $\mu\text{g/g}$. Mercury concentrations in umbilical cord blood showed a similar distribution with a maximum of 351 $\mu\text{g/L}$. The large variation in mercury exposure is associated with differences in the frequency of whale dinners. The average PCB concentration in pilot whale blubber is very high (about 30 $\mu\text{g/g}$). With an estimated daily consumption of 7 g of blubber, the average daily PCB intake could therefore exceed 200 μg (i.e., close to the Acceptable Daily Intake). In Scandinavia, the average daily PCB intake is about 15–20 μg .

In the continuation of this work, Grandjean et al. (1997b, 1998) studied a cohort of 1,022 consecutive singleton births generated during 1986–1987 in the Faroe Islands. Increased methylmercury exposure from maternal consumption of pilot whale meat was estimated from mercury concentrations in cord blood and maternal hair. At approximately 7 years of age, 917 of the children underwent detailed neurobehavioral examination. Neuropsychological tests included Finger Tapping; Hand-Eye Coordination; reaction time on a Continuous Performance Test; Wechsler Intelligence Scale for Children-Revised Digit Spans, Similarities, and Block Designs; Bender Visual Motor Gestalt Test; Boston Naming Test; and California Verbal Learning Test (Children). Neurophysiological tests emphasized motor coordination, perceptual-motor performance, and visual acuity; pattern reversal visual evoked potentials (VEP) with binocular full-field stimulation, brain stem auditory evoked potentials (BAEP), postural sway, and the coefficient of variation for R-R interpeak intervals (CVRR) on the electrocardiogram were measured. Mercury in cord blood, maternal hair (at parturition), child hair at 12 months, and child hair at 7 years of age were measured. The geometric average mercury concentrations were 22.9, 4.27, 1.12, and 2.99 $\mu\text{g/g}$, respectively. Mercury concentrations in cord blood were most closely associated with the concentrations in maternal hair at parturition and less so with children's hair at 12 months and 7 years. Clinical examination and neurophysiological testing did not reveal any clear-cut mercury-related abnormalities. However, mercury-related neuropsychological dysfunctions were most pronounced in the domains of language, attention, and memory, and to a lesser extent in visuospatial and motor functions. The authors state that these associations remain after adjustment for covariates and after exclusion of children with maternal hair mercury concentrations above 10 $\mu\text{g/g}$ (50 nmol/g). They further conclude that the effects on brain function associated with prenatal methylmercury exposure appear diverse, with early dysfunction in the Faroe Island population detectable at exposure levels currently considered to be safe.

2. HEALTH EFFECTS

In animals, there is evidence of developmental effects following oral exposure to organic mercury during gestation, lactation, and/or postweaning. Increases in several parameters indicative of developmental toxicity have been observed. Not all studies have examined neurological end points, but developmental neurotoxicity has been observed at very low exposure levels.

Methylmercuric chloride administered via gavage to pregnant rats at 8 mg Hg/kg on Gd 10 resulted in increased skeletal variations (incomplete fusion of the sternbrae) (Fuyuta et al. 1979). At higher doses, decreased fetal weight and increased malformations (cleft palate) were observed. Administration of lower doses of methylmercury (4 mg Hg/kg/day) for a longer duration of gestation (Gd 7–9 or 6–14) resulted in an increased incidence of rat fetuses with incomplete ossification or calcification (Nolen et al. 1972). The incidence of skeletal variations at 0.2 mg/kg/day was not significantly different from controls. Methylmercuric chloride administered to pregnant rats (n=10) via gavage at 2 mg Hg/kg/day throughout gestation (Gd 0–20) resulted in increased numbers of malformed fetuses (Inouye and Murakami 1975). The most common malformations were generalized edema and brain lesions. When methylmercuric chloride was administered to pregnant rats at 4 mg Hg/kg/day during Gd 7–14, there was a decreased fetal weight and an increased number of total malformations, hydrocephalus, and wavy ribs (Fuyuta et al. 1978). At 6 mg Hg/kg/day, increased resorptions, fetal deaths, cleft palate, generalized edema, brain lesions, absence of vertebral centra, and defects of the sternum were observed. Skeletal variations seen at 6 mg Hg/kg/day included absence of one or more sternbrae, bipartite sternbrae, and bilobed vertebral centra.

Administration of a single dose of 24 mg Hg/kg as methylmercuric chloride to pregnant rats during Gd 6–12 resulted in decreased fetal weights and increased malformations (Inouye and Murakami 1975). The incidence of malformations (hydrocephalus, cleft palate, micrognathia, microglossia, generalized edema, subcutaneous bleeding, and hydronephrosis and hypoplasia of the kidneys) increased with later treatments (after Gd 7). Hydrocephalic brains had lesions in the brain mantle, corpus callosum, caudate putamen, and primordial cerebellum. Brains without hydrocephalus had lesions in similar brain areas, as well as dilation of the third ventricle and partial ablation of the ependymal lining.

Groups of 30 pregnant Fischer 344 rats were orally administered 10, 20, or 30 mg/kg methylmercuric chloride dissolved in saline on Gd 7. Controls were given saline only (n=30). Maternal body weight gain and deaths were monitored. Maternal body weights were decreased for 2 days in rats given 10 mg/kg as methylmercuric chloride and for 6 days in rats given 20 mg/kg and were continuously decreased for those given 30 mg/kg. Maternal death rates were 6.7, 16.7, and 30% in the 10, 20, and 30 mg/kg methylmercuric chloride dose groups; no control dams died. Survival rates of fetuses were 19.2, 41.4, and 91.1%

2. HEALTH EFFECTS

less than controls for the 10, 20, and 30 mg/kg methylmercuric chloride groups, respectively. The LD_{50} of methylmercuric chloride for fetuses was determined to be 16.5 mg/kg. The backbones of fetuses were severely curved at the high-dose level; mean fetal body lengths were reduced by 9.6, 21.7, and 48.8% in the 10, 20, and 30 mg/kg methylmercuric chloride groups, respectively, as compared to controls. Mercury content in maternal organs was highest in kidneys, followed by blood, spleen, liver, and brain, while in fetal organs it was highest in liver. Fetal liver and brain contained more mercury than maternal liver and brain; however, fetal kidneys retained less mercury than maternal kidneys. The fetal ossification center was not completely formed in sternbrae, particularly in the fifth and second bones, pelvic bones, and pectoral phalanges of fetuses in rats treated with 30 mg/kg methylmercuric chloride. The ossified lengths of skeletal bone stained with alizarin red S were developed least in the fifth sternbrae, metacarpals in the pectoral girdle, and ischium in the pelvic girdle, and were severely retarded in development as position of the ribs goes from the sixth bone (center) to the first and 13th bone (each edge) (Lee and Han 1995).

Four groups of 12 pregnant Sprague-Dawley rats were exposed to methylmercury or elemental mercury alone or in combination as follows: one group was administered 2 mg/kg/day methylmercury via gavage during Gd 6–9; another was exposed by inhalation to 1.8 mg/m³ metallic mercury (elemental Hg) vapor for 1.5 hours per day during Gd 14–19; a third was exposed to both methylmercury by gavage (2 mg/kg/day, Gd 6–9) and elemental Hg vapor by inhalation (1.8 mg/m³, Gd 14–19) (methylmercury + elemental Hg); a fourth group was given combined vehicle administration for each of the 2 treatments (control). The inhalation regimen corresponded to an approximate dose of 0.1 mg Hg/kg/day. Maternal body weights were monitored. At postpartum day 3, each litter was reduced to 4 male offspring. Body weight, pinna unfolding, tooth eruption, and eye opening were monitored. Testing of behavioral function was performed between 4 and 5 months of age and included spontaneous motor activity, spatial learning in a circular bath, and instrumental maze learning for food reward. Surface righting reflex and negative geotaxis were measured before weaning. There were no differences between any of the groups in maternal body weight gain or in body weight, pinna unfolding, tooth eruption, surface righting reflex, and negative geotaxis in offspring. Offspring of dams exposed to elemental mercury showed hyperactivity in the spontaneous motor activity test chambers over all three of the following parameters: locomotion, rearing, and total activity. This effect was potentiated in the animals of the methylmercury + elemental mercury group. In the swim maze test, the methylmercury + elemental mercury and elemental mercury groups evidenced longer latencies to reach a submerged platform, which they had learned to mount the day before, compared to either the control or methylmercury groups. In the modified, enclosed radial-arm maze, both the methylmercury + elemental Hg and elemental Hg groups showed more ambulations and rearings in the activity

2. HEALTH EFFECTS

test prior to the learning test. During the learning trial, the same groups (i.e., methylmercury + elemental mercury and elemental mercury) showed longer latencies and made more errors in acquiring all eight pellets. Generally, the results indicate that co-exposure to methylmercury, which by itself did not alter these functions at the dose given in this study, served to significantly enhance the effects of prenatal exposure to elemental mercury (i.e., alterations to both spontaneous and learned behaviors). Brain mercury concentrations in offspring were 1 ng/g w/w in the controls, 4 ng/g in the methylmercury group, 5 ng/g in the elemental mercury group, and 12 ng/g in the methylmercury + elemental mercury group (Fredriksson et al. 1996).

Pregnant Sprague-Dawley rats were treated by gavage with a single oral dose of 8 mg/kg of methylmercury chloride or saline on Gd 15. Within 24 hours after birth, litters were reduced to 6 pups per litter. Pups were weighed weekly and weaned 21 days after birth. Offspring of control and treated rats were killed at 14, 21, and 60 days of age. The binding characteristics of muscarinic receptors labeled in cortical membrane preparation by [3H]-L-quinuclidinyl benzilate were studied, and the mercury level in the same brain area was assessed. Total mercury content in cortical tissues was determined at 21 and 60 days of age. Furthermore, the performance in passive avoidance tasks was evaluated in 10 rats from each group at 8 weeks of age. No differences in mortality or weight gain were observed in methylmercury-exposed pups compared to controls. At 21 days of age, the level of mercury in the cortex was about 30 times higher in exposed rats than in controls (190.2 ng/g w/w versus 6.4 ng/g); at 60 days, mercury levels did not differ significantly (7.4 versus 5 ng/g, respectively). Perinatal exposure to methylmercury significantly reduced the maximum number of muscarinic receptors (B_{max}) in the brain of 14-day-old (53%) and 21-day-old (21.3%) rats, while there was no notable difference in 60-day-old rats. This phenomenon seems to be strictly related to the presence of mercury in the cortex since it disappeared with the normalization of mercury levels in the brain. Despite the recovery of muscarinic receptor densities in methylmercury-exposed rats at 8 weeks of age, the avoidance latency was reduced in passive avoidance tests, indicating learning and memory deficits in these animals (Zanoli et al. 1994).

Similar effects were observed in mice exposed to organic mercury. Methylmercuric chloride administered orally by gavage to mice at 5 mg Hg/kg/day during Gd 6–17 resulted in 100% stillbirths or neonatal deaths and the failure of 6 of 9 dams to deliver, with no apparent maternal toxicity (Khera and Tabacova 1973). At lower doses (2 and 4 mg Hg/kg/day) for a shorter duration during gestation (days 6–13), no increase in deaths or resorptions was observed, but increases in malformations, skeletal variations, and delays in ossification were observed (Fuyuta et al. 1978). A higher dose of methylmercuric chloride (16 mg Hg/kg)

2. HEALTH EFFECTS

administered to mice by gavage on either Gd 10 or 12 resulted in decreased fetal weight, cleft palate, and dilation of the renal pelvis (Yasuda et al. 1985).

Thuvander et al. (1996) evaluated the immunomodulation of methylmercury from perinatal exposure in mice. Offspring from Balb/c mice were exposed to methylmercuric chloride in the diet. Dams (16.0 ± 0.5 g) were exposed to 0 (n=72), 0.5 (n=27), or 5 (n=37) mg Hg/kg for 10 weeks prior to mating, and during gestation and lactation. Pups were exposed to mercury until day 15 of lactation; thereafter, the pups were given control milk and control diet. Samples for mercury analysis were collected from the pups on days 22 and 50, and for immunological studies on days 10, 22, and 50. Immunological parameters included numbers of splenocytes and thymocytes, proportions of lymphocyte subpopulations within the thymus, the proliferative response of splenocytes to the B-cell mitogen LPS, NK-cell activity of splenocytes, and the primary antibody response to a viral antigen. Eight pups (n=8NS) were taken from at least three different litters for the immune function analysis.

No disturbances in the behavior of dams or pups were observed for any of the dose groups. All dams gave birth to normal sized litters (8–10 animals/litter). The high dose dams did have a small (4%) but significant increase in body weight (weeks 4, 5, 9 $p < 0.05$, week 8 $p < 0.01$). The exposure resulted in significantly increased total Hg concentrations in whole blood of offspring on day 22 and 50 from the 5 mg Hg/kg group (170 and 22 ng Hg/g blood in 5 mg/kg dose group compared to 7 and 5 ng Hg/g in control, respectively), and of offspring from the 0.5 mg Hg/kg group on day 22 (24 ng Hg/g compared to 7 ng Hg/g in control). On day 50, blood mercury levels in the 0.5 mg Hg/kg group had decreased to 11 ng Hg/g compared to 5 ng Hg/g in controls. Pups showed a decreased body weight (8%) in the 5 mg/kg group at 10 days of age. Significantly increased numbers of splenocytes were found only in offspring from the 0.5 mg Hg/kg group at 10 and 22 days, and increased number of thymocytes in the 0.5 mg/kg group at 22 days. Flow cytometry analysis of thymocytes revealed increased numbers and altered proportions of lymphocyte subpopulations within the thymus in offspring from both of the exposed groups at 22 days. The only sign of immunosuppression was a decrease in the proportion of CD4+ thymocytes at 10 days, but this was seen in both mercury groups so was probably not related to a decrease in body weight. The proliferative response of splenocytes to the B-cell mitogen LPS was increased in offspring from dams exposed to 5 mg Hg/kg, and the primary antibody response to a viral antigen was stimulated in pups from dams exposed to 0.5 mg Hg/kg. No significant differences were observed in the NK-cell activity of splenocytes except for a transient increase in activity at 22 days in the 5 mg/kg group at one of the two effector-to-target-cell ratios tested. The present results indicate that placental and lactational transfer of

2. HEALTH EFFECTS

low dose mercury affects thymocyte development and stimulates certain mitogen- or antigen-induced lymphocyte activities in mice. The authors note that these results, in the context of other studies where methylmercury was observed to have suppressive effects, suggests that methylmercury enhances immune function within a narrow dose range. The blood levels of mercury in the present study are close to the levels found in fish-eating populations. The authors note that the clinical relevance of slight stimulation of some immune functions is unknown, but the induction of autoimmunity by methylmercury can not be excluded.

Groups of guinea pigs exposed to a single dose of 11.5 mg Hg/kg as methylmercuric chloride at various times during gestation (66–69 days) showed differences in the manifestation of developmental neurotoxicity, depending on the period of development when exposure occurred (Inouye and Kajiwara 1988). Primarily developmental disturbances of the brain (e.g., smaller brains, dilated lateral ventricles, reduced size of hippocampus and nucleus caudate-putamen) occurred with exposures at 3, 4, or 5 weeks of pregnancy. Exposure during a later pregnancy stage (6 or 7 weeks) produced widespread focal degeneration of neurons in the neocortical region of fetal brains. In hamsters, methylmercuric chloride administered as a single dose of 8 mg on Gd 10 or of 1.6 mg Hg/kg/day on Gd 10–15 resulted in degeneration of cerebellar neurons in neonates (Reuhl et al. 1981a). Examination of offspring 275–300 days after birth showed similar degeneration (Reuhl et al. 1981b). It was not reported whether these histopathological changes correlated with behavioral changes.

Functional disturbances have also been observed following exposure to methylmercuric chloride during gestation. A single dose of 16 mg Hg/kg as methylmercuric chloride administered on Gd 13, 14, 15, 16, or 17 resulted in decreased spontaneous locomotor activity at 5 weeks of age, decreased righting response, abnormal tail position during walking, flexion, and crossing of the hindlimbs (Inouye et al. 1985). Histopathological examination of these animals showed dilated lateral ventricles, decreased caudate putamen, and a slightly simplified cerebellar pattern. Neonates in this study were cross-fostered within 24 hours after birth to prevent intake of mercury through the milk. The offspring of mice receiving 3, 5, or 10 mg Hg/kg/day as methylmercuric hydroxide on day 8 of gestation exhibited a decreased number of avoidances, an increased number of escapes, and an increased trials to reach the criterion on a 2-way avoidance task (Hughes and Annau 1976). No effects were present in the 2 mg Hg/kg dose group. Offspring of rats exposed to 4 mg Hg/kg/day as methylmercuric chloride on Gd 6–9 showed impaired swimming behavior, increased passiveness, and an increased startle response (Stoltenburg-Didinger and Markwort 1990). At 0.4 mg Hg/kg/day, the offspring showed an increased startle response, but at 0.04 mg

2. HEALTH EFFECTS

Hg/kg/day, no effects were observed. Exposure to 6.4 mg Hg/kg as methylmercuric chloride on Gd 15 resulted in decreases in spontaneous locomotor activity, increased sensitivity to pentylenetetrazol-induced convulsions, and a transient increase in γ -aminobutyric acid (GABA) and benzodiazepine receptors (Guidetti et al. 1992). Using the same exposure paradigm, shorter avoidance latency was observed in 14-, 21-, and 61-day-old rats (Cagiano et al. 1990). Glutamate receptor binding affinity and dopamine receptor number were also significantly affected in the brains of these offspring. Thus, multiple neurotransmitter systems may participate in the neurological effects observed.

A sensitive test for neurological effects of gestational exposure to methylmercury is operant behavioral performance (i.e., rewarded responses to total lever presses). Bornhausen et al. (1980) reported a significant reduction in operant behavioral performance in 4-month-old rat offspring exposed to methylmercuric chloride at 0.008 mg Hg/kg/day on Gd 6–9. A dose of 0.004 mg Hg/kg/day did not alter the behavioral performance of the offspring. No other studies have confirmed this result to date.

Pregnant hamsters received single oral gavage doses of 2.5–63 mg Hg/kg as mercuric acetate on Gd 8 (Gale 1974). Decreased crown-rump length was observed at 5 mg Hg/kg, although this effect did not increase linearly with the dose level. The incidence of resorptions increased at 22 mg Hg/kg and occurred in a dose-related manner. Other effects that occurred at higher dose levels included growth-retarded or edematous embryos. No significant developmental effects were evident at 2.5 mg Hg/kg.

Developmental neurotoxicity and changes in tissues, including the liver and immune system, have been observed in studies in which exposure occurred prior to gestation and/or was continued after gestation for intermediate durations. Retarded behavioral maturation (swimming behavior, righting reflexes) and learning disability (maze learning) were demonstrated in rat offspring receiving a diet of 0.1 mg Hg/kg/day (unspecified forms of mercury) in a contaminated fish diet from Gd 1 to postnatal day 42 (Olson and Boush 1975). Decreased performance in a paradigm intended to assess tactile-kinesthetic function (use of too much force) was observed in offspring of rats exposed to 0.08 mg Hg/kg/day as methylmercuric chloride for 2 weeks prior to mating through weaning (Elsner 1991). No morphological changes were observed in the brains of the offspring of maternal rats given 0.195 mg Hg/kg/day as methylmercuric chloride for 14 weeks prior to mating through postpartum day 50 (Lindstrom et al. 1991). However, norepinephrine levels in the cerebellum of offspring were significantly increased. Methylmercuric chloride at doses of 0.25 mg Hg/kg/day administered beginning several weeks prior to gestation resulted in an increase in the incidence of unilateral or bilateral ocular lesions in the neonates, associated with histological changes in the

2. HEALTH EFFECTS

Harderian, exorbital lachrymal, and parotid salivary glands (Khera and Tabacova 1973). No effects occurred at the lower dose of 0.05 mg Hg/kg/day. Fetal liver injury at the ultrastructural level (e.g., decreased mitochondrial volume density, enzyme activity, and protein synthesis in fetal hepatocytes) was reported after chronic exposure to low doses of 0.7–1.4 mg Hg/kg/day as methylmercury in the drinking water of rats for 1 month before mating and up to the end of pregnancy (Fowler and Woods 1977). The developing immune system was affected in newborn Sprague-Dawley rats exposed to 0.5 mg Hg/kg/day as methylmercury through the placenta and/or milk (Ilback et al. 1991). Results showed that exposure caused increased thymus lymphocyte activity in offspring exposed during gestation and lactation, while decreased spleen lymphocyte activities were observed in offspring exposed during lactation only. Cell-mediated cytotoxicity was decreased by 41% ($p < 0.01$) in offspring exposed during gestation and lactation.

In chronic-duration studies, impaired visual function has been reported. Impaired visual recognition memory was reported for 50-to-60-day-old monkeys born to mothers that received 0.04 or 0.06 mg Hg/kg/day as methylmercury in apple juice for an average of 168 or 747 days prior to mating (Gunderson et al. 1988). In this study, neonates were separated from their mothers at birth to prevent intake of mercury while nursing. Impaired spatial visual function was observed in another study in which infant monkeys were exposed to 0.01, 0.025, or 0.05 mg Hg/kg/day as methylmercuric chloride throughout gestation, followed by gavage doses 5 days a week until 4–4.5 years of age (Rice and Gilbert 1990). The study was limited, however, because only 1–5 animals were tested at each dose level. Furthermore, two of the high-dose animals were unavailable for testing as a result of overt mercury intoxication, and thus the two most affected animals were eliminated. Slight changes in temporal discrimination were also observed in these monkeys at 2–3 years of age (Rice 1992). However, no LOAEL can be determined for this effect because results from monkeys at the mid- and high doses were pooled.

The highest NOAEL values and all reliable LOAEL values for developmental effects in each species and duration category are recorded in Table 2-3 and plotted in Figure 2-3 for organic mercury.

2.2.2.7 Genotoxic Effects

Several studies were located regarding genotoxic effects in humans after oral exposure to organic mercury. A positive correlation between blood mercury levels and structural and numerical chromosome aberrations was found in the lymphocytes of 23 people who consumed mercury-contaminated fish (Skerfving et al. 1974). However, several factors preclude acceptance of these findings as valid. With respect to the

2. HEALTH EFFECTS

increased incidence of structural aberrations, smokers were not identified, it was unclear whether chromatid and chromosome gaps were excluded from the evaluation, and significant effects were obtained only from lymphocyte cultures initiated several days after collection. The more reliable approach of initiating cultures on the day of collection did not yield significant results. Similarly, the evidence of aneuploidy is suspect. Considering the age of the subjects (54–89 years in the control group and 47–84 years in the exposure group), the average incidence of aneuploidy in the control (1.8%) and exposed (2.8%) groups was lower than would be expected, according to results indicating that aneuploidy in humans increases with age (Cimino et al. 1986). Skerfving et al. (1970) also reported that a significant ($p < 0.05$) correlation was found between mercury concentrations and chromosome breaks in the lymphocytes of 9 subjects who had consumed fish contaminated with methylmercury. For reasons similar to those listed for the evaluation of the report by Skerfving et al. (1974), there is not yet a scientific basis to support an association between consumption of fish containing high methylmercury and clastogenesis in human lymphocytes. In addition, one of the test subjects was regularly medicated with isoproterenol, a known clastogen for mammalian cells. Although an increased incidence of sister chromatid exchange was reported in humans who ate mercury-contaminated seal meat (Wulf et al. 1986), data on smoking and consumption of other heavy metals (lead and cadmium) were not provided. Therefore, the possible relevance of the increase in sister chromatid exchanges (SCEs) cannot be determined. A statistical correlation between micronucleus frequency in peripheral blood lymphocytes and total mercury concentration in blood ($p = 0.00041$), as well as between micronucleus frequency and age ($p = 0.017$), was found in a population of fishers who had eaten mercury contaminated seafood (Franchi et al. 1994).

A single oral gavage administration of mercuric chloride to male Swiss albino mice (5 per group) at doses of 2.2, 4.4, or 8.9 mg Hg/kg induced a dose-related increase in the frequency of chromosome aberrations and the percentage of aberrant cells in the bone marrow (Ghosh et al. 1991). Chromatid breaks were the most common aberration. There was no clear evidence of unscheduled DNA synthesis (UDS) in lymphocytes harvested from male and female cats (3 per group) chronically exposed (39 months) to dietary concentrations of 0.0084, 0.020, or 0.046 mg Hg/kg/day as methylmercury (Miller et al. 1979). In a parallel study, significant increases in nuclear abnormalities were scored in bone marrow cells collected from the three treatment groups (5–8 cats per group); the response, however, was not dose-related. Signs of compound toxicity (slight neurological impairment and minimal central nervous system pathology) were seen in the high-dose group, but these animals yielded the lowest number of abnormal chromosome figures.

Other genotoxicity studies are discussed in Section 2.5.

2. HEALTH EFFECTS

2.2.2.8 Cancer

Inorganic Mercury. No studies were located regarding cancer in humans after oral exposure to inorganic mercury.

Results of a 2-year National Toxicology Project (NTP 1993) study indicated that mercuric chloride may induce tumors in rats. Fischer 344 rats (60 per sex per group) received 0, 1.9, or 3.7 mg Hg/kg/day as mercuric chloride by gavage for 2 years. There were increases in the incidence of forestomach squamous cell papillomas and an increase in the incidence of thyroid follicular cell carcinomas in males in the 3.7 mg/kg group (NTP 1993). In B6C3F₁ mice exposed to 0, 3.7, or 7.4 mg Hg/kg/day as mercuric chloride, renal tubule tumors were evident in 3 of the 49 high-dose males (NTP 1993), but the incidence of these tumors was not significantly increased. There was no evidence of carcinogenicity in the exposed female mice. The cancer effect level (CEL) from this study is recorded in Table 2-2 and is plotted in Figure 2-2.

Organic Mercury. No studies were located regarding cancer in humans following oral exposure to organic mercury.

Significant increases in renal tumors have been observed in rodents exposed either to methylmercuric chloride or phenylmercuric acetate. Dietary exposure of both ICR and B6C3F₁ mice for 2 years has resulted in significant increases in renal epithelial cell tumors (Hirano et al. 1986; Mitsumori et al. 1981, 1990). At the highest dose of 0.69 mg Hg/kg/day (dose levels 0, 0.03, 0.14, 0.69), only male B6C3F₁ mice (n=60M,60F) showed significant increases in the incidence of renal epithelial cell adenomas and carcinomas (Mitsumori et al. 1990). No tumors were observed in the females B6C3F₁ mice exposed to up to 0.6 mg Hg/kg/day. The high dose in males and females also resulted in chronic nephropathy and regeneration of the proximal tubules (more severe in males). At 0.73 mg Hg/kg/day, male ICR mice showed significant increases in the incidence of epithelial cell adenocarcinomas (Hirano et al. 1986). Similar effects were observed in the ICR male mice at the highest dose of 1.6 mg Hg/kg/day (Mitsumori et al. 1981). No increase in tumor incidence was observed in rats exposed via the diet for 2 years to methylmercuric chloride at doses as high as 0.1 mg Hg/kg/day (Verschuuren et al. 1976).

Exposure of male Wistar rats to phenylmercuric acetate in the drinking water at 4.2 mg Hg/kg/day for 2 years resulted in a significant increase in renal cell adenomas (Solecki et al. 1991). However, this report

2. HEALTH EFFECTS

is limited because the assay was not intended as a carcinogenicity assay, and too few animals were used (20 per dose) to adequately assess the carcinogenicity of the phenylmercuric acetate.

No tumors or precancerous lesions were reported in rats administered 0.04–66.0 mg Hg/kg/day as phenylmercuric acetate in the diet for 2 years (Fitzhugh et al. 1950). As discussed above for mercuric acetate, no conclusions can be drawn from this study because of its limitations.

In a 2-year oral chronic-duration feeding study, no tumors or precancerous lesions were noted in rats administered mercuric acetate in the diet at doses of 0.2–66 mg Hg/kg/day (Fitzhugh et al. 1950); no conclusions could be derived on the carcinogenicity of mercuric acetate. The study was limited because the group sizes were small (10–12 rats per group); survival data were not reported; a considerable but unspecified number of rats reportedly died from pneumonia, which reduced the sensitivity of the study to detect a carcinogenic response; and only limited histopathological analyses were performed.

The CELs from these studies are recorded in Table 2-3 and plotted in Figure 2-3.

2.2.3 Dermal Exposure

Occupational exposure to both inorganic and organic mercury compounds may result in dermal as well as inhalation exposure to these chemicals. The results reported in Section 2.2.1 regarding the effects associated with occupational exposure to mercury-containing chemicals will not be repeated here. The studies discussed below concern reports in which dermal exposure was expected to be the primary route of exposure.

2.2.3.1 Death

Inorganic Mercury. A case study reported that a 27-year-old woman died 4 days after inserting an 8.75-g tablet of mercuric chloride (93 mg Hg/kg assuming 70-kg weight) into her vagina (Millar 1916). Another case study described the death of a man who had been receiving treatment for a wound with daily applications for approximately 2 months of a Chinese medicine containing mercurous chloride (Kang-Yum and Oransky 1992). The patient was reported to have died from renal failure.

2. HEALTH EFFECTS

An early study conducted by Schamberg et al. (1918) reported death in rabbits after an ointment containing 50% mercury was “rubbed” into the skin for 5 minutes; however, inadequate experimental methodology and an absence of study details prevent a determination of the amount of mercury involved.

Organic Mercury. No studies were located regarding death in humans or animals after dermal exposure to organic mercury.

2.2.3.2 Systemic Effects

No studies were located regarding respiratory, hematological, musculoskeletal, or hepatic effects in humans or animals after dermal exposure to inorganic or organic mercury.

Cardiovascular Effects

Inorganic Mercury. A number of children who were treated with an ammoniated mercury ointment or whose diapers had been rinsed in a mercuric chloride solution experienced tachycardia and elevated blood pressure (Warkany and Hubbard 1953).

No studies were located regarding cardiovascular effects in animals after dermal exposure to inorganic mercury.

Organic Mercury. No studies were located regarding cardiovascular effects in humans or animals after dermal exposure to organic mercury.

Gastrointestinal Effects

Inorganic Mercury. Patients who were hypersensitive to mercury (indicated by positive patch tests) developed stomatitis at the sites of contact with amalgam fillings (Veien 1990). The contact stomatitis faded when amalgam fillings were removed but persisted in a patient who chose to leave them in place. Abdominal pain, nausea, vomiting, and black stools were seen in a man who had been receiving treatment for a wound with daily applications for about 2 months of a Chinese medicine containing mercurous chloride (Kang-Yum and Oransky 1992). Anorexia was reported in a child who had been treated with an ammoniated mercury-containing ointment (Warkany and Hubbard 1953). Extensive necrosis, swelling, and

2. HEALTH EFFECTS

ulceration in the intestinal mucosa, vomiting, and diarrhea occurred in a woman who inserted a mercuric chloride tablet into her vagina (Millar 1916).

No studies were located regarding gastrointestinal effects in animals following dermal exposure to inorganic mercury.

Organic Mercury. No studies were located regarding gastrointestinal effects in humans or animals after dermal exposure to organic mercury.

Renal Effects

Inorganic Mercury. Congested medulla; pale and swollen cortex; and extensive necrosis, degeneration, and calcification of tubular epithelium were reported in the kidneys of a 27-year-old woman after inserting an 8.75-g tablet of mercuric chloride (93 mg Hg/kg assuming 70-kg weight) into her vagina (Millar 1916). Decreased renal output and renal failure were reported in a man who had been receiving daily applications for 2 months of a Chinese medicine containing mercurous chloride (Kang-Yum and Oransky 1992). A woman who used a depigmenting cream containing mercuric ammonium chloride for approximately 18 years developed an impaired renal function (Dyall-Smith and Scurry 1990). Similarly, a man who used an ointment containing ammoniated mercury for psoriasis for more than 10 years developed a nephrotic syndrome with severe edema (Williams and Bridge 1958). A study of young African women who used skin lightening creams containing ammoniated mercuric chloride for 1–36 months (average, 13 months) showed a nephrotic syndrome among a large portion of the women (Barr et al. 1972). The syndrome was characterized by elevated urinary protein, edema, decreased serum albumin, alpha-1-globulin, beta-globulin, and gamma globulin and increased alpha-2-globulin. Remission was observed in 77% of those who discontinued use of the creams.

No studies were located regarding renal effects in animals after dermal exposure to inorganic mercury.

Organic Mercury. No studies were located regarding renal effects in humans or animals after dermal exposure to organic mercury.

2. HEALTH EFFECTS

Endocrine Effects

No studies were located regarding endocrine effects in humans or animals after dermal exposure to inorganic or organic mercury.

Organic Mercury. No studies were located regarding endocrine effects in humans or animals after dermal exposure to organic mercury.

Dermal Effects

Inorganic Mercury. Contact dermatitis caused by acute, longer-term, or occupational inorganic mercury exposure has been described in a number of case reports (Bagley et al. 1987; Biro and Klein 1967; Faria and Freitas 1992; Goh and Ng 1988; Handley et al. 1993; Kanerva et al. 1993; Nordlind and Liden 1992; Pambor and Timmel 1989; Skoglund and Egelrud 1991; Veien 1990). Patch tests conducted in many of the cases show some cross-reactivity between various inorganic and organic forms of mercury (Faria and Freitas 1992; Handley et al. 1993; Kanerva et al. 1993; Pambor and Timmel 1989; Veien 1990). In these studies, dermal exposure occurred as a result of the breakage of mercury-containing thermometers or sphygmomanometers, dental amalgams containing elemental mercury, inoculation with vaccines containing merthiolate preservatives, or mercuric sulfide in tattoos. One report of contact dermatitis caused by a mercuric sulfide-containing tattoo suggested that the reaction was not to mercuric sulfide itself but to a mercury derivative that was formed in the skin (Biro and Klein 1967).

Excluding reports of contact dermatitis, limited information was obtained regarding the dermal effects of inorganic mercury. Application of an ammoniated mercury ointment to the skin of children or exposure to diapers that had been rinsed in a mercuric chloride-containing solution resulted in itching, flushing, swelling, and/or desquamation of the palms of the hands and soles of the feet (Warkany and Hubbard 1953). In addition, rashes, conjunctivitis, and/or excessive perspiration were observed. These dermal reactions were not attributed to allergic-type reactions to the mercury. A 23-month-old boy who was exposed to an unspecified form of mercury also developed a "diffuse, pinpoint, erythematous, papular rash" and bright red finger tips "with large sheets of peeling skin" (Tunnessen et al. 1987).

Application of a 1% solution of ammoniated mercuric chloride to the skin resulted in only minor irritation in 2 of 11 exposed subjects (Kawahara et al. 1993). After 18 years of using a mercury-containing cream, a

2. HEALTH EFFECTS

patient exhibited blue-black pigmentation in a perifollicular distribution on the chin and glabella (Dyall-Smith and Scurry 1990). A skin biopsy revealed black nonrefractile granules in the cytoplasm of macrophages in the papillary dermis and around the upper part of hair follicles. A boy who broke a thermometer in his mouth developed a mass consisting of hyperplasia of the epidermis, necrosis, and ulceration (Sau et al. 1991). This effect may have resulted from a combined effect of the physical injury and the mercury metal.

No studies were located regarding dermal effects in animals after dermal exposure to inorganic mercury.

Organic Mercury. Case report studies suggest that dermal exposure to methylmercury or phenylmercury in humans can cause rashes and blisters on the skin (Hunter et al. 1940; Morris 1960). A 33-year-old male worker exposed to methylmercury nitrate dust for 2 years developed burns and blisters on his forearm (Hunter et al. 1940). These effects healed within 9 days. Sensitivity to phenylmercuric salts is shown by individuals who developed itchy, pruritic, papular eruptions or rashes on their skin following acute dermal exposure (Morris 1960). A 54-year-old woman with a family history of atopy was found to display erythema (at 30 minutes postexposure) and urticaria (at 60 minutes) when treated topically with a 0.01% solution of phenylmercuric acetate (Torresani et al. 1993). This positive reaction was associated with aggravation of facial edema and an attack of bronchospasm. The woman, who was a farmer, was believed to have been previously exposed to phenylmercuric acetate during contact with pesticides and herbicides used on farm crops.

No studies were located regarding dermal effects in animals following dermal exposure to organic mercury.

Ocular Effects. No studies were located regarding ocular effects in humans or animals after dermal exposure to inorganic or organic mercury.

Body Weight Effects. No studies were located regarding body weight effects in humans or animals after dermal exposure to inorganic or organic mercury.

2.2.3.3 Immunological and Lymphoreticular Effects

Inorganic Mercury. As indicated above, contact dermatitis may develop as a result of acute or occupational exposure to inorganic mercury (Anneroth et al. 1992; Bagley et al. 1987; Biro and Klein

2. HEALTH EFFECTS

1967; Faria and Freitas 1992; Goh and Ng 1988; Nordlind and Liden 1992; Pambor and Timmel 1989; Skoglund and Egelrud 1991; Veien 1990). Patch tests conducted in many of the cases show some cross-reactivity between various inorganic and organic forms of mercury (Faria and Freitas 1992; Pambor and Timmel 1989; Veien 1990). In these studies, dermal exposure occurred as a result of the breakage of mercury-containing thermometers or sphygmomanometers, dental amalgams containing elemental mercury, or mercuric sulfide in tattoos. One report of contact dermatitis caused by mercuric sulfide in a tattoo suggested that the reaction was not to mercuric sulfide itself but to a mercury derivative that was formed in the skin (Biro and Klein 1967).

No studies were located regarding immunological or lymphoreticular effects in animals following dermal exposure to inorganic mercury.

Organic Mercury. No studies were located regarding immunological or lymphoreticular effects in humans or animals after dermal exposure to organic mercury.

2.2.3.4 Neurological Effects

Inorganic Mercury. DeBont et al. (1986) described a 4-month-old boy who had signs of acrodynia accompanied by coma, paralysis of one side of the body, generalized muscle stiffness, and muscular tremors 12 days after he was treated with yellow mercuric oxide ointment for eczema. Topical application of a depigmenting cream containing 17.5% mercuric ammonium chloride for 18 years resulted in mild tremors, anxiety, depression, and paranoid delusions in a 42-year-old woman (Dyall-Smith and Scurry 1990). Children who were treated with an ointment containing ammoniated mercury or who were exposed to diapers that had been rinsed in a mercuric chloride-containing solution experienced irritability, fretfulness, and sleeplessness (Warkany and Hubbard 1953).

No studies were located regarding neurological effects in animals after dermal exposure to inorganic mercury.

Organic Mercury. No studies were located regarding neurological effects in humans or animals after dermal exposure to organic mercury.

2. HEALTH EFFECTS

No studies were located regarding the following effects in humans or animals after dermal exposure to inorganic or organic mercury:

2.2.3.5 Reproductive Effects

2.2.3.6 Developmental Effects

2.2.3.7 Genotoxic Effects

Genotoxicity studies are discussed in Section 2.5.

2.2.3.8 Cancer

No studies were located regarding cancer in humans or animals after dermal exposure to inorganic or organic mercury.

2.3 TOXICOKINETICS

Absorption is high (approximately 70–80%) for inhaled metallic mercury vapor, and negligible for oral exposure to liquid metallic mercury. Absorption of inorganic mercuric salts may range from 2 to 38% depending upon the form and test conditions. Oral absorption of organic mercury is nearly complete, but respiratory absorption data are lacking, particularly for the alkyl mercurials.

The distribution data for metallic, inorganic, and organic mercury are consistent in identifying the kidney as the organ with the highest mercury bioaccumulation. Because of its high lipophilicity, metallic mercury can also be transferred readily through the placenta and blood-brain barrier. The oxidation of metallic mercury to inorganic divalent cation in the brain can result in retention in the brain. Inorganic mercury compounds can reach most organs; however, their low lipophilicity reduces their ability to penetrate barriers to and accumulate in the brain and fetus. The distribution of methylmercury is similar to that of metallic mercury; a relatively large amount of mercury can accumulate in the brain and fetus (compared to inorganic mercury) because of its ability to penetrate the blood-brain and placental barriers and its conversion in the brain and fetus to the inorganic divalent cation.

Metallic mercury can be oxidized to inorganic divalent mercury by the hydrogen peroxidase-catalase pathway, which is present in most tissues. The inorganic divalent cation can, in turn, be reduced to

2. HEALTH EFFECTS

metallic mercury. The mercurous ion is unstable in the presence of sulfhydryl groups, and undergoes disproportionation into one atom of metallic mercury and one ion of mercuric mercury. As with metallic mercury, organic mercury can also be converted to inorganic divalent mercury; however, the extent of conversion is less than with metallic mercury.

Following exposure to metallic mercury, the elimination of mercury can occur via the urine, feces, and expired air. Following exposure to inorganic mercury (mercuric), mercury is eliminated in the urine and feces. Organic mercury compounds are excreted predominantly via the feces in humans. In animals, methylmercury is excreted in the feces, and phenylmercury compounds are initially excreted in the feces and then in the urine. Organic mercury compounds are excreted predominantly in the inorganic form. Both inorganic mercury and methylmercury are excreted in breast milk.

Absorption of metallic mercury vapor is believed to occur by rapid diffusion through the lungs. Oral absorption of inorganic mercuric mercury compounds may also involve rapid diffusion through the gastrointestinal tract. The mechanism for oral absorption of mercurous mercury compounds is not known. Oral absorption of organic mercury is believed to depend on the ability of the organic mercury molecule to bind to molecules such as cysteine. The mechanism of action of inorganic and organic mercury compounds may involve the affinity of these chemicals for sulfhydryl or thiol groups of proteins and other biological compounds.

2.3.1 Absorption

Absorption following inhalation of metallic mercury vapors is relatively high. Absorption following acute oral exposure to metallic mercury is negligible in both humans and animals. Methyl- and phenylmercury compounds are absorbed much more readily than inorganic mercury. Animal studies suggest oral absorption of both organic and inorganic mercury may be influenced by age and diet. Limited information was located regarding dermal absorption of inorganic or organic mercury compounds in humans or animals.

2. HEALTH EFFECTS

2.3.1.1 Inhalation Exposure

Metallic and Inorganic Mercury. There are limited quantitative data on the absorption of metallic mercury vapor by humans after inhalation exposure, although it is the most common route of inorganic mercury uptake. Metallic mercury is highly lipophilic, and absorption of the inhaled vapor, followed by rapid diffusion across the alveolar membranes of the lungs into the blood, has been reported to be substantial. Exposure to 0.1–0.2 mg/m³ elemental mercury vapor resulted in approximately 74–80% of inhaled elemental mercury vapor being retained in human tissues (Hursh et al. 1976; Teisinger and Fiserova-Bergerova 1965). Indirect evidence of rapid absorption was provided by elevated mercury levels found in red blood cells, plasma, and excreta of 5 volunteers who inhaled radiolabeled mercury for 14–24 minutes (Cherian et al. 1978). Elevated blood levels of mercury were also observed in humans following a brief occupational exposure (3 days) to less than 0.1 mg/m³ metallic mercury vapor (Barregard et al. 1992).

Recently, Sandborgh-Englund et al. (1998) evaluated the absorption, blood levels, and excretion of mercury in humans after a single dose of mercury vapor. Nine healthy volunteers (2M, 7F) were exposed to 400 µg Hg/m³ mercury vapor in air (median 399 µg Hg/m³; range, 365–430 µg Hg/m³) for 15 minutes. This dose corresponded to 5.5 nmol Hg/kg body weight. Samples of exhaled air, blood, and urine were collected for 30 days after exposure. The median retention of elemental Hg was 69% of the inhaled dose. During the first 3 days after exposure 7.5–12% of the absorbed dose was lost by exhalation, with the median half-time of Hg in expired breath being 2 days. In blood and plasma, a rapid absorption phase of Hg was seen, followed by a biexponential decline of the curves in both media. A substantial interindividual variation was observed in the area under the concentration-time curves of Hg in blood and plasma. In plasma, the median half-time of the second phase was 10 days. About 1.0% of the absorbed Hg was excreted via the urine during the first 3 days after exposure whereas the estimated amount excreted during the 30 days ranged from 8 to 40%. In order to evaluate the chronic exposure to mercury from dental amalgam in the general population, the daily Hg dose from the fillings was estimated based on the plasma Hg levels of subjects with amalgam fillings and the plasma clearance obtained in this study. The daily dose was estimated to be from 5 to 9 µg/day in subjects with an average number of amalgam fillings.

There are few reports regarding the respiratory absorption of elemental and inorganic mercury compounds in animals. Elevated levels of mercury were detected in blood and tissues of pregnant or nursing guinea pigs after short-term exposure (2–2.5 hours) to metallic mercury vapors (6–10 mg/m³) (Yoshida et al.

2. HEALTH EFFECTS

1990, 1992). Following repeated exposure (5 weeks) of rats to mercury vapor (1 mg/m³), high levels were detected in the blood and brain (Warfvinge et al. 1992). The absorption of inorganic divalent mercury has not been measured, but it is estimated to be approximately 40% in dogs (Morrow et al. 1964).

Organic Mercury. No studies were located regarding absorption in humans or animals after inhalation exposure to compounds of phenyl- or methylmercury. However, indirect evidence indicates organic mercury can be absorbed readily through the lungs. Following inhalation of ²⁰³Hg-labeled dimethylmercury, radioactivity was excreted within 6 hours, followed by a slower excretion phase (Ostlund 1969).

2.3.1.2 Oral Exposure

Metallic and Inorganic Mercury. Few studies in humans were located regarding absorption of ingested metallic or inorganic mercury. For metallic mercury, ingesting small amounts such as contained in a standard thermometer (about 0.1 mL or about 1 g) does not produce symptoms of intoxication (Wright et al. 1980). Reports of ingestion of substantial amounts of elemental mercury indicate that absorption is negligible (Sue 1994; Wright et al. 1980). Two case histories were identified on acute effects of relatively large ingestions of metallic mercury. The first case history was described an ingestion of 15 mL (204 g) of metallic mercury by a 17-year-old male storekeeper who swallowed mercury from the pendulum of a clock (apparently out of curiosity rather than as a suicide attempt). On admission, and 24 hours later, he was symptom free, and physical examination was normal. The patient had no gastrointestinal symptoms, and was treated with a mild laxative and bed rest. The results of serial daily urine mercury estimates were normal (all less than 15 µg), and did not suggest significant absorption. The radiological investigation illustrated a characteristic pattern of finely divided globules of mercury in the gastrointestinal tract (Wright et al. 1980).

A second and massive incidence of ingestion involved a 42-year-old man who had spent much of his life (since the age of 13) repairing instruments that contained mercury. He intentionally ingested an estimated 220 mL (about 3,000 g) of mercury (Lin and Lim 1993). Upon admission, the patient presented with significantly elevated mercury blood levels (103 µg/L, normal <10 µg/L) and urine levels (73 µg/L, normal <20 µg/L). It is not known how much the occupational exposure had contributed to these levels. The patient was treated with immediate gastric lavage and cathartics. He also received D-penicillamine 1 g/day orally for 7 days. Blood and urine mercury levels obtained 3 days after chelation therapy were 116.9 and 22.9 µg/L, respectively. By 2 weeks postexposure, most of the mercury had been excreted in the feces and

2. HEALTH EFFECTS

was measured at a total volume of 220 mL (this number was used to estimate the amount initially ingested). The patient was lost to follow-up for 6 months, but at 10 months following the incident, blood mercury had decreased to 1 µg/L and urine mercury to µg/L.

Approximately 15% of a trace dose of mercuric nitrate in an aqueous solution or bound to calf liver protein was absorbed by the gastrointestinal tract of humans (Rahola et al. 1973). The mercurous ion demonstrated limited absorption. No information was located regarding the percentage of absorption of mercuric chloride by the gastrointestinal tract of humans. However, an extremely high serum inorganic mercury concentration (116.5 nmol/mL) was found in a woman who ingested a potentially lethal dose of powdered mercuric chloride (13.8 mg Hg/kg) (Suzuki et al. 1992). Similarly, no information was located regarding the percentage of absorption of mercuric sulfide by the gastrointestinal tract in humans. However, elevated mercury was detected in the urine of two subjects who ingested an unspecified amount of mercuric sulfide (Yeoh et al. 1989).

A number of animal studies indicate absorption of inorganic mercury in the 10–30% range. In earlier studies, absorption rate was reported as low. Only 1–2% of an orally administered dose of mercuric chloride was absorbed in mice (Clarkson 1971). In rats, using whole-body retention data, estimated mercuric chloride absorptions of 3–4, 8.5, and 6.5% were calculated for single oral doses of 0.2–12.5, 17.5, and 20 mg/kg, respectively (Piotrowski et al. 1992). More recent studies using whole-body retention data, however, indicate absorption of 20–25% calculated from single oral doses of 0.2–20 mg Hg/kg as mercuric chloride in mice. Comparison was made of retention data after oral and intraperitoneal dosing, taking excretion and intestinal reabsorption into account (Nielsen and Andersen 1990). In a subsequent study, the whole-body retention of mercury after mercuric chloride administration was observed to initially decline rapidly, indicating incomplete intestinal absorption (Nielsen and Andersen 1992). Mercury was rapidly cleared from the gastrointestinal tract (to <30% of the initial dose within 2 days), and relative carcass retention increased throughout the experimental period, reaching levels around 40% of initial whole-body retention. Blood levels of mercury were closely correlated to whole-body retention of mercury during the first 3 days after administration of mercuric chloride (1 mg Hg/kg). After the initial 3 days, the amount of mercury in the blood declined more rapidly than the whole-body burden.

Morcillo and Santamaria (1995) report absorption of 30–40% for radiolabeled mercuric chloride when administered in drinking water at 5, 50, and 500 µM Hg for 8 weeks to male rats. The percentage of total

2. HEALTH EFFECTS

mercury excreted by the fecal route was significantly lower in the 500 compared to the 5 and 50 μM Hg group.

The rate of oral absorption of mercuric mercury compounds in rats is dependent on several factors (e.g., intestinal pH, compound dissociation) (Endo et al. 1990). Age and diet also can influence the extent of absorption in mice (Kostial et al. 1978). One-week-old suckling mice absorbed 38% of the orally administered mercuric chloride, whereas adult mice absorbed only 1% of the dose in standard diets. When the adult mice received a milk diet instead of the standard diet, absorption increased to 7% of the administered dose (Kostial et al. 1978).

Several studies suggest that the bioavailability of mercuric sulfide in animals is less than that of mercuric chloride (Sin et al. 1983, 1990; Yeoh et al. 1986, 1989). For example, Sin et al. (1983) found an increase in tissue levels of mercury in mice orally exposed to low doses of mercuric chloride, but elevated levels of mercury were not found in the tissues of mice fed an equivalent weight of mercury as mercuric sulfide. This finding indicates a difference in bioavailability between HgCl_2 and HgS in mice. However, a quantitative determination of the relative bioavailabilities of mercuric sulfide versus mercuric chloride has not been derived in the available studies. Furthermore, the relative bioavailability of mercuric sulfide in humans has not been examined.

Organic Mercury. Organic mercury compounds are more readily absorbed by the oral route than inorganic mercury compounds. Based on retention and excretion studies in humans, approximately 95% of an oral tracer dose of aqueous methylmercuric nitrate was absorbed (Aberg et al. 1969). Absorption of mercury was also reported in studies in which volunteers received doses of methylmercury bound to protein (Miettinen 1973) or ate bread contaminated with a fungicide that contained methylmercury (Al-Shahristani et al. 1976); however, no quantitative data regarding the percentage of absorption were available.

In vitro evidence suggests that organic mercury is also readily absorbed in the gastrointestinal tract and that methylmercuric chloride is absorbed to a greater extent than phenylmercuric chloride (Endo et al. 1989). Complexing of methylmercury with nonprotein sulfhydryls also may play a role in intestinal absorption and reabsorption (Urano et al. 1990). Phenylmercuric salt in the diet was completely absorbed in mice (Clarkson 1972a) and readily absorbed in rats following long-term oral administration (Fitzhugh et al. 1950). Absorption was nearly complete within 6 hours after female cynomolgus monkeys were given 0.5 mg Hg/kg as methylmercuric chloride by gavage (Rice 1989b). Following a single oral exposure

2. HEALTH EFFECTS

(1 mg/kg) of methylmercuric chloride, the level of mercury in the blood of mice declined slowly. At day 14 post-dosing, the blood level was still around 25% of the value at day 1 (Nielsen 1992). Blood levels of mercury were closely correlated to whole-body retention of mercury during the first 3 days after administration of methylmercuric chloride (1 mg Hg/kg) (Nielsen and Andersen 1992). However, at later times after administration, the amount of mercury in the blood declined more rapidly than the whole-body burden. The gastrointestinal retention of mercury slowly decreased in mice given organic mercury. This phenomenon is probably the result of biliary excretion and reabsorption of mercury (Nielsen and Andersen 1992).

Bioavailability of methylmercury in food. Measurements of absorption and toxicity have generally been made using aqueous solutions of methylmercury. The absorption and bioavailability of methylmercury in food, specifically fish and bread, may be affected by dietary components. Potential confounders that may affect bioavailability of methylmercury are dietary phytate and other dietary fibrous materials found in bread and the complexation of methylmercury with selenium in fish.

Dietary fiber and phytate. Dietary fiber and phytate are known as potential inhibitors of the absorption of divalent cations; however, the literature regarding the effect of dietary fiber and phytate on the bioavailability of minerals is contradictory. Data by Yannai and Sachs (1993) indicate that phytate does not affect methylmercury absorption. Yannai and Sachs (1993) compared the absorption by rats of mercury found intrinsically in experimental fish meal with and without added phytate and found no significant differences in the absorption of Hg ($93\pm 5\%$) between 2 experimental fish meal diets (containing 1.4 μmol Hg/kg diet), with or without added sodium phytate. The authors speculated that phytate might be preferentially bound to zinc, iron, and copper, which were present at much higher concentrations in the diet.

In another experiment by Yannai and Sachs (1993), the absorption of mercury was reduced when rats were fed a mercury-contaminated corn diet and corn silage meal. Mercury was incorporated intrinsically into the corn diet using radioactive isotopes (^{203}Hg) infused by capillary action into the stalks of developing corn plants, which then incorporated trace amounts of isotopes into developing kernels. The corn silage meal was from a crop grown in the vicinity of an industrial zone and contained elevated amounts of mercury. Reduced absorptions of 48 and 51% were found for the corn silage and corn diet experiments, respectively.

2. HEALTH EFFECTS

The reduced bioavailability of the plant food diet compared with the animal-based diet (fish meal) may be due to the presence of indigestible fibrous materials present in plants. Another factor that might affect absorption is the form of mercury (^{203}Hg and methylmercury in the corn and fish meal diets, respectively). The experiments by Yannai and Sachs (1993) are different from other absorption experiments because mercury was intrinsic to the fish, grain, or silage, while in other studies mercury is simply mixed with the experimental diet, usually as mercury salts. In the Iraqi epidemic, methylmercury fungicide was applied extrinsically to wheat that was made into bread. However, no studies were located that measured the absorption of methylmercury when mixed with grain. It is also not known whether the putative component(s) of grain affecting bioavailability are the same in corn and wheat.

Interaction with selenium in diet. The co-administration of methylmercury and selenium is known to depress methylmercury toxicity (Cuvin-Aralar and Furness 1991; Imura and Naganuma 1991). Furthermore, the level of selenium in human hair has been found to negatively correlate with the level of mercury in brain tissue (Suzuki et al. 1993). Methylmercury forms a dimethylmercury selenide complex. Selenium in foods (especially fish) may also complex with methylmercury and, therefore, may potentially reduce the bioavailability of methylmercury. The available data indicate that neither methylmercury uptake nor bioavailability is affected by its presence in fish. Experimental studies on the metabolism of methylmercury in humans following oral ingestion using methylmercury bound to fish muscle protein have shown that absorption is almost complete (95% absorbed) (Miettinen 1973). Animal studies also support this absorption value. Data on cats given fish homogenates indicate absorptions of 90% of methylmercury added to the homogenate, of methylmercury accumulated by fish *in vivo*, or from methylmercury proteinate (Berglund et al. 1971). Using blood and tissue levels as evidence of absorption, Charbonneau et al. (1976) concluded that there was no difference in the biological availability of methylmercury administered to adult cats (0.003, 0.0084, 0.020, 0.046, 0.074, or 0.176 mg Hg/kg/day 7 days a week for 2 years) either as pure methylmercuric chloride in corn oil added to a diet containing uncontaminated fish or as methylmercury-contaminated fish. In the 2 highest dose groups (0.074 and 0.176 mg Hg), at 100 weeks of exposure no significant differences were seen in total mercury concentrations in blood between groups receiving the dose as methylmercuric chloride or as contaminated fish at the same dose level. In addition, monthly blood levels were comparable for all dose groups. No significant differences were seen at 100 weeks in total mercury concentrations in the nervous system tissue or other tissues (renal cortex, renal medulla, liver, spleen, adrenal, bladder, atria, ventricle, ovaries, testes, muscle) between the 2 highest dose groups receiving the dose as methylmercuric chloride or as contaminated fish at the same dose level.

2. HEALTH EFFECTS

2.3.1.3 Dermal Exposure

Metallic and Inorganic Mercury. Hursh et al. (1989) conclude that dermal absorption of mercury vapor poses a very minor occupational hazard compared to inhalation exposure. They measured dermal absorption of radiolabeled metallic mercury vapor in five human volunteers, using arm skin as representing the whole body skin. About half of the mercury taken up was shed by desquamation of epidermal cells during the following several weeks. The remainder was slowly and diffusely released into the general circulation in contrast to the rapid release and more focal release from the lungs. When absorption for the total skin area (as represented by the forearm skin) was compared with the inhalation route for the same ambient concentration, the dermal route absorbed was estimated at 2.6% of the amount absorbed by the lung.

There was no information found on the dermal absorption of liquid metallic mercury, but unless the skin surface was damaged or the contaminated surface was occluded, it would not be expected to be high (i.e., in light of the very low absorption rate from the gastrointestinal tract). On the other hand, sloughing from the gastrointestinal tract may account for the low rate of absorption.

Indirect evidence of dermal absorption is provided by clinical case studies in which mercury intoxication was reported in individuals following dermal application of ointments that contained inorganic mercury salts (Bourgeois et al. 1986; DeBont et al. 1986).

Absorption of mercurous salts in animals can occur through the skin (Schamberg et al. 1918); however, no quantitative data are available. The rate of absorption for mercuric chloride was not evaluated in any study. However, skin biopsies taken from 2 to 96 hours after application of a 0.1% solution of mercuric chloride showed electron-dense deposits, tentatively identified as mercury, in the cells in the dermis, indicating that mercuric chloride could penetrate the outer layer of the skin (Silberberg et al. 1969).

Organic Mercury. No information was identified for absorption of methylmercury via dermal absorption. There is extremely important hazard assessment information on the dermal absorption of dialkylmercurials. A case history indicates nearly complete absorption of dimethylmercury through the skin resulting in a highly toxic exposure pathway. The exposure occurred to a 48-year-old female chemistry professor who was admitted to the hospital 5 months (154 days) after she inadvertently spilled several drops (estimated at 0.4–0.5 mL) of dimethylmercury from the tip of her pipette onto the back of her disposable latex gloves

2. HEALTH EFFECTS

(Blayney et al. 1997; Nierenberg et al. 1998). The spill was cleaned and the gloves disposed of. Hair analysis on a long strand of hair revealed that, after a brief lag time, mercury content rose rapidly to almost 1,100 ppm (normal level <0.26 ppm, toxic level >50 ppm), and then slowly declined, with a half-life of 74.6 days. These results support the occurrence of one or several episodes of exposure, and are consistent with laboratory notebook accounts of a single accidental exposure. Testing of family members, laboratory coworkers, and laboratory surfaces also failed to reveal any unsuspected mercury spills or other cases of toxic blood or urinary mercury levels. Permeation tests subsequently performed on disposable latex gloves similar to those the patient had worn at the time of the lone exposure revealed that dimethylmercury penetrates such gloves rapidly and completely, with penetration occurring in 15 seconds or less and perhaps instantly. Severe neurotoxicity developed 5 months postexposure and the patient died 9 months postexposure. The mercury content of hair, blood, and urine were monitored from 5 months postexposure (i.e., following admission of the patient to the hospital) until the patient died. Based on the half-lives and kinetics of mercury in the body, the hair and blood levels were used to estimate the total body burden and the amount of the initial acute dermal dose. They determined that a dose of 0.44 mL of liquid Dimethylmercury (about 1,344 mg), if completely absorbed, would have been sufficient to have produced the levels observed in the patient. This amount is in good agreement with the patient's account and the laboratory records on the amount spilled. Some inhalation exposure, however, could also have occurred during the cleanup of the spill, so this finding needs additional confirmation.

Infants exposed to diapers that had been treated with a phenylmercury fungicide exhibited higher urinary levels of mercury than unexposed infants (Gotelli et al. 1985). In rats, dermal absorption of phenylmercuric acetate from the vaginal tract was 75% of the dose within 8 hours after administration (Laug and Kunze 1949).

2.3.1.4 Other Routes of Exposure

There is some information on the subcutaneous injection of metallic mercury. Schwarz et al. (1996) describe a case history of a female nurse who accidentally plunged a mercury thermometer into her left hand while shaking it. Radiographic imaging revealed that some liquid metallic mercury had infiltrated into the soft tissues of her palm (amount unspecified). The diffusely distributed mercury could not be removed surgically. No immediate follow-up mercury levels in blood or urine were reported. A slightly elevated blood mercury concentration (15 µg/L, toxic level >50) was reported 2 years after this event, which then

2. HEALTH EFFECTS

declined (no reason provided). Other sources of mercury could have caused the increase, so little can be concluded about how much of the subcutaneous liquid mercury entered the systemic circulation.

In a much more informative case history, a 19-year-old man had injected mercury subcutaneously (Bradberry et al. 1996). Blood and urine mercury concentrations were followed for 6 years after presentation. Hematological and biochemical profiles were normal. Histological results indicated a chronic inflammatory reaction with granuloma formation, secondary to the globular mercury. A postoperative X-ray of the elbow indicated persistent subcutaneous mercury particles. Apart from the initial local discomfort, the patient remained asymptomatic and clinical examination revealed no abnormality up to 6 years postsurgery. No systemic features of mercury poisoning were evident. Blood mercury levels declined from 60 to 70 $\mu\text{g/L}$ at 1 year postoperation to 10 $\mu\text{g/L}$ at 6 years. Serial sampling results of total mercury in 24 urine collections indicated peaks up to 1.2 mg during the first year postoperation, which declined to 59 $\mu\text{g/L}$ at 6 years. The elevated blood and urine levels indicate some systemic absorption. The effects of the surgery on migration of mercury from the subcutaneous tissue to the systemic circulation are not known.

2.3.2 Distribution

In humans, metallic mercury is distributed throughout the body following inhalation exposure. It can readily cross the blood-brain and placental barriers because of its high lipophilicity. After oxidation to mercuric mercury, it accumulates primarily in the kidneys. Inorganic divalent mercury compounds similarly reach all organs; however, the extent of accumulation in the brain and fetus is lower than metallic mercury because of the lower lipophilicity of inorganic mercury compounds. Organic mercury compounds distribute throughout the body following oral exposure and have the highest accumulation in the kidneys. As with metallic mercury, the ability of methyl- and phenyl mercury compounds to cross the blood-brain and placental barriers allows distribution, and subsequent accumulation, in the brain and fetus.

2.3.2.1 Inhalation Exposure

Metallic Mercury. The lipophilic nature of metallic mercury results in its distribution throughout the body. Metallic mercury in solution in the body is highly lipophilic, thereby allowing it to cross blood-brain and placental barriers with ease (Clarkson 1989). Mercury distributes to all tissues and reaches peak levels within 24 hours, except in the brain where peak levels are achieved within 2–3 days (Hursh et al. 1976).

2. HEALTH EFFECTS

The longest retention of mercury after inhalation of mercury vapor occurs in the brain (Takahata et al. 1970). Japanese workers who died 10 years after their last exposure to metallic mercury vapors still had high residual levels of mercury in their brains (Takahata et al. 1970). Autopsies of 3 dentists revealed 0.945–2.110 mg Hg/kg in the renal cortex, compared to 0.021–0.810 mg Hg/kg for unexposed controls (Nylander et al. 1989).

In volunteers who inhaled a tracer dose of metallic mercury vapor for 20 minutes, approximately 2% of the absorbed dose was deposited per liter of whole blood after the initial distribution was complete (Cherian et al. 1978). Uptake into the red blood cells was complete after 2 hours, but plasma uptake was not complete until after 24 hours. Mercury concentration in red blood cells was twice that measured in the plasma. This ratio persisted for at least 6 days after exposure. However, the ratios of 1–2 have been reported for metallic mercury vapor (Miettinen 1973).

Exposure of rats to mercury vapor ($10\text{--}100\ \mu\text{g}/\text{m}^3$) for 6 hours a day, 5 days a week from the 4th through 11th weeks of life resulted in measurable amounts of mercury in the blood, hair, teeth, kidneys, brain, lungs, liver, spleen, and tongue, with the kidney cortex having the highest mercury concentration (Eide and Wesenberg 1993). Further, tissue concentrations were positively and significantly correlated with exposure concentrations. In this study, the rat molars were found to have the highest correlation coefficient with measured kidney mercury values, leading to a suggestion by the authors that human deciduous teeth may be useful indicators of chronic mercury exposure and of the mercury uptake by the kidneys and cerebrum (Eide and Wesenberg 1993). In another study, a 4-hour exposure of mice to metallic mercury vapor produced the highest mercury retention in the brain compared to other organs (Berlin et al. 1966). Exposure of mice to metallic mercury vapor ($8\ \text{mg}/\text{m}^3$, for 6 hours a day for 10 days) resulted in higher mercury levels in the gray than in the white brain matter (Cassano et al. 1966, 1969). Exposure of rats to $1\ \text{mg}/\text{m}^3$ metallic mercury vapor for 24 hours a day every day for 5 weeks or 6 hours a day, 3 days a week for 5 weeks resulted in mean mercury brain concentrations of 5.03 and 0.71 $\mu\text{g}/\text{g}$, respectively (Warfvinge et al. 1992). Mercury was found primarily in the neocortex, basal nuclei, and the cerebellar Purkinje cells.

Mercury also accumulates in several cell types populating the dorsal root ganglia (Schionning et al. 1991). After 12–14 hours of exposure of rats to a relatively small amount of metallic mercury vapor ($0.55\ \text{mg}/\text{m}^3$), accumulation of mercury was observed within all cell types examined (ganglion cells, satellite cells, fibroblasts, and macrophages). Mercury has also been detected in dorsal root neurons and satellite cells of

2. HEALTH EFFECTS

primates exposed for one year to mercury through amalgams in dental fillings or the maxillary bone (Danscher et al. 1990).

The kidney is the major organ of mercury deposition after inhalation exposure to metallic mercury vapor. Mercury concentrations in the kidneys are orders of magnitude higher than in other tissues (Rothstein and Hayes 1964). Monkeys exposed for one year to metallic mercury vapor from amalgam in dental fillings accumulated mercury in the spinal ganglia, anterior pituitary, adrenal, medulla, liver, kidneys, lungs, and intestinal lymph glands (Danscher et al. 1990). The largest deposits of mercury were found in the kidneys (2.5–5.2 ppm), specifically in the proximal tubule cells.

The kidney contains metallothionein, a metal-binding protein that is also found in fetal and maternal livers and other organs. In the kidneys, the production of metallothionein is stimulated by exposure to mercury. The increased levels of metallothionein increase the amount of mercuric ion binding in the kidneys (Cherian and Clarkson 1976; Piotrowski et al. 1973). Three classes of sulfhydryl groups have been identified in the kidneys, with metallothionein having the greatest affinity for mercury (Clarkson and Magos 1966). Low molecular-weight complexes of mercury have been identified in the urine, suggesting that they may exist in the kidneys and contribute to the kidneys' accumulation of mercury (Piotrowski et al. 1973).

Metallothionein exists in higher concentration in the fetal liver than in the maternal liver of rats. Exposure to mercury in the pregnant dam results in the binding of mercury to metallothionein in fetal liver initially, followed by a redistribution to other organs (Yoshida et al. 1990). Metallothionein and mercury levels were elevated in the kidneys of guinea pig neonates exposed to 6–10 mg/m³ mercury vapor (Piotrowski et al. 1973).

After exposure to mercury vapor, mercury is distributed throughout the body in different chemical and physical states. Metallic mercury dissolves in the blood upon inhalation, and some remains unchanged (Magos 1967). Metallic mercury in the blood is oxidized to its divalent form in the red blood cells (Halbach and Clarkson 1978). The divalent cation exists as a diffusible or nondiffusible form. The nondiffusible form is mercuric ions that bind to protein and are held in high-molecular weight complexes, existing in equilibrium with the diffusible form.

In the plasma, the mercuric ion is predominantly nondiffusible and binds to albumin and globulins (Berlin and Gibson 1963; Cember et al. 1968; Clarkson et al. 1961). Following mercuric salt administration,

2. HEALTH EFFECTS

levels of mercuric ions in the plasma are similar to levels of mercuric ions in the red blood cells. Binding of mercury also occurs in tissues, and retention varies, with the brain retaining mercury the longest.

The influence of age on mercury distribution following exposure to metallic mercury was evaluated in neonatal (12 hours old) and adult guinea pigs exposed to 8 or 10 mg Hg/m³ vapor for 120 minutes (Yoshida et al. 1989). The mercury concentrations were 28, 58, and 64% higher in the brain, lungs, and heart, respectively, of the neonates compared to the mothers. However, the mercury level in the kidneys was approximately 50% lower in the neonates. The lower uptake of mercury in the kidneys of neonates may be due to the functional immaturity of the kidneys at parturition. The higher levels in other highly perfused tissues suggest that mercury accumulation in organs is dependent on how easily metallic mercury can reach the tissues from blood. Similar findings were reported by Jugo (1976) who found higher mercury concentrations in the liver, blood, and brain, but lower concentrations in the kidneys of 2-week-old rats compared to similar tissues in 21-week-old rats. These results also suggest that infants may accumulate mercury more readily after acute exposure and, therefore, may be more likely to exhibit neurotoxicity from mercury vapors.

The extent of mercury accumulation with aging was studied in mice maintained under normal care conditions in a conventional rodent colony without exposure to known mercury sources other than background concentrations normally found in food, water, and air (Massie et al. 1993). There was no significant change in the total amount of mercury in the organs (lungs, heart, brain, and liver) from male C57BL/6J mice ranging in age from 133 to 904 days. However, the ratios of mercury levels in the brain to mercury levels in the liver and kidneys were found to increase significantly and dramatically with age. The increase with aging in the brain-to-liver and brain-to-kidneys ratios suggests that mercury removal from the brain may be less efficient in some older organisms.

Metallic mercury vapor easily penetrates the placental barrier and accumulates in fetal tissues. The high lipophilicity of metallic mercury favors its penetration across the barrier. The uptake of mercury appears to increase during the later gestation period in mice, as indicated by increased mercury accumulation in the fetus after exposure to metallic mercury (Dencker et al. 1983). Guinea pig fetuses that were exposed to 6–13 mg/m³ mercury vapor during late gestation had elevated mercury concentrations in the liver, while the levels in other tissues were only slightly increased relative to controls (Yoshida et al. 1990). Newborn guinea pigs that were nursed by their mothers, who had been and exposed to mercury vapor (6–9 mg/m³) for 120 minutes immediately after parturition, had the highest mercury concentrations in the kidneys,

2. HEALTH EFFECTS

followed by the liver and lungs (Yoshida et al. 1992). In the brain and whole blood, mercury concentrations were slightly elevated compared to nonexposed controls. Levels of mercury in the fetus were approximately 4 times higher after exposure to metallic mercury vapor than after mercuric chloride administration for mice and 10–40 times higher for rats (Clarkson et al. 1972). The transport of the mercuric ions is limited at the placental barrier by the presence of high-affinity binding sites (Dencker et al. 1983).

Inorganic Mercury. No studies were located regarding the distribution of inorganic mercury in humans or animals following inhalation exposure to inorganic mercury compounds.

Organic Mercury. No studies were located regarding the distribution of organic mercury in humans or animals following inhalation exposure to organic mercury compounds.

2.3.2.2 Oral Exposure

Metallic and Inorganic Mercury. Data on the distribution of ingested elemental mercury were not located, and data on the ingestion of inorganic mercury are limited. The metallic mercury that is absorbed from an oral exposure is expected to resemble many aspects of the distribution of mercuric salts because metallic mercury is oxidized to mercuric ion in biological fluids, and the resulting distribution reflects that of the mercuric ion. Unlike elemental mercury, however, the amount of divalent mercury that crosses the blood-brain and placental barriers is much lower because of its lower lipid solubility (Clarkson 1989).

In some studies there is a combined exposure to both organic and inorganic mercury. Oskarsson et al. (1996) assessed the total and inorganic mercury content in breast milk and blood in relation to fish consumption and amalgam fillings. Total mercury concentrations were evaluated in breast milk, blood, and hair samples collected 6 weeks after delivery from 30 lactating Swedish women. In breast milk, about half of the total mercury was inorganic and half was methylmercury, whereas in blood only 26% was inorganic and 74% was methylmercury. The results of a regression analysis for mercury in hair, blood, and milk indicated that there was an efficient transfer of inorganic mercury from blood to breast milk and that mercury from amalgam fillings was probably the main source of mercury in breast milk, while methylmercury levels in blood did not appear to be efficiently transferred to breast milk. Exposure of the infant to mercury in breast milk was calculated to range up to 0.3 µg/kg/day, of which approximately one-half was inorganic mercury. This exposure corresponds to approximately one-half the tolerable daily

2. HEALTH EFFECTS

intake of total mercury for adults recommended by the World Health organization. The authors concluded that efforts should be made to decrease total mercury burden in women of reproductive age Oskarsson et al. (1996).

Inorganic Mercury. The liver and kidneys of mice had the highest mercury levels 14 days after exposure to a single oral dose of 0.2–20 mg ²⁰³Hg/kg as mercuric chloride (Nielsen and Andersen 1990). The brain has substantially lower mercury levels; however, retention was longest in this tissue. Sin et al. (1983) report that the kidneys also had the highest mercury levels following repeated oral exposure of mice to mercuric chloride (4–5 mg Hg/kg) for 2–8 weeks. Mercuric sulfide did not accumulate in the tissues of mice to any significant extent following exposure to low levels of mercuric sulfide (4–5 mg Hg/kg) for 2–8 weeks (Sin et al. 1983). However, the mercury content in the liver and kidneys of mice treated with higher doses of mercuric sulfide (8–200 mg Hg/kg/day) for 7 days was significantly increased compared to the controls (Yeoh et al. 1986, 1989). Mice fed mercuric sulfide (86 mg Hg/kg/day) for 1 week exhibited a 21-fold increase in the kidneys' mercury content ($p < 0.001$) and an 8.6-fold increase in the liver content compared to controls (Yeoh et al. 1989). Moderate renal effects, with a corresponding mercury concentration of 50 µg/g in the kidneys, were seen in rats exposed to mercuric nitrate (Fitzhugh et al. 1950).

Mercury can accumulate in human hair following oral exposure to mercuric chloride (Suzuki et al. 1992). Hair mercury levels, determined using segmental hair analysis, can be used to monitor exposure to mercury and may leave a historical record of exposure or uptake. In hair cut 41 days after mercuric mercury ingestion (13.8 mg/kg), a sharp peak (40 nmol/g [8 µg/g]) was found in the 1 cm segment closest to the scalp, while the levels were #5 nmol/g in all other segments. Ninety-five days after ingestion, the peak of inorganic mercury shifted to the 2–3 cm segment, while 160 days after ingestion the peak shifted to the 3–4 cm segment. During this time, the height of the peak decreased. An estimated biological half-life of inorganic mercury in hair was 57.8 days. Inorganic mercury in hair had different patterns of longitudinal variation from that of organic mercury.

Organic Mercury. Distribution of organic mercury compounds in humans and animals is similar to that of metallic mercury. Methylmercury distributes readily to all tissues, including the brain and fetus, after absorption from the gastrointestinal tract. The uniform tissue distribution is due to methylmercury's ability to cross diffusion barriers and penetrate all membranes without difficulty (Aberg et al. 1969; Miettinen 1973). Thus, tissue concentrations tend to remain constant relative to blood levels. About 90% of the

2. HEALTH EFFECTS

methylmercury in blood is found in the red blood cells (Kershaw et al. 1980). The mean mercury concentrations in red blood cells were 27.5 ng/g and 20.4 ng/g in males and females, respectively, exposed to mercury, primarily from mercury-contaminated fish (Sakamoto et al. 1991). Because of this uniform distribution in tissues, blood levels are a good indicator of tissue concentrations independent of dose (Nordberg 1976).

Although distribution is generally uniform, the highest levels of organic mercury are found in the kidneys (Nielsen and Andersen 1991b; Rice 1989b; Ryan et al. 1991). After a single oral dose of 0.04, 0.2, 1, or 5 mg Hg/kg as methylmercuric chloride administered to mice, mercury was retained mostly in the kidneys and liver at 14 days postexposure (Nielsen and Andersen 1991a). The deposition of mercury in the carcass was about 70%, with retention primarily in the skin, hair, and muscles and to a lower degree in the fat and bones (Nielsen and Andersen 1991b). More than 200 days after cynomolgus monkeys were given 0.025 and 0.05 mg Hg/kg/day as methylmercuric chloride in apple juice for about 2 years, the kidneys contained 10.18–27.89 ppm mercury in the cortex and 1.12–10.11 ppm in the medulla, compared to <2 ppm in the other tissues measured (Rice 1989b).

Demethylation of methylmercury to inorganic mercury is species-, tissue-, dose-, and time-dependent. The demethylated inorganic mercury accumulates in the kidney and liver. Suda et al. (1991) evaluated the transformation of methylmercury to inorganic mercury by phagocytic cells. The liver and kidneys are also potential sites of biotransformation (Lind et al. 1988; Magos et al. 1976; Norseth and Clarkson 1970).

The distribution of mercury in the brain has been studied in humans following oral absorption of organic mercury. It is suggested by Aschner and Aschner (1990) that, following acute exposure to methylmercury, most of the total mercury in the brain is represented by organic mercury; however, after chronic exposure, most of the mercury in the brain is inorganic mercury. An explanation for these findings is that organic mercury is converted into inorganic mercury in the brain. After chronic methylmercury exposure in monkeys, estimated half-lives were considerably longer in brain than in blood, also possibly due to conversion of methylmercury to a form that is highly bound to brain tissue (Rice 1989b).

The autopsy of a man whose first symptoms of methylmercury poisoning occurred 26 years earlier revealed that the highest mercury levels (0.62–1.19 µg Hg/g) were in the gyrus of the cerebral cortex, cerebellum, pallidum, and occipital pole of the brain (Takeuchi et al. 1989). Furthermore, total mercury levels (0.02–1.19 µg/g) were much higher than methylmercury levels (approximately <0.01 µg/g) in the brain.

2. HEALTH EFFECTS

This finding supports the assumption by Suda et al. (1989) that ingested methylmercury is dealkylated to inorganic mercury in the brain.

Monkeys were fed 0.05 or 0.09 mg Hg/kg/day as methylmercury, containing 5% impurity of inorganic mercury, for 0.5–1.5 years (Lind et al. 1988). The low-dosed monkeys were found to have 10–33% of the total mercury present in the inorganic form in brain cortices, while the high-dosed monkeys had 90% in the inorganic form. Demethylation of methylmercury in the brain, as well as in other organs, including the kidneys and liver, is believed to contribute substantially to the high concentration of inorganic mercury in the brain. Following oral exposure to methylmercuric chloride, regional distribution of total mercury in the brain of monkeys was observed; the highest levels were in the thalamus and hypothalamus (Rice 1989b).

In contrast, in the brain of 21-day-old neonatal rats that had been previously exposed to a gavage dose of 6.4 mg Hg/kg as methylmercury chloride *in utero*, the cerebellum had the highest mercury concentrations and the brainstem had the lowest (Braghiroli et al. 1990). By 60 days of age, concentrations in the brain reached normal values, with an estimated half-life of approximately 37 days (Braghiroli et al. 1990). Therefore, age can affect regional distribution in the brain of animals.

Massie et al. (1993) reported no significant change in the total amount of mercury in the organs (lung, heart, kidney, brain, and liver) of male C57BL/6J mice ranging in age from 133 to 904 days of age maintained under conventional conditions with no known source of mercury exposure other than background concentrations. The ratio of mercury in the brain to that in the liver or to that in the kidney was significantly increased with age, indicating that older mice are less able to maintain a low brain-to-liver ratio of mercury regardless of the total body content of mercury.

In a study of organs from sledge dogs fed methylmercury-laden meat and organs from predatory marine animals (Hansen and Danscher 1995), the highest concentration of total mercury was found in the mesenteric lymph nodes, followed by liver and kidneys, indicating that the lymphatic system may play an important role in the transport of mercury to target organs. The tissue concentrations of mercury observed in this study were found to be age-related, and the results suggest that demethylation takes place in all organs, except the skeletal muscle. Demethylation of methylmercury was found to be lower in the brain than in other organs (Hansen and Danscher 1995).

Mercury accumulates in hair following exposure to methylmercury in humans and mice (Grandjean et al.

2. HEALTH EFFECTS

1992; Nielsen and Andersen 1991a, 1991b; Soria et al. 1992; Suzuki et al. 1992). Hair mercury levels, determined using segmental hair analysis, can be used to monitor exposure to mercury and may leave a historical record of exposure or uptake (Phelps et al. 1980; Suzuki et al. 1992). The concentration of mercury in the hair is considered proportional to the concentration of mercury in the blood. Correlations can be drawn to determine blood concentrations of mercury relative to its concentration in the hair (see the discussion of the methylmercury MRL in Section 2.5). Mercury concentrations in maternal hair were significantly correlated with cord blood levels of mercury in pregnant women who had frequently ingested whale meat throughout pregnancy (Grandjean et al. 1992). The frequent ingestion of whale meat dinners during pregnancy and, to a lesser degree, the frequent consumption of fish, as well as increased parity or age, were associated with high mercury concentrations in cord blood and hair. The incorporation of mercury into hair is irreversible; the loss of hair mercury occurs as the result of hair loss (Nielsen and Andersen 1991b).

As with metallic mercury, methylmercury can readily traverse the placental barrier. In humans with no known exposure to mercury, blood mercury levels increased with advancing gestation such that the mean blood mercury level on admission for delivery (1.15 ppb) was significantly higher than that of the first prenatal visit (0.79 ppb) (Kuntz et al. 1982). Cord blood levels were similar to maternal blood values in labor and postpartum. Concentrations of methylmercury in the fetal blood are slightly higher than in the maternal blood (Inouye and Kajiwara 1988; Kuhnert et al. 1981). Following an oral dose of methylmercuric chloride during gestation, accumulation of mercury was much greater in the fetal kidneys than in the maternal kidneys of guinea pigs (Inouye and Kajiwara 1988). Mercury levels in the liver were slightly higher in the fetus compared to the dam when exposed to organic mercury at late gestation but were similar at early gestation. Distribution of mercury in the maternal and fetal brains was uneven, with the highest concentrations in the neopallium, diencephalon, and mesencephalon and the lowest in the rhombencephalon. Exposure at later gestational weeks resulted in higher concentrations for both maternal and fetal brains (Inouye and Kajiwara 1988).

Methylmercury may also be secreted in mother's milk (Bakir et al. 1973). Following intravenous dosing of methylmercuric chloride (1.6 mg Hg/kg) to pregnant mice on one of days 9–17 of pregnancy, methylmercury was readily transferred to the fetuses from the mothers more predominantly at the later gestational stage (Inouye and Kajiwara 1990). The placental transfer of methylmercury was more efficient compared to the lactational transfer in rats exposed to methylmercury in the diet during 11 weeks prior to mating, during gestation, and during lactation (Sundberg and Oskarsson 1992). A higher concentration of mercury

2. HEALTH EFFECTS

in the brain in relation to the blood mercury concentration was found after exposure *in utero* compared to exposure in milk. Mercury was present as methylmercury in the blood of the offspring exposed only during gestation, indicating little or no demethylation during the first 15 days after birth. However, inorganic mercury was present in the blood of offspring exposed only through milk, probably resulting from demethylation of methylmercury in the dam and transport of inorganic mercury to the sucklings through milk.

In animal studies, mercury transfer to and distribution in offspring depends on the form administered to the dam. Yoshida et al. (1994) administered either mercury chloride or methylmercury at 1 mg Hg/kg body weight to maternal guinea pigs (Hartley strain) via intraperitoneal injection 12 hours after parturition. Exposure of the offspring was studied on days 3, 5, and 10 postpartum. Concentrations of mercury were lower in the milk than in maternal plasma regardless of the form of administered mercury, but total milk mercury was higher in the dams given mercury chloride. While the ratio of methylmercury to total mercury decreased in plasma from dams, it did not decrease in the milk. Regardless of the form of mercury given to the dams, the highest concentration of mercury in the offspring was found in the kidney, followed by the liver and the brain. Brain mercury, however, was significantly higher in the offspring of methylmercury-treated dams. Mercury levels in major organs of the offspring peaked at 5 days from mercury-chloride-treated dams and at 10 days from methylmercury-treated dams.

Tissue distribution of phenylmercury is initially similar to methylmercury. One week after administration, the distribution pattern resembles that seen after administration of inorganic compounds (Nordberg 1976). Once in the blood, phenylmercury distributes to a greater extent into the red blood cells than the plasma. Phenylmercury also predominantly distributes to the liver (Berlin 1963). It is less permeable to the placental and blood-brain barriers than methylmercury (Yamaguchi and Nunotani 1974). Phenylmercury also accumulates in the fur of rats but to a lesser extent than detected with methylmercury exposure (Gage 1964).

2.3.2.3 Dermal Exposure

No information was identified for distribution of metallic, inorganic, or methylmercury via dermal absorption. A case history for a dermal absorption of dimethylmercury (see Section 2.3.1.3) does provide some information on distribution (Blayney et al. 1997; Nierenberg et al. 1998). A 48-year-old female absorbed approximately 0.4–0.5 mL of dimethylmercury (about 1,500 mg) through the skin on the dorsal

2. HEALTH EFFECTS

side of her hand. A preliminary laboratory report at 5 months after exposure indicated that the whole-blood mercury concentration was more than 1,000 µg/L (normal range, 1–8 µg/L; toxic level, >200 µg/L). Chelation therapy with oral succimer (10 mg/kg orally every 8 hours) was begun on day 168 after exposure. Whole blood concentrations rose to 4,000 µg/L after one day of chelation, and urinary mercury levels were 234 µg/L (normal range, 1–5 µg/L; toxic level, >50 µg/L). Chelation therapy continued up to the time of the patient's death 298 days postexposure, with blood mercury level falling to around 200 µg/L. Metal analysis of the patient's tissues revealed extremely high levels of mercury in the frontal lobe and visual cortex (average value, 3.1 µg/g [3,100 ppb]), liver (20.1 µg/g), and kidney cortex (34.8 µg/g). The mercury content in the brain was approximately 6 times that of the whole blood at the time of death, and was much higher than levels in the brains of nonmercury exposed patients (2–50 ppb).

2.3.2.4 Other Routes of Exposure

Strain and sex differences were observed in renal mercury accumulation 4 hours after a subcutaneous methylmercuric chloride injection (1 µmol/kg) to 5 strains (BALB/cA, C57BL/6N, CBA/JN, C3H/HeN, and ICR) of male mice and 3 strains (BALB/cA, C57BL/6N, and ICR) of female mice (Tanaka et al. 1991). Mercury was distributed to the kidneys, brain, heart, lungs, liver, spleen, carcass, plasma, and red blood cells of all mice tested. Strain and sex differences were found in renal mercury content. In three strains (ICR, BALB/cA, and C57BL/6N), males showed higher renal mercury levels than females.

Differences in tissue concentrations in different inbred mice strains were evaluated by Griem et al. (1997). Female mice from five different strains (C57BL/6, B10.D2, B10.S, A.SW, and DBA/2) received 3 weekly subcutaneous injections of 0.5 mg Hg/kg body weight for up to 12 weeks. Except for the thymus, in which mercury concentrations continued to increase, steady state levels were obtained in blood and liver after 4 weeks and in spleen and kidney after 8 weeks. In the closely related strains C57BL/6, B10.D2, and B10.S, which differ only or primarily at the major histocompatibility complex, mercury concentrations in blood and liver were about 2-fold lower and renal concentrations were from 3- to 5-fold lower than measured in A.SW, and DBA/2 strains. Mercury concentrations in the spleen of C57BL/6, B10.D2, B10.S mice were significantly higher than in the spleen of A.SW, and DBA/2 mice. The higher concentration of Hg in this immune system organ concentration of C57BL/6, B10.D2, B10.S correlates with the increased susceptibility of these strains to a mercury chloride-induced systemic autoimmune syndrome. The strains with lower splenic mercury are more resistant.

2. HEALTH EFFECTS

Treatment of mice with ethanol results in increased accumulation of mercury in the fetus (Khayat and Dencker 1982). The concurrent generation of NADPH during the oxidation of alcohol enhances the reduction of mercuric ion to metallic mercury, making it more favorable for permeating the placenta. Mercuric chloride's limited ability to cross the placental barrier was also demonstrated in an intravenous study using mice (Inouye and Kajiwara 1990). Following intravenous dosing of mercuric chloride (1.4 mg/kg) to pregnant mice on 1 day between days 9 and 17 of pregnancy, mercuric chloride was transferred inefficiently to the fetus, being blocked almost completely by the fetal membrane. The mercury accumulated in the placenta and yolk sac but not in the amnion or fetal body (Inouye and Kajiwara 1990). A histochemical study demonstrated that mercuric mercury (Hg^{+2}) was blocked in the proximal wall of the yolk sac.

2.3.3 Metabolism

The available evidence indicates that the metabolism of all forms of mercury is similar for humans and animals. Once absorbed, metallic and inorganic mercury enter an oxidation-reduction cycle. Metallic mercury is oxidized to the divalent inorganic cation in the red blood cells and lungs of humans and animals. Evidence from animal studies suggests the liver as an additional site of oxidation. Absorbed divalent cation from exposure to mercuric mercury compounds can, in turn, be reduced to the metallic or monovalent form and released as exhaled metallic mercury vapor. In the presence of protein sulfhydryl groups, mercurous mercury (Hg^+) disproportionates to one divalent cation (Hg^{+2}) and one molecule at the zero oxidation state (Hg^0). The conversion of methylmercury or phenylmercury into divalent inorganic mercury can probably occur soon after absorption, also feeding into the oxidation-reduction pathway.

Metallic and Inorganic Mercury. Metallic mercury vapor is inhaled through the lungs and rapidly enters the bloodstream. The dissolved vapor can undergo rapid oxidation, primarily in the red blood cells, to its inorganic divalent form by the hydrogen peroxide-catalase pathway (Clarkson 1989; Halbach and Clarkson 1978). It is believed that the rate of oxidation is dependent on: (1) concentration of catalase in the tissue; (2) endogenous production of hydrogen peroxide; and (3) availability of mercury vapor at the oxidation site (Magos et al. 1978). In red blood cells *in vivo*, hydrogen peroxide production is probably a rate-determining step because Nielsen-Kudsk (1973) found that stimulation of hydrogen peroxide production in red cells increased the uptake of mercury vapors in red blood cells. After a low dose, the total mercury content in the blood is proportionately higher than (to the administered dose) after a high dose, indicating that a higher proportion of the lower dose is oxidized (Magos et al. 1989). The hydrogen peroxide-catalase

2. HEALTH EFFECTS

pathway in red cells may become saturated at higher dose levels (Magos et al. 1989). This oxidation pathway of metallic mercury can be inhibited by ethanol since ethanol is a competitive substrate for the hydrogen peroxide catalase and, consequently, can block mercury uptake by red blood cells (Nielsen-Kudsk 1973).

The oxidation of metallic mercury may also occur in the brain, liver (adult and fetal) (Magos et al. 1978), lungs (Hursh et al. 1980), and probably all other tissues to some degree (Clarkson 1989). In rat liver homogenates, hydrogen peroxide catalase is the predominant oxidative pathway in tissues. Its capacity is very high. Unlike oxidation in red cells, the rate-limiting step in *in vitro* oxidation in the liver is dependent on the rate of mercury delivery to the enzyme (Magos et al. 1978). Unoxidized metallic mercury can still reach the brain because the oxidation of metallic mercury is a slow process compared with the circulation time from the lungs to the brain (Magos 1967). In the brain, unoxidized metallic mercury can be oxidized and become trapped in the brain because it is more difficult for the divalent form to cross the barrier. Autoradiographic studies suggest that mercury oxidation also occurs in the placenta and fetus (Dencker et al. 1983), although the extent of oxidation is not known. The rate of distribution of metallic mercury to the brain and fetus is probably nonlinear because the rate of oxidation in red cells is nonlinear (i.e., can become saturated at higher doses) (Magos et al. 1989).

There is evidence to suggest that the divalent inorganic mercury cation is reduced by mammalian tissue to metallic mercury after its oxidation. Rats and mice pretreated parenterally with mercuric chloride exhale metallic mercury vapor (Clarkson and Rothstein 1964; Dunn et al. 1981a). Liver and kidney homogenates in animals also release mercury vapor after exposure to mercuric chloride. The amount of mercury released increases upon treatment with ethanol (Dunn et al. 1981b). This increase suggests that glutathione reductase is responsible for mercuric ion reduction (Williams et al. 1982). Oxidation of alcohol to acetaldehyde stimulates NADPH production, which is required for mercuric ion reduction. However, alcohol is primarily oxidized in the liver, and this location is not consistent with the increases in metallic mercury vapor released from the kidney homogenates (Dunn et al. 1981b).

Organic Mercury. Once absorbed, methylmercury can apparently be converted into inorganic mercury in tissues, specifically the divalent cation (Hg^{+2}) (Dunn and Clarkson 1980). Several investigators have reported high levels of inorganic mercury in tissues (Magos and Butler 1972; WHO 1990) and feces after methylmercury exposure (Turner et al. 1975). Rat liver microsomes can degrade methylmercury into inorganic mercury. Inorganic mercury production from methylmercury paralleled the hydroxyl radical

2. HEALTH EFFECTS

production (Suda and Hirayama 1992). The promotion and inhibition of the hydroxyl radical formation and the hydroxyl radical scavenger, affected inorganic mercury production. These results suggest that hydroxyl radicals produced from microsomes may play a predominant role in alkyl mercury degradation.

NADPH-cytochrome P-450 reductase is known to be responsible for hydroxyl radical production in liver microsomes. Alkyl mercury degradation varied in proportion to the enzyme activities and hydroxyl radical production. These results suggest that hydroxyl radicals produced by cytochrome P-450 reductase might be the primary reactive species that induces alkyl mercury degradation. *In vitro* studies using a peroxidase-hydrogen peroxide-halide system indicated that besides the hydroxyl radical, hypochlorous acid (HOCl) scavengers are also capable of degrading methylmercury (Suda and Takahashi 1992). Also, metallic mercury exhaled in mice dosed with methylmercury was dependent on the level of inorganic mercury present in the tissue (Dunn and Clarkson 1980). The cation then enters the oxidation-reduction cycle, and metabolism occurs as discussed previously under Inorganic Mercury.

A small amount of an oral dose of methylmercuric chloride can also be converted into inorganic mercury in the intestinal flora (Nakamura et al. 1977; Rowland et al. 1980). However, inorganic mercury is poorly absorbed across the intestinal wall and, therefore, most of it is excreted.

Phenylmercury also rapidly metabolizes to inorganic mercury (Nordberg 1976). The metabolism of phenylmercury involves hydroxylation of the benzene ring to an unstable metabolite that spontaneously releases inorganic mercury. Consequently, its tissue disposition following initial metabolism resembles that seen after the administration of inorganic salts (Gage 1973).

Studies in mice indicate that toxicity from exposure to dimethylmercury is the result of metabolic conversion of dimethylmercury to methylmercury, and that dimethylmercury does not enter the brain until it has been metabolized to methylmercury, which occurs over the first several days following absorption (Ostland 1969). Nierenberg et al. (1998) report the results of an analyses of mercury content in the hair of a 48-year-old female who died subsequent to an acute exposure to dimethylmercury. The results are consistent with the kinetic profiles for methylmercury, and support the hypothesis of a rapid conversion of dimethylmercury to a methylmercury metabolite.

2. HEALTH EFFECTS

2.3.4 Elimination and Excretion

Elimination of metallic mercury occurs through the urine, feces, and expired air, while inorganic mercury is excreted in the urine and feces in humans. Animal data on excretion are limited but indicate that excretion is species and dose dependent. The feces are a major elimination route for inorganic mercury compounds, but high acute doses increase the percentage of excretion via the urine. Excretion of organic mercury is predominantly thought to occur through the fecal (biliary) route in humans. In animals, phenylmercury is excreted initially through the bile and then shifts to urine, whereas methylmercury is primarily excreted in the bile and then the feces. Age is a factor in the elimination of mercury in rats following inorganic and organic mercury exposure, with younger rats demonstrating significantly higher retention than older rats. Both inorganic and organic mercury compounds can be excreted in breast milk. There are no data suggesting that the route of exposure affects the ultimate elimination of inorganic and organic mercury that is absorbed into the body.

Metallic and Inorganic Mercury. The urine and feces are the main excretory pathways of metallic and inorganic mercury in humans, with a body burden half-life of approximately 1–2 months (Clarkson 1989). In a study of former chloralkali workers exposed to metallic mercury vapor for 2–18 years (median, 5 years), Sallsten et al. (1995) found that the elimination of mercury in urine was well characterized by a one-compartment model, which estimated a half-life of 55 days. There was a tendency toward longer half-lives with shorter duration exposures than with long-term exposure, when uptake and elimination have reached a steady state. This might be due to the induction of a higher metabolic rate after a longer exposure time, but there is no experimental evidence to support such an effect (Sallsten et al. 1995). For high-level exposure to inorganic divalent mercury, the urine is probably the major elimination route, with a half-life similar to that of metallic mercury (Clarkson 1989). An elimination half-life from urine was estimated to be 25.9 days following an acute exposure to a high level of mercuric chloride (13.8 mg/kg) (Suzuki et al. 1992). Exhalation in the lungs and secretion in saliva, bile, and sweat may also contribute a small portion to the excretion process (Joselow et al. 1968b; Lovejoy et al. 1974). After an acute mercury exposure in humans, urinary excretion accounts for 13% of the total body burden. After long-term exposure, urinary excretion increases to 58%. Humans inhaling mercury vapor for less than an hour expired approximately 7% of the retained dose of mercury (Cherian et al. 1978; Hursh et al. 1976). The half-life for this elimination pathway was 14–25 hours; therefore, excretion through expired air is negligible 5–7 days after exposure (Cherian et al. 1978). Using a two-compartment model, elimination half-lives in the urine of workers exposed for 20–45 hours to $>0.1 \text{ mg/m}^3$ metallic mercury vapor were

2. HEALTH EFFECTS

estimated to be 28 and 41 days for a fast and slow phase, respectively (Barregard et al. 1992). Mercury is excreted in the urine following oral exposure to mercuric sulfide (0.5 mg Hg/kg) (Yeoh et al. 1989).

The overall elimination rate of inorganic mercury from the body is the same as the rate of elimination from the kidneys, where most of the body burden is localized (see Table 2-4). Inorganic mercury is also readily cleared from the lung. Elimination from the blood and the brain is thought to be a biphasic process with an initial rapid phase in which the decline in the body burden is associated with high levels of mercury being cleared from tissues, followed by a slower phase of mercury clearance from the same tissues (Takahata et al. 1970). An even longer terminal-elimination phase is also possible because of persistent accumulation of mercury, primarily in the brain (Takahata et al. 1970). Following a single oral dose of divalent mercury in 10 volunteers, 85% of the ²⁰³Hg activity was excreted within 4–5 days, predominantly in the feces (Rahola et al. 1973).

Following acute mercury vapor intoxication of two humans, it was found that, despite chelation therapy with multiple chelators (2,3-dimercaptopropanol [BAL] followed by 2,3-dimercaptosuccinic acid [DMSA]), relatively high concentrations of mercury remained in the plasma for a very long time (Houeto et al. 1994). The authors suggested that this could be explained by the progressive release of mercury from red blood cells and tissues after oxidation. In a group of chloralkali workers exposed to metallic mercury vapor for 1–24 years (median, 10 years), a decrease in the mercury concentration (following temporary discontinuation of exposure) in whole blood, plasma, and erythrocytes was found to be best characterized by a two-compartment model (Sallsten et al. 1993). Using a two-compartment model, half-lives were estimated, respectively, to be 3.8 and 45 days for the fast and slow phase in whole blood; plasma, 2 and 36 days in plasma, and 3.6 and 16 days in erythrocytes. The half-lives for the slow phases in whole blood and plasma were longer, and the relative fractions of the slow phases were higher (about 50%) after long-term exposures than after brief exposures (Sallsten et al. 1993).

Workers exposed to vapors of 0.016–0.68 mg Hg/m³ had detectable levels of mercury in the urine (>2 µg Hg/L) (Stopford et al. 1978). Metallic mercury accounted for <1% of the total mercury in the urine. The rapid appearance of metallic mercury in the urine is probably due to mercury filtered directly from the blood through the glomerulus, whereas mercuric ions found in the urine are attributable to the mercury taken up by the kidneys prior to excretion. Therefore, urinary metallic mercury provides a relative index for blood levels of metallic mercury, and urinary mercuric ions provide a relative index for kidney levels of inorganic mercury. Three different forms of mercury have been identified in the urine from

2. HEALTH EFFECTS

Table 2-4. Half-lives of Inorganic Mercury in Humans

Tissue	Half-life	Phase	Reference
Lung	2 days	Early phase	Berlin et al. 1969a
Brain	20 days	Biphasic	Hursh et al. 1976
Blood	3.3 days	Early phase	Cherian et al. 1978
Plasma	3.3 days	Early phase	Cherian et al. 1978
Blood	2.4 days	Early phase	Clarkson 1978
Blood	15 days	Late phase	Clarkson 1978
Blood	28 days	Late phase	Rahola et al. 1973
Whole body	60 days		Rahola et al. 1973
Whole body	60 days		Hursh et al. 1976
Kidney	60 days		Hursh et al. 1976

Compiled from: Bakir et al. 1973; Cox et al. 1989; Kershaw et al. 1980; Miettinen et al. 1971; Sherlock et al. 1984

2. HEALTH EFFECTS

workers occupationally exposed to mercury: a metallic form, a mercuric-cysteine complex that is reducible, and a large complex in which the mercury can only be released by organic destruction (Henderson et al. 1974).

Data are limited on elimination of metallic and inorganic mercury in animals. Initial excretion of mercury is predominantly in the fecal matter following inhalation of metallic mercury vapor, but as mercury concentrations increase in the kidneys, urinary excretion increases (Rothstein and Hayes 1964). After inhalation, approximately 10–20% of the total excreted metallic mercury is by exhalation (Rothstein and Hayes 1964). Mercury is excreted in the urine of mice exposed orally to mercuric sulfide (. 8–200 mg Hg/kg) (Yeoh et al. 1986, 1989). The amount of mercury in the urine of the treated group was 4.5–15-fold greater than the control levels. Urinary rates of mercury excretion were 1.6–2.2 ng/hour. Neonatal rats (1, 8, and 15 days old) eliminated mercury slower than older rats (22 and 29 days old) given mercuric chloride subcutaneously (Daston et al. 1986).

Inorganic mercury is also excreted in breast milk (Yoshida et al. 1992). Newborn guinea pigs were exposed to inorganic mercury in breast milk from mothers exposed to mercury vapor (6–9 mg/m³) for 120 minutes after parturition (Yoshida et al. 1992). Mercury concentrations in breast milk were slightly lower than plasma mercury concentrations of the maternal guinea pigs over the observation period. Ratios of milk to plasma were 0.24–0.44 on day 3, 0.45–0.46 on day 5, and 0.46–0.66 on day 10. The decrease in the mercury concentration in breast milk with time was slower than that in maternal plasma. The distribution of mercury to organs in the suckling neonates indicated that they were exposed to the inorganic rather than to elemental mercury.

Sundberg et al. (1998) studied the elimination of radiolabeled inorganic mercury in lactating and nonlactating mice exposed to mercuric chloride via a single intravenous injection at 0.5 mg Hg/kg body weight. A three-compartment pharmacokinetic model was used to fit the data. The study was designed to provide additional information on the speciation of mercury in breast milk and the differences between methylmercury and inorganic mercury migration into milk. Unlike placenta, where methylmercury moves more easily across the placental border than inorganic mercury, inorganic mercury is more readily eliminated in milk than methylmercury. For inorganic mercury, no significant differences were observed between lactating and nonlactating mice for plasma clearance (43.3 and 44.4 mL/hour/kg, respectively) and volume of distribution (4,950 and 3,780 mL/kg). The terminal half-lives of inorganic mercury in plasma were 297 hours for lactating, and 162 hours for nonlactating mice. The milk-to-plasma concentration ratio

2. HEALTH EFFECTS

for inorganic mercury varied between 0.1 and 3.6, with a mean of 0.64 at plasma levels below 300 ng Hg/g (in the linear region of the relationship) and a mean of 0.17 at higher plasma mercury levels. In contrast, the values for the methylmercury kinetic parameters were significantly higher in lactating than nonlactating mice: plasma clearance (93.5 and 47.1 mL/hour/kg, respectively) and volume of distribution (18,500 and 9,400 mL/kg, respectively). The terminal half-life of methylmercury in plasma was 170 hours for lactating and 158 hours for nonlactating mice. The milk-to-plasma concentration ratios for total mercury after methylmercury administration were lower than those seen with inorganic mercury, and varied between 0.1 and 0.7 with a mean of 0.20. The nearly five-fold higher peak value for plasma to blood mercury levels observed for inorganic mercury reflects the more efficient migration of inorganic mercury from blood to milk compared with that for methylmercury. Mercury concentrations in milk also decreased more quickly for inorganic (terminal half-life of 107 hours) than for methylmercury (constant levels throughout the 9-day follow-up period postexposure). The authors hypothesize that the nonlinear relationship between mercury in milk and plasma following inorganic mercury administration suggests that inorganic mercury enters the mammary gland via a carrier-mediated transport system that is saturated at high plasma levels of inorganic mercury. The results suggest that the physiological changes during lactation alter the pharmacokinetics for methylmercury in mice, but not for inorganic mercury.

Organic Mercury. The fecal (biliary) pathway is the predominant excretory route for methylmercury, with less than one-third of the total mercury excretion occurring through the urine, following oral and inhalation exposure (Norseth and Clarkson 1970). In humans, nearly all of the total mercury in the feces after organic mercury administration is in the inorganic form. The conversion of methylmercury to inorganic mercury is a major step that is dependent on the duration of exposure and/or the duration after cessation of exposure.

In rats and nonhuman primates, methylmercury is secreted in the bile and can be reabsorbed in the intestine (Berlin et al. 1975; Norseth and Clarkson 1971; Urano et al. 1990). It is believed that methylmercury is complexed to nonprotein sulfhydryl compounds in the bile and reabsorbed in this form by a transport system (Ballatori and Clarkson 1982; Urano et al. 1990). In guinea pigs, hamsters, and monkeys, methylmercury, but not inorganic mercury, is extensively reabsorbed from the gall bladder, providing evidence for the biliary-hepatic recycling of this metal (Dutczak et al. 1991). The biliary-hepatic cycle probably contributes to the long biological half-life and toxicity of methylmercury. However, methylmercury can be converted into its inorganic form in the gastrointestinal lumen by intestinal flora (Nakamura et al. 1977;

2. HEALTH EFFECTS

Rowland et al. 1980), thus decreasing reabsorption and increasing the rate of fecal excretion (Berlin et al. 1975).

During the first few days after intravenous dosing, phenylmercury compounds are also eliminated primarily in the feces as a result of biliary secretion and its concentration in the gastrointestinal tract (mucosa and lumen) (Berlin and Ullberg 1963). The initial urinary excretion of phenylmercury represents primarily the parent compound (Gage 1964). Several days after exposure, however, elimination is primarily in the urine, which contains predominantly inorganic mercury (Gotelli et al. 1985).

Clearance half-times are longer with methylmercury than with inorganic compounds (see Table 2-5). Elimination of methylmercury compounds generally follows first-order kinetics because excretion is directly proportional to body burden and independent of the route of administration (oral or intraperitoneal) (Nielsen and Andersen 1991a). Furthermore, duration of exposure may affect the excretion process of mercury. A two-compartment model was established by Rice et al. (1989) for a single oral dose study in monkeys because of the appearance of an initial rapid elimination phase followed by a slower elimination phase. However, following repeated dosing for 2 years, a one-compartment model was considered a more reasonable fit for the data. Therefore, it was concluded that the average steady-state blood levels of mercury after chronic-duration exposure should not be estimated on the basis of short-term exposure data.

Elimination rates for methylmercury vary with species, dose, sex, and strain (Nielsen 1992). There is also evidence of sex-related differences in the elimination of methylmercury in humans (Miettinen 1973). The direction of the sex-related difference may differ for the fast and slow components of methylmercury elimination, with males excreting faster during the fast component and females excreting faster during the slow component. The net difference in elimination rates at time points distant from exposure indicates that females excrete methylmercury slightly faster than males. This net difference is seen in whole-body biological half-time derived by combining both fast and slow elimination components (Miettinen 1973). Clear sex-related differences were not reported for these volunteers for time points soon after exposure. In contrast, male mice excreted methylmercury much faster than females did for the first 14 days (i.e., primarily the fast component) (Nielsen 1992). Significant sex-related differences in elimination were also observed in rats dosed at 56 days of age (Thomas et al. 1982). As is apparently the case in humans, the difference was measured in the slow component only, with males excreting slightly slower than females. It should be noted that an insignificant difference in elimination was measured for the fast component of

2. HEALTH EFFECTS

Table 2-5. Elimination Constants for Methylmercury Measured in Blood and Hair

Reference	Clearance half-time in days	Elimination constant ^a	Number of subjects
Cox et al. 1989	48 (hair, women)	0.014	55
Miettinen et al. 1971	53 (blood)	0.013	15
Kershaw et al. 1980	52 (blood)	0.013	7
Sherlock et al 1984	51 (blood, women)	0.0136	6
Sherlock et al 1984	49 (blood, men)	0.0142	14
Bakir et al. 1973	65 ^b (blood)	0.015	16

^aConversions between reported values for elimination constant and clearance half-time are based on the equation $T_{1/2} = \ln 2/b$, where $T_{1/2}$ is clearance half-time and b is elimination constant (WHO 1976).

^bAt least two of these individuals were young males (ages 6 and 10). The sex of the other 14 individuals was not reported.

Compiled from: Bakir et al. 1973; Cox et al. 1989; Kershaw et al. 1980; Miettinen et al. 1971; Sherlock et al. 1984

2. HEALTH EFFECTS

excretion in the rats, with males excreting slightly faster than females. Interestingly, a sex-difference elimination rate was not observed in rats dosed at 24 days or younger (Thomas et al. 1982).

The rate of mercury excretion was also slower in younger animals (7 or 15 days) than in older animals (24 and 56 days) (Thomas et al. 1982). This age-dependent difference in the rate of mercury excretion may reflect differences in the sites of mercury deposition (i.e., hair, red blood cells, skin). In neonatal rats, the excretion of methylmercury is longer than in adult rats because of the inability of the neonatal liver to secrete the toxicant into the bile. Therefore, the immaturity of the transport system in neonatal rats affects the elimination of mercury.

Methylmercury is also excreted in the breast milk of rats, humans, and guinea pigs (Sundberg and Oskarsson 1992; Yoshida et al. 1992). In pups exposed only through milk, approximately 80% of the total mercury in blood was present as methylmercury. Because suckling animals have a limited ability to demethylate methylmercury, the inorganic mercury present in the blood of the offspring probably originated from inorganic mercury in the milk. Since the dams were exposed only to methylmercury in their diet, some demethylation occurred in the dams, followed by the transport of the inorganic mercury to the sucklings via milk.

Sundberg et al. (1998) studied the elimination of radiolabeled methylmercury in lactating and nonlactating mice exposed to methylmercuric chloride via a single intravenous injection at 0.5 mg Hg/kg body weight. A comparison of the results for methylmercury with results for inorganic mercury is discussed in the section above on elimination of "Inorganic Mercury." A three compartment pharmacokinetic model was used to fit the data. The values for the methylmercury kinetic parameters were significantly higher in lactating than nonlactating mice: plasma clearance (93.5 and 47.1 mL/hour/kg, respectively) and volume of distribution (18,500 and 9,400 mL/kg, respectively). The terminal half-life of methylmercury in plasma was 170 hours for lactating and 158 hours for nonlactating mice. The milk-to- plasma concentration ratios for total mercury after methylmercury administration were lower than those seen with inorganic mercury, and varied between 0.1 and 0.7, with a mean of 0.20. Mercury concentrations in milk were constant throughout the 9-day follow-up period postexposure. The results indicate that physiological changes during lactation alter the pharmacokinetics for methylmercury in mice.

2. HEALTH EFFECTS

2.3.5 Physiologically based Pharmacokinetic (PBPK)/Pharmacodynamic (PD) Models

Physiologically based pharmacokinetic (PBPK) models use mathematical descriptions of the uptake and disposition of chemical substances to quantitatively describe the relationships among critical biological processes (Krishnan et al. 1994). PBPK models are also called biologically based tissue dosimetry models. PBPK models are increasingly used in risk assessments, primarily to predict the concentration of potentially toxic moieties of a chemical that will be delivered to any given target tissue following various combinations of route, dose level, and test species (Clewell and Andersen 1985). Physiologically based pharmacodynamic (PBPD) models use mathematical descriptions of the dose-response function to quantitatively describe the relationship between target tissue dose and toxic end points.

PBPK/PD models refine our understanding of complex quantitative dose behaviors by helping to delineate and characterize the relationships between: (1) the external/exposure concentration and target tissue dose of the toxic moiety, and (2) the target tissue dose and observed responses (Andersen et al. 1987; Andersen and Krishnan 1994). These models are biologically and mechanistically based and can be used to extrapolate the pharmacokinetic behavior of chemical substances from high to low dose, from route to route, between species, and between subpopulations within a species. The biological basis of PBPK models results in more meaningful extrapolations than those generated with the more conventional use of uncertainty factors.

The PBPK model for a chemical substance is developed in four interconnected steps: (1) model representation, (2) model parametrization, (3) model simulation, and (4) model validation (Krishnan and Andersen 1994). In the early 1990s, validated PBPK models were developed for a number of toxicologically important chemical substances, both volatile and nonvolatile (Krishnan and Andersen 1994; Leung 1993). PBPK models for a particular substance require estimates of the chemical substance-specific physicochemical parameters, and species-specific physiological and biological parameters. The numerical estimates of these model parameters are incorporated within a set of differential and algebraic equations that describe the pharmacokinetic processes. Solving these differential and algebraic equations provides the predictions of tissue dose. Computers then provide process simulations based on these solutions.

The structure and mathematical expressions used in PBPK models significantly simplify the true complexities of biological systems. If the uptake and disposition of the chemical substance(s) is adequately described, however, this simplification is desirable because data are often unavailable for many biological processes. A simplified scheme reduces the magnitude of cumulative uncertainty. The adequacy of the

2. HEALTH EFFECTS

model is, therefore, of great importance, and model validation is essential to the use of PBPK models in risk assessment.

PBPK models improve the pharmacokinetic extrapolations used in risk assessments that identify the maximal (i.e., the safe) levels for human exposure to chemical substances (Andersen and Krishnan 1994). PBPK models provide a scientifically sound means to predict the target tissue dose of chemicals in humans who are exposed to environmental levels (for example, levels that might occur at hazardous waste sites) based on the results of studies where doses were higher or were administered in different species. Figure 2-4 shows a conceptualized representation of a PBPK model.

PBPK models for mercury exist, and the overall results and individual models are discussed in this section in terms of their use in risk assessment, tissue dosimetry, and dose, route, and species extrapolations.

2.3.5.1 Summary of PBPK Models

Two physiologically based pharmacokinetic models have been developed recently that model the kinetics of methylmercury in rats. Farris et al. (1993) developed a PBPK model that simulates the long-term disposition of methylmercury and its primary biotransformation product, mercuric mercury, in the male Sprague-Dawley rat following a single oral nontoxic exposure. Gray (1995) developed a PBPK model that simulates the kinetics of methylmercury in the pregnant rat and fetus. The Gray model was developed to provide fetal and maternal organ methylmercury concentration-time profiles for any maternal dosing regimen. These models provide useful insight into the key physiological processes that determine the distribution and fate of mercury in the body, but neither model is currently being used in human risk assessment.

2.3.5.2 Mercury PBPK Model Comparison

Both the Farris et al. (1993) and the Gray (1995) PBPK models address the kinetics of methylmercury in rats. Both models provide useful insights into important physiological processes determining methylmercury distribution and changes in tissue concentrations. Also, both studies suggest further work to enhance the utility and accuracy of the models. The Farris et al. model dealt more effectively with the conversion of methylmercury to mercuric mercury, while the Gray model specifically addressed fetal tissue concentrations as a function of maternal exposures and the extrapolation from short-term to continuous

2. HEALTH EFFECTS

Figure 2-4. Conceptual Representation of a Physiologically Based Pharmacokinetic (PBPK) Model for a Hypothetical Chemical Substance

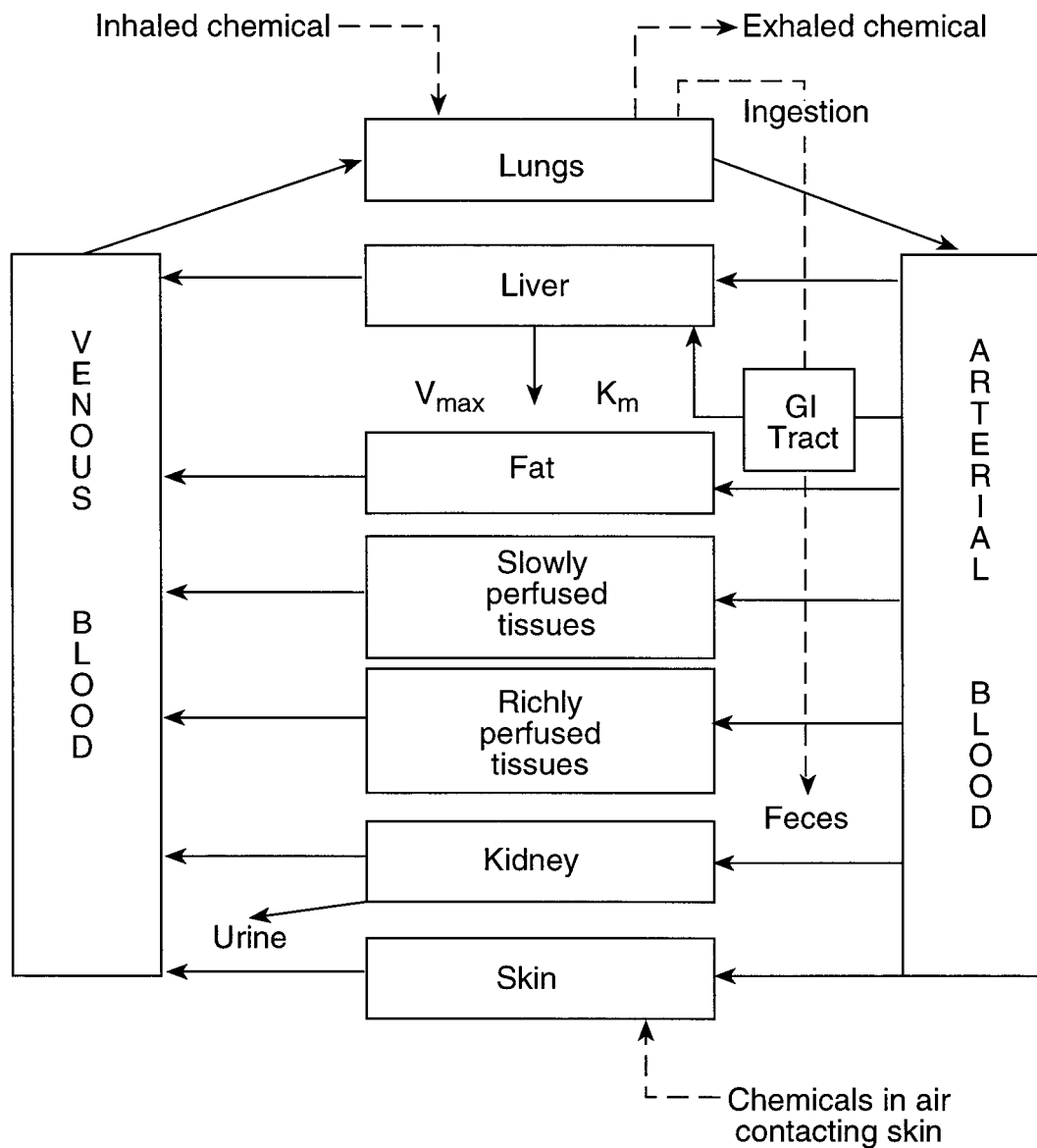

Source: adapted from Krishnan et al. 1994

Note: This is a conceptual representation of a physiologically based pharmacokinetic (PBPK) model for a hypothetical chemical substance. The chemical substance is shown to be absorbed via the skin, by inhalation, or by ingestion, metabolized in the liver, and excreted in the urine or by exhalation.

2. HEALTH EFFECTS

dosing. The latter is of direct relevance to methylmercury risk assessments currently based on human studies of short-term exposures, while the general public exposure is more typically continuous. Neither model ran simulations nor validated against data for other species (including human). Nor did the models address high-to-low dose extrapolations or different routes of exposure.

2.3.5.3 Discussion of Models

The Farris et al. Model for Methylmercury. The Farris et al. (1993) model is a physiologically based model that simulates the long-term disposition of methylmercury and its primary biotransformation product, mercuric mercury, in growing mammals following a single nontoxic oral dose of the parent compound. The test animal used to develop and validate the model was the male Sprague-Dawley rat. A tracer dose was used in the validation studies to preclude the possibility that the results would be biased by toxic or saturation effects. The model incorporates a number of features, including a time-dependent compartment for volume changes (i.e., the rats grew from 300 to 500 g in body weight over the 98-day time course of the validation study), compartment volume-dependent clearances, and the recycling of mercury from ingestion of hair by rats during grooming.

Risk assessment. The Farris et al. model has not been used in human risk assessment. The authors, however, suggest that the model would be useful in developing a better understanding of species differences and in predicting the affects of altered biochemical or physiological states on methylmercury pharmacokinetics. For example, the authors suggest that the model can be adapted to simulate data for neonatal animals or humans that are known to secrete glutathione poorly. It could also help elucidate the mercury kinetics for animals that have altered bile flow or that have nonabsorbable sulfhydryl-containing resins.

Description of the model. The Farris et al. model consists of nine lumped compartments, each of which represent a major site of mercury accumulation, elimination, or effect in mammals. The compartment labeled “carcass” is a residual compartment and consists of all tissues and organs not specifically represented by the other eight compartments in the model. A flow diagram of the model is shown in Figure 2-5. The interdepartmental mass transport parameters used in the model are shown in Table 2-6.

Methylmercury transport between all compartments except brain and hair is modeled as plasma flow limited (i.e., plasma levels rapidly equilibrate with erythrocytes). Mercuric mercury transport parameters

2. HEALTH EFFECTS

Figure 2-5. Compartmental Flow Diagram for a Pharmacokinetic Model of Methylmercury in the Growing Rat

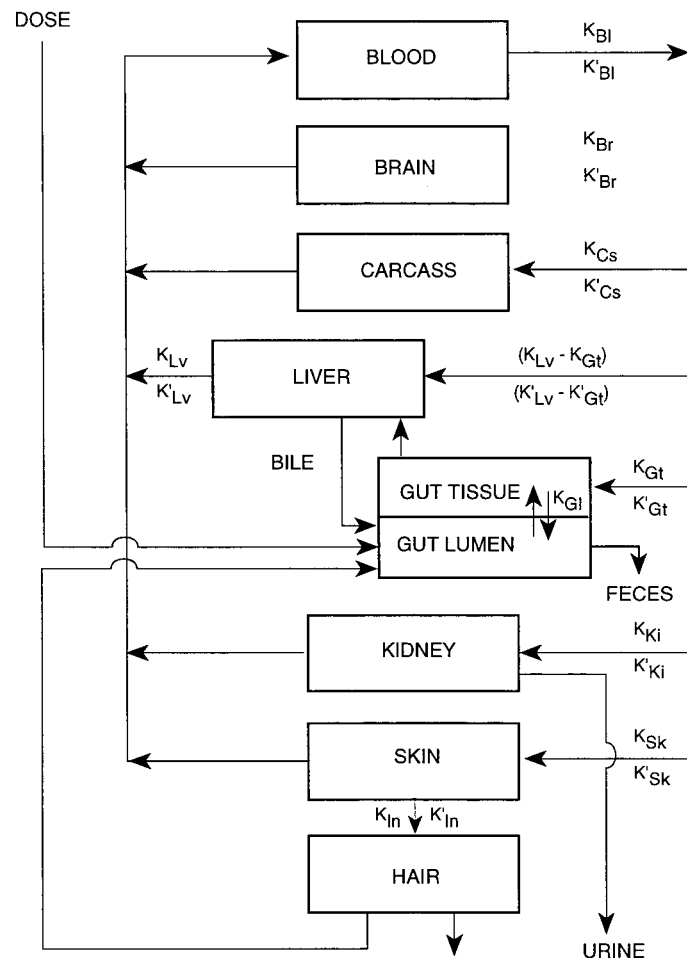

The symbol K represents intercompartmental mass transport parameters. The subscripts Bl , Br , Cs , Gl , Gt , In , Ki , Lv , and Sk denote blood brain, carcass, gut lumen, gut tissue, integument, kidney, liver, and skin, respectively. Primed symbols designate inorganic mercury.

Source: Farris et al. 1993

2. HEALTH EFFECTS

Table 2-6. Intercompartmental Mass Transport Parameters Used to Model Methylmercury and Mercuric Mercury Pharmacokinetics in Rats

Transport processes	Parameter	
	Methylmercury	Inorganic mercury
Blood to brain K_{br} K'_{Br}	3.4×10^{-5} ^{a,b}	3.2×10^{-5} ^{a,b}
Blood to carcass K_{Cs} K'_{Cs}	7.7×10^{-4} ^{a,c}	3.1×10^{-4} ^{a,d}
Blood to liver $(L_{Lv} - K_{Gl})$, $(K'_{Lv} - K'_{Gl})$	9.1×10^{-4} ^{a,c,e}	9.1×10^{-2} ^{a,f}
Blood to kidney K_{Kl} K'_{Ki}	2.0×10^{-2} ^{a,c}	8.4×10^{-3} ^{a,b}
Blood to skin K_{Sk} K'_{Ki}	1.0×10^{-3} ^{a,c}	4.2×10^{-4} ^{a,d}
Blood to GI tissue G_{GT} K'_{Gi}	8.6×10^{-3} ^{a,c}	3.5×10^{-3} ^{a,d}
GI tissue to lumen K_{Gr} K'_{Gi}	1.0×10^{-1} ^g	2.0×10^{-4} ^h
Skin to hair K_{In} K'_{In}	1.2×10^{-4} ^{i,j}	1.2×10^{-4} ^{b,i}

^a Units are mL blood/min g tissue

^b Estimated from experimental data

^c Value is plasma flow rate to tissue divided by 100. Plasma flow rate is calculated from blood flow rate (Bonaccorsi et al. 1978) assuming a hematocrit of 0.374

^d Value is plasma flow rate to tissue divided by 250. Plasma flow rate is calculated as described in footnote^c.

^e Based on flow via hepatic artery

^f Hepatic artery plasma flow

^g Value is based on assumption that transport from gut tissue represents about 79% of total methyl mercury transport to gut lumen. Units are mL tissue/min/g tissue.

^h Value represents the average rate of GI mucosal cell exfoliation. Estimated from Bertalanffy (1960).

ⁱ Units are mL skin/min/g skin.

2. HEALTH EFFECTS

the carcass, gastrointestinal tissue, skin, and kidneys are assumed to follow a common mechanism and are based on the empirically estimated parameter for the kidneys. Transport of both organic and inorganic mercury to brain and hair compartments is assumed to be limited by the blood-brain barrier and the rate of hair growth. Recycled mercury from ingested hair during grooming was assumed available for reabsorption from the gut lumen at 100% for methylmercury and 10% for inorganic mercury.

The authors make the assumption that all of the inorganic mercury resulting from the demethylation of methylmercury is mercuric mercury. Farris et al. (1993) note that the precise site of demethylation is unknown, although the body's tissues and the lumen of the gastrointestinal tract seem most likely. For convenience, however, they modeled demethylation entirely in the liver compartment. Bidirectional and symmetric transport of methylmercury between the gut tissue and lumen is assumed and modeled accordingly. Biliary secretion of both methylmercury and inorganic mercury are modeled as undergoing low-molecular weight nonprotein sulfhydryl (NPSH) secretion d-dependent transport. Methylmercury secreted into the gut lumen, either from biliary secretion or from the gut tissue, is modeled as being readily reabsorbed. In line with previous studies, the model sets a value of 10% for resorption of inorganic mercury secreted into the lumen from bile or from exfoliation of the gastrointestinal mucosal cells.

The assumptions in the model were incorporated into a series of mass-balance differential equations that account for the changes in the amount of methylmercury and mercuric mercury in each compartment. The entire equation set was solved numerically using Gear's method for stiff differential equations (Gear 1971). The initial mercury dose was administered at 100% methylmercury, administered as a bolus to the gut lumen compartment. The mass transport parameters listed in Table 2-6 were multiplied by the time-dependent compartment volumes to give the mass transport parameters used in the model equations.

Validation of the model. The Farris et al. model simulations were compared to an extensive set of data collected by the authors on the metabolism and distribution of an orally dosed bolus of radiolabeled methylmercury in male Sprague-Dawley rats. In a distribution study, tissue samples were collected on days 3, 7, 14, 21, 28, 35, 42, 49, 56, 63, 70, 77, 84, 91, and 98 post-dosing. In a metabolism study with the same dosing regimen, whole body counts and 24-hour feces and urine samples were collected daily for 15 days post-dosing, and then twice weekly.

The model simulations were in close agreement with the observed results from the distribution and metabolism studies. Physiological processes that were highlighted by the results and the discrepancies that

2. HEALTH EFFECTS

did occur include the probable active transport into the brain (versus passive diffusion) of a methylmercury-cysteine complex, the bidirectional transport of methylmercury between the gut lumen and gut tissue as a more important determinant of methylmercury fecal excretion than biliary secretion, the importance for the determination of methylmercury half-life in rats of the recycling of mercury from ingested hair, and the need for better estimates of the rate constants for the demethylation of methylmercury in order to adapt the model to other species.

No human data were presented to validate the model, and validation was not performed for other routes or duration of mercury exposure.

Target tissues. The target tissues for this model included the blood, liver, gut, kidneys, and brain.

Species extrapolation. The model was developed and validated using the male Sprague-Dawley rat. No other species were tested and data from other species were not used to validate the model. The authors, however, suggest that this model would prove useful in developing better rate constants or other important determinants of species differences (for example, demethylation rates, which differ based on differences in gut flora and tissue enzyme levels).

High-low dose extrapolations. Only the single nontoxic dose was evaluated. No data were presented to evaluate the utility of the model for high-to-low dose extrapolations.

Interroute extrapolation. Only the single oral dose was evaluated. No data were presented to evaluate the validity of the model in extrapolating from an oral to an inhalation or dermal dose. No compartment was included for the lungs. Although a skin compartment was included in the model, absorption from a dermal application of methylmercury was not addressed.

The Gray Model for Methylmercury.

The Gray (1995) PBPK model simulates the kinetics of methylmercury in the pregnant rat and fetus. The Gray model was developed to provide fetal and maternal organ methylmercury concentration-time profiles for any maternal dosing regimen.

2. HEALTH EFFECTS

Risk assessment. The Gray model has not been used in human risk assessment. The author, however, suggests that the model would be useful to incorporate rat developmental toxicity data into the assessment of methylmercury risk. Specifically, the author suggests the model be used to convert the short-term exposure data from studies presently being used in risk assessments into continuous-exposure scenarios, which are more typical of the general public's likely exposure pattern.

Description of the model. The Gray model is a membrane-limited PBPK model for methylmercury developed using experimental data from the literature. The model parameters include constants for linear binding, membrane transfer, biliary transport, and gut reabsorption; and physiological parameters for tissue cellular and extracellular volumes and plasma flow rates. Mass balance equations were developed that describe the transport to all organ systems important to the distribution or toxicity of methylmercury to the pregnant rat or fetus. Mass balance equations were solved using an Advanced Continuous Simulation Language (ACSL) program developed by Mitchell and Gauthier Associates.

The compartments and barriers to methylmercury transport in the tissue compartments and placenta are shown in Figure 2-6. The cell membrane is assumed to be the barrier for methylmercury transport for all tissues except the brain and placenta. The barrier to methylmercury transport to the brain is the endothelial cell wall of the cerebral vascular system (the blood-brain barrier). The placenta is modeled as four compartments, with separate transfer constants for placental barrier and placental tissue transport. There is a tissue compartment for both the maternal and fetal sides of the placenta.

The flow chart shown in Figure 2-7 illustrates the transport pathways among the 8 compartments of the pregnant rat, the 5 compartments of the fetus, and the placental interface. The linear binding, membrane transfer transport, and secretion/reabsorption constants used in the Gray model are shown in Tables 2-7 and 2-8. The linear binding constants were estimated directly from *in vivo* tissue distribution studies using the ratio of tissue to plasma concentrations at pseudoequilibrium. They represent the degree to which methylmercury binds to intracellular sites. Because the skin (which includes the outer layers of hair and the pelt) contained excreted methylmercury that does not exchange with plasma, the linear binding constant for a typical organ (in this case the liver) was used as the constant for skin. No experimental data were available for fetal red blood cell (RBC) binding, so the author made the assumption that the fetal RBC binding constant would be equal to the maternal RBC binding constant. The conversion of methylmercury into mercuric mercury in the gut is not explicitly calculated in the Gray model; instead, the calculated

2. HEALTH EFFECTS

Figure 2-6. PBPK Model for Mercury in the Pregnant Rat

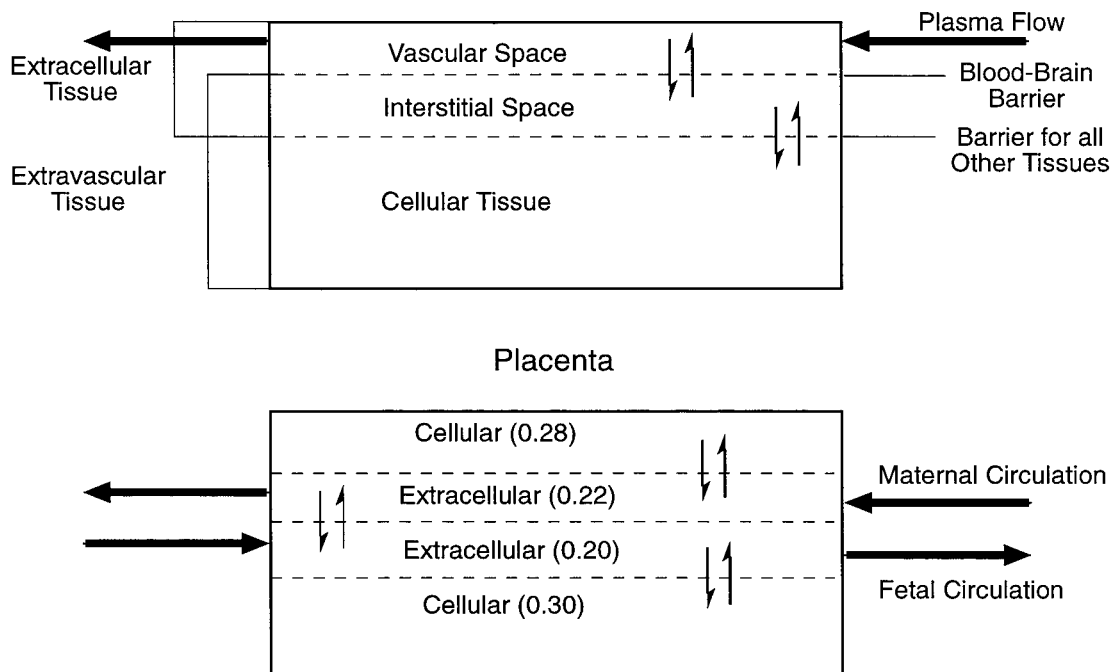

Source: Gray 1995

2. HEALTH EFFECTS

Figure 2-7. Model for Mercury Transport in the Pregnant Rat and Fetus

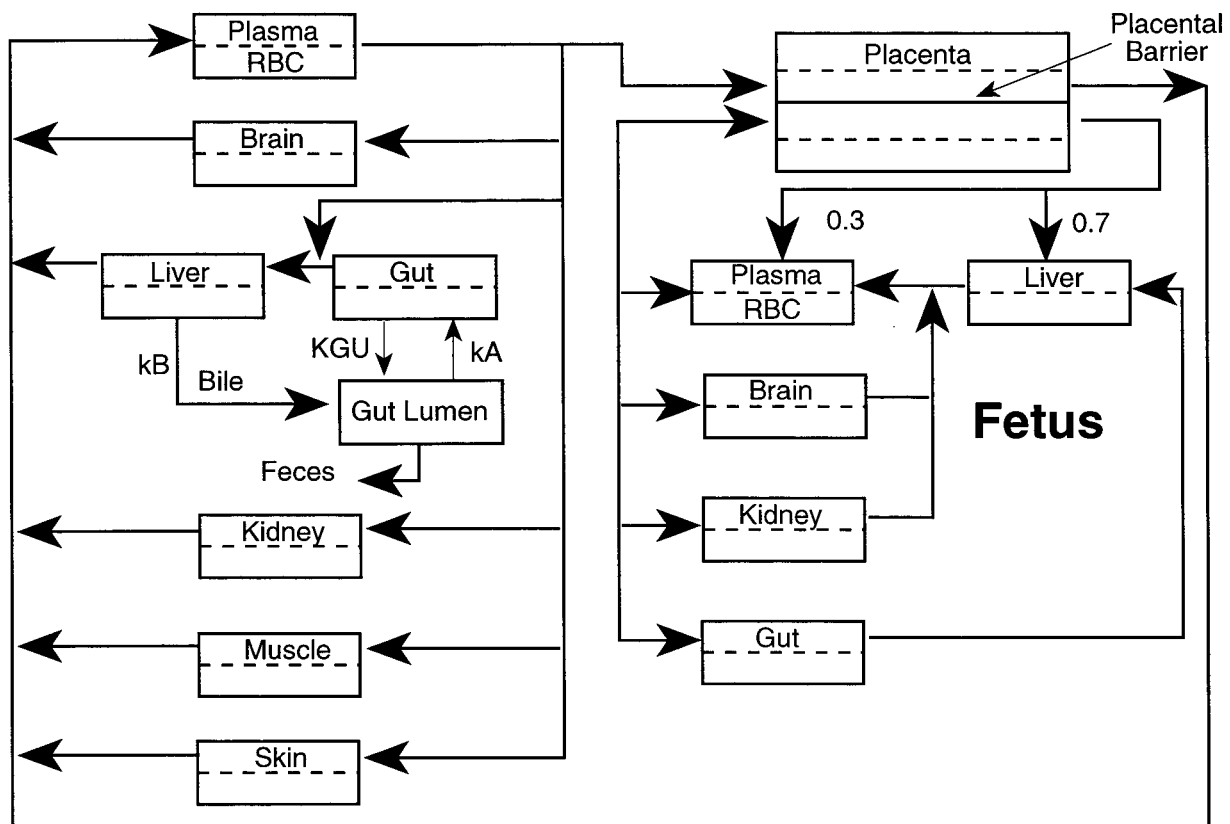

Source: Gray 1995

2. HEALTH EFFECTS

Table 2-7. Linear Binding and Membrane Transfer Constants

Tissue	Linear binding ^a	Membrane transfer (min ⁻¹)
Maternal		
Liver	14.2	0.56 ^b
Kidney	164	1.55 ^b
Brain	11.1	0.02 ^b
Red blood cells	302	1.0 ^c
Muscle	14.5	0.063 ^d
Skin	14.2	0.506
Fetal		
Placenta	102 ^c	0.064 ^c
Placental barrier	—	0.33 ^f
Liver	54.9	0.506
Kidney	21.3	1.55
Brain	23.7	0.028
Red blood cells	302	0.08 ^f

^a Wannag (1976)^b Thomas et al. (1986)^c Hirayama (1985)^d Berlin (1963)^e Mansour et al. (1974)^f Fit to Wannag (1976) data

2. HEALTH EFFECTS

Table 2-8. Secretion/Reabsorption Constants

Rate	Constant
Biliary secretion rate k_B (excretion rate ^a /liver MeHg mass ^b)	0.0021 min ⁻¹
Gut resorption rate k_A (resorption rate ^a /excretion rate x gut)	0.0026 min ⁻¹
Gut volume ^c	24.4 mL
Fecal flow rate ^c	0.069 mL/min
Excretion rate ^a (average over 10 days)	8.68x10 ⁻⁶ mg/min
Reabsorption rate (average over 10 days)	7.99x10 ⁻⁶ mg/min

^a Norseth and Clarkson 1971

^b Wannag 1976

^c Harrison and Gibaldi 1977

2. HEALTH EFFECTS

reabsorption rate of secreted or shed methylmercury in the gut implicitly accounts for the amount converted (i.e., the amount of demethylated mercury that subsequently would not be reabsorbed).

Published data were used directly or to estimate values for the maternal and fetal extracellular space, maternal plasma volume and flow expansion during pregnancy, and maternal and fetal organ volumes and plasma flow.

The model was run with a single intravenous bolus dose of 1 mg/kg at various times during a 22-day rat gestation period and compared with previously published (different author) maternal and fetal organ concentrations. The model was also run with a daily dosing for 98 days, ending on Gd 20, to simulate a typical human dietary exposure pattern for a frequent consumer of methylmercury-contaminated food.

Validation of the model. The Gray model simulations were validated against published values in the literature for mercury concentrations in maternal and fetal rat tissue from a variety of dosing patterns over the 22-day rat gestation period. Model-derived estimates of methylmercury half-life in red blood cells of 14.8 days for the rat were consistent with published values from 14 to 16 days. Consistent values were also obtained for the timing of the peak mercury concentration in the brain. Model estimates were in agreement with published values for most tissue mercury concentrations for dosing at various times, with percent differences generally <25%. Model estimates of maternal kidney methylmercury concentrations were consistently below published values, possibly due to an underestimate of the inorganic fraction of mercuric mercury in the kidneys.

The model results for a total fetal methylmercury concentration of 0.79% 24 hours after maternal methylmercury dosing on Gd 19 compare favorably with published values of 0.6 and 0.88% for administered doses on Gd 19 and 20, respectively.

No human data were presented to validate the model, and validation was not performed for other routes of mercury exposure.

Target tissues. The target tissues for this model included the blood, liver, gut, kidneys, and brain.

Species extrapolation. The model validated the use of published data for the rat. No other species were tested, and data from other species were not used to validate the model. The author, however,

2. HEALTH EFFECTS

suggests that generally good agreement between the model simulated results and the published values indicate that the model accurately reflects the underlying biological processes and that scaling factors for species-to-species extrapolations should be considered.

High-low dose extrapolations. No data were presented to evaluate the utility of the model for high-to-low dose extrapolations. A continuous exposure was simulated, but it was not validated against published data.

Interroute extrapolation. Only the intravenous route of exposure was evaluated. No data were presented to evaluate the validity of the model in extrapolating to an oral, inhalation, or dermal route of exposure. No compartment was included in the model for the lungs. Although a skin compartment was included in the model, absorption from a dermal application of methylmercury was not addressed.

2.4 MECHANISMS OF ACTION

2.4.1 Pharmacokinetic Mechanisms

The absorption of metallic mercury through the lungs is by rapid diffusion. It is suggested that oral absorption of inorganic mercury compounds depends on their dissociation in the intestinal tract. In several cases, the underlying mechanism for the toxic effects of mercury has been attributed to the high affinity of mercury for protein-containing sulfhydryl or thiol groups.

The mechanism of absorption for metallic mercury vapors is rapid diffusion across alveolar membranes (Berlin et al. 1969; Clarkson 1989). Mercury distribution in the brains of mercury-sensitive SJL/N mice exposed for 10 weeks (5 days per week) to relatively high concentrations (0.5–1.0 mg/m³) of mercury vapor was found to be affected by the magnitude of exposure (Warfvinge 1995). In animals exposed to 0.5 mg/m³ for 19 hours a day or 1 mg/m³ for 3 hours a day, mercury was found in almost the entire brain, whereas in those exposed to 0.3 mg/m³ for 6 hours a day, mercury was primarily found in the neocortical layer V, the white matter, the thalamus, and the brain stem. In mice exposed to 1 mg/m³ for just 1.5 hours a day, the white matter and brain stem were the targets for mercury accumulation. These findings in mice were generally in agreement with brain distribution patterns observed in mercury-sensitive rats (Schionning et al. 1991; Warfvinge et al. 1992), except that the white matter was not found to be a target for mercury accumulation.

2. HEALTH EFFECTS

Oral absorption of metallic mercury is low, possibly because of an *in vivo* conversion to divalent mercury and subsequent binding to sulfhydryl groups, or possibly because of poor absorption of the elemental form. For inorganic mercuric compounds, the low absorption in the lungs is probably due to the deposition of particles in the upper respiratory system that should be cleared rapidly (Friberg and Nordberg 1973). Solubility and other chemical properties may also be factors in the absorption. The mechanism for intestinal absorption of inorganic mercuric mercury may also involve the process of diffusion, and the absorption rate is proportional to the concentration of mercury in the lumen of the intestines (Piotrowski et al. 1992). The extent of transport of inorganic mercury across the intestinal tract may depend on its solubility (Friberg and Nordberg 1973) or on how easily the compounds dissociate in the lumen (Endo et al. 1990). Absorption of mercurous compounds is less likely, probably because of solubility (Friberg and Nordberg 1973) or its conversion into the divalent cation in the gastrointestinal tract.

The divalent cation exists in both a nondiffusible form (tissues) and a diffusible form (blood) (Halbach and Clarkson 1978; Magos 1967) (see Section 2.3.2). The mechanism for the distribution of mercury and its compounds probably depends on the extent of uptake of the diffusible forms into different tissues or on the mercury-binding to protein-binding sites (sulfhydryl groups) in red cells and plasma proteins (Clarkson 1972b).

Mechanisms for the toxic effects of inorganic and organic mercury are believed to be similar. It has been suggested that the relative toxicities of the different forms of mercury (e.g., metallic, monovalent, and divalent cations and methyl- and phenylmercury compounds) are related, in part, to its differential accumulation in sensitive tissues. This theory is supported by the observation that mercury rapidly accumulates in the kidneys and specific areas of the central nervous system (Rothstein and Hayes 1960; Somjen et al. 1973).

The accumulation of methylmercury and inorganic mercury in the brain of female monkeys (*Macaca fascicularis*) was studied by Vahter et al. (1994). In this study, animals received oral doses of 50 µg/kg/day for either 6, 12, or 18 months. In normal-weight monkeys (2.4–4.1 kg), a steady-state blood concentration for total mercury was attained in approximately 4 months. The elimination half-life in the blood was found to be 26 days. Accumulation in the brain appeared to be biphasic, with an elimination half-life of 35 days for brain methylmercury in those monkeys exposed for 12 months. The elimination half-life of inorganic mercury, on the other hand, was reported to be on the order of years. It was also found that inorganic mercury accounted for approximately 9% of the total brain mercury at 6–12 months, 18% at

2. HEALTH EFFECTS

18 months, and 74% 6 months after termination of exposure. The authors stated that the presence of inorganic mercury in the brain was thought to be the result of demethylation of methylmercury in the brain. In heavier monkeys, there was a limited distribution of mercury in the fat. A finding of higher brain concentrations in the heavy monkeys than in those of normal weight was probably due to higher blood mercury levels and a higher brain-to-blood distribution ratio. *In vivo* methylation of inorganic mercury, on the other hand, was not shown to occur in occupationally exposed workers (Barregard et al. 1994a, 1994b), contrary to the findings of previous *in vitro* studies.

Distribution of organic mercury is believed to involve complexes with proteins in the body. Methylmercury associates with water-soluble molecules (e.g., proteins) or thiol-containing amino acids because of the high affinity of the methylmercuric cation (CH_3Hg^+) for the sulfhydryl groups ($\text{SH}-$) (Aschner and Aschner 1990). Complexes of methylmercury with cysteine or glutathione have been identified in blood, liver, and bile (Aschner and Aschner 1990). The transport of methylmercury to the brain after subcutaneous injection appears to be closely linked to thiol-containing amino acids (Aschner and Clarkson 1988). The methylmercury cation can bind to the thiol group of the amino acid cysteine, forming a complex in which the valence bonds link the mercury atom to adjacent iron and sulfur atoms at an 180° angle, creating a chemical structure similar to that of the essential amino acid methionine (Clarkson 1995). In such a manner, methylmercury can cross the blood-brain barrier "disguised" as an amino acid via a carrier-mediated system (i.e., transport is not solely the result of methylmercury's lipid solubility). The uptake of methylmercury by the brain is inhibited by the presence of other amino acids such as leucine, methionine, phenylalanine, and other large neutral amino acids (Clarkson 1995).

The mechanism by which methylmercury crosses the blood-brain barrier has also been examined in the rat using a rapid carotid infusion technique (Kerper et al. 1992). The results of this study also showed that methylmercury may enter the brain as a cysteine complex. The uptake of $\text{Me}_2\text{O}_3\text{Hg}$ complexed with either L- or D-cysteine was measured as a function of $\text{Me}_2\text{O}_3\text{Hg}$ -cysteine concentration in the injection solution. There was a faster rate of uptake of $\text{Me}_2\text{O}_3\text{Hg}$ -L-cysteine as compared to the D-cysteine complex. The nonlinearity of $\text{Me}_2\text{O}_3\text{Hg}$ -L-cysteine uptake with the increasing concentration suggests that transport of this complex is saturable, while the D-cysteine complex is taken up by simple diffusion. The mechanism for the distribution in the brain of inorganic mercury (resulting from the demethylation of organic mercury) is not well understood.

2. HEALTH EFFECTS

Strain and sex differences in renal mercury content in mice are attributable, in part, to differences in tissue glutathione content and to differences in renal γ -glutamyltranspeptidase activity, which is controlled, at least in part, by testosterone (Tanaka et al. 1991, 1992). The correlation of hepatic glutathione (or plasma glutathione) with the rate of renal uptake of methylmercury suggests that methylmercury is transported to the kidneys as a glutathione complex (Tanaka et al. 1991). In addition to strain and sex differences in renal mercury content, it has also been demonstrated using mice (133–904 days old) that the ratio of mercury in the brain to that in the liver and the kidneys increased significantly with age (Massie et al. 1993).

In a study of the absorption of inorganic mercury by the rat jejunum, Foulkes and Bergman (1993) found that while tissue mercury could not be rigorously separated into membrane-bound and intracellular compartments (as can the heavy metal cadmium), its uptake into the jejunum includes a relatively temperature-insensitive and rapid influx into a pool readily accessible to suitable extracellular chelators. A separate, slower and more temperature-sensitive component, however, leads to the filling of a relatively chelation-resistant compartment. Nonspecific membrane properties, such as surface charge or membrane fluidity, might account for mucosal mercury uptake (Foulkes and Bergman 1993).

2.4.2 Mechanisms of Toxicity

High-affinity binding of the divalent mercuric ion to thiol or sulfhydryl groups of proteins is believed to be a major mechanism for the biological activity of mercury (Clarkson 1972a; Hughes 1957; Passow et al. 1961). Because proteins containing sulfhydryl groups occur in both extracellular and intracellular membranes and organelles, and because most sulfhydryl groups play an integral part in the structure or function of most proteins, the precise target(s) for mercury is not easily determined, if indeed there is a specific target. Possibilities include the inactivation of various enzymes, structural proteins, or transport processes (Bulger 1986); or alteration of cell membrane permeability by the formation of mercaptides (Sahaphong and Trump 1971). Binding may also occur to other sites (e.g., amine, carboxyl groups) that are less favored than sulfhydryl groups. A variety of mercury-induced alterations are being investigated, including increased oxidative stress, disruption of microtubule formation, increased permeability of the blood-brain barrier, disruption of protein synthesis, disruption of DNA replication and DNA polymerase activity, impairment of synaptic transmission, membrane disruption, impairment of the immune response, and disruption in calcium homeostasis. These alterations may be acting singly or in combination.

2. HEALTH EFFECTS

Mercury has been shown to affect hepatic microsomal enzyme activity (Alexidis et al. 1994). Intra-peritoneal administration of mercuric acetate (6.2 $\mu\text{mol/kg/day}$) once daily for 6 days or once as a single dose of 15.68 $\mu\text{mol/kg}$ resulted in an increase in kidney weight and a significant decrease in total cytochrome P-450 content. The single 15.68 $\mu\text{mol/kg}$ injection resulted in the reduction of both microsomal protein level and P-450 content, possibly resulting from the generation of free radicals during the Hg^{++} intoxication process.

Through alterations in intracellular thiol status, mercury can promote oxidative stress, lipid peroxidation, mitochondrial dysfunction, and changes in heme metabolism (Zalups and Lash 1994). HgCl_2 has been shown to cause depolarization of the mitochondrial inner membrane, with a consequent increase in the formation of H_2O_2 (Lund et al. 1993). These events are coupled with a Hg^{++} -mediated glutathione depletion and pyridine nucleotide oxidation, creating an oxidant stress condition characterized by increased susceptibility of the mitochondrial membrane to iron-dependent lipid peroxidation. Lund et al. (1993) further postulated that mercury-induced alterations in mitochondrial calcium homeostasis may exacerbate Hg^{++} -induced oxidative stress in kidney cells. As a result of oxidative damage to the kidneys, numerous biochemical changes may occur, including the excretion of excess porphyrins in the urine (porphyrinuria). In a study of the mechanism of porphyrinogen oxidation by mercuric chloride, Miller and Woods (1993) found that mercury-thiol complexes possess redox activity, which promotes the oxidation of porphyrinogen and possibly other biomolecules.

The steps between thiol binding and cellular dysfunction or damage have not been completely elucidated, but several theories exist. Conner and Fowler (1993) have suggested that following entry of the mercuric or methylmercuric ion into the proximal tubular epithelial cell by transport across either the brush-border or basolateral membrane, mercury interacts with thiol-containing compounds, principally glutathione and metallothionein. This interaction initially produces alterations in membrane permeability to calcium ions and inhibition of mitochondrial function. Through unknown signaling mechanisms, mercury subsequently induces the synthesis of glutathione, various glutathione-dependent enzymes, metallothionein, and several stress proteins (Conner and Fowler 1993). In the kidneys, epithelial cell damage is believed to occur as the result of enhanced free radical formation and lipid peroxidation (Gstraunthaler et al. 1983). Treatment with mercury results in depletion of cellular defense mechanisms against oxidative damage such as glutathione, superoxide dismutase, catalase, and glutathione peroxidase (Gstraunthaler et al. 1983). Further, enhancement of glutathione peroxidase has been observed in mercury-treated rats in direct relationship with kidney mercury content (Guillermina and Elias 1995), but inhibition of renal redox cycle

2. HEALTH EFFECTS

enzymes *in vivo* did not appear to be a significant determinant of the increased lipid peroxidation observed during HgCl₂-induced nephrotoxicity. The selenium-dependent form of glutathione peroxidase is highly sensitive to inhibition by mercury, and it has been proposed that mercury interactions with selenium in the epithelial cells limit the amount of selenium available for this enzyme (Nielsen et al. 1991). Depletion of mitochondrial glutathione and increases in mitochondrial hydrogen peroxide at the inner mitochondrial membrane (Lund et al. 1991) may contribute to acceleration of the turnover of potassium and magnesium observed at this membrane (Humes and Weinberg 1983). Acute renal failure resulting from mercury exposure has been proposed to result from decreased renal reabsorption of sodium and chloride in the proximal tubules and increased concentrations of these ions at the macula densa (Barnes et al. 1980). This increase in ions at the macula densa, in turn, results in the local release of renin, vasoconstriction of the afferent arteriole, and filtration failure. These authors based this hypothesis on the observation that saline pretreatment of rats prior to mercuric chloride treatment did not prevent the proximal tubular damage but did prevent the acute renal failure. The saline pretreatment was suggested to have depleted the glomerular renin and thereby prevented the cascade of events occurring after accumulation of sodium and chloride ions at the glomerular macula densa (Barnes et al. 1980). A pivotal role for extracellular glutathione and membrane-bound γ -glutamyltransferase has also been identified in the renal incorporation, toxicity, and excretion of inorganic mercury (HgCl₂) in rats (Ceaurreiz et al. 1994).

A similar mechanism for the promotion of neuronal degeneration by mercury has been proposed (Sarafian and Verity 1991). Increases in the formation of reactive oxygen species in several brain areas have been observed following intraperitoneal administration of methylmercuric chloride to rodents (Ali et al. 1992; LeBel et al. 1990, 1992). A dissociation between increases in lipid peroxidation and cytotoxicity has been demonstrated by showing inhibition of the lipid peroxidation with α -tocopherol without blocking the cytotoxicity (Verity and Sarafian 1991). These authors were able to show partial protection against the cytotoxicity with ethylene glycol tetra-acetate (EGTA), suggesting that increases in intracellular calcium may play a role in the cytotoxicity. They ultimately concluded that a synergistic interaction occurred between changes in intracellular calcium homeostasis and intracellular thiol status, culminating in lipoperoxidation, activation of Ca²⁺-dependent proteolysis, endonuclease activation, and phospholipid hydrolysis (Verity and Sarafian 1991). It has been suggested that neurons are highly sensitive to mercury either because of their low endogenous glutathione content or their inefficient glutathione redox activity. Inhibition of protein synthesis has been reported in neurons from rats exposed to methylmercury (Syversen 1977). However, it is unknown whether this inhibition is secondary to neuronal cytotoxicity.

2. HEALTH EFFECTS

At the functional level, both mercuric chloride and methylmercury have been shown to induce a slow inward current in patch-clamped dorsal root ganglion cells (Arakawa et al. 1991). The current does not appear to be mediated by either the sodium or calcium channels, but it may be activated by increases in intracellular calcium. Such slow inward currents suppress voltage- and neurotransmitter-activated currents. Studies of the effects of inorganic mercury, methylmercury, and phenylmercuric acetate on synaptic transmission in rat hippocampal slices (Yuan and Atchison 1994) revealed that the mechanisms that underlie the effects of various mercurials on central synaptic transmission differ with respect to the sites of action, the potency, and the reversibility of the effect. Inorganic mercury (Hg^{++}) appeared to act primarily on the postsynaptic neuronal membrane, whereas the action of methylmercury and phenylmercuric acetate was at both the pre- and postsynaptic sites but primarily on the postsynaptic membranes. Yuan and Atchison (1994) suggested that these differences may result, in part, from the differences in lipophilicity among the different mercurials studied. Differences in lipophilicity were also implicated by Roed and Herlofson (1994) as playing a role in the different effects produced by methylmercuric chloride and mercuric chloride. Roed and Herlofson (1994) suggested that the high lipid solubility of methylmercuric chloride may divert that organomercurial to the myelin of the nerve, where it very efficiently inhibits neuronal excitability. Further, they suggested that mercuric chloride probably causes inhibitory activity by binding to sulfhydryl groups in transport proteins that convey the messenger function of intracellular Ca^{++} . This, in turn, leads to both inhibition of muscle contraction and enhancement of HgCl_2 -induced neuronal inhibition. The authors further suggest that HgCl_2 inhibits an internal Ca^{++} signal necessary for choline re-uptake and acetylcholine resynthesis.

Gallagher and Lee (1980) evaluated the similarity of inorganic and organic mercury toxicity to nervous tissue by injecting equimolar concentrations of both mercuric chloride and methylmercuric acetate directly into the cerebrum of rats, thereby circumventing systemic metabolic conversion pathways. The lesions induced by mercuric chloride were expected to have been much greater after the mercuric chloride injection, since this process circumvents the necessity for biotransformation. However, the lesions were only slightly larger than those seen after methylmercury injection, suggesting that there is a mechanism for organic mercury neurotoxicity that does not involve conversion into inorganic mercury. This suggestion is supported by the findings of Magos et al. (1985) who failed to establish a correlation between neuronal, cytoplasmic, mercuric ions and neuronal degeneration, or clinical evidence of neurotoxicity. These results do not, however, preclude the possibility that intracellular transport of mercuric mercury may be limited, and the limitations on transport may determine the effects observed.

2. HEALTH EFFECTS

Recent data from an *in vitro* study suggest that mercuric mercury may be more effective than methylmercury in some paradigms. Using patch-clamped dorsal root neurons, Arakawa et al. (1991) showed augmentation of the GABA-activated chloride current at extremely low mercuric chloride concentrations (0.1 μM), while a 1,000-fold higher concentration of methylmercury showed no such effect. The correlation between these effects observed *in vitro* and what may be occurring *in vivo*, however, is not known.

The experimental data concerning the mechanism of action of methylmercury on the developing nervous system indicate that effects on the microtubules and amino acid transport are disrupted in neuronal cells before overt signs of intoxication are observed. Vogel et al. (1985) demonstrated the potent inhibitory effects of methylmercury on microtubule assembly at ratios stoichiometric with the tubulin dimer. The effects were thought to be mediated through MeHg binding to free sulfhydryl groups on both ends and on the surface of microtubules, which would provide multiple classes of binding sites for MeHg. In subsequent *in vitro* studies, Vogel et al. (1989) identified a single high affinity class of binding sites on tubulin for methylmercury with 15 sites. The authors report that MeHg binds to tubulin stoichiometrically within microtubules, and does not induce microtubule disassembly at this low binding ratio. Free subunits of tubulin, however, will act as uncompetitive inhibitors for MeHg binding to the polymer, and MeHg binding to the multiple sites in the free dimer blocks subsequent assembly. In contrast, the stoichiometric polymer surface binding sites for MeHg in microtubules apparently do not interfere with subsequent polymerization. Mitotic inhibition from damage to microtubulin and binding to tubulin has also been reported by Sager et al. (1983).

Comparison of the effects of mercury on structural elements and enzyme activities (Vignani et al. 1992) suggests that effects on cytoskeletal elements may be observed at lower concentrations than on enzyme activities. In the *in vivo* study by Sager et al. (1982), it was concluded that methylmercury may be acting on mitotic spindle microtubules leading to cell injury in the developing cerebellar cortex. Cell injury observed in the external granular layer of the cerebellar cortex of 2-day-old rats was attributed to a reduced percentage of late mitotic figures (arrested cell division) due to the loss of spindle microtubules. Mitosis and migration of granule cells in the cerebellum end within weeks following birth; therefore, this observation may suggest potential differences in the sensitivities of children and adults to mercury-induced neurotoxicity. The toxic effects of methylmercury on the developing nervous system may also be due to deranged neuronal cell migration (Choi et al. 1978; Matsumoto et al. 1965). Examination of the brains of two infants who died following *in utero* exposure to methylmercury revealed an abnormal pattern in the

2. HEALTH EFFECTS

organization and a distorted alignment of neurons in the cerebral cortex. Exposures first occurred during the critical period of neuronal migration (from gestation week 7 into the third trimester) in the fetus. Both could result from a direct effect of mercury on microtubule proteins. Cell division and cell migration both require intact microtubules for normal functioning and, therefore, have been suggested as primary targets for methylmercury disruption in the developing nervous system. It is hypothesized by Aschner and Clarkson (1988) that the uptake of methylmercury through the blood-brain barrier in developing and mature animals is closely linked to amino acid transport and metabolism because of the infusion of L-cysteine enhanced ^{203}Hg uptake. The enhanced transport in the fetus may be a result of the immaturity of the transport systems in the blood-brain barrier or of possible physical immaturity of the barrier itself. Methylmercury has also been shown to increase intracellular Ca^{++} and inositol phosphate levels (Sarafian 1993). The observed stimulation of protein phosphorylation in rat cerebral neuronal culture was believed to be the result of elevation of intracellular second messengers (Ca^{++} , inositol phosphate) rather than to a direct interaction between methylmercury and protein kinase enzymes. This observation was considered to suggest a specific interference with neuronal signal transduction.

The mercuric ion is also an extremely potent inhibitor of microtubule polymerization, both *in vivo* and *in vitro* (Duhr et al. 1993). Duhr and his colleagues further reported that the ability of Hg^{++} to inhibit microtubule polymerization or to disrupt already formed microtubules not only cannot be prevented by binding with the chelating agents EDTA and EGTA, but that the binding of these two potent chelators potentiates the Hg^{++} -induced inhibition of tubulin polymerization by disrupting the interaction of GTP with the E-site of brain beta-tubulin, an obligatory step in the polymerization of tubulin.

Mercury has been shown to inhibit a variety of enzymes in the nervous system. The effects of mercuric chloride and methylmercuric chloride on the activity of protein kinase C in rat brain homogenate were studied by Rajanna et al. (1995). In this study, it was found that both forms of mercury inhibited protein kinase C activity in a dose-dependent manner at micromolar concentrations, with methylmercury being a more potent inhibitor than HgCl_2 . Mercuric chloride has also been shown to cause the inhibition and ultrastructural localization of cerebral alkaline phosphatase (Albrecht et al. 1994) following a single intraperitoneal injection of 6 mg HgCl_2/kg body weight. The observed inhibition and subsequent translocation of alkaline phosphatase activity from the luminal to abluminal site and the accompanying ultrastructural alterations were reported to be typical of the formation of "leaky" microvessels known to be associated with damage to the blood-brain barrier. Mercuric chloride has also been demonstrated to block the uptake of $[^3\text{H}]$ -histamine by cultured rat astroglial cells and brain endothelial cells (Huszti and Balogh

2. HEALTH EFFECTS

1995). This effect was seen at mercury concentrations as low as 1 μM , and the inhibition was greater in astroglial cells than in the cerebral endothelial cells. At a concentration of 100 μM , however, HgCl_2 caused the stimulation of histamine uptake, which was greater in the cerebral endothelial than in the astroglial cells. The mechanisms of these dose-dependent effects were considered to be different, with the inhibition of histamine uptake associated with the loss of the transmembrane Na^+ and/or K^+ gradient and the stimulation of histamine uptake by the higher mercury concentration being possibly related to a direct effect on the histamine transporter.

Sekowski et al. (1997) used an intact human cell multiprotein complex (which they call a DNA synthesome) to evaluate the effects of mercuric chloride on DNA synthesome-mediated *in vitro* DNA replication and DNA synthesis. The authors state that the DNA synthesome has the advantage of providing the highly ordered environment in which DNA replication occurs while allowing more precise identification of the mechanism or site of effects than possible from the use of whole cells. The results showed that DNA replication and DNA polymerase activity, as well as DNA replication fidelity of the human cell synthesome, were specifically inhibited by mercuric ion at physiologically attainable concentrations. The results suggest that mercuric ions (at concentrations above 10 μM) actively inhibit the elongation stage of DNA replication.

It has been shown that Hg^{++} promotes dose-dependent toxic effects on heart muscle through actions on the sarcolemma, the sarcoplasmic reticulum, and contractile proteins (Oliveira et al. 1994). In this study, inorganic mercury (HgCl_2) was shown to have a dose-dependent effect on rat papillary muscle, with a concentration of 1 μM causing a small increase in the force of isometric contraction. Concentrations of 2.5, 5, and 10 μM produced a dose-dependent decrease in contractile force. The rate of force development, however, was effected differently, increasing at 1 and 2.5 μM Hg^{++} but decreasing to control levels at 5 and 10 μM concentrations. Oliveira et al. (1994) suggested that this response was due to an observed progressive reduction in the time to peak tension with increasing mercury concentrations, an effect they attributed to the binding of mercuric ions to SH groups inducing Ca^{++} release from the sarcoplasmic reticulum, the activity of which itself was depressed by mercury in a dose-dependent fashion. Further, tetanic tension did not change during treatment with 1 μM Hg^{++} but decreased with 5 μM , suggesting a toxic effect on the contractile proteins only at high Hg^{++} concentrations (Oliveira et al. 1994).

The molecular events leading to activation of the autoimmune response in susceptible individuals have yet to be fully elucidated. However, chemical modification of major histocompatibility complex (MHC) class

2. HEALTH EFFECTS

II molecules or modification of self peptides, T-cell receptors, or cell-surface adhesion molecules has been suggested (Mathieson 1992). The immune suppressive effect of mercury has been examined in human B-cells (Shenker et al. 1993). This study showed inhibition of B-cell proliferation, expression of surface antigens, and synthesis of IgG and IgM by both methylmercury and mercuric mercury. These chemicals caused a sustained elevation of intracellular calcium. Based on concurrent degenerative changes in the nucleus (hyperchromaticity, nuclear fragmentation, and condensation of nucleoplasm) in the presence of sustained membrane integrity, the author suggested that the increase in intracellular calcium was initiating apoptic changes in the B-cells, ultimately resulting in decreased viability.

The glomerulopathy produced by exposure of Brown-Norway rats to mercuric chloride has been related to the presence of antilaminin antibodies (Icard et al. 1993). Kosuda et al. (1993) suggest that both genetic background and immune regulatory networks (possibly acting through T-lymphocytes of the RT6 subset) may play an important role in the expression of autoimmunity after exposure to mercury. A strain (Brown-Norway) of rats known to be susceptible to mercury-induced production of autoantibodies to certain renal antigens (e.g., laminin) and autoimmune glomerulonephritis was compared to a nonsusceptible strain (Lewis). Different responses to subcutaneous injections of mercuric chloride regarding RT6⁺ T-lymphocytes (a subpopulation of lymphocytes considered to have possible immunoregulatory properties) were observed. While a relative decrease in RT6⁺ T-cells occurring with the development of renal autoantigen autoimmune responses was observed in the mercury-treated Brown-Norway rats, the Lewis rats did not develop renal autoimmunity and were found to have undergone significant change in the RT6⁻-to-RT6⁺ T-lymphocyte ratio. When Brown-Norway-Lewis F₁ hybrid rats were similarly dosed, effects similar to those in the Brown-Norway strain were seen, with the autoimmune responses to kidney antigens occurring concomitantly with a change in RT6 population proportionally in favor of T-lymphocytes that do not express the RT6 phenotype. Kosuda et al. (1993) proposed that there are both endogenous and exogenous components of mercury-induced autoimmunity. The endogenous (a genetically determined) component includes T-cell receptors, the major histocompatibility complex, and an immunoregulatory network based upon a rather delicate balance between helper and suppressor (e.g., the RT6⁺ T-lymphocytes) cells; whereas the exogenous component is represented by an environmental factor (e.g., mercury) capable of altering the balance within the immunoregulatory network. The manifestation of autoimmunity requires the presence and interaction of both of these components. In a similar study, Castedo et al. (1993) found that mercuric chloride induced CD4⁺ autoreactive T-cells proliferate in the presence of class II⁺ cells in susceptible Brown-Norway rats as well as in resistant Lewis rats. However, while those cells were believed to collaborate with B-cells in Brown-Norway rats to produce

2. HEALTH EFFECTS

autoantibodies, in Lewis rats they apparently initiate a suppressor circuit involving antiertgotypic CD8⁺ suppressor cells.

In Brown-Norway rats given 5 subcutaneous 1 mg/kg injections of mercuric chloride over a 10-day period, tissue injury (including vasculitis) was seen within 24 hours of the first injection (Qasim et al. 1995). The rapid onset of tissue injury suggests that cells other than T-cells may be involved in the primary induction of vasculitis typically seen as a response to mercuric chloride in this species. It is possible that this injury occurs through a direct action of HgCl₂ on neutrophils or through activation of mast cells, resulting in the release of TNF and IL8, which promote chemotaxis and activation of neutrophils. However, the changes in the Th2-like (CD4⁺CD45) T-cell subsets seen in this study were considered to provide support for the hypothesis that a rise in T helper cells drives the observed autoimmune syndrome, providing B-cell help, which leads to polyclonal activation and production of a range of antibodies.

Jiang and Moller (1995) found that mercuric chloride induced increased DNA synthesis *in vitro* (peak activity between days 4 and 6) in lymphocytes from several mouse strains and suggested a crucial role for helper T-cells in HgCl₂-induced immunotoxicity. The results of this study indicated that: (1) mercuric chloride activated CD4⁺ and CD8⁺ T-cells (*in vitro*) in a manner analogous to a specific antigen-driven response; (2) activation was dependent upon the presence of accessory cells; and (3) helper T-cells were induced to divide and transform in responder organ cells. This led Jiang and Moller (1995) to hypothesize that mercury binds to molecules on the antigen-presenting cell (APC) and transforms molecules on these cells to superantigens capable of activating T-cells with a particular set of antigen-binding receptors. In this manner, mercury could induce an internal activation of the immune system, which would in turn result in a variety of symptoms in predisposed individuals.

Both mercuric chloride (1 μM) and methylmercury (2 μM) have been shown to increase intracellular Ca⁺⁺ concentrations in splenic lymphocytes in a concentration-dependent manner (Tang et al. 1993). The time course for the effect was, however, different for the two mercurials. In the case of methylmercury, the increase in intracellular Ca⁺⁺ was rapid and the increased level was sustained over time, whereas the Ca⁺⁺ rise caused by HgCl₂ was slower. While the effects of those mercurials did not appear to be associated with alterations of membrane integrity, both HgCl₂ and methylmercury did appear to cause membrane damage when the incubation time was extended. This study also found that methylmercury and mercuric chloride appear to exert their effects on internal lymphocyte Ca⁺⁺ levels in different ways. Methylmercury increases intracellular Ca⁺⁺ by both an apparent increase in the permeability of the membrane to

2. HEALTH EFFECTS

extracellular Ca^{++} and the mobilization of Ca^{++} from intracellular stores (perhaps the endoplasmic reticulum and mitochondria), whereas HgCl_2 causes only an increased influx of extracellular Ca^{++} .

2.4.3 Animal-to-Human Extrapolations

Mechanisms for the end toxic effects of inorganic and organic mercury are believed to be similar, and the differences in parent compound toxicity result from difference in the kinetics and metabolism of the parent compound. Animal models generally reflect the toxic events observed in humans (i.e., neurological for methylmercury toxicity and the kidneys for inorganic mercury); however, there are species and strain differences in response to mercury exposure. Prenatal exposures in animals result in neurological damage to the more sensitive developing fetus as is the case in humans. The observed inter- and intraspecies differences in the type and severity of the toxic response to mercury may result from differences in the absorption, distribution, transformation, and end tissue concentration of the parent mercury compound. For example, C57BL/6, B10.D2, B10.S inbred mice accumulated higher concentrations of mercury in the spleen than A.SW, and DBA/2 strains, subjected to the same dosage regimen. The higher concentration of splenic mercury in C57BL/6, B10.D2, B10.S correlated with the increased susceptibility of these strains to a mercury chloride-induced systemic autoimmune syndrome. The lower splenic mercury in A.SW, and DBA/2 strains resulted in more resistance to an autoimmune response (Griem et al. 1997).

A better understanding of certain physiological and biochemical processes affecting mercury kinetics may help explain these species differences. Specific processes that appear likely determinants include differences in demethylation rates affecting methylmercury fecal secretion, reabsorption, and membrane transport (Farris et al. 1993); differences in tissue glutathione content and renal γ -glutamyltranspeptidase activity (Tanaka et al. 1991, 1992), differences in antioxidative status (Miller and Woods 1993), differences in plasma cysteine concentrations compared with other thiol-containing amino acids (Aschner and Clarkson 1988; Clarkson 1995), and differences in factors that could affect gut lumenal uptake (Foulkes and Bergman 1993; Urano et al. 1990). Better controls and reporting of dietary factors, volume and timing of doses, and housing conditions would assist in the comparisons of effects among species and strains.

Further development of PBPK/PBPD models will assist in addressing these differences and in extrapolating animal data to support risk assessments for mercury exposure in humans.

2. HEALTH EFFECTS

2.5 RELEVANCE TO PUBLIC HEALTH**OVERVIEW**

The nature and severity of the toxicity that may result from mercury exposure are functions of the magnitude and duration of exposure, the route of exposure, and the form of the mercury or mercury compound to which exposure occurs. Since the ultimate toxic species for all mercury compounds is thought to be the mercuric ion, the kinetics of the parent compound are the primary determinant of the severity of parent compound toxicity. It is differences in the delivery to target sites that result in the spectrum of effects. Thus, mercury, in both inorganic and organic forms, can be toxic to humans and other animals.

Ingestion of methylmercuric chloride, for example, is more harmful than ingestion of an equal amount of inorganic salts (e.g., mercuric chloride or mercuric acetate), since methylmercury is more readily absorbed through the intestinal tract (about 95%) than are mercuric salts (about 10–30%). In turn, ingestion of inorganic mercury salts is more harmful than ingestion of an equal amount of liquid metallic mercury, because of negligible absorption of liquid metallic mercury (about 0.01%) from the gastrointestinal tract. There is insufficient information to develop a complete matrix of effects for different mercury forms by route of exposure. The information on inhalation exposure to mercury is limited primarily to metallic mercury; only a few case studies are available for exposure to inorganic dusts or volatile organomercurials.

Inorganic salts of mercury do not readily cross the blood-brain barrier or the placenta. They are, therefore, ultimately less toxic to the central nervous system and the developing fetus than either absorbed metallic mercury or organic mercury compounds. Metallic mercury is more readily oxidized to mercuric mercury than is methylmercury, so its transport across the placenta and into the brain may be more limited than that of methylmercury. Once in the central nervous system, however, metallic mercury vapor is oxidized to the mercuric ion (Hg^{++}), which is then trapped in the central nervous system due to the limited ability of the mercuric ion to cross the blood-brain barrier. Mercurous salts are relatively unstable in the presence of sulfhydryl groups and readily transform to metallic mercury and mercuric mercury. Thus, mercurous forms of mercury will possess the toxic characteristics of both metallic and mercuric mercury. All mercury compounds may ultimately be oxidized to divalent (or mercuric) mercury, which preferentially deposits in the kidneys, and all mercury compounds may cause some degree of renal toxicity. While this is not

2. HEALTH EFFECTS

typically the first effect noted in all forms of mercury exposure, it can be an ultimate effect of either low-dose chronic intake or high-dose acute mercury exposure.

The most sensitive end point following oral exposure of any duration to inorganic salts of mercury appears to be the kidneys. Liquid metallic mercury can volatilize at ambient temperatures. The absorption of metallic mercury vapors from lungs is high (about 80%) (Hursh et al. 1976), and the most sensitive target following inhalation exposure to metallic mercury is the central nervous system. Absorbed metallic mercury crosses the placenta, and the fetal blood may concentrate mercury to levels 10 or more times the levels found in the maternal blood. Therefore, the developing fetal nervous system may be quite sensitive to maternal exposures to mercury vapors.

Salts of mercury and organic mercury compounds are far less volatile than liquid mercury under most conditions. Inhalation of mercury vapors from these forms is not considered a major source of exposure. While inhalation of particulate matter containing mercury salts and/or organic compounds is possible, intestinal absorption is a more likely route of exposure. The most sensitive end point for oral exposure to alkyl mercury compounds (e.g., methylmercuric chloride or ethylmercurials) is the developing nervous system, but toxicity to the adult nervous system may also result from prolonged low-dose exposures. Mercury may adversely affect a wide range of other organ systems, if exposures are sufficiently high. These effects may result from the mercuric ion's affinity for sulfhydryl groups, which are ubiquitous in animal tissue.

Pharmacokinetic studies indicate that repeated or continuous exposure to any form of mercury can result in the accumulation of mercury in the body. Numerous studies using laboratory animals have shown that retention of mercury in the brain may persist long after cessation of short- and long-term exposures. Mercury is unusual in its ability to induce delayed neurological effects. This is especially prevalent with exposure to alkyl mercury compounds. In such cases, the onset of adverse effects may be delayed for months after the initial exposure. The delayed effects of methyl- and dimethylmercury reported in human poisonings are thought, in part, to result from binding to red blood cells, and subsequent slow release. Methylmercury also forms a complex in plasma with the amino acid cysteine, which is structurally similar to the essential amino acid methionine (Aschner and Clarkson 1988). Clarkson (1995) proposed that methylmercury can cross the blood-brain barrier "disguised" as an amino acid via a carrier-mediated system (i.e., transport is not solely the result of methylmercury's lipid solubility).

2. HEALTH EFFECTS

Phenylmercuric acetate is another form of organic mercury to which the general public may be exposed. Although phenylmercury compounds are considered organomercurials, they are absorbed less efficiently by the gastrointestinal tract than is methylmercury. Once inside the body, phenylmercury is rapidly metabolized to Hg^{++} , and its effects are, therefore, similar to those of mercuric salts.

Dimethylmercury is an extremely toxic form of organic mercury, and very small exposures can cause severe and irreversible delayed neurotoxicity, including death. Dimethylmercury is thought to be metabolized to methylmercury prior to crossing the blood-brain barrier. Dimethylmercury is used in the calibration of laboratory equipment, as a reagent, and in the manufacture of other chemicals. Unlike other forms of mercury, dimethylmercury is quickly absorbed through intact skin, and it will penetrate latex or polyvinyl gloves. It is highly volatile, will readily evaporate, and can be inhaled. Based on its vapor pressure of 58.8 mm at 23.7 EC, Toribara et al. (1997) estimated that a cubic meter of saturated air could hold more than 600 g of dimethylmercury. A recent case history of a chemist who died from an accidental spill of dimethylmercury is prompting calls for its removal as an analytical standard as a safety precaution to prevent further accidents.

Upon significant inhalation exposure to metallic mercury vapors, some people (primarily children) may exhibit a syndrome known as acrodynia, or pink disease. Acrodynia is often characterized by severe leg cramps; irritability; and erythema and subsequent peeling of the hands, nose, and soles of the feet. Itching, swelling, fever, tachycardia, elevated blood pressure, excessive salivation or perspiration, morbilliform rashes, fretfulness, sleeplessness, and/or weakness may also be present. It was formerly thought that this syndrome occurred exclusively in children, but recent reported cases in teenagers and adults have shown that these groups are also susceptible.

Occupational mercury exposures generally occur when workers inhale metallic mercury vapors. Some dermal absorption may occur from skin contact with contaminated air, but the rate is low (less than 3% of the inhaled dose). Dialkyl mercury compounds, which are not normally found in hazardous waste sites, are rapidly and extensively absorbed from both dermal and inhalation routes of exposure.

Mercury is a naturally occurring element in the earth's crust. It is considered to have been a component of the lithosphere since the planet was formed approximately 4.5 billion years ago. However, levels of mercury at or near the earth's surface (environmental background levels) are increasing as mercury continues to be released from the earth's crust by both natural (weathering, volcanoes) and human (mining,

2. HEALTH EFFECTS

burning of fossil fuels) activities. Background levels, however, are considerable below harmful levels. There are a number of possible pathways for exposure to mercury. For a hazardous waste site that contains mercury that is being released to the environment, pathways that could result in human exposure to mercury include: (1) eating fish or wild game near the top of the food chain (i.e., larger fish, larger mammals) that have accumulated mercury in their tissues from living at or near the site; (2) playing on or in contaminated surface soils; (3) playing with liquid mercury from broken electrical switches, thermometers, blood pressure monitors etc.; or (4) bringing any liquid mercury or broken mercury device into the home, where vapors might build up in indoor air. Other potentially harmful exposure pathways include the excessive use of skin ointments or creams (e.g., skin lightening creams, antiseptic creams) that contain mercury compounds, the use of mercury fungicides (breathing vapors or contact of the skin with the fungicide), or the use of liquid mercury in herbal remedies or religious practices, especially if used indoors. If swallowed, liquid mercury is not very harmful, because it is not easily absorbed into the body from the gastrointestinal tract. However, small amounts of liquid mercury evaporate at room temperature, and the inhaled vapors are harmful.

The developing fetus and breast-fed infants are vulnerable to the harmful effects of mercury. The fetus can be exposed to mercury from the pregnant woman's body through the placenta, and infants may be exposed from the nursing woman's milk. Both inhaled mercury vapors and ingested methylmercury can cross the placenta. Inorganic mercury, and to a lesser extent elemental mercury and methylmercury, will move into breast milk. Pregnant women and nursing women need to be extra cautious in their use of consumer products containing mercury (such as some religious or herbal remedies or skin lightening creams); they should also pay attention to possible exposures to mercury at work and at home.

The primary pathways of mercury exposure for the general population are from eating fish or marine mammals that contain methylmercury, or from breathing in or swallowing very small amounts of mercury that are released from the dental amalgam used for fillings. The relative contribution of mercury from these two main sources will vary considerably for different individuals, depending upon the amount of fish consumed, the level of mercury in the fish, the number of amalgam fillings, eating and chewing habits, and a number of other factors.

Methylmercury levels vary considerably between species and within species of fish (depending on water conditions and size), so there are wide ranges in estimates of the average exposure levels to mercury in the general population from consumption of fish. Some researchers estimate that the typical daily exposure to

2. HEALTH EFFECTS

mercury is 0.49 $\mu\text{g}/\text{day}$ for infants (aged 6–11 months), 1.3 $\mu\text{g}/\text{d}$ for 2-year-old children, 2.9 $\mu\text{g}/\text{day}$ for females aged 25–30 years, and 3.9 $\mu\text{g}/\text{day}$ for males 25–30 years of age. Expressed on a per body weight basis, the intake for all age groups, except for 2-year-old children, was approximately 0.05 $\mu\text{g}/\text{kg}/\text{day}$ (Clarkson 1990; Gunderson 1988). More recently, MacIntosh et al. (1996) estimated mean dietary exposure of 8.2 $\mu\text{g}/\text{d}$ (range, 0.37–203.5 $\mu\text{g}/\text{day}$) for females and 8.6 $\mu\text{g}/\text{day}$ (range, 0.22–165.7 $\mu\text{g}/\text{day}$) for males. For an average body weight of 65 kg for women and 70 kg for men, the daily intakes of mercury would be 0.126 $\mu\text{g}/\text{kg}/\text{day}$ (range, 5.7–3,131 $\text{ng}/\text{kg}/\text{day}$) for women and 0.123 $\mu\text{g}/\text{kg}/\text{day}$ (range, 3.1–2,367 $\text{ng}/\text{kg}/\text{day}$) for men, respectively. Lack of data about the actual amount of food consumed accounted for 95% of the total uncertainty for mercury. This was especially true for consumption levels of canned tuna and other fish (MacIntosh et al. 1996)

The Food and Drug Administration (FDA, 1996) has posted on the Internet advice for consumers recommending that pregnant women and women of childbearing age, who may become pregnant, limit their consumption of shark and swordfish to no more than one meal per month. This advice is given because methylmercury levels are relatively high in these fish species. The FDA's advice covers both pregnant women and women of child-bearing age who might become pregnant, since dietary practices immediately before the pregnancy could have a direct bearing on fetal exposure, particularly during the first trimester of pregnancy. The FDA also states that nursing women who follow this advice will not expose their infants to increased health risks from methylmercury (FDA 1996). For the general population (other than pregnant women and women of child-bearing age), the FDA advises limiting the regular consumption of shark and swordfish (which typically contain methylmercury at 1 ppm) to about 7 ounces per week (about one serving). This level of consumption results in methylmercury exposures below the U.S. FDA acceptable daily intake level for mercury. For fish species with methylmercury levels averaging 0.5 ppm, regular consumption should be limited to 14 ounces per week. Recreational and subsistence fishers who eat larger amounts of fish than the general population and routinely fish the same waters may have a higher exposure to methylmercury if these waters are contaminated (EPA 1995). People who consume greater than 100 grams of fish per day are considered high-end consumers. This is over 10 times the amount of fish consumed by members of the general population (6.5 g/day) (EPA 1995). No consumption advice is necessary for the top 10 seafood species, which make up about 80% of the seafood market: canned tuna, shrimp, pollock, salmon, cod, catfish, clams, flatfish, crabs, and scallops. The methylmercury in these species are generally less than 0.2 ppm, and few people eat more than the suggested weekly limit of fish (i.e., 2.2 pounds). More information on exposure to methylmercury and the levels in fish can be found in Section 5.5, General Population and Occupational Exposures.

2. HEALTH EFFECTS

Estimating mercury exposure from dental amalgams is also difficult because of high variability in the number of amalgam fillings per individual and the differences in chewing, eating, and breathing habits. Dental amalgams, however, would be the most significant source of mercury exposure in the absence of fish consumption or proximity to a waste site or incinerator. A report from the Committee to Coordinate Environmental Health and Related Programs (CCEHRP) of the Department of Health and Human Services determined a level of from 1 to 5 $\mu\text{g Hg/day}$ from dental amalgam for people with 7–10 fillings (DHHS 1993). The World Health Organization reported a consensus average estimate of 10 $\mu\text{g amalgam Hg/day}$ (range: 3–17 $\mu\text{g/day}$) (WHO 1991). Weiner and Nylander (1995) estimated the average uptake of mercury from amalgam fillings in Swedish subjects to be within the range of 4–19 $\mu\text{g/day}$. Skare and Engqvist (1994) estimated that the systemic uptake of mercury from amalgams in middle-aged Swedish individuals with a moderate amalgam load (30 surfaces) was, on the average, 12 $\mu\text{g/day}$, an amount said to be equivalent to a daily occupational air mercury exposure concentration of 2 $\mu\text{g/m}^3$. Other researchers have estimated the average daily absorption of Hg from amalgam at 1–27 $\mu\text{g/day}$, with levels for some individuals being as high as 100 $\mu\text{g/day}$ (Björkman et al. 1997; Lorscheider et al. 1995).

Richardson et al. (1995) estimated total mercury exposure for Canadian populations of different ages to be 3.3 $\mu\text{g/day}$ in toddlers (3–4 years old), 5.6 $\mu\text{g/day}$ in children (5–11 years old), 6.7 $\mu\text{g/day}$ in teens (12–19 years old), 9.4 $\mu\text{g/day}$ in adults (20–59 years old), and 6.8 $\mu\text{g/day}$ in seniors (aged 60+). Of this exposure, amalgam was estimated to contribute 50% to the total Hg in adults and 32–42% for other age groups. Estimates based on 2 independent models of exposure from amalgam alone were 0.8–1.4 $\mu\text{g/day}$ in toddlers, 1.1–1.7 $\mu\text{g/day}$ in children, 1.9–2.5 $\mu\text{g/day}$ in teens; 3.4–3.7 $\mu\text{g/day}$ in adults, and 2.1–2.8 $\mu\text{g/day}$ in seniors (Richardson 1995).

Higher levels of mercury exposure can occur in individuals who chew gum or show bruxism, a rhythmic or spasmodic grinding of the teeth other than chewing and typically occurring during sleep (Barregard et al. 1995; Enestrom and Hultman 1995). Richardson (1995) reported a transient 5.3-fold increase in levels of mercury upon stimulation by chewing, eating, or tooth brushing. Sallsten et al. (1996) also reported over a 5-fold increase in plasma and urinary mercury levels (27 and 6.5 nmol/mmol creatinine versus 4.9 and 1.2 nmol/mmol creatinine, respectively) in a sample of 18 people who regularly chewed nicotine chewing gum (median values of 10 sticks per day for 27 months), compared to a control group.

Berdouses et al. (1995) studied mercury release from dental amalgams using an artificial mouth under controlled conditions of brushing and chewing and found that although the release of mercury during initial

2. HEALTH EFFECTS

nonsteady-state conditions was influenced by both the age of the amalgam and the amalgam type, the steady-state value of the mercury dose released by the amalgam was only 0.03 µg/day.

Sandborgh-Englund et al. (1998) evaluated the absorption, blood levels, and excretion of mercury in nine healthy volunteers (2 males, 7 females) exposed to 400 µg /m³ mercury vapor in air for 15 minutes. This exposure corresponded to a dose of 5.5 nmol Hg/kg body weight. Samples of exhaled air, blood and urine were collected for 30 days after exposure. The median retention of elemental Hg was 69% of the inhaled dose. To evaluate the chronic exposure to mercury from dental amalgam in the general population, the daily Hg dose from fillings was estimated based on the plasma Hg levels of subjects with amalgam fillings and the plasma clearance obtained in this study. The daily dose was estimated to be from 5 to 9 µg/day in subjects with an “average” number (20–35 amalgam surfaces) of amalgam fillings (Sandborgh-Englund et al. 1998)

Halbach (1994) examined the data from 14 independent studies and concluded that the probable mercury dose from amalgam is less than 10 µg/day. When combined with the 2.6 µg/day background intake estimated by WHO (1990) for persons without amalgam fillings and with an estimated methylmercury intake of 5 µg/day from food, Halbach noted that the sum of all those inputs still falls within the WHO's 40 µg/day acceptable daily intake (ADI) level for total mercury. For the ADI of 40 µg total mercury exposure inhaled, approximately 30 µg would be absorbed, assuming 80% absorption (Halbach 1994; WHO 1976).

Whether adverse health effects result from exposure to mercury from amalgams at the levels reported above is currently a topic of on-going research and considerable discussion. A thorough review of this subject is beyond the scope of this profile. Readers are referred to the end of this section (see More on the Effects of Dental Amalgam) for a discussion of some recent reviews of this topic, and a few examples of studies on the putative toxic effects or the lack thereof from continued use of amalgam.

Other Uses of Metallic Mercury

A less well-documented source of exposure to metallic mercury among the general population is its use in ethnic religious, magical, and ritualistic practices, and in herbal remedies. Mercury has long been used for medicinal purposes in Chinese herbal preparations and is also used in some Hispanic practices for medical and/or religious reasons. Espinoza et al. (1996) analyzed 12 types of commercially produced herbal ball preparations used in traditional Chinese medicine. Mercury levels were found to range from 7.8 to

2. HEALTH EFFECTS

621.3 mg per ball. Since the minimum recommended adult dosage is 2 such balls daily, intake levels of up to 1.2 mg of mercury (presumed to be mercury sulfide) might be a daily dosage.

Some religions have practices that may include the use of metallic mercury. Examples of these religions include Santeria (a Cuban-based religion that worships both African deities and Catholic saints), Voodoo (a Haitian-based set of beliefs and rituals), Palo Mayombe (a secret form of ancestor worship practiced mainly in the Caribbean), and Espiritismo (a spiritual belief system native to Puerto Rico). Not all people who observe these religions use mercury, but when mercury is used in religious, folk, or ritualistic practices, exposure to mercury may occur both at the time of the practice and afterwards from breathing in contaminated indoor air. Metallic mercury is sold under the name "azogue" (pronounced ah-SEW-gay) in stores called "botanicas." Botanicas are common in Hispanic and Haitian communities, where azogue may be sold as an herbal remedy or for spiritual practices. The metallic mercury is often sold in capsules or in glass containers. It may be placed in a sealed pouch to be worn on a necklace or carried in a pocket, or it may be sprinkled in the home or car. Some store owners may also suggest mixing azogue in bath water or perfume, and some people place azogue in devotional candles. The use of metallic mercury in a home or apartment not only threatens the health of the current residents, but also poses health risks to future residents, who may unknowingly be exposed to further release of mercury vapors from contaminated floors, carpeting, or walls.

Due to the increased number of reported metallic mercury poisonings and to the widespread potential for exposure to liquid/metallic mercury in school chemistry and science laboratories and other places accessible to the general public, the EPA and ATSDR issued a joint mercury alert in June 1997, alerting school and public health officials to the potential toxicity of this substance. This joint mercury alert also advised restricting access to mercury-containing spaces and storage rooms, and the use of alternative substances or chemicals for purposes for which liquid/metallic mercury is currently used.

Issues relevant to children are explicitly discussed in Sections 2.6, Children's Susceptibility, and 5.6, Exposures of Children.

Minimal Risk Levels for Mercury

A common misconception is that health guidance values, such as the MRL, represent a level above which toxicity is likely to occur. This misconception has occasionally led to unwarranted concern and public

2. HEALTH EFFECTS

apprehension about relatively benign exposures to environmental substances. The MRL is neither a threshold for toxicity, nor a level beyond which toxicity is likely to occur. MRLs are established solely as screening tools for public health officials to use when determining whether further evaluation of potential exposure at a hazardous waste site is warranted. The relevance of the MRL to public health is discussed further in the following sections concerning the derivation of the respective mercury MRLs.

ATSDR has established a chronic inhalation MRL of 0.2 $\mu\text{g}/\text{m}^3$ for metallic mercury. Assuming a ventilation rate of 20 m^3/day for an average adult, and assuming complete absorption, exposure at the level of the MRL would result in a daily dose of 4 μg . This level of exposure is thought to represent no health risk to any element of the human population. No other inhalation MRLs have been derived for mercury or its compounds.

Oral MRLs have been established for acute (0.007 $\text{mg}/\text{kg}/\text{day}$) and intermediate (0.002 $\text{mg}/\text{kg}/\text{day}$) duration exposures to inorganic mercury. ATSDR has also established a chronic oral MRL of 0.0003 $\text{mg}/\text{kg}/\text{day}$ (equivalent to 21 $\mu\text{g}/\text{day}$ for a 70-kg adult) for methylmercury. This MRL is at least four times the estimated average daily intake level for methylmercury from the diet. The FDA has estimated that, on average, the intake rate for total mercury (both inorganic and organic) is 50–100 $\text{ng}/\text{kg}/\text{day}$ (equivalent to 0.05–0.1 $\mu\text{g}/\text{kg}/\text{day}$ or 3.5–7 $\mu\text{g}/\text{day}$ for a 70-kg adult). This figure is based on the FDA total diet study of 1982–1984 (Gunderson 1988). Approximately 80–90% of the mercury in the FDA estimate would be expected to be in the form of methylmercury. A separate estimate of the average intake of methylmercury alone, based on a survey of fish eaters and on average levels of methylmercury in fish, places the average intake of methylmercury at 36 $\text{ng}/\text{kg}/\text{day}$ (equivalent to 0.036 $\mu\text{g}/\text{kg}/\text{day}$ or 2.52 $\mu\text{g}/\text{day}$ for a 70-kg adult), with a 99% upper-bound estimate at 243 $\text{ng}/\text{kg}/\text{day}$ (equivalent to 0.243 $\mu\text{g}/\text{kg}/\text{day}$ or 17 $\mu\text{g}/\text{day}$ for a 70-kg adult) (Clarkson 1990). These results indicate that an assessment of total methylmercury intake and body burden should be conducted when estimating exposure to mercury in populations (especially sensitive populations) living near hazardous waste sites that have the potential to release mercury to the environment.

Inhalation MRLs

No inhalation MRLs were derived for inorganic mercury salts or organic mercury compounds due to the absence of data or to the lack of sufficient information regarding exposure levels associated with the reported observed effects.

2. HEALTH EFFECTS

No MRLs were derived for acute- or intermediate-duration inhalation exposure to metallic mercury vapors. Available studies were either deficient in their reporting of details of experimental protocols and results, used an insufficient number of experimental animals, or tested only one dose/concentration level.

- C An MRL of 0.0002 mg/m³ has been derived for chronic-duration inhalation exposure (365 days or longer) to metallic mercury vapor.

A significant increase in the average velocity of naturally occurring tremors compared to controls was observed in a group of 26 mercury-exposed workers (from 3 industries) exposed to low levels of mercury for an average of 15.3 years (range, 1–41 years) (Fawer et al. 1983). To estimate an equivalent continuous exposure concentration, the average concentration assumed for the 8 hour/day exposures was multiplied by 8/24 and 5/7 ($0.026 \text{ mg/m}^3 \times 8/24 \text{ hours/day} \times 5/7 \text{ days/week} = 0.0062 \text{ mg/m}^3$). Uncertainty factors of 10 for variability in sensitivity to mercury within the human population and 3 for use of a minimal-effect LOAEL in MRL derivation were then applied to the calculated 0.0062 mg/m³ value, yielding a chronic inhalation MRL of 0.2 µg/m³. Although this MRL is based on experimental data from an adult working population, there is no experimental or clinical evidence to suggest that it would not also be sufficiently protective of neurodevelopmental effects in developing embryos/fetuses and children, the most sensitive subgroups for metallic mercury toxicity.

Inhaled metallic mercury is quickly absorbed through the lungs into the blood, and 70–80% is retained. Its biological half-life in humans is approximately 60 days. The half-life is different for different physiological compartments (e.g., 21 days in the head versus 64 days in the kidneys) (Hursh et al. 1976). Since the duration of exposure influences the level of mercury in the body, the exposure level reported in the Fawer et al. (1983) occupational study was extrapolated from an 8-hour day, 40-hour workweek exposure to a level equivalent to a continuous 24 hour/day, 7 day/week exposure, as might be encountered near a hazardous waste site containing metallic mercury.

Gentry et al. (1998) used the neurobehavioral information on a control group and one exposure group from the Fawer et al. (1983) study to derive an inhalation MRL for elemental mercury based upon a benchmark dose (BMD) analysis. Dose-response analysis could be performed on four measures of hand tremor, with tasks performed both at rest and with a load. The exposure level of the exposed group to metallic mercury was assumed to be the mean TWA exposure of 0.026 mg/m³. A physiologically based pharmacokinetic model for metallic mercury vapor was found to be linear through the region of concern from the LOAEL to

2. HEALTH EFFECTS

the MRL; that is, the relationship between inhaled concentration and target tissue concentration at the LOAEL and at lower levels (including the MRL) did not differ. Therefore, exposure concentrations were used directly for the analysis. Gentry et al. (1998) also assumed that 1% of the unexposed population would be considered in the adverse response range. The BMD_{10} was the dose at which the probability of exceeding the 1% adverse response level was 10% greater than in unexposed individuals, and the $BMDL_{10}$ is the 95% lower bound confidence level on that dose. A simple linear model sufficed to describe the dose-response. A $BMDL_{10}$ of 0.017 mg metallic mercury/m³ was derived as a reasonable representation of the sparse data. This level would be equivalent to a NOAEL (i.e., no LOAEL to NOAEL uncertainty factor is needed). Using a PBPK model to estimate target tissue doses from inhaled mercury vapor and adjusting for continuous exposure and interhuman variability (with an uncertainty factor of 10), an MRL of 0.0004 mg/m³ (based on target tissue dose) was derived which is about two times the ATSDR derived MRL of 0.0002 mg/m³ based upon the Fawer et al. (1983) LOAEL.

The ability of long-term, low-level exposure to metallic mercury to produce a degradation in neurological performance was also demonstrated in other studies. One such study (Ngim et al. 1992) attributed adverse neurological effects to a lower average level of exposure than did the Fawer et al. (1983) study; however, this study was not used in deriving a chronic inhalation MRL due to uncertainties concerning the study protocol, including methodological and reporting deficiencies. In the Ngim et al. (1992) study, dentists with an average of 5.5 years of exposure to low levels of metallic mercury were reported to have impaired performance on several neurobehavioral tests. Exposure levels measured at the time of the study ranged from 0.0007 to 0.042 mg/m³, with an average of 0.014 mg/m³. Mean blood mercury levels among the dentists ranged from 0.6 to 57 µg/L, with a geometric mean of 9.8 µg/L. The performance of the dentists on finger tapping (measures digital motor speed), trail-making (measures visual scanning and motor speed), digit symbol (measures visuomotor coordination and concentration), digit span, logical memory delayed recall (measure of verbal memory), and Bender-Gestalt time (measures visual construction) tests was significantly poorer than controls. The exposed dentists also showed higher aggression than did controls. Furthermore, within the group of exposed dentists, significant differences were observed between a subgroup with high mercury exposure compared to a subgroup with lower exposure. These exposure severity subgroups were not compared to controls, and average exposure levels for the subgroups were not reported. The design and reporting of this study limits its usefulness in deriving an MRL for metallic mercury. The exposure status of the subjects was known to the investigator during testing, mercury levels were not reported for controls, and methods used to adjust for potential contributions other than mercury from amalgams to the study results (such as the possible use in this population of traditional medicines

2. HEALTH EFFECTS

containing mercury) were not reported. It was also unclear whether the results for the mercury exposure group were inordinately influenced or skewed by the individual dentists with the highest exposures and/or blood levels. These confounding factors precluded the use of the Ngim et al. (1992) study for the derivation of an MRL, but the study does provide support both for the premise that low-dose chronic exposure to metallic mercury can result in adverse health sequelae and for the chronic inhalation MRL that is based on the Fawer et al. (1983) study of occupationally exposed individuals.

Other occupational studies further support the ability of metallic mercury to induce neurological deficits. Several studies have reported significant effects on tremor or cognitive skills among groups exposed occupationally to comparable or slightly higher (up to 0.076 mg/m³) levels (Ehrenberg et al. 1991; Piikivi et al. 1984; Roels et al. 1982). Difficulty with heel-to-toe gait was observed in thermometer plant workers subjected to mean personal breathing zone air concentrations of 0.076 mg/m³ (range, 0.026–0.27 mg/m³) (Ehrenberg et al. 1991). Tremors have also been reported in occupationally exposed workers with urinary mercury concentrations of 50–100 µg/g creatinine and blood levels of 10–20 µg/L (Roels et al. 1982). By comparison, blood mercury levels in the Fawer et al. (1983) study averaged 41.3 and 16.6 µmol Hg/L for the exposed and control groups, respectively. Urinary mercury levels for the exposed workers in the Fawer et al. (1983) study averaged 11.3 µmol Hg/mol creatinine (about 20 µg/g creatinine), compared with 3.4 µmol/mol creatinine in the controls. Piikivi et al. (1984) found decreases in performance on tests that measured intelligence (based upon a similarities test) and memory (evaluating digit span and visual reproduction) in chloralkali workers exposed for an average of 16.9 years (range, 10–37 years) to low levels of mercury, when compared to an age-matched control group. In this study, significant differences from controls were observed on these tests among 16 workers with blood levels ranging from 75 nmol/L to 344 nmol/L and urine levels ranging from 280 nmol/L (about 56 µg/L) to 663 nmol/L. Abnormal nerve conduction velocities have also been observed in chloralkali plant workers at a mean urine concentration of 450 µg/L (Levine et al. 1982). These workers also experienced weakness, paresthesias, and muscle cramps. Prolongation of brainstem auditory evoked potentials was observed in workers with urinary mercury levels of 325 µg/g creatinine (Discalzi et al. 1993). Prolonged somatosensory-evoked potentials were found in 28 subjects exposed to airborne mercury concentrations of 20–96 mg/m³ (Langauer-Lewowicka and Kazibutowska 1989). All of these studies substantiate the ability of chronic, low- to moderate-level exposure to metallic mercury vapors to cause neurological deficiencies.

2. HEALTH EFFECTS

Employment of the Chronic Inhalation MRL for Metallic Mercury

ATSDR emphasizes that the MRL is not intended to be used as an estimation of a threshold level. Exceeding the MRL does not necessarily mean that a health threat exists. However, the greater the amount by which the MRL is exceeded and the longer or more frequent the individual exposures, the greater the likelihood that some adverse health outcome may occur. Secondly, the chronic inhalation MRL is, by definition, a level that is considered to be without appreciable (or significant) health risk over a lifetime of exposure at that level. It is further considered to be a "safe" level for all factions of the exposed human population, when exposure exists for 24 hours a day, 7 days a week for an extended period of years. The employment of the MRL, therefore, must be geared to the particular exposure scenario at hand. For example, people may be able to "tolerate" metallic mercury levels above the MRL for intermittent periods of exposure (e.g., 1 or 2 hours per day, 5 days per week) without any adverse health sequelae, either overt or covert. The use of the "contaminated area" (e.g., storage versus exercise room versus day care) will largely influence the use of the MRL. Finally, the MRL is intended primarily as a "screening value" for public health officials to use in their assessment of whether further evaluation of the potential risk to public health is warranted in a hazardous waste site scenario. The MRL is *not* intended, nor should it be indiscriminately used, as a clean-up or remediation level, or as a predictor of adverse health effects. While it is considered to afford an adequate degree of protection for the health of all potentially exposed individuals, it might be unnecessarily stringent for application to some exposure situations (i.e., higher air concentrations might afford a similar degree of protection in some exposure scenarios); thus, its relevance in any specific environmental situation is intended to be determined by an experienced public health or medical official.

Oral MRLsMetallic Mercury

No oral MRLs were derived for metallic (elemental) mercury due to the lack of data. Oral exposure to liquid metallic mercury would be expected to present little health risk, since it is so poorly absorbed (<0.01%) through the healthy intestine. Sufficiently large quantities could, however, present a risk of intestinal blockage, and some could enter the systemic circulation (blood or lymphatic) through open lesions, presenting a risk of occlusion of smaller arteries, especially within the pulmonary circulation.

2. HEALTH EFFECTS

Inorganic Mercury

The acute- and intermediate-duration MRLs for oral exposure to inorganic mercury are based on kidney effects reported in a 1993 NTP study of mercuric chloride (NTP 1993). Most of the supporting studies of oral exposure to inorganic mercury also use mercuric chloride.

Mercuric sulfide (also known as cinnabar) is the predominant natural form of mercury in the environment and is a common ore from which metallic mercury is derived. Mercury released to the environment may be transformed into mercuric sulfide. Several studies suggest that the bioavailability of mercuric sulfide in animals is less than that of mercuric chloride (Sin et al. 1983, 1990; Yeoh et al. 1986, 1989). For example, Sin et al. (1983) found an increase in tissue levels of mercury in mice orally exposed to low doses of mercuric chloride, but elevated levels of mercury were not found in the tissues of mice fed an equivalent weight of mercuric sulfide. This finding indicates a difference in bioavailability between HgCl₂ and HgS in mice. However, a quantitative determination of the relative bioavailabilities of mercuric sulfide versus mercuric chloride has not been derived in the available studies, nor has the relative bioavailability of mercuric sulfide in humans been examined.

- C An MRL of 0.007 mg Hg/kg/day has been derived for acute-duration oral exposure (14 days or less) to inorganic mercury.

The MRL was based on a NOAEL of 0.93 mg Hg/kg/day for renal effects in rats administered mercuric chloride 5 days a week for 2 weeks. The dose used in this study was duration-adjusted for a 5-day/week exposure and divided by an uncertainty factor of 100 (10 for extrapolation from animals to humans and 10 for human variability). Increased absolute and relative kidney weights were observed in male rats exposed to 1.9 mg Hg/kg/day as mercuric chloride (NTP 1993). At higher doses, an increased incidence and severity of tubular necrosis was observed.

Several other studies examining the effects of oral exposure to inorganic mercury salts have also shown renal toxicity in humans as a result of acute oral exposures. Kidney effects (i.e., heavy albuminuria, hypoalbuminemia, edema, and hypercholesterolemia) have been reported after therapeutic administration of inorganic mercury (Kazantzis et al. 1962). Acute renal failure has been observed in a number of case studies in which mercuric chloride had been ingested (Afonso and deAlvarez 1960; Murphy et al. 1979; Samuels et al. 1982). The autopsy of a 35-year-old man who ingested a lethal dose of mercuric chloride

2. HEALTH EFFECTS

and exhibited acute renal failure showed pale and swollen kidneys (Murphy et al. 1979). A case study reported acute renal failure characterized by oliguria, proteinuria, hematuria, and granular casts in a woman who ingested 30 mg Hg/kg body weight as mercuric chloride (Afonso and deAlvarez 1960). Another case study reported a dramatic increase in urinary protein secretion by a patient who ingested a single dose of 15.8 mg Hg/kg body weight as mercuric chloride (assuming a body weight of 70 kg) (Pesce et al. 1977). The authors of the report surmised that the increased excretion of both albumin and β_2 -microglobulin were indicative of mercury-induced tubular and glomerular pathology. Acute renal failure that persisted for 10 days was also observed in a 19-month-old child who ingested an unknown amount of powdered mercuric chloride (Samuels et al. 1982). Decreased urine was also observed in a 22-year-old who attempted suicide by ingesting approximately 20 mg Hg/kg (Chugh et al. 1978).

- C An MRL of 0.002 mg Hg/kg/day has been derived for intermediate-duration oral exposure (15–364 days) to inorganic mercury.

This MRL was based on a NOAEL of 0.23 mg Hg/kg/day for renal effects in rats administered mercuric chloride 5 days a week for 6 months (Dieter et al. 1992; NTP 1993). This dose was duration-adjusted for a 5 day/week exposure and divided by an uncertainty factor of 100 (10 for extrapolation from animals to humans and 10 for human variability). Increased absolute and relative kidney weights were observed in rats exposed to 0.46 mg Hg/kg/day, the next higher treatment level. At higher doses, an increased incidence of nephropathy (described as foci of tubular regeneration, thickened tubular basement membrane, and scattered dilated tubules containing hyaline casts) was observed. Renal toxicity is a sensitive end point for inorganic mercury toxicity, as seen in other intermediate-duration oral studies on rats and mice exposed to inorganic mercury (Carmignani et al. 1992; Jonker et al. 1993a; NTP 1993), as well as case reports of humans ingesting inorganic mercury for acute and chronic durations (Afonso and deAlvarez 1960; Davis et al. 1974; Kang-Yum and Oransky 1992; Nielsen et al. 1991; Pesce et al. 1977).

The relatively small difference between the acute-duration MRL (0.007 mg/kg/day) and the intermediate-duration MRL (0.002 mg/kg/day) is not meant, nor is it considered, to imply a high level of precision in the calculation of these health guidance values. Rather, this difference of 5 μ g/kg/day reflects the increased toxicity of continued low-dose exposure for longer periods of time and is consistent with the known build-up of mercury levels in body tissues over a prolonged course of continued exposure. The actual precision of any derived (actually estimated) MRL is dependent upon an encompassing, but not sharply defined, area of uncertainty based upon the database used in its determination.

2. HEALTH EFFECTS

As a method of comparison to evaluate whether use of another method to derive an MRL might result in a different intermediate oral MRL value for inorganic mercury, ATSDR used the same data (Dieter et al. 1992; NTP 1993) to calculate a benchmark dose for inorganic mercury. Using the most sensitive end point identified in this study (relative kidney weight changes in rats), the experimental data were used to obtain a modeled dose-response curve. Benchmark doses were then determined for the 10% response level (0.38 mg/kg/day) and the 5% response level (0.20 mg/kg/day). After adjusting the 5-days/week exposures in the study to 7-days/week equivalent doses, the 10 and 5% response-based benchmarks became 0.27 and 0.15 mg/kg/day, respectively. Application of 10-fold uncertainty factors for each inter- and intraspecies variability resulted in estimated human benchmark doses of 0.003 mg/kg/day for the 10% response level and 0.002 mg/kg/day for the 5% response level. These values strongly support the current existing intermediate oral MRL of 0.002 mg/kg/day for inorganic mercury.

No MRL for chronic-duration oral exposure to inorganic mercury was derived, because the study results showed decreased survival rate for male rats at all LOAELs.

Organic Mercury

Acute, Intermediate, or Chronic Inhalation MRLs: No inhalation MRLs were derived for organic mercury compounds, due to the absence of data or to the lack of sufficient information regarding exposure levels associated with the reported observed effects.

Acute and Intermediate Oral MRLs: No MRLs were derived for acute or intermediate oral exposure to organic mercury compounds due to the absence of data or to the lack of sufficient information regarding exposure levels associated with the reported observed effects.

Chronic Oral MRL for Methylmercury: Hair levels are typically used as an index of exposure to methylmercury. A number of studies report that hair mercury levels correlate with total intake levels and with organ-specific levels of mercury. Suzuki et al. (1993) analyzed 46 human autopsies in Tokyo, Japan and reported that hair mercury levels were highly significantly correlated with organ Hg levels in the cerebrum, cerebellum, heart, spleen, liver, kidney cortex, and kidney medulla, when the total mercury or methyl mercury value in the organ was compared with the hair total mercury or organic mercury, respectively.

2. HEALTH EFFECTS

Nakagawa (1995) analyzed total mercury in hair samples from 365 volunteers in Tokyo, and reported higher mercury levels in those who preferred fish in their diet, compared to those who preferred other foods (preference choices were fish, fish and meat, meat, and vegetables). The mean hair mercury levels were 4 ppm in men who preferred fish and 2.7 ppm in women who preferred fish. The lowest hair mercury levels were seen in men and women who preferred vegetables, 2.27 and 1.31 ppm, respectively. The mean hair level for the whole group was 2.23 ppm (median 1.98).

Drasch et al. (1997) assayed tissue samples of 150 human cadavers (75 males, and 75 females) from a “normal” European (German) population, i.e., there were no occupational or higher than average exposures to metals found in any of the biographies of the deceased. The objective was to evaluate the validity of blood, urine, hair, and muscle as biomarkers for internal burdens of mercury, lead, and cadmium in the general population. All individuals died suddenly and not as a result of chronic ailments. Age ranged from 16 to 93 years, and every decade was represented by approximately 10 males and 10 females. Tissues sampled included kidney cortex, liver, cerebral cortex, cerebellum, petrous portion of the temporal bone, (pars petrosus ossis temporalis), pelvic bone (spina iliaca anterior-superior), muscle (musculus gluteus), blood (heart blood), urine, and hair (scalp-hair). Statistically significant rank correlations between biomarker levels and tissues were observed, but with large confidence intervals for the regressions. The authors conclude that specific biomarkers relative to each metal are useful in estimating body burdens and trends in groups, but are not useful for determining the body burden (and therefore the health risks) in individuals. A notable exception was for correlation to brain mercury. By comparison to a generally poor correlation of cadmium, lead, and mercury between hair and tissue, there was a strong correlation between mercury in hair and mercury in brain (cerebrum and cerebellum). The authors state that this may be due to the high lipophilicity of elemental and short-chain alkyl mercury compounds. As seen in other studies comparing European to Japanese hair mercury levels, the mercury hair levels reported by Nakagawa (1995) of 2–4 ppm for a Japanese population are 10–20 times higher than total mercury levels observed in the Drasch et al. (1997) study (median, 0.247 µg/g in hair; range, 0.43–2.5 µg/g).

Other studies have confirmed a good correlation between hair mercury and brain mercury levels. In a study on the Seychelles Islands cohort, Cernichiari et al. (1995b) compared maternal hair levels, maternal blood levels, fetal blood levels, and fetal brain levels. Autopsy brains were obtained from infants dying from a variety of causes. The concentrations of total mercury in six major regions of the brain were highly correlated with maternal hair levels. This correlation was confirmed by a sequence of comparisons among the four measurements. Maternal hair levels correlated to maternal blood levels ($r=0.82$) and infant brain

2. HEALTH EFFECTS

levels ($r=0.6-0.8$). Concentrations in maternal blood correlated with infant blood levels ($r=0.65$); and infant blood levels correlated to infant brain levels ($r=0.4-0.8$).

Accordingly, ATSDR used maternal hair mercury levels as the exposure measurement to derive a chronic MRL for methylmercury. While hair analysis can be confounded by outside sources of contamination (e.g., as might occur in certain occupational settings) (Hac and Krechniak 1993), the study population used as the basis of the chronic oral MRL for methylmercury is far removed from external or industrial sources of mercury, effectively eliminating this as a consideration for the following analysis.

- C An MRL of 0.0003 mg Hg/kg/day has been derived for chronic-duration oral exposure (365 days or longer) to methylmercury.

The chronic oral MRL for methylmercury is based upon the Seychelles Child Development Study (SCDS), in which over 700 mother-infant pairs have, to date, been followed and tested from parturition through 66 months of age (Davidson et al. 1998). The SCDS was conducted as a double-blind study and used maternal hair mercury as the index of fetal exposure. Enrollees were recruited by the head nurse/hospital midwife by asking the mothers if they wished to participate in the study when they arrived at the hospital for delivery. The first 779 who did not decline participation became the mothers in the study cohort. Of the initial 779 mothers enrolled in the study at parturition, 740 remained at the pre-determined child testing age of 6.5 months, 738 remained in the 19-month cohort, 736 remained at 29 months, and 711 remained for the 66-month neurobehavioral and developmental examinations.

The Seychellois were chosen as a study population for a number of reasons.

- C (1) All fish contain some level of methylmercury (Davidson et al. 1998); and the Seychellois regularly consume a high quantity and variety of ocean fish, with 12 fish meals per week representing a typical methylmercury exposure.
- C (2) The median total mercury concentration in 350 fish sampled from 25 species consumed by the Seychellois was <1 ppm (range, 0.004–0.75 ppm), comparable to the mercury concentration in commercially obtainable fish in the U.S. (It should be noted here that while the methylmercury levels in the Seychellois population are 10–20 times those in the U.S., it is not because they consume more highly contaminated fish, but rather because they consume more fish than the U.S. population.)
- C (3) The Seychelles represents a relatively pristine environment, with no local industry for pollution, and are situated more than 1,000 miles from any continent or large population center.

2. HEALTH EFFECTS

- (4) The population is highly literate, cooperative, and has minimal immigration and emigration.
- C (5) The Seychellois constitute a generally healthy population, with low maternal alcohol consumption and tobacco use (<2%).
- C (6) The large sample size/study population (>700 mother-infant pairs).
- C (7) Excellent retention of mother-infant pairs throughout the study (i.e., 711 of the initially enrolled 778 mother-infant pairs still participating at 66 months post-partum).
- C (8) The use of standardized neurobehavioral tests.

The results of the 66-month testing in the SCDS revealed no evidence of adverse effects attributable to chronic ingestion of low levels of methylmercury in fish (Davidson et al. 1998). In this study, developing fetuses were exposed *in utero* through maternal fish ingestion before and during pregnancy (Davidson et al. 1998). Neonates continued to be exposed to maternal mercury during breastfeeding (i.e., some mercury is secreted in breast milk), and methylmercury exposure from the solid diet began after the gradual post-weaning shift to a fish diet. In the 66-month study cohort, the mean maternal hair level of total mercury during pregnancy was 6.8 ppm (range, 0.5–26.7 ppm; n=711), and the mean child hair level at the 66-month testing interval was 6.5 ppm (range, 0.9–25.8 ppm; n=708). The mean maternal hair mercury level in the highest exposed subgroup in the study was 15.3 ppm (range, 12–26.7; n=95). The 66-month test battery, which was designed to test multiple developmental domains, included the following primary measurements:

- C (1) General Cognitive Index (GCI) of the McCarthy Scales of Children's Abilities (to estimate cognitive ability);
- C (2) the Preschool Language Scale (PLS) total score (to measure both expressive and receptive language ability);
- C (3) the Letter and Word Recognition and
- C (4) Applied Problems subtests of the Woodcock-Johnson (W-J) Tests of Achievement (to measure reading and arithmetic achievement);
- C (5) the Bender-Gestalt test (to measure visual-spatial ability); and
- C (6) the total T score from the Child Behavior Checklist (CBCL) (to measure the child's social and adaptive behavior). Serum sampling revealed no detectable levels of PCBs (detection limit=0.2 ng/mL).

2. HEALTH EFFECTS

None of the tests indicated an adverse effect of methylmercury exposure. As evaluated through regression analyses, there was no reduction in performance with increasing maternal hair mercury levels for the neurobehavioral parameters examined. In contrast, scores were better for four of the six tests in the highest MeHg-exposed groups, compared with lower exposure groups for both prenatal and postnatal exposure (the four test were the (1) General Cognitive Index (GCI) of the McCarthy Scales of Children's Abilities (to estimate cognitive ability); (2) the Preschool Language Scale (PLS) total score (to measure both expressive and receptive language ability); (3) the Letter and Word Recognition and (4) Applied Problems subtests of the Woodcock-Johnson (W-J) Tests of Achievement (to measure reading and arithmetic achievement).

While the positive outcomes are not considered to indicate any beneficial effect of methylmercury on neurological development or behavior, they might be more appropriately attributed to the beneficial effects of omega-3 fatty acids or other constituents present in fish tissue, since the methylmercury levels in hair are known to correlate closely with fish intake. The slight decreases in the subjectively reported activity level of boys reported in the 29-month observations were not seen during the 66-month tests. The mean maternal hair level of 15.3 ppm in the highest exposed group in the 66-month test cohort is, therefore, considered a NOAEL for SCDS and is used by ATSDR as the basis for derivation of a chronic oral MRL for methylmercury. A related study (Myers et al. 1997) by some members of the same team of researchers from the University of Rochester examined the Seychellois children for attainment of the same developmental milestones reported to have been delayed in the Iraqi poisoning incident in the early 1970s (Cox et al. 1989); however, unlike the Iraqi study, no delays in the age of first walking and talking was seen in the Seychellois children exposed in utero.

Sensitivity of Neurobehavioral Measures /Reliability of Tests

The neurobehavioral test battery used in the 66-month Seychelles study was designed to assess multiple developmental domains (Davidson et al. 1998). The tests were considered to be sufficiently sensitive and accurate to detect neurotoxicity in the presence of a number of statistical covariates. On-site test administration reliability was assessed by an independent scorer, and mean interclass correlations for interscorer reliability were 0.96–0.97 (Davidson et al. 1998). The sample size was determined to be sufficient to detect a 5.7-point difference on any test with a mean (SD) of 100 (16) between low (0–3 ppm) and high (>12 ppm) hair mercury concentration groups for a 2-sided test ($\alpha = 0.05$ at 80% power).

2. HEALTH EFFECTS

Supporting Studies

Crump et al. (1998) conducted benchmark dose (BMD) calculations and additional regression analyses of data collected in a study in which a series of scholastic and psychological tests were administered to children whose mothers had been exposed to methylmercury during pregnancy. Hair samples were collected from 10,970 new mothers in New Zealand in 1977 and 1978. High hair mercury levels were considered to be those over 6 ppm, which was the hair level predicted to result at steady state from consumption of mercury at the WHO/FAO Provisional Tolerable Weekly Intake of 0.3 mg total mercury/week and 0.2 mg methylmercury/week. By this criterion, 73 of approximately 1,000 mothers who had consumed fish more than 3 times/week during pregnancy were determined to have high hair mercury levels. In 1985, when the children were 6 to 7 years of age, 61 children (1 set of twins) of the 73 mothers in the high hair mercury group were located; these children constituted the high exposure group, which was matched with three control groups (one with 3–6 ppm maternal hair mercury levels, one with 0–3 ppm whose mothers had been high fish consumers, and one with 0–3 ppm whose mothers had not been high fish consumers). The entire study cohort consisted of 237 children. A battery of 26 psychological and scholastic tests were administered to the children at school during the year 1985. Mothers were interviewed at the time of test administration to obtain additional data on social and environmental factors. In the high exposure group of children, one boy's mother had a hair mercury level of 86 ppm, which was more than four times higher than the next highest hair mercury level of 20 ppm. BMDs (10% response rate) calculated from five tests ranged from 32 to 73 ppm, when the 86 ppm mother's child was included. This corresponded to a BMDL range of 17 to 24 ppm. Although none of the 86 ppm child's test scores was an outlier according to the definition used in the analyses, his scores were significantly influential in the analyses. When this child was omitted from the analyses, BMDs ranged from 13 to 21, with corresponding BMDLs of 7.4 to 10 ppm.

Developing fetuses in the SCDS were exposed through maternal fish ingestion before and during pregnancy. Each child was evaluated at 19 months and again at 29 months (± 2 weeks) for infant intelligence (Bayley Scales of Infant Development [BSID] Mental and Psychomotor Scales), with a modified version of the BSID Infant Behavior Record to measure adaptive behaviors at 29 months (Davidson et al. 1995b). Testing was performed by a team of Seychellois nurses extensively trained in administration of the BSID. Maternal hair concentrations, measured in hair segments that corresponded to pregnancy, ranged from 0.5 to 26.7 ppm, with a median exposure of 5.9 ppm for the entire study group. The mean BSID Mental Scale Indices determined at both 19 and 29 months were found to be comparable

2. HEALTH EFFECTS

to the mean performance of U.S. children. The BSID Psychomotor Scale Indices at both measurement intervals were two standard deviation units above U.S. norms, but were still consistent with previous findings of motor precocity in children reared in African countries. The study found no effect that could be attributed to mercury on the BSID scores obtained at either the 19- or 29-month measurement/testing interval. The 29-month cohort represented 94% of the 779 mother-infant pairs initially enrolled in the study, and approximately 50% of all live births in the Seychelles in 1989.

The only observation in the 29-month testing that might be attributable to prenatal mercury exposure was a slight decrease in the activity level in boys (but not girls) as determined by the Bayley Infant Behavior Record (subjective observation). Whereas this decrease was significant in males ($p = 0.0004$), it was not statistically significant in females ($p = 0.87$). When the subjective activity scores for male and female children were evaluated collectively, no statistically significant or remarkable decrease in activity was apparent outside the >12 ppm maternal hair concentration group. The affect on activity level in boys is not considered an adverse effect by the authors of the study.

Grandjean et al. (1997b, 1998) reported another epidemiological study of methylmercury exposure for a population in the Faroe Islands. Although the Faroese are a fishing culture, the major source of methylmercury exposure for this population is pilot whale meat, which is intermittently consumed as part of the cultural tradition. The initial study cohort consisted of 1,022 singleton births occurring in a 21-month window during 1986-1987. At approximately 7 years of age, neurobehavioral testing was conducted on 917 of the remaining cohort members. No abnormalities attributable to mercury were found during clinical examinations or neurophysiological testing. A neuropsychological test battery was also conducted, which included the following: Finger Tapping; Hand-Eye Coordination; reaction time on a Continuous Performance Test; Wechsler Intelligence Scale for Children - Revised Digit Spans, Similarities, and Block Designs; Bender Visual Motor Gestalt Test; Boston Naming Test; and California Verbal Learning Test (Children). Neuropsychological tests emphasized motor coordination, perceptual-motor performance, and visual acuity. Pattern reversal visual evoked potentials (VEP) with binocular full-field stimulation, brain stem auditory evoked potentials (BAEP), postural sway, and the coefficient of variation for R-R inter-peak intervals (CVRR) on the electrocardiogram were all measured. The neuropsychological testing indicated mercury-related dysfunction in the domains of language, attention, memory, and visuospatial and motor function (to a lesser extent), which the authors considered to remain after the children of women with maternal hair mercury concentrations above $10 \mu\text{g/g}$ (10 ppm) were excluded. While this study represents a significant contribution to the human database for methylmercury exposure

2. HEALTH EFFECTS

and effects, a number of potentially influential factors not fully considered as possible covariates somewhat cloud the interpretation of the results.

These differences between the neuropsychological effects observed in the Faroe Island cohort and the absence of effects reported in the Seychelles Island cohort might result from a variety of factors. The Faroe Island children were older (7–8 years versus 5.5 in the SCDS). Some of the measurement instruments (i.e., the neuropsychological test administered) were also different. Since the first neuropsychological testing in the Faroe study was not conducted until 7 years of age, it is not known whether the observed effects might have been apparent at an earlier age. Ongoing and planned future testing of the Seychelles population will provide additional information on the progression of any observed effects. Further examination of the Seychelles population using the neuropsychological test that showed positive results in the Faroe Island population will also allow a more direct comparison of results.

The diet in the two studies was also considerably different. The majority of the mercury exposure to the Faroe Island population came from whale meat (estimated at about 3 ppm in muscle tissue) with a relatively small portion coming from fish. Some of the mercury in whale meat is in the form of inorganic mercury. In the Seychelles study, all of the mercury came from fish as methylmercury with concentrations of around 0.3 ppm. Whale meat blubber is widely consumed in the Faroe Islands and also contains polychlorinated biphenyls (PCBs). Grandjean et al. (1995b) estimated a daily intake of 200 µg of PCB. This value can be compared to the Tolerable Daily Intake of PCBs established by the FDA of 60–70 µg/day for an adult. Further statistical analysis of the possible influence of PCBs on the observed study results needs to be conducted (see the discussion below on [Peer Panel 1 Review of Key Studies](#) for additional comments).

The primary biomarker used to estimate mercury exposure was also different in the two studies. The Faroe Island analysis used cord blood, and the Seychelles study used maternal hair level. The use of mercury in cord blood has the advantage of being a more direct measure of exposure to the fetus, but the levels at term may not reflect exposures at earlier developmental stages. While Grandjean et al. (1997) did report maternal hair mercury levels, the mean hair level for the interquartile range of 2.6–7.7 ppm was reported only as a geometric average (4.27 ppm). In contrast, the Seychelles study reported only an arithmetic mean level for the entire study population (6.8 ppm). While both are valid measures, a direct comparison of “average” values for the two studies is not possible without further statistical analysis of both data sets.

2. HEALTH EFFECTS

In the case of the Faroe study, no data were presented in the peer-reviewed publications to address variability of food/whale meat or blubber intake among the Faroe Islanders, making it difficult to evaluate the possibility of peak intake levels during critical development phases. Consumption data were reported only as <1 pilot whale meat meal/month and 1–2 fish meals per week. In contrast, the Seychelles dietary habits provide a relatively stable intake, and a high degree of correlation was found between mean hair levels in samples covering each trimester and levels in samples for the entire pregnancy (Cernichiari et al. 1995a). Cernichiari et al. (1995b) also report a good correlation between levels of total mercury in neonatal brain and levels in the corresponding maternal hair. While the contribution of continued mercury exposure through breast feeding or post-weaning diet was not fully addressed in the Seychelles study reports (Davidson 1995, 1998), that is not considered a significant drawback of the study, since no effects on neurobehavioral/neuropsychological testing were seen at any maternal hair level. In the Faroese assessment of latent neuropsychological effects from an *in utero* exposure to mercury, however, the role of continuing postnatal exposure to mercury either from breast milk or from ingestion of methylmercury-containing foods (e.g., pilot whale meat) is less clear. Specifically, it is not known what proportion, if any, of the neuropsychological effects reported in the Faroe Islands population could be attributed to 7 years of postnatal exposure to methylmercury in food. The variability and magnitude of this postnatal exposure should, therefore, be further evaluated.

Peer Panel Review of Key Studies

In addition to the traditional peer review process that precedes publication in most scientific journals, the studies considered by ATSDR for use in estimating a chronic oral MRL for methylmercury underwent two stringent reviews by recognized experts in the environmental health field.

On July 20 and 21, 1998, ATSDR assembled a panel of 18 experts from the scientific and medical communities to review current issues and the relevant literature on mercury and its compounds, including methylmercury (ATSDR 1999). Several members of each of the respective research teams that conducted the Iraqi, Seychelles, Faroe, and Madeira studies were included among the expert panelists, and provided extensive overviews of their studies. The presentations were followed by an open, wide-ranging scientific discussion of the merits and interpretations of the currently available studies. Topics of significant discussion included the relative merits of the respective study populations, exposure regimens, sensitivity of neurobehavioral measures, and determination of an uncertainty factor. While it was unanimously agreed that the Seychelles and Faroe studies were both excellent studies that provided a significant contribution to

2. HEALTH EFFECTS

the human database for methylmercury exposure and effects, a number of factors that could have contributed to the study results, but were not considered as possible statistical covariates, were discussed. In the case of the Faroe study, the consumption of whale blubber, which is known to be contaminated with PCBs, DDT, and possibly other organochlorines, introduces a potentially significant influence on the study results. Weihe et al. (1996) reported that the PCB and DDT concentrations in blubber of pilot whales taken in Faroese waters are about 30 ppm and 20 ppm, respectively. In contrast, the Seychellois population does not eat marine mammals at all. In addition, the Faroe study did not address other possible statistical covariates, such as the dietary and nutritional status of the study population and the use of tobacco during pregnancy, further complicating the interpretation of the neuropsychological test results.

On November 18–20, 1998, a workshop on Scientific Issues Relevant to the Assessment of Health Effects from Exposure to Methylmercury was conducted in Raleigh, North Carolina. The workshop was jointly sponsored by the U.S. Department of Health and Human Services (DHHS), the National Institute of Environmental Health Sciences (NIEHS), the Centers for Disease Control and Prevention (CDC), the Food and Drug Administration (FDA), the U.S. Environmental Protection Agency (EPA), the National Oceanic and Atmospheric Administration (NOAA), the Office of Science and Technology Policy (OSTP), the Office of Management and Budget (OMB), and ATSDR. The purpose of this workshop was to discuss and evaluate the major epidemiologic studies that associated methylmercury exposure and the results of an array of developmental measures in children. These studies monitored and evaluated exposed populations in Iraq, the Seychelles Islands, the Faroe Islands, and the Amazon River Basin. A number of animal studies were also considered in support of a human health risk assessment. Presentation of each study by the research team that conducted the study was followed by an expert panel evaluation that examined each study, taking into consideration the exposure data, experimental design and statistical analysis, potential confounders and variables, and neurobehavioral end points evaluated. A fifth panel evaluated the results of relevant animal studies. Significant issues that were discussed included the use of umbilical cord blood mercury levels versus hair mercury concentrations as an index of methylmercury exposure during pregnancy, the patterns of exposure, the dietary/health status of study populations, other potentially relevant exposures, other confounding influences, and the adjustments made for statistical covariates. All five panels at this workshop commended the efforts of the investigators and respective staffs of the Seychelles and Faroe studies for conducting highly sophisticated investigations under difficult conditions. However, specific findings of several of the panels raise issues that, at present, preclude the Faroe data from consideration as a starting point for MRL derivation.

2. HEALTH EFFECTS

In addressing the potential influence of concurrent PCB exposure on the Faroe results, the Confounders and Variables (Epidemiology) panel indicated that with respect to four of the prenatal outcomes (related primarily to verbal and memory performance), when PCBs were included in the model, only one of these outcomes is specifically related to mercury exposure. Concerning this matter, the panel wrote that "... the most likely explanation is that both (mercury and PCBs)... affect these three outcomes, but their relative contributions cannot be determined given their concurrence in this population." The Neurobehavioral Endpoints Panel also looked at this issue, and noted that "PCB exposure might act as an effect modifier, increasing the susceptibility to MeHg"; however, this panel further indicated that it did not believe that the effects seen in the Faroe Islands were due to uncontrolled confounding by PCBs. A third panel that addressed the issue of concurrent PCB exposures, the Statistics/Design Panel, noted that only 3 of 208 PCB congeners were measured in the Faroe study, and stated that it "seems likely that mercury was measured more accurately than the biologically relevant PCB exposure. Consequently even if the neurological effects seen in this study were caused entirely by PCBs, it is possible that mercury would still be more highly correlated with these effects than PCBs." The Statistics/Design Panel also said that "the best method to deal with this problem would be to study a population where exposure to PCBs is not an issue." This statement points directly to the Seychelles study as the study most appropriate for MRL derivation.

Another issue raised at Raleigh workshop concerned the taking of hair samples for determining pre-natal exposure. In the Seychelles, hair samples were collected 6 months post-partum, and segments corresponding to pregnancy were selected for analysis. In the case of the Faroese, hair samples were taken at the scalp. Regarding that, the Confounders and Variables (Epidemiology) panel stated that "Given the time it takes the Hg to be excreted into the hair, we can assume that samples collected at parturition do not cover the last 6 weeks of gestation, during which critically important neuronal proliferation and differentiation is taking place."

Regarding the Seychelles and Faroe studies, the Neurobehavioral Endpoints Panel found "no specific neurobehavioral signature injury from MeHg" in the data from either study (Seychelles or Faroe). The same panel also noted that episodic exposure in the Faroese (1–2 fish meals/week and <1 pilot whale meal/month) "may reduce the likelihood of detecting a consistent 'neurobehavioral signature injury' specific to MeHg and may account for different observations in children with the same average exposure."

Based upon the discussions at the Raleigh workshop and the individual panel findings, as well as the aforementioned Atlanta expert panel review, ATSDR has determined that the Seychelles study represents

2. HEALTH EFFECTS

the most appropriate and reliable database currently available for calculation of a chronic oral MRL from a population exposed only to methylmercury by a relevant route of exposure for the overall U.S. population.

Again, ATSDR would like to strongly emphasize that both the Seychelles study and the Faroese study represent credible scientific contributions by widely respected research teams. Similarly, both studies extend our knowledge base well beyond that provided by the Iraqi study and make significant contributions to our understanding of the effects of low-level exposure to methylmercury by an exposure route and vehicle (i.e., food) relevant to U.S. populations. The continuing monitoring and evaluation of the Seychellois and Faroese populations with more comparable neurobehavioral indices should help strengthen our understanding of the effects of low-level chronic methylmercury exposure and should reduce the uncertainty regarding the public health implications of exposure.

Other Key Studies Reviewed by ATSDR

Other epidemiology studies were also considered by ATSDR in evaluating the database on human exposure to methylmercury. Lebel et al. (1996) evaluated a fish-eating populations in the Amazon River Basin with a neurofunctional test battery and clinical manifestations of nervous system dysfunction in relation to hair mercury concentrations. The villagers examined live along the Tapajos River, a tributary of the Amazon. The study population consisted of 91 adult inhabitants 15–31 years of age. Hair mercury levels were below 50 µg/g (ppm). Clinical examinations were essentially normal, although persons displaying disorganized movements on an alternating movement task and those with restricted visual fields generally had higher hair mercury levels. Near visual contrast, sensitivity, and manual dexterity (adjusted for age) were found to decrease significantly with increasing mercury levels, while a tendency for muscular fatigue and decreasing strength were observed in women. The authors suggested that dose-dependent nervous system alterations might be associated with hair mercury levels below 50 ppm. This study, however, also had a number of potentially confounding factors. The impact of parasitic and other diseases endemic to the study area is of primary concern in the interpretation of the Lebel et al. (1996) results. In addition, the overall nutritional status of the study population was not known or reported, and the use of neuroactive drugs (from local herbs, plants, roots, or mushrooms) was not considered as a potential confounder or covariate. The previous mercury exposure history of the study cohort is also unclear. This is of particular importance because gold mining procedures that use metallic mercury have been commonly practiced along the Amazon Basin for decades. Finally, the end points of the Lebel et al. (1977) study evaluated adult toxicity and not effects in the developing fetus or the newborn (i.e., the most sensitive human population).

2. HEALTH EFFECTS

Myers et al. (1997) evaluated the population of the SCDS for developmental milestones similar to those determined in Iraq. As part of this ongoing study, cohort children were evaluated at 6.5, 19, 29, and 66 months of age. At 19 months care-givers were asked at what age the child walked (n=720 out of 738) and talked (n=680). Prenatal mercury exposure was determined by atomic absorption analysis of maternal hair segments corresponding to hair growth during the pregnancy. The median mercury level in maternal hair for the cohort in this analysis was 5.8 ppm, with a range of 0.5–26.7 ppm. The mean age (in months) at walking was 10.7 (SD=1.9) for females and 10.6 (SD=2.0) for males. The mean age for talking (in months) was 10.5 (SD=2.6) for females, and 11 (SD=2.9) for males. After adjusting for covariates and statistical outliers, no association was found between the age at which Seychellois children walked or talked and prenatal exposure to mercury. The ages for achievement of the developmental milestones were normal for walking and talking in the Seychellois toddlers following prenatal exposure to methylmercury from a maternal fish diet.

Clarkson (1995) raised some interesting issues concerning whether it is reasonable to apply health effects data based on an acute exposure to methylmercury fungicide eaten in homemade bread (in the 1971–1972 Iraq incident) to fish-eating populations having chronic exposure to much lower concentrations of methylmercury. He addressed two specific issues. The first regards the body's "defense mechanisms" that serve to mitigate the potential damage from mercury. One such mechanism in the case of methylmercury involves an enterohepatic cycling process in which methylmercury from dietary sources absorbed through the intestine is carried to the liver, where substantial quantities are secreted back into the bile and returned to the intestinal tract. During the residence time in the gut, microflora break the carbon-mercury bond, converting methylmercury into inorganic mercury, which in turn is poorly absorbed and is excreted in the feces. This creates an effective detoxification pathway for low-dose dietary exposures to methylmercury, but probably not for acute, high-dose exposures, such as occurred in Iraq. Secondly, the transport of methylmercury into brain tissue is inhibited by the presence of many amino acids, including leucine, methionine, and phenylalanine. Thus, it is possible that the rising plasma concentrations of amino acids from ingestion of fish protein may serve to depress the uptake of methylmercury by the brain.

While both of these issues need further laboratory/clinical investigation, they do raise appropriate questions concerning the relevance of the relatively short-term (i.e., about 6 weeks), high-level contaminated grain exposure scenario encountered in Iraq to the dietary methylmercury exposure scenarios encountered in many fish-eating populations (e.g., the Seychelles Islanders, Faroe Islanders, Peruvian villagers, and Inuit native people of Greenland). This position is supported by Cicmanec (1996), who reviewed data from the

2. HEALTH EFFECTS

Iraqi study, as well as data from studies of fish-consuming populations in the Faroe Islands, Seychelles Islands, and Peruvian fishing villages. Cicmanec concluded that the Iraqi population does not represent a sensitive subpopulation within a perinatal group; rather, the relatively lower threshold identified in that study was the result of confounders. Crump et al. (1995) reanalyzed the dose-response data from the Cox et al. (1989) report of the Iraqi incident and found the results to be potentially skewed by inadequacies in the study design and data-collection methods. Shortcomings or potentially confounding factors include: (1) the retrospective recall of developmental milestones by mothers and other family members; (2) the lack of precision in the determination of birth and other milestone dates; (3) and the possible biasing of the dose-response analysis by variation in symptom reporting and infant sex composition in the two study subcohorts. Crump et al. (1995) noted that perhaps the most serious limitation of the Iraqi study is the inability to assess the potential effects of low-level chronic-duration exposure to methylmercury, as these particular data are based on very high intake levels over a relatively brief period of time.

No increase in the frequency of neurodevelopmental abnormalities in early childhood was observed in a cohort of 131 infant-mother pairs in Mancora, Peru (Marsh et al. 1995b). The mean concentration of mercury in maternal hair was determined to be 8.3 ppm (range, 1.2–30 ppm), and the source of the mercury was believed to be from consumption of marine fish. Similarly, a study of 583 Faroe Island infants for the first 12 months after birth found no decrease in the age of attainment of sitting, creeping (crawling), and standing developmental milestones (Grandjean et al. 1995a). The age at which a child reached a particular developmental milestone was not only not found to be associated with prenatal mercury exposure, but infants that reached a milestone early were found to have significantly higher mercury concentrations in their hair at 12 months of age. It was also found that early milestone attainment was clearly associated with breast-feeding, which was in turn related to higher infant hair mercury levels. The authors (Grandjean et al. 1995a) concluded that the beneficial effects associated with breast-feeding seemed to overrule, or to compensate for, any neurotoxic effects on milestone development that could be due to the presence of contaminants (e.g., mercury) in human milk.

Additional studies have shown developmental toxicity after oral exposure of humans and animals to organic mercury compounds (Amin-Zaki et al. 1974; Bakir et al. 1973; Bornhausen et al. 1980; Cagianò et al. 1990; Elsner 1991; Engleson and Herner 1952; Fowler and Woods 1977; Guidetti et al. 1992; Harada 1978; Hughes and Annau 1976; Ilback et al. 1991; Inouye and Kajiwara 1988; Khera and Tabacova 1973; Lindstrom et al. 1991; McKeown-Eyssen et al. 1983; Nolen et al. 1972; Olson and Boush 1975; Rice 1992; Rice and Gilbert 1990; Snyder and Seelinger 1976; Stoltenburg-Didinger and Markwort 1990).

2. HEALTH EFFECTS

The accumulation of mercury is greater in larger fish and in fish higher in the food chain. The tendency for increased mercury concentration with increasing fish body weight is particularly noticeable in carnivorous fish species. Malm et al. (1995) analyzed mercury concentrations in 16 species of carnivorous fish from the Tapajos River basin in Brazil and hair samples from local populations who regularly ate such fish. Mercury levels in the fish averaged 0.55 ppm (range, 0.04–3.77 ppm), and the mercury levels in the hair of the affected fish-eating populations averaged approximately 25 ppm. In one population that consumed higher quantities of large carnivorous fish at the end of the local rainy season, 8 of 29 persons evaluated had hair mercury levels above 40 ppm, and one individual had a hair mercury concentration of 151 ppm. Some villages along the river can have per capita daily fish consumption rates around 200 g or more, which would greatly impact the human body burden and hair levels of mercury in such populations.

Hair-to-Blood Concentration Ratio

The hair: blood concentration ratio for total mercury is frequently cited as 250. However, a precise basis for this particular value is unclear. Ratios reported in the literature range from 140 to 416, a difference of more than a factor of 2.5 (see Table 2-9). Differences in the location of hair sampled (head versus chest, distance of sample from head or skin) may contribute to differences in observed ratios between studies. For example, as much as a 3-fold seasonal variation in mercury levels was observed in average hair levels for a group of individuals with moderate-to-high fish consumption rates, with yearly highs occurring in the fall and early winter (Phelps et al. 1980; Suzuki et al. 1992). Thus, it is important to obtain hair samples as close to the follicle as possible to obtain an estimate of recent blood levels. Large errors (the direction of which depends on whether samples were taken while blood levels were falling or rising) could result if hair samples are not taken close to the scalp. Several studies did not report the distance to the scalp for the hair samples taken. The high slope reported by Tsubaki (1971a) may have reflected the fact that mercury levels were declining at the time of sampling (Berglund et al. 1971), so the hair levels may reflect earlier, higher blood levels. Hair taken from different parts of the body also may yield different ratios. In 26 subjects with moderate-to-high fish consumption, axillary hair (i.e., from the armpit area) was found to contain an average of 23% less mercury than head hair (Skerfving et al. 1974).

Phelps et al. (1980) obtained multiple blood samples and sequentially analyzed lengths of hair from 339 individuals in Northwestern Ontario. The large sample size and the attention to sampling and analysis with regard to the hair: blood relationship make the results from this study the most appropriate to use for estimating the mercury blood levels of the Seychellois women during pregnancy. The actual ratio Phelps et

2. HEALTH EFFECTS

Table 2-9. Available Data on Hair:Blood Ratio (total Hg)

Reference	Hair to blood ratio	Number of subjects	Hg range in whole blood ($\mu\text{g/L}$)	Hg range in hair (ppm)	Hair sample	
					Length (mm)	Distance to scalp
Sumari et al. 1969 ^a	140	50	5–270	1–56	–	–
Soria et al. 1992	218	16	2.4–9.1	0.15–20	–	At scalp
Tejning 1967 ^a	230	51	4–110	1–30	–	Axillary
Skerfving 1974	230	60	44–550	1–142	5	At scalp
Haxton et al. 1979	250	173	0.4–26	0.1–11.3	20	–
Tsubaki 1971b ^b	260	45	2–800	20–325	–	–
Birke et al. 1972 ^b	280 ^c	12	4–650	1–180	5	At scalp
Den Tonkelaar et al. 1974	280	47	1–40.5	<0.5–13.2	–	–
Kershaw et al. 1980	292 ^d	5	–	–	5	At scalp
Phelps et al. 1980	296	339	1–60	1–150	10	At scalp
Sherlock et al. 1982	367	98	1.1–42.3	0.2–21	24	–
Tsubaki 1971a ^a	370	~25	–	–	"Longer tuft" ^a	–

^a As cited in Berglund et al. 1971

^b As cited in WHO 1976

^c Ratio of methylmercury in hair to methylmercury in blood

^d Based on repeated measurements at different time points (3–8 ratios per individual), of the ratio of 5 mm hair segments to corresponding 2-week average blood levels (assuming hair growth of 1.1 cm/month).

– = Not reported

2. HEALTH EFFECTS

al. (1980) observed between the total mercury concentration in hair taken close to the scalp and simultaneous blood sampling for this group was 296. To estimate the actual ratio, the authors assumed that blood and hair samples were taken following complete cessation of methylmercury intake. They also assumed a half-life of methylmercury in blood of 52 days and a lag of 4 weeks for appearance of the relevant level in hair at the scalp. Based on these assumptions, they calculated that if the actual hair: blood ratio were 200, they would have observed a ratio of 290 (i.e., essentially equivalent to the observed value of 296). Based on these and other considerations, Phelps et al. (1980) state that the actual ratio is "probably higher than 200, but less than the observed value of 296." As the authors point out, two-thirds of the study population were sampled during the falling phase of the seasonal variation and one-third or less in the rising phase. This fact would tend to result in a lower observed ratio; therefore, the actual average value is likely to be >200.

Phelps et al. (1980) also provide estimates assuming a 2-week lag for the appearance of the relevant level of mercury in the centimeter of hair nearest the scalp. For a 2-week lag time, an actual ratio of 250 would have resulted in an observed ratio of 301 (again, essentially identical to the observed value of 296). A study of ingestion of a large dose of mercuric chloride in one individual suggests that the lag time is longer than 2 weeks (Suzuki et al. 1992). Hair samples were taken at 41 and 95 days following ingestion of the mercuric chloride. In the 41-day hair sample, a large mercury peak occurred in the centimeter of hair closest to the scalp, with no elevation in mercury in the second centimeter of hair. Head hair grows at a rate of about 1.1 cm a month (Al-Shahristani and Shihab 1974; Cox et al. 1989). If emergence had occurred so that the elevation in mercury could be measured in the first centimeter of hair by 2 weeks after exposure, then by day 41 after exposure the peak should have moved into the second centimeter of hair, at least enough to raise the mercury level slightly in the second centimeter. Because no elevation was seen in the second centimeter of hair at 41 days, it would appear that emergence occurred at a lag of >2 weeks. In the hair sample taken at 95 days, the leading edge of the mercury peak occurred in the third centimeter of hair.

Based on the data presented in Phelps et al. (1980) and the lag time indicated in the individual studied by Suzuki et al. (1992), the actual average value is likely to be somewhere between 200 and 250. Because the data do not allow a more accurate determination of an average ratio, the value 250 is acceptable for the purpose of estimating average blood levels in the Seychellois population. Using 250 rather than a lower number results in a lower MRL. It should be noted that a wide range in hair: blood ratios has been reported for individuals in various studies: 137–342 in Soria et al. (1992), 171–270 in Phelps et al. (1980), 416 in

2. HEALTH EFFECTS

Cernichiari et al. (1995), and 137–585 in Birke et al. (1972). Therefore, this ratio (250) should not be used as the sole basis for determining levels of exposure and potential effect for individuals.

Calculation of dietary intake of mercury from blood concentration.

Fraction of mercury in diet that is absorbed (A_D). Radiolabeled methyl-mercuric nitrate was administered in water to three healthy volunteers (Aberg et al. 1969). The uptake was >95%. Miettinen et al. (1971) incubated fish liver homogenate with radiolabeled MeHgNO₃ to yield a methylmercury proteinate. The proteinate was then fed to fish that were killed after a week, cooked, and fed to volunteers after confirmation of the methylmercury in the fish. Mean uptake exceeded 94%. For the derivation of an MRL, an absorption factor of 0.95 is used.

Fraction of the absorbed dose that is found in the blood (A_B). The value 0.05 has been used for this parameter in the past (Berglund et al. 1971; WHO 1990). Three studies report observations of the fraction of the absorbed methylmercury dose distributed to blood volume in humans. Kershaw et al. (1980) report an average fraction of 0.059 of the absorbed dose in the total blood volume, based on a study of 5 adult male subjects who ingested methylmercury-contaminated tuna. In a group of 9 male and 6 female volunteers who had received ²⁰³Hg-methylmercury in fish, approximately 10% of the total body burden was present in 1 L of blood in the first few days after exposure, dropping to approximately 5% over the first 100 days (Miettinen et al. 1971). In another study, an average value of 1.14% for the percentage of absorbed dose in 1 kg of blood was derived from subjects who consumed a known amount of methylmercury in fish over a period of 3 months (Sherlock et al. 1984). Average daily intake for the 4 groups observed in the study ranged from 43 to 233 µg/day. The authors report a dose-related effect on the estimated percentage of the absorbed dose in 1 kg of blood, with 1.26% of the absorbed dose in 1 kg of blood at an average daily intake of 43 µg/day and 1.03% of the absorbed dose in 1 kg of blood at an average daily intake of 233 µg/day. The average for all subjects in the study was 1.14%. When individual values for distribution to one kilogram of blood reported in the study are converted into the percentage of the absorbed dose in the total blood volume (assuming that blood is 7% of body weight [Best 1961] and using body weights reported for individuals in the study), the average value for A_B for all individuals is 0.056 (0.057 using the values for percentage in 1 kg normalized for body weight as reported in the study). The average value for A_B for 6 women as reported in Sherlock et al. (1984) is 0.048 (0.047 using values normalized for body weight). The average for 14 men is 0.059 (0.061 using values normalized for body weight).

2. HEALTH EFFECTS

The average values for A_B for all studies ranged from 0.047 to 0.061 (the values for women and men reported in Sherlock et al. [1984]). The data suggest that the average value of A_B for women may be lower than that for men, and they further suggest that 0.05 may be appropriate for modeling intake in a group of women (Sherlock et al. 1984). Based on these studies, the best estimate of A_B based on the available data is 0.05. Use of a higher value (i.e., 0.06 instead of 0.05) for this parameter would result in a lower MRL, but the sensitive populations are pregnant women and developing fetuses, making the 0.05 value more appropriate for the Seychelles study population.

Elimination constant (b). Reported clearance half-times for methylmercury from blood or hair range from 48 to 65 days (Table 2-5). The average elimination constant based on the six studies listed in Table 2-5 is 0.014. The average of the individual values for b reported for 20 volunteers ingesting 42–233 $\mu\text{g Hg/day}$ in fish for 3 months (Sherlock et al. 1984) is also 0.014. Use of the value 0.014 for this parameter, rather than 0.01 (as used by WHO 1990), results in a higher MRL.

Volume of blood in body (V), and body weight. Blood volume is assumed to be 7% of body weight, with an increase to about 9% during pregnancy (Best 1961). Data for the body weight of the Seychelles Islands women were not found. Assuming an average body weight of 60 kg for women, the blood volume is 4.2 L (60 kg x 0.07 L/kg). The 9% of body weight value is not used because it is not representative of the blood volume throughout pregnancy. Blood volume does not begin to increase significantly from the 7% pre-pregnancy level until around the 27th week of pregnancy. It then sharply rises until week 40 or parturition (Guyton 1996). To use the 9% value would, therefore, be representative of the blood volume late in pregnancy (i.e., mid- to late- third trimester), but not throughout most of pregnancy. In contrast, the hair mercury level to which it is compared represents an average value throughout pregnancy. The use of the 9% value would result in a higher MRL, and is not considered appropriate in this instance.

Calculation of Exposure Dose

The concentration of mercury in hair is assumed to be 250 times the concentration in blood. ATSDR's peer-reviewed, published guidance for MRL derivation (Chou et al. 1998) calls for the use of the highest value at which no adverse effects were observed in the critical study. Using, therefore, the 15.3 ppm mean maternal hair (taken at parturition) value from the highest exposure group (range, 12–26.7 ppm) in the Seychellois test population as a NOAEL for the 66-month Seychelles testing (Davidson et al. 1998), the corresponding methylmercury concentration in blood would be: $1/250 \times 15.3 \mu\text{g/g} \times 1 \text{ mg}/1,000 \mu\text{g} \times 1,000 \text{ g/L} = 0.061 \text{ mg/L}$.

2. HEALTH EFFECTS

Converting blood mercury concentration to daily intake.

The concentration of mercury in the blood may be converted to a daily intake by using the following equation from WHO (1990):

$$C = \frac{f(d)}{b(V)} \cdot \frac{A_D(A_B(d))}{b(V)}$$

Where:

- C = concentration in blood
- f = fraction of the daily intake taken up by the blood
- d = daily dietary intake
- b = elimination constant
- A_D = percent of mercury intake in diet that is absorbed
- A_B = percent of the absorbed amount that enters the blood
- V = volume of blood in the body

where:

$$C = (0.95 \times 0.05 \times d) / (0.014 \times 4.2)$$

$$C = 0.81 d$$

$$0.061 \text{ mg} = 0.81 d$$

$$d = 0.075 \text{ mg/day}$$

Using the assumed body weight of 60 kg for women, the estimated dose that would result in a hair level of 15.3 ppm is $0.075/60 \text{ kg} = 0.0013 \text{ mg/kg/day}$. Therefore, the NOAEL derived from the highest exposure group (n = 95) at 66 months is 0.0013 mg/kg/day .

Consideration of Uncertainty

The standard/traditional areas of uncertainty addressed in any duration-specific MRL are: (1) interspecies variability (i.e., cross-species extrapolation of a NOAEL or LOAEL); (2) intra-human variability (i.e., differences in susceptibility to a substance or effect within the human population); (3) use of an LOAEL for MRL derivation when an NOAEL for the critical effect is not available; and (4) extrapolation from subchronic to chronic duration. In addition, a modifying factor may also be used when special circumstances exist that may contribute to, or introduce, uncertainty into the calculated health guidance value (MRL) in an area not typically covered by the traditional uncertainty factor approach.

2. HEALTH EFFECTS

The NOAEL of 15.3 ppm mercury in maternal hair from Davidson et al. (1998) used as the starting point for MRL derivation was based upon an unusually large study cohort of the population considered most sensitive to the neurodevelopmental effects of methylmercury, i.e., pregnant women and their developing fetuses. The negative results of this study are strongly supported by the BMD NOAEL range of 13 to 21 ppm calculated for the New Zealand cohort of 237 mother-child pairs (Crump et al. 1998). Consequently, much of the uncertainty normally present in the MRL derivation process does not exist in the case of methylmercury. Nonetheless, in view of the nature of the most susceptible group (developing fetuses) and some questions raised in the vast human data base for this chemical, an aggregate value of 4.5 was employed.

This value (4.5) was based upon three separate components, two of which are interrelated and the other independent. For the Seychelles data, a value of 1.5 was used to address variability in hair-to-blood ratios among women and fetuses in the U.S. population, as determined by pharmacokinetic modeling of actual data by Clewell et al. (1998); a second value of 1.5 was applied to address the remainder of any inter-individual variability (i.e., pharmacodynamics) in the U.S. population. A third, and independent, factor of 1.5 was employed to account for the possibility that the domain-specific tests, as employed extensively in the Faroe Islands, but not the Seychelles (which used primarily neurobehavioral tests of global function) might be able to detect very subtle neurological effects not tested for in the 66-month Seychelles cohort.

The World Health Organization (WHO, 1993, 1996) has defined the -kinetic and -dynamic components of intrahuman variability as being equal contributors to, and collectively constituting the total of, human variability. In order to assure a conservative approach, these two interdependent components were added to give a composite uncertainty factor of three (i.e., $1.5 + 1.5 = 3$) to account for the full range of variability attributable to mercury in the Seychelles study. A modifying factor of 1.5 was also used to account for the possibility of domain-specific effects, as were seen in the Faroe study, being attributable to mercury. Since these effects were considered to be entirely separate or “independent” events, this modifying factor of 1.5 was multiplied by the uncertainty factor of 3.0 (for uncertainty attributable solely to the Seychelles study) to yield an aggregate uncertainty of 4.5 for chronic oral exposure to methylmercury.

While domain-specific tests from the Seychelles were reviewed at the North Carolina meeting in November 1998 and the results failed to demonstrate effects, the tests do not represent the full range of domain-specific tests that were administered in the Faroe Islands. For these reasons, and based on our consultation with our Board of Scientific Counselors about concerns for “missing” data sets (i.e., in relation to the Executive Order of children’s health and the agency’s efforts to protect the health of children, including the developing fetus), ATSDR determined that an additional factor of 1.5 should be used since the full range of

2. HEALTH EFFECTS

domain-specific neuropsychological test results from the Seychelles are not yet available. When these results become available and if they fail to show domain-specific effects, this additional factor of 1.5 would no longer be needed. At that time ATSDR will re-evaluate its MRL, as well as all other relevant data, in compliance with the agency's mandates and authorities.

Therefore, in the calculation of the chronic oral MRL for methylmercury, the NOAEL of 0.0013 mg/kg/day from the 66-month study (Davidson et al. 1998) is divided by 4.5, giving a chronic oral MRL for methylmercury of 0.0003 mg/kg/day [0.0013 mg/kg/day / 4.5 (UF) = 0.0003 mg/kg/day].

Alternative Derivations of the MRL

To ensure a health guidance value based upon the best use of the Seychelles study data (widely considered the most relevant data available), ATSDR evaluated alternate MRL derivation methods for methylmercury. One such approach is to use the mean total mercury level of 6.8 ppm in maternal hair for the entire Seychellois study cohort. Using the same formula as in the previous MRL calculation,

$$C = (0.95 \times 0.05 \times d) / (0.014 \times 4.2)$$

$$C = 0.81 \text{ d}$$

$$(1/250 \times 6.8) = 0.027$$

$$0.027 \text{ mg/L} = 0.81 \text{ d}$$

$$d = 0.034 \text{ mg/day}$$

$$0.034 \text{ mg/day} / 60 \text{ kg} = 0.0006 \text{ mg/kg/day}$$

In consideration of uncertainty factors for this MRL approach, multiple factors also apply. In this case, the mean value of 6.8 ppm for the NOAEL is for the entire study cohort at 66 months (n = 711). An uncertainty factor of 1.5 was used to account for the pharmacokinetically based variability of hair-to-blood ratios (95% confidence level) in pregnant women and fetuses in the U.S. population (Clewell et al. 1998, 1999). The extremely large size of the study population (n=711), in combination with an uncertainty factor of 1.5, is considered adequate to encompass the full range of pharmacokinetic and pharmacodynamic variability within the human population. An independent modifying factor of 1.5 was also used to take into consideration the positive results of the domain-specific tests administered in the Faroe study (Grandjean et al. 1997, 1998). The uncertainty factor of 1.5, multiplied by the modifying factor of 1.5, yields a total aggregate value of 2.25. Applying the factor of 2.25 to the daily intake calculated from the 6.8 ppm

2. HEALTH EFFECTS

NOAEL yields a chronic oral MRL value of 0.0003 mg/kg/day for methylmercury (0.0006 mg/kg/day divided by 2.25 = 0.0003 mg/kg/day).

A third approach to deriving a health guidance value is the use of bench mark dose (BMD) modeling. Clewell et al. (1998) used a benchmark dose analysis to determine a reference dose (RfD, a health guidance value used by the Environmental Protection Agency and, in some ways, the equivalent of ATSDR's chronic oral MRL). Clewell et al. (1998) used the data from the 29-month test in the Seychellois population (Davidson et al. 1995b) for their analysis (i.e., the 66-month study had not been published at the time of their benchmark dose analysis). The BMD is calculated by fitting a mathematical dose-response model to dose-response data. The bench mark dose level (BMDL) is a lower statistical confidence bound on the BMD and replaces the NOAEL in the calculation of a health guidance value. The BMD approach has been proposed as superior to the use of "average" or "grouped" exposure estimates when dose-response information is available, as is the case for the Seychelles study. Clewell et al. (1998) note that the Faroe Islands study reported by Grandjean et al. (1997b) could not be used for dose-response modeling due to inadequate reporting of the data and the confounding influence of co-exposure to PCBs.

For the 29-month Seychelles data, Clewell et al. (1998) used the 95% lower bound on the 10% benchmark dose level (BMDL), which represents a conservative estimate of the traditional NOAEL. The benchmark dose modeling over the entire range of neurological endpoints reported by Davidson et al. (1995b) yielded a lowest BMDL₁₀ of 21 ppm methylmercury in maternal hair. This BMDL₁₀ was then converted to an expected distribution of daily ingestion rates across a population of U.S. women of child-bearing age by using a Monte Carlo analysis with a physiologically based pharmacokinetic (PBPK) model of methylmercury developed by Gearhart et al. (1995). This analysis addresses the impact of interindividual pharmacokinetic variability on the relationship between ingestion rate and hair concentration for methylmercury. The resulting distribution had a geometric mean value of 0.00160 mg/kg/day (S.D. 0.00133). The 1st, 5th, and 10th percentiles of that distribution were 0.00086, 0.00104, and 0.00115 mg/kg/day, respectively. Clewell et al. (1998) suggested that the 5th percentile of 0.00104 mg/kg/day provides a scientifically based, conservative basis that incorporates the pharmacokinetic variability across the U.S. population of child-bearing women and that no other uncertainty factor for interindividual variability would be needed. To the benchmark-estimated NOAEL of 21 ppm derived from the Seychelles 29-month data, Clewell et al. (1998) applied an uncertainty factor of 3 to account for data base limitations. (Note: The 66-month Seychelles data was not yet published at the time; hence the reliance on the 29-month Seychelles

2. HEALTH EFFECTS

data for the benchmark analysis.) Consequently, Clewell et al. (1998) concluded that using a NOAEL of 7 ppm (21 ppm / 3 (UF) provides additional protection against the possibility that effects could occur at lower concentrations in some populations. Based upon this reasoning, Clewell and his colleagues recommended a health guidance value (i.e., an RfD) of 0.0004 mg/kg/day. If a modifying factor of 1.5 is used to further address the domain-specific findings in the Faroe study, a final MRL of 0.3 µg/kg/day results.

The above benchmark analysis of 29-month data from the Seychelles Child Development Study strongly supports the MRL of 0.0003 mg/kg/day calculated by ATSDR in this profile. Similarly, addressing the Seychellois 66-month data from the perspective of using the mean value (15.3 ppm) of the highest exposure group in the study, a method prescribed in ATSDR's published guidance for MRL development (Chou et al. 1998), also results in an identical MRL. ATSDR therefore has high confidence that this level is protective of the health of all potentially exposed human populations.

Employment of the Chronic Oral MRL for Methylmercury

It should be emphasized that the MRL is considered by ATSDR to be a level of exposure to a single chemical/substance which is considered "safe" for all potentially exposed populations for a specified duration of time (acute, intermediate, or chronic). It is not considered be a threshold for adverse effects, and not address the likelihood of adversity at any incremental level above the MRL value. ATSDR notes that the 0.3 µg/kg/day chronic oral MRL for methylmercury is in close agreement with the tolerable daily intake (ADI) levels of 0.47 and 0.48 µg/kg/day established by the FDA and WHO, respectively.

MRLs are, by definition (Chou et al. 1998), substance-specific and do not include effects attributable to interaction (whether additive, synergistic, or antagonistic) with other chemicals or environmental substances. Their relevance to the mission of ATSDR is to assist public health officials in the identification of chemicals/elements of potential health concern at hazardous waste sites. The ATSDR MRL is not intended to be used in the regulatory or site clean-up process, but is instead intended to serve as a basis of comparison with actual measured levels of environmental exposure. Further, the role of informed biomedical judgment is crucial in the application of any MRL, or the media-specific health guidance values (HGVs) derived from them, in any given exposure scenario (Risher and De Rosa 1997). MRLs for a particular substance are based upon the most sensitive effect/endpoint in that portion of the human population considered to be most susceptible to injury from exposure to that substance. Thus, the MRL has never been intended as a one-size-fits-all tool for all hazardous waste site exposure scenarios; rather, it is merely a starting point for further examination of potential health risk. Therefore, at sites

2. HEALTH EFFECTS

where methylmercury is present in combination with other known or suspected neurodevelopmental toxicants, such as lead or polychlorinated biphenyls (PCBs), and in which exposure is primarily episodic in nature, the health assessor might consider using a value below the chronic oral MRL for methylmercury as a starting point for determination of further site investigation. (A more complete description of the uses of MRLs and other HGVs can be found in Chou et al. 1998 and Risher and De Rosa 1997.)

Background and general population exposures relevant to the oral MRL for methylmercury

Mercury hair levels have been monitored in a variety of populations and generally range from 1 to 4 ppm, depending upon the level of fish consumption. Table 2-10 summarizes the mean (or median) values and the maximum value from a number of these studies.

Diet. Based on the FDA total diet study of 1982–1984 (Gunderson 1988), FDA estimated that the average intake for total mercury (both inorganic and organic) is 50–100 ng/kg/day. Based on the more recent 1989–1990 FDA total diet study, the estimated intake of total mercury is 27–60 ng/kg/day (Cramer 1994). An estimated 86% of the mercury in the total diet study is derived from fish (Tollefson and Cordle 1986). A separate estimate of the average intake of methylmercury alone, based on a survey of fish eaters and average levels of methylmercury in fish, places the average intake of methylmercury at 36 ng/kg/day, with a 99% upper bound at 243 ng/kg/day (Clarkson 1990).

Potential protective effect of selenium in fish. Selenium is known to bioconcentrate in fish, and selenium has been observed to correlate with mercury levels in the blood of fish consumed (Grandjean et al. 1992). Furthermore, there is evidence suggesting that consumption of methylmercury from fish, in conjunction with other beneficial constituents in fish (e.g., omega-3 fatty acids) may not result in the same toxicity dose-response relationship observed with methylmercury exposure from consumption of contaminated grain (as in the Iraqi population) (Davidson et al. 1998).

Regarding the bioavailability of methylmercury in fish, the available data indicate that methylmercury uptake is not affected by its presence in fish. Experimental studies on the metabolism of methylmercury in humans following the ingestion of contaminated fish (using methylmercury bound to fish muscle protein) have shown that absorption is almost complete (95% absorbed) (Miettinen 1973). Animal studies also support this absorption value. Data on cats given fish homogenates indicate absorptions of 90% of methylmercury, whether added to the homogenate, accumulated by fish *in vivo*, or from methylmercury proteinate (Berghlund et al. 1971). Using blood and tissue levels as evidence of absorption, Charbonneau et al. (1976) concluded that there was no difference in the biological availability of methylmercury

2. HEALTH EFFECTS

Table 2-10. Concentration of Total Mercury in Hair

Mean (M) or median (m) (ppm)	Maximum (ppm)	N	Description of population	Reference
1.4 (M)	27.4	942	United Kingdom. Area chosen for "above average fish consumption"	Sherlock et al. 1982
1.35 (M)	5.8	55	United Kingdom. Fishing community, area with lesser contamination	Haxton et al. 1979
1.48 (M)	3.28	34	Islands of the central Adriatic (Yugoslavia). Women; degree of fish consumption not reported. Hair sampled at end of pregnancy	Horvat et al. 1988
2.0 (M)	11.3	119	United Kingdom. Fishing community, area with greater contamination. Fish consumption range 10–225 g/day with 50% eating greater than 50 g/day	Haxton et al. 1979
2.85 (M)	20	50	Spain. Women; degree of fish consumption not reported. Hair sampled at end of pregnancy	Soria et al. 1992
3.2 (M)	10.8	50	Sweden. High consumption of freshwater fish. Mercury levels in fish generally below 1 ppm	Oskarsson et al. 1990
3.9 (M)	21	98	United Kingdom. Consumed an average of 0.36 kg fish/week	Sherlock et al. 1982
5.6 (M)	20	35	Japan. Fish consumption not known	Suzuki et al. 1993
0.8 (m)	2 ^a	18	Faroe Islands. No fish consumption	Grandjean et al. 1992
1.61 (m)	3.7	49	1 fish meal per week	
2.5 (m)	4.7	75	2 fish meals per week	
2.1 (m)	3.6	49	3 fish meals per week	
5.2 (m)	8	17	4 fish meals per week	
1.4 (M)			Eat fish once a month	Airey 1983b
1.9 (M)			Eat fish once every 2 weeks	
2.5 (M)			Eat fish once a week	
11.6 (M)			Eat fish once a day	
0.247 (m)	2.5	150	German sample from 150 cadavers (75 males, 75 females) from the general population (i.e., no occupational or unusual exposures to metals.)	Drasch et al. 1997

^a The "maximums" reported in this column for Grandjean et al. 1992 are the upper values for the "50% range" as reported in Grandjean et al. (1992).

2. HEALTH EFFECTS

administered to adult cats (0.003, 0.0084, 0.020, 0.046, 0.074, or 0.176 mg Hg/kg/day, 7 days a week for 2 years), either as pure methylmercuric chloride in corn oil added to a diet containing uncontaminated fish or as methylmercury-contaminated fish. In the two highest dose groups (0.074 and 0.176 mg Hg/kg body weight at 100 weeks of exposure), no significant differences were seen in total mercury concentrations in the blood between groups receiving the dose as methylmercuric chloride or as contaminated fish at the same dose level. In addition, monthly blood levels were comparable for all dose groups. No significant differences were seen at 100 weeks in total mercury concentrations in nervous tissue or other tissues (renal cortex, renal medulla, liver, spleen, adrenal, bladder, atria, ventricle, ovary, testis, muscle) between the two highest dose groups receiving the dose as methylmercuric chloride or as contaminated fish at the same dose level.

Regarding the effect of selenium on methylmercury toxicity, most studies have shown that the simultaneous administration of mercury and selenium in equimolar doses to animals has resulted in decreased toxicity of both elements for acute- and chronic-duration exposures. This effect has been observed with inorganic and organic mercury and with either inorganic or organic selenium compounds, although inorganic forms of selenium appear to be more effective than organic forms (Chang 1983; Skerfving 1978). Selenium protects against the acute nephrotoxicity of the mercuric ion and methylmercuric ion in rats (Ganter et al. 1972, 1980; Hansen 1988; Magos et al. 1987; Parizek and Ostadolva 1967) and possibly against acute neurotoxicity of methylmercuric ion in rats (Ohi et al. 1980).

Somewhat paradoxically, the protective effect of selenium has been associated with a higher whole-body retention of mercury (Hansen 1988; Magos et al. 1987). In a study of selenium excretion in workers exposed to low levels of metallic mercury vapor in a chloralkali plant, Ellingsen et al. (1995) found that even in a low-to-moderate occupational exposure, mercury may reduce the urinary selenium concentration in humans in a manner that is not yet fully known. Evidence from human autopsy tissues suggests that distribution of mercury throughout the body may be influenced by the presence of selenium (Suzuki et al. 1993). In this study, however, the level of selenium was found to negatively correlate with the level of mercury in some tissues including the cerebrum, spleen, and kidney cortex. Suzuki et al. (1993) also report that hair selenium values negatively correlated with total organ mercury and inorganic mercury levels. The association between concentrations of inorganic mercury and selenium in both the occipital lobe and the thalamus of the brains of methylmercury-exposed female monkeys was reported by Bjorkman et al. (1995). These authors observed a tendency to a "hockey stick-shaped" relationship between concentrations of selenium and inorganic mercury in the thalamus of monkeys with ongoing exposure to methylmercury, and

2. HEALTH EFFECTS

they postulated an important role for selenium in the retention of mercury in the brain. These studies indicate that selenium has an effect on mercury toxicokinetics, although more study is needed to determine the nature of the interaction with respect to different organs and exposure regimens.

Although the specific mechanism for the protection is not well understood, possible mechanisms for selenium's protective effect include redistribution of mercury (Mengel and Karlog 1980), competition by selenium for mercury-binding sites associated with toxicity, formation of a mercury-selenium complex that diverts mercury from sensitive targets (Hansen 1988; Magos et al. 1987; Naganuma and Imura 1981), and prevention of oxidative damage by increasing selenium available for the selenium-dependent glutathione peroxidase (Cuvin-Aralar and Furness 1991; Imura and Naganuma 1991; Nylander and Weiner 1991). One laboratory study showed that selenium-treated animals can remain unaffected, despite an accumulation of mercury in tissues to levels that are otherwise associated with toxic effects (Skerfving 1978). Support for the proposal that an inert complex is formed comes from the 1:1 ratio of selenium and mercury found in the livers of marine mammals and in the bodies of experimental animals administered compounds of mercury and compounds of selenium, regardless of the ratio of the injected doses (Hansen 1988).

Southworth et al. (1994) evaluated the elimination of slurried fly ash discharges into a water-filled quarry and found that the discharge was followed by a steady increase in concentrations of mercury in the axial muscle of resident largemouth bass (*Micropterus salmoides*), increasing from 0.02 to 0.17 µg/g in a period of just 3 years. These authors also found that while selenium concentrations in the quarry decreased from 25 to <2 µg/L during the same period, selenium concentrations in bass remained at about 3 times the background levels. Southworth and his co-authors concluded that the results of their study suggest that selenium may also be effective at blocking the accumulation of methylmercury in harder, more alkaline waters.

SPECIFIC ADVERSE EFFECTS ATTRIBUTABLE TO MERCURY EXPOSURE

Death. Inhalation of sufficiently high concentrations of metallic and organic mercury vapors, ingestion of sufficiently high doses of organic and inorganic mercury, and exposure to dialkyl mercurials by any route can be fatal to humans and animals. In the cases of both inhalation and dermal exposure to dialkyl-organomercurials (e.g., diethyl- and dimethylmercury), acute exposures that appear innocuous or unremarkable at the time of exposure can result in death following a delay period of weeks or months. The tragic case of a delayed neurotoxicity and ultimately fatal poisoning 9 months after an acute dermal

2. HEALTH EFFECTS

exposure to only a few drops of dimethylmercury is striking example of the danger of these forms of organic mercury (Blayney et al. 1997; Nierenberg et al. 1998). At least 5 other deaths have been reported due to alkyl mercury exposure since its first synthesis in the mid-19th century (Toribara et al. 1997). These accidental poisoning cases also reveal a latency period of some months between the exposure and the onset of symptoms. In such cases, irreversible brain damage has already occurred by the time the first symptoms appeared.

No information was located regarding specific concentrations of elemental mercury vapor that may be lethal; however, lethal exposures have generally occurred as a result of exposure under conditions in which exposure levels are likely to be quite high (e.g., heating metallic mercury in a closed space). Death in these cases has generally been attributed to respiratory failure (Campbell 1948; Kanlun and Gottlieb 1991; Matthes et al. 1958; Rowens et al. 1991; Soni et al. 1992; Taueg et al. 1992; Teng and Brennan 1959; Tennant et al. 1961). Deaths resulting from inhalation exposure to organic mercury compounds have also been reported (Brown 1954; Hill 1943; Hook et al. 1954; Lundgren and Swensson 1949). Although the cause of death following inhalation of organic mercury was not reported, severe neurological dysfunction was observed prior to death.

Lethal doses for acute oral exposure to inorganic mercury have been estimated to be 29–50 mg Hg/kg (Troen et al. 1951). Deaths resulting from oral exposure to inorganic mercury have been attributed to renal failure, cardiovascular collapse, and severe gastrointestinal damage (Gleason et al. 1957; Kang-Yum and Oransky 1992; Troen et al. 1951).

Deaths from consumption of methylmercury-contaminated foods are well documented in outbreaks in Japan and Iraq, and lethal doses of 10–60 mg Hg/kg have been estimated from tissue concentrations (Bakir et al. 1973; Tsubaki and Takahashi 1986). Fatalities were attributed to central nervous system toxicity (Bakir et al. 1973; Tamashiro et al. 1984). Pneumonia and nonischemic heart disease were prominent secondary causes of death in the Japan epidemic (Tamashiro et al. 1984). Case reports of deaths associated solely with dermal mercury exposure to inorganic mercury are limited to a woman who died after inserting a mercuric chloride tablet into her vagina (Millar 1916) and a man who died after a 2-month treatment with a topical medicine containing mercurous chloride (Kang-Yum and Oransky 1992). Death was attributed to renal failure in one of these cases (Kang-Yum and Oransky 1992), and severe renal damage was noted at the autopsy in the other (Millar 1916).

2. HEALTH EFFECTS

Animal data support the findings from human studies and provide somewhat more information regarding lethal exposure levels. Deaths associated with acute-duration inhalation exposure to metallic mercury vapor have been observed in rats and rabbits at about 27–29 mg/m³ (Ashe et al. 1953; Livardjani et al. 1991b). Severe pulmonary edema has been reported as the cause of death following such exposures (Christensen et al. 1937). Severe ataxia occurred prior to death in rats exposed to methylmercury iodide vapor for intermediate durations (Hunter et al. 1940). Acute oral LD₅₀ values for inorganic mercury ranged from 25.9 to 77.7 mg Hg/kg, with the most sensitive LD₅₀ for 2-week-old rats (Kostial et al. 1978). Increased mortality in chronic-duration oral studies has been observed at 1.9 mg Hg/kg in male rats gavaged 5 days a week (NTP 1993). Early deaths were attributed to renal toxicity. Oral exposure to methylmercuric compounds has resulted in increased mortality at 16 mg Hg/kg (single dose) (Yasutake et al. 1991b), 3.1 mg Hg/kg/day for 26 weeks (Mitsumori et al. 1981), and 0.69 mg Hg/kg/day for up to 2 years (Mitsumori et al. 1990).

Systemic Effects

Respiratory Effects. The evidence from case report studies suggests that inhalation of metallic mercury vapor may result in clinical respiratory symptoms (e.g., chest pains, dyspnea, cough, reduced vital capacity) (Bluhm et al. 1992a; Gore and Harding 1987; Haddad and Sternberg 1963; Hallee 1969; Kanlun and Gottlieb 1991; King 1954; Lilis et al. 1985; Matthes et al. 1958; McFarland and Reigel 1978; Milne et al. 1970; Rowens et al. 1991; Snodgrass et al. 1981; Soni et al. 1992; Tauzeg et al. 1992; Teng and Brennan 1959; Tennant et al. 1961). In the more severe cases, respiratory distress, pulmonary edema, lobar pneumonia, fibrosis, desquamation of the bronchiolar epithelium, and death due to respiratory failure have been observed (Campbell 1948; Gore and Harding 1987; Jaffe et al. 1983; Kanlun and Gottlieb 1991; Matthes et al. 1958; Tauzeg et al. 1992; Teng and Brennan 1959; Tennant et al. 1961). Acute- and intermediate-duration studies in rabbits appear to corroborate clinical symptoms observed in humans following inhalation exposure to metallic mercury vapors. Mild-to-moderate pathological changes (unspecified) were exhibited in the lungs of rabbits exposed to 6–28.8 mg/m³ mercury vapor for up to 11 weeks (Ashe et al. 1953), and death due to asphyxiation has been observed in rats exposed to 27 mg/m³ for 2 hours (Livardjani et al. 1991b). Lung congestion was observed after 100 hours of continuous exposure of rats to 1 mg/m³ (Gage 1961). The potential for oral exposure was not quantified; however, it is likely that most of the exposure was through inhalation. Inconclusive evidence is available regarding respiratory effects due to inhalation of organic mercury (Brown 1954; Hunter et al. 1940), and there is no conclusive evidence indicating that oral or dermal exposure to inorganic or organic forms of mercury is

2. HEALTH EFFECTS

directly toxic to the respiratory system. Based on these results, it would appear that acute inhalation exposure of humans to high levels of metallic mercury may result in pulmonary effects.

Cardiovascular Effects. The evidence from clinical, occupational, and general population studies suggests that inhalation of metallic mercury may affect the cardiovascular system in humans, producing elevations in blood pressure and/or heart rate (Aronow et al. 1990; Bluhm et al. 1992a; Campbell 1948; Fagala and Wigg 1992; Foulds et al. 1987; Friberg et al. 1953; Haddad and Sternberg 1963; Hallee 1969; Jaffe et al. 1983; Karpathios et al. 1991; Siblingrud 1990; Smith et al. 1970; Snodgrass et al. 1981; Soni et al. 1992; Taueg et al. 1992; Teng and Brennan 1959). Studies of workers chronically exposed to elemental mercury vapor have shown increased incidences of palpitations (Piikivi 1989), high incidences of hypertension (Vroom and Greer 1972), and increased likelihood of death due to ischemic heart and cerebrovascular disease (Barregard et al. 1990). Of particular interest is the study showing slightly higher blood pressure in persons with dental amalgams than in those with no mercury-containing amalgams (Siblingrud 1990). Less information is available regarding inhalation of organic mercury, but one study showed elevated blood pressure in two men occupationally exposed to methylmercury compounds (Hook et al. 1954). Electrocardiographic abnormalities (ventricular ectopic beats, prolongation of the Q–T interval, S–T segment depression, and T-wave inversion) were reported in persons who ate foods contaminated with ethylmercury compounds or who ingested a large dose of mercuric chloride (Chugh et al. 1978; Cinca et al. 1979; Jalili and Abbasi 1961). It is unclear whether these electrocardiographic abnormalities were the result of direct cardiac toxicity or whether they were secondary to other toxicity.

A number of the above cases of mercury-related tachycardia and elevated blood pressure in children inhaling metallic mercury vapors (Aronow et al. 1990; Fagala and Wigg 1992; Foulds et al. 1987; Karpathios et al. 1991) are associated with acrodynia, a nonallergic hypersensitive reaction in children to mercury exposure. Similar elevations in heart rate and blood pressure have been reported in children ingesting mercurous chloride (calomel)-containing medications and in children dermally exposed to ammoniated mercury-containing ointments or diapers that had been rinsed in a mercuric chloride-containing solution (Warkany and Hubbard 1953).

Limited animal data are available regarding inhalation exposure to mercury, but studies indicate that mercury may have a toxic effect on the heart. Effects ranging from mild pathological changes to marked cellular degeneration of heart tissue were exhibited in rabbits inhaling 0.86–28.8 mg/m³ mercury vapor for

2. HEALTH EFFECTS

acute and intermediate durations (Ashe et al. 1953). However, it is unclear whether these changes represent direct toxic effects on the heart or whether they were secondary to shock.

The bulk of information available regarding cardiovascular effects after oral exposure of animals to mercury generally supports findings seen in human inhalation studies. Oral administration of 7 mg Hg/kg/day as inorganic mercury (mercuric chloride) for a year or 0.4 mg Hg/kg/day as organic mercury (methylmercuric chloride) for up to 28 days in rats resulted in elevated blood pressure (Carmignani et al. 1989; Wakita 1987). At higher concentrations (28 mg Hg/kg/day as mercuric chloride for 180 days), decreases in cardiac contractility were observed; these effects were suggested to be due to direct myocardial toxicity (Carmignani et al. 1992). Biphasic effects on myocardial tissue have been demonstrated on isolated papillary muscles from rat ventricles (Oliveira and Vassallo 1992). At low mercury concentrations, an increase in contractile force was observed, whereas at 5–10-fold higher concentrations dose-related decreases in contractile force were observed. The increases in contractile force were suggested to be due to inhibition of Na⁺-K⁺-ATPase, and the decreases were suggested to be due to inhibition of Ca²⁺-ATPase of the sarcoplasmic reticulum. Based on these results, it would appear that children with hypersensitivity to mercury may exhibit tachycardia and elevated blood pressure following inhalation, oral, or dermal exposure to mercury or to mercury-containing compounds. In addition, low-level exposure to mercury for extended periods may cause elevated blood pressure in exposed populations. Chronic-duration inhalation exposures or intermediate-duration oral exposures may also be associated with increased mortality due to ischemic heart or cerebrovascular disease; however, the data supporting this conclusion are more limited.

Gastrointestinal Effects. Both inhalation and oral exposures to mercury have resulted in gastrointestinal toxicity. Mercurial stomatitis (inflammation of the oral mucosa, occasionally accompanied by excessive salivation) is a classic symptom of mercury toxicity and has been observed following inhalation exposure to both inorganic and organic mercury (Bluhm et al. 1992a; Brown 1954; Campbell 1948; Fagala and Wigg 1992; Garnier et al. 1981; Haddad and Sternberg 1963; Hallee 1969; Hill 1943; Hook et al. 1954; Karpathios et al. 1991; Sexton et al. 1976; Snodgrass et al. 1981; Tennant et al. 1961; Vroom and Greer 1972).

Mercuric chloride is caustic to the tissues of the gastrointestinal tract, and persons who have ingested large amounts of this form of mercury have exhibited blisters, ulceration, and hemorrhages throughout the gastrointestinal tract (Afonso and deAlvarez 1960; Chugh et al. 1978; Murphy et al. 1979; Samuels et al.

2. HEALTH EFFECTS

1982). In some cases, gastrointestinal lesions have been observed after inhalation exposure to high concentrations of metallic mercury vapors. The autopsy of a young child who inhaled metallic mercury vapor revealed necrosis in the mucosa of the stomach and duodenum (Campbell 1948). Irritation of the oral mucosa has also been observed at the site of contact with dental amalgams that contain mercury (Veien 1990). However, this type of response appears to be a combination of stomatitis and a contact dermatitis.

Symptoms of abdominal cramps, diarrhea, and nausea have been reported following acute- and/or intermediate-duration inhalation, oral, and dermal exposures of persons to mercury (Afonso and deAlvarez 1960; Bluhm et al. 1992a; Campbell 1948; Cinca et al. 1979; Haddad and Sternberg 1963; Hallee 1969; Jalili and Abbasi 1961; Kang-Yum and Oransky 1992; Kanluen and Gottlieb 1991; Lilis et al. 1985; Milne et al. 1970; Sexton et al. 1976; Snodgrass et al. 1981; Soni et al. 1992; Taueg et al. 1992; Teng and Brennan 1959; Tennant et al. 1961; Warkany and Hubbard 1953).

Rabbits displayed mild pathological changes to marked cellular degeneration and some necrosis in the colon tissue after inhaling 28.8 mg/m³ mercury for 4–30 hours (Ashe et al. 1953). Inflammation and necrosis of the glandular stomach were observed in mice given 59 mg Hg/kg as mercuric chloride by gavage 5 days a week for 2 weeks (NTP 1993). An increased incidence of forestomach hyperplasia was observed in male rats exposed to 1.9 mg Hg/kg/day as mercuric chloride for 2 years (NTP 1993). Necrosis and ulceration of the cecum have been observed in rats after chronic-duration exposure to 4.2 mg Hg/kg/day as phenylmercuric acetate in the drinking water (Fitzhugh et al. 1950; Solecki et al. 1991). Ulceration of the glandular stomach was observed in mice after 2 years of exposure to methylmercuric chloride (0.86 mg Hg/kg/day) in the diet. Acute-duration inhalation exposure or chronic-duration oral exposure to inorganic and organic mercury may, therefore, result in various gastrointestinal symptoms in humans, with possible damage to intestinal tissues.

Hematological Effects. Leukocytosis associated with a metal fume fever-like syndrome has been observed in persons exposed to high concentrations of metallic mercury vapor (Campbell 1948; Fagala and Wigg 1992; Haddad and Sternberg 1963; Hallee 1969; Jaffe et al. 1983; Lilis et al. 1985; Matthes et al. 1958; Rowens et al. 1991). It is probable that this effect is specific to inhalation exposure to mercury. Because of the high concentrations of mercury that have been involved in the studies reviewed, it is unlikely that persons exposed to mercury vapors at hazardous waste sites would be exposed to sufficiently high concentrations of mercury to result in leukocytosis. Other hematological effects associated with exposure to mercury include decreased hemoglobin and hematocrit in persons with dental amalgams (Siblerud 1990)

2. HEALTH EFFECTS

and decreased δ -aminolevulinic acid dehydratase activity in erythrocytes or increased serum proteins involved in the storage and transport of copper in workers exposed to mercury vapor (Bencko et al. 1990; Wada et al. 1969). Anemia was found in a man who ingested a lethal amount of mercuric chloride (Murphy et al. 1979). However, the anemia was most likely the result of massive gastrointestinal hemorrhaging. No reports of effects on blood parameters in humans were located after oral exposure to organic mercury. A decrease in red cell count, hemoglobin, and hematocrit and rupture of erythrocytes were observed after intraperitoneal injection of mice with 19.2 mg Hg/kg as methylmercuric chloride (Shaw et al. 1991). A decrease in hemoglobin, hematocrit, and red blood cell count was observed in rats that received phenylmercuric acetate in their drinking water for 2 years (Solecki et al. 1991). However, this effect was probably due to blood loss associated with intestinal ulcers. Thus, there is limited information that suggests that prolonged exposure of humans to high levels of mercury, possibly from living in the vicinity of hazardous waste sites, may result in hematological changes.

Musculoskeletal Effects. Increases in tremors, muscle fasciculations, myoclonus, or muscle pains have been reported in persons exposed to unspecified concentrations of elemental mercury vapor (Adams et al. 1983; Albers et al. 1982, 1988; Aronow et al. 1990; Barber 1978; Bidstrup et al. 1951; Bluhm et al. 1992a; Chaffin et al. 1973; Chapman et al. 1990; Fawer et al. 1983; Karpathios et al. 1991; McFarland and Reigel 1978; Sexton et al. 1976; Smith et al. 1970; Taueg et al. 1992; Verberk et al. 1986; Vroom and Greer 1972; Williamson et al. 1982), in individuals inhaling alkyl mercury compounds (Brown 1954; Hook et al. 1954; Hunter et al. 1940), and in persons ingesting mercurous chloride (Warkany and Hubbard 1953) or ethylmercury compounds (Jalili and Abbasi 1961). These muscular effects are probably the result of peripheral nervous system dysfunction. It is probable that persons exposed to sufficiently high concentrations of mercury in the air or in foodstuffs (e.g., contaminated fish) at hazardous waste sites may also experience symptoms of tremors, myoclonus, muscle fasciculations, or muscle pains. A single report was identified that found evidence of rhabdomyolysis (destruction of the skeletal muscle) in a 22-year-old man who attempted suicide by ingesting 2 g of mercuric chloride (Chugh et al. 1978). It is extremely unlikely that persons at hazardous waste sites would be exposed to similarly high concentrations of mercuric chloride.

Hepatic Effects. Elevated serum glutamic pyruvic transaminase (SGPT), ornithine carbamyl transferase, and serum bilirubin, as well as evidence of decreased synthesis of hepatic coagulation factors, were reported in a case study of a child who inhaled an unspecified concentration of metallic mercury vapor (Jaffe et al. 1983). Similarly, hepatomegaly and hepatocellular vacuolation were observed in a man who

2. HEALTH EFFECTS

died following acute-duration, high-level exposure to elemental mercury vapor (Kanluen and Gottlieb 1991; Rowens et al. 1991). A lethal oral dose of mercuric chloride in a 35-year-old man also resulted in jaundice, an enlarged liver, and elevated aspartate aminotransferase, alkaline phosphatase, lactate dehydrogenase, and bilirubin (Murphy et al. 1979).

Inhalation of 6–28.8 mg/m³ mercury vapor for 6 hours to 11 weeks by rabbits produced effects ranging from mild pathological changes to severe necrosis in the liver, including necrosis and degeneration; effects were less severe at the shorter durations (Ashe et al. 1953). Intermediate-duration oral exposure to inorganic mercury has also been associated with increases in hepatic lipid peroxidation (Rana and Boora 1992) and in serum alkaline phosphatase (Jonker et al. 1993a). It is unclear to what extent these effects were due to the direct toxic effects of mercury on the liver or were secondary to shock in the exposed animals. Reliable information regarding hepatic effects following organic mercury exposure was not located. These limited data suggest the potential hepatic toxicity of short-term inhalation of high concentrations of mercury vapor to humans. It is unlikely that persons at hazardous waste sites would ingest sufficiently large amounts of mercuric chloride to cause hepatic toxicity.

Renal Effects. The kidney is one of the major target organs of mercury-induced toxicity. Adverse renal effects have been reported following exposure to metallic, inorganic, and organic forms of mercury in both humans and experimental animals. The nephrotic syndrome in humans associated with the ingestion, inhalation, or dermal application of mercury is primarily identified as an increase in excretion of urinary protein, although depending on the severity of the renal toxicity, hematuria, oliguria, urinary casts, edema, inability to concentrate the urine, and hypercholesterolemia may also be observed (Agnier and Jans 1978; Afonso and deAlvarez 1960; Anneroth et al. 1992; Barr et al. 1972; Buchet et al. 1980; Campbell 1948; Cinca et al. 1979; Danziger and Possick 1973; Dyll-Smith and Scurry 1990; Engleson and Herner 1952; Friberg et al. 1953; Hallee 1969; Jaffe et al. 1983; Jalili and Abbasi 1961; Kang-Yum and Oransky 1992; Kanluen and Gottlieb 1991; Kazantzis et al. 1962; Langworth et al. 1992b; Murphy et al. 1979; Pesce et al. 1977; Piikivi and Ruokonen 1989; Roels et al. 1982; Rowens et al. 1991; Samuels et al. 1982; Snodgrass et al. 1981; Soni et al. 1992; Stewart et al. 1977; Tubbs et al. 1982). These effects are usually reversible. However, in the most severe cases, acute renal failure has been observed (Afonso and deAlvarez 1960; Davis et al. 1974; Jaffe et al. 1983; Kang-Yum and Oransky 1992; Murphy et al. 1979; Samuels et al. 1982). Renal biopsies and/or autopsy results have primarily

2. HEALTH EFFECTS

Rowens et al. 1991), but glomerular changes have also been reported (Kazantzis et al. 1962; Tubbs et al. 1982).

Although the primary effect of mercury on the kidneys appears to be a direct toxic effect on the renal tubules, there is also evidence that implicates an immune mechanism of action for mercury-induced glomerular toxicity in some persons. In support of this theory, a few human case studies have reported deposition of IgG, immune complexes, and/or complement C3 along the glomerular basement membrane (Lindqvist et al. 1974; Tubbs et al. 1982).

Studies in animals support the conclusion that the primary toxic effect of both inorganic and organic mercury in the kidneys is on the epithelial cells of the renal proximal tubules. The changes observed in these studies were comparable with those observed in humans (i.e., proteinuria, oliguria, increases in urinary excretion of tubular enzymes, proteinaceous casts, decreased ability to concentrate the urine, decreased phenolsulfonphthalein excretion, increased plasma creatinine) (Bernard et al. 1992; Chan et al. 1992; Dieter et al. 1992; Girardi and Elias 1991; Jonker et al. 1993a; Kirschbaum et al. 1980; Nielsen et al. 1991; NTP 1993; Yasutake et al. 1991b). In addition, the animal studies provided detailed information regarding the histopathological changes occurring in the kidneys (Carmignani et al. 1989, 1992; Chan et al. 1992; Dieter et al. 1992; Falk et al. 1974; Fitzhugh et al. 1950; Fowler 1972; Goering et al. 1992; Hirano et al. 1986; Jonker et al. 1993a; Klein et al. 1973; Magos and Butler 1972; Magos et al. 1985; Mitsumori et al. 1990; Nielsen et al. 1991; NTP 1993; Yasutake et al. 1991b). The progression of renal toxicity included initial degenerative changes in the epithelial cells of the proximal tubules (nuclear swelling, increased eosinophilia/basophilia, vacuolization, and cellular hypertrophy). In the early stages, these degenerative changes were accompanied by tubular regeneration. Occasionally, when there is minor toxic damage, only the regenerative changes were observed. As the lesions progressed, tubular dilation, desquamation of the epithelial cells, and thickening of the tubular basement membrane were observed. Fibrosis, inflammation, necrosis, and atrophy of the tubules and glomerular changes (i.e., hypercellularity, thickening of the glomerular basement membrane) were then observed.

Several investigators have suggested that the renal toxicity exhibited after administration of organic forms of mercury (e.g., methylmercury) may actually result from the *in vivo* metabolism of this form to inorganic mercury (Fowler 1972; Klein et al. 1973; Magos et al. 1985). This hypothesis is supported by the increase in the smooth endoplasmic reticulum, a potential site for this metabolic conversion, and the measurement of

2. HEALTH EFFECTS

substantial levels of inorganic mercury in the kidneys following exposure to methylmercury (Fowler 1972; Klein et al. 1973).

In New Zealand White rabbits and in certain strains of mice and rats, a membranous glomerulonephropathy was the predominant finding in the absence of significant tubular damage. This syndrome was characterized by proteinuria, deposition of immune material (i.e., IgG and complement C3) in the renal mesangium and glomerular blood vessels, and minimal glomerular cell hyperplasia (Aten et al. 1992; Druet et al. 1978; Hirszel et al. 1985; Hultman and Enestrom 1992; Matsuo et al. 1989; Michaelson et al. 1985; Pelletier et al. 1990; Pusey et al. 1990; Roman-Franco et al. 1978; van der Meide et al. 1993). Deposition of antglomerular basement membrane antibodies has been observed in a susceptible strain of rat at subcutaneous doses of mercuric chloride as low as 0.15 mg Hg/kg 4 days a week for 2 weeks (Michaelson et al. 1985). Increases in urinary protein were not observed until 0.74 mg Hg/kg 4 days a week for 2 weeks. In mice, autoantibodies to glomerular basement membrane were not observed, but deposition of IgG in the kidneys occurs as a result of autoantibodies to nucleolar antigens (Hultman and Enestrom 1988). The immune basis for these responses is covered in the section on immunological effects below. The susceptibility to this form of renal toxicity appears to be governed by both MHC genes and nonMHC genes (Aten et al. 1991; Sapin et al. 1984). Among rat strains, Brown-Norway, MAXX, and DZB strains showed susceptibility to renal damage, whereas Lewis, M520, and AO rats did not (Aten et al. 1991; Druet et al. 1978; Michaelson et al. 1985). Among mouse strains, SJL/N mice are susceptible to renal toxicity, whereas DBA, C57BL, and Balb/c mice are not (Hultman and Enestrom 1992; Hultman et al. 1992). The apparent genetic basis for susceptibility to mercury-induced nephrotoxicity in experimental animals has important implications with regard to susceptible subpopulations of humans.

Based on the above information, it is likely that persons exposed to sufficiently high concentrations of mercury may experience renal tubular toxicity. Certain persons who are genetically predisposed may also develop an immunologically based membranous glomerulonephritis.

Dermal Effects. Dermal reactions have been observed in persons exposed to inorganic and organic mercury following inhalation, oral, and/or dermal exposures. The predominant skin reaction is erythematous and pruritic skin rashes (Al-Mufti et al. 1976; Aronow et al. 1990; Bagley et al. 1987; Biro and Klein 1967; Bluhm et al. 1992a; Engleson and Herner 1952; Faria and Freitas 1992; Foulds et al. 1987; Goh and Ng 1988; Hunter et al. 1940; Jalili and Abbasi 1961; Kang-Yum and Oransky 1992; Karpathios et al. 1991; Morris 1960; Pambor and Timmel 1989; Schwartz et al. 1992; Sexton et al. 1976;

2. HEALTH EFFECTS

Tunnessen et al. 1987; Veien 1990; Warkany and Hubbard 1953). In many of the dermal cases, a contact dermatitis type of response was observed. However, a nonallergic pruritus is characteristic of acrodynia, a hypersensitive reaction to mercury exposure observed primarily in children, and several of the above cases may have been attributable to this syndrome (Aronow et al. 1990; Engleson and Herner 1952; Foulds et al. 1987; Jalili and Abbasi 1961; Karpathios et al. 1991; Tunnessen et al. 1987; Warkany and Hubbard 1953). Other dermal reactions characteristic of acrodynia include heavy perspiration (Aronow et al. 1990; Fagala and Wigg 1992; Karpathios et al. 1991; Sexton et al. 1976; Warkany and Hubbard 1953) and itching, reddened, swollen and/or peeling skin on the palms of the hands and soles of the feet (Aronow et al. 1990; Fagala and Wigg 1992; Jalili and Abbasi 1961; Karpathios et al. 1991; Tunnessen et al. 1987; Warkany and Hubbard 1953). No animal studies were located to support these findings. However, these results demonstrate that two populations may experience dermal effects as a result of mercury exposure. One is those persons who develop an allergic reaction to mercury. The other is those who are hypersensitive to mercury and who develop acrodynia upon exposure. It is unknown whether sufficiently high concentrations of inorganic mercury in soil or methylmercury in fish may exist at hazardous waste sites to trigger allergic dermatitis in sensitive persons or acrodynia in those predisposed to develop this syndrome.

Ocular Effects. Ocular effects have been observed in persons exposed to high concentrations of metallic mercury vapors. These effects are probably due to direct contact of the mercury vapor with the eyes. The observed effects include red and burning eyes, conjunctivitis (Bluhm et al. 1992a; Foulds et al. 1987; Karpathios et al. 1991; Schwartz et al. 1992; Sexton et al. 1976), and a yellow haze on the lenses of the eye (Atkinson 1943; Bidstrup et al. 1951; Locket and Nazroo 1952). The yellow haze was associated with long-term occupational exposures. Animal studies were not available to support these findings. However, the evidence suggests that exposure to high levels of mercury vapor may result in ocular irritation.

Other Systemic Effects. Studies of workers exposed to mercury vapor found no effect on serum levels of thyroid-stimulating hormone (Erfurth et al. 1990; McGregor and Mason 1991). However, an enlarged thyroid, with elevated triiodothyronine and thyroxine, as well as reduced thyroid-stimulating hormone developed in a 13-year-old boy exposed to mercury vapor for 2 weeks (Karpathios et al. 1991). Animal studies generally support an effect of acute-duration high-level exposure on the thyroid, although the results have been somewhat variable (Goldman and Blackburn 1979; Sin and The 1992; Sin et al. 1990). A single intramuscular injection of 14.8 mg Hg/kg in rabbits resulted in increased thyroid peroxidase and triiodothyronine and decreased thyroxine (Ghosh and Bhattacharya 1992). A study in which rats received three

2. HEALTH EFFECTS

daily subcutaneous doses of methylmercuric chloride showed slight increases in thyroid weight and basal levels of thyroid-stimulating hormone and thyroxine (Kabuto 1991). However, it was unclear whether these changes were statistically significant. In contrast, a single subcutaneous dose of 6.4 mg/Hg as methylmercuric chloride resulted in significant decreases in serum thyroxine (Kabuto 1987). At higher doses (9.6 and 12.8 mg mercury), increases in prolactin and thyroid-stimulating hormone were observed. The reason for these differences is unclear, but the data suggest that thyroid function may be affected if persons are exposed to sufficiently high concentrations of mercury.

Animal studies also provide evidence of mercury-induced effects on the corticosteroid levels. Increased adrenal and plasma corticosterone levels were reported in rats receiving 2.6 mg Hg/kg/day as mercuric chloride in drinking water after 120 days (Agrawal and Chansouria 1989). At 180 days of exposure, these effects were not evident in the animals. The investigators suggested that mercuric chloride is a dose- and duration-dependent chemical stressor. Subchronic administration of methylmercury to rats caused a diminished secretory response of corticosterone and testosterone serum levels following adrenocorticotropin (ACTH) and human chorionic gonadotropin (HCG) stimulation, respectively (Burton and Meikle 1980). The adrenal glands showed marked hyperplasia and increased weight, and basal levels of these hormones were also depressed. The treated animals exhibited stress intolerance and decreased sexual activity. These results suggest that methylmercury may have an adverse effect on steroidogenesis in the adrenal cortex and testes. Based on these animal studies, inorganic and organic mercury may also act on the corticosteroid system to alter hormonal levels. It is unclear to what extent the effects observed are the result of generalized stress or direct toxic effects on the endocrine system regulating corticosteroid levels.

Inhalation of metallic mercury vapor may result in a metal fume fever-like syndrome characterized by fatigue, fever, chills, cough, and an elevated leukocyte count (Bluhm et al. 1992a; Garnier et al. 1981; Lilis et al. 1985; McFarland and Reigel 1978; Milne et al. 1970; Schwartz et al. 1992; Snodgrass et al. 1981). Also, children with acrodynia frequently exhibit low-grade intermittent fevers (Aronow et al. 1990; Warkany and Hubbard 1953). Animal data are not available to support this finding, but the human data suggest that exposure to sufficiently high concentrations of metallic mercury vapor may result in transient fever (see Hematological Effects).

Immunological Effects. As indicated in the section on dermal effects, allergic dermatological reactions occurred in persons exposed to inorganic mercury from dental amalgams, tattoos, or breakage of medical instruments (Anneroth et al. 1992; Bagley et al. 1987; Biro and Klein 1967; Faria and Freitas

2. HEALTH EFFECTS

1992; Goh and Ng 1988; Pambor and Timmel 1989; Skoglund and Egelrud 1991; Veien 1990). Additionally, mercury may cause either decreases in immune activity or an autoimmune response, depending on the genetic predisposition of the individual exposed. The human data are very limited, and only decreased IgG production has been observed in workers chronically exposed to metallic mercury vapor at chloralkali and ore production plants (Bencko et al. 1990; Moszczynski et al. 1990b). Neither of these studies, however, adjusted for smoking or alcohol. Increases in serum immunoglobulins (IgA, IgG, IgE, or IgM) and autoantibody titres (antilaminin or antiglomerular basement membrane antibodies) have not been observed in similarly exposed populations (Bernard et al. 1987; Cardenas et al. 1993; Langworth et al. 1992b). There is limited information in humans that suggests that certain individuals may develop an autoimmune response when exposed to mercury. Deposition of IgG and complement C3 have been observed in the glomeruli of two workers with mercury-induced proteinuria (Tubbs et al. 1982). Also, increased antiglomerular basement membrane antibodies and elevated antinuclear antibodies have been observed in a few persons with exposure to mercury in dental amalgams (Anneroth et al. 1992). After removal of one dental amalgam, a significant decrease in IgE levels was observed. Within the populations described above that showed no overall increase in immune parameters, individuals in these groups showed either increases in anti-DNA antibody titres or antiglomerular basement membrane responses (Cardenas et al. 1993; Langworth et al. 1992b). Moszczynski et al. (1995) studied workers exposed to mercury vapor and reported a positive correlation between the T-helper cell count and the duration of exposure. The combined stimulation of the T-cell line and an observed decrease in the helper/suppressor ratio were suggestive of an autoimmune response.

The immune system reaction to mercury has been extensively studied in animals. Although it has not been completely described, a great deal of information exists about the changes that occur in the immune system in response to mercury exposure (Bigazzi 1992; Goldman et al. 1991; Mathieson 1992).

Animal strains that are susceptible or predisposed to develop an autoimmune response show a proliferation of autoreactive T-cells (specifically CD4+ T-cells) (Pelletier et al. 1986; Rossert et al. 1988). The fundamental change caused by mercury that results in the autoimmune response appears to be in these autoreactive T-cells, since transfer of these cells to an unexposed animal results in the development of the autoimmune response in the unexposed animal (Pelletier et al. 1988). A subset of the CD4+ T-cells, the Th2 cells, are activated and induce polyclonal B-cell activation (possibly through the release of interleukin-4 [IL-4]), which results in IgE production by the B-cells (Ochel et al. 1991). The increases in serum IgE are paralleled by increases in MHC molecule expression on the B-cells (Dubey et al. 1991a). These changes are accompanied by enlargement of the spleen and lymph nodes, an increase in the number of spleen cells

2. HEALTH EFFECTS

(thought to be associated with the B-cell proliferation) (Hirsch et al. 1982; Matsuo et al. 1989), and marked increases in serum levels of IgE (Dubey et al. 1991b; Hirsch et al. 1986; Lymberi et al. 1986; Prouvost-Danon et al. 1981). Increases in the production of autoantibodies (IgG) to glomerular basement membrane, thyroglobulin, collagen types I and II, and DNA also occur (Pusey et al. 1990). Immune complex deposits occur in blood vessels in several organs (Hultman et al. 1992), and deposition of these autoantibodies and complement in the renal glomerulus ultimately lead to membranous glomerulonephropathy, although the deposition of the IgG alone does not appear to be sufficient to induce renal dysfunction (Michaelson et al. 1985). In rodents, the autoimmune response spontaneously resolves within a few weeks. The mechanism underlying the resolution is unknown, but antiidiotypic antibodies and a change in the balance between Th2 and Th1 (another subset of the CD4+ T-cells) cell activation (see below) have been proposed (Mathieson 1992). After this resolution phase has occurred, affected individuals develop a resistance to future autoimmune toxicity (Bowman et al. 1984). The resistance appears to be mediated by CD8+ T-cells, since depletion of these cells reverses the resistance (Mathieson et al. 1991).

The so-called resistant strains, however, show a different response to mercury exposure. These resistant strains also show an increase in MHC expression molecules on B-cells, but this response is extremely short-lived, and increases in serum IgE were not observed (Dubey et al. 1991a; Prouvost-Danon et al. 1981). The difference in the responses of the so-called resistant and susceptible strains may be found in the activation of Th1 cells and the increase in secretion of γ -interferon by the Th1 cells of resistant animals (van der Meide et al. 1993). The susceptible strains do not show an increase in γ -interferon production with mercury exposure. Because γ -interferon inhibits the proliferation of Th2 cells, the absence of this response in the susceptible strains may allow the Th2 cell-stimulated production of autoantibodies to occur, whereas in the resistant strains the production of antibodies is curtailed. Thus, differences in the activation of Th1 versus Th2 cells may underlie the differences in susceptibility of various individuals. Studies using in-bred strains of mice and rats have determined that the susceptibility to the different immune reactions is governed by both MHC genes as well as other genes (Aten et al. 1991; Druet et al. 1977; Mirtcheva et al. 1989; Sapin et al. 1984). As indicated in the section on renal effects, Brown-Norway, MAXX, and DZB rat strains showed susceptibility, whereas Lewis, M520, and AO rats did not (Aten et al. 1991; Druet et al. 1978; Michaelson et al. 1985). Among mouse strains, SJL/N mice are susceptible and DBA, C57BL, and Balb/c mice are not (Hultman and Enestrom 1992; Hultman et al. 1992). In a resistant strain, the Balb/c mouse, immune suppression was manifested as decreased natural killer cell activity in mice administered a diet containing 0.5 mg Hg/kg/day as methylmercury (Ilback 1991).

2. HEALTH EFFECTS

Neurological Effects. The nervous system is the primary target organ for elemental and methylmercury-induced toxicity. Neurological and behavioral disorders in humans have been observed following inhalation of metallic mercury vapor and organic mercury compounds, ingestion or dermal application of inorganic mercury-containing medicinal products (e.g., teething powders, ointments, and laxatives), and ingestion or dermal exposure to organic mercury-containing pesticides or ingestion of contaminated seafood. A broad range of symptoms has been reported, and these symptoms are qualitatively similar, irrespective of the mercury compound to which one is exposed. Specific neurotoxic symptoms include tremors (initially affecting the hands and sometimes spreading to other parts of the body), emotional lability (characterized by irritability, excessive shyness, confidence loss, and nervousness), insomnia, memory loss, neuromuscular changes (weakness, muscle atrophy, and muscle twitching), headaches, polyneuropathy (paresthesias, stocking-glove sensory loss, hyperactive tendon reflexes, slowed sensory and motor nerve conduction velocities), and performance deficits in tests of cognitive and motor function (Adams et al. 1983; Albers et al. 1982, 1988; Aronow et al. 1990; Bakir et al. 1973; Barber 1978; Bidstrup et al. 1951; Bluhm et al. 1992a; Bourgeois et al. 1986; Chaffin et al. 1973; Chapman et al. 1990; Choi et al. 1978; Cinca et al. 1979; Davis et al. 1974; DeBont et al. 1986; Discalzi et al. 1993; Dyall-Smith and Scurry 1990; Ehrenberg et al. 1991; Fagala and Wigg 1992; Fawer et al. 1983; Foulds et al. 1987; Friberg et al. 1953; Halle 1969; Harada 1978; Hook et al. 1954; Hunter et al. 1940; Iyer et al. 1976; Jaffe et al. 1983; Jalili and Abbasi 1961; Kang-Yum and Oransky 1992; Karpathios et al. 1991; Kutsuna 1968; Langauer-Lewowicka and Kazibutowska 1989; Kutsuna 1968; Langolf et al. 1978; Langworth et al. 1992a; Levine et al. 1982; Lilis et al. 1985; Lundgren and Swensson 1949; Matsumoto et al. 1965; McFarland and Reigel 1978; Melkonian and Baker 1988; Miyakawa et al. 1976; Ngim et al. 1992; Piikivi and Hanninen 1989; Piikivi and Tolonen 1989; Piikivi et al. 1984; Roels et al. 1982; Sexton et al. 1976; Shapiro et al. 1982; Snodgrass et al. 1981; Smith et al. 1970; Tamashiro et al. 1984; Taueg et al. 1992; Tsubaki and Takahashi 1986; Verberk et al. 1986; Vroom and Greer 1972; Warkany and Hubbard 1953; Williamson et al. 1982). Some individuals have also noted hearing loss, visual disturbances (visual field defects), and/or hallucinations (Bluhm et al. 1992a; Cinca et al. 1979; Fagala and Wigg 1992; Jalili and Abbasi 1961; Locket and Nazroo 1952; McFarland and Reigel 1978; Taueg et al. 1992). Although improvement has often been observed upon removal of persons from the source of exposure, it is possible that some changes may be irreversible. Autopsy findings of degenerative changes in the brains of poisoned patients exposed to mercury support the functional changes observed (Al-Saleem and the Clinical Committee on Mercury Poisoning 1976; Cinca et al. 1979; Davis et al. 1974; Miyakawa et al. 1976). Limited information was located regarding exposure levels associated with the above effects, but increased tremors and cognitive difficulties are sensitive end points for chronic low-level exposure to metallic mercury vapor (Fawer et al.

2. HEALTH EFFECTS

1983; Ngim et al. 1992). Photophobia has been reported exclusively in children with acrodynia (Fagala and Wigg 1992; Warkany and Hubbard 1953). The physiological basis for the photophobia is unknown.

The neurotoxicity of inorganic and organic mercury in experimental animals is manifested as functional, behavioral, and morphological changes, as well as alterations in brain neurochemistry (Arito and Takahashi 1991; Ashe et al. 1953; Berthoud et al. 1976; Burbacher et al. 1988; Cavanaugh and Chen 1971; Chang and Hartmann 1972a, 1972b; Chang et al. 1974; Charbonneau et al. 1976; Concas et al. 1983; Evans et al. 1977; Fukuda 1971; Fuyuta et al. 1978; Ganser and Kirschner 1985; Inouye and Murakami 1975; Jacobs et al. 1977; Kishi et al. 1978; Lehotzky and Meszaros 1974; Leyshon and Morgan 1991; MacDonald and Harbison 1977; Magos and Butler 1972; Magos et al. 1980, 1985; Mitsumori et al. 1981; Miyama et al. 1983; Post et al. 1973; Rice 1989c; Rice and Gilbert 1982, 1992; Salvaterra et al. 1973; Sharma et al. 1982; Tsuzuki 1981; Yip and Chang 1981).

Animal studies have shown damage to the cerebellar cortex and dorsal root ganglion cells following both mercuric chloride and methylmercuric chloride exposure (Chang and Hartmann 1972b). These structures appear to be especially sensitive to the toxic effects of mercury (Chang and Hartmann 1972a, 1972b; Chang et al. 1974; Charbonneau et al. 1976; Falk et al. 1974; Hirano et al. 1986; Jacobs et al. 1977; Leyshon and Morgan 1991; MacDonald and Harbison 1977; Magos and Butler 1972; Magos et al. 1980, 1985; Mitsumori et al. 1990; Yip and Chang 1981), although other areas (e.g., the cerebral cortex, corpus striatum, thalamus, hypothalamus, organ of Corti, and peripheral nerves) have also shown degenerative changes after exposure to methylmercury (Berthoud et al. 1976; Chang et al. 1974; Charbonneau et al. 1976; Falk et al. 1974; Fehling et al. 1975; Jacobs et al. 1977; Miyakawa et al. 1974, 1976; Yip and Chang 1981). Cats and monkeys appear to be more sensitive to the toxic effects than rodents and have shown signs of neurotoxicity at approximately 10-fold lower doses (0.05 mg Hg/kg/day) following long-term exposure to methylmercuric chloride (Charbonneau et al. 1976; Rice 1989c; Rice and Gilbert 1982, 1992).

Although it is unclear whether changes in neurochemical parameters are primary targets of mercury or whether the changes are secondary to degenerative changes in neurons, several neurotransmitter systems have been shown to be affected by mercury exposure. Cholinergic transmission at the neuromuscular junction has been shown to be affected by mercury exposure (Eldefrawi et al. 1977; Sager et al. 1982). Changes in GABA receptor activity and number have also been observed (Arakawa et al. 1991; Concas et al. 1983). Changes in the activities of enzymes involved in cholinergic, adrenergic, dopaminergic, and

2. HEALTH EFFECTS

serotonergic synthesis and/or catabolism have also been observed following mercury exposure (Sharma et al. 1982; Tsuzuki 1981).

Collectively, the above information shows the high sensitivity of the nervous system to mercury toxicity and indicates that persons exposed to sufficiently high amounts of mercury may experience adverse neurological symptoms.

Reproductive Effects. Studies in humans indicate that metallic mercury vapor does not cause infertility or malformations following paternal exposure (Aleser et al. 1989; Lauwerys et al. 1985) but may cause an increase in the rate of spontaneous abortions (Cordier et al. 1991). No correlation was observed between levels of testosterone, luteinizing hormone, or follicle-stimulating hormone and occupational exposure to metallic mercury vapor, indicating that the pituitary control of testosterone secretion was not affected (Erfurth et al. 1990; McGregor and Mason 1991). However, *in vitro* studies have shown that mercury can adversely affect human spermatozoa. Inorganic (mercuric chloride) and organic (methylmercuric chloride) mercury decreased the percentage of motile spermatozoa *in vitro* (Ernst and Lauritsen 1991). Incubation of human spermatozoa with inorganic mercury resulted in mercury deposits localized in the membranes of the midpiece and tailpiece. The lack of mercury grains in spermatozoa with methylmercury exposure may be due to the inability of spermatozoa or the semen plasma to demethylate methylmercury in the 15-minute incubation period (Ernst and Lauritsen 1991).

Female dentists and dental assistants exposed to metallic mercury vapors had increased reproductive failures (spontaneous abortions, stillbirths, and congenital malformations) and irregular, painful, or hemorrhagic menstrual disorders (Sikorski et al. 1987). Correlations were observed between the incidence of these effects and hair mercury levels.

Rowland et al. (1994) report that female dental assistants with a high occupational exposure to mercury were found to be less fertile than controls. The probability of conception with each menstrual cycle (called "fecundability" by the authors) in women who prepared 30 or more amalgams per week and who were evaluated as having 4 or more poor mercury-hygiene practices was only 63% of that of unexposed controls. Hygiene was incorporated into the evaluation of the results of this study because occupational groups with roughly the same potential for exposure often contain subjects whose actual exposures are quite different, depending on their particular work environment and their work (and personal) hygiene practices within that environment. Rowland et al. (1994) found that 20% of the women in their final evaluation who prepared

2. HEALTH EFFECTS

more than 30 amalgams a week had 4 or more poor mercury-hygiene factors. Among women preparing a comparable number of amalgams, there were differences in "fecundability," based on the number of self-reported poor hygiene factors. The study is limited in that a group of unexposed women had lower fertility than the low exposed group suggesting other unaccounted for exposures or confounding factors.

Animal data suggest that mercury may alter reproductive function and/or success when administered to either males or females. In males, mercury exposure results primarily in impaired spermatogenesis, sperm motility, and degeneration of seminiferous tubules. Oral administration of methylmercury to males has resulted in decreases in litter size due to preimplantation loss (presumably due to defective sperm) in rats (Khera 1973), decreases in sperm motility in monkeys (at 0.025 mg Hg/kg/day for 20 weeks) (Mohamed et al. 1987), and tubular atrophy and decreased spermatogenesis in mice after prolonged exposure (Hirano et al. 1986; Mitsumori et al. 1990). Parenteral administration of methylmercury has shown similar results. A single intraperitoneal injection of 10 mg/kg of methylmercury in male mice resulted in decreased implantations in females (Suter 1975), and a single intraperitoneal injection of 1 mg/kg of methylmercury resulted in a reversible failure of spermatogenesis and infertility in male mice (Lee and Dixon 1975). Repeated intraperitoneal injections of methylmercury (3.5 mg Hg/kg/day for 6 weeks) in male rats resulted in decreased sexual activity, depression of testosterone levels (Burton and Meikle 1980), and decreased spermatogenesis (0.004 mg Hg/kg/day for 15–90 days) (Vachhrajani et al. 1992). Less is known about the effects of inorganic mercury on the male reproductive system, but a single intraperitoneal injection of mercuric chloride (1 mg Hg/kg) in male rats resulted in decreased conceptions in females (Lee and Dixon 1975), and 0.74 mg Hg/kg resulted in tubular degeneration (Prem et al. 1992). An *in vitro* study (Mohamed et al. 1987) suggested that the decrease in sperm motility observed in monkeys may be due to interference with microtubule assembly or dynein/microtubule sliding function.

In females, mercury exposure results primarily in increases in resorptions and decreases in implantations. Inhalation exposure of female rats to metallic mercury vapor (2.5 mg/m³, 6 hours a day, 5 days a week for 21 days) resulted in a prolongation of the estrous cycle (Baranski and Szymczyk 1973). Oral administration of mercuric acetate (22 mg Hg/kg) to pregnant hamsters resulted in an increase in resorptions (Gale 1974). Oral administration of methylmercury to pregnant guinea pigs (11.5 mg Hg/kg) resulted in an increase in abortions (Inouye and Kajiwara 1988), and 3 mg Hg/kg resulted in a decrease in the number of pups in the litter from pregnant mice (Hughes and Annau 1976). Pregnant mice given a single dose of 20 mg Hg/kg as methylmercuric chloride had increased resorptions, decreased live fetuses, and decreased fetuses per litter (Fuyuta et al. 1978). Repeated oral administration of methylmercury

2. HEALTH EFFECTS

(0.06 mg Hg/kg/day) to female monkeys resulted in an increase in the number of abortions and a decrease in conceptions (Burbacher et al. 1988). No effect on the monkeys' menstrual cycles was observed.

Intraperitoneal administration of mercuric chloride (1.48 mg Hg/kg) to female mice resulted in decreases in litter size and number of litters/female and an increase in dead implants in some strains of mice, but these effects were strain-specific (Suter 1975). In female mice administered a single intraperitoneal dose of 1 mg Hg/kg as mercuric chloride, a decrease in mean implantation sites was observed (Kajiwara and Inouye 1992). Subcutaneous injection of female hamsters with 6.2–8.2 mg Hg/kg as mercuric chloride for 1–4 days resulted in a disruption of estrous (Lamperti and Printz 1973). Inhibition of follicular maturation and normal uterine hypertrophy, morphological prolongation of the corpora lutea, and alteration of progesterone levels were observed. Collectively, these results suggest that at sufficiently high mercury concentrations, men may experience some adverse effects on testicular function and women may experience increases in abortions, decreases in conceptions, or development of menstrual disorders.

Developmental Effects. Mercury is considered to be a developmental toxicant. Extremely limited information was located regarding human developmental effects associated with exposure to inorganic mercury (Alcser et al. 1989; Derobert and Tara 1950; Melkonian and Baker 1988; Thorpe et al. 1992). However, developmental toxicity in humans associated with oral exposure to organic forms of mercury is well recognized (Amin-Zaki et al. 1974; Bakir et al. 1973; Cox et al. 1989; Engleson and Herner 1952; Harada 1978; Marsh et al. 1980, 1981, 1987; McKeown-Eyssen et al. 1983; Snyder and Seelinger 1976). The symptoms observed in offspring of exposed mothers are primarily neurological in origin and have ranged from delays in motor and verbal development to severe brain damage. Subtle changes, such as small changes in intelligence or learning capacity are currently being tested in populations with low-level, chronic exposure to mercury in the diet (Davidson et al. 1998; Grandjean et al. 1997b, 1998). MRLs for acute- and intermediate-duration exposure to methylmercury have been developed based on the lowest observed peak hair level in a mother whose child was reported to have a delayed onset of walking (14 ppm in hair) (Cox et al. 1989; WHO 1990).

Animal studies suggest that both inorganic mercury and organic mercury cause developmental toxicity. Metallic mercury vapor may be transferred across the placenta (Greenwood et al. 1972). The placental transport of mercury in pregnant mice and its localization in the embryo and fetus were studied by autoradiography and gamma counting (Khayat and Dencker 1982). Retention of ²⁰³Hg vapor following inhalation was compared to intravenous injection of ²⁰³Hg as mercuric chloride. The authors reported that inhalation of mercury vapor resulted in a mercury concentration that was four times higher than the

2. HEALTH EFFECTS

concentration resulting from injection of mercuric chloride. Furthermore, the authors reported that metallic mercury appeared to oxidize to Hg^{+2} in the fetal tissues. Evidence that inhalation exposure may result in developmental toxicity comes from a study in which neonatal rats were exposed to metallic mercury vapor during a period of rapid brain development (this occurs postnatally in rodents but prenatally in humans), resulting in impaired spatial learning (Fredriksson et al. 1992). Oral administration of inorganic mercury salts to pregnant hamsters has been observed to produce an increase in the number of resorptions and small and edematous embryos (Gale 1974). Mercury-induced embryotoxicity in one non-inbred and five inbred strains of female hamsters was investigated by Gale and Ferm (1971). A single subcutaneous injection of 9.5 mg Hg/kg as mercuric acetate to dams on Gd 8 produced a variety of malformations, including cleft palate, hydrocephalus, and heart defects, and statistically significant interstrain differences in the embryotoxic response. Single doses of 1.3–2.5 mg Hg/kg as mercuric acetate injected intravenously into pregnant hamsters on Gd 8 produced growth retardation and edema of the fetuses at all 3 dose levels, while an increase in the number of abnormalities was detected at the two higher doses (Gale and Ferm 1971). The relative effectiveness of different exposure routes in hamsters was compared by Gale (1974). The following sequence of decreasing efficacy was noted for mercuric acetate: intraperitoneal > intravenous > subcutaneous > oral. The lowest doses used (2 mg/kg for intraperitoneal and 4 mg/kg for the other 3 routes) were all effective in causing increased resorption and an increased percentage of abnormalities. Intravenous injection of 1.5 mg Hg/kg/day as mercuric chloride also resulted in a significant increase in the number of abnormal preimplantation embryos (Kajiwara and Inouye 1986).

In animals, embryolethal, anatomical, and behavioral effects have been reported following oral exposure of pregnant dams to methylmercury (Bornhausen et al. 1980; Cagiano et al. 1990; Elsner 1991; Fowler and Woods 1977; Fuyuta et al. 1978, 1979; Guidetti et al. 1992; Gunderson et al. 1988; Hughes and Annau 1976; Ilback et al. 1991; Inouye and Kajiwara 1988; Inouye and Murakami 1975; Inouye et al. 1985; Khera and Tabacova 1973; Lindstrom et al. 1991; Nolen et al. 1972; Olson and Boush 1975; Reuhl et al. 1981a, 1981b; Rice 1992; Rice and Gilbert 1990; Stoltenburg-Didinger and Markwort 1990; Yasuda et al. 1985). Thus far, the most sensitive animal assay for developmental neurotoxicity has been a behavioral paradigm that examined the number of rewarded responses to differential reinforcement at high rates (Bornhausen et al. 1980). At doses of 0.008 mg Hg/kg/day and above, a dose-related decrease in rewarded responses was observed in 4-month-old offspring of rats treated on Gd 6–9. The effect was more pronounced in male offspring than females. Foster mothers were used to preclude consumption of contaminated milk during lactation.

2. HEALTH EFFECTS

Developmental toxicity has also been observed with parenteral exposure to methylmercury in pregnant dams during gestation. In mice given methylmercuric hydroxide subcutaneously daily from Gd 7–12, significant dose-related increases in the percentage of litters with resorptions were seen in groups receiving 3.45–8.6 mg Hg/kg/day (Su and Okita 1976). The frequency of cleft palate increased significantly in litters of the 3.45 and 4.3 mg Hg/kg/day groups only. A high incidence of delayed palate closure and cleft palate was also reported in mice injected subcutaneously with 5 mg Hg/kg of methylmercuric chloride on Gd 12 (Olson and Massaro 1977). Gross incoordination and decreased frequencies of defecation and urination in pups were observed following intraperitoneal administration of a single dose of methylmercury dicyandiamide (8 mg/kg/day) to pregnant mice on day 7 or 9 of pregnancy (Spyker et al. 1972). Degenerative changes were observed in the cerebellum and cerebral cortex of rat pups of maternal rats injected with 4 mg Hg/kg as methylmercuric chloride on Gd 8 (Chang et al. 1977). Degenerative renal changes (in epithelial cells of proximal tubules and Bowman's capsule of glomeruli) were reported in rat fetuses of dams exposed intraperitoneally to methylmercuric chloride during Gd 8 (Chang and Sprecher 1976). The studies by Spyker and Smithberg (1972) demonstrated strain differences in susceptibility to the developmental effects of methylmercury dicyandiamide. Intraperitoneal administration of single doses of methylmercury dicyandiamide (2, 4, or 8 mg/kg) to pregnant mice of strains 129 Sv/S1 and A/J during gestation resulted in retardation of fetal growth and increased resorption of implants in both strains. Teratogenic effects, primarily of the palate and jaw, were detected at all dose levels in 129 Sv/S1 mice, but only at the highest dose in strain A/J. The differential effects of methylmercury were dependent on the strain, the dose of the agent, and the stage of embryonic development.

Antilaminin antibodies induced by mercuric chloride have been demonstrated to be detrimental to the development of cultured rat embryos (Chambers and Klein 1993). Based upon that observation, those authors suggested that it might be possible for an autoimmune disease induced by a substance such as mercury at an early age to persist into later life, acting as a teratogen independent of both dose-response relationships and time of exposure, but that possibility remains to be experimentally demonstrated.

One developmental study of phenylmercury compounds was reported by Gale and Ferm (1971) in which hamsters were injected intravenously with phenylmercuric acetate at doses ranging from 5 to 10 mg/kg on Gd 8. With the exception of the lowest dose, all other doses induced increased resorption rates and edema, along with a few miscellaneous abnormalities including cleft palate and exencephaly.

2. HEALTH EFFECTS

The above information clearly indicates the possibility of developmental toxicity in offspring of mothers that ingest sufficient amounts of organic mercury. The animal data also suggest that exposure to sufficient amounts of inorganic mercury by inhalation of metallic mercury vapor or ingestion of inorganic mercury may result in developmental toxicity.

Genotoxic Effects. The overall findings from cytogenetic monitoring studies of workers occupationally exposed to mercury compounds by inhalation (Anwar and Gabal 1991; Barregard et al. 1991; Mabile et al. 1984; Popescu et al. 1979; Verschaeve et al. 1976, 1979) or accidentally exposed through ingestion (Wulf et al. 1986) provided no convincing evidence that mercury adversely affects the number or structure of chromosomes in human somatic cells. Studies reporting a positive result (Anwar and Gabal 1991; Barregard et al. 1991; Popescu et al. 1979; Skerfving et al. 1970, 1974; Verschaeve et al. 1976; Wulf et al. 1986) were compromised either by technical problems, a lack of consideration of confounding factors, or a failure to demonstrate a relationship between mercury exposure and induced aberrations. Therefore, none of these studies can be used to predict the potential genetic hazard to humans associated with exposure to mercury or mercury compounds.

A dose-related increase in chromosome aberrations was observed in the bone marrow of mice administered a single oral dose of mercuric chloride at levels of at least 4.4 mg Hg/kg (Ghosh et al. 1991). By contrast, there was no valid evidence of a genotoxic effect on somatic cells of cats chronically exposed to methylmercury orally (Miller et al. 1979). However, only minimal toxicity was observed at the high dose (0.046 mg Hg/kg/day) in this study. Doses of 0.86, 1.7, or 3.4 mg Hg/kg as methylmercury hydroxide administered once by intraperitoneal injection to groups of 2 male CBA mice did not cause an increase in micronucleated polychromatic erythrocytes harvested from bone marrow cells 24 hours after treatment (Jenssen and Ramel 1980). Similarly, there was no increase in structural chromosome aberrations in bone marrow cells collected from male Swiss OF₁ mice (3–4/group) 12, 24, 36, or 48 hours postexposure to single intraperitoneal doses of 0.7, 1.5, 3.0, or 4.4 mg Hg/kg as mercuric chloride (Poma et al. 1981). The lack of a clastogenic response, particularly with mercuric chloride, should not be viewed as a possible inability of this compound to penetrate somatic cell membranes. There are data from the study of Bryan et al. (1974) indicating that mercuric chloride can bind to chromatin in the livers of mice challenged with 38 mg Hg/kg/day as mercuric chloride for 1 month. Although the overall data are mixed, the findings from a well conducted study using oral dosing suggests that mercury can be clastogenic for somatic cells (Ghosh et al. 1991).

2. HEALTH EFFECTS

The intraperitoneal administration of mercuric chloride at levels comparable to those described above did not induce a clastogenic response in the spermatogonia of the same mouse strain (Poma et al. 1981). Structural chromosome aberrations were not produced in metaphase II oocytes of 15 virgin Syrian hamsters receiving a single intraperitoneal injection of 7.4 mg Hg/kg as methylmercury chloride (Mailhes 1983). However, the frequency of hyperploid cells in the treated animals was significantly ($p < 0.01$) increased compared to the control. A borderline significant increase in hypoploid cells was also seen. By contrast, Jagiello and Lin (1973) found no evidence of aneuploidy in the oocytes of Swiss/Webster mice (6–8/group) for 3 days after receiving a single intravenous injection of dimethylmercury (140 mg Hg/kg) or mercuric acetate (2, 5, or 10 mg Hg/kg). The lack of concordance between these two studies could be related to the different mercurials that were utilized, the different routes of exposure, or the possible differences in species sensitivity. There are data from a series of dominant lethal assays suggesting that variable strain sensitivity to mercury compounds can affect the outcome of germinal cell cytogenetic investigations (Suter 1975). In this study, two strains of male mice, $(101 \times C3H)F_1$ and $(SEC \times C57BL)F_1$, and one strain of female mice, $(101 \times C3H)F_1$, received single intraperitoneal injections of 8.6 mg Hg/kg as methylmercuric hydroxide. An additional group of females was injected intraperitoneally with 1.5 mg Hg/kg as mercuric chloride. Males were sequentially mated with untreated females over the entire spermatogenic cycle; treated females were mated once with untreated males. Methylmercuric hydroxide had no effect on fertility and did not induce a clastogenic response in $(101 \times C3H)F_1$ males. However, a comparable dose administered to $(SEC \times C57BL)F_1$ males adversely affected fertility and caused significant reductions in total and live implants accompanied by increases in the percentage of dead implants following the first two mating cycles. Suggestive evidence of poor reproductive performance and a dominant lethal effect was also seen in female $(101 \times C3H)F_1$ mice treated with methylmercuric hydroxide (8.6 mg Hg/kg) and mercuric chloride (1.5 mg Hg/kg). It was noteworthy that an independent phase of the investigation examined reproduction in females in two additional strains, $(SEC \times C57BL)F_1$ and a mixed stock obtained by crossing $(SEC \times C57BL)F_1$ females with XGSY males. Neither compound had a detrimental effect on the fertility of these females. The single dominant lethal assay conducted with rats (strain not specified) showed that mercuric chloride, administered orally for 12 months (1.8×10^{-3} to 1.8×10^{-4} mg Hg/kg), induced a dose-related increase in dominant lethal mutations, as indicated by increased embryonic death (Zasukhina et al. 1983).

The overall findings from *in vivo* germinal cell assays suggest that mercury compounds are clastogenic for mammalian germ cells. However, the apparent differences in species sensitivity and, in some cases, strain

2. HEALTH EFFECTS

sensitivity preclude an extrapolation of the relevance of these findings to humans. Refer to Table 2-11 for a further summary of these results.

Several *in vitro* assays employing human cells were located. Both structural and numerical chromosomal aberrations were observed following the exposure of human lymphocytes to methylmercury chloride or dimethylmercury *in vitro* (Betti et al. 1992). Although the smoking status of the donor was not reported, all of the cells came from the same donor, and no aberrations were observed in the control cultures. Mercuric acetate caused single-strand breaks in DNA from human KB-cells (Williams et al. 1987). Methylmercuric chloride treatment of human lymphocytes resulted in the formation of chromosome and chromatid aberrations (Betti et al. 1993b). Further, it was found to be a weak inducer of sister chromatid exchange, but that effect did not increase with an increasing dosage. Methylmercuric chloride was also found to be capable of producing aneuploidy (particularly hyperdiploidy). At low doses, more chromosomal aberrations were observed in the second metaphases than in the first, suggesting that several premutational lesions induced by that organomercurial survived through one cell cycle. Thus, the damage produced by methylmercuric chloride appeared to be stable and could lead to chromosome segregation errors. Betti et al. (1993b) concluded that methylmercuric chloride was capable of producing long-lasting damage, which in turn gives rise to both structural and numerical chromosome abnormalities. Bala et al. (1993) reported that methylmercuric chloride in concentrations of 10^{-5} , 10^{-6} , and 10^{-7} M induced aberrant metaphases (including gaps) in cultured human peripheral lymphocytes in a dose-dependent manner ($p < 0.05$). Methylmercuric chloride at the higher concentrations also induced a significant number of breaks. Further, methylmercuric chloride induced a significant number of SCEs per cell in a dose-dependent manner. However, cultures treated with gamma linolenic acid (GLA), a derivative of dietary essential fatty acid, did not differ from controls with respect to aberrations, and GLA reduced the frequency of SCEs induced by methylmercuric chloride in a dose-dependent manner ($p < 0.05$).

Mercuric chloride was not mutagenic in the *Salmonella typhimurium* plate incorporation assay (Wong 1988). These negative results are not unexpected because the Ames test is not suitable for the detection of heavy metal mutagens. Oberly et al. (1982) reported, however, that doses of mercuric chloride (4.4 and 5.9 $\mu\text{g Hg/mL}$) approaching severely cytotoxic levels induced a weak mutagenic response in mouse lymphoma L5178Y cells but only in the presence of auxiliary metabolic activation.

In an *in vitro* study of the clastogenic effects of mercurials in animal cells, Howard et al. (1991) observed a dose-related increase in chromosome aberrations in Chinese hamster ovary (CHO) cells treated with

Table 2-11. Genotoxicity of Mercury *In Vivo*

Species (test system)	End point	Results	Reference
Somatic cells:			
CBA mouse (bone marrow cells)	Micronuclei induction	–	Jenssen and Ramel 1980
Swiss mouse (bone marrow cells)	Chromosome aberrations	–	Poma et al. 1981
Swiss mouse (bone marrow cells)	Chromosome aberrations	+	Ghosh et al. 1991
Swiss mouse (liver chromatin)	Chromatid binding	+	Bryan et al. 1974
Cat (bone marrow cells)	Chromosome aberrations	(+)	Miller et al. 1979
Human (peripheral lymphocytes)	Structural chromosome aberrations	(+)	Skerfving et al. 1970
	Aneuploidy	(+)	Skerfving et al. 1974
Human (peripheral lymphocytes)	Structural chromosome aberrations	(+)	Skerfving et al. 1974
	Aneuploidy	(+)	Skerfving et al. 1974
Human (peripheral lymphocytes)	Structural chromosome aberrations	(+)	Popescu et al. 1979
	Aneuploidy	–	Popescu et al. 1979
Human (peripheral lymphocytes)	Structural chromosome aberrations	(+)	Verschaeve et al. 1976
	Aneuploidy	(+)	Verschaeve et al. 1976
Human (peripheral lymphocytes)	Structural chromosome aberrations	–	Verschaeve et al. 1979
	Aneuploidy	–	Verschaeve et al. 1979
Human (peripheral lymphocytes)	Structural chromosome aberrations	–	Mabille et al. 1984
Human (peripheral lymphocytes)	Micronuclei induction	+ ^a	Barregard et al. 1991
Human (peripheral lymphocytes)	Structural chromosome aberrations	+ ^b	Anwar and Gabal 1991
	Micronuclei induction	+ ^b	Anwar and Gabal 1991
	Aneuploidy	–	Anwar and Gabal 1991
Human (peripheral lymphocytes)	Sister chromatid exchange	(+)	Wulf et al. 1986

Table 2-11. Genotoxicity of Mercury *In Vivo* (continued)

Species (test system)	End point	Results	Reference
Germinal cells:			
Swiss mouse (spermatogonia)	Aneuploidy	–	Poma et al. 1981
Swiss mouse (oocytes)	Aneuploidy	–	Jagiello and Lin 1973
(101×C ₃ H)F ₁ mouse (spermatogonia)	Dominant lethal	–	Suter 1975
(SEC×C ₅₇ BL)F ₁ mouse (spermatogonia)	Dominant lethal	+	Suter 1975
(101×C ₃ H)F ₁ mouse (oocytes)	Dominant lethal	+/-	Suter 1975
Rat (spermatogonia)	Dominant lethal	+	Zasukhina et al. 1983
Syrian hamsters (oocytes)	Structural aberrations	–	Mailhes 1983
	Aneuploidy	+	Mailhes 1983

^aPositive response only in stimulated T-lymphocytes

^bPositive response but no correlation to urinary mercury levels or duration of exposure

– = negative results; + = positive results; (+) = reported as positive but study was either seriously compromised or findings did not provide valid evidence of a positive response; +/- = inconclusive

2. HEALTH EFFECTS

mercuric chloride. In a study of the potentiating effects of organomercurials on clastogen-induced chromosomal aberrations in cultured Chinese hamster cells, Yamada et al. (1993) investigated the effects of five organomercurial compounds (methylmercuric chloride, ethylmercuric chloride, phenylmercuric chloride, dimethylmercury, and diethylmercury) and found all to produce remarkable cytotoxicity. Fifty percent or more depression in the mitotic index was observed following treatment with methylmercuric chloride (2.5 µg/mL), ethylmercuric chloride (2.5 µg/mL), phenylmercuric chloride (1.25 µg/mL), and HgCl and HgCl₂ (1.25 µg/mL). Post-treatment with methylmercuric chloride and ethylmercuric chloride increased the number of breakage and exchange-type aberrations induced by 4-nitroquinoline 1-oxide and methylmethane sulfonate but they did not show any clastogenic effects by themselves. Dimethylmercury, diethylmercury, mercurous chloride, and mercuric chloride did not show any potentiating effects. Following pretreatment with the 4-nitroquinoline 1-oxide or the DNA cross-linking agent mitomycin C, treatment with methylmercuric chloride during the G1 phase resulted in the enhancement of both breakage- and exchange-type aberrations. Ethylmercuric chloride treatment during the G1 phase also enhanced both types of aberrations induced by 4-nitroquinoline 1-oxide, but did not show any potentiating effect. When treatment was during the G2 phase, however, both methylmercuric chloride and ethylmercuric chloride enhanced breakage-type aberrations only. In the Yamada et al. (1993) study, the dialkyl mercury compounds dimethylmercury and diethylmercury did not show any cytotoxicity at 5–40 µg/mL, but they did cause a significant increase in the frequency of aberrant cells at the 40 µg/mL concentration. The authors of this study suggested three possible mechanisms for the observed potentiation of clastogenicity by monoalkylated mercurials: (1) they interfere with the repair of base lesions induced by 4-nitroquinoline 1-oxide and mitomycin C during the prereplication stage, thus increasing unrepaired DNA lesions that subsequently convert into DNA double-strand breaks in the S phase; (2) methylmercuric chloride (but not ethylmercuric chloride) inhibits the repair of cross-linking lesions during the prereplication stage; and (3) their G2 effects enhance breakage-type aberrations only. Yamada et al. (1993) concluded that because mercury compounds are known to react with protein thiol groups to inhibit protein activity, it is possible that they also inhibit some protein activities involved in the DNA repair process. The specific target protein for organomercurials and why the potentiation activities of methylmercury chloride and ethylmercury chloride differ remain to be identified.

There is a sizable database of studies investigating the DNA-damaging activity of mercuric chloride. The finding that mercuric chloride can damage DNA in rat and mouse embryo fibroblasts (Zasukhina et al. 1983), supports the *in vivo* evidence of species- and intraspecies-specific sensitivity to the genotoxic action of mercuric chloride. Marked conversion of DNA into the single-stranded form occurred at 10⁻⁶ M

2. HEALTH EFFECTS

mercuric chloride in rat fibroblasts, while 5×10^{-6} M mercuric chloride produced a comparable response in C57BL/6 mouse cells; at this level, the response in CBA mouse cells was marginal. Mercuric chloride can also bind to the chromatin of rat fibroblasts (Rozalski and Wierzbicki 1983) and Chinese hamster ovary cells (Cantoni et al. 1984a, 1984b; Christie et al. 1984, 1985). Using the alkaline elution assay with intact Chinese hamster ovary cells, several studies have demonstrated that mercuric chloride induces single-strand breaks in DNA (Cantoni and Costa 1983; Cantoni et al. 1982, 1984a, 1984b; Christie et al. 1984, 1985). Furthermore, Cantoni and Costa (1983) found that the DNA-damaging potential of mercuric chloride is enhanced by a concurrent inhibition of DNA repair mechanisms. Methylmercuric chloride induced single-strand breaks in the DNA of intact rat glioblastoma cells, Chinese hamster V79 (fetal lung) cells, human lung cells, and human nerve cells (Costa et al. 1991). Results of the *Bacillus subtilis* rec-assay (Kanematsu et al. 1980) and the sister chromatid exchange assay (Howard et al. 1991) provide additional support to the body of evidence suggesting that mercuric chloride is genotoxic. However, there is no clear evidence that mercury would cause DNA damage *in vivo*.

Two organic mercury compounds (methylmercury chloride at 0.08–0.4 $\mu\text{g Hg/mL}$ and methoxyethyl mercury chloride at 0.04–0.23 $\mu\text{g Hg/mL}$) induced weak but dose-related mutagenic responses in Chinese hamster V-79 cells near the cytotoxic threshold (Fiskesjo 1979). Methylmercury was neither mutagenic nor caused recombination in *Saccharomyces cerevisiae*, but it did produce a slight increase in the frequency of chromosomal nondisjunction (Nakai and Machida 1973). Both methylmercury and phenylmercuric acetate induced primary DNA damage in the *B. subtilis* rec-assay (Kanematsu et al. 1980).

In contrast, high concentrations of methylmercury (1 or 2 μm) did not increase the frequency of sister chromatid exchanges in cultured blastocysts of early ICR mouse embryos (Matsumoto and Spindle 1982). Severe toxicity, which was more intense in blastocysts than in morulae, consisted of cessation of preimplantation development, blastocoel collapse, and mitotic delay.

In summary, the body of evidence showing the induction of primary DNA damage in mammalian and bacterial cells and weak mutagenesis in mammalian cells suggests that inorganic and organic mercury compounds have some genotoxic potential. Although the data on clastogenesis are less consistent, recent well conducted studies suggest that mercury compounds can be clastogenic. Refer to Table 2-12 for a further summary of these results.

Table 2-12. Genotoxicity of Mercury *In Vitro*

Species (test system)	End point	Results		Reference
		With activation	Without activation	
Inorganic Mercury Compounds				
Prokaryotic organisms:				
<i>Salmonella typhimurium</i> (TA1535, TA1537, TA98, TA102)	Gene mutation	-	-	Wong 1988
<i>Bacillus subtilis</i> (H17, M45)	DNA damage	NT	+	Kanematsu et al. 1980
Eukaryotic organisms:				
Mouse lymphoma cells L5178Y	Gene mutation	(+)	-	Oberly et al. 1982
Mouse embryo fibroblasts	DNA damage	NT	+	Zasukhina et al. 1983
Rat embryo fibroblasts	DNA damage	NT	+	Zasukhina et al. 1983
Chinese hamster ovary cells	Chromosome aberrations	NT	+	Howard et al. 1991
Chinese hamster ovary cells	Sister chromatid exchange	NT	+	Howard et al. 1991
Chinese hamster ovary cells	DNA damage	NT	+	Cantoni and Costa 1983
Chinese hamster ovary cells	DNA damage	NT	+	Cantoni et al. 1982, 1984a,b
Chinese hamster ovary cells	DNA damage	NT	+	Christie et al. 1984, 1986
Human KB cells	DNA damage	NT	+	Williams 1987
Rat embryo fibroblasts	Chromatin binding	NT	+	Rozalski and Wierzbicki 1983
Chinese hamster ovary cells	Chromatin binding	NT	+	Cantoni et al. 1984
Organic Mercury Compounds				
Prokaryotic organisms:				
<i>B. subtilis</i> (H17, M45)	DNA damage	NT	+	Kanematsu et al. 1980
Eukaryotic organisms:				
Early mouse embryos (blastocysts)	Sister chromatid exchange	NT	-	Matsumoto and Spindle 1982
Chinese hamster V79 cells	Gene mutation	NT	(+)	Fiskesjo 1979
Chinese hamster V79 cells	DNA damage	NT	+	Costa et al. 1991
Rat glioblastoma cells	DNA damage	NT	+	Costa et al. 1991
<i>Saccharomyces cerevisiae</i>	Gene mutation	NT	-	Nakai and Machida 1973

Table 2-12. Genotoxicity of Mercury *In Vitro* (continued)

Species (test system)	End point	Results		Reference
		With activation	Without activation	
<i>S. cerevisiae</i> /intragenic and intergenic recombination	Recombination	NT	–	Nakai and Machida 1973
<i>S. cerevisiae</i>	Chromosome nondisjunction	NT	(+)	Nakai and Machida 1973
Human (peripheral lymphocytes)	Structural chromosome aberrations	NT	+	Betti et al. 1992
Human (peripheral lymphocytes)	Aneuploidy	NT	+	Betti et al. 1992
Human (nerve cells)	DNA damage	NT	+	Costa et al. 1991
Human (lung cells)	DNA damage	NT	+	Costa et al. 1991

(+) = weakly positive or marginal result; – = negative result; + = positive result; DNA = deoxyribonucleic acid; NT = not tested

2. HEALTH EFFECTS

Cancer. Mercury has not been determined to be carcinogenic in humans (Cragle et al. 1984; Kazantzis 1981). An excess of lung cancer (type not specified) was found in Swedish chloralkali workers, but these workers had also been exposed to asbestos (Barregard et al. 1990). A significant association between the farm use of mercury-containing fungicides and lymphocytic leukemia in cattle was presented by Janicki et al. (1987). However, this study is limited because exposure to other chemicals was not adequately addressed and risk estimates were not adjusted for other risk factors for leukemia.

Animal data, however, suggest that mercuric chloride, and methylmercuric chloride, phenylmercuric acetate are tumorigenic in rats and/or mice. In a 2-year NTP (1993) study, male Fischer 344 rats administered mercuric chloride by gavage had an increased incidence of squamous cell papillomas of the forestomach and an increased incidence of thyroid follicular cell carcinomas at 3.7 mg Hg/kg/day. There is equivocal evidence of carcinogenicity in female rats (a nonsignificant incidence of squamous cell papillomas) and in male B6C3F₁ mice (a nonsignificant incidence of renal tubule adenomas and carcinomas). Dietary exposure of ICR and B6C3F₁ mice to methylmercuric chloride resulted in significant increases in the incidences of renal epithelial cell adenomas and/or carcinomas in males at doses as low as 0.69–0.73 mg Hg/kg/day (Hirano et al. 1986; Mitsumori et al. 1981, 1990). Similar increases were not observed in females. Renal cell adenomas were also significantly increased in male Wistar rats that received 4.2 mg Hg/kg/day as phenylmercuric acetate in their drinking water (Solecki et al. 1991). This study is limited, however, because an insufficient number of animals were tested to adequately assess carcinogenicity.

Swiss mice were exposed for 15 weeks to drinking water containing methylmercuric chloride at concentrations of 0.038, 0.095, and 0.38 mg Hg/kg/day (Blakley 1984). Urethane (1.5 mg/g) was subsequently given intraperitoneally to the mice at week 3 of the study. Methylmercury exposures of 0.038 and 0.095 mg Hg/kg/day produced a significant increase in the incidence of urethane-induced pulmonary adenomas. The author suggested that methylmercury enhances the formation of pulmonary adenomas and that the immunosuppressive activity of methylmercury may be partially responsible for this tumor-enhancing effect. No other studies were located regarding carcinogenic effects in animals following oral exposure to mercury.

The Department of Health and Human Services (DHHS), and the International Agency for Research on Cancer (IARC) have not classified mercury as to its human carcinogenicity. The Environmental Protection Agency has determined that mercury chloride and methylmercury are possible human carcinogens.

2. HEALTH EFFECTS

More on Health Effects and Dental Amalgam.

A number of government sponsored scientific reviews of the literature on the health effects associated with the use of dental amalgam have concluded that the data do not demonstrate a health hazard for the large majority of individuals exposed to mercury vapor at levels commonly encountered from dental amalgam (DHHS 1993; Health Canada 1997). Governments that have restricted the use of amalgam or recommend limited use (e.g., Germany, Sweden, Denmark, and Canada) cite the need to minimize human exposure to all forms of mercury as much as possible and to reduce the release of mercury to the environment (DHHS 1993; Health Canada 1997). The restrictive actions, however are prospective, and none of the government reports recommend removing existing fillings in people who have no indication of adverse effects attributable to mercury exposure. Removal of existing amalgams, if improperly performed or not indicated, may result in unnecessarily high exposure to mercury. Levels of mercury release for various dental procedures have been reported by Eley (1997). Chelation therapy (used to remove metals from the body tissues) also may have adverse health effects (and varying levels of effectiveness), and should be considered only in consultation with a qualified physician.

In 1990 in the United States, over 200 million restorative procedures were provided of which dental amalgam accounted for roughly 96 million (DHHS 1993). In the 1970s, the use of amalgam was 38% higher. The use of mercury amalgam has been steadily declining and is expected to continue to decline due to improvements in dental hygiene and preventive care. Approximately 70% of the restorations placed annually are replacements. Advocates of the safety of amalgam emphasize the long history of use (over 150 years) and the large exposed population without apparent adverse effects as strong support for their position (ADA 1997). They also underscore the poor quality of the studies in the literature reporting adverse effects attributable to amalgam. Researchers concerned about the safety of mercury amalgams counter that sample sizes in the studies that support the safety of amalgams are also too small to detect low frequency effects in the general population, and that the absence of high quality studies simply reflects the relatively small amount of research effort that has gone into resolving this very important issue (Richardson 1995; Weiner et al. 1990).

The general public is also clearly concerned about the placement of mercury, a substance with demonstrated toxic effects, into their mouths. A survey conducted by the American Dental Association in 1991 demonstrated that nearly half of the 1,000 American adults surveyed believed that health problems could develop as a result of dental amalgam (ADA 1991). Increases in life expectancy and increases in the

2. HEALTH EFFECTS

numbers of older adults who still have their permanent teeth will result in longer mercury exposure durations from dental amalgam, which may result in new or increased severity of effects. Recent improvements in neurological measures of performance (especially cognitive and behavior tests) as well as immunological assays have also improved the ability to resolve more subtle or preclinical effects. In this context, DHHS (1993) and other summary reports on the health risks from the use of mercury amalgam generally support the need for further investigations.

Additional recommendations concerning the use of dental amalgam include minimizing exposure to populations susceptible to mercury toxicity including pregnant women and nursing women (to minimize the exposure to their developing young), young children up to the age of 6 (and especially up to the age of 3), people with impaired kidney function, and people with hypersensitive immune response to mercury. People who have higher than average exposures to mercury from other sources (e.g., people who consume large quantities of fish or who work in professions that expose them to mercury) should also consider their total mercury exposure in making their life style and health care decisions. In all cases, the choice not to use mercury amalgam should be made in consultation with a qualified dentists (and/or physician) and weighed against the risk of alternative practices and materials.

The DHHS (1993) report also strongly recommends educating the public on the risks and benefits of dental amalgam. To prevent misleading or unduly alarming the public, the layperson should be informed that the presence of metallic mercury in dental amalgams is, in itself, not sufficient to produce an adverse health effect. Toxic levels of mercury must first be released from the filling, absorbed into the body, and transported to target tissues where adverse effects are produced. What constitutes a “toxic level” from an amalgam exposure has been the focus of recent research. Uncertainty continues concerning the presence or absence of a threshold for adverse effects from low level chronic exposure to mercury. The above mentioned inadequacies in study size, the measures used for effects, the reproducibility of the results, and the subjective nature of some of the low level effects have precluded a consensus in the scientific community on the safety of mercury amalgam. In the absence of clearly defined toxicity from low level exposures, one approach has been to focus upon determining exposure levels from mercury amalgam, and whether these levels exceed recommended guidelines or regulations. Since these guidelines and regulations (including the MRL) are themselves extrapolated from the hazardous effects literature, there is some circularity in the argument that exposures of mercury from amalgam that exceed guidelines like the MRL (or other standard) “support” the position that mercury amalgams pose a health risk. This aspect of the

2. HEALTH EFFECTS

controversy will only be satisfactorily resolved with better toxicity and pharmacokinetic data for chronic low level mercury exposure from amalgams.

People who are concerned that their mercury exposure may be causing adverse effects can be tested for allergies to mercury or to other metals, or for the amount of mercury in their body. Tests that measure the amounts of mercury in hair and urine are available and provide some indication of the potential for adverse effects from mercury. For more information about the tests that are available, see Section 2.7, Biomarkers of Exposure and Effects.

The following studies supporting or refuting the adverse health effects from exposure to dental amalgam provide some examples from the recent literature of effects being evaluated and the procedures that are being used. Some of the studies depend upon the self-reporting of symptoms or may be weakly blinded (i.e., the patients were not completely unaware of the assignment to different exposure groups) which could bias the outcome, especially with respect to some of the end points. An exhaustive analysis of the results presented below, however, is beyond the scope of this profile, and the reader is referred to the cited references for a more complete discussion of the issues concerning the potential adverse effects from exposure to dental amalgam.

Studies reporting no association between adverse effects and mercury amalgam.

Berglund and Molin (1996) evaluated whether a group of patients with symptoms, self-related to their amalgam restorations, experienced an exposure to mercury vapor from their amalgam restorations that reached the range at which subtle symptoms have been reported in the literature. They further evaluated whether the mercury exposure for these patients was significantly higher than for controls with no reported health complaints. The symptom group consisted of 10 consecutively selected patients from a larger group. The larger group consisted of patients who were referred by their physicians for an investigation of a correlation between subjective symptoms and amalgam restorations. The control group consisted of 8 persons with no reported health complaints. The intra-oral release of mercury vapor was measured between 7:45 a.m. and 9:00 p.m. at intervals of 30–45 minutes, following a standardized schedule. The mercury levels in plasma, erythrocytes, and urine were also determined. The calculated daily uptake of inhaled mercury vapor, released from the amalgam restorations, was less than 5% of the daily uptake calculated at the lower concentration range given by the WHO (1991), at which subtle symptoms have been found in particularly sensitive individuals. The symptom group had neither a higher estimated daily uptake

2. HEALTH EFFECTS

of inhaled mercury vapor nor a higher mercury concentration in blood and urine than in the control group. The study provided no scientific support for the belief that the symptoms of the patients examined originated from an enhanced mercury release from their amalgam restorations.

Bagedahl-Strindlund et al. (1997) evaluated Swedish patients with illnesses thought to be causally related to mercury release during dental restorations, and mapped the psychological/psychiatric, odontological, and medical aspects of the patients and their purportedly mercury-induced symptoms. A total of 67 consecutive patients and 64 controls matched for age, sex, and residential area were included in the study.

Questionnaires were completed and a semi-structured psychiatric interview performed. The Comprehensive Psychopathological Rating Scale was used to record psychopathological symptoms. The Karolinska Scales of Personality (KSP) set was used to assess personality traits. The Toronto Alexithymia Scale and the Schalling-Sifneos Personality Scale were completed. The Whitely Index was used to assess hypochondriacal attitudes. The type and number of amalgam-filled surfaces was determined. The most striking result was the high prevalence of psychiatric disorders (predominantly somatoform disorders) in the patients (89%) compared to the controls (6%). The personality traits differentiating the patients according to the Karolinska Scales of Personality were somatic anxiety, muscular tension, psychasthenia, and low socialization. More patients than controls showed alexithymic traits. The prevalence of diagnosed somatic diseases was higher, but not sufficiently so to explain the large difference in perceived health. The multiple symptoms and signs of distress displayed by the patients could not be explained either by the odontological data or by the medical examination. These data indicate that the patients show sociodemographic and clinical patterns similar to those of somatizing patients. The number of amalgam-filled surfaces did not differ significantly between patients and controls; 19% of the patients lacked amalgam fillings.

Grandjean et al. (1997a) evaluated the effects of chelation therapy versus a placebo on patient improvement for patients who attribute their environmental illness to mercury from amalgam fillings. Succimer (meso-2, 3-dimercaptosuccinic acid) was given at a daily dose of 30 mg/kg for 5 days in a double-blind, randomized placebo-controlled trial. Treatment of patients who attribute their environmental illness to mercury from amalgam fillings is largely experimental. On the Symptom Check List, overall distress, and somatization, obsessive-compulsive, depression, and anxiety symptom dimensions, were increased in 50 consecutive patients examined, and Eysenck Personality Questionnaire scores suggested less extroversion and increased degree of emotional lability. Urinary excretion of mercury and lead was considerably increased in the patients who received the chelator. Immediately after the treatment and 5–6 weeks later, most distress

2. HEALTH EFFECTS

dimensions had improved considerably, but there was no difference between the succimer and placebo groups. These findings suggest that some patients with environmental illness may substantially benefit from placebo.

Stoz et al. (1995) studied 185 mothers with tooth amalgam filling surfaces ranging from 0 to 780 mm² and found no relationship between the blood values of the women and their children and the size of the surfaces of the amalgam fillings. All mothers gave birth to healthy children. Malt et al. (1997) evaluated the physical and mental symptomatology of 99 self-referred adult patients complaining of multiple somatic and mental symptoms attributed to dental amalgam fillings. These patients were compared with patients with known chronic medical disorders seen in alternative (n=93) and ordinary (n=99) medical family practices and patients with dental amalgam fillings (n=80) seen in an ordinary dental practice. The assessments included written self-reports, a 131-item somatic symptom checklist, Eysenck Personality Questionnaire, the General Health Questionnaire, and Toronto Alexithymia Scale. Somatic symptom complaints were categorized by exhaustion, and musculoskeletal, cardiovascular, and gastrointestinal effects. The mean number of silver fillings surfaces were 40.96 in self-referents as compared to 36.61 in the dental practice patients. No correlation between number of dental fillings and symptomatology was found. Self-reports suggested that 62% suffered from chronic anxiety. Forty-seven percent suffered from major depression compared with none in the dental control sample. Symptoms suggesting somatization disorder were found in 29% of the dental amalgam sample compared with only one subject in the 272 comparison subjects; 37.5% of the dental amalgam patients reported symptoms of chronic fatigue syndrome compared with none in the dental control sample and only 2 and 6%, respectively, in the two clinical comparison samples. The dental amalgam group reported higher mean neuroticism and lower lie scores than the comparison groups. The authors concluded that self-referred patients with health complaints attributed to dental amalgam are a heterogeneous group of patients who suffer multiple symptoms and frequently have mental disorders. The authors report a striking similarity with the multiple chemical sensitivity syndrome.

An ad hoc review group of the DHHS Working Group on Dental Amalgam examined 175 literature articles concerning mercury amalgam (DHHS, 1997). The articles represented an assortment of literature from peer-reviewed journals and a variety of other print media. None of the 12 expert reviewers evaluating the articles suggested that any study under review would indicate that individuals with dental amalgam restorations would experience adverse health effects. Many of the reviewed articles were reported to suffer from inadequacy of experimental control, lack of dose-response information, poor measurement of exposure, and a variety of other experimental design inadequacies.

2. HEALTH EFFECTS

Studies that report an association between dental amalgam and adverse effects.

Echeverria et al. (1995) evaluated the behavioral effects of low-level exposure to Hg among dentists who had either been exposed to mercury or not as measured in a selection procedure where the exposed group was defined as those with urinary mercury levels greater than 19 µg/L. Exposure thresholds for health effects associated with elemental mercury exposure were examined by comparing behavioral test scores of 19 exposed (17 males, 2 females) with those of 20 unexposed dentists (14 males, 6 females). The mean urinary Hg of exposed dentists was 36.4 µg/L, which was 7 times greater than the 5 µg Hg/L mean level measured in a national sample of dentists (urinary Hg was below the level of detection in unexposed dentists for this study). To improve the distinction between recent and cumulative effects, the study also evaluated porphyrin concentrations in urine, which are correlated with renal Hg content (a measure of cumulative body burden). Significant urinary Hg dose-effects were found for poor mental concentration, emotional lability, somatosensory irritation, and mood scores (tension, fatigue, confusion). Individual tests evaluating cognitive and motor function changed in the expected directions but were not significantly associated with urinary Hg. However, the pooled sum of rank scores for combinations of tests within domains were significantly associated with urinary Hg, providing evidence of subtle preclinical changes in behavior associated with Hg exposure. Coproporphyrin, one of three urinary porphyrins altered by mercury exposure, was significantly associated with deficits in digit span and simple reaction time. Exposed dentists placed significantly more amalgams per week (28.0) than unexposed dentists (19.8). No significant differences were found between exposed and unexposed dentists for the overall number of years in practice or the number of amalgams removed per week.

Altmann et al. (1998) compared visual functions in 6-year-old children exposed to lead and mercury levels, in a cohort of 384 children (mean age 6.2 years) living in three different areas of East and West Germany. After adjusting for confounding effects, statistically significant lead-related changes were found only for some of the visually evoked potentials (VEP) interpeak latencies, while some of the contrast sensitivity values were significantly reduced with increasing mercury concentrations. All other outcome variables were not significantly related to lead or mercury levels. The authors concluded that even at blood lead levels in the range of 14–174 µg/L and at very low urinary mercury levels subtle changes in visual system functions can be measured. The geometric means of urinary mercury concentrations were 0.161, 0.203, and 0.075 µg Hg/24 hours for subjects of the three study areas (0.157 µg Hg/24 hours for the total study); the average numbers of amalgam fillings were 0.76, 1.10, and 1.88, respectively (1.15 amalgam fillings for the total study).

2. HEALTH EFFECTS

Siblerud and Kienholz (1997) investigated whether mercury from silver dental fillings (amalgam) may be an etiological factor in multiple sclerosis (MS). Blood findings were compared between MS subjects who had their amalgams removed (n=50) and MS subjects with amalgams (n=47). All subjects filled out a health survey, an MS health questionnaire, and a psychological profile; the MS amalgam removal group completed a health questionnaire comparing their health before and after amalgam removal. MS subjects with amalgams were found to have significantly lower levels of red blood cells, hemoglobin, and hematocrit compared to MS subjects with amalgam removal. Thyroxine (T-4) levels were also significantly lower in the MS amalgam group, which had significantly lower levels of total T-lymphocytes and T-8 (CD8) suppressor cells. The MS amalgam group had significantly higher blood urea nitrogen (BUN) and BUN/creatinine ratio, and lower serum IgG. Hair mercury was significantly higher in the MS subjects compared to the non-MS control group (2.08 versus 1.32 ppm). A health questionnaire found that MS subjects with amalgams had significantly more (33.7%) exacerbations during the past 12 months compared to the MS volunteers with amalgam removal: 31% of MS subjects felt their MS got better after amalgam removal, 7% felt it was eliminated, 33% felt no change, and 29% believed the condition got worse. In addition, 17% of the MS with amalgam group had more neuromuscular symptoms compared to the amalgam removal group.

Björkman et al. (1997) examined the mercury concentrations in saliva, feces, urine, whole blood, and plasma before and after removal of dental amalgam fillings in 10 human subjects. Before removal, the median mercury concentration in feces was more than 10 times higher than in samples taken from an amalgam-free reference group of 10 individuals. Two days following removal of all amalgams, a considerable increase in mercury appeared in the feces. This initial increase was followed by a significant decrease. In saliva, there was an exponential decline in the mercury concentration during the first 2 weeks after amalgam removal ($t_{1/2}$ of 1.8 days). The authors concluded that while mercury amalgam fillings are a significant source of mercury in saliva and feces, those levels decrease considerably following amalgam removal. Further, the gastrointestinal uptake of mercury seen in conjunction with removal of amalgam fillings appears to be low. Of 108 patients (all with amalgam dental fillings) presenting to an environmental toxicology service, the average salivary mercury level was 11 $\mu\text{g/L}$ (range, <1–19 $\mu\text{g/L}$) before chewing and 38 $\mu\text{g/L}$ (range, 6–500 $\mu\text{g/L}$) after chewing. Six of the 108 patients had salivary mercury concentrations >100 $\mu\text{g/L}$. Of 58 patients with suspected allergic disease, an epicutaneous test for amalgam was positive in 32 of them; however, direct involvement of dental amalgams in these sensitivities was not mentioned. Seventy-five of the total patients presenting with symptoms felt that amalgam fillings

2. HEALTH EFFECTS

or other dental materials were responsible, at least in part, for their symptoms, although no causal relationship was borne out by medical evaluation.

Bratel et al. (1996) investigated (1) healing of oral lichenoid reactions (OLR) following the selective replacement of restorations of dental amalgam, (2) whether there were differences in healing between contact lesions (CL) and oral lichen planus (OLP), and (3) whether there was a difference in healing potential when different materials were selected as a substitute for dental amalgam. Patients included in the study presented with OLR confined to areas of the oral mucosa in close contact with amalgam restorations (CL; n=142) or with OLR which involved other parts of the oral mucosa as well (OLP; n=19). After examination, restorations of dental amalgam which were in contact with OLR in both patient groups were replaced. The effect of replacement was evaluated at a follow-up after 6–12 months. In the CL group, the lesions showed a considerable improvement or had totally disappeared in 95% of the patients after replacement of the restorations of dental amalgam (n=474). This effect was paralleled by a disappearance of symptoms, in contrast to patients with persisting CL (5%) who did not report any significant improvement. The healing response was not found to correlate with age, gender, smoking habits, subjective dryness of the mouth or current medication. However, the healing effect in patients who received gold crowns was superior than in patients treated with metal-ceramic crowns (MC) ($p<0.05$). In the OLP group (n=19), 63% of the patients with amalgam-associated erosive and atrophic lesions showed an improvement following selective replacement. OLP lesions in sites not in contact with amalgams were not affected. Most of the patients (53%) with OLP reported symptoms also after replacement. From these data the authors conclude that in the vast majority of cases, CL resolves following selective replacement of restorations of dental amalgam, provided that a correct clinical diagnosis is established. The authors note that MC crowns did not facilitate healing of CL to the same extent as gold crowns.

Hultman et al. (1994) studied the effects of dental amalgams in in-bred mice genetically susceptible to mercury-induced immunotoxic effects. Following intraperitoneal implantation of a silver amalgam and observation for up to 6 months, chronic hyperimmunoglobulinemia, serum IgG autoantibodies targeting the nucleolar protein fibrillarin, and systemic immune-complex deposits developed in both a time- and dose-dependent manner. The functional capacity of splenic T- and B-cells was affected in a dose-dependent fashion. In this study, not only did the dental amalgam implantation cause chronic stimulation of the immune system with induction of systemic autoimmunity, but the implantation of silver alloy not containing mercury also induced autoimmunity, suggesting that other metals have the potential to induce autoimmunity in that genetically susceptible strain of mice. Accumulation of heavy metals from dental amalgams, as well

2. HEALTH EFFECTS

as from other sources, may lower the threshold of an individual metal to elicit immune aberrations, which could lead to overt autoimmunity.

2.6 CHILDREN'S SUSCEPTIBILITY

This section discusses potential health effects from exposures during the period from conception to maturity at 18 years of age in humans, when all biological systems will have fully developed. Potential effects on offspring resulting from exposures of parental germ cells are considered, as well as any indirect effects on the fetus and neonate due to maternal exposure during gestation and lactation. Relevant animal and *in vitro* models are also discussed.

Children are not small adults. They differ from adults in their exposures and may differ in their susceptibility to hazardous chemicals. Children's unique physiology and behavior can influence the extent of their exposure. Exposures of children are discussed in Section 5.6, Exposures of Children.

Children sometimes differ from adults in their susceptibility to hazardous chemicals, but whether there is a difference depends on the chemical (Guzelian et al. 1992; NRC 1993). Children may be more or less susceptible than adults to health effects, and the relationship may change with developmental age (Guzelian et al. 1992; NRC 1993). Vulnerability often depends on developmental stage. There are critical periods of structural and functional development during both pre-natal and post-natal life and a particular structure or function will be most sensitive to disruption during its critical period(s). Damage may not be evident until a later stage of development. There are often differences in pharmacokinetics and metabolism between children and adults. For example, absorption may be different in neonates because of the immaturity of their gastrointestinal tract and their larger skin surface area in proportion to body weight (Morselli et al. 1980; NRC 1993); the gastrointestinal absorption of lead is greatest in infants and young children (Ziegler et al. 1978). Distribution of xenobiotics may be different; for example, infants have a larger proportion of their bodies as extracellular water and their brains and livers are proportionately larger (Altman and Dittmer 1974; Fomon 1966; Fomon et al. 1982; Owen and Brozek 1966; Widdowson and Dickerson 1964). The infant also has an immature blood-brain barrier (Adinolfi 1985; Johanson 1980) and probably an immature blood-testis barrier (Setchell and Waites 1975). Many xenobiotic metabolizing enzymes have distinctive developmental patterns and at various stages of growth and development, levels of particular enzymes may be higher or lower than those of adults and sometimes unique enzymes may exist at particular developmental stages (Komori et al. 1990; Leeder and Kearns 1997; NRC 1993; Vieira et al. 1996).

2. HEALTH EFFECTS

Whether differences in xenobiotic metabolism make the child more or less susceptible also depends on whether the relevant enzymes are involved in activation of the parent compound to its toxic form or in detoxification. There may also be differences in excretion, particularly in the newborn who has a low glomerular filtration rate and has not developed efficient tubular secretion and resorption capacities (Altman and Dittmer 1974; NRC 1993; West et al. 1948). Children and adults may differ in their capacity to repair damage from chemical insults. Children also have a longer lifetime in which to express damage from chemicals; this potential is particularly relevant to cancer.

Certain characteristics of the developing human may increase exposure or susceptibility while others may decrease susceptibility to the same chemical. For example, the fact that infants breathe more air per kilogram of body weight than adults may be somewhat counterbalanced by their alveoli being less developed, so there is a disproportionately smaller surface area for absorption (NRC 1993).

Adverse health effects from different forms of mercury differ primarily because of differences in kinetics rather than mode of action. As discussed in the introduction to this section, children have different, and sometimes dramatically different, morphology or physiology that alters the way toxic compounds are absorbed and distributed throughout their bodies. For mercury compounds, preventing entry into the systemic circulation is the best means to prevent adverse effects. Once mercury enters the circulation, the tissues that end up as target sites are those that accumulate the most mercuric ion or the ones that are most often exposed to mercuric ion. That is why the kidney is a prime target site, for in fulfilling its major role of filtering and purifying the blood, the kidney is continually exposed to ionic mercury. The central nervous system is a major target site because mercuric ion also concentrates in the brain compartment. Ironically, it may be the blood-brain barrier that contributes to, rather than prevents, mercuric ion “trapping” in the brain. A current hypothesis is that once lipophilic forms of mercury cross the blood-brain barrier, they are oxidized to more hydrophilic species and become trapped inside the brain compartment. This “one way” only kinetic pathway results in continually increasing brain mercuric ion levels, as long as nonpolar forms are in the blood stream. Even small amounts of nonpolar mercury (<2 g) in the body may eventually lead to central nervous system damage (Neirenberg et al. 1998). The low capacity for central nervous system tissues to regenerate and the fact that even subtle damage to small areas of the brain can have profound overall effects, makes this tissue very susceptible to the highly toxic mercuric ion. These factors, and a slow but inevitable trapping of mercuric ions may lead to the mercury-induced delayed central nervous system toxicity observed months to years after exposure ceases (Neirenberg et al. 1998, Rice 1996a). Even potent chelators have not been effective in interfering with progressive central nervous

2. HEALTH EFFECTS

system damage once a nonpolar mercury compound gains access to the circulatory system and begins to concentrate in tissues (Neirenberg et al. 1998, Taueg et al. 1992).

For similar routes and forms of mercury, the adverse health effects seen in children are similar to the effects seen in adults. For example, a young child who was intoxicated with mercury vapor, died of pulmonary edema and had a grayish, necrotic mucosa of the stomach and duodenum (Campbell 1948). These effects are similar to those seen in adult populations occupationally exposures to inhaled metallic mercury vapors. Respiratory effects in adults from inhalation of metallic mercury vapor include pulmonary edema, lobar pneumonia, fibrosis, desquamation of the bronchiolar epithelium, and death in severe cases due to respiratory failure (Gore and Harding 1987; Jaffe et al. 1983; Kanluen and Gottlieb 1991; Matthes et al. 1958; Taueg et al. 1992; Teng and Brennan 1959; Tennant et al. 1961).

The majority of the information regarding cardiovascular effects comes from reports of children who were treated with mercurous chloride tablets for worms or mercurous chloride-containing powders for teething discomfort (Warkany and Hubbard 1953). These authors described multiple cases in which tachycardia and elevated blood pressure were observed in the affected children.

Electrocardiography in four family members who ate meat from a hog that had consumed seed treated with ethylmercuric chloride showed abnormal heart rhythms (ST segment depression and T wave inversion) (Cinca et al. 1979). Death of the two children in the family was attributed to cardiac arrest, and autopsy of these boys showed myocarditis. Cardiovascular abnormalities were also observed in severe cases of poisoning in the Iraqi epidemic of 1956, when widespread poisoning resulted from eating flour made from seed grains treated with ethylmercury *p*-toluene sulfonanilide (Jalili and Abbasi 1961). These abnormalities included irregular pulse, occasionally with bradycardia, and electrocardiograms showing ventricular ectopic beats, prolongation of the Q-T interval, depression of the S-T segment, and T inversion.

Several children who were treated with mercurous chloride for constipation, worms, or teething discomfort had swollen red gums, excessive salivation, anorexia, diarrhea, and/or abdominal pain (Warkany and Hubbard 1953). They also experienced muscle twitching or cramping in the legs and/or arms, but these muscular effects were probably secondary to changes in electrolyte balance (i.e., potassium imbalance due to fluid loss or renal wasting).

2. HEALTH EFFECTS

Acute renal failure that persisted for 10 days was observed in a 19-month-old child who ingested an unknown amount of powdered mercuric chloride (Samuels et al. 1982). Several children who were treated with medications containing mercurous chloride for constipation, worms, or teething discomfort exhibited flushing of the palms of the hands and soles of the feet (Warkany and Hubbard 1953). The flushing was frequently accompanied by itching, swelling, and desquamation of these areas. Morbilliform rashes, conjunctivitis, and excessive perspiration were also frequently observed in the affected children. Patch tests conducted in several children revealed that the rashes were not allergic reactions to the mercury. They also had irritability, fretfulness, sleeplessness, weakness, photophobia, muscle twitching, hyperactive or hypoactive tendon reflexes, and/or confusion.

A 13-month-old child who ingested porridge made from flour that had been treated with an alkyl mercury compound (specific mercury compound not reported) developed a measles-like rash, fever, and facial flushing (Engleson and Herner 1952). A 4-year-old boy who had been given a Chinese medicine containing mercurous chloride for 3 months developed drooling, dysphagia, irregular arm movements, and impaired gait (Kang-Yum and Oransky 1992). A number of children who were treated with an ammoniated mercury ointment or whose diapers had been rinsed in a mercuric chloride solution experienced tachycardia and elevated blood pressure, and anorexia (Warkany and Hubbard 1953).

In addition, rashes, conjunctivitis, and/or excessive perspiration were observed. These dermal and ocular reactions were not attributed to allergic-type reactions to the mercury. A 23-month-old boy who was exposed to an unspecified form of mercury also developed a "diffuse, pinpoint, erythematous, papular rash" and bright red finger tips "with large sheets of peeling skin" (Tunnessen et al. 1987).

A woman chronically exposed to an undetermined concentration of mercury vapor reported that her first pregnancy resulted in spontaneous abortion, and her second resulted in the death of the newborn soon after birth (Derobert and Tara 1950). It is unclear whether the reproductive toxicity experienced by the woman was due to the mercury exposure. However, after recovery from overt mercury poisoning, she gave birth to a healthy child. Not all exposures lead to immediate adverse effects. A woman occupationally exposed to mercury vapors for 2 years prior to pregnancy and throughout pregnancy was reported to have delivered a viable infant at term (Melkonian and Baker 1988). Urinary mercury in the woman at 15 weeks of pregnancy was 0.875 mg/L (normal levels are approximately 0.004 mg/L). A case report of a woman exposed to mercury vapors in her home during the first 17 weeks of pregnancy reported that the woman delivered a normal child who met all developmental milestones (although the child was not formally tested

2. HEALTH EFFECTS

for psychological development) (Thorpe et al. 1992). Mercury exposure was not measured, but the child was born with hair levels of 3 mg/kg (3 ppm) of mercury. This hair level was comparable to that observed in populations consuming fish once a week (WHO 1990) and suggests that exposure in this case may have been relatively low.

In the *in vivo* study by Sager et al. (1982), it was concluded that methylmercury may be acting on mitotic spindle microtubules leading to cell injury in the developing cerebellar cortex. Cell injury observed in the external granular layer of the cerebellar cortex of 2-day-old rats was attributed to a reduced percentage of late mitotic figures (arrested cell division) due to the loss of spindle microtubules. Mitosis and migration of granule cells in the cerebellum end within weeks following birth; therefore, this observation may suggest potential differences in the sensitivities of children and adults to mercury-induced neurotoxicity.

Regardless of whether mercury exposure is through inhalation of mercury vapors, ingestion of organic mercury or mercury salts, or dermal application of mercury-containing ointments, patients (primarily children) may exhibit a syndrome known as acrodynia, or pink disease. Acrodynia is often characterized by severe leg cramps; irritability; and erythema and subsequent peeling of the hands, nose, and soles of the feet. Itching, swelling, fever, tachycardia, elevated blood pressure, excessive salivation or perspiration, morbilliform rashes, fretfulness, sleeplessness, and/or weakness may also be present. It was formerly thought that this syndrome occurred exclusively in children, but recent reported cases in teenagers and adults have shown that these groups are also susceptible.

Developmental effects from prenatal or postnatal exposures to mercury are unique to children. During critical periods of structural and functional development in both prenatal and postnatal life, children are especially vulnerable to the toxic effects of mercury. Inhalation exposures are relatively rare outside of the occupational setting so the exposure route and form of mercury most commonly associated with a risk for development effects is the ingestion of methylmercury on the surface of contaminated foods (methylmercury used as a fungicide on seed grain) or accumulated within the food (methylmercury in fish, wild game, and marine mammals). The exposure route and form of mercury most commonly associated with maternal exposures is to foods contaminated with methylmercury fungicides (Bakir et al. 1973) or foods that contain high levels of methylmercury (Grandjean et al. 1997b, 1998; Tsubaki and Takahashi 1986).

The first such incident was reported in Sweden in 1952 when flour from grain treated with an unspecified alkyl mercury compound ingested by a pregnant woman was associated with developmental toxicity. An

2. HEALTH EFFECTS

apparently normal infant was born, but the infant later displayed brain damage manifested by mental retardation, incoordination, and inability to move (Engleson and Herner 1952). A 40-year-old woman, 3 months pregnant, consumed methylmercury-contaminated meat for an unspecified duration and subsequently delivered a male infant with elevated urinary mercury levels (Snyder and Seelinger 1976). At 3 months, the infant was hypotonic, irritable, and exhibited myoclonic seizures. At 6 years of age, the child displayed severe neurological impairment (e.g., blindness, myoclonic seizures, neuromuscular weakness, inability to speak) (Snyder and Seelinger 1976).

Another incidence of neurodevelopmental effects occurring as a result of *in utero* exposure to methylmercury was reported by Cox et al. (1989) and WHO (1990). The effect of concern was the delayed onset of walking in offspring in Iraqi children whose mothers were exposed to methylmercury through the consumption of seed grain treated with methylmercury as a fungicide (Al-Mufti et al. 1976; Bakir et al. 1973; Cox et al. 1989; Marsh et al. 1981, 1987).

A New Mexico family, including a pregnant woman, a 20-year-old female, and 2 children (a 13-year-old male and an 8-year-old female) ate meat from a hog inadvertently fed seed grain treated with a fungicide containing methylmercury and experienced severe, delayed neurological effects (Davis et al. 1994). Several months after the exposures, the children developed symptoms of neurological dysfunction. The newborn child of the exposed mother showed signs of central nervous system disorder from birth. Twenty-two years after the 3-month exposure period, the people who were 20 and 13 years old at time of exposure had developed cortical blindness or constricted visual fields, diminished hand proprioception, choreoathetosis, and attention deficits. MRI examination of these two revealed residual brain damage in the calcarine cortices, parietal cortices, and cerebellum. The brain of the person who was exposed at age 8 (who died of aspiration pneumonia with a superimposed *Klebsiella* bronchopneumonia and sepsis at age 29) showed cortical atrophy, neuronal loss, and gliosis, most pronounced in the paracentral and parieto-occipital regions. Regional brain mercury levels correlated with the extent of brain damage. The youngest (*in utero* at the time of exposure) developed quadriplegia, blindness, severe mental retardation, choreoathetosis, and seizures, and died at age 21. Since inorganic mercury crosses the blood-brain barrier poorly, biotransformation of the methylmercury to inorganic mercury may have occurred after the methylmercury crossed the blood-brain barrier, accounting for its observed persistence in the brain and its possible contribution to the brain damage.

2. HEALTH EFFECTS

More recently, Grandjean et al. (1997b, 1998) evaluated a cohort of 1,022 consecutive singleton births generated during 1986–1987 in the Faroe Islands. Increased methylmercury exposure from maternal consumption of pilot whale meat was indicated by mercury concentrations in cord blood and maternal hair. Neurophysiological tests emphasized motor coordination, perceptual-motor performance, and visual acuity; pattern reversal visual evoked potentials (VEP) with binocular full-field stimulation, brain stem auditory evoked potentials (BAEP), postural sway, and the coefficient of variation for R-R interpeak intervals (CVRR) on the electrocardiogram were measured. Clinical examination and neurophysiological testing did not reveal any clear-cut mercury-related abnormalities. However, mercury-related neuropsychological dysfunctions were most pronounced in the domains of language, attention, and memory, and to a lesser extent in visuospatial and motor functions. These associations remained after adjustment for covariates and after exclusion of children of mothers with maternal hair mercury concentrations above 10 µg/g (50 nmol/g). The effects on brain function associated with prenatal methylmercury exposure appear widespread, and early dysfunction is detectable at exposure levels currently considered safe.

There are differences in the outcomes of these epidemiology studies on low level chronic exposures to methylmercury in foods. Davidson et al. (1998) report no adverse developmental effects associated with prenatal and postnatal exposure to methylmercury in fish in a Seychelles Island cohort of children at age 66 months (n=708). The exposure levels are reflected in maternal hair levels of 6.8 ppm for the prenatal exposure (SD=4.5, n=711) and children's hair levels of 6.5 ppm (SD=3.3, n=708) for both the prenatal and subsequent postnatal exposure. The age-appropriate main outcome measures included: (1) the McCarthy Scales of Children's Abilities, (2) the Preschool Language Scale, (3) the Woodcock-Johnson Tests of Achievement - Letter and Word Recognition, (4) Woodcock-Johnson Tests of Achievement - Applied Problems and, (5) the Bender Gestalt test, and (6) the Child Behavior Checklist. The test results were similar to what would be expected from a healthy, well-developing U.S. population. No test indicated a deleterious effect of methylmercury from the exposure levels received in this population. Four of the six measures showed better scores in the highest MeHg groups compared with lower groups for both prenatal and postnatal exposure. This result is likely due to the benefits of increased levels of fish in the diet, possibly because of increased consumption of omega-3-fatty acids. Serum from a subset of 49 of the children was sampled for polychlorinated biphenyl levels (PCBs). None of the samples had detectable levels (detection limit 0.2 ng/mL) for any of the 28 congeners assayed (from congener 28 to 206) indicating that was no concurrent (i.e., potentially confounding) exposure to PCBs in this population. The median level of total mercury for each of 25 species sampled was 0.004–0.75 ppm, with most medians in the range of 0.05–0.25 ppm, levels that are comparable to fish in the U.S. market. The authors conclude that this

2. HEALTH EFFECTS

most recent NOAEL of 6.8 ppm for the Seychelles cohort at 66 months of age strongly supports the findings at earlier ages, and that the benefits of eating fish outweigh the small risk of adverse effects from an increased exposure to methylmercury for this exposure pathway.

The differences in these studies highlight the importance of interpreting epidemiology results and, indeed, all study results on mercury toxicity within a fairly comprehensive context of the numerous factors that might affect the toxicokinetics and the amount absorbed (e.g., form of mercury, route of exposure, age, diet of population exposed, health status, other potential sources of exposure to mercury, dose duration, constancy of dose amount over time, etc.)

A route of exposure unique to children is breast milk. Both organic and inorganic mercury can move into breast milk from a nursing woman's body, and children will readily absorb this mercury. Oskarsson et al. (1996) assessed the total and inorganic mercury content in breast milk and blood in relation to fish consumption and amalgam fillings (an exposure source for older children). Total mercury concentrations were evaluated in breast milk, blood, and hair samples collected 6 weeks after delivery from 30 lactating Swedish women. In breast milk, about half of the total mercury was inorganic and half was methylmercury, whereas in blood only 26% was inorganic and 74% was methylmercury. That is because, unlike the placental barrier, which is crossed more easily by methylmercury than by inorganic mercury, inorganic mercury moves more easily into breast milk. Some researchers think that a carrier mediated process is involved (Sundberg et al 1998).

For the Swedish population in the study, Oskarsson et al. (1996) reports that there was an efficient transfer of inorganic mercury from blood to breast milk and that mercury from amalgam fillings was probably the main source of mercury in breast milk, while methylmercury levels in blood did not appear to be efficiently transferred to breast milk. Exposure of the infant to mercury in breast milk was calculated to range up to 0.3 µg/kg/day of which approximately one-half was inorganic mercury. This exposure corresponds to approximately one-half the tolerable daily intake of total mercury for adults recommended by the World Health organization. The authors concluded that efforts should be made to decrease total mercury burden in women of reproductive age Oskarsson et al. (1996).

The metabolism of mercury is relatively straightforward compared, for example, to pesticides or some organic solvents. No information was identified to indicate that metabolic pathways are different for children and adults, or that children have unique metabolites. Once absorbed, metallic and inorganic

2. HEALTH EFFECTS

mercury enter an oxidation-reduction cycle. Metallic mercury is oxidized to the divalent inorganic cation in the red blood cells and lungs of humans and animals. Evidence from animal studies suggests the liver as an additional site of oxidation. Absorbed divalent cation from exposure to mercuric mercury compounds can, in turn, be reduced to the metallic or monovalent form and released as exhaled metallic mercury vapor. In the presence of protein sulfhydryl groups, mercurous mercury (Hg^+) disproportionates to one divalent cation (Hg^{+2}) and one molecule at the zero oxidation state (Hg^0). The conversion of methylmercury or phenylmercury into divalent inorganic mercury can probably occur soon after absorption, also feeding into the oxidation-reduction pathway.

A number of good physiologically based pharmacokinetic models are currently available for mercury, including some that address developmental toxicity and maternal/fetal transfer. Two models were constructed based upon data from the kinetics of methylmercury in rats. Farris et al. (1993) developed a PBPK model that simulates the long-term disposition of methylmercury and its primary biotransformation product, mercuric mercury, in the male Sprague-Dawley rat following a single oral nontoxic exposure. Gray (1995) developed a PBPK model that simulates the kinetics of methylmercury in the pregnant rat and fetus. The Gray model was developed to provide fetal and maternal organ methylmercury concentration-time profiles for any maternal dosing regimen. Sundberg et al. (1998) fitted a three compartment model to the elimination kinetics of methylmercury and inorganic mercury transfer to milk in lactating and nonlactating mice. Luecke et al. (1997) developed a model based on human physiology but extended to simulate animal data that depict internal disposition of two chemicals (singly or in combination) during pregnancy in the mother and the embryo/fetus. Leroux et al. (1996) developed a biologically based-dose-response model to describe the dynamics of organogenesis, based on the branching process models of cell kinetics. Gearhart et al. (1995) developed a PBPK model to coherently describe methylmercury pharmacokinetics in a variety of species (adult rat, monkey, and human), and to predict fetal levels of methylmercury from an *in utero* exposure.

No information was identified on biomarkers of exposure for children. Mercury levels in hair, urine, and blood are the standard measures of exposure. There are biomarkers for developmental effects that are unique to specific ages and stages of development throughout the child's developmental process. Developing the best measures for evaluation of cognitive functions is an area of intense debate and on-going research.

2. HEALTH EFFECTS

Concerning interactions with other chemicals, there is an ongoing debate about the value of fish in the diet versus the risk from increased exposure to methylmercury that may be in the fish. One recent study reported a beneficial effect from increased fish consumption even though mercury body burdens were increased to some extent (Davidson et al. 1998). One possible factor in the fish that could improve health is omega 3-fatty acid. Children and adults both benefit from a healthy diet, but there may more emphasis on the benefits to growing children. Other interactions for mercury include the effect of various substances on its gastrointestinal absorption (e.g., iron, zinc) or possibly protective effects from prevention or repair of mercury related oxidative damage (e.g., interactions with selenium as an antioxidant). No information was identified that specifically addresses differences in these interactions for children compared to adults.

The methods used to reduce peak absorption and to reduce body burdens in exposed adults (i.e., chelation therapy) are also used for exposures in children.

No information was identified on parental exposures affecting children in areas of parental germ cells or germ line mutations. The topic of exposure pathways for mercury via nursing or pregnant women who have been exposed is of main concern and has been addressed earlier in this section.

2.7 BIOMARKERS OF EXPOSURE AND EFFECT

Biomarkers are broadly defined as indicators signaling events in biological systems or samples. They have been classified as markers of exposure, markers of effect, and markers of susceptibility (NAS/NRC 1989).

A biomarker of exposure is a xenobiotic substance or its metabolite(s), or the product of an interaction between a xenobiotic agent and some target molecule(s) or cell(s), that is measured within a compartment of an organism (NAS/NRC 1989). The preferred biomarkers of exposure are generally the substance itself or substance-specific metabolites in readily obtainable body fluid(s) or excreta. However, several factors can confound the use and interpretation of biomarkers of exposure. The body burden of a substance may be the result of exposures from more than one source. The substance being measured may be a metabolite of another xenobiotic substance (e.g., high urinary levels of phenol can result from exposure to several different aromatic compounds). Depending on the properties of the substance (e.g., biological half-life) and environmental conditions (e.g., duration and route of exposure), the substance and all of its metabolites may have left the body by the time samples can be taken. It may be difficult to identify individuals exposed

2. HEALTH EFFECTS

to hazardous substances that are commonly found in body tissues and fluids (essential mineral nutrients [e.g., copper, zinc, and selenium]). Biomarkers of exposure to mercury are discussed in Section 2.7.1.

Biomarkers of effect are defined as any measurable biochemical, physiological, or other alteration within an organism that, depending on magnitude, can be recognized as an established or potential health impairment or disease (NAS/NRC 1989). This definition encompasses biochemical or cellular signals of tissue dysfunction (e.g., increased liver enzyme activity or pathological changes in female genital epithelial cells), as well as physiological signs of dysfunction such as increased blood pressure or decreased lung capacity. Note that these markers are not often substance specific. They also may not be directly adverse, but they can indicate potential health impairment (e.g., DNA adducts). Biomarkers of effect caused by mercury are discussed in Section 2.7.2.

A biomarker of susceptibility is an indicator of an inherent or acquired limitation of an organism's ability to respond to the challenge of exposure to a specific xenobiotic substance. It can be an intrinsic genetic or other characteristic or a pre-existing disease that results in an increase in the absorbed dose, a decrease in the biologically effective dose, or a target tissue response. If biomarkers of susceptibility exist, they are discussed in Section 2.8 (Populations That Are Unusually Susceptible).

2.7.1 Biomarkers Used to Identify or Quantify Exposure to Mercury

Blood and urine mercury concentrations are commonly used as biomarkers of exposure to mercury. Hair has been used as a biomarker of exposure to methylmercury. Occupational studies show that recent mercury exposure is reflected in blood and urine (Naleway et al. 1991; WHO 1991). However, at low exposure levels (<0.05 mg Hg/m³), correlation to blood or urine mercury levels is low (Lindstedt et al. 1979). Blood levels of mercury peak sharply during and soon after short-term exposures, indicating that measurements should be made soon after exposure (Cherian et al. 1978). The specific time frame at which measurements become less reliable has not been determined. Workers exposed for a chronic duration, however, may have a high body burden of mercury, therefore, mercury levels would probably still be elevated in the urine and blood for a long period of time after cessation of exposure (Lindstedt et al. 1979). The following discussion of blood and urine mercury levels generally refers to measurements taken immediately or within a few days following the last exposure.

2. HEALTH EFFECTS

The mean total mercury levels in whole blood and urine of the general population are approximately 1–8 µg/L and 4–5 µg/L, respectively (Gerhardsson and Brune 1989; WHO 1990). Recently, the International Commission on Occupational Health (ICOH) and the International Union of Pure and Applied Chemistry (IUPAC) Commission on Toxicology determined that a mean value of 2 µg/L was the background blood level of mercury in persons who do not eat fish (Nordberg et al. 1992). These blood and urine levels are "background" in the sense that they represent the average levels in blood in the general population and are not associated with a particular source for mercury. However, the intra- and inter-individual differences in these biomarkers are substantial, possibly due to dental amalgams (urine) and ingestion of contaminated fish (blood) (Verschoor et al. 1988; WHO 1991). Long-term consumption of fish is the source of nearly all of the methylmercury measured in the general population, and individuals in communities with high fish consumption rates have been shown to have blood levels of 200 µg/L, with daily intake of 200 µg mercury (WHO 1990). However, acute inhalation exposure to low levels of metallic mercury resulted in much lower levels in the blood (0.028 and 0.18 µg/100 mL) and urine (from 94 to >438 µg/L) (Kanluen and Gottlieb 1991; Rowens et al. 1991).

Urine mercury measurement is reliable and simple, and it provides rapid identification of individuals with elevated mercury levels (Naleway et al. 1991). It is a more appropriate marker of inorganic mercury, because organic mercury represents only a small fraction of urinary mercury. Yoshida (1985) found that urinary mercury levels were better correlated with exposure than were blood inorganic mercury concentrations in workers exposed to metallic mercury vapor.

Several studies have reported a correlation between mercury in blood and urine; however, results vary, and it is not known whether the ratio between concentrations in urine and blood remains constant at different exposure levels (Lindstedt et al. 1979; Roels et al. 1987; Smith et al. 1970). Significant correlations between occupational exposure to mercury vapor and mercury levels in the blood and urine of 642 workers in 21 chloralkali facilities were reported by Smith et al. (1970). According to the investigators, an air concentration (8-hour TWA) of 0.1 mg/m³ was associated with blood levels of 6 µg/100 mL and urine levels of 220 (not corrected for specific gravity), 200, or 260 µg/L (corrected to specific gravities of 1.018 or 1.024, respectively). It is likely that current worker exposure is significantly less than this study indicates, because practices such as requiring showers after workshifts and cleaning work clothes after use have been implemented since 1970, when the Smith study was conducted. Another group of investigators, Henderson et al. (1974), found the concentrations reported in Smith et al. (1970) to be 2–10 times higher than those found 2 years later. As suggested by Roels et al. (1982), the actual mercury absorption by

2. HEALTH EFFECTS

workers exposed to the same air concentration may vary; therefore, researchers should report urine mercury levels together with estimated exposure concentrations to address the issue of variance between individuals.

Studies assessing mercury vapor exposure have suggested various ratios relating the concentration of mercury in the air (in $\mu\text{g}/\text{m}^3$) to the levels of mercury in the urine (in $\mu\text{g}/\text{L}$). Such estimates include 1:1 (Bell et al. 1973), 1:1.22 (Roels et al. 1987), and 1:2.5 (Lindstedt et al. 1979; Rosenman et al. 1986). Urinary metallic mercury levels ranging from 0.05 to 1.7 $\mu\text{g}/\text{L}$ were detected in the urine of workers exposed to mercury vapor ($>0.1 \text{ mg}/\text{m}^3$); this elemental mercury represented $<1\%$ of the inorganic mercury content of the urine (Yoshida and Yamamura 1982). With increased exposure to mercury vapor (0.47–0.67 mg/m^3), the amount of elemental mercury in the urine increased. A "rough" correlation between levels of metallic mercury vapor in air and mercury levels in blood and urine was established by Rosenman et al. (1986). They associated levels of 50 $\mu\text{g}/100 \text{ mL}$ in blood and 250 $\mu\text{g}/\text{L}$ in urine with a mercury level in air of approximately 0.1 mg/m^3 (8-hour TWA), and 28 $\mu\text{g}/100 \text{ mL}$ in blood and 100 $\mu\text{g}/\text{L}$ in urine with a TWA of 0.05 mg/m^3 . Roels et al. (1987) found a correlation between daily mercury vapor exposure and blood or urine mercury levels in 10 workers employed for at least 1 year at an alkaline battery plant. The mercury levels in the air and the pre- or post-workshift levels of blood and urinary mercury correlated well ($r=0.79\text{--}0.86$ [blood] and $r=0.70\text{--}0.80$ [urine]). Based on a ratio of 1:0.045:1.22 (mercury in air: blood mercury: urinary mercury), Roels et al. (1987) concluded that exposure to 0.05 mg/m^3 mercury vapor would result in a blood mercury of 2.26 $\mu\text{g}/100 \text{ mL}$ and a urinary mercury of 61 $\mu\text{g}/\text{g}$ creatinine. This correlation differed from that reported by Rosenman et al. (1986), possibly because fewer subjects were evaluated and determination of mercury vapor concentration by Roels et al. (1987) was based on air sampling collection during 5 consecutive days at 10 different workplaces.

Expired air samples have been considered as possible biomarkers of exposure for mercury. Following inhalation of metallic mercury vapor, some of the mercury may be eliminated in the expired air, but excretion from this pathway is negligible 5–7 days after exposure (Cherian et al. 1978; Hursh et al. 1976). Thus, expired air as a measure of mercury exposure can only be used soon after short-term exposure to mercury vapor. There is no information on the amount of mercury in expired air following long-term exposure to mercury.

Nonoccupational exposure to mercury includes the use of mercury-containing products and consumption of mercury-contaminated food. Urine samples from young women using skin-lightening creams containing

2. HEALTH EFFECTS

5–10% mercuric ammonium chloride had a mean mercury concentration of 109 µg/L, compared to 6 µg/L for urine samples from women who had discontinued use and to 2 µg/L for women who had never used the creams (Barr et al. 1973). Increased urinary excretion and blood levels of mercury were observed in volunteers who used phenylmercuric borate solutions or lozenges intended for the treatment of mouth or throat infections (Lauwerys et al. 1977). Swedes consuming fish contaminated with 0.3–7 mg Hg/kg (0.3–7 ppm) had blood cell levels of total mercury ranging from 8 to 390 ng/g (Skerfving 1974). Long-term exposure to methylmercury at 4 µg Hg/kg/day was associated with a mercury level in blood cells of approximately 300 ng/g (Skerfving 1974). The steady-state concentration of methylmercury in blood may be related to daily intake in the following equation (Task Group on Metal Accumulation 1973; WHO 1990):

$$C = \frac{f(d)}{b(V)} \cdot \frac{A_D(A_B)(d)}{b(V)}$$

Where:

- C = concentration in blood
- f = fraction of the daily intake taken up by the blood
- d = daily dietary intake
- b = elimination constant
- A_D = percent of mercury intake in diet that is absorbed
- A_B = percent of the absorbed amount that enters the blood
- V = volume of blood in the body

Hair is a biomarker of long-term exposure to methylmercury. Once mercury is incorporated into hair, it remains unchanged (Clarkson et al. 1973; Nielsen and Andersen 1991a, 1991b). A number of studies have examined the level of mercury in hair relative to the amount of fish consumed (see Table 2-10) (Airey 1983b; Haxton et al. 1979; Oskarsson et al. 1990; Sherlock et al. 1982). A fairly strong correlation has been demonstrated by these studies between the amount of fish consumed, the level of mercury in the fish, and the level of mercury in hair. Furthermore, the relationship between hair levels and blood levels has been well studied (see Table 2-9) (Amin Zaki et al. 1976; Den Tonkelaar et al. 1974; Haxton et al. 1979; Kershaw et al. 1980; Phelps et al. 1980; Sherlock et al. 1982; Skerfving 1974; Soria et al. 1992).

A number of studies report that hair mercury levels correlate with total intake levels and with organ-specific levels of mercury. Suzuki et al. (1993) analyzed 46 human autopsies in Tokyo, Japan and reported that hair mercury levels were highly significantly correlated with organ Hg levels in the cerebrum, cerebellum, heart, spleen, liver, kidney cortex, and kidney medulla, when the total mercury or methyl mercury value in the organ was compared with the hair total mercury or organic mercury, respectively.

2. HEALTH EFFECTS

When the inorganic mercury value was tested, significant correlations remained, with weaker coefficients in all the organs but the spleen. Stepwise multiple regression analysis indicated that hair organic mercury value was the major correlating variable for the organ total mercury or organ methyl mercury value in all the organs. With respect to the organ inorganic mercury value, the hair organic mercury value was the major correlate for the cerebrum and kidney (both cortex and medulla), the hair inorganic mercury value was the major variable for the cerebellum and heart, and the hair phosphorous and hair organic mercury were the major variables for the liver. No explanatory variable existed for the spleen. Auxiliary correlating variables accounted for the organ total mercury and inorganic mercury levels, among which the hair selenium value was conspicuous and with negative regression coefficients.

Nakagawa (1995) analyzed total mercury in hair samples from 365 volunteers in Tokyo, and reported higher mercury levels in those who preferred fish in their diet, compared to those who preferred other foods (preference choices were fish, fish and meat, meat, and vegetables). The mean hair mercury levels were 4 ppm in men who preferred fish and 2.7 ppm in women who preferred fish. The lowest hair mercury levels were seen in men and women who preferred vegetables, 2.27 and 1.31 ppm, respectively. The mean hair level for the whole group was 2.23 ppm (median 1.98).

Drasch et al. (1997) assayed tissue samples of 150 human cadavers (75 males, 75 females) from a "normal" European (German) population, i.e., there were no occupational or higher than average exposures to metals found in any of the biographies of the deceased. The objective was to evaluate the validity of blood, urine, hair, and muscle as biomarkers for internal burdens of mercury, lead, and cadmium in the general population. All individuals died suddenly and not as a result of chronic ailments. Age ranged from 16 to 93 years, and every decade was represented by approximately 10 males and 10 females. Tissues sampled included kidney cortex, liver, cerebral cortex, cerebellum, petrous portion of the temporal bone, (pars petrosus ossis temporalis), pelvic bone (spina iliaca anterior-superior), muscle (musculus gluteus), blood (heart blood), urine, and hair (scalp-hair). Statistically significant rank correlations between biomarker levels and tissues were observed but with large confidence intervals for the regressions. The authors conclude that specific biomarkers relative to each metal are useful in estimating body burdens and trends in groups, but are not useful for determining the body burden (and therefore the health risks) in individuals. A notable exception was, that in comparison to a generally poor correlation of cadmium, lead, and mercury between hair and tissue, there was a strong correlation between mercury in hair and mercury in brain (cerebrum and cerebellum). The authors state that this may be due to the high lipophilicity of elemental and short-chain alkyl mercury compounds. As seen in other studies comparing European to

2. HEALTH EFFECTS

Japanese hair mercury levels, the hair levels reported by Nakagawa (1995) of 2–4 ppm for a Japanese population are 10–20 times higher than levels observed in the Drasch et al. (1997) study (median, 0.247 µg/g in hair; range, 0.43–2.5 µg/g).

Other studies have confirmed a good correlation between hair mercury and brain mercury levels. In a study on the Seychelles Islands cohort, Cernichiari et al. (1995b) compared maternal hair levels, maternal blood levels, fetal blood levels, and fetal brain levels. Autopsy brains were obtained from infants dying from a variety of causes. The concentrations of total mercury in six major regions of the brain were highly correlated with maternal hair levels. This correlation was confirmed by a sequence of comparisons among the four measures. Maternal hair correlated to maternal blood ($r=0.82$) and infant brain level ($r=0.6–0.8$). Maternal blood correlated to infant blood ($r=0.65$); and infant blood correlated to infant brain ($r=0.4–0.8$).

There are potential confounding factors and other factors to consider when assessing mercury exposure based upon mercury hair levels. Mercury may be deposited to hair from the air when significant sources of mercury are present in the air or when certain hair treatments are used (Hac and Krechniak 1993; WHO 1991). Potential sources of external mercury exposure should, therefore, be evaluated as part of an exposure assessment. Some studies also report a sex related difference in mercury tissue levels. Nielson et al. (1994) observed a significant sex-related differences in the toxicokinetics of methylmercury in mice following administration of a single radiolabeled dose. Drasch et al. (1997) reported that mercury levels in all tissues assayed in their human cadaver study had higher levels compared to male tissues. The difference was significant for the kidney (median female kidney mercury level=92.0 ng/g, males=40.8 ng/g; $p=0.002$). In blood and urine there was a similar trend. In contrast, the authors report that mercury hair levels in females were significantly lower than in males (median females=205 ng/g, males 285 ng/g; $p=0.02$). Nakagawa (1995) also report higher mean mercury hair levels in males (2.98 µg/g) compared with females (2.02 µg/g) in a Japanese population. Further research is, therefore, needed to characterize potential sex related difference in the toxicokinetics of mercury under different exposure scenarios.

Eide and Wesenberg (1993) studied mercury concentrations in various organs and tissues in rats exposed to mercury vapor for approximately 2 months and proposed that human deciduous teeth may be useful indicators of chronic mercury exposure, as well as indicators of mercury uptake in organs such as the kidneys and the brain.

2. HEALTH EFFECTS

Other potential biomarkers of exposure include renal dysfunction parameters, neurological effects, and increased urinary porphyrins, and are discussed below in Section 2.7.2.

2.7.2 Biomarkers Used to Characterize Effects Caused by Mercury

Several potential biomarkers of effect for mercury have been evaluated, usually for neurological and renal dysfunction. Many of these toxic effects have been correlated with blood and urine levels (see Table 2-13). However, most indicators are nonspecific and may have resulted from other influences. As discussed in Section 2.2, many studies have examined the relationship between urine mercury levels and specific renal and neurological effects. Renal dysfunction has been studied extensively as a potential sensitive measure of mercury exposure. Signs of renal dysfunction at mercury air concentration of 0.1 mg/m³ were reported by Stewart et al. (1977). Case reports have associated the therapeutic use of inorganic mercury salts with the occurrence of nephrotic syndrome (Kazantzis et al. 1962).

Several different biomarkers have been evaluated for assessing renal damage; however, renal parameters are interdependent (Verschoor et al. 1988). Furthermore, these markers are not specific for mercury exposure and may be a consequence of other concurrent chemical exposures. Markers for renal toxicity may indicate decreased function, cytotoxicity, or biochemical changes (Cardenas et al. 1993). Biomarkers for decreased function include increases in urinary proteins and elevation of serum creatinine or β_2 -microglobulin. Biomarkers for renal cytotoxicity include increases in urinary excretion of antigens and enzymes located within renal tissues. Biomarkers for biochemical changes occurring within the kidneys include eicosanoids, fibronectin, kallikrein activity, and glycosaminoglycans in urine. Glomerular changes resulting from mercury exposure have predominantly been reported as increases in high-molecular weight proteinuria (Buchet et al. 1980; Kazantzis et al. 1962; Stonard et al. 1983; Tubbs et al. 1982). Renal tubular changes in workers exposed to mercury include increased urinary excretion of *N*-acetyl- β -D-glucosaminidase (NAG), β -galactosidase, and retinol binding protein (Barregard et al. 1988; Langworth et al. 1992b; Rosenman et al. 1986). Elevated urinary NAG levels occurred with urinary mercury levels of 100–250 μ g/L in a study population of mixed ethnic background (Rosenman et al. 1986), with urinary levels of 35 μ g/g creatinine in chloralkali workers (Barregard et al. 1988), with urinary mercury levels >25 μ g/g creatinine in chloralkali workers (Langworth et al. 1992b), and with urinary mercury levels >50 μ g/g creatinine in another group of chloralkali workers (Cardenas et al. 1993). NAG levels were not affected in chloralkali workers with urinary mercury levels of 15 μ g/g creatinine (Piikivi and Ruokonen 1989). No significant increase of proteinuria, albuminuria, and other indicators of renal

Table 2-13. Health Effects Associated with Mercury Levels in Human Blood and Urine

Parameter	Normal levels found in tissue	Observed effect levels	Effect	Reference
Blood (whole)	<0.5–2 µ/100 mL			Iyengar et al. 1978
		<1–>10 µg/100 mL	Increased tremors	Verbeck et al. 1986
		>1.5 µg/100 mL	Disturbances in tests on verbal intelligence and memory. No effect level for proteinuria	Piikivi et al. 1984
		1.6 µg/100 mL	No effect level for proteinuria	Lauwreys et al. 1983
		1–2 µg/100 mL	Increased prevalence of abnormal psychomotor scores	Roels et al. 1982
		12 µg/100 mL	Increased tremors. Impaired eye-hand coordination	Smith et al. 1970
		>3 µg/100 mL	(Estimated threshold level): Increased urinary excretion of β-galactosidase and high molecular weight proteins	Buchet et al. 1980
Urine	0.43–11.4			Iyengar et al. 1978
		2–472 µg/g creatinine	Decreased delta-aminolevulinic acid dehydratase and cholinesterase activity. Increased urine coproporphyrin levels	Wade et ad. 1969
		3–272 µg/g creatinine	Increased anti-laminin antibodies (implicated in the etiology of autoimmune glomerulo-nephritis)	Lauwreys et al. 1983
		50–100 µg/g creatinine	Increased tremors. Impaired eye-hand coordination	Smith et al. 1970
		50 µg/g creatinine	(Estimated threshold level): Increased urinary excretion of β-galactosidase and high molecular weight proteins	Buchet et al. 1980

Table 2-13. Health Effects Associated with Mercury Levels in Human Blood and Urine (continued)

Parameter	Normal levels found in tissue	Observed effect levels	Effect	Reference
Urine (cont.)		56 µg/g creatinine	No effect level for proteinuria	Lauwreys et al. 1983
		7–1,101 µg/24 hours	Abnormal memory tests; decreased tibial nerve velocity; increased median nerve latency in both motor and sensory nerves	Vroom and Greer 1972
		0–510 µg/L	Short-term memory loss	Smith et al. 1983
		5–1,000 µg/L	Increased tremor frequency and reaction time; impaired eye-hand coordination	Miller et al. 1975
		<10–>1,000 µg/L	Increased tremors	Verbeck et al. 1986
		20–450 µg/L	Increased motor and sensory nerve latency	Levine et al. 1982
		>56 µg/L	Disturbances in tests on verbal intelligence and memory	Piikivi et al. 1984
		100–250 µg/L	Increased acetyl β-D-glucosaminidase (NAG) enzyme levels in urine	Rosenman et al. 1986
		>200 µg/L	Increased tremors; impaired eye-hand coordination	Williamson et al. 1982
		300–1,400 µg/L	Nephrotic syndrome; albuminuria; hypercholesterolemia	Kazantis et al. 1962

2. HEALTH EFFECTS

dysfunction was evident in 62 mercury workers with average blood mercury levels of 1.6 $\mu\text{g}/100\text{ mL}$ (range, 0.25–7.56 $\mu\text{g}/100\text{ mL}$) and average urine mercury levels of 56 $\mu\text{g}/\text{g}$ creatinine (range, 3–272 $\mu\text{g}/\text{g}$ creatinine) (Lauwerys et al. 1983). Another renal parameter evaluated is β -microglobulin, which has a normal range of 0.004–0.37 mg/L (Naleway et al. 1991). No statistically significant relationship was found between urinary β -microglobulin levels and elevated urinary mercury concentrations (Ehrenberg et al. 1991; Naleway et al. 1991). Examination of a wide range of biomarkers for renal toxicity in a group of chloralkali workers identified several other changes at low urinary mercury levels (Cardenas et al. 1993). Workers with urinary mercury levels in the range of 5–50 $\mu\text{g}/\text{g}$ creatinine showed statistically significant increases in urinary Tamm-Horsfall glycoprotein (localized in the epithelial cells of the convoluted tubules) and decreases in urinary prostaglandins E2 and F2 α . In workers with >50 $\mu\text{g}/\text{g}$ creatinine, increased NAG, tubular brush border antigens, alkaline phosphatase, thromboxane B2, and glycosaminoglycans were also observed. Urinary porphyrins, which are intermediates in the biosynthesis of heme, may be another potential biomarker of effect for mercury exposure. A correlation was observed between urinary mercury and urinary coproporphyrin (Wada et al. 1969). Correlations were also observed for decreases in δ -aminolevulinic acid-dehydratase and cholinesterase activity with increases in urinary mercury. Porphyrins are considered a nonspecific measure of effect because they are influenced by other metal exposures. Woods et al. (1991) present data suggesting that there is a specific urinary porphyrin profile that may serve as a biomarker of mercury accumulation in the kidneys during prolonged inorganic and organic mercury exposure. A urinary porphyrin pattern, characterized by elevated coproporphyrin, pentacarboxyl porphyrin, and precoproporphyrin, for methylmercury hydroxide exposure was observed in mice for up to 30 weeks. This profile is observed at variable dose levels, as well as up to at least 40 weeks after cessation of exposure. The time course of the profile during prolonged treatment is closely associated with divalent inorganic mercury (Hg^{+2}), suggesting that the effects are mediated by this cation because it inhibits the heme pathway (Woods et al. 1991). Specificity may be a problem unless the porphyrin levels are analyzed at the same time as urinary mercury measurements.

The neurophysiological and neuropsychological health effects of mercury have been extensively studied in occupationally exposed individuals in an effort to monitor body levels and to determine a threshold value below which these effects are unlikely to occur. As with other biomarkers of effect, neurological changes induced by mercury may resemble exposure to other chemicals that can cause damage to the brain.

Case studies have associated exposure to mercury vapor with neurological effects (e.g., tremors, insomnia, shyness, emotional instability, decreased motor function and muscle reflexes, headaches, and abnormal

2. HEALTH EFFECTS

EEGs) (Davis et al. 1974; Jaffe et al. 1983; McFarland and Reigel 1978). Some studies have examined the relationship between nerve function and mercury levels in blood, urine, and tissue. Tissue levels of mercury have also been found to correlate with impaired nerve function. Among 23 dentists with mercury levels greater than 20 $\mu\text{g/g}$ (measured in wrist tissue), 30% exhibited reduced nerve conduction velocity when compared with dentists with tissue levels of mercury below 20 $\mu\text{g/g}$ (Shapiro et al. 1982). The decrease in nerve conduction velocity was observed in both sensory and motor nerves.

A dose-response relationship has also been reported for the association between paresthesia and blood mercury concentrations in an Iraqi population exposed to methylmercury. At a blood mercury level of 24 $\mu\text{g}/100\text{ mL}$ 65 days after cessation of exposure, the incidence of paresthesia caused by methylmercury rose significantly (Clarkson et al. 1976). Below this concentration, any incidence of paresthesia was assumed to be related to other causes, according to the investigators. As a result of the reported blood mercury half-life of 65 days in this population, the maximum blood mercury concentration was likely to have been 48 $\mu\text{g}/100\text{ mL}$ at the end of the exposure. Some evidence of paresthesia, sensory impairment, general ataxia, and visual field effects in exposed Swedes was reported; however, no significant increases in occurrence were found in Swedes with high levels of mercury in blood cells (82–1,100 ng/g) as compared to Swedes with lower blood cell mercury levels (12–75 ng/g) (Skerfving 1974). The study did not include a matched control group.

Many possible biomarkers of effect for mercury exposure have been correlated with urinary mercury levels. Workers exposed to elemental mercury vapor with urinary mercury excretion levels ranging from 7 to 1,101 $\mu\text{g}/\text{day}$ exhibited significantly reduced tibial nerve velocity and increased median nerve latency in both motor and sensory nerves as compared with controls (Vroom and Greer 1972). Prolonged motor and sensory nerve latency was also associated with urine mercury levels ranging from 20 to 450 $\mu\text{g/L}$ in 18 male workers exposed to elemental mercury vapor at a mercury cell chlorine plant (Levine et al. 1982). Urine mercury levels exceeding 200 $\mu\text{g/L}$ have been reported to be associated with tremors and poor eye-hand coordination (Williamson et al. 1982). Twelve workers chronically exposed to elemental mercury vapor had urinary mercury levels ranging from <10 to 670 $\mu\text{g/L}$. A significant relationship between urine mercury and hand steadiness was reported. Increased tremor frequency, increased reaction time, and reduced eye-hand coordination were observed as urine mercury levels increased from 5 to 1,000 $\mu\text{g/L}$ in 77 exposed individuals (Miller et al. 1975). A weak but significant quantitative relationship between urine mercury levels and finger tremors was elucidated by Verberk et al. (1986). The relationship between acceleration of finger tremors and excretion of mercury in the urine of 20 workers exposed to metallic

2. HEALTH EFFECTS

mercury was expressed by the equation $10 \log (\text{acceleration}) = 0.888 + 0.0059 (\text{urine mercury})$ ($r=0.39$, $p<0.05$, $n=20$). Tremors have also been reported in 567 workers from chloralkali production facilities whose blood mercury levels ranged from <1 to $>10 \mu\text{g}/100 \text{ mL}$ and whose urine mercury levels ranged from <10 to $>1,000 \mu\text{g}/\text{L}$. Increased tremors and reduced eye-hand coordination were associated with blood mercury levels of $1\text{--}2 \mu\text{g}/100 \text{ mL}$ and urine mercury levels of $50\text{--}100 \mu\text{g}/\text{g creatinine}$ (Smith et al. 1970). Cavalleri et al. (1995) have suggested that exposure to elemental mercury vapors at levels producing urine mercury concentrations $>50 \mu\text{g}/\text{g creatinine}$ can cause a dose-related loss of color vision.

An association between urine mercury levels and performance on memory tests and verbal intelligence tests has been established. Abnormal results on memory tests were reported for 9 workers exposed to mercury in the production of thermometers; urinary mercury excretion levels were $7\text{--}1,101 \mu\text{g}/24 \text{ hours}$ (Vroom and Greer 1972). The short-term memory span of 26 workers was examined by Smith et al. (1983) and found to decrease with increasing urine mercury levels. The range of mercury found in the urine of these workers was $0\text{--}510 \mu\text{g}/\text{L}$. A significant linear relationship was reported between subjects' 50% memory threshold spans and 12-month urinary mercury concentrations. Disturbances on tests of verbal intelligence and memory were more frequent among individuals with mercury blood levels above $1.5 \mu\text{g}/100 \text{ mL}$ and mercury urine levels above $56 \mu\text{g}/\text{L}$ in 36 male chloralkali workers (Piikivi et al. 1984).

Potential biomarkers for the autoimmune effects of mercury include measurement of antglomerular basement membrane antibodies, anti-DNA antibodies, serum IgE complexes, and total IgE (Cardenas et al. 1993). Elevated IgE, antglomerular basement membrane antibodies, and anti-DNA antibodies have been observed in a few persons with exposure to mercury from dental amalgams (Anneroth et al. 1992). Other individuals have also been shown to have elevated anti-DNA or antglomerular basement membrane antibodies (Cardenas et al. 1993; Langworth et al. 1992b).

Recent data regarding the action of low-level mercury exposure on receptors and signal transduction pathways in peripheral lymphocytes suggest potential applications of certain surrogate markers in mechanistic studies of neurotoxicity and, possibly, in assessing early biochemical effects of neurotoxicants in humans (Manzo et al. 1995). Additional biomarkers for effects on the immune, renal, hepatic, and neurological systems are presented in the CDC/ATSDR (1990) and OTA (1990) reports. See Section 2.2 for a more detailed discussion of the effects caused by mercury.

2. HEALTH EFFECTS

2.8 INTERACTIONS WITH OTHER CHEMICALS

As with many other metals, both toxic and nontoxic, interrelationships exist that can influence and alter the absorption, distribution, excretion, and toxicity of one or more of the component metals. For example, the zinc status of an individual can affect mercury toxicity. Pretreatment with zinc provides some protection from the nephrotoxic effects of inorganic mercury in rats (Zalups and Cherian 1992). The data indicate that zinc-induced metallothionein binds mercury in the renal cortex and shifts the distribution of mercury from its site of toxicity at the epithelial cells of the proximal tubules. Thus, the renal content of mercury is increased, yet less is available to cause toxicity. In contrast, the renal toxicity of mercuric chloride is exacerbated in zinc-deficient animals (Fukino et al. 1992). In the zinc-deficient state, less mercury accumulates in the kidneys, but the toxicity is greater. The mechanism of the protection appears to involve more than simply a redistribution of renal mercury, because in the absence of mercury exposure, zinc deficiency increases renal oxidative stress (increased lipid peroxidation, decreased reduced ascorbate). When mercury exposure occurs, the oxidative stress is compounded (increased lipid peroxidation and decreased glutathione and glutathione peroxidase). Thus, zinc appears to affect the biochemical protective mechanisms in the kidneys as well.

Similarly, in most studies, the simultaneous administration of mercury and selenium in equimolar doses to animals has resulted in decreased toxicity of both elements in acute and chronic exposure studies. This effect has been observed with inorganic and organic mercury and with either inorganic or organic selenium compounds, although inorganic forms of selenium appear to be more effective than organic forms (Chang 1983; Skerfving 1978). Selenium protects against the acute nephrotoxicity of the mercuric ion and the methylmercuric ion in rats (Ganther 1980; Ganther et al. 1972; Hansen 1988; Magos et al. 1987; Parizek and Ostadolva 1967) and possibly against acute neurotoxicity of methylmercuric ion in rats (Ohi et al. 1980). The protective effect of selenium has been associated with a higher whole-body retention of mercury rather than with increased mercury excretion (Hansen 1988; Magos et al. 1987). Mercury-selenium complexes are formed when these chemicals are co-administered. Mercuric mercury forms a complex with selenium and a high-molecular weight protein (Naganuma and Imura 1981). Methylmercury forms a dimethyl-mercury selenide complex. Although the specific mechanism for the protection is not well understood, possible mechanisms for selenium's protective effect include redistribution of mercury (Mengel and Karlog 1980), competition by selenium for mercury-binding sites associated with toxicity, formation of a mercury-selenium complex that diverts mercury from sensitive targets (Hansen 1988; Magos et al. 1987; Naganuma and Imura 1981), and prevention of oxidative damage by increasing

2. HEALTH EFFECTS

selenium available for the selenium-dependent glutathione peroxidase (Civin-Aralar and Furness 1991; Imura and Naganuma 1991; Nylander and Weiner 1991). Selenium-treated animals can remain unaffected despite an accumulation of mercury in tissues to levels that are otherwise associated with toxic effects (Skerfving 1978). Support for the proposal that an inert complex is formed comes from the 1:1 ratio of selenium and mercury found in the livers of marine mammals and in the bodies of experimental animals administered compounds of mercury and compounds of selenium, regardless of the ratio of the injected doses (Hansen 1988). Mercuric mercury has been shown to form a complex with selenium and a high-molecular weight protein (Naganuma and Imura 1981). Methylmercury forms a dimethylmercury selenide complex.

Although the fetotoxicity of methylmercuric chloride has been shown to be enhanced by the feeding of a selenium-deficient diet in mice (Nishikido et al. 1987), additional selenium administration does not appear to protect against teratogenic effects (i.e., cleft palate) of methylmercuric chloride in mice (Lee et al. 1979). High doses of selenium administered as selenite for 30 days prior to gestation and through Gd 18 to mice fed a diet containing high doses of methylmercuric chloride increased the incidence of cleft palate (Nobunaga et al. 1979). It is possible that cleft palate induction by methylmercury is the result of a suppression of growth rather than a tissue-specific teratogenic action (Lee et al. 1979). If this were the case, high doses of selenium that inhibit growth could potentiate the induction of cleft palate by methylmercury administration. Further discussion of selenium-mercury interactions can be found in Section 2.3.1.2.

Ethanol promotes an increase in the respiratory excretion of metallic mercury by inhibiting the enzyme catalase, which is responsible for oxidizing metallic mercury to mercuric mercury. This process was shown in workers who ingested a moderate dose of alcohol and experienced a 50% decrease in mercury retention upon inhalation exposure to metallic mercury vapor (Nielsen-Kudsk 1973). Also, ethanol increased the amount of mercury exhaled by people who inhaled metallic mercury vapor or received trace doses of mercuric chloride (Nielsen-Kudsk 1965). Therefore, less mercury should reach the kidneys and less renal toxicity should be observed (Nielsen-Kudsk 1965). However, ethanol also allows elemental mercury to persist longer in the plasma, resulting in prolonged diffusion of elemental mercury throughout the body (Nielsen-Kudsk 1965). Therefore, ethanol can cause mercury to distribute more easily across the blood-brain barrier and the placenta, thereby increasing the risk of mercury toxicity to the brain and the developing fetus. In addition, the oxidation of ethanol with concurrent NADPH generation enhances

2. HEALTH EFFECTS

the reduction of the mercuric ion to metallic mercury, thereby making it more favorable for permeating the placenta (Khayat and Dencker 1982).

Ethanol also potentiates the toxicity of methylmercury (Rumbeiha et al. 1992; Tamashiro et al. 1986; Turner et al. 1981). Studies in animals have shown increased mortality (Tamashiro et al. 1986), increased severity and decreased time to onset of neurotoxicity (hind-limb ataxia) (Tamashiro et al. 1986; Turner et al. 1981), and increased renal toxicity (increased hematuria, renal weight, blood urea nitrogen, and oliguria) (Rumbeiha et al. 1992; Tamashiro et al. 1986) when methylmercury exposure occurred concomitant with ethanol ingestion. Although increased mercury concentrations were observed in the brain and kidneys, the changes in mercury content were insufficient to fully explain the observed potentiation of toxicity (Tamashiro et al. 1986), suggesting that ethanol may enhance the toxic mechanisms of methylmercury. The mechanism for this enhancement is unknown.

Atrazine and potassium dichromate have also been demonstrated to enhance the toxicity of inorganic mercury. Administration of atrazine, a widely used herbicide, with methylmercury in the diet resulted in a higher deposition of mercury in the liver and an earlier onset of neurotoxicity (Meydani and Hathcock 1984). The mechanism underlying this interaction was unclear. Parenteral administration of minimally toxic doses of potassium dichromate and mercuric chloride resulted in a synergistic inhibition of the renal transport of organic ions *p*-aminohippurate and tetraethylammonium (Baggett and Berndt 1984). Although the mechanism underlying this interaction was not examined, it may be associated with the fact that both mercury and potassium dichromate are both toxic to the renal proximal tubule (Biber et al. 1968).

Agents that deplete nonprotein sulfhydryls may increase the toxicity of mercury. Depletion of glutathione levels with diethylmaleate in rats resulted in greatly increased renal toxicity of mercury chloride (Girardi and Elias 1991). Greater decreases in glomerular filtration and increases in fractional excretion of sodium and lithium, urinary γ -glutamyltransferase, and lipid peroxidation were observed. Conversely, chemicals that protect against oxidative damage may decrease the toxic effects of mercury. Increased survival and decreased toxicity were observed in rats given vitamin E (α -tocopherol) during treatment with methylmercury (Welsh 1979). It is probable that the mechanism for the protection involved the antioxidant properties of vitamin E.

The exogenous application of the monothiols glutathione or its precursor N-acetyl-DL-homocysteine thiolactone (NAHT), or B-complex and E vitamins to mice exposed to methylmercuric chloride injected

2. HEALTH EFFECTS

at dosages of 1 mg/kg/day was reported by Bapu et al. (1994). Therapy with both B-complex vitamins and vitamin E was found to mobilize a significant amount of mercury from all tissues examined (brain, spinal cord, liver, and kidneys), with the maximum mobilization (about 63%, compared with controls) being recorded in the spinal cord following vitamin E treatment. NAHT treatment also produced significant mobilization of mercury from nervous tissue but caused an increase in mercury concentration in non-nervous tissue.

Another group of compounds that combines with mercury (and other divalent cation species) is comprised by those used in chelation therapy to reduce the body burden of mercury by enhancing its elimination from the body. Such chelators include: ethylenediaminetetraacetic acid (EDTA); ethylene glycol bis(beta-aminoethyl ether)N,N,N',N'-tetraacetic acid (EGTA); 2,3-dimercaptopropane-1-sulphonate (DMPS); 2,3-dimercaptosuccinic acid (DMSA); 2,3-dimercaptopropanol (British anti-Lewisite [BAL]; sometimes called dimercaprol); and N-acetylpenicillamine (NAP). While these chelating agents have a very high affinity for Hg^{++} , which makes them effective mercury chelators, they also have an affinity for other divalent cations, many of which are essential for normal physiological function.

BAL was the first chelating agent used for mercury toxicity, and it is still widely used today for inorganic mercury poisoning (ATSDR 1992). BAL is also believed to be effective in treating phenylmercury poisoning, because of the rapid *in vivo* oxidization of phenylmercuric acetate to Hg^{++} , thereby rendering phenylmercury similar in behavior to inorganic mercury. BAL is contraindicated for cases of methylmercury poisoning, however, because it has been demonstrated to increase the concentration of methylmercury in the brain. Possible side effects of BAL include nausea, vomiting, headache, tachycardia, fever, conjunctivitis, blepharospasm, and lacrimation. As an adjunct or alternative to parenterally administered BAL, oral NAP may be used (ATSDR 1992). Side effects of NAP may include fever, rash, leukopenia, eosinophilia, and thrombocytopenia.

DMPS and DMSA are derivatives of BAL, but they have been found to be more effective than BAL in experimental studies. Although still considered an investigational drug, DMPS decreased the mercury excretion half-life from 33.1 to 11.2 days in 2 workers exposed to high levels of mercury vapor (ATSDR 1992). In a study of the influence of DMPS and DMSA on renal deposition of mercury in rats, both chelating agents were found to cause a significantly increased urinary excretion of mercury (Zalups 1993), although significant differences in the extrarenal handling of these two chelators were found. DMPS was also shown to increase the urinary excretion of mercury 7.6-fold in a group of former chloralkali workers

2. HEALTH EFFECTS

3 years after cessation of occupational exposure (Sallsten et al. 1994), probably reflecting the excretion of mercury stored in the kidneys. In a case report of two human mercury vapor intoxication incidents, treatment with BAL followed by DMSA was found to decrease plasma inorganic mercury uptake at concentrations $<50 \mu\text{g/L}$. However, relatively high concentrations of mercury remained in the plasma for a very long time, possibly due to the progressive release of mercury from red blood cells and tissues after oxidation.

EDTA and EGTA also effectively form complexes with Hg^{++} , and enhance its excretion from the body, in what is typically considered a relatively benign or biologically inert fashion. In a study using human brain homogenates from autopsy samples from apparently healthy brains, Duhr et al. (1993) demonstrated that not only is the inhibition of microtubule polymerization and the disruption of already-formed microtubules not prevented by the addition of EDTA and EGTA (which bind Hg^{++} with very high affinity) but, to the contrary, these two chelating agents potentiate the Hg^{++} -induced inhibition of tubulin polymerization. Duhr et al. (1993) further reported that the mercury-EDTA and mercury-EGTA complexes cause the inhibition of tubulin polymerization by disrupting the interaction of GTP with the E-site of brain beta-tubulin, an obligatory step in the polymerization of tubulin.

2.9 POPULATIONS THAT ARE UNUSUALLY SUSCEPTIBLE

A susceptible population will exhibit a different or enhanced response to mercury than will most people exposed to the same level of mercury in the environment. Reasons include genetic makeup, developmental stage, age, health and nutritional status (including dietary habits that may increase susceptibility, such as inconsistent diets or nutritional deficiencies), and substance exposure history (including smoking). These parameters result in decreased function of the detoxification and excretory processes (mainly hepatic, renal, and respiratory) or the pre-existing compromised function of target organs (including effects on clearance rates and any resulting end-product metabolites). Populations more susceptible to the toxic effects of mercury than a healthy young adult include: the elderly because of declining organ function, higher levels of persistent heavy metals (e.g., cadmium) that also accumulate in the kidney, and potentially higher brain to liver or kidney mercury concentrations; people with pre-existing disease (e.g., renal or neurological disease); and the youngest of the population because of their immature and developing organs. Populations at greater risk due to unusually high exposure are discussed in Section 5.7 (Populations With Potentially High Exposure).

2. HEALTH EFFECTS

Probably the most widely recognized form of hypersensitivity to mercury is the occurrence of acrodynia, or pink disease, in persons exposed to mercury. Acrodynia is characterized by itching, flushing, swelling, and/or desquamation of the palms of the hands or soles of the feet, morbilliform rashes, excessive sweating and/or salivation, tachycardia, elevated blood pressure, insomnia, weakness, irritability, fretfulness, and peripheral sensory disturbances (Warkany and Hubbard 1953). The occurrence of acrodynia was determined to be an idiosyncratic reaction to mercury exposure. Despite widespread exposure of children to mercury-containing laxatives, antiascariasis medications, and teething powders in the 1940s and 1950s, only a few children developed acrodynia. The affected population was not the most highly exposed; numerous reports identified higher exposures in others with no evidence of the disease. The physiological basis for this hypersensitivity is unknown, but patch testing indicated that it is not an allergic response to mercury exposure.

Animal studies (Aten et al. 1992; Druet et al. 1978; Hirszel et al. 1985; Hultman and Enestrom 1992; Matsuo et al. 1989; Michaelson et al. 1985; Pelletier et al. 1990; Pusey et al. 1990; Roman-Franco et al. 1978; van der Meide et al. 1993) and limited human data (Lindqvist et al. 1974; Tubbs et al. 1982) also indicate that there may be persons with a genetic predisposition to develop an autoimmune glomerulonephritis upon exposure to mercury. In this form of renal toxicity, proteinuria is observed following the reaction of autoantibodies with renal tissues and deposition of immune material (i.e., IgG and complement C3) in the renal mesangium and glomerular blood vessels. Both susceptible and resistant mouse and rat strains have been identified, and susceptibility appears to be governed by both MHC genes and nonMHC genes (Aten et al. 1991; Druet et al. 1978; Hultman and Enestrom 1992; Hultman et al. 1992; Michaelson et al. 1985; Sapin et al. 1984).

Unborn children are another known susceptible population to the toxic effects of mercury (see Section 2.2.2.4). Data from large-scale poisonings in Japan (Harada 1978) and Iraq (Marsh et al. 1987) indicate that infants exposed *in utero* to alkyl mercury compounds developed severe neurological toxicity whereas their mothers may have experienced no or only mild toxicity. This difference may be due to methylmercury binding to tubulin (Vogel et al. 1985, 1989) and the role of microtubules in neuronal cell division and migration in the developing nervous system (Sager et al. 1982). There is evidence indicating that the developing male fetus may be more susceptible to methylmercury exposure than the female fetus (Buelke-Sam et al. 1985; Grant-Webster et al. 1992; Sager et al. 1984).

2. HEALTH EFFECTS

Neonates may also be especially susceptible to mercury toxicity. Both inorganic and organic forms of mercury are excreted in the milk (Sundberg and Oskarsson 1992; Yoshida et al. 1992). Furthermore, suckling rats exhibit a very high absorption of inorganic mercury as a percentage of the diet (30–40%) compared to adult rats, which absorb approximately 1% of the inorganic mercury from the diet (Kostial et al. 1978). The highest oral toxicity to inorganic mercury as expressed by the LD₅₀ was for 2-week-old rats; by 3–6 weeks of age, rats showed a dramatic drop in sensitivity to inorganic mercury poisoning (Kostial et al. 1978). The transfer of mercury to suckling rats through milk was found to result in greater concentrations of the metal in the brains of the offspring than in the mother (Yang et al. 1973).

Developmental neurotoxicity, similar to that seen with *in utero* exposure, has been observed in an infant exposed to alkyl mercury only after birth (Engleson and Herner 1952).

Individuals with diseases of the liver, kidneys, lungs, and nerves are considered to be at greater risk of suffering from the toxic effects of both organic and inorganic mercury. Individuals with a dietary insufficiency of zinc, glutathione, antioxidants, or selenium or those who are malnourished may be more susceptible to the toxic effects of mercury poisoning because of the diminished ability of these substances to protect against mercury toxicity (see Section 2.8).

2.10 METHODS FOR REDUCING TOXIC EFFECTS

This section describes clinical practice and research concerning methods for reducing toxic effects of exposure to mercury. However, because some of the treatments discussed may be experimental and unproven, this section should not be used as a guide for the treatment of exposures to mercury. When specific exposures have occurred, poison control centers and medical toxicologists should be consulted for medical advice.

Although there are a number of treatments currently available, none are completely satisfactory and additional development of treatment drugs and protocols is needed. The recent death of a researcher poisoned with dimethylmercury is a case in point (Nierenberg et al 1998; Toribara et al. 1997). In spite of prompt action and excellent medical care and monitoring, the clinical course in this patient continued to decline, and ultimately ended in death.

In general, even the inorganic mercurials, that are considered to be more easily chelated, are difficult to remove from the body and are not treated without some side effects. Infants and young children are

2. HEALTH EFFECTS

particularly difficult to treat, sometimes requiring exchange transfusion or other more elaborate measures. Reducing the body burden or toxic effects of mercury in pregnant women presents an even greater challenge (i.e., treatment must be effective for both the mother and the developing child), and specific treatment protocols are needed.

2.10.1 Reducing Peak Absorption Following Exposure

Strategies used to reduce absorption of mercury may differ depending on the route of exposure and the specific chemical to which one is exposed. Elemental mercury and certain organic forms of mercury have high vapor pressures and are readily absorbed by the lungs; inhalation of these chemicals may be the major exposure of concern. Because ingestion of most chemical forms of mercury is possible, strategies for limiting absorption from the gastrointestinal tract would be of utmost concern in such situations. The organic mercury compounds have greater absorption from the gut than elemental and inorganic mercury; thus, strategies differ depending on the form of mercury ingested. Dermal absorption of the various forms of mercury is also possible, so strategies should also consider limiting dermal absorption.

The first step in mitigating the toxic effects of inhalation and dermal exposures to mercury or its compounds is removal from the contaminated area or source (Bronstein and Currence 1988; Gossel and Bricker 1984; Haddad and Winchester 1990; Stutz and Janusz 1988). Since continued exposure may occur when clothing is contaminated, clothing may be removed as well (Bronstein and Currence 1988; Stutz and Janusz 1988). If dermal or ocular exposure has occurred, thoroughly washing the exposed areas with water has been suggested; treatment protocols recommend the use of Tincture of Green® soap a disinfectant) for the skin and normal saline for the eyes (Bronstein and Currence 1988; Stutz and Janusz 1988).

Several treatments have been suggested to reduce absorption of mercury from the gastrointestinal tract; however, most refer to the inorganic forms of mercury. It is likely that strategies that are effective in reducing the absorption of inorganic forms may also have some efficacy for organic forms. Several procedures that have been recommended for trapping mercury in the gastrointestinal tract are based on the mercury's affinity for binding to sulfhydryl groups. For example, oral administration of a protein solution (e.g., milk or egg whites) has been suggested to reduce absorption (Gossel and Bricker 1984; Haddad and Winchester 1990; Stutz and Janusz 1988). Salt-poor albumin administration has also been suggested (Haddad and Winchester 1990). Nonabsorbable agents (e.g., polystyrene resins containing sulfhydryl

2. HEALTH EFFECTS

groups) have been used to decrease the absorption rate of methylmercury (Clarkson et al. 1973). The oral administration of activated charcoal has also been suggested (Gossel and Bricker 1984; Stutz and Janusz 1988). Rapid removal of mercury from the gastrointestinal tract may be indicated in some acute, high-dose situations. In such situations, immediate emesis or gastric lavage has been suggested (Goldfrank et al. 1990; Haddad and Winchester 1990). Inclusion of salt-poor albumin or sodium formaldehyde sulfoxylate in the lavage fluid to convert the mercuric ion into the less soluble mercurous ion in the stomach has also been recommended (Haddad and Winchester 1990). Emesis is contraindicated following the ingestion of mercuric oxide, presumably because of the risk of damage to the esophagus as the potentially caustic compound is ejected. A saline cathartic, such as magnesium sulfate, to speed removal from the gastrointestinal tract has also been recommended unless diarrhea has already begun (Haddad and Winchester 1990; Stutz and Janusz 1988). Giving $\text{CaNa}_2\text{-EDTA}$ is contraindicated because it binds poorly to mercury, may be toxic to the kidneys, chelates other essential minerals, and may cause redistribution of mercury in the body (Gossel and Bricker 1984).

2.10.2 Reducing Body Burden

Since the main source of mercury exposure for the general public is organic mercury in the diet, minimizing the consumption of mercury-laden fish and shellfish is an effective means of reducing the body burden. The amount of inhaled mercury vapor from accidental spills of metallic mercury (e.g., from broken thermometers or electrical switches) can be minimized by informing the general public of the potential dangers and volatility of liquid mercury, and by prompt and thorough clean-up of liquid mercury spills.

Following exposure and absorption, metallic mercury is distributed primarily to the kidneys. Elemental mercury is highly soluble in lipids and easily crosses cell membranes (Gossel and Bricker 1984), particularly those of the alveoli (Florentine and Sanfilippo 1991). Once in the blood, this form of mercury can distribute throughout the body, as well as penetrate the blood-brain barrier, thus accumulating in the brain (Berlin et al. 1969). The body burden half-life of metallic mercury is about 1–2 months (Clarkson 1989). The kidney is also the primary organ of accumulation for compounds of inorganic mercury, but the liver, spleen, bone marrow, red blood cells, intestine, and respiratory mucosa are target tissues as well (Haddad and Winchester 1990; Rothstein and Hayes 1964). Inorganic mercury is excreted primarily through the kidneys; its half-life ranges from 42–60 days (Hursh et al. 1976; Rahola et al. 1973). As with elemental mercury, organic mercury compounds accumulate throughout the body (Aberg et al. 1969; Miettinen 1973). Accumulation of organic mercury also occurs in the liver, where it

2. HEALTH EFFECTS

is metabolized, excreted through the bile, and often reabsorbed in the gastrointestinal tract (Florentine and Sanfilippo 1991; Haddad and Winchester 1990). The half-life of lower alkyl mercurials is about 70–79 days (Aberg et al. 1969; Miettinen 1973).

For several years, diaphoresis (excretion through perspiration) was used to lower the body burden of mercury in miners exposed to mercury vapors (Sunderman 1978). Recently, this method of therapy has also been used to lower tissue levels of mercury in a patient exposed to metallic mercury in the manufacture of thermometers (Sunderman 1978).

Chelation therapy is presently the treatment of choice for reducing the body burden of mercury. There are currently a number of chelators that are either in practical use or under investigation in *in vivo* and *in vitro* studies (Florentine and Sanfilippo 1991; Gossel and Bricker 1984; Haddad and Winchester 1990). These chelators differ in their efficacy for various forms of mercury, routes of administration, side effects, and routes of excretion. Depending on the chemical to which one has been exposed and the health status of the individual, different chelators may be indicated. One popularly used chelator, dimercaprol or BAL, has two sulfhydryl groups that can bind mercury and compete with its binding to sulfhydryl groups in body tissues (Florentine and Sanfilippo 1991; Haddad and Winchester 1990). BAL is one of the more effective chelators for inorganic mercury salts. BAL is administered intramuscularly and is the preferred chelator when oral dosing is impractical (Florentine and Sanfilippo 1991; Gossel and Bricker 1984; Haddad and Winchester 1990). Approximately 50% of the dimercaprol-mercury complex is excreted through the kidneys, while the remainder is eliminated in the bile and feces. Thus, this chelator is preferred when renal impairment has occurred. BAL therapy, however, has several limitations. Significant reabsorption of mercury from the bile occurs (Shimada et al. 1993). Also, multiple toxic side effects including urticaria, elevated blood pressure and heart rate, nausea and vomiting, headache, conjunctivitis, lacrimation, and paresthesias have been reported (Goldfrank et al. 1990). Children may develop fevers, and individuals with a glucose-6-phosphatase deficiency may develop hemolysis. BAL treatment is contraindicated for elemental and organic mercury compounds because it has been shown to increase brain levels of mercury in animal studies when used to treat exposures to phenylmercury or methoxyethylmercury compounds (Berlin 1986; Berlin and Rylander 1964) or elemental mercury vapor (Goldfrank et al. 1990), indicating the possibility of increased neurotoxicity.

Another currently used mercury chelator is D-penicillamine. This drug has been used somewhat effectively to reduce the toxicity of elemental and inorganic mercury exposures. It can be taken orally, and its

2. HEALTH EFFECTS

metabolism is slight in humans. Penicillamine is removed through the kidneys (Florentine and Sanfilippo 1991). However, acute allergic reactions to penicillamine may occur (Goldfrank et al. 1990). An experimental drug, *N*-acetyl-D,L-penicillamine (NAP), is very similar to its analog, penicillamine, in its properties of absorption, metabolism, and excretion; however, it may be more mercury-specific in its chelating abilities and less toxic (Goldfrank et al. 1990; Haddad and Winchester 1990). A high success rate (88%) has been reported by investigators using NAP to treat victims of mercury inhalation (Florentine and Sanfilippo 1991).

2,3-Dimercaptosuccinic acid (DMSA), an analogue of BAL, is another experimental chelating agent. DMSA can be given orally and is primarily excreted through the kidneys (Aposhian et al. 1992b). It has been shown to be an effective chelator for both inorganic and methylmercury (Magos 1967). Comparative studies have demonstrated that DMSA is as effective, if not more so, as dimercaprol, penicillamine, and NAP. Data also suggest that this chelating drug produces fewer adverse effects than NAP (Florentine and Sanfilippo 1991). 2,3-Dimercaptopropane-1-sulfonate (DMPS) is another BAL analogue that is an orally effective chelator for mercury. Reports differ with respect to which of these analogues is less toxic (Ellenhorn and Barceloux 1988; Goldfrank et al. 1990; Jones 1991; Karagacin and Kostial 1991). Better results were obtained in rats with DMPS than with DMSA when the chelating agent was administered at least 24 hours following exposure to mercuric chloride. However, early oral administration of DMPS (within 24 hours) resulted in increased mercury retention (Karagacin and Kostial 1991). In contrast, DMSA resulted in decreased mercury retention irrespective of when it was administered.

Hemodialysis with infusion of a chelator (cysteine, *N*-acetylcysteine, NAP) has been reported to be effective in some severe cases of poisoning where renal failure is a complication (Berlin 1986; Goldfrank et al. 1990; Haddad and Winchester 1990). It has been reported to be advantageous to begin the hemodialysis before substantial renal damage has occurred (Haddad and Winchester 1990).

Because methylmercury undergoes enterohepatic recirculation, nonabsorbable agents have been used to "trap" methylmercury excreted into the bile (Lund et al. 1984). A polystyrene resin containing sulfhydryl groups added to food at a concentration of 1% doubled the elimination rate of methylmercuric chloride when administered to mice. The elimination half-life decreased from 65 to 20 days (Clarkson et al. 1973). Excretion of methylmercury may also be enhanced by bile drainage either through catheterization and drainage of the choledochal duct or by surgical establishment of gallbladder drainage (Berlin 1986). However, this method has not been used therapeutically.

2. HEALTH EFFECTS

2.10.3 Interfering with the Mechanism of Action for Toxic Effects

The majority of metallic mercury vapor and organic mercury absorbed by the body is rapidly oxidized to the more toxic and soluble mercuric ion in the blood and tissues through a hydrogen peroxide catalase pathway (Clarkson 1989; Halbach and Clarkson 1978). It is believed that the high affinity of the cation for protein-containing sulfhydryl or thiol groups is the underlying mechanism for the biological activity of mercury (Clarkson 1972a; Hughes 1957; Passow et al. 1961). In a process that is not yet completely understood, mercury disrupts the intracellular sulfhydryl status, resulting in oxidative stress, followed by activation of catabolic enzymes (i.e., proteases, endonucleases), and ultimately in cellular injury (Verity and Sarafian 1991). Treatment with agents that reduce oxygen radical-producing reactions may be effective in reducing mercury-induced oxidative cell damage. For example, pretreatment of rats with deferoxamine, a potent iron chelator and inhibitor of iron-catalyzed oxygen radical-producing reactions, reduced the increase in reactive oxygen species seen in the cerebellum after methylmercury exposure (LeBel et al. 1992; Sarafian and Verity 1991). Similarly, treatment with *N*-acetylcysteine, an antioxidant, resulted in increased survival time and less severe lung lesions in rats following exposure to mercury vapor (Livardjani et al. 1991b). Vitamin E (alpha tocopherol) and *N,N'*-diphenyl-*p*-phenylenediamine therapy have antioxidant effects and have been shown to be effective in protecting against methylmercury-induced toxicity (Ganther 1980; Welsh 1979).

Strategies to block the oxidation of elemental mercury to mercuric ion through the hydrogen peroxide catalase pathway do not appear to be a viable method for mitigating the effects of mercury exposure because treatment with chemicals (e.g., ethanol) that have been shown to block this reaction (Nielsen-Kudsk 1965) result in higher levels of blood mercury and increased renal toxicity (Rumbeiha et al. 1992). Another option would be to reduce the oxidized mercury ions to the monovalent mercurous form. A treatment of this nature has been suggested for ingested inorganic mercury.

Metals and chemicals shown to be antagonistic to the toxic effects of mercury may offer a possible method of interfering with the mercury's mechanism of action. Selenium, as sodium selenite, has been used in counteracting mercury poisoning, although the specific mechanism is not understood (Mengel and Karlog 1980; Naganuma and Imura 1981). The efficacy of selenium administration also appears to be dependent on the form of mercury to which one is exposed. Co-administration of sodium selenite with mercuric chloride resulted in decreased renal toxicity, whereas co-administration with methylmercuric chloride had no effect on renal toxicity (Yasutake et al. 1991b). The nephrotoxic effects of inorganic mercury may be

2. HEALTH EFFECTS

protected against by pretreatment with zinc (Zalups and Cherian 1992). Data in rats suggest that zinc can induce metallothionein in the renal cortex and cause mercury accumulation in the kidneys to shift from the outer medulla to the cortex, where a greater percentage is bound to the induced metallothionein. However, despite its potential use for interfering with the mercury-induced renal effects, zinc also prolongs retention in the body.

2.11 ADEQUACY OF THE DATABASE

Section 104(i)(5) of CERCLA, as amended, directs the Administrator of ATSDR (in consultation with the Administrator of EPA and agencies and programs of the Public Health Service) to assess whether adequate information on the health effects of mercury is available. Where adequate information is not available, ATSDR, in conjunction with the National Toxicology Program (NTP), is required to assure the initiation of a program of research designed to determine the health effects (and techniques for developing methods to determine such health effects) of mercury.

The following categories of possible data needs have been identified by a joint team of scientists from ATSDR, NTP, and EPA. They are defined as substance-specific informational needs that if met would reduce the uncertainties of human health assessment. This definition should not be interpreted to mean that all data needs discussed in this section must be filled. In the future, the identified data needs will be evaluated and prioritized, and a substance-specific research agenda will be proposed.

2.11.1 Existing Information on Health Effects of Mercury

The existing data on health effects of inhalation, oral, and dermal exposure of humans and animals to inorganic and organic mercury are summarized in Figures 2-8 to 2-11. The purpose of these figures is to illustrate the existing information concerning the health effects of inorganic and organic mercury. Each dot in the figures indicates that one or more studies provide information associated with that particular effect. The dot does not imply anything about the quality of the study or studies. Gaps in this figure should not be interpreted as "data needs." A data need, as defined in ATSDR's Decision Guide for Identifying Substance-Specific Data Needs Related to Toxicological Profiles (ATSDR 1989), is substance-specific information necessary to conduct comprehensive public health assessments. Generally, ATSDR defines a data gap more broadly as any substance-specific information missing from the scientific literature.

2. HEALTH EFFECTS

Figure 2-8. Existing Information on Health Effects of Metallic Mercury

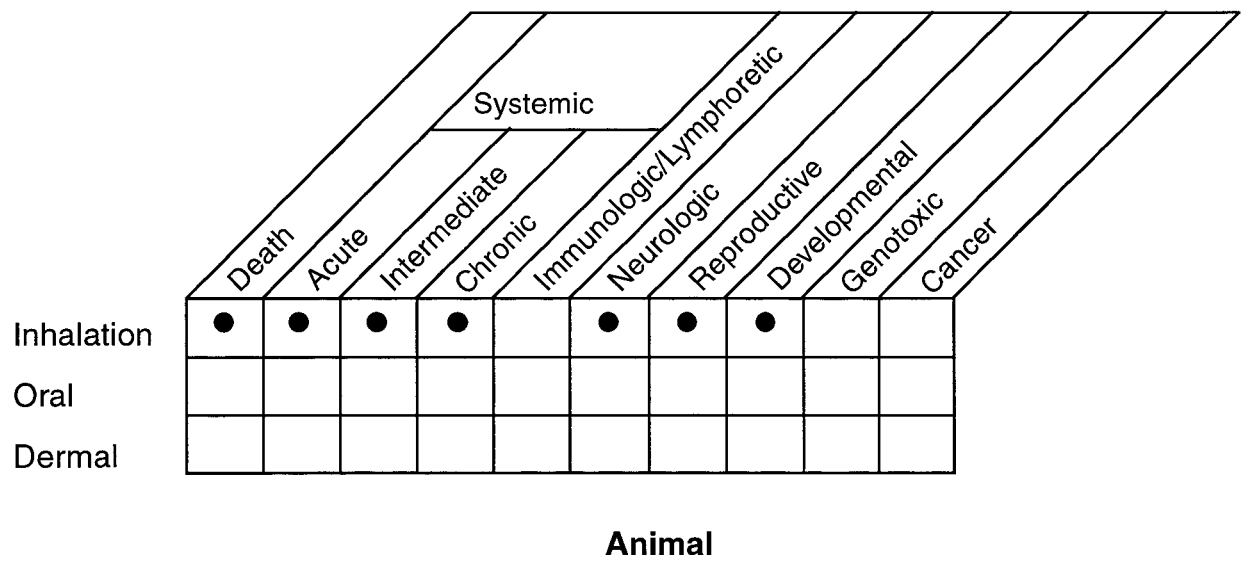
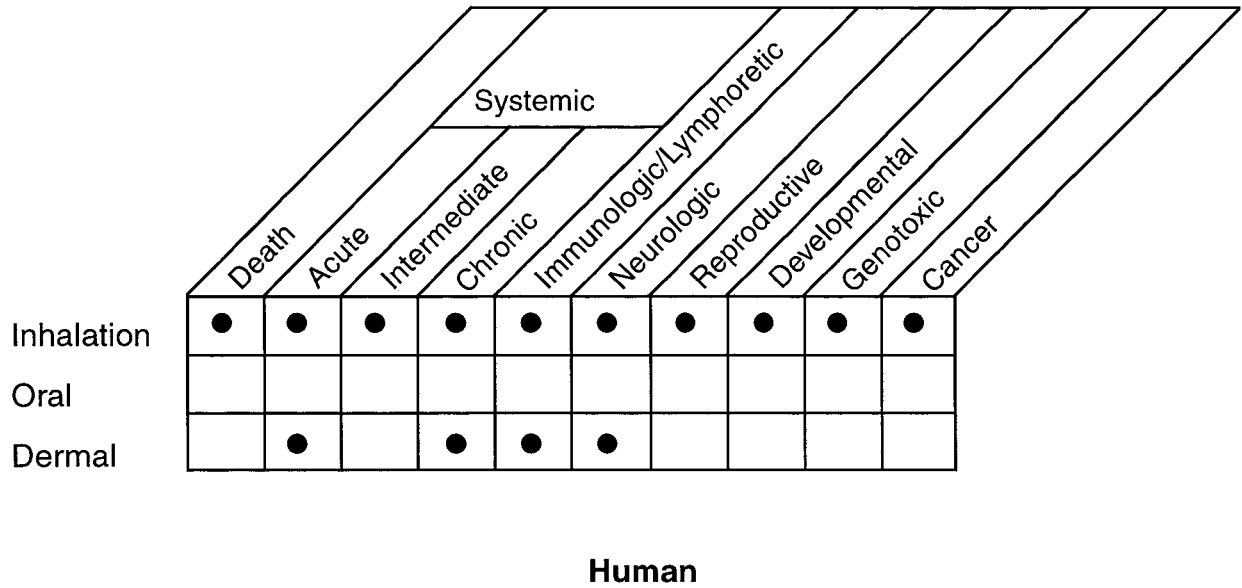

● Existing Studies

2. HEALTH EFFECTS

Figure 2-9. Existing Information on Health Effects of Inorganic Mercury Salts

	Systemic									
	Death	Acute	Intermediate	Chronic	Immunologic/Lymphoretic	Neurologic	Reproductive	Developmental	Genotoxic	Cancer
Inhalation										
Oral	●	●		●		●	●			
Dermal	●	●	●	●	●	●				

Human

	Systemic									
	Death	Acute	Intermediate	Chronic	Immunologic/Lymphoretic	Neurologic	Reproductive	Developmental	Genotoxic	Cancer
Inhalation										
Oral	●	●	●	●	●	●			●	●
Dermal	●									

Animal

● Existing Studies

2. HEALTH EFFECTS

Figure 2-10. Existing Information on Health Effects of Methylmercuric Mercury

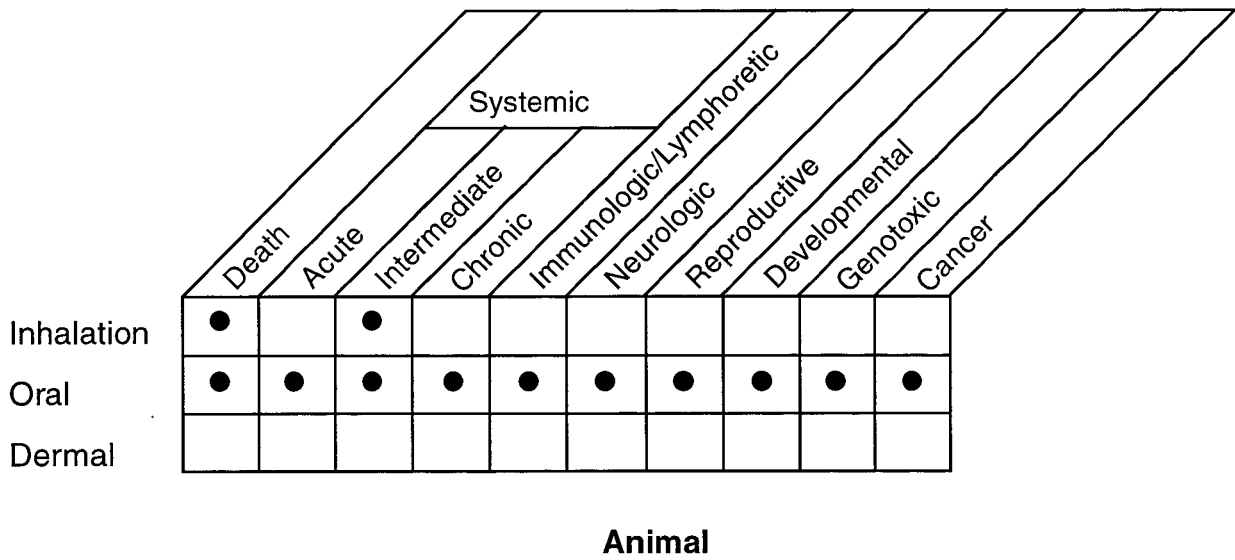
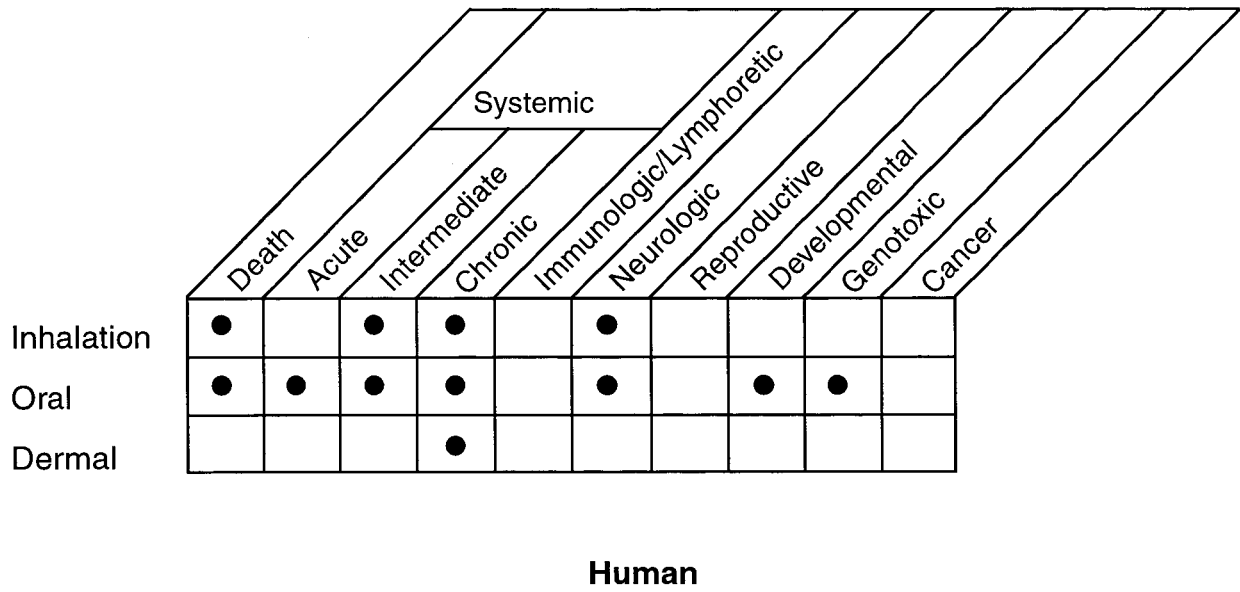

● Existing Studies

2. HEALTH EFFECTS

Figure 2-11. Existing Information on Health Effects of Phenylmercuric Mercury

	Death	Acute	Intermediate	Chronic	Systemic	Immunologic/Lymphoretic	Neurologic	Reproductive	Developmental	Genotoxic	Cancer
Inhalation	●	●		●		●					
Oral											
Dermal		●									

Human

	Death	Acute	Intermediate	Chronic	Systemic	Immunologic/Lymphoretic	Neurologic	Reproductive	Developmental	Genotoxic	Cancer
Inhalation											
Oral				●							●
Dermal											

Animal

● Existing Studies

2. HEALTH EFFECTS

Information concerning metallic mercury exists primarily for the inhalation route of exposure in humans and animals (see Figure 2-8). Human data exist for all categories of effect following inhalation exposure to metallic mercury vapor. The results from inhalation studies in animals have been reported for all end points except immunological and genotoxic effects, and cancer. With the exception of case studies on contact dermatitis and neurological effects after acute and occupational dermal exposure to metallic mercury in humans, no studies were located for either the oral or dermal routes of exposure for either humans or animals.

Existing information on inorganic mercury salts is shown in Figure 2-9. No studies were found on the health effects from inhaled mercury salts in humans or animals. A number of case histories for acute or chronic oral exposure to mercury salts provide information on systemic and neurological effects and death. Some case histories and occupational studies provide information on dermal exposures to mercury salts at acute, intermediate, and chronic exposures leading to death, immunologic, neurologic, and systemic effects. No animal inhalation studies for inorganic mercury salts were identified, and only one acute study provides limited information on death from dermal exposure. A number of animal studies that have investigated the effects from oral exposure to mercury salts provide good information on systemic effects; limited information on cancer, neurologic, immunologic, and genotoxic effects; and no information on reproductive or developmental effects.

Information on methylmercuric and phenylmercuric mercury is presented in Figures 2-10 and 2-11. These two forms of organic mercury were chosen to represent the group of organic mercurials because they have been detected at Superfund sites, and because methylmercury is the predominant form of organic mercury in the environment. There is a paucity of information on phenylmercury. Only a few case histories are available for effects following inhalation exposure (death, acute or chronic systemic effects, and neurologic effects), and the information from these reports is very limited. Only one case history for acute systemic effects following dermal exposure to phenylmercury was identified. One chronic oral study in rats and a cancer study in rats and mice provide the only animal data for phenylmercury. In contrast, there are a number of human studies on systemic, neurologic, and developmental effects resulting from an oral exposure to methylmercury. No human toxicity data were identified for immunologic, reproductive, or genotoxic effect, nor for carcinogenicity. The human data for methylmercury are accompanied by a relatively large number of animal studies representing all three exposure durations and providing some, although often limited, information for all health effects categories. As with phenylmercury, there are only a few case histories for inhalation and dermal exposures, with limited information on neurologic and

2. HEALTH EFFECTS

systemic effects or death from acute poisonings. The animal data for inhalation exposure to methylmercury is equally scarce and nonexistent for dermal exposures.

2.11.2 Identification of Data Needs

Acute-Duration Exposure. The human toxicity information for acute duration exposures to mercury is limited to qualitative data and case histories following oral, inhalation, and dermal routes of exposure. Several case reports described death due to respiratory impairment from inhaled metallic mercury (Campbell 1948; Kanluen and Gottlieb 1991; Soni et al. 1992; Tauzeg et al. 1992). Respiratory, cardiovascular, gastrointestinal, hematological, and renal effects have been observed after acute-duration inhalation exposure to metallic mercury vapors (Bluhm et al. 1992a, 1992b; Campbell 1948; Garnier et al. 1981; Haddad and Sternberg 1963; Hallee 1969; Jaffe et al. 1983; Kanluen and Gottlieb 1991; Karpathios et al. 1991; Lilis et al. 1985; McFarland and Reigel 1978; Milne et al. 1970; Snodgrass et al. 1981; Soni et al. 1992; Tauzeg et al. 1992). Acute exposure to ingested inorganic mercury salts has also resulted in gastrointestinal and renal symptoms (Afonso and deAlvarez 1960; Kang-Yum and Oransky 1992). Tremors, irritability, and decreased motor function and reflexes are common neurological symptoms following high-level acute duration exposures to metallic mercury vapors (Adams et al. 1983; Bluhm et al. 1992a; Hallee 1969; Jaffe et al. 1983; McFarland and Reigel 1978; Snodgrass et al. 1981). Acute exposure to ingested methylmercury has resulted in both neurological and developmental toxicity (Al-Mufti et al. 1976; Amin-Zaki et al. 1974; Bakir et al. 1973; Cox et al. 1989; Engleson and Herner 1952; Harada 1978; Marsh et al. 1980, 1981, 1987; Snyder and Seelinger 1976). Information on short term dermal exposures in humans to inorganic mercury are from case studies, and provide some information on renal, neurological, immunological, and dermatological effects (Bagley et al. 1987; Bourgeois et al. 1986; DeBont et al. 1986; Faria and Freitas 1992; Kawahara et al. 1993; Millar 1916; Pambor and Timmel 1989).

Dermal effects from acute duration dermal exposures to organic mercury compounds have also been reported to a limited extent (Morris 1960). In a highly publicized poisoning, a laboratory researcher was thought to have received a single dermal exposure to the organomercurial, dimethylmercury (estimated at between 0.1 and 0.5 mL at a density of 3 g/mL), that apparently penetrated the researcher's latex safety gloves and resulted in a severe neurotoxicity 5 months later that subsequently ending with death (Blayney et al. 1997; Nierenberg et al. 1998; Toribara et al. 1997). Additional studies on dermal absorption of organic mercury, especially dimethylmercury, are needed to further evaluate the risk to human health.

2. HEALTH EFFECTS

Acute inhalation exposure to metallic mercury in rats and rabbits have resulted in death, respiratory, gastrointestinal, hepatic, renal, neurological, and/or developmental effects (Ashe et al. 1953; Fredriksson et al. 1992; Livardjani et al. 1991b). Acute oral exposures to inorganic mercury have resulted in renal, gastrointestinal, and thyroid effects in rats and/or mice (Dieter et al. 1992; Nielsen et al. 1991; NTP 1993; Sin et al. 1990) and neurological effects in rats (Chang and Hartmann 1972a, 1972b). An acute oral MRL was derived for inorganic mercury based on renal effects in rats (NTP 1993). Acute oral exposures to organic mercury have resulted in renal, neurological, developmental, and reproductive effects in rats, mice, guinea pigs, and rabbits (Arito and Takahashi 1991; Bornhausen et al. 1980; Cagiano et al. 1990; Chang and Hartmann 1972b; Guidetti et al. 1992; Hughes and Annau 1976; Inouye and Kajiwara 1988; Jacobs et al. 1977; Khera 1973; Khera and Tabacova 1973; Magos et al. 1985; Nolen et al. 1972; Post et al. 1973; Stoltenburg-Didinger and Markwort 1990; Yasutake et al. 1991b). Well conducted animal studies on neurological effects from an acute inhalation exposure to metallic mercury or to an acute dermal exposure to organic mercury are needed because of the potential for these kinds of exposures to populations near hazardous waste sites. The potential for latent or delayed expression of toxicity after an acute exposure to mercury from all the most likely routes and forms (especially for a dermal exposure to dimethylmercury) needs to be addressed.

Intermediate-Duration Exposure. Inhalation data on intermediate-duration exposure to metallic mercury vapors are limited to case reports of individuals exhibiting cardiovascular, gastrointestinal, hematological, renal, dermal, immunological, and neurological effects similar to acute exposures (Anneroth et al. 1992; Barber 1978; Fagala and Wigg 1992; Foulds et al. 1987; Friberg et al. 1953; Schwartz et al. 1992; Sexton et al. 1976; Taueg et al. 1992). Workers inhaling diethylmercury vapors developed gastrointestinal and neurological symptoms prior to death (Hill 1943). No inhalation exposure data are available on intermediate-duration exposure to mercuric mercury. Information on intermediate-duration oral exposure to inorganic mercury is limited to the observation of neurological symptoms in a boy who ingested Chinese medicine containing mercurous mercury for several months (Kang-Yum and Oransky 1992). Intermediate-duration oral exposure to organic mercury has resulted in dermal, neurological, and developmental toxicity (Al-Mufti et al. 1976; Amin-Zaki et al. 1974; Bakir et al. 1973; Cox et al. 1989; Harada 1978; Marsh et al. 1980, 1981, 1987; Snyder and Seelinger 1976). Intermediate-duration dermal exposure to inorganic mercury has resulted in adverse gastrointestinal, renal, and immunological health effects (Anneroth et al. 1992; Kang-Yum and Oransky 1992). No studies were located that examined effects resulting from intermediate-duration dermal exposure to organic mercury.

2. HEALTH EFFECTS

Inhalation exposure to metallic mercury vapors for an intermediate duration has resulted in renal and/or neurological effects in rabbits (Ashe et al. 1953) and rats (Fukuda 1971; Kishi et al. 1978). No studies were located regarding effects in animals after intermediate-duration inhalation exposure to organic mercury. An intermediate inhalation MRL was not derived for metallic mercury because studies were considered inadequate. Following intermediate-duration oral exposure to inorganic mercury, adverse cardiovascular, hepatic, and renal health effects have been observed in rats and mice exposed to mercuric chloride (Andres 1984; Carmignani et al. 1992; Dieter et al. 1992; Hultman and Enestrom 1992; Jonker et al. 1993a; NTP 1993; Rana and Boora 1992). Immunological and neurological health effects were also observed (Chang and Hartmann 1972a; Dieter et al. 1983; Hultman and Enestrom 1992). An intermediate oral MRL was derived for inorganic mercury based on increased kidney weight in rats (NTP 1993). Intermediate-duration oral exposure to organic mercury has resulted in adverse cardiovascular, renal, immunological, neurological, and developmental health effects in rats, mice, cats, and monkeys (Berthoud et al. 1976; Burbacher et al. 1988; Chang and Hartmann 1972a; Chang et al. 1974; Concas et al. 1983; Elsner 1991; Evans et al. 1977; Fowler 1972; Fowler and Woods 1977; Ganser and Kirschner 1985; Hirano et al. 1986; Ilback 1991; Khera and Tabacova 1973; Leyshon and Morgan 1991; Lindstrom et al. 1991; MacDonald and Harbison 1977; Magos and Butler 1972; Mitsumori et al. 1981; Olson and Boush 1975; Sharma et al. 1982; Tsuzuki 1981; Wakita 1987; Yip and Chang 1981). The data were insufficient to derive an intermediate-duration MRL for oral exposure to organic mercury because serious adverse health effects (e.g., neurological degeneration, behavioral changes) were observed at the lowest doses (Burbacher et al. 1988; Chang et al. 1974; Chang and Hartmann 1972a). No studies were located regarding intermediate-duration dermal exposure in animals. Because populations surrounding hazardous waste sites might be exposed to higher-than-normal levels of mercury for an intermediate duration, more quantitative information on metallic and organic mercury toxicity, specifically neurotoxicity, following inhalation and oral exposure in humans and animals is needed. The potential for latent or delayed expression of toxicity after an exposure of intermediate duration needs to be addressed.

Chronic-Duration Exposure and Cancer. Occupational exposure to metallic mercury vapors has been reported to result in adverse cardiovascular, gastrointestinal, renal, ocular, immunological, and reproductive health effects (Barregard et al. 1988, 1990; Bencko et al. 1990; Bidstrup et al. 1951; Buchet et al. 1980; Cardenas et al. 1993; Cordier et al. 1991; Danziger and Possick 1973; Ehrenberg et al. 1991; Kazantzis et al. 1962; Langworth et al. 1992b; Lille et al. 1988; Moszczynski et al. 1990b; Piikivi 1989; Piikivi and Hanninen 1989; Roels et al. 1982; Schuckmann 1979; Sibley 1990; Smith et al. 1970; Stewart et al. 1977; Tubbs et al. 1982; Vroom and Greer 1972). Substantial evidence indicates that

2. HEALTH EFFECTS

chronic inhalation of metallic mercury vapors results in neurotoxicity (Albers et al. 1988; Bidstrup et al. 1951; Chapman et al. 1990; Discalzi et al. 1993; Ehrenberg et al. 1991; Fawer et al. 1983; Langauer-Lewowicka and Kazibutowska 1989; Langworth et al. 1992a; Levine et al. 1982; Melkonian and Baker 1988; Ngim et al. 1992; Piikivi and Hanninen 1989; Piikivi and Tolonen 1989; Piikivi et al. 1984; Shapiro et al. 1982; Smith et al. 1970; Verberk et al. 1986; Vroom and Greer 1972; Williamson et al. 1982). A chronic inhalation MRL was derived for neurological effects observed in workers chronically exposed to metallic mercury (Fawer et al. 1983). Very limited information is available indicating that chronic-duration inhalation of organic mercury (sometimes unspecified) causes adverse cardiovascular, gastrointestinal, renal, and neurological health effects (Brown 1954; Hook et al. 1954; Hunter et al. 1940; Williamson et al. 1982). Chronic-duration ingestion of mercurous chloride resulted in dementia and irritability (Davis et al. 1974). Qualitative and quantitative data on organic mercury exposure are provided by the neurological disorders associated with ingestion of methylmercury-contaminated fish, but the length of exposure is unknown (Kutsuna 1968). Chronic occupational exposure to alkyl mercury compounds caused neurological changes in humans (Lundgren and Swensson 1949). The available evidence indicates that the differences in toxicity between inorganic and organic mercury forms are largely the result of the differences in their distribution in the body. Information concerning methylmercury is much more extensive than that for phenylmercury, especially considering the outbreaks of methylmercury poisoning that have occurred in Japan and Iraq.

Cardiovascular and renal health effects in rats and mice after chronic-duration ingestion of inorganic mercury have been reported (Carmignani et al. 1989; Fitzhugh et al. 1950; NTP 1993). An intermediate oral MRL based on renal effects was derived for intermediate oral exposure to inorganic mercury (NTP 1993). Chronic-duration oral exposure to organic mercury has resulted in adverse gastrointestinal, renal, developmental, neurological, and reproductive health effects in rats, mice, cats, and monkeys (Charbonneau et al. 1976; Fitzhugh et al. 1950; Hirano et al. 1986; Mitsumori et al. 1981, 1990; Rice 1989c, 1992; Rice and Gilbert 1982, 1990, 1992; Solecki et al. 1991). A chronic MRL for oral exposure to organic mercury was derived based on a study of prenatal exposures in a fish-consuming population on the Seychelles Islands (Davidson et al. 1998). Additional chronic-duration data on neurological disorders following metallic and organic mercury exposure are needed because they are a sensitive end point. Furthermore, there is a potential for chronic exposure to higher-than-normal levels of mercury in populations living in the vicinity of hazardous waste sites.

2. HEALTH EFFECTS

Additional chronic-duration oral exposure information in animals concerning renal effects following inorganic mercury exposure is needed to evaluate the threshold of this effect in humans following chronic exposure. The data would be useful if populations living near hazardous waste sites were to be exposed chronically to inorganic mercury that leached into near-by wells or water supplies.

Forestomach squamous cell papillomas and thyroid follicular cell carcinomas have been observed in rats and renal tubule tumors have been observed in mice following oral exposure to mercuric chloride (NTP 1993). Renal tumors have also been observed in rats and mice after oral exposure to organic mercury (Hirano et al. 1986; Mitsumori et al. 1981, 1990; Solecki et al. 1991). These results suggest the potential carcinogenicity of mercury to humans. Therefore, additional chronic-duration animal studies on metallic, inorganic, and organic mercury are needed to confirm the findings of the NTP study. Additional long-term follow-up studies examining carcinogenicity in highly exposed populations (i.e., those involved in mercury mining, or the exposed Iraqi or Japanese populations) are needed to evaluate the likelihood of tumors appearing in humans.

Genotoxicity. Although there are data from several *in vivo* studies on rats (oral exposure) and mice (intraperitoneal) indicating that inorganic and organic mercury compounds can cause clastogenic effects in mammalian germinal cells, the differences in species sensitivity, and in some cases strain sensitivity, do not permit the use of these findings for predicting a potential hazard to human genetic material (Suter 1975; Zasukhina et al. 1983). Epidemiological studies of humans occupationally or accidentally exposed to mercurials were inconclusive, but the combined results from these studies did not suggest that metallic mercury and organic mercury are clastogens for human somatic cells (Anwar and Gabal 1991; Barregard et al. 1991; Mabile et al. 1984; Popescu et al. 1979; Verschaeve et al. 1976, 1979; Wulf et al. 1986). There is, however, convincing evidence that inorganic and organic mercury compounds can interact with and damage DNA *in vitro* (Williams et al. 1987). The outcome of this damage has not been characterized, but there is some indication that mercury compounds are weak mutagens for cultured mammalian cells. In addition, *in vitro* results with human cells (Betti et al. 1992) and animal cells (Howard et al. 1991) and *in vivo* data in mice (Ghosh et al. 1991) suggest that mercury compounds can cause clastogenic effects in somatic cells. Considering the problems stated above in using the whole animal data, and the apparent species- and strain-specific responses noted in the DNA damage tests with cultured mammalian cells, the *in vitro* data, while of interest, are probably not reliable indicators of potential adverse effects in humans exposed to mercury. Well controlled human epidemiological studies are needed to determine the genetic hazard of mercury compounds to humans.

2. HEALTH EFFECTS

Reproductive Toxicity. Occupational exposure to metallic mercury has not been shown to result in statistically significant effects on male fertility (Alcser et al. 1989; Lauwerys et al. 1985). However, an increase in the rate of spontaneous abortions may occur (Cordier et al. 1991). A spontaneous abortion occurred in a female after ingesting an acute dose of mercuric chloride (Afonso and deAlvarez 1960). There were no studies available on dermal exposure to metallic, inorganic, or organic mercury. Additional epidemiological studies on inhalation and dermal exposure to mercury are needed to evaluate the threshold of reproductive effects in workers (including dentists and dental assistants).

Inorganic mercury exposure caused a significant increase in the incidence of resorptions in hamsters (Gale 1974). Abortions and decreased mean litter size have been observed in rats, mice, guinea pigs, and monkeys following oral exposure to organic mercury (Burbacher et al. 1988; Hughes and Annau 1976; Inouye and Kajiwara 1988; Khera 1973). There was a decrease in conceptions and an increase in early abortions and stillbirths in female monkeys exposed orally to methylmercury for 4 months, but the menstrual cycle length was not affected (Burbacher et al. 1988). However, prolonged estrous cycles were found in rats inhaling metallic mercury (Baranski and Szymczyk 1973). Adverse effects on spermatogenesis and on histopathology of the testes have been reported in several studies in animals exposed to methylmercury (Hirano et al. 1986; Mitsumori et al. 1990; Mohamed et al. 1987). There was no information on reproductive effects following dermal exposure to mercury in animals. A 90-day study is needed to provide reproductive organ pathology data on male and female animals. Multigenerational studies for inorganic and organic mercury are also needed. Additional reproductive studies are needed because reproductive-aged populations near hazardous waste sites might be exposed to mercury.

Developmental Toxicity. Occupational exposure to metallic mercury in males did not result in statistically significant effects on malformations or the number of children born (Alcser et al. 1989; Lauwerys et al. 1985). The results from an inhalation developmental rat study (Baranski and Szymczyk 1973) suggest that metallic mercury vapors may cause a higher incidence of fetal malformations, resorptions, and deaths. Dermal studies on metallic mercury in humans and animals were not available. Additional well-conducted inhalation and dermal studies on metallic mercury in animals are needed to evaluate the potential for adverse developmental effects to humans from mercury.

Inorganic mercury exposure caused a significant increase in the incidence of resorptions in hamsters (Gale 1974). No other human or animal studies were available on developmental effects following inorganic mercury exposure. Therefore, additional studies for inhalation, oral, and dermal exposures are

2. HEALTH EFFECTS

needed to evaluate the potential developmental toxicity of inorganic mercury to populations, specifically young children, living near hazardous waste sites. Longitudinal studies for higher dose level acute and intermediate exposures are needed to determine the potential delayed expression of toxicity.

Prenatal exposure to methylmercury from contaminated food during the early stages of pregnancy has caused neurological damage in humans (Amin-Zaki et al. 1974; Bakir et al. 1973; Choi et al. 1978; Cox et al. 1989; Engleson and Herner 1952; Harada 1978; Marsh et al. 1980, 1981, 1987; Matsumoto et al. 1965; McKeown-Eyssen et al. 1983; Snyder and Seelinger 1976). Severe neurological impairment developed in a child exposed *in utero* to methylmercury, and effects were still present at 6 years of age (Snyder and Seelinger 1976). In animals, numerous oral exposure studies on the developmental effects of organic mercury have been conducted. Disruptions in the development of the nervous system in rats, mice, hamsters, and guinea pigs (Chang et al. 1977; Inouye and Kajiwara 1988; Khera and Tabacova 1973; Reuhl et al. 1981a, 1981b) and in the immune system in rats (Ilback et al. 1991) have been reported. Behavioral changes were also observed in rats and mice (Bornhausen et al. 1980; Hughes and Annau 1976; Olson and Boush 1975). Additional long-term inhalation, oral, and dermal studies for inorganic and organic mercury are needed to evaluate the threshold of developmental effects in workers chronically exposed to mercury or in populations living near hazardous waste sites.

Immunotoxicity. The results from two occupational studies indicate a decreased serum IgG levels in workers to inhaled metallic mercury vapors (Bencko et al. 1990; Moszczynski et al. 1990b), but these studies are limited and did not evaluate potential confounders (smoking and alcohol). Other studies in similarly exposed populations did not observe an increase in serum immunoglobulins (IgA, IgG, IgE, or IgM) and autoantibody titres (antilaminin or antiglomerular basement membrane antibodies) (Bernard et al. 1987; Cardenas et al. 1993; Langworth et al. 1992b). There is limited information in humans that suggests that certain individuals may develop an autoimmune response (Tubbs et al. 1982; Moszczynski et al. 1995). Data on immunological effects following oral exposure to organic mercury compounds in humans are not available. Oral exposures to inorganic and organic mercury in animals indicate that the immune system may be a target organ for mercury. Immune deposits were observed in the intestines and kidneys of rats exposed to mercuric chloride for 2 months, but no functional changes were evident in these tissues (Andres 1984). Suppression of the lymphoproliferative response occurred at a higher dose of mercury in mice exposed to mercuric chloride for 7 weeks (Dieter et al. 1983). Reduced natural killer cell activity in spleen and blood was exhibited in mice administered a diet containing methylmercury for 12 weeks (Ilback 1991). It is unknown how an adverse effect on the immune system from exposure to one form of mercury

2. HEALTH EFFECTS

might affect the response to other forms or other routes of exposure (e.g., how an adverse immune effect induced by inhalation of mercury vapor from dental amalgam might effect the dose-response from exposure to ingested methylmercury). Therefore, the potential for immunotoxic effects from exposure to mercury vapor, mercury salts, or methylmercury separately or in combination is of considerable importance and warrants further research, especially from low level chronic exposures.

Neurotoxicity. The nervous system is the major target organ for metallic and organic mercury through inhalation and oral routes, respectively. In humans, the neurological effects of metallic mercury have been observed primarily after acute high-concentration exposures (accidental) to intermediate and chronic low-concentration exposures (occupational). Tremors and irritability are the most prominent symptoms of inhaled metallic mercury in humans (Albers et al. 1988; Bidstrup et al. 1951; Fawer et al. 1983; Piikivi et al. 1984). Information on effects in humans from oral exposure includes case histories, for example, a chronic oral exposure to a laxative containing mercurous chloride (Davis et al. 1974), acute to intermediate duration ingestion of high levels of methylmercury-contaminated food (Bakir et al. 1973; Kutsuna 1968), or to chronic low-level exposures from fish or marine mammals containing methylmercury (Davidson et al. 1995aa, 1995b; Grandjean et al. 1997b, 1998). Case histories of dermal exposure to inorganic mercury cite similar neurological effects from acute (Bourgeois et al. 1986; DeBont et al. 1986) or chronic exposures (Dyall-Smith and Scurry 1990).

The neurotoxicity of inhaled metallic mercury has been studied in animals for acute and intermediate exposures (Ashe et al. 1953; Ganser and Kirschner 1985; Kishi et al. 1978). Behavioral, motor, and cognitive effects, as well as histopathological changes in the brain, were reported in rats, rabbits, and mice. Neurological disturbances in rats and mice resulted from acute, intermediate, and chronic oral exposures to mercuric mercury (Chang and Hartmann 1972b; Ganser and Kirschner 1985). Oral exposure to organic mercury in animals produced a range of neurological changes (Charbonneau et al. 1976; Evans et al. 1977; Magos and Butler 1972; Rice and Gilbert 1982; Sharma et al. 1982; Tsuzuki 1981). A chronic inhalation MRL was derived for metallic mercury. Additional animal studies are needed, however, to evaluate the neurotoxicity of inorganic mercuric salts to resolve some of the conflicting findings from previous work (Chang and Hartmann 1972b; Ganser and Kirschner 1985; Goldman and Blackburn 1979; NTP 1993). *In vivo* studies are needed to evaluate the mechanisms of neurotoxic effects seen in *in vitro* studies, i.e., the lipoperoxidation and cell injury in methylmercury-exposed cerebellar granule cells (Sarafian and Verity 1991). Further evaluation is needed in humans and animal models of the potential for neurological effects and delayed neurotoxicity from chronic low level exposures to organic and inorganic mercury, especially

2. HEALTH EFFECTS

from multiple sources (i.e., organic mercury from fish consumption in conjunction with metallic mercury released from dental amalgam).

Epidemiological and Human Dosimetry Studies. There have been a number of occupational studies on workers chronically exposed to metallic mercury vapors. Mercury exposure (as measured by urine or blood mercury levels) and neurological effects have been evaluated (Adams et al. 1983; Miller et al. 1975; Roels et al. 1982; Smith et al. 1970). The most obvious deficiency in these epidemiological studies is the absence of good measures of exposure. Additional data are needed on the potential health effects for populations near hazardous waste sites based upon specific identification of the form of mercury and the pathways of exposure (i.e., the levels of exposure that populations near waste sites may actually experience from inorganic mercury in the air, water, and soil, or methylmercury in contaminated food). An area of considerable controversy, which is in need of good epidemiological data, is the potential for adverse effects from the mercury released from dental amalgam. Although this is not an exposure pathway associated with hazardous waste sites, mercury from amalgam represents a major contributor to the total body burden for a large percentage of the population, and thus must be factored into an assessment of the toxicokinetic behavior and toxic effects of mercury originating from a waste site. Long term longitudinal studies are needed for all dose durations and forms to evaluate delayed or persistent expression of mercury toxicity.

Biomarkers of Exposure and Effect

Exposure. Blood and urine mercury levels have been used as biomarkers of high level exposure in acute and chronic studies for both inorganic and organic mercury (Akesson et al. 1991; Naleway et al. 1991; Verschoor et al. 1988). Hair has been used as a biomarker for chronic low level organic mercury exposure (Nielsen and Andersen 1991a, 1991b; Oskarsson et al. 1990), with an awareness of the potential for external contamination (Clarkson et al. 1983). Further development of more sensitive tests to measure mercury in expired air and retention in hair are needed for monitoring short- and long-term exposures, respectively, for populations at risk.

As seen in other studies comparing European to Japanese hair mercury levels, the hair levels reported by Nakagawa (1995) of 2–4 ppm for a Japanese population are 10–20 times higher than levels observed in the Drasch et al. (1997) study (median, 0.247 µg/g in hair; range, 0.43–2.5 µg/g). These differences in the mercury exposure may affect not only the mercury hair levels but also the mercury hair-to-tissue

2. HEALTH EFFECTS

correlations. Further study is needed on the effects that the exposure level of methylmercury (as well as other forms of mercury) has on tissue distributions and the correlation to biomarkers of exposure.

There are potential confounding factors and other factors to consider when assessing mercury exposure based upon mercury hair levels. Mercury may be deposited to hair from the air when significant sources of mercury are present in the air or when certain hair treatments are used (Hac and Krechniak 1993; WHO 1991). Potential sources of external mercury exposure should, therefore, be evaluated as part of an exposure assessment. Some studies also report a sex related difference in mercury tissue levels. Nielson et al. (1994) observed a significant sex-related differences in the toxicokinetics of methylmercury in mice following administration of a single radiolabeled dose. Drasch et al. (1997) reported that mercury levels in all tissues assayed in their human cadaver study had higher levels compared to male tissues. The difference was significant for the kidney (median female kidney mercury level=92.0 ng/g, males=40.8 ng/g; $p=0.002$). In blood and urine there was a similar trend. In contrast, the authors report that mercury hair levels in females were significantly lower than in males (median females=205 ng/g, males 285 ng/g; $p=0.02$). Nakagawa (1995) also report higher mean mercury hair levels in males (2.98 $\mu\text{g/g}$) compared with females (2.02 $\mu\text{g/g}$) in a Japanese population. Further research is, therefore, needed to characterize potential sex related difference in the toxicokinetics of mercury under different exposure scenarios.

Further research on other biomarkers of mercury does not warrant a high priority.

Of particular importance is the collection of pharmacokinetic data showing the relationship between low-level exposure (acute, intermediate, and chronic) and blood and urine levels throughout the study duration. Also tissue levels at necropsy should be taken immediately after cessation of dosing. In animal studies, a similar group of animals should be followed for urine (and blood, but not as important here) mercury levels for periods of 30, 60, 90, and 120 days postdosing to examine whole-body excretion, and necropsy tissue samples should also be taken from several animals at 30, 60, 90, and 120 days postdosing. Primates would be the best animal model, but rodent models could suffice.

A needed study is a longitudinal epidemiology study that tracked daily individual exposure levels in chloralkali industry workers, fluorescent lightbulb manufacturers, or other mercury utilizing industries, and associated these exposure levels with weekly urine and blood samples for a period of 1–2 years.

Neurobehavioral testing (using tests from ATSDR's recommended test battery for adults) should be used

2. HEALTH EFFECTS

conducted at 6-month intervals. Workers new to these industries would be the best subjects, since their pre-exposure blood and urine levels could be used as reference values.

A biomarker/exposure could also be conducted in persons with dental amalgam fillings. Urine levels should be tracked in those with fillings and in those with removed or replaced amalgam fillings. There are a number of confounding factors and logistical difficulties in conducting such studies, and new study protocols should be developed to address the problems encountered in previous studies.

Effect. Potential biomarkers of effect for mercury-induced renal toxicity have been well described (Cardenas et al. 1993; Lauwerys et al. 1983; Rosenman et al. 1986; Verschoor et al. 1988). Biomarkers for neurological changes (e.g., paresthesia, decreased motor function, and impaired nerve conduction) have also been described (Clarkson et al. 1976; Shapiro et al. 1982). There is long history of evaluation of the neurophysiological and neuropsychological effects associated with mercury levels in blood, urine, and (Levine et al. 1982; Vroom and Greer 1972; Williamson et al. 1982). More recently, studies are evaluating cognitive and neurobehavioral effects with increasing sophistication in the assays and analyses that are used (Davidson et al. 1998; Grandjean et al. 1997b, 1998). Additional biomarkers are needed in this continuing effort to resolve subtle cognitive or neurobehavioral effects, and immune system effects from chronic low level exposures to methylmercury in food or metallic mercury released from dental amalgam, especially in sensitive populations.

Absorption, Distribution, Metabolism, and Excretion. Limited data are available to assess the relative rate and extent of absorption in humans following inhalation exposure to metallic mercury (Barregard et al. 1992; Berlin et al. 1969; Friberg and Vostal 1972; Hursh et al. 1976; Teisinger and Fiserova-Bergerova 1965) and in humans and animals following oral exposure to both inorganic salts and organic mercury (Aberg et al. 1969; Clarkson 1971, 1972a, 1989; Endo et al. 1989, 1990; Fitzhugh et al. 1950; Friberg and Nordberg 1973; Kostial et al. 1978; Miettinen 1973; Nielsen 1992; Nielsen and Andersen 1992; Rice 1989b; Suzuki et al. 1992; Urano et al. 1990; Weiss et al. 1973; Yeoh et al. 1989). Indirect evidence of absorption following inhalation exposure in humans and animals is reported for inorganic and organic mercury (Clarkson 1989; Ostlund 1969; Warfvinge et al. 1992; Yoshida et al. 1990, 1992). Only limited quantitative data were located regarding dermal uptake of metallic mercury in humans (Hursh et al. 1989). Information is needed regarding the rate and extent of dermal absorption of inorganic and organic mercury in humans and animals. Quantitative information concerning the inhalation and oral absorption of mercury (all forms) are needed.

2. HEALTH EFFECTS

In general, quantitative data are available to evaluate the rate and extent of distribution, metabolism, and elimination of mercury in humans and animals following inhalation and oral exposure. Data on distribution, metabolism, and excretion following dermal exposure are lacking for all forms of mercury. The distribution data for metallic, inorganic and organic mercury are similar in humans and animals (Aschner and Aschner 1990; Berlin 1963; Cherian and Clarkson 1976; Cherian et al. 1978; Clarkson 1989; Clarkson and Magos 1978; Danscher et al. 1990; Grandjean et al. 1992; Nielsen and Andersen 1990, 1991a, 1991b; Nordberg 1976; Schionning et al. 1991; Sin et al. 1983; Suzuki et al. 1992; Warfvinge et al. 1992; Yeoh et al. 1989; Yoshida et al. 1990, 1992). No quantitative distribution data were located for organic mercury compounds following inhalation exposure. The oxidation and reduction reactions that control the disposition of elemental mercury were identified in both animals and humans (Clarkson 1989; Halbach and Clarkson 1978; Nielsen-Kudsk 1973). Quantitative data on the biotransformation of organic mercury are limited (Norseth and Clarkson 1970). Reliable quantitative evidence on excretion of metallic and inorganic mercury in humans and animals following inhalation exposure is available (Cherian et al. 1978; Hursh et al. 1976; Joselow et al. 1968b; Lovejoy et al. 1974).

As discussed in the section on data needs for biomarkers, further study is needed on the effects that the exposure level of methylmercury (as well as other forms of mercury) has on tissue distributions and the correlation to biomarkers of exposure. Age appears to be a factor in the elimination of mercury in rats following inorganic and organic mercury exposures (Daston et al. 1986; Thomas et al. 1982). Elimination of methylmercury in rats may also be sex-related (Ballatori and Clarkson 1982). Nielson et al. (1994) observed a significant sex-related differences in the toxicokinetics of methylmercury in mice following administration of a single radiolabeled dose. Drasch et al. (1997) reported that mercury levels in all tissues assayed in their human cadaver study had higher levels compared to male tissues. Nakagawa (1995) also report higher mean mercury hair levels in males (2.98 µg/g) compared with females (2.02 µg/g) in a Japanese population. Further research is, therefore, needed to characterize potential sex related difference in the toxicokinetics of mercury under different exposure scenarios.

Insufficient data are available to assess whether or not there are any differences in absorption, distribution, metabolism, and excretion of mercury with respect to time or dose (i.e., if saturation phenomena occur). The majority of the available toxicokinetic data involve acute exposures to single doses. For all three routes, studies are needed that compare various dose levels and durations in order to determine if there are any differences in the toxicokinetics of mercury. Little is known about how mercurials are eliminated from specific organs. In particular, the mechanism by which mercury is eliminated from the brain is

2. HEALTH EFFECTS

unknown. This information is needed to design better treatment drugs and protocols. Mechanistic studies are needed on how mercury (in its various forms) is excreted and how such activities can be enhanced.

An important priority research and data need is a study of the effects of dietary selenium on the absorption and toxicity of methylmercury. Primates would be the most appropriate species for such a study. Oral dosage levels (in food) should cover a sufficient dose range to provide useful information for high fish consuming populations. Mercury excretion should also be measured and compared with controls at least weekly, with the entire study length being not less than 6 months, and preferably one to two years in duration. Concurrent neurobehavioral testing should be included, if possible, and be conducted at fixed intervals depending upon the duration of the study.

Comparative Toxicokinetics. There is only limited data available on species differences in absorption rates following oral exposures to all forms of mercury, and the results are negative (i.e., no differences) (Clarkson 1971, 1972a; Friberg and Nordberg 1973; Nielsen and Andersen 1990; Rice 1989b). There are data concerning inhalation absorption of metallic and inorganic mercury (Berlin et al. 1969; Cherian et al. 1978; Clarkson 1989; Hursh et al. 1976); however, the data are insufficient to allow for interspecies comparisons (Ostlund 1969). Studies comparing the inhalation absorption of all forms of mercury in humans and animals are needed to improve the utility of animal data in assessing human risk. The limited information available on dermal exposure suggests that dermal absorption of both inorganic and organic mercury compounds occurs in humans and animals, although no comparison of the rate or extent of absorption can be made between species (Gotelli et al. 1985; Hursh et al. 1989; Laug and Kunze 1949; Schamberg et al. 1918). As with inhalation exposure, studies comparing the dermal absorption of all forms of mercury in humans and animals are needed to improve the utility of animal data for assessing human risk.

The distribution of mercury in humans and animals appears to be similar. The lipophilic nature of metallic mercury results in its distribution throughout the body in humans (Takahata et al. 1970) and in animals (Berlin and Johansson 1964; Berlin et al. 1966). Distribution of inorganic mercury compounds resembles that of metallic mercury; however, human distribution is preferentially to the kidneys, liver, and intestines. Also, levels in the brain are substantially lower, as these compounds have a lower lipophilicity. Distribution of organic mercury compounds is also similar to that of metallic mercury. The ability of methylmercuric compounds to cross the blood-brain and placental barriers enables ready distribution to all tissues, although, again, the highest levels are found in the kidneys. Phenylmercuric compounds are

2. HEALTH EFFECTS

initially distributed in a similar manner to methylmercury; however, the distribution eventually resembles that of inorganic mercury.

The available evidence suggests that feces and urine constitute the main excretory pathways of metallic mercury and inorganic mercury compounds in both humans and animals. Additional excretory routes following metallic and inorganic mercury exposure include exhalation and secretion in saliva, sweat, bile, and breast milk (Joselow et al. 1968b; Lovejoy et al. 1974; Rothstein and Hayes 1964; Sundberg and Oskarsson 1992; Yoshida et al. 1992). Excretion following exposure to organic mercury is considered to be predominantly through the fecal route in humans. Evidence from studies in humans and animals (mice, rats) suggests that exposure to methylmercury leads primarily to biliary secretion, while excretion is initially through the bile; it then shifts to the urine following phenylmercury exposure (Berlin and Ullberg 1963; Berlin et al. 1975; Gotelli et al. 1985; Norseth and Clarkson 1971). No further comparative studies on excretion are warranted because there is no apparent difference in the excretion of mercury in any form in humans and animals.

Two PBPK models have recently been published on the pharmacokinetics of methylmercury in rats (Farris et al. 1993; Gray 1995). Additional PBPK studies are needed to support species and dose extrapolations, and a better understanding of the underlying toxic and kinetic mechanisms is needed in support of human risk assessments.

Validation of *in vitro* data is a major need. Much of the data from *in vitro* experimentation is based on unrealistic concentrations of the toxicant or is derived from studies using non-physiological designs. In particular, more validation is needed for immunotoxicity studies and biochemical studies.

Methods for Reducing Toxic Effects. Nonspecific methods or treatments for reducing absorption following mercury exposure include the administration of chelators or protein solutions to neutralize and bind to inorganic mercury compounds (Bronstein and Currence 1988; Florentine and Sanfilippo 1991; Gossel and Bricker 1984). The use of a particular chelator is dependent upon the type of mercury exposure (Gossel and Bricker 1984). Chelation therapy is the treatment of choice for reducing the body burden of mercury (Florentine and Sanfilippo 1991; Gossel and Bricker 1984; Haddad and Winchester 1990). However, chelation releases mercury from soft tissues that can then be redistributed to the brain. Additional research is needed to elucidate the mechanisms of absorption and distribution of inorganic and organic mercury. Animal studies suggest that antioxidants may be useful for decreasing the toxicity of

2. HEALTH EFFECTS

mercury. Additional work studying the effectiveness of prophylactic administration of vitamin E (or other antioxidants) and of proper diet are needed. Improved chelation and drug therapies for treating acute and chronic mercury poisonings are greatly needed.

Children's Susceptibility. The systemic health effects from different forms of mercury and exposure routes have been fairly well characterized (EPA 1997; Sue 1994; WHO 1990). There is generally sufficient information on the symptoms to resolve the form and route of exposure when children are exposed to high levels of mercury. There is less information to assist the physician or public health official in recognizing the symptoms that might arise from lower level exposure to multiple forms of mercury (e.g., dental amalgam and fish) and multiple pathways (inhalation and ingestion). Whether concurrent exposures would result in a different presentation of symptoms would be important information in determining the best therapeutic treatment. Some health effects categories are not well defined (e.g., immune responses). Earlier identification of immunotoxicity is of concern for children because of the progressive nature of hypersensitization to environmental pollutants, and the burden that a compromised immune system can place on a person's long-term health.

There are not presently adequate measures for neurologic development. Delayed developmental effects are of grave concern for children exposed to mercury; methods for early determination and detection of progressively worsening changes in a child's behavioral or cognitive function are needed. For the measures to be truly useful they should in some way be integrated into a more directed exposure assessment and body burden analysis and to resolve the contribution from other influences on cognitive abilities and behaviors. Other data needs related to developmental effects are discussed above under Developmental Toxicity.

Pharmacokinetics are different for children, and more data are needed to improve chelation therapies for both acute high-level poisoning and for chronic low-level exposures. This is perhaps the area that deserves the most attention because accidental poisonings continue to occur and there are virtually no therapies to ameliorate the inevitable progression of mercury intoxication. Since environmental levels of mercury are also continuing to rise, and levels in food will concurrently rise, strategies to boost the body's ability to eliminate absorbed mercury are going to become increasingly important (i.e., the alternative is to change dietary patterns, i.e., eat less fish, and the risk/benefits of doing that are already being hotly debated).

There appears to be adequate information on the metabolism of mercury, and there are no special metabolites or metabolic pathways that are unique to children and require further evaluation.

2. HEALTH EFFECTS

The mechanism of mercury toxicity is still largely unknown. It is not known whether there are unique mechanisms of action for the toxic effects in children that would require special consideration for treatment modalities, but at present it appears that target site is determined more by the pharmacokinetics (i.e., which tissues end up with the highest levels) than by a specific mechanism of action (e.g., a receptor binding-process initiating type of mechanism).

The results of a number of accidental food poisonings indicate that children are more vulnerable, and this vulnerability may be a function of easier access of mercury to the systemic circulation and brain, or it may be because disruption of cell growth and organization is more critical for children in developmental stages of growth. More data are needed to determine if the vulnerability of children is due to less plasticity to insult of analogous target tissue in adults, or because target tissues actually receive more toxic agent.

There are not adequate biomarkers of exposure nor adequate access to biomarkers of exposure. Hair, urine, and blood levels are gross measures of body burden and do not provide the essential information about levels of mercury at target tissues. Research is needed into better (preferably noninvasive) monitoring tools. Research is also needed on how to make monitoring tests readily and inexpensively available to the general public. Mercury is one of the top ten most hazardous substances, and its levels are increasing in the environment. There is considerable anxiety present in the general population about potential mercury toxicity from dental amalgam, but this occurs in the absence of good information on actual body burdens. The general public and health officials would benefit from readily available ways for individuals to measure personal and family member mercury body burdens.

The interactions of immediate interest are those that either affect absorption from the gastrointestinal tract or that prevent or reduce mercury toxicity. No information was identified to indicate that mercury interacts differently with iron or zinc, for example, in a child's body than it would in an adult, although the difference in children's physiology and morphology may result in a different response to that interaction. Except for the latter, which is again a toxicokinetic question, chemical interactions do not appear to be a data need.

There is a data need to develop better chelation therapies, better ways to prevent absorption of mercury into the body of children, and better ways to interfere with the mechanism of action, especially for damage to the nervous system. The current literature continues to grow with case histories of poisonings where

2. HEALTH EFFECTS

supportive therapy and passive observation of a progressively deteriorating health status are the best that can be done.

No information was found that parental exposure to mercury results in heritable defects or deficits in germ cell function that would be translated to the offspring. There is considerable information on the transfer of mercury from the mother to the developing child, both during the prenatal period via the placenta and during postnatal nursing; both inorganic mercury and organic mercury pass from mother to child. This is an area of active research primarily to characterize the dose, duration, and form of mercury to which the child is being exposed. Further work in this area is needed.

Child health data needs related to exposure are discussed in Section 5.8.1, Data Needs: Exposure of Children.

2.11.3 Ongoing Studies

Ongoing studies regarding mercury's health effects and mechanisms of action were reported in the Federal Research In Progress (FEDRIP 1998) database. Table 2-14 lists these studies.

2. PUBLIC HEALTH

Table 2-14. Ongoing Studies on Health Effects of Mercury

Author	Affiliation	Title	Sponsor
Tan, KH	Winston-Salem State University Winston-Salem, NC	Pilot study--astrocyte gene expression and methyl mercury neurotoxicity.	NCRR
Opella, SJ	University of Pennsylvania Philadelphia, PA	Structural studies of mercury transport protein.	NCRR
Prusiner, SB	University of California-SF San Francisco, CA	Nmr structures of recombinant prps.	National Institute of Neurological Disorders
Agre, PC	Johns Hopkins University Baltimore, MD	Red cell aquaporin-1 water transport protein.	National Heart, Lung, and Blood Institute
Rajanna, B	Alcorn State University Lorman, MS	Developmental neurotoxicity of lead and methyl mercury.	NIGMS
Mitra, AK	Scripps Research Institute San Diego, CA	Structure and function of the chip28 water channel.	NIGMS
Miller, S	University of California-SF San Francisco, CA	Cause and effect of dimer asymmetry in mercuric reductase.	NIGMS
Jensen, JL	California State University-LB Long Beach, CA	Reactivity of heavy metal ions with organosulfur moieties.	NIGMS
Rowland, AS		Effects of dental treatment during pregnancy on childhood development.	NIEHS
Rowland, AS		Chronic disease risks associated with mercury vapor exposure.	NIEHS
Longnecker, MP		Validity of toenail element levels as a surrogate measure of exposure.	NIEHS
Kamel, F		Lead and other neurotoxins as risk factors for amyotrophic lateral sclerosis.	NIEHS
Baird, DD		Environmental effects on fertility.	NIEHS
Morgan, DL		Prenatal effects of chemicals on the respiratory tract.	NIEHS
Knudsen,	Thomas Jefferson University Philadelphia, PA	Environmental impact on the embryonic mtdna genome.	NIEHS
Kono, DH	Scripps Research Institute San Diego, CA	Heavy metal induced autoimmunity.	NIEHS

2. PUBLIC HEALTH

Table 2-14. Ongoing Studies on Health Effects of Mercury (continued)

Author	Affiliation	Title	Sponsor
Frumkin, H	Emory University Atlanta, GA	Cohort study of former employees of a chloralkali plant.	NIEHS
Nelson, LM	Stanford University Stanford, CA	Exogenous toxicants and genetic susceptibility in als.	NIEHS
Weiss, B	University of Rochester Rochester, NY	Developmental neurotoxicity of metallic mercury.	NIEHS
Pollard, KM	Scripps Research Institute San Diego, CA	Immunotoxicology of a heavy metal.	NIEHS
Pollard, KM	Scripps Research Institute San Diego, CA	Mercury induced autoimmunity.	NIEHS
Aschner, M	Wake Forest University Winston-Salem, NC	Mechanisms of methylmercury induced neuronal toxicity.	NIEHS
Ballatori, N	University of Rochester Rochester, NY	Methylmercury transport across cell membranes.	NIEHS
Newland, MC	Auburn University at Auburn Auburn, AL	Behavioral teratology of methylmercury.	NIEHS
Kane, AS	University of Maryland Baltimore Baltimore, MD	Mechanisms underlying segment-specific nephrotoxicity.	NIEHS
Zalups, RK	Mercer University Macon Macon, GA	Transport and toxicity of mercury in the nephron.	NIEHS
Korrih, SM	Harvard University Boston, MA	<i>In utero</i> PCB and metal exposure and infant development.	NIEHS
Clarkson, TW	University of Rochester Rochester, NY	Dosimetry.	NIEHS
Myers, GI	University of Rochester Rochester, NY	Child development following prenatal methyl mercury exposure via fish diet.	NIEHS
Clarkson, TW	University of Rochester Rochester, NY	Health hazards of methylmercury.	NIEHS
Zalups, RK	Mercer University Macon Macon, GA	Mercury nephrotoxicity after a reduction of renal mass.	NIEHS
Reuhl, KR	Rutgers The State Univ New Brunswick New Brunswick, NJ	Mechanisms of methylmercury neurotoxicity during development.	NIEHS

2. PUBLIC HEALTH

Table 2-14. Ongoing Studies on Health Effects of Mercury (continued)

Author	Affiliation	Title	Sponsor
Gandolfi, AJ	University of Arizona Tucson, AZ	Metal-metal interactions in the kidney.	NIEHS
Schell, LM	State University of New York a Albany, NY	PCBs and well being of Mohawk children and youth--growth, development, cognition.	NIEHS
Checkoway, H	University of Washington Seattle, WA	Environmental and biochemical risk factors for Parkinson's disease.	NIEHS
Woods, JS	University of Washington Seattle, WA	Porphyryn profiles as biomarkers of trace metal exposure and toxicity.	NIEHS
Silva, P	Mount Desert Island Biological Salsbury Cove, ME	Mercury in chloride transport in shark rectal gland and rabbit thick ascending limb.	NIEHS
Preston, RL	Mount Desert Island Biological Salsbury Cove, ME	Mercury interaction with the taurine transport system of red blood cells.	NIEHS
Kinne, R	Mount Desert Island Biological Salsbury Cove, ME	Effects of cadmium and mercury on na-k-cl cotransporter in shark rectal gland.	NIEHS
Dawson, DC	Mount Desert Island Biological Salsbury Cove, ME	Effect of mercury on thiazide-sensitive sodium chloride cotransporter in flounder.	NIEHS
Boyer, J	Mount Desert Island Biological Salsbury Cove, ME	Mercury impairment of cell volume regulation in skate hepatocytes.	NIEHS
Burbacher, TM	University of Washington Seattle, WA	Developmental effects of methylmercury.	NIEHS
Atchison, WD	Michigan State University East Lansing, MI	Neurotoxic mechanisms of methylmercury poisoning.	NIEHS
Bigazzi, PE	University of Connecticut Farmington, CT	Immune effects of metals--mercury-induced autoimmune disease.	NIEHS
Lawrence, DA	Wadsworth Center Albany, NY	Immunotoxicity of heavy metals.	NIEHS
Crawford, S	New England Research Institute Watertown, MA	Contribution of amalgam restoration to total body burden.	NIDCR
Janoff, EE	University of Washington Seattle, WA	Influence of dental amalgams on mercury and antibiotic resistant bacteria.	NIDCR

2. PUBLIC HEALTH

Table 2-14. Ongoing Studies on Health Effects of Mercury (continued)

Author	Affiliation	Title	Sponsor
De Rouen, TA	University of Washington Seattle, WA	Casa Pia study of dental amalgams in children.	NIDCR
Crawford, SL	New England Research Institute Watertown, MA	Health effects of dental amalgams in children.	NIDCR
Echeverria, D	Battelle Memorial Institute Columbus, OH	Neurologic effects of HgO exposure in dental personnel.	NIDCR
Factor-litvak, P	Columbia University Health Sci New York, NY	Dental amalgams and neuropsychological function.	NIDCR
Shenker, BJ	University of Pennsylvania Philadelphia, PA	Immunotoxic properties of mercuric compounds.	NIDCR
Kingman, A		Correlations between amalgam exposure and mercury levels in urine and blood.	NIDCR
Kingman, A		The NIDR amalgam study and health effects protocol.	NIDCR
Winn, DM		Occupation and reproductive health of women dentists.	NIDCR
Barron, DJ	University of Rochester Rochester, NY	Mercury toxicity and the blood-brain factor.	NIDCR
Sobel, ES	University of Florida Gainesville, FL	Hgc12 induction of systemic autoimmune disease in mice.	National Institute of Arthritis and Musculoskeletal and Skin
Casiano, CA	Loma Linda University Loma Linda, CA	Autoantigen cleavage during apoptosis and necrosis.	National Institute of Allergy and Infectious Diseases
Markesbery, WR	University of Kentucky Lexington, KY	Oxidative, antioxidant and trace element studies in the alzheimer's brain.	National Institute on Aging
Smith DE	North Carolina State University Raleigh, NC	Effects of metal ions on in vitro estrogen action in the rat uterus.	U. S. Department of Agriculture

NCRR = National Center for Research Resources; NIDCR = National Institute of Arthritis and Musculoskeletal Research; NIEHS = National Institute of Environmental Health Science; NIGMS = National Institute of General Medical Sciences