

The Containment of UNDERGROUND NUCLEAR EXPLOSIONS

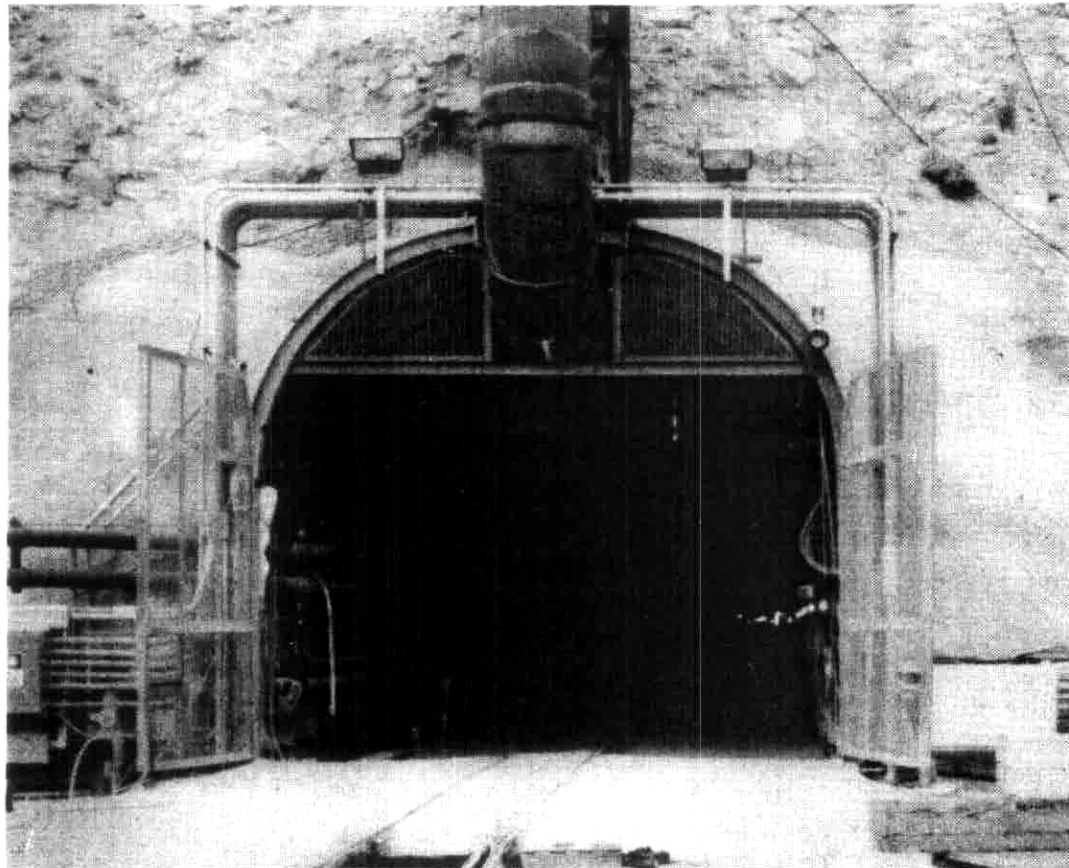

CONGRESS OF THE UNITED STATES OFFICE OF TECHNOLOGY ASSESSMENT



Office of Technology Assessment

The Office of Technology Assessment (OTA) was created in 1972 as an analytical arm of Congress. OTA's basic function is to help legislative policy-makers anticipate and plan for the consequences of technological changes and to examine the many ways, expected and unexpected, in which technology affects people's lives. The assessment of technology calls for exploration of the physical, biological, economic, social, and political impacts that can result from applications of scientific knowledge. OTA provides Congress with independent and timely information about the potential effects—both beneficial and harmful—of technological applications.

Requests for studies are made by chairmen of standing committees of the House of Representatives or Senate; by the Technology Assessment Board, the governing body of OTA; or by the Director of OTA in consultation with the Board.

The Technology Assessment Board is composed of six members of the House, six members of the Senate, and the OTA Director, who is a non-voting member.

OTA has studies under way in nine program areas: energy and materials; industry, technology, and employment; international security and commerce; biological applications; food and renewable resources; health; communication and information technologies; oceans and environment; and science, education, and transportation.

The Containment of UNDERGROUND NUCLEAR EXPLOSIONS



CONGRESS OF THE UNITED STATES OFFICE OF TECHNOLOGY ASSESSMENT

Recommended Citation:

U.S. Congress, Office of Technology Assessment, *The Containment of Underground Nuclear Explosions*, OTA-ISC-414 (Washington, DC: U.S. Government Printing Office, October 1989).

Library of Congress Catalog Card Number 89-600707

For sale by the Superintendent of Documents
U.S. Government Printing Office, Washington, DC 20402-9325
(order form can be found in the back of this report)

Foreword

Within weeks after the ending of World War II, plans for the first nuclear test series "Operation Crossroads" were underway. The purpose then, as now, was to develop new weapon systems and to study the effects of nuclear explosions on military equipment. The development of the nuclear testing program has been paralleled by public opposition from both an arms control and an environmental perspective. Much of the criticism is due to the symbolic nature of testing nuclear weapons and from the radiation hazards associated with the early practice of testing in the atmosphere. Recently, however, specific concerns have also been raised about the current underground testing program; namely:

- Are testing practices safe?
- Could an accidental release of radioactive material escape undetected?
- Is the public being fully informed of all the dangers emanating from the nuclear testing program?

These concerns are fueled in part by the secrecy that surrounds the testing program and by publicized problems at nuclear weapons production facilities.

At the request of the House Committee on Interior and Insular Affairs and Senator Orrin G. Hatch, OTA undertook an assessment of the containment and monitoring practices of the nuclear testing program. This special report reviews the safety of the nuclear testing program and assesses the technical procedures used to test nuclear weapons and ensure that radioactive material produced by test explosions remains contained underground. An overall evaluation considers the acceptability of the remaining risk and discusses reasons for the lack of public confidence.

In the course of this assessment, OTA drew on the experience of many organizations and individuals. We appreciate the assistance of the U.S. Government agencies and private companies who contributed valuable information, the workshop participants who provided guidance and review, and the many additional reviewers who helped ensure the accuracy and objectivity of this report.

JOHN H. GIBBONS
Director

Workshop 1: Containment
Monday, Sept. 26, 1988
Environmental Research Center
University of Nevada, Las Vegas

Neville G. Cook, *Chair*
Department of Material Science and Mineral Engineering
University of California

Frederick N. App
Section Leader
Containment Geophysics
Los Alamos National Laboratory

Norman R. Burkhard
Containment Program Leader
Lawrence Livermore National Laboratory

Jim Carothers
Chairman
Containment Evaluation Panel
Lawrence Livermore National Laboratory

Jack Evernden
Lawrence Livermore National Laboratory
U.S. Geological Survey

Robert A. Fulkerson
Executive Director
Citizen Alert

Jack W. House
Containment Program Manager
Los Alamos National Laboratory

Billy C. Hudson
Deputy Containment Program Leader
Lawrence Livermore National Laboratory

Evan Jenkins
U.S. Geological Survey

Joseph LaComb
Chief
Nevada Operations Office
Defense Nuclear Agency

James K. Magruder
Assistant Manager for Operations and Engineering
Nevada Operations Office
U.S. Department of Energy

Paul Orkild
U.S. Geological Survey

Edward W. Peterson
Containment Project Director
S-CUBED

John Stewart
Director
Test Operations Division
Nevada Operations Office
U.S. Department of Energy

Workshop 2: Monitoring
Tuesday, Sept. 27, 1988
Environmental Research Center
University of Nevada, Las Vegas

Melvin W. Carter, *Chair*
Neely Professor Emeritus
Georgia Institute of Technology

Lynn R. Anspaugh
Division Leader
Environmental Sciences Division
Lawrence Livermore National Laboratory

Bruce Church
Assistant Manager for Environmental Safety and
Health
Nevada Operations Office
U.S. Department of Energy

Charles F. Costa
Director
Nuclear Radiation Assessment Division
United States Environmental Protection Agency

Donald R. Elle
Chief, Technical Projects Branch
Health Physics and Environmental Division
Nevada Operations Office
U.S. Department of Energy

Bernd Franke
IFEU

Robert A. Fulkerson
Executive Director
Citizen Alert

Michael A. Marelli
Chief, Health Protection Branch
Health Physics and Environmental Division
Nevada Operations Office
U.S. Department of Energy

Darryl Randerson
Weather Service
Nuclear Office

OTA Project Staff—The Containment of Underground Nuclear Explosions

Lionel S. Johns, *Assistant Director, OTA
Energy, Materials, and International Security Division*

Peter Sharfman, *International Security and Commerce Program Manager**

Alan Shaw, *International Security and Commerce Program Manager***

Gregory E. van der Vink, *Project Director*

Administrative Staff

Jannie Horne (through November 1988)

Marie C. Parker (through April 1989)

Jackie Robinson

Louise Staley

*Through February 1989

**From March 1989.

Acknowledgments

OTA gratefully acknowledges the valuable contributions made by the following:

| | |
|---|---|
| Lynn R. Anspaugh Lawrence Livermore National Laboratory | David Graham Moore College of Art |
| Frederick N. App Los Alamos National Laboratory | Jack W. House Los Alamos National Laboratory |
| Nick Aquilina U.S. Department of Energy | Billy C. Hudson Lawrence Livermore National Laboratory |
| Charles Archambeau CIRES, University of Colorado, Boulder | Evan Jenkins U.S. Geological Survey |
| Stuart C. Black U.S. Environmental Protection Agency | Gerald W. Johnson University of California |
| Carter Broyles Sandia National Laboratory | Joseph W. LaComb Defense Nuclear Agency |
| Norman R. Burkhard Lawrence Livermore National Laboratory | James K. Magruder U.S. Department of Energy |
| John H. Campbell U.S. Department of Energy | Michael A. Marelli U.S. Department of Energy |
| Jim Carothers Lawrence Livermore National Laboratory | LTC Samuel D. McKinney Defense Nuclear Agency |
| Melvin W. Carter International Radiation Protection Consultant | David N. McNelis University of Las Vegas, Nevada |
| Bruce Church U.S. Department of Energy | Paul Orkild Lawrence Livermore National Laboratory |
| Neville G. Cook University of California, Berkeley | Edward W. Peterson S-CUBED |
| Charles F. Costa U.S. Environmental Protection Agency | Dorothy F. Pope Defense Nuclear Agency |
| Jeff Duncan Office of Congressman Edward J. Markey | Darryl Randerson Weather Service, Nuclear Office |
| Donald R. Elle U.S. Department of Energy | Karen Randolph U.S. Department of Energy |
| Gerald L. Epstein John F. Kennedy School of Government, Harvard University | R.L. Rhodes Diebold, Inc. |
| Jack Evernden U.S. Geological Survey | Patrick Rowe REECo |
| Anthony Fainberg Office of Technology Assessment, U.S. Congress | Robert Shirkey Defense Nuclear Agency |
| Pete Fitzsimmons U.S. Department of Energy | John O. Stewart U.S. Department of Energy |
| Janet Fogg U.S. Department of Energy | Robert Titus Weather Service, Nuclear Office |
| Bernd Franke IFEU | Dean R. Townsend Fenix & Scission, Inc. |
| Robert A. Fulkerson Citizen Alert | Chris L. West U.S. Department of Energy |
| Larry Gabriel Defense Nuclear Agency | Barbara Yoers U.S. Department of Energy |

NOTE: OTA appreciates and is grateful for the valuable assistance and thoughtful critiques provided by the contributors. The contributors do not, however, necessarily approve, disapprove, or endorse this report. OTA assumes full responsibility for the report and the accuracy of its contents.

Contents

| | <i>Page</i> |
|--|-------------|
| Chapter 1. Executive Summary | 3 |
| Chapter 2. The Nuclear Testing Program. | 11 |
| Chapter 3. Containing Underground Nuclear Explosions. | 31 |
| Chapter 4. Monitoring Accidental Radiation Releases. | 59 |

Chapter 1

Executive Summary

CONTENTS

| | |
|--------------------------------|--------|
| INTRODUCTION | Page 3 |
| HOW SAFE IS SAFE ENOUGH? | 3 |
| HOW SAFE HAS IT BEEN? | 3 |
| SPECIFIC CONCERNS | 5 |
| OVERALL EVALUATION | 6 |

Table

| | |
|--|-------------|
| <i>Table</i> | <i>Page</i> |
| 1-1. Releases From Underground Tests | 4 |

The chances of an accidental release of radioactive material have been made as remote as possible. Public concerns about safety are fueled by concerns about the testing program in general and exacerbated by the government's policy of not announcing all tests.

INTRODUCTION

During a nuclear explosion, billions of atoms release their energy within a millionth of a second, pressures reach several million pounds per square inch, and temperatures are as high as one-million degrees centigrade. A variety of radioactive elements are produced depending on the design of the explosive device and the contribution of fission and fusion to the explosion. The half-lives of the elements produced range from less than a second to more than a million years.

Each year over a dozen nuclear weapons are detonated underground at the Nevada Test Site.¹ The tests are used to develop new nuclear weapons and to assess the effects of nuclear explosions on military systems and other hardware. Each test is designed to prevent the release of radioactive material. The objective of each test is to obtain the desired experimental information and yet successfully contain the explosion underground (i.e., prevent radioactive material from reaching the atmosphere).

HOW SAFE IS SAFE ENOUGH?

Deciding whether the testing program is safe requires a judgment of how safe is safe enough. The subjective nature of this judgment is illustrated through the decision-making process of the Containment Evaluation Panel (CEP) which reviews and assesses the containment of each test.² The panel evaluates the probability of containment using the terms "high confidence," "adequate degree of confidence," and "some

doubt." But the Containment Evaluation Panel has no guidelines that attempt to quantify or describe in probabilistic terms what constitutes for example, an "adequate degree of confidence." Obviously, there can never be 100 percent confidence that a test will not release radioactive material. Whether "adequate confidence" translates into a chance of 1 in 100, 1 in 1,000, or 1 in 1,000,000, requires a decision about what is an acceptable level of risk. In turn, decisions of acceptable level of risk can only be made by weighing the costs of an unintentional release against the benefits of testing. Consequently, those who feel that testing is important for our national security will accept greater risk, and those who oppose nuclear testing will find even small risks unacceptable.

Establishing an acceptable level of risk is difficult, not only because of the value judgments associated with nuclear testing, but also because the risk is not seen as voluntary by those outside the testing program. A public that readily accepts the risks associated with voluntary activities—such as sky diving or smoking—may still consider the much lower risks associated with nuclear testing unacceptable.

HOW SAFE HAS IT BEEN?

Some insight into the safety of the nuclear testing program can be obtained by reviewing the containment record. Releases of radioactive material are categorized with terms that describe both the volume of material released and the conditions of the release:

¹Currently, all U.S. nuclear test explosions are conducted at the Nevada Test Site.

²The Containment Evaluation Panel is a group of representatives from various laboratories and technical consulting organizations who evaluate the proposed containment plan for each test without regard to cost or other outside considerations (see ch. 2 for a complete discussion).

Containment Failures: Containment failures are unintentional releases of radioactive material to the atmosphere due to a failure of the containment system. They are termed "ventings," if they are prompt, massive releases; or "seeps," if they are slow, small releases that occur soon after the test.

Late-Time Seeps: Late-time seeps are small releases that occur days or weeks after a test when gases diffuse through pore spaces of the overlying rock and are drawn to the surface by decreases in atmospheric pressure.

Controlled Tunnel Purging: A controlled tunnel purging is an intentional release to allow either recovery of experimental data and equipment or reuse of part of the tunnel system.

Operational Release: Operational releases are small, consequential releases that occur when core or gas samples are collected, or when the drill-back hole is sealed.

The containment record can be presented in different ways depending on which categories of releases are included. **Reports of total numbers of releases are often incomplete because they include only announced tests or releases due to containment failure.** The upper portion of table 1-1 includes every instance (for both announced and unannounced tests) where radioactive material has reached the atmosphere under any circumstances whatsoever since the 1970 Baneberry test.

Since 1970, 126 tests have resulted in radioactive material reaching the atmosphere with a total release of about 54,000 Curies (Ci). Of this amount, 11,500 Ci were due to containment failure and late-time seeps. The remaining 42,500 Ci were operational releases and controlled tunnel purgings—with Mighty Oak (36,000 Ci) as the main source. The lower portion of the table shows that the release of radioactive material from underground nuclear testing since Baneberry (54,000 Ci) is extremely small in comparison to the amount of material released

Table 1-1—Releases From Underground Tests (normalized to 12 hours after event^a)

| | |
|---------------------------------------|-------------------|
| All releases 1971-1988: | |
| Containment Failures: | |
| Camphor, 1971 ^b | 360 Ci |
| Diagonal Line, 1971 | 6,800 |
| Riola, 1980 | 3,100 |
| Agrini, 1984 | 690 |
| Late-time Seeps: | |
| Kappeli, 1984 | 12 |
| Tierra, 1984 | 600 |
| Labquark, 1986 | 20 |
| Bodie, 1986 ^c | 52 |
| Controlled Tunnel Purgings: | |
| Hybla Fair, 1974 | 500 |
| Hybla Gold, 1977 | 0.005 |
| Miners Iron, 1980 | 0.3 |
| Huron Landing, 1982 | 280 |
| Mini Jade, 1983 | 1 |
| Mill Yard, 1985 | 5.9 |
| Diamond Beech, 1985 | 1.1 |
| Misty Rain, 1985 | 63 |
| Mighty Oak, 1986 | 36,000 |
| Mission Ghost, 1987 ^c | 3 |
| Operational Releases: | |
| 108 tests from 1970-1988 ^d | 5,500 |
| Total since Baneberry: 54,000 Ci | |
| Major pre-1971 releases: | |
| Platte, 1962 | 1,900,000 Ci |
| Eel, 1962 | 1,900,000 |
| Des Moines, 1962 | 11,000,000 |
| Baneberry, 1970 | 6,700,000 |
| 26 others from 1958-1970 | 3,800,000 |
| Total: 25,300,000 Ci | |
| Other Releases for Reference | |
| NTS Atmospheric Testing 1951-1963: | 12,000,000,000 Ci |
| 1 Kiloton Aboveground Explosion: | 10,000,000 |
| Chernobyl (estimate): | 81,000,000 |

^aR+12 values apply only to containment failures, others are at time of release.

^bThe Camphor failure includes 140 Ci from tunnel purging.

^cBodie and Mission Ghost also had drill-back releases.

^dMany of these operational releases are associated with tests that were not announced.

SOURCE: Office of Technology Assessment, 1989.

by pre-Baneberry underground tests (25,300,000 Ci), the early atmospheric tests at the Nevada Test Site (12,000,000,000 Ci), or even the amount that would be released by a single 1-kiloton explosion conducted aboveground (10,000,000 Ci).

From the perspective of human health risk:

If the same person had been standing at the boundary of the Nevada Test Site in the area of maximum concentration of radioactivity for every test since Baneberry (1970), that

person's total exposure would be equivalent to 32 extra minutes of normal background exposure (or the equivalent of 1/1000 of a single chest x-ray).

A worst-case scenario for a catastrophic accident at the test site would be the prompt, massive venting of a 150-kiloton test (the largest allowed under the 1974 Threshold Test Ban Treaty). The release would be in the range of 1 to 10 percent of the total radiation generated by the explosion (compared to 6 percent released by the Baneberry test or an estimated 10 percent that would be released by a test conducted in a hole open to the surface). Such an accident would be comparable to a 15-kiloton **above-ground** test, and would release approximately 150,000,000 Ci. Although such an accident would be considered a major catastrophe today, during the early years at the Nevada Test Site 25 **aboveground** tests had individual yields equal to or greater than 15 kilotons.

SPECIFIC CONCERNS

Recently, several specific concerns about the safety of the nuclear testing program have arisen, namely:³

1. *Does the fracturing of rock at Rainier Mesa pose a danger?*

The unexpected formation of a surface collapse crater during the 1984 Midas Myth test focused concern about the safety of testing in Rainier Mesa. The concern was heightened by the observation of ground cracks at the top of the Mesa and by seismic measurements indicating a loss of rock strength out to distances greater than the depth of burial of the nuclear device. The specific issue is whether the repeated testing in Rainier Mesa had fractured large volumes of rock creating a "tired mountain" that no longer had the strength to successfully contain future

underground tests. The inference that testing in Rainier Mesa poses a high level of risk implies that conditions for conducting a test on Rainier are more dangerous than conditions for conducting a test on Yucca Flat.⁴ But, in fact, tests in Rainier Mesa are buried deeper and spaced further apart than comparable tests on Yucca Flat.⁵ Furthermore, drill samples show no evidence of any permanent decrease in rock strength at distances greater than two cavity radii from the perimeter of the cavity formed by the explosion. The large distance of decreased rock strength seen in the seismic measurements is almost certainly due to the momentary opening of pre-existing cracks during passage of the shock wave. Most fractures on the top of the mesa are due to surface spall and do not extend down to the region of the test. Furthermore, only minimal rock strength is required for containment. **Therefore, none of the conditions of testing in Rainier Mesa—burial depth, separation distance, or material strength—imply that leakage to the surface is more likely for a tunnel test on Rainier Mesa than for a vertical drill hole test on Yucca Flat.**

2. *Could an accidental release of radioactive material go undetected?*

A comprehensive system for detecting radioactive material is formed by the combination of:

- the monitoring system deployed for each test;
- the onsite monitoring system run by the Department of Energy (DOE) and;
- the offsite monitoring system, run by Environmental Protection Agency (EPA), including the community monitoring stations.

There is essentially no possibility that a significant release of radioactive material

³Detailed analysis of these concerns is included in chs. 3 and 4.

⁴Approximately 90 percent of all nuclear test explosions are vertical drill hole tests conducted on Yucca Flat. See ch. 2 for an explanation of the various types of tests.

⁵The greater depth of burial is due to convenience. It is easier to mine tunnels lower in the Mesa.

from an underground test could go undetected.

3. *Are we running out of room to test at the Test Site?*

Efforts to conserve space for testing in Rainier Mesa have created the impression that there is a "real estate problem" at the test site.⁶ The concern is that a shortage of space would result in unsafe testing practices. Although it is true that space is now used economically to preserve the most convenient locations, other less convenient locations are available within the test site. **Suitable areas within the test site offer enough space to continue testing at present rates for several more decades.**

4. *Do any unannounced tests release radioactive material?*

A test will be preannounced in the afternoon 2 days before the test if it is determined that the maximum possible yield of the explosion is such that it could result in perceptible ground motion in Las Vegas. An announcement will be made after a test if there is a prompt release of radioactive material, or if any late-time release results in radioactivity being detected off the test site. The Environmental Protection Agency is dependent on the Department of Energy for notification of any late-time releases within the boundaries of the test site. However, if EPA is not notified, the release will still be detected by EPA's monitoring system once radioactive material reaches outside the test site. **If it is judged that a late-time release of radioactive material will not be detected outside the boundaries of the test site, the test may (and often does) remain unannounced.**

OVERALL EVALUATION

Every nuclear test is designed to be contained and is reviewed for containment.⁷ In each step of the test procedure there is built-in redundancy

and conservatism. Every attempt is made to keep the chance of containment failure as remote as possible. This conservatism and redundancy is essential, however; because no matter how perfect the process may be, it operates in an imperfect setting. For each test, the containment analysis is based on samples, estimates, and models that can only simplify and (at best) approximate the real complexities of the Earth. As a result, predictions about containment depend largely on judgments developed from past experience. Most of what is known to cause problems—carbonate material, water, faults, scarps, clays, etc.—was learned through experience. To withstand the consequences of a possible surprise, redundancy and conservatism is a requirement not an extravagance. Consequently, all efforts undertaken to ensure a safe testing program are necessary, and must continue to be vigorously pursued.

The question of whether the testing program is "safe enough" will ultimately remain a value judgment that weighs the importance of testing against the risk to health and environment. In this sense, concern about safety will continue, largely fueled by concern about the nuclear testing program itself. However, given the continuance of testing and the acceptance of the associated environmental damage, the question of "adequate safety" becomes replaced with the less subjective question of whether any improvements can be made to reduce the chances of an accidental release. In this regard, no areas for improvement have been identified. This is not to say that future improvements will not be made as experience increases, but only that essentially all suggestions that increase the safety margin have been implemented. **The safeguards built into each test make the chances of an accidental release of radioactive material as remote as possible.**

⁶See for example: William J. Broad, "Bomb Tests: Technology Advances Against Backdrop of Wide Debate," *New York Times*, Apr. 15, 1986, pp. C1-C3.

⁷See ch. 3 for a detailed accounting of the review process.

The acceptability of the remaining risk will depend on public confidence in the nuclear testing program. This confidence currently suffers from a lack of confidence in the Department of Energy emanating from problems at nuclear weapons production facilities and from radiation hazards associated with the past atmospheric testing program. In the case of the present underground nuclear testing program, this mistrust is exacerbated by DOE's reluctance to disclose information concerning the testing program, and by the knowledge that not all tests releasing radioactive material to the atmosphere (whatever the amount or circumstances) are announced. As the secrecy associated with the testing program is largely ineffective in preventing the dissemination of information concerning

the occurrence of tests, the justification for such secrecy is questionable.⁸

The benefits of public dissemination of information have been successfully demonstrated by the EPA in the area of radiation monitoring. Openly available community monitoring stations allow residents near the test site to independently verify information released by the government, thereby providing reassurance to the community at large. **In a similar manner, public concern over the testing program could be greatly mitigated if a policy were adopted whereby all tests are announced, or at least all tests that release radioactive material to the atmosphere (whatever the conditions) are announced.**

⁸See for example: Riley R. Geary, "Nevada Test Site's dirty little secrets," *Bulletin of the Atomic Scientists*, April 1989, pp. 35-38.

Chapter 2

The Nuclear Testing Program

CONTENTS

| | <i>Page</i> |
|--|-------------|
| INTRODUCTION | 11 |
| THE HISTORY OF NUCLEAR TESTING | 11 |
| LIMITS ON NUCLEAR TESTING | 14 |
| OTHER LOCATIONS OF NUCLEAR TESTS | 15 |
| THE NEVADA TEST SITE | 15 |
| TYPES OF NUCLEAR TESTS | 18 |
| ANNOUNCEMENT OF NUCLEAR TESTS | 20 |
| DETONATION AUTHORITY AND PROCEDURE | 22 |

Figures

| <i>Figure</i> | <i>Page</i> |
|--|-------------|
| 2-1. U.S Nuclear Testing | 13 |
| 2-2. Nevada Test Site | 16 |
| 2-3. Drill-Back Operation | 19 |
| 2-4. Locations of Tunnel Tests in Rainier and Aqueduct Mesas | 21 |

The Nuclear Testing Program

The nuclear testing program has played a major role in developing new weapon systems and determining the effects of nuclear explosions.

INTRODUCTION

In the past four decades, nuclear weapons have evolved into highly sophisticated and specialized devices. Throughout this evolution, the nuclear testing program has played a major role in developing new weapon systems and determining the effects of nuclear explosions.

THE HISTORY OF NUCLEAR TESTING

On July 16, 1945 the world's first nuclear bomb (code named "Trinity") was detonated atop a 100-foot steel tower at the Alamogordo Bombing Range, 55 miles northwest of Alamogordo, New Mexico.¹ The explosion had a yield of 21 kilotons (kts), the explosive energy equal to approximately 21,000 tons of TNT.² The following month, American planes dropped two atomic bombs ("Little Boy," 13 kilotons; "Fat Man," 23 kilotons) on the Japanese cities of Hiroshima and Nagasaki, ending World War II and beginning the age of nuclear weapons.³

Within weeks after the bombing of Hiroshima and Nagasaki, plans were underway to study the effects of nuclear weapons and explore further design possibilities. A subcommittee of the Joint Chiefs of Staff was created, on November 10, 1945, to arrange the first series of nuclear test explosions. President Truman approved the plan on January 10, 1946. The Bikini Atoll was selected as the test site and the Bikinians were relocated to the nearby uninhabited

Rongerik Atoll. Two tests ("Able" and "Baker") were detonated on Bikini in June and July of 1946 as part of "Operation Crossroads," a series designed to study the effects of nuclear weapons on ships, equipment, and material.⁴ The Bikini Atoll, however, was found to be too small to accommodate support facilities for the next test series and so "Operation Sandstone" was conducted on the nearby Enewetak Atoll. The tests of Operation Sandstone ("X-ray," "Yoke," and "Zebra") were proof tests for new bomb designs.

As plans developed to expand the nuclear arsenal, the expense, security, and logistical problems of testing in the Pacific became burdensome. Attention turned toward establishing a test site within the continental United States. The Nevada Test Site was chosen in December 1950 by President Truman as a continental proving ground for testing nuclear weapons. A month later, the first test—code named "Able"—was conducted using a device dropped from a B-50 bomber over Frenchman Flat as part of a five-test series called "Operation Ranger." The five tests were completed within 11 days at what was then called the "Nevada Proving Ground."

Although the Nevada Test Site was fully operational by 1951, the Pacific continued to be used as a test site for developing thermonuclear weapons (also called hydrogen or fusion bombs). On October 31, 1952, the United States exploded the first hydrogen (fusion) device on Enewetak Atoll.⁵ The test, code named "Mike," had an explosive yield of 10,400 kilotons—over 200 times the largest previous test.

¹The Alamogordo Bombing Range is now the White Sands Missile Range.

²A kiloton (kt) was originally defined as the explosive equivalent of 1,000 tons of TNT. This definition, however, was found to be imprecise for two reasons. First, there is some variation in the experimental and theoretical values of the explosive energy released by TNT (although the majority of values lie in the range from 900 to 1,100 calories per gram). Second, the term kiloton could refer to a short kiloton (2×10^6 pounds), a metric kiloton (2.205×10^6 pounds), or a long kiloton (2.24×10^6 pounds). It was agreed, therefore, during the Manhattan Project that the term "kiloton" would refer to the release of 10^{12} (1,000,000,000,000) calories of explosive energy.

³John Malik, "The Yields of the Hiroshima and Nagasaki Nuclear Explosions," Los Alamos National Laboratory report LA-8819, 1985.

⁴The target consisted of a fleet of over 90 vessels assembled in the Bikini Lagoon including three captured German and Japanese ships; surplus U.S. cruisers, destroyers, and submarines; and amphibious craft.

⁵The first test of an actual hydrogen *bomb* (rather than a *device* located on the surface) was "Cherokee" which was dropped from a plane over Bikini Atoll on May 20, 1956. Extensive preparations were made for the test that included the construction of artificial islands to house measuring equipment. The elaborate experiments required that the bomb be dropped in a precise location in space. To accomplish this, the Strategic Air Command held a competition for bombing accuracy. Although the winner hit the correct point in every practice run, during the test the bomb was dropped 4 miles off-target.

The test was followed 2 weeks later by the 500 kiloton explosion "King," the largest fission weapon ever tested.

At the Nevada Test Site, low-yield fission devices continued to be tested. Tests were conducted with nuclear bombs dropped from planes, shot from cannons, placed on top of towers, and suspended from balloons. The tests were designed both to develop new weapons and to learn the effects of nuclear explosions on civilian and military structures. Some tests were conducted in conjunction with military exercises to prepare soldiers for what was then termed "the atomic battlefield."

In the Pacific, the next tests of thermonuclear (hydrogen) bombs were conducted under "Operation Castle," a series of six tests detonated on the Bikini Atoll in 1954. The first test, "Bravo," was expected to have a yield of about 6,000 kilotons. The actual yield, however, was 15,000 kilotons—over twice what was expected.⁶ The radioactive fallout covered an area larger than anticipated and because of a faulty weather prediction, the fallout pattern was more easterly than expected. A Japanese fishing boat, which had accidentally wandered into the restricted zone without being detected by the Task Force, was showered with fallout. When the fishing boat docked in Japan, 23 crew members had radiation sickness. The radio operator died of infectious hepatitis, probably because of the large number of required blood transfusions.⁷ The faulty fallout prediction also led to the overexposure of the inhabitants of two of the Marshall Islands 100 miles to the East. In a similar though less severe accident, radioactive rain from a Soviet thermonuclear test fell on Japan.⁸ These accidents began to focus worldwide attention on the increased level of nuclear testing and the dangers of radioactive fallout. Public opposition to atmospheric testing would continue to mount as knowledge of the effects of radiation increased and it became apparent that no region of the world was untouched.⁹

Attempts to negotiate a ban on nuclear testing began at the United Nations Disarmament Confer-

ence in May 1955. For the next several years efforts to obtain a test ban were blocked as agreements in nuclear testing were linked to progress in other arms control agreements and as differences over verification requirements remained unresolved. In 1958, President Eisenhower and Soviet Premier Khrushchev declared, through unilateral public statements, a moratorium on nuclear testing and began negotiations on a comprehensive test ban. The United States adopted the moratorium after conducting 13 tests in seven days at the end of October 1958. Negotiations broke down first over the right to perform onsite inspections, and then over the number of such inspections. In December 1959, President Eisenhower announced that the United States would no longer consider itself bound by the "voluntary moratorium" but would give advance notice if it decided to resume testing. Meanwhile (during the moratorium), the French began testing their newly acquired nuclear capability. The Soviet Union, which had announced that it would observe the moratorium as long as the western powers would not test, resumed testing in September 1961 with a series of the largest tests ever conducted. The United States resumed testing two weeks later (figure 2-1).¹⁰

Public opposition to nuclear testing continued to mount. Recognizing that the U.S. could continue its development program solely through underground testing and that the ratification of a comprehensive test ban could not be achieved, President Kennedy proposed a limited ban on tests in the atmosphere, the oceans, and space. The Soviets, who through their own experience were convinced that their test program could continue underground, accepted the proposal. With both sides agreeing that such a treaty could be readily verified, the Limited Test Ban Treaty (LTBT) was signed in 1963, banning all aboveground or underwater testing.

In addition to military applications, the engineering potential of nuclear weapons was recognized by the mid-1950's. The Plowshare Program was formed in 1957 to explore the possibility of using nuclear explosions for peaceful purposes.¹¹ Among the

⁶Bravo was the largest test ever detonated by the United States.

⁷See "The Voyage of the Lucky Dragon," Ralph E. Lapp, 1957. Harper & Brothers Publishers, New York.

⁸"Arms Control and Disarmament Agreements," United States Arms Control and Disarmament Agency, Washington, DC, 1982 Edition, p. 34.

⁹Since the large thermonuclear tests, all people have strontium-90 (a sister element of calcium) in their bones, and cesium-137 (a sister element of potassium) in their muscle. Also, the amount of iodine-131 in milk in the United States correlates with the frequency of atmospheric testing.

¹⁰See "Arms Control and Disarmament Agreements," United States Arms Control and Disarmament Agency, 1982 edition.

¹¹The name is from "... they shall beat their swords into plowshares," Isaiah 2:4.

Figure 2-1—U.S. Nuclear Testing

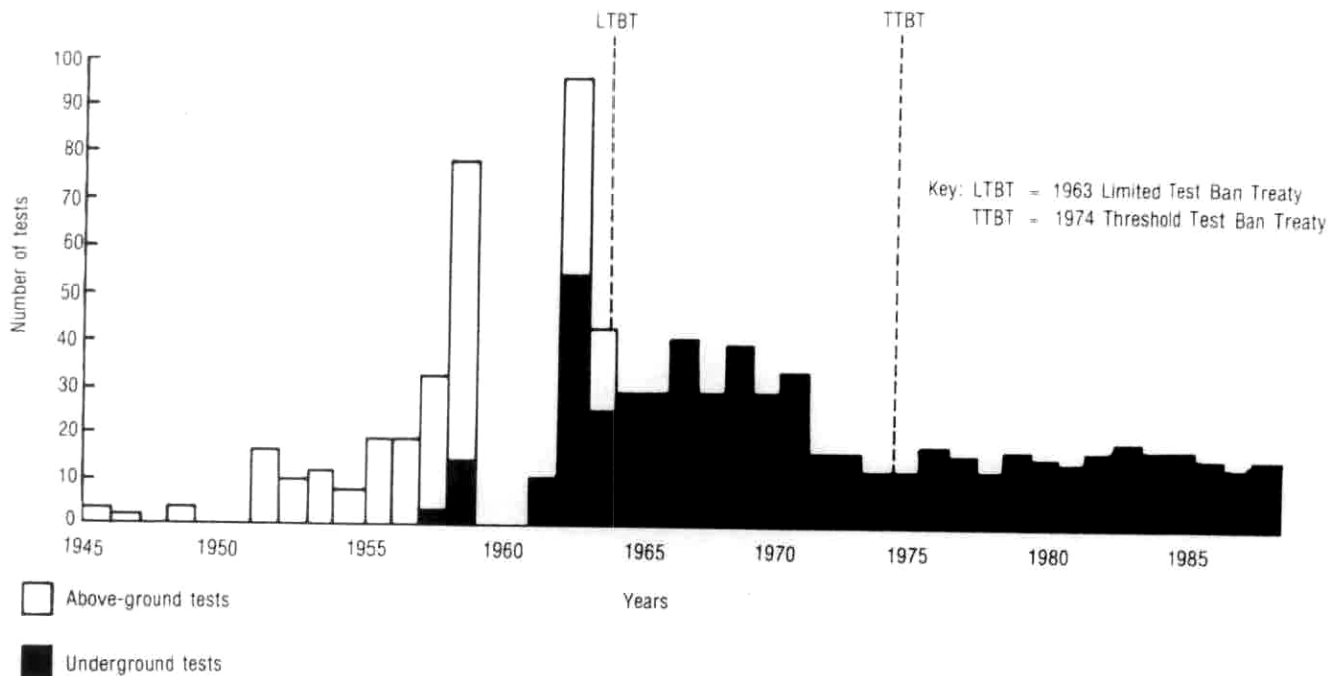

SOURCE: Data from the Swedish Defense Research Institute.

applications considered were the excavation of canals and harbors, the creation of underground storage cavities for fuel and waste, the fracturing of rock to promote oil and gas flow, and the use of nuclear explosions to cap oil gushers and extinguish fires. It was reported that even more exotic applications, such as melting glaciers for irrigation, were being considered by the Soviet Union.

The first test under the Plowshare Program, "Gnome," was conducted 4 years later to create an underground cavity in a large salt deposit. The next Plowshare experiment, Sedan in 1962, used a 104 kiloton explosion to excavate 12 million tons of earth. In 1965, the concept of "nuclear excavation" was refined and proposed as a means of building a second canal through Panama.¹² Three nuclear excavations were tested under the Plowshare program ("Cabriolet," Jan. 26, 1968; "Buggy," Mar. 12, 1968; and "Schooner," Dec. 12, 1968). Schooner, however, released radioactivity off site and, as a consequence, no future crater test was approved. Consideration of the radiological and logistical aspects of the project also contributed to its demise.

Estimates of the engineering requirements indicated that approximately 250 separate nuclear explosions with a total yield of 120 megatons would be required to excavate the canal through Panama. Furthermore, fallout predictions indicated that 16,000 square kilometers of territory would need to be evacuated for the duration of the operation and several months thereafter.¹³ Because it was also clear that no level of radioactivity would be publicly acceptable, the program was terminated in the early 1970s.

In 1974, President Richard Nixon signed the Threshold Test Ban Treaty (TTBT) restricting all nuclear test explosions to a defined test site and to yields no greater than 150 kilotons. As a result, all U.S. underground nuclear tests since 1974 have been conducted at the Nevada Test Site. As part of the earlier 1963 Limited Test Ban Treaty, the United States established a series of safeguards. One of them, "Safeguard C," requires the United States to maintain the capability to resume atmospheric testing in case the treaty is abrogated. The Department of Energy (DOE) and the Defense Nuclear Agency continue today to maintain a facility for the

¹²The 1956 war over the Suez Canal created the first specific proposals for using nuclear explosions to create an alternative canal.

¹³Bruce A. Bolt, "Nuclear Explosions and Earthquakes, The Parted Veil" San Francisco, CA: W.H. Freeman & Co., 1976, pp. 192-196.

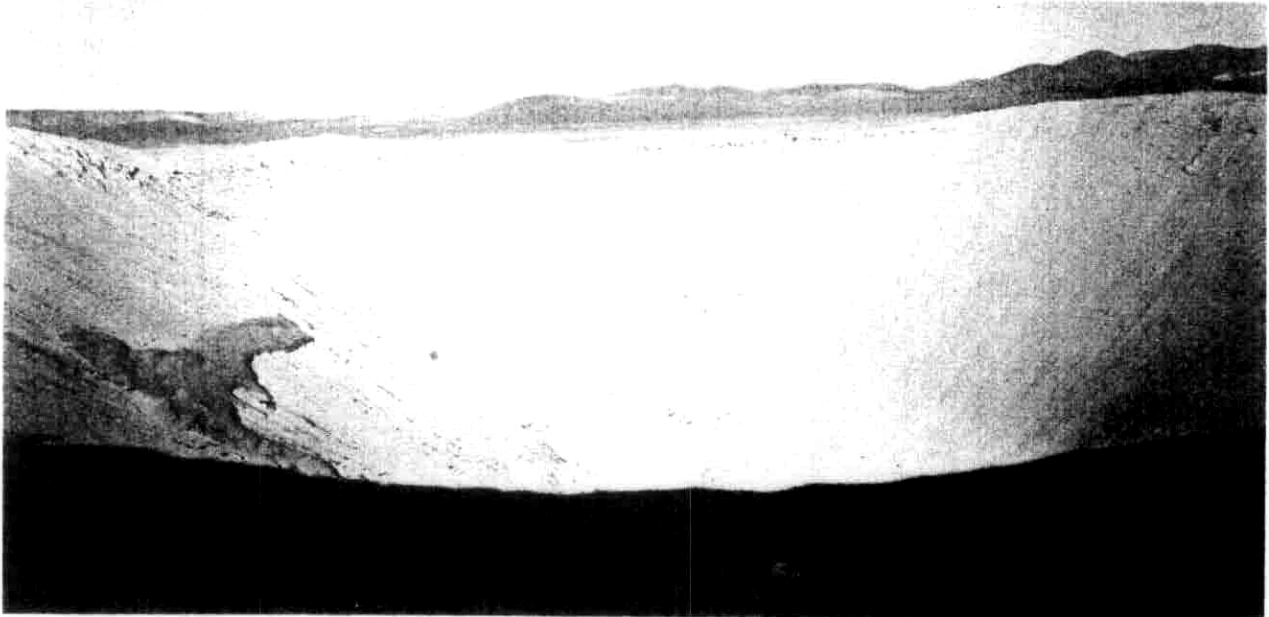

Photo credit: David Graham, 1988

Sedan Crater

atmospheric testing of nuclear weapons at the Johnston Atoll in the Pacific Ocean.

LIMITS ON NUCLEAR TESTING

The testing of nuclear weapons by the United States is currently restricted by three major treaties that were developed for both environmental and arms control reasons. The three treaties are:

1. the 1963 Limited Nuclear Test Ban Treaty, which bans nuclear explosions in the atmosphere, outer space, and underwater, and restricts the release of radiation into the atmosphere,
2. the 1974 Threshold Test Ban Treaty, which restricts the testing of underground nuclear weapons by the United States and the Soviet Union to yields no greater than 150 kilotons, and
3. the 1976 Peaceful Nuclear Explosions Treaty (PNET), which is a complement to the Threshold Test Ban Treaty (TTBT). It restricts individual peaceful nuclear explosions (PNEs) by the United States and the Soviet Union to yields no greater than

150 kilotons, and group explosions (consisting of a number of individual explosions detonated simultaneously) to aggregate yields no greater than 1,500 kilotons.

Although both the 1974 TTBT and the 1976 PNET remain unratified, both the United States and the Soviet Union have expressed their intent to abide by the yield limit. Because neither country has indicated an intention not to ratify the treaties, both parties are obligated to refrain from any acts that would defeat their objective and purpose.¹⁴ Consequently, all nuclear test explosions compliant with treaty obligations must be conducted underground, at specific test sites (unless a PNE), and with yields no greater than 150 kilotons. The test must also be contained to the extent that no radioactive debris is detected outside the territorial limits of the country that conducted the test.¹⁵ Provisions do exist, however, for one or two slight, unintentional breaches per year of the 150 kiloton limit due to the technical uncertainties associated with predicting the exact yields of nuclear weapons tests.¹⁶

¹⁴Art. 18, 1969 Vienna Convention on the Law of Treaties.

¹⁵Art. I, 1(b), 1963 Limited Test Ban Treaty.

¹⁶Statement of understanding included with the transmittal documents accompanying the Threshold Test Ban Treaty and the Peaceful Nuclear Explosions Treaty when submitted to the Senate for advice and consent to ratification on July 29, 1979.

OTHER LOCATIONS OF NUCLEAR TESTS

U.S. nuclear test explosions were also conducted in areas other than the Pacific and the Nevada Test Site.

Three tests with yields of 1 to 2 kilotons were conducted over the South Atlantic as "Operation Argus." The tests ("Argus I," Aug. 27, 1958; "Argus II," Aug. 30, 1958; and "Argus III," Sept. 6, 1958) were detonated at an altitude of 300 miles to assess the effects of high-altitude nuclear detonations on communications equipment and missile performance.

Five tests, all involving chemical explosions but with no nuclear yield, were conducted at the Nevada Bombing Range to study plutonium dispersal. The tests, "Project 57 NO 1," April 24, 1957; "Double Tracks," May 15, 1963; "Clean Slate I," May 25, 1963; "Clean Slate II," May 31, 1963; and "Clean Slate III," June 9, 1963; were safety tests to establish storage and transportation requirements.

Two tests were conducted in the Tatum Salt Dome near Hattiesburg, Mississippi, as part of the Vela Uniform experiments to improve seismic methods of detecting underground nuclear explosions. The first test "Salmon," October 22, 1964, was a 5.3 kiloton explosion that formed an underground cavity. The subsequent test "Sterling," December 3, 1966, was 0.38 kt explosion detonated in the cavity formed by Salmon. The purpose of the Salmon/Sterling experiment was to assess the use of a cavity in reducing the size of seismic signals produced by an underground nuclear test.¹⁷

Three joint government-industry tests were conducted as part of the Plowshare Program to develop peaceful uses of nuclear explosions. The experiments were designed to improve natural gas extraction by fracturing rock formations. The first test, "Gasbuggy," was a 29 kiloton explosion detonated on December 10, 1967, near Bloomfield, New Mexico. The next two were in Colorado: "Rulison" was a 40 kiloton explosion, detonated near Grand Valley on September 10, 1969; and "Rio Blanco"

was a salvo shot of three explosions, each with a yield of 33 kt, detonated near Rifle on May 17, 1973.

Three tests were conducted on Amchitka Island, Alaska. The first (October 29, 1965), "Long Shot" was an 80 kiloton explosion that was part of the Vela Uniform project. The second test, "Milrow," October 2, 1969, was about a one megaton explosion to "calibrate" the island and assure that it would contain a subsequent test of the Spartan Anti-Ballistic Missile warhead. The third test, "Cannikin," November 6, 1971, was the Spartan warhead test with a reported yield of "less than five megatons." This test, by far the highest-yield underground test ever conducted by the United States, was too large to be safely conducted in Nevada.¹⁸

Three individual tests were also conducted in various parts of the western United States. "Gnome" was a 3 kiloton test conducted on December 10, 1961 near Carlsbad, New Mexico, to create a large underground cavity in salt as part of a multipurpose experiment. One application was the possible use of the cavity for the storage of oil and gas. "Shoal" was a 12 kiloton test conducted on October 26, 1963 near Fallon, Nevada as part of the Vela Uniform project. "Faultless" was a test with a yield of between 200 and 1,000 kiloton that was exploded on January 19, 1968, at a remote area near Hot Creek Valley, Nevada. Faultless was a ground-motion calibration test to evaluate a Central Nevada Supplemental Test Area. The area was proposed as an alternative location for high-yield tests to decrease the ground shaking in Las Vegas.

THE NEVADA TEST SITE

The Nevada Test Site is located 65 miles northwest of Las Vegas. It covers 1,350 square miles, an area slightly larger than Rhode Island (figure 2-2). The test site is surrounded on three sides by an additional 4,000 to 5,000 square miles belonging to Nellis Air Force Base and the Tonopah Test Range. The test site has an administrative center, a control point, and areas where various testing activities are conducted.

At the southern end of the test site is Mercury, the administrative headquarters and supply base for

¹⁷For a complete discussion of the issues related to Seismic Verification see, U.S. Congress, Office of Technology Assessment, *Seismic Verification of Nuclear Testing Treaties*. OTA-ISC-361, Washington, DC: U.S. Government Printing Office, May 1988.

¹⁸The predictions of ground motion suggested that an unacceptable amount (in terms of claims and dollars) of damage would occur to structures if the test was conducted in Nevada.

Figure 2-2—Nevada Test Site

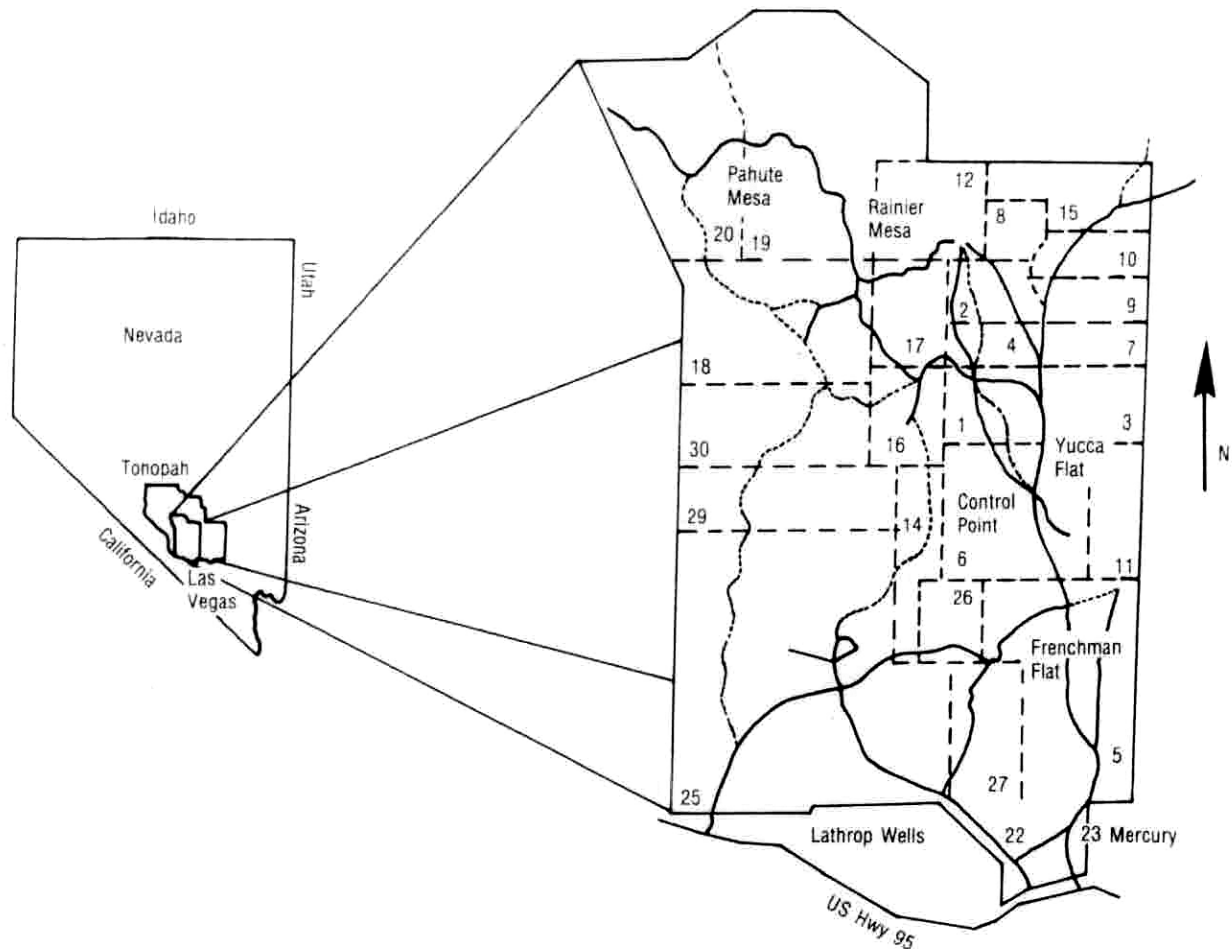

SOURCE: Modified from Department of Energy.

DOE contractors and other agencies involved in Nevada Operations. Mercury contains a limited amount of housing for test site personnel and other ground support facilities.

Near the center of the test site, overlooking Frenchman Flat to the South and Yucca Flat to the North, is the Control Point (CP). The CP is the command headquarters for testing activities and is the location from which all tests are detonated and monitored.

Frenchman Flat is the location of the first nuclear test at the test site. A total of 14 atmospheric tests occurred on Frenchman Flat between 1951 and 1962. Most of these tests were designed to determine

the effects of nuclear explosions on structures and military objects. The area was chosen for its flat terrain which permitted good photography of detonations and fireballs. Also, 10 tests were conducted underground at Frenchman Flat between 1965 and 1971. Frenchman Flat is no longer used as a location for testing. The presence of carbonate material makes the area less suitable for underground testing than other locations on the test site.¹⁹

Yucca Flat is where most underground tests occur today. These tests are conducted in vertical drill holes up to 10 feet in diameter and from 600 ft to more than 1 mile deep. It is a valley 10 by 20 miles extending north from the CP. Tests up to about 300 kilotons in yield have been detonated beneath Yucca

¹⁹During an explosion, carbonate material can form carbon dioxide which, under pressure, can cause venting.



Photo credit: David Graham, 1988

Test Debris on Frenchman Flat

Flat, although Pahute Mesa is now generally reserved for high-yield tests.

Tests up to 1,000 kilotons in yield have occurred beneath Pahute Mesa, a 170 square mile area in the extreme north-western part of the test site. The deep water table of Pahute Mesa permits underground testing in dry holes at depths as great as 2,100 feet. The distant location is useful for high-yield tests because it minimizes the chance that ground motion will cause damage offsite.

Both Livermore National Laboratory and Los Alamos National Laboratory have specific areas of the test site reserved for their use. Los Alamos uses areas 1, 3, 4(east), 5, and 7 in Yucca Flat and area 19

on Pahute Mesa; Livermore uses areas 2, 4(west), 8, 9, and 10 in Yucca Flat, and area 20 on Pahute Mesa (figure 2-2). While Los Alamos generally uses Pahute Mesa only to relieve schedule conflicts on Yucca Flat, Livermore normally uses it for large test explosions where the depth of burial would require the test to be below the water table on Yucca Flat.

The Nevada Test Site employs over 11,000 people, with about 5,000 of them working on the site proper. The annual budget is approximately \$1 billion divided among testing nuclear weapons (81%) and the development of a storage facility for radioactive waste (19%). The major contractors are Reynolds Electrical & Engineering Co., Inc. (REECo).

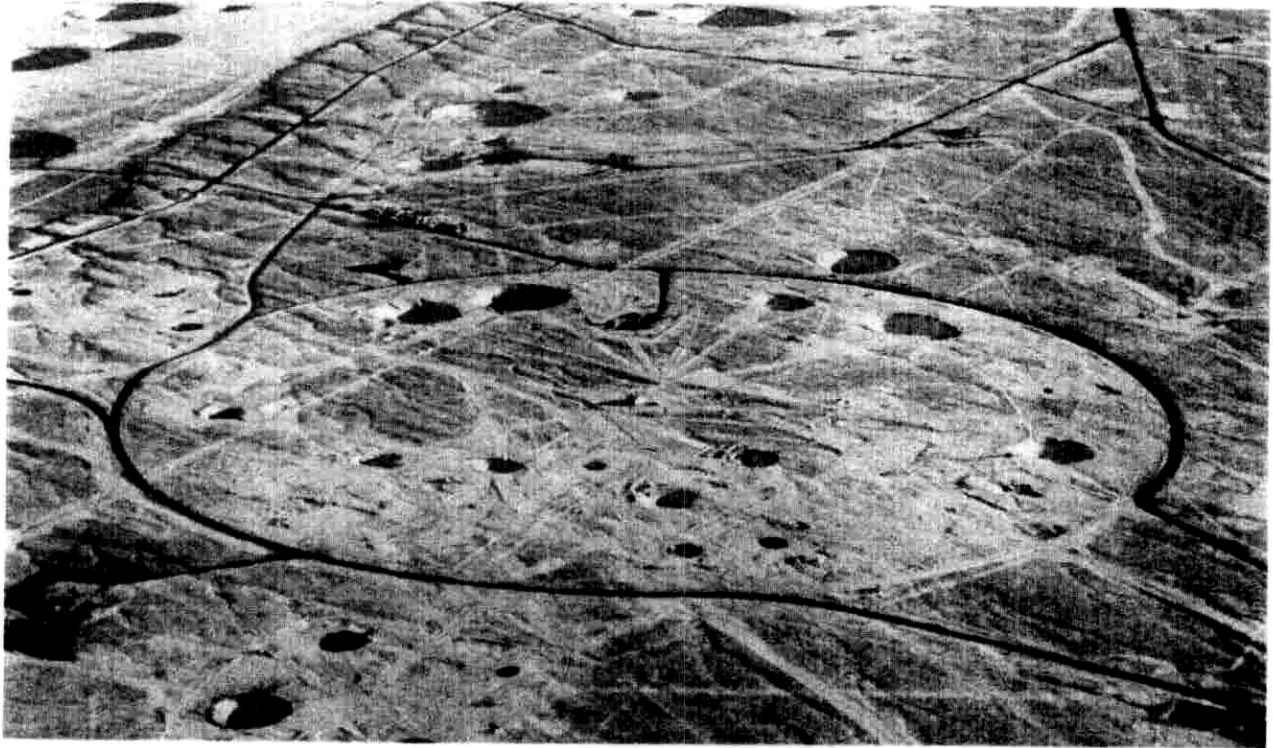

Photo credit: Department of Energy

Aerial View of Yucca Flat

Edgerton, Germeshausen & Greer (EG&G), Fenix & Scisson, Inc., and Holmes & Narver, Inc. REECO has 5,000 employees at the test site for construction, maintenance, and operational support, which includes large diameter drilling and tunneling, on-site radiation monitoring, and operation of base camps. EG&G has 2,200 employees, who design, fabricate, and operate the diagnostic and scientific equipment. Fenix & Scisson, Inc. handles the design, research, inspection, and procurement for the drilling and mining activities. Holmes & Narver, Inc. has responsibility for architectural design, engineering design, and inspection. In addition to contractors, several government agencies provide support to the testing program: the Environmental Protection Agency (EPA) has responsibility for radiation monitoring outside the Nevada Test Site; the National Oceanic and Atmospheric Administration (NOAA) provides weather analyses and predictions; and the United States Geological Survey (USGS) provides geological, geophysical, and hydrological assessments of test locations.

TYPES OF NUCLEAR TESTS

Presently, an average of more than 12 tests per year are conducted at the Nevada Test Site. Each test is either at the bottom of a vertical drill hole or at the end of a horizontal tunnel. The vertical drill hole tests are the most common (representing over 90% of all tests conducted) and occur either on Yucca Flat or, if they are large-yield tests, on Pahute Mesa. Most vertical drill hole tests are for the purpose of developing new weapon systems. Horizontal tunnel tests are more costly and time-consuming. They only occur once or twice a year and are located in tunnels mined in the Rainier and Aqueduct Mesas. Tunnel tests are generally for evaluating the effects (radiation, ground shock, etc.) of various weapons on military hardware and systems. In addition, the United Kingdom also tests at a rate of about once a year at the Nevada Test Site.

It takes 6 to 8 weeks to drill a hole depending on depth and location. The holes used by Livermore and Los Alamos differ slightly. Los Alamos typically uses holes with diameters that range from about 4

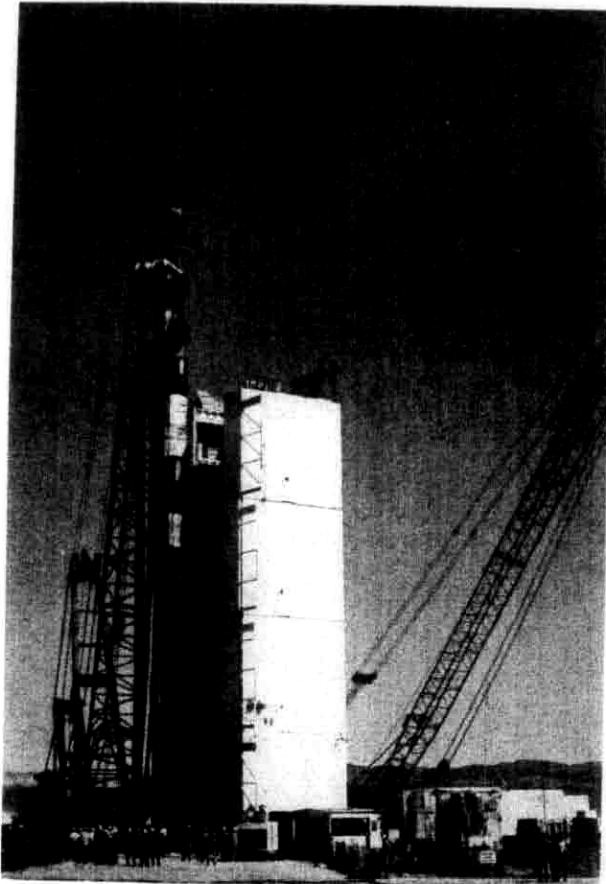

Photo credit: Department of Energy

Emplacement Tower for Vertical Drill Hole Test

1/2 up to 7 ft; while Livermore typically uses 8-ft diameter holes and an occasional 10-ft diameter hole.²⁰ Livermore usually places its experimental devices above the water table to avoid the additional time and expense required to case holes below the water table.

When the device is detonated at the bottom of a vertical drill hole, data from the test are transmitted through electrical and fiber-optic cables to trailers containing recording equipment. Performance information is also determined from samples of radioactive material that are recovered by drilling back into the solidified melt created by the explosion (figure 2-3). On rare occasions, vertical drill holes have been used for effects tests. One such test, "Huron King," used an initially open, vertical "line-of-sight" pipe that extended upwards to a large

²⁰Livermore has considered the use of 12 ft diameter holes, but has not yet used one.

Figure 2-3—Drill-Back Operation

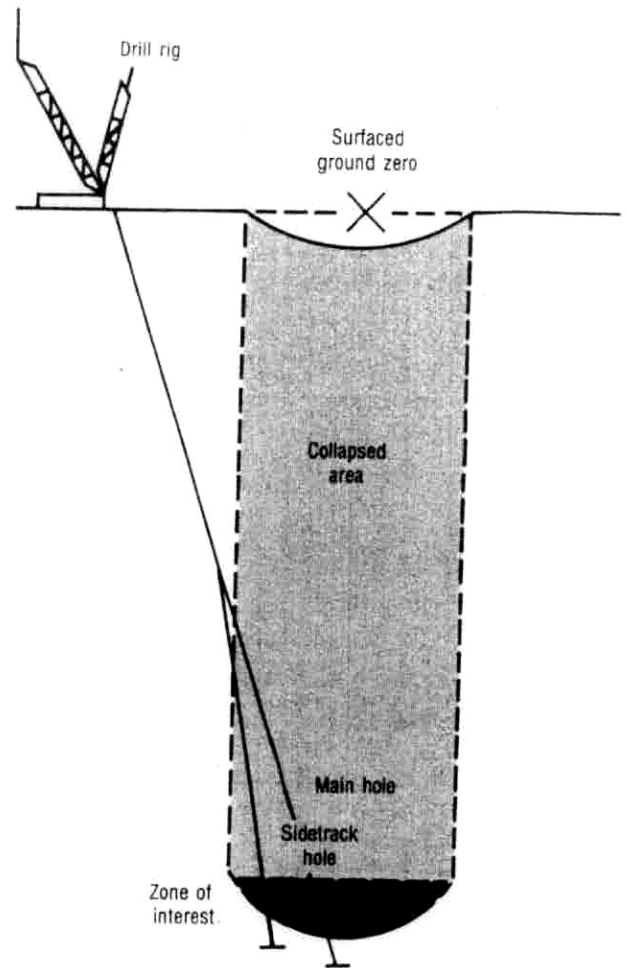

SOURCE: Modified from Michael W. Butler, *Pastshot Drilling Handbook*, Lawrence Livermore National Laboratory, Jan. 19, 1984.

enclosed chamber located at the surface. The chamber contained a satellite inside a vacuum to simulate the conditions of space. The radiation from the explosion was directed up the hole at the satellite. The explosion was contained by a series of mechanical pipe closures that blocked the pipe immediately after the initial burst of radiation. The purpose of the test was to determine how satellites might be affected by the radiation produced by a nuclear explosion.

Tunnel tests occur within horizontal tunnels that are drilled into the volcanic rock of Rainier or Aqueduct Mesa. From 1970 through 1988, there

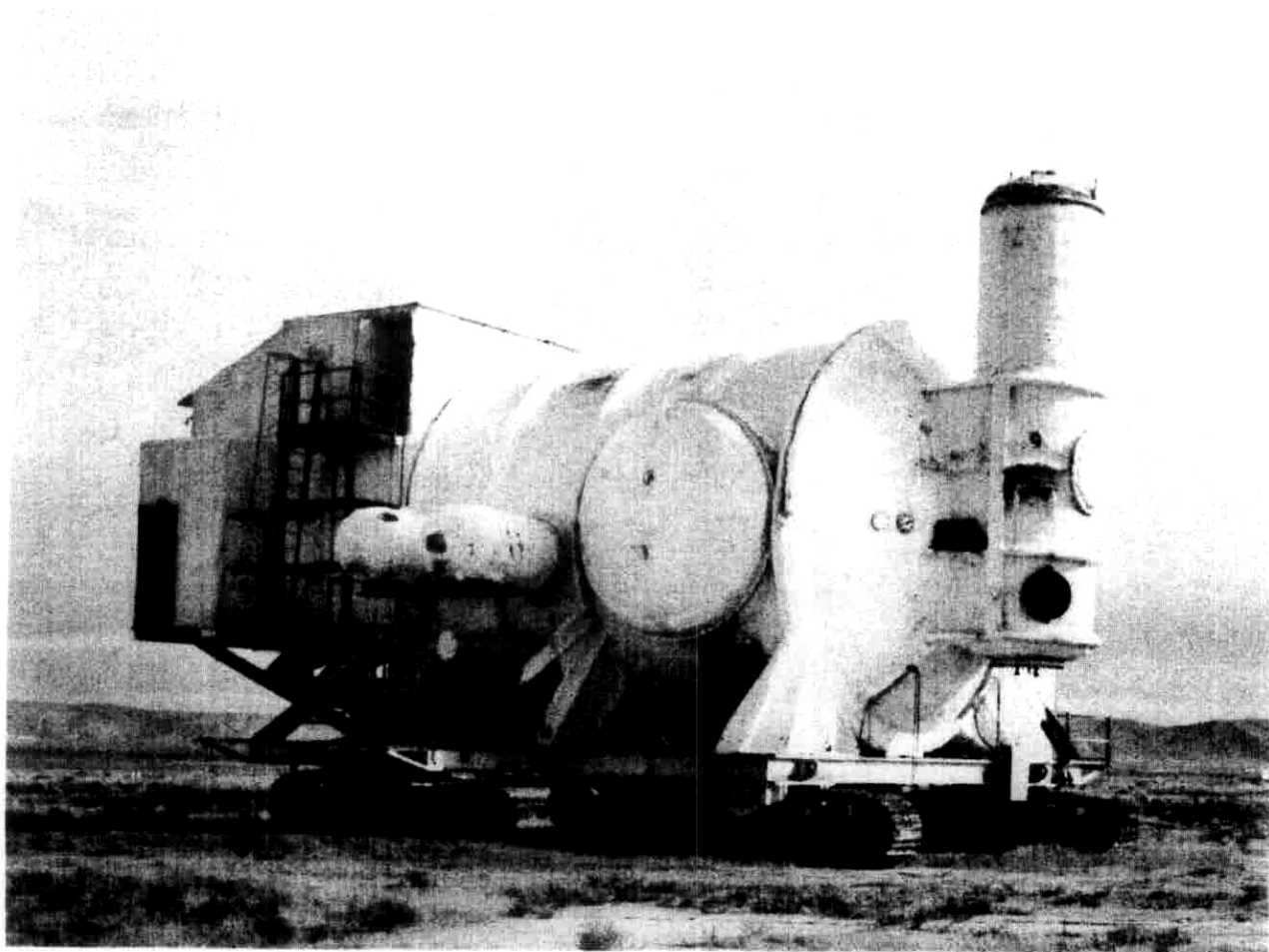

Photo credit: David Graham, 1988

Huron King Test

have been 31 tunnel tests conducted in Rainier and Aqueduct Mesas (figure 2-4). It may require 12 months of mining, using three shifts a day, to remove the 1 million cubic feet of rock that may be needed to prepare for a tunnel test.

Effects tests performed within mined tunnels are designed to determine the effects of nuclear explosion-produced radiation on missile nose cones, warheads, satellites, communications equipment, and other military hardware. The tunnels are large enough so that satellites can be tested at full scale in vacuum chambers that simulate outer space. The tests are used to determine how weapons systems will withstand radiation that might be produced by a nearby explosion during a nuclear war. Nuclear

effects tests were the first type of experiments performed during trials in the Pacific and were an extensive part of the testing program in the 1950s. At that time, many tests occurred above ground and included the study of effects on structures and civil defense systems.

Effects tests within cavities provide a means of simulating surface explosions underground. A large hemispherical cavity is excavated and an explosion is detonated on or near the floor of the cavity. The tests are designed to assess the capability of above-ground explosions to transmit energy into the ground. This information is used to evaluate the capability of nuclear weapons to destroy such targets as missile silos or underground command centers.

Figure 2-4—Locations of Tunnel Tests In Rainier and Aqueduct Mesas

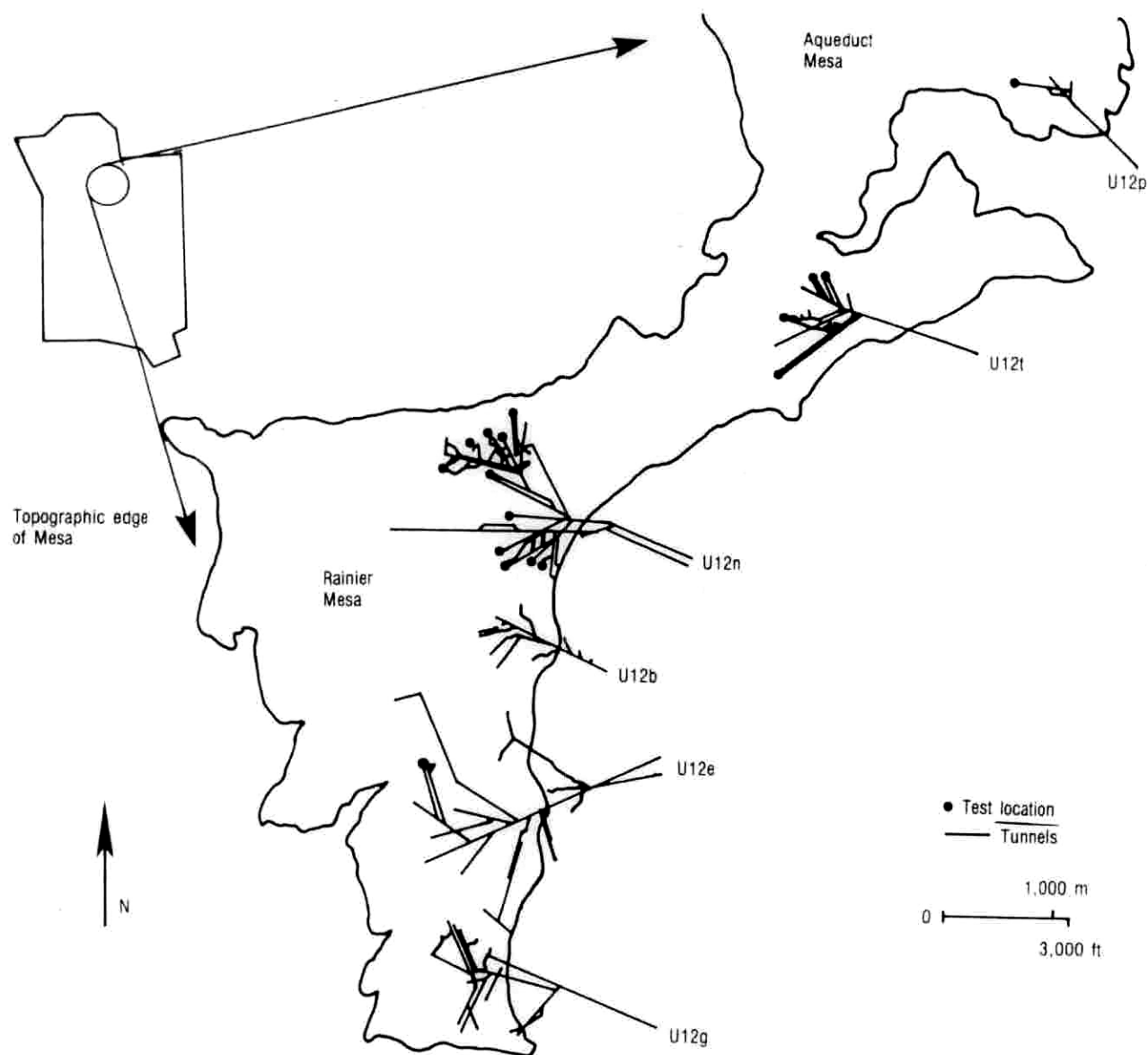

SOURCE: Modified from Defense Nuclear Agency.

ANNOUNCEMENT OF NUCLEAR TESTS

The existence of each nuclear test conducted prior to the signing of the LTBT on August 5, 1963, has been declassified. Many tests conducted since the signing of the LTBT, however, have not been announced. Information concerning those tests is classified. The yields of announced tests are pres-

ently reported only in the general categories of either less than 20 kilotons, or 20 to 150 kilotons. The DOE's announcement policy is that a test will be pre-announced in the afternoon 2 days before the test if it is determined that the maximum credible yield is such that it could result in perceptible ground motion in Las Vegas. The test will be post announced if there is a prompt release of radioactive material or if any late-time release results in

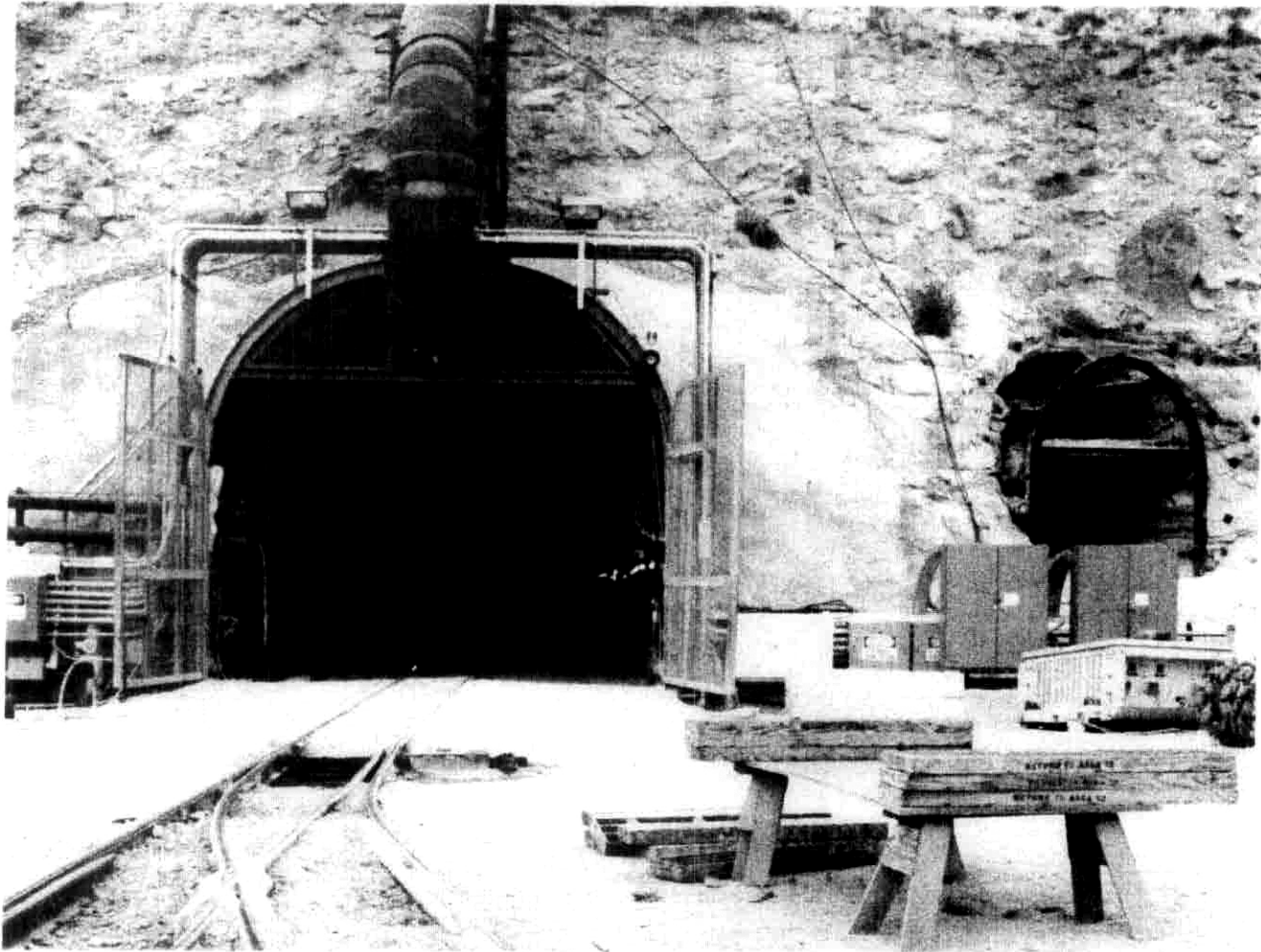

Photo credit: David Graham, 1988

Tunnel Entrance

radioactive material being detected off the test site. In the case of late-time release, however, the test will be announced *only if radioactive material is detected off-site.*

Starting with Trinity, names have been assigned to all nuclear tests. The actual nuclear weapon or device and its description are classified. Consequently, test planners assign innocuous code words or nicknames so that they may refer to planned tests. Early tests used the military phonetic alphabet (Able, Baker, Charlie, etc.). As more tests took place, other names were needed. They include names of rivers, mountains, famous scientists, small mammals, counties and towns, fish, birds, vehicles, cocktails, automobiles, trees, cheeses, wines, fabrics, tools, nautical terms, colors, and so forth.

DETONATION AUTHORITY AND PROCEDURE

The testing of nuclear weapons occurs under the authority of the Atomic Energy Act of 1946 (as amended in 1954), which states:

“The development, use, and control of Atomic Energy shall be directed so as to make the maximum contribution to the general welfare, subject at all times to the paramount objective of making the maximum contribution to the common defense and security.”

The act authorizes the U.S. Atomic Energy Commission (now Department of Energy), to “con-

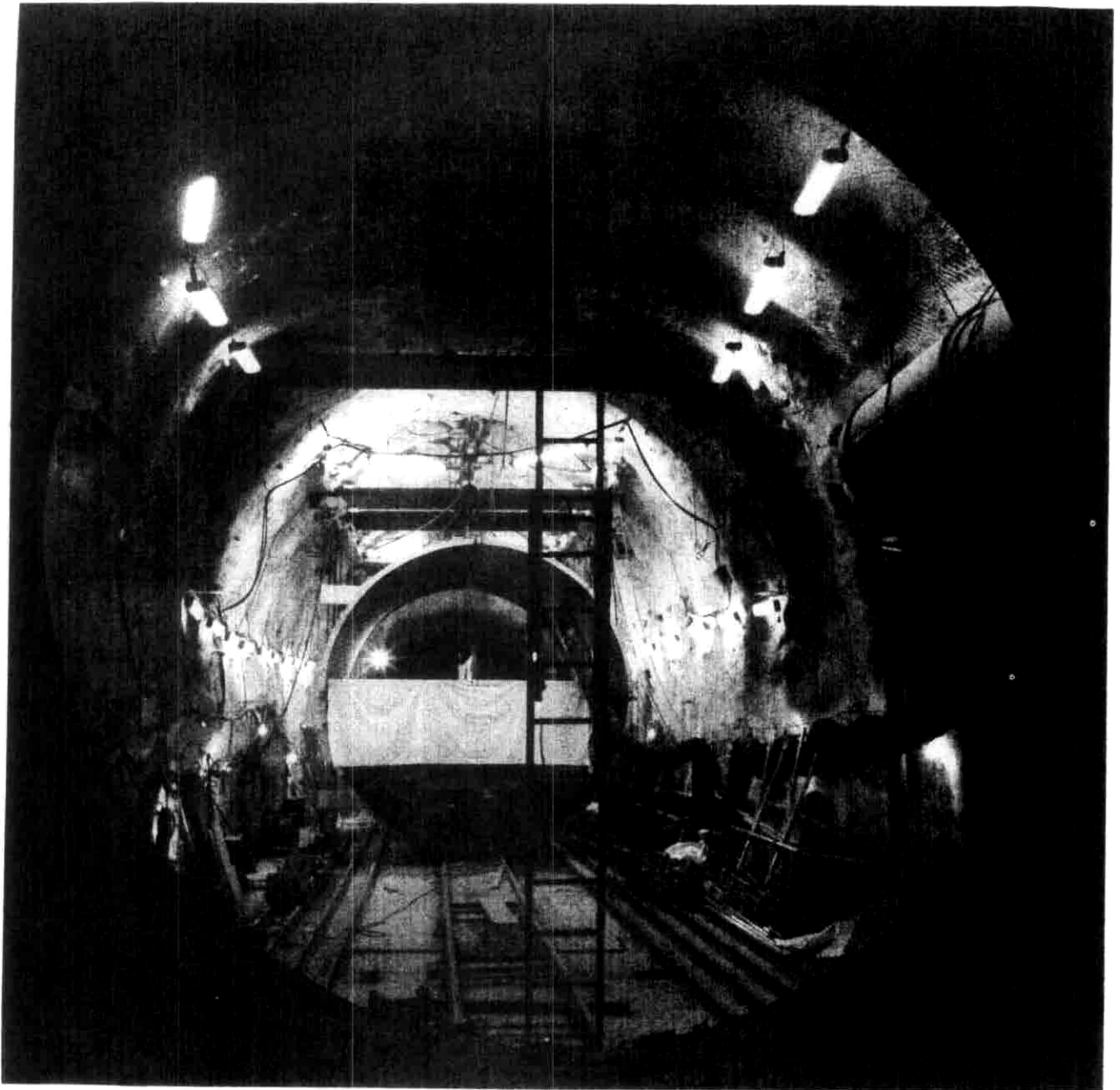

Photo credit: Department of Energy

Interior Tunnel

duct experiments and do research and development work in the military application of atomic energy.”

The fiscal year testing program receives authorization from the President. Each fiscal year, the Department of Defense (DoD), Department of Energy (DOE), and the weapons laboratories (Law-

rence Livermore National Laboratory and Los Alamos National Laboratory) develop a nuclear testing program. The Secretary of Energy proposes the upcoming year’s program in a letter to the President through the National Security Council. The National Security Council solicits comments on the test program from its members and incorporates those

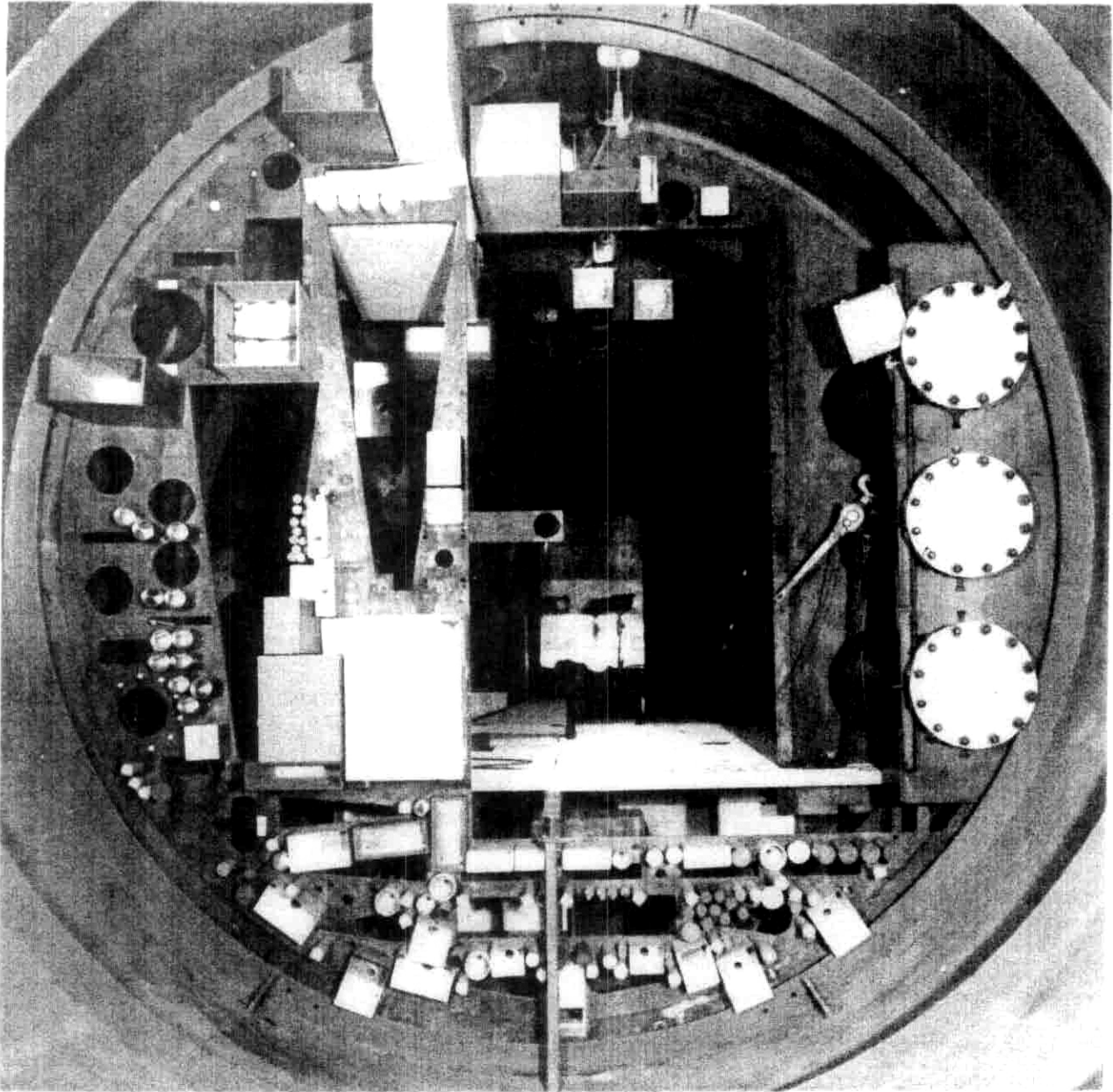

Photo credit: Defense Nuclear Agency

End of Tunnel

comments in its recommendation letter to the President. The Nevada Operations Office plans the individual tests with the responsible laboratory.

Both Livermore and Los Alamos maintain stockpiles of holes in various areas of the test site.²¹ When a specific test is proposed, the lab will check its

inventory to see if a suitable hole is available or if a new one must be drilled.

Once a hole is selected, the sponsoring laboratory designs a plan to fill-in (or "stem") the hole to contain the radioactive material produced by the explosion. The USGS and Earth scientists from several organizations analyze the geology surround-

²¹Each laboratory operates its own drilling crews continuously to maximize the economy of the drilling operation.

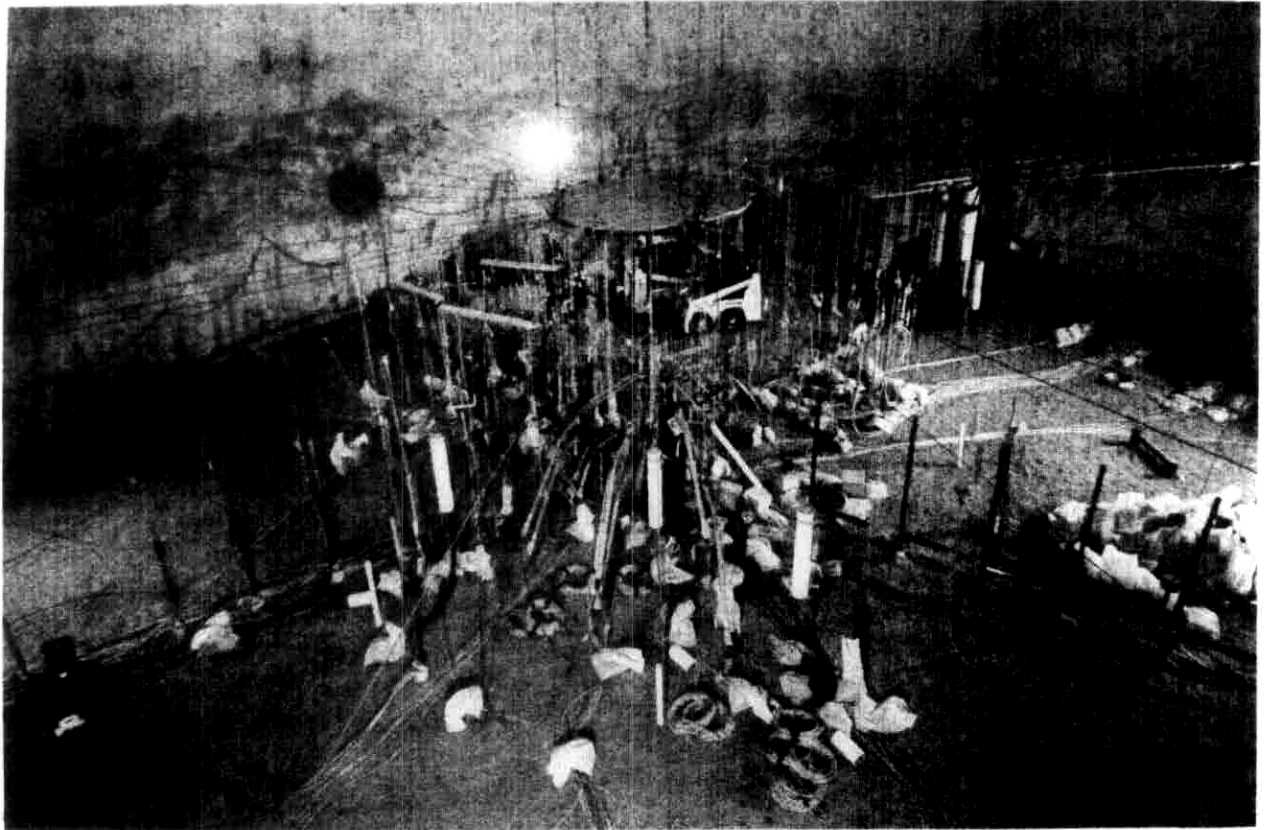

Photo credit: Defense Nuclear Agency

Tunnel Cavity

ing the proposed hole and review it for containment. The laboratory then presents the full containment plan to the Containment Evaluation Panel (CEP) 2 to 3 months in advance of the detonation. The CEP is a panel of experts that review and evaluate the containment plan for each test.²² Each CEP panel member goes on record with a statement concerning his judgment of the containment. The CEP chairman summarizes the likelihood of containment and gives his recommendation to the manager of Nevada Operations.

Following the CEP meeting, a Detonation Authority Request (DAR) package is prepared. The DAR package contains a description of the proposed test, the containment plan, the recommendations of the CEP, the chairman's statement, a review of the

environmental impact, a nuclear safety study,²³ a review of compliance with the TTBT, the public announcement plans, and any noteworthy aspects of the test. The DAR package is sent to the DOE Office of Military Application for approval. Although test preparations are underway throughout the approval process, no irreversible action to conduct the test is taken prior to final approval.

After the test has been approved, the Test Group Director of the sponsoring Laboratory will then request "authority to move, emplace, and stem" the nuclear device from the Nevada test site "Test Controller" for that specific test. The Test Controller also has an advisory panel consisting of a Chairman and three other members. The Chairman (called the Scientific Advisor) is a senior scientist

²²See Ch. 3, "Containment Evaluation Panel."

²³The nuclear safety study prepared by DOE Safety Division contains safety considerations not related to containment, such as the possibility of premature or inadvertent detonation.

²⁴In the case of tests sponsored by the Defense Nuclear Agency (DNA), the Scientific Advisor is from Sandia National Laboratory.

from the sponsoring laboratory.²⁴ The three members are all knowledgeable about the weapons-testing program and consist of:

1. an EPA senior scientist with expertise in radiation monitoring,
2. a weather service senior scientist knowledgeable in meteorology, and
3. a medical doctor with expertise in radiation medicine.

Once the test has been approved for execution by the Test Controller's panel, the Test Controller has sole responsibility to determine when or whether the test will be conducted. The Test Controller and Advisory Panel members conduct the following series of technical meetings to review the test:²⁵

D-7 Safety Planning Meeting: The "D-7 Safety Planning Meeting" is held approximately 1 week before the test. This meeting is an informal review of the test procedure, the containment plan, the expected yield, the maximum credible yield, the potential for surface collapse, the potential ground shock, the expected long-range weather conditions, the location of radiation monitors, the location of all personnel, the security concerns (including the possibility of protesters intruding on the test site), the countdown, the pre-announcement policy, and any other operational or safety aspects related to the test.

D-1 Safety Planning Meeting: The day before the test, the D-1 Safety Planning Meeting is held. This is an informal briefing that reviews and updates all the information discussed at the D-7 meeting.

D-1 Containment Briefing: The D-1 Containment Briefing is a formal meeting. The laboratory reviews again the containment plan and discusses whether all of the stemming and other containment requirements were met. The meeting determines the extent to which the proposed containment plan was carried out in the field.²⁶ The laboratory and contractors provide written statements on their concurrence of the stemming plan.

D-1 Readiness Briefing: The D-1 Readiness Briefing is a formal meeting to review potential

weather conditions and the predicted radiation fallout pattern for the case of an accidental venting.

The night before the test, the weather service sends out observers to release weather balloons and begin measuring wind direction and speed to a height of 1,400 ft above the ground. The area around the test (usually all areas north of the Control Point complex) is closed to all nonessential personnel. The Environmental Protection Agency deploys monitoring personnel off-site to monitor fallout and coordinate protective measures, should they be necessary.

D-Day Readiness Briefing: The morning of the test, the Test Controller holds the "D-Day Readiness Briefing." At this meeting, updates of weather conditions and forecasts are presented. In addition, the weather service reviews the wind and stability measurements to make final revisions to the fallout pattern in the event of an accidental venting. The fallout pattern is used to project exposure rates throughout the potential affected area. The exposure rates are calculated using the standard radiological models of whole-body exposure and infant thyroid dose from a family using milk cows in the fallout region. The status of on-site ground-based and airborne radiation monitoring is reviewed. The location of EPA monitoring personnel is adjusted to the projected fallout pattern, and the location of all personnel on the test site is confirmed. At the end of the meeting, the Scientific Advisor who is chairman of the Test Controller's Advisory Panel makes a recommendation to the Test Controller to proceed or delay.

If the decision is made to proceed, the Test Controller gives permission for the nuclear device to be armed. The operation of all radiation monitors, readiness of aircraft, location of EPA personnel, etc., are confirmed. If the status remains favorable and the weather conditions are acceptable, the Test Controller gives permission to start the countdown and to fire. If nothing abnormal occurs, the countdown proceeds to detonation. If a delay occurs, the appropriate preparatory meetings are repeated.

²⁴In the case of tests sponsored by the Defense Nuclear Agency (DNA), the Scientific Advisor is from Sandia National Laboratory.

²⁵Although the test has been planned to be contained, test preparations include provisions for an accidental release of radioactive material. Such provisions include the deployment of an emergency response team for each test.

²⁶For example, readings from temperature sensors placed in the stemming plugs are examined to determine whether the plugs have hardened.

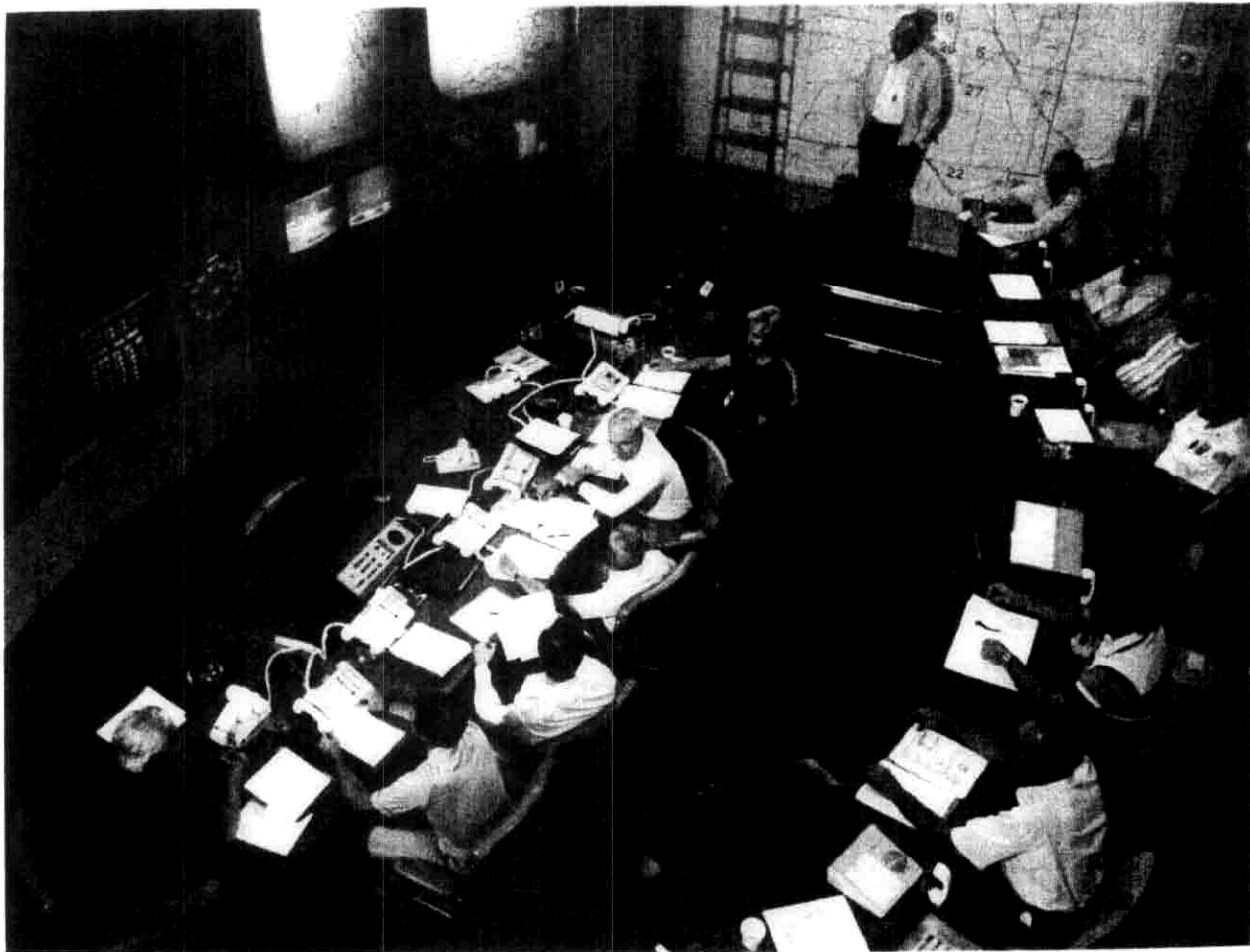

Photo credit: Department of Energy

Test Control Center

Chapter 3

**Containing Underground
Nuclear Explosions**

CONTENTS

| | <i>Page</i> |
|--|-------------|
| INTRODUCTION | 31 |
| WHAT HAPPENS DURING AN UNDERGROUND NUCLEAR EXPLOSION | 32 |
| Microseconds | 32 |
| Milliseconds | 32 |
| Tenths of a Second | 32 |
| A Few Seconds | 32 |
| Minutes to Days | 32 |
| WHY NUCLEAR EXPLOSIONS REMAIN CONTAINED | 34 |
| SELECTING LOCATION, DEPTH, AND SPACING: | 35 |
| REVIEWING A TEST SITE LOCATION | 37 |
| CONTAINMENT EVALUATION PANEL | 38 |
| CONTAINING VERTICAL SHAFT TESTS | 40 |
| CONTAINING HORIZONTAL TUNNEL TESTS | 41 |
| TYPES OF RADIATION RELEASES | 46 |
| Containment Failure: | 46 |
| Late-Time Seep | 46 |
| Controlled Tunnel Purging | 47 |
| Operational Release | 47 |
| RECORD OF CONTAINMENT | 47 |
| Containment Evaluation Panel | 47 |
| Vertical Drill Hole Tests | 48 |
| Horizontal Tunnel Tests | 48 |
| From the Perspective of Human Health Risk | 49 |
| A FEW EXAMPLES: | 49 |
| IS THERE A REAL ESTATE PROBLEM AT NTS? | 51 |
| TIRED MOUNTAIN SYNDROME? | 51 |
| HOW SAFE IS SAFE ENOUGH? | 54 |

Box

| <i>Box</i> | <i>Page</i> |
|----------------------|-------------|
| 3-A. Baneberry | 33 |

Figures

| <i>Figure</i> | <i>Page</i> |
|---|-------------|
| 3-1. Formation of Stress "Containment Cage" | 35 |
| 3-2. Minimum Shot Separation for Drill Hole Tests | 38 |
| 3-3. Minimum Shot Separation for Tunnel Tests | 39 |
| 3-4. "Typical" Stemming Plan | 41 |
| 3-5. Three Redundant Containment Vessels | 42 |
| 3-6. Vessel I | 43 |
| 3-7. Vessel I Closures | 44 |
| 3-8. Tunnel Closure Sequence | 45 |
| 3-9. Typical Post-Shot Configuration | 46 |
| 3-10. Radius of Decrease in Rock Strength | 53 |

Table

| <i>Table</i> | <i>Page</i> |
|---|-------------|
| 3-1. Release From Underground Tests | 48 |

Containing Underground Nuclear Explosions

Underground nuclear tests are designed and reviewed for containment, with redundancy and conservatism in each step.

INTRODUCTION

The United States' first underground nuclear test, codenamed "Pascal-A," was detonated at the bottom of a 499-foot open drill-hole on July 26, 1957.¹ Although Pascal-A marked the beginning of underground testing, above ground testing continued for another 6 years. With testing simultaneously occurring aboveground, the release of radioactive material from underground explosions was at first not a major concern. Consequently, Pascal-A, like many of the early underground tests that were to follow, was conducted "roman candle" style in an open shaft that allowed venting.²

As public sensitivity to fallout increased, guidelines for testing in Nevada became more stringent. In 1956, the weapons laboratories pursued efforts to reduce fallout by using the lowest possible test yields, by applying reduced fission yield or clean technology, and by containing explosions underground. Of these approaches, only underground testing offered hope for eliminating fallout. The objective was to contain the radioactive material, yet still collect all required information. The first experiment designed to contain an explosion completely underground was the "Rainier" test, which was detonated on September 19, 1957. A nuclear device with a known yield of 1.7 kilotons was selected for the test. The test was designed with two objectives: 1) to prevent the release of radioactivity to the atmosphere, and 2) to determine whether diagnostic information could be obtained from an underground test. The test was successful in both objectives. Five more tests were conducted the following year to confirm the adequacy of such testing for nuclear weapons development.

In November 1958, public concern over radioactive fallout brought about a nuclear testing moratorium that lasted nearly 3 years. After the United States resumed testing in September, 1961, almost all testing in Nevada was done underground, while

atmospheric testing was conducted in the Christmas Island and Johnston Island area of the Pacific. From 1961 through 1963, many of the underground tests vented radioactive material. The amounts were small, however, in comparison to releases from aboveground testing also occurring at that time.

With the success of the Rainier test, efforts were made to understand the basic phenomenology of contained underground explosions. Field efforts included tunneling into the radioactive zone, laboratory measurements, and theoretical work to model the containment process. Through additional tests, experience was gained in tunnel-stemming processes and the effects of changing yields. The early attempts to explain the physical reason why underground nuclear explosions do not always fracture rock to the surface did little more than postulate the hypothetical existence of a "mystical magical membrane." In fact, it took more than a decade of underground testing before theories for the physical basis for containment were developed.

In 1963, U.S. atmospheric testing ended when the United States signed the Limited Test Ban Treaty prohibiting nuclear test explosions in any environment other than underground. The treaty also prohibits any explosion that:

... causes radioactive debris to be present outside the territorial limits of the State under whose jurisdiction or control such explosion is conducted.³

With the venting of radioactive debris from underground explosions restricted by treaty, containment techniques improved. Although many U.S. tests continued to produce accidental releases of radioactive material, most releases were only detectable within the boundaries of the Nevada Test Site. In 1970, however, a test codenamed "Baneberry" resulted in a prompt, massive venting. Radioactive material from Baneberry was tracked as far as the Canadian border and focused concern about both the environmental safety and the treaty compliance of

¹The first underground test was the United States' 100th nuclear explosion.

²It is interesting to note that even with an open shaft, 90% of the fission products created by Pascal-A were contained underground.

³Article I.1(b), 1963 Limited Test Ban Treaty

the testing program.⁴ Testing was suspended for 7 months while a detailed examination of testing practices was conducted by the Atomic Energy Commission. The examination resulted in new testing procedures and specific recommendations for review of test containment. The procedures initiated as a consequence of Baneberry are the basis of present-day testing practices.

Today, safety is an overriding concern throughout every step in the planning and execution of an underground nuclear test. Underground nuclear test explosions are designed to be contained, reviewed for containment, and conducted to minimize even the most remote chance of an accidental release of radioactive material. Each step of the testing authorization procedure is concerned with safety; and conservatism and redundancy are built into the system.⁵

WHAT HAPPENS DURING AN UNDERGROUND NUCLEAR EXPLOSION

The detonation of a nuclear explosion underground creates phenomena that occur within the following time frames:

Microseconds

Within a microsecond (one-millionth of a second), the billions of atoms involved in a nuclear explosion release their energy. Pressures within the exploding nuclear weapon reach several million pounds per square inch; and temperatures are as high as 100 million degrees Centigrade. A strong shock wave is created by the explosion and moves outward from the point of detonation.

Milliseconds

Within tens of milliseconds (thousandths of a second), the metal canister and surrounding rock are vaporized, creating a bubble of high pressure steam and gas. A cavity is then formed both by the pressure of the gas bubble and by the explosive momentum imparted to the surrounding rock.

Tenths of a Second

As the cavity continues to expand, the internal pressure decreases. Within a few tenths of a second, the pressure has dropped to a level roughly comparable to the weight of the overlying rock. At this point, the cavity has reached its largest size and can no longer grow.⁶ Meanwhile, the shock wave created by the explosion has traveled outward from the cavity, crushing and fracturing rock. Eventually, the shock wave weakens to the point where the rock is no longer crushed, but is merely compressed and then returns to its original state. This compression and relaxation phase becomes seismic waves that travel through the Earth in the same manner as seismic waves formed by an earthquake.

A Few Seconds

After a few seconds, the molten rock begins to collect and solidify in a puddle at the bottom of the cavity.⁷ Eventually, cooling causes the gas pressure within the cavity to decrease.

Minutes to Days

When the gas pressure in the cavity declines to the point where it is no longer able to support the overlying rock, the cavity may collapse. The collapse occurs as overlying rock breaks into rubble and falls into the cavity void. As the process continues, the void region moves upward as rubble falls downward. The "chimneying" continues until:

- the void volume within the chimney completely fills with loose rubble,
- the chimney reaches a level where the shape of the void region and the strength of the rock can support the overburden material, or
- the chimney reaches the surface.

If the chimney reaches the surface, the ground sinks forming a saucer-like subsidence crater. Cavity collapse and chimney formation typically occur within a few hours of the detonation but sometimes take days or months.

⁴See for example, Bruce A. Bolt, *Nuclear Explosions and Earthquakes* San Francisco, CA. (W.H. Freeman & Co., 1976).

⁵See "Detonation Authority and Procedures" (ch. 2).

⁶See the next section, "How explosions remain contained," for a detailed explanation of cavity formation.

⁷The solidified rock contains most of the radioactive products from the explosion. The performance of the nuclear weapon is analyzed when samples of this material are recovered by drilling back into the cavity.

Box 3-A—Baneberry

The exact cause of the 1970 Baneberry venting still remains a mystery. The original explanation postulated the existence of an undetected water table. It assumed that the high temperatures of the explosion produced steam that vented to the surface. Later analysis, however, discredited this explanation and proposed an alternative scenario based on three geologic features of the Baneberry site: water-saturated clay, a buried scarp of hard rock, and a nearby fault. It is thought that the weak, water-saturated clay was unable to support the containment structure: the hard scarp strongly reflected back the energy of the explosion increasing its force; and the nearby fault provided a pathway that gases could travel along. All three of these features seem to have contributed to the venting. Whatever its cause, the Baneberry venting increased attention on containment and, in doing so, marked the beginning of the present-day containment practices.

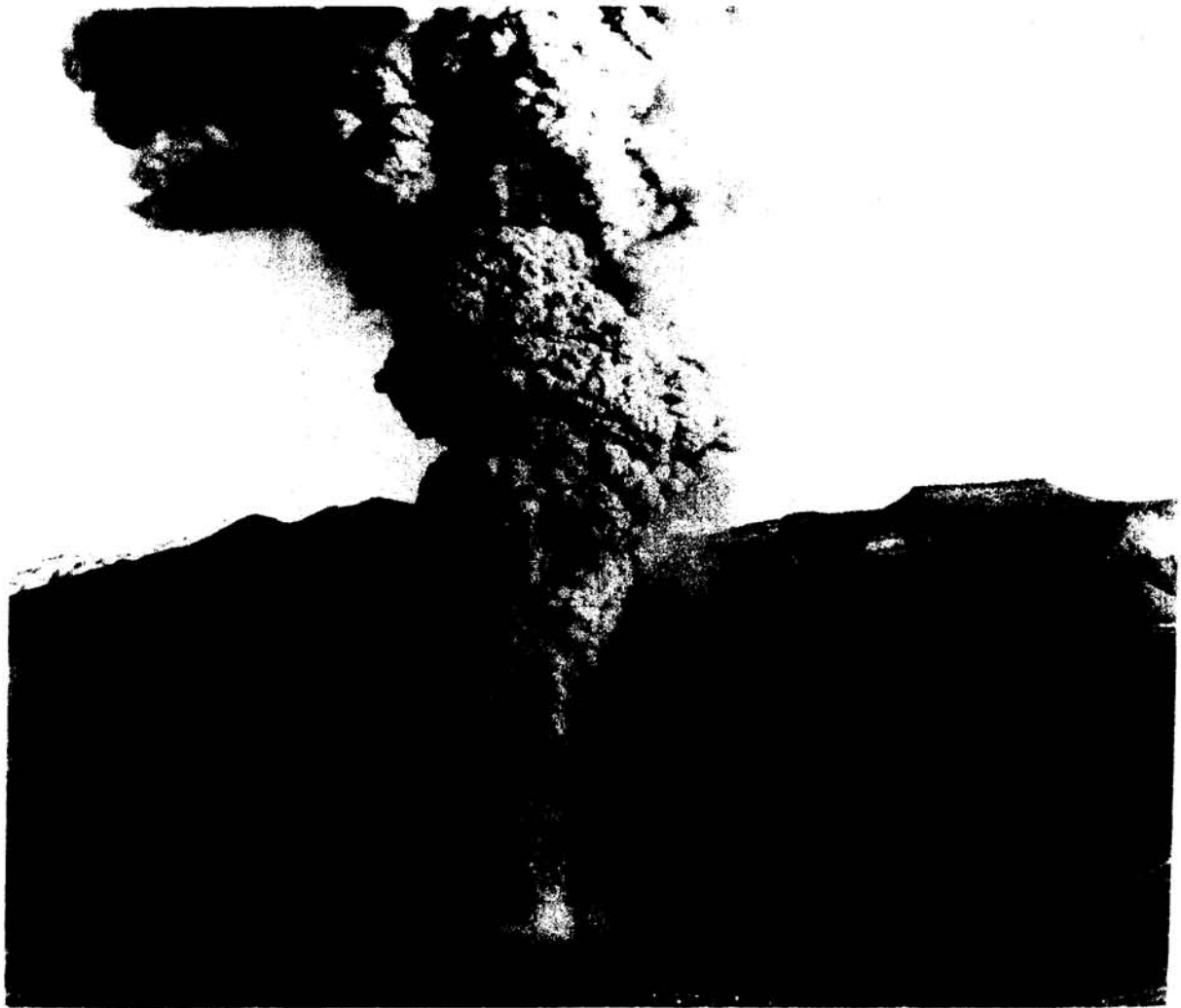

Photo credit: Department of Energy

The venting of Baneberry, 1970.



Photo credit: Harold E. Edgerton

Early phase of fireball from nuclear explosion.

WHY NUCLEAR EXPLOSIONS REMAIN CONTAINED

Radioactive material produced by a nuclear explosion remains underground due to the combined efforts of:

- the sealing nature of compressed rock around the cavity,
- the porosity of the rock,
- the depth of burial,
- the strength of the rock, and
- the stemming of the emplacement hole.

Counter to intuition, only minimal rock strength is required for containment.

At first, the explosion creates a pressurized cavity filled with gas that is mostly steam. As the cavity pushes outward, the surrounding rock is compressed (figure 3-1(a)). Because there is essentially a fixed quantity of gas within the cavity, the pressure decreases as the cavity expands. Eventually the pressure drops below the level required to deform the surrounding material (figure 3-1(b)). Meanwhile, the shock wave has imparted outward motion to the material around the cavity. Once the shock wave has passed, however, the material tries to

return (rebound) to its original position (figure 3-1(c)). The rebound creates a large compressive stress field, called a stress "containment cage", around the cavity (figure 3-1(d)). The physics of the stress containment cage is somewhat analogous to how stone archways support themselves. In the case of a stone archway, the weight of each stone pushes against the others and supports the archway. In the case of an underground explosion, the rebounded rock locks around the cavity forming a stress field that is stronger than the pressure inside the cavity. The stress "containment cage" closes any fractures that may have begun and prevents new fractures from forming.

The predominantly steam-filled cavity eventually collapses forming a chimney. When collapse occurs, the steam in the cavity is condensed through contact with the cold rock falling into the cavity. The noncondensable gases remain within the lower chimney at low pressure. Once collapse occurs, high-pressure steam is no longer present to drive gases from the cavity region to the surface.

If the test is conducted in porous material, such as alluvium or tuff, the porosity of the medium will provide volume to absorb gases produced by the explosion. For example, all of the steam generated by a 150 kiloton explosion beneath the water table can be contained in a condensed state within the volume of pore space that exists in a hemispherical pile of alluvium 200 to 300 feet high. Although most steam condenses before leaving the cavity region, the porosity helps to contain noncondensable gases such as carbon dioxide (CO₂) and hydrogen (H₂). The gas diffuses into the interconnected pore space and the pressure is reduced to a level that is too low to drive the fractures. The deep water table and high porosity of rocks at the Nevada Test Site facilitate containment.

Containment also occurs because of the pressure of overlying rock. The depth of burial provides a stress that limits fracture growth. For example, as a fracture initiated from the cavity grows, gas seeps from the fracture into the surrounding material. Eventually, the pressure within the fracture decreases below what is needed to extend the fracture. At this point, growth of the fracture stops and the gas simply leaks into the surrounding material.

Rock strength is also an important aspect of containment, but only in the sense that an extremely weak rock (such as water-saturated clay) cannot

Figure 3-1—Formation of Stress "Containment Cage"

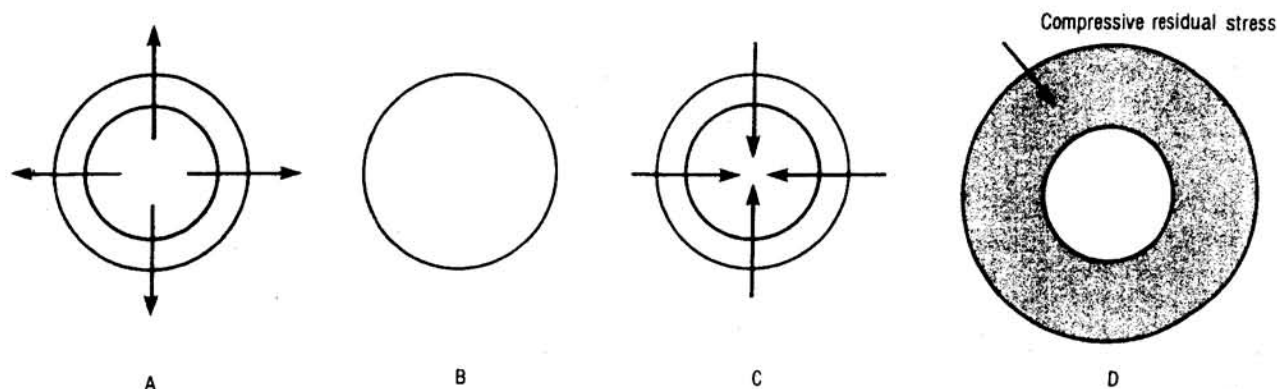

1) Cavity expands outward and deforms surrounding rock. 2) Natural resistance to deformation stops expansion. 3) Cavity contracts (rebounds) from elastic unloading of distant rock. 4) Rebound locks in compressive residual stress around cavity.

SOURCE: Modified from Lawrence Livermore National Laboratory.

support a stress containment cage. Detonation within weak, saturated clay is thought to have been a factor in the release of the Baneberry test. As a result, sites containing large amounts of water-saturated clay are now avoided.

The final aspect of containment is the stemming that is put in a vertical hole after the nuclear device has been emplaced. Stemming is designed to prevent gas from traveling up the emplacement hole. Impermeable plugs, located at various distances along the stemming column, force the gases into the surrounding rock where it is "sponged up" in the pore spaces.

How the various containment features perform depends on many variables: the size of the explosion, the depth of burial, the water content of the rock, the geologic structure, etc. Problems may occur when the containment cage does not form completely and gas from the cavity flows either through the emplacement hole or the overburden material.⁸ When the cavity collapses, the steam condenses and only noncondensable gases such as carbon dioxide (CO₂) and hydrogen (H₂) remain in the cavity.⁹ The CO₂ and H₂ remain in the chimney if there is available pore space. If the quantity of noncondensable gases is large, however, they can act as a driving force to transport radioactivity through

the chimney or the overlying rock. Consequently, the amount of carbonate material and water in the rock near the explosion and the amount of iron available for reaction are considered when evaluating containment.¹⁰

SELECTING LOCATION, DEPTH, AND SPACING

The site for conducting a nuclear test is, at first, selected only on a tentative basis. The final decision is made after various site characteristics have been reviewed. The location, depth of burial, and spacing are based on the maximum expected yield for the nuclear device, the required geometry of the test, and the practical considerations of scheduling, convenience, and available holes. If none of the inventory holes are suitable, a site is selected and a hole drilled.¹¹

The first scale for determining how deep an explosion should be buried was derived from the Rainier test in 1957. The depth, based on the cube root of the yield, was originally:

$$\text{Depth} = 300 (\text{yield})^{1/3},$$

where depth was measured in feet and yield in

⁸Lack of a stress "containment cage" may not be a serious problem if the medium is sufficiently porous or if the depth of burial is sufficient.

⁹The CO₂ is formed from the vaporization of carbonate material; while the H₂ is formed when water reacts with the iron in the nuclear device and diagnostics equipment.

¹⁰The carbonate material in Frenchman Flat created CO₂ that is thought to have caused a seep during the Diagonal Line test (Nov. 24, 1971). Diagonal Line was the last test on Frenchman Flat; the area is currently considered impractical for underground testing largely because of the carbonate material.

¹¹See ch. 2, "The Nevada Test Site," for a description of the areas each Laboratory uses for testing.

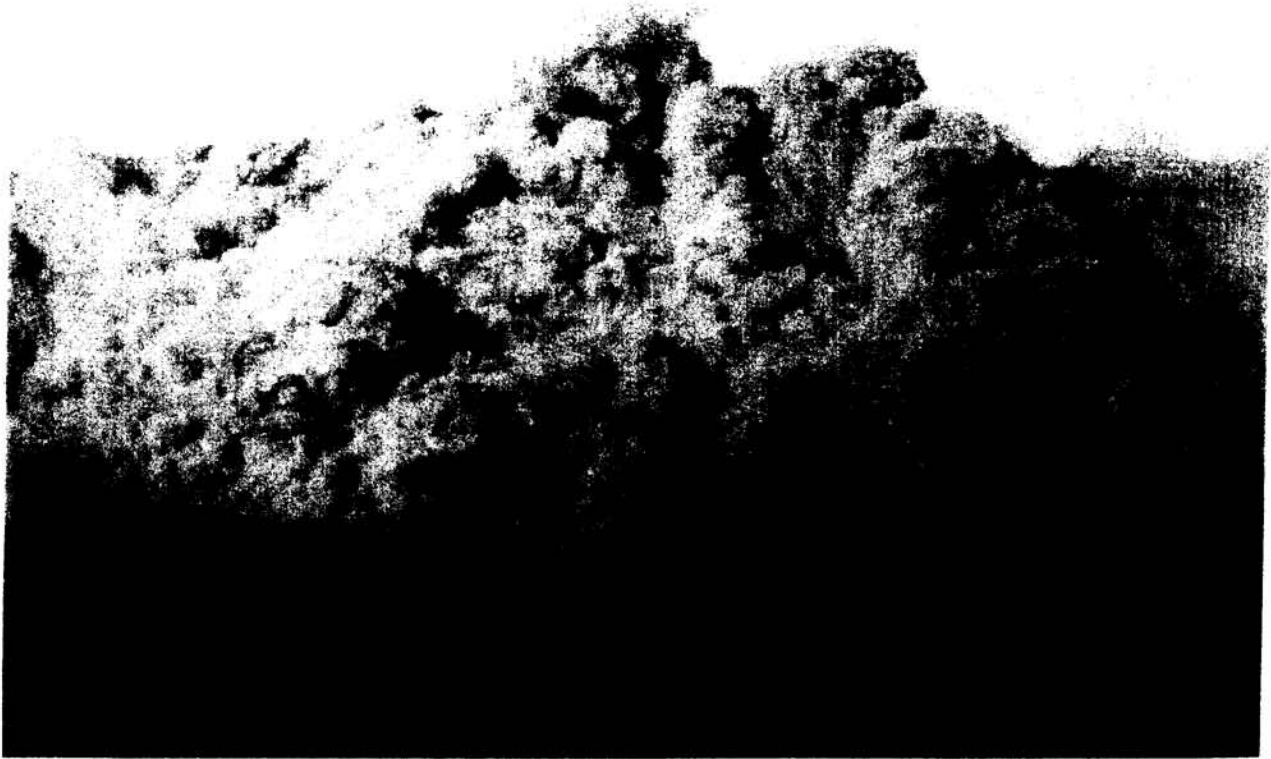

Photo credit: Department of Energy

Blanca containment failure, 1958.

kilotons. The first few tests after Rainier, however, were detonated at greater depths than this formula requires because it was more convenient to mine tunnels deeper in the Mesa. It was not until "Blanca," October 30, 1958, that a test was conducted exactly at $300 (\text{yield})^{1/3}$ feet to test the depth scale. The containment of the Blanca explosion, however, was unsuccessful and resulted in a surface venting of radioactive material. As a consequence, the depth scale was modified to include the addition of a few hundred feet as a safety factor and

thus became: $300 (\text{yield})^{1/3}$ "plus-a-few-hundred-feet."

Today, the general depth of burial can be approximated by the equation:

$$\text{Depth} = 400 (\text{yield})^{1/3},$$

where depth is measured in feet and yield in kilotons.¹² The minimum depth of burial, however, is 600 feet.¹³ Consequently, depths of burial vary from 600 feet for a low-yield device, to about 2,100 feet for a large-yield test. The depth is scaled to the

¹²"Public Safety for Nuclear Weapons Tests." United States Environmental Protection Agency, January, 1984.

¹³The 600-foot depth was chosen as a minimum after a statistical study showed that the likelihood of a seep of radioactive material to the surface for explosions buried 600 feet or more was about 1/2 as great as for explosions at less than 500 feet, even if they were buried at the same scale-depth in each case.

“maximum credible yield” that the nuclear device is thought physically capable of producing, not to the design yield or most likely yield.¹⁴

Whether a test will be conducted on Pahute Mesa or Yucca Flat depends on the maximum credible yield. Yucca Flat is closer to support facilities and therefore more convenient, while the deep water table at Pahute Mesa is more economical for large yield tests that need deep, large diameter emplacement holes. Large yield tests in small diameter holes (less than 7 feet) can be conducted in Yucca Flat. A test area may also be chosen to avoid scheduling conflicts that might result in a test damaging the hole or diagnostic equipment of another nearby test. Once the area has been chosen, several candidate sites are selected based on such features as: proximity to previous tests or existing drill holes; geologic features such as faults, depth to basement rock, and the presence of clays or carbonate materials; and practical considerations such as proximity to power lines, roads, etc.

In areas well suited for testing, an additional site selection restriction is the proximity to previous tests. For vertical drill hole tests, the minimum shot separation distance is about one-half the depth of burial for the new shot (figure 3-2). For shallow shots, this separation distance allows tests to be spaced so close together that in some cases, the surface collapse craters coalesce. The $\frac{1}{2}$ depth of burial distance is a convention of convenience, rather than a criterion for containment.¹⁵ It is, for example, difficult to safely place a drilling rig too close to an existing collapse crater.

Horizontal tunnel tests are generally spaced with a minimum shot separation distance of twice the combined cavity radius plus 100 feet, measured from the point of detonation (called the “working point”) (figure 3-3). In other words, two tests with 100 foot radius cavities would be separated by 300 feet between cavities, or 500 feet (center to center). The size of a cavity formed by an explosion is proportional to the cube root of the yield and can be estimated by:

$$\text{Radius} = 55 (\text{yield})^{1/3},$$

where the radius is measured in feet and the yield in

kilotons. For example, an 8 kiloton explosion would be expected to produce an underground cavity with approximately a 110 foot radius. Two such test explosions would require a minimum separation distance of 320 feet between cavities or 540 feet between working points.

Occasionally, a hole or tunnel is found to be unsuitable for the proposed test. Such a situation, however, is rare, occurring at a rate of about 1 out of 25 for a drill hole test and about 1 out of 15 for a tunnel test.¹⁶ Usually, a particular hole that is found unacceptable for one test can be used for another test at a lower yield.

REVIEWING A TEST SITE LOCATION

Once the general parameters for a drill-hole have been selected, the sponsoring laboratory requests a pre-drill Geologic Data Summary (GDS) from the U.S. Geological Survey. The GDS is a geologic interpretation of the area that reviews the three basic elements: the structures, the rock type, and the water content. The U.S. Geological Survey looks for features that have caused containment problems in the past. Of particular concern is the presence of any faults that might become pathways for the release of radioactive material, and the close location of hard basement rock that may reflect the energy created by the explosion. Review of the rock type checks for features such as clay content which would indicate a weak area where it may be difficult for the hole to remain intact, and the presence of carbonate rock that could produce CO_2 . Water content is also reviewed to predict the amount of steam and H_2 that might be produced. If the geology indicates less than ideal conditions, alternate locations may be suggested that vary from less than a few hundred feet from the proposed site to an entirely different area of the test site.

When the final site location is drilled, data are collected and evaluated by the sponsoring laboratory. Samples and geophysical logs, including down-hole photography, are collected and analyzed. The U.S. Geological Survey reviews the data, consults with the laboratory throughout the process, and reviews the accuracy of the geologic interpretations.

¹⁴In many cases the maximum credible yield is significantly larger than the expected yield for a nuclear device.

¹⁵As discussed later, testing in previously fractured rock is not considered a containment risk in most instances.

¹⁶On three occasions tunnels have been abandoned because of unanticipated conditions such as the discovery of a fault or the presence of too much water.

Figure 3-2—Minimum Shot Separation for Drill Hole Tests

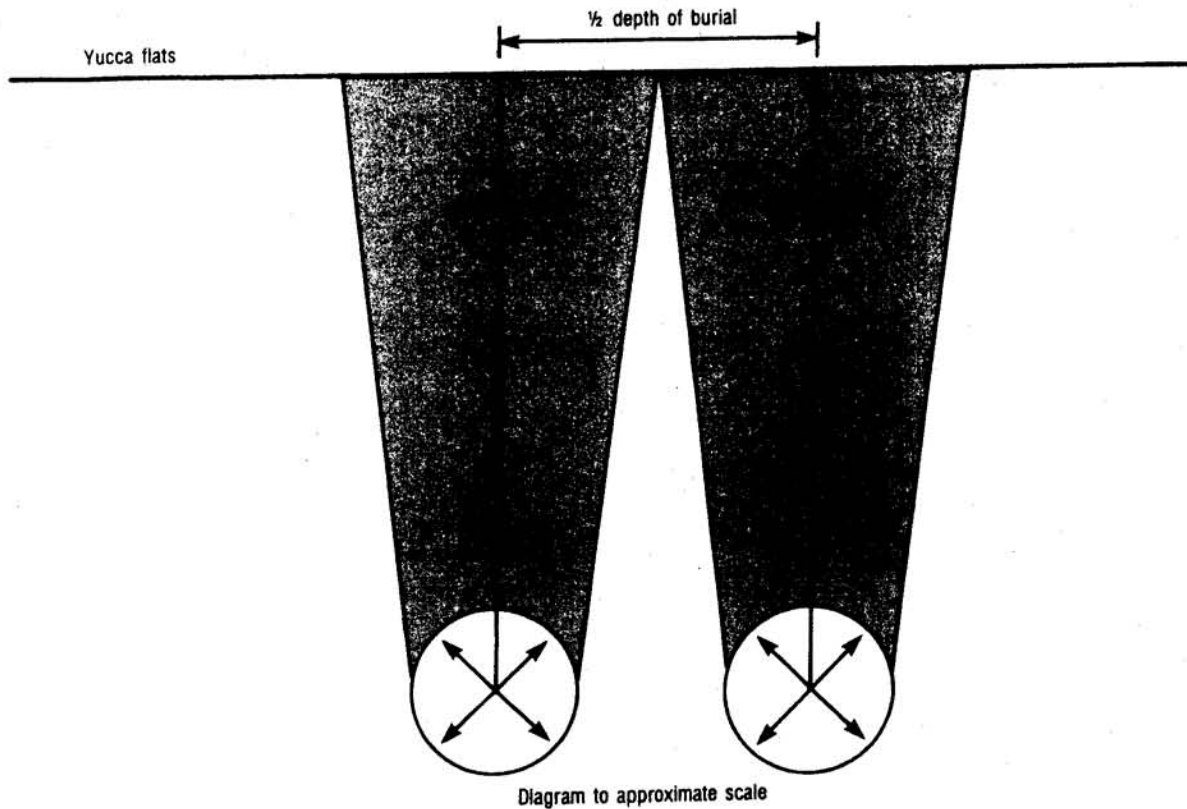

Scale illustration of the minimum separation distance ($1/2$ depth of burial) for vertical drill hole tests. The depth of burial is based on the maximum credible yield.

SOURCE: Office of Technology Assessment, 1989

To confirm the accuracy of the geologic description and review and evaluate containment considerations, the Survey also attends the host laboratory's site proposal presentation to the Containment Evaluation Panel.

CONTAINMENT EVALUATION PANEL

One consequence of the Baneberry review was the restructuring of what was then called the Test Evaluation Panel. The panel was reorganized and new members with a wider range of geologic and hydrologic expertise were added. The new panel was named the Containment Evaluation Panel (CEP); and their first meeting was held in March, 1971.

The Containment Evaluation Panel presently consists of a Chairman and up to 11 panel members.

Six of the panel members are representatives from Lawrence Livermore National Laboratory, Los Alamos National Laboratory, Defense Nuclear Agency, Sandia National Laboratory, U.S. Geological Survey, and the Desert Research Institute. An additional 3 to 5 members are also included for their expertise in disciplines related to containment. The chairman of the panel is appointed by the Manager of Nevada Operations (Department of Energy), and panel members are nominated by the member institution with the concurrence of the chairman and approval of the Manager. The panel reports to the Manager of Nevada Operations.

Practices of the Containment Evaluation Panel have evolved throughout the past 18 years; however, their purpose, as described by the Containment

Figure 3-3—Minimum Shot Separation for Tunnel Tests

Rainier Mesa

Tunnel tests are typically overburied. Collapse chimneys do not usually extend to surface.

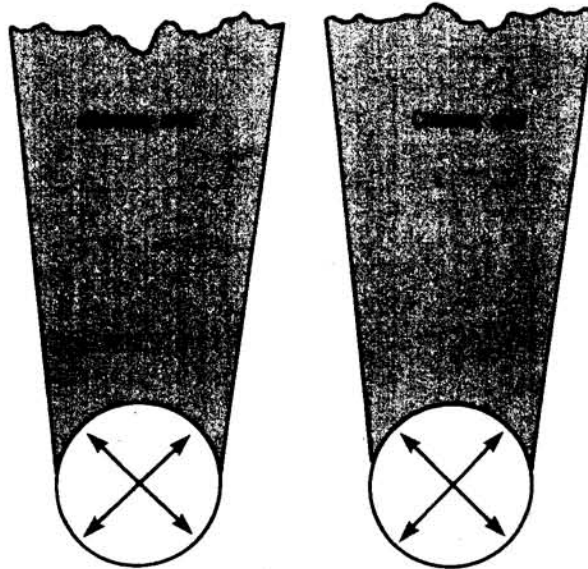

Diagram to approximate scale

Scale illustration of the minimum separation distance (2 combined cavity radii plus 100 feet) for horizontal tunnel tests. Tunnel tests are typically overburied. Collapse chimneys do not usually extend to the surface.

SOURCE: Office of Technology Assessment, 1969

Evaluation Charter, remains specifically defined as follows:¹⁷

1. evaluate, as an independent organization reporting to the Manager of Nevada Operations, the containment design of each proposed nuclear test;
2. assure that all relevant data available for proper evaluation are considered;
3. advise the manager of Nevada Operations of the technical adequacy of such design from the viewpoint of containment, thus providing the manager a basis on which to request detonation authority; and

4. maintain a historical record of each evaluation and of the data, proceedings, and discussions pertaining thereto.

Although the CEP is charged with rendering a judgment as to the adequacy of the design of the containment, the panel does not vote. Each member provides his independent judgment as to the prospect of containment, usually addressing his own area of expertise but free to comment on any aspect of the test. The Chairman is in charge of summarizing these statements in a recommendation to the manager on whether to proceed with the test, based only on the containment aspects. Containment Evaluation Panel guidelines instruct members to make their judgments in such a way that:

¹⁷Containment Evaluation Charter, June 1, 1986, Section II.

Considerations of cost, schedules, and test objectives shall not enter into the review of the technical adequacy of any test from the viewpoint of containment.¹⁸

Along with their judgments on containment, each panel member evaluates the probability of containment using the following four categories:¹⁹

1. *Category A*: Considering all containment features and appropriate historical, empirical, and analytical data, the best judgment of the member indicates a high confidence in successful containment as defined in VIII.F. below.
2. *Category B*: Considering all containment features and appropriate historical, empirical, and analytical data, the best judgment of the member indicates a less, but still adequate, degree of confidence in successful containment as defined in VIII.F. below.
3. *Category C*: Considering all containment features and appropriate historical, empirical, and analytical data, the best judgment of the member indicates some doubt that successful containment, as described in VIII.F. below, will be achieved.
4. *Unable to Categorize*

Successful containment is defined for the CEP as:

... no radioactivity detectable off-site as measured by normal monitoring equipment and no unanticipated release of activity on-site.

The Containment Evaluation Panel does not have the direct authority to prevent a test from being conducted. Their judgment, both as individuals and as summarized by the Chairman, is presented to the Manager. The Manager makes the decision as to whether a Detonation Authority Request will be made. The statements and categorization from each CEP member are included as part of the permanent Detonation Authority Request.

Although the panel only advises the Manager, it would be unlikely for the Manager to request

detonation if the request included a judgment by the CEP that the explosion might not be contained. The record indicates the influence of the CEP. Since formation of the panel in 1970, there has never been a Detonation Authority Request submitted for approval with a containment plan that received a "C" ("some doubt") categorization from even one member.^{20 21}

The Containment Evaluation Panel serves an additional role in improving containment as a consequence of their meetings. The discussions of the CEP provide an ongoing forum for technical discussions of containment concepts and practices. As a consequence, general improvements to containment design have evolved through the panel discussions and debate.

CONTAINING VERTICAL SHAFT TESTS

Once a hole has been selected and reviewed, a stemming plan is made for the individual hole. The stemming plan is usually formulated by adapting previously successful stemming plans to the particularities of a given hole. The objective of the plan is to prevent the emplacement hole from being the path of least resistance for the flow of radioactive material. In doing so, the stemming plan must take into account the possibility of only a partial collapse: if the chimney collapse extends only half way to the surface, the stemming above the collapse must remain intact.

Lowering the nuclear device with the diagnostics down the emplacement hole can take up to 5 days. A typical test will have between 50 and 250 diagnostic cables with diameters as great as 1⁵/₈ inches packaged in bundles through the stemming column. After the nuclear device is lowered into the emplacement hole, the stemming is installed. Figure 3-4 shows a typical stemming plan for a Lawrence

¹⁸Containment Evaluation Panel Charter, June 1, 1986, Section III.D.

¹⁹Containment Evaluation Panel Charter, June 1, 1986, Section VII.

²⁰The grading system for containment plans has evolved since the early 1970's. Prior to April, 1977, the Containment Evaluation Panel categorized tests using the Roman numerals (I-IV) where I-III had about the same meaning as A-C and IV was a D which eventually was dropped as a letter and just became "unable to categorize."

²¹However, one shot (Mundo) was submitted with an "unable to categorize" categorization. Mundo was a joint US-UK test conducted on May 1, 1984.

Figure 3-4—"Typical" Stemming Plan

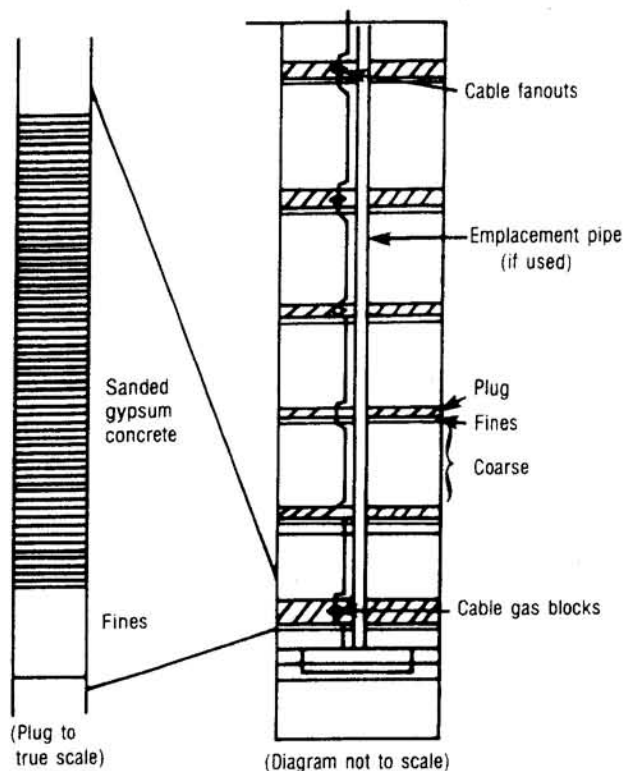

Typical stemming sequence of coarse material, fine material, and sanded gypsum plug used by Lawrence Livermore National Laboratory for vertical drill hole tests.

SOURCE: Modified from Lawrence Livermore National Laboratory.

Livermore test with six sanded gypsum concrete plugs.²² The plugs have two purposes: 1) to impede gas flow, and 2) to serve as structural platforms that prevent the stemming from falling out if only a partial collapse occurs. Under each plug is a layer of sand-size fine material. The sand provides a base for the plug. Alternating between the plugs and the fines, coarse gravel is used to fill in the rest of the stemming. The typical repeating pattern used for stemming by Los Alamos, for example, is 50 feet of gravel, 10 feet of sand, and a plug.

All the diagnostic cables from the nuclear device are blocked to prevent gas from finding a pathway through the cables and traveling to the surface. Cable fan-out zones physically separate the cables at plugs

so that the grout and fines can seal between them. Frequently, radiation detectors are installed between plugs to monitor the post-shot flow of radiation through the stemming column.

CONTAINING HORIZONTAL TUNNEL TESTS

The containment of a horizontal tunnel test is different from the containment of a vertical drill hole test because the experimental apparatus is intended to be recovered. In most tests, the objective is to allow direct radiation from a nuclear explosion to reach the experiment, but prevent the explosive debris and fission products from destroying it. Therefore, the containment is designed for two tasks: 1) to prevent the uncontrolled release of radioactive material into the atmosphere for public safety, and 2) to prevent explosive debris from reaching the experimental test chamber.

Both types of horizontal tunnel tests (effects tests and cavity tests) use the same containment concept of three redundant containment "vessels" that nest inside each other and are separated by plugs (figure 3-5).²³ Each vessel is designed to independently contain the nuclear explosion, even if the other vessels fail. If, for example, gas leaks from vessel I into vessel II, vessel II has a volume large enough so that the resulting gas temperatures and pressures would be well within the limits that the plugs are designed to withstand. The vessels are organized as follows:

Vessel I is designed to protect the experiment by preventing damage to the equipment and allowing it to be recovered.

Vessel II is designed to protect the tunnel system so that it can be reused even if vessel I fails and the experimental equipment is lost.

Vessel III is designed purely for containment, such that even if the experimental equipment is lost and the tunnel system contaminated, radioactive material will not escape to the atmosphere.

In addition to the three containment vessels, there is a gas seal door at the entrance of the tunnel system that serves as an additional safety measure. The gas seal door is closed prior to detonation and the area

²²Although Livermore and Los Alamos use the same general stemming philosophy, there are some differences: For example, Livermore uses sanded gypsum concrete plugs while Los Alamos uses plugs made of epoxy. Also, Livermore uses an emplacement pipe for lowering the device downhole, while Los Alamos lowers the device and diagnostic cannister on a wire rope harness.

²³See ch. 2 for a discussion of types of nuclear tests.

Figure 3-5—Three Redundant Containment Vessels (Plan View)

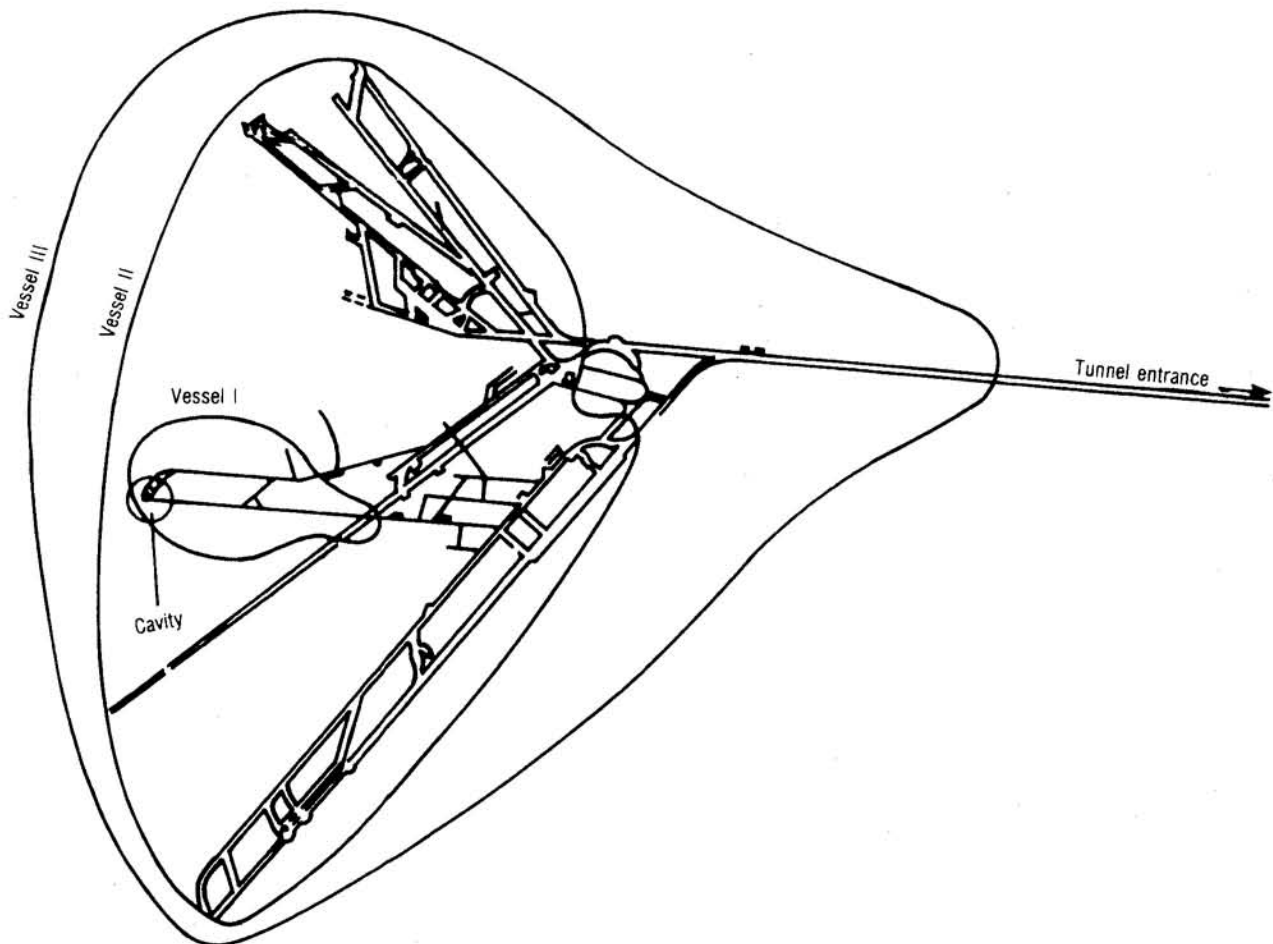

Three containment vessels for the Mighty Oak Test conducted in the T-Tunnel Complex.

SOURCE: Modified from Defense Nuclear Agency.

between it and the vessel III plug is pressurized to approximately 10 pounds per square inch.

The plugs that separate the vessels are constructed of high strength grout or concrete 10 to 30 feet thick. The sides of the vessel II plugs facing the working point are constructed of steel. Vessel II plugs are designed to withstand pressures up to 1,000 pounds per square inch and temperatures up to 1,000 °F. Vessel III plugs are constructed of massive concrete and are designed to withstand pressures up to 500 pounds per square inch and temperatures up to 500 °F.

Before each test, the tunnel system is checked for leaks. The entire system is closed off and pressurized to 2 pounds per square inch with a gas containing tracers in it. The surrounding area is then monitored

for the presence of the tracer gas. Frequently, the chimney formed by the explosion is also subjected to a post-shot pressurization test to ensure that no radioactive material could leak through the chimney to the surface.

The structure of vessel I, as shown in figure 3-6, is designed to withstand the effects of ground shock and contain the pressure, temperatures, and radiation of the explosion. The nuclear explosive is located at the working point, also known as the "zero room." A long, tapered, horizontal line-of-sight (HLOS) pipe extends 1,000 feet or more from the working point to the test chamber where the experimental equipment is located. The diameter of the pipe may only be a few inches at the working point, but typically increases to about 10 feet before it reaches

Figure 3-6—Vessel I

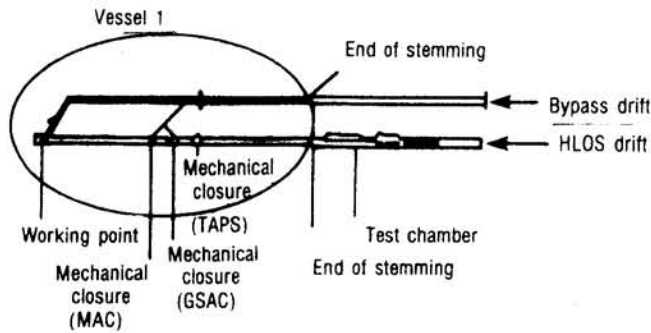

Key: GSAC = gas seal auxiliary closure; MAC = modified auxiliary closure; TAPS = Tunnel and pipe seal

The HLOS Vessel I is designed to protect the experimental equipment after allowing radiation to travel down the pipe.

SOURCE: Modified from Defense Nuclear Agency.

the test chamber.²⁴ The entire pipe is vacuum pumped to simulate the conditions of space and to minimize the attenuation of radiation. The bypass drift (an access tunnel), located next to the line of sight pipe, is created to provide access to the closures and to different parts of the tunnel system. These drifts allow for the nuclear device to be placed in the zero room and for late-time emplacement of test equipment. After the device has been emplaced at the working point, the bypass drift is completely filled with grout. After the experiment, parts of the bypass drift will be reexcavated to permit access to the tunnel system to recover the pipe and experimental equipment.

The area around the HLOS pipe is also filled with grout, leaving only the HLOS pipe as a clear pathway between the explosion and the test chamber. Near the explosion, grout with properties similar to the surrounding rock is used so as not to interfere with the formation of the stress containment cage. Near the end of the pipe strong grout or concrete is used to support the pipe and closures. In between, the stemming is filled with super-lean grout designed to flow under moderate stress. The super-lean grout is designed to fill in and effectively plug any fractures that may form as the ground shock collapses the pipe and creates a stemming plug.

As illustrated in figure 3-6, the principal components of an HLOS pipe system include a working

point room, a muffler, a modified auxiliary closure (MAC), a gas seal auxiliary closure (GSAC), and a tunnel and pipe seal (TAPS). All these closures are installed primarily to protect the experimental equipment. The closures are designed to shut off the pipe after the radiation created by the explosion has traveled down to the test chamber, but before material from the blast can fly down the pipe and destroy the equipment.

The working point room is a box designed to house the nuclear device. The muffler is an expanded region of the HLOS pipe that is designed to reduce flow down the pipe by allowing expansion and creating turbulence and stagnation. The MAC (figure 3-7(a)) is a heavy steel housing that contains two 12-inch-thick forged-aluminum doors designed to close openings up to 84 inches in diameter. The doors are installed opposite each other, perpendicular to the pipe. The doors are shut by high pressure gas that is triggered at the time of detonation. Although the doors close completely within 0.03 seconds (overlapping so that each door fills the tunnel), in half that time they have met in the middle and obscure the pipe. The GSAC is similar to the MAC except that it is designed to provide a gas-tight closure. The TAPS closure weighs 40 tons and the design (figure 3-7(b)) resembles a large toilet seat. The door, which weighs up to 9 tons, is hinged on the top edge and held in the horizontal (open) position. When the door is released, it swings down by gravity and slams shut in about 0.75 seconds. Any pressure remaining in the pipe pushes on the door making the seal tighter. The MAC and GSAC will withstand pressures up to 10,000 pounds per square inch. The TAPS is designed to withstand pressures up to 1,000 pounds per square inch, and temperatures up to 1,000 °F.

When the explosion is detonated radiation travels down the HLOS pipe at the speed of light. The containment process (figure 3-8(a-e)), triggered at the time of detonation, occurs in the following sequence to protect experimental equipment and contain radioactive material produced by the explosion:

- After 0.03 seconds (b), the cavity created by the explosion expands and the shock wave moves away from the working point and approaches the MAC. The shock wave collapses the pipe, squeezing it shut, and forms a stemming "plug." Both the MAC and the GSAC shut off

²⁴On occasion, the diameter of the pipe has increased to 20 feet

Figure 3-7—Vessel I Closures

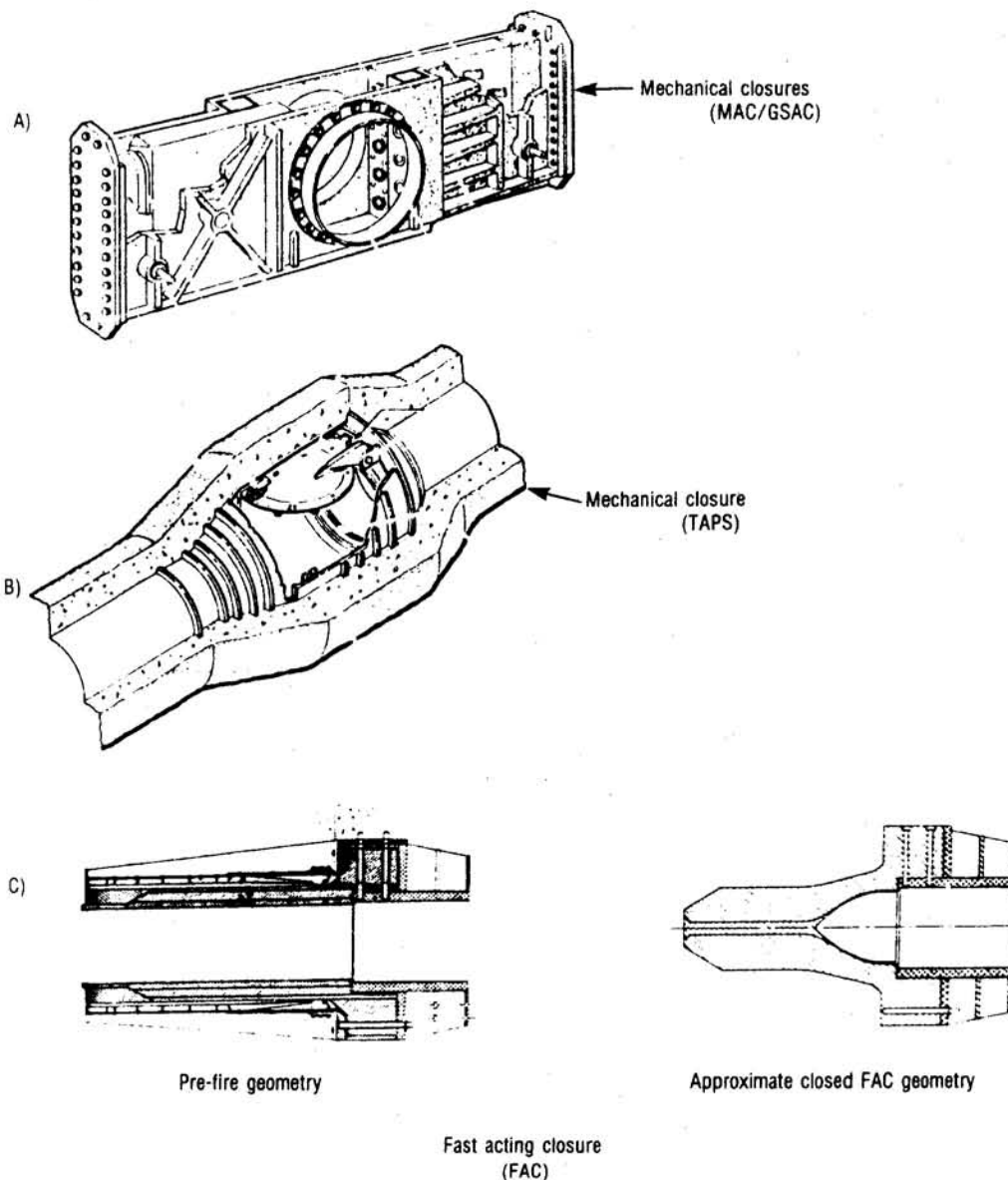

- A) Mechanical Closures (MAC/GSAC)
- B) Tunnel and Pipe Seal (TAPS)
- C) Fast Acting Closure (FAC)

SOURCE: Modified from Defense Nuclear Agency.

the pipe ahead of the shock wave to prevent early flow of high-velocity gas and debris into the experiment chamber.

- After 0.05 seconds (c), the ground shock moves past the second closure and is no longer strong

enough to squeeze the pipe shut. The stemming plug stops forming at about the distance where the first mechanical pipe closure is located.

- After 0.2 seconds (d), the cavity growth is complete. The rebound from the explosion

Figure 3-8—Tunnel Closure Sequence

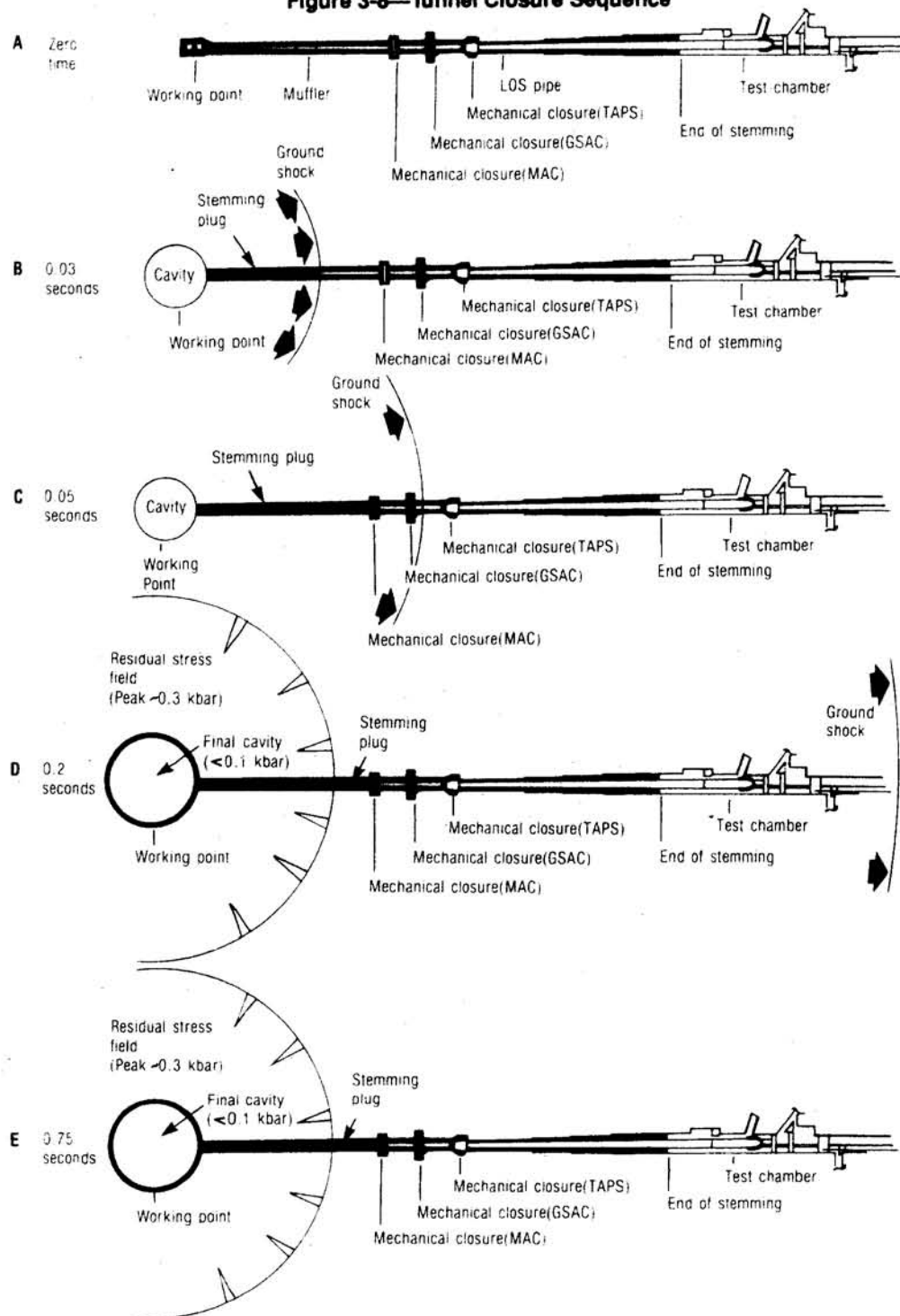

A) Zero Time: Explosion is detonated and the first two mechanical closures are fired. B) Within 0.03 seconds, a stemming plug is being formed and mechanical pipe closure has occurred. C) Within 0.05 seconds, the stemming plug has formed. D) Within 0.2 seconds, cavity growth is complete and a surrounding compressive residual stress field has formed. E) Within 0.75 seconds, closure is complete.

SOURCE: Modified from Defense Nuclear Agency.

locks in the residual stress field, thereby forming a containment cage. The shock wave passes the test chamber.

- After 0.75 seconds (e), the final mechanical seal (TAPS) closes, preventing late-time explosive and radioactive gases from entering the test chamber.

The entire closure process for containment takes less than $\frac{3}{4}$ of a second. Because the tests are typically buried at a depth greater than necessary for containment, the chimney does not reach the surface and a collapse crater normally does not form. A typical post-shot chimney configuration with its approximate boundaries is shown in figure 3-9.

In lower yield tests, such as those conducted in the P-tunnel complex, the first mechanical closure is a Fast Acting Closure (FAC) rather than a MAC.²⁵ The FAC (figure 3-7(c)) closes in 0.001 seconds and can withstand pressures of 30,000 pounds per square inch. The FAC acts like a cork, blocking off the HLOS pipe early, and preventing debris and stemming material from flying down the pipe. A similar closure is currently being developed for larger yield tunnel tests.

TYPES OF RADIATION RELEASES

Terms describing the release or containment of underground nuclear explosions have been refined to account for the volume of the material and the conditions of the release. The commonly used terms are described below.

Containment Failure

Containment failures are releases of radioactive material that do not fall within the strict definition of successful containment, which is described by the Department of Energy as:

Containment such that a test results in no radioactivity detectable off site as measured by normal monitoring equipment and no unanticipated release of radioactivity onsite. Detection of noble gases that appear onsite long after an event, due to changing atmospheric conditions, is not unanticipated. Anticipated releases will be designed to conform to specific guidance from DOE/HQ.²⁶

Containment failures are commonly described as:

²⁵The P-tunnel complex is mined in Aqueduct Mesa and has less overburden than the N-tunnel complex in Rainier Mesa. Therefore, P-tunnel is generally used for lower yield tests.

²⁶Section VIII.F, Containment Evaluation Panel Charter.

Figure 3-9—Typical Post-Shot Configuration

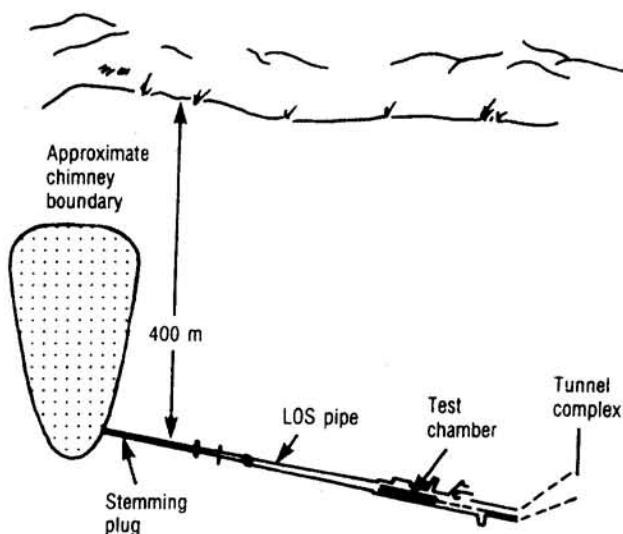

Tunnel shots are typically overburied and the collapse chimney rarely extends to the surface.

SOURCE: Modified from Defense Nuclear Agency.

Ventings

Ventings are prompt, massive, uncontrolled releases of radioactive material. They are characterized as active releases under pressure, such as when radioactive material is driven out of the ground by steam or gas. "Baneberry," in 1970, is the last example of an explosion that "vented."

Seeps

Seeps, which are not visible, can only be detected by measuring for radiation. Seeps are characterized as uncontrolled slow releases of radioactive material with little or no energy.

Late-Time Seep

Late-time seeps are small releases of noncondensable gases that usually occur days or weeks after a vertical drill hole test. The noncondensable gases diffuse up through the pore spaces of the overlying rock and are thought to be drawn to the surface by a decrease in atmospheric pressure (called "atmospheric pumping").



Photo credit: David Graham

Fast acting closure.

Controlled Tunnel Purging

Controlled tunnel purging is an intentional release of radioactive material to recover experimental equipment and ventilate test tunnels. During a controlled tunnel purging, gases from the tunnel are filtered, mixed with air to reduce the concentration, and released over time when weather conditions are favorable for dispersion into sparsely populated areas.

Operational Release

Operational releases are small releases of radioactivity resulting from operational aspects of vertical drill hole tests. Activities that often result in operational releases include: drilling back down to the location of the explosion to collect core samples (called "drill back"), collecting gas samples from

the explosion (called "gas sampling"), and sealing the drill back holes (called "cement back")

RECORD OF CONTAINMENT

The containment of underground nuclear explosions is a process that has continually evolved through learning, experimentation, and experience. The record of containment illustrates the various types of releases and their relative impact.

Containment Evaluation Panel

The Containment Evaluation Panel defines successful containment as no radioactivity detectable offsite and no unanticipated release of activity onsite. By this definition, the CEP has failed to predict unsuccessful containment on four occasions since 1970:

| | |
|----------------|--|
| Camphor: | June 29, 1971, horizontal tunnel test, less than 20 kilotons, radioactivity detected only on-site. |
| Diagonal Line: | November 24, 1971, vertical shaft test, less than 20 kilotons, radioactivity detected off-site. |
| Riola: | September 25, 1980, vertical shaft test, less than 20 kilotons, radioactivity detected off-site. |
| Agrini: | March 31, 1984, vertical shaft test, less than 20 kilotons, radioactivity detected only on-site. |

These are the only tests (out of more than 200) where radioactive material has been unintentionally released to the atmosphere due to containment failure. In only two of the cases was the radioactivity detected outside the geographic boundary of the Nevada Test Site.

There have, however, been several other instances where conditions developed that were not expected. For example, during the Midas Myth test on February 15, 1984, an unexpected collapse crater occurred above the test tunnel causing injuries to personnel. In addition, the tunnel partially collapsed, damaging experimental equipment. During the Mighty Oak test on April 10, 1986, radioactive material penetrated through two of the three containment vessels. Experimental equipment worth \$32 million was destroyed and the tunnel system ventilation required a large controlled release of radioactive material (table 3-1). In the case of Midas Myth, no radioactive material was released (in fact, all radioactive material was contained within vessel I). In the case of Mighty Oak, the release of radioactive material was intentional and controlled. Consequently, neither of these tests are considered containment failures by the CEP.

Vertical Drill Hole Tests

As discussed previously, vertical drill-hole tests commonly use a stemming plan with six sanded gypsum plugs or three epoxy plugs. Approximately 50 percent of the vertical drill hole tests show all radiation being contained below the first plug. In some cases, radiation above the plug may not signify plug failure, but rather may indicate that radioactive material has traveled through the medium around the plug.

Table 3-1—Releases From Underground Tests (normalized to 12 hours after event^a)

| | |
|---|-------------------|
| All releases 1971-1988: | |
| Containment Failures: | |
| Camphor, 1971 ^b | 360 Ci |
| Diagonal Line, 1971 | 6,800 |
| Riola, 1980 | 3,100 |
| Agrini, 1984 | 690 |
| Late-time Seeps: | |
| Kappeli, 1984 | 12 |
| Tierra, 1984 | 600 |
| Labquark, 1986 | 20 |
| Bodie, 1986 ^c | 52 |
| Controlled Tunnel Purgings: | |
| Hybla Fair, 1974 | 500 |
| Hybla Gold, 1977 | 0.005 |
| Miners Iron, 1980 | 0.3 |
| Huron Landing, 1982 | 280 |
| Mini Jade, 1983 | 1 |
| Mill Yard, 1985 | 5.9 |
| Diamond Beech, 1985 | 1.1 |
| Misty Rain, 1985 | 63 |
| Mighty Oak, 1986 | 36,000 |
| Mission Ghost, 1987 ^c | 3 |
| Operational Releases: | |
| 108 tests from 1970-1988 ^d | 5,500 |
| Total since Baneberry: 54,000 Ci | |
| Major pre-1971 releases: | |
| Platte, 1962 | 1,900,000 Ci |
| Eel, 1962 | 1,900,000 |
| Des Moines, 1962 | 11,000,000 |
| Baneberry, 1970 | 6,700,000 |
| 26 others from 1958-1970 | 3,800,000 |
| Total: 25,300,000 Ci | |
| Other Releases for Reference | |
| NTS Atmospheric Testing 1951-1963: .. | 12,000,000,000 Ci |
| 1 Kiloton Aboveground Explosion: | 10,000,000 |
| Chernobyl (estimate): | 81,000,000 |

^aR+12 values apply only to containment failures, others are at time of release.

^bThe Camphor failure includes 140 Ci from tunnel purging.

^cBodie and Mission Ghost also had drill-back releases.

^dMany of these operational releases are associated with tests that were not announced.

SOURCE: Office of Technology Assessment, 1989.

All three of the vertical drill hole tests that released radioactive material through containment failure were low yield tests of less than 20 kilotons. In general, the higher the yield, the less chance there is that a vertical drill hole test will release radioactivity.²⁷

Horizontal Tunnel Tests

There have been no **uncontrolled** releases of radioactive material detected **offsite** in the 31 tunnel tests conducted since 1970. Furthermore, all but one test, Mighty Oak, have allowed successful recovery

²⁷Higher yield tests are more likely to produce a containment cage and result in the formation of a collapse crater. As discussed earlier in this chapter "why nuclear explosions remain contained," such features contribute to the containment of the explosion.

of the experimental equipment. Mighty Oak and Camphor are the only tests where radioactivity escaped out of vessel II. In no test, other than Camphor, has radioactive material escaped out of vessel III. Camphor resulted in an **uncontrolled** release of radioactive material that was detected only **on site**.

There have been several instances when small amounts of radioactivity were released intentionally to the atmosphere through **controlled** purging. In these cases, the decision was made to vent the tunnel and release the radioactivity so the experimental results and equipment could be recovered. The events that required such a controlled release are the 10 tests where radioactive material escaped out of vessel I and into vessel II, namely:

Hybla Fair, October 28, 1974.

Hybla Gold, November 1, 1977.

Miners Iron, October 31, 1980.

Huron Landing, September 23, 1982.

Mini Jade, May 26, 1983.

Mill Yard, October 9, 1985.

Diamond Beech, October 9, 1985.

Misty Rain, April 6, 1985.

Mighty Oak, April 10, 1986.

Mission Ghost, June 20, 1987²⁸

In most cases, the release was due to the failure of some part of the experiment protection system.

Table 3-1 includes *every* instance (for both announced and unannounced tests) where radioactive material has reached the atmosphere under *any circumstances whatsoever* from 1971 through 1988. The lower part of table 3-1 summarizes underground tests prior to 1971 and provides a comparison with other releases of radioactive material.

Since 1970, 126 tests have resulted in radioactive material reaching the atmosphere with a total release of about 54,000 Curies(Ci). Of this amount, 11,500 Ci were due to containment failure and late-time seeps. The remaining 42,500 Ci were operational releases and controlled tunnel ventilations—with Mighty Oak (36,000 Ci) as the main source. Section

3 of the table shows that the release of radioactive material from underground nuclear testing since Baneberry (54,000 Ci) is extremely small in comparison to the amount of material released by pre-Baneberry underground tests (25,300,000 Ci), the early atmospheric tests at the Nevada Test Site, or even the amount that would be released by a 1-kiloton explosion conducted above ground (10,000,000 Ci).

From the Perspective of Human Health Risk

If a single person had been standing at the boundary of the Nevada Test Site in the area of maximum concentration of radioactivity for every test since Baneberry (1970), that person's total exposure would be equivalent to 32 extra minutes of normal background exposure (or the equivalent of 1/1000 of a single chest x-ray).

A FEW EXAMPLES:

Although over 90 percent of all test explosions occur as predicted, occasionally something goes wrong. In some cases, the failure results in the loss of experimental equipment or requires the controlled ventilation of a tunnel system. In even more rare cases (less than 3 percent), the failure results in the unintentional release of radioactive material to the atmosphere. A look at examples shows situations where an unexpected sequence of events contribute to create an unpredicted situation (as occurred in Baneberry (see box 3-1)), and also situations where the full reason for containment failure still remains a mystery.

1. *Camphor* (June 29, 1971, horizontal tunnel test, less than 20 kilotons, radioactivity detected only on-site.)

The ground shock produced by the Camphor explosion failed to close the HLOS pipe fully. After about 10 seconds, gases leaked through and eroded the stemming plug. As gases flowed through the stemming plug, pressure increased on the closure door behind the experiment. Gases leaked around the cable passage ways and eroded open a hole. Pressure was then placed on the final door, which held but leaked slightly. Prior to the test, the containment plan for Camphor received six "I"'s from the CEP.²⁹

²⁸The Mission Ghost release was due to a post-shot drill hole.

²⁹Op. cit., footnote 20.

2. *Diagonal Line* (November 24, 1971, vertical shaft test, less than 20 kilotons, radioactivity detected off-site.)

In a sense, the Diagonal Line seep was predicted by the CEP. Prior to the test, Diagonal Line received all "A" categorizations, except from one member who gave it a "B."³⁰ It was a conclusion of the panel that due to the high CO₂ content, a late-time (hours or days after detonation) seepage was a high probability. They did not believe, however, that the level of radiation would be high enough to be detectable off-site. Permission to detonate was requested and granted because the test objectives were judged to outweigh the risk. Diagonal Line was conducted in the northern part of Frenchman Flat. It is speculated that carbonate material released CO₂ gas that forced radioactive material to leak to the surface. Diagonal Line was the last test detonated on Frenchman Flat.

3. *Riola* (September 25, 1980, vertical shaft test, less than 20 kilotons, radioactivity detected off-site.)

Ironically, Riola was originally proposed for a different location. The Containment Evaluation Panel, however, did not approve the first location and so the test was moved. At its new location, Riola was characterized by the CEP prior to the test with 8 "A"s. Riola exploded with only a small fraction of the expected yield. A surface collapse occurred and the failure of a containment plug resulted in the release of radioactive material.

4. *Agrini* (March 31, 1984, vertical shaft test, less than 20 kilotons, radioactivity detected only on-site.)

The Agrini explosion formed a deep subsidence crater 60 feet west of the emplacement hole. A small amount of radioactive material was pushed through the chimney by noncondensable gas pressure and was detected onsite. The containment plan for Agrini received seven "A"s and two "B"s from the CEP prior to the test. The "B"s were due to the use of a new stemming plan.

5. *Midas Myth* (February 15, 1984, horizontal tunnel test, less than 20 kilotons, no release of radioactive material.)

All of the radioactive material produced by the Midas Myth test was contained within vessel I, with no release of radioactivity to either the atmosphere or the tunnel system. It is therefore not considered a containment failure. Three hours after the test, however, the cavity collapsed and the chimney reached the surface forming an unanticipated subsidence crater. Equipment trailers were damaged and personnel were injured (one person later died as a result of complications from his injuries) when the collapse crater formed.³¹ Analysis conducted after the test indicated that the formation of the collapse crater should have been expected. Shots conducted on Yucca Flat with the same yield and at the same depth of burial did, at times, produce surface collapse craters. In the case of Midas Myth, collapse was not predicted because there had never been a collapse crater for a tunnel event and so the analysis was not made prior to the accident. After analyzing the test, the conclusion of the Surface Subsidence Review Committee was:

That the crater is not an indication of some unusual, anomalous occurrence specific to the U12T.04 emplacement site. Given the normal variation in explosion phenomena, along with yield, depth of burial, and geologic setting, experience indicates an appreciable chance for the formation of a surface subsidence crater for Midas Myth.

Prior to the test, the Containment Evaluation Panel characterized Midas Myth with nine "A"s.

6. *Misty Rain* (April 6, 1985, horizontal tunnel test, less than 20 kilotons, no unintentional release of radioactive material.)

Misty Rain is unusual in that it is the only tunnel test since 1970 that did not have three containment vessels. In the Misty Rain test, the decision was made that because the tunnel system was so large, a vessel II was not needed.³² Despite the lack of a vessel II, the CEP categorized the containment of Misty Rain with eight "A"s, and one "B."³³ During the test, an early flow of energy down the HLOS pipe prevented the complete closure of the MAC doors. The MAC doors overlapped, but stopped a couple inches short of full closure. The TAPS door closed only 20 percent before the deformation from ground shock prevented it from closing. A small amount of

³⁰Ibid.

³¹The injuries were due to the physical circumstances of the collapse. There was no radiation exposure.

³²The drifts in the tunnel system created over 4 million cubic feet of open volume.

³³One CEP member did not initially categorize the test, after receiving additional information concerning the test, he categorized the test with an "A."

radioactive material escaped down the pipe and then seeped from the HLOS pipe tunnel into the bypass tunnel. Subsequently, the tunnel was intentionally vented so that experimental equipment could be recovered.

7. *Mighty Oak* (April 10, 1986, horizontal tunnel test, less than 20 kilotons, no unintentional release of radioactive material.)

During the *Mighty Oak* test, the closure system near the working point was over-pressured and failed. The escaped pressure and temperature caused both the MAC and the GSAC to fail. The loss of the stemming plug near the working point left the tunnel an open pathway from the cavity. Temperatures and pressures on the closed TAPS door reached 2,000 °F and 1,400 pounds per square inch. After 50 seconds, the center part (approximately 6 feet in diameter) of the TAPS door broke through. With the closures removed, the stemming column squeezed out through the tunnel. Radioactive material leaked from vessel I, into vessel II, and into vessel III, where it was successfully contained. Approximately 85 percent of the data from the prime test objectives was recovered, although about \$32 million of normally recoverable and reusable equipment was lost.³⁴ Controlled purging of the tunnel began 12 days after the test and continued intermittently from April 22 to May 19, when weather conditions were favorable. A total of 36,000 Ci were released to the atmosphere during this period.

IS THERE A REAL ESTATE PROBLEM AT NTS?

There have been over 600 underground and 100 aboveground nuclear test explosions at the Nevada Test Site. With testing continuing at a rate of about a dozen tests a year, the question of whether there will eventually be no more room to test has been raised. While such a concern may be justified for the most convenient areas under the simplest arrangements, it is not justified for the test area in general. Using the drill-hole spacing of approximately one-half the depth of burial, high-yield tests can be spaced about 1,000 feet apart, and low-yield tests can be spaced at distances of a few hundred feet. Consequently, a suitable square mile of test site may provide space for up to 25 high-yield tests or over

300 low-yield tests. Even with testing occurring at a rate of 12 tests a year, the 1,350 square miles of test site provide considerable space suitable for testing.

In recent years, attempts have been made to use space more economically, so that the most convenient locations will remain available. Tests have traditionally been spaced in only 2-dimensions. It may be possible to space tests 3-dimensionally, that is, with testing located below or above earlier tests. Additionally, the test spacing has been mostly for convenience. If available testing areas become scarce, it may become possible to test at closer spacing, or even to test at the same location as a previous test.

Area for horizontal tunnel tests will also be available for the future. The N-tunnel area has been extended and has a sizable area for future testing. P-tunnel, which is used for low-yield effects tests, has only been started. (See figure 2-4 in ch. 2 of this report.) Within Rainier and Aqueduct Mesa alone, there is enough area to continue tunnel tests at a rate of two a year for at least the next 30 years. Consequently, lack of adequate real estate will not be a problem for nuclear testing for at least several more decades.

TIRED MOUNTAIN SYNDROME?

The "Tired Mountain Syndrome" hypothesis postulates that repeated testing in Rainier Mesa has created a "tired" mountain that no longer has the strength to contain future tests. Support for this concern has come from the observation of cracks in the ground on top of the Mesa and from seismological measurements, indicating that large volumes of rock lose strength during an underground test. Debate exists, however, over both the inference that the weakened rock is a danger to containment, and the premise that large volumes of rock are being weakened by nuclear testing.

Basic to the concern over tired mountain syndrome is the assumption that weakened rock will adversely affect containment. As discussed previously, only in an extreme situation, such as detonating an explosion in water-saturated clay, would rock strength be a factor in contributing to a leak of radioactive material.³⁵ For example, many tests have

³⁴*Containment and Safety Review for the Mighty Oak Nuclear Weapon Effects Test*, U.S. Department of Energy, Nevada Operations Office, NVO-311, May 1, 1987.

³⁵See earlier section "Why do nuclear tests remain contained?"



Photo credit: Department of Energy

Fracture on Rainier Mesa.

been detonated in alluvial deposits, which are essentially big piles of sediment with nearly no internal strength in an unconfined state. Despite the weakness and lack of cohesiveness of the material, such explosions remain well contained.

Compared to vertical drill hole tests, tunnel tests are overburied and conservatively spaced. The tunnel system in Rainier Mesa is at a depth of 1,300 feet. By the standards for vertical drill hole tests (using the scaled depth formula³⁶), this is deep enough to test at yields of up to 34 kilotons; and yet all tunnel tests are less than 20 kilotons.³⁷ Consequently, all tunnel tests in Rainier Mesa are buried at depths comparatively greater than vertical drill hole tests on Yucca Flat. Furthermore, the minimum separation distance of tunnel shots (twice the combined cavity radii plus 100 feet) results in a greater separation distance than the minimum separation

distance of vertical drill hole shots ($1/2$ depth of burial) for tests of the same yield (compare figures 3-2 and 3-3). **Consequently, neither material strength, burial depth, nor separation distance would make leakage to the surface more likely for a tunnel test on Rainier Mesa than for a vertical drill hole tests on Yucca Flat.**

Despite the relative lack of importance of strength in preventing possible leakage to the surface, the volume of material weakened or fractured by an explosion is of interest because it could affect the performance of the tunnel closures and possible leakage of cavity gas to the tunnel complex. Dispute over the amount of rock fractured by an underground nuclear explosion stems from the following two, seemingly contradictory, but in fact consistent observations:

1. Post-shot measurements of rock samples taken from the tunnel complex generally show no change in the properties of the rock at a distance greater than 3 cavity radii from the point of the explosion. This observation implies that rock strength is measurably decreased only within the small volume of radius = $165 (\text{yield})^{1/3}$,³⁸ where the radius is measured in feet from the point of the explosion and the yield is measured in kilotons (figure 3-10).

2. Seismic recordings of underground explosions at Rainier Mesa include signals that indicate the loss of strength in a volume of rock whose radius is slightly larger than the scaled depth of burial. This observation implies that the rock strength is decreased throughout the large volume of radius = $500 (\text{yield})^{1/3}$, where the radius is measured in feet from the point of the explosion and the yield is measured in kilotons (figure 3-11). The loss of strength in a large volume seems to be further supported by cracks in the ground at the top of Rainier Mesa that were created by nuclear tests.

The first observation is based on tests of samples obtained from drilling back into the rock surrounding the tunnel complex after a test explosion. The core samples contain microfractures out to a distance from the shot point equal to two cavity radii. Although microfractures are not seen past two cavity radii, measurements of seismic shear velocities

³⁶Depth(ft) = $400 (\text{yield(kt)})^{1/3}$

³⁷"Announced United States Nuclear Tests, July 1945 through December 1987," United States Department of Energy, NVO-209 (Rev.8), April, 1988.

³⁸If the radius of a cavity produced by an explosion is equal to $55 (\text{yield})^{1/3}$, a distance of three cavity radii would be equal to three times this, or $165 (\text{yield})^{1/3}$.

Figure 3-10—Radius of Decrease in Rock Strength

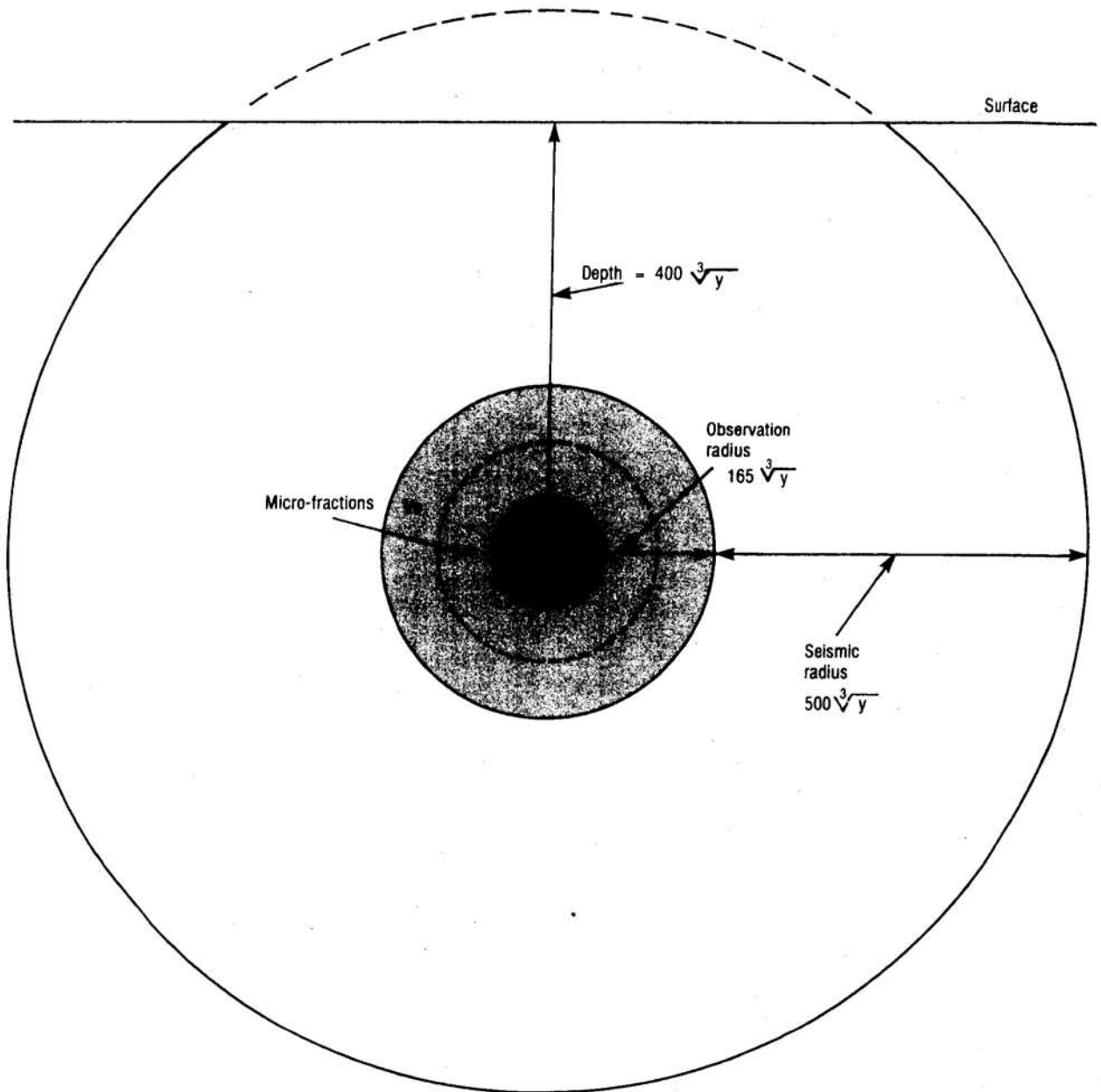

Seismic measurements and measurements taken from drill-back samples indicate a seemingly contradictory (but in fact consistent) radius of decrease in rock strength.

SOURCE: Office of Technology Assessment, 1989.

continue to be low out to a distance of three cavity radii. The decrease in seismic shear velocity indicates that the rock has been stressed and the strength decreased. At distances greater than three cavity

radii, seismic velocity measurements and strength tests typically show no change from their pre-shot values, although small disturbances along bedding planes are occasionally seen when the tunnels are

re-entered after the test. Such measurements suggest that the explosion only affects rock strength to a distance from the shot point to about three cavity radii ($165 (\text{yield})^{1/3}$).

The second observation, obtained from seismic measurements of tectonic release, suggests a larger radius for the volume of rock affected by an explosion. The seismic signals from underground nuclear explosions frequently contain signals created by what is called "tectonic release." By fracturing the rock, the explosion releases any preexisting natural stress that was locked within the rock. The release of the stress is similar to a small earthquake. The tectonic release observed in the seismic recordings of underground explosions from Rainier Mesa indicate the loss of strength in a volume of rock with a minimum radius equal to $500 (\text{yield})^{1/3}$.

Although the drill samples and the seismic data appear to contradict each other, the following explanation appears to account for both: The force of the explosion creates a cavity and fractures rock out to the distance of 2 cavity radii from the shot point. Out to 3 cavity radii, existing cracks are extended and connected, resulting in a decrease in seismic shear velocity. Outside 3 cavity radii, no new cracks form. At this distance, existing cracks are opened and strength is reduced, but only temporarily. The open cracks close immediately after the shock wave passes due to the pressure exerted by the overlying rock. Because the cracks close and no new cracks are formed, the rock properties are not changed. Post-shot tests of seismic shear velocity and strength are the same as pre-shot measurements. This is consistent with both the observations of surface fractures and the slight disturbances seen along bedding planes at distances greater than 3 cavity radii. The surface fractures are due to surface spall, which would indicate that the rock was overloaded by the shock wave. The disturbances of the bedding planes would indicate that fractures are being opened out to greater distances than 3 cavity radii. In fact, the bedding plane disturbances are seen out to a distance of $600 (\text{yield})^{1/3}$, which is consistent with the radius determined from tectonic release.

The large radius of weak rock derived from tectonic release measurements represents the **transient weakening** from the shot. The small radius of

weak rock derived from the post-shot tests represents the volume where the rock properties have been **permanently** changed. From the point of view of the integrity of the tunnel system, it is the smaller area where the rock properties have been permanently changed (radius = $165 (\text{yield})^{1/3}$) that should be considered for containment. **Because the line-of-sight tunnel is located so that the stemming plug region and closures are outside the region of permanently weakened or fractured material, the closure system is not degraded.**

HOW SAFE IS SAFE ENOUGH?

Every nuclear test is designed to be contained and is reviewed for containment. In each step of the test procedure there is built-in redundancy and conservatism. Every attempt is made to keep the chance of containment failure as remote as possible. This conservatism and redundancy is essential, however; because no matter how perfect the process may be, it operates in an imperfect setting. For each test, the containment analysis is based on samples, estimates, and models that can only simplify and (at best) approximate the real complexities of the Earth. As a result, predictions about containment depend largely on judgments developed from past experience. Most of what is known to cause problems—carbonate material, water, faults, scarps, clays, etc.—was learned through experience. To withstand the consequences of a possible surprise, redundancy and conservatism is a requirement not an extravagance. Consequently, all efforts undertaken to ensure a safe testing program are necessary, and they must continue to be vigorously pursued.

Deciding whether the testing program is safe requires a judgement of how safe is safe enough. The subjective nature of this judgement is illustrated through the decision-making process of the CEP, which reviews and assesses the containment of each test.³⁹ They evaluate whether a test will be contained using the categorizations of "high confidence," "adequate degree of confidence," and "some doubt." But, the CEP has no guidelines that attempt to quantify or describe in probabilistic terms what constitutes for example, an "adequate degree of confidence." Obviously one can never have 100 percent confidence that a test will not release radioactive material. Whether "adequate confi-

³⁹The Containment Evaluation Panel is a group of representatives from various laboratories and technical consulting organizations who evaluate the proposed containment plan for each test without regard to cost or other outside considerations (see ch. 2 for a complete discussion).

dence" translates into a chance of 1 in 100, 1 in 1,000, or 1 in 1,000,000, requires a decision about what is an acceptable risk level. In turn, decisions of acceptable risk level can only be made by weighing the costs of an unintentional release against the benefits of testing. Consequently, those who feel that testing is important for our national security will accept greater risk, and those who oppose nuclear testing will find even small risks unacceptable.

Establishing an acceptable level of risk is difficult not only because of value judgments associated with nuclear testing, but also because the risk is not seen as voluntary to those outside the testing program. Much higher risks associated with voluntary, everyday activities may be acceptable even though the much lower risks associated with the nuclear test site may still be considered unacceptable.

The question of whether the testing program is "safe enough" will ultimately remain a value

judgment that weighs the importance of testing against the risk to health and environment. In this sense, concern about safety will continue, largely fueled by concern about the nuclear testing program itself. However, given the continuance of testing and the acceptance of the associated environmental damage, the question of "adequate safety" becomes replaced with the less subjective question of whether any improvements can be made to reduce the chances of an accidental release. In this regard, no areas for improvement have been identified. This is not to say that future improvements will not be made as experience increases, but only that essentially all suggestions that increase the safety margin have been implemented. **The safeguards built into each test make the chances of an accidental release of radioactive material as remote as possible.**

Chapter 4

Monitoring Accidental Radiation Releases

CONTENTS

| | <i>Page</i> |
|---|-------------|
| INTRODUCTION | 59 |
| WHAT IS RADIATION? | 59 |
| PRODUCTS OF A NUCLEAR EXPLOSION | 59 |
| CRITERIA FOR CONDUCTING A TEST | 60 |
| PREDICTING FALLOUT PATTERNS | 63 |
| ACCIDENT NOTIFICATION | 64 |
| Onsite Monitoring by The Department of Energy | 65 |
| Offsite Monitoring by The Environmental Protection Agency | 66 |
| GROUNDWATER | 70 |
| MONITORING CAPABILITY | 74 |

Figures

| <i>Figure</i> | <i>Page</i> |
|---|-------------|
| 4-1. The Typical Bimodal Curve for Fission-Product Yield | 60 |
| 4-2. Controllable and Uncontrollable Areas | 62 |
| 4-3. Projected Fallout Dispersion Pattern | 63 |
| 4-4. Yield v. Distance | 64 |
| 4-5. Typical RAMs Array for Vertical Drill-Hole Shot | 66 |
| 4-6. Typical RAMs Array for Tunnel Shot | 67 |
| 4-7. Air Monitoring Stations | 69 |
| 4-8. Sample Press Release | 72 |
| 4-9. Standby Air Surveillance Network Stations | 73 |
| 4-10. Locations Monitored With Thermoluminescent Dosimeters | 74 |
| 4-11. Milk Sampling Locations | 75 |
| 4-12. Standby Milk Surveillance Network | 76 |
| 4-13. Collection Site for Animals Sampled in 1987 | 77 |
| 4-14. Locations of Families in the Offsite Human Surveillance Program | 78 |
| 4-15. Well Sampling Locations Onsite | 79 |
| 4-16. Well Sampling Locations Offsite | 80 |

Tables

| <i>Table</i> | <i>Page</i> |
|---|-------------|
| 4-1. Common Radionuclides Involved in a Nuclear Explosion | 60 |
| 4-2. Summary of Onsite Environmental Monitoring Program | 68 |
| 4-3. Citizens Alert Water Sampling Program | 78 |

Monitoring Accidental Radiation Releases

Each test is conducted under conditions in which remedial actions could be effective should an accidental release of radioactive material occur.

INTRODUCTION

Although nuclear tests are designed to minimize the chance that radioactive material could be released to the atmosphere, it is assumed as a precaution for each test that an accident may occur. To reduce the impact of a possible accident, tests are conducted only under circumstances whereby remedial actions could be taken if necessary. If it is estimated that the projected radioactive fallout from a release would reach an area where remedial actions are not feasible, the test will be postponed.

Responsibility for radiation safety measures for the nuclear testing program is divided between the Department of Energy (DOE) and the Environmental Protection Agency (EPA). The Department of Energy oversees monitoring within the boundaries of the Nevada Test Site (NTS). The Environmental Protection Agency monitors the population around the test site and evaluates the contribution of nuclear testing to human radiation exposure through air, water, and food.

WHAT IS RADIATION?

The nuclei of certain elements disintegrate spontaneously. They may emit particles, or electromagnetic waves (gamma rays or x-rays), or both. These emissions constitute radiation. The isotopes are called radionuclides. They are said to be radioactive, and their property of emitting radiation is called radioactive decay. The rate of decay is characteristic of each particular radionuclide and provides a measure of its radioactivity.

The common unit of radioactivity was the curie (Ci), defined as 3.7×10^{10} decays per second, which is the radioactivity of one gram of radium. Recently, a new unit, the becquerel (Bq), has been adopted, defined as one decay per second. Exposure of biological tissue to radiation is measured in terms of rems (standing for roentgen equivalent man). A roentgen (R) is a unit of exposure equivalent to the

quantity of radiation required to produce one coulomb of electrical charge in one kilogram of dry air. A rem is the dose in tissue resulting from the absorption of a rad of radiation multiplied by a "quality factor" that depends on the type of radiation. A rad is defined as 100 ergs (a small unit of energy) per gram of exposed tissue. Recently accepted international units of radiation are now the gray (Gy), equal to 100 rads, and the sievert (Sv), equal to 100 rems.

PRODUCTS OF A NUCLEAR EXPLOSION

A nuclear explosion creates two sources of radioactivity: the first source is the direct products of the nuclear reaction, and the second is the radioactivity induced in the surrounding material by the explosion-generated neutrons. In a fission reaction, the splitting of a nucleus creates two or more new nuclei that are often intensely radioactive. The products occur predominantly in two major groups of elements as shown in figure 4-1. The neutrons produced by the reaction also react with external materials such as the device canister, surrounding rock, etc., making those materials radioactive as well. In addition to these generated radioactivities, unburned nuclear fission fuel (especially plutonium) is also a radioactive containment. The helium nuclei formed by fusion reactions are not radioactive.¹ However, neutrons produced in the fusion reaction still will make outside material radioactive. Depending on the design of the explosive device and its percentage of fission and fusion, a wide range of radioactive material can be released with half lives of less than a second to more than a billion years.² The debris from nuclear detonations contain a large number of radioactive isotopes, which emit predominantly gamma and beta radiation. Some of the more common radionuclides involved in a nuclear explosion are listed in table 4-1.

¹This, incidentally, is why commercial fusion reactors (if they could be created) would be a relatively clean source of energy.

²The half-life is the time required for half of the atoms of a radioactive substance to undergo a nuclear transformation to a more stable element.

Figure 4-1—The Typical Bimodal Curve for Fission-Product Yield

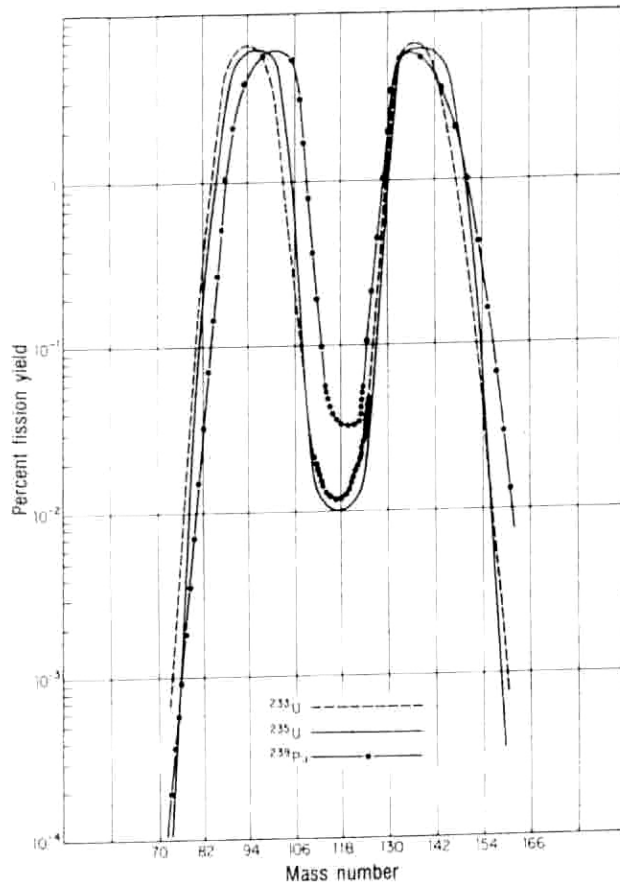

Products of a nuclear explosion occur predominantly in two major groups of nuclides.

SOURCE: Modified from Lapp and Andrews, Prentice-Hall, Inc., 1972.

An individual radioactive species follows the half-life rule of decay—that is, half of the nuclei disintegrate in a characteristic time, called a “half-life.” However, a mixture of fission products has a more complicated decay pattern. The general rule of thumb for a nuclear explosion is that the total activity decreases by a factor of 10 for every sevenfold increase in time. In other words, if the gamma radiation 1 hour after an explosion has an intensity of 100 units, then 7 hours later it will have an intensity of 10. Consequently, the time after the explosion has a dramatic effect on the amount of radioactivity. A 1 kiloton explosion in the atmosphere will produce 41 billion curies 1 minute after determination, but this will decrease to 10 million curies in just 12 hours.

Table 4-1—Common Radionuclides Involved in a Nuclear Explosion

| Radionuclide | Half-Life |
|---------------|---------------------|
| Uranium-238 | 4,500,000,000 years |
| Plutonium-239 | 24,300 years |
| Carbon-14 | 5,800 years |
| Radium-226 | 1,620 years |
| Cesium-137 | 30 years |
| Strontium-90 | 28 years |
| Tritium | 12.3 years |
| Krypton-85 | 10.9 years |
| Iodine-131 | 8 days |
| Xenon-133 | 5.2 days |
| Iodine-132 | 2.4 hours |

The type of release is also important in predicting what radionuclides will be present. For example, atmospheric tests release all radionuclides created. Prompt, massive ventings have released a nonnegligible fraction of the radionuclides created. Late-time, minor seeps, like those since 1970, release only the most volatile radionuclides. In an underground explosion, radionuclides also separate (called “fractionation”) according to their chemical or physical characteristics. Refractory particles (particles that do not vaporize during the nuclear explosion) settle out fast underground, while more volatile elements that vaporize easily condense later. This has a strong effect on radioactive gases that seep slowly through the soil from an underground explosion. In an underground explosion, nearly all the reactive materials are filtered out through the soil column, and the only elements that come up through the soil to the atmosphere are the noble gases, primarily krypton and xenon.

CRITERIA FOR CONDUCTING A TEST

Although every attempt is made to prevent the accidental release of radioactive material to the atmosphere, several safety programs are carried out for each test. These programs are designed to minimize the likelihood and extent of radiation exposure offsite and to reduce risks to people should an accidental release of radioactive material occur. The Environmental Protection Agency monitors the population around the test site and has established plans to protect people should an accident occur. EPA’s preparations are aimed toward reducing the whole-body exposure of the off-site populace and to minimizing thyroid dose to offsite residents, particu-

larly from the ingestion of contaminated milk.³ The whole-body dose is the main concern. However, deposition of radioactive material on pastures can lead to concentration in milk obtained from cows that graze on those pastures. The infant thyroid doses from drinking milk from family cows is also assessed.⁴

The Department of Energy's criteria for conducting a test are:

For tests at the Nevada Test Site, when considering the event-day weather conditions and the specific event characteristics, calculations should be made using the most appropriate hypothetical release models which estimate the off-site exposures that could result from the most probable release scenario. Should such estimates indicate that off-site populations, in areas where remedial actions to reduce whole-body exposures are not feasible, could receive average whole-body dose in excess of 0.17 R/year (170 mR/year), the event shall be postponed until more favorable conditions prevail. In addition, events may proceed only where remedial actions against uptake of radionuclides in the food chain are practicable and/or indications are that average thyroid doses to the population will not exceed 0.5 R/year (500 mR/year).⁵

These criteria mean that a test can only take place if the estimate of the fallout from an accidental release of radioactivity would not be greater than 0.17 R/year in areas that are uncontrollable, i.e., where "remedial actions to reduce whole-body exposures are not feasible." Thus, tests are not conducted when the wind is blowing in the general direction of populated areas considered to be uncontrollable, except under persistent light wind conditions that would limit the significant fallout to the immediate vicinity of the NTS. Areas considered to be uncontrollable by EPA are shown in figure 4-2.

The EPA and DOE have also defined a *controllable* area (figure 4-2), within which remedial actions are considered feasible. Criteria for the controllable area, as defined by the DOE are:

... those areas where trained rad-safe monitors are available, where communications are effective (where the exposure of each individual can be documented), where people can be expected to comply with

recommended remedial actions, and where remedial actions against uptake of radionuclides in the food chain are practicable.

The controllable area is the zone within approximately 125 miles of the test control point (see figure 4-2) for which EPA judges that its remedial actions would be effective. Within this area, EPA has the capability to track any release and perform remedial actions to reduce exposure, including sheltering or evacuation of all personnel (as needed); controlling access to the area; controlling livestock feeding practices, i.e., providing feed rather than allowing grazing; replacing milk; and controlling food and water.

In the case of the controllable area, a test may be conducted if the fallout estimate implies that individuals in the area would not receive whole-body doses in excess of 0.5 R/year and thyroid doses of 1.5 R/year. If winds measured by the weather service indicate that the cloud of radioactive debris produced by the assumed venting would drift over controllable areas, such as to the north, the test is permitted when EPA's mobile monitors are in the downwind areas at populated places. EPA must be ready to measure exposure and to assist in moving people under cover or evacuating them, if necessary, to keep their exposures below allowable levels.

As a consequence of the geometry of the controllable area, tests are generally not conducted if winds aloft blow toward Las Vegas or towards other nearby populated locations. In addition, the test will not be conducted if there is less than 3 hours of daylight remaining to track the cloud.

Prior to conducting a test, detailed fallout projections are made by the weather service for the condition of "the unlikely event of a prompt massive venting." Predictions are made of the projected fallout pattern and the maximum radiation exposures that might occur. An example of such a prediction is shown in figure 4-3. The center line is the predicted path of maximum fallout deposition for a prompt venting, marked with estimated arrival times (in hours) at various distances. Lines to either side indicate the width of the fallout area. The two dashed lines indicate the 500 mR/year area and the

³See "Offsite Remedial Action Capability for Underground Nuclear Weapons Test Accidents," U.S. Environmental Protection Agency, Environmental Monitoring Systems Laboratory—Las Vegas, NV, October 1988.

⁴In the case of an accident, however, the actual dose would be minimized because the milk would be replaced as much as possible.

⁵See "Offsite Remedial Action Capability for Underground Nuclear Weapons Test Accidents," U.S. Environmental Protection Agency, Environmental Monitoring Systems Laboratory—Las Vegas, NV, October 1988.

Figure 4-2—Controllable and Uncontrollable Areas

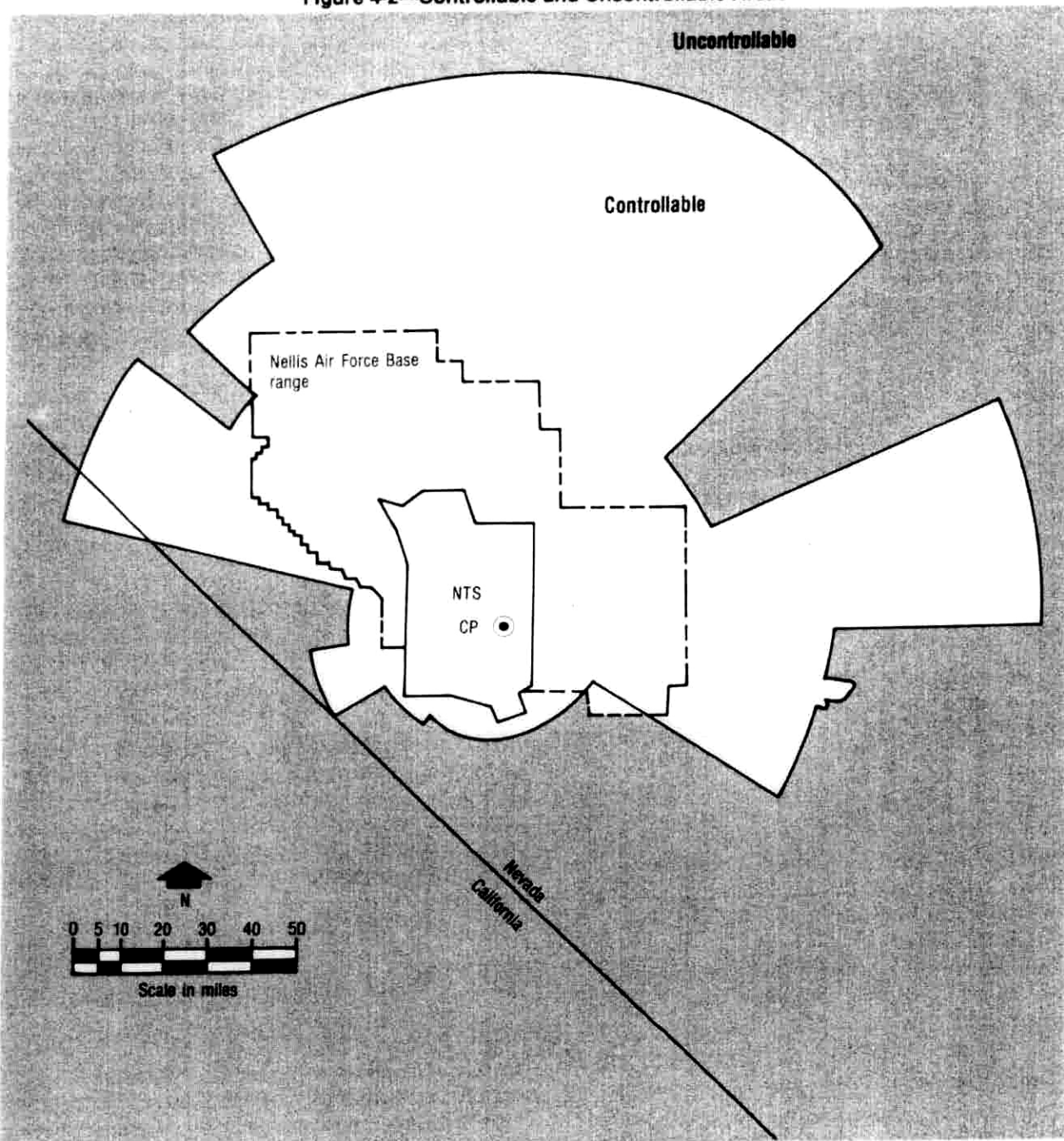

The controllable area is the region within which remedial actions are considered feasible.

SOURCE: Modified from Environmental Protection Agency.

170 mR/year level. If 0.17 mR/year (the maximum external exposure allowed during a 12-month period for an uncontrolled population) or more is predicted to fall outside the controllable area, the test will be

postponed. Within the predictions shown in figure 4-3, the test could be conducted if EPA monitors were prepared to be at each of the ranches, mines, and other populated areas within the dispersion

Figure 4-3—Projected Fallout Dispersion Pattern

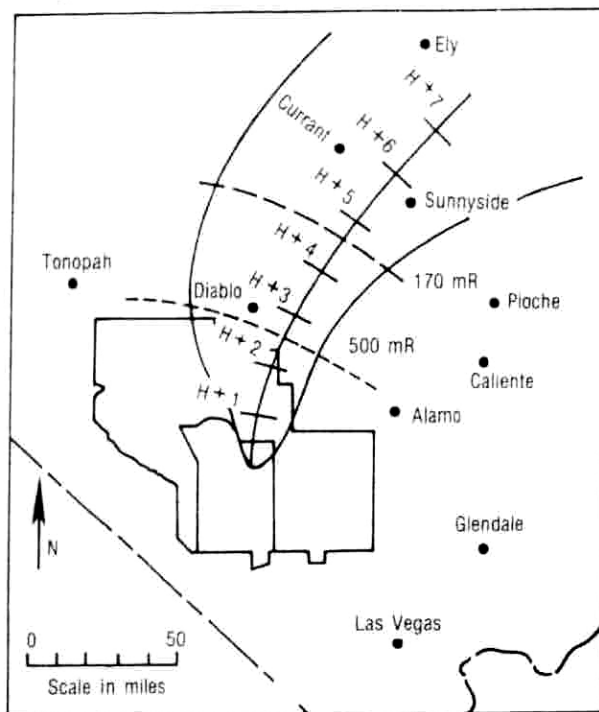

Key: H+ number = time of detonation plus elapsed hours; mR = millirem

Predicted fallout pattern for the case of an accidental venting.

SOURCE: Modified from: "Public Safety for Nuclear Weapons Tests," U.S. Environmental Protection Agency, January 1984.

pattern to measure exposure and perform remedial actions should they be necessary.

The preferred weather conditions for a test are a clear sky for tracking, southerly winds (winds from the south), no thunderstorms or precipitation that would inhibit evacuation, and stable weather patterns. During the test preparations, the Weather Service Nuclear Support Office provides the Test Controller with predicted weather conditions. This information is used by the Weather Service to derive the estimated fallout pattern should an accidental release occur. About one-third of all nuclear tests are delayed for weather considerations; the maximum delay in recent years reached 16 days.

⁶Pike was conducted in alluvium in Area 3 of the test site. The release was attributed to a fracture that propagated to the surface. Other factors contributing to the release were an inadequate depth of burial and an inadequate closure of the line-of-sight pipe.

⁷"1985 Analyses and Evaluations of the Radiological and Meteorological Data from the Pike Event," National Oceanic and Atmospheric Administration, Weather Service Nuclear Support Office, Las Vegas, NV, December, 1986, NVO-308.

⁸The exact amount of material released from the 1964 Pike test remains classified.

⁹See table 3-1 for a comparison of various releases.

PREDICTING FALLOUT PATTERNS

The predicted fallout pattern from an underground test depends on many variables related to the type of nuclear device, the device's material composition, type of venting, weather conditions, etc. With so many variables and so little experience with actual ventings, fallout predictions can only be considered approximations. The accuracy of this approximation, however, is critical to the decision of whether a test can be safely conducted. Fallout predictions are made by the Weather Service Nuclear Support Office using up-to-date detailed weather forecasts combined with a model for a "prompt massive venting." The model uses scaling technique based on the actual venting of an underground test that occurred on March 13, 1964. The test, named "Pike," was a low-yield (less than 20 kilotons) explosion detonated in a vertical shaft. A massive venting occurred 10 to 15 seconds after detonation.⁶ The venting continued for 69 seconds, at which time the overburden rock collapsed forming a surface subsidence crater and blocking further venting. The vented radioactive debris, consisting of gaseous and particulate material, rose rapidly to about 3,000 feet above the surface.

The Pike scaling model has been used to calculate estimates of fallout patterns for the past 20 years because: 1) the large amount of data collected from the Pike venting allowed the development of a scaling model, and 2) Pike is considered to be the worst venting in terms of potential exposure to the public.⁷

The Pike model, however, is based on a very small release of radioactive material compared to what would be expected from an aboveground test of the same size.⁸ The percentage of radioactive material released from the Baneberry venting (7 percent from table 3-1), for example, is many times greater than the percentage of material released from the Pike test.⁹ It would therefore appear that Baneberry provides a more conservative model than Pike. This, however, is not the case because Baneberry was not

a *prompt* venting. Baneberry vented through a fissure and decaying radioactive material was pumped out over many hours. Baneberry released more curies than Pike; however, due to its slower release, a higher percentage of the Baneberry material was in the form of noble gases, which are not deposited. The data suggest that much less than 7 percent of the released material was deposited.¹⁰ Therefore, it is thought that Pike is actually a more conservative model than Baneberry.

The sensitivity of the Pike model can be judged by looking at the degree to which its predictions are affected by the amount of material released. For example, consider a test in which 10 percent of the radioactive material produced by the explosion is accidentally released into the atmosphere; in other words, 10 percent of the material that would have been released if the explosion had been detonated aboveground. This also roughly corresponds to the amount of material that would be released if the explosion had been detonated underground at the bottom of an open (unstemmed) hole. The 10 percent release can therefore be used as a rough approximation for the worst case release from an underground test. To evaluate the adequacy of the Pike model predictions to withstand the full range of uncertainty of an accidental release, the question is: what effect would a release of 10 percent rather than, say 1 percent, have on the location of 170-mR and 500-mR exposure lines? As figure 4-4 illustrates, changing the yield of an explosion by an order of magnitude (in other words, increasing the release from say 1 percent to 10 percent) increases the distance of the 170-mR and 500-mR lines by roughly a factor of 2. Therefore, assuming a worst case scenario of a 10 percent prompt massive venting (as opposed to the more probable scenario of around a 1 percent prompt massive venting), the distance of the exposure levels along the predicted fallout lines would only increase by a multiple of 2. The Pike model therefore provides a prediction that is *at least* within a factor of about 2 of almost any possible worst-case scenario.

ACCIDENT NOTIFICATION

Any release of radioactive material is publicly announced if the release occurs during, or immediately following, a test. If a late-time seep occurs, the release will be announced if it is predicted that the

Figure 4-4—Yield v. Distance

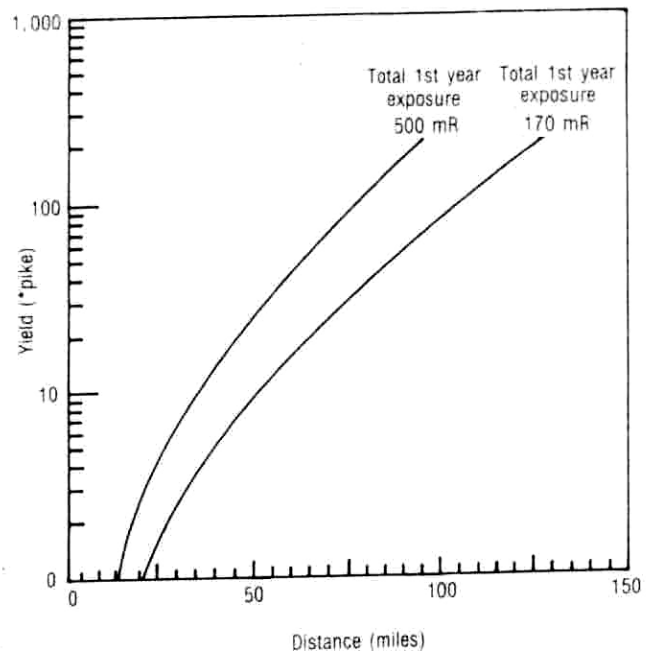

Constant Pike Parameters

Wind speed = 15mph
Vertical wind shear = 20°
Cloud rise = 5,000ft

Variable

Yield × Pike

Yield (in kilotons) v. distance (in miles) for projected fallout using the Pike Model. TYE indicates total first year exposure. Increasing the yield by a factor of 10 roughly doubles the downwind distance of the projected fallout pattern.

SOURCE: Provided by National Oceanic and Atmospheric Administration, National Weather Service Nuclear Support Office, 1988.

radioactive material will be detected outside the boundaries of the test site. **If no detection off-site is predicted, the release may not be announced.** Operational releases that are considered routine (such as small releases from drill-back operations) are similarly announced *only* if it is estimated that they will be detected off-site.

The Environmental Protection Agency is present at every test and is therefore immediately aware of any prompt release. The Environmental Protection Agency, however, is not present at post-test drill-back operations. In the case of late-time releases or operational releases, the Environmental Protection Agency depends on notification from the Department of Energy and on detection of the release (once

¹⁰Baneberry, however, had a limited data set of usable radioactive readings.

it has reached outside the borders of the test site) by the EPA offsite monitoring system.

Estimates of whether a particular release will be detected offsite are made by the Department of Energy or the sponsoring laboratory. Such judgments, however, are not always correct. During the drill-back operations of the Glencoe test in 1986, minor levels of radioactive material were detected offsite contrary to expectations. During the Riola test in 1980, minor amounts of radioactive inert gases were detected offsite. In both cases, DOE personnel did not anticipate the release to be detected offsite and therefore did not notify EPA.¹¹ Although the releases were extremely minor and well-monitored within the test site by DOE, EPA was not aware of the release until the material had crossed the test site boundaries. Both cases fueled concern over DOE's willingness to announce accidents at the test site. **The failure of DOE to publicly announce all releases, regardless of size or circumstance, contributes to public concerns over the secrecy of the testing program and reinforces the perceptions that all the dangers of the testing program are not being openly disclosed.**

Onsite Monitoring by the Department of Energy

The Department of Energy has responsibility for monitoring within the boundaries of the Nevada Test Site to evaluate the containment of radioactivity onsite and to assess doses-to-man from radioactive releases as a result of DOE operations. To achieve these objectives, DOE uses a comprehensive monitoring system that includes both real-time monitoring equipment and sample recovery equipment. The real-time monitoring system is used for prompt detection following a test, the sample recovery equipment is used to assess long-term dose and risk.

The heart of the real-time monitoring system is a network of Remote Area Monitors (RAMs). For all tests, RAMs are arranged in an array around the test hole (figure 4-5). Radiation detectors are also frequently installed down the stemming column so the flow of radioactive material up the emplacement hole can be monitored. In tunnel shots, there are RAMs above the shot point, throughout the tunnel complex, outside the tunnel entrance, and in each containment vessel (figure 4-6). In addition to

RAMs positioned for each shot, a permanent RAM network with stations throughout the test site is in continual operation.

During each test, a helicopter with closed-circuit television circles the ground zero location. Nearby, a second helicopter and an airplane are prepared to track any release that might occur. A third helicopter and an airplane remain on stand-by should they be needed. In addition, a team (called the "Bluebird Team"), consisting of trained personnel in 2 four-wheel drive vehicles outfitted with detection equipment and personnel protection gear is stationed near the projected fallout area to track and monitor any release. Approximately 50 radiation monitoring personnel are available on the Nevada Test Site to make measurements of exposure rates and collect samples for laboratory analysis should they be needed. Prior to the test, portions of the test site are evacuated unless the operation requires manned stations. If manned stations are required, direct communication links are established with the workers and evacuation routes are set-up.

In addition to the real-time monitoring network, air and water samples are collected throughout the Test Site and analyzed at regular intervals. This comprehensive environmental monitoring program is summarized in table 4-2. The network of samplers located throughout the Test Site includes 160 thermoluminescent dosimeters; over 40 air samplers that collect samples for analysis of radioiodines, gross beta, and plutonium-239; and about half a dozen noble gas samplers. Each year over 4,500 samples are collected and analyzed for radiological measurement and characterization of the Nevada Test Site. All sample collection, preparation, analysis, and review are performed by the staff of the Laboratory Operations Section of REECO's Environmental Sciences Department.

In the case of a prompt, massive accidental release of radioactive material, the following emergency procedures would be initiated:

1. any remaining test site employees downwind of the release would be evacuated,
2. monitoring teams and radiological experts would be dispatched to offsite downwind areas.

¹¹In the case of Riola, the release occurred in the evening and was not reported until the following morning. As a result, it was 12½ hours before EPA was notified.

Figure 4-5—Typical RAMs Array for Vertical Drill-Hole Shot

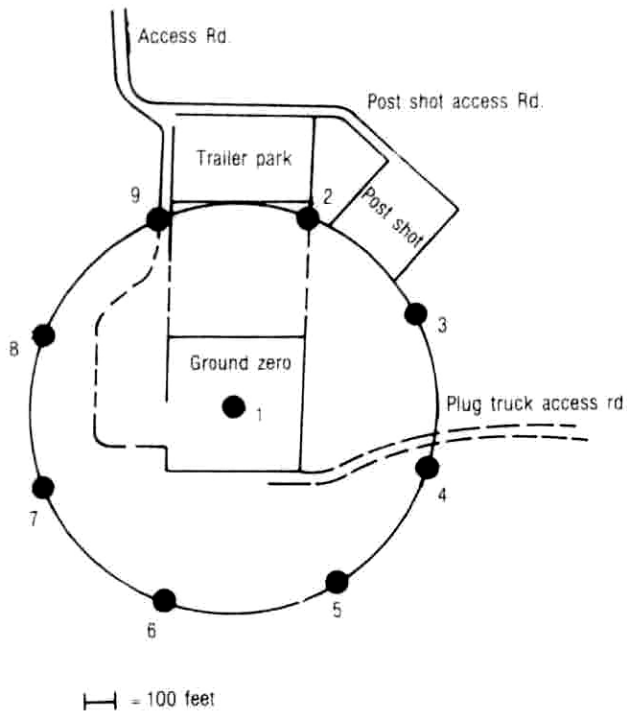

In addition to the RAMs located down the drill hole, nine RAMs are placed at the surface around the test hole.

SOURCE: Modified from Department of Energy

3. ground and airborne monitoring teams would measure radioactive fallout and track the radioactive cloud,
4. Federal, State, and local authorities would be notified, and
5. if necessary, persons off-site would be requested to remain indoors or to evacuate the area for a short time.¹²

Offsite Monitoring by the Environmental Protection Agency

Under an interagency agreement with the Department of Energy, the Environmental Protection Agency is responsible for evaluating human radiation exposure from ingesting air, water, and food that may have been affected by nuclear testing. To accomplish this, EPA collects over 8,700 samples each year and performs over 15,000 analytical

measurements on water, milk, air, soil, humans, plants, and animals.¹³ The sampling system and results are published annually in EPA's "Offsite Environmental Monitoring Report, Radiation Monitoring Around United States Nuclear Test Areas."

The heart of the EPA monitoring system is the network of 18 community monitoring stations. The community monitoring program began in 1981 and was modeled after a similar program instituted in the area surrounding the Three Mile Island nuclear reactor power plant in Pennsylvania. Community participation allows residents to verify independently the information being released by the government and thereby provide reassurance to the community at large. The program is run in partnership with several institutions. The Department of Energy funds the program and provides the equipment. The Environmental Protection Agency maintains the equipment, analyzes collected samples, and interprets results. The Desert Research Institute manages the network, employs local station managers, and independently provides quality assurance and data interpretation. The University of Utah trains the station managers selected by the various communities. Whenever possible, residents with some scientific training (such as science teachers) are chosen as station managers.

There are 18 community monitoring stations (shown as squares in figure 4-7) located around the test site. The equipment available to each station includes:¹⁴

Noble Gas Samplers: These samplers compress air in a tank. The air sample is then analyzed to measure the concentration of such radioactive noble gases as xenon and krypton.

Tritium Sampler: These samplers remove moisture from the air. The moisture is then analyzed to measure the concentration of tritium in the air.

Particulates and Reactive Gases Sampler: These samplers draw 2 cubic feet of air per minute through a paper filter and then through a canister of activated charcoal. The paper filter collects particles and the charcoal collects reactive gases. Both are analyzed for radioactivity.

¹²Modified from "Onsite Environmental Report for the Nevada Test Site" (January 1987 through December 1987), Daniel A. Gonzalez, REECO, Inc., DOE/NV/10327-39.

¹³In addition, EPA annually visits each location outside the Nevada Test Site where a nuclear test has occurred.

¹⁴"Community Radiation Monitoring Program," U.S. Environmental Protection Agency, January 1984.

Figure 4-6—Typical RAMs Array for Tunnel Shot ("Mission Cyber," Dec. 2, 1988)

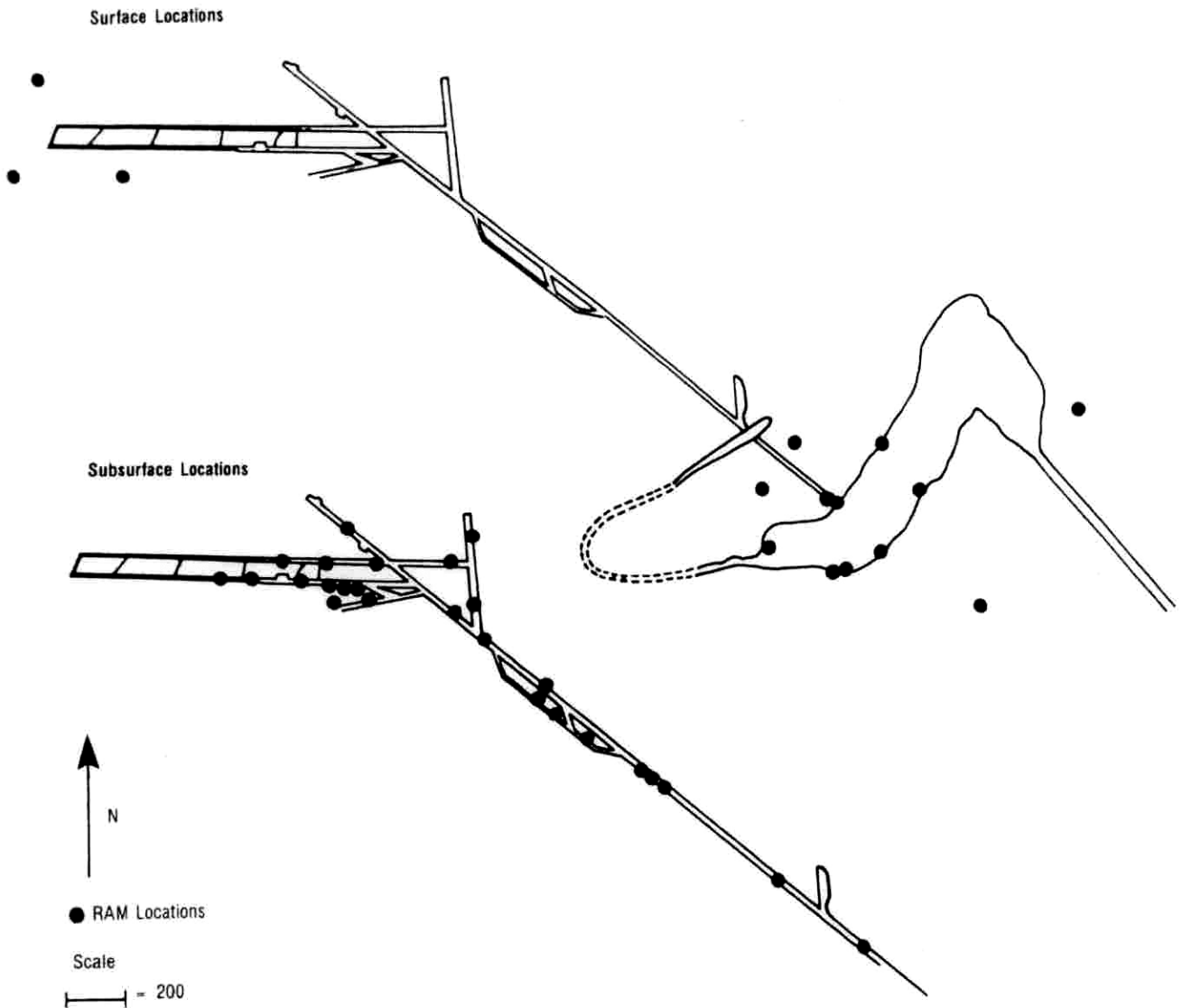

A total of 41 RAMs (15 above the surface, 26 belowground) are used to monitor the containment of radioactive material from a horizontal tunnel test.

SOURCE: Modified from Department of Energy.

Thermoluminescent Dosimeter (TLD): When heated (thermo-), the TLD releases absorbed energy in the form of light (-luminescent). The intensity of the light is proportional to the gamma radiation absorbed, allowing calculation of the total gamma radiation exposure.

Gamma Radiation Exposure Rate Recorder: A pressurized ion chamber detector for gamma radiation is connected to a recorder so that a continuous

record of gamma radiation is obtained and changes in the normal gamma radiation level are easily seen.

Microbarograph: This instrument measures and records barometric pressure. The data are useful in interpreting gamma radiation exposure rate records. At lower atmospheric pressure, naturally occurring radioactive gases (like radon) are released in greater amounts from the Earth's surface and their radioactive decay contributes to total radiation exposure.

Table 4-2—Summary of Onsite Environmental Monitoring Program

| Sample type | Description | Collection frequency | Number of locations | Analysis |
|---------------------------------|---|----------------------|---------------------|---|
| Air | Continuous sampling through gas filter & charcoal cartridge | Weekly | 44 | Gamma Spectroscopy gross beta, Pu-239 |
| | Low-volume sampling through silica gel | Biweekly | 16 | Tritium (HTO) |
| Potable water | Continuous low volume | Weekly | 7 | Noble gases |
| | 1-liter grab sample | Weekly | 7 | Gamma Spectroscopy gross beta, tritium Pu-239 (quarterly) |
| Supply wells | 1-liter grab sample | Monthly | 16 | Gamma Spectroscopy gross beta, tritium Pu-239 (quarterly) |
| Open reservoirs | 1-liter grab sample | Monthly | 17* | Gamma Spectroscopy gross beta, tritium Pu-239 (quarterly) |
| Natural springs | 1-liter grab sample | Monthly | 9* | Gamma Spectroscopy gross beta, tritium Pu-239 (quarterly) |
| Ponds (contaminated) | 1-liter grab sample | Monthly | 8* | Gamma Spectroscopy gross beta, tritium Pu-239 (quarterly) |
| Ponds (effluent) | 1-liter grab sample | Monthly | 5 | Gamma Spectroscopy gross beta, tritium Pu-239 (quarterly) |
| External gamma radiation levels | Thermoluminescent Dosimeters | Semi-annually | 153 | Total integrated exposure over field cycle |

*Not all of these locations were sampled due to inaccessibility or lack of water.

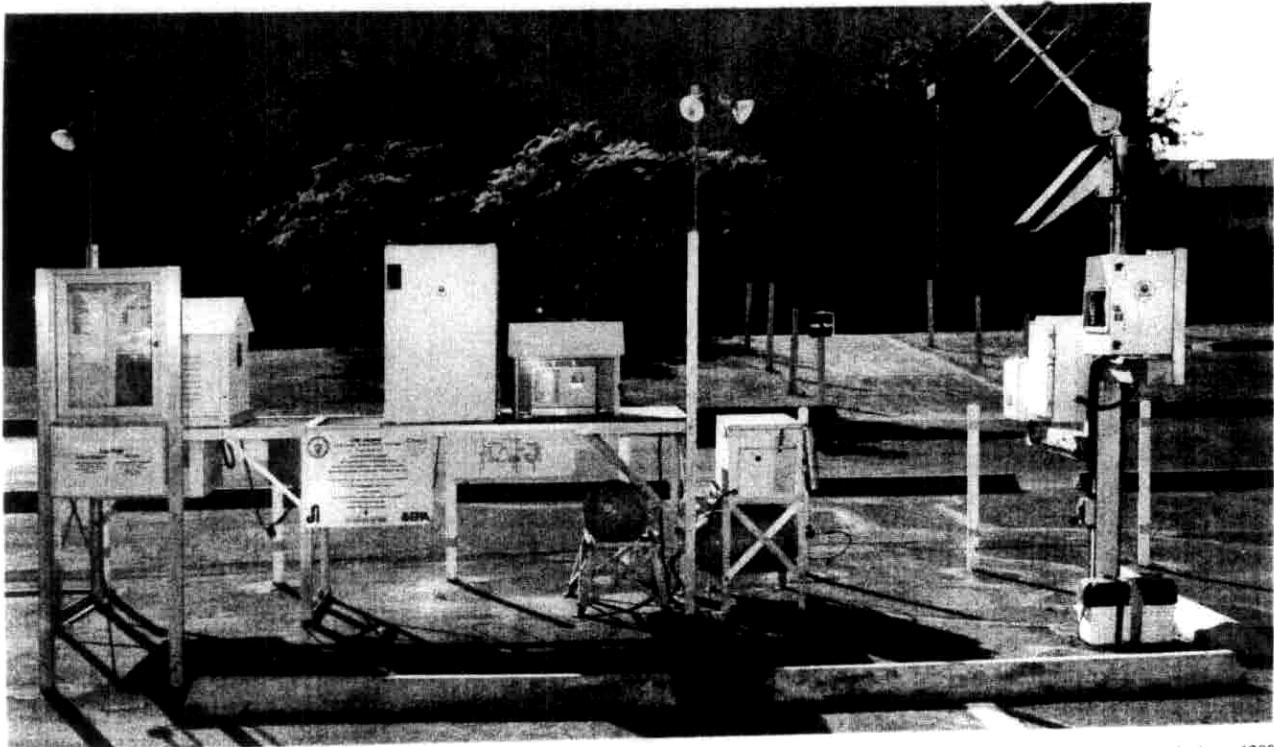
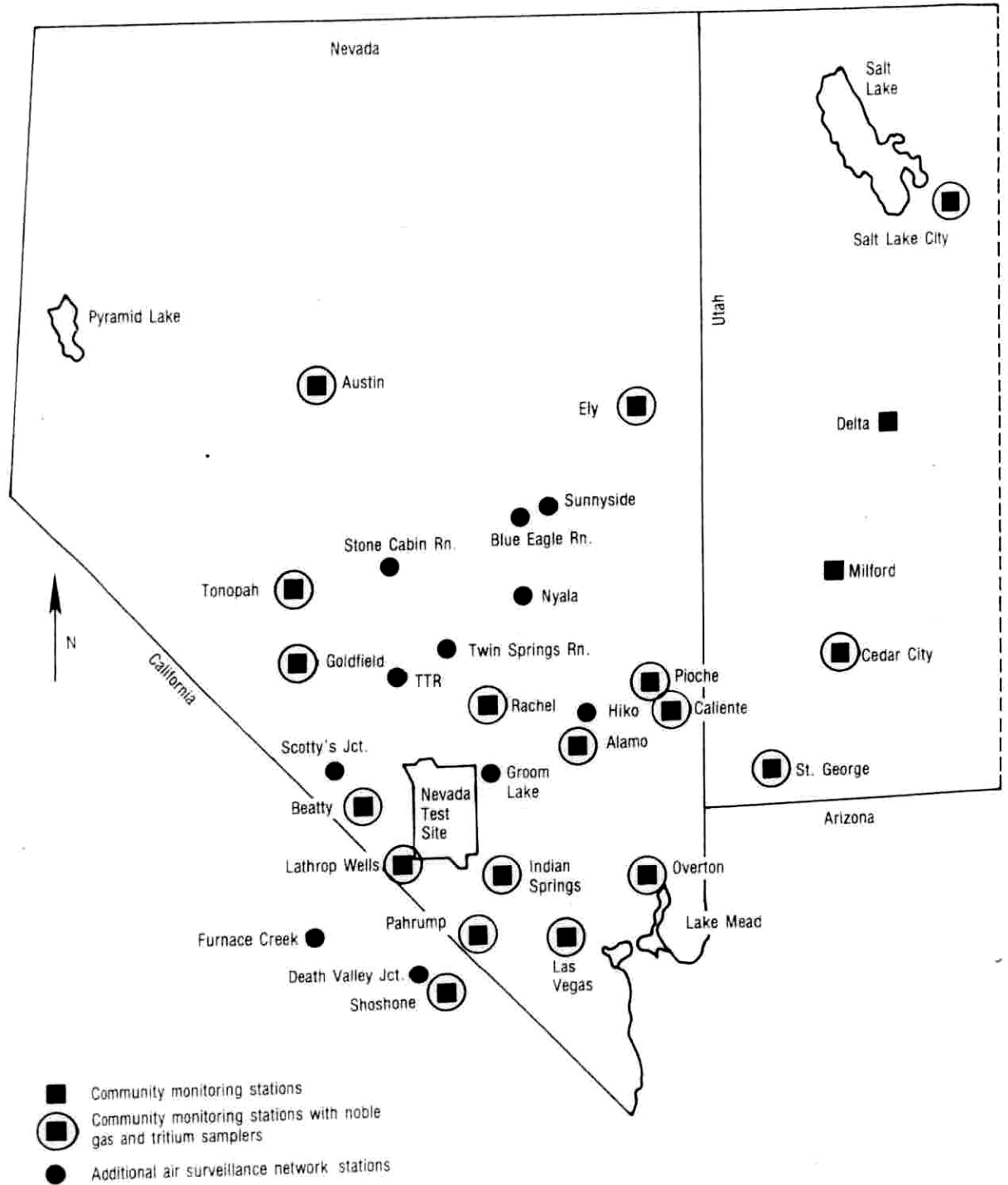

Photo credit: David Graham, 1988

Community Monitoring Station, Las Vegas, NV.

Figure 4-7—Air Monitoring Stations



SOURCE: Modified from Environmental Protection Agency

The monitoring stations are extremely sensitive; they can detect changes in radiation exposure due to changing weather conditions. For example, during periods of low atmospheric pressure, gamma exposure rates are elevated on the order of 2 to 4 uR/hr because of the natural radioactive products being drawn out of the ground. To inform the public, data from the community monitoring stations are posted at each station and sent to local newspapers (figure 4-8).

In addition to the 18 community monitoring stations, 13 other locations are used for the Air Surveillance Network (shown as circles in figure 4-7) to monitor particulates and reactive gases. The air surveillance network is designed to cover the area within 350 kilometers of the Nevada Test Site, with a concentration of stations in the prevailing downwind direction. The air samplers draw air through glass fiber filters to collect airborne particles (dust). Charcoal filters are placed behind the glass fiber filters to collect reactive gases. These air samplers are operated continuously and samples are collected three times a week. The Air Surveillance Network is supplemented by 86 standby air sampling stations located in every State west of the Mississippi River (figure 4-9). These stations are ready for use as needed and are operated by local individuals or agencies. Standby stations are used 1 to 2 weeks each quarter to maintain operational capability and detect long-term trends.

Noble gas and tritium samplers are present at 17 of the air monitoring stations (marked with asterisk in figure 4-7). The samplers are located at stations close to the test site and in areas of relatively low altitude where wind drains from the test site. Noble gases, like krypton and xenon, are nonreactive and are sampled by compressing air in pressure tanks. Tritium, which is the radioactive form of hydrogen, is reactive but occurs in the form of water vapor in air. It is sampled by trapping atmospheric moisture. The noble gas and tritium samplers are in continuous operation and samples are recovered and analyzed weekly.

To monitor total radiation doses, a network of approximately 130 TLDs is operated by EPA. The network encircles the test site out to a distance of about 400 miles with somewhat of a concentration in the zones of predicted fallout (figure 4-10). The TLD network is designed to measure environmental radiation exposures at a location rather than expo-

sure to a specific individual. By measuring exposures at fixed locations, it is possible to determine the maximum exposure an individual would have received had he or she been continually present at that location. In addition, about 50 people living near the test site and all personnel who work on the test site wear TLD's. All TLD's are checked every 3 months for absorbed radiation.

Radioactive material is deposited from the air onto pastures. Grazing cows concentrate certain radionuclides, such as iodine-131, strontium-90, and cesium-137 in their milk. The milk therefore becomes a convenient and sensitive indicator of the fallout. The Environmental Protection Agency analyzes samples of raw milk each month from about 25 farms (both family farms and commercial dairies) surrounding the test site (figure 4-11). In addition to monthly samples, a standby milk surveillance network of 120 Grade A milk producers in all States west of the Mississippi River can provide samples in case of an accident (figure 4-12). Samples from the standby network are collected annually.

Another potential exposure route of humans to radionuclides is through meat of local animals. Samples of muscle, lung, liver, kidney, blood, and bone are collected periodically from cattle purchased from commercial herds that graze northeast of the test site. In addition, samples of sheep, deer, horses, and other animals killed by hunters or accidents are used (figure 4-13). Soft tissues are analyzed for gamma-emitters. Bone and liver are analyzed for strontium and plutonium; and blood/urine or soft tissue is analyzed for tritium.

A human surveillance program is also carried out to measure the levels of radioactive nuclides in families residing in communities and ranches around the test site (figure 4-14). About 40 families living near the test site are analyzed twice a year. A whole-body count of each person is made to assess the presence of gamma-emitting radionuclides.

GROUNDWATER

About 100 underground nuclear tests have been conducted directly in the groundwater. In addition, many pathways exist for radioactive material from other underground tests (tests either above or below the water table) to migrate from the test cavities to the groundwater. To detect the migration of radioactivity from nuclear testing to potable water sources, a long-term hydrological monitoring program is

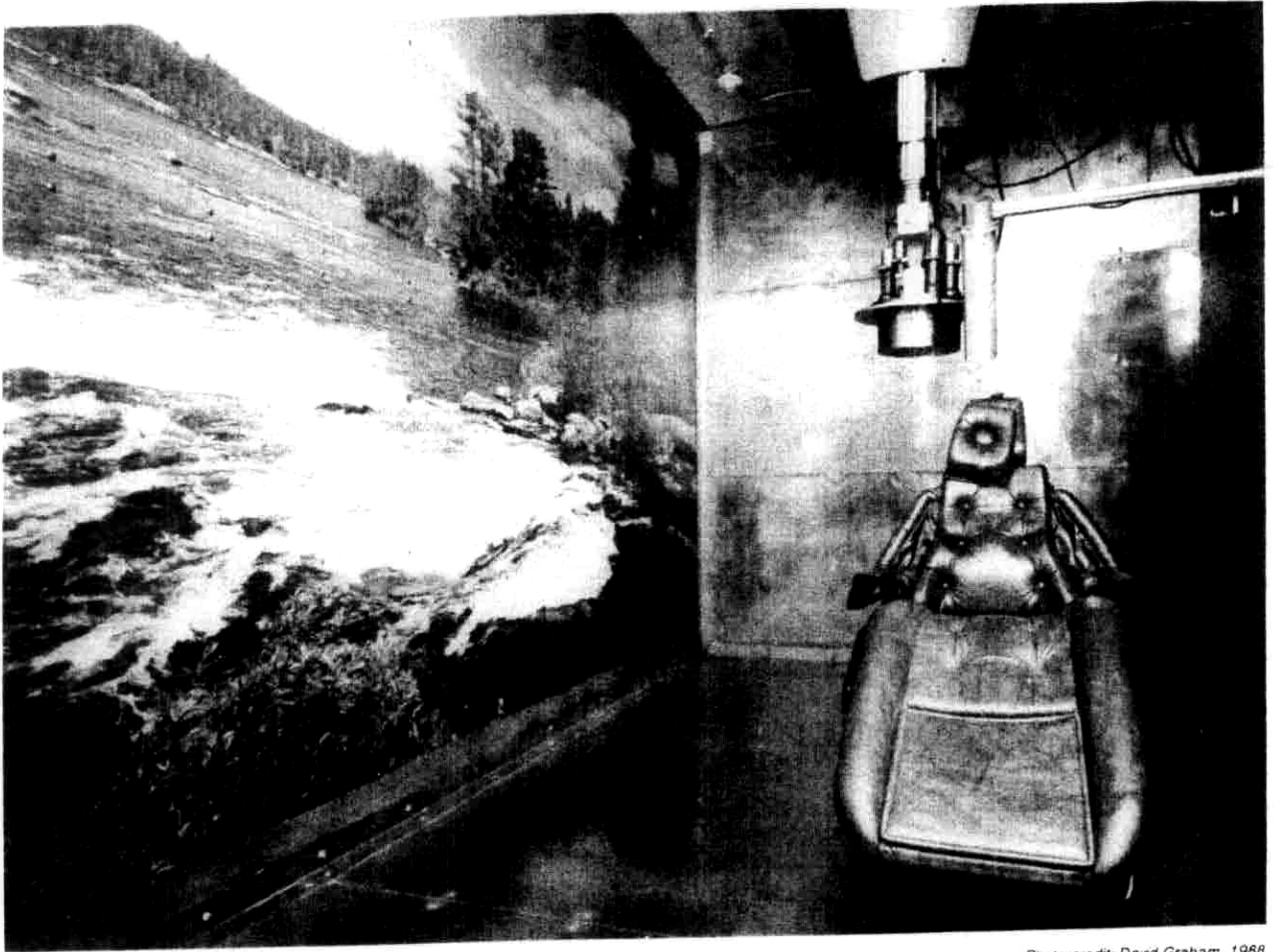

Photo credit: David Graham, 1988

Whole Body Counter, Environmental Protection Agency.

managed by the Environmental Protection Agency at the Department of Energy's direction with advice on sampling locations being obtained from the U.S. Geological Survey. Whenever possible, water samples are collected from wells downstream (in the direction of movement of underground water) from sites of nuclear detonations. On the Nevada Test Site, about 22 wells are sampled monthly (figure 4-15). The 29 wells around the Nevada Test Site (figure 4-16) are also sampled monthly and analyzed for tritium semiannually.

The flow of groundwater through the Nevada Test Site is in a south-southwesterly direction. The flow speed is estimated to be about 10 feet per year, although in some areas it may move as fast as 600 feet per year. To study the migration of radionu-

clides from underground tests, DOE drilled a test well near a nuclear weapons test named "Cambric." Cambric had a yield of 0.75 kilotons and was detonated in a vertical drill hole in 1965. A test well was drilled to a depth of 200 feet below the cavity created by Cambric. It was found that most of the radioactivity produced by the test was retained within the fused rock formed by the explosion, although low concentrations of radioactive material were found in the water at the bottom of the cavity.¹⁵ A satellite well was also drilled 300 feet from the cavity. More than 3 billion gallons of water were pumped from the satellite well in an effort to draw water from the region of the nuclear explosion. The only radioactive materials found in the water were extremely small quantities (below the permitted

¹⁵See "Radionuclide Migration in Groundwater at NTS," U.S. Department of Energy, September, 1987.

Figure 4-8—Sample Press Release

Alamo, NVJuly 11 to July 20, 1988
The Nevada Test Site**COMMUNITY RADIATION MONITORING REPORT**

Dell Sullivan, Manager of the Community Radiation Monitoring Station in Alamo, NV reported the results of the radiation measurements at this station for the period July 11 to July 20, 1988. The average gamma radiation exposure rate recorded by a Pressurized Ion Chamber at this station was 13.0 microentgens* per hour as shown on the chart.

**AVERAGE GAMMA RADIATION EXPOSURE RATE
RECORDED ON THE PRESSURIZED ION CHAMBER AT
ALAMO, NV, DURING THE WEEK ENDING JULY 20, 1988**

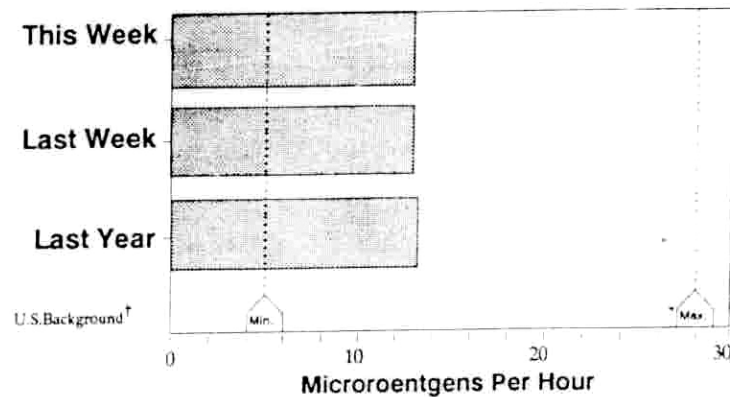

The averages of the 16 Community Monitoring Stations operated for the Environmental Protection Agency, Department of Energy and the Desert Research Institute varied from 6.2 microentgens per hour at Las Vegas, NV to 20.2 microentgens per hour at Austin, NV. All of the rates for the past week were within the normal background range for the United States as shown on the accompanying chart. Environmental radiation exposure rates vary with altitude and natural radioactivity in the soil. Additional information and detailed data obtained from Community Radiation Monitoring Network Stations, including an annual summary of the results from all monitoring around the Nevada Test Site, can be obtained from Mr. Sullivan (702) 725-3544 or by calling Charles F. Costa at the EPA in Las Vegas (702) 798-2305.

*The roentgen is a measure of exposure to X or gamma radiation. A microentgen is 1 millionth of a roentgen. For comparison, one chest x-ray results in an exposure of 10,000 to 20,000 microentgens.

† Sum of cosmic plus terrestrial dose rates in air in the U.S. (pp37,42, BEIR III, 1980).

Example of community radiation monitoring report that is posted at each monitoring station and sent to the press.

SOURCE: Environmental Protection Agency.

Figure 4-9—Standby Air Surveillance Network Stations

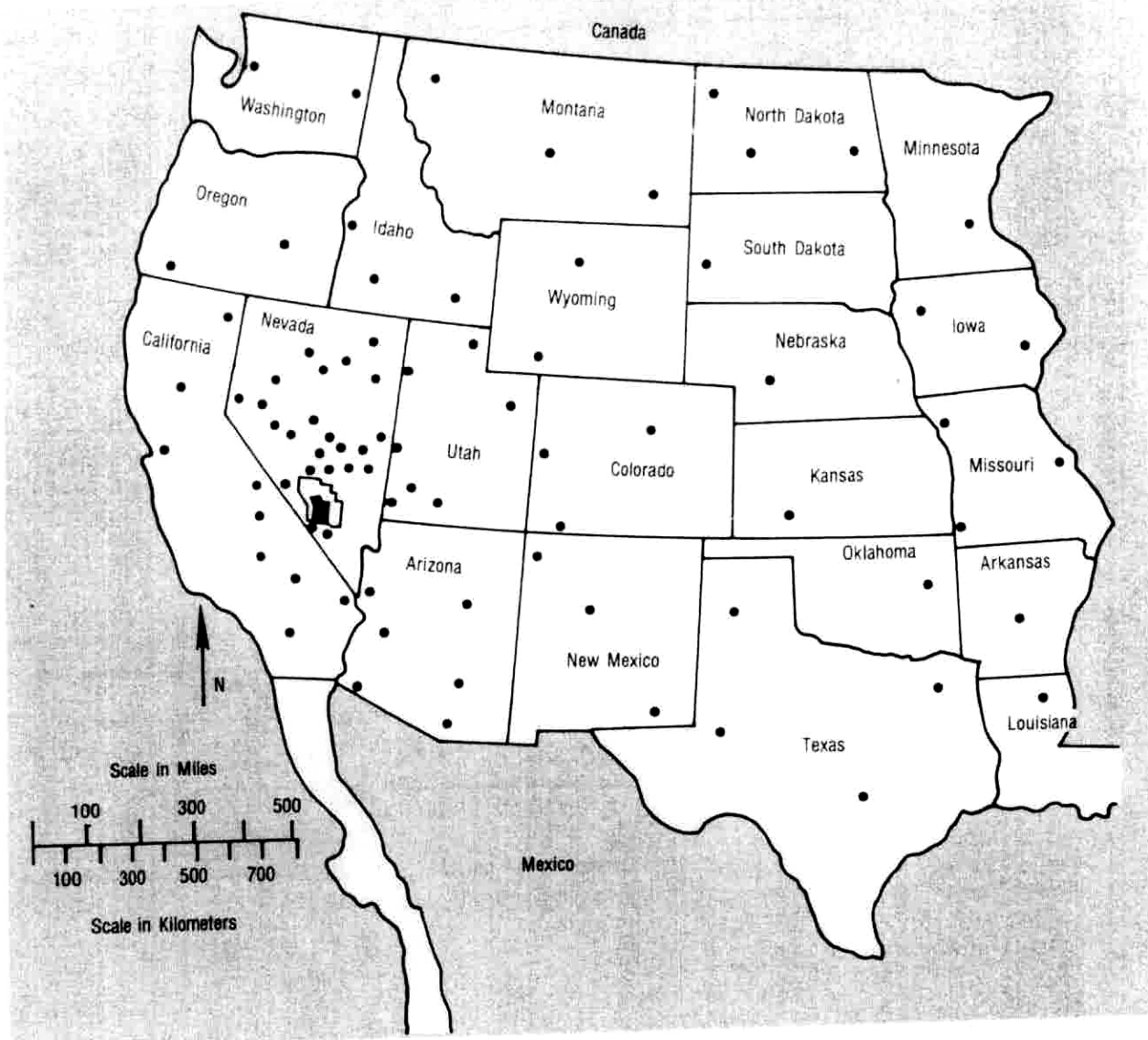

86 standby air surveillance stations are available and samples are collected and analyzed every 3 months to maintain a data base.
SOURCE: Modified from Environmental Protection Agency.

level for drinking water) of krypton-85, chlorine-36, ruthenium-106, technetium-99 and iodine-129.

Radioactive material from nuclear testing moves through the groundwater at various rates and is filtered by rock and sediment particles. Tritium, however, is an isotope of hydrogen and becomes incorporated in water molecules. As a result, tritium moves at the same rate as groundwater. Tritium is

therefore the most mobile of the radioactive materials. Although tritium migrates, the short half-life of tritium (12.3 years) and slow movement of the groundwater prevents it from reaching the Test Site boundary. No analysis of groundwater has ever found tritium at a distance greater than a few hundred meters from some of the old test sites. None of the water samples collected outside the bounda-

Figure 4-10—Locations Monitored With Thermoluminescent Dosimeters (TLDs)

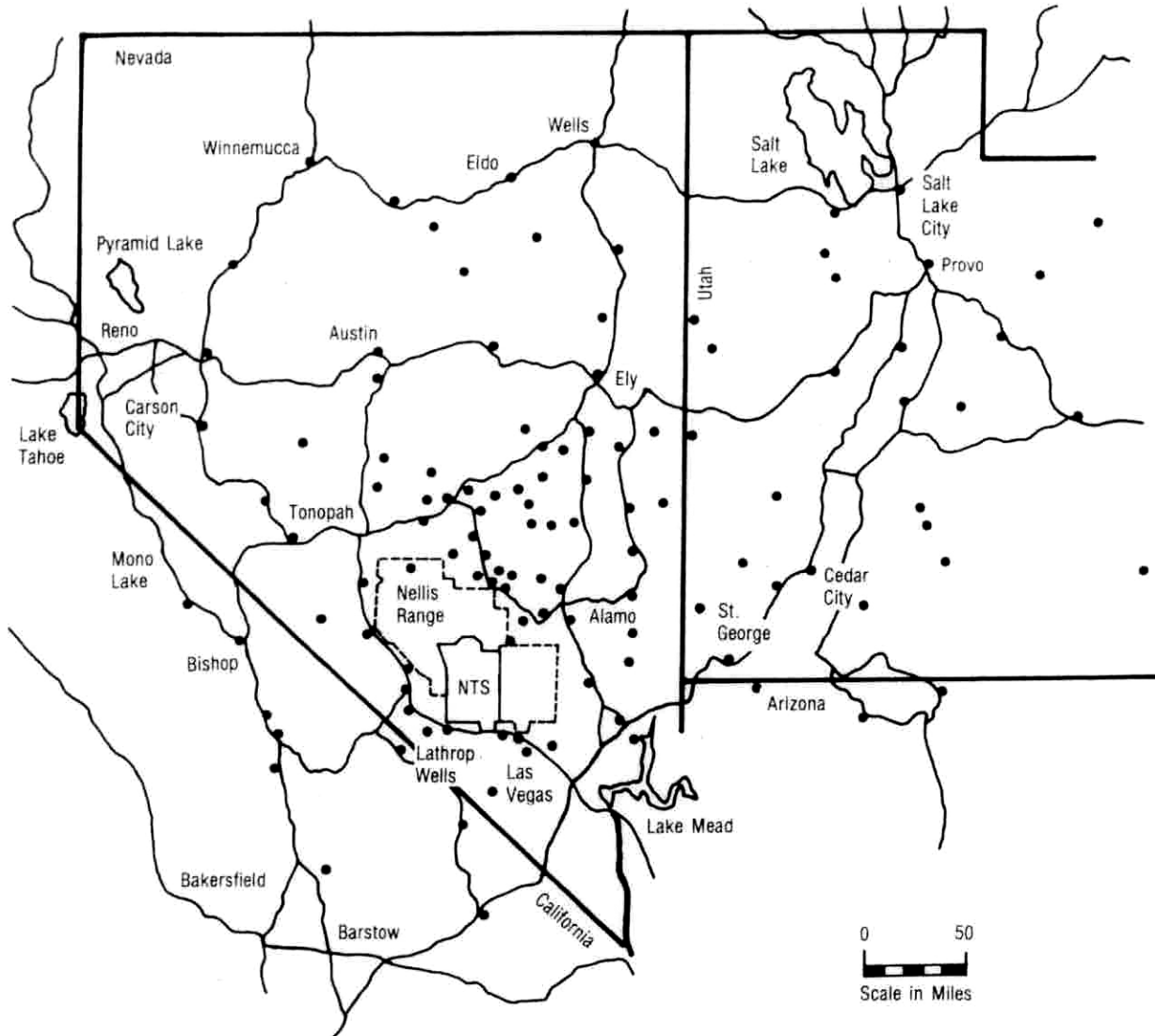

One hundred thirty locations are monitored with TLDs. All TLDs are checked every 3 months for absorbed radiation.

SOURCE: Modified from Environmental Protection Agency.

ries of the test site has ever had detectable levels of radioactivity attributable to the nuclear testing program. An independent test of water samples from around the test site was conducted by Citizen Alert (Reno, Nevada) at 14 locations (table 4-3).

Citizen Alert found no detectable levels of tritium or fission products in any of their samples. Withstanding any major change in the water table, there currently appears to be no problem associated with

groundwater contamination offsite of the Nevada Test Site.

MONITORING CAPABILITY

The combination of: 1) the monitoring system deployed for each test, 2) the onsite monitoring system run by DOE, and 3) the offsite monitoring system run by EPA, forms a comprehensive detection system for radioactive material. **There is**

Figure 4-11—Milk Sampling Locations

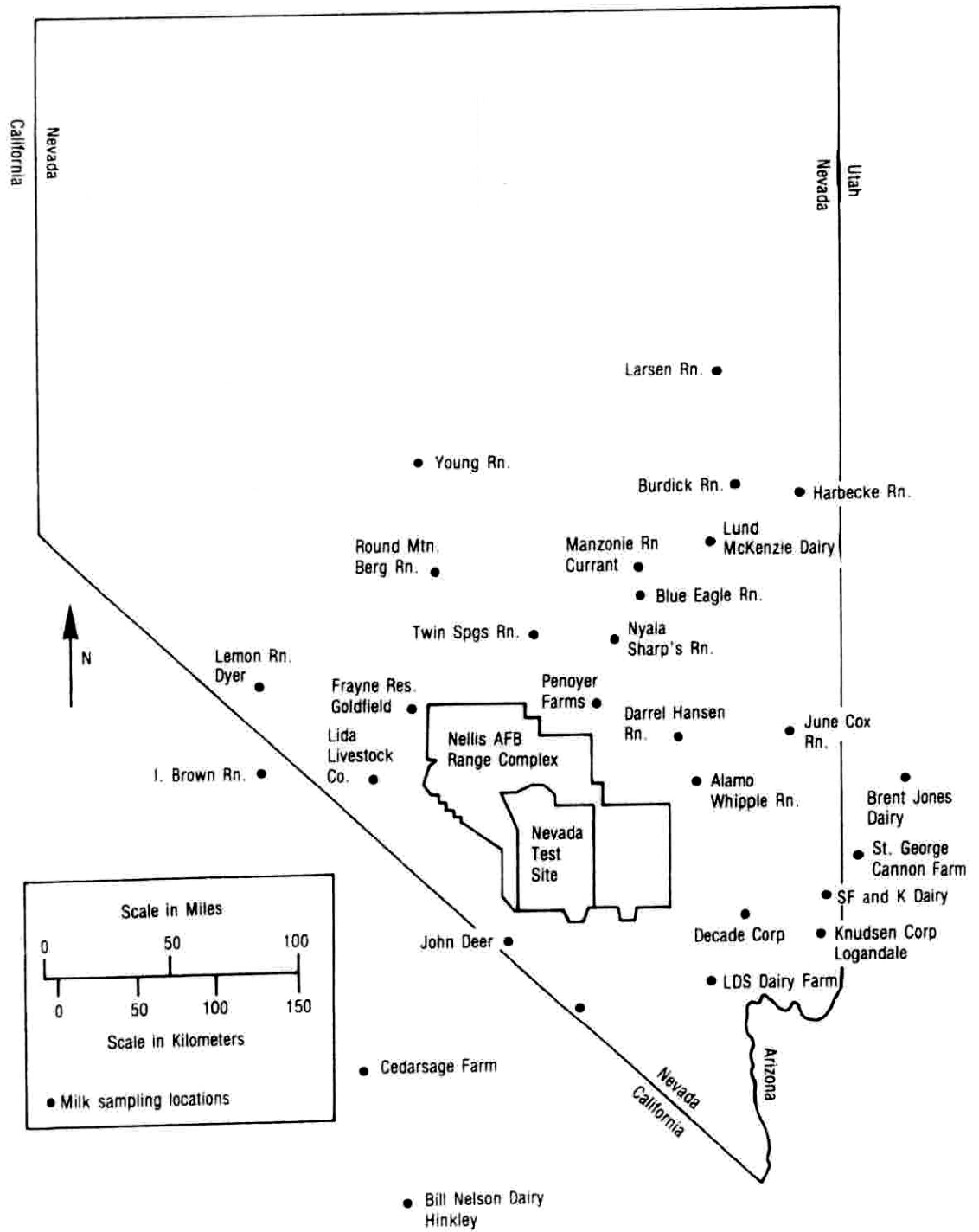

Samples of raw milk are collected each month from about 25 farms surrounding the test site.

SOURCE: Modified from Environmental Protection Agency.

Figure 4-12—Standby Milk Surveillance Network



All major milksheds west of the Mississippi River are part of the standby milk surveillance network. Samples are collected and analyzed annually.

SOURCE: Modified from Environmental Protection Agency.

essentially no possibility that a significant release of radioactive material from an underground nuclear test could go undetected. Similarly, there is essentially no chance that radioactive material could reach a pathway to humans and not be discovered by the Environmental Protection Agency. Allegations that a release of radioactive material could escape from the test site undetected are based on partial studies that only looked at a small portion of the total monitoring system.¹⁶ Such criticisms are invalid when assessed in terms of the total monitoring system.

The radiation monitoring system continues to improve as new measurement systems and techniques become available and as health risks from radiation become better understood. Assuming that

the monitoring effort will continue to evolve, and that such issues as the migration of radioactive material in groundwater will continue to be aggressively addressed, there appear to be no valid criticisms associated with the containment of underground nuclear explosions. This is not to say that future improvement will not be made as experience increases, but only that essentially all relevant suggestions made to date that increase the safety margin have been implemented.

Public confidence in the monitoring system suffers from a general lack of confidence in the Department of Energy that emanates from the environmental problems at nuclear weapons production facilities and from the radiation hazards associated with past atmospheric tests. In the case of the

¹⁶See for example, "A review of off-site environmental monitoring of the Nevada Test Site," Bernd Franke, Health Effects of Underground Nuclear Tests, Oversight Hearing before the Subcommittee on Energy and the Environment of the Committee on Interior and Insular Affairs, House of Representatives, Sept. 25, 1987, Serial No. 100-35, pp. 120-144.

Figure 4-13—Collection Site for Animals Sampled in 1987

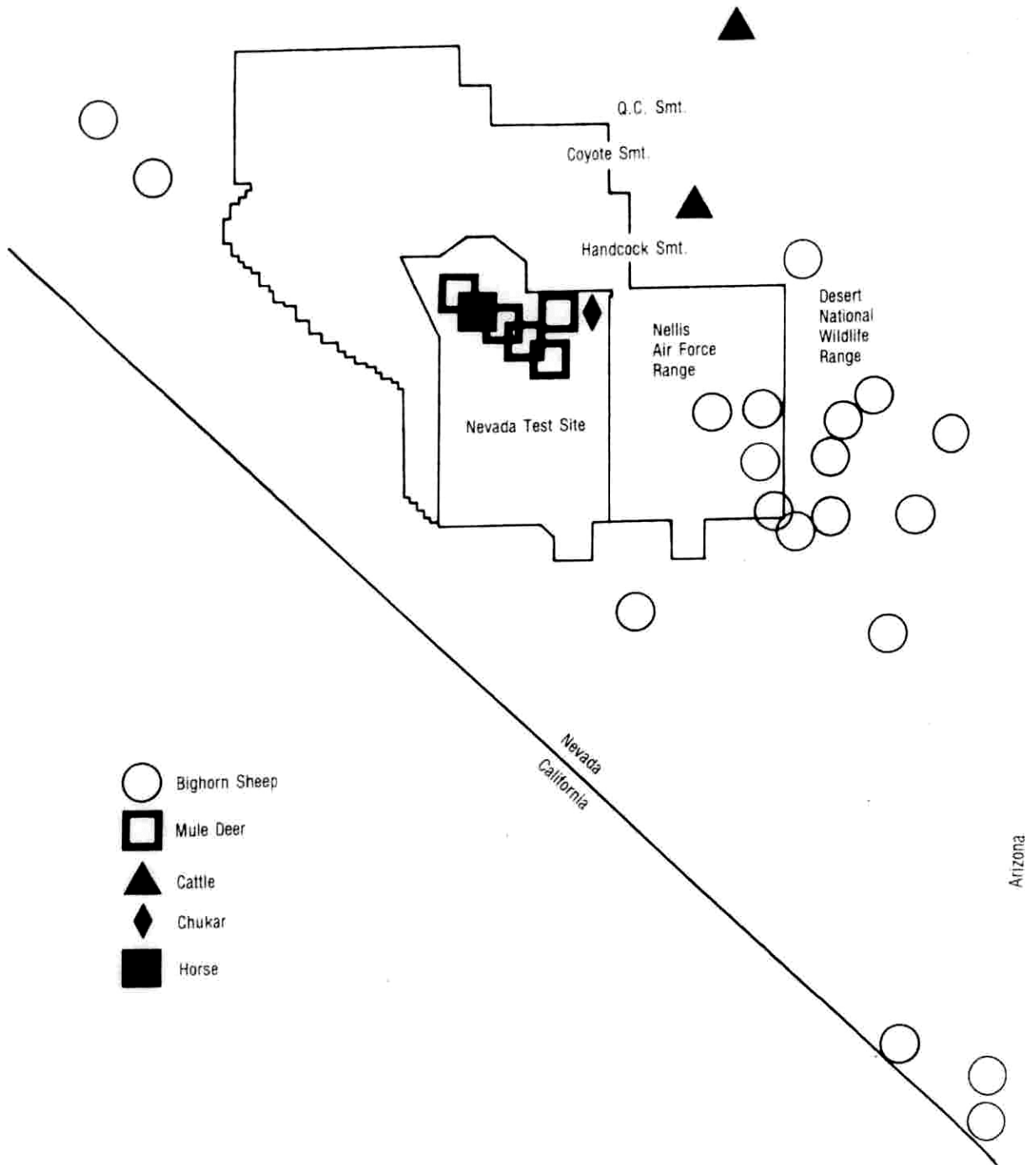

Depending on availability, an assortment of animals are analyzed each year.

SOURCE: Modified from Environmental Protection Agency.

Table 4-3—Citizen Alert Water Sampling Program

| Location | Type of Sample |
|-----------------------------------|------------------------------|
| Springdale Ranch | Well (hose) |
| Barley Hot Springs | Stream |
| 3 mi. south of Flourspar Canyon | Amargosa River |
| Lathrop Wells | Spigot at gas station |
| Point of Rock Spring, Ash Meadows | Pond |
| Devils Hole, Ash Meadows | Pool |
| Shoshone, CA | Stream |
| Amargosa Junction | Well (hose) |
| Goldfield | Well (spigot at gas station) |
| Moore's Station | Pond |
| Six Mile Creek | Stream |
| Tybo and Route 6 (DOE facility) | Well (tap) |
| Hot Creek and Route 6 | Stream |
| Blue Jay | Well (hose) |

SOURCE: Citizen Alert, 1988

underground nuclear testing program, this mistrust is exacerbated by the reluctance on the part of the Department of Energy to disclose information con-

cerning the nuclear testing program, and by the knowledge that not all tests that release radioactive material to the atmosphere (whatever the amount or circumstances) are announced. This has led to allegations by critics of the testing program that:

... the Energy Department is continuing its misinformation campaign by refusing to disclose the size of most underground tests, by hushing up or downplaying problems that occur and by not announcing most tests in advance, thereby leaving people downwind unprepared in the event of an accidental release of radioactive materials.¹⁷

Such concern could be greatly mitigated if a policy were adopted such that all tests were announced, or at least that all tests that released any radioactive material to the atmosphere (whatever the amount or circumstances) were announced.

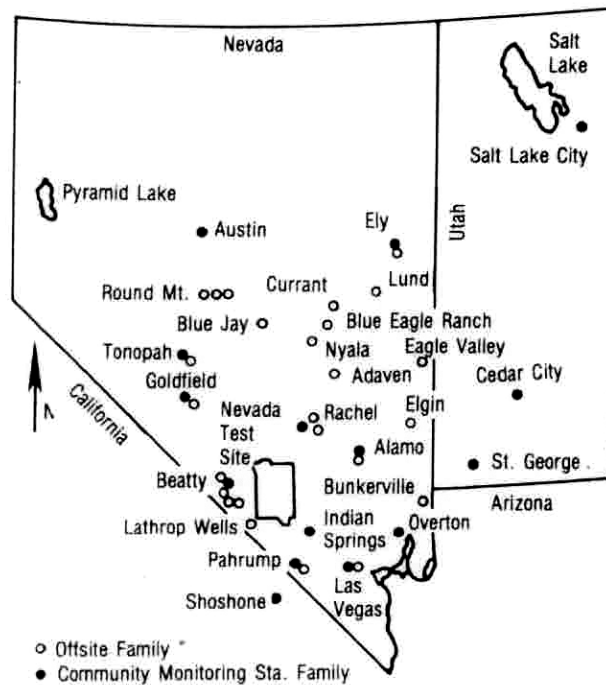
Figure 4-14—Locations of Families in the Offsite Human Surveillance Program

About 40 families from around the test site are brought in to EPA twice a year for whole-body analysis.

SOURCE: Modified from Environmental Protection Agency.

¹⁷John Hanrahan, "Testing Underground," *Common Cause*, vol. 15, No. 1, January/February 1989.

Figure 4-15—Well Sampling Locations Onsite

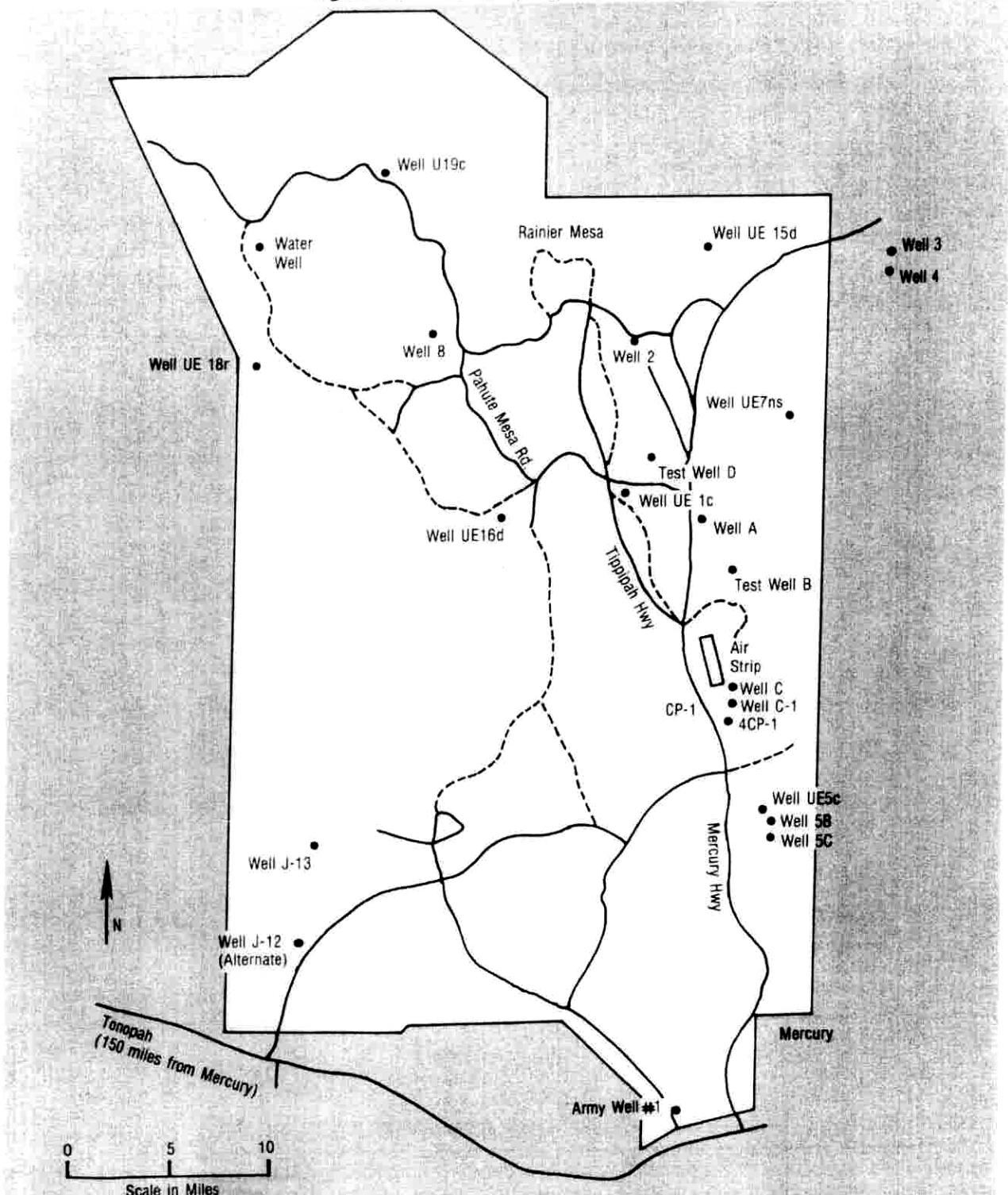

22 wells on the Nevada Test Site are sampled monthly.

SOURCE: Modified from Department of Energy

Figure 4-16—Well Sampling Locations Offsite

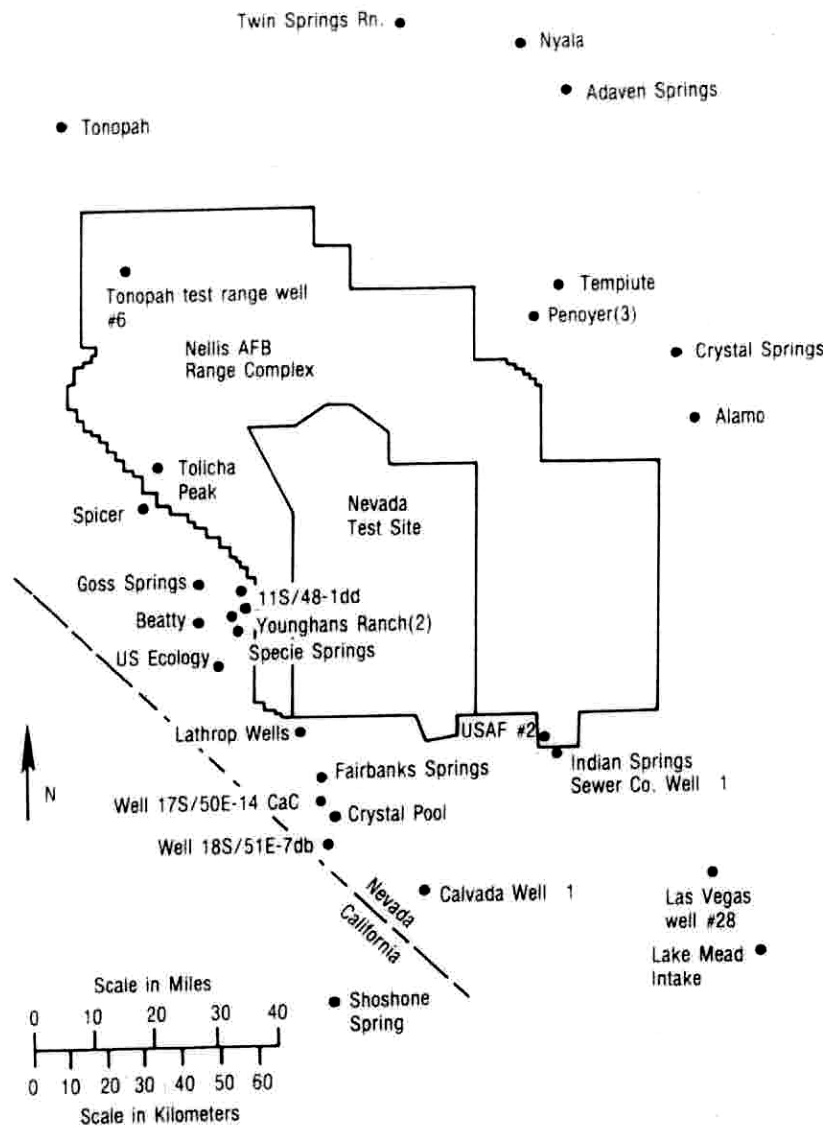

31 wells around the Nevada Test Site are sampled twice a year.

SOURCE: Modified from Department of Energy.

Related OTA Report

- *Seismic Verification of Nuclear Testing Treaties.*
OTA-ISC-361, 5/88; 139 pages. GPO stock #052-003-01108-5; \$7.50.
NTIS order #PB 88-214 853/XAB.

NOTE: Reports are available from the U.S. Government Printing Office, Superintendent of Documents, Washington, D.C. 20402-9325 (202-783-3238); and the National Technical Information Service, 5285 Port Royal Road, Springfield, VA 22161-0001 (703-487-4650).

Office of Technology Assessment

Congressional Board of the 101st Congress

EDWARD M. KENNEDY, *Massachusetts, Chairman*

CLARENCE E. MILLER, *Ohio, Vice Chairman*

Senate

ERNEST F. HOLLINGS
South Carolina

CLAIBORNE PELL
Rhode Island

TED STEVENS
Alaska

ORRIN G. HATCH
Utah

CHARLES E. GRASSLEY
Iowa

House

MORRIS K. UDALL
Arizona

GEORGE E. BROWN, JR.
California

JOHN D. DINGELL
Michigan

DON SUNDQUIST
Tennessee

AMO HOUGHTON
New York

JOHN H. GIBBONS
(Nonvoting)

Advisory Council

DAVID S. POTTER, *Chairman*
General Motors Corp. (Ret.)

CHASE N. PETERSON, *Vice Chairman*
University of Utah

CHARLES A. BOWSHER
General Accounting Office

MICHEL T. HALBOUTY
Michel T. Halbouty Energy Co.

NEIL E. HARL
Iowa State University

JAMES C. HUNT
University of Tennessee

HENRY KOFFLER
University of Arizona

JOSHUA LEDERBERG
Rockefeller University

WILLIAM J. PERRY
H&Q Technology Partners

SALLY RIDE
California Space Institute

JOSEPH E. ROSS
Congressional Research Service

JOHN F.M. SIMS
Usibelli Coal Mine, Inc.

Director

JOHN H. GIBBONS

The Technology Assessment Board approves the release of this report. The views expressed in this report are not necessarily those of the Board, OTA Advisory Council, or individual members thereof.

OTA-ISC-414

OCTOBER 1989