

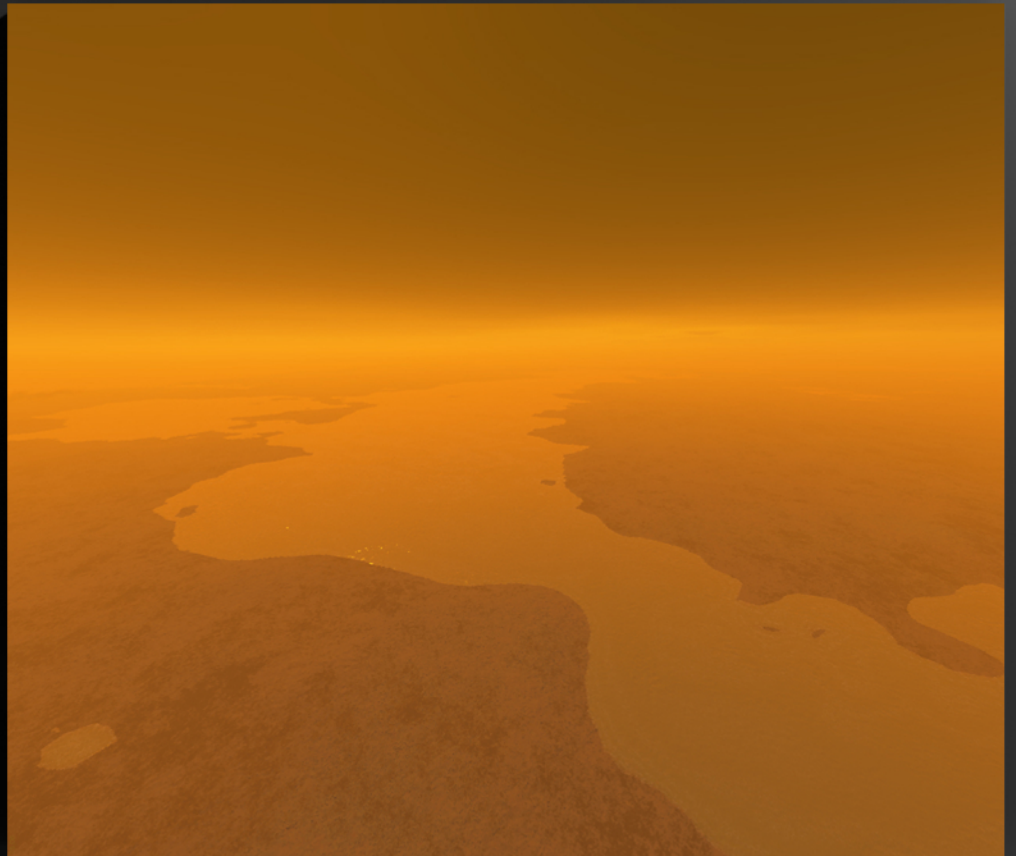

Solar System Exploration

This is the 2006 Solar System Exploration Roadmap
for NASA's Science Mission Directorate

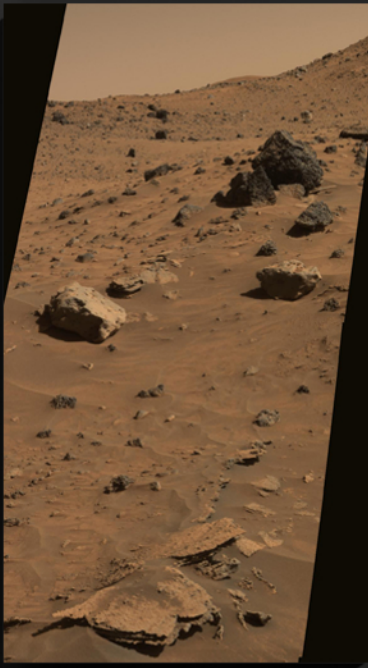
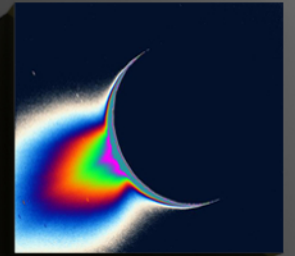
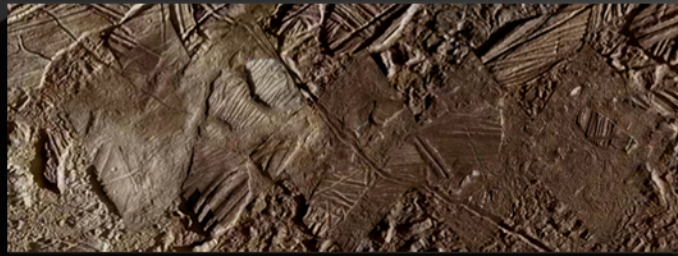
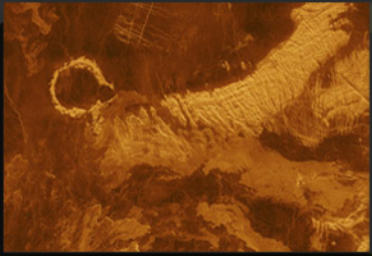

September 2006



SOLAR SYSTEM EXPLORATION

This is the Solar System Exploration Roadmap
for NASA's Science Mission Directorate



September 15, 2006

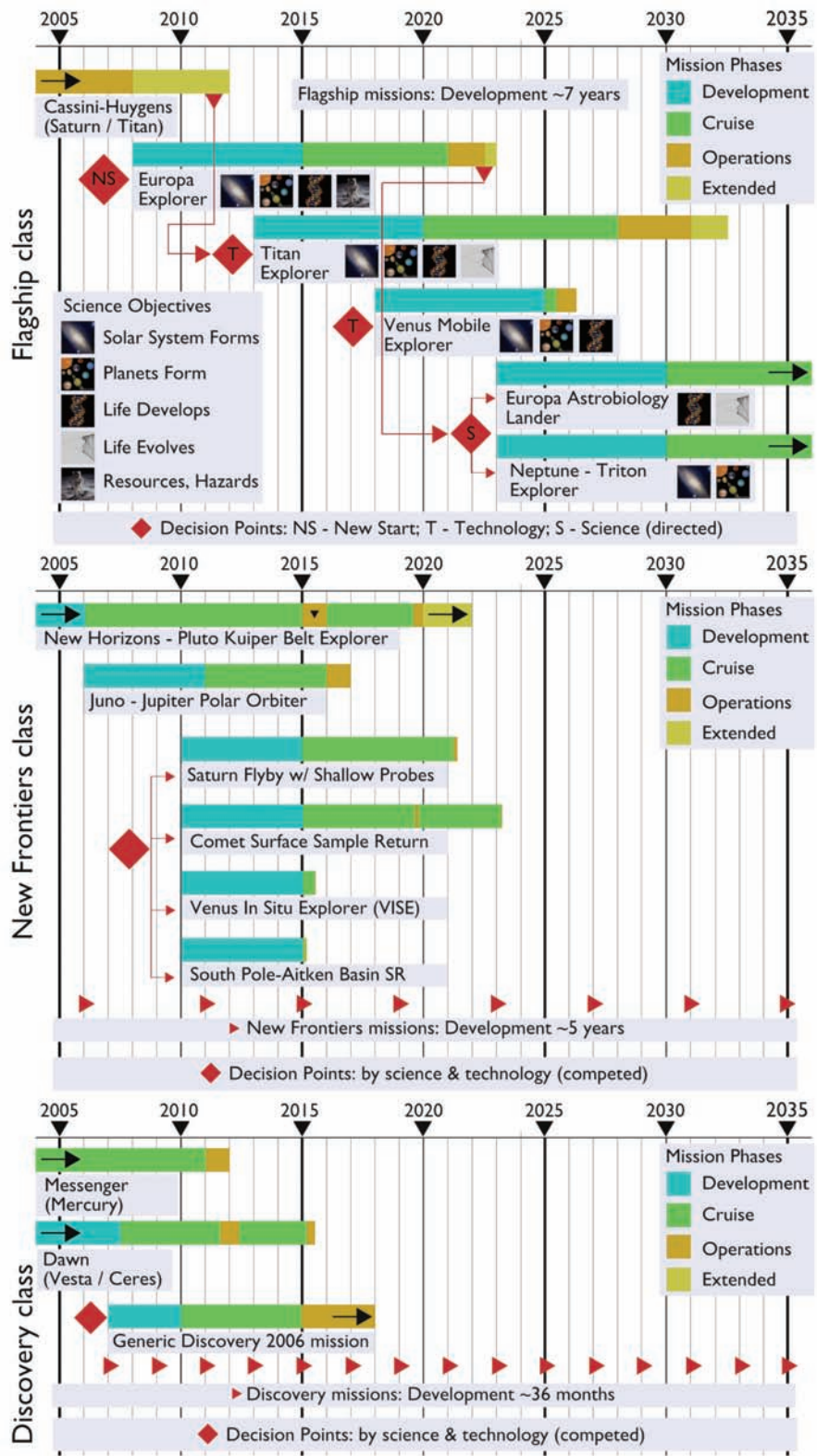

Contents

Executive Summary	1
Scientific Foundation	1
A Balanced Program of Solar System Exploration	2
Large (Flagship Class) Missions	2
Medium (New Frontiers Class) Missions	2
Small (Discovery Class) Missions	3
Technology Development	3
Research and Analysis Programs	3
Education and Public Outreach	4
Programmatic Considerations	4
Summary	5
1 Overview	6
1.1 Background	6
1.2 Strategic Roadmap Process — General	7
1.3 Strategic Roadmap Process for Solar System Exploration (SRM3)	8
1.4 Structure of This Report	10
1.5 Response to the NRC Panel on NASA Science Strategy Roadmaps	11
2 Science Objectives	13
2.1 Habitability — A Guiding Theme	13
2.2 Investigative Framework	14
2.2.1 Question One: How did the Sun’s family of planets and minor bodies originate?	16
2.2.2 Question Two: How did the Solar System evolve to its current diverse state?	18
2.2.3 Question Three: What are the characteristics of the Solar System that led to the origin of life?	21
2.2.4 Question Four: How did life begin and evolve on Earth and has it evolved elsewhere in the Solar System?	28
2.2.5 Question Five: What are the hazards and resources in the Solar System environment that will affect the extension of human presence in space?	34
2.3 Target Objectives for Investigation	40
2.3.1 Venus — Key Member of the Inner Triad of Worlds	40
2.3.2 Europa, Titan, Triton ... and Enceladus	44
2.3.3 Comets	50
2.3.4 Coda	52

3	Missions	53
3.1	Formulating the Mission Set	53
3.1.1	Establishing Priorities	53
3.1.2	The Mission Roadmap	54
3.2	Discovery Program	56
3.3	New Frontiers Program	58
3.3.1	New Frontiers Mission Overview	59
3.3.2	Pluto – Kuiper Belt Explorer (New Horizons)	60
3.3.3	Jupiter Polar Orbiter — Juno	61
3.3.4	Lunar South Pole–Aitken Basin Sample Return	62
3.3.5	Venus In Situ Explorer (VISE)	63
3.3.6	Comet Surface Sample Return	63
3.3.7	Other New Frontiers Candidate Missions	63
3.4	Flagship Missions	64
3.4.1	Europa Explorer	67
3.4.2	Titan Explorer	70
3.4.3	Venus Mobile Explorer	71
3.4.4	Europa Astrobiology Lander	72
3.4.5	Neptune–Triton Explorer Mission	73
3.4.6	Comet Cryogenic Nucleus Sample Return	74
3.4.7	Venus Sample Return	74
3.5	Study Needs	75
4	Technology Development for Solar System Exploration	76
4.1	Overview	76
4.2	Challenges	76
4.3	Spacecraft Systems Technologies	78
4.3.1	Transportation Technologies	78
4.3.2	Power	84
4.3.3	Communications	89
4.3.4	Planetary Protection	91
4.3.5	Autonomous Operations	93
4.4	Technologies for In Situ Exploration	94
4.4.1	Entry, Descent, and Landing	95
4.4.2	Planetary Mobility	97
4.4.3	Extreme Environments	98
4.5	Science Instruments	106
4.5.1	Remote Sensing	107
4.5.2	In Situ Instrumentation	109
4.5.3	Component Development and Miniaturization	111
4.6	Summary	112
4.6.1	Spacecraft Systems	112
4.6.2	In Situ Exploration	114

4.6.3	Science Instruments	114
5	Research and Analysis	115
6	Education and Public Outreach (E/PO)	117
6.1	E/PO Implementation Approach	118
6.2	Future E/PO Efforts	119
7	Interdependencies	121
7.1	Interdependencies Among Missions and Mission Lines	121
7.1.1	Within the Flagship Program	121
7.1.2	Between the New Frontiers and Flagship Programs	122
7.1.3	Among the Discovery, New Frontiers, and Flagship Programs	123
7.1.4	With the Mars Exploration Program	125
7.1.5	With the Robotic Lunar Exploration Program	125
7.1.6	With the Astrophysics Division	126
7.2	Technology Development and Infusion	127
7.2.1	Technology Development	127
7.2.2	With the New Millennium Space Flight Validation Program	127
8	Roadmap Implementation	129
8.1	Flagship Mission Classes and Cost Ranges	129
8.2	Trading Flight Rate Across Mission Classes	130
8.3	Impact of Mission Interdependencies on These Scenarios	132
8.4	Five-Year Investment Plan	132
8.4.1	Flagship Mission Implementation	133
8.4.2	Technology Development	133
8.5	Budget Wedge for the Flagship Program	135
9	Conclusions and Recommendations	137
	Acronyms and Abbreviations	141
	References	142

List of Figures

2.1	Principal linkage between habitability and five major science questions; i.e., (1) the Sun’s origin; (2) Solar System’s evolution; (3) life’s origins; (4) life elsewhere; (5) hazards and resources for humans in space.	15
2.2	Saturn’s moons Iapetus and Phoebe.	20
2.3	Particles collected by Stardust.	23
2.4	Saturn’s moon Enceladus.	27
2.5	Spots and pits on Europa.	31
2.6	Three mosaics of Titan.	32
2.7	Two views of Venus.	41
2.8	The tessera region of Venus.	42
2.9	Surface images of Venus taken by the Russian Venera 9 & 14 landers.	44
2.10	Europa’s chaotic terrain.	46
2.11	Hilly terrain and erosional channels on Titan.	48
2.12	A stereographic, fish-eye projection of Titan.	49
2.13	Global color mosaic of Triton, obtained in 1989 by Voyager 2 during its flyby of the Neptune system.	51
2.14	Excess heat radiation from cracks near the south pole of Enceladus.	52
3.1	Dawn spacecraft with DS–1 heritage ion propulsion and 10kW triple junction solar array (artist’s concept).	55
3.2	Views of the impactor of the Deep Impact mission colliding with Comet Tempel 1 — the pictures were taken at 90 seconds before the collision (left); at impact (center), and at 67 seconds after the collision (right).	56
3.3	Sequence of Discovery missions established by the Roadmap Team.	59
3.4	Sequence of New Frontiers missions established by the Roadmap Team. (The ▼ in the NH timeline represents the closest approach at Pluto on July 14, 2015).	60
3.5	New Horizons spacecraft showing instrument complement.	61
3.6	Juno — Jupiter Polar Orbiter spacecraft concept.	62
3.7	Multi–probes to Saturn (artist’s concept).	65
3.8	Recommended sequence of Flagship missions established by the Roadmap Team.	66
3.9	Europa Explorer concept based on the 2005 study (design concept).	69
3.10	Titan Balloon concepts (design concept).	72
3.11	Venus Mobile Explorer (artist’s concept).	73
3.12	Europa Astrobiology Lander (artist’s concept).	74
4.1	Electric Propulsion System Testing.	80
4.2	Aerocapture (artist’s concept).	82
4.3	Aeroassist with an “ellipsled” (mid–L/D) aeroshell (artist’s concept).	83
4.4	Multi–Mission Radioisotope Thermoelectric Generator (artist’s concept).	85
4.5	Illustration of the MMRTG 6×8 Couple Module.	86

4.6	Thermoelectric conversion: Nanowire materials promise efficiencies much higher than the 6 to 8% possible today.	86
4.7	Illustration of a dynamic Stirling converter.	87
4.8	Illustration of a dynamic Stirling converter.	88
4.9	Illustration future potential DSN configuration (artist's concept). . .	90
4.10	Planetary Protection.	92
4.11	Small body exploration and anchoring.	93
4.12	Autonomy and fault protection.	94
4.13	Accommodation of the back-to-back aeroshells concept for Titan in the L/V fairing. (design concept)	95
4.14	Pressure vessel concept for exploration of extreme environments. . .	101
4.15	High-T electronics.	101
4.16	Galileo Probe Heat Shield Ablation.	104
4.17	Thermal Protection Systems — Materials.	105
4.18	The GCMS instrument on the Huygens probe.	107
4.19	CRISM on MRO.	108
4.20	MARSIS sounder transmit and receive boxes.	109
4.21	In situ sample acquisition and analysis.	110
4.22	Miniature X-ray Diffraction Fluorescence Spectrometer.	112
7.1	Timelines for Flagship class, New Frontiers class and Discovery class missions. The sequence of Flagship missions would be as shown unless new information caused a revision; the sequence of New Frontiers missions is determined competitively.	124
8.1	Investment needs for Solar System Exploration Roadmap program of Flagship missions.	134
8.2	Funding wedge assuming the first Flagship mission launches in FY15, FY16, and FY17. Follow-on Flagship mission launches are assumed at five year intervals. The funding estimates include technology and advanced development as well as mission formulation and development.	136

List of Tables

1.1	SRM3–2005 & SRM3–2006 Solar System Exploration Roadmap — Committee Members.	9
2.1	Question One: How did the Sun’s family of planets and minor bodies originate?	16
2.2	Question Two: How did the Solar System evolve to its current diverse state?	19
2.3	Question Three: What are the characteristics of the Solar System that led to the origin of life?	22
2.4	Question Four: How did life begin and evolve and has it evolved elsewhere in the Solar System?	29
2.5	Question Five: What are the hazards and resources in the Solar System environment that will affect the extension of human presence in space?	34
3.1	Traceability Matrix: Scientific Questions, Objectives, and Missions.	57
4.1	Technology priorities for Solar System exploration.	77
4.2	Extreme Environments of Potential Target Bodies for Solar System Exploration.	99
4.3	Impact of Advanced Technology Development on Roadmap Missions.	113
8.1	Flight rates per decade and corresponding cost per decade in \$B for various options with different rates for Flagship, New Frontiers, and Discovery missions. Flight rates proposed by the NRC Decadal Survey (NRC DS 2003) and NASA’s Solar System Roadmap of 2003 (SSE–RM 2003) are also shown.	131

Executive Summary

The Solar System — our Sun’s system of planets, moons, and smaller debris — is humankind’s cosmic backyard. Small by factors of millions compared to interstellar distances, the spaces between the planets are daunting, but technologically surmountable. And it is within this cosmic backyard that the immediate clues to our own origin — that of life, and of Earth as a persistently habitable world — are to be found. We wonder, as we look up at our neighboring planets on a dark, moonless night, whether life is to be found on these worlds, either viable communities of simple organisms or remains that have been dead for geologically-long periods of time. If so, then perhaps the universe beyond our backyard is teeming with life, from the simple to the complex. If, instead, we find our planetary neighbors to be sterile testaments to a delicate fine-tuning of conditions necessary for initiating and sustaining life, then we must ask ourselves whether we are alone in a vast, impersonal cosmos. The first essential step in addressing this question is the exploration of our Solar System.

This is a Roadmap for the exploration of the Solar System over the next 30 years. It excludes the Moon and Mars, covered in other Roadmaps. It is drawn for a 30-year planning horizon, against the backdrop of the Presidential Initiative “The Vision for Space Exploration” [Hou04], and provides flexibility by offering a number of distinct scenarios that will meet the science goals with staggered project initiation dates. This Roadmap builds on previous NASA Roadmaps and the NRC Decadal Survey of Solar System Exploration [NRC03].

Scientific Foundation

The scientific foundation of this Roadmap is a set of fundamental questions based on five objectives adopted in 2003 by NASA’s then Office of Space Science [NAS03a], in response to the NRC’s Decadal Survey, but modified to reflect the context of the exploration goals of the President’s Vision for Space Exploration [Hou04].

1. How did the Sun’s family of planets and minor bodies originate?
2. How did the Solar System evolve to its current diverse state?
3. What are the characteristics of the Solar System that led to the origin of life?
4. How did life begin and evolve on Earth and has it evolved elsewhere in the Solar System?
5. What are the hazards and resources in the Solar System environment that will affect the extension of human presence in space?

A unifying theme for the exploration of our Solar System is habitability — the ability of worlds to support life. As living, self-aware, sentient entities, we seek to know whether

life is or was present elsewhere in our planetary backyard, how we and our planet came to be, and what are the future prospects for terrestrial life on and off the Earth. Among the five scientific questions articulated above, each approaches a different aspect of habitability; together they encompass all of its characteristics addressable with Solar System exploration. *The Solar System Exploration program described here directly addresses the key science questions regarding habitability in the universe.*

A Balanced Program of Solar System Exploration

This Roadmap describes a series of small, medium, and large class missions and their enabling technologies, supported by a vigorous, balanced program of research and analysis, and creative education and public outreach.

Large (Flagship Class) Missions

The Solar System exploration Flagship missions of the past — Voyager, Magellan, and Galileo — transformed not only our field of science, but humankind’s perception of the Solar System; Cassini–Huygens is doing so today. Large missions capable of reaching distant locations in the outer Solar System with powerful complements of instruments, enabling serendipitous discovery, and conducting adaptive observational programs responsive to these new discoveries is the province of Flagship missions. Flagship missions are an essential component of the Roadmap, if NASA is to make fundamental new discoveries in the Solar System, address the key scientific questions, and maintain public pride and excitement in America’s leadership in deep space exploration. *The program outlined here includes a set of five Flagship missions over 25 years to a variety of destinations in the inner and outer Solar System; namely to Europa, Titan/Enceladus, Venus, and Neptune/Triton. Among these, Europa should be the next target for a Flagship mission.*

Furthermore, international collaboration provides cost reduction, risk sharing, and a broader public base for each of the partners. It also ensures continuation of the positive image of the United States gained from collaboration in missions like Cassini–Huygens. *Existing collaborative models for future Jupiter–Europa exploration should be extended to collaborations on missions to the Saturn system and to Venus.*

Medium (New Frontiers Class) Missions

Medium class missions in Solar System exploration, under the New Frontiers class, are cost capped at approximately \$750 million per mission. Selected through a competitive process, the New Frontiers program targets the major planetary bodies of strategic interest to NASA. However, the operational capabilities of these missions are typically more limited in scope than those of the Flagship missions. Missions in this class will play key roles in Solar System exploration, addressing scientific objectives beyond the reach of ground-based observation and Discovery class missions, but with a flexibility and flight frequency not pos-

sible in the Flagship class. *This Roadmap recommends a flight rate of 2 to 4 New Frontiers missions per decade, and a review of target foci after every two selections.*

Small (Discovery Class) Missions

The small missions, under the Discovery class (approximately \$400 million/mission), are PI-led missions that allow fast response to address a specific set of high-value scientific questions at targets that may be less technically challenging. For this reason, Discovery missions will play a crucial role in the exploration of small bodies (asteroids and comets), which provide key clues to the chemistry of Solar System formation, impact hazards through time, and the shaping of the architecture of our own planetary system. *A steady-state flight rate of 4 to 7 Discovery missions per decade is required to maintain the pace of new results and vigor of the program over the lifetime of this Roadmap.*

Technology Development

The challenges common to virtually all planetary missions — large distances, long flight times, and stringent limitations on mass, power, and data rate — mean that essentially all types of missions can derive significant benefit from, or must be enabled by, technological development. Investments in relevant technologies help to reduce mission costs and increase capabilities for exploration and science return. *Successful execution of this Roadmap's prioritized sequence of missions requires a coordinated technology development program synchronized with mission plans.*

Certain classes of technologies would benefit multiple missions in all cost categories. Improved power conversion technologies and an ensured supply of Pu-238 will directly improve the mass margins for many missions. Furthermore, this Roadmap calls for exploration of a number of targets presenting diverse types of extreme environments. A development program for technologies for extreme environments would benefit most of the missions of all mission classes. Finally, access to the outer Solar System would benefit from the development and validation of aerocapture technology. *Investment in power generation, technologies for extreme environments, and aerocapture technology would reduce costs for multiple missions and enable exploration at targets of greatest interest to the habitability analysis underpinning this Roadmap.*

Research and Analysis Programs

A strong scientific and technical community — to conceptualize, develop, and deploy space missions, and to interpret and apply results from these missions for the benefit of society — is required to achieve NASA's science objectives. Research and Analysis (R&A) Programs furnish the necessary resources to nurture this community, including instrument and technology development; experimental, theoretical, computational modeling and field research; telescopic observations; and sample analyses. Essential supporting facilities, such as ground-based telescopes, laboratory and computing facilities, and the Planetary Data

System, are supported by the R&A Program in order to make these investigations possible. R&A Programs are the primary NASA vehicle for training graduate students, and support training of the next generation of mission team members, principal investigators, and project scientists. Astrobiology is a vital part of this R&A Program for addressing the habitability goals, and includes investments in the science, advanced instruments, and field programs of life detection in extreme terrestrial environments. *In order to maintain world leadership in Solar System exploration, NASA must fund R&A at or above FY2005 levels.*

Data analysis programs support the interpretation of scientific data returned by science missions with the goal of maximizing the science return from NASA's investment in spacecraft and other data-collection sources. *Data analysis programs are essential to deriving full benefit from the program of Solar System exploration missions outlined here.*

Education and Public Outreach

In order to engage the American public in scientific, technological, and engineering aspects of the robotic Solar System Exploration Program, NASA should continue — and in some cases expand — partnerships between formal and information education providers and NASA Solar System Exploration scientists, technologists, and missions.

Programmatic Considerations

This mission series is designed with significant interdependencies among Flagship missions and between the Flagship Program and the New Frontiers and Discovery Programs. Both New Frontiers and Discovery missions have made, and will continue to make, important scientific and technical contributions to the Flagship mission programs. The goal of implementing Flagship missions at the rate of one every five years may require reduction in the rate of existing Discovery and New Frontiers Program elements. An option of one small Flagship mission and one large Flagship mission per decade may represent an appropriate balance with a relatively small impact on Discovery and New Frontiers frequencies. This mission series will require a technology development program, described in this Roadmap, providing the greatest cost and risk reduction benefits.

The successful implementation of this Roadmap requires a great deal of coordination with many communities. Within NASA, Solar System exploration will benefit significantly from the technical contributions of the Mars Exploration Program and the New Millennium Program, as well as from the ongoing scientific insights gained in the Mars Exploration Program. The broader scientific community will continue to be engaged through dedicated Research and Analysis programs as they guide the design of future missions and the interpretation of the returned data from ongoing activities. On a wider scale, public support will also be maintained through effective Education and Public Outreach activities. Finally, NASA could reduce its cost and risk through effective international collaborations that would also provide greater public relations benefits.

This Roadmap presents options for the initiation of the first Flagship mission in the current highly constrained funding environment. An investment of \$50 million in FY07 and \$100 million in FY08 can preserve the option for an FY15 launch of Europa Explorer and would make a significant start in technology development needed for later missions. This would provide the Agency the opportunity to move forward more aggressively on this vitally important program, if circumstances permit, in FY09.

Summary

Data returned from the recent series of successful missions have initiated an exciting new period of exploration, as we begin the process of learning about the vast diversity of environments that may support life. The Solar System exploration program described in this Roadmap calls for a series of missions, that will address the questions of the origin and evolution of habitable environments. This robust program will be enabled by a focused technology investment strategy, and supported by ongoing research and analysis, and partnerships developed through outreach efforts. This program, anchored by the strategic Flagship missions and supported by the competed New Frontiers and Discovery mission sets, is designed with missions launching at rates optimized to meet programmatic budgetary restrictions, while returning quality science.

1 Overview

This document lays out both a scientific rationale and a long-term plan for the exploration of the Solar System. The quest for answers to fundamental questions about the origin and evolution of the Solar System and of life within it is used to motivate missions to the remarkable planets and satellites in the outer Solar System, to the searing surface of Earth's estranged sister planet Venus and to the primitive remnants of planetary formation that orbit in the depths of space as asteroids and comets. This plan does not include Mars and the Moon for which NASA is developing other strategic roadmaps.

This strategic Roadmap spans three decades and includes a series of decision points where scientific discovery, technical developments, and budgetary realities may cause a change in direction. While the Roadmap will be modified to incorporate new information, we believe that the process followed here has enduring value. This Roadmap has been almost two years in preparation and draws heavily on previous work by the National Research Council and NASA's scientific committees. It involved scientists, engineers, and technologists from government, industry, and academia working together in a focused manner to develop a Roadmap in response to the President's Vision for Space Exploration issued in 2004.

The present Roadmap represents the culmination of a NASA-wide planning process that was initiated in the summer of 2004. That effort resulted in a preliminary report referred to here as SRM3-2005, which was published in May 2005. This final report — referred to as SRM3-2006 — has been completed under the auspices of the Planetary Science Division of NASA's Science Mission Directorate. A Congressional mandate for an SMD Science Plan as well as an Implementation Plan for the current fiscal year drove its completion schedule. Here we describe some of the background to SRM3-2006 and some insights into the process that was used in formulating it.

1.1 Background

In the fall of 2004, NASA initiated the development of a set of 13 high-level national roadmaps that were intended to form the foundation of the Agency's strategic plan. The chartered objective of the third Strategic Roadmap (SRM3) — the Strategic Roadmap for Solar System Exploration — was to “*conduct robotic exploration across the Solar System to search for evidence of life, to understand the history of the Solar System, to search for resources and to support human exploration.*” The three co-chairs of SRM3 were G. Scott Hubbard and Orlando Figueroa of NASA and Jonathan Lunine of the University of Arizona.

The Strategic Roadmap process began in the fall of 2004. All 13 strategic roadmaps were originally intended to be integrated during July–August of 2005 with a strategic architecture completed by October 2005. However, in April 2005, the NASA Administrator decided to abbreviate this process and directed that the individual strategic roadmaps should be completed by the end of May. Accordingly, SRM3-2005 was quickly written and after lim-

ited internal review SRM–2005 [NAS05b] was submitted on May 20, 2005.

Six of the 13 strategic roadmaps dealt with science and all six Science Roadmaps, including SRM3–2005, were reviewed by a National Research Council panel in the summer of 2005. The NRC review was issued in draft form in the fall of 2005, and was published in final form in April 2006. The panel made general comments on all of the roadmaps and additional comments that were specific to SRM3–2005.

In January 2006, the Planetary Science Division initiated an effort to revise and update SRM3–2005. The guidelines for the revision were as follows:

- Reflect the essential conclusions and recommendations of the SRM3 team as expressed in SRM3–2005 and in the minutes of each of the three meetings.
- Respond to comments and criticisms of SRM3–2005 in the “Review of Goals and Plans for NASA Space and Earth Science Roadmaps” by the NRC Panel for review of NASA science roadmaps, September 2005.
- Update SRM3–2005 to reflect significant scientific, technical, and programmatic developments in the past year that have clear implications for the Roadmap as originally formulated and as reviewed by the NRC.
- Produce a stand-alone document in which the nature of the roadmap process is adequately documented and any differences with prior NRC recommendations are well communicated.

Melissa McGrath, then deputy director of the Planetary Science Division, initiated the effort. Jonathan Lunine, one of the co-chairs of SRM3, agreed to spearhead the effort. This revision was supported by a JPL team led by James Cutts supporting NASA’s Planetary Science Division. The final report of this revised plan was originally scheduled for submittal to the Planetary Science Division on May 30, 2006. These three individuals in effect served as the three new co-chairs for completing SRM3–2006. A number of the members of the original team and some new participants contributed to SRM3–2006.

One motivation for completing the report on this schedule was a provision in the NASA Authorization Act signed by the President in December for the FY2007 budget that required the Administrator to develop a Science Plan to guide the science programs at NASA through 2016. A preliminary version of this plan — the Solar System Roadmap — Interim Final Report [NAS06] was published on May 3, 2006 in order to provide early guidance for development of the science plan.

1.2 Strategic Roadmap Process — General

A sweeping transformation of the way NASA manages its programs to “more effectively carry out the new Vision for Space Exploration” was initiated in mid-2004 following the

publication of President George W. Bush’s Vision for Space Exploration in February 2004 [Hou04]. An integral part of that transformation was the way NASA planned for the future and monitored its progress against its plans. The Agency created the Advanced Planning and Integration Office (APIO) and charged it with helping to institute a strategic management process that enabled the Agency to do planning and performance monitoring from a corporate perspective. The 13 Strategic Roadmap (SRM) teams were to play a key role in implementing this transformation.

Each SRM team was granted substantial flexibility in creating product formats that best expressed their findings and the unique characteristics of each discipline and were expected to articulate the following:

- Broad science and exploration goals, priorities, recommended activities or investigations, and a summary of anticipated discoveries and achievements;
- High-level milestones, options, and decision points;
- Suggested implementation approaches and mission sets, with options and possible pathways;
- Key dependencies on and relationships to other SRMs; and
- Identification of required capabilities, facilities, and infrastructure.

Each SRM team or committee was constituted under the Federal Advisory Committee Act (FACA) and consisted of three co-chairs (NASA HQ, NASA center, and external), and approximately 12–15 full members with several ex officio members as required. Coordinators were assigned from the lead mission directorate and from the APIO. In addition, each team was assigned several individuals whose primary responsibility was integration with other roadmaps and development of NASA’s strategic architecture. Those individuals included: one or more senior system engineers or scientists, drawn from the NASA centers, an “affordability analyst”, who helped understand the high-level budget requirements and implications of each roadmap, and an education specialist, who was also a member of the education roadmap team.

1.3 Strategic Roadmap Process for Solar System Exploration (SRM3)

The membership of the original SRM3 team, which was active between January and May of 2005, and the team responsible for the revision of SRM3–2005, which functioned between January 2006 and June 2006, is shown in Table 1.1.

Three meetings of SRM3 were held in February, March, and May of 2005. All were open to the public and the SRM3 team was given comprehensive background briefings by other team members as well as the support groups. Planning activities were carefully documented and comprehensive minutes on the presentations and the deliberations at each meeting. Two

Table 1.1: SRM3–2005 & SRM3–2006 Solar System Exploration Roadmap — Committee Members.

2005	2006	Name	Affiliation
<i>Co-Chairs</i>			
▲	●	Orlando Figueroa	NASA Science Mission Directorate
▲	●	G. Scott Hubbard	NASA Ames Research Center
▲	▲	Jonathan Lunine	University of Arizona Lunar & Planetary Laboratory
<i>Members</i>			
●		Andrew Christensen	Northrop Grumman
●		Jerry Chodil	Ball Aerospace (retired)
●	●	Ben Clark	Lockheed Martin Astronautics
●		Greg Davidson	Northrop Grumman
●		David DesMarais	NASA Ames Research Center
●	●	Douglas Erwin	National Museum of Natural History
●		Wes Huntress	Carnegie Institution of Washington
●	●	Torrence V. Johnson	Jet Propulsion Laboratory
●		Thomas D. Jones	Consultant
●	▲	Melissa McGrath	NASA Marshall Space Flight Center
●	●	Karen Meech	University of Hawaii
●	●	John Niehoff	Science Applications International Corporation
●	●	Robert Pappalardo	University of Colorado; Jet Propulsion Laboratory
●	●	Ellen Stofan	Proxemy Research, Inc.
●	●	Meenakshi Wadhwa	The Field Museum
<i>Advanced Planning and Integration Support</i>			
●		Carl Pilcher	Directorate Coordinator, Designated Federal Official
●		Judith Robey	Advanced Planning and Integration Office Coordinator
<i>Ex Officio and Liaison</i>			
●		Andrew Dantzler	NASA Science Mission Directorate
●	●	Heidi Hammel	Space Science Institute, Education Roadmap Committee Liaison
●		Chris Jones	Jet Propulsion Laboratory
●		Jason Jenkins	NASA Exploration Systems Mission Directorate
●		Gregg Vane	Jet Propulsion Laboratory
●		Charles Whetsel	Jet Propulsion Laboratory
<i>Planetary Program Support</i>			
●	▲	James A. Cutts	Jet Propulsion Laboratory
	●	Tibor Balint	Jet Propulsion Laboratory
	●	Andrea Belz	Jet Propulsion Laboratory
	●	Craig Peterson	Jet Propulsion Laboratory
	●	Philippe Crane	NASA HQ
	●	Curt Niebur	NASA HQ
▲ — co-chairs ; ● — team members			

weeks after the final meeting, the SRM3–2005 report was submitted to NASA on May 20, 2005.

The special review panel of the National Research Council to perform a review [NRC05] of the six science strategy roadmaps completed its draft report in September 2006. The panel report stated that the roadmaps had scientific merit and with a few notable exceptions their near term recommendations were consistent with the decadal surveys of the National Research Council. The panel noted that the main sources of gaps and potential missed opportunities in some roadmaps were *a shortage of science justification for the stated goals and an overly narrow interpretation of the Presidential vision* by the NASA Roadmap teams. The panel noted that the short timescale available for writing the roadmaps and the lack of community input may have contributed to these shortcomings. The next section covers how we have responded in this document (SRM3–2006) to the specific criticisms that the NRC panel had of SRM3–2005.

1.4 Structure of This Report

Because this is now a stand-alone document uncoupled from other strategic roadmaps, the form of SRM3–2006 is quite different than SRM3–2005. The essential features of the Solar System Exploration Roadmap remain unchanged; the most significant feature is the recommendation of a program of five Flagship missions over the 30-year period of the Roadmap and a specific sequence for those missions with key decision gates identified. *Sections 2, 3, and 4* are closely coupled sections dealing respectively with Science Objectives, Missions, and Technology. The science objectives are formulated around the concept of habitability: habitability as an element of planetary system architecture, habitability within planetary environments, and human habitability on and off the Earth. We establish a flow down from these concepts to science objectives, measurements, missions, and the technologies that are needed to implement the program.

Section 5 and *Section 6* — are comparatively short sections covering the Research and Analysis (R&A) and Education and Public Outreach (E/PO) Programs. These sections do not describe in detail what is being done in these programs, but rather why they are important to Solar System exploration and why they are significant to this Roadmap.

Section 8 — the Integrated Program Plan — ties together much of the previous material and also makes connections with other programs and projects where there are important interdependencies — particularly in the Mars Exploration and Lunar Programs. In this section, a specific program is laid out and the challenges of starting a Flagship mission line are covered.

Section 9 — Conclusions and Recommendations — concludes the document and brings together the principal findings from throughout the document.

One topic that remains outside the scope of this document is “required capabilities, facilities and infrastructure.” Given the abbreviated nature of the SRM3 process, this subject was never penetrated significantly in the SRM Final Report and is not covered in this report except in the context of technology needs.

Three significant developments which took place since the SRM3 Final Report was published in May 2005 are reflected in SRM3–2006.

- The discoveries of active geothermal activity at the Saturnian moon Enceladus, which has caused this small moon to acquire great astrobiological interest and it became an important new target to explore within our general theme of habitability.
- The selection of Juno as the second New Frontiers mission. The principal consequence of this is that the recommendation to add a Jupiter Flyby with Deep Entry Probes mission to the New Frontiers mission set was replaced by the addition of a Saturn Flyby with Shallow Probes mission.
- The reduction of funds for Robotic Exploration of the Solar System in the President’s FY07 budget released in January 2006, which caused us to reexamine priorities between the Discovery, New Frontiers, and Flagship Programs.

1.5 Response to the NRC Panel on NASA Science Strategy Roadmaps

The NRC panel on scientific roadmaps made a number of sound criticisms of SRM3–2005 which we have endeavored to respond to in SRM3–2006. As the panel surmised, the shortcomings that they identified were primarily due to the short time available to write and internally review the May 2005 report. Specific NRC panel comments and criticisms and the responses in SRM3–2006 appear below.

NRC Panel: The concept of habitability is central to the Roadmap but is not well developed in terms of scientific lines of inquiry and appropriate missions to respond to those lines of inquiry. The committee recommends that where habitability is the main focus of investigation a proper hierarchy of scientific goals and objectives be developed and that stronger pathways between the concept of habitability and proposed missions are articulated and maintained.

Response: Such a hierarchy has now been developed in SRM3–2006 in Section 2, Science Objectives; and the linkage between science and measurement goals is established in Section 3, Missions.

NRC Panel: The (SRM3–2005) Roadmap does not include a summary of how the selected missions in the roadmap will address the five science objectives.

Response: This is now addressed specifically in SRM3–2006 by Table 3.1 in Section 3, Missions.

NRC Panel: The recent selection of the Jupiter Orbiter JUNO spacecraft (announced after the roadmaps were completed) has altered the context of the roadmap, resulting in a new track since the construction of the roadmap. The competitive nature of New Frontiers forestalls a mission queue. However, as indicated in this Roadmap, the initial list should be expanded using community input.

Response: As noted above, SRM3–2006 recommends adding a Saturn Flyby with Shallow Probes mission in response to the Juno selection. The Jupiter Flyby with Deep Entry Probes mission included in SRM3–2005 is now deleted. Further changes to the New Frontiers mission list should certainly be considered when new information becomes available, but SRM3–2006 points out that expanding the mission set is not necessarily prudent when these missions cannot be implemented with existing technology and when a large number of New Frontiers options will further diffuse investment.

NRC Panel: The five Flagship missions chosen have the potential to produce science that is paradigm altering ... However, the committee believes that the Roadmap underestimates the size of some of the missions. Any future roadmaps should include realistic cost analysis to a level of detail consistent with the class of mission.

Response: The SRM team developed a cost estimation process, and indeed many of the missions discussed were at the high end of the cost range within a given mission category cost cap. There were a number of errors in SRM3–2005 in incorporating this information. SRM2–2006 makes a more realistic and measured assessment. The report sets targets for a Flagship Program investment, but recognizes that to meet these targets the missions may need to be significantly descope relative to some of those discussed for later decades. In some cases, international collaboration could make it possible to leverage the NASA investment.

Postscript: In this document, we have followed the long-standing practice in the NRC Decadal Survey and 2003 Solar System Roadmap of describing large missions as Flagship missions. In NASA’s current science plan, the term “core mission” is used to refer to this mission category following the practice in the Mars Exploration Program. Core missions, such as Cassini and the Mars Science Laboratory, are typically managed by a NASA center and the instrument payload is competed. We considered a last mission change to the nomenclature, but found that the term Flagship was so embedded in this report and in the review of SRM3–2005 by the NRC panel on science strategy roadmaps that it was impractical to make a revision. For the record, “core mission” and “Flagship mission” in the sense used here are synonymous.

2 Science Objectives

Today’s Solar System Exploration Program is the product of 40 years of intensive research, engineering ingenuity, and scientific insight. It reflects a maturity and focus that stem from many successful investigations, as well as a sense of excitement and mystery that is borne out of many humbling surprises. Our science objectives are founded on the fundamental human drive to understand our beginnings, our place in the cosmos, and the evolution and destiny of our home and ourselves. Taken together they tell a story, written in the language of the planets, of how our Solar System formed and developed and how life arose within it.

Our exploration strategy has been structured around the concept of habitability — the ability of a planet or moon to sustain life for extended periods of time or for a planetary system to host a planet or moon that can in turn sustain life. The habitability concept provides a unifying theme for an exploration program, which includes research and analysis and leads to a set of exploration objectives. In turn, this results in measurements or investigations that can be conducted by space missions. From there we turn to the planets and satellites themselves, where these investigations must be pursued, and view the most important ones for our purposes in thematic groups — one in the inner Solar System and two in the outer Solar System.

2.1 Habitability — A Guiding Theme

The concept of habitability speaks to a question fundamentally identified in the public mind with space exploration: *“Is there life elsewhere in the cosmos?”* It is a question whose answer requires a broadly based research and exploration program, including large missions to execute the most challenging goals. It also provides a rationale for the ordering of these large missions, which was one of the Roadmap’s principal undertakings.

While the concept of habitability can be articulated crisply, we recognize that the conditions for habitability remain poorly understood. The narrowest definition — that a habitable environment requires liquid water in order to sustain life as we know it — is a motivation for making Europa (which has subsurface liquid water) and Venus (which may have lost oceans of water sometime in its history) high-priority targets. Enceladus, where liquid water might yet exist near-surface, also then becomes an important target. But life might occur where other liquids substitute for water, and in planetary environments where organic molecules are briefly exposed to liquid water and then preserved. Thus, at these places the organic chemical steps leading to life might be available for analysis. For these last two reasons, Titan is considered a high-priority target for further exploration.

Habitability as a theme for the exploration program cannot, however, be simply a search for liquid water. It also requires a search for the sources of organic molecules that seeded our planet and others; specifically, searches for sources of energy available to sustain life-giving reactions, and an overall determination of whether this combination of requirements was

present long enough for life to originate and evolve. For this reason, the targets of Solar System exploration laid out in this Roadmap will go beyond those places that now have or once had liquid water. The distribution of planetary objects today and in the past, the distribution of organics and water in the early solar system, and the pathways by which environments of planets and moons evolve must be addressed in a scientifically comprehensive program.

Habitability's utility as a guiding theme derives from its several interrelated but distinct aspects: a planet's own basic properties and evolution, the architecture of its planetary system, and the hazards external to the planet, which hold the potential for changing in a deleterious way its life-sustaining environment. In this Roadmap we use these three broad aspects of habitability to pose specific questions, which lead, in turn, to the organization of targets and exploration objectives:

Habitability in planetary environments: how have specific planetary environments evolved with time, when and in what way were they habitable, and does life exist there now?

Habitability as an element of planetary system architecture: what determines the arrangements of planetary systems, what roles do the positions and masses of giant planets play in the formation of habitable planets and moons and the delivery to them of the chemical ingredients of life, and how have our own giant planets shaped the evolution of the impact hazard population in our own system?

Human habitability on and off the Earth: what are the hazards that threaten the long-term survival of humankind on our planet, and what threats do we face as individuals and as a species as we move off the Earth into the rest of the Solar System? These threats include small bodies of our Solar System that represent potential collisional hazards, as well as the past, present, and future state of the Sun and the Solar System's galactic environment. The small bodies hazard is addressed in this Roadmap; the Sun and galactic environment in the other appropriate roadmaps.

2.2 Investigative Framework

In order to relate the guiding theme of habitability to the specific research disciplines, and the investigations and measurements that can be executed by space missions, we have reduced the above questions related to the three aspects of habitability to five broad scientific questions about the Solar System, which can be directly related to the five "objectives" that were adopted by the Office of Space Science in 2003 in response to the National Research Council's Decadal Survey of 2003 [NRC03], and modified to reflect the goals for human exploration in the Vision for Space Exploration [Hou04]. These five major questions are (see also Figure 2.1):

1. How did the Sun's family of planets and minor bodies originate?
 2. How did the Solar System evolve to its current diverse state?
-

Figure 2.1: Principal linkage between habitability and five major science questions; i.e., (1) the Sun's origin; (2) Solar System's evolution; (3) life's origins; (4) life elsewhere; (5) hazards and resources for humans in space.

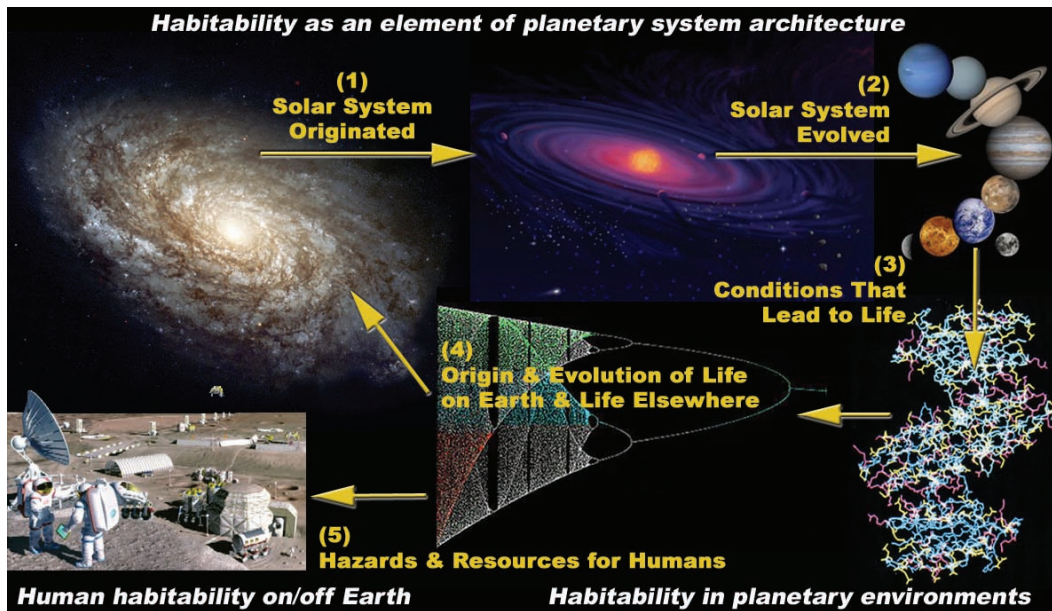

3. What are the characteristics of the Solar System that led to the origin of life?
4. How did life begin and evolve on Earth and has it evolved elsewhere in the Solar System?
5. What are the hazards and resources in the Solar System environment that will affect the extension of human presence in space?

The next step in our process is to move from broad global issues to more specific objectives that can be addressed with measurements and scientific investigations. To do this we have taken each of the scientific questions and defined several specific objectives that can address this question through practical investigation and measurements. Many of those objectives can be found in earlier reports. However, this list has been significantly augmented as a result of new scientific results since 2002–2003, and because of our explicit consideration of the capabilities of specific missions, particularly those in the moderate (New Frontiers) and large (Flagship) categories. The remainder of this section defines the specific objectives.

Table 2.1: Question One: How did the Sun's family of planets and minor bodies originate?

<i>Objectives</i>	<i>Investigations and Measurements</i>
Understand the initial stages of planetary and satellite formation	<ul style="list-style-type: none"> ▷ Determine chemical composition & physical characteristics of Pluto and Kuiper Belt objects. ▷ Determine the chemical composition and physical characteristics of short-period comets. ▷ Analyze the chemical compositions of primitive meteorites and their components. ▷ Perform theoretical modeling and experimental investigations of processes involved in the initial stages of planet formation.
Study the processes that determined the original characteristics of the bodies in the Solar System	<ul style="list-style-type: none"> ▷ Analyze ancient rocks from the Earth, Moon, Mars and asteroids. ▷ Characterize Jupiter's gravity, magnetic fields, and deep atmospheric chemistry.

2.2.1 Question One: How did the Sun's family of planets and minor bodies originate?

Our Solar System began to take shape about 4.6 billion years ago, as the primordial solar nebula of dust and gas began to coalesce around the infant Sun. Within the first billion years or so, the planets formed and life began to emerge on Earth — and perhaps elsewhere. Many of the current characteristics of the Solar System were determined during this critical formative epoch — but because of the tremendous changes that Earth and the planets have undergone over the intervening eons, most physical records have been erased and our understanding of this period is fragmentary at best. Fortunately, however, vital clues are scattered throughout the Solar System — from the oldest rocks on the Earth, Moon, Mars and the asteroids to the frozen outer reaches of the Kuiper Belt. They allow us to look back in time, and to understand the physical setting within which the story of life's origins would unfold. Specific objectives and measurements that can help elucidate the evidence story are summarized in Table 2.1 and elaborated upon in the subsequent paragraphs.

Understand the initial stages of planet and satellite formation.

The process of planet formation proceeds according to physical principles that are generally well understood. Less well known, however, are the ingredients and initial conditions that resulted in the Solar System we know today. Beyond Neptune, icy-rocky bodies that are remnants of the solid material that went into the giant planets during the latter's formation remain preserved. This region, known as the Kuiper Belt, is believed to represent the best available record of the original materials that formed the solar nebula. Pluto is a member of the Kuiper Belt and part of a growing detected class of bodies roughly of lunar size; whether even larger solid bodies exist deeper into the Kuiper Belt remains to be determined. This region is also thought to be the birthplace of the short-period comets, still smaller bodies

that have been gravitationally dislodged from the Kuiper Belt. As the comets enter the inner Solar System, they not only become visible from Earth, but they also become accessible targets for intensive robotic exploration. Determination of the chemical composition and physical characteristics of Pluto, other Kuiper Belt objects, and short-period comets will give us unique insight into the materials and processes that participated in the initial stages of planet and satellite formation.

Other Solar System materials that have preserved a record of the earliest stages of planet formation are the various classes of primitive meteorites thought to have originated from asteroidal bodies. These primitive meteorites are time capsules that preserve information about the chemical and physical processes that operated at microscopic to planetary scales in the early Solar System. Reading this information requires understanding the origin of chemical and isotopic signatures in these samples. Primitive meteorites also harbor genuine stardust, which was present in the molecular cloud from which the Solar System formed. This “presolar dust” formed in the winds and ejecta of dying stars such as red giants and supernovae, and survived a number of potentially destructive processes before being incorporated into the parent asteroids of primitive meteorites. Investigations of the mineralogy and the chemical and isotopic compositions of presolar dust grains will help us to gain an understanding of the initial conditions in the solar nebula and the raw materials that contributed to all matter in our Solar System. It is also desirable to know if any organic compounds were inherited from the interstellar medium, and the extent to which these compounds were chemically processed within the solar nebula. This is likely to have a bearing on the important issues related to the origin and inventory of prebiotic organic materials in the Solar System.

Yet another avenue of understanding the present and past architecture of our Solar System is through theoretical modeling and experimental simulations of the processes involved in planet and satellite formation and of planetary migration caused by interactions with the solar nebula.

Study the processes that determined the original characteristics of the bodies in the Solar System.

Of particular importance is the way that the earliest formative processes, active during the first billion years or so, manifested themselves in the inner Solar System. These processes have left their imprint on the terrestrial planets and on asteroids. Unfortunately, the very early geological history of Earth has been nearly completely obliterated by the actions of tectonics, weathering, and biology; on our home planet the earliest rock records date back about 4.0 billion years, but no further. Nevertheless, petrologic, chemical and isotopic investigations of the most ancient rocks on the Earth — and on Venus — can help us to understand the earliest evolution of the terrestrial planets. Unlike the Earth, the Moon still retains some of the earliest records of the formation of the Earth–Moon system. Leading models suggest a very early origin of the Moon as a result of the collision of a Mars-sized body with the newly formed Earth. Samples from the Apollo and Luna Programs eluci-

dated some of this history, but the nature of these samples, limited to equatorial regions of the lunar near side, leaves many key questions unanswered. The Moon's South Pole–Aitken Basin, one of the largest impact structures known within the Solar System, exposes material from deep within the crust and possibly even the upper mantle that was excavated by the impact, and may preserve melt rocks from the impact itself.

The ancient highlands of Mars also preserve a record of the earliest processes occurring on that planet. Remote analyses by spacecraft and detailed studies in state-of-the-art laboratories on Earth of returned samples of ancient Mars rocks would be invaluable towards a better understanding the earliest conditions and processes occurring on the terrestrial planets. Some meteorites from asteroidal bodies contain a record of processes such as aqueous alteration, differentiation and core formation that occurred at a very early stage on their parent bodies. As such, investigations of the physical characteristics, chemical composition and mineralogy of these meteorites as well as of asteroidal materials through spacecraft observations and analyses of returned samples will be important in understanding the earliest processes occurring on such bodies.

The formation of the giant planets had a major effect on the events and processes at work in the early Solar System. The gravitational influence of Jupiter in particular governed much of the dynamical behavior that in turn determined many key features of the inner planets. An understanding of the processes and timescale of Jupiter's formation is thus of central importance to our study of the early Solar System. Critical clues to giant planet formation can be found in the structure and masses of their rock–ice cores, and in the composition of their deep atmospheres and interiors. Characterization of the gravitational and magnetic fields of Jupiter and Saturn, and measurement of its deep atmospheric composition and water abundance, would enable us to determine the processes and timing of Jupiter's formation. In the longer term, comprehensive exploration of the smaller giant planets, Uranus and Neptune, would provide a more complete understanding of how gaseous planets form and why there is such variety in their properties and masses — within our own Solar System and beyond.

2.2.2 Question Two: How did the Solar System evolve to its current diverse state?

We now know that the Solar System is exceedingly dynamic. Virtually everywhere we look we find continual change — predictable or chaotic, physical or chemical, subtle or catastrophic. Only by observing Solar System bodies under different conditions and from a variety of vantage points can we begin to understand the processes by which they evolved from their initial formative states to the wide diversity we see today. Planetary processes such as impacts, volcanism, tectonics, climate change, and greenhouse–gas warming are difficult to comprehend when their study is confined to just one body — Earth, for example — but by comparing how these processes operate and interact in a variety of planetary settings, we can gain insight into their variations and effects. As we move into the era

Table 2.2: Question Two: How did the Solar System evolve to its current diverse state?

<i>Objectives</i>	<i>Investigations and Measurements</i>
Determine how the processes that shape planetary bodies operate and interact	<ul style="list-style-type: none"> ▷ Multidisciplinary comparative studies of atmospheres, surfaces, interiors, and satellites. ▷ Comparative studies of the climate evolution of Earth, Mars, and Venus. ▷ Comparative studies of the current state and inferred evolution of Moon and Mercury. ▷ Determine how the impactor flux decayed in the early Solar System.
Understand why the terrestrial planets are so different from one another	<ul style="list-style-type: none"> ▷ Study Venus' atmospheric chemistry and surface/atmosphere interactions. ▷ Study Mars meteorology and geophysics.
Learn what our Solar System can tell us about extrasolar planetary systems	<ul style="list-style-type: none"> ▷ Conduct detailed studies of the gas giants and ring systems. ▷ Determine the structure of the Kuiper Belt.

of discovery and study of extrasolar planets, our efforts in our own neighborhood provide context for our observations of these newly found, distant solar systems. (See Table 2.2.)

Determine how the processes that shape planetary bodies operate and interact.

Four decades of exploration have shown us that the underlying physical, chemical, geological, and biological processes that shape the Solar System interact in complex and surprising ways. Planetary interiors, surfaces, atmospheres, and magnetospheres are now known to be highly interdependent. Earth's magnetic field, for example, which is generated by processes within the planet's molten core, shields the atmosphere from the "striping" by the solar wind. Recent observations suggest that Mars may have had a similar protective magnetosphere early in its history. Io's eccentric orbit causes tidal flexing, which drives volcanoes that feed charged particles into Jupiter's magnetosphere, producing lethal radiation; by contrast, Europa's eccentric orbit and tidal flexing may keep an ocean from freezing, which may provide a habitable environment. Comprehending these interactions requires multidisciplinary, comparative studies of planetary atmospheres, surfaces, interiors, and satellites. This relies on a robust program of scientific research and analysis that allows the nation's best scientists to fully and creatively utilize the data returned by our spacecraft.

Impact processes clearly played a crucial role in bringing the Solar System to its present state (Figure 2.2). The young Solar System contained a significant amount of non-accreted material left over from the formation process. A collisional environment, very different from today's, probably dominated the period following planet formation as the gravitational influence of the newly formed giant planets cleared out the surviving smaller debris from vast volumes of space. This Solar System-wide rain of projectiles had a profound effect on all of

Figure 2.2: Saturn's moons Iapetus and Phoebe.

The craters and impact basins testify to ancient surfaces, recording the history of the impactor flux in the early history of the Solar System. On the left, the prominent linear ridge in the center of the dark area of Iapetus marks the equator quite closely and is up to 15 km above the mean elevation.

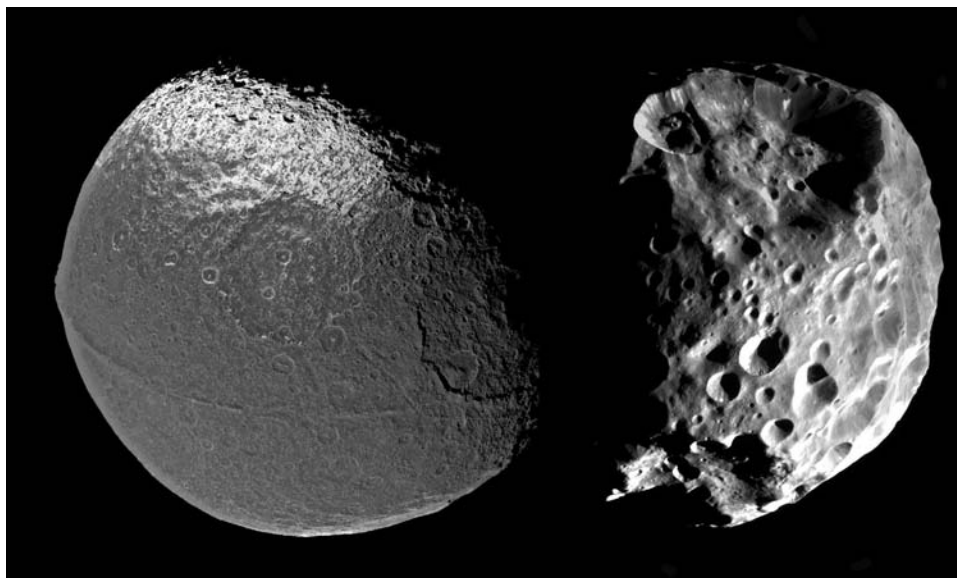

the planets, delivering volatiles and organic material from the colder outer Solar System to the inner planets while at the same time causing frequent, catastrophic impacts. This impact environment must have had a major effect on the emergence of life on Earth, perhaps delaying its expansion or “resetting” the evolutionary clock with periodic global extinctions. The geologic record of this period has long since vanished from Earth, but important links to this era still exist on the Moon and in the outer reaches of the Solar System. While the record of cratering deduced from lunar samples shows a precipitous decline in the impact rate starting about 3.5 billion years ago, we have as yet no direct data relating to the flux in the preceding billion years. Thus a critical step is to determine how the impactor flux varied in the early Solar System. Competing models have vastly different implications for the conditions under which life might have emerged on Earth. The study of material from the Lunar South Pole–Aitken Basin will provide a vital reference point for constraining models of the early impact history, while comparative studies of the cratering records on Pluto, Charon, and other Kuiper Belt objects will allow determination of the impact flux that emanated from that region.

Understand why the terrestrial planets are so different from one another. The terrestrial planets formed at about the same time, in the same general region of space, and experienced similar forces and processes during their development. Yet today they are different in very fundamental ways, for a complex set of reasons that we are only beginning to

understand. The atmospheres of Mars, Venus, and Earth reflect differences in initial volatile content and subsequent atmospheric evolution, with comparison of Mars and Venus providing particularly compelling evidence for completely different developmental pathways. The causes of such climate change are complex and their interactions not fully understood, but they are clearly of tremendous importance to our home planet. Comprehensive comparative studies of the atmospheric chemistry, dynamics, and surface–atmosphere interactions on both Mars and Venus will allow us to better understand their evolutionary pathways and the implications for habitability, both within our Solar System and in other solar systems. Of particular interest at Venus are the elemental, mineralogical, and geochemical nature of surface materials, combined with detailed investigation of noble and trace gases in the atmosphere.

Learn what our Solar System can tell us about extrasolar planetary systems.

We now know that our Solar System is one of many planetary systems in the galaxy. The characteristics of extrasolar planets are raising new questions about the history of our home Solar System and how typical it might be. For instance, the apparent abundance of large gas giant planets, in orbits very close to their stars, has led to new theories of how the forming planets in our system may have migrated or become frozen in their present locations. Models also suggest that giant planet formation is a critical feature of planetary systems in general, and may govern the formation and early evolution of rocky inner planets that can possess habitable environments. Since our current understanding of extrasolar planetary systems depends in large part on our observations of the largest planets within them, study of the gas giants represents an important tie point between those systems and our own. Detailed study of the gas giants Jupiter and Saturn, ring systems, and the Kuiper Belt — our Solar System’s best analogs for the presently observable features of extrasolar planetary systems — will significantly enhance our understanding of the general processes of Solar System formation and evolution.

2.2.3 Question Three: What are the characteristics of the Solar System that led to the origin of life?

In our Solar System, the formative and evolutionary processes that acted on the planets made at least one of them a platform for the development of life. Was this an inevitable outcome of Solar System evolution, and therefore potentially a common phenomenon, or was it merely an accident of chemistry, dynamics, and timing, unlikely to be reproduced elsewhere? And why did it happen so quickly — the first signs of life on Earth possibly emerging just a few hundred million years after the planet cooled? Where else in our Solar System were the conditions right for the formation and development of life? (See Table 2.3.)

The essential requirements for life are a source of usable energy and basic nutrients, organic material, and liquid water. There is strong evidence that these ingredients have been present and in contact with one another on bodies other than Earth. Water and organics appear to have been originally condensed or acquired in the outer reaches of the solar

nebula, where low temperatures favored their retention. Transported aboard cometary and asteroidal materials that were accreted by the planets, these essential ingredients of life were then effectively incorporated into the forming planetary environments. The planetary system we know today — and the questions of habitability — are thus intimately linked to the original distribution and transportation of water, other volatiles, and organic material.

Table 2.3: Question Three: What are the characteristics of the Solar System that led to the origin of life?

<i>Objectives</i>	<i>Investigations and Measurements</i>
Determine the nature, history, and distribution of volatile and organic compounds in the Solar System	<ul style="list-style-type: none"> ▷ Analyze the chemical and isotopic composition of comets. ▷ Determine Jupiter’s water abundance and deep atmospheric composition. ▷ Determine the chemical and isotopic composition of Venus’ surface and atmosphere. ▷ Determine the distribution of organic material on Titan and Enceladus.
Determine the evidence for and age of an ocean on the surface of Venus	<ul style="list-style-type: none"> ▷ Search for granitic and sedimentary rocks. ▷ Analyze the mineral composition of hydrated silicates and oxidized iron. ▷ Investigate the interplay of volcanic activity and climate change.
Identify the habitable zones in the outer Solar System	<ul style="list-style-type: none"> ▷ Characterize the geothermal zones on Enceladus. ▷ Search for volcanically-generated and impact-generated hydrothermal systems on Titan. ▷ Confirm the presence and study the characteristics of Europa’s subsurface ocean. ▷ Conduct comparative studies of the Galilean satellites.

Determine the nature, history, and distribution of volatile and organic compounds in the Solar System.

Most models of the solar nebula suggest that the conditions within it were too hot, at the time and place of Earth’s formation, to retain the relatively large proportion of volatiles seen in the current Earth. Delivery of volatile-rich material from more distant, colder parts of the Solar System is commonly invoked to explain this discrepancy. There are reasons to believe that even Jupiter received much of its volatile inventory in this way. However, the total quantity of volatile material, the relative proportion delivered from different possible sources, and the time period over which it was delivered all remain uncertain.

Today’s short-period comets are the dynamical survivors of the much larger original population of comets that played a role in volatile distribution, and thus knowledge of their

Figure 2.3: Particles collected by Stardust.

The image on the left shows the tracks left by three particles from comet Wild 2 after they impacted the Stardust spacecraft's comet dust collector. Scientists have begun extracting comet particles from these and other similar tadpole-shaped tracks in the dust collector's low-density glass material called aerogel. The image on the right shows a grain of olivine about 2 microns in diameter that was brought to Earth, retrieved from a track similar to those on the left. Preliminary results show a remarkable range of minerals, some which form only at extremely high temperatures that could not have existed where comets themselves formed, suggesting these minerals were transported over large distances.

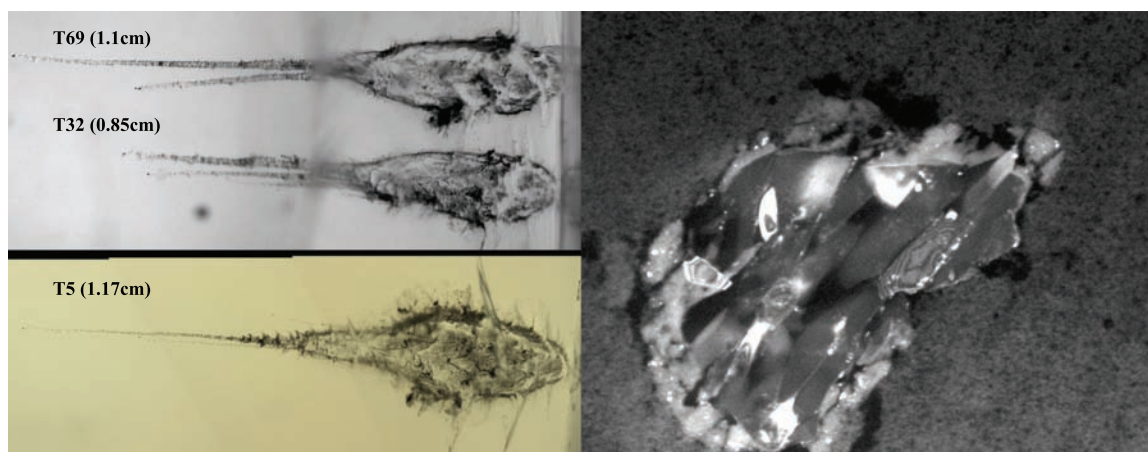

composition is crucial to understanding this process and its results. We know that comets delivered volatiles and organics to the inner planets, contributing to the formation of Earth's hydrosphere, atmosphere, and biosphere. Since comets spend the vast majority of time far from the Sun, their surfaces preserve accessible remnants of the primordial chemical constituents from which the entire Solar System formed. Laboratory analysis of the elemental and isotopic abundances in short-period comets will elucidate the history and transport mechanisms of water, other volatiles, and organics in the Solar System. Analysis of returned samples will also allow us to determine the chemical, physical, and mineralogical properties of their non-volatile components. (See Figure 2.3.)

The abundance of water in the deep interior of Jupiter is a key to understanding the processes by which volatile materials were added to the planet as it formed. Water ice carried other condensed volatiles with it as planetesimals were accreted by Jupiter. However, the water abundance in Jupiter's deep atmosphere and interior remains highly uncertain, because the Galileo atmospheric probe descended in a dry, downdraft region where the water content was not representative of the planet as a whole. Determination of Jupiter's water abundance at significant depth will enable us to estimate the planet's overall water content, and thus better understand the mechanisms that delivered water and volatile components to the forming planets in the early Solar System.

Once delivered to the planets, volatiles may be sequestered in surface and interior reservoirs, partitioned into the atmosphere, or lost to space. The volatile evolution of the three large terrestrial planets — Earth, Venus, and Mars — apparently took radically different paths with fundamentally different outcomes. These differences hold vital clues to understanding both the history and future of Earth and the potential that other planets may have been habitats for life at some point in their histories. One key means of understanding these differences is to trace the volatile history of Venus, and in particular the processes that led to the loss of the water that should originally have been present. Pioneer Venus and Venera provided some insight into the composition of the atmosphere and surface, but more detailed measurement of the chemical and isotopic composition of Venus' surface and atmosphere is required if we are to fully understand its evolutionary history.

We know that carbon dioxide on Mars is cycled between the atmosphere and the winter polar caps. At the poles there is evidence of a long history of frozen volatiles, which may preserve evidence of different climatic regimes and possibly of life-supporting environments. Current missions such as Mars Global Surveyor and Mars Odyssey are revealing striking evidence of past and present reservoirs of water on Mars — frozen at the poles and beneath the surface today, but possibly pooled in large ponds, lakes, or oceans in the past. Determination of the evolutionary processes, sources, and reservoirs of key volatiles on Mars will allow comparison with Earth and Venus and complete the picture of the original distribution of volatiles in the Solar System.

The determination of the distribution and nature of organic material on and in potentially habitable bodies in the outer Solar System includes missions to Europa, Enceladus, and Titan. Galileo data suggests that Europa has liquid water beneath its surface, and salts and CO₂ have been detected in its surface ices. Organic molecules, such as the C–H and C–N compounds identified on Ganymede and Callisto, have not yet been detected, a more difficult task for Europa due to the very high water ice abundance in the surface. Yet organic molecules are essential to life, and if the rocky component of Europa had a composition similar to the outer asteroid belt (“carbonaceous”), then organic molecules should be present. Spectrometric investigations at high spatial resolution from an orbiter, followed by landed analysis at sites where organics may be actively fluxed to the surface, are required. Enceladus' southern hemisphere plume contains methane and other hydrocarbons as measured by Cassini, evidence that the source of the plume contains organic molecules. In addition, spectra of the surface near the vent sources indicate a concentration of at least simple hydrocarbons. The Cassini instrumentation cannot detect high molecular weight organics that would be typical of biopolymers, and so a follow-on mission should (either through landed or close-flyby and orbit investigations) carry the capability to detect and analyze amino acids and other high molecular weight organic molecules. Finally, Titan contains abundant organics in its atmosphere and — based on direct Huygens measurements — on its surface. A future mission to Titan should have the capability to characterize the composition and structure of organic deposits at the surface to determine how far chemical

evolution has progressed toward the origin of life on this giant moon of Saturn.

Determine the evidence for and age of an ocean on the surface of Venus

Measurements by Pioneer Venus of condensed H_2SO_4 in the Venus atmosphere revealed an extremely elevated abundance of deuterium relative to hydrogen, and this in turn suggested that large amounts of water were lost through the atmosphere from the surface of Venus sometime in its history. Estimates of the total water loss vary, but it is generally agreed that at least the equivalent of Earth's oceans was lost by escape to space. However, no information on the timing of the loss is available. Model results have indicated that the loss was early, when ultraviolet fluxes from the Sun were high, but the overall luminosity of the Sun was 30% lower than today. This leads to the paradox that Venus may have lost its water via a runaway process, when the ambient solar flux at Venus was no more than 10% greater than what Earth receives today. The global geologic context revealed by Venera 15 and 16 and Magellan radar images is not constraining in this regard, showing a planet that has been almost completely resurfaced in the last billion years.

It is extremely crucial to understand how much water was lost from the surface and crust of Venus and when this loss occurred, because this bears directly on the long-term habitability of our own planet and the width of the so-called "continuously habitable zone" around solar-type stars. A Venus that remained habitable for billions of years implies a much wider continuously habitable zone than one that lost its water within a few hundred million years after formation; two billion years of biological evolution might have led to complex macroscopic life forms for which physical evidence might remain. To better constrain when Venus lost its water will require more precise atmospheric measurements as well as geochemical measurements on surface rock samples in carefully selected locales. For example, while hydrogen from the vaporized ocean could escape without a problem, the oxygen could not. Unless some other processes enabled all the oxygen to escape to space over time (such as photochemistry and/or solar wind scavenging) or the crust was overturned in an early episode of plate recycling, the crust must be oxidized to some unknown depth. Therefore, understanding the depth to which the surface is oxidized is a critical measurement to understand the history of water on Venus, and whether or not atmospheric escape was much more effective at getting rid of oxygen in the past.

If water persisted beyond the earliest part of Venus' history, there may have been an extensive period of plate tectonics, production of granites, and a hydrological cycle that led to the formation of extensive sedimentary deposits on continental platforms. Evidently much if not all of this putative Earth-like geology has been covered by the subsequent global onslaught of massive basaltic volcanism, but a few features seen in Magellan data hint at the possibility that accessible granites and sedimentary structures might remain. A primary goal of Venusian surface exploration would be to locate and analyze granites and sedimentary structures — and in the case of the former, to use robotic isotopic dating techniques now under development to determine age.

A search for granites is a search for geology like that of our own Earth. But our experience in the exploration of Solar System shows that we consistently underestimate the diversity of expression of physical and chemical processes in planetary bodies. Even with water present in the crust for prolonged periods, it is possible that Venusian tectonics was never like that of Earth, or plate tectonics did not operate long enough or extensively enough to produce granites despite the persistence of liquid water. Therefore, a search for hydrated silicates and oxidized iron, against the possibility that a non-cycling crust was suffused with water for some extended period of time, is an important exploration goal for Venus as well.

Finally, the recent widespread basaltic volcanism on Venus may have altered the atmospheric chemistry and climate from an unknown and different climate state, perhaps one more typical of Venus' history than that observed today — just as the present glacial-interglacial climate regime of Earth is not the typical climate state recorded in isotopic records at least for the last several hundred million years. To search for evidence of different Venusian climate states will again require surface access and sampling of crustal rocks in various terrains and possibly at shallow depths just below the surface.

Identify the habitable zones in the outer Solar System

Recent discoveries suggest that life's "habitable zones" are defined not just by a planet's distance from its parent star, but by a complex relationship involving external and internal energy sources, chemical inventories, and geophysical processes. The chemical building blocks of life and complex organic chemistry are known to exist throughout our Solar System, and there are tantalizing hints that liquid water may be present in a few key environments. This has significantly expanded our view of the number of Solar System environments that might be or might have been conducive to life. Mars is widely regarded as a planet on which the conditions for habitability could have been met. Determination of Mars' volatile history and study of its geological and climatic evolution will tell us whether Martian environments ever became habitable. Remote and in situ investigations, as well as analysis of returned samples, would all provide important data for understanding the habitability of Mars.

Other recently recognized potentially habitable environments are the inferred subsurface liquid oceans on several major satellites of Jupiter, especially Europa. Considered at least a theoretical possibility for nearly three decades, the existence of global liquid layers under the icy crusts of the larger moons has received major support from the Galileo mission's exploration of the Jovian system. Although the evidence for its existence is as yet indirect, there is wide acceptance that Europa does today possess a subsurface global ocean of liquid water. While there are many uncertainties regarding the geology and chemistry of this environment and potential life-supporting energy sources within it, confirmation of the existence and determination of the characteristics of Europa's ocean would allow us to conclude whether it is or ever has been a habitable environment. A positive finding would provide tremendous impetus for future surface and subsurface chemical and geophysical Europa exploration. Both Ganymede and Callisto also show evidence for subsurface oceans similar to that of Europa. If the formation of oceans is found to be a common phe-

Figure 2.4: Saturn’s moon Enceladus.

Saturn’s 504 km diameter moon Enceladus, once believed to be too small to produce endogenic activity, has been discovered by instruments aboard the Cassini spacecraft to be emitting heat and expelling water vapor from its south polar region. At left and middle are monochrome and enhanced color-coded views of these water-vapor geysers, the latter revealing a fainter and much more extended plume component. The image at right shows ~ 2 km wide troughs dubbed “tiger stripes,” which are the locus of heat and vapor in the south polar region.

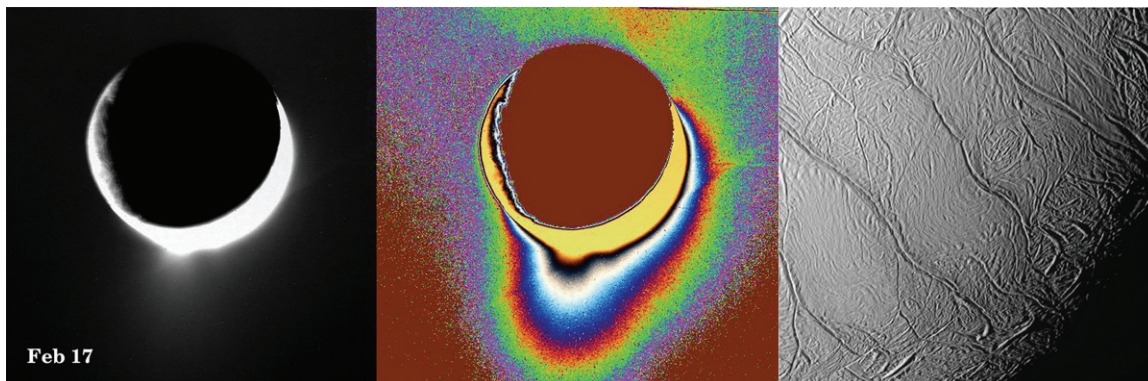

nomenon, the implications for life in the cosmos could be stunning. Comparative intensive studies of Callisto, Ganymede, and Europa could therefore prove to be one of the most important contributions we can make to the understanding of habitability in the Solar System.

The very recent discovery of active geysers in the southern hemisphere of Enceladus raises the possibility that a persistent liquid water environment lies just beneath the surface of this small Saturnian moon. At present no direct evidence for liquid water exists, but consideration of the Cassini multi-instrument data set points to a source of liquid water. The Cassini orbiter will make at least one closer flyby of Enceladus and may further constrain the conditions associated with geyser formation, but it may require a future spacecraft to make other measurements — including on and beneath the surface — to establish the existence and location of liquid water zones. (See Figure 2.4.)

Saturn’s moon Titan is nearly as large as Ganymede and shows evidence for geologic activity in the recent past. Although its surface is too cold for persistent, stable, liquid water, impacts and internal heat are capable of melting the water ice crust and allowing water — possibly with antifreezes such as ammonia — to remain present for some time. It may be that parts of Titan are geologically active at present, and if so they are extremely important sites for examining potential prebiotic or protobiological reactions between liquid water and deposits of organic molecules on the surface. A search for active geysering or “cryo” volcanic activity is ongoing with the brief flybys of the Cassini spacecraft in Saturn orbit, but it will require some luck to see an active volcano in this way, just as it would be for our

own home planet. A dedicated Titan orbiter or lighter-than-air cruise vehicle to observe more closely and continuously the surface of this complex world to find and explore such sites would be a better way to observe potential surface changes associated with geologic activity. The cruise vehicle would provide an opportunity to sample recent or even actively evolving deposits of cryovolcanism or active geysering.

Like Venus, Earth, and to some extent Mars, Titan's present-day climate may not be typical of the bulk of its history. Like Earth, Titan's lower atmosphere and surface climate are driven by a moderate greenhouse effect modified by convection and driven by the cycling of active greenhouse gases through gaseous and liquid phases in the surface-atmosphere system. On Earth, water is the multiphase greenhouse gas in which the other primary greenhouse gases — carbon dioxide and methane — can dissolve and hence create a very complex set of feedbacks on the climate. On Titan, methane is the primary greenhouse gas and surface liquid, in which other greenhouse gases (molecular nitrogen and hydrogen) can dissolve and hence amplify feedbacks. The lack at present of large reservoirs of surface liquid methane combined with the existence of chemically-active atmospheric methane — an intrinsically transient situation on geologic timescales — implies occasional refreshment of methane into the surface-atmosphere system, which constitutes a large-scale perturbation on the climate. What is Titan's climate like when methane is depleted, and conversely after large-scale injection (from the interior, most likely) of fresh methane? Is the present climate condition the result of a recent injection of methane, ongoing geysering of methane from near-surface crustal reservoirs, or a more quiescent descent from an earlier methane-rich to a future methane-depleted state?

This important opportunity to study a fourth planetary body with an actively evolving and complex climate can be realized through orbital and lighter-than-air platform observations of surface geology (including a search for fields of impact craters with a size distribution inconsistent with the present-day atmospheric thickness), examination of regionally-varying erosional features and organic deposits, sampling of selected sites to assess organic deposits for chemical signatures of varying atmospheric methane-to-nitrogen ratios, and relative age dating of organic, cryovolcanic, and impact-related deposits.

2.2.4 Question Four: How did life begin and evolve on Earth and has it evolved elsewhere in the Solar System?

Microbial life forms have been discovered on Earth that can survive and even thrive at extremes of high and low temperature and pressure, and in conditions of acidity, salinity, alkalinity, and concentrations of heavy metals that would have been regarded as lethal just a few years ago. These discoveries include the wide diversity of life near sea-floor hydrothermal vent systems, where some organisms live essentially on chemical energy in the absence of sunlight. Similar environments may be present elsewhere in the Solar System. Understanding the processes that lead to life, however, is complicated by the actions of biology

Table 2.4: Question Four: How did life begin and evolve and has it evolved elsewhere in the Solar System?

<i>Objectives</i>	<i>Investigations and Measurements</i>
Identify the sources of simple chemicals important to prebiotic evolution and the emergence of life	<ul style="list-style-type: none"> ▷ Determine the chemical composition of comets and Kuiper Belt objects. ▷ Study surface organic deposits on Titan, and interaction of surface with atmosphere.
Search for evidence for life on Europa, Enceladus, and Titan	<ul style="list-style-type: none"> ▷ Identify and study organic deposits from the sub-surface ocean on Europa. ▷ Study biomarker signatures in surface organics in active/recently active areas on Titan. ▷ Sample subvent fluids for biological activity.
Search for evidence for past life on Venus	<ul style="list-style-type: none"> ▷ Search Venus samples for chemical and structural signatures of life.
Study Earth's geologic and biologic record to determine the historical relationship between Earth and its biosphere	<ul style="list-style-type: none"> ▷ Investigate biological processes on the early Earth through multidisciplinary studies. ▷ Examine the records of the response of Earth's biosphere to extraterrestrial events.

itself. Earth's atmosphere today bears little resemblance to the atmosphere of the early Earth, in which life developed; it has been nearly reconstituted by the bacteria, vegetation, and other life forms that have acted upon it over the eons. Fortunately, the Solar System has preserved for us an array of natural laboratories in which we can study life's raw ingredients — volatiles and organics — as well as their delivery mechanisms and the prebiotic chemical processes that lead to life. We can also find on Earth direct evidence of the interactions of life with its environments, and the dramatic changes that life has undergone as the planet evolved. This can tell us much about the adaptability of life and the prospects that it might survive upheavals on other planets. (See Table 2.4.)

Identify the sources of simple chemicals important to prebiotic evolution and the emergence of life

Since the outer reaches of the original solar nebula were relatively cool, a variety of volatile compounds could condense from the nebular gas as the Solar System formed. Of particular importance were ices containing carbon, nitrogen, and sulfur, as well as organic materials. The outer Solar System was thus far richer in organic compounds, essential for prebiotic chemistry as we understand it, than was the inner Solar System. Planetesimals that formed in this region probably delivered such materials to the moons of the outer planets and to the inner planets. Comets are volatile-rich and organic-rich samples from reservoirs in the outer Solar System, including the Kuiper Belt beyond Neptune and the more distant Oort Cloud. By determining the chemical composition of comets and Kuiper Belt objects, we can directly study chemical building blocks that may have laid the foundation for life.

Saturn's moon Titan is an organic-rich world that is of tremendous importance to our study of prebiotic chemistry. Data from Voyager, as well as from other observations and experiments, suggest that the pathways and products of long-term organic evolution on Titan may bear similarities to those that existed on the early Earth. The atmosphere and surface of Titan are a virtual time machine, presenting us with unique opportunities for studying photochemistry and chemical reactions that are no longer observable on our planet due to the pervasive effects of biology. A thorough study of Titan's atmospheric chemistry and surface-atmosphere interactions is a key to determining its chemical history and thus to learning about analogous processes that may have occurred on Earth. In 2004 the Cassini-Huygens mission initiated an intensive study of Saturn and Titan that is revolutionizing our understanding of complex organic chemical processes in the Solar System. Based on the preliminary results from this mission, future in situ Titan exploration is a very high scientific priority.

Search for evidence for life on Europa, Enceladus, and Titan

The search for life on Europa requires identifying sites where oceanic material is close to the surface, either because the crust is very thin or upwelling (diapiric) activity is moving oceanic material through a thicker crust into the near-surface environment (Figure 2.5). Chemical, isotopic, and morphological biosignatures will be well-preserved in the icy crust even quite close (meters) to the intense surface radiation environment. Clues to the presence of such oceanic material may be geomorphological, compositional, and thermal in nature, and would require a suite of imaging, spectroscopic, bolometric, and geodetic observations to be made to identify a site where a biomarker analysis package can be deployed for access to the subsurface site of interest. There is also the possibility that fractures in a thin part of the crust open and close on tidal cycles, allowing oceanic material to well up directly to the surface. Deployment of a package to capture such material before it is heavily modified by surface radiation is another approach to the biomarker search.

On Enceladus, aqueous material welling up from fractures associated with active geysering will be preserved against radiation effects much longer than on Europa, making feasible the analysis of recently frozen deposits for evidence of life. Should liquid water, as the source of the geysers, exist within tens of meters of the surface of Enceladus, direct sampling of the fluids may be possible. In view of Cassini's plume sampling of water and organic molecules, establishing that the essential ingredients for life exist, a search for biomarkers within geyser fluids on Enceladus could prove extremely fruitful.

Despite the low surface temperatures on Titan, a search for biosignatures or the indicators of advanced organic chemical evolution on the road to life should be fruitful in places where cryovolcanic or impact-generated hydrothermal systems have interacted with organic deposits. The possibility that the compositional and structural organization of organic material in some places on Titan differs from the random type of organic chemistry seen in short-term laboratory experiments or in meteorites is intriguing and important from the

Figure 2.5: Spots and pits on Europa.

Europa's surface is believed to hide a global ocean. Spots and pits, including those seen here, could be places where liquid water exists at shallow depth and are targets for more intensive orbital investigation.



Figure 2.6: Three mosaics of Titan.

The three mosaics shown here were composed with data from Cassini’s visual and infrared mapping spectrometer taken during three Titan flybys, on Oct. 28, 2005 (left image), Dec. 26, 2005 (middle image), and Jan. 15, 2006 (right image).

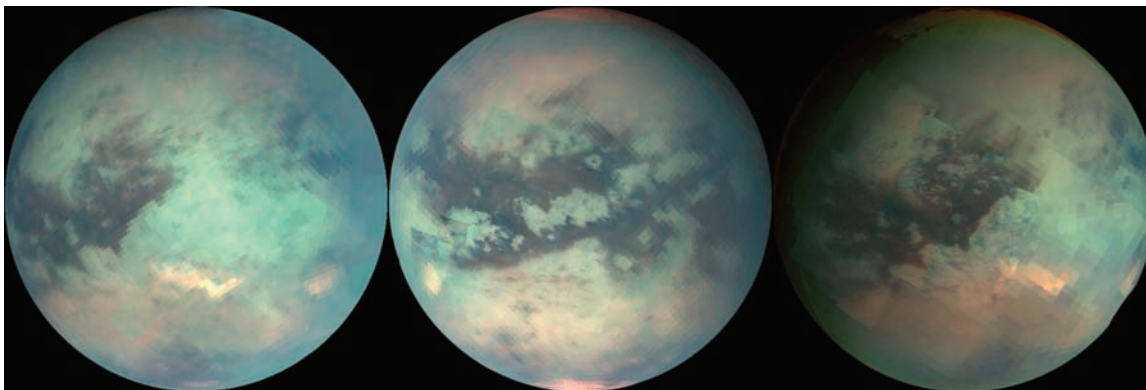

point of view of understanding the origin of life. Generation of preferred polymers in terms of number of carbon atoms, polymer structure (“tacticity”), and enantiomeric (chiral, or handed) state have all been proposed as indications that abiotic organic chemistry is moving toward the very specific and ordered state that we call life. Organic analysis instruments to measure such properties, in deposits selected from orbit or lighter-than-air platforms based on the surrounding geological context, should be a high priority for the next mission to Titan. (See Figure 2.6.)

Although liquid water is regarded by most chemists as a requirement for life, some have pointed out that other liquids might serve to sustain and host exotic organic chemical systems that could also be regarded as living. That is, our experience in exploring the cosmos is that we underestimate the diversity of complex physical and chemical systems, and therefore risk the possibility of missing important phenomena, including potentially exotic types of life. The range and complexity of geological and atmospheric processes on Titan approach that of Earth, and liquid hydrocarbons have flowed or still do flow across the surface. Particularly if mixed with somewhat polar contaminants, such liquids cannot be excluded as a possible medium for exotic life. Therefore, examination of the surface of Titan by landers or lighter-than-air platforms should include instruments that could test, in a general way, for the existence of exotic living chemistries.

Major investigations and measurements are:

- Identify and study organic deposits from the subsurface ocean on Europa.
- Study biomarker signatures in surface organics in active or recently active areas on Titan.

- Sample subvent fluids for biological activity on Enceladus.

Search for evidence for past life on Venus

The putative persistence of liquid water for billions of years on the Venusian surface, which is of highest priority as a motivator for the investigation of Venusian surface geology, leads naturally to the question whether life ever originated or was transplanted to Venus, and the state to which it may have evolved on this nearest planetary neighbor of Earth. Extensive basaltic volcanism and the very high surface temperatures associated with the current extreme greenhouse regime militate against preservation of most types of biomarkers and biosignatures, but not all. Stable isotope biomarkers may have been preserved in ancient sediments. Some parts of the Venusian crust, particularly tectonically elevated terrains, have likely been spared erasure and burial by basaltic volcanism, and certain types of biomarkers such as hard shells or bones would remain stable even under the ambient conditions. Therefore, a search for remains of microscopic or even macroscopic organisms should be conducted on the surface of Venus in conjunction with the geological search for sedimentary deposits.

Study Earth's geologic and biologic records to determine the historical relationship between Earth and its biosphere

Recent discoveries attest to the fact that life is remarkably hardy and that it developed surprisingly quickly. Microbial life on Earth may have come into existence nearly 4 billion years ago, shortly after the end of the most violent phase of formation of the planet. Today it thrives wherever liquid water and usable energy exist together. This includes unlikely environments such as hot deep-sea vents, cold Antarctic rocks, acidic hot springs, and rocks many kilometers below the surface. A full understanding of the historical relationships between life and the environment requires a synthesis that draws from many different fields of science. We seek to investigate the development of biological processes on the early Earth through molecular, stratigraphic, geochemical, and paleontological studies involving a combination of field and laboratory research. Molecular biomarkers uncovered in such research can help to link biological evolution to past environments. Likewise, biogeochemical cycles of carbon, oxygen, sulfur, and iron are integral to Earth's biosphere, and the isotopic records preserved in Earth's geology and in fossils help us to understand how the biosphere evolved.

Our knowledge of chemistry, physics, and Solar System dynamics places constraints on the study of Earth's history of environmental change. With these tools and methodological framework, astrobiologists study the interactions of organisms with the planetary environment. We now know that some of the most cataclysmic disruptions in Earth's history have been due to impacts. By examining the records of the response of Earth's biosphere to extraterrestrial events, including comet and asteroid impacts, we can gain substantial insight into the processes by which life adapts and evolves. We can also learn about the role that impacts may have played in determining the habitability of other planets in our Solar System and beyond.

Table 2.5: Question Five: What are the hazards and resources in the Solar System environment that will affect the extension of human presence in space?

<i>Objectives</i>	<i>Investigations and Measurements</i>
Determine the inventory and dynamics of objects that may pose an impact hazard to Earth	<ul style="list-style-type: none"> ▷ Identify, model, and track near–Earth objects down to 1 km diameter. ▷ Understand the impact process in different planetary settings. ▷ Understand impacts and exogenous delivery / production of organics. ▷ Investigate the relationship between impacts and extinctions.
Inventory and characterize planetary resources that can sustain and protect human explorers	<ul style="list-style-type: none"> ▷ Determine water resources in lunar polar regions and near–Earth asteroids. ▷ Determine the inventory of rare metals. ▷ Assess potential long–term resources.

2.2.5 Question Five: What are the hazards and resources in the Solar System environment that will affect the extension of human presence in space?

Our planet Earth moves through interplanetary space and is continuously bombarded by energetic particles, cosmic rays, dust, and occasionally larger objects, all of which are hazards to human life. These hazards become even more severe for future human and robotic explorers that will move beyond the shielding provided by Earth’s atmosphere and magnetic field, and into space environments that are vastly different than on Earth. Here we catalogue these hazards to human and robotic explorers, and discuss vital resources needed to sustain life beyond Earth.

Once a source of life–giving organics and water, cosmic impacts also have the potential to wreak widespread destruction or even to extinguish much of life — and these events occur regularly on planetary timescales. This sobering conclusion stems from the convergence of many lines of study, from geology to astronomy to paleontology. Evidence continues to mount that the so-called Cretaceous–Tertiary mass extinction event 65 million years ago was caused by the impact of an extraterrestrial body about 10 km in diameter. It has also become apparent that even much smaller objects, which impact Earth much more frequently, are capable of doing serious damage to modern industrialized society. To understand the impact threat posed by asteroids and comets, as well as the feasibility of potential mitigation strategies, we must assess not only the number of potentially hazardous bodies and the frequency of both small and large impacts, but also the physical characteristics of the objects themselves. (See Table 2.5.)

Determine the inventory and dynamics of bodies that may pose an impact hazard to Earth

Update the inventory of small bodies

The interplanetary space between the major bodies in our Solar System is far from empty. Considerable progress has been made in discovering and cataloguing Near–Earth Asteroids (NEAs) that could potentially pose a threat to Earth. As a direct result of increased knowledge of the discovered population, estimates of the total population of potentially hazardous NEAs have become increasingly accurate. Based on this evolved understanding of the population and the threat that it represents, about 52% of the potentially hazardous NEAs larger than 1 km have now been catalogued. It is estimated that approximately 10,000 asteroids of diameter greater than 140 m still exist in orbits that directly represent a collision hazard to Earth. Such objects have orbits that could bring them to within 0.05 AU of Earth and are termed potentially hazardous asteroids (PHAs). Of those, approximately 220 ± 40 have diameters of 1 km or larger, with 115 of these having been discovered to date [SB04]. An impactor at the smaller end of this size range could wipe out a city or an entire coastal region; at the upper end of this range, it could cause global devastation. NASA has played a key role in the discovery of these objects in response to a stated goal of discovering and cataloging 90% of all NEAs with diameters larger than 1 km by 2008. However, based on the evolved understanding of the asteroid population and the threat that it represents, it is appropriate to modify this goal to better focus resources on the truly threatening population of objects. These changes are as follows:

1. The discovery and cataloging goal focuses specifically on the objects in orbits that represent a direct collision threat to Earth. These are the PHAs rather than asteroids in the broad NEA category. Only about 20% of NEAs are actually PHAs.
 2. The goal has been modified to directly address resolving the largest risk for the amount of resources invested. As such, the goal is to “discover and catalog the population of potentially hazardous asteroids sufficient to resolve 90% of the risk from the impact of subkilometer asteroids.” This will also resolve essentially all of the residual collision risk for the 1 km and larger asteroids. This goal indicates the development of a catalog of PHAs that is 90% complete for asteroids larger than 140 m in diameter, which is achievable by the application of currently available technology.
 3. The long–period comets represent less than 1% of the total collision risk and therefore are not an important component of the stated goal. However, any such objects on a collision course likely would be discovered with only a few weeks to months of warning time by systems built to accomplish the asteroid search.
 4. This represents a unique contribution to the protection of our home planet that is synergistic with our objectives of understanding key Solar System processes.
-

Understand the impact process on different planetary settings

Impact cratering is a common geologic process in the Solar System. On Earth, craters in water-saturated sediments are larger than their energy-equivalents in dry soils, which in turn are larger than their energy-equivalents in crystalline rocks. Features of Martian craters have been used to indicate the presence of water in the subsurface. Craters on the icy moons of Jupiter have morphologies that are quite different from those on rocky surfaces. To date there have been no direct observations of the formation of planetary impact craters in recorded history. While NASA's Deep Impact mission provided a unique chance to witness a hypervelocity impact, a comprehensive understanding of the impact cratering process requires the combination of planetary geologic and geophysical observations and experimental and theoretical studies. Terrestrial impact structures are in the unique position of providing ground truth information on the impact cratering process. Their investigation can provide crucial information on the cratering process, in particular the importance of target composition and the amount and nature of deformation outward from the crater. Because of its arid environment and close proximity to Earth, the Moon has been a valuable natural laboratory for studying planetary impact processes at 1 AU. New data from the science and exploration programs will add significant new constraints to our understanding of the Earth-Moon environment.

A critical component of the impact process is the response of materials to the wide range of temperatures and pressures associated with impact cratering. Specific material properties govern the response of materials to stress, resulting in different behaviors of different materials for nominally the same impact conditions. Gravity is another poorly explored parameter that can affect impact cratering, especially for very low-gravity bodies, such as asteroids and comets. As a result, there are clear differences among craters on different planetary surfaces, especially in the outer Solar System. To understand the role of impact cratering on the various planetary surfaces of the Solar System, the science community is in need of experimental data that can characterize the response of different materials in the impact process. This includes shock data relative to the exotic materials making up the surfaces of outer Solar System bodies, such as different ices at very low temperatures, as well as mixed materials with very different characteristics, such as water ice and silicate rocks on the surface of Mars. These data can provide precious information for the development of accurate material models that still represent one of the major problems associated with theoretical modeling of impact cratering. Data on low-gravity impacts are needed to understand impact cratering where usual scaling laws may not work. Measuring the surface and interior composition and structural properties of comets and asteroids will enable modeling of the effects of impacts and the development of credible mitigation strategies. It will also be important to understand the impact processes under low-gravity conditions, such as the one studied with the Deep Impact mission.

Impacts and exogenous delivery/production of organics

Incoming comets and asteroids are rich in organic molecules. Carbonaceous chondrites, the most volatile-rich meteorites, are known to contain several types of amino acids. Comets

appear to contain up to 10 times more organics than carbonaceous chondrites. Objects larger than a few kilometers in diameter are the most important contributors of extraterrestrial material to Earth. Their usefulness in delivering complex organic molecules to a planetary surface is weakened by the extreme thermodynamic conditions occurring during an impact event. As a result, interplanetary dust particles (IDPs) have long been indicated as the main vehicle for carrying organic material to planetary surfaces. However, theoretical and laboratory studies have recently suggested that non-negligible fractions of complex organics can survive the shock events associated with large impacts, and secondary organics have been synthesized in strong shock events in the laboratory. It is becoming clear that asteroid and comet impacts played an important role in the development and evolution of the prebiotic inventory of planetary objects, including Earth. However, our knowledge of the potential effects of shock-loading on the modification of organic material is still sparse. Detailed theoretical and laboratory work is needed to determine the rate of survival and synthesis of complex organics in strong shock events, as well as the role of planetary gravity in retaining impactor material delivered in impact events.

Impacts and extinctions

Collisions of large asteroids and comets with Earth's surface are rare events that punctuate the geologic record. While the existence of large impact structures on Earth is undisputed, their effects on the biosphere are still not well understood. Based on statistics, the number of major mass extinctions characterizing the evolution of Earth's biosphere is close to the number of expected large impact events. On the other hand, hard evidence points to the well-studied end-Cretaceous (K/T) mass extinction (65 million years ago) as the only one that clearly coincides with a major impact event, although mechanisms linking the impact event with the mass extinction are still debated. Attention has recently focused on the possibility of another mass extinction-impact event coincidence, at the Permian/Triassic boundary (P/T) around 250 million years ago. The investigation of Earth's record for the evidence of an impact at the end of the Permian is still in its infancy, and any conclusion of a temporal coincidence with the mass extinction requires a major interdisciplinary investigation effort from the scientific community. The examination of Earth's geologic record coupled to the investigation of the effects of large impacts on the biosphere can provide important insights on the consequences of large impacts on Earth and into the processes by which life adapts and evolves. This in turn can help us learn about the role that impacts may have played in affecting the habitability of other planetary bodies of our Solar System and beyond.

Inventory and characterize planetary resources that can sustain and protect humans as they explore the Solar System

Permanent human habitation of space requires knowledge of the resources available from the Moon, Mars, and asteroids, and access to those resources. Assessing space resources requires missions that (1) determine the global distribution of materials (mineralogy and elemental abundances) with sufficient detail to understand geologic context (origin), (2) land on planetary bodies and characterize the surface and subsurface environments, (3)

carry resource extraction test beds and pilot plants to develop engineering capability to use extraterrestrial resources; and (4) gain an understanding of the bulk densities of asteroids to ascertain which are solid bodies and which might be rubble piles (this is important from both the planetary defense point of view and the issue of asteroid resources). The combined data returned will be of immense long-term value to both science and resource exploration.

There are four areas of investigation:

Determine the nature of water resources in lunar polar regions and on Mars, and the locations of water-bearing NEAs, and the most efficient ways to extract oxygen from non-polar lunar regolith.

Water may be the fuel that allows humans ready access to the Solar System. It is essential for life support, of course, but it is particularly useful because its constituents, hydrogen and oxygen, can be used for rocket fuel. Water is found throughout the Solar System, but we do not have a systematic knowledge of its occurrence on specific bodies.

The Moon. Lunar Prospector data show conclusively that lunar polar regions are enriched in hydrogen. We do not know the precise form of the hydrogen (H, H₂O[ice], H₂O[bound], CH₄, organic compounds, etc.), its distribution in the regolith, or its precise location (permanently shadowed craters or over a broader region). To understand the concentration mechanisms, sources of hydrogen, and composition and total inventory of the deposits requires dedicated mission(s). Such mission(s) would characterize the locations of the hydrogen deposits from orbit and, equally important, make detailed in situ measurements of representative deposits. Subsurface sampling is expected to be important and should reach a depth of at least a meter (ideally to the base of the regolith, several meters). As an independent approach, it has long been known that oxygen can also be extracted from the lunar regolith, particularly from ilmenite and FeO-rich glass such as pyroclastic glass. Landed experiments are needed to test and refine such extraction techniques on the Moon.

Asteroids and Martian moons. Water is abundant in some asteroids, bound in phyllosilicate minerals. CI carbonaceous chondrites, which are believed to come from asteroids, contain about 10 wt% water. Prospecting for water requires missions that characterize the composition and physical properties of a number of specific asteroids that might be accessible for resources. We must identify water-rich NEAs and characterize their surface properties in sufficient detail to design and develop extraction systems.

Mars. A unifying theme of the Mars Exploration Program is to understand the distribution and history of water. Water is also essential for permanent settlements on Mars. Mars Odyssey neutron and gamma-ray spectrometers have shown conclusively that abundant water exists in polar regions within the upper meter of the surface, and modest amounts are present in equatorial regions, probably bound in hydrous minerals. However, we do not have a detailed understanding of water on Mars, e.g., variations laterally or with depth, depth to liquid water, or purity of the water. Understanding water on Mars, along with

hydrous mineralogy of the soil and surface rocks, will involve a continued series of orbital, flying, roving, and drilling measurements.

Determine the inventory of rare metals

We will soon experience a shortage of rare metals needed for industrial processes (e.g., platinum). Some asteroids are known to be rich in these desirable and valuable metals. In certain lower-velocity collisions with the Moon, a large amount of impactor material would survive unvaporized. Thus, it may be possible to prospect for precious metal concentrations on the Moon, which represent the remains of metal-rich asteroids. While a meteoritic component has long been recognized in lunar fines, these arguments speculate that large areal concentrations of ores can exist on the Moon and that these ore bodies could potentially be mined for resources.

Assess potential long-term resources

Permanent settlements will require use of materials from the Moon, Mars, and asteroids (because this is less expensive than bringing materials out of Earth's gravitational potential) to build and maintain the infrastructure. Prospecting for these resources and devising mining and processing techniques are crucial steps in human activities in space. More importantly, some space resources, such as producing solar energy on the Moon, are expected to make the transition to be used for the benefit of people on Earth, while opening new economic markets that might drive the human exploration of space.

Initial lunar resource utilization would focus on the most concentrated deposits of materials of immediate interest (e.g., highest titanium, phosphorous, or zirconium concentrations) and development of efficient techniques to extract those resources and manufacture products from them. Although our understanding of the potential value of specific resources is in its infancy, a thorough inventory of raw materials is the baseline information that is essential for extended planning. This requires a combination of orbital exploration that provides mineral and elemental concentrations in detailed geologic context and coordinated landed (roving) investigations of surface composition and physical properties with tests of extraction technologies. Asteroids are diverse and their surfaces poorly explored (although individual asteroids may be homogeneous; see Objective 1). The distribution of potential useful materials (e.g., iron metal, organic compounds) on asteroids needs to be determined through orbital and landed measurements. Techniques to process materials in low gravity must also be developed and tested.

It will be essential to shield astronauts from cosmic and solar radiation, especially during solar flare events. Current understanding indicates that more than 2 m meters of lunar or asteroidal regolith should provide adequate shielding, although further research will be needed to both establish the radiation environments to which astronauts will be exposed and explore new and innovative shielding techniques and approaches.

Efficient methods must be developed and tested that move large amounts of regolith to construct shielded habitats. Asteroids and the Moon present very different problems for using regolith, however, because physical properties may be different. Measurements of geotechnical properties of asteroid surface materials and development of excavation techniques at very low gravity are needed.

2.3 Target Objectives for Investigation

Now that we have established the basic scientific framework in which to pursue an investigation of habitability within the Solar System, we must address the primary target objectives for this investigation and discuss the technical challenges of carrying out the investigation and measurements we need. It is the challenge of reaching these locations that, in many cases, can only be achieved by the largest class of mission — the Flagship missions — that have historically been responsible for the major discoveries in this field.

2.3.1 Venus — Key Member of the Inner Triad of Worlds

Venus, so similar in size to Earth and our closest planetary neighbor, is a nightmarish world of vast basaltic volcanic flows lying under a carbon dioxide atmosphere whose pressure is 90 times the pressure at sea level on Earth (Figure 2.7). The surface temperature of Venus, over 460 °C, is above the melting point of lead and well above the temperature beyond which water cannot exist as a liquid, no matter what the pressure. Even though Venus is 30% closer to the Sun than is Earth, such extreme conditions are surprising; its globe-circling sulfuric cloud layer reflects so much sunlight that the Venusian lower atmosphere actually receives less sunlight than does the surface of Earth. But the massive carbon dioxide atmosphere creates enormous greenhouse warming, and the resulting complete lack of water in the crust and on the surface not only rules out life as we know it, but also profoundly affects the geology of this otherwise near-twin of Earth. How long Venus has been in this state is unclear — its basaltic veneer formed within the last 1 billion years, erasing surficial signs of most earlier geologic history, and the isotopic enrichment of heavy hydrogen in the atmosphere's trace amount of water points to potentially large amounts of water earlier in Venusian history. The disorganized pattern of highlands and lowlands is a stark contrast to the Earth's granitic continents and basaltic ocean basins, suggesting that an organized system of global tectonics, analogous to terrestrial plate tectonics, failed on Venus eons ago, or never began. (See Figure 2.8.)

But the ancient Sun of 4 billion years ago was 30% fainter than it is today, and early Venus might not have experienced much more solar heating than does Earth today. Did Venus lose its water and form a massive carbon dioxide atmosphere late in its history, or right at the start? There are few constraints on how long a warm ocean existed there. Theoretical studies of the early evolution of Venus' climate suggest that a lower bound for the longevity of an ocean is ~600 million years. However, that work admitted solutions for the longevity of an ocean on the order of the age of the Solar System.

Figure 2.7: Two views of Venus.

The view of Venus from NASA's Pioneer Venus (left) in 1978 is contrasted with the terrains of the planet as revealed by Magellan's radar mapping sensor which operated from Sept 1990 to Sep 1992. The ESA Venus Express is currently observing the atmosphere of Venus and a JAXA Venus Climate Orbiter is planned for launch in 2010, but no firm plans exist yet for follow on missions focused on high-priority science questions regarding the solid surface of Venus. The disorganized pattern of highlands and lowlands on Venus is a stark contrast to the Earth, suggesting that global plate tectonics failed on Venus eons ago or never began.

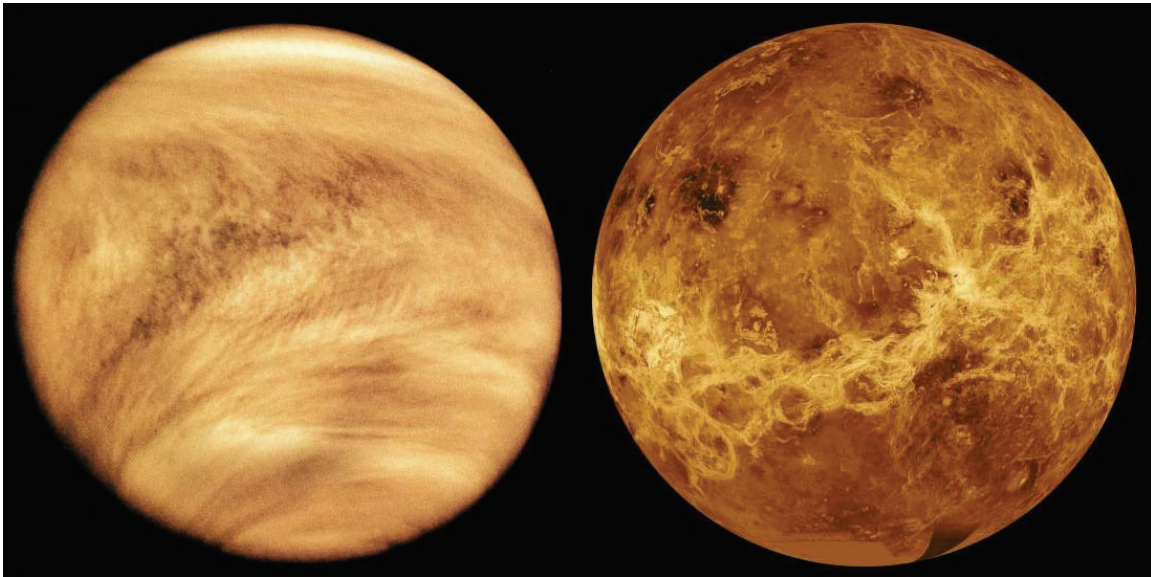
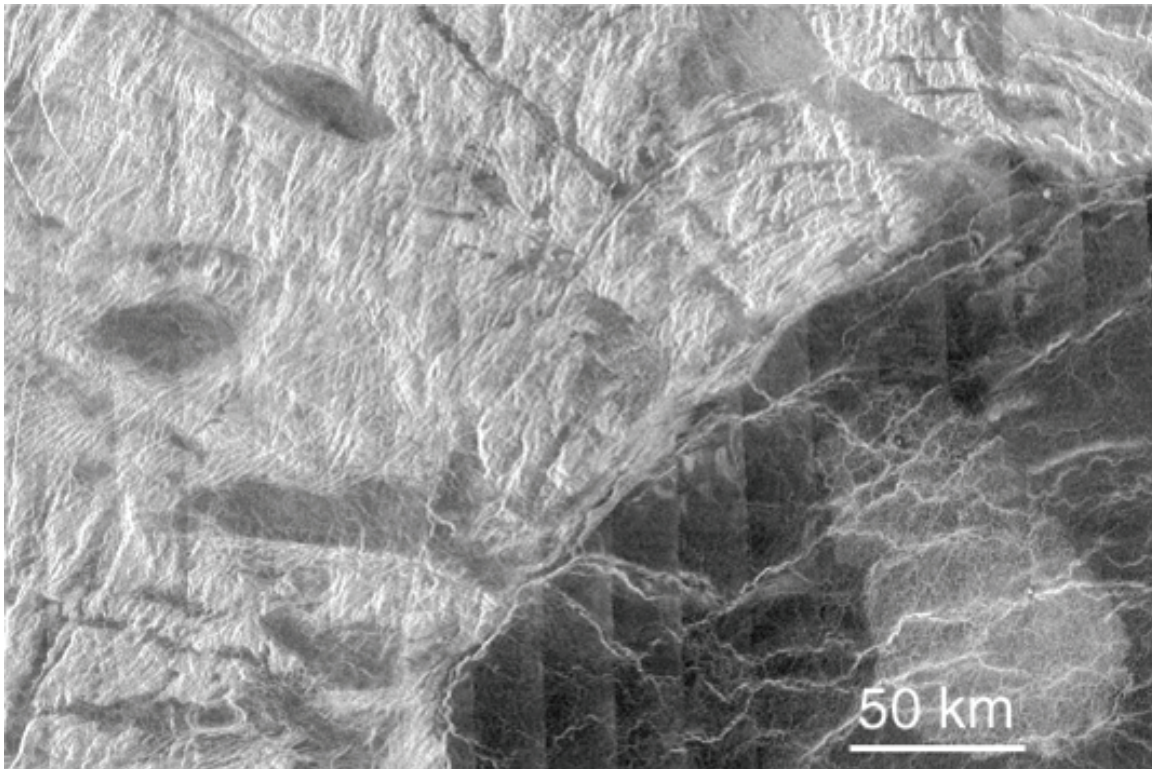

Figure 2.8: The tessera region of Venus.

Radar image of the Venusian highland tessera obtained from the Magellan spacecraft. Tessera are heavily deformed material of unknown origin and composition. Contractional and extensional structures occupy 8% of the planetary surface. One possibility is that these are ancient crustal structures that might retain the signature of a possible early Venus ocean. Determining the origin of these landforms will require measurements in situ and intensive mobile exploration by a vehicle able to traverse substantial distances over these terrains performing close up imaging and sampling at diverse sites.



It is conceivable that warm oceans persisted for billions of years on Venus, providing a crucible for life that may have been superior to that of Mars. The logical status of past life on Venus is in fact no different from that of past life on Mars or Europa. The difference is that telltale signatures of life itself may have disappeared or been severely modified as Venus evolved to the extraordinarily hot and dry planet we see today. On the other hand, the search for evidence of past surface water on Venus, and when it finally disappeared, must be a top priority for the astrobiological exploration of the Solar System.

As such, it is imperative to include a definitive assessment of the petrology and mineralogy of the Venus highlands, analysis of the crust for metastable hydrated silicates, measurements of the oxidation and mineralogical state of iron, and determinations of the C, O, S, and H isotopic abundances in the crust and lower atmosphere.

To know the answer to these questions is to understand whether the 0.7–AU region around a Sun-like star (Earth sits at 1 AU, or 150 million km, from the Sun) forms part of the long-term habitable zone or is just too close. Together with a fuller understanding of the evolution of the Martian climate, we can then address whether the habitable zone around a solar-type star is narrow, perhaps extending only 0.1 AU inward and outward of 1 AU, or occupies a significantly larger volume. Venus is the only planet within at least 4 light years, other than Earth, that has ongoing, active geochemical cycles, volcanism, and attendant climate feedbacks.

To study Venus as an integrated system is to look “outside the box” to understand how planetary processes shape a world that is so different from our own, but that had similar initial conditions. It is very likely that the terrestrial worlds that we will eventually find around other stars will be dominated by CO₂/N₂ atmospheres. Of the three terrestrial planets in our Solar System with substantial atmospheres, two are of this class. Understanding the radiative balance, circulation, geologic history, and internal structure of Venus through intensive spacecraft exploration will no doubt pave the way for an understanding of worlds yet to be discovered around other stars.

The Venus greenhouse is unique in the Solar System and utterly unlike that of Earth. Yet many details of Earth’s climate are poorly understood. This is especially true of how climate is forced by changes in solar insolation [NAS03b]. The study of the Venus environment through measurements of its radiative balance, cloud microphysics, circulation, and atmospheric composition promises a far better understanding of the underlying principles of planetary atmospheres. An understanding of how planetary environments work is the key to better understanding how far in the future our own planet will yield up its life-giving oceans to a relentlessly brightening Sun and become a Dante-esque hell like Venus.

Venus’ atmosphere will not tell us this story by itself. For answers, we must send mobile vehicles to the highlands of Venus, possibly with drills, to find ancient crust that has a

Figure 2.9: Surface images of Venus taken by the Russian Venera 9 & 14 landers.

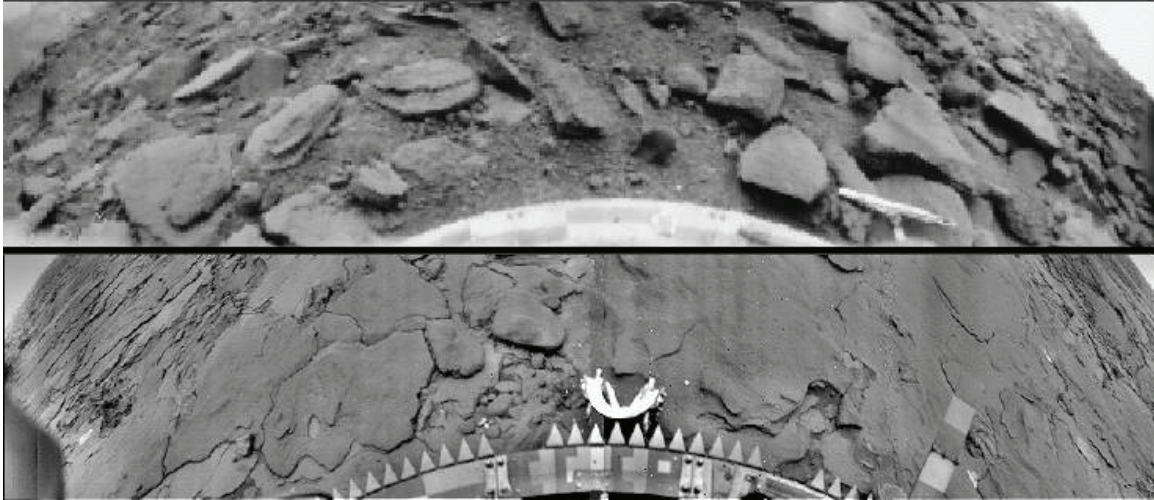

granitic or andesitic signature — the signs of persistent plate tectonics and the action of liquid water on crustal formation. Should we find such a crust — an indication that Venus was at one time more like Earth — we might then plan a later and more ambitious effort to bring samples back to Earth to perform more detailed and delicate chemical and petrologic studies possible only in terrestrial laboratories. (See Figure 2.9.)

The surface exploration of Venus represents a challenging undertaking that will require long-duration mobile operations in Earth-like gravity and potentially rough terrains, under atmospheric conditions 90 times terrestrial pressure at temperatures above the melting point of lead. Sample return missions, given the dense, hot atmosphere and strong gravity well, would be even more ambitious.

The exploration of Venus is a dual attack on the question of habitability from the point of view of planetary architecture (how wide is the long-term habitable zone?) and habitable worlds (by what processes did Venus lose its early habitability, and to what extent was this purely a question of proximity to the Sun versus small differences in intrinsic properties relative to Earth?). In conjunction with the study of Mars, the triad of atmosphere-endowed terrestrial planets will then be fully explored.

2.3.2 Europa, Titan, Triton ... and Enceladus

But a triad of a different kind awaits our robotic explorers in the outer Solar System: three moons with varying atmosphere and ocean environments that parallel in an odd way the differences among Venus, Earth, and Mars. Europa, Titan, and Triton orbit Jupiter, Saturn, and Neptune at distances of 5, 10 and 30 AU, respectively, from the Sun. Europa's

icy surface is believed to hide a global subsurface ocean (Figure 2.10). Europa's surface is young, with an age of about 60 million years, implying that it is most likely geologically active today. The primitive materials that nourish life have rained onto Europa throughout Solar System history, are created by radiation chemistry at its surface, and may pour from vents at the ocean's deep bottom. On Earth, microbial extremophiles take advantage of environmental niches arguably as harsh as within a European subsurface ocean. If the subsurface waters of this Galilean moon are found to contain life, the discovery would spawn a revolution in our understanding of life in the universe. An orbiter mission would explore Europa and determine its potential for life, including characterizing the ocean and ice shell through geophysical measurements and locating potential habitable zones within or beneath Europa's ice shell, the critical first steps in determining Europa's potential habitability. If potentially habitable environments within Europa are affirmed, then a future capable lander mission should be targeted to a place on Europa's surface that has relatively recently been in contact with liquid water. The lander should sample beneath the radiation-processed near surface material to search for signs of life and characterize in situ the potential habitability of this moon.

Titan has a Europa-sized rock core wrapped in a massive mantle of water ice, making it larger than its Jovian cousin. Resident in the colder environment of the Saturn system, Titan has a massive nitrogen-methane atmosphere with a thermal structure much like Earth's but with much lower temperatures (-180°C at the surface), with abundant organics in the atmosphere and apparently (from early Cassini-Huygens results) on the surface. Neptune's moon Triton is less massive than Titan in the same proportion as Mars is to Earth. It too has a nitrogen-methane atmosphere, but because Triton is so far from the Sun, the atmosphere is mostly frozen out on the surface and moves seasonally from pole-to-pole, as does that of Mars. The Earth-Mars analogy carries through nicely with Titan and Triton; the former has methane rain and rivers of methane and perhaps ethane, while the latter is in deep freeze but shows evidence of a much warmer (perhaps tidally-driven) earlier history. Yet the origin of Triton almost certainly lies in the Kuiper Belt, like that of Pluto, and so the nitrogen-methane atmospheres of Titan and Triton could have very different origins.

To explore these three worlds is to address primarily habitability in planetary environments, but also planetary architecture (for example, through understanding the origins of the methane and nitrogen atmospheres of Titan versus Triton). We seek to discover life in the subsurface oceans of Europa, but we must first know how deep we must drill and where to do so: are there places where tidal stresses open fissures and expose the water oceans to space? To address these issues requires sending a spacecraft to orbit Europa and map its crustal thickness and surface geology for as long as the intense Jovian radiation can be withstood, but at least a month. Such a mission would be in the Flagship class, requiring multiple instruments and precision geodetic capabilities, and might include a surface lander.

Cassini-Huygens has revealed Titan to be a world with processes much like those on Earth, but operating under different (colder) conditions and hence on different materials. Vol-

Figure 2.10: Europa's chaotic terrain.

The Galileo spacecraft imaged significantly less than 1% of Europa at very high resolution. Rare 11 m/pixel images of Conamara Chaos show that ice blocks as small as 1 km in size have rotated and translated in a once-slushy matrix. The proposed Europa Explorer mission has the potential to image most of Europa at this high resolution.



canism does not involve melting rock into lava on Titan; here water mixed with antifreeze (perhaps ammonia) produces buoyant “cryolavas” of viscous water that flow across the surface (Figure 2.11). Atmospheric jetstreams transition to variable and gentler surface winds that blow dark material across the surface and appear to form dunes of organic powders. Impact craters are few. Rainfall-driven streams seem to intermingle with intricate springs in the hills of the Huygens landing site (Figure 2.12); liquid methane and ethane evaporated into the warm Huygens probe to reveal their subsurface presence, and may have carved the springs and streams, as well as rounding the pebbles of uncertain composition at the landing site. Hints of benzene and cyanogen in the surface materials bespeak the presence of the products of methane and nitrogen chemistry.

Recent work hints at a prebiotic Earth atmosphere containing not just nitrogen and carbon dioxide, but significant amounts of methane and hydrogen as well. The present Titan environment may be compositionally even more akin to that of the prebiotic Earth than was thought at the time Cassini–Huygens was launched. And the absence of stable liquid water may be a blessing for prebiotic studies rather than a curse; without life gaining dominance on Titan, the surface may preserve the products of occasional encounters between organics and volcanically or impact-generated liquid water. What happens when organic deposits on Titan encounter flows of water and ammonia? Are amino acids and other prebiotic molecules created? How far toward life has organic chemistry proceeded on Titan’s surface over eons of time, protected from destructive UV radiation? Could exotic life forms that utilize liquid hydrocarbons as primary solvents exist on Titan today? Is the chillingly familiar yet alien scene revealed by Huygens only a sampling of Stygian panoramas that await us on Titan? To address these questions, we must return to this complex world with a mobile platform, perhaps taking advantage of the benignly dense atmosphere, to course over the surface and sample where interesting geology has occurred or large deposits of organics are present. While Titan’s atmosphere is supremely well-suited for aerial investigation, such missions would be challenging because of the very low temperatures, need for autonomous operation, and delivery of assets via aerobraking.

Exploration of Triton completes the study of the triad. Just as Cassini will reveal whether Titan has a significant amount of liquid water in its interior, a future mission to Triton would do the same. Such an experiment, as well as closer analysis of the weirdly melted crust of this frigid moon first imaged by Voyager 2 in 1989, would be part of a mission to explore the Neptune system. Triton has a youthful (~100 million years old) surface that is rich in exotic ices and it displays active geyser-like eruptions of volatiles and entrained organic materials. Its surface is tectonically deformed, and it shows the most dramatic examples of icy volcanism and diapirism anywhere in the outer Solar System (Figure 2.13). The moon’s thin atmosphere is in equilibrium with volatile surface ices. Triton’s retrograde orbit implies an origin as a captured Kuiper Belt object, which would have experienced intense tidal heating and internal melting during its capture. Indeed, it is possible that Triton retains an internal liquid ocean today. Neptune itself is a smaller “giant planet,” often called an ice giant, with much less hydrogen and helium than Jupiter or Saturn. It poses a

Figure 2.11: Hilly terrain and erosional channels on Titan.

This complex area of hilly terrain and erosional channels is located atop Xanadu, the continent-sized region on Saturn's moon Titan. Each side of the image covers 200 kilometers. Extending north is a drainage region where liquids flowed, eroding the presumably water-ice bedrock of Xanadu. Faint drainage channels appear to empty into the dark region near the top of the image. Liquid methane might be fed from springs within Xanadu or by occasional rainfall suspected to occur on Titan.

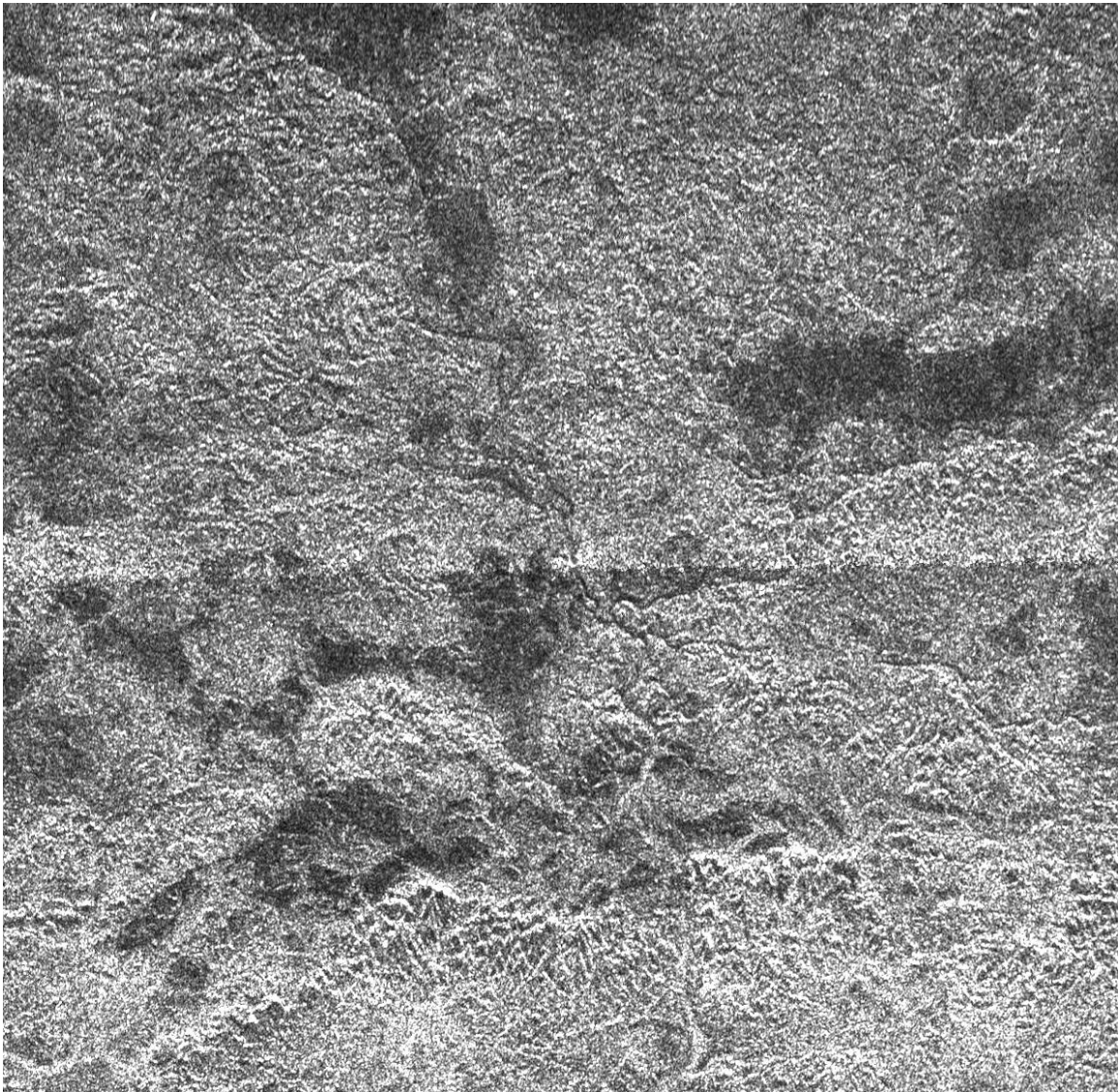
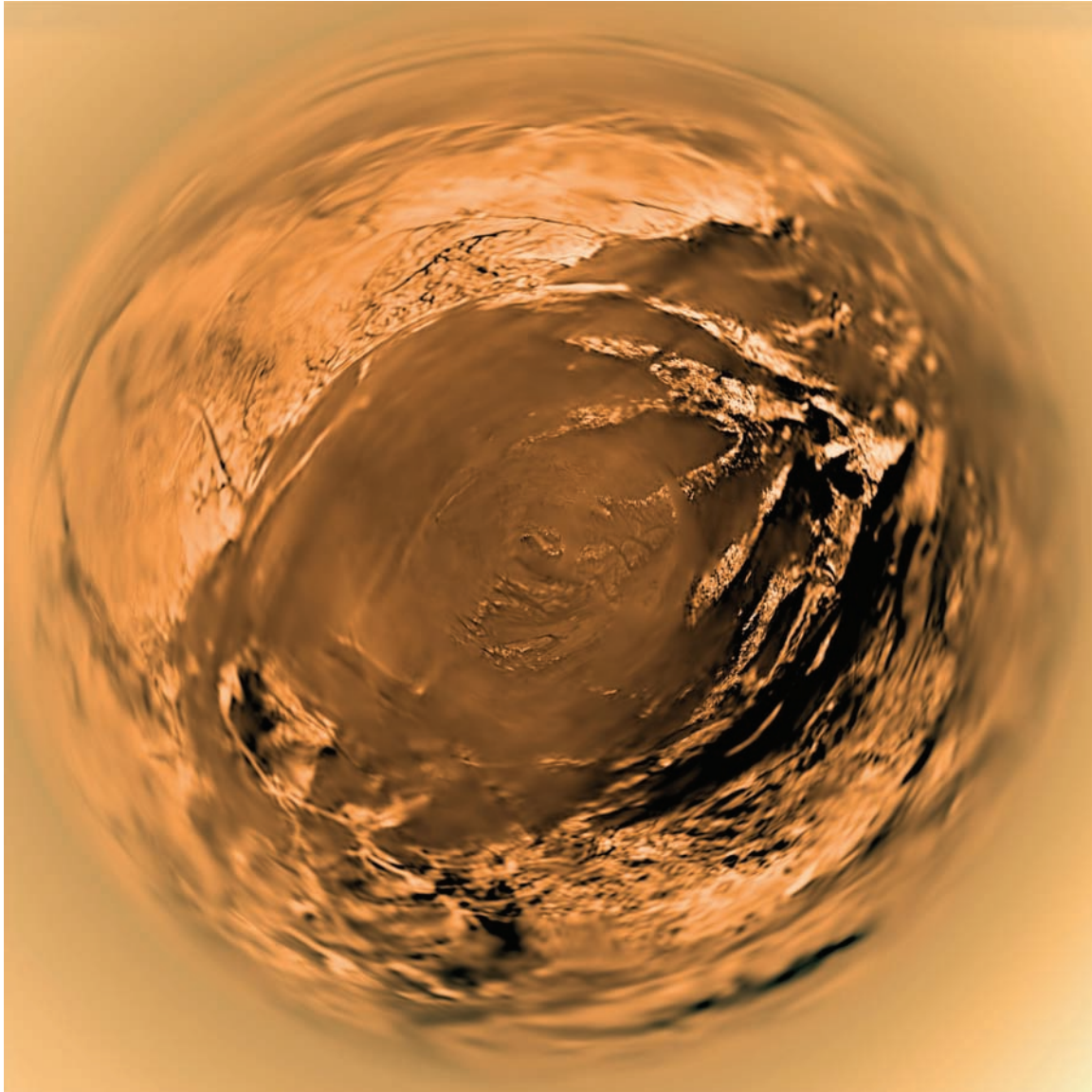

Figure 2.12: A stereographic, fish-eye projection of Titan.

The image mosaic was obtained with the descent imager/spectral radiometer onboard the European Space Agency's Huygens probe, when the probe was about 5 kilometers (3 miles) above Titan's surface.



number of important questions regarding how giant planets form and just what truncates the formation of multiple giant planets in a planetary system. Residing on the edge of our planetary system, Neptune may hold deep in its interior chemical clues to the nature of the rocky and icy debris that formed the giant planets. Because the proportion of rock and ice relative to hydrogen is much larger for Neptune than for Jupiter, the “signal” associated with the abundances of oxygen, carbon, nitrogen, and noble gases more strongly reflects the origin of the solid material. Were the planetesimals primitive, hardly altered from the parent molecular cloud, or were they heavily processed in the outer disk? To what extent are ice giants like Uranus and Neptune the norm in other planetary systems, versus gas giants like Jupiter and Saturn or terrestrial planets like Earth? Neptune may provide a connection to a class of worlds around other stars just barely detectable with current technology, and whose commonality we do not yet understand. A Flagship mission to Neptune would deploy deep probes in its atmosphere for comparison to elemental abundances in Jupiter, revealed in part by Galileo, but completed with New Frontiers class probes. It would make multiple flybys of, or orbit, Triton, exploring that world while it establishes the role our outermost giant planet played in shaping the leftover debris of planet formation we call the Kuiper Belt.

The “triad” of interesting worlds in the outer Solar System may just recently have become a tetrad. Multi-instrument data from the Cassini spacecraft show that Saturn’s small moon Enceladus has plumes of ice and gas rising from warm active fractures in its south polar region, probably the action of localized tidal heating (Figure 2.14). Water is the dominant plume constituent, and trace amounts of the simple organic molecules acetylene and propane are also detected. It is uncertain whether plume material is erupting like geysers, or sublimating from warm fractures. If water exists in the shallow subsurface of Enceladus, then this moon joins the short list of icy bodies that may be habitable environments. These new discoveries at Enceladus are pertinent to all four major science themes pertinent to large satellites, as recommended by the Decadal Survey: origin and evolution of satellite systems, origin and evolution of water-rich environments in icy satellites, exploring organic-rich environments, and understanding dynamic planetary processes. Thus, Enceladus is elevated to a high priority for continued examination by the Cassini spacecraft, to establish whether liquid water exists or is likely to exist near the surface, thereby making this another prime target for future Solar System exploration. The scope of such a mission remains to be determined pending further results from the Cassini orbiter, but would likely involve landing and sampling of material exuded from the subsurface or extracted by drilling. These represent significant operational challenges.

2.3.3 Comets

Comets are samples of rocky and icy bodies from the outer Solar System that survived perturbations by the giant planets, being neither thrown into the Sun nor ejected from the Solar System. They supplied some fraction of Earth’s water and organic inventory, but their importance in making Earth habitable in this regard remains uncertain. They are part of a population of impactors, along with debris in the asteroid belt and elsewhere, that

Figure 2.13: Global color mosaic of Triton, obtained in 1989 by Voyager 2 during its flyby of the Neptune system.

Triton is one of only three objects in the Solar System known to have a nitrogen-dominated atmosphere (the others are Earth and Saturn's moon, Titan). Triton is among the coldest surface in the Solar System (38 K, about -391 degrees Fahrenheit), and most of its nitrogen is condensed as frost. The pinkish deposits are believed to contain methane ice, which would have reacted under sunlight to form organic compounds. The dark streaks may contain carbonaceous dust deposited from huge geyser-like plumes, some of which were active during the Voyager 2 flyby. The bluish-green band may consist of relatively fresh nitrogen frost deposits. The greenish areas include what the "cantaloupe terrain," thought to result from icy diapirism, and a set of "cryovolcanic" landscapes apparently produced by icy-cold liquids (now frozen) erupted from Triton's interior.

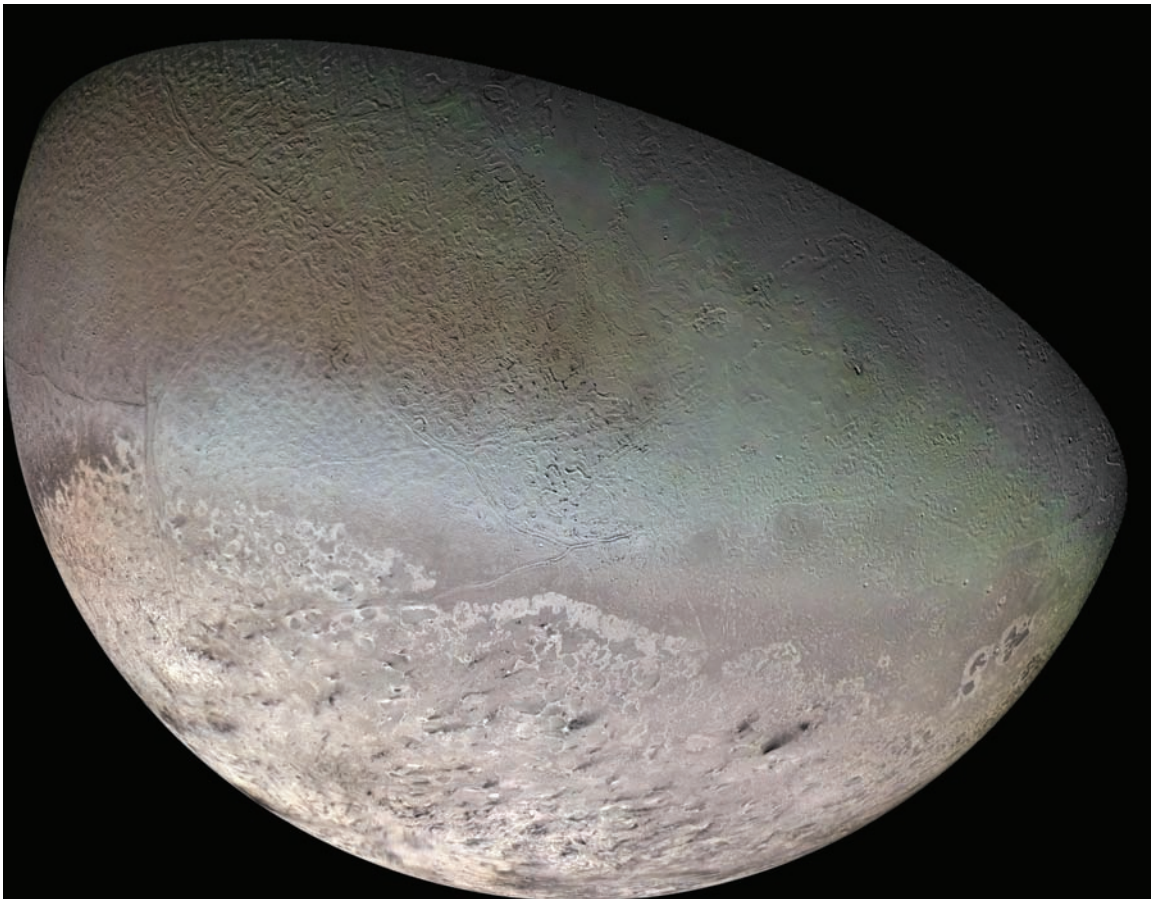
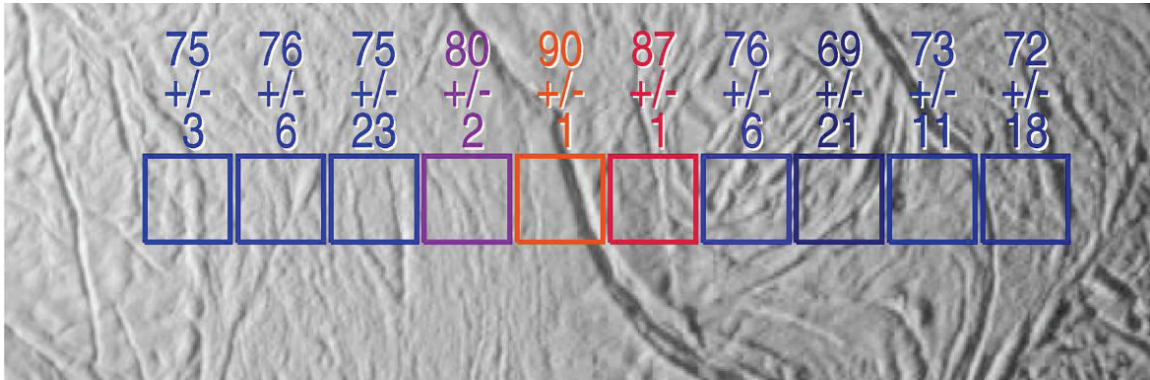

Figure 2.14: Excess heat radiation from cracks near the south pole of Enceladus. Enhanced thermal emission is observed in the vicinity of the prominent “tiger stripe” fissures discovered by the imaging cameras of Cassini. The excess emission is greatest near the center of the composite infrared spectrometer array, directly over a tiger stripe fissure. The peak temperature of 90 Kelvin is an average over the composite infrared spectrometer field of view, and other temperatures of at least 145 Kelvin occur in narrow zones a few hundred meters wide along the tiger stripe fissures.



first frustrated the formation of life on Earth, but then perhaps stimulated the formation of new organisms over time through ecosystem-emptying catastrophic impacts (such as the Chicxulub impact that may have extinguished the dinosaurs 65 million years ago). Placing comets as primitive bodies in the framework of the planetesimals that formed the planets themselves requires understanding their relationship to asteroids and meteorites, a process that will be completed by a New Frontiers class sample return from a comet nucleus. But to understand how comets relate to material in the cold, dark molecular clouds out of which planetary systems like our own may have formed requires preserving and analyzing the most delicate ices and organics present in cometary nuclei. Such preserved samples could contain the most primitive precursors to life that we could obtain from organic molecules resident in ices that have been preserved far from the Sun for much of the age of the Solar System. To return such a sample to Earth would require developing autonomous or semi-autonomous techniques for extraction and preservation of material during flight, reentry, and recovery.

2.3.4 Coda

The science objectives established in this chapter flow naturally into a set of missions of varying sizes and scopes which — combined with robust programs of Research & Analysis, Outreach, and continued ground- and space-based observations — constitute an ambitious yet achievable program of Solar System exploration described in the next chapters.

3 Missions

Planetary exploration missions are conducted by some of the most sophisticated robots ever built. Through them we extend our senses to the farthest reaches of the Solar System and into remote and hostile environments, where the secrets of our origins and destiny lie hidden. This section describes the mission set that was the product of the Roadmap process described in Section 1. It consists of a set of missions in three broad cost and scope driven categories — Discovery, New Frontiers, and Flagship — responding to the science objectives and specific investigations and measurements defined in Section 2. The section includes a matrix showing the traceability between measurements and missions.

3.1 Formulating the Mission Set

In 2003, the National Research Council (NRC) of the National Academies established a set of criteria in the Solar System Exploration Decadal Survey [NRC03] for formulating a program of planetary missions, which were subsequently embraced by the Office of Space Science in its 2003 Roadmap for Solar System Exploration [NAS03a]. The NRC also established three broad categories of planetary missions — small missions (represented by the Discovery Program); medium missions (represented by the New Frontiers Program); and large missions (known as Flagship missions). The Roadmap team reviewed these criteria, both in terms of their continued validity and the continuing success of NASA in applying them.

3.1.1 Establishing Priorities

In establishing program priority — that is, a recommended chronological sequence of missions — we must balance the scientific imperative of each investigation against its cost, technological readiness, and other considerations. Thus each potential mission must be studied in sufficient depth to enable comparisons of scientific merit, opportunity, and technological readiness.

Scientific merit is measured by addressing the following prioritized questions:

1. Does a proposed mission represent significant progress toward achieving the high-priority science objectives of this Roadmap and the NASA Strategic Plan?
2. How might the measurements made by a mission create new or change existing paradigms?
3. How would the new knowledge affect the directions of future research?
4. To what degree would the knowledge gained strengthen the factual base of our understanding and improve predictive models?

The research focus areas and investigations described in this Roadmap are the product of a rigorous process by the broad planetary science community to address these issues of scientific merit. They broadly follow the recommendations of the NRC's priorities in planetary

exploration, documented in the Solar System Exploration Decadal Survey, and represent the activities considered to be the most important, having been derived from a much larger set of possible investigations.

Opportunity comprises a number of factors that can affect mission sequence decisions. These include orbital mechanics, relationships to other missions, public interest, and possible international cooperation. Opportunity can also arise by virtue of a scientific discovery that suddenly makes it the “right time” to undertake a prospective mission.

Technological readiness is frequently the factor that drives choices among missions with relatively equal scientific values and no clear opportunity-based discriminators. It is a major element of the cost versus risk equation for each mission, while a logical flow of technologies from one mission to another is a key factor in building a cost-effective long-term space exploration program. However, technological readiness can also be the most difficult factor to determine, requiring the execution of the most extensive intensive mission and system design trades, cross-referenced with projections of future technological progress.

The Roadmap team put together such a plan using these criteria, but unlike the Solar System Exploration Decadal Survey, which focused on the next decade, the Roadmap team was assigned an explicit 30-year time frame. The Roadmap team also had the benefit of experience with the early implementation of the New Frontiers Program as well as considerations from new scientific results. Most significant was the recognition that while the Prometheus fission-powered technology was too expensive and terminated for budgetary reasons, there were alternative ways of accessing important targets in the satellite systems of the outer planets that could be implemented with technologies of non-nuclear propulsion and aerocapture.

3.1.2 The Mission Roadmap

The mission roadmap developed here addresses the key scientific goals identified in Section 2 by providing the capability to conduct the investigations and make the measurements needed to address the most critical scientific questions. The missions fall into three categories: small or Discovery class; medium or New Frontiers class; and large or Flagship class. The specific definitions of these terms appear in following sections.

At present, there is one Discovery class planetary mission under development (Dawn — Figure 3.1) and two in flight (Deep Impact and Messenger). (Note that Kepler, also under development, is not a planetary mission.) There is one New Frontiers class mission in development (Juno – Jupiter Polar Orbiter) and one in flight (New Horizons: Pluto – Kuiper Belt Explorer). Currently, no Flagship class missions are under development or in a mission planning phase. The only Flagship class mission currently in operation is Cassini, which has made spectacular discoveries in its observations of Saturn, its rings, and its moons, in

Figure 3.1: Dawn spacecraft with DS-1 heritage ion propulsion and 10kW triple junction solar array (artist's concept).

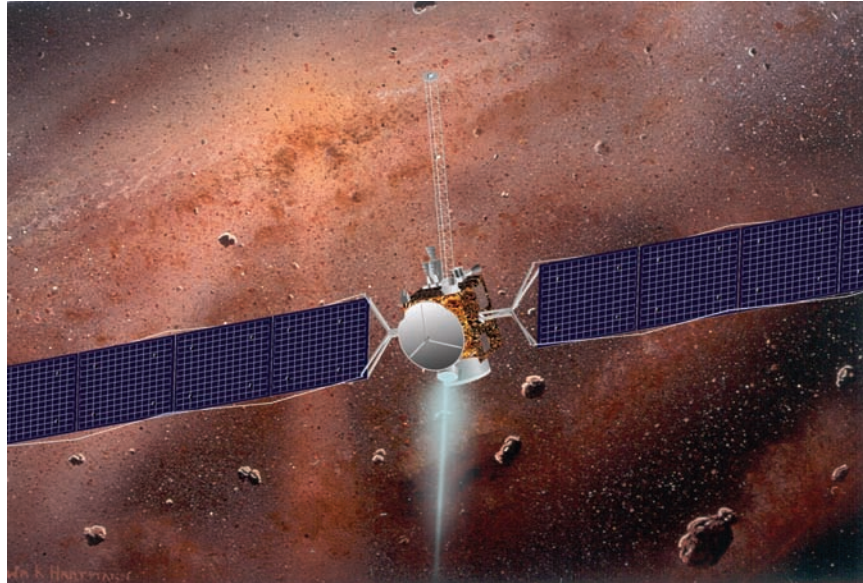

particular Titan and Enceladus.

The Solar System Exploration mission roadmap advocates the continuation of small and medium class competed missions, represented by the Discovery and New Frontiers Programs. However, a key conclusion is that many of the most important questions comprising the guiding theme of habitability cannot be addressed with small and medium missions. This is because many of the required investigations demand journeys into the remote reaches of the Solar System, where propulsion, power, and communications drive operational costs; extreme environments of radiation and cold are encountered; and new types of observational platforms are needed to provide access. For the inner Solar System, many of the secrets can only be unlocked by extended mobile operations in the searing heat and intense pressures of the Venus surface, requiring new technologies and complex flight systems.

The priority goals for the Solar System Exploration Program are listed in Table 3.1, along with the specific investigations needed. In each case, the science objectives are cross-referenced against a specific mission and its mission class. It is evident that while much good science can still be done with a program based only on small and medium class missions, the goals that are central to habitability — understanding the conditions that give rise to life and evidence for life in the Solar System — would require a program of directed Flagship class missions. From these, the three highest priority missions are the Europa Explorer, the Titan–Enceladus Explorer, and the Venus Mobile Explorer.

Figure 3.2: Views of the impactor of the Deep Impact mission colliding with Comet Tempel 1 — the pictures were taken at 90 seconds before the collision (left); at impact (center), and at 67 seconds after the collision (right).



3.2 Discovery Program

The Discovery Program began in the early 1990's and consists of small PI-led missions with a cost cap of \$425M (FY06). It provides opportunities for relatively rapid flight missions responding to new discoveries. Ten full missions and three Missions of Opportunity (investigations flown on a non-NASA spacecraft) have been selected over the past decade. The Discovery Program has not been constrained to address specific strategic objectives, but is open to proposals for scientific investigations that address any area embraced by NASA's Solar System Exploration Program and the search for planetary systems around other stars. It thereby provides an excellent means for tapping the creativity of the planetary science community.

The Discovery Program has thus far included missions to planets (the Messenger mission to Mercury; Mars Pathfinder); to the Moon (Lunar Prospector); to comets and asteroids (NEAR, the Near-Earth Asteroid Rendezvous mission; CONTOUR, the Comet Nucleus Tour mission, which was lost; Deep Impact; Stardust; and Dawn); the Genesis mission to return samples of the solar wind; and the Kepler mission to detect Earth-size planets in the habitable zones around distant stars. Details on these past and current missions can be found on the Discovery Program web site at <http://discovery.nasa.gov/index.html>.

Among the contributions of the Discovery Program have been the first soft-landing and elemental analysis on an asteroid, the first analysis of a comet nucleus by deliberate creation of an impact-generated plume (Figure 3.2), the return of samples of cometary and solar wind material for analysis on Earth, and the first roving analysis of the surface of Mars. Missions underway or under development will map the mineralogy of Mercury and the Moon, analyze

Table 3.1: Traceability Matrix: Scientific Questions, Objectives, and Missions.

Major Questions	R&A		Discovery				New Frontiers					Flagship (Small/Large)									
Objectives	Expt.‡	Theory	SB	Moon	Venus	Mercury	NH	Juno	SPABSR	WISE	CSSR	SP	C-H	EE	TE	VME	EAL	NTE	CCSR*	VSSR*	
How did the Sun’s family of planets and minor bodies originate?																					
Understand the initial stages of planetary and satellite formation	●	●	●	●	▲	▲	●	●	●		▲	●	▲	▲	▲	▲			●	●	●
Study the processes that determine the original characteristics of bodies in the Solar System	●	●	●	●		▲	▲	●	▲		●	●	▲	▲	▲				●	●	●
How did the Solar System evolve to its current diverse state?																					
Determine how the processes that shape planetary bodies operate and interact	▲	▲	▲	▲	▲	▲	▲	▲	▲	▲	▲	▲	●	●	●	●	●	●	●	●	●
Understand why the terrestrial planets are so different from one another	▲	▲			●	▲			▲	●						●					●
Learn what our Solar System can tell us about extrasolar planetary systems	▲	▲					▲	▲				▲	●	▲	▲	●			▲		●
What are the characteristics of the Solar System that led to the origin of life?																					
Determine the nature, history, and distribution of volatile and organic compounds in the Solar System	▲	▲	▲				●	●		▲	●	●	●	●	●	●	●	●	●	●	●
Determine evidence for a past ocean on the surface of Venus	▲	▲			▲					▲						●					●
Identify the habitable zones in the outer Solar System	▲	▲											●	●	●			●	●		
How did life begin and evolve on Earth and has it evolved elsewhere in the Solar System?																					
Identify the sources of simple chemicals important to prebiotic evolution and the emergence of life	●	▲	▲				▲						●	▲	●			●	▲	●	
Evidence for life on Europa, Enceladus, and Titan	▲	▲											▲	▲	●			●			
Evidence for past life on Venus	▲	▲														▲					●
Study Earth’s geologic and biologic record to determine the historical relationship between Earth and its biosphere	●	▲																			
Identify environmental hazards and resources enabling human presence in space																					
Determine the inventory and dynamics of objects that may pose an impact hazard to Earth	●	▲	●				▲														
Inventory and characterize planetary resources that can sustain and protect human explorers	▲	▲	●						▲		●										
Convention: ● Major or Unique Contribution; ▲ Support Contribution SB — small bodies; NH — New Horizons; SPABSR — South Pole–Aitken Basin Sample Return; WISE — Venus In Situ Explorer; CSSR — Comet Surface Sample Return; SP — Saturn Flyby with Shallow Probes; C-H — Cassini–Huygens; EE — Europa Explorer; TE — Titan / Enceladus Exp.; VME — Venus Mobile Exp.; EAL — Europa Astrobiology Lander; NTE — Neptune–Triton Explorer CCSR — Cryogenic Comet Surface Sample Return; VSSR — Venus Surface Sample Return * — beyond the 5 proposed Flagship missions ‡ — “Expt” includes ground- and space-based observations with a range of NASA facilities including the Hubble and Spitzer Space Telescopes and, in the next decade, the proposed James Webb Space Telescope.																					

key large asteroids for their composition and relationship to meteorites, and seek to detect the first Earth-sized and sub-Earth-sized planets beyond our Solar System. Discovery has revolutionized Solar System flight missions by allowing extraordinary flexibility in mission types and targets, and creating a community of potential principal investigators who team with industry and NASA centers to conceive, propose, and implement novel missions.

It is expected that, during the time horizon of the present Roadmap, the Discovery Program will continue to provide competitive opportunities for focused investigations that address some of the scientific objectives described herein. Concerns have been raised by some about the long-term fertility of a program that relies simultaneously on relatively high flight rates and the injection of new technologies to keep costs down while maintaining innovation in flight mission targets and types. Specifically articulated, if injection of new technologies does not keep pace with the rate of new proposals and mission selection, the fear is that Discovery missions will, in the long term, diminish in terms of novel flight experiments and types of targets.

We regard this view as unnecessarily pessimistic, provided that (a) the community of potential Discovery PI's learns from previous PI's in a formal or semi-formal debriefing process, so that this community becomes more expert with time; and (b) development of new technologies for planetary flight, instrumentation, and data downlink is maintained as a high priority during the time horizon of the present Roadmap. Implementing (a) and (b) will help maintain not only the vigor of the Discovery Program, but will benefit NASA's Solar System Exploration Programs in general.

This means that a brisk flight rate of Discovery missions should be maintained (Figure 3.3), ideally one launch every two or three years, and that programmatic mechanisms be developed to ensure that both team-experience and technological developments be continuously injected into the Discovery realm. While specific tactical suggestions for implementing these, as well as dealing with other issues such as launch vehicle costs for Discovery missions, are too detailed for the present Roadmap, we recommend strongly that NASA, together with the science community, regularly review the effectiveness of the Discovery Program and seek ways to maintain its present level of vigor and excitement.

3.3 New Frontiers Program

While the Discovery Program has been and will continue to be an extremely valuable source of flight missions, many of the high-priority science investigations we have identified are too complex to be accomplished within the constraints of that program. Medium-size missions, whose life-cycle costs are approximately double those of Discovery missions, will fill an extremely important niche in the spectrum of Solar System exploration activities. A new NASA program, called New Frontiers, was initiated in 2003 to implement medium class missions to a variety of targets. New Frontiers missions will be competitively selected, with the first set of selections focusing on the specific high-priority investigations identified by

Figure 3.3: Sequence of Discovery missions established by the Roadmap Team.

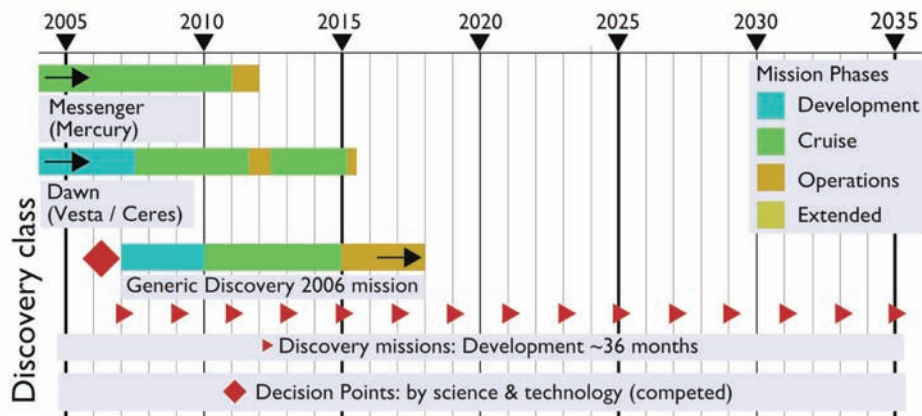

the NRC Solar System Exploration Decadal Survey and reflected in this Roadmap (see Figure 3.4). The flight rate is expected to be approximately one mission in every three years. This section describes the two missions that have now been selected under the New Frontiers mission class, and the three remaining missions that have been identified and proposed to NASA, but for which no selections have been made. This section also identifies other potential high-value missions that may fit the profile of medium class missions. It should be noted that the science represented by these potential New Frontiers missions reflects high-priority goals identified by the Decadal Survey and confirmed by this Roadmap. If the missions described ultimately cannot be accomplished within the New Frontiers cost cap, the scientific objectives remain as high-priority goals to be accomplished by other missions.

3.3.1 New Frontiers Mission Overview

The New Frontiers Program comprises principal investigator-led medium class missions, addressing specific strategic scientific investigations that do not require Flagship class missions. The NRC’s Solar System Exploration Decadal Survey [NRC03] recommended a prioritized list of five New Frontiers class missions for the decade 2003–2013. The first of these, the Pluto – Kuiper Belt Explorer (New Horizons) mission, was already in Phase A at selection and was launched successfully in January 2006. For the remaining four proposed missions, the NRC’s order of priority was — South Pole–Aitken Basin; Jupiter Polar Orbiter with Probes; Venus In Situ Explorer; and Comet Surface Sample Return.

In its Solar System Exploration Roadmap of June 2003 [NAS03a], NASA’s Office of Space Science noted that “*Since the feasibility of these missions within New Frontiers constraints has not yet been fully demonstrated, the details of their implementation and science objectives must remain flexible for the time being.*” On October 2003, NASA issued an

Figure 3.4: Sequence of New Frontiers missions established by the Roadmap Team. (The ▼ in the NH timeline represents the closest approach at Pluto on July 14, 2015)

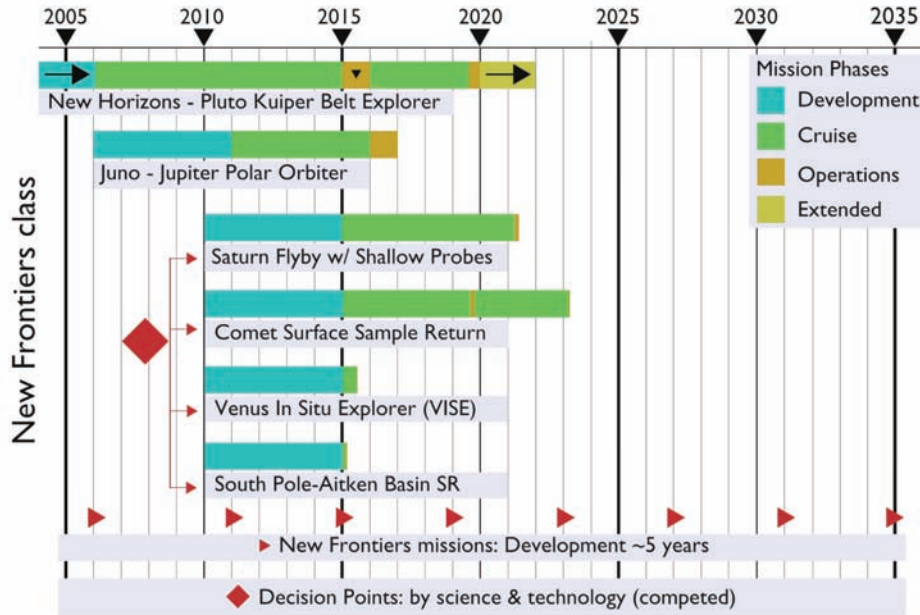

Announcement of Opportunity for the second New Frontiers mission, inviting proposals for these same four missions, but specified no order of priority. For each mission, the AO described the mission architecture discussed in the SSE Decadal Survey, but noted that “any mission architecture that achieves the majority of the science objectives stated above for a cost within the New Frontiers cost cap will be considered responsive to this AO.”

On July 16, 2004, NASA announced the selection of two proposals out of seven submitted: one focused on a Jupiter investigation, the other on lunar sample return. The two winning proposals were then funded for a seven-month implementation feasibility study, focusing on cost, management, and technical plans, including educational outreach and small business involvement. These selections were known prior to the first Strategic Roadmap (SRM) meeting on February 2005. On June 9, 2005, after the third and last of the SRM3 meetings, NASA announced the selection of Juno — a mission targeting Jupiter — as the second New Frontiers mission.

3.3.2 Pluto – Kuiper Belt Explorer (New Horizons)

The Pluto – Kuiper Belt Explorer mission, also known as New Horizons, was conceived before the New Frontiers Program was initiated. It was launched in January 2006; New Horizons (see Figure 3.5) will make the first reconnaissance of Pluto and one of its moons

Figure 3.5: New Horizons spacecraft showing instrument complement.

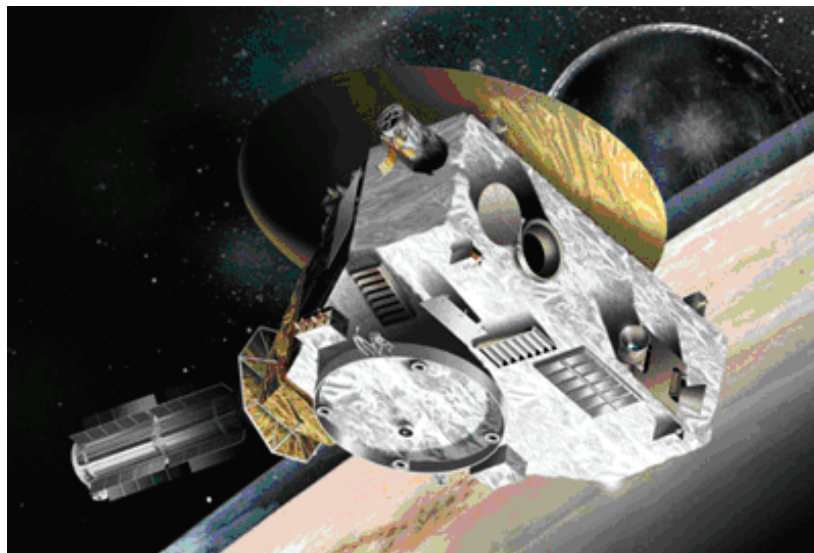

Charon, the last unvisited planetary system in our Solar System. Subsequently, as part of an extended mission, New Horizons would visit one or more objects in the Kuiper Belt region beyond Neptune and Pluto. Study of Kuiper Belt Objects (KBOs) including Pluto will provide important insights into the physical nature of these planetary building blocks and allow us to survey the organic matter and volatiles that they contain. Objects such as these, diverted into the inner Solar System by the gravitational influence of giant planets, may have provided the volatiles and organics needed to create habitable environments on the terrestrial planets.

3.3.3 Jupiter Polar Orbiter — Juno

The Jupiter Polar Orbiter with Probes was identified by the NRC as a high-priority investigation to determine if Jupiter has a core, to measure its water abundance (and hence its O/H ratio, which is uncertain by an order of magnitude), to measure the deep winds down to the 100-bar pressure elevation level, and to explore the magnetosphere, particularly to understand how Jupiter’s magnetic field is generated. Such a mission would contribute greatly to our understanding of how Jupiter formed, and hence to advance knowledge about the second habitability thread, namely, how planetary system architectures affect habitability.

In June 2005, NASA announced the selection of “Juno” (see Figure 3.6), a mission responding to the scientific objectives for the Jupiter Polar Orbiter with Probes. The Juno mission proposes to use a highly instrumented spacecraft placed in a polar orbit around the planet Jupiter to investigate the existence of an ice-rock core; determine the global water and

Figure 3.6: Juno — Jupiter Polar Orbiter spacecraft concept.

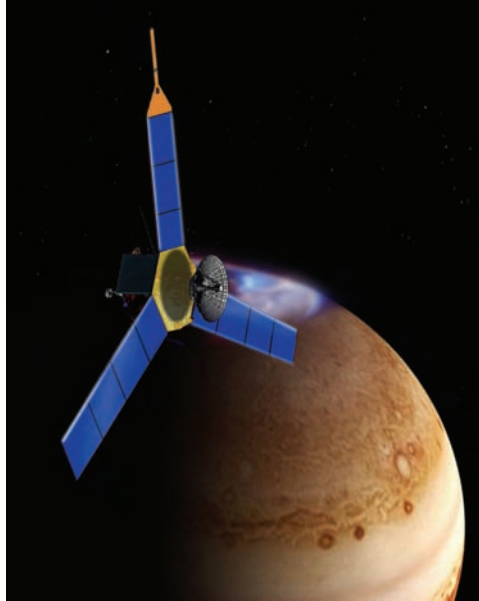

ammonia abundances in Jupiter's atmosphere; study convection and deep wind profiles in the atmosphere; investigate the origin of the Jovian magnetic field; and explore the polar magnetosphere. Juno took advantage of the provision in the Announcement of Opportunity (AO), permitting alternative mission architectures to address all the science objectives with remote sensing instruments.

3.3.4 Lunar South Pole–Aitken Basin Sample Return

The impact that produced the lunar South Pole–Aitken Basin excavated much of the Moon's far-side crust and possibly the upper mantle. Samples of these ancient deepseated rocks and possibly of the melt sheet may be accessible on the surface. Laboratory analysis of this material can provide a unique window into the composition and formation of the Moon and the history of the Earth–Moon system.

The Lunar South Pole–Aitken Basin Sample Return mission was given priority by the NRC in part because of the importance of tying down the Moon's early impact chronology. Radioactive age dating of returned samples from this ancient impact basin could change our understanding of the timing and intensity of the late heavy bombardment suffered by both the early Earth and the Moon. The emergence of life on Earth may have been hindered by the late heavy bombardment, so a better understanding of its chronology could provide important constraints on the timescales for the development of Earth's first life.

The “Moonrise” proposal was selected for an implementation feasibility study in July 2004 along with Juno. This investigation proposed to land two identical landers on the surface near the Moon’s South Pole and to return over 2 kg of lunar materials from a region of the surface believed to harbor materials from the mantle. Following the conclusion of the implementation feasibility study phase in March 2005, Juno was selected to proceed to implementation. However, a Lunar South Pole–Aitken Basin Sample Return mission concept could compete for the next New Frontiers opportunity.

3.3.5 Venus In Situ Explorer (VISE)

The Venus In Situ Explorer (VISE) mission concept was envisaged by the NRC as a balloon mission that would study Venus’ atmospheric composition in detail and descend briefly to the surface to acquire samples that could be then analyzed at a higher altitude where the temperature is less extreme. The VISE scientific measurements would help to constrain models of the Venus greenhouse history and stability as well as the geologic history of the planet, including its extensive resurfacing. VISE would also pave the way for a future Flagship class mission to the surface and low atmosphere of Venus and for a possible subsequent sample return from the extreme environment of Earth’s neighboring sister planet. Although the VISE proposal was not selected in the New Frontiers 2 competition, it is expected that the concept could compete for the next New Frontiers opportunity.

3.3.6 Comet Surface Sample Return

A Comet Surface Sample Return (CSSR) mission, particularly if targeted to an active area, would provide the first direct evidence on how cometary activity is driven, for example, whether water is very close to the surface. Detailed examination of returned samples of comet surface material will help us understand the distribution of volatiles and organics in the Solar System and how it has evolved over time. It would also provide important insight into the mechanisms by which organic material is transported throughout the Solar System, and the structure of potential Earth impactors. Such a mission would provide the first real data on how small bodies form and what they are made of at the molecular level, and information on how the particles in a cometary nucleus are bound together. For example, is there an organic glue? Finally, it would provide direct information on physical and compositional heterogeneity at both microscopic and macroscopic scales. A CSSR proposal was not selected in the New Frontiers 2 competition, but the concept could compete for the next New Frontiers opportunity.

3.3.7 Other New Frontiers Candidate Missions

In initiating the New Frontiers Program, NASA anticipated that other New Frontiers missions would be added to the five that have been identified so far. In its Solar System Roadmap of 2003 [NAS03a], the Office of Space Science stated that *“Science and mission priorities will be regularly reassessed in view of new discoveries and technological advances, with the ultimate sequence of missions to be determined on the basis of technology readiness,*

program budget, and the results of the competitive selection process. All New Frontiers missions, to be solicited by Announcements of Opportunity, will focus on achieving essential Decadal Survey recommendations, while fitting within the New Frontiers Program constraints.”

During its February 2005 meeting, the Strategic Roadmap (SRM3) team reviewed candidate New Frontiers missions, identified by the SSE Decadal Survey for the “second decade.” The SSE Decadal Survey was able to identify only half as many medium class (New Frontiers) candidates as large class (Flagship) candidates among its “Deferred High Priority Missions.” At the envisioned rate of implementation, the five medium class missions represented a little more than a decade-long program, whereas the nine Flagship missions covered the better part of a century. Moreover, some of the contemplated medium class missions did not play a crucial role in the science questions identified in the roadmap. The SRM3 team concluded that there was a mismatch between the cost categories and the real mission needs and opportunities, and initiated a study of a subdivision of the Flagship category to determine if this might yield a more optimal mission complement.

One additional New Frontiers class mission was identified to add to the current NASA list described above. The Juno mission, as noted above, is being implemented without the use of the probe architecture envisaged by the NRC. The SRM3 team was informed that NASA no longer has the technology for implementing a Jupiter probe mission and that this will require a major investment in test facilities for the development, testing, and validation of ablative thermal protection systems for the heat shield. Some of the science questions identified by the NRC require in situ measurements and cannot be implemented with remote sensing alone. (However, it should be noted that the Galileo probe provided in situ measurements that would complement Juno’s planned remote-sensing measurements.) Consequently, in this roadmap, the SRM3 recommended that a Jupiter Flyby with Deep Probes mission be replaced by a Saturn Flyby with Probes mission that might be within the domain of New Frontiers. Due to the smaller gravity well, the probe entry velocities would be significantly lower than at Jupiter (27–30 km/s vs. 47.3 km/s from prograde approach), resulting in a heating rate of less than 3 kW/cm², which is ~20 times lower than at Jupiter. Furthermore, important science could be achieved with a probe that attains only shallow depths to ~10 bars, while higher pressure depths, in the 100 bars region, could be measured through remote sensing before probe entry, using microwave radiometry. This notion arose subsequent to the down-selection of Juno, and NASA is already conducting studies of the feasibility of a Saturn Flyby with Shallow Probes mission as a potential New Frontiers class mission. (See Figure 3.7.)

3.4 Flagship Missions

Certain high-priority investigations are by their nature so challenging that they cannot be done within the cost constraints of the New Frontiers Program. Examples include comprehensive studies of individual planetary systems, such as those undertaken by Galileo and

Figure 3.7: Multi-probes to Saturn (artist's concept).

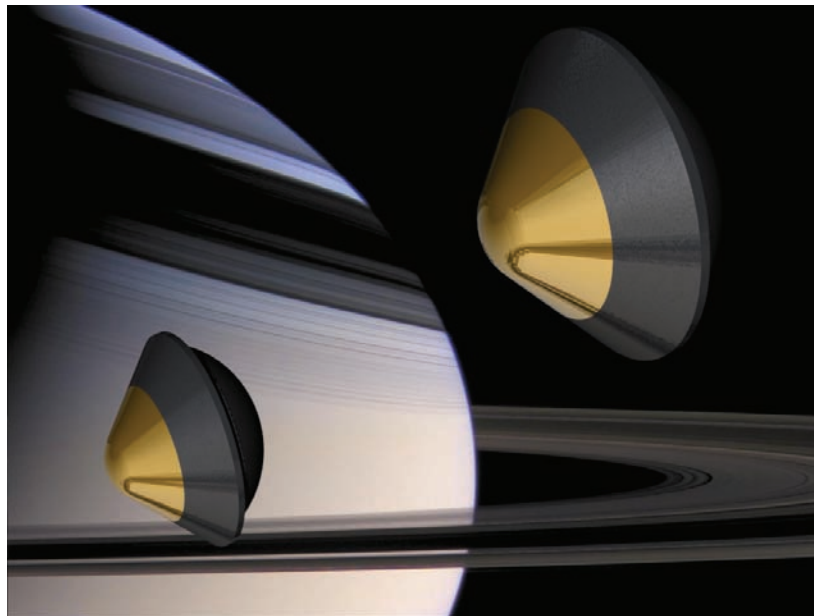

Cassini; energy-intensive missions that also require large propulsion systems and launch vehicles; in-depth studies of outer Solar System satellites; and sample return from planetary surfaces. These types of missions generally require significant focused technology development prior to mission start, and extended engineering developments, as well as extensive predecisional trade studies to determine the proper balance of cost, risk, and science return. At a typical cost significantly larger than that of New Frontiers missions, they represent major national investments that must be selected and implemented in a strategic manner. NASA will strive to gain approval for new Flagship missions approximately twice per decade, to ensure that the Solar System Exploration Program is properly balanced and can undertake the high-priority, challenging investigations that cannot be done any other way. The sequence of the five missions appears in Figure 3.8.

The top priority (non-Mars) Flagship mission objective is intensive exploration of potential subsurface oceans on Jupiter's large icy satellites. The Galileo mission provided strong evidence that a liquid water ocean may exist beneath the ice crust of Europa, and perhaps beneath the surfaces of Ganymede and Callisto as well. This possibility makes these Galilean satellites among the most fascinating bodies in the Solar System from an astrobiological perspective. Verification of the presence of significant amounts of liquid water on one or more of these satellites, study of their surface and subsurface chemistries, and determination of the thicknesses of the ice crusts would allow us to understand the history and biological potential of the Galilean satellites and lay the groundwork for future missions.

Figure 3.8: Recommended sequence of Flagship missions established by the Roadmap Team. Red diamonds are decision points determining proceeding with the mission. Missions occur twice per decade with launches in 2015, 2020, 2025, and 2030.

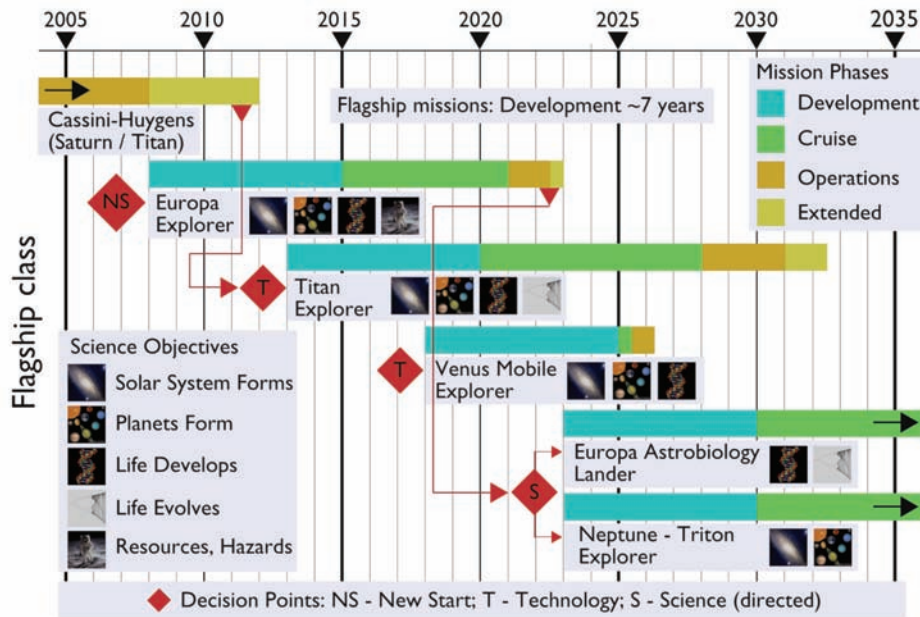

Studies of Europa Explorer mission concepts have been undertaken for the past decade. Recent advances in technology and engineering developments have made such a mission feasible with today's technology. Such a mission would achieve the top-priority Decadal Survey objective of focused Europa geophysical exploration.

Recent Cassini close-up investigations of Titan and the discovery of active ice plumes on Enceladus have tantalized scientists around the world. A future Flagship mission that could perform in situ measurements at Titan is a logical follow-up to the Cassini mission. As Cassini continues to explore Titan, its mission profile can be adjusted to gain invaluable additional information to be used to guide more focused concept studies for a Titan Explorer.

In addition, the Venus Mobile Explorer mission was also identified as a Flagship class mission following missions to Europa and Titan. Its third place is due to technology considerations, which is perceived to be less mature than that for a Titan Explorer mission. The goal of this mission would be to conduct an extended mobile in situ investigation of the surface of Venus, a formidable challenge because of the extreme temperature and pressure reaching $\sim 480^{\circ}\text{C}$ and ~ 90 bars, respectively.

In the mid- and far-term, Flagship missions will be defined and selected to build on the results of earlier investigations. Examples of other high-priority missions that would represent major scientific advances include:

- An Enceladus Explorer that would build on the tantalizing Cassini discovery of ice plumes by performing comprehensive exploration of Enceladus.
- A Neptune-Triton Explorer (orbiter with probes) that would perform the first detailed exploration of this ice giant planet and its major moon Triton that is possibly a captured Kuiper Belt Object.
- A Venus Sample Return that would provide insight into the causes and effects of the apparent global climate change that Venus experienced in the distant past.

NASA will engage the broad science and engineering community in studies of these and other Flagship mission concepts to assess their feasibility and establish technology requirements for near-term investment. One characteristic common to all Flagship missions is that they depend upon continued investments in technology. The definition of these technology needs and the development of investment plans is one of the most important near-term activities that will enable these challenging, scientifically compelling future Flagship missions.

3.4.1 Europa Explorer

The fundamental objectives of any Europa mission will be to determine the existence of a subsurface water ocean and to characterize the composition and physical properties of the overlying ice. Mission concepts vary in relation to the extent to which they define, meet and exceed these two fundamental science objectives.

Europa's sibling moons Ganymede and Callisto likely also contain subsurface watery layers, though much deeper beneath the surface than Europa's. Moreover, long-term variability in Io's heating may intimately affect the evolution and habitability of Europa. It is critical to determine how the components of the Jovian system operate and interact, leading to potentially habitable environments within icy moons. By studying the Jupiter system as a whole, we can better understand the type example for habitable planetary systems within and beyond our Solar System.

There have been significant investments in two prior concepts targeting a focused investigation of Europa. These are the Europa Orbiter and the Jupiter Icy Moons Orbiter concepts. The Europa Orbiter concept, studied in the late 1990s, envisaged a direct transfer from the Earth to Jupiter, followed by orbital insertion into the Jovian system, a Jupiter System "tour" and ultimately orbit around Europa, using high-thrust chemical propulsion. The expected payload allocation and the science operational lifetime associated with this mission architecture were very limited, yet met the fundamental science objectives as determined by the Science Definition Team. The mission was canceled in 2001. In 2003,

contemporaneous with the release of the SSE Decadal Survey [NRC03] and the Office of Space Science Roadmap of 2003 [NAS03a], a much more ambitious concept for Europa exploration was initiated. This mission concept addressed a significantly expanded set of science objectives. The proposed Jupiter Icy Moons Orbiter (JIMO) mission would have used low-thrust nuclear electric propulsion, powered by a nuclear fission reactor. Following Jupiter orbit insertion, the spacecraft would have executed a series of orbital tours around three of the Galilean satellites: first Callisto, then Ganymede, and finally Europa. The required investment in the Prometheus technology development and the changing priorities at NASA contributed to the indefinite deferment of this mission in summer 2005.

In summer 2005, NASA initiated a 45-day study of the Europa Geophysical Explorer (EGE) concept to update the earlier Europa Orbiter concept using a different set of Level 1 requirements and updated technologies. As conceived, the EGE mission still assumed a limited 30-day mission duration around Europa and presented significant technical challenges that required much more in-depth study.

Subsequently, in fall 2005, JPL mounted a concerted effort to address these challenges, which resulted in a concept for the Europa Explorer mission. Though it could not satisfy as many science objectives as a JIMO-type mission, the science value far exceeded the original Europa Orbiter capabilities and it addressed substantial science objectives that are only achievable with an orbiting mission. The Europa Explorer fulfilled an expanded set of science objectives that included:

1. Characterize the three-dimensional configuration of the icy crust, including possible zones of liquid.
2. Map organic and inorganic surface compositions, especially as related to astrobiology.
3. Characterize surface features and identify candidate sites for future exploration.
4. Characterize the magnetic field and radiation environment.
5. Understand the heat source(s) and time history of Europa's ocean.

The Europa Explorer mission would address three of the measurement objectives in Table 3.1.

The Europa Explorer (EE) spacecraft (Figure 3.9) would be launched on an indirect trajectory to Jupiter, exploiting gravity-assist flybys of both Venus and Earth. As conceived, the spacecraft would enter Jupiter orbit and execute a two-year “tour” within the Jovian system, using multiple gravity-assist maneuvers at the Galilean satellites to reduce the orbit approach velocity, and thus propulsion requirements, at Europa. As a result of the Earth and Venus gravity-assist maneuvers, the dry mass of the spacecraft would be expected to be three times that of the Europa Orbiter concept from 2001. Judiciously used, this additional mass was allocated to the baseline spacecraft design to lower the overall risk to mission

success, increase the operational lifetime, and increase the science data return. The EE planning payload consists of 10 instruments, including sounding radar and other remote-sensing instruments. There is also about 340 kg of unallocated mass, which could be used in various ways including further lowering risk or carrying a small lander or impactor. A key feature of the Europa Explorer mission concept is the use of a real-time communication link to reduce the need for onboard data storage. The existing technology for large, radiation-tolerant, onboard memory is power- and/or mass-intensive. This mission would be expected to yield more than 21 GB of data per day during a 90-day prime mission around Europa, while the extended mission operation for up to an additional year would further increase the returned data volume. Though planetary protection requirements are not officially established by NASA's Planetary Protection Officer for any of these mission concepts, this study assumed that the spacecraft would eventually impact the icy surface of Europa, and thus would require sterilization.

Figure 3.9: Europa Explorer concept based on the 2005 study (design concept).

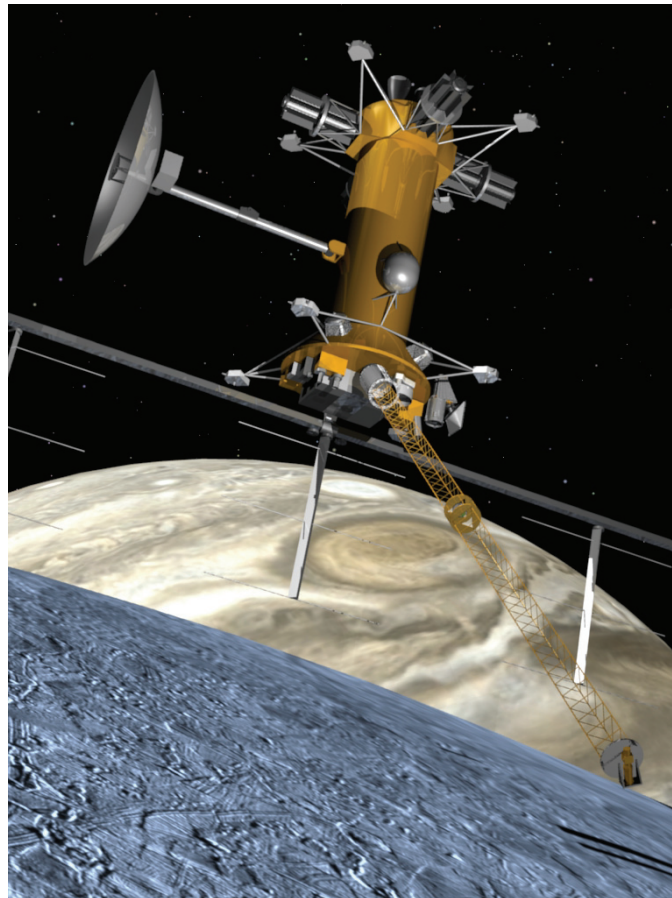

3.4.2 Titan Explorer

A Titan Explorer mission is proposed for a new start at the beginning of the second decade. Scientifically, this mission would build upon the observations of Cassini and Huygens. In addition, air mobility and long mission duration in situ would allow covering significantly more terrain below the haze layer than covered by the Huygens probe. Exploration of lower atmosphere winds, clouds, and precipitation and in situ measurements of ices and organic materials at the surface to assess prebiotic/protobiotic chemistry would be also performed. The science goal for the mission would be the characterization of these organic and inorganic materials, and through observations the determination of the origin of the diverse landforms identified in Huygens visual images and Cassini radar data. Titan can be explored in a variety of ways, but future missions that extend our knowledge of this planet-sized world while capturing the imagination of the public should utilize the dense atmosphere to enable unique means of exploration.

Titan's dense atmosphere allows spacecraft to aerocapture and/or aerobrake into desired orbits, and provides relatively benign entry conditions compared to those of the giant planets, and even to Earth. (Typical entry velocities to Titan and Jupiter from direct entry and to Earth from LEO are ~ 6.5 km/s, 47.3 km/s, and 7.8 km/s, respectively.) Radiation is low around Titan and negligible in the near-surface environment. The air density at lower altitudes is high; the air is cold and consists of mostly stable nitrogen. During planetary entry and descent the dense atmosphere permits hours of time to deploy an airborne platform before reaching the lower atmosphere of Titan. Winds are relatively light and predictable below 10 to 20 km altitudes. The most economical, elegant, and reliable way to navigate this environment is with a Montgolfier (hot air) balloon that uses the varying winds at different altitudes to cruise across the landscape. When required, it could land and sample interesting regions. Titan's surface morphology and chemistry are sufficiently diverse to present many examples of this variability under the eastward-coursing balloon, while its topography is sufficiently subdued to allow safe transit and maneuvering at altitudes down to 1 to 2 kilometers. Diurnal and seasonal wind-shifts are predictable and simple adaptation schemes for unexpected wind-shifts are readily implemented. An alternative powered traversing approach could employ a small blimp that would enable movement against the ambient, gentle winds at low altitude.

A balloon-borne mission (see Figure 3.10) could ride the winds at jetliner-type altitudes, circumnavigating Titan in less than an Earth year, while occasionally descending to the surface to sample sites of particular interest from the point of view of organic chemistry and the exotic geology of a giant water-ice world. Slow meridional winds would allow drift from one latitude region to another. Vistas that the mission would relay to Earth, based on the evocative scene imaged by Huygens, could well prove to be among the most hauntingly familiar yet exotically different landscapes viewed by humankind since the first images of neighboring bodies were returned some four decades ago from the Moon and Mars.

Because Titan is better suited to balloon or airship exploration than any other body in the Solar System, this Roadmap recommends that such a mode be considered as the baseline for a future return to this organic-rich world. The actual mission architecture for this mission should be determined through future studies, to answer whether this mission architecture includes an orbiter or single or multiple in situ elements without an orbiter. Nevertheless, preliminary assessments to date of any of the Titan mission architectures that significantly extend the Cassini-Huygens results will put the Titan mission into the category of large (Flagship) class missions.

Based on an assumed launch in the beginning of the second decade, results from Titan are expected by around 2030. Certain aspects of the extreme environment would make in situ exploration much more challenging than that on Mars. The very cold temperatures (below 100K) at Titan present challenges for materials, mechanisms, and electronics. However, other aspects of the environment — specifically the high atmospheric density at the surface (4.5 times terrestrial) and the very low surface winds — enable the use of a mobile buoyant platform that can move with much less energy use and with much less risk of becoming immobilized than a surface vehicle. Sampling would be performed in a fashion analogous to the acquisition of a sea floor sample by a submersible. Visual imaging and onboard machine vision implemented from a range of altitudes would play a key role in scientific exploration and navigation. The precision of targeting and the degree of mobility control are both subjects for future trade studies.

3.4.3 Venus Mobile Explorer

A Venus Mobile Explorer (VME) is proposed for a new start in the second half of the second decade. This mission is sequenced after the Titan Explorer for several reasons. The later start date would permit an opportunity for the selection of a New Frontiers class Venus In Situ Explorer (VISE) as a precursor mission (currently in the New Frontiers AO mission set). It also provides additional time anticipated to develop high-temperature electronics and power technologies needed at the surface of Venus for long-lived missions. VME would take the next logical step in exploration of the Venus surface beyond the Magellan mission's epic radar reconnaissance and the presumed VISE. This mission would perform extensive measurements at the Venus surface, including a search for granitic and sedimentary rocks; analysis of the crust for metastable hydrated silicates, and measurements of the oxidation and mineralogical state of iron. Together, these landed experiments would enable the determination of how long ago an ocean disappeared from Venus, and therefore how long Venus may have had to potentially nurture life. Equipped with visual imaging and a targeted set of geochemical sensors, VME would use the methods of mobile scientific exploration. Advantages of mobility were demonstrated by the Mars Exploration Rovers, although for VME an air mobility platform (see Figure 3.11) with long traversing would be preferred over a surface rover, which would have a limited range of hundreds of meters. The MER rovers have enabled extraordinary advances in the understanding of geochemistry and hence past climate conditions on Mars. A similar understanding for Venus would be enabled by

Figure 3.10: Titan Balloon concepts (design concept).

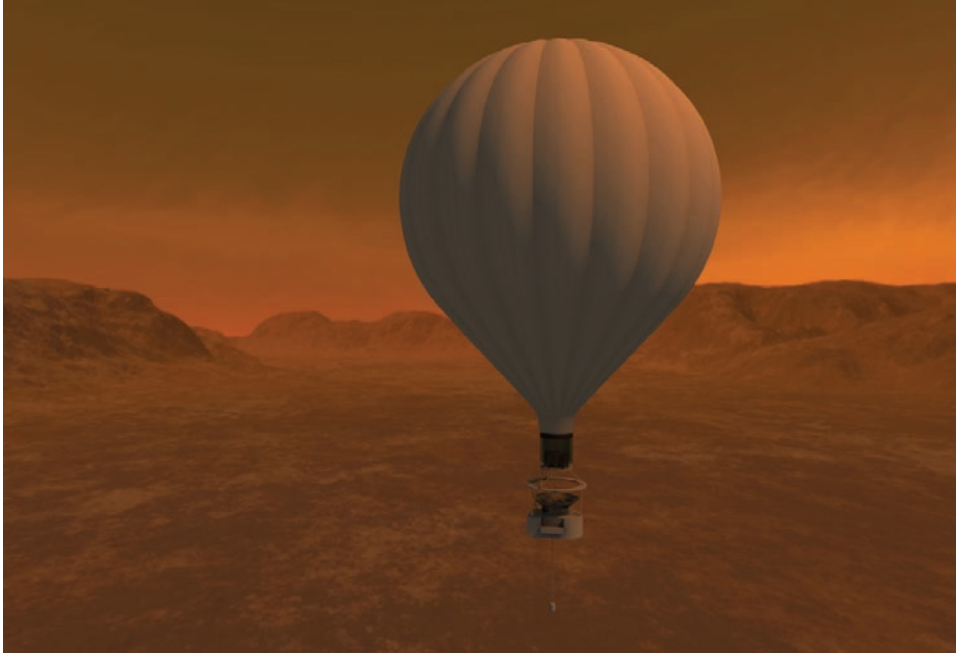

VME, so that a more complete view of the interconnected cycles of chemistry, volcanism, and climate on Venus would be obtained. This understanding would be crucial for interpreting the spectral signatures and other data we would eventually obtain from terrestrial planets around other stars. The entire project, from new start to end-of-mission, could be accomplished in 6–7 years, including a surface stay time of days or weeks. The extreme temperature ($\sim 480^{\circ}\text{C}$), pressure (~ 90 bars) at the surface, and the highly corrosive atmosphere at about 10 km above the surface of Venus present challenges for materials, mechanisms, and electronics. The surface conditions may also be potentially hazardous due to extremely rough terrain, limiting surface access for sample collection. The technology challenges drive previous-decade technology investments and predicate this mission's new start upon a strategic technology decision point early in the decade.

3.4.4 Europa Astrobiology Lander

The Europa Astrobiology Lander mission would focus on the investigation of chemical and biological properties of surface / subsurface materials associated with life (see Figure 3.12). Selection of this Flagship mission would be driven by the results of the Europa Explorer mission undertaken in the first decade. It would have a large payload of scientific instruments and would be equipped to make a precision landing on the surface of Europa to avoid hazardous terrains. It would also have the ability to acquire samples from as deep as a few meters beneath the contaminated surface layer. Long life in the high radiation environment

Figure 3.11: Venus Mobile Explorer (artist's concept).

Showing a metallic bellows, Stirling Radioisotope Generator with active cooling, and pressure vessel for in situ instruments and subsystems.



and planetary protection would therefore be major issues that need to be addressed with appropriate investments in relevant technologies.

3.4.5 Neptune–Triton Explorer Mission

The Neptune–Triton Explorer Mission would be an “all-in-one” exploration package, similar to the way Cassini–Huygens addressed the Saturn system. It would include orbital remote sensing and in situ observations, Neptune atmospheric entry probes, and possibly a Triton Lander. A combination of inner Solar System and Jupiter gravity assists, with either conventional or solar electric propulsion, could send the spacecraft on a fast trajectory to Neptune, using aerocapture technology to enter Neptune orbit. The transit could also be performed with nuclear electric propulsion, with the added benefit of ample power once at Neptune. Subsequently, a tour of the Neptune system involving multiple gravity assists at Triton has been shown to provide comprehensive high-resolution imaging coverage of Triton in as little as two years. A limited-lifetime lander on Triton could be targeted to a site of interest, based on real-time Triton imaging, to measure atmospheric and surface composition and physical properties, including frozen volatiles on the satellite’s surface. Overall mission time from launch would be 10–15 years. If aerocapture at Neptune is employed, the control authority needed to handle uncertainties in targeting the entry corridor and variability of Neptune’s atmosphere requires a second-generation aerocapture technology using high lift-to-drag (L/D) aeroshells. This advanced technology could be used for

Figure 3.12: Europa Astrobiology Lander (artist's concept).



aerocapture at any planet with an atmosphere; however, it is only giant planets for which it is enabling. Conversely, if low-thrust propulsion is chosen, Prometheus class capabilities would be needed, including the development of a high performance space-based fission reactor. For the Neptune probes hypervelocity entry technology is needed to survive the 24–30 km/s entry velocity, but this is well within the requirements of Jupiter entry probes.

3.4.6 Comet Cryogenic Nucleus Sample Return

The Comet Cryogenic Nucleus Sample Return would involve landing on and collecting a sample of the delicate ices and organics that exist on a cold and relatively fresh comet. The intent is to preserve this material in its average ambient state on the comet nucleus, so that isotopic and nuclear spin ratios can be preserved along with the physical-chemical state of the sample. This requires rendezvous with a relatively young comet, which could call for a very large delta-V, and preserving the sample cryogenically through its return to Earth. The propulsion and power requirements these impose on the mission would make it a Flagship class endeavor. Advanced propulsion, sample collection, and refrigeration (hence power) technologies are required for this mission.

3.4.7 Venus Sample Return

A Venus Sample Return is a very difficult mission that would certainly follow a successful Mars Sample Return and an effective Venus Mobile Explorer mission. As for Mars, answers

to detailed questions about the past suitability of Venus for the origin and sustenance of life can only be answered by bringing samples back to terrestrial laboratories. These include definitive interpretations of the petrology and mineralogy of crustal samples over scales from the regional to the microscopic and determinations of the C, O, S and H isotopic abundances in the crust and lower atmosphere. The implementation challenge lies not so much with Venus environmental issues (although they are not trivial) as it does with the mission energetics. There would need to be a buoyant ascent stage to collect the sample either from the surface or from another vehicle (deployed to the surface and back into the atmosphere) and then carried to an altitude from which atmospheric density is low enough for a launch to be feasible. At this point the propulsion needed is equivalent to an inner planet mission starting at Earth's surface. Needless to say, even with a very small sample return payload the buoyant stage would only be capable of reaching Venus orbit, where another Earth Return Vehicle would have to be waiting to rendezvous with the ascent stage, to transfer the sample for a return flight to Earth. Sample recovery at Earth would be similar to the proposed Mars sample return concept with a direct entry to a suitable recovery site (e.g., UTTR) expected. Advanced airborne systems and high-energy in-space propulsion are key capabilities needed for this mission.

3.5 Study Needs

NASA will engage the broad science and engineering community in studies of these and other Flagship mission concepts to assess their feasibility and establish technology requirements for near-term investment. One characteristic common to all future potential Flagship missions is that they require significant technology development before they can be undertaken. In many cases, there are interdependencies between missions and mission lines that can facilitate technology development (discussed in Section 7.1). The definition of critical technology needs and the development of investment plans is one of the most important near-term activities that will lead to the capability to undertake these challenging, scientifically compelling missions.

4 Technology Development for Solar System Exploration

4.1 Overview

Solar System exploration is a uniquely challenging endeavor. It requires that we build efficient, highly capable robotic vehicles and send them across vast distances with the tools they need to make detailed scientific measurements. We must furnish them with the power they need to conduct their missions; we must place them into orbit around or onto the surface of bodies about which we may know relatively little; and we must ensure that they survive and function in environments that can be very hostile. We design them to acquire and transmit the maximum amount of information during their mission lifetimes, and sometimes to return safely to Earth with a cargo of planetary samples. The scientific imperatives of Solar System exploration have motivated some of the most remarkable engineering achievements in history.

In organizing this section, we have used the same framework for describing technologies that was used in NASA's Solar System Roadmap of 2003 [NAS03a]. However, we have revised the priorities for these technologies in the context of the missions in the current roadmap and in particular incorporating what has been learned about the feasibility of these technologies in the intervening three years. These priorities appear in Table 4.1.

4.2 Challenges

The challenges common to virtually all planetary missions — large distances, long flight times, and stringent limitations on mass, power, and data rate — mean that essentially all types of missions can derive significant benefit from technical advances in a number of broad areas. Investments in relevant technologies may reduce mission costs while increasing capabilities for exploration and science return. Since technology development timescales can be long, it is most productive to base technology requirements on the expected general characteristics of future missions in order to provide the greatest benefit. While the strategic Flagship mission concepts are better understood, a general understanding of the needs for the competed small (Discovery and Mars Scout) and medium (New Frontiers) missions can be included in constructing an effective technology investment plan.

Technology investment priorities are guided by the requirements established in mission and system studies. NASA will strive to maximize the payoff from its technology investments, either by enabling individual missions or by enhancing classes of missions with creative solutions to the general limitations on power, communications, and mass. The breadth of technology needs for Solar System exploration calls for an aggressive and efficient technology development strategy, including acquisition of applicable technologies developed elsewhere in NASA, as well as in the government and commercial sectors.

Within SMD itself, technologies of unique importance to Solar System exploration are being developed by the In-Space Propulsion Program, the Radioisotope Power System Program

Table 4.1: Technology priorities for Solar System exploration.

Technology	Priority	Comments
SPACECRAFT SYSTEMS		
Transportation	●	▷ Aerocapture technologies could enable two proposed Flagship missions, and solar electric propulsion could be strongly enhancing for most missions. These technologies provide rapid access, or increased mass, to the outer Solar System.
Power	●	▷ Radioisotope power systems are needed for all five proposed Flagship missions, requiring a sufficient supply of plutonium. Advances in power conversion efficiencies would reduce the need for plutonium for a given power requirement, while the mass savings could be traded against payload, or increase mass margin on the spacecraft.
Communications	●	▷ The science return from every mission would benefit from improvements in direct-to-Earth communications infrastructure. In situ exploration with orbital assets would be strongly enhanced by improved proximity links.
Planetary protection	▲	▷ New planetary protection technologies will be needed to meet the anticipated requirements for in situ exploration to targets of interest for astrobiology.
Autonomy and software	▲	▷ Autonomous systems strongly enhance most missions by providing for more robust operations. New methodologies for software verification and validation and fault protection will substantially reduce the associated risks.
IN SITU EXPLORATION SYSTEMS		
Extreme environments	●	▷ The proposed Flagship mission set spans a number of diverse extreme environments, requiring technology advances in fields ranging from extremes in temperature and pressure, to high radiation and high heat flux during atmospheric entry. These technologies could also enhance the operational capabilities of the Discovery and New Frontiers missions facing temperature extremes or those with returned samples.
Entry, descent, and landing	▲	▷ New propulsive landing systems would enable operations on small bodies and satellites without atmospheres. Entry, descent, landing, and aerial operations on bodies with atmospheres (such as Titan and Venus) would be possible with the associated advances in technologies for extreme environments.
Planetary mobility	▲	▷ Access is critical to the in situ exploration central to the later Flagship mission concepts, making various types of mobility systems enabling for those missions. Advances in mobility technologies could also provide alternatives for various New Frontiers mission concepts.
SCIENCE INSTRUMENTS		
In situ sensing	●	▷ New technologies and instruments will be required for improved science return to targets of astrobiological interest, enabling several of the proposed Flagship missions. The instrument technologies will require associated development in sample acquisition and handling systems.
Components and miniaturization	●	▷ Every mission is either strongly enhanced or enabled by improvements in miniaturization and advanced component design. Missions with systems requiring isolation from the ambient environment will be particularly improved by lighter instrumentation.
Remote sensing	▲	▷ Flagship missions with orbital or extended aerial operations would be strongly enhanced by improved technologies for passive and active remote sensing, and smaller missions would benefit from these technologies, as well.
<p>● Highest priority — new developments are required for all or most roadmap missions</p> <p>▲ High priority — either applications are more limited or can leverage existing work effectively</p>		

and other focused technology programs. The Mars Technology Program is also involved in related technology developments but focused primarily on the Mars core missions set. On a broader scale within NASA, the Exploration Systems Mission Directorate (ESMD) also is pursuing developments in the fields of information technology, energy storage and technologies for cold temperature operation. However, the perspective of this program is short term and it does not include more aggressive developments that require longer lead time and potentially yield major increases in capability.

Certain technologies are of such a mission-critical nature that spaceflight validation is considered a prudent step prior to their actual use. This can be done in two ways: on dedicated technology demonstration missions within the New Millennium Program, or by using other Solar System exploration missions as a platform for their validation. New Millennium missions provide opportunities to validate technologies of a broad system nature, such as solar electric propulsion (flight-proven on the Deep Space 1 mission) or aerocapture. They also provide opportunities to validate sets of individual component technologies. Other technologies may be appropriate for validation on actual science missions in a non-mission-critical role. Early flight validation can ensure that the benefits of new technologies can be made available to future missions in a prudent and cost-effective manner.

This section summarizes the technologies to enable the Flagship missions in the Solar System Exploration Roadmap. Where appropriate, the relevance of technology needs to potential New Frontiers and Discovery missions are also covered. Technology investment needs should be reviewed at least every 2–3 years to ensure that technology readiness levels are met in a timely manner to support the appropriate Roadmap missions under developments, particularly as the evolving scientific knowledge suggests that mission concepts under development require new capabilities.

4.3 Spacecraft Systems Technologies

Spacecraft systems technologies refer to those technologies which have broad applicability to all mission classes (flyby, orbital, in situ exploration, and sample return) and which may apply to various types of flight systems including those that operate in space as well as those designed to enter, descend, land, and move around in a planetary surface environment. While the emphasis here is primarily on the enabling capabilities for Flagship missions, spacecraft systems technologies are also likely to have benefits for Discovery and New Frontiers missions, as they support most basic mission capabilities. A discussion of many of these technologies follows.

4.3.1 Transportation Technologies

Four of the five proposed Flagship missions in this Roadmap involve planetary systems in the outer Solar System. All four of the missions involve orbiting one of the major planets: Jupiter (twice), Saturn, and Uranus. At least three of them involve orbiting a satellite: Europa (twice) and Titan; and for these same three missions, the mission concepts involve

deploying a craft (either a lander or aerial platform) with in situ sampling capabilities.

In the second of the SRM3 meetings, an assessment was conducted of nuclear electric propulsion (NEP) technology then under development as part of the Prometheus Program, as well as alternative approaches that considered other power sources. The Solar System Exploration Roadmap of 2003 had asserted that NEP was an “enabling technology” for outer planet exploration. However, this required the development of a “compact and efficient fission power source” to open the entire solar system to intensive exploration, enable missions that could visit multiple planets and satellites, deliver large payloads, and return samples from virtually any destination.

Outer planet exploration systems using NEP had excessively long trip times and were not scaleable to appropriate and affordable sizes needed for Solar System exploration. Fortunately, alternative Flagship mission transportation approaches requiring a comparatively modest technology investment have been identified. A number of these technologies are under development through NASA’s In-Space Propulsion Program. *However, the In-Space Propulsion Program will need to be refocused to reflect the Flagship mission priorities in this Roadmap and to provide a more rapid insertion of technologies enabling or enhancing future Discovery missions.*

Access to Space

An adequate launch capability is a necessary element in any successful outer planets program. In the last two years, two new large US launch vehicles, the Delta IV Heavy and the Atlas V, have had successful flights. The Delta IV Heavy has a significantly larger payload capacity for outer planet missions and the first two missions in the outer planets sequence can be delivered with this launch vehicle. The Atlas V may also be able to deliver missions of more limited capability.

For later potential missions, such as the Europa Astrobiology Lander (EAL) and the Neptune–Triton Explorer, the capabilities of a heavy lift launch vehicle would be beneficial. For the EAL, such vehicle would enable a faster trip, delivering the large payload capability needed for both the EAL itself and its supporting orbiter (this is also discussed in Section 8, the Integrated Program Plan).

Solar Electric Propulsion

Solar Electric Propulsion (SEP) enables missions requiring large in-space velocity changes over time, approaching and exceeding 10 km/sec. SEP has applications to rendezvous and sample return missions to small bodies and fast trajectories towards the outer planets. This is particularly relevant to the Titan Explorer mission and the Neptune–Triton Explorer mission.

This technology offers major performance gains, only moderate development risk, and has significant impact on the capabilities of new missions. Current plans include completion of

Figure 4.1: Electric Propulsion System Testing.

Ion engines, such as this one under test in a vacuum chamber, provide the ability to achieve very large velocity changes over time. There are large benefits for two potential Roadmap missions, Titan Explorer and Neptune–Triton Explorer, where reductions of trip time can result in large cost savings.

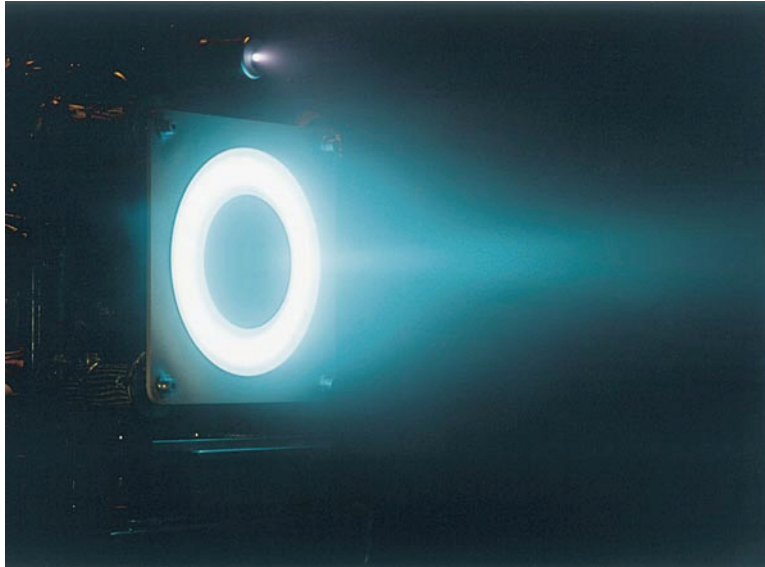

the NASA Evolutionary Xenon Thruster (NEXT) 40 cm engine targeted at New Frontier and small Flagship missions under NASA's In-Space Propulsion Program and development of a standard SEP subsystem architecture to provide lower cost systems for Discovery and New Frontiers class missions (Figure 4.1).

A major step forward in interplanetary transportation technology occurred in 2001 with completion of the space validation of SEP by the New Millennium Program's DS-1 spacecraft. The first planned application of SEP on a dedicated science mission will be Dawn, which will successively orbit the large asteroids Ceres and Vesta; development of this mission recently resumed and launch is now planned in 2007.

Other agencies are also using the technology for lunar and deep space missions. The European Space Agency's SMART-1 mission used SEP to travel to the Moon in September 2003. The Japanese spacecraft Hayabusa also used the technology in an attempt to acquire and return a soil sample from an asteroid in 2006.

SEP technology is now widely accepted for commercial space, with over 100 ion and Hall thrusters flying on communications satellites. Adaptation of commercial SEP technologies, such as the Boeing's Xenon Ion Propulsion System (XIPS) technology, may significantly lower the cost of these systems, enabling wider utilization on cost-capped Discovery/New

Frontiers missions. Fully exploiting the low-thrust SEP technology requires new trajectory design methods to cope with continuous thrusting rather than executing a few large thrust maneuvers at optimal points in the trajectory.

Significant improvements in the efficiency and performance of SEP are underway, and the resulting systems may provide substantial benefits to this Roadmap's planned missions to small bodies and the inner planets. When coupled with aerocapture (rapid aerodynamic braking within a planetary atmosphere), SEP enables rapid and cost-effective delivery of orbital payloads to the outer Solar System. *SEP technologies should be fully integrated with missions planning aerocapture.*

Aerocapture

Aerocapture, a new technology for Solar System exploration, uses a single pass through a planetary atmosphere to decelerate the spacecraft and achieve orbit. It represents a major advance over aerobraking techniques, where a spacecraft already orbiting a body flies repeatedly through the most tenuous parts of a planetary atmosphere to gradually change the orbital parameters. Because of the high heat flux, aerocapture requires a thermal protection system to shield the spacecraft from aerodynamic heating, as well as the use of a guidance system to assure that the spacecraft leaves the planetary atmosphere on the correct trajectory.

Aerocapture enables rapid access to orbital missions at the outer planets and is enabling for two of the potential Flagship missions in this Roadmap — Titan Explorer and Neptune-Triton Explorer. For targets in the outer Solar System, aerocapture technology would enable a substantial reduction in the trip time and/or a larger delivered payload mass, enabling these missions to be implemented with the current generation of heavy lift launch vehicles.

The Titan Explorer would be the first use of this technology in a Flagship mission. Because of the deep atmosphere, large-scale height, and modest entry velocities, Titan is an attractive target for the use of aerocapture. A conventional symmetric aeroshell, such as those used on Mars lander missions (e.g., Mars Exploration Rover and Mars Science Laboratory), can provide the modest lift required to correct for targeting errors at entry or uncertainties in the atmospheric model. Trajectory control would be achieved by rolling the spacecraft in order to change the direction of the lift vector. A New Millennium ST-9 aerocapture flight experiment has been proposed to demonstrate this technique autonomously in an Earth orbital flight experiment. The New Millennium flight experiment would be an important step in retiring the risks of using this technology on Titan Explorer. (See Figure 4.2.)

For a potential Neptune-Triton Explorer (NTE) mission, aerocapture can enable transit from Earth to Neptune in less than 10 years. Because of the much higher entry velocity and a narrow entry corridor, Neptune is a more challenging target for aerocapture than Titan. To achieve the control needed to correct for entry errors and uncertainties in the atmospheric model, a high lift-to-drag (L/D) aeroshell design would be needed. This type

Figure 4.2: Aerocapture (artist's concept).

Aerocapture technology can be used to insert spacecraft into orbit around any planet with a significant atmosphere. The largest benefits would be for the Roadmap missions: Titan Explorer and Neptune–Triton Explorer. A flight validation of the technology has been proposed as a New Millennium ST-9 flight experiment, which is directly applicable to Titan aerocapture. The test vehicle illustrated here would be launched into a geosynchronous transfer orbit and would then pass through the upper reaches of Earth's orbit, in order to brake the vehicle into a near circular orbit. The test vehicle must be controlled by modulating the amplitude and direction of the lift vector.

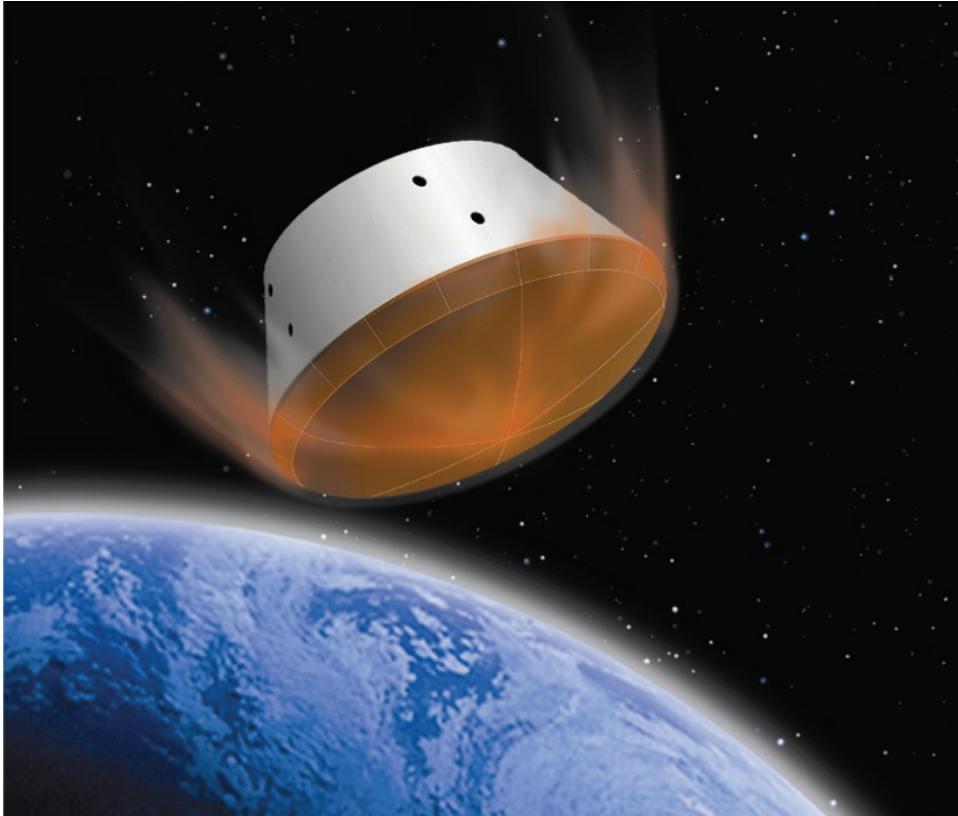
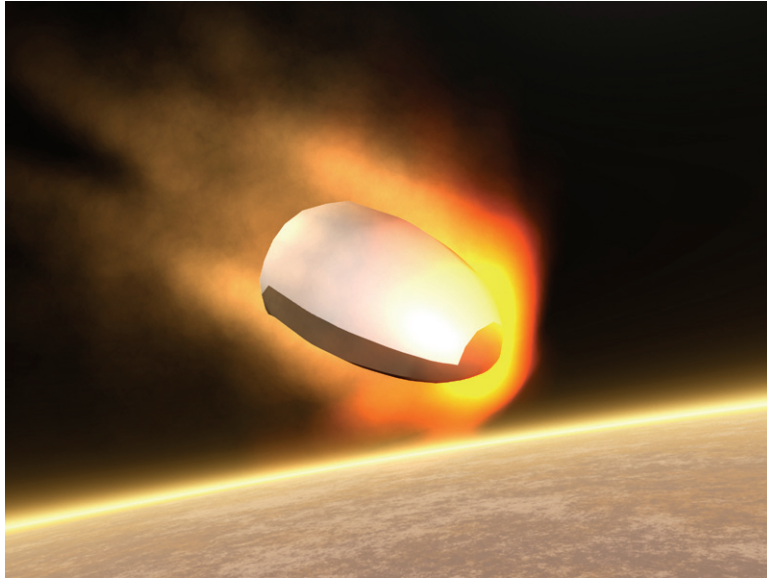

Figure 4.3: Aeroassist with an “ellipsled” (mid- L/D) aeroshell (artist’s concept). For aerocapture at Neptune, larger control authority would be needed. This unsymmetrical “ellipsled” design has a mid- L/D (lift-to-drag) ratio and could accommodate both uncertainties in the trajectory and the density profile of the Neptune atmosphere. Validation of mid- L/D systems at the outer planets should be considered as a flight experiment, prior to their use at Neptune.



of highly asymmetric “ellipsled” design may also need a flight validation experiment before potential use on an NTE mission. (See Figure 4.3.)

For spacecraft, aerocapture introduces packaging constraints similar to those experienced in the design of lander vehicles for Mars because encapsulation in thermal protection material is required. In particular, if a radioisotope power system were used, the spacecraft thermal management system would need to accommodate the energy generated by the RPS during the cruise phase. These challenges have been met successfully on previous Mars missions, such as Viking, and are not viewed as insuperable.

Aerocapture technologies and flight validation are a high priority to Solar System exploration.

Advanced Chemical Propulsion

The early Flagship missions in this Roadmap do not require advances in chemical propulsion technology. The principal beneficiaries of this technology would be missions desiring orbital or landed operations at satellites without significant atmospheres. Specifically, chemical propulsion advances would enable a Europa Astrobiology Lander (EAL) with a larger payload fraction, it would have similar benefits for an Enceladus lander, and may enable a

Triton lander to be deployed as part of the Neptune–Triton Explorer mission. On the other hand, missions entering the Titan atmosphere would not need chemical propulsion.

Progress in chemical propulsion will come from advances in components (tanks, valves, thrusters) and propellants. Lightweight components and gel propellants can improve payload fraction in orbital missions and landed missions at airless bodies.

4.3.2 Power

Power is a critical technology for the proposed missions in this Roadmap and the methods of generating, storing, and managing power are key to their success. Four of the planned Flagship missions are to destinations in the outer Solar System where due to extreme operating environments, RPS may be required for electrical power production and thermal management. In addition, little solar energy reaches the surface of Venus, to which the Venus Mobile Explorer mission would descend; furthermore, power conversion of the remaining solar energy would be infeasible at the ambient temperatures.

Radioisotope Power Systems

Nuclear power has played a significant role in the exploration of the Solar System, in many cases enabling missions that could not have been achieved otherwise. Since 1961, RPSs have been successfully flown by the United States on 25 space missions. Furthermore, Radioisotope Heater Units, or RHUs, have been used on several other missions for component heating. RPSs have consistently demonstrated unique capabilities over other types of space power systems. RPSs generate electrical power by converting the heat released from the nuclear decay of radioactive isotopes (typically plutonium–238) into electricity via static or dynamic conversion processes. The key advantages of RPSs are their long life, robustness, compact size, safety and high reliability. They are able to operate continuously, independent of orientation to and distance from the Sun, on missions where solar photovoltaic power is not feasible to meet mission requirements and stored energy from batteries or fuel cells is inadequate. RPSs are also relatively insensitive to radiation and other environmental effects. These properties have made RPSs ideally suitable for autonomous missions in the extreme environments of outer space and on planetary surfaces. Missions using RPSs have included Earth–orbiting navigation satellites (Transit, Nimbus); Apollo missions (12, 13, 14, and 15); Pioneer 10 and 11; Viking 1 and 2; and Voyager 1 and 2 (still operating after almost 30 years). The Galileo, Ulysses, Cassini, and the New Horizons Pluto–Kuiper Belt missions were equipped with GPHS–RTGs (General Purpose Heat Source – Radioisotope Thermoelectric Generators). These power systems were designed for operations in a space environment without atmospheres. Their production was closed down; however, components for two or three other units still remain and could be potentially considered for future outer planet missions.

Thermoelectric Technology

To respond to future needs for radioisotope power for both Mars and outer planet missions,

Figure 4.4: Multi-Mission Radioisotope Thermoelectric Generator (artist's concept). This MMRTG has been developed for use within an atmosphere, specifically at Mars, and for use on outer planet orbiter missions, such as on the Europa Explorer, Titan Explorer, and Neptune-Triton Explorer, with some compromise in performance (specific power) when used in space. Advanced thermoelectric conversion devices can enable higher electrical power output from these RPS units.

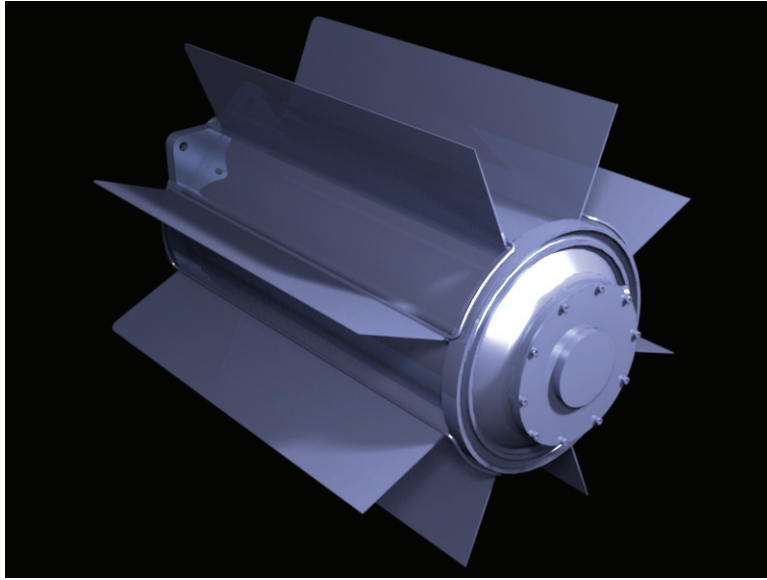

NASA and DoE are currently developing the Multi-Mission Radioisotope Thermoelectric Generator (MMRTG) (Figure 4.4), capable of operating in space or in an atmospheric environment. This dual-purpose system is driven largely by the need for more flexibility in power requirements to support missions with lower power needs. The power of each MMRTG unit is about 100 watts electric which is about 1/3 the power of the GPHS-RTG. The MMRTG can be used in multiples to support missions requiring more power with some mass penalty compared to the GPHS-RTG. Therefore, the MMRTG could support the requirements of the proposed Europa Explorer (EE) mission. Furthermore, advanced versions of RTGs, using thermoelectric converters (Figure 4.5) with efficiencies significantly higher than the current state-of-practice (Figure 4.6), could provide higher specific power and more electric power from within the same physical package. While multi-mission capable, the MMRTG would require small modifications to its heat-rejection system to be useful for the Titan Explorer mission.

Dynamic Conversion Systems

NASA is also currently developing a Stirling Radioisotope Generator (SRG) with a dynamic power converter (Figure 4.7), which has comparable specific power to the MMRTG, but has a significantly higher thermodynamic efficiency. An advanced version of the SRG with an increased specific power is under consideration (Figure 4.8). In view of a shortage

Figure 4.5: Illustration of the MMRTG 6x8 Couple Module.

The radioisotope power systems used on Mars and on all NASA outer planet missions have used thermoelectric converters with low conversion efficiency. Increasing this efficiency involves both the use of advanced thermoelectric materials (in this case skutterudites) and a “segmented” structure, in which the material properties are tuned to the temperature range in which the system operates.

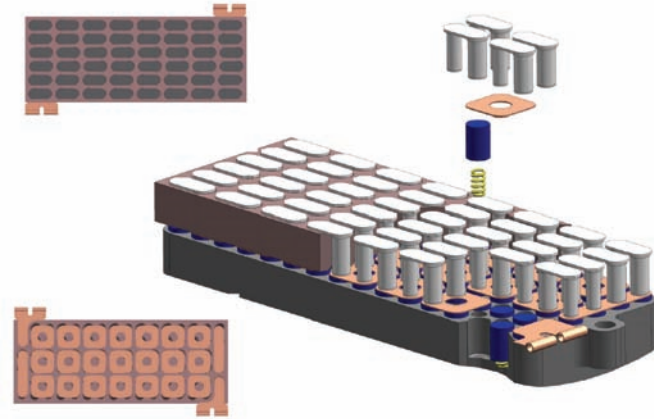

Figure 4.6: Thermoelectric conversion: Nanowire materials promise efficiencies much higher than the 6 to 8% possible today.

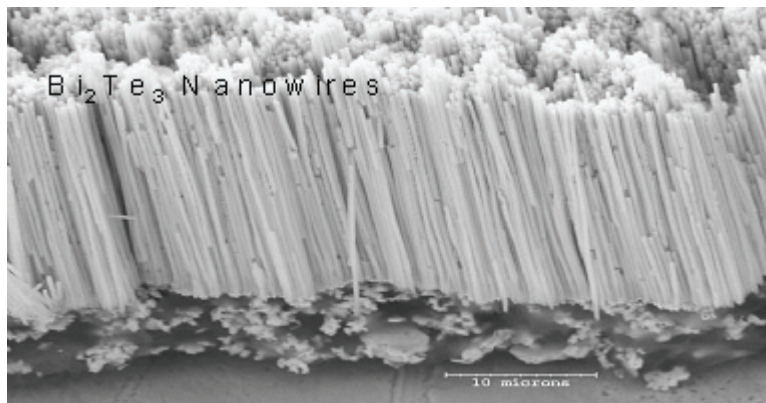
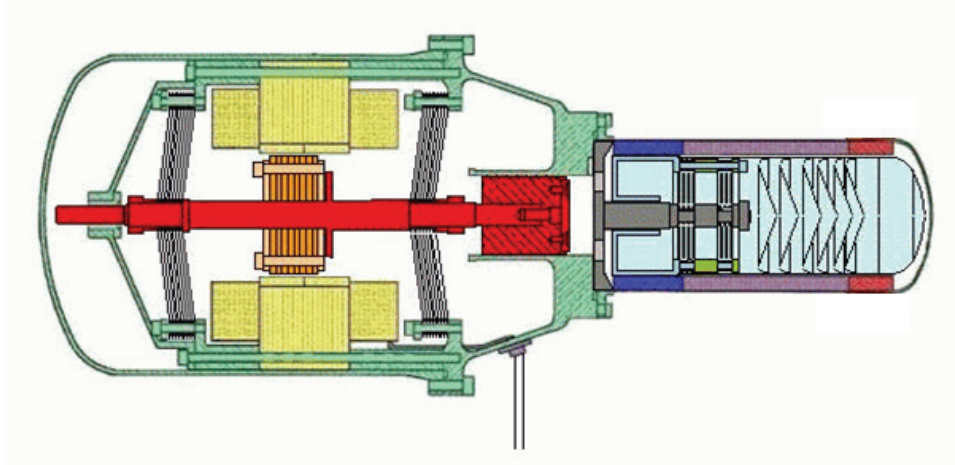

Figure 4.7: Illustration of a dynamic Stirling converter.

Dynamic conversion provides significantly higher conversions efficiency than thermoelectric devices can achieve, but at the expense of moving parts and greater complexity. For long duration outer planet missions, lifetime issues of dynamic converters should be addressed. However, for power-generation in the Venus environment, where the mission lifetime is significantly shorter and the efficiency gain provides a critical advantage, dynamic systems will be required.



of plutonium-238 available to NASA, an SRG technology could be important to the Agency even though it has not reached the maturity level of the thermoelectric-based technology.

The higher thermodynamic efficiency of mechanical devices would be also important for the application of RPS power to the proposed Venus Mobile Explorer mission. Stored power is inadequate for the preliminary mission design of many months of operation near the Venus surface, and no other power generation technologies capable of tolerating the extreme temperature and pressure are likely available. A unique SRG for the Venus Mobile Explorer mission would not only generate electric power, but it would also enable a highly efficient heat pump that would cool the electronics and payload.

Current SRG development work does not include a requirement to operate in the 460°C Venus environment. *Future development work should include work on dynamic conversion systems for power generation and for active cooling to address the need for sustained power at or near the surface of Venus.*

Solar Power Generation

Solar power generation plays an important supporting role for some of the Roadmap Flagship missions and is even more important for missions in the New Frontiers and Discovery Programs. To effectively use solar arrays farther from the Sun, specific power improvements are needed to enable more power per kilogram of solar array and in Low Intensity

Figure 4.8: Illustration of a dynamic Stirling converter.

These devices utilize flexure bearings to minimize wear. The technology has been successfully used in space for cryogenic coolers, but not to date for power generation.



Low Temperature (LILT) technology.

One mission planning to use solar power is Juno, a Jupiter Polar Orbiter selected as the second New Frontiers mission. ESA's Rosetta mission, a comet mission traveling to similar distances from the Sun as Juno is also solar powered. Applications to missions in this Roadmap are also possible.

While advances in solar power generation may allow the use of solar power farther from the Sun than is the current practice, there are many mission architectures for which it may not be feasible. For operations in the atmosphere of Titan for example the solar power reaching a solar array is reduced by at least a factor of five below the free space value and aerial platforms or landed vehicles may spend up to an Earth week without any sunlight as a result of the length of diurnal cycle on Titan.

NASA is currently planning a New Millennium space validation experiment that is seeking to validate arrays with performance of 175 W/kg, double the current state-of-practice.

Energy Storage

Advances in energy storage have played a critical but uncelebrated role in the success of robotic exploration missions such as the Mars Exploration Rovers. In that mission, improvements of almost a factor of two in specific power and a factor of four in specific volume made it possible to pack a significant science payload. Further developments needed to support this program are advances in the performance of rechargeable batteries for operations at both high and low temperatures. The potential and needs for further improvement are

described in [NAS04].

4.3.3 Communications

Progress in Solar System exploration over the past 40 years has required major improvements in deep space telecommunications. Although progress is still continuing, there have not been significant improvements in the ground infrastructure in the last decade. Fortunately, technology developments currently underway will allow improved radio telecommunications performance through a combination of several advances (e.g., greater DSN collecting area, higher power spacecraft transmitters). Because of the short schedule of the Solar System Exploration Roadmap activities, it was not possible to conduct a detailed study of the needs and timing of future telecommunications capabilities.

Direct-to-Earth Communications

Science has benefited from a steady progression in the capabilities of the Deep Space Network (DSN). Between 1960 and 1980, deep space communications capabilities increased by almost eight orders of magnitude. However, in the following two decades progress slowed, yielding a total 10-fold performance gain. Improvement largely resulted from a progression in the frequency used for communications from S-band to X-band and finally to Ka-band, the maximum frequency range that is practical for communications from within Earth's atmosphere. This capability, to be fully demonstrated on the 2005 Mars Reconnaissance Orbiter, provides a data rate from Mars of more than 2 megabits/second.

Despite these impressive advances, there is still considerable room for improvement. Even with the 2 megabits/second data rate achievable now at the distance of Mars, only 1% of the surface of that planet can be covered at the maximum imaging resolution. Missions in the outer Solar System would clearly demand higher capabilities. Multispectral and hyperspectral data types impose even larger demands on data return. The public backing of the President's Vision for Space Exploration will be supported by the return of quality images. Therefore, a progression in imaging quality from still images to video to HDTV to IMAX will drive the need for additional deep space communications capability.

The current DSN provides X-band capability at three very large antennas (70 meters diameter) placed at three sites strategically located in California, Spain, and Australia to provide tracking of a spacecraft with at least one station at all times. There are also a number of smaller 34-meter antennas, many of which are equipped to work at Ka-band. However, because many of these assets are becoming obsolete and are operating well beyond their design lifetimes, they are becoming comparatively more expensive to operate. The current system is not extensible architecturally to meet future needs.

A proposed plan for a next-generation DSN involves arrays of up to several hundred comparatively small but readily producible antennas at each site (Figure 4.9). Each array would be Ka-band capable and provide about 10 times the aperture of the existing DSN.

Figure 4.9: Illustration future potential DSN configuration (artist's concept).

Future advances in deep space communication may be achieved with arrays of antennas, which exploit methods of coherent combination of radio signals perfected in radioastronomy, leverage commercial antenna technology, and represent a highly flexible system for allocating the needed resources to a number of independently tracked targets.

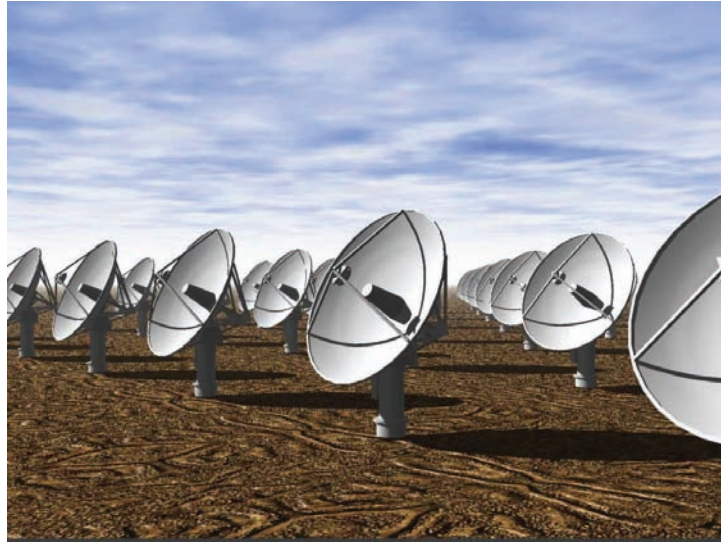

The array approach has more resilience and redundancy than a small number of very large antennas: it provides graceful degradation in performance in case of antenna or receiver failures. The architecture is easily scaled to add capabilities as necessary. It would also enable significant growth in the number of spacecraft simultaneously tracked, and each of these could be tracked with just the required aperture by allocating an appropriate number of antennas to the task.

NASA and JPL have generated a roadmap for this next-generation DSN, based on requirements derived from analysis of probable future mission sets. This DSN Roadmap is being integrated into an overall NASA Space Communications Program Plan by the NASA Space Communications Architecture Working Group (SCAWG). The SCAWG made recommendations about the future of space communications to the NASA Administrator and the NASA Strategic Management Council, including the need for a significant DSN improvement. *Maintaining the DSN capabilities is of vital importance to the goals of this Roadmap. The proposed performance gains for the DSN will clearly benefit the Flagship missions in this Roadmap as well as open new opportunities for other missions.*

Direct-to-Earth radio links have also been used for solar system science investigations on most planetary missions, providing unique information on atmospheres, interiors, rings, solar wind, and fundamental physics. The next generation DSN needs to incorporate the

design requirements of these key measurements.

Proximity Links

In addition to the direct-to-Earth links connecting orbital spacecraft to the DSN, proximity links enabling communications between assets on the surface and in the atmospheres of planets and satellites can provide a major increase in data return relative to communicating data directly to Earth. For instance, most of the Mars Exploration Rovers' data are relayed through orbital assets even though the rovers have functional direct-to-Earth links.

Many of the proposed missions in this Roadmap could benefit directly from the development of proximity link technology for the Mars Exploration Program. This includes establishment of the protocols and various classes of software radios. Collaboration with ESA has resulted in interoperability of NASA and ESA Mars spacecraft for proximity relay purposes. The beneficiaries of this technology could include a small lander or impactor on the Europa Explorer, as well as relay communications for the potential Titan Explorer, Venus Mobile Explorer, and the Europa Astrobiology Lander.

4.3.4 Planetary Protection

It is both a scientific and a legal requirement under a UN treaty [Nat67] that missions to objects of biological interest, such as Europa, Titan, and Enceladus, must not contaminate the target body until the biological exploration of the body is complete. Furthermore, biological contamination must not compromise the integrity of life-detection experiments. Thus measures must be taken to ensure that samples collected by onboard instruments on landed spacecraft do not experience contamination by the spacecraft itself or other materials brought from Earth. Planetary protection regulations specified in international agreements are imposed on robotic space missions to prevent biological contamination of future exploration sites (so-called “forward protection”) and, in sample return missions, to protect the Earth from extraterrestrial contaminants (“back protection”). (See Figure 4.10.)

Planetary protection needs can be categorized broadly as those technologies needed to meet forward protection requirements and those involved in returned sample handling. The forward contamination issues are of most pressing concern to the Roadmap missions. While these might appear to primarily concern in situ exploration, they actually do affect orbital spacecraft because of the risk that those spacecraft could potentially impact targets of biological interest such as Europa, Titan, and Enceladus. The planetary protection architectural approach must be addressed at the earliest stages of mission design. An assessment of how this might be accomplished at the system level has been made recently [NAS05a].

Forward Protection

Historically, the Viking mission to Mars imposed the most stringent forward protection requirements of any planetary mission. After Viking measurements provided a better understanding of the Mars surface environment, contamination control requirements were

Figure 4.10: Planetary Protection.

Planetary protection requirements for missions to targets of biological interest generally involve methodical cleaning and sterilization of spacecraft components. For the proposed Europa Explorer, it would be possible to turn Jupiter's high radiation environment into an advantage, and use it to sterilize the external surfaces of the spacecraft.



adapted for the both the Mars Pathfinder and Mars Exploration Rover missions. The European Beagle mission included a rigorous planetary protection scheme because it included biological experiments. The recognition that there are “special regions” of Mars, where it is more likely that biological activity may be sustainable, has led to more demanding requirements on missions that could encounter these regions, intentionally or otherwise. Two NASA Mars missions currently under development, Phoenix and Mars Science Laboratory, are subject to more demanding requirements. The Mars Exploration Program is developing new planetary protection technologies and approaches to address requirements for future missions. While these technologies are relevant to other target objects, they are likely to be insufficient to meet planetary protection requirements for missions to targets such as Europa, Titan, and Enceladus.

In part, this disparity stems from the extreme environments that would be faced by missions to these targets. For instance, Europa's icy shell, exposed to the vacuum of space, would require different strategies than those applicable to the dehydrated Mars surface and in its atmosphere. Similarly, Titan's organic-rich environment would present new challenges to planetary protection, as will the cleaning processes applicable to materials used for an aerial vehicle.

It is strongly recommended that solutions for planetary protection and contamination control be addressed jointly, as some of the solutions overlap. Furthermore, technologies, and particularly systems analysis, for the mission concepts under consideration will need to reach

Figure 4.11: Small body exploration and anchoring.

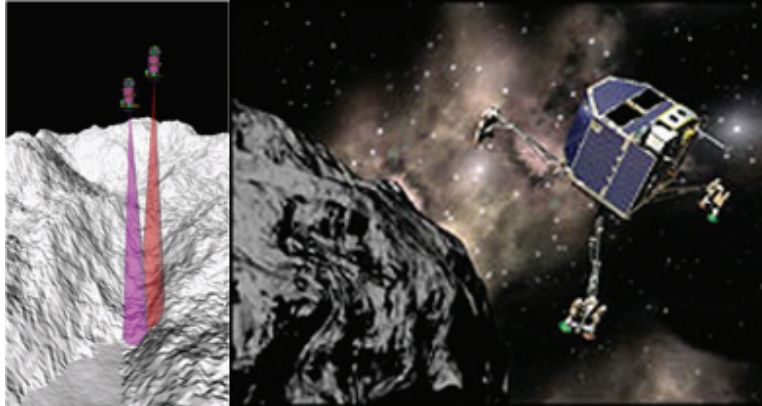

maturity earlier than other technologies so that technology development for subsystems will have access to new methodologies for planetary protection implementation. *System-level technologies for forward planetary protection are critical to missions related to habitability studies and will require earlier investments.*

Returned Sample Handling

Sample return missions to bodies of biological interest would be required to be engineered so that samples are safely contained as they are brought back to Earth and transported to a sample receiving facility, until they can be thoroughly evaluated for potential biological and environmental hazards. New technologies and new system design approaches could eliminate the risk of inadvertent release of sample materials and permit effective study of the contained sample. None of the five Flagship missions has returned sample requirements. However, the New Frontiers Comet Surface Sample Return Mission would face the challenge of returned sample handling under stronger planetary protection requirements than those faced by the Genesis and Stardust missions.

4.3.5 Autonomous Operations

For many of the Flagship missions and several of the New Frontiers missions, complex operations must be implemented autonomously. The primary challenge in implementing mobility is latency, the time delay between sending a command from Earth and determining its effect. During some mission phases, these vehicles may be out of contact with a ground operator for days or even weeks. The challenges are greater for extended operations in close proximity of a small body such as a comet or asteroid (see Figure 4.11) or for aerial mobility vehicles (see next section) that might encounter surface hazards.

Autonomy

Autonomy technology is a key to meeting this challenge, and significant advances are under

development now. Some autonomous operations can draw on the experience in operating the Mars rovers, where commands are typically issued on a daily cycle. The Mars Technology Program, for example, is developing technologies that will enable a rover to travel to and sample a rock 10 m away with a single command, thus greatly amplifying the scientific productivity of the vehicle. (See Figure 4.12.)

Figure 4.12: Autonomy and fault protection.

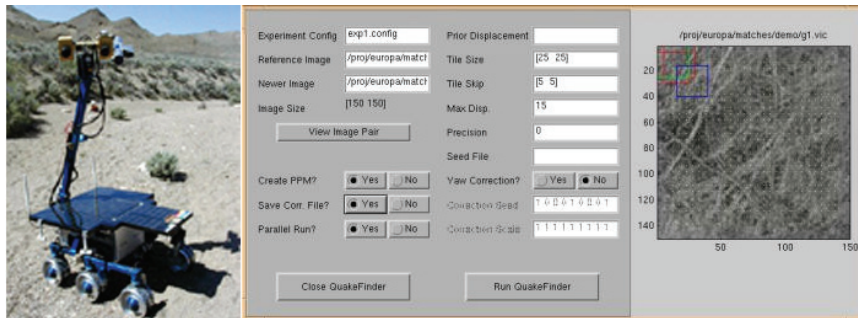

However, Solar System exploration will require additional capabilities without a counterpart in the Mars Exploration Program. For example, the Solar System Exploration Roadmap includes mission concepts calling for proximity operations of sample return missions from small bodies, as well as aerial platforms monitoring and acquiring samples from the surfaces of Titan and Venus. Fortunately, frameworks now exist for autonomy implementation, particularly the Coupled Layer Architecture for Robotic Autonomy (CLARAty), a joint effort by NASA and major robotics universities; these efforts can ensure that investments in Mars technology are fully exploited.

Software Verification and Validation

The expanded use of autonomy in exploration presents new challenges for software verification and system-level validation. Innovative approaches range from effective use of Earth environments as analogues for extreme Solar System environments to optimized applications of commercial software; these approaches will enhance software reliability as they improve our ability to predict software development costs.

4.4 Technologies for In Situ Exploration

Many of the missions in this Roadmap require direct access to the atmosphere and surface of planets and satellites. This is achieved through the use of planetary probes, landers, and mobile surface and aerial platforms. These vehicles would be enabled by a family of technologies for in situ exploration. Entry, descent, and landing (EDL) technologies assure the delivery of exploration platforms and their payloads to the environment of interest.

Figure 4.13: Accommodation of the back-to-back aeroshells concept for Titan in the L/V fairing. (design concept)

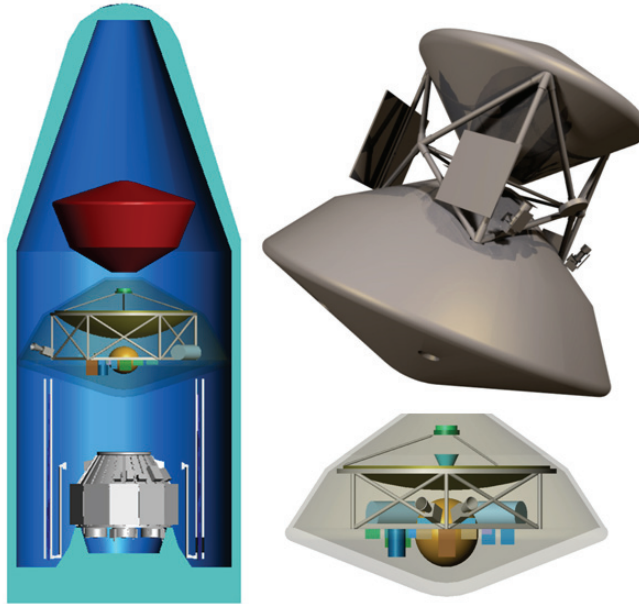

Planetary mobility technologies are used to reach sites where observations and in situ measurements are conducted. Finally, technologies for extreme environments help meet the challenges of surviving and operating through all mission phases including EDL and mobile operations.

4.4.1 Entry, Descent, and Landing

The term “entry, descent, and landing” has become so standard that we apply it here to the delivery of all types of in situ vehicles. The emplacement of aerial platforms generally occurs during the descent phase.

Entry

Many of the targets of interest in this Roadmap have dense atmospheres that can be used to decelerate the vehicle in order to reach its desired location. Entry systems for Titan and Venus could likely be accommodated with existing technology (Figure 4.13). On the other hand, requirements for the proposed New Frontiers Saturn mission and the Flagship Neptune–Triton Explorer mission would present greater challenges to entry technology, and missions entering Jupiter’s atmosphere will present the greatest challenges at entry.

Recent developments in entry technology for robotic spacecraft have focused on Mars exploration, where the next step is precision guidance during entry to refine landing site targeting. Technology development for entry may require revalidation of existing thermal protection system (TPS) materials or development of new lightweight thermal protection technologies. In addition, there are important synergies between entry TPS and appropriate systems for aerocapture. The high heat fluxes experienced during entry into planetary atmospheres are considered to be “extreme environments”; technologies to mitigate these effects, such as TPS materials, are discussed further in the associated section. TPS materials are of particular importance because technology developments may provide significant improvements in payload fraction.

Descent

During the descent phase through a planetary atmosphere, the vehicle generally descends at a steady rate determined by the balance between gravitational and aerodynamic forces. With its thin atmosphere and strong near-surface winds, Mars presents a special challenge for atmospheric descent technology. On the other hand, descent in the thick atmospheres of Venus and Titan, with low surface winds, facilitates soft landings, as the successful landings of the Huygens probe and many Venus probes have demonstrated. It is therefore expected that the deployment and inflation of balloon systems for the proposed Titan Explorer and Venus Mobile Explorer missions would be straightforward, with the descent providing ample time for completing these operations.

Landing

Landing technologies are most challenging for planets and satellites without atmospheres. For landing on both Europa and Enceladus, a delta-V of several km/sec will be required. For a given entry mass, advanced chemical propulsion technology will lower the propellant mass, and consequently will increase the useful payload mass fraction, as discussed in Section 4.3.1. However, guidance, navigation, and control technologies are also important. Although there is no single EDL system applicable to all of the widely diverse types of bodies of interest, the critical advanced technologies for precision landing and hazard avoidance can be utilized as a foundation for the capabilities needed by all missions.

Future potential Solar System exploration missions must land on airless objects of widely divergent gravitational fields, contend with extreme relief, and possibly descend and ascend under conditions of active plumes from the surface. In contrast, landing on bodies with dense atmospheres, such as Venus and Titan, represents comparatively straightforward engineering; for both bodies, descent vehicles designed primarily as atmospheric probes (i.e., Pioneer-Venus on Venus and Cassini-Huygens on Titan) have survived landings.

Precision guidance

A number of the missions described in this Roadmap have stringent requirements for descent and landing, posing technical challenges. The Mars Exploration Program is investing

in technologies that will be applicable to other bodies with atmospheres. For instance, the precision guidance technology under development by the Mars Technology Program will use advanced optical navigation methods and aerodynamic guidance designed to improve landing accuracy by a factor of 20. This would enable landing within roving range of the scientific sites of greatest interest.

However, additional technologies and techniques may be necessary for precision landing on targets without atmospheres, such as Europa and Enceladus. The proposed Comet Surface Sample Return mission requires the capability to rendezvous, descend, and ascend from these low-gravity objects using terrain-relative navigation to ensure the recovery of samples from the required targets. The Europa Astrobiology Laboratory mission would require similar precision, but because it has a substantial gravitational acceleration, terrain-relative navigation would have to be performed at high rates and be tolerant to spurious radiation effects (described further in the section on technologies for extreme environments).

Hazard detection and avoidance

Hazard detection and avoidance technology is complementary to precision guidance. The objective is to integrate the detection of hazardous regions, such as craters, mountains, canyons, and crevasses, with the guidance and control systems. It is therefore necessary to develop effective sensors and algorithms to detect hazards, and then to have control capability during terminal descent with sufficient time to avoid the hazards. Hazard detection and avoidance is closely coupled with autonomy but demands the development of appropriate sensor suites, as well. A New Millennium ST-9 flight validation is planned for validating these capabilities.

Small body anchoring

The proposed Comet Surface Science Return mission would need to land on the surface and conduct sample acquisition activities prior to an ascent. Technologies for landing on and remaining tethered to a small body have not yet been developed.

4.4.2 Planetary Mobility

Two of the potential Flagship missions in this Roadmap, Titan Explorer and Venus Mobile Explorer, would require mobility in order to sample a relatively wide area of heterogeneous surfaces. While surface mobility is the method of choice on airless bodies and in the thin atmosphere of Mars, mobile aerial platforms represent a very attractive option for Venus and Titan.

Aerial

The thick atmospheres of Titan and Venus enable buoyant vehicles that are much less susceptible to being immobilized by surface obstacles or surfaces with low bearing strengths. Aerial vehicles can also travel over much greater distances with less energy consumption and would provide local imaging, as well as chemical and mineralogical sampling, at mul-

multiple sites for both the proposed Venus Mobile Explorer (VME) and Titan Explorer (TE) missions.

In the hot dense atmosphere of Venus, thin metal balloons could provide adequate buoyancy near the Venus surface and yet survive the Venus surface temperatures (Figure 3.11). For Titan, polymer-based films and fabrics that can retain their flexibility and resilience at low temperatures near 90K have been demonstrated (Figure 3.10). Long life, low temperature actuators will be required for altitude control of Titan Aerial vehicles (described further in Section 4.4.3, on technologies for extreme environments).

In order to pass the technology decision gates for both the proposed Titan Explorer and Venus Mobile Explorer, it would be necessary to invest in mobility systems. A sustained effort in both basic technology and advanced development is needed to prepare for these types of missions. Test facilities would be required for validating the performance of mobile vehicles in both extremely hot and extremely cold environments.

Surface

Surface vehicles must tolerate highly irregular terrains, deposits of low bearing strengths and, on Titan, potentially sticky or liquid surfaces. Wheeled vehicles, derived from the Mars Exploration Rover and Mars Science Laboratory, represent an approach to mobility that, although providing more limited access, would provide a firmer platform for drilling and precision surface sampling. Long life, low temperature and high temperature motors will be required for surface mobility.

Subsurface Access

Another dimension of planetary mobility is the exploration of subsurface environments. These may be particularly important to the search for extant life, since it is feasible that such life would be found beneath the surface of Mars or Europa, if it exists at all. Advanced drilling, coring, or boring devices, carrying scientific sensors and tethered to a surface platform, will be required to enable potential in situ exploration of potentially habitable environments.

4.4.3 Extreme Environments

Future Solar System exploration missions will experience a wide range of possible conditions, from the comparatively benign environment of Mars, to the intense radiation environment around Europa, to the intense heat and crushing pressure within the atmospheres of Venus and Jupiter. These environments also include the extreme radiant and convective heating of planetary entry and the frigid temperatures near the surface of Titan. A table summarizing the targets and their extreme environments follows below (Table 4.2). The need for spacecraft to survive and make measurements in this wide variety of environments is a major challenge for the next generation of Solar System missions.

Table 4.2: Extreme Environments of Potential Target Bodies for Solar System Exploration.

Target	MISSION STAGE								
	Space	Entry			In situ				
	Radiation (krad/day)	Entry heat flux	Deceleration (g)	High pressure (bar)	Low temperature (°C)	High temperature (°C)	Day length (Earth day)	Chemical corrosion	Physical corrosion
HIGH TEMPERATURES AND HIGH PRESSURE									
Venus surface		30	400	92		500	400	H_2SO_4	
Jupiter (Gas giant)		42		100		450			
LOW TEMPERATURES									
Lunar permanently shadowed regions					-230				
Comet nucleus		0.5*			-270				
Titan surface					-178			CH_4	
Enceladus					-199				
LOW TEMPERATURES AND HIGH RADIATION									
Europa orbit	40								
Europa surface	30				-180				
Europa subsurface	0.3 at 10 cm								
THERMAL CYCLING									
Moon					-180	120	27		Dust
Mars					-120	+20			Dust

* This heat flux is that at Earth and applies to any returned sample mission, such as the Comet Surface Sample Return.

Technologies for extreme environments are categorized by the challenging environment conditions: High temperature and high pressure, low temperature, high radiation, and high heat flux (i.e., atmospheric entry). In general, technologies may be designed to fulfill one of three goals: to provide isolation from the extreme environment, such as an integrated thermal/pressure control vessel; to tolerate the extreme environment, such as radiation-hardened electronics; or to integrate isolation and tolerance in a system-wide hybrid design.

High Temperatures and High Pressures

The surface of Venus presents a number of formidable challenges to in situ exploration, including temperatures of $\sim 480^\circ\text{C}$ and pressure of 90 bars in an atmosphere of carbon dioxide with corrosive components, such as sulfur dioxide. The New Frontiers class Venus In Situ Explorer (VISE) would have a limited lifetime comparable to those achieved by the Soviet Venera missions (several hours); however, the Venus Mobile Explorer (VME) would operate for months and traverse significant distances to observe the surface at close range and sample from many sites. Probe missions to Saturn may also be targeted to reach a pressure of 10–20 bars, but the temperature there would be less than $\sim 300^\circ\text{C}$ at that pressure–depth. Accordingly, the primary driver for missions requiring extreme temperatures and pressures is Venus. (See Figures 4.14 and 4.15.)

For the proposed VISE, a short-duration mission, passive thermal control approaches may be adequate, while VME, a very long-duration mission, would require active cooling to “refrigerate” the thermally controlled avionics and instruments with minimum heat leaks. An aggressive early program of systems analysis is important to define the best approach and to determine realistic performance goals for this technology. In addition, pressure vessels used in the past may not be adequate for mission durations longer than a few hours and a new, lightweight, creep-resistant pressure vessel will need to be developed.

Use of an active thermal control system alone is not a practical solution because components dissipating a great deal of power would impose excessive demands on the thermal control system. However, components that can operate in the ambient environment, including high-temperature electronics, and energy storage, offer a solution. Hybrid systems combine communications and other high-power components hardened to operate without thermal control in the Venus environment with low power-dissipating, conventional digital electronics, thus operating at Earth-ambient temperatures in an actively controlled pressure vessel.

Both wide-bandgap semiconductor and vacuum tube approaches to high-temperature electronics have been demonstrated to operate at temperatures in excess of $\sim 500^\circ\text{C}$, but there are no strong commercial drivers for this technology. Silicon-based electronics capable of operating at temperatures $\sim 250^\circ\text{C}$ are being developed for the oil drilling and automotive industries. Both the high-temperature electronics capable of operating at Venus surface ambient temperatures, as well as medium temperature ($\sim 250^\circ\text{C}$) electronics technology,

Figure 4.14: Pressure vessel concept for exploration of extreme environments. For potential short-lived giant planet deep entry probes and for Venus in situ missions, the high pressure and temperature must be withstood. The figure shows a pressure vessel concept with thermal insulation outside. The instruments and electronics are placed inside the pressure vessel, with a phase-change material (PCM) tray, which can absorb the heat generated by the instruments for a short period of time, measured in hours.

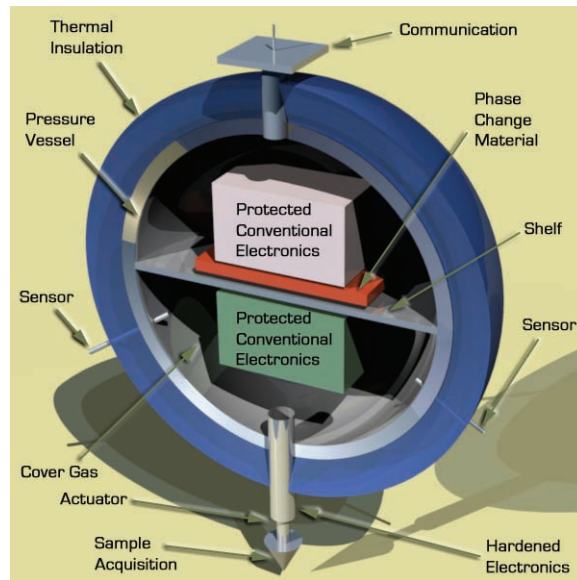
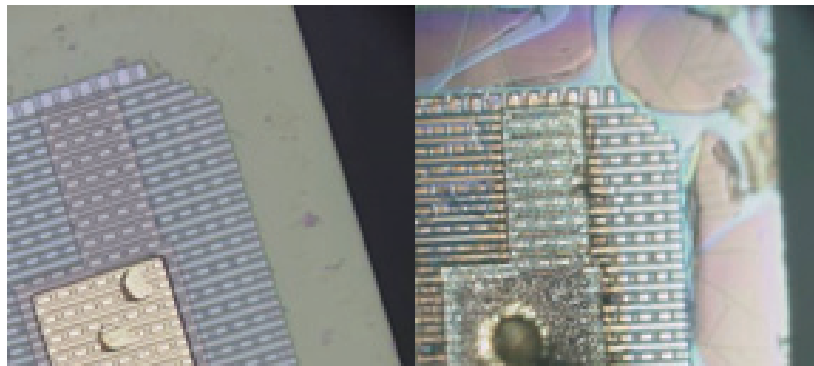

Figure 4.15: High-T electronics.

Electric circuit at normal temperatures (left); and after ~ 24 hours exposed to 500°C (right). Useful high-temperature electronics requires not only electronic materials that retain their properties at high temperatures, but also packaging approaches that retain their integrity under high temperature conditions.



are enabling for the proposed Venus Mobile Explorer (VME) Flagship mission. Medium temperature electronics would operate in *temperature controlled chambers, requiring significantly less active cooling than conventional electronics*. High-temperature electronics could benefit the Venus In Situ Explorer (VISE) mission and a technology validation experiment on that mission might also be appropriate.

Actuators that can operate at extremely high temperatures represent the main focus for technologies needed for sample acquisition mechanisms. These components require permanent magnets, gearboxes, and lubricants with the ability to perform at Venus surface temperatures. High-temperature actuators are needed by both the VME mission and the short-duration VISE mission.

In general, missions to Venus would benefit from a number of technologies for high temperatures, including active thermal cooling, pressure vessels, high-temperature electronics, energy storage, and high-temperature mechanisms.

Low Temperatures

The needs of the Mars Exploration Program for components that can operate or at least survive the diurnal temperature excursions on Mars from 270K down to 180K have driven recent developments of electronic devices and actuators. While Titan's uniform 90K surface does not experience temperature excursions, the extremely low temperature presents additional challenges. Very cold temperatures are also experienced at the surfaces of the Galilean satellites, Enceladus, Triton, and on the surfaces of comets at large heliocentric distances.

Low temperatures affect the operation of chemical, electronic, and mechanical components. Electrochemical batteries, for example, lose their ability to store charge and release it rapidly at low temperatures. Electronic and optoelectronic devices may degrade or cease to operate due to carrier "freeze out" effects. Mechanical components, such as balloon envelopes, may suffer from material embrittlement. New technologies mitigating these effects can enable exploration systems to tolerate operation in very cold environments.

Because normal spacecraft operations usually generate enough heat to raise the ambient temperature to an acceptable level, systems operating in orbiting or cruising spacecraft can be easily maintained at these temperatures. On the other hand, in situ exploration poses the greatest challenge for cold temperature operation because these vehicles must land on and make intimate contact with cold surface materials. *Therefore, sample acquisition systems and in situ science instruments are likely to benefit strongly from the maturing of technologies for low temperatures.*

High Radiation

Two of the Flagship missions in this Roadmap are targeted to Europa and will be exposed to some of the most intense radiation environments in the Jupiter system. In the last five

years there have been significant developments in radiation hard (or “rad-hard”) processors, such as the Rad 750 now flying on the Discovery Program’s Deep Impact mission, the Mars Reconnaissance Orbiter, and those planned for the Mars Science Laboratory. Rad-hard power electronics developed under the Jupiter Icy Moons Orbiter (JIMO) project are now available. However, a persistent problem is the lack of a densely packaged, rad-hard, low-power mass memory. Compact low-power flash memories are notoriously vulnerable to radiation. There are no rad-hard alternatives yet available.

In designing any spacecraft for operations at Europa, the Galileo experience and knowledge base are invaluable. There is now an improved model of the Jovian radiation environment that has been significantly refined with Galileo data. In addition, a detailed history is now available of the failure times and modes of various subsystems on Galileo. Furthermore, the Galileo experience has led to an improved toolkit of mitigation methods, such as annealing and operational work-arounds, as well as new methods of fault handling to minimize the recovery time from radiation-induced anomalies so that the spacecraft can continue its missions.

Near Europa, spacecraft operations expose hardware to the severe Jovian radiation environment. Shielding can mitigate these effects, but at the expense of useful payload. Both the cumulative dose and the prompt effects of the radiation (called single event failure) are of concern to the performance of spacecraft systems and science instruments. Continuing research and advanced development are needed to extend the radiation tolerance of electronic, optical, and sensor components in these radiation environments.

For the proposed Europa Explorer mission, the highest priority Flagship mission described in this Roadmap, a new operational strategy has been devised to cope with the current lack of rad-hard high-density memory. The strategy, involving real-time data transmission from Europa, requires minimal data storage and is therefore feasible with current rad-hard technology. Although this imposes a significant mass and power penalty, this mission has the margins to accommodate this work-around. Another consequence is some minor compromises in data types acquired since real-time data can only be acquired from the Earth-facing side of Europa, generally solar-illuminated.

The New Frontiers Juno mission, currently in formulation, is a Jupiter orbiter in a high-inclination orbit with perijove within $1/10R_J$ of Jupiter, thereby avoiding the most intense parts of the toroidal radiation belts. Nevertheless, characterization of radiation effects in sensor devices for Juno would be relevant for Europa Explorer studies.

For the Europa Astrobiology Laboratory, a proposed mission in the third decade, the mass penalties of radiation shielding become much more significant due to landing requirements. Rad hard, low temperature electronics, including non-volatile, high-density mass memory, is of vital importance for this mission.

Figure 4.16: Galileo Probe Heat Shield Ablation.

Jupiter's environment represents the most difficult atmospheric entry in the Solar System. Burn through of the TPS on the Galileo probe did not correspond to preflight predictions. Improved understanding of the ablation process can be used to improve the mass fraction on entry probes.

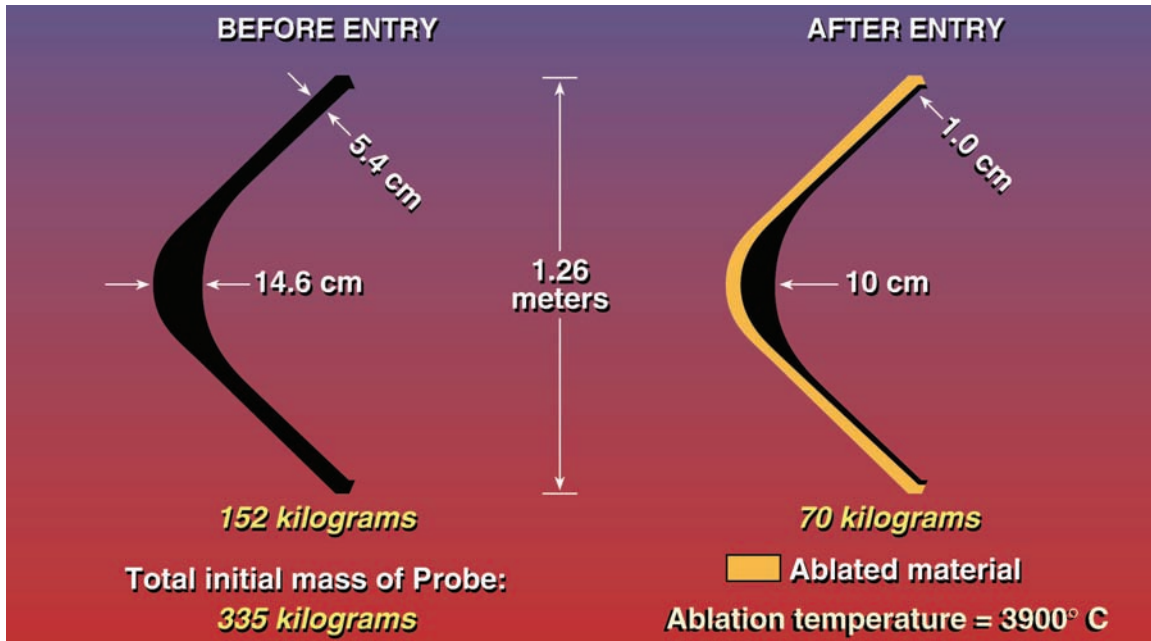

High Heat Flux

Entry into planetary environments exposes the aeroshell to severe thermal environments (Figure 4.16). Atmospheric drag is utilized to reduce the interplanetary hypervelocity entry to low speeds in the atmosphere, where the scientific measurements are performed or where the payload is delivered. This atmospheric entry results in the extreme aerothermal environment around the aeroshell. In conjunction with entry probe shape and velocity, the severity of the environment is driven by atmospheric properties, such as gas composition, density, temperature, and pressure.

At heat fluxes of 120 W/cm^2 , entry into the atmosphere of Mars and Titan is benign compared to conditions at Venus and much less severe than will be encountered by entry probes to the giant planets. Entry probes at Jupiter experience the most severe environment as a consequence of the gravitationally induced high entry velocities. For example, when the Galileo probe entered Jupiter, it experienced radiative heating in excess of $20,000 \text{ W/cm}^2$ and convective heating approaching $10,000 \text{ W/cm}^2$, for a total heat flux exceeding $30,000 \text{ W/cm}^2$ (Figure 4.17). However, the process for fabricating the carbon phenolic material used for Galileo is no longer in use and any new material would need to be requalified for use at Jupiter in a hydrogen arc jet facility (called the Giant Planets Facility at NASA

Ames Research Center), which is no longer operational.

Figure 4.17: Thermal Protection Systems — Materials.

NASA entry probes have survived entry environments ranging from the very mild (Mars Viking ~ 25 W/cm^2) to the extreme (Galileo $\sim 30,000$ W/cm^2). The environment for the proposed Saturn and Neptune probes would be less severe than for the Galileo probe, but the most suitable materials may no longer be available. Aerocapture at Neptune would involve a different set of conditions requiring a tailored solution.

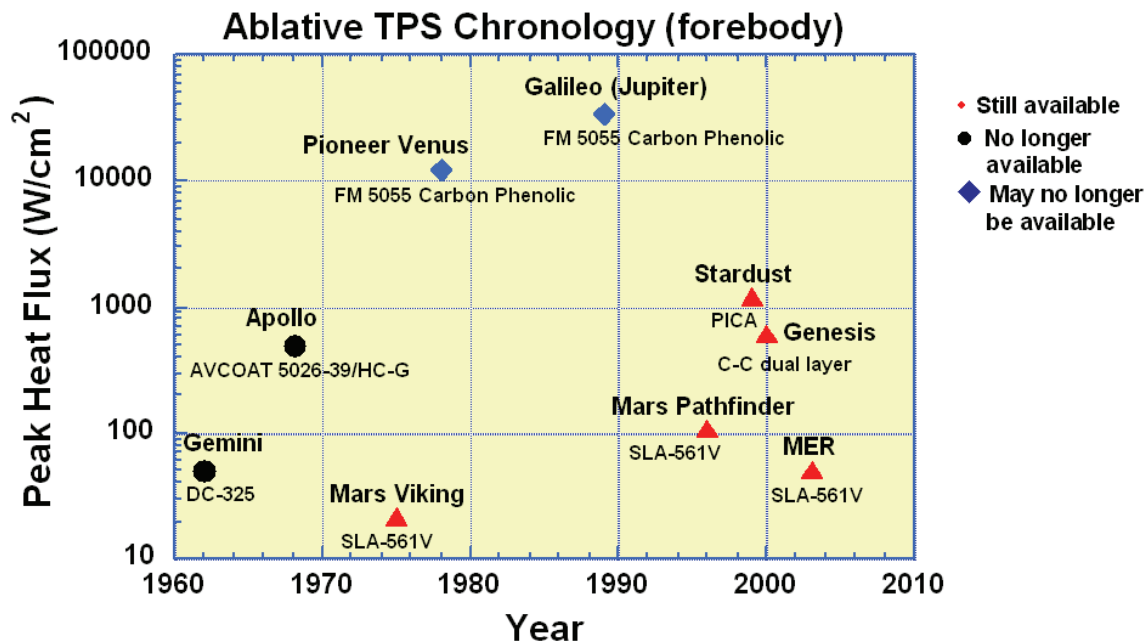

The first proposed probe mission in this Roadmap is the Saturn Flyby with Shallow Probes mission, which would experience a significantly less demanding environment than that of the Galileo probe. NASA should ascertain if there are existing legacy materials appropriate for Saturn probes and if modeling and simulation of material performance properties is a viable alternative to arc jet testing, which would require a major investment in a hydrogen arc jet facility.

The Neptune–Triton Explorer missions would require protection from the heat of entry for both the Neptune entry probe and the aerocapture system. The requirements on the aerocapture system are much more stringent for the probe. The technology investment envisaged here is intended to not only recapture Galileo’s entry capability, but to advance it to higher velocity entry with smaller entry vehicles and with larger payload fractions. A substantial investment in a hydrogen–helium arc jet test facility might be needed for both the development and qualification of thermal protection systems. As noted in the Trans-

portation Technologies section, a technology validation experiment for a mid L/D aeroshell should be considered.

In summary, the investment in thermal protection technology would not only enable a Saturn probe mission but also a Neptune–Triton Explorer mission with probes and an aerocapture orbiter. Moreover, benefits also extend to Venus missions and to sample return missions.

4.5 Science Instruments

To perform investigations at the priority targets over the next decades, many missions would perform intensive orbiting or in situ explorations of planetary bodies and, in some cases, return samples to Earth for detailed analysis. For outer planet missions, payload mass is at a premium. NASA is investing in instrument technologies primarily through the SMD R&A Program.

Several NASA R&A Programs, such as the Planetary Instrument Definition and Development Program (PIDDP), the Mars Instrument Development Program (MIDP), the Astrobiology Science and Technology Instrument Development (ASTID) Program, and the Astrobiology Science and Technology for Exploring Planets (ASTEP) Program, are addressing these instrument technology needs. Recent cutbacks, particularly in astrobiology instrumentation, have severely impacted these programs.

Both remote–sensing and in situ instrument development programs have also benefited from a three–decade–long investment in basic sensor components and advanced measurement device technology most recently managed by the Exploration Systems Mission Directorate (ESMD). That program’s accomplishments include radiation–resistant imaging CCDs (first used on Galileo), solid–state lasers (first used on Mars Global Surveyor) and thermopile detectors and micromachined diffraction gratings (used in Mars Reconnaissance Orbiter). Two years ago this vital program was terminated and funds reprogrammed to address other needs in the ESMD. With no new component technologies in the pipeline, there will be a serious impact on innovation in scientific instruments. *An SMD–wide component development program, analogous to the cancelled program in ESMD, is needed to ensure a continued supply of innovative devices.*

There is one additional gap in the science instrument programs. Whereas the MIDP does an effective job of bridging the gap between instrument concepts and flight instrumentation for instruments applicable to Mars, there is no comparable program devoted to instruments for application at other Solar System exploration targets. The consequence is that many promising instrument concepts “die on the vine” and are not ready to propose for a flight mission when the opportunity arises. A Solar System Instrument Development Program (SIDP) focused on bridging the gap between programs like PIDDP and ASTID and flight

Figure 4.18: The GCMS instrument on the Huygens probe.

Gas Chromatograph and Mass Spectrometer (GCMS) collected data on the composition of the atmosphere from an altitude of 146 km to ground impact and for a further 1 hour and 9 minutes after landing. Mass spectra were collected during descent and on the ground over a range of m/z from 2 to 141. Eight gas chromatograph samples were taken during the descent and two on the ground. The major constituents of the lower atmosphere were confirmed to be N_2 and CH_4 . Isotope ratios for the major carbon and nitrogen isotopes were measured. This instrument was launched in 1997; advances in technology can enable a reduction in mass and power, and improvements in sensitivity of this class of instruments.



could provide a solution.

4.5.1 Remote Sensing

Remote-sensing techniques include passive methods where radiation emitted or reflected from the target object is sensed and active methods where a source of radiation (optical or microwave) is used to illuminate the target and the scattered radiation observed.

Passive Remote Sensing

The power of passive remote sensing has been amply on view with the Cassini mission, which has deployed a comprehensive range of instruments for observing Saturn, and its moons and satellites (Figure 4.18). New technology makes it possible to improve measurement capabilities and deploy them in smaller packages. Key areas where this is possible and has in fact been demonstrated are visual imaging; infrared imaging and radiometry; and ultraviolet, infrared, and microwave spectroscopy (Figure 4.19).

Early definition of future passive remote-sensing instruments is funded by the PIDDP. However, the MIDP has not typically funded this class of instrumentation, leading to a gap in bringing new passive remote-sensing instrument concepts to flight readiness.

Figure 4.19: CRISM on MRO.

The Compact Reconnaissance Imaging Spectrometer for Mars (CRISM) on the Mars Reconnaissance Orbiter is a hyperspectral imaging spectrometer designed to map the surface mineralogy of Mars. It will measure 560 individual wavelengths of sunlight reflected from the surface in the range from 400 to 4050 nm (visible to shortwave infrared) at 6.55 nm/channel.

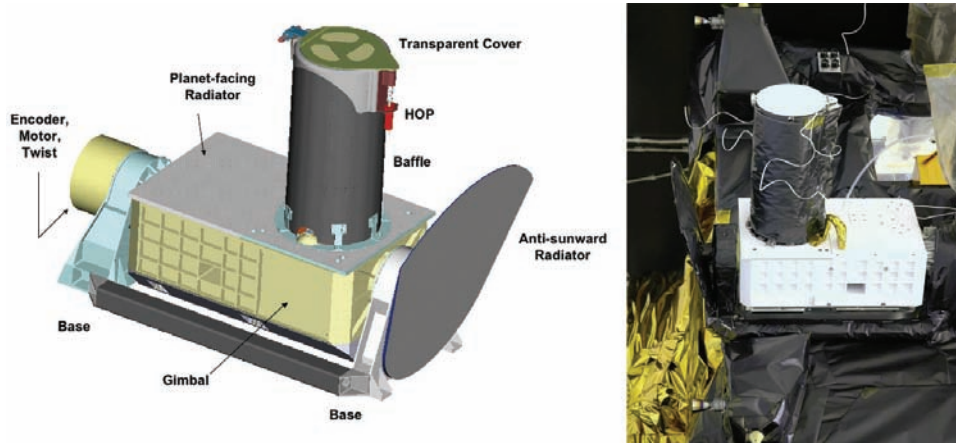

Active Remote Sensing

Technology developments continue to enable new capabilities in active remote-sensing measurements from orbit or from aerial and surface vehicles. The NASA-developed Mars Orbiter Laser Altimeter (MOLA) [Afz94] on Mars Global Surveyor, for example, pioneered the use of solid-state lasers to acquire the first high-precision topographic maps of the surface of Mars. In the future, new types of laser systems will enable the detection of trace atmospheric species by molecular absorption, mineralogical identification exploiting the Raman effect, and elemental analysis using laser ablation (i.e., laser-induced breakdown spectrometry, or LIBS). Active scanning laser systems will enable three-dimensional mapping of landing sites with centimeter-level vertical precision as well as direct detection of ices within shadowed or night-side regions.

Active microwave systems play a key role in image the surfaces of objects with atmospheres that obscure the surface (Venus and Titan) and probing the subsurface of planets and satellites. The success of the Mars Advanced Radar for Subsurface and Ionosphere Sounding (MARSIS) instrument (Figure 4.20) on Mars Express builds confidence in the potential use of this technology in the outer Solar System at Europa, Enceladus, and Titan.

Currently, there are only limited sources of support for active remote-sensing technology. Although motivated originally to explore the potential of a fission-powered orbiter, the High Capability Instruments for Planetary Exploration (HCIPE) Program enabled progress on new kinds of active sensors that would be practical at modest power levels. The cancellation

Figure 4.20: MARSIS sounder transmit and receive boxes.

MARSIS (Mars Advanced Radar for Subsurface and Ionosphere Sounding) is a low-frequency, nadir-looking, pulse-limited radar sounder and altimeter with ground penetration capabilities, which uses synthetic aperture techniques and a secondary receiving antenna to isolate subsurface reflections. Sounding instruments similar to this have applications for investigating subsurface structure including the thickness of icy crusts on outer planet satellites.

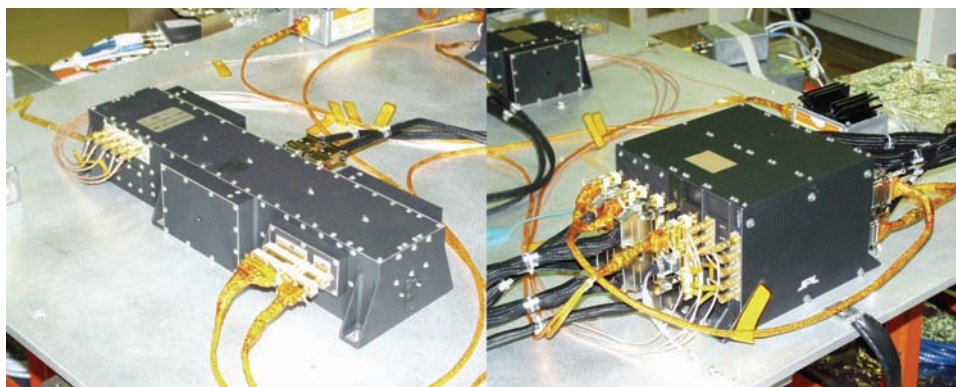

of HCIPE has removed this source of support. As with passive remote sensing, with the exception of short-range techniques that might be applied on a planetary surface, active sensing is not within the scope of the MIDP.

4.5.2 In Situ Instrumentation

In situ measurements would be needed for the three Flagship missions that would descend to the surface of Europa or operate at the surface and within the atmospheres of Venus and Titan. These instruments would be targeted at determining the characteristics of the Solar System that led to the origin of life (see Table 3.1). In this context, they would help answer questions about the nature, history, and distribution of volatile and organic compounds in the Solar System, determining the evidence of a past ocean on the surface of Venus, and identifying the habitable zones in the outer Solar System. They would also address the issue of how did life begin and whether it has evolved elsewhere in the Solar System. In this context, it is necessary to identify the source of simple chemicals important to prebiotic evolution; direct evidence for life on Europa, Titan, and Enceladus; and evidence for past life on Venus. Many of these questions would be much easier to answer if these materials could be returned to terrestrial laboratories. For these targets, this is impractical and hence in situ technologies must be brought to maturity.

Sample Acquisition and Preparation

At the front end of an in situ instrument is the sample acquisition and preparation system. Sample acquisition is a broad system-level capability, requiring by its nature, operation at the extreme environment of the sampling site and, as a result, the interaction of a number

Figure 4.21: In situ sample acquisition and analysis.

Many scientific investigations require retrieval of samples from various depths beneath the surface of the object being investigated. A variety of approaches for acquiring samples are shown here in these instruments developed for sample acquisition in silicate materials. The drill at the left developed by Honeybee Robotics has the ability to autonomously connect drill segments. The mini corer upper right is designed for sampling rock. Sampling devices for the very cold icy surfaces of outer planet satellites will need to be designed specifically for these environments.

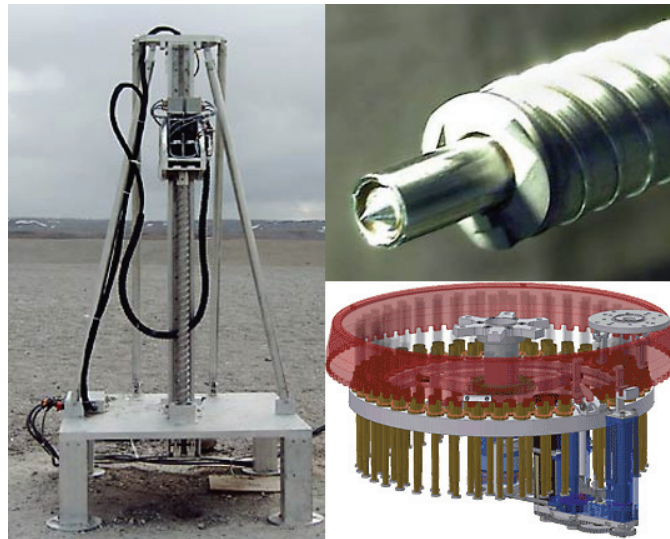

of new technologies. In addition to the development of appropriate mechanical systems, additional research may be required to understand the mechanical properties of natural materials, such as ice and rock, in environments like those of the targets of interest.

It is also important to link this capability to mobility because sample acquisition clearly affects a vehicle's design, whether it is a surface rover with drilling capability, or acquisition of liquid samples from the surface of Titan by an aerial vehicle. On the receiving end, an analytical instrument suite would have its own systems-level requirements for the nature of the received sample. A further challenge is presented by the need (in many cases) to satisfy planetary protection requirements, or contamination control for improved science return.

Sample acquisition, by its nature an interface between a sampling platform and an analytical instrument suite, represents a key systems engineering concern facing different challenges for each target of interest. (See Figure 4.21.) Sample acquisition systems would be an appropriate topic area for inclusion in the SIDP described above.

In situ Analysis and Sensing

Answering questions related to habitability involves a vast range of measurement types far

beyond the scope that can be discussed here. Mineral and isotopic analysis will be important to answer many of the questions related to Venus with instruments deployed on VISE and VME. For Europa, Titan, Enceladus, and comet samples, the focus would be on detecting and characterizing organic materials, possibly with biological significance. While the experience developing instruments for Mars is relevant, most of the target objectives are primarily composed of water ice and not silicates.

4.5.3 Component Development and Miniaturization

For both remote sensing and in situ sensing techniques, advances in components (detectors, sources, transducers) can lead to new measurement capabilities. Miniaturization is another compelling need to increase the capabilities of missions that are highly mass constrained.

Component Development

New components and devices exploiting nanotechnology and microfluidics have potential for more sensitive and precise measurements for characterizing minerals and organic materials. A major focus of this work will be on the detection of evidence for extinct and extant life-forms. In situ measurement capabilities applicable to extreme environments such as those of Venus, where conventional techniques applied at Mars may not be practical, are also needed.

As noted earlier, the NASA pipeline for these technologies has now been shut down. A slowdown in innovation will be the inevitable consequence.

Miniaturization

Miniaturization, even uncoupled with a gain in measurement capability, is important for both orbital and in situ exploration. Recent miniaturization initiatives have achieved real success in mass reduction. NASA-developed thermopile detectors enabled a three-fold (35 kg) mass reduction of the Mars Climate Sounder on the Mars Reconnaissance Orbiter, relative to a comparable instrument flown eight years previously on the ill-fated Mars Climate Orbiter.

For in situ missions, where mass, power, and volume are at a premium, miniaturization can have an even bigger impact (Figure 4.22). For missions requiring radiation shielding, miniaturization of electronics and instrument components could result in a very large savings in shielding mass and volume.

The benefits of advances in miniaturization would apply to all five of the proposed Flagship missions described in this Roadmap. In addition, these benefits will apply to Discovery and New Frontiers missions. For a Saturn probe mission, for example, instrument miniaturization could make it possible to fly multiple probes. There is no single approach to miniaturization. In some cases, a miniature component can make the key difference. In other cases, it may be advances in system design.

Figure 4.22: Miniature X-ray Diffraction Fluorescence Spectrometer.

Advances in component technologies, such as detectors, and radiation sources, can improve the speed and sensitivity of scientific instruments. Carbon nanotube technology may result in miniaturized high performance X ray sources useful in element and mineral identification.

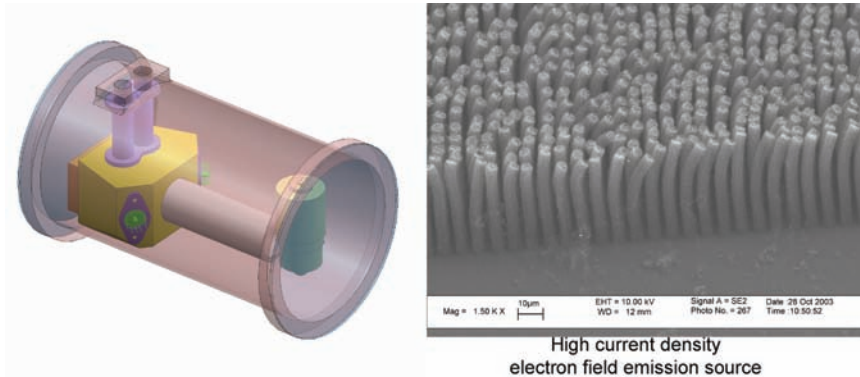

4.6 Summary

Science instrument technology plays a vital role in this Roadmap, and are needed to enhance or enable missions for Solar System exploration. In Table 4.3, the impact of advances in technologies on the Roadmap missions is illustrated. For the Flagship missions, where the objectives are well defined, these assessments necessarily have more fidelity than for Discovery missions where the range of opportunities is much broader. Priorities based principally on the Flagship and New Frontiers section appear in Table 4.1.

4.6.1 Spacecraft Systems

All five Flagship missions described in this plan, due to the extreme environments they would explore, may require RPSs for furnishing electrical power. Currently, there is an insufficient supply of plutonium-238 to fuel all potential RPS systems that would be baselined for these potential Roadmap missions.

Recommendation: *NASA must work with the relevant federal entities to ensure that adequate electrical power is provided for missions that require radioisotope power systems (RPSs).*

Recommendation: *NASA must also develop, at a pace consistent with planned missions, more efficient power conversion technologies to make the best use of the Pu-238 in the inventory. Not only that this would provide a more effective use of plutonium, but the gain in specific power would be advantageous for a number of missions where mass is critical.*

Table 4.3: Impact of Advanced Technology Development on Roadmap Missions.

Major Questions	Discovery				New Frontiers					Flagship (Small/Large)									
Objectives	SB	Moon	Venus	Mercury	NH	Juno	SPABSR	WISE	CSSR	SP	C-H	EE	TE	VME	EAL	NTE	CCSR*	VSSR*	
SPACECRAFT SYSTEMS TECHNOLOGIES																			
Transportation																			
▷ Access to Space					⊕	⊕					⊕				▲	▲			
▷ Solar Electric Propulsion	▲	▲	▲	▲	⊕	⊕			▲	▲	⊕		▲		▲	▲	▲	▲	
▷ Aerocapture / Aeroassist			▲		⊕	⊕	▲				⊕		●	▲		●		▲	
▷ Advanced Chemical Propulsion		▲		▲	⊕	⊕				▲	⊕	▲		▲	●			▲	
Power																			
▷ Radioisotope (RPS)					⊕	⊕					⊕	▲	▲	●	●	▲			
▷ Solar Power	▲	▲	▲	▲	⊕	⊕			▲	▲	⊕		▲		▲	▲	▲	▲	
▷ Energy Storage	▲	▲	▲	▲	⊕	⊕	▲	▲	▲	▲	⊕	▲	▲	▲	▲	▲	▲	▲	
Communications																			
▷ Direct-to-Earth Communications	▲	▲	▲	▲	⊕	⊕	▲	▲	▲	▲	⊕	▲	▲	▲	▲	▲	▲	▲	
▷ Proximity Links					⊕	⊕	▲			▲	⊕		▲		▲	▲		▲	
Planetary Protection																			
▷ Forward Planetary Protection					⊕	⊕					⊕	▲	●		●				
▷ Returned Sample Handling					⊕	⊕			▲		⊕							▲	
Autonomy and Software																			
▷ Autonomous systems	▲	▲	▲	▲	⊕	⊕	▲	▲	▲		⊕		▲	▲	▲	▲	▲	▲	
▷ Software V&V	▲				⊕	⊕			▲		⊕		▲	▲	▲	▲	▲	▲	
IN SITU EXPLORATION TECHNOLOGIES																			
Entry, Descent, and Landing																			
▷ Precision Navigation	▲	▲			⊕	⊕			▲		⊕				●			▲	
▷ Hazard Avoidance	▲				⊕	⊕			▲		⊕		▲	▲	●			▲	
▷ Small Body Anchoring	▲				⊕	⊕			▲		⊕							●	
Planetary Mobility																			
▷ Aerial			▲		⊕	⊕		▲			⊕		●	●					
▷ Surface					⊕	⊕	▲	▲			⊕		▲	●					
▷ Subsurface access					⊕	⊕					⊕				●		●	▲	
Extreme Environments Technologies																			
▷ High Temperature/Pressure			▲		⊕	⊕		●			⊕			●	●			●	
▷ Low Temperature	▲	▲		▲	⊕	⊕	▲		▲		⊕		●		●			▲	
▷ High Radiation					⊕	⊕					⊕	▲			●				
▷ High Heat Flux			▲		⊕	⊕		▲	▲	●	⊕		▲	▲		●	▲	●	
SCIENCE INSTRUMENTS																			
Remote-Sensing Instruments																			
▷ Active Remote Sensing	▲	▲	▲	▲	⊕	⊕					⊕	▲	▲	▲			▲		
▷ Passive Remote Sensing	▲	▲	▲	▲	⊕	⊕				▲	⊕	▲	▲	▲			▲		
In Situ Instruments																			
▷ Analytical Instruments	▲		▲		⊕	⊕	▲	●	▲		⊕		●	●	●			▲	▲
▷ Sample Acquisition & Handling					⊕	⊕	▲	●	●		⊕		●	●	●			●	●
Component Technology and Miniaturization																			
▷ Component Technologies	▲	▲	▲	▲	⊕	⊕	▲	▲	▲	▲	⊕	▲	▲	▲	●	▲	▲	▲	
▷ Miniaturization	▲	▲	▲	▲	⊕	⊕	▲	▲	▲	▲	⊕	▲	▲	●	●	▲	▲	▲	
Convention: ● Major or Unique Contribution; ▲ Support Contribution; ⊕ Ongoing Mission or Project																			
SB — small bodies; NH — New Horizons; SPABSR — South Pole-Aitken Basin Sample Return; WISE — Venus In Situ Explorer; CSSR — Comet Surface Sample Return; SP — Saturn Flyby with Shallow Probes; C-H — Cassini-Huygens; EE — Europa Explorer; TE — Titan / Enceladus Exp.; VME — Venus Mobile Exp.; EAL — Europa Astrobiology Lander; NTE — Neptune-Triton Explorer; CCSR — Cryogenic Comet Surface Sample Return; VSSR — Venus Surface Sample Return * — beyond the 5 proposed Flagship missions																			

Access to the outer Solar System is a vital part of the program described here and space transportation technologies are a key element of this access. Two of the missions — Titan (with or without Enceladus) Explorer and Neptune–Triton Explorer — require the use of aerocapture to deliver payloads of the required mass into orbit with much shorter trip times than could be achieved with chemical propulsion.

Recommendation: *NASA should continue to invest in aerocapture technology and conduct space flight validations of this technology in a time frame synchronized with the decision points identified in this Roadmap.*

4.6.2 In Situ Exploration

Access to extreme environments, both extremely hot near the surface of Venus and extremely cold at the moons of the outer planets, requires investments in a suite of technologies to enable probes and mobile platforms to survive and operate in these environments.

Recommendation: *NASA should initiate a technology development program in technologies for extreme environments. Many of the needed technologies are currently at a very low technology readiness level (TRL) and the gestation period of development is long. Accordingly, initiating this program as soon as practicable will have a major impact on the feasibility of future Flagship missions and will also benefit Discovery and New Frontier missions.*

4.6.3 Science Instruments

There are serious gaps in support of instrument programs. Programs that have historically funded instrument component technologies no longer exist and critical gaps remain in developing the appropriate capabilities. While the Mars Technology Program funds development of instrument technologies, bridging the gap from definition to flight, there is no comparable program for exploration of other Solar System targets.

Recommendation: *NASA should reexamine its Solar System Exploration Instrument Programs, particularly in the light of recent funding reductions, and strive to achieve a better balance between component development, instrument definition, and instrument development, with a focus on bridging the gap to flight. The restoration of funding for programs that have been cut or eliminated in the context of recent reprogramming to meet the needs of human exploration missions needs to be pursued at the earliest opportunity.*

5 Research and Analysis

NASA’s science objectives require a strong scientific and technical community to envision, develop, and deploy space missions, and to interpret and apply results from these missions for the benefit of society. The Research and Analysis (R&A) Programs provide the foundation upon which NASA missions are ultimately built, and the framework within which the nation’s large and unique investment in space exploration is realized.

The mission cycle begins with the definition based on previous discoveries of clear and attainable science objectives, followed by mission concept development, implementation, flight, concluding with data analysis, R&A Programs utilizing the data, and definition of new objectives for follow-on missions. The R&A and instrument and technology development programs enable exploration of innovative concepts in sufficient depth to determine whether they have real potential. Being able to move from a promising science goal to practical mission definition requires the availability of the theories, modeling, data analysis techniques, and instrumentation that are developed in the R&A Programs. The approaches that are suggested on the basis of this groundwork are then tested via NASA-supported laboratory and/or observational (airborne, ground-, and space-based) work. Once a mission has actually flown, its productivity can be multiplied through R&A investigations.

R&A Programs are the **primary NASA vehicle for training** the next generation of mission team members, principal investigators, and project scientists. They furnish the necessary resources to nurture this community by supporting instrument and technology development; experimental, theoretical, computational, modeling and field research; and laboratory studies, telescopic observations, and sample analyses. Astrobiology research programs, which include investments in the science, advanced instruments, and field programs of life detection in extreme terrestrial environments, are a vital part of the overall Solar System exploration R&A Program. Because Solar System exploration stimulates young people to careers in the physical sciences, beyond planetary science itself, R&A Programs are essential contributors to maintaining national competitiveness in science over the three-decade span of the Roadmap. The planetary science community is different from other disciplines in having a much larger fraction of its personnel supported solely by mission and R&A “soft money” programs, and relatively less by “hard money” positions wherein their salary is fully covered by non-competitively selected funding. A strong R&A Program is therefore more critical than in other disciplines for training the next generation of planetary scientists.

IN ORDER TO ACCOMPLISH THE SOLAR SYSTEM EXPLORATION ROADMAP OBJECTIVES, NASA SHOULD FUND R&A AT OR ABOVE 2005 LEVELS.

Data analysis programs support the interpretation of scientific data returned by science missions with the goal of maximizing NASA’s and the nation’s investment in spacecraft and other data-collection resources. Data analysis programs are fundamental to achieving

NASA's science objectives because they fund analysis both during and after a spacecraft's lifespan. NASA also supports long-term data archiving and database services, which are critical to ensuring accessibility and preservation of the large quantity of data returned by its missions. NASA science missions are now returning vast amounts of data, and funding for analysis of these data has not kept pace with funding for the missions themselves. For example, the Mars Reconnaissance Orbiter, which arrived at Mars in 2006, is expected to return 300 TB of data over the course of the mission, which is several orders of magnitude more data than all previous Mars missions combined. In 2005, funding for the R&A Programs comprised only about 10% of the Solar System exploration budget, and budget pressures in 2006 and later are causing this percentage to decrease. Similarly, while the amount of data and the complexity of the data are increasing, the funding for access and preservation of these data via the Planetary Data System is decreasing.

PAST EXPERIENCE INDICATES THAT APPROPRIATE FUNDING OF DATA ANALYSIS AND DATA ARCHIVING ACTIVITIES IS ESSENTIAL TO DERIVING THE FULL BENEFIT FROM THE PROGRAM OF SOLAR SYSTEM EXPLORATION MISSIONS OUTLINED IN THIS STRATEGIC ROADMAP. DATA ANALYSIS PROGRAMS THAT WERE SUCCESSFUL IN PROVIDING IMPORTANT RESULTS IN A TIMELY FASHION FROM SPACE MISSIONS SHOULD BE USED AS MODELS TO SET THE SCOPE AND TIMING OF FUTURE DATA ANALYSIS PROGRAMS.

6 Education and Public Outreach (E/PO)

For nearly 50 years, NASA’s exploration of the Solar System has motivated and inspired young people of all backgrounds to pursue advanced studies in science, technology, engineering, and math (STEM) fields. The leaders of this nation have recognized that the need for a technologically–literate — or at least a technologically–appreciative — public has grown as new technologies have entered virtually all aspects of public life, from grocery shopping to pumping gas. Yet recent studies¹ show the US lagging behind other countries in STEM education, along with other benchmarks of technical innovation (see box). Outsourcing of US jobs at all levels, including those in high–level science and technology fields, has become a topic of increasing debate.

FOR MORE THAN HALF A CENTURY, THE UNITED STATES HAS LED THE WORLD IN SCIENTIFIC DISCOVERY AND INNOVATION... HOWEVER, IN TODAY’S RAPIDLY EVOLVING COMPETITIVE WORLD, THE UNITED STATES CAN NO LONGER TAKE ITS SUPREMACY FOR GRANTED. NATIONS FROM EUROPE TO EASTERN ASIA ARE ON A FAST TRACK TO PASS THE UNITED STATES IN SCIENTIFIC EXCELLENCE AND TECHNOLOGICAL INNOVATION.

Task Force on the Future of American Innovation

Much as the Apollo Moon landings spurred a generation to become science and technology enthusiasts, so too have recent discoveries in our Solar System, and of planets around other stars captured the imagination of a new generation. NASA engages young minds and entices them to continue along educational pathways, providing a wealth of opportunities later in life, to both their benefit and to the benefit of the nation. Solar System Exploration education initiatives continue NASA’s tradition of investing in the nation’s education programs and supporting the country’s educators. These teachers, both formal and informal, play a key role in inspiring, exciting, encouraging, and nurturing the young minds of today who will manage and lead the laboratories and research centers of tomorrow.

In 2006 and beyond, NASA will continue to pursue three major education goals:

- **Strengthen NASA and the nation’s future workforce** — Contribute to the development of the nation’s future STEM workforce through a diverse portfolio of education initiatives that target students at all levels, especially those in traditionally underserved and underrepresented communities.

¹ “*Rising Above The Gathering Storm: Energizing and Employing America for a Brighter Economic Future*,” 2006, National Academy of Sciences Committee on Prospering in the Global Economy of the 21st Century: An Agenda for American Science and Technology (<http://fermat.nap.edu/catalog/11463.html>); and “*The Knowledge Economy: Is the United States Losing Its Competitive Edge? Benchmarks of our Innovation Future*,” 2005, Task Force on the Future of American Innovation (<http://www.futureofinnovation.org/>).

- **Attract and retain students in STEM disciplines** — Focus on engaging and retaining students in STEM education programs to encourage their pursuit of educational disciplines critical to NASA’s future engineering, scientific, and technical missions.
- **Engage Americans in NASA’s mission** — Build strategic partnerships and linkages between STEM formal and informal education providers through hands-on, interactive, educational activities; engage students, educators, families, the general public, and all NASA stakeholders to increase Americans’ science and technology literacy.

6.1 E/PO Implementation Approach

To address the first goal above, Solar System Exploration (SSE) and the Science Mission Directorate (SMD) continue to emphasize NASA’s traditional role in higher education: promoting professional development by supporting undergraduate, graduate, and post-doctoral involvement in research programs. The SMD’s policy has been — and should continue to be — to incorporate education and public outreach integrally in all of its activities, both flight missions and research programs. Science mission personnel and researchers, in particular, are encouraged to become active participants in education and outreach activities. SSE E/PO practitioners focus on identifying and meeting the needs of educators, and on emphasizing the unique contribution NASA SSE science can make to education and to engaging the public in the process of scientific discovery. SSE E/PO Programs use scientific discoveries as vehicles to improve teaching and learning at all levels.

To address the second and third goals, SSE E/PO Programs share the results of missions and research programs with wide audiences. With limited resources, leverage is key to building a national program that contributes both to improving teaching and learning at the pre-college level and to increasing the scientific literacy of the general public. One achieves this leverage by building on existing programs, institutions, and infrastructure, and by coordinating activities and encouraging partnerships with other ongoing education efforts both within and external to NASA. SSE E/PO leads have established alliances for informal education with science centers, museums, and planetariums, as well as producers of public radio and television programs. They bring the results of the science program to teachers, students, and the public through partnerships with community organizations of many different types across the country. In all of these partnerships, Solar System specialists provide science content and expertise, relying on E/PO partners to provide the educational expertise and knowledge of standards (both local and national).

Solar System educational products are readily available to educators through an online education resource directory (<http://solarsystem.nasa.gov/educ>) that is linked to other NASA and national databases of educational materials. To improve opportunities for participation by an increasingly diverse population, SSE E/PO emphasizes inclusiveness and development of special opportunities for minorities (students, educators, and institutions), students with

disabilities, and other targeted groups. Finally, assessment plays a key role in SSE E/PO development: expert feedback is sought on quality and impact through a variety of evaluations by external groups.

6.2 Future E/PO Efforts

NASA should continue to engage the public with Solar System exploration, and to inspire and educate students to pursue STEM careers. One strategic focus for NASA SSE E/PO efforts should be to nurture and expand successful programs, which are aimed at meeting the needs of the educational communities in an accessible and audience-appropriate way. A second focus should be to realign or re-energize programs that have not achieved full potential. Thirdly, we should provide a progression of educational opportunities: identify pathways between programs for the people participating in them, enabling them to continue exploring their interest and enabling life-long learning, and provide clearer pathways to careers supporting NASA and national workforce needs.

The overall goal of future SSE E/PO activities is to improve both quality and impact. The resulting strong program will create and cultivate a technologically-literate 21st century workforce; create and cultivate an E/PO-literate NASA workforce; stimulate scientists in their research endeavors; motivate students from diverse backgrounds to pursue STEM careers; provide teachers with materials and programs to inspire and educate their students; explain what NASA does; and return to the taxpayers — who fund NASA’s work — the fruits of their investment.

Planned activities include the following:

- Coordinate SSE E/PO Programs with other NASA education efforts, such as NASA’s Explorer Schools and NASA’s higher education programs, to optimize SSE’s contribution to achieving the Agency’s overall education goals;
 - Continue the professional training of scientists by supporting research assistantships and postdoctoral opportunities offered through SMD research awards, through Planetary Science Division internships, and through other NASA research and higher education programs;
 - Provide opportunities for students (at both university and precollege levels) to work directly with Solar System Exploration missions, facilities, and data; opportunities such as the Athena Interns and Mars Student Imaging Project often inspire career choices and life-long interests;
 - Increase opportunities for diverse populations to participate in science missions, research, and E/PO Programs: encourage minorities by working in partnership with minority institutions and professional societies; and expand the accessibility of NASA SSE E/PO Programs and products to other underrepresented and underserved groups, including girls, residents of rural areas, and persons with disabilities;
-

- Build on mutual interests between Solar System exploration and the informal education communities (science centers, museums, and planetariums), as is being done in programs like NASA’s Museum Alliance;
 - Enrich the STEM education efforts of community groups such as the Girl Scouts, 4–H Clubs, and Boys and Girls Clubs (SSE’s E/PO partnership with Girl Scouts USA grew into a partnership with all of the Science Mission Directorate, and from that blossomed to a full NASA partnership to reach millions of girls across the nation);
 - Take advantage of the advanced technology required by Solar System exploration to develop new materials and new programs in engineering education, and to work in partnership with technology education organizations such as International Technology Education Association (ITEA) and First Robotic;
 - Assure quality of our education programs and products through rigorous evaluation efforts and sustained professional development for E/PO personnel; and
 - Seek out and capitalize on special Solar System events and promising SSE opportunities to engage the public in the process of scientific discovery and to improve STEM education at all levels.
-

7 Interdependencies

Understanding key relationships between elements of the program and with other roadmaps was a key objective of the Strategic Roadmap process. Section 7.1 covers interdependencies between Flagship class missions, other mission classes, and missions in other programs. Section 7.2 explores dependencies of Flagship missions on the Solar System Technology Development Program and on the Space Flight Validation activities conducted under NASA's New Millennium Program.

7.1 Interdependencies Among Missions and Mission Lines

There are a number of interdependencies between and among Flagship missions and missions in the Discovery and New Frontiers Programs. There are also interdependencies between Flagship class missions and missions in the Mars Exploration Program (MEP) and in the Robotic Lunar Exploration Program (RLEP). These interdependencies have many aspects. Some missions may share a common technology that has not previously been flown in space, and the application to the first mission will usually reduce the cost and risk to the next. Some missions may be coupled because the first mission acquires vital data on the environment of a target planet or satellite that is needed for the design of the subsequent mission. Still others may obtain vital scientific data needed to define scientific investigations of the later mission.

In the MEP, the desire to take advantage of mission interdependencies led to an early decision to fly landed and orbital missions on alternate Mars flight opportunities. Solar System exploration missions involve a variety of targets and long trip times and taking advantage of interdependencies is much more complex. Adding to the complexity is the fact that the required separation between the initial mission and the one that is dependent on it will depend on the nature of the interdependency. In this section, we attempt to characterize some of those interdependencies, which were important in determining the Flagship mission sequence adopted here or will influence actions at the key decision points.

7.1.1 Within the Flagship Program

The sequence and spacing of missions in the Flagship mission set permits both scientific and technological feed forward from early missions to later missions that are more technologically challenging or required more knowledge of the target object. The Flagship mission sequence is illustrated in Figure 3.8. The interdependencies are as follows:

- **Cassini to Titan / Enceladus Explorer:** Cassini has revolutionized humankind's understanding of the Saturn system, and in particular has provided data underscoring the high priority of future missions to Enceladus and Titan. Continued observations from Cassini are needed to formulate a Titan / Enceladus Explorer mission. More extensive surface coverage of Titan at better than 1 km spatial resolution, continued observation on Titan of atmospheric phenomena and changes over time, and deeper
-

exploration of the Enceladus plume and associated active areas will be highly beneficial to follow-on missions to these bodies.

- **Europa Explorer to Europa Astrobiological Laboratory:** Observations from the Flagship mission Galileo elevated Europa to a very high priority for solar system exploration. In turn, observations from Europa Explorer are needed to properly design systems that can safely land and operate on the topographically irregular surface of Europa, to select the most scientifically useful landing sites and to refine the scientific objectives for the follow-on Europa Astrobiological Laboratory mission.
- **Titan Explorer to Neptune–Triton Explorer:** Both of these missions as conceived will require the use of aerocapture. The use of aerocapture at Titan will be the less demanding and could serve as a precursor for some aspects of the more challenging application at Neptune.

7.1.2 Between the New Frontiers and Flagship Programs

New Frontiers (NF) missions are necessarily less ambitious technically than Flagship (FS) missions. In the cases considered here, the less ambitious New Frontiers missions are assumed to precede and feed forward capabilities into the FS missions. However, since the sequence of the New Frontiers missions is determined competitively, the coupling of the interdependencies will need to be less tight and more flexible than among the Flagship class missions. As Figure 7.1 illustrates, the next New Frontiers competition (NF3) is currently planned to occur in 2008. The NF3 selection will result in one of four New Frontiers candidates going forward. These selections may have impacts on the decision points for future FS missions:

- **Venus In Situ Explorer (New Frontiers) and Venus Mobile Explorer (FS)** — Both of these missions operate at or near the Venus surface. VISE is a fixed lander of limited duration (hours); VME would be a mobile mission of extended lifetime (months). The US has no experience in operating spacecraft on the surface of Venus even for limited periods and so VISE would be a valuable precursor to VME. It would still be an effective precursor if the selection of VISE was deferred to NF4 but no later if the VME schedule holds.
- **Saturn Flyby with Shallow Probes (New Frontiers) and Neptune–Triton Explorer (FS)** — The benefits of the Saturn mission to the Neptune mission are twofold. The Saturn Flyby probe can demonstrate thermal protection systems to be used for a Neptune probe, implemented as part of NTE. There is also the potential for a deploying a technology experiment on SFP that might validate a mid-L/D aerocapture system for later use at Neptune.
- **Comet Surface Sample Return (New Frontiers) and Comet Cryogenic Sample Return (FS)** — The Decadal Survey envisaged CSSR as a New Frontiers mission

and CCSR as a Flagship mission. Although these missions are considered in different classes, and the science goals of the latter more ambitious, further technology work may allow for combining of these missions into one. The implementation and objectives of these missions will be updated based on the scientific results from the Deep Impact and Stardust missions.

7.1.3 Among the Discovery, New Frontiers, and Flagship Programs

Since Discovery missions are competitive missions, it is not possible to project how future missions may impact missions in the New Frontiers and Flagship lines. It is likely that, whatever Discovery mission is chosen, it will influence future opportunities and NASA may wish to weigh those impacts in making Discovery selections. For obvious reasons, only those Discovery missions that have passed through the selection gate and are under development or in operation can be included in the present assessment.

- The **Dawn Mission**, which recently resumed development, will provide important experience in using solar electric propulsion (SEP) for interplanetary transfers, which is likely to be used on the Titan Explorer and Neptune–Triton Explorer missions. It may also be relevant to be used on SEP New Frontiers Comet Surface Sample Return and New Frontiers Saturn Flyby with Probes missions.
- **Deep Impact**, which completed its mission in July 2004 as noted above, has yielded knowledge important to formulating the CSSR and CCSR missions.

The timelines of Figure 7.1 can be used to assess the effects of various selection scenarios for New Frontiers missions on the feed forward relationships described here. Since no fixed set of Discovery missions is specified, it is not possible to discuss the *a priori* relationship with the Flagship mission set; however, Discovery missions will inform scientifically, and in limited cases may provide flight experience for technologies associated with, future Flagship missions.

Development work on a Flagship mission also results in major benefits for Discovery and New Frontiers missions. These latter smaller, cost capped missions by their nature cannot include significant costs and risks to develop engineering capabilities and technologies, even though they could greatly benefit future missions. Flagship missions in the past have supported significant technology and engineering developments, forming a foundation upon which smaller cost capped missions can be successful. Specific examples of this are radiation–hard electronics and flight computers (e.g., the RAD750, which is now widely used in cost capped missions); navigation tools; and entry descent and landing capabilities. It can be predicted that without the infusion of new capabilities from Flagship missions or dedicated technology programs, Discovery and New Frontiers class missions will stagnate in capability.

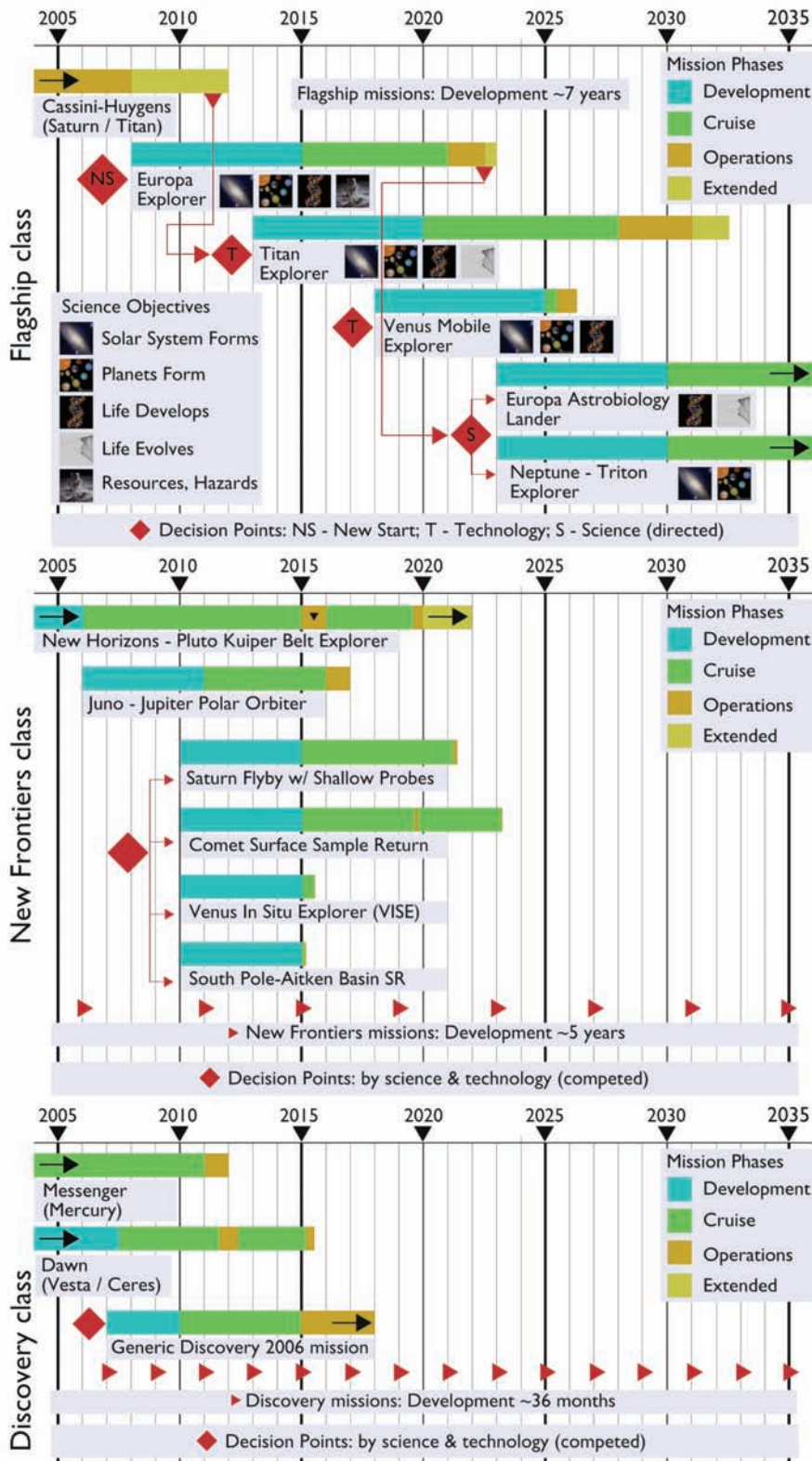

Figure 7.1: Timelines for Flagship class, New Frontiers class and Discovery class missions. The sequence of Flagship missions would be as shown unless new information caused a revision; the sequence of New Frontiers missions is determined competitively.

7.1.4 With the Mars Exploration Program

The MEP includes a set of “core missions,” which are equivalent to the Flagship missions described in this Roadmap, and a set of competed Mars Scout missions with many of the attributes of Discovery, except that they are focused specifically on Mars and the two Martian satellites Phobos and Deimos. The MEP is part of the Planetary Science Division within the Science Mission Directorate. There are many synergies between the Solar System Exploration Program and the Mars Exploration Program. Here we place primary emphasis on the potential for feed forward from MEP core missions to the Flagship missions in this Roadmap.

Mars Reconnaissance Orbiter and Europa Explorer: Both of these missions perform remote sensing in a low-altitude circular orbit using nadir-pointed instrument platforms. Achieving this orbit on MRO is done with aerobraking; this is not available to EE, which contributes to the large size of the propulsion system for this mission. However, there is still potential for feed forward of remote-sensing instrumentation, including high-resolution imaging and radar sounding. Experience with Ka-band communications, which are known to be more sensitive to weather conditions than S- and X-band, will be important in determining if this technology is well suited to missions, where real-time communications are more critical. The EE mission concept study has baselined X-band for this reason. Finally, previous experience with Mars orbiters that used laser altimeters and precision orbit tracking has direct application to geodetic investigation of the shape of Europa from Europa Explorer.

Mars Science Laboratory and Titan Explorer (orbiter): MSL would be the first robotic science mission to use active trajectory control during entry with the objective of improving landing accuracy. Elements of this capability are applicable to the aerocapture systems to be used by Titan Explorer, including aeroshell design, thermal management of RPS heat, and flight control. The New Millennium flight demonstration of aerocapture, discussed in the next section, will provide a complementary end-to-end flight validation of aerocapture for future robotic missions.

Mars Science Laboratory and Titan Explorer (aerial platform): While the means of mobility differ greatly, there are opportunities for exploiting the extensive technology investment in MSL in science instruments, sample acquisition and processing, autonomous control, and RPS systems capabilities.

7.1.5 With the Robotic Lunar Exploration Program

The Robotic Lunar Exploration Program (RLEP) focuses on missions that are complementary to lunar missions in the Solar System Exploration Program and are specifically directed at laying the ground work for a return to the Moon. The RLEP program is managed by the Exploration Systems Mission Directorate (ESMD). Lunar missions with a purely science focus are supported by the Science Mission Directorate (SMD) and can be proposed

to the Discovery Program (the Moon Mineralogy Mapper (MMM) instrument was recently selected as a payload of opportunity on Chandrayaan, an Indian Space Agency mission). New Frontiers is also considering lunar science missions: the Lunar South Pole–Aitken Basin Sample Return (SPABSR) is a New Frontiers candidate mission.

Lunar Reconnaissance Orbiter

Since the RLEP is a very recent program, it is natural for it to take advantage of instruments flown on Mars, Discovery, or New Frontiers missions. Diviner — a modified version of an MRO instrument, is in this category. As the RLEP program expands, instruments developed for lunar opportunities may become available for flight on Solar System exploration missions.

Lunar Crater Observation and Sensing Satellite (LCROSS)

The LCROSS mission is designed to determine if there is water hidden in the permanently dark craters of the Moon’s south pole. As the LCROSS spacecraft approaches the Moon’s south pole, the upper stage will separate, and then will impact a crater in the south pole area. A plume from the upper stage crash will develop as the so-called shepherding spacecraft heads in toward the Moon. The shepherding spacecraft will fly through the plume, and instruments on the spacecraft will analyze the cloud to look for signs of water and other compounds. Additional space and Earth-based instruments also will study the 2.2-million-pound (1000-metric-ton) plume. Impactor experiments clearly have potential for studying the satellites of the outer Solar System and there may be capabilities that emerge from the LCROSS experiment that are pertinent to these solar system exploration applications.

Heavy Lift Launch Vehicles

Although not part of the RLEP, the Agency’s effort to develop a heavy lift launch vehicle motivated by the initiative to return to the Moon with humans has potential utility. However, none of the missions listed here require a larger launch vehicle than the current Evolved Expandable Launch Vehicles (EELVs) with the possible exception of the Europa Astrobiology Lander (EAL).

7.1.6 With the Astrophysics Division

Missions in other NASA Divisions have provided information critical to our knowledge of Solar System bodies; such knowledge directly informs our mission decisions within the Planetary Science Division. Examples include data returned from current and past astrophysics facilities such as the Hubble and Spitzer Space Telescopes, along with Chandra, FUSE, IUE, and EUVE. Looking forward, the James Webb Space Telescope will provide important infrared observations of Solar System objects and extrasolar planets in the next decade. It will be key for determining the physical characteristics of cold bodies at the edge of our solar system: Pluto and the other Kuiper Belt Objects, the icy moons of the giant planets, and distant cometary nuclei.

7.2 Technology Development and Infusion

In Section 4, the types of technology that are needed to enable or enhance the missions in this roadmap were identified. In this section, some of the interdependencies with existing technology development and flight validation programs are examined.

7.2.1 Technology Development

Since the sequence of Flagship missions is defined (see Figure 3.8), it allows for the formulation of a focused and cost-effective technology investment and validation plan for the enabling technologies. For the New Frontiers missions, where the sequence of upcoming missions is not known, a tightly focused program is not possible. Furthermore, in the case of the Discovery Program, where even the missions are uncertain and the cost cap is limited, the assumption is that these missions will leverage existing technologies. One approach, pioneered in the Mars Exploration Program, is to inject new technologies into competitive mission programs, such as Discovery, to fund enabling technologies for mission proposals that were highly ranked scientifically, but which were judged to be technically immature.

Flagship missions drive the development of enabling technologies that can and should be exploited by medium and small missions. Small and moderate missions may also validate new technologies and innovations, which can then be adopted in larger missions. Solar electric propulsion is an example in this Roadmap. The Mars Exploration Program, through its focused technology program, mitigates the risks of introducing many new technologies into science missions. In some cases, these technologies will also be applicable to outer planets, Venus, and other destinations. The New Millennium Program offers much more directed opportunities to validate flight technologies.

7.2.2 With the New Millennium Space Flight Validation Program

This New Millennium Program conducts space flight validation experiments for technologies that are important for Science Mission Directorate missions. Prior Space validation of technologies reduces the risk of first use of a new technology and can be a prerequisite to adoption for science missions. For example, SEP was proposed several times for use in Discovery missions in the early 1990s. However, it was only after the successful flight validation and supporting ground test program on New Millennium DS-1 that a science mission was selected (Dawn).

A number of flight validations of technologies important to this Roadmap are now either in development or planning by the New Millennium pipeline:

- **ST-8 subsystem validation:** This mission will validate two technologies of importance to this Roadmap. First, high specific power solar arrays and high-performance commercial off the shelf (COTS) electronics. The first will extend the applicability
-

of solar array technology. The second technology will enable much greater levels of onboard processing on Solar System exploration missions.

- **ST-9 system validation:** Five candidate concepts are competing for this FY10 flight opportunity, of which two are most pertinent to this Roadmap: aerocapture and terrain guided automatic landing system (TGALS) technology. While both of these technologies are important and should be conducted, aerocapture validation has the highest importance to the goals of this Roadmap. The aerocapture capability is needed for the Titan Explorer, and would be used on other Flagship class missions; in addition, it could also enable many small or moderate missions.
 - **Future subsystem and system demonstrations:** The SMD should identify other subsystem and system level demonstrations for inclusion in the New Millennium Program and consider co-funding both subsystem and system demonstrations. Otherwise the limited number of the system level validation opportunities could be an impediment to implementing Roadmap missions.
-

8 Roadmap Implementation

In earlier sections of this report science objectives are formulated and an exploration strategy developed, centered on improving understanding of habitability. From there, the key measurements needed to address and achieve the science objectives were identified, and a program of missions to carry out the needed measurements was established. In Section 4, the technologies that enable both the missions and the science measurements are described. The R&A and E/PO programs, described in Section 5 and 6, provide critical support by engaging the science community and the public in the program.

This SSE Strategic Roadmap required a careful synthesis of the key elements — science, missions, and technologies — while taking account of the programmatic interrelationships discussed in Section 7. This Roadmap is resilient to potential future changes in scientific and programmatic priorities, enables the reduction of overall cost and risk, and provides a robust scientific portfolio. While it maintains a sustained focus on the primary goal of understanding habitability, it provides the flexibility through the competed mission lines to respond rapidly to new discoveries and to pursue science objectives outside this central theme.

Because the scientific objectives of the roadmap cannot be met in the absence of Flagship missions, an important aspect of this strategic plan is how to include Flagship missions within a balanced overall program. The extent to which a program of Flagship missions can be maintained under an overall cost cap by varying the rates of missions in other categories is examined here. Various options for flight rates in the small (Discovery), moderate (New Frontiers), and large (Flagship) categories of missions are discussed.

A key challenge addressed in this section is initiating the Flagship program in the current financially constrained environment for science and robotic exploration, while maintaining adequate and appropriate balance between the other elements of the Solar System Exploration program. A strategy is developed for allocating resources in order to initiate a program of Flagship missions within the constraints of NASA’s five-year program plan. The funding wedge needed to establish this program is defined.

8.1 Flagship Mission Classes and Cost Ranges

This Roadmap includes *two* Flagship missions per decade, in contrast with the NRC Decadal Survey, which recommended one per decade. The Roadmap team found that smaller missions could not address the prime scientific goals, and implementing this program at the rate of one mission per decade would not achieve the scientific goals within the 30-year time frame of the program.

The Roadmap also specified *two* classes of Flagship missions (Small Flagship and Large Flagship) with both upper and lower cost bounds, whereas the NRC Decadal Survey only

specified a single class with the lower bound, but did not identify an upper bound. This approach provides more discipline for long range planning purposes and provides guidelines for studying the trades between the numbers of missions in different mission classes. International cooperation may permit missions with a total cost exceeding the upper bound. Conversely, NASA may choose to target missions that lie near the middle of these ranges, if this is where the design–cost “sweet spot” is located.

During the Roadmap planning process in the spring of 2005, a *rapid cost estimation technique* was used to classify the candidate SSE Design Reference Missions into New Frontiers, Small Flagship, and Large Flagship categories. Variants of the Roadmap missions may fit into either Small or Large Flagship categories, depending on the desired capabilities and resulting complexities of the missions.

8.2 Trading Flight Rate Across Mission Classes

Table 8.1 shows one set of options for the flight rate of four different mission categories, along with the corresponding cost in each mission category. These are compared with the flight rates recommended in the NRC Decadal Survey of 2003 [NRC03] and NASA’s Solar System Roadmap of 2003 (SSE–RM 2003) [NAS03a]. All costs are expressed in FY06 dollars. The cost caps for Discovery is \$425M in FY06 dollars per the FY06 Announcement of Opportunity (AO). The cost cap for New Frontiers in the last AO in FY03 was \$700M in FY03 dollars. Adjusting for inflations this is \$767M in FY06; which can be rounded to \$750M. The costs ranges for Small Flagship missions are \$750M to \$1.5B and Large Flagship are \$1.5B to \$3.0B. The upper ranges of the Small Flagship and large Flagship estimated are 2 times NF and 4 times NF respectively.

The NRC Decadal Survey proposed one Discovery mission every eighteen months and one New Frontiers mission every two to three years. Actual flight rates for Discovery missions over the duration of the program have been close to these NRC DS recommendations. The NRC DS did not identify a cost class of Flagship mission. The Solar System Exploration Roadmap of 2003 had the same rate for Discovery missions, a slightly lower rate for New Frontiers missions, but it also included a program of Prometheus class missions many times the cost of even the Large Flagship class missions.

The mission portfolio of Options A and B includes the Discovery and New Frontiers missions at the flight rate recommended in the NRC Decadal Survey: where each program element costs \$3.0M per decade in FY03 dollars, based on the cost cap or the upper end of the cost range for each mission category. Option A includes a Large Flagship program at the rate of one mission per decade, but does not incorporate Small Flagship missions. Option B, on the other hand, includes two Small Flagship missions per decade, but without Large Flagship missions. Both of these program elements also have the same average cost of \$3.0M per decade, even with the conservative assumption that costs are based on the upper end of the cost range.

Table 8.1: Flight rates per decade and corresponding cost per decade in \$B for various options with different rates for Flagship, New Frontiers, and Discovery missions. Flight rates proposed by the NRC Decadal Survey (NRC DS 2003) and NASA's Solar System Roadmap of 2003 (SSE-RM 2003) are also shown.

Mission Class	Missions Per Decade					
	NRC DS	SSE-RM	SRM3-2006 (This Roadmap)			
	2003	2003	Option A	Option B	Option C	Option D
Discovery	7	7	7	7	6	4
New Frontiers	4	3	4	4	3	2
Small Flagship	⊗	⊗	0	2	1	0
Large Flagship	1	⊗	1	0	1	2
Prometheus	⊗	1	⊗	⊗	⊗	⊗

Mission Class	Cost Per Decade (\$B)					
	NRC DS	SSE-RM	SRM3-2006 (This Roadmap)			
	2003	2003	Option A	Option B	Option C	Option D
Discovery	2.8	2.8	3.0	3.0	2.6	1.7
New Frontiers	2.8	2.1	3.0	3.0	2.3	1.5
Small Flagship	⊗	⊗	0	3.0	1.5	0
Large Flagship	N/A	⊗	3.0	0	3.0	6.0
Prometheus	⊗	11.0	⊗	⊗	⊗	⊗
Total Cost per Decade*			9.0	9.0	9.3	9.2

Note: * The cost per decade includes direct mission costs only and not the R&A and technology development programs.

This Roadmap has two Flagship missions per decade (Figure 3.8). Therefore, Option A with one Flagship mission per decade is unacceptable, because it will not permit an adequate rate of progress against the highest priority science objectives. While Option B has two Small Flagship missions per decade and provides the flight rate recommended, it is not credible, because not all of the Flagship missions within the program are feasible as Small Flagship missions, even with significantly descoped science and extensive international participation.

Options C and D both include two Flagship class missions per decade and are acceptable in terms of the schedule of Flagship missions and credible in terms of their costs. Option C includes one Small Flagship and one Large Flagship mission in each decade, and is about 5% more expensive than Options A and B. To implement the Roadmap program of Flagship missions under these constraints it would require either some limited descoping of Flagship science, or international participation, or both. It would also require a modest change of the flight rate of Discovery missions (from 7 to 6), and of New Frontiers missions (from 4 to 3). In Option D, which is about the same cost as Option C, there are no Small Flag-

ship missions, but it includes two Large Flagship missions, which would produce excellent science with or without international participation. However, the flight rate of Discovery missions is reduced from 7 to 4 per decade, and New Frontiers missions from 4 to 2.

Clearly there are many other ways of accommodating a program to a budget guideline, but under the present financial constraints, initiating a Flagship mission line would impact the New Frontiers and Discovery programs. Were the budget for Solar System exploration to increase above that considered here, obviously, the impact would be reduced.

8.3 Impact of Mission Interdependencies on These Scenarios

The differences in flight rate among the various mission lines in Options A to D are likely to impact some of the interdependencies discussed in the previous chapter. These interdependencies are complex and the complete evaluation of them is beyond the scope of this Roadmap report. Some issues that need to be further evaluated include:

- The interdependency between NF VISE and the Venus Mobile Explorer. The VISE mission would have to be launched before FY17 to impact the technology decision point for the Venus Mobile Explorer stipulated here.
- The interdependency between the NF Saturn Probe and the Neptune Triton Explorer missions. The NF Saturn Probe mission would have to be launched before FY16 in order to acquire aeroentry data in the atmosphere of Saturn (an analog for Neptune) prior to the technology decision on date for NTE in FY22.
- Interdependencies with Mars Exploration Program missions and New Millennium missions are not adversely impacted by the options discussed here.

The impact of delays in implementing a Flagship program on cost-capped Discovery and New Frontiers missions also needs to be considered. As discussed in Section 7.1.3, new technologies developed for Flagship missions can benefit the smaller cost-capped programs.

8.4 Five-Year Investment Plan

The Solar System Exploration program currently confronts a serious funding constraint triggered by the financial obligations of the human space flight program. Funding previously allocated to space science and robotic exploration has been reallocated to address these difficulties. These are realities that cannot be ignored, and so it is important to present a transition plan for the next five years that can allow the Agency to quickly respond to potential policy changes and ensure a successful path to implementing this scientifically fruitful program when adequate funding becomes available. The plan should be robust and provide a framework for selecting scenarios that respond to future scientific and programmatic priorities. Furthermore, the plan should not be so narrowly focused that it would

potentially cut off an entire set of future options, based on current funding.

8.4.1 Flagship Mission Implementation

To understand some of the implications of funding profile issues associated with Flagship missions, three scenarios were analyzed for near-term budget impacts. A Cassini cost distribution model was assumed along with a *strictly pro forma projection*, based on a total mission cost of \$2B (\$FY05). The projected costs account for technology and advanced development, mission formulation, development and operations costs:

- **Baseline scenario:** Europa Explorer launches in FY15, Titan Explorer in FY20, and Venus Mobile Explorer in FY25 (see Figures 3.8 and 8.1)
- **One-Year Delay:** Europa Explorer launches in FY16, Titan Explorer in FY21, and Venus Mobile Explorer in FY26
- **Two-Year Delay:** Europa Explorer launches in FY17, Titan Explorer in FY22, and Venus Mobile Explorer in FY27

The projected technology and advanced development costs are based on assumptions described below in Section 8.4.2.

The \$2B pro forma projection is in the mid range of Flagship missions. While the estimates are not strictly comparable to those appearing in Table 8.1, they do illuminate some key features of the mission funding profile of Flagship class missions at the mid-range of the cost of \$2B in FY06 dollars. A 5-year separation between launch dates means that the peak spending cycles are well separated, while avoiding the prolonged hiatus caused by launching only one Flagship mission per decade.

8.4.2 Technology Development

The projections of technology and advanced development costs have been developed based on the following assumptions of technology needs for the first three Flagship missions:

- **Europa Explorer** has *no new technology requirements* as an orbiter mission. However, the science data return, mass margins and/or launch vehicle cost may be reduced by introduction of advanced RPS technology and radiation-hard non-volatile memory. An add-on impactor experiment is assumed to be implementable with existing technology. The inclusion of a small lander would not be consistent with the budget assumptions, and also would not be feasible with existing technology. Specifically, for the mass allocation available and for the reliability needed here, existing concepts for small landers would require advances in rad-hard electronics technology. While new power technology is not required for Europa Explorer, development in RPS power would be beneficial. In the event that MMRTGs are not used on this mission, then an
-

Figure 8.1: Investment needs for Solar System Exploration Roadmap program of Flagship missions.

This baseline scenario assumes that the first mission — Europa Explorer — is launched in FY15. The technology and advanced development investment is targeted primarily at the second and third missions, Titan Explorer and Venus Mobile Explorer, which require investments prior to the decision points.

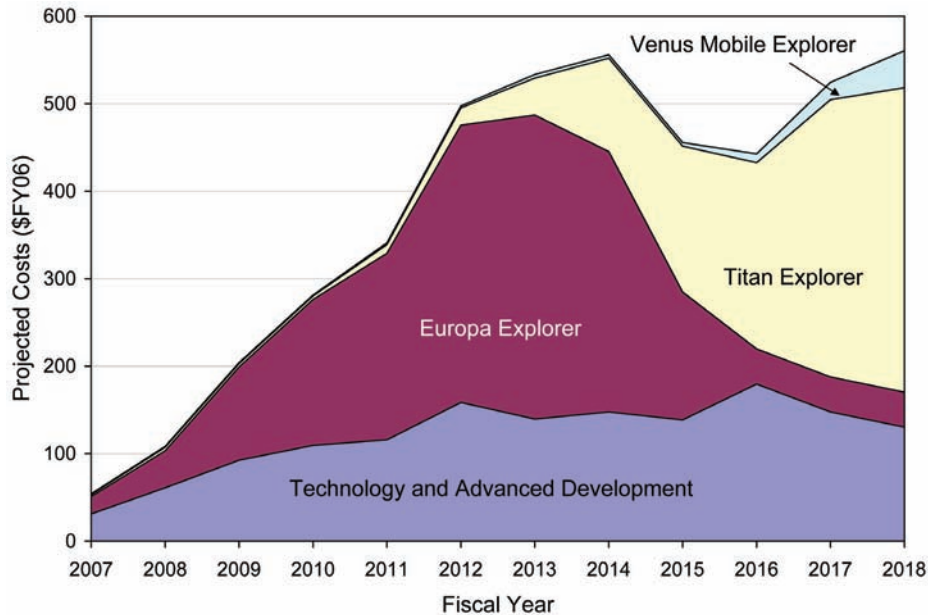

improved RPS could be considered, but such would probably not be available before an FY17 launch.

- Titan Explorer** has *new technology and advanced development needs* in certain well-understood and well-specified areas, requiring early investments in order to be positioned for a technology decision date in FY12. A new type of vehicle that will float in the lower atmosphere of Titan is planned for this mission, and the design space for such a vehicle should continue to be explored. Advances are needed in certain components for operating at cryogenic temperatures, and tests will be required of the vehicle's control systems in a relevant cryogenic environment.
- Venus Mobile Explorer** has *major new technology requirements*. The technology for long duration operation in the high temperature/high pressure environment of Venus requires a long and sustained program of investment. An earlier investment will lead to earlier returns, particularly because early technology development would likely benefit the New Frontiers class Venus mission. The technology development may also point to the need for validation experiments that could be carried out on such a mission.

The technology needs include new areas of investment, as well as funds to mitigate the effects of recent funding cutbacks in the In-Space Propulsion and Radioisotope Power System programs. The entirely new investments are primarily in technologies for extreme environments, planetary protection and instrument components. The estimates for extreme environments and planetary protection technologies are based on recent technology assessments conducted by the Planetary Science Division. Although these assessments point to a number of technology needs for an extended program, this Roadmap includes only those needs critical to the three missions described here. The flight validation of aerocapture is assumed to be conducted under the New Millennium flight technology validation program.

8.5 Budget Wedge for the Flagship Program

The mission and technology budget estimates have been integrated into a summary assessment (Figure 8.2) for the three scenarios described in Section 8.4.1 (baseline, one year delay, two year delay), indicating the budget wedge needed to formulate a program of Flagship missions and to develop the associated technologies. The investments will also support the engineering and technology infrastructure needed for the Discovery and New Frontiers programs. The projected costs in Figure 8.2 cover the time frame from FY07 to FY11 and the data are drawn directly from the cumulative estimates in Figure 8.1 for the baseline scenario (FY15 launch of Europa Explorer) and from additional projections for assumed later launches.

The plans with the one year delay and two year delay have significantly lower nominal costs in the initial FY07 to FY09 time frame. However, these nominal costs include only funding outlays and do not capture the full costs associated with the delay. For example, an extended formulation phase for Flagship missions is known to be the most effective way of controlling cost and risk. Moreover, a prolonged hiatus in funding of the needed technology and engineering developments across the Agency and in industry would erode the intellectual base and essential infrastructure. Rebuilding this capability would be very costly and could lead to further delays in the implementation of the Roadmap.

The baseline scenario also builds robustness into the Agency's programmatic plans. While current Agency plans do not include the resources to proceed to launch Europa Explorer in FY15, there has been a great deal of volatility in Agency programs. The Europa Explorer enjoys a unique position of strong support from the science community, and the exploration of Europa has a central role in the Vision for Space Exploration. In the event of a potential shift in focus from currently higher priority missions or programs, the ability to respond with a mission of this caliber would be a prudent posture for the Agency.

Thus, for the baseline scenario, the investments in FY07 and FY08 would not only preserve the option of a Europa Explorer launch in the FY15 time frame, but could also help contain the cost and limit the risk of that mission, even if the launch is delayed. It would also

Figure 8.2: Funding wedge assuming the first Flagship mission launches in FY15, FY16, and FY17. Follow-on Flagship mission launches are assumed at five year intervals. The funding estimates include technology and advanced development as well as mission formulation and development.

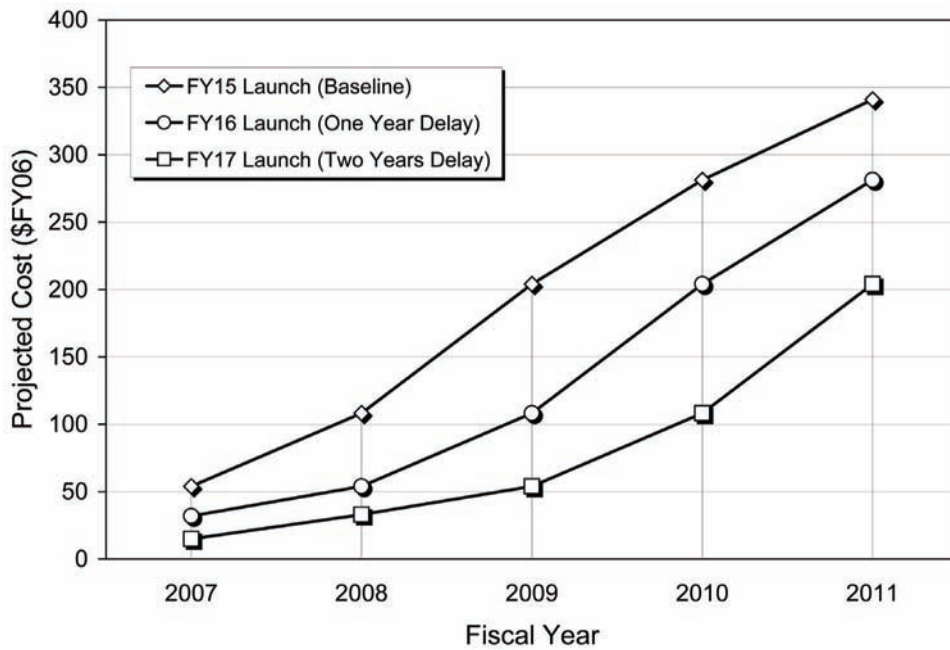

ensure that NASA's intellectual and physical infrastructure is positioned to execute the full sequence of missions in this Roadmap, when the Agency is in a position to carry out this key part of the Vision of Space Exploration.

9 Conclusions and Recommendations

Strategy

The robotic exploration program that the Strategic Roadmap Team 3 was chartered to define requires a balanced program of research and analysis, a range of mission sizes with concomitant technology development, and a strong outreach program. The goals of searching for life across the Solar System and understanding the history of the Solar System require orbital and in situ investigations of the outer planets and their satellites and extended mobile exploration in the extreme environment of Venus. Such investigations are beyond the scope of the Discovery and New Frontiers class missions that constitute today's Solar System Exploration Program. These investigations will require development of technologies that will permit access to and operation within distant environments, environments with high radiation, and environments of extreme heat and cold.

Recommendation: NASA should initiate a program of Flagship missions to specifically address the search for past and present life in the Solar System and the origin and evolution of our planetary system.

Science

The goals of Solar System exploration can be addressed through seeking answers to five questions: How did the Sun's family of planets and minor bodies originate; how did the Solar System evolve to its current diverse state; what are the characteristics of the Solar System that led to the origin of life; how did life begin and evolve on Earth and has it evolved elsewhere in the Solar System; and what are the environmental hazards and resources that will affect the extension of human presence in space? Answering these questions will require intensive investigations of a variety of Solar System targets. Priorities in the near-term part of the Roadmap include Europa, Titan/Enceladus, and Venus.

Recommendation: A balanced program comprising small, medium, and large missions underpinned by a strong research and analysis program and technology program with supporting E/PO is needed to achieve the scientific goals of Solar System exploration.

Research and Analysis

A strong scientific and technical community is needed to conceive, develop, and deploy space missions, and to interpret and apply results from these missions for the benefit of society. The Research and Analysis (R&A) Programs furnish the necessary resources to nurture this community, including: instrument and technology development; experimental, theoretical, computational, modeling and field research; laboratory studies, telescopic observations, and sample analyses. Essential supporting facilities such as ground-based telescopes, laboratory and computing facilities, and the Planetary Data System are also supported by the R&A Program.

Recommendation: In order to maintain international competitiveness in the planetary sciences, a unique NASA responsibility, NASA must fund R&A at or above 2005 levels.

The R&A Programs play a vital role in the achieving the goals of this Roadmap in three broad areas. R&A Programs are the primary NASA vehicle for training graduate students, and support training of the next generation of mission team members, principal investigators, and project scientists. R&A data analysis programs support the interpretation of scientific data returned by science missions with the goal of maximizing the science return from NASA's investment in spacecraft and other data-collection sources. R&A Programs provide research continuity and are essential contributors to maintaining national competitiveness over the three-decade span of the Roadmap.

Recommendation: Appropriate funding of data analysis and data archiving activities is essential to deriving full benefit from the program of Solar System exploration missions outlined in the this Roadmap.

Education and Public Outreach

Solar System Exploration provides a unique opportunity to engage students and the general public in NASA programs. These attributes of the SSE E/PO Program can contribute to the development of the nation's future science, technology, engineering, and math (STEM) workforce through a diverse portfolio of education initiatives that target students at all levels, especially those in traditionally underserved and underrepresented communities. NASA SSE E/PO's efforts to extend student involvement in mission activities can turn this into a practical reality.

Recommendation: In order to engage the American public in scientific, technological, and engineering aspects of the robotic Solar System Exploration Program, NASA should continue — and in some cases expand — partnerships between formal and informal education providers and NASA Solar System Exploration scientists, technologists, and missions.

Missions

A prioritized set of Flagship missions has been developed to address the scientific goals of the Roadmap. The priority order has been established using the three criteria of scientific merit, technological readiness, and opportunity established by the National Research Council in its Decadal Survey of 2003. The first Flagship mission in the sequence with highest priority is the Europa Explorer. With current technology it is practical to conduct intensive investigations from orbit, lasting for at least 90 days and potentially as long as a year.

Recommendation: NASA should initiate a Europa Explorer mission at the earliest possible opportunity beginning in 2015.

Recommendation: The Solar System Exploration program should be anchored by Flagship-class missions and supported by a set of competitive Discovery and New Frontiers missions. The Flagship missions in this program should be implemented as either small Flagship missions (<\$1.4B or twice the cost of a New Frontiers mission) or a large Flagship mission (between \$1.4B and \$2.8B).

Recommendation: The recommended flight rate for Flagship missions is one mission every five years. New Frontiers missions should launch at the rate of 2–4 missions per decade and Discovery missions should fly at the rate of 4–7 missions per decade.

Recommendation: NASA can effectively reduce cost and risk by extending successful international collaboration models to missions to the Saturn system and to Venus.

Technology Development

All five Flagship missions described in this plan would be baselined to use radioisotope power systems (RPSs) for furnishing electrical power. Currently, there is an insufficient supply of plutonium-238 which would be used to fuel potential RPSs for these potential missions.

Recommendation: NASA must work with the relevant federal entities to ensure that adequate electrical power is provided for missions that require radioisotope power systems (RPSs).

Recommendation: NASA must also develop, at a pace consistent with planned missions, more efficient power conversion technologies to make the best use of the Pu-238 in the inventory. Not only will this provide more effective use of plutonium, but the gain in specific power is advantageous for a number of missions where mass is critical.

Access to the outer Solar System is a vital part of the program described here and space transportation technologies are a key element of this access. Two of the missions — Titan (with or without Enceladus) Explorer and Neptune–Triton Explorer — would require the use of aerocapture to deliver payloads of the required mass into orbit with much shorter trip times than could be achieved with chemical propulsion.

Recommendation: NASA should continue to invest in aerocapture technology and conduct space flight validations of this technology in a time frame that is consistent with the decision points identified in this Roadmap.

Access to extreme environments, both extremely hot near the surface of Venus and extremely cold at the moons of the outer planets, requires investments in a suite of technologies to enable probes and mobile platforms to survive and operate in these environments.

Recommendation: NASA should initiate a technology development program in technologies for extreme environments. Many of the needed technologies are currently at a very low technology readiness level (TRL) and the gestation period of development is long. Accordingly, initiating this program as soon as practicable will have a major impact on the feasibility of future Flagship missions and will also benefit Discovery and New Frontier missions.

Integrated Program Plan

There are significant interdependencies among Flagship missions and between Flagship missions and the New Frontiers and Discovery Programs. These interdependencies can be exploited in order to reduce the cost and risk of Flagship missions. Equally important are the contributions of the Mars Exploration Program and the New Millennium Program, where the contributions are primarily technical. However, the goal of implementing the Flagship missions at the rate of one every five years may require reduction in the rate of existing Discovery and New Frontiers Program elements.

Recommendation: One small Flagship mission and one Large Flagship mission per decade may represent an appropriate balance with a small impact on Discovery and New Frontiers frequency.

At present, NASA has no plans to initiate a Solar System exploration Flagship mission in the next five years. In view of the high priority attached to exploration of Europa by the National Academy and other studies, it should be the first Flagship priority. NASA should actively begin preparing for Europa Explorer as the first new Flagship mission. Titan is next in priority, as an object with an Earth-like balance of geological and atmospheric processes, and an active organic chemistry. Together with the exploration of Enceladus, it should further investigations by Cassini, to indicate the presence of accessible liquids on or under their surfaces. Venus is extremely high priority for its potential to tell us where the inner edge of the habitable zone lies for Sun-like stars; technologies for long-lived mobile surface operations will pace the readiness of a Flagship mission there. Following these, the next Flagship should be to Neptune/Triton or to access the European ocean depending on the results found by the earlier Flagships.

Recommendation: An investment of \$100M annually in FY07 and FY08 can preserve the option for an FY15 launch of Europa Explorer and make a significant start in technology development needed for later missions. This would provide the Agency the opportunity to move out more aggressively on initiating the new series of Flagship missions if circumstances allow it.

Acronyms and Abbreviations

APIO	Advanced Planning and Integration Office
ASTEPI	Astrobiology Science and Technology for Exploring Planets
ASTID	Astrobiology Science and Technology Instrument Development Program
AU	Astronomical Unit (defined as the distance between the Sun and Earth)
C-H	Cassini-Huygens mission
CCD	Charge-Coupled Device
CCSR	Cryogenic Comet Surface Sample Return mission
CSSR	Comet Surface Sample Return
CLARAty	Coupled Layer Architecture for Robotic Autonomy
DSN	Deep Space Network (telecommunications)
EAL	Europa Astrobiology Lander mission
EDL	Entry, Descent, and Landing
EE	Europa Explorer mission
EGE	Europa Geophysical Explorer
E/PO	Education and Public Outreach
ESA	European Space Agency
ESMD	NASA's Exploration Systems Mission Directorate
FACA	Federal Advisory Committee Act
FS	Flagship (mission class)
FY	Fiscal Year
GPHS-RTS	General Purpose Heat Source Radioisotope Thermoelectric Generator
HCIPE	High Capability Instruments for Planetary Exploration
IDP	Interplanetary Dust Particle
ITEA	International Technology Education Association
JIMO	Jupiter Icy Moons Orbiter
JPL	Jet Propulsion Laboratory, California Institute of Technology
K/T	Cretaceous / Tertiary
KBO	Kuiper Belt Object
LILT	Low Intensity Low Temperature (solar cell technology)
LIBS	Laser Induced Breakdown Spectrometry
L/V	Launch Vehicle
MARSIS	Mars Advanced Radar for Subsurface and Ionospheric Sounding
MARTE	Mars Analog Research and Technology Experiment
MEP	Mars Exploration Program
MIDP	Mars Instrument Development Program
MMRTG	Multi-Mission Radioisotope Thermoelectric Generator
MOLA	Mars Orbiter Laser Altimeter
NASA	National Aeronautics and Space Administration
NASA HQ	NASA Headquarters
NEA	Near-Earth Asteroid
NEP	Nuclear Electric Propulsion
NEXT	NASA Evolutionary Xenon Thruster
NH	New Horizons - Pluto Kuiper Belt Explorer
NF	New Frontiers (mission class)
NRC DS	National Research Council Decadal Survey
NSE	Neptune System / Triton Explorer mission
NTE	Neptune Triton Explorer
PCM	Phase-change Material
PHA	Potentially Hazardous Asteroids
PI	Principal Investigator
P/T	Permian / Triassic
R&A	Research and Analysis
RHU	Radioisotope Heater Unit
RLEP	Robotic Lunar Exploration Program
RPS	Radioisotope Power System
PIDDP	Planetary Instrument Definition and Development Program
SB	Small Bodies
SCAWG	Space Communications Architecture Working Group
SEP	Solar Electric Propulsion
SFP	Saturn Flyby with Probes mission
SIDP	Solar System Instrument Development Program
SMD	Science Mission Directorate
SP	Saturn Flyby with Shallow Probes
SPABSR	Lunar South Pole-Aitken Basin Sample Return
SRG	Stirling Radioisotope Generator
SRM	Strategic Roadmap
SRM3-2005	2005 SRM
SRM3-2006	2006 SRM
SCAWG	Space Communications Architecture Working Group
STEM	Science, Technology, Engineering and Mathematics
TE	Titan / Enceladus Explorer mission
TPS	Thermal Protection System
TRL	Technology Readiness Level (from 1 to 9)
UTTR	Utah Test and Training Range
VISE	Venus In Situ Explorer
VME	Venus Mobile Explorer mission
VSSR	Venus Surface Sample Return mission

References

- [Afz94] R.S. Afzal. Mars Observer Laser Altimeter: Laser Transmitter. *Applied Optics*, 33:3184–3188, 1994. 108
- [Hou04] The White House. A Renewed Spirit of Discovery, The President’s Vision for U.S. Space Exploration. Website: http://www.whitehouse.gov/space/renewed_spirit.html, January 2004. 1, 8, 14
- [NAS03a] NASA. Solar System Exploration. Technical Report JPL 400-1077 5/03, National Aeronautics and Space Administration, Jet Propulsion Laboratory, California Institute of Technology, Pasadena, CA, 2003. 1, 53, 59, 63, 68, 76, 130
- [NAS03b] NASA. Sun–Earth Connection Roadmap. Technical Report NP-2002-8-500-GSFC, NASA, Washington, D.C., January 2003. 43
- [NAS04] NASA. Energy Storage Technology for Future Space Science Missions. Technical Report JPL D-30268, Rev.A, National Aeronautics and Space Administration, Jet Propulsion Laboratory, California Institute of Technology, Pasadena, CA, November 2004. 89
- [NAS05a] NASA. Planetary Protection and Contamination Control Technologies for Future Space Science Missions. Technical Report JPL D–31974, National Aeronautics and Space Administration, Jet Propulsion Laboratory, California Institute of Technology, Pasadena, CA, June 2005. 91
- [NAS05b] NASA. SRM 3 – The Solar System Exploration Strategic Roadmap. Available from the Outer Planets Assessment Group (OPAG), Website: <http://www.lpi.usra.edu/opag/>, May 2005. 7
- [NAS06] NASA. Solar System Exploration – 2006 Solar System Exploration Roadmap: Interim Final Report. Technical Report JPL D–35005, National Aeronautics and Space Administration, Jet Propulsion Laboratory, California Institute of Technology, Pasadena, CA, May 2006. 7
- [Nat67] United Nations. Outer Space Treaty, UN Resolution 2222 (xxi): Treaty on Principles Governing the Activities of States in the Exploration and Use of Outer Space, Including the Moon and Other Bodies. Website: <http://www.unoosa.org/oosa/SpaceLaw/treaties.html>, 1967. 91
- [NRC03] NRC. New Frontiers in the Solar System, an Integrated Exploration Strategy. Technical report, Space Studies Board, National Research Council, Washington, D.C., 2003. 1, 14, 53, 59, 68, 130
- [NRC05] NRC. Review of Goals and Plans for NASA’s Earth and Space Sciences by Panel on Review of NASA Science Strategy Roadmaps. Technical report, Space Studies Board, National Research Council, Washington, D.C., September 2005. 10
- [SB04] J.S. Stuart and R. P. Binzel. Bias–corrected Population, Size Distribution, and Impact Hazard for the Near–Earth Objects. *ICARUS*, 170:295–311, 2004. 35
-



National Aeronautics and
Space Administration

Jet Propulsion Laboratory
California Institute of Technology
Pasadena, California

CL#06-1867-A