

### 3. HEALTH EFFECTS

#### 3.1 INTRODUCTION

The primary purpose of this chapter is to provide public health officials, physicians, toxicologists, and other interested individuals and groups with an overall perspective on the toxicology of cadmium. It contains descriptions and evaluations of toxicological studies and epidemiological investigations and provides conclusions, where possible, on the relevance of toxicity and toxicokinetic data to public health.

A glossary and list of acronyms, abbreviations, and symbols can be found at the end of this profile.

The form of cadmium and the route of exposure can greatly affect the absorption and distribution of cadmium to various target sites, and therefore, the concentration at the target site and the severity of the observed effect. The mechanism of action, however, involves the cadmium cation's effect on the target site, and the cation is the same regardless of the anionic species. For inhaled cadmium compounds, the size of the cadmium particle (i.e., fume or aerosol) can also affect the absorption and distribution. For oral exposures, cadmium chloride is most often tested in animal studies because of its high water solubility and the resulting high concentrations of cadmium delivered to target sites. Studies on cadmium bound to metallothionein are also of interest because cadmium-metallothionein complexes may have different toxic profiles and are found in relatively high levels in organ meats (e.g., liver and kidney). Cadmium oxide and cadmium carbonate, which are relatively insoluble in water (but may dissolve at gastric pH), appear to be similar in absorption and toxicity to soluble cadmium. There are fewer studies available on other forms of cadmium including insoluble forms in water such as cadmium sulfide (a yellow pigment) and cadmium selenium sulfide (a red pigment), and a soluble form, cadmium sulfate, which is less soluble in a closed air system where there is a limited amount of dissolved carbon dioxide. Chapter 4 lists the chemical and physical properties of several cadmium compounds.

#### 3.2 DISCUSSION OF HEALTH EFFECTS BY ROUTE OF EXPOSURE

To help public health professionals and others address the needs of persons living or working near hazardous waste sites, the information in this section is organized first by route of exposure (inhalation, oral, and dermal) and then by health effect (death, systemic, immunological, neurological, reproductive, developmental, genotoxic, and carcinogenic effects). These data are discussed in terms of three exposure periods: acute (14 days or less), intermediate (15–364 days), and chronic (365 days or more).

### 3. HEALTH EFFECTS

Levels of significant exposure for each route and duration are presented in tables and illustrated in figures. The points in the figures showing no-observed-adverse-effect levels (NOAELs) or lowest-observed-adverse-effect levels (LOAELs) reflect the actual doses (levels of exposure) used in the studies. LOAELs have been classified into "less serious" or "serious" effects. "Serious" effects are those that evoke failure in a biological system and can lead to morbidity or mortality (e.g., acute respiratory distress or death). "Less serious" effects are those that are not expected to cause significant dysfunction or death, or those whose significance to the organism is not entirely clear. ATSDR acknowledges that a considerable amount of judgment may be required in establishing whether an end point should be classified as a NOAEL, "less serious" LOAEL, or "serious" LOAEL, and that in some cases, there will be insufficient data to decide whether the effect is indicative of significant dysfunction. However, the Agency has established guidelines and policies that are used to classify these end points. ATSDR believes that there is sufficient merit in this approach to warrant an attempt at distinguishing between "less serious" and "serious" effects. The distinction between "less serious" effects and "serious" effects is considered to be important because it helps the users of the profiles to identify levels of exposure at which major health effects start to appear. LOAELs or NOAELs should also help in determining whether or not the effects vary with dose and/or duration, and place into perspective the possible significance of these effects to human health.

The significance of the exposure levels shown in the Levels of Significant Exposure (LSE) tables and figures may differ depending on the user's perspective. Public health officials and others concerned with appropriate actions to take at hazardous waste sites may want information on levels of exposure associated with more subtle effects in humans or animals (LOAELs) or exposure levels below which no adverse effects (NOAELs) have been observed. Estimates of levels posing minimal risk to humans (Minimal Risk Levels or MRLs) may be of interest to health professionals and citizens alike.

Levels of exposure associated with carcinogenic effects (Cancer Effect Levels, CELs) of cadmium are indicated in [Tables 3-1](#) and [3-6](#) and [Figures 3-1](#) and [3-2](#). Because cancer effects could occur at lower exposure levels, [Figure 3-1](#) also shows a range for the upper bound of estimated excess risks, ranging from a risk of 1 in 10,000 to 1 in 10,000,000 ( $10^{-4}$  to  $10^{-7}$ ), as developed by EPA.

A User's Guide has been provided at the end of this profile (see Appendix B). This guide should aid in the interpretation of the tables and figures for Levels of Significant Exposure and the MRLs.

### 3. HEALTH EFFECTS

#### 3.2.1 Inhalation Exposure

The information in this section on health effects of inhalation exposure to cadmium in humans is derived from studies of workers exposed to cadmium fume or dusts in industries such as smelting, battery manufacturing, soldering, and pigment production. Adverse effects of human exposure to cadmium were first established among workers in a cadmium battery factory (Friberg 1950). Workers are exposed occupationally to cadmium primarily by inhalation of fumes or dust. Some gastrointestinal tract exposure may also occur when dust is removed from the lungs by mucociliary clearance and subsequently swallowed, or by ingestion of dust on hands, cigarettes, or food (Adamsson et al. 1979). In experiments with animals, some ingestion may also occur from inhalation exposures by mucociliary clearance or from animal grooming. The primary form of cadmium in occupational exposures is cadmium oxide. Experimental studies in laboratory animals have used cadmium oxide, cadmium chloride, and occasionally other forms of cadmium such as cadmium sulfide and cadmium sulfate. In general, the different forms of cadmium have similar toxicological effects by the inhalation route, although quantitative differences may exist from different absorption and distribution characteristics, particularly for the less soluble cadmium pigments such as cadmium sulfide and cadmium selenium sulfide (Buckley and Bassett 1987b; Klimisch 1993; Oldiges and Glaser 1986; Oldiges et al. 1989; Rusch et al. 1986).

Smokers inhale cadmium, but studies of cadmium exposure in the general population are considered in Section 3.2.2 because the primary route of exposure for the general population is through the diet. Also, the many other toxic compounds in cigarette smoke make it difficult to attribute specific adverse effects of smoking to the inhalation of cadmium.

##### 3.2.1.1 Death

Numerous studies have shown that acute inhalation exposure to cadmium can cause death in humans and animals. In humans, several fatal inhalation exposures have occurred in occupational accidents. During the acute exposure, the general symptoms are relatively mild but, within a few days following exposure, severe pulmonary edema and chemical pneumonitis develop, leading to death due to respiratory failure (Beton et al. 1966; Lucas et al. 1980; Patwardhan and Finckh 1976; Seidal et al. 1993). The cadmium concentration in air was not measured in these cases of accidental death in humans. However, the lung concentrations of cadmium in the men who died from these accidental acute exposures were measured. In micrograms of cadmium per gram wet weight (w/w) of lung tissue ( $\mu\text{g/g}$ ), Patwardhan and Finckh (1976) reported 1.5  $\mu\text{g/g}$ , Beton et al. (1966) reported 2.5  $\mu\text{g/g}$ , Barrett et al. (1947) reported 3.5  $\mu\text{g/g}$ , and Lucas et al. (1980) reported 4.7  $\mu\text{g/g}$ . Based upon estimates of the percentage of inhaled cadmium fume

## 3. HEALTH EFFECTS

that would be retained in the lungs, Barrett et al. (1947) calculated an exposure of 2,500 minutes  $\times$  mg/m<sup>3</sup> in air would be fatal to humans. Beton et al. (1966) used a similar technique to estimate that an exposure to cadmium oxide in air of 8.63 mg/m<sup>3</sup> for 5 hours led to the fatal deaths of the five workers with cadmium lung burdens of 2.5  $\mu$ g/g. The lower lung concentrations reported by Patwardhan and Finckh (1976) prompted Elinder (1986b) to estimate that an exposure of 1–5 mg/m<sup>3</sup> for 8 hours could be immediately dangerous. These estimates of air concentrations, however, are based on a number of uncertain assumptions concerning the duration of exposure and the retention of cadmium in the human lung being similar to that found in animal studies (Barrett et al. 1947; Elinder 1986b). No studies on deaths in humans from intermediate inhalation exposures were found. In a study on chronic exposures, Friberg (1950) attributes the deaths of 2 workers to exposure to cadmium dust in the air averaging 6.8 mg Cd/m<sup>3</sup> (range 3–15 mg/m<sup>3</sup>). One worker was 57 years old at death (after 14 years of exposure to the dust) and the other was 60 years old at death (after 25 years of exposure to the dust). A detailed postmortem evaluation for the 60-year-old worker showed the presence of emphysema and the occurrence of hyaline casts in renal tubules, as well as slight nephrotic changes. Pneumonia was the direct cause of death as an acute complication of chronic bronchitis and pulmonary emphysema. The exposure estimate of 6.8 mg Cd/m<sup>3</sup> is from only six samples taken in 1946. The conditions in earlier years were thought to be similar, but this exposure value is, at best, a very rough approximation of the actual exposures spanning 34 years.

Acute inhalation of cadmium oxide fumes has also led to death in rats, mice, rabbits, guinea pigs, dogs, and monkeys, with the mortality rate apparently being directly proportional to the product of the duration of exposure and the concentration of inhaled cadmium (Barrett et al. 1947). The most reliable LC<sub>50</sub> (lethal concentration, 50% kill) (at 7 days) established by this study was 500 minute-mg cadmium oxide/m<sup>3</sup> for rats, equivalent to a 15-minute exposure to 30 mg Cd/m<sup>3</sup> (Barrett et al. 1947). Rusch et al. (1986) demonstrated high mortality rates in the Sprague-Dawley rat from a 2-hour exposure to cadmium fumes at 112 mg Cd/m<sup>3</sup> (25 of 32 died within 1 week). A 2-hour exposure to a different form of cadmium, cadmium carbonate, at 132 mg Cd/m<sup>3</sup> resulted in considerably lower mortality (3 of 22 died by day 30). No deaths resulted from a 2-hour exposure to cadmium sulfide at 99 mg Cd/m<sup>3</sup> or cadmium selenium sulfide (cadmium red pigment) at 97 mg Cd/m<sup>3</sup>. Grose et al. (1987) reported 2 out of 36 rats died from a 2-hour, nose-only inhalation exposure to only 0.45 mg Cd/m<sup>3</sup> of cadmium oxide dusts, but the statistical significance of this low rate of mortality was not reported. A 3-day, 1-hour/day exposure to cadmium chloride aerosol at 61 mg Cd/m<sup>3</sup> resulted in the death of 17 of 18 rats exposed (Snider et al. 1973). In another study, no deaths were observed in rats from a cadmium yellow (cadmium sulfide) pigment exposure 6 hours/day for 10 days at 6.29 mg Cd/m<sup>3</sup> (Klimisch 1993). Thus, it appears that in acute exposures, the relatively more soluble cadmium chloride, cadmium oxide fume, and cadmium

## 3. HEALTH EFFECTS

carbonate compounds are more toxic than the relatively less soluble cadmium sulfide compounds (Klimisch 1993; Rusch et al. 1986). Rusch et al. (1986) attribute this difference to higher lung absorption and retention times for the more soluble compounds, and greater mucociliary clearance for the less-soluble pigments. Glaser et al. (1986), however, demonstrated that toxicity does not strictly correlate with solubility, and that solubility of cadmium oxide in biological fluids may be greater than its solubility in water. In hamsters, Henderson et al. (1979) reported that a 30-minute exposure to 10.1 mg Cd/m<sup>3</sup> from cadmium chloride resulted in the death of 3 of 30 animals by day 6 postexposure. In rabbits, Friberg (1950) reported an LC<sub>50</sub> (by day 14) from a 4-hour exposure to cadmium metal dusts at 28.4 mg Cd/m<sup>3</sup>. Barrett et al. (1947) also reported LC<sub>50</sub> values for cadmium oxide fume of 940 mg Cd/m<sup>3</sup> for a 14-minute exposure in the monkey, 46.7 mg/m<sup>3</sup> for a 15-minute exposure in the mouse, 204 mg Cd/m<sup>3</sup> for a 15-minute exposure in the guinea pig, and 230 mg Cd/m<sup>3</sup> for a 15-minute exposure in the dog. However, the authors report that these LC<sub>50</sub> values are only approximations because of insufficiencies in the data or the small numbers of animals used.

At longer durations of exposure, lower concentrations cause lethality in rats. Cadmium oxide dust resulted in the deaths of 100% of the females at 1 mg Cd/m<sup>3</sup> for 5 hours/day, 5 days/week for 20 weeks, (Baranski and Sitarek 1987), and of 5 of 12 female rats at only 0.105 mg Cd/m<sup>3</sup> 22 hours/day, 7 days/week for 63 days (Oldiges and Glaser 1986). Continuous inhalation exposure to cadmium oxide dust at 0.105 mg Cd/m<sup>3</sup> (i.e., 24 hours/day) for 63 days resulted in 5 of 12 deaths in female rats (Prigge 1978a). Five of 54 males died from a cadmium chloride exposure to 1.06 mg Cd/m<sup>3</sup> for 62 days, 5 days/week, 6 hours/day (Kutzman et al. 1986). Kutzman et al. (1986) determined that the concentration times hours of exposure to produce 50% mortality in rats was 390 mg-hour/m<sup>3</sup> (males) and 489 mg-hour/m<sup>3</sup> (females). Takenaka et al. (1983) reported that cadmium chloride at 0.0508 mg Cd/m<sup>3</sup> 23 hours/day, 7 days/week for 18 months resulted in the death of 5 of 40 male rats.

Oldiges et al. (1989) evaluated the long-term effects in rats of inhaling cadmium as either cadmium chloride, cadmium sulfate, cadmium sulfide, or cadmium oxide. Rats were exposed to aerosols in nearly continuous exposures of 22 hours/day, 7 days/week for 18 months. An observation period of 12 months followed the exposure period. Oldiges et al. (1989) recorded mortality as exceeding 25% of the test animals during the exposure period or 75% of the test animals during the observation period. If either 25 or 75% mortality occurred, the exposure period or the observation period, respectively, was terminated. The results showed that cadmium chloride at 0.030 mg Cd/m<sup>3</sup> was lethal to >75% of the male and female rats by 12 months of exposure; cadmium oxide dusts at 0.090 mg Cd/m<sup>3</sup> were lethal for >25% of the males by 7 months and 25% of the females by 11 months of exposure; cadmium oxide fume at the

### 3. HEALTH EFFECTS

highest dose of 0.03 mg Cd/m<sup>3</sup> did not result in >25% mortality during exposure or 75% during the postexposure period; cadmium sulfate at 0.090 mg Cd/m<sup>3</sup> was lethal for >25% of the males during the exposure and for >75% of the females by 14 months following exposure; and cadmium sulfide at 0.090 mg Cd/m<sup>3</sup> was not lethal during the exposure period but was lethal to >75% of the males and females by 12 months postexposure. In these chronic studies, cadmium's lethal effects differed among the chemical forms in the following order from most to least toxic: cadmium chloride>cadmium sulfate ≈ cadmium oxide dust>cadmium sulfide, but lethality still occurred from all forms of cadmium. Oldiges and Glaser (1986) report that in their chronic studies and at the doses tested, cadmium toxicity appeared to be more related to the long-term lung retention of the bioavailable amounts of cadmium than to a simple function of solubility in water. Representative LOAEL and LC<sub>50</sub> values for lethality in each species and duration category are recorded in [Table 3-1](#) and are plotted in [Figure 3-1](#).

#### 3.2.1.2 Systemic Effects

The highest NOAEL values and all LOAEL values from each reliable study for systemic effects in each species and duration category are recorded in [Table 3-1](#) and plotted in [Figure 3-1](#).

**Respiratory Effects.** In humans, inhalation exposure to high levels of cadmium oxide fumes or dust is intensely irritating to respiratory tissue, but symptoms can be delayed. During and immediately after (up to 2 hours) an acute exposure for 5 hours of 8.63 mg/m<sup>3</sup>, Beton et al. (1966) reported that there were few symptoms of toxicity limited to coughing and slight irritation of the throat and mucosa. From 4 to 10 hours postexposure, influenza-like symptoms began to appear, including cough, tight chest, pain in chest on coughing, dyspnea, malaise, ache, chilling, sweating, shivering, and aching pain in back and limbs. From 8 hours to 7 days postexposure, more advanced stages of pulmonary response included severe dyspnea and wheezing, chest pain and precordial constriction, persistent cough, weakness and malaise, anorexia, nausea, diarrhea, nocturia, abdominal pain, hemoptysis, and prostration. Acute, high-level exposures can be fatal (see Section 3.2.1.1), and those who survive may have impaired lung function for years after a single acute exposure. A 34-year-old worker exposed to cadmium fume from soldering for 1 hour (dose not determined) had persistent impaired lung function when examined 4 years following the exposure (Barnhart and Rosenstock 1984). Initial symptoms were dyspnea, cough, myalgia, and fever. An initial chest X-ray revealed infiltrates. Townshend (1982) reports the case of a male welder who developed acute cadmium pneumonitis from a single exposure (dose not determined). Nine years after the exposure, this worker continued to show signs of progressive pulmonary fibrosis and

Table 3-1 Levels of Significant Exposure to Cadmium - Inhalation

Key to Figure <sup>a</sup>	Species (Strain)	Exposure/Duration/Frequency (Route)	System	NOAEL (mg/m <sup>3</sup> )	LOAEL		Reference Chemical Form	Comments
					Less Serious (mg/m <sup>3</sup> )	Serious (mg/m <sup>3</sup> )		
<b>ACUTE EXPOSURE</b>								
<b>Death</b>								
1	Human	5 hr (occup)				8.63 M (5 male workers died after a 5 hour exposure)	Beton et al. 1966 CdO fume	
2	Rat (NS)	10-15 min				30 (LC50 at 7 days)	Barrett et al. 1947 CdO fume	
3	Rat (Fischer- 344)	6.2 hr/d 5 d/wk 2 wk				8.8 (100% mortality by day 6)	NTP 1995 CdO	
4	Rat (Sprague-Dawley)	2 hr				112 (25/32 died within 1 week)	Rusch et al. 1986 CdO fume	
5	Rat (Sprague-Dawley)	3 d 1 hr/d				61 M (17/18 died within 3 days)	Snider et al. 1973 CdCl <sub>2</sub>	
6	Mouse (B6C3F1)	6.2 hr/d 5 d/wk 2 wk				8.8 (100% mortality by day 7)	NTP 1995 CdO	
7	Rabbit (NS)	4 hr				28.4 (LC50 at 14 days)	Friberg 1950 Cd metal dust	

Table 3-1 Levels of Significant Exposure to Cadmium - Inhalation

(continued)

Key to Figure <sup>a</sup>	Species (Strain)	Exposure/ Duration/ Frequency (Route)	System	NOAEL (mg/m <sup>3</sup> )	LOAEL		Reference Chemical Form	Comments
					Less Serious (mg/m <sup>3</sup> )	Serious (mg/m <sup>3</sup> )		
<b>Systemic</b>								
8	Rat (Long- Evans)	1 hr	Resp				5 M (pulmonary edema, enzyme changes associated with type 2 cell hyperplasia)	<a href="#">Boudreau et al. 1989</a> CdCl <sub>2</sub>
9	Rat (Wistar)	3 hr	Resp		0.4 M (mild hypercellularity at the bronchoalveolar junction and in adjacent alveoli)		4.6 M (persistent focal interstitial thickening, increased collagen, general hypercellularity)	<a href="#">Buckley and Bassett 1987b</a> CdO dust
			Bd Wt	0.4 M	4.6 M (15% decreased body weight)			
10	Rat (Sprague- Dawley)	1 hr	Resp				6.5 M (severe pneumonitis)	<a href="#">Bus et al. 1978</a> CdCl <sub>2</sub>
			Bd Wt		6.5 M (10.8% decreased body weight)			
11	Rat (Sprague- Dawley)	2 hr	Resp	0.45 M			4.5 M (moderate to severe pneumonitis, hemorrhage, edema)	<a href="#">Grose et al. 1987</a> CdCl <sub>2</sub>
			Bd Wt			4.5 M (20% decreased body weight)		



Table 3-1 Levels of Significant Exposure to Cadmium - Inhalation

(continued)

Key to Figure	Species (Strain)	Exposure/Duration/Frequency (Route)	System	NOAEL (mg/m <sup>3</sup> )	LOAEL		Reference Chemical Form	Comments
					Less Serious (mg/m <sup>3</sup> )	Serious (mg/m <sup>3</sup> )		
12	Rat (Sprague-Dawley)	2 hr	Resp		0.45 M (significant increased absolute and relative lung weight)	4.5 M (severe pneumonitis, hyperplasia of type 2 cells and fibroblasts)	Grose et al. 1987 CdO dust	
			Bd Wt	0.45 M				
13	Rat (Lewis)	1-6 wk 5 d/wk 3 hr/d	Resp			1.6 M (interstitial pneumonitis)	Hart 1986 CdO dust	
14	Rat (Wistar)	10 d 6 hr/d	Bd Wt	0.17 M			Klimisch 1993 CdCl <sub>2</sub>	No histopathological examination.
15	Rat (Wistar)	10 d 6 hr/d	Bd Wt	6.29 M			Klimisch 1993 CdS	No histopathological examination.
16	Rat (Fischer- 344)	6.2 hr/d 5 d/wk 2 wk	Resp		0.88 F (degeneration of nasal olfactory epithelium)	8.8 (marked necrosis of alveolar ducts)	NTP 1995 CdO	
				0.088 <sup>b</sup> (alveolar histiocytic infiltrate and focal inflammation in alveolar septa)				
			Hepatic	2.6				
	Renal	2.6						

Table 3-1 Levels of Significant Exposure to Cadmium - Inhalation

(continued)

Key to Figure <sup>a</sup>	Species (Strain)	Exposure/Duration/Frequency (Route)	System	NOAEL (mg/m <sup>3</sup> )	LOAEL		Reference Chemical Form	Comments
					Less Serious (mg/m <sup>3</sup> )	Serious (mg/m <sup>3</sup> )		
17	Rat (Sprague-Dawley)	2 hr	Resp				6 M (alveolar type 1 cell damage and necrosis)	Palmer et al. 1986 CdCl <sub>2</sub>
			Endocr	6 M				
			Bd Wt	6 M				
18	Rat (Sprague-Dawley)	2 hr	Gastro		132	(erosions of the stomach)		Rusch et al. 1986 CdCO <sub>3</sub>
19	Rat (Sprague-Dawley)	5, 10, or 15 d 1 hr/d	Resp				6.1 M (emphysema)	Snider et al. 1973 CdCl <sub>2</sub>
20	Rat (Sprague-Dawley)	3 d 1 hr/d	Resp				61 M (pulmonary hemorrhage)	Snider et al. 1973 CdCl <sub>2</sub>
21	Mouse (B6C3F1)	6.2 hr/d 5 d/wk 2 wk	Resp		0.88	(fibrosis and inflammation around the alveolar ducts, necrosis of the alveolar duct epithelium)		NTP 1995 CdO
					0.088	(histiocytic infiltrates)		
			Hepatic	2.6				
	Renal	2.6						

Table 3-1 Levels of Significant Exposure to Cadmium - Inhalation

(continued)

Key to Figure <sup>a</sup>	Species (Strain)	Exposure/Duration/Frequency (Route)	System	NOAEL (mg/m <sup>3</sup> )	LOAEL		Reference Chemical Form	Comments
					Less Serious (mg/m <sup>3</sup> )	Serious (mg/m <sup>3</sup> )		
22	Hamster (Golden Syrian)	30 min	Resp		1.1 (moderate increase in PMN, 2-fold increase in acid phosphatase)	10.1 (severe pneumonitis)	<a href="#">Henderson et al. 1979</a> CdCl <sub>2</sub>	
23	Rabbit (New Zealand)	2 hr	Resp		4.5 M (mild, multifocal interstitial pneumonitis)		<a href="#">Grose et al. 1987</a> CdCl <sub>2</sub>	
24	Rabbit (New Zealand)	2 hr	Resp		0.45 M (increase in alveolar macrophages)	4.5 M (multifocal interstitial pneumonitis)	<a href="#">Grose et al. 1987</a> CdO dust	
			Bd Wt		0.45 M (unspecified decrease in body weight)			
<b>Immuno/ Lymphoret</b>								
25	Mouse (Swiss)	2 hr		0.11 F	0.19 F (decreased humoral immune response)		<a href="#">Graham et al. 1978</a> CdCl <sub>2</sub>	
26	Mouse (C57Bl/6)	60 min			0.88 F (reduction in spleen lymphocyte viability [35%], numbers, and humoral response (75%))		<a href="#">Krzystyniak et al. 1987</a> CdCl <sub>2</sub>	
<b>INTERMEDIATE EXPOSURE</b>								
<b>Death</b>								
27	Rat (Wistar)	20 wk 5 d/wk 5 hr/d				1 F (13/13 died by week 20)	<a href="#">Baranski and Sitarek 1987</a> CdO dusts	

Table 3-1 Levels of Significant Exposure to Cadmium - Inhalation

(continued)

Key to Figure	Species (Strain)	Exposure/Duration/Frequency (Route)	System	NOAEL (mg/m <sup>3</sup> )	LOAEL		Reference Chemical Form	Comments
					Less Serious (mg/m <sup>3</sup> )	Serious (mg/m <sup>3</sup> )		
28	Rat (Fischer 344)	62 d 5 d/wk 6 hr/d				2.13 M (100% mortality by day 45)	Kutzman et al. 1986 CdCl <sub>2</sub>	
29	Rat (Wistar)	6 mo 40 hr/wk				0.09 (> 75% mortality by 11-12 months postexposure)	Oldiges et al. 1989 CdCl <sub>2</sub>	
30	Rat (Wistar)	6 mo 40 hr/wk				0.27 (> 75% mortality by 21-23 months postexposure)	Oldiges et al. 1989 CdS	
31	Rat (Wistar)	63d 24 hr/d				0.105 F (5/12 died)	Prigge 1978a CdO dust	
<b>Systemic</b>								
32	Rat (Wistar)	20 wk 5 d/wk 5 hr/d	Bd Wt	0.16 F		1 F (30-50% decreased body weight gain)	Baranski and Sitarek 1987 CdO dusts	
33	Rat (Wistar)	30 d 7 d/wk 22 hr/d	Resp		0.105 M (increased total bronchoalveolar macrophage numbers, leukocytes, and macrophage cytotoxicity)		Glaser et al. 1986 CdCl <sub>2</sub>	No histopathology examination.
			Hemato		0.105 M (45% increase in WBC)			

Table 3-1 Levels of Significant Exposure to Cadmium - Inhalation

(continued)

Key to Figure <sup>a</sup>	Species (Strain)	Exposure/ Duration/ Frequency (Route)	System	NOAEL (mg/m <sup>3</sup> )	LOAEL		Reference Chemical Form	Comments
					Less Serious (mg/m <sup>3</sup> )	Serious (mg/m <sup>3</sup> )		
34	Rat (Wistar)	30 d 7 d/wk 22 hr/d	Resp		0.098 M (increased total bronchoalveolar macrophage numbers, leukocytes, and macrophage cytotoxicity)		Glaser et al. 1986 CdO dust	No histopathology examination.
			Hemato		0.098 M (45% increase in WBC)			
35	Rat (Wistar)	30 d 7 d/wk 22 hr/d	Resp		1.034 M (increased total bronchoalveolar macrophage numbers, leukocytes, and macrophage cytotoxicity)		Glaser et al. 1986 CdS	No histopathological examination.
			Hemato	1.034 M				
			Bd Wt	1.034 M				
36	Rat (Fischer 344)	62 d 5 d/wk 6 hr/d	Resp		1.06 M (marked fibrosis with significant increase in collagen)		Kutzman et al. 1986 CdCl <sub>2</sub>	
			Bd Wt	0.33	1.06	(14% decreased body weight)		

Table 3-1 Levels of Significant Exposure to Cadmium - Inhalation

(continued)

Key to Figure <sup>a</sup>	Species (Strain)	Exposure/Duration/Frequency (Route)	System	NOAEL (mg/m <sup>3</sup> )	LOAEL		Reference Chemical Form	Comments
					Less Serious (mg/m <sup>3</sup> )	Serious (mg/m <sup>3</sup> )		
37	Rat (Fischer- 344)	6.33 hr/d 5 d/wk 13 wk	Resp	0.022 F	0.022 F	0.88	NTP 1995 CdO	(epithelial degeneration in the larynx)
					0.22			
			Cardio	0.88				
			Gastro	0.88				
			Hemato	0.88				
			Hepatic	0.88				
			Renal	0.88				
Bd Wt	0.88							
38	Rat (Fischer 344)	4 wks 5 d/wk 6 hr/d	Resp	0.1 M			Oberdorster et al. 1994 CdCl <sub>2</sub>	

Table 3-1 Levels of Significant Exposure to Cadmium - Inhalation

(continued)

Key to Figure <sup>a</sup>	Species (Strain)	Exposure/ Duration/ Frequency (Route)	System	NOAEL (mg/m <sup>3</sup> )	LOAEL		Reference Chemical Form	Comments
					Less Serious (mg/m <sup>3</sup> )	Serious (mg/m <sup>3</sup> )		
39	Rat (Wistar)	63 or 90 d 24 hr/d	Resp		0.025 F (proliferations, histiocytic cell granulomas)		Prigge 1978a CdO dust	
			Hemato		0.052 F (increased hemoglobin and hematocrit)			
			Hepatic	0.105 F				
			Renal	0.105 F				
			Bd Wt		0.105 F (11% decrease in body weight)			
		Metab		0.105 F (decreased blood pH and pO <sub>2</sub> , increased pCO <sub>2</sub> )				
40	Rat (Wistar)	21 d Gd 1-21 24 hr/d	Resp		0.204 F (77% increased lung relative weight)		Prigge 1978b CdCl <sub>2</sub>	
			Hemato		0.204 F (8% increased hemoglobin, 5% increased hematocrit)			
			Hepatic	0.581 F				
			Renal	0.581 F				
			Bd Wt	0.394 F				

Table 3-1 Levels of Significant Exposure to Cadmium - Inhalation

(continued)

Key to Figure	Species (Strain)	Exposure/Duration/Frequency (Route)	System	NOAEL (mg/m <sup>3</sup> )	LOAEL		Reference Chemical Form	Comments
					Less Serious (mg/m <sup>3</sup> )	Serious (mg/m <sup>3</sup> )		
41	Rat (Wistar)	21 d Gd 1-21 24 hr/d	Resp		0.204 F (70% increased lung relative weight)		Prigge 1978b CdCl <sub>2</sub>	
			Hemato		0.581 F (increased hemoglobin [12%], hematocrit [12%], total biliurin [2-fold])			
			Hepatic	0.581 F				
			Renal	0.581 F				
			Bd Wt		0.394 F (12% decreased maternal weight gain)			
42	Mouse (B6C3F1)	6.33 hr/d 5 d/wk 13 wk	Resp		0.088 M (Degeneration of nasal olfactory epithelium)		NTP 1995 CdO	
					0.022 (alveolar histiocytic infiltrates and squamous metaplasia of the larynx)			
			Cardio	0.88				
			Gastro	0.88				
			Hepatic	0.88				
			Renal	0.88				
			Bd Wt	0.88				



Table 3-1 Levels of Significant Exposure to Cadmium - Inhalation

(continued)

Key to Figure <sup>a</sup>	Species (Strain)	Exposure/ Duration/ Frequency (Route)	System	NOAEL (mg/m <sup>3</sup> )	LOAEL		Reference Chemical Form	Comments
					Less Serious (mg/m <sup>3</sup> )	Serious (mg/m <sup>3</sup> )		
43	Mouse (BALB/c)	4 wks 5 d/wk 6 hr/d	Resp		0.1 M (increased neutrophils, LDH and beta-glucuronidase; pulmonary inflammation)		<a href="#">Oberdorster et al. 1994</a> CdCl <sub>2</sub>	
44	Rabbit (NS)	9 mo 21 d/mo 3 hr/d	Resp			4 (chronic pneumonia, emphysema)	<a href="#">Friberg 1950</a> Cd metal dust	
			Hemato		4 (eosinophilia, lower hemoglobin)			
			Renal			4 (proteinuria)		
45	Rabbit (NS)	7 mo 23 d/mo 3 hr/d	Resp			5.6 (emphysema)	<a href="#">Friberg 1950</a> Cd metal dust	
			Renal			5.6 (proteinuria in 6/10 surviving to the end of exposure)		
46	Rabbit (NS)	4-6 wk 5 d/wk 6 hr/d	Resp			0.4 M (lung interstitial inflammation, type 2 cell hyperplasia)	<a href="#">Johansson et al. 1984</a> CdCl <sub>2</sub>	

Table 3-1 Levels of Significant Exposure to Cadmium - Inhalation

(continued)

Key to Figure <sup>a</sup>	Species (Strain)	Exposure/Duration/Frequency (Route)	System	NOAEL (mg/m <sup>3</sup> )	LOAEL		Reference Chemical Form	Comments
					Less Serious (mg/m <sup>3</sup> )	Serious (mg/m <sup>3</sup> )		
<b>Reproductive</b>								
47	Rat (Wistar)	5 hr/d 5 d/wk 5 mo prematuring, mating, Gd 1-20		0.16 F			Baranski 1984 CdO	
48	Rat (Wistar)	20 wk 5 d/wk 5 hr/d			1 F (increased duration of estrous cycle)		Baranski and Sitarek 1987 CdO dusts	
49	Rat (Fischer 344)	62 d 5 d/wk 6 hr/d		1.06 M (t)			Kutzman et al. 1986 CdCl <sub>2</sub>	
50	Rat (Fischer- 344)	6.33 hr/d 5 d/wk 13 wk		0.22 M 0.22 F	0.88 M (decreased spermatid counts)  0.88 F (increased estrous cycle length)		NTP 1995 CdO	
<b>Developmental</b>								
51	Rat (Wistar)	5 hr/d 5 d/wk 5 mo prematuring, mating, Gd 1-20			0.02 F (altered performance on neurobehavioral tests)		Baranski 1984 CdO	

Table 3-1 Levels of Significant Exposure to Cadmium - Inhalation

(continued)

Key to Figure <sup>a</sup>	Species (Strain)	Exposure/Duration/Frequency (Route)	System	NOAEL (mg/m <sup>3</sup> )	LOAEL		Reference Chemical Form	Comments	
					Less Serious (mg/m <sup>3</sup> )	Serious (mg/m <sup>3</sup> )			
52	Rat (Wistar)	4-5 mo 5 d/wk 5 hr/d			0.02	(altered performance on neurobehavioral tests)	0.16	(decreased pup viability)	Baranski 1985 CdO dusts
53	Rat (Sprague-Dawley)	6.27 hr/d 7 d/wk Gd 4-19		0.4 F	1.7 F	(decreased fetal body weight and reduced ossification)			NTP 1995 CdO
54	Rat (Wistar)	21 d Gd 1-21 24 hr/d			0.581	(9% decreased fetal body weight, 12% increase in fetal alkaline phosphatase)			Prigge 1978b CdCl <sub>2</sub>
55	Mouse (Swiss)	6.27 hr/d 7 d/wk Gd 4-17		0.04 F	0.4 F	(decreased fetal body weight)			NTP 1995 CdO
<b>Cancer</b>									
56	Rat (Wistar)	6 mo 40 hr/wk					0.09	(CEL: lung bronchioalveolar adenomas, adenocarcinomas, and squamous cell carcinomas)	Oldiges et al. 1989 CdCl <sub>2</sub>
<b>CHRONIC EXPOSURE</b>									
<b>Death</b>									
57	Human	1-34 yr 5 d/wk 8 hr/d (occup)					6.8 M	(2 fatalities from 14 years or 25 years of exposure to Cd dust)	Friberg 1950 Cd dust

Table 3-1 Levels of Significant Exposure to Cadmium - Inhalation

(continued)

Key to Figure	Species (Strain)	Exposure/Duration/Frequency (Route)	System	NOAEL (mg/m <sup>3</sup> )	LOAEL		Reference Chemical Form	Comments
					Less Serious (mg/m <sup>3</sup> )	Serious (mg/m <sup>3</sup> )		
58	Rat (Wistar)	413-455 d 7 d/wk 22 hr/d					0.095 M (6/20 died)	Oldiges and Glaser 1986 CdSO <sub>4</sub>
59	Rat (Wistar)	18 mo 7 d/wk 22 hr/d					0.03 M (>75% mortality by 12 months postexposure)	Oldiges et al. 1989 CdCl <sub>2</sub>
60	Rat (Wistar)	18 mo 7 d/wk 22 hr/d					0.09 (more than 25% died after 7 months [M] and 11 months [F] of exposure)	Oldiges et al. 1989 CdO dust
61	Rat (Wistar)	18 mo 7 d/wk 22 hr/d					0.09 (>75% mortality after 12 months postexposure)	Oldiges et al. 1989 CdS
62	Rat (Wistar)	18 mo 7 d/wk 22 hr/d					0.09 M (>25% mortality by 14 months of exposure)  0.09 F (>75% by 11 months postexposure)	Oldiges et al. 1989 CdSO <sub>4</sub>
<b>Systemic</b>								
63	Human		Renal	0.0001 <sup>C</sup> F				Buchet et al. 1990; Jarup et al. 2000; Suwazono et al. 2006 form not specified

Table 3-1 Levels of Significant Exposure to Cadmium - Inhalation

(continued)

Key to Figure <sup>a</sup>	Species (Strain)	Exposure/Duration/Frequency (Route)	System	NOAEL (mg/m <sup>3</sup> )	LOAEL		Reference Chemical Form	Comments
					Less Serious (mg/m <sup>3</sup> )	Serious (mg/m <sup>3</sup> )		
64	Human	4-24 yr 5 d/wk 8 hr/d (occup)	Resp	0.025			Edling et al. 1986 CdO fume	
65	Human	30 yr 5 d/wk 8 hr/d (occup)	Renal	0.033		0.067 (pronounced proteinuria)	Elinder et al. 1985b CdO fume	
66	Human	30 yr 5 d/wk 8 hr/d (occup)	Renal	0.0153 M		0.0379 M (100% incidence of proteinuria in the cohort exposed to this level for 21 years)	Falck et al. 1983 CdO fume	
67	Human	30 yr 5 d/wk 8 hr/d (occup)	Renal	0.017		0.023 (9.2% incidence of proteinuria)	Jarup et al. 1988 CdO dust	
68	Human	30 yr 5 d/wk 8 hr/d (occup)	Renal	0.0367 M			Mason et al. 1988 form not specified	
69	Human	30 yr 5 d/wk 8 hr/d (occup)	Renal	0.027			Thun et al. 1989 CdO dust or fume	

Table 3-1 Levels of Significant Exposure to Cadmium - Inhalation

(continued)

Key to Figure <sup>a</sup>	Species (Strain)	Exposure/Duration/Frequency (Route)	System	NOAEL (mg/m <sup>3</sup> )	LOAEL		Reference Chemical Form	Comments
					Less Serious (mg/m <sup>3</sup> )	Serious (mg/m <sup>3</sup> )		
70	Rat (Wistar)	18 mo 7 d/wk 23 hr/d	Resp			0.0134 M (adenomatous hyperplasia in the bronchoalveolar area)	Takenaka et al. 1983 CdCl <sub>2</sub>	
			Bd Wt	0.0508 M				
<b>Cancer</b>								
71	Human	6 mo - 43 yr 7 d/wk 8 hr/d (occup)				0.1 M (CEL: 50-111 lung cancer deaths per 1000 workers; 45 year exposure)	Stayner et al. 1992 CdO dust or fumes	
72	Rat (Wistar)	18 mo 7 d/wk 22 hr/d				0.03 (CEL: lung bronchioalveolar adenomas, adenocarcinomas, and squamous cell carcinomas)	Oldiges et al. 1989 CdCl <sub>2</sub>	
73	Rat (Wistar)	18 mo 7 d/wk 22 hr/d				0.03 (CEL: lung bronchioalveolar adenomas, adenocarcinomas, and squamous cell carcinomas)	Oldiges et al. 1989 CdO dust	

Table 3-1 Levels of Significant Exposure to Cadmium - Inhalation

(continued)

Key to Figure <sup>a</sup>	Species (Strain)	Exposure/ Duration/ Frequency (Route)	System	NOAEL (mg/m <sup>3</sup> )	LOAEL		Reference Chemical Form	Comments
					Less Serious (mg/m <sup>3</sup> )	Serious (mg/m <sup>3</sup> )		
74	Rat (Wistar)	18 mo 7 d/wk 22 hr/d				0.03	(CEL: lung bronchioalveolar adenomas, adenocarcinomas)	<a href="#">Oldiges et al. 1989</a> CdO fume
75	Rat (Wistar)	18 mo 7 d/wk 22 hr/d				0.09	(CEL: lung bronchioalveolar adenomas, adenocarcinomas, and squamous cell carcinomas)	<a href="#">Oldiges et al. 1989</a> CdS
76	Rat (Wistar)	18 mo 7 d/wk 22 hr/d				0.09	(CEL: lung bronchio-alveolar adenomas, adenocarcinomas, squamous cell carcinomas)	<a href="#">Oldiges et al. 1989</a> CdSO <sub>4</sub>

Table 3-1 Levels of Significant Exposure to Cadmium - Inhalation

(continued)

Key to Figure	Species (Strain)	Exposure/Duration/Frequency (Route)	System	NOAEL (mg/m <sup>3</sup> )	LOAEL		Reference Chemical Form	Comments
					Less Serious (mg/m <sup>3</sup> )	Serious (mg/m <sup>3</sup> )		
77	Rat (Wistar)	18 mo 7 d/wk 23 hr/d					0.0134 M (CEL: lung epidermoid carcinomas, adenocarcinomas, and mucoepidermoid carcinomas)	Takenaka et al. 1983 CdCl <sub>2</sub>

a The number corresponds to entries in Figure 3-1.

b Used to derive an acute-duration inhalation minimal risk level (MRL) of 0.00003 mg Cd/m<sup>3</sup> (0.03 ug Cd/m<sup>3</sup>); concentration was adjusted for intermittent exposure (6.2 hours/day, 5 days/week) and divided by an uncertainty factor of 300 (10 for use of a LOAEL, 3 for extrapolation from animals to humans with dosimetric adjustment, and 10 for human variability).

c The chronic-duration inhalation MRL of 0.00001 mg Cd/m<sup>3</sup> (0.01 ug Cd/m<sup>3</sup>) was calculated from the 95% lower confidence limit of the urinary cadmium level associated with a 10% increased risk of low molecular weight proteinuria (0.5 ug/g creatinine) estimated from a meta-analysis of select environmental exposure studies. An air concentration (together with an assumed dietary intake of 0.3 ug Cd/kg/day) which would result in this urinary cadmium concentration was estimated using the ICRP human respiratory tract model and a modification of the Nordberg-Kjellström pharmacokinetic model (see Appendix A for details on the meta-analysis and extrapolation to air concentration). This air concentration of 0.1 ug Cd/m<sup>3</sup> was divided by an uncertainty factor of 3 for human variability and a modifying factor of 3.

Bd Wt = body weight; Cardio = cardiovascular; CEL = cancer effect level; d = day(s); Endocr = endocrine; F = Female; Gastro = gastrointestinal; Gd = gestational day; Hemato = hematological; hr = hour(s); Immuno/Lymphoret = immunological/lymphoreticular; LC50 = lethal concentration, 50% kill; LDH = lactate dehydrogenase; LOAEL = lowest-observed-adverse-effect level; M = male; min = minute(s); Metab = metabolic; mo = month(s); NOAEL = no-observed-adverse-effect level; NS = not specified; occup = occupational; PMN = polymorphonuclear leukocyte; Resp = respiratory; WBC = white blood cells; wk = week(s); yr = year(s)



Figure 3-1 Levels of Significant Exposure to Cadmium - Inhalation

Acute (≤14 days)

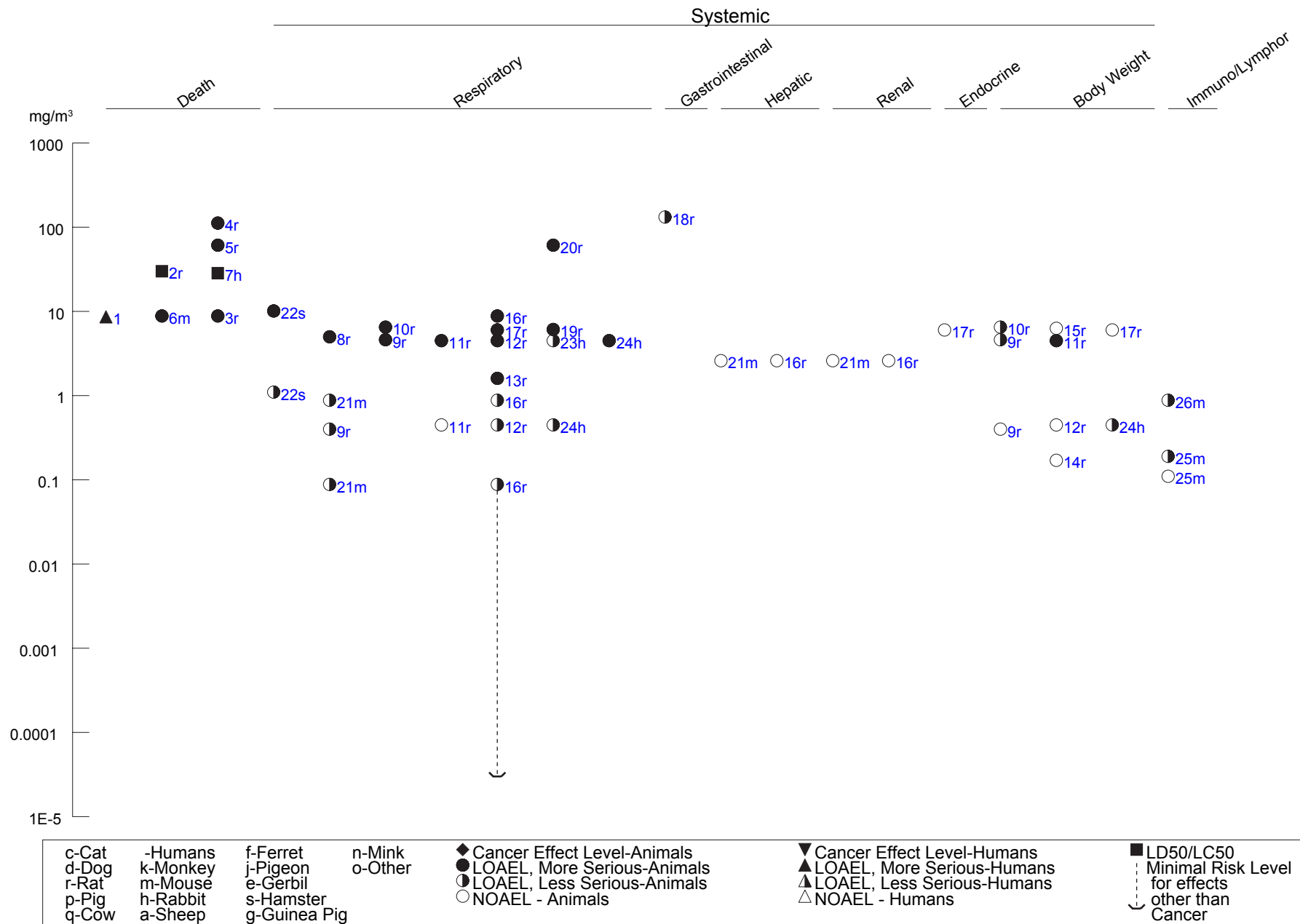

Figure 3-1 Levels of Significant Exposure to Cadmium - Inhalation (Continued)

Intermediate (15-364 days)

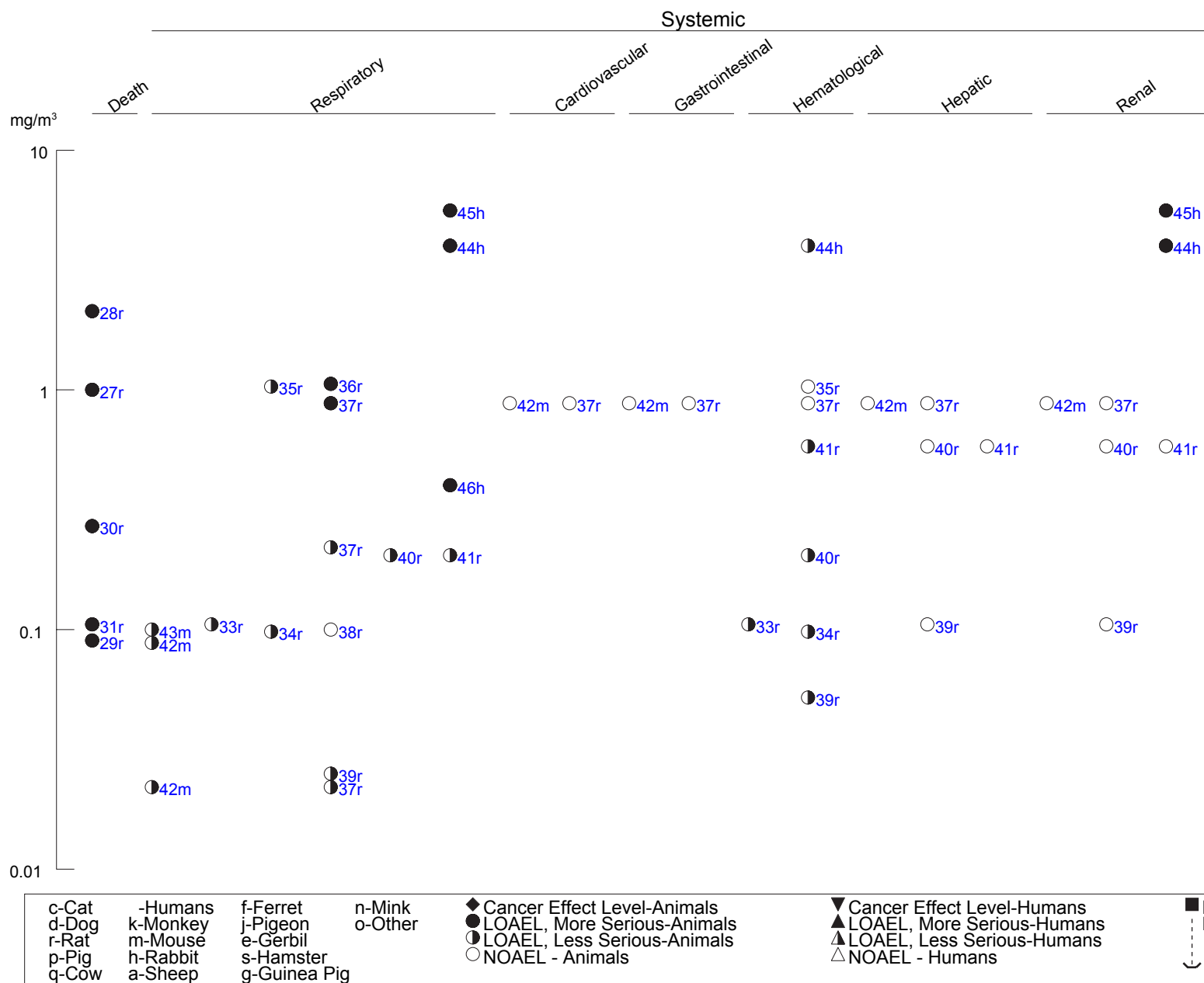

Figure 3-1 Levels of Significant Exposure to Cadmium - Inhalation (Continued)

Intermediate (15-364 days)

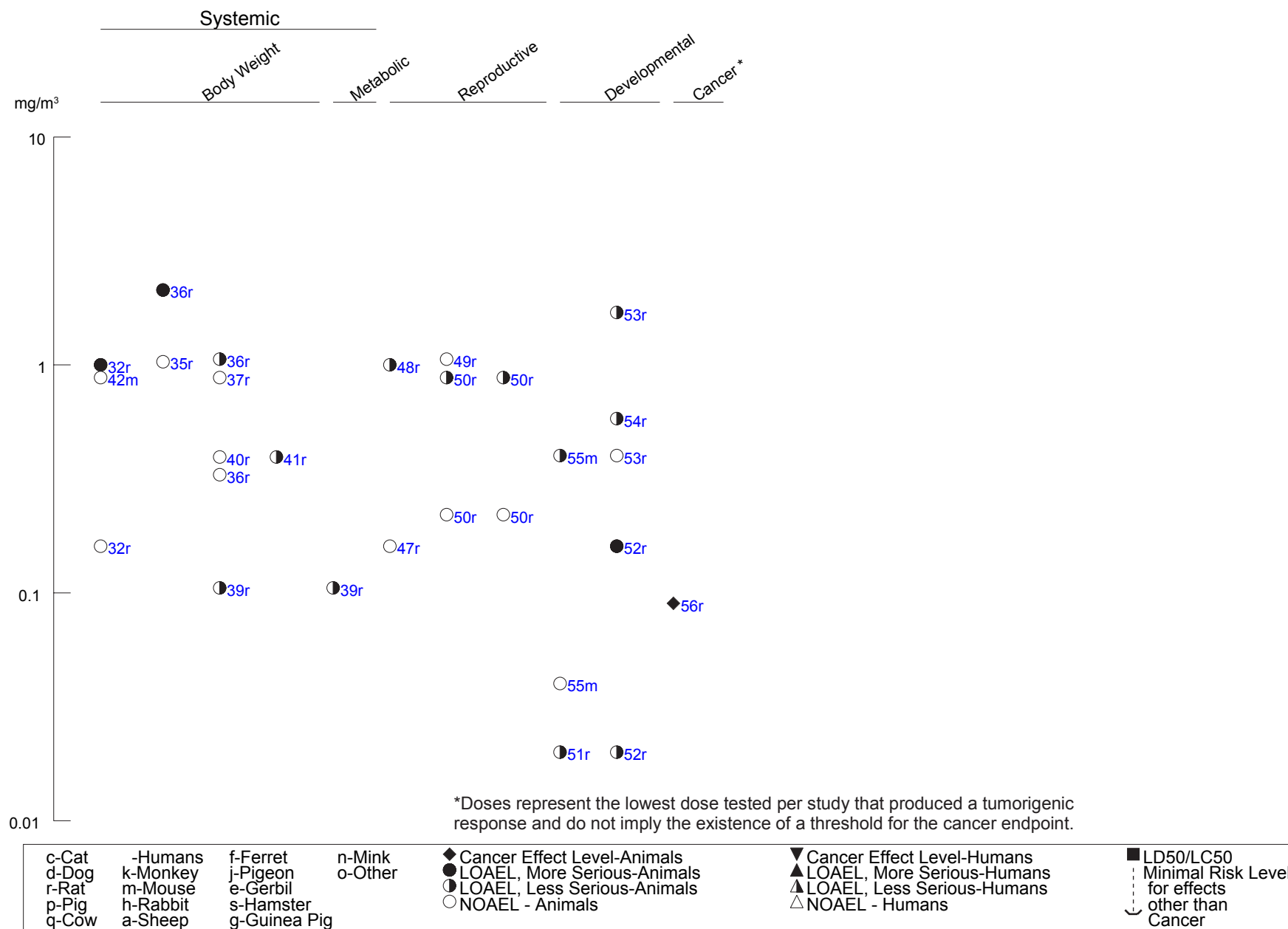
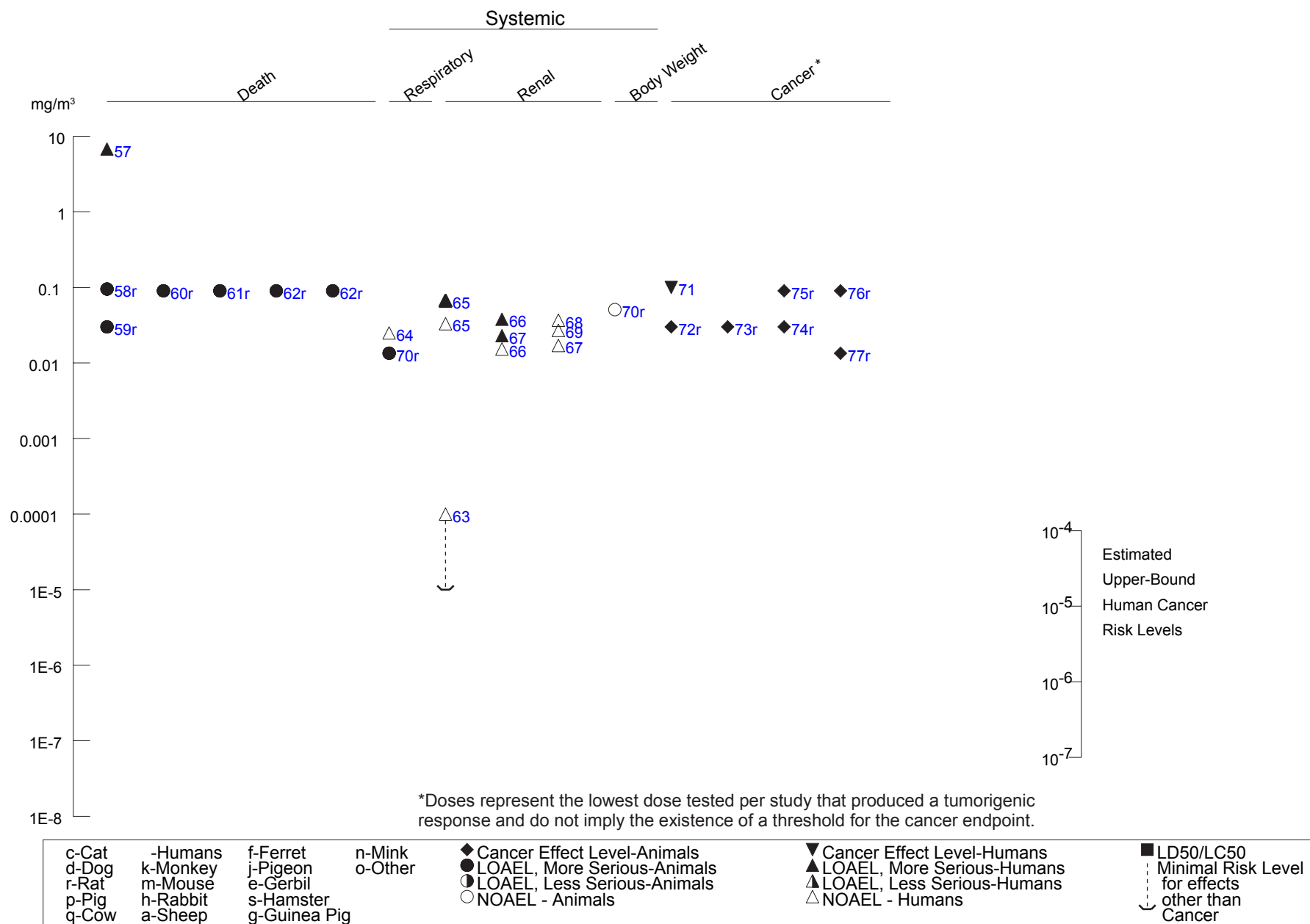

Figure 3-1 Levels of Significant Exposure to Cadmium - Inhalation (Continued)

Chronic (≥365 days)



## 3. HEALTH EFFECTS

had no improvement in respiratory function. Precise estimates of cadmium concentrations leading to acute respiratory effects in humans are not currently available.

The initial symptoms of respiratory distress observed in the higher acute exposures do not occur following lower-level, longer-term inhalation exposures (Friberg 1950). Longer-term occupational exposure to levels of cadmium below those causing lung inflammation, however, have been reported to cause emphysema and dyspnea in humans (Bonnell 1955; Friberg 1950; Lane and Campbell 1954; Smith et al. 1960). Kjellström et al. (1979) reported a significant increase in deaths due to respiratory diseases in cadmium-exposed battery factory workers exposed for >5 years.

A significant, dose-dependent excess in the ratio of observed to expected deaths from bronchitis (i.e., standardized mortality ratio [SMR]=434) but not emphysema was found among 6,995 men occupationally exposed to cadmium for an average of 11 years (Armstrong and Kazantzis 1983). The dose level was not determined.

The earlier occupational studies did not control for the health effects of cigarette smoking. There is some evidence that cadmium may accelerate the development of emphysema in smokers. Leduc et al. (1993) report a case history of a 59-year-old male worker who smoked a pack of cigarettes per day since age 16, but had no prior history of respiratory disease in 1975 until developing emphysema in 1979 after inhaling various concentrations of cadmium (range of 0.0164–1.192 mg/m<sup>3</sup>, mean of 0.446 mg/m<sup>3</sup>, about nine times the threshold value of 0.050 mg/m<sup>3</sup>) for 4 years as a furnace operator. Very high levels of cadmium in air samples at the workplace and in the patient's blood, urine, and lung tissue confirmed massive exposures. Lung-function tests declined rapidly, with a faster than usual onset of emphysema compared to other smokers. The mean concentration of cadmium in a removed section of lung was 580 µg/g dry tissue, compared to 14 µg/g in three unexposed controls matched for age, sex, and smoking habit who had also undergone resection of a bronchial carcinoma. The authors state that this case supports the hypothesis for an etiological role of cadmium fume inhalation in the development of emphysema.

More recent studies that controlled for smoking report lung impairment in cadmium-exposed workers (Chan et al. 1988; Cortona et al. 1992; Davison et al. 1988; Smith et al. 1976). Cortona et al. (1992) measured respiratory function parameters in 69 smoking and nonsmoking male subjects (average age 45) who were exposed to concentrations of 0.008–1.53 mg/m<sup>3</sup> of cadmium fumes over a period of several years in a factory that produced cadmium alloys (silver-cadmium-copper). Forced Expiratory Volume (FEV), Forced Vital Capacity (FVC), Residual Volume (RV), Transfer Factor by the carbon

## 3. HEALTH EFFECTS

monoxide method (TLCO), and Transfer Coefficient (KCO) were measured in these exposed individuals. The study found that there were no significant differences in the FVC, FEV, TLCO, and KCO between the workers exposed to cadmium fumes and control (non-exposed) individuals. There was a significant increase in RV of >8% in exposed workers; this effect was notably greater in those with higher cumulative exposures to cadmium (>10%). It is uncertain how much of a factor on the increased RV was due to the tendency of smokers to develop an initial emphysematous alteration in lung tissue due to smoking.

Davison et al. (1988) evaluated lung function in 101 men who had manufactured copper-cadmium alloy in a plant in England for  $\geq 1$  years since 1926. The exposed men were compared to controls from the factory's other seven divisions matched for age and employment status. Smoking in exposed and control men was similar. Between 1951 and 1983, 933 measurements of airborne cadmium had been made, 697 with static samplers and 236 with personal samplers. The various sampling methods used before 1964 are no longer considered to be reliable, so estimates of air concentrations were made based on changes in production techniques, ventilation, levels of production, and discussions with occupational health physicians, industrial hygienist, the management, and the workers. Cadmium concentrations in air from 1926 to 1972 were determined to have declined from 0.6 to 0.156 mg/m<sup>3</sup>. In 1973, concentrations were 0.085 mg/m<sup>3</sup>; from 1974 to 1983, concentrations ranged from 0.034 to 0.058 mg/m<sup>3</sup>. The lung function of 77 of the men occupationally exposed to cadmium was significantly impaired compared to the unexposed controls, with the greatest abnormalities in the highest-dose group. Forced expiratory volume in one second, ratio of forced expiratory volume to forced vital capacity, transfer factor, or transfer coefficient were significantly lower than expected and radiographic total lung capacity, residual volume, and the ratio of these two were significantly higher than expected. The greatest abnormalities were observed in workers with the highest cumulative exposure and the highest liver cadmium levels. Regression of the lung transfer coefficient versus cadmium exposure indicated a linear relationship with no apparent threshold.

Smith et al. (1976) studied the pulmonary function of 17 high-exposure workers, 12 low-exposure workers, and 17 controls. Cadmium air concentrations where high-exposure subjects worked were >0.2 mg/m<sup>3</sup>. High-exposure subjects had worked at the plant a median of 26.4 years, with a maximum of 40.2 years, and low-exposure subjects had worked a median of 27.1 years, with a maximum of 34.8 years. Workers with high exposure to cadmium had significantly decreased the FVC compared to low-exposure workers and controls. Chest X-rays indicated mild or moderate interstitial fibrosis in 29% of high exposure workers. A dose-response relationship was found between FVC and urinary cadmium, and

## 3. HEALTH EFFECTS

with months of exposure to cadmium fume, but not cadmium sulfate aerosol. In an analysis of the smoking habits, there was no significant difference between the two cadmium-exposed groups with respect to the proportion of present or past cigarette smokers, the intensity or duration of cigarette smoking, or cigar or pipe smoking habits. The control subjects, however, had a significantly ( $p < 0.05$ ) “higher” exposure to cigarette smoke than the cadmium exposed workers with substantially greater numbers of pack-years, cigarettes smoked per day, and years smoked. A step-down and multiple regression analyses with a dependent variable of FVC (as percent of predicted), and the independent variables, age-height, cigarette pack-years, and urinary cadmium, resulted in no indication that an interaction between the independent variables led to the observed relationship between FVC and cadmium excretion.

Other studies, however, have not shown a cadmium-related increase in impaired respiratory function. Edling et al. (1986) studied Swedish workers occupationally exposed to cadmium oxide fume from cadmium-containing solders. Cadmium-containing solder had been used at the plant from 1955 to 1978. The results from the lung-function analysis showed no significant difference in symptoms or lung function between the cadmium-exposed and the reference group. The exposed and the reference groups were similar with respect to sex, age, and height. There was a higher percentage of smokers in the reference group (52%) than in the exposed group (42%), but the difference was not statistically significant. The authors could not explain why significant differences in effects were not seen in these workers since other studies have shown significant effects at comparable cadmium exposure levels. The authors suggest that a possible bias could have been introduced if people who had worked for  $>5$  years in the plant had changed their occupation because of lung disease, so that only “healthy” workers remained. Significant effects may also have been found if the reference group included workers other than those who worked with solder, but the purpose of the study was to resolve the effects of cadmium exposure among workers with similar occupations. Evaluating the data from smokers and nonsmokers separately also showed no significant impairment in lung function between smoking exposed and smoking unexposed or nonsmoking exposed and nonsmoking unexposed. The lung impairment due to smoking was observed in that smokers in both the exposed and unexposed groups had a somewhat deteriorated closing volume and other lung function indicators in accordance with previous studies on the effects of smoking. These results support the hypothesis that the response to occupational dust exposure differs from the response to tobacco smoking.

Another possible reason for differing results is that lung injury caused by high-level cadmium exposure may be partially reversible (Bonnell 1955; Chan et al. 1988), with a return towards normal several years

## 3. HEALTH EFFECTS

after exposures have been significantly reduced. Chan et al. (1988) studied a cohort of 36 female and 8 male workers at a Singapore cadmium battery factory exposed to cadmium oxide dust. Cadmium concentrations in air were 0.03–0.09 mg/m<sup>3</sup> (geometric means). Lung function was measured using spirometry, helium dilution, tidal sampling, X-ray, and respiratory symptoms. The recovery of lung function after reduction or cessation of occupational exposure to cadmium dusts was assessed. Total lung capacity increased following reduction of exposure and, following cessation of exposure, vital capacity, FEV<sub>1</sub>, and prevalence of respiratory symptoms all improved. Blood and urine cadmium concentrations were considerably lower with the reduction or cessation of exposure and were consistent with a decrease in the cadmium air levels.

Additional respiratory symptoms less frequently reported in workers occupationally exposed to cadmium are chronic rhinitis and impairment or loss of the sense of smell (Adams et al. 1969; Bonnell 1955; Friberg 1950; Liu et al. 1985; Rose et al. 1992). The cause of these effects may be chronic irritation or necrosis of the nasal membranes, as they are generally found only in individuals with high-level exposure. An increased prevalence of abnormal paranasal radiographic findings in cadmium-exposed workers compared to other published reports on non-exposed populations was reported by Shaham et al. (1993).

Studies in animals confirm that inhalation exposure to cadmium can lead to respiratory injury. Single acute exposures in rats to 5–10 mg Cd/m<sup>3</sup> as cadmium oxide dust, cadmium oxide fume, or cadmium chloride for 1–5 hours resulted in moderate to severe, multifocal interstitial pneumonitis, diffuse alveolitis with hemorrhage, increased lung weight, inhibition of macrophages, focal interstitial thickening, edema, and necrosis of alveolar type 1 cells leading to type 2 cell hyperplasia and fibroblasts (Boudreau et al. 1989; Buckley and Bassett 1987b; Bus et al. 1978; Grose et al. 1987; Hart et al. 1989a; NTP 1995; Palmer et al. 1986). Similar results (i.e., severe pneumonitis) were seen in hamsters exposed to cadmium chloride at 10 mg/m<sup>3</sup> for 30 minutes (Henderson et al. 1979) and in rabbits exposed to cadmium oxide dusts at 4.5 mg/m<sup>3</sup> for 2 hours (Grose et al. 1987). Exposures in rats to cadmium chloride at 6.1 mg Cd/m<sup>3</sup> 1 hour/day for 5, 10, or 15 days resulted in emphysema; a 3-day exposure to 61 mg Cd/m<sup>3</sup> for 1 hour/day resulted in pulmonary hemorrhage (Snider et al. 1973). Repeated exposure to 0.088 mg Cd/m<sup>3</sup> as cadmium oxide for 2 weeks resulted in minimal to mild alveolar histiocytic (macrophage) infiltration in rats and mice, focal inflammation surrounding alveolar ducts and extending into the adjacent alveolar septa in rats, and hyperplasia in tracheobronchial lymph nodes in mice (NTP 1995). At higher concentrations, the severity of these lesions increased (the severity of the lung lesions was scored as moderate at  $\geq 0.88$  mg Cd/m<sup>3</sup>) and necrosis of the epithelial lining of the alveolar ducts was observed at  $\geq 0.26$  mg Cd/m<sup>3</sup> in rats and 0.88 mg Cd/m<sup>3</sup> in mice. The NTP (1995) study also found significant



## 3. HEALTH EFFECTS

increases in the incidence of lesions in the nasal cavity; minimal-to-mild degeneration of the olfactory epithelium was observed in rats and mice exposed to 0.88 mg Cd/m<sup>3</sup> and hyperplasia and inflammation of respiratory epithelium were observed in rats at 2.6 mg Cd/m<sup>3</sup>.

Persistent damage has been reported in an animal model following a single intratracheal exposure to 25, 100, or 400 µg cadmium chloride/kg body weight (Driscoll et al. 1992). Although most BALF biochemical (lactate dehydrogenase, total protein, and N-acetylglucosaminidase) and cellular (neutrophils and lymphocyte numbers) parameters returned to control levels 28 days after exposure, histopathological alterations including inflammation and fibrosis were still present 90 days post-exposure and the incidence and severity of the lesions were greater at 90 days compared to 28 days.

Intermediate-duration exposure to cadmium results in similar respiratory effects as seen in the acute exposures. Concentration-related increases in the severity and types of respiratory lesions have been observed. Because the intermediate-duration studies used different exposure protocols, intermittent exposure studies were duration-adjusted to continuous exposure (Table 3-2) to facilitate comparisons across these studies. The lowest adverse effect level for lung effects was 0.004 mg Cd/m<sup>3</sup> for alveolar epithelial hyperplasia in mice (NTP 1995). At 0.008–0.07 mg Cd/m<sup>3</sup>, inflammation and minimal fibrosis were observed in rats, mice, and rabbits (Johansson et al. 1984; NTP 1995; Oberdörster et al. 1994) and marked inflammation and moderate fibrosis were observed in rats at 0.17 mg Cd/m<sup>3</sup> (NTP 1995). At ≥0.34 mg Cd/m<sup>3</sup>, emphysema and chronic pneumonia were observed in rats and rabbits (Friberg 1950; Prigge 1978b). In addition to the widely reported effects in the lungs, NTP (1995) reported minimal lesions in the larynx of rats (epithelial degeneration) and mice (squamous metaplasia) exposed to 0.022 mg Cd/m<sup>3</sup> and minimal lesions in the nasal cavity in rats (inflammation of respiratory epithelium) and mice (degeneration of olfactory epithelium) exposed to 0.088 mg Cd/m<sup>3</sup>. The toxicity of cadmium to the respiratory tract following intermediate-duration exposure is highlighted by the NTP (1995) rat and mouse studies. As summarized in Table 3-3, rats and mice were exposed to five concentrations (0.022, 0.044, 0.088, 0.22, and 0.88 mg Cd/m<sup>3</sup> as cadmium oxide) 6.33 hours/day, 5 days/week for 13 weeks. The earliest effects observed were alveolar histiocytic infiltrates, alveolar epithelial hyperplasia, and tracheal epithelial hyperplasia or squamous metaplasia; these lesions were all graded as minimal. With increasing concentrations, the severity of most lesions increased as did the type of lesion.

There are fewer chronic-inhalation exposure studies that specifically reported systemic respiratory effects. Oldiges and Glaser (1986) report increased lung weights (amount unspecified) in rats from exposure to either cadmium sulfate at 0.092 mg Cd/m<sup>3</sup> or cadmium sulfide at 0.254 mg Cd/m<sup>3</sup> for 22 hours/day,

## 3. HEALTH EFFECTS

**Table 3-2. Comparison of Lung Effects Across Intermediate-Duration Inhalation Studies**

Species	Exposure frequency/duration	Adverse effect level (mg Cd/m <sup>3</sup> )	Duration-adjusted adverse effect level (mg Cd/m <sup>3</sup> )	Effect	Reference
Mouse	6.33 hours/day, 5 days/week, 13 weeks	0.022	0.004	Alveolar hyperplasia	NTP 1995
Rat	6.33 hours/day, 5 days/week, 13 weeks	0.044	0.008	Alveolar histiocytic infiltrates and hyperplasia	NTP 1995
Mouse	6.33 hours/day, 5 days/week, 13 weeks	0.044	0.008	Minimal fibrosis	NTP 1995
Mouse	6.33 hours/day, 5 days/week, 13 weeks	0.088	0.017	Moderate inflammation	NTP 1995
Rat	6.33 hours/day, 5 days/week, 13 weeks	0.22	0.017	Minimal fibrosis	NTP 1995
Mouse	6 hours/day, 5 days/week, 4 weeks	0.1	0.02	Inflammation	Oberdörster et al. 1994
Rat	24 hours/day, 7 days/week, 90 days	0.025	0.025	Proliferations	Prigge 1978a
Rat	6.33 hours/day, 5 days/week, 13 weeks	0.22	0.04	Inflammation	NTP 1995
Rat	6.33 hours/day, 5 days/week, 13 weeks	0.88	0.17	Marked inflammation and moderate fibrosis	NTP 1995
Mouse	6.33 hours/day, 5 days/week, 13 weeks	0.88	0.17	Moderate fibrosis	NTP 1995
Rat	6 hours/day, 5 days/week, 62 days	0.33	0.06	Fibrosis	Kutzman et al. 1986
Rabbit	6 hours/day, 5 days/week 4–6 weeks	0.4	0.07	Inflammation	Johansson et al. 1984
Rabbit	3 hours/day, 21 days/month, 9 months	4	0.34	Pneumonia/emphysema	Friberg 1950
Rabbit	3 hours/day, 23 days/month, 7 months	5.6	0.53	Emphysema	Friberg 1950
Rat	24 hours/day, 7 days/week				Prigge 1978b

## 3. HEALTH EFFECTS

**Table 3-3. Severity of Respiratory Effects in Rats and Mice Exposed to Cadmium Oxide for 13 Weeks<sup>a</sup>**

	Concentration (mg Cd/m <sup>3</sup> )					
	0	0.022	0.044	0.088	0.22	0.88
Male rats						
Lung						
Alveolar histiocytic infiltrate	—	— <sup>b</sup>	1.0 <sup>c</sup>	2.0	3.0	3.0
Alveolar epithelial hyperplasia	—	—	1.0	1.0	2.0	2.1
Inflammation	—	—	—	—	2.6	4.0
Fibrosis	—	—	—	1.0	2.0	2.7
Mediastinal lymph node						
inflammation	—	—	—	1.3	3.2	3.3
Larynx						
Epithelial degeneration	—	1.0	1.0	1.0	1.0	1.0
Nose						
Olfactory epithelium degeneration	—	—	—	—	1.0	3.0
Olfactory epithelium respiratory metaplasia	—	—	—	—	—	1.3
Olfactory epithelium squamous metaplasia	—	—	—	—	—	1.9
Respiratory epithelium inflammation	—	—	—	—	1.0	2.6
Respiratory epithelium degeneration	—	—	—	—	—	1.5
Female rats						
Lung						
Alveolar histiocytic infiltrate	—	—	1.0	2.1	3.0	3.0
Alveolar epithelial hyperplasia	—	—	1.0	1.0	2.0	2.1
Inflammation	—	—	—	—	1.6	3.5
Fibrosis	—	—	—	1.0	2.0	2.1
Mediastinal lymph node						
inflammation	—	—	1.0	1.5	3.6	4.0
Larynx						
Epithelial degeneration	—	1.0	1.0	1.0	1.0	1.0
Nose						
Olfactory epithelium degeneration	—	—	—	—	1.0	2.8
Olfactory epithelium respiratory metaplasia	—	—	—	—	1.0	1.0
Olfactory epithelium squamous metaplasia	—	—	—	—	—	1.4
Respiratory epithelium inflammation	—	—	—	1.0	1.8	1.8

## 3. HEALTH EFFECTS

**Table 3-3. Severity of Respiratory Effects in Rats and Mice Exposed to Cadmium Oxide for 13 Weeks<sup>a</sup>**

	Concentration (mg Cd/m <sup>3</sup> )					
	0	0.022	0.044	0.088	0.22	0.88
Male mice						
Lung						
Alveolar epithelial hyperplasia	—	1.0	1.0	1.8	1.7	2.0
Inflammation	—	—	—	3.0	2.2	2.7
Fibrosis	—	—	1.0	1.0	1.0	1.0
Tracheobronchial lymph node						
hyperplasia	—	—	1.0	2.3	2.4	2.7
Larynx						
Squamous metaplasia	—	1.0	1.0	1.0	1.0	1.1
Nose						
Olfactory epithelium degeneration	—	—	—	1.0	1.7	2.0
Olfactory epithelium respiratory metaplasia	—	—	—	—	1.0	1.5
Olfactory epithelium squamous metaplasia	—	—	—	—	—	1.0
Respiratory epithelium hyaline droplets	—	—	—	—	1.0	1.0
Female mice						
Lung						
Alveolar histiocytic infiltrate	—	1.0	1.0	2.0	2.0	3.0
Alveolar epithelial hyperplasia	—	—	—	1.4	2.0	2.0
Inflammation	—	—	—	2.3	2.1	2.9
Fibrosis	—	—	1.0	1.0	1.0	1.0
Tracheobronchial lymph node						
hyperplasia	—	—	1.0	1.5	2.0	2.4
Larynx						
Squamous metaplasia	—	1.0	1.0	1.0	1.0	1.0
Nose						
Olfactory epithelium degeneration	—	—	—	1.0	1.0	2.0
Olfactory epithelium respiratory metaplasia	—	—	—	—	—	1.0
Respiratory epithelium hyaline droplets	—	—	—	—	1.0	1.0

<sup>a</sup>Animals were exposed for 6.33 hours/day, 5 days/week.

<sup>b</sup>No lesions present or not significantly different from control group.

<sup>c</sup>Severity score: 1 = minimal, 2 = mild, 3 = moderate, 4 = marked

Source: NTP 1995

## 3. HEALTH EFFECTS

7 days/week for 413–455 days. Takenaka et al. (1983) observed adenomatous hyperplasia in the bronchoalveolar region in rats from exposure to cadmium chloride at 0.0134 mg Cd/m<sup>3</sup> for 23 hours/day, 7 days/week for 18 months.

The available data suggest that there may be species differences in the respiratory toxicity of cadmium. In a comparison of the pulmonary response to exposure to 0.1 mg Cd/m<sup>3</sup> as cadmium chloride 6 hours/day, 5 days/week for 4 weeks, Oberdörster et al. (1994) found that the inflammatory response in the lungs of mice was greater than that of rats exposed to the same cadmium concentration. However, the cadmium lung burden in mice was twice as high as the rat's lung burden. In the NTP (1995) study, adverse lung effects were observed at lower concentrations in mice compared to rats, but at the higher concentrations, the severity of the lung effects were greater in the rats. Although these data suggest species differences in the pulmonary toxicity of cadmium, more information is needed to evaluate if there are differences at given lung burdens.

Based on differences in the pharmacokinetic properties of various cadmium compounds, it is expected that differences in toxicity would be observed. As discussed in Oberdörster (1992), cadmium chloride and cadmium oxide elicited similar responses following a single intratracheal dose, whereas no response was observed for cadmium sulfide. However, Glaser et al. (1990) found similar responses following repeated exposures to various cadmium compounds.

Hart and colleagues (Hart 1986; Hart et al. 1989a, 2001) demonstrated that repeated low-concentration exposure to cadmium results in the development of adaptive survival response. In rats exposed to 1.6 mg Cd/m<sup>3</sup> as cadmium acetate 3 hours/day, 5 days/week, thickening of the alveolar septa and mononuclear cell and polymorphonuclear leukocyte aggregates were observed after 2 weeks of exposure (Hart 1986). However, the inflammatory response was decreased after 3 weeks of exposure and no significant histopathological alteration were observed in rats exposed for 4, 5, or 6 weeks. After 5 weeks of cadmium exposure, a single high concentration (8.4 mg Cd/m<sup>3</sup>) resulted in less pulmonary damage compared to non-pretreated animals (Hart et al. 1989a). Multiple pulmonary resistance factors appear to contribute to this resistance/tolerance. These factors include increased levels of metallothionein, glutathione, and  $\gamma$ -glutamylcysteinesynthetase (Hart et al. 2001). However, as suggested by Hart et al. (2001), cadmium-adapted alveolar epithelial cells have a reduced ability to repair DNA damage and apoptotic cell death is attenuated in these cells; thus, cadmium adapted animals may be more susceptible to tumor formation.

## 3. HEALTH EFFECTS

**Cardiovascular Effects.** Inhalation exposure to cadmium does not appear to have significant effects on the cardiovascular system. Most studies of workers occupationally exposed to cadmium have not found cadmium-related cardiovascular toxicity. In some studies, the mortality from cardiovascular disease was lower in the cadmium-exposed population. Armstrong and Kazantzis (1983) reported that a cohort of 6,995 British men occupationally exposed to cadmium for an average duration of 11 years had a significantly lower mortality from vascular disease.

Fifty-three male workers exposed to cadmium and lead and 52 male controls were examined for correlations in urine levels and blood pressure. The average duration of exposure was 12.5 years. Correlations between blood pressure and urinary cadmium in exposed workers were not significant after controlling for age or age and heart rate. Exposure to lead was a significant confounding factor (de Kort et al. 1987).

Friberg (1950) investigated the health of workers in a manufacturing plant that made cadmium-containing electrodes used in the production of batteries. Fifty-eight workers (30–50 years of age) were divided into two groups based on number of years at the plant. Workers were clinically examined for subjective symptoms and corresponding morphological or functional changes of the respiratory, cardiovascular, and excretory systems. The cardiovascular exam was largely unremarkable. Only a slight rise in blood pressure in a few cases was observed in Group 1. Electrocardiograms (EKG) were not significantly different from a matched control group in Group 1. Group 2 had neither increased blood pressure nor altered EKGs.

Kazantzis et al. (1988) studied mortality in a cohort of 6,958 cadmium-exposed male workers with average occupational exposures of 12 years. This was a follow-up study to the work of Armstrong and Kazantzis (1983). There was a significant deficit in deaths from cerebrovascular disease among men occupationally exposed to cadmium. There was no significant excess risk from hypertensive or renal disease.

Smith et al. (1980) studied 16 male high-exposure production workers and 11 male low-exposure office and supervisory workers for renal function. Average duration of exposure was 25 years. High-exposure workers were exposed to cadmium oxide concentrations of 0.23–45.2 mg/m<sup>3</sup> and cadmium sulfide concentrations of 0.04–1.27 mg/m<sup>3</sup>. No difference was found in hypertension between high- and low-exposure workers, adjusted for age and weight or cigarette smoking.

### 3. HEALTH EFFECTS

Sorahan and Waterhouse (1983) examined mortality rates in a cohort of 3,025 nickel-cadmium battery workers (2,559 males and 466 females). Cadmium levels in air ranged from 0.05 to 2.8 mg/m<sup>3</sup>, primarily as cadmium oxide. Duration of exposure ranged from 1 to >6 years. No increase in mortality from diseases of the circulatory system (e.g., hypertension) was seen in cadmium-exposed workers.

Staessen and Lauwerys (1993), in a study known as the Cadmibel Study (a cross-sectional population study), evaluated 2,327 people from a random sample of the population of four Belgian districts chosen to provide a wide range of environmental exposure to cadmium. Participants completed a questionnaire regarding their medical history, current and past occupations, smoking habits, alcohol consumption, and intake of medications. Urine and blood samples were taken, and pulse rate, blood pressure, height, and weight were recorded. Exposure to cadmium was considered to be by both the oral and inhalation routes. Cadmium levels in blood and urine were significantly increased in the high-exposure areas compared to the low-exposure areas ( $p < 0.001$ ). Blood pressure was not correlated with the urine or blood cadmium levels. The prevalence of hypertension or other cardiovascular diseases was similar in all four districts, and was not correlated with urine or blood cadmium levels. A follow-up investigation of 692 participants of this study also showed no correlation with urine or blood cadmium levels and the prevalence of hypertension after 5 years (Staessen et al. 2000). These results do not support a hypothesis that cadmium increases blood pressure, prevalence of hypertension, or other cardiovascular diseases.

One study found a statistically significant increase in blood pressure in exposed workers compared to controls (Thun et al. 1989), but mortality in this cohort was lower than expected (Thun et al. 1985).

There are limited data on the cardiotoxicity of cadmium in animals. No significant alterations in systolic blood pressure or histological alterations in the heart were observed in rats exposed to cadmium oxide concentrations as high as 0.88 mg Cd/m<sup>3</sup> for 13 weeks (NTP 1995).

**Gastrointestinal Effects.** In the cohort he studied, Friberg (1950) found no association between inhalation cadmium exposure in workers and symptoms of gastrointestinal toxicity. Symptoms that had been reported in case histories from the 1920s included pain or tenderness at the epigastrium associated with nausea and some constipation. No other human studies report any cadmium associated gastrointestinal toxicity from inhalation exposure.

In the only animal study located, Rusch et al. (1986) observed erosion of the stomach in rats from exposure to cadmium carbonate at 132 mg Cd/m<sup>3</sup> for 2 hours. Postmortem evaluation was performed at

## 3. HEALTH EFFECTS

1, 3, 7, and 30 days postexposure. After the inhalation exposure in a whole-body chamber, rats were vacuumed to remove any cadmium carbonate dust adhering to the ventral and dorsal fur. The 132 mg Cd/m<sup>3</sup> dose is relatively high. Three of the 10 test animals died during the 2-hour exposure so the significance of the gastrointestinal effect in this study is unclear.

**Hematological Effects.** The evidence concerning hematological effects following inhalation exposure to cadmium is conflicting. Lowered hemoglobin concentrations and decreased packed cell volumes have been observed in some studies of workers occupationally exposed to cadmium (Bernard et al. 1979; Friberg 1950; Kagamimori et al. 1986), but not in others (Bonnell 1955; Chan et al. 1988; Davison et al. 1988). The changes that were found often were not statistically significant (Bernard et al. 1979; Friberg 1950), and examination of bone marrow of some workers with lowered hemoglobin revealed no detectable abnormalities (Friberg 1950).

Conflicting results on the hematologic effect of cadmium after inhalation exposure have also been obtained with animal studies. Rabbits exposed to cadmium oxide dust at 4 mg/m<sup>3</sup> for 3 hours/day, 21 days/month for 9 months developed eosinophilia and a slightly lower hemoglobin (Friberg 1950). In contrast, rats exposed to cadmium oxide dust at 0.052 mg Cd/m<sup>3</sup> for 24 hours/day for 90 days had increased hemoglobin and hematocrit that were attributed to decreased lung function (Prigge 1978a). Prigge (1978b) also reported increased hemoglobin and hematocrit in rats continuously exposed to cadmium chloride at 0.204 mg Cd/m<sup>3</sup> and higher for 21 days. Other studies report no Cd-related hematological effects. A nearly continuous 30-day exposure in rats to cadmium sulfide at 1.034 mg Cd/m<sup>3</sup> had no effect on red blood cell counts (Glaser et al. 1986). A nearly continuous 218-day exposure in rats to cadmium oxide dust or fume at 0.090 mg Cd/m<sup>3</sup> had no effect on a routine hematological evaluation (specific tests not reported) (Oldiges and Glaser 1986). A partial explanation for these conflicting results may be that Cd-induced anemia primarily results from impaired absorption of iron from the diet following gastrointestinal exposure to cadmium (see Section 3.2.2.2), and the amount of gastrointestinal exposure following cadmium inhalation is variable depending on the form and dose.

**Musculoskeletal Effects.** Case studies indicate that calcium deficiency, osteoporosis, or osteomalacia can develop in some workers after long-term occupational exposure to high levels of cadmium (Adams et al. 1969; Blainey et al. 1980; Bonnell 1955; Kazantzis 1979; Scott et al. 1980). Effects on bone generally arise only after kidney damage has occurred and are likely to be secondary to resulting changes in calcium, phosphorus, and vitamin D metabolism (Blainey et al. 1980).



## 3. HEALTH EFFECTS

No studies were located regarding musculoskeletal effects in animals after inhalation exposure to cadmium.

**Hepatic Effects.** Liver effects are not usually associated with inhalation exposure to cadmium. Friberg (1950) reported some nonspecific signs of liver disease in some workers from a group exposed to cadmium in the air for 20 years. Test results included increased serum gamma-globulin, and other indicators of abnormal serum globulins, including the flocculation test results of a positive Takata reaction and/or an elevated thymol values. These tests (the latter of which are not used today) were nonspecific indicators of cirrhosis or hepatitis. The significance of these test results with respect to cadmium exposure is questionable. Subsequent studies on workers exposed to cadmium in the air have not reported adverse liver effects (Adams et al. 1969; Bonnell 1955).

Liver effects have occasionally been found in animal studies. Cats examined within one day of inhalation exposure to an unspecified concentration of cadmium oxide fume had a variety of hepatic lesions, and liver changes from cell granulation at low doses to fatty infiltration at high doses (Prodan 1932). Increased serum alanine aminotransferase activity, indicative of liver damage, was seen in rats exposed for 30 days to 0.1 mg/m<sup>3</sup> cadmium, but activity had returned to normal 2 months after exposure (Glaser et al. 1986). Kutzman et al. (1986) reported an increased liver relative weight in rats from a cadmium chloride exposure at 1.06 mg Cd/m<sup>3</sup> for 6 hours/day, 5 days/week, for 62 days. Increased liver weight was not observed from a continuous cadmium chloride exposure at 0.029 mg Cd/m<sup>3</sup> for 255 days, from a continuous cadmium oxide exposure at 0.090 mg Cd/m<sup>3</sup> for 218 days, or from a continuous cadmium sulfate exposure at 0.095 mg Cd/m<sup>3</sup> for 413 days (Oldiges and Glaser 1986). Similar negative results were reported by Prigge (1978a, 1978b) for a 21-day exposure to cadmium chloride at 0.581 mg Cd/m<sup>3</sup>, and for a 63-day exposure to cadmium oxide at 0.105 mg Cd/m<sup>3</sup> (a dose that was very toxic to the lungs). A continuous high-dose exposure to cadmium sulfide at 2.247 mg Cd/m<sup>3</sup> for 105 days did result in an unspecified increase in liver weight in surviving rats (Oldiges and Glaser 1986). Cadmium accumulates in the liver as well as the kidney, the main target organ for cadmium toxicity. The resistance of the liver to toxic effects from cadmium may be related to a higher capacity of the liver to produce metallothionein that would bind to cadmium and would lower the concentrations of free cadmium ions (see Section 3.4.3).

**Renal Effects.** There is very strong evidence that the kidney is one of the main target organ of cadmium toxicity following extended inhalation exposure. The sensitivity of the kidney to cadmium was recognized in an early investigation of workers exposed to cadmium oxide dust and cadmium fumes in a factory producing nickel-cadmium batteries (Friberg 1950). These workers suffered from a high

## 3. HEALTH EFFECTS

incidence of abnormal renal function, indicated by proteinuria and a decrease in glomerular filtration rate. Many studies examining cadmium workers have reported various effects on the kidneys. Similar signs of renal damage have been observed in many other studies of workers occupationally exposed to cadmium (Adams et al. 1969; Bernard et al. 1979; Beton et al. 1966; Bonnell 1955; Bustueva et al. 1994; Chia et al. 1989; Elinder et al. 1985a, 1985b; Falck et al. 1983; Gompertz et al. 1983; Iwata et al. 1993; Jakubowski et al. 1987; Järup and Elinder 1993; Järup et al. 1988; Kjellström et al. 1977a; Liu et al. 1985; Mason et al. 1988; Piscator 1966; Roels et al. 1981b; Rose et al. 1992; Smith et al. 1980; Thun et al. 1989). Most of these studies did not report cadmium exposure levels; rather, urinary cadmium, blood cadmium, or cumulative exposures were used as biomarkers of exposure. Thus, these studies are not presented in the LSE table (Table 3-1). Selected occupational exposure studies are summarized in Table 3-4.

One of the first signs of kidney effects is tubular dysfunction characterized by an increased urinary excretion of low-molecular-weight proteins such as  $\beta$ 2-microglobulin, human complex-forming glycoprotein (pHC) (also referred to as  $\alpha$ 1-microglobulin), and retinol binding protein or increased urinary levels of intracellular enzymes such as N-acetyl- $\beta$ -glucosaminidase (NAG) (European Chemicals Bureau 2007; Järup et al. 1998b). Numerous occupational exposure studies have reported increases in urinary levels of these biomarkers (Bernard et al. 1990; Chen et al. 2006a, 2006b; Chia et al. 1992; Elinder et al. 1985b; Falck et al. 1983; Jakubowski et al. 1987, 1992; Järup and Elinder 1994; Järup et al. 1988; Kawada et al. 1989; Roels et al. 1993; Shaikh et al. 1987; Thun et al. 1989; Toffoletto et al. 1992; Verschoor et al. 1987). At higher exposure levels, increased urinary levels of high-molecular-weight proteins such as albumin have been reported (Bernard et al. 1979, 1990; Chen et al. 2006a, 2006b; Elinder et al. 1985b; Mason et al. 1988; Roels et al. 1989, 1993; Thun et al. 1989), but there is some debate as to whether this represents glomerular damage (Bernard et al. 1979; Roels et al. 1989) or severe tubular damage (Elinder et al. 1985a; Mason et al. 1988; Piscator 1984).

Chronic exposure to very high cadmium levels can result in glomerular damage resulting in decreases in glomerular filtration rate (GFR) (Friberg 1950; Järup et al. 1995b; Roels et al. 1991). Järup et al. (1995b) found a dose-response relationship between blood cadmium levels and GFR in cadmium workers. At blood cadmium levels of 5.6 to  $<8.4$   $\mu\text{g/L}$ , 33.3% of the workers had decreased GFR (defined as  $<80\%$  of referents); whereas all subjects with blood cadmium levels of  $\geq 8.4$   $\mu\text{g/L}$  exhibited a decreased GFR.

Another study did not find alterations in GFR in workers with urinary cadmium levels of approximately 11  $\mu\text{g/g}$  creatinine; however, an exacerbation of the age-related decline in maximal GFR was observed

## 3. HEALTH EFFECTS

**Table 3-4. Summary of Occupational Exposure Studies Examining Renal Effects**

Population	Effect	Adverse effect level	Reference
Zinc-cadmium smelter workers (n=87)	Age-related decline in maximal GFR was exacerbated in workers with cadmium-induced microproteinuria.	U-Cd: 11.1 µg/g creatinine	Roels et al. 1991
Workers using cadmium pigments in plastic production or using cadmium in welding (n=27)	Significant increase in urinary β2M and NAG levels.	U-Cd: 5 µg/g creatinine	Verschoor et al. 1987
Cadmium alloy workers (n=164)	Higher incidence of increased urinary β2M levels (>250 µg/L cut-off) when urinary cadmium levels exceeded 10 µg/g creatinine on one or more occasions, as compared to workers who never exceeded the 10 µg/g creatinine level.	U-Cd: 10 µg/g creatinine	Toffoletto et al. 1992
Cadmium smelter workers (n=53)	Significant increase in urinary protein and β2M levels.	U-Cd: 13.3 µg/g creatinine	Shaikh et al. 1987
Non-ferrous smelter workers (n=58)	Significant increase in urinary β2M, RBP protein, pHc, albumin, and transferrin levels.	U-Cd: >10 µg/g creatinine	Bernard et al. 1990
Workers exposed to cadmium pigment dust (n=58)	Significant correlation between urinary cadmium and NAG levels; significant correlation with β2M at one of the two time points.	U-Cd: 1.1–1.4 µg/g creatinine	Kawada et al. 1989
Zinc-cadmium smelter workers (n=50)	Significant association between urinary cadmium levels and urinary levels of NAG, albumin, and transferrin. At higher urinary cadmium levels (10 µg/g creatinine), there were significant associations with RBP and β2M.	U-Cd: 4 µg/g creatinine	Roels et al. 1993
Battery workers (n=561)	10% prevalence of abnormal β2M levels (220 µg/g creatinine cut-off).	U-Cd: 1.5 µg/g creatinine for ≥60 years of age U-Cd: 5 µg/g creatinine for <60 years of age	Järup and Elinder 1994
Alkaline battery factory workers (n=102)	10% prevalence of renal dysfunction (β2M >380 µg/g creatinine; RBP >130 µg/g creatinine).	U-Cd: 10–15 µg/g creatinine	Jakubowski et al. 1987
Workers at a factory using cadmium-containing solders (n=60)	25% prevalence of abnormal β2M levels (300 µg/g creatinine cut-off).	U-Cd: 2–5 µg/g creatinine	Elinder et al. 1985a

## 3. HEALTH EFFECTS

**Table 3-4. Summary of Occupational Exposure Studies Examining Renal Effects**

Population	Effect	Adverse effect level	Reference
Workers at nickel-cadmium battery factory (n=92)	Significant increase in pHC and NAG levels (after adjustment for age, gender, and race).	U-Cd: 5–10 µg/g creatinine	Chia et al. 1992
Cadmium smelter workers (n=85)	Significant increases in levels β2M and NAG levels and increased prevalence of abnormal levels of these biomarkers.	U-Cd: 5–10 µg/g creatinine	Chen et al. 2006a, 2006b
Alkaline battery factory workers (n=141)	10% prevalence of renal dysfunction (β2M >300 µg/L; RBP >300 µg/L).	B-Cd: 300 µg-years/L (30 years of 10 µg/L)	Jakubowski et al. 1992
Battery workers (n=440)	Approximately 10% prevalence of abnormal β2M levels (35 µg/mmol creatinine cut-off).	B-Cd: 5.6 µg/L Cumulative exposure: 691 µg-years/m <sup>3</sup>	Järup et al. 1988
Cadmium recovery plant workers (n=45)	Significant association between cumulative exposure and urinary β2M, RBP, phosphate, and calcium and serum creatinine levels.	Cumulative exposure: 300 mg/m <sup>3</sup>	Thun et al. 1989
Workers exposed to cadmium fumes (n=33)	Increased urinary β2M and protein levels (mean 6,375 µg/g creatinine and 246 mg/g creatinine, respectively) in 7 workers (mean in remaining 23 workers 53 µg/g creatinine and 34 mg/g creatinine).	Cumulative exposure: 1,137 µg/m <sup>3</sup> /years	Falck et al. 1983

U-Cd = urinary cadmium, B-Cd = blood cadmium; GFR = glomerular filtration rate; pHC = human complex-forming glycoprotein (also referred to as α1-microglobulin); NAG = N-acetyl-β-glucosaminidase; β2M = β2-microglobulin; prt = protein; RBP = retinol binding protein

## 3. HEALTH EFFECTS

(Roels et al. 1991). Other studies reported increases in serum creatinine levels, which are suggestive of impaired GFR (Roels et al. 1989; Thun et al. 1989).

Depressed tubular resorption of other solutes such as enzymes, amino acids, glucose, calcium, copper, and inorganic phosphate have been reported in workers with signs of tubular proteinuria (Elinder et al. 1985a, 1985b; Falck et al. 1983; Gompertz et al. 1983; Mason et al. 1988). An increased frequency of kidney stone formation has also been reported in cadmium workers (Elinder et al. 1985a; Falck et al. 1983; Järup and Elinder 1993; Kazantzis 1979; Scott et al. 1978; Thun et al. 1989; Trevisan and Gardin 2005). This effect is likely to be secondary to disruption of calcium metabolism due to kidney damage. Järup and Elinder (1993) calculated an incidence rate ratio (IRR) (after adjustment for age and calendar time) of 3.0 (95% CI 1.3–6.8) for the occurrence of kidney stones among workers with a cumulative exposure of  $\geq 5000 \mu\text{g}/\text{m}^3$  years; the IRR was not significantly elevated at lower cumulative exposure levels. Significant increases in kidney stone formation were observed in workers with increased urinary cadmium (median of 3.7  $\mu\text{g}/\text{g}$  creatinine), blood cadmium (median of 7  $\mu\text{g}/\text{L}$ ), and urinary  $\beta_2$ -microglobulin (median of 155  $\mu\text{g}/\text{g}$  creatinine). The increased kidney stone formation may be secondary to the cadmium-induced kidney damage disruption of calcium metabolism.

Hellström et al. (2001) evaluated the association between occupational cadmium exposure and end stage renal disease among cadmium workers and residents living near a cadmium facility; renal replacement therapy was used as a surrogate for renal disease. The standardized rate ratios (SRRs) (95% CI) were 2.1 (0.6–5.3) and 2.5 (0.7–6.5) in male workers aged 20–79 or 40–79 years, respectively. Although the SRRs were not statistically significant, the ratios were significantly elevated in residents presumably exposed to lower cadmium levels (see Section 3.2.2.2 for more information on these results). Studies examining the cause of death among cadmium workers have not found significant increases in the standardized mortality ratios (SMRs) for nephritis or nephrosis (Armstrong and Kazantzis 1983; Järup et al. 1998a) or nonmalignant renal disease (Thun et al. 1985).

The data from studies of cadmium workers provide strong, clear evidence that the kidney is a sensitive target following chronic exposure, but the data do not clearly identify a threshold of toxicity. The earliest indication of an effect on the kidney is an increase in urinary levels of low molecular weight proteins particularly  $\beta_2$ -microglobulin, retinol binding protein, and pHC. However, there is some question as to the adversity of these early indicators because increased excretion of low molecular weight proteins precede the clinical manifestations (Bernard et al. 1997; Järup et al. 1998b). As noted by Bernard et al. (1997), the assessment of the health significance of changes affecting a biomarker involves localizing the

## 3. HEALTH EFFECTS

changes in the sequence of events that ultimately results in compromised renal function and appreciating the probability that these changes may lead to a deterioration of renal function. Their guidelines for interpreting  $\beta$ 2-microglobulin levels in cadmium workers are presented in [Table 3-5](#).

Another aspect of interpreting alterations in renal biomarkers and assessing risk is the issue of the reversibility of cadmium-induced tubular dysfunction and impaired glomerular filtration rate. In workers exposed to high levels of cadmium, cessation of exposure does not generally result in a reversibility of kidney damage. Increases in urinary levels of  $\beta$ 2-microglobulin, retinol binding protein, or total protein (Elinder et al. 1985b; Järup et al. 1993; Mason et al. 1999; Piscator 1984; Roels et al. 1989; Thun et al. 1989) or a decrease in glomerular filtration rate (Järup et al. 1993; Piscator 1984; Roels et al. 1989) have been observed in workers years after cadmium exposure cessation. However, in workers exposed to low levels of cadmium, cessation of exposure resulted in decreased or no change in urinary  $\beta$ 2-microglobulin levels (McDiarmid et al. 1997; van Sittert et al. 1993). In studies by Roels et al. (1997) and Trzcinka-Ochocka et al. (2002), former cadmium workers were divided into groups based on historical cadmium levels and urinary  $\beta$ 2-microglobulin or retinol binding protein levels. Both studies found that the reversibility of tubular dysfunction was dependent on the cadmium body burden and the severity of microproteinuria at the time cadmium exposure was reduced or ceased. In the Roels study, significant decreases in retinol binding protein levels and no change in  $\beta$ 2-microglobulin levels were observed in workers whose urinary cadmium levels never exceeded 10  $\mu\text{g/g}$  creatinine. Decreases in  $\beta$ 2-microglobulin and retinol binding protein levels were also observed in workers whose  $\beta$ 2-microglobulin levels were  $<300$   $\mu\text{g/g}$  creatinine or between 300 and 1,500  $\mu\text{g/g}$  creatinine and urinary cadmium levels were  $>10$   $\mu\text{g/g}$  creatinine, but were never  $>20$   $\mu\text{g/g}$  creatinine. However, a progression of microproteinuria (increased urinary levels of  $\beta$ 2-microglobulin and retinol binding protein levels) was observed in workers who had initial  $\beta$ 2-microglobulin levels  $>1,500$   $\mu\text{g/g}$  creatinine and urinary cadmium levels  $>20$   $\mu\text{g/g}$  creatinine. In contrast, Trzcinka-Ochocka et al. (2002) found decreases in  $\beta$ 2-microglobulin and retinol binding protein levels in groups of workers with initial  $\beta$ 2-microglobulin and retinol binding protein levels of  $\leq 300$ ,  $>300$ ,  $\leq 1,500$ , or  $\geq 1,500$   $\mu\text{g/g}$  creatinine; in all groups, the initial mean urinary cadmium levels were  $>20$   $\mu\text{g/g}$  creatinine. However, the risk of increased excretion of retinol binding protein was higher in the groups of workers with initial retinol binding protein levels of  $>300$   $\mu\text{g/g}$  creatinine. Logistic regression analysis demonstrated that the initial level of retinol binding protein was the most important determinant in reversibility of tubular proteinuria and that the influence of urinary cadmium level or length of time since exposure cessation was not statistically significant.

## 3. HEALTH EFFECTS

**Table 3-5. Guidelines for Interpreting  $\beta$ 2-microglobulin Levels**

$\beta$ 2-Microglobulin level	Significance
<300 $\mu$ g/g creatinine	Normal value.
300–1,000 $\mu$ g/g creatinine	Incipient cadmium tubulopathy (possibility of reversibility after removal from exposure). No change in GFR.
1,000–10,000 $\mu$ g/g creatinine	Irreversible tubular proteinuria which may lead to accelerated decline in the GFR with age. GFR normal or slightly altered.
>10,000 $\mu$ g/g creatinine	Overt cadmium nephropathy usually associated with decreased GFR.

GFR = glomerular filtration rate

Source: Bernard et al. 1997

## 3. HEALTH EFFECTS

The available occupational exposure data suggest that tubular dysfunction generally develops only after cadmium reaches a threshold concentration in the renal cortex. However, a number of factors can influence urinary levels of  $\beta$ 2-microglobulin or retinol binding protein and direct relationship between urinary levels of these proteins and a kidney cadmium concentration has not been established. Based on the findings of early occupational exposure studies, a number of investigators estimated that the “critical concentration” of cadmium in the renal cortex associated with increased incidence of renal dysfunction in an occupational setting was about 200  $\mu\text{g/g}$  wet weight (Friberg et al. 1974; Kjellström et al. 1977a; Roels et al. 1983); this corresponds to a urinary cadmium levels of 5–10  $\mu\text{g/g}$  creatinine (European Chemicals Bureau 2007). Although 10  $\mu\text{g/g}$  creatinine was initially established as a threshold urinary cadmium concentration, there is sufficient evidence to suggest that adverse effects occur at lower urinary cadmium levels (Chen et al. 2006a, 2006b; Chia et al. 1992; Elinder et al. 1985b; Järup and Elinder 1994; Kawada et al. 1989; Roels et al. 1993; Verschoor et al. 1987).

Indications of renal dysfunction associated with airborne cadmium exposure has also been observed in residents living near a lead/zinc smelter in the United Kingdom with high cadmium stack emissions (Thomas et al. 2009) and a zinc smelter in Norway (Bråtveit et al. 2011). In both studies, the subjects were exposed to airborne cadmium and elevated cadmium levels in the soil. The Thomas et al. (2009) study found a significant association between urinary cadmium levels and modeled atmospheric cadmium concentrations. The mean urinary cadmium concentrations were 0.22 and 0.34 nmol/mmol creatinine (approximately 0.22 and 0.34  $\mu\text{g/g}$  creatinine) in males and females, respectively, in the Thomas et al. (2009) study and 0.44 and 0.42  $\mu\text{g/g}$  creatinine in males and females, respectively, in the Bråtveit et al. (2011) study; Bråtveit et al. (2011) also measured urinary cadmium levels in the residents living in a nonpolluted area and found no significant differences in urinary cadmium levels between the two groups. Thomas et al. (2009) found significant correlations between urinary cadmium levels and urinary NAG levels in males and females and pHC in females. Additionally, the study found a significant dose-response relationship between urinary cadmium levels and NAG levels above the reference level of 1.25 IU/mmol creatinine. Bråtveit et al. (2011) also found a significant association between urinary pHC levels and urinary cadmium levels; however, there were no significant differences in pHC levels between residents living in the polluted areas and the control area.

Early animal studies confirmed that renal damage occurs following inhalation exposure to cadmium. Rabbits developed proteinuria after a 4-month inhalation exposure to cadmium metal dust at 4  $\text{mg/m}^3$  for 3 hours/day, 21 days/month; histologic lesions were found after an additional 3–4 months of exposure (Friberg 1950). Friberg (1950) noted that the degree of proteinuria was not especially pronounced. Most



### 3. HEALTH EFFECTS

subsequent studies using inhalation exposure have not found proteinuria (Glaser et al. 1986; Kutzman et al. 1986; Prigge 1978a, 1978b), primarily because the levels of exposure and durations of follow up (e.g., 1–5 mg/m<sup>3</sup> for intermediate exposures; 0.2–2 mg/m<sup>3</sup> for chronic exposures) that produce serious respiratory effects have not been sufficient to produce a critical concentration of cadmium in the kidney.

**Dermal Effects.** Dermal toxicity does not appear to be a significant effect of inhalation exposure to cadmium. Studies of workers occupationally exposed to cadmium have not reported dermal effects following acute or chronic exposure (Barnhart and Rosenstock 1984; Bonnell 1955; Friberg 1950). No study was located that specifically examined dermal toxicity in humans or animals following inhalation exposure to cadmium.

**Ocular Effects.** Ocular toxicity does not appear to be a significant effect of inhalation exposure to cadmium. Studies of workers occupationally exposed to cadmium have not reported ocular effects following acute or chronic exposure (Barnhart and Rosenstock 1984; Bonnell 1955; Friberg 1950). No study was located that specifically examined ocular toxicity in humans following inhalation exposure to cadmium.

Rats exposed to a single 2-hour inhalation exposure to about 100 mg Cd/m<sup>3</sup> as cadmium pigments had excessive lacrimation 4 hours after exposure (Rusch et al. 1986), but this was likely due to a direct irritation of the eyes rather than a systemic effect.

**Body Weight Effects.** No data were found regarding the effects of inhaled cadmium on human body weights.

In animals, cadmium has been shown to significantly reduce body weights. An acute exposure to cadmium oxide fumes at 112 mg Cd/m<sup>3</sup> for 2 hours (Rusch et al. 1986) and cadmium oxide dust at 4.6 mg Cd/m<sup>3</sup> for 3 hours (Buckley and Bassett 1987b) resulted in a significant reduction of body weight in male rats. Cadmium chloride at 6.5 mg Cd/m<sup>3</sup> for 1 hour or 4.5 mg Cd/m<sup>3</sup> for 2 hours produced significant reductions in male rat body weights (Bus et al. 1978; Grose et al. 1987). Cadmium carbonate at 132 mg Cd/m<sup>3</sup> for 2 hours slowed rat body weight gains (Rusch et al. 1986). NOAELs for acute cadmium chloride exposure have been reported at 0.45 mg Cd/m<sup>3</sup> for 2 hours (Grose et al. 1987); 0.17 mg Cd/m<sup>3</sup> for 6 hours/day for 10 days (Klimisch 1993); and 6 mg Cd/m<sup>3</sup> for 2 hours (Palmer et al. 1986). NOAELs for cadmium sulfide and cadmium selenium sulfide were much higher at 99 mg Cd/m<sup>3</sup> for 2 hours and 97 mg Cd/m<sup>3</sup> for 2 hours, respectively (Rusch et al. 1986). The effect of cadmium on body weight gain

### 3. HEALTH EFFECTS

appears to compound-related, with cadmium chloride the most toxic and cadmium sulfide the least toxic. These compound-related differences are probably related to difference in absorption.

The body weight response also appears to be duration-related; lower NOAELs and LOAELs have been identified for intermediate-duration exposure. Levels of cadmium that significantly reduce rat body weights when administered for an intermediate exposure duration have been reported for cadmium chloride at around 1 mg Cd/m<sup>3</sup> for female and male rats (Baranski and Sitarek 1987; Kutzman et al. 1986), for cadmium chloride at around 0.394 mg Cd/m<sup>3</sup> for pregnant female rats (Prigge 1978a), and for cadmium dusts at 0.1 mg Cd/m<sup>3</sup> for female rats (Prigge 1978a). NOAELs have been reported for intermediate exposures to cadmium chloride at 0.394 mg Cd/m<sup>3</sup> for female nonpregnant rats (Prigge 1978a), 0.33 mg Cd/m<sup>3</sup> for rats (Kutzman et al. 1986), and 0.0508 mg Cd/m<sup>3</sup> for male rats (Takenaka et al. 1983). NOAELs have been reported for intermediate exposures to cadmium oxide dust at 0.16 mg Cd/m<sup>3</sup> for female rats (Baranski and Sitarek 1987) and 0.45 mg Cd/m<sup>3</sup> for male rabbits (Grose et al. 1987); and for cadmium sulfide at 1.034 mg Cd/m<sup>3</sup> for male rats (Glaser et al. 1986). A NOAEL for chronic exposure in rats to cadmium sulfate has been reported as 0.95 mg Cd/m<sup>3</sup> (Oldiges and Glaser 1986).

**Other Systemic Effects.** Yellow discoloration of the teeth has occasionally been reported in workers occupationally exposed to high levels of cadmium (Friberg 1950; Liu et al. 1985). No data were located to indicate that this was related to any functional impairment.

#### 3.2.1.3 Immunological and Lymphoreticular Effects

There is limited evidence for immunological effects following inhalation exposure to cadmium. The blood of workers exposed to cadmium for 1–14 years had a slight but statistically significant decrease in the generation of reactive oxygen species by leukocytes compared to unexposed controls (Guillard and Lauwerys 1989). The toxicological significance of this effect is unclear.

Karakaya et al. (1994) measured blood and urine concentrations of cadmium, and serum IgG, IgM, and IgA in a group of 37 males employed in zinc/cadmium smelters and a small Cd-electroplating plant. Blood cadmium concentrations were significantly higher in exposed workers compared to controls in both the urine (2.39 versus 0.69 µg/100 mL, p<0.001) and the blood (5.55 versus 2.01 µg/g creatinine, p<0.05). No differences between the exposed and control serum concentrations of IgG, IgM, and IgA populations were observed. No changes in blood counts of white blood cells (lymphocyte, neutrophil, and eosinophil)

### 3. HEALTH EFFECTS

were found between exposed and control populations, except for significantly increased monocyte counts. No other studies were located regarding immunological effects in humans following inhalation exposure to cadmium.

Acute inhalation exposure to cadmium chloride in mice at 0.190 mg Cd/m<sup>3</sup> for 2 hours can affect immune function, causing suppression of the primary humoral immune response (Graham et al. 1978). The NOAEL for immunological effects from the study by Graham et al. (1978) was 0.11 mg Cd/m<sup>3</sup>. Krzystyniak et al. (1987) reported spleen lymphocyte cytotoxicity at 0.88 mg Cd/m<sup>3</sup> for 1 hour.

At intermediate-duration exposures, Kutzman et al. (1986) observed increased spleen relative weights and lymphoid hyperplasia from inhalation of cadmium chloride aerosols at 1.06 mg Cd/m<sup>3</sup> 6 hours/day, 5 days/week for 62 days. Prigge (1978b) also observed increased relative spleen weights in pregnant females at 0.394 mg Cd/m<sup>3</sup> for an exposure of 24 hours/day for 21 days during gestation. Oldiges and Glaser (1986) observed enlarged thoracic lymph nodes in dead animals in a chronic-exposure study with cadmium sulfate at 0.092 mg Cd/m<sup>3</sup> for 22 hours/day, 7 days/week for 413–455 days; and in an intermediate study with cadmium oxide dust at 0.090 mg Cd/m<sup>3</sup> for 22 hours/day, 7 days/week for 218 days. However, other studies have found no effect on natural killer cell activity or viral induction of interferon in mice (Daniels et al. 1987). Evidence concerning the effect of inhalation exposure to cadmium on resistance to infection is conflicting, because the same exposure decreases resistance to bacterial infection while increasing resistance to viral infection (Bouley et al. 1982). The highest NOAEL values and all LOAEL values from each reliable study for immunological effects in each species and duration category are recorded in [Table 3-1](#) and plotted in [Figure 3-1](#).

#### **3.2.1.4 Neurological Effects**

Neurotoxicity is not generally associated with inhalation exposure to cadmium, although a few studies have specifically looked for neurological effects. Hart et al. (1989b) reported that in a group of 31 men occupationally exposed to cadmium in a refrigerator coil manufacturing plant (average exposure=14.5 years) there was a modest correlation between cadmium exposure and decreased performance on neuropsychologic tests for attention, psychomotor speed, and memory. The limited number of men studied makes it difficult to evaluate the significance of this effect.

Rose et al. (1992) studied the presence and severity of olfactory impairment in workers chronically exposed to cadmium fumes generated during a brazing operation. Detailed occupational history, medical

## 3. HEALTH EFFECTS

history, and smoking history, and symptoms were collected for 55 workers. Body burden was estimated using urinary cadmium levels, and renal damage was assessed by urinary  $\beta_2$ -microglobulin levels. Olfactory test scores from these workers were compared to a reference group of 16 male subjects that were selected according to the following criteria: (1) no history of taste or smell complaints, (2) no history of surgery to the upper respiratory tract, (3) no upper respiratory tract infection within 2 days of testing, and (4) no history of having been tested. The dose of the cadmium oxide fume received by the workers being evaluated in this study was not reported or estimated. For both the exposed workers and the reference group, 38% were smokers. A significant olfactory impairment was observed in the workers compared to the reference group ( $p < 0.003$ ). Thirteen percent of the workers were either moderately or severely hyposmic compared to none in the reference group, 44% of the workers were mildly hyposmic compared to 31% of the reference group, and only 44% of workers were normosmic. Although the odor-identification test findings for workers were similar to those of the reference group, butanol detection threshold scores were significantly lower in the worker population ( $p < 0.005$ ). The workers with both higher urinary cadmium levels and tubular proteinuria had the most significant olfactory dysfunction, with a selective defect in odor threshold. The results suggest that chronic occupational cadmium exposure sufficient to cause renal damage is also associated with impairment in olfactory function. Some limitations of the study are that historical exposure to other confounders cannot be ruled out, the classification for nephrotoxicity is based on a single 24-hour urine  $\beta_2$ -microglobulin level, and the smoking history of the reference group was unknown. No other human neurological studies from inhaled cadmium were found.

In rats, cadmium carbonate produced tremors from exposure to  $132 \text{ mg Cd/m}^3$  for 2 hours, and cadmium fumes produced reduced activity at  $112 \text{ mg Cd/m}^3$  for 2 hours (Rusch et al. 1986). Studies on continuous exposure to cadmium for 30 days have shown no neurological effects at  $0.105 \text{ mg Cd/m}^3$  for cadmium chloride,  $0.098 \text{ mg Cd/m}^3$  for cadmium dusts, or  $1.034 \text{ mg Cd/m}^3$  for cadmium sulfide (Glaser et al. 1986). Cadmium chloride had no neurological effects at  $0.33 \text{ mg Cd/m}^3$  for 5 days/week, 6 hours/day for a total of 62 daily exposures, but did significantly increase relative brain weight at  $1.034 \text{ mg Cd/m}^3$  (Kutzman et al. 1986). No other studies were located regarding neurological effects in adult animals after inhalation exposure to cadmium. Neurological effects in offspring of rats exposed to cadmium by inhalation during gestation are discussed in Section 3.2.1.5. The highest NOAEL values and all LOAEL values from each reliable study for neurological effects in each species and duration category are recorded in [Table 3-1](#) and plotted in [Figure 3-1](#).

## 3. HEALTH EFFECTS

**3.2.1.5 Reproductive Effects**

Evidence is insufficient to determine an association between inhalation exposure to cadmium and reproductive effects.

Gennart et al. (1992) studied male reproductive effects of cadmium in 83 occupationally exposed blue-collar Belgian workers in two smelting operations. The workers were exposed to cadmium in dust and fumes. Information was recorded on age, residence, education, occupational and health history, actual and previous occupations, smoking habits, and coffee and alcohol consumption. Fertility parameters included dates of birth of wife and husband, date of marriage, and number of children born alive and their dates of birth. Blood and urine samples were also collected from each worker. Some cadmium workers had been excessively exposed; 25% of them already had signs of kidney dysfunction as evidenced by microproteinuria and/or a serum creatinine level  $>13$  mg/L. No effects were observed on male fertility as evidenced by no significant influence of cadmium on the probability of a live birth. The limitation of this study, as described by the authors, included the fact that the wives were not interviewed and, therefore, factors that could have influenced their reproductive ability were not considered.

Men occupationally exposed to cadmium at levels causing renal damage had no change in testicular endocrine function, as measured by serum levels of testosterone, luteinizing hormone, and follicle-stimulating hormone (Mason 1990).

Noack-Fuller et al. (1993) measured concentrations of cadmium, lead, selenium, and zinc in whole semen and seminal fluid of 22 unexposed men (13 were smokers) to evaluate intra-individual variability and to examine the statistical association between element concentrations and semen characteristics and sperm motion parameters. None of the men had any known occupational exposure to cadmium.

Concentrations of cadmium were similar in semen and seminal plasma ( $0.40 \pm 0.23$  and  $0.34 \pm 0.19$   $\mu\text{g/L}$ , respectively). Sperm motility ( $p < 0.02$ ), linear velocity ( $p < 0.001$ ), and curvilinear velocity (CV) ( $p < 0.002$ ) were significantly correlated with semen cadmium levels. Intra-individual coefficients of variation for sperm count ( $\text{CV} = 46 \pm 4\%$ ) and sperm concentration ( $\text{CV} = 37 \pm 6\%$ ) showed the highest variability. No positive correlation was found between cadmium concentration in semen and sperm density. The smokers had slightly elevated levels of cadmium. The concentrations of cadmium in semen of these volunteers were very low. Additional studies are needed (preferably with larger sample sizes) to evaluate the robustness of this association between cadmium (at the low levels detected) and sperm motion parameters. Saaranen et al. (1989) measured cadmium, selenium, and zinc in seminal fluid and

## 3. HEALTH EFFECTS

serum in 64 men, half of whom were smokers. Smokers had significantly higher serum cadmium concentration than nonsmokers. Seminal fluid cadmium was also elevated in smokers, and was higher than serum cadmium in smokers consuming >20 cigarettes daily. Semen quality was measured for volume, sperm density, morphology, motility, and number of immature germ cells. No differences were found in semen quality or fertility between smokers and nonsmokers. There was no significant correlation between seminal fluid cadmium levels and semen quality or fertility.

Xu et al. (1993a) measured trace elements in blood and seminal plasma and their relationship to sperm quality in 221 Singapore men (age range 24–54; mean 34.8) who were undergoing initial screening for infertility. Men with significant past medical history and those who had been occupationally exposed were excluded. Parameters monitored included semen volume and sperm density, motility, morphology, and viability. Graphite furnace atomic absorption was used to determine cadmium concentration in blood and semen. No differences were observed in sperm quality (density, motility, morphology, volume, and viability) of the 221 men compared to a cohort of 38 fertility proven men (wives had recently conceived). Cadmium levels in blood did have a significant inverse relationship with sperm density ( $r=-0.15$ ,  $p<0.05$ ) in oligospermic men (sperm density <20 million/mL), but not in normospermic men. There was a significant reduction in sperm count in men with blood cadmium of >1.5  $\mu\text{g/L}$ . Also, there was a weak negative correlation between defective sperm and concentration of cadmium in semen ( $r=-0.21$ ,  $p<0.05$ ). The volume of semen was inversely proportional to the cadmium concentration in semen ( $r=-0.29$ ,  $p<0.05$ ). These findings suggest that cadmium may have an effect on the male reproductive system. Limitations of the study include lack of control for potential confounding factors such as the lower levels of zinc in seminal plasma, and the validity of using infertile men as the study group (i.e., again because of confounding factors that may be affecting both cadmium levels and sperm levels).

A postmortem study of men occupationally exposed to cadmium who died from emphysema found high levels of cadmium in their testes, but no histologic lesions other than those attributable to terminal illness (Smith et al. 1960)

Russian women occupationally exposed to cadmium concentrations up to 35  $\text{mg/m}^3$  had no irregularities in their menstrual cycles (Tsvetkova 1970). Fertility and other indices of reproductive function were not measured. No studies were located that showed reproductive effects in women following inhalation exposure to cadmium.

### 3. HEALTH EFFECTS

In rats, exposure to cadmium oxide dusts at 1 mg Cd/m<sup>3</sup> for 5 hours/day, 5 days/week for 20 weeks, increased the duration of the estrous cycle (Baranski and Sitarek 1987). Male and female rats exposed to cadmium concentrations of 1.06 mg/m<sup>3</sup> as cadmium chloride for 6 hours/day, 5 days/week for 62 days and subsequently mated with unexposed controls showed no loss in reproductive success measured by viable embryos and preimplantation losses, but males did have an increased relative testes weight (Kutzman et al. 1986). Similarly, no alterations in fertility in female rats exposed to 0.16 mg Cd/m<sup>3</sup> as cadmium oxide for 5 months prior to mating with unexposed males and during the mating and gestation periods (Baranski 1984). Tsvetkova (1970) studied rats exposed to cadmium sulfate aerosols at 2.8 mg Cd/m<sup>3</sup> before and during pregnancy. A lengthening of the estrous cycle was observed 2 months after the start of exposure in one-half of the exposed animals. By the fourth month, diestrus was 6.2 days in the exposed group compared to 1.2 days in controls. An increased in estrous cycle length was also observed in rats exposed to 0.88 mg Cd/m<sup>3</sup> as cadmium oxide for 13 weeks (NTP 1995); this study also reported a significant decrease in spermatid counts in males exposed to the same cadmium concentration. No other studies were found on reproductive effects in animals. The highest NOAEL values and all LOAEL values from each reliable study for reproductive effects in each species and duration category are recorded in [Table 3-1](#) and plotted in [Figure 3-1](#).

#### 3.2.1.6 Developmental Effects

Russian women occupationally exposed to cadmium at concentrations ranging from 0.02 to 35 mg/m<sup>3</sup> had offspring with decreased birth weights compared to unexposed controls, but without congenital malformations (Tsvetkova 1970). No association was found between birth weights of offspring and length of maternal cadmium exposure. Moreover, no control was made for parity, maternal weight, gestational age, or other factors known to influence birth weight (Tsvetkova 1970). A nonsignificant decrease in birth weight was found in offspring of women with some occupational exposure to cadmium in France; however, no adverse effects were documented in these newborns (Huel et al. 1984). Huel et al. (1984) used hair samples to estimate exposure, and this method is limited without controls to distinguish between exogenous and endogenous sources. No other studies were located regarding developmental effects in humans after inhalation exposure to cadmium.

*In utero* exposure to cadmium results in significant decreases in pup viability, fetal body weight, pup body weight gain, delays in ossification, and impaired performance on neurobehavioral tests. Decreases in pup viability (percentage of pups born alive that survived until postnatal day 4) were observed in the offspring of rats exposed to 0.16 mg Cd/m<sup>3</sup> as cadmium oxide for 5 months prior to mating and during

### 3. HEALTH EFFECTS

mating and gestation day 1–20 (Baranski 1984). Decreases in fetal body weight were observed in the offspring of rats exposed to  $\geq 0.581$  mg Cd/m<sup>3</sup> as cadmium chloride (Prigge 1978b) or cadmium oxide (NTP 1995) and mice exposed  $\geq 0.4$  mg Cd/m<sup>3</sup> as cadmium oxide (NTP 1995); maternal toxicity (decreased body weight gain and/or hypoactivity and dyspnea) were also observed at these exposure levels. Although Baranski (1984) did not find significant alterations in birth weight, a decrease in pup body weight gain was observed in the offspring of rats exposed to 0.16 mg Cd/m<sup>3</sup> as cadmium oxide. Delays in skeletal ossification have also been observed in the offspring of rats and mice exposed to 1.7 mg Cd/m<sup>3</sup> as cadmium oxide (NTP 1995); although Baranski (1985) also reported a delay in ossification in the offspring of rats, it is unclear whether the effect was observed at 0.02 mg Cd/m<sup>3</sup>, 0.16 mg Cd/m<sup>3</sup>, or both.

Baranski (1984, 1985) evaluated the potential of cadmium to induce neurobehavioral effects in the offspring of rats exposed to 0.02 or 0.16 mg Cd/m<sup>3</sup> as cadmium oxide for 5 months prior to mating, during mating and gestation day 1–20; the studies reported similar effects and it is unclear whether the papers are reporting the results from separate experiments. The neurobehavioral alterations included decreased exploratory motor activity and avoidance acquisition in 3 month old male and female offspring, respectively, exposed to 0.02 mg Cd/m<sup>3</sup>. At 0.16 mg Cd/m<sup>3</sup>, decreased avoidance acquisition in 3 month old female offspring, exploratory motor activity in 3 month old male and female offspring, ambulations in open field test in 5 month old male offspring, and spontaneous mobility in male offspring and prolongation of latency in negative geotaxis test.

#### 3.2.1.7 Cancer

The relationship between occupational exposure to cadmium and increased risk of cancer (particularly lung and prostate cancer) has been explored in a number of occupational exposure studies. The results of these studies are conflicting and the carcinogenicity of cadmium has not been unequivocally established. Overall, the results provide suggestive evidence of an increased risk of lung cancer in humans following prolonged inhalation exposure to cadmium. Initial studies indicated an elevation in prostate cancer among men occupationally exposed to cadmium (Kipling and Waterhouse 1967; Kjellström et al. 1979; Lemen et al. 1976), but subsequent investigations found either no increases in prostate cancer or increases that were not statistically significant (Elinder et al. 1985c; Kazantzis et al. 1988; Sorahan 1987; Sorahan and Esmen 2004; Thun et al. 1985). Based on an analysis of the mortality data from a 5-year update of the cohort from 17 plants in England and a review of the other epidemiological evidence, Kazantzis et al. (1992) concluded that cadmium does not appear to act as a prostatic carcinogen.



## 3. HEALTH EFFECTS

Significant increases in mortality from lung cancer have been reported in workers employed at a U.S. cadmium recovery facility (Stayner et al. 1992a; Thun et al. 1985), nickel-cadmium battery facilities in England (Sorahan 1987) and Sweden (Järup et al. 1998a), and in a cohort of workers at cadmium processing facilities and/or smelters (Ades and Kazantzis 1988; Kazantzis et al. 1988). However, no clear relationships between level and duration of cadmium exposure and lung cancer risk have been established and many of these studies did not account for confounding exposure to other carcinogenic metals (particularly arsenic and nickel) and cigarette smoking.

The possible association between occupational exposure to cadmium and lung cancer was investigated in several studies of a cohort of workers employed at a U.S. cadmium recovery facility. The cohort was initially examined by Lemen et al. (1976) who found a significant increase in deaths from malignant neoplasms of the respiratory tract among hourly workers employed for at least 2 years between 1940 and 1969. A re-examination of the cohort (deaths through 1978) also found statistically significant standardized mortality rates (SMRs) for malignant neoplasms in the respiratory tract (Thun et al. 1985). To adjust for possible arsenic exposure (between 1918 and 1925, the facility functioned as an arsenic smelter), workers were divided based on year of hire. Mortality from lung cancer was significantly elevated in workers hired prior to 1926 and among workers hired after 1926 with 2 or more years of employment. Dividing the workers into three exposure groups based on estimated cumulative exposure resulted in a significant dose-related trend for lung cancer deaths; in the highest exposure group (cumulative exposures  $>8$  years-mg/m<sup>3</sup>), a 2- to 8-fold increase in the risk of lung cancer deaths was observed (Thun et al. 1985). A subsequent analysis of these data (workers followed through 1985) used comparisons of rates with the cohort rather than the U.S. population (Stayner et al. 1992a). Lung cancer mortality was significantly increased among non-Hispanic whites, among workers with the highest cumulative exposure ( $>2,291$  days-mg/m<sup>3</sup>), and among workers with the longest time since first exposure ( $>20$  years). Lamm et al. (1992, 1994) used nearly the same data set for the U.S. cohort as Stayner et al. (1992a) in a nested case-control analysis that used the period of hire as a surrogate for arsenic exposure. Based on this analysis as a means to control for the confounding factor of arsenic exposure, Lamm et al. (1992, 1994) reported no residual association of lung cancer with cadmium. They also reported that cases were eight times more likely to have been cigarette smokers than were controls. Lamm et al. (1992, 1994) conclude that arsenic exposure and cigarette smoking were the major determinants of lung cancer risk, not cadmium exposure.

## 3. HEALTH EFFECTS

The reasons for these conflicting conclusions based on the same cohort data are unclear. Doll (1992) suggested some possible reasons including: (1) that the total number of cases was small ( $n=25$ ) and that only 21 of these cases were included in both studies (i.e., each study included some cases that were not included in the other study); (2) that Stayner et al. (1992a) used national rather than regional mortality rates; (3) that the Lamm et al. (1992, 1994) control series was overmatched, although the matching by date of hire was necessary to control for arsenic exposure; and (4) that there are some concerns about the validity (i.e., biological relevance) of the dose-response-models used by Stayner et al. (1992a). In a response to Doll (1992), Stayner et al. (1993) reported that use of regional mortality rates would increase rather than decrease support for their conclusion, and that the nested case-control analysis of Lamm et al. (1992) used overmatched controls. Stayner et al. (1993) provided additional analyses including the use of the Armitage-Doll multistage model to support the conclusion of an increased risk of cancer from cadmium exposure. Sorahan and Lancashire (1994) subsequently raised concerns about inconsistencies and inaccuracies in the NIOSH job history data used in these studies on the U.S. cohort. Sorahan and Lancashire (1997) then conducted further analyses, based on detailed job histories extracted from time sheet records, to better resolve the potential confounding effects of arsenic. Poisson regression was used to investigate risks of mortality from lung cancer in relation to four concentrations of accumulative exposure to cadmium ( $<400$ ,  $400-999$ ,  $1,000-1,999$ , and  $>2,000$  mg-days/ $m^3$ ). After adjustment for age attained, year of hire, and Hispanic ethnicity; Sorahan and Lancashire (1997) report a significant positive trend ( $p<0.05$ ) between cumulative exposure to cadmium and risks of mortality from lung cancer. However, when the exposure to cadmium was evaluated with or without concurrent exposure to arsenic, a significant trend for lung cancer was only found for exposure to cadmium received in the presence of arsenic trioxide. Since there were only 21 deaths from lung cancer, Sorahan and Lancashire (1997) state that it is impossible to determine which of the following three hypotheses is the correct one: (1) cadmium oxide in the presence of arsenic trioxide is a human lung carcinogen, (2) cadmium oxide and arsenic trioxide are human lung carcinogens and cadmium sulphate and cadmium sulphide are not (i.e., cadmium sulphate and cadmium sulphide were the main cadmium compounds of exposure when arsenic was not present), or (3) arsenic trioxide is a human carcinogen and the three cadmium compounds are not carcinogenic.

The carcinogenicity of cadmium has also been examined in European alloy, battery, smelter, and process workers. A study of workers at two copper-cadmium alloy facilities in the United Kingdom found no significant increase in lung cancer mortality (Sorahan et al. 1995). Dividing the workers into groups based on cumulative cadmium exposure or time since first exposure did not result in significant increases in lung cancer deaths in the alloy workers. An initial study of workers at nickel-cadmium battery

## 3. HEALTH EFFECTS

manufacturing facilities in the United Kingdom found a significant increase in cancer of the respiratory tract (Sorahan and Waterhouse 1983). A subsequent study (Sorahan 1987) found an increase in lung cancer deaths among workers with the highest exposure first employed between 1926 and 1946; no association was found in workers employed after 1946. Another study of nickel-cadmium battery workers in the United Kingdom did not find significant increases in lung cancer deaths (Sorahan and Esmen 2004), although a significant increase in pharyngeal cancer deaths was observed. A study of nickel cadmium battery workers in Sweden found an increase in lung cancer mortality, but the increase was not statistically significant (Elinder et al. 1985c). An update of this study, which includes additional workers, found a significant increase in lung cancer deaths (Järup et al. 1998a). However, there was no exposure-response relationship between cumulative exposure to cadmium (or nickel) and the risk of lung cancer. A significant increase in lung cancer mortality was observed in workers employed at a zinc-lead-cadmium smelter (Ades and Kazantzis 1988). However, no relationship between cumulative cadmium exposure and lung cancer deaths was found, suggesting that cadmium was not the causative agent. Another study of workers in 19 facilities in the United Kingdom that process cadmium did not find a statistically significant increase in lung cancer deaths (Armstrong and Kazantzis 1983). An update of this study found a significant increase in lung cancer deaths (Kazantzis et al. 1988). However, >60% of the lung cancer deaths were workers at the zinc-lead-cadmium smelter examined by Ades and Kazantzis (1988).

Studies in rats provide strong evidence of the lung carcinogenic potential of chronically inhaled cadmium. Oldiges et al. (1989) reported a clear dose response increase in lung tumors in male and female rats from an 18-month continuous exposure to either cadmium chloride, cadmium oxide dusts, cadmium oxide fume, cadmium sulfate, or cadmium sulfide. In the cadmium chloride study at  $30 \mu\text{g}/\text{m}^3$ , the observation period in the males had to be shortened to 30 months (rather than 31) because of mortality in excess of 75%. No lung tumors were observed in control rats after 31 months of observation. A high incidence of nodules and tumors was seen in  $30 \mu\text{g}/\text{m}^3$  exposures to cadmium chloride in both males and females. Results showed lung nodules in 18 of 20 males and 15 of 18 females and primary lung tumors in 15 of 20 males and 13 of 18 females. Tumor incidence as bronchioalveolar adenomas, adenocarcinomas, squamous cell carcinomas, or combined epidermoid carcinoma and adenocarcinoma were 2, 12, 0, and 1 for males; and 4, 7, 0, and 2 for females, respectively. Increased lung tumors in males and females were also observed with chronic exposures to cadmium oxide dust or fume at  $30 \mu\text{g}/\text{m}^3$ , to cadmium sulfate at  $90 \mu\text{g}/\text{m}^3$ , and to cadmium sulfide at  $90 \mu\text{g}/\text{m}^3$  (Oldiges et al. 1989). Cadmium sulfate produced by photolysis of cadmium sulfide under the experimental conditions may have contributed to some of the response observed with cadmium sulfide (Konig et al. 1992).

## 3. HEALTH EFFECTS

Takenaka et al. (1983) also demonstrated cadmium carcinogenicity in male rats exposed to cadmium chloride aerosols at 0.0134, 0.0257, and 0.0508 mg Cd/m<sup>3</sup> for 18 months. The exposure produced a dose-related increase in lung epidermoid carcinomas, adenocarcinomas, and mucoepidermoid carcinomas starting at 20 months. No other type of tumor was observed to increase with increasing dose.

In a protocol similar to the studies by Oldiges et al. (1989), Heinrich et al. (1989) did not observe an increase in lung tumors in male or female Syrian golden hamsters from chronic inhalation exposure to either cadmium oxide dust or fumes, cadmium chloride, cadmium sulfate, or cadmium sulfide. In female mice, lung tumor incidence increased at all dose levels, but incidence in the controls was also high, and the cadmium-induced increases were not statistically significant. Lung tumors in the cadmium-treated mice also did not increase in a dose-responsive manner except for a weak increase from exposure to the cadmium oxide fumes (Heinrich et al. 1989).

The available data provide inconclusive evidence on the potential of cadmium to induce lung cancer in humans. The strongest evidence comes from early studies of workers at a U.S. cadmium recovery facility (Stayner et al. 1992a; Thun et al. 1985), but later examinations of this cohort did not find conclusive evidence (Lamm et al. 1992, 1994; Sorahan and Lancashire 1997). The inconsistent results may be due to the small number of lung cancer cases and adjustments for possible early exposure to arsenic. Some studies of European cadmium workers have found significant increases in lung cancer (Ades and Kazantzis 1988; Järup et al. 1998a; Kazantzis et al. 1988; Sorahan 1987; Sorahan and Waterhouse 1983), but lung cancer deaths were not significantly associated with cumulative cadmium levels or duration of exposure and the investigators concluded that the effects may not have been related to cadmium exposure. Based on an early 1990s analysis of the available human and animal data, IARC (1993) classified cadmium as carcinogenic to humans (Group 1), based on sufficient evidence for carcinogenicity in both human and animal studies. Similarly, the DHHS (NTP 2011) classified cadmium and certain cadmium compounds as substances known to be human carcinogens. EPA classified cadmium as a probable human carcinogen by inhalation (Group B1), based on limited evidence of an increase in lung cancer in humans and sufficient evidence of lung cancer in rats (IRIS 2012). EPA estimated an inhalation unit risk (the risk corresponding to lifetime exposure to 1 µg/m<sup>3</sup>) of 1.8x10<sup>-3</sup> based on the Thun et al. (1985) study (IRIS 2012). A range of concentrations that correspond to upper bound lifetime excess risks of 10<sup>-4</sup>–10<sup>-7</sup> is shown in [Figure 3-1](#).

## 3. HEALTH EFFECTS

**3.2.2 Oral Exposure**

Information on health effects of oral exposure to cadmium in humans is derived mainly from studies of residents living in cadmium-polluted areas. Cadmium exposure in these populations is often estimated by blood or urinary cadmium levels (see Section 3.8.1). Exposure in these cases occurs primarily through the diet, but smokers in these cohorts are also exposed to cadmium by inhalation. When evaluating oral exposure studies, smoking was treated as a confounding variable rather than an exposure route because of the large number of toxic compounds (in addition to cadmium) present in cigarette smoke, and because the primary concern is effects attributable to cadmium. Cadmium is more readily found in the free ionic form in water, while in food, the cadmium ion generally exists in a complex with a variety of ligands, including proteins such as metallothionein (Crews et al. 1989; Groten et al. 1990; Nordberg et al. 1986). Experimental studies in animals have generally used soluble salts of cadmium (such as cadmium chloride) for food, drinking water, and gavage exposures. The toxicological properties of the cadmium ion do not appear to depend on the counter ion, although absorption may be significantly affected by protein complexes (see Section 3.3.1.2).

**3.2.2.1 Death**

Intentional ingestion of cadmium has been used as a means of suicide, causing death due to massive fluid loss, edema, and widespread organ destruction (Buckler et al. 1986; Wisniewska-Knypl et al. 1971). The doses ingested in two known fatal cases were estimated to be 25 mg Cd/kg from cadmium iodide (Wisniewska-Knypl et al. 1971) and 1,840 mg Cd/kg from cadmium chloride (Buckler et al. 1986). Time to death after cadmium iodide ingestion was 7 days (Wisniewska-Knypl et al. 1971) and 33 hours after ingestion of the cadmium chloride (Buckler et al. 1986).

In rats and mice, acute oral LD<sub>50</sub> (lethal dose, 50% kill) values for cadmium range from about 100 to 300 mg/kg (Baer and Benson 1987; Basinger et al. 1988; Kostial et al. 1978; Kotsonis and Klaassen 1978; Shimizu and Morita 1990). The lowest dose causing death (2 of 20 animals) was 15.3 mg/kg in Sprague-Dawley rats (Borzelleca et al. 1989). Very young animals have lower LD<sub>50</sub> values than adult animals (Kostial et al. 1978, 1989); this effect may be related to the greater fractional absorption of ingested cadmium in the immature organism (see Section 3.4.1.2). For example, the LD<sub>50</sub> values in rats aged 2, 3, 6, 18, and 54 week are 47, 240, 216, 170, and 109 mg/kg, respectively (Kostial et al. 1978).

Deaths related to cadmium exposure have been reported in only two of the intermediate exposure studies found. In a study in Wistar rats exposed to cadmium chloride by gavage at 40 mg Cd/kg/day,

### 3. HEALTH EFFECTS

5 days/week for up to 14 weeks; 4 of 13 female Wistar rats died by 8 weeks (Baranski and Sitarek 1987). In mice, Blakley (1986) studied the effect of cadmium on chemical- and viral-induced tumor production. Female albino Swiss mice (8 weeks old, n=41) were administered cadmium chloride in the drinking water for 280 days at doses of 0, 5, 10, or 50 ppm. These mice have a high incidence of spontaneous lymphocytic leukemia of thymic origin. A significant 33% increase ( $p=0.0228$ , chi-square analysis) in deaths from virally induced leukemia was observed from exposure to 1.9 or 9.5 mg Cd/kg/day. The deaths were attributed to cadmium-impaired immunosurveillance mechanisms that control expression of the murine lymphocytic leukemia virus.

The LOAEL values from each reliable study for lethality in each species and duration category are recorded in [Table 3-6](#) and plotted in [Figure 3-2](#).

#### 3.2.2.2 Systemic Effects

The highest NOAEL values and all LOAEL values from each reliable study for systemic effects in each species and duration category are recorded in [Table 3-6](#) and plotted in [Figure 3-2](#).

**Respiratory Effects.** No studies were located regarding respiratory effects in humans after oral exposure to cadmium.

No respiratory effects were observed in Rhesus monkeys from 4 mg/kg/day of cadmium chloride in the food for 9 years (Masaoka et al. 1994). Intermediate-duration oral exposure caused fibrosis in lungs of rats exposed to 2.4 mg Cd/kg/day of cadmium chloride after 6 and 16 weeks (Miller et al. 1974b). Petering et al. (1979) observed a reduced static compliance and lung lesions (not specified) in male Sprague-Dawley rats exposed to 1.2 mg Cd/kg/day in water for 200 days. Zinc-deficient rats were more susceptible to lung lesions from exposure to cadmium chloride (Petering et al. 1979). Rats exposed to cadmium chloride at 3.62 mg Cd/kg/day in the drinking water for 120 days developed emphysema (Petering et al. 1979). No histopathologic lesions of the lung were found in male Sprague-Dawley rats after 24 weeks of exposure to cadmium in drinking water at a maximum dose of 8 mg/kg/day (Kotsonis and Klaassen 1978). Lung weight was unchanged in Wistar rats after 90 days of exposure in drinking water at 16 mg/kg/day (Prigge 1978a). Effects on the lung following oral exposure to cadmium may be secondary to systemic changes (Petering et al. 1979); however, the studies that found lung effects did not examine other systemic effects in the exposed rats (Miller et al. 1974b; Petering et al. 1979).

Table 3-6 Levels of Significant Exposure to Cadmium - Oral

Key to Figure <sup>a</sup>	Species (Strain)	Exposure/Duration/Frequency (Route)	System	NOAEL (mg/kg/day)	LOAEL		Reference	Comments
					Less Serious (mg/kg/day)	Serious (mg/kg/day)		
<b>ACUTE EXPOSURE</b>								
<b>Death</b>								
1	Rat (NS)	once (G)				29 (LD50 at 8 days; 2 weeks old)	<a href="#">Kostial et al. 1978</a> CdCl <sub>2</sub>	
						129 F (LD50 at 8 days; 6 weeks old)		
						104 F (LD50 at 8 days; 18 weeks old)		
2	Rat (Sprague-Dawley)	once (GW)				225 M (LD50 at 14 days)	<a href="#">Kotsonis and Klaassen 1977</a> CdCl <sub>2</sub>	
3	Rat (Sprague-Dawley)	2 wk (W)				42 M (7/9 died within 2 weeks)	<a href="#">Kotsonis and Klaassen 1978</a> CdCl <sub>2</sub>	
4	Rat (Sprague-Dawley)	once (GW)				327 M (LD50 at 24 hours; fed rats)	<a href="#">Shimizu and Morita 1990</a> CdCl <sub>2</sub>	
						107 M (LD50 at 24 hours; fasted rats)		
5	Mouse (Swiss-Webster)	once (GW)				95.5 M (LD50 at 96 hours)	<a href="#">Baer and Benson 1987</a> CdCl <sub>2</sub>	
6	Mouse (ICR)	once (GW)				112 M (5/10 died within 8 days)	<a href="#">Basinger et al. 1988</a> CdCl <sub>2</sub>	

Table 3-6 Levels of Significant Exposure to Cadmium - Oral

(continued)

Key to Figure	Species (Strain)	Exposure/Duration/Frequency (Route)	System	NOAEL (mg/kg/day)	LOAEL		Reference Chemical Form	Comments
					Less Serious (mg/kg/day)	Serious (mg/kg/day)		
<b>Systemic</b>								
7	Rat (Wistar)	10 d Gd 7-16 once (GW)	Bd Wt	2 F	12 F (14% decreased maternal body weight)		Baranski 1985 CdCl <sub>2</sub>	
8	Rat (Sprague-Dawley)	10 d 1 x/d (GW)	Hemato	31.3 M 138 F	65.6 M (increased hemoglobin, hematocrit, erythrocytes)		Borzelleca et al. 1989 CdCl <sub>2</sub>	
			Hepatic	65.6 M	138 M (focal necrosis of hepatocytes)			
			Renal		15.3 (focal necrosis of tubular epithelium)			
			Bd Wt	15.3 M (18% decreased body weight) 31.3 F 65.6 F (18% decreased body weight)	31.3 M (23% decreased body weight)			
9	Rat (Sprague-Dawley)	10 d (W)	Hepatic	13.9			Borzelleca et al. 1989 CdCl <sub>2</sub>	
			Renal	13.9				
			Bd Wt	13.9 1.1 M	7.8 M (14% decreased body weight)	11.2 M (25% decreased body weight)		



Table 3-6 Levels of Significant Exposure to Cadmium - Oral

(continued)

Key to Figure <sup>a</sup>	Species (Strain)	Exposure/Duration/Frequency (Route)	System	NOAEL (mg/kg/day)	LOAEL		Reference Chemical Form	Comments
					Less Serious (mg/kg/day)	Serious (mg/kg/day)		
10	Rat (Sprague-Dawley)	once (GW)	Cardio	150 M			<a href="#">Kotsonis and Klaassen 1977</a> CdCl <sub>2</sub>	
			Hemato	150 M				
			Hepatic	150 M				
			Renal		25 M (50% decrease in urine flow for first 2 days)			
			Bd Wt	100	150 M (initial 12% decreased body weight)			
11	Rat (Long-Evans)	Gd 6-15 (GW)	Gastro	6.13 F		61.32 F (intestinal necrosis, hemorrhage, ulcers)	<a href="#">Machemer and Lorke 1981</a> CdCl <sub>2</sub>	
			Bd Wt	1.84 F	6.13 F (27% decrease in body weight gain during treatment)	18.39 F (persistent 50% decrease in maternal body weight gain)		
12	Rat (Long-Evans)	Gd 6-15 (F)	Gastro	12.5 F			<a href="#">Machemer and Lorke 1981</a> CdCl <sub>2</sub>	
			Bd Wt	3.5 F	12.5 F (transient 19% decrease in maternal body weight gain during treatment)			
13	Rat (Wistar)	12 d (W)	Hemato		12 M (anemia)		<a href="#">Sakata et al. 1988</a> CdCl <sub>2</sub>	

Table 3-6 Levels of Significant Exposure to Cadmium - Oral

(continued)

Key to Figure <sup>a</sup>	Species (Strain)	Exposure/ Duration/ Frequency (Route)	System	LOAEL			Reference Chemical Form	Comments
				NOAEL (mg/kg/day)	Less Serious (mg/kg/day)	Serious (mg/kg/day)		
14	Rat (Sprague- Dawley)	once (GW)	Hepatic		75 M (focal degeneration and necrosis of parenchymal cells)		<a href="#">Shimizu and Morita 1990</a> CdCl <sub>2</sub>	
15	Mouse (CBA/Bom)	once (GW)	Gastro	15.7 M	30.4 M (gastritis and enteritis)	88.8 M (severe gastric necrosis)	<a href="#">Andersen et al. 1988</a> CdCl <sub>2</sub>	
			Hepatic	15.7 M	30.4 M (fatty infiltration of liver cells, occasional hepatocellular necrosis)			
			Renal	59.6		88.8 M (tubular necrosis and casts)		
16	Mouse (ICR)	once (GW)	Gastro			112 M (glandular stomach epithelial necrosis)	<a href="#">Basinger et al. 1988</a> CdCl <sub>2</sub>	
			Hepatic			112 M (extensive hepatocellular coagulative necrosis)		
			Renal	112 M				
<b>Immuno/ Lymphoret</b>								
17	Rat (Sprague- Dawley)	10 d 1 x/d (GW)		65.6 M 31.3 F	65.6 F (increased leukocyte counts)		<a href="#">Borzelleca et al. 1989</a> CdCl <sub>2</sub>	
<b>Neurological</b>								
18	Rat (Sprague- Dawley)	once (GW)		25 M	50 M (decreased motor activity)		<a href="#">Kotsonis and Klaassen 1977</a> CdCl <sub>2</sub>	

Table 3-6 Levels of Significant Exposure to Cadmium - Oral

(continued)

Key to Figure <sup>a</sup>	Species (Strain)	Exposure/ Duration/ Frequency (Route)	System	NOAEL (mg/kg/day)	LOAEL		Reference Chemical Form	Comments
					Less Serious (mg/kg/day)	Serious (mg/kg/day)		
<b>Reproductive</b>								
19	Rat (Wistar)	once (GW)		50 M		100 M (testicular necrosis)	<a href="#">Bomhard et al. 1987</a> CdCl <sub>2</sub>	
20	Rat (Sprague- Dawley)	10 d 1 x/d (GW)		138 F		65.6 M (testicular atrophy and loss of spermatogenic elements)	<a href="#">Borzelleca et al. 1989</a> CdCl <sub>2</sub>	
21	Rat (Sprague- Dawley)	once (GW)		25 M			<a href="#">Dixon et al. 1976</a> CdCl <sub>2</sub>	
22	Rat (Sprague- Dawley)	once (GW)		50 M		100 M (testicular necrosis; decreased spermatogenesis; decreased number females producing pups)	<a href="#">Kotsonis and Klaassen 1977</a> CdCl <sub>2</sub>	
23	Mouse (CBM/ Bom)	once (GW)		30.3 M		59.6 M (testicular necrosis)	<a href="#">Andersen et al. 1988</a> CdCl <sub>2</sub>	
<b>Developmental</b>								
24	Rat (Wistar)	10 d Gd 7-16 once (GW)			2 F (delayed ossification of the sternum and ribs)	40 (fused lower limbs, absent limbs, decreased number of live fetuses, increased number of resorptions)	<a href="#">Baranski 1985</a> CdCl <sub>2</sub>	

Table 3-6 Levels of Significant Exposure to Cadmium - Oral

(continued)

Key to Figure <sup>a</sup>	Species (Strain)	Exposure/Duration/Frequency (Route)	System	NOAEL (mg/kg/day)	LOAEL		Reference Chemical Form	Comments
					Less Serious (mg/kg/day)	Serious (mg/kg/day)		
25	Rat (Long- Evans)	1 x/d Gd 6-15 (GW)		6.13		18.39	(increased number of fetuses with malformations)	<a href="#">Machemer and Lorke 1981</a> CdCl <sub>2</sub>
26	Rat (Long- Evans)	10 d Gd 6-15 (F)		12.5				<a href="#">Machemer and Lorke 1981</a> CdCl <sub>2</sub>
<b>INTERMEDIATE EXPOSURE</b>								
<b>Death</b>								
27	Rat (Wistar)	14 wk 5 d/wk (GW)				40 F	(4/13 died by week 8; 7/13 by week 14)	<a href="#">Baranski and Sitarek 1987</a> CdCl <sub>2</sub>
28	Mouse (Swiss)	280 d (W)				1.9 F	(24/41 died by 280 days)	<a href="#">Blakley 1986</a> CdCl <sub>2</sub>
<b>Systemic</b>								
29	Monkey (Rhesus)	10 wk (F)	Bd Wt	5 M				<a href="#">Chopra et al. 1984</a> CdCl <sub>2</sub>
30	Rat (Wistar)	14 wk 5 d/wk (GW)	Bd Wt	4 F		40 F	(29% decreased maternal body weight)	<a href="#">Baranski and Sitarek 1987</a> CdCl <sub>2</sub>
31	Rat (Sprague-Dawley)	2-10 mo (W)	Renal			30 F	(B2-microglobulinuria)	<a href="#">Bernard et al. 1988a</a> CdCl <sub>2</sub>

Table 3-6 Levels of Significant Exposure to Cadmium - Oral

(continued)

Key to Figure <sup>a</sup>	Species (Strain)	Exposure/Duration/Frequency (Route)	System	NOAEL (mg/kg/day)	LOAEL		Reference Chemical Form	Comments
					Less Serious (mg/kg/day)	Serious (mg/kg/day)		
32	Rat (Wistar)	daily 12 mo (W)	Musc/skel	0.2 M	0.5 M (increased lumbar spine deformities, decreased in lumbar spine and femur mineralization, altered bone turnover parameters)		Brzoska and Moniuszko-Jakoniuk 2005a, 2005b; Brzoska et al. 2010 CdCl <sub>2</sub>	
33	Rat (Wistar)	daily 12 mo (W)	Musc/skel		<sup>b</sup> 0.2 F (decreased bone mineralization, mechanical properties of tibia and femur, and altered bone turnover parameters)		Brzoska and Moniuszko-Jakoniuk 2005d; Brzoska et al. 2005a, 2005c CdCl <sub>2</sub>	
34	Rat (Wistar)	daily 12 mo (W)	Musc/skel		0.3 F (alterations in bone mineral content and density and mechanical properties of lumbar vertebral and femoral bones)		Brzoska et al. 2004b, 2005b CdCl <sub>2</sub>	
35	Rat (Sprague-Dawley)	4 or 7 mo (W)	Renal			15.2 F (albuminuria, transferrinuria, B <sub>2</sub> -microglobulinuria)	Cardenas et al. 1992a CdCl <sub>2</sub>	
36	Rat (Sprague-Dawley)	190 d (W)	Cardio		1.4 M (20% increase in diastolic blood pressure)		Carmignanti and Boscolo 1984 Cd acetate	
			Bd Wt	2.8 M				

Table 3-6 Levels of Significant Exposure to Cadmium - Oral

(continued)

Key to Figure	Species (Strain)	Exposure/Duration/Frequency (Route)	System	NOAEL (mg/kg/day)	LOAEL		Reference Chemical Form	Comments
					Less Serious (mg/kg/day)	Serious (mg/kg/day)		
37	Rat (Sprague-Dawley)	12 wk (W)	Hepatic		8.58 M (necrosis of central lobules)		Cha 1987 CdCl <sub>2</sub>	
			Renal		8.58 M (necrosis of proximal tubular epithelial cells and cloudy swelling)			
			Bd Wt		8.58 M (23% decreased in body weight gain; 9% total body weight decrease)			
38	Rat (Wistar)	170 d (W)	Bd Wt	56 F			Cifone et al. 1989a CdCl <sub>2</sub>	
39	Rat (Sprague-Dawley)	3 mo (W)	Hemato		2 (anemia)		Decker et al. 1958 CdCl <sub>2</sub>	
			Bd Wt		2 F (15% decreased body weight)	2 M (25% decreased body weight)		
40	Rat (Wistar)	4-60 wk (W)	Renal		1.18 (vesiculation of proximal tubules)		Gatta et al. 1989 CdCl <sub>2</sub>	
41	Rat	4 wk (F)	Hemato		2.5 M (anemia)		Groten et al. 1990 CdCl <sub>2</sub>	
			Renal	2.5 M				

Table 3-6 Levels of Significant Exposure to Cadmium - Oral

(continued)

Key to Figure <sup>a</sup>	Species (Strain)	Exposure/Duration/Frequency (Route)	System	NOAEL (mg/kg/day)	LOAEL		Reference Chemical Form	Comments
					Less Serious (mg/kg/day)	Serious (mg/kg/day)		
42	Rat (Wistar)	120 d (W)	Hemato		3.6 M (anemia)		Itokawa et al. 1974 CdCl <sub>2</sub>	
			Renal		3.6 M (tubular necrosis and casts, glomerular adhesions)			
43	Rat (Sprague-Dawley)	7 wk (F)	Cardio			2.5 M (congested myocardium, separation of muscle fibers)	Jamall et al. 1989 CdCl <sub>2</sub>	
			Renal	2.5 M				
			Bd Wt	2.5 M				
44	Rat (Wistar)	90 d (W)	Hemato		8 F (anemia)		Kawamura et al. 1978 CdCl <sub>2</sub>	
			Musc/skel		8 F (osteomalacia changes)			
			Renal		8 F (decreased renal clearance)			
			Endocr	8 F				
			Bd Wt		8 F (12% decreased body weight)			
45	Rat (Sprague-Dawley)	22 d Gd 0-21 (W)	Hemato		1.5 F (slight anemia)		Kelman et al. 1978 form not specified	
			Musc/skel	3.8 F				

Table 3-6 Levels of Significant Exposure to Cadmium - Oral

(continued)

Key to Figure <sup>a</sup>	Species (Strain)	Exposure/ Duration/ Frequency (Route)	System	NOAEL (mg/kg/day)	LOAEL		Reference Chemical Form	Comments
					Less Serious (mg/kg/day)	Serious (mg/kg/day)		
46	Rat (Sprague- Dawley)	24 wk (W)	Resp	8 M			Kotsonis and Klaassen 1978 CdCl <sub>2</sub>	
			Cardio	8 M				
			Gastro	8 M				
			Hemato	8 M				
			Musc/skel	8 M				
			Hepatic	8 M				
			Renal	1.2 M	3.1 M (proteinuria, slight focal tubular necrosis)			
			Endocr	8 M				
Bd Wt	8 M							
47	Rat (Wistar)	8 weeks daily (W)	Hepatic		18 M (increased serum and liver triglyceride levels; increased serum cholesterol levels)		Larregle et al. 2008 CdCl <sub>2</sub>	
48	Rat (Wistar)	3 mo (F)	Cardio	3			Loeser and Lorke 1977a CdCl <sub>2</sub>	
			Hemato	3				
			Hepatic	3				
			Renal	3				
			Endocr	3				
			Bd Wt	3				



Table 3-6 Levels of Significant Exposure to Cadmium - Oral

(continued)

Key to Figure <sup>a</sup>	Species (Strain)	Exposure/Duration/Frequency (Route)	System	NOAEL (mg/kg/day)	LOAEL		Reference Chemical Form	Comments
					Less Serious (mg/kg/day)	Serious (mg/kg/day)		
49	Rat (Sprague-Dawley)	6-16 wk (W)	Resp			2.4 (lung fibrosis)	Miller et al. 1974b CdCl <sub>2</sub>	
50	Rat (Sprague-Dawley)	6 wk 5 d/wk 1 x/d (GW)	Hepatic	0.25 M			Muller et al. 1988 Cd acetate	
			Bd Wt	0.25 M				
51	Rat (NS)	4 wk (W)	Hemato		0.8 F (decreased hematocrit and hemoglobin)		Ogoshi et al. 1989 CdCl <sub>2</sub>	
			Musc/skel		0.8 F (decreased bone strength in young animals)			
			Bd Wt	0.8	1.6 F (10% decreased body weight gain)			
52	Rat (NS)	200 d (W)	Resp	0.6 M	1.2 M (reduced static compliance, lung lesions)		Petering et al. 1979 CdCl <sub>2</sub>	
53	Rat (Sprague-Dawley)	120 d (W)	Resp			3.62 M (emphysema)	Petering et al. 1979 CdCl <sub>2</sub>	

Table 3-6 Levels of Significant Exposure to Cadmium - Oral

(continued)

Key to Figure <sup>a</sup>	Species (Strain)	Exposure/Duration/Frequency (Route)	System	NOAEL (mg/kg/day)	LOAEL		Reference Chemical Form	Comments
					Less Serious (mg/kg/day)	Serious (mg/kg/day)		
54	Rat (Sprague-Dawley)	111 d (90 d prior to Gd 1-21) (W)	Hemato	5.23 F			Petering et al. 1979 CdCl <sub>2</sub>	
55	Rat (Sprague-Dawley)	Gd 1- Ld 1 (F)	Bd Wt			19.7 F (77-80% decreased maternal weight gain)	Pond and Walker 1975 CdCl <sub>2</sub>	
56	Rat (Wistar)	90 d (W)	Resp	16 F			Prigge 1978a CdCl <sub>2</sub>	
			Hemato		4 F (23% decreased serum iron)			
			Renal	4 F	8 F (35% increase in urine protein)			
56	Rat (Wistar)	90 d (W)	Bd Wt	8 F				
57	Rat (Wistar)	12, 26, 50, or 100 d (W)	Hemato			12 M (iron deficient anemia)	Sakata et al. 1988 CdCl <sub>2</sub>	
58	Rat (Sprague-Dawley)	7-12 mo (W)	Renal	13 F			Viau et al. 1984 CdCl <sub>2</sub>	
			Bd Wt	13 F				

Table 3-6 Levels of Significant Exposure to Cadmium - Oral

(continued)

Key to Figure	Species (Strain)	Exposure/Duration/Frequency (Route)	System	NOAEL (mg/kg/day)	LOAEL		Reference Chemical Form	Comments
					Less Serious (mg/kg/day)	Serious (mg/kg/day)		
59	Mouse (CF1)	252 d (F)	Musc/skel		0.65 F (decrease in femur calcium content in mice undergoing repeated pregnancy/lactation periods)		<a href="#">Bhattacharyya et al. 1988a, 1988b</a>	
60	Mouse (C57BL/6)	3-11 wk (W)	Bd Wt			12.5 M (63% decreased body weight gain)	<a href="#">Malave and de Ruffino 1984</a> CdCl <sub>2</sub>	
61	Mouse (B6C3F1)	16-46 wk (W)	Bd Wt			232 M (45% decreased body weight)	<a href="#">Waalkes et al. 1993</a> CdCl <sub>2</sub>	
62	Mouse (QS/CH)	Gd 1-19 (W)	Hemato	4.8 F	9.6 F (anemia)		<a href="#">Webster 1978</a> CdCl <sub>2</sub>	
			Bd Wt	4.8 F	9.6 F (14% decrease in maternal weight gain)			
63	Dog (Beagle)	3 mo (F)	Cardio	0.75			<a href="#">Loeser and Lorke 1977b</a> CdCl <sub>2</sub>	
			Hemato	0.75				
			Hepatic	0.75				
			Renal	0.75				
			Bd Wt	0.75				

Table 3-6 Levels of Significant Exposure to Cadmium - Oral

(continued)

Key to Figure	Species (Strain)	Exposure/ Duration/ Frequency (Route)	System	NOAEL (mg/kg/day)	LOAEL		Reference Chemical Form	Comments
					Less Serious (mg/kg/day)	Serious (mg/kg/day)		
64	Rabbit (New Zealand)	9 mo (W)	Cardio		1.6 M (increased aortic resistance, reduced contractility)		Boscolo and Carmignani 1986 CdCl <sub>2</sub>	
			Renal	1.6 M				
			Bd Wt	1.6 M				
65	Rabbit (New Zealand (W) and Belgian Giant)	200 d (W)	Hemato		14.9 M (anemia)		Stowe et al. 1972 CdCl <sub>2</sub>	
			Hepatic		14.9 M (focal hepatic fibrosis and biliary hyperplasia)			
			Renal			14.9 M (tubular necrosis, glomerular and interstitial fibrosis)		
			Endocr	14.9				
			Bd Wt		14.9 M (11% decrease in body weight)			
66	Monkey (Rhesus)	10 wk (F)	Immuno/ Lymphoret		5 M (increased cell-mediated immune response)		Chopra et al. 1984 CdCl <sub>2</sub>	
67	Rat (Wistar)	170 d (W)			28 F (biphasic decrease then increase in natural killer cell activity)		Cifone et al. 1989a CdCl <sub>2</sub>	

Table 3-6 Levels of Significant Exposure to Cadmium - Oral

(continued)

Key to Figure <sup>a</sup>	Species (Strain)	Exposure/Duration/Frequency (Route)	System	NOAEL (mg/kg/day)	LOAEL		Reference Chemical Form	Comments
					Less Serious (mg/kg/day)	Serious (mg/kg/day)		
68	Rat (Wistar)	3 mo (F)		3			Loeser and Lorke 1977a CdCl <sub>2</sub>	
69	Mouse (BDF1)	3 wk (W)		1.4 F	2.8 F (decreased humoral immune response)		Blakley 1985 CdCl <sub>2</sub>	
70	Mouse (Swiss)	280 d (W)			1.9 F (greater susceptibility to murine lymphocytic leukemia virus)		Blakley 1986 CdCl <sub>2</sub>	
71	Mouse (BDF1)	26 d (W)		12.5 F			Blakley 1988 CdCl <sub>2</sub>	
72	Mouse (Swiss-Webster)	30 d (W)		22 M			Bouley et al. 1984 Cd acetate	
73	Mouse (Swiss-Webster)	10 wk (W)		57 M			Exon et al. 1986 CdCl <sub>2</sub> , Cd acetate, or Cd sulfate	
74	Mouse (C57BL/6N)	12-16 wk (W)		19 F	57 F (reduced number of SRBC-activated, plaque-forming cells)		Krzystyniak et al. 1987 CdCl <sub>2</sub>	

Table 3-6 Levels of Significant Exposure to Cadmium - Oral

(continued)

Key to Figure	Species (Strain)	Exposure/Duration/Frequency (Route)	System	NOAEL (mg/kg/day)	LOAEL		Reference Chemical Form	Comments
					Less Serious (mg/kg/day)	Serious (mg/kg/day)		
75	Mouse (C57BL/6)	3-11 wk (W)			12.5 M (decreased suppressor cell activity)		Malave and de Ruffino 1984 CdCl <sub>2</sub>	
76	Mouse (ICR)	10 wk (W)			0.75 M (induction of anti-nuclear autoantibodies)		Ohsawa et al. 1988 CdCl <sub>2</sub>	
<b>Neurological</b>								
77	Rat (Wistar)	14 wk 5 d/wk (GW)		4 F	40 F (aggressive behavior)		Baranski and Sitarek 1987 CdCl <sub>2</sub>	
78	Rat (Sprague-Dawley)	3-24 wk (W)		1.2 M	3.1 M (decreased motor activity)		Kotsonis and Klaassen 1978 CdCl <sub>2</sub>	
79	Rat (Sprague-Dawley)	55 d (F)		1 M	5 M (increased passive avoidance)		Nation et al. 1984 CdCl <sub>2</sub>	
80	Rat (Sprague-Dawley)	60 d (F)			9 M (decreased motor activity)		Nation et al. 1990 CdCl <sub>2</sub>	
<b>Reproductive</b>								
81	Rat (Wistar)	14 wk 5 d/wk (GW)		4 F	40 F (increased duration of estrus cycle)		Baranski and Sitarek 1987 CdCl <sub>2</sub>	

Table 3-6 Levels of Significant Exposure to Cadmium - Oral

(continued)

Key to Figure <sup>a</sup>	Species (Strain)	Exposure/Duration/Frequency (Route)	System	NOAEL (mg/kg/day)	LOAEL		Reference Chemical Form	Comments
					Less Serious (mg/kg/day)	Serious (mg/kg/day)		
82	Rat (Wistar)	11 wk 5 d/wk (GW)		4 F			Baranski et al. 1983 CdCl <sub>2</sub>	
83	Rat (Wistar)	10 wk 1 x/wk (GW)		5 M			Bomhard et al. 1987 CdCl <sub>2</sub>	Histopathology only.
84	Rat (Sprague-Dawley)	12 wk (W)			8.58 M (necrosis and atrophy of seminiferous tubule epithelium)		Cha 1987 CdCl <sub>2</sub>	
85	Rat	4 wk (F)		2.5 M			Groten et al. 1990 CdCl <sub>2</sub>	Histopathology only.
86	Rat (albino)	4 wk (W)		4.8 F			Kostial et al. 1993 CdCl <sub>2</sub>	
87	Rat (Sprague-Dawley)	24 wk (W)		8 M			Kotsonis and Klaassen 1978 CdCl <sub>2</sub>	
88	Rat (Wistar)	3 mo (F)		3			Loeser and Lorke 1977a CdCl <sub>2</sub>	Histopathology only.
89	Rat (NS)	120 d (W)			12.6 M (decreased sperm count and motility, seminiferous tubular damage)		Saxena et al. 1989 Cd acetate	

Table 3-6 Levels of Significant Exposure to Cadmium - Oral

(continued)

Key to Figure <sup>a</sup>	Species (Strain)	Exposure/ Duration/ Frequency (Route)	System	NOAEL (mg/kg/day)	LOAEL		Reference Chemical Form	Comments
					Less Serious (mg/kg/day)	Serious (mg/kg/day)		
90	Rat (Long- Evans)	70-80 d (W)		4.64 M			Zenick et al. 1982 CdCl <sub>2</sub>	
91	Dog (Beagle)	3 mo (F)		0.75			Loeser and Lorke 1977b CdCl <sub>2</sub>	
<b>Developmental</b>								
92	Rat (Wistar)	21 d Gd 1-21 (W)			0.706	(delayed development of sensory motor coordination reflexes; increased motor activity)	Ali et al. 1986 Cd acetate	
93	Rat (Wistar)	20 d Gd 1-20 (W)			9.6	(decreased fetal body weight [12%], body length [7%], and hematocrit [13%])	Baranski 1987 CdCl <sub>2</sub>	Decreased maternal water and food consumption.
94	Rat (Wistar)	11 wk 5 d/wk 1 x/d (GW)			0.04	(pup behavioral alterations)	Baranski et al. 1983 CdCl <sub>2</sub>	



Table 3-6 Levels of Significant Exposure to Cadmium - Oral

(continued)

Key to Figure <sup>a</sup>	Species (Strain)	Exposure/ Duration/ Frequency (Route)	System	NOAEL (mg/kg)	LOAEL		Reference Chemical Form	Comments
					Less Serious (mg/kg)	Serious (mg/kg)		
95	Rat (Wistar)	11-94 d Gd 5-15 Ld 2-28 1 x/d ppd 1-56 5 d/wk 1 x/d (GW)			14 M (decreased horizontal ambulation and rearing activity; increased frequency of somatosensory, visual, and auditory electrocorticogram; prolonged latency and duration of evoked potentials)		<a href="#">Desi et al. 1998</a> CdCl <sub>2</sub>	
96	Rat (Druckery)	Gd 0- Ld 21 (W)			5 (decreased pup brain and body weight at 7, 14, and 21 days)		<a href="#">Gupta et al 1993</a> Cd acetate	
97	Rat (Sprague- Dawley)	Gd 0-20 (W)			1.5 (12% decreased hematocrit)		<a href="#">Kelman et al. 1978</a> form not specified	
98	Rat (albino)	10 wk (W)			4.8 (12% decrease in pup body weight at weaning)		<a href="#">Kostial et al. 1993</a> CdCl <sub>2</sub>	
99	Rat (Wistar)	approx. 49 d 4 wk old through mating 7 d/wk 1 x/d (GO)			7 M (alterations in ambulation behavior; prolonged latency and duration of somatosensory evoked potentials)		<a href="#">Nagymajtenyi et al. 1997</a> CdCl <sub>2</sub>	

Table 3-6 Levels of Significant Exposure to Cadmium - Oral

(continued)

Key to Figure <sup>a</sup>	Species (Strain)	Exposure/Duration/Frequency (Route)	System	NOAEL (mg/kg/day)	LOAEL		Reference Chemical Form	Comments
					Less Serious (mg/kg/day)	Serious (mg/kg/day)		
100	Rat (Sprague-Dawley)	60 d prior to Gd 1 or Gd 1-21 (W)			2.61	(decreased live birth weight)	Petering et al. 1979 CdCl <sub>2</sub>	
101	Rat (Sprague-Dawley)	Gd 1- Ld 1 (F)			19.7	(13-19% decreased pup birth weight)	Pond and Walker 1975 CdCl <sub>2</sub>	
102	Rat (ITRC)	21 d Gd 0-20 (W)		21			Saxena et al. 1986 Cd acetate	
103	Rat (Sprague-Dawley)	15 d Gd 6-20 (W)		0.63	4.7	(8% decreased fetal body weight)	Sorell and Graziano 1990 CdCl <sub>2</sub>	
104	Rat (Sprague-Dawley)	9 wk 1 x/d (GW)		1	10	(delayed ossification, decreased body weight)	Sutou et al. 1980 form not specified	
105	Mouse (QS/CH)	19 d Gd 1-19 (W)			2.4	(decreased fetal body weight; severe anemia)	Webster 1978 CdCl <sub>2</sub>	
<b>CHRONIC EXPOSURE</b>								
<b>Systemic</b>								
106	Human		Renal	0.0003 <sup>c</sup> F			Buchet et al. 1990; Jarup et al. 2000; Suwazono et al. 2006 form not specified	

Table 3-6 Levels of Significant Exposure to Cadmium - Oral

(continued)

Key to Figure <sup>a</sup>	Species (Strain)	Exposure/ Duration/ Frequency (Route)	System	NOAEL (mg/kg/day)	LOAEL		Reference Chemical Form	Comments
					Less Serious (mg/kg/day)	Serious (mg/kg/day)		
107	Human	NS lifetime (F)	Renal	0.0021			<a href="#">Nogawa et al. 1989</a> form not specified	
108	Human	>25 yr lifetime (environ)	Hemato	0.0078			<a href="#">Shiwen et al. 1990</a> Cd metal	
			Musc/skel	0.0078				
			Renal		0.0078	(increased excretion of low molecular weight proteins)		
109	Monkey (Rhesus)	9 yr (F)	Cardio	0.53 M	1.71 M	(increased blood pressure during the first 1.5 years)	<a href="#">Akahori et al. 1994</a> CdCl <sub>2</sub>	
110	Rat (Sprague- Dawley)	18 mo (W)	Renal			13 F (loss of glomerular polyanion charge barrier, proteinuria)	<a href="#">Bernard et al. 1992</a> CdCl <sub>2</sub>	
111	Rat (Wistar)	72 wk (F)	Renal	3.5	17.5	(8 to 9-fold increase in LDH and GST starting at 13 weeks)	<a href="#">Bomhard et al. 1984</a> CdCl <sub>2</sub>	

Table 3-6 Levels of Significant Exposure to Cadmium - Oral

(continued)

Key to Figure <sup>a</sup>	Species (Strain)	Exposure/Duration/Frequency (Route)	System	NOAEL (mg/kg/day)	LOAEL		Reference Chemical Form	Comments
					Less Serious (mg/kg/day)	Serious (mg/kg/day)		
112	Rat (Wistar)	daily 24 mo (W)	Musc/skel		0.08 F	(decreases in bone mineral content and density of lumbar spine, altered bone turnover parameters, increases in deformed and fractured vertebral bodies)	Brzoska and Moniuszko-Jakoniuk 2004a, 2004b; Brzoska 2011 CdCl <sub>2</sub>	
113	Rat (Sprague-Dawley)	12 mo (W)	Hemato	0.79			Decker et al. 1958 CdCl <sub>2</sub>	
			Bd Wt	0.79				
114	Rat (Sprague-Dawley)	M: 92 wk F: 84 wk (W)	Cardio	4.01			Fingerle et al. 1982 CdCl <sub>2</sub>	
			Renal	0.8	1.51	(proximal tubule lesions)		
			Bd Wt	4.01				
115	Rat (Sprague-Dawley)	6, 12, or 18 mo (W)	Cardio	2.281 F			Mangler et al 1988 CdCl <sub>2</sub>	
			Hepatic	2.281 F				
			Renal		2.337 F	(cloudy swelling of tubular cells)		
			Bd Wt	2.281 F				

Table 3-6 Levels of Significant Exposure to Cadmium - Oral

(continued)

Key to Figure <sup>a</sup>	Species (Strain)	Exposure/Duration/Frequency (Route)	System	NOAEL (mg/kg/day)	LOAEL		Reference Chemical Form	Comments
					Less Serious (mg/kg/day)	Serious (mg/kg/day)		
116	Rat (Wistar)	31 mo (W)	Musc/skel			3.6	(muscle atrophy)	<a href="#">Sato et al. 1978</a> CdCl <sub>2</sub>
			Bd Wt	3.6				
117	Rat (Wistar)	2 yr (W)	Renal	2.6 M				<a href="#">Shaikh et al. 1989</a> CdCl <sub>2</sub>
118	Rat (Wistar)	77 wk (F)	Bd Wt	3.5 M	7 M (10% decreased body weight)			<a href="#">Waalkes and Rehm 1992</a> CdCl <sub>2</sub>
119	Mouse (CF1)	18 months (F)	Musc/skel	0.65 F	6.5 F (loss of bone calcium in ovariectomized mice)			<a href="#">Bhattacharyya et al. 1988c</a>
120	Mouse (CBA/H)	12 mo (W)	Hemato			57	(anemia and bone marrow hypoplasia)	<a href="#">Hays and Margaretten 1985</a> form not specified
			Renal	57				
			Bd Wt			57	(21% decreased terminal body weight)	
<b>Neurological</b>								
121	Rat (Wistar)	31 mo (W)				3.6	(peripheral neuropathy)	<a href="#">Sato et al. 1978</a> CdCl <sub>2</sub>

Table 3-6 Levels of Significant Exposure to Cadmium - Oral

(continued)

Key to Figure <sup>a</sup>	Species (Strain)	Exposure/ Duration/ Frequency (Route)	System	NOAEL (mg/kg/day)	LOAEL		Reference Chemical Form	Comments
					Less Serious (mg/kg/day)	Serious (mg/kg/day)		
<b>Cancer</b>								
122	Rat (Wistar)	77 wk (F)					3.5 M (CEL: increased rates of prostatic adenomas)	Waalkes and Rehm 1992 CdCl <sub>2</sub>

a The number corresponds to entries in Figure 3-2.

b The intermediate-duration oral MRL of 0.0005 mg Cd/kg/day (0.5 ug Cd/kg/day) was calculated using a benchmark dose analysis. The BMDL1std of 0.05 mg Cd/kg/day was divided by an uncertainty factor of 100 (10 to account for extrapolation from animals to humans and 10 for human variability).

c The chronic-duration oral MRL of 0.0001 mg Cd/kg/day (0.1 ug Cd/kg/day) was calculated from the 95% lower confidence limit of the urinary cadmium level associated with a 10% increased risk of low molecular weight proteinuria (0.5 ug/g creatinine) estimated from a meta-analysis of select environmental exposure studies. An intake which would result in this urinary cadmium concentration was estimated using a modification of the Nordberg-Kjellström pharmacokinetic model (see Appendix A for details on the meta-analysis and extrapolation to dietary intake). This dose of 0.3 ug/kg/day was divided by an uncertainty factor of 3 for human variability.

Bd Wt = body weight; Cardio = cardiovascular; CEL = cancer effect level; d = day(s); Endocr = endocrine; (F) = feed; F = Female; (G) = gavage; Gastro = gastrointestinal; Gd = gestational day; (GO) = gavage in oil; GST = glutathione-S-transferase; (GW) = gavage in water; Hemato = hematological; Immuno/Lymphoret = immunological/lymphoreticular; LD50 = lethal dose, 50% kill; LDH = Lactate dehydrogenase; LOAEL = lowest-observed-adverse-effect level; M = male; mo = month(s); Musc/skel = musculoskeletal; NOAEL = no-observed-adverse-effect level; NS = not specified; ppd = post-parturition day; Resp = respiratory; SRBC = sheep red blood cells; (W) = drinking water; wk = week(s); x = time(s); yr = year(s)

Figure 3-2 Levels of Significant Exposure to Cadmium - Oral

Acute (≤14 days)

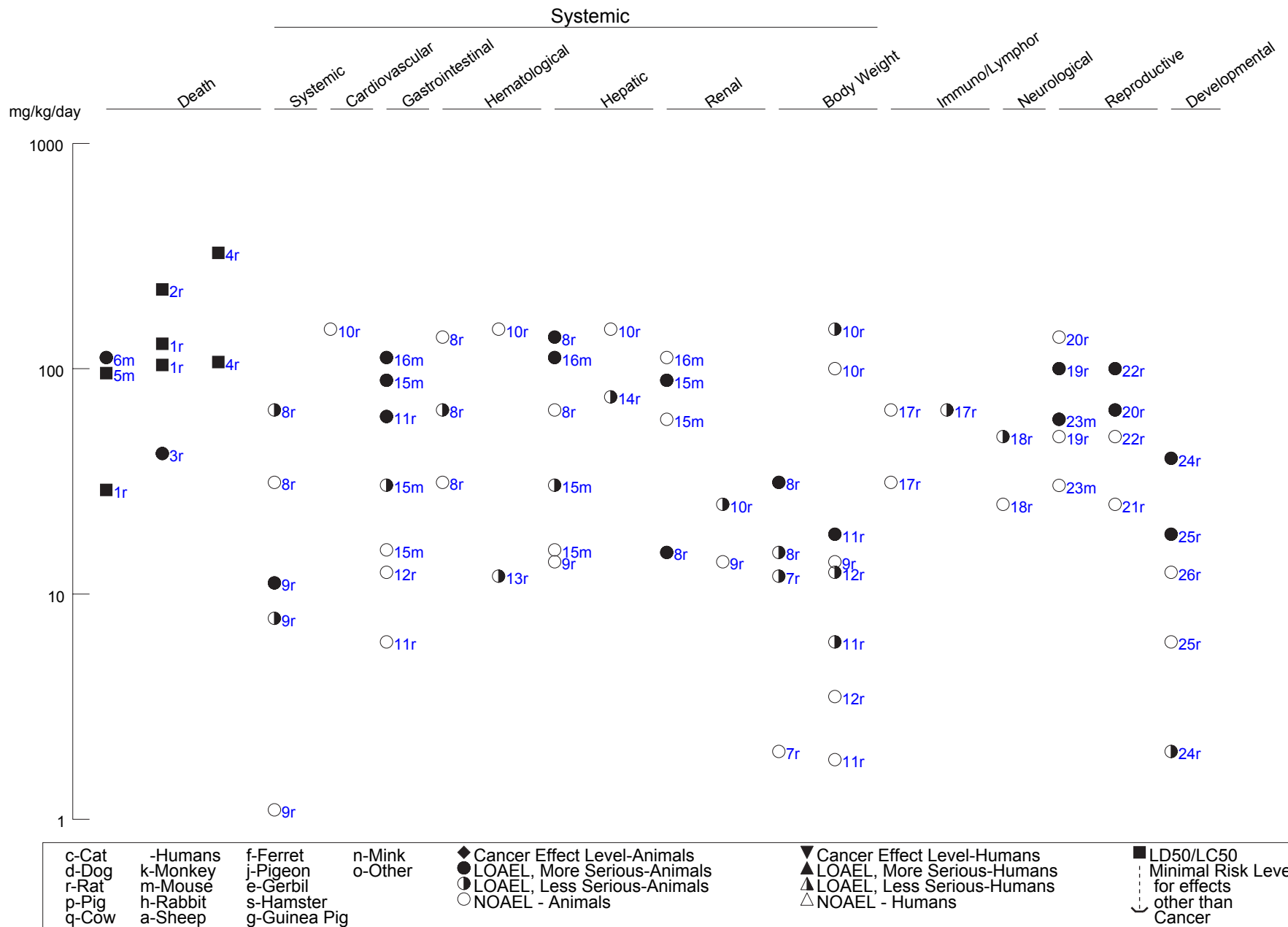

Figure 3-2 Levels of Significant Exposure to Cadmium - Oral (Continued)

Intermediate (15-364 days)

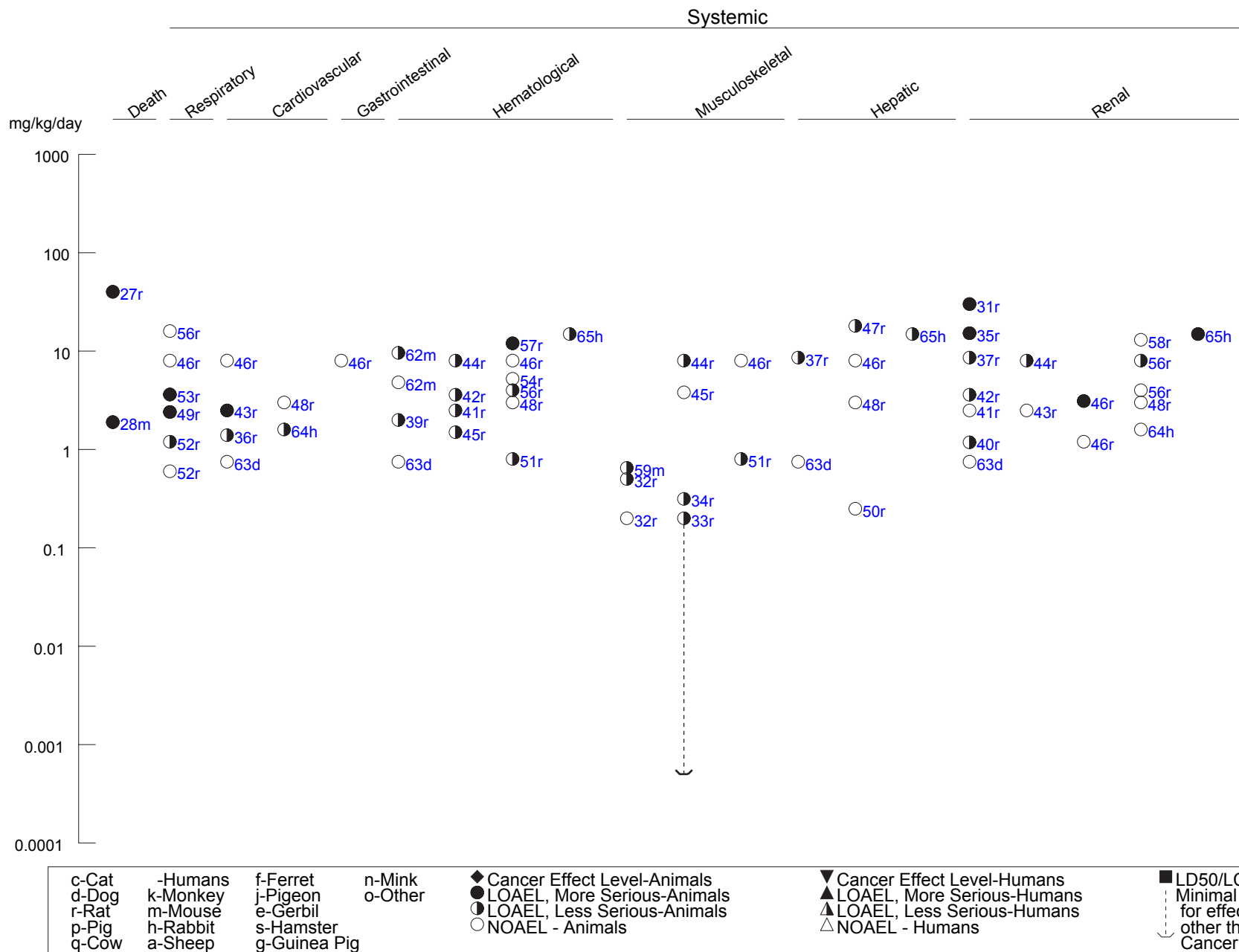



Figure 3-2 Levels of Significant Exposure to Cadmium - Oral (Continued)

Intermediate (15-364 days)

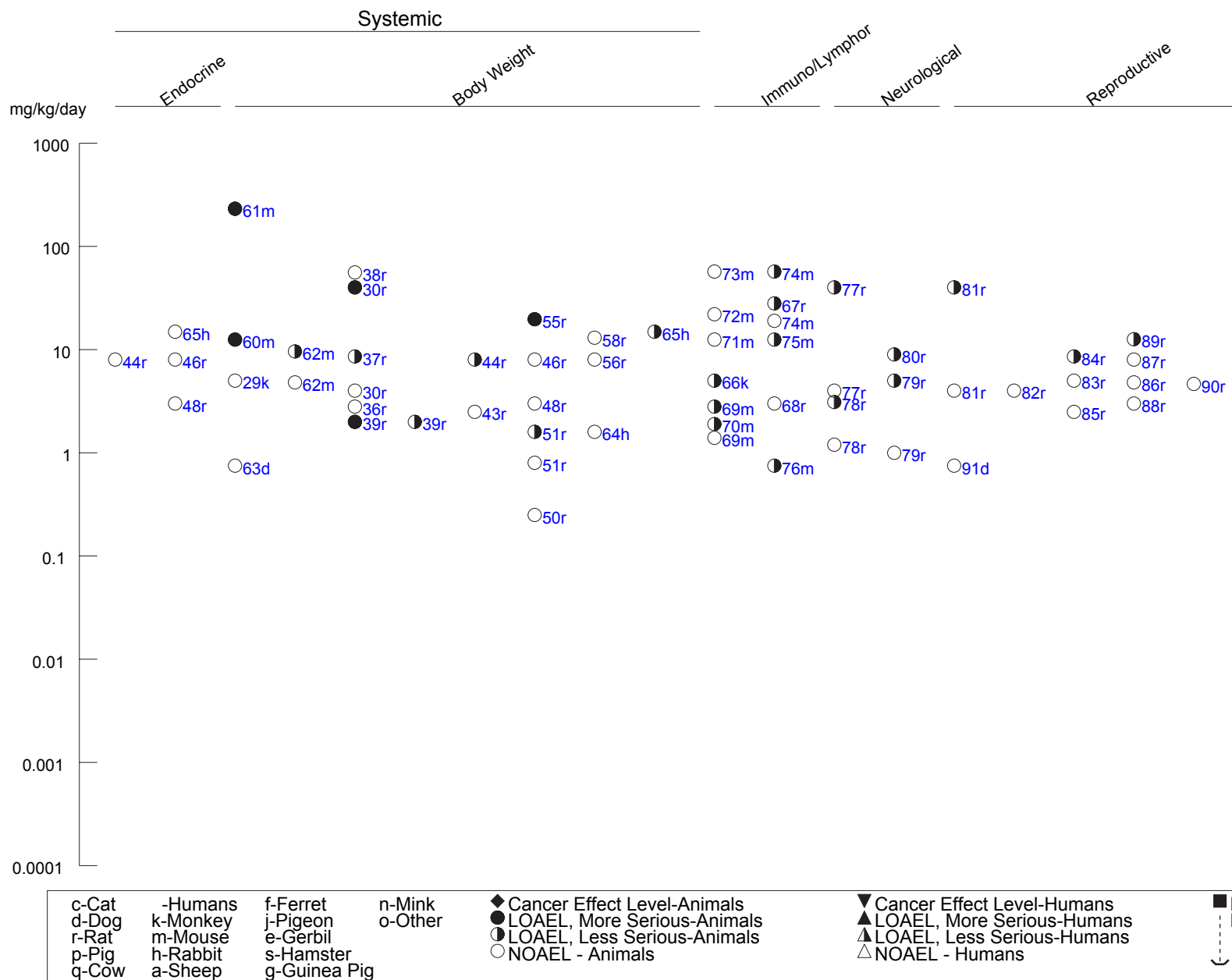

Figure 3-2 Levels of Significant Exposure to Cadmium - Oral (Continued)

Intermediate (15-364 days)

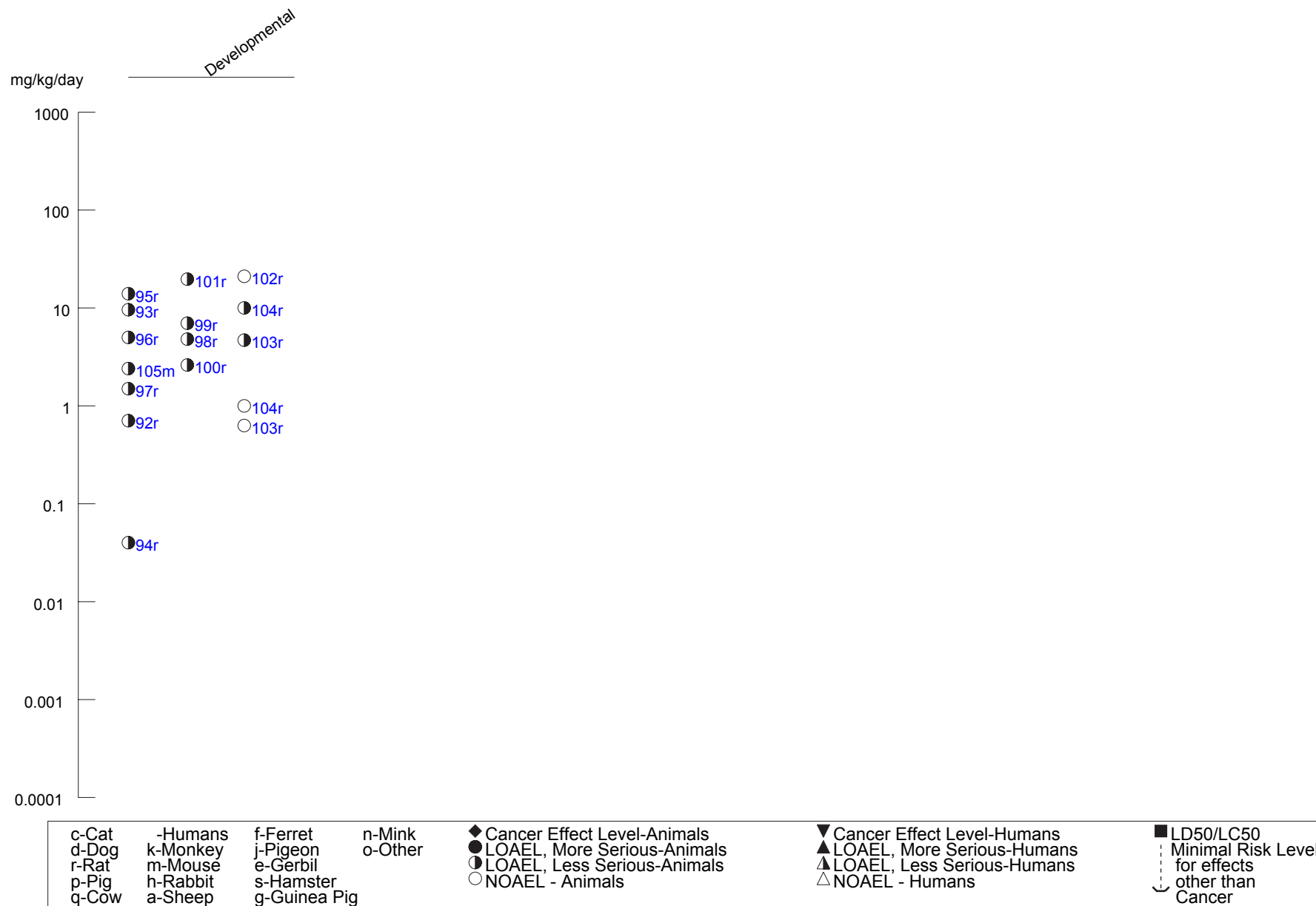
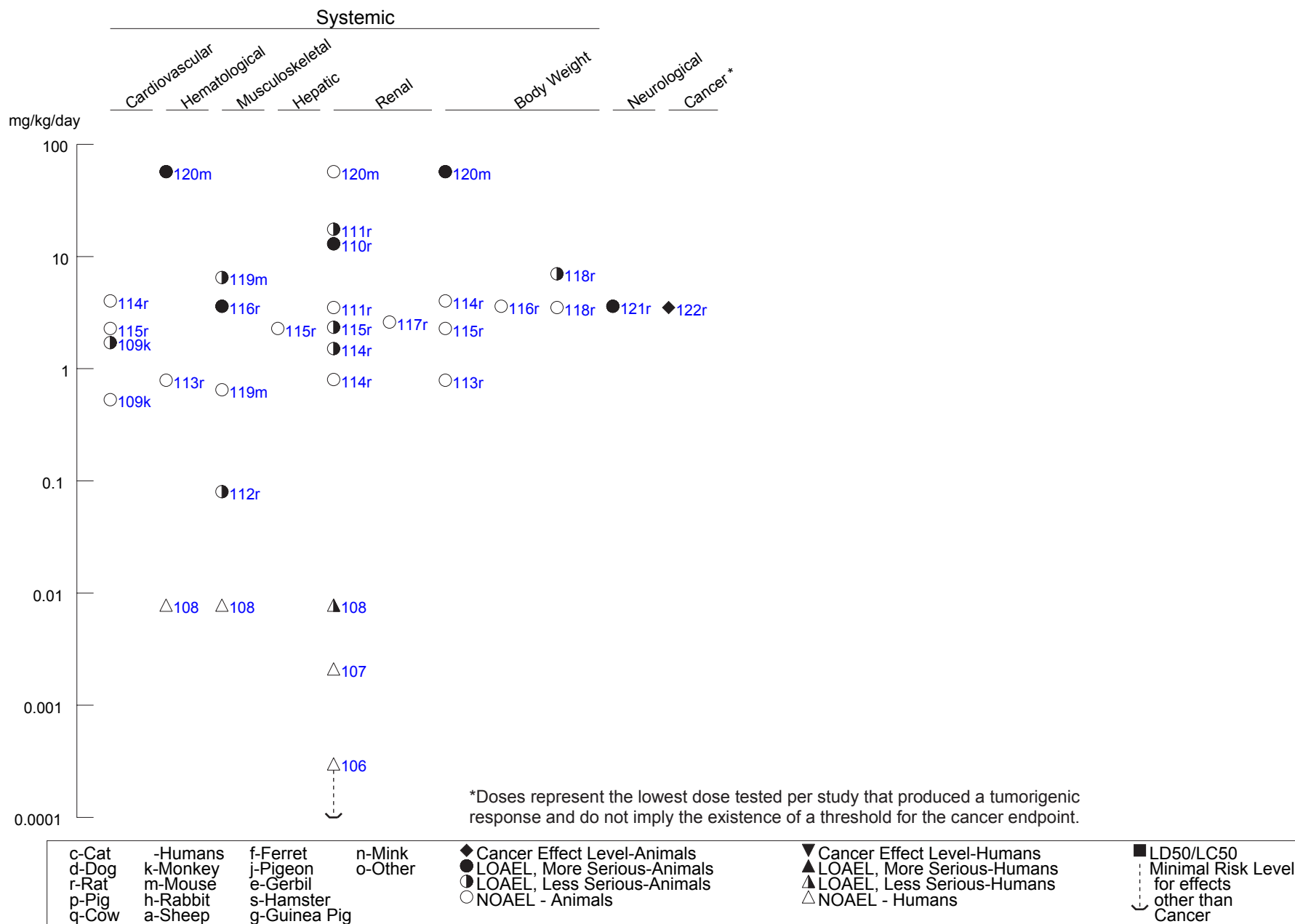

Figure 3-2 Levels of Significant Exposure to Cadmium - Oral (Continued)

Chronic (≥365 days)



## 3. HEALTH EFFECTS

**Cardiovascular Effects.** Studies regarding cardiovascular effects in humans after oral exposure to cadmium have primarily investigated relationships between blood pressure and biomarkers of cadmium exposure such as cadmium levels in blood, urine, or other tissues. Smoking is an important confounding factor, because of the higher blood, urine, and tissue cadmium levels of smokers (see Section 3.4) and the known cardiovascular toxicity of cigarette smoking. Case-control and cohort epidemiologic studies that adequately control for smoking have typically found no association between body cadmium levels (primarily reflecting dietary exposure) and hypertension (Beevers et al. 1980; Cummins et al. 1980; Ewers et al. 1985; Lazebnik et al. 1989; Satarug et al. 2005; Shiwen et al. 1990); however, some studies have found positive correlations (Geiger et al. 1989; Swaddiwuhipong et al. 2010; Tulley and Lehmann 1982) or negative correlations (Kagamimori et al. 1986; Staessen et al. 1984). Similar conflicting findings have been reported in studies analyzing death rates from cardiovascular disease among populations with dietary cadmium exposure (Inskip et al. 1982; Shigematsu 1984). Disorders of the cardiac conduction system, lower blood pressure, and decreased frequency of cardiac ischemic changes were found among elderly women with past high dietary exposure to cadmium (Kagamimori et al. 1986). Rhythmic disturbances, including ventricular fibrillation, were seen in an individual who had ingested 25 mg/kg cadmium as cadmium iodide (Wisniewska-Knypl et al. 1971).

Several studies conducting cross-sectional analysis on data from the National Health and Nutrition Examination Surveys (NHANES), investigated associations between blood and urine cadmium levels and cardiovascular effects (Agarwal et al. 2011; Eguogu et al. 2009; Everett and Frithsen 2008; Menke et al. 2009; Navas-Acien et al. 2005; Peters et al. 2010; Tellez-Plaza et al. 2008, 2010). Among adult participants in the NHANES 1988–1994 survey followed for mortality through 2000, the multivariable (including smoking)-adjusted hazard ratios of cardiovascular mortality associated with a 2-fold increase in creatinine-corrected urinary cadmium were 1.21 (95% CI of 1.07–1.36) in men and 0.93 (95% CI of 0.84–1.04) in women (Menke et al. 2009). The hazard ratios for coronary heart disease mortality were 1.36 (95% CI of 1.11–1.66) and 0.82 (95% CI of 0.76–0.89). Thus, the study suggests an association between elevated cadmium exposure and increased risk of cardiovascular mortality in men, but not in women. Urinary cadmium levels were found to be strongly associated with peripheral arterial disease (PAD, defined as blood pressure ankle brachial index <0.9 in at least one leg) in analysis conducted on 728 participants (at least 40 years of age) in the NHANES 1999–2000 study (Navas-Acien et al. 2005) and approximately 6,500 participants ( $\geq$ 40 years of age) in the NHANES 1999–2004 survey (Tellez-Plaza et al. 2010). Navas-Acien et al. (2005) reported that individuals with PAD had a 36% higher mean urine cadmium level than individuals without PAD; this study also found that individuals with PAD had 49%

## 3. HEALTH EFFECTS

higher urinary tungsten levels and urinary antimony levels exceeding 0.1 µg/L. In the Tellez-Plaza et al. (2010) analysis, the odds ratio for PAD comparing men with urinary cadmium levels in the highest quartile ( $\geq 0.69$  µg/g creatinine) with the lowest quartile ( $< 0.20$  µg/g creatinine) was 4.90 (95% CI of 1.55–15.54), after adjustment for age, race/ethnicity, education, smoking habits, and a variety of cardiovascular risk factors. In contrast, the odds ratio in women was 0.56 (95% CI of 0.18–1.71). When the women were divided by smoking habit, there was a positive progressive dose-response relationship and the odds ratio for PAD comparing the 80<sup>th</sup> with the 20<sup>th</sup> percentile for urinary cadmium was 1.46 (95% CI of 0.75–2.85) and for blood cadmium was 2.88 (95% CI of 1.10–7.50). Another study found a modest increase in systolic or diastolic blood pressure associated with increasing blood cadmium levels (geometric mean blood cadmium levels among all participants was 0.4 µg/L); no associations with blood pressure and urinary cadmium levels were found (Tellez-Plaza et al. 2008). The association between blood cadmium levels and blood pressure was stronger in participants who never smoked than in former smokers or current smokers. There were no associations between hypertension and cadmium levels in blood or urine. In the third study, analysis on 4,912 participants (45–79 years old) in the NHANES 1988–1994 survey found a significant association between urinary cadmium levels and myocardial infarction in women, but not men (Everett and Frithsen 2008). After adjusting for numerous risk factors including smoking, race, and family history, a significant increase in the risk of myocardial infarction was observed in women with urinary cadmium levels of  $\geq 0.88$  µg/g creatinine. Agarwal et al. (2011) found significantly higher blood cadmium levels among participants with cardiovascular and cerebrovascular disease in the NHANES 1999–2006 survey, as compared to participants without disease. The odds ratio of cardiovascular and cerebrovascular disease comparing the lowest blood cadmium quartile to the highest quartile was 1.44 (95% CI of 1.07–1.95) after adjusting for age, gender, race, education, hypertension, diabetes, hypercholesterolemia, BMI, c-reactive protein, and smoking. Peters et al. (2010) found that a 50% increase in blood or urinary cadmium levels resulted in a significant increase in the risk of stroke and congestive heart failure among participants in the NHANES survey. After adjusting for age, gender, race/ethnicity, education, BMI, poverty income ratio, alcohol consumption, smoking status, and disease (diabetes, hypertension, hypercholesterolemia, and chronic kidney disease), the odds ratios (95% CI) for stroke were 1.38 (1.14–1.67) and 1.10 (1.00–1.20) for 50% increases in blood and urinary cadmium levels, respectively; 50% increases in blood and urinary cadmium levels resulted in odds ratios (95% CI) for congestive heart failure of 1.48 (1.17–1.87) and 1.12 (1.04–1.21), respectively. A significant negative correlation between urinary cadmium levels and volume of oxygen consumed at sub-maximum activity (VO<sub>2</sub> max) among white males or Mexican American females (Egwuogu et al. 2009); however, no significant associations were found in black or Mexican American males and white and black females. Using a similar approach, Eum et al. (2008) and Lee et al. (2011) used data from the

## 3. HEALTH EFFECTS

Korean National Health and Nutrition Examination Survey (KNHANES) to assess the possible associations between cadmium exposure and cardiovascular effects. Eum et al. (2008) found a positive association (adjusted for age, gender, education, smoking status, alcohol intake, BMI, self-reported hypertension, family history of hypertension, and blood lead level) between blood cadmium levels and systolic, diastolic, and mean arterial blood pressure among adults. When comparing participants with the highest tertile of blood cadmium (1.87–5.52  $\mu\text{g/L}$ ) to those in the lowest tertile (0.18–1.28  $\mu\text{g/L}$ ), the multivariable adjusted odds ratio was 1.521 (95% CI of 1.129–2.049). In a similar analysis, Lee et al. (2011) divided the subjects by gender and found that an interquartile range increase (0.91  $\mu\text{g/L}$ ) in blood cadmium was associated with an elevated risk of hypertension (odds ratio of 1.4; 95% CI of 1.1–1.8) only in men. Lee et al. (2011) also found significant associations between an interquartile range increase in blood cadmium and the risk of ischemic heart disease in women (odds ratio of 2.28; 95% CI of 1.26–4.15). No significant associations between blood cadmium and risk of stroke were found.

In a study of children enrolled in the Treatment of Lead-Exposed Children trial, no significant associations between blood cadmium levels and blood pressure in 5 and 7 years olds following treatment for elevated blood lead levels (Cao et al. 2009).

A single gavage dose of 150 mg/kg cadmium in male Sprague-Dawley rats had no effect on blood pressure (Kotsonis and Klaassen 1977). Oral exposure of rats, rabbits, and monkeys to cadmium over intermediate and chronic durations has been found to increase blood pressure in some studies (Akahori et al. 1994; Boscolo and Carmignani 1986; Carmignani and Boscolo 1984; Kopp et al. 1982; Perry et al. 1989; Tomera and Harakal 1988), but not in others (Fingerle et al. 1982; Kotsonis and Klaassen 1978; Loeser and Lorke 1977a, 1977b; Mangler et al. 1988; Wills et al. 1981). In general, studies showing an effect on blood pressure have had control groups with lower blood pressure than studies showing no effect, and observed increases in blood pressure are generally small. At least in rats, the effect on blood pressure appears to be biphasic, reaching a maximum effect (an increase of 12–14 mm Hg in average systolic pressure) at intakes of 0.07 mg/kg/day, but decreasing to normal or even below normal at intakes 10–100 times higher (Kopp et al. 1982). Enlarged and arteriosclerotic hearts have been found in rats orally exposed to 0.35 mg Cd/kg/day for 3 years (Schroeder et al. 1965) or to 2.79 mg Cd/kg/day for 100 days (Wilson et al. 1941), but this effect is likely to be secondary to cadmium-induced anemia (Wilson et al. 1941). Histopathologic lesions of heart tissues (congestion, separation of muscle fibers) and decreased activity of antioxidant enzymes, but no increase in peroxidation, were found among rats given 2.5 mg/kg/day of cadmium in the diet for 7 weeks (Jamall et al. 1989).

## 3. HEALTH EFFECTS

**Gastrointestinal Effects.** Numerous human and animal studies indicate that oral exposure to cadmium in high concentrations causes severe irritation to the gastrointestinal epithelium (Andersen et al. 1988; Frant and Kleeman 1941). Common symptoms in humans following ingestion of food or beverages containing high concentrations of cadmium include nausea, vomiting, salivation, abdominal pain, cramps, and diarrhea (Baker and Hafner 1961; Buckler et al. 1986; Frant and Kleeman 1941; Nordberg et al. 1973; Shipman 1986; Wisniewska-Knypl et al. 1971). Although exact doses have not been measured, gastrointestinal symptoms have been caused in children by 16 mg/L cadmium in soft drinks (Nordberg et al. 1973) and 13 mg/L cadmium in popsicles (Frant and Kleeman 1941). Assuming an intake of 0.15 L (Nordberg et al. 1973) and a body weight of 35 kg, the emetic dose is 0.07 mg/kg. Although few studies have specifically examined gastrointestinal effects of longer-term cadmium exposure, no surveys of environmentally exposed populations have reported gastrointestinal symptoms (Morgan and Simms 1988; Roels et al. 1981a; Shigematsu 1984).

In rats and mice, histopathologic lesions (e.g., severe necrosis, hemorrhage, ulcers) in the gastrointestinal epithelium have been observed after high (>30 mg/kg/day) acute-duration oral cadmium exposure by gavage (Andersen et al. 1988; Basinger et al. 1988; Machemer and Lorke 1981), but not after lower levels (8 mg/kg/day in drinking water) for 24 weeks (Kotsonis and Klaassen 1978).

**Hematological Effects.** Oral cadmium exposure reduces gastrointestinal uptake of iron, which can result in anemia if dietary intake of iron is low. Anemia has been found in some instances among humans with chronic dietary exposure to cadmium (Kagamimori et al. 1986), but other studies have found no significant relationship between dietary cadmium exposure and anemia in humans (Roels et al. 1981a; Shiwen et al. 1990). Hypoproteinemia and hypoalbuminemia were reported in a male who ingested 25 mg/kg cadmium as cadmium iodide (Wisniewska-Knypl et al. 1971).

A number of studies have demonstrated that oral exposure to cadmium frequently produces anemia in laboratory animals, and that additional iron prevents anemia (Decker et al. 1958; Groten et al. 1990; Hays and Margaretten 1985; Itokawa et al. 1974; Kawamura et al. 1978; Kelman et al. 1978; Kozłowska et al. 1993; Ogoshi et al. 1989; Pleasants et al. 1992, 1993; Pond and Walker 1972; Sakata et al. 1988; Sorell and Graziano 1990; Stowe et al. 1972; Watanabe et al. 1986; Webster 1978; Wilson et al. 1941). Decreases in serum iron have also been reported (Prigge 1978a). Borzelleca et al. (1989) reported slight but statistically significant increases in hemoglobin, hematocrit, and erythrocytes in male rats at 65.6 mg/kg/day once a day for 10 days, but no change in females. Male Sprague-Dawley rats receiving a single gavage dose of 150 mg/kg cadmium showed no signs of anemia 14 days later (Kotsonis and

## 3. HEALTH EFFECTS

Klaassen 1977), but anemia was produced in male Wistar rats after 12 days of drinking-water exposure to 12 mg/kg/day (Sakata et al. 1988). Most intermediate-duration exposure studies in rats have shown evidence of anemia at doses of 2–14 mg/kg/day (Decker et al. 1958; Groten et al. 1990; Itokawa et al. 1974; Kawamura et al. 1978; Pleasants et al. 1993; Pond and Walker 1972; Sakata et al. 1988; Wilson et al. 1941). However, some intermediate-duration studies have found no change in hemoglobin (Kotsonis and Klaassen 1978; Loeser and Lorke 1977a; Petering et al. 1979; Prigge 1978a) in rats treated at similar doses. Anemia has also been seen in intermediate-duration studies in mice (Webster 1978) and rabbits (Stowe et al. 1972), but not in dogs (Loeser and Lorke 1977b). The result in dogs may be due to the relatively low dose of cadmium (0.75 mg/kg/day) used in this study. Hematological effects following chronic-duration oral exposure to cadmium are less well characterized. In monkeys maintained on 4 mg/kg/day cadmium in food, pale feces, and clinical signs of anemia occurred after 90 weeks, but the anemia was associated with a decreased food intake rather than an increase in reticulocytes (Masaoka et al. 1994). Anemia was not present in rats exposed via drinking water for 12 months to the relatively low dose of 0.79 mg/kg/day (Decker et al. 1958). The number of erythroid progenitor cells in bone marrow is decreased in mice exposed to 57 mg/kg/day of cadmium in drinking water for 12 months (Hays and Margaretten 1985), but is increased in rats exposed to 12 mg/kg/day of cadmium in drinking water for up to 100 days (Sakata et al. 1988). Thus, the question remains open whether factors, in addition to reduced gastrointestinal absorption of iron, such as direct cytotoxicity to marrow or inhibition of heme synthesis may contribute to anemia.

**Musculoskeletal Effects.** Osteomalacia, osteoporosis, bone fractures, and decreased bone mineral density have been observed in several populations exposed to elevated levels of cadmium in the diet. Bone effects were first reported in residents in the Jinzu River Basin, a cadmium-contaminated area in Japan. The disease termed Itai-Itai or "ouch-ouch" disease most often affected women with several risk factors such as poor nutrition, multiparity, and postmenopausal status (Shigematsu 1984). The disease was characterized by multiple fractures of the long bones, osteomalacia, and osteoporosis in combination with proteinuria (Järup et al. 1998b; Nordberg et al. 1997). Other Japanese populations with dietary cadmium exposure have also been found to have elevated osteoporosis and osteomalacia in both men and women (Kido et al. 1989b). Kagamimori et al. (1986) evaluated elderly Japanese women with heavy cadmium exposure from ingesting polluted drinking water, rice, and fish during World Wars I and II; and continued low-grade cadmium exposure from agricultural produce. Of 56 cases of Itai-Itai disease, 26 were accompanied by osteomalacia and 26 were without osteomalacia. Another study found that the degree of loss of bone density is correlated with urinary excretion of  $\beta_2$ -microglobulin, an index of renal injury (see Section 3.5.2) (Kido et al. 1990a). The bone effects observed in Itai-Itai disease and in other



## 3. HEALTH EFFECTS

studies of Japanese populations exposed to high levels of cadmium in rice are primarily due to kidney damage, which results from a progressive disturbance in renal metabolism of vitamin D to its biologically active form (Nogawa et al. 1987, 1990) and an increased urinary excretion of calcium (Buchet et al. 1990). These results suggest that bone changes may be secondary to disruption in kidney of vitamin D metabolism and resulting imbalances in calcium absorption and excretion. A recent study of women living in the Jinzu River basin found that bone turnover, particularly bone formation, was influenced by renal tubular function (Aoshima et al. 2003). However, it is possible that some bone effects are not mediated via the kidney.

Bone effects have also been observed in communities outside of Japan and in populations exposed to low levels of cadmium. In a study of Swedish women environmentally exposed to cadmium, a significant negative relationship between urinary cadmium levels and bone mineral density was observed (Åkesson et al. 2005); the mean urinary cadmium level of the population was 0.52 µg/L. In Swedish residents living in an area with known cadmium pollution from battery manufacturing facilities, significant associations were noted between blood cadmium levels and bone mineral density and between urinary cadmium levels and risk of fractures and osteoporosis. There were significant decreases in bone mineral density in environmentally exposed subjects older than 60 years of age with blood cadmium levels of  $\geq 0.56$  µg/L (Alfvén et al. 2002a). Increases in the risk of bone fractures were observed in subjects (approximately 10% of all subjects examined had environmental and occupational exposure to cadmium) older than 50 years of age with urinary cadmium levels  $>2$  µg/g creatinine; no significant associations were found in subjects under 50 years of age (Alfvén et al. 2004). Another study of this population found significant increases in the risk of osteoporosis among men  $>60$  years of age with urinary cadmium levels  $\geq 5$  µg/g creatinine; however, an increased risk of osteoporosis was not observed in women (Alfvén et al. 2000). A Belgian study in which residents living near zinc smelters found a 2-fold increase in cadmium exposure (as assessed via urinary cadmium levels) was associated with a decrease in proximal and distal forearm bone density of approximately 0.1 g/cm<sup>2</sup> among postmenopausal women (Staessen et al. 1999). For women with urinary cadmium levels  $>1$  µg/day, the incidence of bone fracture was 13.5 per 1,000 person-years. Another study of a subset of the women living near a zinc smelters (Schutte et al. 2008) provides suggestive evidence that cadmium has a direct osteotoxic effect. Significant associations between urinary cadmium levels and the levels of two pyridinium crosslinks of collagen (urinary levels of hydroxylsypyrinoline and lysypyrinoline), proximal forearm bone mineral density, and serum parathyroid hormone levels were found. In almost all of the examined women, urinary levels of retinol binding protein were below the cut-off level of 338 µg/day, suggesting no cadmium-induced effect on renal tubular function. Several biomarkers of bone damage were examined in a subsequent follow-up

## 3. HEALTH EFFECTS

study of some of the women (Schutte et al. 2008) only 1 of the 294 women examined had evidence of renal dysfunction (increased retinol binding protein). Significant associations between urinary cadmium excretion and two biomarkers of bone resorption (urinary hydroxylysylpyridinoline and lysylpyridinoline) were found. Although significant associations between urinary cadmium levels and biomarkers of renal dysfunction were observed in Polish adults living in a cadmium-polluted area, the only association between urinary cadmium and bone biomarkers was a significant decrease in bone mineral density among males with urinary cadmium levels of  $\geq 2 \mu\text{g/g}$  creatinine (Trzcinka-Ochocka et al. 2010). Similar results have been observed in several studies of residents living in areas of China with moderate or high cadmium pollution levels (Jin et al. 2004b; Nordberg et al. 2002; Wang et al. 2003; Zhu et al. 2004). There were significant increases in the prevalence of low forearm bone mineral density in postmenopausal women with urinary cadmium levels  $>20 \mu\text{g/g}$  creatinine and in men, premenopausal women, and postmenopausal women with blood cadmium levels  $>20 \mu\text{g/L}$  (Nordberg et al. 2002). An increase in bone fractures was observed in males and females over the age of 40 years living in the area of high cadmium exposure (mean urinary cadmium levels in the area were 9.20 and 12.86  $\mu\text{g/g}$  creatinine in the males and females, respectively) (Wang et al. 2003). A significant dose-response relationship between urinary cadmium levels and the prevalence of osteoporosis was observed (Jin et al. 2004b; Wang et al. 2003; Zhu et al. 2004); the Jin et al. (2004b) study found that 23 of the 31 subjects with osteoporosis also exhibited signs of renal dysfunction. A subsequent study by this group examined 316 male and female residents living in areas with moderate or heavy cadmium pollution 10 years after the source of rice was switched to commercially available rice from nonpolluted areas (Chen et al. 2009). As in the earlier studies, significant decreases in forearm bone mineral density were observed in the women living in the moderately polluted area and in the men and women living in the heavily polluted areas. When the subjects were divided by age, decreases in bone mineral density were observed in women 60–69 or  $\geq 70$  years old in both cadmium polluted areas and in men  $\geq 70$  years living in the heavily polluted area. A significantly higher prevalence of osteoporosis was also observed in women living in the polluted areas and the prevalence increased with increasing urinary cadmium levels. In another study of this population, Chen et al. (2011) found a higher prevalence of osteoporosis (assessed in 2006) among women with renal dysfunction (urinary albumin  $>15 \text{ mg/g}$  creatinine and urinary NAG  $\geq 12 \text{ IU/g}$  creatinine; renal biomarkers assessed in 1998) or tubular damage (urinary NAG  $\geq 12 \text{ IU/g}$  creatinine); no significant association was found for glomerular damage (urinary albumin  $\geq 15 \text{ mg/g}$  creatinine). Significantly lower bone mineral density levels were also found in women with tubular damage, as compared to those without tubular damage. In men, no significant associations between the prevalence of osteoporosis or bone mineral density and alterations in renal biomarkers were found. Chen et al. (2011) also compared the change in bone mineral damage from 1998 to 2006 in subjects with and without evidence of kidney

## 3. HEALTH EFFECTS

damage and found a significantly greater decrease in bone mineral density among women with tubular damage. In a study of adults living near an industrial complex in Korea, significant associations between high urinary cadmium levels ( $\geq 1.0 \mu\text{g/g}$  creatinine) and osteopenia were observed in males and females (Shin et al. 2011). Bone mineral density was also negatively associated with urinary cadmium levels.

In a substudy of a population-based health survey in Sweden (Engström et al. 2009), a significantly lower bone mineral density was observed in postmenopausal women with elevated urinary cadmium levels (median of  $1.1 \mu\text{g/g}$  creatinine, 5–95<sup>th</sup> percentile of  $0.69\text{--}1.7 \mu\text{g/g}$  creatinine) as compared to women with low urinary cadmium levels (median of  $0.36 \mu\text{g/g}$  creatinine; 5–95<sup>th</sup> percentile of  $0.18\text{--}0.73 \mu\text{g/g}$  creatinine). Significant decreases in serum parathyroid hormone levels and increases in urinary deoxypyridinoline levels (indicative of increased bone resorption) were also found in the high urinary cadmium group; however, there were no significant alterations in serum 1,25-dihydroxyvitamin D levels. Significant elevations in biomarkers of renal dysfunction (urinary NAG and pHC and estimated glomerular filtration rate) were also in the high urinary cadmium group. In the U.S. general population (using data collected during NHANES III, 1988–1994), a significant association was found between urinary cadmium levels and osteopenia and osteoporosis among adults with urinary cadmium levels of  $>1 \mu\text{g/g}$  creatinine (Wu et al. 2010). Using the same NHANES data set, Gallagher et al. (2008) found a 43% increased risk of osteoporosis (hip bone mineral density defined) (odds ratio of 1.43; 95% CI of 1.02–2.00) among women  $\geq 50$  years of age with urinary cadmium levels of  $0.50\text{--}1.00 \mu\text{g/g}$  creatinine, as compared to women with urinary cadmium levels of  $<0.50 \mu\text{g/g}$  creatinine.

Using data collected during NHANES III (1988–1994), Arora et al. (2008, 2008) examined the possible association between urinary cadmium levels and dental health in children and adults. In children aged 6–12 years, a significant association (adjusted for age, gender, ethnicity, education level, poverty status, log-transformed blood lead, log-transformed serum cotinine, and dietary sucrose intake) between urinary cadmium levels and dental caries in deciduous teeth among children with low external tobacco smoke exposure; no significant associations were found in permanent teeth (Arora et al. 2008). A significant association (after adjustment for gender, age, education level of household head, race/ethnicity, household poverty status, time since last visit to dentist, missing teeth, serum cotinine, smoking habits, exposure to external tobacco smoke, blood lead, diabetes, renal dysfunction, and bone mineral density) between urinary cadmium and periodontal disease (presence of attachment loss of at least 4 mm in  $>10\%$  of sites examined) in adults ( $\geq 18$  years of age) (Arora et al. 2009). A logistic regression model predicted a 56% increase in the prevalence of periodontal disease associated with a 3-fold increase in urinary cadmium levels ( $0.18\text{--}0.63 \mu\text{g/g}$  creatinine).

## 3. HEALTH EFFECTS

A number of animal studies confirm the findings of the epidemiology data suggesting that the bone is a sensitive target of cadmium toxicity. Decreases in bone mineralization and bone mineral density have been observed in female rats exposed to  $\geq 0.2$  mg Cd/kg/day in the lumbar spine, femur, and tibia (Brzóška et al. 2004b, 2005a, 2005b, 2005c) and in male rats exposed to  $\geq 0.5$  mg Cd/kg/day (Brzóška and Moniuszko-Jakoniuk 2005a, 2005b; Brzóška et al. 2010; Yokota and Tonami 2008) for an intermediate duration and in female rats chronically exposed to 0.08 mg Cd/kg/day (Brzóška 2012; Brzóška and Moniuszko-Jakoniuk 2004a, 2004b). In the series of studies conducted by Brzóška and associates, the occurrence of osteopenia and osteoporosis was evaluated using data for bone mineral density of the cadmium-exposed rats, control rats, and healthy adult rats. Osteopenia was observed in male rats exposed to 0.5 mg Cd/kg/day for 12 months (Brzóška and Moniuszko-Jakoniuk 2005a, 2005b) and in female rats exposed to 0.08 mg Cd/kg/day for 12 or 18 months (Brzóška and Moniuszko-Jakoniuk 2004a, 2004b); osteoporosis was observed in male rats exposed to 4 mg Cd/kg/day for 12 months (Brzóška and Moniuszko-Jakoniuk 2005a, 2005b) and in female rats exposed to 0.08 mg Cd/kg/day for 24 months (Brzóška and Moniuszko-Jakoniuk 2004a, 2004b).

The decreases in bone mineralization resulted in altered mechanical properties (e.g., stiffness, load, displacement at load) of the vertebral body, femur, and tibia and increases in the number of animals with deformed or fractured lumbar spinal bone in female rats exposed to  $\geq 0.2$  mg Cd/kg/day for an intermediate duration (Brzóška and Moniuszko-Jakoniuk 2005d; Brzóška et al. 2004b, 2005b, 2005a, 2005c, 2010; Ogoshi et al. 1989); increases in lumbar spine deformities were also observed in male rats exposed to 0.5 mg Cd/kg/day for 12 months (Brzóška and Moniuszko-Jakoniuk 2005a, 2005b) and in female rats exposed to 0.08 mg Cd/kg/day for 24 months (Brzóška 2012; Brzóška and Moniuszko-Jakoniuk 2004a, 2004b).

The studies by Brzóška and associates reported significant alterations in biochemical markers of bone turnover. During the first 6 months of a 1-year study, significant decreases in osteocalcin concentrations were observed in female rats exposed to  $\geq 0.2$  mg Cd/kg/day; no alterations were observed during the last 6 months of the study (Brzóška and Moniuszko-Jakoniuk 2005d). Observed changes in alkaline phosphatase levels included decreases in total serum levels in the 4 mg Cd/kg/day group after 6, 9, or 12 months of exposure, decreases in trabecular bone levels at  $\geq 0.2$  mg Cd/kg/day after 3, 6, or 9 months of exposure and at 0.5 mg Cd/kg/day at 12 months, decreases in cortical bone levels at 4 mg Cd/kg/day after 3 months of exposure, and increases in trabecular bone and cortical bone alkaline phosphatase at 4 mg Cd/kg/day after 12 months (Brzóška and Moniuszko-Jakoniuk 2005d). Serum C-terminal

## 3. HEALTH EFFECTS

telopeptides of type I collagen concentration (CTX) was significantly decreased after 3 or 6 months of exposure or increased after 9 or 12 months in rats exposed to  $\geq 0.2$  mg Cd/kg/day (Brzóška and Moniuszko-Jakoniuk 2005d). As noted by Brzóška and Moniuszko-Jakoniuk (2005d), these alterations in bone turnover markers indicate that cadmium exposure at the stage of intensive skeletal development leads to low bone turnover and induces high bone turnover due to enhanced resorption at the stage of consolidation of bone mass and at skeletal maturity.

Decreased calcium content of bone and increased urinary calcium excretion are common findings in intermediate- and chronic-duration studies in the 0.2–8 mg Cd/kg/day range (Brzóška and Moniuszko-Jakoniuk 2005d; Kawamura et al. 1978; Nogawa et al. 1981b; Pleasants et al. 1992; Watanabe et al. 1986). In contrast, Kotsonis and Klaassen (1978) reported no change in bone calcification after a 24-week exposure via drinking water at 8 mg/kg/day, and Kelman et al. (1978) reported no significant change in stable or radiolabeled calcium in any maternal rat tissues from a 3.8 mg/kg/day in drinking water for 22 days during gestation.

Gender, age, and nutritional state appear to influence cadmium toxicity on bone. In the series of experiments conducted by Brzóška and associates, alterations in bone mineral density and the mechanical strength of the lumbar spine and femur were observed in female rats exposed to  $\geq 0.2$  mg Cd/kg/day and in male rats at 0.5 mg Cd/kg/day (Brzóška and Moniuszko-Jakoniuk 2005a, 2005b, 2005d; Brzoska et al. 2005a, 2005c); no adverse bone effects were observed in males exposed to 0.2 mg Cd/kg/day. In the Ogoshi et al. (1989) study, decreases in the mechanical strength of the femur bone were observed in young rats (21 days of age) exposed to 0.8 mg Cd/kg/day for 4 weeks; however, no alterations in bone strength were observed in adult (24 weeks of age) or elderly (1.5 years of age) rats exposed to cadmium doses as high as 25.6 mg Cd/kg/day for 4 weeks. Adverse effects on bone are exacerbated by a calcium-deficient diet (Itokawa et al. 1974; Kimura et al. 1974; Larsson and Piscator 1971; Wang and Bhattacharyya 1993; Wang et al. 1994), by ovariectomy (Bhattacharyya et al. 1988c), or by multiple rounds of gestation and lactation (Bhattacharyya et al. 1988b).

**Hepatic Effects.** Liver damage is not usually associated with oral cadmium exposure, except at very high levels of exposure. In humans, a fatal dose of cadmium can cause pronounced liver damage (Buckler et al. 1986; Wisniewska-Knypl et al. 1971). Nishino et al. (1988) reported increased serum concentrations of the urea-cycle amino acids among individuals exposed to cadmium in the diet, and that these levels reflected liver as well as kidney damage. No cadmium-related alterations in liver biomarkers including serum levels of alkaline phosphatase, alanine aminotransferase, aspartate aminotransferase,

## 3. HEALTH EFFECTS

lactate dehydrogenase, and  $\gamma$ -glutamyl transpeptidase were observed in women living in cadmium nonpolluted areas in Japan (Ikeda et al. 1997, 2000). No other studies were located regarding hepatic effects in humans after oral exposure to cadmium.

Hepatic effects have been found in rats, mice, and rabbits after oral cadmium exposure. Acute exposure via gavage at doses of 30–138 mg/kg/day causes liver necrosis in most studies (Andersen et al. 1988; Basinger et al. 1988; Borzelleca et al. 1989; Shimizu and Morita 1990), although histopathologic evidence of liver damage was not seen in one study at a gavage dose of 150 mg/kg (Kotsonis and Klaassen 1977). Exposure of rats for 10 days to drinking water containing 13.9 mg Cd/kg/day was without effect on the liver (Borzelleca et al. 1989). Depletion of liver glutathione by fasting increases the liver necrosis following acute oral exposure to cadmium in rats (Shimizu and Morita 1990).

In a 10-week study, male Rhesus monkeys exposed to 4 mg/kg/day cadmium chloride via gavage, had a significant decrease in glutathione peroxidase in liver, kidney, heart, and lung in the following order: liver>kidney>heart>lung; a significant decrease in glutathione *S*-transferase (GST) activity towards 1-chloro-2,4-dinitrobenzene in all four organs in the following order: liver>lung>kidney>heart; and a significant increase in GST activity towards ethacrynic acid in all four organs in the following order: heart>lung>kidney>liver (Sidhu et al. 1993). Intermediate-duration exposure causes histopathologic changes in the liver (e.g., necrosis of central lobules, focal hepatic fibrosis, biliary hyperplasia) at doses of 1.6–15 mg/kg/day (Cha 1987; Gill et al. 1989b; Miller et al. 1974a; Renugadevi and Prabu 2010; Schroeder et al. 1965; Stowe et al. 1972; Wilson et al. 1941), and metabolic alterations (e.g., decreased cytochrome c oxidase activity in mitochondria, increased ALT and AST activities) at doses of 0.05–10 mg/kg/day (Groten et al. 1990; Muller and Stacey 1988; Muller et al. 1988; Renugadevi and Prabu 2010; Sporn et al. 1970; Steibert et al. 1984; Tewari et al. 1986b). Decreased relative liver weight to body weight has also been reported in male rats fed 5.95 mg/kg/day for 6 weeks (Kozłowska et al. 1993).

Hypertriglyceridemia was observed in male rats exposed to 18 mg Cd/kg/day as cadmium chloride in the drinking water for 8 weeks (Larregle et al. 2008); the increase in plasma triglycerides was likely due to a decrease in lipoprotein lipase activity (key enzyme in triglyceride hydrolysis). A significant increase in liver triglyceride level was also observed; this increase was attributed to increased triglyceride synthesis.

Other intermediate and chronic duration studies have not found liver effects in animals following oral exposure. These studies include a daily gavage exposure of 14 mg/kg/day for 6 weeks in rats (Hopf et al. 1990), a 3-month exposure to cadmium in food at 3 mg/kg/day in rats (Loeser and Lorke 1977a), a

## 3. HEALTH EFFECTS

24-week exposure to cadmium in water at 8 mg/kg/day in rats (Kotsonis and Klaassen 1978), and a 3-month exposure in food at 0.75 mg/kg/day in dogs (Loeser and Lorke 1977b). Kopp et al. (1982) report no hepatic effects from a chronic exposure of 18 months to cadmium in water at 0.65 mg/kg/day in rats.

**Renal Effects.** Numerous studies indicate that the kidney is the primary target organ of cadmium toxicity following extended oral exposure, with effects similar to those seen following inhalation exposure (see Section 3.2.1.2). Most of the data involves chronic exposure to cadmium; two case reports involving acute exposure to large doses of cadmium also found kidney effects. In two fatal cases of oral cadmium poisoning, anuria was present in one individual who ingested 25 mg/kg cadmium as cadmium iodide. Damage to the kidneys was reported at autopsy, but was not further specified (Wisniewska-Knypl et al. 1971). The kidneys were reported as normal at autopsy in an individual who died 2 days after ingesting 1,840 mg/kg cadmium (Buckler et al. 1986).

Several studies have found associations between increased mortality and renal dysfunction in residents living in cadmium polluted areas. Significant increases in SMRs were found in residents living in cadmium polluted areas of Japan with elevated levels of biomarkers of renal dysfunction (Arisawa et al. 2001, 2007b; Iwata et al. 1991a, 1991b; Matsuda et al. 2002; Nakagawa et al. 1993; Nishijo et al. 1995, 2004a, 2006). Among the studies that examined cause of death, significant increases in deaths from renal diseases were found in the residents that were categorized as biomarker-positive (urinary levels of the renal biomarker was higher than the cut-off value); the cut-off values used were  $\beta$ 2-microglobulin  $\geq 1,000$   $\mu\text{g/g}$  creatinine (Arisawa et al. 2001, 2007b; Iwata et al. 1991a, 1991b; Nakagawa et al. 1993; Nishijo et al. 2004a, 2006) or retinol binding protein  $\geq 4$  mg/L (Nishijo et al. 1995). Other studies have found that mortality increased in proportion to the renal biomarker level ( $\beta$ 2-microglobulin, protein, or glucose) (Iwata et al. 1991a, 1991b; Matsuda et al. 2002; Nakagawa et al. 1993; Nishijo et al. 2004a, 2006). Increases in mortality from renal diseases have also been observed among populations living in cadmium polluted areas of Belgium (Lauwerys and De Wals 1981) and England (Inskip et al. 1982); however, statistical analysis was not reported in the Belgium study and the increase in renal disease was not statistically significant in the other study. In a nationwide study in Japan, no significant associations between the levels of cadmium in brown rice and deaths from all causes or age-adjusted renal insufficiency mortality rate were found (Koizumi et al. 2010).

Elevated levels of several biomarkers of renal dysfunction and/or associations between cadmium burden and these biomarkers have been found in studies of populations living in cadmium nonpolluted areas of Japan (Ezaki et al. 2003; Ikeda et al. 1999; Suwazono et al. 2000; Oo et al. 2000; Uno et al. 2005;

## 3. HEALTH EFFECTS

Yamanaka et al. 1998), South Korea (Hwangbo et al. 2011), Belgium (Buchet et al. 1990; Roels et al. 1981a), and the United States (Ferraro et al. 2010; Noonan et al. 2002) and in populations living in cadmium polluted areas of China (Cai et al. 1990, 1992, 1998; Jin et al. 2002, 2004a, 2004c; Nordberg et al. 1997; Wu et al. 2001), Japan (Cai et al. 2001; Hayano et al. 1996; Horiguchi et al. 2010; Ishizaki et al. 1989; Izuno et al. 2000; Kawada et al. 1992; Kido and Nogawa 1993; Kobayashi et al. 2002b, 2009b; Monzawa et al. 1998; Nakadaira and Nishi 2003; Nakashima et al. 1997; Nogawa et al. 1989; Osawa et al. 2001; Watanabe et al. 2002), Thailand (Honda et al. 2010; Teeyakasem et al. 2007), Sri Lanka (Bandara et al. 2010), Sweden (Järup et al. 2000; Olsson et al. 2002), and Poland (Trzcinka-Ochocka et al. 2004). Most of these studies did not estimate cadmium intake; rather, exposure was characterized based on the levels of cadmium in rice, blood, or urine. The oral route is assumed to be the primary route of exposure, although the inhalation route, particularly in smokers, may have contributed to the overall cadmium body burden. The epidemiology data are summarized in [Table 3-7](#) and brief discussions of the better designed studies providing valuable dose-response data follows.

Buchet et al. (1990) examined 1,699 non-occupationally exposed males and females (aged 20–80 years) living in Belgium. Urinary cadmium levels significantly correlated with urinary  $\beta$ 2-microglobulin, retinol binding protein, NAG, amino acid, and calcium levels; the partial  $r^2$  values were 0.0036, 0.0210, 0.0684, 0.0160, and 0.0168, respectively. The probability that individuals would have abnormal values for the renal biomarkers (defined as  $>95^{\text{th}}$  percentile for subjects without diabetes or urinary tract diseases and who did not regularly take analgesics) was estimated using logistic regression models with adjustments for age, gender, smoking, disease, and use of analgesics. It was estimated that  $>10\%$  of  $\beta$ 2-microglobulin, retinol binding protein, amino acid, and calcium values would be abnormal when 24-hour urinary cadmium levels were  $>3.05$ ,  $2.87$ ,  $2.74$ ,  $4.29$ , or  $1.92 \mu\text{g}/24$  hour, respectively.

Järup et al. (2000) examined 1,021 individuals living near a nickel-cadmium battery plant in Sweden for at least 5 years ( $n=799$ ) or employed as battery workers ( $n=222$ ). The mean urinary cadmium levels were  $0.81$  and  $0.65 \mu\text{g}/\text{g}$  creatinine in males and females, respectively. Urinary cadmium levels were significantly associated with urinary human complex-forming glycoprotein (pHC; also referred to as  $\alpha$ 1-microglobulin) levels, after adjustment for age. The relationship remained statistically significant after removal of the cadmium workers from the analysis. The prevalence of abnormal pHC values (defined as exceeding the  $95^{\text{th}}$  percentile in a Swedish reference population;  $>7.1$  and  $5.3 \text{ mg}/\text{g}$  creatinine for males and females, respectively) was estimated to increase by  $10\%$  at urinary cadmium levels of  $1 \mu\text{g}/\text{g}$  creatinine. The European Chemicals Bureau (2007) recalculated the probability of HC proteinuria (using the raw data from Järup and associates) to account for the differences in age of the reference



## 3. HEALTH EFFECTS

**Table 3-7. Summary of Human Studies Examining Renal Effects**

Population studied	Mean urinary cadmium level	Effect biomarker	Results	Reference
General population (Japan) 10,753 females; 35–60 years old	1.26 µg/g creat.	β2M pHC	Significant correlation between urinary cadmium and effect biomarkers; however, no significant relationship was established when age was factored into analysis.	Ezaki et al. 2003
General population (Japan) 470 nonsmoking females	2.1 µg/g creat.	β2M pHC	Significant correlation between urinary cadmium (not corrected for creat.) and pHC and β2M.	Ikeda et al. 1999
General population (Japan) 1,105 males, 1,648 females; >50 years old	1.8 µg/g creat. (M) 2.4 µg/g creat. (F)	β2M Total protein NAG	Significant correlation between urinary cadmium and protein and β2M. Dose-response relationship between urinary cadmium and prevalence of abnormal effect biomarker levels.	Suwazono et al. 2000
General population (Japan) 568 males, 742 females; ≥50 years old	2.2–3.4 µg/L (M) 2.8–3.9 µg/L (F)	total protein NAG β2M	Significant correlation (with age adjustment) between urinary cadmium and effect biomarkers.	Oo et al. 2000
General population (Japan) 558 males, 743 females; ≥50 years old	1.3 µg/g creat. (M) 1.3 µg/g creat. (F)	β2M total protein NAG	Significant correlation between urinary cadmium and effect biomarkers (NAG was only significant in females). Dose-response relationship between urinary cadmium and prevalence of abnormal effect biomarker levels.	Yamanaka et al. 1998
General population (Japan) 410 males, 418 females; 40–59 years old	0.8 µg/g creat. (M) 1.8 µg/g creat. (F) (median levels)	β2M protein NAG	Significant associations between urinary cadmium and effect biomarkers (protein only significant in males). Dose-response relationship between urinary cadmium and prevalence of abnormal effect biomarker levels.	Uno et al. 2005
General population (South Korea) 955 males, 954 females; ≥20 years of age		Glomerular filtration rate	Significant association between elevated blood cadmium levels and decreased glomerular filtration rate in females only.	Hwangbo et al. 2011

## 3. HEALTH EFFECTS

**Table 3-7. Summary of Human Studies Examining Renal Effects**

Population studied	Mean urinary cadmium level	Effect biomarker	Results	Reference
General population (Belgium) 175 females; mean age 81.1–82.3 years old	0.040–0.093 µg/hour	β2M protein amino acids albumin	Dose-response relationship between urinary cadmium and urinary protein and amino acids; significant relationship with β2M and albumin only in the two areas with highest urinary cadmium levels.	Roels et al. 1981a
General population (Belgium) 1,699 males, females; 20–80 years old		β2M protein NAG amino acids calcium	Significant correlation between urinary cadmium and effect biomarkers. Dose-response relationship between urinary cadmium and prevalence of abnormal effect biomarker levels.	Buchet et al. 1990
General population (United States) 88 males, 71 females; 6–17 years old; 71 males, 80 females; ≥18 years old	0.07 µg/g creat. (M, child) 0.08 µg/g creat. (F, child) 0.24 µg/g creat. (M, adult) 0.23 µg/g creat. (F, adult)	β2M NAG AAP albumin	No significant associations (after correction for age, sex) between urinary cadmium and effect biomarkers in children. Significant association (after age and gender adjustment) between urinary cadmium and NAG and AAP in adults. Dose-response relationship between urinary cadmium and NAG and AAP.	Noonan et al. 2002
General population (United States) 2,644 males, 2,782 females ≥20 years old (data from NHANES 1999–2006)	0.29 µg/g creat.	albumin	Significant association (after age, gender, race/ethnicity, and BMI adjustment) between urinary cadmium >1 µg/g creatinine and urinary albumin to creatinine ratio of >20 mg/g (males) or 30 mg/g (females).	Ferraro et al. 2010
Residents in cadmium-polluted area (China) 433 males and females	11.27 µg/g creat.	β2M NAG	Significantly higher effect biomarkers levels.	Cai et al. 1990, 1992
Residents in cadmium-polluted area (China) 219 males and females		β2M	Significant dose-response relationship between urinary cadmium, blood cadmium, and cumulative Cd intake and β2M; prevalence of abnormal values.	Cai et al. 1998

## 3. HEALTH EFFECTS

**Table 3-7. Summary of Human Studies Examining Renal Effects**

Population studied	Mean urinary cadmium level	Effect biomarker	Results	Reference
Residents in cadmium-polluted area (China) 118 males, 170 females in high exposure group 80 males, 158 females in moderate exposure group	High: 11.18 µg/g creat. Mod.: 3.55 µg/g creat.	β2M RBP albumin	Significant correlation between urinary cadmium and effect biomarkers.  Dose-response relationship between urinary cadmium and prevalence of abnormal effect biomarker levels.	Jin et al. 2002
Residents in cadmium-polluted area (China) 118 males, 170 females in high exposure group 80 males, 158 females in moderate exposure group		β2M NAG NAG-B RBP albumin	Dose-response relationship between urinary cadmium and prevalence of abnormal effect biomarker levels.	Jin et al. 2004c
Residents in cadmium-polluted area (China) 66 males, 22 females	9.12 µg/g creat.	β2M NAG albumin	Dose-response relationship between urinary cadmium and prevalence of abnormal effect biomarker levels.	Jin et al. 2004a
Residents in cadmium-polluted area (China) 120 males, 127 females in high exposure group 125 males, 122 females in moderate exposure group	High: 9.40 µg/L (M) 12.13 µg/L (F) Mod.: 1.28 µg/L (M) 2.05 µg/L (F)	β2M albumin	Dose-response relationship between urinary cadmium and prevalence of abnormal effect biomarker levels.	Nordberg et al. 1997
Residents in cadmium-polluted area (China) 122 males, 125 females	6.1 µg/g creat. (M) 7.5 µg/g creat. (F)	β2M NAG calcium	Effect biomarkers significantly higher than controls. Dose-response relationship between urinary cadmium and effect biomarkers.	Wu et al. 2001
Residents in cadmium-polluted area (Japan) 127 males; mean age 72.1–73.6 years old	6.8–6.9 µg/g creat.	β2M	Higher prevalence of abnormal effect biomarkers compared to controls.	Cai et al. 2001

## 3. HEALTH EFFECTS

**Table 3-7. Summary of Human Studies Examining Renal Effects**

Population studied	Mean urinary cadmium level	Effect biomarker	Results	Reference
Residents in cadmium-polluted area (Japan) 1,178 females	3.16–4.08 µg/g creat.	β2M	No significant association between urinary cadmium and effect biomarkers.	Horiguchi et al. 2004
Residents in cadmium-polluted area (Japan) 82 males, 56 females		β2M	Significant association between cadmium intake and effect biomarkers in males only.	Izuno et al. 2000
Residents in cadmium-polluted area (Japan) 634 males, 411 females		Protein	Significant association between cadmium intake and increased prevalence of abnormal levels of urinary protein in males.	Kobayashi et al. 2002a; Watanabe et al. 2002
Residents in cadmium-polluted area (Japan) 1,419 males, 1,745 females	4.6 µg/g creat. (M) 7.2 µg/g creat. (F)	Potassium sodium	Significantly higher urinary potassium levels, compared to controls. Significant correlation between urinary potassium and urinary cadmium and β2M. Urinary sodium not significantly different than controls and not correlated with urinary cadmium.	Monzawa et al. 1998
Residents in cadmium-polluted area (Japan) 44 males, 54 females	2.69 µg/g creat. (M) 4.68 µg/g creat. (F)	β2M pHC NAG protein inorganic phosphorus	Significant correlation between urinary cadmium and effect biomarkers (except β2M in males).	Nakadaira and Nishi 2003
Residents in cadmium-polluted area (Japan) 832 males, 871 females		β2M protein amino nitrogen	Significant correlation between cadmium concentration in rice and effect biomarkers. Dose-response relationship between cadmium levels in rice and prevalence of abnormal β2M (males) and protein (females) levels.	Nakashima et al. 1997
Residents in cadmium-polluted area (Japan) 826 males, 641 females		Protein	Dose response relationship between cadmium levels in rice and prevalence of abnormal effect biomarker levels.	Osawa et al. 2001
Residents in cadmium-polluted area (Japan) 878 males, 972 females		β2M	Dose response relationship between cadmium in rice and effect biomarkers.	Nogawa et al. 1989

## 3. HEALTH EFFECTS

**Table 3-7. Summary of Human Studies Examining Renal Effects**

Population studied	Mean urinary cadmium level	Effect biomarker	Results	Reference
Residents in cadmium-polluted area (Japan) 1,424 males, 1,754 females	4.56 µg/g creat. (M) 7.15 µg/g creat. (F)	β2M	β2M significantly higher than controls. Dose-response relationship between urinary cadmium and prevalence of abnormal β2M levels.	Ishizaki et al. 1989
Residents in cadmium-polluted area (Japan) 878 males, 972 females		β2M	Dose response relationship between cadmium in rice and prevalence of abnormal β2M levels.	Kido and Nogawa 1993
Residents in cadmium-polluted area (Japan) 1,403 males, 1,716 females; ≥50 years old	4.56 µg/g creat. (M) 7.15 µg/g creat. (F)	β2M	Dose response relationship between urinary cadmium and prevalence of abnormal β2M levels.	Hayano et al. 1996
Residents in cadmium-polluted area (Japan) 120 males, 280 females	1.78 µg/g creat. (M) 2.27 µg/g creat. (F)	NAG	Significant correlation between urinary cadmium and NAG.	Kawada et al. 1992
Residents in cadmium-polluted area (Japan) 129 females; 34– 74 years of age	6.30 µg/g creat.	β2M	Significant correlation between urinary cadmium and β2M.	Horiguchi et al. 2010
Residents in cadmium-polluted area (Thailand) 58 males, 70 females	12 µg/g creat.	β2M pHC NAG protein albumin	Significant correlation between urinary cadmium and effect biomarkers. Dose-response relationship between urinary cadmium and prevalence of abnormal β2M levels.	Teeyakasem et al. 2007
Residents in cadmium-polluted area (Thailand) 307 males, 488 females; >30 years of age	5.3 µg/g creat. (M) 5.8 µg/g creat. (F)	β2M NAG	Dose-response relationship between urinary cadmium and prevalence of abnormal β2M levels (≥1,000 µg/g creatinine) in females and NAG (≥9 IU/g creatinine) in males and females.	Honda et al. 2010
Residents in cadmium-polluted area (includes occupationally exposed subjects (Sweden)	0.81 µg/g creat. (M) 0.66 µg/g creat. (F)	pHC	Linear relationship between urinary cadmium and pHC (relationship remained significant after removal of occupationally exposed subjects.	Järup et al. 2000

## 3. HEALTH EFFECTS

**Table 3-7. Summary of Human Studies Examining Renal Effects**

Population studied	Mean urinary cadmium level	Effect biomarker	Results	Reference
Residents in cadmium-polluted area (Sweden) 57 males, 48 females	0.26 µg/g creat.	β2M protein HC NAG albumin	Significant correlation between urinary and blood cadmium and effect biomarkers. β2M clearance was significantly explained by urinary cadmium levels.	Olsson et al. 2002
Residents in cadmium-polluted area (Poland) 44 males, 128 females only exposed as adults 72 males, 64 females exposed as children	0.97 µg/g creat. (childhood exposure) 2.23 µg/g creat. (adult exposure)	β2M RBP NAG NAG-A NAG-B albumin	In childhood exposure group, significant correlations between urinary cadmium and β2M, RBP, and albumin. In adult exposure group, significant correlations between urinary cadmium and all effect biomarkers.	Trzcinka-Ochocka et al. 2004

AAP = alanine aminopeptidase; β2M = β2-microglobulin; creat. = creatinine; BMI = body mass index; F = female; M = male; Mod. = moderate; NAG = N-acetyl-β-glucosaminidase; NHANES = National Health and Nutrition Examination Survey; pHC = human complex-forming glycoprotein, also referred to as α1M; RBP = retinol binding protein

## 3. HEALTH EFFECTS

population (mean of 40 years) and study population (mean of 53 years). Based on these recalculations, the urinary cadmium level associated with a 10% increased probability of abnormal pHc values (20% total probability) was 2.62  $\mu\text{g/g}$  creatinine for the total population. In the environmental exposed subgroup, a urinary cadmium level of 0.5  $\mu\text{g/g}$  creatinine was associated with a 13% probability (doubling of the probability in reference population) of abnormal pHc values.

Noonan et al. (2002) examined residents in Pennsylvania living near a defunct zinc smelting facility (geometric mean urinary cadmium level of 0.14  $\mu\text{g/g}$  creatinine) and a reference community located 10 miles from the facility (geometric mean urinary cadmium levels of 0.12  $\mu\text{g/g}$  creatinine). The data from the two communities were pooled because there were no differences in urinary cadmium levels between them.  $\beta$ 2-microglobulin, NAG, alanine aminopeptidase (AAP), and albumin levels were measured as biomarkers of renal dysfunction. The geometric mean urinary cadmium levels were 0.07 and 0.08  $\mu\text{g/g}$  creatinine in 88 males and 71 females aged 6–17 years and 0.24 and 0.23  $\mu\text{g/g}$  creatinine in 71 males and 80 females aged  $\geq 18$  years. No significant correlations between urinary cadmium levels and renal biomarkers were observed in the children, after adjustment for creatinine, age, and gender. In adults, significant correlations (after adjustment for creatinine, age, gender, smoking, and self-reported diabetes or thyroid disease) between urinary cadmium and NAG (partial correlation coefficient of 0.20, 95% CI of 0.05–0.36) and AAP (partial correlation coefficient of 0.21 and 95% CI of 0.05–0.36) were observed. Significant dose-effect relationships were also found for these two biomarkers. Urinary cadmium levels were not significantly associated with elevated levels of  $\beta$ 2-microglobulin or albumin.

Nogawa et al. (1980) examined 878 males and 972 females aged  $\geq 50$  years living in the Kakehashi River basin in Japan; the Kakehashi River, cadmium polluted from an upstream mine, was used to irrigate rice fields.  $\beta$ 2-Microglobulin measured in morning urine samples was used as a biomarker of renal dysfunction and cadmium intake was estimated from rice samples collected in 1974. Cadmium levels in rice were considered to be representative of cadmium intake because over 70% of the total cadmium intake has been shown to come from rice. Cadmium in the rice ranged from 0.10 to 0.69  $\mu\text{g/g}$ .  $\beta$ 2-Microglobulin levels were significantly higher in the study population compared to a reference population of 113 males and 161 females living in a nearby area. A significant dose-related association between total cadmium intake and prevalence of abnormal  $\beta$ 2-microglobulin values (defined as  $\beta$ 2-microglobulin levels of  $\geq 1,000$   $\mu\text{g/g}$  creatinine) was found. The total cadmium intake, which resulted in a prevalence of abnormal  $\beta$ 2-microglobulin levels equal to the control group, was 1,678 mg in males (prevalence in controls was 6.0%) and 1,763 mg in females (prevalence in controls was 5.0%). A further analysis of the exposed subjects (Hochi et al. 1995) found that the prevalence of abnormal

## 3. HEALTH EFFECTS

$\beta$ 2-microglobulin levels (using a cut-off level of 1,000  $\mu\text{g/g}$  creatinine) exceeded the prevalence in the reference population when cadmium intake was  $\geq 2$  g and the subjects were divided into subgroups by age. The prevalence of abnormal  $\beta$ 2-microglobulin levels at a given cadmium intake increased with age.

Yamanaka et al. (1998) examined 558 males and 743 females aged  $\geq 50$  years living in a cadmium nonpolluted area in Japan. Urinary cadmium level was used as a biomarker of exposure and urinary  $\beta$ 2-microglobulin, total protein, and NAG as biomarkers of renal dysfunction. The geometric mean urinary cadmium levels were 1.3 and 1.3  $\mu\text{g/g}$  creatinine in males and females, respectively. Significant correlations (after adjustment for age) between urinary cadmium levels and total protein,  $\beta$ 2-microglobulin, and NAG were found. Abnormal levels of renal biomarkers were defined as exceeding the 84% upper limit value calculated from a referent group of 2,778 non-exposed individuals; the cut-off values were 124.8 and 120.8 mg/g creatinine for total protein in males and females, 492 and 403  $\mu\text{g/g}$  creatinine for  $\beta$ 2-microglobulin, and 8.0 and 8.5 U/g creatinine for NAG. Dose-response relationships between urinary cadmium levels and prevalence of abnormal levels of  $\beta$ 2-microglobulin, total protein, and NAG were found. The odds ratios (95% CI) were 6.589 (3.383–12.833), 3.065 (1.700–5.526), and 1.887 (1.090–3.268) for protein,  $\beta$ 2-microglobulin, and NAG in males and 17.486 (7.520–40.660), 5.625 (3.032–10.435), and 2.313 (1.399–3.824) for protein,  $\beta$ 2-microglobulin, and NAG in females.

Another study of residents living in a cadmium nonpolluted area of Japan examined 346 males and 529 females from one area (area A) and 222 males and 413 females in another area (area B); all subjects were  $\geq 50$  years of age and were not occupationally exposed to heavy metals (Oo et al. 2000). The geometric mean urinary cadmium levels were 2.2 and 2.8  $\mu\text{g/L}$  in males and females in area A and 3.4 and 3.9  $\mu\text{g/L}$  in area B. Significant correlations (with adjustment for age) were found between urinary cadmium and urinary levels of protein,  $\beta$ 2-microglobulin (not significant in males in area B) and NAG levels. A significant association between urinary cadmium levels and the prevalence (cut-off levels from same referent population as Yamanaka et al. 1998) of abnormal levels of urinary protein (cut-off level of 113.8 and 96.8  $\mu\text{g/L}$  in males and females),  $\beta$ 2-microglobulin (378 and 275  $\mu\text{g/L}$ ) (only significant in females in area A), and NAG (8.0 and 7.2  $\mu\text{g/L}$ ). The odds ratios (95% CI) for an increase in prevalence of abnormal renal biomarkers were 8.810 (3.401–22.819) and 11.282 (3.301–38.362) for protein in males in areas A and B, respectively, 8.234 (3.696–18.343) and 23.901 (8.897–64.210) for protein in females in areas A and B; 2.558 (1.246–5.248) for  $\beta$ 2-microglobulin in females in area A; 47.944 (14.193–161.954) and 9.940 (3.153–31.340) for NAG in males in areas A and B; and 72.945 (21.873–243.263) and 25.374 (9.452–68.117) for NAG in females in areas A and B.



## 3. HEALTH EFFECTS

In a re-examination of the populations studied by Yamanaka et al. (1998) and Oo et al. (2000), Suwazono et al. (2000) measured cadmium levels in blood and urine and urinary levels of total protein,  $\beta$ 2-microglobulin, and NAG in 1,105 males and 1,648 females over the age of 50 years. The geometric mean concentrations of cadmium in urine were 1.8 and 2.4  $\mu\text{g/g}$  creatinine in males and females, respectively, and blood cadmium levels were 2.0 and 1.8  $\text{ng/g}$  in males and females. After adjustment for age, significant associations between urinary cadmium levels and urinary protein and  $\beta$ 2-microglobulin in males and females were found. Additionally, blood cadmium levels were significantly associated with urinary protein and NAG levels in males and urinary protein,  $\beta$ 2-microglobulin, and NAG levels in females. Cut-off levels (defined as the 84% upper limit values from 424 male and 1,611 female nonsmoking subjects) of 157.4 and 158.5  $\text{mg/g}$  creatinine for protein in males and females, respectively, 507 and 400  $\mu\text{g/g}$  creatinine for  $\beta$ 2-microglobulin in males and females, respectively, and 8.2 and 8.5  $\mu\text{g/g}$  creatinine for NAG in males and females, respectively, were used to evaluate the prevalence of abnormal levels of renal biomarkers. Logistic regression analysis demonstrated significant associations between urinary cadmium levels and increased prevalence of abnormal levels of total protein (odds ratio of 3.923, 95% CI of 2.2028–7.590) and  $\beta$ 2-microglobulin (odds ratio of 2.259, 95% CI of 1.372–3.717) in males; in females, significant associations were found for total protein (odds ratio of 7.763; 95% CI of 4.231–14.243),  $\beta$ 2-microglobulin (odds ratio of 2.259, 95% CI of 1.879–4.281), and NAG (odds ratio of 1.882, 95% CI of 1.311–2.702). For blood cadmium levels, the only significant association found was for an increased prevalence of abnormal total protein levels in females (odds ratio of 3.490, 95% CI of 1.661–7.331).

Jin et al. (2002) examined three populations living various distances from a nonferrous metal smelter. The geometric mean levels of urinary cadmium were 11.18 and 12.86  $\mu\text{g/g}$  creatinine in males ( $n=294$ ) and females ( $n=171$ ) in the highly polluted area, 3.55 and 4.45  $\mu\text{g/g}$  creatinine in males ( $n=243$ ) and females ( $n=162$ ) in the moderately polluted area, and 1.83 and 1.79  $\mu\text{g/g}$  creatinine in males ( $n=253$ ) and females ( $n=155$ ) in the control area. Significant correlations were found between urinary (and blood) cadmium levels and renal biomarkers ( $\beta$ 2-microglobulin, retinol binding protein, and albumin). Cut-off values for  $\beta$ 2-microglobulin, retinol binding protein, and albumin of 300  $\mu\text{g/g}$  creatinine, 300  $\mu\text{g/g}$  creatinine, and 15  $\text{mg/g}$  creatinine, respectively, were used to assess possible dose-response relationships (no additional information was provided); although 300  $\mu\text{g/g}$  creatinine was reported as the cut-off values for  $\beta$ 2-microglobulin, subsequent analysis of this data set (Jin et al. 2004c) reported a cut-off value of 800  $\mu\text{g/g}$  creatinine. Significant dose-response relationships between urinary (and blood) cadmium and the prevalence of abnormal levels of renal markers of kidney dysfunction were found.

## 3. HEALTH EFFECTS

Unlike the studies discussed above, Hellström et al. (2001) used the incidence of renal replacement therapy (dialysis or kidney transplantation) as an indicator of renal dysfunction, in particular, end-stage renal disease. Residents of Kalmar County, Sweden were divided into four exposure groups: high exposure (workers at cadmium battery production facility), moderate (residents living within 2 km of the cadmium battery facility), low (residents living between 2 and 10 km of the facility), and no exposure (residents living at least 10 km from the facility); all subjects were 20–79 years of age. The Mantel-Haenszel rate ratio (MH-RR) for renal replacement therapy in the cadmium exposed group was 1.8 (95% CI 1.3–2.3); among the environmentally exposed group, the MH-RR was 1.7 (95% CI 1.3–2.3). The age SRRs were 1.9 (95% CI 1.3–2.5) and 1.9 (95% CI 1.2–2.6) for subjects in the moderate exposure group aged 20–79 years or 40–79 years, respectively. The trend for increasing MH-RR with increasing exposure was statistically significant. The age SRRs were not significantly elevated in the low exposure group. The investigators noted that the causes of end stage renal disease were similar in the cadmium exposed and unexposed groups. When only primary renal diseases (excludes renal failure secondary to diabetes or vascular or systemic diseases) were considered, the MH-RR was 1.7 (95% CI 1.1–2.6) for all cadmium exposed individuals and 2.1 (95% CI 1.4–3.2) for cadmium exposed individuals aged 40–79 years. Although urinary cadmium levels were not assessed in this study, other studies in this area found mean urinary cadmium levels of 1.0 and 0.46  $\mu\text{g/g}$  creatinine in residents living within 0.5 and 0.5–1 km, respectively, of the battery facility (Järup et al. 1995a) and 0.38 and 0.55  $\mu\text{g/g}$  creatinine in men and women, respectively, living in the contaminated area (Alfvén et al. 2000). Ferraro et al. (2011) and Swaddiwudhipong et al. (2011) used another approach for evaluating kidney damage by examining the association between elevated urinary cadmium levels and kidney stone formation. Using the NHANES survey data from 1988 to 1994, Ferraro et al. (2011) found significantly higher urinary cadmium levels in individuals with a history of kidney stone formation, as compared to individuals without a history of kidney stone formation. However, after adjusting for age, race/ethnicity, BMI, smoking habits, region of residence, and daily intake of calcium and sodium, a significant association was only found in females; the odds ratio of kidney stones was 1.40 (95% CI of 1.06–1.86) among individuals with a urinary cadmium level of  $>1 \mu\text{g/g}$ . Swaddiwudhipong et al. (2011) found a significant association between urinary cadmium levels and prevalence of urinary stone formation among adults living in cadmium-contaminated areas of Thailand.

Although there is strong evidence to suggest a relationship between urinary cadmium excretion and excretion of renal biomarkers (particularly low molecular weight proteins such as  $\beta 2$ -microglobulin, pHC, and retinol binding protein), there is less agreement about the significance of the early renal changes and the threshold urinary cadmium levels associated with renal damage. Several studies monitoring

## 3. HEALTH EFFECTS

populations following a decrease in cadmium exposure have attempted to address the question of the reversibility of early renal changes. In Japan, cadmium-contaminated soil used in rice paddies was replaced resulting in decreasing urinary cadmium levels in residents consuming rice grown in these fields (Cai et al. 2001; Iwata et al. 1993; Kobayashi et al. 2008b; Sato et al. 2010). Although, cadmium exposure decreased over the same time period, the levels of renal biomarkers increased (Cai et al. 2001; Iwata et al. 1993; Kido et al. 1988; Kobayashi et al. 2008b; Sato et al. 2010) and the prevalence of abnormal values remained higher compared to the reference population (Cai et al. 2001). Although significant decreases in urinary cadmium levels were observed over time, cadmium burdens still remained high; urinary cadmium levels at the later time periods were 6.03–9.6  $\mu\text{g/g}$  creatinine (Cai et al. 2001; Iwata et al. 1993; Kido et al. 1988). Kobayashi et al. (2008b) found significant correlations (after adjustment for age) between the amount of time since soil replacement and increases in urinary levels of retinol binding protein, total protein, and glucose (males only). In contrast, a follow-up study of a portion of the population examined by Buchet et al. (1990) found small, but statistically significant, decreases in urinary cadmium levels and urinary levels of  $\beta$ 2-microglobulin, NAG, and retinol binding protein (Hotz et al. 1999). Urinary cadmium levels in this study (0.6–0.9  $\mu\text{g/g}$  creatinine at baseline and 0.5–0.8  $\mu\text{g/g}$  creatinine at follow up) were much lower than levels in the Japanese studies. Wu et al. (2008) examined biomarkers of renal dysfunction before (measured in 1995) and after (measured in 1998) remediation in 148 adults living in an area of China with cadmium pollution. The subjects were divided into two groups based on whether or not they had elevated  $\beta$ 2-microglobulin levels in 1995. Among the subjects with no alteration in  $\beta$ 2-microglobulin levels in 1995, there were no significant changes in  $\beta$ 2-microglobulin levels in subjects with urinary cadmium levels of  $<10$   $\mu\text{g/g}$  creatinine in 1995 and significant increases in  $\beta$ 2-microglobulin levels in the subjects with initial urinary cadmium levels of  $\geq 10$   $\mu\text{g/g}$  creatinine. In the subjects with elevated  $\beta$ 2-microglobulin levels in 1995, there were significant decreases in  $\beta$ 2-microglobulin in subjects with urinary cadmium levels of  $<5$   $\mu\text{g/g}$  creatinine, no changes in subjects with urinary cadmium levels of 5  $\mu\text{g/g}$  creatinine, and significant increases in  $\beta$ 2-microglobulin levels in subjects with urinary cadmium levels of  $\geq 10$   $\mu\text{g/g}$  creatinine. A similar pattern was found for urinary albumin levels, with significant decreases in urinary albumin levels in subjects previously diagnosed with albuminuria and urinary cadmium levels of  $<5$   $\mu\text{g/g}$  creatinine and no changes in urinary albumin levels in subjects with urinary cadmium levels of  $\geq 5$   $\mu\text{g/g}$  creatinine. In subjects without albuminuria in 1995, there were increases at the higher urinary cadmium levels (5 and 20  $\mu\text{g/g}$  creatinine). Although the data are inconclusive, the results of these studies provide some indication of reversibility of renal damage resulting from substantial decreases in cadmium exposure among subjects exposed to low levels of cadmium. However, renal damage may continue to progress in subjects initially exposed to higher levels of cadmium.

## 3. HEALTH EFFECTS

A number of investigators have examined different approaches to establishing a safe cadmium body burden (as assessed by urinary cadmium levels). Several BMD analyses of data from populations living in cadmium nonpolluted areas in Sweden (Suwazono et al. 2006) or Japan (Kobayashi et al. 2006, 2008a; Suwazono et al. 2011a, 2011b, 2011c; Uno et al. 2005) or cadmium polluted areas in Japan (Shimizu et al. 2006) or China (Jin et al. 2004c) have been conducted. The analyses used urinary cadmium levels as a biomarker of cadmium exposure and the prevalence of abnormal levels of  $\beta$ 2-microglobulin, pHc, protein, NAG, retinol binding protein, albumin, or glomerular filtration rate as biomarkers of renal effects. Two approaches were used for BMD modeling: dichotomous variable (Jin et al. 2004c; Kobayashi et al. 2006; Shimizu et al. 2006; Uno et al. 2005) or hybrid (Kobayashi et al. 2008a; Suwazono et al. 2006, 2011a, 2011b, 2011c) approaches. In the dichotomous variable approach, urinary cadmium excretion was divided into categories and the distribution of abnormal values (exceeding the cut-off value) was fit to dichotomous BMD models. As noted by Suwazono et al. (2010), one limitation of this approach is that it does not allow for adjustment for potential covariates, particularly age; additionally, the results may fluctuate depending on the categorization of exposure, number of categories, or dose intervals. The hybrid approach eliminates the categorization of subjects by exposure (e.g., urinary cadmium levels) and is based on a continuous measure of outcome and allows for the adjustment of potential covariates such as age and BMI. As summarized in [Table 3-8](#), the BMDs for urinary cadmium levels vary widely between the studies depending on the renal biomarker and the cut-off level used. For example, when NAG is used as the effect biomarker, the BMD<sub>0.05</sub> (dose associated with a 5% extra risk) values of 0.64, 12.0–10.8, and 6.36–7.74  $\mu\text{g/g}$  creatinine were calculated by Suwazono et al. (2006), Kobayashi et al. (2006), and Jin et al. (2004c) when the 95% upper limit cut-off value of 3.6, 16.0–16.6, and 15.0 U/g creatinine, respectively, was used. The results of the two BMD approaches were similar when similar cut-off levels were used. The BMDL (95% confidence bound of the BMD) is typically considered a no adverse effect level; the results of these BMD analyses suggest that chronic exposure to cadmium resulting in urinary cadmium levels of 0.3–11.31 or 0.6–11.4  $\mu\text{g/g}$  creatinine would be associated with a 5 or 10% additional risk of renal dysfunction.

Ikeda and associates used regression analysis to predict a threshold urinary cadmium level. Plotting urinary cadmium levels against  $\beta$ 2-microglobulin levels taken from published data from populations living in cadmium polluted and non polluted areas of Japan resulted in a distribution shaped like the letter “J”. The threshold level was defined as the point of flexion in the “J” shaped curve. In the first investigation (Ikeda et al. 2003b), the point of flexion was estimated as the point of intersection between two regression lines: one with no elevation in  $\beta$ 2-microglobulin from non-exposed populations and the

## 3. HEALTH EFFECTS

**Table 3-8. Benchmark Dose Estimations of Urinary Cadmium Levels ( $\mu\text{g/g}$  Creatinine)**

Study population	Effect biomarker	Response criterion	BMD model	5% BMR		10% BMR		Reference
				BMD	BMDL	BMD	BMDL	
General population (Sweden) 790 females; 53–64 years old	NAG	3.6 U/g creat. (95% cut-off) <sup>a</sup>	Profile likelihood method	0.64	0.50	1.08	0.83	Suwazono et al. 2006
	pHC	6.8 mg/g creat. (95% cut-off) <sup>a</sup>		0.63	0.49	1.05	0.81	
	Estimated GFR	78.5 mL/minute (95% cut-off) <sup>a</sup>		1.08	0.70	1.80	1.18	
Residents in cadmium-polluted (1,397 males, 1,706 females) and cadmium nonpolluted areas (Japan) (130 males, 159 females); $\geq 50$ years old	$\beta 2\text{M}$	507 $\mu\text{g/g}$ creat. (M)	Quantal linear model	1.5 (M)	1.2 (M)	3.1 (M)	2.5 (M)	Shimizu et al. 2006
		400 $\mu\text{g/g}$ creat. (F)		1.4 (F)	1.1 (F)	2.9 (F)	2.3 (F)	
		507 $\mu\text{g/g}$ creat. (M)	Log-logistic model	3.7 (M)	2.9 (M)	5.1 (M)	4.2 (M)	
		400 $\mu\text{g/g}$ creat. (F)		2.6 (F)	1.5 (F)	6.3 (F)	2.7 (F)	
		994 $\mu\text{g/g}$ creat. (M)		Quantal linear model	2.3 (M)	1.8 (M)	4.7 (M)	
784 $\mu\text{g/g}$ creat. (F)	1.7 (F)	1.4 (F)			3.5 (F)	2.9 (F)		
994 $\mu\text{g/g}$ creat. (M)	Log-logistic model	4.8 (M)	3.9 (M)	6.3 (M)	5.5 (M)			
784 $\mu\text{g/g}$ creat. (F)		4.4 (F)	3.2 (F)	6.4 (F)	5.1 (F)			
Residents in cadmium-polluted (1,397 males, 1,706 females) <sup>d</sup> and cadmium nonpolluted areas (Japan) (520 males, 700 females); $\geq 50$ years old	$\beta 2\text{M}$	915.5 $\mu\text{g/g}$ creat. (M)	Profile likelihood method	4.0 (M)	3.5 (M)			Suwazono et al. 2011b
		897.1 $\mu\text{g/g}$ creat. (F)		4.0 (F)	(3.7) (F)			

## 3. HEALTH EFFECTS

**Table 3-8. Benchmark Dose Estimations of Urinary Cadmium Levels ( $\mu\text{g/g}$  Creatinine)**

Study population	Effect biomarker	Response criterion	BMD model	5% BMR		10% BMR		Reference
				BMD	BMDL	BMD	BMDL	
General population (Japan) 1,114 males, 1,664 females	Protein	157 mg/g creat. (M)	Log-logistic model	3.6 (M)	3.1 (M)	5.6 (M)	4.9 (M)	Kobayashi et al. 2006
		159 mg/g creat. (F)		4.8 (F)	4.2 (F)	7.5 (F)	6.6 (F)	
		(84% cut-off) <sup>f</sup>						
		309 mg/g creat. (M)		10.6 (M)	6.8 (M)	15.3 (M)	9.6 (M)	
		311 mg/g creat. (F)		8.7 (F)	7.3 (F)	12.0 (F)	9.9 (F)	
		(95% cut-off) <sup>g</sup>						
	$\beta\text{2M}$	507 $\mu\text{g/g}$ creat. (M)		2.9 (M)	2.4 (M)	5.0 (M)	4.0 (M)	
		400 $\mu\text{g/g}$ creat. (F)		3.8 (F)	3.3 (F)	6.6 (F)	5.5 (F)	
		(84% cut-off) <sup>f</sup>						
		994 $\mu\text{g/g}$ creat. (M)		6.4 (M)	4.5 (M)	10.2 (M)	7.1 (M)	
		784 $\mu\text{g/g}$ creat. (F)		8.7 (F)	7.3 (F)	12.0 (F)	9.9 (F)	
		(95% cut-off) <sup>g</sup>						
NAG	8.2 U/g creat. (M)	4.8 (M)	3.3 (M)	8.3 (M)	5.7 (M)			
	8.5 U/g creat. (F)	4.7 (F)	3.7 (F)	8.3 (F)	6.4 (F)			
	(84% cut-off) <sup>f</sup>							
	16.0 U/g creat. (M)	12.0 (M)	7.7 (M)	16.4 (M)	10.3 (M)			
	16.6 U/g creat. (F)	10.8 (F)	8.5 (F)	14.8 (F)	11.4 (F)			
	(95% cut-off) <sup>g</sup>							
General population (Japan) 1,181 males, 1,748 females	$\beta\text{2M}$	492 $\mu\text{g/g}$ creat. (M)	Multiple logistic model	3.0 (M)	2.7 (M)	5.0 (M)	4.6 (M)	Kobayashi et al. 2008a
		407 $\mu\text{g/g}$ creat. (F)		3.4 (F)	3.2 (F)	5.7 (F)	5.4 (F)	
		(84% cut-off) <sup>h</sup>						
		965 $\mu\text{g/g}$ creat. (M)		4.9 (M)	4.5 (M)	7.4 (M)	6.8 (M)	
		798 $\mu\text{g/g}$ creat. (F)		5.9 (F)	5.6 (F)	8.6 (F)	8.1 (F)	
(97.5% cut-off) <sup>i</sup>								
1,000 $\mu\text{g/g}$ creat.	5.0 (M)	4.6 (M)	7.5 (M)	6.9 (M)				
	6.7 (F)	6.3 (F)	9.4 (F)	8.9 (F)				

## 3. HEALTH EFFECTS

**Table 3-8. Benchmark Dose Estimations of Urinary Cadmium Levels ( $\mu\text{g/g}$  Creatinine)**

Study population	Effect biomarker	Response criterion	BMD model	5% BMR		10% BMR		Reference
				BMD	BMDL	BMD	BMDL	
General population (Japan) 547 males, 723 females; aged $\geq 50$ years	Protein	159 mg/g creat. (M)	Profile likelihood method	2.6 (M)	2.1 (M)			Suwazono et al. 2011c
		93 mg/g creat. (F) (95% cut-off) <sup>a</sup>		1.7 (F)	1.5 (M)			
	$\beta 2\text{M}$	708 $\mu\text{g/g}$ creat. (M) 415 $\mu\text{g/g}$ creat. (F) (95% cut-off) <sup>e</sup>		3.4 (M) 1.7 (F)	2.6 (M) 1.4 (F)			
	NAG	10.7 IU/g creat. (M) 11.1 IU/g creat. (F) (95% cut-off) <sup>i</sup>		6.3 (M) 4.3 (F)	4.1 (M) 3.1 (F)			
General population (Japan) 410 males, 418 females; 40–59 years old	Protein	70 mg/g creat. (M)	Quantal linear model	0.9 (M)	0.6 (M)	1.9 (M)	1.2 (M)	Uno et al. 2005
		70 mg/g creat. (F) (84% cut-off) <sup>k</sup>		3.2 (F)	1.8 (F)	6.6 (F)	3.6 (F)	
	$\beta 2\text{M}$	233 $\mu\text{g/g}$ creat. (M) 274 $\mu\text{g/g}$ creat. (F) (84% cut-off) <sup>k</sup>		0.5 (M) 0.9 (F)	0.4 (M) 0.8 (F)	1.0 (M) 1.8 (F)	0.7 (M) 1.3 (F)	
	NAG	2.4 U/g creat. (M) 2.5 U/g creat. (F) (84% cut-off) <sup>k</sup>		0.3 (M) 0.8 (F)	0.3 (M) 0.6 (F)	0.7 (M) 1.6 (F)	0.6 (M) 1.2 (F)	
General population (Japan) <sup>l</sup> 209 males, 215 females; 40–49 years old	Protein	67.7 mg/g creat. (M)	Profile likelihood method	1.3 (M)	0.9 (M)			Suwazono et al. 2011a
		94.6 mg/g creat. (F) (95% cut-off) <sup>a</sup>		3.2 (F)	1.9 (F)			
	$\beta 2\text{M}$	224.5 $\mu\text{g/g}$ creat. (M) 298.9 $\mu\text{g/g}$ creat. (F) (95% cut-off) <sup>a</sup>		0.9 (M) 2.2 (F)	0.7 (M) 1.5 (F)			
	NAG	2.2 IU/g creat. (M) 2.1 IU/g creat. (F) (95% cut-off) <sup>a</sup>		0.7 (M) 1.3 (F)	0.6 (M) 0.6 (F)			

## 3. HEALTH EFFECTS

**Table 3-8. Benchmark Dose Estimations of Urinary Cadmium Levels ( $\mu\text{g/g}$  Creatinine)**

Study population	Effect biomarker	Response criterion	BMD model	5% BMR		10% BMR		Reference
				BMD	BMDL	BMD	BMDL	
General population (Japan) <sup>f</sup> 201 males, 203 females; 50–59 years	Protein	94.5 mg/g creat. (M)	Profile likelihood method	1.6 (M)	1.1 (M)			Suwazono et al. 2011a
		92.7 mg/g creat. (F) (95% cut-off) <sup>a</sup>		5.7 (F)	3.4 (F)			
	$\beta$ 2M	322.1 $\mu\text{g/g}$ creat. (M)	1.8 (M)	1.2 (M)				
296.7 $\mu\text{g/g}$ creat. (F) (95% cut-off) <sup>a</sup>		2.4 (F)	1.8 (F)					
	NAG	2.5 IU/g creat. (M)		1.0 (M)	0.8 (M)			
		3.3 IU/g creat. (F) (95% cut-off) <sup>a</sup>		3.2 (F)	2.3 (F)			
Residents in cadmium highly polluted area (China) <sup>d</sup> 123 males, 171 females	NAG	15.0 U/g creat. (95% cut-off) <sup>m</sup>	Quantal linear logistic regression model	6.36 (M)	5.83 (M)			Jin et al. 2004c
	NAG-B	4.0 U/g creat. (95% cut-off) <sup>k</sup>		7.74 (F)	5.46 (F)			
		$\beta$ 2M		800 $\mu\text{g/g}$ creat. (95% cut-off) <sup>m</sup>	4.88 (M)	3.98 (M)		
Residents in cadmium moderately polluted area (China) <sup>d</sup> 81 males, 162 females	RBP	0.300 mg/g creat. (95% cut-off) <sup>m</sup>		5.86 (M)	4.74 (M)			
				9.98 (F)	8.47 (F)			
	Albumin	25.0 mg/g creat. (95% cut-off) <sup>m</sup>		5.99 (M)	4.87 (M)			
				9.03 (F)	7.63 (F)			
				16.72 (M)	11.18 (M)			
				14.42 (F)	11.31 (F)			

<sup>a</sup>95<sup>th</sup> percentile of effect biomarkers on the “hypothetical” control distribution at a urinary cadmium level of zero.

<sup>b</sup>84% upper limit values from a group of 424 males and 1,611 females who did not smoke and lived in three different cadmium nonpolluted areas.

<sup>c</sup>95% upper limit values from a group of 424 males and 1,611 females who did not smoke and lived in three different cadmium nonpolluted areas.

<sup>d</sup>Same population of residents living in polluted area as Shimizu et al. (2006).

<sup>e</sup>95<sup>th</sup> percentile calculated by benchmark model at no cadmium exposure (urinary cadmium equal to zero), adjusted to mean age.

<sup>f</sup>84% upper limit value of the target population of people who have not smoked.

<sup>g</sup>95% upper limit value of the target population of people who have not smoked.

<sup>h</sup>84<sup>th</sup> percentile level in subjects from nonpolluted areas.

<sup>i</sup>97.5<sup>th</sup> percentile level in subjects from nonpolluted areas.

<sup>j</sup>95<sup>th</sup> percentile calculated by benchmark model at no cadmium exposure (urinary cadmium equal to zero), adjusted to mean age in females only.

<sup>k</sup>84% upper limit value of the target population.

<sup>l</sup>Same population as Uno et al. (2005), divided into two age groups.

<sup>m</sup>95% upper limit value from a control group 98 males and 155 females living in a cadmium nonpolluted area.

BMD = benchmark dose; BMDL = lower 95% confidence limit on the benchmark dose; BMR = benchmark response;  $\beta$ 2M =  $\beta$ 2-microglobulin; creat. = creatinine; F = female; M = male; NAG = *N*-acetyl- $\beta$ -D-glucosaminidase; NAG-B = *N*-acetyl- $\beta$ -D-glucosaminidase's isoform B; RBP = retinol binding protein



## 3. HEALTH EFFECTS

other when  $\beta$ 2-microglobulin was  $>400$  or  $>1,000$   $\mu\text{g/g}$  creatinine using data from exposed populations. Although no specific data were given for the two populations, the investigators noted that the highest urinary cadmium levels in the non-exposed populations were 5.6 and 3.6  $\mu\text{g/g}$  creatinine in females and males, respectively. The points of intersection of the regression lines were 11.0 and 11.7  $\mu\text{g/g}$  creatinine in females using the  $>400$  and 1,000  $\mu\text{g/g}$  creatinine criteria, respectively, and 10.0 and 11.0  $\mu\text{g/g}$  creatinine in males. The second investigation also used published data on Japanese populations living in polluted and nonpolluted areas (Ikeda et al. 2005b). The urinary cadmium levels ranged from 0.2 to 7.8  $\mu\text{g/g}$  creatinine and from 0.8 to 31.6  $\mu\text{g/g}$  creatinine in the nonpolluted and polluted areas, respectively, and the data for the two populations were combined. Plotting urinary cadmium levels against  $\beta$ 2-microglobulin levels showed that there was a marked increase in  $\beta$ 2-microglobulin levels (levels exceeded 1,000  $\mu\text{g/g}$  creatinine) when urinary cadmium levels exceeded 4  $\mu\text{g/g}$  creatinine. The urinary cadmium levels at the point of intersection of the regression line for urinary cadmium levels of  $\leq 2$  or  $\leq 5$   $\mu\text{g/g}$  creatinine was 6.7 and 6.7  $\mu\text{g/g}$  creatinine using ordinary scales and 3.7 and 3.7  $\mu\text{g/g}$  creatinine using double logarithmic scales. These urinary cadmium levels corresponded to  $\beta$ 2-microglobulin levels of 139 and 267  $\mu\text{g/g}$  creatinine with the ordinary scales and 118 and 118  $\mu\text{g/g}$  creatinine using the double logarithmic scales. Using these regression equations and a critical  $\beta$ 2-microglobulin level of 1,000  $\mu\text{g/g}$  creatinine resulted in urinary cadmium levels of 7.6 (ordinary scales) or 8.1 (double logarithmic scales)  $\mu\text{g/g}$  creatinine. Based on this analysis, the investigators concluded that at urinary cadmium levels of  $>4$   $\mu\text{g/g}$  creatinine, there is a substantial increase in  $\beta$ 2-microglobulin levels (Ikeda et al. 2005b). Similarly, Kobayshi et al. (2009a) estimated the threshold level for lifetime cadmium intake using BMD modeling in 2607 adults, aged  $\geq 50$  years, residing for at least 30 years in an area of Japan with known cadmium contamination. A lifetime cadmium intake of 1.16–2.43 g in males and 0.86–1.79 g in women would be associated with a 5% additional risk of proteinuria and/or glucosuria.

A third approach used to identify a threshold level was a meta-analysis conducted by Gamo et al. (2006) using published data on environmentally exposed populations. Urinary cadmium was used as a biomarker of exposure and the prevalence of abnormal levels of  $\beta$ 2-microglobulin as an indicator of renal dysfunction. The investigators estimated maximum permissible geometric mean urinary cadmium levels in age- and gender-specific populations that would not result in a significant increase in the prevalence of abnormal  $\beta$ 2-microglobulin levels. They concluded that the geometric mean urinary cadmium level for a population in a small geographical area should not exceed 3  $\mu\text{g/g}$  creatinine; in a nationwide population, the geometric mean should not exceed 2  $\mu\text{g/g}$  creatinine.

## 3. HEALTH EFFECTS

Numerous studies in rats, mice, and rabbits confirm that oral exposure to cadmium causes kidney damage including proteinuria and tubular damage (Andersen et al. 1988; Bernard et al. 1980, 1988a, 1992; Bomhard et al. 1984; Borzelleca et al. 1989; Cardenas et al. 1992a, 1992b; Cha 1987; Fingerle et al. 1982; Gatta et al. 1989; Gill et al. 1989b; Itokawa et al. 1974; Kawamura et al. 1978; Kotsonis and Klaassen 1978; Kozłowska et al. 1993; Mangler et al. 1988; Masaoka et al. 1994; Pleasants et al. 1992, 1993; Prigge 1978a; Steibert et al. 1984; Stowe et al. 1972; Wilson et al. 1941). Histopathological findings include focal necrosis of proximal tubular epithelial cells and cloudy swelling in renal tubules (Cha 1987). Some studies have also shown no effect on renal function (Basinger et al. 1988; Borzelleca et al. 1989; Boscolo and Carmignani 1986; Groten et al. 1990; Jamall et al. 1989; Loeser and Lorke 1977a, 1977b).

In acute-duration gavage studies in rats, decreased urine flow (Kotsonis and Klaassen 1977) and histopathologic evidence of kidney damage have been reported (Borzelleca et al. 1989) at the very high doses of 150 and 138 mg/kg/day, respectively. No effect on renal function was reported in rats receiving 13.9 mg/kg/day for 10 days in drinking water (Borzelleca et al. 1989). Mice treated with a single gavage dose showed tubular necrosis at 88.8 mg/kg in one study (Andersen et al. 1988), but no effects on the kidney in another study at a dose of 112 mg/kg (Basinger et al. 1988). Proteinuria is a common finding in intermediate-duration oral exposure studies in rats (Bernard et al. 1988a; Cardenas et al. 1992a, 1992b; Kotsonis and Klaassen 1978; Prigge 1978a), as are histopathologic changes in the kidney (Gatta et al. 1989; Itokawa et al. 1974; Kotsonis and Klaassen 1978; Wilson et al. 1941). Renal clearance was decreased in one study (Kawamura et al. 1978). Both increases (Pleasants et al. 1992, 1993) and decreases (Kozłowska et al. 1993) in relative kidney weight have been reported. These effects occurred in rats at doses ranging from 2 to 30 mg/kg/day. No renal effects were seen in dogs receiving 0.75 mg/kg/day cadmium for 3 months (Loeser and Lorke 1977b), but interstitial renal fibrosis was observed in rabbits exposed to 14.9 mg/kg/day for 200 days (Stowe et al. 1972). Renal dysfunction has been reported in Rhesus monkeys exposed to 1.2 mg/kg/day for 9 years, but not at 0.4 mg/kg/day (Masaoka et al. 1994). Adverse renal effects are common in rats following chronic-duration oral exposure to cadmium. Proteinuria (Bernard et al. 1992; Bomhard et al. 1984) and histopathologic damage (Fingerle et al. 1982; Mangler et al. 1988) have been reported at doses ranging from 1.8 to 12.5 mg/kg/day cadmium.

The hypothesis that a critical concentration of approximately 200  $\mu\text{g/g}$  in the renal cortex must be reached before proteinuria develops is generally supported by the animal data (Bhattacharyya et al. 1988c; Kotsonis and Klaassen 1978; Mangler et al. 1988; Shaikh et al. 1989; Viau et al. 1984).

## 3. HEALTH EFFECTS

**Endocrine Effects.** Using data from the NHANES 1988–1994, Schwartz et al. (2003) investigated possible associations between cadmium exposure (as measured by urinary cadmium levels) and the prevalence of impaired fasting glucose and diabetes. Analysis on 8,722 participants of the survey ( $\geq 40$  years old) showed a dose-related increase in both impaired fasting glucose and diabetes after adjusting for age, ethnicity, sex, and BMI. No other studies were located regarding endocrine effects in humans after oral exposure to cadmium.

Studies on the potential toxicity of cadmium to the endocrine system consist of studies conducting histopathologic examination of endocrine tissues and studies examining 24-hour variations in hormone release. No adverse effects were seen in parathyroid glands from female Wistar rats exposed to 8 mg Cd/kg/day via drinking water for 90 days (Kawamura et al. 1978) or in adrenal gland from male Sprague-Dawley rats exposed to 8 mg/kg/day via drinking water for 24 weeks (Kotsonis and Klaassen 1978). Pituitary, adrenals, thyroid, and thymus were unaffected in Wistar rats exposed to 3 mg/kg/day cadmium via feed for 3 months (Loeser and Lorke 1977a). Wilson et al. (1941) reported pancreatic atrophy and pancreatitis in rats from cadmium at 2.79 mg/kg/day via feed for 100 days. In rabbits exposed to 14.9 mg Cd/kg body weight/day via drinking water for 200 days, the pancreas had moderate concentrations of cadmium, but no interstitial fibrosis or other pathologic alterations (Stowe et al. 1972). Alterations in the 24-hour pattern of plasma adrenocorticotropin hormone and growth hormone levels were observed in rats exposed to 0.92 or 1.8 mg Cd/kg/day as cadmium chloride in drinking water for 30 days (Caride et al. 2010b); significant increases in adrenocorticotropin hormone and thyroid stimulating hormone levels were also observed. Cadmium also disrupted the daily pattern of aspartate, glutamate, and glutamine content in the anterior and posterior pituitary gland in rats exposed to 0.92 or 1.8 mg Cd/kg/day as cadmium chloride in drinking water for 30 days (Caride et al. 2010a).

**Dermal Effects.** No studies were located regarding dermal effects in humans after oral exposure to cadmium.

Coarse fur was reported in Long-Evans rats receiving 6.13 mg/kg/day cadmium during Gd 6–15 (Machemer and Lorke 1981). A ruffled hair coat was reported in Wistar rats receiving 40 mg/kg/day cadmium by gavage 5 days/week for 14 weeks (Baranski and Sitarek 1987). No other reports of dermal effects after oral exposure to cadmium were located.

**Ocular Effects.** No studies were located regarding ocular effects in humans or animals after oral exposure to cadmium.

## 3. HEALTH EFFECTS

**Body Weight Effects.** No studies were located regarding body weight effects in humans after oral exposure to cadmium.

Decreased body weight and decreased rates of growth are common findings in studies where experimental animals are orally exposed to cadmium. Sprague-Dawley rats receiving a single gavage dose of 150 mg/kg cadmium exhibited a 12% decrease in body weight, but 100 mg/kg had no effect (Kotsonis and Klaassen 1977). Daily gavage doses of 15.3 mg/kg over a 10-day period caused a 79% decrease in body weight gain in male Sprague-Dawley rats (Borzelleca et al. 1989). Significant reductions in maternal weight gain have also been reported (Baranski 1985; Machemer and Lorke 1981).

Body weight reductions are also seen in intermediate-duration studies. For example, in a 14-week exposure via drinking water in male Long-Evans rats, 2.9 mg/kg/day had no effect on body weight gain; however, 5.8 mg/kg/day caused a 6–23% decrease and 11.6 mg/kg/day caused a 47–58% decrease (Pleasant et al. 1992, 1993). In general, intermediate-duration doses in feed or drinking water of  $\leq 3$  mg/kg/day have either no effect or only a small effect (10–20% decrease) on body weight in rats (Carmignani and Boscolo 1984; Jamall et al. 1989; Loeser and Lorke 1977a; Muller et al. 1988; Ogoshi et al. 1989; Perry et al. 1989; Wilson et al. 1941). Higher doses (4–14 mg/kg/day) had no effect in some studies (Kostial et al. 1993; Kotsonis and Klaassen 1978; Prigge 1978a; Viau et al. 1984) and small effects in others (Cha 1987; Kawamura et al. 1978; Kozłowska et al. 1993). A 29% decrease in maternal weight gain was observed in rats exposed to a high dose of 40 mg/kg/day (Baranski and Sitarek 1987). In mice, a dose of 4.8 mg/kg/day had no effect on maternal weight gain, but a dose of 9.6 mg/kg/day caused a 14% decrease (Webster 1978). A high dose of 232 mg/kg/day in mice caused a 29% decrease in body weight (Waalkes et al. 1993). Beagle dogs were unaffected at 0.75 mg/kg/day (Loeser and Lorke 1977b), as were rabbits at up to 2.2 mg/kg/day (Boscolo and Carmignani 1986; Tomera and Harakal 1988). A small decrease (11%) was seen in rabbits exposed to 14.9 mg/kg/day for 200 days (Stowe et al. 1972).

A chronic-duration study in Rhesus monkeys reported decreased growth rates at 0.4 mg/kg/day, but no effect at 0.12 mg/kg/day (Masaoka et al. 1994). No effect on body weight was seen in rats at up to 4.4 mg/kg/day (Decker et al. 1958; Fingerle et al. 1982; Mangler et al. 1988), but a small effect was seen at 7 mg/kg/day (Waalkes and Rehm 1992). Decreased terminal body weight was observed in mice after 12 months of drinking-water exposure to a high dose of 57 mg/kg/day (Hays and Margaretten 1985).

## 3. HEALTH EFFECTS

**Metabolic Effects.** Hyperthermia and metabolic acidosis were reported in a human male who had ingested 25 mg/kg cadmium as cadmium iodide (Wisniewska-Knypl et al. 1971).

No studies were located regarding metabolic effects in animals after oral exposure to cadmium.

### 3.2.2.3 Immunological and Lymphoreticular Effects

No studies were located regarding immunological effects in humans after oral exposure to cadmium.

Numerous studies in rats, mice, and monkeys have established the capability of cadmium to affect the immune system, but the clinical significance of the effects is not clear. In mice, intermediate-duration oral exposure to cadmium has been shown to increase resistance to viral infection (Exon et al. 1986), to be without effect on natural or acquired resistance to infection (Bouley et al. 1984), and to increase mortality from virally-induced leukemia (Blakley 1986; Malave and de Ruffino 1984). Oral cadmium exposure has also been found to suppress the humoral immune response of mouse splenic cells to sheep red blood cell antigen in 6-week-old mice (Blakley 1985), but not in 12-month-old mice (Blakley 1988). The author suggests that “natural” age-related immune system dysfunction masked any cadmium suppressive effect in the 12-month-old mice, and that immunotoxicological investigations in aged models appear to be a poor indicator of immune response in the general population. Oral cadmium exposure has also been found to increase the cell-mediated immune response of monkeys (Chopra et al. 1984), to induce anti-nuclear antibodies in mice (Ohsawa et al. 1988), to increase circulating leukocytes in female rats (Borzelleca et al. 1989), and to exhibit time-dependent inhibitory and stimulative effects (Cifone et al. 1989b) or no effect (Stacey et al. 1988a) on natural killer cell activity in rats. The highest NOAEL values and all LOAEL values from each reliable study for immunological effects in each species and duration category are recorded in [Table 3-6](#) and plotted in [Figure 3-2](#).

### 3.2.2.4 Neurological Effects

A few studies have reported an association between environmental cadmium exposure and neuropsychological functioning. These studies used hair cadmium as an index of exposure (see Section 3.8.1 for a discussion of the limitations of using hair as an indicator of exposure). End points that were affected included verbal IQ in rural Maryland children (Thatcher et al. 1982), acting-out and distractibility in rural Wyoming children (Marlowe et al. 1985), and disruptive behavior in Navy recruits (Struempfer et al. 1985). The usefulness of the data from these studies is limited because of the potential confounding

### 3. HEALTH EFFECTS

effects of lead exposure; lack of control for other possible confounders including home environment, caregiving, and parental IQ levels; and an inadequate quantification of cadmium exposure.

Although cadmium-induced neurotoxicity has not been clearly demonstrated in human studies, it has been observed in animal studies. Both a single oral exposure (Kotsonis and Klaassen 1977) and intermediate-duration exposure of adult rats to cadmium resulted in significantly decreased motor activity (Kotsonis and Klaassen 1978; Nation et al. 1990). Intermediate-duration oral exposure to cadmium has also been reported to cause weakness and muscle atrophy (Sato et al. 1978), induce aggressive behavior (Baranski and Sitarek 1987), induce anxiety as manifested by increased passive avoidance behavior (Nation et al. 1984) and by increased ethanol consumption (Nation et al. 1989), and alter brain biogenic amine content and enzyme activities (Murthy et al. 1989). Doses associated with these effects range from 5 to 40 mg/kg/day cadmium. Degenerative changes in the choroid plexus have been reported in mice exposed to 1.4 mg/kg/day cadmium in drinking water for 22 weeks (Valois and Webster 1989). Peripheral neuropathy has been reported in rats after a 31-month exposure to cadmium in drinking water (Sato et al. 1978). Neurological effects in offspring of animals orally exposed to cadmium during gestation are discussed in Section 3.2.2.5. The highest NOAEL values and all LOAEL values from each reliable study for neurological effects in each species and duration category are recorded in [Table 3-6](#) and plotted in [Figure 3-2](#).

#### 3.2.2.5 Reproductive Effects

Several studies have examined the possible association between increased cadmium exposure and male reproductive toxicity; however, most studies focused on sex steroid hormone levels and the results appear to be inconsistent. Akinloye et al. (2006) found significant associations between increasing blood cadmium levels and increasing levels of serum luteinizing hormone, follicle stimulating hormone, prolactin, and testosterone among infertile men (sperm counts <20 million/cm<sup>3</sup> or no spermatozoa in semen). A significant association between increased blood cadmium levels and increased serum testosterone was also found in a group of workers with slight to moderate lead exposure (Telišman et al. 2000); however, neither study controlled for smoking. A study by Jurasović et al. (2004) found significant associations between blood cadmium levels and increased serum estradiol, follicle stimulating hormone, and testosterone levels in infertile men after adjusting for age, smoking, alcohol consumption, and biomarkers of lead, copper, zinc, and selenium. In contrast, a study of Chinese men living in areas with high levels of cadmium in rice did not find significant correlations between urinary or blood cadmium levels and serum testosterone, follicle stimulating hormone, or luteinizing hormone levels after

## 3. HEALTH EFFECTS

adjusting for BMI, age, smoking, and alcohol consumption (Zeng et al. 2004a). However, they did find that the prevalence of abnormally elevated serum testosterone levels (>95<sup>th</sup> percentile for controls) increased with exposure to cadmium. Using NHANES III data, Menke et al. (2008) found significant associations between urinary cadmium levels and serum testosterone and estradiol levels, but the associations were no longer significant after adjusting from smoking status and serum cotinine levels. Differences in study populations (e.g., infertile men, background cadmium exposure, high cadmium dietary exposure) and confounding factors (e.g., smoking, lead exposure) limit the interpretation of these results.

Four studies examined the possible association between cadmium exposure and sperm quality. In infertile men, increasing serum cadmium levels were significantly associated with abnormal sperm morphology and decreased sperm counts, sperm motility, and sperm viability (Akinloye et al. 2006). Another study found significant associations between blood cadmium levels and abnormal sperm morphology and decreased sperm motility in workers with slight to moderate lead exposure (Telišman et al. 2000). As noted previously, neither study adjusted for smoking. No significant correlations between blood cadmium levels and sperm quality were observed in infertile men with or without adjustment for smoking (Jurasović et al. 2004). Similarly, no significant association between blood cadmium levels and abnormal semen parameters were observed in infertile men (Benoff et al. 2009), although seminal plasma cadmium levels were significantly negatively correlated with sperm concentration and sperm motility in whole semen. Among men exposed to high levels of environmental cadmium, blood cadmium levels were significantly higher in men with abnormal digital rectal examinations of the prostate and trend analysis showed a dose-response relationship between cadmium exposure and the prevalence of abnormal prostate specific antigen (Zeng et al. 2004b).

Data on possible reproductive toxicity of cadmium in women are limited to two studies examining the possible association between cadmium body burden and endometriosis and one study examining fecundability. Among infertile Japanese, no association between urinary cadmium levels and the risk of endometriosis was observed (Itoh et al. 2008). Jackson et al. (2008) found a significant association between blood cadmium levels and risk of endometriosis using NHANES 1999–2002 data. Blood cadmium levels were significantly higher among women with endometriosis as compared to women without endometriosis. When comparing participants with the highest tertile of blood cadmium (0.5–8.5 µg/L) with the lowest tertile (<0.3 µg/L), the multivariate (including lead and mercury blood levels, race/ethnicity, smoking status, age) adjusted odds ratio was 3.39 (95% CI of 1.37–8.40). No association between blood cadmium levels and risk of uterine myomas was found. The possible association between

## 3. HEALTH EFFECTS

elevated cadmium body burden and time to pregnancy was examined among 400 couples participating in the Longitudinal Investigation of Fertility and the Environment (LIFE) Study (Buck Louis et al. 2012). After adjusting for several variables (age, BMI, cotinine, parity, and serum lipids), female urine cadmium levels were associated with a reduction in the fecundability odds ratio (0.78; 95% CI of 0.63–0.97) (a fecundability odds ratio of <1 denotes a longer time to pregnancy).

A number of animal studies have shown adverse reproductive effects to male and female reproductive capacity from cadmium exposure. In male rats and mice, acute oral exposure to near-lethal (60–100 mg/kg) doses can cause testicular atrophy and necrosis (Andersen et al. 1988; Bomhard et al. 1987; Borzelleca et al. 1989), and concomitant decreased fertility (Kotsonis and Klaassen 1978). Lower-dose acute exposures of 25–50 mg/kg did not result in reproductive toxicity in male animals (Andersen et al. 1988; Bomhard et al. 1987; Dixon et al. 1976).

The following intermediate-duration dosing regimens resulted in neither testicular histopathologic lesions nor a decrease in male reproductive success: 0.25 mg Cd/kg/day via gavage for 10 weeks (Bomhard et al. 1987); 5 mg/kg/day via water for 30–90 days (Dixon et al. 1976); 2.5 mg/kg/day via food for 4 weeks (Groten et al. 1990); 8 mg/kg/day via water for 24 weeks (Kotsonis and Klaassen 1978); 3 mg/kg/day via food for 12 weeks (Loeser and Lorke 1977a, 1977b); 2.9 mg/kg/day via water for 14 weeks (Pleasants et al. 1992); and 4.64 mg/kg/day via water for 70–80 days (Zenick et al. 1982). Some dosing regimens have resulted in adverse reproductive effects. Male rats exposed to 8.58 mg Cd/kg/day in water for 10 weeks developed necrosis and atrophy of seminiferous tubule epithelium (Cha 1987). Rats exposed to 5.8 mg/kg/day via water for 14 weeks (Pleasants et al. 1992) or 11.6 mg/kg/day via water for 14 weeks (Pleasants et al. 1993) developed increased testes weight. Rats exposed to 12.9 mg/kg/day in water for 120 days developed significantly increased relative testis weight, decreased sperm count and motility, decreased seminiferous tubular diameter, and seminiferous tubular damage (pyknotic nuclei, multinucleated giant cells, interstitial edema, and dilated blood vessels) (Saxena et al. 1989). In a protocol designed to assess the effects of vitamins on cadmium toxicity, Pleasants et al. (1992, 1993) reported that vitamins A and D<sub>3</sub> reduced the amount of cadmium-related increase in testis weight. Bomhard et al. (1987) reported no histopathologic lesions (other than those found in control animals as part of aging) in testes of rats receiving 10 weekly doses of 5 mg Cd/kg and followed for up to 30 months.

Higher doses of cadmium were generally needed to elicit a reproductive toxic response in females compared to the males. Although a dose of 65.6 mg Cd/kg/day via gavage for 10 days was sufficient to produce testicular atrophy and loss of spermatogenic element in male rats, no effects were seen in female



## 3. HEALTH EFFECTS

rats up to 138 mg/kg/day (Borzelleca et al. 1989). Decreased percentage of fertilized females and percentage of pregnancies were reported at 61.32 mg Cd/kg/day via gavage for 10 days during gestation (Gd 6–15) (Machemer and Lorke 1981). No effect was seen at doses up to 18.39 mg/kg/day (Machemer and Lorke 1981). Baranski (1987) also reported no treatment related effects on number or percentage of females pregnant with 28.8 mg Cd/kg/day via gavage for gestation days (Gds) 1–20. Baranski and Sitarek (1987), however, administered 40 mg/kg by gavage 5 days/week for 14 weeks to female rats and observed a significant increased duration (twice as long) of the estrus cycle starting at 7–8 weeks and persisting to 14 weeks of exposure and the termination of the experiment. This adverse effect was not seen at 4 mg/kg (Baranski et al. 1983; Baranski and Sitarek 1987).

Petering et al. (1979) exposed female rats to either 2.61 mg/kg/day via drinking water for 60 days prior to gestation or during gestation, or 5.23 mg/kg/day via drinking water for 111 days including 90 days prior gestation plus 21 days during gestation. These doses had no significant effects compared with controls for the number of pups stillborn. Pond and Walker (1975) also observed no effects in females from a cadmium exposure of 19.7 mg/kg/day via food for 21–25 days, including Gd 1 through lactation day (Ld) 1, on number of pups born. No effects from a cadmium exposure on number of pups born to females were observed for an exposure of 8.2 mg/kg/day via food for 15 days, including Gd 6–20 (Sorell and Graziano 1990).

A dose of 10 mg Cd/kg/day once a day via gavage for 9 weeks (6 weeks prior to gestation and 3 weeks of gestation) significantly decreased the number of copulating and pregnant females, and the number of implants and live fetuses (Sutou et al. 1980). No effect was seen at 1 mg/kg/day (Sutou et al. 1980).

Reproductive effects on both male and female rats orally exposed to 2.5 mg/kg/day via drinking water for 180 days may have resulted in the observed decrease in litter size and increased interval between litters. Both males and females were treated over two generations. Three of five pairs failed to breed in the second generations (Schroeder and Mitchener 1971). No histopathologic lesions were found in testes or uteri of dogs given cadmium chloride at 0.75 mg/kg/day via food for 3 months (Loeser and Lorke 1977b).

Male rats were exposed to 0–14 mg Cd/kg/day via food for 77 weeks. The incidence of prostatic hyperplasias was increased above controls (1.8%) from the 3.5 mg Cd/kg/day dose. The overall incidence for prostatic lesions for all cadmium-treated groups was much lower in zinc-deficient rats, possibly because of a marked increase in prostatic atrophy that was associated with reduced zinc intake. Moreover, there was not a clear dose-response increase in prostatic proliferative lesions. Testicular

## 3. HEALTH EFFECTS

tumors (exclusively benign interstitial tumors) increased significantly only at the highest-dose cadmium with diets adequate in zinc. Male Wistar rats exposed to cadmium in the drinking water at 0, 25, 50, 100, or 200 ppm developed tumors of the prostate (50 ppm), testes (200 ppm), and hematopoietic system (50 ppm), while dietary zinc deficiency has complex, apparently inhibitory effects on cadmium carcinogenesis by this route (Waalkes and Rehm 1992).

The highest NOAEL values and all LOAEL values from each reliable study for reproductive effects in each species and duration category are recorded in [Table 3-6](#) and plotted in [Figure 3-2](#).

### 3.2.2.6 Developmental Effects

There are very limited data on the developmental effects of cadmium in humans. Several studies have examined the possible relationship between maternal cadmium levels and newborn size. No significant association between maternal blood cadmium levels and newborn body weight were observed in women with mean blood cadmium levels of 0.7 µg/L (Mokhtar et al. 2002), 1.04 µg/L (Nishijo et al. 2004b), 1.4 µg/L (Galicía-García et al. 1997), or 1.72 µg/L (Zhang et al. 2004) or urinary cadmium levels of >2 nmol/mmol creatinine (Nishijo et al. 2002); the Nishijo et al. (2002, 2004b), and Zhang et al. (2004) studies used statistical adjustments for maternal age, maternal size, and/or gestation age. Two studies found an association between cord blood cadmium levels and decreasing birthweight (Galicía-García et al. 1997; Salpietro et al. 2002); however, the association was only statistically significant in the Salpietro et al. (2002) study. A significant association between newborn height and maternal blood cadmium levels was observed in women with a mean blood cadmium level of 9.29 nmol/L (Nishijo et al. 2004b); other studies have not found this association (Mokhtar et al. 2002; Nishijo et al. 2002; Zhang et al. 2004). Nishijo et al. (2002) found a significant negative correlation between maternal urinary cadmium levels and gestation length; Mokhtar et al. (2002) did not find a significant association between maternal blood cadmium levels and gestation length.

Urinary cadmium content was measured in women 3 days after giving birth and compared to smoking habits and birth weight of offspring. Among nonsmoking women, when cadmium content was expressed as µg/L, cadmium levels were higher in women with infants of below-normal birth weight. However, when cadmium content was expressed as µg/g creatinine, cadmium levels were lower in women with infants with below-normal birth weight. Cadmium levels in smoking women were lower in both µg/L and µg/g in women with infants with below-normal birth weight (Cresta et al. 1989).

## 3. HEALTH EFFECTS

Cao et al. (2009) examined the possible association between postnatal exposure to cadmium (as measured by blood cadmium) and neurodevelopment in children participating in the Treatment of Lead-Exposed Children trial. Blood cadmium levels in the children were comparable to levels in the NHANES 2005–2006 survey, and blood lead levels were between 20 and 44  $\mu\text{g}/\text{dL}$  at referral. No significant associations (after adjustment for multiple variables including parent's education, gender, and concurrent blood lead levels) between blood cadmium levels and scores on neuropsychological and behavioral tests were found in children evaluated at age 5 and 7 years or IQ evaluated at 2, 5, and 7 years of age.

A number of studies in rats and mice indicate that cadmium can be fetotoxic from oral exposures prior to and during gestation. This fetotoxicity is most often manifested as reduced fetal or pup weights (Ali et al. 1986; Baranski 1987; Gupta et al. 1993; Kelman et al. 1978; Kostial et al. 1993; Petering et al. 1979; Pond and Walker 1975; Sorell and Graziano 1990; Sutou et al. 1980; Webster 1978; Whelton et al. 1988), but malformations, primarily of the skeleton, have been found in some studies (Baranski 1985; Machemer and Lorke 1981; Schroeder and Mitchener 1971). Malformations or skeletal effects reported include sirenomelia (fused lower limbs), amelia (absence of one or more limbs), and delayed ossification of the sternum and ribs (Baranski 1985); dysplasia of facial bones and rear limbs, edema, exenteration, cryptorchism, and palatoschisis (Machemer and Lorke 1981); and sharp angulation of the distal third of the tail (Schroeder and Mitchener 1971). Dosing levels were in the 1–20  $\text{mg}/\text{kg}/\text{day}$  range.

The most sensitive indicator of developmental toxicity of cadmium in animals appears to be neuro-behavioral development. Offspring of female rats orally exposed to cadmium at a dose of 0.04  $\text{mg}/\text{kg}/\text{day}$  prior to and during gestation had reduced exploratory locomotor activity and rotorod performance at age 2 months (Baranski et al. 1983). Pups from dams exposed to 0.7  $\text{mg}/\text{kg}/\text{day}$  during gestation had significant delays in cliff aversion and swimming behavior. Locomotor activity was significantly increased. In post-weaning measurements, locomotor activity was significantly decreased in treated groups at 60 days of age; conditioned avoidance behavior was also significantly decreased when tested at 60 and 90 days of age (Ali et al. 1986).

Nagymajtenyi et al. (1997) also reported behavioral and functional neurotoxicological changes caused by cadmium in a three-generational study in rats. Three consecutive generations of Wistar rats were orally treated by gavage with 3.5, 7.0, or 14.0  $\text{mg Cd}/\text{kg bw}$  (as cadmium chloride diluted in distilled water) over the period of pregnancy, lactation, and 8 weeks after weaning. Behavioral (open field behavior) and electrophysiological (spontaneous and evoked cortical activity, etc.) parameters of male rats from each generation were investigated at the age of 12 weeks. The main behavioral outcomes were increased

## 3. HEALTH EFFECTS

vertical exploration activity (rearing) and increased exploration of an open-field center. The spontaneous and evoked electrophysiological variables showed dose- and generation-dependent changes (increased frequencies in the electrocorticogram, lengthened latency and duration of evoked potentials, etc.) signaling a change in neural functions. The results indicate that low-level, multigeneration exposure of rats to inorganic cadmium can affect nervous system function.

Desi et al. (1998) continued the above studies to further evaluate cadmium associated changes in behavior and neurological function in rats following different dosage regimens during pregnancy. Female Wistar rats were given 3.5, 7.0, or 14.0 mg Cd/kg body weight (cadmium chloride dissolved in distilled water) in three different treatment regimes: days 5–15 of pregnancy; days 5–15 of pregnancy + 4 weeks of lactation; and days 5–15 of pregnancy + 4 weeks of lactation followed by the same oral treatment of male rats of the F<sub>1</sub> generation for 8 weeks. The behavioral (open-field exploration) and electrophysiological (electrocorticogram, cortical-evoked potentials, conduction velocity and refractory periods of a peripheral nerve) parameters of F<sub>1</sub> male rats exposed by various treatments were investigated at the age of 12 weeks. The results indicate that cadmium altered the spontaneous and evoked electrophysiological functions (e.g., increased the frequency of the electrocorticogram, lengthened the latency and duration of evoked potentials, etc.) in a dose- and duration-dependent manner. Only combining treatment during the prenatal development and the 4-week suckling period resulted in a significant dose-dependent decrease of horizontal and vertical exploratory activity and a significantly lower exploration frequency of the open-field center. The results suggest that low-level pre- and postnatal inorganic cadmium exposure affects the electrophysiological and higher order functions of the nervous system.

Neurochemical alterations have also been observed in the offspring of rats administered cadmium acetate in drinking water during gestation (1.12 mg Cd/kg/day) and lactation (2.41 mg Cd/kg/day) (Antonio et al. 2010). The alterations included decreased serotonin in dorsal hippocampus and dihydroxyphenylacetic acid in brain cortex and rostral neostriatum and increased 5-hydroxyindolacetic acid in dorsal hippocampus and brain cortex and glutamate in the dorsal hippocampus.

A study by Gupta et al. (1993) examined the developmental profiles of DNA, RNA, proteins, DNA synthesis, thymidine kinase activity, and concentrations of zinc and cadmium in the brain of neonates from dams exposed to cadmium acetate at 5–6.3 mg/kg/day in drinking water during gestation, and 7–8 mg/kg/day during a 21-day lactation period. Pup brain and body weights were significantly decreased in the cadmium exposed pups on Ld 7–21. Cadmium brain accumulation was significantly increased in exposed pups on Ld 7 and remained at similar levels on Ld 14 and 21. DNA and thymidine kinase brain

### 3. HEALTH EFFECTS

levels were significantly decreased in treated pups compared with controls on Ld 7, 14, and 21. The toxicological significance of changes in DNA incorporation and thymidine kinase activity are uncertain.

Xu et al. (1993b) determined lipid peroxide (LPO) concentrations in rat pups in various organs as an index of cadmium toxicity. Male and female Wistar mice were exposed to cadmium in drinking water at 0, 5.7, or 14.25 mg/kg/day for 2 months prior to mating. The pregnant females continued to be exposed during gestation and lactation. Litter size and pup survival rates were unaffected by cadmium. Body weights were not statistically different between the exposed and control groups. In pups, brain weights (at 5.7 and 14.25 mg/kg/day) and liver, kidney, and heart weights (at 14.25 mg/kg/day) were significantly decreased. Although the relative organ weights were lower in the high-dose group, the difference from controls was not statistically significant. LPO concentrations in all organs were significantly increased in pups on Ld 7 at 14.25 mg/kg/day except in the kidney; concentrations in the liver, heart, and brain were 131.5, 156, and 237.4%, respectively, of the concentrations in controls.

In contrast to most of the study results, Saxena et al. (1986) reported no developmental effects from an exposure to 21 mg Cd/kg/day via drinking water during gestation (Gd 0–20). This study evaluated simultaneous exposure to lindane (20 mg lindane/kg via gavage on Gd 6–14) and cadmium acetate in drinking water at doses that individually did not cause maternal or developmental effects. Maternal toxicity (significantly decreased weight gain) and developmental toxicity were only observed in the cadmium plus lindane group. Fetal body weight was significantly decreased; intrauterine death and the rate of skeletal anomalies were significantly increased. Anomalies consisted of decreased ossification, wavy ribs, and scrambled sternbrae.

The highest NOAEL values and all LOAEL values from each reliable study for developmental effects in each species and duration category are recorded in [Table 3-6](#) and plotted in [Figure 3-2](#).

#### **3.2.2.7 Cancer**

Epidemiology studies have examined the possible association between exposure to elevated levels of cadmium and overall cancer rates or specific cancer rates. Older studies have examined cancer rates among residents of cadmium polluted areas but did not estimate cadmium exposure levels. No significant increase in cancer rates was found among residents of a cadmium-polluted village in England (Inskip et al. 1982) or in prostate, kidney, or urinary tract cancer among residents of a cadmium-polluted area of Belgium (Lauwerys and De Wals 1981). Another study found that the geographic distribution of elevated

## 3. HEALTH EFFECTS

rates of prostate cancer incidence paralleled the distribution of elevated cadmium concentrations in water, soil, or grain crops in Alberta, Canada (Bako et al. 1982). In a retrospective mortality study of residents of three areas of Japan classified on the basis of rice cadmium content as highly polluted, slightly polluted, or nonpolluted, no significant differences were found in mortality from cancer of all sites including prostate cancer (Shigematsu 1984). Inhabitants of cadmium-polluted areas of Japan with elevated urinary retinol binding protein excretion had a mortality rate from malignant neoplasms no different from expected (Nakagawa et al. 1987).

Three more recent studies of populations living in cadmium-polluted areas have used blood or urine to examine dose-response relationships for carcinogenic risk. Among residents living in a cadmium-polluted area of China, significantly higher blood cadmium levels were observed in subjects with suspected prostate cancer (based on digital rectal examination) as compared to subjects with normal digital rectal examination results (Zeng et al. 2004); there were no significant differences in urinary cadmium levels. However, a significant trend was found for the number of cases with positive prostate-specific antigen levels and urinary cadmium levels. In a study of residents living in an area of Japan that previously had high levels of cadmium contamination, a significant increase in cancer mortality was observed among subjects with urinary  $\beta$ 2-microglobulin levels of  $\geq 1,000$   $\mu\text{g/g}$  creatinine (Arisawa et al. 2001); however, no increases in cancer incidence were observed in exposed subjects or in subjects with elevated urinary  $\beta$ 2-microglobulin, urinary cadmium, or blood cadmium levels. In a follow-up study that extended the observation period from 15 to 23 years, no alterations in cancer mortality or cancer incidence were observed in the exposed population as compared to referent populations (Arisawa et al. 2007b). However, when the subjects were divided into two groups based on urinary  $\beta$ 2-microglobulin levels, the relative risk of cancer deaths in males and females with  $\beta$ 2-microglobulin levels of  $\geq 1,000$   $\mu\text{g/g}$  creatinine was 2.58 (95% CI of 1.25–5.36) compared to residents with urinary  $\beta$ 2-microglobulin levels of  $< 1,000$   $\mu\text{g/g}$  creatinine.

Several case-control studies have examined the possible association between cadmium body burden and increased risk of cancer among the general populations. In a study conducted in Belgium, a significant relationship between bladder cancer and blood cadmium levels was reported (Kellen et al. 2007). After adjustment for age, gender, occupational exposure to polyaromatic hydrocarbons or aromatic amines, and smoking, the odds ratio was 5.7 (95% CI of 3.3–9.9) when comparing the risk of bladder cancer for subjects in the highest blood cadmium tertile to those in the lowest tertile. Another case-control study examined the possible relationship between urinary cadmium levels and breast cancer risk in the United States (McElroy et al. 2006). The breast cancer risk (after adjustment for a number of variables including

## 3. HEALTH EFFECTS

age, parity, family history of breast cancer and BMI) in women with urinary cadmium levels in the highest quartile was 2.29 (95% CI of 1.3–4.2) as compared to women in the lowest quartile; the investigators noted that adjusting for smoking status did not change the risk estimate. Similarly, a significant increase in the risk of breast cancer was observed among women living in Long Island, New York with urinary cadmium levels  $>0.60 \mu\text{g cadmium/g creatinine}$ , as compared to women with urinary cadmium levels of  $<0.22 \mu\text{g cadmium/g creatinine}$  after controlling for age, menopausal status, smoking and alcohol use, and family history (Gallagher et al. 2010). Another study of residents of the East Nile Delta region in Egypt with pancreatic cancer found a significant association between pancreatic cancer risk and serum cadmium levels; the odds ratio was 1.12 (95% CI of 1.04–1.23) (Kriegel et al. 2005). The study also found a significant association between farming and risk of pancreatic cancer. The results of this study should be interpreted cautiously since the study did not adjust for smoking status or farming occupation.

In a Swedish population-based study of postmenopausal women, an increased risk of endometrial cancer was found in women with elevated cadmium intake (Åkesson et al. 2008). Among women who never smoked, did not use postmenopausal hormones, had a BMI of  $<27 \text{ kg/m}^2$ , and consistently had a cadmium intake above the median intake for the study, the relative risk of endometrial cancer was 2.86 (95% CI of 1.05–7.79).

One study examined cadmium, zinc, and copper in human kidney tumors and normal kidneys. Kidneys with renal cell carcinoma in cortex from 31 cases (20 men and 11 women) were compared to kidneys of patients who had died from causes other than a malignant disease from 17 controls (9 men and 8 women). No patients in this study had been occupationally exposed. Smoking habits for patients were recorded. The level of cadmium in tumor tissue did not correlate with cadmium in cortex or medulla in the same kidney. No significant difference was found between cases and controls, although smoking cases had higher levels of cadmium. It was concluded that cadmium was not a risk factor for renal cell carcinoma (Hardell et al. 1994).

In rats and mice, earlier studies on chronic oral exposure to cadmium did not report an increased overall cancer incidence or the incidence of specific tumor types (Kanisawa and Schroeder 1969; Levy and Clack 1975; Levy et al. 1975; Löser 1980; Mangler et al. 1988; Schroeder et al. 1964, 1965). However, maximum daily doses tested were only 1 mg/kg/day in mice (Schroeder et al. 1964) and 3.5 mg/kg/day in rats (Löser 1980) and, in most of these studies, histopathologic examination was limited compared to contemporary standards. Löser (1980) did perform a relatively thorough histological examination. A few

## 3. HEALTH EFFECTS

additional animal studies of noncancer effects of chronic-duration oral cadmium exposure have indicated that no dose-related increases in tumors were found at maximum doses of 4.01 mg/kg/day in rats (Fingerle et al. 1982) or 8 mg/kg/day in mice (Watanabe et al. 1986).

Waalkes and Rehm (1992) evaluated the effects of chronic dietary zinc deficiency on oral cadmium carcinogenesis in male Wistar rats. Rats were exposed for 77 weeks to cadmium at 0, 1.75, 3.5, 7.0, or 14.0 mg cadmium/kg/day as cadmium chloride in a diet containing an adequate or a deficient amount of zinc. A significant increase in the incidence of proliferative lesions (hyperplasia and adenomas) was observed in the prostate of rats exposed to 1.75 mg cadmium/kg/day in the zinc-adequate (22.7%) or zinc-deficient (15.4%) groups, as compared to controls (1.9%). However, the incidences of prostatic lesions were not significantly increased in rats exposed to higher cadmium doses. The incidence of large granular lymphocyte leukemia was significantly increased in rats fed the zinc-adequate diet with 3.5 or 7.0 mg cadmium/kg/day, but not at 14.0 mg cadmium/kg/day; however, an increased incidence was observed at 14.0 mg cadmium/kg/day in the zinc-deficient rats. Exposure to 14.0 mg cadmium/kg/day also resulted in a significant increase in interstitial cell tumors of the testes in the group fed a zinc-adequate diet. The results of the study suggest that dietary zinc deficiency may inhibit the carcinogenic potential of cadmium, but additional research is needed.

A subsequent study by Waalkes et al. (1993) using male B6C3F1 mice evaluated the effects of cadmium exposure on tumor incidence at various times after the initiation of the carcinogenic process. The possible role of metallothionein in the susceptibility of transformed cells to cadmium cytotoxicity was also evaluated. At 5 weeks of age, mice received an intraperitoneal injection of *N*-nitrosodiethylamine (NDEA) at 90 mg/kg. At 2, 4, 8, 16, or 32 weeks post-NDEA injection, mice received water containing 1,000 ppm cadmium *ad libitum* for up to 48 weeks of post-NDEA exposure. Cadmium exposure caused a marked "reduction" in liver tumor incidence in NDEA-treated mice even when given as late as 32 weeks after the initial NDEA treatment. Cadmium alone eliminated the spontaneously occurring incidence of liver tumors (i.e., 0 of 25 compared with 5 of 25 in the controls). Liver tumors produced by NDEA were typically basophilic adenomas. Cadmium resulted in a modest reduction in lung tumor incidence, statistically significant (28% reduction) only for the 16–48-week cadmium-treated group pretreated with NDEA. Lung tumors were typically adenomas of alveolar cell origin. Cadmium alone eliminated spontaneously occurring lung tumors compared with the controls. Cadmium significantly reduced the multiplicity of tumors induced by NDEA. NDEA alone typically induced seven tumors per lung, while NDEA plus cadmium treatment reduced the number of tumors to 2.5–3.5 (data taken from a graph) with some cases showing an 80% reduction in tumor numbers. Lung tumors found in the cadmium plus



### 3. HEALTH EFFECTS

NDEA-treatment groups were also smaller in overall size than those found in the NDEA-only treatment groups. Relatively little metallothionein was present in liver carcinomas, liver adenomas, and lung adenomas as indicated by immunohistochemistry. This finding was confirmed biochemically for the liver tumors. The authors concluded that cadmium can effectively “impair” tumor formation in the lungs and liver of male B6C3F1 mice and that cadmium appears to be able to selectively destroy existing preneoplastic and/or tumor cells (adenomas). The mechanism may involve a reduced activity and responsiveness of the metallothionein system in transformed liver cells.

A two-stage initiation/promotion experiment evaluated the promoting effects of cadmium chloride in the drinking water in rats. Cadmium exposure resulted in the following alterations in tumorigenic outcome: in the liver, hepatocellular carcinomas (initiated with diethyl nitrosamine) were decreased; in the stomach, tumors (initiated with *N*-methyl-*N'*-nitro-nitrosoguanidine plus NaCl at 10% in the diet) were not affected; in the kidney, tumors (initiated with *N*-ethyl-*N*-hydroxyethyl nitrosamine) showed increased dysplastic foci but no increase in renal cell tumors; in the pancreas, tumors (initiated with *N*-nitrosobis [2-oxopropyl] amine) had a nonsignificant increase in adenocarcinomas (female hamster study); and in the skin (initiated with 7,12-dimethyl benz(a)anthracene), there was no effect (female SENCAR mouse study) (Kurokawa et al. 1989).

#### 3.2.3 Dermal Exposure

##### 3.2.3.1 Death

No studies were located regarding death in humans after dermal exposure to cadmium.

Some guinea pigs died 2 or 6 weeks after being exposed in a skin depot (3.1 cm<sup>2</sup>) to 2 mL of 0.239 molar aqueous of cadmium chloride (0.14 mg/kg body weight) (Wahlberg 1965). However, it is difficult to attribute these deaths to cadmium exposure, due to the low dose compared to oral LD<sub>50</sub> values and to the fact that no necropsy was done to determine whether the exposed guinea pigs might have died from pneumonia (which killed some control guinea pigs) (Wahlberg 1965).

##### 3.2.3.2 Systemic Effects

No studies were located regarding respiratory, cardiovascular, gastrointestinal, hematological, musculoskeletal, hepatic, or renal effects in humans or animals after dermal exposure to cadmium.

### 3. HEALTH EFFECTS

**Dermal Effects.** Among eczema patients routinely patch-tested with 2% cadmium chloride, 25 out of 1,502 showed some reaction (Wahlberg 1977). Since no reaction was found at lower dilutions in reactive patients (Wahlberg 1977), the effect was likely direct irritation of the skin and is indicated as a LOAEL value in [Table 3-9](#).

No studies were located regarding dermal effects in animals after dermal exposure to cadmium.

**Ocular Effects.** No studies were located regarding ocular effects in humans after dermal exposure to cadmium.

Rats exposed to high concentrations of cadmium pigments or cadmium oxide in air had excessive lacrimation four hours after exposure (Rusch et al. 1986), possibly due to a direct irritation effect on the eyes.

#### 3.2.3.3 Immunological and Lymphoreticular Effects

Dermal exposure to cadmium does not appear to affect the immune system significantly. One report of workers with extensive exposure to cadmium dust reported an increase in complaints of eczema (Friberg 1950); however, no subsequent studies have confirmed any association. Routine patch tests among dermatitis and eczema patients using up to 2% cadmium chloride solutions have found skin irritation at 2%, but no evidence of allergic reactions at a dose of 1% among people without known prior cadmium exposure (Rudzki et al. 1988; Wahlberg 1977) or among workers occupationally exposed to cadmium (Rudzki et al. 1988). Individuals with yellow tattoos containing cadmium sulfide often experience swelling of the surrounding skin on exposure to ultra violet (UV) irradiation (Bjornberg 1963); however, this may be the result of dermal damage from the photoconductivity of cadmium sulfide rather than a direct immunological reaction.

Guinea pigs showed no contact sensitization following intradermal or topical exposure to cadmium chloride at concentrations up to 0.5% (Wahlberg and Boman 1979). The NOAEL values from each reliable study for immunological effects in each species and duration category are recorded in [Table 3-9](#).

Table 3-9 Levels of Significant Exposure to Cadmium - Dermal

Species (Strain)	Exposure/Duration/Frequency (Route)	System	LOAEL				Reference Chemical Form	Comments
			NOAEL	Less Serious		Serious		
<b>ACUTE EXPOSURE</b>								
<b>Systemic</b>								
Human	once	Dermal	1 Percent (%)	2 (skin irritation) Percent (%)			<a href="#">Wahlberg 1977</a> CdCl <sub>2</sub>	
Rat (Sprague-Dawley)	2 hr	Ocular		99 mg/m <sup>3</sup> (excessive lacrimation)	112 mg/m <sup>3</sup> (eyes closed from exposure)		<a href="#">Rusch et al. 1986</a> CdSeS	
				97 mg/m <sup>3</sup> (excessive lacrimation)				
<b>Immuno/ Lymphoret</b>								
Human	once		1 Percent (%)				<a href="#">Rudzki et al. 1988</a> CdCl <sub>2</sub>	

hr = hour(s); Immuno/Lymphoret = immunological/lymphoreticular; LOAEL = lowest-observed-adverse-effect level; NOAEL = no-observed-adverse-effect level

### 3. HEALTH EFFECTS

No studies were located regarding the following health effects in humans or animals after dermal exposure to cadmium:

#### **3.2.3.4 Neurological Effects**

#### **3.2.3.5 Reproductive Effects**

#### **3.2.3.6 Developmental Effects**

#### **3.2.3.7 Cancer**

### **3.3 GENOTOXICITY**

The genotoxic potential of cadmium has been studied in *in vivo* studies of cadmium workers, members of the general population, and rodents as summarized in [Table 3-10](#). Although not always consistent, these results suggest that cadmium is a clastogenic agent, as judged by the induction of DNA damage, micronuclei, sister chromatid exchange (SCE), and chromosomal aberrations.

Palus et al. (2003) examined peripheral lymphocytes from workers occupationally exposed to cadmium and found statistically significant increases compared to the control population in micronuclei rates and sister chromatid exchanges as well as evidence of an increased incidence of leukocytes with DNA fragmentation. Examination of lymphocytes and leukocytes from workers occupationally exposed to cadmium and lead or to cadmium, lead, and zinc showed increased frequency of chromosomal aberrations compared to control groups (Abraham et al. 2011; Bauchinger et al. 1976; Deknudt and Leonard 1975; Deknudt et al. 1973), but this effect was not observed in men exposed primarily to cadmium (Bui et al. 1975; O'Riordan et al. 1978). Human lymphocytes from individuals inhabiting cadmium-polluted areas of China have been found to have increased micronuclei rates and a higher frequency of chromosomal aberrations and severe aberration types, in comparison to control populations with either no known exposure to cadmium or low-level exposure (Fu et al. 1999; Tang et al. 1990). Bui et al. (1975) examined blood samples from four female Japanese patients with Itai-Itai disease and found no evidence to indicate that cadmium is capable of inducing chromosomal damage.

For the most part, cadmium exposure via inhalation (Valverde et al. 2000), oral (Devi et al. 2001; Kasuba et al. 2002), and parenteral (Fahmy and Aly 2000; Kasuba et al. 2002; Mukherjee et al. 1988a; Saplakoglu et al. 1997; Wronska-Nofer et al. 1999; Zhou et al. 2004b) routes has been shown to be associated with DNA damage and induction of micronuclei in rodent cells.

## 3. HEALTH EFFECTS

**Table 3-10. Genotoxicity of Cadmium *In Vivo***

Species (test system)	End point	Results	Reference
Mammalian cells:			
Inhalation exposure:			
Human lymphocytes	Chromosomal aberrations	+	Deknudt et al. 1973
Human lymphocytes	Chromosomal aberrations	–	Bui et al. 1975
Human lymphocytes	Chromosomal aberrations	+	Deknudt and Leonard 1975
Human lymphocytes	Chromosomal aberrations	+	Bauchinger et al. 1976
Human lymphocytes	Chromosomal aberrations	–	O’Riordan et al. 1978
Human lymphocytes	Chromosomal aberrations	+	Alessio et al. 1993
Human lymphocytes	Chromosomal aberrations	+	Abraham et al. 2011
Human lymphocytes	Sister chromatid exchanges	+	Abraham et al. 2011
Human lymphocytes	Sister chromatid exchanges	+	Palus et al. 2003
Human lymphocytes	Micronuclei	+	Palus et al. 2003
Human lymphocytes	DNA damage	+	Palus et al. 2003
Mouse bone marrow	DNA damage	+	Valverde et al. 2000
Mouse brain cells	DNA damage	+	Valverde et al. 2000
Mouse testicular cells	DNA damage	+	Valverde et al. 2000
Mouse liver cells	DNA damage	+	Valverde et al. 2000
Mouse kidney cells	DNA damage	+	Valverde et al. 2000
Mouse lung cells	DNA damage	+	Valverde et al. 2000
Mouse nasal epithelial cells	DNA damage	+	Valverde et al. 2000
Oral exposure:			
Rat bone cells	Altered gene expression	+	Ohba et al. 2007
Mouse bone marrow	Chromosomal aberrations	–	Deknudt and Gerber 1979
Mouse bone marrow	Chromosomal aberrations	+	Mukherjee et al. 1988b
Rat bone marrow	Chromosomal aberrations	–	Desi et al. 2000
Human leukocytes	Chromosomal aberrations	+	Shiraishi and Yoshida 1972
Human lymphocytes	Chromosomal aberrations	–	Bui et al. 1975
Human lymphocytes	Chromosomal aberrations	+	Tang et al. 1990
Human lymphocytes	Chromosomal aberrations	+	Fu et al. 1999
Mouse leukocytes	DNA damage	+	Devi et al. 2001
Rat lymphocytes	DNA damage	+	Kasuba et al. 2002
Rat spermatogenesis	Dominant lethal mutations	–	Sutou et al. 1980
Rat spermatogenesis	Dominant lethal mutations	–	Zenick et al. 1982
Rat lymphocytes	Micronuclei	+	Kasuba et al. 2002
Human lymphocytes	Micronuclei	+	Fu et al. 1999
Intraperitoneal exposure:			
Mouse oocytes	Aneuploidy	–	Mailhes et al. 1988
Mouse spermatocytes	Chromosomal aberrations	+	Selypes et al. 1992

## 3. HEALTH EFFECTS

**Table 3-10. Genotoxicity of Cadmium *In Vivo***

Species (test system)	End point	Results	Reference
Mouse bone marrow	Chromosomal aberrations	+	Fahmy and Aly 2000
Mouse spermatocytes	Chromosomal aberrations	+	Fahmy and Aly 2000
Mouse bone marrow	Chromosomal aberrations	–	Bruce and Heddle 1979
Mouse bone marrow	Chromosomal aberrations	+	Mukherjee et al. 1988a
Mouse spermatocytes	Chromosomal translocations	–	Gilliavod and Leonard 1975
Rat lung cells	DNA strand breaks	+	Saplakoglu et al. 1997
Rat kidney cells	DNA strand breaks	+	Saplakoglu et al. 1997
Rat liver cells	DNA strand breaks	–	Saplakoglu et al. 1997
Mouse spermatogenesis	Dominant lethal mutations	–	Epstein et al. 1972
Mouse spermatogenesis	Dominant lethal mutations	–	Gilliavod and Leonard 1975
Mouse oocytes	Dominant lethal mutations	–	Suter 1975
Rat lymphocytes hprt locus	Gene mutation	±	Jianhua et al. 2006
Mouse bone marrow	Micronuclei	±	Mukherjee et al. 1988a
Mouse bone marrow	Micronuclei	+	Wronska-Nofer et al. 1999
Mouse bone marrow	Micronuclei	+	Fahmy and Aly 2000
Mouse bone marrow	Sister chromatid exchanges	+	Mukherjee et al. 1988a
Mouse bone marrow	Sister chromatid exchanges	+	Fahmy and Aly 2000
Mouse spermatozoa	Sperm morphology	–	Bruce and Heddle 1979
Mouse spermatozoa	Sperm morphology	+	Mukherjee et al. 1988a
Syrian hamster embryo cells	Transformation	+	DiPaulo and Castro 1979
Subcutaneous exposure:			
Mouse testicular cells	Altered gene expression	+	Zhou et al. 2004b
Mouse blastocysts	Aneuploidy	+	Watanabe and Endo 1982
Syrian hamster oocytes	Aneuploidy	+	Watanabe et al. 1979
Mouse bone marrow	Chromosomal aberrations	+	Karmakar et al. 1998
Mouse testicular cells	DNA damage	–	Zhou et al. 2004b
Rat lymphocytes	DNA damage	+	Kasuba et al. 2002
Rat lymphocytes	Micronuclei	+	Kasuba et al. 2002
Mouse bone marrow	Sister chromatid exchanges	–	Nayak et al. 1989
Mouse fetal liver and lung cells	Sister chromatid exchanges	–	Nayak et al. 1989

– = negative result; + = positive result; ± = weakly positive result; DNA = deoxyribonucleic acid

## 3. HEALTH EFFECTS

Evidence of the potential for cadmium to induce SCE (Fahmy and Aly 2000; Mukherjee et al. 1988a; Nayak et al. 1989) and chromosomal aberrations (Bruce and Heddle 1979; Desi et al. 2000; DiPaulo and Castro 1979; Fahmy and Aly 2000; Karmakar et al. 1998; Mukherjee et al. 1988a; Tang et al. 1990; Watanabe et al. 1979) is mixed. Data regarding the aneugenic potential of cadmium are limited and also conflicting. Watanabe and Endo (1982) observed an increased incidence of mouse blastocysts with trisomies and triploidies from female mice treated subcutaneously with cadmium compared to control mice. Watanabe et al. (1979) reported that subcutaneous exposure to cadmium induced mutagenicity in hamster oocytes, and in particular, induced the production of diploid oocytes. However, Mailhes et al. (1988) did not observe an increased incidence of hyperploid oocytes in female mice treated with cadmium via intraperitoneal injection.

No evidence for germ cell mutations (the dominant lethal test) has been observed in male rats orally exposed to cadmium (Sutou et al. 1980; Zenick et al. 1982) or in mice exposed to cadmium via inhalation (Gilliavod and Leonard 1975; Suter 1975) or intraperitoneal exposure (Epstein et al. 1972). However, chromosomal aberrations in mouse spermatocytes and Syrian hamster oocytes (Fahmy and Aly 2000; Selypes et al. 1992; Watanabe et al. 1979) and altered gene expression in mouse testicular cells (Zhou et al. 2004b) have been observed following cadmium exposure.

Data based on *in vitro* examination of the genotoxic effects of cadmium in microorganisms, yeast, insects, and mammalian cells are summarized in [Table 3-11](#). For the most part, *in vitro* data support the *in vivo* data suggesting that cadmium has the potential to induce DNA damage, micronuclei, chromosomal aberrations, and genetic mutations.

*In vitro* studies have shown that cadmium induces genetic mutations in hamster and mouse cells (Amacher and Paillet 1980; Filipic and Hei 2004; Honma et al. 1999; Jianhua et al. 2006; Oberly et al. 1982), transformation in rodent cells (Casto et al. 1979; Terracio and Nachtigal 1988), unscheduled DNA synthesis in rat cells (Denizeau and Marion 1989), DNA breaks in human cells (Depault et al. 2006; Lopez-Ortal et al. 1999; Mikhailova et al. 1997), DNA lesions in hamster cells (Jianhua et al. 2006), and inhibits DNA repair in human and hamster cells (Lutzen et al. 2004; Lynn et al. 1997). Misra et al. (1998) did not observe DNA damage in rat cells following treatment with cadmium, but DNA damage has been noted in human cells (Fatur et al. 2002; Rozgaj et al. 2002).

Chromosomal aberrations following cadmium exposure have been observed in Chinese hamster ovary cells (Cai and Arenaz 1998; Deaven and Campbell 1980; Rohr and Bauchinger 1976), but studies on

## 3. HEALTH EFFECTS

**Table 3-11. Genotoxicity of Cadmium *In Vitro***

Species (test system)	End point	Results		Reference
		With activation	Without activation	
Prokaryotic organisms:				
<i>Bacillus subtilis</i>	DNA repair	No data	±	Nishioka 1975
<i>B. subtilis</i>	DNA repair	No data	±	Kanematsu et al. 1980
<i>Salmonella typhimurium</i> (plate incorporation)	Gene mutation	–	–	Bruce and Heddle 1979
<i>S. typhimurium</i> (liquid suspension)	Gene mutation	–	–	Milvy and Kay 1978
<i>S. typhimurium</i> (liquid suspension)	Gene mutation	No data	±	Mandel and Ryser 1984
<i>S. typhimurium</i> (plate incorporation)	Gene mutation	–	+	Wong 1988
Eukaryotic organisms:				
Yeast:				
<i>Saccharomyces cerevisiae</i>	Gene mutation	No data	+	Putrament et al. 1977
<i>S. cerevisiae</i>	Intrachromosomal recombination	No data	+	Schiestl et al. 1989
Insects:				
<i>Drosophila melanogaster</i>	Dominant lethal mutations	No data	+	Vasudev and Krishnamurthy 1979
<i>D. melanogaster</i>	Nondisjunction	No data	–	Ramel and Magnusson 1979
<i>D. melanogaster</i>	Sex-linked recessive lethal mutations	No data	–	Inoue and Watanabe 1978
Mammalian cells:				
Mouse spleen cells	Chromosomal aberration	No data	+	Fahmy and Aly 2000
Chinese hamster ovary Hy cells	Chromosomal aberration	No data	+	Rohr and Bauchinger 1976
Chinese hamster ovary CHO cells	Chromosomal aberration	No data	+	Deaven and Campbell 1980
Chinese hamster ovary CHO cells	Chromosomal aberration	No data	+	Cai and Arenaz 1998
Human leukocytes	Chromosomal aberrations	No data	+	Shiraishi et al. 1972
Human blood lymphocytes	Chromosomal aberration	No data	–	Paton and Allison 1972
Human blood lymphocytes	Chromosomal aberration	No data	+	Shiraishi et al. 1972



## 3. HEALTH EFFECTS

**Table 3-11. Genotoxicity of Cadmium *In Vitro***

Species (test system)	End point	Results		Reference
		With activation	Without activation	
Human blood lymphocytes	Chromosomal aberration	No data	–	Deknudt and Deminatti 1978
Human blood lymphocytes	Chromosomal aberration	No data	±	Gasiorek and Bauchinger 1981
Human blood lymphocytes	DNA breaks	No data	+	Depault et al. 2006
Human lymphoblastoid cells	DNA breaks	No data	+	Mikhailova et al. 1997
Human fetal hepatic WRL-68 cells	DNA breaks	No data	+	Lopez-Ortal et al. 1999
Chinese hamster ovary CHO-K1 cells	DNA damage	No data	–	Misra et al. 1998
Rat L6 myoblast cells	DNA damage	No data	–	Misra et al. 1998
Rat Clone 9 liver cells	DNA damage	No data	–	Misra et al. 1998
Rat TRI 1215 liver cells	DNA damage	No data	–	Misra et al. 1998
Human blood lymphocytes	DNA damage	No data	+	Rozgaj et al. 2002
Human hepatoma cells (HepG2)	DNA damage	No data	+	Fatur et al. 2002
V79 Chinese hamster lung cells	DNA lesions	No data	+	Jianhua et al. 2006
Chinese hamster ovary CHO-K1 cells	DNA repair	No data	+	Lynn et al. 1997
Human 293T-Tet-Off-hMLH1 cells	DNA repair	No data	+	Lutzen et al. 2004
V79 Chinese hamster lung cells hprt locus	Gene mutation	No data	+	Jianhua et al. 2006
A <sub>L</sub> human-hamster hybrid CD59 gene	Gene mutation	No data	+	Filipic and Hei 2004
Mouse lymphoma L5178Y thymidine kinase locus	Gene mutation	No data	±	Amacher and Paillet 1980
Mouse lymphoma L5178Y thymidine kinase locus	Gene mutation	No data	+	Oberly et al. 1982
Mouse lymphoma L5178Y thymidine kinase locus	Gene mutation	+	+	Honma et al. 1999
Human blood lymphocytes	Micronuclei	No data	+	Migliore et al. 1999
Human blood lymphocytes (G <sub>0</sub> phase)	Micronuclei	No data	–	Kasuba and Rozgaj 2002
Human blood lymphocytes (S phase)	Micronuclei	No data	+	Kasuba and Rozgaj 2002
Human diploid fibroblasts (MRC-5)	Micronuclei	No data	+	Seoane and Dulout 2001
Mouse spleen cells	Sister chromatid exchanges	No data	+	Fahmy and Aly 2000

## 3. HEALTH EFFECTS

**Table 3-11. Genotoxicity of Cadmium *In Vitro***

Species (test system)	End point	Results		Reference
		With activation	Without activation	
Human blood lymphocytes	Sister chromatid exchanges	No data	–	Bassendowska-Karska and Zawadzka-Kos 1987
Human blood lymphocytes (G <sub>0</sub> phase)	Sister chromatid exchanges	No data	–	Saplakoglu and Iscan 1998
Human blood lymphocytes (S phase)	Sister chromatid exchanges	No data	+	Saplakoglu and Iscan 1998
Syrian hamster embryo cells	Transformation	No data	+	Casto et al. 1979
Rat ventral prostate cells	Transformation	No data	+	Terracio and Nachtigal 1988
Rat hepatocytes	Unscheduled DNA synthesis	No data	+	Denizeau and Marion 1989

– = negative result; + = positive result; ± = weakly positive; CHO = Chinese hamster ovary; DNA = deoxyribonucleic acid; NA = not applicable; RNA = ribonucleic acid

### 3. HEALTH EFFECTS

human cells have shown mixed results (Deknudt and Deminatti 1978; Gasiorek and Bauchinger 1981; Paton and Allison 1972; Shiraishi et al. 1972). For the most part, *in vitro* studies have not shown cadmium to induce SCE in human cells (Bassendowska-Karska and Zawadzka-Kos 1987; Saplakoglu and Iscan 1998). However, a study by Fahmy and Aly (2000) did observe SCE in mouse spleen cells following cadmium treatment. Kasuba and Rozgaj (2002) and Saplakoglu and Iscan (1998) evaluated the ability of cadmium to induce micronuclei and SCE in human lymphocytes *in vitro* respectively, at two different stages of the cell cycle, G<sub>0</sub> and S phase. These studies observed that the genotoxicity of cadmium may vary depending on the stage of the cell cycle as both micronuclei and SCE were induced in cells in S phase, but not in cells in G<sub>0</sub> phase. These observations may in part explain some of the contradictory findings regarding cadmium genotoxicity in the literature.

Positive mutagenicity results have been found in some studies using bacterial cells (Kanematsu et al. 1980; Mandel and Ryser 1984; Nishioka 1975; Wong 1988), in studies using yeast (Putrament et al. 1977; Schiestl et al. 1989), and in a single study using *Drosophila melanogaster* (Vasudev and Krishnamurthy 1979). Other studies report negative mutagenicity results in bacterial cells (Bruce and Heddle 1979; Milvy and Kay 1978) and in *D. melanogaster* (Inoue and Watanabe 1978; Ramel and Mangusson 1979).

#### 3.4 TOXICOKINETICS

Cadmium metal and cadmium salts are not well absorbed; approximately 25, 1–10, or <1% of the dose is absorbed following inhalation, oral, or dermal exposure. Several factors can influence inhalation and oral absorption efficiency; for example, cadmium in cigarette smoke has a higher absorption efficiency due to its small particle size and cadmium absorption from the gastrointestinal tract is increased in individuals with poor iron status. Following absorption from any route of exposure, cadmium widely distributes throughout the body, with the highest concentrations found in the liver and kidney. Cadmium is not known to undergo any direct metabolic conversion such as oxidation, reduction, or alkylation. Absorbed cadmium is excreted very slowly, with urinary and fecal excretion being approximately equal. Approximately 0.007 and 0.009% of the body burden is excreted in the urine and feces, respectively, per day.

## 3. HEALTH EFFECTS

**3.4.1 Absorption****3.4.1.1 Inhalation Exposure**

Cadmium metal and cadmium salts have low volatility and exist in air primarily as fine suspended particulate matter. When inhaled, some fraction of this particulate matter is deposited in the airways or the lungs, and the rest is exhaled. Large particles (greater than about 10  $\mu\text{m}$  in diameter) tend to be deposited in the upper airway, while small particles (approximately 0.1  $\mu\text{m}$ ) tend to penetrate into the alveoli. While some soluble cadmium compounds (cadmium chloride and cadmium sulfate) may undergo limited absorption from particles deposited in the respiratory tree, the major site of absorption is the alveoli. Thus, particle size, which controls alveolar deposition, is a key determinant of cadmium absorption in the lung (Nordberg et al. 1985).

No direct data are available on cadmium deposition, retention, or absorption in the human lung. Data from animal studies indicate that lung retention is greatest after short-term exposure (5–20% after 15 minutes to 2 hours) (Barrett et al. 1947; Henderson et al. 1979; Moore et al. 1973; Rusch et al. 1986). The initial lung burden declines slowly after exposure ceases (Henderson et al. 1979; Moore et al. 1973; Rusch et al. 1986) due to absorption of cadmium and lung clearance of deposited particles. After longer periods of inhalation exposure to cadmium, somewhat lower lung retentions are found (Glaser et al. 1986). The absorption of cadmium in lung differs somewhat among chemical forms, but the pattern does not correlate with solubility (Glaser et al. 1986; Rusch et al. 1986).

Based on comparison of cadmium body burdens in human smokers and nonsmokers, cadmium absorption from cigarettes appears to be higher than absorption of cadmium aerosols measured in animals (Nordberg et al. 1985). The chemical form of cadmium in cigarette smoke is likely to be similar to that produced by other combustion processes, primarily cadmium oxide aerosols. The greater absorption of cadmium from cigarette smoke is likely due to the very small size of particles in cigarette smoke and the consequent very high alveolar deposition (Nordberg et al. 1985; Takenaka et al. 2004).

Based on the physiology of the human respiratory tree, a comprehensive model has been developed to predict the kinetics of inhaled cadmium in humans (Nordberg et al. 1985). Results of this model suggest that only about 5% of particles  $>10 \mu\text{m}$  in diameter will be deposited, up to 50% of particles  $<0.1 \mu\text{m}$  will be deposited, and between 50 and 100% of cadmium deposited in the alveoli will ultimately be absorbed (Nordberg et al. 1985).

## 3. HEALTH EFFECTS

**3.4.1.2 Oral Exposure**

Most ingested cadmium passes through the gastrointestinal tract without being absorbed (Kjellström et al. 1978). Measurement of gastrointestinal absorption is complicated by the fact that not all of a dose initially retained in the gastrointestinal system can be considered to be absorbed, because some portion may be trapped in the intestinal mucosa without crossing into the blood or lymph (Foulkes 1984). Thus, measures of whole-body cadmium retention may overestimate cadmium absorption (at least in the short-term). On the other hand, some absorbed cadmium may be excreted in urine or feces, so that retention may underestimate exposure. However, this underestimate is probably minor because excretion of absorbed cadmium is very slow (see Section 3.4.4.2).

Cadmium absorption has been estimated based on the retention of cadmium in the bodies of humans following ingestion of radioactive cadmium. Estimated cadmium absorption ranged from 1.1 to 10.6% (Flanagan et al. 1978; McLellan et al. 1978; Newton et al. 1984; Rahola et al. 1973; Shaikh and Smith 1980; Vanderpool and Reeves 2001). Although some studies have reported higher absorption levels (25–42%), this was based on cadmium retention measurements for 3–5 days after exposure that was probably too short to accurately measure cadmium transfer from the intestinal mucosa to circulation (Crews et al. 2000; Rahola et al. 1973). Using estimated cadmium intakes from national data and measured renal and urinary cadmium levels in healthy nonsmokers, cadmium absorption rates of 3–5% have been estimated (Ellis et al. 1979; Morgan and Sherlock 1984). In a balance study of women with high background cadmium intakes (mean urinary cadmium levels of 2.7–5.16 µg/g creatinine); the mean absorption rate in subjects examined for 7 days was 6.5% (Horiguchi et al. 2004).

The body store of iron influences cadmium absorption; subjects with low iron stores (assessed by serum ferritin levels) had an average absorption of 6 and 8.9%, while those with adequate iron stores had an average absorption of 2.3 and 2.4% (Flanagan et al. 1978; Shaikh and Smith 1980). Several epidemiology studies have found significant negative correlations between body iron (assessed via serum ferritin and/or transferrin levels) and cadmium body burden (blood cadmium and/or urinary cadmium levels) among men and women (Apinan et al. 2010) and among never-smoking, nonpregnant, nonmenopausal women (Gallagher et al. 2011; Meltzer et al. 2010). Studies in rats have shown that iron deficiency results in the upregulation of divalent metal transporter 1 (DMT1) and metal transporter protein 1 (MTP1) in the duodenum, which may facilitate the absorption of cadmium (Kim et al. 2007; Ryu et al. 2004). Other epidemiology studies have found significantly higher cadmium body burdens in women with lower iron stores (Kippler et al. 2009). In contrast, a study of anemic females with high

## 3. HEALTH EFFECTS

background cadmium levels did not find a significant alteration in cadmium absorption, as compared to healthy females; however, cadmium absorption was lower in the anemic group (13.6%) than in healthy group (27.4%) (Horiguchi et al. 2004). It is not known if the differences in the methods used to estimate cadmium absorption (kinetic study using radiolabelled cadmium versus a balance study) or the high background cadmium intake in the Horiguchi study resulted in the discrepancy between the two studies. There is some indication that not all forms of cadmium are equally absorbed. Some populations with high dietary-cadmium exposure from Bluff oysters (McKenzie-Parnell et al. 1988) or seal meat (Hansen et al. 1985) have been found not to have elevated blood-cadmium levels, perhaps due to the particular form of cadmium in these foods.

Crews et al. (2000) estimated that 42% of a cadmium dose incorporated into porridge was retained in the body 5 days after exposure (as measured by fecal excretion of radiolabelled cadmium); however, the fecal collection period was probably too short to accurately measure cadmium absorption. The investigators also attempted to measure cadmium absorption in 12-month-old infants; 18% of the labeled cadmium in the porridge was retained in the body after 4 days. As with the adult data, the collection period may have been too short to accurately measure cadmium absorption in the infants.

Most estimates of cadmium absorption in animals are somewhat lower than the values found from human studies, particularly after prolonged exposure. In mice, 0.27–3.2% of an oral dose of cadmium chloride was retained after 3–5 days (Bhattacharyya et al. 1981; Engstrom and Nordberg 1979), and in rats, 2–3% of a single oral dose of cadmium chloride was retained (Moore et al. 1973; Schafer et al. 1990). Following 30 days of oral exposure, 0.2–0.3% of an administered dose was retained in rats (Muller et al. 1986). After 4 weeks of dietary exposure to cadmium, absorption of cadmium was reduced to one-third the absorption of rats without pre-exposure to cadmium (Schafer et al. 1990). Cadmium pigments (cadmium sulfide and cadmium sulfoselenide) appear to be absorbed much less than cadmium chloride in rats (ILZRO 1977). Increases in absorption have been observed during gestation and lactation, 0.37 and 0.35% of cadmium administered via gavage was absorbed in mice on gestation days 8 and 15 and 0.56, 0.60, and 0.30% on lactation days 10, 17, and 24, as compared to 0.27% in nonpregnant controls; absorption was only significantly different from nonpregnant controls on lactation days 10 and 17 (Bhattacharyya et al. 1981). Similar findings were observed in mice continuously exposed to cadmium during pregnancy and/or lactation (Bhattacharyya et al. 1982, 1986).

The absorption of cadmium from the gastrointestinal tract has been extensively studied in rats and mice, and a number of factors are recognized that influence absorption. Absorption appears to take place in two

## 3. HEALTH EFFECTS

phases: uptake from lumen into mucosa, and transfer into the circulation (Foulkes 1985). Phase 1 may involve sequestering of cadmium by metallothionein (Foulkes 1980), but any protective effect is overloaded at moderate doses (Kotsonis and Klaassen 1978). Uptake behaves like a saturable process with fractional absorption decreasing at high concentrations (Foulkes 1980). There is evidence, however, to suggest that this saturation results from charge neutralization at the membrane (Foulkes 1985), so that it need not be assumed that there is a specific system for carrying cadmium into the body. At doses high enough to damage gastrointestinal mucosa, fractional absorption is increased (Andersen et al. 1988; Goon and Klaassen 1989; Lehman and Klaassen 1986). Cadmium bound to metallothionein was absorbed by rats to a lesser extent than cadmium added to the diet as cadmium chloride, but kidney cadmium content was only slightly less (Groten et al. 1990).

Maitani et al. (1984) compared the distribution of cadmium after oral administration of either cadmium ions or Cd-thionein in male CF-1 mice given 0.5 mg Cd/kg, per os (po), as cadmium chloride in saline, cadmium chloride in control rat liver homogenate, cadmium thionein in saline, Cd-TH in liver homogenate, or liver homogenate from Cd-treated rats. In all cases, 85–90% of the cadmium dose was present in feces within 24 hours. However, in groups receiving cadmium chloride, more cadmium was found in feces on days 2 and 3, compared to those receiving cadmium-thionein. In a companion study, tissue levels indicated that less cadmium was absorbed when rats received cadmium-thionein in saline than cadmium chloride in saline. Cadmium-thionein added to liver homogenate or liver homogenate containing cadmium-thionein increased the absorption of cadmium, resulting in renal cadmium levels similar to those in mice receiving cadmium chloride in saline. The kidney/liver cadmium concentration ratio (9) was the same for cadmium-thionein in all three media. Although Cd-TH gave much higher kidney/liver cadmium ratios than cadmium chloride (9 versus 2), renal cadmium concentrations were the same or lower than after cadmium chloride treatments. The authors concluded that the high kidney/liver cadmium ratio after cadmium-thionein treatment versus cadmium chloride was due to lower concentrations of cadmium in liver rather than marked increases in renal cadmium levels. While the chemical form of cadmium administered affects the absorption and distribution, the amount of cadmium reaching the kidney after cadmium-thionein administration is similar to that after cadmium chloride administration.

At moderate doses of cadmium, the presence of divalent and trivalent cations, such as calcium, chromium, magnesium, and zinc, may decrease cadmium uptake, probably by a nonspecific effect on the charge distribution of the intestinal brush border membrane (Foulkes 1985). However, the influence of cations on cadmium absorption is complex, because zinc can increase the amount of cadmium absorbed

## 3. HEALTH EFFECTS

from the intestine (Jaeger 1990). A refined diet high in fat and protein increases cadmium absorption in mice, partially due to increased gastrointestinal passage time (Schafer et al. 1986). Studies in newborn rats and pigs also provide evidence that diet constituents influence cadmium absorption; absorption of cadmium chloride was higher when administered in water compared to cereal-based infant formula (Eklund et al. 2001, 2004). Diets low in iron increase cadmium absorption (Flanagan et al. 1978; Reeves and Chaney 2001, 2002; Schafer et al. 1990); a diet low in calcium will also increase cadmium absorption (Reeves and Chaney 2001, 2002). In contrast, low levels of dietary iron did not increase cadmium absorption in suckling piglets; however, iron supplementation did increase cadmium absorption (Öhrvik et al. 2007); this difference may be due to the high cadmium dose used in the study. Zinc deficiency may result in an increased accumulation of cadmium in the intestinal wall, but does not affect transport into the blood (Foulkes and Voner 1981; Hoadley and Cousins 1985). The absorption of cadmium in rats depends on age, with measured absorption decreasing from 12 to 5 to 0.5% at 2 hours, 24 hours, and 6 weeks after birth, respectively (Sasser and Jarboe 1977). Sasser and Jarboe (1980) also reported that absorption of cadmium in the gastrointestinal tract of young guinea pigs was 20-fold higher than in adult guinea pigs. Thus, for a given individual, the absorption following oral exposure to cadmium is likely to depend on physiologic status (age; body stores of iron, calcium, and zinc; pregnancy history; etc.) and, also, on the presence and levels of ions and other dietary components ingested with the cadmium.

**3.4.1.3 Dermal Exposure**

A few measurements of dermal absorption of cadmium in animals have been made, with only one *in vitro* study using human skin to determine the percutaneous absorption of cadmium.

A study by Wester et al. (1992) evaluated the percutaneous absorption of cadmium from water and soil into and through human skin using *in vitro* skin cells. Radioactive cadmium ( $^{109}$ cadmium chloride) was made to a concentration of 116 ppb in water or 13 ppb in filtered soil (26% sand, 26% clay, 48% silt, 0.9% organic content). Cadmium chloride was administered either at 5  $\mu\text{L}/\text{cm}^2$  or 2 volumes of 2.5  $\mu\text{L}/\text{cm}^2$  (the same amount of cadmium apparently applied). Human cadaver skin dermatomed at 500  $\mu\text{m}$  was placed in flow-through skin cells and perfused with human plasma. Approximately 0.1–0.6% of the cadmium chloride in water entered the plasma perfusate over the 16-hour perfusion period, while 2.4–12.7% of applied dose remained in the skin. Most of the cadmium (74–93%) remained unabsorbed and was recovered from the skin surface. Total recoveries ranged from  $88 \pm 20$  to  $103 \pm 3$ . When cadmium-contaminated soil (13 ppb cadmium chloride) was applied to the skin surface, plasma levels ranged from 0.02 to 0.07% of the applied dose, while the skin contained 0.06–0.13% of applied



## 3. HEALTH EFFECTS

dose. Surface wash ranged from 82 to 102% of applied dose. Total recoveries were from  $83 \pm 33$  to  $106 \pm 2$ . The large differences between water and soil absorption into the plasma and retention in the skin were attributed to differences in cadmium partition coefficients, measured to be  $3.61 \times 10^1$  for stratum corneum (powdered):water and  $1.03 \times 10^5$  for soil:water. These measurements indicate that soil has a relatively higher affinity for cadmium than does the stratum corneum. The transfer of cadmium from soil to skin depends on the soil's binding capacity and water retention and variables describing the physical contact with the skin. When cadmium levels in the soil were increased from 6.5 to 65 ppb, skin levels correspondingly increased, but plasma receptor fluid levels remained constant. This suggests that, with *in vitro* perfusion, the surface concentration of cadmium will influence skin cadmium concentration, but that absorption into plasma receptor fluid is relatively independent of the skin surface concentration. The authors offer the caveat that *in vitro* methods can influence results and therefore, the receptor fluid accumulation must be interpreted with caution. The authors calculate that a whole-body exposure to cadmium at 116 ppb in water with 0.5% absorption will result in a daily systemic intake of about 10  $\mu\text{g}$  cadmium.

A few animal studies are available that describe the percutaneous absorption of cadmium as estimated from the accumulation of cadmium in the liver and kidneys of mice and rabbits. Male rabbits (strain not specified) dosed with cadmium chloride percutaneously via a 1% aqueous solution (6.1 mg cadmium) or 2% ointment (12.2 mg cadmium) over a 10-cm<sup>2</sup> shaved area (Kimura and Otaki 1972). Animals were treated 5 times over 3 weeks (duration of exposure not reported) and were killed 2 weeks after the last application. Only cadmium contents of liver and kidney were measured, so total absorption through the skin may have been greater. Accumulated amounts of cadmium in the liver and kidneys were found to be 0.4–0.61% 2 weeks after the end of cadmium exposure. This percentage was similar for aqueous solution or hydrocarbon ointment. Similarly, male hairless mice (strain not specified) were dosed with cadmium chloride percutaneously with a 2% ointment (containing 0.61 mg cadmium) 1 or 5 times in a week (duration of exposure not reported) and killed 1 week later (Kimura and Otaki 1972). Accumulated amounts of cadmium in the liver and kidneys were found to be 0.2–0.87%.

Cadmium was detected in liver, kidneys, and urine following dermal exposure in guinea pigs (Skog and Wahlberg 1964). The disappearance of cadmium from cadmium chloride in water applied to guinea pig skin was dependent on concentration, with a peak mean absorption of 1.8% over 5 hours at 0.239 molar cadmium (about a 2.7% solution). Less absorption occurred both at higher and lower concentrations of a cadmium chloride solution applied to the skin (Skog and Wahlberg 1964).

## 3. HEALTH EFFECTS

The results from all of these studies suggest that dermal absorption is slow, and would be of concern only in situations where concentrated solutions would be in contact with the skin for several hours or longer.

### 3.4.2 Distribution

Cadmium is widely distributed in the body, with the major portion of the body burden located in the liver and kidney. Animals and humans appear to have a similar pattern of distribution that is relatively independent of route of exposure, but somewhat dependent on duration of exposure.

#### 3.4.2.1 Inhalation Exposure

Cadmium was found in autopsy samples from nearly all organs of a worker extensively exposed to cadmium dust, with greatest concentrations in the liver, kidney, pancreas, and vertebrae (Friberg 1950). In workers dying from inhalation of cadmium, lung-cadmium concentration was somewhat lower than liver or kidney cadmium concentration (Beton et al. 1966; Lucas et al. 1980; Patwardhan and Finckh 1976). The concentration of cadmium in the liver of occupationally exposed workers generally increases in proportion to intensity and duration of exposure to values up to 100 µg/g (Gompertz et al. 1983; Roels et al. 1981b). The concentration of cadmium in the kidney rises more slowly than in the liver after exposure (Gompertz et al. 1983) and begins to decline after the onset of renal damage at a critical concentration of 160–285 µg/g (Roels et al. 1981b).

In animals acutely exposed to cadmium carbonate aerosols, about 60% of the inhaled dose is found in the gastrointestinal tract, transported by mucociliary clearance (Moore et al. 1973). Following a 2-hour inhalation of approximately 100 mg/m<sup>3</sup> of cadmium, cadmium concentration in rat liver increased from an initial concentration of 0.8 µg/g in males and 1.9 µg/g in females immediately after exposure up to a peak of about 2 µg/g in males and 3.8 µg/g in females 1 week postexposure, then declined to 1.7 and 2.5 µg/g, respectively, by 30 days postexposure. The kidney concentrations were initially <0.5 µg/g in males and females, rising to approximately 8 µg/g in both sexes by 1 week postexposure and to 18 µg/g in males and 15 µg/g in females by 30 days postexposure (Rusch et al. 1986).

#### 3.4.2.2 Oral Exposure

As discussed in Chapter 6, most nonoccupationally exposed people are exposed to cadmium primarily through the diet. Cadmium can be detected in virtually all tissues in adults from industrialized countries, with greatest concentrations in the liver and kidney (Chung et al. 1986; Sumino et al. 1975). Average

## 3. HEALTH EFFECTS

cadmium concentrations in the kidney are near zero at birth, and rise roughly linearly with age to a peak (typically around 40–50  $\mu\text{g/g}$  wet weight) between ages 50 and 60, after which kidney concentrations plateau or decline (Chung et al. 1986; Hammer et al. 1973; Lauwerys et al. 1984). Liver cadmium concentrations also begin near zero at birth, increase to typical values of 1–2  $\mu\text{g/g}$  wet weight by age 20–25, then increase only slightly thereafter (Chung et al. 1986; Hammer et al. 1973; Lauwerys et al. 1984; Sumino et al. 1975).

Distribution of cadmium in animals after oral exposure is similar to that found in humans, with highest accumulation in the liver and kidneys, and lower levels spread throughout the rest of the body (Kotsonis and Klaassen 1978; Weigel et al. 1984). Liver and kidney cadmium concentrations are comparable after short-term exposure (Andersen et al. 1988; Jonah and Bhattacharyya 1989), but the kidney concentration exceeds the liver concentration following prolonged exposure (Kotsonis and Klaassen 1978), except at very high exposures (Ando et al. 1998; Bernard et al. 1980; Hiratsuka et al. 1999). In mice orally exposed to cadmium during lactation, 53% of the whole-body cadmium was found in the kidneys as compared to 27% in nonpregnant controls (Bhattacharyya et al. 1982).

Maitani et al. (1984) compared the distribution of cadmium in rats after an acute oral administration of either cadmium ions or cadmium bound to metallothionein. In all cases, 85–90% of the dose was present in the feces within 24 hours postexposure. More of the cadmium-thionein was retained after 2–3 days, and less of the cadmium-thionein was distributed to the liver than was the case for the ionic cadmium. Kidney levels were comparable.

The placenta may act as a partial barrier to fetal exposure to cadmium. Cadmium concentration has been found to be approximately half as high in cord blood as in maternal blood in several studies including both smoking and nonsmoking women (Kuhnert et al. 1982; Lauwerys et al. 1978; Truska et al. 1989). Accumulation of cadmium in the placenta at levels about 10 times higher than maternal blood cadmium concentration has been found in studies of women in Belgium (Roels et al. 1978) and the United States (Kuhnert et al. 1982); however, in a study in Czechoslovakia, the concentration of cadmium in the placenta was found to be less than in either maternal or cord blood (Truska et al. 1989). In mice orally exposed to cadmium during pregnancy, maternal blood, placental, and fetal cadmium concentrations were essentially equal among control animals (with environmental cadmium exposure), but placental concentration increased with cadmium dose much more rapidly than either maternal blood or fetal cadmium concentration (Sorell and Graziano 1990). Thus, timing and level of cadmium exposure may influence the uptake of cadmium by the placenta, perhaps explaining the conflicting human studies.

### 3. HEALTH EFFECTS

Goyer and Cherian (1992) localized metallothionein in full-term human placenta and in fetal cells in human placenta. Metallothionein was present in trophoblasts (which facilitate transport of substances entering the placenta from the maternal blood), Hofbauer cells (motile macrophages capable of phagocytosis and protein ingestion), amniotic epithelial cells (fetal derivatives), and decidual cells (endometrial stromal cells that have been transformed under hormonal influence into large pale cells, rich in glycogen). The mechanism by which the placenta transports the essential metals, copper and zinc, while limiting the transport of cadmium is unknown, but may involve the approximately 1,000-fold higher concentration of zinc in the placenta and the higher affinity of cadmium than zinc for metallothionein.

Cadmium levels in human milk are 5–10% of levels in blood, possibly due to inhibited transfer from blood because of metallothionein binding of cadmium in blood cells (Radisch et al. 1987). Bhattacharyya et al. (1982) examined the maternal transfer of cadmium to pups during gestation and lactation in mice. Approximately 3, 11, and 25% of maternal cadmium was transferred to the pups following gestation-only exposure, lactation-only exposure, and gestation and lactation exposure, respectively.

#### **3.4.2.3 Dermal Exposure**

No studies were located regarding distribution in humans after dermal exposure to cadmium. Elevated levels of cadmium were found in the liver and kidneys of rabbits and mice dermally exposed to cadmium (Kimura and Otaki 1972).

#### **3.4.3 Metabolism**

Cadmium is not known to undergo any direct metabolic conversion such as oxidation, reduction, or alkylation. The cadmium (+2) ion does bind to anionic groups (especially sulfhydryl groups) in proteins (especially albumin and metallothionein) and other molecules (Nordberg et al. 1985). Plasma cadmium circulates primarily bound to metallothionein, and albumin (Foulkes and Blanck 1990; Roberts and Clark 1988).

#### **3.4.4 Elimination and Excretion**

Most cadmium that is ingested or inhaled and transported to the gut via mucociliary clearance is not absorbed and is excreted in the feces. Absorbed cadmium is excreted very slowly, with urinary and fecal

### 3. HEALTH EFFECTS

excretion being approximately equal (Kjellström and Nordberg 1978). The half-time for cadmium in the whole body in humans was >26 years (Shaikh and Smith 1980) and half-times of several months up to several years have been calculated in mice, rats, rabbits, and monkeys (Kjellström and Nordberg 1985). Half-times in the slowest phase were from 20 to 50% of the maximum life span of the animal (Kjellström and Nordberg 1985). In the human body, the main portion of the cadmium body burden is found in the liver and kidney and in other tissues (particularly muscle, skin, and bone). After reviewing the literature, Kjellström and Nordberg (1985) developed a range of half-times from their kinetic model of 6–38 years for the human kidney and 4–19 years for the human liver.

#### 3.4.4.1 Inhalation Exposure

Cadmium excretion in urine of occupationally exposed workers increases proportionally with body burden of cadmium, but the amount of cadmium excreted represents only a small fraction of the total body burden unless renal damage is present; in this case, urinary cadmium excretion markedly increases (Roels et al. 1981b). Fecal excretion in workers occupationally exposed to cadmium reflects mainly cadmium dust swallowed from industrial air and/or incidentally ingested from contaminated hands (Adamsson et al. 1979).

In rats, following a 2-hour inhalation exposure to cadmium carbonate, cadmium was primarily eliminated in the feces, with a minor component (approximately 1% of fecal excretion) in the urine (Rusch et al. 1986). Cadmium excretion by both routes declined with time after exposure, with significantly elevated excretion found at 7 days, but not 30 days, after exposure (Rusch et al. 1986). Most of the cadmium initially excreted in the feces was probably not absorbed, but rather represented particles transported from the lung to the gastrointestinal tract (Moore et al. 1973).

#### 3.4.4.2 Oral Exposure

Following oral exposure, the major proportion of administered cadmium is found in the feces, because absorption is so low (see Section 3.4.1.2) (Kjellström et al. 1978). Among five healthy adult volunteers, fecal excretion of a single dose of radiolabeled cadmium declined with time up to 45 days after ingestion, while urinary excretion remained at a low, near-constant level (Rahola et al. 1973). After about 20 days, fecal and urinary excretion appeared to be comparable (Rahola et al. 1973). In contrast, among four healthy adults ingesting cadmium in intrinsically labeled crabmeat, fecal excretion was 30 times higher than urinary excretion up to 10 weeks after ingestion of the test meal (Newton et al. 1984). In rats orally exposed to up to 0.35 mg/kg/day of cadmium in the diet for 60 days, no significant increase in

### 3. HEALTH EFFECTS

urinary cadmium content was found (Weigel et al. 1984). The overall excretion of absorbed cadmium is slow, with biological half-times of 70–270 days in rats or mice orally exposed to cadmium (Engstrom and Nordberg 1979; Moore et al. 1973).

In a comprehensive model developed for human cadmium toxicokinetics, parameters for urinary and fecal excretion were derived by adjustments to empirical data derived from human and animal studies (Kjellström and Nordberg 1978, 1985). Fecal excretion constitutes unabsorbed cadmium plus "true" excretion originating from blood via the intestinal wall (a function of cadmium body burden) and from bile via the liver (a function of cadmium liver burden) (Kjellström and Nordberg 1985). Urinary excretion depends on blood concentration and kidney concentration, and total excretion is assumed to equal daily intake at steady state. Using these methods and assumptions, daily fecal and urinary excretion is estimated to be 0.007 and 0.009% of body burden, respectively (Kjellström and Nordberg 1978, 1985). A whole-body retention half-time estimate of >26 years was obtained by Shaikh and Smith (1980) in a study using orally ingested radiolabelled cadmium and monitoring a subject for over 2 years.

Groups of 10 female outbred albino rats were exposed to cadmium in drinking water (as cadmium chloride) at 0 or 4.8 mg/kg/day for 10 weeks (at 4 weeks prior to mating, at 3 weeks of gestation, or 3 weeks into lactation). After weaning, exposure to cadmium was terminated. In dams, kidney concentrations exceeded liver concentrations, while in pups, the renal and liver concentrations were similar at all times during exposure. In pups, both hepatic and renal cadmium concentrations considerably increased only during the second half of the lactation period (Ld 11–21). The concentrations in the dams were several orders higher than in the offspring. After discontinuation of exposure, organ concentration slightly decreased in dams (2% in liver and 12% in kidneys), while in pups, the decrease was 84% in the liver and 62% in the kidneys. These values do not indicate cadmium elimination but rather dilution caused by growth (Kostial et al. 1993).

#### **3.4.4.3 Dermal Exposure**

No studies were located regarding excretion in humans after dermal exposure to cadmium. Cadmium was reportedly detected in urine in guinea pigs dermally exposed to aqueous cadmium chloride, but no details are available (Skog and Wahlberg 1964).

## 3. HEALTH EFFECTS

**3.4.5 Physiologically Based Pharmacokinetic (PBPK)/Pharmacodynamic (PD) Models**

Physiologically based pharmacokinetic (PBPK) models use mathematical descriptions of the uptake and disposition of chemical substances to quantitatively describe the relationships among critical biological processes (Krishnan et al. 1994). PBPK models are also called biologically based tissue dosimetry models. PBPK models are increasingly used in risk assessments, primarily to predict the concentration of potentially toxic moieties of a chemical that will be delivered to any given target tissue following various combinations of route, dose level, and test species (Clewell and Andersen 1985). Physiologically based pharmacodynamic (PBPD) models use mathematical descriptions of the dose-response function to quantitatively describe the relationship between target tissue dose and toxic end points.

PBPK/PD models refine our understanding of complex quantitative dose behaviors by helping to delineate and characterize the relationships between: (1) the external/exposure concentration and target tissue dose of the toxic moiety, and (2) the target tissue dose and observed responses (Andersen and Krishnan 1994; Andersen et al. 1987a). These models are biologically and mechanistically based and can be used to extrapolate the pharmacokinetic behavior of chemical substances from high to low dose, from route to route, between species, and between subpopulations within a species. The biological basis of PBPK models results in more meaningful extrapolations than those generated with the more conventional use of uncertainty factors.

The PBPK model for a chemical substance is developed in four interconnected steps: (1) model representation, (2) model parameterization, (3) model simulation, and (4) model validation (Krishnan and Andersen 1994). In the early 1990s, validated PBPK models were developed for a number of toxicologically important chemical substances, both volatile and nonvolatile (Krishnan and Andersen 1994; Leung 1993). PBPK models for a particular substance require estimates of the chemical substance-specific physicochemical parameters, and species-specific physiological and biological parameters. The numerical estimates of these model parameters are incorporated within a set of differential and algebraic equations that describe the pharmacokinetic processes. Solving these differential and algebraic equations provides the predictions of tissue dose. Computers then provide process simulations based on these solutions.

The structure and mathematical expressions used in PBPK models significantly simplify the true complexities of biological systems. If the uptake and disposition of the chemical substance(s) are adequately described, however, this simplification is desirable because data are often unavailable for

### 3. HEALTH EFFECTS

many biological processes. A simplified scheme reduces the magnitude of cumulative uncertainty. The adequacy of the model is, therefore, of great importance, and model validation is essential to the use of PBPK models in risk assessment.

PBPK models improve the pharmacokinetic extrapolations used in risk assessments that identify the maximal (i.e., the safe) levels for human exposure to chemical substances (Andersen and Krishnan 1994). PBPK models provide a scientifically sound means to predict the target tissue dose of chemicals in humans who are exposed to environmental levels (for example, levels that might occur at hazardous waste sites) based on the results of studies where doses were higher or were administered in different species.

Figure 3-3 shows a conceptualized representation of a PBPK model.

If PBPK models for cadmium exist, the overall results and individual models are discussed in this section in terms of their use in risk assessment, tissue dosimetry, and dose, route, and species extrapolations.

#### 3.4.5.1 Summary of Cadmium PBPK Models

Several models have been reported to describe the kinetics of cadmium in mammalian systems. Of these models, the Nordberg-Kjellström model (Kjellström and Nordberg 1978; Nordberg and Kjellström 1979) has been the most widely used for cadmium risk assessment. Three of the most relevant cadmium models will be discussed here.

#### 3.4.5.2 Cadmium PBPK Model Comparison

Although the Nordberg-Kjellström model (Kjellström and Nordberg 1978; Nordberg and Kjellström 1979) has its limitations, it provides the best overall description of cadmium toxicokinetics and is largely based on human data. The Shank (Shank et al. 1977) and Matsubara-Khan (Matsubara-Khan 1974) models are not as useful for human risk assessment applications, but they do provide useful insights into the absorption, distribution, and compartmentalization of cadmium in laboratory animals. These insights may have some future use in human risk assessment as PBPK models for cadmium continue to be refined.



3. HEALTH EFFECTS

**Figure 3-3. Conceptual Representation of a Physiologically Based Pharmacokinetic (PBPK) Model for a Hypothetical Chemical Substance**

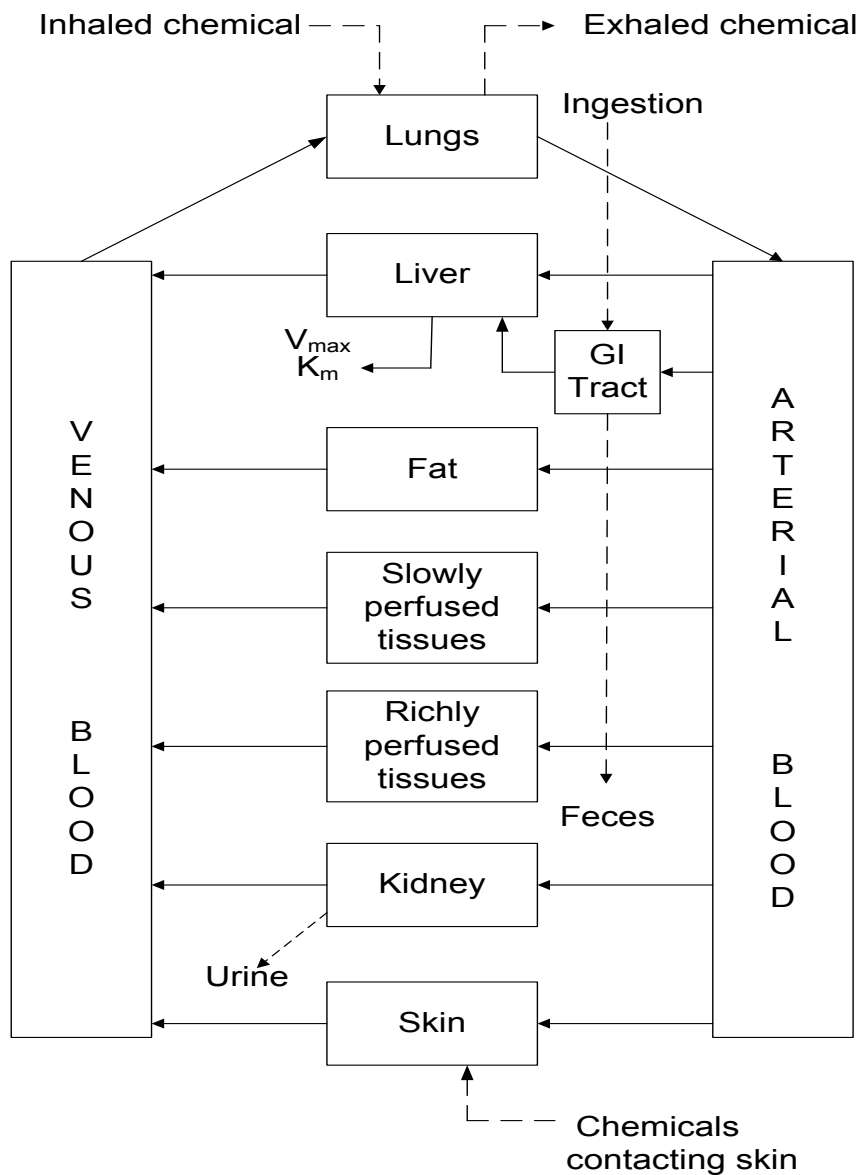

Note: This is a conceptual representation of a physiologically based pharmacokinetic (PBPK) model for a hypothetical chemical substance. The chemical substance is shown to be absorbed via the skin, by inhalation, or by ingestion, metabolized in the liver, and excreted in the urine or by exhalation.

Source: adapted from Krishnan and Andersen 1994

### 3.4.5.3 Discussion of Cadmium Models

#### The Nordberg-Kjellström Model

The Nordberg-Kjellström model (Kjellström and Nordberg 1978; Nordberg and Kjellström 1979) is a linear multicompartment model that is the most commonly used model for cadmium risk assessment work today. The Nordberg-Kjellström schematic model diagram is shown in [Figure 3-4](#).

**Risk assessment.** The Nordberg-Kjellström model has been demonstrated to be a useful model in human risk assessment work. Frazier (1994), however, noted that the model has two major limitations: (1) the linear nature of the model may not adequately allow a good description of known nonlinearities in biological responses to cadmium dosing, and (2) the phenomenological approach taken with this model does not provide a foundation for incorporating biological variability into the model parameters.

**Description of the Model.** The Nordberg-Kjellström model (see [Figure 3-4](#)) is a linear multicompartment model that describes the disposition of cadmium via the oral and inhalation routes of exposure only. Dermal exposure and subsequent absorption through the skin were assumed to be negligible in this model. For inhalation exposures, the model accounts for different deposition patterns for different size particles in nasopharyngeal, tracheobronchial, and alveolar regions of the respiratory tract. Particles with mass median aerodynamic diameter (MMAD) of 5  $\mu\text{m}$  (i.e., cadmium-laden dust) were assumed to distribute mainly to the nasopharyngeal region (75%), with lesser amounts depositing in the alveolar (20%) and tracheobronchial (5%) regions. Particles of 0.05  $\mu\text{m}$  MMAD (i.e., cigarette smoke) were assumed to deposit 50% in the alveolar compartment, 10% in the tracheobronchial compartment, and none in the nasopharyngeal compartment. The remaining amounts are exhaled. For all particle sizes initially deposited in the nasopharyngeal and tracheobronchial compartments, mucociliary clearance clears some particles from the respiratory tract to enter the oral compartment for absorption or out of the body and back to the environment. Assumed model coefficient values and the available physiological parameters are shown in [Table 3-12](#).

For the oral route of exposure, cadmium may enter the gastrointestinal tract via food or water contaminated with cadmium, or as cadmium particles embedded in mucus from the respiratory tract via the mucociliary/tracheobronchial escalator. By either route of exposure, the model assumes that cadmium enters into any of three blood compartments (B) (see [Figure 3-4](#)). B1 is the plasma compartment where

3. HEALTH EFFECTS

Figure 3-4. A Schematic Representation of the Nordberg-Kjellström Model

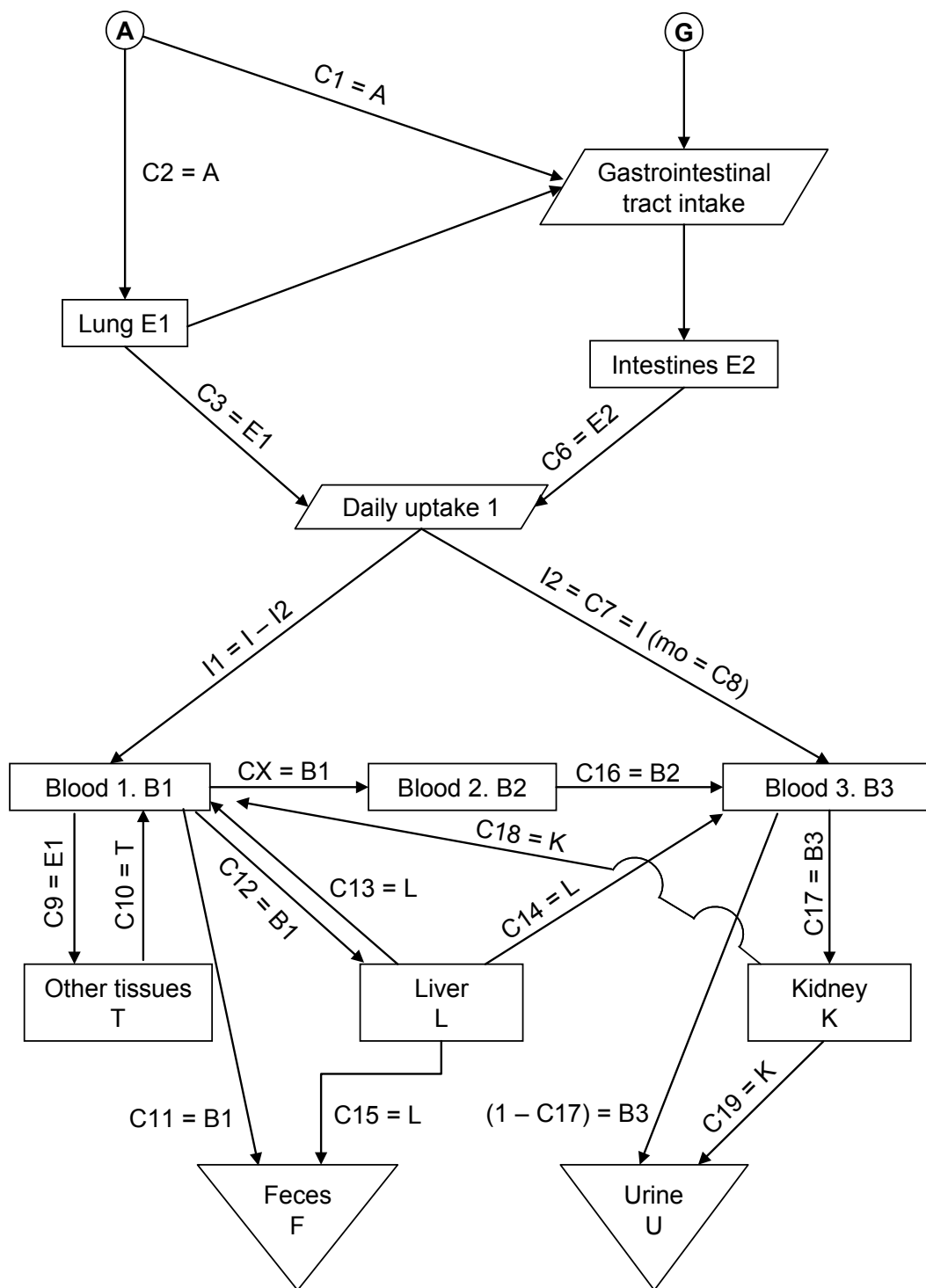

Source: Kjellström and Nordberg 1978

## 3. HEALTH EFFECTS

**Table 3-12. Assumed Model Parameters and Some Physiologic Parameters for the Nordberg-Kjellström Model**

Coefficient or parameter	Assumed range	Unit <sup>a</sup>	Values fitting to empirical data
Model parameters			
C1	0.1–0.2 (cigarette smoke)		0.1
	0.4–0.9 (factory smoke)		0.7
C2	0.4–0.6 (cigarette smoke)		0.4
	0.1–0.3 (factory smoke)		0.13
C3	0.01–1.0	day <sup>-1</sup>	0.05
C4	0.1xC3 = 0.001–0.1	day <sup>-1</sup>	0.005
C5	0.03–0.1		0.048
C6	0.05	day <sup>-1</sup>	0.05
C7	0.2–0.4		0.25
C8	0.5–5.0	µg	1
C9	0.4–0.8		0.44
C10	0.00004–0.0002	day <sup>-1</sup>	0.00014
C11	0.05–0.5		0.27
C12	0.1–0.4		0.25
C13	0–0.0001	day <sup>-1</sup>	0.00003
C14	0.0001–0.0003	day <sup>-1</sup>	0.00016
C15	0–0.0001	day <sup>-1</sup>	0.00005
C16	0.004–0.015	day <sup>-1</sup>	0.012
C17	0.8–0.98		0.95
C18	0–0.0001	day <sup>-1</sup>	0.00001
C19	0.00002–0.0002	day <sup>-1</sup>	0.00014
CX	0.01–0.05		0.04
C20	0.05–0.5		0.1
C21	0–0.000002	day <sup>-1</sup>	0.0000011
Physiologic parameters			
Average liver weight	1,500	gram	
Average blood volume	70	mL/kg	
Average blood specific gravity	1.06		
Average daily urine excretion (adult)	1.0	L	
Average daily urine excretion (aged)	0.9	L	
Average daily urine excretion (child)	0.5	L	

<sup>a</sup>Blanks indicate a unitless value.

Source: Kjellström and Nordberg 1978; Nordberg and Kjellström 1979

## 3. HEALTH EFFECTS

cadmium may bind to plasma components (i.e., albumin and other organic constituents). B2 is the red-blood cell compartment, which represents the accumulation of cadmium in erythrocytes, while B3 represents the binding of cadmium to metallothionein. The model does not take into account induction of metallothionein after cadmium exposure. From the blood, cadmium is calculated to distribute to either the liver, kidney, or "other tissues," the major accumulation sites. Elimination is either via the feces or in the urine. The transport of cadmium between the compartments is assumed to follow first-order exponential functions and is driven on concentration-dependent gradients.

**Validation of the model.** The Nordberg-Kjellström model was validated using several independent sets of human data from both Sweden and Japan. The data set by Friberg et al. (1974) estimated that smoking 20 cigarettes a day would result in an inhalation of 2–4  $\mu\text{g}/\text{day}$  of cadmium, assuming smoking started at 20 years of age and daily cadmium intake from food was 16  $\mu\text{g}/\text{day}$ . Based on the Friberg et al. (1974) data, the model predictions of cadmium concentrations in the kidney agreed well with the observed data from a study by Elinder et al. (1978); however, the model predicted higher than expected values for liver cadmium compared to the observed data from the Elinder study. The model's urinary excretion of cadmium (0.84  $\mu\text{g}/24$  hours for a 50-year-old person) agreed well with the observed data (0.56–0.8  $\mu\text{g}/24$  hours). The model predicted blood cadmium levels for Swedish smokers to be about 2 ng/g which compared well to the actual concentration of 1.6 ng/g.

The model was also validated against a data set for an average 45-year-old Japanese person living in Tokyo whose daily intake of cadmium is 40  $\mu\text{g}$  via food and 2.7  $\mu\text{g}$  via the inhalation route. Subjects were assumed to be smokers averaging 24 cigarettes a day starting at age 20. Based on these exposure conditions, the measured values for cadmium in the kidney, liver, and "other tissues" (in this case, muscle only) were reported to be 65, 3.4, and 0.2  $\mu\text{g}/\text{g}$ , respectively, with the model predicting 48, 3.2, and 0.18  $\mu\text{g}/\text{g}$ . For blood and urine, the measured values were 4.5  $\mu\text{g}/\text{g}$  for blood and 1.1  $\mu\text{g}/\text{L}$  for urine; the model predicted 3.4  $\mu\text{g}/\text{g}$  and 1.3  $\mu\text{g}/24$  hours (assuming 1 L of urine output/day, the value would be 1.3  $\mu\text{g}/\text{L}$ ).

Another study of Japanese people reported cadmium concentrations in urine in relation to high cadmium concentrations in rice in their daily diet. For people who consumed rice containing 0.04  $\mu\text{g}/\text{g}$  of rice (240  $\mu\text{g}/\text{day}$ ), the observed urinary level of cadmium was 7  $\mu\text{g}/\text{L}$ ; consumption of rice containing 1.1  $\mu\text{g}$  cadmium/g of rice (660  $\mu\text{g}/\text{day}$ ), resulted in an observed value of 14  $\mu\text{g}/\text{L}$  of urine. After making certain assumptions about the average daily consumption of rice containing an assumed amount of cadmium, and

## 3. HEALTH EFFECTS

assuming an average urine production of 1 L/day, the model calculated urinary levels of 4.8 and 15.5 µg/L of urine, agreeing well with the observed values.

The model was also validated against a data set with high concentrations of cadmium in air (50 µg/m<sup>3</sup>) (Piscator 1972) and blood cadmium concentrations ranging from 10 to 50 ng/g whole blood. Calculated blood, urine, liver, and kidney levels of cadmium agreed only roughly with the observed values; however, the authors concluded that the model predictions may not be accurate based on the observations that workers with long exposure histories had most likely experienced higher exposure levels in the past, skewing the data set, resulting in poor model predictions. Another data set by Piscator (1984) involved a group of Swedish workers involved in polishing cadmium-plated objects, who were exposed to high concentrations of cadmium for ≤2 years. Cadmium levels were measured in the urine and blood. When this exposure data set was input into the model, the model could not adequately predict blood and urine levels for these workers.

**Target tissues.** The Nordberg-Kjellström model assumes that the kidney and liver are the two specific target tissues in which cadmium accumulates. The model also accounts for all other tissue accumulation in the "other tissues" compartment (i.e., muscle). The model assumes a human liver tissue half-life ( $t_{1/2}$ ) of 4–19 years and a kidney  $t_{1/2}$  of 6–38 years. For the "other tissue" compartments,  $t_{1/2}$  was assumed to be 9–47 years. The Nordberg-Kjellström model does account for the loss of renal tubular epithelial cells leading to a loss of tubular reabsorptive capacity. This loss of cells could conceivably result in an increase in the excretion of cadmium from the tubules and an increase in the transport of cadmium from the tubules to the blood. This loss of cells is theorized to account for the large  $t_{1/2}$  range for cadmium in the kidney. The model assumed that no changes in the movement of cadmium from the kidney to blood occurred with age and that the loss of cadmium from the kidney to the urine increased linearly after the age of 30.

The Nordberg-Kjellström model also accounted for differences in kidney and liver weights among different age groups and between peoples of different ethnic origins. The model corrected for differences in liver, kidney, blood, and "other tissue" weights with relation to age (1 and 79 years of age) and ethnicity (Japan and Sweden).

**Species extrapolation.** The Nordberg-Kjellström model was based solely on data collected from humans and was intended for human risk assessment applications. The model did not address any potential application for this model of cadmium in laboratory animals.

## 3. HEALTH EFFECTS

**High-low dose extrapolation.** The Nordberg-Kjellström model has been shown to adequately predict fluid and tissue concentrations via the oral and inhalation routes of exposure for humans exposed to low doses of cadmium. However, the model has difficulty in adequately predicting fluid and tissue concentrations in humans exposed to high concentrations of cadmium, especially for those individuals exposed to high concentrations via the inhalation route.

**Interroute extrapolation.** The Nordberg-Kjellström model adequately predicted the fate of cadmium in target tissues after exposure via the inhalation and oral routes. The dermal route of exposure was not incorporated into the model parameters and was considered an insignificant route of exposure in humans.

### The Shank Model

**Risk assessment.** The Shank model (Shank et al. 1977) may have the potential to serve as an alternative mathematical model for predicting the retention of cadmium in biological systems. Unfortunately, no human data were used to validate the Shank model for use as a risk assessment tool in cases of human exposure. In addition, the Shank model was validated only for the intravenous and subcutaneous routes of exposure; no data were presented for the oral, inhalation, or dermal routes of exposure.

**Description of the model.** A schematic representation of the Shank model is illustrated in [Figure 3-5](#). The model mathematically represents the dynamic transport of cadmium between compartments in a mammalian biological system based on the male adult SW/NIH mouse as the test animal species. The intent was to predict the retention of cadmium in other species of animals (including humans) without requiring an adjustment of species-specific rate constants from within the model.

Male adult mice of the SW/NIH strain were dosed intravenously with  $^{109}\text{Cd}$  as  $^{109}\text{Cd}$  acetate. Mice received 1–3 intravenous injections spaced 48 hours apart. Animals in each group were sacrificed at 2 and 10 minutes and 1, 10, and 48 hours after the last dose. Tissues (liver, kidney, pancreas, spleen, gastrointestinal tract, testes, carcass, and feces) were harvested and the radioactivity recorded. A nine-compartment model was derived. Cadmium kinetics between compartments are described by first-order kinetics. The individual compartment retention values, obtained from the distribution study, were incorporated into the model equations and the rate constants derived.

3. HEALTH EFFECTS

Figure 3-5. A Schematic Representation of the Shank Model

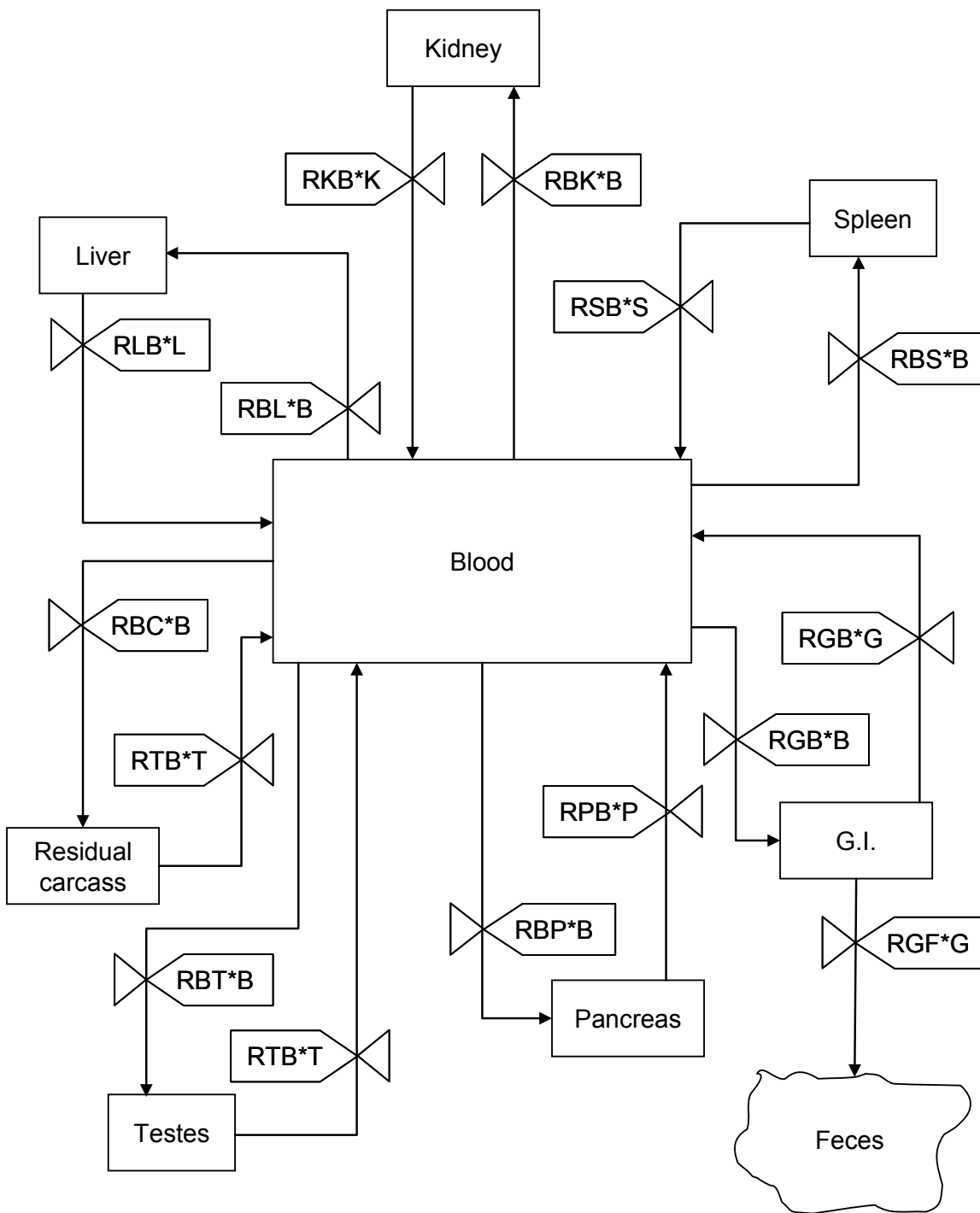

Source: Forrester 1968



## 3. HEALTH EFFECTS

**Validation of the model.** The Shank model was validated using three independent data sets. Mann (1973) dosed dogs, goats, and sheep with one intravenous injection of  $^{109}\text{Cd}$  acetate (30  $\mu\text{Ci}$ ), and the liver and kidneys were examined for cadmium content 8 weeks after administration. The Shank model's predicted values of cadmium retention in liver and kidneys at 8 weeks after a single administration were in good agreement with the observed values of the Mann (1973) study in all three species. Only data from the liver and kidneys were available for evaluation. A data set from a study by Gunn et al. (1968b) was used to evaluate the ability of the Shank model to predict the retention of cadmium in liver and kidney after a single subcutaneous administration of cadmium chloride. Animals in that study were sacrificed 2 weeks after administration, and the liver and kidneys were examined for cadmium content. The model values for the same time period were in very close agreement with observed values. Again, only data from the liver and kidneys were available for evaluation. Finally, a data set by Shanbaky (1973) was used to test the model's validity with multiple injections of cadmium acetate in rats. Five injections of cadmium acetate were administered over a 48-hour period; liver, kidneys, pancreas, spleen, and gastrointestinal tract were examined for cadmium content. The Shank model was found to be in close agreement with the arithmetic means of observed values found in the Shanbaky (1973) study.

No human data were presented to validate the model's effectiveness in predicting the cadmium retention in human target tissues after either a single or multiple dosing regime.

**Target tissues.** The target tissues for this model included the liver, kidney, pancreas, spleen, gastrointestinal tract, testes, and carcass of laboratory animals. No human tissue was used to derive cadmium retention in any of these tissues.

**Species extrapolation.** The model used goats, dogs, rats, mice, and sheep with various doses and dosing schemes of cadmium acetate and cadmium chloride and was found to serve as a good predictor of cadmium retention in the target tissues listed above. No human data were presented to determine if the model could satisfactorily predict the cadmium retention in human target tissues.

**High-low dose extrapolation.** High- and low-dose extrapolation was not specifically addressed by the Shank model.

**Interroute extrapolation.** Interroute extrapolations were addressed in a limited fashion by the Shank model. The model appeared to adequately predict the amount of cadmium retention in the target organs

## 3. HEALTH EFFECTS

of laboratory animals, in particular the liver and kidney, when dosed by either the intravenous or subcutaneous routes. The inhalation and dermal routes of exposure, and other parenteral routes of exposure (intramuscular, intraperitoneal, intradermal, etc.) were not addressed by the Shank model. No human data were presented to determine if interroute extrapolations were valid.

### The Matsubara-Khan Model

**Risk assessment.** The Matsubara-Khan model (Matsubara-Khan 1974) has not been used as a tool in risk assessment for humans. This model does demonstrate that cadmium kinetics and biological half-lives vary by tissue.

**Description of the model.** The Matsubara-Khan model is a simple model that attempted to fit cadmium elimination kinetic parameters into either a one- or two-compartment model. To obtain the data for the model, male and female ICR mice (8 weeks of age) were administered a single subcutaneous injection of a known amount of  $^{109}\text{Cd}$  cadmium chloride. Specific groups of mice were sacrificed at 1, 2, 4, 8, 16, 32, 64, or 128 days after injection. At the time of sacrifice, blood, liver, kidney, salivary gland, stomach wall and stomach contents, small intestine and small intestine contents, and colon wall and colon contents were removed and the amount of  $^{109}\text{Cd}$  remaining in these tissues was determined.

An oral study was conducted in conjunction with the subcutaneous study described above. In the oral study, 8-week-old male mice (ddd x BALB/c; F<sub>1</sub>) were orally administered  $^{115\text{m}}\text{Cd}$  cadmium chloride by gavage. Groups of mice were sacrificed at 1, 2, 4, 8, 16, 32, 64, or 128 days after injection. At the time of sacrifice, liver, kidney, salivary gland, stomach wall, gonad, and spleen were removed and the amount of  $^{115\text{m}}\text{Cd}$  remaining in these tissues was determined.

The rate of uptake, rate constants, and biological half-lives determined for the subcutaneous and orally dosed mice are summarized in [Table 3-13](#). Matsubara-Khan found that tissue kinetics in mice dosed subcutaneously with  $^{109}\text{Cd}$  cadmium chloride fit into either a one- or two-compartment model, depending on the tissue. The data from the digestive tract organs (stomach wall, small intestine, and colon) were best fitted into a 1-compartment model, with a strained fit of the data from the digestive tract contents (stomach, small intestine, and colon contents) to the one-compartment model. Data from the blood, liver, kidneys, and salivary glands were best fitted to the two-compartment model. Extremely small second-rate constants in the kidneys and salivary glands indicate that the elimination of cadmium from these tissues is

## 3. HEALTH EFFECTS

**Table 3-13. Estimated Parameters, Rate of Uptake, Rate Constants, and Biological Half-Lives in Selected Mouse Organs After Subcutaneous and Oral Administrations of  $^{109}\text{CdCl}_2$**

Organ	Rate of uptake (95% CL)		Rate constants b and c (95% CL)		Biological half-life (days)	
	SC	PO	SC	PO	SC	PO
Liver	21	8.7	0.011 0.57	0.016 0.91	631.2	430.76
Kidney	22	1.4	0.0007 0.30	0.016 0.30	9902.3	4332.3
Salivary gland	21	0.33	0.0016 0.73	0.0047 0.78	4330.95	1500.89
Blood	0.15	NM	0.024 0.65	NM	291.1	NM
Stomach wall	1.7	0.36	0.0073	0.017	95	41
Stomach contents	0.68	NM	0.062	NM	11	NM
Small intestine	0.95	NM	0.01	NM	69	NM
Small intestine contents	2.5	NM	0.067	NM	10	NM
Colon	1.4	NM	0.013	NM	53	NM
Colon contents	4.1	NM	0.15	NM	4.6	NM
Gonad	NM	0.37	NM	0.012	NM	58
Spleen	NM	0.44	NM	0.0011	NM	630

CL = confidence limits; PO = oral; SC = subcutaneous; NM = not measured

Source: Matsubara-Khan 1974

### 3. HEALTH EFFECTS

very slow. For the oral study, similar findings were observed, with data from the gonads and spleen fitting the one-compartment model best. Biological half-lives were invariably longer for the subcutaneously dosed animals, while the rate constants were slightly smaller for the subcutaneously dosed animals. Sex-related differences in rate of uptake, rate constants, and biological half-lives were not found, except in the kidney data in which females had slightly smaller rate constants.

**Validation of the model.** No independent data sets were used to validate the Matsubara-Khan model.

**Target tissues.** For the subcutaneous injection study, the Matsubara-Khan model used blood, liver, kidney, salivary gland, stomach wall and stomach contents, small intestine and small intestine contents, and colon wall and colon contents. For the oral study, the model used liver, kidney, salivary glands, stomach wall, gonads, and spleen.

**Species extrapolation.** No species extrapolations were performed in the Matsubara-Khan model.

**High-low dose extrapolation.** No high-low dose extrapolations were performed in the Matsubara-Khan model.

**Interroute extrapolation.** The Matsubara-Khan model compared the oral and subcutaneous routes and reported similar rate constants for many of the tissues examined. Biological half-lives varied considerably for the kidney and salivary gland, but were not much different for liver between the two routes of exposure.

## 3.5 MECHANISMS OF ACTION

### 3.5.1 Pharmacokinetic Mechanisms

**Absorption.** Cadmium can be absorbed by the inhalation, oral, and dermal routes of exposure regardless of its chemical form (chloride, carbonate, oxide, sulfide, sulfate, or other forms). Absorption by the dermal route of exposure, however, is relatively insignificant for cadmium, although small amounts are absorbed percutaneously over a long period of time (Wester et al. 1992). Absorption is mainly of concern from inhalation and oral exposures.

## 3. HEALTH EFFECTS

Gastrointestinal tract absorption of cadmium (in any chemical form) is relatively low when compared to the total amount of cadmium absorbed via the inhalation route. In humans, cadmium absorption has been reported to be approximately 1–10% ((Flanagan et al. 1978; McLellan et al. 1978; Newton et al. 1984; Rahola et al. 1973; Shaikh and Smith 1980; Vanderpool and Reeves 2001). In other species, gastrointestinal tract absorption of cadmium has been determined to be 1–2% in mice and rats (Decker et al. 1958; Ragan 1977), 0.5–3.0% in monkeys (Friberg et al. 1974), 2% in goats (Miller et al. 1969), 5% in pigs and lambs (Cousins et al. 1973; Doyle et al. 1974), and nearly 16% in cattle (Miller et al. 1967). Lehman and Klaassen (1986) investigated the dose-dependence of cadmium absorption and disposition in male Sprague-Dawley rats. Cadmium absorption was estimated to be 0.35 and 1% following oral exposure to 1 or 10,000 µg/kg, respectively. Goon and Klaassen (1989) measured absorption of cadmium in rat intestine *in situ* and reported that the intestinal absorption of cadmium is dosage independent at low dosages of cadmium (<10 µg/kg) and dosage dependent at high dosages (>10 µg/kg). They also evaluated the role of metallothionein and concluded that saturation of intestinal metallothionein is not a major determinant of the observed dosage-dependent absorption of cadmium.

Although the mechanism involved in the intestinal absorption of cadmium has not been fully elucidated, there is evidence that one or more transporter proteins are involved. Several studies have found evidence that divalent metal transporter I protein plays an important role in the gastrointestinal absorption of cadmium (Kim et al. 2007; Park et al. 2002; Ryu et al. 2004). However, studies in knockout mice suggest that other transporter proteins are involved with cadmium absorption (Min et al. 2008; Ryu et al. 2004; Suzuki et al. 2007).

In some cases, cadmium bound to metallothionein (as in food) is not absorbed or distributed from the gastrointestinal tract as readily as ionic cadmium. Mice had lower blood and liver cadmium levels from oral exposure to cadmium-metallothionein, compared to levels from cadmium chloride exposure for comparable doses, but the cadmium-metallothionein resulted in higher kidney cadmium levels. Sharma et al. (1983) reported that human exposure to very high intakes of cadmium during the consumption of oysters resulted in increases in whole blood and urine cadmium levels; however, the increase was not proportional to the level of intake.

A higher fraction of inhaled cadmium than ingested cadmium is absorbed. The total amount of cadmium absorbed by the body via the lungs depends on the particle size. Larger particles are deposited in the nasopharyngeal and tracheobronchial airways via impaction, and are largely cleared by mucociliary processes, leading to absorption by the gastrointestinal tract. Smaller particles reach the smaller airways

## 3. HEALTH EFFECTS

and alveoli, and depending on the particle's solubility, are absorbed and distributed to the rest of the body. Solubility in lung fluids plays a role in absorption from the lung into the body of cadmium salts.

Theoretically, the highly soluble salts, chloride, nitrate, acetate, and sulfate would be expected to give the highest blood levels following inhalation exposure to a given air concentration. The insoluble cadmium salts, the various sulfides, should yield the lowest blood level. The lung, however, is rich in carbon dioxide that is continuously transferred from the blood. Particles of the various cadmium sulfides within the lung can react with this carbon dioxide. Lung tissue may then absorb and transfer solubilized or released cadmium ions to the blood.

No direct data, however, are available on cadmium deposition, retention, or absorption in the human lung. Data from animal studies indicate that lung retention is greatest after short-term exposure, 5–20% after 15 minutes to 2 hours (Barrett et al. 1947; Henderson et al. 1979; Moore et al. 1973; Rusch et al. 1986). The initial lung burden declines slowly after exposure ceases (Henderson et al. 1979; Moore et al. 1973; Rusch et al. 1986), due to the absorption of cadmium and the lung clearance of deposited particles. After longer periods of inhalation exposure to cadmium, somewhat lower lung retentions are found (Glaser et al. 1986). The absorption of cadmium in the lung differs somewhat among chemical forms, but the pattern apparently does not correlate well with solubility in water (Glaser et al. 1986; Rusch et al. 1986). Retention of cadmium has been reported to be >40% in rats (Moore et al. 1973), 40% in canines (Friberg et al. 1974), and 10–20% in mice (Potts et al. 1950).

The cadmium levels in cigarettes range from 0.28 to 3.38  $\mu\text{g}$  (Elinder et al. 1985b; Watanabe et al. 1987); the mean in 38 U.S. brands was 1.07  $\mu\text{g}$  (Watanabe et al. 1987). Approximately 10% of the cadmium in cigarettes is inhaled (Elinder et al. 1985b). Based on comparison of cadmium body burdens in human smokers and nonsmokers, cadmium absorption from cigarettes appears to be higher than absorptions of cadmium aerosols measured in animals (Nordberg et al. 1985). The chemical form of cadmium in cigarette smoke is likely to be similar to that produced by other combustion processes, primarily cadmium oxide aerosols. The greater absorption of cadmium from cigarette smoke is likely due to the very small size of particles in cigarette smoke and the consequent very high alveolar deposition (Nordberg et al. 1985).

**Distribution and Metabolism.** Absorbed cadmium is distributed throughout the body, with the highest concentrations found in the liver and kidneys. Cadmium is not known to undergo direct metabolic conversions. It has a high affinity for the sulfhydryl groups of albumin and metallothionein (Nordberg et al. 1985). The interaction between cadmium and metallothionein plays a critical role in the

## 3. HEALTH EFFECTS

toxicokinetics and toxicity, as discussed in Section 3.5.2, of cadmium. Metallothionein sequesters a large fraction of tissue cadmium (Shaikh 1982) and studies in metallothionein transgenic and metallothionein-null mice suggest that metallothionein influences tissue retention, but may not affect cadmium distribution to the liver, kidney, pancreas, or spleen (Liu and Klaassen 1996; Liu et al. 1996; Wong and Klaassen 1980a). Metallothionein turns over with half-lives of 2.8 days in the rat liver and 5 days in the kidney (Shaikh and Smith 1976); however, cadmium is retained in both organs bound mainly to metallothionein. It has a retention half-time of 73 days in the liver and a life-time in the kidneys (Shaikh 1982).

Shaikh et al. (1993) report that disposition of cadmium in mouse liver, kidney, and testes is different for different strains, sex, or age. Different dose levels (i.e., subcutaneous doses in the 5–30  $\mu\text{mol/kg}$  body weight range) also altered the disposition. Liver cadmium levels and metallothionein levels did not always correlate with hepatotoxicity. The difference in the tissue accumulation of cadmium may relate to variations in the hormonal or other intrinsic factors that affect cellular uptake of cadmium, subcellular distribution of cadmium, or metallothionein metabolism.

**Excretion.** Since a small fraction of the cadmium presented to the gastrointestinal tract is absorbed, most of the oral dose is excreted via the feces. After inhalation exposure to cadmium, the initial lung burden of cadmium-laden particles depositing in the nasopharyngeal or central airways will be cleared via the mucociliary mechanisms, possibly undergoing a small amount of absorption by the oral route. The remaining cadmium particles will be absorbed in the lung. Once absorbed cadmium has distributed throughout the body (primarily to the liver and kidney), the amounts of fecal and urinary excretion of cadmium are approximately equal. The amount of cadmium in the urine of occupationally exposed workers increases proportionally with body burden of cadmium, but the amount of cadmium excreted represents only a small fraction of the total body burden unless renal damage is present; in this case, urinary cadmium excretion increases markedly (Roels et al. 1981b).

Klaassen and Kotsonis (1977) evaluated biliary excretion of an intravenous bolus of cadmium chloride in the rat, rabbit, and dog. Marked species variation in biliary excretion was observed with rabbits at about 1/6th the rate of the rats, and dogs about 1/300th the rate of the rats. In the rat, the bile/plasma concentration ratio of cadmium was highly dose dependent, increasing with higher dose; at 0.1 mg/kg, the bile/plasma ratio was 2.6 and at 3.0 mg/kg, the bile/plasma ratio was 133. The bile/liver concentration ratio of cadmium was equal to or much lower than 1 decreasing to <1% for the low dose regimen.

## 3. HEALTH EFFECTS

**3.5.2 Mechanisms of Toxicity**

Cadmium is toxic to a wide range of organs and tissues; however, the primary target organs of cadmium toxicity are the kidneys; bone and lung (following inhalation exposure) are also sensitive targets of toxicity. Changes in the kidney due to cadmium toxicity have been well established. Chronic exposure to cadmium by the oral or inhalation routes has produced proximal tubule cell damage, proteinuria (mainly low-molecular weight proteins, such as  $\beta$ 2-microglobulin), glycosuria, amino aciduria, polyuria, decreased absorption of phosphate, and enzymuria in humans and in a number of laboratory animal species. The clinical symptoms result from the degeneration and atrophy of the proximal tubules, or (in worse cases) interstitial fibrosis of the kidney (Stowe et al. 1972). Cadmium has been shown to perturb lipid composition and enhance lipid peroxidation (Gill et al. 1989b). Depletion of antioxidant enzymes, specifically glutathione peroxidase and superoxide dismutase, has been proposed as the mechanism of cadmium's cardiotoxic effects (Jamall and Smith 1985a), but subsequent studies showed that cardiotoxic mechanisms other than peroxidation are also present (Jamall et al. 1989). Cadmium has been shown to alter zinc, iron and copper metabolism (Petering et al. 1979) as well as selenium (Jamall and Smith 1985b). Xu et al. (1995) propose that an initiating step in cadmium-induced toxicity to the testes is cadmium interference with zinc-protein complexes that control DNA transcription which subsequently leads to apoptosis. Cadmium sequestration by metallothionein (or a chelator in the case of the Xu et al. [1995] study) prevents cadmium from disrupting zinc-dependent transcriptional controls.

Cardenas et al. (1992a) investigated a cadmium-induced depletion of glomerular membrane polyanions and the resulting increased excretion of high-molecular-weight proteins. Interference with glomerular membrane polyanionic charge may precede the tubular damage as a more sensitive and early response to cadmium (Roels et al. 1993). Acute or chronic doses of cadmium have also been reported to reduce hepatic glycogen stores and to increase blood glucose levels. Intralobular fibrosis, cirrhosis, focal mononuclear infiltrates, and proliferation of the smooth endoplasmic reticulum are among the nonspecific histopathological indicators of cadmium toxicity.

Cadmium complexed with metallothionein from the liver can redistribute to the kidney (Dudley et al. 1985). When metallothionein-bound cadmium is transported to the kidney, it readily diffuses and is filtered at the glomerulus, and may be effectively reabsorbed from the glomerular filtrate by the proximal tubule cells (Foulkes 1978). In the kidneys, exogenous metallothionein is degraded in lysosomes and released cadmium is sequestered by the endogenous metallothionein as well as other proteins (Cherian



## 3. HEALTH EFFECTS

and Shaikh 1975; Squibb et al. 1984; Vestergaard and Shaikh 1994). This non-metallothionein-bound cadmium can then induce new metallothionein synthesis in the proximal tubule (Squibb et al. 1984).

Early work indicated that metallothionein binding decreased the toxicity of cadmium, and the ability of the liver to synthesize metallothionein appeared to be adequate to bind all the accumulated cadmium (Goyer et al. 1989; Kotsonis and Klaassen 1978). The rate of metallothionein synthesis in the kidney is lower than in the liver (Sendelbach and Klaassen 1988), and is thought to be insufficient, at some point, to bind the intrarenal cadmium (Kotsonis and Klaassen 1978). Renal damage is believed to occur when the localization of cadmium, or an excessive concentration of cadmium, is unbound to metallothionein. Acute exposure to low levels of cadmium bound to metallothionein produced an intracellular renal damage as described above (Squibb et al. 1984), but damage to brush-border membranes of the renal tubule has also been reported from metallothionein-bound cadmium (Suzuki and Cherian 1987) suggesting other toxic mechanisms may be present.

Dorian et al. (1992a) evaluated the intra-renal distribution of  $^{109}\text{Cd}$ -metallothionein injected (intravenously) into male Swiss mice at a nonnephrotoxic dose (0.1 mg Cd/kg) and concluded that cadmium-metallothionein-induced nephrotoxicity might be due, at least in part, to its preferential uptake of cadmium-metallothionein into the S1 and S2 segments of the proximal tubules, the site of cadmium-induced nephrotoxicity. In a companion study, Dorian et al. (1992b) reported that this preferential renal uptake was also observed after administration of various doses of [ $^{35}\text{S}$ ]cadmium-metallothionein. In contrast to the earlier observed persistency of  $^{109}\text{Cd}$  in the kidney after  $^{109}\text{Cd}$ -metallothionein administration, however,  $^{35}\text{S}$  disappeared rapidly (with a half-life of approximately 2 hours); 24 hours after injection of [ $^{35}\text{S}$ ]cadmium-metallothionein, there was very little  $^{35}\text{S}$  left in the kidneys. These observations indicate that the protein portion of cadmium-metallothionein is rapidly degraded after renal uptake of cadmium metallothionein and that the released cadmium is retained in the kidney.

The toxic effects and distribution of cadmium were compared after intravenous injection of  $^{109}\text{Cd}$ -metallothionein at 0.05–1 mg Cd/kg body weight and  $^{109}\text{Cd}$  chloride at 0.1–3 mg/kg in male Swiss mice (Dorian et al. 1995). Cadmium-metallothionein increased urinary excretion of glucose, and protein indicated renal injury, with dosages as low as 0.2 mg Cd/kg. In contrast, renal function was unaltered by cadmium chloride administration, even at dosages as high as 3 mg Cd/kg. Cadmium-metallothionein distributed almost exclusively to the kidney, whereas cadmium chloride preferentially distributed to the liver. However, a high concentration of cadmium was also found in the kidneys after cadmium chloride administration (i.e., the renal cadmium concentration after administration of a high but nonnephrotoxic

## 3. HEALTH EFFECTS

dose of cadmium chloride was equal to or higher than that obtained after injection of nephrotoxic doses of cadmium-metallothionein). Light microscopic autoradiography studies indicated that cadmium from cadmium-metallothionein preferentially distributed to the convoluted segments (S1 and S2) of the proximal tubules, whereas cadmium from cadmium chloride distributed equally to the various segments (convoluted and straight) of the proximal tubules. However, the concentration of cadmium at the site of nephrotoxicity, the proximal convoluted tubules, was higher after cadmium chloride than after cadmium-metallothionein administration. A higher cadmium concentration in both apical and basal parts of the proximal cells was found after cadmium chloride than after cadmium-metallothionein administration. The authors suggest that cadmium-metallothionein is nephrotoxic, and cadmium chloride is not nephrotoxic because of a higher concentration of cadmium in the target cells after cadmium-metallothionein. Dorian and Klaassen (1995) evaluated the effects of zinc-metallothionein on <sup>109</sup>cadmium-metallothionein renal uptake and nephrotoxicity and concluded that zinc-metallothionein is not only nontoxic to the kidney at a dose as high as 5 µmole metallothionein/kg, but it can also protect against the nephrotoxic effect of cadmium-metallothionein without decreasing renal cadmium concentration.

To further test the hypothesis that nephrotoxicity produced from chronic cadmium exposure results from a cadmium-metallothionein complex, Liu et al. (1998) exposed metallothionein-null mice to a wide range of cadmium chloride doses, 6 times/week for up to 10 weeks. Renal cadmium burden increased with dose and duration up to 140 µg Cd/g kidney in control mice (i.e., metallothionein normal) with a 150-fold increase in renal metallothionein levels (800 µg metallothionein/g kidney). Renal cadmium was much lower in metallothionein-null mice (10 µg Cd/g), and metallothionein levels were not detectable. The maximum tolerated dose of cadmium (as indicated by routine urinalysis and histopathology measures) was approximately 8 times higher in control mice than in metallothionein-null mice. Lesions were more severe in metallothionein-null mice than in controls.

The critical concentration of cadmium in the renal cortex that is likely to produce renal dysfunction also remains a topic of intense investigation. Whether the critical concentration of urinary cadmium is closer to 5 or 10 µg Cd/g creatinine, corresponding to about 100 and 200 µg cadmium/g kidney, respectively, is the current focus of the debate. In one analysis, the critical concentration producing dysfunction in 10% of a susceptible population has been estimated to be approximately 200 µg cadmium/g kidney; 50% of the susceptible population would experience dysfunction with a kidney concentration of 300 µg/g (Ellis et al. 1984, 1985; Roels et al. 1983).

### 3. HEALTH EFFECTS

Studies in humans and animals have demonstrated that the bone is a sensitive target of cadmium toxicity. It is likely that cadmium acts by direct and indirect mechanisms, which can lead to decreased bone mineral density and increased fractures (Brzóška and Moniuszko-Jakoniuk 2005c, 2005d). Studies in young animals suggest that cadmium inhibits osteoblastic activity, resulting in a decrease in the synthesis of bone organic matrix and mineralization (Brzóška and Moniuszko-Jakoniuk 2005d). The decreased osteoblastic activity may also influence osteoclastic activity leading to increased bone resorption. During intense bone growth, effects on osteoblasts result in decreased bone formation; after skeletal maturity, cadmium exposure results in increased bone resorption. Cadmium-induced renal damage can also result in secondary effects on bone (Brzóška and Moniuszko-Jakoniuk 2005c). Cadmium-induced renal damage interferes with the hydroxylation of 25-hydroxy-vitamin D to form 1,25-dihydroxy-vitamin D. Decreased serum concentration of 1,25-dihydroxy-vitamin D, along with impaired kidney resorptive function, result in calcium and phosphate deficiency (via decreased gastrointestinal absorption and increased calcium and phosphate urinary loss). To maintain calcium and phosphate homeostasis, parathyroid hormone is released, which enhances bone resorption.

#### 3.5.3 Animal-to-Human Extrapolations

The effects of cadmium exposure have been studied in humans and in many laboratory animal species. The target organs are similar among species, with the kidneys, bone, and lungs (inhalation only) being the primary organs for cadmium induced toxicity. Absorption, distribution, and excretion of cadmium after oral and inhalation exposures are roughly similar among species; however, there are some notable differences and caveats. Most estimates of cadmium absorption in animals are somewhat lower than the values found from human studies, particularly after prolonged exposure. Differences in the breathing patterns between rats (obligatory nose breathers) and humans (mouth and nose breathers) may also result in radically different lung burden patterns (and hence, different absorption profiles) of cadmium particles in the lungs. Many of the common laboratory animals (in particular the mouse and rat) provide useful information on the toxic effects of cadmium; due to their relatively short lifespan, however, they may not be as useful from a risk assessment point of view in determining the human lifetime effects from inhaling cadmium in air, or ingesting it in food and water. Rates of synthesis and inducibility of metallothionein also differ among species, sex, and target organ.

Even within species there can be significant differences in metallothionein synthesis, and these differences correlate to the degree of cadmium toxicity observed (e.g., the mouse) (Shaikh et al. 1993). The Shaikh et al. (1993) study employed acute exposures. Strain differences in carcinogenic effects have

## 3. HEALTH EFFECTS

also been reported for chronic exposures of subcutaneously administered cadmium chloride in male DBA and NFS mice. DBA mice developed lymphomas, while NFS mice developed hepatocellular adenomas and carcinomas, and sarcomas at the injection site. Both strains developed nonneoplastic testicular lesions (fibrosis and mineralization) (Waalkes and Rhem 1992).

Metal-metal interactions are also an important factor in cadmium kinetics and toxicity, and organ specific metal concentrations and metabolism can differ among species. It is thought that further development of PBPK/PD models will assist in addressing these differences and in extrapolating the animal data to support risk assessments in humans.

### 3.6 TOXICITIES MEDIATED THROUGH THE NEUROENDOCRINE AXIS

Recently, attention has focused on the potential hazardous effects of certain chemicals on the endocrine system because of the ability of these chemicals to mimic or block endogenous hormones. Chemicals with this type of activity are most commonly referred to as *endocrine disruptors*. However, appropriate terminology to describe such effects remains controversial. The terminology *endocrine disruptors*, initially used by Thomas and Colborn (1992), was also used in 1996 when Congress mandated the EPA to develop a screening program for "...certain substances [which] may have an effect produced by a naturally occurring estrogen, or other such endocrine effect[s]...". To meet this mandate, EPA convened a panel called the Endocrine Disruptors Screening and Testing Advisory Committee (EDSTAC), and in 1998, the EDSTAC completed its deliberations and made recommendations to EPA concerning *endocrine disruptors*. In 1999, the National Academy of Sciences released a report that referred to these same types of chemicals as *hormonally active agents*. The terminology *endocrine modulators* has also been used to convey the fact that effects caused by such chemicals may not necessarily be adverse. Many scientists agree that chemicals with the ability to disrupt or modulate the endocrine system are a potential threat to the health of humans, aquatic animals, and wildlife. However, others think that endocrine-active chemicals do not pose a significant health risk, particularly in view of the fact that hormone mimics exist in the natural environment. Examples of natural hormone mimics are the isoflavonoid phytoestrogens (Adlercreutz 1995; Livingston 1978; Mayr et al. 1992). These chemicals are derived from plants and are similar in structure and action to endogenous estrogen. Although the public health significance and descriptive terminology of substances capable of affecting the endocrine system remains controversial, scientists agree that these chemicals may affect the synthesis, secretion, transport, binding, action, or elimination of natural hormones in the body responsible for maintaining homeostasis, reproduction, development, and/or behavior (EPA 1997a). Stated differently, such compounds may cause toxicities that

## 3. HEALTH EFFECTS

are mediated through the neuroendocrine axis. As a result, these chemicals may play a role in altering, for example, metabolic, sexual, immune, and neurobehavioral function. Such chemicals are also thought to be involved in inducing breast, testicular, and prostate cancers, as well as endometriosis (Berger 1994; Giwercman et al. 1993; Hoel et al. 1992).

No studies were located regarding endocrine disruption in humans and/or animals after exposure to cadmium.

No *in vitro* studies were located regarding endocrine disruption of cadmium.

### 3.7 CHILDREN'S SUSCEPTIBILITY

This section discusses potential health effects from exposures during the period from conception to maturity at 18 years of age in humans, when all biological systems will have fully developed. Potential effects on offspring resulting from exposures of parental germ cells are considered, as well as any indirect effects on the fetus and neonate resulting from maternal exposure during gestation and lactation. Relevant animal and *in vitro* models are also discussed.

Children are not small adults. They differ from adults in their exposures and may differ in their susceptibility to hazardous chemicals. Children's unique physiology and behavior can influence the extent of their exposure. Exposures of children are discussed in Section 6.6, Exposures of Children.

Children sometimes differ from adults in their susceptibility to hazardous chemicals, but whether there is a difference depends on the chemical (Guzelian et al. 1992; NRC 1993). Children may be more or less susceptible than adults to health effects, and the relationship may change with developmental age (Guzelian et al. 1992; NRC 1993). Vulnerability often depends on developmental stage. There are critical periods of structural and functional development during both prenatal and postnatal life, and a particular structure or function will be most sensitive to disruption during its critical period(s). Damage may not be evident until a later stage of development. There are often differences in pharmacokinetics and metabolism between children and adults. For example, absorption may be different in neonates because of the immaturity of their gastrointestinal tract and their larger skin surface area in proportion to body weight (Morselli et al. 1980; NRC 1993); the gastrointestinal absorption of lead is greatest in infants and young children (Ziegler et al. 1978). Distribution of xenobiotics may be different; for example, infants have a larger proportion of their bodies as extracellular water, and their brains and livers are

## 3. HEALTH EFFECTS

proportionately larger (Altman and Dittmer 1974; Fomon 1966; Fomon et al. 1982; Owen and Brozek 1966; Widdowson and Dickerson 1964). The infant also has an immature blood-brain barrier (Adinolfi 1985; Johanson 1980) and probably an immature blood-testis barrier (Setchell and Waites 1975). Many xenobiotic metabolizing enzymes have distinctive developmental patterns. At various stages of growth and development, levels of particular enzymes may be higher or lower than those of adults, and sometimes unique enzymes may exist at particular developmental stages (Komori et al. 1990; Leeder and Kearns 1997; NRC 1993; Vieira et al. 1996). Whether differences in xenobiotic metabolism make the child more or less susceptible also depends on whether the relevant enzymes are involved in activation of the parent compound to its toxic form or in detoxification. There may also be differences in excretion, particularly in newborns who all have a low glomerular filtration rate and have not developed efficient tubular secretion and resorption capacities (Altman and Dittmer 1974; NRC 1993; West et al. 1948). Children and adults may differ in their capacity to repair damage from chemical insults. Children also have a longer remaining lifetime in which to express damage from chemicals; this potential is particularly relevant to cancer.

Certain characteristics of the developing human may increase exposure or susceptibility, whereas others may decrease susceptibility to the same chemical. For example, although infants breathe more air per kilogram of body weight than adults breathe, this difference might be somewhat counterbalanced by their alveoli being less developed, which results in a disproportionately smaller surface area for alveolar absorption (NRC 1993).

Occupational and environmental exposure studies in adults provide strong evidence that the lung (inhalation exposure only) and kidneys are sensitive targets of toxicity; it is likely that these effects would also be seen in children. Because cadmium is a cumulative toxin and has a very long half-time in the body, exposures to children in even low amounts may have long-term adverse consequences. Average cadmium concentrations in the kidney are near zero at birth, and rise roughly linearly with age to a peak (typically around 40–50  $\mu\text{g/g}$  wet weight) between the ages of 50 and 60 years, after which kidney concentrations plateau or decline (Chung et al. 1986; Hammer et al. 1973; Lauwerys et al. 1984). There are limited data on the renal toxicity of cadmium in children. One study found significant associations between urinary and blood cadmium levels with urinary levels of NAG and retinol binding protein (de Burbure et al. 2006); however, the investigators cautioned that the early response observed in this group of children exposed to elevated levels of cadmium (and other metals) may reflect an early renal response that may be adaptive and/or reversible. Another study (Trzcinka-Ochocka et al. 2004) found higher urinary concentrations of  $\beta$ 2-microglobulin and retinol binding protein in a population exposed to high

## 3. HEALTH EFFECTS

levels of cadmium starting in childhood as compared to a group only exposed as adults even though urinary cadmium levels were lower (statistical comparisons of urinary cadmium levels were not made between the groups). These data suggest that adults exposed to cadmium as children may be more susceptible to the renal toxicity of cadmium than persons only exposed as adults. This is supported by the findings of Jacquillet et al. (2007) of renal damage in mature rats exposed to cadmium via gestation and lactation.

There are epidemiological data suggesting that the bone is also a sensitive target of cadmium toxicity (Åkesson et al. 2005; Alfvén et al. 2000, 2002a, 2004; Aoshima et al. 2003; Jin et al. 2004b; Nordberg et al. 2002; Staessen et al. 1999; Wang et al. 2003; Zhu et al. 2004). Epidemiology studies suggest that the elderly may be more susceptible than younger adults; however, no studies examined childhood exposure. Animal studies suggest that young animals are more susceptible than adult or elderly animals (Ogoshi et al. 1989).

A potential for cadmium to have adverse neurological effects is an important consideration. However, only a few studies have reported an association between environmental cadmium exposure and neuropsychological functioning. End points that were affected included verbal IQ in rural Maryland children (Thatcher et al. 1982), and acting-out and distractibility in rural Wyoming children (Marlowe et al. 1985). The usefulness of the data from these studies is limited, however, because of the potential confounding effects of lead exposure; lack of control for other possible confounders including home environment, caregiving, and parental IQ levels; and inadequate quantification of cadmium exposure (i.e., the studies used hair cadmium as an index of exposure, which has some limitations because of potential confounding from exogenous sources). Several animal studies have reported alterations in performance on neurobehavioral tests in rats exposed to cadmium via gestation and lactation (Ali et al. 1986; Baranski et al. 1983; Desi et al. 1998; Nagymajtenyi et al. 1997). Several studies have examined the possible association between cadmium exposure and newborn birth weight, and most reliable studies have not found a significant association (Galicía-García et al. 1997; Mokhtar et al. 2002; Nishijo et al. 2002, 2004b; Zhang et al. 2004). Animal studies have found significant decreases in body weight or skeletal anomalies or malformations in the offspring of rats exposed to high doses of cadmium (Ali et al. 1986; Baranski 1985, 1987; Gupta et al. 1993; Kelman et al. 1978; Kostial et al. 1993; Machermer and Lorke 1981; Petering et al. 1979; Pond and Walker 1975; Schroeder and Mitchener 1971; Sorell and Graziano 1990; Sutou et al. 1980; Webster 1978; Whelton et al. 1988).

## 3. HEALTH EFFECTS

Oral cadmium exposure has also been reported to suppress the T-lymphocyte and macrophage-dependent humoral immune response of 6-week-old mice against sheep red blood cells (Blakley 1985), but not of 12-month-old mice (Blakley 1988). The investigators cautioned that “natural” age-related immune system dysfunction may have masked any cadmium suppressive effect.

Children are most likely to be exposed to cadmium in food or water. Most ingested cadmium passes through the gastrointestinal tract without being absorbed. In adults, only about 1/20 of the total ingested cadmium (in food or water) is absorbed (McLellan et al. 1978, Rahola et al. 1973; Shaikh and Smith 1980). The retention of cadmium in the gut slowly decreases over a period of 1–3 weeks after ingestion in adults (Rahola et al. 1973). The absorption of cadmium in rats depends on age, with measured absorption decreasing from 12 to 5 to 0.5% at 2 hours, 24 hours, and 6 weeks after birth, respectively (Sasser and Jarboe 1977). Sasser and Jarboe (1980) also reported that absorption of cadmium in the gastrointestinal tract of young guinea pigs was 20-fold higher than in adult guinea pigs.

Tissue distribution and retention of cadmium differed between 4- and 70-day-old rats. Cadmium was 3–6 times more concentrated in the newborn spleen, bone, brain, testes, and muscle than in the adult rat 2 hours after an intravenous administration of 1 mg Cd/kg body weight. Liver concentration of metallothionein was 20 times greater in the newborn than in the adult; kidney metallothionein concentrations were comparable, but liver cadmium was only 30% higher and kidney cadmium was 50% higher in the newborn. Nineteen days post-cadmium exposure, the retention of cadmium in the liver, kidney, and lung was similar in both the newborn and the adult rat (Wong and Klaassen 1980a). Goering and Klaassen (1984b) report that high levels of metallothionein in 10-day-old rats play an important role in their resistance to liver damage, presumably by binding and retaining cadmium. However, the tissue distribution data led Wong and Klaassen (1980a) to propose that metallothionein does not play a major role in the tissue distribution and retention of cadmium in the young.

Cadmium can be transferred to offspring in breast milk. Cadmium levels in human milk are 5–10% of levels in blood, possibly due to inhibited transfer from blood because of metallothionein binding of cadmium in blood cells (Radisch et al. 1987). A significant association between urinary cadmium levels and cadmium levels in breast milk was found in women environmentally exposed to cadmium (Nishijo et al. 2002). In female outbred albino rats exposed to cadmium in drinking water (as cadmium chloride) at 0 or 4.8 mg/kg/day for 10 weeks (at 4 weeks prior to mating, 3 weeks of gestation, or 3 weeks into lactation), kidney concentrations exceeded liver concentrations, while in their pups, the renal and liver concentrations were similar at all times during exposure. In pups, both hepatic and renal cadmium



## 3. HEALTH EFFECTS

concentrations considerably increased only during the second half of the lactation period (Ld 11–21). The cadmium tissue concentrations in dams were several orders higher than in offspring. Another study found a positive correlation between cadmium levels in breast milk and cadmium levels in the pups' kidneys in rats receiving an intravenous injection of cadmium on lactation days 3–16 (Petersson Grawé and Oskarsson 2000).

Although studies on elimination of cadmium from the tissues of children are not available, the results of studies in animals provide some insight. Most cadmium that is ingested or inhaled and transported to the gut via mucociliary clearance is excreted in the feces. Of the cadmium that is absorbed into the body, most is excreted very slowly, with urinary and fecal excretion being approximately equal (Kjellström and Nordberg 1978). Half-times for cadmium in the whole body of mice, rats, rabbits, and monkeys have been calculated to be from several months up to several years (Kjellström and Nordberg 1985). Half-times in the slowest phase were 20–50% of the maximum life span of the animal (Kjellström and Nordberg 1985). In the human body, the main portion of the cadmium body burden is found in the liver and kidney and in other tissues (particularly muscle, skin, and bone). After reviewing the literature, Kjellström and Nordberg (1985) developed a range of half-times from their kinetic model of between 6 and 38 years for the human kidney and between 4 and 19 years for the human liver. These high values indicate the persistence of cadmium in the body and the importance of minimizing exposures in children to prevent long-term accumulation and toxicity.

The placenta may act as a partial barrier to fetal exposure to cadmium. Cadmium concentration has been found to be approximately half as high in cord blood as in maternal blood in several studies including both smoking and nonsmoking women (Kuhnert et al. 1982; Lauwerys et al. 1978; Truska et al. 1989). Accumulation of cadmium in the placenta at levels about 10 times higher than maternal blood cadmium concentration has been found in studies of women in Belgium (Roels et al. 1978) and the United States (Kuhnert et al. 1982); however, in another study in Czechoslovakia, the concentration of cadmium in the placenta was found to be less than in either maternal or cord blood (Truska et al. 1989). In mice orally exposed to cadmium during pregnancy, maternal blood, placental, and fetal cadmium concentrations were essentially equal among control animals (with environmental cadmium exposure), but placental concentration increased with cadmium dose much more rapidly than either maternal blood or fetal cadmium concentration (Sorell and Graziano 1990). Thus, timing and level of cadmium exposure may influence the uptake of cadmium by the placenta, perhaps explaining the conflicting human studies.

### 3. HEALTH EFFECTS

Of particular importance to the toxicokinetics and toxicity of cadmium is its interaction with the protein metallothionein. Metallothionein is a low-molecular-weight protein, very rich in cysteine, which is capable of binding as many as seven cadmium atoms per molecule and is inducible in most tissues by exposure to cadmium, zinc, and other metals (Waalkes and Goering 1990). Metallothionein binding decreases the toxicity of cadmium (Goyer et al. 1989; Kotsonis and Klaassen 1978). Goyer and Cherian (1992) localized metallothionein in full-term human placenta and in fetal cells in human placenta. Metallothionein was present in trophoblasts (which facilitate transport of substances entering the placenta from the maternal blood), Hofbauer cells (motile macrophages capable of phagocytosis and protein ingestion), amniotic epithelial cells (fetal derivatives), and decidual cells (endometrial stromal cells that have been transformed under hormonal influence into large pale cells, rich in glycogen). The mechanism by which the placenta transports the essential metals, copper and zinc, while limiting the transport of cadmium is unknown, but may involve the approximately 1,000-fold higher concentration of zinc in the placenta and the higher affinity of cadmium than zinc for metallothionein.

Chan and Cherian (1993) report that pregnancy in Sprague-Dawley rats previously administered cadmium chloride (1.0 mg Cd/kg body weight subcutaneously, daily for 8 days) leads to a mobilization of cadmium from the liver (40% decrease compared to nonpregnant cadmium treated controls) and an increase in the kidneys (60% increase). A similar pattern is seen for metallothionein. Plasma cadmium and metallothionein also increased in the pregnant group. Placental cadmium increased in the cadmium-treated rats compared to the untreated controls. In this rat model, then, pregnancy resulted in a transfer of hepatic cadmium and metallothionein via the blood to the kidney and placenta.

#### **3.8 BIOMARKERS OF EXPOSURE AND EFFECT**

Biomarkers are broadly defined as indicators signaling events in biologic systems or samples. They have been classified as markers of exposure, markers of effect, and markers of susceptibility (NAS/NRC 1989).

The National Report on Human Exposure to Environmental Chemicals provides an ongoing assessment of the exposure of the U.S. population to environmental chemicals using biomonitoring. This report is available at <http://www.cdc.gov/exposurereport/>. The biomonitoring data for cadmium from this report is discussed in Section 6.5. A biomarker of exposure is a xenobiotic substance or its metabolite(s) or the product of an interaction between a xenobiotic agent and some target molecule(s) or cell(s) that is measured within a compartment of an organism (NAS/NRC 1989). The preferred biomarkers of exposure

### 3. HEALTH EFFECTS

are generally the substance itself, substance-specific metabolites in readily obtainable body fluid(s), or excreta. However, several factors can confound the use and interpretation of biomarkers of exposure. The body burden of a substance may be the result of exposures from more than one source. The substance being measured may be a metabolite of another xenobiotic substance (e.g., high urinary levels of phenol can result from exposure to several different aromatic compounds). Depending on the properties of the substance (e.g., biologic half-life) and environmental conditions (e.g., duration and route of exposure), the substance and all of its metabolites may have left the body by the time samples can be taken. It may be difficult to identify individuals exposed to hazardous substances that are commonly found in body tissues and fluids (e.g., essential mineral nutrients such as copper, zinc, and selenium). Biomarkers of exposure to cadmium are discussed in Section 3.8.1.

Biomarkers of effect are defined as any measurable biochemical, physiologic, or other alteration within an organism that, depending on magnitude, can be recognized as an established or potential health impairment or disease (NAS/NRC 1989). This definition encompasses biochemical or cellular signals of tissue dysfunction (e.g., increased liver enzyme activity or pathologic changes in female genital epithelial cells), as well as physiologic signs of dysfunction such as increased blood pressure or decreased lung capacity. Note that these markers are not often substance specific. They also may not be directly adverse, but can indicate potential health impairment (e.g., DNA adducts). Biomarkers of effects caused by cadmium are discussed in Section 3.8.2.

A biomarker of susceptibility is an indicator of an inherent or acquired limitation of an organism's ability to respond to the challenge of exposure to a specific xenobiotic substance. It can be an intrinsic genetic or other characteristic or a preexisting disease that results in an increase in absorbed dose, a decrease in the biologically effective dose, or a target tissue response. If biomarkers of susceptibility exist, they are discussed in Section 3.10, Populations That Are Unusually Susceptible.

#### **3.8.1 Biomarkers Used to Identify or Quantify Exposure to Cadmium**

Cadmium levels in blood, urine, feces, liver, kidney, hair, and other tissues have been used as biological indicators of exposure to cadmium. A discussion of the utility and limitations of each for human biomonitoring is provided below.

Blood cadmium levels are principally indicative of recent exposure(s) to cadmium rather than whole-body burdens (Ghezzi et al. 1985; Järup et al. 1988; Lauwerys et al. 1994; Roels et al. 1989). The 50<sup>th</sup>

## 3. HEALTH EFFECTS

percentile of blood cadmium concentrations in adults living in the United States was 0.330 µg/L (CDC 2011). Environmental exposure can elevate blood cadmium concentration to above 10 µg/L (Kido et al. 1990a, 1990b; Shiwen et al. 1990). Workers occupationally exposed to cadmium by inhalation may have blood cadmium levels ranging up to 50 µg/L (Roels et al. 1981b).

Urine cadmium levels primarily reflect total body burden of cadmium, although urine levels do respond somewhat to recent exposure (Bernard and Lauwerys 1986). Use of a biokinetic model, such as the Nordberg-Kjellström model, allows estimation of cadmium dietary consumption or airborne cadmium levels from urinary cadmium levels; these models are described in greater detail in Section 3.4.5.3. When the critical level for renal damage has been reached, urinary cadmium levels rise sharply because of the release of intrarenal cadmium along with decreased renal reabsorption of cadmium (Lauwerys et al. 1994; Roels et al. 1981b). In the U.S. general population, the geometric mean urinary cadmium level in adults is 0.232 µg/L (or 0.247 µg/g creatinine) (CDC 2011). In populations with substantial environmental or occupational exposure, values can range up to 50 µg/g creatinine, (Falck et al. 1983; Roels et al. 1981b; Tohyama et al. 1988). In environmentally exposed individuals, Buchet et al. (1990) report that abnormal values of various biomarkers are found in 5% of the population with urinary excretion of cadmium above the 2–4 µg Cd/24 hour level (approximately 1–3 µg/g creatinine). Significant correlations between total cadmium exposure and urinary cadmium levels have been found in environmentally exposed populations (Kido et al. 2004; Kobayashi et al. 2005; Shimbo et al. 2000). Among environmentally exposed subjects, there was good agreement between urinary cadmium levels measured at different times, suggesting that a single determination would be an accrument measure (Ikeda et al. 2005a).

Fecal cadmium may be used as a direct indicator of daily dietary intake of cadmium because dietary cadmium is poorly absorbed in the gastrointestinal tract (Kjellström et al. 1978). In workers exposed by inhalation, fecal cadmium has been used to estimate the amount of inhaled cadmium transported to the gastrointestinal tract and the amount of dust ingested incidentally at work (Adamsson et al. 1979). Fecal cadmium primarily reflects recently ingested cadmium and, therefore, is not a good indicator of past cadmium exposure (Shaikh and Smith 1984).

Liver and kidney tissues preferentially accumulate cadmium, and concentrations of cadmium in liver and kidney may be measured using non-invasive techniques such as *in vivo* neutron activation analysis or in the kidney by X-ray fluorescence analysis (Christofferson et al. 1987; Scott and Chettle 1986); however, the limit of detection is near background levels (Nordberg 2010). Levels in both tissues increase with age and level of cadmium exposure, but kidney cadmium concentration tends to peak around age 50–60,

## 3. HEALTH EFFECTS

while liver cadmium concentration continues to rise. Typical values for a 60-year-old North American with average environmental cadmium exposure are 25–40 µg/g wet weight in kidney cortex and 1–3 µg/g wet weight in liver (Elinder 1985b). In workers exposed to cadmium by inhalation, values up to 300 µg/g wet weight in kidney and 100 µg/g wet weight in liver can be found (Christoffersson et al. 1987; Roels et al. 1981b). Because kidney cadmium content begins to decline after the onset of cadmium-induced renal dysfunction, liver cadmium may be a better indicator of cadmium exposure than kidney cadmium, and it has been suggested that kidney dysfunction is likely to appear at liver cadmium concentrations between 30 and 60 µg/g wet weight (Roels et al. 1981b). *In vivo* liver and kidney cadmium measurements involving neutron activation analysis or X-ray fluorescence require complex and costly equipment and may pose a radiation hazard (Shaikh and Smith 1984), and those involving biopsy specimens (Lindqvist et al. 1989) require a painful and invasive procedure. Therefore, these methods for *in vivo* analysis are better suited for monitoring of occupationally exposed workers than environmentally exposed populations (Scott and Chettle 1986). Among cadmium workers, significant correlations of kidney cadmium levels with urinary and blood cadmium levels and liver cadmium with urinary cadmium levels were found (Börjesson et al. 1997, 2001). Similar correlations (urinary cadmium with renal cadmium) in an autopsy study of subjects without occupational exposure to cadmium; a urinary cadmium level of 1.7 µg/g creatinine was equivalent to a renal cadmium level of 50 µg/g (Orlowski et al. 1998).

Hair levels of cadmium have been used as a measure of cadmium exposure, although the possibility of exogenous contamination has led to substantial controversy concerning the reliability of hair levels as a measure of absorbed dose (Frery et al. 1993; Huel et al. 1984; Lauwerys et al. 1994, Shaikh and Smith 1984; Wilhelm et al. 1990). Recent evidence has shown a correlation between cadmium levels in the hair of newborn infants and their mothers (Huel et al. 1984) and between cadmium levels in scalp and pubic hair (Wilhelm et al. 1990), indicating that among environmentally exposed populations, external contamination may not be significant for hair samples taken close to the scalp. Under occupational conditions, external contamination may be a more substantial problem (Shaikh and Smith 1984).

On the other hand, Frery et al. (1993) evaluated hair levels in a male population with a high expected exposure to tobacco smoke and in a population of pregnant woman and their newborns; they concluded that cadmium hair analysis was a reliable indicator for the subjects with the highest exposure, but was not sensitive enough to resolve differences for low level exposures. Newborn cadmium hair levels were a more sensitive indicator than mother's hair, but the research was not able to determine if this was attributable to physiological changes or the lower reliability of the mother's head hair. Exogenous contamination is not considered a problem for newborn hair. The authors state that the variability

### 3. HEALTH EFFECTS

introduced by exogenous contamination can be minimized by using the first 8 cm of hair from the scalp and by using careful washing techniques. There was also no significant difference between hair levels for passive or nonsmokers indicating that either the above mentioned precautions worked or that the passive smoke source of exposure was not significant.

Cadmium measurements have been made on a variety of other biological materials, including milk (Schulte-Lobbert and Bohn 1977; Sikorski et al. 1989), placenta (Kuhnert et al. 1982; Roels et al. 1978; Saaranen et al. 1989), nails (Takagi et al. 1988), teeth (Sharon 1988), and cataractous lenses (Racz and Erdohelyi 1988). Although in some cases it could be established that levels in these tissues were higher among smokers than nonsmokers, the significance of cadmium levels as a marker of recent or total cadmium exposure has not been established for any of these tissues.

Studies in cadmium workers suggest that metallothionein levels may also be a biomarker of cadmium exposure. Elevated levels of metallothionein gene expression were observed in peripheral blood lymphocytes in highly exposed workers. The level of metallothionein gene expression was significantly correlated with blood and urinary cadmium levels (Lu et al. 2001). Urinary metallothionein correlates with cadmium concentrations in liver, kidney, and urine (Shaikh and Smith 1984; Tohyama et al. 1981). Relatively strong correlations have been found between urinary metallothionein and urinary cadmium levels in exposed humans (Kawada et al. 1990), and a dose-related increase in urinary metallothionein was found in rats exposed to cadmium in drinking water for up to 2 years (Shaikh et al. 1989). Hochi et al. (1995) also found a significant relationship between cadmium intake and urinary metallothionein levels among residents consuming cadmium-contaminated rice.

#### **3.8.2 Biomarkers Used to Characterize Effects Caused by Cadmium**

Acute inhalation exposure to high levels of cadmium causes respiratory damage and may lead to death. No information was located on biomarkers of respiratory effects in humans, but based on animal experiments, activity of alkaline phosphatase in the surfactant fraction of BALF has been suggested as a sensitive marker of pulmonary damage following acute cadmium inhalation (Boudreau et al. 1989). Such a biomarker of effect is not specific to cadmium exposure and would be most relevant to occupational exposures.

Renal dysfunction, usually first manifested as impaired tubular reabsorption of filtered solutes, is generally considered the primary toxic effect of chronic cadmium exposure (see Section 3.2). Impaired

## 3. HEALTH EFFECTS

kidney function has been measured by increased levels of solutes (proteins, amino acids, uric acid, calcium, copper, phosphorous, etc.) in urine and/or serum. Excess urinary excretion of low-molecular-weight proteins and solutes is associated with decreased tubular reabsorption. Increased excretion of high-molecular-weight proteins or decreased serum clearance of creatinine reflect glomerular dysfunction, which is generally associated with progressive renal damage (Roels et al. 1989). A brief discussion of the utility and limitations of several measures of tubular damage as biomarkers of effects of cadmium exposure is provided below. These biomarkers are normally found in the urine and elevated levels are not specific for cadmium.

Urinary  $\beta$ 2-microglobulin, a low molecular weight protein, has been widely used as an indicator of tubular renal dysfunction (Arisawa et al. 1997; Piscator 1984; Roels et al. 1981a; Smith et al. 1980). However, tubular renal dysfunction can be caused by exposures and diseases other than cadmium, so  $\beta$ 2-microglobulin is not a specific marker of cadmium-induced effects (Shaikh and Smith 1984). Practical considerations in using urinary  $\beta$ 2-microglobulin as a marker of tubular renal dysfunction include the need to control the pH of samples to prevent the rapid degradation that occurs at pH values below 5.5 (Shaikh and Smith 1984), and the fact that urinary  $\beta$ 2-microglobulin excretion normally rises with age (Roels et al. 1989).

Urinary retinol-binding protein is also considered to be a sensitive indicator of decreased tubular reabsorption, but it also is not specific for cadmium-induced damage in the kidney (Shaikh and Smith 1984; Topping et al. 1986). Retinol-binding protein is more stable in urine than  $\beta$ 2-microglobulin (Bernard and Lauwerys 1981) and appears to be of approximately equal sensitivity and specificity for detecting tubular proteinuria in cadmium-exposed populations (Topping et al. 1986). Levels of both proteins fluctuate over time, so regular, repeated sampling may be necessary to establish abnormal levels (Ormos et al. 1985).

Human complex-forming glycoprotein (pHC, also referred to as  $\alpha$ <sub>1</sub>-microglobulin) is another sensitive marker of tubular renal dysfunction (Moriguchi et al. 2004, 2005a; Pless-Mulloli et al. 1998; Tohyama et al. 1986). As with retinol binding protein, pHC is more stable in urine than  $\beta$ 2-microglobulin at room temperature and low urinary pH levels.

Urinary N-acetyl- $\beta$ -D-glucosaminidase (NAG), a lysosomal enzyme present in high concentrations in the proximal tubule, has been shown to correlate with urinary cadmium levels in occupationally and environmentally exposed subjects (Jin et al. 1999; Kalahasthi et al. 2007) and has a better correlation with

## 3. HEALTH EFFECTS

urinary cadmium levels than does  $\beta$ 2-microglobulin at low cadmium exposure levels (urinary cadmium  $<10 \mu\text{g/g}$  creatinine) (Chia et al. 1989; Kawada et al. 1990; Mueller et al. 1989). However, increased urinary NAG activity can result from effects other than nephrotoxicity (Bernard and Lauwerys 1989). Jin et al. (1999) suggest that measurement of the B isozyme (NAG-B), which is released into the urine following tubular cell breakdown, may be a sensitive measure of renal damage.

Other enzymes, proteins, and amino acids in urine have been suggested as biological markers of incipient renal or liver damage resulting from cadmium exposure. Markers found to be sensitive indicators in exposed humans include trehalase (Iwata et al. 1988), alanine aminopeptidase (Mueller et al. 1989), and calcium (Buchet et al. 1990). Changes in urinary alkaline phosphatase,  $\gamma$ -glutamyl transferase, urate, and phosphate tend to be significant only after other markers of renal damage are clearly elevated (Mason et al. 1988). Several other enzymatic markers of cadmium-induced renal damage have been suggested based on animal studies (Bomhard et al. 1984; Gatta et al. 1989; Girolami et al. 1989). Aminoaciduria has been found to be more sensitive than proteinuria for renal damage in animal studies (Nomiyama et al. 1975), but less sensitive in humans (Axelsson and Piscator 1966). Recent work by Prozialeck et al. (2007) suggest that kidney injury molecule 1 may be a sensitive marker for renal dysfunction. At present, not enough information is available to determine which, if any, of these parameters provide sensitive and specific indicators of cadmium-induced renal damage.

At the present time, there is no single biological indicator for cadmium toxicity that is entirely adequate when considered alone. Measurement of cadmium levels in various biological materials can provide an indication of recent or total cadmium exposure, but the probability of adverse effects cannot be reliably predicted except at high exposure levels. Measurement of a variety of markers of renal dysfunction can provide a sensitive measure of early kidney toxicity, but cannot establish whether cadmium exposure was the cause.

There is also considerable controversy as to whether the critical concentration of urinary cadmium is closer to 5 or 10  $\mu\text{g Cd/g}$  creatinine, corresponding to about 100 and 200 ppm in the kidney, respectively. Roels et al. (1993) correlated a number of markers with cadmium in blood and urine in a study population of workers occupationally exposed to cadmium from cadmium smelting operations. Three main groupings of thresholds were identified corresponding with different markers of effects: one around 2  $\mu\text{g Cd/g}$  creatinine mainly associated with biochemical alterations (increased urinary 6-keto-prostaglandin  $F_{1x}$  and urinary sialic acid), a second around 4  $\mu\text{g Cd/g}$  creatinine associated with increased excretion of high molecular weight proteins (possibly due to disruption of the glomerular membrane polyanionic



## 3. HEALTH EFFECTS

charge) and tubular antigens or enzymes (BBA, NAG), and a third around 10  $\mu\text{g Cd/g creatinine}$  associated with increased excretion of low molecular weight proteins and other indicators. The 10  $\mu\text{g Cd/g creatinine}$  level had previously been proposed as the biological threshold for cadmium-induced nephropathy. Whether the earlier changes are indicative of irreversible adverse renal effects remains an area of continued investigation.

To further evaluate the reversibility of proteinuria, Roels et al. (1997) studied the progression of cadmium-induced renal tubular dysfunction in cadmium workers according to the severity of the microproteinuria at the time the exposure was substantially decreased. A total of 32 cadmium male workers were divided into two groups on the basis of historical records of urinary cadmium concentration (CdU) covering the period until 1984. The workers with CdU values of  $>10 \mu\text{g Cd/g creatinine}$  were subdivided further on the basis of the urinary concentration of  $\beta_2$ -microglobulin ( $\beta_2$ -MG-U) measured during the first observation period (1980–1984). In each group, the tubular microproteinuria as reflected by  $\beta_2$ -MG-U and the concentration of retinol-binding protein in urine as well as the internal cadmium dose as reflected by the concentration of cadmium in blood and urine were compared between the first and second (1990–1992) observation periods. Increased microproteinuria was often diagnosed in cases with CdU values of  $>10 \mu\text{g Cd/g creatinine}$ . The progression of tubular renal function was found to depend on the extent of the body burden of cadmium (as reflected by CdU) and the severity of the initial microproteinuria at the time high cadmium exposure was reduced or ceased. When cadmium exposure was reduced and  $\beta_2$ -MG-U did not exceed the upper reference limit of 300  $\mu\text{g/g creatinine}$ , the risk of developing tubular dysfunction at a later stage was likely to be low, even in cases with historical CdU values occasionally  $>10$  but always  $<20 \mu\text{g Cd/g creatinine}$ . When the microproteinuria was mild ( $\beta_2$ -MG-U  $>300$  and  $\leq 1,500 \mu\text{g/g creatinine}$ ) at the time exposure was reduced, and the historical CdU values had never exceeded 20  $\mu\text{g Cd/g creatinine}$ , there was indication of a reversible tubulotoxic effect of cadmium. When severe microproteinuria ( $\beta_2$ -MG-U  $>1,500 \mu\text{g/g creatinine}$ ) was diagnosed in combination with historical CdU values exceeding 20  $\mu\text{g Cd/g creatinine}$ , Cd-induced tubular dysfunction was progressive in spite of reduction or cessation of cadmium exposure.

For more information on biomarkers for renal and hepatic effects of chemicals see Agency for Toxic Substances and Disease Registry *Subcommittee Report on Biological Indicators of Organ Damage* (Agency for Toxic Substances and Disease Registry 1990a). For information on biomarkers for neurological effects see OTA (1990).

## 3. HEALTH EFFECTS

**3.9 INTERACTIONS WITH OTHER CHEMICALS**

Cadmium toxicity can be influenced by a wide variety of other chemicals. In humans, dietary deficiencies of calcium, protein, and vitamin D are likely to account for increased susceptibility to bone effects following cadmium exposure (Kjellström 1986c). Iron deficiency has been shown to increase gastrointestinal absorption of cadmium in humans (Flanagan et al. 1978), while oral zinc supplementation has been demonstrated to decrease the oral absorption of cadmium. No other information was located concerning interaction of cadmium with other chemicals in humans.

In animals, a few interactions following inhalation exposure have been evaluated. In rats exposed to cadmium chloride by inhalation, simultaneous exposure to zinc oxide prevents fatalities (Oldiges and Glaser 1986) and lung cancer (Oldiges et al. 1989). Exposure to an atmosphere containing 80% oxygen aggravated pulmonary damage from cadmium chloride inhalation in mice (Martin and Witschi 1985).

The toxicity of oral exposure to cadmium in animals has been shown to be influenced by several factors. In Japanese quail, cadmium toxicity was intensified by single or combined deficiencies of zinc, copper, iron, calcium, and protein (Fox et al. 1979). A calcium-deficient diet in animals has been shown to aggravate cadmium immunotoxicity (Chopra et al. 1984) and fetotoxicity (Pond and Walker 1975). Simultaneous exposure to lindane increased the developmental toxicity of cadmium in rats (Saxena et al. 1986). Female rats have an increased susceptibility to cadmium-induced bone loss due to multiple rounds of gestation and lactation (Bhattacharyya et al. 1988b) or ovariectomy (Bhattacharyya et al. 1988c), possibly related to associated effects on trace element status. Hopf et al. (1990) report that exposure to ethanol and cadmium in a liquid diet produced liver damage in rats at doses that were not separately hepatotoxic. In contrast, Kershaw et al. (1990) reported that ethanol pretreatment in male Sprague-Dawley rats substantially reduced the lethal and hepatotoxic properties of cadmium, possibly due to a reduced interaction between cadmium and target sites in liver organelles and cytosolic high-molecular-weight (HMW) proteins. Ethanol pretreatment in this study decreased (approximately 60%) the content of cadmium in nuclei, mitochondria, and endoplasmic reticulum, and nearly eliminated the association of cadmium with cytosolic HMW proteins. Reduction in the concentration of cadmium in potential target sites of intoxication was caused by a metallothionein-promoted sequestration of cadmium to the cytosol.

When cadmium is co-administered with ethanol in rats, there is a pronounced increase in cadmium accumulation in various regions of the brain (e.g., the corpus striatum and cerebral cortex). The cadmium is not bound to metallothionein, and there is a marked increase in lipid peroxidation and inhibition of

## 3. HEALTH EFFECTS

membrane bound enzymes (Pal et al. 1993a, 1993b). Rats pretreated with acetaminophen are more sensitive to the renal toxicity of cadmium in water (Bernard et al. 1988a). Co-administration of lead and cadmium in the diet of rats had additive effects in reducing body weights, but neurologic toxicity was antagonized (Nation et al. 1990).

Numerous interactions have been demonstrated in animals using parenteral exposure, generally indicating that induction of metallothionein by pretreatment with zinc, selenium, or other metals, reduces toxicity of parenteral cadmium exposure (Gunn et al. 1968a, 1968b; Naruse and Hayashi 1989; Yamane et al. 1990). Zinc, calcium, or magnesium can prevent injection site, testicular, and prostatic cancers induced by subcutaneous or intramuscular injection of cadmium, but these interactions have been shown to be a complex phenomenon, dependent on dose, route, and target organ (Poirier et al. 1983; Waalkes et al. 1989). Mn(II) pretreatment reduces Cd(II)-induced lethality (Goering and Klaassen 1985). Cadmium has been noted to have an inhibitory effect on manganese uptake (Gruden and Matausic 1989). In addition, manganese appears to be capable of increasing the synthesis of the metal-binding protein metallothionein (Waalkes and Klaassen 1985). Data from a study by Goering and Klaassen (1985) suggest that manganese pretreatment increases the amount of Cd<sup>+2</sup> bound to metallothionein, thereby decreasing hepatotoxicity due to unbound Cd<sup>+2</sup>. The significance of these observations to humans exposed to cadmium and manganese by the oral or inhalation routes is not clear.

Induction of hepatic metallothionein by cold stress reduced the acute toxicity of cadmium given by gavage to mice (Baer and Benson 1987). In addition to effects on metallothionein induction, substances may interact with cadmium by altering the competition among metal ions for enzyme or regulatory protein binding sites. For example, simultaneous administration of garlic (which is high in reduced sulfhydryl groups) decreases oral cadmium renal toxicity in rats (Cha 1987).

Coexposure to selenium reduced the clastogenic effect of cadmium on mouse bone marrow (Mukherjee et al. 1988b). Selenium deficiency enhances cadmium-induced cardiotoxicity possibly mediated via lipid peroxidation indicated by a significant reduction in the activities of the selenoenzyme, glutathione peroxidase. Selenium supplements in the diet prevented cadmium's cardiotoxic effect (Jamall and Smith 1985a). Selenium has also been shown to prevent testicular damage in rats (Kar et al. 1960; Omaye and Tappel 1975). In testes, selenium as selenite given before or during cadmium administration was shown to divert the binding of cadmium from low molecular proteins to higher molecular weight proteins (Chen et al. 1975; Whanger 1992). In contrast, Jamall and Smith (1985c) report a shift in cadmium binding from metallothionein to lower weight proteins in kidney and liver from a diet supplemented with

## 3. HEALTH EFFECTS

selenium compared to a selenium deficient diet. The selenium-cadmium interaction thus appears to be dependent on the duration and sequence of coexposure and possibly the organ-specific levels of selenoenzymes or other essential metals.

**3.10 POPULATIONS THAT ARE UNUSUALLY SUSCEPTIBLE**

A susceptible population will exhibit a different or enhanced response to cadmium than will most persons exposed to the same level of cadmium in the environment. Reasons may include genetic makeup, age, health and nutritional status, and exposure to other toxic substances (e.g., cigarette smoke). These parameters result in increased absorption, reduced detoxification or excretion of cadmium, or compromised function of organs affected by cadmium. Populations who are at greater risk due to their unusually high exposure to cadmium are discussed in Section 6.7, Populations with Potentially High Exposures.

Differences in individual sensitivity to cadmium have not been systematically studied, but based on what is known about cadmium toxicity, some inferences can be made. Populations with depleted stores of calcium, iron, or other dietary components due to multiple pregnancies and/or dietary deficiencies could be expected to have increased cadmium absorption from the gastrointestinal tract. Urinary cadmium levels have been shown to be correlated with iron status among pregnant women (Åkesson et al. 2002). However, a general population study of women living in Japan (Tsukahara et al. 2003) did not find significantly elevated levels of urinary cadmium,  $\beta$ 2-microglobulin, or pHC among women with anemia or iron deficiency, as compared to healthy women. Populations with kidney damage from causes unrelated to cadmium exposure, including diabetes, some drugs and chemicals, and the natural age-related decline in kidney function, could be expected to exhibit nephrotoxicity at lower cadmium exposures than those of normal healthy adults (Buchet et al. 1990). There is also some evidence to suggest that diabetics may be more susceptible to the toxicity of cadmium (Åkesson et al. 2005; Buchet et al. 1990; Haswell-Elkins et al. 2008). Elevated levels of metallothionein-antibody have been significantly associated with excretion of biomarkers of tubular dysfunction among cadmium workers (Chen et al. 2006a), but not with urinary or blood cadmium levels. In a study of diabetics, metallothionein-antibodies were significantly associated with urinary levels of  $\beta$ 2-microglobulin levels, which were indicative of cadmium toxicity but not with urinary albumin levels, which would be indicative of glomerular damage (Chen et al. 2006c). However, a significant association between elevated albumin creatinine ratio and urinary cadmium levels was found in another study of diabetics (Haswell-Elkins et al. 2008) and the frequency of albuminuria

## 3. HEALTH EFFECTS

was 64% among diabetics with high urinary cadmium levels of 1–2 µg/g creatinine and 80% among those with urinary cadmium levels of >2 µg/g creatinine.

A discussion of the susceptibility of children is found in Section 3.7, Children's Susceptibility.

### 3.11 METHODS FOR REDUCING TOXIC EFFECTS

This section will describe clinical practice and research concerning methods for reducing toxic effects of exposure to cadmium. However, because some of the treatments discussed may be experimental and unproven, this section should not be used as a guide for treatment of exposures to cadmium. When specific exposures have occurred, poison control centers and medical toxicologists should be consulted for medical advice. The following texts provide specific information about treatment following exposures to cadmium:

Caravati EM, McGuigan MA, MacGregor Whyte I, et al. Cadmium fume pneumonitis. In: Medical toxicology, 3rd ed. Philadelphia, PA: Lippincott Williams & Wilkins, 1411-1414.

Leikin JB, Paloucek FP. 2002. Cadmium. In: Poisoning and toxicology handbook. Hudson, OH: Lexi-Comp, Inc., 309-310.

Viccellio P. 1998. Cadmium, mercury, and arsenic. In: Emergency toxicology. 2nd ed. Philadelphia, PA: Lippincott-Raven Publishers, 379-380.

#### 3.11.1 Reducing Peak Absorption Following Exposure

Inhalation exposure to high concentrations of cadmium can be particularly dangerous because initial symptoms are often as mild as those associated with low-level exposure, and exposed individuals who are unaware either of the presence of cadmium or of the dangers of inhaling cadmium may allow exposure to continue until a harmful or even fatal dose is received (Beton et al. 1966; Lucas et al. 1980). Severe respiratory symptoms that may develop within a few hours of high-dose inhalation exposure include tracheobronchitis, pneumonitis, and pulmonary edema, accompanied by additional nonspecific flu-like symptoms (sweating, shivering, malaise) (Beton et al. 1966). Aside from removing a victim to fresh air and providing supportive medical care, no effective means have been reported for reducing absorption following inhalation exposure to cadmium (Bronstein and Currance 1988; EPA 1989d). Supportive medical care of individuals with inhalation exposure to high levels of cadmium includes monitoring for respiratory distress, assisting ventilation as needed, and administering humidified oxygen (Bronstein and Currance 1988; EPA 1989d). If pulmonary edema develops, individuals may be treated with

## 3. HEALTH EFFECTS

supplemental oxygen, positive-pressure mechanical ventilation, and administration of diuretics, intravenous fluids, and steroid medications. Antibiotic therapy and monitoring fluid balance (due to kidney function impairment) may also be required (Beton et al. 1966; Bronstein and Currance 1988; EPA 1989d; Haddad and Winchester 1990).

Oral exposure to cadmium is not an immediate threat because high doses are irritating enough to induce vomiting. In fact, the only known acute fatalities from oral exposure to cadmium followed intentional ingestion of high doses (Baker and Hafner 1961; Buckler et al. 1986; Frant and Kleeman 1941; Nordberg et al. 1973; Shipman 1986; Wisniewska-Knypl et al. 1971). Although inducing vomiting is sometimes recommended following ingestion of cadmium (Ellenhorn and Barceloux 1988; Stutz and Janusz 1988), concentrated cadmium solutions may be caustic, and esophageal damage could result from spontaneous or induced vomiting. Administration of water or milk may be indicated for patients able to swallow (Bronstein and Currance 1988; EPA 1989d). Administration of cathartics such as sorbitol or magnesium sulfate to enhance elimination from the gastrointestinal tract has been recommended (EPA 1989d; Stutz and Janusz 1988); however, the administration of activated charcoal to bind unabsorbed cadmium does not appear to be effective (Agency for Toxic Substances and Disease Registry 1990b; Ellenhorn and Barceloux 1988).

The intestinal absorption of cadmium at levels below those leading to gastrointestinal damage is relatively low (5–10% of the administered dose) (Flanagan et al. 1978; McLellan et al. 1978; Newton et al. 1984; Rahola et al. 1973). Other polyvalent cations including calcium, magnesium, and zinc can interfere with cadmium uptake (Foulkes 1985), but administration of competing cations can in some cases increase rather than decrease cadmium absorption (Jaeger 1990), and is therefore not recommended for the treatment of cadmium ingestion. Oral administration of some compounds that chelate cadmium such as meso-2,3-dimercaptosuccinic acid has been found in rodent studies to reduce absorption following acute oral exposure to cadmium, but other chelators such as dithiocarbamates can increase toxicity (see Section 3.4.1.2). At present, no recommendations for chelation treatment to reduce absorption can be made (Jones and Cherian 1990). Administration of garlic (which is high in reduced sulfhydryl groups) has been shown to decrease oral cadmium toxicity in rats (Cha 1987). Thus, use of garlic could be an area of future research.

Dermal or ocular exposure to high levels of cadmium may cause irritation (Wahlberg 1977) and should be treated by removing contaminated clothing, washing the skin, and thoroughly flushing the eyes (EPA

## 3. HEALTH EFFECTS

1989d; Stutz and Janusz 1988). These measures will also reduce the relatively small potential for dermal absorption of cadmium (see Section 3.4.1.3).

### 3.11.2 Reducing Body Burden

A variety of chelating agents have been evaluated (Cantilena and Klaassen 1981; Jones et al. 1992, 1994; Kostial et al. 1996; Singh et al. 1996). Some of the more familiar chelators that are beneficial for other toxic metals actually increase cadmium toxicity by mobilizing the cadmium and substantially increasing the renal concentrations and toxicity (Agency for Toxic Substances and Disease Registry 1990b; Goldfrank et al. 1990; Jones and Cherian 1990). One such agent is the chelating agent dimercaprol (also known as BAL, British Anti-Lewisite), commonly used for treating cases of lewisite toxicosis. BAL is widely recognized as harmful in treating cadmium exposures. Some sources recommend using ethylenediamine tetraacetic acid (EDTA) salts (Cantilena and Klaassen 1980, 1981; Ellenhorn and Barceloux 1988; Stutz and Janusz 1988) or use of EDTA with caution about potential nephrotoxicity (EPA 1989d; Haddad and Winchester 1990). Other chelators that have reduced the cadmium burden in animal studies include diethylenetriaminepentaacetic acid (DTPA), 2,3-dimercaptosuccinic acid (DMSA), and various dithiocarbamates (Cantilena and Klaassen 1981, 1982b; Kamenosono et al. 2002a; Wang et al. 1999).

Cantilena and Klaassen (1982a) demonstrated the importance of rapid administration of DTPA, EDTA, or DMSA following acute cadmium exposure if they are to be effective. Waalkes et al. (1983) evaluated the role of metallothionein in the acute drop in chelator efficacy following cadmium poisoning in male Sprague-Dawley rats. Although the chelator, DTPA, reduced cadmium content in the various organs when given immediately after cadmium, it was ineffective at all later times. Increases in hepatic and renal metallothionein did not occur until 2 hours after cadmium, and did not coincide with the earlier drop in chelator efficacy. Blockade of metallothionein synthesis by actinomycin D treatment (1.25 mg/kg, 1 hour before Cd) failed to prolong the chelators effectiveness. Furthermore, newborn rats have high levels of hepatic metallothionein, which had no effect on the time course of chelator effectiveness since DTPA still decreased cadmium organ contents, if given immediately following cadmium, but had no effect if given 2 hours after cadmium. The authors concluded that metallothionein does not have an important role in the acute decrease in efficacy of chelation therapy for cadmium poisoning. The quick onset of chelator ineffectiveness may be due to the rapid uptake of cadmium into tissues, which makes it relatively unavailable for chelation.

### 3. HEALTH EFFECTS

Jones et al. (1992, 1994) investigated a series of monoalkyl and monoalkyl esters of meso-2,3-dimercaptosuccinic acid. Monoisoamyl meso-2,3-dimercaptosuccinate (Mi-ADMS) was an effective chelating agent for reduction of kidney and liver cadmium when administered either parenterally or orally (Jones et al. 1992). This finding was supported by a study by Eybl et al. (1994), which showed that Mi-ADMS, administered orally every 48 hours for 12 days after acute cadmium exposure, was effective at reducing cadmium in the kidney and liver, but not in the testes and brain. Monophenethyl meso-2,3-dimercaptosuccinic acid, mono(3-phenylpropyl) meso-2,3-dimercaptosuccinic acid, and mono(2-phenoxyethyl) meso-2,3-dimercaptosuccinic acid compounds successfully remove “aged” cadmium deposits and can be administered via a variety of routes (Jones et al. 1994).

Another area of chelation therapy research is in the use of multiple chelators. Blaha et al. (1995) evaluated the ability of two carbodithioate chelators, sodium N-(4-methylbenzyl)-4-O-( $\beta$ -D-galactopyranosyl)-D-glucamine-N-carbodithioate (MeBLDTC) and sodium 4-carboxyamidopiperidine-N-carbothioate (INADTC), singly or in combination to reduce cadmium burden from chronically exposed rats. The combination therapy resulted in a synergistic effect on increased biliary excretion and reduced renal cadmium that, in the case of biliary excretion, was more than doubled that expected for a simple additive interaction.

#### **3.11.3 Interfering with the Mechanism of Action for Toxic Effects**

The toxic effects of cadmium are generally thought to be caused by “free” cadmium ions; that is, cadmium not bound to metallothionein or other proteins (Goyer et al. 1989). However, cadmium bound to metallothionein may have the capacity to directly damage renal tubular membranes during uptake (Suzuki and Cherian 1987). Free cadmium ions may have a number of adverse effects, including inactivation of metal-dependent enzymes, activation of calmodulin, and initiation of the production of active oxygen species (Palmer et al. 1986; Waalkes and Goering 1990).

Respiratory damage caused by acute, high-level inhalation exposure to cadmium can cause impaired lung function that can last many years after exposure (Barnhart and Rosenstock 1984; Townshend 1982). No treatments other than supportive care and avoidance of additional risk factors for lung injury are presently known.

The kidneys appear to be highly vulnerable to chronic cadmium exposure by either the oral or inhalation routes. The basis for the preferential sensitivity of the kidney is related to the filtering and reabsorption of



## 3. HEALTH EFFECTS

circulating cadmium-metallothionein complex, which is then thought to be degraded in the tubular cell lysosomes and released as free intracellular cadmium. The toxic effect results from the limited ability of the kidney to synthesize new cytosolic metallothionein in response to an increasing cadmium load (Goyer et al. 1989). Cadmium bound to metallothionein, however, may also have nephrotoxic activity (Suzuki and Cherian 1987).

No treatments are currently available that specifically target free cadmium ions in the renal cortex, but zinc and calcium can stimulate metallothionein synthesis and may also compete with cadmium for enzyme binding sites. Thus, zinc, and/or calcium supplementation might help reduce renal cadmium toxicity, at least in zinc- or calcium-deficient individuals. It is not known whether administration of these compounds would be beneficial in individuals with adequate zinc and calcium intakes, and their clinical use is not currently recommended. Since one of the postulated mechanisms of cadmium toxicity is the stimulation and production of active oxygen species, it is possible that increasing the cellular levels of antioxidants such as superoxide dismutase, reduced sulfur compounds (particularly glutathione), vitamin C, vitamin E, or  $\beta$ -carotene could reduce renal cadmium toxicity by scavenging active oxygen species prior to reaction with cellular components. Several animal studies have examined co-administration of several antioxidants on cadmium-induced kidney damage. Beneficial effects were found for vitamin E (Shaikh and Tang 1999; Shaikh et al. 1999a), N-acetyl cysteine (Kaplan et al. 2008; Shaikh et al. 1999a, 1999b), glycine (Shaikh and Tang 1999), glycyrrhizin (Nomiya and Nomiya 1998), and a drug containing glycyrrhizin, glycine, and cysteine (Shaikh and Tang 1999; Shaikh et al. 1999a). However, antioxidants are not currently recommended for the treatment of cadmium-exposed humans.

Treatments for the cadmium-related effects on bone have not been evaluated. Although the mechanism of bone damage has not been fully elucidated, it is likely that calcium loss and altered vitamin D metabolism, which result from cadmium-induced kidney damage, play an important role. Thus, treatments that interfere with the renal damage will likely have a beneficial effect on bone.

Research in chelation therapy is promising for agents that can interfere or possibly reverse the toxic effects of cadmium. Xu et al. (1995, 1996) demonstrated that monoisoamyl meso-2,3-dimercaptosuccinate, when administered within 1 hour after acute exposure, prevents the formation of cadmium-induced apoptotic DNA fragmentation and associated histopathological injury in the testes of rats. Perry et al. (1989) report a reversal of the cadmium induced hypertension in rats with the chelator d-myo-inositol-1,2,6-triphosphate.

## 3. HEALTH EFFECTS

**3.12 ADEQUACY OF THE DATABASE**

Section 104(I)(5) of CERCLA, as amended, directs the Administrator of ATSDR (in consultation with the Administrator of EPA and agencies and programs of the Public Health Service) to assess whether adequate information on the health effects of cadmium is available. Where adequate information is not available, ATSDR, in conjunction with the National Toxicology Program (NTP), is required to assure the initiation of a program of research designed to determine the health effects (and techniques for developing methods to determine such health effects) of cadmium.

The following categories of possible data needs have been identified by a joint team of scientists from ATSDR, NTP, and EPA. They are defined as substance-specific informational needs that if met would reduce the uncertainties of human health assessment. This definition should not be interpreted to mean that all data needs discussed in this section must be filled. In the future, the identified data needs will be evaluated and prioritized, and a substance-specific research agenda will be proposed.

**3.12.1 Existing Information on Health Effects of Cadmium**

The existing data on health effects of inhalation, oral, and dermal exposure of humans and animals to cadmium are summarized in [Figure 3-6](#). The purpose of this figure is to illustrate the existing information concerning the health effects of cadmium. Each dot in the figure indicates that one or more studies provide information associated with that particular effect. The dot does not necessarily imply anything about the quality of the study or studies, nor should missing information in this figure be interpreted as a “data need”. A data need, as defined in ATSDR’s *Decision Guide for Identifying Substance-Specific Data Needs Related to Toxicological Profiles* (Agency for Toxic Substances and Disease Registry 1989), is substance-specific information necessary to conduct comprehensive public health assessments. Generally, ATSDR defines a data gap more broadly as any substance-specific information missing from the scientific literature.

There is a massive database regarding the health effects of cadmium. In humans, the majority of studies have involved workers exposed by inhalation or residents of cadmium-polluted areas exposed primarily in the diet. Quantitative estimates of exposure levels are not available for many of these studies; however, many studies provided information on urinary cadmium levels that would be reflective of the cadmium body burden. Lethality, systemic toxicity, genotoxicity, and cancer have been studied in humans more

3. HEALTH EFFECTS

**Figure 3-6. Existing Information on Health Effects of Cadmium**

	Systemic									
	Death	Acute	Intermediate	Chronic	Immunologic/Lymphoretic	Neurologic	Reproductive	Developmental	Genotoxic	Cancer
Inhalation	●	●	●	●	●	●	●	●	●	●
Oral	●	●	●	●		●	●		●	●
Dermal		●			●					

**Human**

	Systemic									
	Death	Acute	Intermediate	Chronic	Immunologic/Lymphoretic	Neurologic	Reproductive	Developmental	Genotoxic	Cancer
Inhalation	●	●	●	●	●		●	●	●	●
Oral	●	●	●	●	●	●	●	●	●	●
Dermal	●				●					

**Animal**

● Existing Studies

## 3. HEALTH EFFECTS

extensively than immunotoxicity or neurotoxicity, with less being known about reproductive or developmental toxicity of cadmium in humans following inhalation or oral exposure. In animals, effects following oral exposures have generally been more thoroughly investigated than those following inhalation exposure, and few studies of cadmium toxicity following dermal exposure in humans were located.

### 3.12.2 Identification of Data Needs

**Acute-Duration Exposure.** There are limited data on the acute toxicity of cadmium in humans. Although there are numerous reports of respiratory effects in workers exposed to high concentrations of cadmium, there are no reliable estimates of levels associated with these effects. Animal studies provide support for identification of the respiratory tract as the most sensitive target of toxicity following inhalation exposure. Acute exposures to high levels of airborne cadmium has resulted in pneumonia, emphysema, and edema in laboratory animals (Boudreau et al. 1989; Buckley and Bassett 1987b; Bus et al. 1978; Grose et al. 1987; Hart 1986; Henderson et al. 1979; NTP 1995; Palmer et al. 1986) and lower concentrations were associated with focal inflammation and minimal fibrosis (NTP 1995). A decreased immune response in mice was observed at similar cadmium concentrations (Graham et al. 1978; Krzystyniak et al. 1987). Other adverse effects observed at higher concentrations include erosions of the stomach, decreases in body weight, and reduced activity (Rusch et al. 1986). The available acute-duration animal data were considered adequate for derivation of an acute-duration inhalation MRL for cadmium.

There are no reliable human studies on the toxicity of cadmium following acute-duration oral exposure. In laboratory animals, acute exposure to high doses of cadmium resulted in a variety of effects, including altered hematological parameters, focal necrosis and degeneration of the liver, focal necrosis in renal tubular epithelium, necrosis and ulceration in the stomach and intestines, decreased motor activity, and testicular atrophy and necrosis (Andersen et al. 1988; Basinger et al. 1988; Bomhard et al. 1987; Borzelleca et al. 1989; Dixon et al. 1976; Kotsonis and Klaassen 1977; Machemer and Lorke 1981; Sakata et al. 1988; Shimizu and Morita 1990). There is some indication that developmental effects (delays in ossification and increased malformations) may occur at lower cadmium doses (Baranski 1985; Machemer and Lorke 1981). The acute-duration oral database was not considered adequate for derivation of an MRL because the results of the study that identified the lowest LOAEL (Baranski 1985) were inadequately reported and were inconsistent with a longer-duration study conducted by the same investigator. Although the data suggest that the developing organism is the most sensitive target,

## 3. HEALTH EFFECTS

additional studies are needed to support this assumption. Studies characterizing the dose-response relationships for the most sensitive effects are needed for derivation of an acute-duration oral MRL.

No reliable information was located regarding toxicity following dermal exposure to cadmium, but based on the lack of reported effects in the workers handling cadmium compounds, it seems unlikely that dermal exposure could deliver a significant dose of cadmium.

**Intermediate-Duration Exposure.** There are limited data on the toxicity of cadmium in humans following intermediate-duration exposure.

Intermediate-duration inhalation studies in laboratory animals have identified several targets of toxicity including the respiratory tract (Glaser et al. 1986; Kutzman et al. 1986; NTP 1995; Prigge 1978a), reproductive effects (Baranski and Sitarek 1987; NTP 1995), and developing nervous system (Baranski 1984, 1985). At the lowest cadmium concentration tested, alveolar histiocytic infiltration and degeneration or metaplasia in the larynx were observed in mice (NTP 1995) and neurodevelopmental effects were observed in rats (Baranski 1984, 1985). These LOAELs were considered for derivation of an intermediate-duration inhalation MRL; however, an MRL based on the human equivalent concentration of the LOAELs would be lower than the chronic-duration inhalation MRL based on human data. Additional studies are needed to identify no-adverse-effect levels in animals for these sensitive targets of toxicity.

A number of studies have been conducted involving intermediate-duration oral exposure to laboratory animals. The results of these studies suggest that the growing bone is the most sensitive target. The skeletal effects observed in young rats include decreases in bone mineral density, impaired mechanical strength, increased fractures, and increased bone turnover (Brzóška and Moniuszko-Jakoniuk 2005a, 2005b, 2005d; Brzóška et al. 2004b, 2005a, 2005b, 2005c; Ogoshi et al. 1989). Developmental effects, including impaired renal function and neurodevelopmental alterations, have been observed at similar dose levels (Ali et al. 1986; Baranski et al. 1983; Jacquillet et al. 2007). At higher doses, observed effects included renal damage (proteinuria, tubular necrosis, and decreased renal clearance), liver necrosis, and anemia (Cha 1987; Gatta et al. 1989; Groten et al. 1990; Itokawa et al. 1974; Kawamura et al. 1978; Kawamura et al. 1978; Kotsonis and Klaassen 1978; Prigge 1978a), altered immune response (Blakley 1985, 1986; Chopra et al. 1984), decreased motor activity (Kotsonis and Klaassen 1978; Nation et al. 1990), and necrosis and atrophy of seminiferous tubules and decreased sperm count and motility (Cha

## 3. HEALTH EFFECTS

1987; Saxena et al. 1989). The database of intermediate-duration animal studies was considered adequate for derivation an intermediate-duration oral MRL based on skeletal effects in growing rats.

No intermediate-duration dermal data were identified in humans or animals. Studies of possible toxicity in animals following intermediate-duration dermal exposure to cadmium are needed to evaluate potential health effects in humans exposed to cadmium primarily by the dermal route.

**Chronic-Duration Exposure and Cancer.** Data on the chronic toxicity of inhaled cadmium in humans come from numerous occupational exposure studies; no reliable animal studies examining noncancerous end points were identified. These studies have identified the respiratory tract (emphysema, impaired lung function) (Chan et al. 1988; Cortona et al. 1992; Davison et al. 1988; Smith et al. 1976) and the kidney (tubular proteinuria, decreased glomerular filtration rate, increased excretion of low molecular weight proteins) (Bernard et al. 1990; Chen et al. 2006a, 2006b; Chia et al. 1992; Elinder et al. 1985a; Falck et al. 1983; Jakubowski et al. 1987, 1992; Järup and Elinder 1994; Järup et al. 1988; Shaikh et al. 1987; Toffoletto et al. 1992; Verschoor et al. 1987) as the most sensitive targets of toxicity. Comparisons of the adverse effect levels for these two end points are difficult because the studies on respiratory effects typically reported air concentrations (current levels or estimated cumulative exposure) as the exposure biomarker and those examining renal effects typically used urinary cadmium levels as the exposure biomarker; based on limited data, the kidney appears to be the more sensitive target. Studies examining both end points in occupationally exposed populations would provide valuable information on sensitivity. None of the available human studies were considered adequate for derivation of an inhalation MRL because cadmium air concentrations were poorly characterized or no data were provided on the contribution of dietary cadmium to the cadmium body burden. However, the similarities on the toxicity and toxicokinetics of cadmium following inhalation and oral exposure allow for the use of the oral database to derive an inhalation MRL.

There is an extensive database of studies examining the chronic oral toxicity of cadmium in humans. These environmental exposure studies have identified two sensitive targets of cadmium toxicity—the skeletal system and the kidney. The skeletal effects included increased risk of osteoporosis and bone fractures and decreases in bone mineral density (Alfvén et al. 2000, 2004; Nordberg et al. 2002; Schutte et al. 2008; Staessen et al. 1999; Wang et al. 2003). Renal effects range from death due to renal failure (Arisawa et al. 2001, 2007b; Iwata et al. 1991a, 1991b; Matsuda et al. 2002; Nakagawa et al. 1993; Nishijo et al. 1995, 2004a, 2006) to increases in the prevalence of low molecular weight proteinuria (Buchet et al. 1990; Cai et al. 1990, 1992, 1998, 2001; Hayano et al. 1996; Ishizaki et al. 1989; Izuno et

## 3. HEALTH EFFECTS

al. 2000; Järup et al. 2000; Jin et al. 2002, 2004a, 2004c; Kawada et al. 1992; Kido and Nogawa 1993; Kobayashi et al. 2002a; Monzawa et al. 1998; Nakashima et al. 1997; Nogawa et al. 1989; Noonan et al. 2002; Nordberg et al. 1997; Olsson et al. 2002; Oo et al. 2000; Osawa et al. 2001; Roels et al. 1981b; Suwazono et al. 2006; Teeyakasem et al. 2007; Trzcinka-Ochocka et al. 2004; Uno et al. 2005; Yamanaka et al. 1998; Wu et al. 2001). Animal studies confirm the identification of the kidney and bone as the most sensitive targets of cadmium toxicity (Akaori et al. 1994; Bernard et al. 1992; Bomhard et al. 1984; Brzóska and Moniuszko-Jakoniuk 2004a, 2004b; Fingerle et al. 1982; Mangler et al. 1988). Sufficient information from human studies is available to derive a chronic oral MRL. No information was located regarding dermal toxicity of chronic cadmium exposure in humans or animals, and studies of dermal toxicity are needed to evaluate risks to populations exposed to cadmium primarily by dermal contact.

The evidence of carcinogenicity from human studies is limited, due to uncertainties in cadmium exposure estimates and confounding factors including exposure to arsenic, a known human lung carcinogen, and smoking. Occupational exposure studies have found significant increases in lung cancer mortalities (Ades and Kazantzis 1988; Järup et al. 1998a; Kazantzis et al. 1988; Stayner et al. 1992a; Sorahan 1987; Sorahan and Waterhouse 1983; Thun et al. 1985). However, lung cancer deaths were often not significantly associated with cadmium exposure or duration. Other studies have not found increases in lung cancer deaths (Armstrong and Kazantzis 1983; Elinder et al. 1985c; Lamm et al. 1992, 1994; Sorahan and Esmen 2004; Sorahan and Lancashire 1997). Additional occupational exposure studies controlling for these exposures and providing more precise cadmium dose estimates are needed to provide more definitive evidence of the carcinogenic potential in humans of inhaled cadmium. Evidence for the carcinogenicity of cadmium by the inhalation route is available from studies in rats (Takenaka et al. 1983). Additional studies in animals are needed to evaluate the lack of an observed increase in lung cancer in mice and hamsters exposed to cadmium by inhalation (Heinrich et al. 1989). Cadmium has not been shown to be carcinogenic following oral exposure in humans (Bako et al. 1982; Hardell et al. 1994; Inskip et al. 1982; Lauwerys and De Wals 1981; Nakagawa et al. 1987; Shigematsu 1984). In rats, however, cadmium increased tumors of the prostate, testes, and hematopoietic system (Waalkes et al. 1992). Additional lifetime-exposure studies in rats, mice, and hamsters orally exposed to cadmium at sufficiently high doses are needed to further define the carcinogenic potential of cadmium.

**Genotoxicity.** The evidence for the genotoxicity of cadmium is mixed (see [Tables 3-10](#) and [3-11](#)). *In vitro* studies have provided both positive and negative results (Amacher and Paillet 1980; Bruce and Heddle 1979; Casto et al. 1979; Denizeau and Marion 1989; Depault et al. 2006; Fatur et al. 2002; Filipic and Hei 2004; Honma et al. 1999; Jianhua et al. 2006; Lopez-Ortal et al. 1999; Lutzen et al. 2004; Lynn et

## 3. HEALTH EFFECTS

al. 1997; Mikhailova et al. 1997; Oberly et al. 1982; Rozgaj et al. 2002; Shiraishi et al. 1972; Terracio and Nachtigal 1988). Studies of chromosomal aberrations in humans (Bui et al. 1975; Deknudt and Leonard 1975; Fu et al. 1999; O'Riordan et al. 1978; Tang et al. 1990) and animals (Bruce and Heddle 1979; Desi et al. 2000; DiPaulo and Castro 1979; Fahmy and Aly 2000; Karmakar et al. 1998; Mukherjee et al. 1988a; Tan et al. 1990; Watanabe et al. 1979) exposed to cadmium have also found both positive and negative results. DNA damage has been consistently observed in *in vitro* studies (Devi et al. 2001; Fahmy and Aly 2000; Kasuba et al. 2002; Mukherjee et al. 1988a; Saplakoglu et al. 1997; Valverde et al. 2000; Wronska-Nofer et al. 1999; Zhou et al. 2004b). In animals, parenteral, but not inhalation or oral, cadmium exposure has been found to cause germ cell mutations (Gillivod and Leonard 1975; Suter 1975; Sutou et al. 1980; Watanabe and Endo 1982; Zenick et al. 1982). Additional studies investigating effects in exposed humans using larger populations with quantitative estimates of exposure would be useful to evaluate the human genotoxicity of cadmium.

**Reproductive Toxicity.** Only limited or conflicting evidence is available to evaluate the potential for cadmium exposure to cause reproductive toxicity in humans. Some studies report no effect on male fertility (Gennart et al. 1992), sex hormone levels (Mason 1990; Menke et al. 2008; Zeng et al. 2004a), sperm density (Noack-Fuller et al. 1993), or semen quality (Jurasović et al. 2004; Saaranen et al. 1989), while others report a reduction in sperm number or viability (Akinloye et al. 2006; Telišman et al. 2000; Xu et al. 1993a) or alterations in sex steroid hormone levels (Akinloye et al. 2006; Jurasović et al. 2004; Telišman et al. 2000). In one study, men occupationally exposed to cadmium at levels resulting in renal damage had no change in testicular function (Mason 1990). Adverse effects in animals from inhalation exposure have been reported including increased duration of the estrous cycle (Baranski and Sitarek 1987; NTP 1995; Tsvetkova 1970), and increased relative testes weight but no loss in reproductive success (Kutzman et al. 1986). Adverse reproductive effects in animals from high-dose, acute, oral cadmium exposure have been reported including testicular atrophy and necrosis (Andersen et al. 1988; Bomhard et al. 1987; Borzelleca et al. 1989), and decreased fertility (Kotsonis and Klaassen 1978; Machemer and Lorke 1981). At lower doses and intermediate exposures, adverse effects have included necrosis and atrophy of seminiferous tubule epithelium (Cha 1987), increased testes weight (Pleasant et al. 1992, 1993), increased prostatic hyperplasias (Waalkes and Rehm 1992), significantly increased relative testes weight, decreased sperm count and motility, decreased seminiferous tubular diameter, seminiferous tubular damage (Saxena et al. 1989), and decreased fertility (Sutou et al. 1980). Other animal studies for lower dose intermediate exposures, however, report no adverse effects (Baranski et al. 1983; Bomhard et al. 1987; Groten et al. 1990; Kostial et al. 1993; Kotsonis and Klaassen 1978; Loeser and Lorke 1977a; Pleasants et al. 1992; Pond and Walker 1975; Zenick et al. 1982). Additional studies in animals, as well



## 3. HEALTH EFFECTS

as retrospective, case-matched studies of reproductive success of populations for which occupational or environmental exposure to cadmium has been estimated, are needed to further evaluate the potential reproductive toxicity of cadmium in humans. Additional studies would be useful (preferably with larger sample sizes) to evaluate the robustness of the association between cadmium and adverse effects on sperm.

**Developmental Toxicity.** The potential for cadmium exposure to cause developmental toxicity from pre- or postnatal exposures in humans is not known. One study in occupationally exposed women reported children with lowered birth weights, but with no increase in malformations (Tsvetkova 1970). However, no control was made for parity, maternal weight, gestational age, or other factors known to influence birth weight. Many animal studies demonstrate that developmental toxicity may occur following cadmium exposure by oral routes with a relatively few studies reporting developmental effects following inhalation or oral exposure (Ali et al. 1986; Baranski 1985, 1987; Baranski et al. 1983; Gupta et al. 1993; Kelman et al. 1978; Kostial et al. 1993; Macheimer and Lorke 1981; Petering et al. 1979; Pond and Walker 1975; Schroeder and Mitchener 1971; Sorell and Graziano 1990; Sutou et al. 1980; Webster 1978; Whelton et al. 1988). At lower inhalation and oral doses, impaired performance on neurobehavioral tests have been observed (Ali et al. 1986; Baranski et al. 1983; Desi et al. 1998; Nagymajtenyi et al. 1997). Retrospective, case-matched studies of developmental toxicity among children of women with known occupational or environmental exposure to cadmium are needed to evaluate the potential for cadmium exposure to cause human developmental toxicity such as skeletal malformations and neurobehavioral effects (as suggested in animal studies). Studies are also needed to follow up on the results of increased susceptibility of young to bone damage (Ogoshi et al. 1989) or suppression of the immune response (Blakley 1985) reported in animals. The difference in the immune response (using the same protocol) between young mice (Blakley 1985) and older mice (Blakley 1988) should also be further evaluated. Studies of postnatal cadmium exposure to children, especially for children with diets deficient in calcium, protein, or iron, would be useful to evaluate whether increased cadmium absorption from the diet leads to developmental effects.

**Immunotoxicity.** A variety of immunologic effects have been found in animals exposed to cadmium by the oral or inhalation routes (Blakley 1988; Bouley et al. 1984; Cifone et al. 1989a). However, the biological significance of these effects is not clear, and there is little information available on immunotoxicity in humans. Investigations of immunologic function of populations occupationally or environmentally exposed to cadmium, and follow-up mechanistic studies in animals are needed to evaluate the potential immunotoxicity of cadmium exposure in humans.

## 3. HEALTH EFFECTS

**Neurotoxicity.** A few studies have suggested an association between cadmium exposure in humans and impaired neuropsychologic functioning at levels below those causing nephrotoxicity (Hart et al. 1989b; Marlowe et al. 1985; Thatcher et al. 1982). Neurotoxicity has also been found in animal studies (Nation et al. 1984; Wong and Klaassen 1982). Additional studies to investigate neurologic effects in populations with known cadmium exposure and studies of possible mechanisms of neurotoxicity in animals are needed to evaluate the potential neurotoxicity of cadmium exposure to humans. In addition, studies examining neurobehavioral end points in children would be useful.

**Epidemiological and Human Dosimetry Studies.** Cause/effect relationships for renal toxicity of cadmium have been derived from studies of workers occupationally exposed to cadmium by inhalation (Bernard et al. 1990; Chen et al. 2006a, 2006b; Chia et al. 1992; Elinder et al. 1985b; Falck et al. 1983; Jakubowski et al. 1987, 1992; Järup and Elinder 1994; Järup et al. 1988; Kawada et al. 1989; Roels et al. 1993; Shaikh et al. 1987; Thun et al. 1989; Toffoletto et al. 1992; Verschoor et al. 1987) and of populations environmentally exposed to cadmium in the diet (Buchet et al. 1990; Cai et al. 1990, 1992, 1998, 2001; Hayano et al. 1996; Ishizaki et al. 1989; Izuno et al. 2000; Järup et al. 2000; Jin et al. 2002, 2004a, 2004c; Kawada et al. 1992; Kido and Nogawa 1993; Kobayashi et al. 2002b; Monzawa et al. 1998; Nakadaira and Nishi 2003; Nakashima et al. 1997; Nogawa et al. 1989; Noonan et al. 2002; Nordberg et al. 1997; Roels et al. 1981a; Olsson et al. 2002; Oo et al. 2000; Osawa et al. 2001; Suwazono et al. 2000; Teeyakasem et al. 2007; Trzcinka-Ochocka et al. 2004; Uno et al. 2005; Watanabe et al. 2002; Wu et al. 2001; Yamanaka et al. 1998). There is also epidemiological evidence that chronic environmental exposure to cadmium can result in decreases in bone mineral density and increases in the risk of bone fractures and osteoporosis (Åkesson et al. 2005; Alfvén et al. 2000, 2004; Schutte et al. 2008; Staessen et al. 1999). Additional studies are needed to elucidate the mechanisms of these bone effects in humans and to determine if the skeletal system is a more sensitive target of cadmium toxicity than the kidney effects. Measurement of additional toxicity end points (reproductive, developmental, immunological, and neurological) in these well characterized populations are needed to evaluate whether any of these effects may occur at exposure levels below those leading to kidney damage. Additional development of PBPK/PD models is needed to evaluate human exposure scenarios. In its assessment of the U.S. population's exposure to environmental chemicals, the CDC measured urinary cadmium levels. If urinary cadmium levels are monitored in future assessments, it would be useful to also measure biomarkers of tubular dysfunction; these data would be useful in examining possible relationships between cadmium exposure and renal function in the general population.

## 3. HEALTH EFFECTS

**Biomarkers of Exposure and Effect.**

**Exposure.** Cadmium levels can be measured in a variety of tissues and fluids, including blood, urine, milk, liver, kidney, hair, and nails (Elinder and Lind 1985; Roels et al. 1981b; Sharma et al. 1982). Blood cadmium is a useful indicator of recent cadmium exposure, and urinary cadmium is a useful indicator of total body burden (Shaikh and Smith 1984). The most important indicator of the potential for toxicological injury is generally considered to be the cadmium concentration in the renal cortex, but individuals vary in the concentration causing renal effects (the "critical concentration") (Roels et al. 1981b). Methods for *in vivo* measurement of cadmium content in the kidney exist, but they are complex and expensive, and involve some exposure to ionizing radiation (Scott and Chettle 1986). Efforts to develop easier, safer, and less costly methods for *in vivo* analysis are needed, as well as studies to determine factors influencing individual variation in critical concentrations. Although many studies correct urinary cadmium levels for creatinine concentration, several investigators (Alessio et al. 1985; Ikeda et al. 2003a; Moriguchi et al. 2005b) have questioned the validity of this approach due to wide intra- and interindividual variability and age-related decline in levels. Additional studies are needed to further investigate methods to account for dilution in urine spot samples.

**Effect.** A number of sensitive tests are available to detect early stages of renal dysfunction that are known to be caused by cadmium exposure. These include analysis of urinary excretion of  $\beta$ 2-microglobulin, retinol-binding protein, metallothionein, or enzymes (Shaikh and Smith 1984). However, renal damage detected by these tests is not necessarily associated with cadmium exposure. Additional studies are needed to evaluate current or potentially new urinary or serum biomarkers in cadmium-exposed populations and their association with incipient injury to the kidney caused by cadmium. The bone is a sensitive target of cadmium toxicity, particularly during growth and in the elderly; studies are needed to develop sensitive biomarkers to detect early signs of bone damage.

**Absorption, Distribution, Metabolism, and Excretion.** Good information exists on cadmium toxicokinetics in humans and animals. PBPK/PD models have been developed to predict the critical organ dose as a function of route, duration, and level of exposure by the inhalation and oral routes (Kjellström and Nordberg 1978, 1985). Although general factors influencing absorption, distribution, metabolism, and excretion are known, additional studies are needed to provide information on metal metabolism and interactions that support quantitative evaluation of individual variations and resulting differences in renal cadmium accumulation. Very limited information exists on the dermal absorption of

## 3. HEALTH EFFECTS

cadmium (Skog and Wahlberg 1964; Wester et al. 1992). Additional studies on the dermal absorption of cadmium are needed.

**Comparative Toxicokinetics.** Animal and human studies have generally reported comparable toxicokinetics of cadmium (Kjellström and Nordberg 1985; Nordberg et al. 1985), suggesting that rats, mice, and rabbits are suitable models for cadmium toxicity in humans. However, some concerns have been raised about the appropriateness of the rat model for cadmium-induced lung tumors in humans because of differences in the morphology of the rat respiratory tract and resulting differences in cadmium particle deposition patterns and target cell populations. This is especially of concern because cadmium appears to be a contact carcinogen for lung cancer. Additional studies on the differences between the rat and human clearance rates, speciation at the level of the target cell, and protein transporters (as they relate to solubility and susceptibility) are needed to evaluate the appropriateness of the rat model for predicting cadmium-induced human lung cancers. Additional studies on differences in species, strain, sex, age, and other factors on cadmium kinetics and carcinogenic or other systemic effects are also needed to extrapolate the animal data to potential human toxicity. Additional studies establishing the toxicokinetics of cadmium in pregnant animals are needed to assess the relevance of the developmental effects observed in animals.

**Methods for Reducing Toxic Effects.** The mechanisms of cadmium absorption across epithelial layers are likely to be via nonspecific mechanisms (Foulkes 1989). No methods are known for influencing absorption across the lung, but absorption across the gastrointestinal tract may be influenced by dietary status (Flanagan et al. 1978). Studies to determine whether dietary adjustments might help decrease cadmium uptake from food or water are needed. Studies to determine the effects of dietary deficiencies in calcium are needed to further evaluate the risk of cadmium exposure to susceptible populations. Uptake across the skin is probably sufficiently slow that simple washing of exposed areas is adequate to prevent excessive absorption (Skog and Wahlberg 1964).

Once cadmium is absorbed, it tends to accumulate in the kidney, which is the main target tissue for chronic low-dose exposure. The cellular and molecular basis for the preferential accumulation in the kidney is only partially understood (Waalkes and Goering 1990), and additional studies to define the rate-limiting steps in renal uptake and renal clearance of cadmium are needed to design strategies for reducing the rate of cadmium accumulation in this tissue. Additional studies on existing and new chelating agents and different treatment regimens are needed to improve the clinical therapies for acute and chronic exposures to cadmium.

### 3. HEALTH EFFECTS

The mechanism of cadmium toxicity in renal cells and other tissues probably involves binding of free cadmium ions to key cellular enzymes and proteins (Waalkes and Goering 1990). Thus, any agent that prevents cadmium from binding might help prevent toxicity. The endogenous cadmium-binding protein can serve this function; however, metallothionein-cadmium complexes may have renal toxicity (Suzuki and Cherian 1987). Additional studies on the role of metallothionein in cadmium toxicity would be useful. Additional studies are needed on alternative substrate molecules or drugs that could interact with free cadmium and prevent binding to key cellular enzymes, as well as the ability of antioxidants to reduce damage from active-oxygen species produced by cadmium in tissues.

The impaired renal function that is the typical adverse effect of excessive cadmium exposure is neither clinically treatable nor reversible (Agency for Toxic Substances and Disease Registry 1990b; Roels et al. 1989). Studies on potential supportive treatment or remedies for cadmium-induced mild renal impairment would be valuable.

The bone is also a sensitive target of cadmium toxicity; however, methods for the treatment of the observed effects, decreased bone mineral density and increased fractures, have not been developed and are needed.

**Children's Susceptibility.** Data needs relating to both prenatal and childhood exposures, and developmental effects expressed either prenatally or during childhood, are discussed in detail in the Developmental Toxicity subsection above.

There is limited information on the toxicity of cadmium in children. Although it is likely that children will have similar effects as adults, there is some suggestive evidence that childhood exposure may result in increased renal toxicity, as compared to persons only exposed as adults (Trzcinka-Ochocka et al. 2004). Additionally, studies in animals suggest that young animals are more susceptible to cadmium-induced bone damage than adults (Ogoshi et al. 1989); this has not been investigated in humans. Studies are needed to evaluate whether there are age-specific differences in the toxicity of cadmium in humans. As discussed in the Developmental Toxicity section above, there are limited data on the developmental toxicity of cadmium in humans, particularly potential neurodevelopmental effects and additional studies are needed.

### 3. HEALTH EFFECTS

Additional research is needed on the toxicokinetics of cadmium during long-term, low-level exposures to determine the potential long-term tissue burdens that are likely to result especially for the susceptible tissues of liver, kidney, and bone. Data in animals suggest that children may absorb more cadmium than adults, but there are no human data examining these potential differences in the toxicokinetic properties of cadmium. Additional information is needed on cadmium transport across the blood-brain barrier in the developing fetus, and the role of metallothionein in the placenta.

Neurological and behavioral studies are needed that use the more sophisticated measures available today to evaluate children for *in utero*, acute, and longer term exposures. These studies should have the appropriate controls for confounding factors such as lead, parental use of ethanol, and living conditions.

Additional studies are needed to evaluate whether or not biomarkers of cadmium exposure and effects that have been developed for adults are also applicable to children. If not, new biomarkers of exposure and effect need to be developed.

The effects of nutritional status (iron, zinc, and calcium levels) on cadmium absorption and accumulation in children need further evaluation. Improved regimens and choices for chelation therapy are also needed.

Child health data needs relating to exposure are discussed in Section 6.8.1, Identification of Data Needs: Exposures of Children.

#### **3.12.3 Ongoing Studies**

A number of research projects are in progress investigating the health effects of cadmium. These projects are summarized in [Table 3-14](#).

## 3. HEALTH EFFECTS

**Table 3-14. Ongoing Studies on Cadmium**

Investigator	Study topic	Institution	Sponsor
Fadrowski, J	Determination if environmental cadmium exposure is associated with chronic kidney disease in children	John Hopkins University	National Institute of Environmental Health Sciences
Nebert, DW	Identify and characterize genes responsible for interindividual differences in the response to cadmium	University of Cincinnati	National Institute of Environmental Health Sciences
Thomas, DG and Kennedy, TS	Examination of the possible association between cadmium levels in maternal blood and breast milk and cognitive development in infants	Oklahoma State University	National Research Initiative
Newcomb, PA	Examination of the possible association between cadmium exposure and risk of breast cancer	Fred Hutchinson Cancer Research Center	National Institute of Environmental Health Sciences
Louie, MC	Examination of the contribution of cadmium to the progression of breast cancer	Dominican University of California	National Cancer Institute
Meliker, JR	Examination of possible association between cadmium exposure and breast cancer risk	State University of New York, Stony Brook	National Institute of Environmental Health Sciences
Rull, RP	Examination of possible association between cadmium exposure and endometrial cancer risk	Northern California Cancer	National Institute of Environmental Health Sciences
El Mauayed, M	Examination of the possible association between cadmium exposure and diabetes risk in carriers of a genetic variation of the zinc transporter ZnT8	Northwestern University	National Institute of Environmental Health Sciences
Guallar, EO	Possible association between cadmium exposure and cardiovascular risk in children	Johns Hopkins University	National Institute of Environmental Health Sciences
Heggland, SJ	Mechanisms of cadmium-induced osteotoxicity	Albertson College of Idaho	National Institute of Environmental Health Sciences

Source: FEDRIP 2012