

Fast Ignition: Physics Progress in the US Fusion Energy Program and Prospects for Achieving Ignition

*M.H. Key, C. Andersen, T. Cowan, N. Fisch, R. Freeman,
S. Hatchett, J. Hill, J. King, J. Koch, B. Lasinski, B.
Langdon, A. MacKinnon, P. Patel, P. Patel, P. Parks, M.
Rosenbluth, H. Ruhl, R. Snavely, R. Stephens, M. Tabak,
and R. Town*

U.S. Department of Energy

Lawrence
Livermore
National
Laboratory

This article was submitted to 19th International Atomic Energy
Agency-Fusion Energy Conference, Lyons, France, October 14-19,
2002

October 16, 2002

DISCLAIMER

This document was prepared as an account of work sponsored by an agency of the United States Government. Neither the United States Government nor the University of California nor any of their employees, makes any warranty, express or implied, or assumes any legal liability or responsibility for the accuracy, completeness, or usefulness of any information, apparatus, product, or process disclosed, or represents that its use would not infringe privately owned rights. Reference herein to any specific commercial product, process, or service by trade name, trademark, manufacturer, or otherwise, does not necessarily constitute or imply its endorsement, recommendation, or favoring by the United States Government or the University of California. The views and opinions of authors expressed herein do not necessarily state or reflect those of the United States Government or the University of California, and shall not be used for advertising or product endorsement purposes.

This is a preprint of a paper intended for publication in a journal or proceedings. Since changes may be made before publication, this preprint is made available with the understanding that it will not be cited or reproduced without the permission of the author.

This report has been reproduced directly from the best available copy.

Available electronically at <http://www.doc.gov/bridge>

Available for a processing fee to U.S. Department of Energy
And its contractors in paper from
U.S. Department of Energy
Office of Scientific and Technical Information
P.O. Box 62
Oak Ridge, TN 37831-0062
Telephone: (865) 576-8401
Facsimile: (865) 576-5728
E-mail: reports@adonis.osti.gov

Available for the sale to the public from
U.S. Department of Commerce
National Technical Information Service
5285 Port Royal Road
Springfield, VA 22161
Telephone: (800) 553-6847
Facsimile: (703) 605-6900
E-mail: orders@ntis.fedworld.gov
Online ordering: <http://www.ntis.gov/ordering.htm>

OR

Lawrence Livermore National Laboratory
Technical Information Department's Digital Library
<http://www.llnl.gov/tid/Library.html>

Fast Ignition: Physics Progress in the US Fusion Energy Program and Prospects for Achieving Ignition

M. H. Key¹, C. Andersen², T. Cowan³, N. Fisch⁴, R. Freeman², S. Hatchett¹, J. Hill², J. King², J. Koch¹, B. Lasinski¹, B. Langdon¹, A. MacKinnon¹, P. Patel¹, P. Parks³, M. Rosenbluth³, H. Ruhl³, R. Snavely², R. Stephens³, M. Tabak¹, R. Town¹.

¹Lawrence Livermore National Laboratory, Livermore, CA 94550, USA.

²Department of Applied Sciences, University of California, Davis, Davis, CA 95616, USA.

³General Atomics, San Diego, CA, 92186, USA.

⁴Princeton University, Princeton NJ, 08543, USA

(Also see acknowledgements to other colleagues)

E-mail contact of main author: key1@llnl.gov

Abstract. Fast ignition (FI) has significant potential advantages for inertial fusion energy and it is therefore being studied as an exploratory concept in the US fusion energy program. FI is based on short pulse isochoric heating of pre-compressed DT by intense beams of laser accelerated MeV electrons or protons. Recent experimental progress in the study of these two heating processes is discussed. The goal is to benchmark new models in order to predict accurately the requirements for full-scale fast ignition. An overview is presented of the design and experimental testing of a cone target implosion concept for fast ignition. Future prospects and conceptual designs for larger scale FI experiments using planned high energy petawatt upgrades of major lasers in the US are outlined. A long-term roadmap for FI is defined.

1. Introduction

Fast Ignition (FI) has attractive features relative to conventional Inertial Confined Fusion (ICF) for Inertial Fusion Energy (IFE). These include a higher ratio of fusion burn energy to driver energy (about 300:1) allowing use of less efficient drivers. Lower fuel density and absence of need for an implosion induced central ignition spark relax the drive pressure and symmetry requirements. Target surface smoothness can be relaxed easing target fabrication. Laser drivers of longer wavelength may be suitable and would have less problem of optics damage. FI is also compatible with other drivers such as ion beams and Z pinches. Lower ignition threshold and reduced fuel density also permit reduction of the total driver energy and the yield, leading to advantages in a power plant.

FI requires heating to 10 keV in <20 ps of typically a 50 μm diameter hot spot in 300 gcm^{-3} pre-compressed Deuterium-Tritium fuel by deposition of 20 kJ by relativistic electrons¹ or alternatively by laser generated protons². It also uses novel target designs for compression of the fuel³, notably implosion at the tip of a cone, which has recently been shown to allow >20% efficient coupling of short pulse laser radiation to heating of compressed CD⁴. This high efficiency implies a practically realistic <100kJ, 20 ps requirement for the ignitor laser.

The potential of FI for IFE has been recognized in the US fusion energy program, which has for the last two years supported study of FI research as a promising exploratory concept with emphasis on the new physics of short pulse ignition. During the last year, a Department of Energy (DOE) PW laser initiative was begun in the US National Laboratories and this should provide new high energy petawatt (HEPW) laser beamlines at the large implosion facilities (National Ignition Facility (NIF), the Omega Laser and Z/beamlet). The new HEPW

capability could support a transition to a more substantial 'proof of principle' program in Fast Ignition for IFE and the NIF laser has the longer term potential to demonstrate high gain FI.

This paper summarizes recent work in the US program on isochoric heating by laser generated electrons and protons and briefly outlines the connection to studies of FI target hydro-dynamics and the prospects in the US for progress to full scale FI.

2. Isochoric Heating by Electrons

In electron fast ignition the efficiency of conversion of laser energy to relativistic electrons has been shown to exceed 30%⁵ and modeling has suggested that self induced magnetic collimation may efficiently transport energy from the laser focal spot to the hot spot^{6,7}. If however there is significant divergence of the energy flow, the transfer efficiency to the hot spot is reduced. This transport issue is the focus of the electron isochoric heating studies reported here. The goal is to use experiments to benchmark models, which will give a predictive capability for full-scale fast ignition.

The recent experiments discussed here have studied electron transport and isochoric heating in Al and CH targets at normal density. Laser pulse lengths have been short (0.1 to 1 ps) relative to the 20 ps envisaged for FI. Focal spot size has been small (10 μm) and power has been up to 100 TW. In this way intensity has reached a FI relevant regime $10^{19} < I < 10^{20}$ Wcm^{-2} with generation of relativistic electrons of the required > 1 MeV energy. Targets have been heated to 10 eV $< kT < 100\text{eV}$. Given their high Z relative to DT and their low temperature relative to the 10 keV ignition temperature, the experiments have been in a resistivity dominated regime where the Ohmic potential due to the return current is comparable with the electron energy and plays a dominant role in the transport. In the DT fuel of a full scale fast ignition target, resistivity would be a negligible effect so that the current experiments are a test of our understanding of transport rather than a direct demonstration of for example, the degree of collimation of the electron flow, which will occur in a fast ignition target.

The experiments were conducted in international collaborations at the LULI laboratory in France with a 40TW, 0.5 ps laser, at the Vulcan laser facility in the UK with a 100TW, 1 ps laser and at LLNL in the US using a 100TW, 0.1 ps laser (JanUSP). Two diagnostic methods developed by the US participants are discussed here: spherical crystal imaging of $\text{K}\alpha$ fluorescence from thin fluor layers incorporated in planar foil targets⁸ and spherical mirror XUV imaging of thermal emission from the rear surface of planar foil targets⁹.

Figure 1 summarizes data from the $\text{K}\alpha$ images recorded from a 20 μm Cu fluor layer following electron transport through an Al layer. The image radius as a function of the thickness of Al is presented. The data define a truncated cone of angle 40° and minimum radius 37 μm . the range of the relativistic electrons is much greater than the target thickness. Images are formed by the fluorescence produced as relativistic electrons reflux between Debye sheaths at the front and back surfaces of the target. Monte Carlo modeling shown in figure 2 confirms the refluxing model from the diminution of the spatially integrated fluorescence with increasing thickness of the Al layer. The predicted change is very small if only the first pass is considered. The MC modeling also shows that that the measurement of the image radius in figure 1 gives a result close to the radius of the electron beam on the first pass with refluxing contributing mainly to the wings of the intensity profile.

More difficult to explain is the minimum diameter much greater than the laser focal spot and the 40° cone angle of the transport. The MonteCarlo modeling does not treat the self consistent electric and magnetic fields generated in the transport process and this is an area where the hybrid particle in cell computational method⁷ offers the best prospects for a complete description of the physics.

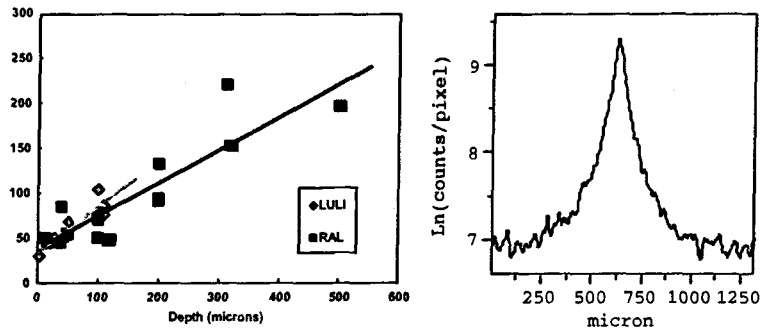

FIG. 1. Left, $K\alpha$ image radius as a function of Al thickness, Cu $K\alpha$ at RAL, (squares) and Ti $K\alpha$ at LULI, (diamonds). Linear fits defining the minimum radius and cone angle are also shown. Right a typical line out showing the natural logarithm of the recorded counts per pixel in a Cu $K\alpha$ image.

An existing hybrid PIC code (LSP)¹⁰ is being adapted and developed for this purpose and is beginning to produce data which model the experiments. The model correctly describes the effect of Ohmic potential and collimation by the temporally growing B field driven by the curl of the Ohmic E field.⁶ As yet there is a discrepancy between the experiments and modeling with this and other hybrid PIC models. These typically show collimated transport at the laser spot size with heating to about 1 keV producing a channel where resistive inhibition is insignificant. The observed spreading of the beam to an area much greater than the laser focal spot area at the entry surface and its subsequent propagation in a 40° cone are not predicted.

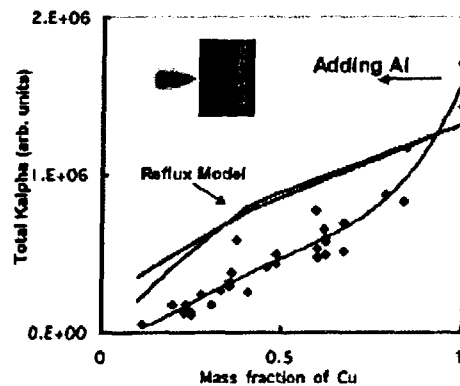

FIG. 2. MonteCarlo model of the integrated fluorescence in refluxing electron transport and measured data.

The larger diameter electron beam experiences relatively little loss of energy to Ohmic potential and relatively little self magnetic collimation. Cone-like propagation can therefore be consistent with the spread of directions of the electrons modified slightly by scattering. The kernel of the difficulty in understanding the initial spreading of the electron beam lies probably in the transport through the surface plasma formed by the laser. The focal spots of most high intensity lasers have broad low intensity wings which contain typically 60 to 70 % of the energy at intensities in the range 10^{-1} to 10^{-3} relative to the central focal spot. This plasma provides a conducting path for radial transport and the role of effects such as ExB radial drift of magnetized electrons¹¹ (due to the toroidal thermoelectric magnetic field and the axial electric field of the plasma expansion into vacuum) must be understood. Relevant also may be transfer of energy from the beam to this plasma by saturated non-linear Weibel-like instability occurring where the ratio of beam density to background density is not insignificant¹². These transport issues are discussed in more detail in a new paper¹³ and will be satisfactorily resolved only when modeling and experiments reach reasonable agreement.

Isochoric heating by the electrons has been measured experimentally. For example XUV images (at 18 nm) of the rear surface of Al targets irradiated with the 100 TW, 1ps laser at RAL produced data illustrated in figure 3. The absolute image intensity gives a measure of the temperature of the rear surface of the target after the electron heating. The advantage of an XUV measurement is a rapid variation of intensity with temperature compared to that for visible radiation. In the range of interest 10 to 100 eV there is a 3 order of magnitude increase. The temperature determination was from the absolute sensitivity of the CCD and the collection solid angle and transmission efficiency of the optics, coupled with a modeling prediction of time integrated XUV emission.

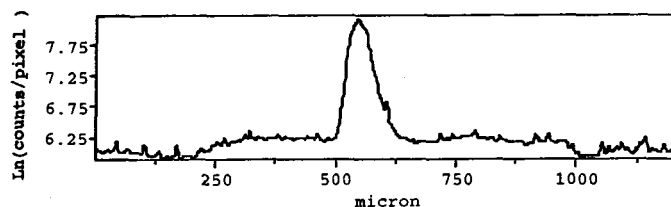

FIG. 3. XUV image - logarithmic line out through its center- for a 100 μm Al target at RAL. It has an 80 μm f.w.h.m. central peak. Maximum temperature is 30 eV.

The modeling assumed instantaneous homogeneous heating of the solid and treated the 1D explosion and cooling of the rear surface with a hydrodynamic and radiation physics code (Lasnex). The time resolved emission was calculated then integrated in time to compare with the data. The brightness was greatest at $t=0$ and fell to half peak in about 50 ps. In a later experiment with the 100TW, 100fs laser at LLNL the XUV emission was streak time resolved and found to show similar time resolved behavior to that calculated. The data in figure 2 for a 100 μm thick Al target indicate a peak temperature of 30 eV. [40 micron thick Al foils reached >100 eV temperature]. The XUV peak is 80 μm wide at fwhm. If the intensity is interpreted as temperature the temperature peak is 120 μm wide at fwhm. The size of the heated region is consistent with figure 2, which shows a similar electron beam width at 100 μm depth.

The magnitude of the temperature rise is consistent with the area of the electron beam. The heated region at 100 μm depth is too wide to be satisfactory for fast ignition but as noted previously, the experiment is a benchmarking test of modeling rather than a demonstration of the heating pattern in fast ignition.

3. Isochoric Heating by Protons

Proton FI is illustrated schematically in figure 4. It has one major advantage relative to electron ignition, which is the avoidance of the need to deliver electrons, with their complex transport behavior, to the ignition hot spot.

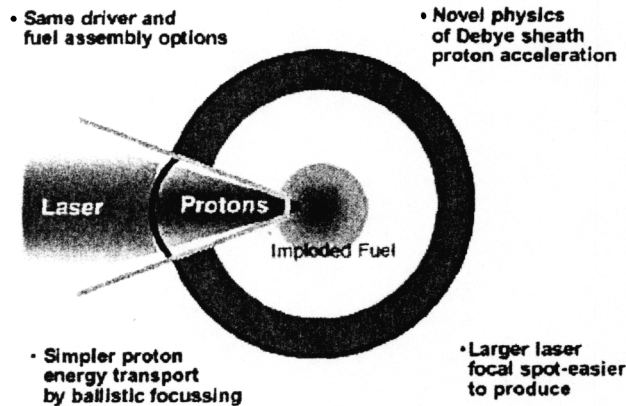

FIG. 4. Schematic of fast ignition by laser accelerated protons

The approach is relatively new dating from the discovery of highly collimated proton beams from the rear surface of flat foil targets accelerated by the strong Debye sheath electric field due to the relativistic electrons¹⁴. When it was first proposed, no consideration was given to the effect of transit time variation in the quasi-Maxellian energy spectrum typically seen in experiments. Ignition modeling including this effect¹⁵ showed an advantage, whereby the more energetic protons arrived early and penetrated the necessary $\rho r = 0.5 \text{ gcm}^{-2}$ of plasma. Their heating effect raised the temperature allowing later arriving slower protons to penetrate to a similar depth thus widening the useful energy band, utilizing the larger number of lower energy protons and reducing the required mean energy to about 4 MeV. This made proton fast ignition more compatible with laser induced proton sources.

Requirements for proton ignition include adequate (>10%) efficiency of generating the protons with laser pulses of 10 to 20 ps. Other necessary conditions are production of an exponential energy spectrum with a mean energy of about 4 MeV; adequate focusing (<50 μm spot); absence of any major changes in energy deposition due to collective effects and absence of loss of beam generation due to plasma closure of the accelerating gap in a structure similar to that in figure 4.

High conversion efficiency to protons (energy integrated conversion approaching 40%) and several MeV mean energy have been observed using a PW laser¹⁴. The beam has been shown to have a very low transverse temperature (emittance). Modeling has predicted good

focusing from a spherically concave surface¹⁶. Until recently, however there was no experimental verification of focussing and heating. We report the first experiment to observe both effects.

The experiment used a 100 TW, 100fs laser (JanUSP at LLNL) which was de-focussed to produce a 50 μm spot. A control experiment on a 20 μm flat foil of Al with 2 μm spaced grooves on its rear surface, produced images of the proton beam on radiochromic film. These images gave the divergence angle (RC film exposure diameter) and spatial origin diameter (number of grooves seen in the proton beam¹⁷). The beam was very uniform. Its cone angle and size of spatial origin increased from 80 to 250 μm as energy increased from 6 MeV to 12 MeV. This indicated that the same laser irradiating the pole of a hemispherical shell of 250 μm diameter and 10 μm thickness would generate protons over most of the inner surface. Such a target was prepared with a very smooth inside surface and having a 10 μm thick planar strip of Al foil attached across the open end of the hemisphere. An optical streak camera recorded an image of the rear surface of the flat foil and a ps pulse interferometer recorded interferograms in the direction tangential to the flat foil.

Figure 5 shows the streak results. It includes (1) two planar foils 250 μm apart (2) the 250 μm hemisphere target and (3) a similar hemisphere target with the flat foil moved back beyond the center plane a further 250 μm .

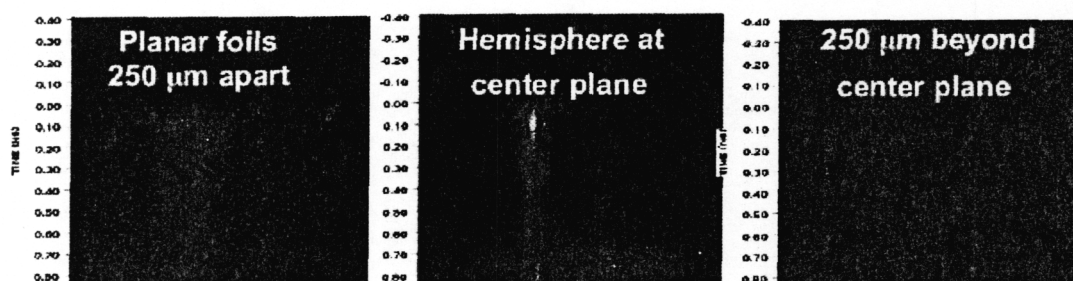

FIG. 5. Proton focusing: streaked images of Planckian emission. Time from top to bottom. Images span 1.2 ns. Space transverse. Images span 1.2 mm.

In an initial experiment a streak from a single 20 μm Al foil showed a flash of optical transition radiation, subsequent Planckian emission due to electron isochoric heating and then break through of a shock wave. The pair of flat foils in figure 5 show a 200 μm wide region of Planckian emission at the rear surface of the second foil due to heating by the proton beam. With the flat foil at the hemisphere center plane the Planckian emission is 6x brighter and only 50 μm wide. Moving the foil back 250 μm the intensity is severely reduced and the heated region is greater than the width of the flat foil i.e. >400 micron. Significant in these data is the 6x enhanced Planckian emission indicating enhanced isochoric heating and the 50 μm heated region indicating focusing. Interesting also is that the Planckian emission is brighter than that from electron isochoric heating of the single foil.

Protons deposit energy most strongly at their Bragg peak so that heating at any depth is dominated by a relatively narrow band of energies. This is at about 0.8 MeV for 10 μm Al. The data did not record the spatial origin diameter for protons of this low energy but since the diameter increases as energy is reduced it must have been > 300 μm and thus must have

covered most of the hemisphere. The expected focussing is from Debye sheath acceleration perpendicular to the spherical surface. The large increase in heated region for a 250 μm displacement of the foil beyond the center plane suggests a highly convergent beam from most of the hemisphere surface. The high convergence means a strong sensitivity of the focal spot size to the axial location of the heated foil. Since the proton beam from a planar target is divergent, it is anticipated that the best focus of the proton beam will be slightly displaced from the center of the sphere. Further work will examine this possibility. These data which will be published, give an encouraging start to the investigation of laser accelerated protons as a possible ignitor beam for FI.

4. Concepts and Hydrodynamics of Fast Ignition Targets

Prospects in the US for more integrated FI experiments are based principally but not exclusively on implosion around a cone to provide a path for the ignitor beam^{2,3} as illustrated in figure 6. Which summarizes the scientific issues.

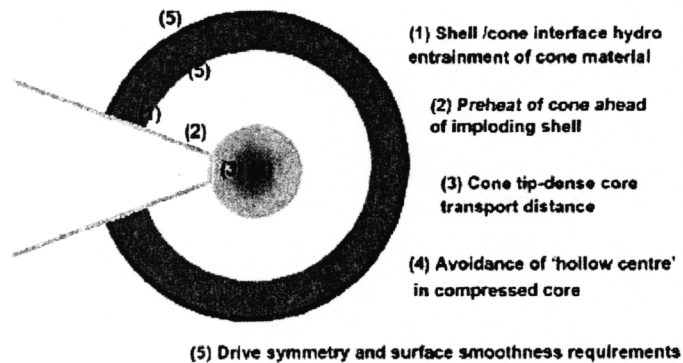

FIG. 6. The cone target concept for fast ignition, with identification of the main physics issues in the hydrodynamics.

Targets at full ignition scale and also hydro-dynamically equivalent targets compatible with current driver capabilities are being designed using 2D radiation-hydrodynamic models including Lasnex and Draco. These designs are being tested using radiographic diagnostics in experiments both at the Omega laser facility and the Z X-ray source. Another paper in these proceedings gives more details of the modeling and the experimental work at Omega¹⁸. Figure 7 illustrates work at Z in which an extreme case of the cone concept (i.e. implosion of a hemisphere in contact with a plane) is being studied both through modeling and experiments.

5. Proof of Principle FI Experiments at Future HEPW Lasers in the US

A current initiative of the US DOE is aimed at adapting laser beamlines for HEPW operation at NIF, Omega and the Z Beamlet laser, for a range of scientific applications in the general field of high energy density science. This initiative should provide HEPW capabilities

coming on line in the next 3 to 5 years, suitable for integrated fast ignition experiments at proof of principle level using multi-kilojoule short pulses. A central element of the initiative is the development of improved technologies for the generation and compression of frequency chirped stretched pulses. The preferred diffraction grating concept for compression to fast ignition relevant pulse durations of typically 20 ps, is the multi-layer dielectric diffraction grating (MLD). An MLD has an order of magnitude higher damage threshold at 20 ps than the Au coatings used in the grating pulse compressors of current PW class lasers. For example a new compressor design for CPA operation of the 40x40 cm NIF beams provides 5kJ capability in 20 ps pulses.

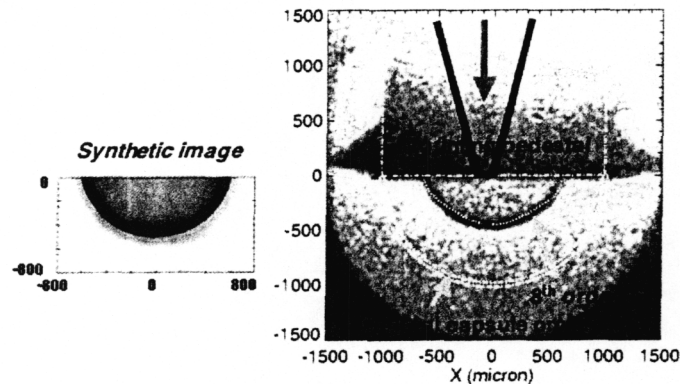

FIG. 7. An initial FI target hydro experiment at Z showing implosion of a hemisphere diagnosed by laser radiography, with an indication of how it could be adapted for cone guided ignition (right) and a numerical simulation of the same implosion (left)

A numerical modeling design has been carried out for a near term (2006) conceptual proof of principle experiment at NIF. A 750 μm radius 160 μm thick CD shell/cone fast ignition target is Hohlräum driven with 250kJ of long pulse laser energy to produce compressed CD with ρr of 1.0 gcm^{-2} at a density of 250 gcm^{-3} . 4 beamlets of NIF converted to CPA operation provide a 20kJ ignitor pulse. The model assumes 30% conversion of 40% of the laser energy (the central focal spot only) to electrons in either a parallel beam or a 40° cone angle with a quasi Maxwellian spectrum of mean energy 1 MeV and the electron beam source confined within a 50 μm disc. Transport is modeled in a simplified manner treating electrons as 'protons' of mass equal to the electron mass. Heating, DD fusion and xray emission are computed. An example of the results is shown in figure 8. The outline shows a density contour enclosing the compressed fuel, which is located about 100 μm from the tip of the cone. The DD fusion is shown as a neutron image for both parallel and 40° cone transport. Experiments of this type would provide a strong benchmarking of integrated codes and should therefore lead to a reliable predictions enabling the design of full scale fast ignition experiments.

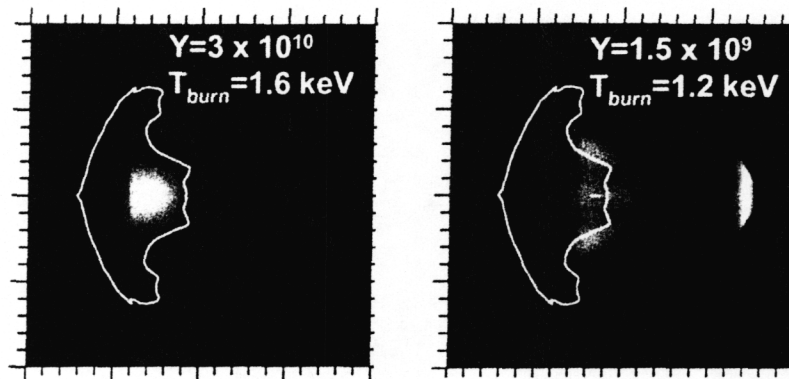

FIG. 8. Radiation /hydro- dynamic modeling of compression and simplified modeling of short pulse heating of a conceptual FI proof of principle target at NIF. The simulations show neutron images. Y is the yield and T_{burn} is the peak temperature. Left assumes parallel transport. Right assumes a 40° cone. Pictures span approx. $200 \mu\text{m}$. Tip of cone is at right edge of pictures.

An important potential use of the planned HEPW facilities is the study of FI targets with cryogenic D_2 which will first be possible at the Omega laser where cryogenic D_2 targets are already being used for direct drive ICF research. This is important because the resistivity of imploded D_2 plasma is 3x lower than that of CD. FI in DT takes place at low Z and high temperature where the Ohmic potential due to return current is negligible relative to the energy of the primary electrons. It is a rather significant effect in the CD targets used in current integrated experiments at relatively low temperatures.⁴ With stronger compression and higher temperatures, CD experiments also provide good tests of FI physics with only mild resistive effects as in the example for NIF discussed previously. Preliminary modeling indicates the possibility of reaching ρr levels of about 0.5 gcm^{-2} at densities of about 500 gcm^{-3} in D_2 . With the 2kJ short pulse planned for Omega, modeling of the same type used to estimate the NIF target performance suggests yields of neutrons from short pulse heating, which would give clear information on the heating efficiency. Figure 9 illustrates the Omega target chamber adapted for FI and cryo DT targets.

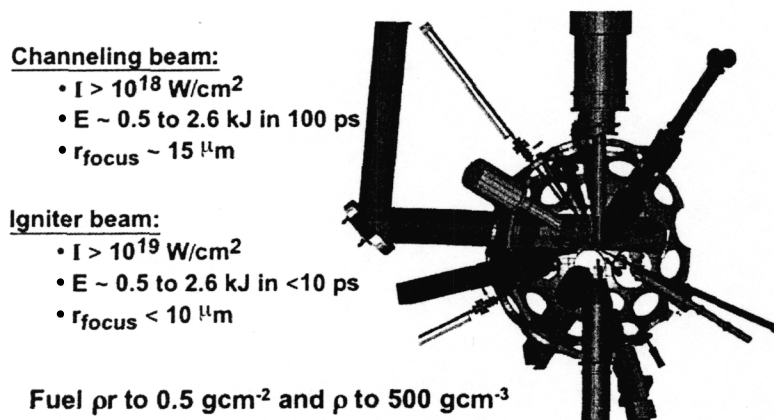

FIG. 9. Omega target chamber with HEPW adaptation. HEPW beam shown in purple.

Proof of principal scale experiments will in due course be designed and interpreted with progressively better integrated numerical modeling. PIC description of the laser plasma interaction will be coupled to hybrid PIC modeling of the transport of relativistic electrons and of proton beam generation. These microscopic models describing the short pulse ignition process will be linked to hydro-dynamic modeling of fuel compression. At present these modeling capabilities are being developed separately and are being benchmarked against experiments to the greatest extent possible with the partially complete modeling. Integrated modeling is required to provide predictive capability for full scale fast ignition of sufficient accuracy to warrant adaptation of for example, as many as 20 HEPW beamlines at NIF to deliver the presently estimated 100kJ short pulse required for ignition. An engineering CAD drawing of the CPA compressors for 20 beam fast ignition at NIF is shown in figure 10.

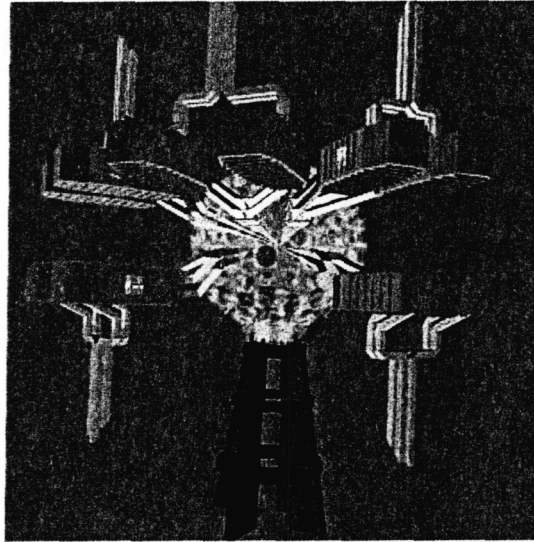

FIG. 10. Engineering concept for adapting NIF for full scale fast ignition. HEPW beamlines with grating compressors are shown. Long pulse beamlines are omitted.

6. Long-term Strategy

The target physics studies discussed here are linked to work on the technology of FI based power plants. This includes conceptual power plant design, the development of high repetition rate laser drivers and focussing optics, pellet fabrication and pellet factory studies and assessment of operational issues such as pellet injection and debris and radiation effects on final optics. These technology aspects are currently modestly supported as variant studies on the technologies for IFE plants based on conventional ICF¹⁹. FI specific studies will be accelerated when a transition to FI proof of principle work occurs. A long term road map for fast ignition envisages concept exploration transitioning to proof of principle in 3 years and an ignition demonstration (most probably at NIF) within 10 years. Parallel technology developments include an integrated research experiment (IRE) for target fabrication and injection and another for high rep rate short pulse laser technology within 10 years. If FI proves successful on all these levels, an engineering test facility (ETF) can be envisaged on a <20-year time scale.

Acknowledgements

The technical co-authors this paper are grateful to Steve Slutz and Craig Sangster respectively for supplying overviews of FI research at the Sandia National Laboratory and the University of Rochester Laboratory for Laser Energetics. International collaborators in experiments at RAL in the UK and LULI in France have also given valuable support in the form of other diagnostic measurements²⁰ to the experiments described here.

Work performed under the auspices of the U.S. Department of Energy by the Lawrence Livermore National Laboratory under Contract No. W-7405-ENG-48 and by General Atomics (GA) under contract No. DE-FG03-00ER54606. We also benefited from corporate support of GA and Hertz Foundation support at UC Davis.

References

- [1] M. TABAK et al. Phys. Plasmas 1, 1626 (1994)
- [2] M. ROTH et al. Phys. Rev. Letts. 86,436 (2000)
- [3] S HATCHETT Anomalous Absorption Conf. June (2001) and APS DPP Oct. (2001)
- [4] R. KODAMA, et al., Nature, 412, 798 (2001) and Nature 418,933,(2002)
- [5] K. B. WHARTON, et.al. Phys. Rev. Lett. 81, 822 (1998)
- [6] J. R. DAVIES, A. R. BELL, AND M. TATARAKIS, Phys. Rev. E 59, 6032 (1999)
- [7] L. GREMILLET PhD Thesis--Theoretical and experimental study of fast electron transport in ultra-high intensity laser-solid interaction ,Ecole Polytechnique, France (2001)
- [8] J. KOCH et al. Appl. Opt. 37,1784(1998)
- [9] M H KEY et al .Inertial Fusion Sciences Applications 2001, K.A.Tanaka, D.D. Meyerhofer, and J. Meyer-ter Vehn, Eds., ELSEVIER, Paris., P 357, (2002)
- [10] D. R. WELCH et al. , Nucl. Inst. Meth. Phys. Res. A 242 134 (2001).
- [11] R. FABBRO and P. Mora, Phys. Lett. A 90 48 (1985).
- [12] M. HONDA, et al., Phys. Rev. Lett. 85 2128 (2000).
- [13] R STEPHENS et al. (submitted to Phys Rev. Lett.).
- [14] R. SNAVELY et al.Phys. Rev. Lett.85,2945,(2000)
- [15] M TEMPORAL J Honrubia, S Atzeni. Phys. Plas.9,3102,(2002)
- [16] H RUHL Plasma Phys.Rep. 27,363,(2001)
- [17] T COWAN (to be published)
- [18] R. STEPHENS et al. ibid.
- [19] W MEIR et al Inertial Fusion Sciences Applications 2001, K.A.Tanaka, D.D. Meyerhofer, and J. Meyer-ter Vehn, Eds., ELSEVIER, Paris, (2002)
- [20] S.D. BATON, et al., Inertial Fusion Sciences Applications 2001, K.A.Tanaka, D.D. Meyerhofer, and J. Meyer-ter Vehn, Eds., ELSEVIER, Paris, (2002), page 375. and J SANTOS et.al. Phys. Rev. Lett.89, 025001(2002)