

**SITKA HARBOR, ALASKA
CHANNEL ROCK BREAKWATERS**

DEFICIENCY CORRECTION EVALUATION REPORT

APPENDIX B

ENGINEERING ANALYSIS

February 2012

Table of Contents

1.0	Introduction.....	1
1.1	Location.....	1
2.0	Problem Identification.....	2
2.1	Purpose.....	4
2.2	Tide.....	4
2.3	Instrumentation.....	5
2.4	Design Wave.....	5
2.5	Physical Model Study.....	5
2.6	Additional Plans.....	24
3.0	Option Descriptions.....	31
3.1	Plan 1.....	31
3.2	Plan 2.....	32
3.3	Plan 3.....	31
3.4	Plan 4.....	32
3.5	Plan 14 – Angled Extension, Gap Closure and Spur.....	33
3.6	Plan 15.....	34
3.7	Plan 15 – Bulbous Head Option.....	35
3.8	Plan 16 – Spending Beach and Gap Closure.....	36
3.9	Plan 17.....	37
3.10	Plan 18 – Stub and Gap Closure.....	38
4.0	Circulation.....	41
5.0	Risk and Uncertainty.....	44
5.1	Physical Modeling.....	44
5.2	Physical Model Scale Effects.....	45
5.3	Wave Climate.....	46

List of Figures

Figure .1 Channel Rock Breakwater Features.....	2
Figure 2. Eliason Harbor and Crescent Harbor locations.....	4
Figure 3. Wave generator along the southwest.....	9
Figure 4. Wave generator along the north.....	9
Figure 5. Wave generator aligned with breakwater.....	9
Figure 6. Instrument location along main dock. Gages 1, 2, and 3 were used to measure the incoming wave from the generator.....	10
Figure 7. Additional instrumentation location in the area near proposed float plane dock.....	10
Figure 8. Plan 1 Breakwater modification, energy reduction at gages 8 and 9, and wave height plots of all gages with and without breakwater modification.....	11
Figure 9. Plan 2 Breakwater modification, energy reduction at gages 8 and 9, and wave height plots of all gages with and without breakwater modification.....	12
Figure 10. Plan 3 Breakwater modification, energy reduction at gages 8 and 9, and wave height plots of all gages with and without breakwater modification.....	13
Figure 11. Plan 4 Breakwater modification, energy reduction at gages 8 and 9, and wave height plots of all gages with and without breakwater modification.....	14
Figure 12. Plan 5 Breakwater modification, energy reduction at gages 8 and 9, and wave height plots of all gages with and without breakwater modification.....	15
Figure 13. Plan 6 Breakwater modification, energy reduction at gages 8 and 9, and wave height plots of all gages with and without breakwater modification.....	16
Figure 14. Plan 7 Breakwater modification, energy reduction at gages 8 and 9, and wave height plots of all gages with and without breakwater modification.....	17
Figure 15. Plan 8 Breakwater modification, energy reduction at gages 8 and 9, and wave height plots of all gages with and without breakwater modification.....	18
Figure 16. Plan 9 Breakwater modification, energy reduction at gages 8 and 9, and wave height plots of all gages with and without breakwater modification.....	19
Figure 17. Plan 10 Breakwater modification, energy reduction at gages 8 and 9, and wave height plots of all gages with and without breakwater modification.....	20
Figure 18. Plan 11 Breakwater modification, energy reduction at gages 8 and 9, and wave height plots of all gages with and without breakwater modification.....	21
Figure 19. Plan 12 Breakwater modification, energy reduction at gages 8 and 9, and wave height plots of all gages with and without breakwater modification.....	22
Figure 20. Plan 13 Breakwater modification, energy reduction at gages 8 and 9, and wave height plots of all gages with and without breakwater modification.....	23
Figure 21. Plan 14, energy reduction at gages 8 and 9, and wave height plots of all gages with and without breakwater modification.....	26
Figure 22. Plan 15, energy reduction at gages 8 and 9, and wave height plots of all gages with and without breakwater modification.....	27
Figure 23. Plan 16, energy reduction at gages 8 and 9, and wave height plots of all gages with and without breakwater modification.....	28
Figure 24. Plan 17, energy reduction at gages 8 and 9, and wave height plots of all gages with and without breakwater modification.....	29
Figure 25. Plan 18, energy reduction at gages 8 and 9, and wave height plots of all gages with and without breakwater modification.....	30
Figure 26. Plan 1. Stub from shore, overall and close up view.....	29
Figure 27. Plan 2. Breakwater overlap inside overall and close up view.....	30
Figure 28. Plan 3. Breakwater overlap outside overall and close up view.....	31
Figure 29. Plan 4. Closed gap overall and close up view.....	32
Figure 30. Plan 14. Angled extension, spur, and gap closure.....	33
Figure 31. Plan 15. Angled extension over all and close up view.....	34
Figure 32. Plan 15 (bulbous head option). Bulbous head at the gap between the main and north breakwaters. Overall and close up views.....	35
Figure 33. Plan 16. Spending beach and gap closure overall and close up view.....	36
Figure 34. Plan 17. Spending beach over all and close up view.....	37
Figure 35. Plan 18. Stub and gap closure overall and close up views.....	38

Figure 36. Option 1, 2, 3 and 5a breakwater head.....	39
Figure 37. Breakwater trunk.....	39
Figure 38. Bulbous head cross section.....	40
Figure 39. Plan 15 Angled entrance channel extension cross section.....	40
Figure 40. Plan 17 spending beach cross section.....	40
Figure 41.....	41
Figure 42.....	41
Figure 43.....	41
Figure 44.....	41
Figure 45.....	42
Figure 46.....	42
Figure 47.....	42
Figure 48. Example of circulation pattern.....	42

ENGINEERING ANALYSIS
CHANNEL ROCK BREAKWATERS
SITKA HARBOR, SITKA, ALASKA

1.0 INTRODUCTION

The Channel Rock Breakwaters at Sitka were authorized as a Federal project in 1992 and were constructed in 1994. New Thomsen Harbor (now known as Eliason Harbor) is protected from wave action by the three rubble mound breakwaters. The breakwaters are known as the south breakwater, which is 320 feet long and is detached from Japonski Island; the main breakwater, which is 1,200 feet long and consists of a breakwater with a bend in the center; and the north breakwater, which is 480 feet long and is detached from Baranof Island. The gaps between the breakwaters at MLLW are 190 feet between Japonski Island and the south breakwater, 260 feet between the south breakwater and the main breakwater, 400 feet between the main breakwater and the north breakwater, and 175 feet between the north breakwater and Baranof Island. The breakwater crest is +16.4 feet MLLW.

1.1 Location

Sitka is located on the west coast of Baranof Island fronting the Pacific Ocean on Sitka Sound. Sitka is approximately 95 air miles southwest of Juneau and 185 miles northwest of Ketchikan.

ENGINEERING ANALYSIS
CHANNEL ROCK BREAKWATERS
SITKA HARBOR, SITKA, ALASKA

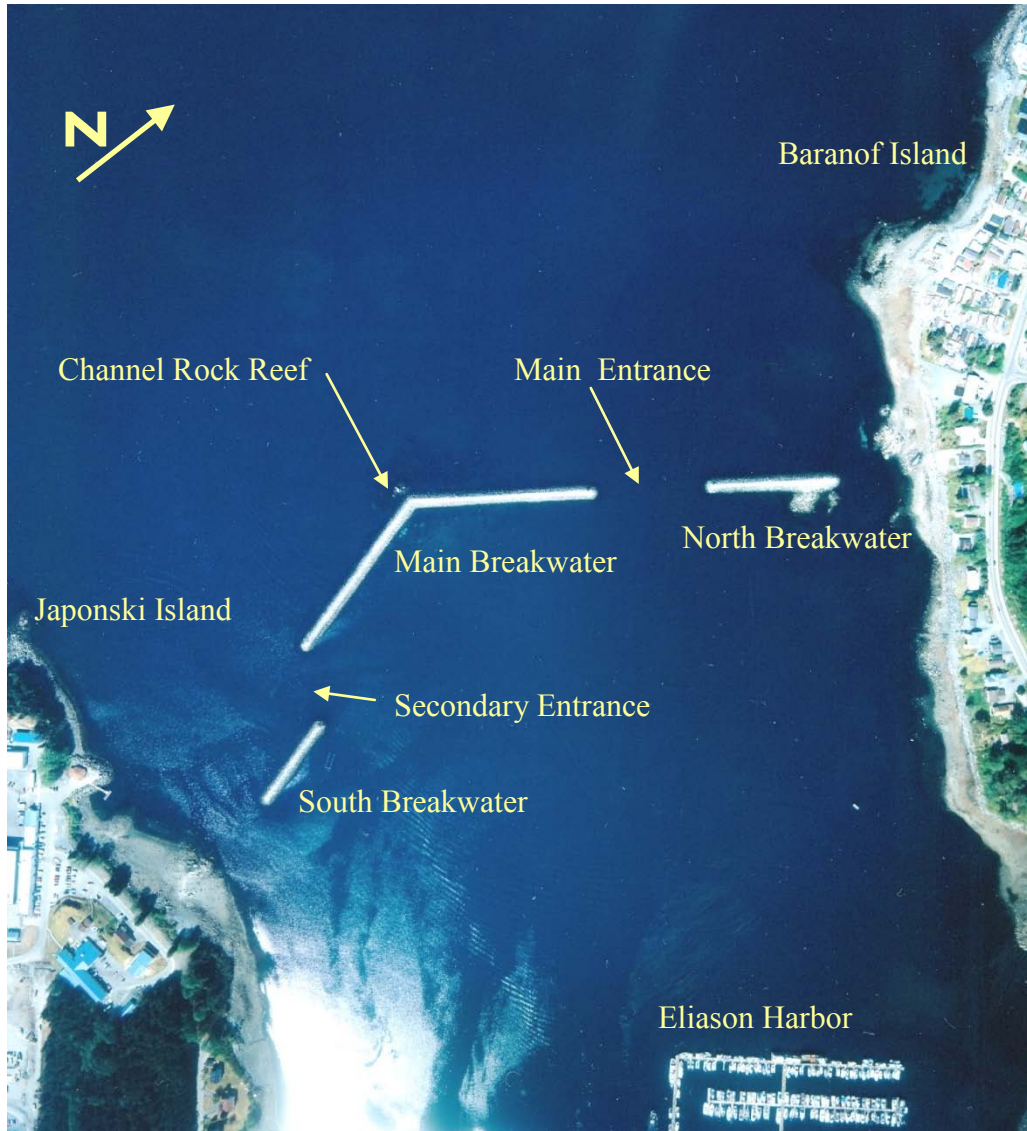


Figure .1 Channel Rock Breakwater Features.

2.0 PROBLEM IDENTIFICATION

The City of Sitka Harbor Department (2001) reported on a “surge” that enters the harbor and sets the docks and boats into motion causing increased wear on the harbor facilities. At times, the motion is so severe that local harbor users consider the movement to be a safety hazard for walking down the floats. Local observations indicate that the high motion events occur during and after storms in the Gulf of Alaska, which are most prevalent in the fall and winter months. Swell associated with these storms are in the range of 8 to 12 seconds. A movie of a high motion event made by the harbormaster’s office indicates that there are several wave trains that are impacting the floats, resulting in short-period dock motion (3 to 5 seconds), coupled with longer period motion and larger vertical displacement.

Evaluation of the breakwater configuration, harbor configuration, and bathymetry indicates that there are several possible contributors to the excessive motion experienced at the harbor:

ENGINEERING ANALYSIS
CHANNEL ROCK BREAKWATERS
SITKA HARBOR, SITKA, ALASKA

- Wave energy from Gulf storms travels down the length of the breakwater and enters the harbor through the gaps between the breakwaters where it is realigned by topography and reflection so that it excites the main float.
- At higher water levels the breakwater gaps have an increased width so higher levels of energy enter the harbor area as opposed to energy levels seen at lower water levels when widths are decreased.
- At higher water levels the incoming waves are less susceptible to the effects of refraction, diffraction, and increased wave breaking
- The rocky shoreline is more reflective at high water and provides a better surface to conserve wave energy and reflect the longer period waves at high water over that experienced at low water.
- The harbor float system and its moorage appear to be very responsive to the incoming wave energy.
- The harbor pilings are susceptible to horizontal translation during high tides when loaded laterally by waves or moored vessels.
- There is an area with a high bathymetric elevation that acts like a lens. The lens effect is capable of focusing the incoming wave energy at the harbor.

Attempts to capture wave data associated with a high dock motion event were unsuccessful due to two successive calm seasons. The lack of wave data associated with large dock motion events prevented the development of a transfer function that could link the dock motion with the incoming wave train. Without a transfer function, the study proceeded under the premise that a reduction of wave energy impacting the harbor area would result in reduced float motion. This premise was supported by experience with a similar problem after the initial construction of Crescent Harbor (figure 2). Interviews with local harbor users indicate that Crescent Harbor experienced a motion problem similar to Eliason Harbor when it was first constructed. Swell entered the harbor and caused excessive motion to occur at the outer ships and floats. The solution for Crescent Harbor was to reduce wave energy entering the harbor by reducing the breakwater entrance gap. Once the entrance channel breakwater at Crescent Harbor was extended, excessive motion after storms was greatly minimized. Eliason Harbor and Crescent Harbor are both in locations where they could experience similar long-period swell from Gulf storms.

ENGINEERING ANALYSIS
CHANNEL ROCK BREAKWATERS
SITKA HARBOR, SITKA, ALASKA

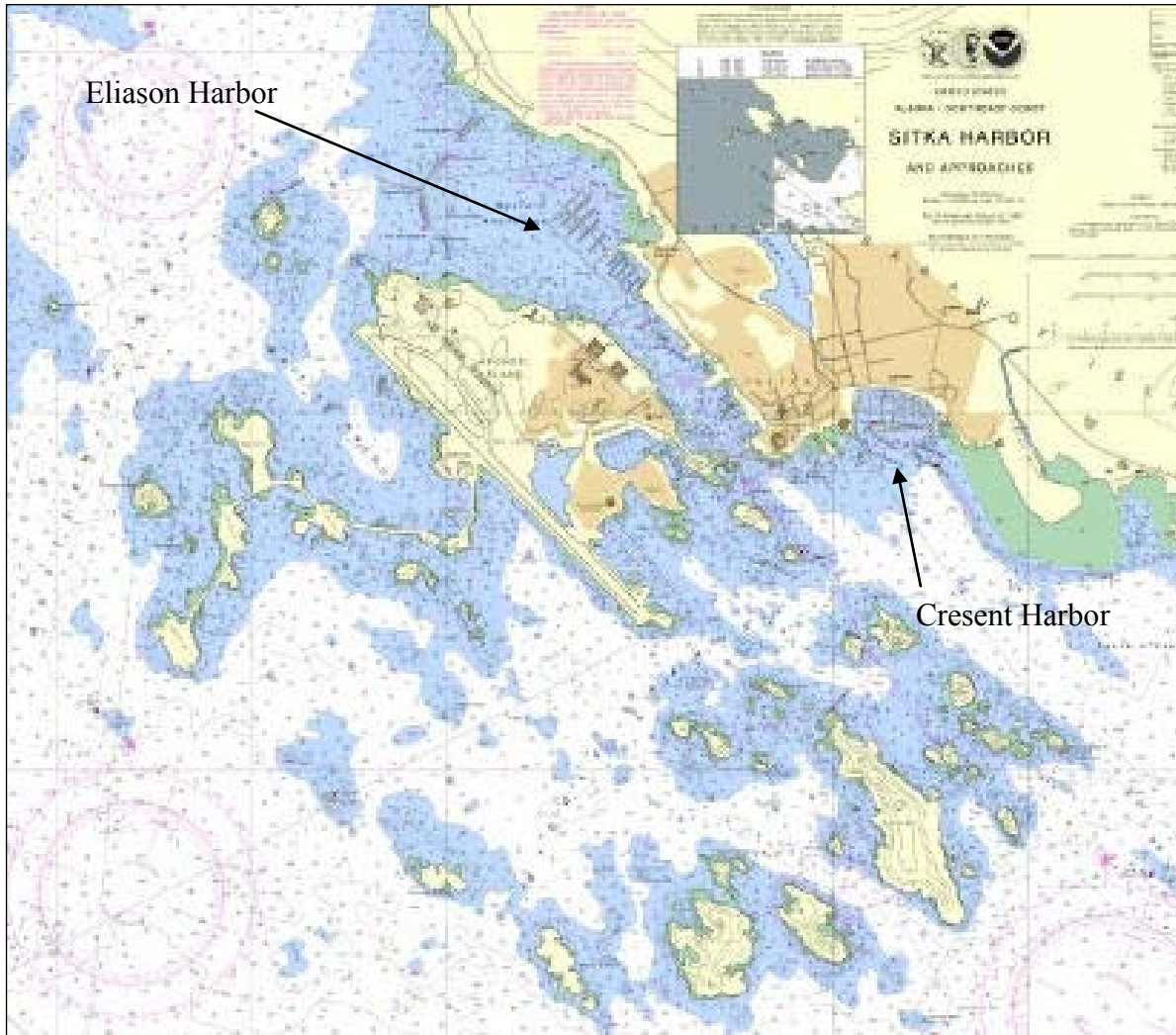


Figure 2. Eliason Harbor and Crescent Harbor locations.

2.1 Purpose

The purpose of this analysis is to identify cost effective breakwater configurations that can reduce wave energy entering through the breakwater gaps to make Eliason Harbor less active, and the western channel area behind the breakwater more usable.

2.2 Tide

Tide data at Sitka was obtained from the National Oceanic and Atmospheric Administration (NOAA) Station ID: 9451600

Tidal datums at Sitka, Baronof Island, Sitka Sound based on:

Length Of Series:	19 Years
Time Period:	January 1983 - December 2001
Tidal Epoch:	1983-2001

ENGINEERING ANALYSIS
CHANNEL ROCK BREAKWATERS
SITKA HARBOR, SITKA, ALASKA

Elevations of tidal datum referred to Mean Lower Low Water (MLLW), in feet:

Highest Observed Water Level (11/02/1948)	= 14.88
Mean Higher High Water (MHHW)	= 9.94
Mean High Water (MHW)	= 9.16
Mean Tide Level (MTL)	= 5.31
Mean Sea Level (MSL)	= 5.28
Mean Low Water (MLW)	= 1.46
Mean Lower Low Water (MLLW)	= 0.00
Lowest Observed Water Level (01/01/1991)	= -4.02

2.3 Instrumentation

Eliason Harbor was instrumented to measure "surge" events associated with high motions at the docks for two fall/winter (2004-2005 and 2005-2006) seasons. During the 2004-2005 instrumentation effort, the maximum significant wave height measured was 6 inches with a period of 11.6 seconds inside the area protected by the Channel Rock Breakwaters. During the 2005-2006 instrumentation effort, the maximum significant wave height measured just outside Eliason Harbor was 7.5 inches with a 12-second period. Conversation with the harbormaster indicated that the 2004-2005 and the 2005-2006 measurement seasons were some of the calmest seasons he had ever seen, so the collected data was not analyzed to develop a transfer function.

Concurrent with the instrumentation effort, a physical model was constructed at the Waterways Experiment Station (WES) in Vicksburg, Mississippi, with the intention of using the data collected from the instrumentation to simulate the conditions that cause the high motion events and test modifications to reduce the wave energy. Plans to model an event that caused excessive dock motion and subsequent fixes were limited by the lack of data from a high motion event.

2.4 Design Wave

A hindcast study for a design wave was not performed for this project because the intent was to capture a high motion event with instrumentation. The existing armor stone on the Channel Rock Breakwaters were designed for a 5.3-foot wave based on a single wind speed, wind direction, and fetch. Swell was accounted for in the 1992 Feasibility Report HH Appendix by using the wave period from a single hindcast point in the Gulf of Alaska to set the crest height. The breakwaters have not required any major rehabilitation to date and there have been no reports of overtopping, so the design wave of 5.3 feet was used in the physical model study. Recent inspection has indicated that there has been some armor displacement in the area along the main breakwater by the main entrance between the main and north breakwater. Physical model testing showed that this section of breakwater is subject to a wave that travels in a mach stem fashion down the length of the breakwater, so the armor stone size for breakwater modification at the gap between the main and north breakwaters was increased to account for this wave.

2.5 Physical Model Study

The physical model was run with a variety of wave heights and periods in an attempt to understand the conditions that cause the excessive float motion at Eliason Harbor. As previously stated, a wave hindcast was not performed. Instead instrumentation was deployed to measure an

ENGINEERING ANALYSIS
CHANNEL ROCK BREAKWATERS
SITKA HARBOR, SITKA, ALASKA

event to use in the model; however, the years of instrumentation were calm years. In the absence of measured data, the working assumption for evaluating the physical model results was that the wave energy entering the harbor is the exciting mechanism for the harbor floats and a reduction of wave energy impacting the harbor floats will result in a reduction of harbor float motion. The majority of the wave heights tested were 5 feet with a water level of +11 feet MLLW.

A water level of +11 feet MLLW was selected as the water level for the runs in the physical model. This was approximately 1 foot higher than mean higher high water. This water level was not an infrequent occurrence and had a high chance of occurring during a storm in the Gulf of Alaska.

Because of the small wave height associated with the swell, wave energy reduction rather than the traditional wave height reduction was used for evaluation and comparison of a measure's effectiveness since the wave height is a manifestation of the wave energy.

Three different wave directions were evaluated during the physical model study (figures 3 to 5). The figure 3 configuration was used to simulate storms from the Gulf of Alaska, figure 4 configuration simulated strong wind events out of the north, and the configuration shown in figure 5 was used to simulate waves from the Gulf of Alaska that could be steered through the breakwater gaps nearest Japonski Island.

Results of the physical model study for the wave generator configured as shown in figures 3 and 4 are documented in the Engineering Research and Development Laboratory's (ERDC) report: ERDC/CHL TR-08-2 *Physical Model Study of Wave Action in New Thomsen Harbor, Sitka, Alaska*. This study found that for the 5-foot, 12-second waves generated from the southwest, the majority of energy enters the harbor through the gap between Japonski Island and the south breakwater and the main entrance between the main and north breakwaters. The largest amount of energy entered through the main entrance between the main and north breakwaters.

The study also examined different methods of reducing the energy entering through the breakwater gaps. The elevation of the core height was evaluated and determined to be a possible factor in the excessive harbor motion events through energy leakage, but one that was neither easily evaluated nor easily solved. The low joint probability of excessive high tides and waves makes the transfer of energy above the core a very short duration event. Dock excitation would have to occur very fast for this to be the main contributor to movement. An attempt was made to quantify the energy that leaked into the harbor at the start of the physical model tests. The data from this run was used for information only because wave transmission through a breakwater is poorly simulated due to viscous effects. A 5-foot wave with an 11.5-second period was generated at with a +11-foot water level. This resulted in a 0.5-foot wave with all of the gaps and entrances open, and a 0.2-foot wave with all of the gaps and entrances closed. This was an 84 percent reduction in energy, so 16 percent of the incoming wave energy leaked through the breakwater. Direct observation from a boat in December 2009 during a +12-foot tide indicated that there was swell and reflection on the sea side of the breakwater as evidenced by the roll of the boat; however, the lee side of the breakwater was calm, indicating negligible leakage of energy over the breakwater core. A second line of evidence against the idea of excessive energy leakage is that the core at Eliason Harbor and Crescent Harbor are similar in height and are

ENGINEERING ANALYSIS
CHANNEL ROCK BREAKWATERS
SITKA HARBOR, SITKA, ALASKA

subject to similar ocean swells. The design height of the core at Crescent harbor is 9.5 feet and the design height for the core at Eliason Harbor is 9.2 feet. No direct assumption on core heights can be made because of the different lengths of structures involved; however, the low combined probability of wave and extreme tide duration prevail at both locations. Crescent Harbor experienced excessive motion when it was first completed, similar to the motion currently experienced at Eliason Harbor. An extension of the breakwater that reduced the exposure at the entrance to ocean swells quieted Crescent Harbor. Wave energy leaking above the core at Crescent Harbor was not the main contributor to the excessive motion at Crescent Harbor, and it does not appear to be the main contributor at Eliason Harbor. The energy that enters through the gaps and entrances impacts the harbors much more than the energy leaking through the breakwater.

The energy entering through the breakwater gaps was examined to determine how much reduction could be achieved by closing or reducing the gap openings. Testing with the wave generator parallel to the runway on Japonski Island indicated that the energy entering through the gaps ranged from 19 percent to 32 percent, with the most energy entering through the main entrance between the main and north breakwaters. The non linear nature of the main breakwater tends to redirect the wave energy through the main entrance between the main and north breakwaters. The energy enters through the main entrance and recombines with the wave energy entering through the other breakwater gaps and the secondary entrance. This recombination occurs at or very near Eliason Harbor. Closing or overlapping one or both gaps by Japonski Island was shown in the physical model to reduce the wave energy along the main dock. Reducing the main entrance width between the main and north breakwater and redirecting the wave energy entering through this entrance was shown in the physical model to provide the greatest energy reduction at the dock. This option has not been optimized to find out the best length and configuration to attenuate the waves.

The wave generator configuration shown in figure 5 was used after ERDC/CHL TR-08-2 was published to see if waves steered through the gap between Japonski Island and the south breakwater, and the opening at the secondary entrance, could result in a more severe wave condition at the harbor. The results of this additional work were documented in ERDC/CHL TR-08-2 Addendum titled *Physical Model Study of Wave Action in New Thomsen Harbor, Sitka, Alaska Unpublished Addendum to Final Report July 2009*. This study did not focus on the amount of energy entering through the gaps; rather it focused on the energy reduction realized by different breakwater modifications. Alterations to the main entrance, particularly when the wave energy was redirected, resulted in the greatest energy reduction in the main float area. This supports the conclusion of the initial study that most of the wave energy enters through the main entrance. Lesser, but still significant, wave energy reduction was achieved in the main float area by closing off or restricting the secondary entrance.

In the absence of a measured event or a hindcast, the modeling effort focused on matching local observations. The wave generator configuration shown in figure 5 produced the largest waves in the harbor and best matched local observations. Wave gages were placed down the length of the main float location (figure 6). Four other gages were used to evaluate the effectiveness of breakwater modifications in the area of a proposed float plane dock (figure 7).

ENGINEERING ANALYSIS
CHANNEL ROCK BREAKWATERS
SITKA HARBOR, SITKA, ALASKA

The rest of this report addresses the energy reduction associated with breakwater modifications with the wave generator in the configuration shown in figure 5.

The water elevation was kept at +11 feet mean lower low water (MLLW) with the exception of plan 11 (figure 18), where the water level was reduced to +7 feet MLLW. This plan compared the energy entering the harbor at higher and lower water levels. The wave energy associated with the 7-foot water level was significantly lower due to energy losses from refraction, diffraction, increased wave breaking, and reduced gap widths in the breakwater.

For each test, the incoming wave generated was 5 feet with 10, 12, and 14-second periods. The modification evaluated and the associated energy reduction at gage 8 and gage 19 are shown in figures 6 and 7 and the wave height measured at each gage with and without breakwater modifications is shown in figures 8 through 20. Gage 8 was chosen to evaluate the energy reduction in the harbor area since it typically recorded the largest wave height during testing. Gage 19 was chosen to evaluate the energy in the proposed float plane area since it was closest to the proposed float plane location. It is important to note that the effectiveness of each option varies with the wave period and is not uniform for each gage.

Plans 4, 7, 9, and 11 all resulted in energy reduction greater than 30 percent at gage 8 while plans 3, 6, 8, and 10 all resulted in energy reduction greater than 10 percent at gage 8. As previously noted, plan 11 evaluated a reduced water level and is impossible to implement as an energy reduction option. It was run to compare the energy that could enter the harbor during high water events, not for plan modification evaluation. A plan that incorporates one or a combination of plans 3, 4, 6, 7, 8, 9, or 10 will result in lower energy being realized at the harbor area. Plan views and cross sections were developed for individual components of each of these plans.

ENGINEERING ANALYSIS
CHANNEL ROCK BREAKWATERS
SITKA HARBOR, SITKA, ALASKA

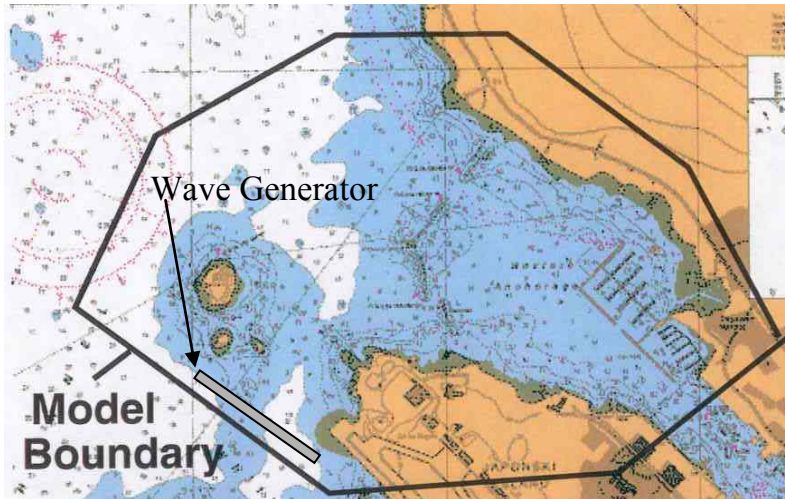


Figure 3. Wave generator along the southwest

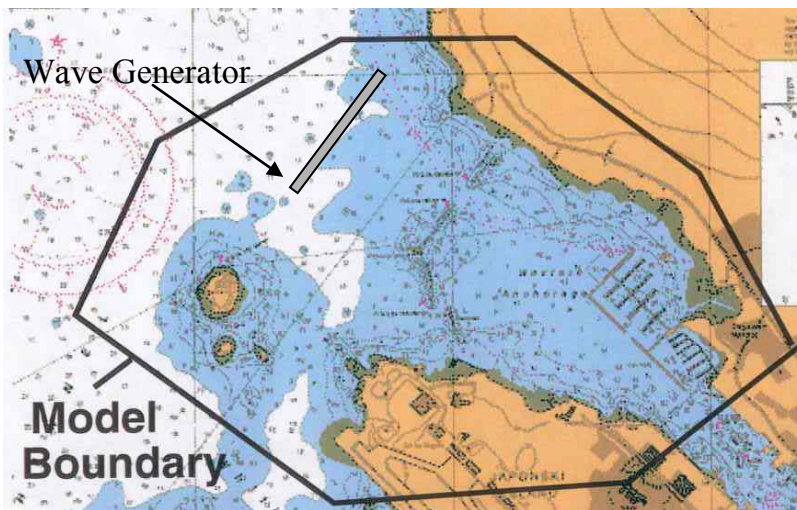


Figure 4. Wave generator along the north

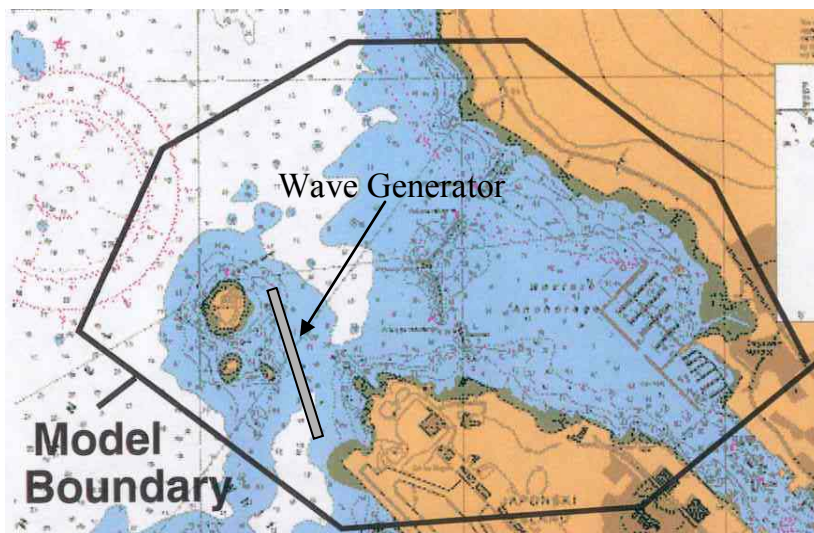


Figure 5. Wave generator aligned with breakwater

ENGINEERING ANALYSIS
CHANNEL ROCK BREAKWATERS
SITKA HARBOR, SITKA, ALASKA

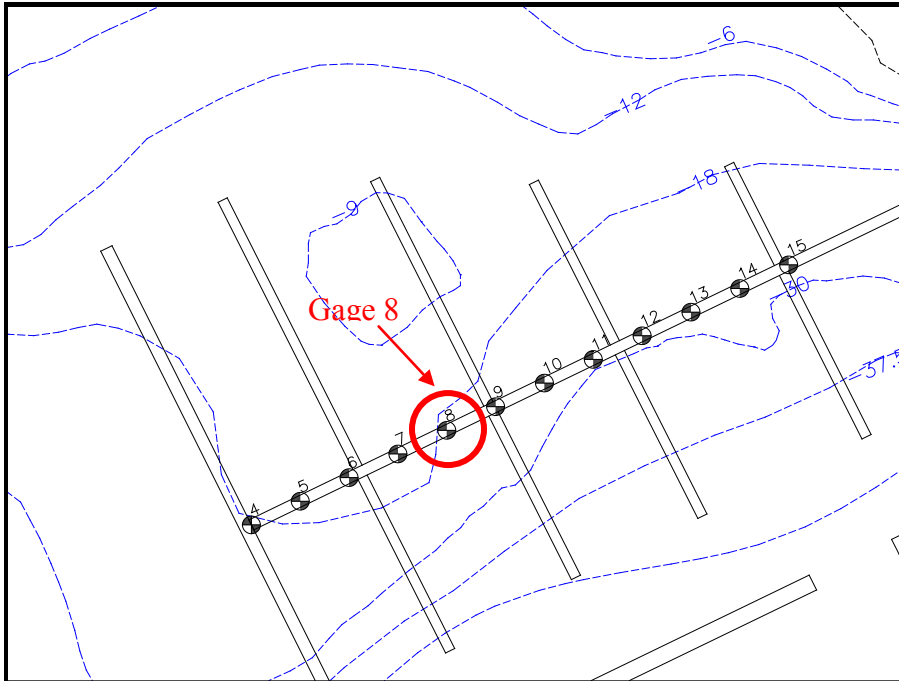


Figure 6. Instrument location along main dock. Gages 1, 2, and 3 were used to measure the incoming wave from the generator.

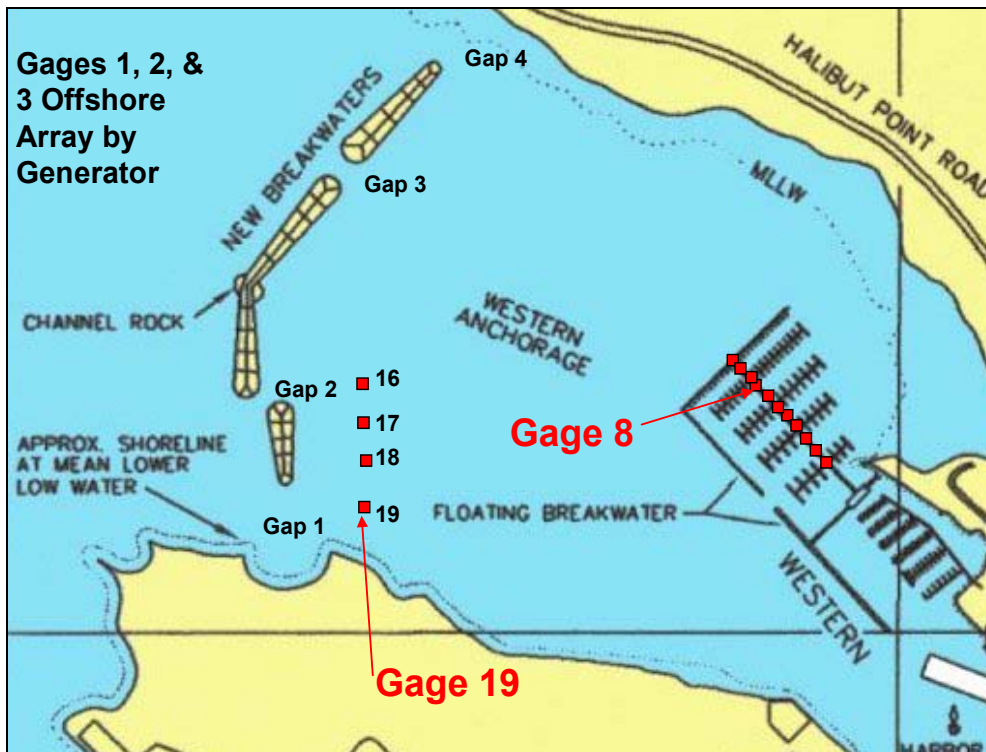
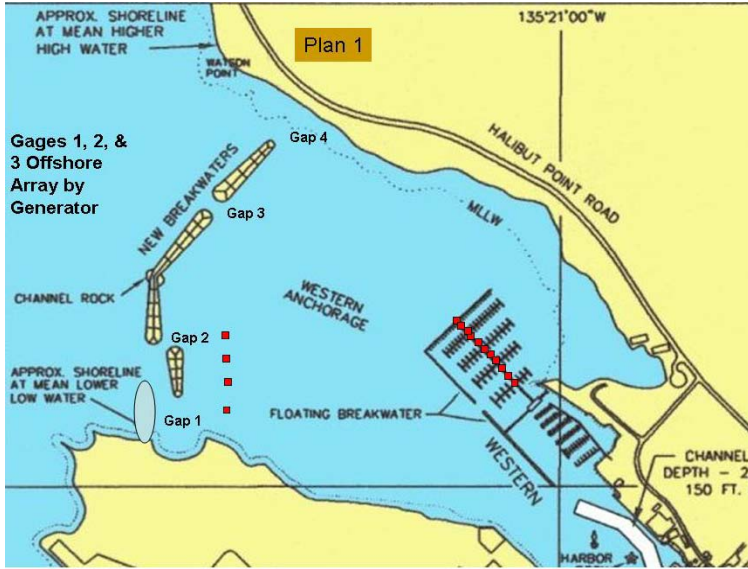


Figure 7. Additional instrumentation location in the area near proposed float plane dock.

ENGINEERING ANALYSIS CHANNEL ROCK BREAKWATERS SITKA HARBOR, SITKA, ALASKA



Period [s]	Gage 8	Gage 19
10	17%	+2%
12	+14%	+10%
14	22%	+4%

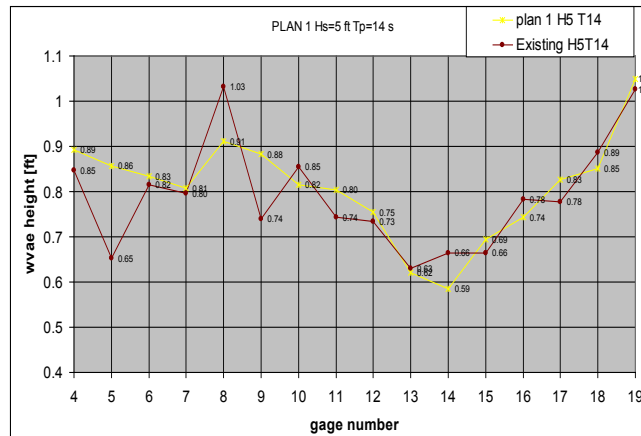
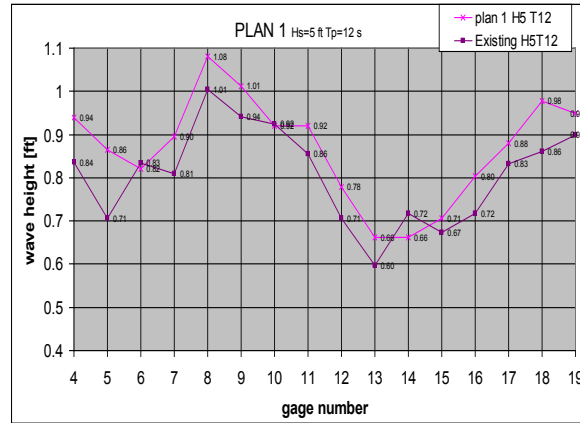
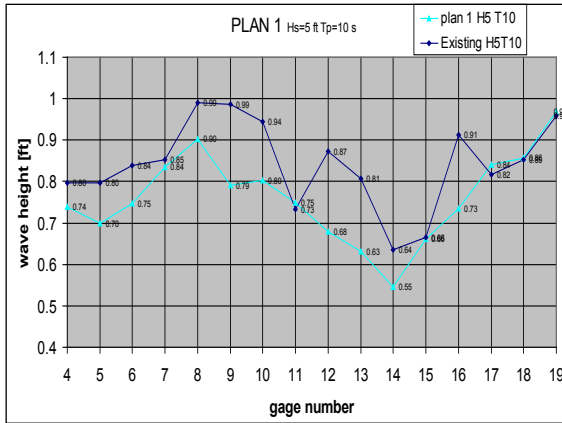
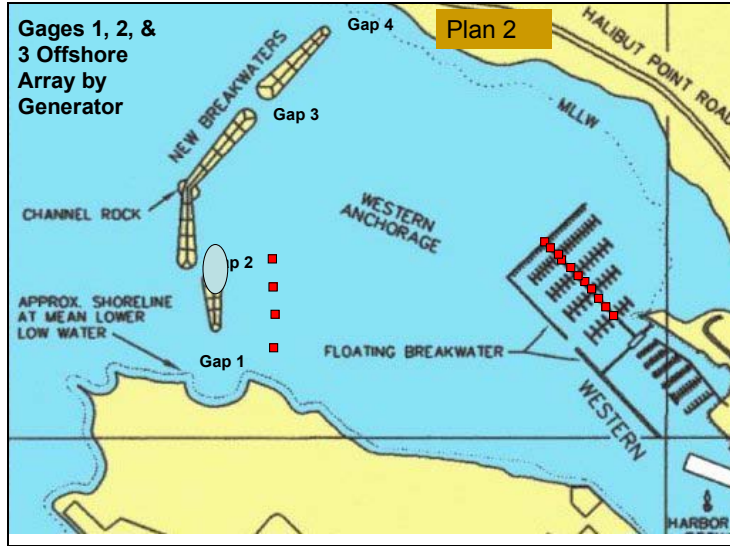


Figure 8. Plan 1 Breakwater modification, energy reduction at gages 8 and 9, and wave height plots of all gages with and without breakwater modification. Wave height = 5 feet, Period = 10, 12, and 14 seconds.

ENGINEERING ANALYSIS CHANNEL ROCK BREAKWATERS SITKA HARBOR, SITKA, ALASKA



Plan 2 Energy Reduction at Gage 8 and Gage 19		
Period [s]	Gage 8	Gage 19
10	25%	45%
12	4%	31%
14	27%	35%

Yellow highlight indicates energy reduction for all periods is greater than 30%

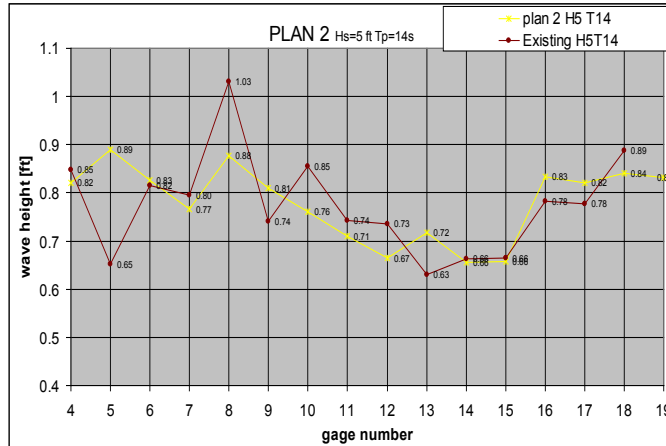
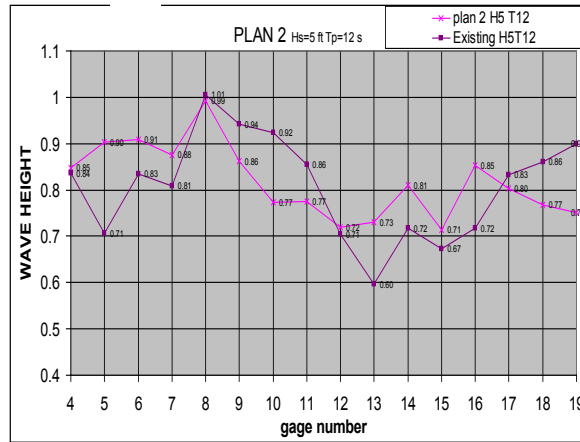
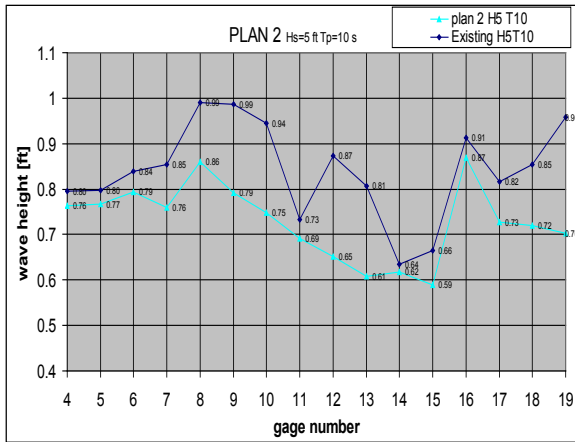
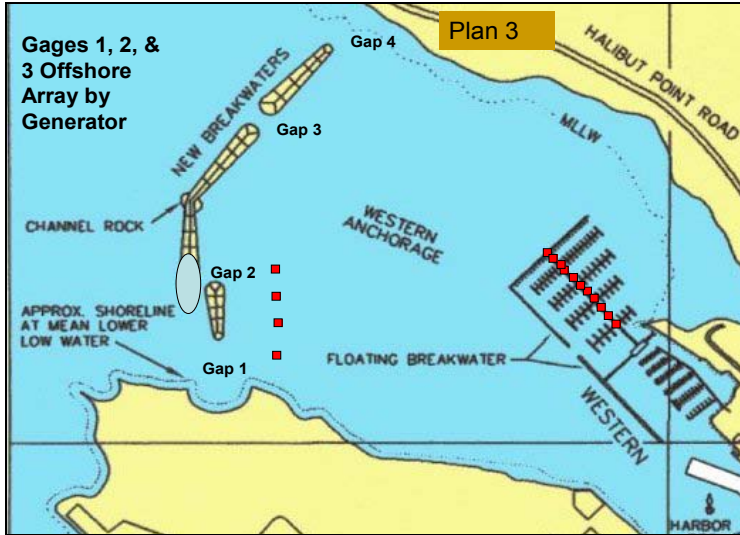


Figure 9. Plan 2 Breakwater modification, energy reduction at gages 8 and 9, and wave height plots of all gages with and without breakwater modification. Wave height = 5 feet, Period = 10, 12, and 14 seconds.

ENGINEERING ANALYSIS CHANNEL ROCK BREAKWATERS SITKA HARBOR, SITKA, ALASKA



Period [s]	Gage 8	Gage 19
10	43%	44%
12	17%	29%
14	24%	18%

Orange highlight indicates energy reduction for all periods is greater than 10%

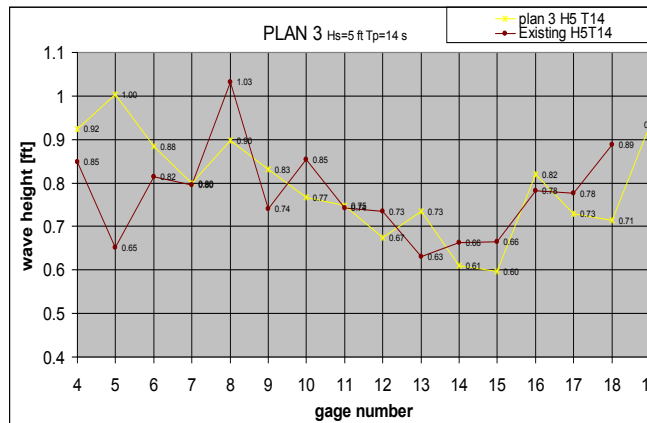
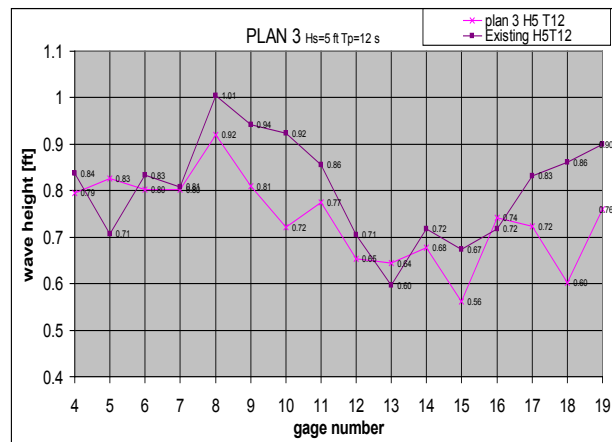
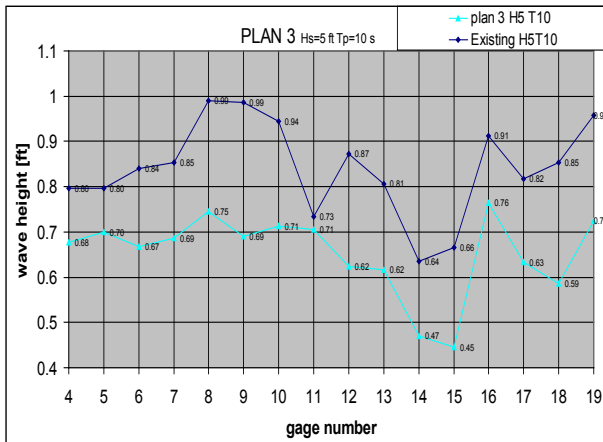
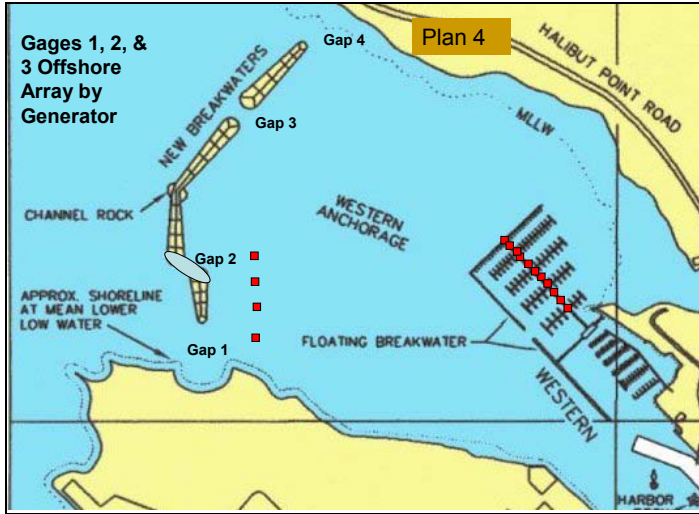


Figure 10. Plan 3 Breakwater modification, energy reduction at gages 8 and 9, and wave height plots of all gages with and without breakwater modification. Wave height = 5 feet, Period = 10, 12, and 14 seconds.

ENGINEERING ANALYSIS CHANNEL ROCK BREAKWATERS SITKA HARBOR, SITKA, ALASKA



Period [s]	Gage 8	Gage 19
10	50%	70%
12	32%	58%
14	35%	44%

Yellow highlight indicates energy reduction for all periods is greater than 30%

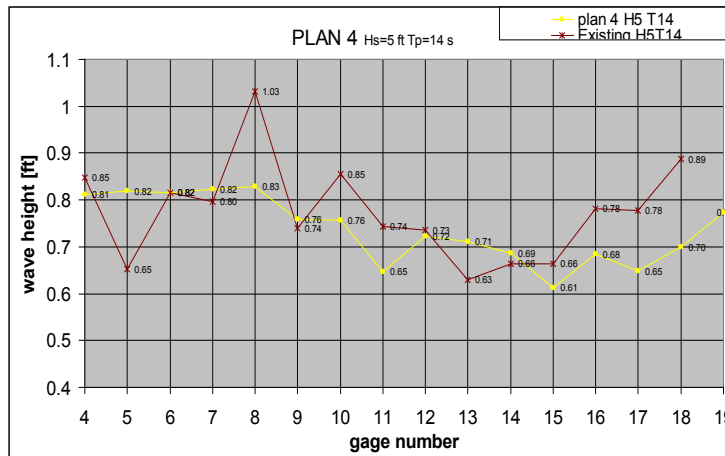
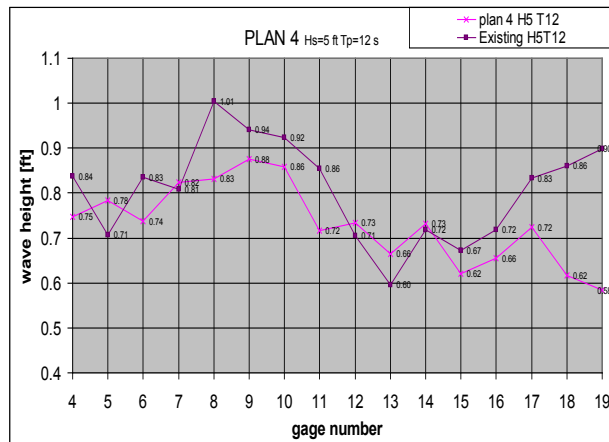
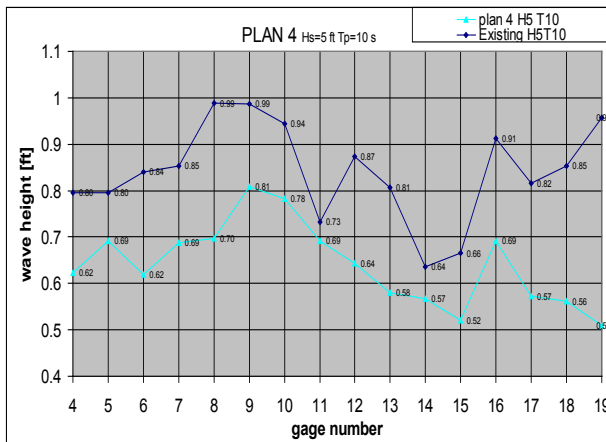
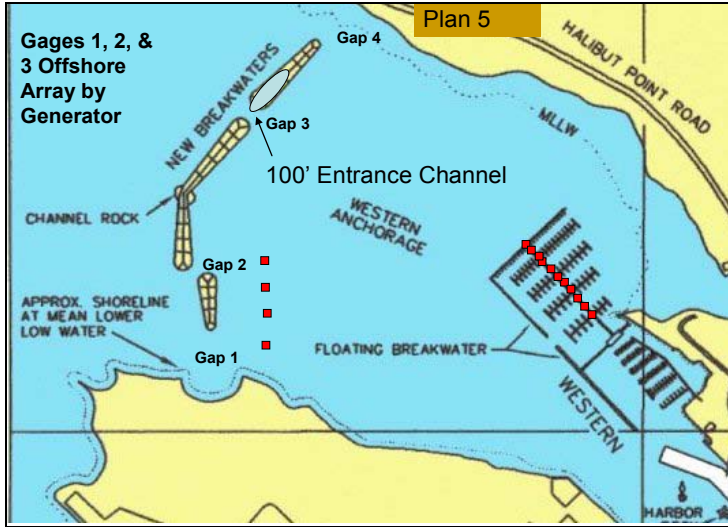


Figure 11. Plan 4 Breakwater modification, energy reduction at gages 8 and 9, and wave height plots of all gages with and without breakwater modification. Wave height = 5 feet, Period = 10, 12, and 14 seconds.

ENGINEERING ANALYSIS CHANNEL ROCK BREAKWATERS SITKA HARBOR, SITKA, ALASKA



Period [s]	Gage 8	Gage 19
10	23%	+2%
12	4%	+21%
14	25%	+4%

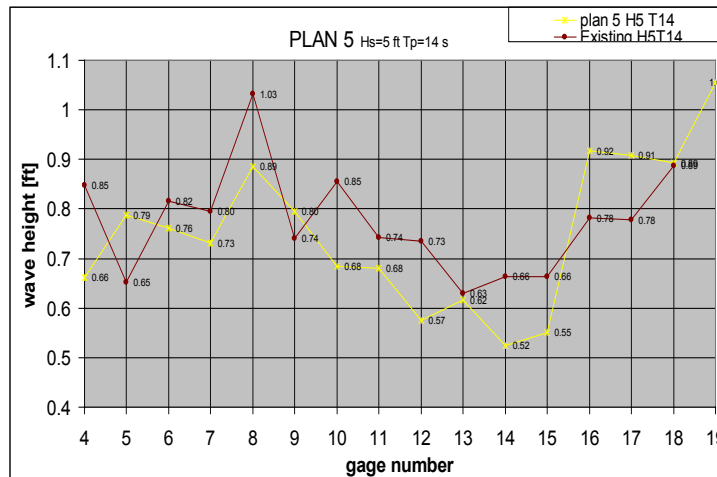
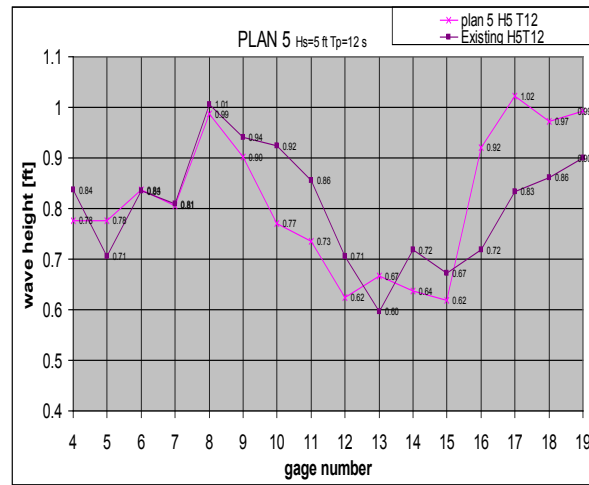
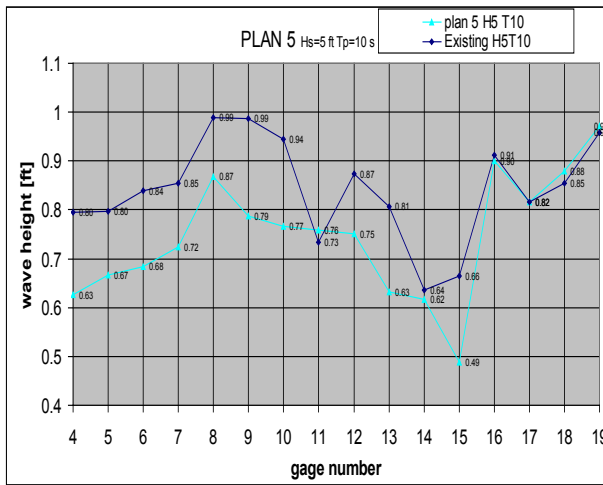
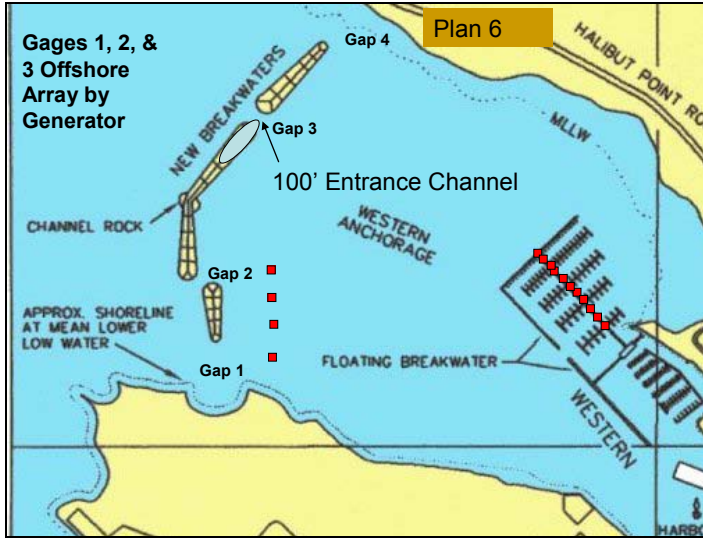


Figure 12. Plan 5 Breakwater modification, energy reduction at gages 8 and 9, and wave height plots of all gages with and without breakwater modification. Wave height = 5 feet, Period = 10, 12, and 14 seconds.

ENGINEERING ANALYSIS
CHANNEL ROCK BREAKWATERS
SITKA HARBOR, SITKA, ALASKA



Period [s]	Gage 8	Gage 19
10	19%	+6%
12	22%	+9%
14	22%	24%

Orange highlight indicates energy reduction for all periods is greater than 10%

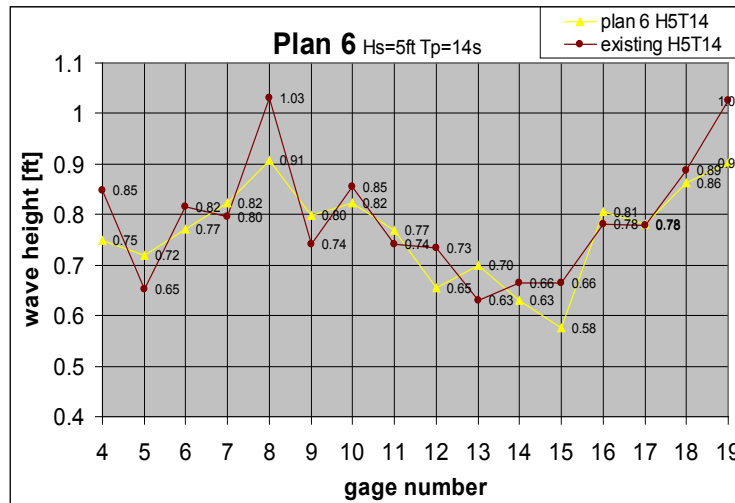
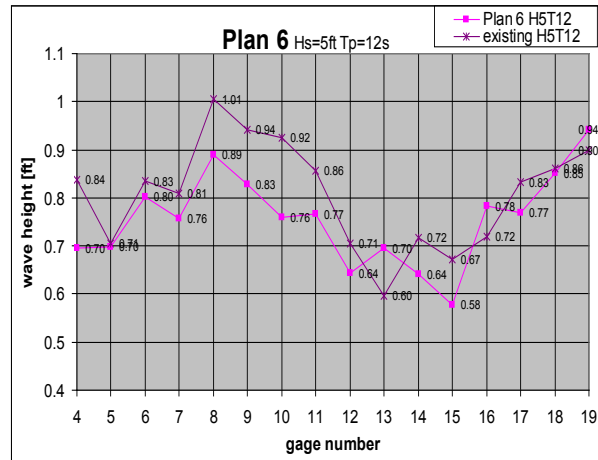
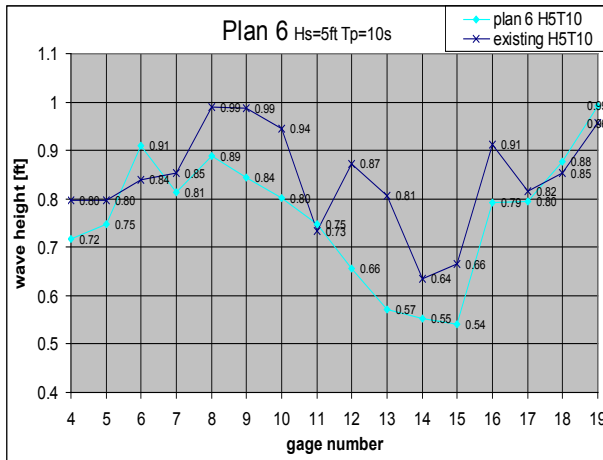
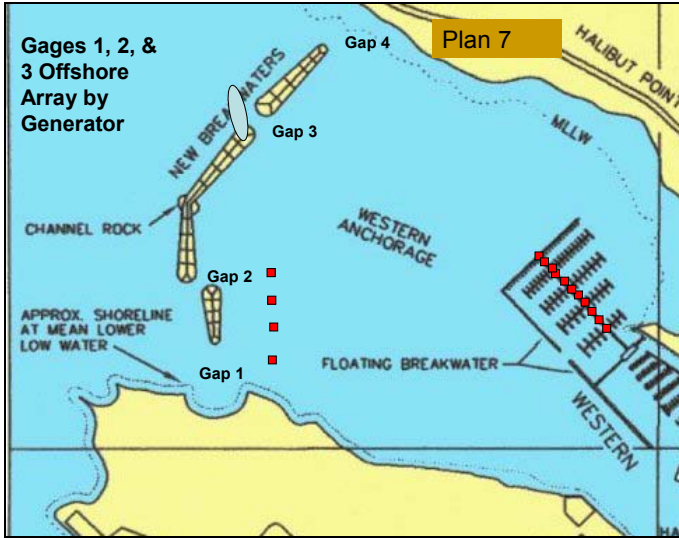


Figure 13. Plan 6 Breakwater modification, energy reduction at gages 8 and 9, and wave height plots of all gages with and without breakwater modification. Wave height = 5 feet, Period = 10, 12, and 14 seconds.

ENGINEERING ANALYSIS
CHANNEL ROCK BREAKWATERS
SITKA HARBOR, SITKA, ALASKA



Period [s]	Gage 8	Gage 19
10	50%	16%
12	52%	0%
14	52%	4%

Yellow highlight indicates energy reduction for all periods is greater than 30%

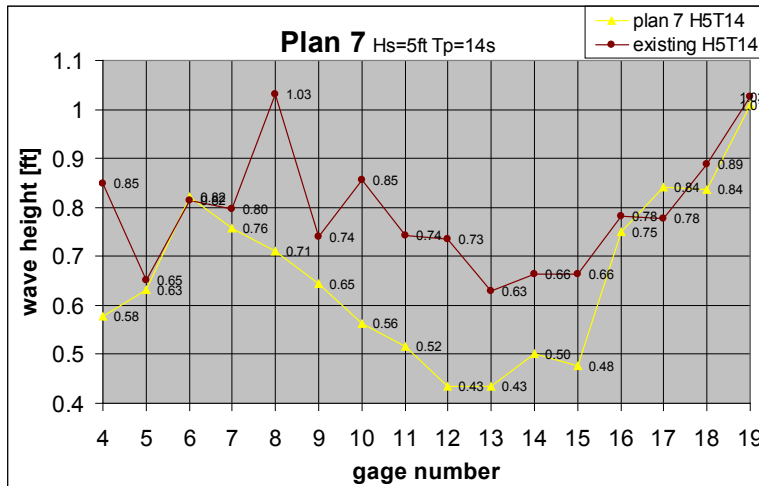
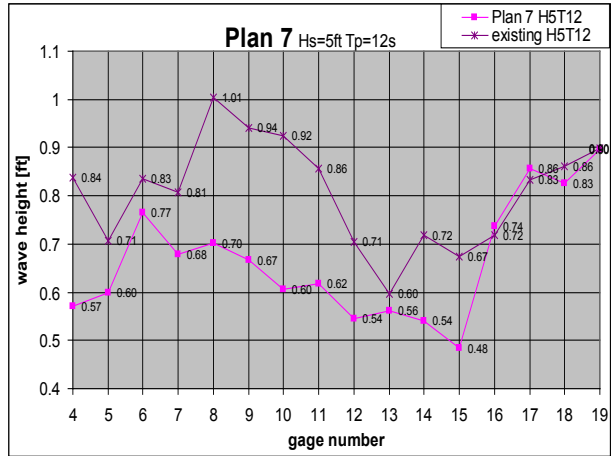
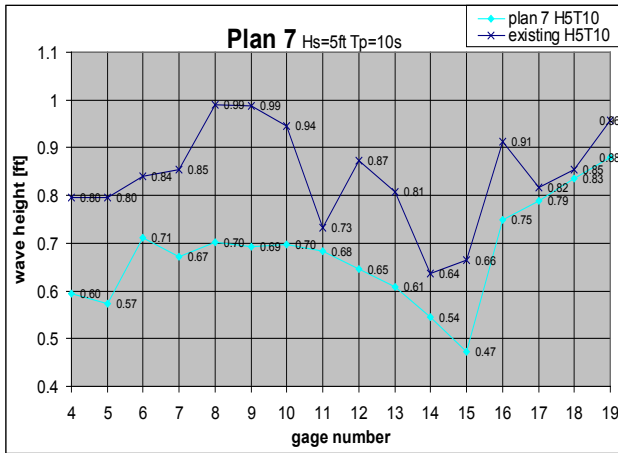
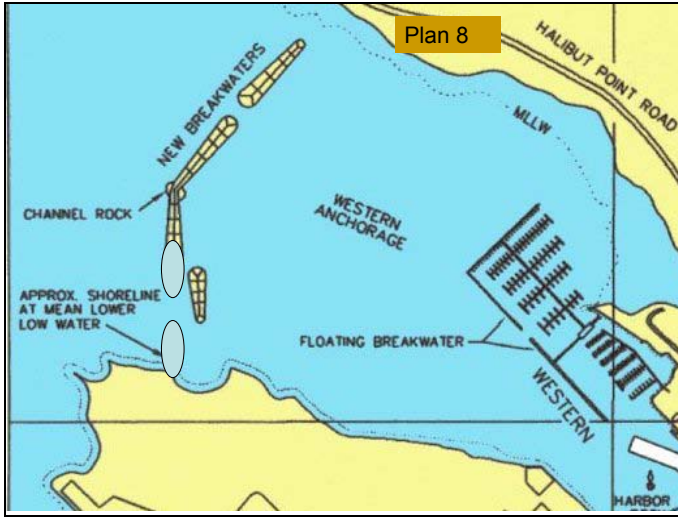


Figure 14. Plan 7 Breakwater modification, energy reduction at gages 8 and 9, and wave height plots of all gages with and without breakwater modification. Wave height = 5 feet, Period = 10, 12, and 14 seconds.

ENGINEERING ANALYSIS
CHANNEL ROCK BREAKWATERS
SITKA HARBOR, SITKA, ALASKA



Period [s]	Gage 8	Gage 19
10	30%	56%
12	12%	54%
14	27%	4%

Orange highlight indicates energy reduction for all periods is greater than 10%

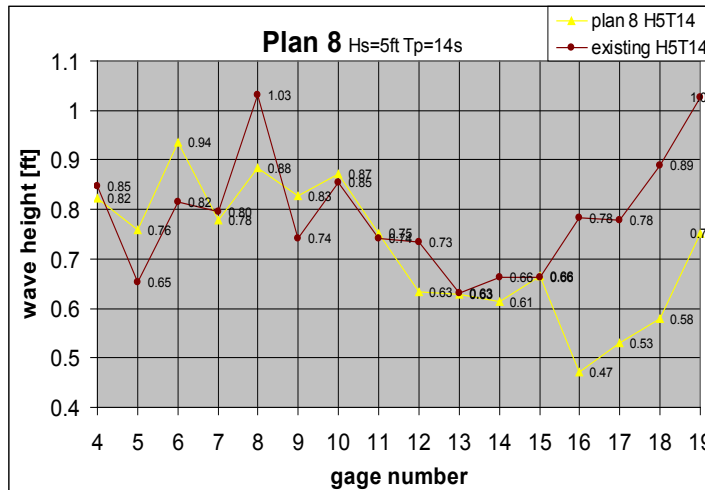
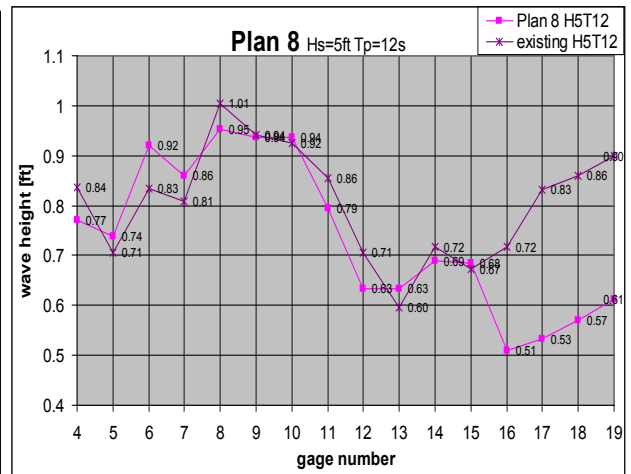
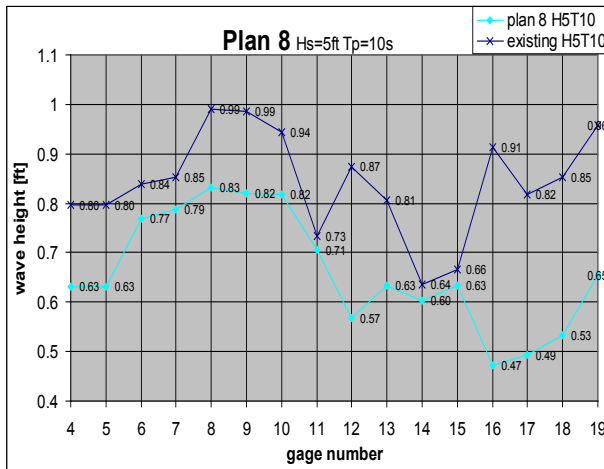
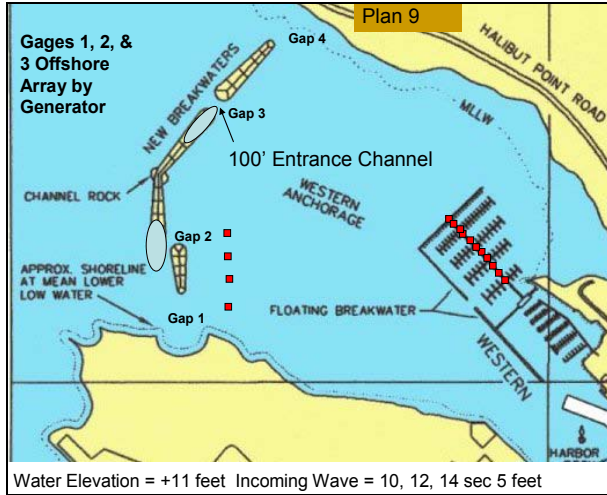


Figure 15. Plan 8 Breakwater modification, energy reduction at gages 8 and 9, and wave height plots of all gages with and without breakwater modification. Wave height = 5 feet, Period = 10, 12, and 14 seconds.

ENGINEERING ANALYSIS CHANNEL ROCK BREAKWATERS SITKA HARBOR, SITKA, ALASKA



Period [s]	Gage 8	Gage 19
10	47%	50%
12	37%	45%
14	44%	63%

Yellow highlight indicates energy reduction for all periods is greater than 30%

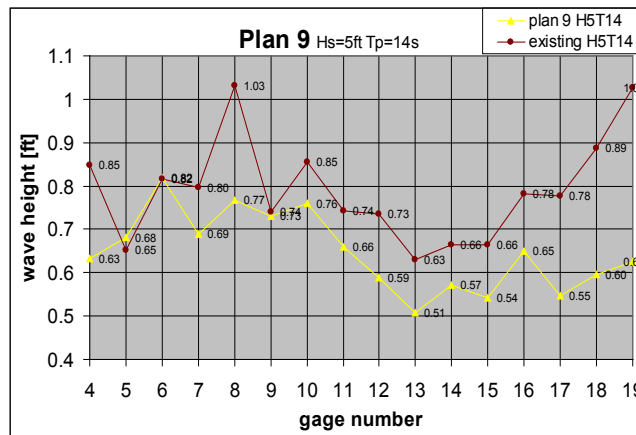
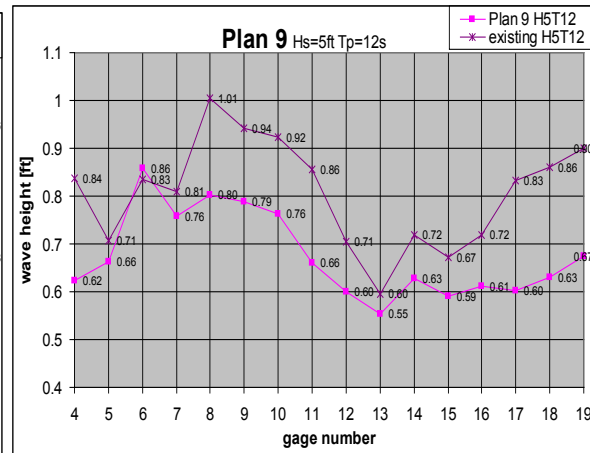
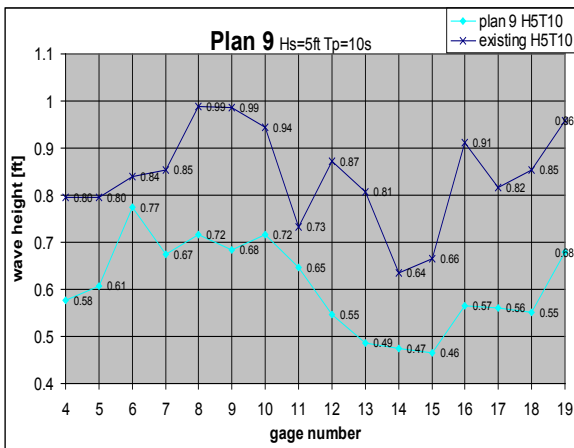
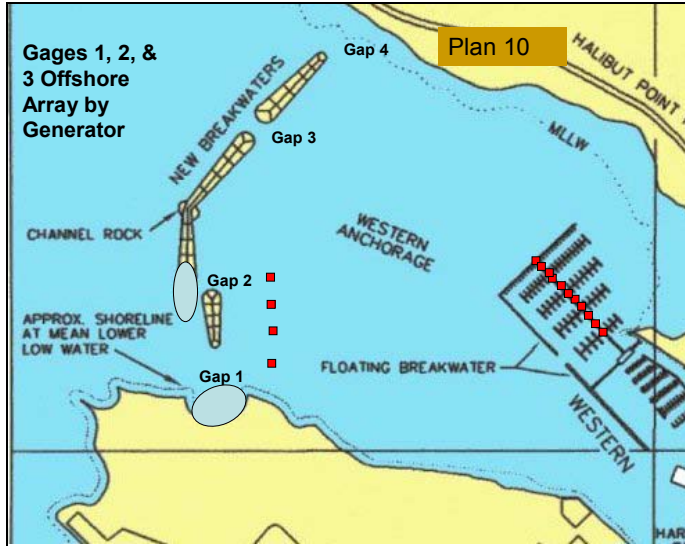


Figure 16. Plan 9 Breakwater modification, energy reduction at gages 8 and 9, and wave height plots of all gages with and without breakwater modification. Wave height = 5 feet, Period = 10, 12, and 14 seconds.

ENGINEERING ANALYSIS CHANNEL ROCK BREAKWATERS SITKA HARBOR, SITKA, ALASKA



Plan 10 Energy Reduction at Gage 8 and Gage 19		
Period [s]	Gage 8	Gage 19
10	35%	48%
12	17%	23%
14	35%	47%

Orange highlight indicates energy reduction for all periods is greater than 10%

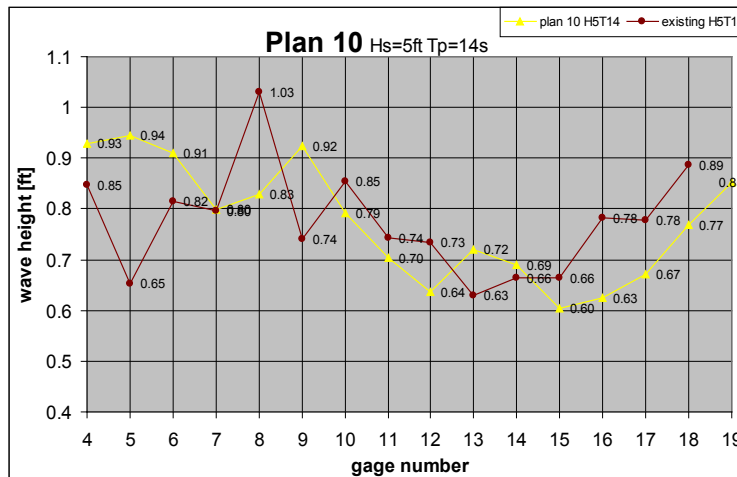
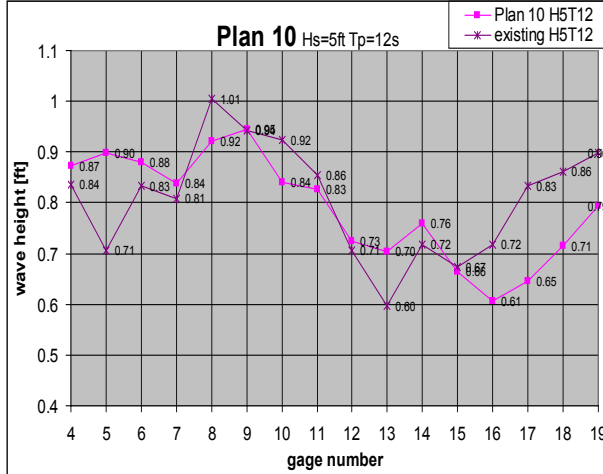
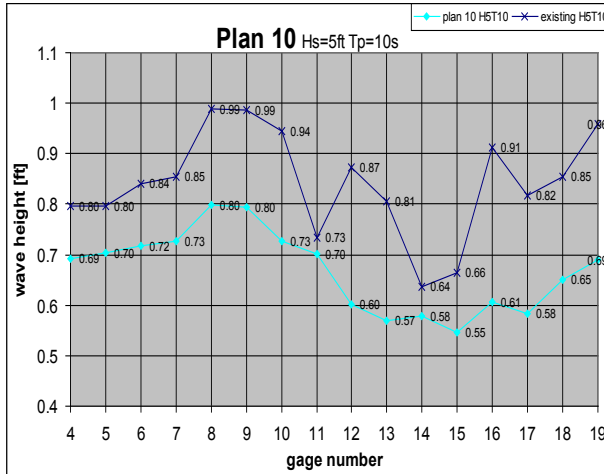
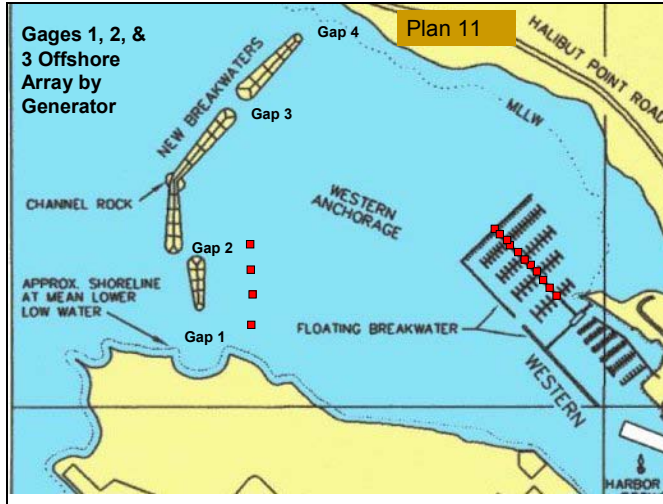


Figure 17. Plan 10 Breakwater modification, energy reduction at gages 8 and 9, and wave height plots of all gages with and without breakwater modification. Wave height = 5 feet, Period = 10, 12, and 14 seconds.

ENGINEERING ANALYSIS CHANNEL ROCK BREAKWATERS SITKA HARBOR, SITKA, ALASKA



Plan 11 Energy Reduction at Gage 8 and Gage 19

Period [s]	Gage 8	Gage 19
10	72%*	12%
12	67%*	19%
14	52%*	38%

The energy reduction associated with this option is due to reduced gap widths at lower water levels, increased refraction, diffraction, and wave breaking. This run was made for comparison only. Orange highlight indicates energy reduction for all periods is greater than 10%
Yellow highlight indicates energy reduction for all periods is greater than 30%

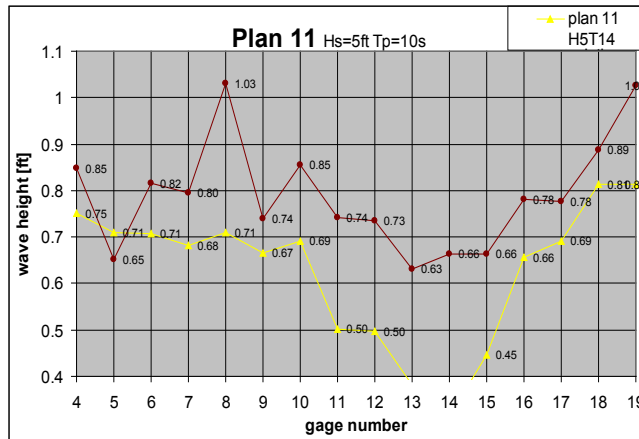
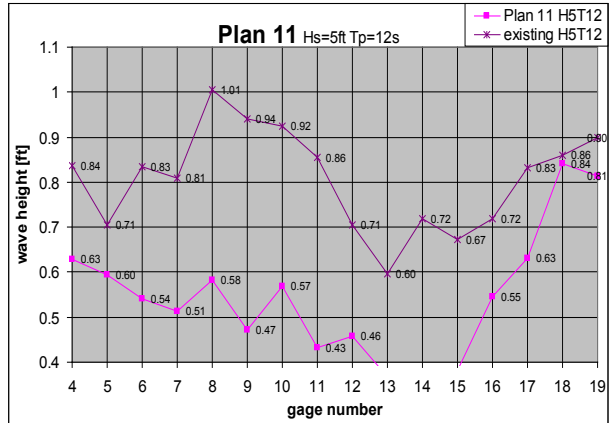
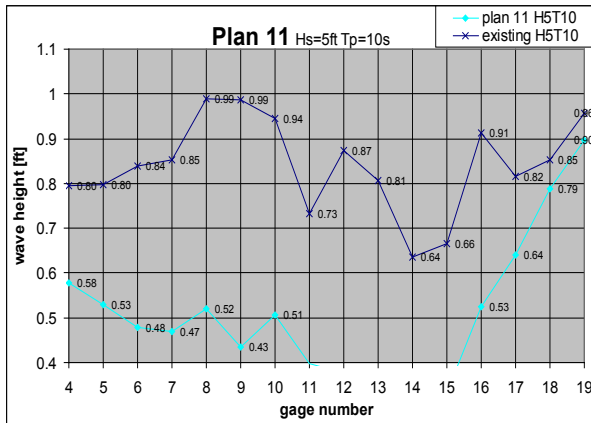
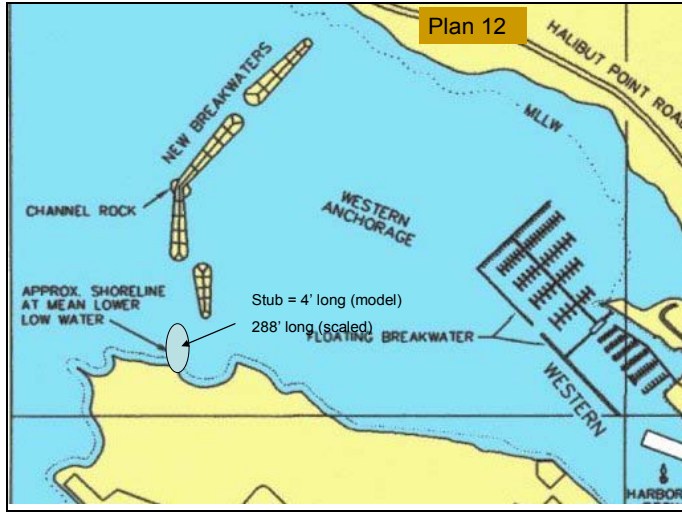


Figure 18. Plan 11 Breakwater modification, energy reduction at gages 8 and 9, and wave height plots of all gages with and without breakwater modification. Wave height = 5 feet, Period = 10, 12, and 14 seconds.

ENGINEERING ANALYSIS CHANNEL ROCK BREAKWATERS SITKA HARBOR, SITKA, ALASKA



Period [s]	Gage 8	Gage 19
10	8%	2%
12	10%	0%
14	19%	8%

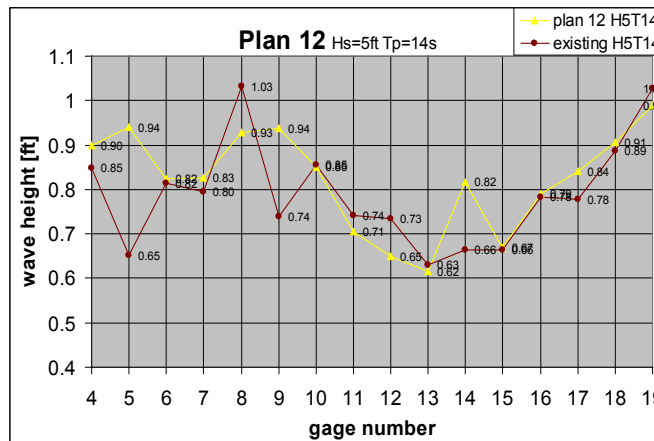
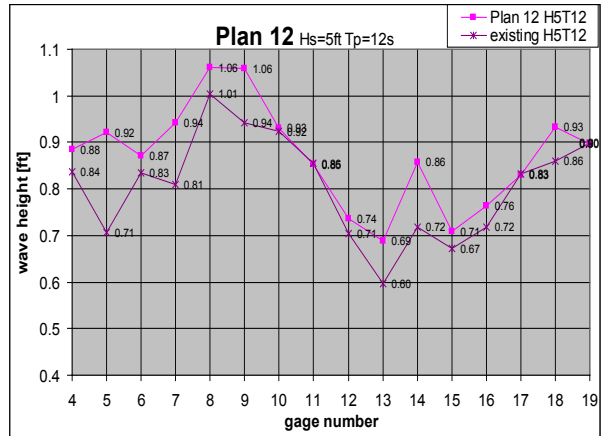
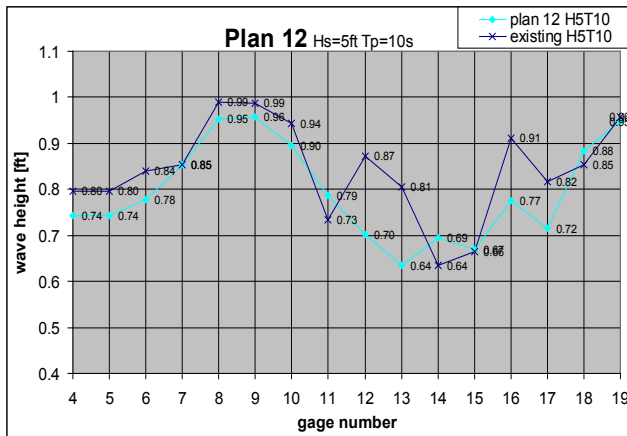
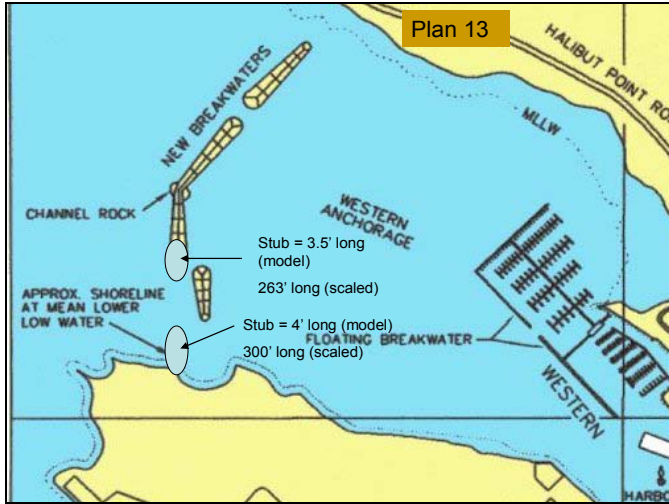


Figure 19. Plan 12 Breakwater modification, energy reduction at gages 8 and 9, and wave height plots of all gages with and without breakwater modification. Wave height = 5 feet, Period = 10, 12, and 14 seconds.

ENGINEERING ANALYSIS
CHANNEL ROCK BREAKWATERS
SITKA HARBOR, SITKA, ALASKA



Period [s]	Gage 8	Gage 19
10	23%	51%
12	6%	41%
14	17%	44%

Yellow highlight indicates energy reduction for all periods is greater than 30%

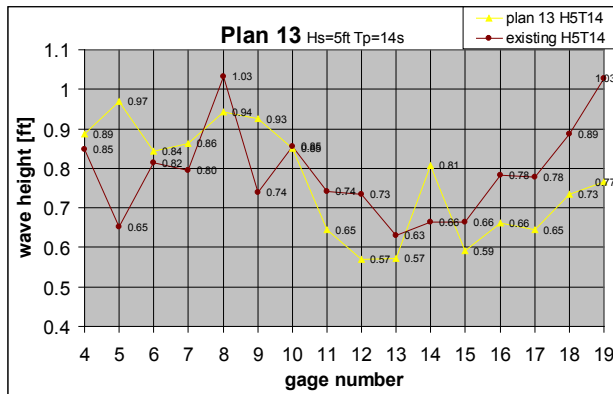
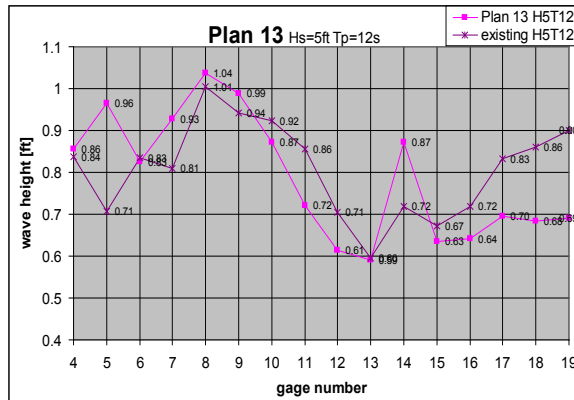
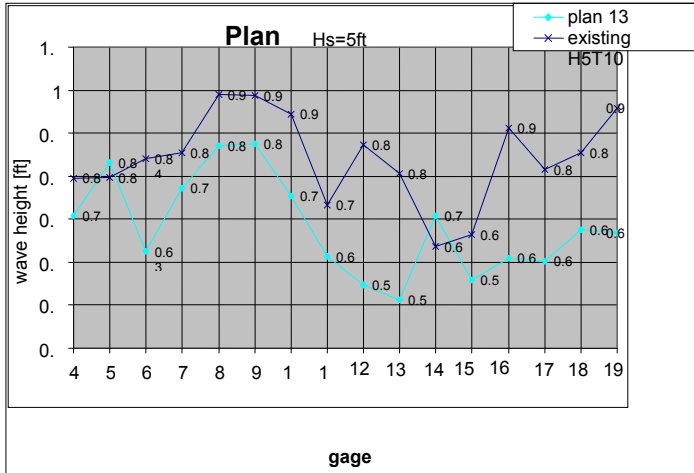
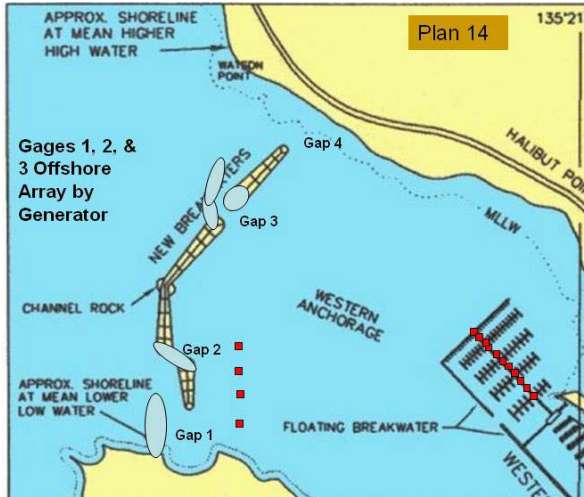


Figure 20. Plan 13 Breakwater modification, energy reduction at gages 8 and 9, and wave height plots of all gages with and without breakwater modification. Wave height = 5 feet, Period = 10, 12, and 14 seconds.

ENGINEERING ANALYSIS
CHANNEL ROCK BREAKWATERS
SITKA HARBOR, SITKA, ALASKA

2.6 Additional Plans

Additional combinations of the plans run in the physical model were evaluated to expand the alternative evaluation. The energy reduction for the additional plans at gages 8 and 19 and the wave heights for all of the options and all gages are shown in figures 21 through 25.



Plan 14 Estimated Energy Reduction at Gage 8 and Gage 19		
Period [s]	Gage 8	Gage 19
10	67%	75%
12	74%	70%
14	43%	68%

Yellow highlight indicates energy reduction for all periods is greater than 30%

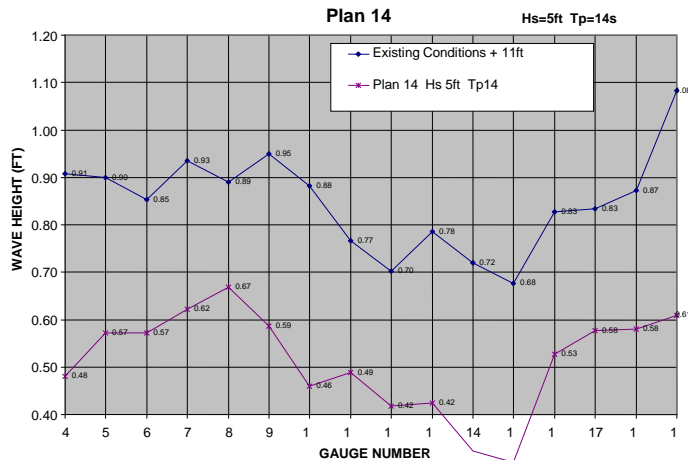
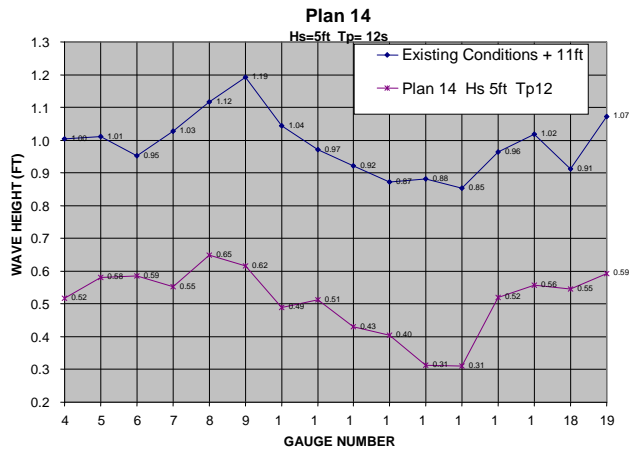
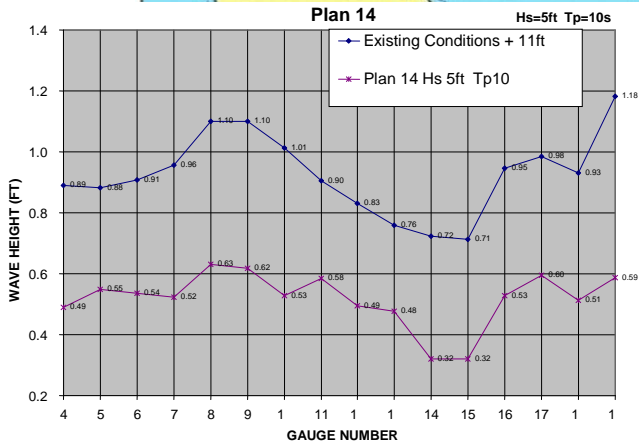
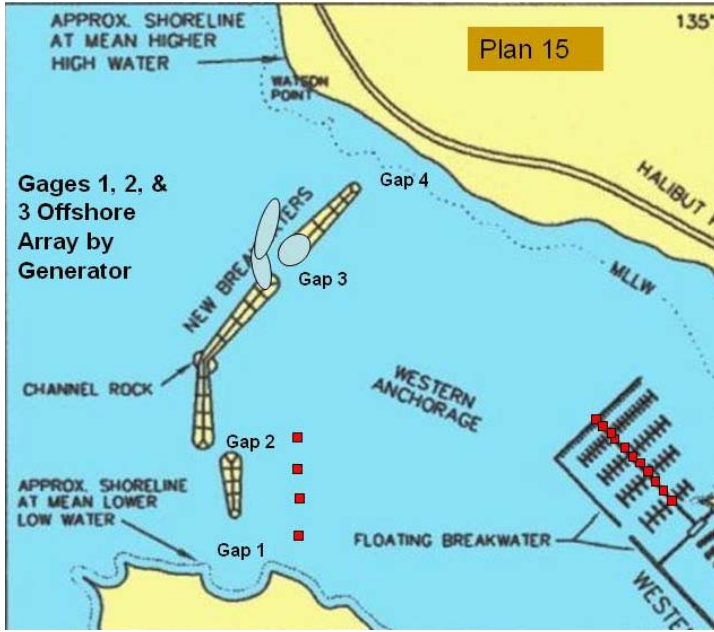


Figure 21. Plan 14, energy reduction at gages 8 and 9, and wave height plots of all gages with and without breakwater modification. Wave height = 5-foot, Period = 10, 12, and 14 seconds.

ENGINEERING ANALYSIS CHANNEL ROCK BREAKWATERS SITKA HARBOR, SITKA, ALASKA



Period [s]	Gage 8	Gage 19
10	54%	10%
12	48%	+4%
14	41%	+4%

Yellow highlight indicates energy reduction for all periods is greater than 30%

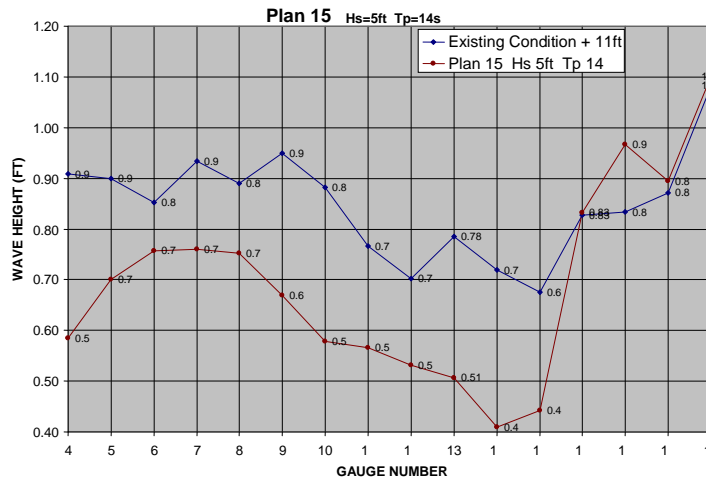
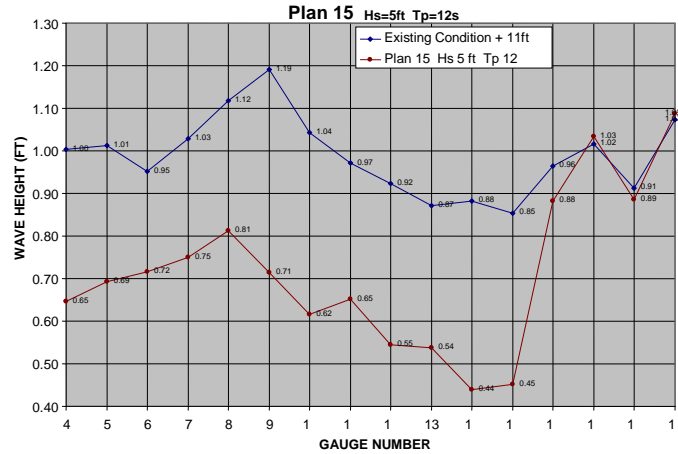
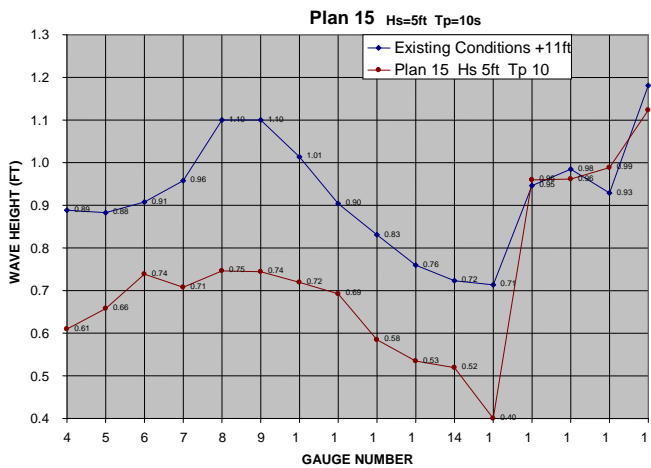
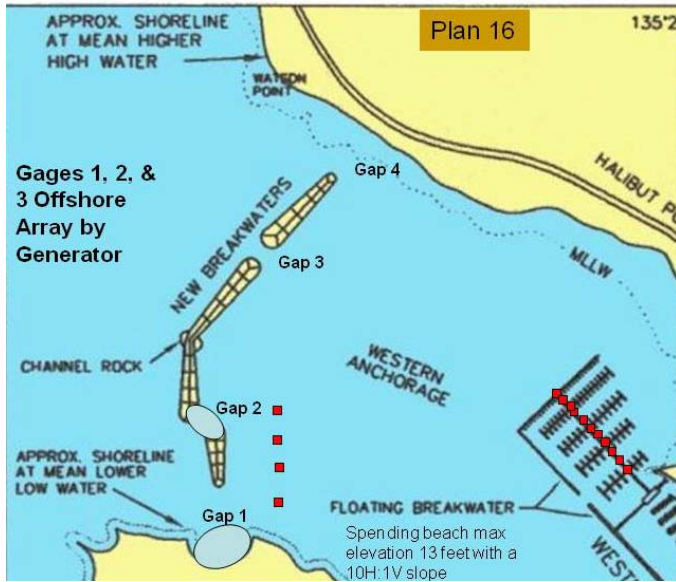


Figure 22. Plan 15, energy reduction at gages 8 and 9, and wave height plots of all gages with and without breakwater modification. Wave height = 5-foot, Period = 10, 12, and 14 seconds.

ENGINEERING ANALYSIS CHANNEL ROCK BREAKWATERS SITKA HARBOR, SITKA, ALASKA



Plan 16 Estimated Energy Reduction at Gage 8 and Gage 19		
Period [s]	Gage 8	Gage 19
10	32%	60%
12	20%	58%
14	+2%	53%

Yellow highlight indicates energy reduction for all periods is greater than 30%

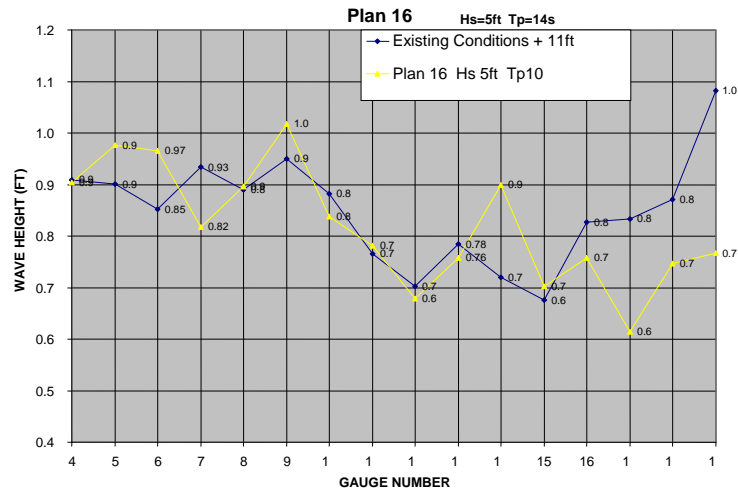
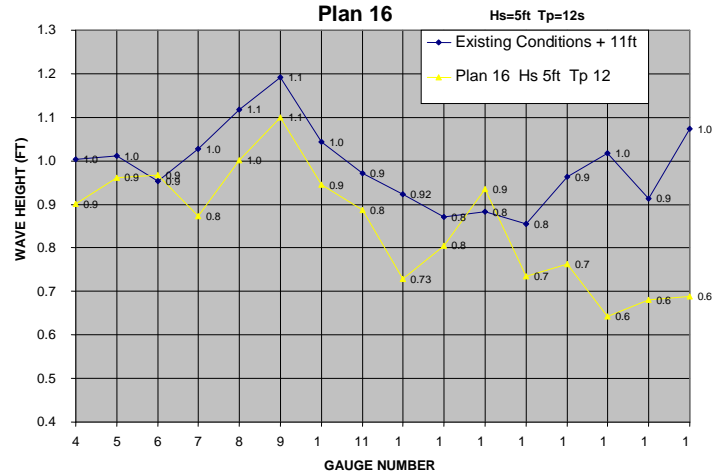
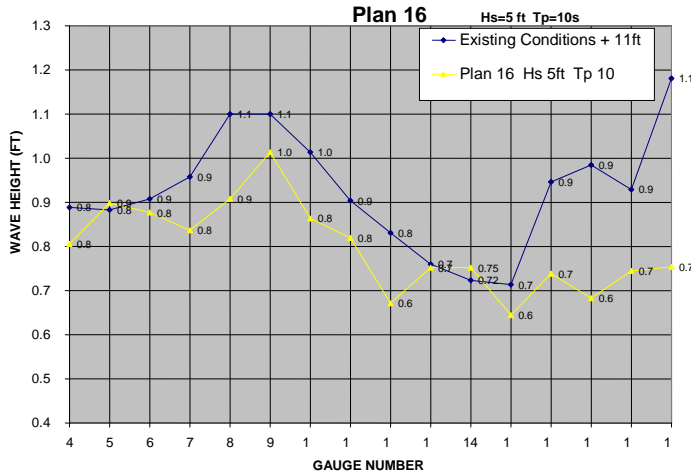
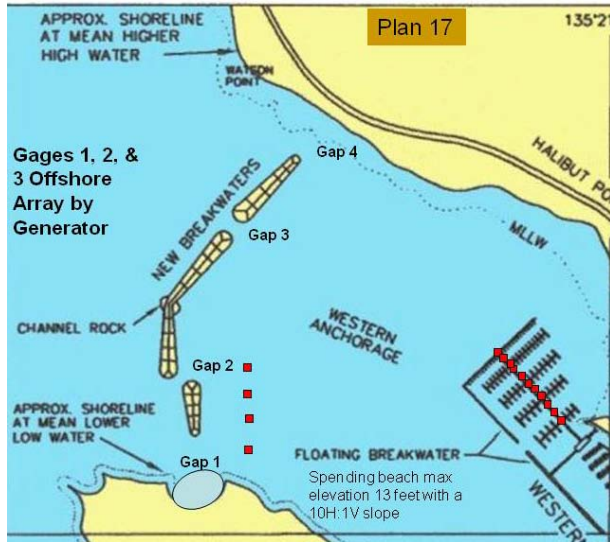


Figure 23. Plan 16, energy reduction at gages 8 and 9, and wave height plots of all gages with and without breakwater modification. Wave height = 5-foot, Period = 10, 12, and 14 seconds.

ENGINEERING ANALYSIS CHANNEL ROCK BREAKWATERS SITKA HARBOR, SITKA, ALASKA



Plan 17 Estimated Energy Reduction at Gage 8 and Gage 19		
Period [s]	Gage 8	Gage 19
10	12%	13%
12	5%	14%
14	+14%	11%

Orange highlight indicates energy reduction for all periods is greater than 10%

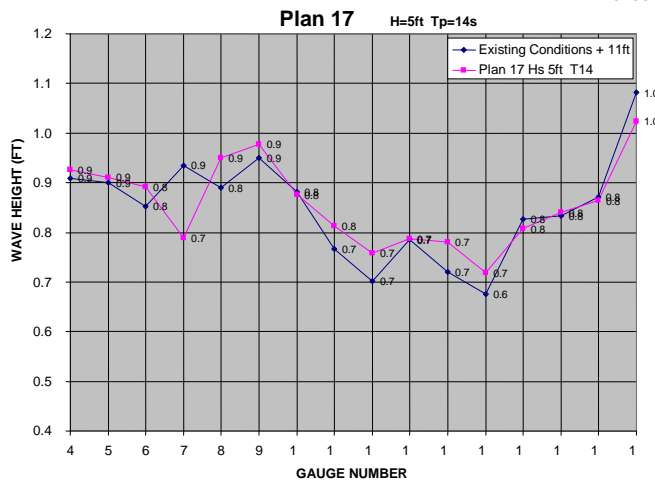
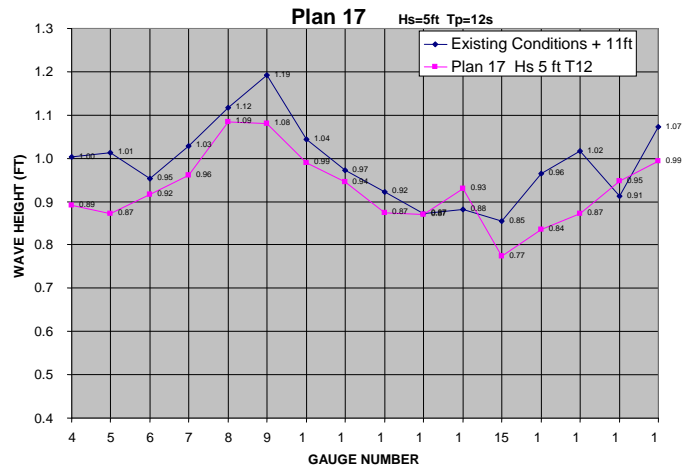
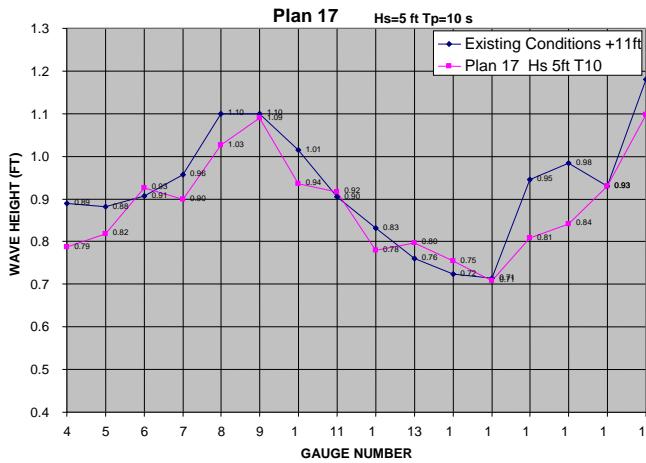
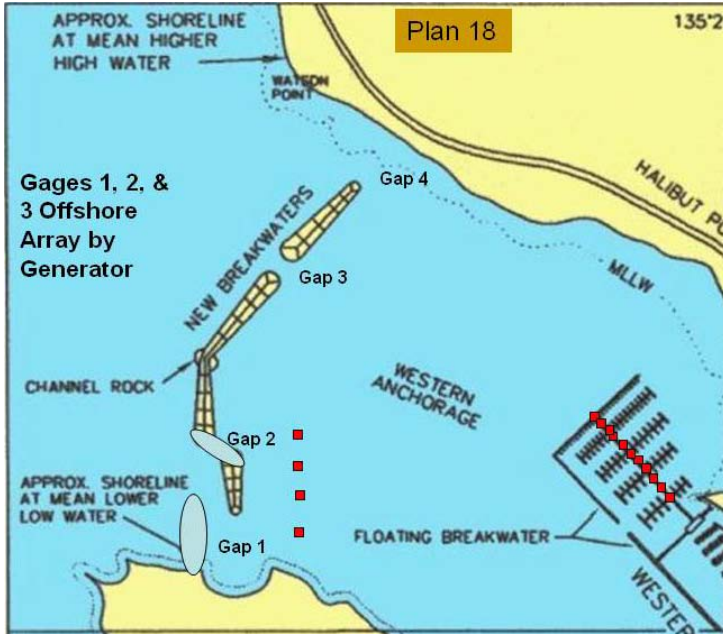


Figure 24. Plan 17, energy reduction at gages 8 and 9, and wave height plots of all gages with and without breakwater modification. Wave height = 5-foot, Period = 10, 12, and 14 seconds.

ENGINEERING ANALYSIS CHANNEL ROCK BREAKWATERS SITKA HARBOR, SITKA, ALASKA



Plan 18 Estimated Energy Reduction at Gage 8 and Gage 19		
Period [s]	Gage 8	Gage 19
10	36%	67%
12	17%	74%
14	+7%	38%

Yellow highlight indicates energy reduction for all periods is greater than 30%

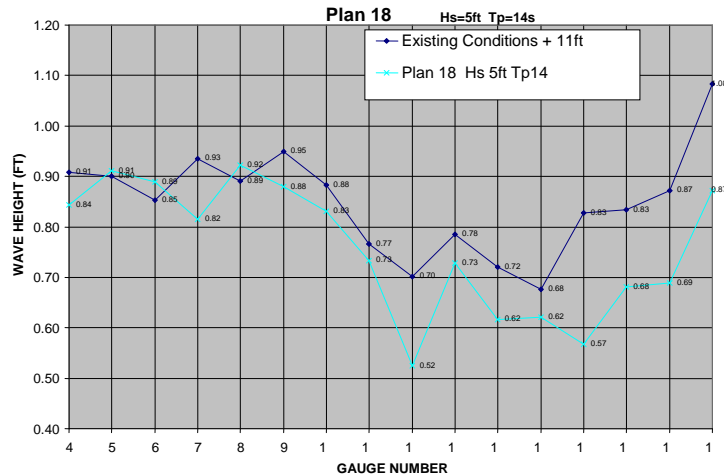
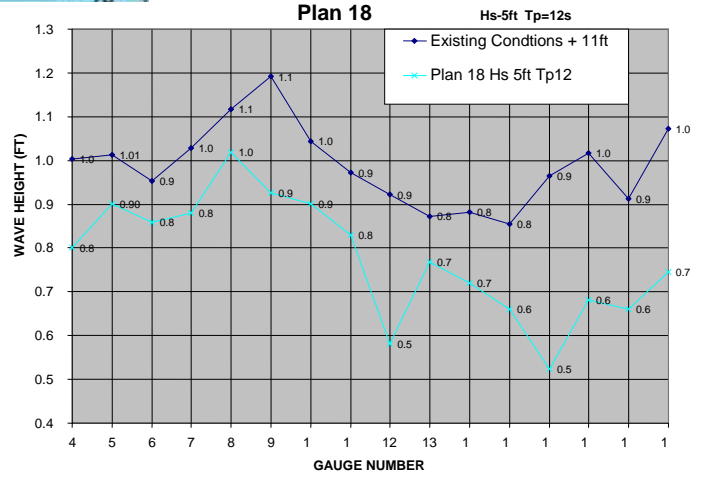
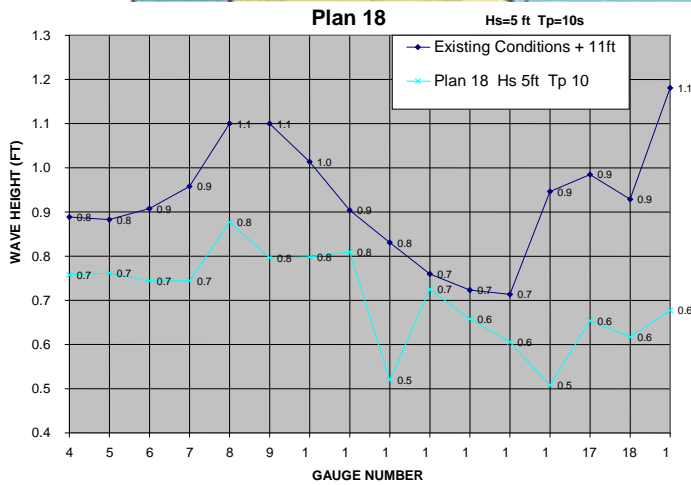


Figure 25. Plan 18, energy reduction at gages 8 and 9, and wave height plots of all gages with and without breakwater modification. Wave height = 5-foot, Period = 10, 12, and 14 seconds.

ENGINEERING ANALYSIS
CHANNEL ROCK BREAKWATERS
SITKA HARBOR, SITKA, ALASKA

3.0 OPTION DESCRIPTIONS

Figures 26 through 35 show the plan view for each proposed breakwater configuration and figures 36 through 40 show the associated cross sections. Plan 15 and 15a (bulbous head option) showing gap modifications between the main and north breakwaters were carried forward in detail for cost purposes only. The bulbous head length has not been optimized and would need to be optimized if this concept is selected for implementation. The angled extension included increased armor size, but decreased core height. The affect of this modification on wave penetration through the breakwater would need to be tested in a flume during the design phase if this plan is carried forward for implementation.

3.1 Plan 1

Plan 1 would involve constructing a 500-foot-long stub breakwater from Japonski Island to provide a 100-foot over lap of the south breakwater. Plan views of this option are shown in figure 26, cross sections for the trunk of the breakwater are shown in figure 37, and the nose of the breakwater is shown in figure 36. Armor rock for this option is 2,000-pound armor stone. Approximately 7,000 cubic yards of armor stone, 10,000 cubic yards of B rock, and 21,000 cubic yards of core material would be required for this option.

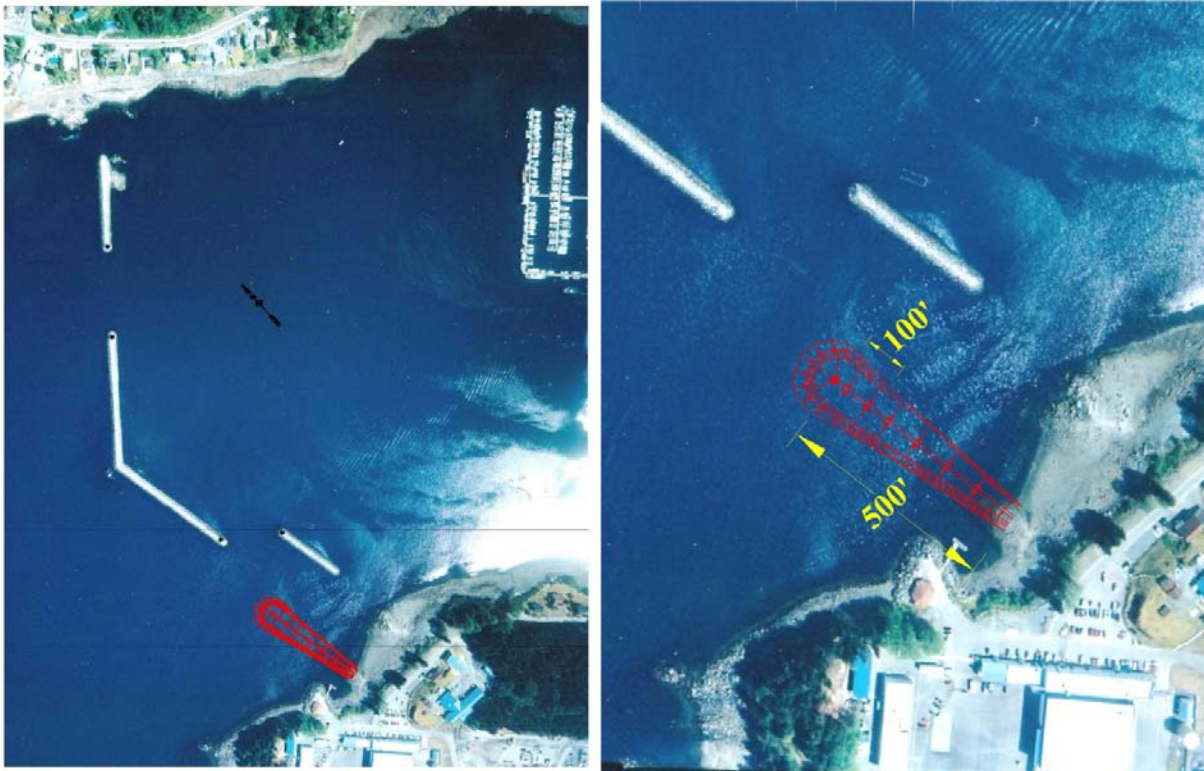


Figure 26. Plan 1. Stub from shore, overall and close up view – drawing not to scale

ENGINEERING ANALYSIS
CHANNEL ROCK BREAKWATERS
SITKA HARBOR, SITKA, ALASKA

3.2 Plan 2

Plan 2 would involve constructing a 330-foot-long extension to the south breakwater to provide a 100-foot overlap with the main breakwater. Plan views of this option are shown in figure 27, cross sections for the trunk of the breakwater are shown in figure 37, and the nose of the breakwater is shown in figure 36. Armor rock for this option is 2,000-pound armor stone. Approximately 9,500 cubic yards of armor stone, 19,000 cubic yards of B rock, and 45,000 cubic yards of core material would be required for this option. The armor and B rock on the existing breakwater will be removed where the extension begins. Approximately 1,150 cubic yards of armor stone and 450 cubic yards of B rock would be removed. This material could be used in construction of the extension.



Figure 27. Plan 2. Breakwater overlap inside overall and close up view – drawing not to scale.

ENGINEERING ANALYSIS
CHANNEL ROCK BREAKWATERS
SITKA HARBOR, SITKA, ALASKA

3.3 Plan 3

Plan 3 would involve constructing a 330-foot-long extension to the main breakwater to provide a 100-foot-long overlap with the south breakwater. Plan views of this option are shown in figure 28, cross sections for the trunk of the breakwater are shown in figure 37, and the nose of the breakwater is shown in figure 36. Armor rock for this option is 2,000-pound armor stone. Approximately 9,500 cubic yards of armor stone, 16,000 cubic yards of B rock, and 54,000 cubic yards of core material would be required for this option. The armor and B rock on the existing breakwater would be removed where the extension begins. Approximately 1,100 cubic yards of armor stone and 400 cubic yards of B rock would be removed. This material could be used in construction of the extension.



Figure 28. Plan 3. Breakwater overlap outside overall and close up view – drawing not to scale.

ENGINEERING ANALYSIS
CHANNEL ROCK BREAKWATERS
SITKA HARBOR, SITKA, ALASKA

3.4 Plan 4

Plan 4 would involve constructing a 315-foot long extension to connect the main breakwater and the south breakwater. Plan views of this option are shown in figures 29, and cross section for the trunk of the breakwater are shown in figure 37. Armor rock for this option is 2,000-pound armor stone. Approximately 9,000 cubic yards of armor stone, 13,000 cubic yards of B rock, and 30,000 cubic yards of core material would be required for this option. The armor and B rock on the existing breakwater would be removed where the extension begins. Approximately 3,000 cubic yards of armor stone and 1,100 cubic yards of B rock would be removed. This material could be used in construction of the extension.



Figure 29. Plan 4. Closed gap overall and close up view – drawing not to scale.

ENGINEERING ANALYSIS
CHANNEL ROCK BREAKWATERS
SITKA HARBOR, SITKA, ALASKA

3.5 Plan 14 – Angled Extension, Gap Closure and Spur

Plan 14 would involve constructing a 500-foot-long stub breakwater from Japonski Island, a 315-foot-long extension to connect the main and south breakwaters, an angled extension on the main breakwater, and an extension on the north breakwater to narrow the gap between the main and north breakwaters. This option would provide a 100-foot-long over lap of the south breakwater at the gap between Japonski Island and the south breakwater. The angled extension would be 450 feet long and the stub extension would be 60 feet long. These modifications would block wave energy entering through all of the breakwater gaps. Plan views of this option are shown in figure 30. A cross section of the trunk for all breakwaters except the angled extension is shown in figure 37, and the nose of the breakwaters is shown in figure 36. A cross section of the angled extension is shown in figure 39. Armor rock size for the angled extension is 4,800-pound stone. A larger wave height was used to size the armor stone for the angled extension since this portion of the breakwater is subject to a wave traveling along the length of the breakwater and then being forced to turn. Armor rock for all other breakwaters is 2,000-pound stone. Approximately 21,000 cubic yards of armor stone, 28,000 cubic yards of B rock, and 58,000 cubic yards of core material would be required for all the breakwaters except the angled extension. The armor and B rock on the existing breakwater would be removed where the extension begins. Approximately 21,000 cubic yards of armor stone, 16,000 cubic yards of B rock, and 48,000 cubic yards of core material would be used for the angled extension.

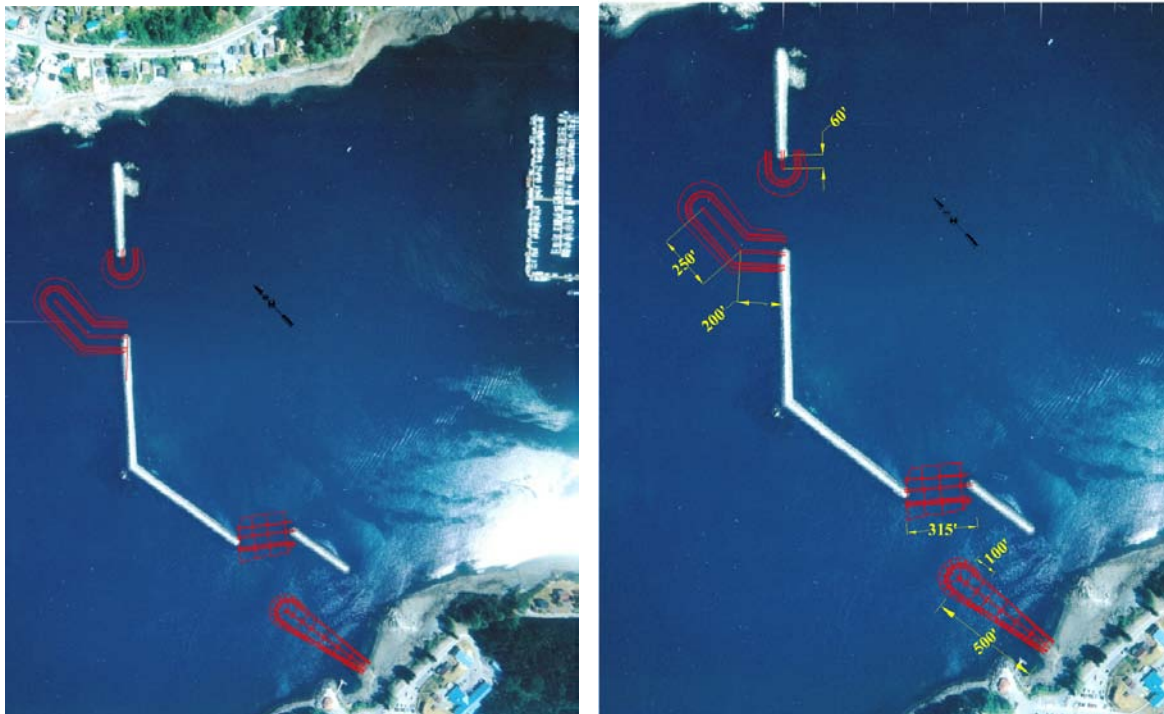


Figure 30. Plan 14. Angled extension, spur, and gap closure – drawing not to scale.

ENGINEERING ANALYSIS
CHANNEL ROCK BREAKWATERS
SITKA HARBOR, SITKA, ALASKA

3.6 Plan 15

Plan 15 would involve constructing an angled extension on the main breakwater and extending the north breakwater to narrow the gap between the main and north breakwaters. The angled extension would be 450 feet long, and the north breakwater extension would be 60 feet long. Plan views of this option are shown in figure 31, and a cross section for the angled extension is shown in figure 39. The stub extension would have a cross section as shown in figure 36.

Armor rock size for the angled extension is 4,800-pound stone. A larger wave height was used to size the armor stone for the angled extension since this portion of the breakwater is subject to a wave traveling along the length of the breakwater and then being forced to turn.

Approximately 21,000 cubic yards of armor stone, 16,000 cubic yards of B rock, and 48,000 cubic yards of core material would be required for this option. The north breakwater extension would require 5,000 cubic yards of armor, 5,000 cubic yards of B rock, and 7,000 cubic yards of core material. The armor for the stub extension could be sized similarly to options 1, 2, and 3 with 2,000-pound stone. The armor and B rock on the existing breakwater would be removed where the extension begins. Approximately 3,500 cubic yards of armor stone and 1,000 cubic yards of B rock would be removed. This design is provided for cost purposes.

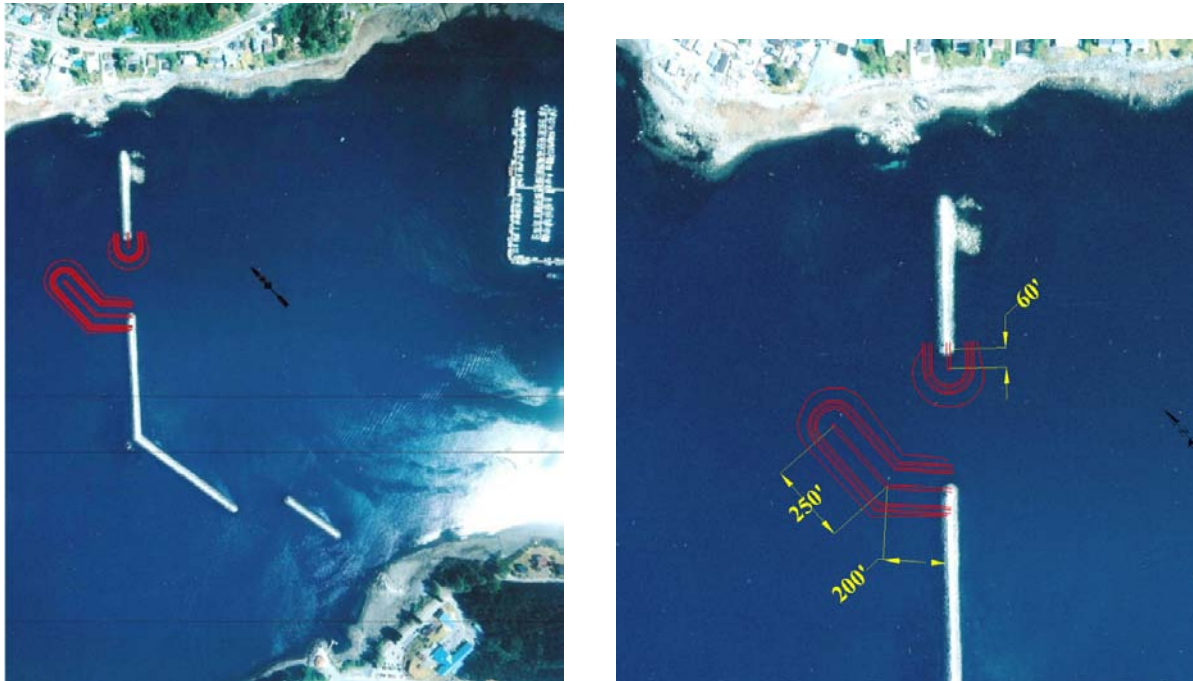


Figure 31. Plan 15. Angled extension over all and close up view – drawing not to scale.

ENGINEERING ANALYSIS
CHANNEL ROCK BREAKWATERS
SITKA HARBOR, SITKA, ALASKA

3.7 Plan 15 – Bulbous Head Option

Plan 15 (bulbous head option) would involve constructing a bulbous head on the main Channel Rock Breakwater that would consist of a 130-foot angled extension on the main breakwater into the gap between the main and north breakwater. Plan views of this option are shown in figure 32, and a cross section for the bulbous head of the breakwater is shown in figure 38. Armor rock for this option is 4,800-pound stone. A larger wave height was used to size the armor stone for the bulbous head since this portion of the breakwater is subject to a wave traveling along the length of the breakwater and then being forced to turn. Approximately 14,000 cubic yards of armor stone, 24,000 cubic yards of B rock, and 36,000 cubic yards of core material would be required for this option. The armor and B rock on the existing breakwater would be removed where the extension begins. Approximately 2,500 cubic yards of armor stone and 800 cubic yards of B rock would be removed. This design is provided for cost purposes. The additional length and radius need to be optimized if this option should go forward to design.



Figure 32. Plan 15 (bulbous head option). Bulbous head at the gap between the main and north breakwaters. Overall and close up views – drawing not to scale.

ENGINEERING ANALYSIS
CHANNEL ROCK BREAKWATERS
SITKA HARBOR, SITKA, ALASKA

3.8 Plan 16 – Spending Beach and Gap Closure

Plan 16 would involve constructing a spending beach on Japonski Island and a 315-foot-long extension to connect the main and south breakwaters. This option would block wave energy entering through the gap and bleed off energy through the gap between Japonski Island and the south breakwater. Plan views of this option are shown in figure 33. A cross section for the trunk of the breakwater is shown in figure 37, and a cross section for the spending beach is shown in figure 40. Armor rock for the gap closure section is 2,000-pound stone. Armor rock for the spending beach option is 260-pound stone. The spending beach would extend up to + 13 feet MLLW. This would put the crest 3 feet above mean higher high water and almost 2 feet below the highest observed water level, and will raise the -10-foot contour to approximately -6.5 MLLW. Approximately 13,500 cubic yards of armor stone and 20,500 cubic yards of core material would be required for this spending beach, and approximately 9,000 cubic yards of armor stone, 13,000 cubic yards of B rock, and 30,000 cubic yards of core material would be required for this option. The armor and B rock on the existing breakwater would be removed where the extension begins. Approximately 3,000 cubic yards of armor stone and 1,100 cubic yards of B rock would be removed. This material could be used in the extension construction.

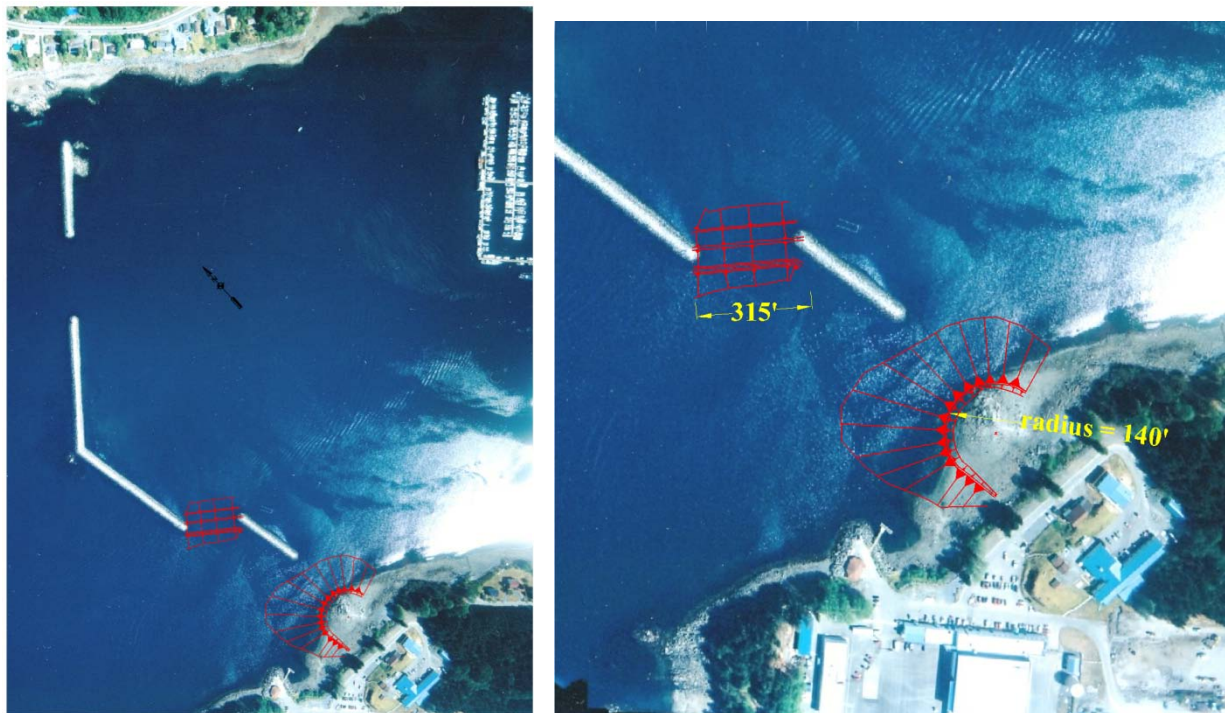


Figure 33. Plan 16. Spending beach and gap closure overall and close up view – drawing not to scale.

ENGINEERING ANALYSIS
CHANNEL ROCK BREAKWATERS
SITKA HARBOR, SITKA, ALASKA

3.9 Plan 17

Plan 17 would involve constructing a spending beach on Japonski Island. This option would bleed off energy through the gap between Japonski Island and the south breakwater by raising the bathymetry to steer the incoming wave around the spending beach and into the shore. Plan views of this option are shown in figure 34, and a cross section for the spending beach is shown in figure 40. Armor rock for this option is 260-pound stone. The spending beach would extend up to + 13 feet MLLW. This would put the crest 3 feet above mean higher high water and almost 2 feet below the highest observed water level, and would raise the -10-foot contour to approximately -6.5 MLLW. Approximately 13,500 cubic yards of armor stone and 20,500 cubic yards of core material would be required for this option.

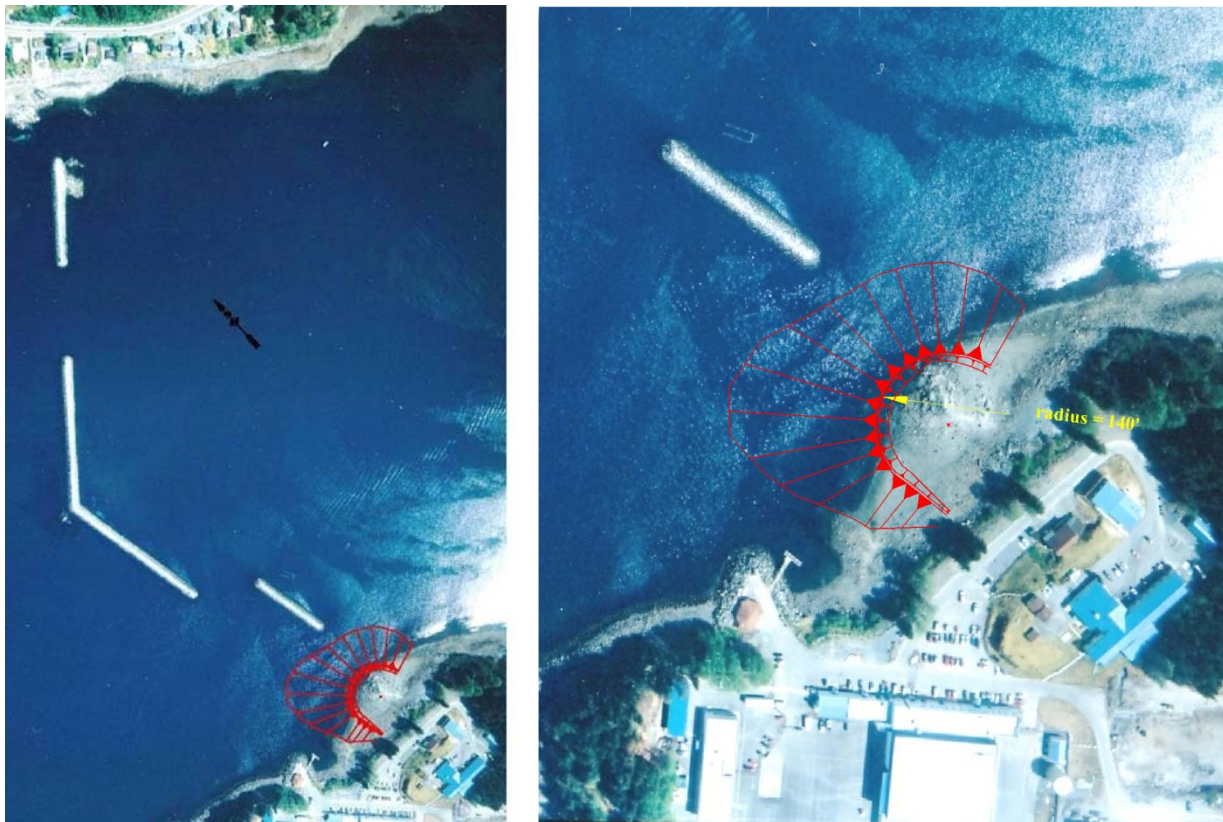


Figure 34. Plan 17. Spending beach over all and close up view – drawing not to scale.

ENGINEERING ANALYSIS
CHANNEL ROCK BREAKWATERS
SITKA HARBOR, SITKA, ALASKA

3.10 Plan 18 – Stub and Gap Closure

Plan 18 would involve constructing a 500-foot-long stub breakwater from Japonski Island and a 315-foot-long extension to connect the main and south breakwaters. This option would provide a 100-foot overlap of the south breakwater at the gap between Japonski Island and the south breakwater and block wave energy entering through the gap between the south and main breakwaters. Plan views of this option are shown in figure 35. A cross section for the trunk of the breakwater is shown in figure 37 and the nose of the breakwater is shown in figure 36. Armor rock for this option is 2,000-pound stone. Approximately 16,000 cubic yards of armor stone, 23,000 cubic yards of B rock, and 51,000 cubic yards of core material would be required for this option. The armor and B rock on the existing breakwater would be removed where the extension begins. Approximately 3,000 cubic yards of armor stone and 1,100 cubic yards of B rock would be removed. This material could be used in construction of this option.

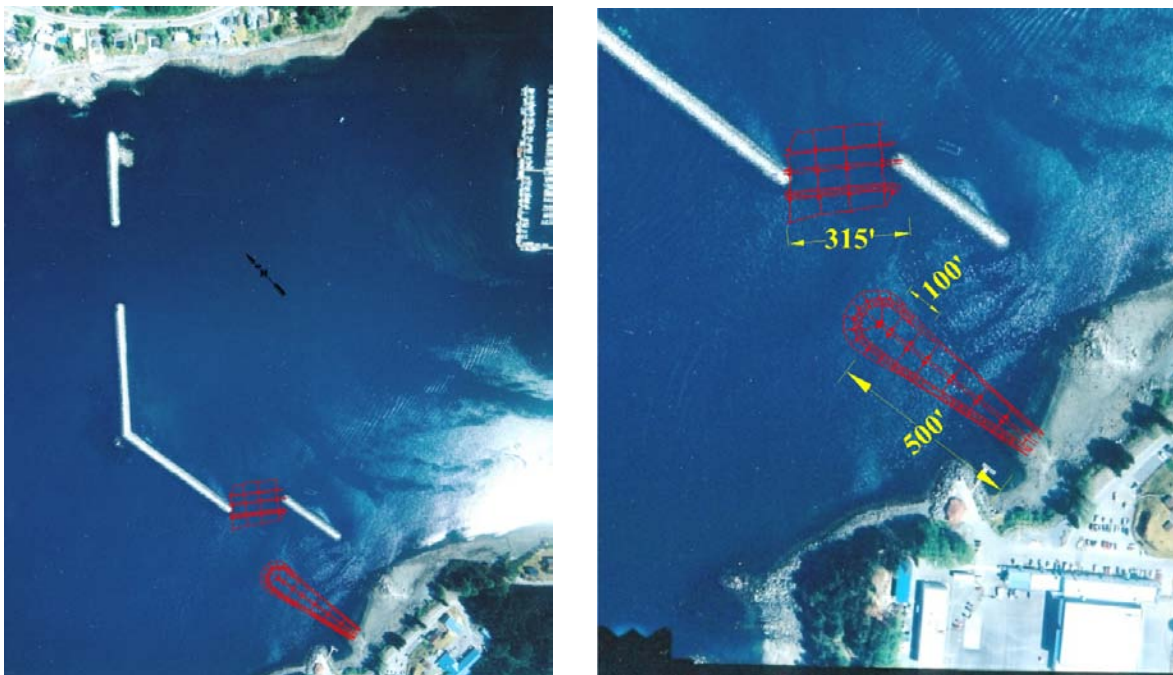


Figure 35. Plan 18. Stub and gap closure overall and close up views – drawing not to scale.

ENGINEERING ANALYSIS
CHANNEL ROCK BREAKWATERS
SITKA HARBOR, SITKA, ALASKA

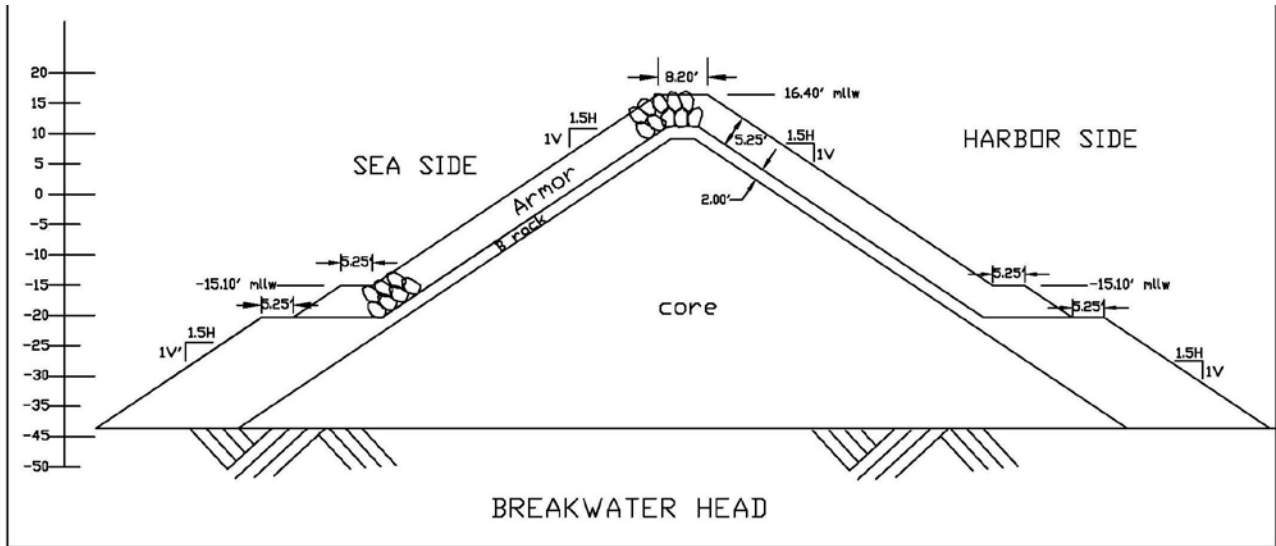


Figure 36. Option 1, 2, 3 and 5a breakwater head..

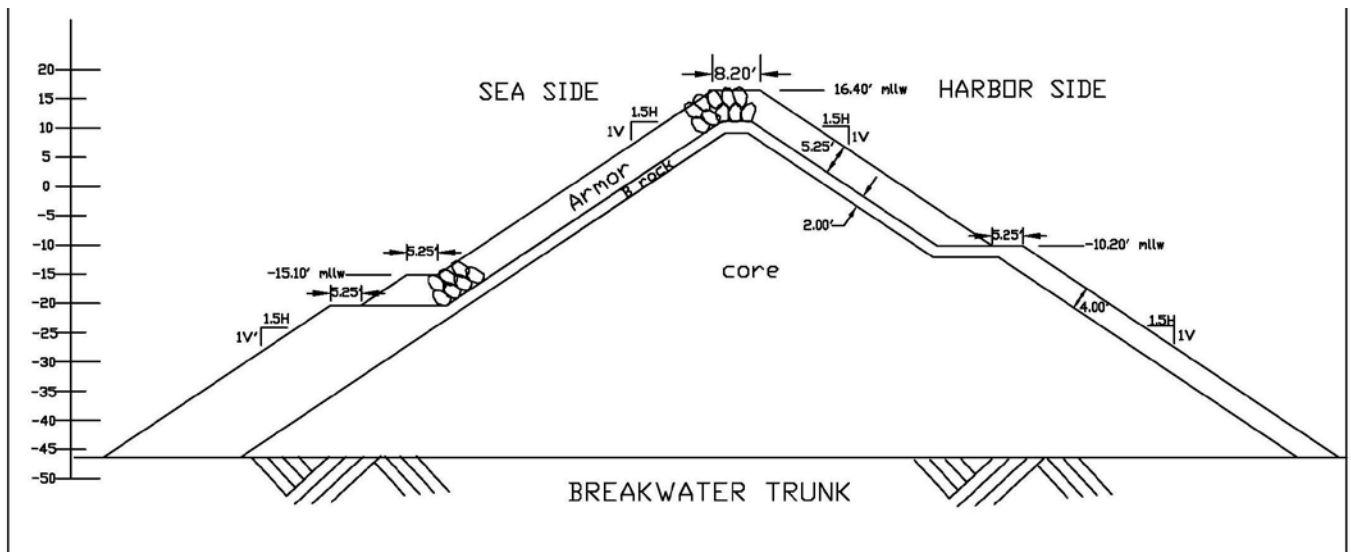


Figure 37. Breakwater trunk

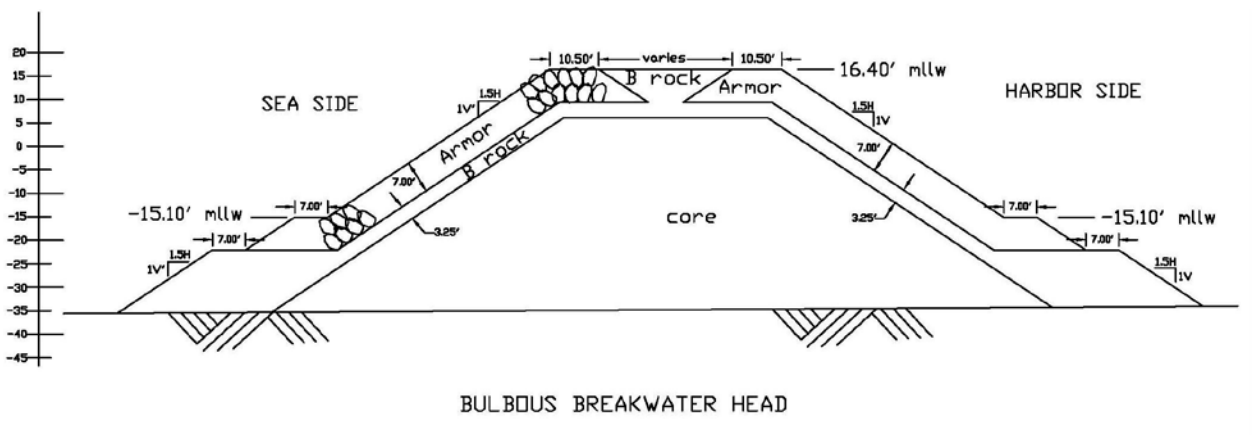


Figure 38. Bulbous head cross section

ENGINEERING ANALYSIS
CHANNEL ROCK BREAKWATERS
SITKA HARBOR, SITKA, ALASKA

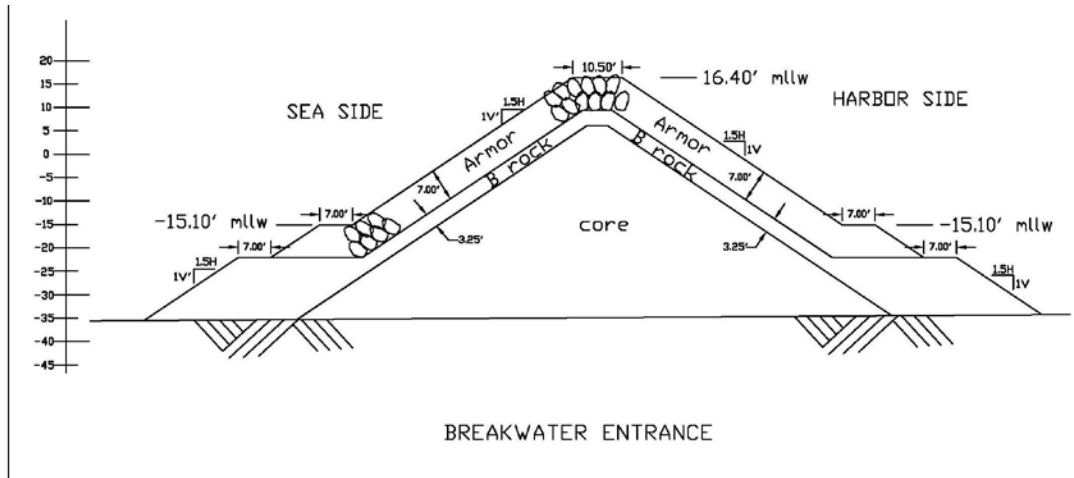


Figure 39. Plan 15 Angled entrance channel extension cross section

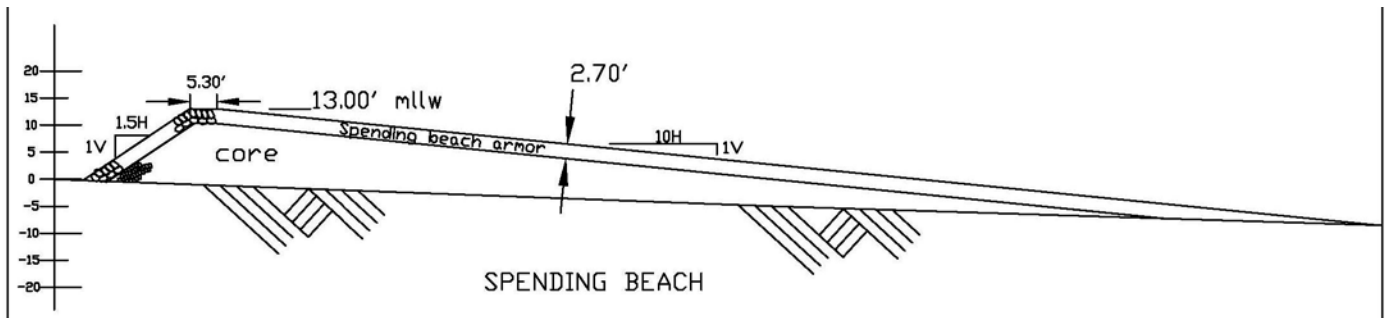
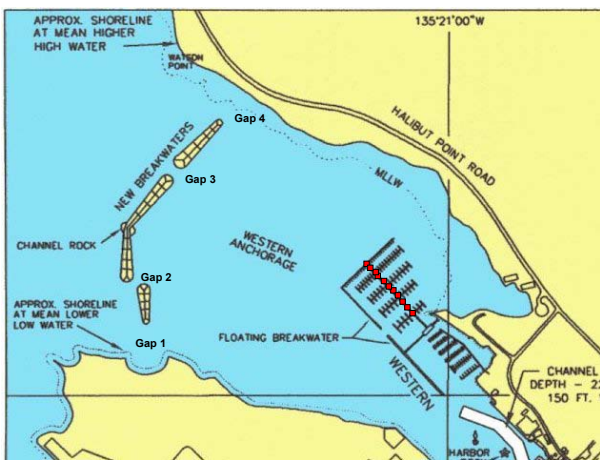


Figure 40. Plan 17 spending beach cross section

ENGINEERING ANALYSIS
CHANNEL ROCK BREAKWATERS
SITKA HARBOR, SITKA, ALASKA

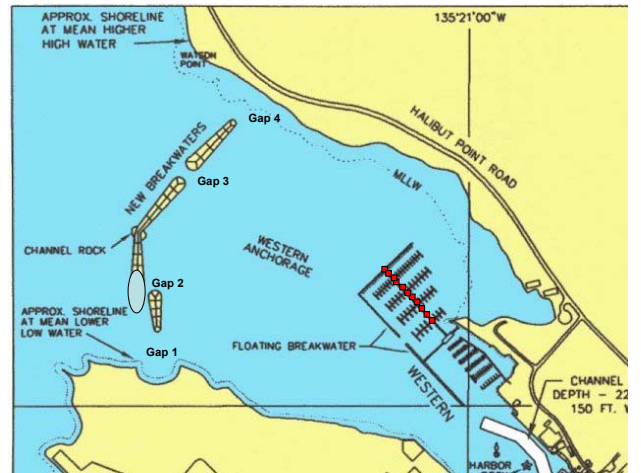
4.0 CIRCULATION

A qualitative circulation study was performed using the physical model of Eliason Harbor at the Engineer Research and Development Center's (ERDC) Waterways Experiment Station (WES). The study looked at the circulation associated with a falling tide only. Circulation associated with wind or wave activity in addition to the tide was not examined. This resulted in a conservative evaluation. Seven variations of breakwater configurations were tested. Each configuration exhibited circulation being set up and flushing out of the Western Anchorage area. The different breakwater configurations examined are shown in figures 41 through 47. An example of the circulation pattern set up during the test is shown in figure 48. Movie loops of the circulation were made using time lapse photography. These loops were presented to the environmental resource agencies for coordination on plan selection.



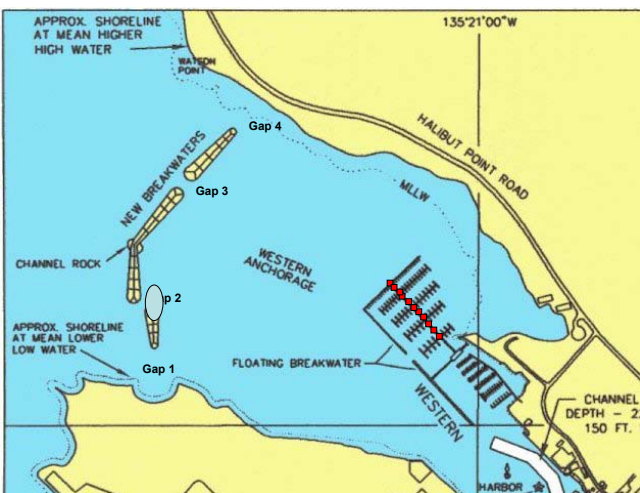
No Modifications

Figure 41



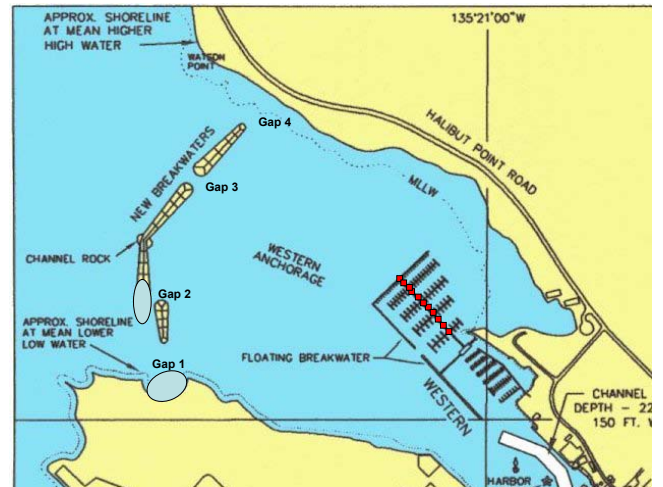
Overlap outside

Figure 43



Overlap Inside

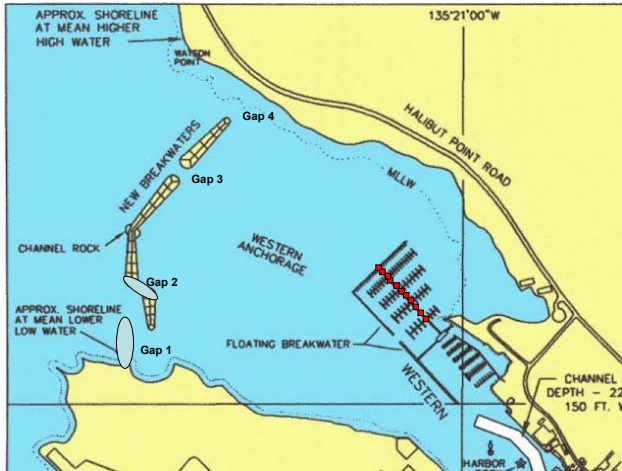
Figure 42



Overlap outside and spending beach

Figure 44

ENGINEERING ANALYSIS
CHANNEL ROCK BREAKWATERS
SITKA HARBOR, SITKA, ALASKA

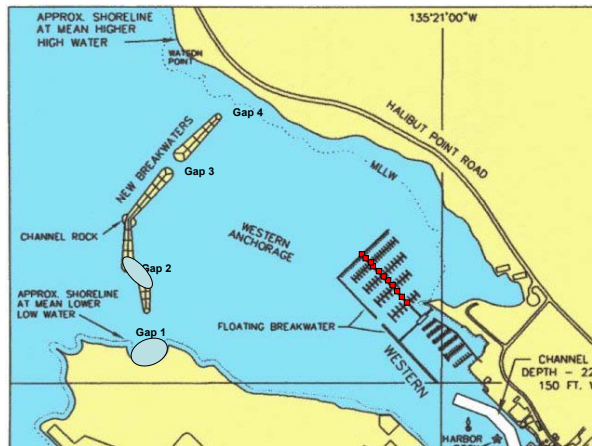


Stub Breakwater And Gap Closure

Figure 45

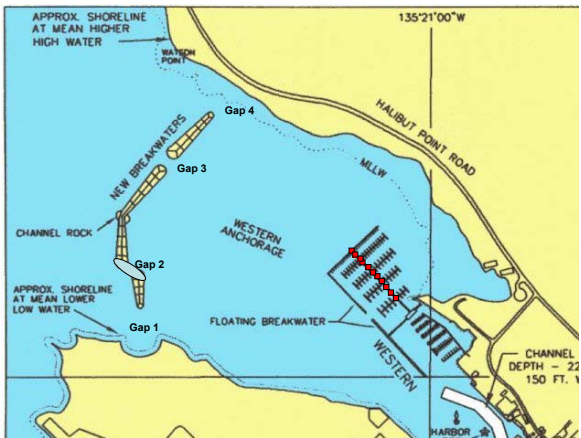


Figure 48. Example of circulation pattern.



Gap Block With Spending Beach

Figure 46



Gap Block Without Spending Beach

Figure 47

ENGINEERING ANALYSIS
CHANNEL ROCK BREAKWATERS
SITKA HARBOR, SITKA, ALASKA

	Plan 1		Plan 2		Plan 3		Plan 4		Plan 14				Plan 15 (bulbous head option)		Plan 15 Angled Extension			
	Weight [lbs]	Volume [cy]	Weight [lbs]	Volume [cy]	Weight [lbs]	Volume [cy]	Weight [lbs]	Volume [cy]	Weight [lbs]	Volume [cy]	Weight [lbs]	Volume [cy]	Weight [lbs]	Volume [cy]	Weight [lbs]	Volume [cy]	Weight [lbs]	Volume [cy]
Armor	2000	7,000	2000	9,500	2000	9,500	2000	9,000	4800	21,000	2000	21,000	4800	14,000	4800	21,000	2000	5,000
B rock	200	10,000	200	19,000	200	16,000	200	13,000	480	16,000	200	28,000	480	24,000	480	16,000	200	5,000
Core	10	21,000	10	45,000	10	54,000	10	30,000	24	48,000	10	58,000	24	36,000	24	48,000	10	7,000

	Plan 16				Plan 17		Plan 18	
	Weight [lbs]	Volume [cy]	Weight [lbs]	Volume [cy]	Weight [lbs]	Volume [cy]	Weight [lbs]	Volume [cy]
Armor	2000	9,000	260	13,500	260	13,500	2000	16,000
B rock	200	13,000	---	---	---	---	200	23,000
Core	10	30,000	13	20,500	13	20,500	10	51,000

	Plan 1	Plan 2	Plan 3	Plan 4	Plan 14	Plan 15 (bulbous head option)	Plan 15 Angled Extension	Plan 17	Plan 16	Plan 18
	Volume [cy]	Volume [cy]	Volume [cy]	Volume [cy]	Volume [cy]	Volume [cy]	Volume [cy]	Volume [cy]	Volume [cy]	Volume [cy]
Armor	---	1,150	1,100	3,000	6,500	2,500	3,500	---	3,000	3,000
B rock	---	450	400	1,100	2,100	800	1,000	---	1,100	1,100

5.0 RISK AND UNCERTAINTY

5.1 Physical Modeling

The basis of all physical modeling is the idea that the model behaves in a manner similar to the prototype it is intended to emulate. Thus, a properly validated physical model can be used to predict the prototype (real world) under a specified set of conditions. However, there is a possibility that physical model results may not be indicative of prototype behavior due to scale effects or laboratory effects. The role of the physical modeler is to minimize scale effects by understanding and applying proper similitude relationships, and to minimize laboratory effects through careful model operation. Similarity between the real world (prototype) and a small-scale replica (model) of a coastal project area is achieved when all major factors influencing reactions are in proportion between prototype and model while those factors that are not in proportion throughout the modeled domain are so small as to be insignificant to the process. For coastal shortwave models, three general conditions must be met to achieve model similitude:

- a. Geometric similarity exists between two objects or systems if the ratios of all corresponding linear dimensions are equal. This relationship is independent of motion of any kind and involves only similarity in form (Warnock 1950). Geometrically similar models are also known as geometrically undistorted models because the horizontal and vertical length scales are the same. (Departure from geometric similarity is restricted to hydrodynamics of long waves and unidirectional flows.)
- b. Kinematic similarity indicates a similarity of motion between particles in model and prototype. Kinematic similarity is achieved when the ratio between the components of all vectorial motions for the prototype and model is the same for all particles at all times (Hudson et al. 1979). In a geometrically similar model, kinematic similarity gives particles paths that are geometrically similar to the prototype. Kinematic similarity assures wave motions and associated flow kinematics are correctly replicated in the physical model.
- c. Dynamic similarity between two geometrically and kinematically similar systems requires that the ratios of all vectorial forces in the two systems be the same (Warnock 1950). This means that there must be constant prototype-to-model ratios of all masses and forces acting on the system. The requirement for dynamic similarity arises from Newton's second law that equates the vector sum of the external forces acting on an element to the element's mass reaction to those forces. For example, dynamic similitude is required when the model is used to simulate the damping effect of floating docks or moored vessels.

Perfect similitude requires that the prototype-to-model ratios of the inertial, gravitational, viscous, surface tension, elastic, and pressure forces be identical. In practice, perfect similitude is impossible at reduced model scale. Fortunately, many coastal problems and flow regimes are adequately modeled by an imperfect similitude where inertia and gravity forces dominate while all other forces are small in comparison.

5.2 Physical Model Scale Effects

Scale effects in coastal hydrodynamic models result primarily from the Froude scaling assumption that gravity is the dominant physical force balancing the inertial forces. The other physical forces of viscosity, elasticity, and surface tension are incorrectly scaled with the belief that these forces contribute little to the physical processes. Scale effects in physical models are analogous to decreased accuracy that occurs in numerical models when complex physical processes are represented by simplified mathematical formulations (Kamphuis 1991). In fixed-bed models the primary scale effect occurs wherever flows in the model become so slow that the flow regime might transition from turbulent to laminar flow conditions whereas such a transition would not occur in the prototype. In this case the viscous forces in the model would not be in similitude.

Laboratory effects in coastal physical models are primarily related to the following:

- a. Physical constraints on flow in the model are caused by the need of representing a portion of the prototype in a finite amount of space. Model boundaries may exist where there is no boundary in the prototype. Waves reflect off model boundaries and introduce reflected wave trains back into the simulated wave field. This problem is partially solved using energy dissipating beaches composed of gentle slopes and rubberized horsehair mats that can minimize reflection to less than 5 percent.
- b. Mechanical means of wave and current generation may introduce unintentional nonlinear effects. The most common example is incorrect reproduction of bound long waves that sometimes cause problems for harbor basins. The model engineer must attempt to make the mechanical waves resemble reasonably well the waves observed in nature.
- c. Prototype forcing conditions are simplified and only a subset of all possible conditions can be selected for testing. A common laboratory effect in wave basins is when long-crested unidirectional waves are generated to approximate directional waves that occur in nature. This compromise is not considered serious if the testing covers multiple approach angles, but the engineer must assess the approximation to determine whether it is reasonable. Another example is simulating a storm using a constant water level as opposed to a time-varying surge hydrograph. Laboratory effects in physical models are analogous to problems in numerical models caused by numerical approximation to the equations, roundoff and truncation errors, and computer speed, memory, and availability (Kamphuis 1991).

The key laboratory effects in the Eliason Harbor physical model were related either to wave generation, water level, or model boundaries. Waves were generated by a plunger-type wave maker that reproduced long-crested, irregular waves scaled to match wave spectra typical of those generated by storms in the Gulf of Alaska to the west and southwest of Sitka. Wave approach direction was fixed by the orientation of the wave machine within the basin. The use of long-crested waves to represent multidirectional wave conditions in the prototype was a reasonable compromise, especially at Sitka where incident storm waves are channeled by the surrounding land masses and wave approach directions are somewhat limited.

Water level was identified as an important factor in harbor wave agitation at Eliason Harbor. Water level in the physical model was kept static at a level approximately 1-foot higher than

ENGINEERING ANALYSIS
CHANNEL ROCK BREAKWATERS
SITKA HARBOR, SITKA, ALASKA

mean higher high water. This assured the transmission of wave energy into the protected harbor area that corresponded to local observations.

Model boundaries are responsible for two laboratory effects: unwanted reflections and unwanted current patterns. Reflections from vertical walls in the model basin were kept to a minimum by placement of rubberized “horsehair” mats that are effective in absorbing incident wave energy. Wave guides (vertical walls) were used at the ends of the wavemaker to prevent immediate diffraction of waves before they entered into the modeled region. Diffraction would reduce wave height along the crest. Waves passing through the western channel into the narrow connecting channel southeast of Eliason Harbor were absorbed in the small basin shown at the bottom of figure 5 where the map ends. Wave absorbing material was placed in this small basin to minimize reflection of wave energy back into the study area.

5.3 Wave Climate

As previously stated, the wave climate associated with the exciting mechanism at Eliason Harbor was never defined. The project began with the premise that the harbor would be instrumented and the harbor exciting mechanism would be identified using the instrument data and local observation. The instrumentation was deployed for two seasons, and both seasons experienced a mild wave climate, so no exciting mechanism was identified. In the absence of measured data, the original design wave height was used as the exciting wave height, and a range of periods was tested. The majority of the periods bracketed the period noted as the problem by the harbormaster’s office. The wave direction associated with high energy in the harbor was also not defined, so local knowledge was used to determine the wave directions for the study.

The alternative to using local knowledge to define the wave climate was to perform a wave hindcast to produce the wave heights, directions, and periods experienced in the Sitka area. The waves resulting from the hindcast could then be transformed into the near shore environment to determine the waves impacting the channel rock breakwater. This was not done primarily because it was anticipated that a wave event would be captured by the instrumentation.

The lack of a hindcast with the percent occurrence statistics for wave height and period also prevented the development of joint probability statistics for this project. Local harbor users have consistently requested breakwater improvements to reduce the long period residual swell associated with high water events and storms in the Gulf of Alaska. Statistics on the frequency of these two events occurring at the same time was not developed due to the lack of hindcast data.

The refinement of the wave environment by hindcast would help define the wave dynamics, but the interaction between the floats and the waves continues to be an unknown factor in the problem definition. The float motion has typically been related to storms in the Gulf of Alaska by the local users. Using this information, the assumption for this investigation is that any reduction in wave energy entering through the Channel Rock Breakwaters would result in decreased movement of the floats. The amount of decreased motion in the floats and the sensitivity of the motion to wave period cannot be determined by the studies performed to date. The solution to a similar problem at Crescent Harbor in Sitka was reduction of the entrance channel width, which reduced the wave energy entering the harbor. The reduction in wave energy resulted in dampened float motion.