



**STUDY PLAN
FOR THE
ENVIRONMENTAL STUDIES PROGRAM
IN THE CHUKCHI & BEAUFORT SEAS
2011**



Olgoonik-Fairweather LLC
Olgoonik Fairweather
3201 C Street, Suite 700
Anchorage, Alaska 99503-3934
July 2011

This page left intentionally blank.

TABLE OF CONTENTS

Section I	STUDY DESCRIPTION.....	I-1
1.0	INTRODUCTION	I-1
2.0	GENERAL OBJECTIVES	I-1
3.0	PROJECT AREA	I-2
4.0	PERIOD OF STUDY	I-2
5.0	DESCRIPTION OF VESSELS.....	I-3
6.0	OUTLINE.....	I-3
Section II	PHYSICAL OCEANOGRAPHIC MEASUREMENTS IN THE NORTHEAST CHUKCHI SEA OCEANOGRAPHY	II-1
1.0	INTRODUCTION	II-1
1.1	Mean Circulation	II-1
1.2	Measurement History.....	II-4
1.3	Purpose of Study and Rationale.....	II-4
1.4	Objectives of Study	II-4
2.0	METHODS AND PROCEDURES.....	II-4
2.1	Sampling or Survey Design and Technical Rationale	II-4
2.2	Field Team Size and Composition.....	II-5
2.3	Data-collection Procedures.....	II-5
2.4	Analytical Procedures	II-5
2.5	Data-storage Procedures.....	II-6
2.6	Quality-control Procedures	II-6
3.0	COORDINATION	II-6
3.1	OLF	II-6
3.2	Other Studies in the Chukchi Sea Program	II-6
3.3	Current Studies in the Region	II-7
4.0	DELIVERABLES	II-7
4.1	Field Data Summary	II-7
4.2	Draft Report.....	II-7
4.3	Final Report.....	II-7
5.0	SCHEDULE WITH MILESTONES.....	II-7
5.1	Field Studies	II-7
5.2	Coordination Meetings.....	II-7
5.3	Deliverables	II-7
6.0	REFERENCES	II-8
Section III	PLANKTONIC COMMUNITIES	III-1
1.0	INTRODUCTION	III-1
1.1	Brief History of Planktonic Biological Oceanography in the Chukchi Sea ..	III-1
1.2	Objectives of Study	III-4
2.0	METHODS AND PROCEDURES.....	III-4
2.1	Sampling or Survey Design and Technical Rationale	III-4
2.2	Field Team Size and Composition.....	III-4
2.3	Data-collection Procedures.....	III-4
2.4	Analytical Procedures	III-5
2.5	Data-storage Procedures.....	III-6
2.6	Quality-control Procedures	III-6
3.0	COORDINATION	III-6
3.1	Olgoonik-Fairweather	III-6

3.2	Other Studies in the Chukchi Sea Program	III-6
3.3	Current Studies in the Region	III-6
4.0	DELIVERABLES	III-7
4.1	Data.....	III-7
4.2	Draft Report.....	III-7
4.3	Final Report.....	III-7
5.0	SCHEDULE WITH MILESTONES.....	III-7
5.1	Field Studies	III-7
5.2	Coordination Meetings.....	III-7
5.3	Deliverables	III-7
6.0	REFERENCES	III-8
Section IV BENTHIC COMMUNITIES OF THE BURGER, KLONDIKE, AND		
STATOIL SURVEY AREAS IN THE CHUKCHI SEAIV-1		
1.0	INTRODUCTION	IV-1
1.1	Brief history of Subject Research in Chukchi Sea	IV-1
1.2	Purpose of Study and Rationale.....	IV-2
1.3	Objectives	IV-2
2.0	METHODS AND PROCEDURES.....	IV-4
2.1	Sampling or Survey Design and Technical Rationale.....	IV-4
2.2	Field Team Size and Composition.....	IV-4
2.3	Data Collection Procedures.....	IV-4
2.4	Analytical Procedures	IV-5
2.5	Data Storage Procedures	IV-5
2.6	Quality Control Procedures.....	IV-6
3.0	COORDINATION	IV-6
3.1	OLF	IV-6
4.0	DELIVERABLES	IV-6
4.1	Field Data.....	IV-6
4.2	Annual and Final Report.....	IV-6
5.0	SCHEDULE WITH MILESTONES.....	IV-7
5.1	Field Studies	IV-7
5.2	2011 Coordination Meetings.....	IV-7
5.3	Deliverables	IV-7
6.0	REFERENCES	IV-7
Section V EVALUATING OCEAN ACIDIFICATION IN THE CHUKCHI SEA		
ENVIRONMENTAL STUDIES PROGRAMV-1		
1.0	INTRODUCTION	V-1
1.1	The Carbon Cycle and Ocean Acidification in the Chukchi Sea.....	V-1
1.2	Purpose of Study and Rationale.....	V-3
1.3	Objectives of Study.....	V-3
2.0	METHODS AND PROCEDURES.....	V-4
2.1	Sampling or Survey Design and Technical Rationale	V-4
2.2	Field Team Size and Composition.....	V-4
2.3	Data-collection Procedures.....	V-4
2.4	Analytical Procedures	V-4
2.5	Data-storage Procedures.....	V-4
2.6	Quality-control Procedures	V-5
3.0	COORDINATION	V-5
3.1	OLF	V-5
3.2	Other Studies in the Chukchi Sea Program	V-5

3.3	Current Studies in the Region	V-5
4.0	DELIVERABLES	V-5
4.1	Field Data	V-5
4.2	Draft Report.....	V-5
4.3	Final Report.....	V-6
5.0	SCHEDULE WITH MILESTONES.....	V-6
5.1	Field Studies	V-6
5.2	Coordination Meetings.....	V-6
5.3	Deliverables	V-6
6.0	REFERENCES	V-6
Section VI FISH TRAWL ASSESSMENT		VI-1
1.0	INTRODUCTION	VI-1
1.1	Brief History of Subject Research in Chukchi Sea.....	VI-1
1.2	Objectives	VI-2
2.0	METHODS AND PROCEDURES.....	VI-2
2.1	Trawl Survey Station Pattern.....	VI-2
2.2	Trawling Procedures.....	VI-3
2.3	Personnel.....	VI-4
2.4	Equipment.....	VI-4
2.5	Bottom Trawl Gear Description	VI-5
2.6	Pelagic Trawl Gear Description	VI-5
3.0	ANALYSES AND REPORTING.....	VI-5
3.1	Area Swept Calculations.....	VI-5
3.2	Absolute Abundance and Biomass	VI-6
3.3	Biological Analyses	VI-6
3.4	Final Report.....	VI-6
4.0	SCHEDULE.....	VI-7
Section VII SEABIRD ECOLOGY		VII-1
1.0	INTRODUCTION	VII-1
1.1	Brief History of Subject Research in the Chukchi Sea.....	VII-1
1.2	Objectives of Study.....	VII-2
2.0	METHODS AND PROCEDURES.....	VII-2
2.1	Sampling or Survey Design and Technical Rationale	VII-2
2.2	Field Team Size and Composition.....	VII-3
2.3	Data-collection Procedures.....	VII-3
2.4	Analytical Procedures	VII-4
2.5	Data-storage Procedures.....	VII-5
2.6	Quality-control Procedures	VII-5
3.0	COORDINATION	VII-6
3.1	Olgoonik-Fairweather	VII-6
3.2	Other studies in the Chukchi Sea Program	VII-6
3.3	Current studies in the region	VII-6
4.0	DELIVERABLES.....	VII-6
4.1	Field Data	VII-6
4.2	Draft Report.....	VII-7
4.3	Final Report.....	VII-7
5.0	SCHEDULE WITH MILESTONES.....	VII-7
5.1	Coordination Meetings.....	VII-7
5.2	Dates of deliverables	VII-8
6.0	REFERENCES	VII-8

Section VIII	MARINE MAMMAL ECOLOGY.....	VIII-1
1.0	INTRODUCTION	VIII-1
1.1	Brief History of Marine Mammal Research in Chukchi Sea.....	VIII-1
1.2	Objectives	VIII-2
2.0	METHODS AND PROCEDURES.....	VIII-2
2.1	Sampling Design.....	VIII-2
2.2	Field Team Size and Composition.....	VIII-3
2.3	Data-collection Protocols and Procedures	VIII-3
2.4	Analytical Procedures	VIII-4
2.5	Data-storage Procedures.....	VIII-4
2.6	Quality-control Procedures	VIII-4
3.0	COORDINATION	VIII-5
3.1	Marine Mammal Study Organization	VIII-5
3.2	Chukchi Sea Study Integration	VIII-5
3.3	Other Studies in the Region	VIII-5
4.0	DELIVERABLES	VIII-5
4.1	Field Data.....	VIII-5
4.2	Final Report.....	VIII-6
5.0	REFERENCES	VIII-6
6.0	MMO APPENDIX.....	VIII-8
6.1	APPENDIX A- Data Recording Field Codes for MMOs	VIII-8
6.2	APPENDIX B- Beaufort Wind Force Scale Codes.....	VIII-1
Section IX	CHUKCHI SEA ACOUSTIC MONITORING	IX-1
1.0	INTRODUCTION	IX-1
1.1	Program Description	IX-1
1.2	Acoustics Program Purpose	IX-2
2.0	FIELD METHODS.....	IX-2
2.1	Equipment and Sampling Parameters.....	IX-2
2.2	Deployment Geometry and Schedule	IX-5
3.0	DATA EXTRACTION AND QUALITY CONTROL.....	IX-8
3.1	Data Extract and Backup	IX-8
3.2	Quality-control Procedures	IX-8
Section X	BEAUFORT SEA ACOUSTIC MONITORING	X-1
1.0	INTRODUCTION	X-1
2.0	METHODS	X-2
2.1	Equipment.....	X-2
2.2	DASAR Hydrophone Calibration	X-4
2.3	Field Procedures.....	X-4
2.4	Clock and Bearing Calibrations in the Field	X-4
2.5	Health Checks.....	X-5
3.0	DATA ANALYSIS.....	X-5
4.0	REFERENCES	X-5

LIST OF FIGURES

Figure I-1 Map Showing 2010 Study Areas with Transect and Sampling Locations.

Figure I-2. Map showing 2011 Chukchi biological sampling with transect and sampling locations

Figure I-3. Map of 2011 Chukchi Sea acoustic and metocean locations

Figure I-4. Location of the study area, proposed station grid and important lease blocks for fish survey coverage.

Figure II-1. Schematic circulation map of the Bering–Chukchi–Beaufort seas ecosystem

Figure III-1. Chukchi sea sampling region

Figure IX-1. Photograph of AMAR acoustic buoy.

Figure IX-2. AMAR and AURAL deployment configuration.

Figure IX-3. AMAR acoustic recorder locations

Figure IX-4. AMAR acoustic recorder locations

Figure X-1. DASAR deployment locations planned for the 2011 field season

Figure X-2. DASAR recorder (model C08).

LIST OF TABLES

Table IX-1: Planned geographic coordinates of AMAR locations in first deployment scheduled for late July, 2011

Table IX-2: Planned geographic coordinates of AURAL recorder locations in second deployment scheduled for mid-August, 2011

Table IX-3: Planned geographic coordinates of AURAL recorder locations in third deployment scheduled for October, 2011

SECTION I

STUDY DESCRIPTION

1.0 INTRODUCTION

In February 2008, the Minerals Management Service (MMS), now known as the Bureau of Ocean Energy Management, Regulation, and Enforcement (BOEMRE), held Lease Sale 193 of blocks in federal waters of the Chukchi Sea. ConocoPhillips (COP) obtained 98 lease blocks within two main former well sites areas, Klondike and Burger. Shell Exploration & Production Company (Shell) obtained 275 lease blocks near the Crackerjack, Shoebill, and Burger well sites. Statoil USA Exploration & Production (Statoil) obtained 16 bids north of Burger. In the open water seasons of 2008 and 2009, COP operated, on behalf of itself and Shell, an integrated ecosystem-based environmental studies program to gather baseline, or pre-exploitation, exploration, and development data in the Chukchi Sea.

In 2010 and 2011, Olgoonik-Fairweather LLC (OLF) operated the Chukchi Sea environmental studies program funded by COP, Shell, and Statoil. The studies program includes various disciplines of the marine ecosystem including: physical oceanography, chemical oceanography (new in 2010), plankton ecology, benthic ecology (infaunal and epibenthic communities), seabird ecology, marine mammal ecology, pelagic and demersal fisheries, and the hydroacoustic environment.

The Studies Program in 2011 will be the fourth year in a multi-disciplinary baseline program in the northeastern Chukchi Sea. In 2008 and 2009, the program consisted of two prospect-specific study areas: “Klondike” for ConocoPhillips and “Burger” for Shell. In 2010, an additional prospect-specific study area (“Statoil”) was added north of Burger for Statoil (Figure I-1). In 2011, OLF will conduct a more regional area survey that encompasses the three prospect-specific study areas, but will include Hanna Shoal to the north (Figure I-2). The study design is based on the systematic sample and transect grid used in 2008-2010, but on a more coarse scale to cover a greater area in a shorter amount of time. We will sample at the finer transect scale within the 2008-2010 prospect-specific study areas to allow for data continuity (Figure I-2). The location of the acoustic recorders and metocean instrumentation are shown in Figure I-3 and fish survey locations are shown in Figure I-4. Details of each sampling point are shown on figures located in the Appendix.

In addition to the Chukchi Sea, OLF is providing logistical support for deployment of physical oceanography and hydroacoustic instruments in support of Shell operations in the Beaufort Sea. A brief discussion of the Beaufort Sea program is provided in Section X, but is not included in any earlier sections.

2.0 GENERAL OBJECTIVES

The overall purpose of the study is to provide to COP, Shell, and Statoil necessary baseline information about the marine environment in their respective lease areas that can be used in applications for permits, in a National Environmental Policy Act (NEPA) compliance document, and in other documents and to help manage these resources. The study will provide valuable information for the regulatory agencies to conduct

realistic evaluations on the potential impacts of oil and gas activities and thus issue permits with reasonable stipulations and guidance. It will also contribute to the overall knowledge of the Chukchi Sea marine ecosystem. It is anticipated that future studies in the lease areas will involve additional collaborators including, but not limited to, the BOEMRE, the North Pacific Research Board (NPRB), the National Marine Fisheries Service (NMFS), United States Fish and Wildlife Service (USFWS), United States Geological Survey (USGS), Alaska Eskimo Whaling Commission (AEWC), Alaska Beluga Whale Committee (ABWC), Ice Seal Commission, and Alaska Eskimo Walrus Commission.

3.0 PROJECT AREA

The project area consists of an overall regional survey approach, encompassing the three prospect-specific study areas from the previous years (Klondike, Burger, and Statoil), as well as areas north to Hanna Shoal and to the east and west of the prospect-specific study areas. In addition, several types of metocean-gathering instrumentation will be deployed in the Chukchi Sea to collect environmental conditions in the air and water. For the 2011 program, the physical and biological oceanographic sample stations will be laid out on the same 15 NM grid as in previous years. The regional study area will be sampled on a 15 NM grid and the prospect-specific study areas will be sampled on a 7.5 NM grid. As shown in Figure I-2, each of these stations will be sampled for physical oceanography, zooplankton and primary productivity, and chemical oceanography (i.e., ocean acidification). A total of 156 stations will be sampled; 25 of these are in Klondike, 25 in Burger, and 22 in Statoil (4 shared with Burger). Also shown on Figure I-2, 62 of these stations will be sampled for benthic infauna (9 in Klondike, 10 in Burger, and 11 in Statoil).

We have also included two north-south regional transect lines; one from the southeastern corner of the regional study area to the northern boundary of the regional study area in Hanna Shoal and the transect line to the west of that transect (Figure I-2). These transects will be sampled twice during the open-water season to characterize the environment across a large vertical area across the study area in all disciplines (seabird/mammal and physical/biological/chemical oceanography).

Fish will be sampled using a separate National Oceanic and Atmospheric Administration (NOAA) research vessel and trawl techniques. Figure I-4 shows proposed trawl locations.

4.0 PERIOD OF STUDY

The Chukchi Sea studies program consists of three “mooring” cruises – to deploy and/or retrieve the various acoustic and metocean instruments distributed throughout the Chukchi Sea; and two “science” cruises – to collect biological information as described further below. The mooring program consists of summer deployments (late July-early August), late summer deployments (late August), and end of season retrievals/deployments (early October). The mooring cruises will occur on the *R/V Westward Wind* and *R/V Norseman II*. The science program consists of one prospect-specific cruise and regional north-south lines generally occurring mid- to late August and the regional survey occurring late August to late September. The science cruises will occur on the *R/V Westward Wind*.

5.0 DESCRIPTION OF VESSELS

The data will be collected using three vessels: the *R/V Westward Wind*, *R/V Norseman II*, and *F/V Pandalus*. The *Westward Wind* is a 142-ft long aft-house vessel. The *Norseman II* is a 128-ft long forward-house vessel. Both vessels were used in 2009 and 2010 for this program. The fishing trawls will occur off the *R/V Pandalus*, a 66-ft long forward-house vessel. All vessels have been outfitted with the appropriate cranes, winches, and navigation to allow safe efficient and safe deployment of all gear and equipment.

6.0 OUTLINE

This Studies Plan is separated into specific disciplines that will describe a brief history of the study region, methods and procedures for both data collection and analysis, and a description of the deliverables.

The Studies Plan is outlined as follows:

- Section II: Physical Oceanography
- Section III: Planktonic Communities and Chemical Oceanography
- Section IV: Benthic Communities
- Section V: Ocean Acidification
- Section VI: Fisheries Ecology
- Section VII: Seabirds Ecology
- Section VIII: Marine Mammal Ecology
- Section IX: Chukchi Sea Acoustic Monitoring
- Section X: Beaufort Sea Acoustic Monitoring

SECTION II

PHYSICAL OCEANOGRAPHIC MEASUREMENTS IN THE NORTHEAST CHUKCHI SEA OCEANOGRAPHY

THOMAS J. WEINGARTNER

PRINCIPAL INVESTIGATOR

INSTITUTE OF MARINE SCIENCES, UNIVERSITY OF ALASKA

FAIRBANKS, AK

1.0 INTRODUCTION

The Chukchi Sea is properly a part of the western Arctic Ocean, but it is intimately linked, atmospherically and oceanographically, to the Pacific Ocean. The atmospheric connection is primarily via the Aleutian Low, whose varying position and strength and interactions with polar air masses affects the regional meteorology. The oceanographic connection is solely through Bering Strait, where the mean northward flow transports waters and organisms from the Bering Sea shelf and basin. This Pacific connection profoundly influences the wind and wave regimes, the seasonal distribution of sea ice, the regional hydrologic cycle, and the water masses and circulation characteristics of the Chukchi Sea

The shallow (~50 m) Chukchi Sea shelf extends ~800 km northward from Bering Strait to the shelf-break at about the 200-m isobath. The mean flow over much of the shelf is northward due to the Pacific–Arctic oceanic pressure gradient and opposes the prevailing northeasterly winds. The Bering Strait influx of heat, nutrients, carbon, and organisms bestows the Chukchi shelf with physical and ecological characteristics that are unique among arctic shelves.

Much of our understanding of the Chukchi shelf derives from the early syntheses of Coachman et al. (1975) and Walsh et al. (1989) and, more recently (since 1985), in the papers by Aagaard et al. (1985), Aagaard and Roach (1989), Weingartner et al. (1998), Weingartner et al. (1999), Münchow and Carmack (1997), Münchow et al. (1999), Münchow et al. (2000), Weingartner et al. (2005), and Woodgate et al. (2005). The physical oceanographic summary of the Chukchi shelf is drawn primarily from these papers.

1.1 Mean Circulation

The Bering Strait through-flow crosses the Chukchi Sea along three principal pathways associated with distinct bathymetric features (Figure II-1). A western branch flows northwestward from the strait and exits the shelf through Herald Valley. While most of this outflow probably descends through Herald Valley, some of it spreads eastward across the central shelf. A second branch flows northward across the central channel shelf and then probably splits; with some water continuing eastward toward the Alaska coast while the remainder flows northeastward toward the continental slope. The third branch flows northeastwards along the Alaska coast towards Barrow Canyon, which lies at the junction of the Chukchi and Beaufort shelves. In summer, this flow includes the northward extension of the Alaska Coastal Current (ACC) that originates south of Bering

Strait. Within the canyon, the ACC is joined by waters flowing eastward from the central shelf; the merged flow then moves down-canyon toward the shelf-break. Mean current speeds within the Herald and Barrow canyons are swift (~25 cm s⁻¹), are more moderate in the central channel (~10 cm s⁻¹), but generally are 5 cm s⁻¹ elsewhere on the shelf. Long-term transport estimates for these three pathways are only approximate but suggest that the flow across the central Chukchi shelf is ~200,000 m³ s⁻¹ while the branches in both Herald Valley and Barrow Canyon carry ~300,000 m³ s⁻¹. In summer and fall, the influence of the warm Bering Sea inflow along these pathways is manifested in the form of “melt-back embayments” indenting the ice edge (Paquette and Bourke 1981). Finally, there is also a small fraction of the strait through-flow that flows westward through Long Strait into the East Siberian Sea and appears to be an important nutrient source to this shelf (Codispoti and Richards 1968; Codispoti et al. 1991).

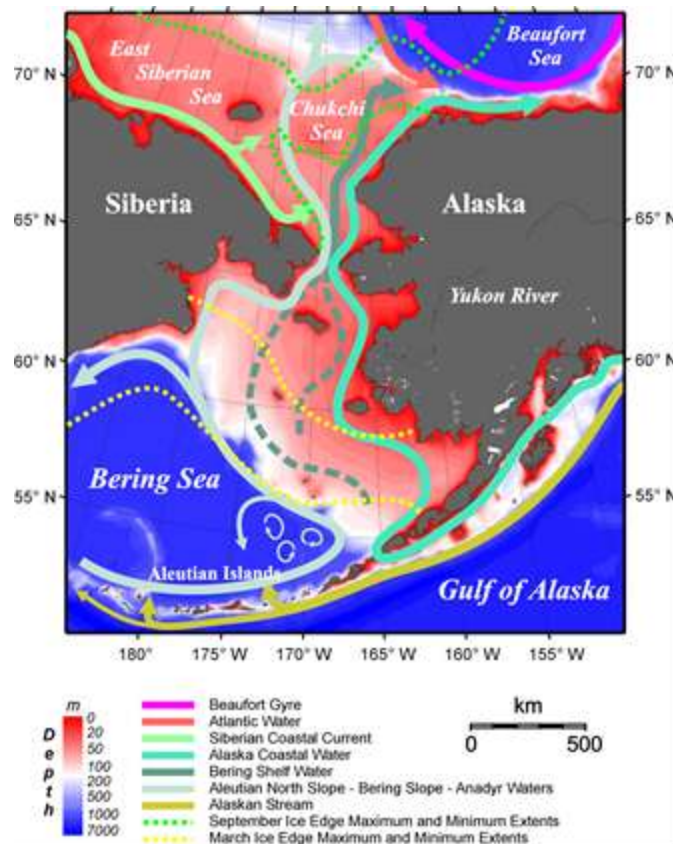

Figure II-1. Schematic circulation map of the Bering–Chukchi–Beaufort seas ecosystem.

The nutrient and carbon loads carried along these branches differ (Walsh et al. 1989, Hansell et al. 1993; Cooper et al. 1997). The Herald Valley outflow is saltier, colder, and richer in nutrients and marine-derived carbon than the waters transported in the Alaska Coastal Current, whereas waters crossing the central shelf have intermediate properties. In winter, shelf waters decrease to the freezing point and salinities increase due to salt rejection from growing sea ice. These seasonal changes in shelf salinities have important implications on the fate of the nutrients and carbon in the Chukchi shelf waters

that enter the basin. Low-density summer waters are confined to the upper 75 m of the shelf-break and slope, whereas denser winter waters descend to 100–150 m depth.

There are two other aspects of the Chukchi shelf circulation of importance. The first is the buoyancy-influenced Siberian Coastal Current (SCC) that originates in the East Siberian Sea and flows southeastward along the Siberian coast into the Chukchi Sea. The SCC carries cold, low-salinity, nutrient-poor ice-melt, and river waters that enter the East Siberian and Laptev seas. The SCC is confined to within ~60 km of the Chukotka coast and is bounded on its offshore side by an unstable front, which appears to be an important bowhead whale foraging zone (Moore et al. 1995). Nearing Bering Strait, the SCC narrows and turns offshore to mix with waters exiting the strait. Most of the resulting mix is most likely transported through Herald Valley and across the central shelf. It also appears likely that surface waters over the outer shelf and slope are flowing westward on average (Muench et al. 1991), bringing sea ice and cold, low-salinity waters of the polar mixed layer over the outer shelf and slope.

The mean circulation results from the large scale pressure field between the Pacific and Arctic oceans and opposes the mean winds, which are from the northeast. The winds are, however, the principal cause of flow variability. Wind forcing varies seasonally with both wind magnitude and variability being largest in fall-winter and smallest in summer. In particular, in fall and winter, the winds can frequently reverse the shelf flow field or redistribute the flow from one branch to another (Weingartner et al. 1998). As a consequence of this seasonality, transit times along the three flow pathways across the Chukchi shelf are 3–6 months in spring and summer but are longer in fall and winter.

In general, wind-forced current fluctuations are coherent over much of the shelf, although, for reasons not known, the correlation is substantially weaker over the western shelf than for the eastern shelf (Woodgate et al. 2005b). Westward winds induce upwelling at the continental slope, which could be an important nutrient source at the shelf-break. While no measurements have been made of this phenomenon along the Chukchi slope, data from Barrow Canyon indicate that wind-forced upwelling carries waters from ~250 m depth or more toward the head of the canyon, which lies ~150 km from the canyon mouth (Aagaard and Roach 1990; Weingartner et al. 1998). Winds also appear to be important in the dynamics of the SCC. For example, in some years, the winds along the Chukotka coast are persistently upwelling and prevent the SCC from entering the Chukchi Sea (Münchow et al. 1999; Weingartner et al. 1999). The consequences of this variability are unknown, but if the SCC front is an important foraging zone for bowhead whales, its absence in some years could affect whale foraging behavior.

The other major sources of current variability are associated with mesoscale (10–50 km) instabilities associated with large cross-frontal density gradients. Mesoscale flows can be vigorous (>20 cm/s) and uncorrelated with winds. The instabilities initially appear as meanders along the front but can rapidly grow in strength and/or detach into eddies that move across the axis of the front. Eddies and meanders are very prominent within the SCC front and promote cross-shore mixing between SCC and Bering Strait waters flowing northward through the Hope Sea Valley. Eddies and cross-shore mixing result from frontal instabilities along the edge of polynyas due to the large salinity differences between high salinity polynya waters and less saline offshore waters (Gawarkiewicz and Chapman 1995). Finally, fronts associated with melting along the ice-edge often include

vigorous three-dimensional mesoscale motions (Liu et al. 1994; Muench et al. 1991) that often lead to enhanced biological production at the ice edge. Moreover, the mixing and circulation fields associated with the mesoscale motions associated with the SCC and ice edge may also be important in establishing biologically-rich mesoscale patches.

1.2 Measurement History

Prior to the 1970s, several hydrographic expeditions were collected throughout the Chukchi Sea and summarized by Coachman et al. (1975). In the 1970s and 1980s, several year-round moored measurement programs were conducted in the US EEZ and supported by the Outer Continental Shelf Environmental Assessment Program (OCSEAP), as summarized by Aagaard (1988). Beginning in 1990, NSF, ONR, and MMS supported a number of physical-oceanographic programs, the results of which were summarized above. Most recently, these included the NSF-ONR sponsored Shelf–Basin Interaction (SBI), which recently completed a three-year field program (2001–2004). The SBI program focused primarily upon biogeochemical processes over the outer shelf and shelf-break. More recently, COP has funded seasonal bio-physical surveys in the Klondike and Burger lease sites of the northeast Chukchi Sea. This research work is a continuation of those previous efforts.

1.3 Purpose of Study and Rationale

Chukchi Lease Sale 193 occurred in February 2008. Prior to any exploration, development, or production activities being conducted in a lease block, BOEMRE requires specific baseline information to be collected. Multiple years of data will be necessary to for permits in support of exploratory drilling and eventual development. Circulation characteristics and physical-oceanographic influences on biological oceanography and production form one aspect of these baseline studies. The physical oceanography may influence design considerations, and it may affect spatial and temporal patterns of biological production and the distribution and abundance of organisms.

1.4 Objectives of Study

The primary objective is to describe spatial and seasonal characteristics of the water masses and circulation in the Northeast Chukchi Sea. The main objectives of the 2011 oceanographic data are to combine the physical-oceanographic data with the various biological measurements planned and to define the major physical oceanographic characteristics (hydrography and circulation) during the study period. This will help determine spatial and temporal patterns of biological production and the distribution and abundance of organisms in this region.

2.0 METHODS AND PROCEDURES

2.1 Sampling or Survey Design and Technical Rationale

There will be 2 cruises. The first cruise of 18 days duration will occupy the Klondike, Burger, and Statoi survey areas in August. At this time the sampling will be conducted on a 5 x 5 station grid with station spacing at ~7.5 nm spacing. This cruise will be followed by a 40-day cruise during which time the entire grid of the Chukchi Study Area

will be occupied. At each station a CTD (conductivity-temperature-depth) cast will be made and water samples will be collected by Hopcroft for nutrients and chlorophyll. The CTD will include a fluorometer (as an index of chlorophyll biomass) and a transmissometer (as index of water-column turbidity). Finally, a vessel-mounted Teledyne ADCP was installed and the current data will provide an estimate of the water-column current structure and its spatial and temporal variability.

2.2 Field Team Size and Composition

We have no personnel available to support field work in 2011. Instead, a marine-technician service group on the vessel deploy, recover, and collect the various physical-oceanographic data sets.

2.3 Data-collection Procedures

CTD data will be collected with a Seabird system with a descent rate of no more than 30 meters/minute. The SSTS system will also include a flow monitor in the intake system, and the data stream should ideally be blended with the ship's navigation system so that GPS time and position are recorded. At each CTD cast, the operator will record time of CTD deployment and position. The operator will also record the temperature and salinity values of the SSTS system once the CTD is ready to descend through the water column. (This will allow us to compare the underway system values with the CTD data; which is usually more accurate than the underway system.) Vessel-mounted ADCP (VM-ADCP) data will be collected from a 600, 300, or 150-kHz Teledyne RDI system. The instrument will be run in bottom-track and broadband modes with a 2-m bin size and 2-second ping rate. Both raw (single-ping) and 10-minute averaged data will be stored (with duplicate copies). The ADCP data stream will also include the GPS position and time.

All files associated with the CTD and ADCP systems are required in their native formats in order to process the data. This includes the hexadecimal (*.hex) data files, the bottle trip (*.bl) files and the configuration (*.con) files created by the Sea-Bird SeaSave real-time data collection program. ADCP data recording will include all raw ping, navigation, bottom track, diagnostics, setup and ensemble averaged data files are required.

To the extent that cloud cover permits, we will collect remotely-sensed thermal infrared for sea surface temperature and ocean color (chlorophyll or suspended sediment). Imagery will be made available approximately bi-weekly. In previous years we have provided maps of the QuikSCAT wind field over the Chukchi Sea shelf. That satellite's mission ended in fall 2009. As we did in 2010, we will use winds based on the National Center for Environmental Prediction (NCEP) forecast models for the study period. The model results are generated 4 times daily on a 2.5 degree grid.

2.4 Analytical Procedures

All of the processing procedures used are routine and are based on common physical-oceanographic standard practices used at the Institute of Marine Sciences and most other oceanographic institutions. Hydrographic processing of the CTD data will include application of calibration values and our standard quality-control routines used in processing CTD data sets. Standard procedures are to be used for assessing the

SSSTF and remotely-sensed images, which are all geo-referenced. Our analyses will include describing the seasonally (and, if possible, shorter-period) variations in fronts, water masses, geostrophic current fields, and stratification. CTD and satellite image processing will require about 2.5 months. ADCP data processing may be time-consuming (see below). We will allocate four months for ADCP processing and will attempt to provide summary statistics on the ocean currents for each cruise. At the very least, the analyses will provide OLF with an estimate of data quality and simplified analyses of the circulation within the boxes (e.g., means and variances). Time permitting, we will examine shorter-period variations in the currents.

2.5 Data-storage Procedures

Data files collected during cruises will be backed up after each cast with multiple copies sent to UAF. At UAF, data are backed up routinely onto departmental servers.

2.6 Quality-control Procedures

We require the manufacturer's pre- and post-season calibration values for the CTD temperature and conductivity sensors. The CTD will be sent to the manufacturer immediately after the October cruise so that the post-season calibration values are available as soon as possible after the end of the season. Final processed data sets cannot be made available until the post-season calibration values have been inspected and adjustments applied (if necessary). The underway sensors will also be calibrated prior to and after the cruise by the manufacturer. We will examine for systematic offsets between the CTD surface values and the underway system (usually in temperature). ADCP data-processing procedures include an exhaustive screening procedure based on ship accelerations, backscatter intensity, error values, etc. Bias and misalignment errors of the ADCP will be corrected for, following Joyce et al. (1989). Note, however, that ADCP quality control and data processing can be a time-consuming process if there are problems with the installation of the ADCP on the vessel. Moreover, 60 days of ADCP data could require several months of processing time. We have allocated a maximum of four months for processing and analysis of the ADCP data.

3.0 COORDINATION

3.1 OLF

The PI will attend all proposed meetings and interact regularly as needed with OLF.

3.2 Other Studies in the Chukchi Sea Program

I regularly interact with other PIs involved in this program. I have a long collaborative relationship with Hopcroft (zooplankton) in particular through the GLOBEC and NPRB Seward Line time-series, and I have worked with Hopcroft on a recent interdisciplinary synthesis of studies from the Chukchi and Beaufort region. Blanchard (benthos) and I have discussed fish and benthic biomass and abundance distributions in the Chukchi Sea and have a long-term working relationship. Day (seabirds) and I have consulted with each other on numerous occasions over the years, and we worked together during the GLOBEC program.

3.3 Current Studies in the Region

Recent and ongoing studies have been described in Section 1.1. Weingartner is a PI in the NSF and NOAA-funded RUSALCA program that began in 2004 and that involves year-round current meter sampling in both the US and Russian EEZs of Bering Strait. The PI will also begin to map the surface currents within 150 km of the coast between Wainwright and Barrow beginning August 2009, under a program jointly sponsored by BOEMRE, ConocoPhillips and Shell and continuing through 2011. Weingartner is also involved with research in the Bering Strait and the Beaufort Sea in 2009.

4.0 DELIVERABLES

4.1 Field Data Summary

A list of sampling activities will be submitted within 30 days of reception of the data from the summer and fall 2011. This will consist of an inventory of the data sets that we have received from ConocoPhillips.

4.2 Draft Report

The Draft Report, including CDs with the processed data, will be submitted 4 -6 months after receipt of the data sets and the post-season CTD calibration reports, assuming that neither have any unusual problems.

4.3 Final Report

The Final Report will be within 30 days of receipt of comments on Draft Report.

5.0 SCHEDULE WITH MILESTONES

5.1 Field Studies

- Aug 2011—Cruise 1
- Sept 2011—Cruise 2

5.2 Coordination Meetings

We assume the following coordination meeting schedules.

- May-June 2011—Chukchi Sea scientific studies coordination meeting in Fairbanks, AK (1 day).
- Nov 2011—OLF Chukchi Sea scientific studies debriefing, Anchorage, AK (1 day).
- Jan 2012—Chukchi Sea scientific studies technical workshop at Alaska Marine Science Symposium (AMSS), Anchorage (2 days).

5.3 Deliverables

- Field data— within 3 months of receipt of complete data sets and post-season calibration reports from OLF.

- Draft Report— within 3 months of receipt of complete data sets and post-season calibration reports from OLF.
- Final Report— 1 month after receipt of comments on Draft Report

6.0 REFERENCES

- Aagaard, K. 1988. Current, CTD, and pressure measurements in possible dispersal regions of the Chukchi Sea. Outer Continental Shelf Environmental Research Program, Final Reports of Principal Investigators 57: 255–333.
- Aagaard, K., and Roach. 1990. Arctic ocean-shelf exchange: measurements in Barrow Canyon, *Journal of Geophysical Research* 95: 18163–18175.
- Aagaard, K., C. H. Pease, A. T. Roach, and S. A. Salo. 1989. Beaufort Sea Mesoscale Circulation Study—Final Report. NOAA Technical Memorandum ERL PMEL-90. 114 pp.
- Aagaard, K., J. H. Swift, and E. C. Carmack. 1985. Thermohaline circulation in the Arctic Mediterranean seas. *Journal of Geophysical Research* 90: 4833–4846.
- AMAP (Arctic Monitoring and Assessment Programme). 2003. AMAP Arctic Pollution 2002: Persistent organic pollutants, heavy metals, radioactivity, Human health, changing pathways. Arctic Monitoring and Assessment Programme (AMAP), Oslo, Norway. 112 pp.
- Carmack, E. C. 1986. Circulation and mixing in ice-covered waters. In N. Unstersteiner (Ed.). *The geophysics of sea ice*. Plenum Press, New York, NY. Pp. 641–712.
- Carmack, E. C., and D. C. Chapman. 2003. Wind-driven shelf/basin exchange on an Arctic shelf: the joint roles of ice cover extent shelf-break bathymetry. *Geophysical Research Letters* 30 (14): 1778. [available at: doi: 10.1029/2003GL017526]
- Coachman, L. K., K. Aagaard, and R. B. Tripp. 1975. Bering Strait: the regional physical oceanography. University of Washington Press, Seattle, Washington, Seattle, WA. 172 pp.
- Codispoti, L., G. E. Friederich, C. M. Sakamoto, and L. I. Gordon. 1991. Nutrient cycling and primary production in the marine systems of the Arctic and Antarctic. *Journal of Marine Systems* 2: 359–384.
- Codispoti, L., and F. A. Richards. 1968. Micronutrient distributions in the East Siberian and Laptev seas during summer 1963. *Arctic* 21: 67–83.
- Cooper, L. W., J. Grebmeier, T. Whitley, and T. Weingartner. 1997. The nutrient, salinity, and stable oxygen isotope composition of Bering and Chukchi sea waters in and near Bering Strait. *Journal of Geophysical Research* 102: 12563–12578.
- Gawarkiewicz, G., and D. C. Chapman. 1995. A numerical study of dense water formation and transport on a shallow, sloping continental shelf. *Journal of Geophysical Research* 100: 4489–4508.
- Joyce, T. 1989. On in situ “calibration” of shipboard ADCPs. 1989. *Journal of Atmospheric and Oceanographic Technology* 6: 169–172.
- Hansell, D., T. E. Whitley, and J. J. Goering. 1993. Patterns of nitrate utilization and new production over the Bering-Chukchi shelf. *Continental Shelf Research* 13: 601–627.

- Liu, A. K., C. Y. Peng, and T. J. Weingartner. 1994. Ocean–ice interaction in the marginal ice zone using SAR. *Journal of Geophysical Research* 99: 22391–22400.
- Muench, R. D., C. H. Pease, and S.A. Salo. 1991. Oceanographic and meteorological effects on autumn sea-ice distribution in the western Arctic. *Annals of Glaciology* 15: 171–177.
- Münchow, A., E. C. Carmack, and D. A. Huntley. 2000. Synoptic density and velocity observations of slope waters in the Chukchi and East Siberian Seas. *Journal of Geophysical Research* 105: 14103–14119.
- Münchow, A., T. Weingartner, and L. Cooper. 1999. The summer hydrography and surface circulation of the East Siberian Shelf Sea. *Journal of Physical Oceanography* 29: 2167–2182.
- Münchow, A., and E. C. Carmack. 1997. Synoptic flow and density observations near an Arctic shelf break. *Journal of Physical Oceanography* 6: 461–470.
- Paquette, R. G., and R. H. Bourke. 1981. Ocean circulation and fronts as related to ice melt-back in the Chukchi Sea. *Journal of Geophysical Research* 86: 4215–4230.
- Walsh, J. J., C. P. McRoy, L. K. Coachman, J. J. Goering, J. J. Nihoul, T. E. Whitledge, T. H. Blackburn, P. L. Parker, C. D. Wirick, P. G. Shuert, J. M. Grebmeier, A. M. Springer, R. D. Tripp, D. A. Hansell, S. Djenedi, E. Deleersnijder, K. Henriksen, B. A. Lund, P. Andersen, F. E. Müller-Karger, and K. Dean. 1989. Carbon and nitrogen cycling within the Bering/Chukchi seas: source regions for organic matter affecting AOU demands of the Arctic Ocean. *Progress in Oceanography* 22: 277–359.
- Walsh, J. J., D. A. Dieterle, F. E. Muller-Karger, K. Aagaard, A. T. Roach, T. E. Whitledge, and D. Stockwell. 1997. CO₂ cycling in the coastal ocean. II: Seasonal organic loading of the Arctic Ocean from source waters in the Bering Sea. *Continental Shelf Research* 17: 1–36.
- Weingartner, T., K. Aagaard, R. Woodgate, S. Danielson, Y. Sasaki, and D. Cavalieri. Circulation on the north-central Chukchi Sea shelf. 2005b. *Deep-Sea Research (II)* 52: 3150–3174.
- Weingartner, T. J., S. R. Okkonen, and S. L. Danielson. 2005c. Circulation and water-property variations in the nearshore Alaskan Beaufort Sea. Final Report, OCS Study No. MMS 2005-028. 103 pp.
- Weingartner, T. J., S. Danielson, Y. Sasaki, V. Pavlov, and M. Kulakov. 1999. The Siberian Coastal Current: a wind- and buoyancy-forced arctic coast current. *Journal of Geophysical Research* 104: 26697–29713.
- Weingartner, T. J., D. J. Cavalieri, K. Aagaard, and Y. Sasaki. 1998. Circulation, dense water formation, and outflow on the northeast Chukchi shelf. *Journal of Geophysical Research* 103: 7647–7661.
- Woodgate, R. A., K. Aagaard, and T. J. Weingartner. In press. Changes in the Bering Strait fluxes of volume, heat and freshwater between 1991 and 2004. *Geophysical Research Letters*.
- Woodgate, R. A., and K. Aagaard. 2005. Revising the Bering Strait freshwater flux into the Arctic Ocean. *Geophysical Research Letters* 32: L02602. [available at doi:10.1029/2004GL021747]

- Woodgate, R. A., K. Aagaard, and T. Weingartner. 2005. Monthly temperature, salinity, and transport variability for the Bering Strait throughflow. *Geophysical Research Letters* 32: L04601. [available at doi:10.1029/2004GL021880]
- Woodgate, R. A., K. Aagaard, and T. Weingartner. 2005. A year in the physical oceanography of the Chukchi Sea: moored measurements from autumn 1990–91. *Deep-Sea Research (II)* 52: 3116–3149.

SECTION III PLANKTONIC COMMUNITIES

RUSSEL D. HOPCROFT

PRINCIPAL INVESTIGATOR

INSTITUTE OF MARINE SCIENCES, UNIVERSITY OF ALASKA

FAIRBANKS, AK

1.0 INTRODUCTION

1.1 Brief History of Planktonic Biological Oceanography in the Chukchi Sea

The Chukchi Sea, in particular, represents a complex gateway into the Arctic Ocean, where variation in climate may have profound impacts due to the complex interplay of several distinct water masses of Pacific origin with those of the central Arctic Ocean and its marginal seas. Large quantities of Pacific nutrients, phytoplankton, and zooplankton enter the region through the Bering Strait in a complicated mixture of water masses (i.e., Alaska Coastal, Bering Shelf, and Anadyr Water), each with unique assemblages and quantities of zooplankton (Springer et al. 1989; Coyle et al. 1996). This inflow is diluted by Coastal Arctic waters carried along by the East Siberian Current and water carried in from the deeper waters of the Canada Basin or Chukchi Plateau (Grebmeier et al. 1995). The influx of the “rich” Pacific water determines the reproductive success of both the imported and resident zooplankton communities (Plourde et al. 2005). Both interannual and long-term variation in climate will affect the relative transport of these various water masses and, hence, the composition, distribution, standing stock, and production of zooplankton and their predators within the Chukchi Sea.

Historically, the zooplankton of the Western Arctic and Northern Bering Sea have not been well studied compared with most U.S. oceanographic regions because of the remoteness and extensive seasonal ice coverage. Much of what is known of the region comes from sporadic, spatially-restricted, and non-repeated surveys that often undertake incomplete analysis of their samples. Consequently, much of the research conducted does not appear in the primary scientific literature but remains buried in the “gray literature.” Although physical-oceanographic measurements typically have earlier histories, the first scientific records of planktonic work in the Bering Strait and Chukchi Sea appear to be those of Johnson (1934), Stepanova (1937), Bogorov (1939), and Jaschnov (1940), all of whom noted the significant influence of Pacific fauna in the Chukchi Sea.

Further work resumed after World War II, with the results of the early Russian sampling reported in Brodsky (1950, 1957), the English translation of which still remains a primary reference source for the region. Work more specific to this region appeared in Virketic (1952). North American work in the region initially maintained a quantitative and taxonomic dimension (Johnson 1953, 1956, 1958), but then interest waned. The results of the 1959 and 1960 Brown Bear cruises were never published as more than displacement volumes (English 1966) and, although the U.S. Coast Guard (USCG) Cutter Northwind appears to have sampled zooplankton in the Bering Strait and Chukchi Sea during the 1960s, the data are either unpublished or buried in the gray literature. Chukchi Sea collections by the USCG Glacier in 1970 as part of Western Bering Sea

Ecological Cruise (WEBSEC) were reported quantitatively (Wing 1974), while samples collected in the Northern Bering and Chukchi seas (Cooney 1977) by the OCSEAP (1960–1981) were never published as more than presence–absence data (although raw data still exist at UAF). Only limited additional quantitative zooplankton sampling occurred in the Chukchi Sea under the OCSEAP program (English and Horner 1977), as most effort became focused on the nearby waters of the Beaufort Sea (ibid; Redburn 1974; Horner 1981; Horner and Schrader 1984) and the southeastern Bering Sea (Cooney 1977; followed by PROBES, FOCI). It was the mid-1980s before quantitative sampling resumed in Bering Strait and the Chukchi Sea with the Inner Shelf Transfer and Recycling (ISHTAR) program (see below). Russian research in this region has undoubtedly continued since the 1950s, but the results are often buried in their own gray literature and are generally unavailable to the international community (see Herman 1989). No doubt, the relative paucity of information north of Bering Strait is a consequence of limited commercial harvesting there in comparison with the Bering Sea.

From the North American perspective, post OCSEAP science begins with the ISHTAR program in 1985 and 1986 (Springer et al. 1989) and, more peripherally, the 1994 Trans-arctic Section (Thibault et al. 1999) and the Surface Heat Budget of the Arctic (SHEBA) drift across the Chukchi Plateau in 1997–1998 (Ashjian et al. 2003). In the past decade, our knowledge of plankton in the Chukchi Sea and Western Arctic has improved considerably due to ongoing efforts such as NSF's SBI program (2002–2004) on the Beaufort and Chukchi shelves (e.g., Plourde et al. 2005; Llinas 2007; Lane et al. 2008), plus cross-sea cruises by NOAA's RUSALCA Program (e.g., Lee et al. 2007; Hopcroft and Kosobokova, in review), and the Northward extension of the Bering–Aleutian Salmon International Survey (BASIS) into the Chukchi Sea beginning in 2006. More limited sampling in the Chukchi has occurred during northward transit of Canadian ice breakers during the past decade, and the Japanese ship Oshoro Maru began last year extending its annual cruise into northward into the Chukchi Sea.

A notable exception to the political boundaries imposed on most post-WWII sampling in the Bering and Chukchi seas has been the Joint U.S.-USSR Central Pacific Expedition (BERPAC) program. Five such cruises were executed between 1977 and 1993 (Tsyban 1999). BERPAC 1988 is particularly relevant to this proposal because it encompassed stations from the southern Bering Sea to the mid-Chukchi Sea (Kulikov 1992). The RUSALCA program, which begun sampling in 2004, re-sampled in 2008 and will again in 2012, continues this bi-national sampling effort.

A regional and basin-wide review of Arctic zooplankton, their composition, seasonal life cycles, and trophic interactions was completed nearly two decades ago (Smith and Schnack-Schiel 1990). The review emphasizes the larger copepods in the genus *Calanus*. A more recent effort emphasizing the Russian literature for just the Bering Sea has also been completed (Coyle et al. 1996). One common shortcoming of all this initial work is that sampling techniques were not standardized; in particular, the use of only a single net of 303 to ~600 micrometer (μm) mesh as employed in these studies missed the majority of the zooplankton community numerically and missed a substantial proportion of the community biomass and diversity. For the most part, Arctic studies have now standardized on 150- μm mesh nets (e.g., Kosobokova and Hirche 2000; Ashjian et al. 2003; SBI and OE program) that more completely sample the numerically-dominant copepods in the genera *Oithona*, *Oncaea*, *Microcalanus*, and *Pseudocalanus* (ibid; Auel and Hagen 2002; Hopcroft et al. 2005). In fact, to ensure that all

developmental stages of these species, including nauplii, are sampled, a mesh as fine as 53 μm is required (Hopcroft et al. 2005). While these more recent studies have been conducted primarily in deeper waters, an even greater contribution of smaller neritic species occurs on the Chukchi shelf (Hopcroft et al. 2009, 2010a,b) consistent with observations from other shallow Arctic shelves where finer-meshed nets have been employed (e.g., Grice 1962; Conover and Huntley 1991).

Although we now have a fairly complete description of the species that have been found regionally in the Arctic (e.g., Sirenko 2001), we still lack unbiased and comprehensive estimates of the abundance, biomass, and composition of the zooplankton in the Chukchi Sea due to sampling inadequacies of the past. Significant progress is finally being made toward this end by programs such as RUSALCA, SBI, the oil and gas industry, and various international programs. Within the Chukchi Sea, there is notable diversity of both small and large jellyfishes, hydromedusae, and ctenophores that are often overlooked: more than a dozen species were encountered in RUSALCA 2004 (Hopcroft et al. 2010a), and more are reported from the nearby deep basins (Raskoff et al. 2005, 2010). There were also considerable populations of larvaceans, particularly the large arctic *Oikopleura vanhoeffeni* throughout the sampling area. Larvaceans are increasingly implicated as key players in polar systems (e.g., Acuna et al. 1999; Deibel et al. 2005; Hopcroft et al. 2005, 2010a,b) due to their high grazing and growth rates. At times, the biomass of larvaceans can rival that of the copepods, particularly at the ice-edge stations (Hopcroft et al. 2010a). Shifts from copepod-dominated communities to larvacean-dominated can have large consequences on the export of phytoplankton to the benthos (Gorsky and Feanaux 1998; Alldredge 2005). As in many arctic ecosystems, chaetognaths remain an important and neglected predatory group (Ashjian et al. 2003; Hopcroft et al. 2005, 2010; Lane et al. 2008, Kosobokova and Hopcroft 2010). The meroplanktonic larvae of benthic organisms were also exceptionally common throughout the sampling region in 2004, and better knowledge of their abundance and distribution is of high relevance to understanding recruitment to the rich benthic communities in this region. To a large extent, the spatial distribution of these zooplankton communities is tied to the different water masses present in this region (Hopcroft et al. 2010).

In the early 1980s the ISHTAR program estimated that 1.8 million metric tons of Bering Sea zooplankton are carried into the Chukchi Sea annually (Springer et al. 1989) and that this, along with the entrained phytoplankton communities, are responsible for the high productivity of the Chukchi Sea in comparison with adjoining regions of the Arctic Ocean (e.g., Plourde et al. 2005). The multi-year observations by the ISHTAR program also show the high interannual variability in the timing and extent ice retreat in the Chukchi Sea leads to large interannual variability in the production and structure of the ecosystem (Turco 1992a,b) as confirmed by recent observations (Hopcroft et al. 2009, 2010b). All observation to date indicate that in summer of 2004, the southern and eastern central Chukchi zooplankton fauna is primarily Pacific in character, and there are clear signs that Pacific species are carried northward as far as the eastern side of Wrangel Island and Harold Canyon (Hopcroft et al. 2010), while in the northeastern Chukchi transitions to fully Arctic communities do not occur until the shelf break (Lane et al. 2008). Ongoing climate-related changes in the Chukchi Sea are anticipated to transport even more Pacific zooplankton through Bering Strait, with even further penetration into the Arctic. Changes in the transport rates and the seasonal temperature cycle ultimately affect the species-composition of this region as well as the absolute zooplankton biomass, and such shifts may result in changes in the size-structure of zooplankton communities. Since most higher trophic levels select their prey based on

size, the consequences of size-structure shifts could be as, if not more, important than changes in zooplankton biomass.

1.2 Objectives of Study

The primary objective is to describe spatial, seasonal and inter-annual characteristics of the plankton (phytoplankton and zooplankton) communities with specific detail in the three study areas. Secondly, we will obtain opportunistic samples of zooplankton where bowhead whales are observed feeding to determine both the type of prey as well as the concentration that elicits bowhead feeding activity.

2.0 METHODS AND PROCEDURES

2.1 Sampling or Survey Design and Technical Rationale

We propose to sample two 30 X 30 m box, with a grid of 5 X 5 stations, at ~7.5-m spacing, within Klondike and Burger, and one irregular shaped box (Statoil) of ~900 sq m consisting of 22 stations at ~7.5 m spacing twice in 2011. A broader scale survey will be conducted consisting of 84 additional stations at ~15-m spacing. Both phytoplankton (as chlorophyll) and zooplankton will be sampled at all stations because the phytoplankton is the major prey for the zooplankton and for the benthos once it settles. Together, nutrients, phytoplankton, and zooplankton form effective biological tracers of the waters masses present in this region.

In general, re-sampling of fixed sampling locations over time along transects/grids (a model-based rather than a probability-based design) will provide the highest power for statistical comparisons between years (but limit inferences) and will result in spatially and temporally correlated data. Thus, statistical methodologies considered will include methods for analyzing data in the presence of correlated error structures (e.g., linear models through SAS Proc Mixed, SAS Institute, Cary, NC, or geostatistical methods) and multivariate procedures. Additional sets of collections will be conducted in any area where bowhead whales are observed to feed, with a pair of collections taken inside the feeding area and a pair taken outside for reference.

2.2 Field Team Size and Composition

The field team will consist of two personnel on both cruises Jennifer Questel will train incoming student Pallavi Hariharan during the first biology cruise. Hariharan and Questel (or an alternate) will staff the second cruise. Questel will travel to Seward in early July to inventory supplies and equipment at the ship. Assistance will be provided for launch and recovery of gear from Aldrich Offshore Services (AOS) technicians.

2.3 Data-collection Procedures

Routine methods are nearly identical to COP's 2008 and 2009 program, as well as similar to those employed during the 2004 and 2009 RUSALCA expeditions and the 2006 and 2007 BASIS cruises. Phytoplankton will be assessed as chlorophyll a concentration from samples collected with a CTD rosette on upcasts at 6 depths/station (0, 5, 10, 20, 30 m, and near-bottom). Samples (~500 milliliters [ml]) will be filtered under low pressure onto a Whatman GF/F filters, with extracted chlorophyll a being determined

fluorometrically post-cruise from frozen samples (Parsons et al. 1984) for all stations. Measurements will be used to calibrate the in vivo fluorescence profiles measured at all stations. Nutrient samples will be taken from the same bottles as chlorophyll, frozen immediately, and measured for all stations post-cruise using an Alpkem Rapid Flow Analyzer (Whitledge et al. 1981); analyses will conform to WOCE standards (Gordon et al. 1993).

Zooplankton will be collected routinely by a pair of 150- μm mesh Bongo nets of 60-cm diameter hauled vertically at 0.5 m s⁻¹ from within 3 m of the bottom; the volume of water filtered will be measured by SeaGear flow meters in each net that are rigged not to spin during descent. To target larger, more mobile zooplankton, a set of 60-cm-diameter 505- μm Bongo nets equipped with General Oceanic flow-meters will be deployed in a double-oblique tow while the ship is moving at 2 knots. Opportunistic samples of zooplankton where bowhead whales are observed feeding will employ only the 505- μm net because they exploit only larger prey items. Upon retrieval, one sample of each mesh size will be preserved in 10% formalin, and the other in 95% non-denatured ethanol (required for molecular identification).

2.4 Analytical Procedures

Formalin-preserved samples will be processed for quantitative determination of species - composition and biomass (predicted) at alternate stations only, as per previous years. During laboratory processing, all larger organisms (primarily shrimp and jellyfishes) will be removed, enumerated, and weighed; then, the sample will be Folsom split until the smallest subsample contains about 100 specimens of the most abundant taxa. The most abundant taxa will be identified, copepodites will be classified to stage, and will be enumerated and measured (Roff and Hopcroft 1986). Each larger subsample will be examined to identify, measure, enumerate, and weigh the larger, less-abundant taxa. The three lead zooplankton technicians at UAF each have been working in Alaska waters from 8–20 years. When needed, specimens will be compared with the voucher set housed at UAF or will be sent to an appropriate taxonomic expert.

To estimate biomass, blotted wet weights of larger animals will be weighed directly, whereas the weight of smaller animals will be predicted from measurements of length using species-specific relationships. Wet-weight measurements are generally taken to ± 10 micrograms (μg) (or as needed for length-weights to ± 0.1 μm). Measured weights will be periodically compared to those predicted from length-weight equations to compare the two methods. The data will be uploaded to an Excel and/or Microsoft Access database for sorting and analysis. At present, multidimensional scaling of similarity or dissimilarities between samples has proven an effective method of revealing distributional patterns (Coyle and Pinchuk 2003, 2005; Hopcroft et al. 2010a,b) and will be conducted with the Primer software package.

Ethanol samples will be scanned for representatives of the species and contribute to a growing international “molecular bar-coding” library lead by the Census of Marine Zooplankton (CMarZ) at the University of Connecticut focused on the Cytochrome Oxidase I gene. This gene’s sequence has been identified for the universal molecular “bar-coding” of eukaryotic organisms (Hebert et al. 2003) and is currently being employed for global analysis of zooplankton (e.g., Bucklin et al. 2003, 2010). Initially, these sequences will simply serve to catalogue the species encountered, but they

ultimately will become the preferred method of ensuring taxonomic consistency of identification within long-term studies. We will also use molecular approaches to look at species-specific patterns with the most abundant calanoid copepod genus, *Pseudoclanus*, a species complex thought to hold a sensitive signal of Pacific water mass penetration in the Arctic (Hopcroft and Kosobokova 2010).

2.5 Data-storage Procedures

Data files collected during cruises will be backed up periodically, and multiple copies will be transported back to UAF at the completion of each cruise along with copies of notebooks. At UAF, data are backed up routinely onto departmental servers.

2.6 Quality-control Procedures

In the field, samples are always collected in duplicate, so any discrepancy in the flowmeter readings become readily apparent. Replicate samples are not routinely analyzed but serve as insurance in the event that one sample is compromised. Periodically, the same subsamples are processed by several technicians to ensure taxonomic consistency. When taxonomic questions arise, specimens will be compared with the voucher set housed at UAF, will be sent to an appropriate taxonomic expert, or will be identified through emerging molecular-identification libraries.

3.0 COORDINATION

3.1 Olgoonik-Fairweather

The PI, or an alternate team member, will attend all proposed meeting and interact regularly as needed with OLF.

3.2 Other Studies in the Chukchi Sea Program

The PI regularly interacts with other PI currently at UAF and has a long collaborative relationship with Drs. Weingartner, Blanchard and Mathis, in particular, through the GLOBEC and NPRB Seward Line time-series. Dr. Hopcroft oversaw a recent multidisciplinary synthesis of studies from the Chukchi and Beaufort region, which has connected him to investigators in many other disciplines.

3.3 Current Studies in the Region

Recent and ongoing studies have been described in Section 1.1. Hopcroft is a PI within the NOAA-funded RUSALCA program begun in 2004, which re-sampled a broad domain of the Chukchi Sea in September 2009 and will again in 2012. He interacts routinely with most other zooplankton researchers working in the Chukchi and Beaufort Seas, as well as in the deep Canada Basin. Dr. Hopcroft is also a lead PI in the ongoing Arctic Ocean Biodiversity project (www.arcodiv.org), which, among other goals, is compiling biological data from the Chukchi Sea, in conjunction with colleagues and ongoing efforts by NOAA-NMFS, ArcOD has digital access to much of the zooplankton data from OCSEAP, ISHTAR, WEBSEC, SBI, Ocean Exploration cruises. Recently, many of these datasets have been made available on-line.

4.0 DELIVERABLES

4.1 Data

Quality control of sampling activities will be returned within 30 days of receipt from OLF. QCed electronic biological data (and any geo-referenced images) will be submitted by 1 June 2012.

4.2 Draft Report

Provided samples can be shipped to UAF at the completion of each cruise, the Draft Report, including appendices with sample analysis, will be submitted by 1 June 2012.

4.3 Final Report

The Final Report will be submitted 15 August 2012 or within 30 days of receipt of comments on the Draft Report.

5.0 SCHEDULE WITH MILESTONES

5.1 Field Studies

- Late June 2011 – Warehouse inventory check (Anchorage)
- July 6-10th 2011— Planning meeting, HSE and cold-water training (Anchorage)
- July 10th 2011 – Ship walkthrough and inventory check in Seward
- August–mid October 2011—Scientific Cruises

5.2 Coordination Meetings

- April 2011—OLF Chukchi Sea scientific studies kickoff meeting, and scientific studies coordination meeting – meeting continue at a weekly or fortnightly schedule as needed until project completion.
- July 2011—OLF coordination meeting in conjunction with HSE (Anchorage)
- December Nov 2011—OLF Chukchi Sea scientific studies debriefing. Anchorage, AK (1 day)
- Jan 2012—Chukchi Sea PI meeting
- Jan 2012—AMSS, Anchorage (4 days), plus associated meetings

5.3 Deliverables

- Final Study Plan for the plankton component—15 May 2011.
- Field data—within 30 days of final cruise.
- Draft Report—1 June 2012.
- Final Report—15 August 2012 or within 30 days of receipt of comments on Draft Report.

6.0 REFERENCES

- Acuna, J. L., D. Deibel, A. B. Bochdansky, and E. Hatfield, E. 1999. In situ ingestion rates of appendicularian tunicates in the Northeast Water Polynya (NE Greenland). *Marine Ecology Progress Series* 186: 149–160.
- Allredge, A. 2005. The contribution of discarded appendicularian houses to the flux of particulate organic carbon from oceanic surface waters. In G. Gorsky, M. J. Youngbluth, and D. Deibel (Eds.). *Response of marine ecosystems to global change: ecological impact of appendicularians*. Gordon and Breach, Paris, France. Pp. 309–326.
- Ashjian, C. J., R. G. Campbell, H. E. Welch, M. Butler, and D. V. Keuren. 2003. Annual cycle in abundance, distribution, and size in relation to hydrography of important copepod species in the western Arctic Ocean. *Deep-Sea Research (I)* 50: 1235–1261.
- Auel, H., and W. Hagen. 2002. Mesozooplankton community structure, abundance and biomass in the central Arctic Ocean. *Marine Biology* 140: 1013–1021.
- Bogorov, V. G. 1939. The characteristics of seasonal phenomena in the plankton of the Arctic seas and their significance for ice forecastings. *Zoologicheskii Zhurnal* 18 (5): [in Russian].
- Brodsky, K. A., 1950. Copepods (Calanoida) of the far-eastern seas of the USSR and the polar basin. Zoological Institute of the Academy of Sciences of the USSR, Leningrad.
- Brodsky, K. A., 1957. The copepod fauna (Calanoida) and zoogeographic zonation of the North Pacific and adjacent waters. Akademiya Nauk SSSR, Leningrad.
- Bucklin, A., B. W. Frost, J. Bradford-Grieve, L. D. Allen, and N. J. Copley. 2003. Molecular systematic and phylogenetic assessment of 34 calanoid copepod species of the Calanidae and Clausocalanidae. *Marine Biology* 142: 333–343.
- Bucklin, A., R.R. Hopcroft, K.N. Kosobokova, L.M. Nigro, B.D. Ortman, C.J. Sweetman and R.M. Jennings. 2010. DNA barcoding of Arctic Ocean holozooplankton for species identification and recognition *Deep-Sea Research II*. 57:40-48
- Conover, R. J., and M. Huntley. 1991. Copepods in ice-covered seas—distribution, adaptations to seasonally limited food, metabolism, growth patterns, and life-cycle strategies in polar seas. *Journal of Marine Systematics* 2: 1–41.
- Cooney, R. T. 1977. Zooplankton and micronekton studies in the Bering-Chukchi/Beaufort seas. NOAA OCSEAP Annual Reports 10: 275–363.
- Coyle, K. O., V. G. Chavtur, and A. I. Pinchuk. 1996. Zooplankton of the Bering Sea: a review of Russian-language literature. In A. O. Mathisen and K. O. Coyle (Eds.). *Ecology of the Bering Sea: a review of the Russian literature*. Alaska SeaGrant College Program, University of Alaska, Fairbanks, AK. Pp. 97–133.
- Coyle, K. O., and A. I. Pinchuk. 2003. Annual cycle of zooplankton abundance, biomass and production on the northern Gulf of Alaska shelf, October 1997 through October 2000. *Fisheries Oceanography* 12: 227–251.
- Coyle, K. O., and A. I. Pinchuk. 2005. Cross-shelf distribution of zooplankton relative to water masses on the northern Gulf of Alaska shelf. *Deep-Sea Research (II)* 52: 217–245.
- Deibel, D., P. A. Saunders, J. L. Acuna, A. B. Bochdansky, N. Shiga, and R. B. Rivkin. 2005. The role of appendicularian tunicates in the biogenic carbon cycle of three Arctic polynyas. In G. Gorsky, M. J. Youngbluth, and D. Deibel (Eds.). *Response*

- of marine ecosystems to global change: ecological impact of appendicularians. Gordon and Breach, Paris, France. Pp. 327–356.
- English, T. S. 1966. Net plankton volumes in the Chukchi Sea. In N. J. Wilimovsky, and J. N. Wolfe (Eds.). Environment of the Cape Thompson region, Alaska. U.S. Atomic Energy Commission, Washington, DC. Pp. 809–915.
- English, T. S., and R. Horner. 1977. Beaufort Sea plankton studies. NOAA OCSEAP Annual Reports 9: 275–627.
- Gordon, C., A. A. Jennings, and J. M. Krest. 1993. A suggested protocol for continuous flow automated analysis of seawater nutrients (phosphate, nitrate, nitrite, and silicic acid) in the WOCE Hydrographic Program and the Joint Global Ocean Fluxes Study. Oregon State University, Corvallis, OR. P. 51.
- Gorsky, G., and R. Fenaux. 1998. The role of Appendicularia in marine food chains. In Q. Bone (Ed.). The biology of pelagic tunicates. Oxford University Press, New York, NY. Pp. 161–169.
- Grebmeier, J. M., W. O. Smith, Jr., and R. J. Conover. 1995. Biological processes on Arctic continental shelves: ice-ocean-biotic interactions. In W. O. Smith, Jr., and J. M. Grebmeier (Eds.). Arctic oceanography: marginal ice zones and continental shelves. American Geophysical Union, Washington, DC. Pp. 231–261.
- Grice, G. D. 1962. Copepods collected by the nuclear submarine Seadragon on a cruise to and from the North Pole, with remarks on their geographic distribution. Journal of Marine Research 20: 97–109.
- Hebert, P. D. N., A. Cywinska, S. L. Ball, and J. R. deWaard. 2003. Biological identifications through DNA barcodes. Proceedings of the Royal Society of London (B) 270: 313–321.
- Hopcroft, R. R., C. Clarke, R. J. Nelson, and K. A. Raskoff. 2005. Zooplankton communities of the Arctic's Canada Basin: the contribution by smaller taxa. Polar Biology 28: 197–206.
- Hopcroft, R. R., J. Questel and C. Clarke-Hopcroft. 2009. Oceanographic assessment of the planktonic communities in the Klondike and Burger prospect regions of the Chukchi Sea: Report for Survey year 2008. University of Alaska, Fairbanks
- Hopcroft, R. R., and K. N. Kosobokova. 2010. Distribution and production of Pseudocalanus species in the Chukchi Sea. Deep-Sea Research II. 57:49-56
- Hopcroft, R. R., K. N. Kosobokova and A.I. Pinchuk. 2010a. Zooplankton community patterns in the Chukchi Sea during summer 2004. Deep-Sea Research II. 57:27-39.
- Hopcroft, R. R., J. Questel and C. Clarke-Hopcroft. 2010b. Oceanographic assessment of the planktonic communities in the Klondike and Burger prospect regions of the Chukchi Sea: Report for Survey year 2009. University of Alaska, Fairbanks
- Horner, R. 1981. Beaufort Sea plankton studies. NOAA OCSEAP Final Reports 13: 65–314.
- Horner, R. 1984. Analysis of Harrison Bay zooplankton samples. NOAA OCSEAP Final Reports 25: 65–314.
- Huntley, M. E., 1996. Temperature and copepod production in the sea: a reply. American Naturalist 148: 407–420.
- Jaschnov, V. 1940. Plankton productivity of the northern seas of the USSR. Moscovskoe Obshestvo Ispytatelei Prirody Press, Moscow, Russia.

- Johnson, M. W. 1934. The production and distribution of zooplankton in the surface waters of the Bering Sea and Bering Strait, Part II. Report of the oceanographic cruise U.S. Coast Guard Cutter Chelan—1934. Pp. 45–82.
- Johnson, M. W., 1953. Studies on the plankton of the Bering and Chukchi Seas and adjacent areas. Proceedings 7th Pacific Science Congress (1949), Vol. 4, 'Zoology'. Pp. 480–500.
- Johnson, M. W., 1956. The plankton of the Beaufort and Chukchi Sea areas of the Arctic and its relation to hydrography. Arctic Institute of North America, Montreal, Canada.
- Johnson, M. W. 1958. Observations on inshore plankton collected during the summer 1957 at Point Barrow, Alaska. *Journal of Marine Research* 17: 272–281.
- Kosobokova, K., and H.-J. Hirche. 2000. Zooplankton distribution across the Lomonosov Ridge, Arctic Ocean: species inventory, biomass and vertical structure. *Deep-Sea Research (I)* 47: 2029–2060.
- Kosobokova, K. N. and R. R. Hopcroft. 2010. Diversity and vertical distribution of mesozooplankton in the Arctic's Canada Basin. *Deep-Sea Research II*. 57: 96-110
- Kulikov, A. S. 1992. Characteristics of zooplankton communities. In P. A. Nagel (Ed.). Results of the third Joint US–USSR Bering and Chukchi seas expedition (BERPAC), summer 1988. U.S. Fish and Wildlife Service, Washington, DC. Pp. 161–XXX.
- Lane, P. V. Z., L. Llinás, S. L. Smith, and D. Pilz. 2008. Zooplankton distribution in the western Arctic during summer 2002: hydrographic habitats and implications for food chain dynamics. *Journal of Marine Research* 70: 97–133.
- Lee, S. H., T. E. Whitley, and S.-H. Kang. 2007. Recent carbon and nitrogen uptake rates of phytoplankton in Bering Strait and the Chukchi Sea. *Continental Shelf Research* 27: 2231–2249.
- Llinás, L. 2007. Distribution, reproduction, and transport of zooplankton in the western Arctic, University of Miami, Coral Gables, FL.
- Parsons, T. R., Y. Maita, and C. M. Lalli. 1984. A manual for chemical and biological methods in seawater. Pergamon Press, Toronto, Canada.
- Plourde, S., R. G. Campbell, C. J. Ashjian, and D. A. Stockwell,. 2005. Seasonal and regional patterns in egg production of *Calanus glacialis/marshallae* in the Chukchi and Beaufort seas during spring and summer, 2002. *Deep-Sea Research (II)* 52: 3411–3426.
- Raskoff, K. A., R. R. Hopcroft, K. N. Kosobokova, M. J. Youngbluth, and J. E. Purcell. 2010. Jellies under ice: ROV observations from the Arctic 2005 Hidden Ocean Expedition. *Deep-Sea Research II*. 57:111-126.
- Raskoff, K. A., J. E. Purcell, and R. R. Hopcroft. 2005. Gelatinous zooplankton of the Arctic Ocean: in situ observations under the ice. *Polar Biology* 28: 207–217.
- Redburn, D. R. 1974. The ecology of the inshore marine zooplankton of the Chukchi Sea near Point Barrow, Alaska. M.S. thesis, University of Alaska, Fairbanks, AK.
- Roff, J. C., and R. R. Hopcroft. 1986. High precision microcomputer based measuring system for ecological research. *Canadian Journal of Fisheries and Aquatic Sciences* 43: 2044–2048.
- Sirenko, B. I. 2001. List of species of free-living invertebrates of Eurasian arctic seas and adjacent deep waters. Russian Academy of Sciences, St. Petersburg, Russia.

- Smith, S. L. 1990. Egg production and feeding by copepods prior to the spring bloom of phytoplankton in Fram Strait, Greenland Sea. *Marine Biology* 106: 59–69.
- Springer, A. M., C. P. McRoy, and K. R. Turco. 1989. The paradox of pelagic food webs in the northern Bering Sea. II: Zooplankton communities. *Continental Shelf Research* 9: 359–386.
- Stepanova, V. S. 1937. Biological indicators of currents in the northern Bering and southern Chukchi Seas. *Issled. Morei SSSR* 25: 175–216 [in Russian].
- Thibault, D., E. J. H. Head, and P. A. Wheeler. 1999. Mesozooplankton in the Arctic Ocean in summer. *Deep-Sea Research (I)* 46: 1391–1415.
- Tsyban, A. V. 1999. The BERPAC pProject: development and overview of ecological investigations in the Bering and Chukchi seas. In T. R. Loughlin and K. Ohtani (Eds.). *Dynamics of the Bering Sea*. Alaska SeaGrant College Program, University of Alaska, Fairbanks, AK. Pp. 713–731.
- Turco, K. 1992a. Zooplankton taxa, abundance and biomass data. ISHTAR Data Report No. 6, Part 1 (1985-1987). Institute of Marine Science, University of Alaska Fairbanks, Fairbanks, Alaska
- Turco, K. 1992b. Zooplankton taxa, abundance and biomass data. ISHTAR Data Report No. 6, Part 2 (1988-1989). Institute of Marine Science, University of Alaska Fairbanks, Fairbanks, Alaska
- Virketis, M. 1952. Zooplankton of the Chukchi Sea and Bering Strait. In K. A. Brodsky (Ed.). *The extreme north-east of the USSR. 2. Fauna and flora of the Chukchi Sea*. Akademiya Nauk SSSR, Moscow, USSR. XXX pp. [in Russian].
- Whitledge, T. E., S. C. Malloy, C. J. Patton, and C. D. Wirick,. 1981. Automated nutrient analyses in seawater. Brookhaven National Laboratory, Upton, NY. 216 pp.
- Wing, B. L. 1972. Preliminary report on the zooplankton collected on WEBSEC-70. In M. C. Ingham, B. A. Rutland, P. W. Barnes, G. E. Watson, G. J. Divoky, A. S. Naidu, G. D. Sharma, B. L. Wing, and J. C. Quast (Eds.). *An ecological survey in the eastern Chukchi Sea*. U.S. Government, Washington, DC.

SECTION IV BENTHIC COMMUNITIES OF THE BURGER, KLONDIKE, AND STATOIL SURVEY AREAS IN THE CHUKCHI SEA

**ARNY L. BLANCHARD
PRINCIPAL INVESTIGATOR
INSTITUTE OF MARINE SCIENCES, UNIVERSITY OF ALASKA
FAIRBANKS, AK**

1.0 INTRODUCTION

1.1 Brief history of Subject Research in Chukchi Sea

The last 30 years have seen tremendous development and resource use in Arctic Alaska. Development and extraction of petroleum reserves and associated industrial and urban growth has increased the potential for adverse anthropogenic effects on the environment (Naidu et al., 1997). Concern for the Arctic environment is growing and efforts continue to be directed towards understanding the Arctic and its seas, including the Chukchi Sea (Hopcroft et al., 2006). In the Chukchi Sea, cultural and subsistence resources of interest mainly include marine mammals and sea birds, some of which feed on sediment-dwelling (benthic) organisms (e.g., Lovvorn et al., 2003; Grebmeier et al., 2006). These resources in the Chukchi Sea are of great cultural and economic value to a broad variety of stakeholders including Native subsistence hunters, environmental organizations, and those interested in extracting resources of economic value. Disturbance to the short food chains in the arctic has the potential for large effects on higher trophic levels making assessment of benthic community species composition and structure important components for monitoring.

The first quantitative investigation of macrobenthic community structure in the northeast Chukchi Sea was performed in 1971 to 1974 by Stoker (1978). This study was followed in 1986 by investigations of benthos/environmental interactions by Feder et al. (1994b) who assessed community structure of infauna (organisms that live within the sediments) and of pelagic/benthic coupling by Grebmeier et al. (1988). A rich epifaunal community (organisms that live on top of the sediments) is also known for the area including mollusks, crabs, and echinoderms (e.g., Feder et al., 1994a; Ambrose et al., 2001). These studies provided insights into the benthic fauna present and factors structuring infaunal communities. The benthic biomass of the region is high in spite of the seasonal ice cover due to the tight coupling of pelagic and ice-edge primary production and benthic community structure and production (Grebmeier et al., 2006). In addition to the present environmental baseline study performed in 2008 and 2009, investigations in the region include the Shelf-Basin interaction study (SBI; <http://sbi.utk.edu>), and the Russian-American Long-term Census of the Arctic (RUSALCA) investigating ecosystem dynamics, food-webs, and benthic ecology.

The northeastern Chukchi Sea is a productive shallow sea influenced by advective processes (Grebmeier et al., 2006). Water advected into the region includes Bering Shelf (BSW) and Alaska Coastal water (ACW) (e.g., Coachman, 1987). The BSW has

relatively high nutrient concentrations (derived in part from water from the Gulf of Anadyr off Russia) that enhance benthic biomass whereas the ACW along the Alaska coast is comparatively nutrient poor (Feder et al., 1994b; Codispoti et al., 2005; Grebmeier et al., 2006). The differences in nutrient concentrations in water masses lead to substantial differences in primary production, and thus, benthic community structure (Feder et al., 1994b, 2005, 2007) and benthic food web structure (Iken et al. 2010). Factors influencing benthic community structure of the Chukchi Sea include sediment granulometry, and sediment organic carbon to nitrogen ratios (C/N ratio) (Feder et al., 1994b). Sediment granulometry (e.g., percent gravel, sand, or mud) reflects a number of environmental processes, including hydrodynamics (strong currents, storms, ice gouging, etc.), sediment deposition, and proximity to sediment sources. The C/N ratio in sediments reflects availability of particulate organic carbon to benthic animals, which is of particularly high nutrient value when derived from phytoplankton as opposed to terrigenous carbon.

The benthic fauna in the Chukchi Sea and northern Bering Sea are an important prey resource for higher trophic level organisms such as fishes, walrus, and gray whales (e.g. Oliver et al., 1983; Barber et al., 1997; Moore et al., 2003; Highsmith et al., 2006; Bluhm et al., 2007). Traditional feeding hot spots are located south of St. Lawrence Island and the Chirikov Basin (both Bering Sea) and the south-central Chukchi Sea, but recent marine mammal observations have shown that these hotspots may be changing because of changes in sea ice as resting platforms for walrus and seals between feeding bouts and in the benthic community structure. While the survey areas of the NE Chukchi Sea in the present study are not known as important feeding grounds for gray whales, there is the possibility that these areas may become feeding grounds in the future. Therefore, the benthic studies suggested here will be an opportunity to provide valuable baseline information, should these areas become more important for marine mammals and birds in the future.

1.2 Purpose of Study and Rationale

This is the fourth year of sampling for the Chukchi Sea Environmental Studies Program (CSESP) to collect benthic macrofaunal invertebrates within the northeastern Chukchi Sea encompassing the Burger, Klondike, and Statoil Survey areas and Hanna Shoal. The work in the survey areas will continue investigation of benthic ecology component in the CSESP and provide background information for environmental impact statements and future monitoring efforts (Blanchard et al., 2010 a and b).

1.3 Objectives

The objective of this study is to understand the ecology of macrobenthic fauna in the Burger, Klondike, and Statoil survey areas and the broader region surrounding the three survey areas and Hanna Shoal. This addresses the benthic ecology component of the 2011 environmental studies program in the Chukchi Sea. The scope of work in the 2011 proposal includes field sampling for infauna with a van Veen grab and a Haps corer, as well as collection of samples for tissue isotope analysis and sediments for isotope, grain-size, and chlorophyll a determinations. The field portion of the scope of work for 2011 also includes a survey of epifauna using digital and video photography. The scope of work also encompasses the non-field components including laboratory analyses of samples collected, statistical analyses of macrofauna data, analysis of digital photo-

graphs of benthic communities from field surveys, continuation of photo archiving, and reporting. Specific objectives of the proposed work are:

Task 1: Benthic ecology: Infauna.

- Sample the sediment-dwelling invertebrates (infauna) within the Chukchi Sea to assess species composition, abundance and biomass of communities within the study area and to document community structure,
- Sample the benthos where marine mammals might be observed feeding in the area,
- Continue measurement of tissue carbon and nitrogen isotope of key species for food web structure as necessary,
- Continue development of photo archive of infaunal species using digital microscopy,
- Develop database for benthic data sets including photo archival specimens.

Task 2: Benthic ecology: Infauna.

- Sample deeper-dwelling fauna with a Haps corer to assess species composition, abundance and biomass of communities of marine mammal prey deeper than the depth sampled by the van Veen grab.

Task 3: Benthic ecology: Epifauna.

- Sample the larger animals dwelling on the sediment surface (epifauna) to assess species composition and abundance quantitatively using digital photography,
- Determine, as possible from digital photography, the factors associated with community structure.

Task 4: Report results.

- Describe spatial variability of faunal communities over the larger study area in 2011,
- Determine associations of measured physical factors (as available from physical oceanography) to faunal community structure,
- Provide preliminary assessments of the potential linkages between infaunal and epibenthic communities, and
- Provide preliminary assessments of the potential linkages between macrofauna and higher predators.

Task 5: Statistical methodology.

- Refine an integrated statistical methodology for ecological data analysis for the CSESP team.

A multi-year record of variability is required to understand benthic communities and, to support this, sampling of selected sites will continue in 2011. The project is also expanded to encompass a larger area to gain insights into the ecology of the Hanna Shoal region. The isotope work and a portion of the community structure analyses will comprise MS theses for two students.

2.0 METHODS AND PROCEDURES

2.1 Sampling or Survey Design and Technical Rationale

In 2011, benthic sampling will include selected fixed stations in each survey area and the region surrounding the survey boxes as well as near Hanna Shoal. Sampling of infauna with a van Veen grab will be performed at 62 stations within the overall study area. Sampling of infauna will be accomplished using a Haps corer at a minimum of 50% of the infauna sites and up to 100%, as vessel time allows. Benthic sampling of surface dwelling communities will be performed using digital photography at a minimum of 50% and up to 100% of sampling stations, as vessel time allows.

2.2 Field Team Size and Composition

The benthic ecology field team will consist of three personnel for sampling infauna on two sampling cruises. The teams will be led by research technicians trained in field sampling.

2.3 Data Collection Procedures

Infaunal benthic invertebrates will be sampled with a double 0.1 m² van Veen grab sampler at 62 benthic stations. in 2011 encompassing the Burger, Klondike, and Statoi survey areas and Hanna Shoal. Methods will follow those outlined by Blanchard et al. (2010 a and b). Three samples will be collected at each station. Three replicate samples are generally considered as the minimum number for benthic studies due to the high variability within a station. Samples will be washed through a 1.0-mm-mesh stainless-steel screen until all that is left is biological material and larger sediments. Samples will be preserved in 10% hexamine-buffered formalin. In 2011, sub-samples will also be taken at each station and washed over smaller screens (0.5 mm) to document the presence of juvenile organisms on the sediment surface. Identifications of each organism will be made to the lowest practical taxon (likely family level with dominants identified to species), counted and weighed (blotted wet weight). Average faunal abundance (individuals m⁻²) and biomass (g m⁻²) will be estimated for each site. Additional information collected at time of sampling includes sampling depth and GPS coordinates. This information will be recorded for every grab sample taken. Samples will be shipped to Fairbanks from Wainwright at the appropriate crew change. Sediments for sediment-grain-size analyses will be collected from the first grab at each station. Surface sediments will also be collected for percent organic carbon and nitrogen determinations and separately for chlorophyll and phaeopigment concentrations. These sediment samples will be frozen until delivery to UAF.

Infauna will also be sampled using a Haps corer at selected sites within the study area. Two replicates will be expected to be collected at a minimum of 31 sampling stations and up to all 62 stations, as time allows (the number of stations dependent on equipment performance and time available for sampling and processing). These samples will be sieved over a larger screen (~ 3 mm mesh) to collect larger animals for taxonomic identification. Sample will be preserved and delivered to UAF in the same manner as infaunal samples described above.

Digital photography will be performed to capture still photographs and videos (as time allows) to quantitatively document the distribution and abundance of larger surface-dwelling animals. The photographic equipment will be provided by Aldrich Offshore Services. The photographic equipment includes a frame which rests on the sediment for photographing a 1 m² surface area as well as lasers with a separation width of 10 cm to assist with quantitatively documenting the scale and measuring animals. Three to five replicates of still photographs will be taken at a minimum of 50% of the infaunal stations (as time allows) and video transects taken at approximately 50% of the stations, as time allows.

2.4 Analytical Procedures

Benthic community data will be analyzed using appropriate and available statistical techniques. Descriptive measures, average abundance (ind. m⁻²), biomass (g wet weight m⁻²), number of taxa, and diversity measures are useful for summarizing benthic infaunal information. Transformations of data are often required to meet assumptions of normality when using parametric statistical methods and will be considered. Expected transformations include the $\ln(x+1)$ transformation for abundance data and the $\ln(x)$ transform for biomass data. Data will be analyzed as appropriate using a range of methods including analysis of variance, linear regression, cluster analysis, and multidimensional scaling. Geostatistical methods may also apply. The emphasis in these analyses will be to document community structure of the benthic communities and determine their spatial variability. Depending on availability of results from the other components of the CESP science team, such as physical oceanography and zooplankton ecology, other methods including canonical correspondence analysis, may be performed to assess baseline associations between infaunal communities and environmental factors. Sediments will be analyzed for gross sediment-grain-size characteristics (percent gravel, sand, and mud). Surface sediments will be analyzed for percent organic carbon and nitrogen by the University of Alaska's Stable Isotope Laboratory. Chlorophyll will be determined using the spectrophotometer by trained IMS personnel.

2.5 Data Storage Procedures

Growing data requirements and changes in the computing technology necessitate an upgrade to the existing benthic database. A MS Access benthic database entry system has been in use for a number of years and has eliminated transcription and data entry errors by over 95%. This database system has become outdated and is unable to incorporate the photo voucher or the digital photographs expected in 2011. Thus, a new database will be designed by a MS graduate student to incorporate the key aspects of the old database and developing needs. Consistent with prior methods, data for this project will be entered and stored in computer systems at UAF. The taxonomic names, counts, and wet biomass weights are entered and stored in the MS Access database but hard copies are printed out and archived as well. For the UAF system, backups of all data maintained there will be performed weekly. The data on the UAF computer system will be incorporated into databases and excel spreadsheets. The resulting data sets will be one of the project deliverables.

Voucher collections will be maintained at the University of Alaska Fairbanks. The voucher collection will include at least one representative specimen of each species

identified in the study. Specimens will be evaluated by a taxonomic specialist to ensure correct identification as necessary. Remaining biological specimens will be stored at IMS. Sorted sediment remains are not considered to be part of the biological samples and will be discarded once the sorting has been checked for accuracy. The identifications of voucher specimens will be confirmed by experts as necessary.

2.6 Quality Control Procedures

The following quality control procedures are followed in processing samples. The work of sorters is monitored throughout the project. At a minimum, 10%, but more often up to 50%, of samples sorted by student employees are checked as students are trained. Of the samples checked, the sorted material is examined to be certain that 100% of the organisms in each sample are removed. One hundred percent of the work performed by junior taxonomists is checked and verified by a senior taxonomist until trained. Work is verified to ensure that all counts are accurate and all organisms are correctly identified. A voucher collection is maintained at IMS and includes examples of organisms found throughout a thirty-year study period in Port Valdez and past studies in the Chukchi Sea conducted in 1986. These collections are used to ensure that identification of organisms is consistent from year to year and may be sent to experts and museums for identifications and archiving. Sorted debris from each annual survey collection will be discarded once quality control checks have been performed.

3.0 COORDINATION

3.1 OLF

Logistical support will be provided directly by Olgoonik/Fairweather LLC. This includes purchasing, transport, and loading of sampling gear on the vessel, purchasing of tickets for the sampling crews to travel to Wainwright, and associated travel costs (air and hotels). The PI and research technicians will attend meetings and interact as needed by Olgoonik/Fairweather LLC.

4.0 DELIVERABLES

4.1 Field Data

Field data deliverables include the benthic abundance and biomass, sediment and tissue isotope ratios, and environmental data (chlorophyll, phaeopigments, grain size) for benthic stations sampled in 2011 in a spreadsheet format by June 1, 2012. Geo-referenced photographs from the field will be provided by June 1, 2012.

4.2 Annual and Final Report

A draft report will be provided by May 1, 2012 summarizing findings of the 2011 environmental studies or as determined in association with Olgoonik/Fairweather LLC. The final report will be provided to Olgoonik/Fairweather LLC by 15 August, 2012.

5.0 SCHEDULE WITH MILESTONES

5.1 Field Studies

The schedule for field studies and related events:

- Field team will attend safety training in Anchorage July 6-10, 2012.
- Field work for the first cruise — estimated dates of 3-23 August (20 days).
- Field work for the second cruise — estimated dates of 28 August to 6 October 2011 (38 days).

5.2 2011 Coordination Meetings

The Principal Investigator and research leads (as appropriate) will attend the coordination meetings including:

- Debrief Meeting in December, 2011 in Anchorage (1 day).
- PI meeting prior to the Alaska Marine Science Symposium in Anchorage, AK (2 days) — January 2012.

5.3 Deliverables

The schedule for deliverables is:

- Draft Report — due 1 May 2012. (Draft report based on 1st priority infaunal stations plus ½ 2nd priority stations completed.)
- Final Report — due 15 August 2012.
- Data submission — 1 June 2012.

6.0 REFERENCES

- Ambrose, W. G., Clough, L. M., Tilney, P. R., and Beer, L., 2001. Role of echinoderms in benthic remineralization in the Chukchi Sea. *Marine Biology*, 139: 937-949.
- Barber, W. E., Smith, R. L., Vallarino, M., Meyer, R. M., 1997. Demersal fish assemblages of the northeastern Chukchi Sea, Alaska. *Fishery Bulletin*, 95: 195-209.
- Blanchard, A. L., Nichols, H., Parris, C., 2010a. 2008 Environmental Studies Program in the Chukchi Sea: Benthic Ecology of the Burger and Klondike Survey Areas. Final report to ConocoPhillips, Inc. and Shell Exploration & Production Co. by the Institute of Marine Science, University of Alaska Fairbanks.
- Blanchard, A. L., Parris, C., Nichols, H., 2010b. 2009 Environmental Studies Program in the Chukchi Sea: Benthic Ecology of the Burger and Klondike Survey Areas. Draft report to ConocoPhillips, Inc. and Shell Exploration & Production Co. by the Institute of Marine Science, University of Alaska Fairbanks.
- Bluhm, B. A., Coyle, K. O., Konar, B., Highsmith, R., 2007. High gray whale relative abundances associated with an oceanographic front in the south-central Chukchi Sea. *Deep Sea Research II*, 54: 2919–2933.
- Coachman, L.K., 1987. Advection and mixing on the Bering-Chukchi Shelves. Component A. Advection and mixing of coastal water on high latitude shelves. ISHTAR 1986 Progress Report, Vol. 1. Institute of Marine Science, University of Alaska Fairbanks, pp 1-42.
- Codispoti, L.A., Flagg, C., Kelly, V., Swift, J.H., 2005 Hydrographic conditions during the 2002 SBI process experiments. *Deep-Sea Res. II* 52: 3199-3226.

- Feder, H. M., Foster, N. R., Jewett, S. C., Weingartner, T. J., Baxter, R., 1994a. Mollusks of the northeastern Chukchi Sea. *Arctic*, 47: 145-163.
- Feder, H. M., Iken, K., Blanchard, A. L., Jewett, S. C., Schonberg, S. 2011. Benthic food web structure in the southeastern Chukchi Sea: an assessment using $\delta^{13}\text{C}$ and $\delta^{15}\text{N}$ analyses. *Polar Biology* 34, 521.
- Feder, H. M., Jewett, S. C., & Blanchard, A., 2005. Southeastern Chukchi Sea (Alaska) epibenthos. *Polar Biology*, 28: 402-421.
- Feder H. M, Jewett, S. C., Blanchard, A. L., 2007. Southeastern Chukchi Sea (Alaska) Macrobenthos. *Polar Biology*, 30: 261-275.
- Feder, H. M., Naidu, A. S., Jewett, S. C., Hameedi, J. M., Johnson, W. R., Whitley, T. E., 1994b. The northeastern Chukchi Sea: benthos-environmental interactions. *Marine Ecology Progress Series*, 111: 171-190.
- Grebmeier, J. M., Cooper, L. W., Feder, H. M., Sirenko, B. I., 2006. Ecosystem dynamics of the Pacific-influenced Northern Bering and Chukchi Seas in the Amerasian Arctic. *Progress in Oceanography*, 71: 331–361.
- Grebmeier, J. M., McRoy, C. P., Feder, H. M., 1988. Pelagic-benthic coupling on the shelf of the northern Bering and Chukchi Seas. I. Food supply source and benthic biomass. *Marine Ecology Progress Series*, 48: 57-67.
- Highsmith, R. C., Coyle, K. O., Bluhm, B. A., Konar, B., 2006. Gray Whales in the Bering and Chukchi Seas. In Estes, J., DeMaster, D. P., Doak, D. F., Williams, T. M., Brownell, R. L. (eds) *Whales, Whaling and Ocean Ecosystems*. UC Press, pp 303-313
- Hopcroft, R., Bluhm, B., Gradinger, R., Whitley, T., Weingartner, T., Norcross, B., Springer, A., 2006. Arctic Ocean Synthesis: Analysis of Climate Change Impacts in the Chukchi and Beaufort Seas with Strategies for Future Research. Final report to North Pacific Research Board, 152 pp.
- Iken, K., Bluhm, B., Dunton, K. 2010. Benthic food web structure serves as indicator of water mass properties in the southern Chukchi Sea. *Deep-Sea Research II*, 75: 71-85.
- Lovvorn, J. R., Richman, S. E., Grebmeier, J. M., Cooper, L. W., 2003. Diet and body condition of spectacled eiders wintering in pack ice of the Bering Sea. *Polar Biology* 26, 259-267.
- Moore, S. E., Grebmeier, J. M., Davies, J. R., 2003. Gray whale distribution relative to forage habitat in the northern Bering Sea: current conditions and retrospective summary. *Can. J. Zool*, 81, 734-742.
- Naidu, A. S., Blanchard, A., Kelley, J. J., Goering, J. J., Hameedi, J. M, Baskaran, M., 1997. Heavy metals in Chukchi Sea sediments as compared to selected circumpolar shelves. *Marine Pollution Bulletin*, 35:260-269.
- Oliver, J. S., Slattery, P. N., O'Connor, E. F., Lowry, L. F., 1983. Walrus, *Odobenus rosmarus*, feeding in the Bering Sea: a benthic perspective. *Fish. Bull.* 81, 501-512.
- Pearson, T.H., Mannvik, H-P., 1998. Long-term changes in the diversity and faunal structure of benthic communities in the northern North Sea: natural variability or induced instability? *Hydrobiologia* 375/376, 317-329.
- RWJ Consulting, 2001. DeLong Mountain Terminal 2000 Environmental Studies. Final report to Cominco Alaska, Inc., 108 pp. + appendices.

- Shaw, D. G., Hameedi, M. J. (Eds.), 1988. Environmental studies in Port Valdez, Alaska: A basis for management. New York: Springer-Verlag, 423
- Stoker, S. W., 1978. Benthic invertebrate Macrofauna on the eastern continental shelf of Bering and Chukchi Seas. Ph.D. Dissertation. Institute of Marine Science, University of Alaska Fairbanks.
- Weingartner, T. J., Aagaard, K., Woodgate, R., Danielson, S., Sasaki, Y., Cavalieri, D., 2005. Circulation on the north central Chukchi Sea shelf. Deep Sea Research II, 52: 3150-3174.

SECTION V

EVALUATING OCEAN ACIDIFICATION IN THE CHUKCHI SEA ENVIRONMENTAL STUDIES PROGRAM

JEREMY T. MATHIS

PRINCIPAL INVESTIGATOR

INSTITUTE OF MARINE SCIENCES, UNIVERSITY OF ALASKA

FAIRBANKS, AK

1.0 INTRODUCTION

1.1 The Carbon Cycle and Ocean Acidification in the Chukchi Sea

There have been relatively few studies of the marine carbon cycle in the Chukchi Sea (Bates et al., 2006; Semiletov, 1999; Pipko et al., 2002; Murata and Takizawa, 2003; Bates et al., 2005; Bates, 2006; Chen and Gao, 2007) however it has been shown that shelf surface waters experience large seasonal drawdown of $p\text{CO}_2$ and dissolved inorganic carbon (DIC) during the open water season associated with high rates of phytoplankton primary production (PP) and cooling during water transit poleward (Bates et al., 2006). Early carbon mass balance estimates of the rate of air-sea CO_2 exchange suggested that the entire Arctic Ocean was a sink for CO_2 in the range of -70 to -129 Tg C year⁻¹ (Anderson et al., 1990; Anderson et al., 1994; Lundberg and Haugen, 1996) (note; negative values denote sink of CO_2 ; Tg = 10¹² g), but subsequently revised downward to -24 to -31 Tg C yr⁻¹ (Anderson et al., 1998; Kaltin and Anderson, 2005). More recently, direct $\Delta p\text{CO}_2$ observations and air-sea CO_2 exchange rate estimates revised the Chukchi Sea shelf CO_2 sink alone as -36 to -53 Tg C yr⁻¹ (Bates et al., 2006; Bates, 2006; Kaltin and Anderson, 2005). In comparison to the mean annual global ocean CO_2 uptake of approximately -1400 Tg C yr⁻¹ (Takahashi et al., 2002; Takahashi et al., in press), the Arctic Ocean CO_2 sink potentially contributes ~5-14% to the global balance of CO_2 sinks and sources, and thus important for the global carbon cycle and climate change feedbacks.

The inorganic carbon cycle in the western Arctic Ocean is dominated by inter-ocean exchanges with Pacific derived water, with subsequent biogeochemical modifications and transformations of water while resident in the Arctic during transit between the north Pacific/Bering Sea and the central Arctic Ocean. In addition, river inputs (e.g. Cooper et al., 2005) of and materials, sea-ice production and melting, and atmosphere-ocean interaction and exchanges also have profound influence (Bates et al., 2009). The effect of physical and biological controls on the marine inorganic carbon cycle can be opposing or amplifying, dampening or variable in nature to the sink of CO_2 in the Arctic, making future predictions of the Arctic Ocean CO_2 sink/source trajectory difficult to make at present.

In the near-term, sea-ice loss is expected to increase the uptake of CO_2 by surface waters (Anderson and Kaltin, 2001), but over time, inorganic carbon distributions, air-sea CO_2 disequilibrium and the capacity of the Arctic Ocean to uptake CO_2 is expected to alter in response to environmental changes driven largely by climate. The loss of sea-ice

earlier this decade reduced % sea-ice cover ($\sim 36,000 \text{ km}^2 \text{ yr}^{-1}$ (Cavalieri et al., 2003)) and exposed undersaturated surface waters of the Chukchi Sea and central basin, thereby potentially increasing the Arctic Ocean CO_2 sink by $2.0 \pm 0.3 \text{ Tg C yr}^{-1}$ (Bates et al., 2006). In 2007 and 2008, sea-ice extent reached a seasonal minima 25% lower than any previously observed in the satellite record constituting an additional exposure of $\sim 600,000 \text{ km}^2$ of surface waters to air-sea gas exchange. Assuming a status quo of inorganic carbon distributions in surface waters of the Arctic, this recent loss of summertime sea-ice may have increased the ocean uptake of CO_2 in the Arctic by an additional $-33 \pm 10 \text{ Tg C year}^{-1}$ (Bates, 2009).

The loss of sea-ice in the Arctic and greater open water area should also enhance upwelling at the shelf-break and potentially increase the input of nutrients from subsurface waters to the Arctic shelves. In the Chukchi Sea, the phytoplankton-growing season has apparently increased in the last decade (Arrigo et al., 2008) with reduced sea-ice extent and longer open-water conditions, especially. As a consequence of increased phytoplankton PP, the drawdown of pCO_2 and DIC should increase the air-sea CO_2 disequilibrium (i.e., ΔpCO_2) and increase the net oceanic uptake of CO_2 .

Other factors may also influence the marine inorganic carbon cycle and present-day CO_2 sink in the Arctic. Reduced sea-ice cover has been proposed to favor a 'phytoplankton–zooplankton' dominated ecosystem over the more typical 'sea-ice algae –benthos' ecosystem over the Arctic shelves in particular (Piepenburg, 2005). At present on the highly productive Chukchi Sea shelf, $\sim 10\%$ of PP is converted to dissolved organic carbon (DOC) and $\sim 15\%$ of PP is converted to suspended particulate organic carbon (POC) (Mathis et al., 2007; Mathis et al., 2009) that gets exported from the shelf into the Canada Basin beneath the mixed layer (Bates et al., 2005). The remaining 75% of PP is exported from the mixed layer to the sea floor as sinking particles that sustain the rich benthos on the sea floor of the Chukchi Sea shelf. In the Bering Sea, earlier sea-ice loss has led to ecosystem changes and altered pelagic-benthic coupling (e.g. Grebmeier et al., 2008). If there are ecosystem shifts in the future, for example on the Chukchi Sea shelf, the export of organic carbon and pelagic-benthic coupling might decrease, despite concurrent increases in phytoplankton PP.

As a consequence of the ocean uptake of anthropogenic CO_2 , surface pCO_2 and DIC contents have increased while pH has decreased in the upper ocean over the last few decades (Winn et al., 1994; Bates et al., 1996; Bates, 2007; Bates and Peters, 2007). This gradual process, termed ocean acidification, has long been recognized by chemical oceanographers (Broecker and Takahashi, 1971; Broecker et al., 1973; Bacastow et al., 1973). The predicted ocean uptake of anthropogenic CO_2 using the IPCC (Intergovernmental Panel on Climate Change) scenarios is expected to increase hydrogen ion concentration by 185% and decrease pH by 0.3-0.5 units over the next century and beyond (Solomons et al., 2007; Caldeira and Wickett, 2003; Caldeira and Wickett, 2005; Doney, 2006), with the Arctic impacted before other regions (Orr et al., 2005; Steinacher et al., 2009). The effects of ocean acidification are potentially far-reaching in the global ocean, particularly for calcifying fauna (Buddemeier et al., 2004; Royal Society, 2005; Fabry et al., 2008) but its impact on Arctic Ocean ecosystems is uncertain at present.

Ocean acidification and decreased pH reduces the saturation states (Ω) of calcium carbonate (CaCO_3) minerals such as aragonite ($\Omega_{\text{aragonite}}$) and calcite (Ω_{calcite}), with

many studies showing decreased CaCO_3 production by calcifying fauna and increased dissolution of CaCO_3 in the water-column and sediments. Recently, upwelling and impingement of corrosive waters to CaCO_3 has been demonstrated (Feely et al., 2008) on the west coast of the U.S. In the Arctic Ocean, potentially corrosive waters are found in the halocline layer of the central basin (Jutterstrom and Anderson, 2005). On the Chukchi Sea, waters corrosive to CaCO_3 seasonally impact the shelf sediments and benthos due to summertime phytoplankton PP, vertical export of organic carbon and buildup of CO_2 in subsurface waters that has been amplified by ocean acidification over the last century (Bates et al., in press). Given the scenarios for pH changes in the Arctic Ocean, the Arctic shelves will be increasingly impacted by ocean acidification and presence of carbonate mineral undersaturated waters, with implications for shelled benthic fauna, and those animals that feed on the benthos (Feder et al., 1994; Feder et al., 2005; Feder et al., 2007).

1.2 Purpose of Study and Rationale

Chukchi Lease Sale 193 occurred in February 2008. Prior to any exploration, development, or production activities being conducted in a lease block, BOEMRE requires specific baseline information to be collected. Multiple years of data are necessary to prepare a defensible NEPA document to support exploratory drilling and future development. Pelagic chemical oceanography forms one aspect of these baseline studies because the seasonally varying chemical properties of the water column can have a significant impact on phytoplankton/zooplankton to higher trophic levels such as fishes, seabirds, and marine mammals. Alterations to water-column chemistry as a result of development activities, or long-term climate change, could therefore have direct impact on the ecosystem. Long-term studies with direct observations of the key chemical components are the only means to compare temporal variation in ecosystem with environmental change. In an effort to begin to provide baseline values for pH and carbonate mineral saturation states in the lease areas, monitoring began in 2010 with the collection of 450 samples. These samples are currently being analyzed and data products will be made available during the summer of 2011. To continue building the necessary time-series, the ocean acidification program will continue during the field season of 2011, with results available in 2012.

1.3 Objectives of Study

The primary objective is to describe spatial, seasonal and interannual variability in the marine carbon cycle to assess the extent and potential impacts of ocean acidification. In future years, it will be essential to survey the surrounding region to provide oceanographic context, because the study area is near the historical transition between Alaska Coastal waters and Bering Shelf waters, both of which have unique assemblages of benthic calcifiers which are a critical component of the food web and particularly sensitive to ocean acidification. It is therefore critical to assess the extent and controls on ocean acidification concurrent with other physical and chemical (i.e., nutrients) oceanographic measurements to ensure that appropriate baselines are available for the water column. Secondly, we will obtain data that will better characterize how much of a sink the Chukchi Sea provides for atmospheric CO_2 , which will be critical to long-term projections of how the Arctic Ocean will respond under future climate scenarios.

2.0 METHODS AND PROCEDURES

2.1 Sampling or Survey Design and Technical Rationale

The regional study area will be sampled on a 15 NM grid and the prospect specific study areas will be sampled on a 7.5 NM grid. Each of these stations will be sampled for physical oceanography, zooplankton and primary productivity, and chemical oceanography (i.e., ocean acidification). A total of 156 stations will be sampled; 25 of these are in Klondike, 25 in Burger, and 22 in Statoil (4 shared with Burger); 62 of these stations will be sampled for benthic infauna (9 in Klondike, 10 in Burger, and 11 in Statoil). Samples will be collected at every other station to coincide with inorganic nutrient analysis. Approximately 450 samples will be collected for DIC/TA and will be used to determine pH and water column carbonate chemistry including saturations for the two most important carbonate ions (calcite and aragonite).

2.2 Field Team Size and Composition

Field samples for this project will be collected by Jennifer Questel or alternate on the cruises in 2011. We are not requesting to send a dedicated person due to berthing limitations on the vessel. Sample collection for DIC/TA is straight forward and will not interfere with any other activities and will require a minimal amount of time.

2.3 Data-collection Procedures

Samples for DIC and TA will be drawn from the core hydrography CTD/hydrocast. Samples are fixed with saturated mercuric chloride solution (200 µl), the bottles sealed, and stored until analysis. To eliminate the handling of mercuric chloride onboard the vessel the sample bottles will be pretreated. The bottles will then be filled using a 12" piece of flexible Teflon tubing attached to the Niskin bottle. An effort should be made to reduce the amount of bubbling that occurs while the bottle is filled. We anticipate ~120 - 150 samples to be taken during each cruise (360 – 450 total samples).

2.4 Analytical Procedures

DIC and TA samples will be shipped back to Fairbanks and analyzed using a VINDTA (Versatile Instrument for Detection of TA) DIC/TA analytical system in Mathis' Chemical Oceanography lab. High-quality DIC data is achieved using a highly precise (0.02%; 0.4 µmoles kg⁻¹) VINDTA-coulometer system. Accuracy of DIC (and TA) measurements will be maintained by routine analyses of Certified Reference Materials (CRM's, provided by A.G. Dickson, Scripps Institution of Oceanography).

2.5 Data-storage Procedures

Data files collected during cruises should be backed up periodically, and multiple copies will be transported back to UAF at the completion of each cruise along with copies of notebooks. At UAF, data are backed up routinely onto departmental servers.

2.6 Quality-control Procedures

Inorganic carbon datasets from the project will be prepared expeditiously in post-cruise analysis and synthesis using established integrated steps. For water-column observations, QC/QA protocols follow established methods for the repeat hydrography and U.S. time-series programs. Routine CRM analyses provide high-quality data and initial QC/QA diagnostics for DIC and TA measurements from the field program. Subsequently, DIC and TA data will be merged with core hydrographic data (e.g., T, S, inorganic nutrients) and quality flagged as good, questionable and bad data (e.g., bottle misfires, analytical problems, etc.).

3.0 COORDINATION

3.1 OLF

The PI, or an alternate team member, will attend all proposed meeting and interacts regularly as needed with OLF.

3.2 Other Studies in the Chukchi Sea Program

The PI regularly interacts with other PI currently at UAF and has a long collaborative relationship with Weingartner, in particular, through the GLOBEC and NPRB Seward Line time-series. Mathis is currently working on a multidisciplinary synthesis of the marine carbon cycle in the Chukchi and Beaufort region, which has connected him to investigators in many other disciplines.

3.3 Current Studies in the Region

Recent and ongoing studies have been described in Section 1.1. Mathis is a PI within the NASA-funded ICECAPES program beginning in July 2010, which will be sampling over a broad domain of the Chukchi Sea. Mathis and his students are actively involved with the BEST program in the Bering Sea, as well as synthesis efforts in the Pacific sector of the Arctic Ocean.

4.0 DELIVERABLES

4.1 Field Data

A list of sampling activities will be submitted within 30 days of the final cruise.

4.2 Draft Report

Provided there is no delay in shipping samples to UAF at the completion of the final cruise, the Draft Report, including appendices with sample analysis, will be submitted by 1 October 2012.

4.3 Final Report

The Final Report will be submitted 1 December 2012 or within 30 days of receipt of comments on the Draft Report.

5.0 SCHEDULE WITH MILESTONES

5.1 Field Studies

- Early July 2011— Planning meeting, ship walk-through, (Anchorage)
- Late July–mid October 2011 —Cruises

5.2 Coordination Meetings

- May 2011 —OLF Chukchi Sea scientific studies kickoff meeting, and scientific studies coordination meeting. Fairbanks, AK (1 day)
- Nov. 2011 — OLF Chukchi Sea scientific studies debriefing. Anchorage, AK (1 day)
- Jan 2012 — Chukchi Sea scientific studies technical workshop at AMSS, Anchorage (2 days).

5.3 Deliverables

- Field data (i.e. # of samples collected and locations) — within 30 days of final cruise.
- Draft Report — 1 October 2012.
- Final Report—1 December 2012 or within 30 days of receipt of comments on Draft Report.

6.0 REFERENCES

- Anderson, L.G., Dyrssen, D., and Jones, E.P., 1990. An assessment of the transport of atmospheric CO₂ into the Arctic Ocean. *Journal of Geophysical Research*, 95, 1703-1711.
- Anderson, L.G., Olsson, K., and Skoog, A., 1994. Distributions of dissolved inorganic and organic carbon in the Eurasian Basin of the Arctic Ocean. In *The Polar Oceans and Their Role in Shaping the Global Environment* (O.M. Johannessen, R.D. Muench, and J.E. Overland, editors). American Geophysical Union, *Geophysical Monograph*, 85, 252-262.
- Anderson, L.G., Olsson, K., and Chierici, M., 1998a. A carbon budget for the Arctic Ocean. *Global Biogeochemical Cycles*, 12 (3), 455-465.
- Anderson, L.G., and Kaltin, S., 2001. Carbon fluxes in the Arctic Ocean - potential impact by climate change. *Polar Research*, 20 (2), 225-232.
- Arrigo, K.R., van Dijken, G.L., and Pabi, S., 2008. The impact of a shrinking Arctic ice cover on marine primary production. *Geophysical Research Letters*, 35, L19603, doi:10.1029/2008GL035028.
- Bacastow, R.D., and Keeling, C.D., 1973. Atmospheric carbon dioxide and radiocarbon in the natural carbon cycle: II. Changes from A.D. 1700 to 2070 as deduced from a geochemical model. In: Woodwell, G.M., and Pecan, E.V. (editors) *Carbon and the biosphere*. U.S. Atomic Energy Commission, pp. 86-135.

- Bates, N.R., Moran, S.B., Hansell, D.A., and Mathis, J.T., 2006. An increasing CO₂ sink in the Arctic Ocean due to sea-ice loss? *Geophysical Research Letters*, 33, L23609, doi:10.1029/2006GL027028.
- Bates, N.R., 2009. The Arctic Ocean Marine Carbon Cycle: Estimates of Air-Sea CO₂ Exchanges and Potential Feedbacks. Chapter in review for the WWF report on Arctic Ocean Feedbacks.
- Bates, N.R., Best, M.H.P., and Hansell, D.A., 2005. Spatio-temporal distribution of dissolved inorganic carbon and net community production in the Chukchi and Beaufort Seas. *Deep-Sea Research II*, 52, 3303-3323.
- Bates, N.R., Hansell, D.A., Moran, S.B., and Codispoti, L.A., 2005b. Seasonal and spatial distributions of particulate organic matter (POM) in the Chukchi Sea. *Deep-Sea Research II*, 52, 3324-3343.
- Bates, N.R., Michaels, A.F., and Knap, A.H., 1996. Seasonal and interannual variability of the oceanic carbon dioxide system at the U.S. JGOFS Bermuda Atlantic Time-series Site. *Deep-Sea Research II*, 43(2-3), 347-383.
- Bates, N.R., 2006. Air-sea CO₂ fluxes and the continental shelf pump of carbon in the Chukchi Sea adjacent to the Arctic Ocean. *Journal of Geophysical Research (Oceans)*, 111, C10013, doi 10.129/2005JC003083, 12 Oct. 2006.
- Bates, N.R., 2007. Interannual variability of the oceanic CO₂ sink in the subtropical gyre of the North Atlantic Ocean over the last two decades. *Journal of Geophysical Research (Oceans)*, 112, doi:10.1029/2006JC003759.
- Bates, N.R., and Peters, A.J., 2007. The contribution of atmospheric acid deposition to ocean acidification in the subtropical North Atlantic Ocean. *Marine Chemistry*, 107, 547-558.
- Broecker, W.S., and Takahashi, T., 1966. Calcium carbonate precipitation on the Bahama Banks. *Journal of Geophysical Research*, 71, 1575–1602.
- Broecker, W.S., Li, Y-H., Peng, T-H., 1971. Carbon dioxide—man's unseen artifact. In: Hood, D.W. (editor) *Impingement of man on the oceans*. John Wiley and Sons, Inc, pp 287-324.
- Buddemeier, R.W., Kleypas, J.A., and Aronson, R.B., 2004. Coral Reefs and Global Climate Change: Potential Contributions of Climate Change to Stresses on Coral Reef Ecosystems, p. 44, (download report at http://www.pewclimate.org/global-warming/indepth/all_reports/coral_reefs/index.cfm). Pew Center on Climate Change.
- Caldeira, K., and Wickett, M.E., 2003. Anthropogenic carbon and ocean pH, *Nature*, 425 (6956), 365-365.
- Caldeira, K., and Wickett, M.E., 2005. Ocean model predictions of chemistry changes from carbon dioxide emissions to the atmosphere and ocean. *Journal of Geophysical Research, Oceans*, 110, (C9), C09S04, doi 10.1029/2004JC002671.
- Cavalieri, D.J., Parkinson, C.L. and Vinnikov, K.Y., 2003. 30-year satellite record reveals contrasting Arctic and Antarctic decadal sea ice variability. *Geophysical Research Letters*, 30 (18), Art. No. 1970 SEP 30 2003.
- Chen, L., and Gao, Z., 2007. Spatial variability in the partial pressures of CO₂ in the northern Bering and Chukchi Seas. *Deep-Sea Research II*, 54, 2619-2629
- Cooper, L.W., Benner, R., McClelland, J.R., Peterson, B.J., Holmes, R.M., Raymond,

- P.A., Hansell, D.A., Grebmeier, J.M., and Codispoti, L.A., 2005. The linkage between runoff, dissolved organic carbon, and the stable oxygen isotope composition of seawater and other water mass indicators in the Arctic Ocean. *Journal of Geophysical Research*, 110, G02013, doi:1029/2005JG000031.
- Doney, S.C., 2006. The dangers of ocean acidification. *Scientific American*, March 2006, 58-65.
- Fabry, V.J., Seibel, B.A., Feely, R.A., and Orr, J.C. 2008. Impacts of ocean acidification on marine fauna and ecosystem processes. *ICES Journal of Marine Science*, 65, 414–432.
- Feder, H.M., Naidu, A.S., Jewett S.C., Hameedi, J.M., Johnson, W.R., and Whitley, T.E., 1994. The northeastern Chukchi Sea-benthos-environmental interactions. *Marine Ecology Progress Series*, 111, 171-198.
- Feder, H.M., Jewett S.C., and Blanchard A., 2005. Southeastern Chukchi Sea (Alaska) epibenthos. *Polar Biology*, 28(5), 402-421.
- Feder, H.M., Jewett S.C., and Blanchard A., 2007. Southeastern Chukchi Sea (Alaska) macrobenthos. *Polar Biology*, 30 (3), 261-275.
- Feely, R.A., Sabine, C.L, Hernandez-Ayon, J.M., Ianson, D., and Hales, B., 2008. Evidence for upwelling of corrosive "acidified" water onto the continental shelf. *Science*, 320, 1490-1492.
- Grebmeier, J.M., Bates, N.R., and Devol, A. 2008. Continental Margins of the Arctic Ocean and Bering Sea. In *North American Continental Margins: A Synthesis and Planning Workshop*. U.S. Carbon Cycle Science Program, Washington D.C., (Editors, B. Hales, W.-J. Cai., B.G. Mitchell, C.L. Sabine and O. Schofield, 120 pp), p. 61-72.
- Jutterström, S., and Anderson, L.G., 2005. The saturation of calcite and aragonite in the Arctic Ocean. *Marine Chemistry*, 94, 101-110.
- Kaltin, S., and Anderson, L.G., 2005. Uptake of atmospheric carbon dioxide in Arctic shelf seas: Evaluation of the relative importance of processes that influence pCO₂ in water transported over the Bering-Chukchi Sea shelf. *Marine Chemistry*, 94, 67–79,
- Lundberg, L., and Haugen, P.M., 1996. A Nordic Seas – Arctic Ocean carbon budget from volume flows and inorganic carbon data. *Global Biogeochemical Cycles*, 10, 493–510.
- Mathis, J.T., Hansell, D.A., Kadko, D., Bates, N.R., and Cooper, L.W., 2007b. Determining net DOC production in the hydrographically complex western Arctic Ocean. *Limnology and Oceanography*, 52(5), 1789-1799.
- Mathis, J.T., Hansell, D.A., and Bates, N.R., 2009. Interannual variability of dissolved inorganic carbon distribution and net community production during the Western Arctic Shelf-Basin Interactions Project. *Deep-Sea Research II* (in press).
- Murata, A., and Takizawa, T., 2003. Summertime CO₂ sinks in shelf and slope waters of the western Arctic Ocean. *Continental Shelf Research*, 23 (8), 753-776.
- Orr, J.C., Fabry, V.J., Aumont, O., Bopp, L., Doney, S.C., Feely, R.A., Gnanadesikan, A., Gruber, N., Ishida, A., Joos, F., Key, R.M., Lindsay, K., Maier-Reimer, E., Matear, R., Monfray, P., Mouchet, A., Najjar, R.G., Plattner, G. K., Rodgers, K.B., Sabine, C.L., Sarmiento, J.L., Schlitzer, R., Slater, R D., Totterdell, I.J., Weirig, M.F., Yamanaka, Y., and Yool, A., 2005. Anthropogenic ocean acidification over the

- twenty-first century and its impacts on calcifying organisms. *Nature*, 437, 681–686.
- Piepenburg, D., 2005. Recent research on Arctic benthos: common notions need to be revised. *Polar Biology*, 28(10), 733-755.
- Pipko I.I., Semiletov I.P., Tishchenko P.Y., Pugach S.P., and Christensen J.P., 2002. Carbonate chemistry dynamics in Bering Strait and the Chukchi Sea. *Progress Oceanography*, 55 (1-2), 77-94.
- Royal Society, 2005. Ocean acidification due to increasing atmospheric carbon dioxide. The Clyvedon Press, Ltd, Cardiff, UK.
- Semiletov, I.P., 1999. Aquatic sources of CO₂ and CH₄ in the Polar regions. *Journal of Atmospheric Sciences*, 56(2), 286-306.
- Solomons, S., Qin, D., Manning, M., Marquis, M., Averyt, K., Tignor, M.M.B., Miller, H.L., and Chen, Z., 2007. Contribution of Working Group I to the Fourth Assessment Report of the Intergovernmental Panel on Climate Change (Cambridge Univ. Press, Cambridge and New York, 2007).
- Steinacher, M., Joos, F., Frolicher, T.L., Plattner, G.-K., and Doney, S.C., 2009. Imminent ocean acidification of the Arctic projected with the NCAR global coupled carbon-cycle climate model. *Biogeosciences*, 6, 515-533.
- Takahashi, T., Sutherland, S.G., Sweeney, C., Poisson, A.P., Metzl, N., Tilbrook, B., Bates, N.R., Wanninkhof, R.H., Feely, R.A., Sabine, C.L., and Olafsson, J., 2002. Biological and temperature effects on seasonal changes of pCO₂ in global ocean surface waters. *Deep-Sea Research II*, 49, 1601-1622.
- Takahashi, T., Sutherland, S.C., Wanninkhof, R., Sweeney, C., Feely, R.A., Chipman, D.W., Hales, B., Friederich, G.E., Chavez, F.P., Watson, A.J., Bakker, D.C.E., Schuster, U., Metzl, N., Yoshikawa-Inoue, H., Olafsson, J., Arnarson, T.S., Tilbrook, B., Johannessen, T., Olsen, A., Bellerby, R.J., de Baar, H.J.W., Nojiri, Y., Wong, C.S., Delille, B., and Bates, N.R., 2009. Climatological mean and decadal change in surface ocean pCO₂, and net sea-air CO₂ flux over the global oceans. *Deep-Sea Research II* (in press).
- Winn, C.D., Mackenzie, F.T., Carillo, C.J., Sabine, C.L., and Karl, D.M., 1994. Air-sea carbon dioxide exchange in the North Pacific subtropical gyre: Implications for the global carbon budget. *Global Biogeochemical Cycles*, 6, 157-163.

SECTION VI FISH TRAWL ASSESSMENT

JEFF JUNE

PRINCIPAL INVESTIGATOR

NATURAL RESOURCES CONSULTANTS, INC.

SEATTLE, WASHINGTON

1.0 INTRODUCTION

1.1 Brief History of Subject Research in Chukchi Sea

Fishes are the least-studied biological group in the western Arctic, if one considers the number of gear deployments that have taken place. There have been far more observations of lower trophic levels such as zooplankton and benthos, and higher trophic levels such as seals and whales, than of fishes in Arctic regions. Most of what is known about the ecology and life history of Alaskan Arctic marine fishes comes from work associated with marine mammals (Frost and Lowry 1981, 1983, 1984) and oil and gas exploration (Craig and McCart 1976; Craig et al. 1982, 1984). The general consensus seems to be that little is known about the ecosystem in general and Arctic marine fishes in particular (e.g., Johnson 1997; Power 1997; Mecklenburg et al. 2002; MMS 2006). The paucity of information on fish distribution and ecology is a critical gap in the understanding of this changing ecosystem.

Very little is known about arctic fish species that have no commercial or cultural significance (Power 1997). It is important to note that no commercial fisheries target fishes in the offshore Chukchi Sea, and that fishes utilized by subsistence users are nearly all nearshore (defined as within 20 miles of shore). Existing information published on fish distribution in the northeastern Chukchi Sea, including online sources, peer-reviewed and gray literature, is based entirely on catches of demersal fish trawls and ichthyoplankton collected 1959 – 1992, and the 2004 –2008 research in which UAF participated. In the early 1990s, 72 fish species were thought to occupy the Chukchi Sea, and more recently FishBase (Froese and Pauly 2006) lists 80 species of fishes inhabiting the Chukchi Sea. The majority of these species are demersal (living on or near the bottom), many are benthopelagic (living or feeding near the bottom as well as in mid-water or near the surface), and far fewer are pelagic (at surface or mid-depths), bathydemersal (living below 200 m), or reef-associated. The dominant Arctic fish families are cods, eelpouts, snailfishes, sculpins, and salmonids. Arctic cod was the dominant species captured in all earlier surveys (Alverson and Wilimovsky 1966; Frost and Lowry 1983; Fechhelm et al. 1985; Barber et al. 1997).

As it has the highest commercial importance, Arctic cod is also the best studied species (Hop et al. 1997). Recent distributional, biological, and ecological knowledge about fishes in the northern Chukchi Sea comes from cruises in 1990 – 91 (Barber et al. 1997), 1991 – 92 (Hokkaido University 1992, 1993), the RUSALCA 2004 expedition (Mecklenburg and Sheiko 2006; Mecklenburg et al. 2007; Norcross et al. submitted) and our unpublished collections from three cruises in the northeastern Chukchi Sea in July-September 2007 and 2008. The 15,061 fishes caught by bottom trawl during those three

recent cruises were predominantly (>80% by number) sculpins, pricklebacks, cods, and flatfishes. Other fishes such as eelpouts, ronquils, snailfishes, and poachers also were captured.

The Chukchi Sea has an extremely high biomass of benthic organisms for an Arctic area (Grebmeier and Dunton 2000). Until recently, the northern Bering Sea has been a benthic-dominated ecosystem, i.e., very similar to that of the Chukchi Sea. With Arctic warming (ACIA 2004, www.amap.no/acia), the composition of marine fish and benthic communities is expected to change. The northern Bering Sea is now shifting from a shallow, ice-dominated system in which bottom-dwelling fishes prevail to one more dominated by pelagic fishes (Grebmeier et al. 2006). It is possible that the Chukchi Sea may experience similar changes, but those changes cannot be detected without a baseline of the current state of ecosystem. Scientific collections in 2004 documented some species of demersal fishes in the Chukchi Sea north of where they had been observed in earlier years (Mecklenburg et al. 2007). This could be because of northward expansion of fishes or merely due to an increased northward effort of scientific sampling in the Chukchi Sea. Observed changes in distribution and abundance of walleye pollock (*Theragra chalcogramma*) and Arctic cod (*Boreogadus saida*), in response to changes in sea ice cover and subsurface temperatures, provide insight as to how Arctic climate change affects marine ecosystems (Wyllie-Echeverria and Wooster 1998). With the limited availability of information in the Chukchi Sea, we can only speculate what may be occurring in benthic and pelagic biological communities, and the proposed research will yield much needed baseline data necessary to describe and quantify potential changes in these communities.

1.2 Objectives

Natural Resources Consultants, Inc. (NRC) has been contracted to undertake a trawl survey to assess the relative abundance of fish and invertebrate resources in an oil and gas lease area in the Arctic Ocean on behalf of Aldrich Offshore, LLC (ALDRICH). The survey will provide estimates of relative abundance and biomass, species composition and biological information on marine fish and invertebrate communities within the study area. The trawl survey methodology, equipment proposed, analyses and reporting follows the established National Oceanographic and Atmospheric Administration (NOAA) procedures for conducting fish and invertebrate stock assessments on the U.S. West Coast and Alaska. NRC principals have extensive experience in conducting NOAA stock assessment surveys in Alaska and were responsible for developing much of the equipment and techniques currently deployed by NOAA. This study plan provides a description of the survey methodology, equipment proposed, data collected and preliminary summaries before final reporting.

2.0 METHODS AND PROCEDURES

2.1 Trawl Survey Station Pattern

The area for trawl survey coverage consists of approximately 11,068 square nautical miles (nm). Annual trawl surveys conducted in the Bering Sea by NMFS vessels prescribe a sampling density of one tow per 400 square nm and the total Bering Sea survey area exceeds 130,000 square nm. Preliminary plans for coverage of the Arctic Sea area of interest prescribed a similar sampling density of approximately one bottom

and one pelagic tow per 400 square nm to provide a comparably high-resolution assessment over the 11,068 square nm areas. Current plans were revised given more precise estimates of time for actual trawling days during the charter and for the transit distances between planned stations that covers the entire study area. The current plan anticipates completion of 20 bottom and 20 pelagic trawl survey tows in the area. The planned stations were selected from approximate centers or intersections of a 400 square nm grid or groupings of those grids (outside the lease block but inside the study area) or centers of subgrids of 100 square nm (quadrants of the larger grid inside the lease blocks). The number and location of both bottom trawl and pelagic trawl tows has been designed to prioritize the three lease areas, cover the different seabed types found in the area, and cover areas determined to be potentially productive based on split-beam sonar at or near the planned locations. The location of some pelagic trawl tows may change, to be determined based on areas with abundant pelagic fish as determined by split-beam sonar conducted just prior to the trawl survey. Average distance between most stations will be approximately 12 nm with a few longer distances outside of the lease block areas. Transit times between each station would average 90 minutes with the survey vessel speed of 9 knots. A total of 5 to 7 tows bottom trawl tows would be planned per day for 3.5 to 4 days and the same for pelagic tows per day for a total survey period of 7 to 8 days. Transit days, weather days or other non-trawl sampling days would be in addition to the total of 8 trawl days for the survey. The 7 to 8 trawl survey days would be completed over a two-week operational period. The density of trawl stations within the area will provide levels of accuracy and confidence limits for the estimation of abundance (numbers) and biomass (weight) of fish and invertebrates sampled similar to the groundfish /crab trawl surveys conducted by NOAA/NMFS in the Bering Sea.

2.2 Trawling Procedures

For each survey trawl tow, bottom temperature, depth and salinity will be recorded using a CTD device dropped to the seabed and retrieved. The bottom trawl net will be deployed at each station and towed for approximately 5 to 15 minutes depending upon average total catch volume experienced in the area at an approximate speed of 2 to 2.5 knots. On average a 15 minute trawl tow will cover a distance of approximately 926 meters (3,050 ft) with an effective trawl width of 13.5 m (44 ft) and a total area swept of 0.0125 square kilometers or 0.0036 square nm per trawl tow. The net instrumentation will record all trawl performance data during each tow. Measurements will include wing spread, headrope height off the seabed, depth of the headrope in the water column, and footrope bottom contact with the seabed. The net measurement data is transmitted via telemetry between the sensors (NETMIND) and a hydrophone on a paravane towed off a davit from the port stern of the vessel. The bottom contact sensors collect data continuously during the trawl tow, one transmitting to the hydrophone and the other remotely downloads its data once the net is back on the vessel. The location of the vessel is recorded continuously during the trawl tow and the time stamp synchronized with time stamp on the net measurement and bottom contact sensor data. Post-survey an algorithm is applied to the trawl warp movement during bottom contact to accurately estimate the distance traveled by the trawl net on the seabed during each tow.

After haulback, the codend contents will be dumped into a sorting table and all captured fish, invertebrates and marine plants will be sorted, identified, counted, weighed and length frequency (fish) or carapace width measurements (crab) taken from high volume

or commercially important species. Several individuals from high frequency fish and invertebrate species will be subsampled for detailed sex, maturity, length and weight measurements. In the event that a large total catch is obtained that prevents whole-haul processing, a standardized sub-sampling procedure will be followed. The catch will be mixed evenly on the sorting table and placed in baskets. All of the baskets will be weighed to get a total haul weight. A subsample of randomly selected baskets will be placed back on the sorting table and processed in the usual method. The count and weight of subsampled animals will then be expanded to the total haul weight. Any large animals or invertebrates that may not be applicable to subsampling will be removed from the whole haul catch prior to subsampling.

Any unidentifiable fish or invertebrate species will be photographed, assigned a unique identifying specimen code and either frozen or otherwise preserved (alcohol or formalin) for later identification at the University of Washington – School of Aquatic and Fishery Sciences. All catches will be documented with digital photos showing the station number, date and time. At several stations the trawl survey operations and catch recording will be videotaped to document procedures employed. The expected time to complete trawling and all data recording at each station will range from 30 to 60 minutes depending on the size of catch and the number of identifiable species captured.

Both day and night trawl tows will be conducted in each area and if apparent differences in species composition or relative abundance are observed, a series of paired day and night tows will be conducted at a subsample of trawl stations to allow statistical analyses of any differences due to diel migrations.

The pelagic trawl will be equipped with the same net instrumentation that provides wing spread, a measure of the vertical opening of the net from the headrope to the footrope and the distances from the headrope to the seabed and the surface of the water. The pelagic trawl tow times will be adjusted based on the catch experienced during the survey - however, trawl periods of 20 to 30 minutes are anticipated. The objective of the pelagic trawling will be ground truth the information on schooling fish collected with the split-beam sonar. Catch will be identified to species and measured for length. The length of trawl haul will be recorded in addition to set and haul back times. The course of each pelagic trawl tow will be tracked on chart plotter using GPS.

2.3 Personnel

NRC will provide Mr. Jeff June as the overall project manager. Mr. June will assist Mr. Goodman in analysis of the fishery data and preparation of the final report. Mr. Scott Goodman will be NRC's lead project person on the vessel during the survey and will oversee all fishing activities and assure proper data collection is accomplished. Mr. Kyle Antonelis will assist Mr. Goodman on the survey vessel. Mr. Antonelis has experience in Bering Sea marine animal identification and standard fishery surveys methodologies. NRC will utilize the two or three crew members on the fishery survey vessel to assist in sorting and processing the catch.

2.4 Equipment

The trawl survey vessel will have trawl winches equipped with the necessary trawl warp wire (9/16" diameter) and an acoustic link for trawl performance data transmission. The

vessel will have two senior NRC personnel as project managers and utilize the two or three vessel deck hands in haul sampling and data collection. The vessel will be equipped with a sorting table, sorting baskets and storage for preserved or frozen specimens.

2.5 Bottom Trawl Gear Description

The survey trawl is a modified 400 Eastern survey trawl package originally used for surveys in the nearshore areas of the eastern Bering Sea by the Alaska Department of Fish and Game. The net is a two-panel, semi-balloon design. The body of the net is constructed of 10.2 cm polyethylene mesh. The cod end of the net will be lined with a 0.05 cm No. 10 mesh liner. The headrope is approximately 21.7 m long and the footrope is 28.7 m in length. The otter doors are vee-style doors 1.5 m by 2.1 m and weigh 364 kg each.

2.6 Pelagic Trawl Gear Description

The contract has acquired pelagic trawls manufactured by Gurock that are owned by ADF&G and have been used several times by the *R/V Pandalus* for other chartered pelagic trawl surveys. Specifications of this gear are not available to NRC at this time. The trawl will be instrumented in a similar manner to the bottom trawl to record all of the functional geometry of this pelagic gear as it fishes during the survey.

3.0 ANALYSES AND REPORTING

3.1 Area Swept Calculations

For the bottom trawl sampling, the area swept by the trawl is critical to the calculation density of animals per unit of seabed sampled and when extrapolated to the total area of interest the estimation of the absolute abundance (numbers) and biomass (weight) of each species of animals captured in the trawl net.

The data from the NETMIND sensors, modified bottom contact sensor and the GPS unit will be incorporated into a relational database utility for reviewing synchronized data from all sources. For each tow, all sensor data will be incorporated and reviewed graphically allowing for the times to be clearly chosen for on-bottom at the beginning of the tow and off-bottom at the end of the tow. These times will determine the start and end points for effective fishing of the survey trawl tow on the seabed and will be important for the determination of distance fished per tow. Distance fished will be calculated for three periods of the tow. This is necessary since past experience shows with the synchronized data that the net may be traveling at different speeds on the seabed during different time periods during the tow. These estimates will provide the best estimate of the distance fished per tow and the swept area per tow.

Because the NETMIND wing sensors intermittently provided raw data containing erroneous readings, survey trawl spread readings will be filtered and smoothed. Filtering routines for wing spread readings will throw out values that are not possible based on adjacent readings. Smoothing of the filtered readings provide a smoothed interpolated value at each second during the tow. The smoothed and filtered spread readings are then averaged for the three periods of the tow. These averages produce

the final width component of the swept area per tow. Total tow area swept is then calculated by taking the sum of the products of length and width per tow period.

3.2 Absolute Abundance and Biomass

The calculation of area swept densities of animals caught with the bottom trawl will be calculated using the standard area swept technique employed by NOAA where the number of captured animals are divided by the area swept yielding a density expressed in numbers of animals per square unit of seabed (typically per square nautical mile). The general summary of abundance and biomass from the survey area swept densities will be calculated using the standard statistical approach of multiplying area-wide animal density averages for each species times the total area of interest. Both relative abundance (numbers of animals) among species and an estimate of absolute abundance (numbers) and biomass (weight) by species for each lease area will be calculated. These values provided the basis for a direct comparison between year to year survey results and comparisons with other areas that have been surveyed using a similar methodology (Beaufort Sea, Eastern Bering Sea, Aleutian Islands, etc).

For the pelagic trawl we will measure the wing spread calculate the distance towed and the approximate water volume sampled during each trawl tow and relative catch volume to density in the water column. However, the main goal of the pelagic trawl is not to assess absolute fish density but to ground truth split-beam sonar data on schooling fish identifying species and size composition.

3.3 Biological Analyses

Length-frequency information by sex will be summarized for each major species finfish (Arctic cod, Pacific cod, Greenland halibut, Bering flounder, walleye pollock and any other potentially commercially valuable species) encountered during the survey. Carapace widths will be collected by sex for commercially important crab species (mainly *C. opilio*) encountered and gravid female crabs will be noted. Samples will be collected for stable isotope analysis to be performed on species and age classes of species that have not yet been encountered in previous fishery studies within the survey area.

3.4 Final Report

The final report for the project will follow the standard NOAA stock assessment cruise report format as used in the Gulf of Alaska, Bering Sea, Aleutian Islands, Chukchi Sea and Beaufort Sea. The report will provide the objectives of the project, the methodology and equipment employed, the results of the survey analyses and recommendations for future work. The survey results will include a GIS plot of the stations sampled and a table providing key data by tow including date, start and stop time, latitude, longitude, depth range, bottom type, average tow speed, average effective net width, distance covered, area swept, total tow time, total time on bottom and total catch. Relative abundance, absolute abundance and biomass estimates with confidence intervals for all animals encountered during the survey based on the area swept method commonly employed by NOAA. Length and carapace width frequencies (by sex for some species) histograms will be presented for major species and the frequency of gravid female crab reported. GIS plots will display relative abundance and biomass distribution within each

lease area. The final report will include recommendations for improving future surveys if applicable.

4.0 SCHEDULE

The preliminary scheduled charter for *R/V Pandalus* to conduct these surveys is from August 25, 2011 to September 8, 2011. The Arctic Ocean should be at full productivity at this time and both day and night sampling opportunities will occur. A total of 8 trawl survey days should be accomplished during the 2-week survey period, with geographic priority placed on the three prospect-specific study areas (Klondike, Burger and Statoil).

SECTION VII SEABIRD ECOLOGY

ROBERT H. DAY & ADRIAN E. GALL

CO-PRINCIPAL INVESTIGATORS

ABR, INC. – ENVIRONMENTAL RESEARCH & SERVICES

FAIRBANKS, AK

1.0 INTRODUCTION

1.1 Brief History of Subject Research in the Chukchi Sea

Historical data on seabirds in the northeastern Chukchi Sea during the open-water season are limited, primarily because of the region's inaccessibility. Much of the interest in seabirds in this area has concentrated on mainland seabird colonies and on seabirds at sea in the vicinity of the Hope Basin, which lies immediately north of Bering Strait, in the southern Chukchi Sea. The focus of seabird colony research has been Cape Lisburne, which is part of the Alaska Maritime National Wildlife Refuge; data also have been collected at irregular intervals ~50 mi south of there at Cape Thompson. These colonies have been studied periodically since 1976 by David Roseneau and others at the USFWS who built on earlier work begun on nesting seabirds by Swartz (1966) during the Cape Thompson environmental studies of the U.S. Atomic Energy Commission in the 1950s.

Another area of research has been use of the coastal-lagoon systems of the northeastern Chukchi Sea by birds. The earlier work by Johnson (1993) and Johnson et al. (1993) described use of the Chukchi lagoon systems by birds, whereas recent work has focused on monitoring population trends of birds in all lagoon systems in northern and northwestern Alaska annually (e.g., Dau and Larned 2004 and related annual reports). There also have been extensive studies of eider migration at Barrow, which has perhaps the highest concentration of migrating waterfowl on this continent (Thompson and Person 1963; Woodby and Divoky 1982; Suydam et al. 1997, 2000a, 2000b; Day et al. 2004), and studies of migrating Ross's Gulls, which concentrate at Barrow in the fall (Divoky et al. 1988). Aerial surveys for and satellite telemetry of migrating and staging Spectacled (*Somateria fischeri*) and Steller's eiders (*Polysticta stelleri*), both of which are protected under the Endangered Species Act (ESA), in the Chukchi Sea have indicated that shallow, nearshore waters of Ledyard Bay and Peard Bay form important stopover areas for migrating Spectacled and King (*S. spectabilis*) eiders in both the summer and fall (Balogh 1997, Oppel et al. 2009).

In contrast to the well-known coastal seabird community, few historical data on the at-sea distribution and abundance of seabirds are available for the northern Chukchi Sea. The first research was conducted by Jacques (1930), who surveyed birds in the Bering Sea and western Chukchi Sea in July–August 1928. Later, Swartz (1967) examined the at-sea distribution of seabirds in the southern and central Chukchi during the environmental studies at Cape Thompson. The interest in oil development in arctic Alaska in the 1970s prompted a decade of research on seabirds and other marine organisms in this region. The main seabird studies in areas important for oil development were conducted by (1) Watson and Divoky (1972), who studied seabirds in the eastern Chukchi Sea from a USCG icebreaker; (2) Divoky (1979), who described

some aspects of the Chukchi Sea open-water and ice-edge avifauna; and (3) Divoky (1987), who studied seabirds throughout the Chukchi Sea in the early 1980s as part of the Outer Continental Shelf Environmental Assessment Program (OCSEAP). The latter report was never released by OCSEAP as part of its "Environmental Assessment of the Alaskan Continental Shelf" publication series, so it is not widely available or widely known. Another source of information on seabirds near this area is found in Divoky and Springer (1988), who provided an overview of the data available on seabirds in the southern Chukchi Sea for an BOEMRE synthesis report.

Although limited historical data exist for the region (Hopcroft et al. 2008), studies conducted during the past decade are filling in the gaps in knowledge about the ecology of the northern Chukchi Sea. Most recently, there has been some ship-of-opportunity sampling of seabirds in the Chukchi Sea conducted primarily by the USFWS. These data have not been published yet, but they have been contributed to the North Pacific Pelagic Seabird Database (NPPSD), a publicly available information resource maintained by the USGS that is updated periodically. The current version includes data from USFWS surveys as recent as October 2009. Other ongoing studies that are providing detail on the use of nearshore and offshore waters by birds include satellite-telemetry studies of Long-tailed Ducks (*Clangula hyemalis*) and King Eiders (Dickson and Bowman 2008) and of Yellow-billed Loons (*Gavia adamsii*; Rizzolo and Schmutz 2008). The present study begun in 2008–2010 and continuing in 2011 provides information on the distribution and abundance of seabirds in the northern Chukchi Sea.

1.2 Objectives of Study

The specific objectives of the seabird component of this study are to:

- describe spatial, seasonal, and interannual characteristics of the seabird community in the development areas and the region including Hanna Shoal;
- describe community-level attributes such as species-richness and species-composition;
- provide detailed information on species that are of conservation concern (e.g., endangered, threatened, candidate species); and
- when possible, integrate the data on distribution and abundance of seabirds in this area with the data on physical and biological oceanography that are collected concurrently by the survey vessel.

2.0 METHODS AND PROCEDURES

2.1 Sampling or Survey Design and Technical Rationale

We will survey seabirds (and other observers will survey marine mammals concurrently) along a series of parallel survey lines that run north–south through the study region. During the first science cruise, sampling will focus on the prospect-specific study-area boxes. Within the study-area boxes, lines will be spaced 3.75 NM apart, creating a set of 9 parallel survey lines in Klondike and Burger and 11 parallel survey lines in Statoil; in a few cases, lines will be closer than 3.75 NM apart so that we can use the existing set of survey lines. Each survey line within a study-area box is 30 NM long, and every other line will coincide with, or be very close to, a line of oceanographic stations that will be sampled by other researchers on the boat. At a ship's speed of ~8 knots, each of the 30-NM lines can be surveyed in ~3.5 h, so several lines may be sampled in a day if weather

and daylight permit. However, if inclement weather is limiting our ability to sample the entire area, the top priority on a cruise will be those lines that include the core parts of each study-area box. If possible, the Klondike, Burger, and Statoil study areas will be surveyed at least once over a period of ~5 days on each of the two research cruises. In addition, we will survey two regional transect lines spaced 7.5 NM apart that run north–south through the middle of the entire Hanna Shoal survey area to provide a synoptic sample of the entire study region.

During the second research cruise, the sampling area will expand to include waters east, west, and north of the prospect areas, covering most of Hanna Shoal. Sampling lines outside of the prospect boxes will be spaced 7.5 NM apart, whereas lines within the prospect boxes will maintain the 3.75-NM spacing specified for the first research cruise. This intensive sampling within the study-area boxes will maintain comparability with the previous 3 years of data collection, and the wider spacing of lines outside of the prospect boxes will provide a broad-scale perspective comparable to data collected historically. We will sample the southern section (which encompasses all of Klondike and areas to the east) first, the middle section (which encompasses Burger and Statoil and areas to the east and west) second, and the northern section (Hanna Shoal) third; finally, we again will sample the two regional transects that run north–south through the middle of the entire Hanna Shoal survey area, as was done on the first research cruise.

An important aspect of the study design is the use of line-transect sampling within a zone ~300 m wide. The use of this sampling design allows the calculation of the bias in detectability of individual species (i.e., a small phalarope is much more difficult to detect than is a large albatross or a medium-sized gull), so that numbers of individuals seen can be corrected to actual estimates of densities. Thus, the bias in detectability of individual species will be incorporated into the density estimates, increasing the accuracy of the estimates.

2.2 Field Team Size and Composition

The seabird team will consist of 6 observers total who will rotate through the two research cruises and two of the acoustic deployment cruises planned for 2011. For the research cruises, each individual cruise team will consist of two observers who will trade off observation duties throughout the day. One member of the seabird team will function as the crew leader and will be primarily responsible for assessing survey conditions, managing data collection and processing, submitting daily and weekly progress reports to the Chief Scientist/Program Manager, and coordinating with other research groups and crew on the vessel. For the acoustic-deployment cruise in August and the acoustic-retrieval cruise in October, a single observer will sample because the ship will be operating within the Ledyard Bay Critical Habitat Unit (LBCHU), an area designated for the protection of federally-threatened Spectacled Eiders. The observer will remain on watch during daylight hours when the ship is operating or transiting through the LBCHU, in compliance with the conditions specified by the U.S. Fish and Wildlife Service.

2.3 Data-collection Procedures

The surveys will be conducted in 10-min counting periods (hereafter, transects) when the ship is moving along a straight-line course at a minimal velocity of 5 kt. Data will be collected 9–12 h/day, weather permitting; surveys generally will be stopped when sea

height is greater than Beaufort 5 (seas to ~6 ft), although sampling may occur in higher seas if observation conditions are still good. At the beginning of each transect, observers will record start time, sea ice cover (to nearest 10%), sea height (Beaufort scale), visibility, observation conditions, and transect width. If the ship's course or speed changes substantially during a transect, that sample will be discarded if <5 min long, and a new transect will be started on the new course/with the new speed.

One observer stationed on one side of the vessel's bridge will record all birds seen within a radius of 300 m and in a 90° arc from the bow to the beam on one side of the ship. For each bird or group of birds, the observer will record:

- species (to lowest possible taxon);
- total number of individuals in the observation;
- distance from the observer when sighted (use reticle binoculars to determine distance);
- radial angle of the observation from the ship (to the nearest 1°);
- number in each age-class (juvenile, subadult, adult, unknown age);
- immediate habitat (air, water, flotsam/jetsam, ice); and
- behavior (sitting, swimming, feeding, comfort behavior, courtship behavior, interacting with marine mammals, other).

For birds on the water, all birds seen within the defined survey area will be counted. For flying birds, however, observers will conduct scans for them once every minute and record a "snapshot" count of all birds flying within the 90° arc from the bow to the beam of the ship and within 300 m of the ship (Tasker et al. 1984; Gould and Forsell 1989). Birds that enter the count zone ahead of the ship are counted during the snapshot counts, whereas birds that enter from behind the ship (i.e., the area that already has been surveyed) are not counted, to avoid the possibility of counting birds that may be following the ship. This snapshot method reduces the bias of overestimating the density of flying birds.

Observations of all birds will be entered directly into a computer that is connected to a GPS by using TigerObserver software (TigerSoft, Las Vegas, NV), so that every observation will be time-stamped and geo-referenced. The time stamp will be synchronized with data from on-board computers to facilitate matching bird observations with other environmental measurements (e.g., water depth, sea-surface temperature, sea-surface salinity).

2.4 Analytical Procedures

We will estimate density (birds/km²) for each species or species-group by using distance-sampling analyses available in the program DISTANCE (Thomas et al. 2010). The analysis consists of three steps. First, a detection function for each species is fitted to the observed distances of sightings from the transect line to estimate probability of detection for each species separately. Next, the observed flock sizes are used to estimate the mean flock size for the population. Finally, the density of birds is estimated for the entire study area by incorporating the probability of detection, the area surveyed,

and the mean flock size. Results will be presented by study-area box and season and by regional sections.

In addition to the bird-observation data, we will use data from the physical and biological oceanography disciplines to investigate relationships between oceanographic conditions and seabird distribution and abundance. Examples of data related to individual records that we have collected include GPS locations, positional accuracy of those readings, sea-surface temperature, sea-surface salinity, fluorometry reading, and water depth. Examples of data that may be summarized for all data collected within a study area and cruise include zooplankton species-composition, abundance, and distribution; and fish species-composition, abundance, and distribution.

We will summarize species-richness and species-composition of the bird community by study-area box and cruise to examine temporal and spatial patterns in these community-level attributes (Magurran 2004). In addition, we will use the geo-located observations to generate maps of distribution and abundance for all birds combined, for individual species of interest, and for species-groups of interest.

Additional perspective on the distribution and abundance of seabirds in this general area will be gained by a retrospective analysis of historical data on seabirds in this region. We will calculate uncorrected densities of birds (birds observed/km²) to compare our data with historical data (e.g., Divoky 1987) compiled in the NPPSD.

We will partition out those historical data that apply to the general vicinity of the study-area boxes and will summarize the data to determine the abundance of seabirds in the general Hanna Shoal study area. We also will compare species-composition and species-richness between the historical dataset and the results of the current study.

2.5 Data-storage Procedures

We will enter data electronically on a laptop computer real-time during the surveys. Data managers aboard the vessels will back up those data files onto the ship's RAID array and a portable hard drive at least once every 24 h in the field. Every day, we will review the data collected with TigerObserver and saved into the project database for data proofing, management, and archiving. After the conclusion of each cruise, we will receive the observational data from OLF and will load them onto the secure server at ABR, Inc. We will deliver proofed and archived data to OLF as a deliverable item, following the guidelines in COP document "Data Protocols Version 6.4 March 2010."

2.6 Quality-control Procedures

Prior to surveys, the Co-PIs or their designee will conduct data-collection, identification, and data-entry training for personnel who will be participating on these cruises. The data-collection training will emphasize procedures for detecting and quantifying bird observations within the survey area. The identification training will emphasize the primary species that may occur in the study area and molt sequences for aging birds in the field. When possible, photographic slides or written documents will be used. The data-entry training will emphasize an understanding of the data-entry software itself and entry procedures.

Data will be entered on the laptop real-time during the surveys. A field notebook and digital voice recorder also will be kept at the observation station, so that the observer can record any adjustments or corrections that may arise during the surveys. Each survey file will be reviewed for accuracy and completeness at the end of a survey day, and any corrections noted during the surveys will be made to the survey file at that time. Each record will be identified with the initial of the observer, and any changes to records will be noted in a separate table within the Microsoft Access database.

3.0 COORDINATION

3.1 Olgoonik-Fairweather

We will coordinate with OLF on all aspects of the study. We will attend a pre-cruise meeting to coordinate planning. The Co-PIs or their designee (the "Seabird Lead" on each cruise) also will provide daily and weekly summaries of information to the Chief Scientist/Project Manager on each cruise so that reports can be sent to OLF from the field. In addition, we will attend a post-field meeting in Anchorage to discuss the research program.

3.2 Other studies in the Chukchi Sea Program

This research will be conducted at sea as part of an interdisciplinary team of oceanographers and ecologists who are part of the CSESP. We will make every attempt to coordinate the sampling with the other researchers who will be aboard at that time. The seabird sampling will be coordinated with the marine-mammal observers, in particular, because of the similarity in sampling methods and survey tracklines.

The Co-PIs have conducted collaborative research with all of the other members of the Research Team. Co-PI Robert Day has conducted research at sea with Dr. Weingartner (physical oceanographer) as part of the oceanographic study GLOBEC, which was a joint research program of the NSF and the NOAA. He also has been involved in research on seabirds at sea for more than 35 years and on the effects of the Exxon Valdez oil spill for more than 20 years. Co-PI Adrian Gall conducted research at sea with the other members of the research team in the Chukchi Sea during the 2008–2010 field seasons.

3.3 Current studies in the region

There are few, if any, dedicated at-sea studies of seabirds occurring at this time in the Chukchi Sea. The USFWS conducts ship-of-opportunity data collection on seabirds at sea in Alaska, but it is not clear at this time whether they will be doing any in the Chukchi Sea in 2011.

4.0 DELIVERABLES

4.1 Field Data

Three primary types of data will be generated, and copies of them will be provided to OLF. These data files will include:

- Seabird-observation database; this file will contain the bulk of the data that we collect, including the bird and environmental field described above and the data downloaded from the ship's system.
- GIS database and maps, following the guidelines in COP document "Data Protocols Version 6.4 March 2010."
- Photo files, following the guidelines in COP document "Data Protocols Version 6.4 March 2010."

4.2 Draft Report

The primary deliverable will consist of a Draft Report that will contain a summary of the data collected in 2011, a cumulative analysis of data collected in 2008–2011, and the retrospective analysis of historical data. This report will describe background information on seabirds in the general area, methods and results of the 2008–2011 field studies, analysis of historical data, and a discussion of those results. This Draft Report will be submitted to OLF electronically, including an editable electronic copy of text and tables (in MS Word) and a PDF of figures.

4.3 Final Report

After review of the Draft Report, we will provide a Final Report that has been revised after input from reviewers. This Final Report will be submitted in both electronic format (PDF and Word versions on 9 CD copies) and as hard copies (12 copies).

5.0 SCHEDULE WITH MILESTONES

Field Studies (dates are approximate)

- Mooring-deployment cruise—20 July to 3 August 2011
- First research cruise—3 to 23 August 2011
- Second research cruise—28 August to 6 October 2011
- Mooring-retrieval cruise—6 to 16 October 2011

5.1 Coordination Meetings

- Call in to the weekly scientific-studies coordination teleconferences—June to October 2011.
- Attend a pre-cruise Health, Safety, and Environment seminar in Anchorage—early July 2011.
- Attend a vessel inventory review in Seward—early July 2011.
- Call in to the bi-weekly data-analysis coordination teleconferences—November 2011 to August 2012.
- Attend an OLF Chukchi Sea Scientific Studies debrief meeting in Anchorage—December 2011.
- Attend an OLF Chukchi Sea Scientific Studies meeting and technical workshop in Anchorage, tentatively scheduled to be concurrent with the AMSS—January 2012.

5.2 Dates of deliverables

- Draft Study Plan—27 May 2011.
- Final Study Plan—about 6 June 2011.
- Draft Report will be submitted electronically—by 1 May 2012, assuming that all data are released to ABR, Inc., no later than 5 business days after the completion of the final research cruise (i.e., no later than 21 October 2011). Any delay in access to the data will result in a subsequent delay of report submission.
- Submission of data and photo deliverables—by 1 June 2012, assuming that the raw data are released to ABR, Inc., no later than 5 business days after the completion of the final research cruise (i.e., no later than 21 October 2011). Any delay in access to the data will result in a subsequent delay of submission of these deliverables.
- Final Report will be submitted in electronic format (PDF and Word versions)—by 1 August 2012, or within 3 weeks following receipt of comments, whichever comes first. As with the Draft Report, any delay in access to the data will result in a subsequent delay of report finalization.
- Archiving and completion of project—by 30 September 2012.

6.0 REFERENCES

- Balogh, G. R. 1997. Status report of the Spectacles Eider (*Somateria fischeri*), a threatened species. Unpublished report prepared by U.S. Fish and Wildlife Service, Anchorage, AK. 62 pp.
- Dau, C. P., and W. W. Larned. 2004. Aerial population survey of Common Eiders and other waterbirds in near shore waters and along barrier islands of the Arctic Coastal Plain of Alaska, 24–27 June 2004. Unpublished report prepared by U.S. Fish and Wildlife Service, Anchorage, AK. 19 pp.
- Day, R. H., J. R. Rose, A. K. Prichard, R. J. Blaha, and B. A. Cooper. 2004. Environmental effects on the fall migration of eiders at Barrow, Alaska. *Marine Ornithology* 32: 13–24.
- Dickson, L. and T. Bowman. 2009. Identification of Chukchi and Beaufort Sea migration corridor for sea ducks. Unpublished annual project summary submitted to the Sea Duck Joint Venture by U.S. Fish and Wildlife Service, Anchorage, AK. 6 pp. Date of use: 14 April 2010. <http://www.seaduckjv.org/studies/pro3/pr02B.pdf>
- Divoky, G. J., 1979. Sea ice as a factor in seabird distribution and ecology in the Beaufort, Chukchi, and Bering Seas. Pp. 9–17 in *Conservation of marine birds of northern North America* (J. C. Bartonek and D. N. Nettleship, Eds.). U.S. Fish and Wildlife Service, Wildlife Research Report No. 11.
- Divoky, G. J. 1987. The distribution and abundance of birds in the eastern Chukchi Sea in late summer and early fall. Unpublished report prepared for National Oceanic and Atmospheric Administration/Outer Continental Shelf Environmental Assessment Program (NOAA/OCSEAP), Boulder, CO, by Arctic Environmental Information and Data Center, Anchorage, AK. 96 pp.
- Divoky, G., G. A. Sanger, S. A. Hatch, and J. C. Haney. 1988. Fall migration of Ross' Gull (*Rhodostethia rosea*) in Alaska Chukchi and Beaufort seas. U.S. Fish and Wildlife Service, Anchorage, AK. OCS Study MMS 88–0023. 120 pp.
- Divoky, G. J., and A. M. Springer. 1988. Pelagic and coastal birds. Pages 69–83 in *The environment and resources of the southeastern Chukchi Sea* (M. J. Hameedi and

- A. S. Naidu, eds.). National Oceanic and Atmospheric Administration, Anchorage, AK.
- Hopcroft, R., B. Bluhm, and R. Gradinger (eds.). 2008. Arctic Ocean synthesis: analysis of climate change impacts in the Chukchi and Beaufort seas, with strategies for future research. Unpublished report to the North Pacific Research Board, Anchorage, AK, by the Institute of Marine Sciences, University of Alaska, Fairbanks, AK. 184 pp.
- Gould, P. J., and D. J. Forsell. 1989. Techniques for shipboard surveys of marine birds. U.S. Fish Wildlife Service Technical Report No. 25. 22 pp.
- Jaques, F. L. 1930. Water birds observed on the Arctic Ocean and the Bering Sea in 1928. *Auk* 47: 353–366.
- Johnson, S. R. 1993. An important early-autumn staging area for Pacific Flyway Brant: Kasegaluk Lagoon, Chukchi Sea. *Journal of Field Ornithology* 64: 539–548.
- Johnson, S. R., D. A. Wiggins, and P. F. Wainwright. 1993. Late-summer abundance and distribution of marine birds in Kasegaluk Lagoon, Chukchi Sea, Alaska. *Arctic* 46: 212–227.
- Magurran, A. E. 2004. Measuring biological diversity. Blackwell Science Ltd, Malden, MA. 256 pp.
- Oppel, S., D. L. Dickson, and A. N. Powell. 2009. International importance of the eastern Chukchi Sea as a staging area for migrating King Eiders. *Polar Biology* 32: 775–783.
- Rizzolo, D. J., and J. A. Schmutz. 2008. Monitoring marine birds of concern in the eastern Chukchi nearshore area (loons). U.S. Geological Survey, Alaska Science Center, Anchorage, AK. OCS Study MMS 2008. 36 pp.
- Suydam, R. S., D. L. Dickson, J. B. Fadely, and L. T. Quakenbush. 2000a. Population declines of King and Common eiders of the Beaufort Sea. *Condor* 102: 219–222.
- Suydam, R. S., L. T. Quakenbush, D. L. Dickson, and T. Obritschkewitsch. 2000b. Migration of King, *Somateria spectabilis*, and Common, *S. mollissima* v *nigra*, eiders past Point Barrow, Alaska, during spring and summer/fall 1996. *Canadian Field–Naturalist* 114: 444–452.
- Suydam, R., L. T. Quakenbush, M. Johnson, J. C. George, and J. Young. 1997. Migration of King and Common eiders past Point Barrow. Pages 21–28 in *King and Common eiders of the western Canadian Arctic* (D. L. Dickson, ed.). Canadian Wildlife Service, Occasional Papers No. 94.
- Swartz, L. G. 1966. Sea-cliff birds. Pp. 611–678 in *Environment of the Cape Thompson Region* (N. J. Wilimovsky and J. N. Wolfe, Eds.). U.S. Atomic Energy Commission, Oak Ridge, TN.
- Swartz, L. G. 1967. Distribution and movement of birds in the Bering and Chukchi seas. *Pacific Science* 21: 332–347.
- Tasker, M. L., P. H. Jones, T. J. Dixon, and B. F. Blake. 1984. Counting seabirds at sea from ships: a review of methods employed and a suggestion for a standardized approach. *Auk* 101: 567–577.
- Thomas, L., J. L. Laake, S. Strindberg, F. F. C. Marques, S. T. Buckland, D. L. Borchers, D. R. Anderson, K. P. Burnham, S. L. Hedley, J. H. Pollard, J. R. B. Bishop, and T. A. Marques. 2010b. Distance Version 6.0 (Release 2). Research Unit for Wildlife Population Assessment, University of St. Andrews, St. Andrews, United Kingdom. [available at <http://www.ruwpa.st-and.ac.uk/distance/>]

- Thompson, D. Q., and R. A. Person. 1963. The eider pass at Point Barrow, Alaska. *Journal of Wildlife Management* 27: 348–356.
- Watson, G. E., and G. L. Divoky. 1972. Pelagic bird and mammal observations in the eastern Chukchi Sea, early fall 1970. Pages 111–172 in WEBSEC–70: An ecological survey in the eastern Chukchi Sea, September–October 1970. U.S. Coast Guard Oceanographic Report No. 50 (CG 373–50).
- Woodby, D.A., and G. J. Divoky. 1982. Spring migration of eiders and other waterbirds at Point Barrow, Alaska. *Arctic* 35: 403–410.

SECTION VIII MARINE MAMMAL ECOLOGY

LISANNE AERTS, PRINCIPAL INVESTIGATOR

OASIS ENVIRONMENTAL, INC.

ANCHORAGE, AK

1.0 INTRODUCTION

1.1 Brief History of Marine Mammal Research in Chukchi Sea

Marine mammal research in the Chukchi Sea has a history that goes back at least 30 years. In 1975, the Department of Interior initiated the Outer Continental Shelf Environmental Assessment Program (OCSEAP) to establish an environmental baseline for the Beaufort and Chukchi Seas. The objective was to use this dataset for predicting and mitigating potential impacts from oil and gas explorations and developments. Research from the late '70s to the early '90s was conducted by ADF&G, NOAA, NMFS, USFWS, and MMS (now BOEMRE) to obtain information on the distribution, feeding ecology and behavioral aspects of marine mammals in the Chukchi and Beaufort Seas (e.g., Burns and Eley 1978, Burns et al. 1981, Burns and Seaman 1986, Gilbert 1989, Gilbert et al. 1992, Lowry et al. 1978, 1980a, 1980b, 1981, Ljungblad et al. 1984, 1986, 1987). Other marine mammal monitoring during these years occurred in conjunction with industrial activities (e.g., Brueggeman et al. 1990, 1991, 1992a, 1992b). After a reduction in research intensity from early 1990 to 2000, there was again an increased focus on marine mammal distribution and abundance research in the Chukchi Sea, mainly due to a renewed interest in offshore oil and gas developments and also possible threats on Arctic species from global warming. For example, recent distribution and abundance surveys in the Chukchi Sea were conducted for bearded and ringed seals (Bengtson et al. 2005), polar bears (Evans et al. 2003), beluga whales (Suydam et al. 2005), bowhead whales (George and Suydam 2009, Quakenbush et al. 2009), and gray whales (Moore et al. 2006). BOEMRE initiated a long-term marine mammal aerial survey program in the Chukchi Sea in 2008 under the COMIDA (Chukchi Offshore Monitoring In Development Area) project. This aerial survey is coordinated through NOAA's National Marine Mammal Lab (NMML), and is designed to document marine mammal distribution in the Chukchi Sea Planning area during the open-water months, from mid-June to the end of October.

Nearshore marine mammal aerial surveys and vessel-based marine mammal observations were also conducted during 2006–2009 as part of a monitoring and mitigation program for seismic and shallow hazard surveys (Ireland et al. 2007, Brueggeman 2009b, Funk et al. 2009, Reiser et al. 2010). In addition, ConocoPhillips started an ecosystem-based Chukchi Sea Environmental Studies Program (CSESP), co-funded by Shell and in 2010 also by Statoil. Monitoring marine mammal distribution and abundance through vessel-based line transect surveys is one of the components of this program.

1.2 Objectives

The purpose of this marine mammal survey is to increase current knowledge about movements, distribution and abundance of marine mammals in the Chukchi Sea lease areas of ConocoPhillips, Shell and Statoil. This information, combined with results from oceanographic, plankton, benthos, and fish research, will contribute to developing a baseline for determining potential changes in marine mammal distribution and abundance as a result of natural environmental and anthropogenic influences. The marine mammal information obtained through the CSESP will also be used in developing mitigation measures during offshore oil and gas developments and for evaluation of the effectiveness of these measures.

There are four general objectives identified to achieve this main goal.

- Determine marine mammal species composition and numbers for each study area;
- Determine the annual and seasonal abundance of marine mammal species within the study areas;
- Identify habitat use and importance of the study areas for marine mammals, based on distribution and behavioral data (e.g. feeding areas, migration routes);
- Integrate results with the other components of the CSESP (i.e., oceanographic, plankton, benthic, fish, and acoustic information) to increase our understanding of ecological relationships.

2.0 METHODS AND PROCEDURES

2.1 Sampling Design

Trained marine mammal observers (MMOs) will record all marine mammals sighted during daylight hours along predetermined transect lines. In 2008 and 2009 the survey area included ConocoPhillips' and Shell's offshore prospects, referred to as Klondike and Burger area, respectively. In 2010, a third area was added, the Statoil area. In 2011, a more regional area will be covered, encompassing the three study areas and Hanna Shoal to the north. The study design is based on the systematic sample and transect grid used in 2008 to 2010, with transect lines running from north to south. However, the line spacing will be larger to be able to cover a greater area. Line spacing will be 7.5 nm, except within the three study areas where the spacing will be 3.75 nm, to allow for better coverage and comparison with data from previous years. In addition, two regional north-south lines will be surveyed, with one line running from the southeast corner to the northern border of the study area and the other line just west of the other regional transect line.

The 2011 survey will consist of two cruises. The first cruise will comprise of approximately 15 days, with 5 days in each of the three prospect-specific study areas. It is anticipated that during the first cruise the survey will start in the Klondike study area (southernmost area), move to the Burger study area and then to the Statoil study area (northernmost area). During the second cruise the regional area will be covered in a cruise of approximately 38 days, weather depending. The regional study area will be broken into three sections – north, middle, and south. The southern section (which includes the Klondike area) will be sampled first, the middle section (comprising Burger

and Statoil study areas) second, and the northern section (including Hanna Shoal) last. The order of the surveys will depend on ice conditions and possible industrial activity in the study area. Cruising speed during the marine mammal surveys will be on average 8 to 9 knots. The number and sequence of transect lines surveyed may be modified to accommodate changing weather or sea ice conditions to ensure the surveys cover most if not all of the area planned to be sampled.

2.2 Field Team Size and Composition

A total of four MMOs will participate in the 2011 marine mammal survey. All MMOs participated in the program since 2008 or 2009, which provides consistency, continuity, and on-site experience. An additional MMO will be available as back-up. All MMOs will attend a refresher MMO training session before initiation of the research program coordinated and provided by the marine mammal PI. The training will consist of evaluating previous year's experiences and reviewing the current protocols and procedures for data collection, data recording and quality control. Species identification and equipment use will also be discussed during this training.

2.3 Data-collection Protocols and Procedures

A total of two MMOs will be present on each cruise. At least one MMO will watch for marine mammals from the best available vantage point on the vessel, which is the bridge or flying bridge. The MMOs will scan systematically with the naked eye and Fujinon 7x50 reticule binoculars. While the vessel is moving forward with a constant average speed of 9 knots, the MMOs will scan the 180° area centered on the vessel's trackline. Fujinon 16x gyroscopically-stabilized binoculars will be used to verify species identification and behavior, where needed and possible. A Canon SLR camera with a 120-400 mm zoom lens will also be available for capturing photographs of marine mammals and can be used as an additional tool for marine mammal identification. Marine-mammal observations will occur for up to 16 hours/day, depending on weather conditions and day length. MMOs will alternate watches, so each observer is on watch for no more than 8 hours/day. Observations will begin when light conditions allow reliable detection of marine mammals. Data will be entered and stored using Panasonic Toughbook computers and TigerObserver data acquisition software developed specifically for the science program. Data collection codes and the equipment list are provided in MMO Appendix A and B.

When a marine mammal (or group of animals) is sighted, the following information will be entered into a Toughbook with TigerObserver software:

- Sighting info: species, group size, number of juveniles, behavior, heading, bearing and distance of the animal relative to the vessel, sighting cue, and identification reliability;
- Environmental data: sea state, ice cover (10% increments), visibility, and sun glare; and
- Other: the position(s) of any other vessel(s) in the vicinity of the research vessel.

Distances to marine mammals will be estimated visually or with sighting aids (e.g., laser range-finder, clinometer, or reticule binoculars). Observers will also use these sighting

aids to test and improve their abilities for visually estimating distances to objects in the water.

Sea state, ice cover, visibility, and sun glare will also be recorded at the start and end of each transect line, and whenever there is a change in one or more of those variables.

Observations will generally be suspended if (i) sea states exceed Beaufort scale 5, because the probability of detecting marine mammals in high seas is too low or (ii) visibility along the transect is less than 300 m.

As in 2010, TigerNav, a navigation based software system, will be used to record all vessel position information on a real time basis. This information includes date, time, vessel position, speed, and heading, water depth, sea surface temperature and salinity, and weather. Both TigerObserver and TigerNav are synchronized to a server system present on the vessel. This allows for all marine mammal sighting data to be automatically linked to the relevant navigational and weather data. Data collection codes and Beaufort wind force scale are provided in MMO Appendix A and B.

2.4 Analytical Procedures

The data analyses approach will mainly be determined by the sample size of the marine mammal data collected in 2011, but will be conducted in combination with available data from 2008 to 2010. Analyses will include simple summary statistics of effort, species sighted, abundance, behavior, etc. In addition, the program DISTANCE will be used to estimate spatial and seasonal densities of species with a high enough sample size. Depending on the data quality and sample sizes, density plots or kernel density maps will be generated that could show effort corrected 'hot spot' areas of certain marine mammal groups or, if possible, for each species. Ideally, the marine mammal data from historical studies and from other ongoing surveys in the area would be integrated in these density maps. Whether this is possible will, among other factors, depend on the survey designs and sighting sample sizes of the surveys. Data from other disciplines will be incorporated in the analyses where possible and applicable.

2.5 Data-storage Procedures

Each day, after the end of the observation period, the field data entered on the Toughbooks and vessel data recorded by TigerNav will be synchronized to the server. A copy of the raw marine mammal data will remain stored on the Toughbook, as well as in the master database on the server computer. The main server contains a system containing a redundant array of independent disks to preserve storage reliability and data integrity. Furthermore, the server is connected via USB to a 2TB external hard drive, used as a third backup of all data files.

2.6 Quality-control Procedures

The lead MMO or PI are responsible for checking the integrity of their own data. The TigerObserver software contains a function that allows the lead MMO or PI on the vessel to perform a quality control of the database entries in either Microsoft Access or Excel formats. Additional checking will occur in the office after the field season.

3.0 COORDINATION

3.1 Marine Mammal Study Organization

ConocoPhillips, Shell, and Statoil jointly fund the offshore Chukchi Sea Environmental Study Program (CSESP). They contracted Olgoonik-Fairweather (OLF) to coordinate and execute the program and are in direct communication with their program managers on field logistics data analysis, and reporting. OLF will contract OASIS to deliver the marine mammal PI, and will hire the MMOs directly. The MMOs report all technical aspects of the survey directly to the PI, who is responsible for scheduling, data recording, data quality assurance, and reporting. The PI communicates with OLF on all these aspects and works directly with the OLF project manager to resolve any potential concerns or issues.

3.2 Chukchi Sea Study Integration

The marine-mammal study will be closely coordinated with the other studies of the CSESP. The coordination effort will be discussed between investigators of the studies prior to the fieldwork, during fieldwork, and during data analyses and will include:

- Seabird study: the bird observers will work closely with the MMOs on the vessel, sharing sighting information.
- Fish, Zooplankton and Benthic studies: close communications between the scientists of these disciplines will occur during the field season and data analyses to allow correlation between prey composition, prey abundance and marine mammal distribution and abundance.
- Acoustic study: close communications between the acoustic scientists will occur during data analyses to allow linking of visual records with acoustic detection of calling marine mammal species.

3.3 Other Studies in the Region

The integration of research information is important in obtaining an increased understanding of the ecology of marine mammals and the environment that they inhabit. Efforts will be made to establish close communication with scientist from other programs that conduct marine mammal, benthic and acoustic studies in the Chukchi Sea. These include the COMIDA surveys, Shell's nearshore aerial surveys, and satellite tagging surveys.

4.0 DELIVERABLES

4.1 Field Data

Throughout the entire period of data collection, the Chief Scientist on board the vessel will compile daily reports, 72-hour reports, and weekly reports. This field data will be provided to the OLF project manager who will distribute it to the clients as required. The daily reports will summarize information on marine mammal sightings over the previous 24-hour period. The 72-hour reports will serve to forecast what marine mammal transects will be surveyed over that period, and the weekly reports will comprise a

compilation of the daily report information plus any quantitative information on observations where applicable.

4.2 Final Report

At the end of the field season all marine mammal data will be analyzed and summarized in a final report. This final report will include data from previous years and data from other disciplines where possible and applicable. The marine mammal PI will be responsible for writing this final report. Currently, the draft report is due 1 May 2012, and the final report 1 August 2012. The QAQC-ed electronic data will be delivered 1 June 2012. Any changes to the schedule will be communicated between the PI and OLF.

The final report will be prepared according to standard format for scientific documents and will conform to project guidelines. In general, the format will include a Summary, Introduction, Purpose and Objectives, Study Area, Results, Discussion, Conclusions, and Literature Cited.

5.0 REFERENCES

- Bengston, J. L., L. M. Hiruki-Raring, M. A. Simpkins, and P. L. Boveng. 2005. Ringed and bearded seal densities in the eastern Chukchi Sea, 1999–2000. *Polar Biology*. 28: 833–845.
- Brueggeman, J. J., R. A. Grotefendt, M. A. Smultea, G. A. Green, R. A. Rowlett, C. C. Swanson, D. P. Volsen, C. E. Bowlby, C. I. Malme, R. Mlawski, and J. J. Burns. 1992a. 1991 Marine Mammal Monitoring Program, Walruses and Polar Bears, Crackerjack and Diamond Prospects, Chukchi Sea. Shell Western E&P, Inc., and Chevron USA, Inc. 109 pp. + appendices.
- Brueggeman, J. J., R. A. Grotefendt, M. A. Smultea, G. A. Green, R. A. Rowlett, C. C. Swanson, D. P. Volsen, C. E. Bowlby, C. I. Malme, R. Mlawski, and J. J. Burns. 1992b. 1991 Marine Mammal Monitoring Program, Whales and Seals, Crackerjack and Diamond Prospects, Chukchi Sea. Shell Western E&P, Inc., and Chevron USA, Inc. 62 pp. + appendices.
- Brueggeman, J. J., D. P. Volsen, R. A. Grotefendt, G. A. Green, J. J. Burns, and D. K. Ljungblad. 1991. 1990 Walrus Monitoring Program, Popcorn, Burger, and Crackerjack Prospects in the Chukchi Sea. Shell Western E&P. Inc. 53 pp. + appendices.
- Brueggeman, J. J., C. I. Malme, R. A. Grotefendt, D. P. Volsen, J. J. Burns, D. G. Chapman, D. K. Ljungblad, and G. A. Green. 1990. 1989 Walrus Monitoring Program, Klondike, Burger, and Popcorn Prospects in the Chukchi Sea. Shell Western E&P, Inc. 121 pp. + appendices.
- Evans, T. F., A. S. Fischbach, S. Schliebe, S. Kalxdorff, G. York, and B. Manly. 2003. Polar Bear Aerial Survey in the Eastern Chukchi Sea. *Arctic* 56: 359–366.
- George, J.C. and R. Suydam. 2009. Preliminary Report of the Spring 2009 Ice-Based Bowhead Whale Census Activities Near Barrow, Alaska. IWC SC/61/BRG23
- Gilbert, J.R. 1989. Aerial census of Pacific walruses in the Chukchi Sea, 1985. *Marine Mammal Science*.5(1):17-28.
- Gilbert, J., G. Fedoseev, D. Seagars, E. Razlivalov, and A. Lachugin. 1992. Aerial Census of Pacific Walrus, 1990. USDI U.S. Fish and Wildlife Service. Marine Mammal Management. Anchorage, Alaska.

- Quakenbush, L.T., J.J. Citta, J.C. Craig, R. Smith, and M.P. Heide-Jorgensen. 2009. Fall movements of bowhead whales in the Chukchi Sea. Paper presented at the Alaska Marine Science Symposium, January 19-23, 2009, Anchorage, AK.
- Ljungblad, D. K., S. E. Moore, and D. R. Van Schoik. 1984. Aerial surveys of endangered whales in the Beaufort, eastern Chukchi, and northern Bering seas, 1983: with a five year review, 1979–1983. Report from Naval Ocean Systems Center, San Diego, CA, for U.S. Minerals Management Service, Anchorage, AK. NOSC Technical Report No. 955. 356 pp. [NTIS AD-A146 373/6]
- Ljungblad, D. K., S .E. Moore, and D. R. Van Schoik. 1986. Seasonal patterns of distribution, abundance, migration, and behavior of the Western Arctic stock of bowhead whales, *Balaena mysticetus*, in Alaskan seas. Reports of the International Whaling Commission, Special Issue 8: 177–205.
- Ljungblad, D. K., S.E. Moore, J. T. Clarke, and J. C. Bennett. 1987. Distribution, abundance, behavior, and bioacoustics of endangered whales in the Alaskan Beaufort and eastern Chukchi seas, 1979–86. Report from Naval Ocean Systems Center, San Diego, CA, for U.S. Minerals Management Service, Anchorage, AK. NOSC Tech. Rep. 1177; OCS Study MMS 87-0039. 391 pp. [NTIS PB88-116470]
- Ljungblad, D. K., B. Würsig, S. L. Swartz, and J. M. Keene. 1988. Observations on the behavioral responses of bowhead whales (*Balaena mysticetus*) to active geophysical vessels in the Alaskan Beaufort Sea. *Arctic* 41: 183–194.
- Moore, S.E., K.M. Stafford, D.K. Mellinger, and J.A. Hildebrand. 2006. Listening for large whales in the offshore waters of Alaska. *BioScience* 56(1):49-55.
- Moore, S. E., and R. R. Reeves. 1993. Distribution and movement. In J. J. Burns, J. J. Montague, and C. J. Cowles (Eds.). *The bowhead whale*. Society of Marine Mammalogy, Lawrence, KS. Special Publication No. 2. Pp. 313–386
- Suydam, R. S., L. F. Lowry, and K. J. Frost. 2005. Distribution and movements of beluga whales from the eastern Chukchi Sea stock during summer and early autumn. Final Report, OCS Study No. MMS 2005-035. 48 pp.

6.0 MMO APPENDIX

6.1 APPENDIX A- Data Recording Field Codes for MMOs

Field Name	Codes	Description		
TigerOBserver_MARINE MAMMAL EFFORT				
Vessel Name		Name of vessel on which data were collected		
Cruise ID		Cruise Identifier		
	WWW1001	mooring deployments (Jul 22-31)	NII1001	Mooring deployments (Jul 20-31)
	WWW1002	Science Leg 1 (Aug 1-31)		
	WWW1003	Science Leg 2 (Sep 1-30)	NII1002	Science Leg 2 (Sep 1-23)
	WWW1004	Science Leg 3/mooring retrieval (Oct 1-15)	NII1003	Mooring retrieval (Sep 24 - Oct 15)
Line ID	KLH	Klondike high-priority line (001-016)	KLL	Klondike low-priority line (021-035)
	BUH	Burger high-priority line (001-016)	BUL	Burger low-priority line (021-035)
	STH	Statoil high-priority line (001-019)	STL	Statoil low-priority line (021-039)
	KHN/KHS	Klondike deadhead line = northern or southern end of high-priority line (001-015)		
	BHN/BHS	Burger deadhead line = northern or southern end of high-priority line (001-015)		
	SHN/SHS	Statoil deadhead line = northern or southern end of high-priority line (001-019)		
	* KOT	Klondike other line = for other movements within the box (201-2XX)		
	* BOT	Burger other line = for other movements within the box (201-2XX)		
	* SOT	Statoil other line = for other movements within the box (201-2XX)		
	KNN	"near-Klondike" line = in case ice prevents sampling within the box (1-3)		
	BNN	"near-Burger" line = in case ice prevents sampling within the box (1-3)		
	SNN	"near-Statoil" line = in case ice prevents sampling within the box (1-3)		
	KBT	Klondike-Burger transit line (1-3)		
	KWT	Klondike-Wainwright transit line (1-3)		
	BWT	Burger -Wainwright transit line, Statoil -Wainwright transit line (1-3)		
	OTH	other transit line generally far from study area (1-3, but can be more if needed)		
Line Replicate	number	If line is re-surveyed. 0= no replicate, 1= first replicate, 2 = second replicate, etc.		
Num Observer		Number of observers on watch, conducting dedicated observations		
Observer Location	BR	Bridge	ST	Stern
	FB	Flying Bridge	SD	Ship's deck
Observer Port		MMO's initials on port side		
Observer Center		MMO's initials in the center of the ship		
Observer Starboard		MMO's initials on the starboard side		
Sea State / Wind Force		See Appendix B for Beaufort windforce scale codes and descriptions		
Visibility	0 - 10 km	use 0 for visibility <500 m and 1 for visibility from 500 m to 1 km		
	> 3.5	variable but more than 3.5 km		
	< 3.5	variable but less than 3.5 km		
Glare Amount	NO	None	SE	Severe (glare prevents from observing)
(viewing are is 180°)	LI	Little (glare not very bright)	VA	Variable
	MO	Moderate (glare moderately bright)		

Field Name	Codes	Description		
Glare Position From		Clockface position where glare begins (1200 is at the bow of the vessel, 0000 = N/A)		
Glare Position To		Clockface position where glare ends (1200 is at the bow of the vessel, 0000 = N/A)		
Ice Percent		Ice cover within 2 km of vessel 360 degrees (0 - 100 % in 10% increments)		
Pack Ice Distance		Distance (km) from vessel to pack ice edge, if visible		
TigerObserver_MARINE MAMMAL OBSERVATIONS				
Sighting ID		Consecutive number for each new marine mammal sighting (start at 1 for each vessel each season)		
Sighting Record Number		For resighting of the same animal or group of animals. Include the original Sighting ID in this field		
Species		<i>Mysticetes/Odontocetes</i>		<i>Pinnipeds</i>
	BHW	Bowhead whale (BW)	RS	Ringed seal
	GW	Gray whale	SS	Spotted seal
	HW	Humpback whale	RSS	Ringed/Spotted seal
	MW	Minke whale	BS	Bearded seal
	FW	Fin Whale	RBS	Ribbon Seal (RB)
	NPRW	North Pacific right whale	HBS	Harbor seal
	WW	Beluga whale	NFS	Northern fur seal
	KW	Killer whale	SSL	Steller's Sea Lion
	NW	Narwhal	WA	Pacific Walrus
	HP	Harbor porpoise	US	Unidentified seal
	DP	Dall's porpoise	UP	Unidentified pinniped
			U or	
	UMW	Unidentified baleen (mysticete) whale	UN	Unknown marine mammal
	UTW	Unidentified toothed (odontocete) whale		<i>Fissipeds</i>
	UW	Unidentified whale or dolphin	PB	Polar bear
For groups with multiple species use resight to record all species				
Individuals		Total number of animals in the group		
Juveniles		Number of juveniles within the group (subset of individuals)		
Where at		Clockface position where marine mammal was first observed (1200 is at the bow of the vessel)		
Where to		Animal's direction of movement, in clockface coordinates relative to vessel		
Behavior 1/2	BL	Blow	MI	Milling
	BO	Bow Riding	NO	None (Seen sign only)
	BR	Breach	OT	Other
	DE	Dead	RE	Resting (includes logging)
	DI	Diving	SA	Surface Active (includes splash)
	FE	Feeding	SH	Spyhop
	FL	Fluking	SI	Sink
	FS	Flipper Slap	SW	Swim
	LO	Look	TR	Travel
	LT	Lobtail	U	Unknown
	MA	Mating	WK	Walking

Field Name	Codes	Description		
Movement	SA	Swimming away	PE	Swimming perpendicular to vessel
	SP	Swimming parallel to vessel	NO	None, not applicable
	ST	Swimming towards	U	Unknown
Pace		Animal's travel speed	VI	Vigorous
Animal's travel speed	SE	Sedate	U	Unknown
	MO	Moderate	X	Not Applicable
Reaction		Reaction to vessel		
	LO	Look	SP	Splash (= trash)
	CD	Change direction	SG	Interactions with gear
	IS	Increase in speed	FL	Flee
	DI	Dive	U	Unknown
	DS	Decrease in speed	X	None
Water or Ice	W	Animal observed in water		
	IL	Animal observed on ice or land		
Reticles		Number of reticles, or use "E" when estimated by eye		
Sighting Distance		Distance in meter to animal(s) when first sighted		
Sighting Cue	HE	Head	SP	Splash
	FL	Fluke	BL	Blow
	BO	Body	BI	Birds feeding
	DO	Dorsal fin/ridge		
ID Reliability	MA	Maybe		
	PR	Probably		
	PO	Positive		
Sighting Observed By		Initials of observer that first sighted the marine mammal		
Notes		Any additional information on sighting, e.g. presence of boats during sighting		

TigerNav_VESSELDATA
Date
Time
Vessel position (lat-long), heading
Water depth
Sea surface salinity
Sea surface temperature

6.2 APPENDIX B- Beaufort Wind Force Scale Codes

Sea State Code	Wind speed		Wave Height		Description
	(km/hr)	(knots)	(meter)	(feet)	
0	0-2	0-1	0	0	Calm, sea like a mirror.
1	2-5.5	1-3	0-0.2	<0.5	Ripple with the appearance of scales are formed, but without foam crests.
2	7.5-11	4-6	0-0.5	0.5-1	Small wavelets, still short, but more pronounced. Crests have a glassy appearance and do not break.
3	13-18.5	7-10	0.5-1	2-3	Large wavelets. Crests begin to break. Foam of glassy appearance. Perhaps scattered white caps.
4	20.5-30	11-16	1-2	3-5	Small waves, becoming larger; fairly frequent white caps.
5	31.5-39	17-21	2-3	6-8	Moderate waves, taking a more pronounced long form; many white caps are formed. Chance of some spray.
6	41-50	22-27	3-4	9-12	Large waves begin to form; the white foam crests are more extensive everywhere. Spray probable.
7-12	> 50	> 27	> 4	> 13	7 is near gale, 10 is storm, and 12 is hurricane

SECTION IX CHUKCHI SEA ACOUSTIC MONITORING

DAVID HANNAY

**PRINCIPAL INVESTIGATOR
JASCO APPLIED SCIENCES
VICTORIA, BC**

1.0 INTRODUCTION

The 2011 passive acoustic monitoring program continues the jointly-sponsored Chukchi Sea acoustic studies performed yearly from 2006 to 2010. It will use similar equipment and deployment geometries. The objectives of the program remain as from previous years: to quantify the soundscape of the Chukchi Sea and to identify and localize marine mammal vocalizations to provide improved understanding of marine mammal habitat usage, migration paths and temporal and spatial presence. The data acquired from the program will be used to assist in the assessment of potential noise effects of industrial activities associated with oil and gas exploration and production on marine mammals.

The 2011 acoustics field program will involve deploying forty autonomous acoustic recorders in three separate cruises. Twenty-five recorders will be deployed in late July 2011 along four lines perpendicularly offshore Cape Lisburne, Point Lay, Wainwright and Barrow. At the same time we will retrieve the 8 recorders that were deployed in October 2010. A second mid- to late-August deployment of 6 recorders will then be performed to extend the northern extent of acoustic monitoring coverage over Hanna Shoal as soon as ice conditions allow. The final 9 recorders will be deployed in early October at the same time the 25 early summer (July) recorders are retrieved. The late summer-deployed recorders will be left in place with the winter recorders to capture acoustic data on 15 recorders through the winter. The two significant differences between the 2011 program and the 2010 program are: inclusion of six new long-duration late-summer recorders, and the removal of the three cluster arrays used in 2009-2010 at Shell's Burger prospect, COP's Devil's Paw (Klondike) prospect, and Statoil's prospect. We will keep only the central station of each of those 3 cluster arrays in 2011. The acoustic data acquired by all 40 recorders will be analyzed to detect vocalizations and classify the calling species using approaches similar to that employed for analysis of the previous seasons' data. We point out that the data from the August and October recorders will be retrieved in summer 2012. The recorders deployed in July will be retrieved in October 2011 and available for analysis with the 2010 overwinter data to be retrieved in this field program.

1.1 Program Description

Marine mammal species in the Chukchi Sea use sound for communication, navigation, predator avoidance, defense, breeding, care of young and feeding. Industrial activities by ConocoPhillips, Shell and Statoil, and other operators in the Chukchi will generate underwater noise that could interfere with the natural uses of sound listed above. Noise exposures can also induce physiological responses that could lead to secondary effects such as habitat abandonment and reduction of foraging or breeding efficiency.

The arctic seas have historically experienced less industrial activity than most other marine environments. Marine mammals in the Chukchi consequently have had less opportunity to habituate to anthropogenic noise. Regulatory permitting for recent projects has acknowledged this and as a result applied rather strict requirements for operators working in the Chukchi to quantify and mitigate sound exposures of marine mammals. Acoustic programs have been performed by COP, Shell and Statoil and other operators since 2006 to address these permitting requirements related to noise for offshore operations there. Olgoonik-Fairweather's (OLF) 2011 program has been designed to extend the multi-year dataset and to provide new information about region-wide and localized migration zones for several species. The 2011 program extends the northern extent of the monitored region over previous years' studies.

1.2 Acoustics Program Purpose

The proposed acoustics program has been designed to address the following main goals: 1) to assess ambient and industrial noise levels and 2) to detect and classify species of vocalizing marine mammals over the eastern Chukchi Sea and in vicinity of the Burger, Devil's Paw (Klondike) and Statoil prospects. The 2011 field program extends the measurement programs performed by JASCO Research Ltd and Bioacoustics Research Program at Cornell University in 2006-2010 for COP, Shell and Statoil. The 2011 program will be performed by JASCO Research Ltd under contract to Olgoonik-Fairweather.

The regional program will instrument a large area of the Chukchi Sea off the Alaskan coast out to approximately 160 km (100 miles) offshore. Statoil may perform a shallow hazards seismic survey and some geotechnical coring to the north of Burger and extending to approximately 72 degrees north during the program. We expect to capture those sounds on several of the recorders and this will allow characterization of specialized oil and gas related anthropogenic activities. The acoustic field measurement program will directly measure seismic survey sounds and vessel noise and it will detect vocalizations from several marine mammal species. Detections are expected from belugas (*Delphinapterus leucas*), bowheads (*Balaena mysticetus*), gray whales (*Eschrichtius robustus*), fin whales (*Balaenoptera physalus*), killer whales (*Orcinus orca*), walrus (*Odobenus rosmarus*) and several species of ice seals. Other extra-limital species may also be acoustically detected.

2.0 FIELD METHODS

2.1 Equipment and Sampling Parameters

All acoustic measurements will be performed using JASCO's calibrated autonomous multi-channel acoustic recorders (AMARs) and Multi-Electronic AURAL-M2 recorders. The AMAR's are shown in Figures IX-1 and IX-2. These recorders sample continuously or on a pre-programmed schedule. We plan to set the programmable sample rate to 16,000 samples per second using 24-bit samples on continuous setting. These are the same settings that have been employed from 2007 to 2010. The sampling rate is higher than used by most other long-period sound recording programs in the Chukchi Sea. The chosen sample rate provides 8 kiloHertz (kHz) of acoustic bandwidth which is sufficient to capture a sufficient component of beluga vocalizations and most of the frequency content of the other present species' vocalizations. It is not high enough to capture click sounds from harbor porpoises that are at much higher frequencies, above 100 kHz.

The AMARs will be configured with omni-directional hydrophones. The hydrophones are calibrated in the lab prior to deployment, and a final calibration is performed in the field immediately prior to deployment and upon retrieval using a pistonphone calibrator that generates a reference signal accurate to 0.1 decibel (dB) at 250 Hz. The calibration signals are recorded into the data stream for confirmation of overall recording system gain upon data analysis. The late summer and overwinter deployments will use Multi-Electronique AURAL-M2 autonomous recorders. These recorders are similar to AMARs and will be set to sample at the same 16 kHz rate that has been used in summer and winter recordings for this program. The AURAL's use only 16-bit samples but this has been found satisfactory for the purposes of the program.



Figure IX-1. Photograph of AMAR acoustic buoy.

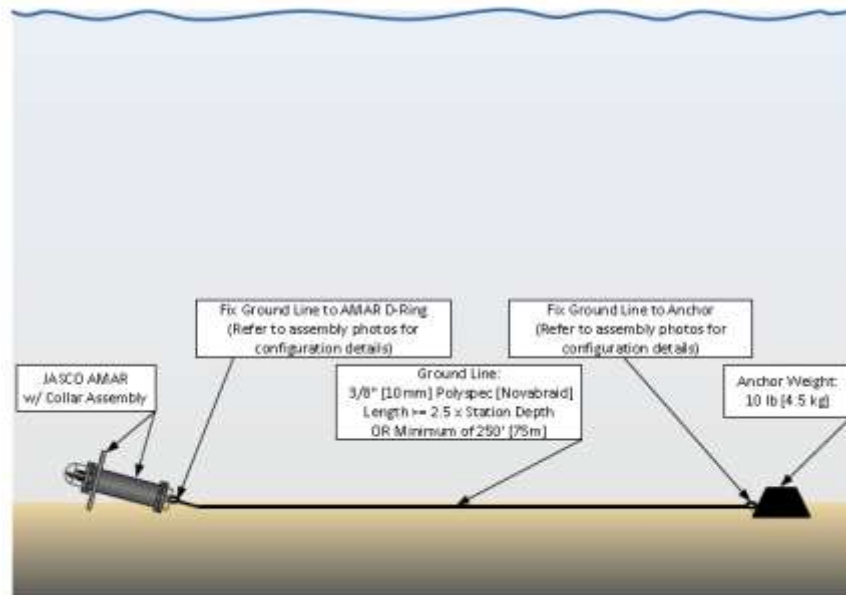

Figure IX-2. AMAR and AURAL deployment configuration planned for OLF 2011 acoustics program. Retrievals are made by grappling the line between the recorder and the anchor. This is a modified version of the 2010 mooring that suspended the recorder with flotation above a heavy anchor. The modification is to simplify deployment and reduce mooring noise.

2.2 Deployment Geometry and Schedule

The recorders will be positioned on the seabed as shown in the diagram in Figure IX-2. The late July recorders will be deployed at the locations in the map of Figure IX-3 that are listed in Table IX-1. They will be retrieved in October. The August and October deployment locations are shown in the map of Figure IX-4 and are listed in Tables IX-2 and IX-3. These fifteen recorders (6 from the August deployment and 9 from the October deployment) will be left in-place to operate through the winter.

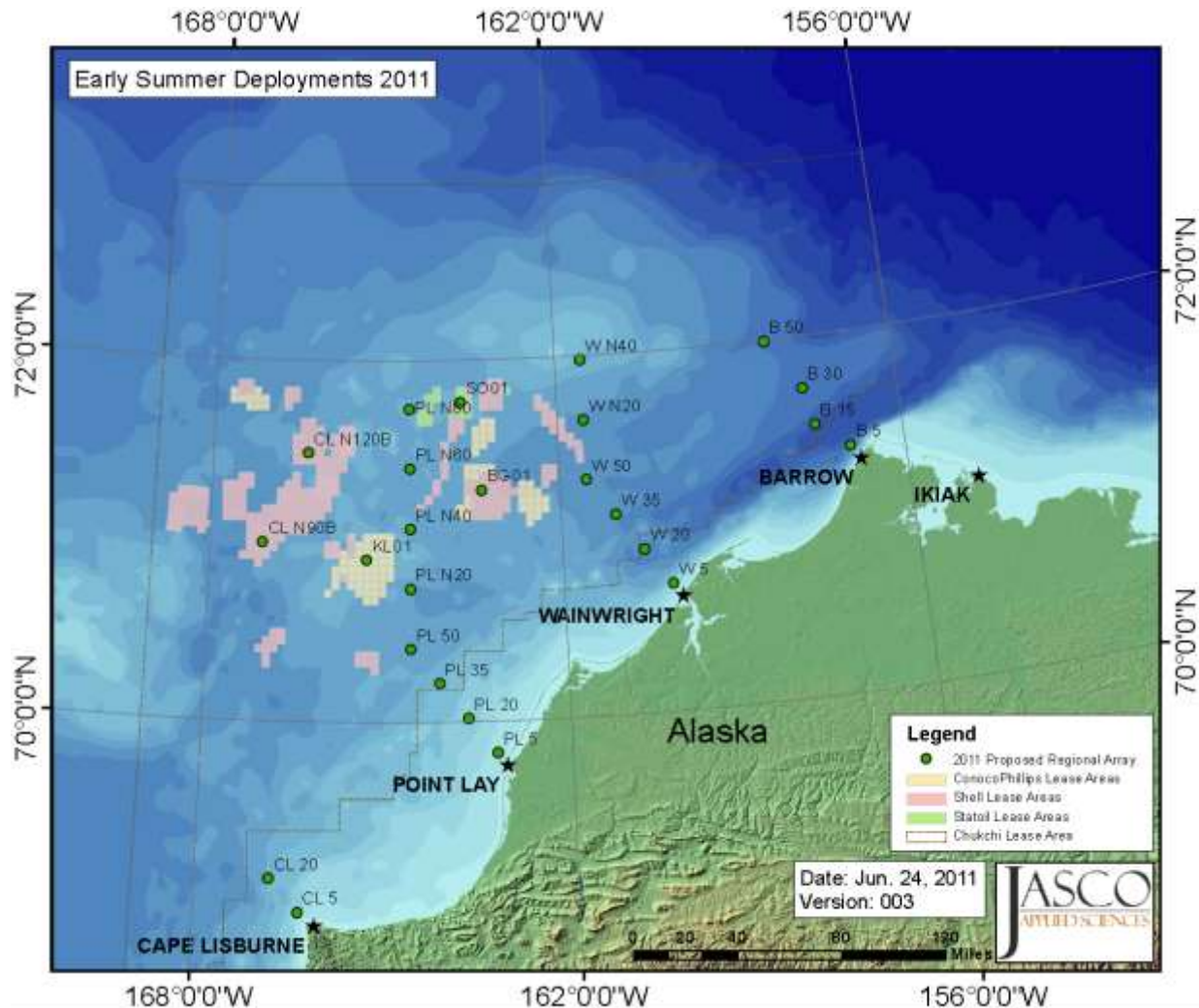

Figure IX-3. AMAR acoustic recorder locations for deployment in late July 2011.

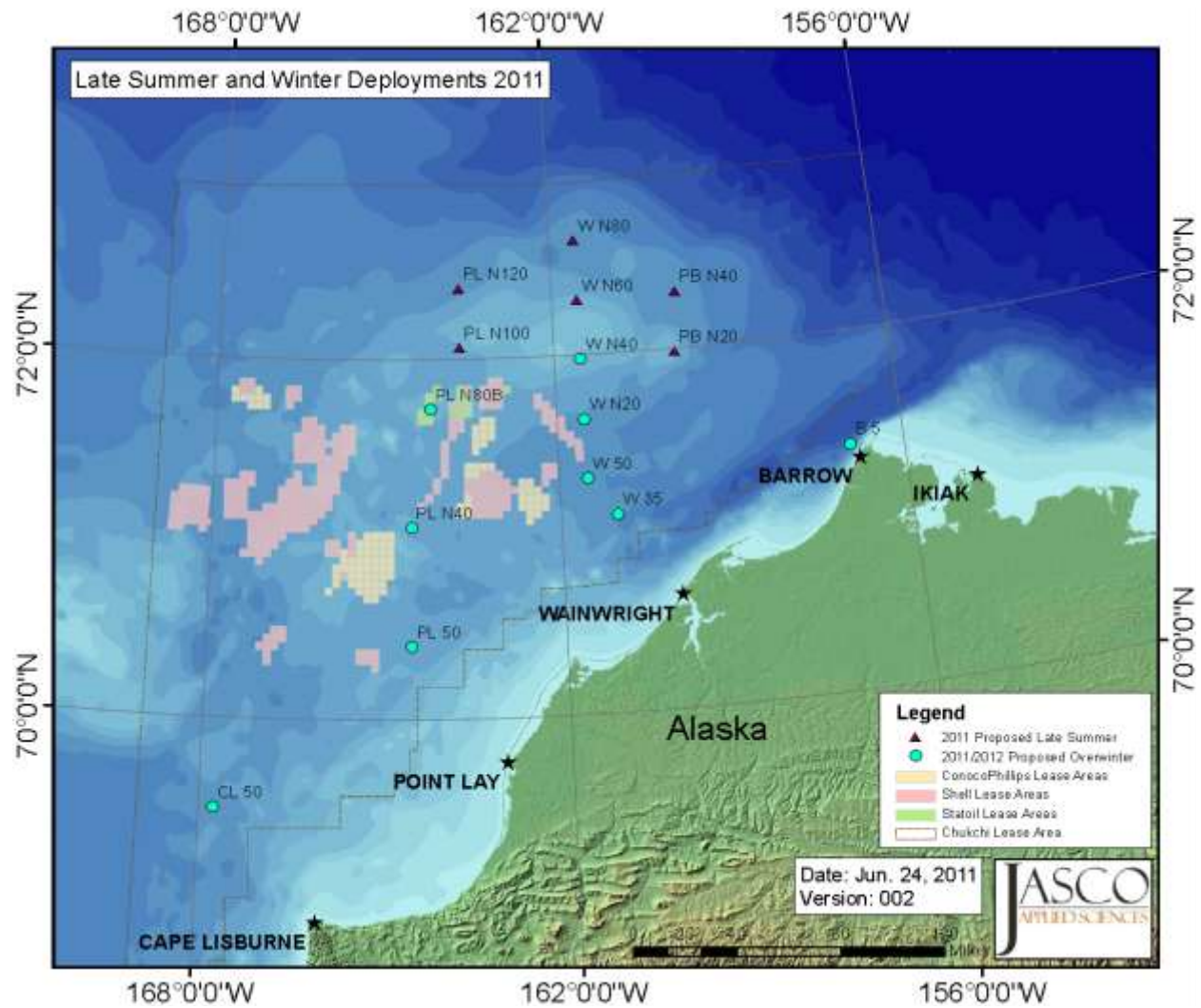

Figure IX-4. AMAR acoustic recorder locations for deployment in August and October 2011.

**Table IX-1: Planned geographic coordinates of AMAR locations in first deployment
scheduled for late July, 2011**

Site	Depth (m)	Longitude	Latitude	UTM Easting (N4)	UTM Northing (N4)
CL 5	29.0	-166.37506797	68.94154544	204850.71875000	7665422.50000000
CL 20	34.7	-166.83663243	69.12756867	189109.73437500	7688312.50000000
CL N90B	42.1	-167.10000000	70.98819873	206272.00000000	7895750.00000000
CL N120B	44.9	-166.35000000	71.48573000	240077.90000000	7947406.40000000
PL 5	14.6	-163.20331881	69.82357532	338302.12500000	7751593.00000000
PL 20	29.1	-163.65622939	70.01797811	322561.12500000	7774483.00000000
PL 35	34.4	-164.11766298	70.21117547	306820.15625000	7797373.00000000
PL 50	42.5	-164.58781993	70.40313001	291079.15625000	7820263.00000000
PL N20	42.6	-164.58763387	70.73506803	294488.97650357	7857145.71581430
PL N40	40.0	-164.58763108	71.06699952	297898.79675715	7894028.43162860
PL N60	42.3	-164.58781780	71.39892456	301308.61701072	7930911.14744290
PL N80	39.5	-164.58820071	71.73084320	304718.43726430	7967793.86325719
W 5	23.2	-160.18006593	70.70823963	456488.03125000	7845107.50000000
W 20	49.3	-160.62339064	70.91015233	440747.03125000	7867997.50000000
W 35	47.1	-161.07581434	71.11096837	425006.06250000	7890887.50000000
W 50	48.1	-161.53758290	71.31065034	409265.06250000	7913777.50000000
W N20	45.6	-161.53749811	71.64269686	410823.16812095	7950784.71425444
W N40	37.4	-161.53749688	71.97473276	412381.27374190	7987791.92850888
B 5	75.0	-156.93722834	71.36311003	573564.50000000	7918980.00000000
B 15	101.5	-157.50104845	71.50413259	553071.30694375	7934112.96369108
B 30	63.8	-157.64861331	71.71163843	547329.50000000	7957130.00000000
B 50	62.2	-158.23675428	71.98850796	526341.56250000	7987650.00000000
BG01	43.9	-163.34978297	71.27738885	559113.25000000	7909140.50000000
KL01	35.7	-165.32875087	70.89726745	487992.12500000	7865971.50000000
SO01	39.7	-163.69688354	71.76515292	545508.00000000	7963229.00000000

Table IX-2: Planned geographic coordinates of AURAL recorder locations in second deployment scheduled for mid-August, 2011

Site	Depth (m)	Longitude	Latitude	UTM Easting (N4)	UTM Northing (N4)
PL N100	40.1	-163.69190593	72.06275583	338858.36878732	8002046.56392605
PL N120	46.5	-163.69190593	72.39466194	341744.09992715	8038969.12832504
W N60	39.7	-161.53758221	72.30675820	413939.37936286	8024799.14276332
W N80	46.9	-161.53775734	72.63877334	415497.48498381	8061806.35701776
PB N20	38.5	-159.82624	71.98591		
PB N40	48.0	-159.73247	72.3166		

Table IX-3: Planned geographic coordinates of AURAL recorder locations in third deployment scheduled for October, 2011

Site	Depth (m)	Longitude	Latitude	UTM Easting (N4)	UTM Northing (N4)
CL 50	45.0	-167.78370432	69.49563211	157627.75000000	7734092.50000000
PL 50	42.5	-164.58781993	70.40313001	291079.15625000	7820263.00000000
PL N80B	40.0	-164.24037000	71.72381700	316785.44000000	7966089.50000000
W 35	47.1	-161.07581434	71.11096837	425006.06250000	7890887.50000000
W 50	48.1	-161.53758290	71.31065034	409265.06250000	7913777.50000000
W N20	45.6	-161.53749811	71.64269686	410823.16812095	7950784.71425444
W N40	37.4	-161.53749688	71.97473276	412381.27374190	7987791.92850888
B 5	75.0	-156.93478000	71.36400000	573644.93000000	7919251.70000000

3.0 DATA EXTRACTION AND QUALITY CONTROL

3.1 Data Extract and Backup

The acoustic data will be downloaded from the AMAR and AURAL recorders after they arrive at JASCO's laboratory in Halifax. The data will be extracted from internal RAM memory (AMARS) and hard disks (AURALS) and checked for quality, and then copied to a hard disk drive array for delivery to the client. Two copies will be provided. One copy may be retained in Halifax for analysis upon approval by client.

3.2 Quality-control Procedures

Separate quality control procedure documentation has been submitted that describes comprehensive equipment testing that will be performed on each recorder before it is provided for deployment. The documentation also describes the protocols employed for recording and tracking test results. Performance metrics (e.g. system power draw, digitizer voltage sensitivity, etc.) are recorded and documented in formats specified in the quality control documentation. The hydrophones and recording systems are calibrated prior to leaving the laboratory, and pistonphone calibrations will be carried out immediately prior to deployment and upon retrieval. These pistonphone tests involve recording a 1-minute calibrated pressure signal into the recorder's data stream to provide absolute calibration signals directly in the data.

SECTION X BEAUFORT SEA ACOUSTIC MONITORING

CHARLES GREENE JR. & SUSANNA BLACKWELL

CO-PRINCIPAL INVESTIGATORS

GREENERIDGE SCIENCES, INC.

SANTA BARBARA, CA

1.0 INTRODUCTION

The objectives of the acoustics program are to characterize industrial sounds and marine mammal vocalizations in the Alaska Beaufort Sea (Blackwell et al. 2008, 2009, 2010, 2011). This work has been performed annually since 2007 in support of Shell's acoustic research program to provide an improved understanding of marine mammal habitat usage, migration paths and temporal and spatial presence. The results of the program will be used to assist in the assessment of the potential effects of sound associated with oil and gas exploration and production on marine mammals.

The 2011 acoustics program will involve deploying 40 directional autonomous seafloor acoustic recorders (DASARs), including an array of seven recorders at five sites between Harrison Bay and Kaktovik, Alaska (see Figure X-1).

The objective of this study is to investigate possible effects of anthropogenic sounds on measurable aspects of bowhead whale behavior, such as call detection rates and whale movements. Using passive acoustics with directional autonomous recorders, the locations of calling whales will be observed at five coastal sites. The 2011 field season is planned for approximately August 1 through September 26.

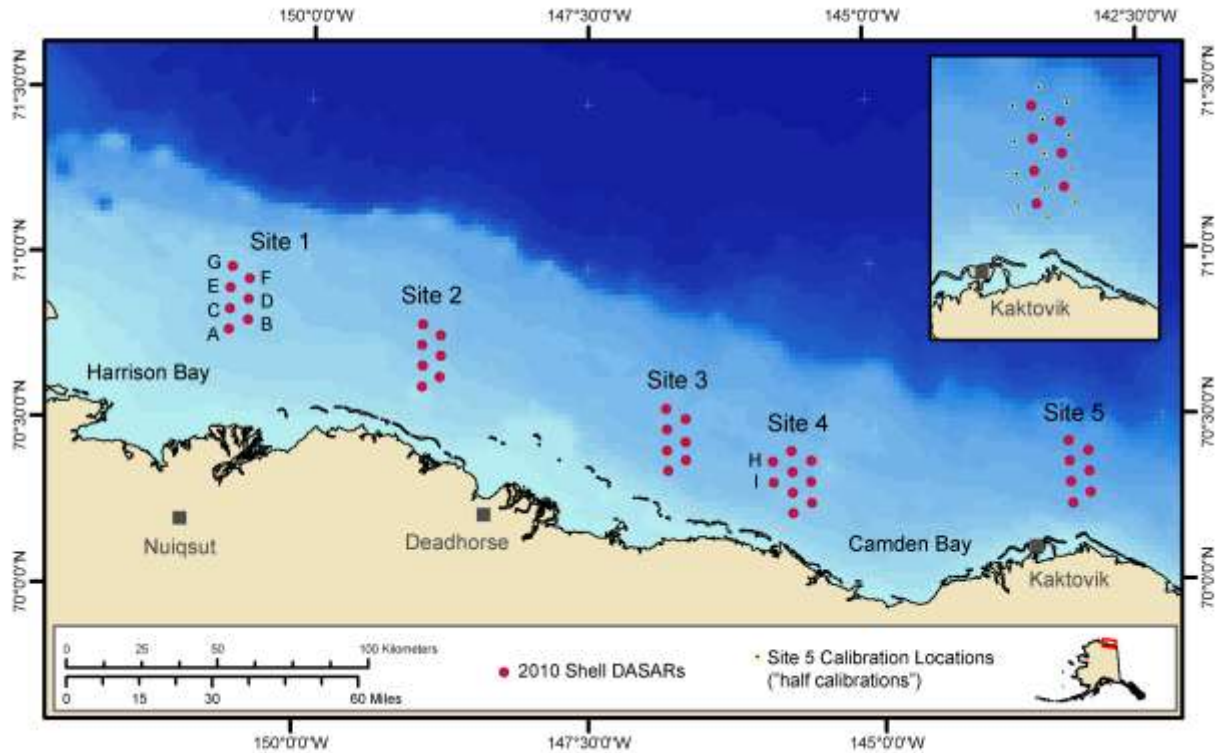

Figure X-1. DASAR deployment locations planned for the 2011 field season. The five sites are labeled 1–5 from west to east, and A–G from south to north (as shown for site 1). Two additional deployment locations are planned in 2011 (as they were in 2010), labeled “H” and “I” at site 4. The insert shows how 13 calibration locations were placed in relation to the DASARs at site 5. The same relative locations, with three calibrations locations around each DASAR, will be used at each site. The distance from site 1 to site 5 is ~280 km (~174 mi or ~151 n.mi.).Acoustics Program Purpose

2.0 METHODS

2.1 Equipment

Recordings will be made using Directional Autonomous Seafloor Acoustic Recorders model C08 (DASAR-C08). A picture and schematic representation of such a DASAR are shown in Figure X-2. The DASAR consists of a pressure housing (17.8 cm high and 32.4 cm in diameter, or ~7 inches and 12.75 inches, respectively) containing the recording electronics and alkaline batteries. A sensor suspended elastically about 12.7 cm (5 inches) above the pressure housing includes two particle motion sensors mounted orthogonally in the horizontal plane for sensing direction. It also includes a flexural pressure transducer for the omnidirectional sensor. Because of corrosion concerns during the 2008 deployments, spherical sensors on all DASARs were treated by the manufacturer with an anti-corrosion coating before the 2010 field season.

The DASAR pressure housing is bolted to a square frame with 66 cm (26”) sides. A spandex “sock” stretched over the tubular “cage” surrounding the pressure housing (see Figure X-2B)

protects the sensors from motion in water currents. The total in-air weight is ~32.2 kilogram (kg) (71 pounds [lb]) and the in-water weight is ~15 kg (33 lb).

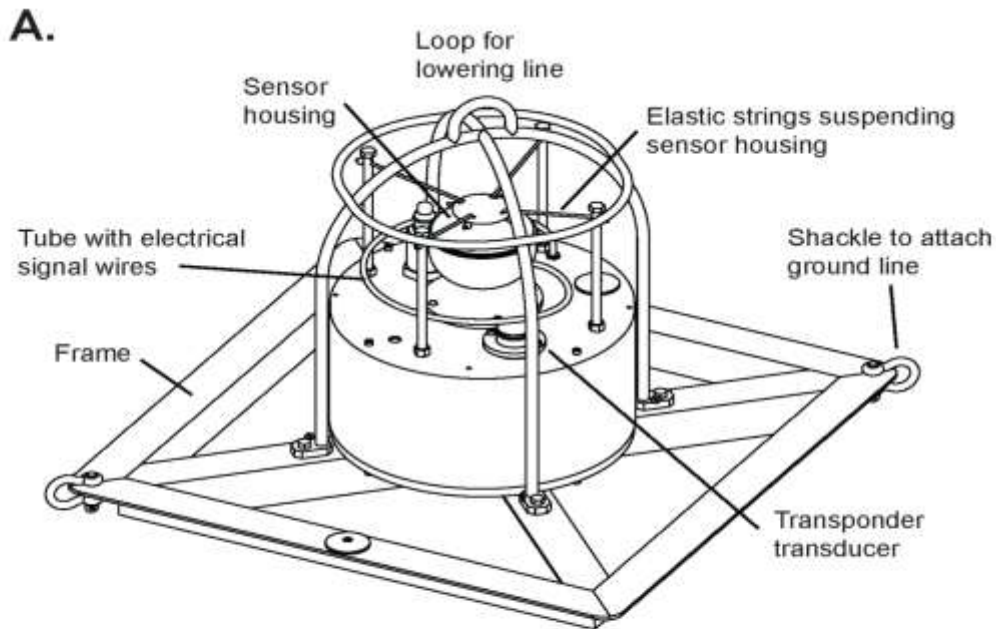

Figure X-2. DASAR recorder (model C08).

(A) Schematic diagram of the components of the DASAR-C08 recorder. **(B)** A DASAR about to be deployed. The lowering line (shown) is looped through the top of the frame and is removed after the DASAR is set on the ocean floor. The ground line is attached with a shackle to the bottom left corner of the DASAR frame on the picture. At the end of its 110 m length, this line is connected to a chain and Danforth anchor, which are deployed last.

DASARs record sound at a 1 kHz sampling rate (1000 samples / s) on each of three data channels: (1) an omnidirectional channel, (2) a “cosine channel” on the primary horizontal axis, and (3) a “sine channel” on the axis perpendicular to the cosine channel. Each channel has maximum sensitivity in its primary direction, and the sensitivity falls off with the cosine of the angle away from the axis. The recorder includes a signal digitizer with 16-bit quantization. The samples are buffered for about 45 minutes, then written to an internal 60 GB hard drive, which takes about 20 s. Allowing for anti-aliasing, the 1 kHz sampling rate allows for 116 days of continuous recording and a data bandwidth of 450 Hz.

2.2 DASAR Hydrophone Calibration

The omnidirectional hydrophone in each DASAR, an acoustic pressure sensor, will be used for sound pressure measurements of the background and whale calls. The hydrophone was procured with information from the manufacturer permitting their sensitivity to be computed. In addition, in Spring 2008 two DASARs were taken to the U.S. Navy’s sound transducer calibration facility TRANSDEC at San Diego, for calibration. The two DASARs calibrated at TRANSDEC were then used as secondary standards for comparison with the remaining DASARs. The DASAR sensitivities are very stable and do not vary significantly from year-to-year.

2.3 Field Procedures

DASARs will be installed on the seafloor with no surface expression, which is important to avoid entanglement with ice floes. One corner of the DASAR frame will be attached with a shackle to 110 m (360 ft) of “ground line”, which will end with 1.5 m (5 ft) of chain and a small Danforth anchor. During deployment, the DASAR will be lowered onto the seafloor using a line passed through the loop at the top of the “cage” (see Figure 2B). One end of the lowering line will then be released from the vessel and the line retrieved. The vessel will then move away from the DASAR location while laying out the ground line in a straight line. As the end of the ground line was reached, the Danforth anchor will be dropped into the water. GPS positions will be obtained of both the DASAR and anchor locations.

The DASARs will be retrieved by grappling. The grappling setup will consist of either one or two four-prong grappling hooks interconnected with a four-foot section of long-link chain. The grappling setup will be determined by the crew of the Norseman II. It will be dragged over the center of the ground line and perpendicular to it.

2.4 Clock and Bearing Calibrations in the Field

When DASARs are lowered to the seafloor there is no way to control their orientation in relation to true north. In addition, each DASAR contains a clock that has a small but significant drift, which needs to be compensated for over the course of the deployment period (Greene et al. 2004). Field calibrations consist of projecting test sounds underwater at known times and known locations, and recording these sounds on the DASARs. After processing, the collected data allow us to determine each DASAR’s orientation on the seafloor, so that the absolute direction of whale calls can be obtained. The calibration transmissions also will allow us to synchronize the clocks from the various DASARs, so that the bearings from a call heard by more than one DASAR can be combined, allowing an estimate of the caller’s position by triangulation.

Calibration transmissions will be projected at six locations around each DASAR, at a distance of about 4 km.

Equipment used for calibrations included a J-9 sound projector, an amplifier, a computer to generate the projected waveform, and a GPS to control the timing of the sound source. The waveform projected will consist of a 2-s tone at 400 Hz, a 2-s linear sweep from 400 to 200 Hz, a 2-s linear sweep from 200 to 400 Hz, a 2-s linear sweep from 400 to 200 Hz, and finally a 4-s long section of pseudo-random noise, i.e., an m-sequence with 255 chips, repeated once every second and on a 255 Hz carrier frequency. Each site will be calibrated directly following the deployment of its seven DASARs, and again before retrieval.

2.5 Health Checks

To insure that the recorders and their software are functioning as expected, a health check will be performed on each DASAR during the calibrations following deployment. Each DASAR will therefore be health-checked after it had had the chance to write data to disk one or more times (this happens about every 45 min during normal recording). A surface-deployed transducer (a line-mounted Benthos DRI-267A Dive Ranger Interrogator) will be placed in the water at the recorded GPS location of each DASAR. The transducer interrogates an acoustic transponder (Benthos UAT-376, operational range 25–32 kHz) in each recorder, which respond on one channel if it is recording and on another channel if it is not.

3.0 DATA ANALYSIS

After retrieval, the DASARs will be opened up and dismantled. The sampling program will be shut down, the 60 GB hard drives removed and hand-carried back to Greeneridge headquarters where they are backed up. Data will be transferred to workstations running MATLAB and custom analysis software.

The analysis portion of this program is funded directly by Shell and is therefore not included as part of this study plan prepared by OLF.

4.0 REFERENCES

- Blackwell, S.B., C.R. Greene, Jr., T.L. McDonald, M.W. McLennan, C.S. Nations, R.G. Norman, and A. Thode. 2008. Beaufort Sea bowhead whale migration route study. (Chapter 8) *In*: Funk, D.W., R. Rodrigues, D.S. Ireland, and W.R. Koski (eds.). Joint monitoring program in the Chukchi and Beaufort seas, July-November 2007. LGL Alaska Report P971-1, Report from LGL Alaska Research Associates, Inc., LGL Ltd., JASCO Research, Ltd., and Greeneridge Sciences, Inc., for Shell Offshore, Inc., ConocoPhillips Alaska, Inc., and National Marine Fisheries Service, U.S. Fish and Wildlife Service. 445 p. + Appendices.
- Blackwell, S.B., C.S. Nations, T.L. McDonald, K.H. Kim, C.R. Greene, Jr., A. Thode., and R.G. Norman. 2009a. Beaufort Sea acoustic monitoring program. (Chapter 9) *In*: Funk, D.W., D.S. Ireland, R. Rodrigues, and W.R. Koski (eds.). Joint Monitoring Program in the Chukchi and Beaufort Seas, open water seasons, 2006–2008. LGL Alaska Report P1050-1, Report from LGL Alaska Research Associates, Inc., LGL Ltd., Greeneridge Sciences, Inc., and JASCO Research, Ltd., for Shell Offshore, Inc., and Other Industry

Contributors, and National Marine Fisheries Service, U.S. Fish and Wildlife Service. 488 p. + Appendices.

- Blackwell, S.B., C.S. Nations, T.L. McDonald, K.H. Kim, C.R. Greene, Jr., A. Thode., and R.G. Norman. 2010. Beaufort Sea acoustic monitoring program. (Chapter 6) *In*: Funk, D.W., D.S. Ireland, R. Rodrigues, and W.R. Koski (eds.). Joint Monitoring Program in the Chukchi and Beaufort Seas, open water seasons, 2006–2009. LGL Alaska Report P1050-1, Report from LGL Alaska Research Associates, Inc., LGL Ltd., Greeneridge Sciences, Inc., and JASCO Research, Ltd., for Shell Offshore, Inc., and Other Industry Contributors, and National Marine Fisheries Service, U.S. Fish and Wildlife Service.
- Greene, C.R., Jr., M.W. McLennan, R.G. Norman, T.L. McDonald, R.S. Jakubczak, and W.J. Richardson. 2004. Directional frequency and recording (DIFAR) sensors in seafloor recorders to locate calling bowhead whales during their fall migration. *Journal of the Acoustical Society of America* 116(2):799–813.

Figure I-1. Map Showing 2010 Study Areas with Transect and Sampling Locations.

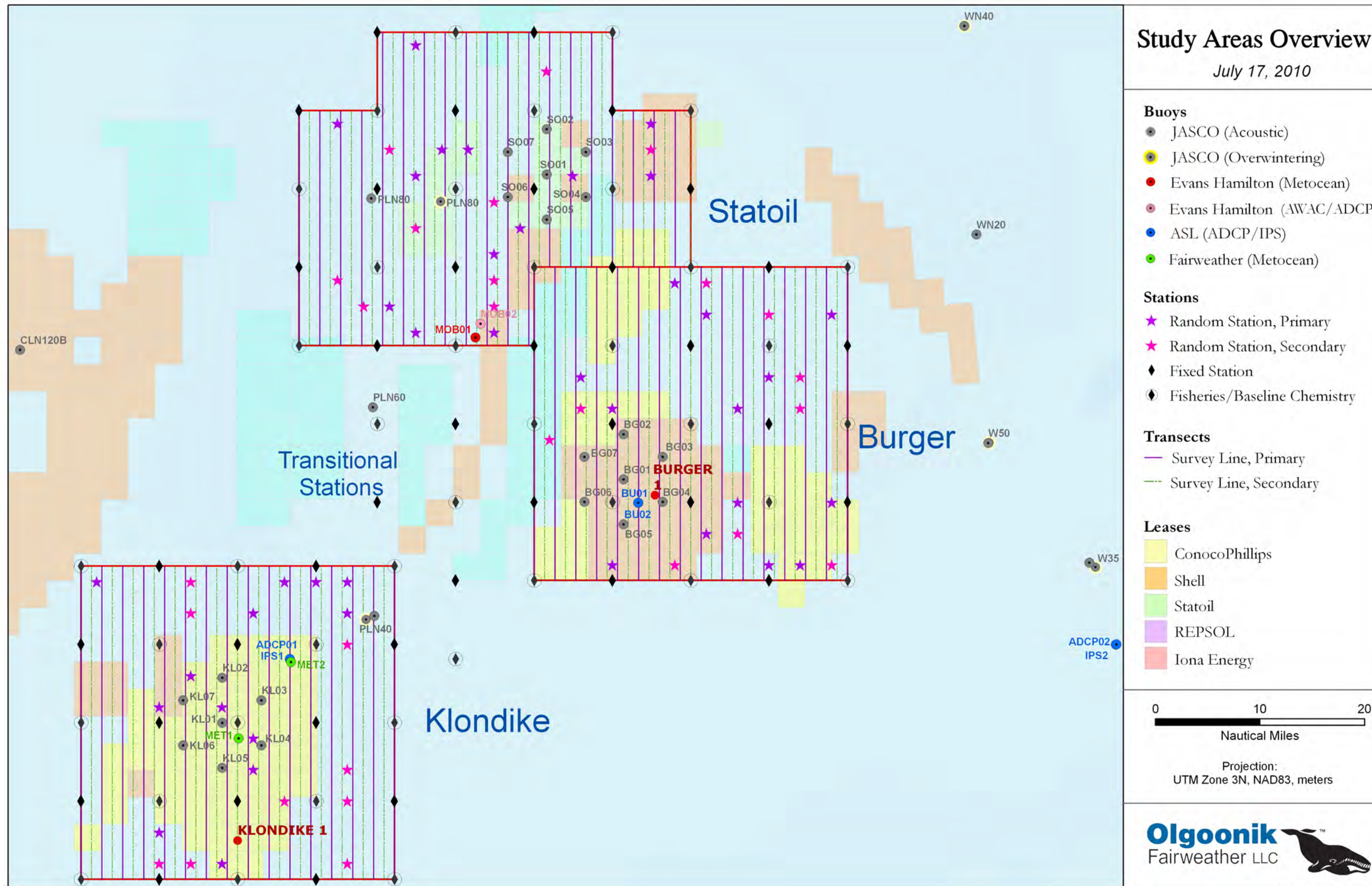

Figure I-2. Map Showing 2011 Chukchi Biological Sampling with Transect and Sampling Locations.

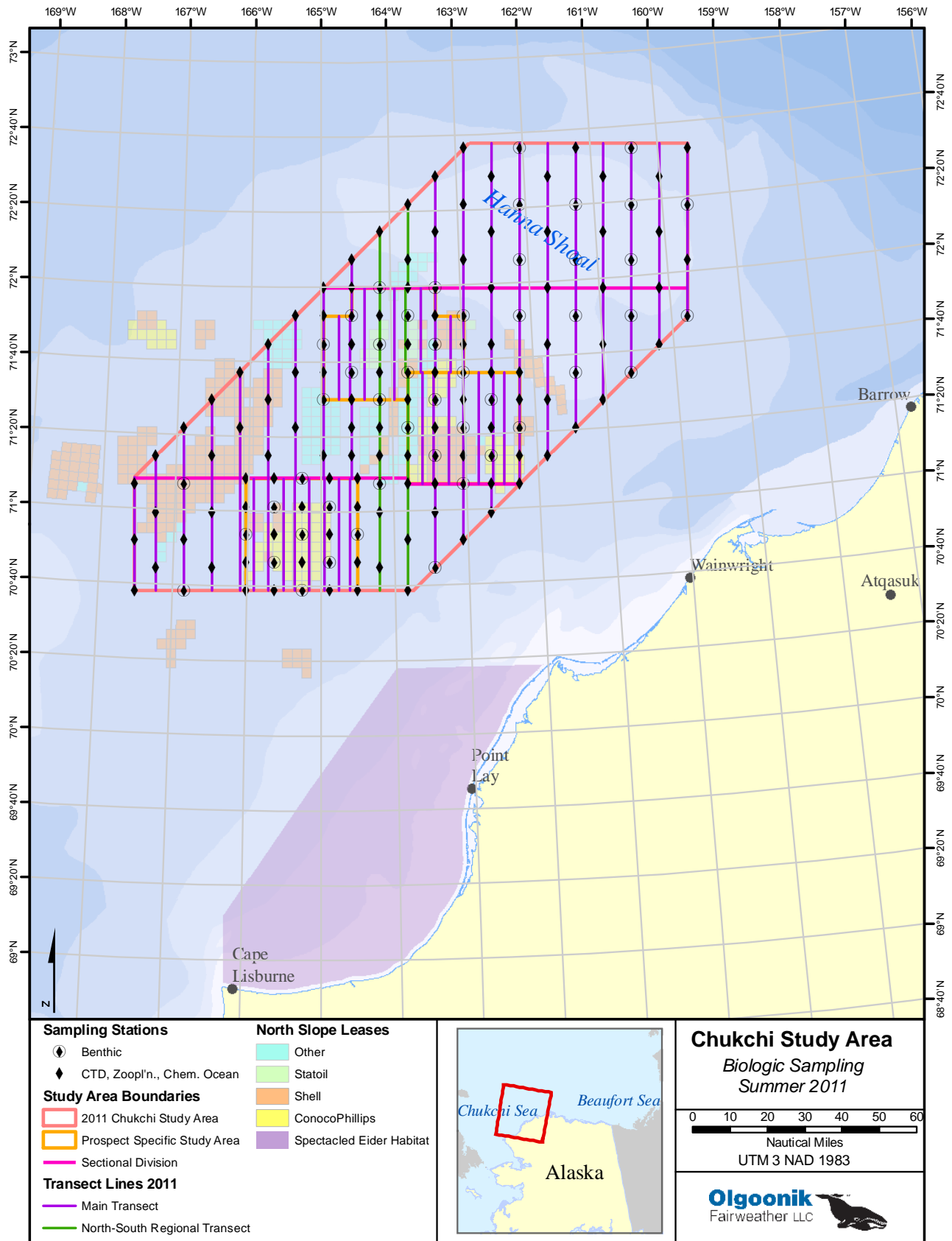

Figure I-3. Map of 2011 Chukchi Sea acoustic and Metocean Locations.

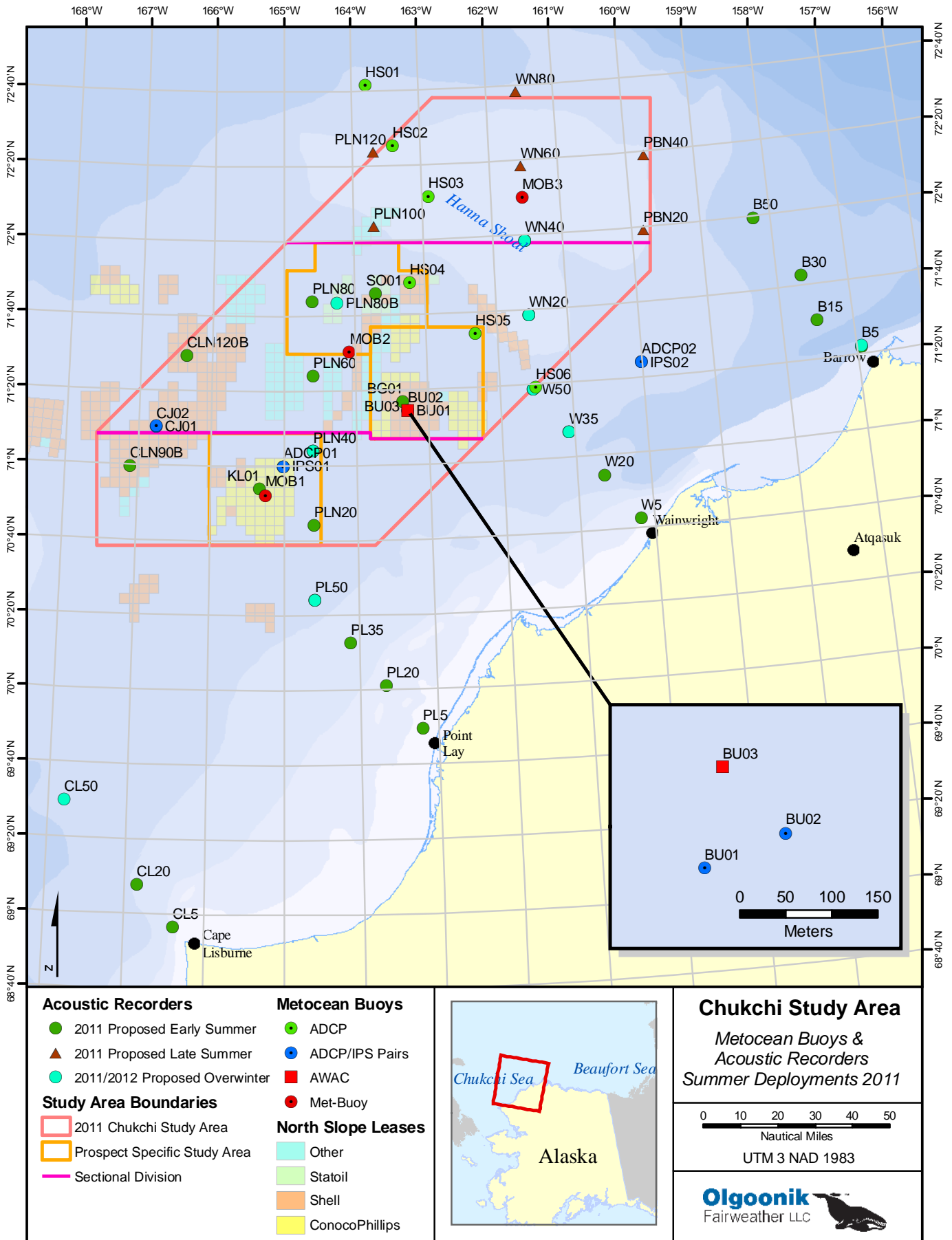
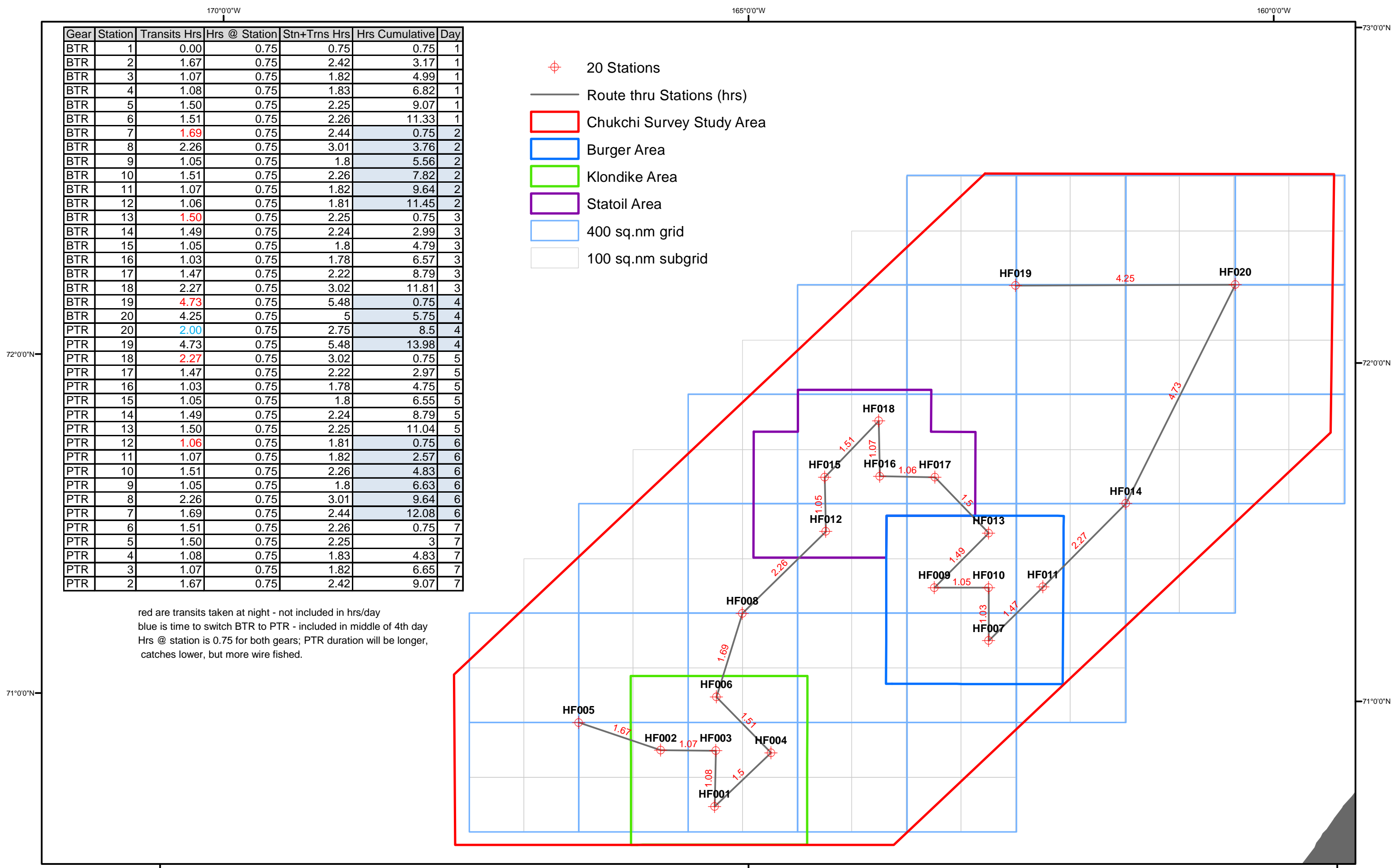

Figure I-4. Map of Fisheries Trawling Survey Coverage



Gear	Station	Transits Hrs	Hrs @ Station	Stn+Trns Hrs	Hrs Cumulative	Day
BTR	1	0.00	0.75	0.75	0.75	1
BTR	2	1.67	0.75	2.42	3.17	1
BTR	3	1.07	0.75	1.82	4.99	1
BTR	4	1.08	0.75	1.83	6.82	1
BTR	5	1.50	0.75	2.25	9.07	1
BTR	6	1.51	0.75	2.26	11.33	1
BTR	7	1.69	0.75	2.44	0.75	2
BTR	8	2.26	0.75	3.01	3.76	2
BTR	9	1.05	0.75	1.8	5.56	2
BTR	10	1.51	0.75	2.26	7.82	2
BTR	11	1.07	0.75	1.82	9.64	2
BTR	12	1.06	0.75	1.81	11.45	2
BTR	13	1.50	0.75	2.25	0.75	3
BTR	14	1.49	0.75	2.24	2.99	3
BTR	15	1.05	0.75	1.8	4.79	3
BTR	16	1.03	0.75	1.78	6.57	3
BTR	17	1.47	0.75	2.22	8.79	3
BTR	18	2.27	0.75	3.02	11.81	3
BTR	19	4.73	0.75	5.48	0.75	4
BTR	20	4.25	0.75	5	5.75	4
PTR	20	2.00	0.75	2.75	8.5	4
PTR	19	4.73	0.75	5.48	13.98	4
PTR	18	2.27	0.75	3.02	0.75	5
PTR	17	1.47	0.75	2.22	2.97	5
PTR	16	1.03	0.75	1.78	4.75	5
PTR	15	1.05	0.75	1.8	6.55	5
PTR	14	1.49	0.75	2.24	8.79	5
PTR	13	1.50	0.75	2.25	11.04	5
PTR	12	1.06	0.75	1.81	0.75	6
PTR	11	1.07	0.75	1.82	2.57	6
PTR	10	1.51	0.75	2.26	4.83	6
PTR	9	1.05	0.75	1.8	6.63	6
PTR	8	2.26	0.75	3.01	9.64	6
PTR	7	1.69	0.75	2.44	12.08	6
PTR	6	1.51	0.75	2.26	0.75	7
PTR	5	1.50	0.75	2.25	3	7
PTR	4	1.08	0.75	1.83	4.83	7
PTR	3	1.07	0.75	1.82	6.65	7
PTR	2	1.67	0.75	2.42	9.07	7

red are transits taken at night - not included in hrs/day
 blue is time to switch BTR to PTR - included in middle of 4th day
 Hrs @ station is 0.75 for both gears; PTR duration will be longer, catches lower, but more wire fished.

Appendix A

MAPS

2011 Chukchi Baseline Studies Program

As of July 27, 2011

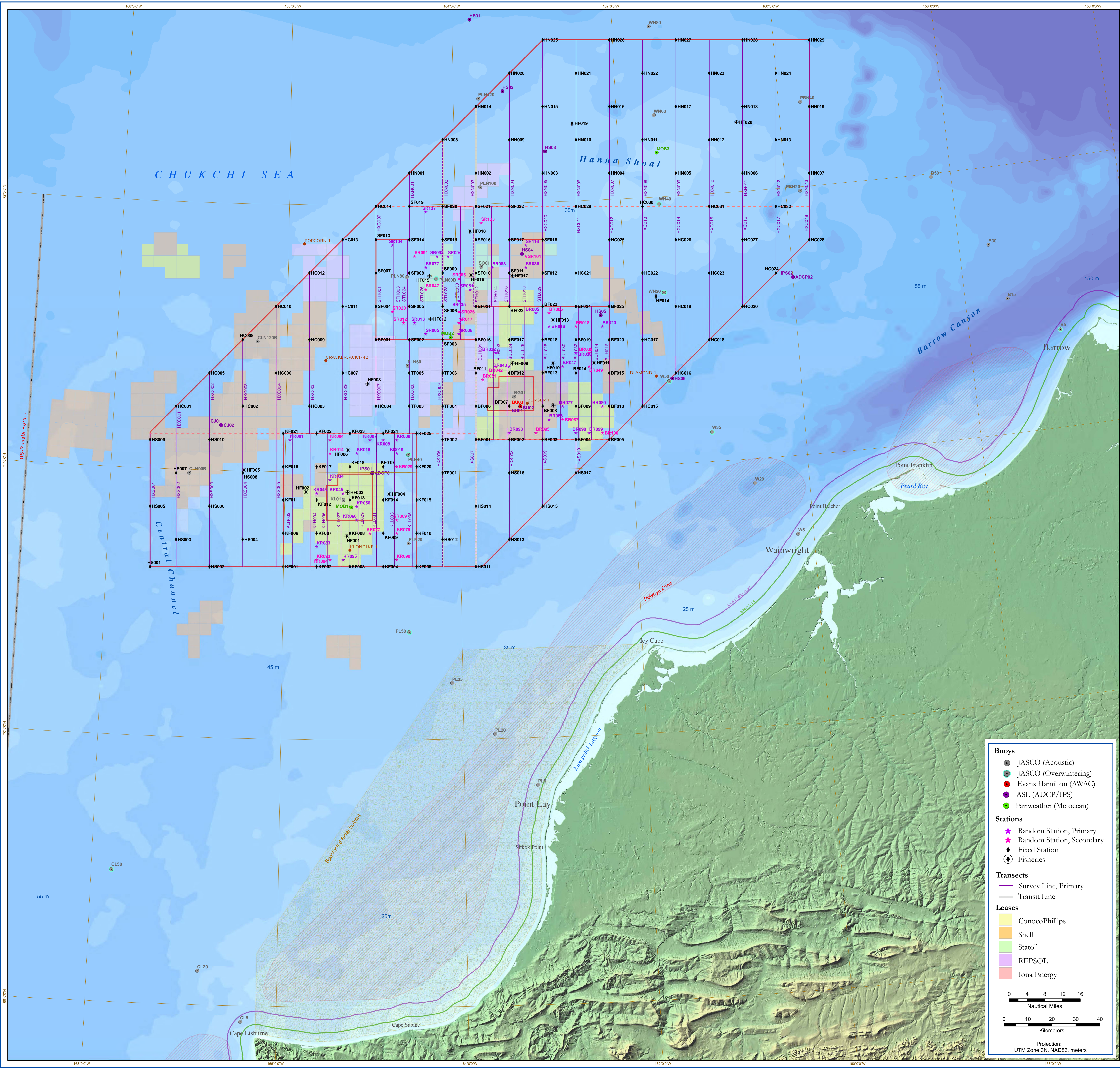

Buoys

- JASCO (Acoustic)
- JASCO (Overwintering)
- Evans Hamilton (AWAC)
- ASL (ADCP/IPS)
- Fairweather (Metocan)

Stations

- ★ Random Station, Primary
- ★ Random Station, Secondary
- ◆ Fixed Station
- ◆ Fisheries

Transects

- Survey Line, Primary
- Transit Line

Leases

- ConocoPhillips
- Shell
- Statoil
- REPSOL
- Iona Energy

0 4 8 12 16
Nautical Miles

0 10 20 30 40
Kilometers

Projection:
UTM Zone 3N, NAD83, meters

2011 Chukchi Baseline Studies Program - Burger

As of July 28, 2011

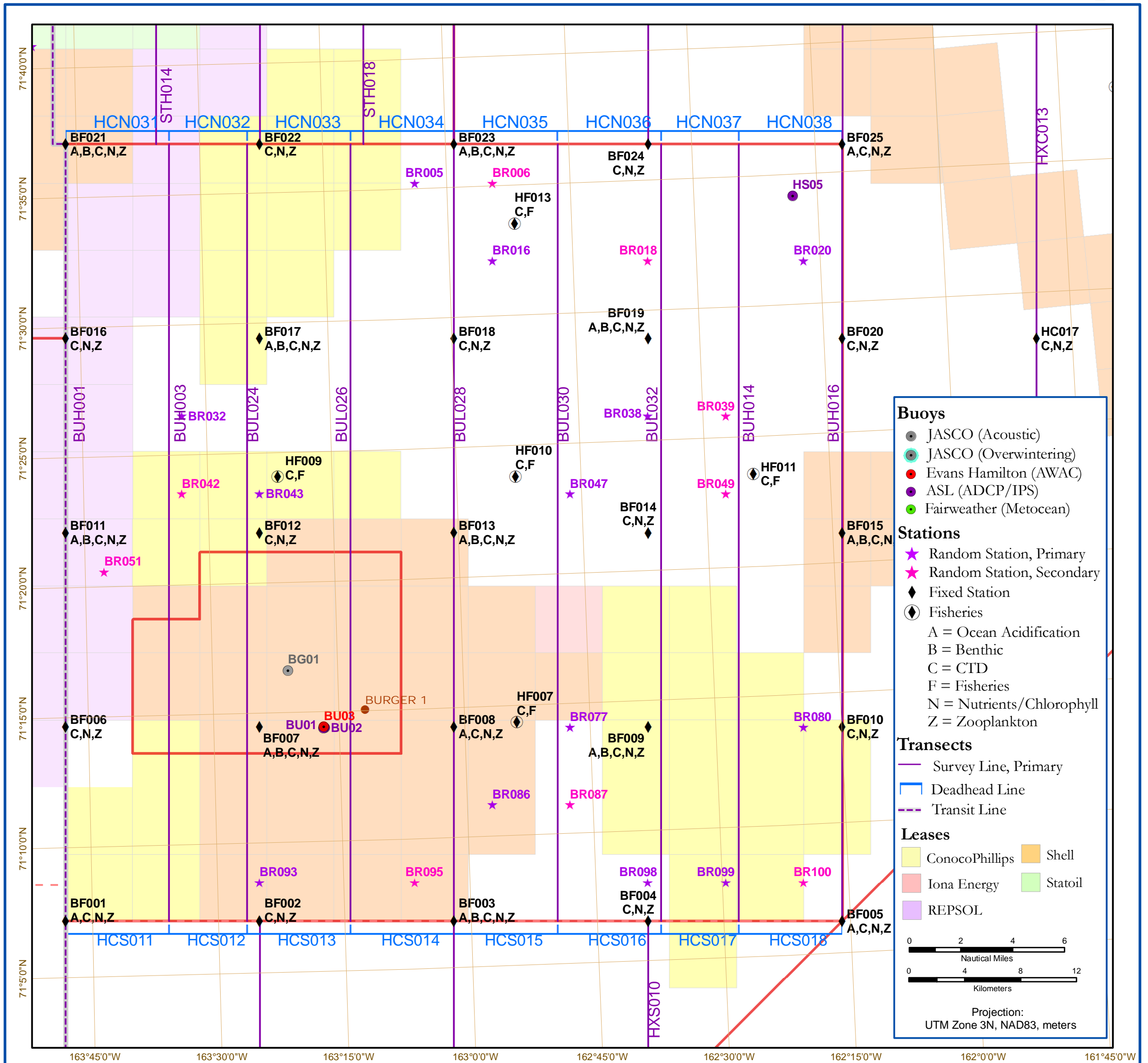

2011 Chukchi Baseline Studies Program - Klondike

As of July 28, 2011

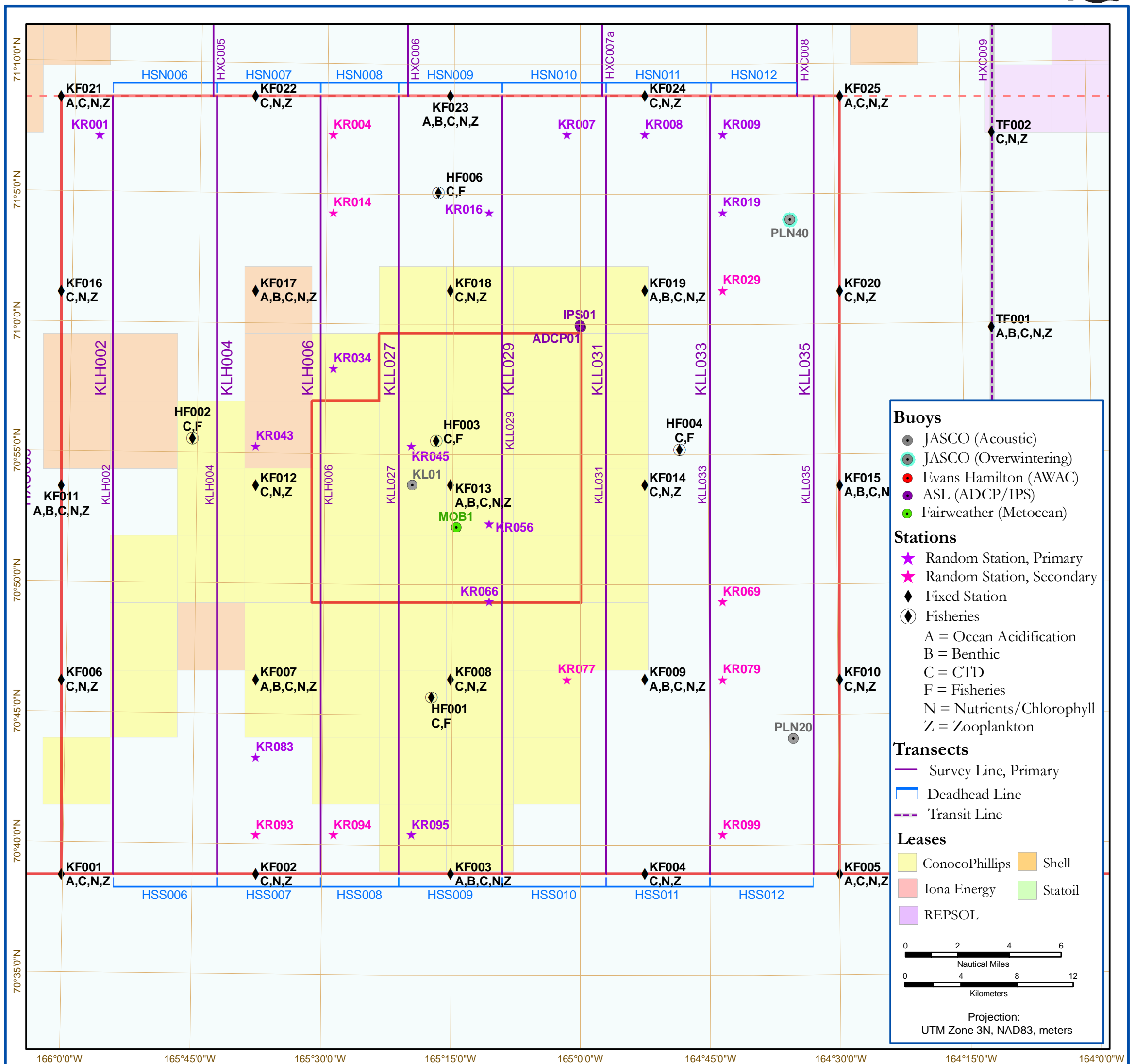

2011 Chukchi Baseline Studies Program - Statoil

As of July 28, 2011

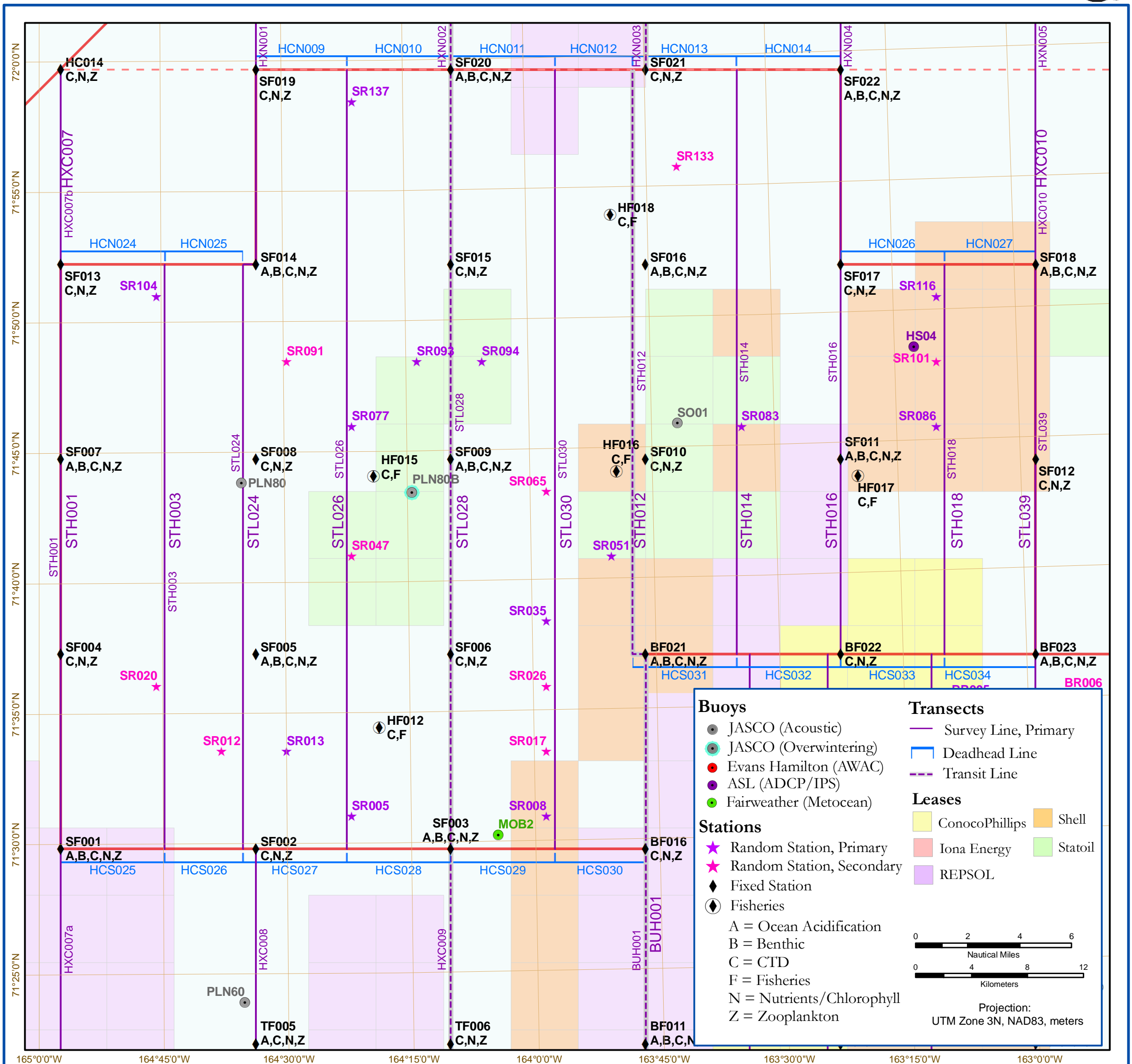

Hanna Central East

July 28, 2011

Buoys

- JASCO (Acoustic)
- JASCO (Overwintering)
- Evans Hamilton (AWAC)
- ASL (ADCP/IPS)
- Fairweather (Metocean)

Stations

- ◆ Fixed Station
- ◆ Fisheries
- A = Ocean Acidification
- B = Benthic
- C = CTD
- F = Fisheries
- N = Nutrients/Chlorophyll
- Z = Zooplankton

Transects

- Survey Line, Primary
- - - Transit Line

Leases

- ConocoPhillips
- Shell
- Iona Energy
- Statoil
- REPSOL

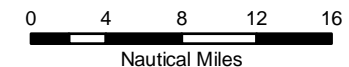

Projection:
UTM Zone 3N, NAD83, meters

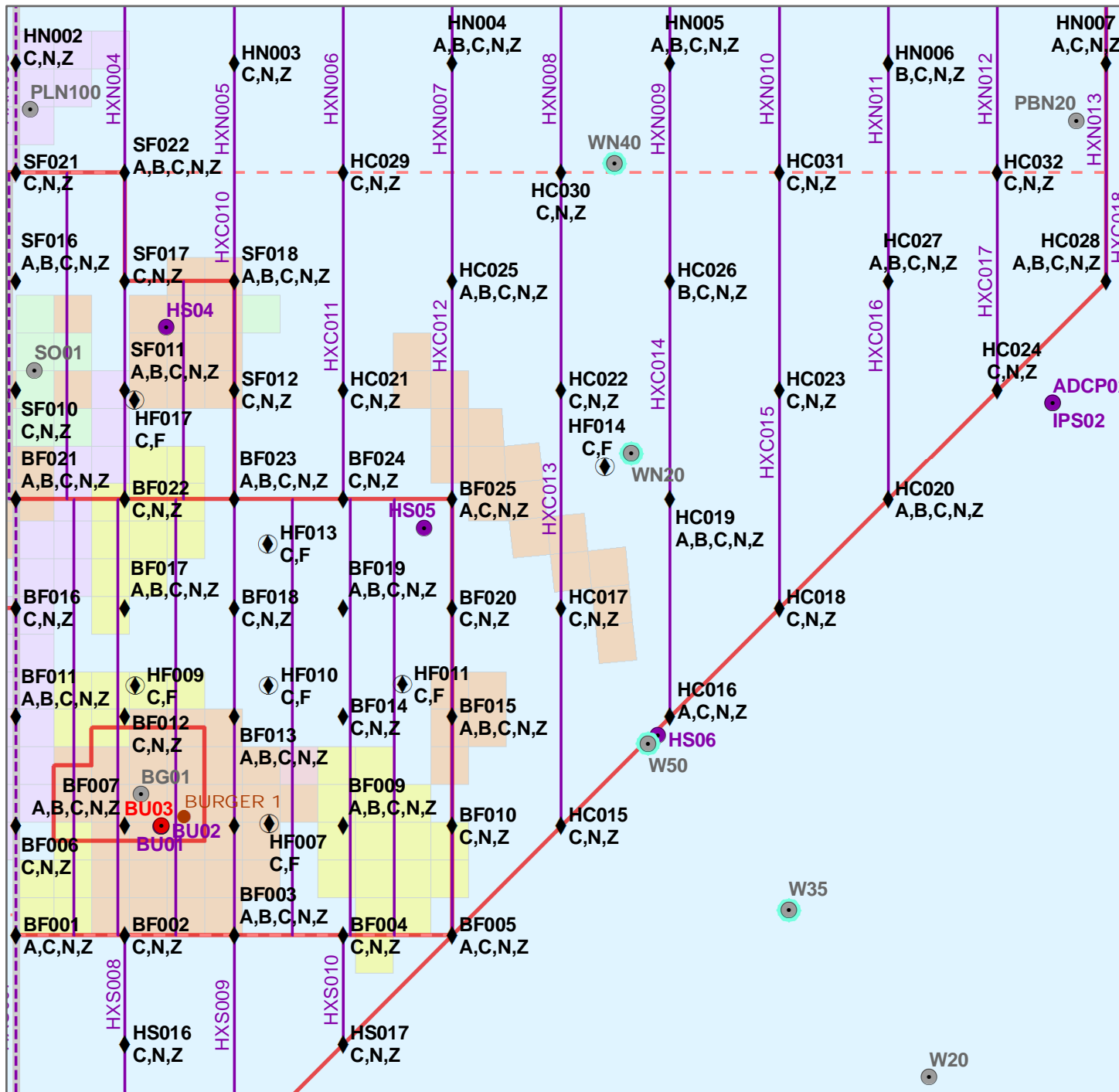

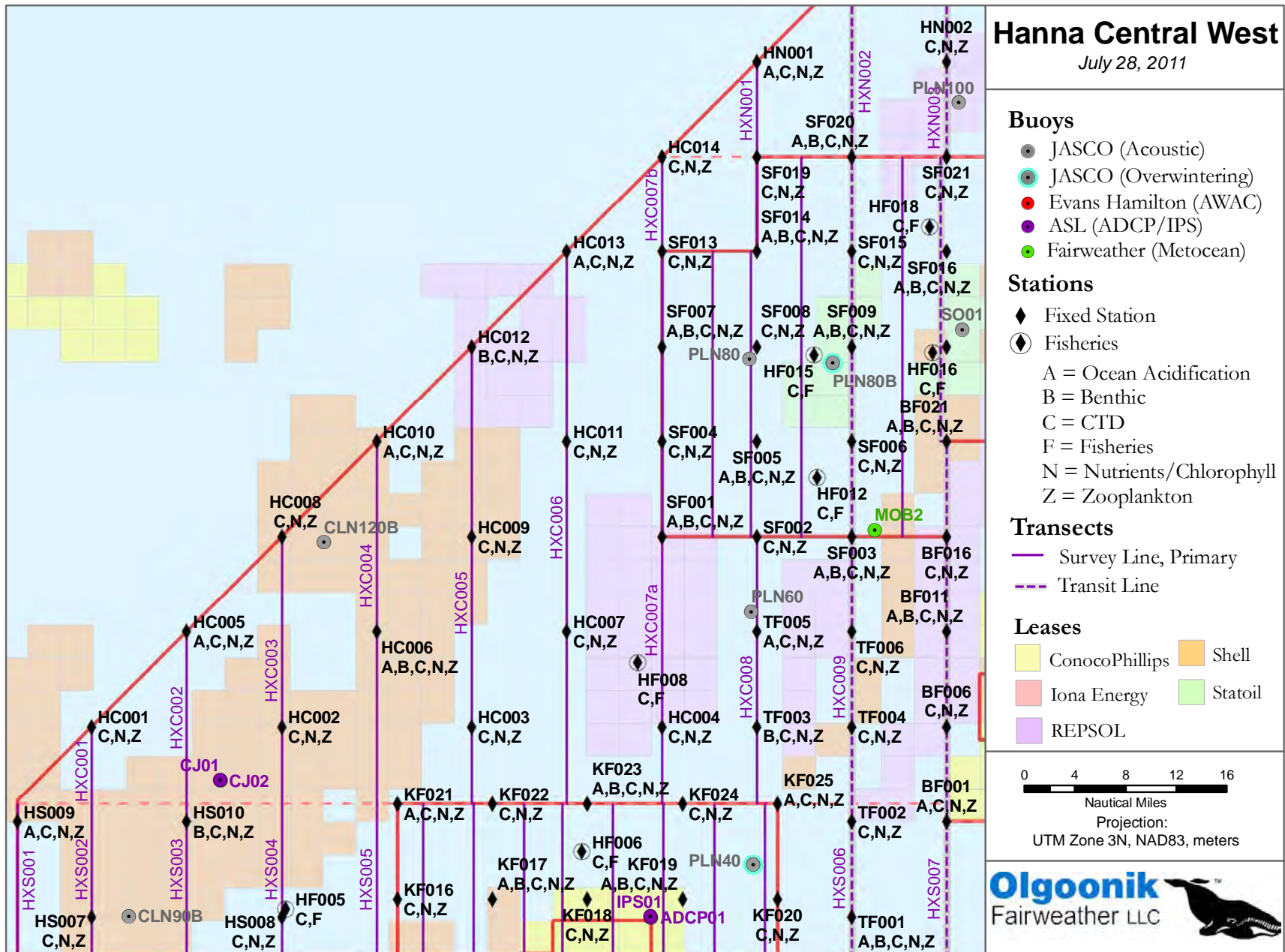

Hanna North East

July 28, 2011

Buoys

- JASCO (Acoustic)
- JASCO (Overwintering)
- Evans Hamilton (AWAC)
- ASL (ADCP/IPS)
- Fairweather (Metocean)

Stations

- ◆ Fixed Station
- ◆ Fisheries
- A = Ocean Acidification
- B = Benthic
- C = CTD
- F = Fisheries
- N = Nutrients/Chlorophyll
- Z = Zooplankton

Transects

- Survey Line, Primary
- - - Transit Line

Leases

- ConocoPhillips
- Shell
- Iona Energy
- Statoil
- REPSOL

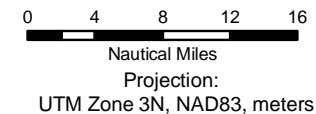

Study Area - Hanna Region 2011 - Official.mxd

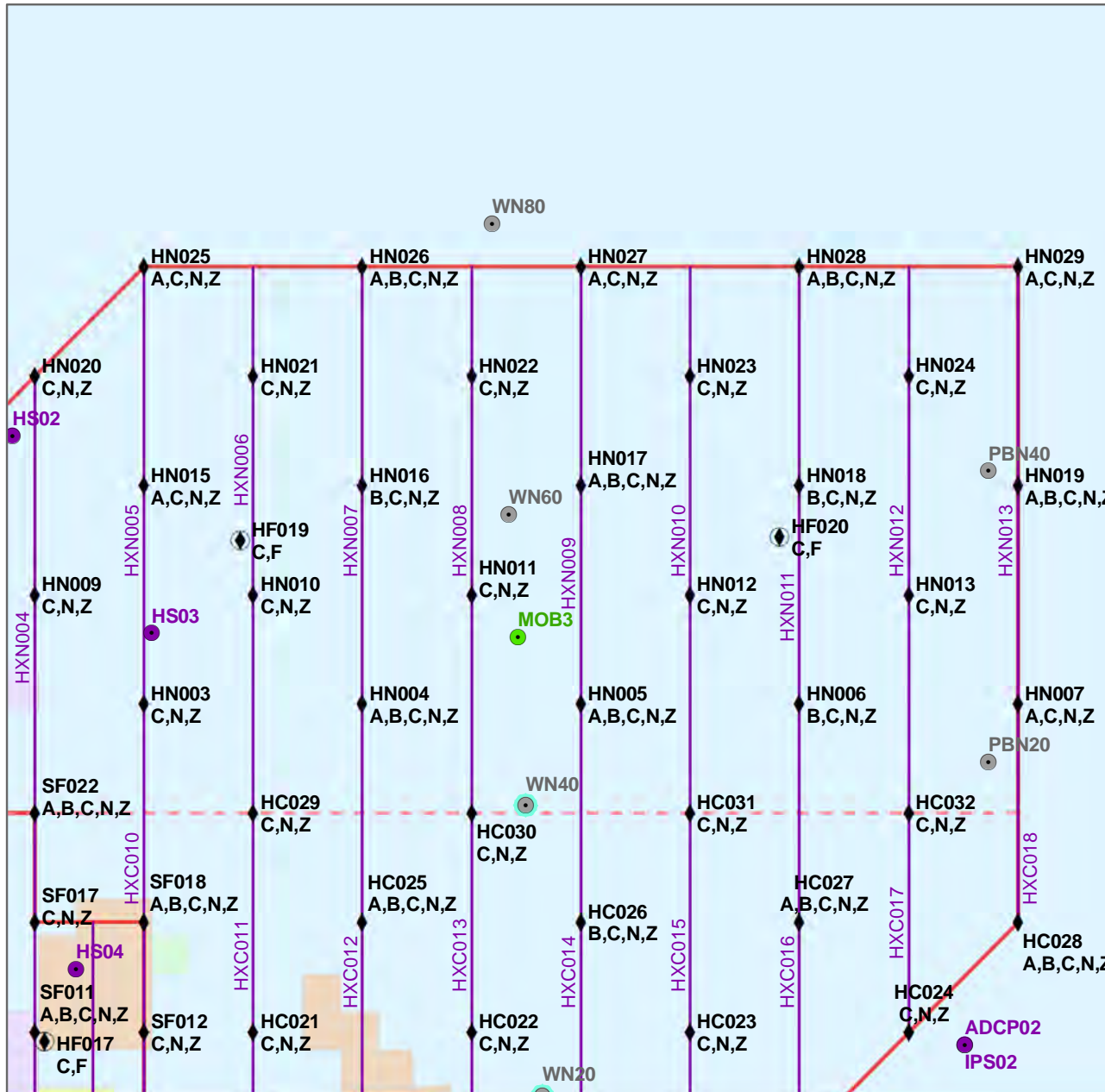

Hanna North West

July 28, 2011

Buoys

- JASCO (Acoustic)
- JASCO (Overwintering)
- Evans Hamilton (AWAC)
- ASL (ADCP/IPS)
- Fairweather (Metoccean)

Stations

- ◆ Fixed Station
- ◆ Fisheries
- A = Ocean Acidification
- B = Benthic
- C = CTD
- F = Fisheries
- N = Nutrients/Chlorophyll
- Z = Zooplankton

Transects

- Survey Line, Primary
- - - Transit Line

Leases

- ConocoPhillips
- Shell
- Iona Energy
- Statoil
- REPSOL

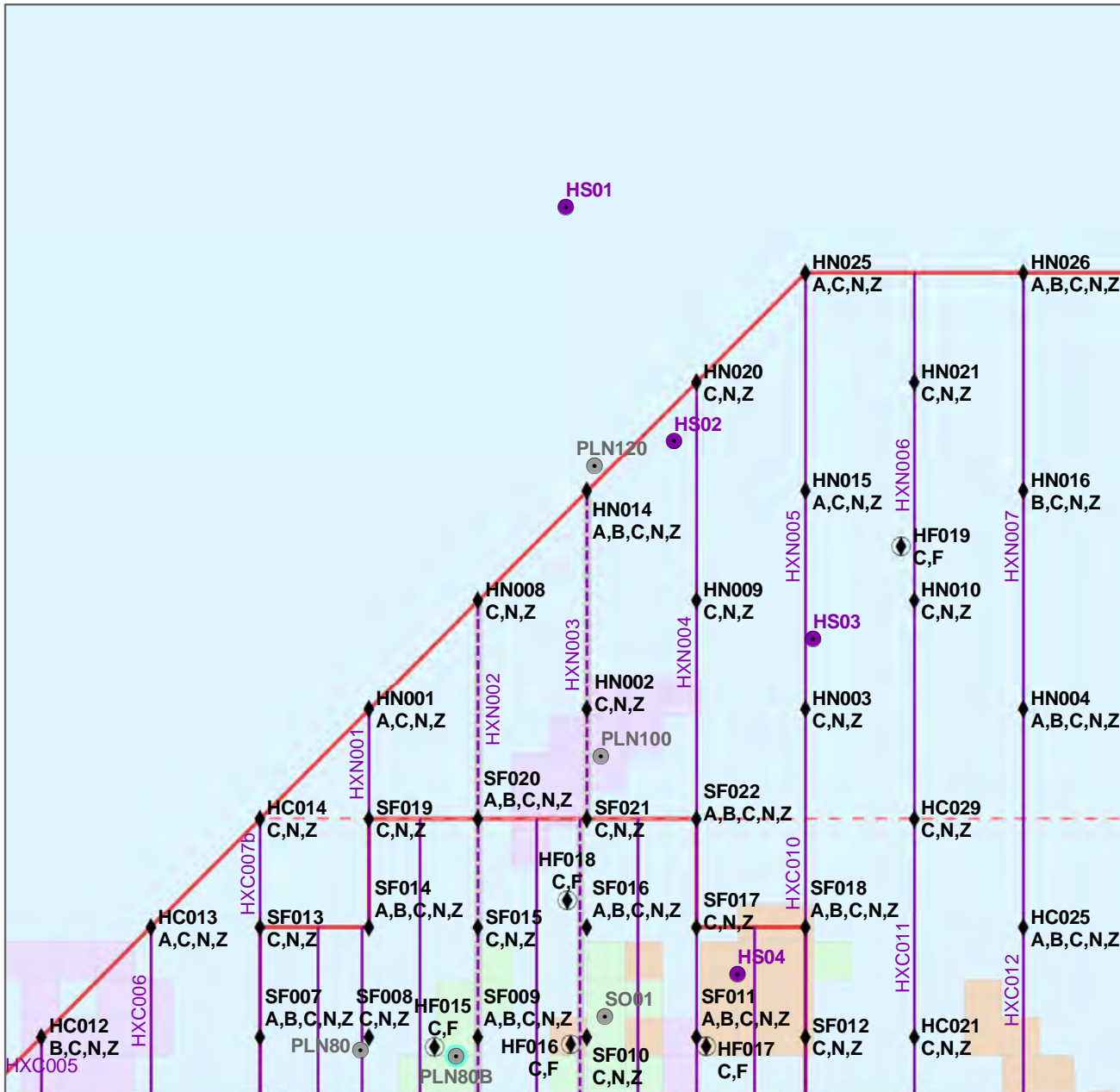
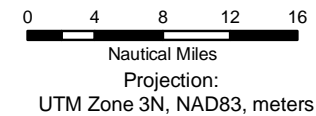

Study Area - Hanna Region 2011 - Official.xmd

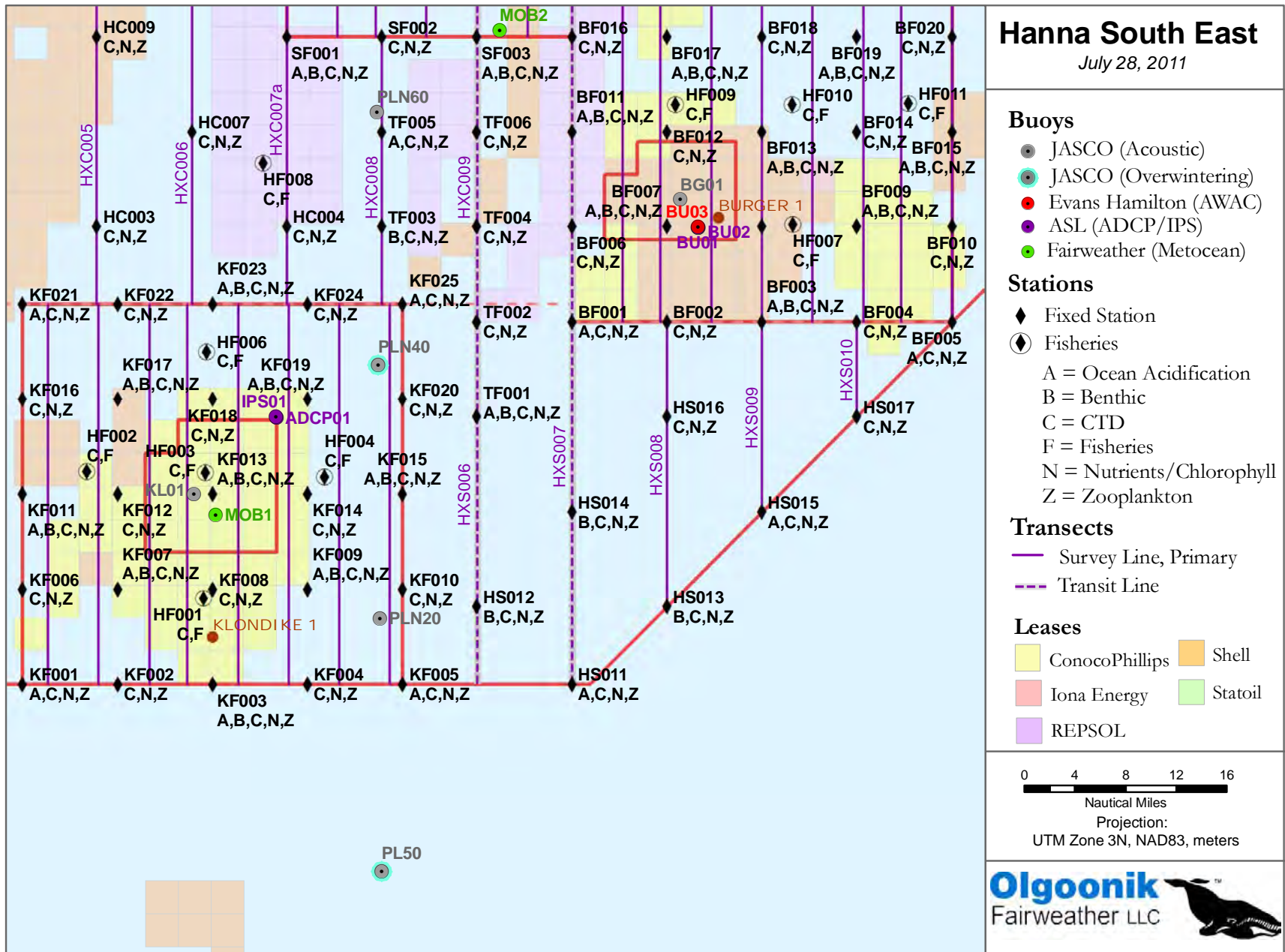

Study Area - Hanna Region 2011 - Official.xmd

