

FILE FOLDER

DESCRIPTION ON TAB:

6240

Outside/inside of actual folder did not contain hand written information

Outside/inside of actual folder did contain hand written information

***Scanned as next image**

Confidential Records Management, Inc.

New Bern, NC

1-888-622-4425

9/08

JAN 01 1982

MAIN/DDS/th
6240

MAY 0 5 1982

Mr. O. W. Strickland
Solid and Hazardous Waste Management Branch
Environmental Health Section
North Carolina Division of Health Services
Post Office Box 2091
Raleigh, North Carolina 27602-2091

Dear Sir:

This is in response to your 27 April 1982 letter regarding status reports of hazardous waste Treatment, Storage and Disposal (TSD) facilities subject to subpart F of 40 CFR 265. Marine Corps Base, Camp Lejeune, (ID# N66170022580) is currently registered as a generator, transporter and long term storer of hazardous waste. Marine Corps Base, Camp Lejeune, is not registered for treatment or disposal of hazardous waste.

Base facilities for long term storage of hazardous waste are utilized for the accumulation of hazardous waste for disposal at commercial, privately operated TSDs. Disposal is accomplished through contracts administered by the Defense Property Disposal Officer, Camp Lejeune or by Marine Corps Base, Camp Lejeune, depending on the type of waste involved.

The requirements outlined in your letter of 27 April 1982 do not appear applicable to Marine Corps Base, Camp Lejeune. Questions regarding this matter should be forwarded to Mr. J. I. Wooten, Director, Natural Resources and Environmental Affairs Branch, Base Maintenance Division, telephone (919) 451-5003.

Sincerely,

B. W. ELSTON
Acting Base Maintenance Officer
By direction of the Commanding General

MAY 0 7 1982

NEW YORK

MAY 0 7 1982

... ..
... ..
... ..
... ..

... ..
... ..
... ..
... ..

... ..
... ..
... ..
... ..

... ..
... ..
... ..
... ..

... ..
... ..

SJA

3 May 80

Jackie,

Please have chopped

→ return to B Main Div,

NR&AB, Please call

when ready
thxs

Tuyet

SECURITY CLASSIFICATION

DATE TIME GROUP

Return to Mr. Southland

SPECIAL INSTRUCTIONS

Scudder

Mar

wh
3/100

5

SJA - This appears to be the correct status under RCRA

May Scudder



Ronald H. Levine, M.D., M.P.H.
STATE HEALTH DIRECTOR

DIVISION OF HEALTH SERVICES
P.O. Box 2091
Raleigh, N.C. 27602-2091

April 27, 1982

Danny Sharpe, Ecologist
I.D.# NC6170022580
Marine Corps Base Camp Lejeune
N.C. Hwy. 24 & U.S. Hwy. 16
Camp Lejeune, NC 28542

Dear Sir:

We are asking for a status report of those RCRA facilities subject to Subpart F, ground-water monitoring, requirements. Please check the appropriate items listed below as they apply to your facility:

- Ground-water Sampling and Analysis Plan complete (265.92).
- Ground-water monitoring wells installed.
- First quarterly samples collected.
- Analyses on file for first quarter's sampling.
- Outline of Ground-water Quality Assessment Plan complete (265.93).
- Analyses from first quarter's sampling submitted to N.C. Solid and Hazardous Waste Management Branch.
- Constituent(s) exceeded allowable concentrations. (If any constituent exceeded allowable concentration, results must be submitted to this office immediately.)
- Facility has received a waiver from Subpart F requirements.
- Facility is in the process of requesting a waiver or delisting. Has a delisting petition been filed with this office? _____

Please return this form no later than May 7, 1982. Thank you for your cooperation.

Sincerely,

D. W. Strickland, Jr., Head
Solid & Hazardous Waste Management Branch
Environmental Health Section

GDB:ns

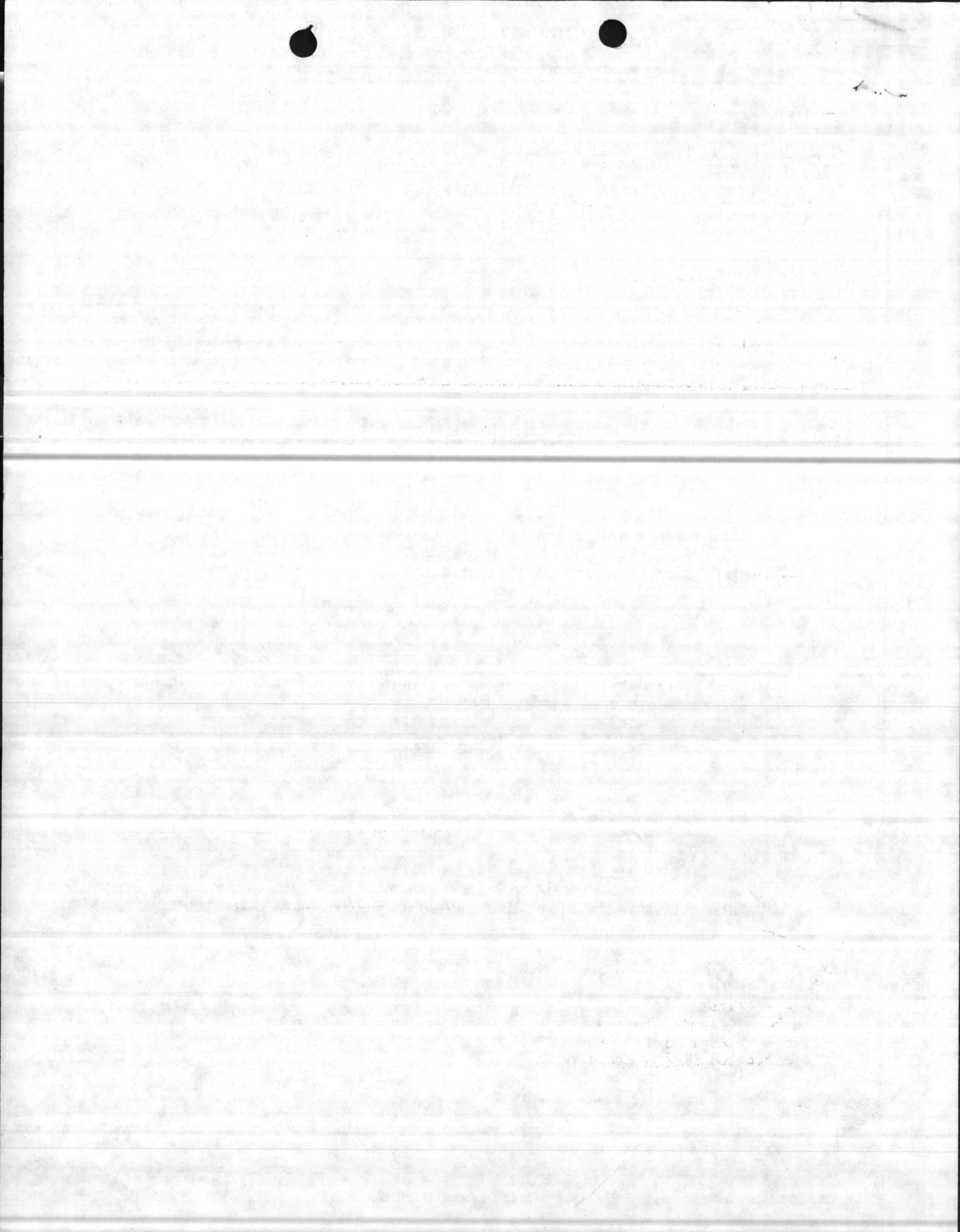

MAIN/DDS/th
6240
MAY 06 1982

From: Commanding General
To: Defense Property Disposal Officer
Subj: Application for Hazardous Waste Permit
Ref: (a) DPDO Lejeune memo of 2 Apr 1982
Encl: (1) EPA Forms 3510-1 and 3510-3; Marine Corps Base, Camp Lejeune
1. The enclosure is forwarded as requested by the reference.

B. M. ELSTON
By direction

MAY 3 0 YAM

Faint, illegible text, possibly a header or address, located in the upper right quadrant of the page.

ROUTING SLIP

APR

8 1982

	ACTION	INFO	INITIAL
BMO			
ABMO			✓ <i>ew</i>
ADMIN		✓	✓ <i>S</i>
ENVIOR AFF	✓		<i>J U W</i>
F&A SEC			
MAINT NCO			
M&R			
OPNS			
PROP			
UMACS			
UTIL			
SECRETARY			

COMMENTS:



807

ASSISTANT CHIEF OF STAFF, FACILITIES
HEADQUARTERS, MARINE CORPS BASE

DATE 4-7-82

TO:

[BASE MAINT O]

DIR, FAMILY HOUSING

PUBLIC WORKS O

DIR, UNACCOMPANIED PERS HSG

COMM-ELECT O

BASE FIRE CHIEF

MOTOR TRANSPORT O

ATTN: NREA Div.

1.) Attached is forwarded for ~~info~~/action.

2. Please initial, or comment, and return all papers to this office.

3. Your file copy

J. H. Fitzgerald
By direction

"LET'S THINK OF A FEW REASONS
WHY IT CAN BE DONE"



J. H. Fitzgerald
Member

LET'S THINK OF A FEW REASONS
WHY IT CAN BE DONE

ROUTING AND TRANSMITTAL SLIP

ACTION

1 TO (Name, office symbol or location) <div style="font-size: 1.5em; font-family: cursive;">Col MILICZ</div>	INITIALS	CIRCULATE
	DATE	COORDINATION
2 <div style="font-size: 1.5em; font-family: cursive;">AEL'S FACILITIES</div>	INITIALS	FILE
	DATE	INFORMATION
3	INITIALS	NOTE AND RETURN
	DATE	PER CON-VERSATION
4	INITIALS	SEE ME
	DATE	SIGNATURE

REMARKS

PLEASE furnish us a copy
of RM 3510-3

msg. AFSALEX

L. J. ...

NOTE: PLEASE CALL AND will
pick up.

Do NOT use this form as a RECORD of approvals, concurrences, disapprovals, clearances, and similar actions.

FROM (Name, office symbol or location) <div style="font-size: 1.5em; font-family: cursive;">L. J. DPO-LEJame</div>	DATE	42 82
	PHONE	5613

ROUTING AND TRACKING SHEET

DATE	TIME	INITIALS	REMARKS

[Faint, illegible handwritten notes and markings, possibly including a signature or date.]

DATE	TIME	INITIALS	REMARKS

2011.2

* U N C L A S S I F I E D *

ROUTINE

088/17197

PT00141

PAGE 01

RAIUZYUW RUCLEF03432 0881522-UUUU--RUEPDO.

ZNR UUUUU

R 2014007 MAR 82

FM DPDR MEMPHIS TN

TO AIG 4544 //ACT: DPDO//

BT

UNCLAS DPDR-MR 131-82 PASS TO DEF PROP DTSP OFCS

SUBJ: EPA FM 3510-3

1. REQ THAT COPIES OF THE COUNTERSIGNED EPA FM 3510-3 FOR EA DPDO AND OSB BE FURNISHED TO DPDR-MR NLT COB 21 APR 82. ACTIVITIES NOT POSSESSING RCRA INTERM STATUS ARE REQUESTED TO PROVIDE THE STATUS OF PERMIT FILING
2. INQUIRIES OF THIS MATTER SHOULD BE DIRECTED TO CPT SIDNEY PHILLIPS OR BOBBY GREENWALL, DPDR-MR, AV 966-9866

BT

#3432

NNNN

DPDO, /343

29

4

0

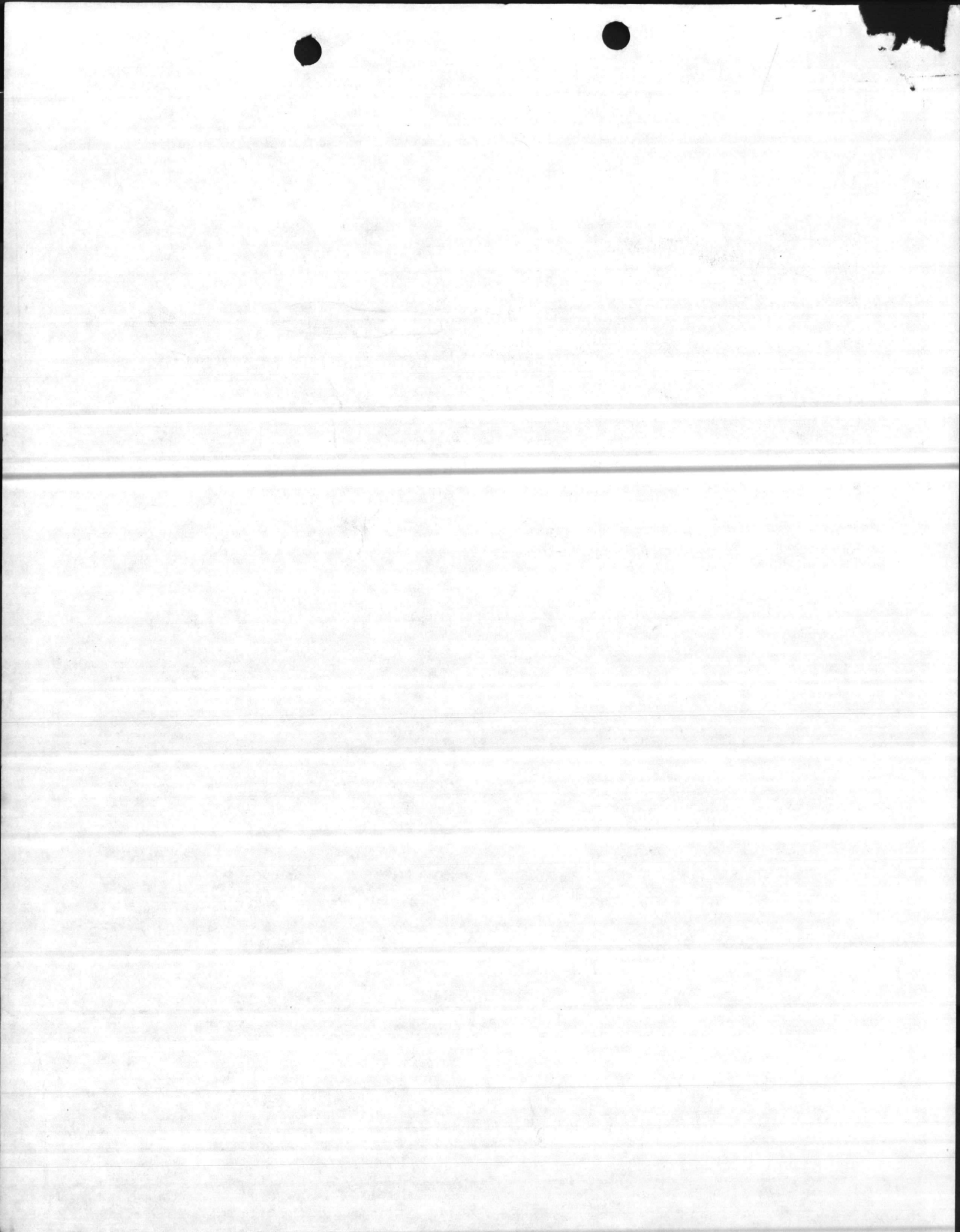

ROUTINE

070/07342

* U N C L A S S I F I E D *

PT00142

DISTRIBUTION

Bmu

BMOPAGE 01

- ABMO
- NREAD
- Admin D.
- Oper D.
- M&R D.
- Tele D.
- Util D.
- F&C
- Pr. C.
- Maint. NCO
- Secretary

ORIGINAL ACTION

TTUZYUW RUEA CMC 55 80 0700732-UUUU--RUE BOOA
NR UUUUU

R 101425Z MAR 82

FM CMC WASHINGTON DC
TO AIG EIGHT ACT: CG MCB
BT

UNCLAS //N11000//

SUBJ: HAZARDOUS WASTE RECORDKEEPING AND REPORTING REQUIREMENTS

A. FEDERAL REGISTER 47 FR 7841 OF 23 FEB 82 (NOTAL)

B. MCRUL 6280 OF 1 MAY 1980 WITH CH 1-2

1. BY REF A THE ENVIRONMENTAL PROTECTION AGENCY (EPA) HAS DELAYED COMPLIANCE DATES FOR THREE REQ UNDER ITS HAZARDOUS WASTE (HW) REGULATIONS WHICH WERE PUBLISHED UNDER SUBTITLE C OF RESOURCE CONSERVATION AND RECOVERY ACT (RCRA) AND IMPLEMENTED BY REF B. THE FOL DATA REQTS ARE POSTPONED FROM 1 MAR 82 TO 1 AUG 82:

- A. SUBMISSION OF ANNUAL REPORTS BY HW GENERATORS AND OWNERS AND OPERATORS OF HW TREATMENT, STORAGE, AND DISPOSAL (TSD) FACILITIES;
- B. SUBMISSION OF INITIAL-YEAR QUARTERLY GROUNDWATER MONITORING PARAMETER READINGS BY TSD FACILITIES;
- C. PREPARATION OF GROUNDWATER QUALITY ASSESSMENT PROGRAM OUTLINES BY TSD FACILITIES.

2. THIS POSTPONMENT DOES NOT RELIEVE TSD FACILITY OPERATORS FROM

PAGE 02 RUEA CMC 5580 UNCLAS

MAINTENANCE OF RECORDS REQUIRED TO PREPARE THESE REPORTS. IT IS ANTICIPATED THAT DURING THE LATE SPRING/EARLY SUMMER TIMEFRAME EPA WILL ISSUE CONSOLIDATED REQTS REGARDING REPORTING PROCEDURES.

3. QUESTIONS RE THIS SUBJ SHOULD BE DIRECTED TO MR. PAUL HUBBELL AT A/V 224-2171/3188.

BT
#5580

NNNN
ACT: FAC
INFO: ADJ / 136

ROUTINE

* U N C L A S S I F I E D *

10

14
101425Z MAR 82

MAR 82
25 Z

DISTRIBUTION

- _____ BMO
- _____ ABMO
- _____ INRAD
- _____ Admin D
- _____ Oper D
- _____ MCT D
- _____ Tele D
- _____ Mail D

Memorandum

DATE: 3 March 82

FROM: Paul Hubbell
TO: Mr. Julian Wooten, Director, Natural Resources Division
SUBJ: Recordkeeping and Reporting Requirements for
Hazardous Wastes.

Encl: Federal Register Vol 47 No 36 of 23 Feb 82
pp 7841-7842

1. The enclosure is forwarded for your info / use as appropriate. A message is on the way announcing this change. It is expected that reporting requirements will be better defined early this summer.

Sincerely,

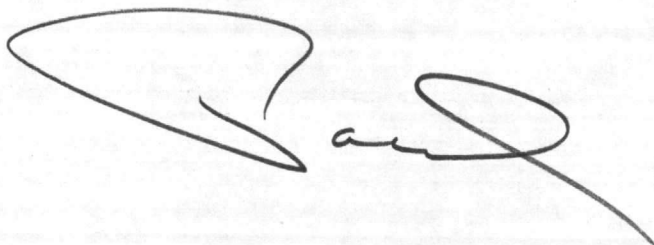

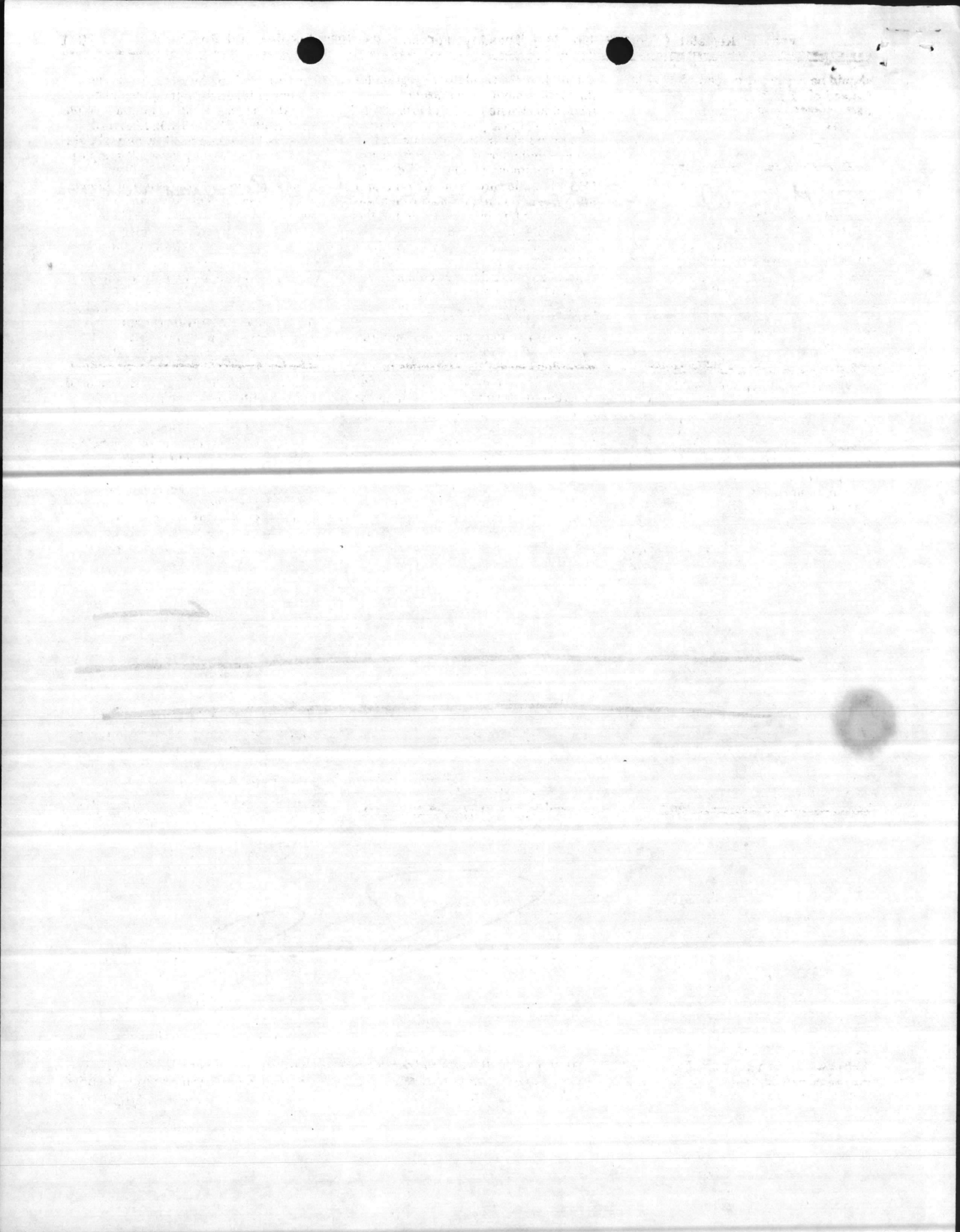

should be corrected to read "§ 52.2470" instead of "§ 52.247."

[FR Doc. 82-4797 Filed 2-22-82; 8:45 am]

BILLING CODE 6560-38-M

40 CFR Parts 262, 264, and 265

[SW-FRL 2041-5]

Hazardous Waste Management System: Standards Applicable to Generators of Hazardous Waste and Standards Applicable to Owners and Operators of Hazardous Waste Treatment, Storage, and Disposal Facilities

AGENCY: Environmental Protection Agency.

ACTION: Delayed Compliance Dates.

SUMMARY: The Environmental Protection Agency (EPA) is today delaying the compliance dates for three requirements of its hazardous waste regulations under Subtitle C of the Resource Conservation and Recovery Act (RCRA) until August 1, 1982. The three requirements concern: (1) The submission of annual reports by hazardous waste generators and owners and operators of treatment, storage, and disposal facilities, under 40 CFR 262.41, 264.75, and 265.75; (2) the submission of initial-year quarterly groundwater monitoring parameter readings by treatment, storage, and disposal facilities, under 40 CFR 265.94(a)(2)(i); and, (3) the preparation of groundwater quality assessment program outlines by treatment, storage, and disposal facilities, under 40 CFR 265.93(a).

EPA is taking these actions because it is currently developing formal proposals to substantially streamline or eliminate these requirements, and the Agency wishes to prevent the regulated community from expending resources toward complying with them in their present form.

DATE: Effective February 23, 1982.

ADDRESSES: The Docket Clerk (Docket 3002/3004—Annual Survey/RCRA Burden Reduction), Office of Solid Waste (WH-562), U.S. Environmental Protection Agency, 401 M Street, SW., Washington, D.C., 20460.

FOR FURTHER INFORMATION CONTACT: Michael E. Burns, Office of Solid Waste (WH-562), U.S. Environmental Protection Agency, 401 M Street, SW., Washington, D.C., 20460, (202) 755-9158.

SUPPLEMENTARY INFORMATION:

I. Introduction

Pursuant to Subtitle C of the Solid Waste Disposal Act, as amended by the Resource Conservation and Recovery Act of 1976 (RCRA), as amended, EPA promulgated regulations establishing a

comprehensive regulatory program for the management and control of hazardous waste (40 CFR Parts 260-267 and 122-124). As part of the regulations, generators of hazardous waste and owners and operators of hazardous waste treatment, storage, and disposal (TSD) facilities are required to prepare annual reports on their hazardous waste management activities and submit them to the EPA Regional Administrator by March 1 of the following year (40 CFR 262.41, 264.75, and 265.75). Annual reports covering the 1981 calendar year are required to be submitted to EPA Regional Administrators by March 1, 1982.

In addition, the regulations require owners and operators of certain hazardous waste TSD facilities to implement a groundwater monitoring program by November 19, 1981, unless an appropriate waiver is prepared and maintained at the facility (40 CFR 265.90). Unless an alternate groundwater monitoring system is implemented at the facility, as provided under 40 CFR 265.90(d), owners and operators are required during the initial year of their monitoring programs to conduct quarterly analyses (40 CFR 265.92(c)), to, among other things, characterize the suitability of the groundwater in the uppermost aquifer as a drinking water supply (265.92(b)(1)). Within 15 days after the completion of each quarterly analysis, owners and operators are required to report to EPA Regional Administrators the concentrations or values of the observed parameters specified in the EPA Interim Primary Drinking Water Standards (see Appendix III to 40 CFR Part 265) for each groundwater monitoring well (40 CFR 265.94(a)(2)(i)). As part of these reports, owners and operators must separately identify for each monitoring well any parameter whose concentration or value has been found to exceed the maximum contaminant levels listed in the EPA Interim Primary Drinking Water Standards.

Finally, as part of the groundwater monitoring regulations, owners and operators of certain TSD facilities that have not implemented an alternate groundwater monitoring program are required to prepare an outline of a groundwater quality assessment program by November 19, 1981 (40 CFR 265.93(a)).

II. Description of Today's Actions and Rationales

A. Annual Reports

EPA is today delaying the compliance date for submission of 1981 generator and TSD facility annual reports from

March 1, 1982, to August 1, 1982. The Agency is taking this action for two primary reasons. First, as announced on July 31, 1981 (46 FR 39426), EPA now believes that it can meet its annual data needs through surveying small samples of the generator and TSD facility populations instead of requiring annual reports from all generators and TSD facilities. Furthermore, EPA believes that this sampling approach is less costly and burdensome to both the Agency and the regulated community. EPA is therefore developing a Federal Register notice to propose replacing the annual reporting requirements with annual surveys. However, final promulgation of this proposed amendment is not expected until this summer, by which time the 1981 annual reports will have already been prepared and submitted. Extending the compliance deadline until August 1, 1982, will allow the Agency sufficient time to issue its proposal, review public comments, and come to a final determination regarding the ultimate status of the annual reporting requirements prior to preparation and submission of the 1981 reports by the regulated community.

EPA's second reason is that it will conduct an extensive survey of the regulated populations of hazardous waste generators and TSD facilities this Spring in support of its Regulatory Impact Analyses (RIAs) on several components of its RCRA regulations. Since this survey will obtain data substantially equivalent to that to be submitted in annual reports, EPA believes that requiring submission of annual reports at this time will be duplicative for those handlers surveyed and unwarranted because the Agency intends to meet its current information needs through the survey.

B. Quarterly Groundwater Reporting

EPA also is today delaying, until August 1, 1982, the compliance dates for submission of the first two quarterly groundwater monitoring parameter readings (now required to be submitted by or before March 6 and June 3, 1982, under 40 CFR 265.94(a)(2)(i)), except where parameters are observed whose concentration or value is found to exceed the maximum contaminant levels listed in the EPA Interim Primary Drinking Water Standards (see Appendix III to 40 CFR Part 265). Where concentrations or values exceed the maximum contaminant levels, owners and operators must report their quarterly parameter readings to EPA Regional Administrators within 15 days after completing each quarterly analysis.

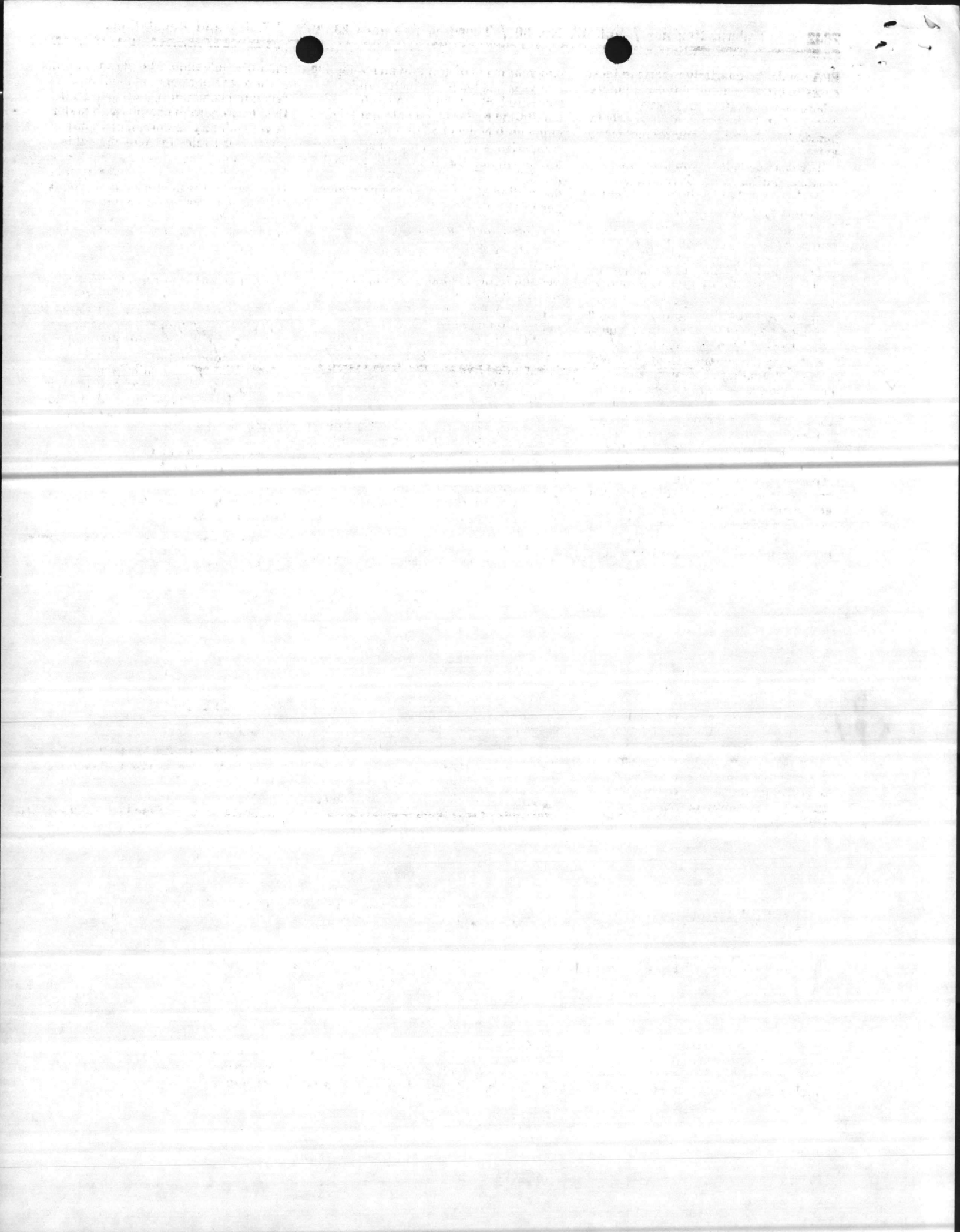

EPA needs the quarterly reports in these cases in order to identify those aquifers where contamination may have occurred and where potential threats to human health and the environment may exist.

The Agency is taking this action because it is currently developing a formal proposal to institute an exception reporting system for all of the groundwater monitoring reporting requirements. The nature of this proposal is outlined in an analysis submitted to the Office of Management and Budget (OMB) by EPA as a follow-up to its July 31, 1981, Federal Register notice. Copies of EPA's analysis can be obtained by submitting written requests to the Docket Clerk (see Addresses).

Delaying the submission of quarterly parameter readings unless maximum contaminant levels are exceeded until August 1, 1982, will allow EPA sufficient time to complete the new rulemaking prior to the submissions of most parameter readings by the regulated community, and will avoid imposing reporting requirements that EPA may change. It should be noted that today's action does not relieve owners and operators from the requirement to conduct the quarterly analyses and to keep records of the analyses throughout the active life of their facilities, and, for disposal facilities, throughout the post-closure period as well. Therefore, EPA believes the environmental impact of the delay is minimal.

C. Assessment Program Outlines

Finally, EPA is today delaying, until August 1, 1982, the compliance date by which owners and operators of certain TSD facilities are required to have prepared an outline of a groundwater quality assessment program. The Agency is taking this action because it is currently developing a formal proposal to eliminate the outline requirement entirely. The nature of this proposal is outlined in an analysis submitted to OMB by EPA as a follow-up to its July 31, 1981, Federal Register notice. Copies of EPA's analysis can be obtained by submitting written requests to the Docket Clerk (see Addresses).

As above, delaying the preparation of the groundwater quality assessment program outlines until August 1, 1982, will allow EPA sufficient time to complete rulemaking on this matter and will avoid interim imposition of a requirement that it intends to eliminate. EPA sees minimal environmental consequences resulting from today's action because the groundwater quality assessment programs that are the subject of the outlines would not be implemented in most cases until after a

one-year cycle of groundwater sampling analyses has been conducted and compared. Since the groundwater monitoring requirements did not take effect until November 19, 1981, comparisons with initial background levels will not take place until at least the Fall of 1982, well after the final disposition of the outline requirements has been determined.

III. Compliance Date Delays

To delay the compliance dates for the three RCRA requirements described in Section II, EPA is today taking the following actions:

(1) The compliance date for submission of generator and TSD facility 1981 annual reports, required under 40 CFR 262.41, 264.75, and 265.75, is extended five months, from March 1, 1982, to August 1, 1982.

(2) The compliance dates for submission of the first two quarterly groundwater readings by TSD facilities, required under 40 CFR 265.94(a)(2)(i), are extended from March 6 and June 3, 1982, to August 1, 1982, except where parameters are observed whose concentration or value is found to exceed the maximum contaminant levels listed in the EPA Interim Primary Drinking Water Standards (see Appendix III to 40 CFR Part 265). Where concentrations or values exceed the maximum contaminant levels, owners and operators must continue to report their quarterly parameter readings to EPA Regional Administrators within 15 days after completing each quarterly analysis.

(3) The compliance date for preparation of groundwater quality assessment outlines, required under 40 CFR 265.93(a), is extended from November 19, 1981, to August 1, 1982.

IV. Effective Date

Today's actions are final and immediately effective. The Agency has determined that there is good cause under 5 U.S.C. 553(b) to make these changes immediately effective without prior notice or public comment. Since the Agency will be proposing substantial changes that would render these requirements unnecessary, EPA believes it is essential to take these actions before the regulated community expends resources toward complying with them in their present form. Because today's changes are minor and will have little or no adverse impact on the environment; EPA has concluded that it would be contrary to the public interest to delay this action.

Section 3010(b) of RCRA requires that revisions to the hazardous waste regulations take effect six months after

their promulgation. The purpose of this statutory requirement is to allow the regulated community sufficient lead time to prepare to comply with major new regulatory requirements. That purpose is irrelevant here since this action is not imposing new requirements but rather is affording temporary relief from existing regulatory requirements. Furthermore, an effective date six months after promulgation would defeat the very purpose of these actions. EPA is therefore making these delays effective on February 23, 1982.

Section 8(a)(1) of Executive Order 12291 provides for exemption from the procedures established by the Order in emergency situations. Because any delay in issuing this notice will increase the likelihood that the regulated community will expend resources to comply with the requirements in their present form, it is impractical to follow the procedures of Executive Order 12291.

Dated: February 12, 1982.

John W. Hernandez, Jr.,
Acting Administrator.

[FR Doc. 82-4817 Filed 2-22-82; 8:45 am]
BILLING CODE 6560-30-M

DEPARTMENT OF THE INTERIOR

Bureau of Land Management

43 CFR Public Land Order 6111

[OR-19062]

Oregon; Powersite Restoration No. 695; Partial Revocation of Powersite Reserve No. 294

Correction

In FR Doc. 82-3063 appearing on page 5419 in the issue of Friday, February 5, 1982, make the following corrections:

(1) On page 5419, in the fourth line from the bottom of the last column, there should have been a comma and a space between S $\frac{1}{2}$ NW $\frac{1}{4}$ and SW $\frac{1}{4}$.

(2) On page 5420, in the fifth line from the top of the first column, there should have been a comma and a space between W $\frac{1}{2}$ NE $\frac{1}{4}$ and NW $\frac{1}{4}$.

(3) Also on page 5420, first column, under T. 7 S., R. 11 E., in Sec. 9, ". . . W $\frac{1}{2}$ SW $\frac{1}{4}$, . . ." should have read ". . . W $\frac{1}{2}$ SE $\frac{1}{4}$, . . .".

(4) In the same column, under T. 8 S., R. 11 E., in Sec. 19, there should have been a comma and a space between SE $\frac{1}{4}$ NW $\frac{1}{4}$ and E $\frac{1}{2}$ SW $\frac{1}{4}$.

(5) In the second column of page 5420, under T. 9 S., R. 12 E., in Sec. 18, ". . . S $\frac{1}{2}$ NW $\frac{1}{4}$, . . ." should have read ". . . S $\frac{1}{2}$ NE $\frac{1}{4}$, . . .".

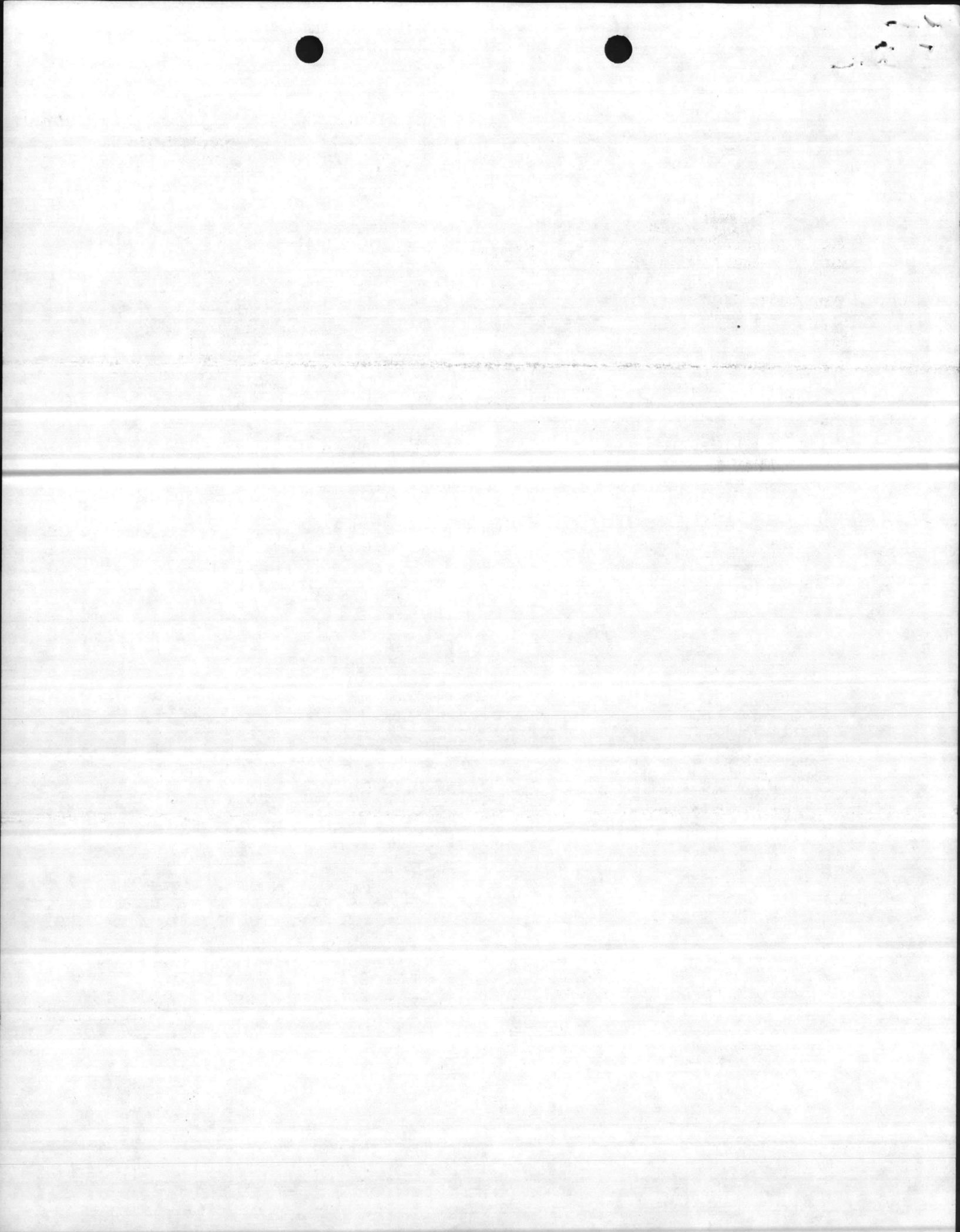

MAIN/DDS/spk
6240
17 May 1982

From: Director, Natural Resources and Environmental Affairs Branch
To: Base Maintenance Officer

Subj: Marine Corps Air Station (Helicopter), New River (MCAS(H),NR) Hazardous Waste Disposal Program

Ref: (a) FONECON btw Ms. Mary Wheat, S-4 Office, MCAS(H) NR, and Mr. D. Sharpe, BMaintDiv of 12 May 1982

Encl: (1) Dir, NREAB ltr MAIN/RTS/spk 62805 of 19 Apr 1982

1. During the reference, Ms. Wheat advised that the Defense Property Disposal Officer, Cherry Point (DPDO, CP) had accepted approximately 150 gallons of hazardous waste (mixture of solvents and waste oil) from Marine Air Group-29, MCAS(H), New River. The enclosure describes the circumstances which led to Marine Air Group-29 generating these wastes at building AS-4107.
2. During the reference, Ms. Wheat advised that the DPDO, CP accepted the item as a hazardous material. Ms. Wheat indicated that Marine Air Group-29 transported the item and that the Station S-4 Officer became aware of the occurrence after the fact.
3. The actions by Marine Air Group-29 appears to be inconsistent with current Federal/State hazardous waste regulations. However, in Natural Resources and Environmental Affairs Branch's opinion, Marine Corps Base, Camp Lejeune, is not responsible in any manner. However, it is recommended Assistant Chief of Staff, Facilities be made aware of where this hazardous material went and it is also recommended the SJA be requested to review and comment on this matter before any followup action is considered.

J. I. WOOTEN

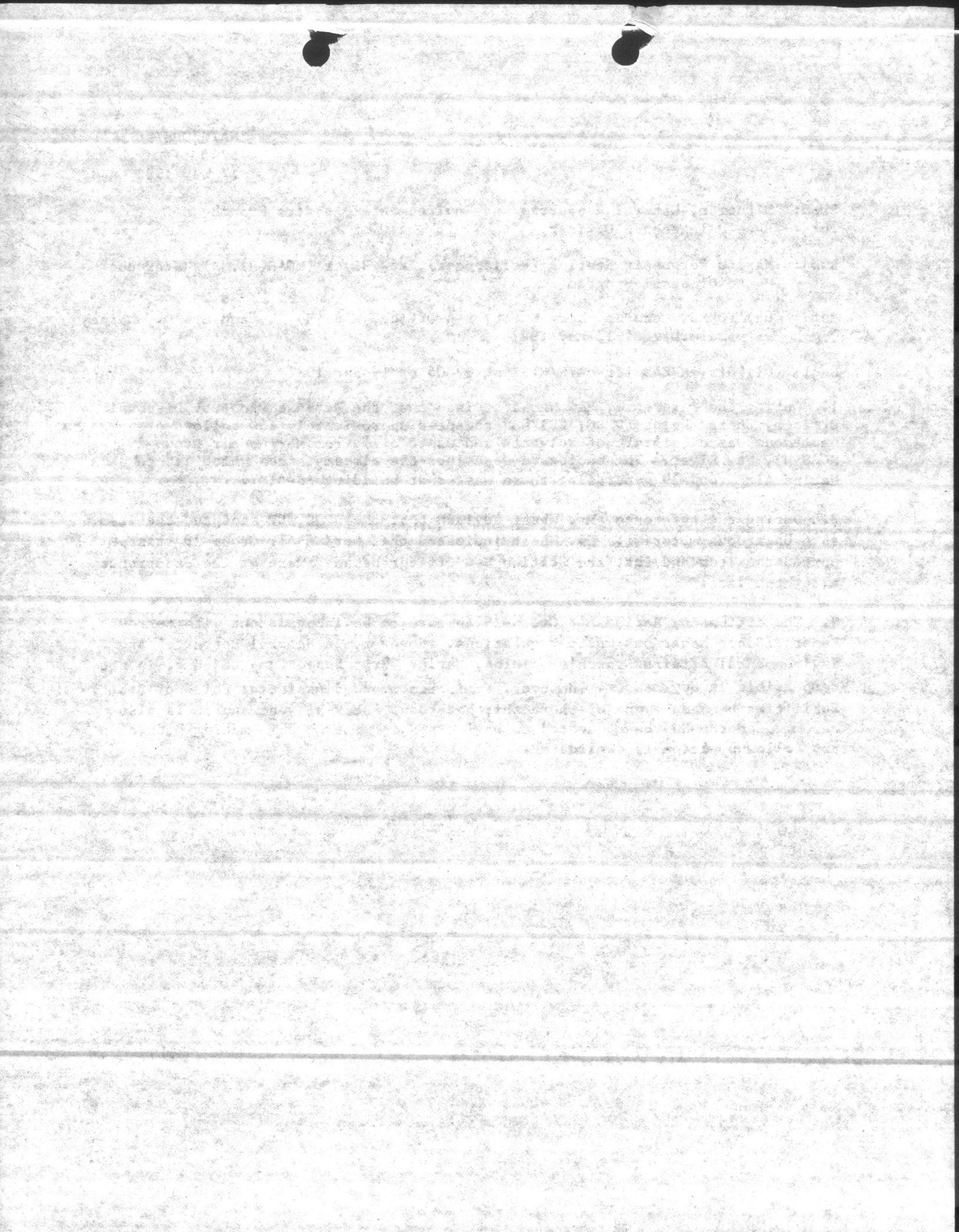

BASE MAINTENANCE DIVISION
Marine Corps Base
Camp Lejeune, North Carolina 28542

MAIN/DDS/spk
6240
17 May 1982

BMO
From: ~~Director, Natural Resources and Environmental Affairs Branch~~
To: ~~Base Maintenance Officer~~ *ACS, Faulstich*
Subj: Marine Corps Air Station (Helicopter), New River (MCAS(H),NR) Hazardous Waste Disposal Program
Ref: (a) FONECON btw Ms. Mary Wheat, S-4 Office, MCAS(H) NR, and Mr. D. Sharpe, BMaintDiv of 12 May 1982

Encl: (1) Dir, NREAB ltr MAIN/RTS/spk 62805 of 19 Apr 1982

1. During the reference, Ms. Wheat advised that the Defense Property Disposal Officer, Cherry Point (DPDO, CP) had accepted approximately 150 gallons of hazardous waste (mixture of solvents and waste oil) from Marine Air Group-29, MCAS(H), New River. The enclosure describes the circumstances which led to Marine Air Group-29 generating these wastes at building AS-4107.

2. During the reference, Ms. Wheat advised that the DPDO, CP accepted the item as a hazardous material. Ms. Wheat indicated that Marine Air Group-29 transported the item and that the Station S-4 Officer became aware of the occurrence after the fact.

3. The actions by Marine Air Group-29 appears to be inconsistent with current Federal/State hazardous waste regulations. ~~However, in Natural Resources and Environmental Affairs Branch's opinion, Marine Corps Base, Camp Lejeune, does not appear~~ *to be* responsible in any manner. ~~However, it is recommended Assistant Chief of Staff, Facilities be made aware of where this hazardous material went and it is also recommended the SJA be requested to review and comment on this matter before any followup action is considered.~~ *by copy herof it is* *recommended* *followup further*

~~J. I. Wooten~~
J. I. WOOTEN
BWE

Copy to: SJA

RESEARCH DIVISION

MEMORANDUM FOR THE DIRECTOR

Subject: [Illegible]

Reference is made to [Illegible]

It is noted that [Illegible]

The following information [Illegible]

Very truly yours,
[Illegible Signature]

MAIN/DDS/spk
6240

MAY 20 1982

From: Base Maintenance Officer
To: Assistant Chief of Staff, Facilities

Subj: Marine Corps Air Station (Helicopter), New River (MCAS(H),NR) Hazardous
Waste Disposal Program

Ref: (a) FONECON btw Ms. Mary Wheat, S-4 Office, MCAS(H) NR, and Mr. D. Sharpe,
BMaintDiv of 12 May 1982

Encl: (1) Dir, NREAB ltr MAIN/RTS/spk 6280/5 of 19 Apr 1982

1. During the reference, Ms. Wheat advised that the Defense Property Disposal Officer, Cherry Point (DPDO, CP) had accepted approximately 150 gallons of hazardous waste (mixture of solvents and waste oil) from Marine Air Group-29, MCAS(H), New River. The enclosure describes the circumstances which led to Marine Air Group-29 generating these wastes at Building AS-4107.

2. During the reference, Ms. Wheat advised that the DPDO, CP accepted the item as a hazardous material. Ms. Wheat indicated that Marine Air Group-29 transported the item and that the Station S-4 Officer became aware of the occurrence after the fact.

3. The actions by Marine Air Group-29 appears to be inconsistent with current Federal/State hazardous waste regulations. Marine Corps Base does not appear to be responsible in any manner. However, by copy hereof, it is recommended the Staff Judge Advocate review and comment on this matter before any further action is considered.

B. W. ELSTON
Acting

Copy to:
SJA

SECRET

5-25-82

Danny,

Note + Return

Mr. Epton wants us to hold

See his note + instruction

D.O.S

Duty

is done

DDB.

File Hg Wash
Juhar

5-2482

Danny,
Note & Return

D. Sharpe:

This plus our memo
should adequately define
the "problem".

Tuplak,

Put this with the memo we
wrote on this subj last week.

Julian

26 MAY 82

Julian

Done

sh

HEADQUARTERS, MARINE CORPS BASE
CAMP LEJEUNE, NORTH CAROLINA

Date 19 May 82

From: Assistant Chief of Staff Facilities

To: _____

Subj: _____

Req to N F C

or Contract

62-dlm
6260.10
19 May 1982

From: Chief, Occupational & Preventive Medicine Service
To: Commanding Officer, H&MS-26, MAG-26, 2d MAW, MCAS(H),
New River, Jacksonville, NC 28545

Subj: Industrial Hygiene Hazardous Substances Survey

Ref: (a) FONECON request from Ms. M. Wheat, MCAS(H) Safety
Specialist on 26 March 1982

Encl: (1) Survey Report
(2) Push-Pull Exhaust Program

1. As requested by reference (a) the subject survey was conducted on 29 March 1982. Survey data is forwarded in enclosures (1) and (2).
2. Should further information or assistance be desired, please contact the Industrial Hygiene Section at ext. 5707 or 2707.

G. L. WINTERS
By direction

Copy to:
CO, MCAS(H), New River
Ground Safety Off, Bldg AS-504
Sta Safety Off, MCAS(H)
→Envir. Affairs, CLNC
S-4 Officer, MCAS(H)

62-11
3200.10
19 May 1952

Chief, Occupational & Preventive Medicine Service
Commanding Officer, 100-10, 100-10, 100-10 (1)
New River, Jackson, W. Va.

Industrial Hygiene Section
(a) Forwarded from 100-10, 100-10, 100-10 (1) Safety
Section on 10 May 1952

- (1) Survey Report
- (2) High-Pollutant Program
- (3) As indicated by reference (a) the subject survey was conducted on 10 May 1952. Survey data is forwarded in enclosure (1) and (2).
- (4) Should further information or assistance be desired, please contact the Industrial Hygiene Section at ext. 2727 or 2727.

E. W. WILKINS
By direction

Copy to
100-10, New River
100-10, New River
100-10, New River
100-10, New River
100-10, New River
S-4 Officer, MCA2(H)

I. TITLE: Industrial Hygiene Survey - Hazardous Substances.
H&MS-26, MAG-26, 2d MAW, MCAS(H), New River,
Jacksonville, NC 28545

II. DATE/CONDUCTED BY: LT G. Winters, MSC, USN, Industrial
Hygienist; Mr. John McCloskey, Health
Technician

III. INTRODUCTION: The Industrial Hygiene Section was requested to evaluate an intended bearing cleaning and chromium plating process which reportedly involves the use of Hydrochloric, Hydrofluoric and Nitric Acids. The OLD Battery Locker in Bldg. #518 was pointed out as the space to be utilized for this operation. Ms. M. Wheat, MCAS(H) Safety Specialist and GySgt Hammontree, USMC, Ground Safety, accompanied the Surveyors.

IV. FINDINGS: The old Battery Locker is an isolated room at the rear of the building. The space is, approximately, 15 x 15 x 20 feet and has vented (slotted) door which opens to the outside. There is a ventilation duct along one wall but no exhaust ventilation capability was noticed. Deluge shower equipment is installed in the room but it was not determined whether the device was operative.

V. COMMENTS/RECOMMENDATIONS: Information available at the time of survey indicates an Industrial type process which will require customized exhaust ventilation and protective devices. It is, also, recognized that the materials involved are hazardous substances and as such require specialized handling. Exposure to the aforementioned acids/solutions is a potential health hazard which may effect the eyes, skin, other body tissues, teeth and/or the lungs. In addition, specialized methods of waste treatment and disposal will be necessary.

DIPTANKS/VENTILATION: The process, as described will require installation of open surface tanks with push-pull lateral exhaust systems. Tank construction materials should be compatible with contained materials. An acceptable push-pull lateral exhaust is shown in enclosure (2). Lateral exhaust tanks are vulnerable to crossdrafts and for effective control, crossdrafts must be kept to a minimum. The installation of side shields may be necessary. The air velocity at any point in front of the hood opening (slots) must be sufficient to overcome opposing currents, capture contaminated air and cause it to flow into the hood. For this type operation 100 to 150 cubic feet/minute capture velocity is necessary. Exhaust ducts from acid bath operations may be combined. The exhaust system from plating tanks should be separate. Exhaust should not be located at a point where contaminated air may be recirculated within any structure. The introduction of make up air in an amount sufficient to offset exhaust volumes should be provided for. The temperature of make up air should aid in regulating the work space climate.

TITLE: Industrial Hygiene Survey - Hazardous Substances
WMS-20, WMS-21, WMS-22, WMS-23, WMS-24, WMS-25, WMS-26, WMS-27, WMS-28, WMS-29, WMS-30, WMS-31, WMS-32, WMS-33, WMS-34, WMS-35, WMS-36, WMS-37, WMS-38, WMS-39, WMS-40, WMS-41, WMS-42, WMS-43, WMS-44, WMS-45, WMS-46, WMS-47, WMS-48, WMS-49, WMS-50, WMS-51, WMS-52, WMS-53, WMS-54, WMS-55, WMS-56, WMS-57, WMS-58, WMS-59, WMS-60, WMS-61, WMS-62, WMS-63, WMS-64, WMS-65, WMS-66, WMS-67, WMS-68, WMS-69, WMS-70, WMS-71, WMS-72, WMS-73, WMS-74, WMS-75, WMS-76, WMS-77, WMS-78, WMS-79, WMS-80, WMS-81, WMS-82, WMS-83, WMS-84, WMS-85, WMS-86, WMS-87, WMS-88, WMS-89, WMS-90, WMS-91, WMS-92, WMS-93, WMS-94, WMS-95, WMS-96, WMS-97, WMS-98, WMS-99, WMS-100

DATE: 10/15/68
BY: J. W. Smith, Industrial Hygienist
Reviewed by: John J. ...

III. EXPOSURE: The Industrial Hygiene Section was requested to evaluate an intended breathing apparatus and chemical plant process which reportedly involves the use of Hydrochloric, Hydrofluoric and Nitric acids. The OIR Battery Locker is also mentioned as the space to be utilized for this operation. The OIR Battery Locker is located in the basement of the building. Ground safety, accompanied the Surveyor.

IV. FINDINGS: The OIR Battery Locker is a confined space at the rear of the building. The space is approximately 15 x 15 x 10 feet. There is a ventilation system in the room but it was not determined whether the device was operative.

V. COMMENTS AND RECOMMENDATIONS: Information available at the time of survey indicates an industrial type process which will require customized exhaust ventilation and protective devices. It is also recommended that the materials involved are hazardous substances and an authorized specialized handling, PPE, health hazard which may affect the eyes, skin, other body tissues, coat, and/or the lungs. In addition, specialized methods of waste treatment and disposal will be necessary.

VI. RECOMMENDATIONS: The process as described will require installation of open surface tanks with push-down lateral exhaust systems. Tank construction materials should be compatible with contained materials. An acceptable push-down lateral exhaust is shown in enclosure (1). Lateral exhaust tanks are vulnerable to crossdrafts and for effective control crossdrafts must be kept to a minimum. The installation of side shields may be necessary. The air velocity at any point in front of the hood opening (lets) must be sufficient to overcome opposing currents, capture contained air and cause it to flow into the hood. For this type operation 100 to 150 cubic feet/minute capture velocity is necessary. Exhaust ducts from acid bath operations may be combined. The exhaust system from dilute tanks should be separate. Exhaust should not be located at a point where contaminated air may be recirculated within any structure. The structure of make up air in an amount sufficient to offset exhaust volumes should be provided for. The temperature of make up air should not be regulating the work space climate.

HAZARDOUS MATERIALS MANAGEMENT: The handling of hazardous materials involves the establishment of a management plan which includes, not only, special protective devices/procedures but, also, measures which deal with:

- a. Spill prevention
- b. Spill containment/clean up
- c. Disposal
- d. Control of pollutants and assessment of hazard

Installation of equipment and use of containers which minimize the chance of spills is preferred. Separated curbed, concrete containment areas should be constructed for each hazardous substance. The containment area should be large enough to accommodate the maximum volume of spill to be expected plus neutralizing agents. Hydrochloric and Nitric Acids may be neutralized with soda ash/slaked lime. Hydrofluoric Acid may be neutralized with excess lime treatment. The Chromium solution may have to be chemically reduced and precipitated. Sufficient pre-treatment and disposal methods/sites will have to be determined. Disposal should be coordinated through the S-4 Office, MCAS(H), New River.

PROTECTIVE DEVICES/SAFETY MEASURES: The following is a minimum listing of protective devices/measures which should be made available to personnel:

- a. DeLuge Shower and eye wash station. The water lines should be protected from freezing.
- b. Safety goggles - should be acid resistant and splash proof
- c. Clothing (aprons, etc.) provided should be acid resistant.
- d. Gloves should be of the gauntlet type and acid resistant.
- e. Safety Shoes
- f. Face shields should be acid resistant and, at least 8 inches in length
- g. Respirators should be acid gas approved by the National Institute of Safety and Health (NIOSH). Continuous, type "C", air supplied respirators should be on hand for use in atmospheres over the Threshold Limits for hazardous substances involved.
- h. Storage facilities for bulk quantities of hazardous materials should be separate
- i. Personnel should be trained in safety precautions and first aid procedures.

MEDICAL MONITORING: The following medical surveillance procedures should be instituted for personnel working in this shop:

- a. Initial Medical History. Special attention should be given to the skin, mucus membrane and eyes.
- b. Base line chest x-ray with follow up. Frequency to be determined by Medical Officer
- c. Annual Pulmonary Lung Function Test

... materials involves the establishment of a management system which includes not only special protective devices, but also measures which will...

... level of maintenance and repair of equipment of hazard...

... the design of equipment and use of materials which will...

... the design of equipment and use of materials which will...

... the design of equipment and use of materials which will...

... the design of equipment and use of materials which will...

... the design of equipment and use of materials which will...

... the design of equipment and use of materials which will...

... the design of equipment and use of materials which will...

... the design of equipment and use of materials which will...

... the design of equipment and use of materials which will...

... the design of equipment and use of materials which will...

... the design of equipment and use of materials which will...

A visit to the Naval Air Rework Facility (NARF), MCAS, Cherry Point, NC indicated that this organization has an established acid bath and Chromium plating system. It is strongly recommended that accomplishment of the intended local operation be transferred to the NARF.

1944
The following information was obtained from the records of the
Department of the Interior, Bureau of Land Management, at
Washington, D. C., on August 1, 1944.
The land described in this report is situated in the
County of [redacted] State of [redacted].

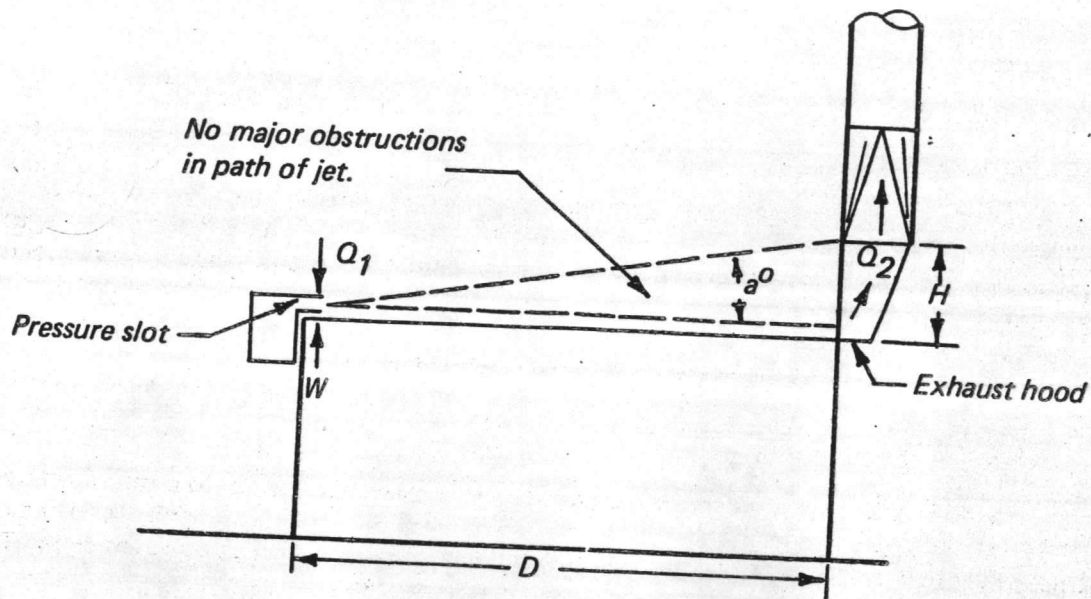

Exhaust Hood
 Quantity of air exhausted
 $Q_2 = 100 - 150 \text{ cfm/sq ft}$
 tank area

Pressure Slot
 Quantity of air supplied,
 $Q_1 = \frac{1}{D \times E} \times Q_2$
 where; $D = \text{length of throw, feet}$
 $E = \text{entrainment factor.}$

Hood height (H) should be $\geq 0.2 D$

$$\frac{H}{D} = \tan \alpha$$

for $\frac{H}{D} = 0.2, \alpha = 11^\circ$

Throw length, D , feet	Entrainment factor, E
0-8	2.0
8-16	1.4
16-24	1.0
over 24	0.7

Slot velocity = 2000 fpm
 Duct velocity = 1500 fpm minimum

Design such systems so they can be easily modified or adjusted to obtain desired results and can be fixed or locked to retain desired adjustments and settings.

FIGURE 6 PUSH-PULL HOOD

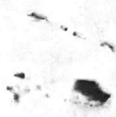

BASE MAINTENANCE DIVISION
Marine Corps Base
Camp Lejeune, North Carolina 28542

MAIN/DDS/spk
16475

From: Base Maintenance Officer
To: Assistant Chief of Staff, Facilities

Subj: Proposed Installation of Chromium Plating Facility at Building 518,
Marine Corps Air Station (Helicopter) (MCAS(H)), New River

Ref: (a) FONECON btw Mr. McClosky, Preventive Medicine Unit, NRMC, and Mr.
D. Sharpe, BMaintDiv of 18 May 1982
(b) FONECON btw Ms. Wheat, S-4 Office, MCAS(H), NR and Mr. D. Sharpe,
BMaintDiv of 18 May 1982
(c) BO 11000.1A
(d) NPDES Permit NCO003239

1. During reference (a), it was learned that action had been initiated by H&MS-26, MCAS(H), New River, to install the subject facility. Further discussion during reference (b) did not indicate that the proposed facility had been designed by a qualified engineer. While there are significant safety considerations associated with the proposed facility, the following are of direct concern: ~~to this Command:~~

a. A preliminary environmental assessment (PEA) should be submitted in accordance with reference (c).

b. Pretreatment of waste water, as required, to neutralize acids and remove toxic constituents prior to discharge to sewer.

c. Disposal of hazardous waste (i.e., sludges) generated by the facility.

2. It is recommended that this Command request a copy of plans and specifications for the proposed facility (specifically for any connections to sanitary sewer) so that any adverse impact on the sewage treatment facilities and compliance with reference (d) can be evaluated by Base Utilities and Environmental personnel.

B. W. ELSTON
Acting

~~2. H Col Nelson, Station S/4, was advised the date of the potential problem, and associated with the proposed facility. H Col Nelson stated that they were aware of the -~~
~~2. The station S/4 has been advised of the ^{potential} problem.~~

REPUBLIC OF THE PHILIPPINES
Department of Education
Division Office - Manila

MEMORANDUM FOR THE RECORD
SUBJECT: [Illegible]

[Illegible text]

[Illegible text]

[Illegible text]

From: Base Maintenance Officer
To: Assistant Chief of Staff, Facilities

Subj: Proposed Installation of Chromium Plating Facility at Building 518,
Marine Corps Air Station (Helicopter) (MCAS(H)), New River

Ref: (a) FONECON btw Mr. McClosky, Preventive Medicine Unit, NRMC, and Mr.
D. Sharpe, BMaintDiv of 18 May 1982
(b) FONECON btw Ms. Wheat, S-4 Office, MCAS(H), NR and Mr. D. Sharpe,
BMaintDiv of 18 May 1982
(c) BO 11000.1A
(d) NPDES Permit NCO003239

1. During reference (a), it was learned that action had been initiated by H&MS-26, MCAS(H), New River, to install the subject facility. Further discussion during reference (b) did not indicate that the proposed facility had been designed by a qualified engineer. While there are significant safety considerations associated with the proposed facility, the following are of direct concern to this Command:

a. A preliminary environmental assessment (PEA) should be submitted in accordance with reference (c).

b. Pretreatment of waste water, as required, to neutralize acids and remove toxic constituents prior to discharge to sewer.

c. Disposal of hazardous waste (i.e., sludges) generated by the facility.

2. It is recommended that this Command request a copy of plans and specifications for the proposed facility (specifically for any connections to sanitary sewer) so that any adverse impact on the sewage treatment facilities and compliance with reference (d) can be evaluated by Base Utilities and Environmental personnel.

B. W. ELSTON
Acting

MAIL/DBS/epf
15473

From: Lead Maintenance Officer
To: Assistant Chief of Staff, Facilities

Subject: Proposed Installation of Chromium Plating Facility at Building 318,
Maine Corps Air Station (MCAAS), New River

Re: (a) COMCON by Mr. McCloskey, Preventive Medicine Unit, TRMC, and Mr.
F. Sharpe, WHAS/Div of 18 May 1987
(b) COMCON by Mr. Whelan, 8-4 Office, MCAAS, TR and Mr. B. Sharpe,
WHAS/Div of 18 May 1987
(c) SO 11000.1A
(d) TRMC Form 110000333

1. During reference (a), it was learned that action had been initiated by
MCAAS to install the subject facility. The above-
mentioned reference (b) did not indicate that the proposed facility had
been designed by a qualified engineer. While there are no minimum salary
considerations associated with the proposed facility, the following are of
direct concern to this command:

- a. A preliminary environmental assessment (PEA) should be submitted in
accordance with reference (c).
- b. Treatment of waste water, as required, to neutralize acids and
remove toxic constituents prior to discharge to sewer.
- c. Disposal of hazardous waste (i.e., sludge) generated by the facility.
- d. It is recommended that this Command request a copy of plans and speci-
fications for the proposed facility (specifically for any connections to
sanitary sewer) so that any adverse impact on the sewer treatment facilities
and compliance reference (d) can be evaluated by Base Utilities and
Environmental personnel.

B. W. HILTON
Acting

MAIN/DDS/spk
16475

From: Base Maintenance Officer
To: Assistant Chief of Staff, Facilities

Subj: Proposed Installation of Chromium Plating Facility at Building 518,
Marine Corps Air Station (Helicopter) (MCAS(H)), New River

Ref: (a) FONECON btw Mr. McClosky, Preventive Medicine Unit, NRMG, and Mr.
D. Sharpe, BMaintDiv of 18 May 1982
(b) FONECON btw Ms. Wheat, S-4 Office, MCAS(H), NR and Mr. D. Sharpe,
BMaintDiv of 18 May 1982
(c) BO 11000.1A
(d) NPDES Permit NCO003239

1. During reference (a), it was learned that action had been initiated by H&MS-26, MCAS(H), New River, to install the subject facility. Further discussion during reference (b) did not indicate that the proposed facility had been designed by a qualified engineer. While there are significant safety considerations associated with the proposed facility, the following are of direct concern to this Command:

a. A preliminary environmental assessment (PEA) should be submitted in accordance with reference (c).

b. Pretreatment of waste water, as required, to neutralize acids and remove toxic constituents prior to discharge to sewer.

c. Disposal of hazardous waste (i.e., sludges) generated by the facility.

2. It is recommended that this Command request a copy of plans and specifications for the proposed facility (specifically for any connections to sanitary sewer) so that any adverse impact on the sewage treatment facilities and compliance with reference (d) can be evaluated by Base Utilities and Environmental personnel.

B. W. ELSTON
Acting



The following information was obtained from the records of the Department of the Interior, Bureau of Land Management, regarding the land parcels identified in the attached map. The parcels are located in the vicinity of the town of [Name], [County], [State]. The parcels are identified by their BLM parcel numbers and are described as follows:

- Parcel 1: [Parcel Number], [Description]
- Parcel 2: [Parcel Number], [Description]
- Parcel 3: [Parcel Number], [Description]
- Parcel 4: [Parcel Number], [Description]
- Parcel 5: [Parcel Number], [Description]
- Parcel 6: [Parcel Number], [Description]
- Parcel 7: [Parcel Number], [Description]
- Parcel 8: [Parcel Number], [Description]
- Parcel 9: [Parcel Number], [Description]
- Parcel 10: [Parcel Number], [Description]

The parcels are situated on the [Type] of land, and are currently held in fee simple by [Owner Name]. The parcels are shown in [Color] on the map. The total area of the parcels is approximately [Area] acres. The parcels are bounded by [Neighboring Land/Features].

From: Base Maintenance Officer
To: Assistant Chief of Staff, Facilities

Subj: Proposed Installation of Chromium Plating Facility at Building 518,
Marine Corps Air Station (Helicopter) (MCAS(H)), New River

Ref: (a) FONECON btw Mr. McGlosky, Preventive Medicine Unit, NRMC, and Mr.
D. Sharpe, BMaintDiv of 18 May 1982
(b) FONECON btw Ms. Wheat, S-4 Office, MCAS(H), NR and Mr. D. Sharpe,
BMaintDiv of 18 May 1982
(c) BO 11000.1A
(d) NPDES Permit NCO003239

1. During reference (a), it was learned that action had been initiated by H&MS-26, MCAS(H), New River, to install the subject facility. Further discussion during reference (b) did not indicate that the proposed facility had been designed by a qualified engineer. While there are significant safety considerations associated with the proposed facility, the following are of direct concern to this Command:

a. A preliminary environmental assessment (PEA) should be submitted in accordance with reference (c).

b. Pretreatment of waste water, as required, to neutralize acids and remove toxic constituents prior to discharge to sewer.

c. Disposal of hazardous waste (i.e., sludges) generated by the facility.

2. It is recommended that this Command request a copy of plans and specifications for the proposed facility (specifically for any connections to sanitary sewer) so that any adverse impact on the sewage treatment facilities and compliance with reference (d) can be evaluated by Base Utilities and Environmental personnel.

B. W. ELSTON
Acting

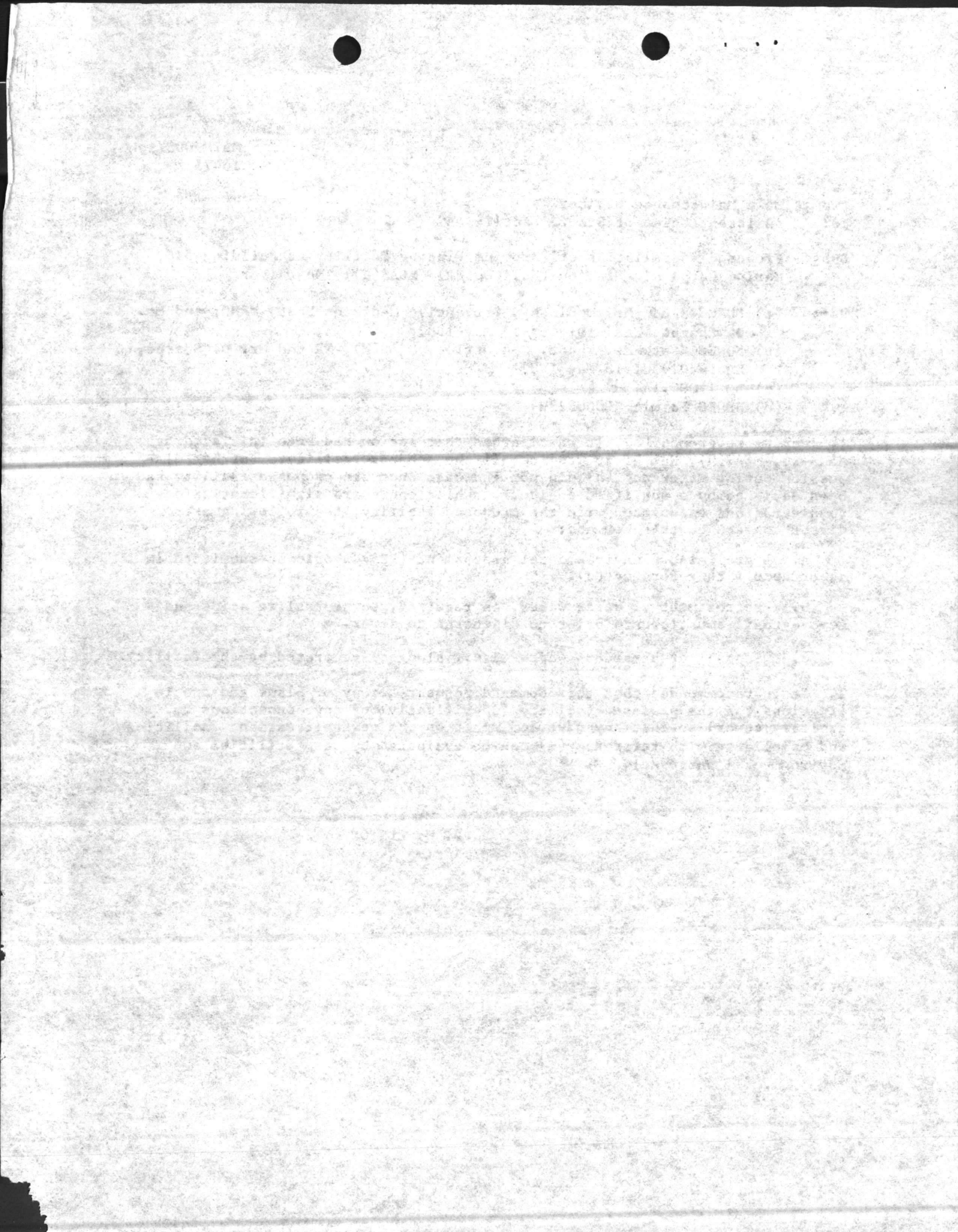

BASE MAINTENANCE DIVISION
Marine Corps Base
Camp Lejeune, North Carolina 28542

From: Assistant Base Maintenance Officer

To: *AREA*

Subj:

Julian, I have discussed the situation with Hol Nelson. He states that they have requested a PEA from HEMS 26 which presumably would be submitted to the EIKB before installation. Hold on ^{to} your letter and let's give them a chance to do it the proper way. Keep it ~~the~~ checked to make sure they don't go into operation before a PEA is approved.

*The
BWR*



1934

I have been thinking
 of you very much lately
 and wondering how you
 are getting on. I hope
 you are well and happy
 as usual. I have not
 heard from you for some
 time and it is a pity
 that I cannot write to
 you more often. I am
 well at present and
 hope these few lines
 will find you the same.
 I am sure you are
 enjoying your life and
 all the good things that
 are coming your way.
 I am sure you are
 very happy and contented.
 I am sure you are
 very well and happy.
 I am sure you are
 very well and happy.

I am sure you are
 very well and happy.
 I am sure you are
 very well and happy.
 I am sure you are
 very well and happy.
 I am sure you are
 very well and happy.
 I am sure you are
 very well and happy.

MAIN/DDS/spk
16475

From: Base Maintenance Officer
To: Assistant Chief of Staff, Facilities

Subj: Proposed Installation of Chromium Plating Facility at Building 518,
Marine Corps Air Station (Helicopter) (MCAS(H)), New River

Ref: (a) FONECON btw Mr. McClosky, Preventive Medicine Unit, NRMG, and Mr.
D. Sharpe, BMaintDiv of 18 May 1982
(b) FONECON btw Ms. Wheat, S-4 Office, MCAS(H), NR and Mr. D. Sharpe,
BMaintDiv of 18 May 1982
(c) BO 11000.1A
(d) NPDES Permit NCO003239

1. During reference (a), it was learned that action had been initiated by H&MS-26, MCAS(H), New River, to install the subject facility. Further discussion during reference (b) did not indicate that the proposed facility had been designed by a qualified engineer. While there are significant safety considerations associated with the proposed facility, the following are of direct concern to this Command:

a. A preliminary environmental assessment (PEA) should be submitted in accordance with reference (c).

b. Pretreatment of waste water, as required, to neutralize acids and remove toxic constituents prior to discharge to sewer.

c. Disposal of hazardous waste (i.e., sludges) generated by the facility.

2. It is recommended that this Command request a copy of plans and specifications for the proposed facility (specifically for any connections to sanitary sewer) so that any adverse impact on the sewage treatment facilities and compliance with reference (d) can be evaluated by Base Utilities and Environmental personnel.

B. W. ELSTON
Acting



BASE MAINTENANCE DIVISION
Marine Corps Base
Camp Lejeune, North Carolina 28542

6/4/62

From: Assistant Base Maintenance Officer

To:

Subj:

Julian

ACS, Jax. is sending a
copy of their L CO, MCAS,
along with a note
from Col Millier. I
believe it will get
their attention.

KVE

File

Julian



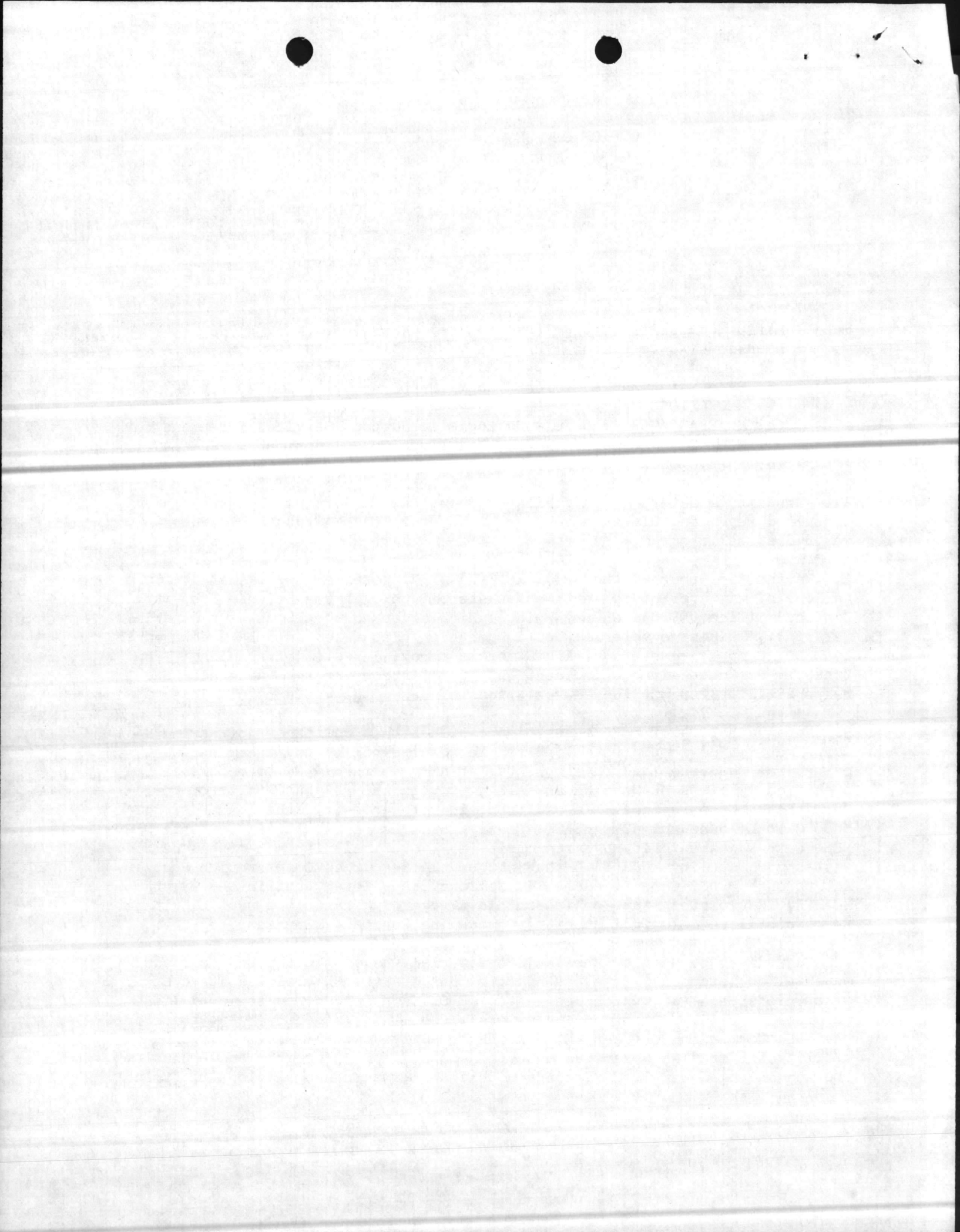

BASE MAINTENANCE DIVISION
Marine Corps Base
Camp Lejeune, North Carolina 28542

MAIN/DDS/spk
6240

MAY 20 1982

From: Base Maintenance Officer
To: Assistant Chief of Staff, Facilities

Subj: Marine Corps Air Station (Helicopter), New River (MCAS(H),NR) Hazardous Waste Disposal Program

Ref: (a) FONECON btw Ms. Mary Wheat, S-4 Office, MCAS(H) NR, and Mr. D. Sharpe, BMaintDiv of 12 May 1982

Encl: (1) Dir, NREAB ltr MAIN/RTS/spk 6280/5 of 19 Apr 1982

1. During the reference, Ms. Wheat advised that the Defense Property Disposal Officer, Cherry Point (DPDO, CP) had accepted approximately 150 gallons of hazardous waste (mixture of solvents and waste oil) from Marine Air Group-29, MCAS(H), New River. The enclosure describes the circumstances which led to Marine Air Group-29 generating these wastes at Building AS-4107.

2. During the reference, Ms. Wheat advised that the DPDO, CP accepted the item as a hazardous material. Ms. Wheat indicated that Marine Air Group-29 transported the item and that the Station S-4 Officer became aware of the occurrence after the fact.

3. The actions by Marine Air Group-29 appears to be inconsistent with current Federal/State hazardous waste regulations. Marine Corps Base does not appear to be responsible in any manner. However, by copy hereof, it is recommended the Staff Judge Advocate review and comment on this matter before any further action is considered.

B. W. ELSTON
Acting

Copy to:
SJA

MAY 20 1982

OSJA, MCB, CLNG

SJA
DSJA
MJO _____
CRO _____
SAUSA _____
LAO _____
CTC _____
CDC _____
LSC _____
LEGASST _____
CCR _____
CIV LAW

For action

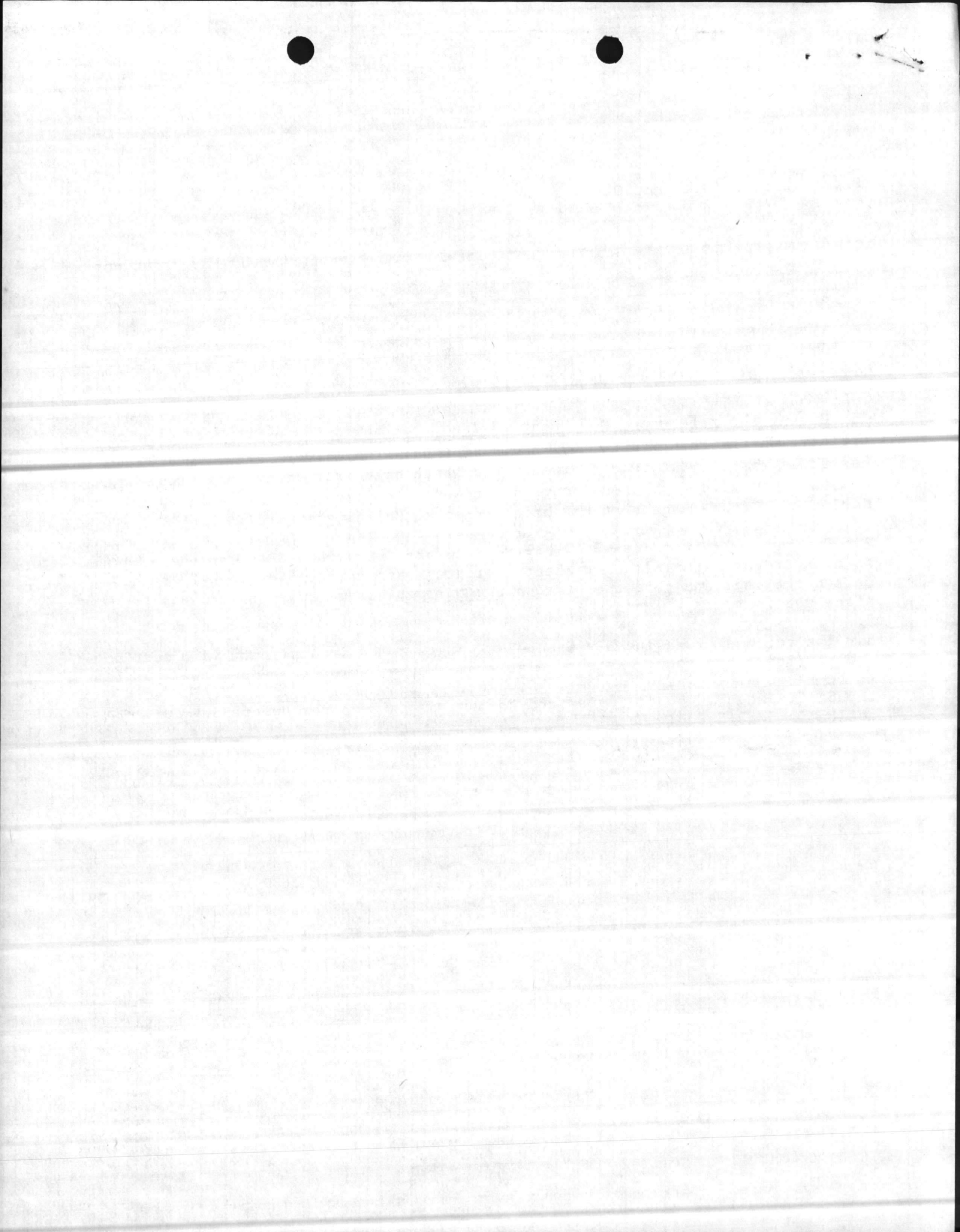

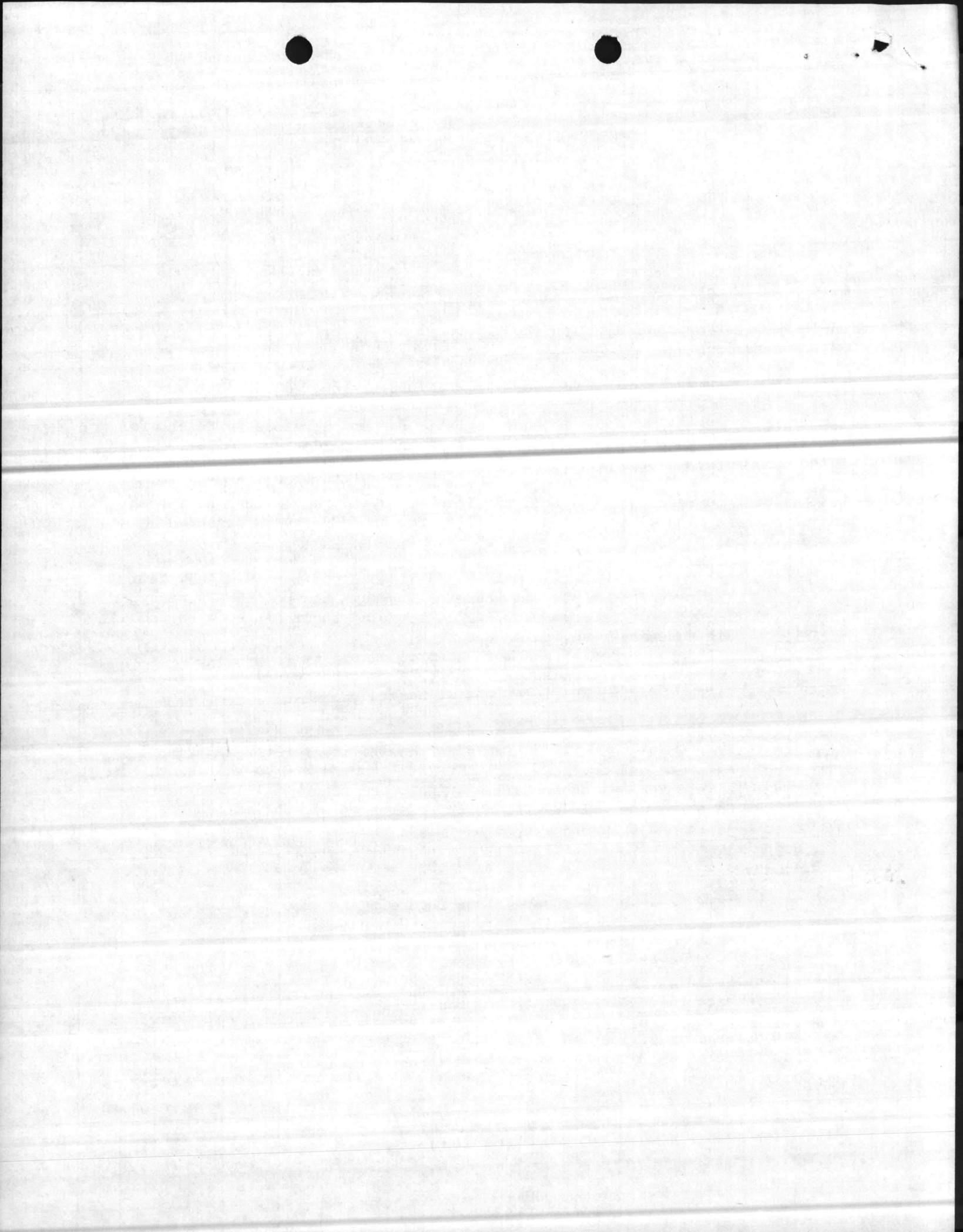

BASE MAINTENANCE DIVISION
Marine Corps Base
Camp Lejeune, North Carolina 28542

MAIN/DDS/spk
6240

MAY 20 1982

From: Base Maintenance Officer
To: Assistant Chief of Staff, Facilities
Subj: Marine Corps Air Station (Helicopter), New River (MCAS(H),NR) Hazardous Waste Disposal Program
Ref: (a) FONECON btw Ms. Mary Wheat, S-4 Office, MCAS(H) NR, and Mr. D. Sharpe, BMaintDiv of 12 May 1982
Encl: (1) Dir, NREAB ltr MAIN/RTS/spk 6280/5 of 19 Apr 1982

1. During the reference, Ms. Wheat advised that the Defense Property Disposal Officer, Cherry Point (DPDO, CP) had accepted approximately 150 gallons of hazardous waste (mixture of solvents and waste oil) from Marine Air Group-29, MCAS(H), New River. The enclosure describes the circumstances which led to Marine Air Group-29 generating these wastes at Building AS-4107.
2. During the reference, Ms. Wheat advised that the DPDO, CP accepted the item as a hazardous material. Ms. Wheat indicated that Marine Air Group-29 transported the item and that the Station S-4 Officer became aware of the occurrence after the fact.
3. The actions by Marine Air Group-29 appears to be inconsistent with current Federal/State hazardous waste regulations. Marine Corps Base does not appear to be responsible in any manner. However, by copy hereof, it is recommended the Staff Judge Advocate review and comment on this matter before any further action is considered.

B. W. ELSTON
Acting

MAY 20 1982
OSJA, MCB, CLNG

SJA
DSJA
MJO _____
CRO _____
SAUSA _____
LAO _____
CTC _____
CDC _____
LSC _____
LEGASST _____
CCR _____
CIV LAW

For action

Copy to:
SJA

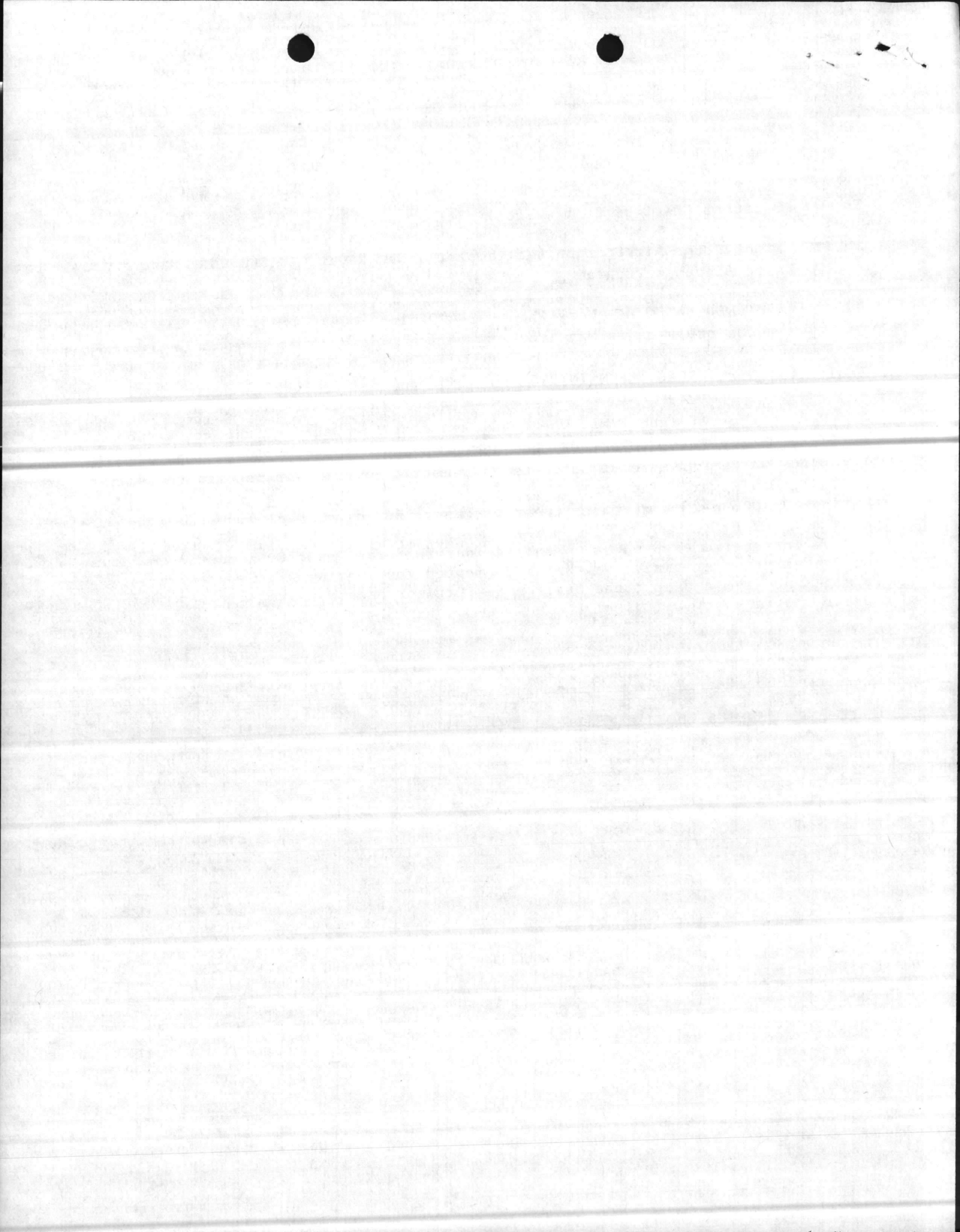

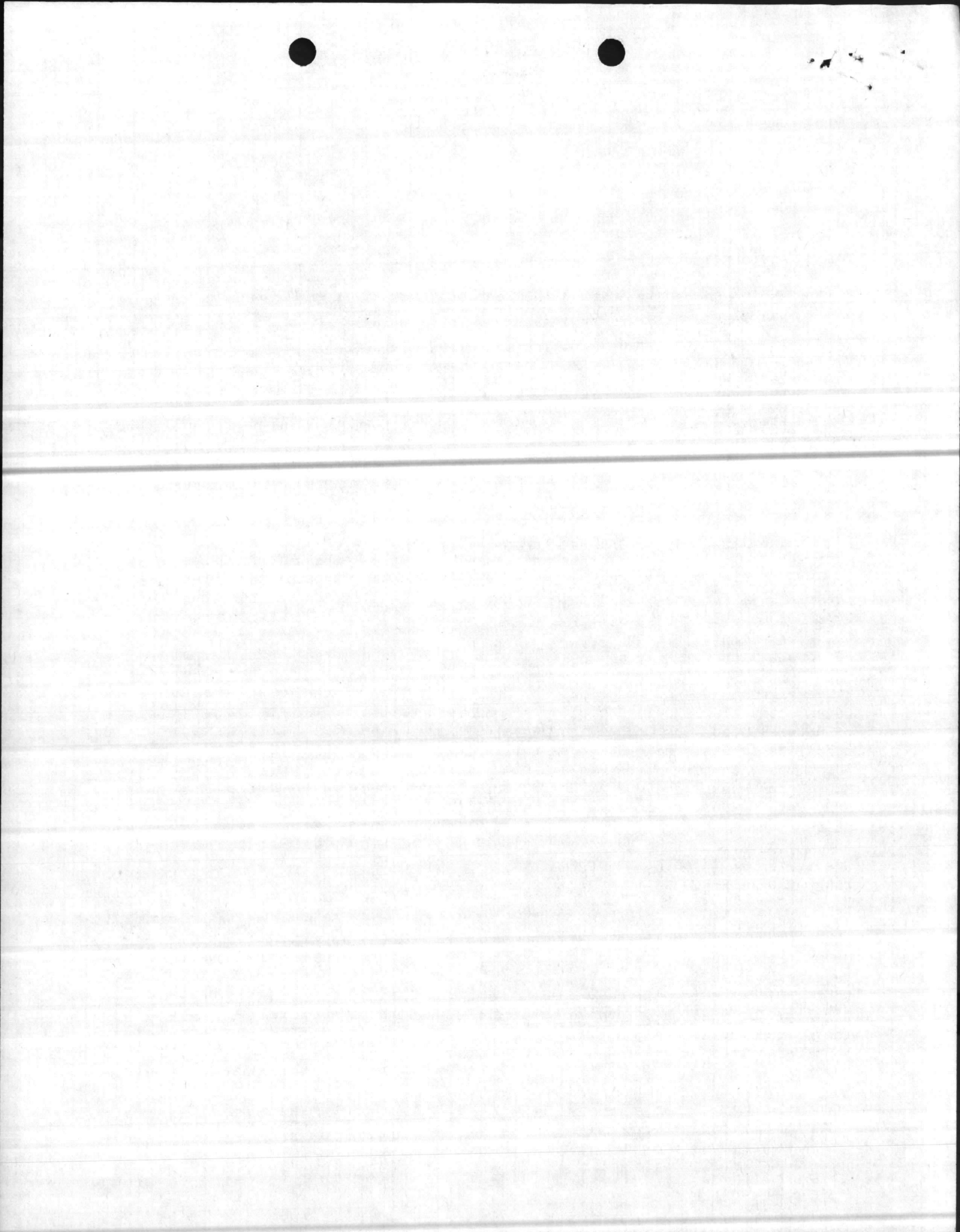

BASE MAINTENANCE DIVISION
Marine Corps Base
Camp Lejeune, North Carolina 28542

MAIN/DDS/spk
6240

MAY 20 1982

From: Base Maintenance Officer
To: Assistant Chief of Staff, Facilities
Subj: Marine Corps Air Station (Helicopter), New River (MCAS(H),NR) Hazardous Waste Disposal Program
Ref: (a) FONECON btw Ms. Mary Wheat, S-4 Office, MCAS(H) NR, and Mr. D. Sharpe, BMaintDiv of 12 May 1982
Encl: (1) Dir, NREAB ltr MAIN/RTS/spk 6280/5 of 19 Apr 1982

1. During the reference, Ms. Wheat advised that the Defense Property Disposal Officer, Cherry Point (DPDO, CP) had accepted approximately 150 gallons of hazardous waste (mixture of solvents and waste oil) from Marine Air Group-29, MCAS(H), New River. The enclosure describes the circumstances which led to Marine Air Group-29 generating these wastes at Building AS-4107.
2. During the reference, Ms. Wheat advised that the DPDO, CP accepted the item as a hazardous material. Ms. Wheat indicated that Marine Air Group-29 transported the item and that the Station S-4 Officer became aware of the occurrence after the fact.
3. The actions by Marine Air Group-29 appears to be inconsistent with current Federal/State hazardous waste regulations. Marine Corps Base does not appear to be responsible in any manner. However, by copy hereof, it is recommended the Staff Judge Advocate review and comment on this matter before any further action is considered.

MAY 20 1982

B. W. ELSTON
Acting

OSJA, MCB, CLNG

SJA _____
DSJA _____
MJO _____
CRO _____
SAUSA _____
LAO _____
CTC _____
CDC _____
LSC _____
LEGASST _____
CCR _____

CIV LAW

For action

Copy to:
SJA



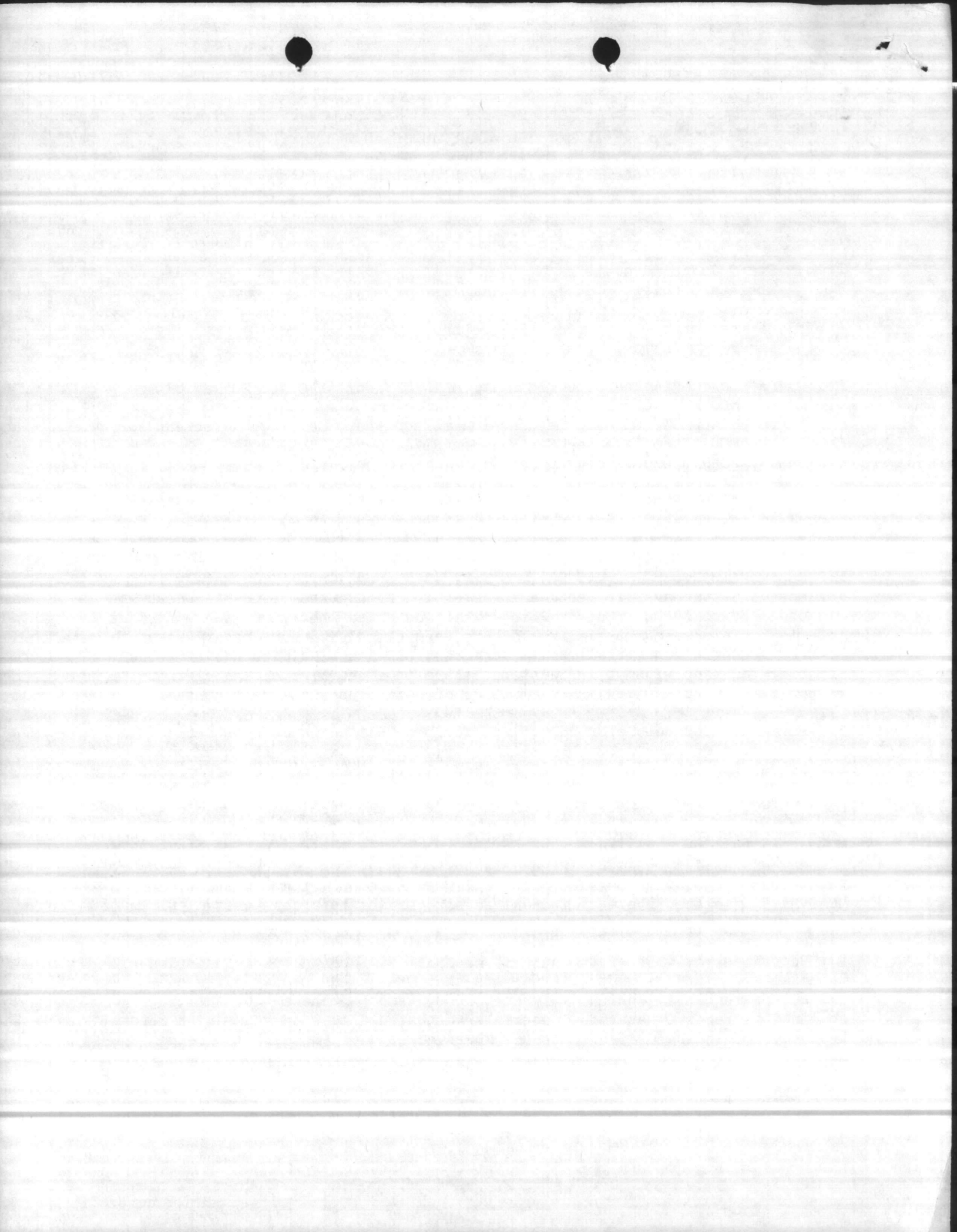

BASE MAINTENANCE DIVISION
Marine Corps Base
Camp Lejeune, North Carolina 28542

MAIN/DDS/spk
6240

MAY 20 1982

From: Base Maintenance Officer
To: Assistant Chief of Staff, Facilities
Subj: Marine Corps Air Station (Helicopter), New River (MCAS(H),NR) Hazardous Waste Disposal Program
Ref: (a) FONECON btw Ms. Mary Wheat, S-4 Office, MCAS(H) NR, and Mr. D. Sharpe, BMaintDiv of 12 May 1982
Encl: (1) Dir, NREAB ltr MAIN/RTS/spk 6280/5 of 19 Apr 1982

1. During the reference, Ms. Wheat advised that the Defense Property Disposal Officer, Cherry Point (DPDO, CP) had accepted approximately 150 gallons of hazardous waste (mixture of solvents and waste oil) from Marine Air Group-29, MCAS(H), New River. The enclosure describes the circumstances which led to Marine Air Group-29 generating these wastes at Building AS-4107.
2. During the reference, Ms. Wheat advised that the DPDO, CP accepted the item as a hazardous material. Ms. Wheat indicated that Marine Air Group-29 transported the item and that the Station S-4 Officer became aware of the occurrence after the fact.
3. The actions by Marine Air Group-29 appears to be inconsistent with current Federal/State hazardous waste regulations. Marine Corps Base does not appear to be responsible in any manner. However, by copy hereof, it is recommended the Staff Judge Advocate review and comment on this matter before any further action is considered.

B. W. ELSTON
Acting

MAY 20 1982
OSJA, MCB, CLNG

SJA
DSJA
MJO _____
CRO _____
SAUSA _____
LAO
CTC _____
CDC _____
LSC _____
LEGASST _____
CCR _____
CIV LAW

For action

Copy to:
SJA

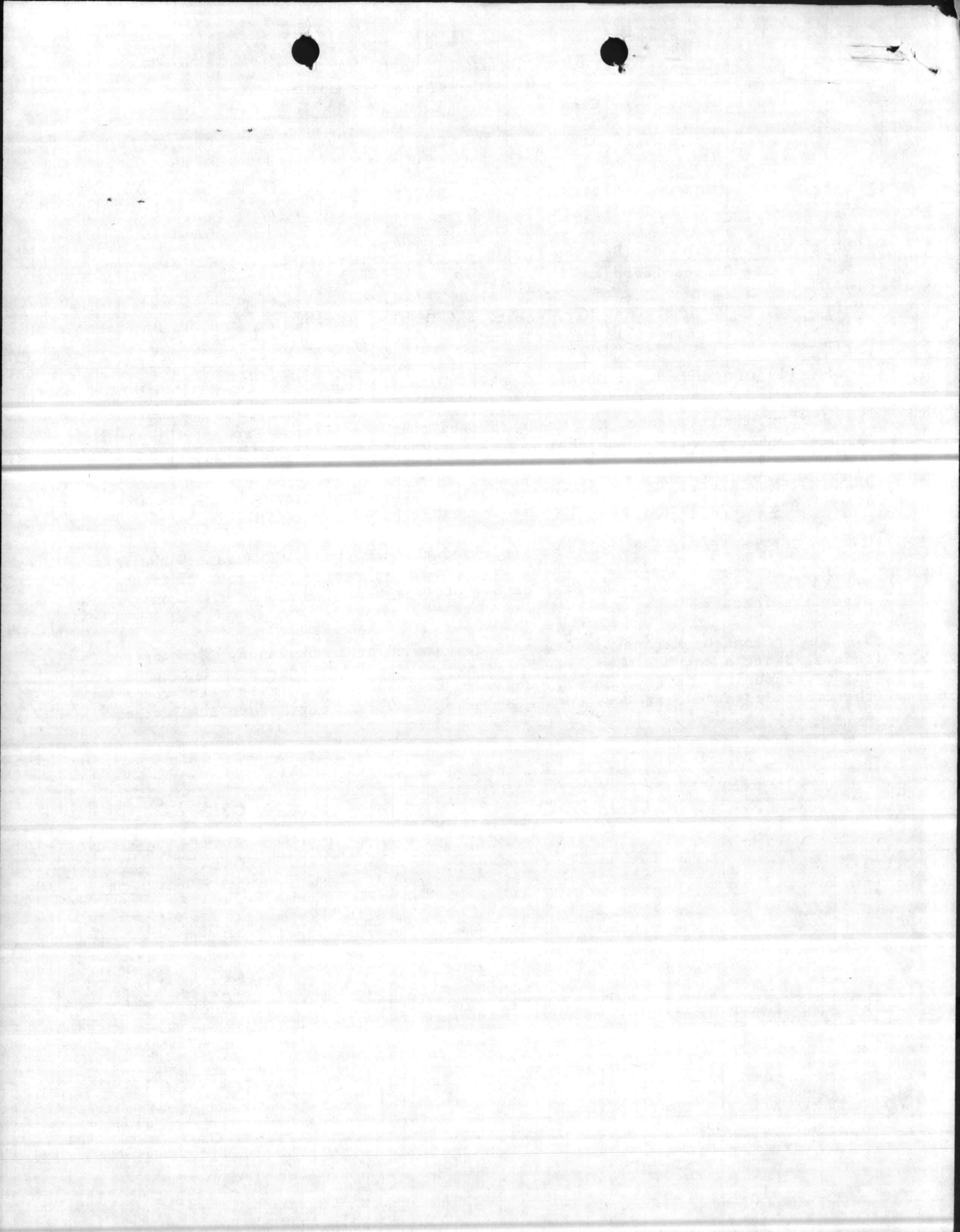

Darling,

I have sent a copy to
Col Marshall.

John

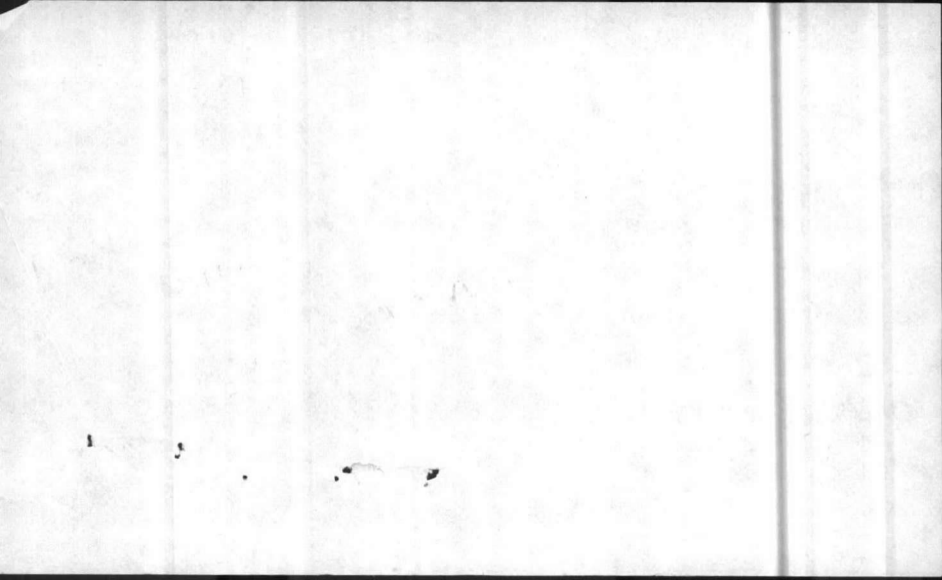

8 OCT 1982

FAC ROUTING

	ACTION	INFO	INT
FACG			f
1A			
1B			
1C			
1D			
1E			
1F			
1G			
1H			
1I			
1J			
1K			
1L			
1M			
1N			
1O			
1P			
1Q			
1R			
1S			
1T			
1U			
1V			
1W			
1X			
1Y			
1Z			

Col. Marshall

I am not aware of the
letter referred to in
the letter. Appears medicines
must be held by FSSG (Mg.
Banque's name med). Must be
from out-dated mount-out
blocks.

41C
I

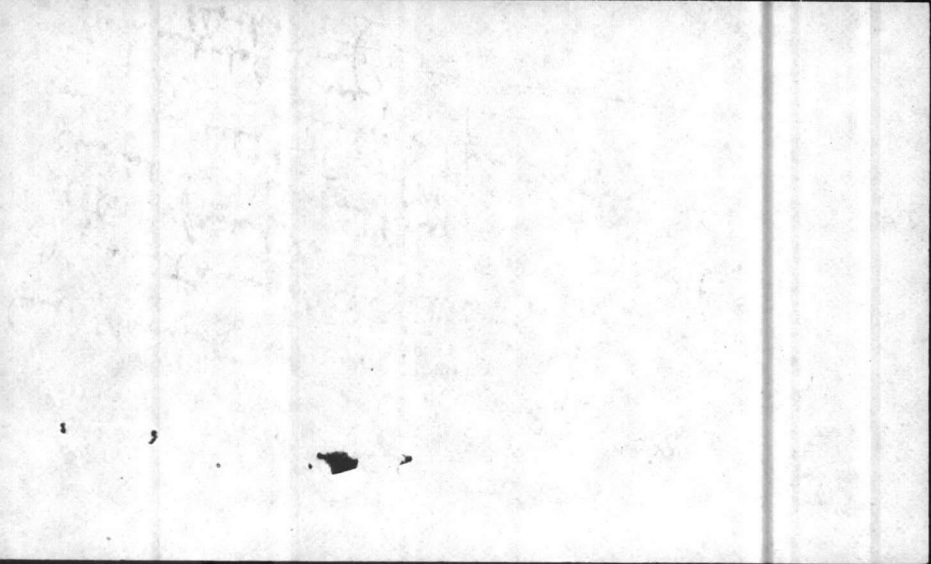

NATURAL RESOURCES-AND ENVIRONMENTAL AFFAIRS DIVISION
Marine Corps Base
Camp Lejeune, North Carolina 28542

13 Oct 82
Date

From:

To: Danny

Subj: Medical Supplies

Maj Bourque is going to
pressure from from 2DFSSG
position. (Swing chemicals away)

We will send a copy to SJA.

During the ~~mean~~ ^{MEAN} Time 2DFSSG
wants to dispose of some chemical
medicines now.

See me

Juhair

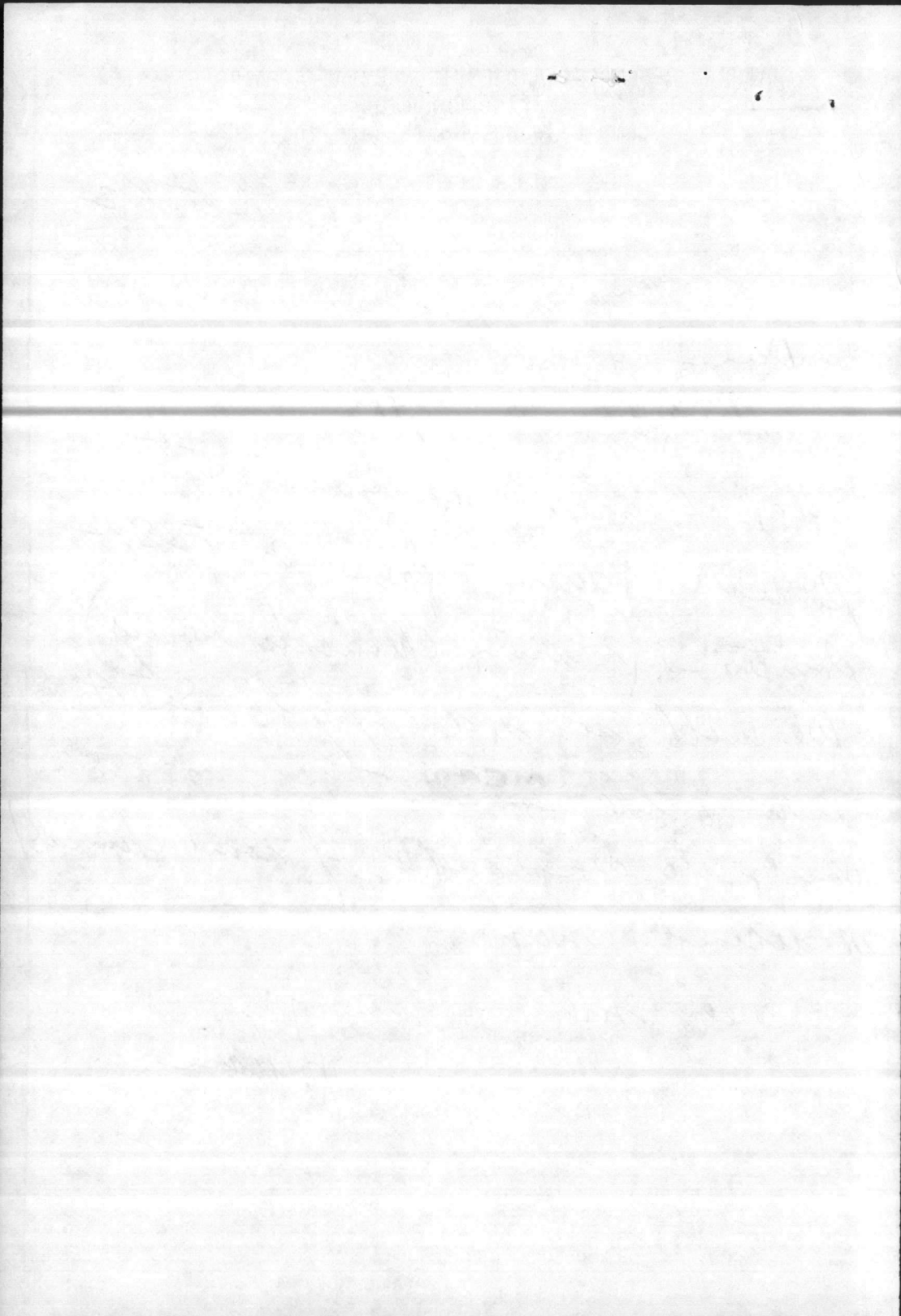

DEPARTMENT OF THE NAVY

Memorandum

DATE: 12 OCT 82

FROM: Dir NR12A

TO:

SUBJ:

Juchan:

what now? I think DOD reqs preclude us giving them away. Check with FSSC to see what they know and also with our SJA.

J J Marshall

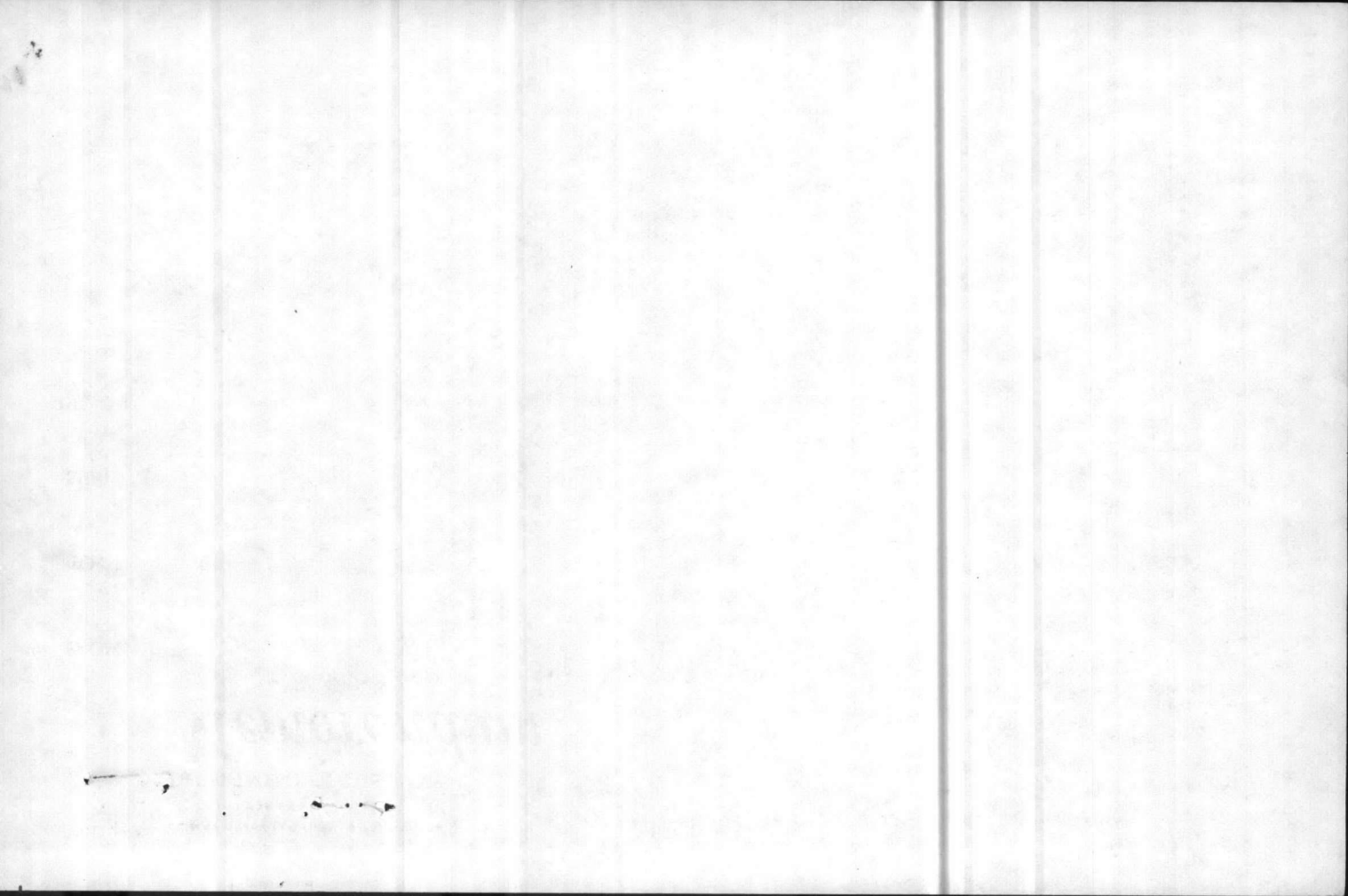

ROUTING SLIP

	ACTION	INFO	INITIAL
BMO		✓	
ABMO		✓	<i>SWR</i>
ADMIN			
ENVIOR AFF	✓		<i>DWW</i>
F&A SEC			
MAINT NCO			
M&R			
OPNS			
PROP			
UMACS			
UTIL			
SECRETARY			

COMMENTS:

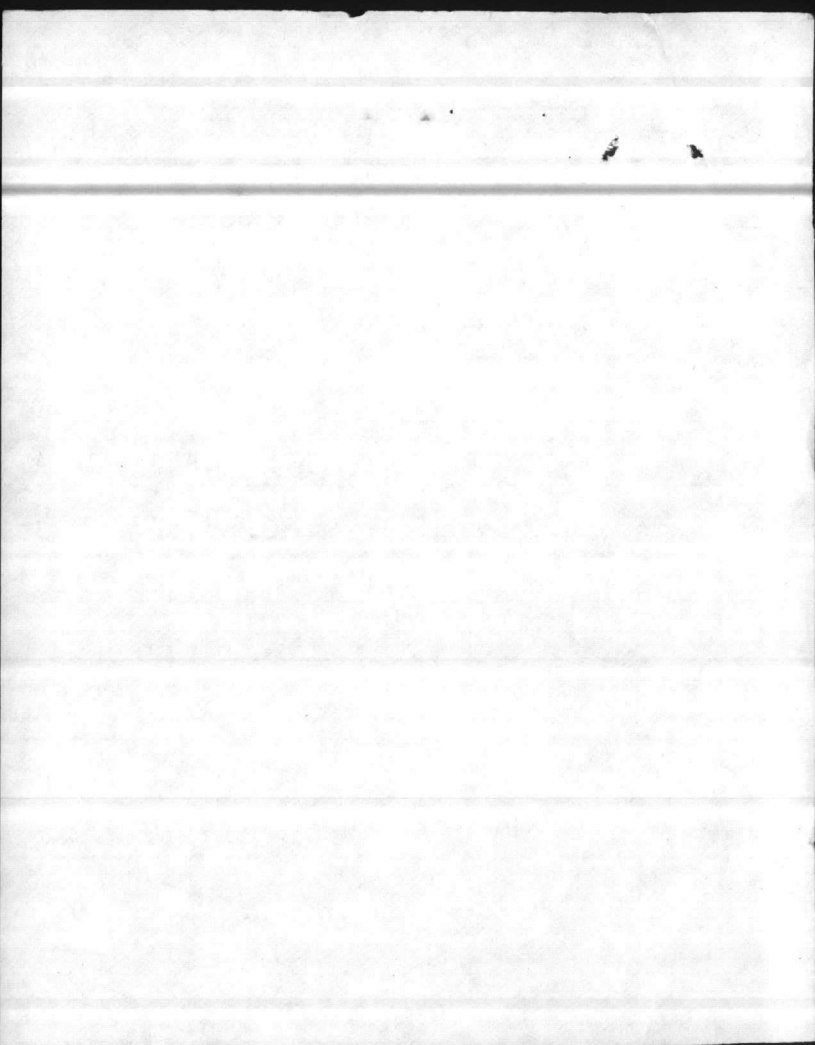

NATURAL RESOURCES AND ENVIRONMENTAL AFFAIRS BRANCH
Base Maintenance Division
Marine Corps Base
Camp Lejeune, North Carolina 28542

Date 9-8-82

From: Director, NREAB

To: Danny

Subj: See attached

Can we put in landfill?

Jubian

DIAN to

Send List to State Health

Gordon Layton. I HAVE

a POC ⁽⁵⁰⁾ ON SPECIFIC

QUESTIONS WITHING

Medlog Congress (2059)

Do you concur - ? 9-21-82

Danny, ✓
Yes Draft short letter - Ref phone
conversation.

Jubian

Talked with Maj' Hoek on 9-22-82
about sending ltr to State. He
advised to go ahead.

JdW

ASSISTANT CHIEF OF STAFF, FACILITIES
HEADQUARTERS, MARINE CORPS BASE

Date 2 SEPT 82

To: Base Maintenance Officer
~~Public Works Officer~~
~~Communications—Electronics Officer~~

Subj: DISPOSAL of MEDICAL MAT'L
REF: a. CO FSSG 42/RDB/wao 11000 1 Sept 82

1. ~~Forwarded, approved.~~
2. Forwarded, for information/action.
3. Forwarded, for comment and return endorsement hereon.
4. ~~Forwarded, requesting cost estimate.~~
5. Forwarded, requesting light/air conditioning survey.
6. ~~Forwarded, for your files.~~

It is requested the proposal contained in the reference be reviewed and comments provided to be used as a basis for a reply to FSSG. Reply by 16 Sep.

V/R
J. S. HACK

J. S. HACK

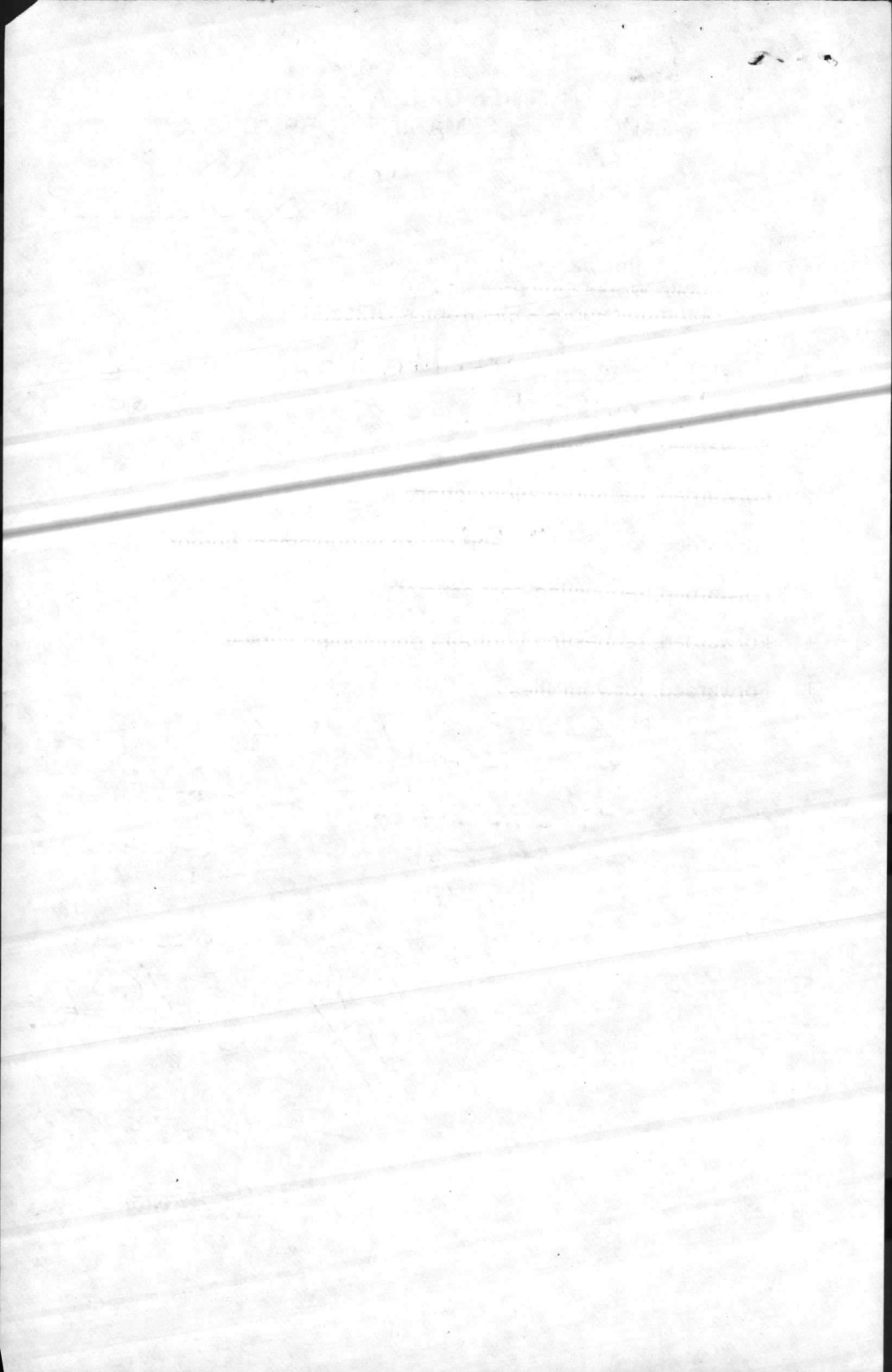



UNITED STATES MARINE CORPS
2D FORCE SERVICE SUPPORT GROUP (REIN)
FLEET MARINE FORCE, ATLANTIC
CAMP LEJEUNE, NORTH CAROLINA 28542

IN REPLY REFER TO

42/RDB/vao
11000
1 September 1982

From: Commanding Officer
To: Commanding General, Marine Corps Base, Camp Lejeune
(Attn: Assistant Chief of Staff, Facilities)

Subj: Disposal of Medical Materials

1. Enclosure (1) contains a listing of Medical Materials requiring disposal/destruction due to expiration of shelf life. This list represents amounts of materials requiring disposal annually. However, procedures for quarterly inventory of expired materials is under development. Burial in the Base landfill has been suggested as a proper means of disposal.
2. It is requested that enclosure (1) be reviewed for approval of burial of these materials in the Base landfill. Should some materials be considered environmentally hazardous, it is requested that alternative methods of disposal/destruction be identified.

R. D. Bourque
R. D. BOURQUE
By direction

Copy to:
A/C of S, CSS, 2dFSSG



Faint, illegible text, possibly a header or introductory paragraph, located in the upper half of the page.

Main body of faint, illegible text, appearing as several paragraphs of very light print.

Continuation of VI-B24

ty will advise the DPDO of such latent defects by attaching a copy of the technical inspection report and/or appropriate annotation on the DTID, or may, when deemed appropriate, accomplish the mutilation prior to turn-in. To the extent mutilation is required to comply with the preceding, such mutilation will be effected by breaking, shearing, cutting or other methods to preclude any possibility of the items' subsequent use for their originally intended purposes.

25. Demilitarization. See DoD 4160.21-M-1, Defense Demilitarization Manual.

26. Dental Scrap. Precious Metal scrap derived from the practice of dentistry (amalgam, bench grindings, sweepings, polishing residue, restorations, bridges, etc.) will be accumulated and processed for precious metal recovery in accordance with paragraph C3f, Chapter XVII, this manual.

27. Desalting Kits. Some sea water desalting kits contain reclaimable silver. These kits will be processed as prescribed in paragraph C3d, Chapter XVII, this manual.

28. Distinctive Markings.

a. Invitations for Bids will provide for the purchaser to remove, destroy or obliterate distinctive markings on aircraft. IFBs will also provide for removal or obliteration of all identifying outside markings on ships prior to release to the successful bidder. The hull number in the keelson or other interior area of boats and small craft will not be obliterated but will be retained for identification purposes.

b. Distinctive markings on other property, such as "US," the designation of a Military Service, the emblem of a Military Service or Office of Civil Defense, the registration number or serial number assigned to a military vehicle, will be removed, or obliterated with a paint or substance which does not weather easily. Any markings on military vehicles that relate back to the Military Services (e.g. "Join the Marines," "Marine Recruiting," etc.) will be regarded as distinctive. DPDO personnel will accomplish the required removal/obliteration prior to delivery unless:

(1) To remove or obliterate the distinctive markings will destroy the utility of the property.

(2) The cost of removal or obliteration is disproportionate in relation to the value of the property.

(3) The item is donated for display purposes.

29. Distress Signaling Devices.

a. Aircraft signaling kits contain projectors and explosive-loaded flares and smoke signals which are considered dangerous if used improperly. The projector, capable of firing a 10 gauge shotgun shell, is classified as a firearm by federal law enforcement agencies.

b. Surplus explosives and explosive-loaded distress signaling devices will be removed from kits and will be reported for disposal or processing instructions to the appropriate Military Service. If the material is authorized for disposal by sale, it will first be mutilated to the extent that it is incapable of being rehabilitated for use as originally intended or, in the case of projectors, as a firearm. Other internationally recognized distress signals, such as dye markers, etc., also will be destroyed and under no circumstances will be sold to the general public.

30. Drugs, Biologicals and Reagents (Including Controlled Substances).

a. Utilization. Drugs, biologicals and reagents, including controlled substances, are not reportable for utilization screening in accordance with Chapter VII, Attachment 3, nor are they authorized for physical transfer to DPDOs. Consequently, DPDOs will not participate in administrative utilization actions. Instructions on this subject are contained in DLAR 4145.11, AR 740-7, NAVSUPINST 4440.146, Safeguarding of Sensitive, Drug Abuse Control, and Pilferable DLA Items of Supply; USAF Supply Manual, AFM 67-1, Volume V; and AR 40-61, Medical Materiel Policies and Procedures.

b. The DPDO will assist only as requested and within the restrictions shown below in donation and sales efforts of drugs, biologicals and reagents, including controlled substances. Items referred for assistance in effecting donation or sale will be picked up, in place, on the accountable record of the DPDO.

c. Donation.

(1) Controlled substances shall not be donated for any purpose.

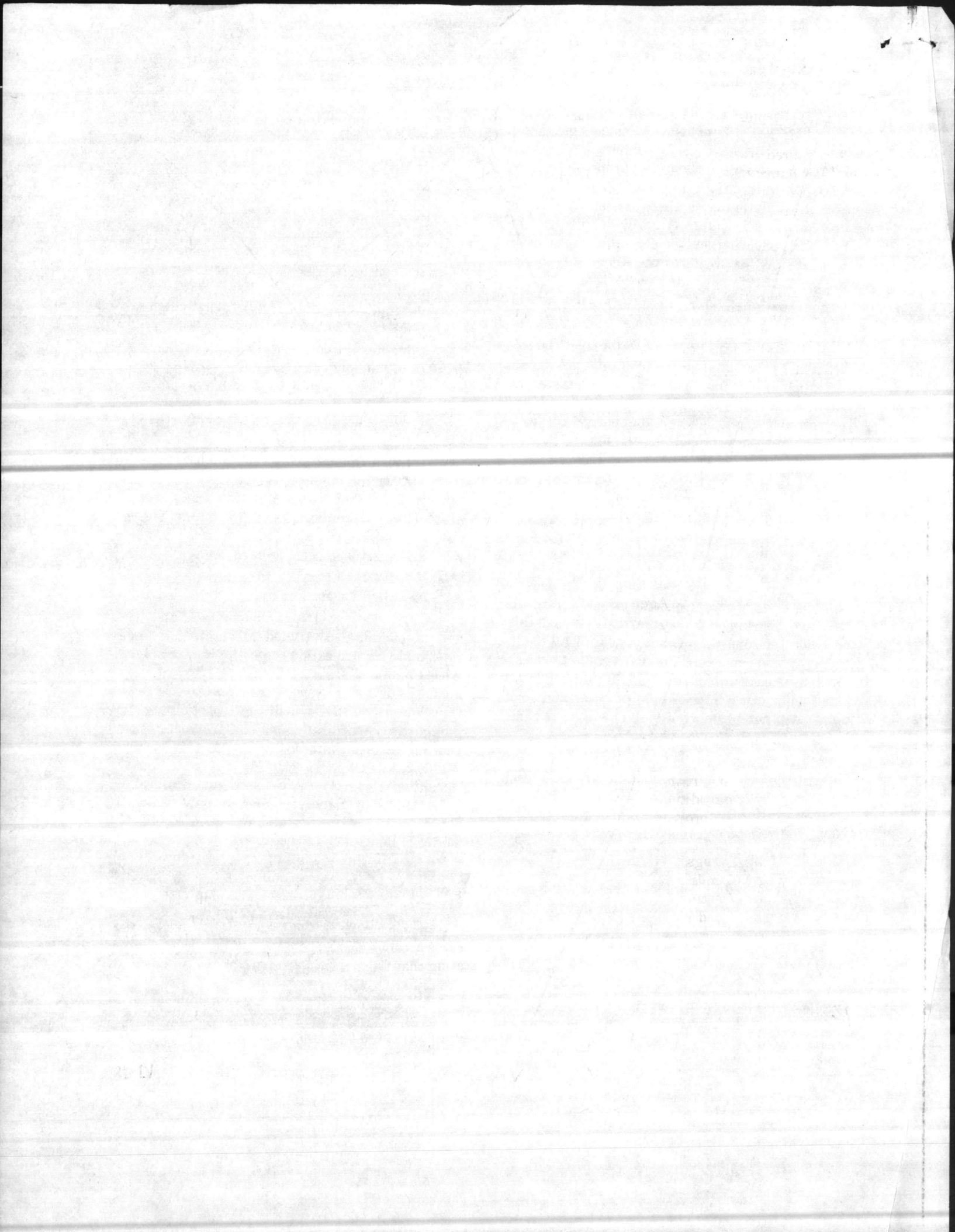

(2) Surplus drugs, biologicals and reagents, which are in FSC 6505, and which are neither required to be destroyed nor designated as unfit for human use, may be donated to Public Agencies for authorized public purposes and to nonprofit health educational institutions. When surplus drugs, biologicals, and reagents are considered for donation, a letter of clearance shall be obtained by the State Agency or designated donee from the Food and Drug Administration (FDA) indicating which items may be safely donated. The State Agency or designated donee shall obtain the letter of clearance and ensure that the letter accompanies the SF 123. Items which do not fall within the purview of FDA, or which FDA indicates are unsuitable, have been designated by GSA for disapproval. The State Agency or designated donee also shall be responsible for obtaining and providing samples of any items, as required by FDA to effect the clearance. Any payment of costs for laboratory examinations for quality assurance of samples shall be arranged by the State Agency. Before laboratory examinations are undertaken by FDA, an estimate of the expected cost of the quality assurance shall be furnished by FDA to the State Agency.

(3) Installation Medical Supply Officers will assist in donation actions for other than controlled substances by furnishing samples of surplus drugs, biologicals and reagents to State Agencies or designated donees upon request and "freezing" requested quantities pending administrative actions between the requestor, FDA and GSA.

(4) Under no circumstances will any donations of these commodities be consummated except upon receipt of properly authorized SF 123 from GSA.

d. Sale. Surplus drugs, biologicals and reagents (including controlled substances), which survive utilization, destruction and donation procedures, may be considered for disposition by sale. Drugs, biologicals and reagents, including controlled substances, rejected for nonconformance with Government specifications but authorized for sale may be reported to the Sales Office. The description will include a statement as to reason for its rejection, expressed in specific terms. However, prior to transfer of title, the

DPDO will ensure removal or obliteration of Government identification such as contract numbers, specification numbers, NSN and any other printing that would identify the item with the Government and the IFB will include a statement to this effect.

(1) Controlled Substances. Guidance pertaining to sale of controlled substances, including composition and distribution of sales offering, special condition of sale, certification (by bidder) requirement and preaward coordination with Drug Enforcement Administration, Department of Justice, is set forth in Chapter XI, paragraph D5.

(2) Drugs (other than controlled substances), biologicals and reagents. Prior to using the services of DPDOs in reporting to Sales Offices for sales purposes, it is the responsibility of the installation medical supply officer, or the activity supply office at stations where there is no medical supply officer, to request that an examination be made by the Field Scientific Coordination Staff, ACFA-CF-80, located in the appropriate Food and Drug District Office (Supplement A5) of surplus unexpired drugs and reagents authorized for sale, i.e., having an acquisition cost of \$500 or more per manufacturer's lot/batch number. When requesting such an examination, FDA requires the submission of a list and one sample of each of the drugs to be examined. Additional samples may be requested if necessary for laboratory examination. Reimbursement for examination of the surplus drugs, biologicals or reagents may be required by FDA. Before laboratory examinations are undertaken, FDA will give the medical supply officer or activity supply officer an estimate of the expected costs. If, in accordance with Chapter XIV, the cost of the quality assurance is not justified by the value of the material involved, the lot or lots shall be destroyed. The supply officer will have attached to the document requesting the services of the PDO a copy of the letter received from FDA stating that the articles have been reviewed and may appropriately be sold, subject, when necessary, to specified limitations. Guidance pertaining to the sale of drugs, biologicals, and reagents, including composition and distribution of sales offering, special condition of sale and

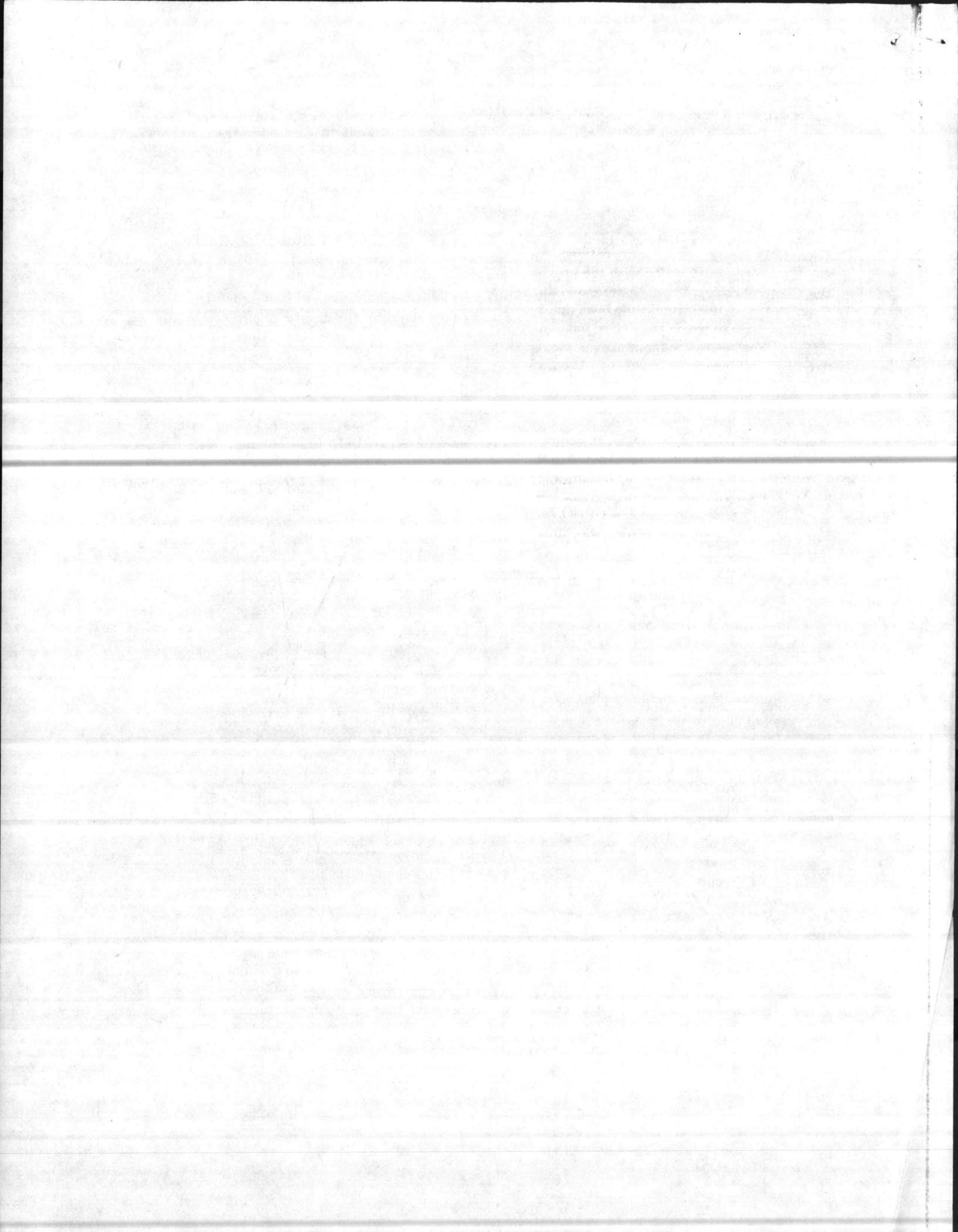

Continuation of VI-B30d(2)

certification (by bidder) requirement is set forth in Chapter XI, paragraph D5.

e. Foreign Excess Drugs (Including Controlled Substances), Biologicals and Reagents. Guidance set forth in the foregoing subparagraphs with respect to utilization, destruction and donation are equally applicable in the disposal of foreign excess generations. All sales will be made in conformity with the provisions of the Comprehensive Drug Abuse Prevention and Control Act of 1970, applicable laws and controls of the country in which the drugs, biologicals and reagents are located, and applicable international treaties. All proposed sales of foreign excess controlled substances will be submitted to the Legal Advisor for legal review and approval of the proposed sale.

f. In all cases, destruction of drugs, biologicals and reagents, including controlled substances will be accomplished by a responsible officer assigned by the generating activity. When the items have been referred for DPDO service but the donation and sale effort was unsuccessful, the DPDO may provide a witness to the destruction; however, whether or not the DPDO provides a witness, a copy of the record of destruction, containing the required signatures (two witnesses), will be provided to the DPDO to clear his inventory record.

31. Electron Tubes.

a. Spent Magnetrons. Magnetrons contain a variety of critical metals such as cobalt, gold, silver, and platinum. When practicable, these metals will be salvaged and sold as such rather than as part of spent magnetrons. Spent classified magnetrons should be declassified in accordance with appropriate Military Service instructions prior to turn-in to a DPDO for disposal. Salvaged precious metals will be segregated by metal type and processed in accordance with applicable accumulation/reporting instructions contained in paragraph C3f, Chapter XVII, this manual.

b. Many other types of electron tubes used in telecommunication applications contain small quantities of radioactive material. Individually, these tubes present little or no hazard, particularly if the glass or metal envelope is unbroken. In quantity, however, a real or potential hazard may exist, depending on total quantity of radioiso-

tope, the condition of the envelope and the method of disposal. All sales offerings containing electron tubes will include the article "Radioactive Material" contained in Chapter XI. (See also paragraph B75, Radioactive Material, this chapter.)

32. Exchange/Sale Property. The exchange/sale authority contained in Section 201(c) of the Federal Property and Administrative Services Act of 1949, as amended, will be exercised by DoD components as prescribed in DoDI 4160.1. Exchange/sale property, as defined, is property not excess to the needs of the owning agency but which is eligible for replacement. This U.S. Government-owned property, located within and outside the United States, may be offered for exchange or sale in order to apply the exchange allowance or sales proceeds thereof in whole or in part payment for replacement items.

a. Attachment 8, Part I, this chapter, contains the approved list of generic categories of property eligible for processing under exchange/sale authority. Excluded from processing through DPDOs as exchange/sale property are otherwise eligible items in new/unused or scrap condition. Those FSGs which are not eligible for processing under exchange/sale authority are listed in Attachment 8, Part II, this chapter. Property which is not listed in Part I as eligible but is not shown in Part II as ineligible may be processed by procurement officers on an exchange basis only.

b. It is the responsibility of the turn-in activity to designate property as exchange/sale property. DPDOs are not authorized to make this determination.

(1) In the absence of such designation, even though property falls within one of the generic categories listed in Attachment 8, Part I, this chapter, the property will not be processed as exchange/sale, but will be processed as normal Service/Agency excess.

(2) If the property identified on the DTID as exchange sale is not listed in Attachment 8, Part I, the DPDO will contact the generating activity for clarification. The generating activity will notify the DPDO within 3 working days if the property is to be returned or processed as excess.

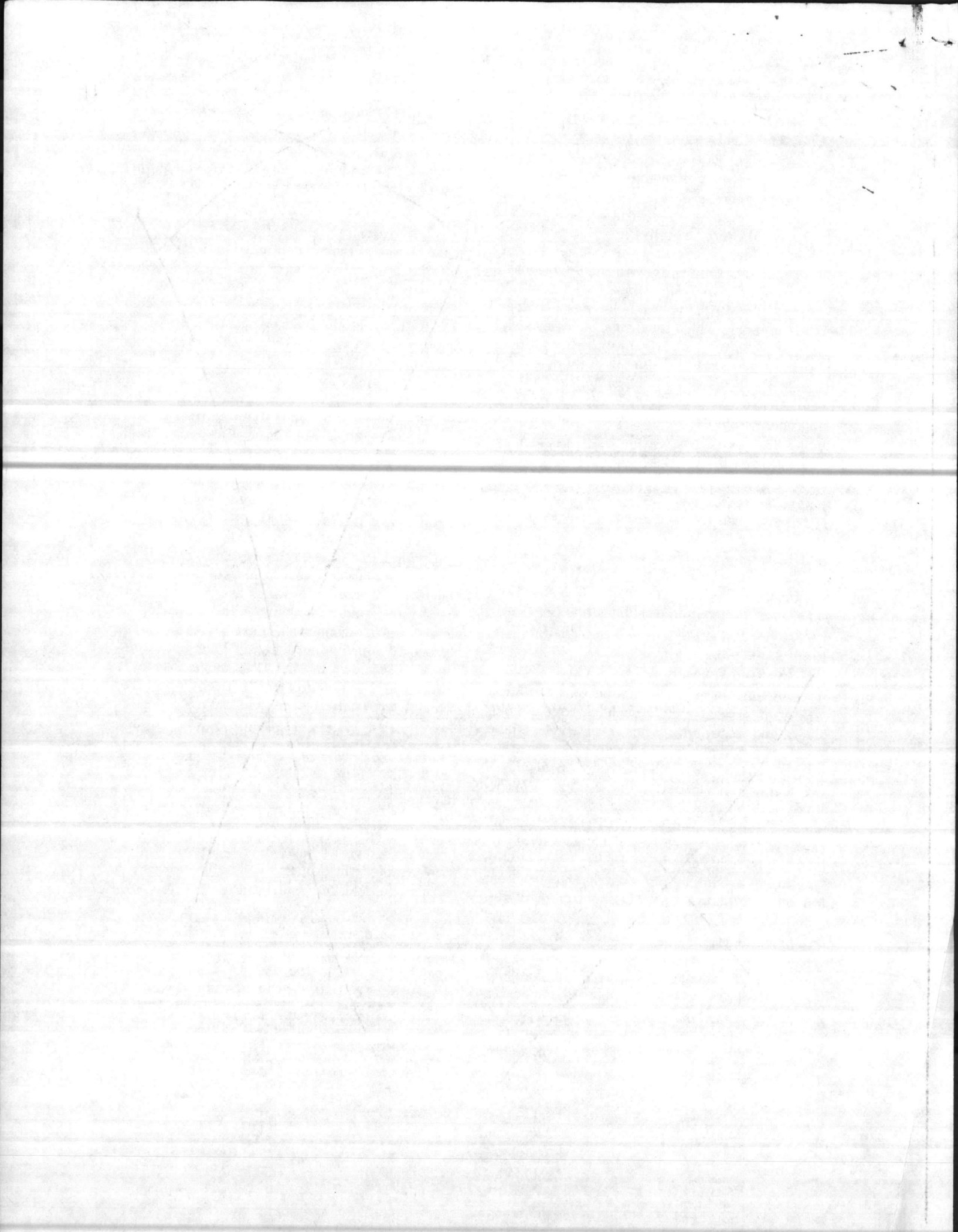

Send copy to Ac/s Log
Guard mail John



J W
ASSISTANT CHIEF OF STAFF, FACILITIES
HEADQUARTERS, MARINE CORPS BASE

DATE 20 Oct 82

TO: DIR, NREA

BASE MAINT O

DIR, FAMILY HOUSING

PUBLIC WORKS O

DIR, UNACCOMPANIED PERS HSG

COMM-ELECT O

BASE FIRE CHIEF

ATTN: Julian Wooten

1. Attached is forwarded for ~~info~~ action.

2. Please initial, or comment, and return all papers to this office.

3. Your file copy

*VIR
SSGT*

DD
"LET'S THINK OF A FEW REASONS
WHY IT CAN BE DONE" *21 Oct 82*

Danny,
See if you can find out what this
is about.

Julian



11007-11008

11009-11010

11011-11012

11013-11014

11015-11016

11017-11018

11019

11020-11021

ROUTINE

* U N C L A S S I F I E D *

292/2043Z

PT00351

PAGE 01

RT TUZYUW RUEACMC5239 2922044-UUUU--RUEBDOA.

ZNR UUUUU

R 181428Z OCT 82

FM CMC WASHINGTON DC

TO AIG EIGHT ACT:CG MCB

BT

UNCLAS //N11000//

SUBJ: DISPOSAL OF SPILL RESIDUES (CMC CODE LFF-2)

A. HQDPDS BATTLE CREEK MI 011912Z OCT 82 (PASEP)

B. MCO 4570.24A OF 20 JAN 82

C. MCO P11000.8A

1. REF A FORWARDED FOR ACTION AS APPROPRIATE. ITS CONTENTS WILL BE INCORPORATED INTO FORTHCOMING UPDATES OF REFS B AND C.

BT

#5239

NN NN

ACT|BFAC
INFO|BADJ|COMP|MAIN|BPWO|DOST|410

*copy to
Logistics*

ORIGINAL
ACTION

18

14

28 = Oct 82

ROUTINE

* U N C L A S S I F I E D *

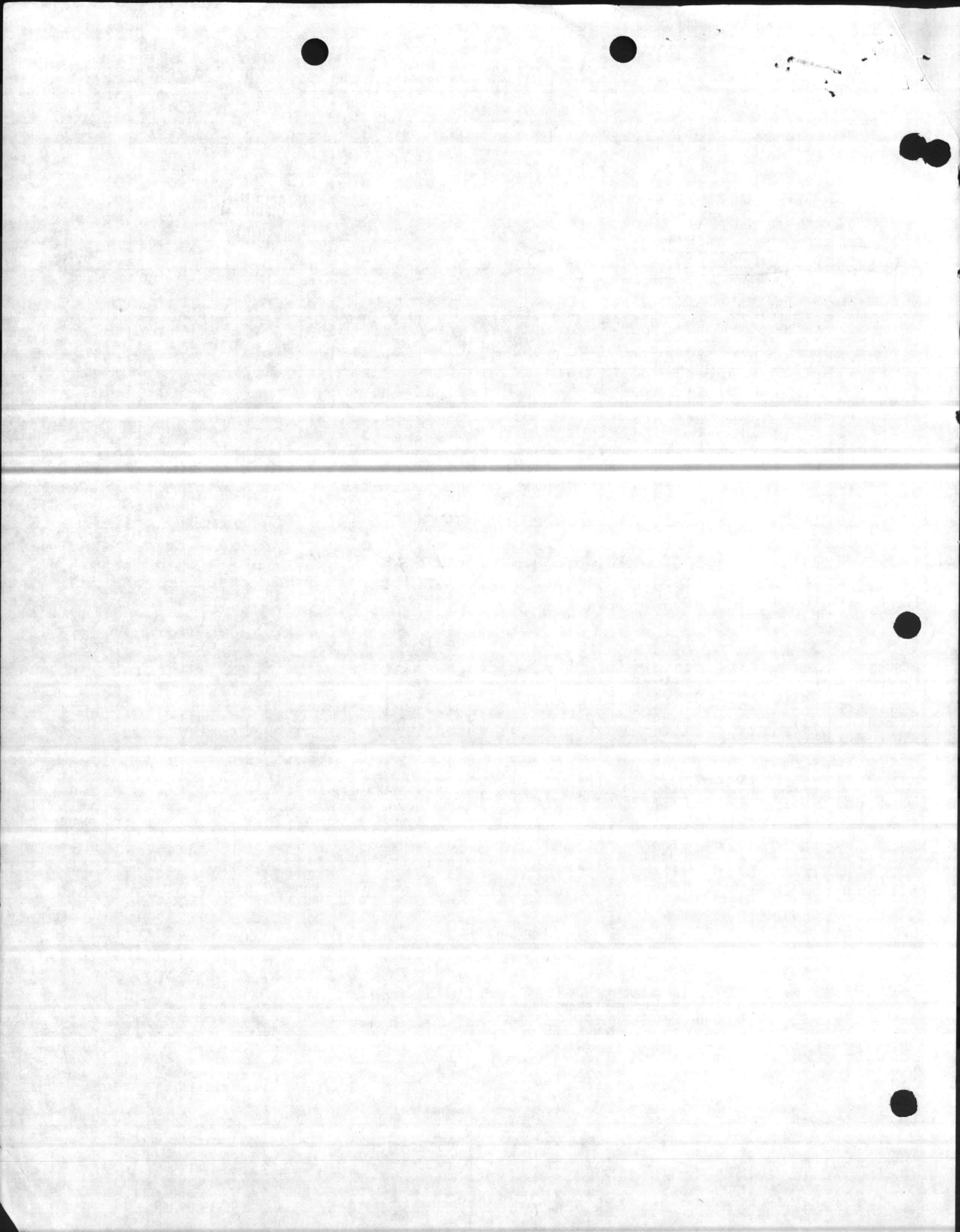

ROUTINE

* UNCLASSIFIED *

NREA
DDSD

294/0320Z

PT00058

PAGE 01

R 010320Z RUFACMC 9891 2940321-UUUU--RUEBDOA.

ZNR UUUUU

R 191427Z OCT 82

← READDRESSAL DTG

FM CMC WASHINGTON DC

TO AIG EIGHT //ACT: CG MCB//

INFO RUERUAR/HQ DPDS BATTLE CREEK MI

R 011912Z OCT 82

← ORIGINAL DTG

FM HQ DPDS BATTLE CREEK MI

TO RUEBDSA/HQ DLA CAM STA VA//DLA SME//

RUEBDSA/HQ DLA CAM STA VA//DLA OW//

RUEADWD/HQ DA WASH DC//DALO SMP U//

RUKLDAR/DARCOM DRCSM PSP ALEX VA

RUEAHOF/NAVFACENGCOR ALEX VA//CODE 112//

RULSSAA/COM NAVSUSPSYSCOM WASH DC//SUP 0422D//

RUEACMC/HQ USMC WASH DC//LMM 2//

RUVAFLC/HQ AFLC WPAFR OH//AFLC LOLP//

RUEADWD/DA WASH DC//DAEN ZCE//

BT

UNCLAS DPDS-HP 6978. ATTN: DLA SME PAULA MC LAIN, DLA OW JOHN FRICK, DALO SMP U WASH DC SAM HOOVER, DARCOM ALEX VA HERB REYNOLDS, NAVFACENGCOR TED ZAGRORELY, NAVSUSPSYSCOM WASH DC JOHN DICKHUTE, HQ USMC ROSE BUCKLER, WPAFR PAT SIDES, DA WASH DC DAEN ZCE DAVE PALMER. SUBJECT: DISPOSAL OF SPILL RESIDUES.

REFERENCES: A. DEFENSE ENVIRONMENTAL QUALITY PROGRAM POLICY MEMORANDUM (DEQPPM) 81-3, 15 JUN 81, SUBJECT: DEPARTMENT OF DEFENSE (DOD) HAZARDOUS MATERIAL DISPOSAL POLICY.

PAGE 2 RUERUAR9891 UNCLAS

B. DPDS-HP MESSAGE R021420Z SEP 82, SUBJECT:

DISPOSAL OF SPILL RESIDUES.

1. AS INDICATED IN REFERENCE A, AS OF 1 OCT 82, DLA/DPDS WILL ASSUME DISPOSAL RESPONSIBILITY OF SPILL RESIDUES (AS DEFINED BY 40 CFR 261.3 OR 40 CFR 761 FOR PCRS), FOR SPILLS THAT OCCUR IN FISCAL YEAR 83 AND LATER.

2. REFERENCE B PROPOSED PROCEDURES TO IMPLEMENT THIS DISPOSAL RESPONSIBILITY. CONCURRENCES/COMMENTS WERE RECEIVED AND REVIEWED. AS APPLICABLE, COMMENTS HAVE BEEN INCORPORATED AND THE FOLLOWING PROCEDURES WILL BE EFFECTIVE 1 OCT 82.

3. DPDS WILL DISPOSE OF SPILL RESIDUES THROUGH THE TURN-IN PROCEDURES OUTLINED IN PARAGRAPH 4 BELOW OR IF COST EFFECTIVE, THROUGH A FUNDING PROCESS OUTLINED IN PARAGRAPH 6 BELOW.

4. TURN-IN ACTIVITIES WILL PROPERLY IDENTIFY (E.G., SOIL CONTAMINATED WITH METHYL ETHYL KETONE), PACKAGE, LABEL AND MEET ALL TURN-IN REQUIREMENTS OF THE CONSOLIDATED HAZARDOUS MATERIAL/HAZARDOUS WASTE DISPOSAL GUIDANCE, WHEN TURNING IN SPILL RESIDUES TO THE DPDS. DUE TO THE UNIQUENESS OF THE ITEM BEING TURNED IN, PRIOR COORDINATION BY THE TURN-IN ACTIVITY WITH THE DPDS IS ESSENTIAL TO

ROUTINE

* UNCLASSIFIED *

01

19

28 OCT 82

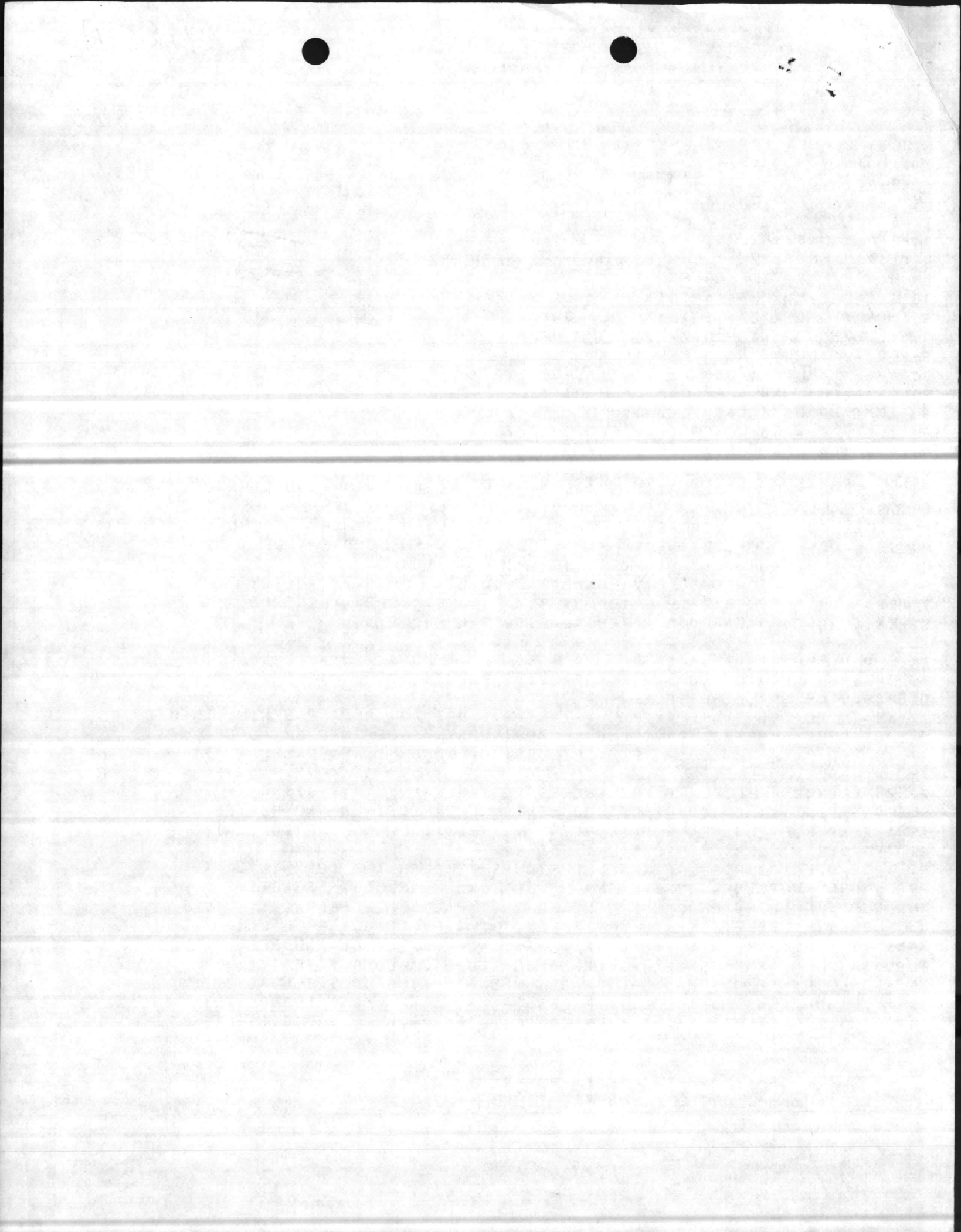

ROUTINE

* U N C L A S S I F I E D *

294/0321Z

PT00058

PAGE 02

ENSURE DISPOSAL MEETS ALL REQUIREMENTS YET IS COMPLETED IN THE MOST COST EFFECTIVE MANNER TO DOD. THE STANDARD LOCAL STOCK NUMBER

PAGE 3 RUEBUAB9891 UNCLAS

(LSN) "9999-00-SPILRES" HAS BEEN DEVELOPED BY DPDS TO BE USED BY GENERATORS FOR THE TURN-IN OF ALL SPILL RESIDUES INCLUDING PCBs. THE TURN-IN ACTIVITY WILL PLACE THE STANDARD LOCAL STOCK NUMBER (LSN), "9999-00-SPILRES", ON THE DISPOSAL TURN-IN DOCUMENT (DTID) AND CODE "HW" FOR HAZARDOUS WASTE IN BLOCK C OF THE DTID. IF THE TURN-IN ACTIVITY POSSESSES ADDITIONAL INFORMATION (E. G., CHEMICAL ANALYSIS OF SPILL RESIDUE), IT SHOULD BE ATTACHED TO THE DTID UPON TURN-IN TO THE DPDO. ACCEPTANCE OF PHYSICAL CUSTODY OF SPILL RESIDUES BY DPDOs WILL BE IN ACCORDANCE WITH ESTABLISHED CRITERIA.

5. IF AFTER THE INITIAL SPILL HAS BEEN CONTAINED AND THE TURN-IN ACTIVITY CAN PROVIDE A MORE COST EFFECTIVE SPILL RESIDUE DISPOSAL SERVICE AS PART OF SPILL CLEANUP, THE ACTIVITY MAY OBTAIN THE NECESSARY FUNDING FOR SUCH DISPOSAL FROM DPDS THROUGH PRIOR COORDINATION, AS INDICATED IN PARAGRAPH 6 BELOW, WITH THE FOLLOWING OFFICE:

DEFENSE PROPERTY DISPOSAL SERVICE
FEDERAL CENTER
ATTN: DPDS-HP
BATTLE CREEK, MI 49016

PAGE 4 RUEBUAB9891 UNCLAS

AV 369-6977
COMMERCIAL (616) 962-6511 EXT 6977
FTS 372-6977

6. THIS COORDINATION WILL BE IN WRITING AND CONSIST OF THE FOLLOWING:

- A. REQUEST FOR FUND CITATION ALONG WITH SPECIFIC ADDRESS, INCLUDING OFFICE SYMBOL TO WHICH FUND CITATION SHOULD BE SENT BY ELECTRONIC MEANS. LINE ITEM ON SERVICE CONTRACT FOR SPILL RESIDUE DISPOSAL MUST DESIGNATE THAT DPDS-CF IS THE PAYING OFFICE.
- B. IDENTIFICATION OF THE PROPERTY TO BE DISPOSED OF (E.G., SOIL CONTAMINATED WITH METHYL ETHYL KETONE).
- C. INDICATION OF QUANTITY OF MATERIAL SPILLED AND QUANTITY OF MATERIAL TO BE DISPOSED OF.
- D. INDICATION OF HOW MATERIAL WILL BE HANDLED OR TREATED FOR DISPOSAL (E.G., WILL IT BE IN SOLID OR LIQUID FORM).
- E. STATEMENT OF WORK FOR SERVICE CONTRACT AND PROPOSED METHOD OF DISPOSAL.
- F. ESTIMATED COST FOR DISPOSAL OF SPILL RESIDUE AND COST ANALYSIS.
- G. CIRCUMSTANCES OF SPILL, INCLUDING WHEN SPILL OCCURRED

ROUTINE

* U N C L A S S I F I E D *

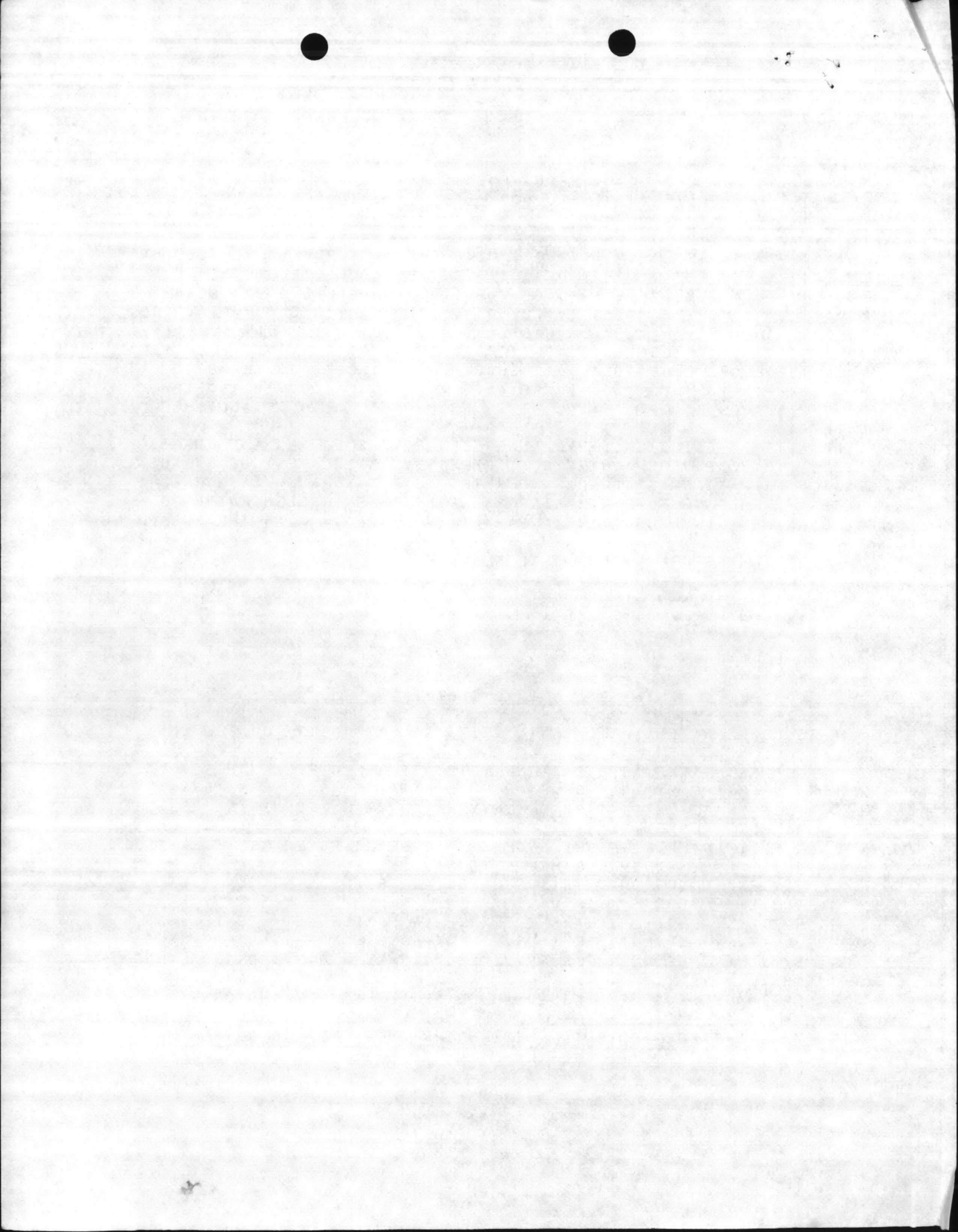

GE 5 RUEPIIAB 9891 UNCLAS
AND LOCATION OF SPILL.

H. CONTACT PERSON WITHIN TURN-IN ACTIVITY WHO CAN, IF NECESSARY, ANSWER FURTHER QUESTIONS.

7. TO PRECLUDE THE HARDSHIP OF ADDITIONAL PAPERWORK ON TURN-IN ACTIVITIES. THE INFORMATION REQUESTED ABOVE IN PARAGRAPHS 6B THROUGH H MAY BE PROVIDED IN THE FORM OF A COPY OF THE DTID AND THE PROPOSED SERVICE CONTRACT, BUT ALL ITEMS MUST BE ADDRESSED.

8. UPON DPDS APPROVAL OF THE SERVICE CONTRACT FOR DISPOSAL THE TURN-IN ACTIVITY WILL BE PROVIDED A FUND CITATION AND INSTRUCTIONS INDICATING WHICH DPDO WILL TAKE ACCOUNTABILITY OF THE PROPERTY. THE DTID WILL THEN BE PREPARED BY THE TURN-IN ACTIVITY IN ACCORDANCE WITH PROCEDURES OUTLINED ABOVE.

9. AFTER COMPLETION OF THE DISPOSAL, THE TURN-IN ACTIVITY WILL FORWARD A COPY OF THE RESULTING SERVICE CONTRACT TO ABOVE DPDS ADDRESS.

10. THIS POLICY WILL BE DISSEMINATED TO OUR REGION OFFICES AND TO OUR DEFENSE PROPERTY DISPOSAL OFFICES.

11. THIS POLICY WILL BE SUBMITTED THROUGH CHANNELS FOR INCORPORATION IN THE DOD 4160.21-M, DEFENSE DISPOSAL MANUAL.

BT

#9891

MM MN
ACT: |BFAC|
INFO: |BADJ|442|

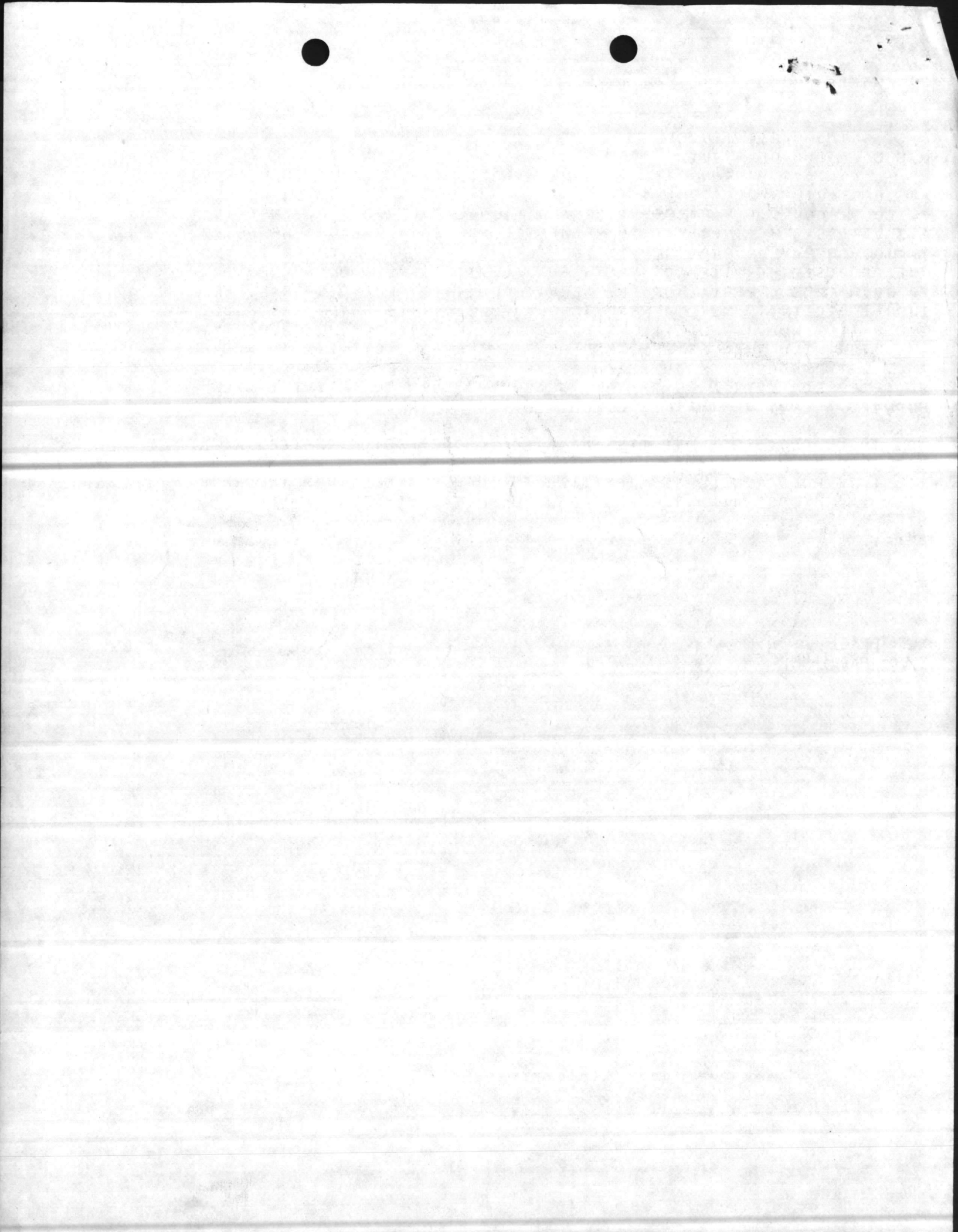

Jan/Twylah

DPDO doesn't come under MCB -- they come under the Defense Logistics Agency out of Memphis.

Also, when you ref LANTDIV in a ltr or msg it is correct to leave out DIV; i.e., COMNAVANTNAVFACENGCOM. "Atlantic Division" must be spelled out in the address of a ltr, however.

Hazel

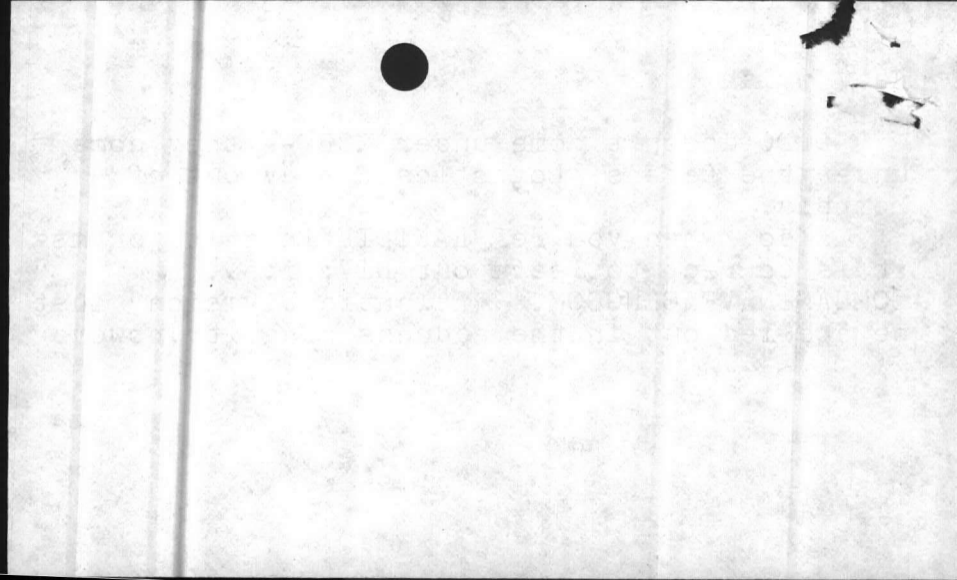

NREAD/DDS/hf
6280

1 6 DEC 1982

From: Commanding General
To: Defense Property Disposal Officer, Lejeune, Building 906,
Camp Lejeune, NC 28542

Subj: Fluorescent Lamp Disposal

Encl: (1) COMLANTNAVFACENGCOM ltr 114:JGW:mbe 6280 dtd 20 Sep 1982
(2) Fluorescent Lamps: Usage Trends by NSN

1. As recommended by enclosure (1), this command plans to initiate recycling of fluorescent lamp tubes. Please identify considerations and constraints related to DPDO, Lejeune, handling and reselling used fluorescent lamp tubes that are generated aboard this installation. Enclosure (2) provides information related to current usage of the subject lamps.

J. T. MARSHALL
By direction



DEPARTMENT OF THE NAVY
ATLANTIC DIVISION
NAVAL FACILITIES ENGINEERING COMMAND
NORFOLK, VIRGINIA 23511

TELEPHONE NO.
(804) 444-9566
IN REPLY REFER TO:

114 :JGW:mbe
6280

20 SEP 1982

From: Commander, Atlantic Division, Naval Facilities Engineering Command
To: Distribution

Subj: Fluorescent lamp disposal

Ref: (a) Solid Waste Management, Department of Defense, NAVFAC MO-213, Air Force AFP 91-8, Army PAM 420-47 of June 1978
(b) COMNAVFACENGCOM ltr 1122A/TJZ of 18 April 1980
(c) Pollution Solution PS-018, Navy Energy and Environmental Support Activity (NAVENENVSA) of December 1981

Encl: (1) Sheet VI-20 from Defense Disposal Manual, DOD 4160.21-M of July 1979

1. Because fluorescent lamp tubes contain phosphorus, argon and trace quantities of mercury, much has been written concerning handling and disposal requirements as indicated in references (a), (b) and (c).
2. Defense Property Disposal Offices (DPDO) can and do handle used lamps for sale to commercial firms for reconditioning and resale. Specifics of DPDO disposition are included as enclosure (1).
3. Activities should contact cognizant DPDOs for handling capabilities and requirements and, where appropriate, initiate lamp recycle rather than landfill disposal.
4. It is understood that NAVENENVSA is preparing a Pollution Solution which will address fluorescent lamp handling and disposal in greater detail, however in the interim DPDO recycling if arranged or landfill disposal at the rate of 1-10 lamps per ton of refuse should be followed.
5. IANTNAVFACENGCOM point of contact is Mr. Jerry Wallmeyer at (804) 444-9566 or A/V 690-9566.

J. R. Bailey
J. R. BAILEY, P.E.
By direction

Distribution:

Part II

- List A (5,7,11,14,16,18,31)
- List B (2,3,4,5)
- List F (1,2)
- List G (1,2)
- List H (2 only)
- List I (3,5,7,11)
- List K (6,8)
- List L (1 only)
- List M (1,2)
- List R (2,3,6)

(Distribution continued on next page)

Encl(1)

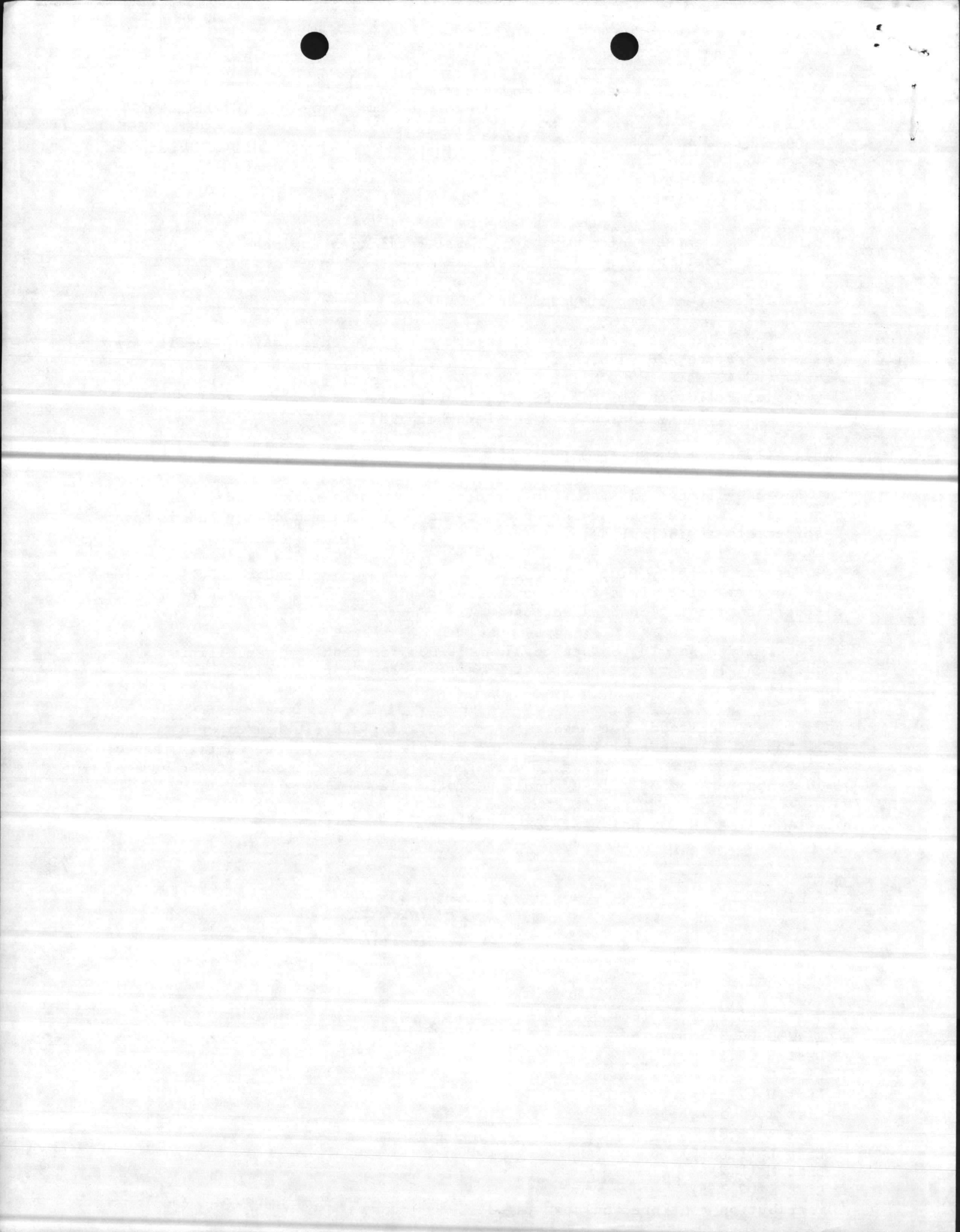

Distribution: (continued)

COMEODGRU TWO FORT STORY

AFXTRACTY CAMP PEARY

FMFLANT

LANTFLT HEDSUPPACT

AFSC

Part III

List A (3,5,7,9,10,11,14,17,18,19,20,22,25,26)

List B (1,6,8,10,11,12,15,18,20,21)

List F (4,8)

List G (1,3,5,7,8,9,11)

List H (2,3,4,9,11)

Part IV

List H (1 only)

Copy to:

Part I

List A (13 only)

Part II

List A (5,6,9,10,12,15,33)

List B (1 only)

List K (2 only)

List Q (3 only)

CINCLANTFLT

DPDS BATTLE CREEK

DPDR COLUMBUS

DPDR MEMPHIS

DPDO KNOX

DPDO LEJEUNE

DPDO CHERRY POINT

DPDO NORFOLK

DPDO PORTSMOUTH

Part III

List A (1,8)

List B (15 only)

DPDR EUROPE

DPDO ARGENTIA

DPDO BERMUDA

DPDO ATHENS

DPDO AVIANO

DPDO KEFLAVIK

DPDO LAJES FIELD

DPDO LIVORNO

DPDO ROTA

DPDO TORREJON

DPDO GUANTANAMO BAY

DPDO ROOSEVELT ROADS

Part IV

List I (1)

COMNAVFACENCOM (Code 112)

CMC (Code FF.21)

NAVENENVSA

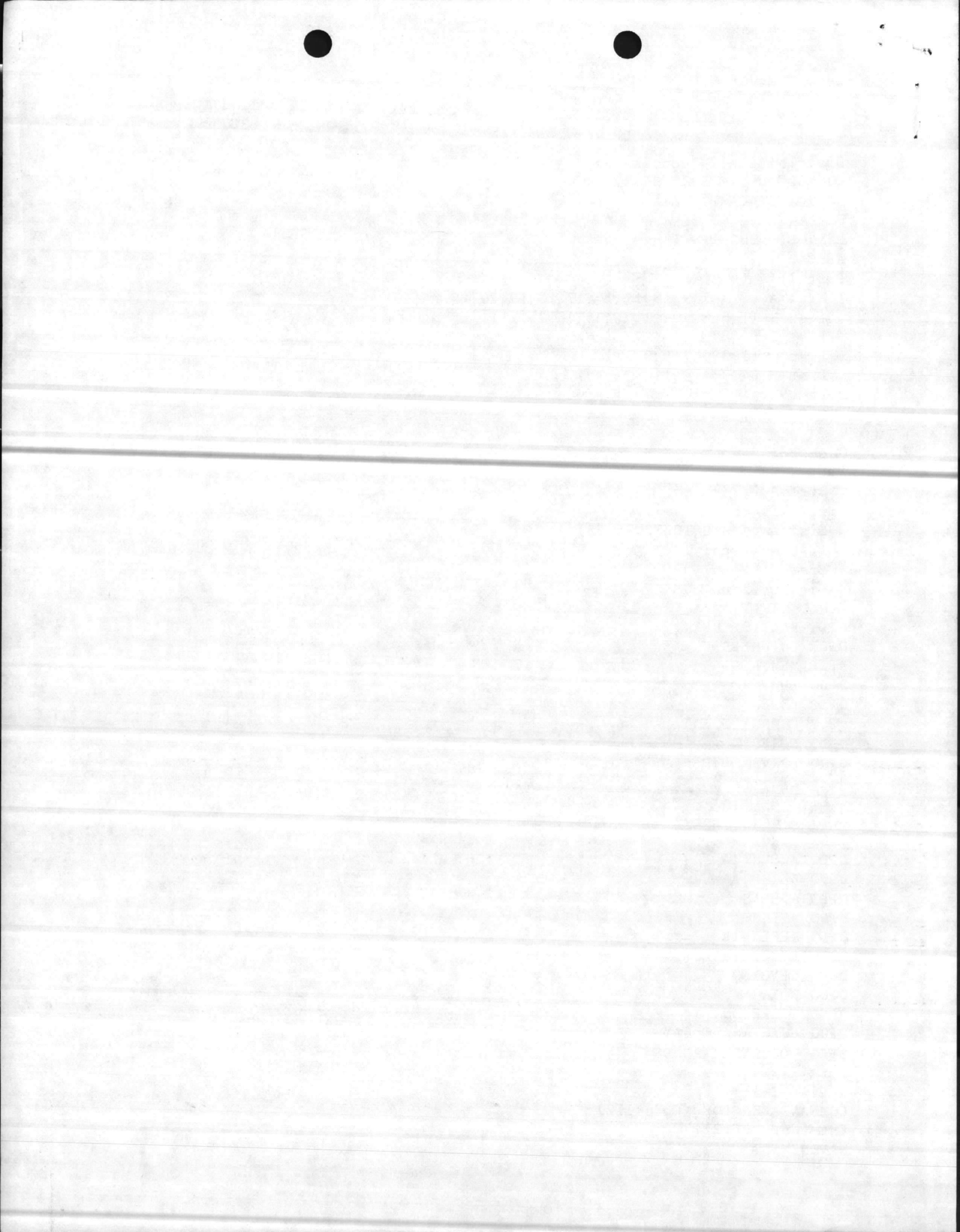

will be offered for sale to the general public without a requirement that it be mutilated. However, film will not be sold unless it is more cost effective to do so than to process the film for silver recovery.

d. Outdated and Unexposed Film (other than X-ray). After appropriate utilization screening, outdated or unexposed film will be offered for sale. However, sale will be made only if such sale is cost effective as per paragraph C3d, Chapter XVII, this manual.

e. Exposed Film and Photographic Paper (including silver-bearing microfiche and microfilm). Such property will be processed for silver recovery. Exposed scrap microfiche and microfilm masters contain recoverable silver and will not be offered for sale. Microfiche and microfilm copies do not contain silver and need not be reported for recovery.

35. Fire Extinguisher, Carbon Tetrachloride (CTC). The toxic and dangerous characteristics of carbon tetrachloride are universally recognized as a health hazard. These extinguishers will be crushed and disposed of as scrap.

36. Fired Cartridge Cases. Fired cartridge cases will not be accepted for disposal without receipt of signed certificate from the generating activity stating that the material has been inspected and that it does not contain any live rounds, unfired primers, explosives or other dangerous material.

37. Flags. Flags (including foreign flags) pennants, streamers and guidons, no longer considered to be fitting emblems for display, should not be used or disposed of in any manner that might be viewed as disrespectful. Those items having a particular historical or sentimental value by reason of association with a significant event, place or person will be referred to the owning Military Service or Defense Agency and retired from active use and preserved as historical property. However, when a U.S. flag, having a historical or sentimental value to a city, other public body, museum or veterans organization, is requested for display in museums or other collections, it may be donated to an authorized donee in accordance with Chapter X. If donated to a public body the procedures contained in Chapter XIV, paragraph A2, are not required. Items not possessing particular historical or

sentimental significance will be destroyed as a whole, privately, preferably by burning, in such a manner as not to suggest disrespect.

38. Fluorescent Lamps. When quantities of fluorescent lamps at any DPDO exceed 1,000 lamps per year, these items may be disposed of either by one-time or running-term sale to commercial firms for reconditioning and resale. The used lamps scheduled for sale will be placed in replacement lamp cartons, when available, and retained by the DPDO for pickup by the purchaser. In all other cases, the lamps will be destroyed as required by current safety directives of DLA.

39. Food (Other Than Food Waste and Refuse).

a. General. This paragraph does not apply to garbage, bones, greases, fats, or food waste material generated by the preparation of meals (see paragraph B40, this chapter).

b. Usable Foodstuffs. Usable foodstuffs will not be declared for sale as surplus without prior approval of the Subsistence Office of the Military Service having jurisdiction over the generating source at which the foodstuff is located. Food items (such as items in broken/damaged packaging, or rejected for non-conformance with Government specifications but authorized for sale), may be reported through the DPDO to the Sales Office. The description will include a statement as to reason for its rejection, expressed in specific terms. However, prior to transfer of title, the generating activity will remove or obliterate Government identification such as contract numbers, NSNs and any other printing that would identify the item with the Government and the IFB will include a statement to this effect.

c. Meals or rations, including survival packets, that have been prepared and packaged in advance of the anticipated time or date of consumption may be received by DPDOs. At the time of receipt, information will be obtained regarding age and estimated condition of the food. Medical and veterinary authority will be consulted to determine suitability of the food for human or animal consumption. In the event of any possible question regarding its suitability, it will be destroyed in lieu of transfer, donation or sale. Some food packages may contain tax-free cigarettes. State laws affecting sale, donation to penal institutions, etc., will be examined and the

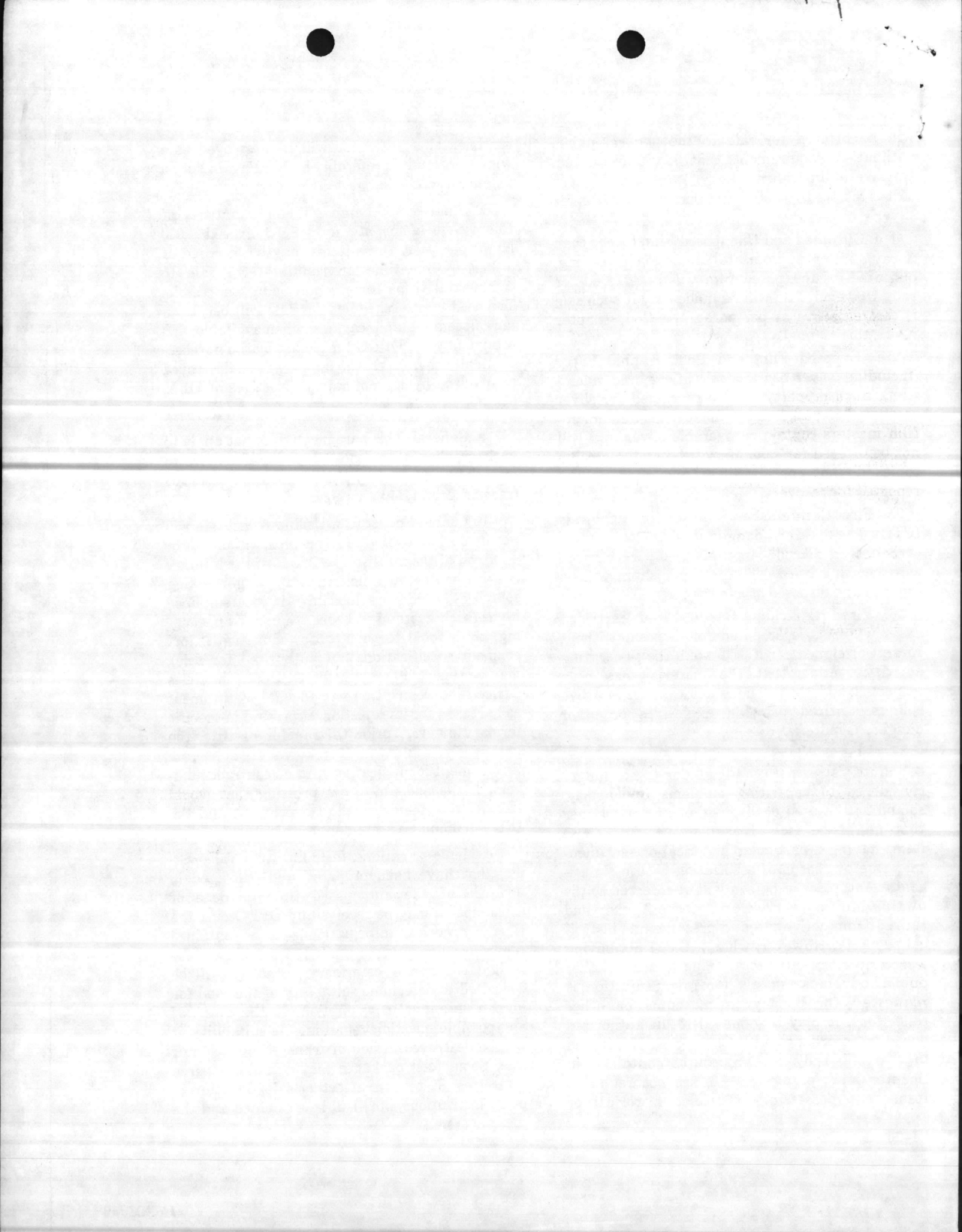

CAMP LEJEUNE DSSC

FLUORESCENT LAMPS - USAGE TREND BY NSN

<u>NSN</u>		<u>FY-81</u> <u>(12 Months)</u>	<u>FY-82</u> <u>(7 Months)</u>
6240-00-152-2981	15W	787	2,326
6240-00-152-2985	30W	306	84
6240-00-152-2987	40W	29,005	16,770
6240-00-152-2993	20W	1,035	1,049
6240-00-247-7358	90W	32	43
6240-00-299-2897	49W	552	228
6240-00-299-5964	38.5W	1,688	1,115
6240-00-299-7252	6W	222	69
6240-00-519-2110	50W	322	391
6240-00-556-8655	22W	-	22
6240-00-702-6955	22W	-	10
6240-00-752-2081	215W	-	86
6240-00-826-5168	30W	487	308
6240-00-945-7575	110W	218	54
6240-00-973-8237	105W	700	1,616
6240-00-985-5238	32W	12	26
6240-01-016-2174	40W	19	11
6240-01-077-1127	60W	2,348	4,375
TOTAL		37,733	28,583 *

* Extrapolated to 12 Months 49,000

Enclosure (2)



(Faint handwritten text, possibly a signature or date)

File f d w
UNITED STATES MARINE CORPS
Marine Corps Base
Camp Lejeune, North Carolina 28542

FAC/JSH/hf
6280
15 Oct 1982

From: Assistant Chief of Staff, Facilities
To: Base Maintenance Officer
Base Communications-Electronics Officer
Base Fire Chief

Subj: Hazardous Waste Storage Facility, Bldg. TP-451 and adjacent building

Encl: (1) Dir, NREA ltr NREAD/TS/th 6240 of 8 Oct 1982

1. During a recent meeting between members of the Base Natural Resources and Environmental Affairs Division, and Mr. CHURCH of the N. C. Division of Health Resources, it was noted that additional requirements must be met to prepare the subject facility for use as noted in the enclosure. In that activation of the subject facility is considered of high priority, requirements noted in the enclosure should be accomplished as soon as possible.

2. Accordingly, responsibility for the additional requirements noted in the enclosure are assigned as follows:

- a. Base Maintenance Officer: Paragraphs 1a, 1b and 1c.
- b. Base Communications-Electronics Officer: Paragraph 1e.
- c. Base Fire Chief: Paragraph 1c and 1e. Coordinate latter with CEO.

3. Points-of-contact for this project are Major HACK or SSgt HARRIS (3034/3035).

J. T. MARSHALL

Copy to:
AC/S, Log
NREAD (w/o encl)

1944
1945
1946

1947

1948

1949

1950

1951

1952

1953

1954

1955

1956

1957

1958

1959

1960

1961

1962

1963

1964

1965

1966
1967
1968
1969
1970

8d6
FAC/ACA/hf
6280
3 November 1982

From: Commanding General
To: Commander, Atlantic Division, Naval Facilities Engineering
Command, Norfolk, VA 23511 (Attn: Code 1142)

Subj: Agricultural Quarantine Decontamination Facility (AQDF)
Point of Contact

Ref: (a) Your ltr 114:DPG:mbe 6280 of 4 Oct 1982

1. The reference requested a point of contact for the subject study. The contact for Marine Corps Base, Camp Lejeune, is:

Mr. Robert Alexander
Office of Assistant Chief of Staff, Facilities
Marine Corps Base, Building 1
Camp Lejeune, NC 28542
(919) 451-2544, AV: 484-2544

J. T. MARSHALL
By direction

Blind Copy to:
PWO
NREA
→

1972

MEMORANDUM FOR

TO: SAC, NEW YORK
FROM: SAC, NEW YORK

RE: [Illegible text]

1. [Illegible text]

2. [Illegible text]

3. [Illegible text]

4. [Illegible text]

200-100-1000
100-100-1000
100-100-1000

1972

Memorandum

File

Downy
DDE Attached

11-15-82

DATE: 1 Oct 82

FROM: Paul Hubbell

TO: Julian Wooten

SUBJ: Information Transfer

Encl: (1) p684 of 9/17/82 Environment Reporter
(2) Hazardous Waste Facility Operator's Course (WEPSS)
(3) Government Institutes Hazardous Wastes Regulations Course
(4) Safestep Literature

1. Happy New Year! Just a note to relay some program items and pass along some information that has crossed my desk.

- It appears that the once cancelled twice delayed annual report for Hazardous Waste generators and Facilities is finally coming due. (See enclosure 1). I will get a message out as soon as the Federal Register item appears.
- FY84 project validations are rapidly approaching. Pollution Abatement (P/A) minor construction and repair projects are to appear on the minor construction and BMAR lists due at USMCHQ now. However, if you know of projects that need to be done and failed to make these lists, coordinate with your Public Works/Facilities Office to ensure that the validator reviews the projects while he is visiting your activity during the next couple of months.
- I just got back from a visit to West Coast activities. Considerable interest was generated in Hazardous Waste training geared to the handlers and operators of HW facilities. I will try to set up an East and West Coast training session for this Fiscal Year.



- Enclosures (2) and (3) are forwarded to give you a heads up on other courses being given this Fiscal Year. The NEPSS course is geared to operators while the GI course is directed to managers.

✓ - The Military Construction appropriations bill has made considerable revisions to the way activities may use revenues generated from resource recovery programs. Guidance on this will be out sometime this fall. It appears that much more money will be available for environmental, energy, OSHA, and Morale Welfare and Recreation projects.

- Enclosure (4) is forwarded for information/use as appropriate. I keep receiving a lot of product literature from Andesite. This is the first time, however, that I've seen any comments on SAFESTEP by others. You may also wish to pass this to safety and/or fire personnel at your activity.

2. Marlo says hello.

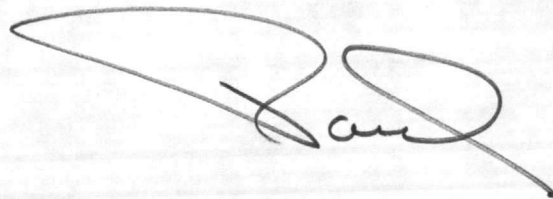
A handwritten signature in black ink, appearing to be "Dan", written in a cursive style.

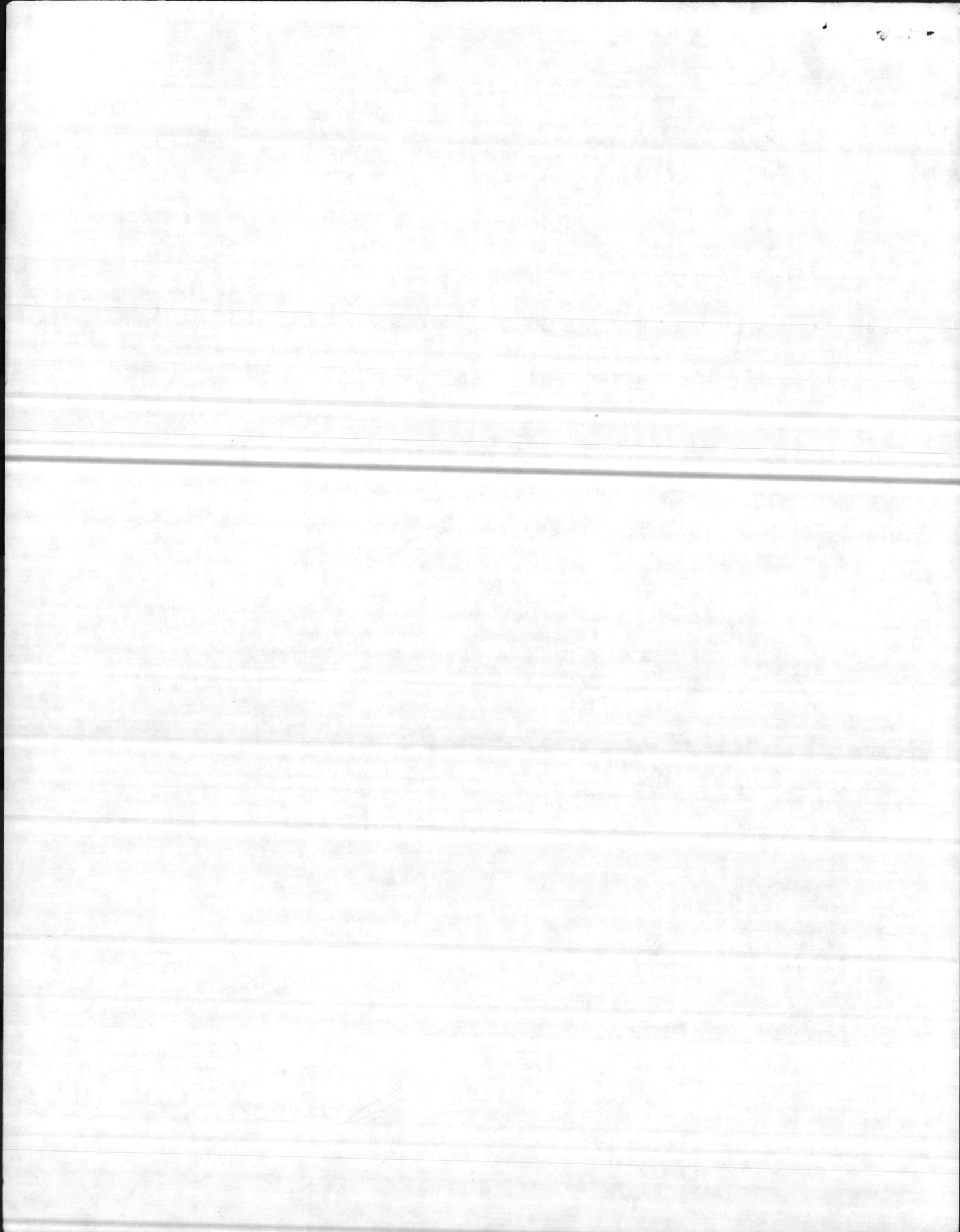

Hazardous Waste

OMB DROPS OPPOSITION TO ANNUAL REPORT; EPA TO PUBLISH NOTICE REQUIRING SUBMITTAL

The Office of Management and Budget has withdrawn its opposition to an annual report form required of hazardous waste generators and facilities under the Resource Conservation and Recovery Act, clearing the way for the Environmental Protection Agency to publish a notice requiring that the report be submitted soon, according to officials of both agencies.

In a related development, OMB recently proposed regulations to carry out its duties under the Paperwork Reduction Act. Under the proposed rules, OMB can review existing regulations, but any changes to them must go through the regular proposal and public comment processes of the Administrative Procedure Act.

The RCRA hazardous waste regulations required that the annual report on hazardous waste activities be submitted by generators and facilities to EPA by Aug. 1. In late July, however, OMB denied clearance for the annual report form on the basis of its burdensome information requests. EPA told the regulated community that, absent OMB clearance, hazardous waste generators and facilities need not submit annual reports, which prompted the Environmental Defense Fund to file a lawsuit (Current Developments, Aug. 27, p. 556).

Edwin Dale, an assistant to the director of OMB public affairs, Sept. 13 told BNA, "We have agreed to withdraw our opposition under the Paperwork Reduction Act to the annual report requirement for 1981." He said OMB will allow annual reports to be submitted at least once, because the office realized the forms "would have more value than once thought."

More Waste Data Said Needed

Dale told BNA, "We're doing this because we realized we don't have enough good baseline data on hazardous waste generation." Kristine Hall, staff attorney with the Environmental Defense Fund, Sept. 10 said the data EPA currently is using on hazardous waste generation and its ultimate disposal were acquired before RCRA was enacted in 1976.

According to Dale, EPA will have to resubmit the annual report with a new justification, and "we'll clear it promptly." EPA officials Sept. 13 and 14 confirmed that they had resubmitted the annual report form for clearance.

John Skinner, acting director of EPA's office of solid waste, Sept. 10 told BNA that the agency soon will publish a Federal Register notice announcing that the annual report has been cleared and must be submitted to EPA within about 60 days. Skinner noted that OMB has not yet cleared a statistical survey form that EPA hopes eventually will replace the annual report.

Dale said, "There's no doubt that the agreement should render moot EDF's lawsuit."

Hall told BNA Sept. 13, however, "It's good news, but the relief we asked for was for EPA to publish a notice in the Federal Register reinstating all three reporting requirements" — the annual report, the initial year quarterly groundwater monitoring parameter readings, and the groundwater quality assessment program outlines (Feb. 26, p. 1358). She continued, "Until that is done, I don't think the case is moot."

An EPA official Sept. 13 said the agency plans to publish a Federal Register notice that will address all three reporting requirements. According to the official, "It's a very nice

notice. We're giving them [EDF] everything." The official said EPA intends for the notice to settle EDF's lawsuit.

OMB Authority To Review Rules?

Hall said that although OMB admitted the annual report is needed to provide better data on hazardous waste activities, "below the surface, it was probably OMB's desire to avoid a court case ruling that OMB has no authority [under the Paperwork Reduction Act] to review existing regulations and forms."

A recent Justice Department opinion rejected OMB's argument that under the Paperwork Reduction Act it has authority to disapprove information collection requests imposed under existing regulations. Justice said recordkeeping and labeling requirements imposed under existing rules cannot be disapproved and held up by OMB, although the budget office has authority to review and disapprove regulations imposing paperwork burdens adopted after the law's April 1, 1981, effective date (July 16, p. 368).

OMB Sept. 8 proposed regulations to require that paperwork requirements not be imposed by federal agencies unless the practical value of the information is worth the imposition of the burden (47 FR 39515).

In a preamble to the proposed rules, OMB said application of the Paperwork Act to existing rules was the most difficult question faced in interpreting the statute. If paperwork control under the law did not extend to existing regulations, OMB said, virtually all recordkeeping and most other types of information collection requests would be exempt from scrutiny and burden reduction.

In view of Justice's opinion, however, OMB concluded that it will not assert authority to disapprove information collection requirements contained in existing rules adopted after public notice and comment "without further notice and comment." Moreover, OMB said, reporting and recordkeeping requirements in agency regulations will not automatically lapse in the absence of OMB reapproval at the end of the clearance period.

If OMB determines that reporting or recordkeeping requirements in existing regulations are unnecessary, the office must direct the affected federal agency to initiate rulemaking proceedings with public comment under the Administrative Procedure Act to "investigate the advisability of modifying or rescinding the requirements."

The budget office said the proposed rules, to replace OMB Circular No. A-40 that carries out the Federal Report Act, will substantially reduce the paperwork burden imposed on small businesses and other entities by the federal government.

Comments on OMB's proposal should be submitted by Oct. 25 to Nat Scurry, Reports Management Branch, Office of Information and Regulatory Affairs, Office of Management and Budget, Washington, D.C. 20503.

Air Pollution

LITTLE HOPE SEEN FOR ACT AMENDMENTS OR EVEN 'SHORT' EXTENSION BILL THIS YEAR

With about 10 working days remaining in the House this session, passage this year of Clean Air Act amendments or even a "short bill" extending the attainment deadlines is improbable, according to industry and congressional representatives.

Passage of amendments would require that they be approved by the House Energy and Commerce Committee where they have been stalled since Aug. 19, be cleared by

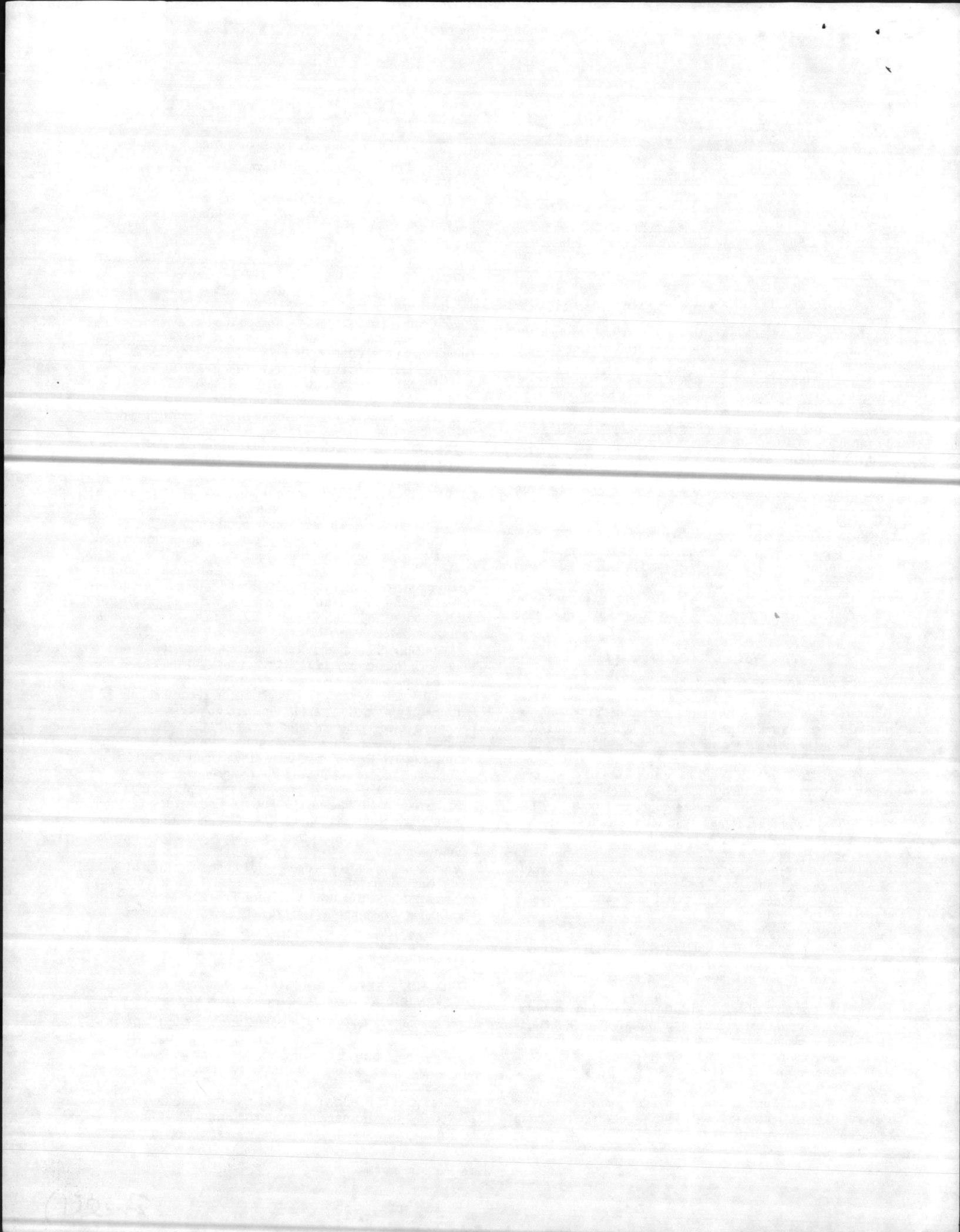

Snel (2)

NEPSS



Naval
Environmental
Protection
Support
Service

HAZARDOUS WASTE FACILITY OPERATORS COURSE

SPONSORED BY:

SOUTHERN DIVISION
NAVAL FACILITIES ENGINEERING
COMMAND
CHARLESTON, SC 29411

AND

NAVAL ENERGY AND ENVIRONMENTAL
SUPPORT ACTIVITY
PORT HUENEME, CA 93043



DEPARTMENT OF THE NAVY

NAVAL ENERGY AND ENVIRONMENTAL SUPPORT ACTIVITY
PORT HUENEME, CALIFORNIA 93043

OFFICIAL BUSINESS

PENALTY FOR PRIVATE USE \$300
11ND-NEESA-3110/2 (8-80)

POSTAGE AND FEES PAID
DEPARTMENT OF THE NAVY
DOD-316



PURPOSE

This four-day course will provide the students with the knowledge required to perform their jobs in a safe, efficient, and environmentally sound manner. The course also fulfills regulatory training requirements. Students successfully completing this course are awarded a certificate.

TARGET AUDIENCE

This course is specifically directed to Navy personnel who actually package, label, handle, transport, sample, and store hazardous materials and wastes. This course is not intended for program managers or others whose involvement is peripheral or policy-oriented.

COURSE CONTENT

The course provides knowledge and guided exercises in the safe and environmentally sound operations of hazardous material and waste facilities in accordance with all applicable EPA and Navy guidelines. The curriculum of the Navy hazardous waste course includes hazardous materials and waste laws and regulations; Navy hazardous materials environmental management program policy; hazardous material identification and classification; health effects and personal safety; labeling, packaging, handling, storage, and transportation procedures; spill response planning; emergency procedures; information sources; and specific on-site training procedures.

NOMINATION PROCEDURE

Submit nominations, by message, to: NAVENENVSA PORT HUENEME CA. Nominee's name, rank or grade, social security number, job title, activity name, class date and location desired should appear on the message. An information copy of the message should be sent to the cognizant EFD. These messages must be received at the Naval Energy and Environmental Support Activity (NEESA) by the deadline shown below, for a given class, as classes are limited to 30 students. Nominating activities are responsible for arranging and funding necessary travel and lodging.

This training is provided by NEESA through NAVFACENCOM arrangements with the Army Logistics Management Center (ALMC), Fort Lee, Virginia. The NEESA-acceptance notification will be sent by message to the nominee's activity. This notification includes student's name, reporting instructions, and classroom location. Further information may be obtained by telephoning Elizabeth Ford (NEESA) at A/V 360-4504 or Joe McCauley (SOUTHNAVFACENCOM) at A/V 794-5510.

COURSE SCHEDULE

<u>LOCATION</u>	<u>CLASS DATES</u>	<u>NOMINATION DEADLINE</u>
Charleston, SC	5-8 26-29 Oct 82	1 15 Oct 82
Seattle, WA	16-19 Nov 82	19 Oct 82
Jacksonville, FL	7-10 Dec 82	9 Nov 82
San Francisco, CA	7-10 Dec 82	9 Nov 82
Pearl Harbor, HI	11-14 Jan 83	14 Dec 82
Philadelphia, PA	26-29 Apr 83	29 Mar 83
Norfolk, VA	7-10 Jun 83	10 May 83
Washington, DC	14-17 Jun 83	17 May 83
San Diego, CA	30 Aug-2 Sep 83	2 Aug 83



Naval
Environmental
Protection
Support
Service

HAZARDOUS WASTE FACILITY OPERATORS COURSE



-TUESDAY-

HOURS	SUBJECT	INSTRUCTOR	REFERENCES/REMARKS
0800-0815	INTRODUCTORY REMARKS	SPONSOR	
0815-0900	COURSE OVERVIEW	NEESA	
0900-1030	HM & HW PROBLEM	NEESA	
1030-1130	HM & HW LAWS, REGULATIONS & POLICY	NEESA	
1130-1230	LUNCH		
1230-1400	HM CLASSIFICATION	ALMC	
1400-1500	HEALTH & ENVIRONMENTAL EFFECTS	ALMC	
1500-1600	PERSONAL SAFETY	ALMC	
1600-1830	REVIEW AND DISCUSSION	ALMC	

NEPSSNaval
Environmental
Protection
Support
Service**HAZARDOUS WASTE FACILITY OPERATORS COURSE****-WEDNESDAY-**

HOURS	SUBJECT	INSTRUCTOR	REFERENCES/REMARKS
0800-0900	PERSONAL SAFETY	NAVY	
0900-1030	HM IDENTIFICATION & LABELING	NEESA	
1030-1130	HM EXERCISE	NEESA	
1130-1230	LUNCH		
1230-1300	HM EXERCISE	NEESA	
1300-1400	HM PACKAGING	ALMC	
1400-1430	HM HANDLING	ALMC	
1430-1530	HM STORAGE	ALMC	
1530-1630	REVIEW AND DISCUSSION	ALMC	



Naval
Environmental
Protection
Support
Service

HAZARDOUS WASTE FACILITY OPERATORS COURSE



-THURSDAY-

HOURS	SUBJECT	INSTRUCTOR	REFERENCES/REMARKS
0800-0900	HM STORAGE	NAVY	
0900-0930	HM TRANSPORTATION	NEESA	
0930-1030	HM CONSIDERATIONS IN THE NAVY	NAVY	
1030-1130	HM INCIDENT PREVENTION EXERCISE	ALMC	
1130-1230	LUNCH		
1230-1300	HM INCIDENT PREVENTION EXERCISE	NEESA	
1300-1400	CONTINGENCY PLANNING	NEESA	
1400-1600	SPILL RESPONSE, CLEANUP & DECONTAMIN- ATION	NEESA	
1600-1630	REVIEW AND DISCUSSION	NEESA	

NEPSSNaval
Environmental
Protection
Support
Service

HAZARDOUS WASTE FACILITY OPERATORS COURSE



-FRIDAY-

HOURS	SUBJECT	INSTRUCTOR	REFERENCES/REMARKS
0800-0900	EXAM	NEESA	
0900-1030	FIELD TRIP LOCAL CONSIDERATION'S	NAVY	
1030-1100	EXAM REVIEW	NEESA/ALMC	
1100-1200	OUTPROCESSING AND GRADUATION		

*Practical course to aid your career growth and protect your company...
informed managers save money!*

HAZARDOUS WASTES REGULATIONS COURSE

November 18-19, 1982
Washington, D.C.

a comprehensive analysis of current developments
under RCRA and Superfund

*...from the Environmental Information Institute
and
Pollution Engineering Magazine*



Administered by:
Government Institutes, Inc. • Washington, D.C.

Amel(3)

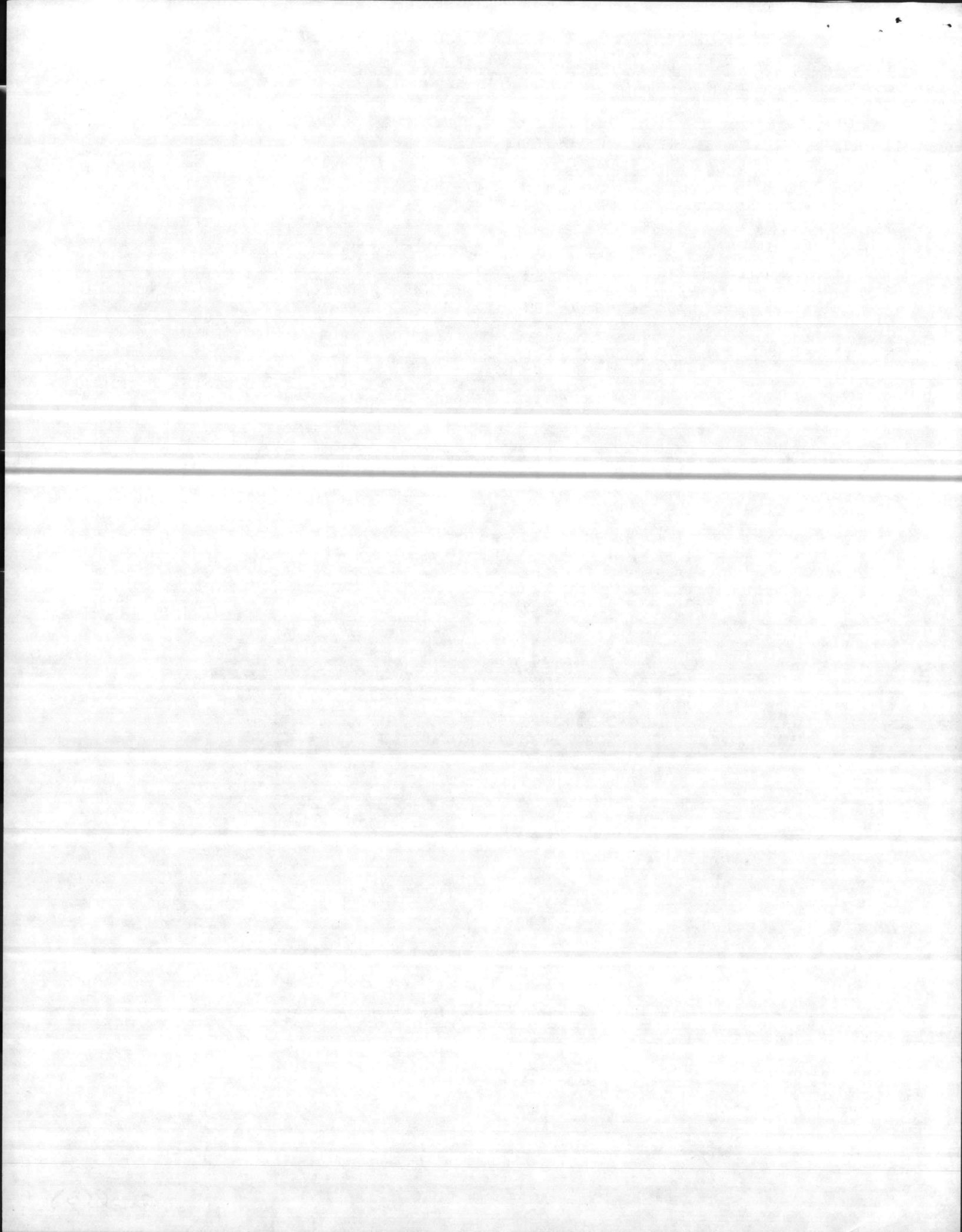

Hazardous Wastes Regulations

Informed managers save money and avoid embarrassments. This is particularly true in the hazardous waste field. The control of hazardous waste is such a top national priority that it has resulted in the largest and most confusing regulatory program ever undertaken. The complex RCRA and Superfund regulations encompass over a thousand pages and impact literally hundreds of thousands of businesses.

Now, the Reagan Administration, in its efforts to ease the regulatory burden, is making changes, including adding to the list of hazardous wastes some basic chemicals found in many products and processes. The new land disposal regulations also were recently promulgated. It is critical for you to be well-informed, or you will waste time and money.

At this Hazardous Wastes Regulations Course, you can learn all about the broad RCRA and Superfund regulatory programs plus their impact on your business operations. The law, regulations, cancellations, postponements, revisions and new regulations—plus the impact of recent court decisions and enforcement actions—all will be discussed in this concentrated course.

If you don't have current information, you could be wasting your time and money plus risking the personal embarrassment of an enforcement action.

The Course

This course is *not* merely a series of nice lectures. To provide the practical information you need, we bring together the real experts to present a *structured and well-organized* two-day course based on a comprehensive text, the Hazardous Waste Handbook, 4th Edition (Sept. 1982). These lecturers include Washington attorneys who daily advise their clients on environmental matters; EPA personnel involved in the development of the regulations and their enforcement, and industry representatives with years of experience. These lecturers provide a comprehensive yet concentrated description of the RCRA Hazardous Waste Program, the Superfund (CERCLA) Program and current developments, but more importantly, what these really mean to the regulated community and what you must do for cost-effective compliance.

Question and answer periods have been set aside so that you can ask those questions for which you need answers and to discuss your compliance problems and concerns specifically with these experienced professionals. This is an information-packed course with a professional text designed to save you time, money and worry.

This is a proven course that has been offered for six years. Each year, it is completely updated and improved.

Please review the course carefully. If you're involved with hazardous waste, we are sure you will agree that this is a good investment of your time and money. If you have any questions about the course, please call 301/251-9250. Our job is to serve your informational needs.

PROGRAM AGENDA

November 18-19, 1982

**Stouffer's National Center
Arlington, VA (Washington, DC)**

First Day — November 18, 1982

Ridgway M. Hall, Jr.
Program Chairman
Crowell & Moring
Washington, DC

9:00 am **COMPREHENSIVE DESCRIPTION OF RCRA
AND THE REGULATORY PROGRAM**
Ridgway M. Hall, Jr.

What are the key sections; what does the law say in laymen's terms; what are the practical implications; amendments to RCRA and their meaning; practical review of the hazardous waste regulatory program mandated by RCRA, Superfund, Used Oil Act and other statutes—how they interact.

10:00 am **WHAT WASTES ARE HAZARDOUS?**
Alan S. Corson
Chief, Waste Characterization
EPA Headquarters
Washington, DC

A description of the complex Section 3001 regulations for identification and listing of hazardous wastes; criteria; characteristics; testing methods; lists of wastes, sources and processes; demonstrating non-inclusion; exemptions; what you should do about these regulations; new list revisions; new definition and the impact of the '82 changes.

11:00 am **GENERATOR REQUIREMENTS**
David R. Case
Crowell & Moring
Washington, DC

The regulations applicable to generators of hazardous wastes will be described including requirements for recordkeeping, the *new* uniform manifests, labeling, containers, storage, reporting, contracting problems, exemptions and regulatory changes.

11:30 am **Questions and answers with**
Messrs. Case, Corson & Hall

12:30 pm Luncheon with your colleagues and the speakers

2:00 pm **TRANSPORTER REQUIREMENTS**
David R. Case

Regulatory requirements for transporters; legal relationships between generators, transporters and disposers; hazardous waste spills; DOT regulations and DOT-EPA relations; negotiating responsibility; on-site vs. off-site, and more.

2:30 pm **TREATMENT, STORAGE & DISPOSAL
REQUIREMENTS**
David R. Case

Analysis of the treatment, storage & disposal regulatory requirements, performance standards, recordkeeping, reporting, monitoring, location, design, construction, maintenance, operation, financial responsibility changes, interim status, compliance schedules, siting issues, and new changes.

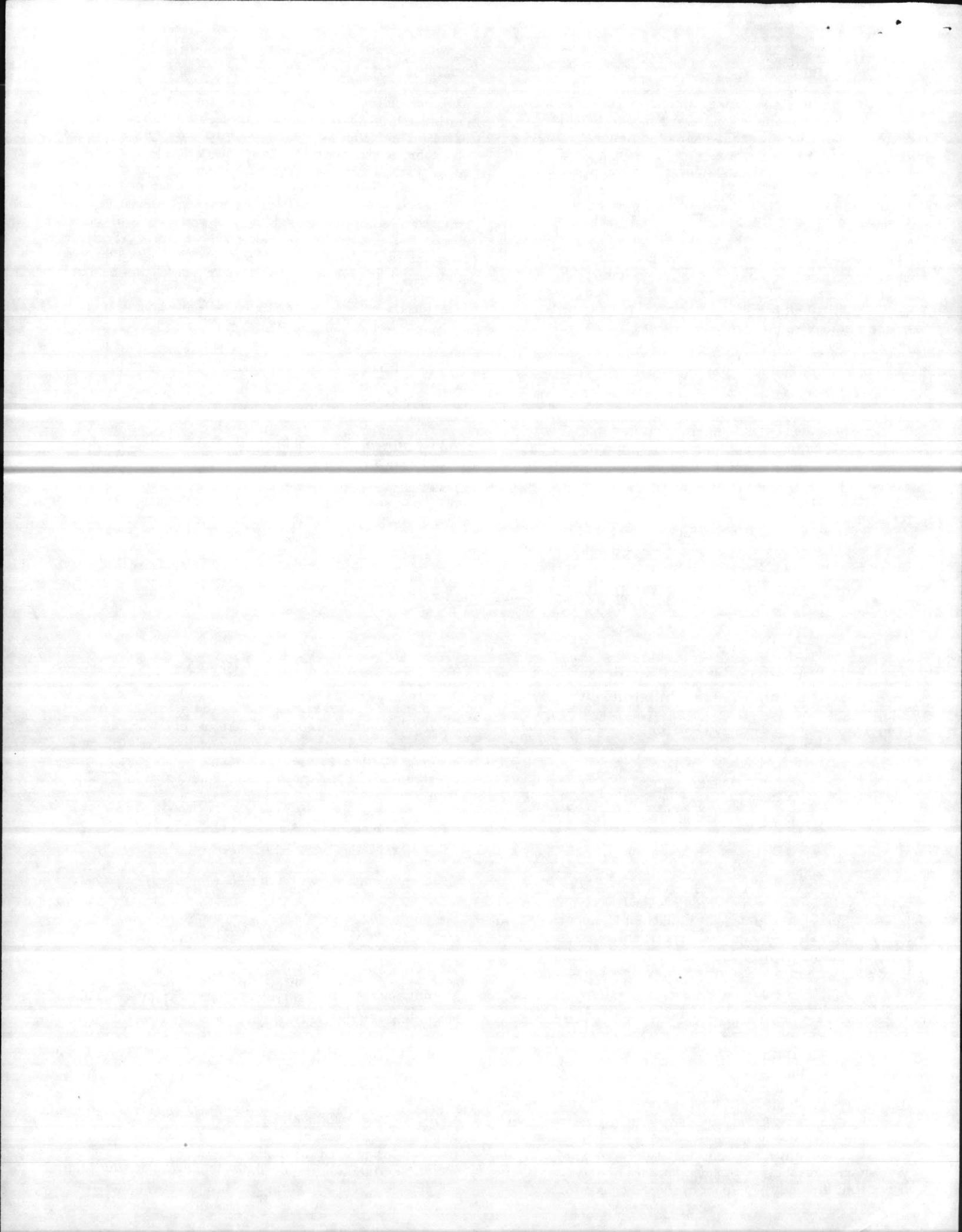

First Day — November 18, 1982 (continued)

3:30 pm EPA CONSIDERATIONS IN DEVELOPING AND IMPLEMENTING THE RCRA REGULATORY PROGRAM

John Skinner
Director
Office of Solid Waste
EPA Headquarters
Washington, DC

4:00 pm INDUSTRY PERSPECTIVE OF THE REGULATORY PROGRAM

Anne M. Toothaker
Regulatory Affairs
General Electric Co.
Schenectady, NY

4:15 pm Questions and answers/discussion with Messrs. Case, Hall, Skinner and Ms. Toothaker

5:00 pm Reception: that invaluable opportunity to discuss informally your specific concerns with the faculty and your colleagues.

Second Day — November 19, 1982

9:00 am RCRA PERMITS AND THE CONSOLIDATED PERMIT PROGRAM
Ridgway M. Hall, Jr.

The RCRA regulations require permitting for treatment, storage and disposal facilities. Many organizations need to know the how, who, when, and other details for compliance plus an analysis of what is happening in the new consolidated permit program.

9:45 am STATES' EMERGING ROLE
David R. Case

Many states are taking responsibility for these regulatory programs. What the states are doing and their changing roles under the Reagan Administration will be described.

10:30 am HAZARDOUS WASTES MANAGEMENT

Gary Dietrich
(former Director, Solid Waste, EPA)
Senior Vice President
Clement Associates, Inc.
Washington, DC

A whole new hazardous waste era is dawning involving recycling, recovery, re-use and their attendant economic considerations. This presentation will describe these changes and discuss the future in the light of the changing regulatory environment.

11:00 am EPA ENFORCEMENT

Gene A. Lucero
Director
Waste Programs Enforcement
EPA Headquarters
Washington, DC

What are EPA's plans for enforcement: civil and criminal

penalties? What are their priorities? How are EPA and the states handling these enforcement programs?

11:30 am Questions and answers/discussion with Messrs. Case, Hall, Dietrich & Lucero

1:15 pm SUPERFUND STATUS REPORT
Ridgway M. Hall, Jr.

The Comprehensive Environmental Response, Compensation and Liability Act (Superfund) is a topic of national prominence. The law, regulations, current litigation, regulatory developments, and the new National Contingency Plan revisions will be described.

1:45 pm USED OIL RECYCLING ACT
David R. Case

This law and its impact on industry will be described. EPA submitted a report to Congress and is considering regulations. What is happening and what will develop in the future?

2:00 pm PROSPECTUS PANEL
Roger J. Gray
Vice President
Ecology & Environment
and
Carl St. Cin
Monsanto Chemical Co.

What's evolving from EPA's hazardous waste site investigations? What's really going to happen with EPA, states, industry, environmental groups? Court challenges? What are practical considerations? Timetables? Other interesting issues focusing on what should you do to avoid liability and save money.

3:30 pm Adjournment

Sampling of Previous Registrants' Comments:

George Schupp, Soabar Division of Avery International: "Individually and collectively, your speakers were the most informed I have yet to listen to. Your annual update on hazardous waste regulations will be a must on my calendar."

R.B. Tabakin, American Cyanamid: "Very good and timely!"

Anthony Catanese, New Jersey Dept. of Environmental Protection: "Well prepared speakers and up-to-date text. Excellent, professional program."

Robert Zayko, Residuals Management Technology, Inc.: This course was very informative in that key employees of EPA were present to give pertinent background on the regulations as well as answer questions."

Janos Schulze, Ciba-Geigy Corp.: "Excellent course offering not only updated knowledge of RCRA and Superfund but insights into present and future problem areas."

Will Solomon, Raltech Scientific Services: "Well organized, covered all points well. Good speakers."

Barbara Jarvis, U.S. EPA: "Very thorough and useful."

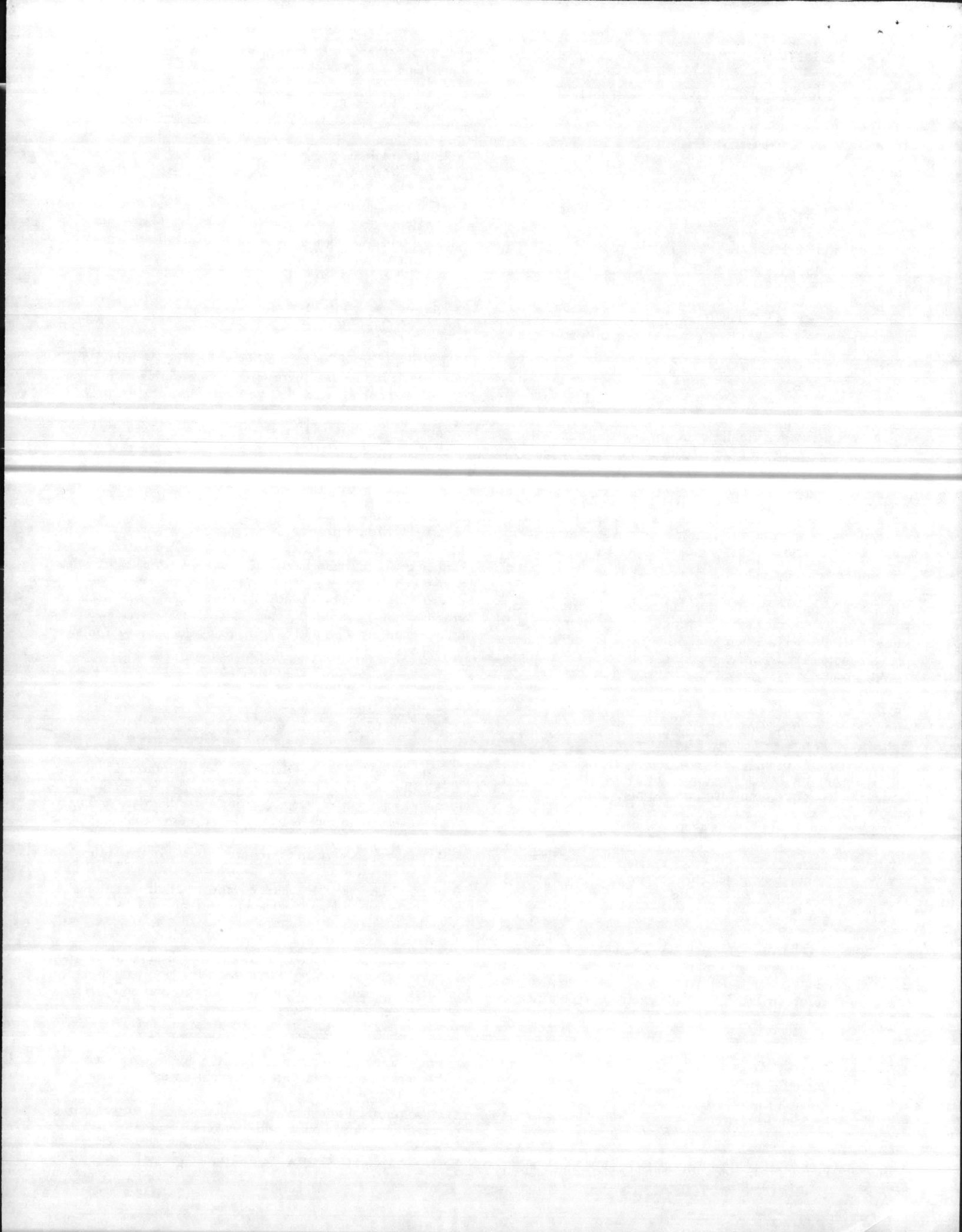

Environmental Reference Books

EPA's RCRA Inspection Manual

The regulatory program created by the Resource Conservation and Recovery Act (RCRA) is now basically in place. The federal and state governments are moving into enforcement and the key enforcement tool is a RCRA inspection. The U.S. Environmental Protection Agency has developed the RCRA Inspection Manual to support its inspectors in conducting the complex field inspections fundamental to hazardous waste enforcement. Now Government Institutes is making this Manual available to industry so that you can better understand what compliance is expected of you and how you can most effectively and efficiently comply with the law—before the inspector arrives. The Manual contains information-packed pages covering the key topics that will help you eliminate deficiencies and satisfy an inspection, thereby avoiding civil and criminal penalties. If you and your business are subject to RCRA regulations, you can't afford to be without a copy of this Manual and its invaluable inspection checklists.

300 pages, soft cover, Available September 1982, \$35.00

Environmental Law Handbook, 6th Edition

Environmental law is not the exclusive domain of lawyers. Those who are in the forefront of compliance plus lawyers and government personnel are the intended readers for the Environmental Law Handbook. A best-seller in the environmental field, this remarkably useful handbook provides practical information on the major environmental areas with a chapter each on water pollution, air pollution, land use, pesticides, toxic substances, noise, hazardous and solid wastes, plus a single chapter on some of the fundamentals basic to environ-

mental law: environmental torts, constitutional law considerations, evidence, defenses, who can sue, civil and criminal liability.

Its sharp, insightful analyses are written in a clear, non-legalese style to make an easy reference for both lawyers and all environmental professionals responsible for understanding and complying with the laws and regulations. This is not a dust collector for your shelf but a handy reference that you will read and use as thousands of others already do.

Hardcover, 349 pp., \$39.50

1982 Hazardous Material Spills Conference Proceedings — NEW!

Hazardous materials is a topic of major national concern. The Federal Government—represented by the Coast Guard, EPA and Bureau of Explosives—teamed with the Chemical Manufacturers Association and a number of other affiliated groups to document the current status of industry and government activities in their sixth biennial conference. The proceedings of the conference feature the top 80 authorities in the field on such topics as: Emergency Response;

Prevention of Hazardous Spills; Automatic Data Support Systems; PCB's; Detection/Monitoring; Personnel Safety; Legislation (Superfund) Groundwater Contamination, Mitigation and Remedial Action; Case Histories on Pesticide Fires and Other Spills; Contingency Planning; Who's in Charge; Movement/Modeling; Training; Prevention; Disposal, and Cleanup Liability.

510 pages, 1982, \$48.50

New 1982 Environmental Statutes

This unique reference incorporates all major environmental laws into a single, convenient book. The complete text of each statute as currently amended is included with a detailed Table of Contents for your quick referral. You'll want to keep this handy and inexpensive volume on your desk so that the specific sections and amendments you must understand are at your fingertips. It's so good and so valuable that EPA and the Congress rely on it. You'll want one for yourself and for each member of your environmental team!

Contents: Clean Air Act as amended; Federal Water Pollution Control Act (Clean Water Act); National Environmental Policy Act; Noise Control Act as amended; Occupational Health and Safety Act; Resource Conservation and Recovery Act as amended; Safe Drinking Water Act as amended; Toxic Substances Control Act; Comprehensive Environmental Response, Compensation and Liability Act of 1981 (Superfund); and the Used Oil Recycling Act of 1980.

601 pp., August 1982, \$18.95

EPA's Official TSCA Inspection Manual — NEW!

EPA has published for use by its inspectors in their enforcement activities the Toxics Substances Control Act Inspection Manual. The manual was developed to support inspection personnel in conducting the complex field inspections that are fundamental to TSCA enforcement. Although intended as the guide for EPA inspectors, this manual also should be an invaluable aid to those in industry so that they can better understand

what compliance is expected of them.

The manual contains 300 information-packed pages covering such topics as EPA Inspector's authority and responsibilities, inspection procedures, post-inspection activities for the inspector, special procedures, forms, samples, PCB's enforcement program, and much more.

300 pp., \$35.00

NEW
September '82



NEW
August '82

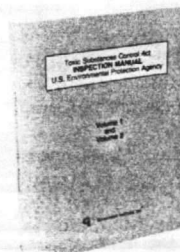

he
erts
ed
n
rs;
s of
n-
e
t
n-
can
s
e
se
l
ch
ar-
st-
ut
in-
stes
ing,
age,
tory
ers
hips
dous
ons;
y re-
port-
ance,
atus,

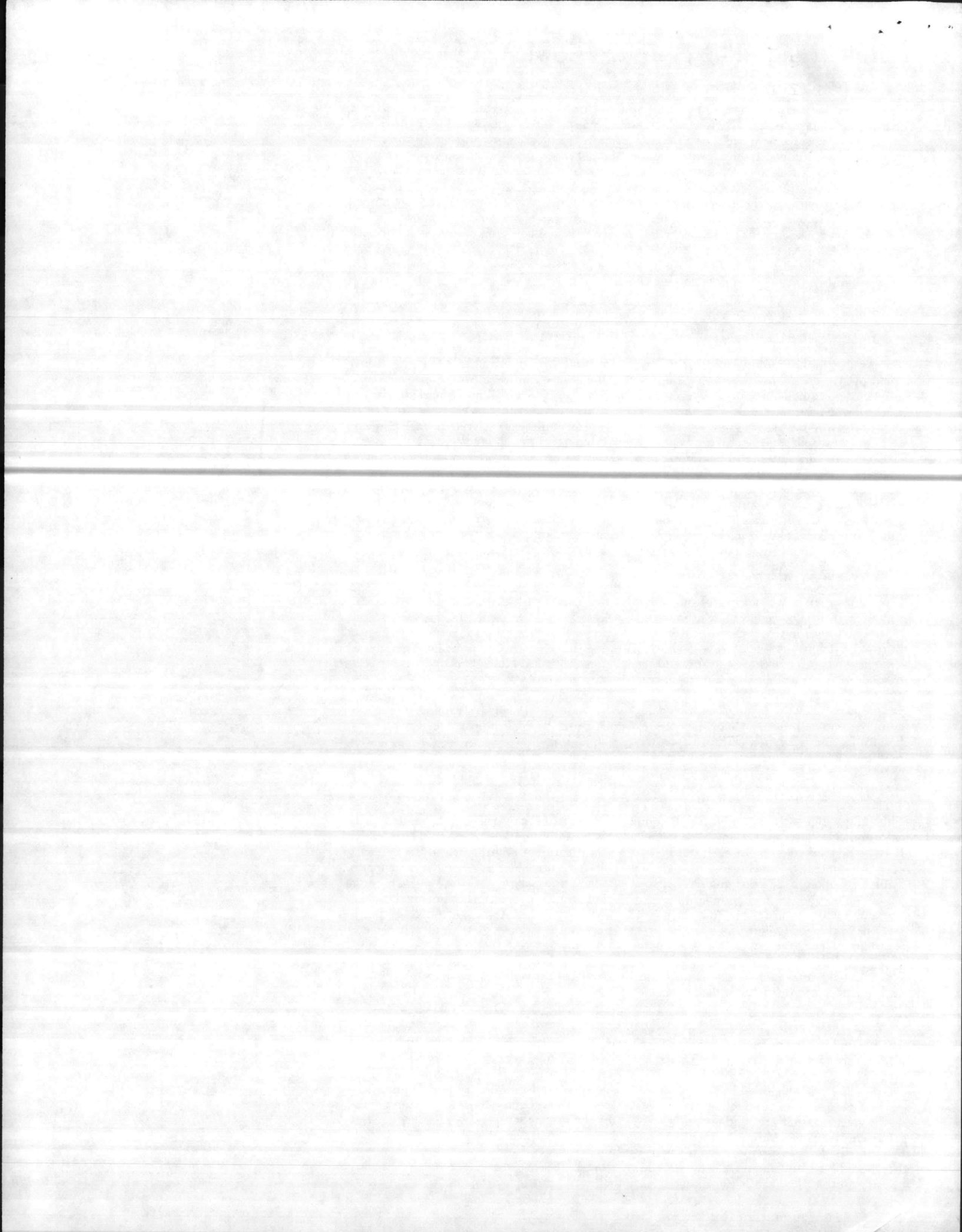

First

The Course Text: Hazardous Wastes Handbook,

3:3

4th Edition (September 1982)

All the latest information you need to comply

Cut through the confusing red tape surrounding your industrial wastes with the new, totally revised 4th Edition of the **Hazardous Wastes Handbook**, exclusively from Government Institutes. Get clear and concise answers which take you step-by-step through the maze of EPA regulations.

4:0

This easy-to-read book contains a specially commissioned 350-page analysis of the laws and regulations prepared by a team of Washington lawyers from the firm of Crowell & Moring. The authors have a wide range of experience representing both large and small business firms. So, this is a practical book with invaluable analysis and insights based on years of actual experience.

4:1

5:0

Since the initiation of the complex RCRA and Superfund (CERCLA) programs, many statutory amendments and extensive additions have been made to the regulations. Reflecting these changes, the 4th Edition carefully analyzes the impact of all these regulatory programs on your business and provides practical suggestions—in non-legal language—on how you can cost-efficiently and effectively comply with the latest regulations including the new land disposal regulations and other new developments.

Sec

9:0

More than 1,000 industrial managers like yourself already have benefited from earlier editions of this Handbook's clear and concise guidelines to compliance. Avoid needless costs, business disruptions, and yes, even your own liability by calling in your order today or checking the box on the registration form!

The stor
know plus
per

9:4

This 600-page professional text is the course manual for the Hazardous Wastes Regulation Course.

Man
grat
und

10:3

Table of Contents

Chapter One—Overview of RCRA: The RCRA Act; Hazardous Waste Program; Compliance Deadlines; EPA Interpretations of the Regulations; Congressional Amendments.

A v
recy
side
disc
virc

Chapter Two—Identification of Hazardous Wastes: Statutory Requirements; Definition of Solid Waste & Hazardous Waste; Lists; Characteristics Testing; Mixtures; Delisting; Special Requirements for Small Generators; Hazardous Wastes which are Reused, Recycled, or Reclaimed; Residues.

11:0

Chapter Three—Notification of Hazardous Waste Management Activities: Statutory Requirements; Use of EPA Form 8700-12; Who Must File a Notification; Where the Notification Must be Filed; Claims of Confidentiality; Consequences of the Failure to Comply with the Notification Requirements.

Chapter Four—Generators of Hazardous Waste: Who is a "Generator" of Hazardous Waste?; Requirements Imposed Upon Generators; Responsibility to Identify Wastes; EPA ID Number; Manifests; Pretransport Requirements; Recordkeeping; Reports; Exceptions; Temporary Storage.

Wh

Chapter Five—Transporters: Overview; Statutory Requirements; Transporters Obligation Under the RCRA Regulations; Hazardous Waste Discharges; DOT & EPA Enforcement.

Chapter Six—Treatment, Storage and Disposal (T/S/D) Facilities: Identification of T/S/D Facilities; Statutory Requirements for T/S/D Facilities; The Active/Inactive Facility Distinction; EPA's Two-Prong Approach to Regulating T/S/D Facilities; Interim Status T/S/D Facility Regulations; General & Specific Interim Status Standards; Standards for Permitted T/S/D Facilities; Standards for Special Types of Hazardous Waste T/S/D Facilities.

Chapter Seven—Permit Requirements: Statutory Requirements for Permitting T/S/D Facilities; Implementing Regulations; Interim Status Under the Regulations; General Status and the RCRA Permits; Permitting Procedures.

Chapter Eight—Authorization of States: Statutory Requirements; EPA's Implementing Regulation; Cooperative Agreements; Progress of States in Obtaining Authorization.

Chapter Nine—Inspection and Enforcement: Inspection Authority; Civil Enforcement; Criminal Liability; Imminent Hazard Liability; Enforcement Litigation; Citizen Suits; Summaries of Thirty Hazardous Waste Enforcement Cases.

Chapter Ten—Superfund Legislation: Description of the Act; Reportable Quantities; Response and Clean Up Authority; Liability and Financial Responsibilities; The Hazardous Substance Response Fund; The Post-Closure Liability Trust Fund; Reports; Administration, Miscellaneous Provisions.

APPENDIX

1. RCRA Statute
2. Superfund (CERCLA) Statute
3. Regulations from the Code of Federal Regulations
4. List of Federal Registers published under RCRA

Environmental Information Institute

The Environmental Information Institute—co-sponsor of this course—has been established as a non-profit, membership organization to encourage and promote continuing education in the environmental field. Through a computerized information storage and retrieval system, EII will document and certify your continuing education activities. It will set standards for the awarding of environmental continuing education units (CEU's) and certify to your employer that you are maintaining and improving your base of knowledge in the environmental field. This independent verification of the quantity and quality of your continuing education can enhance your career growth and pave the way to promotions and salary increases. To become a member of EII and begin accumulating your environmental CEU's (this course is worth 11 units), check the box on the registration form for details.

Government Institutes

Government Institutes has been in the environmental information field for over 10 years—we were the first firm to offer publicly environmental laws and regulations courses, and we have been improving on them ever since. We strive for quality in our educational endeavors to benefit you.

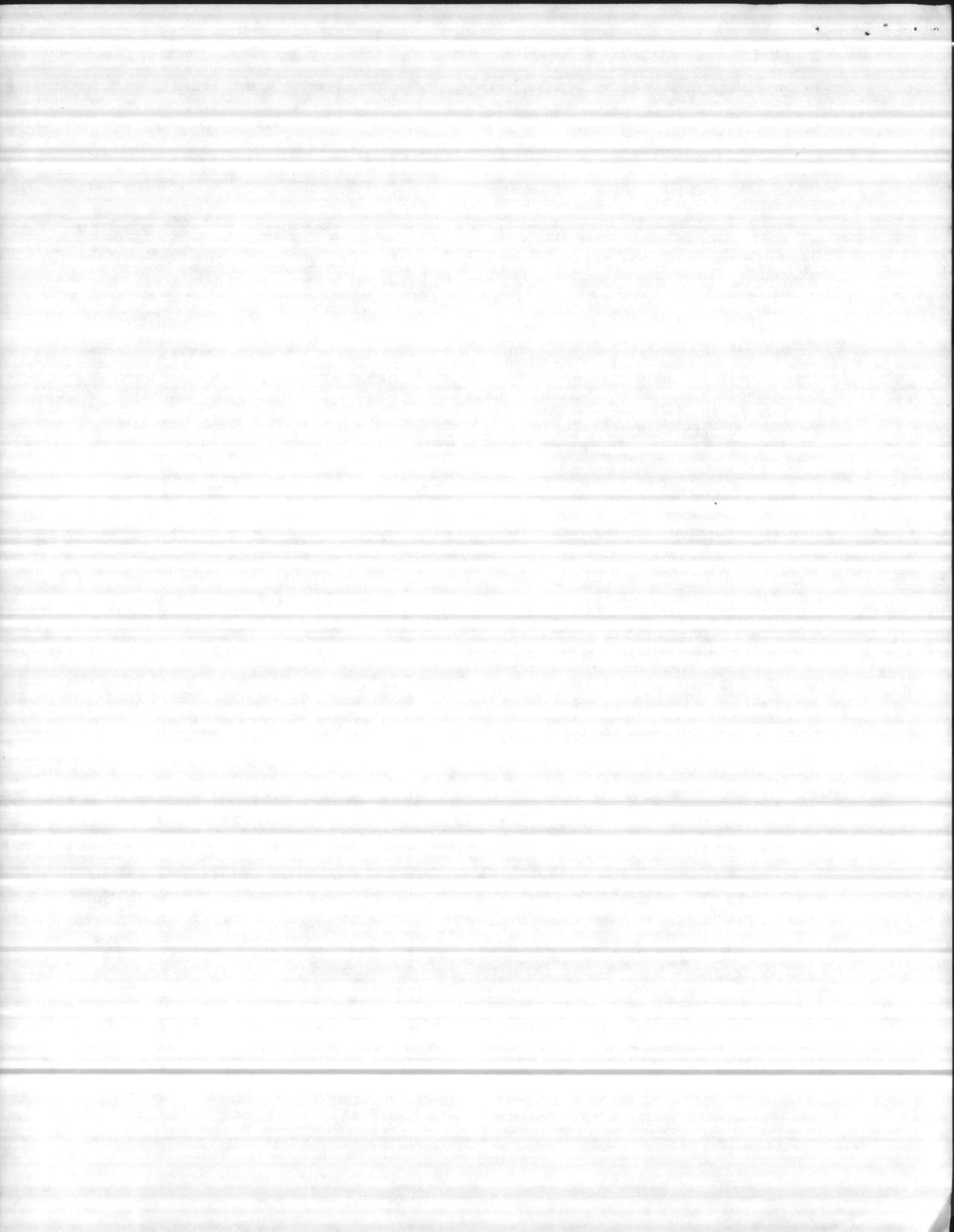

COURSE MATERIALS: The Hazardous Wastes Handbook, 4th Edition — one of the most respected works in this field — will be distributed as the course text. The purpose is twofold: to relieve you of the burden of taking voluminous notes—thus freeing you for greater concentration on the words of each lecturer—and to provide you with a ready-reference working aid for daily use. It is an easy-to-read, detailed analysis that comprehensively covers the many regulations. It gives suggestions on how to comply and tells you what you must do.

COURSE: This is NOT a loose collection of speakers but an organized course with a text that is supplemented by presentations. To give you a concentrated program without requiring you to sacrifice valuable business time, we have limited the program to two days filled with intense instruction. To provide you with the most information in the shortest possible time, plus the opportunity to discuss your particular problems, a combination of formal lectures and question/answer periods is employed. Each day, information-packed lectures are given. These are followed by Q/A periods in which the day's instructors will answer your questions, consider your problems, and concentrate on particular aspects of their subjects which are of interest to you. The result: a balanced program of instruction and individual discussion.

FACULTY: They bring with them an awesome accumulation of knowledge and instructional experience. They are involved in the environmental field day-to-day and can clearly sift through the thousands of details to inform you about the key considerations in this complex and changing field.

SUBSTITUTIONS/CANCELLATIONS: A full refund will be given for cancellations received in writing at least 10 working days before the course. A \$75 service charge will be levied against cancellations received in writing less than 10 working days before the course—but at least one working day before the course. No refunds will be given for cancellations received the day of the course or afterward. Substitutes may be designated up to the start of the course.

ACCOMMODATIONS: You are responsible for making your own housing reservations. A block of rooms for registrants at this course has been set aside at the Stouffer's National Center, 2399 Jefferson Davis Highway, Arlington, VA 22202, (703) 979-6800. A hotel reservation request card will accompany your registration acknowledgement. Reservations should be made at least three weeks prior to the course date to ensure obtaining accommodations. If you prefer to call the hotel directly for your reservation, please indicate that you will be attending the Hazardous Wastes Regulations Course.

CERTIFICATE AND ACCREDITATION: A handsome Certificate of Completion will be issued to those who faithfully attend and complete the course. In addition, the course has been approved for credit by many Continuing Legal Education authorities. Inquiries on accreditation are welcome. This course is accredited for 11 Environmental CEU hours by the Environmental Information Institute.

New & Unique
Environmental Professional Days
 November 8-10, 1982
 Philadelphia, PA

Eight intensive courses for you to choose from so you can improve yourself (to get promotions and raises) and save your company money. Course topics are: RCRA Inspections; Environmental Audits; Incinerators; Water Pollution; TSCA Inspections; Communications & Training; Environmental Insurance and Risk Assessments; Superfund. Call us *now* for a descriptive brochure on this new and cost-effective approach to environmental education at 301/251-9250.

Two ways to register:

- (1) Telephone 301/251-9250 with your credit card
 or
 (2) Detach and mail with payment to the address below (include your address label)

- Enclosed is \$590 for one Course registration and one Hazardous Waste Handbook, 4th Edition (the Course materials).
 Enclosed is \$495 for one Course registration. I already have the Hazardous Waste Handbook, 4th Edition.

Fee includes 2-day concentrated course sessions, refreshments, first-day luncheon and reception. An acknowledgement of this registration will be forwarded upon receipt of application and will include hotel reservation request form. Make checks payable to Environmental Information Institute, and mail to the course administrators: Government Institutes, 966 Hungerford Dr., #24, Rockville, MD 20850.

I wish to order the following books:

- Hazardous Wastes Handbook, 4th Edition, \$95.00
 EPA RCRA Inspection Manual, \$35.00
 Environmental Law Handbook, 6th Ed., \$39.50
 Hazardous Materials Spills Proceedings, \$48.50
 1982 Environmental Statutes Book, \$18.95
 EPA TSCA Inspection Manual, \$35.00

- Send me details on the Environmental Professional Days.
 Send me Environmental Information Institute Membership Application

Name _____
 Title _____
 Company/Organization _____
 Address _____
 City, State, Zip Code _____
 Telephone (a/c) _____

HW 1 2 3 4 5 6

Environmental Information Institute
 966 Hungerford Drive, #24
 Rockville, MD 20850

Bulk Rate
 US Postage
 PAID
 Permit No. 4695
 Rockville, MD

COMMANDANT MARINE CORPS 40771
 ATT: PAUL HUBBELL
 LFF2
 WASHINGTON DC 20380

Sponsored by Environmental Information Institute
 and Pollution Engineering Magazine
Continue your career growth through continuing education!

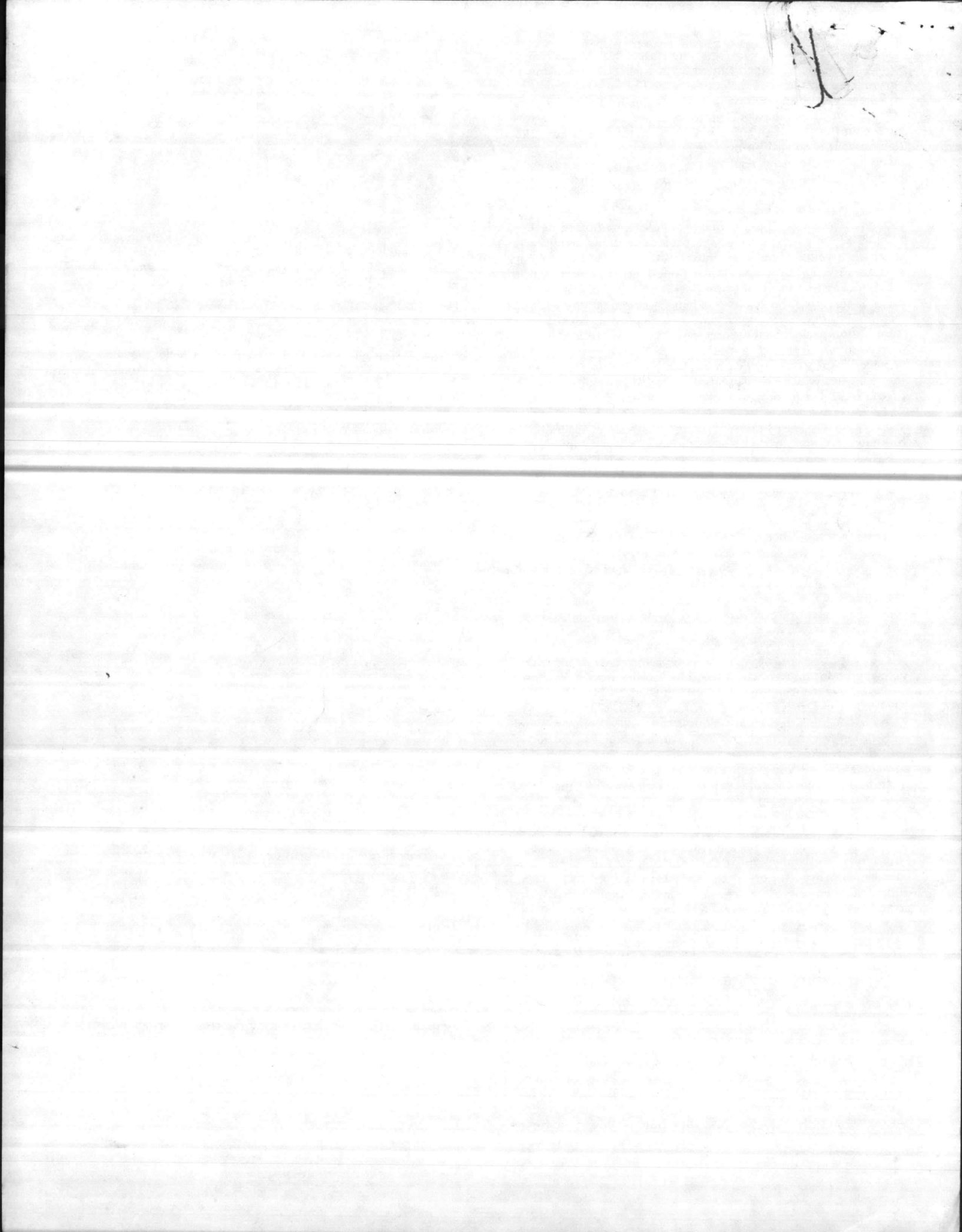

NATURAL RESOURCES AND ENVIRONMENTAL AFFAIRS BRANCH
Base Maintenance Division
Marine Corps Base
Camp Lejeune, North Carolina 28542

2456
Date

9-27-82

From: Director, NREAB

To: BMO

Subj:

2D FSSG has been disposing of medicines + medical supplies primarily at the Sanitary Landfill with some going into the sanitary sewer according to Chief Murray + Chief Almon.

J. Khan

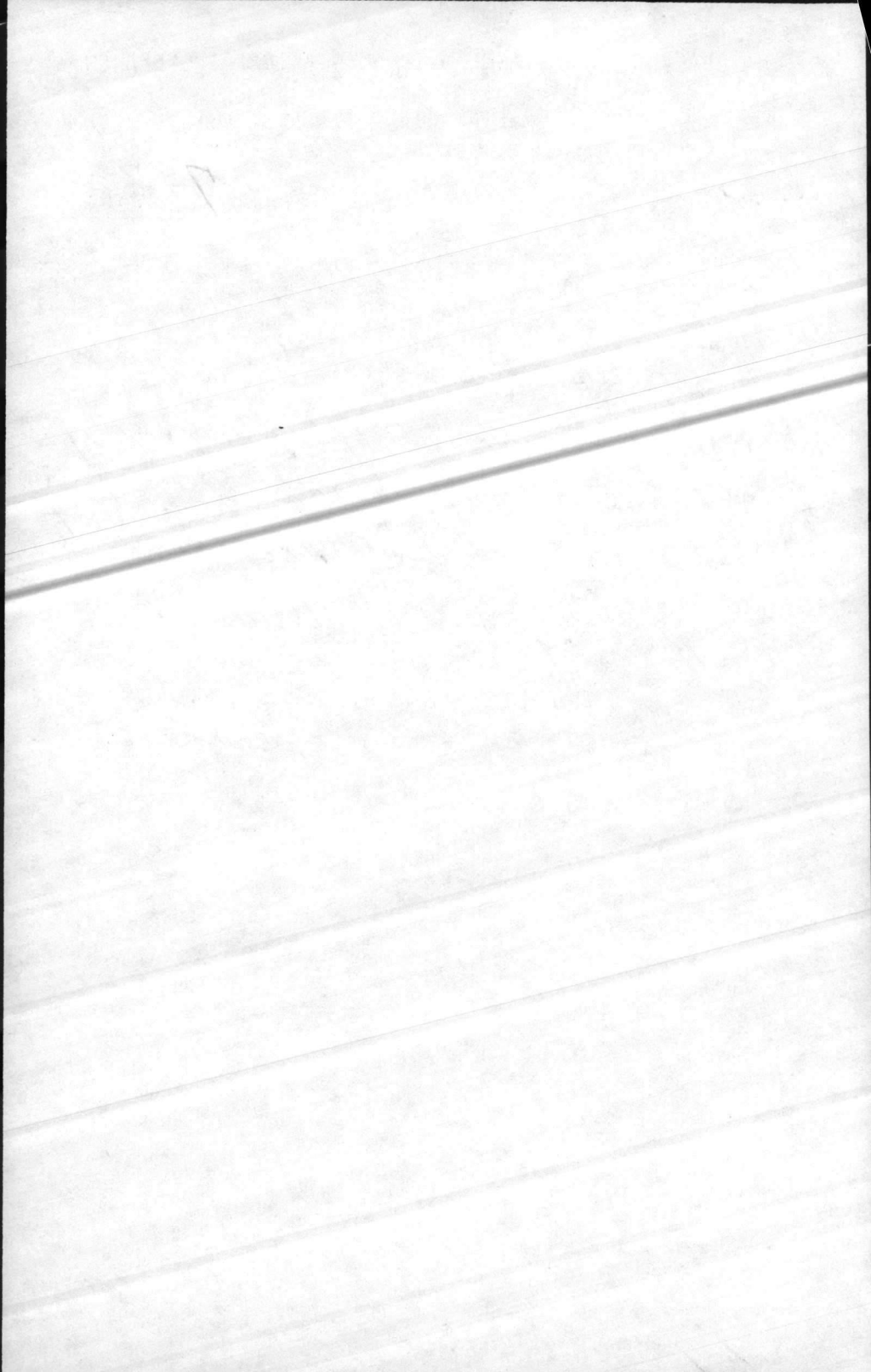

ASSISTANT CHIEF OF STAFF, FACILITIES
HEADQUARTERS, MARINE CORPS BASE

DATE 24 Nov 82

TO:

BASE MAINT O

DIR, FAMILY HOUSING

PUBLIC WORKS O

DIR, UNACCOMPANIED PERS HSG

COMM-ELECT O

BASE FIRE CHIEF

ATTN: NREA

1. Attached is forwarded for info/~~action~~.

NO ACTION REQUIRED.

~~2. Please initial, or comment, and return all papers to this office.~~

3. Your file copy

DD
Ally Doo 82
"LET'S THINK OF A FEW REASONS
WHY IT CAN BE DONE"

Darning
Note + Review
7 Dec 82

File

DDS

Jukin

46

COPY FOR NREA

* U N C L A S S I F I E D *

ROUTINE

29 5/2323Z

PT00549

PAGE 01

RTTUZYUW RUEACMC6537 2952323-UUUU--RUEB00A.

ZNR UUUUU

R 221444Z OCT 82

TO AIG EIGHT ACT: MCB

BT

UNCLAS //N11000//

SUBJ: ~~HAZARDOUS WASTE RECORDKEEPING AND REPORTING RQMTS (CMC CODE 15F-2)~~

- A. CMC 101425Z MAR 82
- B. MCBUL 6280 OF 1 MAY 80 WITH CH 1-2
- C. FEDERAL REGISTER VOL 47 FR44938 OF 12 OCT 82 (NOTAL)
- 1. REF A ADVISED OF ENVIRONMENTAL PROTECTION AGENCY (EPA) SANCTIONED DELAY FOR IMPLEMENTING THREE RQMTS UNDER ITS HAZARDOUS WASTE (HW) REGULATIONS, PUBLISHED UNDER SUBTITLE C OF RESOURCE CONSERVATION AND RECOVERY ACT (RCRA), AND IMPLEMENTED BY REF B. FOL SUMMARIZES REF C ANNOUNCEMENT RE SUBJ RQMTS:
 - A. 1981 ANNUAL RPT: GENERATOR AND TREATMENT, STORAGE, AND DISPOSAL (TSD) FACILITY RPTS FOR CALENDAR YEAR 1981 MUST BE POSTMARKED TO APPROPRIATE REGIONAL OFFICE OF EPA NLT 10 JAN 83. (EPA TO PRINT AND DISTRIBUTE ANNUAL RPT FORMS. IF FORMS NOT RCVD BY 30 NOV 82, REC CONTACT COGNIZANT ENGINEERING FIELD DIV OF

PAGE 02 RUFACMC6537 UNCLAS

(FACENGCOR FOR ASSISTANCE).

- B. QUARTEPLY GROUND-WATER MONITORING RPTS: OPERATORS OF HW SURFACE IMPOUNDMENTS, LANDFILLS, AND LAND TREATMENT FACILITIES MUST SUBMIT 6 MAR 82, 3 JUN 82, AND 3 SEP 82 GROUND-WATER MONITORING ANALYSIS RPTS IMMEDIATELY. (THE FINAL QUARTERLY RPT IS DUE 4 DEC 82).
- C. GROUND-WATER QUALITY ASSESSMENT PROGRAM OUTLINE: THOSE TSD FACILITIES PEQUIRING AN OUTLINE OF A GROUND-WATER QUALITY ASSESSMENT PROGRAM SHOULD NOW HAVE IT ON-SITE, AVAILABLE FOR REVIEW UPON REQUEST BY EPA REGULATORY OFFICIALS.
- 2. THESE CHANGES DO NOT AFFECT ANY MORE STRINGENT RQMTS IMPOSED BY STATES.
- 3. QUESTIONS RE THIS SUBJ SHOULD BE DIRECTED TO MR. PAUL HUBBELL AT AV 224-2171/3188.

BT

#6537

ORIGINAL
RECORDED

NN NN

ACT: BFAC

INFO: BADJ, COMP, MAIN, BPWO, DOST //345//

ROUTINE

* U N C L A S S I F I E D *

111 OCT

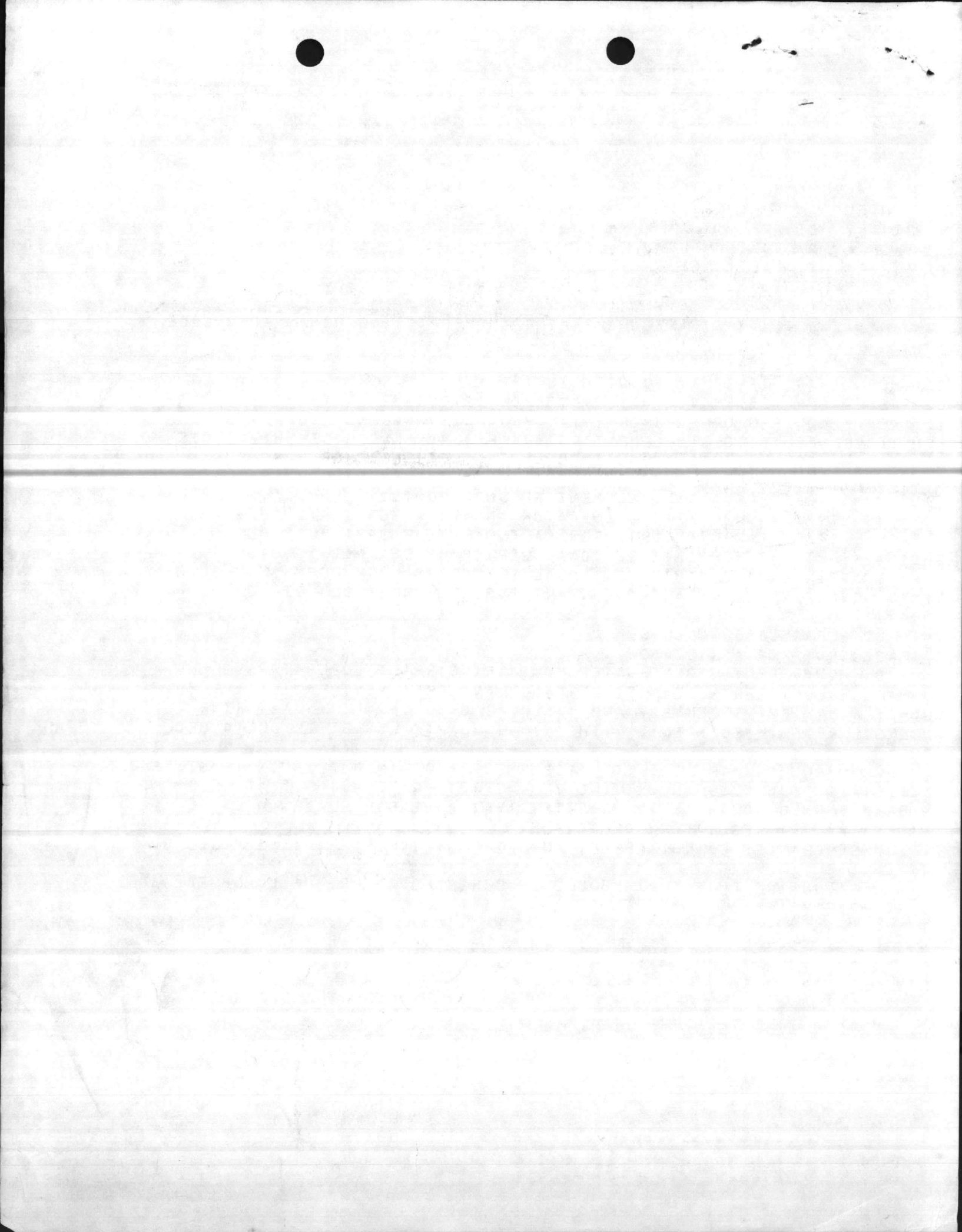

MAIN/DDS/th
6240

JUN 17 1982

From: Commanding General
To: Distribution List

Subj: Hazardous Material/Waste Disposal Program

Encl: (1) NC State Utilities Commission Docket No. M-100, Sub 91 of 7 Jun 1982

1. The enclosure addresses state regulations applicable to the subject program and is forwarded for your information.

R. F. CALTA
By direction

DISTRIBUTION:

CO MCAS(H), NR
CG 2dFSSG (Attn: PP&P)
DPDO
AC/S LOG (Attn: TMO)

CG 2DMARDIV

JUN 1 1985

Copy to:

CG SP4RDIV



UNITED STATES MARINE CORPS
MARINE CORPS BASE
CAMP LEJEUNE, NORTH CAROLINA 28542

IN REPLY REFER TO
MAIN/DDS/th
6240

JUN 17 1982

From: Commanding General
To: Distribution List

Subj: Hazardous Material/Waste Disposal Program

Encl: (1) NC State Utilities Commission Docket No. M-100, Sub 91 of 7 Jun 1982

1. The enclosure addresses state regulations applicable to the subject program and is forwarded for your information.

R. F. Calta
R. F. CALTA
By direction

DISTRIBUTION:
CO MCAS(H), NR
CG 2dFSSG (Attn: PP&P)
DPDO
AC/S LOG (Attn: TMO)
CG 2dMARDIV

SEP 14 1960

VICTIMS 00



UNITED STATES MARINE CORPS
MARINE CORPS BASE
CAMP LEJEUNE, NORTH CAROLINA 28542

IN REPLY REFER TO

MAIN/DDS/th
6240

JUN 17 1982

From: Commanding General
To: Distribution List

Subj: Hazardous Material/Waste Disposal Program

Encl: (1) NC State Utilities Commission Docket No. M-100, Sub 91 of 7 Jun 1982

1. The enclosure addresses state regulations applicable to the subject program and is forwarded for your information.

R. F. CALTA
By direction

DISTRIBUTION:
CO MCAS(H), NR
CG 2dFSSG (Attn: PP&P)
DPDO
AC/S LOG (Attn: TMO)
CG 2dMARDIV

UNITED STATES MARINE CORPS
MARINE CORPS BASE
CAMP BELLEVUE, NORTH CAROLINA 28543



JUN 17 1982

Copy to:

State of North Carolina
Utilities Commission
Raleigh

DOCKET NO. M-100, SUB 91

BEFORE THE NORTH CAROLINA UTILITIES COMMISSION

In the Matter of

Revision of Rule R2-46, Safety Rules and
Regulations, Transportaion of Hazardous
Materials by Private and For-Hire Motor
Carriers

) ORDER REVISING
) RULE R2-46
)
)

BY THE COMMISSION: On March 1, 1982, the North Carolina Utilities Commission entered an Order in this docket entitled "Notice of Proposed Rule Revision" whereby the Commission gave notice that it would revise Rule R2-46 in conformity with Appendix A attached to said Order unless significant protests pertaining to said rule revision and requests for hearing were received on or before June 1, 1982.

No protests or requests for hearing in this matter have been received by the Commission. By letter filed with the Commission on March 15, 1982, the Solid and Hazardous Waste Management Branch of the Environmental Health Section of the North Carolina Division of Health Services has indicated that it strongly supports the proposed rule revision.

IT IS, THEREFORE, ORDERED that Rule R2-46 be, and the same is hereby, revised in conformity with Appendix A attached hereto.

ISSUED BY ORDER OF THE COMMISSION.

This the 7th day of June 1982.

NORTH CAROLINA UTILITIES COMMISSION

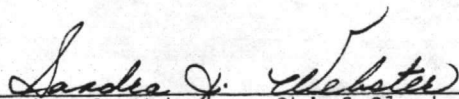

Sandra J. Webster, Chief Clerk

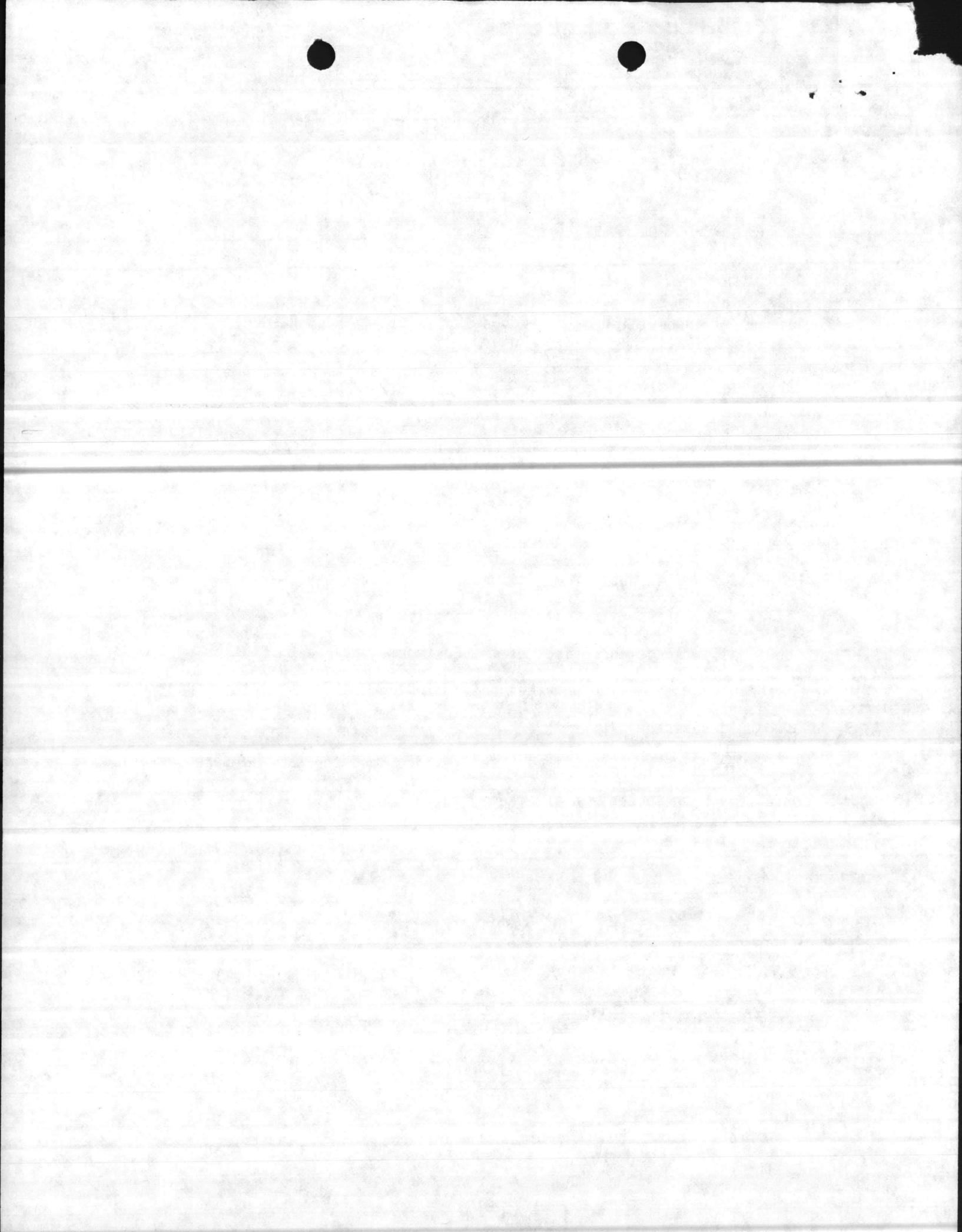
(SEAL)

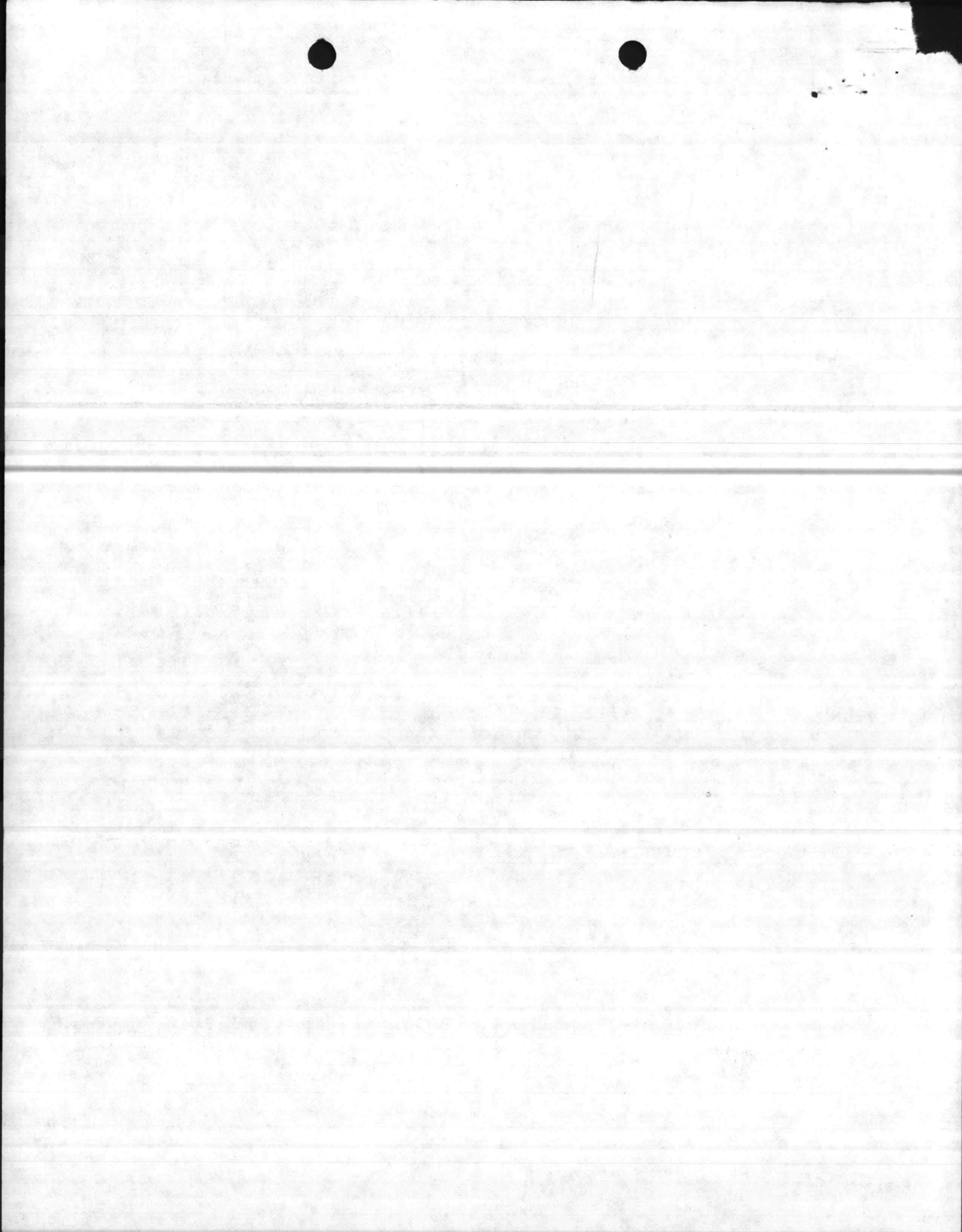

DOCKET NO. M-100, SUB 91

Rule R2-46. Safety rules and regulations. -- The rules and regulations adopted by the U. S. Department of Transportation relating to safety of operation and equipment (49 CFR Parts 390-398 - formerly Parts 290-298 - and amendments thereto) and the rules and regulations adopted by the U. S. Department of Transportation relating to hazardous materials (49 CFR Parts 170-190 - formerly Parts 71-79 - and amendments thereto) shall apply to all for-hire motor carrier vehicles engaged in interstate commerce and intrastate commerce over the highways of the State of North Carolina, whether common carriers, contract carriers or exempt carriers; provided, that Section 393.95(d) is amended by inserting the words "or snow tires" immediately following the words "tire chains." The rules and regulations adopted by the U. S. Department of Transportation relating to safety of operation and equipment (49 CFR Parts 390-398 and amendments thereto) and the transportation of hazardous materials (49 CFR Parts 170-190 and amendments thereto) shall also apply to all private motor carriers engaged in the transportation of hazardous waste and radioactive waste in interstate and intrastate commerce over the highways of the State of North Carolina.



NATURAL RESOURCES AND ENVIRONMENTAL AFFAIRS BRANCH
BASE MAINTENANCE DIVISION
MARINE CORPS BASE
CAMP LEJEUNE, NORTH CAROLINA 28542

4 June 82
Date

From: Director

To: BMO

Subj:

1.

Hazardous Mat/Waste State
inspection.

Danny was advised by a phone
call from state that an inspection
of MCB + MCA S(H)NR would
take place soon. a letter is
on the way so advising.

Jubain

ok
BWR

Handwritten text at the top of the page, possibly a name or title.

Main body of handwritten text, appearing as a list or series of notes. The text is mirrored and difficult to decipher due to bleed-through from the reverse side of the paper. Some faint words like "MCA" and "THINGS" are visible.

Handwritten text at the bottom of the page, possibly a signature or date.

MAIN/DDS/th
6240

MAY 24 1982

From: Base Maintenance Officer
To: Public Works Officer

Subj: Disposal of Low-Level Radioactive Waste; request for assistance

Ref: (a) CG MCB ltr MAIN/BWE/th 6240 of 9 Sep 1982
(b) NAVSUPINST 5101.9B
(c) FONECON btwn Ms. Irene Uselski, NSC (Code 105.1), and Mr. Danny Sharpe, BMAINDIV, on 5 Mar 1982

Encl: (1) NRMC ltr 62-khc 6260.5 of 12 Aug 1981
(2) West Nuclear Corporation ltr of 31 Mar 1982

1. The subject waste, described in enclosure (1), is presently stored aboard Marine Corps Base, Camp Lejeune, awaiting disposal. Reference (a) requested assistance with disposal from Naval Supply Center (NSC), Norfolk, Virginia (Code 105.1). Reference (b) requires activities to utilize NSC services with the disposal of radioactive waste. NSC has contacted West Nuclear Corporation regarding the subject disposal. Enclosure (2) discusses several technical problems which have to be addressed before the subject materials can be disposed of.

2. NSC advised during reference (c) that this Command would have to satisfy all technical, legal, permit, etc. requirements before NSC would process the contract to dispose of the subject waste. Base Maintenance does not have technical expertise required to address the problems discussed in enclosure (2). Therefore, it is requested that an Engineering Service Request (ESR) be submitted to the Engineering Field Division (EFD), Norfolk, Virginia, requesting technical assistance required to address requirements discussed in enclosure (2). Specifically, the EFD should be requested to:

a. Determine the physical condition of the waste and accomplish packaging to satisfy both requirements of transporter and local, state and federal regulations applicable at the disposal site.

b. Obtain necessary permits, registration numbers, authorizations, etc. required to deliver the waste to the transporter/disposer selected by NSC to handle the subject disposal.

3. Point of contact in this matter is Mr. Danny Sharpe, Natural Resources and Environmental Affairs Branch, telephone 2083.

B. W. ELSTON
Acting

MAY 8 1952

[Faint, mostly illegible text, possibly a letter or report, with some words like "Dear Sir" and "Very truly yours" visible.]

[Faint, mostly illegible text, possibly a second page or a separate section.]

NAVAL REGIONAL MEDICAL CENTER
CAMP LEJEUNE, N.C. 28542

IN REPLY REFER TO
62-khc
6260.5
12 August 1981

From: Commanding Officer
To: Commanding General, Marine Corps Base, Camp Lejeune, North Carolina
28542 (Attn: Director, Natural Resources, Base Maintenance)
Subj: Radioactive Waste; disposal of
Ref: (a) NAVSUPINST 5101.9B

1. As requested in the conversation between Ens B. Kalisch, Occupational and Preventive Medicine Service, and Mr. D. Sharp, Natural Resources on 6 August 1981, the following information is needed to complete reference (a). This data is current as of 10 August 1981.

5b(7)(a). NA

5b(7)(b). NA

5b(7)(c). NA

5b(7)(d). Radioactive Element - Strontium 90
Mass number - 90
Liquid

5b(7)(e). 400 microcuries per button (493 total buttons)

5b(7)(f). Number of containers - 6

Type of container - DOT Spec. 17H-Steel drum 8110-00-823-8121

All beta buttons, animal remains, and soil are packaged in 4 mil polyethylene bags and cushioned with vermiculite.

Each container has a volume of 5.6 cubic feet.

5b(7)(g).	Container	Wt(lbs)	Contact Readings	3 Feet Readings
#1	125 beta buttons	127.5	0.25 mr/hr	<0.05 mr/hr
#2	125 beta buttons and 3 bags of soil	278	0.15 mr/hr	<0.05 mr/hr
#3	125 beta buttons and 3 bags of soil	320	0.10 mr/hr	<0.05 mr/hr
#4	118 beta buttons and 3 bags of soil	230	0.25 mr/hr	<0.05 mr/hr
#5	1 bag of soil and animal remains, and 3 bags of soil	370	<0.05 mr/hr	<0.05 mr/hr
#6	3 bags of soil	335	<0.05 mr/hr	<0.05 mr/hr

ENCLOSURE (1)

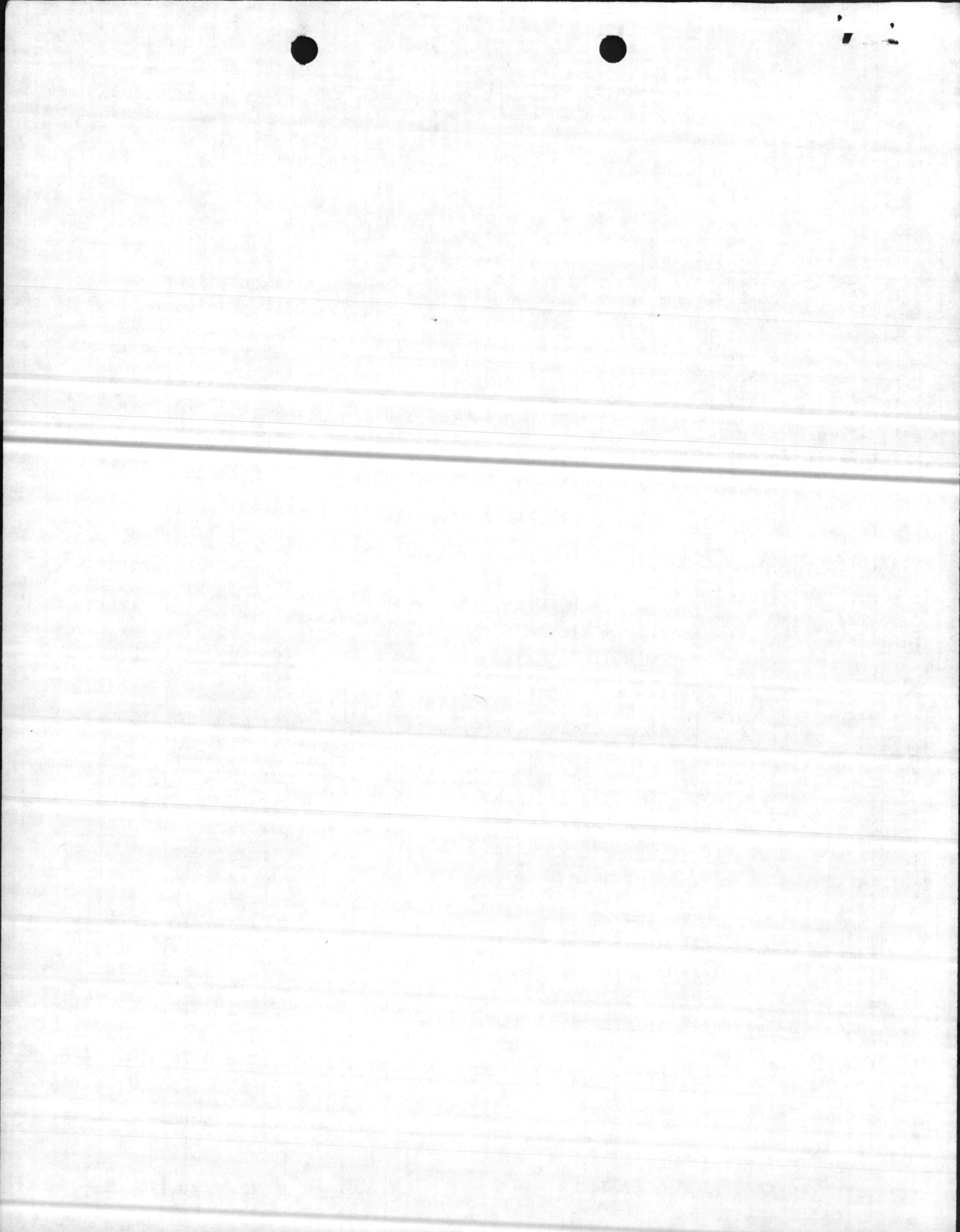

5b(7)(h). Location - Building PT 25, Insect Vector Control compound,
Camp Lejeune, North Carolina

5b(7)(i). Not desired.

5b(7)(j). Material is not subject to inventory control.

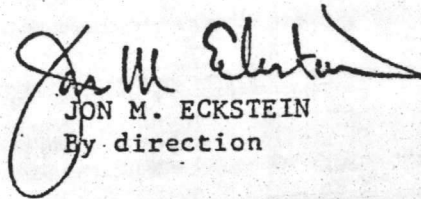
JON M. ECKSTEIN
By direction

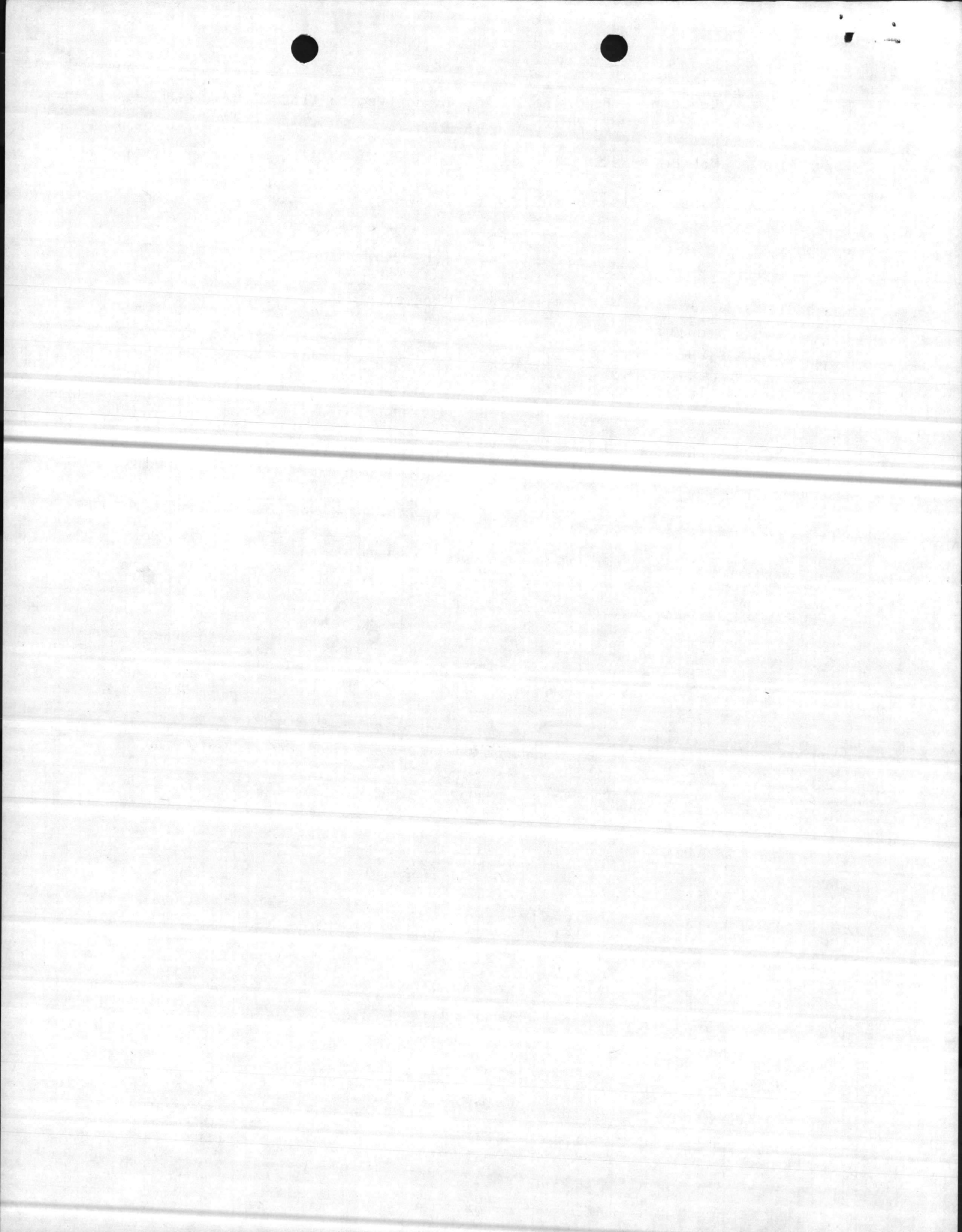

SOUTHWEST NUCLEAR COMPANY

906 MONTGOMERY ST., • LAUREL, MD. 20810
(301) 490-7100

Commanding General
Marine Corp Base
ATTN: Assistant Chief of Staff, Facilities
Camp Lejune, North Carolina 28542

March 31, 1982

Gentlemen:

Pursuant to verbal request of Mrs. Irene Uselski, Naval Supply Center, Norfolk, Virginia, we are pleased to submit the following information regarding preparation for shipment of six (6) 55 gallon drums of Radioactive waste for disposal.

The State of Washington, ultimate point of disposal, requires each generator of waste to apply for a burial permit. The burial permit form is enclosed and should be submitted to the Olympia, Washington address indicated at the lower left corner. Generally, the time lapse to receipt of permit number is 10 to 15 days.

When the burial permit number is received, it will be necessary to apply for a "Low-Level Radioactive Waste Generator Registration" symbol, a 12 character letter/number combination used to categorize the generator's classification and types of waste to be disposed. This form with instructions is enclosed for your subsequent use. You will then receive the symbol from U. S. Ecology, Louisville, Kentucky, operators of the burial site.

At the time of shipment of the waste, an executed "Low-level Radioactive Waste Shipment Certification for the Federal Government as Generator/Packager, and its Brokers and Carriers" copy must be submitted to the broker for subsequent use.

Additionally, a detailed description of the waste must be provided on the "Radioactive Waste Shipment and Disposal Form". We are enclosing a set of forms for your eventual use or information. Should you require more space than the numbered set contains, a continuation sheet will accommodate additional packages and applicable detailed description. The enclosed directions for completing the form will be helpful in this regard.

NSC has indicated to the writer the general contents of the drums. In my conversation with Mr. Sharp, he indicated the beta-buttons may contain a liquid, or the light emitting media may have degenerated to liquid form. If this is the case, a problem exists since the State of Washington does not license free liquid burial, or devices which, when broken, could allow escape of liquid. A review of the physical condition of the beta-buttons should be held, and an estimate of the amount of liquid be determined. It is possible, with detailed description, to obtain a one-time waiver of certain burial requirements if the

ENCLOSURE (2)

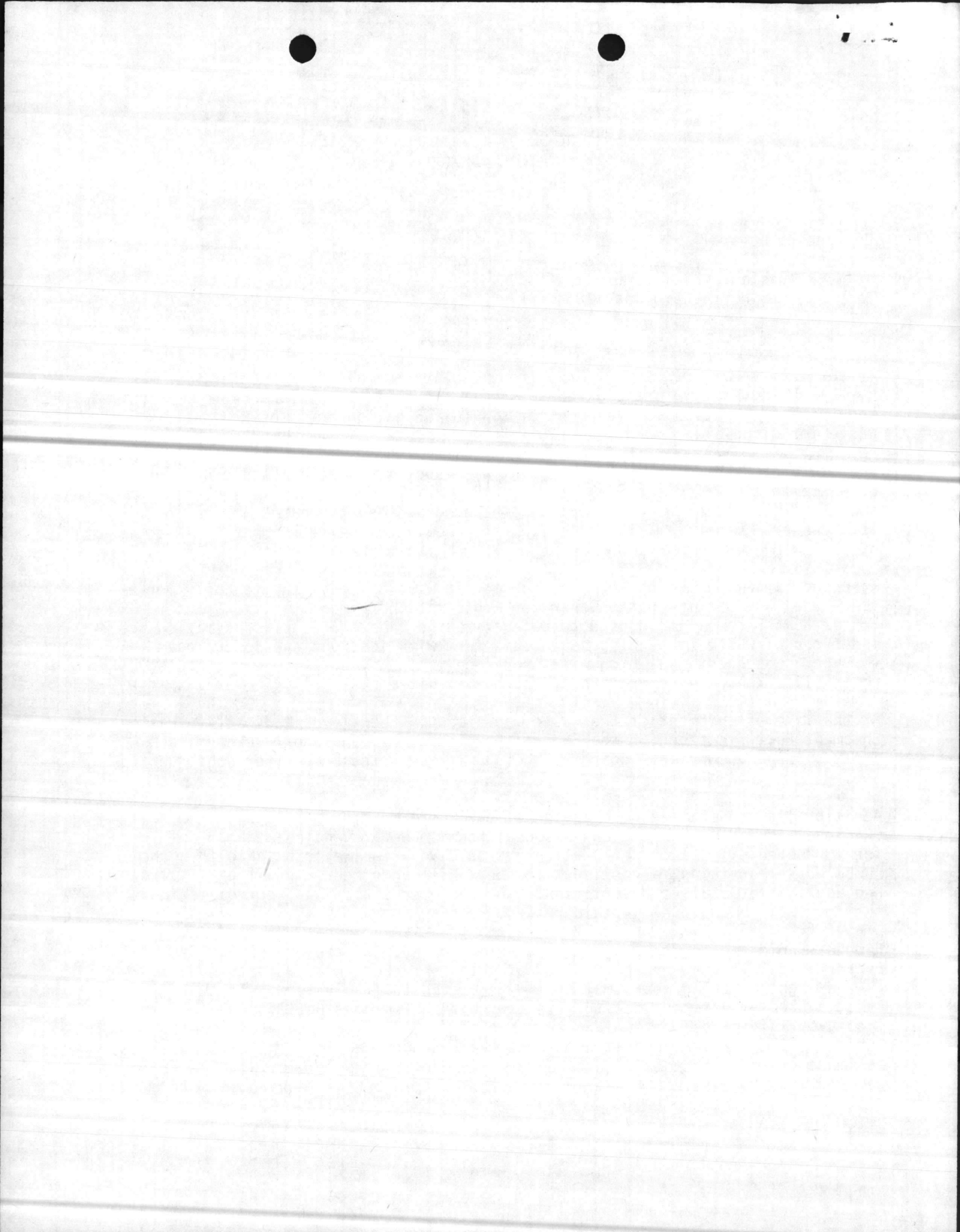

March 31, 1982

escape of liquid would pose no threat to the environment or health and safety of people. There could be specific packaging instructions required, however.

Drum #5 is said to contain animal bones and soil. The State of Washington requires animal carcasses to be double contained, that is, the bones, in this case, have to be placed in a 30 gallon drum with lime and absorbent, sealed, then placed in a 55 gallon drum with absorbent filling the void between the two containers. Unfortunately, animal bones are still considered to be biological waste, even though there is no flesh left to deteriorate.

Containers authorized for burial must have a 12 gauge ring with welded lugs, 5/8" diameter bolt and lock nut. Additionally, when shipped, they must have a security seal attached among other requirements for labeling and marking.

In order to provide as much information as possible, we are enclosing a copy of our packaging requirements for each category of waste. We hope you find it useful.

This information is supplied to the Government at no charge.

Please telephone if you have any questions.

Yours very truly:
SouthWest Nuclear Company

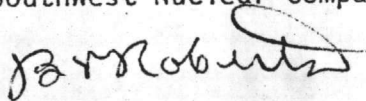

B. V. Roberts
Vice President

encl:

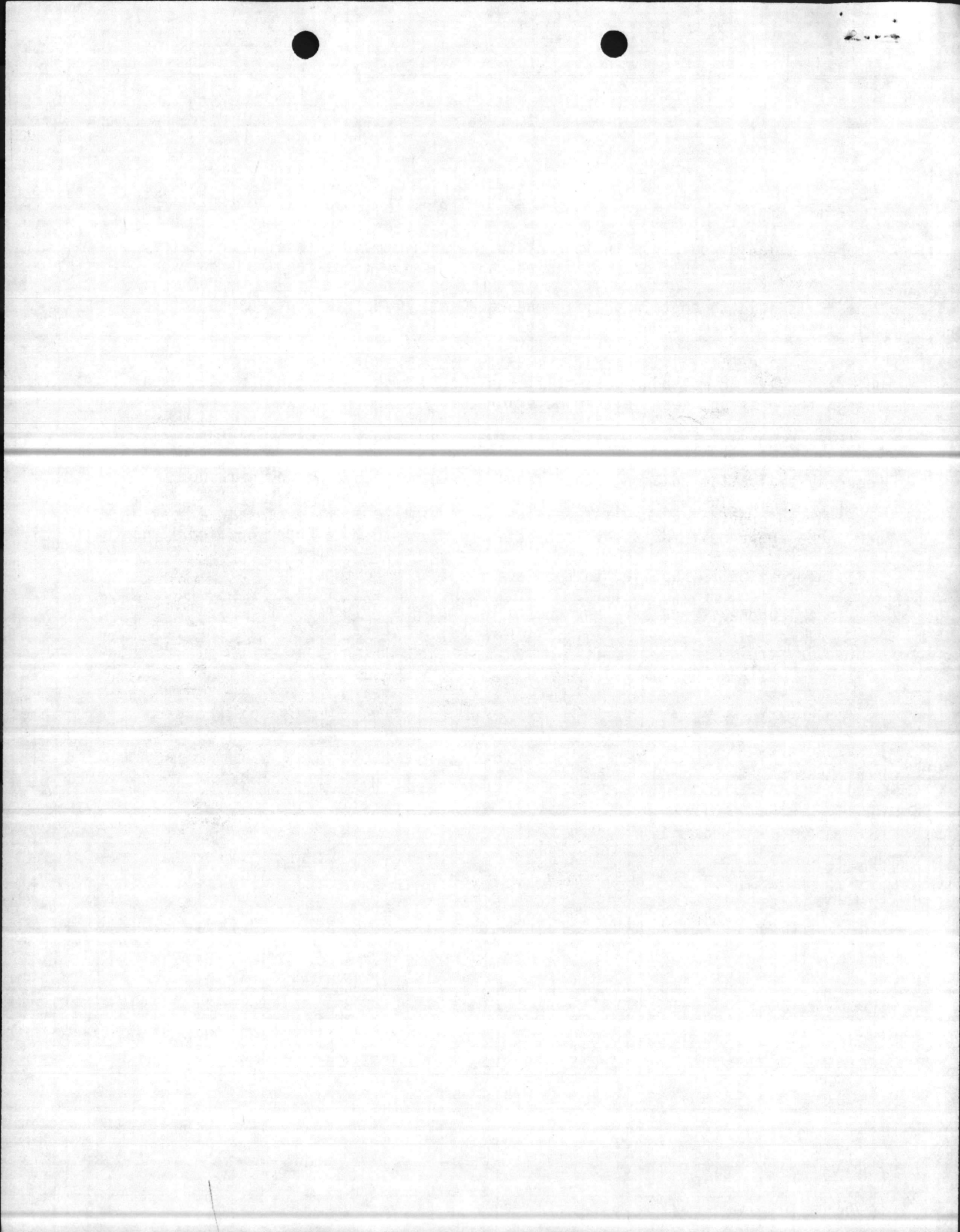

OK
gjtW

MAIN/DDS/spk
6280

From: Base Maintenance Officer
To: Public Works Officer

Subj: Disposal of Low-Level Radioactive Wastes; request for assistance
~~with~~

Ref: (a) CG MCB ltr MAIN/BWE/th 6240 of 9 Sep 1982
(b) NAVSUPINST 5101.9B
(c) FONECON btw Ms. Irene Uselski; NSC (Code 105.1) and Mr. D. Sharpe, BMainTDiv of 5 Mar 1981

Encl: (1) NRMC ltr 62-khc 6260.5 of 12 Aug 81
(2) West Nuclear Corporation ltr of 31 Mar 1982

1. The subject waste, described in enclosure (1), is presently stored aboard Marine Corps Base, Camp Lejeune, awaiting disposal. Reference (a) requested assistance with disposal from Naval Supply Center (NSC), Norfolk, (Code 105.1). Reference (b) requires activities to utilize NSC services with the disposal of radioactive waste. NSC has contacted West Nuclear Corporation regarding the subject disposal. Enclosure (2) discusses several technical problems which have to be addressed before the subject materials can be disposed of.

2. NSC advised during reference (c) that this Command would have to satisfy all technical, legal, permit, etc. requirements before NSC would process the contract to disposal of the subject waste. Base Maintenance does not have technical expertise required to address the problems discussed in enclosure (2). Therefore, it is requested that an Engineering Service Request be submitted to the Engineering Field Division (EFD), Norfolk, requesting technical assistance required to address requirements discussed in enclosure (2). Specifically, the EFD should be requested to:

a. Determine the physical condition of the wastes and accomplish packaging to satisfy both requirements of transporter and local, State and Federal regulations applicable at the disposal site.

b. Obtain necessary permits, registration numbers, authorizations, etc., required to deliver the wastes to the transporter/disposer selected by NSC to handle the subject disposal.

3. Point of contact in this matter is Mr. Danny Sharpe, Natural Resources and Environmental Affairs Branch, telephone 2083.

BWE
acting

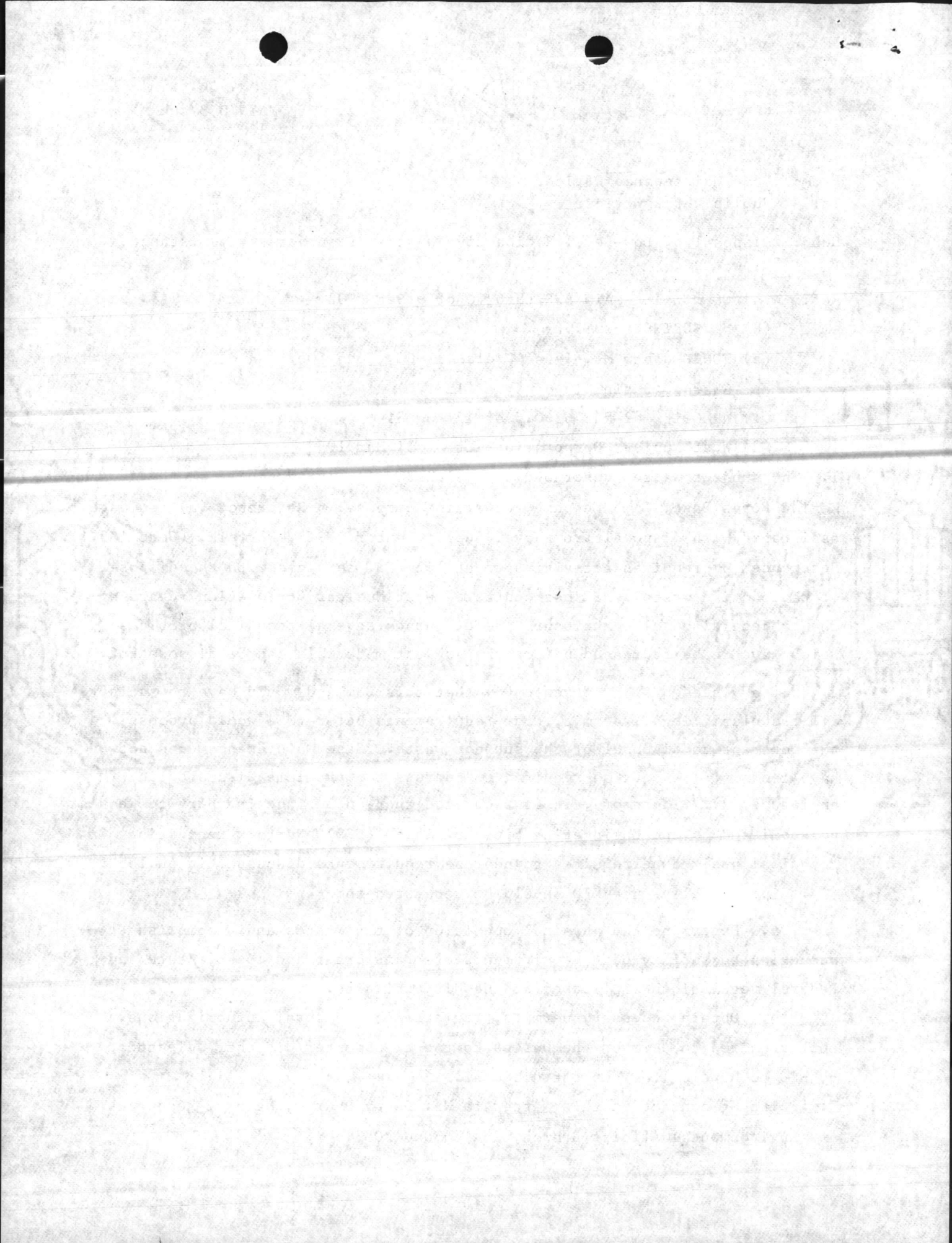

Twyble

Rough

gllw

From: BMO

TO: PWD

Subj: Disposal of low-level radioactive wastes,
request for assistance with

Ref (a) CG MCB Ltr MAIN/BWE/HL 6240 of 9 Sep 1982

Ref

Ref (b) NAVSUPINST 5101.9B

Ref (c) Funccon between Ms Irene Usovski, NSC (Code 105.1)
and Mr. D. Sharpe, BMAIN Div of 5 March 1981

Encl (1) NRMCLtr 62-KHC 6260.5 of 12 Aug 81
of 25 June 1981

Encl (2) West Nuclear Corporation Ltr. of 31 March 1982.

1. The subject waste, described in enclosure (1), is presently stored aboard Marine Corps Base, Camp Pease, awaiting disposal. Reference (a) requested assistance ^{with disposal} from Naval Supply Center (NSC), Norfolk (Code 105.1). Reference (b) requires activities to utilize NSC services with the disposal of radioactive wastes. NSC has contacted West Nuclear Corporation (WNC) regarding the subject disposal. Enclosure (2) discusses several technical problems which have to be addressed before the subject materials can be disposed of.

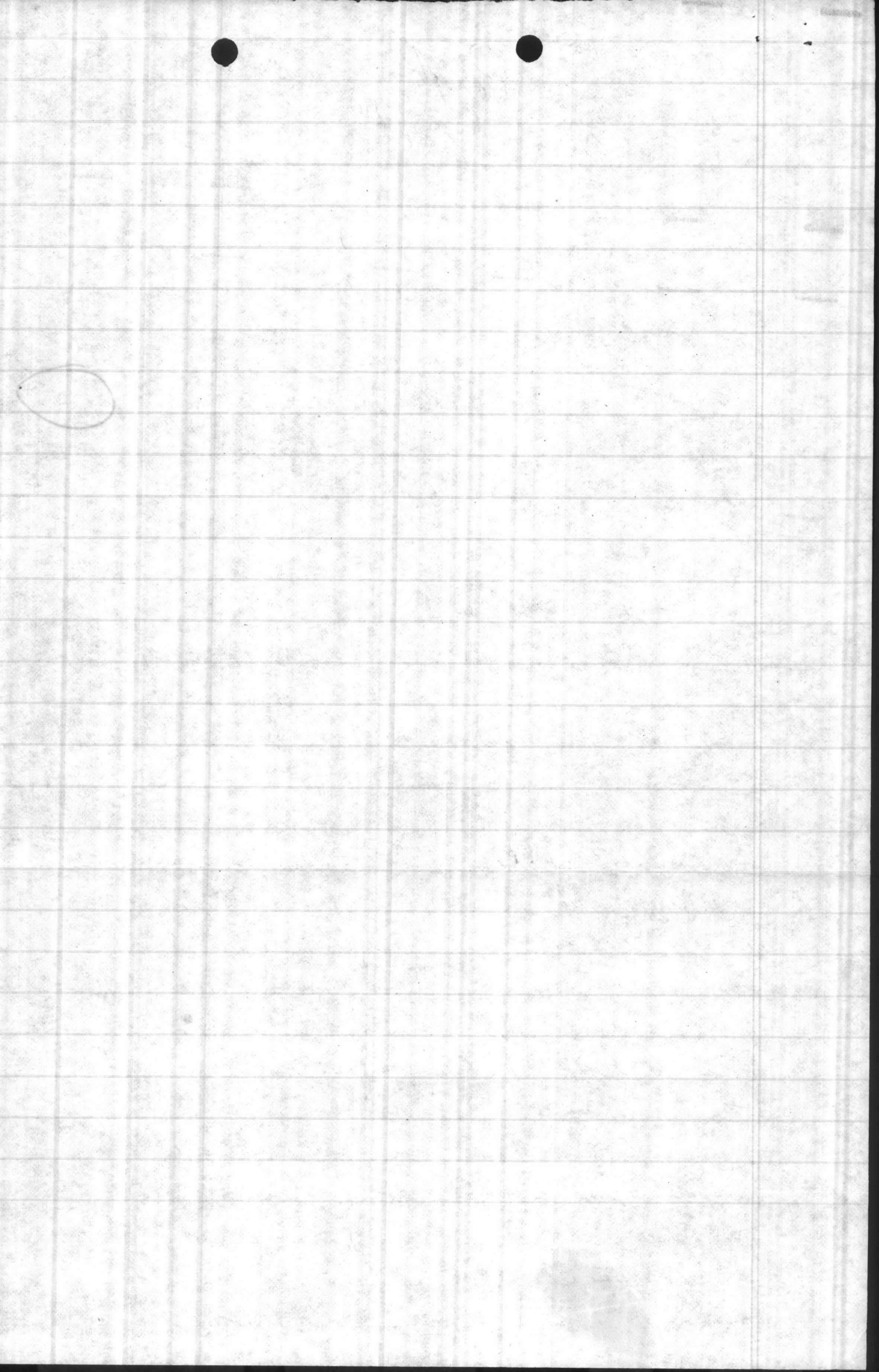

2 NSC advised during ref (c) that this command would have to satisfy all technical, legal, permit, etc. requirements before NSC would process the contract to disposal of the subject wastes. Base Maintenance does not have technical expertise required to address the problems discussed in enclosure (2). Therefore, it is requested that an Engineering Service Request be submitted to the Engineering Field Division ^(EFD), Norfolk requesting technical assistance required to address requirements discussed in enclosure (2). Specifically, the EFD should be requested to:

- (a) determine the physical condition of the wastes and accomplish packaging to satisfy both requirements of transporter and local, state, federal regulations applicable at the disposal site.
- (b) Obtain necessary permits, registration numbers, authorizations, etc required to deliver the wastes to the transporter / disposer selected by NSC to handle the subject disposal.

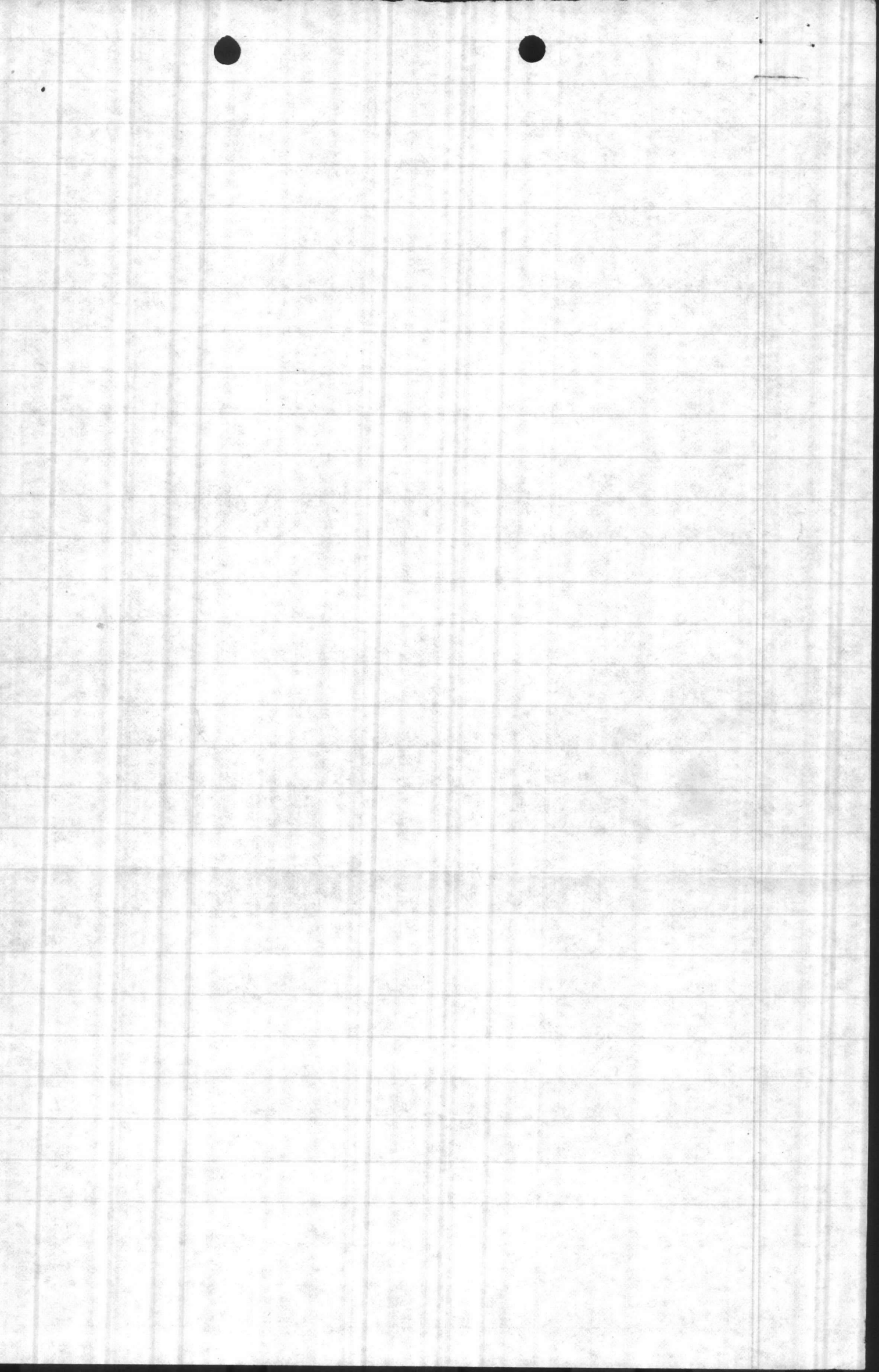

BASE MAINTENANCE DIVISION
Marine Corps Base
Camp Lejeune, North Carolina 28542

MAIN/DDS/spk
6240

MAY 17 1982

From: Base Maintenance Officer
To: Public Works Officer (PWO)
Via: Assistant Chief of Staff, Facilities

Subj: Disposal of Low-Level Radioactive Wastes; request for assistance with

Ref: (a) NAVSUPINST 5101.9B
(b) FONECON btw Ms. Irene Uselski, NSC, and Mr. D. Sharpe, BMaintDiv,
of 8 Feb 82

Encl: (1) CG MCB ltr MAIN/BWE/th 6240 of 9 Sep 1982
(2) West Nuclear Corps ltr of 31 Mar 1982

1. The subject materials, described in enclosure (1), were generated by the Naval Medical Field Research Laboratory formerly located aboard Camp Lejeune. Enclosure (1) requested assistance from Naval Supply Center (NSC), Norfolk, (Code 105.1) in accordance with reference (a) and provided required funding documentation. This command initiated enclosure (1) with the understanding that NSC would handle the disposal including providing all technical expertise required. However, during reference (b), Marine Corps Base, Camp Lejeune personnel were advised that NSC's role would be basically clerical in nature. NSC also advised that the contractor would deal directly with Camp Lejeune. NSC advised that after all technical problems were addressed and necessary permits obtained, NSC would draw up the disposal contract. Enclosure (2) outlines information/action required.

2. Base Maintenance Division does not have technical expertise in this area. Therefore, it is requested PWO submit an Engineering Service Request requesting assistance from the Engineering Field Division, Norfolk with this matter. In that the NSC has apparently entered some type of arrangement with West Nuclear Company (see enclosure (2)), the possibility of contracting for technical assistance from West Nuclear should be pursued. *Tech*

3. Point of contact in this matter is Mr. Danny Sharpe, Natural Resources and Environmental Affairs Branch, telephone 2083.

B. W. Elston
B. W. ELSTON
Acting

*Filed as info
ESR went to PWO on 27 March 82*

STATE DEPARTMENT

Foreign Affairs

Office of the Secretary



MAIN/BWE/th
6240

SEP 09 1981

From: Commanding General
To: Commanding Officer, Naval Supply Center, Norfolk, Virginia 23511
(Code 105.1)

Subj: Disposition of Radioactive Materials

Ref: (a) NAVSUPINST 5101.9B
(b) FONECON btwn CHDR Gibson, Naval Sup Center, and Mr. Sharpe,
BMainDiv, on 13 Jan 1981

Encl: (1) CO NRMC ltr 62-khc 6260.5 of 12 Aug 1981
(2) Form DD-1149

1. In accordance with reference (a), request assistance with disposition of the low level radioactive items discussed in reference (b) and described in enclosure (1). Enclosure (2) provides appropriation data and job order number.

2. Point of contact with this matter is Mr. Julian Wooten, Director, Natural Resources and Environmental Affairs Branch, Base Maintenance Division, (AUTOVON) 484-5003/2083.

F. H. MOUNT
By direction

ENCLOSURE (/)

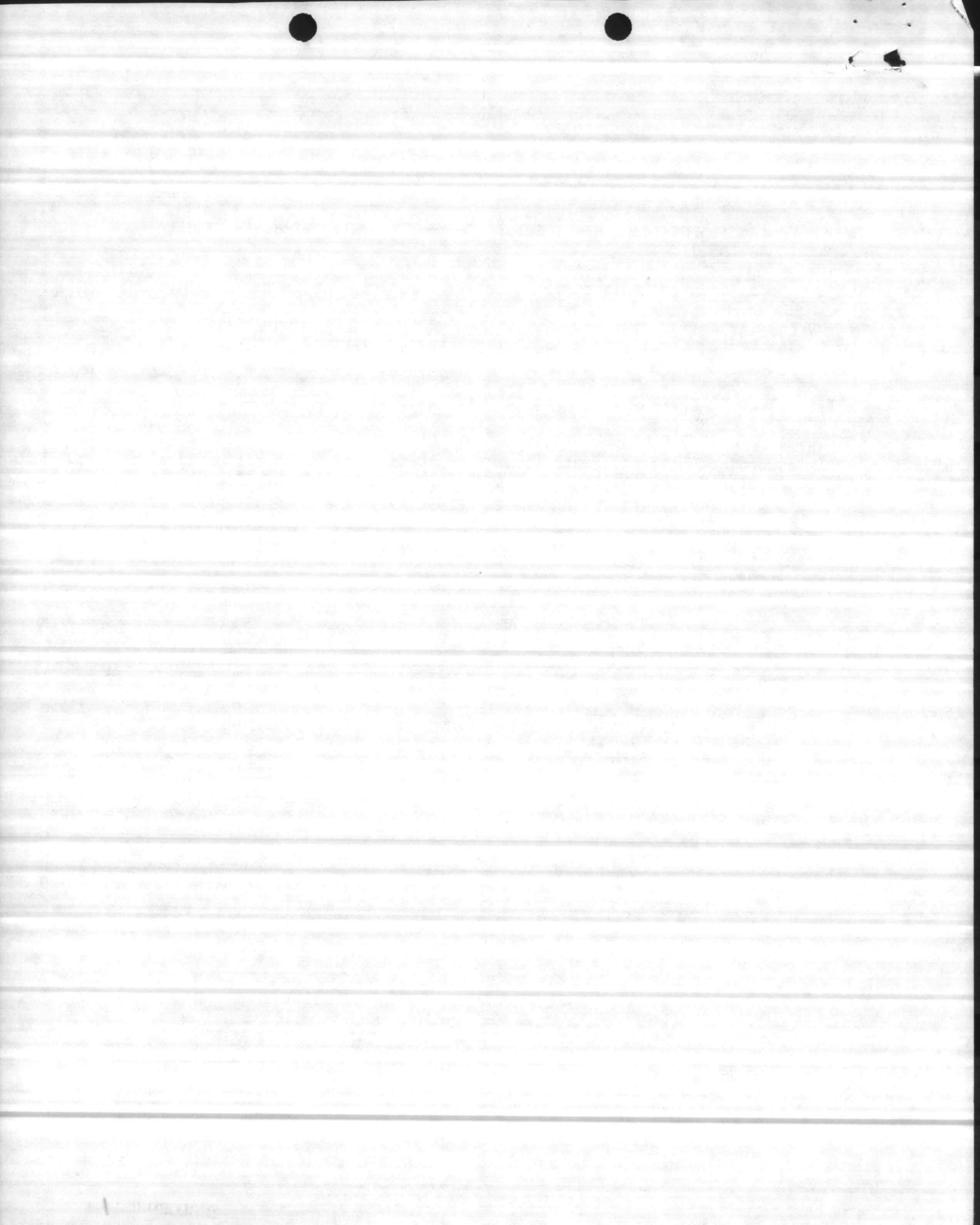

NAVAL REGIONAL MEDICAL CENTER
CAMP LEJEUNE, N.C. 28542

IN REPLY REFER TO
62-khc
6260.5
12 August 1981

From: Commanding Officer
To: Commanding General, Marine Corps Base, Camp Lejeune, North Carolina
28542 (Attn: Director, Natural Resources, Base Maintenance)

Subj: Radioactive Waste; disposal of

Ref: (a) NAVSUPINST 5101.9B

1. As requested in the conversation between Ens B. Kalisch, Occupational and Preventive Medicine Service, and Mr. D. Sharp, Natural Resources on 6 August 1981, the following information is needed to complete reference (a). This data is current as of 10 August 1981.

5b(7)(a). NA

5b(7)(b). NA

5b(7)(c). NA

5b(7)(d). Radioactive Element - Strontium 90

Mass number - 90

Liquid

5b(7)(e). 400 microcuries per button (493 total buttons)

5b(7)(f). Number of containers - 6

Type of container - DOT Spec. 17H-Steel drum 8110-01-823-8121

All beta buttons, animal remains, and soil are packaged in 4 mil polyethylene bags and cushioned with vermiculite.

Each container has a volume of 5.6 cubic feet.

5b(7)(g).	Container	Wt(lbs)	Contact Readings	3 Feet Readings
#1	125 beta buttons	127.5	0.25 mr/hr	<0.05 mr/hr
#2	125 beta buttons and 3 bags of soil	278	0.15 mr/hr	<0.05 mr/hr
#3	125 beta buttons and 3 bags of soil	320	0.10 mr/hr	<0.05 mr/hr
#4	118 beta buttons and 3 bags of soil	230	0.25 mr/hr	<0.05 mr/hr
#5	1 bag of soil and animal remains, and 3 bags of soil	370	<0.05 mr/hr	<0.05 mr/hr
#6	3 bags of soil	335	<0.05 mr/hr	<0.05 mr/hr

ENCLOSURE (1)

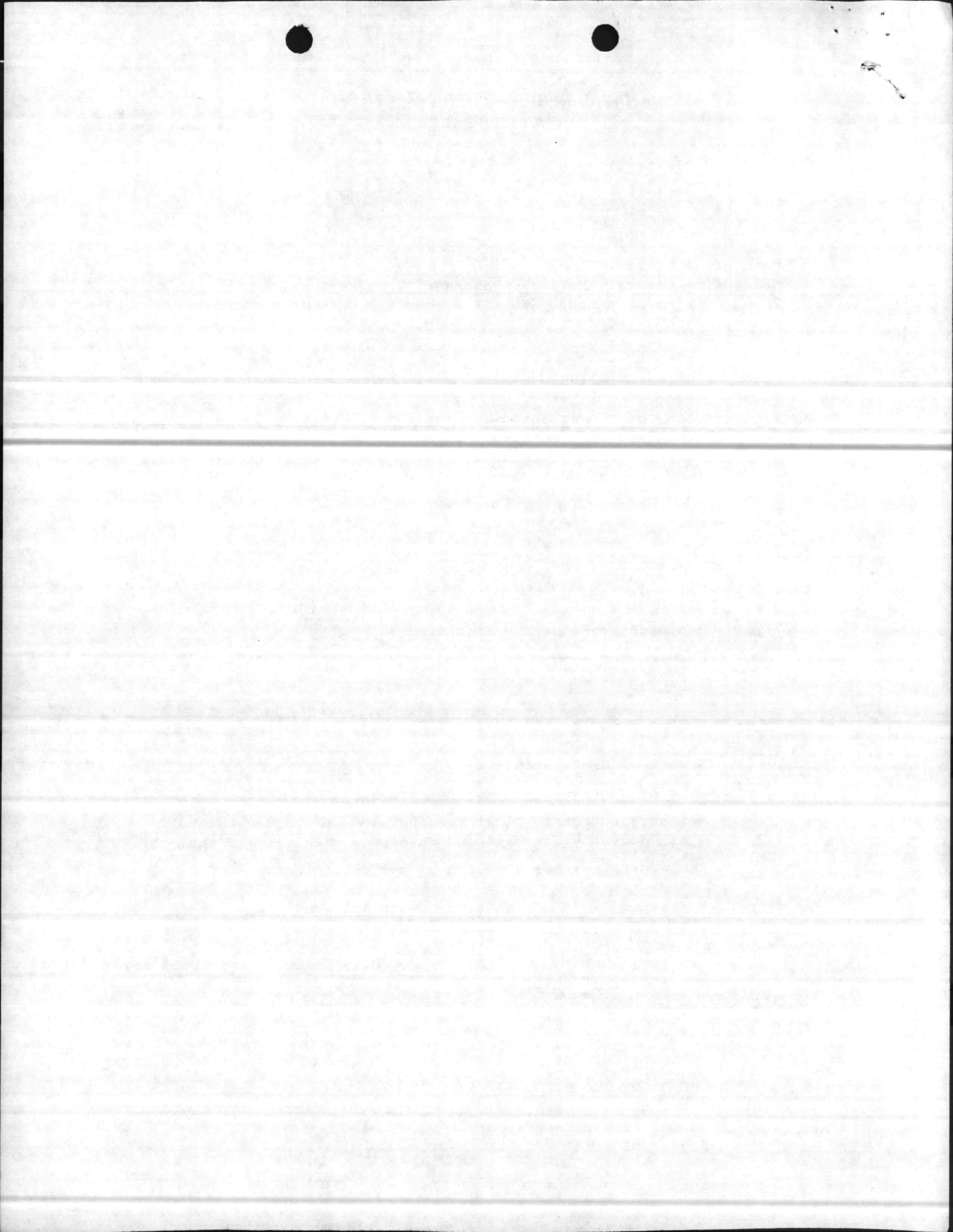

5b(7)(h). Location - Building PT 25, Insect Vector Control compound,
Camp Lejeune, North Carolina

5b(7)(i). Not desired.

5b(7)(j). Material is not subject to inventory control.

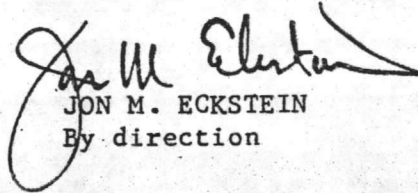
JON M. ECKSTEIN
By direction

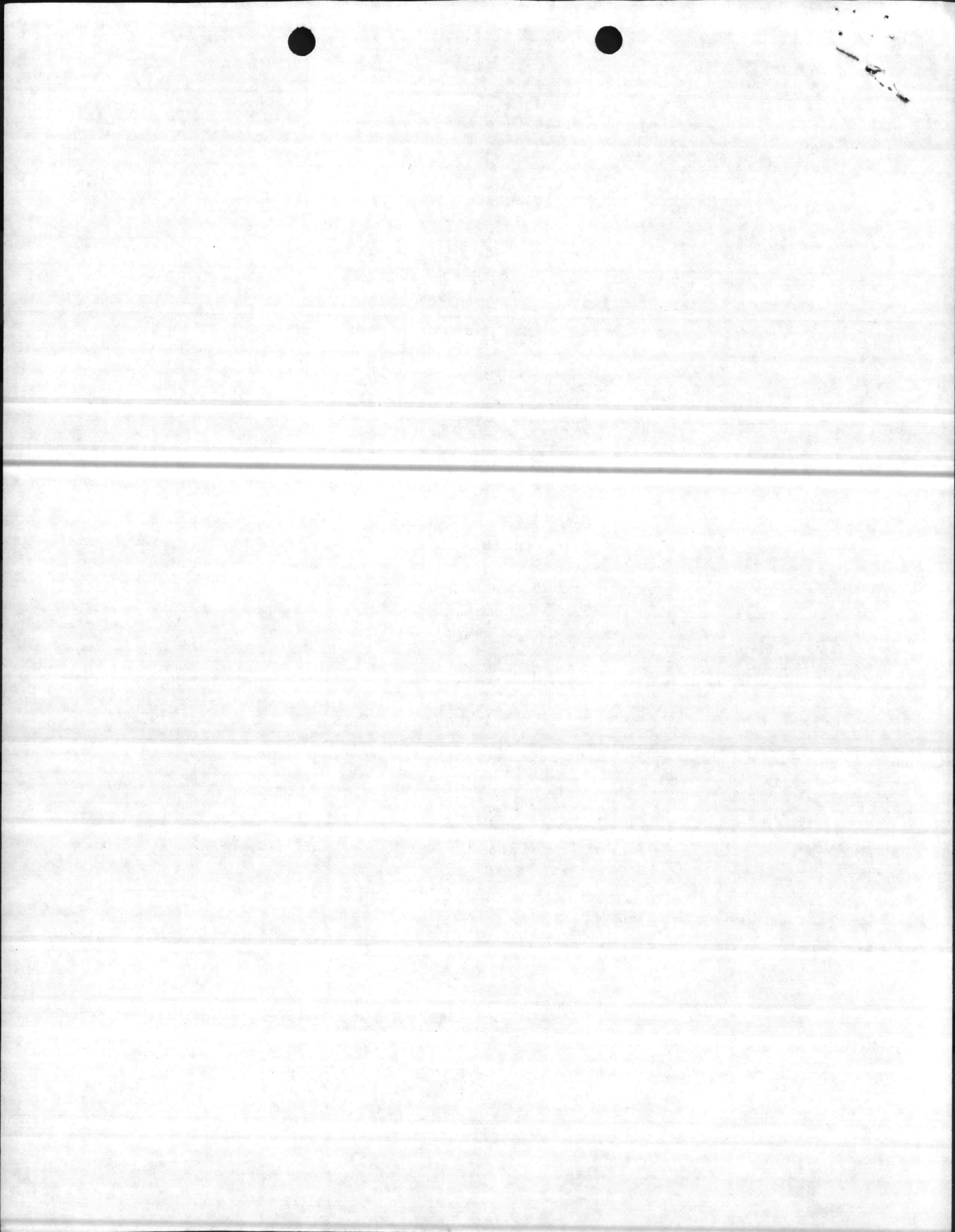

SOUTH WEST NUCLEAR COMPANY

906 MONTGOMERY ST., • LAUREL, MD. 20810
(301) 490-7100

Commanding General
Marine Corp Base
ATTN: Assistant Chief of Staff, Facilities
Camp Lejune, North Carolina 28542

March 31, 1982

Gentlemen:

Pursuant to verbal request of Mrs. Irene Uselski, Naval Supply Center, Norfolk, Virginia, we are pleased to submit the following information regarding preparation for shipment of six (6) 55 gallon drums of Radioactive waste for disposal.

The State of Washington, ultimate point of disposal, requires each generator of waste to apply for a burial permit. The burial permit form is enclosed and should be submitted to the Olympia, Washington address indicated at the lower left corner. Generally, the time lapse to receipt of permit number is 10 to 15 days.

When the burial permit number is received, it will be necessary to apply for a "Low-Level Radioactive Waste Generator Registration" symbol, a 12 character letter/number combination used to categorize the generator's classification and types of waste to be disposed. This form with instructions is enclosed for your subsequent use. You will then receive the symbol from U. S. Ecology, Louisville, Kentucky, operators of the burial site.

At the time of shipment of the waste, an executed "Low-level Radioactive Waste Shipment Certification for the Federal Government as Generator/Packager, and its Brokers and Carriers" copy must be submitted to the broker for subsequent use.

Additionally, a detailed description of the waste must be provided on the "Radioactive Waste Shipment and Disposal Form". We are enclosing a set of forms for your eventual use or information. Should you require more space than the numbered set contains, a continuation sheet will accommodate additional packages and applicable detailed description. The enclosed directions for completing the form will be helpful in this regard.

NSC has indicated to the writer the general contents of the drums. In my conversation with Mr. Sharp, he indicated the beta-buttons may contain a liquid, or the light emitting media may have degenerated to liquid form. If this is the case, a problem exists since the State of Washington does not license free liquid burial, or devices which, when broken, could allow escape of liquid. A review of the physical condition of the beta-buttons should be held, and an estimate of the amount of liquid be determined. It is possible, with detailed description, to obtain a one-time waiver of certain burial requirements if the

ENCLOSURE (2)

WEST NUCLEAR COMPANY

1000 WEST NUCLEAR COMPANY

1000 WEST NUCLEAR COMPANY

March 31, 1982

escape of liquid would pose no threat to the environment or health and safety of people. There could be specific packaging instructions required, however.

Drum #5 is said to contain animal bones and soil. The State of Washington requires animal carcasses to be double contained, that is, the bones, in this case, have to be placed in a 30 gallon drum with lime and absorbent, sealed, then placed in a 55 gallon drum with absorbent filling the void between the two containers. Unfortunately, animal bones are still considered to be biological waste, even though there is no flesh left to deteriorate.

Containers authorized for burial must have a 12 gauge ring with welded lugs, 5/8" diameter bolt and lock nut. Additionally, when shipped, they must have a security seal attached among other requirements for labeling and marking.

In order to provide as much information as possible, we are enclosing a copy of our packaging requirements for each category of waste. We hope you find it useful.

This information is supplied to the Government at no charge.

Please telephone if you have any questions.

Yours very truly:
SouthWest Nuclear Company

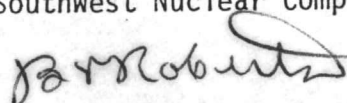

B. V. Roberts
Vice President

encl:

MADE IN U.S.A.
100% PURE
COTTON
FOX BIBLE BOND

Handwritten signature



JdW
~~*File*~~
mat
Hor

27 April 82

Return to Tuzlak

UNITED STATES MARINE CORPS
MARINE CORPS BASE
CAMP LEJEUNE, NORTH CAROLINA 28542

IN REPLY REFER TO
CPD/LHP/smb
12410
23 April 1982

From: Commanding General
To: Distribution List

Subj: Defense Packaging of Hazardous Materials for Transportation; announcement of

Encl: (1) Course Brief

1. Subject course will be conducted by the Department of the Army Joint Military Packaging Training Center, Aberdeen Proving Ground, Maryland, at the Civilian Training Classroom, Building 1006, Marine Corps Base, Camp Lejeune, 10-18 June 1982. The enclosure is provided for information.

2. Using the course prerequisites set forth in the enclosure as a guide addressees are requested to submit nominations for personnel requiring this training by memorandum to this Division (Attn: Training Branch) not later than 7 May 1982 providing the following information:

- a. Name
- b. Social Security Number
- c. Grade/Rank
- d. Title/Billet Assignment

3. Nominees selected to attend will be notified and reporting instructions provided no later than 21 May 1982.

Hosea Horne, Jr.
HOSEA HORNE, JR.
By direction

Distribution:

CG, 2dMarDiv
Maj Babin, 2dMarDiv
Capt Thompson, 2dMarDiv
CG, 2d FSSG
Maj Clampitt, 2d FSSG
CO, MCAS (H)
Capt Brookins, MCAS (H)
CO, NRDC
Lt Johnson, NRDC
DT2 Hise, NRDC
AC/S, Logistics
LtCol Smith, Logistics Dept
Maj McNutt, Logistics Dept
WO Lambert, Logistics Dept

Fire Chief
Safety Dir
DPDO
MAINO
Mr. D. Sharpe, Main Div



5-5-81 *Linda Passingham contacted - course will be held.*



The page contains extremely faint, illegible text that appears to be bleed-through from the reverse side of the document. The text is scattered across the page and is not readable.

COURSE BRIEF

DEFENSE PACKAGING OF HAZARDOUS MATERIALS FOR TRANSPORTATION

Length: 7 Days

Purpose. To train military personnel, civilian Government employees, and qualified members of industry in the current requirements and procedures in the preparation of hazardous materials for transportation, including marking, certification, handling, and storage through the approved methods and techniques of DoD and DOT.

Scope: Use of DoD and DoT publications, International Air Transport Association (IATA) and Inter-government Maritime Consultative Organization (IMCO) publications; currently approved processes, procedures, and materials used for packaging packing hazardous materials; comparison of DoT, IATA and Federal military specification containers; regulatory documents for the transportation of hazardous materials by rail, commercial aircraft, public highway, and vessel (CFR TITLE 49, transportation, IATA, IMCO); Official Air Transport Restricted Articles Tarriff and Circular No. 6-D; military aircraft (AFR 71-4, Preparation of Hazardous Materials for Military Air Shipment); MIL-STD129 marking methods, materials and procedures; identification of DoT-United Nations hazardous materials labels; DD Form 1387-2 certification and documentation.

Prerequisites: Military and civilian Government employees. This course is designed for commissioned and warrant officers, enlisted personnel, and civilian employees who are assigned in one of the following or similar categories: Personnel in charge of packaging hazardous military supplies and equipment; procurement and military installation inspectors responsible for inspecting packaged and packed hazardous materials for shipment; installation or service school instructors on this subject; personnel engaged in consultant or laboratory work pertaining to hazardous materials; personnel responsible for preparing specifications or technical instructions in the field; and related duties. All nominees must possess the ability to read and comprehend regulatory documents and Federal-military specifications and standards governing the transportation of hazardous materials. Personnel nominated should have at least 1 year of service remaining after completion of the course.

NOTE: Successful completion of this course meets the qualification requirements of AFR 71-4/TM 38-250/NAVSUP PUB 505 (Rev)/MCO P4030.19D/DLAM 4145.3, Preparation of Hazardous Materials for Military Air Shipment, for personnel designated to sign DD Form 1387-2.

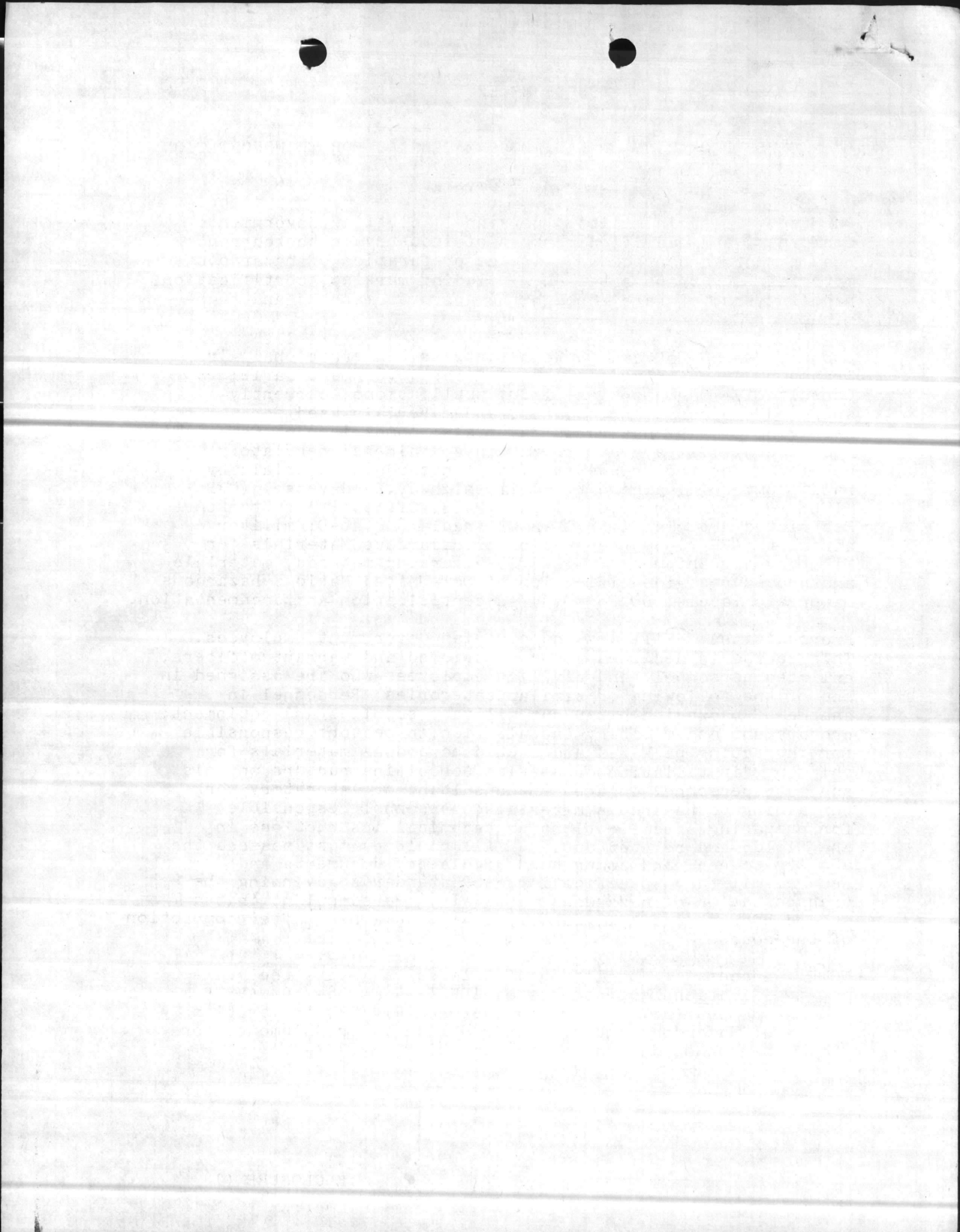

Sally,

~~Make a copy of 16 April 82
Memo to BMO + attach
my 25 April 82 Note to ID Shepard.~~

File Original - Hog Mat

Juboi

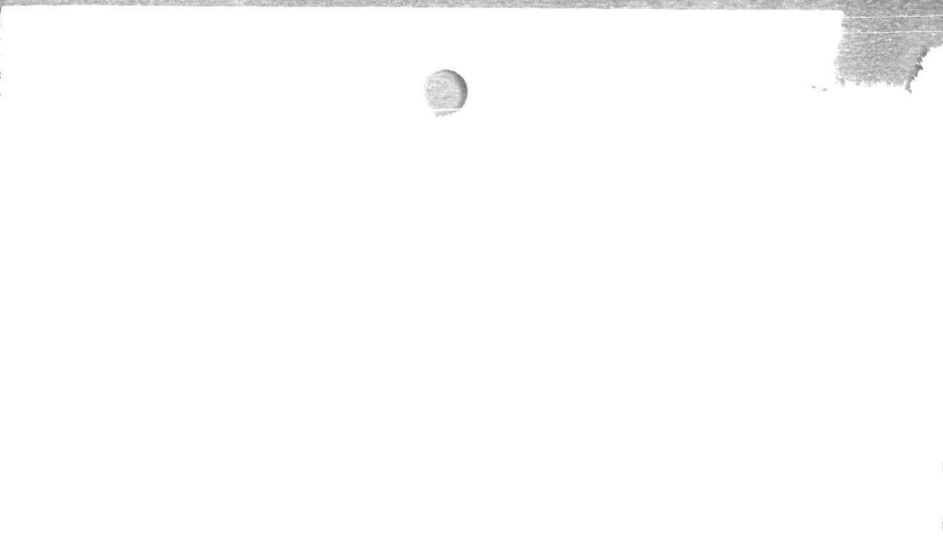

BASE MAINTENANCE DIVISION
Marine Corps Base
Camp Lejeune, North Carolina 28542

DDJ

MAIN/RTS/spk
6280/5
APR 16 1982

From: Director, Natural Resources and Environmental Affairs Branch
To: Base Maintenance Officer

Subj: Waste Oil Tanks at Buildings 4107 and 4146, MCAS(H), New River; servicing of

Ref: (a) FONECON btwn Don Gurganus, HE, and D. Sharpe, NREAB of 15 Apr 82
(b) 40 CFR 261 and 262
(c) FONECON btwn Mary Wheat, MCAS(H), New River, and Tim Stamps, NREAB of 15 Apr 82
(d) Air Station Order 6280.5

1. During reference (a), NREAB was advised that, during routine servicing, the subject tanks were found to contain paints, solvents and paint thinner. During reference (a), Mr. Gurganus also advised that his driver did not pump out the subject tanks.
2. Regulations contained in reference (b) require that the contents of subject tanks be disposed of as hazardous wastes. During reference (c), cognizant MCAS(H), N.R. office was advised of the problem and the requirement that the entire contents of the subject tanks be transferred to properly labeled barrels and disposed of in accordance with references (b) and (d). Mrs. Wheat advised during reference (c) that the Air Station would take corrective action.
3. It is recommended that the subject tanks not be serviced until Air Station officials have properly corrected the discrepancy and NREAB personnel have inspected the tanks.
4. It is recommended the Assistant Chief of Staff, Facilities be advised of this continuing problem involving hazardous waste.

J. I. Wooten
J. I. WOOTEN

NREAB, 4/19/82

Have advised ACS, Inc. Let me know if MCAS does not correct the situation.

Julian:

Subject tanks inspected by Stamps on 23/APR/82. Tanks had been pumped out. Using units appear to understand nature of problem. Recommend that Heavy Equipment resume servicing the subject tanks and carefully check prior to pumping. D Sharpe

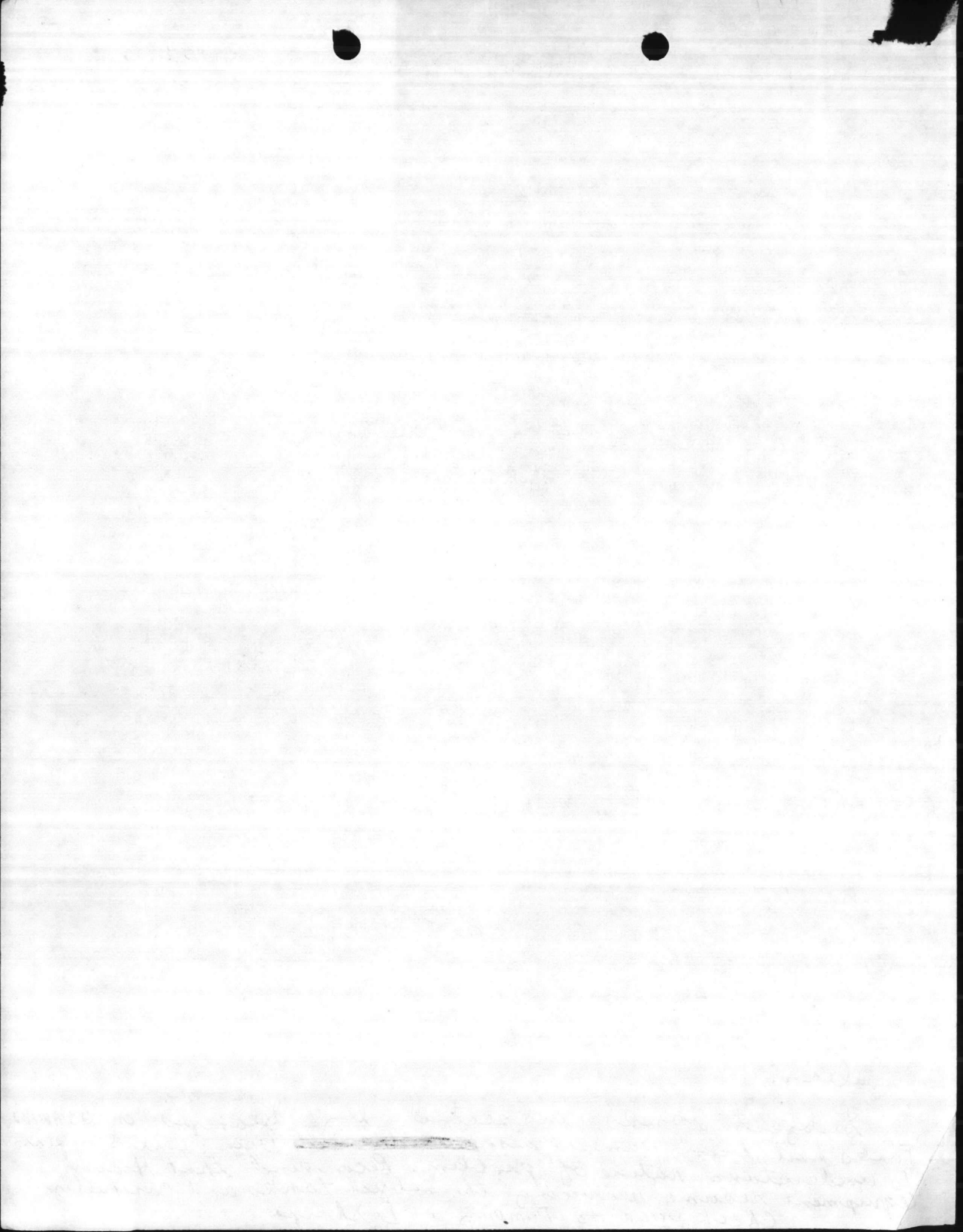

BASE MAINTENANCE DIVISION
Marine Corps Base
Camp Lejeune, North Carolina 28542

MAIN/RTS/spk
6280/5
APR 16 1982

From: Director, Natural Resources and Environmental Affairs Branch
To: Base Maintenance Officer

Subj: Waste Oil Tanks at Buildings 4107 and 4146, MCAS(H), New River; servicing of

Ref: (a) FONECON btwn Don Gurganus, HE, and D. Sharpe, NREAB of 15 Apr 82
(b) 40 CFR 261 and 262
(c) FONECON btwn Mary Wheat, MCAS(H), New River, and Tim Stamps, NREAB of 15 Apr 82
(d) Air Station Order 6280.5

1. During reference (a), NREAB was advised that, during routine servicing, the subject tanks were found to contain paints, solvents and paint thinner. During reference (a), Mr. Gurganus also advised that his driver did not pump out the subject tanks.
2. Regulations contained in reference (b) require that the contents of subject tanks be disposed of as hazardous wastes. During reference (c), cognizant MCAS(H), N.R. office was advised of the problem and the requirement that the entire contents of the subject tanks be transferred to properly labeled barrels and disposed of in accordance with references (b) and (d). Mrs. Wheat advised during reference (c) that the Air Station would take corrective action.
3. It is recommended that the subject tanks not be serviced until Air Station officials have properly corrected the discrepancy and NREAB personnel have inspected the tanks.
4. It is recommended the Assistant Chief of Staff, Facilities be advised of this continuing problem involving hazardous waste.

J. I. Wooten
J. I. WOOTEN

NREAB, 4/19/82

Have advised ACS, Fac. Let me know if MCAS does not correct the situation.

*By
BOOR*

BASE MATERIALS DIVISION

Form No. 100

U.S. DEPARTMENT OF COMMERCE

28 April 82

File
mat
ddw
Hay

DRAFT

HAZARDOUS MATERIALS ENVIRONMENTAL MANAGEMENT ASHORE

(Chapter 11 Excerpted from Draft OPNAVINST 6240.3F

"Navy Environmental Protection Manual")

Index

- Part 1 - "Hazardous Materials and Hazardous Waste Management." Navy compliance with "Resource Conservation and Recovery Act (RCRA)" Pg. 11-1
- Part 2 - "Inactive Hazardous Substance Disposal Sites." Describes Navy program to seek out abandoned hazardous waste disposal sites, evaluate effects on the environment, and take corrective action. Pg. 11-20
- Part 3 - "Polychlorinated Biphenyls (PCB's)." Navy compliance with EPA regulations concerning PCB's. Pg. 11-25
- Part 4 - "Hazardous Material/Waste Spill Prevention, Control and Countermeasures." Navy program to prevent hazardous material/waste spills. Pg. 11-32

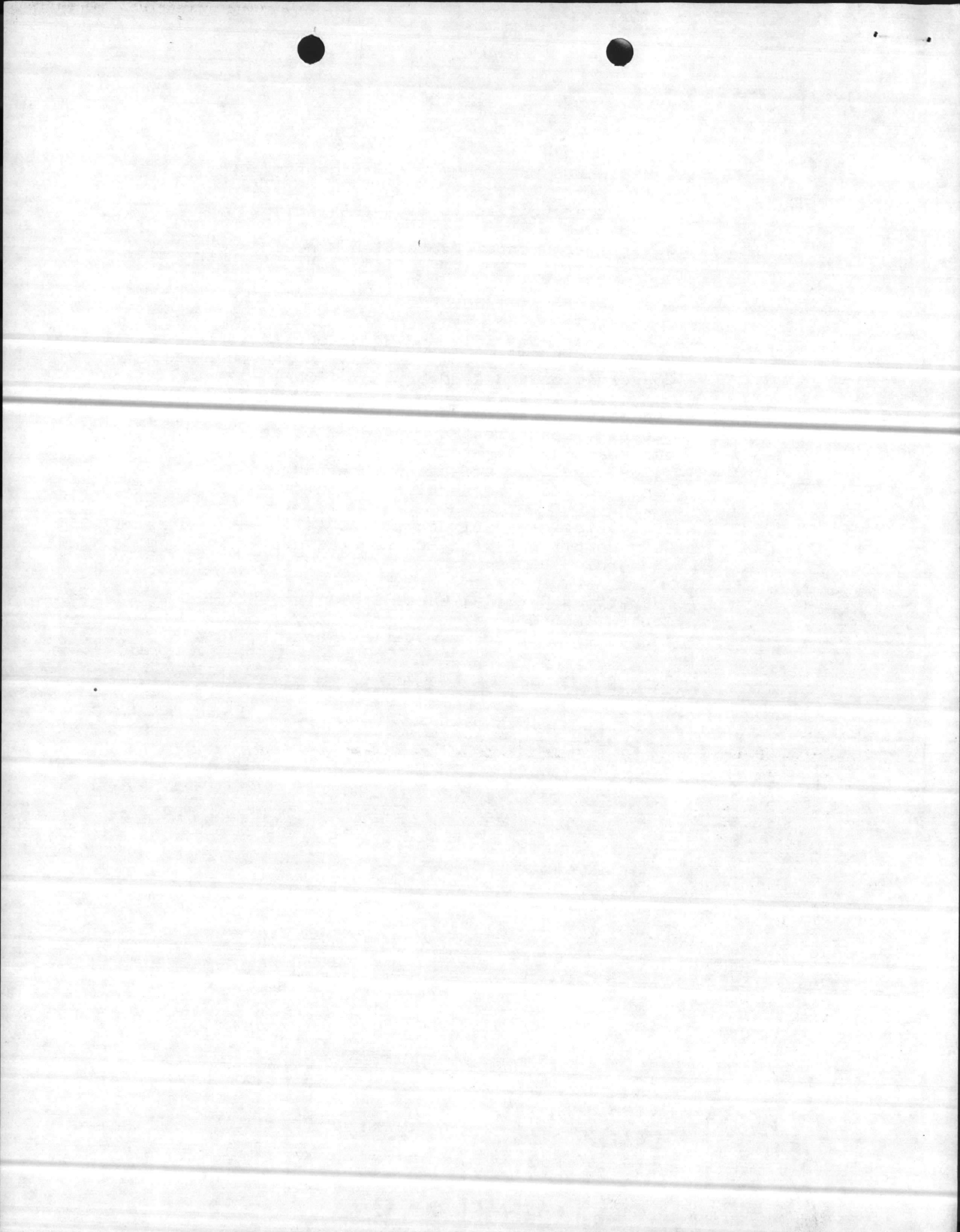

11100. Purpose

Part 1 provides information and guidance applicable to generation, transportation, storage, treatment, and disposal operations associated with hazardous materials and hazardous materials that have been designated as hazardous waste.

11101. Discussion

a. Definitions

(1) Hazardous material (HM) or hazardous substance (HS). Any material, which because of its quantity, concentration or physical, chemical or infectious characteristics may pose a substantial hazard to human health or the environment when released or spilled to the environment. In the case of ships, this includes hazardous materials turned into store (HMTIS).

(2) Hazardous waste (HW). Any discarded material, liquid, solid, or gaseous, that meets the definition of a HM and/or is designated a hazardous waste by the Environmental Protection Agency or State hazardous material control authority.

(3) Hazardous material turned into store (HMTIS). Excess material no longer needed by a ship that is classifiable as HM.

b. Applicability to Navy Activities in Foreign Countries. Navy activities in foreign countries are not, in general, subject to specific requirements of this Part as the requirements are based on U.S. laws and regulations. Nevertheless, HM, including HW, must be properly managed to assure protection of the environment. Specific responsibilities for Navy activities in foreign countries are given in paragraph 11105.

c. Federal Legislation. The Resource Conservation and Recovery Act (RCRA) provides a national strategy for management of HW. The strategy, as implemented by EPA involves the identification, management and tracking of a HW from the time it is generated to the time it is finally and properly disposed. Functions specifically controlled are generation, transportation, storage, treatment and disposal of HW. The thread that ties all of these functions together is the

CHAPTER 11

HAZARDOUS MATERIALS ENVIRONMENTAL MANAGEMENT ASHORE

11000. Scope

This chapter, in addition to chapters 1, 2, 3, and 4, identifies requirements and responsibilities applicable to the prevention and control of pollution from hazardous materials, including hazardous waste at Navy shore facilities within the United States, Puerto Rico, Virgin Islands, Guam, Midway, American Samoa, and the Commonwealth of Northern Mariana Islands. Responsibilities and requirements pertaining to Navy activities in foreign countries are also prescribed, where appropriate.

The control of hazardous substances in wastewater discharges is discussed in chapter 5, and in air emissions in chapter 6. Oil pollution prevention is discussed in chapter 10, shipboard hazardous waste and oil pollution management in chapter 12, and pesticides pollution abatement in chapter 9.

11001. Safety and Occupational Health

This chapter deals entirely with environmental protection aspects associated with hazardous materials. It must be noted that an effective overall program for handling hazardous materials must also include the safety and occupational health aspects. CNO instructions in these areas are:

(1) OPNAVINST 5100.23, Navy Occupational Safety and Health Program

(2) OPNAVINST 5100.24, Navy System Safety and Management

(3) OPNAVINST 5103.1, Navy Hazardous Material Information System (HMIS)

PART 1

HAZARDOUS MATERIALS AND HAZARDOUS WASTE MANAGEMENT

OPNAVINST 6240.3F

263	Standards Applicable to Transporters of Hazardous Waste	3003
264	Standards Applicable to Owners and Operators of Hazardous Waste Treatment, Storage, and Disposal Facilities	3004
265	Interim Status Standards Applicable to Owners and Operators of Hazardous Waste Treatment, Storage, and Disposal Facilities	3004
122 and 124	Permits for Treatment, Storage, and Disposal of Hazardous Waste	3005
123	Guidelines for Authorized State Hazardous Waste Programs	3006
-	Preliminary Notification of Hazardous Waste Activity. February 26, 1980 Federal Register	3010

c. RCRA/EPA Identification of HW. EPA has defined HW at 40CFR261. Essentially, any liquid, contained gaseous material, solid or semi solid material is a HW if it:

(1) is listed in 40CFR 261 as a HW, or

(2) exhibits the characteristics, as defined in 40CFR261, of ignitability, corrosivity, reactivity or toxicity (extraction procedure),

and

(3) is discarded, or is being accumulated, stored, or physically, chemically, or biologically treated prior to being discarded, or

"manifest," a document describing the waste that is developed at the time a waste is generated and that accompanies the waste until disposal, whereon it is returned to the generator to indicate final disposal. Another important feature is the assignment by EPA of identification numbers to generators, transporters, storers, treaters, and disposers of HW. Thus, by means of the identification numbers and the manifest plus considerable reporting to EPA, EPA is able to track every HW subject to RCRA.

11102. General Standands

a. Federal facility compliance. The RCRA requires that Federal facilities comply with all federal, state, interstate and local requirements, both substantive and procedural, concerning control and management of HW. The RCRA provides that EPA may transfer their responsibility for implementation and enforcement of HW programs to the states. If a state has a program, and EPA has not approved the state program, the Navy must comply with both federal and state requirements.

b. Federal Regulations. The following federal regulations have been promulgated by EPA under RCRA to implement the National hazardous waste management program.

40 CFR	Regulation Description	Implements RCRA Section
Part:		
260	Definitions used in other Parts and general provisions applicable to these Parts	3001-3004
261	Identification and Listing of Hazardous Waste	3001
262	Standards Applicable to Generators of Hazardous Waste	3002

(3) Reporting, and record keeping.

(4) HW may be accumulated by a generator on-site for a period up to 90 days before such accumulation makes the generator subject to all regulations for operating a storage facility. Nevertheless, even in the case of less than 90 days storage, the generator must meet certain requirements in 40CFR265 relative to personnel training, contingency plans and physical layout.

e. Notification of hazardous waste activity. Navy installations that generate (exclusive of "small generators"), or transport HW off-site on public access roads, or own (including tenant activities) or operate a TSD facility are required to notify EPA Regional Administrators of such action. Each notifying installation is then assigned one identification number by EPA which must be used for all reporting, manifesting and permit applications for all activities on the installation (including tenant activities). Notification of existing activity was required by 19 August 1980. If a new HW is generated/handled in a facility covered by an existing installation notification, no change or further notification is required. However, notification is required if the facility is not covered by an installation notification and HW generation is initiated. Need for notification should be anticipated as an identification number is essential for generators to be able to transport HW off the installation.

f. HW Transportation. If the transportation of HW requires a manifest, the transporter was required to notify EPA as a HW transporter and obtain an identification number. The transporter is subject to transportation requirements in 40CFR263 that, in large part, incorporate Department of Transportation regulations concerning labeling, marking, placarding, use of proper containers and spills reporting.

g. HW Treatment, Storage, and Disposal (TSD)

(1) Every HW TSD facility owner or operator was required to notify EPA of such facility and obtain an identification number.

(2) RCRA requires that operators of HW TSD facilities obtain a permit to continue/initiate new operations. EPA

(4) has served its original intended use and sometimes is discarded, or

(5) is a manufacturing or mining by-product and is sometimes discarded,

and

(6) is not domestic sewage, or is not a mixture of domestic sewage and other wastes that pass through a sewer system to a publicly owned treatment works for treatment, or

(7) is not an industrial wastewater point source discharge subject to regulation under Section 402 of the CWA, or

(8) is not a household waste, or

(9) is not otherwise exempted in 40CFR261.

d. HW Generation. A waste generator must first determine whether the waste is a HW. If the waste is a HW, the next determination is whether or not the threshold monthly generation rates or accumulation quantities in 40CFR261 are exceeded. If the threshold rates or accumulation quantities are exceeded, the generator and the waste are entirely regulatable under RCRA; if not exceeded, the generator is a "small quantity generator" and subject to RCRA requirements only to the extent indicated in 40CFR261, ie, the HW (1) must be treated and disposed of on-site in facilities that are permitted by EPA or a state, have interim status, or that are permitted, licensed or registered by a State or (2) be delivered to an off-site treatment, storage or disposal facility which meets the same requirements. In the case where threshold HW monthly generation rates or accumulation quantities are exceeded, the generator is subject to all RCRA requirements pertaining to generators. The requirements include the following:

(1) All generators were required to file a "Notification of Hazardous Waste Activity" with EPA by 19 August 1980 and were subsequently issued identification numbers by EPA.

(2) All HW wastes must be shipped by manifest.

o Additional requirements include: closure procedures for all hazardous waste facilities, post-closure procedures for disposal facilities; use and management of containers and tanks, surface impoundments, waste piles, land treatment, land fills, incinerators, thermal treatment, and chemical, physical, and biological treatment.

h. HW Manifest System. The HW manifest is a shipping document which must be originated and signed by the generator before the HW may be transported, or offered for transportation off the installation. The generator must provide specific information on the manifest (40CFR262) as well as designate one permitted TSD facility to handle the waste. An alternate permitted facility may also be named if an emergency prevents delivery to the primary facility. There is no standard EPA form for the manifest; generally, it is a document containing the required information and attached to the government bill of lading or Disposal Turn-in Document (DD 1348-1). Where states have prescribed the use of specific forms, such forms must be used. A sufficient number of copies of the manifest must be provided to allow the generator, each transporter and the owner or operator of the designated facility one copy each for their records and another copy to be returned to the generator.

i. Reporting and recordkeeping

(1) Generator reports. Upon request by EPA, generators must submit annual reports to the appropriate Regional EPA Offices. "Exception reports" must be provided to Regional EPA Offices immediately if the TSD facility designated to receive the waste has not returned a copy of the manifest within 45 days of the date the HW was shipped (Specific exception report requirements are at 40CFR262).

(2) Generator recordkeeping. Each manifest and copies of reports filed with EPA must be retained for three years. Records of test results or waste analyses must be kept for three years from the date the waste was last sent to a TSD facility.

(3) Transporter reports. None required

(4) Transporter recordkeeping. Copies of manifests

anticipates it will take several years to issue all TSD permits after applications are made. Accordingly, EPA has developed a two-part permitting procedure wherein a Part A application immediately confers "interim status" to a TSD facility allowing the facility to operate until a Part B application for a final permit is made and approved by EPA. The permitting procedures and application forms are at 40CFR 122 and 124. Interim status requirements are at 40CFR 265; permitting requirements are at 40CFR 264.

(3) Navy installations that own (including tenant activities) or operate TSD facilities applied for interim status from Regional EPA Offices by 19 November 1980. TSD facilities may be expanded or significantly changed and remain in "interim status" only with the approval of Regional EPA offices. Interim status cannot be conferred on a new TSD facility if construction commenced after 19 November 1980. In such instances, a final permit must be applied for and obtained before operation may begin.

(4) The following is a resume of the interim status standards:

- o A plan must be developed for each TSD facility to cover HW chemical analysis, security of the facility, facility inspection and facility personnel training. Operating requirements include separation of incompatible wastes, and specific safety features including a contingency plan designed to minimize hazards to human health or the environment from fires, explosions or any unplanned sudden or non-sudden release of hazardous waste constituents to the air, soil or surface water. Such contingency plans should be made a part of Spill Prevention, Control and Countermeasure Plans (Part 4).

- o Extensive ground water monitoring requirements must be implemented by 19 November 1981 for HW surface impoundments, landfills and land treatment facilities. The requirements include at least one monitoring well upgradient from the facility and three monitoring wells downgradient as well as specific requirements for operation of the monitoring system. There is provision for waiving monitoring well requirements in cases where low potential for migration of hazardous pollutants can be proven.

spill residue disposal service a part of spill clean up, the Navy may obtain necessary funding for the service after coordination with DLA.

(4) Accept custody of hazardous materials within the following guidelines:

- o If DLA possesses conforming storage at defense property disposal offices (DPDO), DLA will accept physical custody at the time it accepts accountability.

- o If DLA does not possess conforming storage at the DPDO, and the generating activity has conforming storage in support of mission requirements, the generating activity will retain physical custody, and DLA will accept accountability.

- o In those instances where neither DLA nor the generating activity possess conforming storage, the activity with the "most nearly" conforming storage will accept or retain physical custody and DLA will accept accountability.

- o DLA will be responsible for the long term programming of military construction funding for conforming storage in support of its disposal mission.

- o If DLA or DPDS and the installation involved cannot mutually agree on the best procedure for storage and handling pending final disposal, the issue shall be referred to CNO (OP-45) for resolution.

(5) Provide any required repackaging or management of hazardous materials subsequent to acceptance of accountability from the generating activity.

(6) Establish an inventory control system for the types, quantities, and locations of available items for which DLA is responsible in the event that some other activity might be able to use a particular material as a resource.

(7) Minimize environmental risks and costs associated with extended care, handling, and storage of hazardous materials by accomplishing disposal within a significantly compressed disposal cycle. Initiate actions and projects within DOD and in conjunction with federal and civil agencies and industry to

signed by the generator, the transporter and the TSD owner or operator must be maintained for three years from the date the HW was accepted by the original transporter.

(5) TSD reports. Upon request by EPA, operators of TSD facilities must submit annual reports to Regional EPA Offices. "Unmanifested waste" reports must be filed with the Regional EPA Offices within 15 days from when a TSD facility accepts hazardous wastes that are not accompanied by a manifest (with the exception of HW from a "small generator", which does not require manifesting). Both of these reports should be made on EPA form 8700-13. Additional reports are required for specific types of TSD facilities.

(6) Navy Hazardous Waste Annual Report. All Navy shore activities that generate, store, treat and/or dispose of HW, and are subject to local state or federal HW regulations, shall prepare an annual report in the Form of Appendix E. The completed annual report shall be sent by 1 March via the cognizant NAVFAC EFD to the Naval Energy and Environmental Support Activity, Port Hueneme, California 93043.

j. Navy and Defense Logistic Agency (DLA) HW Interface The Department of Defense has designated DLA as the responsible agency within DOD for worldwide disposal of all hazardous materials, except for those categories of materials specifically designated for DOD component disposal.

k. DLA responsibilities (worldwide) as assigned by DOD

(1) Initiate contracts or agreements for disposal.

(2) Accept accountability for all hazardous materials, except those categories specifically excluded in para 1110215 that have been properly identified, packaged, labeled, and certified in conformance with established criteria.

(3) Provide, upon request and as disposal service contracts are available, spill residue disposal service for disposal of hazardous residues resulting from HM/HW spills by Navy activities. Such disposal services will be funded by the Navy through FY82. Beginning in FY83, DLA will program and fund the service. Where the Navy can provide a more cost effective

accountable records of DLA.

(5) Navy activities shall be responsible for disposal of the following categories of hazardous materials that have not been assigned to DLA:

- o Toxicological, biological, radiological, and lethal chemical warfare materials which, by U.S. law, must be destroyed. Disposal of the by-products of such material is the responsibility of the DOD component with assistance from DLA.

- o Hazardous Material that cannot be disposed of in its present form due to military regulations, e.g., consecrated religious items and cryptographic equipment.

- o Contractor generated hazardous materials that are the contractor's responsibility for disposal under the terms of the contract.

- o Sludges and residues generated as a result of industrial plant processes or operations.

- o Sludges generated by municipal type wastewater treatment facilities.

- o Refuse and other discarded materials generated from mining, dredging, construction, and demolition operations.

- o Unique HW and hazardous residues of a non-recurring generated by which research and development experimental programs.

m. Application of RCRA to Navy Ships. In instances where Navy ships transfer HMTIS or HW ashore, responsibility for proper management is transferred to the receiving facility; however, it is necessary that ships forces use proper containers for HMTIS or HW, and properly label the containers. Requirements for Navy ships are given in Chapter 12.

n. Navy Facility HW Management Plan. Each Navy facility that generates HW shall develop a HW management plan. The plan shall identify HW generated and handled by the facility, determine applicable Federal, state or local requirements, and describe the system for handling and disposing of the HW in

realize this objective and expedite final disposal.

(8) Devise a system by which the time of turn-in will be highly visible on hazardous materials to insure proper application of resources to dispose of these materials. DLA should insure that sufficient disposal capability is programmed to preclude extended delays in the hazardous materials disposal process.

1. Navy HW responsibilities as assigned by DOD

(1) Where feasible, minimize quantities of hazardous waste through resource recovery, recycling, source separation, and acquisition policies.

(2) Provide all available information to DLA, as required, to complete environmental documentation, e.g., environmental impact statements associated with disposal.

(3) Properly identify, package, label, and certify conformance with established criteria prior to transfer of accountability to DLA. Subsequent repackaging or handling is the responsibility of DLA.

(4) Navy activities will retain custody of hazardous materials within the following guidelines:

o If DLA does not possess conforming storage at the DPDO, and the generating activity has conforming storage in support of mission requirements, the Navy activity will retain physical custody, and DLA will accept accountability.

o In those instances where neither DLA nor the Navy activity possesses conforming storage, the activity with the "most nearly" conforming storage will accept/retain custody.

o If DLA and the activity involved cannot agree on the best procedure for storage and handling pending final disposal, the issue will be referred to CNO(OP 45) for resolution.

o When a DOD component retains custody of a hazardous material, the hazardous material shall be kept on the

d. Navy Guidance. The following documents are available from the Naval Energy and Environmental Support Activity, Port Hueneme, CA 93042.

(1) Navy Hazardous Materials Environmental Management Guide, NESO 20.2-024. Provides guidance on the Navy HM management program.

(2) Navy Hazardous Materials Environmental Management Program, Guide for the Hazardous Waste Management Plan, NESO 20.2-029. Provides guidance on how to prepare and maintain Hazardous waste management plans.

(3) Hazardous Waste Management Regulations, NESO 8-027. Consolidates and summarized the federal regulations affecting Hazardous Waste Management.

Space — 11104. Responsibilities (within the U.S., Puerto Rico, Virgin Islands, Guam, Midway, American Samoa and the Commonwealth of Northern Mariana Islands)

a. The Chief of Naval Material is responsible for

(1) Evaluating alternatives to current shore facility hazardous material management processes.

(2) Developing training programs for personnel involved in the management and operation of HW facilities.

(3) Through NAVFACENGCOM/EFDs:

(a) Designating Public Works Centers (PWCs) to receive ship and shore generated HW and to provide central area-wide storage facilities and contract disposal for those HW for which the Navy has storage and disposal responsibilities (see para. 11102 j, k, l).

(b) Maintaining and updating the "Navy Hazardous Materials Environmental Management Guide"

(c) Assisting fleet and shore commands to identify applicable hazardous material/waste management laws and regulations.

accordance with these requirements. Several activities, or even an entire complex, may be covered by a single plan, if appropriate. The plan shall be kept up to date to reflect changes in HW generation and applicable state and federal regulations.

o. Storage and Disposal of non-DoD-owned Hazardous or Toxic Materials on Navy Installations. In accordance with Department of Defense policy in DOD Directive 6050.8, Navy installations shall not be used for the storage or the disposal of non-DoD-owned toxic or hazardous materials, except in certain specific situations. Implementation of the DoD Directive has been assumed by ASN(S&L).

11103. Applicable Guidelines

a. Compliance with Federal HW Management Requirements. Compliance with all aspects of an EPA-approved state HW Management program is deemed compliance with all Federal requirements. If a state has a program which is not approved by EPA, Navy activities must comply with both the state and federal program requirements.

b. Citations and Fines. Chapter 1, subpart 1212 provides guidelines for dealing with citations for alleged violations of any HW generation, transportation, storage, treatment, or disposal requirement, or for any attempt by a court or regulatory agency to levy a fine for violation.

c. Site Inspections

(1) Authorized EPA or state representatives, upon presentation of proper credentials, must be allowed to enter a Navy facility at reasonable times to examine or copy records, inspect hazardous waste management practices and facilities, and to take waste or other samples. Activities should request EFD assistance at such inspections.

(2) Inadequately cleared personnel should not be allowed access to classified areas. Where such entry may be necessary, access by a representative with appropriate security clearance should be negotiated with the requesting agency. If an adequately cleared individual is not available, the matter should be referred to CNO (Op-45) for resolution.

(1) Designating, in accordance with paragraph 0903 of U.S. Navy Regulations, coordinators for area-wide actions to develop and implement HW management procedures for compliance with state and local requirements regarding the identification, generation, storage, transportation, treatment and disposal of HW where Public Work Centers do not exist.

(2) In cooperation with PWCs, assisting in coordinating Navy compliance with area-wide HM and HW requirements.

c. Major Claimants and Subordinate Commands are responsible for:

(1) Ensuring that their ships and shore activities comply with Federal, state and local requirements regarding the identification, generation, storage, transportation, treatment and disposal of HW.

(2) Identifying and programming, in accordance with chapter 2, pollution abatement modifications required to bring all sources of hazardous pollutants into compliance with applicable standards.

(3) Budgeting and allocating of sufficient resources to operate and maintain facilities in compliance with applicable hazardous material/waste pollution abatement requirements.

(4) Maintaining activity personnel training in HW management.

(5) In accordance with chapter 1, subpart 1216, providing all modifications and procedures to ensure compliance with applicable requirements at government-owned, contractor-operated facilities.

d. Commanders/Commanding Officers of shore activities are responsible for:

(1) Designating an activity focal point to coordinate activity hazardous material management programs.

(2) Determining, evaluating, and complying with those Federal, state, and local laws and regulations that are

(d) Providing technical assistance, including workshops, briefings, and reports, to assist commands in complying with federal, state and local HW requirements and in preparing activity HW management plans.

(e) Periodically assessing, by means of regularly scheduled on-site surveys, the compliance status of Navy facilities with respect to management of HM and reporting all findings to activity commanding officers, major claimants, and other appropriate command levels.

(f) Assisting commands in the preparation and submittal of pollution abatement projects related to management of hazardous materials.

(g) Coordinating the review and permitting of all new HW management facilities with appropriate state and EPA regional offices to ensure early identification of siting restrictions and procedural requirements.

(h) Signing, as required, applications and permits for construction of MCON funded HW management facilities and paying associated fees from the funds appropriated and budgeted for the project.

(4) Through COMNAVSUP:

(a) Maintaining and updating procedures to ensure environmentally safe transportation, storage, and distribution of stock hazardous materials.

(b) Developing a program for the acquisition, stocking, and supply of suitable containers required for the transportation and storage of hazardous waste.

(c) Reviewing shelf-life policies with the objectives of reducing HW generation (while maintaining product acceptability) and specifying alternate uses of materials after shelf-lives are exceeded.

b. Environmental Coordinators as assigned in paragraph 1305, responsible for:

^A
are

e. Commanders and commanding officers of shore activities assigned to receive HMTIS and HW from ships and other shore activities are responsible for:

(1) Providing accessible facilities to receive the HMTIS and HW and to store it in accordance with applicable EPA and/or state regulations until disposal of the materials or transfer to DLA.

(2) Providing for disposal of HMTIS or HW in accordance with applicable EPA and/or state regulations and local disposal instructions.

f. Fleet and Type Commanders, as appropriate, are responsible for reimbursing Navy shore activities receiving ships HMTIS and HW for expenses incurred in handling, storing and disposing of the material.

11105. Responsibilities (within foreign countries)

a. The Chief of Naval Material , through NAVFACENGCOM/EFDS, is responsible for:

(1) Designating Public Works Center (PWCs) to receive ship and shore generated HW and provision of central area-wide storage facilities and contract disposal for those HW for which the Navy has storage and disposal responsibilities (see para. 11102 j, k, l).

(2) Assisting fleet and shore commands to identify applicable hazardous material/waste management laws and regulations of foreign countries.

(3) Providing technical assistance, including workshops, briefings, and reports, to assist commands in complying with HW requirements and in preparing activity HW management plans.

(4) Periodically assessing, by means of regularly scheduled on-site surveys, the status of Navy facilities with respect to management of hazardous materials and reporting all findings to activity commanding officers, major claimants, and other appropriate command levels.

(5) Assisting commands in the preparation and submittal

applicable to HM and HW at the Navy activity.

(3) Surveying the activity's HM use, storage and handling procedures and developing a HW management plan. The plan should incorporate existing activity HW programs and any area-wide responsibilities assigned by Environmental Coordinators. The plan shall be reviewed by the cognizant NAVFAC EFD prior to finalization. Copies of final surveys and plans shall be provided to cognizant NAVFAC EFD, activity major claimant, Environmental Coordinators and the Navy Energy and Environmental Support Activity, Port Hueneme, California 93043.

(4) Disposing of excess or unusable HM found to be in storage during the HM survey. Such disposal should be made through the Navy designated lead activity with area-wide storage and disposal responsibilities and must be in an environmentally safe manner and in accordance with existing Federal, state, and local HW requirements.

(5) Submitting and signing, as appropriate, reports and other required data to EPA, state or local agencies. Such submittals shall include HW operations of tenant activities and be made via the cognizant NAVFAC EFD with copy to the Naval Energy and Environmental Support Activity, Port Hueneme, CA, 93042.

(6) Submittal of an annual Navy HW report by 1 March of each year as prescribed in paragraph 11102i(6).

(7) Requesting technical assistance, as required, from cognizant NAVFAC EFD's in carrying out required actions.

(8) Budgeting and funding the operation and maintenance of facilities and equipment necessary to handle, store, transport, treat and dispose of Navy HW in accordance with applicable Federal, state and local requirements and implementing hazardous materials SPCC plans and spill contingency plans.

(9) Training personnel involved in HW operations. Such training shall meet federal and state requirements relative to the handling of HW.

plans, to cognizant NAVFAC EFD's, activity major claimant, Environmental Coordinators and Naval Energy and Environmental Support Activity, Port Hueneme, CA 93043, and the area coordinator.

(5) Requesting technical assistance, as required, from cognizant NAVFAC EFD's in carrying out required actions.

11106. Report and Form

Report Symbol DD-M(A&SA)148(6240) is assigned to the annual reporting requirements described in paragraph 11102i(6). The Form is provided in Appendix E and is approved for local reproduction.

PART 2

INACTIVE HAZARDOUS SUBSTANCE DISPOSAL SITES

11200. Purpose

Part 2 provides information and guidance applicable to the assessment and control of pollutants from inactive hazardous substance disposal sites.

11201. Discussion

a. Definition. Definitions in paragraph 11101a are applicable.

b. Federal Legislation. The Comprehensive Environmental Response, Compensation and Liability Act of 1980 (CERCLA) provides a system to identify inactive hazardous substance sites and contains authorities for establishing liabilities and responses for releases of hazardous substances from such sites.

b. Past Practices. Past hazardous substance disposal commonly relied on burial. This method, although acceptable at the time, has often caused long term problems through release of hazardous pollutants into the environment, predominantly the soil and groundwater. Residential and municipal wells have been contaminated by hazardous substances improperly dumped or buried many years ago. In some cases, residential and commercial developments have been built on old disposal sites resulting in

of pollution abatement projects related to management of hazardous materis.

b. Environmental Coordinators as assigned in paragraph 1305 are responsible for:

(1) Designating, in accordance with paragraph 0903 of U.S. Navy Regulations coordinators for area-wide actions to comply with foreign country requirements regarding the identification, generation, storage, transportation, treatment and disposal of HW where Public Work Centers do not exist.

(2) In cooperation with PWCs, assisting in coordinating Navy compliance with area-wide HM and HW requirements.

c. Major Claimants and Subordinate Commands; Commanders and commanding officers of shore Activities Assigned to receive HMTIS and HW from ships and other shore activities; and Fleet and Type Commanders, as appropriate have responsibilities as listed in paragraph 11104.

d. Commanders/Commanding officers of Navy Activities in Foreign Countries are responsible for:

(1) Designating an activity focal point to coordinate activity HW management programs.

(2) Surveying the activity's HM and developing a HW management plan. The plan shall be designed and implemented, as a minimum, to comply with environmental standards of general applicability in the host country, or jurisdiction, and go beyond such regulations as necessary to insure reasonable protection off the envornment and human health in the handling and disposal of HW. Where host country regulations do not adequately define/list HW, the list in 40 CFR 261 shall be used as a basis. The activity HW management plan shall be reviewed by the cognizant NAVFAC EFD prior to finalization.

(3) Disposing of excess or unusable HM found to be in storage during the HM survey. It is noted that Defense Logistic Agency responsibilities as assigned by DOD (paragraph 11102k) are worldwide relative to HW disposal and storage.

(4) Providing copies of HM survey and HW management

o Initial assessment study. A priority list of activities to receive initial assessment studies will be maintained based on existing information. The list shall include facilities which have been identified for release to other than DoD use. Activities placed on this list will be investigated by the special NACIP team or contractor. The initial assessment will involve an extensive review and evaluation of existing records located at the activity and elsewhere, an examination of the activity's waste disposal history, and identification of any potential or existing pollutant problems at the activity.

o Confirmation study. A confirmation study will investigate specific sites identified by the initial assessment study through physical and/or analytical testing and monitoring of suspected hazardous pollutants. Confirmation studies might include, but are not limited to, soil and ground water sampling and analysis. Initial assessment studies and confirmation studies will both be funded from pollution abatement funds managed by NAVFAC.

o Project identification. The confirmation study may indicate the need for remedial actions. Corrective measures will be programmed in normal appropriation accounts utilizing pollution abatement funds except that Navy industrial funded activities and RDT&E funded activities shall fund corrective measures for sites or releases which are traceable to their disposal practices. First priority of remedial efforts shall be directed toward the control of contamination migrating from Navy owned property when such migration poses an immediate threat to the health and welfare of the installation and/or the adjacent community.

11203. Applicable Guidelines

a. Citations and Fines. Chapter 1, subpart 1212, provides guidelines for dealing with citations for alleged violations of federal regulations concerning inactive hazardous substance disposal sites or any attempt by a court or regulatory agency to levy a fine for violations.

b. Site Inspections

serious human health problems. These environmental and health problems have led to greatly increased national concern and state and federal laws regarding past disposal practices.

11202. General Standards

a. Federal Facility Compliance. The CERCLA requires that federal facilities comply with the Act in the same manner and to the same extent, both procedurally and substantially, as any non-governmental entity, including liability provisions as prescribed in the Act.

b. Inactive hazardous substance disposal site notification. CERCLA required that owners or operators of facilities where hazardous substances have been stored, treated, or disposed of shall notify the Administrator of EPA of the facility specifying the amount and type of hazardous substance and likely releases from the facility. Such notification was made in June 1981 and is the basis on which EPA, with state advice, will develop a priority listing the most severe problems for further action.

c. Navy Assessment and Control of Installation Pollutants (NACIP) Program

(1) The Department of Defense (DoD) has promulgated a basic concept plan for assessment and control of installation pollutants. The plan specifies basic requirements for Military Departments' programs. Military Department liaison is accomplished through a Technical Coordinating Committee consisting of DOD component representatives.

(2) The NACIP program has been developed in accordance with the DoD concept plan to identify, evaluate, control and correct past deficient waste disposal sites and practices. Similar to other Navy environmental programs, the NACIP program is oriented toward compliance with Federal and state environmental laws and regulations using the structure of the existing Naval Environmental Protection Support Service (NEPSS).

(3) The NACIP program consists of three major phases - two to identify the presence of hazardous wastes and evaluate effects on the environment, and a third phase to identify and program any required corrective measures.

(c) Performing initial assessment studies at activities approved by CNO. This includes coordination with major claimants and briefing of activity commanding officers prior to commencement of studies, preparation of the study report, coordination of the report for comments and distribution of final report copies.

(d) Developing a priority listing of activities that require confirmation studies based on initial assessment findings and/or other available information in coordination with major claimants.

(e) Implementing confirmation studies by contract, in house effort, or combination. Coordination with activity commanding officers prior to initiating on-site efforts, preparation of the confirmation report, coordination for comments and distribution of final report copies to the activity and major claimant.

(f) As required, assisting activities in developing corrective projects to control underground contaminants. Where criteria, technology, or procedures are not available, or proven, coordinating necessary Research, Development, Test and Evaluation with the DOD Technical Coordinating Committee.

b. Commanders and commanding officers of Navy shore activities are responsible for:

(1) Providing an activity contact and logistical support for the initial assessment study team at activities selected for the initial assessment study.

(2) Providing an activity contact and logistical support for the confirmation study effort at activities selected for the confirmation study.

(3) Developing and submitting exhibits for pollution abatement projects identified in the confirmation study in accordance with Chapter 2.

(4) Submitting data to EPA, state or local agencies as appropriate, when required, and in the format required. Such submittals will be made via the cognizant NAVFAC Engineering

(1) Authorized EPA or state representatives, upon presentation or proper credentials, must be allowed to enter a Navy facility at reasonable times to examine or copy records, inspect inactive hazardous substance disposal facilities and to take samples. Activities should request EFD assistance at such inspections.

(2) Inadequately cleared personnel should not be allowed access to classified areas. Where such entry may be necessary, access by a representative with appropriate security clearance should be negotiated with the requesting agency. If an adequately cleared individual is not available, the matter should be referred to CNO (Op-45) for resolution.

11204. Responsibilities

a. The Chief of Naval Material is responsible for:

(1) Operation of the NACIP program for the CNO, including the necessary overall planning, programming and budgeting.

(2) Advising CNO of each activity scheduled for initial assessment or confirmation studies at least three months prior to initiation of studies.

(3) Serving as Navy representative to the DOD Technical Coordinating Committee established by the DoD concept plan to exchange information between the Army, Navy and Air Force for assessment and control of installation pollutants.

(4) Through NAVFACENGCOM,

(a) Developing and maintaining, in cooperation with major claimants, an integrated priority list of activities which require initial assessment studies.

(b) Developing an initial assessment study team of Navy personnel (civilian and/or military) supplemented, as appropriate, by experts from within or outside the Navy. The team will coordinate all investigations through cognizant NAVFAC EFD's who will provide direct liaison between the team and activities.

Nevertheless, it is required that PCBs and PCB items be properly managed in foreign countries to assure protection of public health and the environment. Specific actions for Navy activities in foreign countries are given in paragraph 11304C(5).

c. Federal Legislation. The Toxic Substances Control Act (TSCA) prohibits the manufacture, processing and distributing in commerce of PCB's, except as exempted by EPA. The act also prescribes that the use, disposal and marking of PCB's shall be strictly controlled by EPA.

d. PCB's and their characteristics

(1) PCBs have a heavy liquid, oil-like consistency, and weigh 10-12 pounds per gallon. The properties that have made them commercially attractive include: a high degree of chemical stability, high heat capacity, low electrical conductivity, and a favorable dielectric constant.

(2) PCBs released into the environment do not break into new chemical arrangements: PCBs biomagnify in the food chain -- that is, they accumulate in the tissues of living organisms and as one organism feeds on another, progressively greater concentrations occur as the food chain progresses upward towards man. PCBs may cause, among other things, reproductive failures, gastric disorders, skin lesions, and tumors in laboratory animals. Studies of workers exposed to PCBs have shown a number of symptoms and adverse effects including, but not limited to, chloracne and other epidermal disorders, digestive disturbances, jaundice, impotence, throat and respiratory irritations, and severe headaches.

(3) Monsanto Corporation was the principal manufacturer of PCBs in the United States. They began production of PCBs in 1929; in 1977 production was voluntarily terminated because of the widespread environmental concerns about PCBs. Monsanto Corporation sold PCBs under the tradename "Askarel". Companies who used PCBs in the manufacture of transformers and capacitors, and for other uses, often used other tradenames. The following list is representative of PCB tradenames: Aroclor, Pydraul, Therminol, Pyroclor, Santotherm, Pyralene, Pyranol, Inerteen, Asbestol, Chlorextol, Diachlor, Dykanol, Elemex, Hyvol, No-Flamol, Saf-T-Kuhl, Aroclor B, Clorinol, Clorphen, Eucarel.

Field Division (EFD).

PART 3

POLYCHLORINATED BIPHENYLS (PCBs)

11300. Purpose

Part 3 provides information and guidance applicable to the implementation of rules promulgated by the Environmental Protection Agency (EPA) for the use, storage, marking, inspection, recordkeeping and disposal of PCBs.

11301. Discussion

a. Definitions

(1) PCB Article. Any manufactured article, other than a PCB container, that contains PCBs and whose surface has been in direct contact with PCBs. Includes transformers and capacitors.

(2) PCB Item. Any PCB Article, PCB Article Container, PCB Container, or PCB Equipment, that deliberately or unintentionally contains, or has as a part of it any PCB or PCBs at a concentration of 50 ppm or greater.

(3) PCB Transformer. Any transformer that contains 500 ppm PCB or greater.

(4) PCB Contaminated Transformer. Any transformer that contains 50 ppm or greater of PCB, but less than 500 ppm PCB.

(5) PCB Leak. Any instance in which a PCB transformer or, PCB contaminated transformer has any PCB on any portion of its external surface.

(6) Moderate PCB Leak. Any leak which results in any quantity of PCBs running off, or about to run off, the external surface of a PCB transformer or PCB contaminated transformer.

b. Applicability to Navy Activities in Foreign Countries. Navy activities in foreign countries are not, in general, subject to specific requirements of this Part as the requirements are based on U.S. laws and regulations.

(5) PCB fluids (containing more than 500 ppm PCB) must be disposed of in special high temperature incinerators approved by EPA. PCB contaminated mineral oil (less than 500 ppm PCB) may be burned in high efficiency boilers provided specific EPA requirements are met and EPA and appropriate local and state approvals are obtained. Hazardous waste landfills, approved by EPA for PCB disposal, may be used for disposal of specific PCB items such as drained transformers, large capacitors and debris from PCB spills.

(6) Requirements relative to the inspection and maintenance (for PCB leaks) of transformers are contained in the Federal Register, Volume 46, Number 46 of March 10, 1981, pages 16090-16098. Where there is an exposure risk to food and feed products by PCB transformers or PCB contaminated transformers, the transformers must be visually inspected once per week inspection records must be maintained, cleaning and repair of moderate leaks must be initiated within 2 business days, and a report must be made to EPA within 5 days of when a moderate leak is observed. Where there is no exposure risk to food and feed products, PCB transformers which are in use, or stored for reuse, must be visually inspected at least once every three months beginning on 9 Aug 1981, inspection records must be maintained, and repair of moderate leaks must be commenced within 2 business days of when the leak is observed.

b. Foreign country operations

(1) The specific restrictions in 40CFR761 concerning the import and export of PCB's and PCB items are not applicable to:

o The overseas deployment of DoD owned PCB or PCB or PCB items for use by U.S. military forces.

o The return of DoD owned PCB or PCB items to the U.S. for continued use by U.S. military forces or for disposal in accordance with regulations.

(2) The use of PCB's and PCB items in foreign countries should be minimized insofar as possible, provided that mission performance is not degraded.

(4) The primary use of PCBs has been in electrical transformers, capacitors, heat transfer systems, and hydraulic systems. PCBs have also been used in paints, adhesives, caulking compounds, plasticizers, inks, lubricants, carbonless copy paper, sealants, coatings and dust control agents. Most of the PCBs marketed in the United States are still in service primarily in electrical equipment. Within the Navy, the greatest quantities of PCB's are found in PCB contaminated transformers, PCB transformers and in PCB capacitors.

11302. General Standards

a. Federal Facility Compliance. The PCB requirements of the TSCA, as implemented by EPA regulation (40CFR 761), are applicable to federal facilities. The following are the principal elements of the regulation.

(1) PCB items, PCB storage areas and transport vehicles must be marked with special labels.

(2) An annual report showing the disposition of PCB's and PCB items must be developed by each 1 July and kept on hand for review by EPA personnel. The Navy report form in Appendix I contains the required information. Additional recordkeeping requirements exist for storage and disposal facilities, PCB dielectric analyses, and inspections of transformers that contain PCB.

(3) Any PCB article or PCB container stored for disposal before January 1, 1983 must be removed from storage and disposed of before January 1, 1984. After January 1, 1983, PCB articles or PCB containers stored for disposal must be disposed of within one year of the date that storage commenced.

(4) PCB's and PCB items designated for disposal must be stored in facilities which comply with specific design requirements. The facility must be operated, maintained and inspected in accordance with specific requirements. It should be noted that there are no special facility requirements for storage of non-leaking PCB transformers and PCB contaminated transformers when stored for eventual service. Nevertheless, such transformer should be stored in a space which protects the transformers from incidents which could cause spills of PCB.

proper credentials, must be allowed to enter a Navy facility at reasonable times to examine or copy records, inspect PCB and PCB item management practices and facilities, and to take samples. Activities should request NAVFAC EFD assistance at such inspections.

(2) Inadequately cleared personnel should not be allowed access to classified areas. Where such entry may be necessary, access by a representative with appropriate security clearance should be negotiated with the requesting agency. If an adequately cleared individual is not available, the matter should be referred to CNO (Op-45) for resolution.

c. Navy Guidance. "PCB Compliance, Assessment and Spill Control Guide", NESO 20.2-028 is available from the Naval Energy and Environmental Support Activity, Port Hueneme, CA 93043. The guide provides detailed concise summaries of the 40CFR761 requirements, and practical information on means to comply with the requirements and occupational health aspects of handling PCB's.

11304. Responsibilities

a. The Chief of Naval Material is responsible for:

(1) Providing technical advice to major claimants and Navy shore activities on the implementation of the PCB provisions of TSCA and 40 CFR 761. Emphasis will be made, at the installation level, on the dangers of PCBs to the environment and as an occupational health hazard.

(2) Exploring alternatives to the use of PCB's in existing transformers and providing such information to appropriate commands and activities.

(3) Assuring the availability of labels prescribed in 40 CFR 761 for marking of PCB items, storage areas and transport vehicles.

(4) Making appropriate changes to design and operation manuals to incorporate the requirements of 40CFR761.

b. Major Claimants are responsible for budgeting and allocating sufficient resources to operate and maintain

(3) The labeling, safe storage, inspection for leaks, rapid spill clean up, inventory, and disposal of PCB and PCB items shall be consistent with standards to protect public health and the environment as prescribed by applicable SOFAs or other stationing agreements. In the absence of such agreements, PCB's and PCB items should be minimized consistent with substantive portions of 40CFR761.

(4) Shipment containers of PCB's and PCB items shipped to and from overseas locations shall be clearly labeled and accounted for in movement and made available for customs inspections.

c. PCB Spills. PCB's are listed in 40CFR117 as a reportable HM in the event of spill. Accordingly, a spill of a reportable quantity (10 lbs.) of PCB, as specified in 40CFR117, must be reported as required in Chapter 13.

d. Navy and Defense Logistic Agency (DLA) Interface. The Department of Defense (DOD) has assigned DLA as worldwide executive for the storage (for disposal) and the disposal of PCB's and PCB items within DoD. This assignment includes the budgeting for disposal and storage facilities as well as maintaining state of the art knowledge on technical developments for PCB disposal. DLA will accept accountability for storage for disposal of PCBs and PCB items. DLA will also accept custody where the Defense Property Disposal Office (DPDO) has conforming storage. If neither the DPDO nor the generating activity has conforming storage, the activity with the "most nearly conforming storage" will accept or retain custody.

11303. Applicable Guidelines

a. Citations and Fines. Chapter 1, subpart 1212 provides guidelines for dealing with citations for alleged violations of federal regulations concerning environmental management of PCB's or PCB items or any attempt by a court or regulatory agency to levy a fine for violation.

b. Site Inspections

(1) Authorized EPA representatives, upon presentation of

OPNAVINST 6240.3F

transferring PCBs and PCB items to be disposed of to DPDOS, within the guidelines prescribed in paragraph 11302d, for storage and disposal; (c) taking actions concerning potential PCB hazards as prescribed in paragraph 11304C(4); and (d) complying with the policies in paragraph 11302b.

(6) Testing bulk used oil for PCB's if there is reason to believe such oil has become contaminated with PCB. Used oil containing 50 ppm or more PCB must be disposed of in accordance with requirements in 40 CFR 761.

(7) Reporting PCB spills as prescribed in Chapter 13 when the spill exceeds reportable quantities established in reference 40CFR117.

11305. Report Symbol OPNAV 6240-11 is assigned to the requirement contained in paragraph 11304c(3) and (5). The form is provided as Appendix F and is approved for local reproduction.

. PART 4

HAZARDOUS MATERIAL/WASTE SPILL PREVENTION, CONTROL AND COUNTERMEASURES

11400. Purpose. Part 4 provides information applicable to planning, development, and implementation of procedures and provision of appurtenances to prevent and contain spills of materials and wastes that are identified as hazardous.

11401. Discussion

a. Definitions Definitions in paragraph 11101a are applicable.

b. Spill Potential. The storage of hazardous materials (HM), including hazardous waste (HW), creates the potential of accidental spills with varying degrees of adverse effects. Human error or mechanical failures can result in a spill of hazardous materials, which may subsequently enter a sewer system/storm drain or runoff directly into a waterway, or be absorbed into the groundwater.

c. HM spill prevention control and countermeasure plans

facilities in compliance with 40 CFR 761.

c. Commanders/Commanding officers of Navy shore activities are responsible for:

(1) Transferring accountability and custody of PCBs and PCB items for storage for disposal and for disposal, insofar as possible within the guidelines of paragraph 11302d.

(2) Handling, storing, marking, and inspecting PCBs and PCB items, for which they have accountability, in accordance with 40CFR761. With regard to PCB transformers and PCB contaminated transformers, inspecting for PCB leaks, repairing moderate leaks, maintaining records and providing notification to EPA, all as specified in Federal Register Volume 46 Number 46 of March 10, 1981 pages 16090-16098. Leak repair shall be accomplished using funds normally available to activities.

(3) Annually, by 1 July, inventoring or validating PCBs and PCB items in their accountability utilizing the form in appendix F. Reports shall be maintained at the activity for at least five years. Copies of the completed annual report shall be forwarded annually by 1 July to cognizant NAVFACENGCOM EFDs, the Naval Energy and Environmental Support Activity, Port Hueneme, CA, 93043 and the cognizant major claimants. Additional records, as prescribed in 40 CFR 761, for testing of PCB concentrations in railroad transformers, hydraulic systems, heat transfer systems and converted or reclassified transformes shall be maintained at the activity.

(4) Reviewing the risks associated with possible leaks or spills of PCBs from PCB items in areas that are particularly susceptible to serious environmental damage or human exposure and, if appropriate, moving or replacing the items. Such risk areas include include food staorage, preparation or serving areas and areas which drain to surface or ground waters or a wastewater treatment plant. Funding for moving/replacing PCB transformers and PCB contaminated transformers in these instances shall be through the environmental protection program using procedures given in Chapter 2.

(5) When located in foreign countries: (a) annually inventoring PCBs and PCB items using the form in Appendix F and providing report copies as described in paragraph 11304C(3); (b)

OPNAVINST 6240.3F

is responsible for providing technical assistance, coordination and otherwise assisting individual commands to develop HM SPCC plans.

b. Commanders/Commanding officers are responsible for:

(1) Preparing and implementing HM SPCC plans and providing copies of the plans to the cognizant NAVFAC EFD, activity major claimant, and the Naval Energy and Environmental Support Activity, Port Hueneme, CA 93043.

(2) Identifying HM SPCC plan facility and equipment deficiencies in cooperation with cognizant EFD's and reporting such deficiencies and funding requirements in the existing Navy Pollution Control Reporting System administered by COMNAVFACENGCOM as prescribed in Chapter 2.

(SPCC). SPCC plans are the means by which facilities identify, plan and implement the necessary measures to prevent and contain spills of HM. The objective of such plans is to minimize hazards to human health or the environment from fires, explosions or any unplanned sudden or non-sudden release of hazardous materials to the air, soil or water.

13402. General Standards

a. HM SPCC plan relationship to spill contingency plans. SPCC plans deal with prevention of HM spills. Spill contingency planning (Chapter 13) deals with the organization and mobilization of resources to report, clean up, and mitigate the effects of HM spills.

b. Combined SPCC plans. Wherever possible, HM SPCC plans should be combined with oil SPCC plans (Chapter 10), as many of the provisions will be identical. Similarly, a single SPCC plan should normally be developed for all activities within the boundaries of a single host installation, or even for all activities within a complex.

11403. Applicable Guidelines

a. Affected Installations. An installation which has one or more TSD facilities which have "interim status", or are permitted (Part 1), shall have an SPCC plan for the facilities. Further, any installation that stores or transports any HM listed in 40CFR117 in quantities that could cause health or environmental effects in the event of spill, vandalism, fire or explosion shall develop an SPCC plan for such materials.

b. Activity HM SPCC Plan. In general, the plans shall include equipment necessary to prevent the accidental discharge of hazardous substances; information on the direction, rate of flow, and quantity of hazardous substances that could be accidentally discharged; necessary diversion structures and means for secondary containment; and procedures for inspection, security and personnel training.

11404. Responsibilities.

a. The Chief of Naval Material, through NAFACENCOM EFD's,

NATURAL RESOURCES AND ENVIRONMENTAL AFFAIRS BRANCH
BASE MAINTENANCE DIVISION
MARINE CORPS BASE
CAMP LEJEUNE, NORTH CAROLINA 28542

13 April 82
Date

From: Director

To: *Danny*

Subj:

1. What is King addressing
in the form of containers?

Anhui

Essentially - 55 gallon

Drums. Again - this just makes
it harder to dispose of them

Through DPDO

DDS

*Taylor,
File - Hwy waste
JWW*



Handwritten text, possibly a signature or initials, located in the lower right quadrant of the page. The text is faint and difficult to decipher, appearing to consist of several lines of cursive or semi-cursive writing.

To: Danny

6240

MAN

PTTUZYUW RUEBDOA7870 0981500-UUUU--RUEBDOB RUEBDOD RUEBNMA. DISTRIBUTION
ZNR UUUUU

P 081927Z APR 82
FM DPDO CAMP LEJEUNE NC
TO ZEN/CG MCB CAMP LEJEUNE NC
RUEBDOD/CG SECOND MARDIV
RUEBDOB/CG SECOND FSSG
RUEBNMA/MCAS H NEW RIVER NC
ZEN/NAVREGMEDCEN CAMP LEJEUNE NC
ZEN/NAVREGDNCEN CAMP LEJEUNE NC
BT

<input checked="" type="checkbox"/>	BMO
<input checked="" type="checkbox"/>	ABMO
<input checked="" type="checkbox"/>	NREAD
<input checked="" type="checkbox"/>	Admin D.
<input type="checkbox"/>	Oper D.
<input type="checkbox"/>	M&R D.
<input type="checkbox"/>	Util D.
<input type="checkbox"/>	F&A O.
<input type="checkbox"/>	Prop O.
<input type="checkbox"/>	MME
<input type="checkbox"/>	Maint NCO
<input type="checkbox"/>	Secretary

APR 9 02 53 82

UNCLAS //N04470//

SUBJ: DISPOSAL OF EMPTY CONTAINERS

1. REF: DPDR-MR MSG. 133-82 AND 134-82.
2. ALL CONTAINERS MUST BE SAFE TO HANDLE AND NON-LEAKING WHEN TURNED IN TO THE DPDO.
2. CONTAINERS MUST HAVE BUNG'S, GASKETS, SEALS, COVER, ETC., IN PLACE OR BE OTHERWISE SEALED AND NSN/LSN OR NOUN NAME OF THE CONTAINERS PREVIOUS CONTENTS WILL BE ANNOTATED ON CONTAINER BY INDELIBLE MARKINGS OR LABELS. TRIPLE RINSED CONTAINERS ARE AN EXCEPTION AND SHOULD BEAR THE APPROPRIATE STATEMENT ON TURN IN DOCUMENTATION (1348-1).

PAGE 02 RUEBDOA7870 UNCLAS

2. CONTAINERS NOT MEETING THE ABOVE REQUIREMENTS WILL BE REJECTED AND RETURNED TO THE GENERATING ACTIVITY.

BT
#7870

REL: M.J. KING, CHIEF, DPDO,
ACT: LOG,
INFO: DSSC, FSMA0-1, DOSET, GEN & SPEC STAFF,
DPDO, NRMIC, NRDC /ELE

NNNN

08



19

278 APR 82



DISTRIBUTION

- _____ RMO
- _____ OMO
- _____ TREAD
- _____ Admin D
- _____ C par D
- _____ MS D
- _____ W D
- _____ A D

Bmo. 
Apmo 

NATURAL RESOURCES AND ENVIRONMENTAL AFFAIRS DIVISION
BASE MAINTENANCE DEPARTMENT
MARINE CORPS BASE
CAMP LEJEUNE, NORTH CAROLINA 28542

6 April 81

From: Director, NREA Division
To: *BMD* *M*

Subj: PCB's + PCB Contaminated Transformers
1.

all subj items have been turned
in to DPDO CL except 30±
transformers which are located at
Hot 140. Samples have been sent
to Norfolk. When Lab results are
received Mr Cone M+R can turn
these in to DPDO.

Jubia

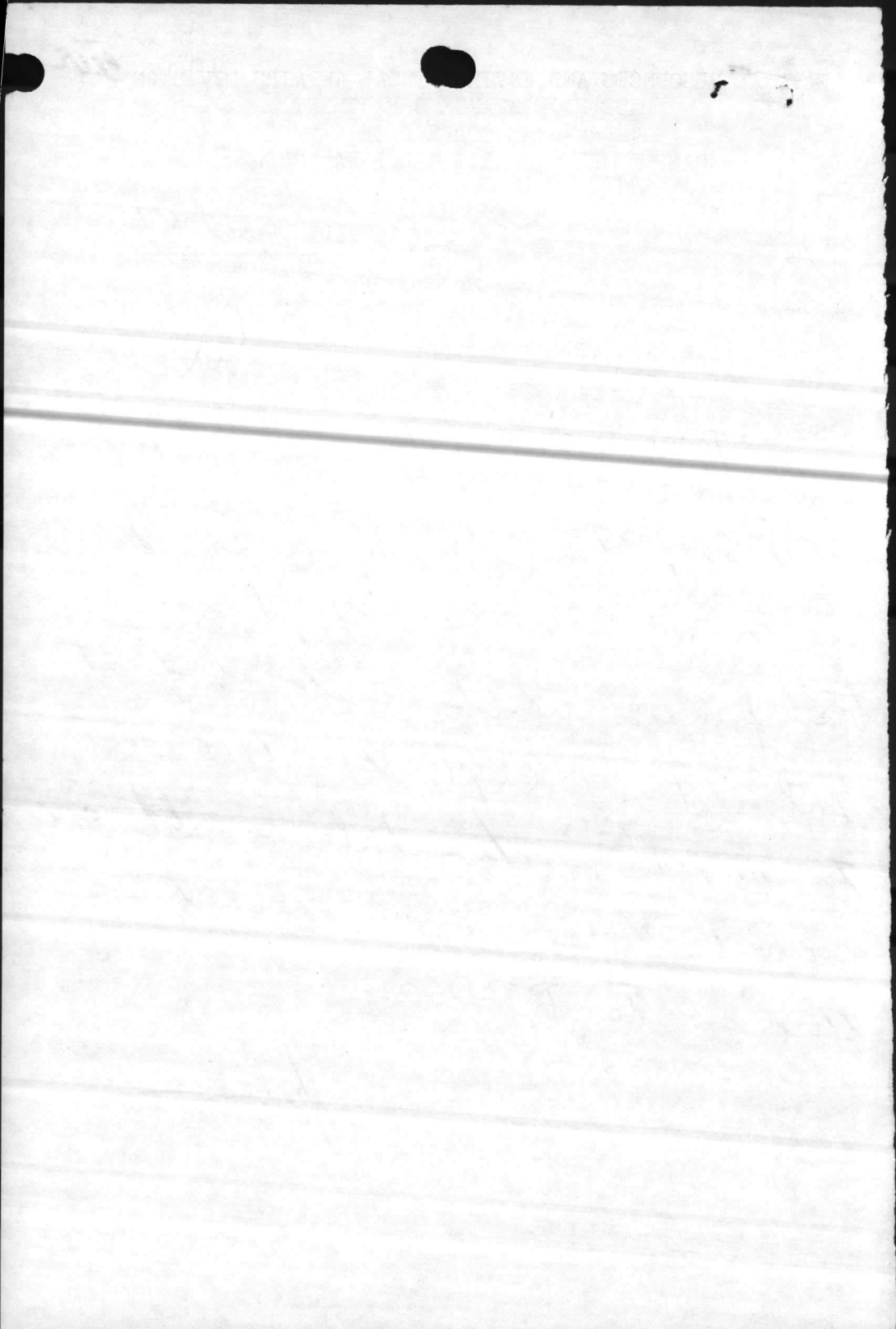

ROUTING SLIP

APR 0 2 1981

ACTION	INFO	INITIAL
BMO		✓ M
ABMO		✓ BK
ADMIN		✓
ENVIRON AFF		✓
F&A BRANCH		
MAINT NCO		
M&R		
OPNS		
PROP		
TELE		
UMACS		
UTIL		
SECRETARY		

COMMENTS:

Due date: 31 Mar 81



ASSISTANT CHIEF OF STAFF, FACILITIES
HEADQUARTERS, MARINE CORPS BASE

DATE 4-2-81

TO:

BASE MAINT O

DIR, QUARTERS & HOUSING

PUBLIC WORKS O

DIR, BOQ/BSQ

COMM-ELECT O

BASE FIRE CHIEF

MOTOR TRANSPORT O

ATTN: _____

1. Attached is forwarded for info/action.

2. Please initial, or comment, and return all papers to this office.

3. Your file copy.

J.C. Smith
By dir

"LET'S THINK OF A FEW REASONS
WHY IT CAN BE DONE"

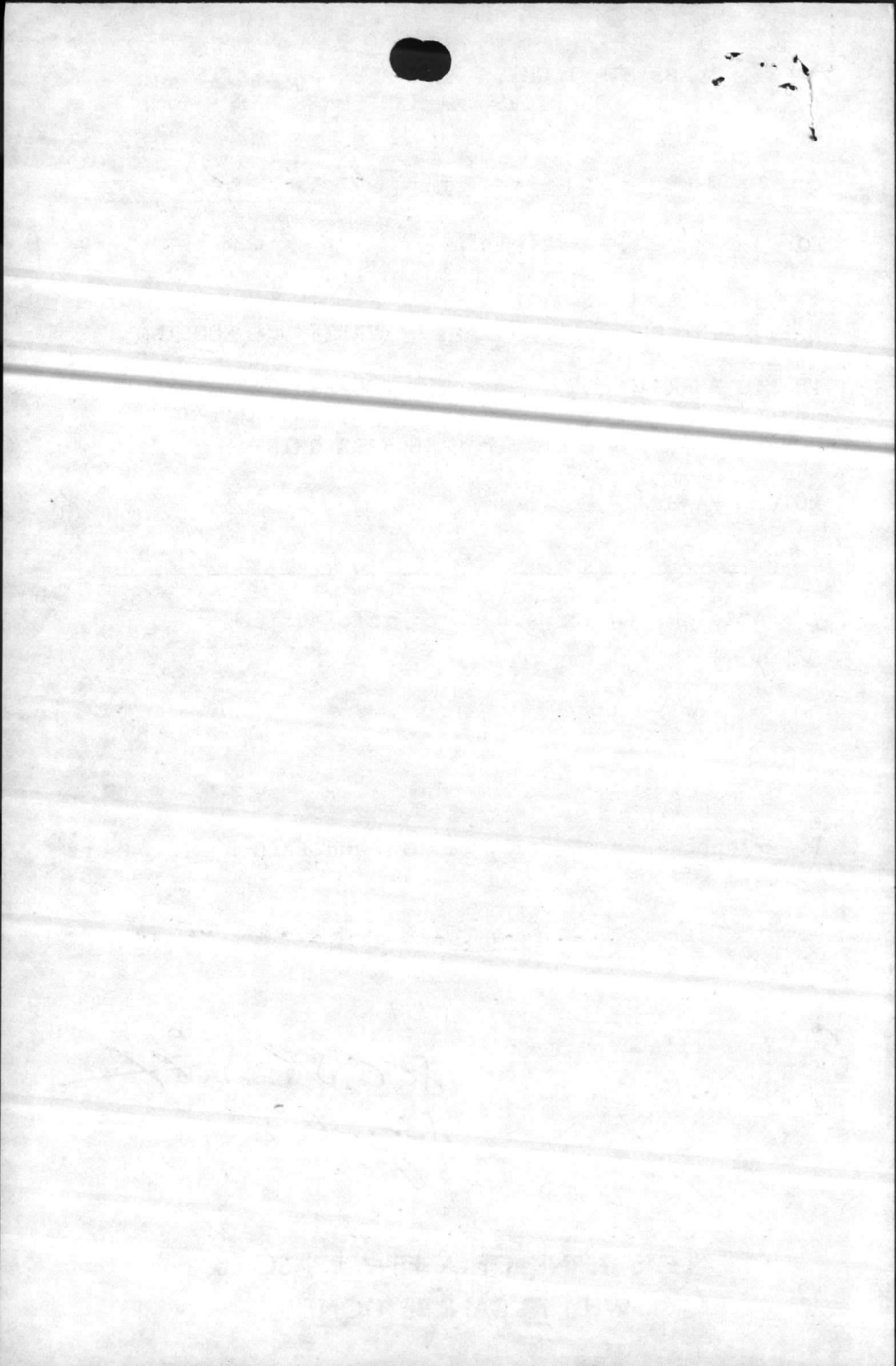

6240

FAC
Read for 2 Apr 81

ROUTINE

* U N C I A S S I F I E D *

PT 00359 090/22287

PAGE 01

RTTUZYUW RUEACMC7653 0902031-UUUU--RUCRNA.
7NR UUUUU
R 271513Z MAR 81
FM CMC WASHINGTON DC
TO ALMAR
INFO RUEMAAA/CMO WASHINGTON DC
RUEAHOF/COMNAVFACENGCOM ALEXANDRIA VA
RUEBUAB/HQ DPDS BATTLE CREEK MI
NA-CNPF
BT

//COMM NOTE//
ROUTED BY SSIC 06200

UNCLAS //NO6280//
ALMAR 57/81

SUBJ: MCBUL 6280. CALL FOR POLYCHLORINATED BIPHENYL (PCB) ITEMS
(CMC CODE LEF-2)

- A. MCO 4570.24
- 1. REF A DIRECTED ADDEES TO TURN IN ALL EXCESS HAZARDOUS MATERIALS (HM) (ITEMS, SCRAP, OR WASTE) FOR WHICH THE DEFENSE LOGISTICS AGENCY HAS RESPONSIBILITY FOR DISPOSAL. MCBUL'S IN THE 4570 SERIES SPECIFICALLY HIGHLIGHTED THAT VALID DISPOSAL TURN-IN DOCUMENTS (DTID'S) BE PREPARED FOR EXCESS PCB'S AND UNSERVICEABLE PCB ITEMS.
- 2. RECENT ADVANCES IN HM MANAGEMENT TECHNOLOGY PROVIDES AN AVENUE FOR FINAL DISPOSAL OF PCB'S AND PCB ITEMS. THE DEFENSE PROPERTY

AGE 02 RUEACMC7653 UNCLAS
DISPOSAL SERVICE IS CURRENTLY DEVELOPING DISPOSAL CONTRACTS FOR THESE MATERIALS. TO MAXIMIZE UTILIZATION OF THESE CONTRACTS, ADDEES ARE REQUESTED TO ENSURE BY 31 MAR 1981 THAT DTID'S HAVE BEEN PREPARED FOR ALL EXCESS PCB'S AND PCB ITEMS CURRENTLY OUT OF SERVICE AWAITING DISPOSAL.

- 3. THE POINT OF CONTACT REGARDING THE SUBJECT IS MR. PAUL HURBELL, AUTOVON 224-1425/224-2171.
- 4. THIS BULLETIN IS APPLICABLE TO THE MCR.
- 5. THIS BULLETIN CANCELED 30 JUN 1981.

FAC ROUTING

	ACTION	INIT	RET
FACO			VW
4A			SO
4G			
4C	X		
3D			
4H			X
4E			

BT
#7653

NNNN

ACT: TRNG
INFO: CBC, IAW Enclosure (2) of current CG MCB Ltr (SSIC 2340)
NRMC/44

*This should be
Base maint Action.
Keep on board.*

ROUTINE

* U N C I A S S I F I E D *

137 MAR

15 9/15/1914

15

MAIN/JIW/spk
6240

MAR 19 1982

From: Base Maintenance Officer
To: Assistant Chief of Staff, Facilities

Subj: Hazardous Waste Recordkeeping and Reporting Requirements

Ref: (a) PONECON btwn LTCOL Fitzgerald and J. I. Wooten, NREAD on
17 March 82

Encl: (1) AC/S fac memo of 15 March 1982

1. As discussed during the reference, the enclosure is returned for routing to Assistant Chief of Staff, Logistics for action.

B. W. ELSTON
Acting

THE UNIVERSITY OF CHICAGO
LIBRARY

1950

1950

1950

1950

LINE

10/0734Z

RTTU7YUW RUEA CMC 55 80 0700732-UUUU--RUE R00A.

ZNR UUUUU
R 1014257 MAR 82
FM CMC WASHINGTON DC
TO AIG EIGHT ACT: CG MCB
BT

//COMM NOTE DISTRIBUTION CORRECTED BY
COMMEN DESTROY ALL PREVIOUS COPIES//

UNCLAS //N11000//

SUBJ: HAZARDOUS WASTE RECORDKEEPING AND REPORTING REQUIREMENTS
A. FEDERAL REGISTER 47 FR 7841 OF 23 FEB 82 (NOTAL)
B. MCRUL 6280 OF 1 MAY 1980 WITH CH 1-2
1. BY REF A THE ENVIRONMENTAL PROTECTION AGENCY (EPA) HAS DELAYED COMPLIANCE DATES FOR THREE REG UNDER ITS HAZARDOUS WASTE (HW) REGULATIONS WHICH WERE PUBLISHED UNDER SUBTITLE C OF RESOURCE CONSERVATION AND RECOVERY ACT (RCRA) AND IMPLEMENTED BY REF B. THE FOL DATA REQTS ARE POSTPONED FROM 1 MAR 82 TO 1 AUG 82:
A. SUBMISSION OF ANNUAL REPORTS BY HW GENERATORS AND OWNERS AND OPERATORS OF HW TREATMENT, STORAGE, AND DISPOSAL (TSD) FACILITIES;
B. SUBMISSION OF INITIAL-YEAR QUARTERLY GROUNDWATER MONITORING PARAMETER READINGS BY TSD FACILITIES;
C. PREPARATION OF GROUNDWATER QUALITY ASSESSMENT PROGRAM OUTLINES BY TSD FACILITIES.
2. THIS POSTPONMENT DOES NOT RELIEVE TSD FACILITY OPERATORS FROM

PAGE 02 RUEA CMC 5580 UNCLAS
MAINTENANCE OF RECORDS REQUIRED TO PREPARE THESE REPORTS. IT IS ANTICIPATED THAT DURING THE LATE SPRING/EARLY SUMMER TIMEFRAME EPA WILL ISSUE CONSOLIDATED REQTS REGARDING REPORTING PROCEDURES.
3. QUESTIONS RE THIS SUBJ SHOULD BE DIRECTED TO MR. PAUL HUBBELL AT A/V 224-2171/3188.

BT
#5580

NN NRS
ACT: FAC
INFO: ADJ, COMP, MAIN, PWO, DOSET /126

- _____ BMO
- _____ ABMO
- _____ NREAD
- _____ Admin D.
- _____ Oper D.
- _____ M&R D.
- _____ Tele D.
- _____ Int D.
- _____ F&A O.
- _____ Insp O.
- _____ MME
- _____ Maint NCO
- _____ Secretary

ROUTINE

MAR 82
256

10

14

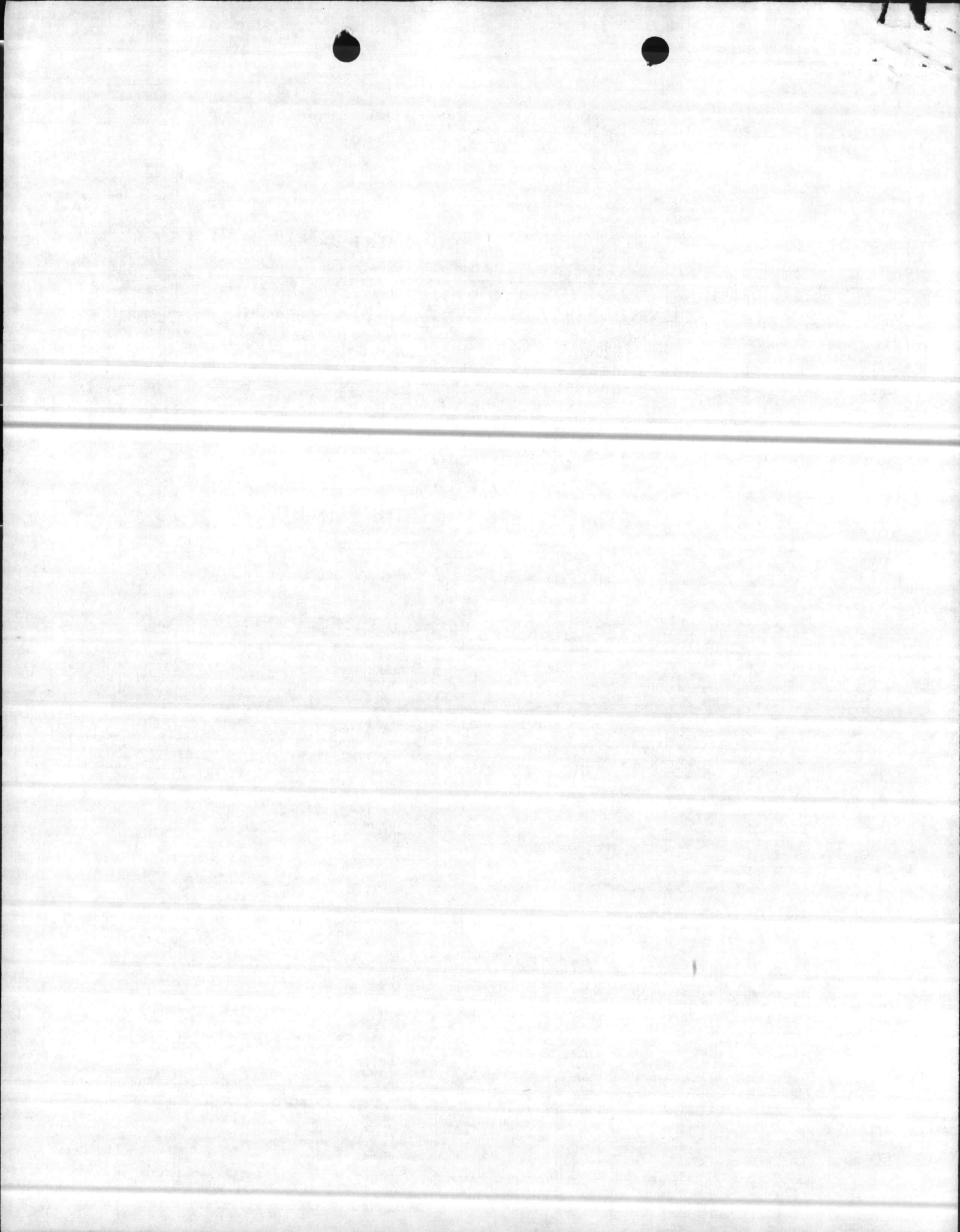

File #9 wants adw

TRAFFIC MANAGEMENT DIVISION
Assistant Chief of Staff, Logistics
Marine Corps Base
Camp Lejeune, North Carolina 28542

TMD/ELF/law

6240

26 Feb 1982

Mr. O. W. Strickland, Head
Solid and Hazardous Waste Management Branch
Environmental Health Section
Division of Health Services
Post Office Box 2091
Raleigh, North Carolina 27602

Dear Sir:

Enclosed please find the following:

- (1) N. C. 1981 Hazardous Waste On-Site TSD Facility Annual Part B Report
- (2) Closure Plan for Hazardous Waste Storage Facility, Building TP-451
- (3) Emergency Procedures and Spill Contingency Plan for the Hazardous Waste Storage Facility, Building TP-451 w/attachments (a) and (b)

Questions regarding this matter should be forwarded to the Commanding General, Marine Corps Base, Camp Lejeune, North Carolina. Point of contact is Mr. Danny Sharpe, Natural Resources and Environmental Affairs Branch, telephone (919) 451-2083.

Sincerely,

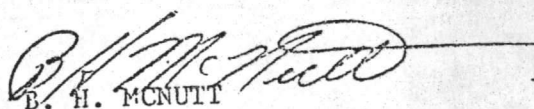
B. H. MCNUTT

BCC:
AC/S, Logistics
AC/S, Facilities

W. J. ...
1944

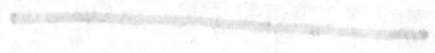
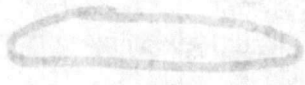

N. C. 1991 HAZARDOUS WASTE ON-SITE TSD FACILITY
ANNUAL PART B REPORT *

I. Installation EPA ID Number: N C 6 1 7 0 0 2 2 5 8 0

II. Name of Installation: Marine Corps Base

III. Location of Installation: Camp Lejeune
(Street or Route Number)

Camp Lejeune, NC Onslow North Carolina 28542
(City or Town) (County) (State) (Zip Code)

IV. Installation Contact: Base Maintenance Officer 919 451-5003
(Name) (Area Code) (Phone Number)

V. Waste Identification:

Line Number	A. EPA Waste Number	B. Description of Waste	C. Quantity Generated (COO's LBS)	D. Amount of Waste by Handling Method			
				1. Handling Method Code	2. Quantity Stored, Treated Disposed, or Recovered On-Site	Shipped to Off-Site Treatment, Disposal, or Recovery Facility	
						3. Quantity	4. Facility EPA ID No./Recovery Facility Name
1	F005	Methyl Ethyl Ketone	.386	S01	.386	--	---
2	U061	DDT	2.820	S01	---	2.820	ALT000622464
4							
5							
6							
7							
8							
9							
10							
11							
12							

(If more space is needed check and complete attachment 1)

VI. Comments:

VII. Signature: *Benjamin H. McNutt* B. H. MCNUTT, Hazardous Waste
(Signature) Material Storage & Disposal Officer
(Print or Type Name)

*Read instructions before completing form.

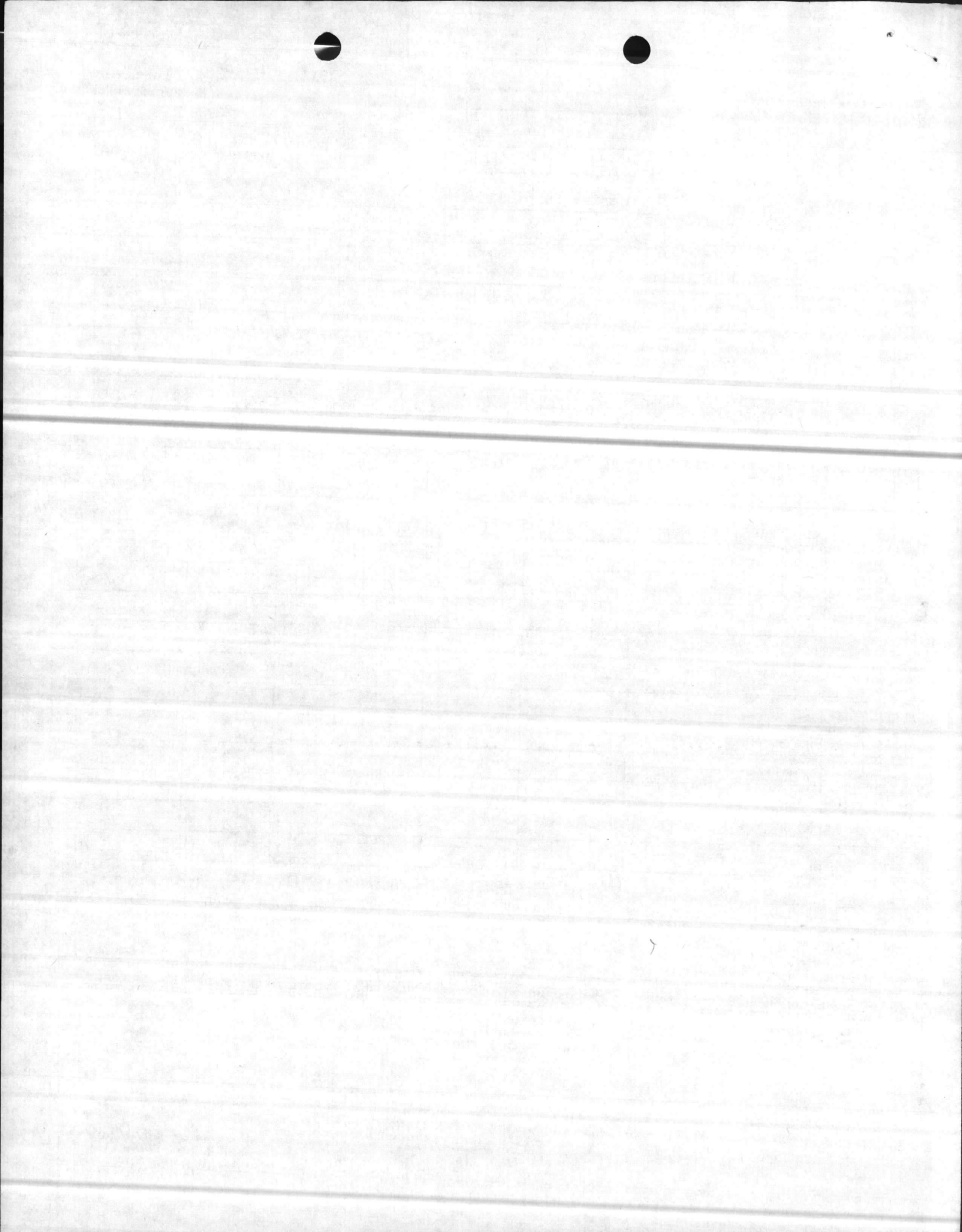

Closure Plan for Hazardous Waste Storage Facility, Building TP-451

Marine Corps Base, Camp Lejeune, North Carolina

a. Background. The Facility has been used for several years to store various types of hazardous materials/wastes. A study is being conducted by the Navy Energy and Environmental Support Activity to determine if there have been any significant releases of hazardous materials to the environment at the facility. Action will be initiated to correct any discrepancies. Existing procedures require that spills are immediately reported, contained, and cleaned up (see Base Order 11090.1B). At present, the site will be used only for the storage of properly containerized (generally barrels) wastes. Future use of the site for storage of wastes in above ground tanks is likely. However, tanks would be protected with properly constructed containment devices. Prior approval by appropriate State and Federal regulatory agencies would be required in that EPA Interim Permit Application, Form 3510-3, did not address storage of wastes in tanks. This facility is operated as a collection point for wastes prior to shipment to off Base TSD facility. Facility is for wastes generated within the Camp Lejeune military complex.

B. Anticipated Closure Date. The facility is expected to remain in operation until replaced by another properly constructed and permitted facility or until waste generation aboard Base ceases. The latter would not be expected unless the Base itself were closed. At this time, replacement/relocation of the waste storage facility is not anticipated.

C. Closing Procedures. If existing spill cleanup procedures are properly carried out, the major closure requirement will be to arrange for the transportation of the inventory of wastes on-hand to Environmental Protection Agency (EPA) approved TSD Facility. Unless some major changes in the mission of the Base occur, volumes of wastes on-hand are expected to be substantially less than the 2,000 barrels reflected on the EPA Interim Permit Application, Form 3510-3. Once a decision to close the facility is made, a specific schedule of milestone dates will be established and this closure plan modified to address specific conditions existing at the time. Development and implementation of the closure plan will be supervised by qualified engineers. The following steps will be followed:

1. Updated closure plan will be forwarded to EPA approximately one year (but not later than 180 days) prior to beginning of closure.
2. Updated closure plan will specify date that wastes generated on Base will not be accepted at the facility.
3. Wastes on-hand will be transported to approved TSD Facility.
4. Grounds, deck, storage building, tanks and equipment will be cleaned to remove residues of regulated materials.
5. Residues, rinsate and other contaminated items will be properly containerized and disposed of in an approved manner. Disposal will be at an approved TSD Facility or Base sanitary sewer (in accordance with NPDES Permit and other applicable regulations).
6. A certification that the facility has been properly closed will be submitted to the EPA and appropriate State agency. The certification will be prepared and signed by a professional engineer.

APPROVED BY:

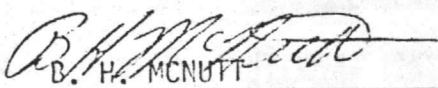
B. H. MCNUTT
Name
Haz Waste Mtl Stge & Disp Ofcr
Title
25 Feb. 1982
Date

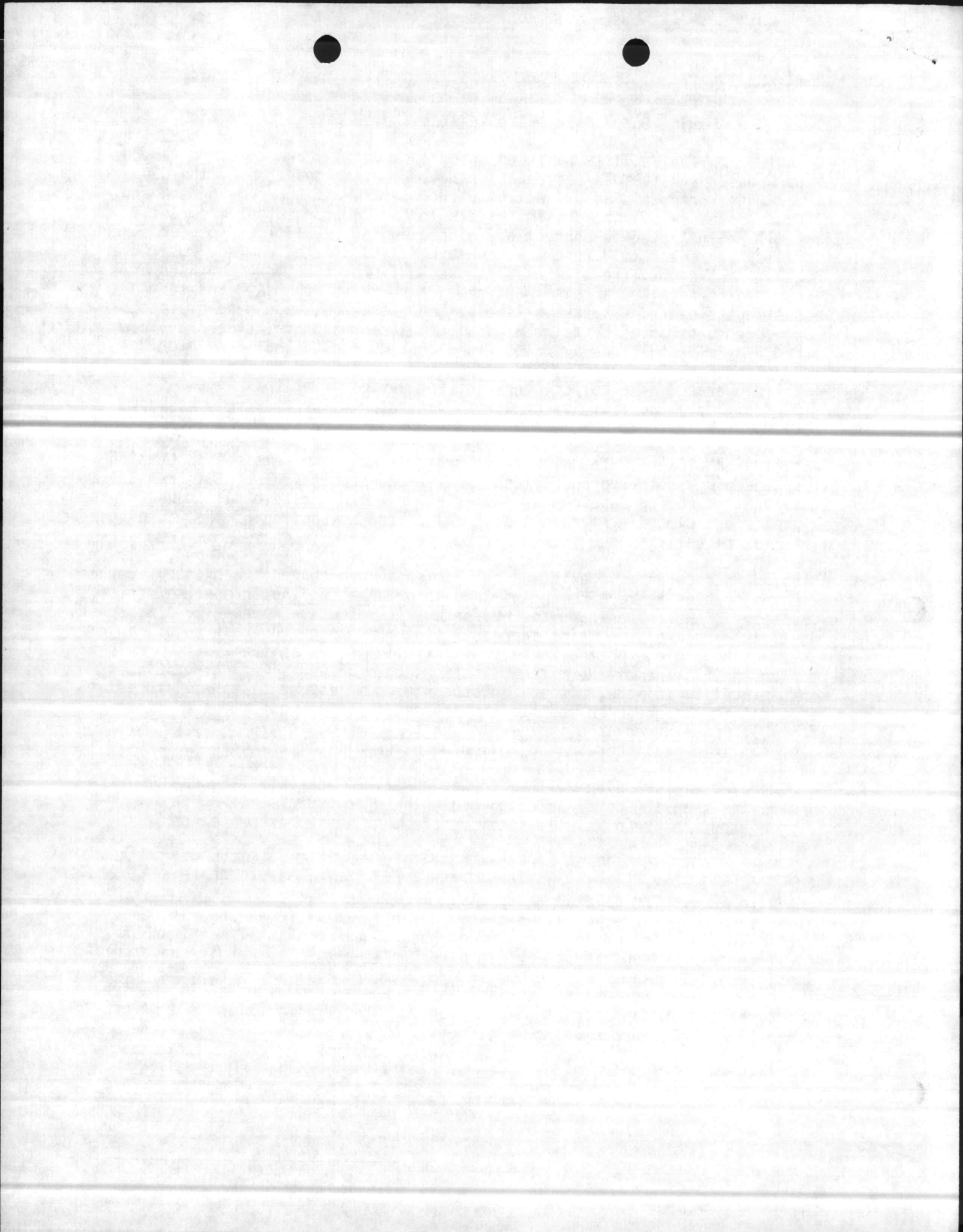

Emergency Procedures and Spill Contingency Plan for the Hazardous
Waste Storage Facility, Building TP-451

1. Emergency Procedures: In the event of fire, spills, suspected release of gases, etc., immediately take the following actions:

- a. Notify Base Fire Department (451-3333)
- b. Alert personnel at the facility
- c. Notify Emergency Coordinator:

EDWARD L. FOUNTAIN

Coordinator's Name

451-2541

Telephone Number

d. If personnel at scene are qualified and are wearing proper safety equipment, action to extinguish fire, contain spill, stop leaks, etc., may be appropriate. Remember: Fire Department will arrive in 3-4 minutes. Do not take unnecessary personal risks. Be prepared to inform firemen as to the location in facility where emergency exists and the nature of situation.

- 2. Emergency equipment and supplies are available as indicated in attachment (a).
- 3. General guidelines for spill prevention and cleanup are contained in attachment (b). (BO 11090.1B)

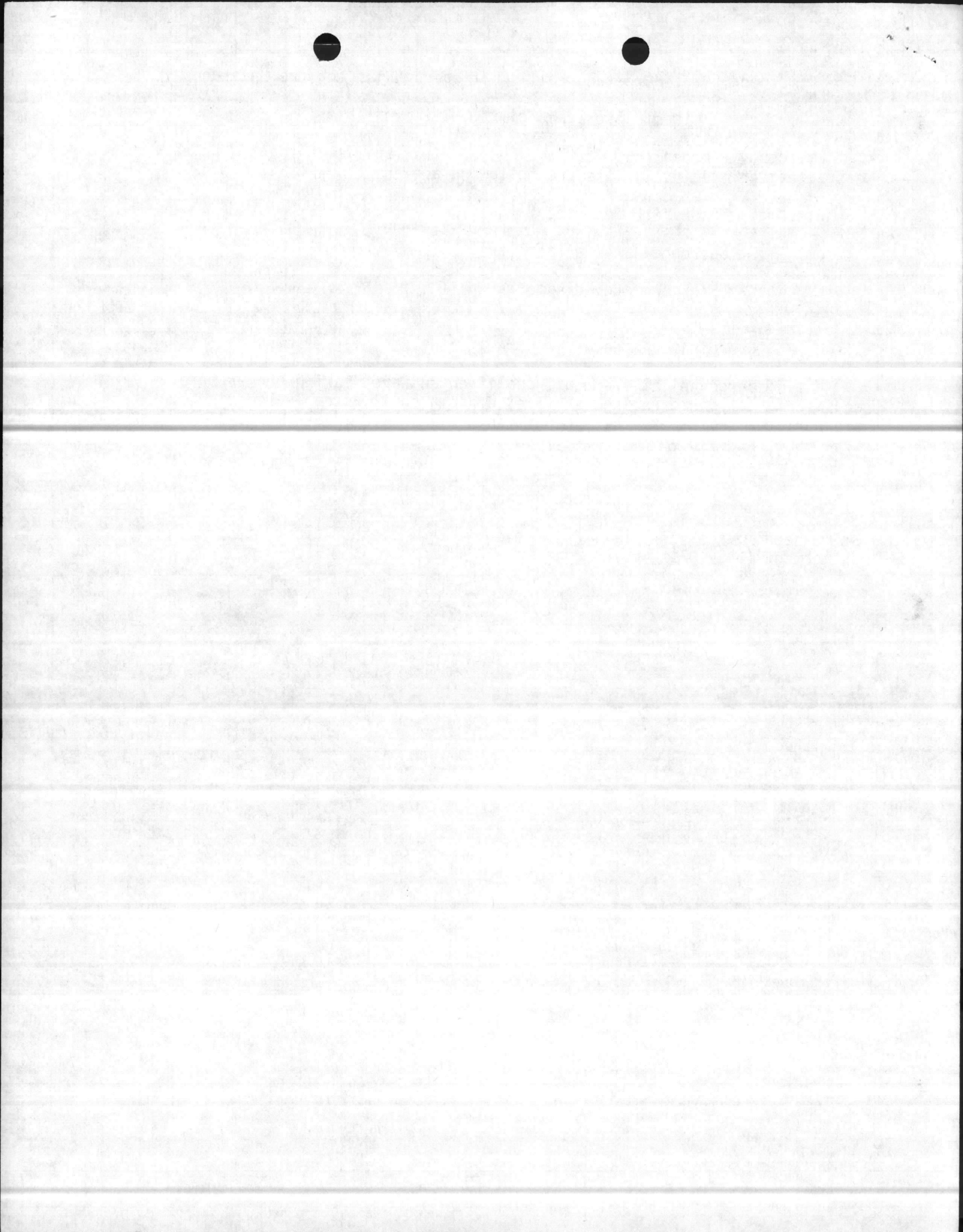

Guidelines for Stocking of Emergency Supplies and Equipment for
Hazardous Waste Storage Facility Building TP-451

Emergency Coordinator will take action required to ensure the following items are on hand and in good working order.

<u>Item</u>	<u>Where Stored</u>	<u>Minimum Inventory</u>
Fire Extinguishers	TP 451	1
Non-Sparking Shovels	Fire Dept Truck	
Oil Absorbent (granular)	TP 451	1 CTN
Oil Absorbent (rolls) (etc.)		
Respirator (etc.)	Fire Dept Truck	

(Note: Fire Department will be equipped to deal with emergency. This will reduce need for safety apparatus at the site.)

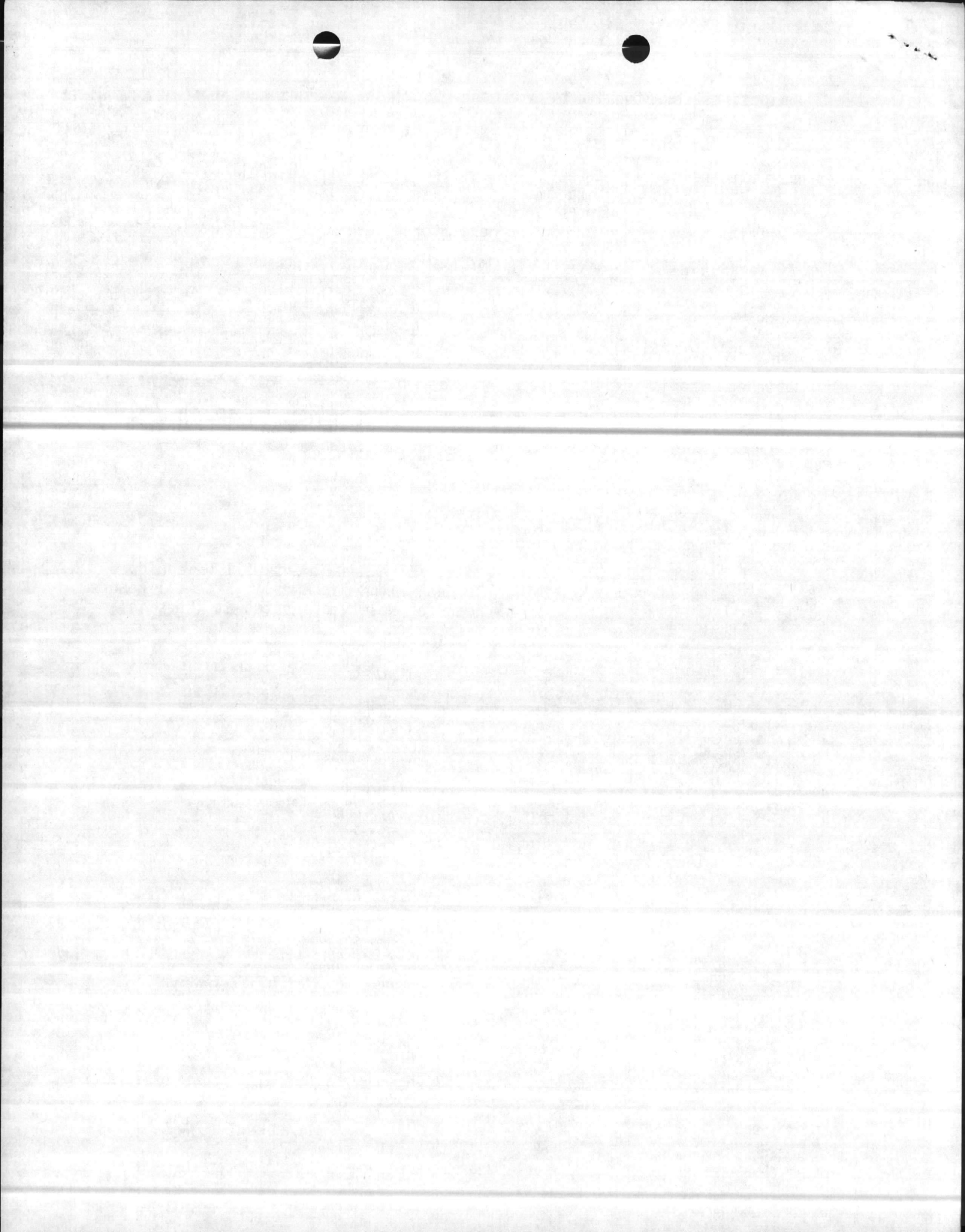

File

RTTUZYUW RUEBDOA8257 0431130-UUUU--RUEBBSA.

FEB 12 23 13:82

ZNR UUUUU

R 122014Z FEB 82

FM CG MCB CAMP LEJEUNE NC

TO NSC NORFOLK VA

BT

UNCLAS //N06240//

NSC FOR CODE 105.1

SUBJ: DISPOSAL OF BETA BUTTONS; REQUEST FOR ASSISTANCE

A. FONECON BTWN MS IRENE USOWSKI, NSC, AND MR. SHARPE, MCBOL, ON 8 FEB 1982

B. CG MCB LTR MAIN/BWE/TH 6240 OF 9 SEP 1981

1. REF A ADVISED THIS CMD THAT SUBJ REQUEST ORIGINATED BY REF B HAS BEEN DELAYED DUE TO INADEQUATE INFORMATION.

2. IT IS REQUESTED THAT NSC IDENTIFY BY MESSAGE THE SPECIFIC INFORMATION REQUIRED TO COMPLETE DISPOSAL (INCLUDING RELATED TRANSPORTATION) OF ITEMS IDENTIFIED IN REF B.

3. POC IS MR. JULIAN WOOTEN, BMAINDIV (AUTOVON) 484-5003.

BT

#8257

REL: F. H. MOUNT, COL., MAIN

DIST: FAC, MAIN/324

NNNN

12

20

12/2 FEB 82

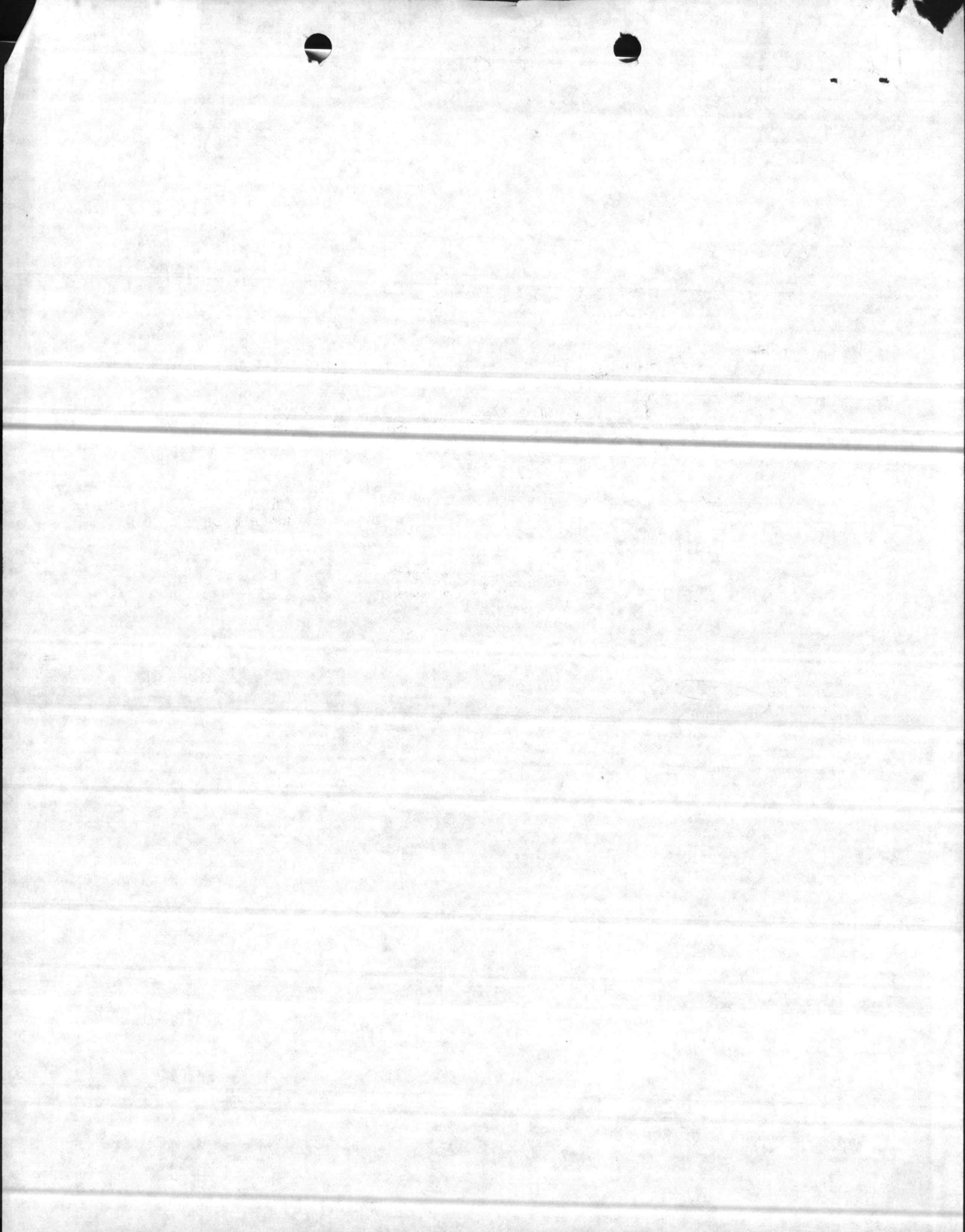

6240

pls return to NREA

JOINT MESSAGEFORM

SECURITY CLASSIFICATION

UNCLASSIFIED

PAGE	DTG RELEASER TIME			PRECEDENCE		CLASS	SPECAT	LMP	CIC	ORIG MSG IDENT
	DATE TIME	MONTH	YR	ACT	INFO					
X 01 01				RR	RR	UUUU				0431130

BOOK

MESSAGE HANDLING INSTRUCTIONS

FROM: CG MCB CAMP LEJEUNE NC

122014Z FEB 82

TO: CO NSC NORFOLK VA

UNCLAS //NO6240//

NSC FOR CODE 105.1

SUBJ: DISPOSAL OF BETA BUTTONS; REQUEST FOR ASSISTANCE

A. FONECON BTWN MS IRENE USOWSKI, NSC, AND MR. SHARPE, MCBCL, ON 8 FEB 1982

B. CG MCB LTR MAIN/BWE/TH 6240 OF 9 SEP 1981

1. REF A ADVISED THIS CMD THAT SUBJ REQUEST ORIGINATED BY REF B HAS BEEN DELAYED DUE TO INADEQUATE INFORMATION.

2. IT IS REQUESTED THAT NSC IDENTIFY BY MESSAGE THE SPECIFIC INFORMATION REQUIRED TO COMPLETE DISPOSAL {INCLUDING RELATED TRANSPORTATION} OF ITEMS IDENTIFIED IN REF B.

3. POC IS MR. JULIAN WOOTEN, BMAINDIV {AUTOVON} 484-5003.

DISTR:

MAIN|FAC|

PREPARED BY NAME, TITLE, OFFICE SYMBOL AND PHONE

J. WOOTEN, CIV GS-12, NREAD, 5003

SPECIAL INSTRUCTIONS

ADMIN _____ ABMO _____

FORWARDED BY NAME, TITLE, OFFICE SYMBOL AND PHONE

F. H. MOUNT, BMAINDIV, COL 2511

SECURITY CLASSIFICATION

UNCLASSIFIED

DATE TIME GROUP

0000

1969 assumed control from ~~XXXXXXXX~~ predecessor. Plat of area showing lot numbers and chemicals buried in those lots were listed in the folder (quantity, contents and all amounts buried in area) shadowed in red on plat. This continued until approximately 1973 when correspondence was directed to CG, Attention Assistant Chief of Staff, Facilities from Base Safety Manager requesting guidance and advice as to whether this dump site should continued to be used or to be channeled in another direction, new location, etc. The response to this was to ~~ix~~ continue same procedure and include chemicals from the Air Station.

In 1974, B05100.13B was published to include Air Station. This procedure continued until 1975-1976. NREA requested all information for review. The folder containing all records was turned over to NREA. The folder was returned. Absent from the folder was the plat and could not be located. At that period, a new plat was developed listing all ~~xxxx~~ deposits of chemical wastes in landfill and was shadowed in red as was the original plat. Sometime later this folder was turned over to Base Maintenance, NREA people upon their request and they assumed control of the chemical disposal area. Since that I have no ^{knowledge} knowledge of what has transpired in that area.

COMMON CHEMICALS buried in the dump were:

DDT - estimated quantity - 50 barrels

Trichlorethylene sludge - estimated quantity unknown

Used varisal (cleaning purposes)

Calcium hypochloride - HTH

Wood preservative (Carpenter Shop) vats emptied in landfill

#2 Fuel oil sludge

PCB - buried in concrete septic tanks, sealed according to instructions from EPA - 3-4 tanks)

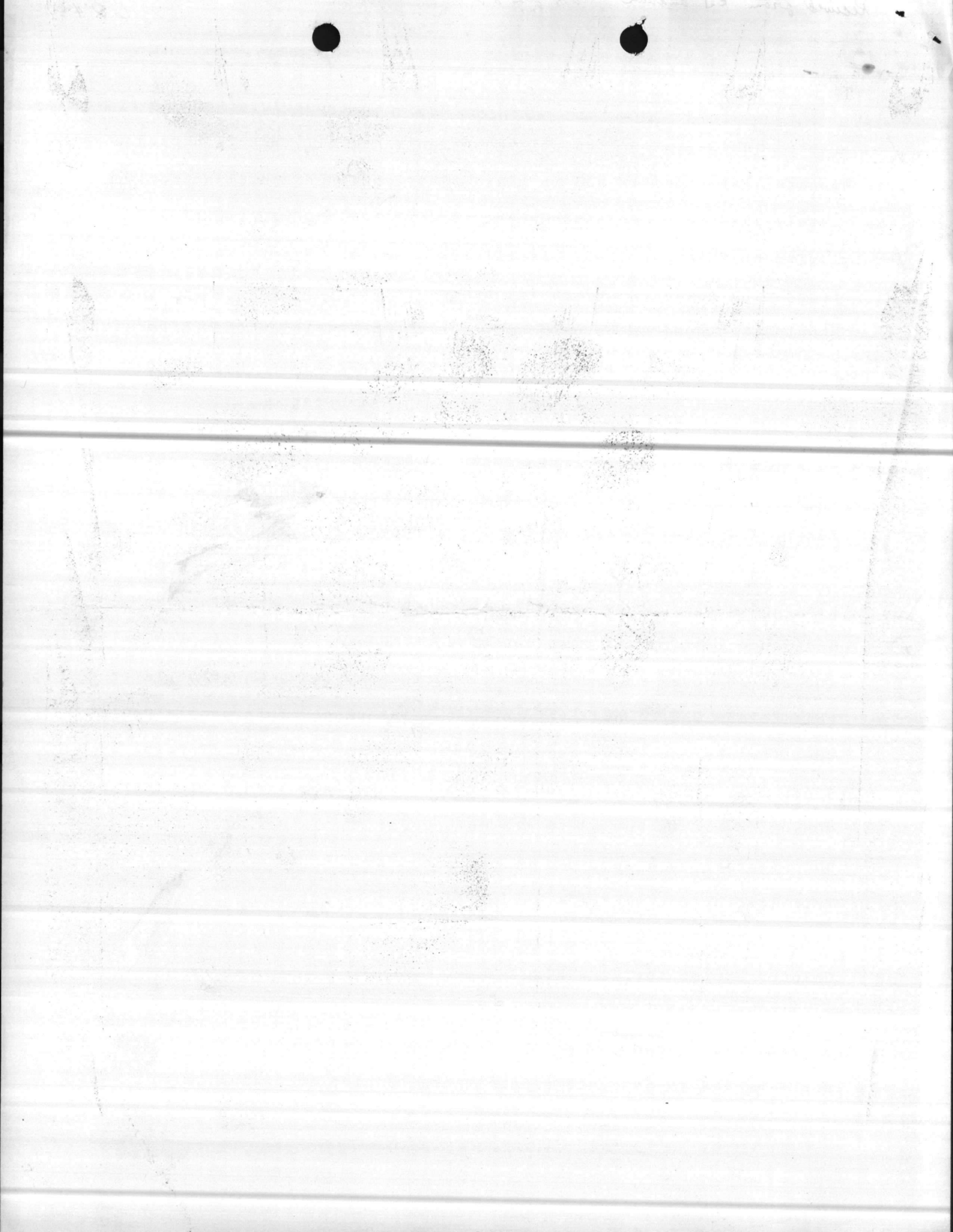

File Hazard Waste
JHW

6240

ROUTINE

* U N C L A S S I F I E D *

07/0734Z

PT00142

PAGE 01

RTTUZYUW RUEACMC5580 0700732-UUUU--RUE R00A.

ZNR UUUUU

R 1014257 MAR 82

//COMM NOTE DISTRIBUTION CORRECTED BY
COMMEN DESTROY ALL PREVIOUS COPIES//

FM CMC WASHINGTON DC

TO #IG EIGHT ACT: CG MCB

BT

UNCLAS //N11000//

SUBJ: HAZARDOUS WASTE RECORDKEEPING AND REPORTING REQUIREMENTS

A. FEDERAL REGISTER 47 FR7841 OF 23 FEB 82 (NOTAL)

B. MCRUL 6280 OF 1 MAY 1980 WITH CH 1-2

1. BY REF A THE ENVIRONMENTAL PROTECTION AGENCY (EPA) HAS DELAYED COMPLIANCE DATES FOR THREE REG UNDER ITS HAZARDOUS WASTE (HW) REGULATIONS WHICH WERE PUBLISHED UNDER SUBTITLE C OF RESOURCE CONSERVATION AND RECOVERY ACT (RCRA) AND IMPLEMENTED BY REF B. THE FOL DATA REQTS ARE POSTPONED FROM 1 MAR 82 TO 1 AUG 82:

A. SUBMISSION OF ANNUAL REPORTS BY HW GENERATORS AND OWNERS AND OPERATORS OF HW TREATMENT, STORAGE, AND DISPOSAL (TSD) FACILITIES;

B. SUBMISSION OF INITIAL-YEAR QUARTERLY GROUNDWATER MONITORING PARAMETER READINGS BY TSD FACILITIES;

C. PREPARATION OF GROUNDWATER QUALITY ASSESSMENT PROGRAM OUTLINES BY TSD FACILITIES.

2. THIS POSTPONMENT DOES NOT RELIEVE TSD FACILITY OPERATORS FROM

FILE 02 RUEACMC5580 UNCLAS

MAINTENANCE OF RECORDS REQUIRED TO PREPARE THESE REPORTS. IT IS ANTICIPATED THAT DURING THE LATE SPRING/EARLY SUMMER TIMEFRAME EPA WILL ISSUE CONSOLIDATED REQTS REGARDING REPORTING PROCEDURES.

3. QUESTIONS RE THIS SUBJ SHOULD BE DIRECTED TO MR. PAUL HUBBELL AT A/V 224 -2171/3188.

BT

#5580

NNNN

ACT: FAC

INFO: ADJ, COMP, MAIN, PWO, DOSET /126

**ORIGINAL
ACTION**

ROUTINE

* U N C L A S S I F I E D *

MAR 82

25 E

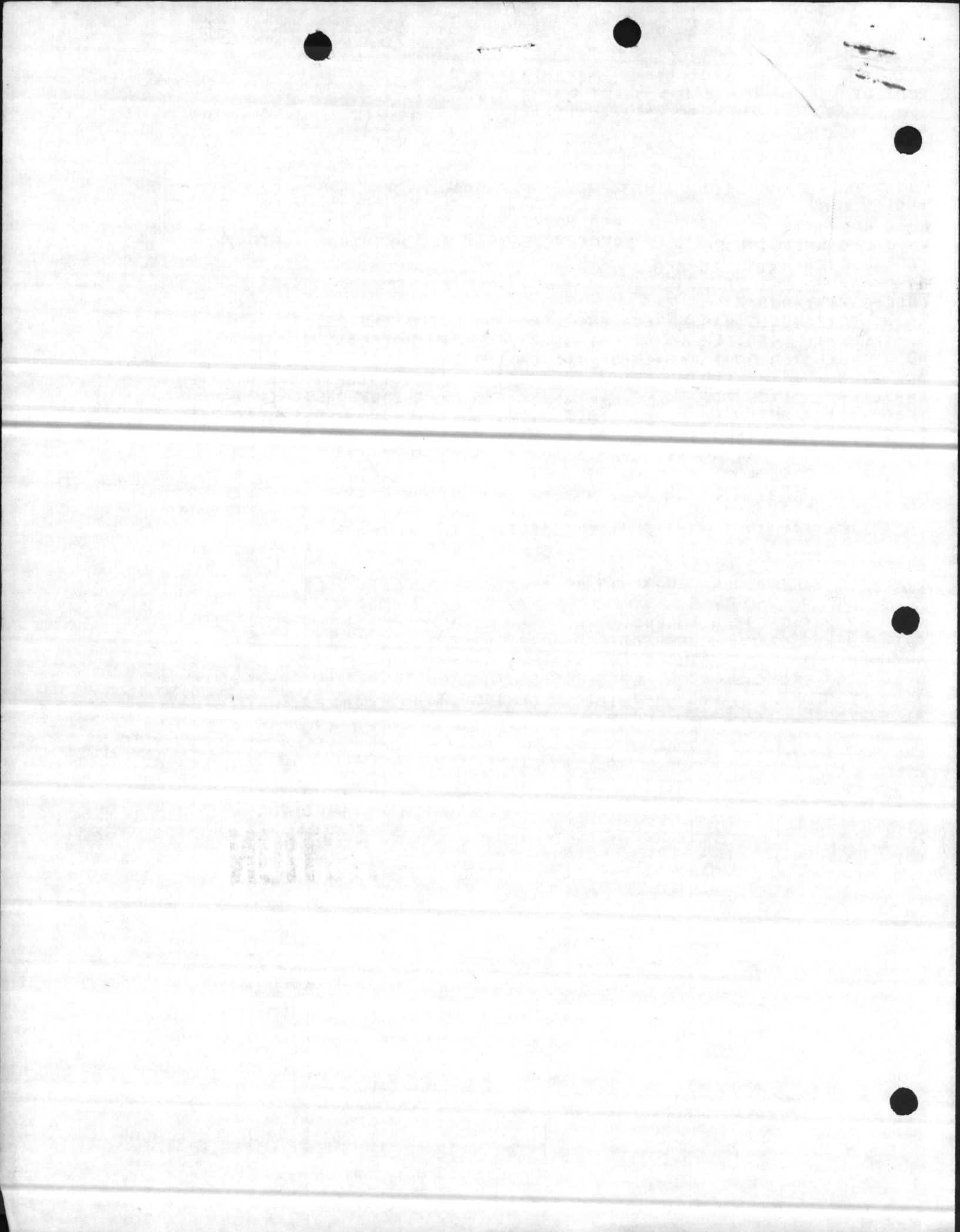

Received 11 Feb 82
PUC

6470/js
25JUNE1981

From: Radiation Safety Officer, Naval Regional Medical Center,
Camp LeJeune, North Carolina, 28542

To: Mr. Kipp Rimm, Radiological Safety Officer, Radiological Affairs Support Office,
Navy Environmental Support Activity, Port Hueneme, California, 93043

Subj: Findings, Clean-up procedures and packaging of radioactive material,
Strontium (Sr) 90, "Beta-Buttons", report of;

Ref: (a) Message #012240Z. DEC 80 from: NAVENSUAC, To: Occupational and Preventive
Medicine Unit
(b) Memorandum from 04N2, Subj: Strontium (Sr) 90- "Beta-Buttons", dtd 21MAR78
(c) NAVSUPINST 5101.9B dtd 8DEC78
(d) NAVSUPINST 5101.11 dtd 7NOV77
(e) 10 CFR, parts 19 and 20, NRC
(f) 49 CFR, parts 171 and 179, DOT
(g) NAVMED P5055
(h) MIL-STD 1458

Encl: (1) Report of Findings, Clean-up procedures and Packaging of Radioactive
Material, Strontium (Sr) 90, "Beta-Buttons"
(2) Reference (b), memorandum
(3) Diagram of primary gridded area
(4) Diagram of radioactive gridded area
(5) Radioactive material storage log with readings, (primary)
(6) Memorandum requesting Radiation Safety Officer
(7) Documentation of container used for packaging RAM for transportation
(8) Radioactive material storage log with weights, serial numbers and survey readings

J. Saurini
J. SAURINI
HM1 USN

pk 4469

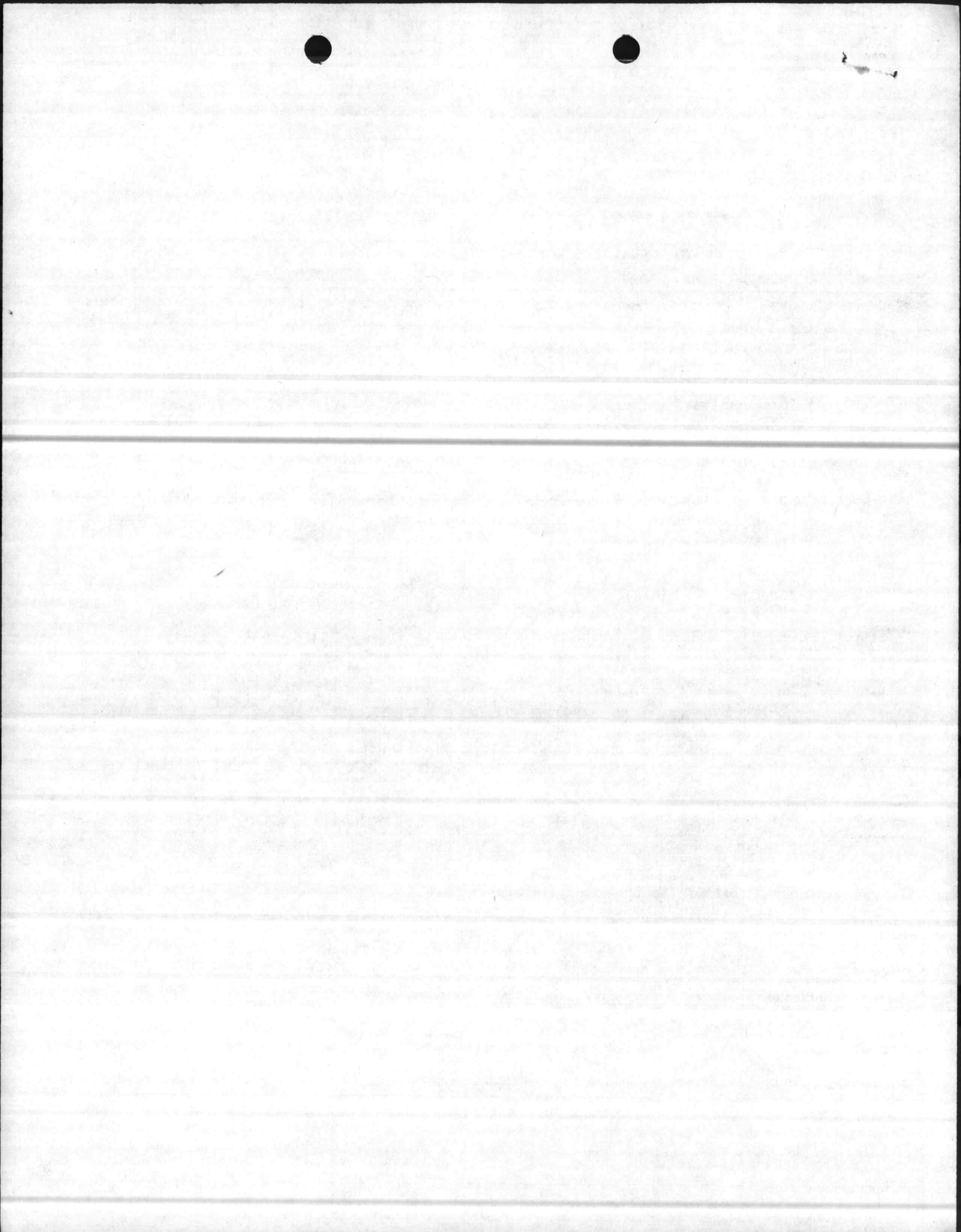

FORWARD

The area of concern is the northwest corner of compound PT-37, The Insect Vector Control Center, Marine Corps Base, Camp LeJeune, North Carolina, 28542. Coordinates of the site are 21 degrees north latitude by 41 degrees west longitude.

The previous name of the compound was, The Naval Field Medical Research Lab, Animal Facility Compound, Marine Corps Base, Camp LeJeune, North Carolina, 28542. In the 1950's there was limited work done with radioactive materials. The personnel attached worked with medical tracer isotopes of low radioactivity.

Apparently sometime in the 50's a quantity of reflector discs were buried within the confines of the compound. These reflectors were vintage World War II and were experimentally used by the Army and Navy to locate and identify such things as troop locations, gear and battle stations at night. Seven cases of these reflectors reportedly were disposed of in the northwest corner of the compound, the actual quantity is unknown.

The proper name of the reflectors mentioned is, "MARKERS, SELF-LUMINOUS", MIL-M-3935. Enclosure (2) of this report was reference available for information concerning these reflectors. Attempts were made to contact persons listed on enclosure (2) for further information on the reflectors. No firm confirmation was made on whether or not these people were contacted.

The reflector contains the radioactive material Strontium (Sr) 90. This material is in the solid form in the reflectors. This material is contained in a plastic sheathing, this plastic is joined together by a seam. It is then enclosed in a metal casing with a screw type probe on the posterior side of it. They were manufactured by the U.S. RADIUM CORP and labeled as a "RADIOACTIVE POISON INSIDE", also on the label is printed, "BURY IF DAMAGED". The dimensions of the reflector are 2 7/16" wide by 3/4" deep, the posterior probe measures 1".

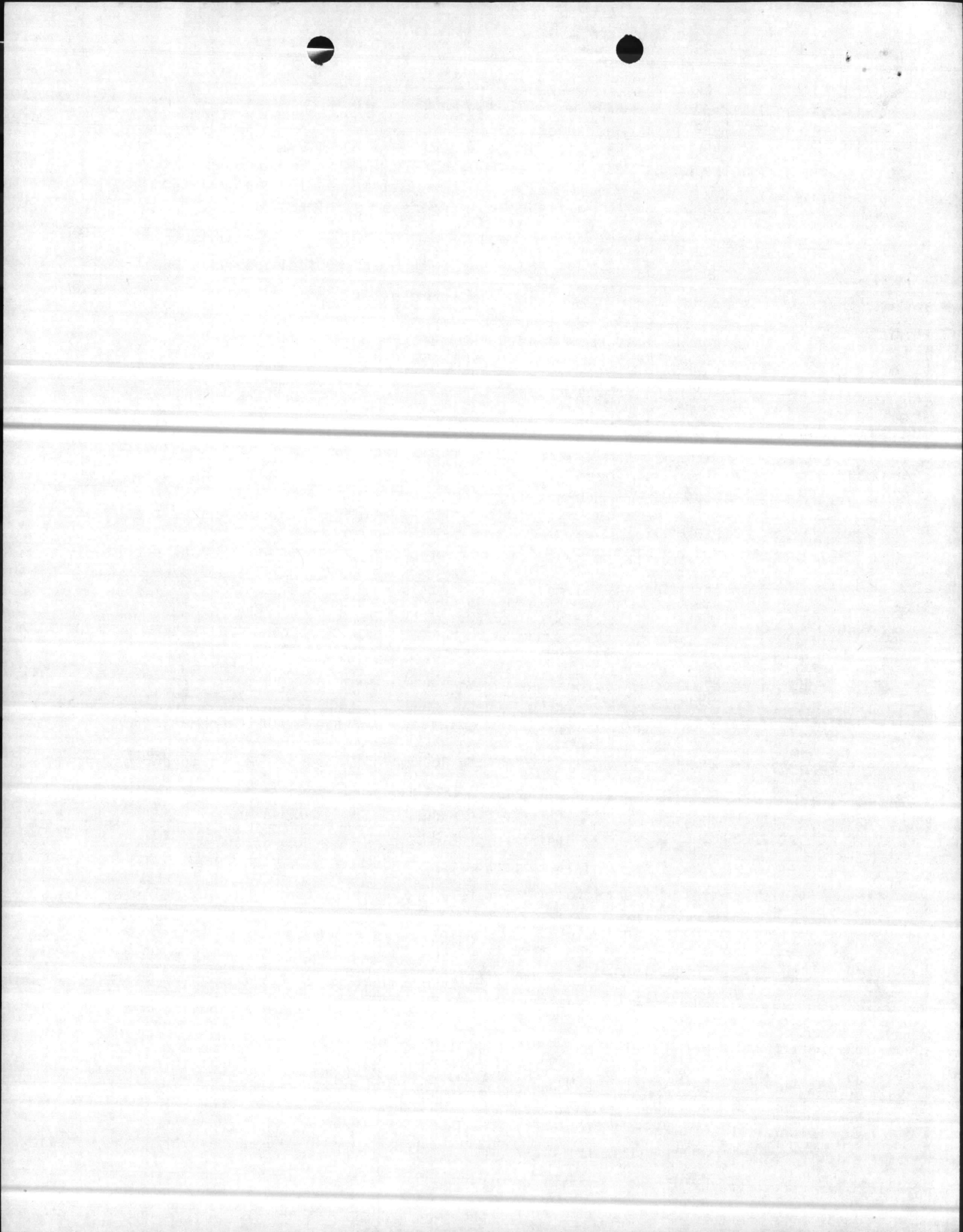

Throughout this report the reflectors will be identified by a name given them, "Beta-Buttons". The radioactive material gives off a beta-ray. Each button contains 400 microcurries of Sr-90.

As stated in enclosure (2), the Navy likely had an authorization to process these buttons but it was not known for sure if the Navy acquired a license when licensing became effective. It also states that authorizations were in effect before licensing was implemented in accordance with Atomic Energy Act of 1954, however there was informal history of the regulatory process through about 1967. A copy of this history was unavailable as was all old records or files concerning the luminators. It was found that all files had been lost in St Louis, Mo.

Enclosure (1) is the report of the findings, clean-up and packaging of the "Beta-Buttons" found at the Insect Vector Control Center, Marine Corps Base, Camp LeJeune, North Carolina, 28542.

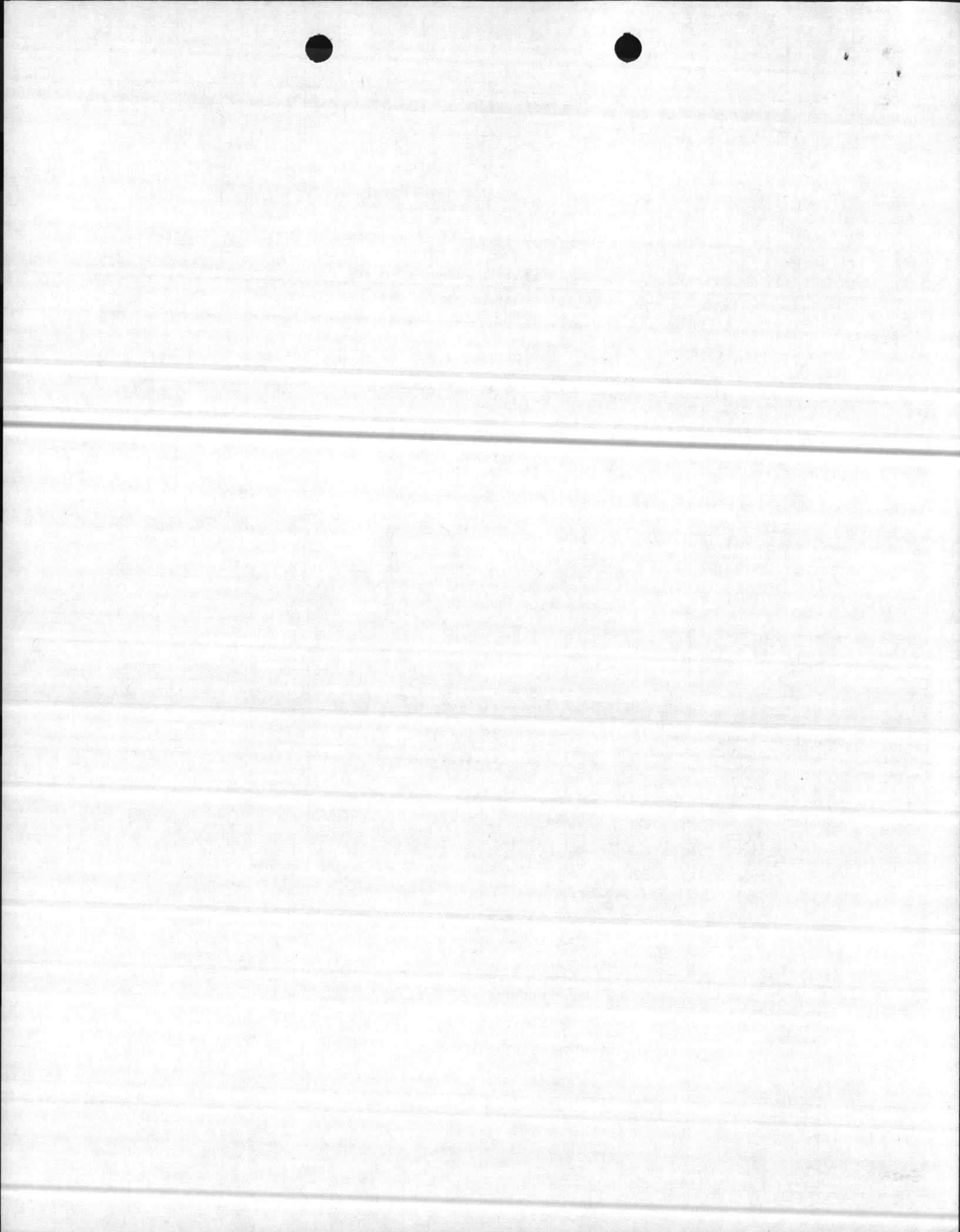

25 JUNE 1981

FILE: 6470

REPORT OF: FINDINGS, CLEAN-UP PRODECURES AND PACKAGING OF
RADIOACTIVE MATERIAL: STRONTIUM (Sr) 90
"BETA-BUTTONS"

SITE: INSECT VECTOR CONTROL CENTER
COMPOUND PT-37
MARINE CORPS BASE
CAMP LEJEUNE, NORTH CAROLINA 28542

SUBMITTED BY: *Joseph Saurini*
MM1 JOSEPH SAURINI, USN
RADIATION SAFTEY OFFICER
NAVAL REGIONAL MEDICAL CENTER
CAMP LEJEUNE, NORTH CAROLINA 28542

APPROVED BY: MR. KIPP RIMM
RADIOLOGICAL SAFETY OFFICER
RADIOLOGICAL AFFAIRS SUPPORT OFFICE
NAVY ENVIRONMENTAL SUPPORT ACTIVITY
PORT HUENEME, CALIFORNIA 93043

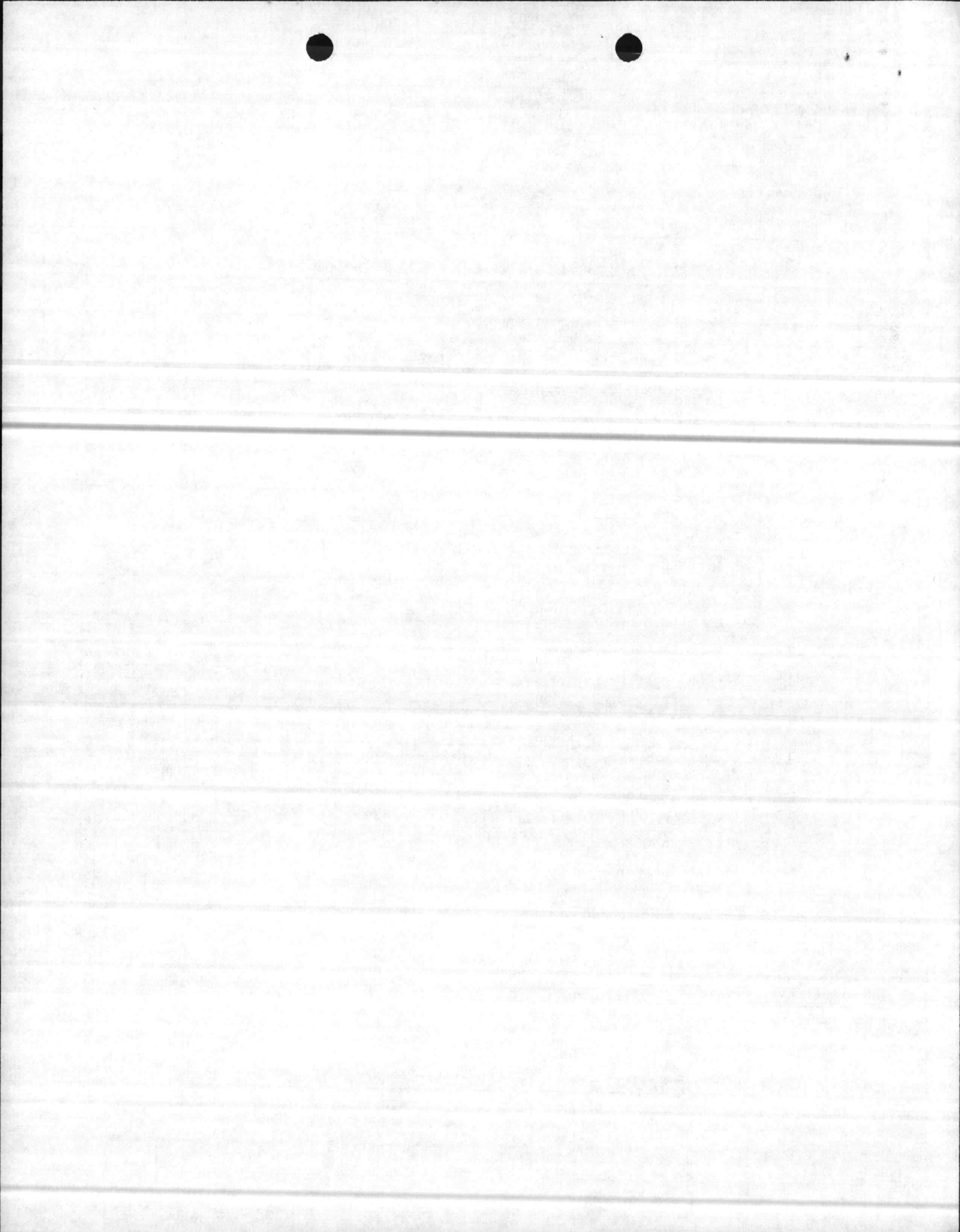
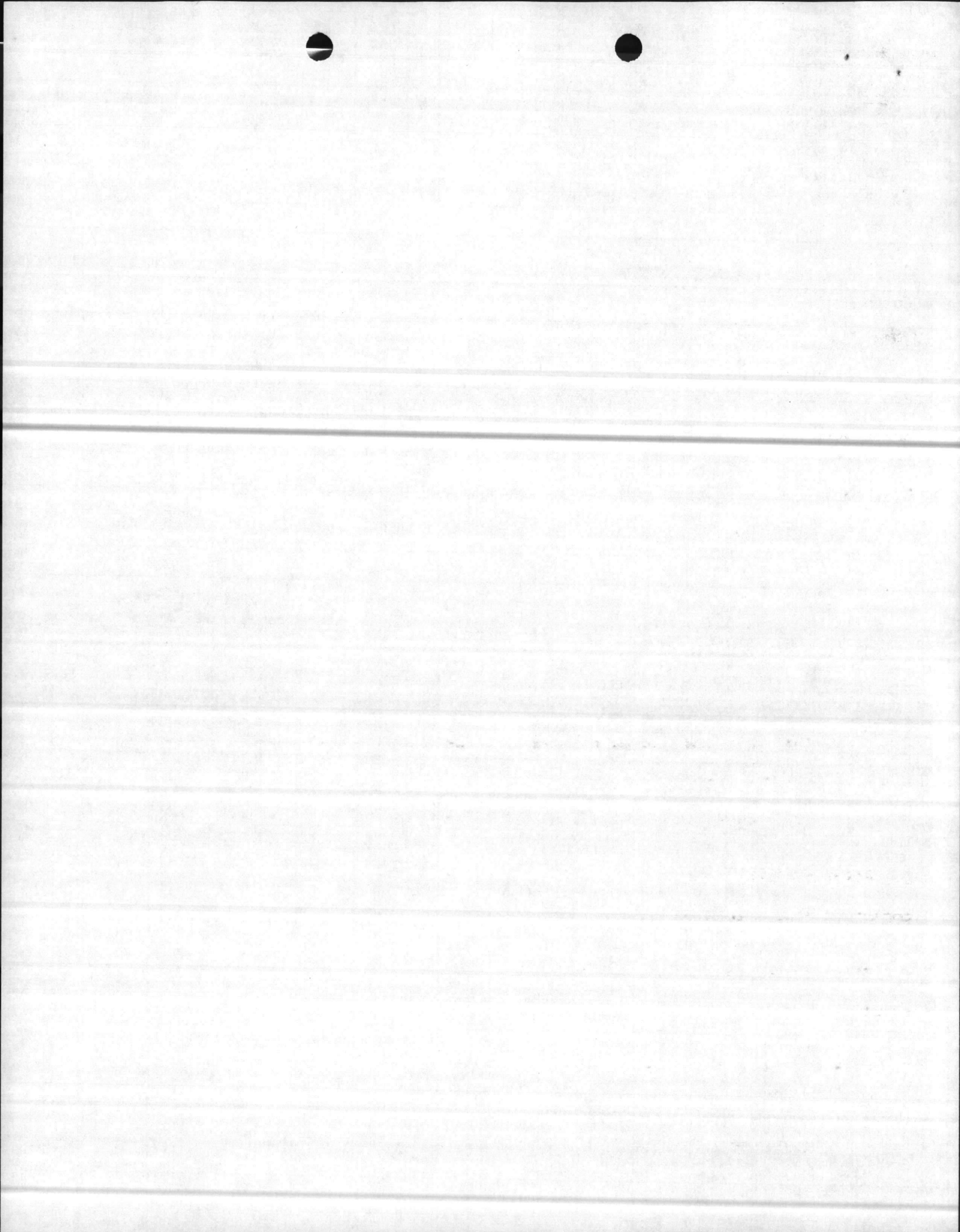

TABLE OF CONTENTS

- I DISCUSSION
- II FINDINGS
- III RECOMMENDATIONS
- IV FOLLOW-UP ON RECOMMENDATIONS
- V FOLLOW-UP WORK COMPLETED AT SITE
- VI TRANSPORTATION



I DISCUSSION

A. In accordance with references (a) through (h), Mr. Kipp RIMM, GS-11, representative of the Radiological Affairs Support Office, Naval Environmental Support Activity, Port Hueneme, California, 93043 conducted a Health Physics Support Visit to determine whether or not a hazardous condition existed at the Insect Vector Control Center, Compound PT-37, Marine Corps Base, Camp LeJeune, North Carolina, 28542, on December 1980.

B. The situation existed of a finding of a number of luminous reflectors in the northwest corner of the IVC. These reflectors contain a radioactive material.

C. The following personnel were either contacted or were involved during the visit:

- (1) MCDONOUGH, James, LTjg, MSC, USN, 215 66 6127
Industrial Hygiene Officer
- (2) KALISCH, Bert, ENS, MSC, USNR, 485 72 8407
Environmental Health Officer
- (3) SAURINI, Joseph, HM1, USN, 088 44 5748
Radiation Safety Officer
- (4) Mr. Carl JONES, GS-8, Supervisor, IVC
- (5) COL MOUNT, USMC, Base Maintenance Officer
- (6) Mr. TAYLOR, Base Safety Officer
- (7) Mr. Ripp JACKSON, Former employee of NFMRC, circ: 1950

D. After confirmation that the site in question was a radiation area the RASO REP commenced proceedings to survey, excavate and package the radioactive material

E. All personnel involved in the procedures were briefed by the RASO REP as to existing situations and major objectives of the visit.

F. Radiation detection and measuring equipment used by the RASO REP consisted of:

- (1) PRM5/S3
- (2) E140N-304

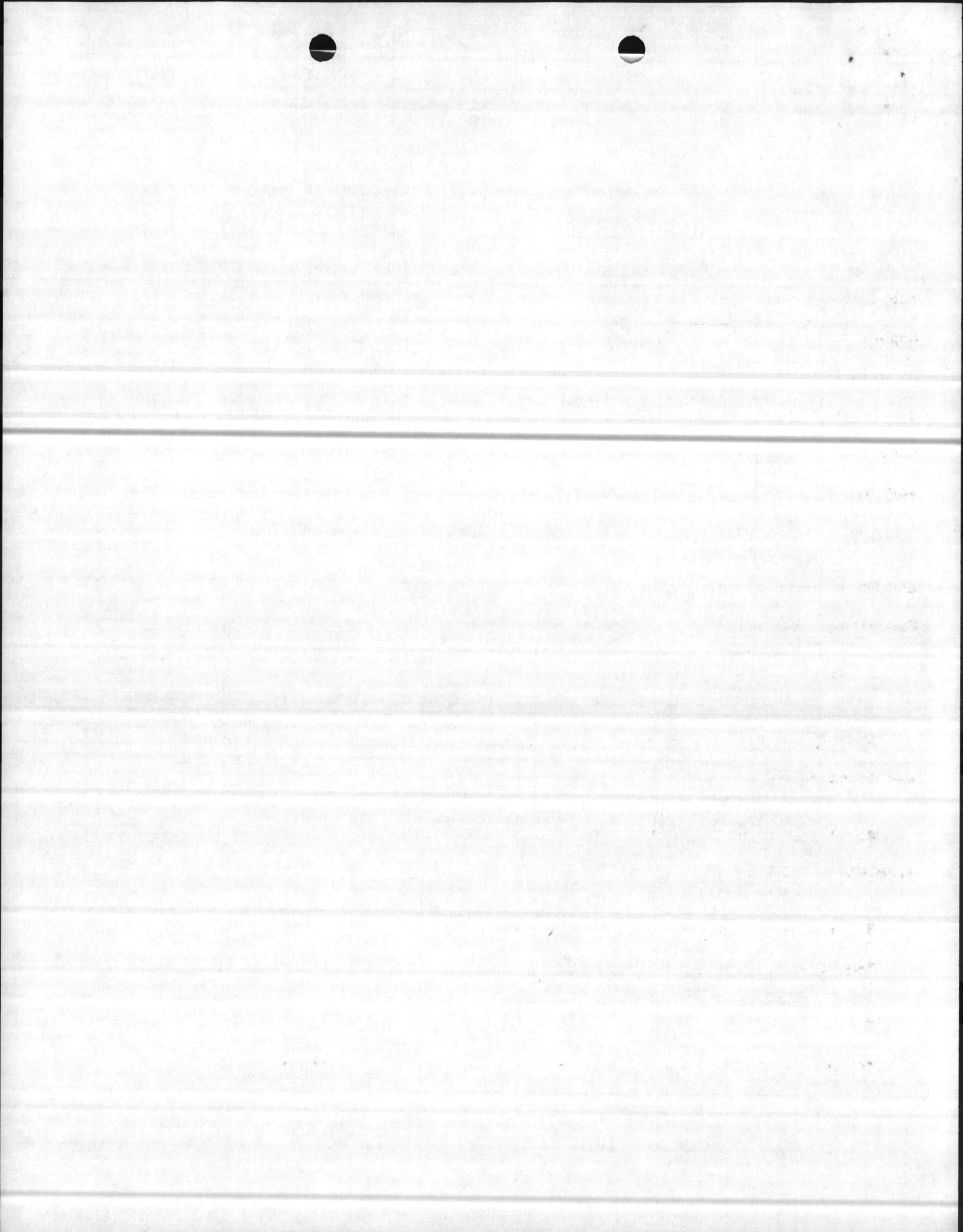

II FINDINGS

The following is a report of events leading up to the arrival of the RASO REP including activities done during the visit and after his departure.

A. On November 18, 1981, procedures were underway to clear the northwest corner of the IVC, during the work procedure a maintenance man uncovered a metallic object, apparently^{not} concerned with the finding he thru it into some surrounding woods. Continuing on with his work he uncovered somemore of the objects and brought them to the attention of the area supervisor. It was later found that this was a "Self-luminious Marker" pocessing a radioactive material. The markers came from the surface soil of the working area.

1. The supervisor in turn notified the Industrial Hygiene Officer, Occupational and Preventive Medicien Service, Naval Regional Medical Center, Camp LeJeune, North Caronina, LTjg James MCDONOUGH, MSC, USN.

2. The area was visited by LTjg MCDONOUGH on the same day.

3. LTjg MCDONOUGH commenced investigating as to what the object was, where it was found and questioned personnel attached to the compound.

4. Accompanying LTjg MCDONOUGH were personnel attached to the NBC section and from NARF, this was GYSGT'S LONG and BOGART.

5. Twelve more buttons were recovered by means of detection by radiac monitors. The type of the monitors was unknown.

6. An area, 50' x 24' was roped off and caution signs put up. Personnel attached to the compound were cautioned to remain clear from the area until further notice.

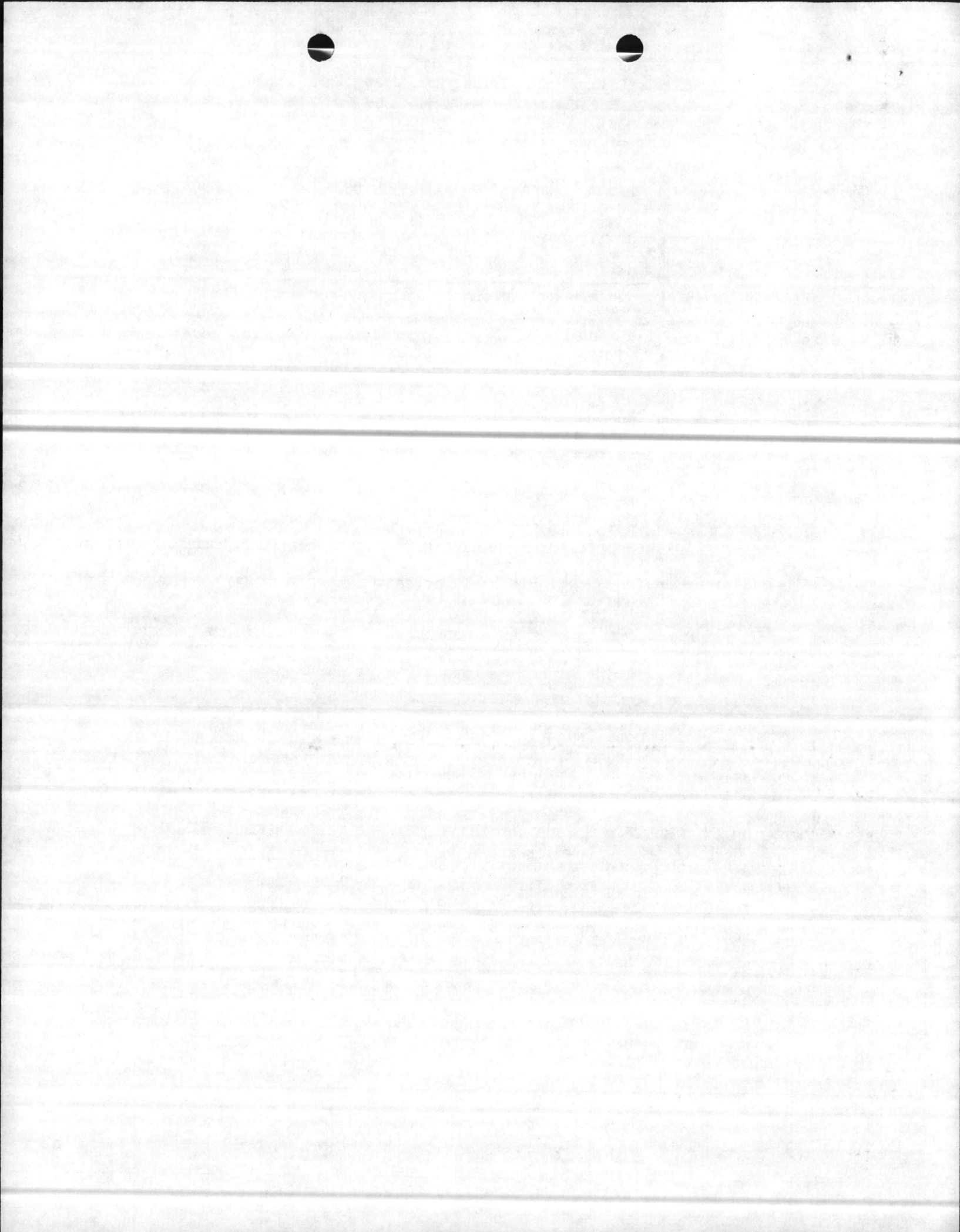

7. LTjg MCDONOUGH notified HM1 SAURINI, Radiation Safety Officer, Naval Regional Medical Center, Camp LeJeune, NORTH Carolina, of the situation. Assistance was requested by LTjg MCDONOUGH as to regulations and procedures for a potentially contaminated area.

8. Situations stood as follows:

- (a) 13 "Beta-Buttons" were found in surface soil of the IVC compound.
- (b) Area roped off.
- (c) Suspected luminous substance to be RADIUM 226 in solid form decaying to a liquid state.
- (d) Readings at ground level were .2 to .3mR/hr.
- (e) Seven cases were reportedly disposed of in a burial site.

9. HM1 SAURINI instructed LTjg MCDONOUGH to send one of the markers to be analyzed to RASO, NAVENVSUAC, Port Hueneme, Ca. Also message them or call and inform them of findings and request technical assistance.

10. Between 19,20 and 21 November, LTjg MCDONOUGH contacted local people for any information about the "Beta-Buttons". It was learned that the buttons were buried sometime in the 50's when the compound was a research laboratory. NAVRESDEVCOM was contacted to search for any old files concerning the research lab. It was found that all old files were lost in St. Louis, Mo.

11. Reference (a) was received from NAVENESUAC informing of Health Physics Support Visit.

12. Analysis complete showing the radioactive material to be Strontium (Sr)90, 400 microcurries per button. Also instructed to insure integrity of site and continue surveillance until arrival of RASO REP.

13. 1 thru 10 DEC 80, continued surveillance to insure integrity of site.

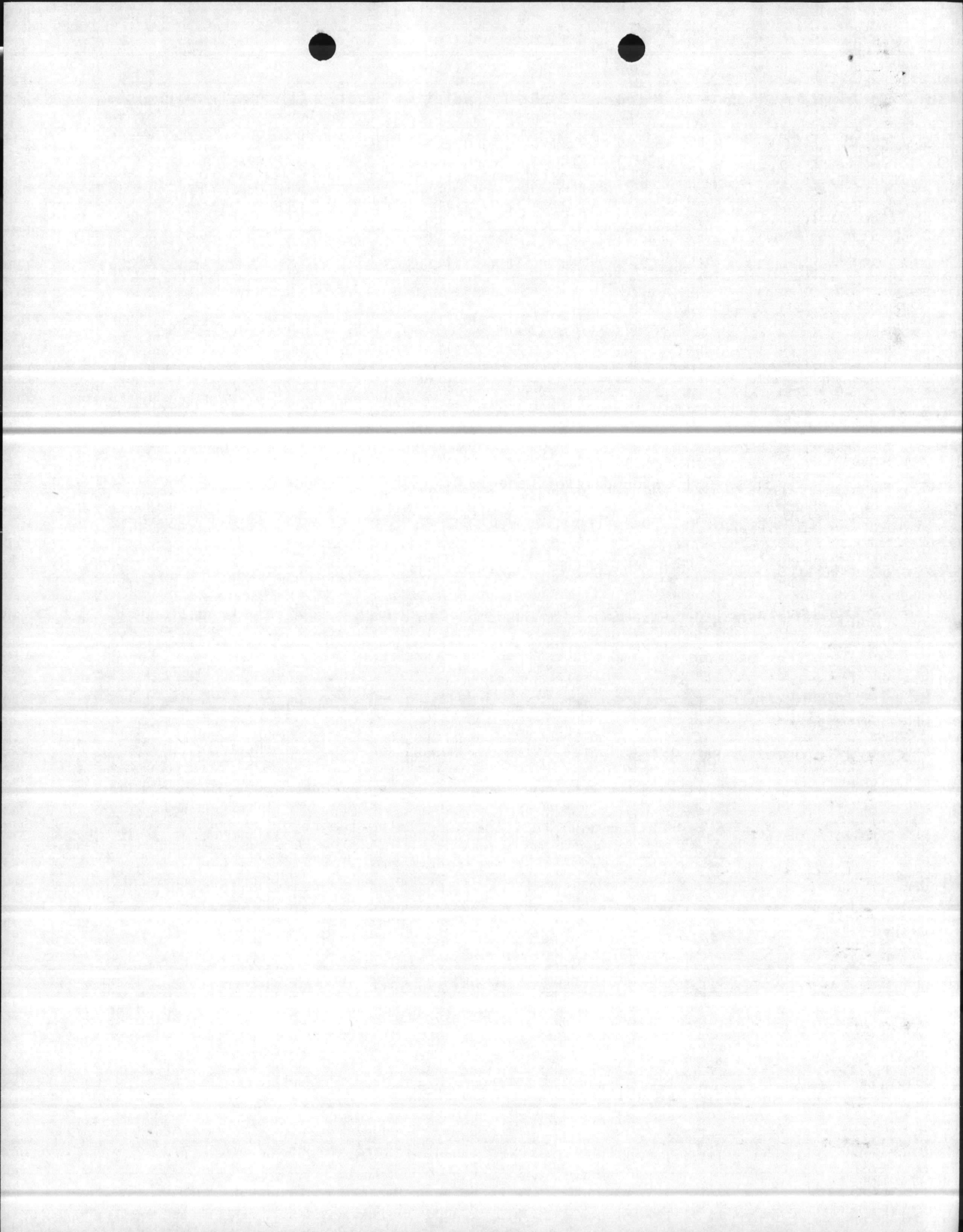

B. The following is a list of events from 11 DEC80 thru 13 DEC 80 concerning the Health Physics Visit.

1. Mr RIMM arrived at 0900 and initiated investigation of the site. Found area adequately secured, no health hazard to personnel working in adjacent areas.
2. Preliminary Radiation Contamination Survey made by RASO REP. The area was roped off 100' north to south by 25' east to west. (see enclosure (3)).
3. RASO REP briefed workers and supervisors at site on the significant of the problem and insured them no health hazards existed as long as they stayed out of the roped off area.
4. Radiation survey conducted with a PRM5/S3. This brought the area down to 5' by 5' grids, 15 in number. (see enclosure (4)).
5. Advised by the foreman that on 18 NOV 80 the maintenance man had thrown one of the buttons in a southwesterly direction into the woods prior to the knowledge of nature of the material. RASO REP conducted survey of contaminated area using an E140N/304 for Beta. No loose surface contamination found in gridded area.
6. Recovered the "Beta-Button" from woods which personnel through. Button surveyed for loose surface contamination: none found.
7. Surveyed incinerator and areas adjacent to gridded area. Ash samples taken from incinerator and mailed to Port Huenneme for isotopic analysis.
8. Found 15 "Beta-Buttons" in extreme south end of gridded area at about a depth of 1" from the surface. All buttons were intact and free of loose surface contamination.
9. Released southern portion of grid for unrestricted use and minimize restricted area to 26'8" east to west by 16' north to south, in the northwest portion of the compound. (see enclosure (4)).
10. Set up controlled area, following individuals were allowed entry by RASO REP: Industrial Hygiene Officer, Environmental Officer, Radiation Safety Officer.

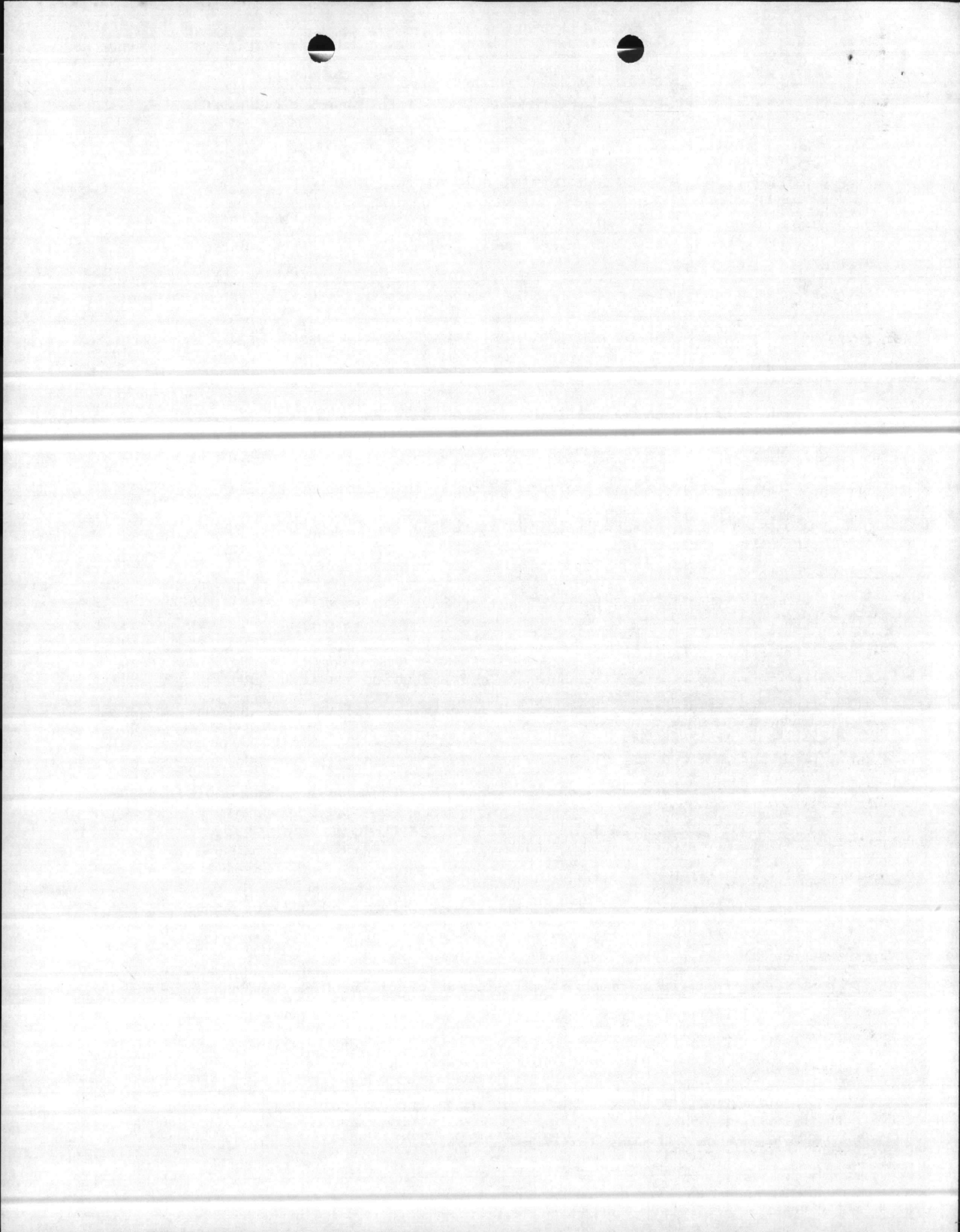

11. Individuals badged by RSO, briefed on radiological control procedures for handling radioactive materials, donning and removing ANTI-C's and conducting whole body self frisking procedures.
12. Commenced digging in grid #1. Fifteen "Beta-Buttons" found in depths from 1" to 1½'. Soil samples taken from surface and at 1½ feet and sent to Port Huenneme for isotopic analysis. Radioactive material storage area set aside on east side of gridded area. Radioactive Material Storage Log initiated. Enclosure(5).
13. Commenced digging in grid #8 and recovered 25 buttons and remains of 2 dogs at a depth of 2'. Soil immediately adjacent to dog remains found to be contaminated. Two soil samples sent to Port Huenneme for isotopic analysis. Soil adjacent to animal remains placed in radioactive material storage container.
14. At 1900 the area was secured for the day.
15. At 0800, 12 DEC 80, returned to area and commenced digging grid #2. Requested back hoe and sifter from Base Maintenance.
- 16- Utilized back hoe and sifter to systematically extricate Beta-Buttons from gridded area. No further animal remains were found.
17. A total of ~~491~~⁴⁷⁰⁻⁴⁶⁹ (fourhundred-nintyone) "Beta-buttons" recovered. No detectable soil contamination encountered.
18. Radiation survey conducted on grids 1 through 15, no readings above background noted.
19. Former research custodian interviewed by EHO, this revealed the location of incinerator ash dump site. Soil sample taken and sent for isotopic analysis. Also revealed no other burial sites existed beyond those identified by RASO REP.
20. Back hoe and sifter surveyed by RASO REP and released for unrestricted use. Anti-C's disposed of as radioactive Waste.
21. At 2000 the area was secured for the day.
22. A debriefing was held at 1300 on 13 DEC 80 by the RASO REP and was attended by the IHQ, EHO and RSO.

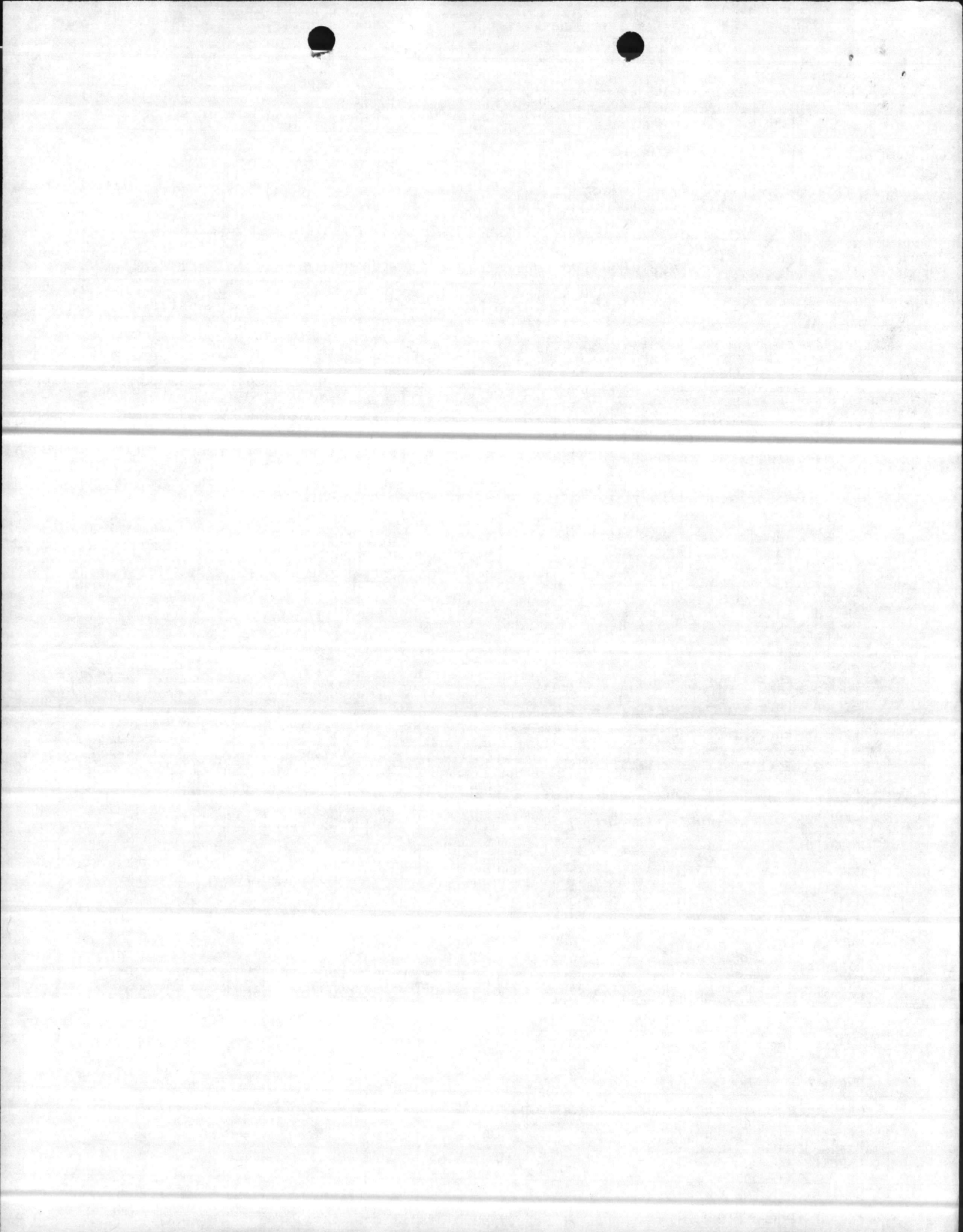

III RECOMMENDATIONS

Upon completion of clean-up procedures of the site the RASO REP made the following recommendations prior to his departure:

- A. Store radioactive material in enclosed secure area and mark area in accordance with reference (e).
- B. Contact Naval Supply Center Norfolk, Va. for proper packaging and disposition of radioactive material.
- C. Take soil samples in grids 1 thru 15, three from each grid. One from the surface, one from six inches and one at the one foot level. Send the samples to Port Huenneme for isotopic analysis ASAP.
- D. Retain grids 1 thru 15 as restricted area pending results of isotopic analysis.
- E. Area to be released by RSO.
- F. RSO take wet rag survey with E140/DT304 or HP210 probe of work sites inside building inside PT-37 compound.

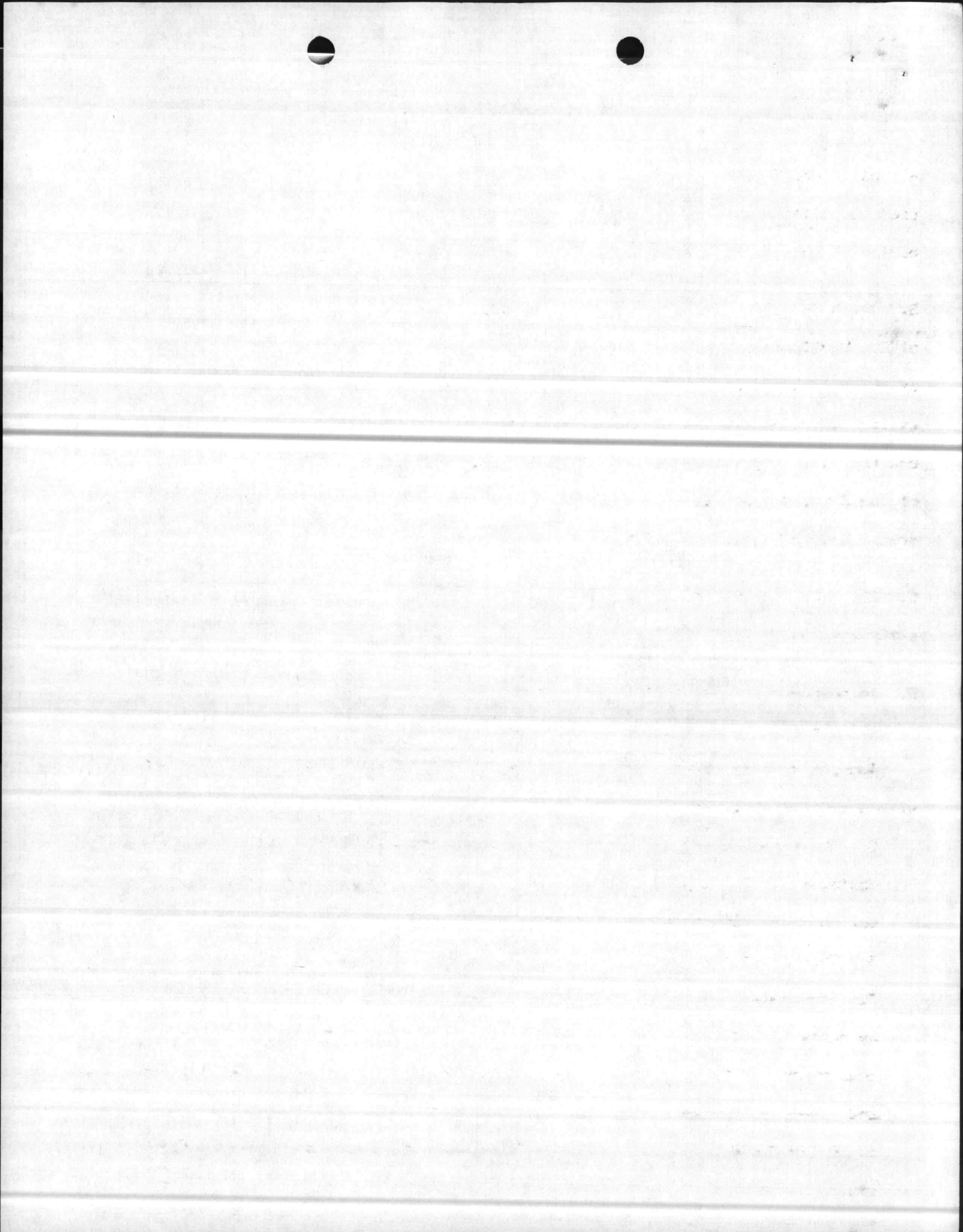

IV FOLLOW-UP ON RECOMMENDATIONS

- A. On 13 DEC 80 the RASO REP departed MCB, CLNC. The list of recommendations were used as guidelines for further work accomplished on the site under direction and action of the EHO and the RSO.
- B. On 18 DEC 80 at 1015 a debriefing was held by the EHO and RSO in the office of COL MOUNT, Base Maintenance Officer, MCB, CLNC, as to how situations stood. A copy of notes compiled during the debriefing by the RASO REP, IHO, EHO and RSO, were made available to the colonel and the base safety officer. Questions concerning instructions and regulations governing storage, handling and transportation of the RAM were asked of the EHO and RSO. The colonel seemed satisfied with answers given and offered support from the Base Maintenance section whenever needed.
- C. COL MOUNT in turn debriefed the Commanding General of MCB, CLNC of existing situations and further procedures.
- D. In response to the first recommendation:
1. The RAM were placed in small polyethelene bags, 2mm per each bag totaling 4mm per 25 beta-buttons. These bags were double goose-necked, taped and labeled with a radiation sticker.
 2. The total number of "Beta-Buttons" were placed in 2 intermediate storage containers, (2- 30 gallon trash cans). The third can contained the contaminated soil and the remains of the 2 dogs.
 3. These containers were marked 1,2,3 and labeled, "CONTAMINATED WASTE".
 4. The containers were placed in an area just adjacent to the site, surrounded by empty 55 gallon drums and surveyed for attenuated readings. This survey was done by the RASO REP prior to his departure from the site. A barrier was established and label was placed around the RAM storage area.
 5. On 19 DEC 80, at 1330, the containers were transfered by hand from the site storage area to an interim storage area located on the IVC. The building ~~3~~ PT-25. The RAM storage area was surveyed by the RSO with an ANPDR 27/DPR 27 probe to



detect any loose surface contamination: none noted. RAM storage area adjacent to the site was cleared for unrestricted use by the RSO. Barriers and labels removed.

E. Contacting the Naval Supply Center Norfolk for proper packaging and disposition of the RAM was accomplished by the EHO. Information and documentation concerning the packaging containers is submitted as enclosures (7) and (8) respectively.

F. On 19 DEC 80, the EHO, RSO and accompanied by HMC WASLICKI, O&PMS gathered the recommended soil samples. Each sample was placed in a ziplock bag and numbered. These samples were sent to Port Huenneme for isotopic analysis. Grids 1 thru 15 remain restricted pending results of the isotopic analysis.

G. Wet rag readings were also conducted on 19 DEC 80 by the EHO and RSO. Areas swiped and read with an ANPDR27/DPR27, work areas, storage shops and lunch room. Zip lock bags sealed and numbered and sent for analysis.

NOTE: Results of soil samples and wet rag surveys were received via telephone.

H. In April 80 the RASO REP conducted a second Health Physics Visit to MCB, CLNC, to observe the interim storage area .

1. Arrived at 1000 to conduct survey and take soil samples from each grid at the 2 and 4 foot level.
2. Above background readings were noted at the 2' level of grid #2.
3. Digging commenced in grid #2 and 20 "Beta-Buttons were found at the 2' level.
4. Buttons were double bagged, goose-necked and taped. These buttons were added to the count bringing to a total of 490.
5. Continued taking soil samples in remaining grids.
6. Survey of interim storage area conducted by RASO REP, no readings above background noted.

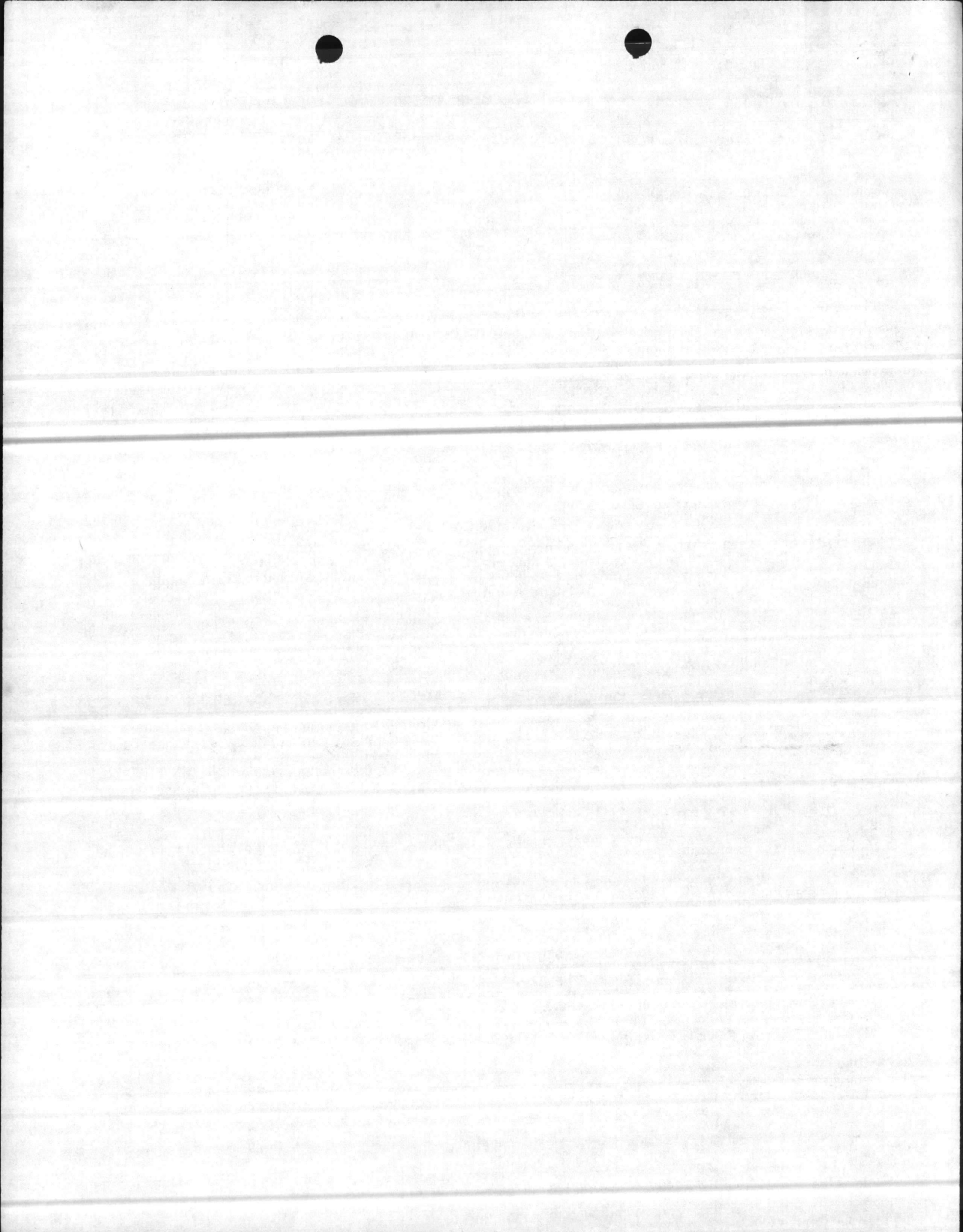

7. Soil samples taken to O&PMS for mailing to Port Huenneme for isotopic analysis. Surveys conducted on each hole dug for soil samples.
8. Gridded area remained restricted.
9. RASO REP departed on 11APR81 making the following recommendations:
 - (a) Continue restricted use of site.
 - (b) Transfer RAM into permanent containers from interim storage containers when they are received from NAVSUPCEN, NORVA.
 - (c) Survey interim storage containers when transferred occurs and release them if free of contamination.
 - (d) RASO REP will contact O&PMS with results of isotopic analysis when completed and issue further instructions.
1. The following are procedures completed from recommendations from RASO REP.
 1. In MAY 81, proceedings continued at the IVC. Results of the isotopic analysis were received via telephone by the EHO.
 2. RASO REP recommended soil samples be taken from 4 sites of grid #1. Also recommended that a metal detector be used over entire area to possibly detect anymore buttons.
 3. The containers were also received from NAVSUPCEN along with ~~the~~ vermiculite insulation for packaging RAM and contaminated soil.
 4. Digging proceeded for soil samples in four sites of grid #1. During the digging another "Beta-Button" was found at a level of 10" from the surface of grid #2. Metal detectors used in grid #1 found one more button at a level of 2' from the surface.
 5. The buttons were transferred to the interim storage area to be added to the count.
 6. Transferred the "Beta-Buttons" from interim storage containers to permanent storage containers. The contaminated soil was also transferred. This was accomplished by the EHO and RSO.
 7. Five of the six barrels used. Barrels 1 thru 4 contained "Beta-Buttons". Barrel contained the contaminated soil and animal remains.

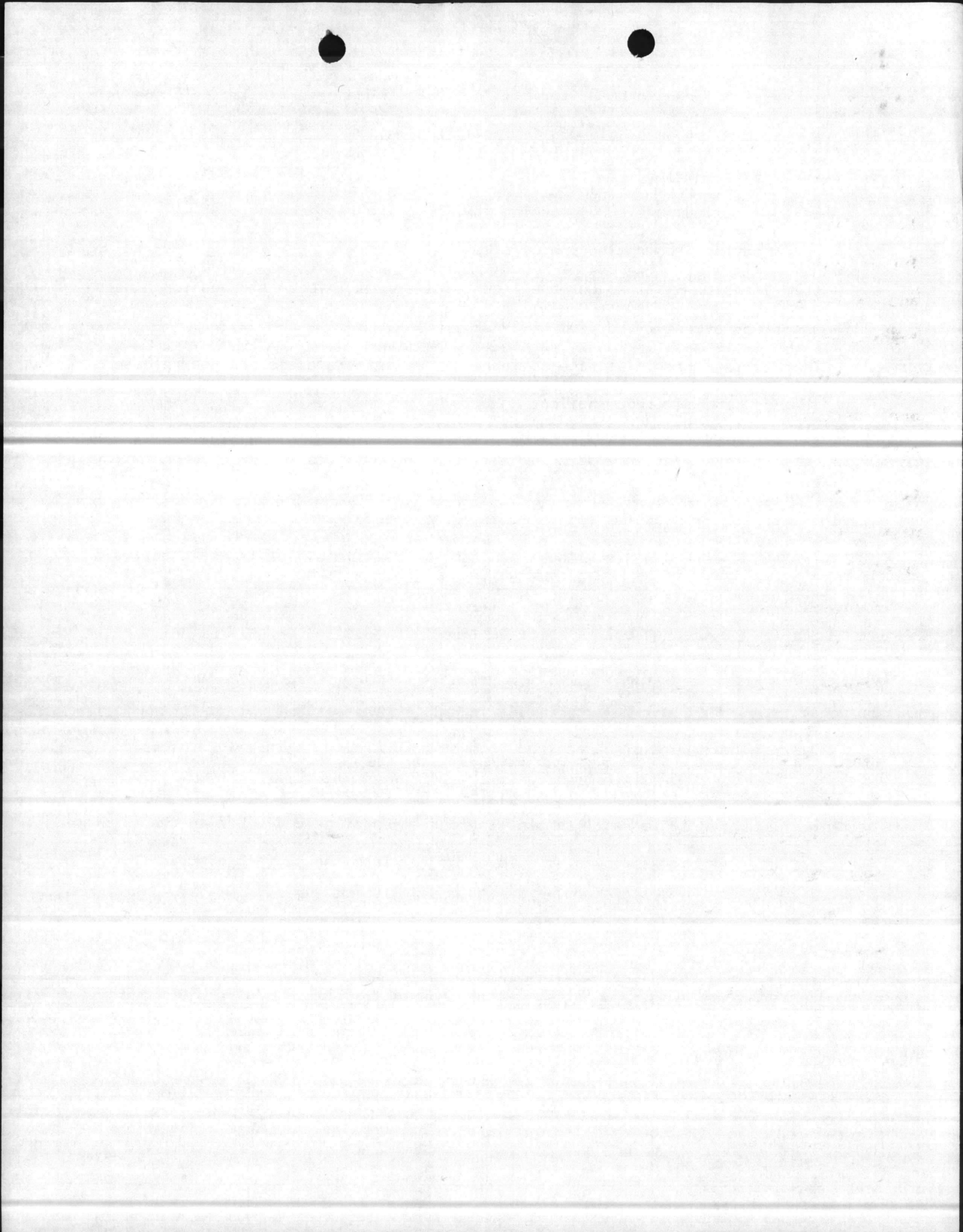

8. Interim storage containers surveyed by RSO with PRM5 and E140N. No readings above background. Containers released for unrestricted use.

9. Soil samples from grid #1 sent to Port Huenneme for isotopic analysis.

J. Meetings between the EHO and RSO continued concerning completion of proceedings for packaging and transportation of RAM containers. Communication between RASO REP and EHO continued via telephone. Instructions concerning packaging, handling and transportation were received.

K. Labeling and survey procedures commenced by RSO along with research for category and transportation index. Found to be RADIOACTIVE CATEGORY II, NORMAL FORM, TRANSPORTATION INDEX B.

L. RSO accompanied by O&PMS person, HN P. SOTO, USN, 129 50 8410, commenced counting packaging, labeling, weighting and survey readings as specified in references(c) thru (f) in MAY 81.

1. Each container was opened and emptied of it's contents.

2. 125 (onehundredtwentyfive) "Beta-Buttons counted, double-bagged, goose-necked resealed, labeled and repackaged ^{per} ~~in~~ containers.

3. Total number of buttons: 491 (Fourhundred ninetyone) placed in 5 containers. Barrel #5 contained buttons and approximately 250 pounds of soil.

4. Each barrel was labeled with a Radioactive II sticker, Contents: STRONTIUM (Sr) 90, "BETA-BUTTONS", #of curries 400 MICROCURRIES per button, Transportation Index "B". Each container weighted.

5. Survey readings conducted on sealed barrels with an ANPDR27/DPR27. Readings were done on the X5 scale:

(a) Containers 1 thru 4

Contact: 3.5 mR/hr

1 ft.: 2.mR/hr

3 ft.: .5 mR/hr

(b) Container 5

Contact: 1 mR/hr

3 ft.: .5mR/hr

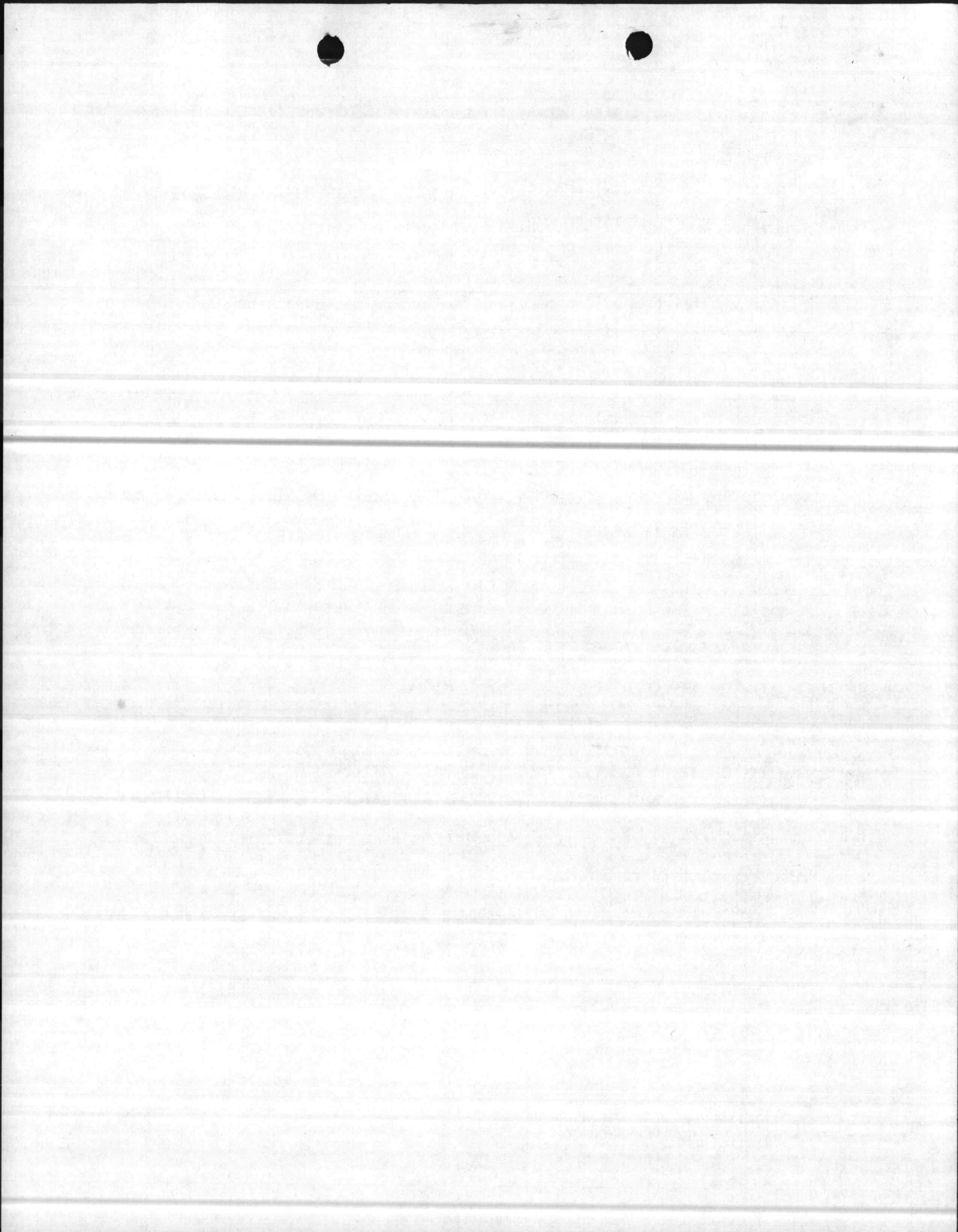

6. Containers returned to the interim storage area and area secured.
- M. On 16 JUNE 81 a telephone conversation between the RASO REP and EHO revealed, a high reading was noted from soil samples received from grid #1 at the 4ft level.
1. Recommendations from RASO REP:
 - (a) Dig down to 3½ ft level in grid #1 and excavate 6" of soil bringing the level to 4 feet.
 - (b) Survey soil at each level of a foot.
 - (c) Package soil in double bags, goose neck, tape and put in RAM containers.
 - (d) Take soil sample from the 6 ft level and sent for isotopic analysis.
 2. Instructions relayed to the RSO.
- N. On 23 JUNE 81, RSO accompanied by HN SOTO commenced excavation procedures.
- (a) RSO conducted survey of surface soil to detect any loose surface contamination with ANPDR27/DPR27: No readings noted.
 - (b) Digging commenced in grid #1. One "beta-button" found at a level of 22". EHO notified. Instructed RSO to continue digging.
 - (c) Soil excavation and surveys continued to a level of 42".
 - (d) Six inches of PCS, (potentially contaminated soil) excavated and placed in a total number of 15 bags.
 - (e) Soil sample taken at 6 ft level and sent for isotopic analysis.
 - (f) PCS transferred to RAM storage site.
 - (g) One "Beta-Button" found in soil excavated from grid #1.
 - (h) Area secured at 1600.
- O. On 24 JUNE 81, RSO and HN SOTO returned to IVC to package soil in containers.
1. Container #1 contains only "Beta-Buttons".
 2. Containers 2 thru 4 contain buttons and PCS
 3. Containers 5 and 6 contain PCS.
- P. Survey readings done with ANPDR27/DPR27. See enclosure (8) for readings, weights and serial numbers of containers.

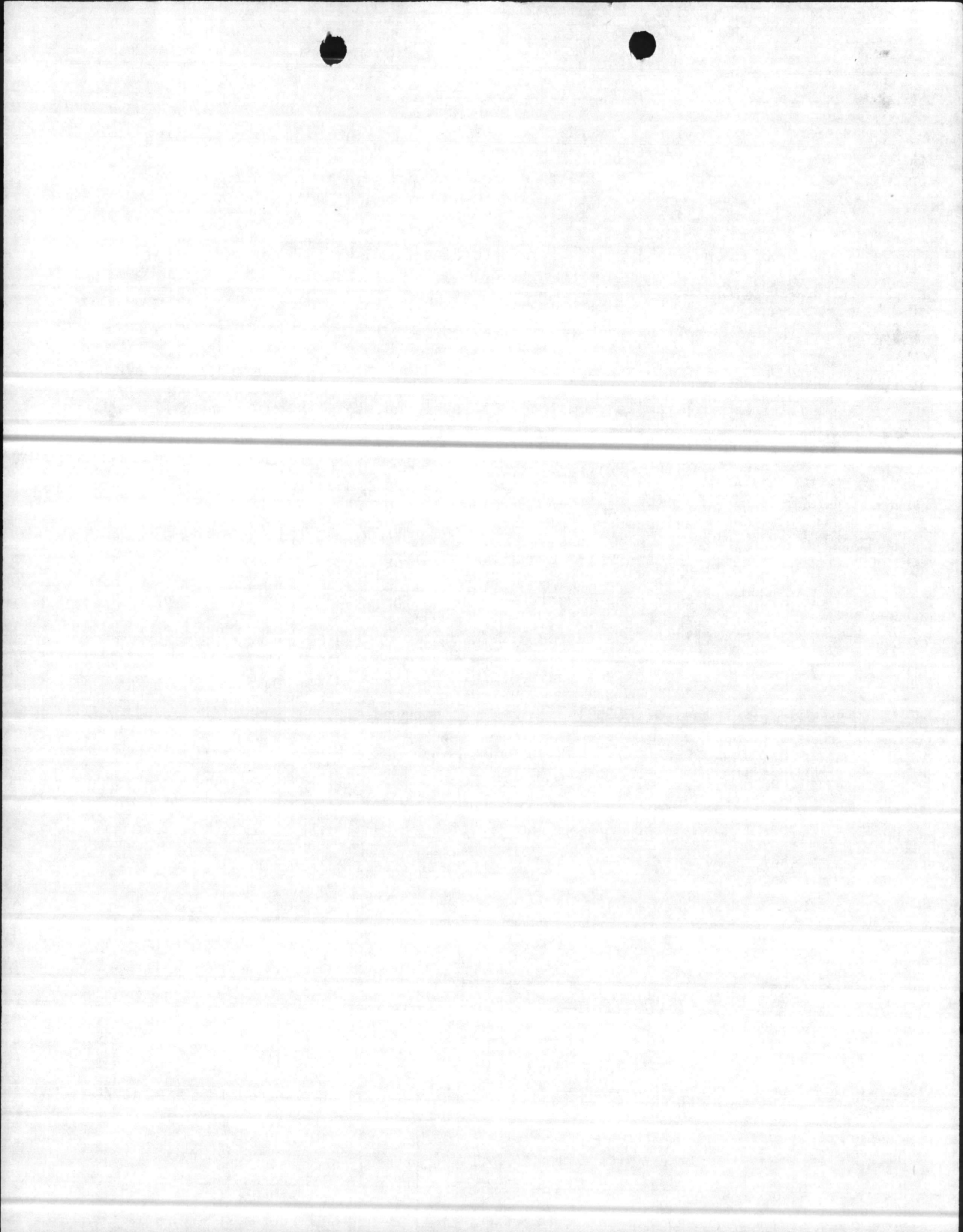

VI TRANSPORTATION

- A. Submitted for disposition of packaged radioactive material:
 - 1. 6 (six) DOT Spec 17H steel drums, 55 gallon. Enclosure (8)
 - 2. Volume and weights included.
- B. All requirements as set forth by reference (d) followed.
- C. All requirements as set forth by reference (f) followed.
- D. Awaiting transportation carrier.

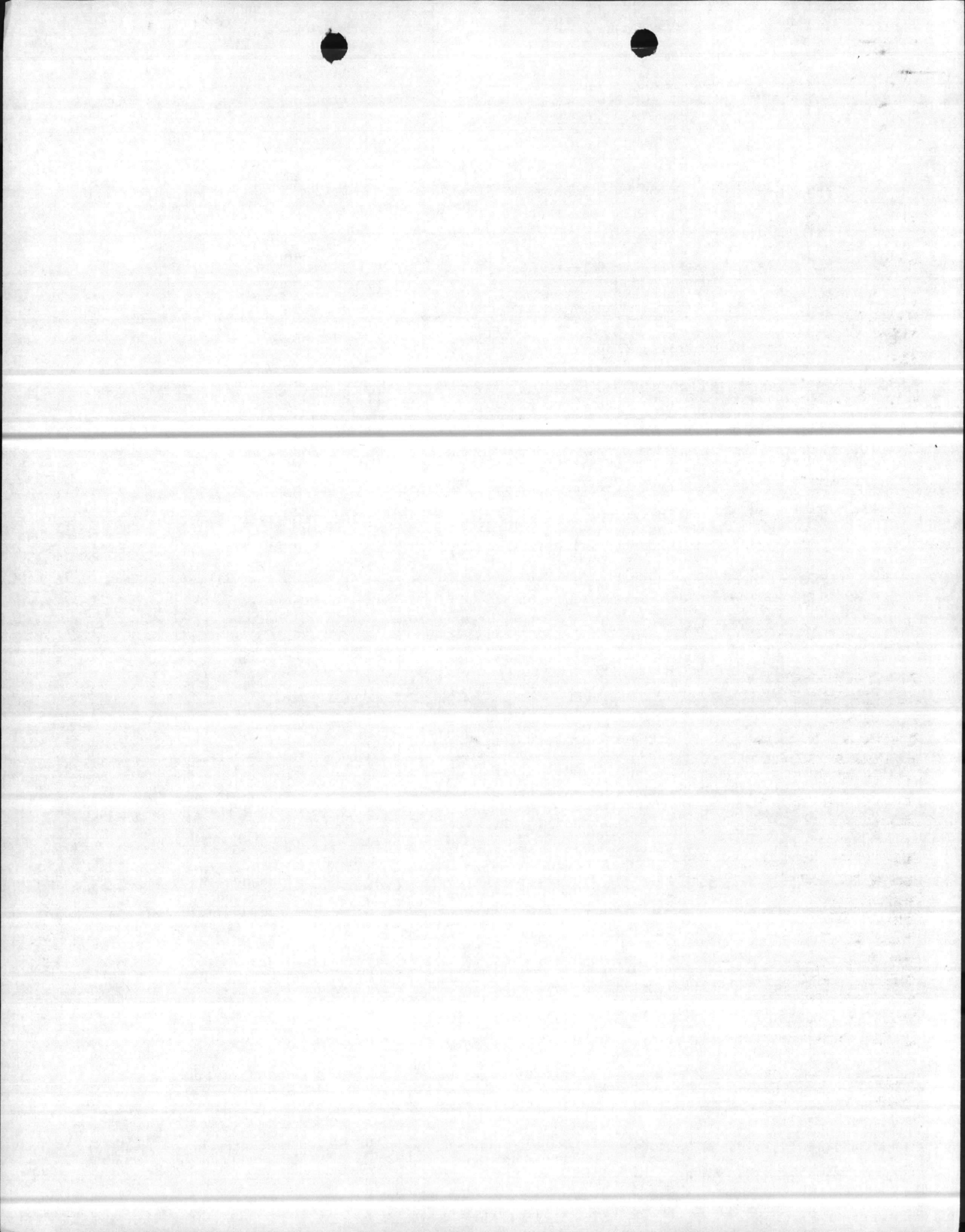

04N2/GWH
5100.00/8
5100.00/22
21 MAR 1978

From: 04N2
To: Files 5100.00/8 and 5100.00/22

Subj: Strontium (Sr)-90 beta buttons; licensing of

1. During January 78 several beta buttons were found at a park in Norfolk, VA. The investigation conducted by Region II of NRC indicated that at least one of the buttons was a Navy button containing Sr-90. Since the Navy does not have a license for the buttons and since some buttons are still in the Navy, it was decided to gather background information on Sr-90 beta buttons for reference purposes.

2. The following people were contacted to gather information:

George Mahaffey	NAVELEX	retired
Jack Bell	NRC	443-6920
Robert Barker	NRC	443-6976
Don Smith	NRC	443-6976
Jerry Hutton	NRC	492-7211
Carl Hoff	ONRL	(615) 483-8611 Ex. 1131
Harry Dooley	American Atomics	(602) 622-4881
Nate Bassin	NRC	427-4228

The only significant information came from Mrs. Dooley, Bell and Bassin. Mr. Dooley used to work for U. S. Radium Corporation. He remembered the buttons and referenced NRL report 4655 "Measurements and Evaluation of Luminous Material" and Mil-M-3935 "Markers, Self-Luminous". Mr. Bell furnished a copy of an informal history of the regulatory process through about 1967. The paper states that authorizations were in effect before licensing was implemented in accordance with the Atomic Energy Act of 1954, as amended.

The Navy likely had an authorization for the buttons. No one knew for sure if the Navy got a license when licensing became effective. Mr. Bassin remembered that the Navy made a large effort to remove all buttons and then terminated its authorization or license. He said it was understood at the time that some buttons may still be in the Navy and when located they would be disposed of as waste. He did not know if the authorization/licensing files still exist in NRC storage. No effort to locate the files was requested, but that is a possibility should the need arise in the future. Mr. Bassin was of the opinion NRC would not give the Navy a "hard time" if a few buttons turn up.

During the authorization/licensing process Mr. Bassin worked with Mr. Vince Saittia, deceased, and CDR Gordon Bell of BUSHIPS.

(encl 2)

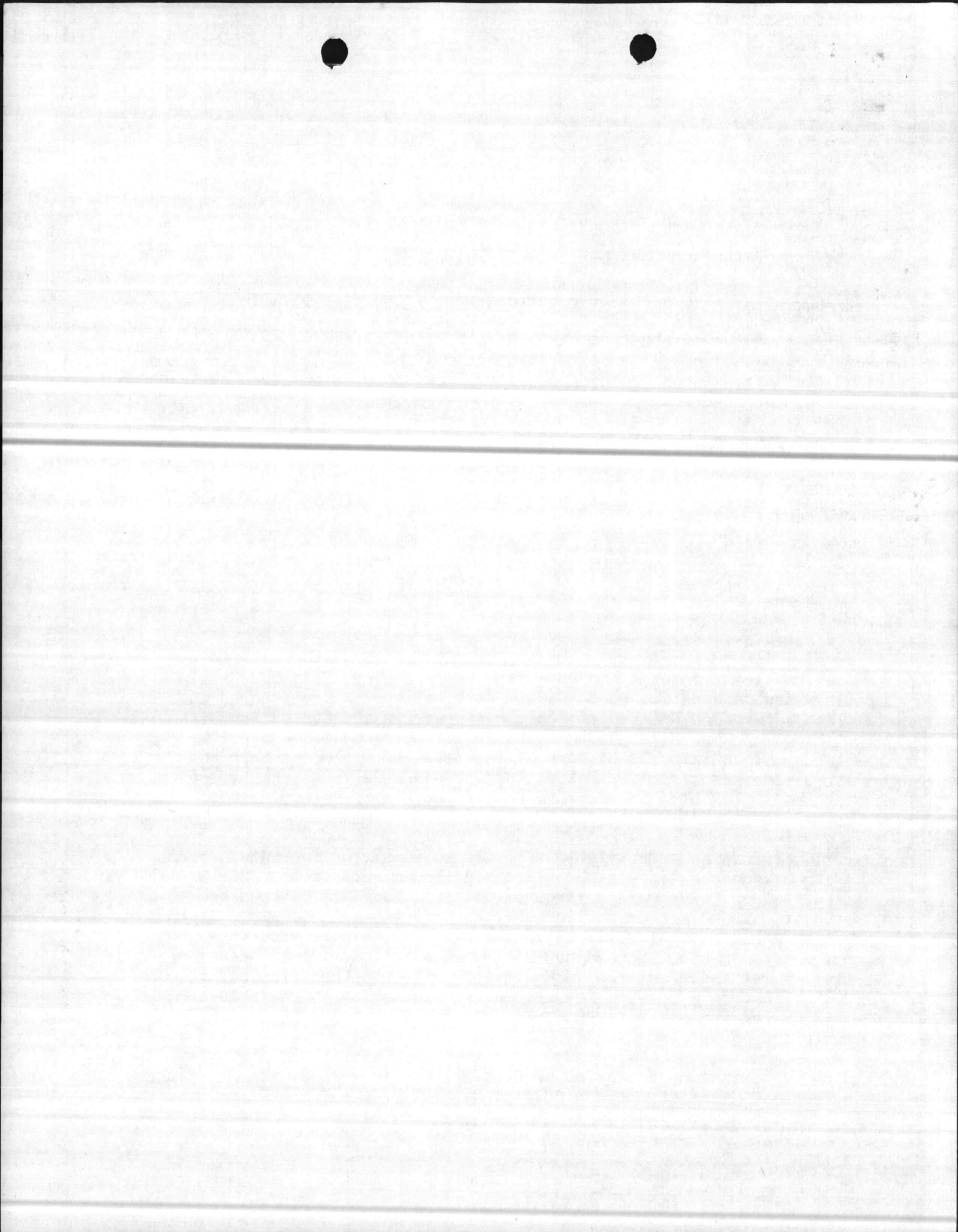

04N2/GWH
5100.00/8
5100.00/22
21 MAR 1978

Subj: Strontium (Sr)-90 beta buttons; licensing of

A copy of the NRL report and the information from Mr. Bell has been sent to NNPU.

Gene Hendrix

Gene W. Hendrix

copy to:
AVNUPWRU (40)

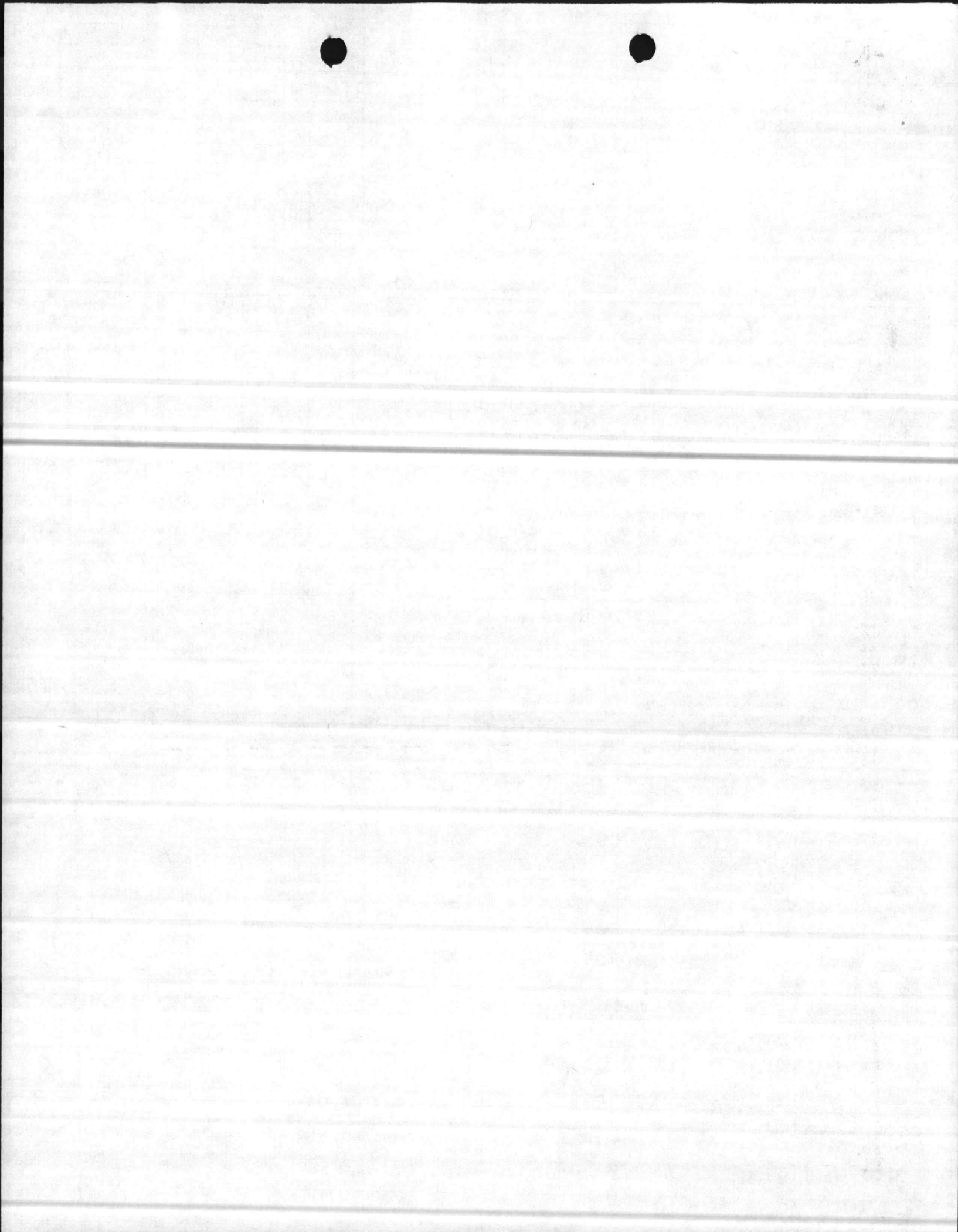

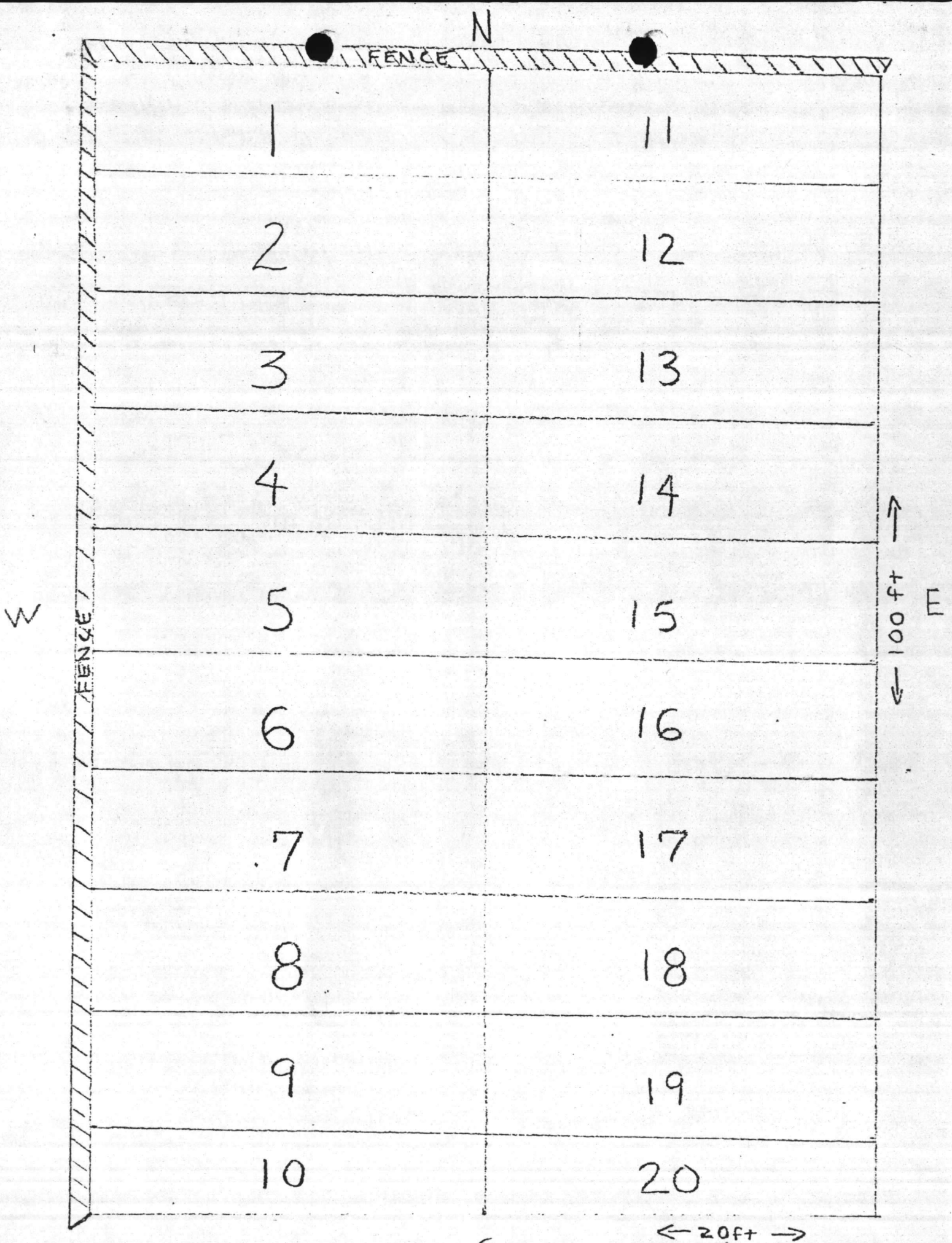

Enclosure (3) Diagram of primary gridded area ^S

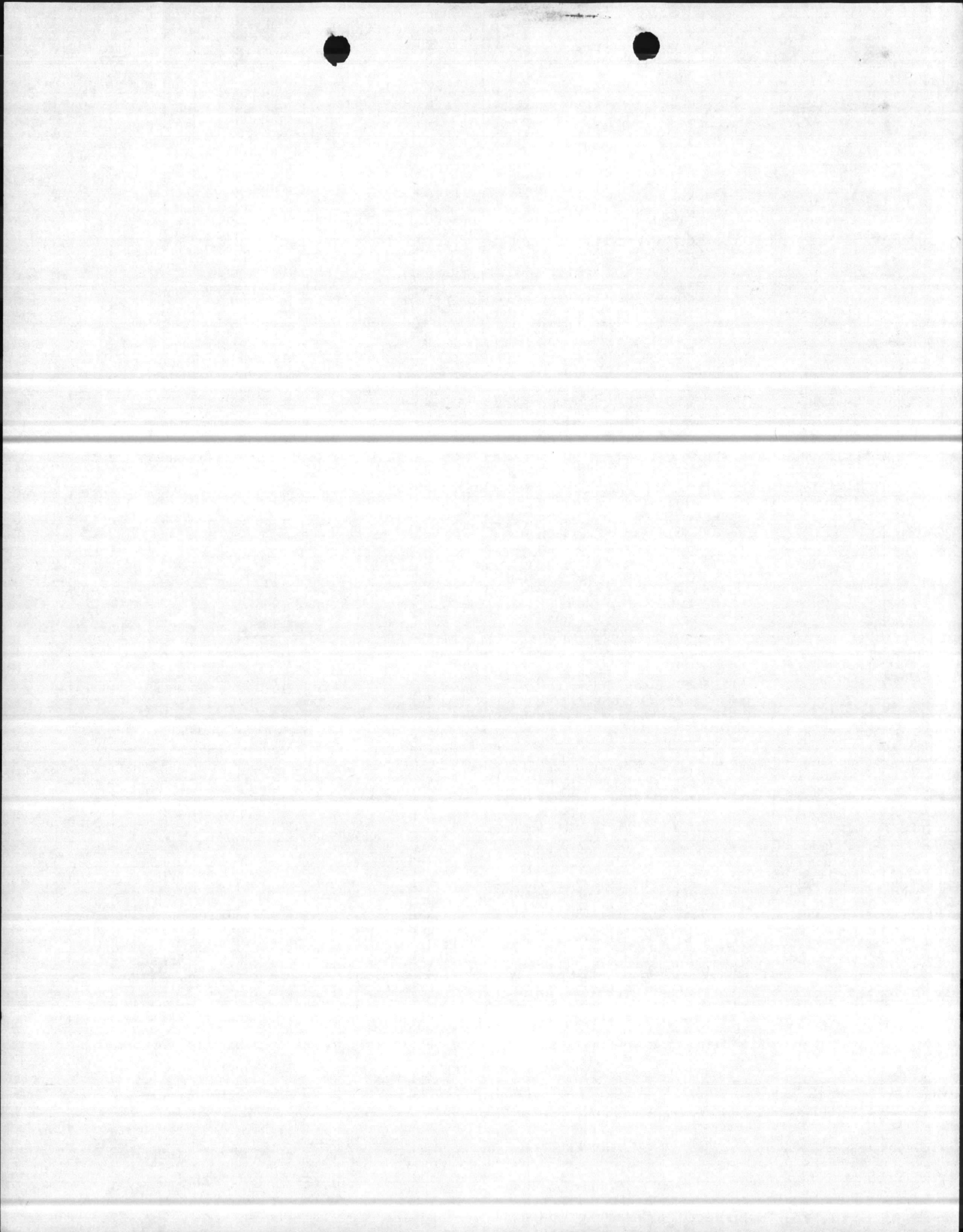

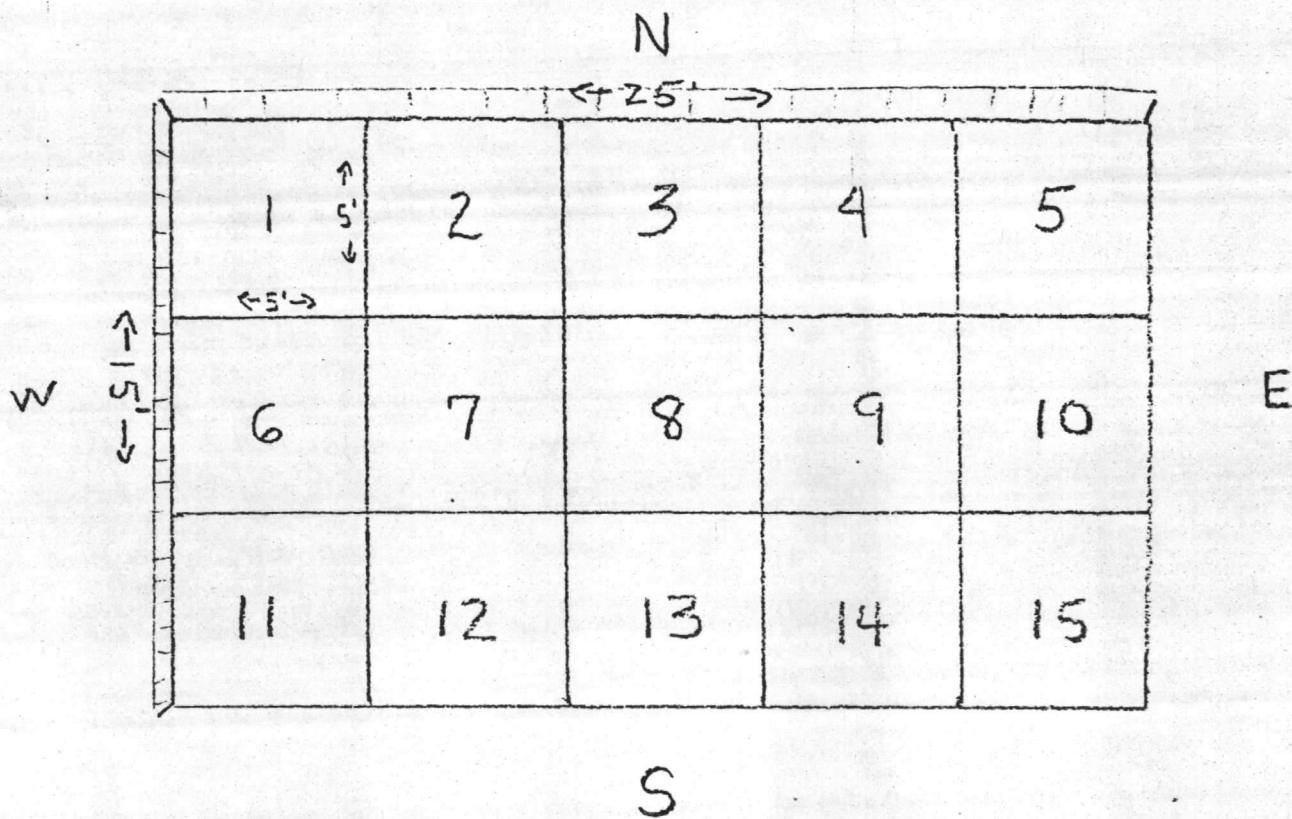
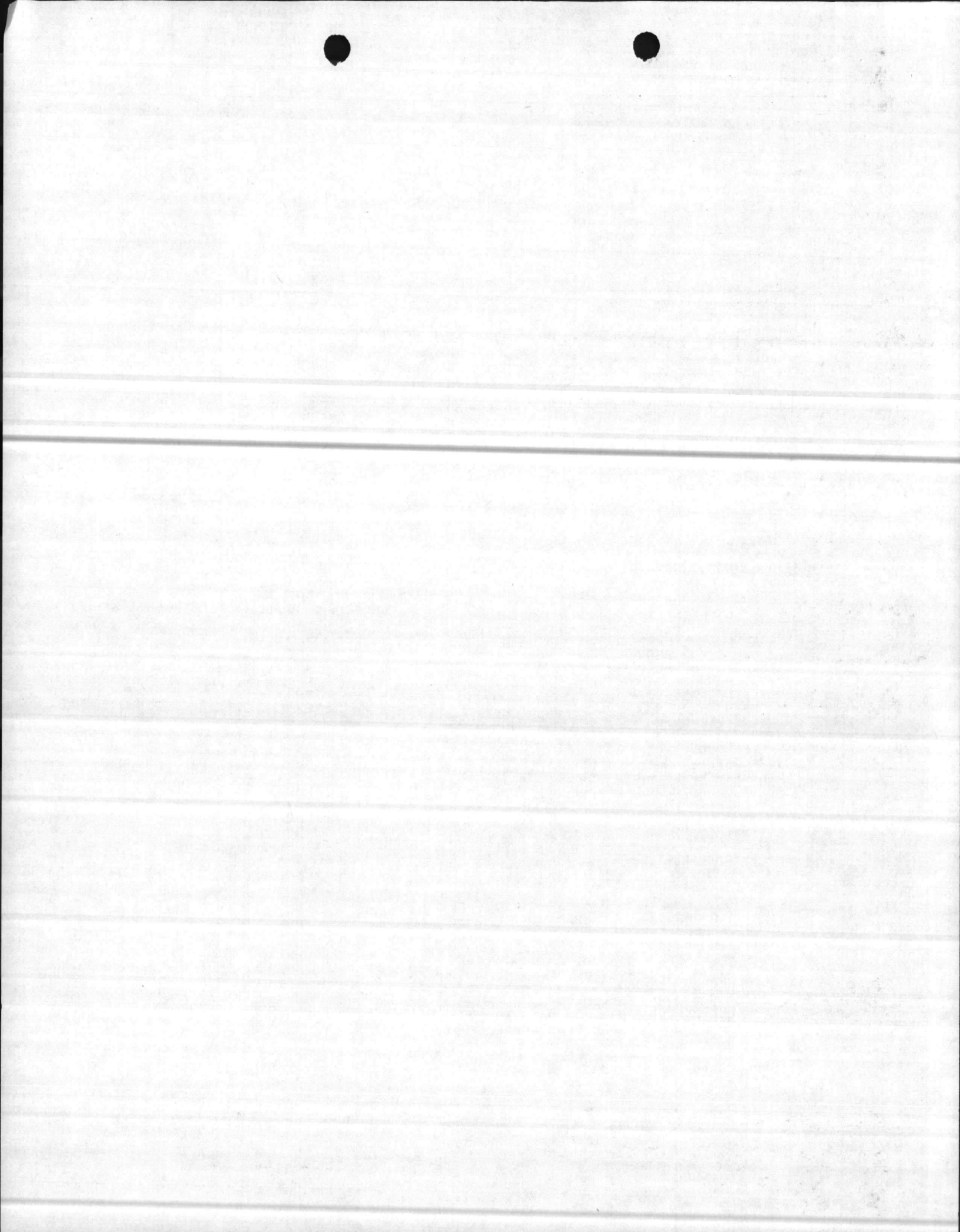

Diagram of radioactive gridded area.



Enclosure (3)

Strontium - 90	Beta Button	GC#	Buttons	Soa (cpm/hr) Contact	(cpm/hr.) BARRIER
11 Dec	1	50	1.5c	20.1w	
12 Dec	1	150	3.0c	20.1w	
12 Dec	1	100	3.6c	20.1w	
12 Dec	2	100	1.6c	20.1w	
12 Dec	2	25 50m	1.8c	20.1w	
12 Dec	2	44	2.6c	20.1w	
12 Dec	2	19 (small)	3.1c	20.1w	

12 DEC 3 CARCASS ANIMAL + Soil 2 | ~65lbs | 20.1c 20.1w

13 Dec 2 11 3.4c 20.1w

total beta buttons = 498^w 499

Radiation readings taken with ANPDR-27
 A3564 Calibrated 11/17/80
 w = wait level GC# = garbage can number
 c = Contact with GC

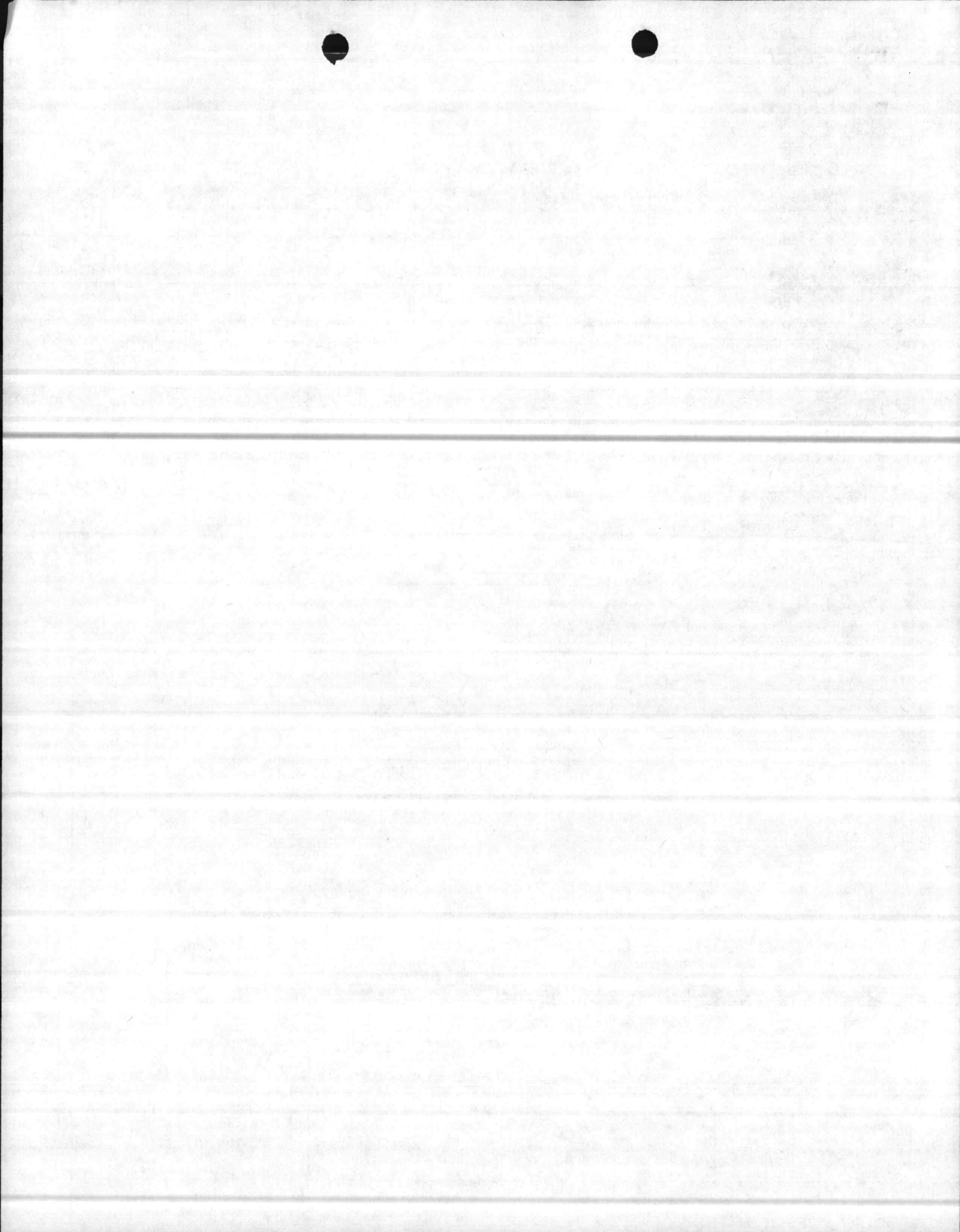

13 January 1981

Environmental Health Officer

Chief, Occupational and Preventive Medicine Service

Request for Radiation Safety Officer to report to O&PMS

1. I am requesting that HMI Saurini report to the Occupational and Preventive Medicine Service for a period of two weeks to assist in carrying out the recommendations of the Radiological Affairs Support Office in Port Hueneme, California.

2. HMI Saurini is the Radiation Safety Officer for CLNC, and his knowledge and expertise in working with radioactive materials will be invaluable to the efficient and expeditious completion of this task. HMI Saurini's two weeks here should allow for sufficient time to finish the Strontium 90 incident at the IVC, and to investigate another potential radioactive dump site at CLNC. A complete survey of this potential health hazard needs to be performed so as to identify the boundaries of the site. Soil samples must be collected, properly packaged and sent to Port Hueneme, California for analysis. If the site in question establishes itself as an extreme hazard, it may be necessary to extend this request.

3. It is requested that HMI Saurini report to the O&PMS starting ^{26 JAN} ~~19 Jan~~ 1981 through ~~30 Jan~~ _{6 Feb} 1981.

4. For further details concerning this request, contact ENS B. Kalisch, Environmental Health Officer, NRMC, CLNC.

B. KALISCH
ENS MSC USNR

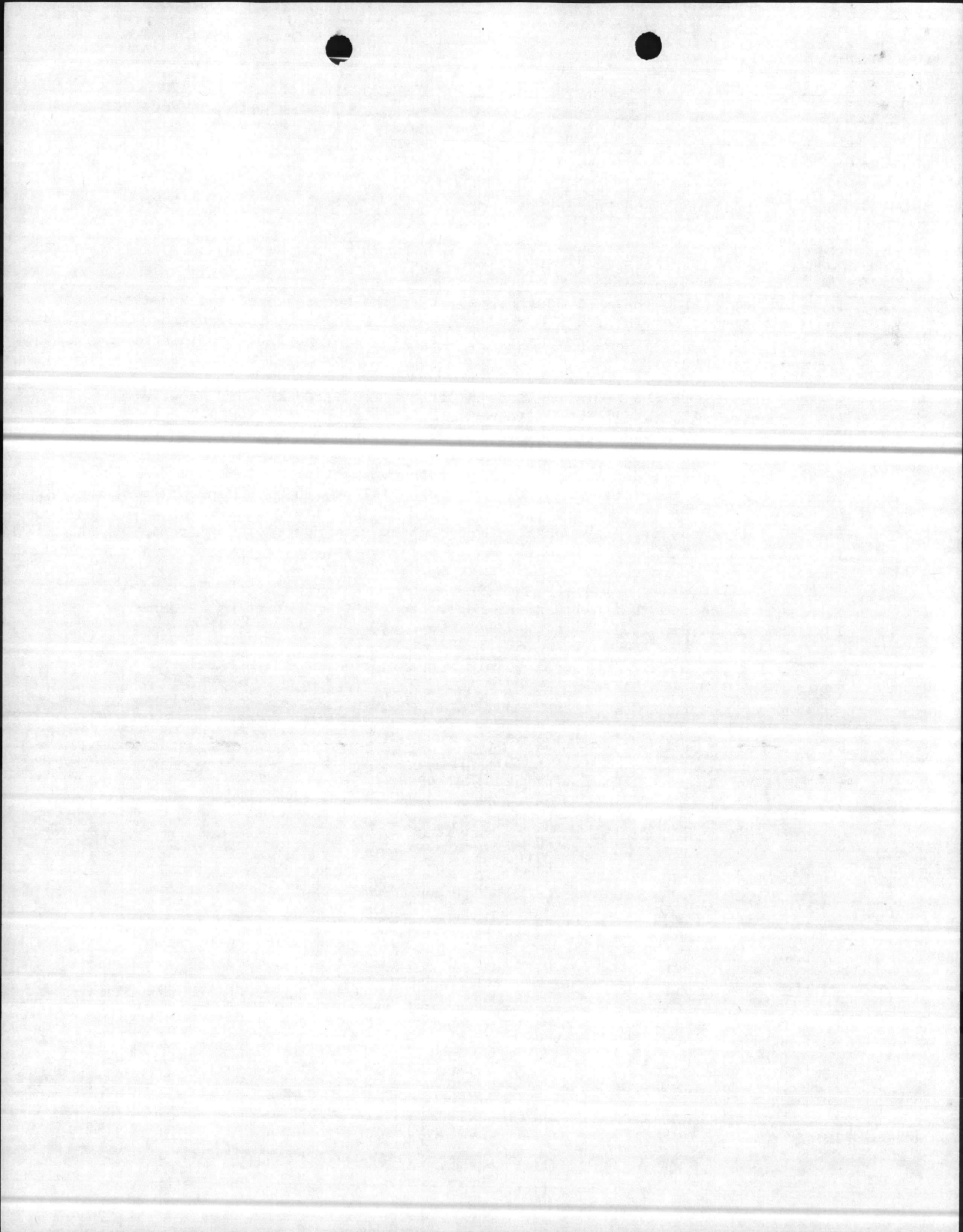

1) Common Name of Container:

Spec 17H 55 Gallon Steel Drum

2) Authorized Contents:

Type "A" quantities of solid radioactive material in normal or special form.

3) Dimensions:

Interior: 22-1/2 in. i.d. x 33-1/4 in. usable inside height

Exterior: 24 in. o.d. x 35 in. outside height

4) Description of Container:

- 55 gal Spec 17H steel drum
- 18 gauge sides and bottom head sheet
- 14 or 16 gauge removable head sheet (16 gauge authorized provided there are one or more corrugations in the cover near the periphery)
- Gasket (see item 5)

5) Specifications and Restrictions:

- Authorized Gross Weight - 840 lb
- Any bulky equipment with sharp corners, protrusions, etc. must be securely positioned within drum.
- Gasket material must have minimum operating range of -40°F to +130°F. If sponge rubber gasket is used, minimum of 1/2 in. required.

6) Test Results:

<u>Test</u>	<u>Results</u>	<u>Environmental Conditions</u>	<u>Discussion and/or Reference</u>
a) Heat, +130°F	Pass		Engineering Analysis (EA) - Temperature is within normal operating range for materials of construction.
b) Cold, -40°F	Pass		EA - Temperature is within normal operating range for materials of construction.
c) Reduced Pressure	Pass		"Spec 17H 55 Gallon Steel Drum," <u>Technical Support Document - Type A Study, MLM-2229 (1975).</u>

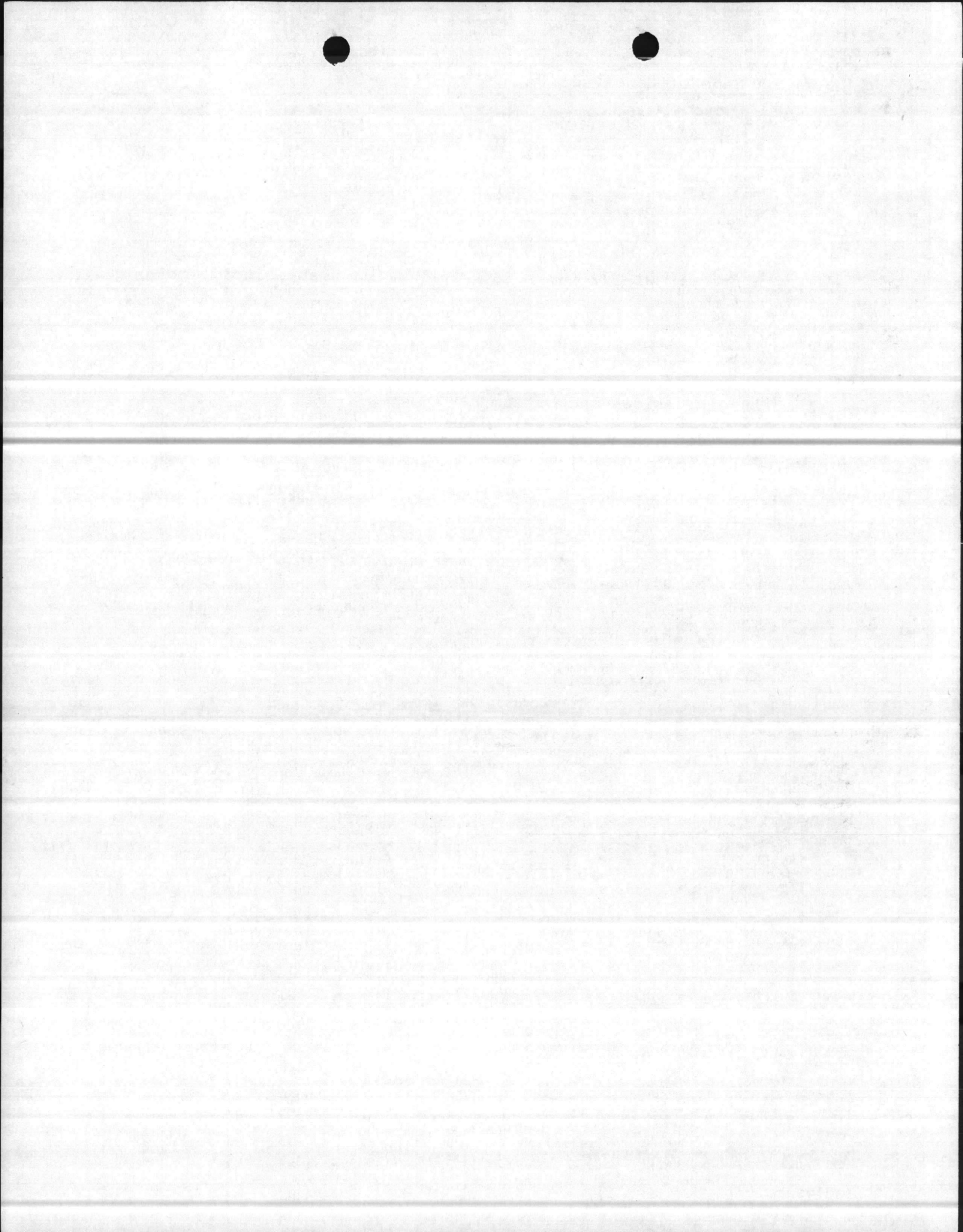

<u>Test</u>	<u>Results</u>	<u>Discussion and/or Reference</u>
d) Vibration	Pass	Containers have withstood years of transport with no occurrence of significant damage due to normal vibration.
<u>Test Conditions</u>		
e) Water Spray	Not Required	CFR49 § 173.398(b)(3)(i)
f) Free Drop (4 ft)	Pass	Tested with 843 lb gross weight. "Spec 17H 55-Gallon Steel Drum," <u>Technical Support Document - Type A Study, MLM-2229 (1975).</u>
g) Corner Drop	Not Required	As long as packages are Fissile Class I or exempt. CFR49 § 173.398(b)(3)(iii)
h) Penetration	Pass	"Spec 17H 55-Gallon Steel Drum," <u>Technical Support Document - Type A Study, MLM-2229 (1975).</u> ORNL-TM-3468, December 1972, page 77.
i) Compression	Pass	Tested with 4600 lb load. "Spec 17H 55-Gallon Steel Drum," <u>Technical Support Document - Type A Study, MLM-2229 (1975).</u>

7) For Additional Information Contact:

D. A. Edling
Monsanto Research Corporation
Mound Laboratory
P. O. Box 32
Miamisburg, Ohio 45342

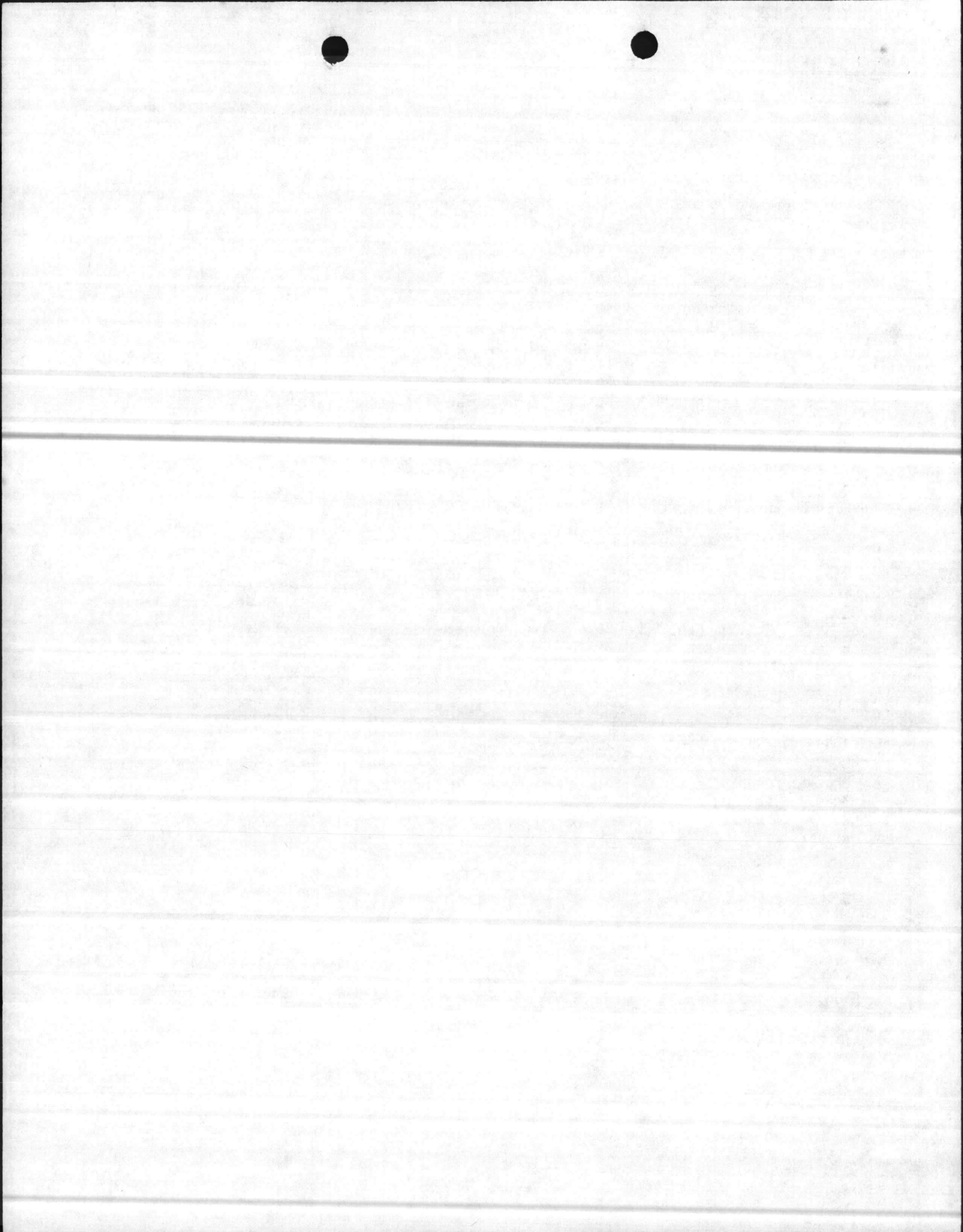

DOT SPEC. 17H STEEL DRUM (55 gallon)
(CFR49 §178.118)

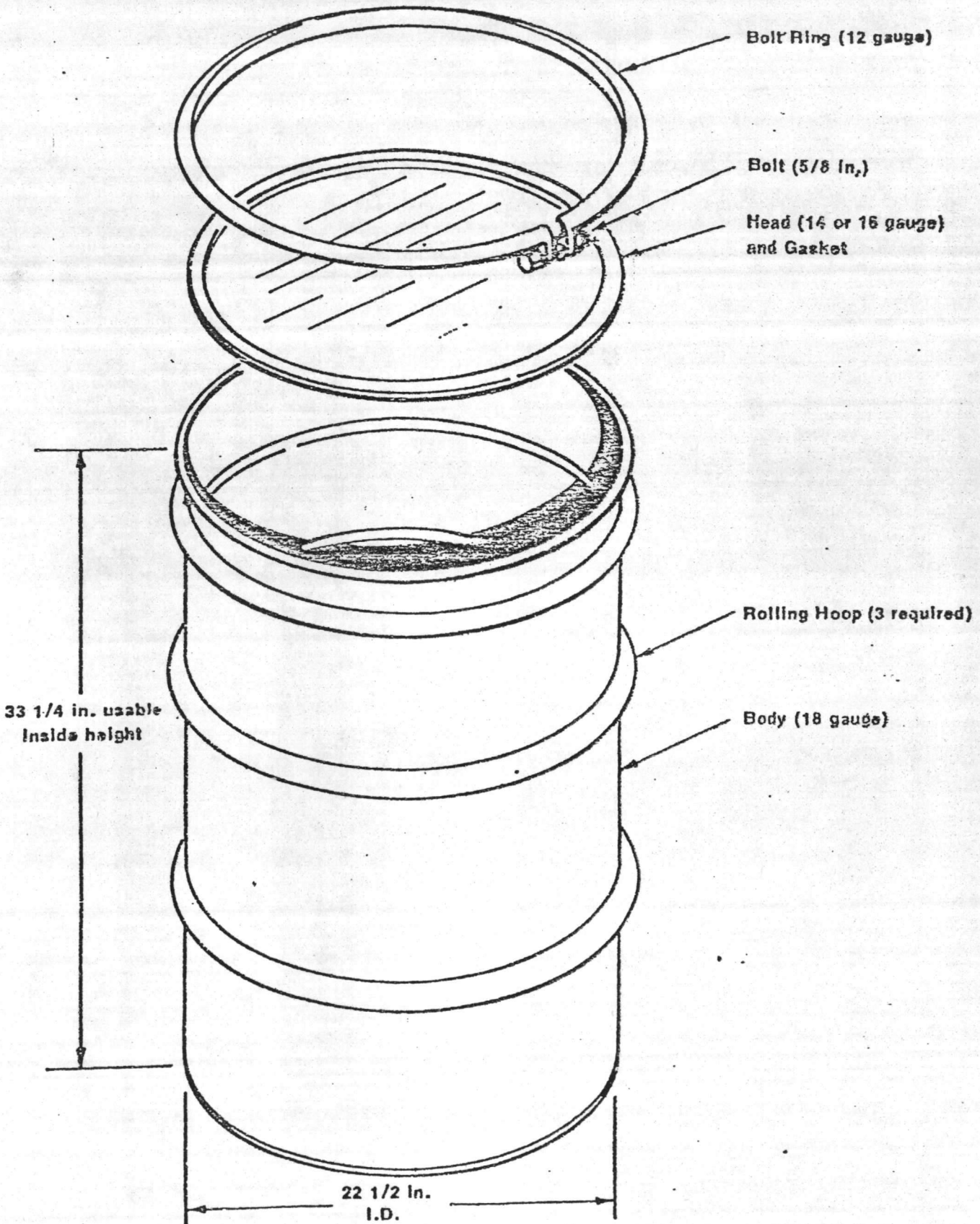

823-8121
NSN 8110-00-030-7779
DRUM, SHIPPING AND STORAGE
FED. AIRMAIL CAP 17-H

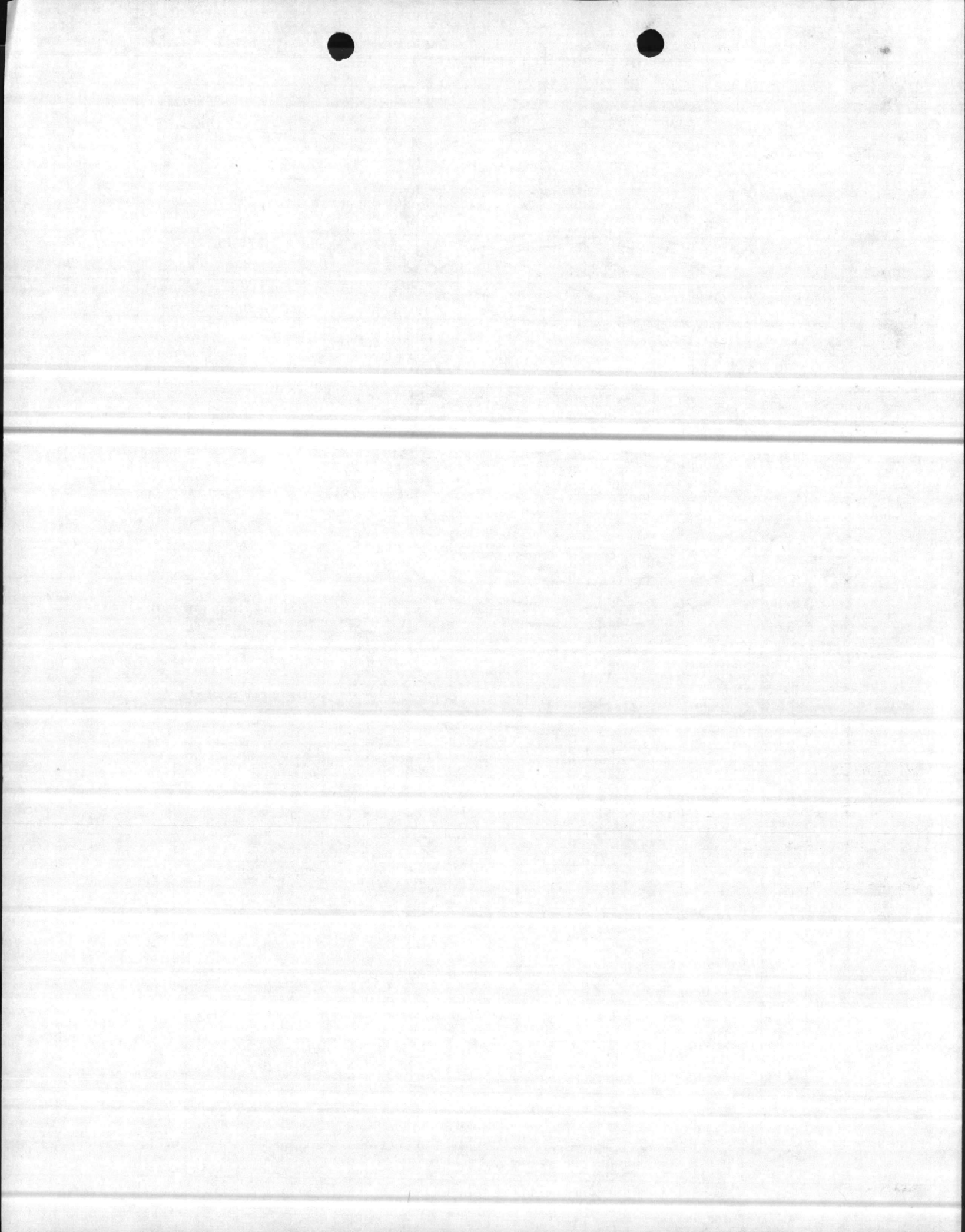

RADIOACTIVE MATERIAL STORAGE LOG

Readings taken with an ANPDR27/DPR27 on the X5 scale

CONTAINER 1

Total Volume: 5.6 cu ft.

Weight: 127.5 pounds

Seal number: U.S. 2714328 tagged 26 JUNE 1981

Readings:

Contact reading on top of container: .1 mR/hr

N: contact: .3 mR/hr

1 ft: .1 mR/hr

3 ft: less than .05

S: contact: .2 mR/hr

1 ft: .1 mR/hr

3 ft: less than .05 mR/hr

E: contact: .3 mR/hr

1 ft: .1 mR/hr

3 ft: less than .05 mR/hr

W: contact: .25 mR/hr

1 ft: .1 mR/hr

3 ft: less than .05 mR/hr

Contents: 125 "Beta-Buttons"

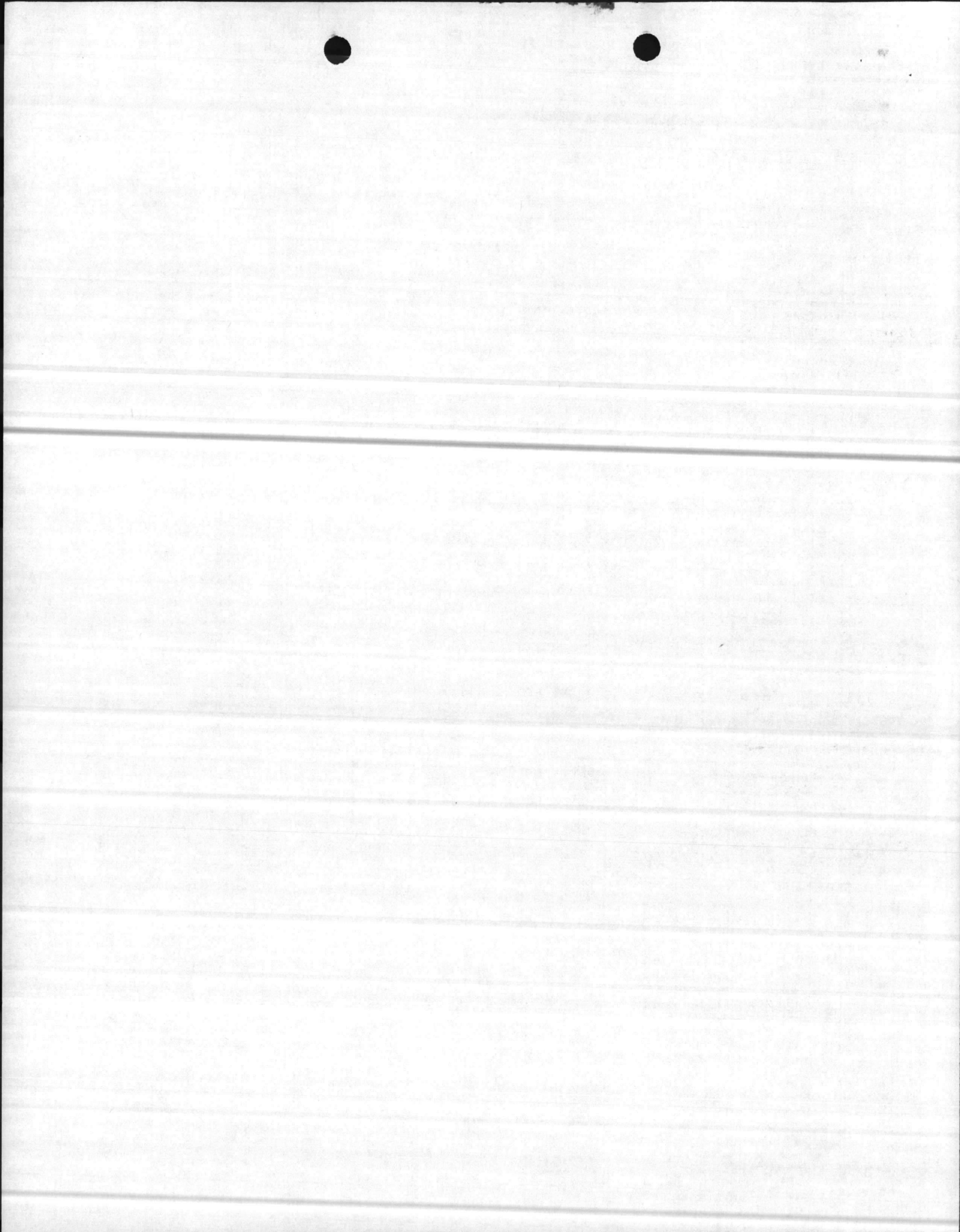

CONTAINER 2

Total Volume: 5.6 cu ft

Weight: 278 pounds

Seal number: U.S. 2714330 tagged 26 JUNE 1981

Readings:

Contact reading on top of container: less than .05 mR/hr

N: Contact: .15 mR/hr

1 ft: .05 mR/hr

3 ft: less than .05 mR/hr

S: contact: .15 mR/hr

1 ft: .05 mR/hr

3 ft: 0

E: contact: .15 mR/hr

1 ft: .05 mR/hr

3 ft: less than .05 mR/hr

W: contact: .1 mR/hr

1 ft: .05 mR/hr

3 ft: less than .05 mR/hr

Contents: 125 "Beta-Buttons, 3 bags of soil

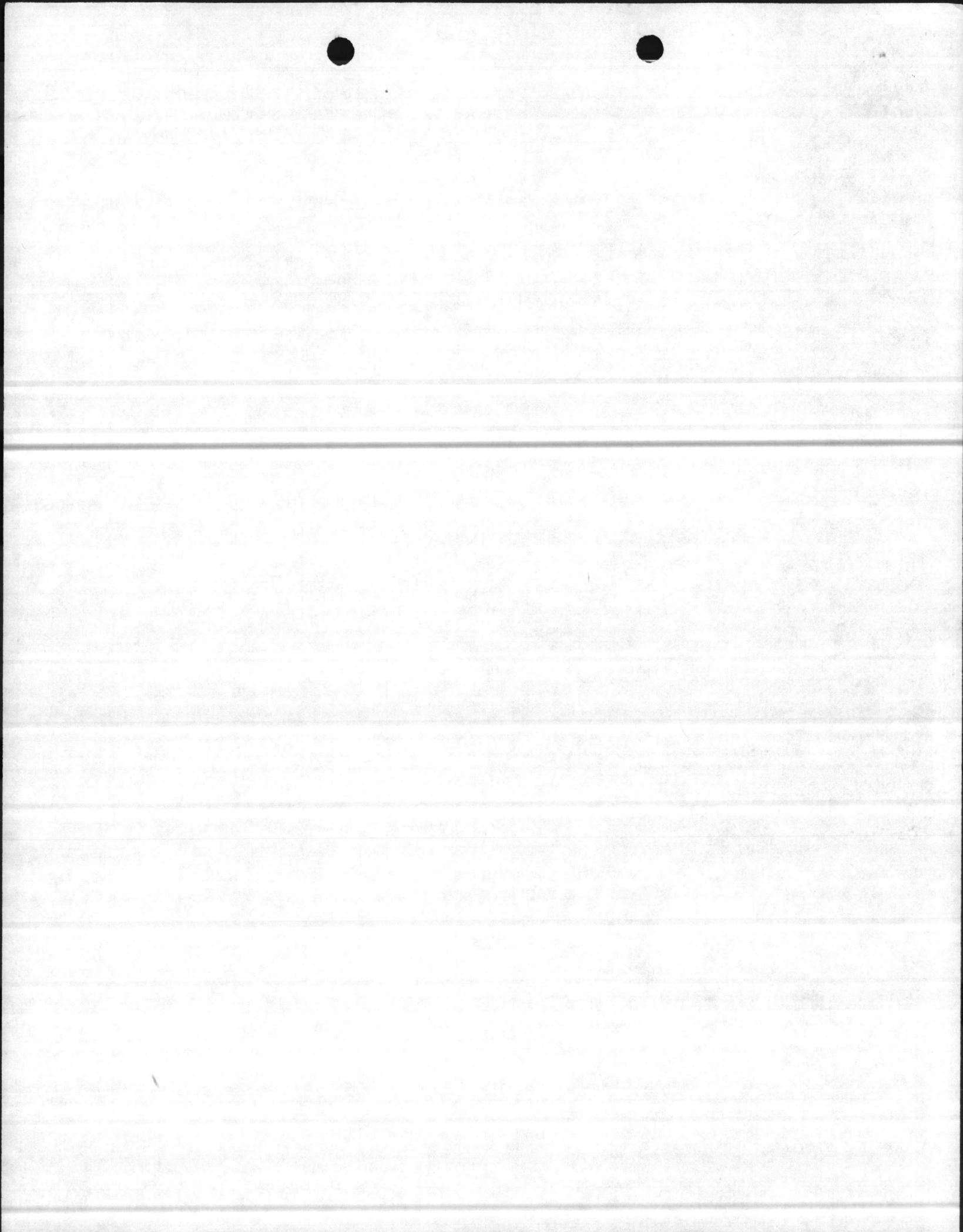

CONTAINER 3

Total Volume: 5.6 cu ft

Weight: 320 pounds

Seal number: U.S. 2714339 tagged 26 JUNE 1981

Readings:

Contact readings on top of container: 00.00

N: contact: .1 mR/hr

1 ft: .05 mR/hr

3 ft: less than .05 mR/hr

S: contact: .1 mR/hr

1 ft: .1 mR/hr

3 ft: less than .05 mR/hr

E: contact: .1 mR/hr

1 ft: .05 mR/hr

3 ft: less than .05 mR/hr

W: contact: .1 mR/hr

1 ft: .05 mR/hr

3 ft: less than .05 mR/hr

Contents: 125 "Beta-Buttons" and 3 bags of soil.

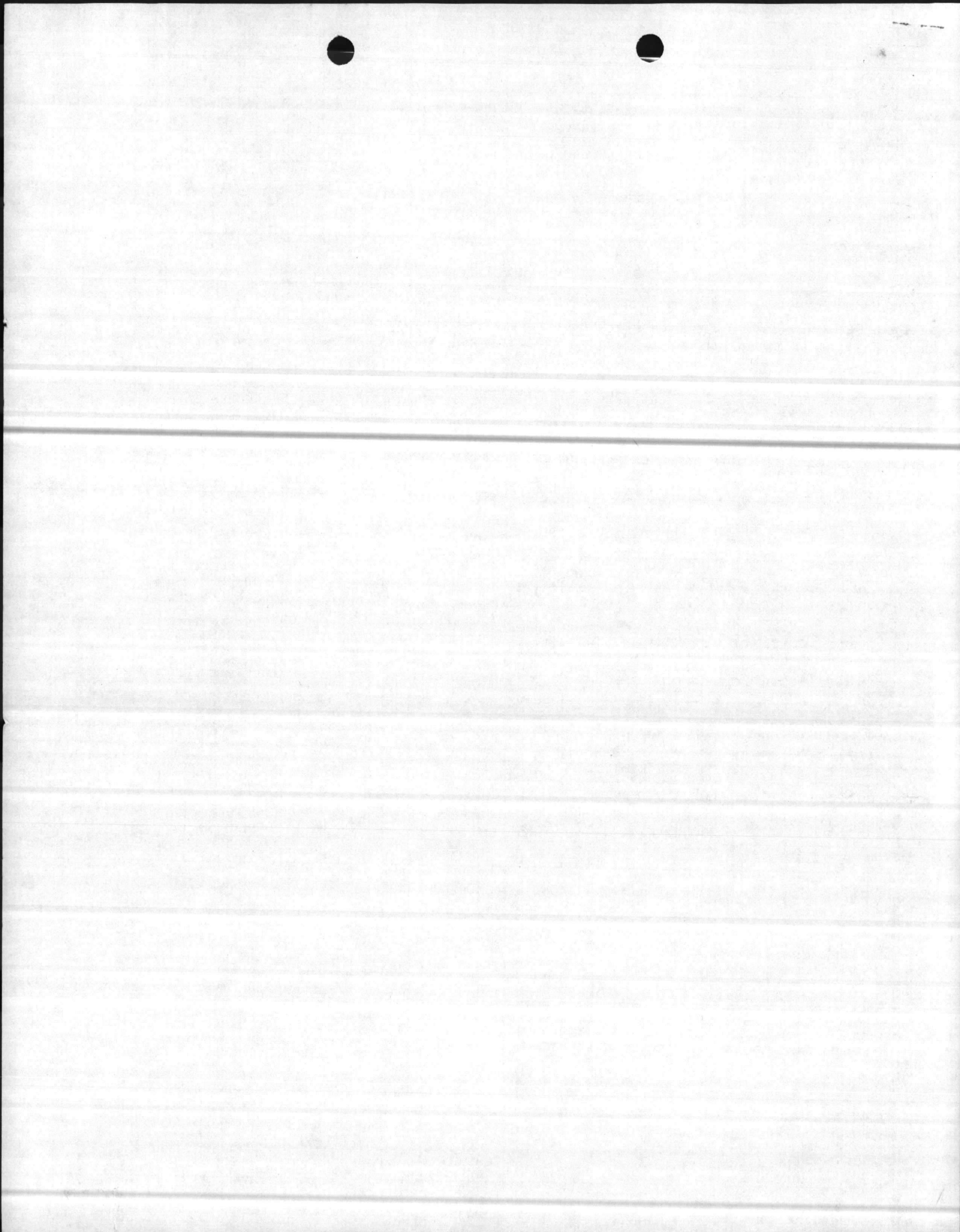

MAIN/DDS/spk
6240

FEB 22 1982

From: Base Maintenance Officer
To: Assistant Chief of Staff, Logistics
Via: Assistant Chief of Staff, Facilities

Subj: Annual Hazardous Waste Report; North Carolina requirements for

Encl: (1) NC Div of Health Services (DHS) memo of 20 Jan 1982

1. Enclosure (1) advised that on or before 1 March 1982, Marine Corps Base must submit an annual report to the Solid and Hazardous Waste Management Branch, North Carolina Division of Health Services (DHS) for the period 1 January 1981 to 31 December 1981.

2. The DHS Form 3037 provided by enclosure (1) should be completed and forwarded to DHS not later than 28 February 1982. Questions regarding this matter should be forwarded to Mr. Danny Sharpe, Natural Resources and Environmental Affairs Branch, extension 2083.

F. H. MOUNT

FILE 2

THE STATE OF TEXAS
COUNTY OF DALLAS

Know all men by these presents, that _____

of the County of Dallas, State of Texas, do hereby certify

that _____

is the true and correct copy of _____

as the same appears from the records of _____

in _____

BASE MAINTENANCE DEPARTMENT
Marine Corps Base
Camp Lejeune, North Carolina 28542

2-16-82

From: Assistant Base Maintenance Officer

To: NREA

Subj:

See no problem with leaving Danny's name as is. He is acting under the cognizance of the BMO. ACS, Fac. or others would not know the answers. If questions arise on the form, Danny can always request a letter if they need info. Will discuss further if you desire.

DVE

NATURAL RESOURCES AND ENVIRONMENTAL AFFAIRS BRANCH
BASE MAINTENANCE DIVISION
MARINE CORPS BASE
CAMP LEJEUNE, NORTH CAROLINA 28542

12 Feb 82
Date

From: Director

To: BMO

Subj: Haz Waste Info

1.

Haz Waste info is coming directly to Danny - in some cases he is signing for Certified Mail. I recommend action be initiated to get Danny Sharpe's name off of EPA and state forms and replace with CG or AC's Fac with NREA phone number for contact.

Julian



Small, faint handwritten marks or characters in the top right corner.

The page contains extremely faint, illegible handwriting that appears to be bleed-through from the reverse side. The text is scattered across the page and is not readable.



Ronald H. Levine, M.D., M.P.H.
STATE HEALTH DIRECTOR

DIVISION OF HEALTH SERVICES
P.O. Box 2091
Raleigh, N.C. 27602-2091

January 20, 1982

MEMORANDUM

TO: North Carolina Generators and On-Site Treaters, Storers,
or Disposers (TSD's) of Hazardous Waste

FROM: *OW*
O. W. Strickland, Head
Solid and Hazardous Waste Management Branch
Environmental Health Section

SUBJECT: Notice of Annual Report Under N. C. Hazardous Waste
Management Program

- ✓ On or before March 1, 1982 each facility that generates, stores, treats, or disposes of hazardous waste will submit an annual report to the Solid and Hazardous Waste Management Branch. A copy of the report form is attached. This annual report shall cover the period January 1, 1981 to December 31, 1981.

Data from the annual report will be used to provide information needed by the State. Annual report information will also be used for planning future facilities and to assist industry in the management of hazardous waste.

If there are questions call Emil Breckling or William Paige at (919) 733-2178 for assistance.

OW/EB/yar

Attachment
DHS Form 3037

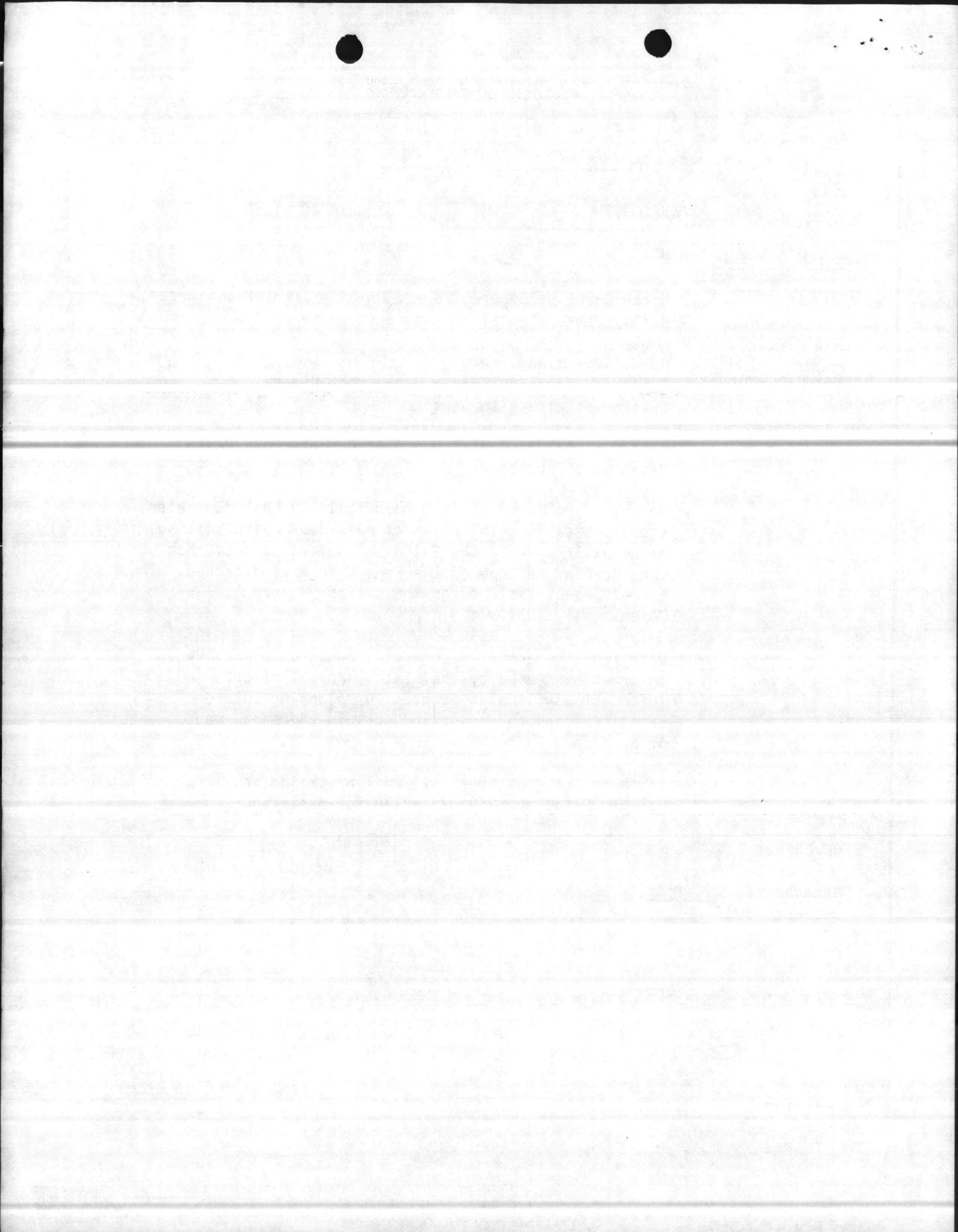

N. C. DEPARTMENT OF HUMAN RESOURCES
DIVISION OF HEALTH SERVICES

N. C. 1981 HAZARDOUS WASTE ON-SITE TSD FACILITY
ANNUAL PART B REPORT *

I. Installation EPA ID Number:

II. Name of Installation: _____

III. Location of Installation: _____
(Street or Route Number)

(City or Town) (County) (State) (Zip Code)

IV. Installation Contact: _____
(Name) (Area Code) (Phone Number)

V. Waste Identification:

Line Number	A. EPA Waste Number	B. Description of Waste	C. Quantity Generated (000's LBS)	D. Amount of Waste by Handling Method			
				1. Handling Method Code	2. Quantity Stored, Treated, Disposed, or Recovered On-Site	Shipped to Off-Site Treatment, Disposal, or Recovery Facility	
						3. Quantity	4. Facility EPA ID No./Recovery Facility Name
1							
2							
3							
4							
5							
6							
7							
8							
9							
10							
11							
12							

(If more space is needed check and complete attachment 1)

VI. Comments:

VII. Signature: _____
(Signature)

(Print or Type Name)

*Read instructions before completing form.

Important: READ INSTRUCTIONS BEFORE COMPLETING THIS FORM.

Purpose: This form will provide N. C. with information needed for EPA reports and to manage hazardous wastes.

Mailing: Complete and send one copy to - Solid & Hazardous Waste Management Branch
Department of Human Resources
Post Office Box 2091
Raleigh, NC 27602

Be sure to complete the proper form

- Part A: GENERATOR ANNUAL REPORT - For generators who ship their waste off-site.
- Part B: ON-SITE TSD FACILITY ANNUAL REPORT - For owners or operators of on-site facilities that treat, store, or dispose of hazardous waste.
- Part C: OFF-SITE TSD FACILITY ANNUAL REPORT - For owners or operators of facilities that treat, store, or dispose of hazardous waste from off-site sources.
- Part D: UNMANIFESTED WASTE REPORT - For facility owners or operators who accept for treatment, storage, or disposal any hazardous waste from an off-site source without an accompanying manifest.

Part B Form

SECTION IV. Installation Contact
Enter the name and telephone number of the person who may be contacted regarding information contained in this report.

SECTION V. Waste Identification
All information in this section must be entered by line number. Each line entry will describe the total annual amount of each waste shipped.

SECTION V-A. EPA Hazardous Waste Number
For listed wastes, enter the EPA Hazardous Waste Number from 40 CFR Part 261, Subpart D, which identifies the waste.

For a mixture of more than one listed waste, enter each of the applicable EPA Hazardous Waste Numbers. If more space is needed, continue on the next line(s) and leave all other information on that line blank.

For unlisted hazardous wastes, enter the EPA Hazardous Waste Numbers from 40 CFR Part 261, Subparts C, applicable to the waste. If more space is required, follow the procedure described above.

SECTION V-B. Description of Waste
For hazardous wastes that are listed under 40 CFR Part 261, Subpart D, enter the EPA listed name, abbreviated if necessary. Where mixtures of listed wastes were shipped, enter the description which you believe best described the waste.

For unlisted hazardous waste identified under 40 CFR Part 261, Subpart C, enter the description which you believe best describes the waste. Include the specific manufacturing or other process generating the waste, (e.g., green sludge from widget manufacturing) and, if known the chemical or generic chemical name of the waste.

SECTION V-C. Enter total amount generated in reporting year.

SECTION V-D.1. Handling Method
Enter the handling code(s) listed below that most closely represent the technique(s) used to treat, store, dispose or recover the hazardous waste.

Enter one EPA handling code for each waste line entry. Where several handling steps have occurred during the year, report only the handling code representing the waste's status at the end of the reporting year or its final disposition.

Storage (Indicate volume (in 000's) remaining at your site December 31, 1981.)

- S01 Containers (barrel, drum, etc.) (gallons)
- S02 Tank (gallons)
- S03 Waste Piles (cubic yards)
- S04 Surface impoundment (gallons)

Treatment (000's LBS)

- T01 Incinerator
- T02 Chemical treatment
- T03 Physical treatment
- T04 Removal of specific components
- T05 Biological treatment

Disposal (000's LBS)

- D01 Landfill
- D02 Other specify _____

Resource Recovery (000's LBS)

- R01 Resource recovery
(include also unmanifested waste exempt from RCRA)

SECTION V-D.2. Quantity Stored, Treated, Disposed or Recovered
Enter the amount of waste you treated, disposed, or recovered on-site as indicated by handling method.

SECTION V-D.3. Quantity Shipped
Enter the amount of waste you shipped off-site to TSD or recovery facility.

SECTION V-D.4. TSP Facility EPA Identification Number/Resource Recovery Facility Name
Enter the EPA identification number of the facility or Resource Recovery facility name to which you sent the waste described in V-A. (a separate line must be used for each facility to which you sent hazardous waste.)

SECTION VI. Comments
This space may be used to explain or clarify any entry. If used, enter a cross reference to the appropriate section number.

SECTION VII. Signature
The generator or his authorized representative to the owner must sign the report.

ATTACHMENT I

V. Waste Identification:

Line Number	A. EPA Waste Number	B. Description of Waste	C. Quantity Generated (000's LBS)	D. Amount of Waste by Handling Method			
				1. Handling Method Code	2. Quantity Stored, Treated, Disposed, or Recovered On-Site	Shipped to Off-Site Treatment, Disposal, or Recovery Facility	
						3. Quantity	4. Facility EPA ID No./Recovery Facility Name
1							
2							
3							
4							
5							
6							
7							
8							
9							
10							
11							
12							
13							
14							
15							
16							
17							
18							
19							
20							
21							
22							
23							
24							
25							

MAIN/JIW/spk
6240

FEB 1 6 1982

From: Base Maintenance Officer
To: Resident Officer in Charge of Construction, Jacksonville, North Carolina Area

Subj: Cement-Asbestos Siding; disposal of

Ref: (a) ROICG, Jacksonville, N.C. ltr JAX/80/GNS/fao of 1 Feb 1982

Encl: (1) Procedures for Disposal of Cement-Asbestos Siding by Contractors at Base Sanitary Landfill

1. The proposed procedures for the subject procedure furnished by reference (a) have been reviewed. Enclosure (1) provides procedures and guidelines to be followed in the future regarding disposal of the subject wastes at the Base Sanitary Landfill. Enclosure (1) has been developed with the understanding that the Industrial Hygienist, Naval Regional Medical Center, will conduct on-site air monitoring of asbestos handling activities at the landfill.

2. Point of contact with this matter is Mr. L. D. Shepard, extension 5158.

F. H. MOUNT

Copy to:
BSafetyO
NRMC (Industrial Hygienist)

HH 1 2 195

The following information was obtained from the records of the...

State Department, Bureau of Consular Affairs, Office of the...

Consular Officer, New York, New York, on the date of...

the above mentioned individual, who is the subject of...

the above mentioned individual, who is the subject of...

the above mentioned individual, who is the subject of...

the above mentioned individual, who is the subject of...

the above mentioned individual, who is the subject of...

the above mentioned individual, who is the subject of...

the above mentioned individual, who is the subject of...

the above mentioned individual, who is the subject of...

the above mentioned individual, who is the subject of...

the above mentioned individual, who is the subject of...

the above mentioned individual, who is the subject of...

the above mentioned individual, who is the subject of...

the above mentioned individual, who is the subject of...

the above mentioned individual, who is the subject of...

the above mentioned individual, who is the subject of...

the above mentioned individual, who is the subject of...

PROCEDURES FOR DISPOSAL OF CEMENT-ASBESTOS SIDING

BY

CONTRACTORS AT BASE SANITARY LANDFILL

1. Director, Maintenance and Repair Branch (M&R), Base Maintenance Division, (451-5855, 5184) will be given 5 working days notice of initial delivery of asbestos-cement siding.
2. M&R Director will be furnished a schedule showing estimated volume (in cubic feet or yards/week) of asbestos to be disposed of. Unless the above prior arrangements are made, contractor may incur delays in disposal of the asbestos material.
3. Asbestos-cement will be accepted for disposal only if:
 - a. Asbestos-cement is free of lumber and other debris and refuse.
 - b. Truck is securely covered with tarpaulin (or equivalent) to prevent discharge of asbestos dust or debris during transportation.
 - c. Asbestos-cement is thoroughly moist.
4. Transporter will submit vehicle to inspection by a landfill operator prior to uncovering truck.
5. Transporter will dump the debris where directed by the landfill operator. After dumping debris, vehicle will not be moved until securely covered.
6. Transporter will clean up any asbestos-cement improperly spilled during disposal.
7. The landfill operator will normally cover the debris at 0900 and after 1500. Debris dumped between 0900 and 1500 will be covered with polyethylene sheet by the transporter to prevent release of dust prior to covering by landfill operator.
8. Transporters not following above procedures will be barred from the landfill.

Enclosure (1)



TO THE HONORABLE MEMBERS OF THE HOUSE OF REPRESENTATIVES

1901

REPORT OF THE COMMISSIONER OF THE GENERAL LAND OFFICE

IN RESPONSE TO A RESOLUTION PASSED BY THE HOUSE OF REPRESENTATIVES
MAY 15, 1900, RELATIVE TO THE LANDS BELONGING TO THE UNITED STATES
AND TO THE LANDS BELONGING TO THE SEVERAL STATES

WASHINGTON: GOVERNMENT PRINTING OFFICE: 1901.

THE COMMISSIONER OF THE GENERAL LAND OFFICE

REPORT OF THE COMMISSIONER OF THE GENERAL LAND OFFICE

IN RESPONSE TO A RESOLUTION PASSED BY THE HOUSE OF REPRESENTATIVES

MAY 15, 1900, RELATIVE TO THE LANDS BELONGING TO THE UNITED STATES

AND TO THE LANDS BELONGING TO THE SEVERAL STATES

WASHINGTON: GOVERNMENT PRINTING OFFICE: 1901.

THE COMMISSIONER OF THE GENERAL LAND OFFICE

REPORT OF THE COMMISSIONER OF THE GENERAL LAND OFFICE

IN RESPONSE TO A RESOLUTION PASSED BY THE HOUSE OF REPRESENTATIVES

MAY 15, 1900, RELATIVE TO THE LANDS BELONGING TO THE UNITED STATES

AND TO THE LANDS BELONGING TO THE SEVERAL STATES

WASHINGTON: GOVERNMENT PRINTING OFFICE: 1901.

THE COMMISSIONER OF THE GENERAL LAND OFFICE

REPORT OF THE COMMISSIONER OF THE GENERAL LAND OFFICE

IN RESPONSE TO A RESOLUTION PASSED BY THE HOUSE OF REPRESENTATIVES

MAY 15, 1900, RELATIVE TO THE LANDS BELONGING TO THE UNITED STATES

AND TO THE LANDS BELONGING TO THE SEVERAL STATES

2 Feb 82

Danny,
Hold on response until
we get the one from Col Mount
Julian

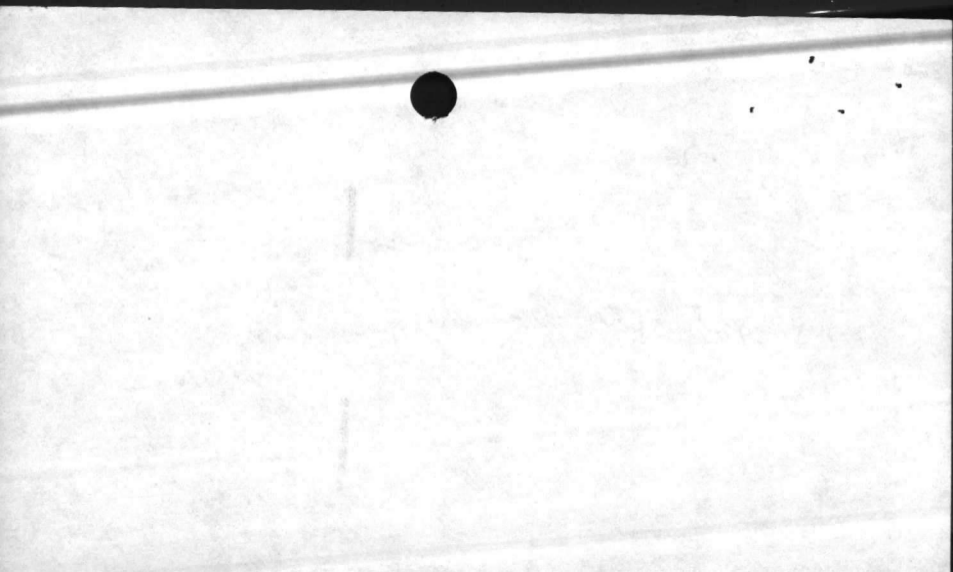

BASE MAINTENANCE DEPARTMENT
Marine Corps Base
Camp Lejeune, North Carolina 28542

2/2/82

From: Assistant Base Maintenance Officer

To: **AREA**

Subj:

By your response. Procedures
look ok to me and appear
to meet State guidelines.

Should establish who, specifically,
will maintain records of
quantity being dumped and
how that info will flow
back to you for permanent
record keeping. Coordinate
w/ J. D. Sheford.

BW Elton



1/10

1/10

[Faint, illegible handwriting on lined paper]

DEPARTMENT OF THE NAVY
OFFICER IN CHARGE
NAVAL FACILITIES ENGINEERING COMMAND CONTRACTS
CAMP LEJEUNE, NORTH CAROLINA 28542

IN REPLY REFER TO:

JAX/80/GNS/fao
1 February 1982

From: Resident Officer in Charge of Construction, Jacksonville NC Area
To: Base Maintenance Officer

Subj: Cement-asbestos siding; disposal of

Ref: (a) Civil Engineering Laboratory Technical Note N-1593 of
October 1980
(b) Meeting among LCDR Sniffin (ROICC), Lt. Winters (NRMC),
Mr. Sharp (BMO) and Mr. Andrews and Mr. Smith (Base Safety)
on 1 February 1982

Encl: (1) North Carolina Department of Natural Resources and Community
Development letter dated 14 December 1981
(2) Cement-Asbestos Siding Disposal Procedures

1. Enclosure (1) was forwarded to the Atlantic Division, Naval Facilities Engineering Command (LANTDIV) as an alternate to the standard double-bagging method of disposal applicable to friable asbestos. As reflected in enclosure (1), the EPA has determined that the siding need not be handled as friable asbestos so long as it is removed by hand. Reference (a) confirms that cement-asbestos shingles are nonfriable so long as they are not cut, ground or abraded and as such may be disposed of in a sanitary landfill, provided that dust from these products is not visible.

2. During reference (b), the removal and disposal of cement-asbestos siding was discussed and the recommended disposal procedures contained in enclosure (2) were developed. In addition, Lt. Winters agreed to provide air monitoring services to measure the breathing zone asbestos fiber concentrations for the contractor personnel removing, transporting and placing the debris in the landfill and for the Base Maintenance personnel covering the debris. Provided those samples show no hazardous exposure, it is recommended that enclosure (2) be adopted indefinitely for disposal of cement-asbestos siding. An early response is requested, as removal of siding has commenced.

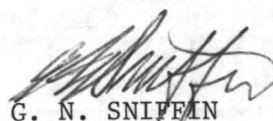
G. N. SNIFFIN
By direction

Copy to:
NRMC (Lt. Winters)
Base Safety Manager

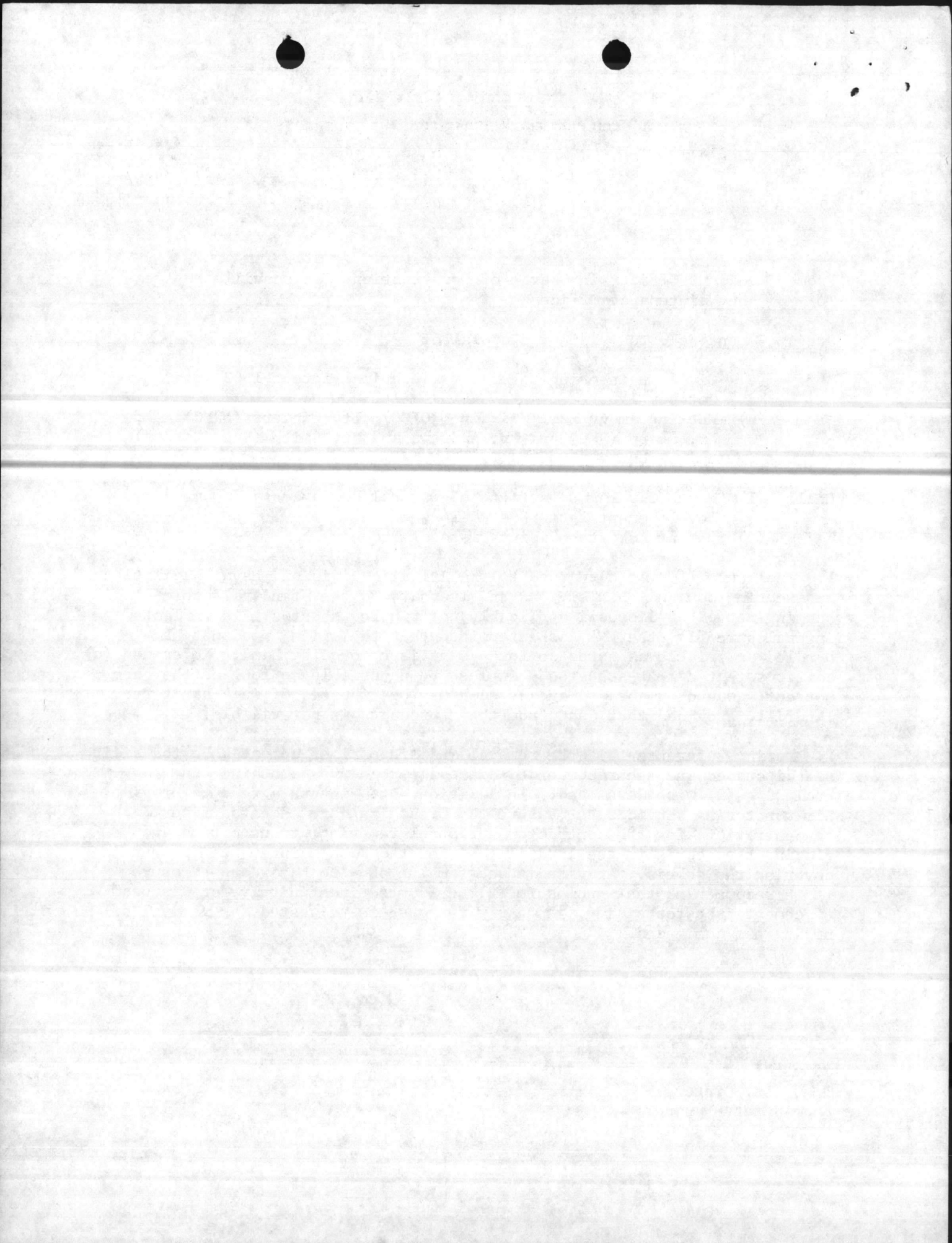

CEMENT-ASBESTOS SIDING DISPOSAL PROCEDURES

1. Contact the Director of Maintenance and Repair Division, Base Maintenance, 451-5855 to make arrangements for date and time of delivery. Asbestos will not be accepted by the landfill operator unless prior arrangements have been made.
2. Prior to arrival of the siding debris, the landfill operator will prepare a trench in the asbestos portion of the landfill.
3. The debris will arrive in a moist condition and covered securely to prevent release of dust during transportation.
4. The transporter will dump the debris where directed by the landfill operator. The truck will be securely covered after dumping the debris.
5. The landfill operator will normally cover the debris at 0900 and after 1500. Debris dumped between 0900 and 1500 will be covered with polyethylene sheet by the transporter to prevent release of dust prior to covering. While covering and compacting the debris, the landfill operator shall maintain an adequate earth cushion between the debris and the compacting/covering equipment to prevent the release of dust.



1980



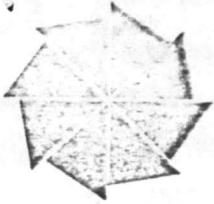

North Carolina Department of Natural Resources & Community Development

James B. Hunt, Jr., Governor

Joseph W. Grimsley, Secretary

DIVISION OF ENVIRONMENTAL MANAGEMENT

December 14, 1981

	ROUTING ORDER	INT
1	80	
2		
3		
4		
5		
6		
7		
8		
RETURN TO		

LT Cdr Gary L. Sniffin
Building 1005
Marine Corps Base
Camp Lejeune, North Carolina 28542

Subject: Asbestos Siding Removal
Marine Corps Base
Camp Lejeune, North Carolina
Onslow County

Dear Mr. Sniffin:

On November 20, 1981, Mr. Robert Miles of the Westminister Company called to determine if removal of asbestos siding from buildings would classify the asbestos material as friable.

Joe Riley of EPA, Atlanta Regional Office, was contacted to make this determination. After discussions with his group in Atlanta, they determined that if the buildings were not pushed down and removed with heavy equipment, that asbestos material should not be considered friable.

It is our understanding that the shingles will be removed by hand and that they will be replaced with vinyl siding.

Even though this material has been determined not to be friable, the following precautions should be taken:

1. Signs should be posted around each area warning people of asbestos removal.
2. The area should be closed to all unauthorized personnel.
3. There should be no resale of the asbestos material.
4. A place in the landfill should be designated for the burial of the asbestos. This area also should be marked and records maintained concerning its disposal.
5. A water spray system should be operated to wet all asbestos material. This should prevent migration of the asbestos dust.

ENCL (1)

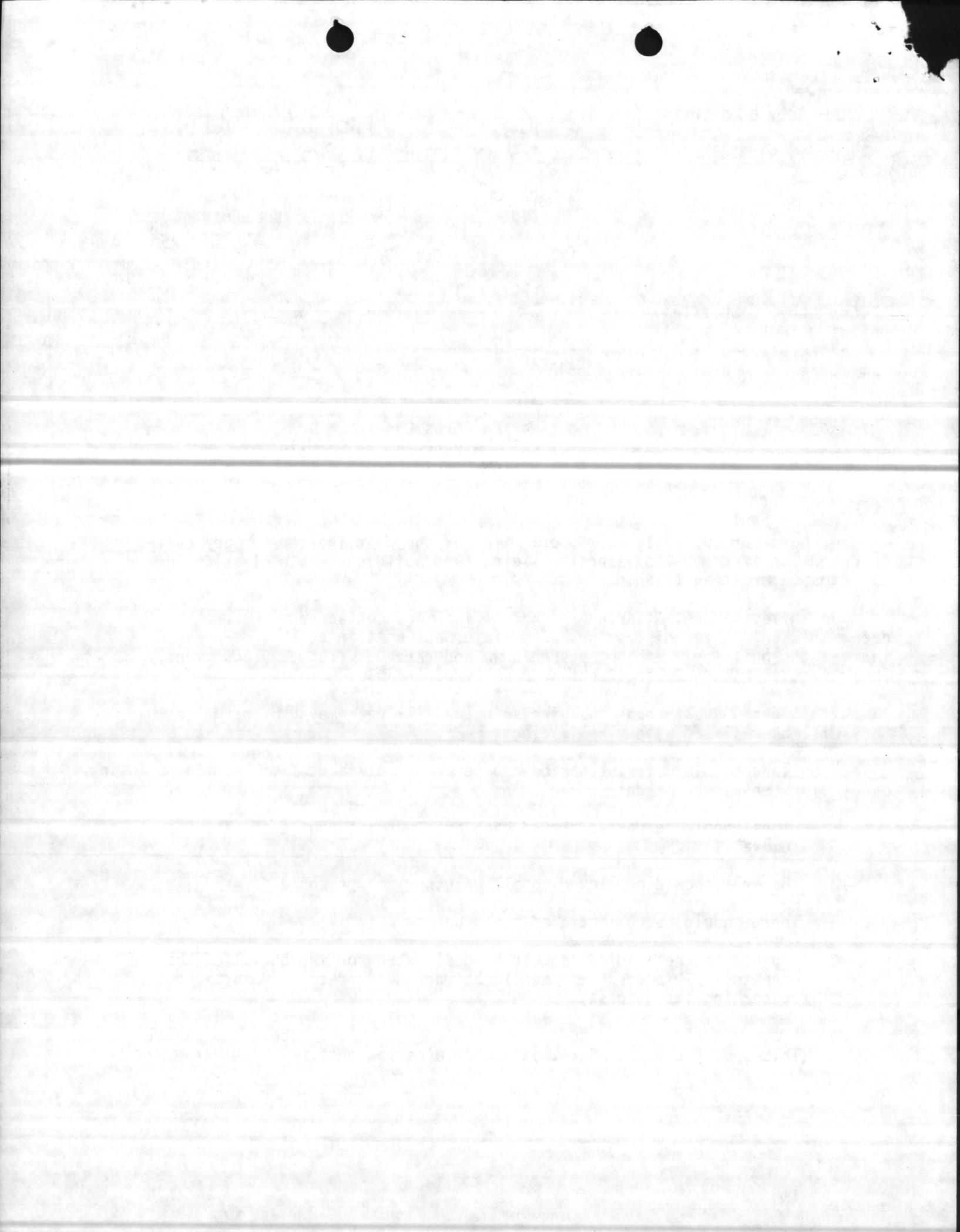

LT Cdr Gary L. Sniffin
Page 2
December 14, 1981

If you have any further questions, please do not hesitate to call me at
(919) 256-4161.

Sincerely,

William C. Cochran

William C. Cochran
Environmental Engineer II

cc: Anne Taylor
Robert Miles
Central Files
Marshall Rackley
Wilmington Regional Office

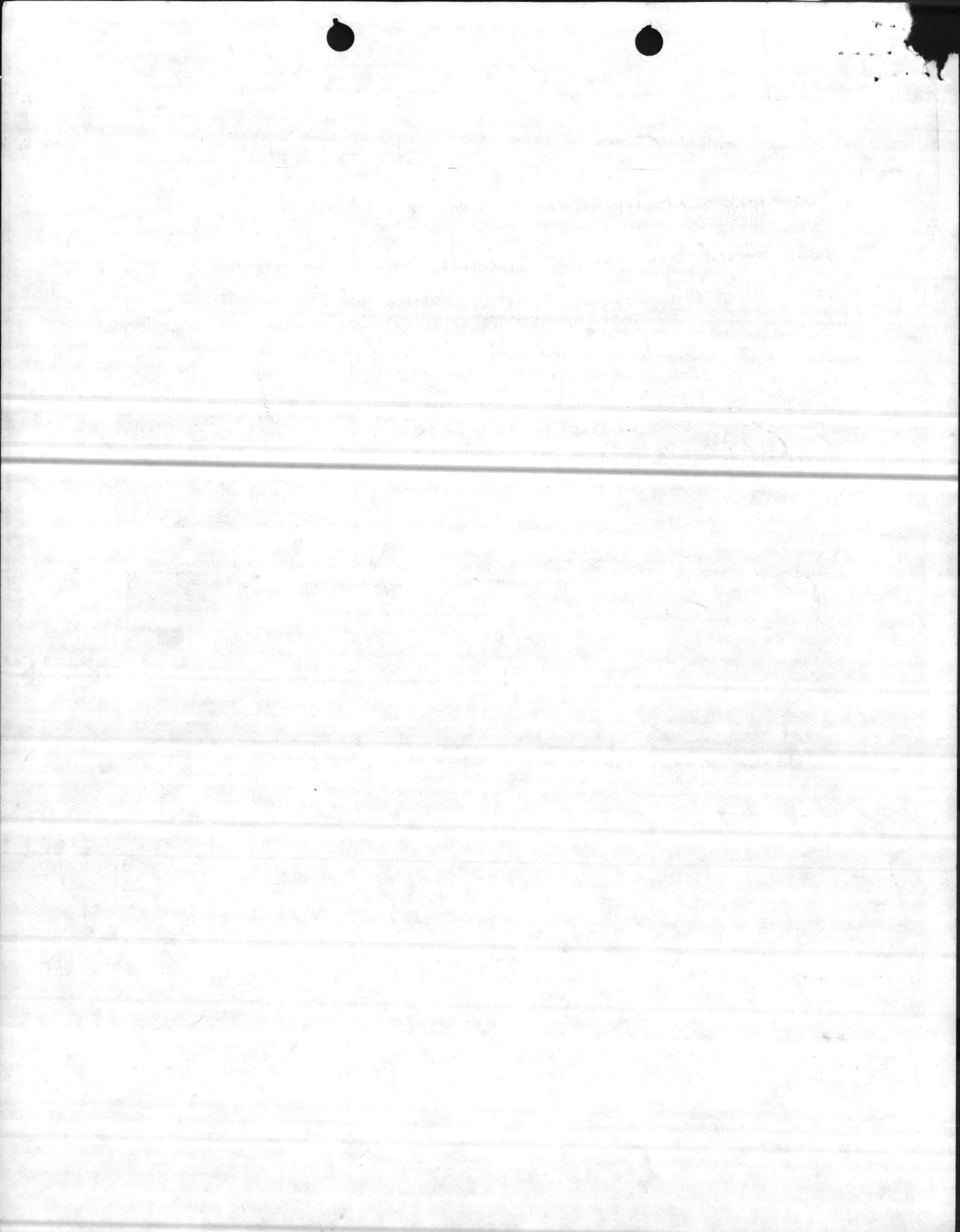

CONTAINER 4

Total Volume: 5.6 cu ft.

Weight: 230 pounds

Seal number: U. S. 2714340 tagged 26 JUNE 81

Readings:

Contact Readings on top of container: less than .05 mR/hr

N: contact: .45 mR/hr

1 ft: .05 mR/hr

3 ft; less than .05 mR/hr

S: contact: .15 mR/hr

1 ft: .05 mR/hr

3 ft: less than .05 mR/hr

E: contact: .2 mR/hr

1 ft: .05 mR/hr

3 ft: less than .05 mR/hr

W: contact: .2 mR/hr

1 ft: .05 mR/hr

3 ft: less than .05 mR/hr

contents: 118 "Beta-Buttons" and 3 Bags of soil

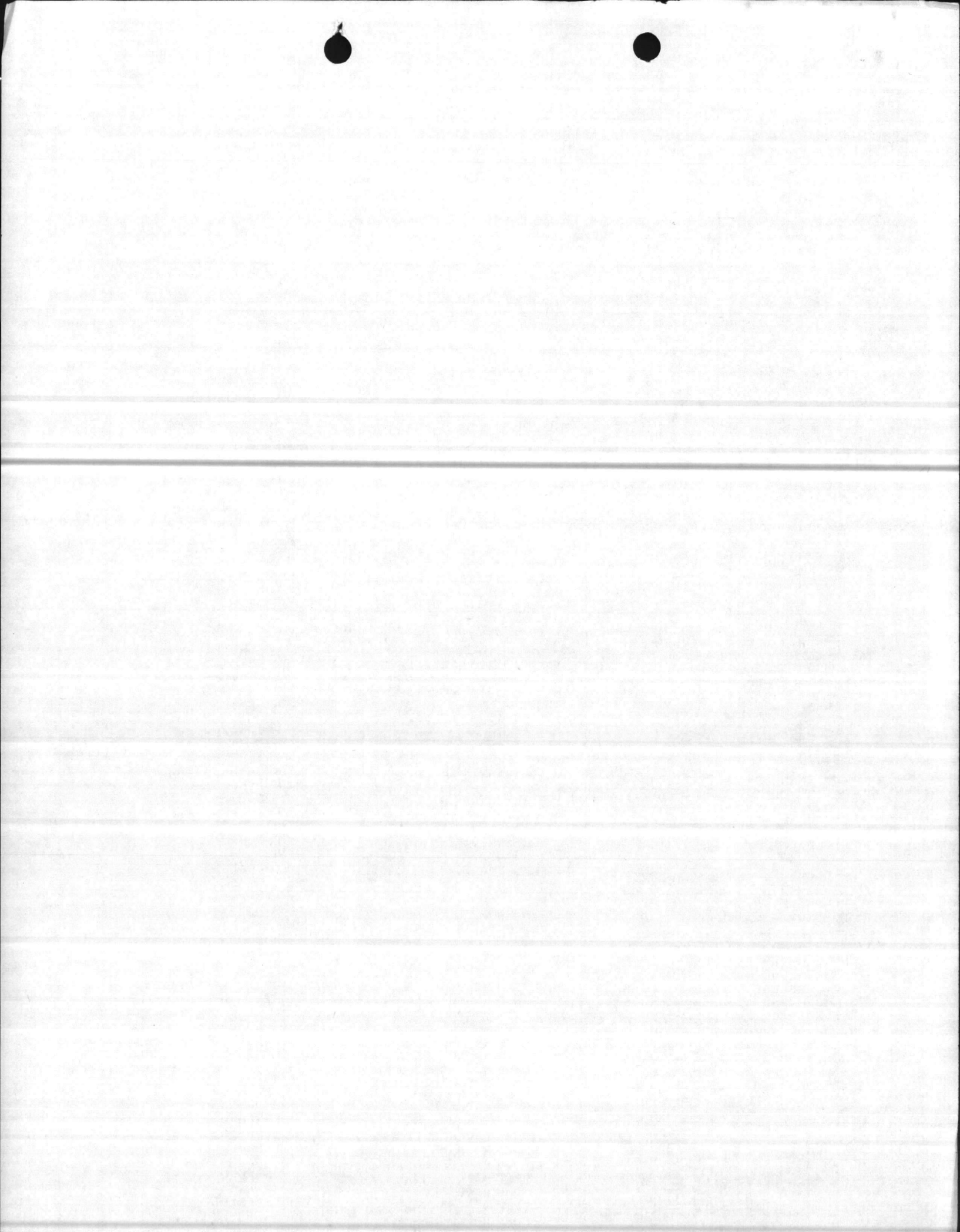

CONTAINER 5

Total Volume: 5.6 cu ft

Weight: 370.pounds

seal number: U.S. 2714342 tagged 26 JUNE 1981

No readings were noted on any part of the container.

Contents: One large bag with soil and animal remains and 3 bags of soil.

CONTAINER 6

Total Volume: 5.6 cu ft

Weight: 335 $\frac{1}{4}$ pounds

Seal number: U.S. 2714341 tagged 26 JUNE 81

No readings were noted on any part of the container

Contents: 3 bags of soil.

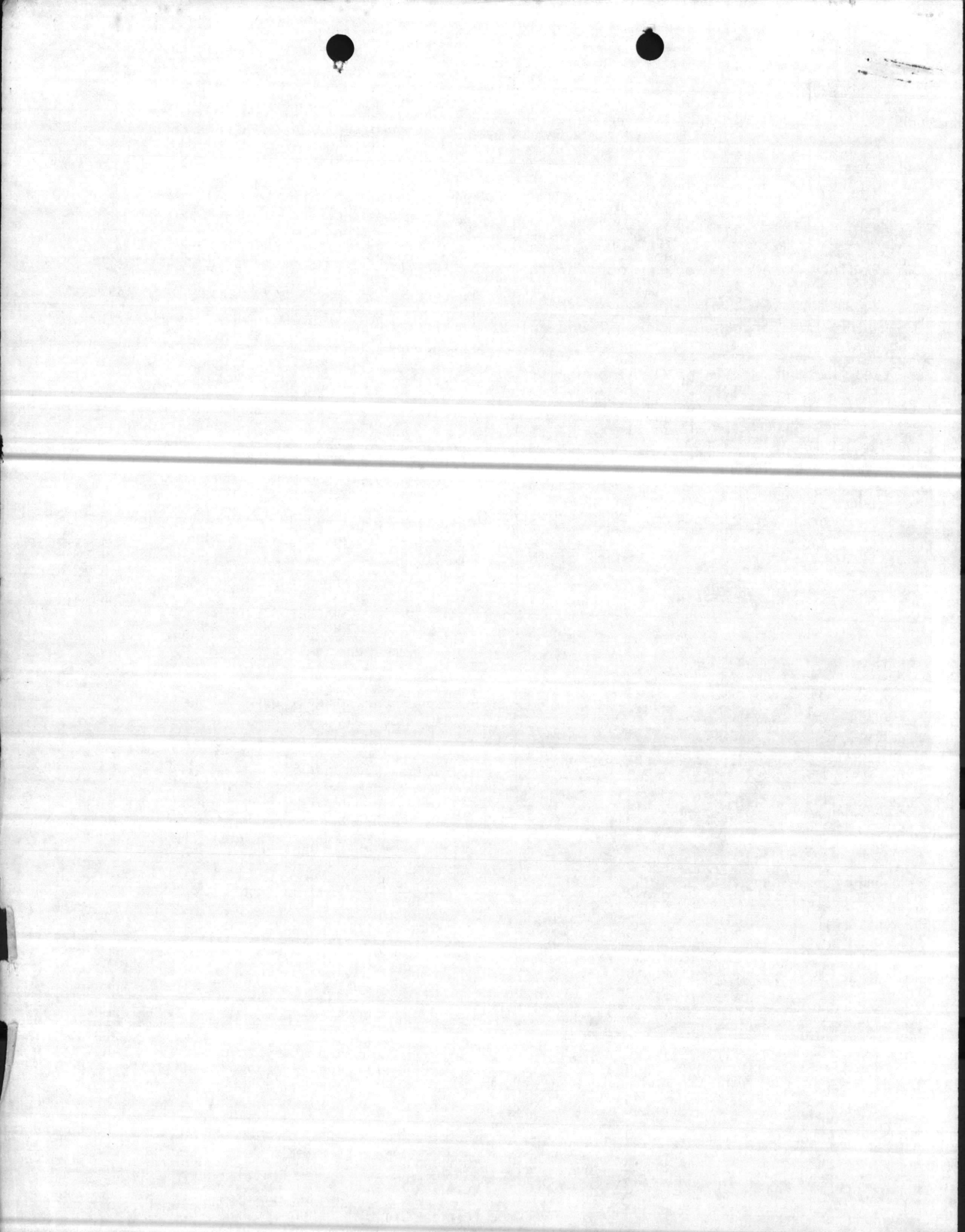

20 MAY 1981



OFFICER IN CHARGE
NAVAL ENERGY AND ENVIRONMENTAL SUPPORT ACTIVITY
PORT HUENEME, CALIFORNIA 93043

IN REPLY REFER TO:
113S:KR:lm
3263.3A
Ser: 693

22 MAY 1981

From: Officer in Charge
To: Commanding General, Marine Corps Base, Camp Lejeune, NC 28542
Subj: Status of Health Physics Support At Insect Vector Compound and Hazardous Waste Disposal Pit; interim report of
Ref: (a) FONECON btwn Industrial Hygiene Officer (NRMCC Camp Lejeune) and J. Orr (NEESA) on 1 Dec 80
(b) NAVSUPINST 5101.9B

1. As requested by reference (a), the Naval Energy and Environmental Support Activity (NEESA), Port Hueneme, California conducted a health physics support visit during the period 11-13 December 1980 to evaluate the Naval Field Research Laboratory site, adjacent areas, and a hazardous waste disposal pit. A follow-up visit was made during 9-11 April 1981 to conduct additional sampling.
2. Five-hundred-eighteen beta buttons containing 207,200 uCi of strontium-90, two animal carcasses contaminated with strontium-90, and 160 pounds of soil contaminated with strontium-90 have been recovered from the burial site located in the northwest corner of the Insect Vector Compound. The contaminated material has been safely stored in Building PT-26 awaiting containerization and shipment to an Nuclear Regulatory Commission (NRC) approved burial site at Barnwell, South Carolina. The material is expected to be placed in Department of Transportation authorized shipping containers before 1 July 1981. Actual shipment of the material will depend on coordination with the Naval Supply Center, Norfolk, Virginia in accordance with reference (b). No health hazard exists to Marine Corps Base (MCB), Camp Lejeune personnel under the current storage conditions.
3. Seventy-five soil samples have been taken from the burial site. Results of laboratory analysis of these samples has not provided conclusive evidence that the site may be released for unrestricted use. Additional sampling from one portion of the burial site is required and currently is underway. Final sampling results and release of the site is expected before 1 July 1981.
4. Personnel interviews generated concern that:
 - a. Rooms formerly used as laboratories in Building PT-37 may be contaminated.
 - b. An incinerator adjacent to Building PT-37 may be contaminated from burning of animal carcasses injected with strontium-90.
 - c. Radioactive material may be present in a man-made pit located in the hazardous material dump site.

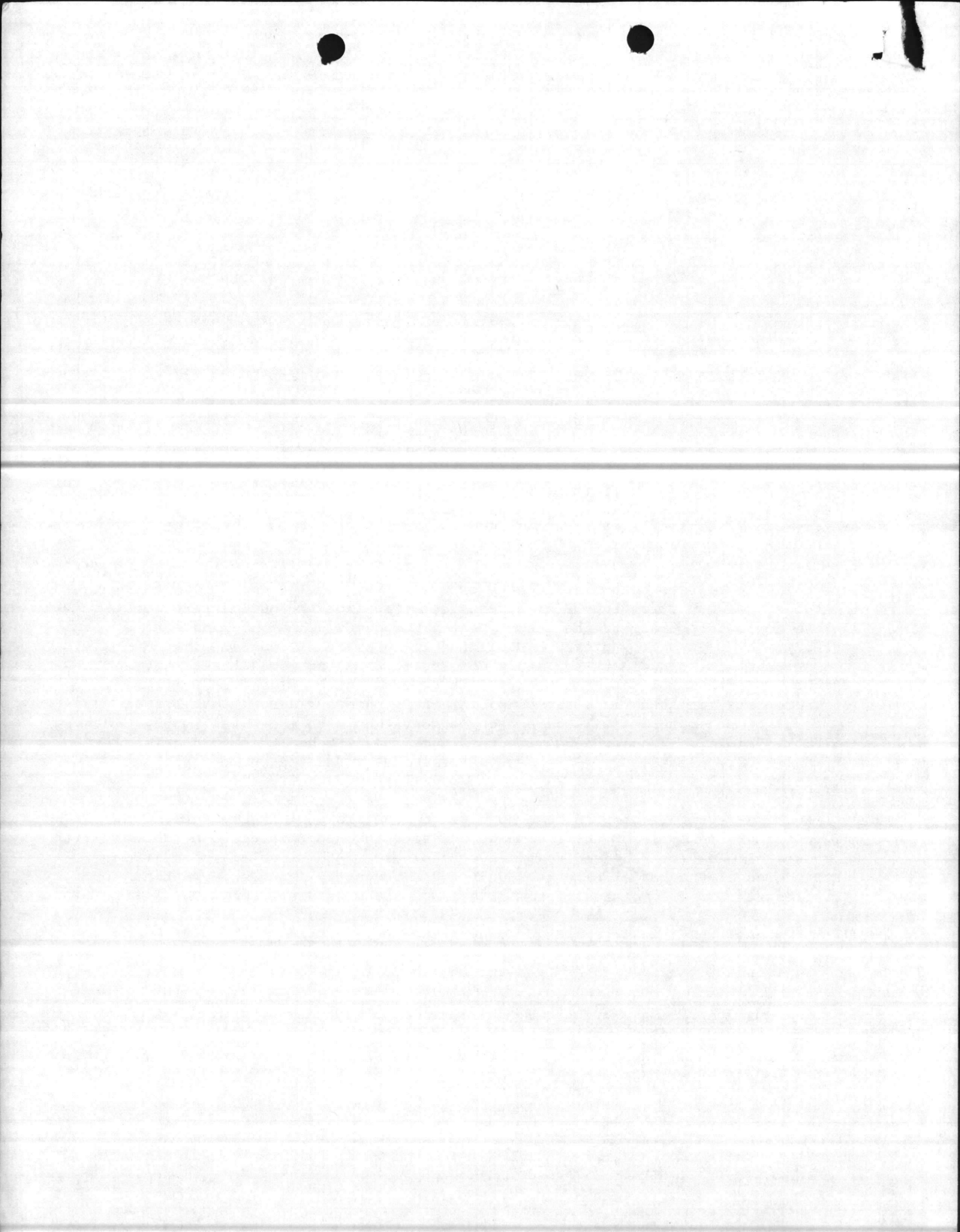

113S:KR:1m
3263.3A
Ser: 690
22 MAY 1981

5. Wet rag and paint samples were taken from rooms in Building PT-37. Ash samples were taken from the incinerator and the incinerator ash dump site. Soil and water samples were taken from the dump site pit and adjacent areas. Analysis of samples indicated that strontium-90 and cesium-137 were not present.
6. A comprehensive detailed report containing background information, actions taken, results of soil samples and recommendations will follow this interim report.

William J. Morris
W. J. MORRIS
By direction

Copy to:
NAVFACENGCOM (112N)
→ NRMCC Camp Lejeune

- according to H.M. I Sawvini USN X-Ray Dept NRMCC
Camp Lejeune N.C. info paragraph 4 has not been received

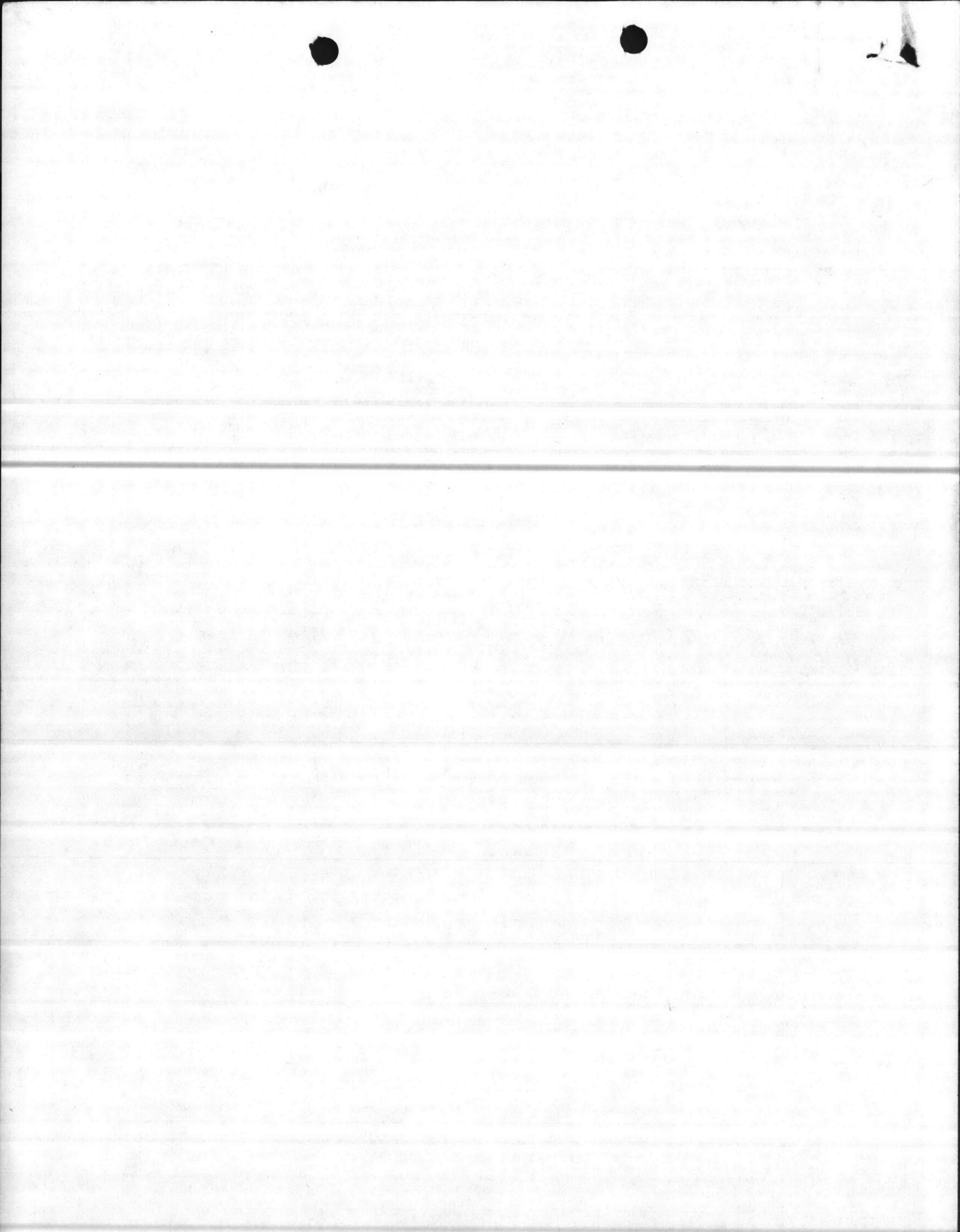

MAIN/DDS/th
6240

FEB 23 1982

From: Commanding General
To: Commanding Officer, Naval Regional Medical Center, Camp Lejeune,
North Carolina 28542

Subj: Asbestos Disposal at the Sanitary Landfill, Marine Corps Base,
Camp Lejeune; monitoring of

Ref: (a) ROICC ltr JAX/80/GNS/fao of 1 Feb 1982

1. It is requested that air monitoring of the subject disposal be provided, as discussed in reference (a).
2. Point of contact on this matter is Mr. L. D. Shepard, extension 5158.

F. H. MOUNT
By direction

