

NOTES

(1) (2) (3) (4) (5) (6) (7) (8) (9) (10)

Indicate terminal strips for connections of field wiring on following pages

- 4002-7001 CPU-8 Zones Class B  
2 Signal Circuits
- 4002-5001 8 Zones Class B
- 4002-4101 2 Signal Circuits Class B

4 UNIT CLASS B MONITOR ZONE TERMINATIONS

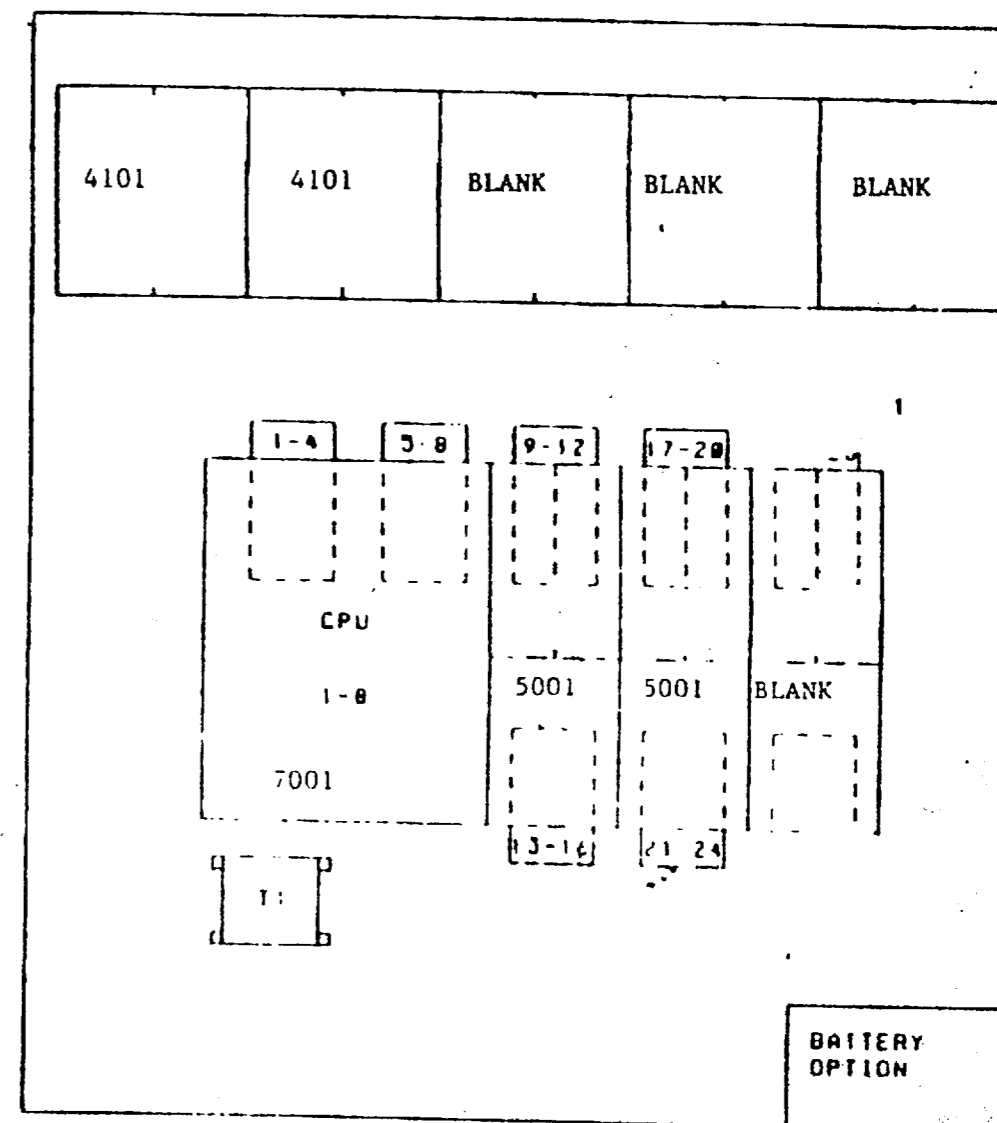
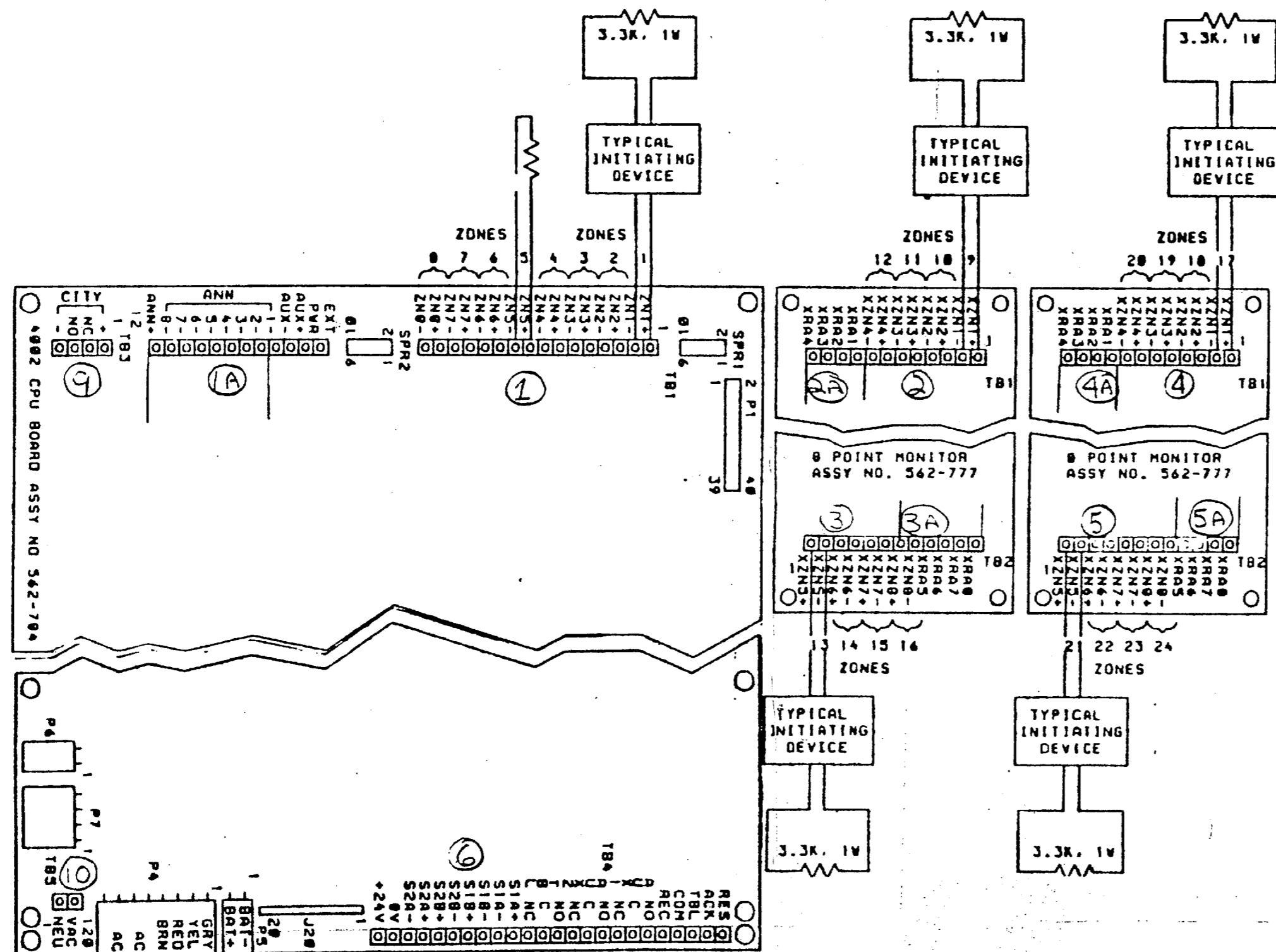

4 UNIT PANEL LAYOUT

		PROJECT	FIELD MAINT. COMPLEX	DWG. NO.	REV.
			CAMP LESEUNE	1 OF 5	
BRANCH OFFICE	44 33 BERYL RD			ORDER NO.	
LOCATION	RALEIGH NC		REAGAN ELEC	RPO NO.	
TEL. NO.	829-0555	DRN. BY		APPVD. BY	



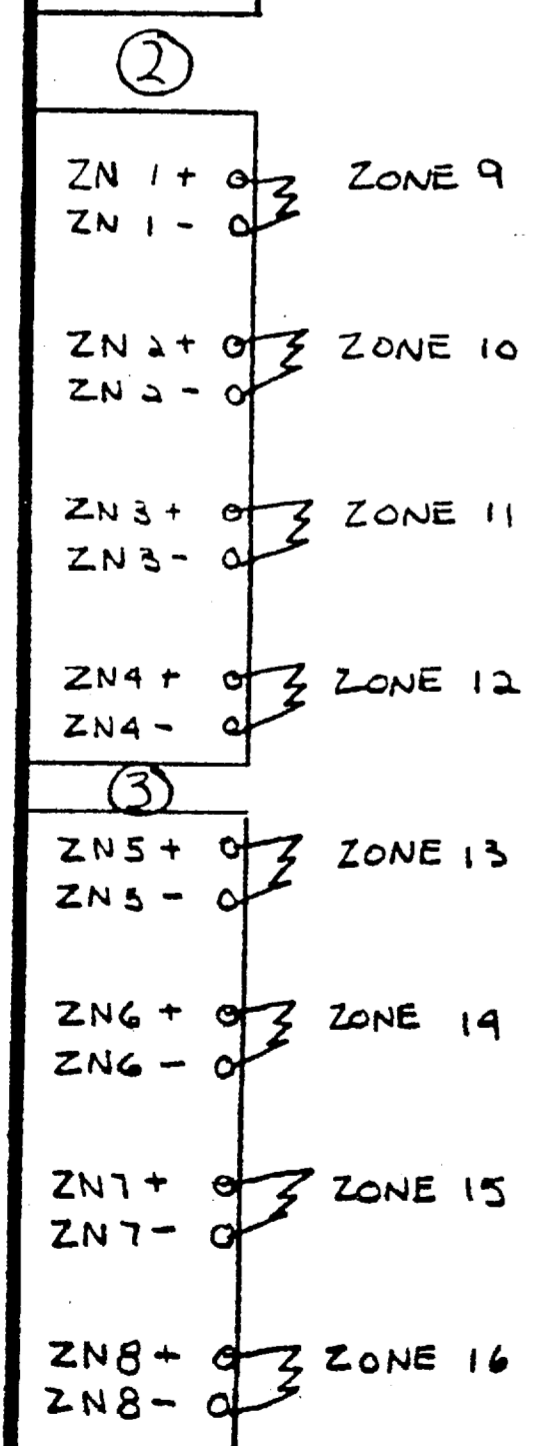
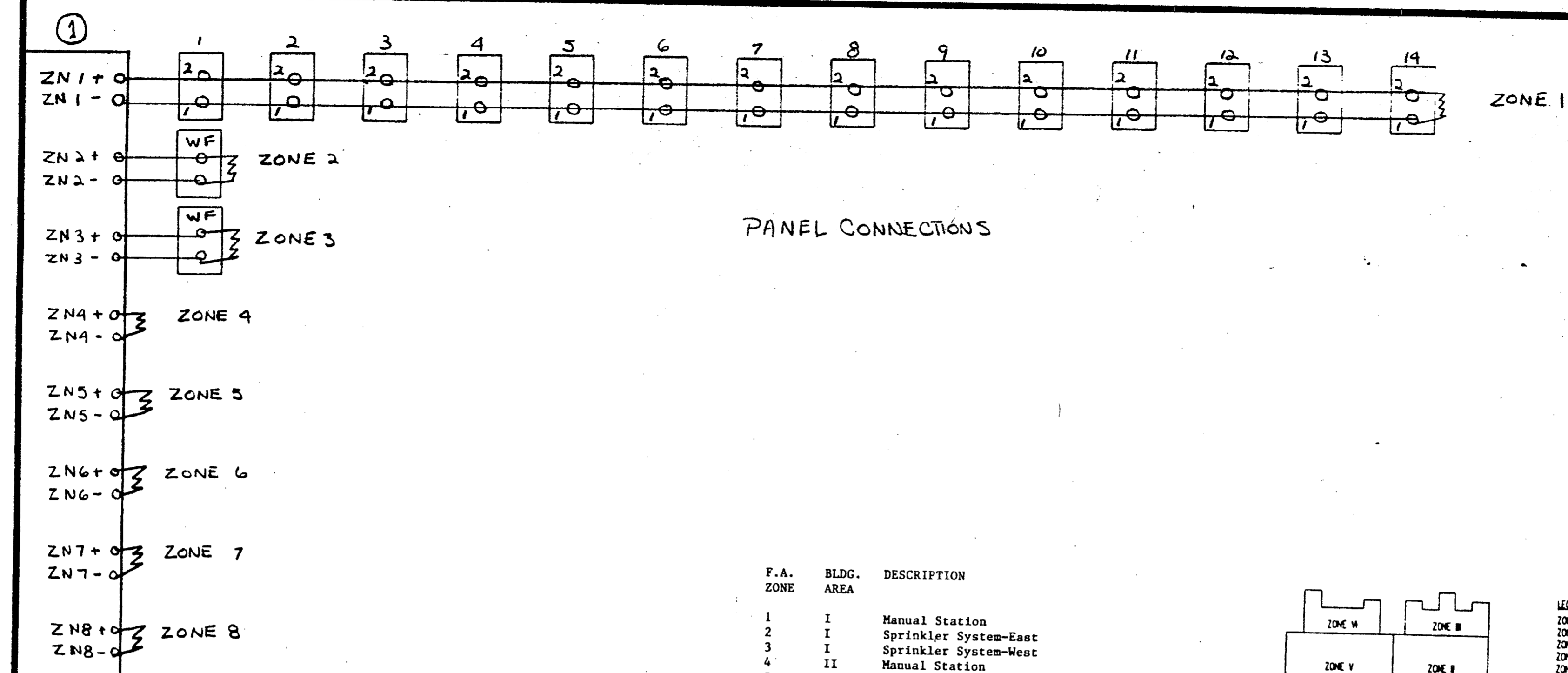

PANEL CONNECTIONS

F.A. ZONE	BLDG. AREA	DESCRIPTION
1	I	Manual Station
2	I	Sprinkler System-East
3	I	Sprinkler System-West
4	II	Manual Station
5	II	Sprinkler System
6	II	Spare
7	III	Manual Station
8	III	Sprinkler System
9	III	Spare
10	IV	Manual Station
11	IV	Sprinkler System
12	IV	Spare
13	V	Manual Station
14	V	Sprinkler System
15	V	Spare
16	VI	Manual Station
17	VI	Sprinkler System
18	VI	Spare
19	VII	Spare
20	VII	Sprinkler System
21		Spare
22		Spare
23		Spare
24		Spare

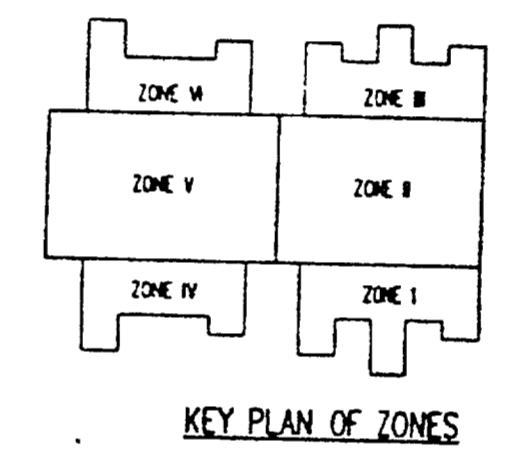

LEGEND  
 ZONE I & VI - CURRENT  
 ZONE II - FUTURE  
 ZONE III - FUTURE  
 ZONE IV - FUTURE  
 ZONE V - FUTURE  
 ZONE VI - FUTURE

<b>Simplex Time Recorder Co.</b> BRANCH OFFICE: 4433 BERYL RD LOCATION: RALEIGH NC TEL. NO. 829-0555	PROJECT: FIELD MAINT. COMPLEX CAMP LESEUNE	DWG. NO.: 2 OF 5 ORDER NO.: RPQ NO.:	REV.:
	DRN. BY: REAGAN ELEC	APPVD. BY:	

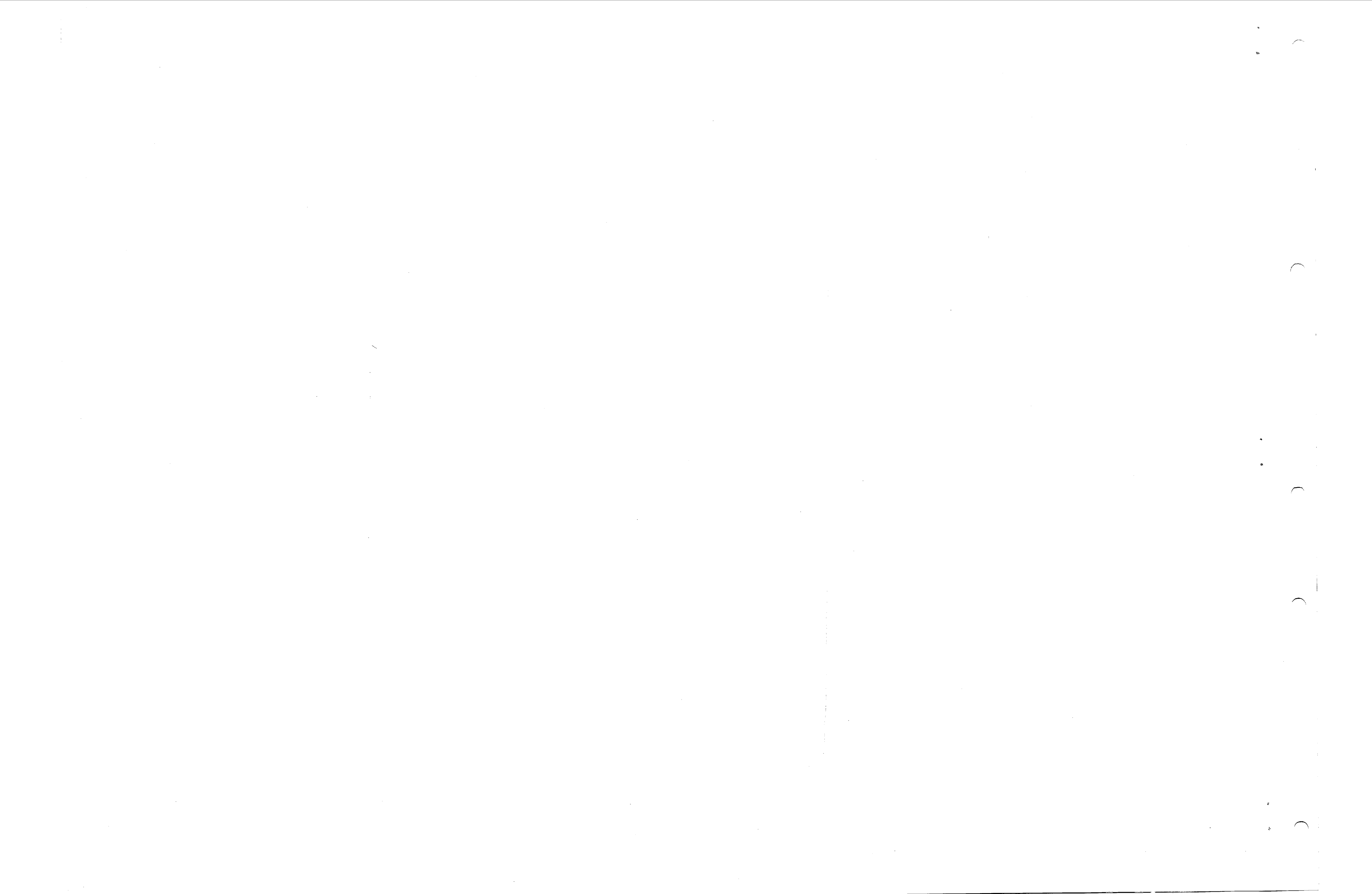

# PANEL CONNECTIONS

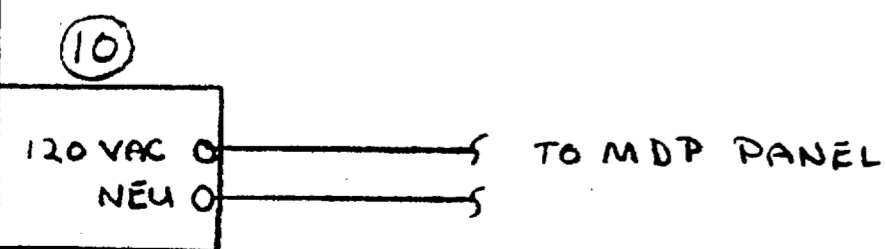
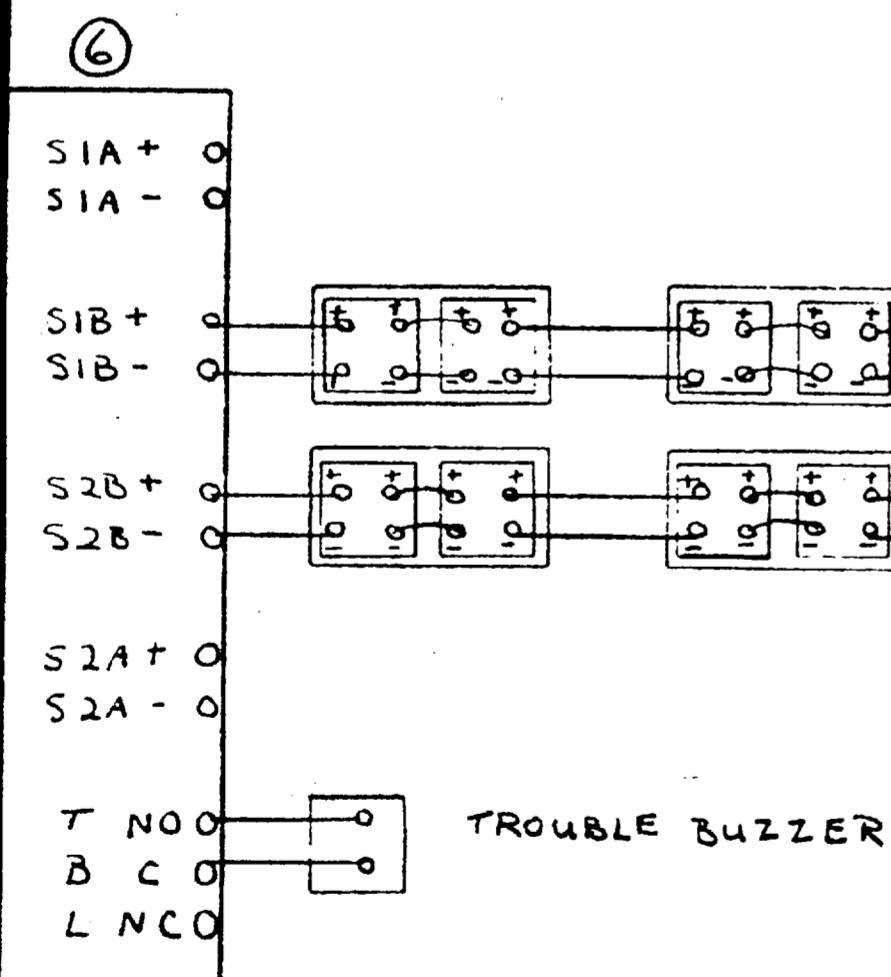
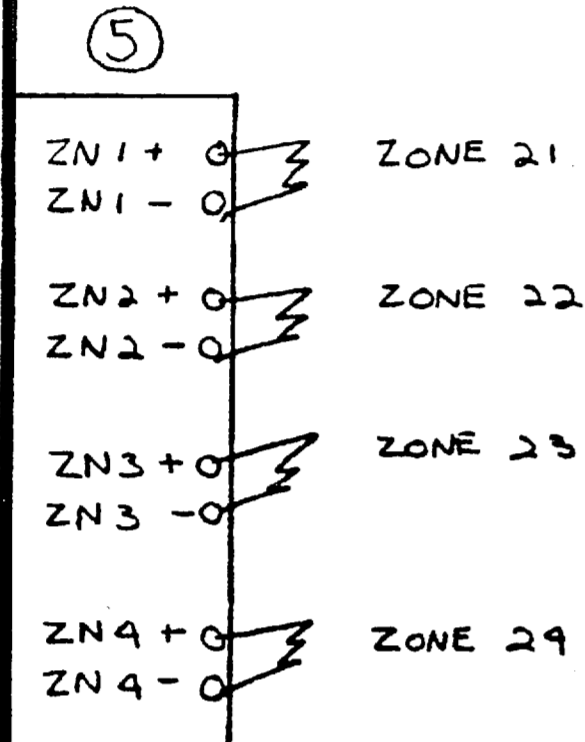
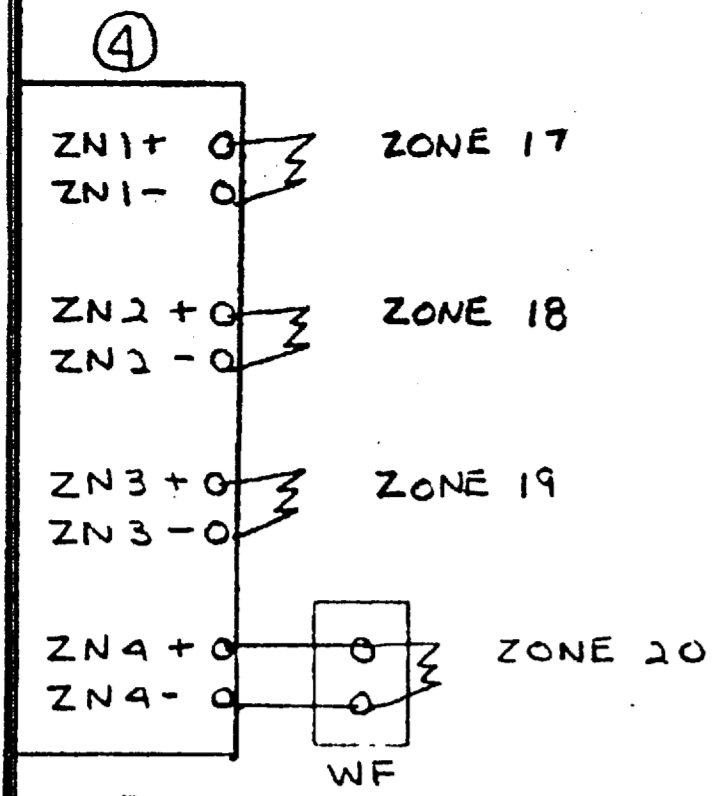

F.A. ZONE	BLDG. AREA	DESCRIPTION
1	I	Manual Station
2	I	Sprinkler System-East
3	I	Sprinkler System-West
4	II	Manual Station
5	II	Sprinkler System
6	II	Spare
7	III	Manual Station
8	III	Sprinkler System
9	III	Spare
10	IV	Manual Station
11	IV	Sprinkler System
12	IV	Spare
13	V	Manual Station
14	V	Sprinkler System
15	V	Spare
16	VI	Manual Station
17	VI	Sprinkler System
18	VI	Spare
19	VII	Spare
20	VII	Sprinkler System
21		Spare
22		Spare
23		Spare
24		Spare

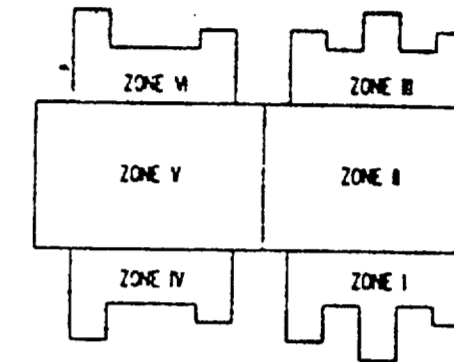

LEGEND  
 ZONE I & VI - CURRENT  
 ZONE II - FUTURE  
 ZONE III - FUTURE  
 ZONE IV - FUTURE  
 ZONE V - FUTURE  
 ZONE VII - FUTURE

<b>Simplex Time Recorder Co.</b> BRANCH OFFICE 4433 BERYL RD LOCATION RALEIGH NC TEL. NO. 328-0555	PROJECT FIELD MAINT. COMPLEX CAMP LESEUNE	DWG. NO. 3 OF 5 ORDER NO. RPQ NO.	REV.
	DRN. BY APPVD. BY		

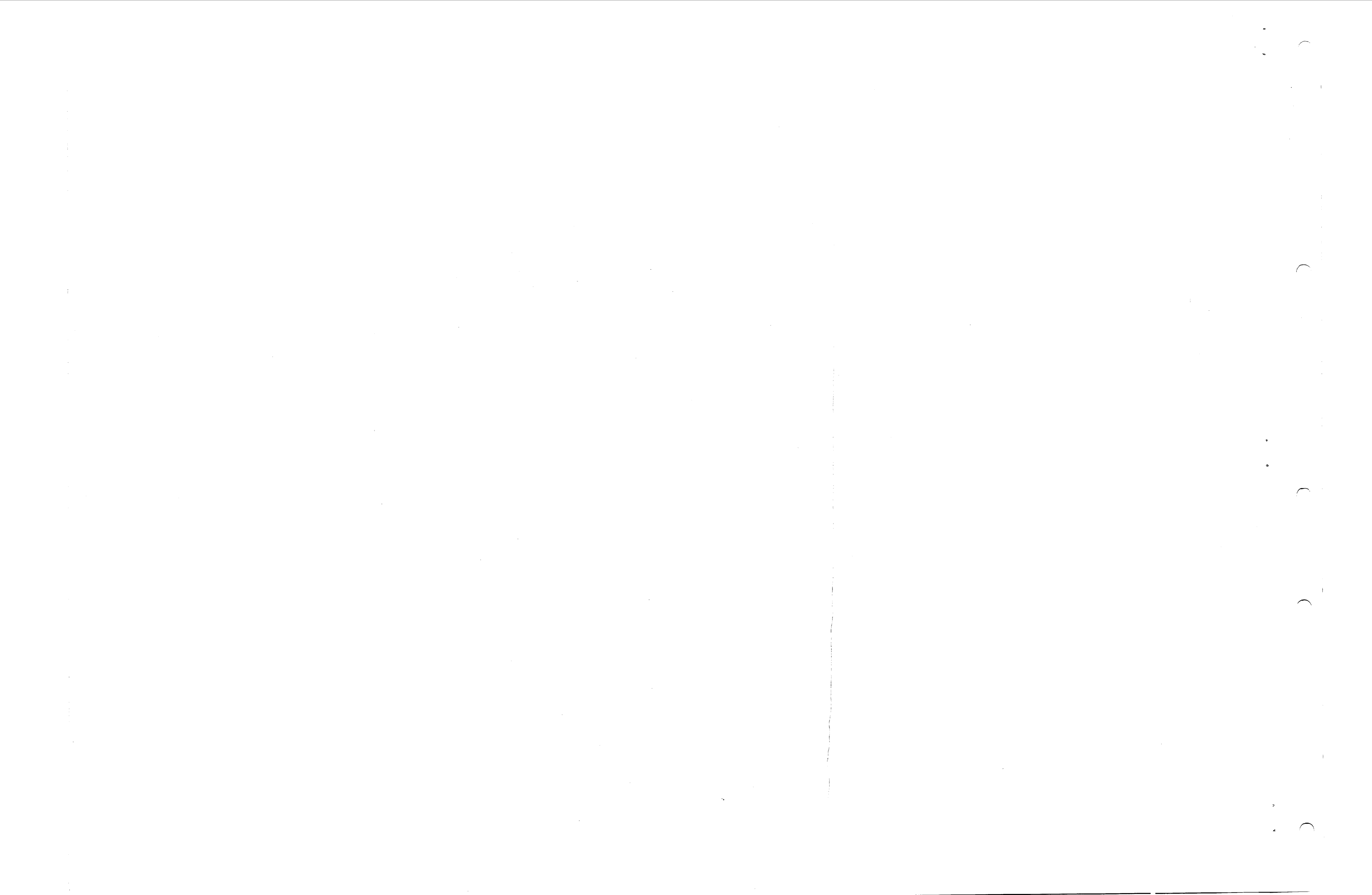

# PANEL CONNECTIONS

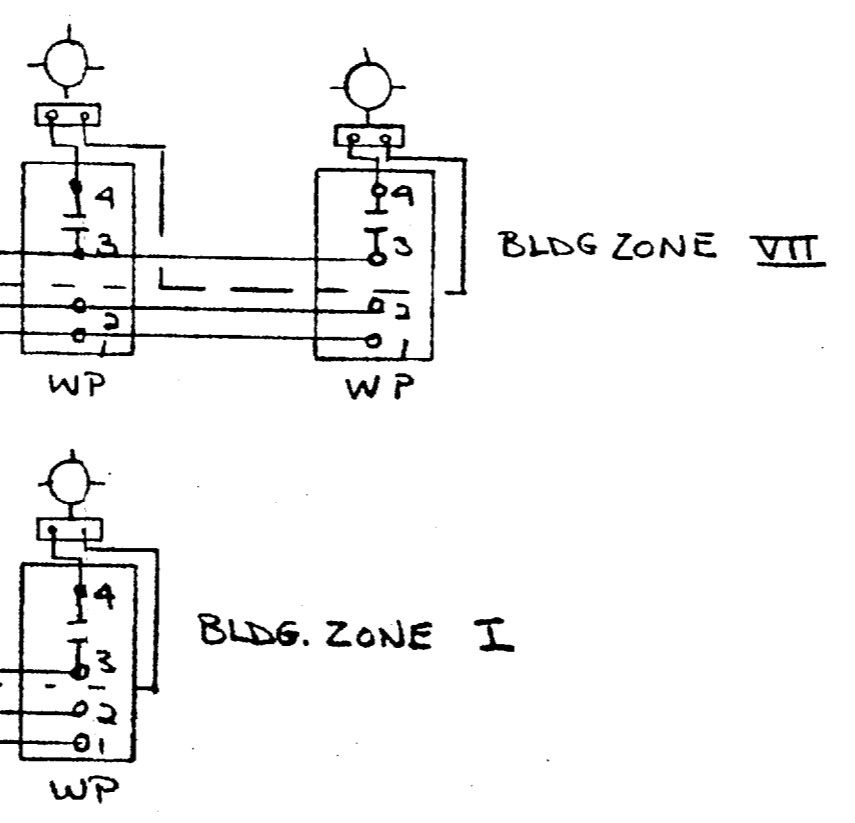
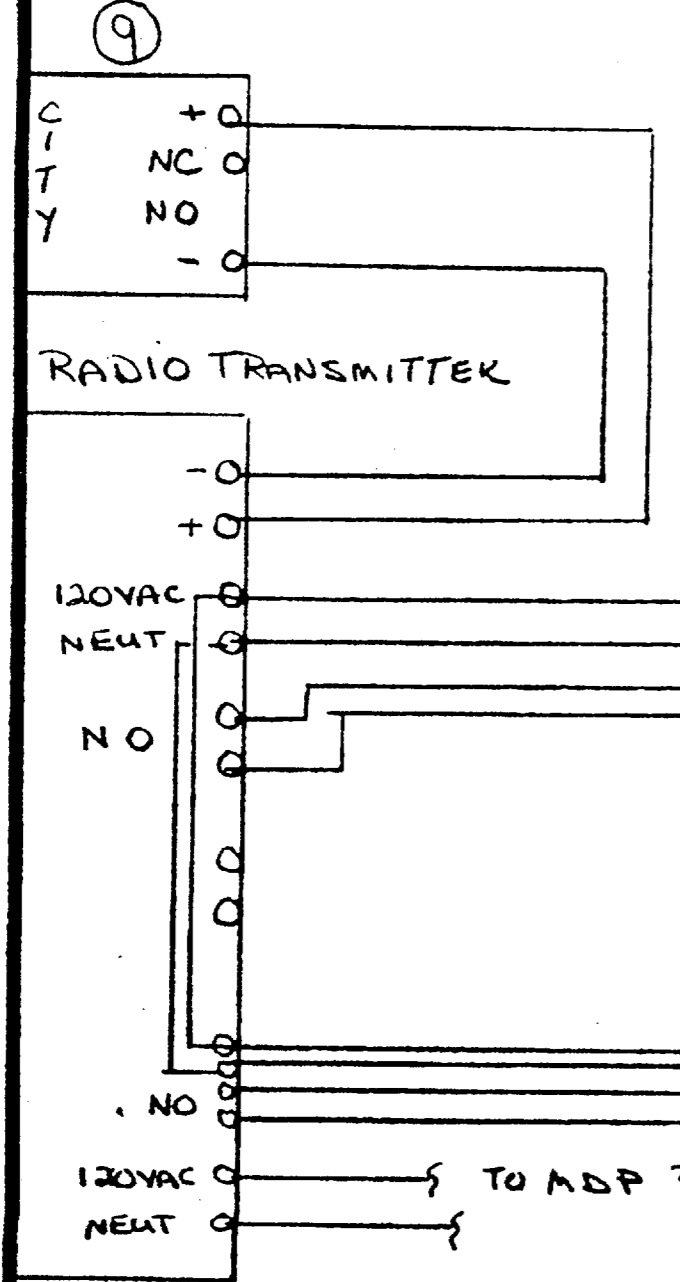
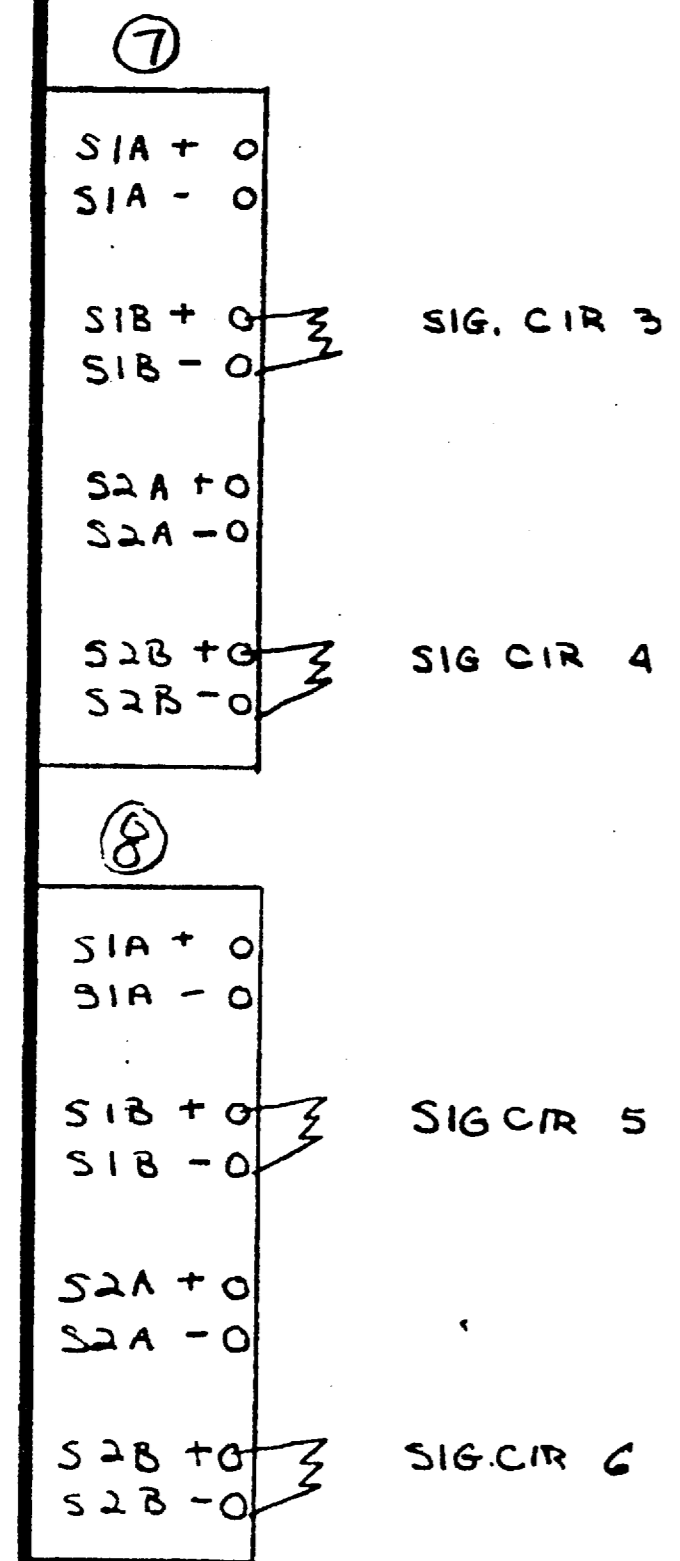

## SYMBOL LEGEND

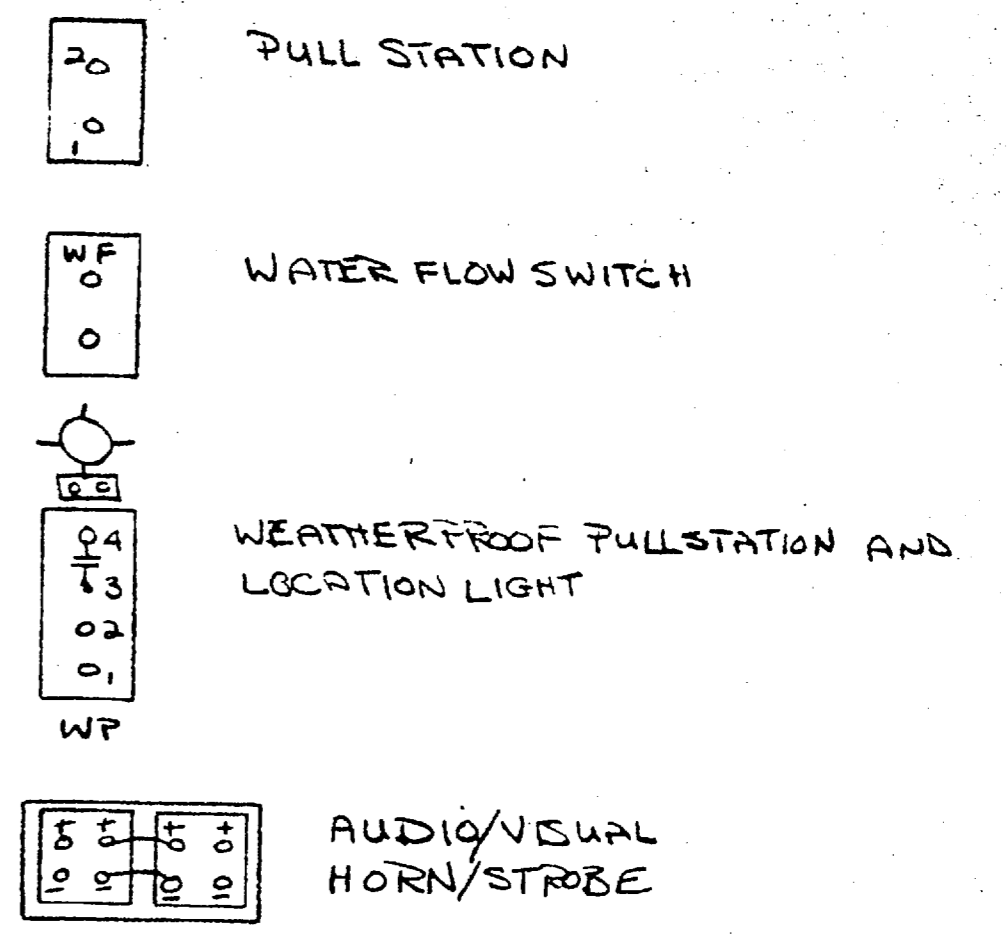

<b>Simplex Time Recorder Co.</b>		PROJECT <u>FIELD MAINT. COMPLEX</u>	DWG. NO. <u>4 OF 5</u>	REV.
BRANCH OFFICE <u>4433 BERYL RD</u>		<u>CAMP LEJEUNE</u>		ORDER NO.
LOCATION <u>RALEIGH NC</u>		<u>REAGAN ELEC</u>		RPO NO.
TEL. NO. <u>829-0555</u>		DRN. BY	APPVD. BY	DATE

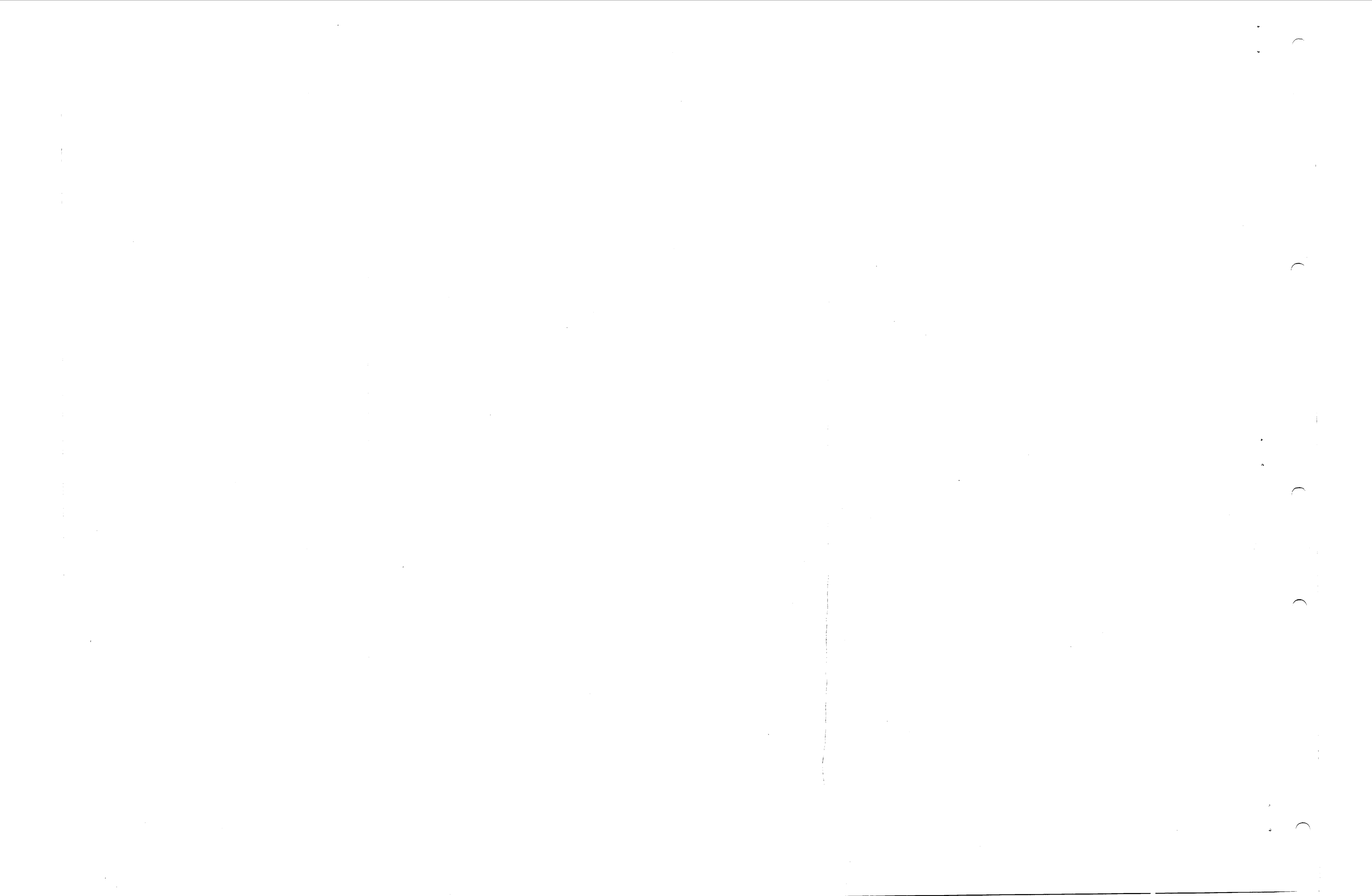



ANNUNCIATOR CONNECTIONS

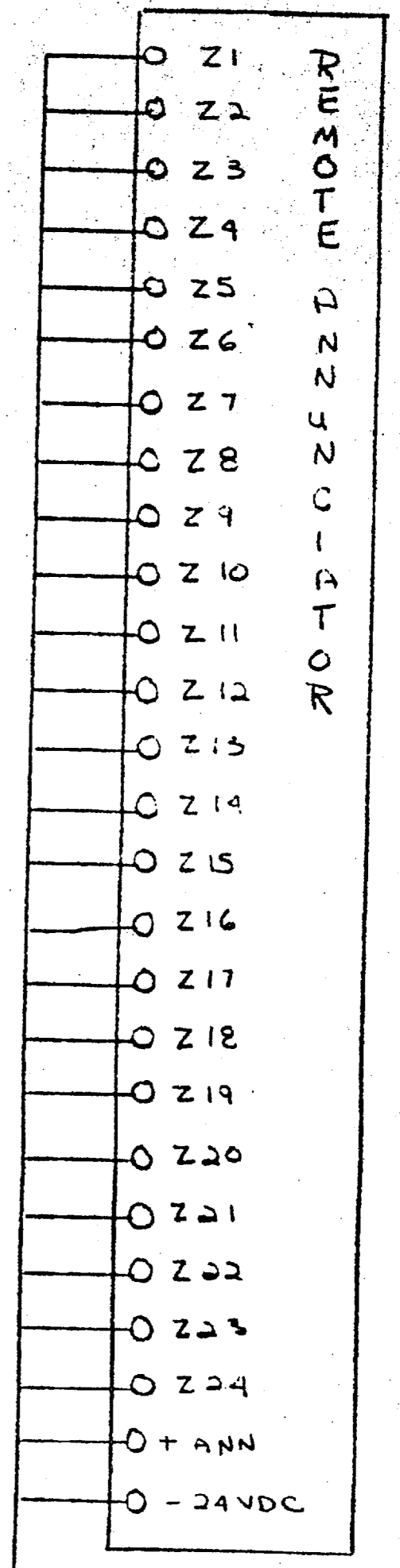
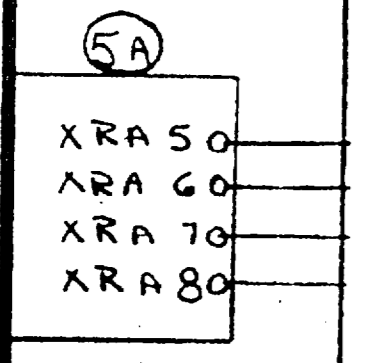
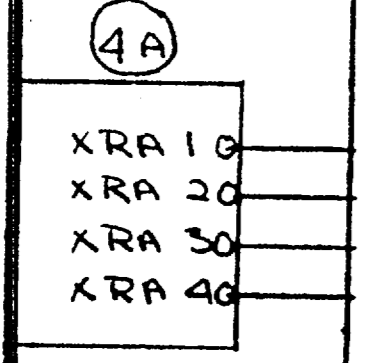
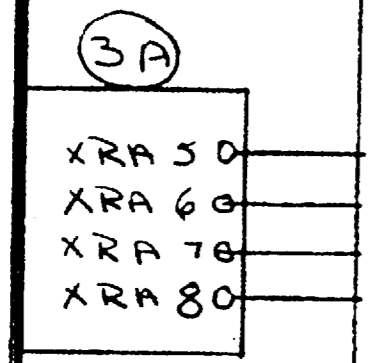
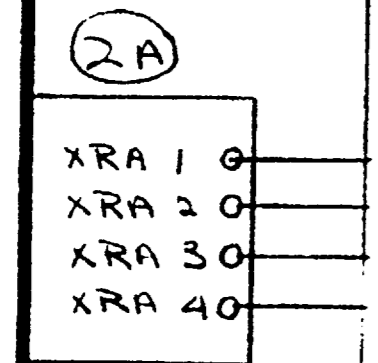
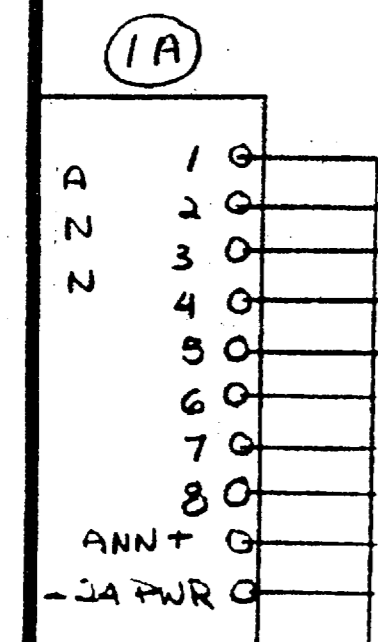

26 #14

		PROJECT	FIELD MAINT COMPLEX	DWG. NO.	5 OF 5
BRANCH OFFICE		4933 REEVE RD		CAMP LESEUNE	
LOCATION		RALEIGH NC		REAGAN FLEC.	
TEL. NO.		324 0515		DRN. BY	APPVD. BY
M 313F				ORDER NO.	
				RPQ NO.	

