

ORDER NO. 1000
 DATE 10/10/1950
 TO THE
 FROM THE
 1000
 1000
 1000

NAME
 ADDRESS
 CITY
 STATE
 ZIP

MANUFACTURING SPECIFICATIONS
 CASE FINISH - CASE PLASTIC
 FRONT - FRONT PANEL SHAPED TO FIT
 FRONT CASE - FRONT COVERED TO FIT
 APPROX. 1000
 TEMPERATURE CONTROL
 APPROX. 1000
 SHIPMENT DIRECT TO CUSTOMER
 1000

TOTAL
 ORDER CHARGE
 AMOUNT OF
 1000

TOTAL 1000
 ORDER CHARGE 1000
 AMOUNT OF 1000

ORDER DATA SHEET

CUSTOMER SERVICE/EMK/vo

DATE TYPED 4/24/64

CUSTOMER FISCHER AND PORTER COMPANY
P. O. NO. 39497
JOB CAMP LEJUNE, NO. CAROLINA

D-I-F ORDER NO. R41692-E-0101

SCHEDULE		DATE
R	DRAWINGS TO CUSTOMER	4/8/64
X	NR CUSTOMER APP. DUE	4/23/64
Y	ENG. DATA TO P.C.---	
X	P SHIPMENT 10 WKS.	AA-00
G	CALCS REQ'D? <input checked="" type="checkbox"/> YES <input type="checkbox"/> NO	

INSTRUCTION MANUALS: 9 TO PURCHASER
DRAWINGS: 12 CERTIFIED SETS WITH CUSTOMER'S TRANSMITTAL COPY (In LOF) FOR APPROVAL MARKED AS BELOW

DWGS. & MANUALS TO: PURCHASER
QUAN. ATTN.: PURCHASING DEPARTMENT

C

CODE NO.

TAG: P. O. #15-11 SPEC. 22.3.1 TRANSMITTER
RESERVOIR WATER LEVEL
6403A2916J4 ITEM 22.3.1

1 0231-03 Chronoflo Transmitter, Serial No. 41692-1

0231-03-0101

OPERATES: Model 1102 MF 04NS Receiver. Serial No. 6403A 2916J-4 by others

FLUID: Water
RANGE: 0 - 15 Ft.
MAX. FLOAT TRAVEL: Approx. 15 Ft.
CASE: Weatherproof
MOUNTING: Floor Flange
CAM CYCLE: 15 Sec., 3 Sec. = zero, 12 Sec. = max.
POWER: 110 Volt, 60 Cycle
CAM TYPE: Linear
FLOAT WITH CABLE: 6-11/16" dia.

0302
0405
0501
0603

SEGMENTAL INDICATOR GRADUATED IN WLF
THERMOSTAT AND HEATER

BMC-93621
0901

GOVERNMENT SOURCE INSPECTION REQUIRED AT BIF
MARK DRAWINGS: Brown Construction Co., Order No. 15-11

TAG: P. O. #15-11 SPEC. 22.4.1 TRANSMITTER
DETENTION TANK LEVEL
6403A2916J6 22.4.1

1 0231-03 Chronoflo Transmitter, Serial No. 41692-2

0231-03-0101

OPERATES: Model 1102 MF 94NS, Receiver, Serial No. 6403A2916J-7 by others

FLUID: Water
RANGE: 0 - 10 Ft.
MAX. FLOAT TRAVEL: Approx. 10 Ft.
CASE: Weatherproof
MOUNTING: Floor Flange
CAM CYCLE: 15 Sec., 3 Sec. = zero, 12 sec. = max.
POWER: 110 volt, 60 cycle
CAM TYPE: Linear
FLOAT WITH CABLE: 6-11/16" Dia.

0302
0405
0501
0603

SEGMENTAL INDICATOR GRADUATED IN WLF
THERMOSTAT AND HEATER

BMC-93621

GOVERNMENT SOURCE INSPECTION REQUIRED AT BIF
MARK DRAWINGS: Brown Construction Co., Order No. 15-11

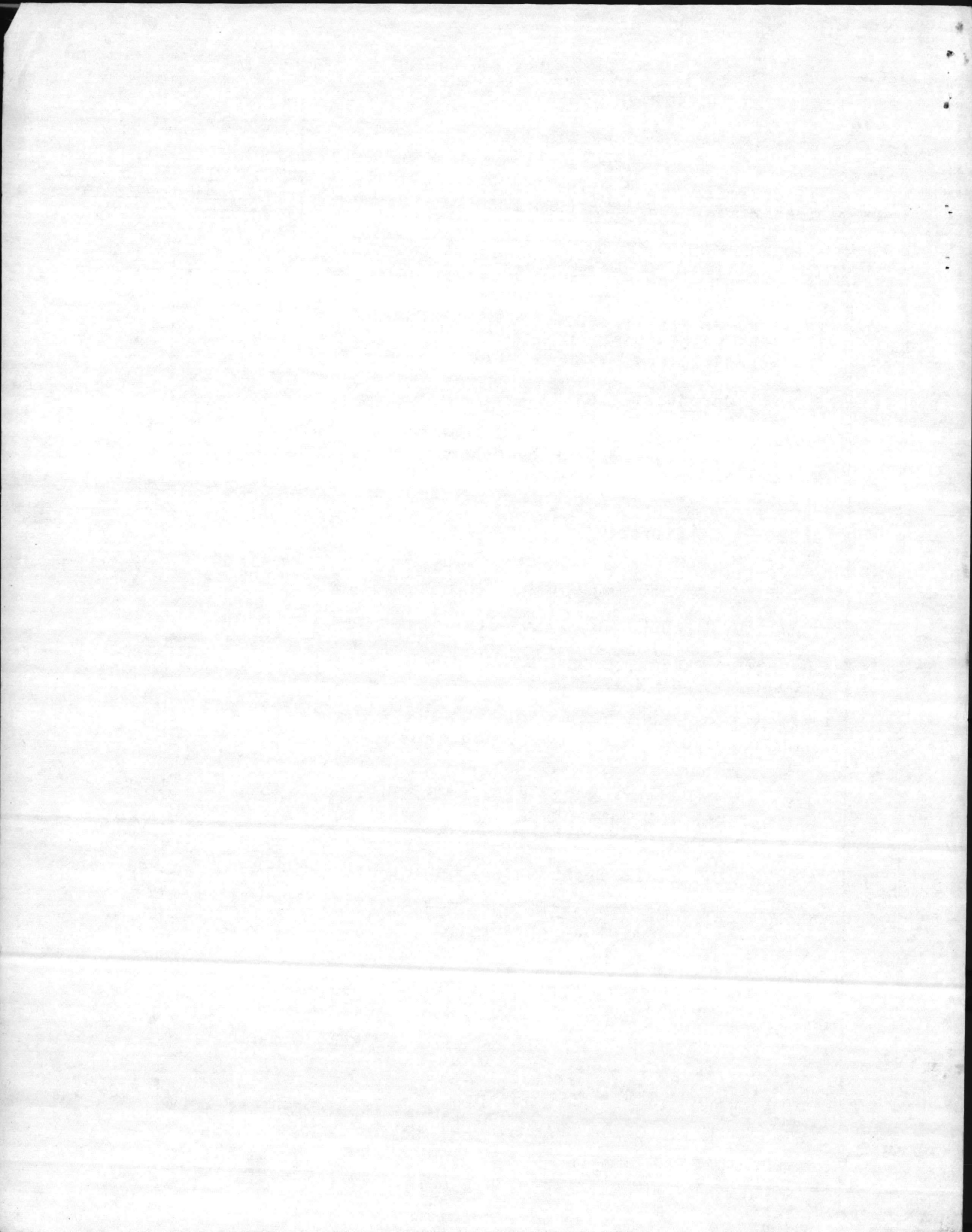



Industries

BUILDERS • PROVIDENCE • PROPORTIONERS • OMEGA
PROVIDENCE, RHODE ISLAND, U.S.A.

DIMENSIONS

CHRONOFLO LEVEL TRANSMITTER
Float Operated Model 231-03

*For Brown Construction Co.
Order No. 15-11
I & P Serial No. 6403A 291614
Tag 22.3.1 Transmitter Reservoir Water
I & P Serial No. 6403A 291616
Tag 22.4.1 Transmitter Retention Tank
Water Level*

THIS PRINT IS REPRODUCIBLE

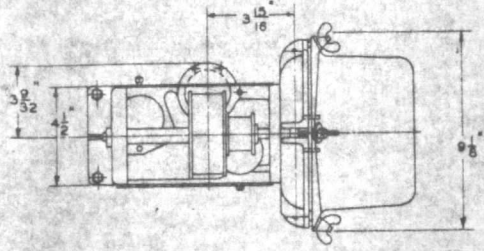

IF SIDES OF COVER INTERFERE WITH CABLE BEND AT SLOTS & BREAK OFF LOWER SECTION.

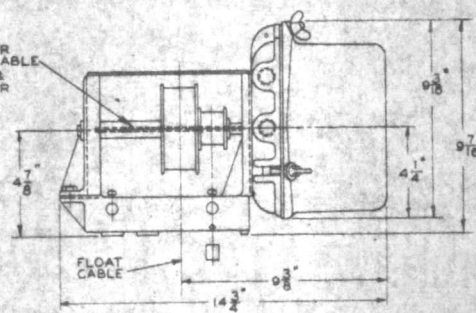

2-1/2" PIPE TAPS FOR MOTOR & SIGNAL WIRE CONDUITS

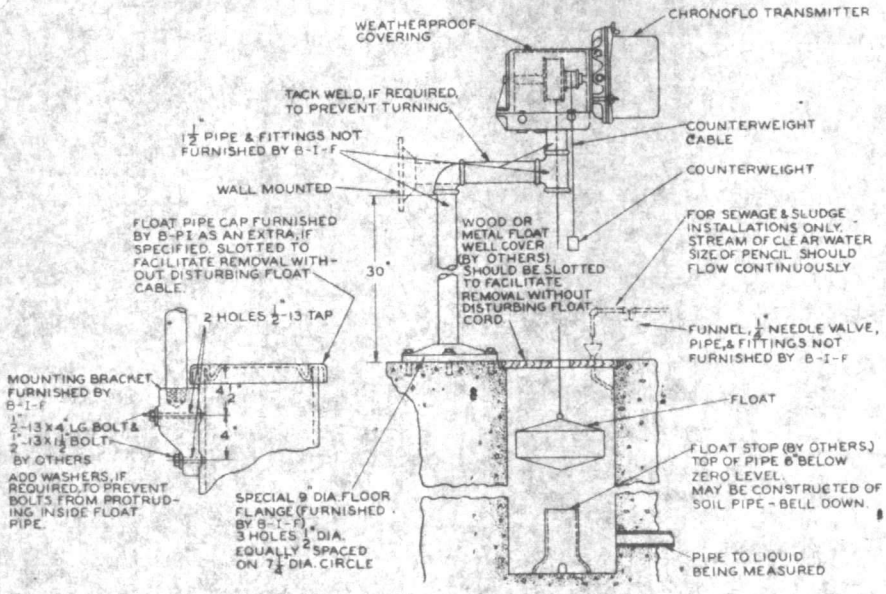
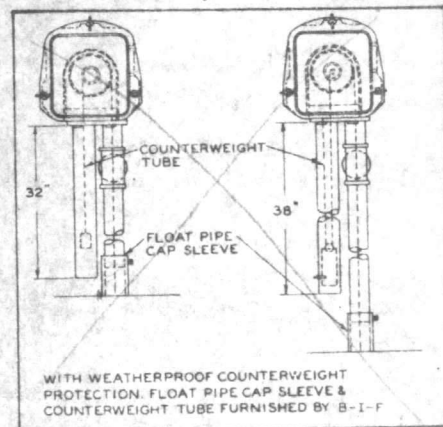
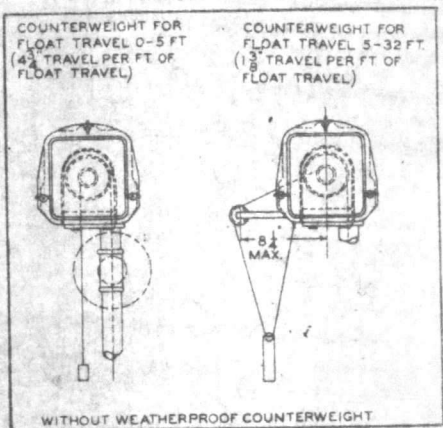
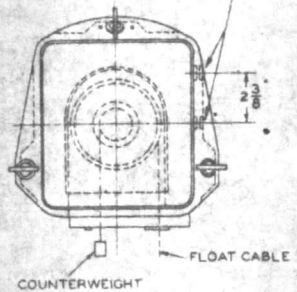

FLOAT PIPE MOUNTED

FLOOR FLANGE MOUNTED

- MOUNTING**
- FLOOR OR WALL MOUNTED
 - FLOAT PIPE MOUNTED
- FLOAT TRAVEL**
- 0 TO 5 FT.
 - 5 TO 32 FT.
- COUNTERWEIGHT**
- WITHOUT WEATHERPROOF HOUSING
 - WITH WEATHERPROOF HOUSING

THIS PRINT CORRECT ONLY FOR
CUSTOMER'S ORDER NO. 31497
OUR ORDER NO. 291614
APP'D BY R. V. Baker Date MAY 4 1964
B-I-F INDUSTRIES

