

Appendix E

MATERIAL SPECIFICATIONS FOR REINFORCING BARS

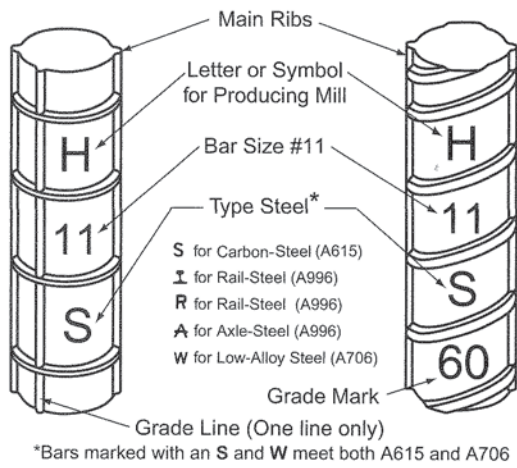

GRADE 60

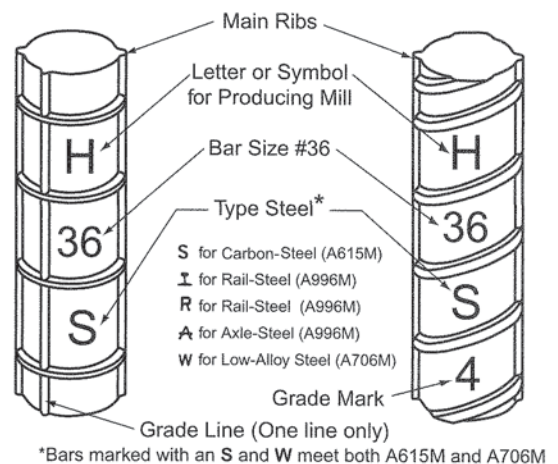

GRADE 420

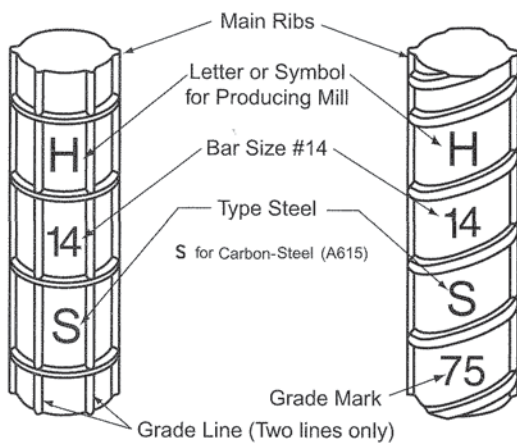

GRADE 75

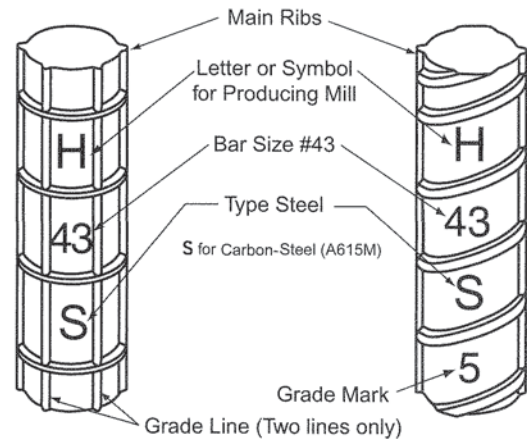

GRADE 520

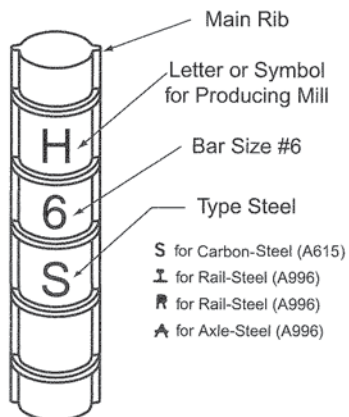

GRADE 40 AND 50

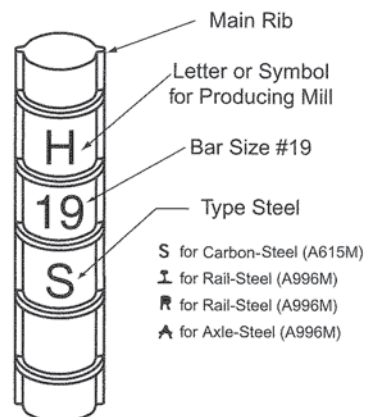

GRADE 280 AND 350

MATERIAL SPECIFICATIONS FOR REINFORCING BARS

ASTM SPECIFICATIONS – BAR SIZES, GRADES, TENSILE AND BENDING REQUIREMENTS

Type of Steel and ASTM Specification	Bar Sizes	Grade	Minimum Yield Strength, psi [MPa]	Minimum Tensile Strength, psi [MPa]	Minimum Percentage Elongation in 8 in. [203.2 mm]	Bend Test Pin Diameter (d = nominal diameter of bar)
Carbon-Steel A615/A615M	#3 - #6 [#10 - #19]	40 [280]	40,000 [280]	60,000 [420]	#3 [#10]11 #4, #5, #6 [#13, #16, #19] 12	#3, #4, #5 [#10, #13, #16] ... $.3\frac{1}{2}d$ #6 [#19] $5d$
	#3 - #18 [#10 - #57]	60 [420]	60,000 [420]	90,000 [620]	#3, #4, #5, #6 [#10, #13, #16, #19]9 #7, #8 [#22, #25]8 #9, #10, #11, #14, #18 [#29, #32, #36, #43, #57]7	#3, #4, #5 [#10, #13, #16] ... $.3\frac{1}{2}d$ #6, #7, #8 [#19, #22, #25] $.5d$ #9, #10, #11 [#29, #32, #36] $.7d$ #14, #18 (90°) [#43, #57 (90°)] $.9d$
	#3 - #18 [#10 - #57]	75 [520]	75,000 [520]	100,000 [690]	#3, #4, #5, #6, #7, #8 [#10, #13, #16, #19, #22, #25]7 #9, #10, #11, #14, #18 [#29, #32, #36, #43, #57]6	#3, #4, #5, #6, #7, #8 [#10, #13, #16, #19, #22, #25] $.5d$ #9, #10, #11 [#29, #32, #36] $.7d$ #14, #18 (90°) [#43, #57 (90°)] $.9d$
Low-Alloy Steel A706/A706M	#3 - #18 [#10 - #57]	60 [420]	60,000 [420]	80,000 [550]	#3, #4, #5, #6 [#10, #13, #16, #19]14 #7, #8, #9, #10, #11 [#22, #25, #29, #32, #36]12 #14, #18 [#43, #57]10	#3, #4, #5 [#10, #13, #16] $.3d$ #6, #7, #8 [#19, #22, #25] $.4d$ #9, #10, #11 [#29, #32, #36] $.6d$ #14, #18 [#43, #57] $.8d$
Stainless-Steel A955/A955M	#3 - #6 [#10 - #19]	40 [280]	40,000 [280]	70,000 [500]	#3, #4, #5, #6 [#10, #13, #16, #19]20	#3, #4, #5 [#10, #13, #16] ... $.3\frac{1}{2}d$ #6 [#19] $5d$
	#3 - #18 [#10 - #57]	60 [420]	60,000 [420]	90,000 [620]	#3 - #18 [#10 - #57]20	#3, #4, #5 [#10, #13, #16] ... $.3\frac{1}{2}d$ #6, #7, #8 [#19, #22, #25] $.5d$ #9, #10, #11 [#29, #32, #36] $.7d$ #14, #18 (90°) [#43, #57 (90°)] $.9d$
	#6 - #18 [#19 - #57]	75 [520]	75,000 [520]	100,000 [690]	#6 - #18 [#19 - #57]20	#6, #7, #8 [#19, #22, #25] $.5d$ #9, #10, #11 [#29, #32, #36] $.7d$ #14, #18 (90°) [#43, #57 (90°)] $.9d$

For low-alloy steel reinforcing bars, ASTM A706/A706M prescribes a maximum yield strength of 78,000 psi [540 MPa] and tensile strength must be 1.25 times the actual yield strength.

Bend tests are 180° except ASTM A615/A615M permits 90° for bar sizes #14 and #18 [#43 and #57].

RECOMMENDED INDUSTRY PRACTICE FOR DETAILING CONCRETE REINFORCING STEEL

STANDARD HOOKS

All specific dimension recommended by CRSI below meet minimum requirements of ACI 318 [318M]. Galvanized bars that are bent cold prior to galvanizing may have finished bend diameters larger than those shown below. See ASTM A767/A767M, Section 7.

RECOMMENDED END HOOKS ALL GRADES OF STEEL D = Finished bend diameter

Bar Size	D, in. [mm]	180° Hooks, ft-in. [mm]		90° Hooks, ft-in. [mm]
		A or G	J	A or G
#3 [#10]	2 1/4 [60]	0-5 [125]	0-3 [80]	0-6 [150]
#4 [#13]	3 [80]	0-6 [150]	0-4 [105]	0-8 [200]
#5 [#16]	3 3/4 [95]	0-7 [175]	0-5 [130]	0-10 [250]
#6 [#19]	4 1/2 [115]	0-8 [200]	0-6 [155]	1-0 [300]
#7 [#22]	5 1/4 [135]	0-10 [250]	0-7 [180]	1-2 [375]
#8 [#25]	6 [155]	0-11 [275]	0-8 [205]	1-4 [425]
#9 [#29]	9 1/2 [240]	1-3 [375]	0-11 1/4 [300]	1-7 [475]
#10 [#32]	10 3/4 [275]	1-5 [425]	1-1 1/4 [335]	1-10 [550]
#11 [#36]	12 [305]	1-7 [475]	1-2 3/4 [375]	2-0 [600]
#14 [#43]	18 1/2 [465]	2-3 [675]	1-9 3/4 [550]	2-7 [775]
#18 [#57]	24 [610]	3-0 [925]	2-4 1/2 [725]	3-5 [1050]

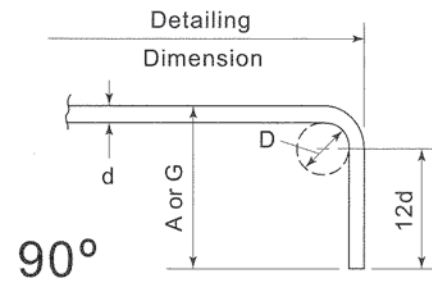
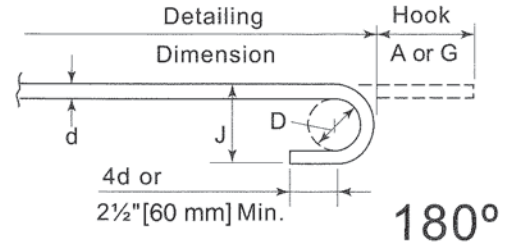

90° AND 135° STIRRUP AND TIE HOOKS

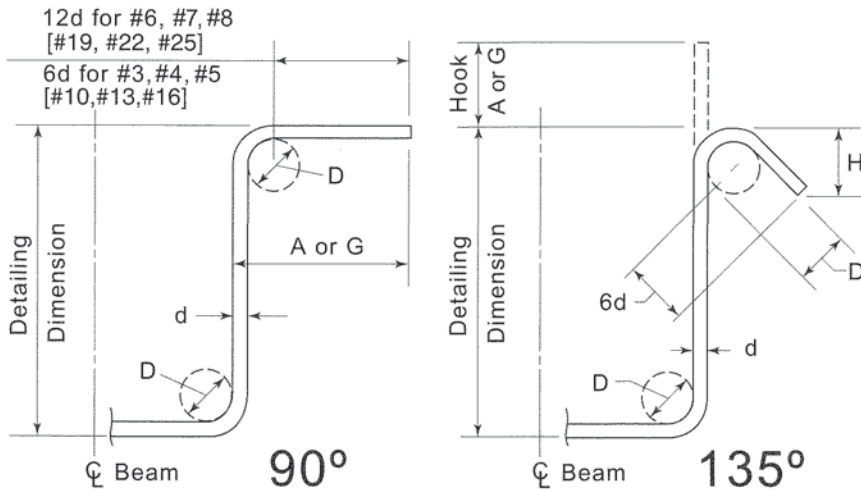

135° SEISMIC STIRRUP/TIE HOOKS

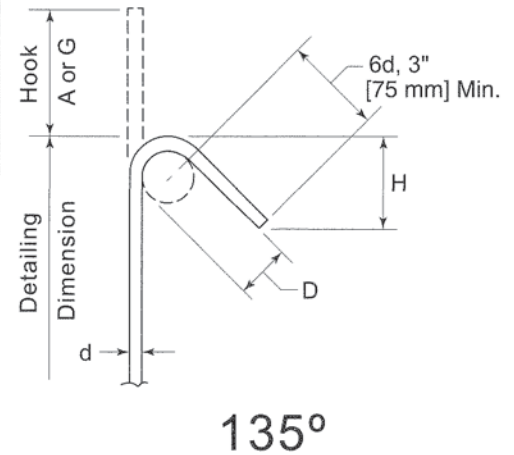

STIRRUP (TIES SIMILAR) STIRRUP/TIE HOOK DIMENSIONS ALL GRADES OF STEEL

Bar Size	D, in. [mm]	90° Hook, ft-in. [mm]	135° Hook, in. [mm]	
		Hook A or G	Hook A or G	H (Approx.)
#3 [#10]	1 1/2 [40]	0-4 [105]	4 [105]	2 1/2 [65]
#4 [#13]	2 [50]	0-4 1/2 [115]	4 1/2 [115]	3 [80]
#5 [#16]	2 1/2 [65]	0-6 [155]	5 1/2 [140]	3 3/4 [95]
#6 [#19]	4 1/2 [115]	1-0 [305]	8 [205]	4 1/2 [115]
#7 [#22]	5 1/4 [135]	1-2 [355]	9 [230]	5 1/4 [135]
#8 [#25]	6 [155]	1-4 [410]	10 1/2 [270]	6 [155]

135° SEISMIC STIRRUP/TIE HOOK DIMENSIONS ALL GRADES OF STEEL

Bar Size	D, in. [mm]	135° Hook, in. [mm]	
		Hook A or G	H (Approx.)
#3 [#10]	1 1/2 [40]	4 1/2 [110]	3 [80]
#4 [#13]	2 [50]	4 1/2 [115]	3 [80]
#5 [#16]	2 1/2 [65]	5 1/2 [140]	3 3/4 [95]
#6 [#19]	4 1/2 [115]	8 [205]	4 1/2 [115]
#7 [#22]	5 1/4 [135]	9 [230]	5 1/4 [135]
#8 [#25]	6 [155]	10 1/2 [270]	6 [155]