

**(DRAFT) Final Report to the NPFMC**

**EFP 03-01: Test of a Salmon Excluder Device for the Pollock Trawl Fishery January 2003 through March 2004**

May 12, 2004

John R. Gauvin Principal Investigator

Brent Paine Industry Coordinator

**EXECUTIVE SUMMARY**

**EFP Permit 2003-01:** The North Pacific Fishery Management Council and Alaska Region of the National Marine Fisheries Service approved EFP 03-01 in June of 2003. The objective of the EFP was to determine the effectiveness of modifications to a standard Bering Sea pollock trawl to allow escapement of chum and Chinook salmon while minimizing the loss of pollock. The exempted fishing permit holders in conjunction with Dr. Craig Rose of NMFS' RACE Division conducted two stages of testing of the device from September 2003 through February of 2004. The first stage in the fall of 2003 focused on the ability of the newly designed excluder device to reduce chum salmon bycatch. The second stage in January of 2004 focused on Chinook salmon bycatch using a modified excluder design attempting to increase salmon escapement based on design elements from the 2003 excluder.

**The salmon excluder:** The main component of the excluder devices tested in the EFP was a three-sided, tapered tunnel approximately 4 meters in length, made of four-inch knotless square mesh. This tunnel was inserted in the trawl intermediate with its open side downward into the mesh tube. The square mesh tunnel denied fish direct access to four escape portals positioned above and beside the tunnel. Fish could only get to those portals by swimming forward after exiting the aft end of the tunnel. This exploited observations that salmon commonly swam forward in the net, while pollock rarely were able to swim forward and then only for short distances. Escapement of salmon and pollock in the EFP tests was measured via a recapture net placed above the escapement portals running back toward the cod-end.

**EFP field Tests:** The EFP testing in the fall of 2003 and winter of 2004 was conducted under scientifically controlled protocols aboard the F/V Auriga, a 193 foot 4,600 HP trawler that is a full time participant in the Bering Sea pollock fishery. Because incidental catch of salmon in the Bering Sea pollock fishery is a relatively rare occurrence with, on average, less than one salmon taken per ten tons of pollock, the experiment relied upon the retention and identification of fish escaping via the excluder to achieve statistical power. Testing protocols required separate handling and accounting of pollock and salmon accruing to the main cod-end and recapture device cod-end. These handling requirements were successfully achieved in both stages of EFP testing. Total groundfish catch for the two stages of testing in the fall 2003 and winter 2004 tests was 982 and 1,247 MT respectively for a total of 2,229 MT of the total allowable groundfish catch of 2,270. The total number of chum salmon caught during the fall EFP test was 1,196 and for the winter 2004 work, a total of 58 Chinook salmon were taken in the EFP. Salmon sample size objectives were accomplished in both stages of field work.

**Results:** Chum salmon bycatch was reduced by 12.3% (escapement of 123 of a total of 1005 chum salmon) in the fall 2003 test. Pollock escapement for that stage of the test was 2.6% by weight (12.3 MT out of a total pollock catch of 464.6 MT). For the second stage in winter of 2004, the excluder design was modified and an additional escapement tunnel was added to the net in an attempt to increase salmon escapement. This goal, however, was not achieved. Chinook salmon escapement in the winter 2004 test was approximately the same amount as it was in fall of 2003, (12.9%), but pollock escapement increased to 4.1% (30.9 MT out of a total pollock catch of 745.7 MT).

For both stages of field work, problems with reversed escapement of salmon occurred. These were noted through underwater video and sonar observations. While the return of salmon from the recapture device to the main net during haulback may indicate that salmon escapement was underestimated, there is no reliable way to document the extent that this influenced the overall results hence our measurement of the actual performance of the device was not adequate. Additionally, the relatively large quantity of pollock escapement in the winter of 2004 overwhelmed the recapture device system and served to invalidate a considerable portion of the EFP test fishing.

**Findings Overall and Future Direction for Development of a Salmon Excluder:** Our test demonstrated that it is possible to reduce salmon bycatch in pelagic pollock nets via an excluder that relies on behavioral differences between the species. While headway was made in the development of an effective excluder, the end goal of escapement of a large portion of the salmon was not achieved. Based our experiences thus far, successful attainment of an effective salmon excluder will be a significant challenge requiring considerable additional design work and field verification.

Future development efforts should continue to prioritize increasing salmon escapement even at the cost of higher pollock escapement. Evidence thus far suggests that once higher escapement of salmon is achieved, it is likely feasible that pollock escapement can be addressed while maintaining salmon escapement performance. As work on the excluder progresses, additional video and sonar observation of fish behavior in response to the excluder (and possibly other stimuli introduced to create a behavioral response) will be obtained. This will likely be of vital importance to the overall development of the excluder. This added information on fish behavior may expose new and more productive designs for salmon excluders that more effectively exploit differences in behavior between salmon and pollock.

### **Introduction**

Chinook salmon *Oncorhynchus tshawytscha* and chum salmon *O. keta* are caught incidentally in Alaska groundfish fisheries, primarily in the trawl fishery for walleye pollock *Theragra chalcogramma*. For management purposes, salmon are listed as a prohibited species in the groundfish fishery management plans, meaning that they cannot be retained and sold if taken incidentally.

Beginning in 1994, the North Pacific Fisheries Management Council approved measures to reduce salmon bycatch in groundfish fisheries by establishing Savings Areas encompassing extensive locations with high historical bycatch rates for chum salmon and Chinook salmon. These areas close to pollock trawling during pre-established periods each year and for additional periods if salmon bycatch exceeds fixed caps.

Through its implementation of a voluntary system to rapidly identify and avoid salmon bycatch “hotspots”, the pollock industry has had some success staying under the bycatch caps in most years, however, fishermen have incurred substantial costs in these efforts. Costs occur in the form of forfeited fishing time while seeking fishing grounds with lower salmon bycatch rates, added fuel expenses in these efforts, and lower quality pollock catches when high-quality fish are mostly located in areas with high salmon bycatch rates.

With the advent of salmon bycatch agreements via cooperative management of pollock fishing under the American Fisheries Act, the need for new approaches to salmon bycatch management became apparent to the pollock industry. This motivated the development of an exempted fishing permit (EFP) application and all the related efforts described below to develop a salmon excluder over the last 18 months. The EFP was used to conduct a rigorous test of the newly-developed excluder’s performance. EFP tests were carried out under conditions closely resembling actual fishing for pollock in the Bering Sea.

**EFP 03-01:** The North Pacific Fishery Management Council and Alaska Region of the National Marine Fisheries Service formally approved EFP 03-01 in June of 2003. The exempted fishing permit holders in conjunction with Dr. Craig Rose of NMFS’ RACE Division then conducted two stages of testing of the excluder device from September 2003 through February of 2004. The first stage in September of 2003 focused on the ability of the

device to reduce chum salmon bycatch and the second stage in January of 2004 focused on Chinook salmon bycatch. The objective of both field tests was to determine the effectiveness of modifications to Bering Sea pollock trawl gear to allow escapement of chum and Chinook salmon while minimizing the loss of pollock.

During the year before the EFP test, gear modifications were conceptualized through a series of informal meetings with interested pollock skippers and gear manufacturers. These ideas were developed after reviewing underwater video depicting the behavior of chum salmon in a pollock net, provided by Dr. Rose. Next, Mr. John Gruver of the United Catcher Boats Association developed formal designs based upon his own experiences as a former pollock captain as well as incorporating some of the industry's ideas from the meetings. Lastly, approximately 30 hours of flume tank testing of these designs was carried out with scale models at the Marine Institute at Memorial University in St. Johns, Newfoundland, Canada. The above work, done in preparation for the EFP, was funded and otherwise supported by the United Catcher Boats Association, At-sea Processors Association, Pacific Seafood Processors Associations, Marine Conservation Alliance, and the Community Development Quota (CDQ) groups. This project also benefited greatly from the countless hours donated by John Gruver, pollock fishermen and gear manufacturers, and Dr. Rose and other NMFS scientists.

Just prior to the EFP field-test itself, pre-testing of full-scale gear was undertaken during a NMFS charter arranged for and carried out by Dr. Craig Rose aboard the F/V Vesterallen. The method for pre-testing during the NMFS charter was observation of gear deployment and some fish behavior in response to the excluder via underwater video from cameras and sonars attached to several key points located fore and aft of the excluder.

The EFP testing was conducted under scientifically controlled protocols aboard the F/V Auriga (federal fisheries permit # AFA2889). F/V Auriga is a 193 foot 4,600 HP trawler that is a full time participant in the Bering Sea pollock fishery. The vessel was selected for the EFP test through an RFP process administered by the EFP applicants with technical assistance from the Alaska Fisheries Science Center. The RFP process utilized an application review panel headed by Dr. Gary Stauffer of the AFSC to select the vessel for the EFP. The panel was composed of NMFS scientists with experience putting together and reviewing applications for NMFS' resource assessment and conservation engineering charters.

**Description of the salmon excluder tested in the fall of 2003:** To facilitate insertion of the excluder into the vessel's trawl, an untapered mesh tube was constructed of 4 inch mesh with 2.5 mm polyester twine. This tube was 100 meshes long and 364 meshes around. The host trawl was separated at a point with the same diameter (approximately 7/8<sup>th</sup> distance back from the mouth of the net to the cod-end (see Figure 1a)) and the tube was installed between the resulting ends. The main component of the excluder device tested last fall was a three-sided, tapered tunnel approximately 4 meters in length, made of four-inch knotless square mesh. This tunnel was inserted with its open side downward into the mesh tube (Figure 1b).

The square mesh tunnel tapered from the full diameter of the tube at its forward end to an opening with approximately two-thirds of that diameter at its aft end (Figure 1b). This effectively reduced the space inside the trawl intermediate, forcing everything passing through the trawl toward the bottom panel of the net. The tunnel was designed to create a “lee” (area of slower water flow) in the flow of water through the intermediate around the aft section of the tunnel.

**Figure 1a. Excluder location in pelagic trawl**

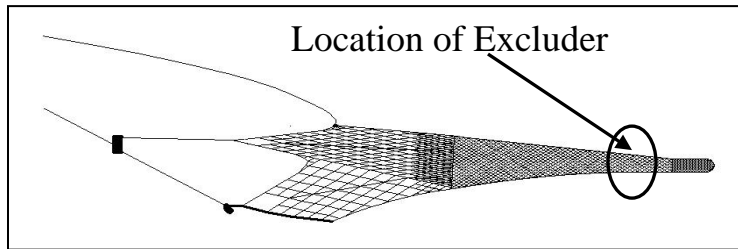

**Figure 1b. Excluder Design**

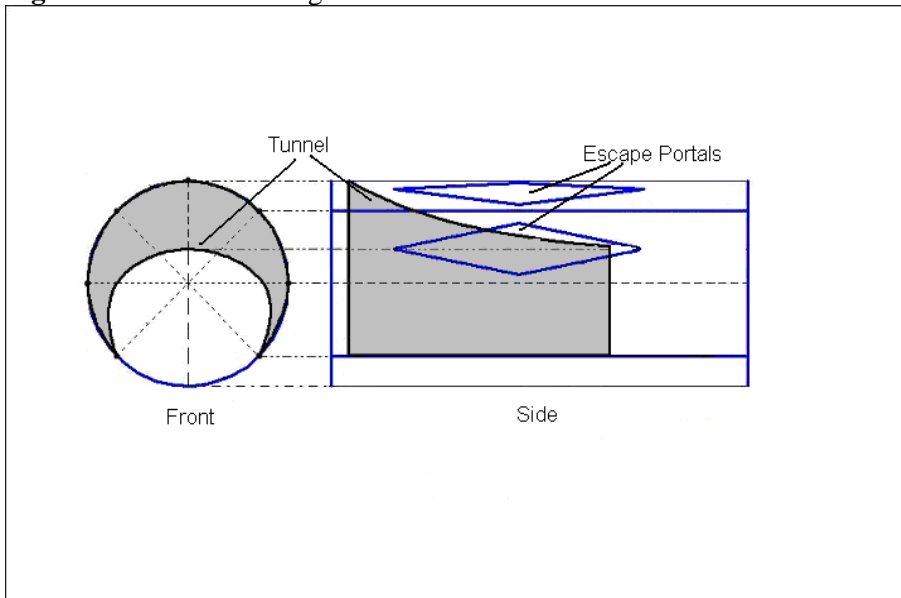

The square mesh tunnel denied fish direct access to four escape portals positioned above and beside the tunnel. Fish could only get to those portals by swimming forward after exiting the aft end of the tunnel. This exploited observations that salmon commonly swam forward in the net, while pollock rarely were able to swim forward and then only for short distances. The lee is created above and beside the tunnel’s aft opening thus making it theoretically easier for salmon to swim forward to the escape portals. The four diamond-shaped escape portals were placed parallel to each other with the pointed ends running fore and aft. The escape portals were cut out sections of the trawl intermediate approximately three meters in length and 1.5 meters in width at their centers. Two escape portals were in the top panel of the trawl intermediate above the tunnel and the remaining two were in the top halves of the starboard and port side panels of the intermediate (Figure 1b).

Escapement of salmon and pollock in the EFP tests was measured via a recapture net placed above the escapement portals running back toward the cod-end. The recapture net was made of relatively light (small diameter) four inch webbing that was fastened to the intermediate approximately five meters ahead and 1 meter behind the escapement portals in the trawl intermediate. This formed a “hood” above the escapement portals which was “flown” up and away from the escapement portals via 12 arc shaped water kites. The kites were constructed of reinforced vinyl and were attached to the top and side portion of the recapture device via square mesh attachment panels running across the recapture net.

The aft section of the recapture device extended back into a second cod-end device via a tapered mesh tube of approximately 30 meters in length. The recapture device’s cod-end was designed to hold approximately five metric tons of catch.

### **Experimental design**

Key to understanding the selection of experimental methods for our EFP is the recognition that incidental catch of salmon in the Bering Sea pollock fishery is a relatively rare occurrence with, on average, less than one salmon taken per ten tons of pollock (approximately 30,000 pollock). To achieve statistical power despite the infrequent bycatch of salmon, our experiment relied upon the retention and identification of fish escaping via the excluder.

The decision to employ a recapture device involved the consideration of tradeoffs. The principal drawback to recapture devices has been ‘masking’: the reduction of fish escapes through physical blocking of escape portals or the presence of stimuli that inhibit escape behaviors. If this problem can be avoided, every tow with a recapture device should provide an independent estimate of escape rate affected only by sampling variability. In contrast, each estimate from a paired testing approach of treatment and control tows requires two tows and has much higher variability due to differences between those tows in the number of fish encountered and gear performance.

This means that the recapture design can provide useful evaluations of device performance with relatively few tows compared to those required for a paired tow design. Therefore, the decision to use a recapture device was mostly based on the practical need to achieve statistical power with a reasonable amount of EFP fishing. Paired tows would have required a much more extensive field testing effort than was practical at this early stage of the development of the excluder device. Additionally, while concerns over changing fish behavior with a recapture device are always an important consideration, Mr. Gruver’s design appeared likely to avoid significant inhibition of escape by using water kites to hold the recapture netting well away from the escape portals.

With an experimental design relying on a recapture device, there are essentially two conceptual outcomes of interest: an individual fish (pollock or salmon) can drop back into the trawl cod-end or it can “escape” through the excluder, and either outcome can be accounted for in the main cod-end of the trawl or via the recapture device cod-end used for our experiment. This set of two discrete outcomes is suited to statistical treatments that evaluate the probability of detecting the proportion of effect.

In this case, the principle proportion of interest is the percentage of individual salmon escaping (desired effect of the device), thus the proportion of the total number of salmon accounted for in the recapture device relative to total number of salmon caught in the recapture device and trawl cod-end. Equally important to the EFP is the proportion of pollock catch that is lost, i.e. recovered in the recapture device.

The approach we used to determine minimum sample size for estimating proportions was to generate a statistical power relationship based on the binomial probability distribution between sample size and statistical power to detect a given effect at a desired confidence level. Lacking an expectation for this underlying proportion, we chose to assume a proportion of 50%, (probability of 0.50).

For chum salmon, which are taken more frequently as incidental catch than Chinook salmon, the specific goal was based on the number of chums needed to have an 80% chance of detecting an effect that is 10% different from the

underlying expected effect of 50%, at a 95% degree of statistical confidence (Figure 2). Due to lower expected incidental catch rates for Chinook salmon, the goal selected was an 80% power to detect a 25% difference from the underlying proportion of 0.50 with 95% statistical confidence (Figure 4). These goals produced target salmon sample size (in numbers of salmon) of 200 and 30 chum and Chinook salmon respectively.

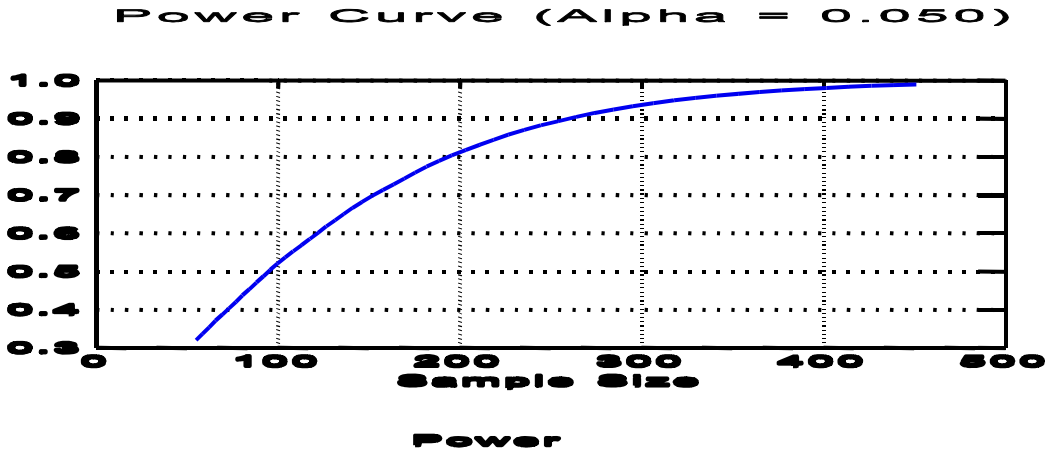
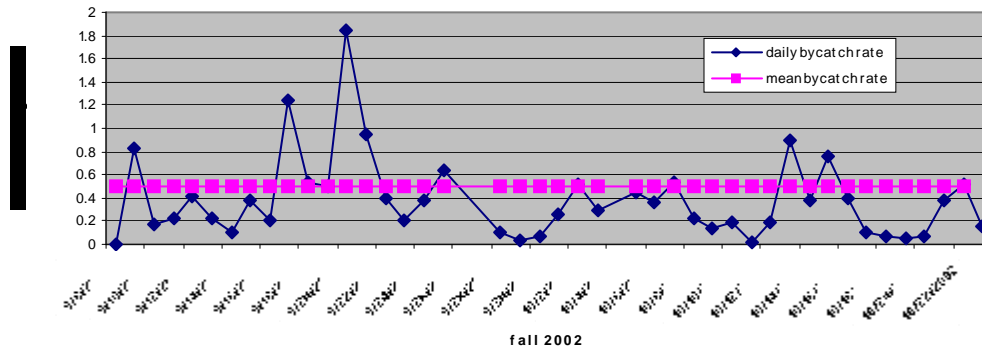

Figure 2: Probability of detecting difference from proportion of 0.6, when the underlying proportion is 0.5 as was used to determine chum salmon sample size

Figure 3: Daily Chum Bycatch Rates





**Figure 4: Probability of detecting difference from proportion of 0.75, when the underlying proportion is 0.5 as was used to determine Chinook salmon sample size**

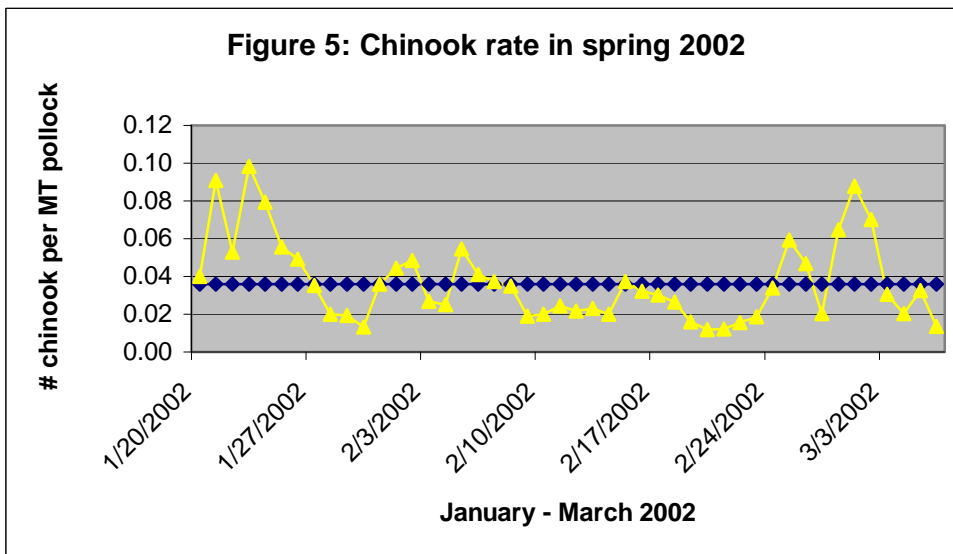

Daily Chinook rates in yellow Average rates 1/20 – 3/06/ in blue

Salmon bycatch rates from the pollock fishery for the prior year were used to make estimates of the quantity of pollock needed to achieve salmon sample size goals. The approach taken was then to estimate the amount of pollock that one would expect to have to harvest in order to catch at least the desired minimum salmon sample size based on expected bycatch rates. Data were treated in a conservative fashion for sample size estimation such that only below average bycatch rates for the period covered by the data were used for sample size calculations (Figures 3 and 5). This was adopted to increase the probability that the EFP achieved its goals even if the EFP fieldwork encountered “below average” salmon abundance conditions in areas where pollock fishing occurs.

An additional consideration was the desire to possibly achieve a sample greater than the minimum sample size. This was desirable from the perspective of both adding power to the test as well as testing the excluder under a variety of ambient conditions so as to gain some level of insights as to factors that might affect performance.

Some of these potential covariates were daylight versus night time fishing, fishing in heavy pollock sign versus lower catch rate conditions, sea state, etc.

Using the method of relying on desired minimum salmon sample size to derive the amount of pollock needed for the experiment as described above, it was determined that the experiment required 970 MT of pollock for the chum salmon bycatch reduction test in the fall of 2003 and 1,300 MT of pollock in the winter of 2004 for the test on Chinook salmon bycatch reduction.

**Field Testing Protocols for the EFP test:** Applicants for the EFP work had to commit to conduct the test fishing according to a protocol that differed somewhat from its usual fishing operations. Many larger pollock vessels (the size of vessel needed to accommodate the compliment of EFP scientists and project personnel) normally attempt to catch approximately 200 metric tons of pollock per haul and hence make two to three hauls per trip (before having to offload its catch as a shoreside processing facility). For the EFP work, however, it was decided that tows targeting approximately 60 metric tons were preferable. This was required for two reasons. First, from the perspective of the EFP test, it was highly desirable to spread the allowable catch over a variety of fishing conditions to hopefully get some preliminary information about factors affecting the performance of the excluder. The second reason was that the vessel was required to attempt to target fishing locations where chum and Chinook (respectively) salmon bycatch was relatively high along with fishable concentrations of pollock. As a practical matter, if the vessel's usual 200 ton target size of hauls were used, then a large fraction of the allowed EFP harvest would be made before there was any information as to whether the fishing was occurring in areas with suitable ambient conditions in terms of salmon bycatch. Adherence to the 60 metric ton target amount per haul was accomplished through use of catch indicating devices to signal when approximately 60 metric tons of catch were in the cod-end. Towing speed for the EFP was in the 4-4.5 knots range, as is typical for directed pollock fishing.

In addition to installing and maintaining the excluder and recapture device, deck crew assisted Dr. Rose's installation and retrieval of underwater camera and recorder equipment during setting and net retrieval. After each haul, the captain (or mate depending on shifts) reviewed the data from the prior haul with the EFP project manager to ensure that the areas selected for the haul were suitable for EFP testing. The criteria for suitability was that pollock catch rates were representative of actual fishing conditions in the regular fishery and that salmon bycatch rates were sufficient for attainment of the EFP sample goals. Additionally, the skipper or mate provided a wealth of information on expected gear performance under the conditions and how the excluder and recapture device might be affecting that performance.

The major requirement for the EFP vessel personnel in terms of handling of catches and sampling during the EFP test was that catches from the recapture device and the main cod-end would be kept completely separate until all salmon could be removed from each device and amount of pollock in the recapture device and main cod-end could be determined for each haul. This necessitated that crew members undertake special handling of catches. Specifically, before placing catch from either the recapture net or main net in the vessel's live tank, all fish were required to be removed (hence sampled and placed in the vessels holding tanks) prior to the next placement of catch.

As a condition for being selected to conduct the EFP work, a motion-compensated flow scale was installed by the vessel owner on a sorting belt to accomplish these tasks. All of the EFP catch was routed across this belt and scale during the EFP. NMFS-trained observers were used in combination with the EFP project manager and other vessel personnel (as requested) to remove salmon, take species composition samples, and take lengths of approximately 100 pollock for each cod-end and recapture bag separately. Observers and the project managers collected data on weight of pollock and numbers of salmon for each regular cod-end and recapture bag for each haul. Species composition and pollock lengths by sex which were also recorded on a haul by haul basis.



These testing protocols were used for both the fall and winter field tests. Total groundfish catch for the two stages of testing, in fall 2003 and winter 2004 tests was 982 and 1,247 MT respectively for a total of 2,229 MT of the total allowable groundfish catch of 2,270. The total number of chum salmon caught during the fall EFP test was 1,196 and for the winter 2004 work, a total of 58 Chinook salmon were taken in the EFP. Although not all catches were eventually used for the analysis (see below), salmon sample size objectives were accomplished in both stages of field work.

EFP testing occurred during an eight day period starting on September 12, 2003. Testing in the winter of 2004 commenced on January 20<sup>th</sup> and covered a ten day period. Because adjustments to the excluder and recapture device were made following the fall 2003 field work in an attempt to improve the performance, results for the two stages of testing will be discussed separately below.

### **EFP Test Results from the fall of 2003 Chum salmon Excluder Test**

Selection of data for the analysis: The results presented below are for tows 2-7 from the fall EFP test. The selection of that subset of the 15 tows overall was done for the following reasons. The first tow was deleted from the dataset for purposes of performance in terms of salmon and pollock escapement. For that tow, underwater video had indicated that the shape of the excluder as deployed in the net of the F/V Auriga was inconsistent with the excluder shape as deployed in the net of the F/V Vesterallen during the NMFS pre-EFP video charter. The excluder location was therefore adjusted to achieve the desired position in the aft section of the square mesh tunnel relative to the escape portals by reducing the back portion of the side escapement portals relative to the aft section of the square mesh tunnel.

Following this, no further changes were made to the excluder for the next six hauls. When those six tows alone are used as data for this analysis, they account for 499.2 metric tons of groundfish and 1005 chum salmon. Noting that the target sample size objective for the chum salmon phase of the experiment was 200 chums, this essentially achieved the salmon (and obviously the pollock) sample size goals of the fall EFP experiment by a factor of roughly five times.

The selection of these tows for the analysis was made because they were sufficient for the experimental design and because due to unanticipated circumstances relating to the performance of the recapture device, a decision was made to abandon reliance on the recapture device in favor of a pilot test of paired tow comparisons. Recognition of problems with the recapture system became evident from video footage of the escape portals from one tow, showing that a minimum of 12 salmon that had “escaped” actually returned to the main net via the escape portals during retrieval of the net at the end of the tow. Video monitoring was unavailable for most of the first set of tows and could not cover all escape holes, so it was impossible to know whether similar reversed escapes occurred during other tows.

While the long delay to re-entry made this very different from the classic ‘masking’ problem that can occur with recapture devices, its effect was similar; fish that would have escaped if the recapture bag had been absent were instead counted as caught in the main net cod-end. This unanticipated outcome presented a problem for the experimental design for our EFP. It suggested that our data might underestimate salmon and possibly pollock escapement. This was a significant problem for the EFP because the degree of reversed escapement appeared to be significant and any potential remedies presented large design issues that could not be addressed at sea during our EFP.

Another important observation was that the unexpected ability of the vessel captain to apparently succeed in finding consistently high numbers of chum salmon per tow. This raised the possibility that much lower tow-to-tow variability could be achieved than that represented in the fishery data used to evaluate, and reject, the paired test design. Lower variability would require fewer tows, possibly making the paired design feasible.

Based on these observations, we opted to use the remaining balance of pollock and salmon for the EFP to make a set of tows with the recapture device removed and the escape portals closed and opened for the paired comparisons. While it was clear from the outset that there would not necessarily be a sufficient number of paired comparisons to make statistically relevant comparisons, we felt that the following could be achieved:

- 1) Obtainment of underwater video of salmon and pollock behavior in response to the excluder in the absence of the recapture net,
- 2) Evaluation of the feasibility of conducting a future EFP test based on paired comparisons by estimating tow-to-tow variability with intentionally matched tows,
- 3) Evaluation of whether the physical work for the crew and project managers associated with switching from open to closed mode for the escapement portals of the excluder could be practically achieved.

Given that we already possessed sufficient data to conduct an analysis of excluder performance under the original experimental design, subject to the influence of reversed escapes, and that the recapture device issues could not be addressed without a dedicated effort to re-design the recapture system, achievement of the three goals above was considered more useful to the long term success of the project than further tows with the recapture device.

**Major findings from the analysis of data from tows 2-7 (with recapture net) in the fall of 2003:**

Subject to the discussion above, the performance of the excluder on chum salmon was analyzed based on the experimental and data collection methods originally proposed for the EFP work. The following results were obtained:

1. Deployment: Although the excluder and recapture device were developed from a set of steps involving flume tank work and pre-testing on a lower horsepower pollock catcher vessel, through video observation we were able to confirm that the gear took the desired shape and began functioning as we expected with one minor adjustment made after the first tow.
2. Ease of setting and retrieving gear and equipment: Due to the above average deck length on the F/V Auriga, the excluder, recapture device, and particularly the 12 water kites could be placed to the side of the trawl alley and did not have to be reeled onto the vessel's net reel. Retrieving the gear did take some additional time due to the need to dump the fish from the recapture bag into the fish hold and weigh and remove the salmon, but this added only approximately 10-20 minutes per haul. In some cases, additional time was also needed to remove camera and recorder equipment from each daytime haul, however, much of this work was accomplished while fish from the recapture bag were being sorted and weighed.
3. Sampling in the EFP: With the sorting belt and flow scale installed for the EFP and with the protocols developed for the EFP, the team of project managers, NMFS-trained observers, and vessel crew were able to account for catches from recapture and main nets separately. Removal of all salmon, pollock length data collection, and species composition sampling for all tows were also accomplished with little or no difficulty.
4. Excluder Performance:
  - Chum salmon bycatch was reduced by 12.3% (escapement of 123 of a total of 1005 chum salmon)
  - Pollock escapement by weight was 2.6% (12.3 MT out of a total pollock catch of 464.6 MT)
  - Of the groundfish captured in the main cod-end, pollock comprised 99.1% by weight. Pollock comprised 99.8% by weight of the groundfish in the recapture net. This suggests that among groundfish species, pollock escaped at a higher rate than other groundfish species in the catch (such as cod and flatfish)
  - Pollock of less than 40 cm escaped at around 2% while those 41 cm and larger escaped at approximately 3.5%.

### **Findings from paired treatment and control tows (tows 8-15):**

Paired comparisons were achieved by rotating tows with the recapture device removed. For treatments, the excluder escape portals were left open as the device would be used in an actual application in the regular fishery. Control tows were achieved by reinserting the webbing that was originally removed to make the escape portals. These diamond-shaped pieces were reattached via a twine zipper that so that they could be removed again for the treatments.

1. Approximately one and one-half hours of work by deck crew and project managers were required to close the escape portals as described above. Weather conditions were ideal during the fall 2003 field work. At least under these conditions, it appears that the physical work for testing paired comparisons is feasible.
2. Based on the control tows during the paired comparisons as compared to overall salmon bycatch rates for tows 2-7 (pooling data from excluder and recapture device), it appears that salmon bycatch rates were both lower and more variable in tows 8-15. Because the paired comparisons were done approximately 60 hours later after offloading catch from the prior trip and possibly because a weather system had moved through in the interim (which served to delay the start of the testing with paired comparisons), it is possible that salmon bycatch conditions experienced during tows 2-7 had actually changed. Pollock catch rates in the prior area also appeared to be lower. For these reasons or possibly unknown differences, the steady and high salmon bycatch conditions that had encouraged our assessment of feasibility of testing with paired comparisons were not experienced when the EFP resumed. The vessel had returned to the former fishing area and, finding conditions had changed, moved to adjacent areas but these attempts to recreate former conditions were not successful.
3. While salmon bycatch rates for the treatment tows were nominally lower for treatments within all the pairs, these differences were not significantly different statistically (@  $\alpha = 0.10$ ). In evaluating these paired comparisons, differences in salmon bycatch rates were evaluated on a bycatch per distance towed, salmon bycatch per time, and finally bycatch per ton of pollock basis. None of these different ways of evaluating the data showed a significant effect.
4. Using salmon bycatch rate per ton of pollock to evaluate the data (the most promising index from the paired comparisons) and assuming the conditions (variance) experienced during tows 8-15, it would take approximately 50 paired comparisons (assuming performance and variance remained consistent during the time needed for 50 pairs) to achieve statistical significance for a paired test of the excluder.
5. The captain and mate of the F/V Auriga were asked to comment on the potential effect of the excluder on pollock catch rates. From their knowledge of what kind of catch rates they would expect to find for the treatment tows, both thought that pollock escapement was minimal. Both stated that the pollock catch rate per hour with the excluder was sufficiently high to allow successful commercial operations under the ambient conditions.

### **Discussion of results from tows with the recapture device (1-7) and paired comparisons in tows 8-15:**

The EFP test demonstrated that the sampling and handling protocols were feasible. Using the counts of salmon at the shoreside processing facility as a check for estimation of salmon bycatch on a trip by trip basis (salmon bycatch can not be effectively estimated on a haul by haul basis through deliveries to shoreside facilities because multiple hauls are placed in a single tank), salmon counts were off by one for the second trip and four for the first trip during the fall 2003 EFP work. Relative to the overall number of chum salmon taken in the fall EFP, these differences were minimal thus indicating that haul by haul estimation of salmon numbers on the vessel's sorting belt was largely successful.

Whether for the protocols under hauls 2-7 or the paired comparisons, the gear and catch handling requirements and task for NMFS-trained observers and vessel crew were accomplished without significant difficulties. This attests to the hard work of both parties because the EFP required a great deal of additional work of both parties relative to duties during regular fishing trips for a shoreside delivery pollock vessel.

With certain limitations, the chum salmon bycatch reduction performance of the excluder in tows 2-7 (12% reduction) can be viewed as a minimum estimate of the excluder's effectiveness. Due to the lack of underwater camera placement to observe salmon returning from the recapture device to the regular net, however, the assumption that it occurred on other or all other tows is certainly speculative. Upon review of the video for tow 4 where reversed escapes were observed, it was decided that a conservative estimate of the number of salmon (12) that reversed their escape would be made to adjust the performance data for that tow. With this adjustment, the salmon bycatch reduction on that tow increased from 13% to slightly higher than 20% (Table 1). Engaging in this use of tow-by-tow performance to describe general performance should, however, only be done with the caveat that the experiment was not designed to reliably evaluate haul by haul performance of the excluder.

Table 1. Haul by haul data from the fall 2003 chum salmon excluder EFP

tow number	cod-end MT	recapture MT	% pollock escape	cod-end salmon	recapture salmon	% salmon escape
2	57.9	3.7	6.0%	261	33	11.2%
3	75.1	1.5	1.9%	77	11	12.5%
4	60.2	1.2	2.0%	*138	*35	*20.2%
5	82.0	1.8	2.1%	153	20	11.6%
6	84.8	1.7	1.9%	106	15	12.4%
7	92.3	2.4	2.6%	147	9	5.8%
Overall	452.3	12.3	2.6%	*882	*123	*12.2%

\*Note: these numbers reflect the adjustment of 12 salmon to the recapture net count on tow 4 (see above)

Measurement of the pollock escapement rate for tows 2-7 is far more likely to be accurate given that the reversed escapement of a few hundred or even thousand pollock from the recapture device to the main net would not have affected the results. Likewise, if multiple tons of pollock had returned to the main net, cameras placed in other locations would almost certainly have observed this phenomenon. For this reason, our confidence is high that the loss of pollock associated with using the excluder is in the range of 2-3%.

The relative ability of pollock of different lengths to escape the trawl was of significant interest to the pollock industry due to the higher value of larger pollock in general. Overall, it appears that the excluder did allow larger pollock to escape at a slightly higher rate than smaller pollock. In analyzing the length data, it must be noted that estimates of percent escapement at the extremes of the length range were likely to be highly variable due to few fish represented in the data. To smooth out this problem, we grouped cm-groups together at both ends of the length range. Length groupings were also standardized by requiring that each range have at least 2% of the fish in it so that the results were more stable (Figure 6).

While consistent with the expectation that larger pollock would have a better chance of escaping because they are likely stronger swimmers than smaller pollock, there is also some chance that the small difference by size reflects that smaller pollock may have been able to escape through the 4 inch meshes of the recapture bag at a higher rate than through the meshes of the main net. This is a plausible outcome given that the smaller diameter twine used for the recapture device may have created a slightly greater effective hole size between meshes. Likewise, the small recapture cod-end provided each fish greater access to those holes than the large, crowded, main cod-end.

Figure 6: Length frequency effects of 2003 excluder in terms of percentage of pollock by length class

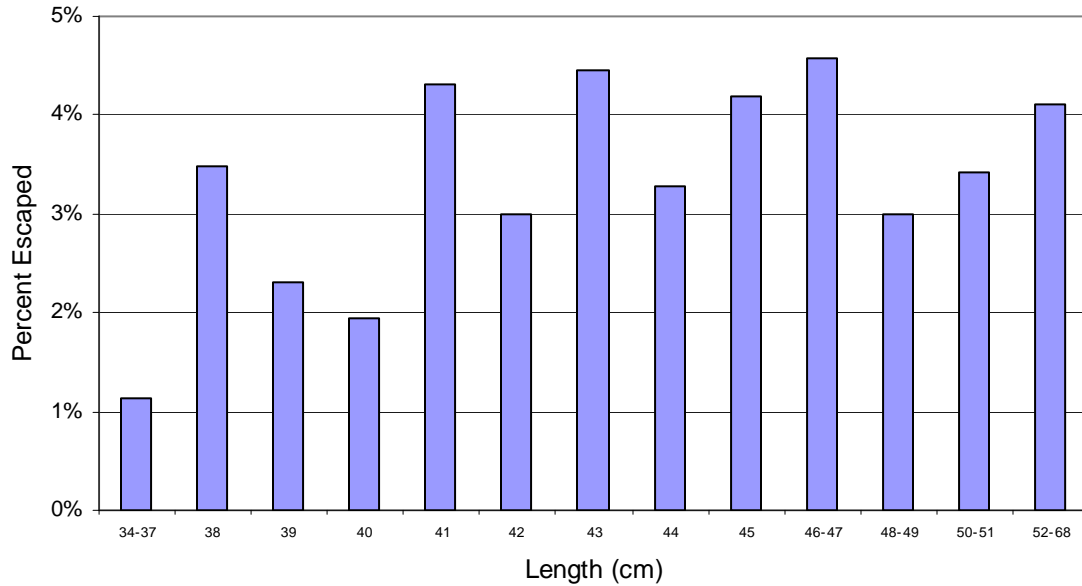

Upon discussing the results in terms of effects on pollock catches with the captain and mate of the F/V Auriga, neither thought that the rate of loss of pollock overall was problematic, nor that the slightly higher fraction of escapement of larger pollock was an issue. The same was true when the results were made available to pollock skippers at a follow-up meeting on the EFP results last fall. Most feel that from the perspective of filling the vessel’s hold in a timeframe to achieve the required quality standards for the aging of pollock, such a loss has little or no effect. Additionally, many have noted that if the performance of the excluder is in the range of 12-20% reduction of chum salmon bycatch and thus corresponds to an equivalent related decrease in the Chum Salmon Savings Area closure time, then the tradeoff for loss of 2-3% of pollock catch is well justified.

Because the EFP testing covered a set of limited conditions such as good weather in September with up to 14 hours of daylight per day and little or no problems with jellyfish and other elements that might confound the results, captains (and EFP investigators) are quick to point out that the validity of these results to other conditions is unknown. It is worth noting that even if an additional 8 tows had been made with the recapture device and experimental methods used in tows 2-7, this would not have extended the testing over a much wider set of conditions in order to learn about the performance of the excluder under all relevant conditions. The gains would have been in terms of testing under conditions of lower average salmon bycatch rates but would not have included differences in terms of average daylight per day or abundance of jellyfish.

The testing of pairs of treatments and controls should be viewed as a pilot test to evaluate this approach for potential future application. It might have been preferable to modify the recapture net to prevent the reversed escapes once that problem was detected in lieu of embarking into a pilot test of paired tows. Attempting to implement changes to the recapture device without thoughtful design and testing, however, appeared to be as likely to introduce new problems as to solve the existing one. The potential alternative of monitoring all escape portals with cameras was also not feasible given the limitations of available video systems. These include limited recording times (shorter duration than many full tows), inability to consistently image the full area of all escape portals, and insufficient ambient light at night and at the deeper end of the fished depth range.

While tows 8-15 proved that the rotations between control and treatment were feasible (a big issue given the size of a pelagic pollock net and hence the relative size of the escapement portals), as with all field research, the difficulty of holding excellent experimental conditions constant was once again noted. With the consistent and high chum bycatch rates of tows 2-7 and the possibility that escapement rates without the potential effects of recapture net could be as high as 20%, the prospect of actually finding that such an effect could be determined reliably in a manageable amount of EFP fishing was very attractive.

Testing without a recapture device is inherently more appealing overall because as noted above, recapture devices can influence fish behavior. We now also know that they can confound the effects of the device. In any case, the paired tows portion of the work was useful from the perspective of getting some feedback from the skipper as to how the net actually fished with the excluder minus the recapture device. The exercise also allowed for estimates of some statistical power relationships for the conditions we were experiencing (a less than ideal set of conditions) and this will be useful for evaluating potential for paired comparisons under other sets of conditions.

### **EFP Test in the winter 2004 Chinook salmon Excluder Test**

#### Gear modifications for the winter 2004 test

Given the early stage of development of the salmon excluder and the possibility that the first stage of testing might uncover problems or possibly new areas of focus, our application for and exempted fishing permit anticipated making adjustments to the excluder for the second stage of testing. The potential need for changes to adapt the excluder for expected behavioral differences between chum and Chinook salmon was also highlighted. In light of the fall test results, two areas emerged for adjustments to the experiment and excluder.

Pertaining to the excluder itself, although we could not determine with certainty the exact performance of the device in terms of its ability to exclude salmon, even assuming the most optimistic estimate of performance (20%) from the single tow in 2003 where the underwater camera allowed for adjustment of the salmon escapement rate, performance was still at a level where improvements were desirable. The goal of prioritizing the objective of salmon escapement over pollock retention was consistent with our underlying approach for the EFP. Therefore, we aggressively concentrated on the pursuit of salmon bycatch reduction, relying on future efforts, either through EFPs or independent industry efforts, to find ways to reduce pollock escapement. Aggressive modifications to increase salmon escapement would, at a minimum, increase our information on whether such performance gains were possible as well as allowing us to start to explore the tradeoffs in terms of loss of pollock.

Towards this goal, one possible direction to pursue was to change the square mesh tunnel so as to increase the incentives it created for salmon to escape. Another approach might be to insert multiple excluder tunnels into the intermediate with additional sets of escape portals so as to potentially increase performance by providing multiple chances at essentially the same type of excluder. These possible adjustments were conceptualized after review of underwater video showing that some chum salmon responded immediately to the lee that was created aft of the tunnel. For those that responded immediately, a subset escaped successfully while others appeared to abandon their attempt after a period of time of swimming in proximity to the escape portals. Other salmon passing through the net appeared to go through the square mesh tunnel and keep moving back toward the cod-end of the main net with no apparent response to the excluder. Still others attempted to escape after passing through the tunnel and later moving forward, mostly at a time when the relative net speed slowed such as during haulback. Lastly, in some cases, salmon could be observed swimming in front of the square mesh tunnel for a period of time before eventually moving through it. Most of these salmon did not make an escapement attempt when they passed through the tunnel.

While not inclusive of every outcome observed, these were the main responses to the excluder and escape portals that were observed through video and sonar equipment inserted into the net around the excluder. Based on this information, the plan adopted for modifications to the excluder amounted to a middle ground between modifying the excluder and adding multiple excluder tunnels with additional sets of escapement portals. The first change to the tunnel was the use of 3 inch knotless square mesh in lieu of the 4 inch knotless mesh used before. The switch

to 3 inch was made to reduce “gilling” of pollock in the tunnel that occurred to some degree in the 2003 test. While the number of pollock that became caught in the meshes of the 4 inch square mesh tunnel was not thought to be problematic, there was some concern that with the higher catch rates expected with winter season fishing in 2004, “gilling” might increase and restrict flow through the excluder.

The second change was to add an additional tunnel. The added tunnel reduced the diameter of the passage by a smaller percentage than the 2003 tunnel design. Tests using the 2003 design had shown that the dramatic decrease in diameter change in that tunnel was potentially problematic. For the 2004 design, the new tunnel was installed in front of a tunnel identical to the 2003 tunnel and thus served as an intermediary step to gradually reducing the diameter of the passage. Because it was shorter (4 meters) and had less of a taper, the additional tunnel reduced the passageway (effective diameter of intermediate) at its aft end by approximately one-quarter of the diameter of the intermediate. The second tunnel was exactly as in the 2003 design which reduced the diameter of the passageway inside the intermediate by one-third (Figure 7).

The design objective of the two slightly different tapered tunnels approximately one meter apart was to provide an escapement opportunity for those salmon that appeared to hesitate in front of the excluder used in 2003. With the less dramatic change in diameter of the first tunnel, it was hoped that salmon would be less likely to swim in front of the first excluder tunnel and, if they hesitated in front of the second, they could escape by swimming up and forward via the escape portals located above the first tunnel. With this configuration, it was hoped that an additional escapement opportunity would be created that would have little or no effect on escapement potential for the second tunnel.



Figure 7.

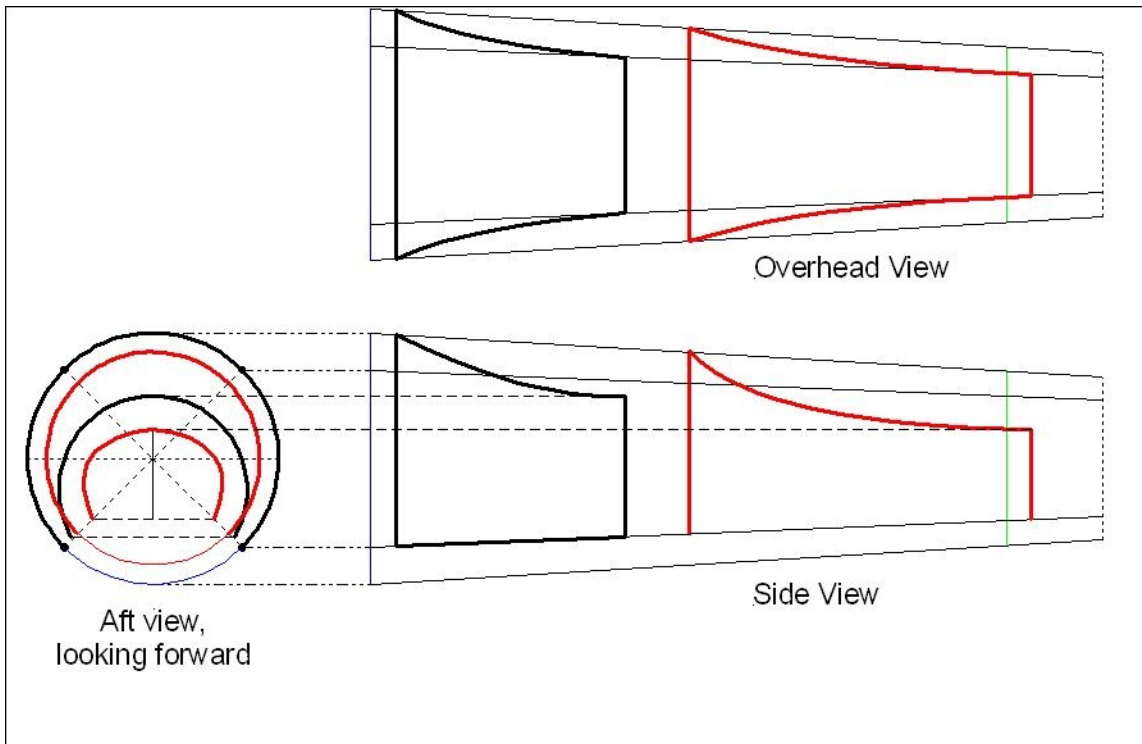

One final adjustment to the excluder involved a redesign of the escape portals. Video had revealed that some salmon swam near the diamond-shaped holes for a 5 to 20 second duration and a subset of these salmon eventually failed to escape. The aft end of the diamond-shaped portals appeared to be the area where this behavior was concentrated and the question emerged as to whether this area attracted the salmon via a water flow issue or some visual or other sensory response. In the end, the portals were reshaped to increase the escapement area into a rectangle covering nearly all of the top panel, with only lines (0.5 inch diameter) connecting the meshes ahead of and behind it. Smaller triangles of mesh spread the force of those lines across the forward and aft edges of the portals.

The other major logical area of focus for the winter 2004 work was to modify the recapture device so as to reduce or prevent the return of salmon from the recapture net to the main net upon net retrieval. This also involved conceptual tradeoffs. Any modification to the recapture device to reduce potential for salmon to return from the recapture device to the main net could possibly jeopardize the positive performance attributes that had been attained, that of minimizing the recapture net's influence on escapement behavior of salmon. The use of water kites in the fall of 2003 and the light materials and design features of the recapture device had, based on observations with video, achieved sufficient lift of the recapture net such that it appeared to allow salmon to use the escape portals with little or no difficulty. This was no small accomplishment given the engineering necessary to essentially append a second net on to the upper portion of the main net. The second net would have to assume a normal shape despite reduced water flow.

Regarding the problems encountered with salmon returning from the recapture net to the main net at the time of haulback, several approaches were discussed to attempt to address this outcome. In the end, however, after reviewing the steps taken to design the recapture system, there was considerable concern that any major changes could radically affect the effectiveness of the recapture system in terms of creating enough of a distance between the escape portals and the outside of the recapture net. If the recapture net was too close to the escape portals, everyone felt that some fish seeking to exit would not do so because either there would be insufficient room for

fish to exit or the proximity of the netting would create a negative stimulus. From the meetings and internal discussions with the chief designer of the excluder and recapture system, Mr. Gruver of Untied Catcher Boat Association, it was recognized that the only truly effective approach to working on the recapture net would have been to go back to the flume tank after designing an improved recapture system. That new system would include increased water flow so that more of the escaping catch would move back into the back portion and eventually to the cod-end of the recapture net. Alternatively, a one-way valve made of webbing similar to a pot tunnel used in cod and crab pots (on a larger scale) could be designed for the recapture device. Either approach to a potential remedy, however, would virtually require some engineering steps that could only be efficiently undertaken in a flume tank.

Because neither the time nor the resources existed to develop major modifications to the recapture system, it was decided that the only interim solution for the winter 2004 field work would be to emphasize placement of cameras and sonar to provide a better means of estimating the degree that reversed escapes occurred. Additionally, the field testing protocols were reviewed in an attempt to reduce the period of time where the relative speed of the net was effectively reduced, because the video work suggested that this was the most likely period for the reversed escapes to occur. Most of these slowdowns were associated with the time needed to remove both the vessel's headrope net sounder, experimental camera gear, and the time needed to remove and account for the catch in the recapture net. For the winter 2004 field work, steps were implemented to reduce this time to the degree possible without compromising the collection of data for the experiment. This was the only available approach although everyone involved with the EFP recognized this plan was not without its inherent limitations.

#### **EFP Test Results from the winter 2004 Chinook Salmon Excluder Test**

Selection of data for the analysis: The results presented below are for tows 1-9 from the winter 2004 EFP test. The selection of that subset of the 14 tows made with the new excluder configuration was necessary because of damage to the excluder and recapture net. The recapture net from tow 10 contained so much pollock that its cod-end split open as it was hauled up the stern ramp. When the same problem occurred on haul 11, the excluder was spread out for examination. The forward tunnel had split down both its seams (the tunnel was constructed from three similar size panels of netting sewn together along two longitudinal seams) and had torn away from the intermediate along half of its forward attachment. This allowed fish to swim directly into the forward escape hole without passing through a tunnel, the likely cause of the two large recapture catches. Those two catches severely damaged the recapture net and its attachment to the main net. While repairs were attempted for tows 12 – 14, none lasted throughout an entire tow. Each time, the recapture net came up with enough damage that substantial loss of recapture fish was considered likely. Therefore, data from tows 10-14 were not included in this analysis.

The analysis of winter EFP results below, based on the first nine tows, accounted for 745.7 metric tons of groundfish and 31 Chinook salmon. Noting that the target sample size objective for the Chinook salmon phase of the experiment was 30, it should be noted that this only minimally accomplished our salmon sample size objectives (exceeding the minimum by only one salmon in contrast to the 2003 work where the sample size was exceeded by a factor of close to five times).

A total of 84 Chinook salmon were caught in the winter 2004 EFP work. This does not account for whatever salmon might have been in the recapture net for tow 11 where the recapture net ruptured and nearly all the catch escaped. This means that overall, approximately 60% of the Chinook salmon taken in the EFP occurred on tows that we eventually excluded from the analysis due to the malfunction of the excluder. Likewise, the tow that had the greatest number of Chinook salmon turned out to be tow 11 where the recapture net failure did not allow accounting for salmon that escaped through the excluder and 22 Chinooks were recovered in the cod-end of the main net.

#### **Major findings from the analysis of data from tows 1-9 in the winter of 2004:**

Subject to the above discussion of data selected for the analysis, the performance of the excluder on Chinook salmon was analyzed for tows 1-9.

1. **Deployment:** For tows 1-9, the gear deployed as it was designed. This was confirmed through video and sonar observations. The excluder tunnels acquired the desired shapes and the recapture net was flying sufficiently above the eight escapement portals so as to avoid impeding fish escapement from the excluder.
2. **Ease of setting and retrieving gear and equipment:** For the first nine tows, no new issues emerged for setting and handling. Due to reduced daylight in the winter season, camera work on deck was limited and for many tows, only the sonar camera was attached to the net. Although attempts were made to reduce the time taken for net retrieval, winter weather conditions did frustrate this effort to some degree.
3. **Sampling in the EFP:** For tows 1-9, sampling presented no new difficulties. Because Chinook salmon are generally less abundant as bycatch in the pollock fishery (compared to chums), removal of salmon was less physically demanding than for chum salmon in 2003. Greater amounts of pollock in the recapture net increased the time needed to sort through and sample the recapture net fish in some cases. According to our protocols, removal and accounting of recapture net catch had to be completely finished before any of the catch from the main net could be placed in the vessel's live tank.
4. **Excluder Performance:**
  - Chinook salmon bycatch was reduced by 12.9% (escapement of 4 of a total of 31 Chinook salmon).
  - Pollock escapement by weight was 4.1% (30.9 MT out of a total pollock catch of 745.7 MT). The percentage of pollock escapement per tow varied from a low of 1.8% and a high of 9% (Figure 8).
  - Of the groundfish captured in the main cod-end, pollock comprised 95.4% by weight. Flatfish and cod were the primary incidental catch species. Pollock comprised 98.4% by weight of the groundfish in the recapture net. This suggests once again, that among groundfish species, pollock escaped at a higher rate than other groundfish species in the catch.
  - The average size of pollock escaping via the excluder does not appear to be different from the average size of pollock in the catch for our winter 2004 work (Figure 9).

Figure 9: Length frequency effects of 2004 excluder in terms of percentage of pollock by length class

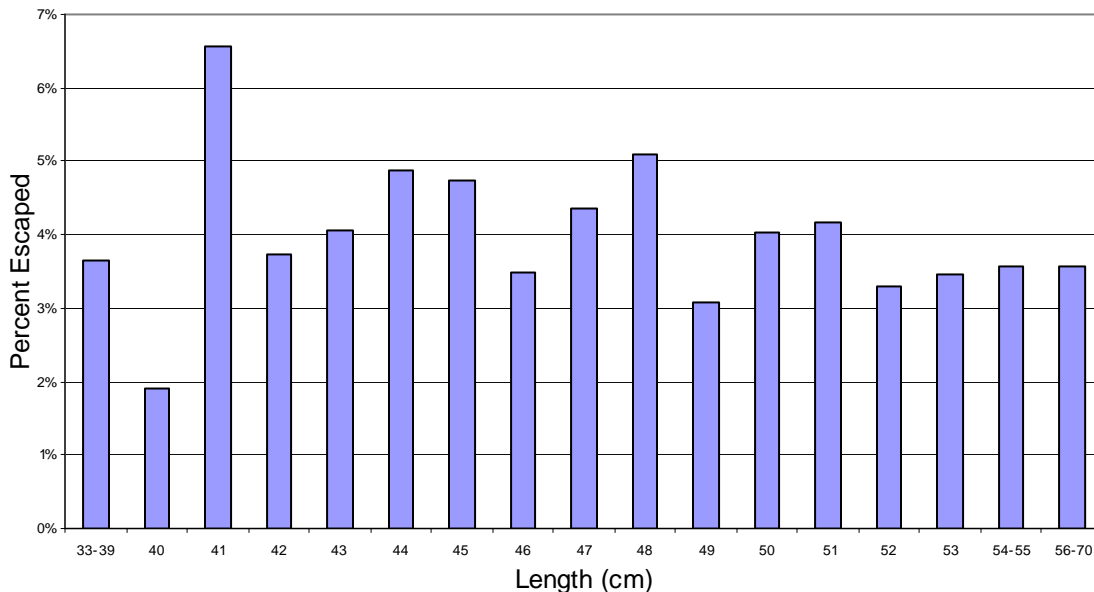

#### Discussion of results from the winter 2004 experiment

The EFP test demonstrated once again that the EFP sampling and handling protocols were feasible although the handling and accounting of large pollock catches in the recapture net were problematic on some tows. Problems here surfaced because the recapture net was not sufficiently reinforced to hold these large quantities (> 10 MT).

Using the counts of salmon at the shoreside processing facility as a check for estimation of salmon bycatch on a trip by trip basis, salmon counts onboard the Auriga (haul by haul accounting) were off by only one for the three trips taken for winter of 2004 EFP work. Relative to the overall number of Chinook taken in tows 1-9, the influence on the results was minimal because the overlooked salmon was almost certainly attributable to the main cod-end, not the recapture net. This is because the much smaller amount of fish in the recapture net makes it unlikely that a salmon (retained) in the recapture net was not discovered.

The Chinook salmon bycatch reduction performance of the excluder in tows 1-9 (~13% reduction) can once again be viewed as a minimum effectiveness of the excluder. This is because sonar observations did reveal that at least one salmon that had passed into the recapture device returned into the main net. No returns to the main net were observed through video for the winter 2004 experiment. Our ability to detect a reversed escape through our fast-updating sonar “camera” was an encouraging finding. Unlike video observations, with the sonar, the species of salmon could not be determined. For this reason, data used for the analysis were not adjusted for the tow where a reversed escape was recorded. For purposes of evaluating the inherent variability between hauls, tow by tow performance data for the winter 2004 EFP is reported in Table 2.

Table 2. Haul by haul performance of winter 2004 chinook salmon excluder

<u>tow number</u>	<u>cod-end MT</u>	<u>recapture MT</u>	<u>% pollock escape</u>	<u>cod-end salmon</u>	<u>recapture salmon</u>	<u>% salmon escape</u>
1	98.8	6.4	6.1%	2	0	0%
2	64.9	1.3	2.0%	1	1	50%
3	102.5	3.6	3.4%	0	0	n/a
4	41.3	4.1	9.0%	4	0	0%
5	75.7	3.6	4.5%	2	0	0%
6	108.1	2.0	1.8%	2	1	33%
7	99.5	5.4	5.1%	5	2	29%
8	60.1	1.1	1.8%	5	0	0%
9	63.9	3.3	5.0%	6	0	0%
Overall	714.8	30.9	4.1%	27	4	12.9%

The failure to achieve a higher percentage of Chinook salmon escapement was surprising and somewhat disappointing given that the modifications to the excluder appeared to greatly increase the likelihood that salmon would escape. The increase of pollock escapement to over 4% from the 2.6% achieved in the 2003 work appears to suggest that at least one species in the catch made use of the increased opportunities for escapement.

There are several possible explanations for the failure to increase escapement performance of salmon. The first is that Chinook may behave differently from chum salmon. Chinook may be less inclined to swim above the pollock in the trawl intermediate or may be less inclined to swim up as an escape behavior response relative to chum salmon. We are unable to discern whether ambient light conditions affect the ability of salmon to utilize the excluder as well and there is certainly less daylight in the winter compared to when testing occurred in 2003. Interestingly, however, some of the best tow by tow escapement rates for the 2003 test occurred on tows made entirely during night fishing conditions.

An equally plausible explanation is that the higher catch rates of pollock may simply mean that Chinook salmon are more “walled in” by pollock than was the case for chums in fall 2003 EFP fishing given that pollock are more densely schooled in the winter prior to spawning. This might mean that Chinooks are less likely to even have access to the excluder or less likely to respond to the water flow changes it creates. Lastly, given that the minimum sample size amounts were just barely attained, there is certainly less assurance that the test actually demonstrated the actual performance of the winter 2004 device.

The performance results during the EFP were discussed with the captain and mate of the Auriga following the EFP test. We were once again interested in their feedback regarding the tradeoffs in terms of bycatch reduction and loss of pollock. While a 4 percent loss of pollock was not seen as problematic in terms of being able to fill the vessel’s hold sufficiently rapidly to be able to meet quality specifications, the real issue for the captain and mate is why the 2004 excluder would be preferred over the simpler 2003 version. In the end, it would have been informative to test the performance of the excluder used in the 2003 stage of the EFP for the winter 2004 test to see how it performed for Chinook salmon under winter fishing conditions. It is certainly possible that the 2003 version of the excluder would have performed as well as the two-tunnel model, possibly better. Overcoming the higher abundance of pollock in the net and/or providing better access and stimulus to salmon seems, however, less probable with a single tunnel and one set of escape tunnels.

The results on relative ability of pollock of different lengths to escape the trawl were of significant interest due to the higher value of larger pollock, especially given that pre-spawning pollock or larger size tend to have higher roe recovery rates and higher quality roe. In analyzing the length data, it must be noted that estimates of percent escapement at the extremes of the length range were likely to be highly variable due to few fish represented in the data. To smooth out this problem, we grouped cm-groups together. Length groupings were also standardized by requiring that each range have at least 2% of the fish in it so that the results were more stable.

Our findings on relative length of pollock escaping suggest that the winter 2004 excluder did not allow larger pollock to escape at a higher rate. This was a somewhat surprising result. Larger pollock can be expected to be stronger swimmers and hence more likely to make use of the excluder. While mostly speculative at this point, a possible explanation is that with the high catch rates of winter pollock fishing, a portion of the pollock escapement may occur as a result of large pulses of catch moving through the excluder which is an area of somewhat rapidly reduced circumference with the taper of the second excluder tunnel reducing the passage area by as much as one-third. When these pulses of fish moved through the tunnel, the change in water flow may be so dramatic that pollock escapement is essentially random in terms of escapement being comprised of whatever fish are closest to the escape portals.

Our winter 2004 video footage at times appeared to show that large pulses of pollock moving through the excluder at times essentially appeared to push some of the fish up toward the top of the intermediate where the escapement portals were located. This phenomenon was not observed in fall 2003 video. Last fall, virtually all pollock and salmon escapement observed appeared to occur from deliberate attempts to respond to the excluder. For the winter of 2004, there may actually have been a random selection of the fish sizes moving through the net when large bursts of fish passed through the excluder although this only appeared to occur at times of extremely high catch rates. In any case, we do not have any way of knowing whether these large pulses of fish moving through the excluder are responsible for the failure to detect a size difference effect in the pollock length data.

**Findings Overall and Future Direction for Development of a Salmon Excluder:** Our test demonstrated that it is possible to reduce salmon bycatch in pelagic pollock nets via an excluder that relies on behavioral differences between the species. While headway was made in the development of an effective excluder, the end goal of escapement of a large portion of the salmon was not achieved. Based our experiences thus far, successful attainment of an effective salmon excluder will be a significant challenge requiring considerable additional design work and field verification.

Future development efforts should continue to prioritize increasing salmon escapement even at the cost of higher pollock escapement. Evidence thus far suggests that once higher escapement of salmon is achieved, it is likely feasible that pollock escapement can be addressed while maintaining salmon escapement performance. As work on the excluder progresses, additional video and sonar observation of fish behavior in response to the excluder (and possibly other stimuli introduced to create a behavioral response) will be obtained. This will likely be of vital importance to the overall development of the excluder. This added information on fish behavior may expose new and more productive designs for salmon excluders that more effectively exploit differences in behavior between salmon and pollock.

The logical direction for development of the excluder is to return to the fall 2003 design that employed a single square mesh tunnel and make adjustments to improve salmon escapement. One productive direction may be to redesign the square mesh tunnel so that it loses its rigid shape and collapses with reduced water flow, such as during haulback. Our work showed that a considerable number of salmon that did not respond to the excluder during their first pass through the net appeared to move forward to the intermediate from the cod-end section of in the trawl during haulback. If the excluder tunnel could be designed to collapse at that point, then those salmon might find their way out the escape portals because they could no longer simply move forward through the tunnel toward the mouth of the trawl.

Regarding the direction for further development and testing of the excluder, because of the magnitude of the challenge and the fact that the excluder is truly still in its infancy, further research charters and EFP testing are warranted before a viable application to the regular fishery can be made. Future tests under charters and EFPs will likely have to continue to rely on recapture devices to obtain statistical power for measurement of effects. Design of a one-way recapture system is therefore of paramount importance. This will undoubtedly require significant design work.

**Acknowledgements:** We wish to thank the following individuals, companies, institutes, and associations for their financial support for this project and in many cases their willingness to donate countless hours of technical assistance and manpower during the many stages of our design work and field testing:

Associations: United Catcher Boats Association, At-sea Processors Association, Pacific Seafood Processors Association, Marine Conservation Association, Aleutian Pribilof Island Community Development Association, Bristol Bay Economic Development Corporation, Central Bering Sea Fishermen’s Association, Coastal Villages Region Fund, Norton Sound Economic Development Corporation, Yukon Delta Fisheries Development Association.

Companies: Swan Nets USA, Unisea Corporation, Alaska Ocean Seafoods, Lummi Fisheries Supply, NET Systems.

Agencies and Institutes: National Marine Fisheries Service (RACE Division of the Alaska Fisheries Science Center and Sustainable Fisheries of the Alaska Region), North Pacific Fishery Management Council, Marine Institute of Memorial University of Newfoundland.

Individuals: John Gruver (United Catcher Boats), Dr. Craig Rose (NMFS RACE Division), Dr. Gary Stauffer and Dr. Russ Nelson (NMFS RACE Division), Seamus Melly (Swan Nets USA), Charles Bronson (F/V Great Pacific), Brian Melvin and Matt Lieske (F/V Auriga), John Olson (NMFS AK Region), Diana Stram (NPFMC), Mike Stone (Fury Group), Sylvia Ettefagh, Harold DeLouche and Carl Harris (Memorial University).