

History of the NOAA Satellite Program

Gary Davis

NOAA Satellite and Information Service
1335 East-West Highway, Silver Spring, Maryland, 20910, USA
www.osd.noaa.gov

Abstract

For more than 50 years, NOAA's environmental satellites have been an integral key to life-saving weather and climate forecasts for the United States. NOAA, the National Oceanic and Atmospheric Administration, has a rich history of successfully operating geostationary operational environmental satellites (GOES) and polar-orbiting environmental satellites (POES) that have helped take some of the mystery out of atmospheric phenomenon. Through the years, NOAA, with cooperation with NASA, has developed increasingly advanced satellites that have provided higher spatial and temporal resolution images, operational soundings, atmospheric temperature and moisture data in all weather situations. During those 46 years, NOAA has also built strong partnerships within the U.S. and throughout the world, leading to satellite-data sharing agreements that will strengthen the scientific community's understanding of the world's changing climate. The article, History of the NOAA Satellite Program, traces the development of the U.S. weather satellite system from an early commitment in 1953 by the Eisenhower administration to hoist an Earth satellite in orbit in 1958, to the next generation polar-orbiting system, the Joint Polar Satellite System (JPSS).

1. Introduction

The National Oceanic and Atmospheric Administration's (NOAA) satellite program has stood watch over the American public and partner nations for more than four decades developing and applying space based Earth remote sensing for NOAA's National Weather Service (NWS) forecasts. The NWS is responsible for weather warning services (the geostationary satellites) and their global forecasts (the polar program). NOAA's satellite operations grew out of the early space program and the desire to study our Earth from a vantage point high in the sky. Over the past half century, NOAA's satellites have evolved from weather satellites to environmental satellites. Data is used for applications related to the oceans, coastal regions, agriculture, detection of forest fires, detection of volcanic ash, monitoring the ozone hole over the South Pole, and the space environment. As NOAA has evolved from weather only sensing to environmental sensing, it has aligned about strategic themes. Current and future generations of satellites support all of the NOAA's strategic goals.

- . Protect restore and manage the use of coastal and ocean resources through an ecosystems approach to management
- . Support society's needs for weather and water information

- . Understand climate variability and change to enhance society's ability to plan and respond
- . Support the Nation's commerce with information for safe, efficient, and environmentally sound transportation

Operating the country's environmental satellite program, whose cloud images are seen daily on television weather forecasts, is one of NOAA's major responsibilities. Within [NOAA](#), the National Environmental Satellite, Data, and Information Service ([NESDIS](#)) office operates the satellites and manages the processing, distribution, and archival of the data. The NOAA satellite constellation is made up of complimentary operational environmental satellites: the Geostationary Operational Environmental Satellites ([GOES](#)) and Polar-orbiting Operational Environmental Satellites ([POES](#)). Both types of satellites are necessary for a complete global weather network.

In addition, each day NOAA's NESDIS processes and distributes more than 3.5 billion vital bits of data and images to forecasters globally. The timeliness and quality of the combined polar and geostationary satellite data have been greatly improved by enhanced computer installations, upgraded ground facilities, and data sharing agreements with military weather services.

2. Birth of Today's U.S. Space Programs

Today's U.S. space programs trace back to the Department of Defense (DoD) rocket, sensor, and satellite development projects that began in the decade following World War II. With little theory and very little experience available to guide these projects, DoD's development teams learned their space trade on the job, often resulting from analyses of catastrophic failures. Early on, DoD developed instruments to measure meteorological parameters needed to determine the atmospheric conditions that the rockets were encountering as they were propelled to then extraordinary altitudes. These measurements, recovered from salvaged recorders or from radio transmissions, were the basis for meteorological research. Still cameras became part of the payload and recovered film depicted images of the Earth's surface and cloud cover from space. These first ventures into "Earth remote sensing" from rockets were practical and efficient ways to gather environmental data that was critical to advancing the United States space efforts and provided a perspective from space and near space. These images gave investigators views of the patterns imbedded into an environmental infrastructure.

The United States, in 1953, committed to placing an Earth satellite in orbit for the International Geophysical Year of 1958. By 1956, a meteorological satellite was under development at the Redstone Arsenal for the Army's Ballistic Missile Agency, with RCA Astro-Electronics, Princeton, NJ as the prime contractor. The conceptual design would mount a television system for weather reconnaissance onto a satellite that would be launched by the Jupiter-C rocket, a research rocket with the boosting capability to reach near space or ~354 miles. The research rocket was renamed to Juno-1 just prior to the launch on January 31, 1958 at 10:48 PM EST. This initial

concept for a meteorological satellite called Janus, evolved from a lightweight, cylindrical spacecraft into disk-shaped spacecraft as rocket power increased and was renamed to the Television Infra-Red Observation Satellite (TIROS).

1957	Important Space History Milestones
Oct 4	The Soviet Union announced that it had successfully orbited an Earth-orbital satellite, Sputnik 1, as its contribution to the International Geophysical Year. Data returned was instrumental in the discovery of the Van Allen radiation belts.
Nov 3	The Soviet Union launched Sputnik 2, a spacecraft three times as large as its predecessor that carried a dog as a passenger.
Nov 7	President Dwight Eisenhower named James Killian, head of the Massachusetts Institute of Technology, as Special Assistant for Science and Technology and chairman of the President's Science Advisory Committee.
1958	
Mar 5	The Advisory Committee on Government Organization was re-designated the National Advisory Committee for Aeronautics (NACA) and approved to lead civil space efforts.
Mar 27	Eisenhower approved a plan for outer space exploration. The Advanced Research Project Agency (ARPA) was designated to undertake several space projects.
Apr 2	Eisenhower proposed the establishment of the National Aeronautics and Space Administration (NASA), into which the NACA would be absorbed. This agency would perform space research for civilian and military programs
Jul 29	The National Aeronautics and Space Act was signed (PL 85-568); this established NASA
1964	
Jan 30	A basic agreement between NASA and U.S. Weather Bureau was created to establish a National Operational Meteorological Satellite System. The Weather Bureau determined overall requirements, operated command and data acquisition stations, and processed data for integration into weather analyses. NASA designed and launched spacecraft, operated launch sites, and conducted launch operations.

In parallel efforts, the Department of Commerce U.S. Weather Bureau (USWB) started the Weather Satellite Program in the mid 1950s. The first known paper proposing meteorological satellites was published in 1954 by Dr Harry Wexler,

Director of Research in the USWB. In 1957, Dr Siegfried Fred Singer, who in June 1962 became the first Director of the National Weather Satellite Service, published a paper proposing meteorological measurements from satellites. In March 1958, the Chief of the USWB, Dr. Francis Wilton Reichelderfer, established a special unit called the "Meteorological Satellite Research Unit" and named Dr. Sigmund Fritz as the head of the Meteorological Satellite Section. During the last half of the 1950s, President Eisenhower and Congress were seeking to put U.S. space activities on a more stable footing by establishing a policy of "open skies" and "peaceful uses of outer space." This resulted in the 1958 establishment of the National Aeronautics and Space Administration (*actually Agency*) (NASA) as the U.S. civil space agency, with DoD retaining responsibility for space matters bearing on national security interests.

In September 1958, Dr. Wexler sent a memo to the USWB units indicating the formation of NASA and stating that the Weather Bureau would be designated as their meteorological agent providing the meteorological instrumentation, data reduction, and analysis of observations taken by satellites. This small USWB group, the Meteorological Satellite Section, moved to Suitland, MD, and co-located its offices with the USWB offices in that area. The original group consisted of Dr. Fritz, David S. Johnson, Jay S. Winston, Lester .F. Hubert, David Q. Wark, and Donald T. Hillary. Within a few months, several more people were recruited and added to the group. With the expansion of activities, the name was changed to "Meteorological Satellite Laboratory" (MSL), the beginning of NOAA's major satellite system, and has further evolved into today's NESDIS now headquartered in Silver Spring, MD.

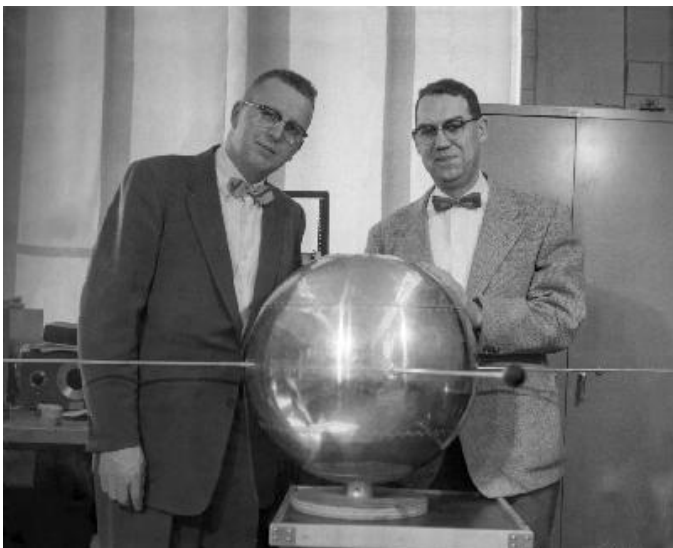

Professors Suomi and Parent pose with the Explorer VII satellite. The black ball is part of their heat budget experiment.

and Robert Parent at the University of Wisconsin to provide a very basic meteorological measurement: the balance between the radiation input to the atmosphere from the sun and the radiation exiting from the atmosphere as a result of reflection and emission processes. The spatial distribution of the radiation imbalances between incoming and outgoing radiation (the net radiation) is the

3. Polar Satellites

The 1950s saw numerous military sponsored experimental satellite systems for weather observations. The DoD meteorological satellite research program Janus was renamed TIROS and transferred to NASA, and the first meteorological satellite experiment flew on the Explorer VII spacecraft on October 13, 1959. This experiment was devised by Professor Verner Suomi

primary driving force of atmospheric circulation. The solar input had already been measured from ground-based and balloon borne platforms. However, satellites are the only platform capable of measuring the global distribution of the radiation budget correlating space and time. Geographic and seasonal patterns revealed interesting features associated with El Niño (observed when the easterly trade winds weaken, allowing warmer waters of the western Pacific to migrate eastward and eventually reach the South American Coast) and Southern Oscillation (a large fluctuation in atmospheric pressure) events. When the Southern Oscillation is coupled with warming of the ocean off Peru and Ecuador (El Niño) the resulting El Niño/Southern Oscillation (ENSO) event can affect weather and precipitation over much of the tropics and subtropics. Professor Suomi's experiment was the first to measure the energy loss to space. Designed from the ground up for its environmental observation mission, its technical, scientific, and utilitarian success led to scores of U.S. and foreign satellite missions. TIROS-1 showed not only that it could be done, but that it was worth doing. The satellite weighed 122 kg and carried two TV cameras, two video recorders, and the power, communications, and other systems needed to fulfill its mission.

One of the most exciting moments in NOAA history occurred on April 1, 1960, when the first weather satellite was launched from Cape Canaveral, FL. The satellite weighed 122 kg and carried two TV cameras, two video recorders, and the power, communications, and other systems needed to fulfill its mission. From its orbit 450 miles above the Earth's surface and inclined at 50° to the equator, TIROS-1 provided forecasters with the first view of cloud formations as they developed and moved across the continent.



At this juncture, the United States had two credible space agencies -- NASA and DoD. Each agency continued research and development efforts aimed at improving space capabilities for remote sensing of Earth's system components and better data interpretation. During this same period, President Kennedy announced the intention of the United States to conduct an operational weather satellite program to provide day and night observations of global cloud cover and open broadcasts of the information collected by the on-board sensors. These broadcasts were to be available for collection by any ground station in line of sight of the satellite without restriction on the collection and use or any requirement to pre-notify the United States.

Additional polar-orbiting TIROS research satellites were launched over the next several years as NASA developed the technology (e.g., new optical lenses and transmission techniques) that would eventually be incorporated into the operational series. The successful launch of TIROS-8 tested an Automatic Picture Transmission (APT) system and relayed imagery to ground receiving stations globally along the satellite's track in near real-time. The TIROS-9 satellite, the first to be launched into

sun-synchronous, near polar-orbit (99° inclination) on July 1, 1965, gave the first complete daily coverage of the entire sun-illuminated portion of the Earth.

Also in 1965, the Nimbus-1 satellite (an advanced research satellite) carried an infrared (IR) sensor permitting the first nighttime images from space. The early TIROS spacecraft and Nimbus-2 provided the feasibility required for an operational system of weather satellites. Its many instrument types and orbital configurations led to the development of more sophisticated meteorological observation satellites.

Management and operation of the Nation's new civil operational weather satellite system was vested in the Environmental Sciences Services Administration (ESSA), the predecessor agency of NOAA, by the Reorganization Plan No 2 of 1965, [Reorg. Plan No. 2 of 1965, 3 C.F.R. xxx (1965), reprinted in 5 U.S.C. app. at 1517 (1994), and in 79 Stat. 1318-20 (1965), and in 30 Fed. Reg. 8819-xx (1965)].

SECTION 3. *Environmental Science Services Administration.* (a) The Coast and Geodetic Survey and the Weather Bureau are hereby consolidated to form a new agency in the Department of Commerce which shall be known as the Environmental Science Services Administration, hereinafter referred to as the Administration.

The world's first operational weather satellite system was achieved with the launch of Environmental Science Services Administration-1 (ESSA-1) on February 3, 1966, and ESSA-2 on February 28, 1966. The ESSA program (initiated as an extension and compliment to the TIROS program) provided cloud-formation photography to the Weather Bureau's National Meteorological Center. For nearly four years, ESSA satellites transmitted thousands of images back to Earth, enabling ground station predictions of weather patterns, including hurricanes. NOAA's operational weather satellite service—now environmental satellites because of their capabilities—continues today.

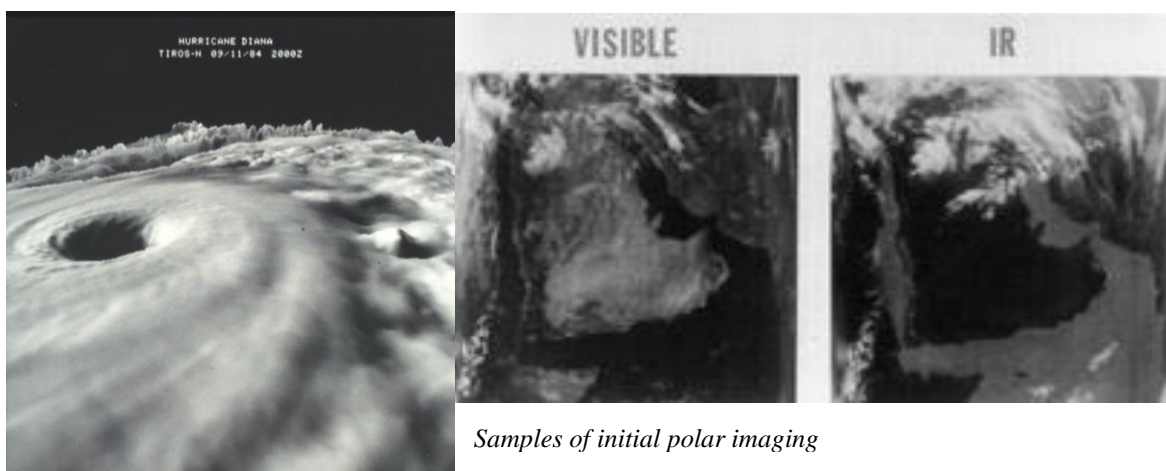

Samples of initial polar imaging

A period of phenomenal discovery and development in remote sensing characteristics ensued in the late 1960s and early 1970s as the three agencies (NASA, DoD, and NOAA) developed a symbiotic and productive relationship. NOAA was heir to the environmental satellite technology developed by NASA and DoD, and NASA and DoD received from NOAA insights concerning the conduct of daily satellite operations, data processing, and timely delivery of products, as well as application of these data. NOAA and its predecessor agencies within the Department of Commerce reimbursed NASA and DoD for the personnel and other costs they incurred when helping NOAA meet its space mission. General and specific agreements between NOAA and NASA and DoD governed the relationship, responsibilities, and costs of the support provided to NOAA. A tri-agency group, with the farcical name of "POOMSCOB" (for Polar-Orbiting Operational Meteorological Satellite COordinating Board) coordinated activities among the three agencies. NOAA was charged with the responsibility for determining the requirements of the (civilian) users of its satellite services, specifying the performance of the systems needed to satisfy these requirements and obtaining the funds needed to build and launch the satellites and build and operate the ground segments of the systems.

NOAA scientists made significant contributions to the development of remote-sensing instrumentation for these satellites. The satellite infrared spectrometer (one of the first instruments for measuring atmospheric temperatures) was launched on the NASA Nimbus-3 research satellite, was developed in the ESSA Meteorological Satellite Laboratory. When compared with radiosonde (usually a balloon carried instrument) observed profiles showed that the satellite-derived temperature profiles were very representative overall, with detailed vertical features smoothed out. The major problems with these early observations were caused by clouds which usually existed within the instrument's 250 km diameter field of view. Also, the observations were only along the suborbital track, and consequently there were large gaps in data between orbits. In spite of these problems, the data immediately showed promise of befitting the current weather analysis/forecast and operation and was put into operational use on May 24, 1969, barely one month after launch (Smith et al, 1970.)

Succeeding generations of NASA research spacecraft were replaced by newer technologies. By 1972, the TIROS/ESSA series (nine satellites) was completed and the launch of the first Improved TIROS Operational System (ITOS) took place. Simultaneously, NASA was engaged in the Nimbus Research and Development programs. With the conclusion of the ESSA series, NOAA launched the first of the "NOAA" series of operational satellites. Based on the NASA ITOS series, NOAA-1 was a vast improvement. These second generation satellites provided day and night viewing of the Earth's cloud formulation with visible and infrared scanning radiometers, simultaneous direct readout broadcasts, and data storage for later playback to a central processing ground station. These satellites also measured snow and ice extent, sea surface temperatures, and gathered vertical atmospheric temperature and moisture profiles over the entire globe daily.

In 1973, President Nixon authorized the declassification of the previously secret Defense Meteorological Satellite Program (DMSP). Because this program had

somewhat different requirements from the NOAA program, these satellites were flown as a separate series. Clearly, there was the danger of partial duplication in funding two similar series. DoD had paid for the development of a new spacecraft concept, referred to as Block 5D. To avoid redundant development cost, NOAA was directed to use the DoD spacecraft design for the next generation of polar-orbiting satellites. In order to achieve daily, day and night global atmospheric sounding coverage, a principal objective of the next generation, a two spacecraft NOAA system was used.

In 1978, the first next generation polar satellite TIROS-N was successfully launched. The TIROS-N imaging system, a four spectral channel Advanced Very High Resolution Radiometer (AVHRR), provided visible and infrared data for night and daytime. In the 1980s, NOAA needed to balance the high cost of space systems and the growing need to provide a complete and accurate description of the atmosphere at regular intervals as input to numerical weather prediction and climate monitoring support systems. This led NOAA to enter into discussions and agreements



Polar satellite image of storm formation

with the European Organisation for the Exploitation of Meteorological Satellites (EUMETSAT) to provide continuity of measurements from operational satellites in polar orbits, cost sharing, and improved forecast and monitoring capabilities through the introduction of new technology.

Building upon the Polar-orbiting Operational Environmental Satellite (POES) program, an agreement is in place between NOAA and EUMETSAT on the Initial Joint Polar-orbiting operational Satellite (IJPS) System. This program includes two series of independent but fully coordinated NOAA and EUMETSAT satellites, exchange of instruments and global data, cooperation in algorithm development, and plans for real-time direct broadcasting. Under terms of the IJPS agreement, NOAA provides NOAA-18 and NOAA-19 satellites for flight in the afternoon orbit and EUMETSAT provides MetOp-A and MetOp-2 (B) satellites for flight in the mid-morning orbit. These satellites carry a common core of instruments that includes:

- . Third Generation Advanced Very High Resolution Radiometer (AVHRR/3): A six-channel imaging radiometer to detect energy in the visible and IR portions of the electromagnetic spectrum.
- . High Resolution Infrared Radiation Sounders (HIRS/4): A multispectral atmospheric sounding instrument to measure scene radiance in the IR spectrum.
- . Advanced Microwave Sounding Unit (AMSU-A): A cross-track scanning total power radiometer to measure scene radiance in the microwave spectrum.

- . Data Collection System (DCS): To collect and store environmental study data from multiple platforms for transmission to the ground once per orbit to NOAA Command and Data Acquisition stations.
- . Search and Rescue Satellite-Aided Tracking (SARSAT) Instruments: These are part of the international COSPAS-SARSAT system designed to detect and locate Emergency Locator Transmitters (LET), Emergency Position-Indicating Radio Beacons (EPIRB), and Personal Locator Beacons (PLB) operating at 121.5 MHz, 243 MHz, and 406 MHz to subsequently downlink to a Local User Terminal .
- . Space Environmental Monitor (SEM): Provides measurements to determine the intensity of the Earth's radiation belts and the flux of charged particles at satellite altitude.
- . Microwave Humidity Sounder (MHS): A five-channel microwave instrument to measure profiles of atmospheric humidity.

In addition, NOAA satellites fly a Solar Backscatter Ultraviolet (SBUV) Radiometer instrument (a nadir pointing, nonspatial, spectrally scanning, ultraviolet radiometer), while EUMETSAT's additional payloads include an infrared interferometer sounder, a scatterometer, an ozone instrument, and a Global Positioning System (GPS) occultation sounder.

Coordination on associated ground segments included in this agreement ensures the sharing of all mission data, blind-orbit data capture support, and telecommunications paths through each other's ground stations for back-up command and control functions. The first MetOp satellite launched on October 19, 2006 from Baikonur Cosmodrome, Kazakhstan using a Soyuz-ST Fregat launcher. (Originally MetOp was to be a part of a much larger satellite concept called the Polar-Orbit Earth observation Mission [POEM]. However, the European Space Agency [ESA] Ministerial Council decided to split this mission into two separate satellite concepts: environmental and meteorological.)

As of 2011, the U.S. has launched 43 U.S. polar-orbiting weather/environmental satellites: ten TIROS (1960-65), nine ESSA (1966-69), eight ITOS (1970-76), with two launch failures, and sixteen TIROS-N/NOAA (1978 to present) with 1 launch failure.



GOES satellite view of Hurricane Katrina, 2005

4. Geostationary Satellites

On 6 December 1966, a momentous day in satellite meteorology, NASA launched the first Applications Technology Satellite (ATS-1), demonstrating the value of a geostationary orbit for maintaining a continuous watch over one spot on the globe, especially the continental land mass of the United States where severe weather events are more frequent and of greater variety than other land areas. ATS-1's spin scan cloud camera, invented by Professor Verner Suomi and Robert Parent at the University of Wisconsin, was capable of

providing full disk visible images of the Earth and its cloud cover every 20 minutes. The inclusion of the spin scan cloud camera on ATS-1 occurred because of an extraordinary effort by Professor Suomi and Homer Newell of NASA, who made it possible to add this new capability to ATS-1 when the satellite was already well into its fabrication. Meteorologists were astounded by the first views of clouds and cloud formations in motion. Professor Suomi noted, "Now the clouds move and not the satellite." Research into tracking clouds and producing wind products using image sequences began almost immediately. Professor Ted Fujita at the University of Chicago developed techniques for precise analysis of satellite measurements and related them to flow patterns in the atmosphere.

ATS-3, a larger version of ATS-1, was the first spacecraft to routinely transmit full disk Earth-cloud images in living color. Earlier series spacecraft had peak sensitivity in the green region of the visible spectrum. However, the ATS-3's Multicolor Spin Cloudcover Camera advanced peak sensitivity to the red, blue, and green visible spectrum using three photo-multiplier light detectors.

The ATS environmental series continued development through six spacecraft. ATS-6 was the most powerful, versatile, and unique communication satellite developed, using a three axis stabilization system, which obviated the need for spin stabilization. This allowed the instruments to view the Earth's surface quasi-full-time rather than the 1/20th time for a spinning instrument.

By the early 1970s ATS imagery was being used in operational forecast centers, with the first movie loops being used at the National Severe Storm Forecast Center (NSSFC) in the spring of 1972. Atmospheric motion depiction from geostationary satellite image loops was transferred into routine operations at the national forecast centers, and the resulting cloud motion vectors evolved into an important data source of meteorological information, especially over the oceans.

The success of the meteorological experiments carried aboard the ATS led to NASA's development of a satellite specifically designed to make atmospheric observations in a geostationary orbit, 35,786 km (~22,000 miles) above the equator.

NOAA's Geostationary Operational Environmental Satellite (GOES) program began in this cooperative period when NASA designed, built, and launched the first two geosynchronous meteorological satellites: Synchronous Meteorological Satellite-1 (SMS-1) in May 1974 and SMS-2 in February 1975. These two spacecraft were the prototypes for the NOAA GOES program. GOES-1 was launched on October 16, 1975, followed by GOES-2 and 3, which were similar and provided continuity of service. The primary instrument on the SMS 1-2 and GOES 1-3 spacecraft was the Visible/IR Spin Scan Radiometer (VISSR), Professor Soumi's conceptual design. The VISSR, a true radiometer, provided day and night observations of cloud and surface temperatures, cloud heights, and wind fields.

Rapid interval imaging has been an important component of the GOES research program since 1975. In 1979 during a project known as SESAME (Severe Environmental Storm and Mesoscale Experiment) two GOES satellites were synchronized to produce three minute interval rapid scan imagery to study storm development. Professor Ted Fujita of the University of Chicago and Dr. A. F. Hasler of NASA used these data to produce very accurate cloud height assignments using stereographic techniques. By the mid-1980s, five-minute interval imagery became a routine part of satellite operations during severe storm outbreaks.

GOES-4, launched in 1980, advanced meteorologists' capabilities by continuously profiling vertical temperature and water vapor. This major advancement permitted, for the first time, the monitoring of frame-to-frame movement of water vapor concentrations, a technique introduced by the European Meteosat-1 satellite. Meteosat-1 did not have profiling capability, but pioneered water vapour imaging in 1977. This new capability led to a greatly improved knowledge of global atmospheric circulation by revealing motions in clear areas where no visible clouds were present.

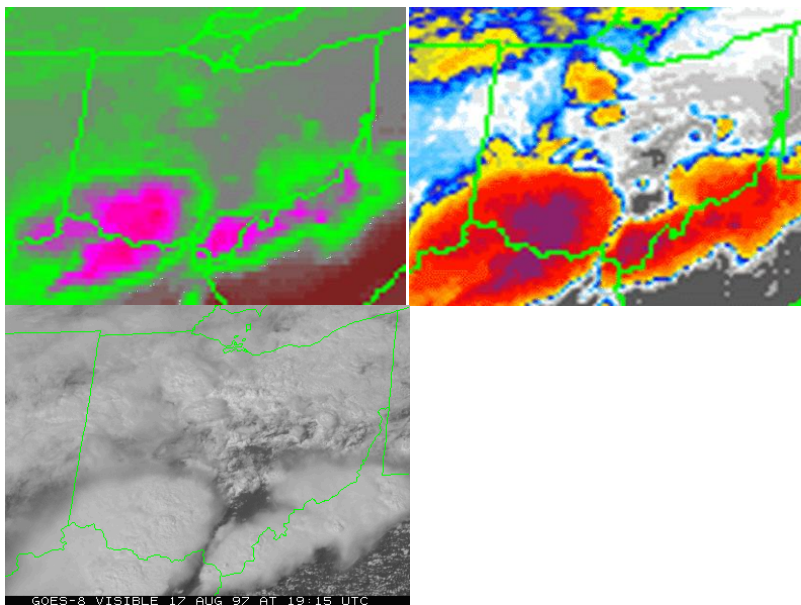

GOES Water, IR, and Visible imaging used to locate and monitor severe storms.

GOES spacecraft operate as a two-satellite constellation above the equator, each observing around 60 percent of the Earth's surface and measuring atmospheric temperature and moisture, cloud cover, and the solar and geosynchronous space environment. The eastern and western satellites are positioned to provide a best view from near Africa to beyond the central part of North America and from the center of the United States to beyond Hawaii. The operational GOES system was achieved with the launch of GOES-2 in 1977, although the system had been *de facto* operational since the launch of SMS-2 in February, 1975.

NOAA presented the mission requirements for GOES-Next (later renamed GOES I-M) to NASA in 1983. The GOES-8, the first 3-axis body-stabilized geostationary environmental satellite, was launched in April 1994, with the first fully independent sounder along with a newly designed imager.

When the US GOES-6 (East) satellite failed in 1989, it was replaced by moving the GOES-7 (West) satellite to the 135°W position. To cover the 75°W position, EUMETSAT "loaned" Meteosat-3 to the USA, repositioning it to the 75°W to provide coverage of the USA, until the 1994 launch of GOES-8. This was operated as the Meteosat XADC (extended Atlantic data coverage) downlinking data to the NOAA agency Command and Data Acquisition station at Wallops VA for US weather forecasting.

The GOES system has continued to improve with new technological innovations and sensors. To date there have been eighteen U.S. geostationary weather/environmental satellite launches: two SMS (1974-75), sixteen GOES (1975-present, with 1 launch failure).

Operational geostationary environmental satellites are also supported by EUMETSAT and by Japan. Semi-operational programs are found in Russia, India, and China. All are coordinated by a group referred to as the Coordinating Group for Meteorological Satellites (CGMS), founded in 1974 by NOAA and now includes representation from the World Meteorological Organization (WMO).

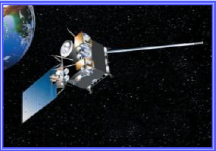

- 2000's: GOES-N/O/P, Simultaneous, independent imaging/sounding.** *Proj Operations: mid-2000's -2018*
- Improved "Stare" capability with improved INR and less thermal distortion allows more frequent imaging
 - Image Navigation and Registration (INR) subsystem, using geographic landmarks and star locations sensed, provides daily imaging and sounding data on a precisely located, fixed earth coordinate grid without ground interpolation
 - Flexible scan control allows small-area coverage for improved short-term weather forecasts over local areas
 - Power subsystem using a single panel solar array and NiCad battery
 - Operate during eclipse periods

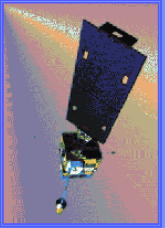

- 1990's: GOES 8-12 (GOES I-M), new generation of three-axis stabilized spacecraft equipped with separate imager/sounder.** *Operational: 1994-present*
- Provided simultaneous imaging and sounding, 100 percent of the time (visual and infrared imagery)
 - Received transmissions from free-floating balloons, buoys and remote automatic data collection stations around the world



- 1980's: GOES 4-7 added Vertical Sounding.** *Operational: 1980-1996*
- First geostationary satellite to provide vertical profiles of atmospheric temperature and moisture
 - Principle on board instruments (imaging and sounding could not operate simultaneously)
 - Visible Infrared Spin Scan Radiometer Atmospheric Sounder (VAS) and its sunshade
 - Soundings were still on an hourly basis
 - GOES-7 carried experimental search and rescue equipment for near-instantaneous detection of emergency distress signals..

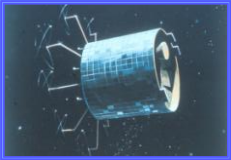

- 1960-70's: NASA's Synchronous Meteorological Satellites (SMS) 1 and 2, prototype for NOAA's GOES and GOES 1-3.** *Operational: 1974 until 1982*
- Geostationary satellite experiment begun in 1966
 - spin stabilized satellite (rotating at 100 revolutions per minute) viewing the earth only about ten percent of the time
 - monitor cataclysmic weather events
 - Principle on board instrument
 - Visible Infrared Spin Scan Radiometer (VISSR) providing full-disk day and night imagery of cloud conditions

5.0 Future NOAA Satellites

Joint Polar Satellite System (JPSS)

On February 1, 2010, the Executive Office of the President restructured National Polar-orbiting Operational Environmental Satellite System (NPOESS) into two separate development programs one aimed at the civilian community (JPSS) and the Defense Weather Satellite System (DWSS) to satisfy Defense Department requirements. The civilian and scientific community program is led by NOAA who sets the requirements and NASA who is directing the acquisition. JPSS will provide operational continuity of satellite-based polar missions in the afternoon orbit that support its civil regional and global weather and climate requirements. In addition, JPSS will provide oceanographic, environmental, and space environmental information. The system Instrumentation is illustrated and described below.

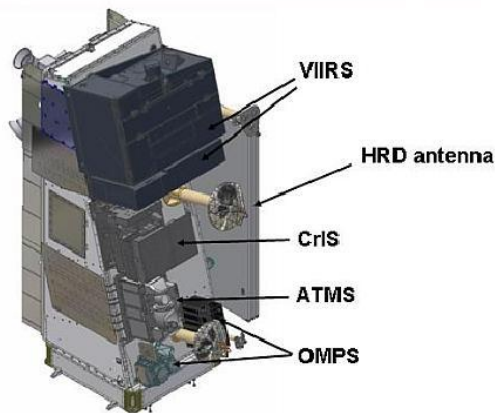

Notional JPSS Satellite

Visible/Infrared Imager/Radiometer Suite (VIIRS): VIIRS is an electro-optical imager having multi-band imaging capabilities which collects calibrated visible/infrared radiances to produce data products for cloud and aerosol properties, land surface type, vegetation index, ocean color, land and sea surface temperature, and low light visible imagery. The 22-channel VIIRS will fly on the NPOESS Preparatory Project (NPP) and on all JPSS platforms to provide complete daily global coverage over the visible, short/medium-infrared, and long-wave infrared spectrum at horizontal spatial resolutions of 370 m and 740 m at nadir. VIIRS is the primary instrument for 21 environmental data records.



Cross-track Infrared Sounder (CrIS): CrIS is a Fourier Transform Spectrometer that uses a Michelson interferometric sounder capable of sensing upwelling infrared radiances from 3 to 16 μm at very high spectral resolution (~ 1300 spectral channels) to determine the vertical atmospheric distribution of temperature, moisture, and pressure from the surface to the top of the atmosphere across a swath width of 2200 km.

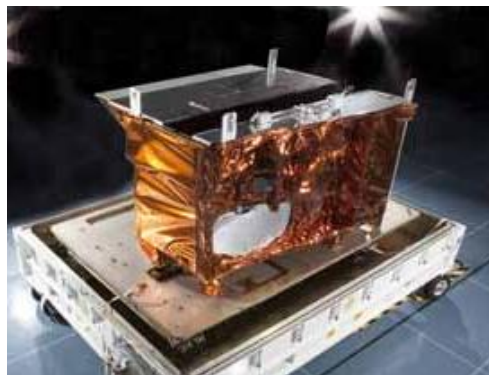

Advanced Technology Microwave Sounder (ATMS):



ATMS is a cross-track high spatial resolution microwave sounder. ATMS data will support temperature and humidity sounding generation in cloud covered conditions. ATMS has 22 microwave channels to provide temperature and moisture sounding capabilities in the 23/31, 50, 89, 150, and 183 GHz spectral range.

Ozone Mapping and Profiler Suite (OMPS): The OMPS monitors ozone from space. OMPS will collect total column and vertical profile ozone data and continue the daily global data produced by the current ozone monitoring systems, the Solar Backscatter Ultraviolet radiometer (SBUV)/2 and Total Ozone Mapping Spectrometer (TOMS), but with higher fidelity.

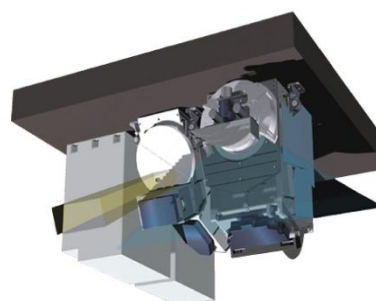

The nadir sensor uses a wide field-of-view push-broom telescope to feed two separate spectrometers. The nadir total column spectrometer (mapper) measures the scene radiance between 300 and 380 nanometers (nm) with a resolution of 1 nm sampled at 0.42 nm and a 24-hour ground revisit time.

The limb sensor measures the along-track limb scattered solar radiance with 1 km vertical sampling in the spectral range of 290 to 1000 nm. Three vertical slits sample the limb at 250 km cross-track intervals to provide for better than 7-day ground revisit

times to improve the precision of the ozone profiles. The three slits are imaged onto a single charge-coupled device (CCD) (identical to both nadir CCDs). Due to limitations with flight hardware transferred from NPOESS to JPSS, the OMPS on JPSS J1 will consist of a nadir sensor only.

Cloud and Earth Radiant Energy System (CERES): The CERES instrument seeks to develop and improve weather forecast and climate models prediction, to provide measurements of the space and time distribution of the Earth's Radiation Budget (ERB) components, and to develop a quantitative understanding of the links between the ERB and the properties of the atmosphere and surface that define that budget. CERES consists of three broadband radiometers that scan the earth from limb to limb. Data from CERES will be used in conjunction with VIIRS to study changes in the Earth's energy balance and key changes in clouds and aerosols to determine the effect of changing clouds on the Earth's energy balance.



Total Solar Irradiance Sensor (TSIS): The Total Solar Irradiance Sensor (TSIS) will measure variability in the sun's solar output, including total solar irradiance. TSIS consists of two instruments: the Total Irradiance Monitor (TIM) that measures the total light coming from the sun at all wavelengths; and the Spectral Irradiance Monitor (SIM) that will measure how the light from the sun is distributed by wavelength. These measurements are needed to understand how solar radiation interacts with the Earth's surface and atmosphere. TSIS is an important climate sensor that will help

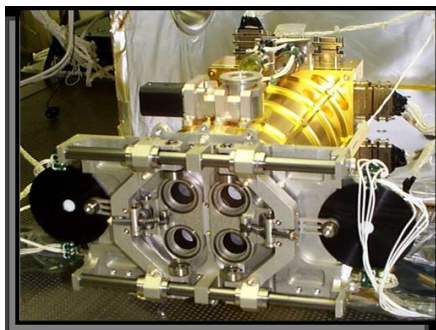

maintain continuity of the climate data record for space-based solar irradiance measurements that now spans over three decades.

JPSS will ensure continuity of crucial climate observations and weather data in the future. Data and imagery obtained from the JPSS will increase timeliness and accuracy of public warnings and forecasts of climate and weather events reducing the potential loss of human life and property damage. The data collected by JPSS will contribute to the unified and coherent long-term environmental observations and products that are critical to climate modelers and decision makers concerned with advancing climate change understanding, prediction, mitigation and adaptation strategies, policies, and science. JPSS, with its global view, will play a vital role in continuing these climate data records for the US and the international community.

Additional information for NOAA's JPSS program can be found at:
<http://www.nesdis.noaa.gov/jpss/>

GOES-R Series

The GOES-R, expected to launch in 2015 with a mission design life of 7 years, will improve on the current GOES capabilities and support the GOS 2025 vision in several ways. GOES has been and will continue to be collaboratively developed and acquired by NOAA and NASA. The acquisition of the end-to-end GOES system includes spacecraft, sensors, launch services, and ground system elements consisting of mission management, product generation, product distribution, archive and access interface, and user interface. New GOES-R instrumentation includes:

- Advanced Baseline Imager: The ABI is the primary instrument on GOES-R for imaging Earth's weather, climate, and environment. ABI will be able to view the Earth with 16 different spectral bands, including two visible channels, four near-infrared channels, and ten infrared channels. It will provide three times more spectral information, four times the spatial resolution, and more than five times faster temporal coverage than the current system. Forecasters will be able to use the higher resolution images to track the development of storms in their early stages related to weather, oceans, land, climate, and hazards (fires, volcanoes, hurricanes, and storms that spawn tornados). It is designed to observe the western hemisphere in various time intervals at 0.5, 1, and 2 km spatial resolutions in visible, near-infrared (IR), and IR wavelengths, respectively. The ABI has two main scan modes. The "flex" mode will concurrently allow full disk imagery every 15 minutes, the continental US every 5 minutes, and a mesoscale region as often as every 30 seconds. It is expected that two mesoscale regions will be scanned, resulting in a 1 minute cadence for those sectors. The ABI will be calibrated to an accuracy of 3% (1σ) radiance for visible and near-infrared wavelengths. For infrared channels, the ABI will be accurate to 1K (1σ) at 300K.

The ABI will [improve](#) every product from the current GOES Imager and introduce new products for severe weather forecasting, fire and smoke monitoring, volcanic ash advisories, and more. Two improved products are:

- Fog Probability
- Atmospheric Motion Vectors

Product Example: Hurricane Katrina

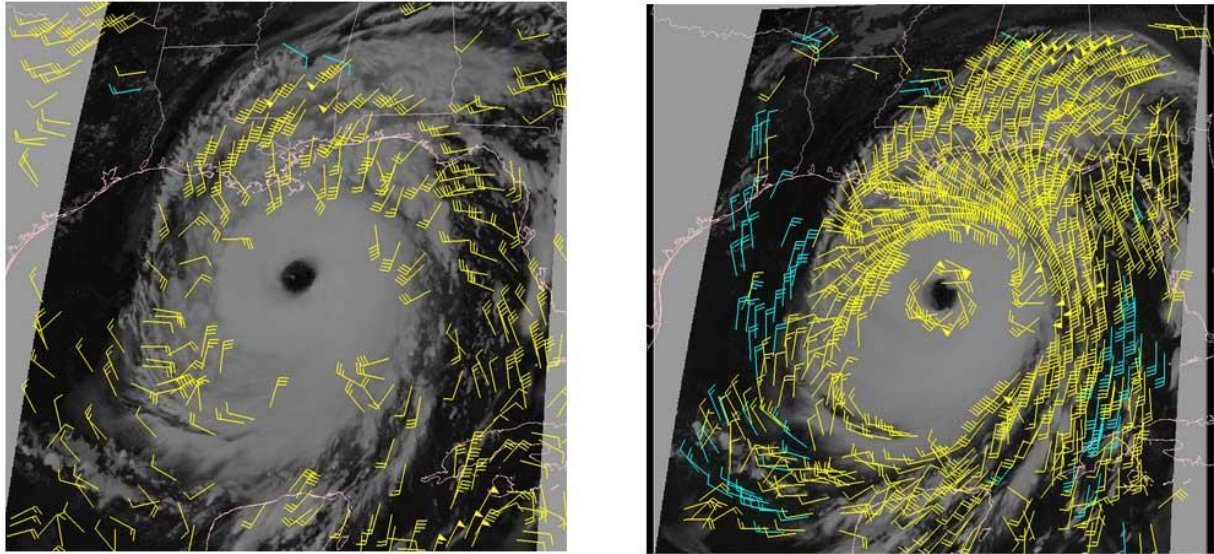

Low-mid level vectors- cyan Upper-level vectors - yellow

IR AMVs derived from current GOES-12
4km resolution; 15-minute time step

IR AMVs derived from WRF model images
using simulated future GOES-R radiances
2 km resolution; 5-minute time step

Current benefits from the ABI are projected to be \$4.6B over the lifetime of the series due to improved tropical cyclone forecasts, fewer weather-related flight delays and airline incidences with volcanic plumes, improved production and distribution of electricity and natural gas, increased efficiency in irrigated water usage in agriculture, and higher protection rates for recreational boats in the event of a tropical storm or hurricane

- Geostationary Lightning Mapper: The GLM is an optical transient detector and imager operating in the near-IR that [maps](#) total lightning (in-cloud and cloud-to-ground) activity with near uniform spatial resolution of approximately 10 km continuously day and night over the Americas and adjacent ocean regions. The GLM will provide early indication of storm intensification and severe weather events, improved tornado warning lead time of up to 20 minutes or more, and data for long-term climate variability studies. It is anticipated that GLM data will have immediate applications to aviation weather services, climatological studies, and severe thunderstorm forecasts and warnings. The GLM will provide information to identify growing, active, and potentially destructive thunderstorms over land as well as ocean areas.

GLM measurements can provide vital information to help the operational weather, aviation, disaster preparedness, and fire communities in a number of

areas:

- Improvement in tornado and severe thunderstorm lead times and false alarm reduction
- Early warning of lightning ground strike hazards
- Advancements in the initialization of numerical weather prediction models through better identification of deep convection
- Improved routing of commercial, military, and private aircraft over oceanic regions where observations thunderstorms intensity are scarce.
- Improved ability to monitor intensification or decay of storms during radar outages, or where radar coverage is poor or scarce, such as in mountainous areas and oceanic regions.
- Better detection and short range forecasts of heavy rainfall and flash flooding
- Ability to monitor the intensity change of tropical cyclones, which is often accompanied by increased lightning activity
- Continuity and refinements of lightning climatology within the GOES field of view

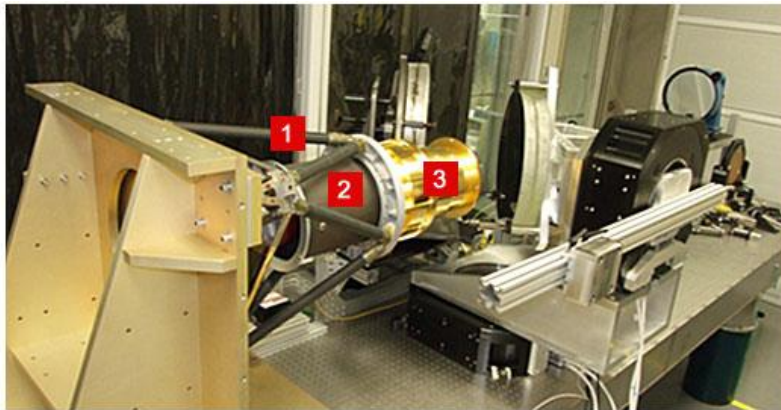

- 1 Sensor Unit Mechanical Support Structure
- 2 Metering Tube
- 3 Optical Assembly

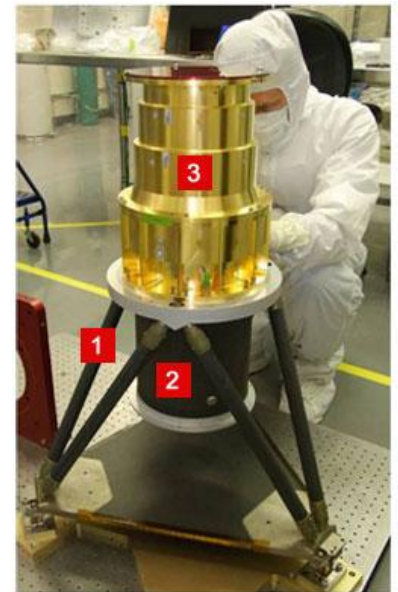

The **GOES Ground System** is a “System-of-Systems” that comprises the end-to-end framework for collecting, processing, and disseminating critical environmental data and information from the satellites. It supports the launch, activation, and evaluation of new satellites and the in-depth assessments of satellite data quality. Data from the satellites are received at ground facilities, where the data are processed to monitor and control the satellite and to generate products that are used by NOAA, its users, and the world meteorological community. The GOES ground system consists of components at the Satellite Operations Control Center (SOCC) at Suitland, Maryland;

Command and Data Acquisition (CDA) facilities at Wallops, Virginia, and Fairbanks, Alaska; and Wallops Backup (WBU) facility at NASA Goddard Space Flight Center (GSFC) in Greenbelt, Maryland.

Additional GOES-R information can be found at: <http://www.goes-r.gov/>

Addendum 1
Satellite Launch Tables

TIROS Satellites

Name	Launch Date	Operating Life (days)^a	Orbit	Features
TIROS-1	1 Apr 60	89	Inclined	2 TV cameras
TIROS-2	23 Nov 60	376	Inclined	2 TV cameras, Radiometer
TIROS-3	12 Jul 61	230	Inclined	2 TV cameras, Radiometer ^b
TIROS-4	8 Feb 62	161	Inclined	1 TV camera, Radiometer ^b
TIROS-5	19 Jun 62	321	Inclined	2 TV cameras
TIROS-6	18 Sep 62	389	Inclined	2 TV cameras
TIROS-7	19 Jun 63	1,809	Inclined	2 TV cameras, Radiometer ^b
TIROS-8	21 Dec 63	1,287	Inclined	1 TV camera, APT ^c
TIROS-9	22 Jan 65	1,238	Sun Synch ^d	Global coverage, 2 TV cameras
TIROS-10	2 Jul 65	730	Inclined	2 TV cameras

^a Number of days until satellite was turned off or failed. Various sensors and other units could have degraded or failed before the satellite was turned off.

^b Radiometer (visible and infrared channels).

^c Automatic picture transmission for direct readout locally.

^d Sun-synchronous.

ESSA Satellites—The First Operational Weather Satellite System

Name	Launch Date ^a	Operating Life (days) ^b	Features
ESSA-1	3 Feb 66	861	2 AVCS ^c
ESSA-2	28 Feb 66	1,692	2 APT ^d
ESSA-3	2 Oct 66	738	2 AVCS
ESSA-4	26 Jan 67	465	2 APT
ESSA-5	20 Apr 67	1,034	2 AVCS
ESSA-6	10 Nov 67	763	2 APT
ESSA-7	16 Aug 68	571	2 AVCS
ESSA-8	15 Dec 68	2,644	2 APT
ESSA-9	26 Feb 69	1,726	2 AVCS

^a All spacecraft were placed in near-polar, sun-synchronous orbits.

^b Number of days until satellite was turned off or failed. Various sensors and other units could have degraded or failed before the satellite was turned off.

^c Advanced Vidicon Camera System with data recorders to obtain cloud pictures globally for central analysis.

^d Automatic Picture Transmission Vidicon camera for local direct readout over the Earth.

ITOS Satellites

Name ^a	Launch Date	Operating Life (days) ^b	Features
ITOS-1 ^d	23 Jan 70	510	2 APT, ^e 2 AVCS, ^f 2 SR ^g
NOAA-1	11 Dec 70	252	2 APT, 2 AVCS, 2 SR
ITOS-B	Failure	—	
NOAA-2	15 Oct 72	837	2 SR, ^g 2 VHRR, ^h 2 VTPR ⁱ
ITOS-E	Failure	—	
NOAA-3	6 Nov 73	1,029	2 SR, 2 VHRR, 2 VTPR
NOAA-4	15 Nov 74	1,463	2 SR, 2 VHRR, 2 VTPR
NOAA-5	29 Jul 76	1,067	2 SR, 2 VHRR, 2 VTPR

^a All spacecraft were placed in near-polar, sun-synchronous orbits.

^b Number of days until satellite was turned off or failed. Various sensors and other units could have degraded or failed before the satellite was turned off.

^c Primary sensors of high priority in the current modernization of the NWS, that is, imagers and atmospheric sounders.

^d ITOS-1, the prototype of this new series of satellites, was funded, named, and operated by NASA. The subsequent operational satellites were funded by NOAA and named by them.

^e Automatic Picture Transmission Vidicon camera for local direct readout over the Earth.

^f Advanced Vidicon Camera System with data recorders to obtain cloud pictures globally for central analysis.

^g Two-channel (visible and infrared), medium-resolution scanning radiometer providing image data day and night for immediate broadcast (APT function) and stored for later playback to provide global coverage for central analysis.

^h Very High Resolution Radiometer (visible and infrared).

ⁱ Vertical Temperature Profile Radiometer; the first instrument for obtaining temperature soundings of the Earth's atmosphere from the operational satellite system.

TIROS-N Series of Operational Satellites

Name	Launch Date	End of Useful Life	Orbit	Features
TIROS-N ^e	13 Oct 78	1 Nov 80	PM	AVHRR, ^f HIRS, ^g MSU, ^h SSU, ⁱ DCS ⁱ
NOAA-6	27 Jun 79	19 Sep 83	AM	same
NOAA-B	29 May 80	launch failure		
NOAA-7	23 Jun 81	7 Feb 85	PM	same
NOAA-8	28 Mar 83	26 May 84	AM	same
NOAA-9	24 Dec 84	13 Feb 98	PM	same
NOAA-10	17 Sep 86	17 Sep 91	AM	same, except no SSU
NOAA-11	24 Sep 88	16 Jun 04	PM	same, with SSU
NOAA-12	14 May 91	10 Aug 07	AM	same, except successfully flew developmental model non-flight SSU that was provided by the UK
NOAA-13	9 Aug 93	21 Aug 93	PM	same, with SSU, carried a DoD Space Test experimental aurora imager Program (MAXIE) Spacecraft failed on 13 th day of flight
NOAA-14	30 Dec 94	23 May 07	AM	same, with SSU
NOAA-15	13 May 98	Secondary	AM	1 st of series to support dedicated microwave instruments-suite of three Advanced Microwave sounding Units-AMSU-A1, AMSU-A2, AMSU-B
NOAA-16	21 Sep 00	Secondary	PM	Same
NOAA-17	24 Jun 02	Backup	AM	Same
NOAA-18	20 May 05	Secondary	PM	HIRS LW channels/imagery improved
NOAA-19	4 Feb 09	Operational	PM	ADCS and SARP-3 upgrades

^a All spacecraft placed in near-polar, sun-synchronous orbits

^b Various sensors and other units have degraded or failed before the satellite was turned off.

^d Primary sensors of high priority in the current modernization of the NWS, that is, imagers and atmospheric sounders

^e TIROS-N, the prototype of this new series of satellites, was funded, named, and operated by NASA. The subsequent operational satellites were funded and named by NOAA.

^f Advanced very high resolution radiometer.

^g High resolution infrared radiation sounder.

^h Microwave sounding unit.

ⁱ Stratospheric sounding unit (provided by the United Kingdom).

^j Data collection system (provided by France).

SMS and GOES Series Satellites

Name	Launch Date	End of Useful Life	Features
SMS-1	17 May 74	21 Jan 81	VISSR, SEM, GOES DCS, WEFAX
SMS-2	6 Feb 75	5 Aug 81	same
GOES-1	16 Oct 75	3 Feb 85	same
GOES-2	16 Jun 77	26 Jan 79	same
GOES-3	15 Jun 78	5 Mar 81	Same, used to support the Global Atmospheric Research Program (GARP) over the Indian Ocean
GOES-4	9 Sep 80	26 Nov 82	VAS (VISSR Atmospheric Sounder) (provided day and night imagery of cloud conditions), GOES DCS, WEFAX. 1 st satellite to provide continuous vertical profiles of atmospheric temperature and moisture. 1 st satellite to use despun S-band and UHF antennas to relay data from more than 10,000 surface locations into a central processing center.
GOES-5	22 May 81	30 Jul 84	same
GOES-6	28 Apr 83	21 Jan 89	same
GOES-G	3 May 86	3 May 86	Launch Vehicle Failure
GOES-7	26 Feb 87	Jun 96	(University of Hawaii's Pan-Pacific Educational and Cultural Satellite (PEACESAT) Programme, carried experimental search and rescue equipment that allowed near-instantaneous detection of emergency distress signals on the ground transmitting at 405 MHz, VAS upgraded to use light emitting diodes (LED) in the encoder (replaced failure prone light bulbs)
GOES-8	13 Apr 94	5 May 04	GOES-I-M separate imager and sounder, DCS, WEFAX; 1 st in a new series of three-axis stabilized GOES
GOES-9	23 May 95	28 Jul 98	same
GOES-10	25 Apr 97	2 Dec 09 Coverage	Deorbit planned for 1 Dec 2009 Same

GOES-11	3 May 00	West Operational	Same
GOES-12	23 Jul 01	60 West for South America	Same; 1 st to fly an SXI-type instrument
GOES-13	24 May 06	East Operational	Improved INR system, stable optical bench, Reduced KOZ, more power for eclipse season operations, 14+ years fuel life
GOES-14	27 Jun 09	On-orbit spare	Imager 13-um channel improved from 8km to 4 km resolution
GOES-15	4 Mar 10	Standby	same
<p>NOTE: All spacecraft placed in geostationary orbit. When at least two spacecraft are operational, one is usually located over the Pacific Ocean at about 135 degrees west longitude and the other at about 75 degrees west longitude. When only one spacecraft has been operational, it is usually moved to about 98 degrees to 112 degrees west longitude</p>			

Addendum 2
Acknowledgement

1. Major contributors to this paper are Eric Clemons, Elizabeth Nolan (Carson), Thomas Wrublewski, Thomas Bucher and Michael Haas of NOAA's Office of System Development.
2. E. Larry Heacock, former NOAA Director of Satellite Operations
3. References include previous papers authored by P. Krishna Rao, Russell Koffler, Daniel Cotter, W. Paul Menzel, James Purdom, James Greaves, W. Shenk, and A. Schnapf
4. "Continuity of NOAA Satellites", National Research Council, National Weather Service Modernization Committee and the Commission on Engineering and Technical Systems, 1997
5. The authors wish to acknowledge the late David S. Johnson who was the inspiration for putting this paper together and whose personal library contributed to much of the article, www.osd.noaa.gov/johnson