

# The VINCI Program

An Introduction to Services, Tools, and Sources of Information

---

*Lanny Derby and Tim Trautman*

VA Salt Lake City



VA Informatics &  
Computing  
Infrastructure



# About VINCI

---

- VINCI is a secure, high performance computing environment where Researchers can access software, tools, and data
- Background
- Same research methods researchers typically use except they are conducted in a window to a secure server farm.
- *FREE* service to Researchers - Not mandatory!
- Partnership between HSR&D, OI&T, and VHA ORD



# What VINCI IS & IS Not

---

## ■ IS

- Computing Workspace (CPU, RAM, storage)
- Facilitation of Approval for Data Access
- Materializing & Hosting Data sets
- Software (commercial and custom)

## ■ IS NOT

- Data custodian (does not own data)
- VINCI does not do data analysis for you
- Software provider outside of VINCI Workspace



# VINCI Infrastructure

- 500+ TB Storage Area Network
- 70+ Servers
- Many servers are 64 core
- Windows Server 2008R2 64-bit OS
- Key servers have 2TB RAM
- SAS and Database TEMP spaces utilize FUSION-iO solid-state memory storage
- VINCI datacenter network uses InfiniBand high-speed networks
- Processes running within the VINCI environment are not affected by VA Intranet traffic

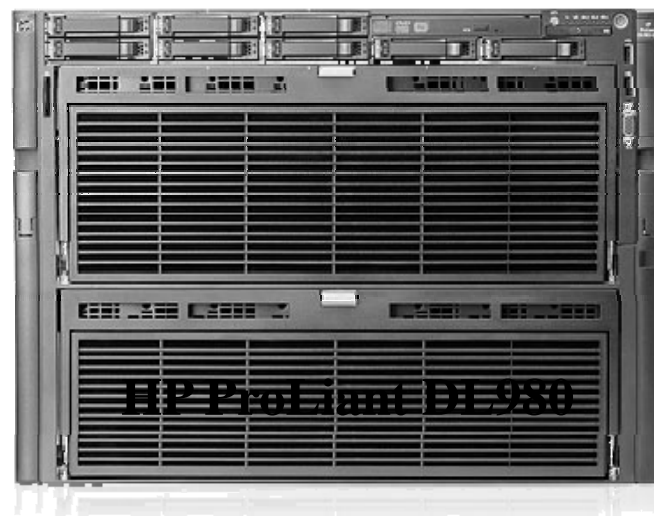

# VINCI Products & Services

---

## ■ Products - *tools for research*

- Data; SAS Grid; Collaboration Site; VINCI Workspace; Software; Custom Software



## ■ Services - *info & VINCI business processes*

- VINCI Central; Study Registration; Software Needs Assessment; Data Needs Assessment; Data Access Request Tracker (DART); Data Services

# VINCI Central

---

- Outside the Gateway (<http://vaww.vinci.med.va.gov>)
- Service utilities that support VINCI users in business processes required to use the VINCI Workspace
- Documentation on VINCI and how to use VINCI
- Access VINCI Workspace
- Access Collaboration Sites
- Announcements



# VINCI Central



## Administration

- Operations
- DART
- Customer Tracker
- Study Registration

## Studies

- Initiate New Study
  - ADE Alerts
  - Annotation - DeID
  - Automated Data Acquisition for Heart Failure
  - BI\_ORD\_Trautman 201102002D
  - Chart Reader
  - CHIR - Annotation
  - CHIR - Challenge Evaluation
  - CHIR - Clinical Inference and Modeling
  - CHIR - Contraception
  - CHIR - CXR
  - CHIR - De-Identification
  - CHIR - Document Quality
  - CHIR - Ejection Fraction
  - CHIR - General "Consortium for Healthcare



## Welcome! - How can VINCI help you today?

[What is VINCI?](#)

[How do I use VINCI?](#)

[How do I get VINCI support?](#)

[What is the VINCI Workspace?](#)

[What data does VINCI have?](#)

[What software is available?](#)

[How do I collaborate using VINCI?](#)

[How do I submit a data access request?](#)

[Where do I find guides and instructions?](#)

[Links to related organizations](#)

[Launch the VINCI Workspace](#)

[VINCI Quick Start Guide](#)

## Announcements

**VINCI: Cyber Seminar on VINCI Natural Language Processing Oct. 25th** 9/19/2011 3:49 PM  
by Trautman, Timothy N.  
VINCI Natural Language Processing tools and techniques.

**VINCI: Cyber Seminar on VINCI Data Services Oct. 11** 9/19/2011 3:48 PM  
by Trautman, Timothy N.  
Introduction to VINCI data services - An introduction to the data sources and services available through VINCI.

**VINCI: Cyber Seminar on VINCI Program 9/22@Noon ET** 9/6/2011 1:38 PM  
by Trautman, Timothy N.  
The VINCI Program - An introduction to services, tools and sources of information. This session will give the background for the VINCI environments, the relationship with VA data sources, and the partnership with Corporate Data Warehouse (CDW). We...

**VINCI: Cyber Seminar on Data Access 9/22@Noon ET** 9/6/2011 1:37 PM



# VINCI Workspace

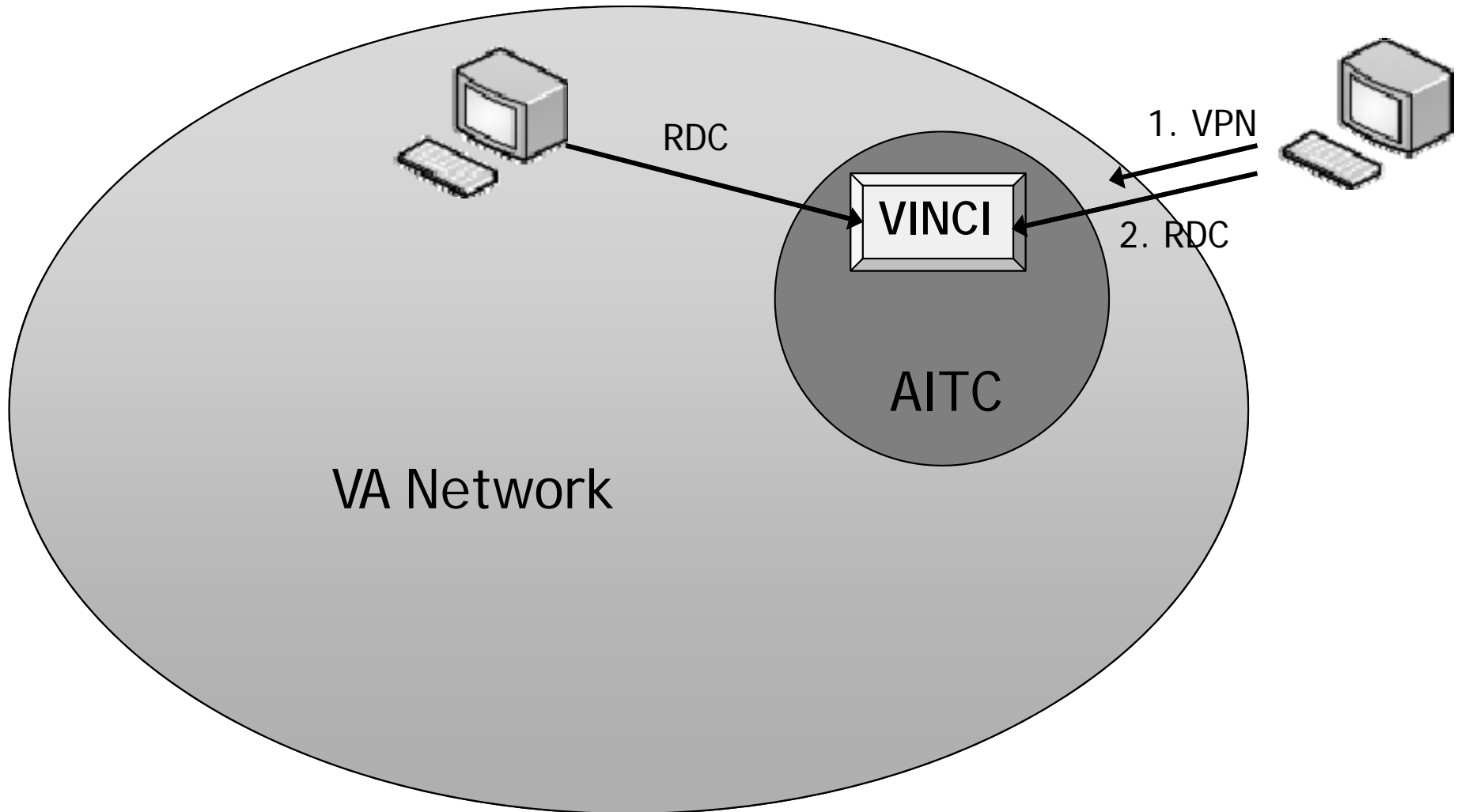



# VINCI Workspace

- Behind the Gateway
- Supporting a study through the entire project including exporting study artifacts
- Access to
  - Software Tools
  - Data
  - SAS Grid
- VINCI File Transfer Utility
- H-drive / P-drive folders

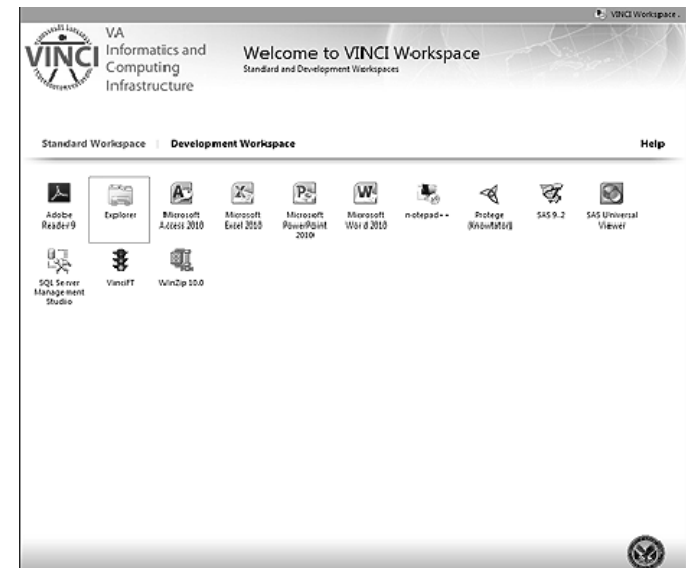

# Data Storage Options

---

- H-Drive
  - 2 GB limit
  - Intended for personal file storage only
  - Specifically NOT for storing study data
- P-Drive Project Folders
  - Intended for storage of shared project files
  - Access is controlled and limited to study staff
  - Specifically intended for study data storage
- Databases
  - Microsoft SQL server by default
  - Can provide MySQL when necessary



# Software

- Over 50 programs available
  - Commercial, Open Source, Freeware, Shareware, & Government programs
  - Utility, Productivity, Programming, & Analysis
- Custom Software
  - V3NLP
    - V3NLP Interface
    - V3NLP Modules
    - V3NLP Framework
  - Annotation
    - Knowtator, eHOST
    - Annotation Admin
    - Chart Reader



# Data

---

- Partnership with Corporate Data Warehouse (CDW) to *host* National-level data: 30 domains and growing
- CDW - Appointment, Consult, Demographics, Health Factor, Immunization, Lab Chemistry, Mental Health, Outpatient Encounters, Outpatient Pharmacy, PCMM, and Vital Sign
- VINCI - Allergies, Administrative data, ECHO, EDIS, Equipment Inventory, Fee Basis, Non-VA Meds, Prosthetics, Inpatient (PTF), Radiology, Surgery, TIU (except for 8 sites), and Vital Status
- We can help get access to other VA data sets
- **Bring in your own data!**



# SAS Grid Computing

- Dedicated 80 node grid with enormous capacity and processing power to support large, complex processes
- 2 Dedicated SAS Engineers
  - Improving process performance
- 9 SAS modules
  - Enhanced Statistical Package; Graph; Econometrics and time series; Operations research; Matrix language; Quality control; Connect; Access; and Enterprise miner

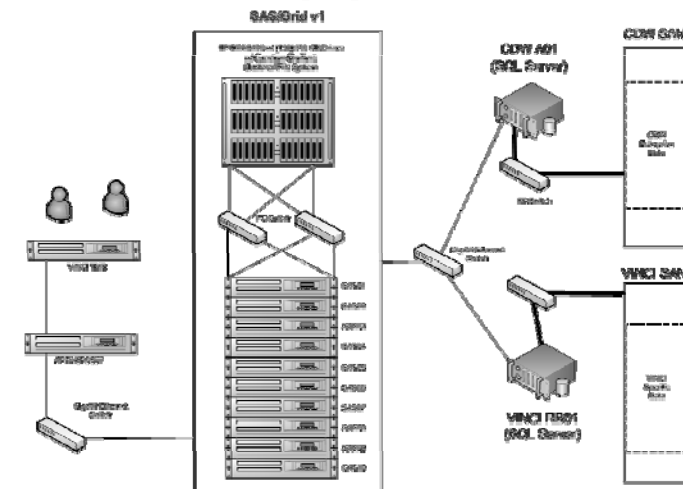

# VINCI File Transfer Utility

---

- Workspace utility for copying files out
- Files copied for auditing purposes
- Audit Process
  - Copies of transferred files are archived
  - Copied files are audited for for PHI, PII, and SI
- Can transfer out
  - Aggregate data
  - Documents - papers, analysis, presentations
- Cannot transfer identifiable data out
  - Never any PHI, PII, or SI; even if you brought it in and own it



# VINCI Process

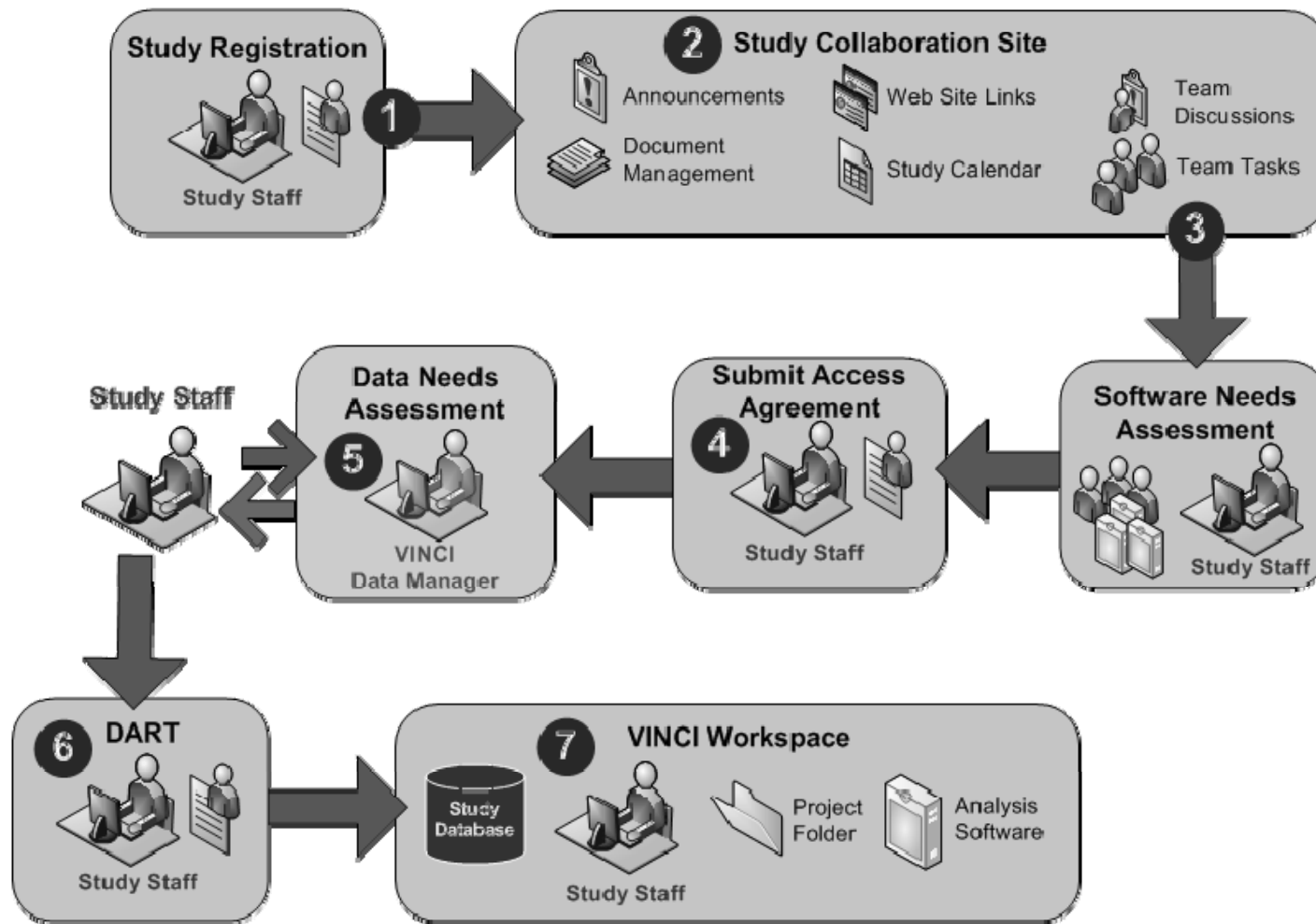

# Study Registration

---

- Available from VINCI Central
- For collecting information to support your project
- For creating a Study Collaboration Site

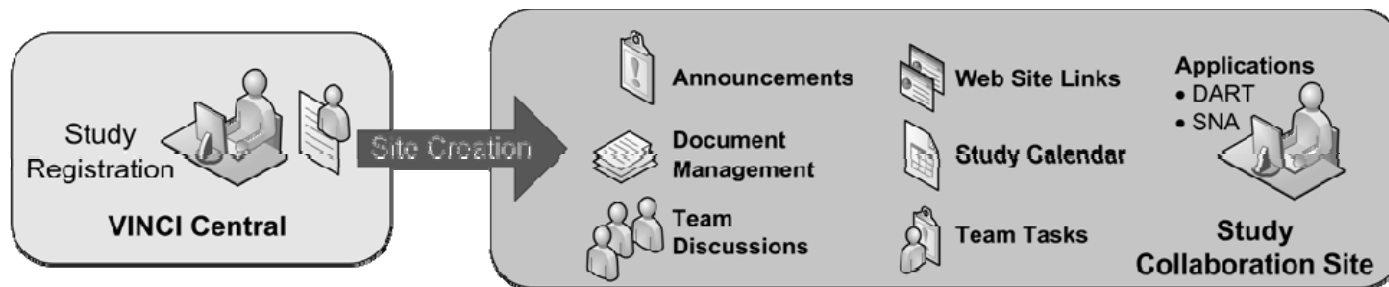

- For setting up initial site users



# Collaboration Site

- Designed by Researchers for Researchers
- Access to study-specific DART and Software Needs Assessment applications
- Facilitate communication
  - Announcements & Calendar
  - Team Discussion & Team Tasks
- Information
  - Links to resources and user guides
- Manage Documentation
  - Document repository

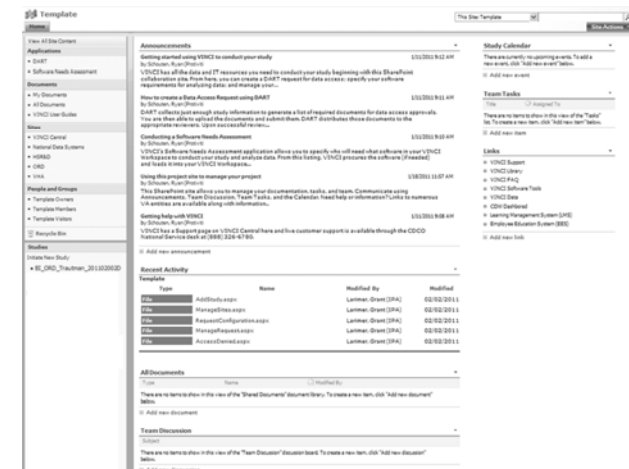

# Collaboration Site

VA Informatics and Computing Infrastructure - VINCI Central > VINCI Operations > Template

Welcome Trautman, Timothy N. | My Site | My Links

This Site: Template

Site Actions

**Template**

Home

View All Site Content

**Applications**

- DART
- Software Needs Assessment

**Documents**

- My Documents
- All Documents
- VINCI User Guides

**Sites**

- VINCI Central
- National Data Systems
- HSR&D
- ORD
- VHA

**People and Groups**

- Template Owners
- Template Members
- Template Visitors

Recycle Bin

**Studies**

Initiate New Study

- ADE Alerts
- Annotation - DeID
- Automated Data Acquisition for Heart Failure
- BI\_ORD\_Trautman 201102002D
- Chart Reader
- CHIR - Annotation
- CHIR - Challenge Evaluation

**Announcements**

**Getting help with VINCI** 6/30/2011 11:35 AM  
by Larimer, Grant (UofU)  
VINCI has a Support page on VINCI Central here and live customer support is available through the CDCO National Service desk at (888) 326-6780.

**Conducting a Software Needs Assessment** 6/30/2011 11:35 AM  
by Larimer, Grant (UofU)  
VINCI's Software Needs Assessment application allows you to specify who will need what software in your VINCI Workspace to conduct your study and analyze data. From this listing, VINCI procures the software (if needed) and loads it into your VINCI Workspace....

**How to create a Data Access Request using DART** 6/30/2011 11:36 AM  
by Larimer, Grant (UofU)  
DART collects just enough study information to generate a list of required documents for data access approvals. You are then able to upload the documents and submit them. DART distributes those documents to the appropriate reviewers. Upon successful...

**Getting started using VINCI to conduct your study** 6/30/2011 11:36 AM  
by Larimer, Grant (UofU)  
VINCI has all the data and IT resources you need to conduct your study beginning with this SharePoint collaboration site. From here, you can create a DART request for data access; specify your software requirements for analyzing data; and manage your...

**Using this project site to manage your project** 6/30/2011 11:36 AM  
by Larimer, Grant (UofU)  
This SharePoint site allows you to manage your documentation, tasks, and team. Communicate using Announcements, Team Discussion, Team Tasks, and the Calendar. Need help or information? Links to numerous VA entities are available along with information...

Add new announcement

**Recent Activity**

Type	Name	Modified By	Modified
File	ManageSites.aspx	Larimer, Grant (UofU)	08/22/2011
File	RequestConfiguration.aspx	Larimer, Grant (UofU)	08/22/2011
File	AddStudy.aspx	Larimer, Grant (UofU)	08/22/2011
File	ManageRequest.aspx	Larimer, Grant (UofU)	08/22/2011
File	AmendRequest.aspx	Larimer, Grant (UofU)	08/22/2011

**Study Calendar**

There are currently no upcoming events. To add a new event, click "Add new event" below.

Add new event

**Team Tasks**

Title Assigned To

There are no items to show in this view of the "Tasks" list. To create a new item, click "Add new item" below.

Add new item

**Links**

- VINCI Library
- VINCI FAQ
- VINCI Software Tools
- CDW Dashboard
- Talent Management System (TMS)
- Employee Education System (EES)
- VINCI Support
- VINCI Data
- Launch VINCI Workspace

Add new link



# Software Needs Assessment

- Specify who needs what software in the VINCI Workspace

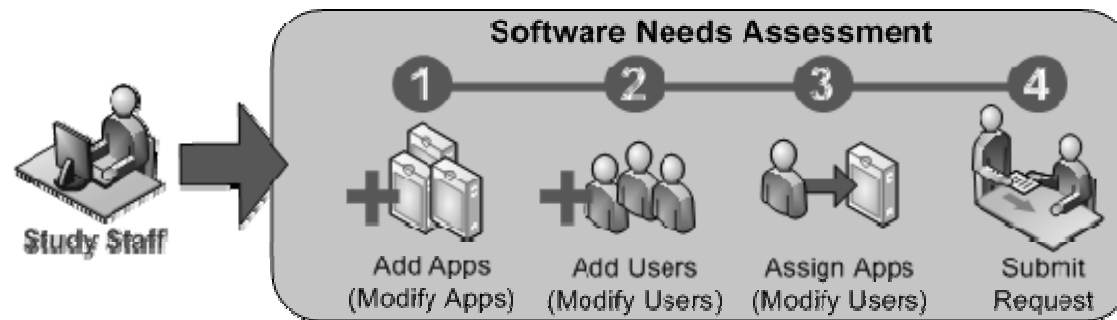

- Fulfillment tracking
- Software acquisition
  - VINCI is funded to buy software but VA process is slow
- License management

# Data Needs Assessment

---

- Manual process for working with VINCI Data Managers to determine data needs

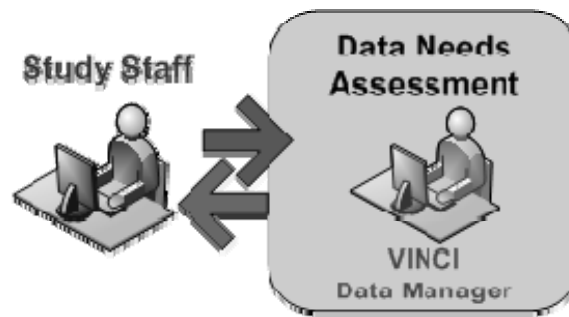

- Data Manager helps you understand and select from the various data sources

# Data Access Request Tracker (DART)

- Application for obtaining data *access* approvals, not the data itself
- Select data sources and DART tells you what documents are required
- Upload documents to DART
- It distributes documents to approvers
- Facilitates communications
- Facilitates tracking

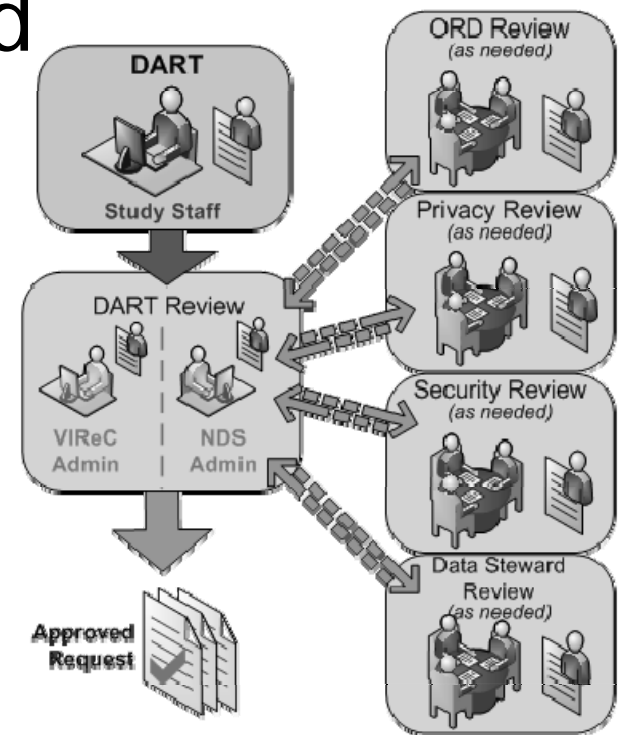

# Support

- VINCI Central
  - Support page

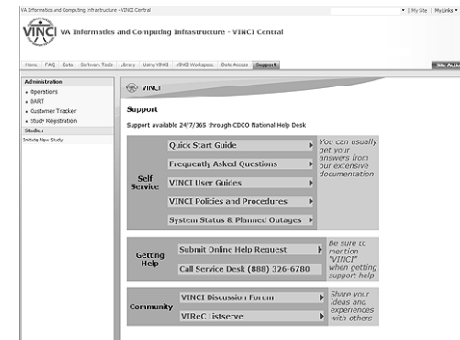

- Tier 1 - CDCO National Service Desk in Austin
  - Available 24/7/365
  - (888) 326-6780 or [cdco-nsd@va.gov](mailto:cdco-nsd@va.gov)
- Tier 2 - VINCI Service Desk
  - VINCI Staff
  - Normal working hours

# Data Services

---

- Data Managers for VINCI & CDW
- Data extractions
- Data transformations
- Data views
- Help with accessing datasets using various analytical tools
- Help understanding the data
- Data profile information
- Metadata information
- *Does not do data analysis for you*

# Resources

- VINCI Central  
<http://vaww.vinci.med.va.gov>
- VINCI Quick Start Guide
- Contact [VINCI@va.gov](mailto:VINCI@va.gov)

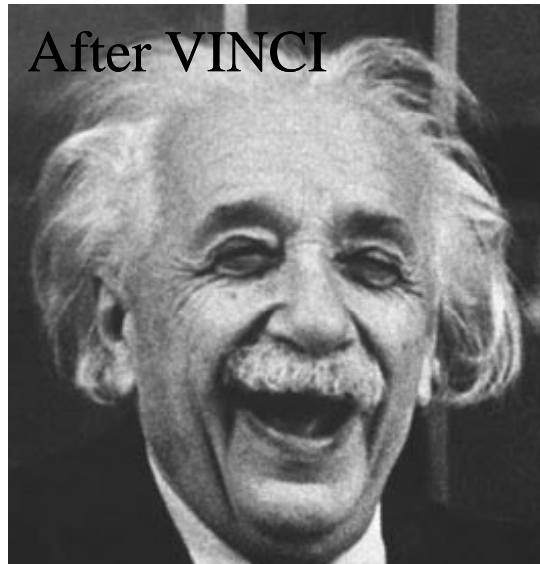
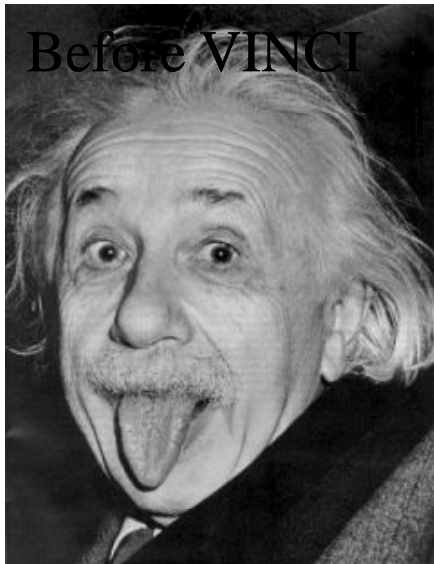
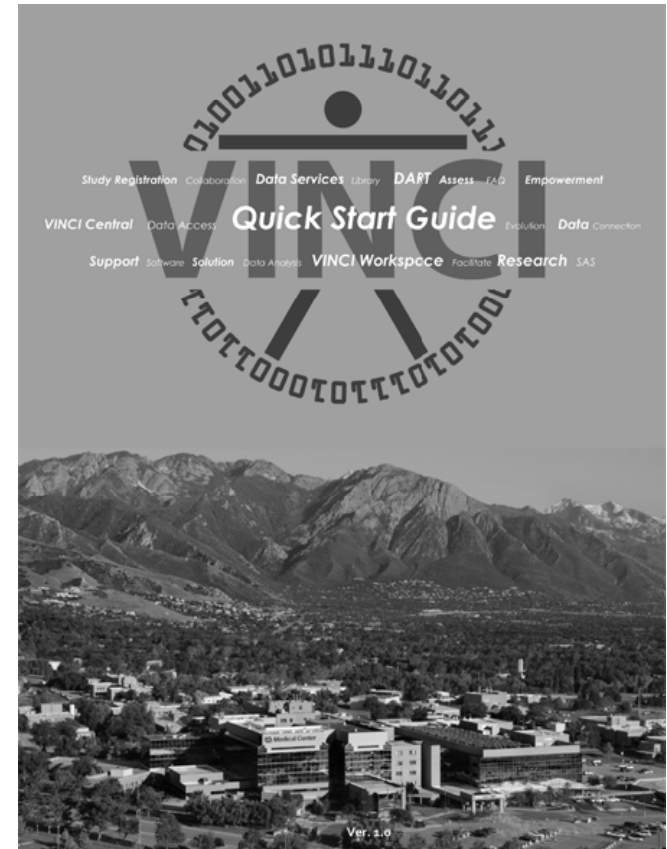



# Survey

---

- How is the computer you use connected to the VA Network?
  - GFE computer connected directly to the network
  - GFE Laptop via VPN
  - Non-GFE computer connected via VPN
  
- What operating system does your computer you use?
  - Windows XP
  - Windows Vista
  - Windows 7
  - Mac OSX
  - Linux
  
- If you connect over VPN, what VPN client do you use?
  - Rescue GFE
  - Rescue OE
  - Citrix Access Gateway (CAG)
  - One-VA VPN
  - AnyConnect



# Survey

---

- If you have an FTP client installed on your computer for transferring files, what is it?
  - CoreFTP
  - FileZilla
  - Other (please specify)
  
- Do you use a virtual machine to connect to the VA network from your computer?
  - Yes
  - No