

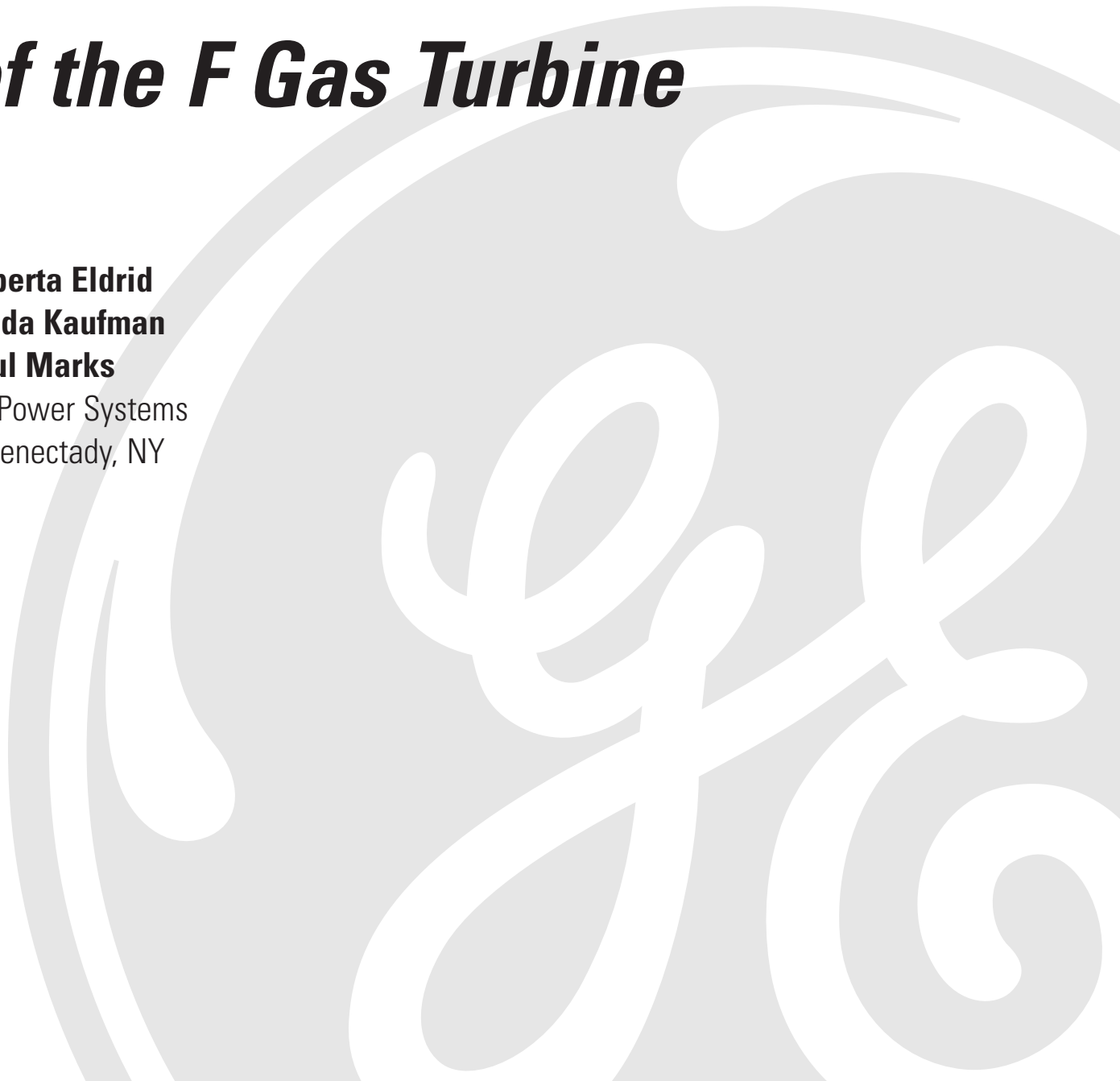

GE Power Systems

***The 7FB:
The Next Evolution
of the F Gas Turbine***

**Roberta Eldrid
Lynda Kaufman
Paul Marks**
GE Power Systems
Schenectady, NY



Contents

Introduction	1
Critical Issues in the F Evolution	1
<i>Life-Cycle Economics</i>	1
<i>The F Series Gas Turbine Experience</i>	3
<i>Reliability and Availability</i>	4
<i>The Evolution of Cost Improvements</i>	5
<i>The FA Compressor Test</i>	7
<i>The H Gas Turbine Combined Cycle</i>	8
<i>The Flowback of H Technology into the F Platform</i>	8
Applying Six Sigma to Determine the Future Evolution of the F/FA	9
<i>The Next Step in the F Product Evolution: The 7FB</i>	11
Conclusion	14
Acknowledgments	15
References	16
List of Figures	17
List of Tables	17

The 7FB: The Next Evolution of the F Gas Turbine

Introduction

Global deregulation of the power generation industry and the emergence of a merchant plant market have accelerated the demand for high-efficiency, lower-cost power plants. The drive for efficiency has been reinforced by growing concern over global warming, which has been attributed to the burning of fossil fuels. In view of these market demands, GE has continued to evolve its F technology, which has been the standard setter for economical, clean power generation during the last decade. GE introduced the MS7001FB in November 1999 at Power-Gen International (*Figure 1*). The 7FB is better by over 1 percentage point in net plant combined-cycle efficiency and greater by nearly 7% in combined-cycle output than its predecessor, the MS7001FA.

Some of the many factors that were considered in advancing the F/FA product line to the FB included life-cycle economics, the F/FA operating experience, a comprehensive FA compressor test and applicable technologies that were developed under the *H System* program. The *H System* program was supported by the ATS Program, which was sponsored by the U.S. Department of Energy. Six Sigma, GE's statistical process, was used to evaluate these factors and examine potential next steps in arriving at the optimal solution – the 7FB.

Critical Issues in the F Evolution

Life-Cycle Economics

In the 1950s, when gas turbines were first used for power generation in large numbers, they were applied almost exclusively to peaking duty. Designs were required for this mode of service that featured low specific cost and good starting reliability.

Through the 1960s and early 1970s, continuing advances in efficiency, reliability and availability facilitated a wider range of applications for gas turbines. Today, with the addition of low emissions, low overall life-cycle cost and fast installation time, the gas turbine-based power plant has become the most widely used method for power production.

Many gas turbine applications today require the gas turbine to run nearly continuously. With this increase in operating hours, the cost of fuel has assumed greater significance in optimizing machine design. As operating (or fuel) cost has become more important, technology development has been focused on improving efficiency, primarily through increasing firing temperature. But higher operating temperatures can drive design engineers to use more expensive parts that may affect operating and maintenance practices.

So, in today's environment, with gas turbines in

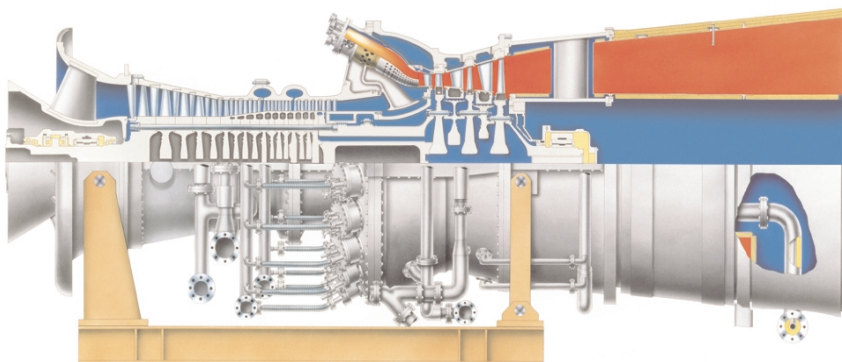

Figure 1. The MS7001FB gas turbine

The 7FB: The Next Evolution of the F Gas Turbine

widespread use in power generation and cogeneration applications as baseload machines in combined-cycle configurations, optimizing gas turbine design requires balancing multiple objectives of low first cost, fuel cost, and operation and maintenance costs over the life of a machine.

GE continues to evolve its gas turbine product lines to address the growing challenge of meeting multiple objectives. *Figure 2* shows the major elements of the life-cycle cost of a representative combined-cycle power plant. Clearly, the largest component of life-cycle cost, or cost of electricity (COE), is fuel cost, which is a function of fuel price and a power plant's overall

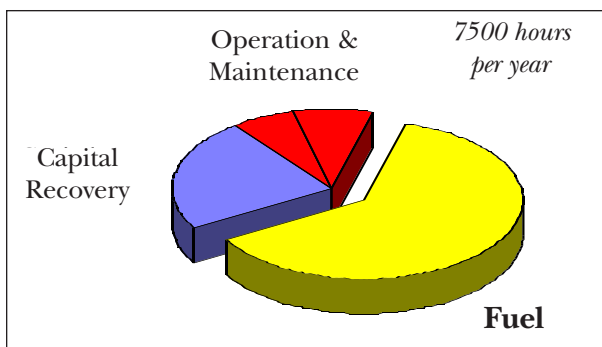

Figure 2. Major elements of the life-cycle cost of ownership (present value) for a typical combined-cycle power plant

thermal efficiency. The percent contribution to the overall COE of each of these elements has varied over time. As economies of scale have reduced capital cost and improved efficiency has reduced fuel cost, operation and maintenance (O&M) costs, which have exhibited little change, have become a larger and more significant fraction of total life-cycle cost.

Designers may select more expensive materials to achieve higher efficiencies, and their cost must be offset by the power plant's increased

performance. A look at capital costs (*Figure 3*) shows the gas turbine flange-to-flange (GT) cost is a relatively small portion of the overall power plant capital cost. However, the gas turbine consumable components make up the largest contribution to maintenance costs, as shown in *Figure 4*.

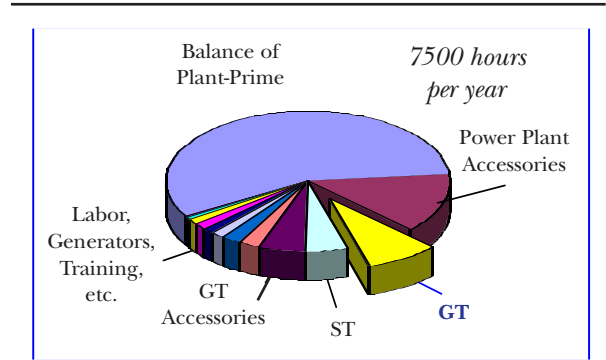

Figure 3. Elements of capital cost for typical combined-cycle plant

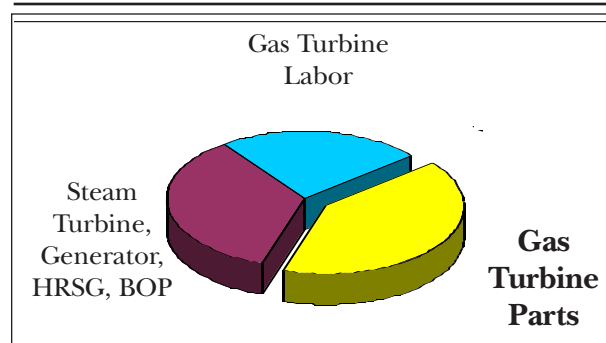

Figure 4. Elements of maintenance costs for a typical combined-cycle power plant

This discussion, thus far, has illustrated trends for average plants. GE has made a statistical assessment of the variations expected in plant cost; efficiency based on plant-to-plant differences, given a single design; and maintenance costs, based on the differences in experience from one plant to another. Of these variations, O&M variability has the greatest impact on life-cycle cost.

The 7FB: The Next Evolution of the F Gas Turbine

Figure 5 shows the effect on the probability of achieving various levelized electricity costs with and without consideration of O&M variation. The expected O&M cost itself is the same in both cases. Various approaches could be taken to compensate for O&M uncertainty (worth, in this example, 1% in a levelized COE). For example, pursuit of higher fuel efficiency would require a 1.5% improvement in heat rate to offset the total uncertainty of O&M cost.

commercial service June 6, 1990, at Virginia Electric & Power Company's Chesterfield site. Since that time there has been a continuum of new units entering service, incremental refinements and improvements. As of February 24, 2000, there are currently 93 F/FA gas turbines in service with a cumulative operating experience of 1,695,579 fired hours and 43,437 starts.

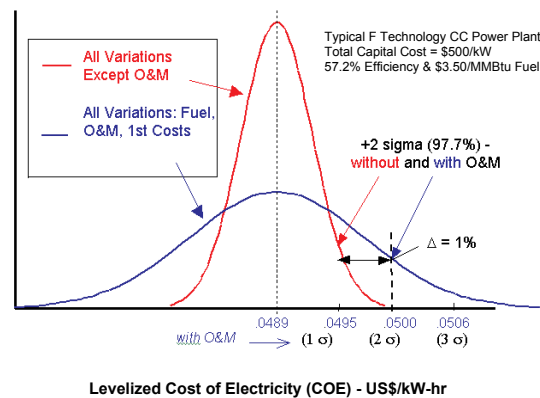

Figure 5. Ignoring operation and maintenance (O&M) cost variation would require an additional 1% in levelized cost of electricity (COE) for a given level of confidence

This example illustrates the importance of not only the magnitude of the elements of COE for the average plant but the variability of these elements. In light of this, designers are obliged to make design choices that minimize COE and, at the same time, must consider how to reduce the variation of design parameters so as to minimize the resultant variability of COE.

The F Series Gas Turbine Experience

The F technology was initially designed in the 1980s; it represented a quantum leap in the operating temperatures, cooling technology and aerothermal performance of heavy-duty gas turbines. GE's first F-technology unit entered

The F technology has also been scaled upward to the MS9001F, 50 Hz machines and downward to the MS6001F, 50/60 Hz machines for a grand total of 158 F units now in service with 2,680,497 fired hours and 55,872 starts. This experience includes operation in duty cycles from peak-shaving to baseload to daily start-stop mode, as shown in Figure 6.

Figure 7 illustrates the rate at which GE is accumulating hours on the F/FA fleet. In 1999 the average number of fired hours grew at a rate of 60,000 per month. The projected rate of growth for 2000 is about 100,000 per month.

The introduction of the F-class machine in the early 1990s was impelled by the concurrent

The 7FB: The Next Evolution of the F Gas Turbine

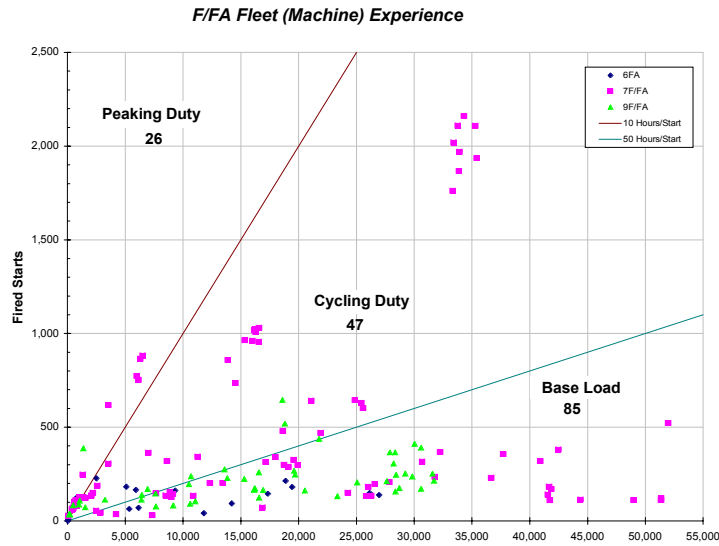

Figure 6. F series machines are used in a variety of applications, including baseload, cycling and peaking duties

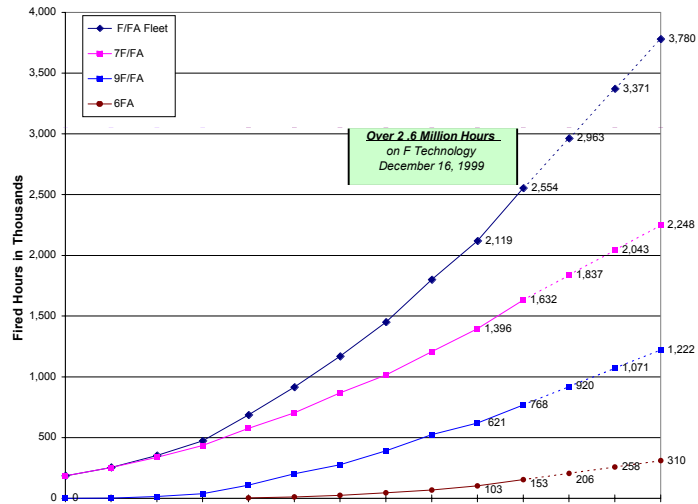

Figure 7. F/FA machines have accumulated over 2.6 million operating hours in all operating modes and now have an accumulation rate of over 100,000 hours per month

needs to press the limits on aerothermal performance, meet drastically lowered emissions standards (with new Dry-Low-NO_x combustion systems) and succeed in a fiercely competitive market that was paying 20% to 40% less per installed kilowatt. The multifront advances yielded the overall necessary performance increases but also led to several shortcomings in equipment design that had a negative impact on availability. These were addressed and resolved by means of extensive root-cause analyses (RCA) and have been corrected at the

design level for the current offering of GE MS7001FA gas turbines.

Reliability and Availability

In the United States there are two organizations that collect reliability-related operating data from utility-sized generating plants. The older and more broadly recognized is the U.S. government-sponsored North American Electric Reliability Council (NERC), which has been collecting this data under government mandate from regulated utilities since the 1970s. NERC

The 7FB: The Next Evolution of the F Gas Turbine

does not currently collect data from GE F-class gas turbines. The second organization is Strategic Power Systems, Inc. (SPS), a privately held firm that focuses on the reliability of gas turbine electrical generation plants, worldwide and application-wide, using their ORAP data system to collect data from many heavy-duty gas turbine manufacturers.

Ultimately the quality of any design is measured in terms of the resulting units' reliability and availability as they perform their service. GE uses a sophisticated reliability model for estimating reliability, availability and maintainability performance for equipment guarantees. Data collected from various sources, including SPS's ORAP, as well as the 7F User's Group and directly from some customers are used to calibrate the reliability model that can be passed along to GE's customers and clients. The current model shows that the typical current-production MS7001F gas turbine will average about 99.0% reliability and 95.0% availability on a life-cycle basis. Note that *reliability* is measured as:

$$100 \times (1 - FOF),$$

where FOF is the forced outage factor.

Availability is measured as:

$$100 \times (1 - FOF - SOF),$$

where SOF is the scheduled outage factor.

The 1999 ORAP average of 25 GE units at 89.3% availability and the 75-unit-year survey that averaged 89.35% availability are showing low averages because of a relatively few number of units with significantly long scheduled outages related to the correction of generic problems. Newer units will not experience these now-resolved problems.

Figures 8A and 8B illustrate GE's competitive assessment of the independent SPS ORAP data. In 1999 GE's simple-cycle availability of 89.3% compared most favorably with the industry aver-

age of 84.9%, which includes GE and other major gas turbine manufacturers. Simple-cycle reliability of 99.4% compared most favorably with the industry average of 95.7%. This data illustrates the GE advantage of the F-class gas turbines' reliability and availability.

A first look at the 7F/FA reliability figures, in *Figure 8B*, affirms that the units are now clearly meeting and exceeding the simple-cycle plant average reliability target levels of 99.0%. This demonstrates that the fleet availability numbers are driven by scheduled outage events. Now, recognizing that a significant part of scheduled outage hours are due to correction of old but solved issues, this data can be interpreted as a confirmation of the equipment's inherent capability to achieve 95.0% average availability.

The Evolution of Cost Improvements

Gas turbine designers are obliged to pursue opportunities for improving efficiency, reliability and maintenance cost to avoid invalidating the machine's experience base. This experience base, from whichever gas turbine product it comes, can benefit multiple product lines. *Figure 9* shows the incremental evolution of the E-class machine. As the E class matured, a decision was made to introduce the F-class machines – the 7F and its scaled versions, the 9F and the 6F. Many factors drove this decision, but once the F machines were introduced, technological advancement or operating experience on the F product line has helped drive further evolution of the older E-class machines. Likewise, the next-generation product, the H machine, will have an impact on the E and F products.

Design improvements in the F/FA product line are made incrementally and are based on proven materials, extensive laboratory or engine testing and operating experience. When the F technology was announced, its uprate potential was projected and these uprates

The 7FB: The Next Evolution of the F Gas Turbine

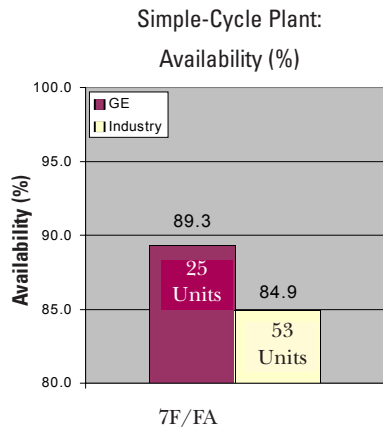

FIG 8A

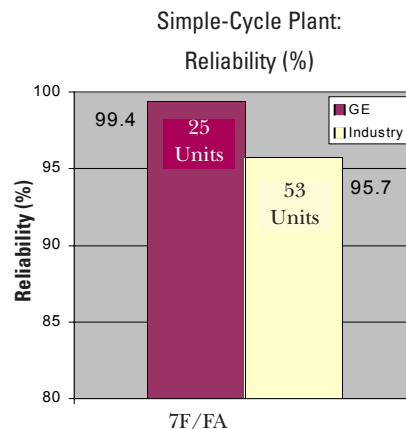

FIG 8B

Figure 8. GE's 7F/FA availability (Figure 8A) and reliability (Figure 8B) for simple-cycle power plants relative to the F industry (source: Strategic Power Systems, Inc., ORAP data)

began immediately upon completion of the prototype testing at the Greenville factory. One projection made was that the combined-cycle efficiency would be increased from the 50% cited in the introduction paper to 55%. The 55% level was achieved in 1994 with the testing of Korea's first MS7001F unit in combined-cycle mode.

Upgrades continue as the technology becomes available and as experience on the high-temperature components of the F/FA fleet remains

favorable. Table 1 shows the evolution of the MS7001F machine. Each uprate has been achieved without reducing inspection intervals below those established by the original design. The first uprate of the MS7001F simply took advantage of the better-than-expected performance observed in testing. Firing temperature upgrades involved modifications to component cooling and pressure ratio. Higher pressure ratio prevents the overheating of the last-stage buckets. Improvements in bucket and nozzle

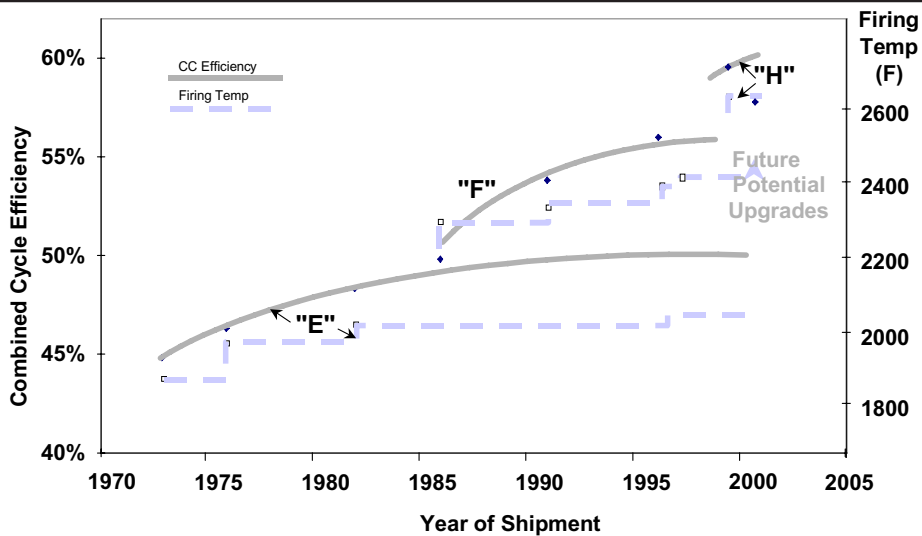

Figure 9. Continuous technology development and experience benefits flow across product lines

The 7FB: The Next Evolution of the F Gas Turbine

	PG7191(F)	PG7221(FA)	PG7231(FA)	PG7241(FA)
Output	150 MW	159 MW	167.8 MW	171.7 MW
Heat Rate (LHV)	9880 BTU/kWh	9500 BTU/kWh	9380 BTU/kWh	9360 BTU/kWh
Pressure Ratio	13.5:1	15.1:1	14.9:1	15.5:1
Firing Temp. Class	2300 F	2350 F	2400 F	2420 F
Compressor Stages	18	18	18	18
Turbine Stages	3	3	3	3
Combustion System	Can-annular	Can-annular	Can-annular	Can-annular
Year of Introduction	1990	1993	1997	1999

Table 1. MS7001F gas turbines

cooling have been achieved by increasing the use of film cooling. The original MS7001F first-stage bucket cooling system was derived from the CF6 aircraft engine bucket’s system, but it did not employ the CF6’s film-cooled leading edge. The current buckets now use more of the full CF6 system.

Other technologies have been imported from GE Aircraft Engines including improved clearance and leakage control. An example of this technology is honeycomb seals, which have been used for years in the MS9001E and MS7001EA machines. *Figure 10* shows the evolution of the PG7231FA to the PG7241FA, illustrating the incremental enhancements that

were incorporated recently into the 7F product line.

The FA Compressor Test

Incremental improvements in the F series compressor were incorporated during the F series’ evolutionary life. Consequently, in 1998 a FA compressor test was performed to revalidate the compressor’s capability (*Figure 11*).

The objectives of the test were twofold: (1) to thoroughly map the FA compressor’s aerodynamic and aeromechanical behavior and (2) to characterize the thermal behavior of a high-radius rabbet (HRR) compressor rotor structure. One significant result of the test was the

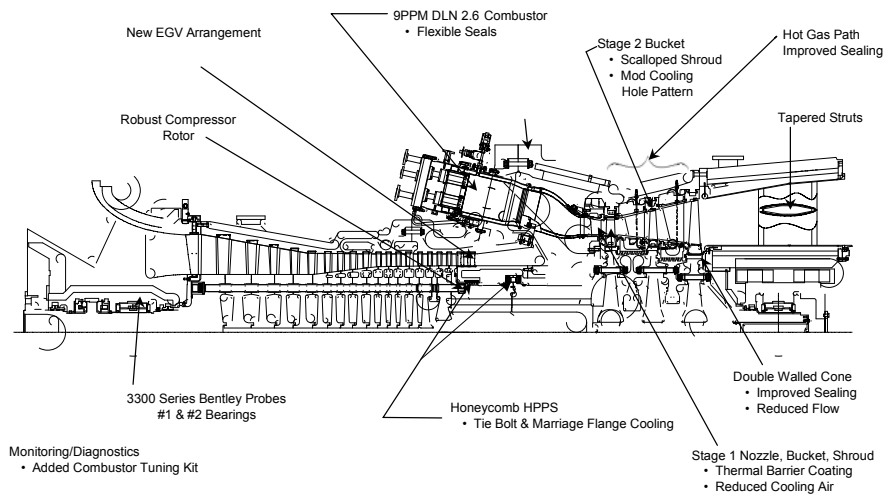

Figure 10. The transition from PG7231FA to PG7241FA gas turbine illustrates incremental improvement philosophy

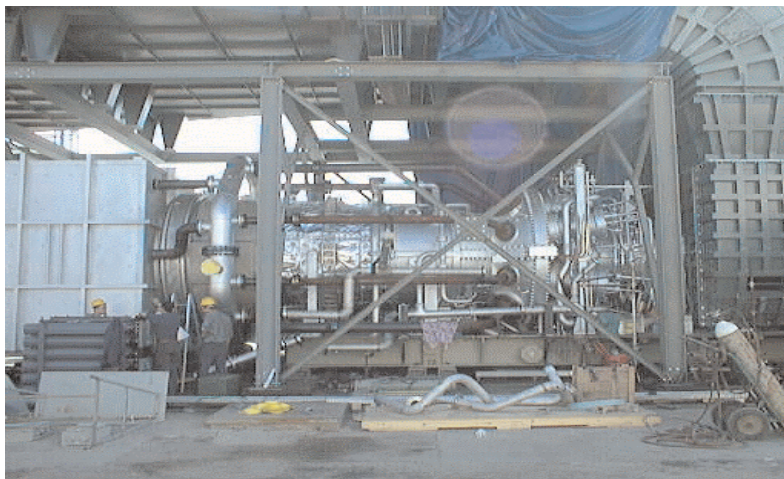

Figure 11. A FA compressor test vehicle (CTV) was constructed to comprehensively determine aerodynamic and structural behavior

establishment of compressor surge and stall characteristics, which demonstrated a compressor operating limit that would allow significant pressure ratio growth. Another significant result was the empirical determination of rotor thermal transients which was used to validate analytical predictions for the HRR rotor structure.

The H Gas Turbine Combined Cycle

A key advantage to gas turbine power-generation systems is their ability to continue evolving to higher firing temperatures (at the inlet to first rotational stage) because each increase in firing temperature yields a dual benefit of increased efficiency and increased specific work to overall power plant life-cycle cost. This had led to the step in technology from the E-class to F-class gas turbines and, more recently, to the beginning of yet another evolutionary path, GE's *H System* technology and the GE H-class gas turbine (*Figure 12*).

The *H System* is designed to achieve 60% net plant combined-cycle efficiency. The three key components of the H-technology gas turbine are shown in *Figure 13*: (1) closed-loop steam cooling, which is used for the first and second

stages of its four-stage turbine; (2) a higher-pressure-ratio compressor, derived from the GE Aircraft Engines CF6-80C2, optimizes efficiency and specific work with the 2600°F class of firing temperatures; and (3) the DLN combustion system now in service across GE's commercial product lines, which has been adapted to the H gas turbine.

The Flowback of H Technology into the F Platform

The H program took proven aircraft engine materials and developed the casting and forging processes necessary to scale from aircraft engine-sized components to power system-sized components. The FB program leveraged H material process development specifically in the areas of bucket materials and rotor forgings.

As an example, the stage-three and -four buckets on the 7H are using GE Aircraft Engines' single-crystal N4 alloy with grain boundary strengtheners added for use as DSN4 or GTD444. Rapid-prototype tooling facilitated early casting trials on both 7H bucket stages in GTD444, producing over 90% casting yields for the first 7H build. These successful results will

The 7FB: The Next Evolution of the F Gas Turbine



Figure 12. The first H gas turbine

- DLN 2.6 Combustor**
- 12 Cans
 - GE FA Experience

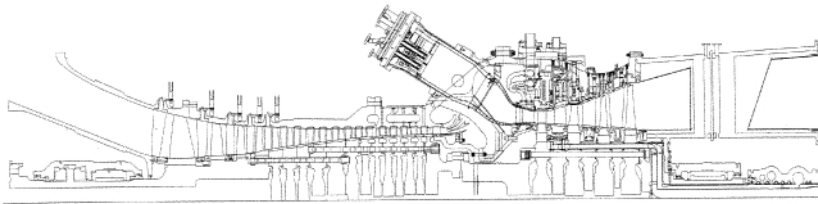

- 18 Stage Compressor**
- 23:1 Pressure Ratio
 - 1230 pps Airflow
 - GE Aircraft Engine Derived

- 4 Stage Turbine**
- 2600F Class
 - Closed Circuit Steam Cooled
 - GEAE/GEPS Materials

Figure 13. Key components of the MS7001H gas turbine

be directly applied to the stage-two and -three buckets on the 7FB.

Another example of technology developed on the *H System* that will be incorporated into the 7FB is the Mark VI control system. Requirements of the combined-cycle *H System* drove the need for a more capable control system. The Mark VI will also be used to control the next upgrade of the 7F platform.

The 7FB compressor rotor design will incorporate a high-radius rabbet configuration. This

configuration has significant operating experience in aircraft engines. It was demonstrated on the FA test in 1998 and is being utilized on the *H System*.

Applying Six Sigma to Determine the Future Evolution of the F/FA

As GE looked forward to the continued evolution of the F/FA product line, a range of factors were considered. Key factors that had to be weighed carefully included the continuing improvement in F reliability and growing expe-

The 7FB: The Next Evolution of the F Gas Turbine

rience base, the development and testing of H and other technologies and the recent FA compressor test results.

The question that remained was how to combine the complexities of power plant life-cycle economics with the choices that exist to arrive at an optimum design solution. GE Power Systems used the company’s Six Sigma methodology to combine these advantages for its customers’ satisfaction in the development of the 7FB. The Six Sigma process permeates GE’s design, manufacturing, and operational processes and applies a precise methodology to a complex multivariable situation. Its statistical capabilities permit incorporation of the extensive database of GE gas turbine operational experience to quantify the effect and expected range of design modifications under analysis. Where data is not available, the Six Sigma process provides the framework to ensure that design trade-offs are made rigorously and reviewed thoroughly.

One multivariable situation that needed to be evaluated involved looking at all aspects of increasing the pressure ratio, which permits an increase in firing temperature and efficiency.

But this presents challenges involving the turbine section and its design. Also, NO_x goals can conflict with the pursuit of efficiency. Our customers’ top priority – achieving the lowest life-cycle cost – was the focal point of our decision-making process.

One Six Sigma tool, Quality Function Deployment (QFD) has become the starting point for any development task at GE and was used to kick off the development of the 7FB. While QFD is in itself a powerful analytic tool, its greatest value lies in the debates and innovative thought that it informs and fosters.

The QFD process (*see Figure 14*) begins with identifying and ranking customers’ requirements through interviews and discussions. Next, relevant functional requirements are identified and an analysis is performed to determine the level at which each functional requirement affects each customer requirement. Point values are assigned to indicate level of effect. Finally, a score is calculated that shows the significance of each functional requirement to satisfying the customer requirements and, thus, identifying where the development efforts should be focused. It should be noted, the QFD

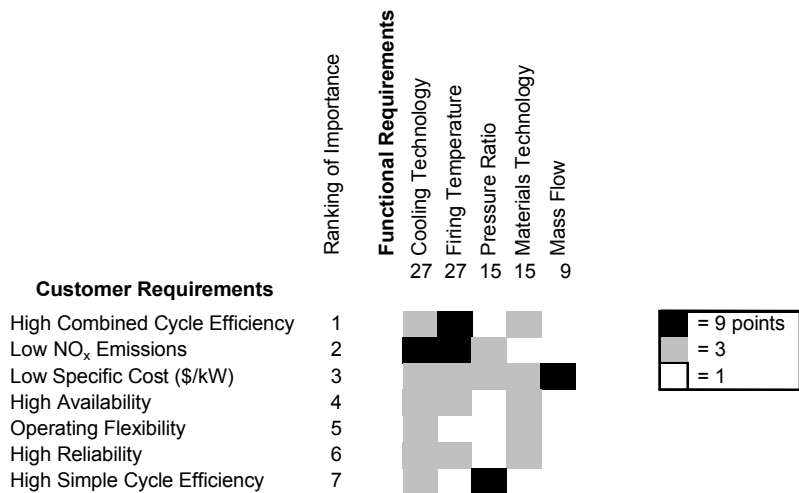

Figure 14. An example of Quality Function Deployment analysis

The 7FB: The Next Evolution of the F Gas Turbine

example cited here has been greatly simplified for illustrative purpose.

The QFD process, as applied to the 7FB, generated a series of analyses, or “houses,” beginning at the power plant level and working down to the gas turbine component level of functional requirements. The results of one house flows into the next, ensuring the calculated importance of meeting the customers’ requirements in the first house is retained as one drills down to each of the subsequent levels.

The results of the 7FB QFD indicated life-cycle cost and proven technology were the two functional requirements that would most satisfy customers’ needs. The QFD process was used to weigh internal requirements simultaneously with customer requirements.

Many factors influence one or more of the components of power plant life-cycle cost. (See Figure 15.) In turn, each of these factors is influenced by design choices for such things as firing temperature, efficiency, material selection, pressure ratio and mass flow.

Another Six Sigma tool, Design of Experiment (DOE), was used to quantify the optimal combination of these parameters. In terms of this DOE analysis, these parameters are the input

variables, or x 's, for the response variable, or y , which is COE. Execution of a DOE leads to finding the most influential variables and determining their mathematical relationship. Once this relationship, or transfer function, is developed, it can be used to determine an optimum combination of x 's for a minimum y -COE.

The Next Step in the F Product Evolution: The 7FB

The use of Six Sigma tools optimized choices for the design teams based on reduced variation (low risk) and minimized COE. As a result, it was decided not to create a new platform but, rather, to continue the F-series machine’s evolution to the next step – the 7FB.

Figure 9 illustrated how the E product line has benefited from proven F technology. It also illustrated how the F product line could further benefit from the wide variety of technologies related directly to the H machine that have completed sufficient proof testing to flow back into the F product.

Moreover, many of the H components and systems have themselves evolved from F technology melded with long-term GEAE technology. As an example, stage-one bucket material technology has advanced in two ways: from equiaxed

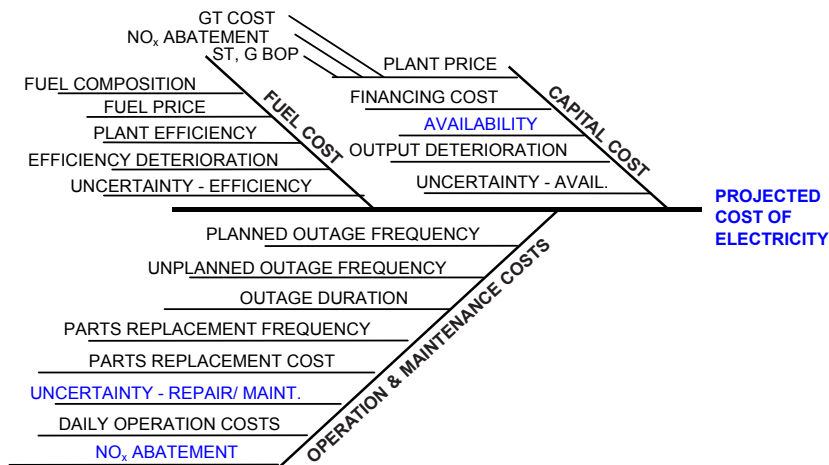

Figure 15. Factors that influence the components of power plant cost of electricity production

The 7FB: The Next Evolution of the F Gas Turbine

(EA) to directionally solidified (DS) to the current advanced TBC-coated single-crystal (SC) technology used in the H machine and, concurrently, from radial to serpentine to serpentine with advanced film cooling to the current closed-loop steam-cooling technology used in the H. The next logical step in the bucket's development is to evolve the F stage-one bucket to an H material (*Figure 16*), which, as a component-development plan, illustrates GE's overall evolution-based design philosophy.

Other materials developed and implemented at GEAE and for the H machine have been adapted for use in the 7FB to further improve performance and reliability. *Table 2* defines which materials are being adapted to the 7FB and their prior service.

Other technologies such as honeycomb and brush seals, which have a significant operating history in GEAE engines, GE steam turbines and GE E-class gas turbines, are being considered for various locations in the 7FB (*Figure 17*). Rough coatings used to enhance cooling-side heat transfer, smooth coatings to reduce aerodynamic drag and reduce hot gas-side heat

transfer, and radiation coatings may also be utilized.

Again, with many choices of technologies, the final design features were chosen to yield an optimum configuration to meet all customer requirements. Some of these features for the resultant 7FB configuration are illustrated in *Figure 18*.

The resultant performance characteristics of the 7FB are compared to its predecessor, the 7FA, and the next-generation 7H machine in *Table 3*. The increase in firing temperature from the 7FA to the 7FB has led to higher combustion flame temperature for the 7FB and, consequently, higher gas turbine NO_x. One of the advantages of the advanced H-technology machine is its ability to maintain low NO_x despite higher firing temperature by way of closed-looped steam cooling of the first-stage nozzle.

Another characteristic of the 7FB is its performance as a function of ambient temperature, shown in *Figure 19*. This ambient behavior results in higher performance for the 7FB relative to the current 7FA for all ambient tempera-

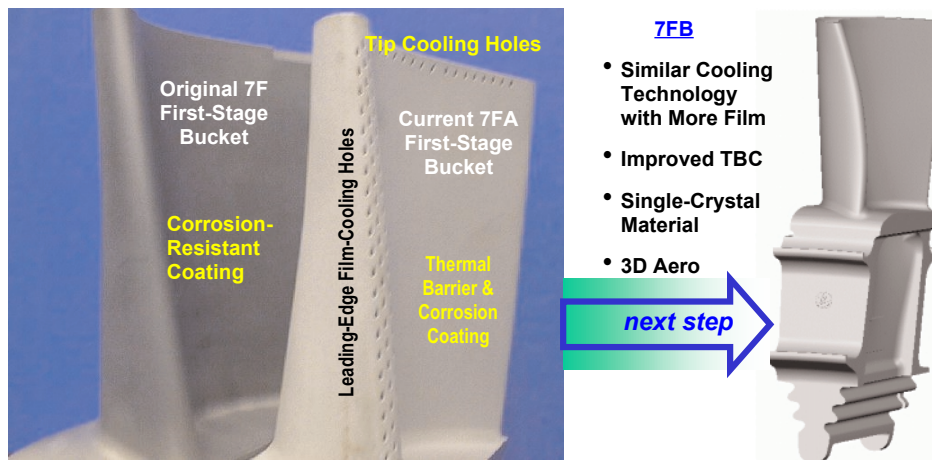

Figure 16. Evolution of the F series first-stage bucket to allow higher firing temperature and reduce performance degradation

The 7FB: The Next Evolution of the F Gas Turbine

Component	7FA (Ref.)	7FB	Prior Service	
			GEAE	GEPS
S1B	DS GTD111	SX N5	✓	✓ (H)
S2B & S3B	DS GTD111	DS GTD444	✓	✓ (H)
S1N & S2N	FSX414	GTD111	✓	✓
S3N	GTD222	GTD222	✓	✓
Combustor	HastX/N263	HastX/N263	✓	✓
Transition Pieces	N263	N263	✓	✓
Coating	TBC	TBC	✓	✓
Turbine Wheels & Spacers	IN706	IN706/IN718	✓	✓ (H)

Table 2. 7FB materials experience

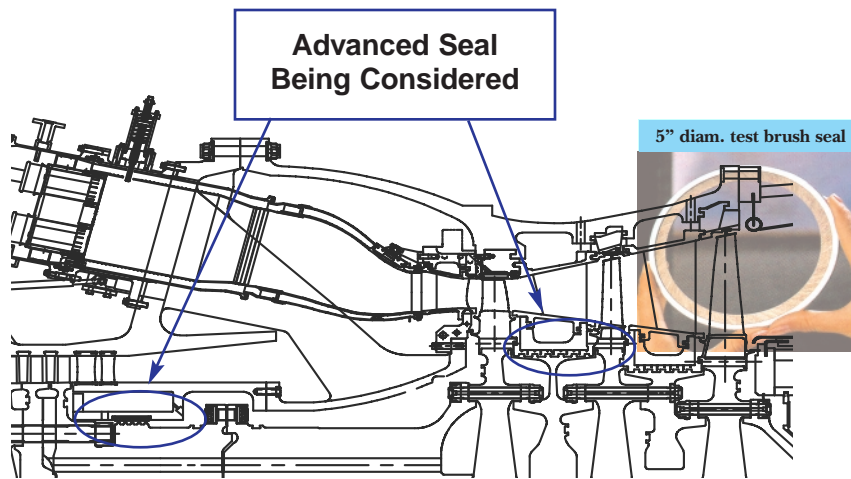

Figure 17. Advanced seals are critical to improved performance

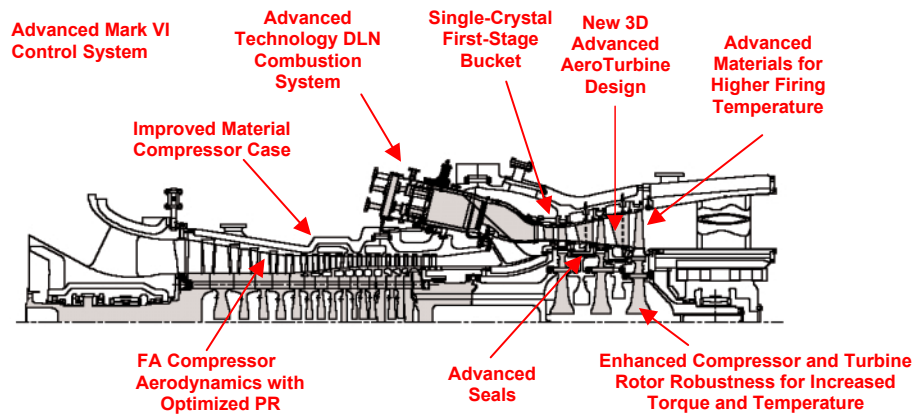

Figure 18. FB design features make maximum use of evolutionary designs and extensive operation experience

The 7FB: The Next Evolution of the F Gas Turbine

Characteristics	7FA	7FB	7H
Firing Temperature Class, F	2420	2500+	2600
Airflow, Lbs/sec	950	950	1230
Pressure Ratio	15.5	18.5	23
Emissions			
NOx, ppm	9	25	9
Combined Cycle Performance	STAG 107FA	STAG 107FB	STAG 107H
Net Output, MW	263	280	400
Net Efficiency, %	56	57.3	60
Heat Rate	6095	5956	5690

Table 3. FA, FB and H System™ performance characteristics

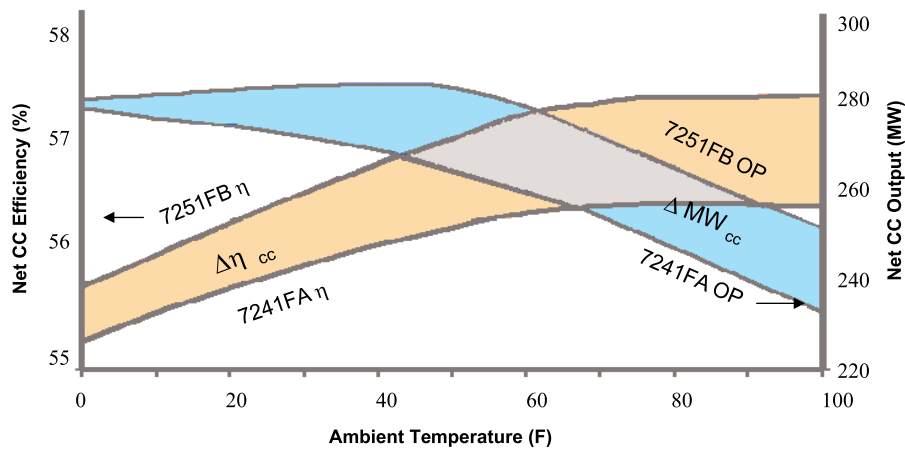

Figure 19. The 7FB maintains a performance benefit over all ambient temperatures above 0°F and has a maximum benefit of ISO and above

tures above 0°F with a maximum benefit for ISO and higher ambient temperatures.

The 7FB design is currently in the detailed design phase with a scheduled completion at the end of 2000. First-unit manufacturing, assembly and testing will be completed in 2001 with first-unit shipment planned for the end of that year. More scheduling details are shown in *Figure 20*.

The first power plant for the 7FB will be based on an 800 megawatt, 307FB combined-cycle system consisting of three gas turbines and one steam turbine. Commercial operation of this power plant will begin in 2003. A total of 15 7FBs have been committed as of this writing, and the next available units are planned for shipment in the first quarter of 2003.

Conclusion

Firing temperature is the key to combined-cycle efficiency and, consequently, to minimizing fuel cost. H technology and F experience enable a significant and vigorous advance in firing temperature on the F/FA product. Developments at GE Aircraft Engines and GE Corporate Research and Development continue to provide valuable contributions to product technology and design and manufacturing techniques to further enhance performance and reduce overall power plant costs of the F product.

However, designing gas turbines in today's deregulated market requires balancing all three major elements of life-cycle cost: capital cost, O&M cost and fuel cost. Determining the optimum design solution – that is, determining

The 7FB: The Next Evolution of the F Gas Turbine

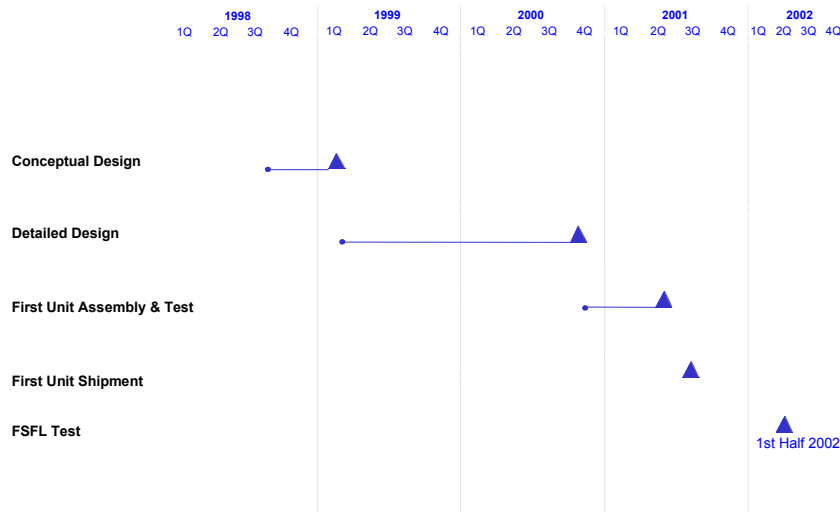

Figure 20. The 7251FB program schedule

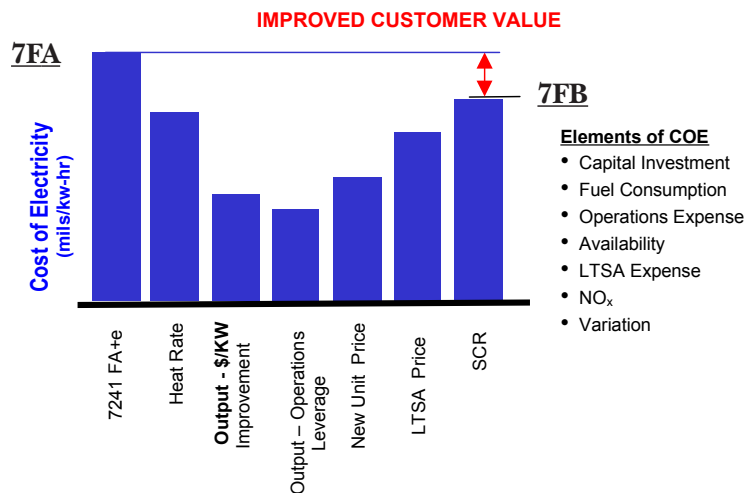

Figure 21. This waterfall of elements of the COE of the 7FB versus that of the current 7FA+e shows an increase in customer value

which advancements to incorporate – is a very complex exercise in designing for multiple objectives.

GE is systematically applying the advanced statistical tools of its corporate-wide Six Sigma initiative to facilitate finding the balance among these multiple objectives for satisfying specific customer needs. The solution is the 7FB – a combination of proven, robust design options that not only will minimize life-cycle costs but

will minimize the variation of those costs (Figure 21). In this way, GE will deliver the next evolutionary step in the F product line and significantly improve on its leadership in low-cost, clean, reliable power generation.

Acknowledgments

The ATS Program is sponsored by the U.S. Department of Energy under Cooperative Agreement DE-FC21-93MC31176 with GE

The 7FB: The Next Evolution of the F Gas Turbine

Power Systems, 1 River Road, Schenectady, NY 12345, 518-385-2968. The DOE/FETC Contracting Officer's Representative is Mr. Kanwal Mahajan, and the period of performance is July 1995 to December 31, 2000 (Phase 3R).

References

Miller, Harold, "Engineering Gas Turbines for Best Value over Time," Power-Gen '98 Europe, Milan, Italy, June 1998.

List of Figures

- Figure 1. The MS7001FB gas turbine
- Figure 2. Major elements of the life-cycle cost of ownership (present value) for a typical combined-cycle power plant
- Figure 3. Elements of capital cost for typical combined-cycle plant
- Figure 4. Elements of maintenance costs for a typical combined-cycle power plant
- Figure 5. Ignoring operation and maintenance (O&M) cost variation would require an additional 1% in levelized cost of electricity (COE) for a given level of confidence
- Figure 6. F series machines are used in a variety of applications, including baseload, cycling and peaking duties
- Figure 7. F/FA machines have accumulated over 2.6 million operating hours in all operating modes and now have an accumulation rate of over 100,000 hours per month
- Figure 8. GE's 7F/FA availability (Figure 8A) and reliability (Figure 2B) for simple-cycle power plants relative to the F industry (*source: Strategic Power Systems, Inc., ORAP data*)
- Figure 9. Continuous technology development and experience benefits flow across product lines
- Figure 10. The transition from PG7231FA to PG7241 gas turbine illustrates incremental improvement philosophy
- Figure 11. An FA compressor test vehicle (CTV) was constructed to comprehensively determine aerodynamic and structural behavior
- Figure 12. The first H gas turbine
- Figure 13. Key components of the MS7001H gas turbine
- Figure 14. An example of Quality Function Deployment analysis
- Figure 15. Factors that influence the components of power plant cost of electricity production
- Figure 16. Evolution of the F series first-stage bucket to allow higher firing temperature and reduce performance degradation
- Figure 17. Advanced seals are critical to improved performance
- Figure 18. FB design features make maximum use of evolutionary designs and extensive operation experience
- Figure 19. The 7FB maintains a performance benefit over all ambient temperatures above 0°F and has a maximum benefit of ISO and above
- Figure 20. The 7251FB program schedule
- Figure 21. This waterfall of elements of the COE of the 7FB versus that of the current 7FA+e shows an increase in customer value

List of Tables

- Table 1. MS7001F gas turbines
- Table 2. 7FB materials experience
- Table 3. FA, FB and *H System*[™] performance characteristics

The 7FB: The Next Evolution of the F Gas Turbine