



ARMY LOGISTICIAN

MAY-JUNE 2002

Supporting
Enduring Freedom

ARMY LOGISTICIAN

PROFESSIONAL BULLETIN OF UNITED STATES ARMY LOGISTICS

PB 700-02-3
VOLUME 34, ISSUE 3
MAY-JUNE 2002

- 1 News
- 2 Log Notes
- 3 Defining and Improving Reverse Logistics—Robert Banks
- 6 The Americas Contingency Energy Solutions Program
—Captain Derek J. Draper
- 8 Aviation Contract Maintenance: A True Combat Multiplier
—Captain Jack R. Leech III, Lieutenant Colonel Kyle D. Campbell,
and Major Robert L. Goodman
- 12 An Estimation Technique for Transport Missions
—Major Mark W. Brantley
- 15 Measuring Supply Management Change
—Chief Warrant Officer (W-4) Matthew A. Anderson, Sr.
- 18 Emergency Essential Civilians in Korea—John Di Genio
- 22 MTMC Team Fights War on Terrorism—Staff Feature
- 25 The Army's Enlisted Acquisition Workforce
—Sergeant Major Ethan A. Jones
- 26 Supporting the African Crisis Reaction Initiative
—Major Barthelemy Diouf, Senegalese Army
- 30 A Primer on Acquisition Logistics—James J. Clark
and Thomas D. Johnson
- 36 Convoy Rat Patrol—Captain Dean J. Dominique
- 38 Commentary: Realistic Training for Power Projection
—Colonel Gary C. Howard, USAR,
and Major Gregory K. Johnson, USAR
- 40 Combat Health Logistics Support in Kosovo
—Major William E. Ackerman

Army Logician (ISSN 0004-2528) is a bimonthly professional bulletin published by the Army Logistics Management College, 2401 Quarters Road, Fort Lee, Virginia 23801-1705. Periodicals postage paid at Petersburg, VA 23804-9998 and additional mailing offices.

Mission: *Army Logician* is the Department of the Army's official professional bulletin on logistics. Its mission is to publish timely, authoritative information on Army and Defense logistics plans, programs, policies, operations, procedures, and doctrine for the benefit of all logistics personnel. Its purpose is to provide a forum for the exchange of information and expression of original, creative, innovative thought on logistics functions.

Disclaimer: Articles express opinions of authors, not the Department of Defense or any of its agencies, and do not change or supersede official Army publications. The masculine pronoun may refer to either gender.

Submissions: Articles and information on all facets of logistics operations and functions are solicited. Direct communication is authorized and should be addressed to: EDITOR ARMY LOGISTICIAN/ALMC/2401 QUARTERS RD/FT LEE VA 23801-1705. Phone numbers are: (804) 765-4761 or DSN 539-4761; Fax (804) 765-4463 or DSN 539-4463; email alog@lee.army.mil. **Reprints:** Articles may be reprinted with credit to *Army Logician* and the author(s), except when copyright is indicated.

Distribution: Units may obtain copies through the initial distribution system (DA 12-series). Private subscriptions are available through the Superintendent of Documents, U.S. Government Printing Office (order form is on inside back cover). Subscribers should submit address changes directly to *Army Logician* (see **Submissions**, above). *Army Logician* also has a homepage on the Internet's World Wide Web at <http://www.almc.army.mil/alog>.

Postmaster: Send address changes to: EDITOR ARMY LOGISTICIAN/ALMC/2401 QUARTERS RD/FT LEE VA 23801-1705.

BOARD OF DIRECTORS

Chairman

Lieutenant General Billy K. Solomon
Commander, Army Combined Arms
Support Command

Members

The Honorable Claude M. Bolton, Jr.
Assistant Secretary of the Army
Acquisition, Logistics, and Technology

Lieutenant General Charles S. Mahan, Jr.
Deputy Chief of Staff, G-4
Department of the Army

General Paul J. Kern
Commander, Army Materiel Command

ARMY LOGISTICS MANAGEMENT COLLEGE

Colonel Grady S. Mills
Commandant

Barbara G. Mroczkowski
Assistant Commandant

STAFF

Janice W. Heretick, Editor
Robert D. Paulus, Associate Editor
Janice L. Simmons, Assistant Editor
April K. Morgan, Assistant Editor
Joyce W. Pawlowski, Design Specialist
Darlene A. Marker, Administrative Assistant

COVER

Forward deployment support teams from the Army's Military Traffic Management Command make it possible to deploy a port operations capability quickly anywhere in the world. The article on page 22 tells how a team from Headquarters, 599th Transportation Group, at Wheeler Army Airfield, Hawaii, is playing a pivotal role in support of Operation Enduring Freedom. On the cover, the team commander helps a sailor remove straps from equipment just discharged from the *SS Cornhusker State*.

This medium is approved for the official dissemination of material designed to keep individuals within the Army knowledgeable of current and emerging developments within their areas of expertise for the purpose of enhancing their professional development.

By Order of the Secretary of the Army:

ERIC K. SHINSEKI
General, United States Army
Chief of Staff

Official:



JOEL B. HUDSON
Administrative Assistant to the
Secretary of the Army
0205706



ALOG NEWS

ARMY SLATED FOR MAJOR GAIN IN FUNDS

The Army will receive a significant spike in funds as part of the President's proposed fiscal year (FY) 2003 Defense budget. The President is seeking an increase in total Army spending of \$9.903 billion, or 12.2 percent. That will raise the Army budget to \$90.978 billion from spending of \$81.075 billion in FY 2002. (All figures are total obligation authority.)

The budget is designed to support the Army's continuing Transformation effort while ensuring that the Army is ready to meet current national security demands and fulfill its role in homeland security and the war against terrorism. As Secretary of the Army Thomas E. White commented in testimony before Congress, "The global war on terrorism reinforces the need for a transformed Army that is more strategically responsive, deployable, lethal, agile, versatile, survivable, and sustainable than current forces."

Proposed spending in the major appropriations categories is \$35.619 billion for military personnel (an increase of 17 percent from actual FY 2002 spending); \$30.641 billion for operation and maintenance (up 11.5 percent); \$12.280 billion for procurement (up 16.2 percent); \$6.919 billion for research, development, test, and evaluation (down 1.9 percent); \$1.637 billion for military construction (down 30.2 percent); \$1.405 billion for Army family housing (up 1.4 percent); \$1.490 billion for chemical demilitarization (up 35.7 percent); and \$396 million for environmental restoration (up 2.3 percent).

The budget request will support an operating tempo of 800 home-station miles for M1 Abrams tanks and 14.5 flying hours a month for each Active Army aircrew and 9 hours a month for each Reserve component aircrew. Ten brigade rotations are scheduled for the National Training Center (including 1 Army National Guard), 10 for the Joint Readiness Training Center (including 1 Army National Guard), and 5 for the Combat Maneuver Training Center; the Battle Command Training Program will conduct 2 corps warfighter exercises and train 6 division command and staff groups.

To improve the Army's deployment capabilities, three brigade sets of pre-positioned stocks in Europe are being reconfigured into one set tailored to support U.S. European Command contingency requirements. Excess stocks also are being redistributed to fill shortages in

Army pre-positioned stocks afloat in Southwest Asia and the Pacific.

The Army plans to begin fielding the Objective Force in this decade. To achieve this goal, the Army will devote 97 percent of its science and technology spending in FY 2003 to design and develop Objective Force technologies. Most prominent among these is the Future Combat Systems.

Modernization and recapitalization will enable the Army to maintain the combat superiority of current and interim systems. The modernization budget will fund 332 interim armored vehicles for the third interim brigade combat team and continue development of the Comanche helicopter. Aviation modernization eventually will reduce the helicopter inventory by 25 percent. Recapitalization will focus on 17 systems in selected units, including the Abrams tank, M2/3 Bradley fighting vehicle, and AH-64 Apache, UH-60 Black Hawk, and CH-47 Chinook helicopters.

Highlights of combat service support procurement include the following—

- ◆ \$681.4 million (an increase of 46.8 percent) for 3,574 trucks in the family of medium tactical vehicles. These 2½- and 5-ton trucks will perform over 55 percent of the Army local and line-haul transport and unit resupply missions.

- ◆ \$40.6 million (an increase of 176 percent) for 74 forward repair systems (FRSs). The FRS is a highly mobile forward maintenance facility that will reduce repair-cycle time. It also will eliminate the need to use the M88 recovery vehicle as a battlefield repair facility.

- ◆ \$50.8 million for 314 M915/916A3 truck tractors. The M915A3 is slated for fielding to newly activated petroleum companies, which are needed to increase fuel-handling capability on the battlefield. Both tractors will replace 18- to 20-year-old vehicles that are not meeting mission-capable-rate goals.

- ◆ \$49.1 million for 96 improved rough-terrain container handlers (RTCHs). These RTCHs have a lift capacity of 53,000 pounds (compared to 50,000 pounds with previous models) to handle the new ISO containers.

- ◆ \$2.3 million for 10 vehicles under the materials-handling equipment (MHE) extended service program. This program extends the service life of MHE for 10 to 15 years at 30 to 40 percent of the cost of a new vehicle.

- ◆ \$119.9 million (up 286 percent) for 652 vehicles

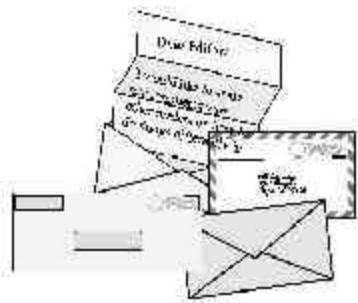

LOG NOTES

Enforcing PMCS

In response to the commentary, "Maintenance: Are We Missing the Mark?" in the November-December 2001 issue, I strongly agree with most of CWO3 Allen's comments. However, when it comes to enforcing PMCS, I think he missed the mark.

I agree company commanders should get more involved with periodic spot-checking; but if the maintenance program is going to be a success, the NCOs will have to do their part to ensure that the standards are met. As a young soldier, I remember my section chief and NCOs watching over me to ensure that the task was completed to standard and that TMs were on hand and being used.

We place too much blame on the OPTEMPO instead of on the first-line leaders. NCOs must make the maintenance program a priority. Walk the lines of the motor pool, and ensure that vehicles, communications equipment, and all other maintenance-related equipment have trained operators assigned and performing all tasks to standard. This is a function of the NCOs, not the officers. If we are falling short, it's because some-

one with stripes on their shoulders allows it to happen.

SFC Michael Hudson
Fort Drum, New York

TRIADS Isn't New

Your news article on the humanitarian airdrops in Afghanistan in the January-February 2002 issue states, "This was the first time the airmen and soldiers had used the new TRIAD system." This is a bit misleading. TRIADS is not new; it has been around since Operation Provide Promise in Bosnia in 1993. The process used in Afghanistan is an improved version of TRIADS, designed to correct some of the problems encountered in Bosnia.

For more information on the use of the TRIADS, see the *Quartermaster Bulletin* article on the Quartermaster Museum/Foundation Web site: www.qmfound.com/air_bosnia.htm

MAJ Kevin Born
Fort Lee, Virginia

Log Notes provides a forum for sharing your comments, thoughts, and ideas with other readers of *Army Logistician*. If you would like to comment on an *Army Logistician* article, take issue with something we've published, or share an idea on how to do things better, consider writing a letter for publication in *Log Notes*. Your letter will be edited only to meet style and space constraints. All letters must be signed and include a return address. However, you may request that your name not be published. Mail letters to EDITOR ARMY LOGISTICIAN, ALMC, 2401 QUARTERS ROAD, FT LEE VA 23801-1705; send a FAX to (804) 765-4463 or DSN 539-4463; or send email to alog@lee.army.mil.

(News continued from page 1)

under the heavy, expanded-mobility tactical truck (HEMTT) extended service program. This program is the Army's only production source for the HEMTT load handling system (LHS) configuration. The HEMTT LHS is crucial to achieving the Army's goal of a transportation-based, just-in-time supply system.

◆ \$227.4 million for physical security systems. This request represents an increase of 231 percent over

the baseline funding for FY 2002 (not including supplemental spending after 11 September). The systems will protect chemical storage facilities, munitions storage areas, sensitive compartmented information facilities, areas designated mission essential and vulnerable, and other high-risk targets.

Production of the heavy equipment transporter system (HETS) will end in FY 2002 with 2,342

HETSs in the Army inventory. The HETS provides the only tactical transportation and evacuation capability for the Abrams tank and other heavy tracked combat vehicles.

The chemical demilitarization budget will provide for the start of operations at the facilities at Anniston, Alabama, and Aberdeen, Maryland, and continue preparations for operations at Pine Bluff, Arkansas, and Umatilla, Oregon.

(News continued on page 41)

Defining and Improving Reverse Logistics

by Robert Banks

The Army is paying new attention to the reverse pipeline. Better management of reverse logistics will make the most of the Army dollar.

Reverse logistics (RL) has existed in one form or another since the advent of the Army, but until recently it has received little more than cursory examination. So why do Army leaders now want to study RL using the velocity management (VM) process methodology of define, measure, and improve (DMI)?

Reverse logistics is the timely and accurate movement of serviceable and unserviceable materiel from a user back through the supply pipeline to the appropriate activity. In the past, the Army has placed RL on the proverbial back burner for several reasons. RL is not “glamorous” or “high tech.” To the tactician, RL cannot be linked directly to readiness drivers. Few commands include RL as a component in their performance reviews or review and analysis briefings. When a unit initiates an RL action, it seldom realizes any financial benefit from doing so. The list can go on and on.

In recent years, industry has placed greater emphasis on RL. Ten years ago, literature on RL was uncommon. Today, entire textbooks are devoted to the subject. So why has industry moved RL to the front burner? The simple answer is buying power, or, more correctly, the avoidance of lost buying power; RL makes the greatest and most efficient use of existing resources. In order to maximize the Army’s buying power, we too must adopt the same philosophy for the same reasons (though obviously in a different context). Make no mistake, maximizing buying power is the logistician’s “ace in the hole.”

Customer wait time (CWT)—previously order ship time (OST)—and requisition wait time (RWT) are the latest performance metrics for determining logistics re-

sponsiveness. So why has the Army had difficulty defining and developing performance goals for materiel in the reverse pipeline? The answer is rather simple. RL is like skeet shooting: you always are aiming at a moving target. As a point of comparison, the RL forward pipeline starts at the customer—generally at the unit level—and ends at the same point. However, while RL starts with the unit, it can stop at multiple distribution or maintenance activities in the retail or wholesale pipelines.

To better determine the flow of the RL pipeline, the Department of the Army Deputy Chief of Staff, G-4, and the Army Combined Arms Support Command (CASCOM) at Fort Lee, Virginia, formed the Reverse Logistics Process Action Team (RLPAT). This team is under the direction of Brigadier General Jeanette K. Edmunds, the Army G-4 Director of Sustainment, and Tom Edwards, the Deputy Commander of CASCOM. These leaders instructed the team to use the VM DMI methodology to define the RL pipeline process flow. As a result of a series of RLPAT meetings and conferences, a detailed RL process map was identified (see chart on page 4).

When Does RL Start and Stop?

The immediate questions confronting the RLPAT were: When does the RL process start, and when does it stop?

The starting point is the Julian date placed on the turn-in documentation at the unit level. To the purist, this date may not be the “true” starting date of the process.

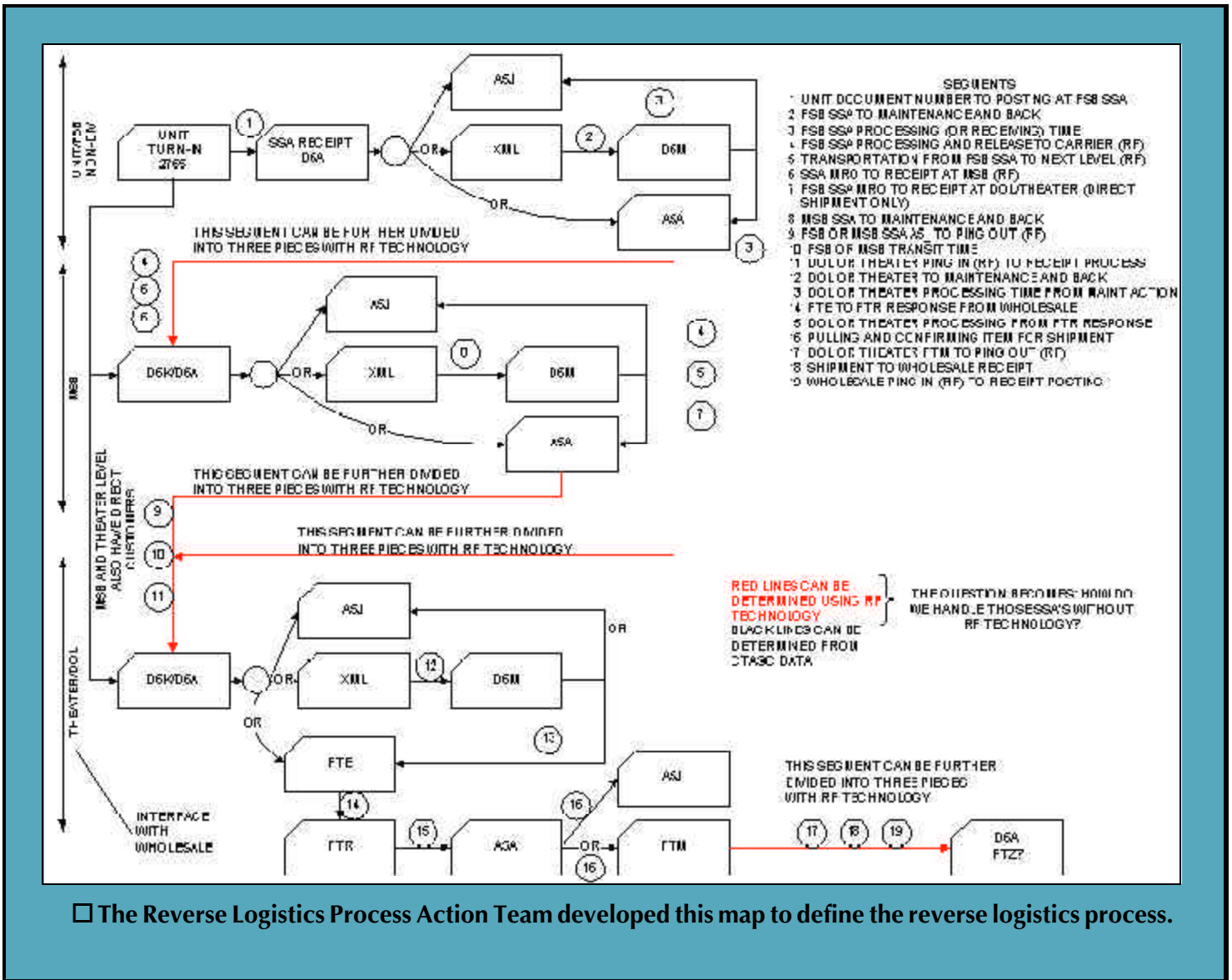

□ The Reverse Logistics Process Action Team developed this map to define the reverse logistics process.

However, until we can link the Unit Level Logistics System (ULLS) successfully with the Standard Army Maintenance System (SAMS) and the Standard Army Retail Supply System (SARSS), the Julian date of the turn-in document will have to suffice.

The ending point for the RL process is infinitely more complex to determine. It either will be when an item is available for issue; when an A5J, Disposal Release Order, has been issued directing an item be shipped to the Defense Reutilization and Marketing Office; or when an item has been received at the maintenance depot. Again, the purist may argue that this is not the true end of the process. But until we can link SARSS successfully with the Depot Standard System (DSS) and Commodity

Standard System (CSS), then this too will have to suffice.

A detailed review of the diagram will reveal the melding of supply, maintenance, and transportation functions. The system of record from an accountability and financial perspective is SARSS. (Our comptroller friends will argue that the Standard Army Finance and Accounting System is the financial system for RL. However, one needs the input from supply systems to debit or credit our financial systems, which leads to the assertion that the process truly starts with a supply transaction.) However, the developers of SARSS did not account for the disconnects in automated system interfaces among quartermaster, ordnance, and transportation functions.

For example, when an unmatched recoverable report shows up on an accountable officer's desk, he will point out very quickly that his maintenance brethren failed to turn in the unserviceable part.

Three Tenets of RL

From this beginning, three tenets of RL have emerged: predictability, reliability, and visibility. We can *predict* successfully when a retrograde item will arrive, our prediction is *reliable* to the 95th percentile, and we have *visibility* of the shipment throughout the process. With a system in place that can meet these tenets, maintenance personnel can schedule maintenance activities and more accurately order repair sets or kits. Central shipping and receiving personnel also can adjust workloads to handle inbound or surge shipments as well as to schedule outbound trucks or containers more accurately.

The question now becomes: how do we gain this predictability, reliability, and visibility? The answer is a combination of supply discipline and SARSS data, coupled with radio frequency identification (RFID) technology; both are in use throughout the Army but are nowhere more prevalent than in U.S. Army Europe (USAREUR).

Supply discipline for all RL operations starts at the unit (customer) or supply support activity (SSA) level. SSA personnel must prepare an Automated Manifest System (AMS) card for each retrograde shipment. Every SSA in the Army currently has this capability. Next, the main support battalion (MSB) SSA or the next higher SSA should have the Defense Logistics Agency "tactical" manifest system installed and operational. It is this system that will gather the data from the SARSS AMS cards and generate a global AMS card along with an RF tag. The Logistics Automation Division of the USAREUR DCSLOG has conducted studies and concluded that trained and competent personnel can create a global AMS card and RFID tag in about 10 minutes from multiple SARSS AMS cards. This truly is a small investment in time to achieve the three tenants of RL.

These data are uploaded automatically on a regular basis to a central repository. Within USAREUR, this repository is the Freidrichsfeld server located at the Logistics Automation Division of the USAREUR DCSLOG. The Freidrichsfeld server also will send this same information to the continental United States server in Reston, Virginia, and to the Logistics Support Activity (LOGSA) at Redstone Arsenal, Alabama, where the Army's central automated data repository is maintained.

SARSS automatically sends an electronic copy of all retrograde transaction data to LOGSA, which deposits the data in the Logistics Intelligence File (LIF). Anyone with access to the Logistics Integrated Data Base

(LIDB) can view or extract these data. What SARSS does not transmit, and thus what LOGSA does not capture, are the intransit data; that means lost visibility. We can gain visibility of these data by applying already existing RF technology, which is the third piece of the RL puzzle.

One Source for Intransit Visibility

RFID technology can capture the actual intransit status, so we know the last "gate" a shipment has passed through at any time. This information currently is available through Total Asset Visibility (TAV) as long as we know the document number, the transportation control number, or the RFID tag number. (Each RFID tag has a unique number much like a license plate number.) This information is not passed to LOGSA (and thus the LIF) because LOGSA depends on standard Document Identifier Codes (DICs). To resolve this obstacle and provide one source for complete retrograde intransit visibility would require converting the RFID data into either DIC TK4 or DIC TK6 data. This type of conversion would require a programming change. This is not likely to happen until the Global Combat Service Support-Army (GCSS-Army) replaces the current Standard Army Management Information Systems (STAMIS).

No one will argue with the point that our weapon systems are more sophisticated, logistically complex, costly, and automated than at any time in our history. No one will argue that components eventually will fail and have to be replaced. And no one will argue that it generally is more cost effective to repair or rebuild these components than to purchase new ones. To this extent, it makes perfect sense that we manage our repair and rebuild programs to maximize our logistics resources. Having and maintaining predictability, reliability, and visibility of the RL pipeline will help us achieve this objective. **ALOG**

Robert Banks is the repair cycle change agent at the Army Combined Arms Support Command at Fort Lee, Virginia, and a member of the Reverse Logistics Process Action Team. When this was written, he was a logistics management specialist in the Support Operations Directorate, 21st Theater Support Command, in Kaiserslautern, Germany. He has a B.A. degree from Ohio State University and an M.S. degree from West Coast University.



The Americas Contingency Energy Solutions Program

by Captain Derek J. Draper

The mission of the Defense Energy Support Center-Houston (DESC-Houston) is to provide uninterrupted quality fuel support to its customers in the event of national disasters, terrorist activities, or war. To support that mission, DESC-Houston developed the Americas Contingency Energy Solutions (ACES) program. (The program's name reflects DESC-Houston's affiliation with DESC-Americas, one of four major organizational elements of the Defense Logistics Agency's Defense Energy Support Center. The others are DESC-Europe, DESC-Middle East, and DESC-Pacific.)

ACES is a volunteer program open to Army Active, Army National Guard, and Army Reserve units. Units request permission from DESC-Houston to rehearse possible contingency missions. If not otherwise funded, DESC-Houston funds the units' fuel, tolls, and temporary duty costs. A memorandum of agreement (MOA) between DESC-Houston and the rehearsing units outlines funding details and lists the quantity of fuel to be transported, the delivery point, and the reimbursement rate if appropriate. Any deviation from the agreement must be approved by DESC-Houston.

In May 2001, the 416th Transportation Company (Petroleum, Oils, and Lubricants), an element of the 260th Quartermaster Battalion (Petroleum Support), from Hunter Army Airfield, Georgia—for which I serve as the petroleum operations officer—participated in the first ACES program test. To date, only one other unit, the Army Reserve's 319th Transportation Company from Augusta, Georgia, has participated in an ACES mission. Additional units will participate in the program as it expands nationwide over the next 2 years. Although some units have assisted DESC-Houston in times of crisis, none has done so under the auspices of the ACES program.

ACES Players

To test the 260th under wartime conditions, its commander planned a field training exercise that incorporated the ACES mission assigned to the 416th Transportation Company.

The 416th is a multicomponent company consisting

of two Active Army platoons and one Army Reserve platoon. The company is authorized sixty 7,500-gallon petroleum tank semitrailers and 166 soldiers. It can transport more than 1.3 million gallons locally and line-haul 675,000 gallons a day when its Reserve platoon is active. Without the Reserve platoon, the company can local-haul 900,000 gallons and line-haul 450,000 gallons daily.

Three movement control teams (MCTs) from the Headquarters and Headquarters Detachment of the 260th Quartermaster Battalion helped to move and track the convoys along the route during the test. The commander of DESC-Houston authorized moving the fuel from Defense Fuel Supply Point (DFSP)-Macon, Georgia, to Fort Stewart and Hunter Army Airfield for the test mission. The fuel remained in DESC-Houston ownership throughout the mission.

ACES Planning

The planning phase of the ACES mission laid a solid foundation for its execution. After initial contact between the 260th Quartermaster Battalion and DESC-Houston, an MOA outlining the general requirements of each was drafted. Then the 260th sent a request to conduct an ACES mission to DESC-Houston. After several conference calls and e-mails, the request was approved and DESC-Houston sent an ACES mission notice to the 416th detailing which DFSP it would draw fuel from, the delivery location, the quantity of fuel to be transported, and reimbursements, if any.

ACES Pre-execution

The MCTs conducted route reconnaissance to determine the locations of rest stops and checkpoints and to detect any problem areas. The 416th conducted its own reconnaissance, focusing on locations for refueling, maintenance, rest stops, and food service. Their route reconnaissance continued all the way to the terminal, where they met with the terminal manager controlling the fuel delivery. One week before the first mission, a quality surveillance representative from DFSP-Charleston, South Carolina, inspected the 7,500-gallon

A terrorist attack or natural disaster could stop commercial fuel carriers in their tracks. Where can Army units train for such a contingency? Here's the "ACE Solution."



□ The 416th Transportation Company departs for DFSP-Macon, Georgia, a distance of 173 miles, with six 7,500-gallon tankers.

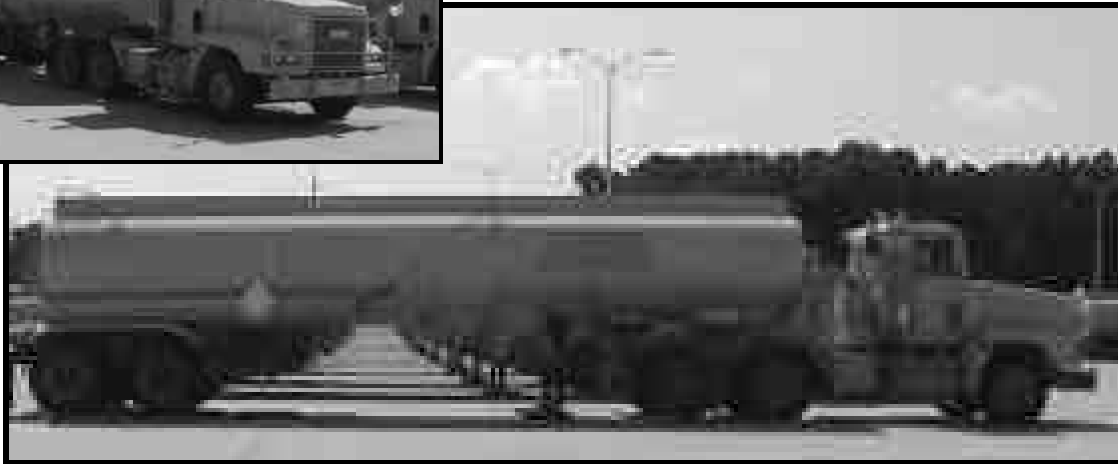

tankers for suitability. His inspection confirmed what we already knew—that our tankers were well maintained and ready for the mission.

ACES Execution

At 0400 on 15 May, the MCTs moved to their checkpoints to begin the ACES mission. With no reports of obstacles or congestion along the primary route from the MCTs, the 416th departed for DFSP-Macon, approximately 173 miles away, with six 7,500-gallon tankers. As the convoy approached each checkpoint, the assigned MCT was notified by radio. The MCT then called the battalion tactical operations center, which was monitoring convoy movements, by cellular phone. Our contingency communication plan called for the use of cellular phones because the military radios were committed elsewhere.

We tracked the convoy movement on both military and civilian maps to make sure we got all of the information we needed. The ability to track the convoy and monitor the routes not only helped us to maintain

accountability but also allowed us the flexibility to direct the convoy to alternate routes if needed. We also were able to inform the pickup location of any changes that would affect the scheduled arrival time.

The mission concluded on 18 May with a total of 153,000 gallons of fuel moved from DFSP-Macon to Fort Stewart and Hunter Army Airfield. As a result of the ACES mission, our unit is better trained, and we know that, if needed, we are prepared to carry out a real contingency mission. **ALOG**

Captain Derek J. Draper, a Quartermaster officer, is the petroleum operations officer of the 260th Quartermaster Battalion (Petroleum Support), at Fort Stewart, Georgia. He has a bachelor's degree in general studies from Indiana University. He is a graduate of the Quartermaster Officer Basic Course, the Combined Logistics Captains Career Course, and the Airborne, Air Assault, Rigger, Mortuary Affairs, and Petroleum Officers Courses.

Aviation Contract Maintenance: A True Combat Multiplier

by Captain Jack R. Leech III, Lieutenant Colonel Kyle D. Campbell, and Major Robert L. Goodman

In May 1999, the 498th Medical Company (Air Ambulance) at Fort Benning, Georgia, was recovering from a major deployment to Central America in support of the Hurricane Mitch disaster relief effort. At the same time, the company was struggling with multiple maintenance challenges, which were intensified because their supporting aviation intermediate maintenance (AVIM) unit was more than 260 miles away. An AVIM is a divisional or nondivisional aviation unit that provides intermediate-level maintenance and repairs for helicopters and, on a limited basis, performs unit-level maintenance. AVIMs are a critical element for Army aviation units to keep their aircraft safe and flyable.

In the past, the Fort Benning Department of Training's aviation maintenance support shop, known as Shop 4, had provided maintenance for various aviation training missions. The 498th had used Shop 4 on a reimbursable basis for intermediate-level maintenance services. However, Shop 4 was reducing its labor force, and it no longer would be able to provide maintenance services for the 498th.

The joint airframe condition evaluation (ACE) had identified significant cracks in major structural panels in several of the aircraft during the three previous inspections. Since the 498th's 15 UH-60A Black Hawk helicopters had an average age of over 13 years, the reduction in maintenance support created significant difficulties.

Background

The operating tempo (OPTEMPO) of the 498th began increasing shortly after it returned from Central America as the unit resumed its traditional tasks and missions. The 498th's OPTEMPO for 15 aircraft and flight crews averaged 6 crews on duty each day, with increases to 9 aircraft and crews when providing a forward support medical evacuation team in support of various major exercises during the spring of 1999.

As part of its support to the Fort Benning installation, the 498th routinely supports the 5th and 6th Ranger Training Battalions during the swamp and mountain phases of the Army Ranger School. Moreover, the 498th routinely supports the 3d Infantry Division (Mechanized) and the garrison at Fort Stewart, Georgia. The unit also regularly participates in exercises such as Purple Dragon

and Bright Star and in Joint Readiness Training Center rotations.

Historically, the unit had struggled with a variety of maintenance challenges, including low staffing and a chronically high OPTEMPO. From 1995 to 1998, the 498th averaged an operational readiness (OR) rate of only 69 percent fully mission capable. In 1998, it met or exceeded the Department of the Army (DA) OR goal in only 5 of the 12 months.

After the 498th's return from Central America in the spring of 1999, its bank time was below 31 percent. Bank time, or time until phase, expresses the percentage of usable flight hours available before a phase is required. A phase is a periodic preventive maintenance service during which maintainers perform thorough inspections of the aircraft (for example, every 500 flight hours on a Black Hawk). Ideally, bank time should be above 50 percent. Thirty-one percent is an unacceptably low percentage of available hours because it forces maintenance managers to either perform two phases simultaneously or run two back-to-back phases without a break. Both of these options create pressure on the phase team to deliver a product based on time, not quality.

The company also had a large number of maintenance issues identified in the logbooks and was behind on completing several modification work orders (MWOs). At the same time, the phase maintenance inspections were being performed by the unit's supporting AVIM. This resulted in two problems: The phases were taking an inordinate amount of time, and the 498th soldiers lost tremendous training opportunities because none of them were able to work on the phase team. The situation demanded immediate planning and organization and a change in management styles.

Solving the Problem

The company leaders reviewed the situation and assembled facts and pertinent data. They determined that establishing a new maintenance plan that focused on long-term, systematic improvement would be better than continuing their case-by-case, short-term-focus maintenance program. They then briefed the chain of command about the implications of this decision. It was unlikely that the 498th would be able to achieve the DA OR goal of 75 percent for several months because of the

large number of aircraft requiring phases. The company also was initiating a rigid corrosion-control program and, over the course of several months, would be sending nine aircraft to Blue Grass Army Depot, Kentucky, to be painted. The 498th felt that this short-term reduction in the OR rate would yield improvements in the future maintenance posture and provide significant improvements in their long-term combat readiness.

The most important question during the spring of 1999 was how to develop a maintenance plan that would increase the OR rate and maximize training for the 498th's soldiers, despite the facts that Shop 4 was reducing services and the supporting AVIM was not on the same installation. Although the AVIM charged with supporting the 498th had provided fair service on component repair and some individual maintenance repairs, its average time for a phase far exceeded the DA standard. Therefore, one of the primary objectives and measures of success was to reduce unnecessary aircraft downtime by completing phases internally.

The 498th team gathered maintenance program information from other medical evacuation units. It determined that most of the other medical evacuation units were using various levels of contract aircraft maintenance. As Joe A. Fortner wrote in *Army Logistician* (July-August 2000), "Contractors provide a source of high-tech, low-density skills. The Army is reaching the point where it no longer can afford to maintain the training infrastructure for military occupational specialties with a density of a few dozen soldiers."

Historically, the Army Forces Command (FORSCOM) had made money available to Fort Benning for maintenance contracts. The 498th had not obligated those funds fully. The unit formed a small team, which was led by the aviation unit maintenance (AVUM) platoon leader, to write a statement of work (SOW) for contracting civilian aviation maintenance personnel to augment, but not replace, the company's maintenance soldiers.

As Joe A. Fortner noted in his September-October 2000 *Army Logistician* article, "The Army does not command and control contractors in the sense that it commands and controls military units and soldiers. Instead, contractors are managed, and the management mechanism is the contract itself." Therefore, the 498th would manage the contractor team through the terms of the contract, and they specified exactly what they wanted in their SOW.

The 498th's chain of command reviewed the situation and facts and then considered several alternatives presented by the company's leaders. The company's superiors selected the course of action that was the most methodical, would improve the long-term maintenance posture of the unit, and had the greatest long-term benefits for training the maintenance personnel for their

wartime mission.

The chain of command also accepted that the price for these long-term benefits was approximately 6 months of poor OR rates, because there was so little bank time left on the aircraft. They recognized that, with the bank time so depleted, the 498th would remain in crisis management and would not meet the OR goals unless they significantly altered the company's internal business processes.

While the chain of command fully supported the company's efforts, some senior leaders expressed concerns that contract maintenance was too costly and would reduce training opportunities for the soldiers. They argued that, in the end, this would be detrimental to the warfighting mission. However, experience would resolve their concerns. As of May 2001, the 498th exceeded the DA OR goal of 75 percent fully mission capable for 19 of 24 months. Perhaps more important than the increase in fully mission capable rates was the improved level of training, confidence, and abilities of the maintenance soldiers to perform their wartime mission.

Developing the Contract

As the contracting team began writing the parameters and guidelines of the SOW, they considered the chain of command's concerns, financial constraints, the growing maintenance crisis, and the importance of creating a better training environment for the aircraft mechanics. The team developed an SOW that required a lead man, two electrical technicians, two general mechanics, a sheet metal technician, and a technical supply clerk. Fortunately, funds to cover the total cost of the contract were immediately available and fully funded by FORSCOM.

After the SOW was approved, the company began interviewing potential contractors. During the interviews, the 498th asked the contractors if they would allow the soldiers with military occupational specialties in the 67 and 68 series (aviation maintenance) to work with them on the aircraft. Lockheed Martin was the only potential contractor that welcomed the opportunity to provide training for the soldiers. While other contractors may provide training to soldiers, Lockheed Martin guaranteed that the working relationship between contractor and soldier would be one of teamwork and collaboration.

Implementing the Contract

The Lockheed Martin team arrived in late June 1999. The seven personnel had an average of 15 years of experience. They were skilled, mature, and willing to provide training for the soldiers immediately.

The contract specified that Lockheed Martin could perform all unit-level maintenance, limited intermediate-level maintenance, and, on a case-by-case basis, depot-level repairs. Working with the 498th's leaders, they quickly



□ **Mechanics of the 498th Medical Company (Air Ambulance) work alongside Lockheed Martin mechanics to maintain a UH-60A Black Hawk helicopter.**

integrated their workflow into the company's daily operations. Their lead man attended the production control meetings and provided guidance to the junior leaders on technical maintenance decisions. They presented alternative sources of supplies and helped reduce delivery times for critical parts. The result of the initial integration was the rapid and efficient completion of required MWOs that had been delayed over the preceding few months. Among the upgrades completed were the installation of lower console lighting for night-vision-goggle (NVG) operations, a new auxiliary fuel management system, and the 128B global positioning system (GPS).

During the first 6 months of the new contract, the 498th completed numerous MWOs, reduced maintenance deficiencies, and began to improve their bank time. This initially resulted in a reduced OR rate. Aircraft maintenance is a pay now or pay later proposition, and the 498th, with the full support of its chain of command, elected to pay now (with a reduced OR rate) for a greater planned return in the future. In fact, during the first 6 months, the 498th only achieved the DA OR goal twice.

During those 6 months, the 498th leaders began exploring ways to complete aircraft phases internally and improve the training of their soldiers. They identified two of the 498th's best Black Hawk helicopter mechanic (military occupational specialty 67T) soldiers and assigned them to a phase team. They completely altered work schedules, physical fitness training, and other company-related duties for the two soldiers for a 5-week period. These two soldiers worked alongside the Lockheed Martin contract maintenance team for the 5 weeks of the first internal phase performed by the 498th.

Much to the delight of the company leaders, selecting the better soldiers for the phase team created internal competition among the 67T soldiers assigned to the AVUM platoon. This selection process helped focus AVUM's personnel and allowed the leaders to reward the soldiers' hard work and dedication with improved training opportunities. The 67T soldiers also received

hands-on training from the highly skilled and experienced Lockheed Martin personnel. This process became standardized and was still in effect in May 2001.

However, the maintenance program accomplished far more. Teamwork and planning were reinstated throughout the company. The maintenance officer, noncommissioned officers, and Lockheed Martin personnel worked together to build a new and thorough maintenance phase plan for the 15 aircraft. They used maintenance statistics, such as OR rates, bank time, and partially mission capable rates, as feedback. They developed a detailed schedule for the first three phases based on the contractors' and noncommissioned officers' experience and a guarantee of six to eight people to work on the aircraft each day of the phase.

The phase team completed their first phase in 38 days. By Christmas 1999, the 498th had completed three phases with an average of 42 days each, which far exceeded the DA goal of 60. Multiple maintenance training opportunities occurred during the phase rotations, which improved soldier skill levels and experience. The company leaders began feeling more comfortable that the AVUM platoon was prepared to perform their technical mission in a wartime environment.

By June 2000, the 498th had completed six phases and increased the bank time to 61 percent, a tremendous improvement over the 31-percent rate. The enhanced maintenance posture and the improved bank time helped the unit surpass the DA OR rate for 5 consecutive months. The 498th decreased their average phase time to 35 days. Once they had increased the bank time and decreased the phase time, the maintenance managers could choose when they wanted to put the next helicopter into phase. This allowed flexibility for ensuring that they exceeded OR rates each month.

These changes in the 498th's internal practices and the full cooperation of the Lockheed Martin contractors provided tremendous improvements in all aspects of the company's operation. At the end of the fiscal year 2000 flying-hour program, the 498th had executed 102 percent of the flying hours on 90 percent of the budget. This allowed the unit to purchase maintenance components needed for future operational deployments.

The flexibility built into the contract allowed the unit to reallocate assets within the original contract and obtain a Lockheed Martin contractor to serve as the Unit Level Logistics System-Aviation (ULLS-A) administrator. With a dedicated administrator to work exclusively on ULLS-A, the 498th freed up another 67T soldier to conduct valuable aviation maintenance training

and work on aircraft.

Most importantly, the improved maintenance posture allowed the 498th to meet its increasing OPTEMPO during fiscal year 2000. The unit began supporting a nearly constant eight-crew requirement. During Exercise Purple Dragon and a rotation to the Joint Readiness Training Center, the daily commitment spiked to 11 aircraft. Given the 15-ship company, the unit was stressed to support all of its commitments. However, with the long-term systems in place and the full collaboration among the Lockheed Martin contractors and the soldiers of the 498th, the unit exceeded DA standards every month for 12 consecutive months and earned the Aviation and Missile Command Masters of Readiness Award for 2000. Concurrently, the improved maintenance posture enabled the unit to plan and conduct company (-) field training exercises with other medical units on Fort Benning. This critical training was possible only because of the close working relationship with the Lockheed Martin contractors, and it resulted in a significant improvement in the company's tactical capabilities.

Lessons Learned and Recommendations

Buying manpower will not fix maintenance problems. Leadership must integrate the contractors fully into the operation, and the contractors must want to be part of the team. Clearly, an advantage for the 498th was that they were able to lay down the ground rules from the beginning. They did not have to create a paradigm shift for existing contractors. The 498th used solid leadership and training to develop the kind of teamwork needed to accomplish the mission.

Maintenance managers and company commanders must ensure that the chain of command stays informed and fully supports the concept. If they are not familiar with the legitimate challenges that exist in the hangar, then they must be taught. Develop long-term plans, establish time lines, and follow-up by using original projections to determine success. Ensure that the contractor is willing to allow cross-leveling of tools and experience. Design a solid plan and build a consensus to make the contractor an integral part of the unit. Avoid having the hangar divided down the middle with tape, and ensure positive communication between contractors and soldiers.

A well-managed, properly led contract maintenance team can increase the OR rate dramatically and allow combined training. Like other combat multipliers, contract maintenance can increase the OR tremendously and create cost savings. Contractors can show soldiers what "right" looks like the first time, thereby saving the soldiers time, parts, and equipment. With a well-managed contract, the overall unit maintenance posture will al-

low most of the military aviation maintenance soldiers to participate in collective field training exercises. In addition, having contractors available also enables the maintenance section to meet unforecasted maintenance demands while the AVUM platoon members, and the company as a whole, focus on field training exercises.

While no metric exists to quantify the impact of training with contractors, we fully believe that the enhanced maintenance posture, the ability to meet OPTEMPO, and the ability to train collectively in both technical and tactical skills make the employment of civilian contract maintenance teams cost effective. The overall result is aviation maintenance soldiers who have a solid base of technical and tactical expertise and who will arrive at their next duty stations ready to contribute fully to the mission.

The common belief is that contractors cost more money than they are worth and lead to less aviation maintenance training for the unit, resulting in decreased readiness. The fact is that the 498th's Lockheed Martin contractors are cost effective, have provided significant increases in both individual and collective training, and have enabled a tremendous increase in combat readiness of the entire unit. The teamwork between Lockheed Martin and the 498th Medical Company (Air Ambulance) keeps the medical evacuation crews on station at Fort Benning, Fort Stewart, and the Ranger training camps in northern Georgia and the swamps of Florida.

This teamwork approach and management of the Lockheed Martin contractors enabled the 498th to improve its OR rate, improve bank time, and maximize training opportunities for soldiers in both technical and tactical skills. The 498th's development and implementation of the Lockheed Martin contract team resulted in a true win-win situation for both organizations that can serve as a model for other aviation units. **ALOG**

Captain Jack R. Leech III is the aeromedical evacuation/operations officer for the Division Surgeon's Section, 1st Cavalry Division, at Fort Hood, Texas. He was the maintenance officer for the 498th Medical Company (Air Ambulance) from June 1998 to August 2000.

Lieutenant Colonel Kyle D. Campbell commanded the 498th Medical Company (Air Ambulance) from June 1999 to May 2001. He is currently the deputy commander of Rodriguez Army Health Clinic at Fort Buchanan, Puerto Rico.

Major Robert L. Goodman is the chief of resource management at Moncrief Army Community Hospital at Fort Jackson, South Carolina.

An Estimation Technique for Transport Missions

by Major Mark W. Brantley

The more one examines the course of past wars the more one is impressed by the frequency with which military policy and preparations have taken the wrong turning. And this abnormal percentage of error can be traced to the habit of basing policy and preparations on an assumption, without adequate verification. The way that decisions are reached on questions of strategy, tactics, and organization is lamentably unscientific. The War Office has organs for research into weapons, but not into the probable conditions of future warfare. Any military research is no more than an incidental diversion on the part of officers who are busily occupied with day-to-day affairs. There are no means for the comprehensive analysis of past experience, and thus no synthesis of adequately established data to serve as a guide in framing policy.

—Liddell Hart, *Thoughts on War*, 1944

To find a way for the British Army to examine and thus learn from past experience, Liddell Hart proposed “a body of officers who can devote their whole time to exploring the data on record, collecting it from outside, and working out the conclusions in a free atmosphere.” Our own Army force structure has many examples of this “body of officers”: combat development analysts, operations research analysts, and simulation specialists. However, these groups generally focus on exploring and synthesizing existing data to make force structure and materiel decisions instead of collecting data for adequate mission planning and analysis. As a result, mission plans often are based on broad, dated planning factors and result in inefficient operations and missed deadlines.

I hope to motivate the logistics community to devote more resources to gathering data from field exercises, training center rotations, and military operations. Although information provided here will benefit the analytic community, I would like to focus primarily on how it can benefit logisticians by providing better ways to estimate the number of soldiers and the amount of equipment required to accomplish missions efficiently.

Consider a simple transportation problem that involves four processes: loading, delivering, unloading, and returning. This is a common problem faced daily by military planners from the tactical to the theater levels. An example is a logistics over-the-shore operation in which supplies and equipment are unloaded from a large ocean-going vessel, loaded onto lighters, and transported to a beach or causeway. The lighters then return for another load. The commander must decide how many lighters to deploy for this mission. If the unit does not deploy enough lighters, the large vessel will spend more time anchored than necessary. This could be expensive and also could delay the movement of critical equipment. On the other hand, if the commander commits too many lighters, they will spend too much time waiting in queues to be loaded or unloaded. This is a waste of valuable assets that could be used on other missions.

A similar scenario can be found with construction units pouring concrete. A steady stream of concrete trucks usually is required to maintain the proper bonding between concrete layers to achieve the necessary strength, water-tightness, appearance, and durability. However, a long queue of concrete trucks at the construction site also can jeopardize the project, since concrete generally should be poured within 90 minutes of adding water. The project engineer must program the number of trucks required each day and delicately balance their loading and unloading.

A Simple Scenario

Let us consider a scenario consisting of a loading point that takes 30 minutes to load a vehicle, a delivery trip that takes 12 minutes, an unloading point that takes 20 minutes to unload a vehicle, and a return trip that takes 12 minutes. We want to determine how many vehicles we should commit to this mission. We would like to maximize the loading and unloading process and minimize the number of vehicles we commit. In the spirit of keeping the model simple, we will make the following assumptions—

- ◆ There is a large quantity of materials at the loading point. Transport vehicles wait for loading but do not wait for materials to arrive.

Gathering data for planning and simulations can be a daunting task. The author shows how a concerted effort by the operational and analytical communities can help make the job easier.

- ◆ There is adequate capacity to remove the materials from the unloading point.
- ◆ The vehicles are allowed to pass each other while transporting and returning.

To keep the analysis simple, we will use the loading point utilization rate as the main performance criterion, since loading is the limiting factor in this scenario. Other performance measures, such as the time it takes to complete the mission and the length of the queue at the loading point, are calculated just as easily using the same techniques used to track the utilization of the loading and unloading points.

Although there are a few specialized planning tools and simulations available for some of these missions, most mission analyses use deterministic estimates (constant values) of the average process times taken from doctrinal manuals or field experience. For example, Field Manual (FM) 55–15, Transportation Reference Data, provides general motor transport planning factors for vehicle availability, payload capacity, hours per shift, hours per day, number of round trips, distance per shift, rate of march, loading times, and unloading times. FM 5–412, Project Management, provides similar estimates for engineer activities such as dredging, excavating, and hauling materials.

By assuming that our scenario processes are deterministic, we obtain the following results for our scenario. If we commit one truck to the mission, the loading point's utilization rate would be 41 percent, and the unloading point would be used 27 percent of the time. We obtain the 41-percent utilization rate by dividing the 30 minutes required for loading by the 74 minutes required to complete a round trip. The unloading point's utilization rate is calculated using the same method. If we dedicate more trucks to this mission, the utilization rate will increase. For example, if we have two dedicated vehicles, the loading point will have an 81-percent utilization rate. This is determined by dividing the 60 minutes of loading time by the 74 minutes needed to make a round trip. Note that if we dedicate 3 vehicles, we have a 100-percent utilization rate. Committing more than 3 vehicles would only lengthen the queue at the loading point and waste these resources.

Common Analysis Methods: Markov Processes

Most processes do not have fixed durations. Stochastic (random) processes assume that there is some variability in each of the service times that often can be modeled with standard distributions. The most basic queuing model contains Markov processes, where all of the service times are exponentially distributed. Although Markov processes usually are not used to plan actual missions, many studies and simulations assume that their processes can be approximated by an exponential distribution. According to Leonard Kleinrock in *Queuing Systems, Volume I: Theory*, this is because “numerous natural and physical and organic processes exhibit behavior that is probably meaningfully modeled” by exponential distribution. Kleinrock provides documented examples of processes modeled by exponential distribution, ranging from modeling gamma rays emitted by a particle to the number of soldiers killed as a result of being kicked by their horses.

The type of problem presented in the scenario can be solved using elementary queuing methods taught in most operations research courses. These methods generally are not very difficult to compute and can be solved using spreadsheet calculations or short computer programs. The chart on the next page compares the loading point's utilization using from 1 to 16 transport vehicles. If we assume that all of the processes are deterministic, employing three or more transport vehicles results in full utilization of our loading point. On the other hand, modeling all of the processes with an exponential distribution produces only about an 80-percent utilization of the loading point when using three vehicles. This reduced utilization results in a 25-percent increase in the time required to complete the mission.

Other Distributions

Sometimes it may not be appropriate to model processes deterministically or with an exponential distribution. Using the wrong distribution could result in either an insufficient or an excessive commitment of resources. However, determining the proper distribution may require a significant investment in people, time, money, and equipment.

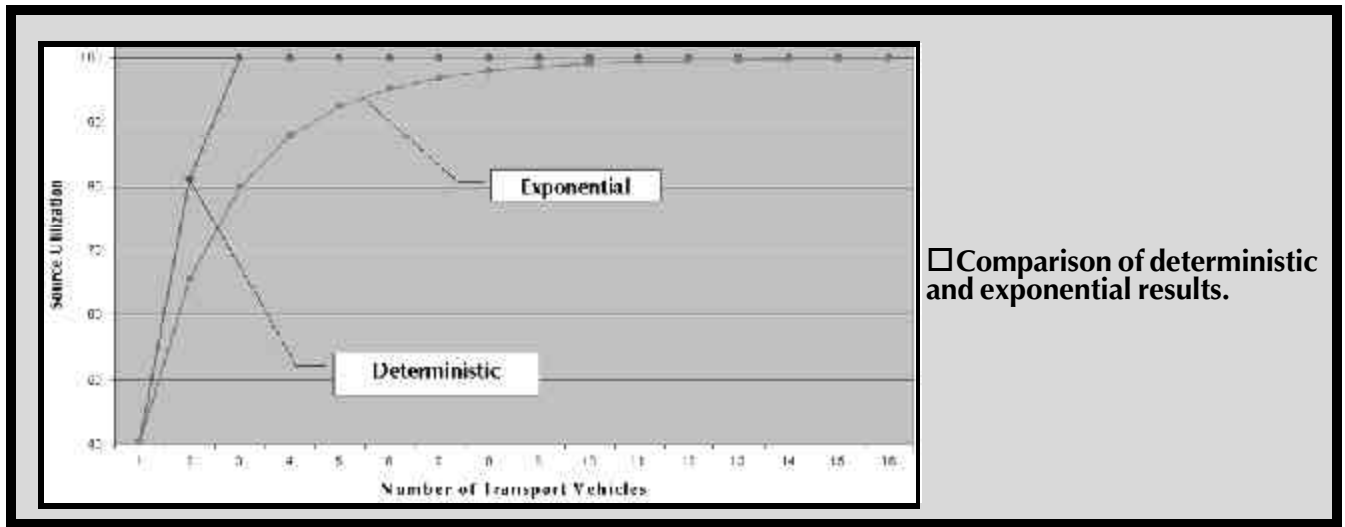

Sometimes it is possible to reach a compromise between using adequate models and gathering enough data, which is illustrated in the following example. For a deterministic model, the standard deviation (SD) is zero. For a model assuming an exponential distribution, the mean and the SD are the same. What happens when we have shipment models with various distributions, but all of the models have process SDs equal to one-half of the average process times? To conduct this analysis, I used the ProModel discrete event package to simulate transporting 4,000 loads for each run. I conducted 200 runs for 6 different distributions: gamma, beta, uniform, bimodal, lognormal, and triangular. The results were essentially the same for all six distributions. The results also indicated that the trend is for the results of these distributions with $SD = \frac{1}{2}$ mean to fall approximately halfway between the curve of the deterministic model with $SD = 0$ and the exponential model with $SD = \text{mean}$.

The results of the previous example highlight the value of knowing more about our processes than just the average process time. You will recall that committing three transport vehicles caused the loading point to be fully utilized using deterministic planning factors and to have an 80-percent utilization rate with exponentially distributed processes. If the SDs of the processes are one-half of the average process times, we will have a 90-percent utilization. This means that our mission completion time only increases by 11 percent compared to the 25 percent with the exponential distributions. The results of the example also are heartening, since they suggest that, for this transportation network, the average process time and the SD are the main influences on the outcome performance measures. This knowledge provides a rationale for using the deterministic curve and the exponential curve as approximate bounds for decision-making. It also suggests that the SD provides a rough location for the actual curve. This eliminates the need to determine the actual process distributions.

Commanders can use these results to establish an initial plan and then refine the number of resources allocated as appropriate.

Gathering data for planning and simulations requires people, time, money, and equipment. Most units and organizations lack some or all of these resources. Scheduling conflicts, cancelled exercises, broken instruments, and unrealistic training conditions caused by administrative requirements compound these data-collection problems. After gathering the data, the organization must have the expertise and resources to interpret the results. Incorporating higher order information also requires models and simulations that can accept that level of complexity. Together, these tasks are rather daunting for one unit or analytical organization to tackle.

However, a concerted effort by the operational and analytical communities will help solve the problem. Much of the data is being collected indirectly already during exercises and operations through administrative records such as dispatch records and logbooks. Emphasis by unit leaders on tracking and reporting this information accurately will provide a reliable source of logistics information, as well as help the units improve their processes. The analytical community can contribute to the effort by interpreting the data, providing a central repository for the data, and distributing the information to the rest of the logistics community. The analytical community benefits by having more knowledge to incorporate into the models and simulations they use to make force structure and materiel decisions. **ALOG**

Major Mark W. Brantley is a Corps of Engineers officer. He wrote this article while serving as an analyst in the Operations Research Center of Excellence at the U.S. Military Academy.

Measuring Supply Management Change

by Chief Warrant Officer (W-4) Matthew A. Anderson, Sr.

Past experience in both the Army and the private sector has shown that organizations are slow to change and are aggressively unsympathetic toward change unless it results in a dramatic and immediate improvement in service level or financial status. An organization-wide “buy-in” of the goals and objectives of the change and acceptance of the integrity, frequency, and display of supporting data are critical to implementing any proposed change.

The key to making a dramatic change in an organization is establishing specific performance metrics and goals, as well as milestones to meet those goals. The ability to acquire real-time data and effect system changes provides an organization with the capability to influence or “own” the change. Power is not just in information but also in understanding and using information appropriately.

The Army and the commercial sector approach change management in similar ways. They both strive to influence human behavior through training or incentive-based payment systems or by improving processes through new equipment or infrastructure investments. Perhaps the most influential change mechanism, however, is performance metrics. Employees perform according to how their performance is measured. When measured, performance improves.

Six Sigma Model

One method of measuring and quantifying performance that has been used extensively within the commercial sector is a model originally developed by Motorola. Six Sigma uses customer-focused goals and measurements to drive continuous improvement at all levels. The Six Sigma model attempts to insert the hard-nosed science of statistics into the foggy philosophy of quality and performance. The goal is to develop processes so robust that defects are measured at levels of only a few parts per million (for example, 3.4 defects per 1 million opportunities, or 99.999-percent perfect). The process is cyclical and

involves several iterative processes as shown in the chart below.

Like industry, the Army had to reduce the cost of maintaining inventories and the associated cost of distribution throughout the supply chain. However, the prevailing work environment in the Army has not focused on cost savings and return on investment, as is typical for a commercial enterprise; rather, it focused on winning wars and providing a range of options to the Secretary of Defense.

Now, leaders and managers throughout the Army understand the need to become proficient in all facets of logistics in their quest to drive down costs. Managers must have knowledge of inventory-carrying costs in order to make informed decisions about the design of logistics systems, customer service levels, the number and location of distribution centers, inventory levels and locations, transportation modes, production schedules, and minimal production runs.

To help managers gain the skills needed to reduce operating costs, the Army initiated a total quality management process improvement task force and began implementing a define-measure-improve methodology

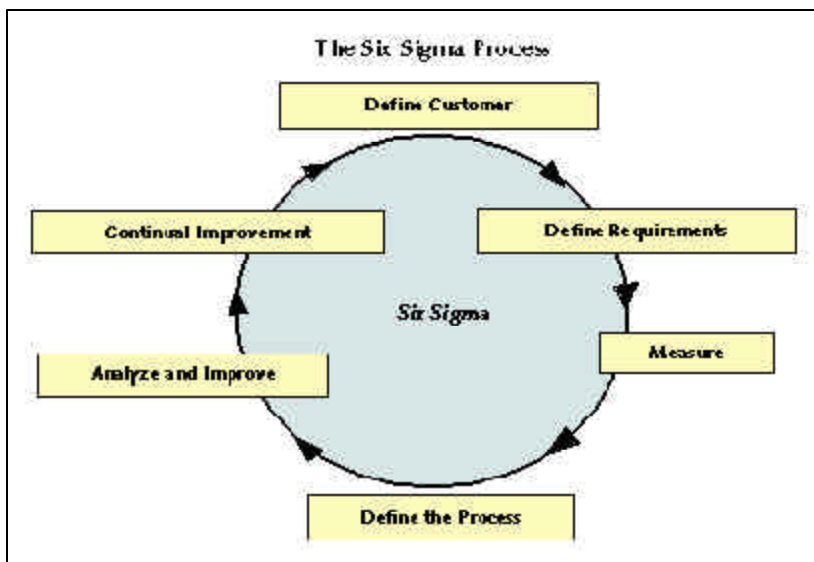

□ The Six Sigma process is cyclical and involves several iterative processes.

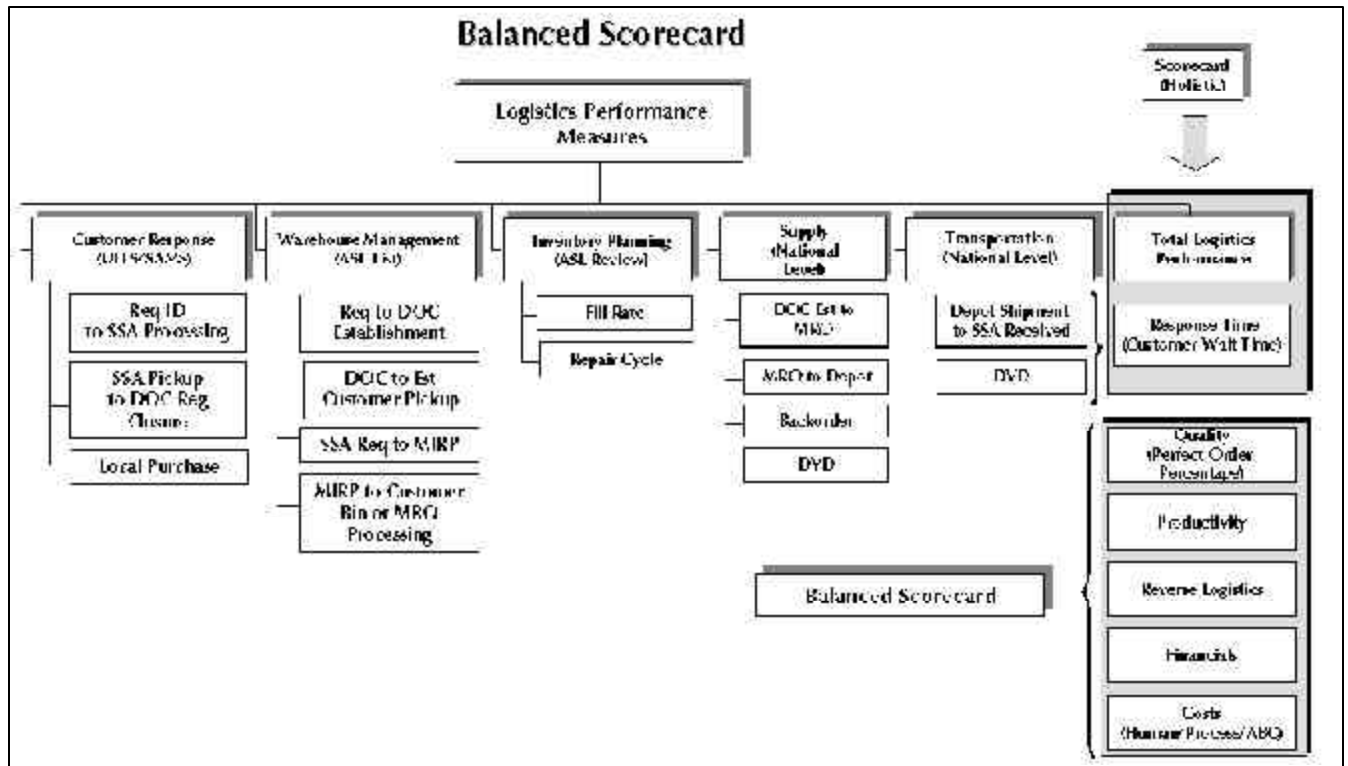

□ The Balanced Scorecard measures the intangibles of quality in perfect order percentage.

Army-wide. The Army also developed a series of performance metrics with which to establish and monitor baseline process improvements.

Establishing a Baseline

In most corporations, customer service is defined in one of three ways—

- ◆ As an activity that has to be managed, such as processing orders, invoicing, or handling customer complaints.

- ◆ As a measure of performance, such as the ability to ship 95 percent of received orders within 48 hours.

- ◆ As an element in the total corporate philosophy.

Of these three ways, the most difficult to determine is measure of performance. To measure performance, it is necessary to capture data, build a database, and establish a baseline for study and analysis. Data sources may or may not be readily accessible or available. Measurement is defined as the internal and external monitoring of operations. In the words of one corporate executive, “If it moves, we measure it. We measure how much it costs to move, what resources were used, did we move it to the right place without damaging it, and how long it took. If it does not move, we measure how long it stays there and what resources are consumed while it sits.”

The end-state metric of logistics efficiency focuses on the costs of meeting customer service objectives: the costs involved in purchasing, warehousing, inventory

management, order entry, shipment scheduling, and transportation. The goal of establishing performance-based metrics is to eliminate variability and unpredictability and to build trust and confidence in the customer support base. Metrics will drive behavior, and the cost-benefit tradeoff must be weighed to determine whether the cost of an investment in new technology or training will outweigh the competitive advantage gained by efficiency.

Key factors for both commercial and military operations are ensuring that leaders are involved and periodically reviewing operations as they relate to established performance objectives. The challenge is to understand the data sources and the various means used to capture the data flowing through the supply chain. There will be gaps where the pipeline segment analysis appears to be in error, simply does not exist, or is a small percentage of the overall population and therefore is statistically irrelevant.

Establishing Goals and Objectives

Setting goals and objectives across the supply chain is tricky business. Resulting behavioral changes may benefit one link of the supply chain while harming or detracting from another link. Such changes ultimately could have an adverse impact on the total performance of the system. Continually evaluating the performance of the complete supply chain and modifying manage-

ment objectives accordingly will ensure a progressive and successful attainment of performance goals. Therefore, a holistic look at the complete system is critical, and periodic evaluations and continued data-mining are necessary.

A Holistic Look at the Supply Chain

While Six Sigma is used by many industry leaders to ensure quality control, the drive to secure quality and value while ensuring that cost and performance are measured is moving the Army toward a “Balanced Scorecard,” which is a means of measuring the intangibles of quality in perfect order percentage (see chart at left).

The Balanced Scorecard approach to strategic management is a program that grew out of a study group comprised of executives from companies like Apple Computer, Bell South, CIGNA, DuPont, and General Electric. It presents a holistic view of performance metrics that must be assessed together in a way that will ensure a collaborative enterprise solution.

Viewed individually, supply chain components may deliver optimal performance. However, viewed holistically, their collective performance may impact quality, productivity, financial, and human costs that affect the “bottom line” in acquisition policies and practices. The goal is to align Army logistics performance with world-class industry standards and, in doing so, allow logistics managers to “see” the direct impact of their decisions and practices on customer satisfaction.

Logistics automation tools are becoming sophisticated to the point of real-time analysis. After walking through the define-measure-improve process, a process action team or change agent can use performance metrics to set goals and objectives for studying individual pipeline segments and ensuring that end-state objectives are met. Metrics and goals associated with those segments will drive behavior.

Using Velocity Management

Performance, by its very nature, is an expectation of achieved service or production. In the Army, a continual performance evaluation process is conducted through Velocity Management. The aim of Velocity Management is to get logistics support into the hands of soldiers as fast as any world-class commercial firm while providing a hedge against unforeseen interruptions in the logistics pipeline. The core challenge is that human behavior will need to change as the systems providing logistics information change dramatically.

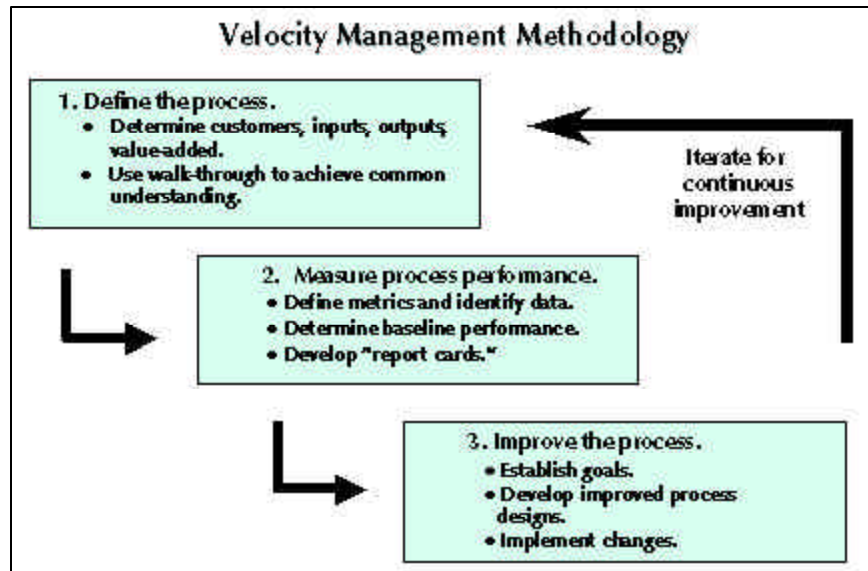

□ Continuous evaluation and improvement are inherent in Velocity Management.

An example of a private sector success story is Harley Davidson, the motorcycle manufacturer. The company began to seriously study the logistics of building and selling motorcycles in the early 1980’s, when it was near bankruptcy. It reviewed the procurement process, inventory stock theory and practice, and the parts marketing process to ensure a holistic, end-to-end supply chain approach to supporting the company vision. By performing a thorough study of the entire supply chain, Harley Davidson’s logistics personnel were able to define, measure, and improve their processes. A key corporate decision was made to reduce the number of suppliers from 500 to 200. A smaller supplier base made quality improvements easier to implement and facilitated the detection, tracking, and resolution of quality problems.

Through a similar holistic approach, the Army’s Velocity Management Program has produced tremendous supply chain improvements that rival those of commercial industry. The results have been a 59-percent reduction in the time required to deliver materiel within the United States, a 25-percent reduction in repair-cycle time for major end item repairs, improved inventory levels, and greater customer order satisfaction and confidence.

Chief Warrant Officer (W-4) Matthew A. Anderson, Sr., is a change agent for the Velocity Management Program at the Army Combined Arms Support Command at Fort Lee, Virginia. He holds a bachelor’s degree from Virginia State University and recently completed a 1-year training with industry program at Sears, Roebuck, and Company’s Logistics Division.

Emergency Essential Civilians in Korea

by John Di Genio

Despite North Korea's continuing interests in foreign aid and economic reform, the Kim regime continues to field far more conventional military force than any conceivable sense of self-defense would warrant. We and our allies . . . must encourage tangible military confidence building measures that are verifiable and reciprocal. The measures taken so far . . . are first steps, but tangible military measures are key to reducing the risk of conflict.

—General Thomas A. Schwartz
Commander in Chief
United Nations Command/
Combined Forces Command
and Commander, U.S. Forces, Korea

Title 10 of the U.S. Code states that civilian positions can be designated as “emergency essential” if they—

- ◆ Support combat operations or provide maintenance and repair to essential combat systems.
- ◆ Are needed after the evacuation of noncombatants.
- ◆ Cannot be converted to military billets without disrupting operations.

By supplementing U.S., Korean, and allied military personnel, emergency essential civilians play a vital role in defending the Republic of Korea. They help greatly to shape the “tangible military confidence building measures” about which General Schwartz spoke. The emergency essential civilians in Korea who deploy with their military counterparts have reported that they gain a better understanding of the important roles that service members play in fulfilling missions consistent with national military and security strategies for the Korean theater.

Strategic planners in deployed environments such as Korea need to consider seriously the benefits of organizational and mission continuity that result from retaining a core of skilled U.S. and local national civilian employees in times of transition from peace to hostilities. Indeed, the prudent use of emergency essential civilians increases the overall readiness posture of the

military and greatly facilitates the ability of military commands to go to war.

Emergency essential civilian positions should satisfy minimal essential staffing levels to sustain operations during contingencies. However, command analysts need to ensure that the proper numbers and types of emergency essential civilians have been identified. Having too many emergency essential civilians increases costs, reduces the military's ability to execute its wartime mission efficiently and effectively, and strains the military's ability to provide adequate life support, logistics, force protection, and physical space at deployment sites.

Let us take a look at the North Korean threat and how U.S. Forces Korea executes its Emergency Essential and Mission Essential Civilian Program in defense of the Korean peninsula.

The North Korean Threat

Make no mistake about it: The North Korean threat is very real! Although talks between North Korea and South Korea have yielded some diplomatic successes, North Korea has done nothing to reduce its large, forward-deployed army. In fact, the number of North Korean forces positioned within 90 miles of the demilitarized zone continues to increase. North Korea is enhancing its ballistic missile capabilities, to include multistage missiles capable of hitting targets in South Korea and Japan. North Korea also has the capability to manufacture chemical weapons. North Korea's special operations forces are highly mobile and extremely lethal.

All of this hardly suggests that enduring peace on the peninsula is close at hand. The proximity of North Korea's forward-deployed military machine and the resulting short warning time of an invasion require that U.S. forces be ready to “fight tonight.” The distance between the Korean theater and U.S.-based power projection platforms, however, presents many logistics challenges—primarily the need to get forces and materiel to the foxhole in time to deter North Korean aggression.

This is where deployed civilian personnel assets enter the operational picture. U.S. Forces Korea's deployed civilians represent a stopgap measure. The command's general strategy is to deploy U.S. and local national civilian employees to support contingency operations until

military augmentation arrives in the theater. Having deployed civilians working on support functions allows military personnel to focus on their combat roles.

Emergency and Mission Essential Civilians

U.S. civilian employees in the Korean theater are designated as emergency essential. However, U.S. Forces Korea employs more local national employees than U.S. civilians. The indigenous workforce performs functions that are vital to successful mission accomplishment. This was proven recently when U.S. Forces Korea went to Force Protection Condition Delta in response to the tragic terrorist attacks in New York City and at the Pentagon. Under Force Protection Condition Delta, local national employees, unless otherwise designated on their identification cards, are prohibited from entering U.S. facilities. During the time of heightened security following 11 September, restricting the access of Korean employees critically hindered installation management, logistics, and base operations and support missions throughout Korea. Activities at U.S. facilities in Korea were virtually at a standstill.

When a mobilization occurs, local national employees of U.S. Forces Korea generally are released to the Republic of Korea Government to perform either a combat support or civil defense function. Since the blue-collar, manual-labor workforce of U.S. Forces Korea primarily consists of local national employees, releasing these personnel to the Korean Government would impede the command's ability to assume a wartime posture. Hence, local national workers who will be needed to support U.S. Forces Korea's war efforts are designated as "mission essential."

The U.S. Army Materiel Support Center-Korea at Camp Carroll in Waegwan (some 180 miles south of Seoul) provides an excellent example of how the local national workforce will be needed should there be a resumption of hostilities on the Korean peninsula. The Materiel Support Center-Korea maintains, receives, ships, stores, and repairs tactical equipment and supplies needed to maintain readiness and sustain mobilization in the event of hostilities. Should war break out on the peninsula, the Korean local national employees at the center will remain in place to perform a variety of supply and maintenance functions until augmentation arrives in the theater to assume those responsibilities.

U.S. Forces Korea also deploys civilian contractors and the Korean Service Corps during exercises and contingency operations. The Assistant Chief of Staff for Acquisition Management at U.S. Forces Korea has general administrative oversight responsibility for contractors with mobilization clauses in their contracts. The Korean Service Corps—a local national civilian paramilitary organization—falls under the purview of the

Assistant Chief of Staff, G3 (Operations), of Eighth U.S. Army.

History of the Program

Initially, the Office of the Civilian Personnel Director administered the U.S. Forces Korea Emergency Essential Civilian Program. In the mid-1990s, the command Inspector General pointed out that the Office of the Civilian Personnel Director administered the Emergency Essential Civilian Program as a "personnel program," not as a wartime program. This meant that those designated to deploy were emergency essential civilians in name only. It also meant that critical elements of the program were not being accomplished; medical screenings were not being performed; training was not being monitored by the command structure; and some civilians erroneously believed that being designated as emergency essential guaranteed them continuous overseas tour extensions and onpost housing.

To correct deficiencies in administering the program, and to emphasize its wartime necessity, responsibility for administration of the Emergency Essential Civilian Program was reassigned to a coordinating staff—the Joint Manpower and Organizations Division under the Assistant Chief of Staff, J1 (Manpower and Personnel), of U.S. Forces Korea. This division now establishes policy to administer the Emergency Essential and Mission Essential Civilian Program to support the United Nations Command/Combined Forces Command, U.S. Forces Korea, Eighth U.S. Army, stovepipe organizations, and tenant agencies. A representative of the Joint Manpower and Organizations Division chairs the Emergency Essential and Mission Essential Civilian Program Board, which consists of representatives from the command's principal coordinating staffs.

The Board

U.S. Forces Korea has adopted the use of a board to evaluate requests to designate emergency essential and mission essential civilians against such criteria as identifiable mission, costs to the command, ability of the command to provide adequate life support, and force protection concerns. At this board, command analysts have an opportunity to play "devil's advocate." For example, the representative of the Assistant Chief of Staff, J4 (Logistics), may ask such questions as—

- ◆ Would these positions improve the command's overall readiness posture and its ability to transition to war expeditiously?
- ◆ Can the organization requesting the designation adequately equip its emergency essential and mission essential civilian personnel without putting a strain on its military assets?
- ◆ Can the logistics base accommodate the transfer

of emergency essential and mission essential civilian personnel to their designated locations while supporting the movement of military personnel and equipment, noncombatant evacuation efforts, and enemy prisoner of war operations?

The logistics representative also may address issues concerning food (such as meal, ready to eat, stocks) and the blood supply (the U.S. Forces Korea Surgeon falls under the Assistant Chief of Staff, J4) to support the number of deployed civilians in theater.

Nominations that do not meet the emergency essential and mission essential civilian criteria and Title 10 requirements are dismissed because the civilians have no wartime mission, will place too great a strain on life support systems, and do not add any value to the command's readiness posture. Those that do survive scrutiny are approved and forwarded to the appropriate manpower office to have the authorization documents coded to indicate that the positions have been designated as either emergency essential civilians or mission essential billets.

Identifiable Mission

To have its emergency essential or mission essential positions designated, an organization should have an identifiable wartime mission. Typical logistics wartime missions in Korea include coordinating with the Republic of Korea Government for assets to sustain mobilization efforts, such as buildings, vehicles, and other wartime host nation support and logistics cost-sharing items; transporting military personnel and materiel from the port of debarkation to the front; setting up field kitchens, laundries, and shower facilities; supplying fuel, potable water, and blood; conducting mortuary affairs operations; and maintaining equipment. Emergency essential and mission essential civilians could perform any number of tasks associated with these crucial wartime functions.

An old axiom is that a military activity should organize in peace as it would function in war. An organization should list the core wartime functions that it would be expected to accomplish during mobilization and then identify the minimal essential civilian staffing to complete those functions. To ensure continuity of operations, it is important that emergency essential and mission essential civilians perform the same duties in peacetime that they will perform during mobilization.

Leadership has to be the standard bearer for the Emergency Essential and Mission Essential Civilian Program. If leadership shirks its responsibility to champion this essential wartime program, then subordinates will be less than enthusiastic about supporting it. If a subordinate is expected to deploy as an emergency essential or mission essential civilian, then someone in that civilian's chain of command also should deploy. Otherwise, it

appears that management has no interest in the program. In Korea, supervisory personnel and subordinates have deployed during exercises to receive essential training.

Cost Considerations

Deployed civilians are not a source of cheap labor to satisfy an organization's deployment requirements. Nor are they a cost-effective substitute for deploying Reserve component personnel from the United States. Instead, emergency essential and mission essential civilians are an investment that the command makes to enhance and add value to its readiness and go-to-war postures. As such, each emergency essential or mission essential civilian carries a cost for the command.

For example, it costs about \$450 to clothe an emergency essential or mission essential civilian properly, including battledress uniform, boots, undergarments, and other organizational clothing. Yearly medical examinations run about \$140 per deployed civilian. During a typical exercise, a participating emergency essential or mission essential civilian potentially can accumulate (at a minimum) 44 hours of overtime.

About 420 emergency essential civilians (deployed U.S. civilians) are identified on the various United Nations Command/Combined Forces Command, U.S. Forces Korea, and Eighth U.S. Army authorization documents. This requires an initial outlay of \$189,000 for clothing. It costs an additional \$58,800 annually for medical examinations. Since there are three major exercises in Korea annually, overtime can run about \$5,000 a year for each deployed emergency essential civilian. This does not include the costs of maintaining a viable, deployable mission essential civilian workforce. The chart at right lists some of the major cost elements of sustaining a robust emergency essential and mission essential civilian workforce in Korea. Some of these cost elements may apply to either an emergency essential or a mission essential civilian.

Command analysts need to determine the best point at which the benefits derived from sustaining an emergency essential or mission essential civilian workforce outweigh the costs. This is not to say that cost considerations are the driving force in determining the number of emergency essential or mission essential civilians needed to sustain operations during mobilization. However, adding emergency essential and mission essential civilian requirements above the level that satisfies minimal staffing needs will yield diminishing returns; it does not provide a corresponding increase in mission readiness or augment the command's ability to perform essential wartime functions. Instead, increasing the number of emergency essential and mission essential civilians above minimal staffing requirements adds unnecessary costs and actually detracts from readiness and mission accomplishment.

Direct Costs

- ◆ Uniforms and clothing
- ◆ Equipment (TA-50 and NBC gear)
- ◆ Medical (examinations, vaccinations, and inoculations)
- ◆ Overtime and compensatory time
- ◆ Hazardous duty pay and allowances (if applicable)
- ◆ Training (basic soldier skills, NBC, etc.)
- ◆ Life support

Indirect Costs

- ◆ Storage space (for clothing and equipment)
- ◆ Administration (personnel administration, occupational health and training records, etc.)
- ◆ Substitute personnel (to perform normal duties of emergency essential and mission essential civilians while they are deployed; potential learning curve costs)
- ◆ Transportation of families of mission essential personnel in the event of mobilization

□ Factors affecting the cost of deploying emergency essential and mission essential civilians in Korea.

Space Considerations

Organizations with identifiable wartime missions should deploy emergency essential or mission essential civilians (where permitted) to major exercises and contingency operations. However, organizations that deploy emergency essential and mission essential civilians simply to “preserve their footprint” at a deployment site are selfish. Office space and life support at deployment sites are rather spartan and extremely limited.

Sending a superfluous contingent of emergency essential or mission essential civilians to a deployment site creates diminishing returns. Less essential deployed civilians will crowd out those who are needed to conduct wartime missions or to practice skills during exercises.

Training

Emergency essential and mission essential civilians in Korea receive training to perform their wartime missions and to survive during combat. Participation in exercises ensures that emergency essential and mission essential civilians are ready to deploy expeditiously to their wartime locations and perform their assigned duties.

For example, wartime host nation support, a key logistics program essential to successful mission accomplishment, is practiced regularly during major command post exercises in Korea. The headquarters staffs conduct regular training on how to properly wear and care for nuclear, biological, and chemical gear. Emergency essential and mission essential civilians also are taught basic first aid and other common soldier tasks that a civilian may be required to know on the battlefield. The staff judge advocate holds sessions on the rules of

engagement and what to do if captured.

The command has made a conscientious decision not to arm emergency essential and mission essential civilians in Korea. Although emergency essential and mission essential civilians carry the Geneva Convention Card, North Korea is not a signatory to the Geneva Convention. Some local nationals have claimed that if they are captured by North Korean forces, possession of a Geneva Convention Card will be like carrying a “hip pocket death warrant.”

North Korea remains a threat to the peace and stability of the region. U.S. Forces Korea uses deployed U.S. and local national civilians to perform vital support roles during mobilization and contingency operations until augmentation forces arrive from the United States. Emergency essential and mission essential civilians are an investment; they are not an economic substitute for deploying Reserve component personnel to a theater.

Leadership has to embrace the Emergency Essential and Mission Essential Civilian Program. U.S. Forces Korea’s “civilian warriors” are force enablers who can be counted on to perform their duties, assist in the defense of the Korean peninsula, and help their military counterparts achieve the desired results during contingency operations. In Korea, the deployed civilian program is a success story.

ALOG

John Di Genio is a management analyst in the office of the Assistant Chief of Staff for Resource Management at Headquarters, Eighth U.S. Army, at Yongsan Garrison in Seoul, Korea.

MTMC Team Fights War on Terrorism

A forward-deployed Military Traffic Management Command (MTMC) deployment support team (DST) is playing a pivotal role in the U.S. war on terrorism.

The DST works with the Navy to load armaments and supplies onto Air Force warplanes at an operating location in support of the U.S. Central Command execution of Operation Enduring Freedom. The Naval Cargo Handling and Port Group, which operates the port

there, relies on the DST to oversee port operations and provide visibility of cargo in transit.

In early October, personnel from Headquarters, 599th Transportation Group, at Wheeler Army Airfield, Hawaii, and subordinate battalions assembled in Yokohama, Japan, for an intensive 2-week DST train-up and mission rehearsal in preparation for a possible deployment in support of Operation Enduring Freedom. Later that month, a start-up team that included representatives from

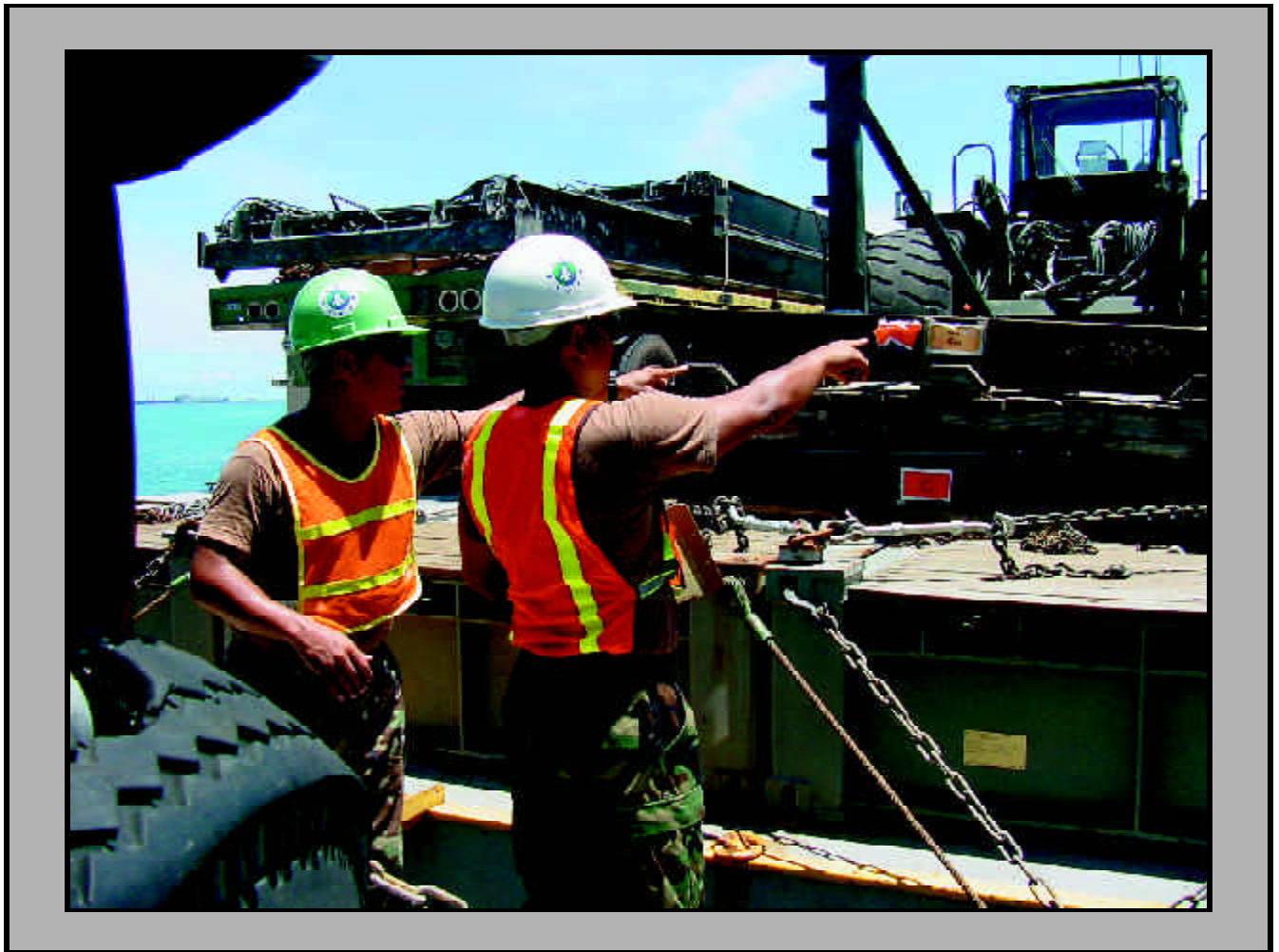

□ Members of the 599th Transportation Group's DST identify equipment to be discharged from the *SS Cornhusker State*.



□ A DST member reviews documents to ensure that all equipment to be discharged has been identified.

the 599th Transportation Group; the 836th Transportation Battalion in Yokohama; and the 835th Transportation Battalion in Okinawa, Japan, arrived at the operating location. A representative of the 837th Transportation Battalion in Pusan, Korea, joined the team in December.

In its first 4 months of operation, the DST discharged and uplifted equipment, supplies, and ammunition from the Military Sealift Command's *SS Cornhusker State*, a Ready Reserve Force auxiliary crane ship; and the large, medium-speed, roll-on-roll-off cargo ships *USNS Fisher* and *USNS Red Cloud*. Normally, in order to maintain in-transit visibility, the DST uses scanners to capture bar-code data electronically from each piece of cargo to input into MTMC's Worldwide Port System (WPS). This information then is uplinked to the U.S. Transportation Command's Global Transportation Network. However, because of the unique aspects of the wartime mission in a joint service environment, the DST had to develop a number of "work-arounds" in both the WPS and the Integrated Computerized Deployment System (ICODES).

There were no shipping labels on any of the Air Force containers, so all cargo data had to be tallied manually, explained Tom Brewer, DST commander. The tallied data then were sent to the host server in Yokohama for processing into the WPS.

Additionally, "the ships' characteristics were not available when the ships were loaded several years ago, so the stow plans were not available to the DST in the ICODES format," said Brewer. "The team built the stow plans in ICODES based on a variety of data sources, including the manifests."

Many containers stowed below deck had to be discharged while containers stowed above deck stayed onboard. Careful planning by the DST prevented double handling of the containers and established a pattern for efficient cargo operations.

The deployment presented a number of personal challenges to team members because it was on short notice and to an undisclosed location. However, when the team members found out that their assignment was directly supporting Operation Enduring Freedom, they were ready and eager to go.



□ Data on cargo to be discharged are tallied manually.



□ Sailors from the Naval Cargo Handling and Port Group work with the SS *Cornhusker State*'s crane to discharge equipment.

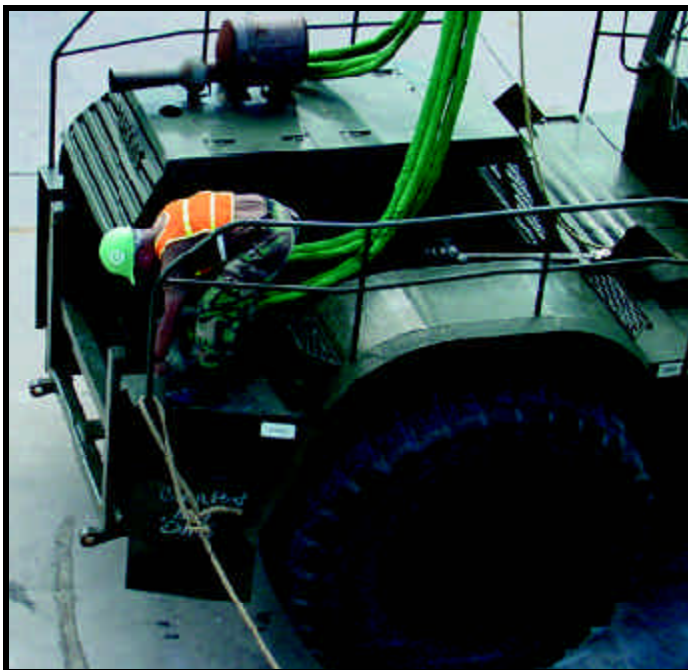

□ Strapping is removed from equipment offloaded from the SS *Cornhusker State*.

“Deployment support teams provide us with the flexibility to rapidly deploy our port operations capability anywhere in the world,” said Colonel Peter J. Gitto, commander of the 599th Transportation Group. “The ability of [the DST] to execute these operations directly supports the Air Force’s ability to place bombs on target. This is how we are supporting Enduring Freedom.”

How long the DST will be required on site is uncertain, but, according to Gitto, the team will be MTMC’s forward element in the war on terrorism for as long as necessary.

ALOG

The Army Logistician staff thanks Terri Kojima, command affairs officer of the 599th Transportation Group, for providing the information and photos contained in this article.

The Army's Enlisted Acquisition Workforce

by Sergeant Major Ethan A. Jones

Contracting has proven to be an effective force multiplier during both military operations and peacekeeping missions. Contracting allows the Army to find alternative sources of supplies and services in areas where previously none were thought to exist.

The Army Enlisted Acquisition Workforce Program was established as part of an initiative to support the Army's transformation in the 21st century and to support warfighters during contingency operations. Under the provisions of this program, noncommissioned officers (NCOs) in the acquisition workforce perform routine base contracting and contingency contracting operations.

The Quartermaster Branch of the Total Army Personnel Command selects highly skilled and trained NCOs from the Quartermaster Corps to be members of the Army Acquisition and Technology Workforce. The records of the nominated NCOs are sent to the NCO Army Acquisition Corps Proponency Office for screening and further evaluation. After selection, the NCOs are enrolled in three mandatory courses offered by the Defense Acquisition University: Basics of Contracting (CON 101), Principles of Contract Pricing (CON 104), and Contingency Contracting (CON 234). After completing those courses, the NCOs receive additional skill identifier G1, Contracting Agent. These NCOs receive the same training, education, and professional development opportunities as do their officer and Department of the Army civilian counterparts.

Contracting has three levels of certification. Based on their grades, positions, education, experience, and length of tours, NCOs typically attain certification in levels I and II. In addition to the mandatory courses, level I certification requires formal secondary education in a business-related discipline and 1 year of documented contracting experience. Level II certification requires successful completion of Intermediate Contracting (CON 202), Intermediate Contract Pricing (CON 204), and Government Contract Law (CON 210) and 1 additional year of documented contracting experience.

Headquarters, U.S. Army Contracting Command Europe, training guidance requires NCOs to complete levels I and II within 24 months. NCOs also must complete formal hands-on training, which is documented in their NCO Evaluation Reports.

Certification is required before authorization to award contracts (or a "warrant") is issued for amounts exceeding the simplified acquisition threshold. The simplified acquisition threshold usually is \$100,000. However, when referring to a contract to be awarded and performed outside of the United States in support of a contingency operation

or a humanitarian or peacekeeping operation, the simplified acquisition threshold is \$200,000. Depending on the experience levels of the NCOs and the contingency operation, warrants can be issued to the NCOs before they complete level II requirements, provided the authorizations do not exceed the applicable simplified acquisition threshold. These steps ensure that the NCO is able to provide stability and continuity in contingency contracting situations.

Contracting NCOs can prepare and execute contract support plans for sustainment and retrograde of Army forces conducting joint and combined exercises, humanitarian assistance, or contingency or war operations. They also can deploy on short notice and serve as warranted contracting officers responsible for purchasing, renting, and leasing supplies and equipment where such actions serve as force multipliers in direct support of the warfighters. This ensures that contracts are valid and legally enforceable documents that comply with applicable procurement regulations.

U.S. Army Europe (USAREUR) has five contracting NCOs, and seven more are en route. These NCOs are assigned to various regional contracting offices within USAREUR, where they provide support to the 7th Army Training Center in Grafenwoehr, Germany; sustain the warfighters of the Southern European Task Force in Vicenza, Italy; and facilitate contracting actions in the Balkans.

The Quartermaster Corps currently is the only source of Enlisted Acquisition Workforce nominees. However, once an official acquisition military occupational specialty (MOS) is established, all qualified, promotable E-5s with a minimum of 6 years of service through E-8s in noncritically short MOSs will have an opportunity to accession into that MOS. Then, any NCO who adheres to strong and sound leadership principles and who has the technical know-how required to make the swift and tough decisions that contracting demands will be able to become part of the Army Enlisted Acquisition Workforce. **A LOG**

Sergeant Major Ethan A. Jones was selected as the first sergeant major of the U.S. Army Contracting Command Europe. He serves concurrently as the sergeant major of the Joint Contracting Center in the Balkans and as the sergeant major to the principal assistant responsible for contracting in U.S. Army Europe. He has bachelor's degrees in mass communications from Paine College in Georgia and in public relations from Clark-Atlanta University.

Supporting the African Crisis Reaction Initiative

by Major Barthelemy Diouf, Senegalese Army

If the nations of Africa are to assume primary responsibility for ensuring peace in their region, the United States and other Western nations must increase their logistics assistance.

After the Somalia crisis in 1992, African leaders, in a meeting of the Organization of African Unity, agreed that it was time for the continent to take charge of its own security. However, other than Nigeria and South Africa, none of the countries south of the Sahara were economically capable of supporting a projected military force for a long period of time.

To assist African nations in assuming greater responsibility for their own regional security, developed Western nations agreed to provide the necessary support for peace operations. To demonstrate their resolve, the Economic Community of West African States (ECOWAS) sent a force to Liberia in 1993 to bring peace and organize democratic elections. The United States provided the logistics support for the Senegalese regiment in that operation.

With the idea of ensuring peace on the African continent, U.S. Secretary of State Warren Christopher, while traveling in Congo in 1996, proposed the idea of “working with armies in African nations, creating a peacekeeping force that would operate under standard procedures, and would be equipped to handle missions outside of their own countries.” This idea evolved into the African Crisis Reaction Initiative (ACRI).

The goal of the ACRI is to train and equip a force of 10 to 12 infantry battalions and

4 to 6 special companies—a total of 10,000 to 12,000 men—that will be able to operate together during contingencies. The ACRI partner nations decide to deploy the ACRI force following a request from the United Nations, the Organization of African Unity, or a regional organization like ECOWAS. The United States provides financial assistance to equip and train units in selected African countries.

For the moment, the ACRI is limited to training personnel in peacekeeping operations and convoy security. However, if a major crisis occurred on the African continent, the current economic situations of the ACRI partner nations would not permit their respective armies to

project a force and sustain it. If the United States wants to ensure peace in Africa, I believe that it must make a long-term commitment to the transportation and logistics support of African forces.

In order to create an efficient plan for supporting the projection of the ACRI forces and their required logistics support, the U.S. Army must recognize the logistics factors that limit the capabilities of West African armies to project a force; the effects of infrastructure deficiencies on the ability of West African states to deploy and to conduct reception, staging, onward movement, and integration (RSO&I) operations; and the challenges of sustaining an ACRI force.



□ Senegal is located on the Atlantic coast of West Africa.



□ Soldiers of the 1st Battalion of the Senegal Army train for their mission in Sierra Leone under a U.S. Special Forces instructor.

Limited Projection Capabilities

Other than Nigeria, none of the armies in ECOWAS has the strategic transportation capability to project brigade-sized forces and sustain them for at least 6 months. In reality, the logistics concepts and structures of the armies in West Africa are not configured for force projection. Above all, the economic circumstances of those countries do not allow their governments to equip armies for a force-projection mission.

Western European countries such as France and Great Britain influenced the organization of the armies in West Africa. The support concepts conceived since the independence of many African countries in the 1960s have not changed. The ordnance, quartermaster, engineer, health, and signal functions constitute the combat service support units of those countries. Each of those functions is a separate directorate that supports the Army, Air Force, and Navy. There is no unity of command at the operational and tactical levels for logistics support of combat forces above the battalion. Combat service support units are tailored for Army operations.

The limited capacity of West African armies for RSO&I is not due solely to a lack of qualified personnel in robust combat service support organizations. These armies also lack adequate materials-handling equipment (MHE) and large-capacity trucks. During the 1993 operation in Liberia, pallets of supplies received from the United States by the Senegalese Army had to be broken down, put on 2½-ton trucks, and stored. If transshipment was required, the same supplies were collected again, transferred by hand, and palletized. All of those operations were performed manually because the

Senegalese Army lacked compatible MHE and large-capacity trucks.

The strategic mobility needed for force projection depends on airlift and sealift capabilities. The air forces in West African countries are equipped mainly with aircraft that have a very limited cargo capacity, like the Fokker F27, which can transport only a platoon and its combat load of ammunition. Their navies also do not have adequate military ships for large logistics operations. Some countries, like Senegal, have one or two infantry landing craft that can each carry one battalion with its combat load or one armored troop with its mission-configured load.

In short, the West African armies are not organized and equipped for projecting forces out of their own countries. Their air forces and navies do not have the aircraft and ships needed to perform significant logistics operations. If the United States wants the African states to take charge of their own security according to the ACRI concept, it must agree to provide all of the transportation needed to get the African forces to the field on time and when needed. When making that commitment, the United States must understand that African armies are not equipped with adequate MHE. Packaging and palletizing may differ from typical U.S. standards.

Limited Infrastructure

Army equipment and organization are not the only factors that affect force projection. Infrastructure, such as airfields, ports, roads, and railroads, must be available to support the deployment and RSO&I of African forces.



□ U.S. Army Special Forces soldiers help load boxes of military attire that will be issued to the 1st Infantry Battalion of the Senegal Army. The Senegalese soldiers were participating in Operation Focus Relief II, during which U.S. Special Forces trained the Senegal Army on new equipment so they would be ready for peace-keeping duty in Sierra Leone.

Peacekeeping is a joint mission that requires forces to deploy from power-projection platforms within their own countries. Typically, most troops travel by air while the majority of equipment is transported by sea. All large-scale deployments consist of three distinct and interrelated deployment segments. These are port to port, port to port, and port to foxhole. Each segment directly affects the others and influences the entire deployment.

Airfields that serve as airports of debarkation and embarkation, along with en route airfields that support flights, normally determine the airflow into a theater of operations. Each ACRI partner nation has at least one airport where heavy aircraft, such as C-5 and C-141 transports, can land and receive adequate assistance. However, servicing these airfields is a challenge. The West African air forces assist with flight operations. However, private companies may manage the technical equipment. To unload materiel received by strategic aircraft, for instance, the Senegalese Army has requested the assistance of Air Africa. At times, the unloading process may be interrupted because the MHE is needed to support civilian flight operations.

In some cases, hostile forces can occupy an airport and deny its use to ACRI forces. In 1993, C-5, C-17, and C-141 aircraft used by the U.S. Army to sustain the Senegalese regiment in Liberia could not be sent to Monrovia, Liberia's capital, because the rebels controlled the international airport for a few months. Only C-130 aircraft could land on the small airport controlled by friendly forces.

Port infrastructure includes MHE, longshoremen, terminal pipelines, storage facilities, and terminal railways. Barges and waterways often can support the movement of materiel. Countries along the Atlantic coast of Af-

rica have adequate port facilities for receiving heavy equipment. The sea transportation infrastructure in West Africa has many of the same deficiencies associated with the region's air transportation infrastructure, such as lack of sufficient MHE.

Land transportation infrastructure consists of two primary elements: roads and railroads. The lines of communication in West African countries will not facilitate forward movement. The road network in West Africa cannot support heavy traffic like that required by U.S. forces in Saudi Arabia during the Persian Gulf War. Roads around main cities are serviceable, but they are not large enough for certain heavy major end items. The rail transportation network can transport large quantities of goods in a reasonable time and often at a low price. The principal difficulty is the transportation of heavy equipment. Ninety percent of the railroads are not equipped with loading and unloading infrastructure for major items like trucks, tanks, and engineer equipment. Many railroad stations are not equipped with a loading area for these types of heavy materiel.

Public-service buses can be found in urban areas. The private sector also can provide transportation services. Host nation governments probably will not provide public-service buses for extended periods because that would paralyze transport systems within their cities. The best solution to this problem might be to contract in the private sector.

In summary, adequate infrastructure exists in main cities in West Africa. Each nation's capital has at least one airport where strategic aircraft can land. Coastal countries can provide adequate seaports. However, private companies manage all the support in airports and seaports and support commercial flights and ships; they

will consider their commercial interests ahead of military interests. The use of land transportation infrastructure will be limited by the quality of the roads. The rail and road capacities are very limited for heavy equipment. Light forces are better adapted to the terrain. Host nation support will be very limited for commercial vehicles. The United States should plan on providing the resources required for force projection.

Sustaining an ECOWAS Projection Force

While addressing U.S. and Senegalese soldiers during ACRI training at Thiès, Senegal, President Bill Clinton stated, "ACRI is to provide peacekeeping training and nonlethal equipment to African soldiers, with the goal of helping African nations to prepare their military units, led by African commanders, to respond quickly and effectively to humanitarian and peacekeeping challenges in Africa and around the world." The West African armies have the skills they need to accomplish a peacekeeping mission. However, they require training for cohesion because not all of the countries have the same doctrine. Their main difficulty is logistics support for a projected force.

Like the Senegalese regiment in Liberia in 1993, army partners of the ACRI will expect to receive class IV (construction and barrier materials), V (ammunition), VII (major end items), and IX (repair parts) support from the United States during contingency operations. Classes IV, V, and VII probably will be delivered at the beginning of a mission. Since repair parts for U.S. equipment are hard to find in West Africa, class IX supplies should be delivered with the major items and requisitioned as needed during a mission. The documentation required to requisition desired repair parts and perform maintenance must be readily available.

The logisticians who process the requisitions have to be trained to understand the U.S. logistics supply system. They also need to know what items are available and can be delivered. For example, the Senegalese regiment in Liberia requested some unavailable rocket launchers, while the M203 rifle grenade launcher was available and better suited to their mission. This was due to a lack of knowledge of what the U.S. Army was willing to provide.

All U.S. support will be in vain if the African armies do not perform required maintenance. In 1993, the Senegalese regiment went to Liberia equipped for the first time with M1008 cargo trucks; however, no one was trained to maintain those vehicles. Two years later, 60 percent of the trucks were not mission capable.

The armies in West Africa have limited experience with supporting U.S. weapon systems. African personnel must be trained in the U.S. Army support system and in

the maintenance of U.S. equipment fielded to them. The present ACRI program does not provide training for technicians because the United States has not committed itself to sustain the ACRI forces in case of engagement. If we wait until a crisis happens, it will be too late. The African partner nations and the U.S. Department of State should study this issue. At the least, countries expecting to receive U.S. equipment must start training with the minimum materiel on hand.

The West African nations that take part in the ACRI have the knowledge and skills to operate convoys and create secure environments. However, the organization and equipment of their armies does not allow them to project a force out of their own territories. If the United States wants to achieve the goals set for the ACRI, it must commit to providing the transportation and sustainment necessary to project the force in case of contingencies. The West African countries should use light rather than heavy U.S. equipment because of their limited lines of communication. The United States should plan to provide its own support when needed because host nation support will be very limited for transporting and providing repair parts for U.S. equipment. West African ACRI partner nations should train their logisticians on the use of the U.S. Army supply system and have their maintenance personnel qualified to repair U.S. equipment.

The African continent will not be developed until there is peace in all of its countries. The ACRI goal is to have a force ready to maintain peace and conduct humanitarian missions where and when needed, so that tragedies like Rwanda will not happen again. The African states do not have the economic capacity to achieve this future alone. Developed countries like the United States must take the necessary actions to get African military peacekeeping personnel and adequate materiel on site at the right time. If not, the millions of dollars spent for training 10,000 to 12,000 African personnel since 1996 will have been wasted.

ALOG

Major Barthelemy Diouf is an officer in the Senegalese Army. This article is adapted from a paper he prepared while attending the Logistics Executive Development Course at the Army Logistics Management College at Fort Lee, Virginia.

A Primer on Acquisition Logistics

by James J. Clark and Thomas D. Johnson

In late 1975, the Navy was about to proceed with contracts for full development for the F/A-18 Hornet fighter. Reports from the fleet showed that existing aircraft required repairs after only 30 to 45 minutes in the air. The planes were superb—when everything was working. However, they were not working long enough to get the job done. At this point, the Navy Material Command brought in Willis Willoughby.

During the Apollo space program, Willoughby had been responsible for making sure that the spacecraft worked perfectly all the way to the moon and back. In coming to the Navy, he was appalled by what he saw. He knew that the Navy could not afford unreliable aircraft, so he insisted that contracts for the F/A-18 contain specifications for reliability and maintainability instead of just flight performance.

Willoughby's efforts were successful. The F/A-18, with some revolutionary new performance capabilities, entered the fleet with greater reliability than more mature systems and required less than half as many man-hours of maintenance. In the first operational deployment of the F/A-18 in 1985, a day of flying would end with F/A-18s still ready to fly while the F-14s and A-6s were in for repairs. This success came about because the Navy focused on sustainable design far earlier in the acquisition process than it had before.

The F/A-18 acquisition team had two design goals: to create an engine that could be changed with little logistics difficulty, and to create an engine that could be changed in 20 minutes. The result was an engine that attached to the fuselage at only three points. One engine could be lowered through a hatch on the bottom of the fuselage and another inserted in less than 17 minutes. Contrast this with a Vietnam-era Navy aircraft, the A-4 Skyhawk, where the first step for replacing an engine was to remove the airplane's tail.

Acquisition logistics is the multifunctional, technical management discipline associated with designing and developing systems like the F/A-18. However, acquisition logistics might not be the discipline it is today without the people and tools used to develop complex

and expensive weapon systems. Every discipline evolves in time; yet the evolution of acquisition logistics in recent years remains elusive to many practicing logisticians. Major systems historically have been planned, designed, developed, and delivered to their customers with very little consideration given to logistics support. Today's systems cannot afford to shortchange logistics. To appreciate how acquisition logistics incorporates support considerations, one must understand the entire acquisition process, from the beginning to the end of a system's life cycle.

Logistics Supportability and Performance

Department of Defense (DOD) policy states that performance encompasses both the operational and the support characteristics of a system that allow it to perform its assigned mission effectively and efficiently over time. Supportability is a subset of performance and must be considered part of the performance criteria. The mechanism used to ensure that a holistic system design is achieved is called the systems engineering process. This process is applied to many functional areas by both the Government and contractors. Logistics considerations are just one part of the process. The systems engineering process used by DOD is depicted in the chart at right.

A system is more than just an end item or a single piece of equipment. It includes operators and maintainers, spare parts, support equipment, facilities, and training. In addition, systems designers are expected to address the system's compatibility with the rest of the support infrastructure. Logistics support begins with early planning for the system and continues throughout its useful life. Reliability, maintainability, and availability parameters are key leverage points in determining the depth and range of logistics support. The process is the same for all items, regardless of whether they are minor or major systems.

The process should emphasize the need to establish a logistics support management team early in the life cycle of a system. Acquisition logisticians work hand in hand with other engineering personnel to ensure that support

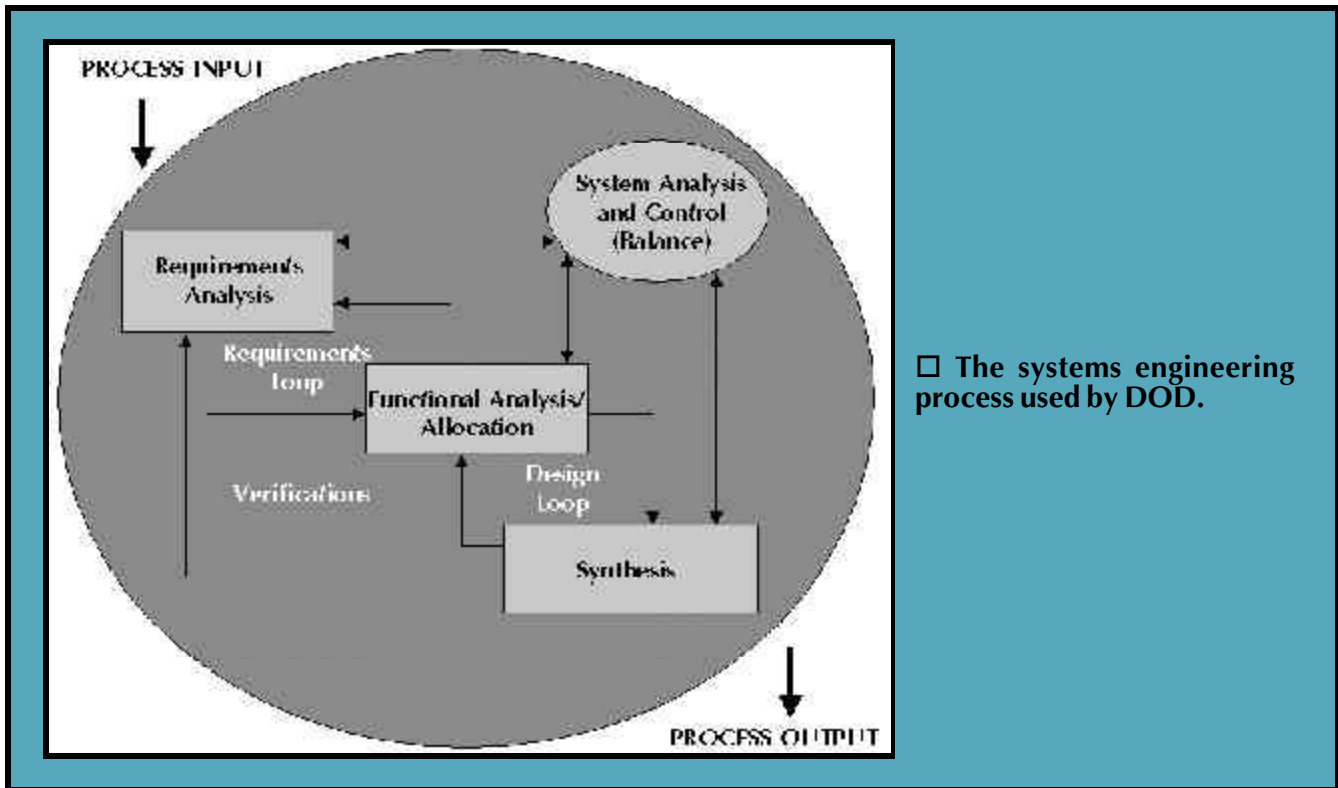

is considered during the design process. The acquisition logistician in the program manager's office acts as the central point of contact for the program manager to assist each area in resolving problems affecting support of the emerging system. The logistics management integrated product team helps the acquisition logistician establish effective support for the system. Generally, the Government and the developing contractor cochair the logistics management integrated product team.

Before the adoption of DOD 5000.2-R, Mandatory Procedures for Major Defense Acquisition Programs (MDAPs) and Major Automated Information System (MAIS) Acquisition Programs, in 1996, the acquisition logistician was called an integrated logistics support manager in all of the services. The Army still uses this term. The equivalent Air Force and Navy terms are assistant program manager of logistics and deputy program manager for logistics, respectively.

Regardless of the title, the acquisition logistician is responsible for—

- ◆ Influencing the system's design.
- ◆ Preparing logistics support documents.
- ◆ Coordinating the system support package.
- ◆ Coordinating the materiel fielding agreements.

Available information will be limited at the early stage of the process; however, this should not stop the logistician from using historical data gathered from previously fielded comparable systems. Typically, historical data

come from service repositories that capture supply and maintenance information on existing systems. (For the Army, the systems are the Standard Army Maintenance System, Standard Army Retail Supply System, and Unit Level Logistics System; the repositories are the Work Order Logistics File, Central Demand Database, and The Army Maintenance Management System Database.) Any data identifying how, when, and where the system will be used and maintained will establish a framework around which supportability factors can be formulated.

Since logistics is essentially a management of parts, keeping the cost of parts to a minimum is an essential task. Every part, no matter how small, has significant overhead costs. These costs are generated by such activities as ordering, receiving, stocking, delivering, reworking, and reordering the parts and supplying spares and technical manuals. To determine the total cost of a part, one must multiply these activities by the number of times they will be performed or acquired over the entire life of the system. The magnitude of the challenge can be seen when one understands that the C-17 transport has 9 million parts, the F/A-18 has 750,000 parts, and the AH-64 Apache helicopter has 30,000 parts.

Reliability, Maintainability, and Availability

The key to successful logistics support is detailed planning before the acquisition program starts. A supportability strategy, although not mandated, should be

established early in the life cycle of a system. The Government must make a deliberate decision about the levels of support needed to sustain the system. The contractor will respond to the Government's vision of support by submitting a support plan. One of the key ingredients in developing the range and depth of support resources is forecasting the reliability of the system's design.

Reliability is the probability that an item can perform its intended function for a specified interval of time under stated conditions. Reliability also is the ability of an item or piece of equipment to operate consistently. Reliability describes in quantitative terms how free of failure the system is likely to be during a period of operation. An example of this is the frequency of problems experienced by the Navy's F-14s and A-6s.

Reliability can be defined as mean time between failure (MTBF). The ability to express reliability numerically is crucial because it identifies in concrete terms not only the user's needs but also contractual specifications, test guidelines, and performance assessments. This definition stresses four factors: probability, satisfactory performance, time, and specified conditions.

Probability is expressed as a percentile specifying the number of times that one can expect an event to occur in a total number of trials. For instance, a probability of failure-free performance of .75 for an item performing for 80 hours indicates that, 75 times out of 100, we can expect that item to function properly for 80 hours. Reliability depends heavily on concepts derived from probability theory.

Satisfactory performance uses specific criteria in qualitative or quantitative terms to define what the system ultimately must accomplish; these criteria usually are found in the Operational Requirements Document.

Time represents a measure against which system performance can be analyzed. Time is not measured strictly in terms of seconds, minutes, or hours. It is preferable to use an interval based on particular mission profiles (number of missiles fired, number of miles traveled, number of hours spent communicating, or length of mission).

Specified conditions constitute the scenarios in which the system will operate. These conditions might include temperature; humidity; weather; terrain; roads; desert, jungle, or arctic environments; mountains or rivers; operating tempo; nuclear, biological, and chemical conditions; mental ability of users; and hours of operation.

Maintainability measures an item's ability to be retained in or restored to a specified condition, when maintenance is performed by personnel having specified skill

levels and using prescribed procedures and resources at each prescribed level of maintenance. Maintainability refers to the ease, accuracy, and economy of performing a maintenance action.

Maintainability is an inherent design characteristic of a system. The goal of maintainability is to design and develop a system that can be maintained in the least time, at the least cost, and with a minimum expenditure of support resources (such as manpower, spare parts, tools, and test, measurement, and diagnostic equipment [TMDE]). Maintainability refers to the ability of an item of equipment to be maintained, while maintenance refers to a series of actions that retain or restore an item to an operational state (such as inspecting, servicing, repairing, or overhauling). Maintainability design features might include redundancy, interchangeability of common modules, use of throw-away replaceable modules, and accessibility of parts. Thus, maintainability is a design parameter, while maintenance is a result of that design.

One typical measure of maintainability is mean time to repair (MTTR). This is the total elapsed time (typically expressed in clock hours) for performing corrective maintenance, divided by the total number of maintenance actions during a given period of time. In other words, MTTR shows how long it takes to fix and how difficult it is to repair or service a system.

Reliability and maintainability are two major system characteristics that combine to form the most commonly used measure of effectiveness—availability.

Availability is a measure of the degree to which an item is in an operable and committable state at the start of a mission that can be called for at a random time. The combination of reliability (MTBF) and maintainability (MTTR) is used to predict the amount of time a system will be available for use after it is fielded; in other words, how ready is a system to perform when needed?

Availability predictions are used when making tradeoffs among different system design concepts. Tradeoffs can be made to gain higher availability. A very expensive system can be designed with the intent that it will never break. A very cheap system can be designed with the intent that it will be thrown away when it breaks or is expended; it thus will be purchased in large quantities.

The results of reliability and maintainability studies are needed to form any measure of availability. Nevertheless, early in the conceptual phase of a system's life cycle, acquisition logisticians can, and often do, draw on information for existing systems to make assump-

tions about the availability of the new system before actual measures of that system's reliability and maintainability are produced.

As a characteristic of design, supportability of a system is affected directly by the decisions made during the design process of the system's hardware, software, and support infrastructure. For example, part of the manufacturing plan defines 25 engineering characteristics for each part that will be used in a system, such as dimensions, surface finishes, hardness, and material composition. This can equate to millions of specific engineering characteristics in large systems.

Acquisition Logistics Support Elements

The acquisition logistician must integrate diverse support elements to ensure effective support of a system. Each element must be orchestrated by a single entity to ensure that the resources needed to sustain operations are available when needed. The elements determine the life-cycle costs and the degree of operational readiness of the system after it is fielded. Although each of these elements may be developed or managed by different individuals or activities, the focal point is the logistician. If properly applied and monitored through the design and production phases of the acquisition process, the 10 elements described below will optimize the supportability of the system over its entire life.

Design interface is the relationship of logistics-related design parameters to readiness and support resource requirements. These logistics-related design goals are expressed in operational terms rather than as inherent values and specifically relate to system readiness objectives and support costs of the system. Design goals include—

- ◆ Improved ease of maintenance and repair and operational availability and reduced MTTR and MTBF.
- ◆ Minimized requirements for total number of parts and repair tools.
- ◆ Standardization of parts and use of multifunctional parts and multi-use parts.
- ◆ Use of modular designs, standard components, and embedded work platforms.
- ◆ Use of known materials and known manufacturing processes.
- ◆ Incorporation of human factors engineering (such as skill requirements, safety, and reduced hazardous materials).
- ◆ Accessibility, visibility, simplicity, and testability (such as built-in test equipment and TMDE).
- ◆ Use of labeling, identification, color coding, and quick connect and disconnect fasteners.

- ◆ Use of DOD standard data and digitized technical data.

- ◆ Use of open systems architecture for all designs.

Maintenance planning is the process of establishing maintenance concepts and requirements for the lifetime of the system. Essentially, this is selecting the appropriate level of maintenance: organizational, intermediate, depot, total contractor logistics support, or a combination of these.

Manpower and personnel is the element that identifies and acquires military and civilian personnel who have the skills needed to operate and support the system over its lifetime at both peacetime and wartime rates. Once the levels of maintenance are established, manning documents can be developed or changed for the system. Personnel can train at the contractor's facility to help the service schools develop the curriculum and program of instruction for the system. User aptitudes and individual capabilities are considered in relation to the system design.

Supply support includes all management actions, procedures, and techniques used to determine requirements for acquiring, cataloging, receiving, storing, transferring, issuing, and disposing of secondary items. Parts must be on hand to fix broken equipment. This includes provisioning for both initial support and replenishment supply support and for support and test equipment.

Support equipment includes all equipment (mobile or fixed) required to support the operation and maintenance of the system.

Technical data includes technical information on the system in a digitized medium, including engineering drawings, specifications, maintenance allocation charts, and repair parts and special tools lists. Excluded are financial data or other information related to contract administration.

Training and training support covers the processes, procedures, techniques, training devices, and equipment used to train civilian and military personnel to operate and support the system.

Computer resources support includes the facilities, hardware, system software, software development and support tools, documentation, and people needed to operate and support embedded computer systems.

Facilities are the permanent, semipermanent, and temporary real property assets required to support the system.

Packaging, handling, storage, and transportation includes the resources, processes, procedures, design considerations, and methods used to ensure that all system, equipment, and support items are preserved, pack-

aged, handled, and transported properly. This element covers environmental considerations, equipment preservation for short- and long-term storage, and transportability.

Supportability Strategy and Analysis

The acquisition logistician is responsible for preparing a supportability strategy that describes the support envisioned for the system. The supportability strategy provides the plan for operational support and the details of how the supportability program fits into the overall acquisition program. The supportability strategy serves as a source document for consolidating and summarizing the logistics support information needed to make sound decisions during the system's development and production.

Integral to the design process is supportability analysis (SA). SA is a set of activities conducted as a part of the systems engineering process to assist in complying with support objectives. (See chart at right.) The SA is accomplished in a rational, analytical manner and is not based on rules of thumb or best guesses. Reliability and maintainability studies, fuel and ammunition consumption, operator training, and transportation requirements will determine the logistics support resources needed by the system. SA is the principal tool for bringing supportability goals into reality. Although the current guidance set forth in DOD 5000.2-R does not stipulate specific procedures or guides for conducting any type of analysis, it seems logical to assume that any assessment by either the Government or a contractor should not be done in a haphazard fashion. The standard for this process is Military Handbook 502, Acquisition Logistics.

SA ensures that all elements of support are planned, acquired, tested, and deployed. Design changes should occur before the design is final in order to minimize problems before the system is put into operation. Typically, this takes place during the critical design review. The level and type of SA will vary from phase to phase; the current handbook on logistics indicates that there is an explicit need for SA throughout a system's life cycle. Verification of the systems engineering process provides the logistician with feedback over the entire acquisition process. The system verification review helps ensure that logistics data are valid and that the logistics pro-

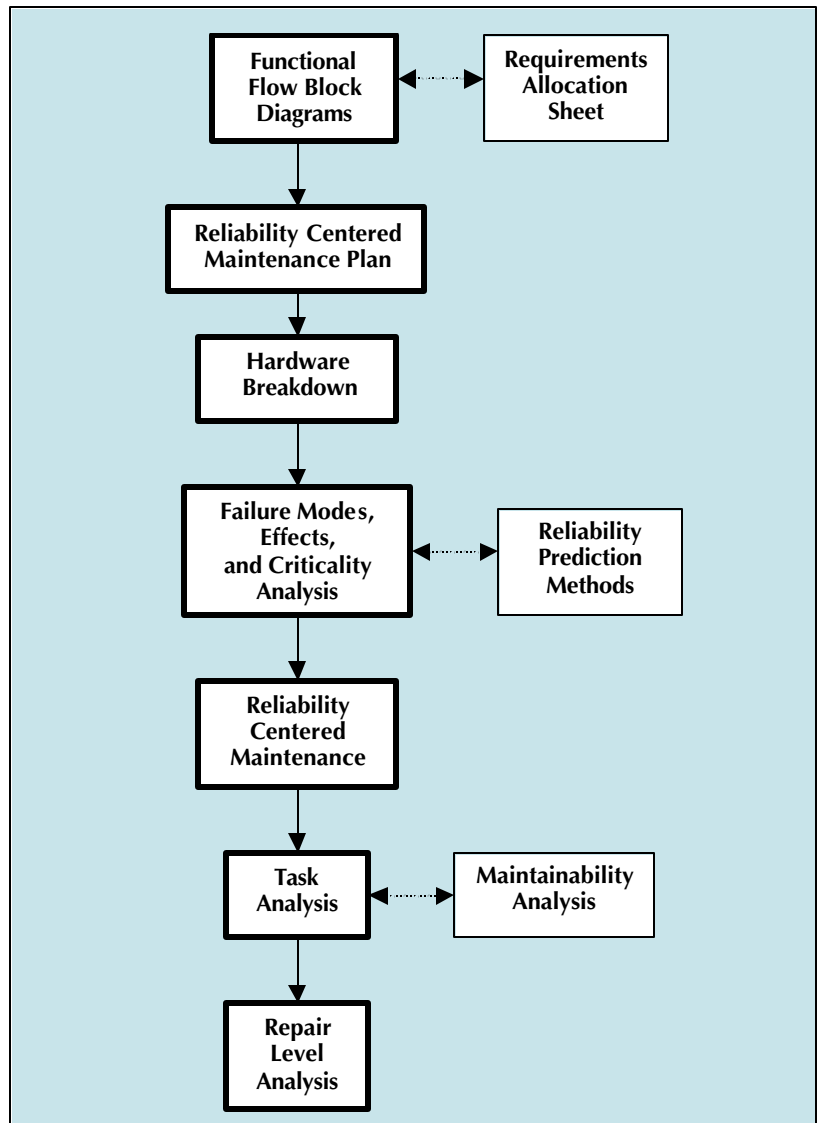

□ An abridged depiction of the supportability analysis process.

gram is reaching its objective. The chart above is an abridged depiction of the overall SA. This process, which usually is performed by the contractor, is very analytical, time consuming, and expensive. However, the result is generally worth any resources expended.

Decisions Influencing Life-Cycle Costs

Life-cycle costs are a critical element in the decisions made when acquiring systems. Life-cycle costs include the costs of developing, acquiring, and maintaining a system over its lifetime. Since systems often are projected to be in service for more than 50 years, life-cycle costs can be very substantial. Most life-cycle costs occur after the system is delivered.

Support costs generally make up over 60 percent of

the total cost of a system over its lifetime. Support costs include maintenance personnel, fuel, repair parts, technical orders, facilities, and engineering changes. During the conceptual stage, participants in the integrated product team work primarily with paper studies, so design changes are relatively cheap and easily made. The engineers should not concern themselves solely with such characteristics such as performance, weight, or size. The logistician should try to establish a dialogue among the user, designer, manufacturer, tester, and all members of the integrated product team to bring support issues to bear on design.

As the design process moves from requirements analysis to functional analysis, logistics requirements will be refined. During functional analysis, information on what the proposed system will accomplish in a typical wartime mission will be examined along with system functions. Having all the functions identified at a specific level permits the logistician to define support needs. The logistics engineer will perform “what if” drills to determine the support resources needed for a given design. By exploring these and many other alternatives, the logistician can fully develop the best support for the eventual design.

Every operational and maintenance task should be evaluated and performed on the system. The major goal of this exercise is to pinpoint the need for facilities, spare parts, tools, support equipment, special training, and other support. The analysis should highlight mission-critical changes that exceed either cost or schedule objectives or that might warrant possible changes in the system’s design.

Once the system’s design has matured sufficiently and logistics support concepts have been formulated, the next step is to apply the results of the SA process to pinpoint the detailed logistics support resources that will be needed when the system is deployed. The emphasis of various tests will be on identifying and correcting deficiencies before the system is produced. Even commercial items must be evaluated to determine if they are suitable for military use.

Before the system’s hardware and software are operationally tested, the current logistics support infrastructure must be assessed in a logistics demonstration. If the demonstration is conducted in a realistic combat scenario using current facilities, tools, personnel, and other support infrastructure, logistics weaknesses can be pinpointed. A thorough analysis of supply support requirements will dictate planning for the availability of parts once the production run is completed. When inadequate sources for spares are uncovered, alternative solutions should be analyzed and a preferred solution recommended.

The bottom line is to correct any known or potential post-production support problems before the system begins full-rate production. After production and into deployment, the emphasis shifts to verifying supportability and making improvements. The logistician will conduct an early fielding analysis to address the system’s resource needs when it is in its projected combat environment. Failure to address potential problems adequately may degrade the new system’s capability and lessen the readiness of gaining units for combat.

Deployment

The deployment plans for the Army, Air Force, and Navy are called the Materiel Fielding Plan, Site Activation Plan, and Phased Support Plan, respectively. The Navy also has another deployment plan, the User Logistics Support Summary, the primary purpose of which is support certification and user acceptance. The service-specific names for personnel conducting deployment are New Equipment Training Team for the Army, Bed-down Team for the Air Force, and Fleet Intro Team for the Navy. Deployment poses the greatest challenge to logisticians because failing to address logistics support thoroughly in the early stages of system development or to meet support milestones can translate into delays or, more importantly, a system that does not meet a unit’s readiness goals. Even with the best analysis, potential support problems can surface later in the system’s life cycle: uncertain system lifespans, long lead times, uneconomical order quantities, budget problems, increased parts usage, inadequate technical data packages, deleted or no substitutes, obsolete design, lower reliability, inadequate sources of supply, or closing factories.

As DOD continues to change policies on logistics, our aging systems will present more challenges for acquisition logisticians. A continued focus on supportability in acquiring systems will ensure that logistics requirements will not hinder mission accomplishment. **ALOG**

James J. Clark is an adjunct professor for Florida Institute of Technology at Fort Lee, Virginia.

Thomas D. Johnson is a professor for the Defense Acquisition University at Fort Lee, Virginia.

Convoy Rat Patrol

by Captain Dean J. Dominique

The ambush is set. As the enemy commander waits for his target, he goes over every detail repeatedly. Although this is supposed to be an easy target, he still wants to make sure nothing is left to chance. The mission is to interdict a logistics convoy in order to deny his U.S. opponent critical supplies. Intelligence indicates that the U.S. supply convoys pass this same route twice a day at regular intervals. The command and control element usually is leading with little, if any, security.

Out of the corner of his eye, the enemy commander sees a flash of light in the distance. The convoy is lumbering slowly into the kill zone. A smile comes across his face as he notices what looks like the command vehicle leading the way. He activates the command-detonated mine under the lead vehicle, thereby eliminating the convoy commander along with his communications. The machineguns open fire and destroy the targets in priority order: supplies, troops, and equipment. As his soldiers sweep the kill zone, he reflects back on his intelligence brief. The information was correct; it was an easy target. He has destroyed all supplies, troops, and equipment. His mission is complete.

Logistics convoys are prime targets for an enemy force. They typically are large, lumbering beasts heading to troops on the front lines with essential supplies. A typical convoy can have supplies of different classes mixed together and travel with little or no security. Destroying the convoy can mean that the maneuver unit not only will go hungry but also may run out of ammunition. This is one of the reasons convoys are a high payoff target for an enemy.

In a perfect world, each convoy would have an escort provided by either military police or tactical support elements. But the world is rarely perfect, especially on the battlefield, and such support often is not available. This leaves convoys on their own and often unprotected. The enemy needs only minimal force to destroy poorly protected convoys. By interdicting supplies, the enemy



□ A soldier test-fires a gun truck's .50-caliber machinegun.

can have a direct impact on the combat power they face.

As a convoy commander, how do you prevent such a calamity? One technique is the "rat patrol." What is a rat patrol? you ask. Simply put, the rat patrol is an advance security element that precedes a convoy in the absence of a military police or other escort. The rat patrol reconnoiters the route, provides overwatch, and possibly prevents the enemy from destroying the convoy. The fundamentals of a well-executed rat patrol are organization, training, planning, precombat checks, and rehearsals.

Organization

One technique for organizing a rat patrol is to reserve two high-mobility, multipurpose, wheeled vehicles with two or more heavily armed soldiers per vehicle. Do not use your gun truck in place of the rat patrol or vice versa; instead, use them together as a complementary force. Generally, it is best to have the same personnel run each rat patrol to provide experience and reduce training time. This allows the rat patrol members to get better at their missions and not have to retrain each time a convoy moves out. Better performance means increased survivability for both the convoys and the rat patrols.

These patrols need to be well equipped. At a minimum, this includes an automatic weapon (make sure it is test-fired), communications (also tested), binoculars, a compass, and a map with graphics. If possible, have your mechanics remove the windshield along with the doors and vehicle top. This will allow a maximum observation of the battlefield and minimize the signature caused by light reflection. When you are running multiple convoys, rotating your personnel will be crucial, and you may be able to lead each convoy with only one vehicle. In that case, use the most experienced and rehearsed team members.

Training

Rat patrol leaders must be well trained on mounted land navigation and call-for-fire skills. The team members need to understand that their mission is scouting and, on occasion, breaking contact with the enemy. That means the team must establish battle drills for reconnaissance, reaction to contact, and breaking contact. It also means that the team members must be qualified on their individual weapons or the crew-served weapons they use. They also need to know what the enemy looks like and what his most probable course of action will be.

Planning

The rat patrol team leaders must have a comprehensive understanding of the route, the enemy, and the terrain along the route. Each rat patrol team must know the enemy's capabilities and potential ambush sites. This begins with a detailed consultation with the S2. If possible, named areas of interest and en route indirect targets should be developed and submitted to the commander. The team members must understand the commander's intent for the rat patrol. They need to recognize that the rat patrol is not normally a fighting force; it must not become decisively engaged. If the rat patrol members spot the enemy, they should stay out of the enemy's range and call back with a systematic size, activity, location, unit, time, and equipment report. If they are fired on, they should return fire and move back while informing the convoy. Again, the rat patrol should be a reconnaissance element, not a fighting force.

Precombat Checks and Rehearsals

The unit should develop internal standing operating procedures, battle drills, and checklists for precombat checks or inspections and for actions on contact. Before departing on a patrol, the team leaders must inspect all personnel, weapons, and equipment for serviceability and accountability. A "single-shot" machinegun will do little to deter an enemy bent on killing.

All key elements—the convoy commander, the rat patrol, the gun truck, and higher headquarters—must participate in rehearsals. Instructions must be clear-cut, and all actions must be rehearsed. The team leaders must establish communications with the convoy commander, higher headquarters, and the gun truck to coordinate fires if needed. If time is limited, rehearsals should focus first on actions on contact.

Execution

Tactically, the rat patrol moves ahead of the convoy in a bounding overwatch. The commander should designate points on the map to which each element will bound. The rat patrol teams should alternately move ahead of the convoy to reconnoiter possible ambush sites and stop short of intervisibility lines to provide eyes and ears for the convoy commander. This can alleviate the misfortune of large convoys rolling into a roadblock or bottleneck.

The rat patrol does not need to travel precisely on the convoy route. Conversely, they should use the terrain to their full advantage to mask their movements while they try to locate the enemy.

A properly executed rat patrol can save lives and ensure that the soldiers engaged in active combat on the front lines have the supplies they need to close with and destroy the enemy. If the convoy in the vignette at the beginning of the article had organized, planned, rehearsed, and executed a rat patrol, it could have been saved. The convoy could have used an alternate route, increased the security placed along that route, or rained artillery on the ambush to clear the route. The soldiers and supplies may have arrived late, but they would have arrived.

ALOG

Captain Dean J. Dominique is the senior Transportation and Division Support Command (Forward) observer-controller for the Combat Service Support Division, Operations Group, Joint Readiness Training Center, at Fort Polk, Louisiana.



□ A rat patrol team member drives the team's high-mobility, multipurpose, wheeled vehicle.

Realistic Training for Power Projection

by Colonel Gary C. Howard, USAR, and Major Gregory K. Johnson, USAR



In the last decade, the U.S. military has transitioned from a forward-deployed force to one based on power projection from the continental United States. This change in strategy has put a premium on our ability to move soldiers and equipment quickly and to provide training to prepare them for deployment.

Deployment Simulations

The National Training Center (NTC) at Fort Irwin, California, is the Army's premier training center for brigade- and battalion-sized units. For both Active Army and Reserve component units, moving the rotating units to the NTC has become a major driver of reception, staging, onward movement, and integration (RSO&I) training and other transportation operations. By combining sealift emergency deployment readiness exercises (SEDREs) with support of NTC rotations, the Army can manage its training dollars and get better quality training.

Seaport of debarkation operations, previously carried out notionally in the desert, now are conducted by transportation soldiers at sites in southern California. Pierside

discharges at Port Hueneme and San Diego and in-stream discharges and logistics over the shore operations on the beaches at Marine Corps Base Camp Pendleton have added realism to the training. The Pacific Ocean also provides challenging sailing conditions, with routine sea states of 2 and 3 (wave heights of 2½ to 3 feet).

In September 2000, Exercise Turbo Patriot included the first successful joint logistics-over-the-shore (JLOTS) exercise conducted on the west coast in over 7 years. Over 1,100 soldiers, sailors, airmen, and marines replicated the deployment of a U.S. force into a degraded port by moving equipment of the 25th Infantry Division (Light) from Schofield Barracks, Hawaii, over the beach at Camp Pendleton. The 7th Transportation Group (Composite) from Fort Eustis, Virginia, supervised the discharge from the *USNS Seay*, a large, medium-speed, roll-on-roll-off ship, onto Army Reserve landing craft, utility, 2000-class vessels and Navy barge ferries. Army Reserve M915 trucks and M872 trailers completed the move to the NTC. The operation also involved container discharge operations from the *SS Grand Canyon State*, a T-class auxiliary crane ship. The Navy's Amphibious

Construction Battalion 1 simulated a fuel delivery from ship to shore. Water, instead of fuel, was delivered over the beach from the *SS Chesapeake*, a Maritime Pre-positioning Program tanker anchored a few miles offshore. Each of these operations used the latest Army and Navy equipment to add realism to the training.

Operation Native Atlas, held at Camp Pendleton in April, built on Exercise Turbo Patriot with an in-stream discharge of a slice of the 3d Infantry Division (Mechanized) from Fort Stewart, Georgia. Future exercises likely will add more elements of RSO&I, such as down-loading equipment from an Army pre-positioning ship.

Power Projection Simulation

Supporting the units that rotate to the NTC has provided soldiers with outstanding training during the RSO&I phases of a deployment. We believe that similar training synergies exist for the upload phases of SEDRE and NTC rotations. The fact that the commanding general of the Army Forces Command has directed the Army to increase the number of SEDREs from two to four per year in fiscal year 2003 doubles the possible training opportunities next year. The upload phases of SEDRE and NTC rotations could provide excellent mission-essential training for 1,000 soldiers or more.

Training could occur both at the fort and at the port. At the fort, deployment support brigades already help combat units prepare for movement. Cargo transfer companies could load and tie down the equipment on railcars and truck trailers. Line-hauling a portion of the equipment to the port would provide excellent training for motor transport battalions, truck companies, trailer transfer points, and movement control and maintenance support units. Operations at the port would provide training for transportation terminal brigades, port security companies, and cargo documentation detachments.

In particular, we believe it is imperative that regular SEDREs test the ports on the west coast. Critical units deploy through west coast ports. For example, the 1st Corps and interim brigade combat teams (IBCTs) deploy from Fort Lewis, Washington, through Seattle, and the 3d Armored Cavalry Regiment and Army National Guard enhanced brigades deploy from Fort Carson, Colorado, through Oakland, California. In spite of those facts, the upload phase of a SEDRE has not been exer-

cised at a west coast port in years.

We also recommend that retrograde missions from NTC rotations be examined for training value. The retrograde phase offers large-scale load-ups especially well suited for training transportation terminal brigades and deployment support brigades. Currently, the equipment is transported back to home stations commercially. Of course, only a few years ago, the equipment was hauled by commercial transportation to the notional seaport of debarkation in the desert as well.

Combining SEDREs with NTC rotations has enhanced the training benefits greatly to both warfighters and support organizations while maximizing training dollars. It is critical that we continue to look for ways to enhance Active Army and Reserve component unit readiness by getting the most out of existing facilities and funded training. We believe this concept can be expanded to provide similar high-quality training to a variety of Active Army and Reserve component combat and combat service support units on the power-projection half of the equation.

Colonel Gary C. Howard, USAR, commands the 1397th Transportation Terminal Brigade at Mare Island, California. His Army Reserve career has encompassed 10 units in 4 states. He is a graduate of the Army Command and General Staff College. He has a Ph.D. in biological sciences from Carnegie Mellon University and is a senior scientific editor for an independent biomedical research institute that is affiliated with the University of California.

Major Gregory K. Johnson, USAR, is the S3 of the 1397th Terminal Transportation Brigade at Mare Island, California. He has held significant positions in Army National Guard and Army Reserve units in Pennsylvania and California. He is a graduate of the Army Command and General Staff College. He has a B.S. degree in civil engineering from Bucknell University and an M.B.A. degree from the Wharton School at the University of Pennsylvania. He is a real estate executive in Seattle, Washington.

Combat Health Logistics Support in Kosovo

by Major William E. Ackerman

During their deployment to Kosovo as part of Task Force Medical Falcon, the medical logistics (MEDLOG) specialists of the 226th Medical Logistics Battalion (Forward) from Miesau, Germany, provided medical materiel management, medical equipment maintenance, optical fabrication, blood support, and transportation services. Although this mission was complex and sometimes overwhelming, the 226th met these challenges and, along the way, picked up a few valuable strategies to improve operations the next time they deploy.

Task Force Medical Falcon provides healthcare that ranges from combat lifesaver services to level III healthcare (lifesaving surgery and resuscitative care) in support of U.S. forces located in Kosovo and Macedonia. When the 226th arrived in theater, the level III health care facility provided medical materiel management. Despite this, deploying combat units had their home stations send them medical materiel in the mail or by other nontraditional methods, which resulted in some units waiting more than 45 days to get their medical supplies.

To remedy this situation, the 226th established a forward combat health logistics team in Kosovo. This dramatically improved medical materiel management. This team became the single integrated medical logistics manager (SIMLM) and supported Army, Air Force, Marine Corps, and State Department personnel operating in Kosovo and Macedonia.

The 226th's MEDLOG specialists responded swiftly and accurately when emergency supply requests for materiel were not readily available from the SIMLM. Medical supply data show that 94 percent of the 2,400 materiel items were available within 10 days and that, 45 percent of the time, 650 other items were available the same day they were requested from the SIMLM. By analyzing the actual data, the specialists determined medical supply planning factors for future peacekeeping operations. Some of these are—

- ◆ Medical supply support requires 0.1 pound per man per day of class VIII.
- ◆ The average pallet weight of medical supplies is 535 pounds.
- ◆ The average pallet of medical supplies is 83.3 cubic feet.

The medical equipment maintenance support provided by the 226th proved to be invaluable as well. Equipment items such as a computed tomography (CT) scanner, x-ray machines, anesthesia machines, and operat-

ing room tables were just some of over 450 different types of deployed medical equipment. Because of its heavy use, this equipment required a vigilant maintenance program. Medical equipment repairmen traveled about the area constantly to repair and service equipment at the point of use, which resulted in a medical equipment readiness rating of better than 98 percent.

Soldiers never went without eyeglasses because limited optical fabrication capabilities were on site to support urgent needs. For soldiers who could wait for their corrective lenses, prescription eyeglasses usually were delivered by the military postal service (MPS). The MPS was used because, although soldiers and units normally rotated every 6 months, some soldiers rotated in 90 days or less. By using the MPS, eyeglasses that were still being fabricated when a soldier rotated found their way to the soldier at his next duty station.

A 226th MEDLOG medical supply specialist served as a liaison at the medical materiel point of debarkation in Skopje, Macedonia. This proved to be invaluable because sensitive materiel such as blood, refrigerated items, and laboratory reagents had to be transported quickly in order to meet quality control standards. The backhaul of lab specimens also required the liaison's daily attention.

Information technology allowed nondeployed MEDLOG personnel to support the peacekeeping operation from the 226th MEDLOG Battalion (Main) in Germany. These medical supply technicians used the Joint Medical Asset Repository (JMAR) to establish asset visibility, including requisition visibility, and to resolve problems with overdue requests and zero-balance materiel. JMAR also proved useful for healthcare providers and medics at the deployed hospital and battalion aid stations by providing visibility of medical materiel stored at the MEDLOG SIMLM, the hospital, the supply transfer point in Skopje, and numerous other sites around the world. The Global Transportation Network provided visibility of materiel in the transportation system and enabled the nondeployed MEDLOG personnel to resolve frustrated cargo issues quickly and expedite cargo when required.

The technicians of the 226th Medical Logistics Battalion are an integral part of the healthcare system. They are ready, responsive, and relevant in supporting warriors on and off the battlefield. **ALOG**

Major William E. Ackerman is assigned to the Office of the Chief of Logistics Operations, 18th Medical Command, in Korea. He was previously the executive officer of the 226th Medical Logistics Battalion (Forward). He has a master's degree in business management from the Florida Institute of Technology and is a graduate of the Army Logistics Management College's Logistics Executive Development Course and the Army Command and General Staff College.



NEWS

(News continued from page 2)

INTERIM ARMORED VEHICLE NAMED AFTER ARMY HEROES

The Army has announced that the new interim armored vehicle will be named the “Stryker” after two Medal of Honor winners. Private First Class Stuart S. Stryker received the Nation’s highest award posthumously for heroism in World War II, and Specialist Robert F. Stryker was awarded the medal posthumously for heroic service in the Vietnam War.

The Stryker is a keystone weapon system for the Army’s interim brigade combat teams (IBCTs). It is a 19-ton armored vehicle that can be transported aboard a C-130 cargo plane; can sustain speeds of 62 miles per hour; and has common parts among its different versions, a central tire inflation system, and self-recovery capabilities. The Stryker will come in 10 versions: infantry carrier vehicle, mobile gun system, antitank guided missile vehicle, mortar carrier vehicle, reconnaissance vehicle, fire support vehicle, engineer squad vehicle, commander’s vehicle, medical evacuation vehicle, and nuclear-biological-chemical reconnaissance vehicle.

The Army plans to field over 300 Strykers in each of 6 IBCTs.



□ The Stryker infantry carrier vehicle.

PLANS UNDERWAY FOR TRANSFORMATION OF INSTALLATION MANAGEMENT

Management of the Army’s installations will be transformed by 1 October to improve the quality of life for soldiers and their families and save money at the same

time, according to Major General Robert Van Antwerp, the Army’s Assistant Chief of Staff for Installation Management.

Major Army commands no longer will be the sole management authority for installations. Instead, management authority will be centralized under regional installation directors who will be assigned to oversee 20 to 26 installations each. The regional directors will report to the Assistant Chief of Staff for Installation Management. Implementation will occur through geographic realignment. There will be three regions located in Europe, Korea, and the Pacific and four regions located within the continental United States. Command and control and funding of garrisons will come directly from the regional offices.

“Under the new structure, funds at the garrison level will be fenced and base operations funds will be used for base operations services and repairs,” said Van Antwerp. “There will be no migration of funds, and the flow of funds will be consistent and more standardized. We’re going after the well-being of soldiers and their families with this program. It’s our commitment to put our money where our mouth is when it comes to where our people play, live, and work.”

COALITION LAND COMMAND ESTABLISHED

The new Coalition Forces Land Component Command (CFLCC) for Operation Enduring Freedom will serve as the headquarters land component for a multinational fight against terrorism, according to Third U.S. Army/U.S. Army Forces Central Command (ARCENT) officials. The command is operating from permanent facilities within ARCENT’s area of responsibility and from forward positions near Afghanistan.

The CFLCC (pronounced “C flic”) was established in November to coordinate, control, and synchronize all land operations in Afghanistan and surrounding countries. One of the command’s operational goals is to destroy the Al Qaeda terrorist network and prevent the re-emergence of international terrorist activities within Afghanistan.

Units under the command and control of the CFLCC include not only some U.S. Army and Marine Corps land forces, but also units from Australia, France, Great Britain, and other countries. Army Special Operations Command Central oversees Army Special Forces operations, but their objectives and missions fall under CFLCC’s command in order to synchronize military efforts.

FORCE PROVIDER MODULES USED AS AFGHANISTAN BASE CAMP

In support of Operation Enduring Freedom, the Army Materiel Command (AMC) transported and set up three Force Provider modules to serve as a base camp in Afghanistan.

Force Provider is a modular system of housing; food service; laundry; water and fuel storage and distribution; wastewater collection; electrical power; showers; latrines; and morale, welfare, and recreation kits. Each module can support 550 people.

In November, soldiers from active duty and Reserve component units in the United States and Europe moved more than 450 containers of tents, power generators, water storage and distribution systems, and kitchen equipment from storage in Luxembourg and Albany, Georgia. The containers were shipped to a staging area near Ramstein Air Base in Germany, where soldiers from the 21st Theater Support Command, based in Germany, and AMC's Combat Equipment Battalion, based in Luxembourg, palletized the containers for military airlift to the Afghanistan theater of operations.

In Afghanistan, civilian technical specialists from the Product Manager-Force Sustainment Systems office in Natick, Massachusetts, surveyed the site, designed the layout, organized the site preparations, supervised the shipment and receipt of the containers, and directed setup of the camp.

AMC estimates that the camp will generate up to 939 kilowatts of power and use over 6,700 gallons of fuel and nearly 62,500 gallons of water each day. Soldiers from two Army Reserve Force Provider companies, the 542d Quartermaster Company from Erie, Pennsylvania, and the 802d Quartermaster Company from Columbus, Georgia, are responsible for camp sustainment operations.



□ A look at the ovens in the Force Provider kitchen.

ARMY ACQUISITION QUALIFICATION COURSE TO REPLACE MAM

A new 8-week Army Acquisition Qualification Course (AAQC) will replace the Army Logistics Management College's (ALMC's) Materiel Acquisition Management Course (MAM). The course will be taught by ALMC at a new satellite campus in Huntsville, Alabama.

MAM has been the primary training for officers entering the Army Acquisition Corps since 1985. Last July, General Paul J. Kern, then Director of the Army Acquisition Corps and MAM Course proponent, approved a new, expanded curriculum to better equip the Army's acquisition workforce to manage the highly complex task of systems acquisition.

The AAQC curriculum will include instruction in requirements determination, program management, acquisition logistics, contracting, materiel testing, software acquisition, and other related functional areas.

Working with the course proponent, ALMC developed the new course curriculum, and a cadre of Army officers and civilians are developing course materials.

Students attending the AAQC will receive constructive credit for a wide range of Defense Acquisition University-sponsored courses—

- Fundamentals of Systems Acquisition Management (ACQ 101).
- Intermediate Systems Acquisition (ACQ 201).
- Basics of Contracting (CON 101).
- Fundamentals of Contract Pricing (CON 104).
- Basic Information Systems Acquisition (IRM 101).
- Acquisition Logistics Fundamentals (LOG 101).
- Introduction to Acquisition Workforce Test and Evaluation (TST 101).

The first offering of AAQC is scheduled tentatively for January 2003. Additional information is available on the Web at <http://www.almc.army.mil/AMD/ALMC-QA/Index.asp>.

CONTRACTORS CHOSEN TO BEGIN DEVELOPING THE FUTURE COMBAT SYSTEMS

In a significant step toward the creation of the Army's future Objective Force, the Department of Defense has selected the Boeing Company and Science Applications International Corporation (SAIC) to act as the lead systems integrator for the Future Combat Systems (FCS). Under the \$154-million contract, the Boeing-SAIC team, over a 16-month period, will research and evaluate potential concepts and technologies for the FCS, conduct demonstrations, and select the most promising outcomes for further development. The goal is to identify "leap ahead" technology upgrades for use in the FCS. The selection of Boeing and SAIC followed a 21-month concept design phase involving four contractor teams.

The FCS will be a keystone of the Objective Force. Planned as a "networked system of systems," it will include manned and unmanned platforms that will perform assault, indirect fire, and air defense; reconnaissance, surveillance, and target acquisition; and battle communications and control missions. The FCS is a joint program of the Army and the Defense Advanced Research Projects Agency.

MTMC CONTRACTS RAILCAR MANAGEMENT

The Military Traffic Management Command (MTMC) has contracted for the management of its fleet of railcars. The 2-year contract, with three 1-year renewable options, was awarded to IntelliTrans of Atlanta, Georgia. The company will be responsible for all railcar movements, tracking, maintenance management, repairs, and records. It will provide Department of Defense customers with forecasting, railcar ordering, intransit visibility, and data collection services.

The Defense Freight Railway Interchange Fleet includes 2,200 railcars, including 566 heavy-duty cars that each can carry 2 M1 Abrams tanks.

E-BOOK HELPS ACQUISITION PERSONNEL ANSWER MANPOWER QUESTIONS

An electronic book with information on manpower, personnel, and training (MPT) issues that should be considered in systems acquisition is now available. Known as the MPT Tool, it is designed to help program manag-

ers, manpower and personnel integration (MANPRINT) analysts, and other users identify MPT issues and risks in developing and acquiring an emerging materiel system, automated information system, product improvement, or nondevelopmental item.

The MPT Tool asks questions keyed to each phase of the Department of Defense (DOD) Directive 5000-series acquisition model. Each question identifies MPT risks or issues that should be analyzed for their impacts. The questions are supported by regulatory guidance and reference sources that can be accessed through the Internet. The MPT Tool can provide information about the status and progress of a proposed system.

The MPT Tool was developed by the Manpower, Personnel, and Training Domain Branch of the Total Army Personnel Command. It can be accessed at <ftp://ftp.hoffmann.army.mil/DB7K9V/MPT%20Tool/MPT%20Tool.zip>.

PERFORMANCE-BASED CONTRACTS USED FOR ENVIRONMENTAL CLEANUP

The Army Training and Doctrine Command is conducting an environmental cleanup effort using a pilot performance-based contract. The pilot contract may become the model for cleaning up all potentially hazardous sites throughout the Department of Defense.

The 8-year, \$20 million contract was awarded to ARCADIS G&M, Inc., to clean up 26 of 30 contaminated sites on Fort Gordon, Georgia. (The remaining four sites require more study to find the right approach to cleaning them up.) The post was chosen as the pilot contract site because the former maintenance areas, old landfills, and areas where pesticides were mixed for use in family housing and on training ranges at Fort Gordon are representative of the 177 polluted sites found throughout the Army Training and Doctrine Command.

This is the first performance-based environmental cleanup contract to be used at an active military installation that contains a requirement for the contractor to obtain insurance against cost overruns. The Army spent \$900 million on environmental cleanup in fiscal year 2001. This form of contracting should reduce this cost significantly.

Also unique to this contract is that it does not specify how the contractor should do the job. Instead, the contractor must determine how to complete the cleanup to the satisfaction of the Environmental Protection Agency and state regulators.

A pilot with the Army Corps of Engineers for a simi-

lar cleanup is in the works at Fort Leavenworth, Kansas. The Air National Guard also is exploring the possibility of using the same type of contracts for comparable programs for the Air Force. The Army Forces Command has used similar contracts for some bases phased out under the Base Realignment and Closure program.

IMPROVED EYE PROTECTION SYSTEM UNDER DEVELOPMENT

Soldiers soon will have a new eye protection system to replace the array of protective eyewear now available. The Military Eye Protection System, which was developed at the Army Soldier Systems Center (Natick), consists of a pair of protective spectacles, a pair of sleek goggles, and a set of interchangeable lenses that fit both.

An estimated 10 percent of all battlefield injuries are to the eye. Explosive fragments, tree branches, blowing sand and rocks, and lasers present the major battlefield hazards to the eye.

The new gear offers increased eye protection, works with half the number of interchangeable lenses currently required by available eye protection systems, and expands peripheral protection. The new protection system is made of the same lightweight, tough polycarbonate used in current protective eyewear.

Unlike the old system that required soldiers who needed vision correction to wear their eyeglasses under the protective eyewear, this system has prescription lens carriers that snap into the protective eyewear.

The goggles are being evaluated at the Marine Corps Air-Ground Combat Center at Twentynine Palms, California, and both goggle and spectacle prototypes are being evaluated at Fort Campbell, Kentucky. Fielding is expected to begin in 2005.

SOLE ANNOUNCES INTERNATIONAL CONFERENCE

SOLE—The International Society of Logistics—will hold its 37th Annual International Conference and Exhibition 11 through 15 August at the Pointe South Mountain Resort in Phoenix, Arizona. The theme of the conference is “21st Century Logistics: The Global Bridge.” Scheduled speakers include senior logistics planners

from the Department of Defense and major logistics contractors. For registration information, visit the SOLE Web site at www.sole.org or call (301) 459-8446.

PLANS UNDERWAY FOR AMC MOVE TO FORT BELVOIR

Plans are in motion to move Army Materiel Command (AMC) headquarters from Alexandria to Fort Belvoir, Virginia, with the goal of completing the move by January 2003. General Paul J. Kern, AMC commander, said that the terrorist attacks on 11 September put greater emphasis on force protection. The building currently housing the headquarters in Alexandria does not offer the kind of protection now mandated for military organizations.

The move has been endorsed by union representatives, the appropriate members of the U.S. House of Representatives, Chief of Staff of the Army General Eric K. Shinseki, and Secretary of the Army Thomas E. White.

Representatives of AMC and the Military District of Washington have identified an area near the Night Vision Laboratory at Fort Belvoir for AMC's new home. If the move goes according to plan, more than 1,000 AMC personnel will relocate into high-quality, temporary, portable buildings with access to a ready-made road network and a secure parking area.

DEPLOYABLE LOGISTICS PACKAGE WILL SUPPORT CHAPLAINS IN THE FIELD

The Army Soldier Systems Center (Natick) has developed a portable package of religious items and furniture for chaplains to use in the field. Known as the Chaplaincy Logistical Support Package, it allows chaplains to move items they need for their religious support mission to any place troops are located and then set up a workstation or altar.

The package consists of a plastic desk, a removable plastic table, a folding metal-and-cloth chair, and a bag of altar linens. For movement, the chair and bag fit underneath the table and the table then is attached to the desk. The desk drawers can hold a laptop computer and printer, two chaplain resupply kits (which hold religious items such as Bibles, communion wine and wafers, and

Coming in Future Issues—

- ◆ Force Protection in the Future
- ◆ Logistics Lessons Learned by Lieutenant Grant in Mexico
- ◆ Statement of Requirements in Special Operations
- ◆ Chemical Warfare Service in Southwest Asia
- ◆ Less Bang for the Buck
- ◆ Technical Competence Versus Jack-of-All-Trades
- ◆ Forward Logistics Elements in the 25th Infantry Division
- ◆ Stretching the OMA Dollar
- ◆ Logistics Down Under
- ◆ Wheeled Vehicle Recovery Course
- ◆ Emulating Peripherals on Legacy Computer Platforms
- ◆ The Attack on Attu
- ◆ Enabling and Enhancing FSB Battle Command
- ◆ Deploying Medical Units
- ◆ Anticipatory Logistics
- ◆ Information Management in the Brigade Rear Command Post

ISSN 0004-2528
DEPARTMENT OF THE ARMY
ARMY LOGISTICIAN
US ARMY LOGISTICS MANAGEMENT COLLEGE
2401 QUARTERS ROAD
FORT LEE VIRGINIA 23801-1705

PERIODICALS POSTAGE
AND FEES PAID
AT PETERSBURG VIRGINIA
AND ADDITIONAL CITIES

Official Business